

NO LONGER LIBRARY
UNIVERSITY of TENN. MED. UNITS

Electronics®

OCT 30 1967

W/D 2/9/72

I-f amplifier with linear IC's: page 66

Hardening semiconductors against radiation: page 73

Computer speeds cable link: page 85

October 30, 1967

\$1.00

A McGraw-Hill Publication

Below: An abstract view of
pattern recognition, page 91

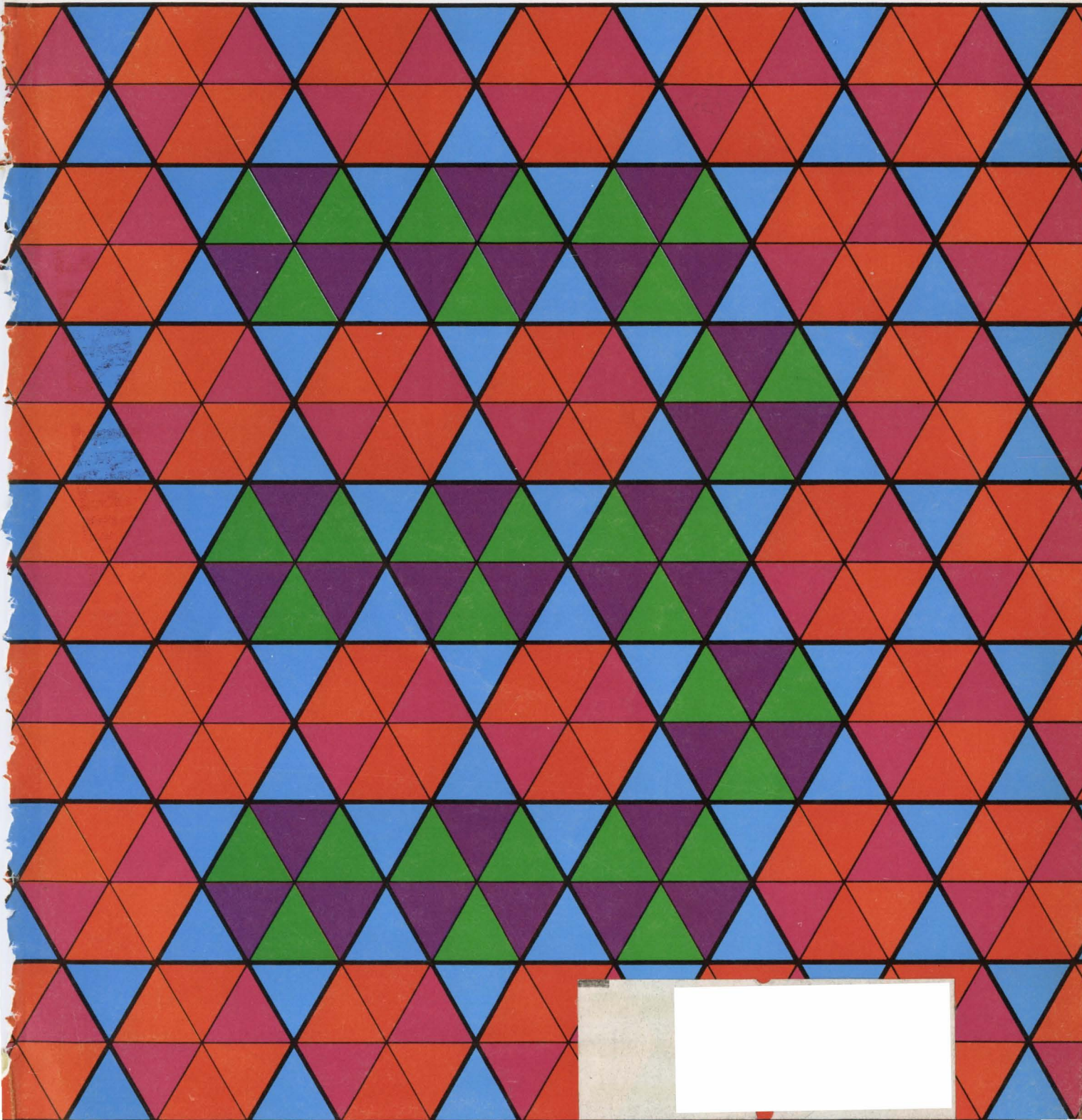



We've Pushed Signal-Generator Performance to the Limits

An innovation in signal-generators brings about 10-to-1 better frequency stability and improved accuracy and resolution, without sacrificing other performance features. The key to this performance is the frequency-generating system — a single-range, optimally designed oscillator followed by frequency dividers to provide the successively lower ranges. Thus, the stability of one range is the stability of all, and range switching is accomplished without transient instability. After warmup, drift is typically less than 1 ppm per ten minutes, at least 10 times better than that of any other generator. Because of all-solid-state circuitry, total warmup drift is less than 150 ppm in three hours. Frequency changes caused by band switching or variations in line voltage, load, or level are virtually nonexistent.

The 1003 covers a 67-kHz-to-80 MHz frequency range, and tuning this instrument is as much fun as it is convenient and fast. You can coarse-tune by motor over the main slide-rule dial to within 0.25% at a rate of about 7% per second, and fine-tune manually with a large control whose dial divisions correspond to 0.01% of the main scale. For greater resolution, a "ΔF" control provides electronic, backlash-free settability to 2 ppm. The motor-driven frequency control is fully utilized in the model containing the auto-control unit, which lets you preset frequencies. The preselected frequencies are useful either as limits for automatic sweeping or for programmed frequency selection (repeatable to 0.1%).

Frequency, incremental frequency, and automatic sweeping can all be pro-

grammed, as can output level and modulation-percentage. A crystal calibrator with 1-MHz, 200-kHz, and 50-kHz outputs is also supplied with the model containing the auto-control unit. This calibrator allows you to calibrate to within 0.002 percent.

The 1003 requires only 20 watts and delivers 180 milliwatts of leveled CW power into a 50-ohm load (6 volts behind 50 ohms). Envelope distortion is less than 2% at 70% a-m, with the modulating signal of 400 Hz or 1 kHz provided. Incidental phase modulation is less than 0.1 radian with 30% a-m. The highly accurate, 10-dB-per-step attenuator and a continuously adjustable carrier-level control give an over-all 155-dB dynamic range.

This instrument must be seen to be appreciated. A demonstration will show that very-narrow-bandwidth measurements can be made in 10 seconds with a 1003 signal generator and an oscilloscope. Try that with any other signal generator.

Price of the 1003 is \$2995 (\$2795 without the auto-control unit and crystal calibrator). For complete information, write General Radio Company, 22 Baker Avenue, W. Concord, Massachusetts 01781; telephone (617) 369-4400; TWX (710) 347-1051.

GENERAL RADIO

CURRENT SHELF

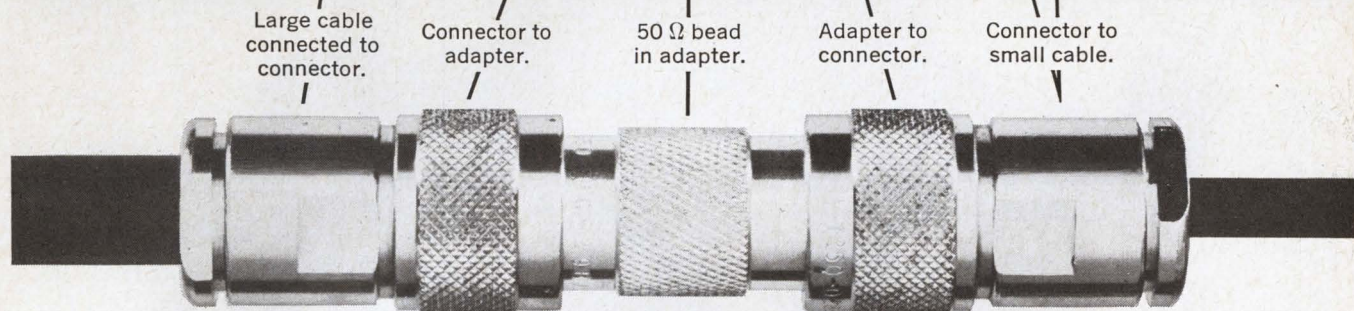
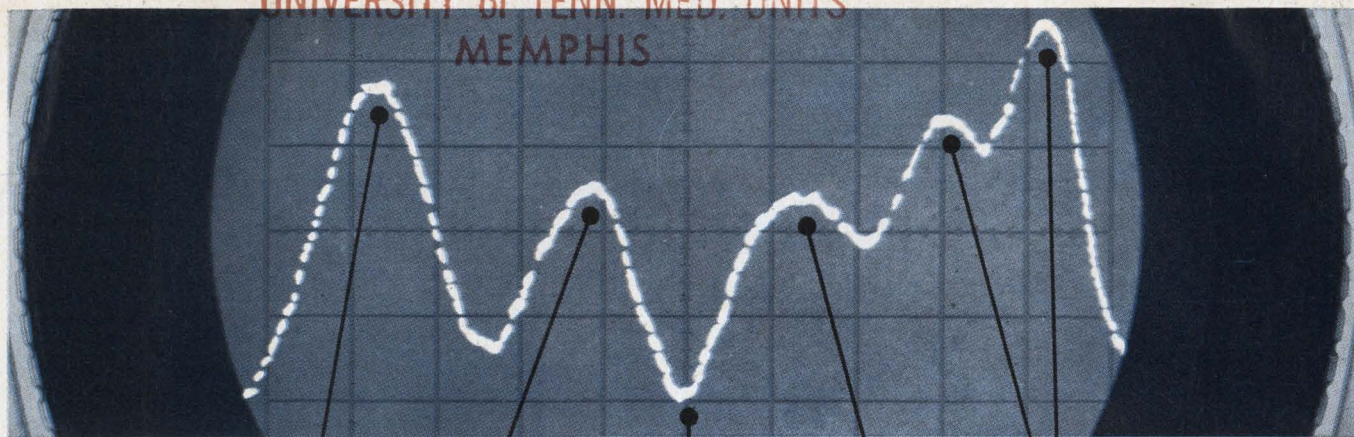

Here's a measurement you've never seen before!

40 ps TDR resolves and locates discontinuities to a half centimeter in systems through X band.

Minute discontinuities mean reflections and trouble at GHz frequencies. They are also the ones almost impossible to discern in slower TDR systems.

With 40 ps TDR, you can pinpoint fault locations down to within 0.4 cm in polyethylene, 0.6 cm in air. This is four times the resolution you have had up to now. (Reflection coefficient sensitivity extends to 0.002/cm.)

You not only have precision location, but you can clearly identify high frequency transmission line reflections—inductive discontinuities down to 0.01 nH, and capacitive discontinuities down to 0.004 pF.

If you design or build in the GHz region, here is an essential instrument for quickly checking and correcting attenuators, delay lines, distributed deflection plates, strip lines, switches and connectors.

If you already have a new hp 28 ps Sampling System, add the hp 1105/1106A Fast Rise Pulser (\$750) and you have a 40 ps TDR System. 28 ps Sampling System: 140A Oscilloscope Mainframe, \$595 (or 141A Variable Persistence and Storage Oscilloscope Mainframe, \$1395); 1424A Time Base, \$1200 (or 1425A Time Base, \$1600); 1411A Vertical Amplifier, \$700; 1430A 28 ps Remote Sampling Head, \$3,000.

Ask your hp field engineer for the complete story on

hp TDR systems. Or, write to Hewlett-Packard, Palo Alto, California 94304. Europe: 54 Route des Acacias, Geneva.

hp 140 — The Scope System that gives you



20 MHz Wideband • High-Sensitivity, no drift • 40 or 150 ps TDR
12.4 GHz Sampling • Variable Persistence and Storage

HEWLETT  PACKARD

OSCILLOSCOPE SYSTEMS

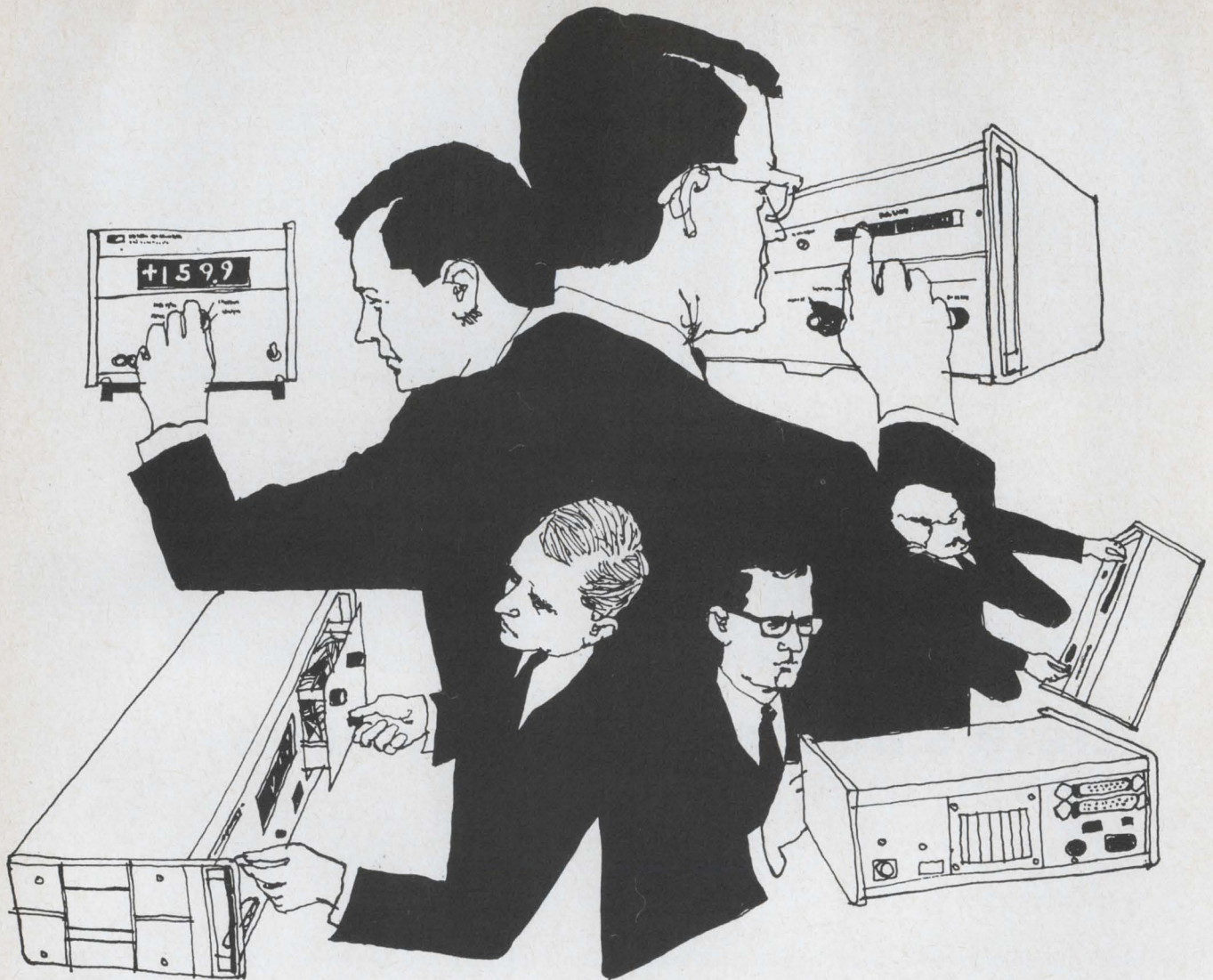

LOOKING FOR MORE RETURN ON YOUR DVM DOLLAR?

Hewlett-Packard gives you more capability per measurement dollar with the widest choice of DVM's in the industry! Choose from 3, 4, 5, and 6-digit instruments with a variety of accuracies, sensitivities, functions and prices.

+ 1599

Looking for Economy?

There's the three-digit hp 3430A for measurements within $\pm(0.1\% + 1 \text{ digit})$ and a sensitivity of $100 \mu\text{V}$, with up to 60% overranging capability indicated by a fourth digit. Low price of only \$595.

+ 9999

Looking for Plug-In Capability?

It's yours with the four-digit hp 3440A. Six plug-ins give ac volts, dc volts, dc current and ohms. Basic dc accuracy is $\pm 0.05\%$ of reading ± 1 digit. The 3440A has BCD printer output and rear terminals in parallel. Price: hp 3440A, \$1160; plug-ins, \$40 to \$575. For bench use, get lower-priced hp 3439A (no BCD outputs), \$950.

+ 119999

Looking for Accuracy and Speed?

For laboratory precision and systems speed, try the five-digit (plus a sixth digit for 20% overranging) hp 3460B. It has $\pm 0.004\%$ of reading $\pm 0.002\%$ full scale accuracy. The 3460B

has $10 \mu\text{V}$ sensitivity and makes automatic and remote-controlled dc measurements at up to 15 readings per second. The guarded 3460B has high common mode rejection, and $>10^{10}\Omega$ input resistance at balance on the 1 V and 10 V ranges (minimum $10 \text{ M}\Omega$). On the 100 V and 1000 V ranges, input resistance is $10 \text{ M}\Omega$. Price: hp 3460B, \$3600; hp 3459A, (no BCD outputs), \$2975.

+ 1199999

Looking for Highest Accuracy and Sensitivity?

hp HO4-3460A gives resolution of 1 part in 1.2×10^6 , sensitivity of $1 \mu\text{V}$, accuracy of $\pm 0.005\%$ of reading or $\pm 0.0005\%$ of full scale . . . with six-digit readout and seventh digit for 20% overranging. The guarded HO4-3460A has 160 dB effective common mode rejection at dc, and uses integration to reduce effect of superimposed noise. Automatic, manual or remote operation is possible. Instrument has BCD printer output. Price: hp HO4-3460A, \$4600.

For full details on the hp DVM that fits your needs—contact your nearest hp field engineer. Or, write to Hewlett-Packard, Palo Alto, California 94304. In Europe: 54 Route des Acacias, Geneva.

097/17

HEWLETT  **PACKARD**

Electronics Newsletter

October 30, 1967

DOT will build electronics center near Denver . . .

An electronics proving ground for high-speed ground transportation will be built by the Department of Transportation near Denver, Colo. The 60-square-mile facility, site of the Lowry Bombing and Gunnery Range, will be equipped with two or more tracks to study trains capable of speeds up to 250 miles an hour. It is expected to be operational in eight to 12 months.

The range will be fully instrumented—including telemetry systems—to study waveguides for power transmission and distribution, linear induction motors, and the like. Government officials estimate they'll spend \$50 million on the facility in the next three years. An aerospace company is considered likely to win the contract to operate the facility.

. . . with laser first on test list

First to be tested at the Department of Transportation's Denver center will probably be a laser obstruction detector. A gallium-arsenide injection-laser diode in a sensor warns of obstructions on the tracks. Under the terms of an unsolicited proposal, RCA will install the pulsed infrared devices every 400 yards to give a 200-mph train up to five miles warning. Obstructions as small as 1 cubic inch can be detected.

IC's behind slump of discrete devices

Fast selling integrated circuits have been eating into discrete device sales with bigger and faster bites than the semiconductor industry would admit. Up till now, the slump in discretely has been attributed by industry experts to the general sluggishness of the economy. But now Patrick E. Haggerty, Texas Instruments board chairman, concedes "No one really expected IC's to come on so fast, and in such great numbers."

Fairchild using junction FET's in microwave circuits

Late-starting Fairchild Semiconductor hopes to leapfrog its rivals in the microwave integrated circuit race by using junction field effect transistors. Its R&D Laboratory has developed an epitaxial FET containing a Schottky barrier gate on a semi-insulating gallium arsenide substrate, which operates to 3.5 gigahertz.

Most companies active in microwave IC's have dismissed the FET as a usable device—believing maximum operating frequencies too low and fabrication methods too difficult—and have been using bipolar transistors instead [see p. 107].

Going to a GaAs junction FET structure containing a Schottky barrier gate for microwave IC's buys two things, Fairchild says. The high mobility GaAs permits higher operating frequencies, and the FET structure is easier to fabricate than bipolars and insulated-gate FET's that require intricate diffusions and pose more isolation problems at higher frequencies. Fairchild believes its FET is usable up to 10 to 14 ghz, offering a flatter high frequency response and possibly better noise performance than the bipolars.

High court to rule on FCC vs CATV

The Supreme Court will decide whether the FCC has the right to regulate cable-television broadcasting. The high court's ruling, the first involving operation of a CATV station, will be based on an appeal by the FCC and two San Diego tv stations of a pro-CATV decision handed

Electronics Newsletter

down by a U.S. Circuit Court of Appeals in California.

The CATV industry is hoping that the court will not only look into the broad question of FCC regulation but also expand its inquiry to include copyright of over-the-air material. Expected by next spring, the ruling will also cover the FCC's right to suspend CATV growth while the agency ponders how the industry should be regulated. [For more on CATV, see p. 23.]

Now's the time for fast Fourier

Within a year IBM may market a special-purpose computer that calculates Fourier transforms in real time. The machine would be functionally identical to the one designed at Bell Telephone Laboratories [Electronics, Sept. 4, p. 40]. Applications would include analyzing speech waveforms, radar signals, seismic signals, and data transmission.

IBM's work reflects the growing interest in developing software and hardware using the fast Fourier transform algorithm. Sylvania has developed a special-purpose computer that uses the fast Fourier transform to digitize speech signals in real time. And a research team from Stanford Research Institute will describe at the Fall Joint Computer Conference next month a technique for analyzing radar signals in real time, using the transform technique on a general purpose computer.

Philco tunes up with IC for organs

Philco-Ford is ready to challenge Motorola for a share in the lucrative electronic organ IC market [see p. 45]. The company will introduce an IC containing a seven flip-flop frequency divider developed especially for organs in just four weeks. The monolithic MOS device, a 14-lead dual in-line package, will cost \$2.10 each in lots of 1,000. The Motorola device sells for \$2 in large quantities [Electronics, July 24, p. 196]. Its operating frequency range extends from d-c to 500 kilohertz; output impedance is less than 1,000 ohms and dissipation is 300 milliwatts. The device will be available in quantity by the end of the year.

Stability achieved in thin-film FET

By using a plasma-anodized aluminum oxide for the gate insulator, RCA Laboratories in Princeton, N. J., has come up with what it believes is the first thin-film field effect transistor that is stable at room temperatures. RCA researchers say the way may now be open for the use of this type of transistor in IC's made with cadmium selenide. The new material reduces the trapping effects of the insulator-semiconductor interface.

Previous thin-film devices, with silicon monoxide as the gate insulator, showed a drift in threshold voltage when the gate voltage was changed. In RCA's transistor, these voltages are independent of each other.

Addenda

Frank W. Lehan, an engineering consultant long on government and electronic industry experience, has been named to the top research job at the Department of Transportation—assistant secretary for research and development. . . . Victor Comptometer Corp. has finally started delivery of the Victor 3900—the electronic calculator built with Philco-Ford MOS circuits—two years after it was introduced. The 3900 was plagued by technical difficulties that prevented its production as the first calculator made with integrated circuits. Miscalculating the difficulty of building the complex MOS IC's, Philco-Ford had to redesign most of the circuits before making them commercially [Electronics, Mar. 6, p. 231].

IDEAS

from SYLVANIA Electronic Components Group

CRTs

3" x 5" CRT prints out signal records up to 1 MHz



Video pictures
printed out in a series
of individual frames

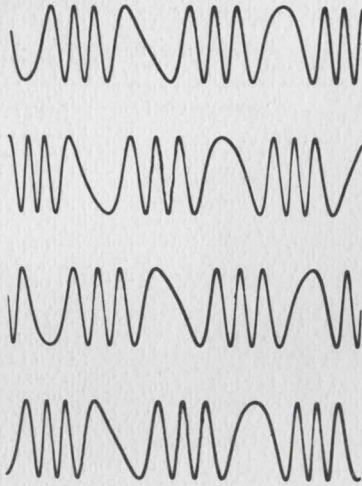

Continuous record,
transverse signal pattern

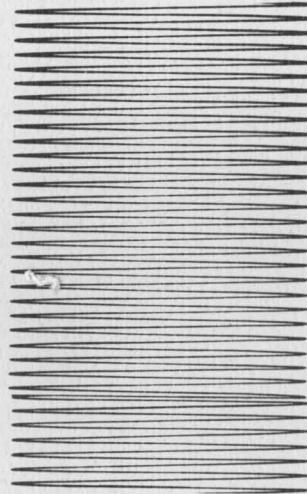

Continuous record,
longitudinal waveform

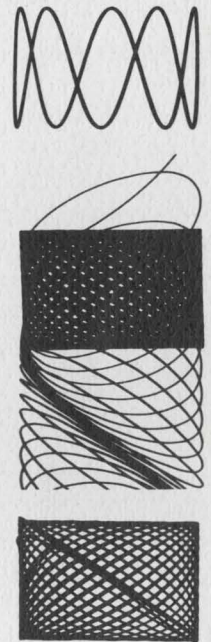

Printout of simultaneous
X-Y plot and Lissajous pattern

Photos courtesy of Honeywell Inc. Test Instrument Division

Direct printout speeds 100 times faster than previously available in commercial oscillographs . . . Spot resolution of less than 0.008-in. diameter . . . Recording of both black-and-white and halftone data . . . Signal recording and printout from dc to 1 MHz . . . Waveform or alphanumeric printout . . .

All of these are well within the capability of the Sylvania SC-4082E fiber-optic cathode-ray tube, which has the largest fiber-optic faceplate commercially available today: 3" x 5".

The faceplate consists of more than 35 million light-conductive fibers, each only 10-15 microns in diameter, fused into one bundle about 1/2-inch thick and coated on the back with Sylvania P16 high-output phosphor.

The small diameter of the faceplate fibers, combined with an improved electron gun, assures extremely fine spot resolution on the output side of the faceplate: 4 to 7 mils as opposed to the 15 to 30-mil range of typical laboratory oscilloscopes.

As shown here, this fiber-optic CRT is used in Honeywell Test Instrument Division's Model 1806 Visicorder, which combines a precision oscilloscope for visual signal monitoring with a high-speed oscillograph recorder.

The Visicorder is a single-channel, 4-axis unit which uses the light output from the fiber-optic CRT faceplate to record continuous transient data directly on standard ultra violet-sensi-

(continued)

This issue in capsule

Integrated Circuits—Tailor amplifier response without complex networks.

Readouts—"Bar-graph" analog indicators with resolution to 30 lines per inch.

Rectifiers—50-amp glass rectifiers absorb 1000-watt reverse transients.

Microwave Components—High-power avalanche diode oscillators open new application areas.

Manager's Corner—Thick-film microcircuits: reliability at low cost.

Television—New, more economical 15" and 19" color picture tubes.

CRTs (continued from page 1)

tive oscillograph paper. Signal variations are recorded as the paper passes over the faceplate. Low-level ultraviolet light develops the paper as it comes out of the Visicorder to give a permanent record within seconds.

Thanks to the speed, light output and resolution of this fiber-optic CRT (and with a well-deserved bow to the ingenuity of Honeywell's design engineering staff), the Visicorder records signal responses from dc to 1 MHz, on either the vertical or the horizontal axis or simultaneously on both, and has continuous or intermittent chart-drive modes.

In addition, video pictures can be recorded as a continuous series of individual 3" x 4" frames on the direct-record paper at the rate of 30 pictures per second.

The SC-4082E fiber-optic CRT uses electrostatic focus and deflection, although Sylvania makes many fiber-optic CRTs with magnetic focus and deflection. Helical-resistor post-deflection acceleration is employed to get a high writing rate, high deflection sensitivity and freedom from pattern distortion.

Unique and specialized as it is, the SC-4082E represents only a tiny part of Sylvania's full capability in fiber-optic cathode ray tubes. Sylvania can make them in circular or rectangular configurations, and with wide, shallow faceplate strips for alphanumeric readout exclusively. CIRCLE NUMBER 300

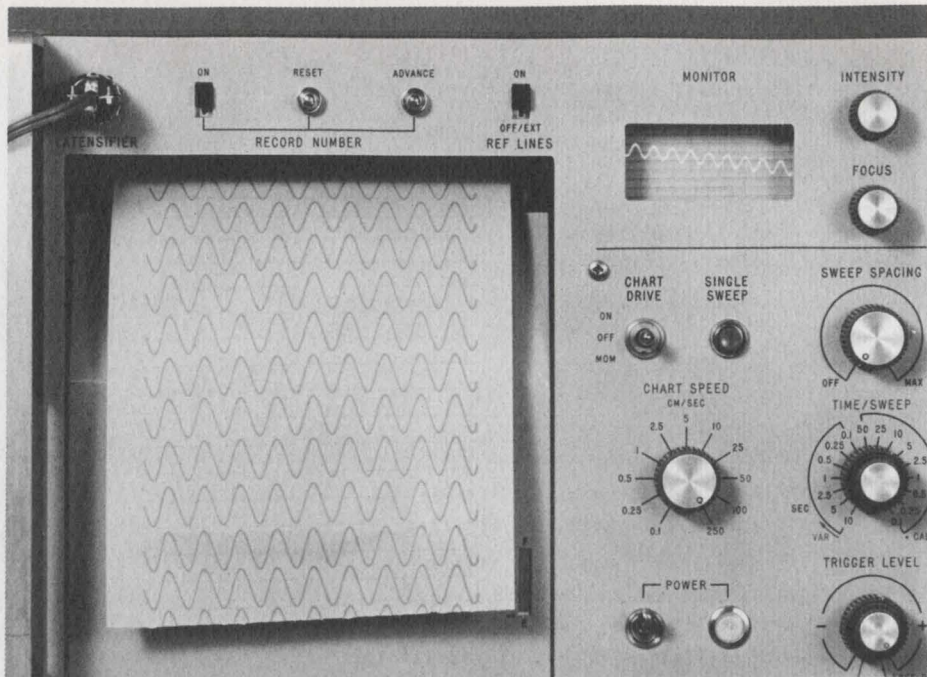

Honeywell Model 1806 CRT Visicorder

BASIC CHARACTERISTICS OF TYPICAL FIBER-OPTIC CRTS

Tube Type	Fiber Strip Size	Focus	Bulb Size
SC-3304	2 3/4" x 1/4"	magnetic	3" x 1 1/2"
SC-3507	8 11/16" x 1/2"	magnetic	10" x 3 1/2"
SC-3800	8 11/16" x 1/2"	electrostatic	10" x 3 1/2"
SC-3850	4 1/2" x 1/2"	magnetic	5" dia.
SC-3876	8 11/16" x 1/2"	magnetic	10" x 3 1/2"



Sylvania fiber-optic CRT Model SC-4082E as used in Honeywell Visicorder above

INTEGRATED CIRCUITS

You can tailor amplifier response without complex networks

Sylvania's SA-20 series of linear ICs offers more than just an excellent wideband amplifier. The ability to externally control the amplifier's gain and bandwidth means this device can be easily tailored to meet specific system needs. Electrical performance is not sacrificed to obtain this external flexibility. The SA-20 is characterized by stable voltage gain, high output voltage swings, low output impedance, excellent frequency and pulse response, excellent intermodulation product and high linearity.

Now you can get a wideband, bandpass, or notch amplifier simply

by changing a simple external network connected between two terminals of an IC. Sylvania's SA-20 integrated circuits (Figure 1) are basically wide band video amplifiers consisting of three direct-coupled linear amplifier stages. Frequency response characteristics are determined by a simple external network connected between the collector (pin 2) and base (pin 1) of the second stage. The complex external networks often needed with other ICs are not required when designers use these Sylvania units.

How the value of a compensating

capacitor between terminals 1 and 2 influences broadband characteristics is indicated in Figure 2.

The selective amplifier configurations of Figure 3 show how notch and bandpass characteristics are obtained with simple L-C feedback networks. In the notch configuration, there will be a dip in the gain-frequency characteristics at the resonant frequency. Very narrow notch bandwidth can be obtained by operating in the series resonant mode.

In the bandpass option, maximum gain is obtained at the resonant frequency of L and C. Capacitor C

News Features

Probing the News

- 107 **Microwave IC's come of age**
115 **Bantam computers cutting into heavyweight territory**

Electronics Review

- 43 **Military electronics:** Out of the deep; Three-in-one mission; Getting warmer
45 **Consumer electronics:** Hitting high IC; Big play for playback
46 **Companies:** Going down
46 **Industrial electronics:** Mix and match
48 **Communications:** Mallard on the wing
50 **Space electronics:** All talk, no money
50 **Avionics:** The matchmaker
50 **Instrumentation:** Outside looking in
52 **Solid state:** On the skids
52 **For the record**

Electronics Abroad

- 169 **West Germany:** Horning in; Simple answer
170 **Great Britain:** IC time at ICT
171 **Japan:** Slow color; By the numbers
172 **France:** Traffic talk

New Products

- 125 Tape, disk recorders make wider color splash
126 Little Shaver convention-bound
129 **New components review**
129 **New components:** Logarithmic diodes for analog computers; Here's a switch—with resistors
135 **New semiconductor review**
135 **New semiconductors:** Jack-of-all-trades op amp; Channel protects leads from bending; Tv transistor handles 1,400 v
141 **New instrument review**
141 **New instruments:** Transceiver expands sonar jobs
145 **New subassemblies review**
145 **New subassemblies:** IC servo loops control tape transport
149 **New microwave review**
New microwave: Getting specific about frequencies

Technical articles

I. Design

- Integrated electronics** 66 **It's not how much an IC costs . . . but how much it can save**
In choosing an integrated circuit, you should avoid one that requires a lot of special testing
D.W. Ford, M.M. Gutman, W.F. Allen, Jr.
Philco-Ford Corp.
- Circuit design** 69 **Designer's casebook**
▪ SCR takes bounce out of switching
▪ Unijunction improves timing-circuit accuracy
▪ MOS FET takes the push out of elevator push button
▪ Capacitor sensor monitors stored liquid levels
▪ Time delay stretched with new bias scheme
- Military electronics** 73 **Equivalent circuits estimate damage from nuclear radiation**
With device models, the engineer can calculate the effect of nuclear radiation on components, and the over-all change in a circuit
Joseph T. Finell Jr., David D. Bertetti and Fred W. Karpowich, Avco Corp.

II. Application

- Communications** 85 **Computer aid on the ocean floor**
To lay a cable between Vietnam and the Philippines in less than two weeks, engineers devised some techniques that can be used in many communications systems
Oswald R. Reh, U.S. Underseas Cable Corp.
- Advanced technology** 91 **Machine looks, listens, learns (cover)**
New pattern recognizer can identify both spoken and written inputs
G.L. Clapper, IBM

Departments

- | | | | |
|----|-----------------|-----|------------------------|
| 4 | Readers Comment | 25 | Electronics Newsletter |
| 8 | People | 57 | Washington Newsletter |
| 14 | Meetings | 152 | New Books |
| 16 | Meeting Preview | 154 | Technical Abstracts |
| 23 | Editorial | 156 | New Literature |

159 Newsletter from Abroad

INTEGRATED CIRCUITS (continued)

blocks dc. When the SA-20 is connected in this way, the gain approaches the maximum open loop gain at the resonant frequency. The response curves shown were obtained with components listed. Using higher-Q inductors and series tuning L with C_2 at a frequency below F_0

would improve circuit selectivity. Using a crystal operating in a parallel resonant mode will give a more selective bandpass characteristic.

If precise matching of the amplifier gain to a specific application is required, external resistance is added in parallel with an internal feedback

resistor R4 or R6. Padding R4 increases the gain, and padding R6 decreases the gain. Padding resistors should be DC-isolated from the circuit with capacitance to prevent a shift in DC quiescent levels.

CIRCLE NUMBER 301

Figure 1

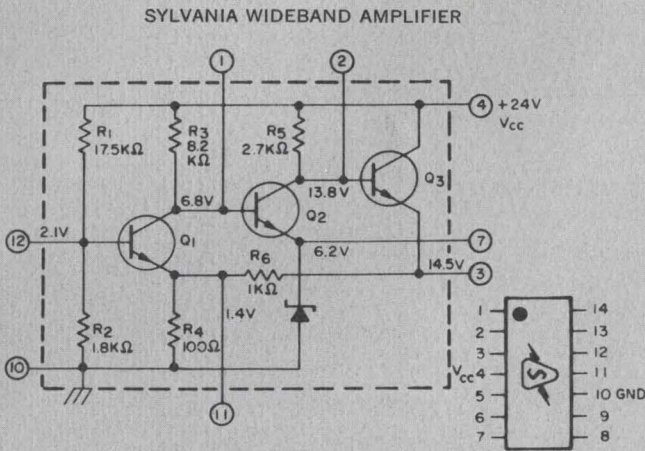

NOTE:
VOLTAGES DENOTED ARE NOMINAL QUIESCENT VALUES AT 25° C, AND ARE SHOWN FOR INFORMATION ONLY

Figure 2

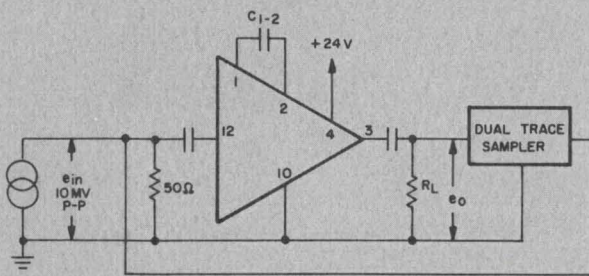
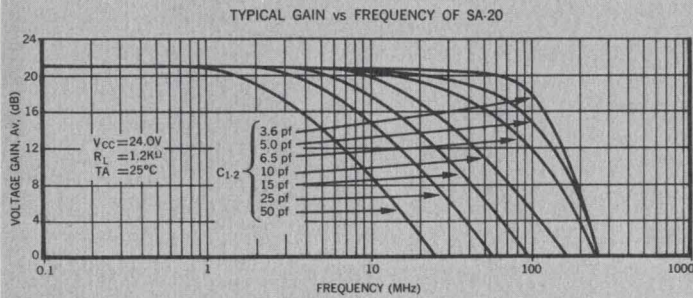

C_{1-2} * INCLUDES SOCKET CAPACITY BETWEEN PIN 1 AND 2

Figure 3

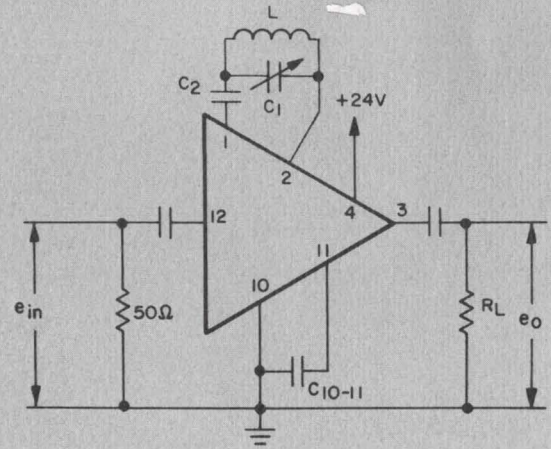
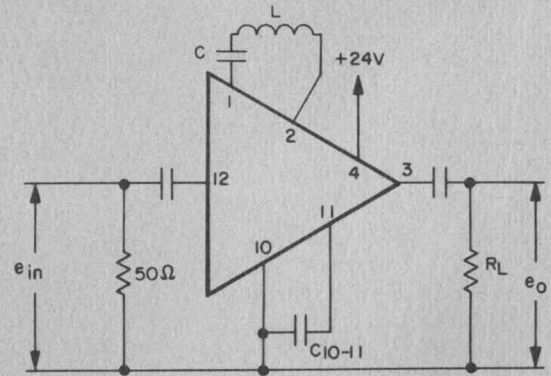

TYPICAL SA-20 BANDPASS CHARACTERISTICS

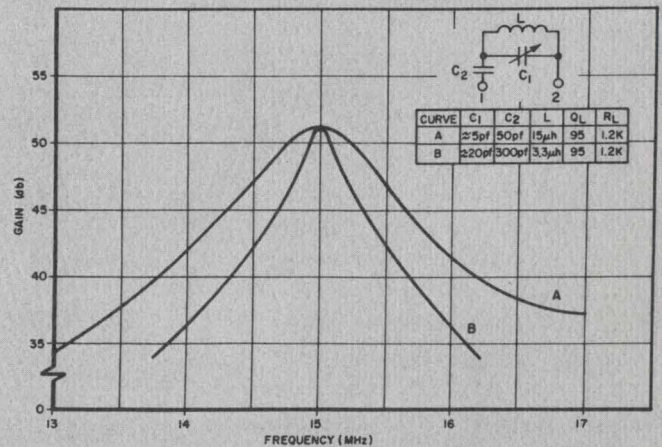

EL "bar-graph" analog indicators, now with resolution to 30 lines per inch

The effectiveness of any analog indicator is measured in terms of how accurately it displays the information and how immediately comprehensible the information is to the viewer. Sylvania has developed a plug-in EL bar-graph indicator which we consider a major advance in instrumentation.

Let's take a typical application for our EL bar-graph indicators: a tachometer array for a 4-engine jet aircraft.

A metered display would look like this:



Our EL bar-graph display of the same input data would look like this:

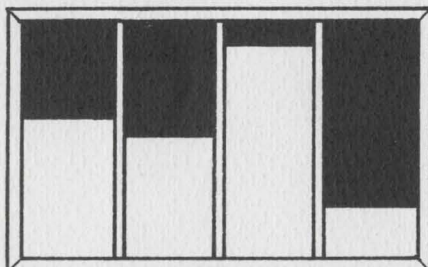

Notice how much more quickly and easily the comparative speed of the engines may be seen on the bar-graph display.

EL bar-graph analog indicators can be used for general instrumentation, aircraft, spacecraft and shipboard applications—anywhere that quantitatively variable input data must be monitored.

How they work

Each indicator consists of an array of horizontal parallel EL lines deposited on a glass film. The devices—in standard or custom design—can be provided with from 8 to 30 lines per inch, depending on the resolution required. And they are available in hermetically sealed construction. Sylvania bar-graphs offer the inherent design advantages of all EL read-out units: solid-state reliability, low power consumption, wide viewing angle, light weight, low reflection, stable performance, freedom from catastrophic failure, and rapid information display.

These bar-graph analog indicators are available in 115 V and 250 V versions: our "P" Series and "C" Series respectively.

The "P" Series is designed for low voltage operation—115 volts RMS, 400 Hz with a peak voltage rating of 300 volts over the temperature range of -55 to +71°C. This series yields a higher average initial brightness of 15 foot-lamberts at the lower voltage of 115 volts RMS, 400 Hz.

The "C" Series is designed to operate typically at 250 volts RMS, 400 or 800 Hz with a peak voltage rating of 420 volts over the temperature range of -55 to +94°C. This series yields an average initial brightness of 8 foot-lamberts operating at 250 volts RMS, 400 Hz and 12 foot-lamberts at 250 volts RMS, 800 Hz. CIRCLE NUMBER 302

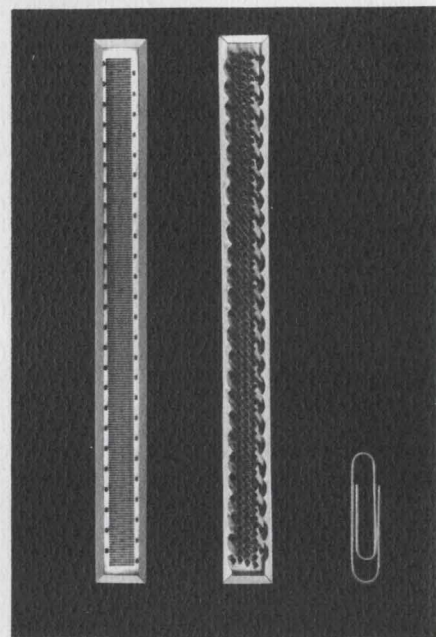

Sylvania electroluminescent bar-graph-type plug-in analog indicators.

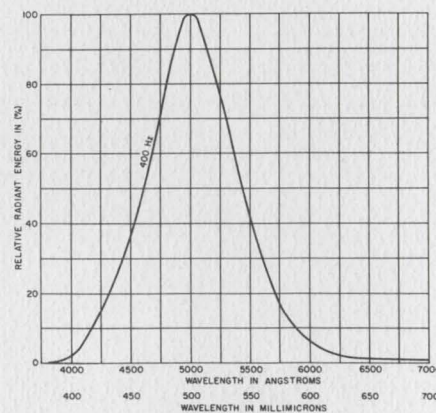
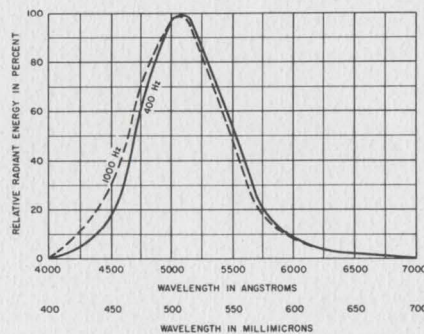
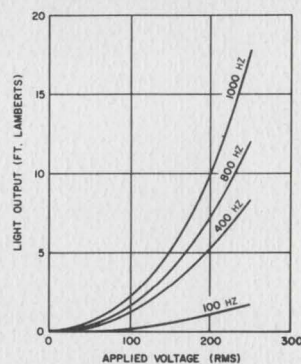
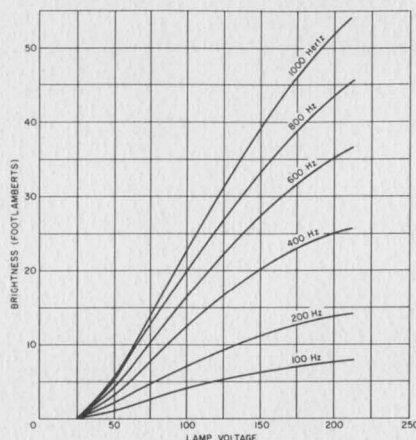

TYPICAL OPERATING CHARACTERISTICS AND MAXIMUM RATINGS (All Segments Lighted)

Type	OPERATING CHARACTERISTICS				MAXIMUM RATINGS						
	Light Output		V-AC RMS	F Hz	Maximums			Peak Voltage	RMS Voltage	Peak Transient Voltage	Operating Temperature Range (°C)
	Brightness (Initial) FL	Wavelength Angstroms			I Ma	P Mw	Pf				
C-Series	6-10	5100	250	400	1.0	50	.50	420	300	500	-55 to +94
	10-14	5100	250	800	1.2	85	.50	420	300	500	-55 to +94
P-Series	12-18	5100	115	400	1.1	55	.85	300	210	350	-55 to +71

Sylvania 50-amp glass rectifiers withstand 1000-watt reverse transients

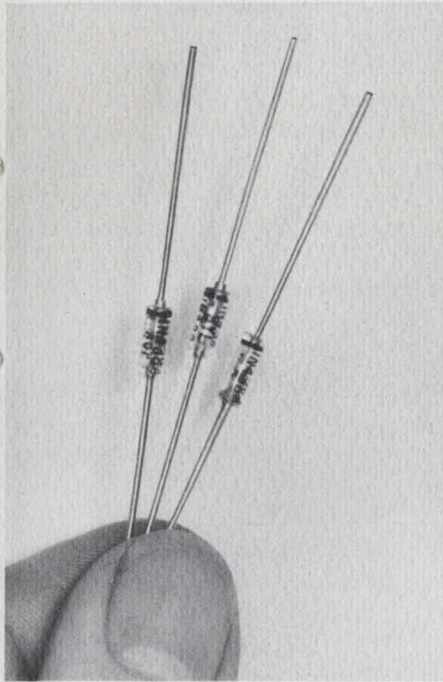

Circuit designers are finding that Sylvania's glass rectifiers are better than other glass rectifiers. In this instance, the improved characteristics result in enhanced circuit performance and increased device reliability. Sylvania has coupled the inherent advantages of glass encapsulation with superior device design to make these glass diodes rugged enough for military applications. This designed-in dependability also makes this line of glass units an excellent choice for many other uses in computer, industrial and communications equipment. It is the improvements in device design that make Sylvania's glass silicon rectifier line stand out from other glass units.

In the improved devices, a large double diffused junction allows handling of 1000-watt reverse power transients while still maintaining the standard 50-amp forward surge capability. Sylvania's first glass rectifiers can take outputs of up to 1 amp at reverse working voltage of 1000 volts without damage.

Heat dissipation is aided by welding a solid high conduction power lead to an oversized heat conduction stud. This enhances power handling capability while extending device life by keeping the unit cooler. The glass package is electrically neutral and smaller than many metal rectifiers,

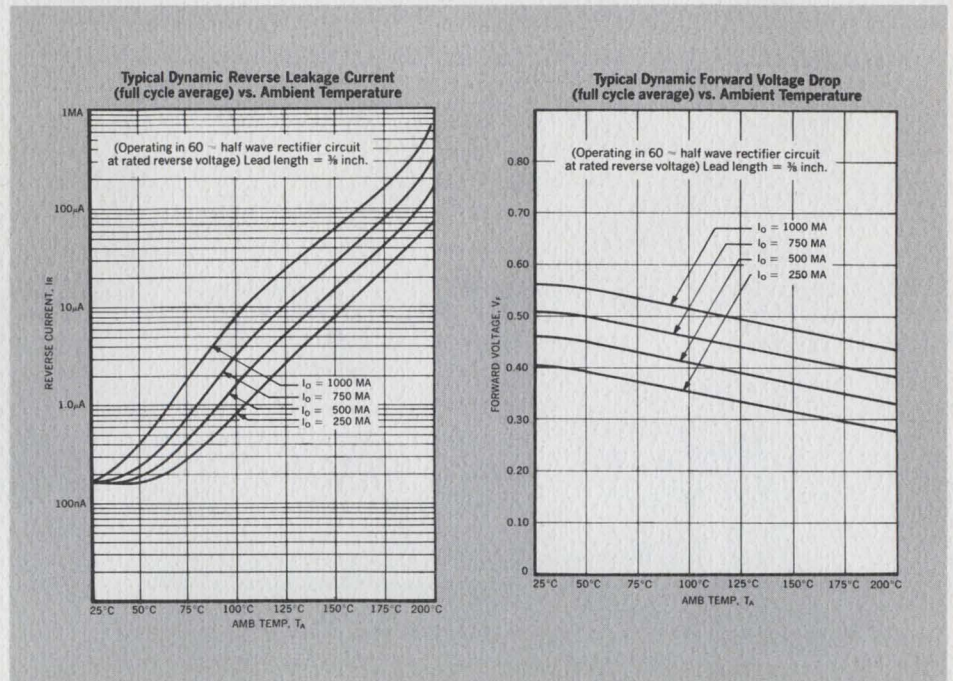

thus permitting greater stacking and card densities. With Sylvania's sealing techniques, the designer gets the benefits of improved device design without sacrificing any of the advantages of glass encapsulation. Use of a glass package means not only improved insulating characteristics but units that can be hermetically sealed. Radiflo leakage rate for these devices is less than 1×10^{-10} cc/sec. Low leak rates extend life and increase reliability. The glass body also enhances the thoroughness of in-process quality control by allowing visual inspection during production.

In addition to the ability to handle

high reverse pulses, these rectifiers have low reverse leakage current. Typical rating is 10 na at 25°C ambient and rated reverse voltage. The high voltage rating and wide temperature operating range (-65°C to 175°C) capability of these units can't be matched by ordinary non-hermetically sealed devices.

All units in the Sylvania series are packaged in the conventional DO-29 outline. They are replacing existing glass, epoxy or top hat types in applications which demand higher reliability levels. These devices meet or exceed all the standard life and design requirements of MIL-S-19500.

CIRCLE NUMBER 303

ABSOLUTE MAXIMUM RATINGS: -65°C to +175°C - Resistive and Inductive Loads - Single Phase, half wave at 60 cps.						
	Units	1N4383	1N4384	1N4385	1N4585	1N4586
Continuous Reverse Working Voltage, V_R	volts	200	400	600	800	1000
RMS Input Voltage, V_{rms}	volts	140	280	420	560	710
Average Forward Current, I_o	amps					
@ 50°C		1.0	1.0	1.0	1.0	1.0
@ 100°C		1.0	1.0	1.0	0.6	0.6
@ 150°C		0.3	0.3	0.3	0.2	0.2
Forward Surge Current, 1 cycle - $I_{F sur}$	amps	50	50	50	50	50
Forward Surge Current, Recurrent, $I_{F sur}$	amps	6	6	6	6	6
ELECTRICAL CHARACTERISTICS:						
Typ. Dynamic Forward Voltage Drop, V_F @ 1.0 amp	volts					
@ 50°C					.56	.56
@ 100°C		.52	.52	.52		
Typ. Dynamic Reverse Current, I_R @ V_R	μa @ 1.0 amps					
@ 50°C		8	8	8	.55	.55
@ 100°C						
Typ. Reverse Current, I_R @ V_R and +25°C	na	10	10	10	10	10
Typical Junction Capacitance - All Types -	@ 0 V 80 picofarads					
	@ 10 V 21 picofarads					

Thick-film microcircuits: Reliability at low cost

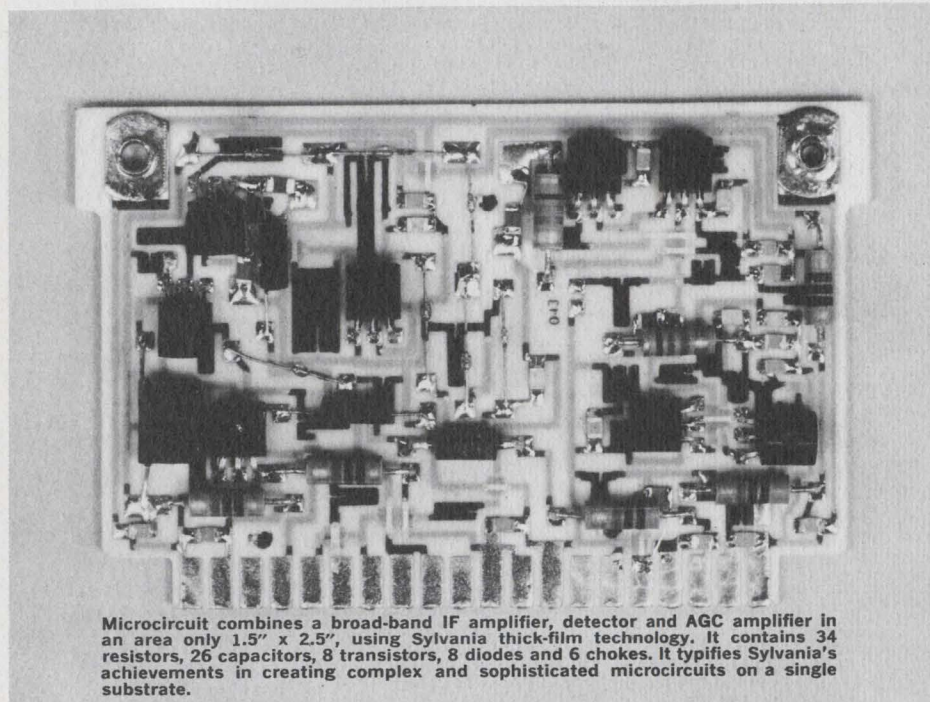

Microcircuit combines a broad-band IF amplifier, detector and AGC amplifier in an area only 1.5" x 2.5", using Sylvania thick-film technology. It contains 34 resistors, 26 capacitors, 8 transistors, 8 diodes and 6 chokes. It typifies Sylvania's achievements in creating complex and sophisticated microcircuits on a single substrate.

It's a truism that electronics has had to shrink rapidly in order to grow.

Because as systems became more complex, they grew larger, heavier... and less reliable.

(And slower. What profiteth man to switch in a picosecond when it may take the switching signal a thousand times longer to get where it's going?)

Hence the proliferating technology of microelectronics.

While space, weight and speed are important, no less so is reliability. Most of the many approaches to microelectronics have aimed at improving reliability at the same time they cut bulk and increased speed.

So a major problem facing the design engineer today is the bewildering variety of microelectronic technologies available to him: thick-film circuits, thin-film circuits, monolithic IC's, MOS units and many combinations.

The role of Sylvania

Sylvania has been involved in microcircuit R & D for about 7 years. We've looked into just about every major technology: vacuum-deposited films, sputtered films, active thin-film semiconductors, screened-and-fired or thick-film microcircuits... you name it.

But since we can't be all things to all people, we concentrated, starting in 1964, on thick films because this

technology is most applicable to automation and low-cost microcircuitry.

Why hybrid microcircuits?

For one thing, they are economical.

They can be packaged in virtually any size or shape.

They make it practical and economical to produce prototype-quantities of modules containing complex circuit configurations.

In addition, they can handle high voltages, currents and frequencies and have capability of producing high resistances and capacitances.

Sylvania has not only demonstrated all these advantages of microcircuitry, but has cut costs enough to make microcircuits competitive with many discrete-circuit components.

Microcircuit capabilities

Sylvania has designed and manufactured microcircuits ranging from simple resistor matrices to complex digital, analog and RF circuits operating up to 250 MHz.

We produce networks of conductors, resistors and capacitors by successively screening and firing conductive, resistive and dielectric compounds onto a single substrate. Our dielectric materials provide 0.001 to 0.5 μ fd per square inch; resistive materials cover the range from 10 ohms to 1 megohm.

In the thick-film technique, successive layers are sequentially fired in

the temperature range of 600°C to 1000°C. This high-temperature stabilization, combined with the molecular codiffusion that occurs at the layer interfaces, yields microcircuits with high inherent stability, ruggedness and reliability. All film elements are protected by two layers of glass fired in place to assure additional long-term stability.

Reliability standards

Because most of our microcircuits so far have been designed for military use, reliability standards are stringent. Our units have survived (and thrived on) such typical torture tests as:

Shock—100 G

Vibration—15 G; 20 to 2,000 cps

Humidity—95% relative humidity at 85°C

Drop Test—36 inches onto concrete floor

Temperature Shock—125°C to -54°C in two minutes

Low Pressure—3.44 inches of mercury at -54°C

Accelerated Life Tests—elevated temperatures and voltages used as stresses

Non-military applications

There is now a growing trend toward use of hybrid microcircuits, like the one above, in industrial and consumer applications. We feel that as we continue to bring costs down, hybrid microcircuits will soon be used, for example, in television, hi-fi, automotive and appliance control systems.

And finally—asking for the order

The unit above is unique, custom-built to a specific customer requirement. Par for the course in the microcircuit business.

We'd expect to do the same for you.

We offer you a fully systems-oriented design and manufacturing capability, staffed to provide cost-effective microcircuits designed to your specific needs. Whether you need a few prototypes or volume production quantities, we'd like to work with you to develop exactly the microcircuits you require.

Irving Greenberg
IRVING GREENBERG
PRODUCT MANAGER, MICROELECTRONICS

High power avalanche diode oscillators open new application areas

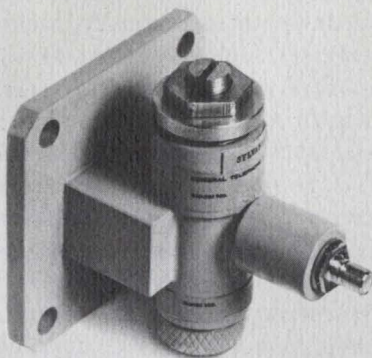

When Sylvania introduced its SYA-3200 avalanche diode oscillator a few months ago, we said continued development was expected to lead to improved devices with higher output power. We were right. Power levels have now been raised by a factor of five. And there's a total of three units with waveguide outputs, and three to come with coaxial outputs, to make it even easier to convert dc to rf directly at X-band frequencies.

Now there are even more reasons for using solid-state avalanche diode oscillators—with new devices from Sylvania. Our new units have a minimum power output rating as high as 50 mW and are available in waveguide configuration (now) and coaxial (soon). Type SYA-3200A is rated at 25 mW, Type 3200B at 50 mW. Both these units, and the original 10 mW Sylvania avalanche diode oscillator (Type SYA-3200), are for

use in waveguide systems.

Soon we'll announce three coaxial versions with electrical characteristics similar to the 3200, -A and -B.

Use of the SYA-3200 series as pumps for parametric amplifiers reduces the size and complexity associated with klystron drivers without degrading performance.

In addition to providing direct dc to rf conversions, other advantages of this line include: only one dc input required, small size and light weight (less than 5 ounces), lower dc consumption (60 to 90 V, 10 to 20 mA), and no spurious outputs up to twice output frequency. Operating temperature range is -40 to $+85^{\circ}\text{C}$. These new sources are mechanically tunable by a single screw adjustment over a range of at least 200 MHz and have a typical temperature coefficient of frequency of 200 KHz/ $^{\circ}\text{C}$.

Tests show that parametric amplifiers pumped by these avalanche diode oscillators exhibit performance which is indistinguishable from that obtained with conventional klystrons. In one application, a parametric amplifier operating in L-band was pumped at 11 GHz by a SYA-3200.

The noise figure was 1.8 dB, exactly that obtained using a klystron. Saving in power supply, size, and weight reduced the overall weight and size of the amplifier by fifty percent. Gain, bandwidth, and stability were unchanged from that obtained with a klystron.

Particularly suited for use in doppler radar, these oscillators can function as local oscillators in heterodyne receivers as well as beacon transponder sources.

Continued device development is expected to result in devices with even higher output power and additional frequency-band coverage. Sylvania's application specialist will work with designers in tailoring these new devices to meet specific system requirements. The aim is to be able to use these devices as direct replacements for many of the reflex klystrons now in use.

CIRCLE NUMBER 304

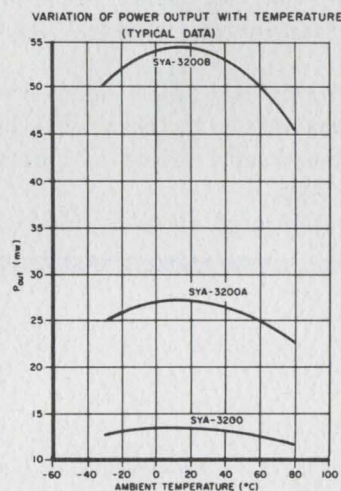
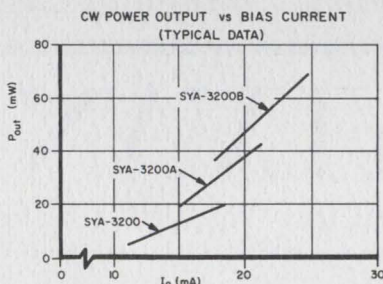

SEE OUR SPECIFICATIONS IN
VSMF
MICROFILM CATALOG FILE

Use Sylvania's "Hot Line" inquiry service, especially if you require full particulars on any item in a hurry. It's easy and it's free. Circle the reader service number(s) you're most interested in; then fill in your name, title, company and address. We'll do the rest and see you get further information

BUSINESS REPLY MAIL

No Postage Stamp Necessary if Mailed in the United States

POSTAGE WILL BE PAID BY

SYLVANIA ELECTRONIC COMPONENTS GROUP

Sylvania Electric Products Inc.
1100 Main Street
Buffalo, New York 14209

FIRST CLASS
Permit No. 2833
Buffalo, N. Y.

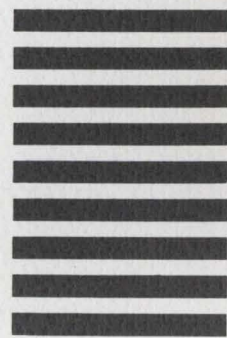

New, more economical 15" and 19" color picture tubes

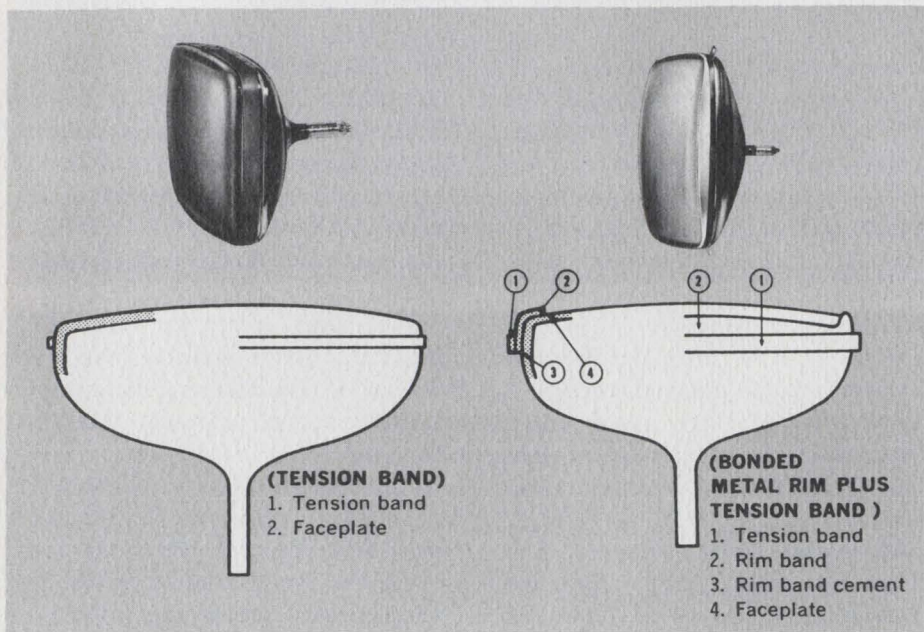

Sylvania offers these two new color picture tubes in the popular 15" and 19" shadow-mask styles. Their integral implosion protection systems eliminate the need for separate safety glass in the set chassis or heavy, plastic-laminated bonded-shield tubes.

On the 15" tube, the weight saving is approximately 1½ lbs; on the 19" tube, the weight saving is approximately 3 lbs.

Proven through years' use in black-

and-white picture tubes, the T-band and Kimcode systems are available now for the first time in Sylvania 15" and 19" color tubes. For manufacturers who prefer it, however, tubes will still be available with the familiar PPG safety system.

The RE-ST4561A, for the first time in a shadow-mask color tube, offers a low focus voltage (-75 to +400 volts), and is a 15" size. This eliminates the need for a separate high-voltage focus rectifier circuit, permit-

ting lower set design costs.

Both new tubes are manufactured with spherical faceplate and have dark-tint glass for high contrast. Each uses three electrostatically focused electron guns spaced 120° apart, with axes tilted to facilitate convergence of the three beams at the shadow mask. Each uses magnetic deflection and convergence, an aluminized screen and is capable of producing high-resolution pictures in both color and black-and-white. The screen incorporates the unique Sylvania screening process and high light-output rare-earth phosphor system.

SPECIFICATIONS

	15"-TYPE RE-ST4561A	19"-TYPE RE-ST4562A
Implosion Protection	T-Band	Kimcode
Glass transmission characteristic	52%	43.5%
Minimum useful faceplate area	11.689 x 9.139 in.	15.585 x 12.185 in.
Deflection Angles (approx)		
Diagonal	90 deg.	89 deg.
Horizontal	79 deg.	78 deg.
Vertical	63 deg.	63 deg.
Minimum projected picture area	102 sq. in.	180 sq. in.
Phosphors	Sylvania P22 Rare-Earth Type	

Sylvania designed these new tubes to help you broaden your set line and cut set costs. Complete specifications are available from your Sylvania representative.

CIRCLE NUMBER 305

SYLVANIA

A SUBSIDIARY OF
GENERAL TELEPHONE & ELECTRONICS

NEW CAPABILITIES IN: ELECTRONIC TUBES • SEMICONDUCTORS • MICROWAVE DEVICES • SPECIAL COMPONENTS • DISPLAY DEVICES

This information in Sylvania Ideas is furnished without assuming any obligations

NAME _____
 TITLE _____
 COMPANY _____
 ADDRESS _____
 CITY _____ STATE _____

Circle Numbers Corresponding to Product Item

300 301 302 303 304
 305

Please have a Sales Engineer call



HOT LINE INQUIRY SERVICE

Need information in a hurry? Clip the card and mail it. Be sure to fill in all information requested. We'll rush you full particulars on any item indicated.

You can also get information using the publication's card elsewhere in this issue. Use of the card shown here will simplify handling and save time.

These 5 blowers

belong

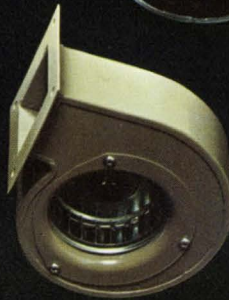
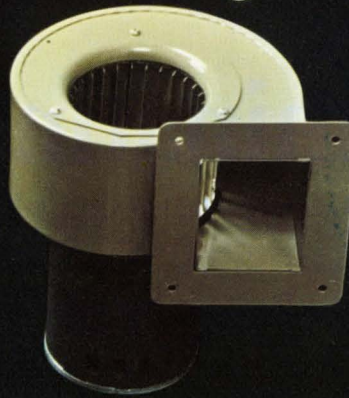
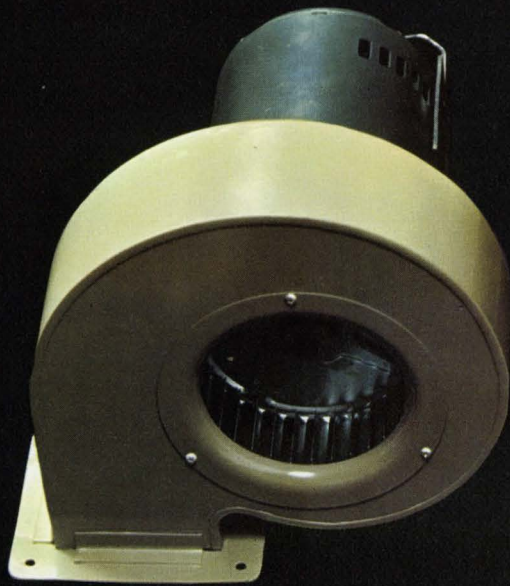

to the

world's

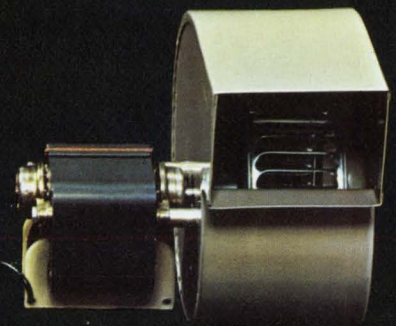
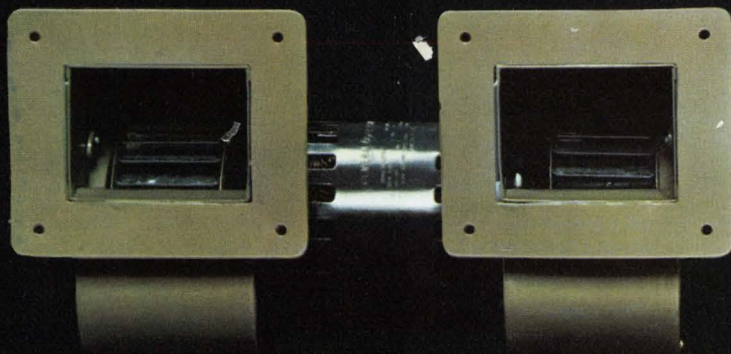

biggest

fan club.

TORRINGTON

Despite any resemblance, no two centrifugal blowers shown above are alike. For that matter, neither are any of Torrington's 67 other in-stock blowers identical. Except for one outstanding fact.

All 72 of these blowers are immediately available "off-the-shelf" units . . . models designed to lend themselves to a variety of adaptations. By merely interchanging standard parts these in-stock units have produced 216 different models for Torrington customers, and the end is nowhere in sight.

Whatever your specifications, whether high or low air flow, A.C. or D.C. motors, high or low resistance, single or double inlet, Torrington can make the centrifugal blower you need — faster, more economically, and in any quantity you desire, from mere dozens to the thousands.

We can't illustrate every type of blower produced in our plant. But if you'd care to see how far we'll go to meet your needs, write today for our catalog "Centrifugal Blowers by Torrington." Address your request to Torrington Manufacturing Company, Torrington, Connecticut.

A very discriminating scaler

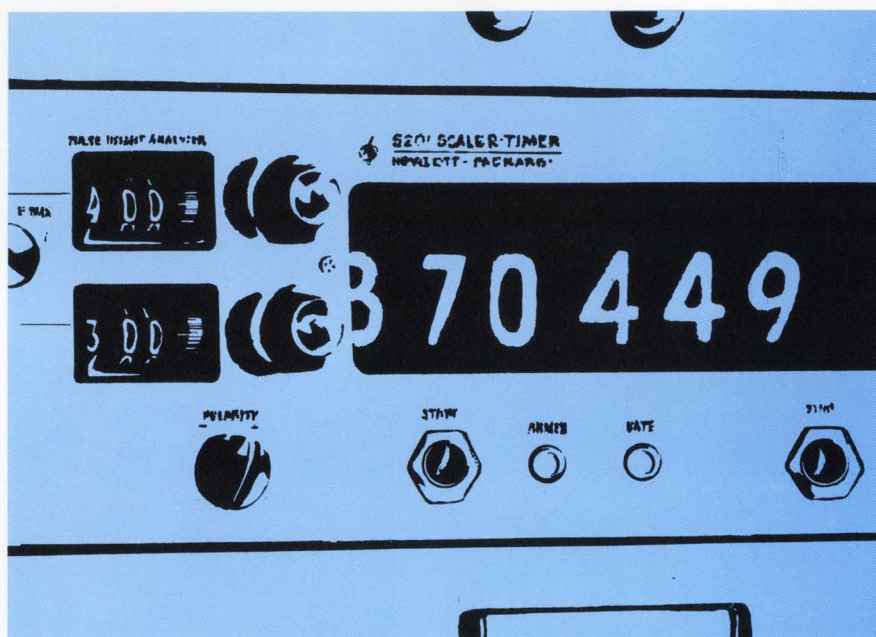

The Hewlett-Packard 5201L Scaler Timer does more than simply count total numbers of events. Two highly-stable discriminators perform true pulse height analysis which enables the 5201L to totalize the number of times an amplitude lies within an exactly defined (voltage, energy) range. This adjustable "window" makes the scaler valuable for many areas outside of nuclear applications.

The 5201L can be used to count the number of vibrations within a selected range, for damage predictions on mechanical systems. It can—with a sampler—monitor the amount of time receiver signal strength is at a useful level during 24-hour reception. It could even be used to count the number of ocean waves with a given amplitude that roll in during a preset time interval. It can answer many questions that come down to: "How many times over a specified time interval does a signal amplitude lie within a defined range?"

The pulse height analyzer comprises a voltage reference, two discriminators and an anti-coincidence circuit. When an input pulse is within the "window" defined by the upper and lower discriminators, the totalizing circuit receives a pulse. When the pulse lies outside the window no pulse is sent to the totalizing circuit. At the end

of a pre-set time, which can vary from 0.1 second to 10,000 minutes, an in-line digital readout displays the count total.

The operation just described is but one mode of three. The discriminators can also totalize all pulses which rise over a pre-set level or to track, stepwise, the narrow "window" over the voltage range for differential counting. This series of high-resolution readings yields an amplitude histogram plot which, with a system including the HP 5552A Spectrum Scanner, can be plotted automatically.

The 5201L, by means of its standard features, can be used with automatic recording equipment in combination with data acquisition instrumentation. It has 200 nsec multiple pulse resolution; 6-digit in-line display capability; automatic recycling with storage.

Price: \$1950.

For more information, call or write Jim Sheldon, Hewlett-Packard, Palo Alto, California 94304; Europe: 54 Route des Acacias, Geneva.

HEWLETT  **PACKARD**

02715

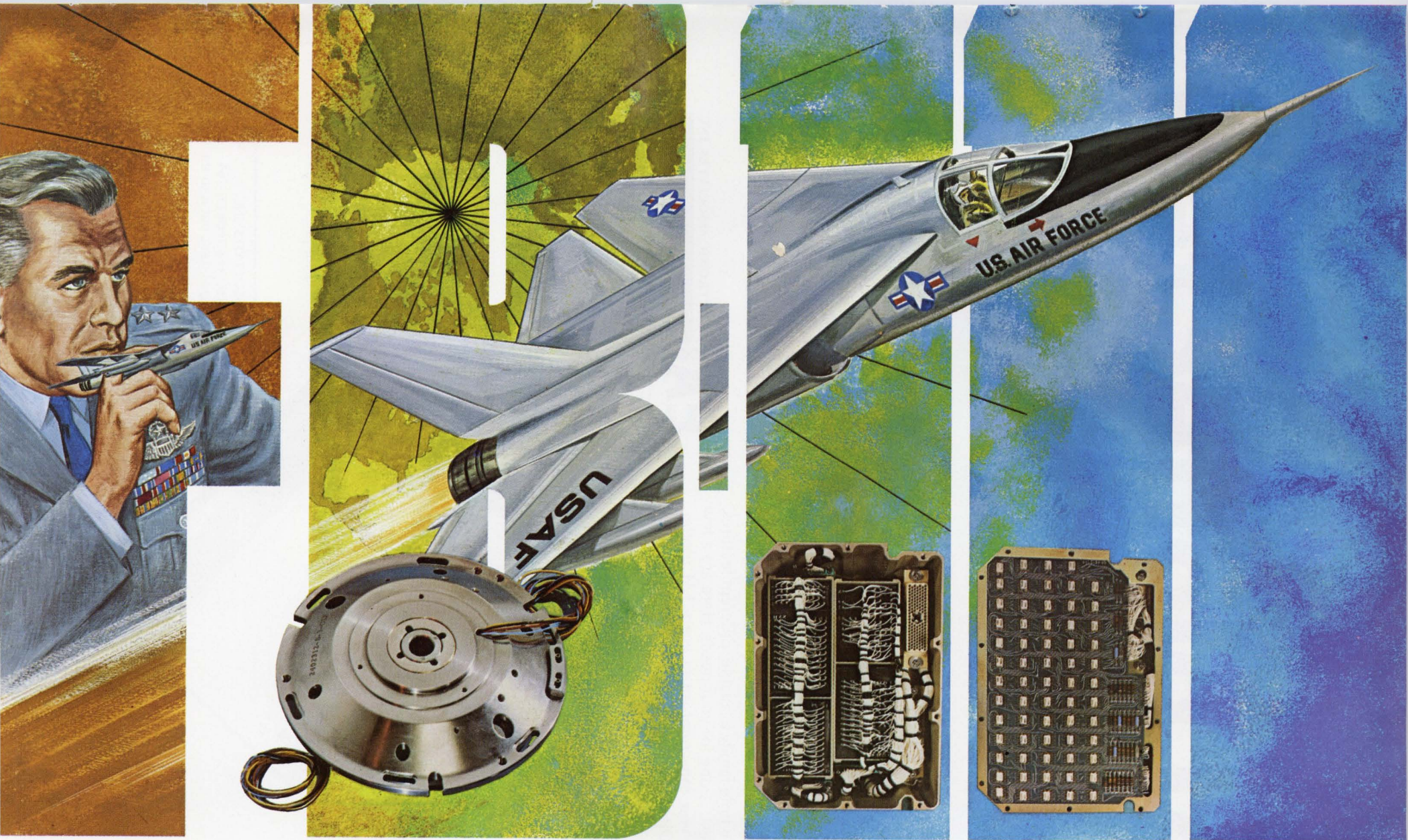

PINPOINT NAVIGATION for the FB-111

Clifton's A/D, D/A Converters consisting of multispeed transducers combined with miniature, all solid state integrated circuitry, offer ideal solutions in the navigation equipment of the FB-111. They are a rugged, high density package, highly accurate, with system resolution from 13 to 21 bits. Talk about state-of-the-art. This is it! In a practical, in production piece of hardware.

DITRAN Division of Clifton *Advances The State-Of-The-Art*

CLIFTON 
DIVISION OF LITTON INDUSTRIES

Circle 37 on reader service card

Take the EAI plotter test.

Give us your signal, and we'll show you better results on EAI X-Y plotters than any comparable machine on the market . . . often at lower cost.

We state emphatically: EAI has the finest machines available. And a superior service reputation that backs them to the hilt.

We developed the first commercially produced X-Y plotters to tie in with our analog computers, and we've been building them at the computer-quality level ever since.

There is a whole family available: different features, different prices . . . one for *your* needs. Here are a few of the extras you can count on in every EAI plotter. Single Loop Direct Drive — eliminates complex string

and pulley systems. Plug-in Inking System — writes in any position at top plotter speed. Simple cartridge replacement. High Dynamic Performance — the real test of an outstanding plotter.

The sure way to confirm these facts is to ask for a demonstration.

Tell us what you're looking for in a X-Y plotter.

We'll set up a test date.

Don't pass it up.

EAI[®] ELECTRONIC ASSOCIATES, INC.
West Long Branch, New Jersey

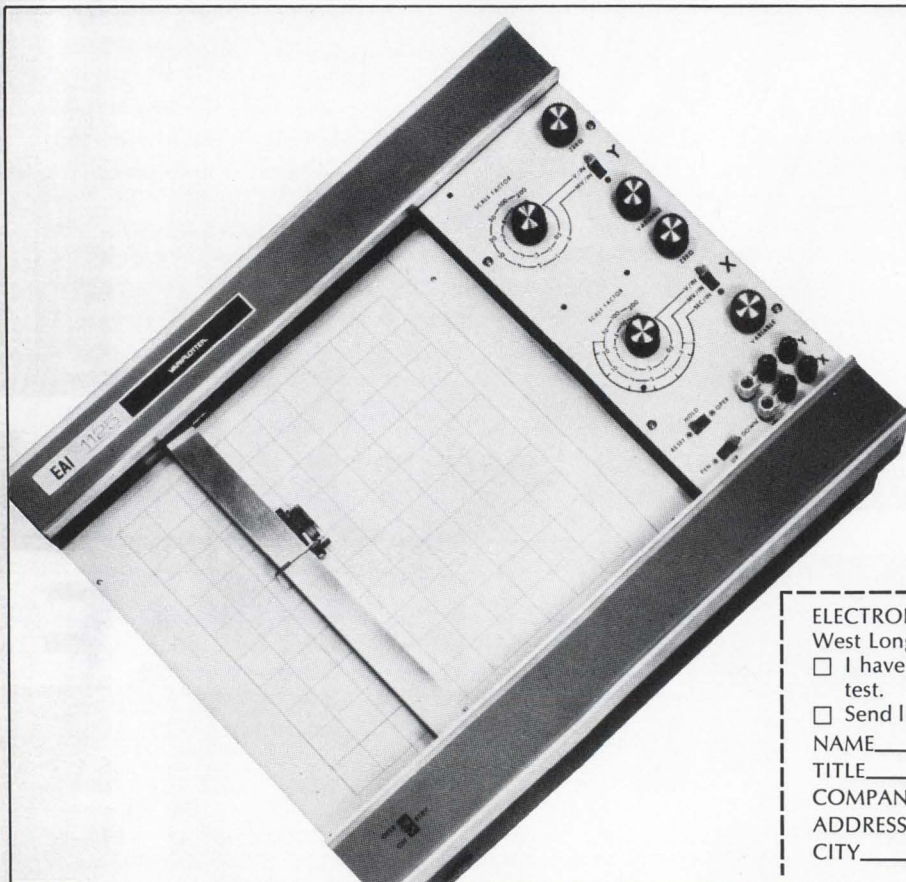

Here's just one member of the family we'd like to show you. It has the features you want plus a full 10" x 10" plotting area. Check the brief specs:

Series 1125—\$1590

- Accuracy 0.1%
- 18 calibrated D.C. ranges with variable control
- 1/2 mv/inch sensitivity
- Built-in multi-range time base
- Rack or bench mount without adapters
- Inch or centimeter scaling
- Plug-in disposable ink cartridge
- Ten-turn zero and scale factor pots

ELECTRONIC ASSOCIATES, INC.
West Long Branch, New Jersey 07764

E-107

I have the signal. Let's put it to the EAI plotter test.

Send literature on X-Y plotters.

NAME _____

TITLE _____

COMPANY _____

ADDRESS _____

CITY _____ STATE _____ ZIP _____

Electronics

Editor-in-Chief: Lewis H. Young

Associate managing editors

Technical: Donald Christiansen

News: Robert Henkel

Copy: Sally Powell

Senior associate editors

John F. Mason, Joseph Mittleman, Stephen E. Scrupski, Harry R. Karp

Department editors

Advanced technology: Stephen E. Scrupski

Avionics & Space: Alfred Rosenblatt

Computers: Wallace B. Riley

Consumer electronics: John Drummond

Design theory: Joseph Mittleman

Industrial electronics: Harry R. Karp

Instrumentation: Carl Moskowitz

Military electronics: John F. Mason

New Products: William P. O'Brien, Stephen Fields

Solid state: Mark B. Leeds

Staff writer: Howard Wolff

Section editors

Electronics abroad: Arthur Erikson

Electronics review: Stanley Zarowin

New Products: H. Thomas Maguire

Probing the news: Eric Aiken

Regional bureaus

Domestic

Boston: James Brinton, manager; Robin Carlson

Los Angeles: Lawrence Curran, manager; June Ranill

San Francisco: Walter Barney, manager; Mary Jo Jadin

Washington: Robert Skole, manager; William D. Hickman, Paul Dickson, Patricia C. Hoehling

Foreign

Bonn: John Gosch

London: Michael Payne

Tokyo: Charles Cohen

Copy editors

James Chang, Frederick Corey

Graphic design

Art director: Saul Sussman

Assistant art directors: Ann Mella, Valerie Betz

Production editor: Arthur C. Miller

Editorial secretaries: Claire Benell, Lynn Emery, Kay Fontana, Patricia Gardner, Lorraine Longo

McGraw-Hill News Service

Director: John Wilhelm; Atlanta: Fran Ridgway; Chicago: James Rubenstein;

Cleveland: Arthur Zimmerman; Dallas: Marvin Reid;

Detroit: J. Wirgo; Houston: Robert E. Lee; Los Angeles: Michael Murphy, Gerald Parkinson

Pittsburgh: Louis Gomolak

San Francisco: William F. Arnold

Seattle: Ray Bloomberg; Washington: Arthur L. Moore, Charles Gardner,

Herbert W. Cheshire, Seth Payne, Warren Burkett, James Canan, William Small

McGraw-Hill World News Service

Bonn: John Johnsrud; Hong Kong: Don Kirk; London: John Shinn;

Mexico City: Bruce Cross; Milan: Ronald Taggiasco;

Moscow: Howard Rausch; Paris: Peter Kilborn;

Rio de Janeiro: Wes Perry; Tokyo: Marvin Petal

Reprints: Susan Nugent

Circulation: Milton Drake

Publisher: Gordon Jones

Electronics: October 30, 1967, Vol. 40, No. 22

Published every other Monday by McGraw-Hill, Inc. Founder: James H. McGraw 1860-1948.

Printed at 99 North Broadway, Albany, N.Y. 12207; second class postage paid at Albany, N.Y.

Executive, editorial, circulation and advertising addresses: McGraw-Hill Building, 330 W. 42nd Street New York, N.Y. 10036. Telephone (212) 971-3333. Teletype TWX N.Y. 710-581-4235. Cable address: MCGRAWHILL N.Y.

Subscriptions solicited only from those professionally engaged in electronics technology. Subscription rates: qualified subscribers in the United States and possessions and Canada, \$8.00 one year; \$12.00 two years; \$16.00 three years; all other countries \$25.00 one year. Non-qualified subscribers in the U.S. and possessions and Canada, \$25.00 one year; all other countries \$50.00. Air freight service to Japan \$50.00 one year. Single copies: United States and possessions and Canada, \$1.00; all other countries, \$1.75.

Officer of McGraw-Hill Publications: Joseph H. Allen, President; Bayard E. Sawyer, Executive Vice-President; J. Elton Tuchig, Senior Vice-President-Operations; Vice Presidents: John R. Callahan, Editorial; John M. Holden, Marketing; Paul F. Cowie, Circulation; Angelo R. Venezian, Production; Jerome D. Luntz, Planning & Development; Robert M. Wilhelmy, Controller.

Officers of the Corporation: Donald C. McGraw, Chairman of the Board; Shelton Fisher, President; L. Keith Goodrich, Robert E. Slaughter, Executive Vice Presidents; Donald C. McGraw, Jr., Senior Vice-President; John J. Cooke, Vice-President & Secretary; John L. McGraw, Vice-President & Treasurer.

Title © registered in U.S. Patent Office; © Copyright 1967 by McGraw-Hill, Inc. All rights reserved. The contents of this publication may not be reproduced either in whole or in part without the consent of copyright owner.

Subscribers: The publisher, upon written request to our New York office from any subscriber, agrees to refund that part of the subscription price applying to copies not yet mailed. Please send change of address notices or complaints to Fulfillment Manager; subscription orders to Circulation Manager, Electronics at address below. Change of address notices should provide old as well as new address, including postal zip code number. If possible, attach address label from recent issue. Allow one month for change to become effective.

Postmaster: Please send form 3579 to Fulfillment Manager, Electronics, P.O. Box 430, Hightstown, New Jersey 08520

Readers Comment

Starting point

To the Editor:

The "new laser" described [Electronics, July 24, p. 35] as a development of IBM's Watson Research Center appears to be essentially identical to the first ring-discharge ion laser invented in 1965 by W.E. Bell, then of Spectra-Physics Inc. Mountain View, Calif. The similarities between Bell's device and the IBM device are, in my opinion, too close to preclude, for the record, a mention of Bell's prior work.

Eugene L. Watson

President

Coherent Radiation Labs.

Palo Alto, Calif.

▪ The ring discharge ion laser, designed by Bell and his colleagues at Spectra-Physics was, in fact, the starting point for the design of IBM's inductively excited laser, says its developer, physicist Charles Zarowin. But the IBM design differs in several fundamental ways: IBM's laser is squarewave pumped by audio frequencies (about 2.5 kilohertz), whereas the S-P design is pumped by sinewave radio frequencies (about 10 megahertz); S-P had to turn to the higher frequencies to avoid the "on," "off," or flickering effect of the output beam. The IBM design is driven by a small and lightweight (about 150 pounds), solid state power supply, while the S-P unit requires a much larger and heavier (about 1,000 pounds) vacuum tube power supply. In addition, the S-P design involves resonant operation of the inductive coupling, while IBM's unit is non-resonant. As a result of these unique design features IBM's laser provides a high numerical aperture (15 centimeters long by 1 cm in diameter), while the S-P unit is limited to a numerical aperture only about 1/10 that of IBM's.

Mini interference

To the Editor:

In the article "Power grab by linear IC's [Aug. 21, p. 81], I noticed the sentence: "Also, radio-frequency interference is minimal though no rfi filters are used." I think that the authors as well as

WAVETEK uses Allen-Bradley Type F variable resistors exclusively because of their

- * Quality performance
- * Excellent stability
- * Infinite resolution

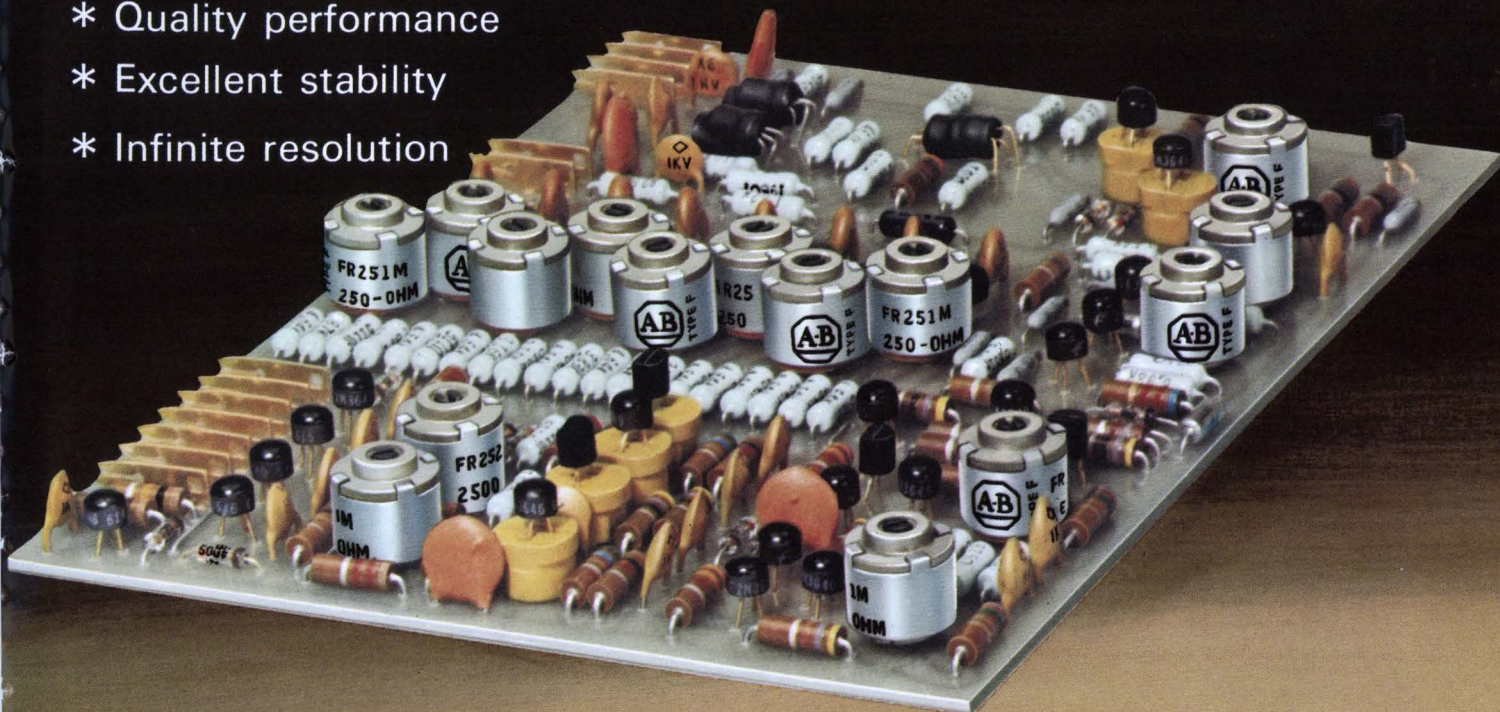

One of the 5-inch by 6½-inch Wavetek printed circuit cards, showing 15 of the 25 Allen-Bradley Type F hot molded variable resistors and numerous hot molded fixed resistors used in the Model 111 VCG function generator.

Type F variable resistor with pin type terminals for mounting directly on printed wiring boards. Rated ¼ watt at 70°C. Total resistance values from 100 ohms to 5 megohms.



Actual Size



Wavetek Model 111 VCG generates sine, square, triangle, and ramp waves from 0.0015 Hz to 1 MHz, and offers precision control of the frequency of the waveforms by external voltage.

■ The precision waveforms generated by Wavetek's Model 111 VCG place exacting demands on the large number of variable resistors used to set amplitudes to very precise values and assure symmetry of all functions. They must provide velvet smooth control, and quiet operation. And since this is a Wavetek adjustment, it is essential that the variable resistors, once adjusted, will stay "put".

Allen-Bradley Type F variable resistors satisfy all of these requirements, because they have the same solid hot molded resistance track as the famous Type J and Type G variable resistors. There's velvet smooth control at all times—never the problem of discrete steps com-

mon to all wire-wound units. And since Type F variable resistors are essentially noninductive and have low distributed capacitance, they can be used at high frequencies where wire-wound controls are useless.

When a manufacturer like Wavetek has standardized on the quality of A-B electronic components, you can be sure of the superior performance of such equipment.

For more details on the complete line of Allen-Bradley quality electronic components, please write for Publication 6024. Allen-Bradley Co., 222 W. Greenfield Avenue, Milwaukee, Wis. 53204. In Canada: Allen-Bradley Canada Limited. Export Office: 630 Third Avenue, New York, N.Y., U.S.A. 10017.



ALLEN-BRADLEY

QUALITY ELECTRONIC COMPONENTS

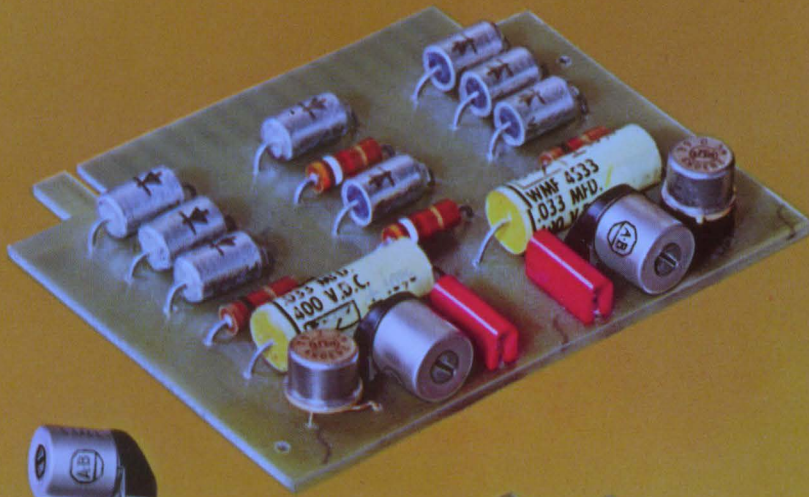

All components shown actual size

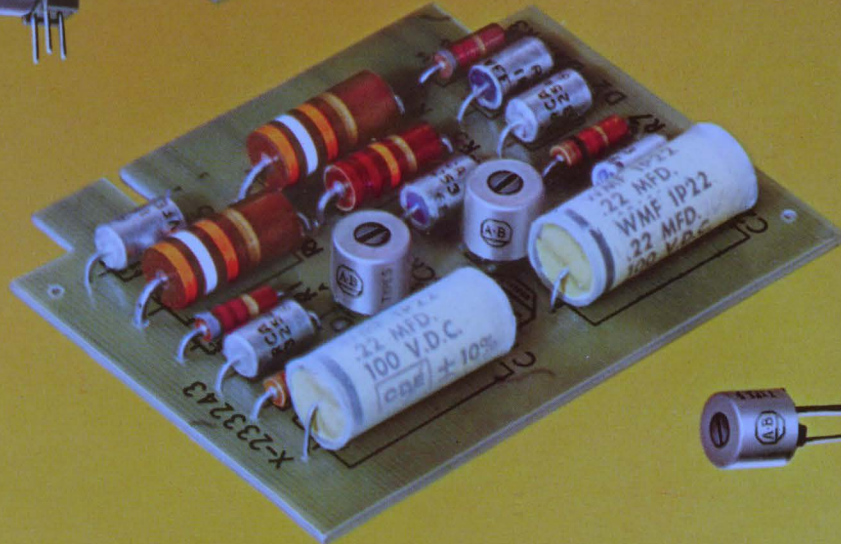

Only the new Allen-Bradley Type S cermet trimming resistors have all these features

Type S
shown twice actual size

for side adjustment



for top adjustment



The Allen-Bradley Type S is a one turn cermet trimmer in which you will find incorporated a wider range of features than in any other trimmer now on the market. Here are a few of the more important features.

- **COMPACT**—body is $\frac{3}{8}$ " dia.
- **BUILT FOR EITHER TOP OR SIDE ADJUSTMENT**
- **50 OHMS THRU 1 MEGOHM**
- **THE SEALED UNIT** is immersion-proof
- **TEMPERATURE COEFFICIENT** less than 250 ppm/°C over *all resistance values and complete temperature range*
- **UNIQUE ROTOR DESIGN** provides exceptional stability of setting under shock and vibration
- **SMOOTH CONTROL**, approaches infinite resolution
- **PIN TYPE TERMINALS** for use on printed circuit boards with a 1/10" pattern

- **VIRTUALLY NO BACKLASH**
- **WIDE TEMPERATURE RANGE** from -65°C to +150°C
- **RATED $\frac{1}{2}$ watt @ 85°C**
- **EXCEPTIONAL STABILITY** under high temperature or high humidity
- **MEETS OR EXCEEDS ALL APPLICABLE MIL SPECS**
- **COMPETITIVELY PRICED!**

You'll find the new Type S trimmer equal to the traditional Allen-Bradley quality. You really ought to know more about the Type S. Won't you write for detailed specifications? Allen-Bradley Co., 222 W. Greenfield Ave., Milwaukee, Wis. 53204. In Canada: Allen-Bradley Canada Limited. Export Office: 630 Third Ave., New York, N. Y., U.S.A. 10017.



ALLEN - BRADLEY
QUALITY ELECTRONIC COMPONENTS

RESOLVER/SYNCHRO INSTRUMENTATION

A very short course for engineers engaged in testing and evaluation of resolvers and synchros as components or as system transducers.

Selecting a resolver/synchro test instrument for any engineering, production or system requirement is remarkably simple from North Atlantic's family of resolver and synchro instrumentation. Because this group has been developed to cover every area of need in both manual and automatic testing, obtaining the desired combination of performance and package configuration usually demands no more than 1) determining what you need and 2) asking for it.

Remote Readout of Angular Position

For remote indication of resolver or synchro transmitters in system testing, North Atlantic's Angle Position Indicators (Figure 1) provide the advantages of low cost and continuous counter or pointer readout. These high-performance instrument servos are accurate to 4 minutes of arc, with 30 arc seconds repeatability and 25°/second slew speed. Dual-mode capability, multi-speed inputs, integral retransmit components and other optional features are available to match application needs. Priced from \$895.



Figure 1. Angle Position Indicators are available in half-rack, quarter-rack and 3-inch round servo packages.

High-Accuracy Testing Of Receivers And Transmitters

Measuring receiver and transmitter performance to state-of-art accuracy is readily accomplished with North Atlantic's Resolver/Synchro Simulators and Bridges (Figure 2). Each of these dual-mode instruments tests both resolvers and synchros, and provides direct in-line readout of shaft angle, accurate to 2 arc seconds. Simulators supply switch-selected line-line voltages

from 11.8 to 115 volts from either 26 or 115 volts excitation, and so can be used to test any standard receivers. Bridges have constant null voltage gradients, making them ideally suited for rapid deviation measurements. Simulators and Bridges each occupy only 3½ inches of panel height and are available in a choice of resolutions. They are priced in the \$1500 to \$3000 range.

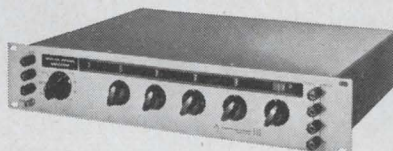

Figure 2. Resolver/Synchro Simulator provides ideal source for receiver testing.

Automatic Measurement And Conversion

Where systems require continuous or on-command conversion of resolver or synchro angles to digits, North Atlantic's Automatic Angle Position Indicators (Figure 3) handle the job without motors, gears or relays. These solid-state automatic bridges accommodate all standard line-to-line voltages and provide both Nixie display and printer output, accurate to 0.01° and with less than 1 second update time. Many variations, including 10 arc second accuracy; binary, BCD or decimal outputs; multiplexed channels and multispeed operation, are available for specific requirements. Ballpark price: \$5900.

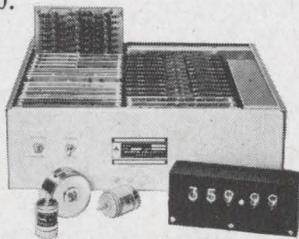

Figure 3. Model 5450 Automatic Angle Position Indicator. It measures shaft angles, converts them to digital data.

Measuring Electrical Characteristics

Combine a Resolver/Synchro Bridge and a Simulator with a North Atlantic Ratio Box, a Phase Angle Voltmeter and a test selection panel and you have an integrated test facility for determining all electrical characteristics of resolvers and synchros in component production or Quality Control. An example is the North Atlantic Resolver/Synchro Test Console shown in Figure 4. It measures phasing, electrical zero, total and fundamental nulls, phase shift and input current, as well as angular accuracy. Standard North Atlantic instruments are used as modules, making it a simple matter to fill the exact need. The unit shown sells for about \$7500.

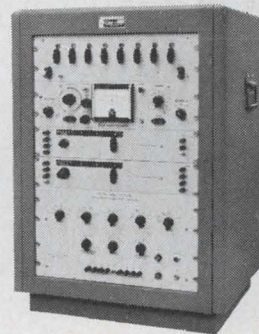

Figure 4. Model RTS-573 Test Console is a complete facility for the production line or in quality control.

If you require performance, reliability and convenience in resolver and synchro testing, we want to send you detailed technical information on these instruments (also on related instruments for computer system interface). Or, if you prefer, we will arrange a comprehensive technical seminar at your plant. Simply write to: North Atlantic Industries, Inc., 200 Terminal Drive, Plainview, N.Y. 11803 • TWX 516-433-9271 • Phone (516) 681-8600.





(Actual Size)

Weight-conscious engineers like what they don't see here.

Bendix® size 08 Autosyn® Synchronizers average only 1.3 ounces. And their maximum diameter is 0.750 inch.

It's this combination that explains the success of the 08 models in such a wide range of applications. In addition, all 16 standard 08 units feature 12-inch flexible leads, aluminum housings and corrosion-resistant construction. They're also available with stainless steel housings.

Some models are accurate and stable at operating

temperatures up to 800° F. Others are radiation-resistant. And if you can't find the 08 that's just right, we can build one to meet your needs exactly.

Need a larger size? Check our sizes 10, 11, 15 and 22.

Of course, the performance and reliability of every Bendix Autosyn Synchronizer are backed by one of the best names in the business. Write for our 42-pg. catalog. Flight & Engine Instruments Division, Montrose, Pa.

Bendix **Aerospace
Products**

Military electronics

Out of the deep

The ocean is the harshest enemy of electronics. Many conventional attempts to develop pressurized packaging for deep-sea operation have run into hot water. But North American Rockwell Corp.'s ocean systems operation borrowed standard aerospace techniques to come up with a new approach: circuit boards sandwiched in a protective honeycomb structure.

Although its new underwater module hasn't been tested, the company is so confident it will work that it has made the module a key part of its design in competing for a contract to develop a Navy swimmer-delivery vehicle.

Details are scanty on the two-man delivery vehicle project, except that it is being managed by a new special projects office—PM-12 (program manager for the Office of Naval Inshore Warfare). Among the firms said to be competing with North American are the General Dynamics Corp., the Ryan Aeronautical Co., and the Aerojet-General Corp.

For frogmen. The vehicle will be carried on the decks of submarines for use by underwater demolition teams (UDT). What makes the program particularly exciting to the electronics industry is that the little submersibles will carry a good deal of electronics—comparable to that on a low-flying military aircraft. And it would be a large order—involving between 100 and 200 vehicles. They apparently will contain such subsystems as control, communications, and sonar.

North American's module is a marriage of two in-house technologies that are already proved in aerospace applications—the honeycomb structure used in the B-70 Valkyrie aircraft and the integrated

circuit-multilayer board assemblies used in both the Minuteman 2 computer and the Mark 2 integrated-avionics system, which is now under development at the company's Autonetics division for the Air Force F-111A.

Previous approaches to pressurizing electronics fall into three basic types: pressure vessels, circuits packed in oil, and circuits potted in hard plastics. Pressure vessels, which are inefficient in terms of component density, lack standard modules, pay heavy weight penalties, and provide inadequate cooling. Packing circuits in oil exposes components to oil impurities or moisture and unpredictable pressure effects because of manufacturing variations in semiconductor components that alter device pressure sensitivity. Potting circuits in hard plastics such as polymers is limited to applications where high component density isn't needed or where low component power dissipation is.

Sandwich type. The North American module, which measures about 4½ by 5½ inches and has a thick-

ness of 1½ inches, provides pressure isolation of standard micro-electronic active and passive elements, says Robert G. Cook, a design specialist who came from the B-70 program. P.F. Godwin, a research specialist moved in from the Mark 2 project, says the modules will house bipolar and metal oxide semiconductor IC's in combinations of linear and digital monolithic and hybrid circuits.

Two standard 3-by-2½-in. alumina or beryllia ceramic-circuit boards are mounted back-to-back and separated by a dummy board enclosed by two formed stainless-steel can halves. Two grid assemblies similar to egg crates form the sandwich-type structure that resists high water pressures, thus eliminating the need to pressurize the electronic components. The circuit boards are part of the structure that isolates components from external loads. A standard Mark-2 board was used in a module mockup and the grid, having ¾-in. spacing, doesn't interfere too much with component density.

Wet weight of the module will be 1.64 pounds for a 7,600-foot operating depth and 1.85 pounds for 10,600 feet. For the swimmer vehicle, the module can be made even lighter. Thus, the module can be placed anywhere without affecting trim. Two cans could handle a basic sonar unit, Godwin says, and about 15 watts can be dissipated by one module.

State of the art. Since all technology here is state of the art, North American is predicting high reliability—extremely high for underwater systems. "We're shooting for 10 years," says Godwin. The module can easily be disassembled without destroying the circuit or components.

North American couldn't find a commercial connector suited for the module, so it developed a 24-contact, two-prong insulated connector

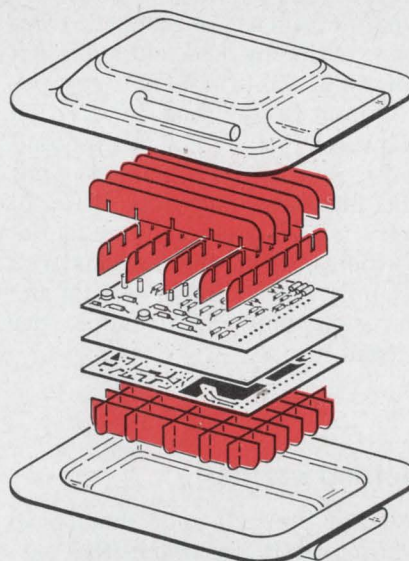

Egg crate. Honeycomb principle is used to protect circuit boards from underwater pressure.

probe with annular contact rings. Here, O-ring seals serve to pressure-isolate air chambers around pins and sockets, and a squeegee wiping action eliminates all air and water around the contacts. The connection can be made underwater with less than 50 pounds of pressure, Cook says.

Three-in-one mission

Spurred by Vietnam needs, a prototype three-function laser system for forward air controllers will undergo additional tests this week at Eglin Air Force Base in Florida. If the system becomes operational, it will be the Air Force's first laser unit for ground-to-ground ranging [Electronics, July 10, p. 26].

Unlike the Army's laser system, which is limited to ranging, the Air Force's unit is a 3-in-1 package: it locates targets, detects intrusion, and provides secure voice communication. It was developed for the Rome, N. Y., Air Development Center by the Radio Corp. of America's Aerospace Systems division at Burlington, Mass., which also designed the Army rangefinder.

Two for three. The Air Force system uses two lasers—a neodymium-doped, yttrium-aluminum garnet (yag) laser to measure range, bearing, and elevation of the target, and a gallium-arsenide laser to provide high-fidelity, noise-free voice communication up to 2.5 miles and to trigger an alarm when an intrusion interrupts the beam. An optically aligned Starlight scope—a light-enhancement device—can be adapted to the set to improve target location at night. The Army system uses a ruby laser.

According to the Air Force, the yag laser has several advantages over the ruby: it uses one-fifth the input power (40 joules per pulse); it is less hazardous to the eye (by a factor of seven if both lasers are transmitting at the same power level); and its 1.06-micron wavelength is an invisible beam (the ruby laser's 0.7-micron beam is visible). The GaAs laser's 0.902-micron beam is also invisible.

Ruby's plus. The Air Force chose yag over ruby because better and

larger crystals are now being produced. Since it settled on its laser design three years sooner than the Air Force, the Army wasn't confronted with a choice between the two; yag hadn't been fully developed at the time. However, the Army claims the ruby lasers offer two advantages—ruby material is relatively low-priced and detectors are extremely sensitive.

Range of the Air Force system is 9,990 feet in clear weather and 5,700 feet in haze, with an accuracy

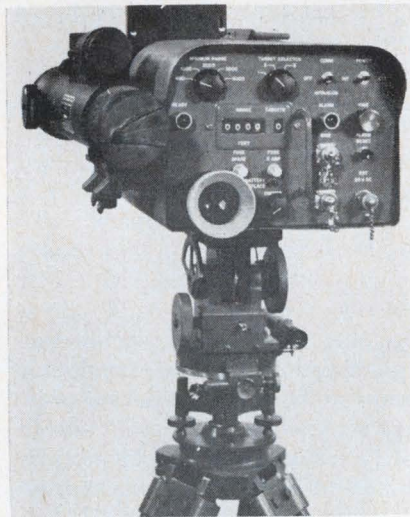

Eyes. Two-laser device for ranging, communications, intrusion alarm.

of ± 10 feet. The tripod mount can be positioned to true north with an accuracy of ± 1 minute of arc by means of a sensitive magnetic compass. Azimuth and elevation accuracy is within ± 0.1 degree.

Output for the rangefinder is 750 kilowatts in a 20-microsecond pulse, and for the communications and intrusion unit, from 10 to 20 watts in a 56-nanosecond pulse. Repetition rate for the rangefinder is six pulses per minute, and for the intrusion unit, 8,000 pulses per second.

Getting warmer

It takes from 20 to 75 minutes to warm up and align the inertial navigation systems of U.S. Navy carrier-based aircraft. During that time, the ship's turning can alter

the reference information being fed to the inertial navigators through bulky umbilicals that clutter the flight deck.

The Navy would like to eliminate warmup and the hazardous umbilicals, slash alignment time to five minutes, and allow the ship to turn without affecting the reference data. Toward that end, the Naval Air Systems Command has asked the Naval Air Development Center, Johnsville, Pa., to develop a brassboard or feasibility model of an inertial navigation system that can be aligned by a radio-frequency data link between the ship's own inertial navigation system and the aircraft via computer.

Tests with the feasibility model of the inertial navigator and data link next July or August will establish specifications the Navy can use to buy a preproduction prototype that might undergo sea tests by midsummer of 1969.

SINS and Cains. Lloyd A. Iddings says the intent of the Carrier Aircraft Inertial Navigation System is to produce a standard inertial navigation system that is interchangeable among various Navy aircraft, and which is compatible with the ship's inertial navigation system (SINS). Iddings is section head for gyroscopes and inertial navigation at NASC in Washington. He adds that another aim of the program is to have one maintenance console aboard the carrier to service both the ship's and the aircraft navigation units.

Besides the five-minute alignment time requirement, Iddings says the Navy wants these features in a standardized inertial navigation unit:

- The ability to replace the system in 4½ minutes;
- A purchase price between \$45,000 and \$80,000 for quantities of 1,500 to 2,000 units, compared with an average of \$135,000 for present operational inertial navigation systems.

▪ A total system weight of about 65 pounds, with no subsystem (inertial platform, power supply, battery and computer) weighing more than 25 pounds.

Iddings emphasizes that the Cains program is not intended to

come up with a new inertial navigation system, nor will the Navy try to improve the accuracy of inertial units. The aim is to modify existing hardware so that the next generation of Navy aircraft inertial systems will be compatible with the data-link alignment method. "We examined most of the inertial equipment available from industry. We wanted a system that is the right size, is already in production, and has been flight-tested."

The only platform meeting those requirements is the LN-15 inertial navigation system made by the Guidance and Control Systems division of Litton Industries Inc. It will serve as the inertial navigator in the feasibility model.

The LN-15 is a general-purpose system that weighs 40 pounds without cockpit control and display equipment. It has been flight-tested at Holloman Air Force Base. Warmup time is two to three minutes.

New thinking. The Navy's adoption of an r-f data link to align inertial navigators represents a shift. The Cains program is an outgrowth of an earlier effort called Pinsac (for Portable Inertial Systems Alignment Console). The earlier program concept was to have the aircraft navigation units slaved to the ship's inertial navigation system, then taken to the plane running on battery power and plugged in. Iddings says the Navy abandoned the insertion technique because it imposed too much of a load on flight deck personnel.

The characteristics of the data link and five-minute alignment time are outgrowths of an in-house development program at the Autonetics division of North American Rockwell Corp. Tests last summer of the Autonetics NI16 inertial navigator and the data link have been described as successful by both Navy and Autonetics officials. Iddings explained that the Navy was most interested in the fast alignment capability of the Autonetics system, but will use standard hardware based on techniques in the Autonetics data link feasibility model.

Operating frequency of the data link hasn't been determined. Idd-

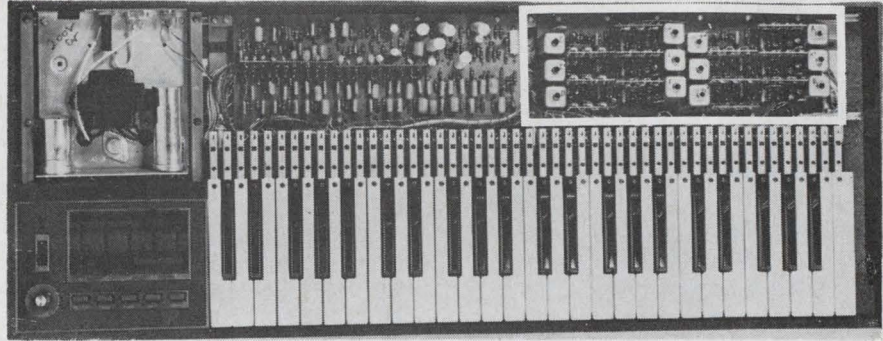

IC tone generators. Heart of lightweight organ is printed circuit board, upper right, which mounts 36 digital integrated circuits.

ings says the Naval Applied Science Laboratory in Brooklyn is about to go shopping for brass-board data processing equipment. The Navy won't say much about signal range, except that it must not be detected beyond short ranges.

Consumer electronics

Hitting high IC

The giant organ at New York's Radio City Music Hall is famous for its size. Last week the maker of that organ—Wurlitzer—introduced a model it hopes will be famous for its compact size.

What Wurlitzer has done is produce the first commercial electronic organ using monolithic integrated circuits. While there is an IC designed specifically for the electronic organ industry—Motorola's MC-1124P, a four flip-flop frequency divider [Electronics, July 24, p. 196]—Wurlitzer's 24-pound organ employs 36 standard dual flip-flops—Motorola's MC-790L—as frequency generators. Each IC replaces 24 transistors and 32 resistors, reducing the size of the instrument to 4 x 14 x 36 inches while maintaining its seven-octave keyboard. Price: \$695, less amplifier.

Now that Wurlitzer has paved the way, other producers can be expected to follow soon. With the organ industry gobbling up transistors at a rate that reached a peak of 26.8 million units last year, every major microcircuit producer can be expected to go after the industry which last year sold 124,000 elec-

tronic organs for \$192.6 million.

Split. The IC's are used as frequency dividers in the tone-generating circuits, which produce 84 discrete frequencies from 65 hertz to 7,902 hertz. The 12 notes—C through B—are produced by separate Hartley master oscillators.

The output of each master oscillator is buffered and used as the top note of the organ. At the same time, it's coupled to the first flip-flop divider stage which divides the signal to produce two related notes. The output of the first IC is applied to the second IC, which divides the signal again. This frequency division continues.

When a key is depressed the required tone signal is sent through active and passive filters to separate transistor preamplifiers before being switched to a master preamplifier. The output signal from this preamplifier, which is in the order of 5 volts with impedance of 10 kilohertz, is then used to drive any desired power amplifier.

Big play for playback

Electronic Video Recording (EVR) is growing faster than CBS Laboratories thought it would. When the color and black-and-white system was introduced two months ago, EVR was to have been a playback-only unit for educational or home use with standard television sets [Electronics, Sept. 4, p. 25]. Now it appears EVR may be used by tv stations to supplement film or video-tape systems.

A spokesman for CBS Labs says its parent organization, Columbia Broadcasting Systems Inc., will begin on-the-air tests of broadcast

EVR "within the next few months." Picture and color quality are said to equal that of the best 35-millimeter film or video tape. The spokesman also claims that the cost of broadcast-EVR equipment would be about one-third that of equivalent video-tape gear, and that the cost of EVR film would be about one-eighth that of tape.

Since the cost to educational-tv stations for color-tape equipment averages about \$75,000 and that of a 1-hour roll of tape about \$225, the cost savings predicted by CBS would make EVR attractive to them.

But CBS plans to sell only playback equipment, offering a mastering service itself for any programs that stations or networks would wish duplicated. The service will be available first to educational broadcasters, then to other markets.

Differences. Although the same electron-beam method is used to record picture and color information, broadcast EVR and the system introduced earlier have basic differences. Broadcast EVR masters are made on 16-mm film rather than on 8-mm film. Also, a reel-to-reel rather than a cartridge mechanism is used.

Playback mechanics have also been changed. First an EVR master is used to make a film print with sprocket holes to fit the projection equipment already on hand in most tv stations. This print is then projected into a special-camera system using twin vidicons, one to accept the picture and the other to accept coded chrominance and luminance information.

Companies

Going down

There was nothing but bad news when the board of directors of the Fairchild Camera & Instrument Corp. met recently to review the company's performance in the third quarter. Earnings were \$137,000 or three cents a share, compared to \$3,061,000 and 71 cents a share in the same quarter last year when earnings had disappointed Wall Street.

When the shock waves subsided, John Carter, chairman of the board, resigned, and Sherman Fairchild, the company's biggest stockholder, had replaced him on a temporary basis as chairman and chief executive officer.

The fortunes of Fairchild are tied closely to the Semiconductor division in Mountain View, Calif., which accounts for more than half the company's sales and probably three quarters of its profits. And so far this year the division has not done well. It has been caught in a slump for discrete components, particularly those used in consumer applications.

Departures. The division has also been hurt by the loss of top level management during the past year, a factor that insiders lay partially to Carter. Earlier this year, when Charles Sporck and four other top executives left to join the neighboring National Semiconductor Corp., a good portion of the blame was attributed to Carter because he opposed a reorganization plan that Sporck had suggested.

During his tenure as chief executive officer, Carter raised Fairchild from a company whose sales were about \$30 million in 1957 to more

than \$300 million last year, primarily because he guessed right in backing Robert Noyce and seven other people when they left Shockley Semiconductor to found the Fairchild Semiconductor division.

But the financial community has complained that other of Carter's acquisitions have not been so successful. Only three other divisions—Aerospace, Graphic Equipment, and Instrumentation—are thought to be in the black. Some financial men have urged Fairchild to sell the money losers.

Industrial electronics

Mix and match

Designers of some industrial electronic equipment have ambivalent feelings about integrated circuits: ic's can be giant helpers or maddening little demons. What brings out the demon in ic's is the high unit cost when they're made in small production quantities for custom applications.

Now, fast photocomposition of a set of masks for making complex ic's is being investigated by IRT Semiconductors as a means of

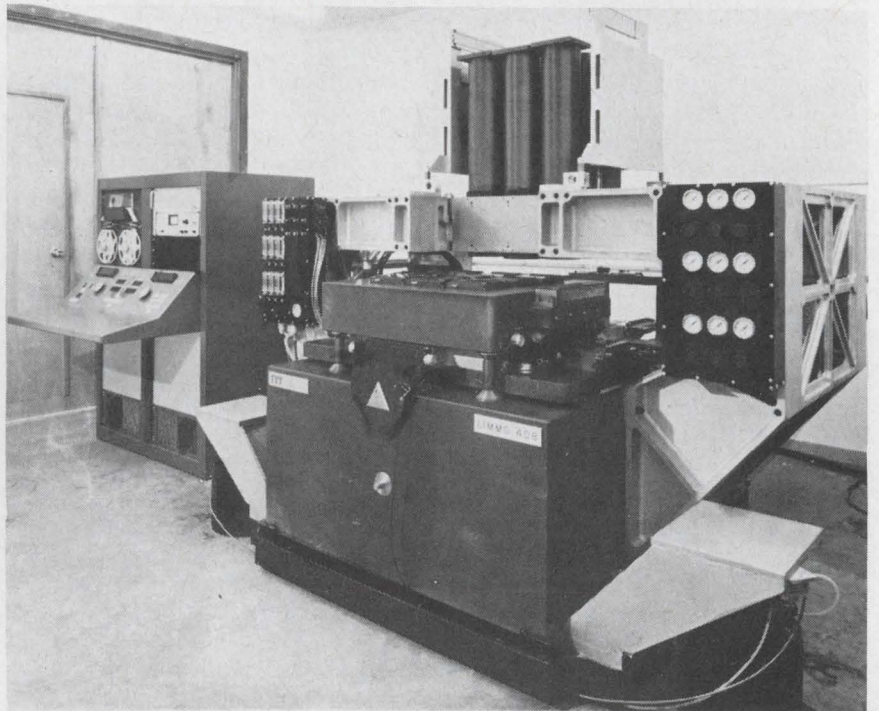

Step-and-repeat. Once the masters are in the optics of the mask maker, tapes direct and control table position and exposure time.



In-depth software...

...at your fingertips
for the finest 24-bit
I/C computer buy

...DDP-124

NOW—
60 DAY DELIVERY
ON BASIC SYSTEMS
NEW LOW PRICES

Every μ -COMP DDP-124 includes 253 field-proven software programs, FORTRAN IV compiler with Boolean capabilities, compatible symbolic assembler . . . and more. That's a lot of 24-bit software strength at your fingertips to help solve your programming problems.

Hardware? DDP-124 features I/C μ -PAC logic modules for high reliability, high performance, high speed at low cost . . . and its specs make it an ideal computer for flight simulation, message switching, physics research, radar tracking, data acquisition, scientific computation, missile tracking, impact prediction.

Interested in the finest 24-bit I/C computer? Write today for new DDP-124 brochures with complete software listing. Honeywell, Computer Control Division, Old Connecticut Path, Framingham, Massachusetts 01701.

Honeywell



COMPUTER CONTROL
DIVISION

Circle 47 on reader service card

breaking through that cost barrier. To try the idea, IRT designed a mask-making machine that assures 3 microinch positioning accuracy between adjacent cells across the mask. Such accuracy—four times better than previous machines—makes it feasible to mix-and-match separate master mask sets for components like transistors and resistors, for simple functions like gates, and more complex functions like shift registers. The sets are then photocomposed side by side to form one mask for each process step in fabricating custom IC devices.

Chips and chunks. If the mix-and-match idea becomes a reality—and machine trials look good—a chunk of the \$20,000 to \$50,000 now spent for developing a master IC mask set should be eliminated and the lead time to production shortened. Cutting the cost of mask-making will be a boon for industrial electronics designers who have been frustrated in obtaining small quantity custom IC's at prices low enough to justify new and re-designed products for customers.

The lucrative but elusive industrial market for custom IC's is one major reason IRT sought a 3 microinch accuracy in the 11-ton, laser-positioned, tape-controlled machine installed last week at its plant in West Palm Beach, Fla. The other major reason for buying the advanced machine, which can shoot up to nine masks simultaneously, was to increase production to meet growing demand for IRT's present line of IC devices.

Tightening technology. While IRT Semiconductors looks to its new mask-maker to boost IC technology, the machine itself doesn't depend on major innovations. Instead, consultant-designer James R. Nall sought the best in laser interferometry, in table-positioning servos, in machinery design, and in optics to get 3 microinch accuracy.

For example, to position the machine's granite table that rides on Pyrex ways, photodetectors count fringes from a helium-neon laser interferometer emitting light at a 24.34 microinch wavelength. But unlike other similar machines that divide one wavelength by two [Electronics, Aug. 7, p. 119], a

special arrangement of beam splitters and photodetectors are positioned to receive fringes from a phase relationship equal to one-eighth the laser wavelength, or 3.08 microinches.

R&D and production. With this one machine, IRT engineers say they have taken mask-making out of the laboratory into the production process. Integrated circuits made from mass-produced masks that can be aligned to 3 microinches should offer a much improved yield, Nall's studies show. And high yields are important to IC makers and their quality-minded customers alike.

Communications

Mallard on the wing

Every designer of tactical communications equipment had better keep close tabs on the Mallard program. Untouched by the squeeze on R&D due to Vietnam spending, the four-nation, integrated tactical trunking and distribution system is moving ahead fast as three contractor teams begin to design the revolutionary system. What they come up with is expected to significantly affect the basic design of all future tactical communications gear.

To make sure that all its tactical equipment under development will be compatible with the international program, the Army has given the Mallard manager, Brig. Gen. Paul A. Feyereisen, a second hat—that of deputy commanding general of the Electronics Command in charge of tactical communications. It won't be easy and there are bound to be some exceptions, particularly since equipment commonality is necessary for all three services.

"We'll have real problems standardizing such things as components and frequencies," says Feyereisen, who will get his second star next spring. Still to be decided, for example, is whether Mallard will use the metric system for measurements—a step that would be costly to U.S. companies [Electronics, May 15, p. 153]. But Mallard is far

enough away—now scheduled to be fully operational by the 1975-1977 period—and is a big enough jump in the state of the art that "we can set our own standards," he says.

United. Existing projects, including the tactical communications satellite and the random access discrete address (RADA) system, will continue apart from Mallard, but their designs will be affected by technical constraints emanating from the program so that they can all work together. Mallard will decide such important specifications as frequencies, bit rates, channel allocations, and power levels.

The military services are already working on the commonality problem. An Air Force team of 12 officers will be assigned to Mallard's Fort Monmouth, N.J., headquarters by the end of the year. And the Army is about to start work for the Navy Electronics Laboratory on the interface problems between Mallard and the Navy's new amphibious tactical communications system.

Two U.S. contractor teams are at work on system design. Radio Corp. of America heads one on a \$4 million award; Sylvania Electric Products Inc. leads the other on a \$3.5 million contract. A third team, from Great Britain, is said to include Marconi Co., the Plessey Co., Standard Telephone and Cables Ltd., and General Electric Co., Ltd. The four governments—Australia, Canada, Great Britain, and the U.S.—will select the system.

Mallard will not go into operation as a full system, but major subsystems, such as switching, trunking, single-channel access, or communications satellite, could be phased in one at a time, possibly beginning as early as 1973. Conceivably, Mallard could cost as much as \$1 billion, with U.S. firms expected to get at least two-thirds of the business.

From all directions. Feeding into the three major system studies are some 20 to 25 technique-support efforts, being done in-house by the military and by companies from all four nations. This work will look at such areas as the RADA-Mallard interface, routing, steerable antennas,

First from Sprague Electric!

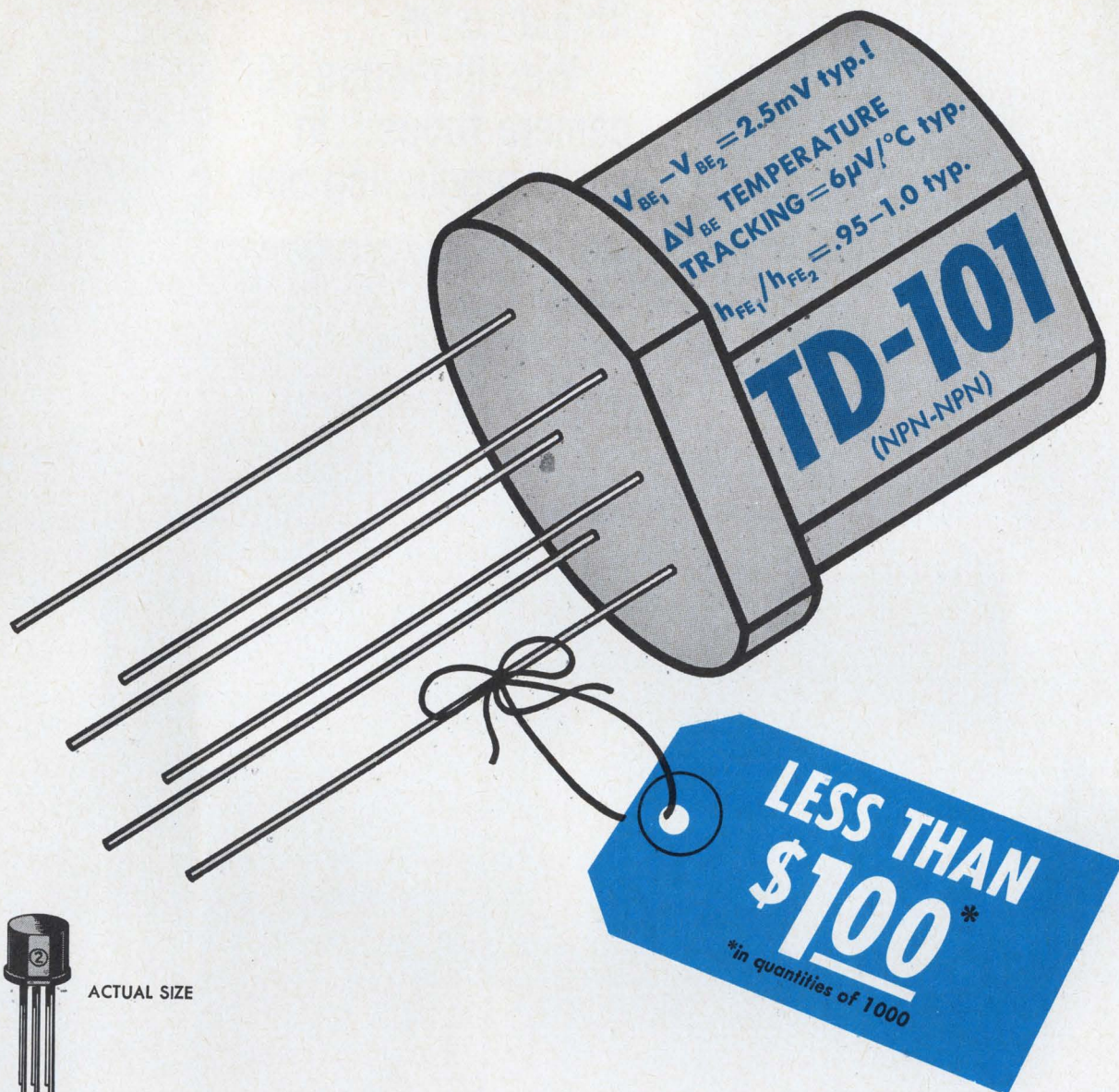

ECONOLINE[★] SILICON PLANAR PLASTIC DIFF AMP PAIRS

Other Sprague Econoline[★] differential amplifier transistor pairs available as PNP-PNP and NPN-PNP types.

For samples and complete technical data, call your Sprague district office or representative, or write on your letterhead to Sprague Electric Co., Concord, N.H. 03301.

[★]Trademark

SPRAGUE COMPONENTS

TRANSISTORS

INTEGRATED CIRCUITS

THIN-FILM MICROCIRCUITS

CAPACITORS

RESISTORS

455-7139

PULSE TRANSFORMERS

INTERFERENCE FILTERS

PULSE-FORMING NETWORKS

TOROIDAL INDUCTORS

ELECTRIC WAVE FILTERS

CERAMIC-BASE PRINTED NETWORKS

PACKAGED COMPONENT ASSEMBLIES

BOBBIN and TAPE WOUND MAGNETIC CORES

SILICON RECTIFIER GATE CONTROLS

FUNCTIONAL DIGITAL CIRCUITS



Sprague' and '®' are registered trademarks of the Sprague Electric Co.

SPEER COMPONENT COMMENTS

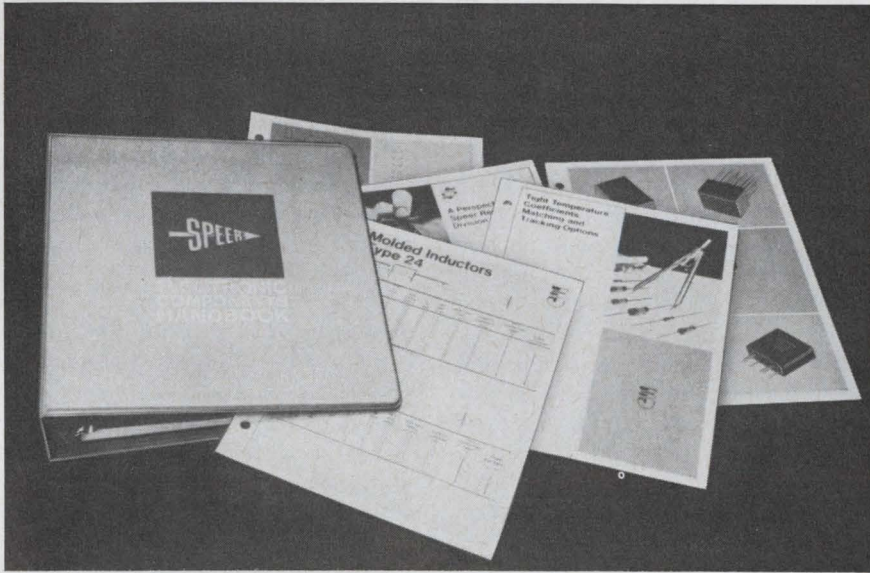

Over 2 pounds of electronics lore that you may not already have

Does your company have a copy of the new 94-page Speer Electronic Components Handbook? It's 2 pounds and 5 ounces of useful electronics information plus up-to-date data on our inductors, capacitors, carbon composition resistors and JXP precision resistors. (Actually, much of the Handbook's total weight consists merely of a heavy loose-leaf binder. But look at it this way. The binder contributes both permanence and — paradoxically — flexibility. As data becomes obsolete, you'll receive revised pages which you'll be able to substitute immediately.)

Here, in one handy Handbook, is everything—from how our composition resistors are made to how our MIL Conformance Program for inductors operates.

Ask your Speer representative for a free copy of this weighty reference work. When he stops by with it, he'll also give you some interesting tips on how to get the most value from it.

If you need the name and address

of your representative, just mail us the coupon.

How to correct for Typical Error #5 when you're testing inductors

From time to time, we've been highlighting the various test errors that are commonly made when measuring inductance and Q in accordance with MIL-C-15305. There are eight errors in all.

Error #5? Failing to apply the Correction Factor when it's applicable.

Inductance values of 10 μ h and lower must be corrected. Use of the TFA Test Fixture (also standardized by MIL-C-15305) should give a -0.06μ h factor.

For still more errors—and their "correction factors"—stay with us.

How the curious economics of precision resistor technology can benefit your commercial products

As you may already know, TCs of ± 2 PPM/ $^{\circ}$ C and tolerances of

$\pm 0.02\%$ are available upon request with our JXP precision resistors.

But did you also know that you don't have to pay more to start enjoying this greater precision?

Curiously enough, you'll pay less—particularly if the precision resistors you're now using are of the "wire-wound" type.

JXP metal film resistors reflect important Speer advances in evaporated metal film technology. As a result, they can be produced to tighter tolerances than wire-wounds at significantly less cost for most resistance ranges. And they automatically incorporate faster response and settling times at no additional cost—making them especially ideal for high frequency and high-speed computer applications.

JXPs can benefit your commercial products in other surprising ways as well. (Also your military products, needless to say.) Mail the coupon for complete information.

AIRCO Speer Electronic Components

St. Marys, Pa. 15857

Rush the name and address of the Speer representative who has my company's free copy of your weighty Electronic Components Handbook.

Rush complete information on your surprising JXP precision resistors.

Name _____

Title _____

Company _____

Street _____

City _____ State _____ Zip _____

and system integration and evaluation. What project people know now is that Mallard will be a secure system, automatically switched, that will digitally transmit voice, teletype, facsimile, and computer data. Cryptographic techniques also will be used.

One particular problem that will be investigated is how RADA will fit into Mallard. Feyereisen says only that "a type of RADA will be used" and that tradeoffs and alternatives to RADA will be explored. At work on the Army's RADA since 1965 is Martin Marietta Corp. The pulse-modulation radio system automatically switches communication channels, utilizing simultaneous transmissions in a common-frequency band. The question is how far into the Army field organization should RADA links be used; if the system is only partially used, new set of converters and buffers will be necessary. Another problem is understood to be the complexity of prototype RADA-switching equipment.

Space electronics

All talk, no money

Remote sensing of the earth from a satellite—to find a wide range of resources—has been discussed for a long time. However, nothing more than discussion seems to be happening. More than one scientist has observed that the recent success of the lunar orbiter program gives us a better knowledge of the lunar surface than the earth's surface.

Earth resources programs seem further from orbit now than ever. The Earth Resources Observation Satellite program announced by the Department of the Interior last year with the prediction of an EROS in orbit in 1969 is now, according to program manager William Fisher, "a concept embodying satellite missions which will serve the needs of the Department of the Interior."

Nothing doing. The department has no satellite or funds lined up for a satellite. But the National Aeronautics and Space Administra-

tion has planned earth-sensing missions for the Apollo Applications Program, currently without funds, and several unmanned earth resources satellites for the early 1970's. At NASA headquarters a spokesman says officially that earth resources "are being examined as a possible application of space technology," but admits that nobody seems to know at this point what will happen to the earth resources concept.

A study announced by NASA earlier this year to unify earth missions on one satellite—called USAM (Unified Space Applications Mission)—is not moving because funds are not available for a follow-on. The first USAM study contract now being conducted by the Federal Systems division of International Business Machines Corp. (now running behind IBM's predicted delivery date of mid-October) is coming under fire before it has even been completed. Says EROS manager Fisher, "In this case commonality will lead to degradation. Very few sensing missions will be able to use a common orbit."

Avionics

The matchmaker

Maneuvering for midair plane refueling is a ticklish proposition with the hit-or-miss aiming now employed. Microwave radar isn't a useful alternative because the tanker craft and the plane trying to fuel up are too close. But a new laser technique may help effect the coupling.

That's one application for the International Business Machines Corp.'s new rendezvous and station-keeping optical radar (Raskor), a system that employs two gallium-arsenide injection lasers and six solid state optical detectors. The system can pick up a target within an area of 40° azimuth and 10° elevation at a range of up to 60,000 feet.

IBM's Federal Systems division in Gaithersburg, Md., will be sending a prototype to Wright-Patterson Air

Force Base, Dayton, Ohio, by the end of the year. Raskor hasn't yet been earmarked for any specific tanker planes.

On the track. Currently in bread-board form, the system ranges and tracks well in ground testing, according to IBM. Its lasers provide optical radiation in fog, darkness, or haze, and are designed to work with a retrodirective reflector attached to the homing aircraft. The optical unit occupies a space no bigger than 6 x 6 x 12 inches.

One laser handles the tracking of planes from 1,000 to 20 feet away, while the other, a high-power device, tracks planes at greater distances. Range is determined by measuring the round-trip time of a transmitter pulse.

Find, fix, fuel. The system's detectors—silicon photodiodes—can receive a laser emission at about 0.9 microns. The center of the detector section is used for "track and acquisition" and the wings for "search and acquisition." The system switches into and out of these phases as it tracks the homing aircraft. If the target is lost during track, for instance, the transmitter is switched to the acquisition mode and servos sweep over a 5° azimuth field to regain contact.

This application of Raskor will be described in detail at the Northeast Research and Engineering Meeting in Boston, Nov. 1.

Instrumentation

Outside looking in

Instead of tearing apart an engine, aircraft mechanics may soon be probing for blade defects from the outside—with the remote sensing of a millimeter-wave interferometer system. Researchers at the Illinois Institute of Technology Research Institute have concluded that such a system is the most promising of several remote inspection methods.

When the millimeter-wave system analyzes the compressor section of a running jet engine, it can see lead-edge defects as small as

Caught with their "ceramics" down

all similarly rated tubes are not equal

Construction of the high-gain Cermolox[®] RCA-4628 is far superior. For example, the G-1 and G-2 "cups" are locked together in a rigid assembly, then simultaneously electrically machined to produce grid wires precisely aligned with respect to each other. The result: a simplified, unitized construction. In SSB Communications and FM Broadcast service, particularly, the RCA-4628 delivers even more outstanding performance as a result of its compact coaxial structure, precision-aligned electronically-machined grids, and ceramic-to-metal seals.

RCA-4628, rated to 400 MHz, provides 10 kW PEP output in the 2 to 30 MHz range with lower distortion and better gain than its nearest counterpart. In FM Broadcast service, it offers higher gain with non-critical broadband neutralization techniques.

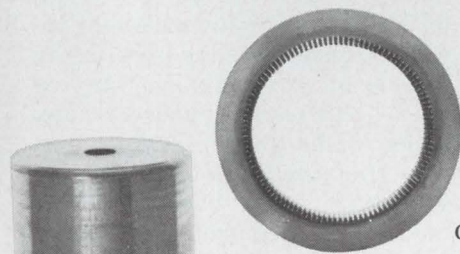

G-2 "Cup"

Electrical
Machining
Tool

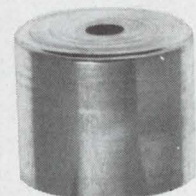

G-1 "Cup"

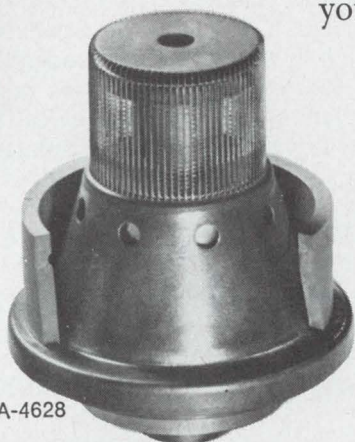

RCA-4628

From now on, look "inside" as well as outside when you need tubes. In the RCA-4628, you'll find ruggedness, compactness, and long-life reliability. Mechanically-induced noise is very low and, because of UHF capabilities, you have no need for complex neutralization circuits at HF. The RCA-4628 is your obvious choice.

For more information on this and other RCA Cermolox[®] tubes, see your RCA Representative. For technical data on specific tube types, write: RCA Commercial Engineering, Section J19Q-1, Harrison, New Jersey 07029.

ALSO AVAILABLE FROM YOUR RCA INDUSTRIAL TUBE DISTRIBUTOR

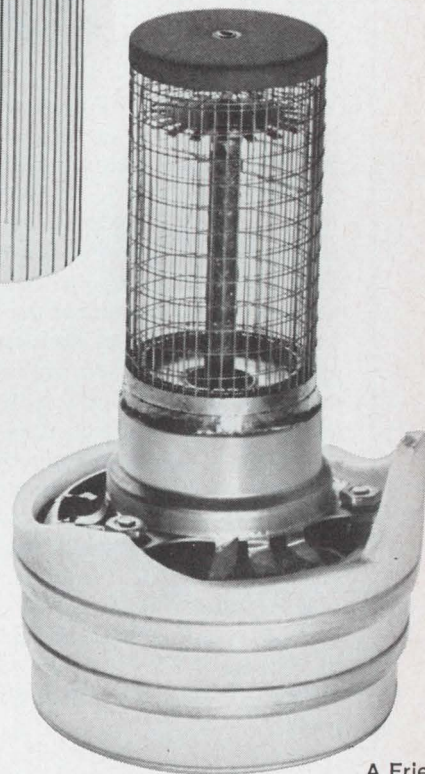
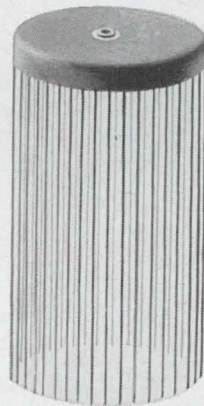
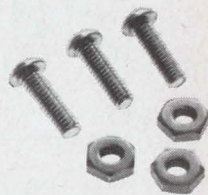
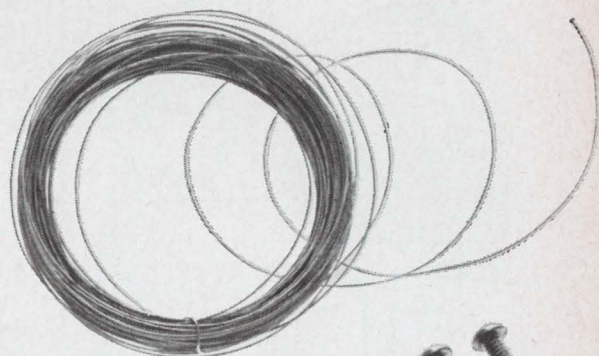

A Friend

RCA Electronic Components and Devices



The Most Trusted Name in Electronics

Catch 1 μ s
voltage peaks.

Why?

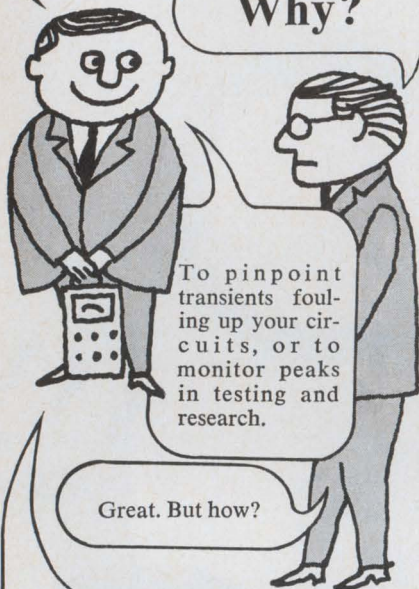

With PEAK LOK. It measures positive, negative or bipolar peaks with 1% full scale accuracy, holds its reading in an analog state until it's reset. Use it to measure physical parameters in environmental tests, record surges in power lines and supplies, detect overload transients in electronic and electrical systems . . . everywhere precise determination of voltage peaks can help solve a problem. It has an output for data logging, can be remotely reset, has nine ranges from 0.1 to 1000v full scale, and can go up to 30 kv with a high voltage probe. When you're not catching transients, use PEAK LOK as a sensitive DC voltmeter, to measure that hard to get to voltage with a quick touch of the probe.



For complete specifications

write to PEAK LOK Sales, Dept. 219, Analog-Digital Systems Division, Control Data Corporation, 4455 Eastgate Mall, La Jolla, California 92037. Or phone 714/453-2500.

CONTROL DATA

CORPORATION

4455 Eastgate Mall, La Jolla, Calif.

Electronics Review

0.03 inch and 0.015 inch defect areas caused by foreign objects.

Compare. To take into account the tolerance variations between blades, two beams of energy are focused on adjacent areas of the same blade. After the returning energy from each area is collected by a lens system, it's compared in a bridge circuit. A defect illuminated by one source causes an output from the bridge that locates the defect, while the output's amplitude determines the defect's size.

Illinois Institute researchers think that two modifications may make the system an even better detective. Increasing the operating frequency from 88 Ghz to 220 Ghz and using more sensitive heterodyne detectors could lead to the identification of defects as small as 0.005 to 0.010 inch radius.

Solid state

On the skids

For years, the kingpin of the operational amplifiers has been the 709. But users have started complaining that the 709 is too limited in its potential applications, and at least two companies are doing something about it.

One is Westinghouse. A marketing spokesman in the Molecular Electronics division says: "It's a device that's too limited by its input and output characteristics."

Westinghouse's answer to the problem is the model WC306 [see p. 135]. This unit has both high and low impedance inputs and single-ended as well as differential outputs. To achieve this flexibility, open loop gain had to be sacrificed, but the designers are convinced it's worth it. The 306 sells for \$6.60 each in 50-unit lots and is available off the shelf.

Motorola is also introducing a replacement for the 709, along the same lines as Westinghouse—lower gain, higher bandwidth, and differential inputs and outputs. Designated the MC1520, it's for applications requiring high power bandwidth. It will sell for \$10 each in

quantities of 100 units and distributors are now being stocked.

On the other side of the coin, Fairchild Semiconductor, father of the 709, says that devices like the old 709 are too general. So its engineers have come out with a more specialized unit. They call it a low noise, low drift version of the 709, and it has a higher open loop gain, and a narrower bandwidth. The 709 has a gain of 45,000; by replacing the Darlington configuration in the front end with a single emitter coupled pair, Fairchild has achieved a gain of about 100,000 and a noise improvement of about 30 db.

For the record

White paper. The Government and the Communications Satellite Corp., in a position paper giving the American position on the future of the 59-member International Telecommunications Satellite Consortium, suggests that any nation's voting share be changed regularly to reflect its use of Intelsat services. The paper was sent earlier this month to the Interim Communications Satellite Committee, which is meeting to make recommendations for the 1969 renegotiation of Intelsat. It also recommends that Intelsat expand satellite services to include air navigation, as one example. The paper implies that any nation wishing to operate its own domestic satellite would have to get along without the services of the National Aeronautics and Space Administration in launching and tracking.

Highest. Fairchild Semiconductor has developed what may be the industry's highest voltage-rated transistor, an npn silicon switching device that handles 1,600 volts or more. The device, whose cutoff frequency is 40 megahertz, may lead to eventual displacement of vacuum tubes in the horizontal deflection circuitry of tv sets.

Fairchild expects to have the unit in production by next year for military and industry applications. Pricing isn't expected to be low enough to crack the consumer market until 1969 or 1970.

Will the right Celanese Nylon please stand up!



Now, there's a right Celanese Nylon 6/6 molding or extrusion compound for just about any product application. Introducing, from left to right: Celanese Nylon 1000, a general purpose automotive and industrial molding resin. 1003, a heat stabilized form of 1000. 1200, a high viscosity extrusion resin for tubing, rod, film, etc. 1500 and 1503, glass reinforced compounds of low creep, high stiffness and high heat resistance. And Celanese Nylon 1000, 1003, 1503 are available in black resin.

All of these Celanese Nylons are fully competitive in meeting established specifications for physical, electrical, chemical, molding and extrusion properties.

This means that you now have a new, dependable, volume source for a complete line of 6/6 nylon. And isn't that welcome!

Celanese Nylon is available right now. With more to come. Like more resins. More advanced nylon technology. More molding and marketing assistance.

Send for the complete facts about Celanese Nylon. To: Celanese Plastics Company, Dept. 233-J, P.O. Box 629, Linden, New Jersey 07036. Celanese®



Celanese Plastics Company is a division of Celanese Corporation. Canadian Affiliate: Canadian Chemical Company, a division of Chemcell (1963), Limited. Export Sales: Amcel Co., Inc., and Pan Amcel Co., Inc., 522 Fifth Ave., New York 10036.

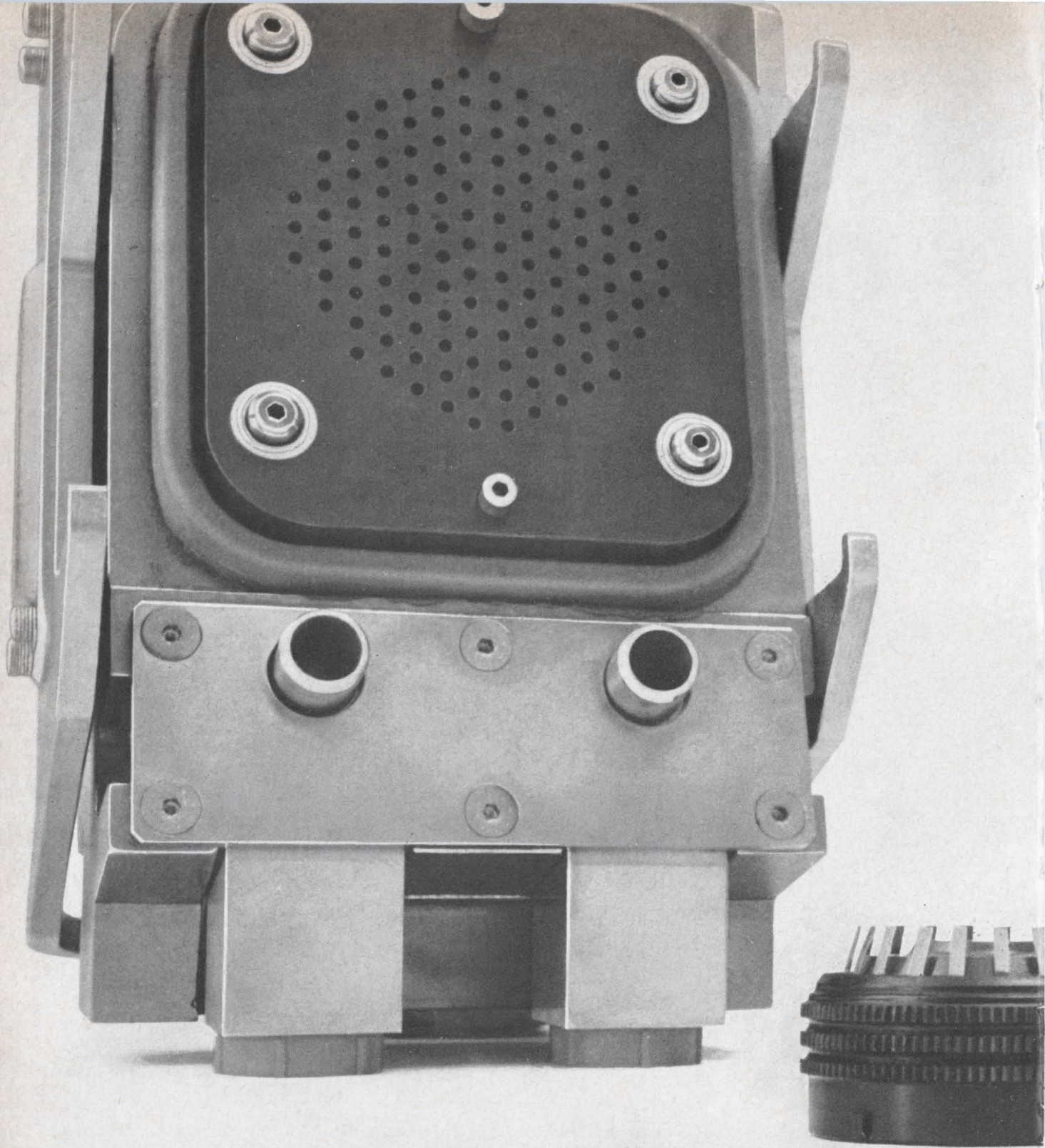

**First-of-a-kind connectors for sale
from Amphenol Space And Missile Systems**

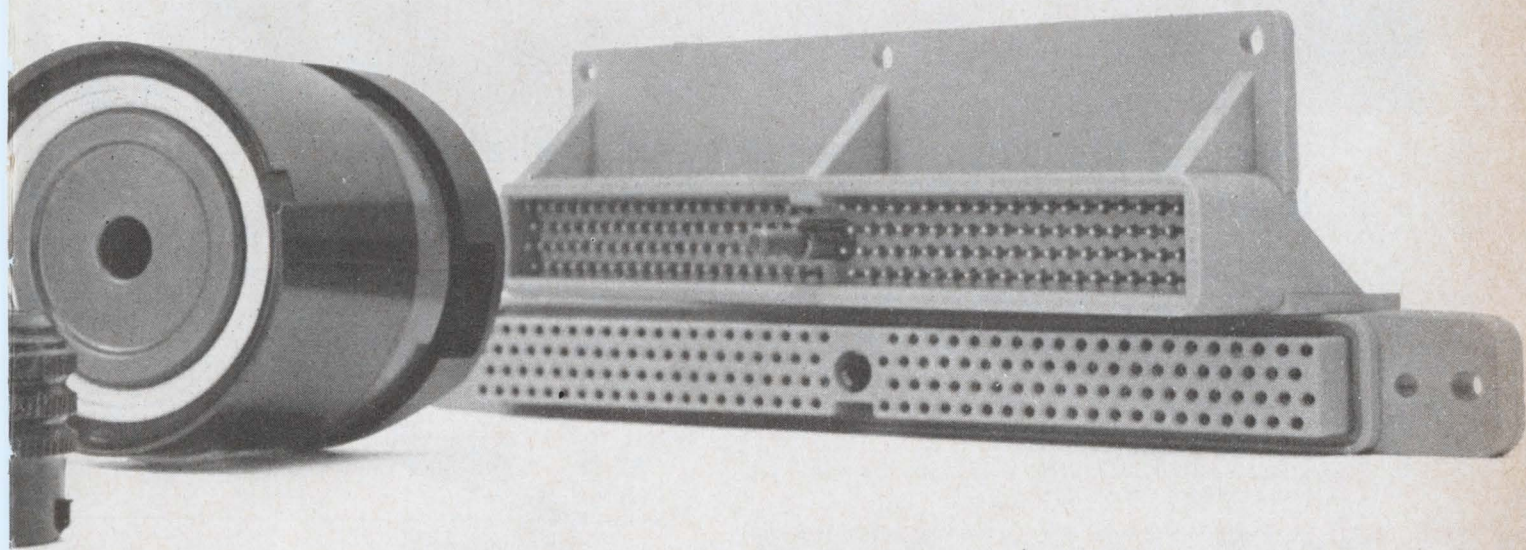

Sometimes the right connector doesn't appear in a catalog. Especially when it's destined for unusual uses.

That's why we developed our S A M S facility—to provide new solutions to interconnection problems.

At Amphenol, we've designed and produced interconnecting systems

for Minuteman, Titan, Agena, SST, and Poseidon—to name a few. Our mission profile includes every type of application from GSE to satellites. Every connector type, too. Some carry several hundred circuits, withstand 1000F, offer "dead-facing" or resist exotic fuel corrosion damage.

Ask us to help you solve your interconnection problems. Write us. **Amphenol Connector Division**, Chatsworth, California 91311.



AMPHENOL

Circle 55 on reader service card

Specify Amphenol . . . the leading name in cable, connectors, assemblies, RF switches, potentiometers, microelectronics.



DALE[®]

**3-in-1 T-pot design
gives you more
for your money!**



One simple, rugged design adds reliability to all three rectilinear Mil wirewound styles

RT-10, RT-11, RT-12 – Dale meets all three with a single design. You benefit from this simplification through increased reliability, faster delivery, better price. Call us today!

- ① **ALL-MOLDED HOUSING** design eliminates seal problems. Meets MIL-STD-202 and MIL-R-27208A.
- ② **RUGGED COLLECTOR SYSTEM** assures you of noise levels well below mil requirements.
- ③ **FULL LENGTH WINDING** allows increased power handling capability. Permits use of large diameter thermoconductive mandrel which eliminates "hot spots" by acting as high mass heat sink.
- ④ **1-PIECE WIPER ASSEMBLY** of precious metal insures setting stability under all environmental conditions.
- ⑤ **STAINLESS STEEL ADJUSTMENT SCREW** is electrically isolated by insulated head. Metal-to-metal clutching prevents over-travel damage.
- ⑥ **CONSTANT LEAD SCREW SEAL** is assured by shaft-retaining spring which maintains unvarying pressure against high temperature silicone rubber "O" ring.

DALE MIL-R-27208A MODELS

RT-10

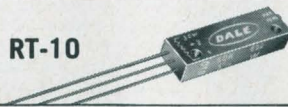

Model 691 P.C. Pin
Model 697 Flex. Leads

RT-11



Model 1287 P.C. Pin
Model 1288 Flex. Leads

RT-12

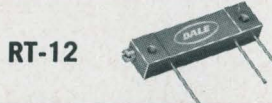

Model 1680 P.C. Pin
Model 1697 Flex. Leads

RT-22



5000 Series — 1/2" square-trim models meet RT-22, made with same basic design considerations shown here.

WRITE FOR CATALOG B — containing specifications on 57 Dale T-Pots including many special models.



DALE ELECTRONICS, INC.
1300 28th Avenue, Columbus, Nebraska



Washington Newsletter

October 30, 1967

Double audit trend riles contractors

More Government agencies are expected to follow the Defense Department's lead in expanding double-check audits to sole-source, fixed-price contracts. Making the major contracting-policy change probably will be NASA, the FAA, AEC, and General Services Administration.

The Pentagon made the switch only after heavy pressure from Congress and the General Accounting Office. Previously, it ran two audits only on cost reimbursable contracts. A post-award audit has been added to the pre-award examination of cost data the contractor uses to negotiate the fixed price. If the second study uncovers errors or false cost data leading to undue profit, the Government can demand an adjustment.

About 12% of Pentagon procurement—close to \$5 billion a year—will start getting the double audit.

Satellites require less space to park

It now looks like there'll be room to park more stationary satellites along the equator than originally estimated. Preliminary data from an experiment being conducted by Comsat indicates that two communications satellites can function without interfering with one another at less than 2° separation in a 23,000-mile-high orbit.

Previously, separation estimates ranged from 6° down to more than 2°; a degree at stationary orbit is about 500 miles. Comsat, which started the experiment this month by gradually moving its Pacific-2 satellite closer to Pacific 1, will issue detailed data in a few weeks.

Navy salvage job on Ilaas subsystems

Now that the Sperry-developed integrated light attack avionics system is almost certain never to go into production as a system, the Navy is trying hard to salvage some of the subsystems. The Naval Air Development Center in Johnsville, Pa., is considering Garrett AiResearch's inertial-navigation system and Elliott Automation's head-up display, among others, for possible jobs on their own.

Adding to Sperry's woes is the postponement of the first R&D flight tests of Ilaas until Vietnam spending tapers off. This delay comes even though \$5 million has been budgeted, an A-6A Intruder aircraft is available and Sperry has a prototype Ilaas in final assembly.

Comsat plans push for Intelsat 4

The Communications Satellite Corp. will do some hard selling of its 10,000-channel, Intelsat 4 satellite at the November meeting of the International Telecommunications Union in Mexico City. Its pitch will be made to member nations of the International Telecommunications Satellite consortium. Comsat's first attempts to move ahead with the big satellite flopped earlier this month when it failed to convince the Intelsat interim committee that Intelsat 4 was economically justified.

The FCC, which also has to approve the satellite plan, has asked Comsat to answer 24 questions by early November. The FCC wants to know, among other things, how the new satellite affects the 1,000-channel Intelsat 3 due to go up next year, and how it contrasts economically with the TAT-5, the 720-circuit transistorized cable proposed for 1970 operation. Two years ago, the situation was reversed: Comsat pushed the Intelsat 3 while the FCC wanted a bigger satellite.

Washington Newsletter

Weigh second job for Navy's F-111B

The Navy may give its overweight and overpriced F-111B another mission in an attempt to get more for its money. It is considering equipping the fighter with a stand-off missile system for air-to-ground attack—possibly North American's television-guided Condor now being developed for the Navy's A-6 and A-7 attack craft. The Navy still plans to use the F-111B primarily as a platform for the Hughes Phoenix missile system, an air-to-air weapon.

Hams on television

Hams are about to get a new dimension. By the end of the year, the FCC is expected to approve the transmission of slow-scan television by some 40,000 radio amateurs now holding advanced or extra-class licenses. Needing only the bandwidth now used for ordinary single sideband voice transmission—up to 3,000 hertz—a standard 525-line picture can be transmitted in about eight seconds.

Although no company now offers amateurs the required equipment, at least one firm, Ball Bros. Research Corp. of Boulder, Colo., is considering marketing a camera and monitor unit priced at about \$1,000. It would include either a Westinghouse or General Electric slow-scan vidicon.

MOL on target

The Manned Orbiting Laboratory (MOL) will remain on schedule despite the Pentagon's heavy slashing of non-Vietnam spending. Air Force project officials plan to spend the entire \$430 million appropriated for 1968. They say \$400 million to \$500 million annually is required to keep the program on target. Insiders say MOL has been untouched because of the enthusiastic backing it has always received from Congress. The nation's only military manned-space effort will cost at least \$2.2 billion before its seven R&D flights are finished early in the 1970's. First flight is now scheduled for 1970.

Reducing plan for sensor unit

NASA's Goddard Space Flight Center is using large scale integration to develop by 1971 a two-pound earth sensor package for its interrogation recording and location system (IRLS). The sensor would be small enough to attach to animals for migration and biological studies. It might also permit the use of smaller and cheaper buoys and balloons for worldwide oceanographic and meteorological studies in the 1970's. So far, 18 elements—shift registers, gates and demodulators—of the sensor have been put on a single chip.

IRLS packages weighing 30 pounds will communicate with next year's Nimbus B satellite, and work is proceeding on a 10-pound package for the Nimbus-D satellite tests in 1970. Balloons, aircraft, buoys and icebergs will carry the sensor packages in the two Nimbus experiments.

Addenda

Surprised by Congressional allocation of more money than the FAA requested for facilities and equipment for fiscal 1968, agency officials say they don't know at this time how they will spend the money. FAA originally asked for \$28.4 million and Congress gave it \$54.5 million . . . The General Services Administration is increasing efforts to sell its mounting surplus of electronics gear. The GSA will display communications, radar, and navigation equipment in a show next month at its Washington headquarters.

Simplify night vision
systems dramatically
with exclusive
Westinghouse SEC
camera tubes... in
quantity production now.

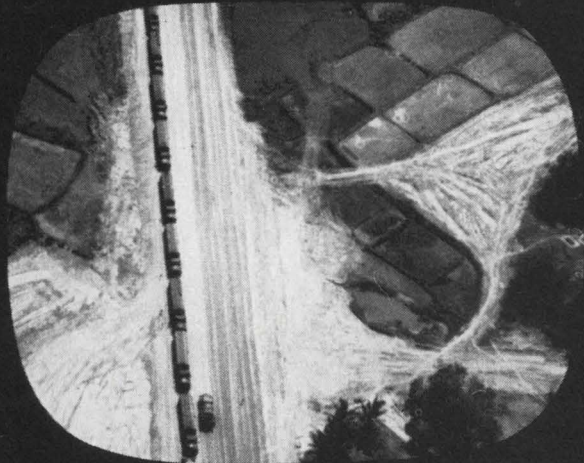

The Westinghouse Secondary Electron Conduction Camera Tube does everything image orthicons can ... but without a mass of complex circuitry to compensate for motion-blurring, halo effects, and changes in light level.

Result: the SEC tube makes possible more compact, rugged, and economical night vision systems. Ones that outperform orthicon-based systems in important ways.

And Westinghouse production lines have been turning out SEC's for over two years. They're off-the-shelf items! Write for the data you desire. We have over 400 vacuum electronics engineers who want to help you. Westinghouse Tube Division, Elmira, New York 14902.

ET-4002

You can be sure if it's Westinghouse



THESE CIRCUIT PROTECTORS ARE ENTIRELY MAGNETIC TRIP

Hermetically sealed AP Protectors meet or exceed MIL-C-39019. They repeatedly rupture 300A 250V AC, 500A 125V AC, 500A 50V DC, have magnetic time delay, but open a 1000% overload in 4 milliseconds. There is no trip at 100G shock or 20 G vibration, carrying rated current. Available 10 MA to 20A, with a wide variety of circuit combinations, delay curves and auxiliary signal circuits. Ask for bulletin 16E-4.

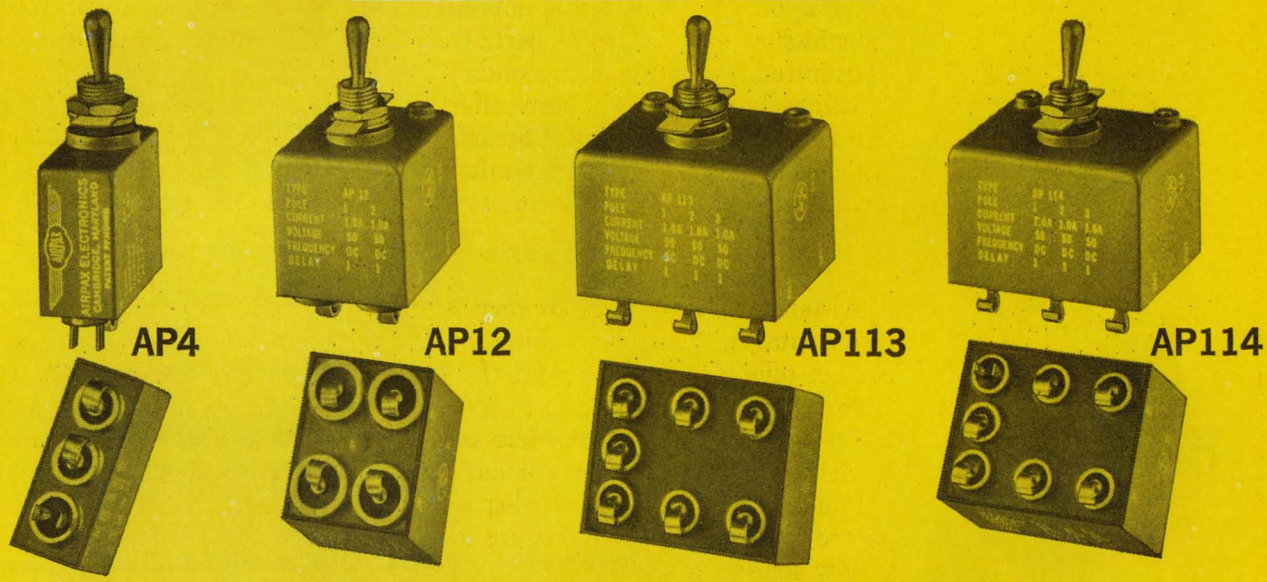
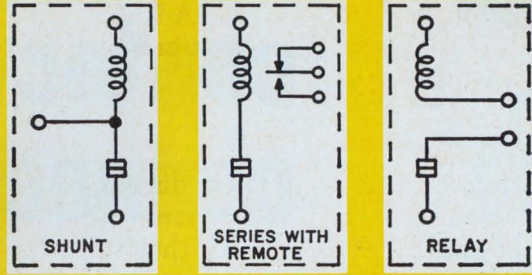

Type UPL1, UPL11, and UPL111 are Underwriters' Laboratory recognized for appliance protection.

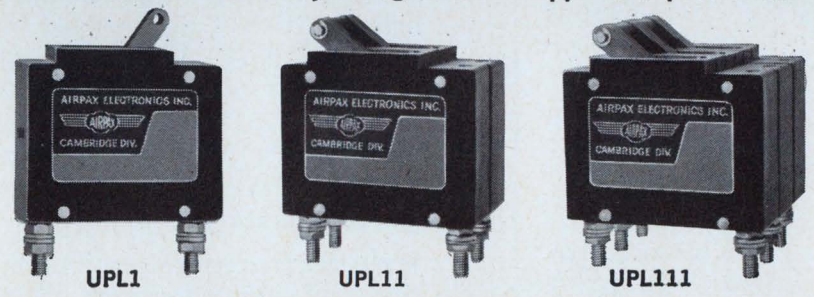

UL RATED at:

.050-50.0 Amps, 50V DC.; .050-50.0 Amps, 120V AC, 60 Hz.; .050-20.0 Amps, 240V AC, 60 Hz.

Series units with enclosed remote switches are available in any combination of delays (Fast — 0.4 to 4.0 sec., Slow — 4.0 to 40 sec., Motor Start — 1.0 sec. at 600%) or UL listed ratings are available in a single pole, two pole or a three pole appliance protector.

AIRPAX ELECTRONICS Cambridge, Maryland 21613 (301) 228-4600

SERIES MMM

ACTUAL SIZE

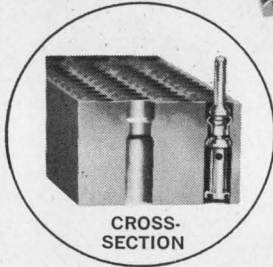
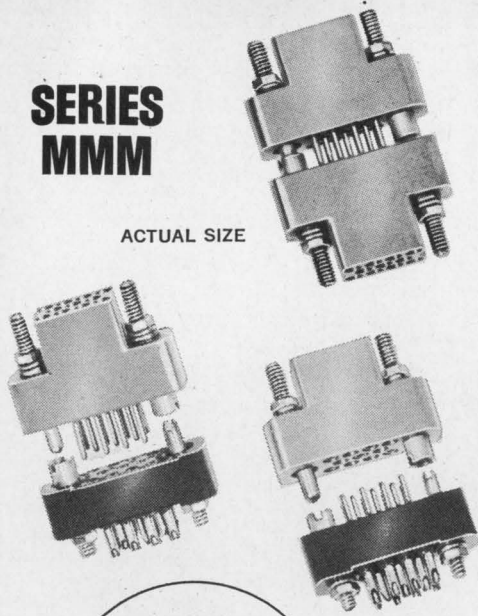

CROSS-SECTION

TOOLS



CRIMPING
TOOL
NO. 11331

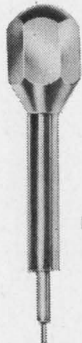

INSERTION
TOOL
NO. 2558



SPRING LOADED
REMOVAL TOOL
NO. 2559

microminiature removable contact connectors with wire crimp termination

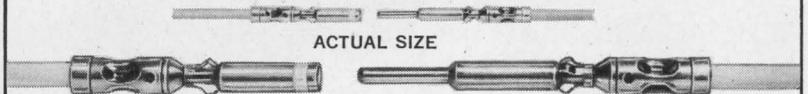

ACTUAL SIZE

ENLARGED VIEW OF CONTACT SHOWS DETAIL OF THREE-TINE TENSION SPRING CLUTCH AND CLOSED ENTRY SOCKET CONSTRUCTION

Removable contacts with microminiature size rack and panel connectors are now available in Continental Connector's Series MMM. Rugged, three-tine tension spring clutch on both pin and socket contacts provides maximum holding area between contact and molded block. Available sizes: 5, 7, 9, 11, 14, 18, 20, 26, 29, 34, 44 and 50 contacts are interchangeable with fixed contact Series MM-22. In addition to the guide pins and guide sockets illustrated, you can also order optional polarizing screwlocks, aluminum hoods and cable brackets.

Write for free brochure with complete specifications and outline drawings. Phone sales department (212) 899-4422 for immediate action on quotations and catalog.

For the Sales Representative Nearest You, See Our Listings in EEM and VSMF Directories.

CONTINENTAL CONNECTORS

CONTINENTAL CONNECTOR CORPORATION ■ WOODSIDE, NEW YORK 11377

Are you ready for the new sweep generation?

There's an entirely new way to sweep test now — with the Model 2003 brought to you by Telonic. That name alone means it's an instrument backed by a wealth of design experience, highest quality construction, and engineering way ahead of the field. What other sweep generator can offer these features —

Total plug-in versatility

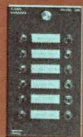

The 2003 is all modular, permitting a wide selection of frequency ranges, frequency marking systems, attenuation, and output control. As your test requirements vary, the 2003 can instantly be oriented for the new application.

5 to 1500 MHz in one sweep

Five different plug-in oscillators available for the 2003 permit frequency coverage from 100 kHz to 1500 MHz. One oscillator, No. 3305, is capable of sweeping a width over its entire range, 5 to 1500 MHz, providing a complete trace of frequency response.



Tilting frequency markers



This output plug-in for the 2003 allows control of frequency marker height and angle, providing sharp determinations on near-vertical traces.

This is the 2003 story — Accuracy, Versatility, Reliability — details and specifications may be found in catalog 70-A together with a number of helpful Sweep Generator Applications. Write for your copy.

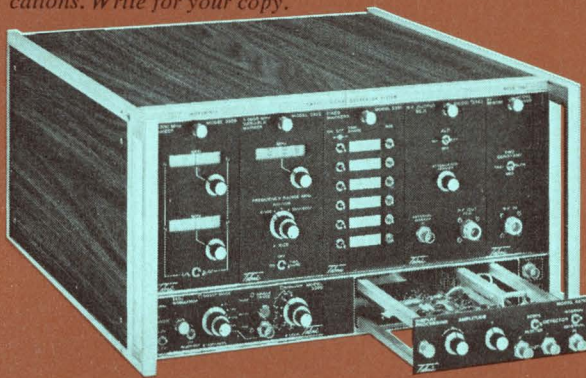

Telonic[®] INSTRUMENTS

A DIVISION OF TELONIC INDUSTRIES, INC.

60 N. First Ave., Beech Grove, Ind. 46107
Tel.: (317) 787-3231 TWX: 810-341-3202

Representatives throughout the U.S. and Foreign countries. Factory offices in Maidenhead, England, Frankfurt, Germany, and Milan, Italy.

Nothing Can Test the 709 Linear IC Automatically

(except the 553)

Make us prove it! Call Test Systems collect in Houston at 713-227-3611 for information on the 553 Dynamic Test System. Or write TI, P.O. Box 66027, Houston, Texas 77006.

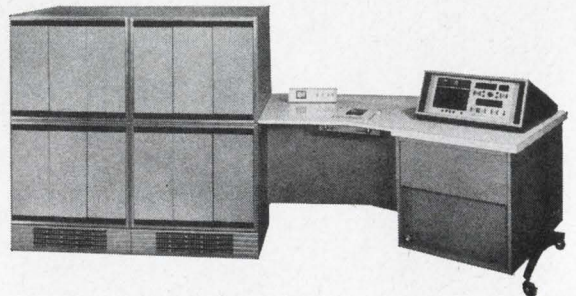

TEXAS INSTRUMENTS
INCORPORATED

Designed AS An Industrial...

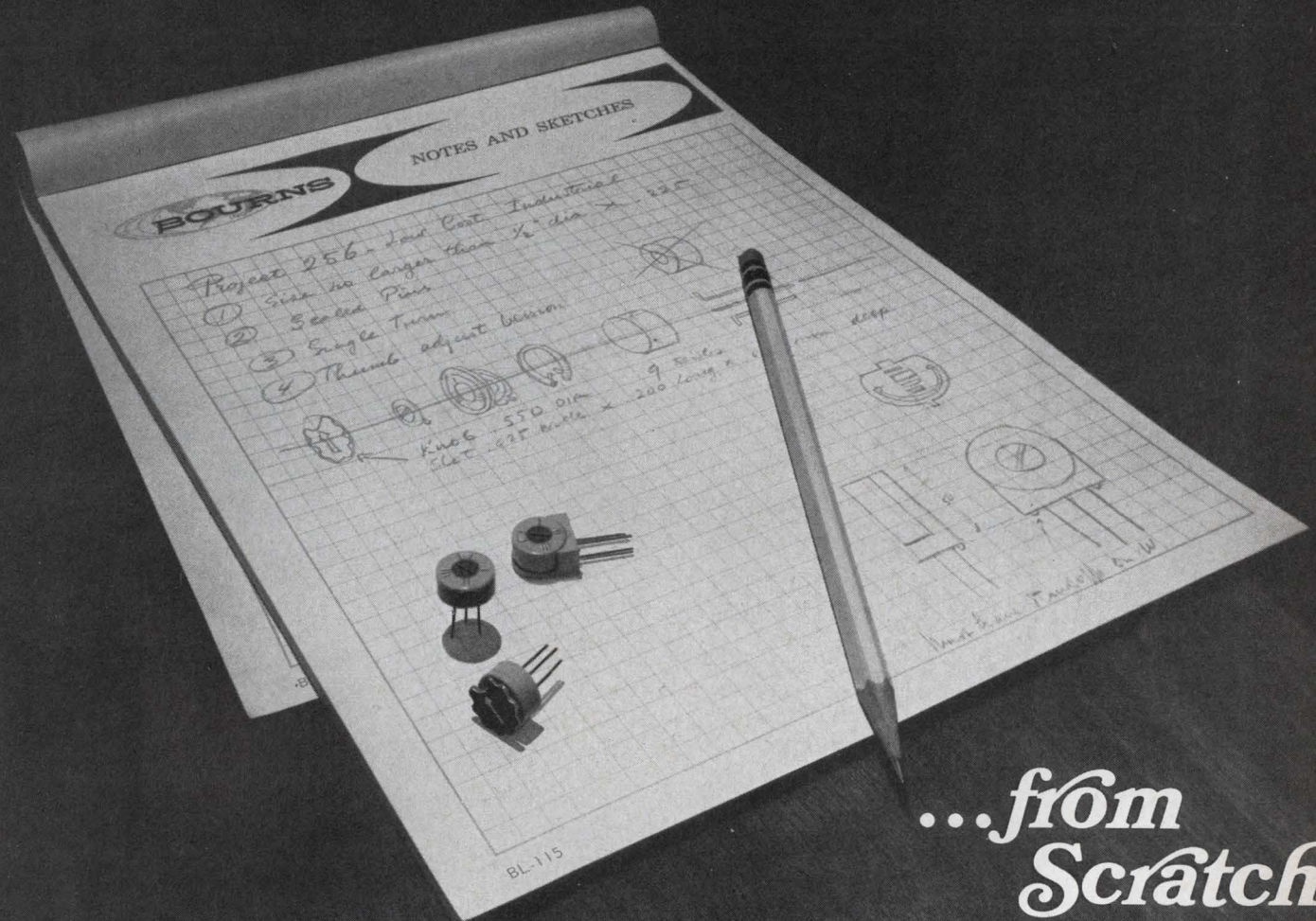

...from
Scratch

The Model 3365 TRIMIT® adjustment potentiometer is an industrial unit . . . designed from the ground up for industrial applications. It is brand new! This low cost single-turn wirewound unit is available in two printed circuit styles . . . each style is also available with thumb adjustment knob. Standard and special resistances are from 10 ohms to 50K. Resistance tolerance is $\pm 5\%$. It is small . . . $\frac{1}{2}$ " diameter by less than $\frac{1}{4}$ ". It is light weight . . . approximately 0.05 oz., in an all-plastic case.

There are several other points we would like to mention about the Model 3365. Its pins are sealed, its terminals gold plated, making it suitable for production fluxing and soldering processes employed on printed circuit boards. The exclusive SILVERWELD® process is used, thus eliminating vulnerable single wire terminations.

We think you will be even more impressed when you have read the complete, detailed specifications and technical data . . . they are available to you by contacting your nearest Bourns office or representative, or writing the factory direct.

Circle 63 on reader service card



3365P

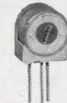

3365W



3365SP-1-(RC)T

SPECIFICATIONS:

Standard Resistance Range	10 to 50K ohms
Resistance Tolerance	$\pm 5\%$ standard
Resolution	0.08 to 0.88%
Power Ratings:	
40°C Ambient	0.5 watt
105°C Ambient	0 watt
Operating Temperature Range	-55 to +105°C
Temperature Coefficient	70 PPM/°C
Humidity, MIL-STD-202, Method 103	100 megohms min. insulation resistance
Shaft Torque	8 oz-in max.
Mechanical Adjustment	280° nominal



BOURNS, INC., TRIMPOT DIVISION • 1200 COLUMBIA AVE., RIVERSIDE, CALIF.
TELEPHONE 714 684-1700 • TWX: 910-332 1252 • CABLE: BOURNSINC.

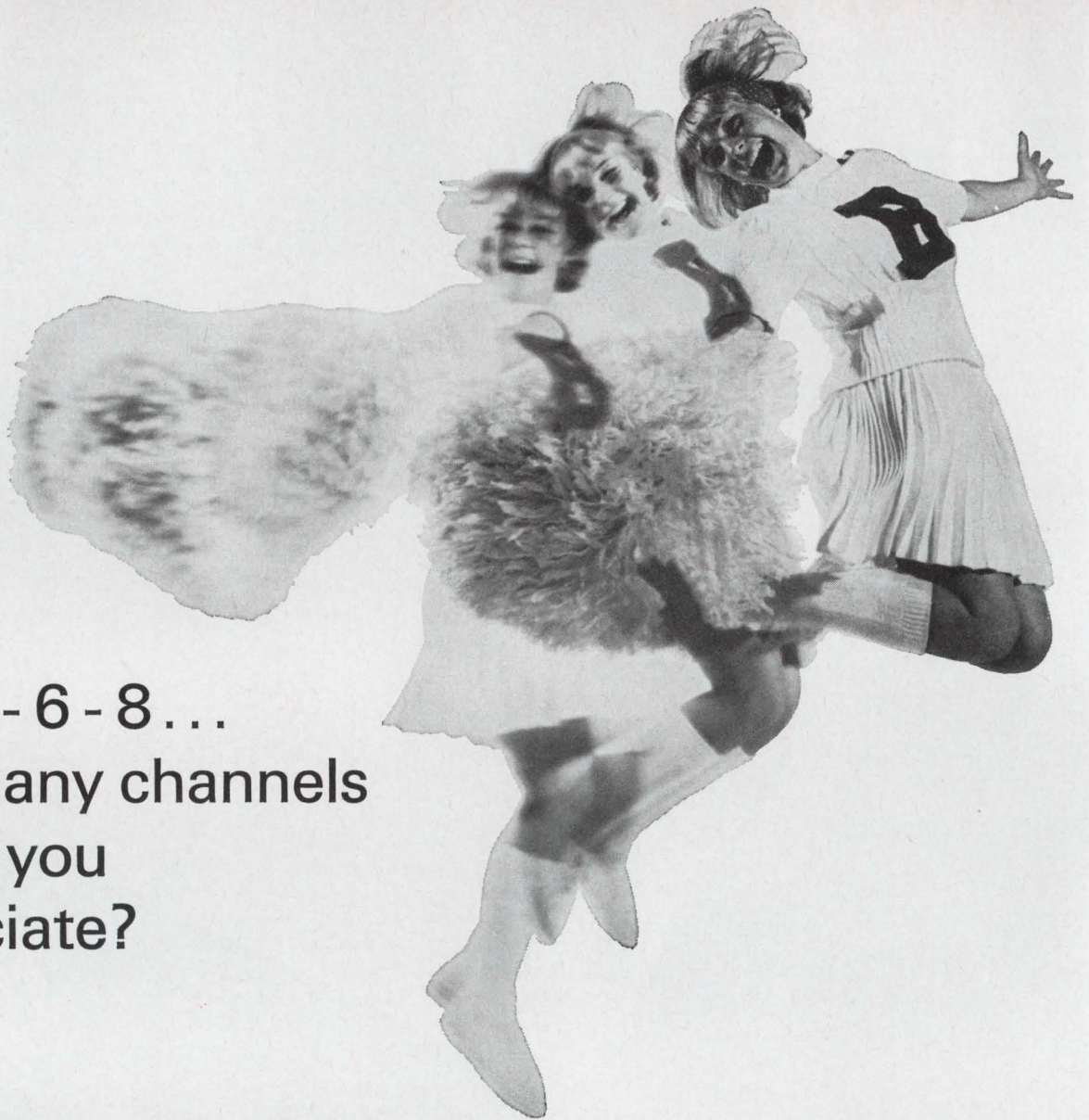

2-4-6-8...
how many channels
would you
appreciate?

Beckman EiD runs a whole series of options off one high-scoring basic formation: the R-2000 Series Dynograph® Recorders.

Six job-rated models...up to 8 channels
...automatic stylus temperature control
...standard sensitivity of 100 millivolts per division, or optional auxiliary amplifiers that increase it to 1.0 microvolt per division, with differential and floating input. And a variety of configurations to handle any and all analog applications.

The basic version? High frequency response of 100 Hz and rapid rise time of less than 2.2 milliseconds, both full scale—through use of new high torque writer units, advanced thermal recording, and high power, all silicon solid-state electronics.

Other cheering aspects: Choice of chart speeds. Zero suppression. Stylus centering and limiting controls. No loss of data following transient or other overload signals. Basic unit requires only 15¾ inches of vertical panel space. High gain version accepts all 9800 Series Input couplers.

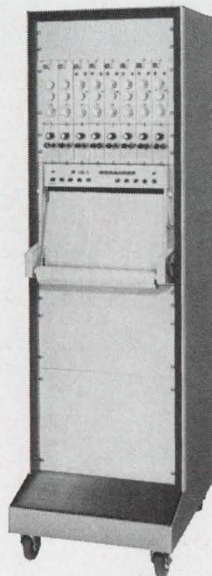

Huddle with your local EiD Sales Representative for all the facts...or write direct to our nearest regional office, listed at right.

EiD more than
measures up.

Beckman®

INSTRUMENTS, INC.
ELECTRONIC INSTRUMENTS
DIVISION

2400 Harbor Blvd., Fullerton, Calif. 92634,
(213) 691-0841

7360 N. Lincoln Avenue, Lincolnwood, Ill.
60646, (312) 583-1020

1830 York Road, Timonium, Maryland
21093, (301) 252-4810

International Subsidiaries: Geneva; Munich;
Genrothes, Scotland; Tokyo; Paris; Cape-
town; London; Mexico City

Technical Articles

It's not how much an IC costs . . . but how much it can save
page 66

Although the use of integrated circuits holds out the promise of lower costs, there are no guarantees that savings will accrue to every user. If an engineer chooses the wrong circuit, he can end up paying a penalty for using IC's rather than saving money. The critical item is special testing that an IC may require before it is incorporated into equipment.

Equivalent circuits estimate damage from nuclear radiation
page 73

The formulas of physicists, explaining what happens to semi-conductors when they are exposed to nuclear radiation, don't help engineers design radiation-resistant circuits. More useful are radiation-equivalent circuits. Using them increases the confidence in a circuit's survivability when it's exposed to nuclear radiation.

Computer aid on the ocean floor
page 85

The only way communications engineers could lay a cable between Vietnam and the Philippines in less than the two weeks the military demanded was to design the equalizers and calculate the position of repeaters as the cable was laid, and thus keep the operation continuous. Using a computer, the engineers devised techniques that can be applied to any communication system where on-the-spot adjustment of signal strength is required. That would include: high-speed data transmission, computer-controlled relay, missile range testing, satellite tracking, and missile detection systems.

Machine looks, listens, learns
page 91

Electronics

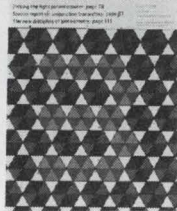

Electronic equipment that can respond to written or oral commands could find wide acceptance in military and industrial applications, so there is a huge amount of effort aimed at developing such gear. A new machine just built can learn to identify both graphic and spoken inputs. It demonstrates the feasibility of three previously untried techniques. Because the machine is adap-

tive, it can learn to respond to commands like "up" or "down" or—without any redesign—their foreign equivalents such as "montez" or "descendez" in French or "suba" and "baja" in Spanish. For the cover, art director Saul Sussman symbolized the pattern recognition problem by picking out a numeral from a color pattern.

**Coming
November 13**

- Special report: a survey of gallium arsenide technology
- Faster testing of r-f devices
- A computer with a suitcase memory
- Battery charging for consumer products

It's not how much an IC costs ... but how much it can save

By carefully selecting the right integrated circuit for the job, designers of an r-f amplifier were able to cut costs in half because they avoided special tests that are time consuming

By D.W. Ford, M.M. Gutman and W.F. Allen Jr.

Philco-Ford Corp.

At first glance, the use of integrated circuits holds out the promise of lower costs. But savings don't necessarily come about. If an engineer chooses the wrong integrated circuit, he can end up paying a penalty in unexpected costs for special testing.

An example of what the right circuits can do in a design is a 70-megahertz intermediate-frequency amplifier that goes into a communications receiver. The use of three ic's as automatic gain control (agc) stages reduced the cost to about half that of an all-transistor version. Although the cost of components for the ic version was greater, it was offset by the simpler assembly. The higher costs of a transistor version stem from the complexity of discrete circuitry—assembling its associated biasing and decoupling networks, and external agc circuitry.

Not only does simpler circuitry cut costs, but it clears the deck of some knotty design problems. With discrete components, the yeoman effort usually goes into the circuit layout to minimize interactions of the components. If the amplifier is to remain stable at the maximum gain condition, special precautions are needed to prevent feedback currents through ground paths, which can cause oscillations. Problems like this are taken into consideration in the original design of ic's.

With only three ic's making up the heart of the amplifier system, each in effect, becomes a subsystem. As a result, the ic's require systems-type tests that go beyond the circuit-type tests normally performed by the manufacturer. But such tests would pare the ic's cost advantage. The trick is to find circuits that would work in the system based on their usual parameters—gain, bandwidth, and noise figure.

At the Philco-Ford Corp.'s Communications and Electronics division, designers were seeking an ic for the 70-Mhz i-f amplifier used in the receivers in the microwave- and troposcatter-equipment product line. Specifications called for a 1-decibel bandwidth of 20 Mhz, a gain of 80 db, an automatic gain control range of 60 db when the agc voltage varies from -6 to -2 volts d-c, and an output of 0.5 volts across 75 ohms. And, since the application was for frequency-division multiplex systems with several hundred voice channels, the amplifier had to have low intermodulation distortion.

With an over-all bandwidth of 20 Mhz, the bandwidth for each stage had to be much wider—in the neighborhood of 80 Mhz. Of the commercially available r-f integrated-circuit amplifiers, used mostly in television and frequency-modulation broadcast tuners, none approached this.

However, a broadband ic had recently been developed for an electronic countermeasures (ECM) receiver designed at Philco-Ford's Aeronutronic division. The ic characteristics and design were set by Earl Johnson of that division, and the mask and final design were done at the company's Microelectronics division. The circuit, the PA7601, offered a good possibility of fulfilling the system needs since it also had the proper agc scheme.

Gain control

Unlike narrowband i-f amplifiers, agc can't be achieved on wideband systems by simply varying the bias on a transistor because large variations adversely affect the bandpass characteristic. This problem was solved in the PA7601 integrated amplifier by using the input stage of the ic as an electronically controlled attenuator. The input stage

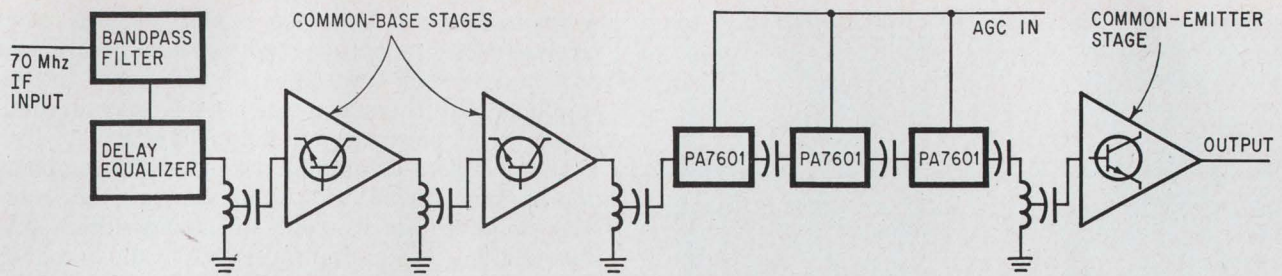

is a common base amplifier with the emitter of a second transistor connected across the input to shunt some of the signal to ground when the gain-control voltage is applied. Frequency response then remains unaltered, even with the required wide range of agc. This scheme also minimizes input-impedance changes since the input signal is not changed, but only redirected.

The amplifying portion of the ic, at right, which follows the agc stage, uses an input transistor with emitter degeneration to obtain broad bandwidth and a shunt-series feedback pair, Q_3 and Q_4 . Transistor Q_5 serves as a variable load resistance that increases as the frequency increases. This unloads the amplifier and compensates for droop in the gain characteristic at high frequencies. The bandpass characteristic, extending from 45 to 130 Mhz at the 3-db points, can be controlled externally with emitter bypass capacitors. No inductances are required with this circuit.

Distortion requirements

In an r-f application in which a large number of voice channels must be transmitted, it is common practice to use frequency-division multiplex, where each voice channel is frequency modulated onto a subcarrier and then the assembly of subcarriers is frequency modulated onto the r-f carrier. Because intermodulation affects quality, it must be minimized. The distortion stems from the multiplexed frequencies passing through the amplifier with different time delays. To overcome this, the i-f amplifier must have a linear phase response.

One test for intermodulation distortion—prescribed by the International Radio Consultative Committee—is to generate a wide band of noise, notch out a narrow range free of noise, pass the band through the amplifier, and then measure how much noise has appeared in the notched-out portion of the spectrum at the amplifier's output. If no distortion has occurred, the notch appears at the output noise-free. However, when the amplifier produces distortion, it adds noise across the entire spectrum, the notch included.

Intermodulation is expressed in terms of noise power ratio—transmitted noise to amplifier-generated noise. A high ratio is desirable; in this case, at least 55 db for the receiver system and 60 db for the i-f amplifier.

The test for determining this ratio, though not difficult to perform on a receiver, would be time-consuming and costly if it had to be performed for

Greater flexibility. Designed as a universal broadband circuit with an interchangeable bandpass filter setting the over-all bandwidth for specific applications, Philco-Ford's 70 Mhz i-f amplifier uses three PA7601 integrated circuits as automatic-gain-control stages. Two common-base stages serve as broadband amplifiers and a common-emitter stage is the power amplifier.

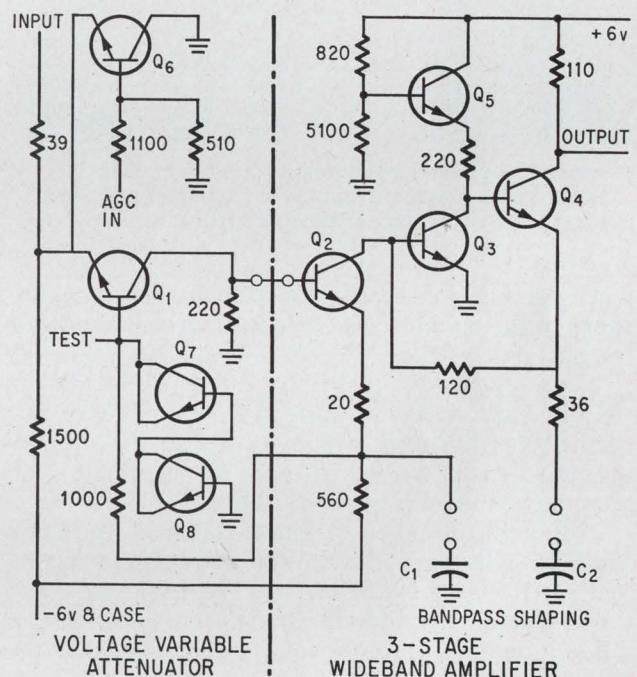

Basic circuit. The PA7601 integrated amplifier uses a voltage-variable attenuator for gain control to preserve frequency response.

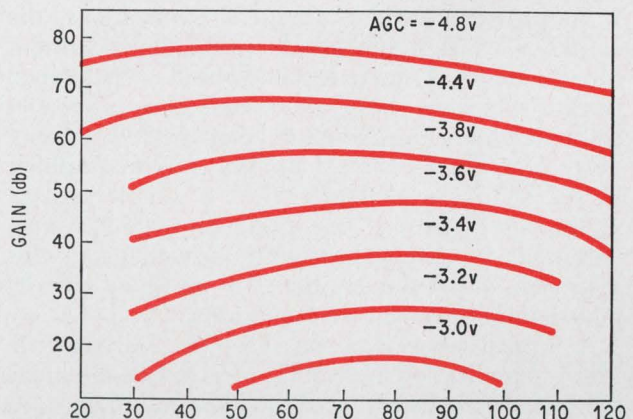

Variable gain. The amplifier's bandpass characteristic continues to be broad despite wide changes in agc voltage.

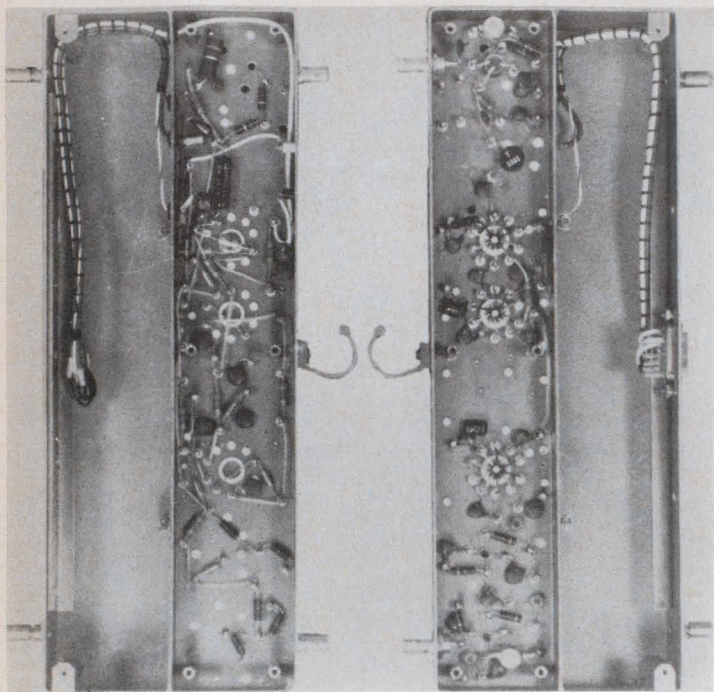

Package. The commercial version of the amplifier has the three integrated circuits in the center and the discrete transistor stages above and below.

each IC. A better method is to make the specifications of the circuit tight enough to meet the requirements.

Since the over-all passband was held flat to within 1 db across the range of 60 to 80 Mhz, the flatness specification was extended to the individual IC's—each circuit had to be flat to within 1 db across the range of 50 to 120 Mhz.

Although unrelated to phase response, the noise figure also entered into the intermodulation specification. If the noise figure was too high, the noise level would mask the intermodulation noise and, in effect, degrade the noise power ratio. Because the noise figure of the chosen IC was 15 db, two transistor stages—to provide enough gain to mask the noise—preceded the IC's in the r-f amplifier.

Widening the applications

To provide a wider range of applications, the amplifier was designed as a broadband unit without tuned circuits. A separate filter—built with lumped passive elements whose delay and gain properties can be closely controlled and compensated for with delay equalizers—is used in front of the amplifier to set bandpass characteristics. A simple change in the filter can suit the amplifier to any system within its frequency band. The advantage of this approach is that the amplifier has no tuned circuits that require extreme care in alignment.

A typical filter is a three-section Butterworth. Phase equalization networks are used to minimize the time-delay distortion of the filter and to improve the noise power ratio characteristics.

Positioning of the agc circuits is critical in enabling the amplifier to handle high-level signals

without saturating. If the agc is placed too near the receiver input, its output might be less than its input, and it will contribute to the noise in the amplifier. The thermal or shot noise may become greater than the intermodulation effects.

The complete i-f amplifier is a hybrid combination of three PA7601 IC's, three conventional transistor-amplifier stages, and the bandwidth-determining filter. Two of the transistors, at the amplifier input, are common-base broadband-amplifier stages. Broadband transformers are used for interstage coupling of the transistors.

The output of the second transistor-amplifier is transformer-coupled to the first of the IC amplifier stages. The IC's are broadband gain-control stages, each producing 20 db gain with $-6v$ agc voltage, decreasing to 0 db for $-2v$ agc voltage. The three IC's control the gain from 80 db down to 20 db. The output of the third IC is transformer-coupled to a common-emitter power amplifier stage, which delivers 0.5 volt rms across an output load resistance of 75 ohms.

Capacitive coupling is used between successive IC stages. The over-all 3-db bandwidth of the amplifier, exclusive of the bandpass filter, is greater than 40 Mhz. The nominal 1-db bandwidth is 20 Mhz.

Some tilt in the amplifier's passband characteristics occurs as the gain is reduced from maximum. The tilt, which could cause a nonlinear phase response, can be held within ± 1 db across the 60-to-80-Mhz frequency range with capacitive tuning of the emitter circuit at the output of the integrated-circuit amplifiers.

The authors



David W. Ford is an engineer in the advanced engineering and research group at the Communications and Electronics division in Blue Bell, Pa. He is presently working on wideband communications systems. He has a master's degree from the University of Iowa.



An engineer in the transmission equipment laboratory of the Communications and Electronics division in Philadelphia, Michael M. Gutman is working on the development of i-f amplifiers for microwave and troposcatter equipment.



A project engineer with the Microelectronics division in Blue Bell, Pa., William F. Allen is responsible for design and applications of linear IC's. He holds a master's degree from the University of Pennsylvania.

the readers might be interested to know how minimal the minimal rfi is.

Two graphs will predict the conducted interference resulting from zero axis switching at 60 and 400 hz.

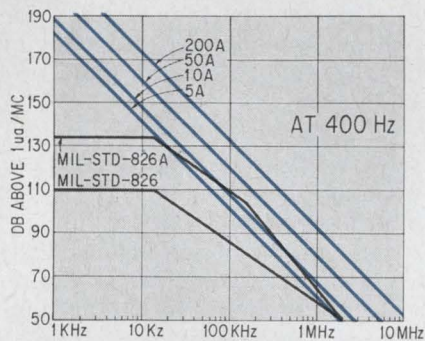
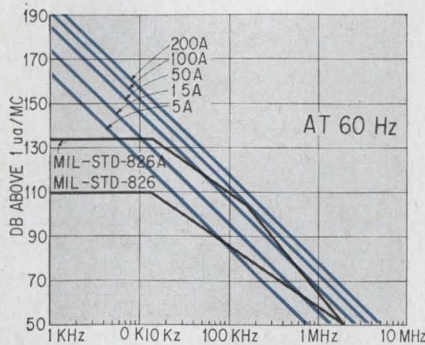

Superimposed on each of these graphs are the limits of Mil Std. 826 and 826A per method 3002. The parameter in these graphs is load current in rms amperes. The straight diagonal lines represent the noise generated as a function of frequency for a particular load current. These graphs were prepared as a result of a Fourier analysis of the waveform in question.

Verification of the method used for this prediction is shown on the 400-hz graph in the form of measured data at 10 amperes rms. This

data is in good agreement with the prediction.

Steve Jensen

Product development engineer
Genisco Technology Corp.
Compton, Calif.

Toward better standards

To the Editor:

Referring to Lt. John K. Lynn's letter on standard sheets [Aug. 7, p. 7], I should like to point out that standards for data sheets already exist, not only on a U.S. national basis but as international standards.

Technical Committee 47 (semiconductor devices) of the International Electrotechnical Commission (IEC) has been active in this field for 10 years and has succeeded in having several IEC publications issued, the most important being number 147, Essential Ratings and Characteristics for Semiconductor Devices, which contains recommendations regarding data sheets.

An appendix to that publication, to be issued in the near future, will recommend a standard format for the representation of all data.

The main difficulty probably is that these publications are not well known. Moreover, it certainly is deplorable that some manufacturers, although they have knowledge of the existence of such standards, do not pay any attention to them.

Maybe the method proposed by Lt. Lynn—to refuse to purchase such manufacturers' products—could be successful but I should prefer to point out as often as possible that standards do exist and that they should be followed.

H. Oswalt

Laboratorium der
Stiftung Hasler-Werke
Zurich, Switzerland

Make your oscilloscope display linear in db

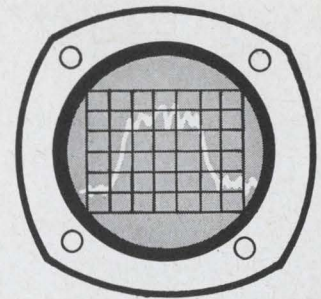

with the new 120 db ultra-fast LOGARITHMIC CONVERTER

This new logarithmic converter provides two unique features: The 120 db dynamic range (one-million-to-one) allows full coverage of virtually any phenomena in a single range. The microsecond response of the PM 1002 makes it the first logarithmic converter fast enough to work with oscilloscopes, integrating digital voltmeters or high speed graphic recorders.

Small, solid state, rugged, and drift free, the PM 1002 is invaluable for all types of ratio measurements and for applications where dynamic range is unknown.



Let us prove it
—write or call

\$660.00

PM PACIFIC
MEASUREMENTS
INCORPORATED

940 INDUSTRIAL AVENUE,
PALO ALTO, CALIFORNIA
(415) 328-0300

SUBSCRIPTION SERVICE

Please include an Electronics Magazine address label to insure prompt service whenever you write us about your subscription.

Mail to: Fulfillment Manager
Electronics
P.O. Box 430
Hightstown, N.J. 08520

To subscribe mail this form with your payment and check new subscription renew my present subscription

Subscription rates: qualified subscribers in the U.S.: 1 year \$8; two years, \$12; three years, \$16. Non-qualified: 1 year \$25. Subscription rates for foreign countries available on request.

CHANGE OF ADDRESS

ATTACH
LABEL
HERE

If you are moving, please let us know five weeks before changing your address. Place magazine address label here, print your new address below.

name _____

address _____

city _____

state _____

zip code _____

Designer's casebook

Designer's casebook is a regular feature in Electronics. Readers are invited to submit novel circuit ideas, packaging schemes, or other unusual solutions to design problems. Descriptions should be short. We'll pay \$50 for each item published.

SCR takes bounce out of switching

By Roy A. Wilson

Hycon Manufacturing Co., Monrovia, Calif.

Logic-level signals generated by a pushbutton or toggle switch may be followed by a false triggering signal or noise voltage if the switch contact bounces. Turning on a silicon controlled rectifier with the switch makes it bounceless. The SCR circuit consumes no quiescent power, unlike the flip-flops and one-shots customarily used to overcome contact bounce.

With the switch, S_1 , in the off position, capacitor C_1 charges to -15 volts through resistor R_1 when power is first applied to the circuit.

If S_1 is toggled to the on position, the silicon controlled rectifier also turns on, and stays on, regardless of any bounce S_1 may have. The 2 volts applied to the SCR gate, Q_1 , through the voltage divider, R_2 and R_3 , is positive with respect to the cathode.

When Q_1 is conducting, C_1 discharges through the SCR, diode D_1 , and resistor R_4 . The zener diode, D_2 , clamps the voltage across the load. When S_1 returns to the off position, a shunting path for the SCR current is provided through C_1 , momentarily dropping the current below Q_1 's holding value. Therefore, the SCR turns off and stays off, since R_2 and R_3 have been switched out.

Now, D_1 prevents the capacitor from being charged through the load during the time that the switch contact might bounce on again. The chance of the circuit generating a false transient signal is eliminated.

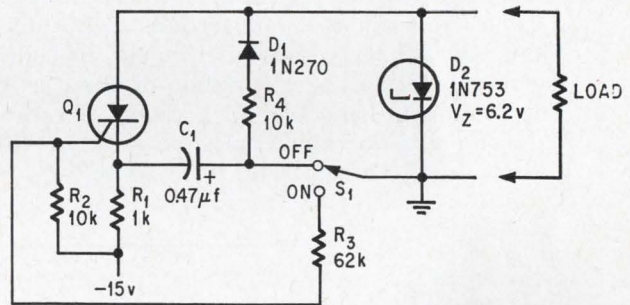

Tandem switch. Silicon controlled rectifier turns on and off with switch positions, but not with contact bounce.

Unijunction improves timing-circuit accuracy

By Arthur J. Lim

University of California, Brain Research Institute, Los Angeles

An inexpensive timer that maintains 2% accuracy over a wide variable range is accomplished by driving a unijunction trigger pulse generator with an astable multivibrator. The circuit consists of conventional components including a metalized-paper timing capacitor having an epoxy transistor current source.

In the circuit, the astable multivibrator formed by Q_1 and Q_2 operates as a variable-frequency pulse generator whose alternate half-cycle pulses turn on transistor Q_3 . Transistor Q_3 places a small charge on capacitor C_1 . The charging curve shows how the voltage steps on C_1 builds up until they

reach V_p , the peak point of unijunction transistor Q_4 . Then Q_4 fires, generating a timing pulse.

Leakage currents discharge some voltage on C_1 when the current source, Q_3 , is not conducting. At a given multivibrator frequency, the off-times for Q_3 are equal; thus, V_p is always reached by the accumulated voltage steps on C_1 . Since the timing period T is the sum of the fixed identical voltage steps, this period remains constant despite leakage and the timer's accuracy is not impaired.

The voltage on C_1 need not equal V_p to trip unijunction Q_4 . Before the voltage on C_1 reaches V_p , the pulse's negative trailing edge at the base of Q_2 is transmitted to base 2 of Q_4 via R_3 and C_2 . This negative voltage lowers V_p momentarily so

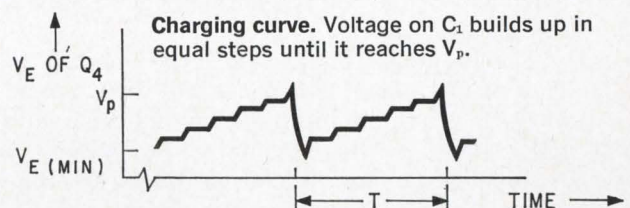

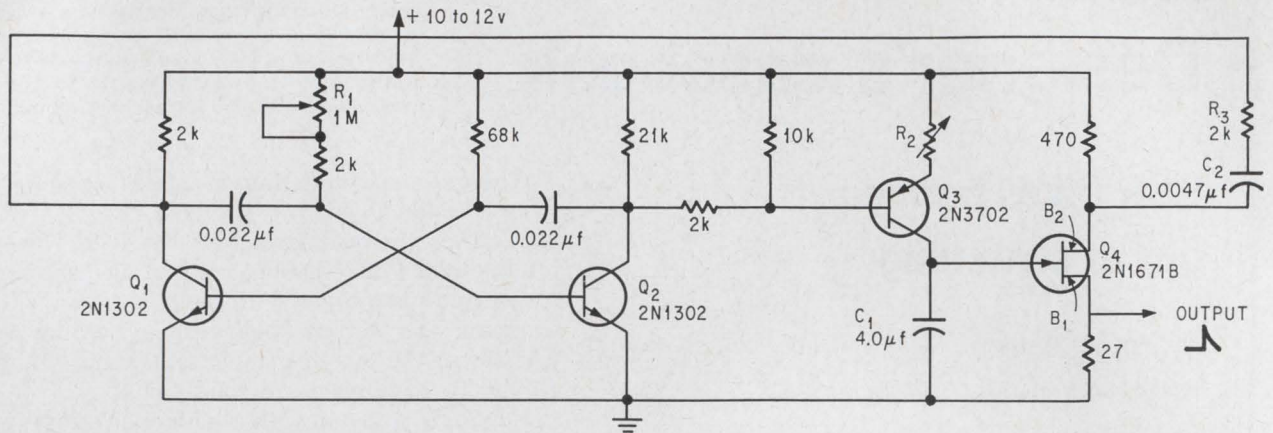

Timing circuit. Multivibrator Q₁-Q₂ drives Q₃ until C₁ charges up V_p and trips Q₄ generating a triggering pulse.

that a voltage on C₁, which is less than the previous V_p, is sufficient to trigger Q₄.

Varying R₂ from 1 kilohm to 10 megohms gives a range from about 4 milliseconds to 32 minutes. Fine adjustment is handled through rheostat R₁, which provides a linear variation of about a 100:1. The breadboard model had a timing accuracy of ±2% for a temperature range of +15° to +35°C and for a voltage range of 10 to 20 volts.

The timing period, T, can be expressed by

$$T = \frac{C_3 [V_p - V_{E(\min)}]}{nI_3 - I_L}$$

where n is the duty cycle of Q₂, I₃ is the on current from Q₃, I_L is the sum of leakage currents, and V_{E(min)} is the minimum emitter voltage of Q₄ in repetitive operation.

MOS FET takes the push out of elevator push button

By Fred G. Geil

Westinghouse Electric Corp., Pittsburgh

Because modern elevators are automatically controlled, buzzer systems are no longer used to bring the vehicle up or down. Instead, the signaling is accomplished with a field effect transistor and capacitor coupling. As an elevator rider places his finger near the up or down button, a hum signal from the building ground, which has been capacitively coupled through his body, is picked up by a sensing screen. The screen passes the signal to a MOS FET lamp driver that turns on a lamp behind the direction selected and fires the appropriate elevator command relay. Since the system operates capacitively, the control can be triggered by a person wearing gloves.

The metal sensing screen is connected to the gate of Q₁, MEM511. Because the input impedance of Q₁ is extremely high, the tiny 60-cycle hum signal coupled to the screen by the person's finger is sufficient to saturate and cut off Q₁ 60 times per

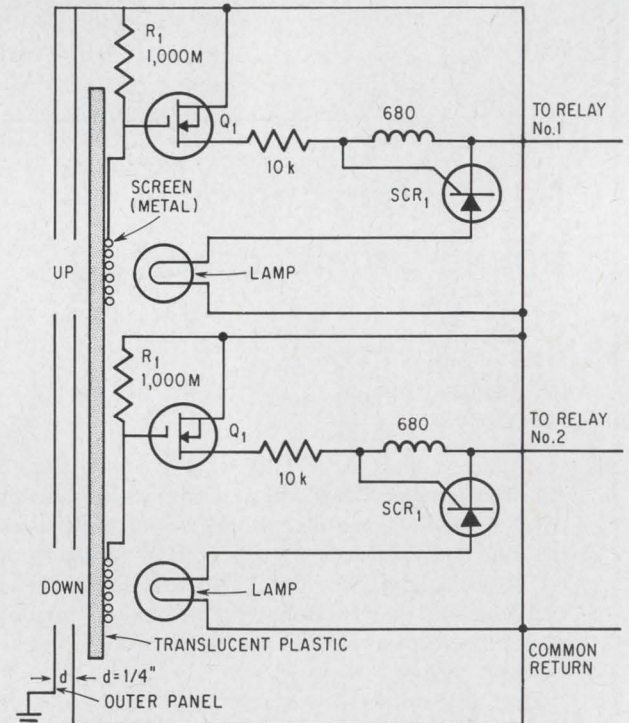

Physical layout. Metal screens placed opposite the two openings in the face plate (and behind the translucent plastic slab) are connected to the gates of the MOS FET's Q₁ and Q₁'.

Control circuit. Small hum signal from person's finger turns Q_1 on which causes SCR_1 and the lamp to turn on and pull in a relay.

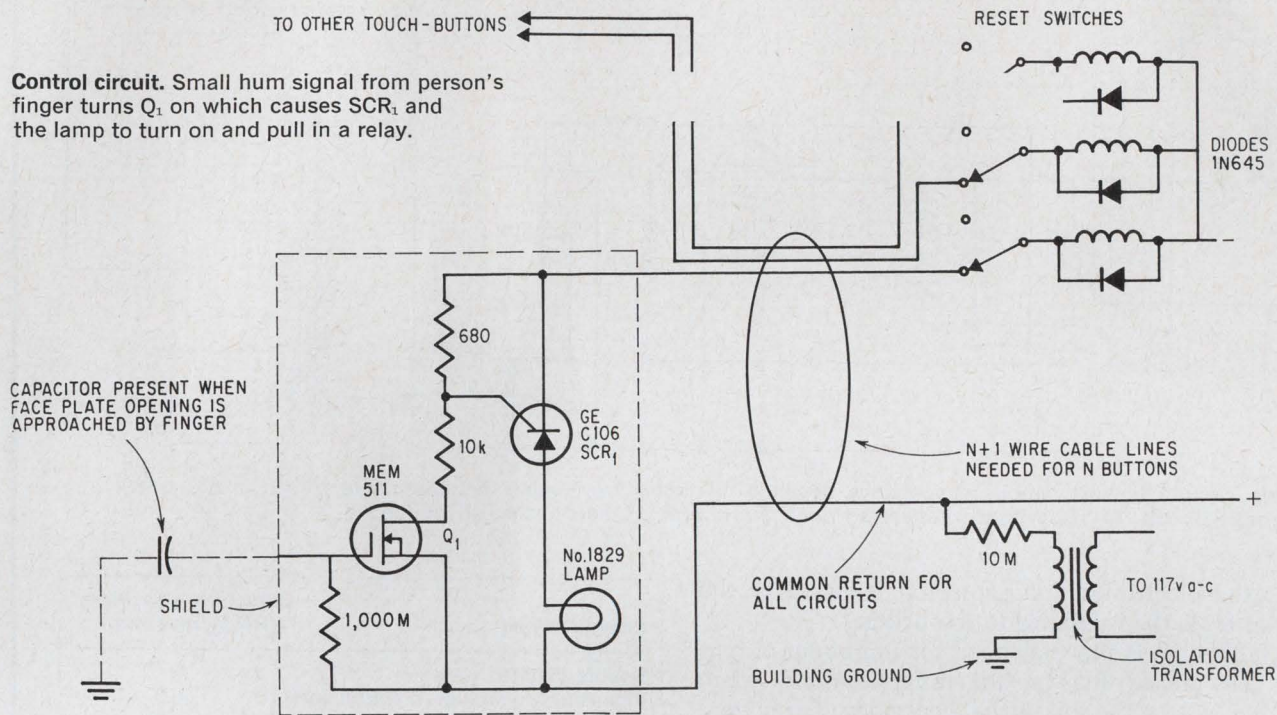

second. The first time Q_1 turns on, the silicon controlled rectifier SCR_1 also turns on and lights the lamp. The resulting lamp current is sufficient to pull in a relay in the control center and hold it in until the circuit is reset. The MOS field effect transistor, Q_1 , provides its own internal protection against excessive gate voltage; this protection is important

because a person may be carrying a relatively high charge when his finger approaches the elevator control.

The circuit is mounted in a shielded box, as shown, to prevent stray capacitances from tripping the control. Circuit's sensitivity is varied by changing the value of R_1 , a 680-ohm resistor.

Capacitors sensor monitors stored liquid levels

By P. K. Mital

Division of Applied Physics, National Research Council, Ottawa, Canada

A simple variable-capacitance sensor connected in a bridge circuit monitors the level of liquid stored in a tank. The sensor is placed around a glass gauge outside the tank. As the liquid's level changes, so does the capacitance across the sensor and the output of the bridge.

The sensor consists of two electrodes, 1 millimeter thick, made of either brass or stainless steel and held by clamps.

A coaxial cable connects the electrodes to one arm of the bridge and a 3.2-megahertz oscillator supplies the bridge with 10-volt excitation. To prevent stray fields, an aluminum shield is placed

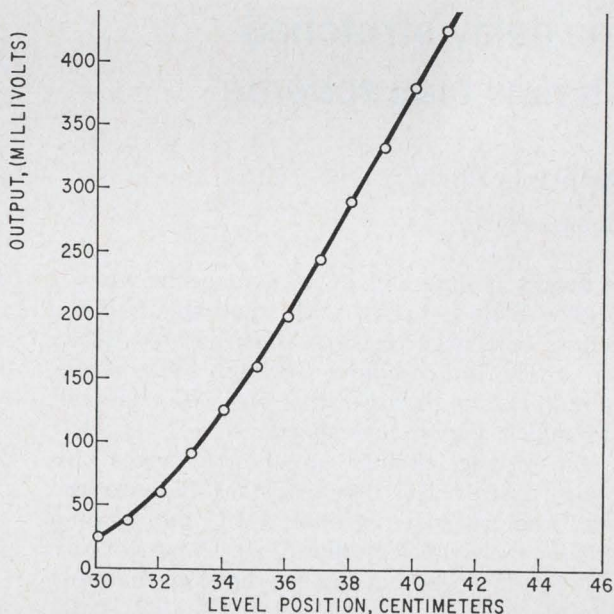

Bridge output. For ordinary water, bridge output varies linearly over 450-millivolt range as liquid level rises from 34 to 44 centimeters. Electrode size is 15.5 cms.

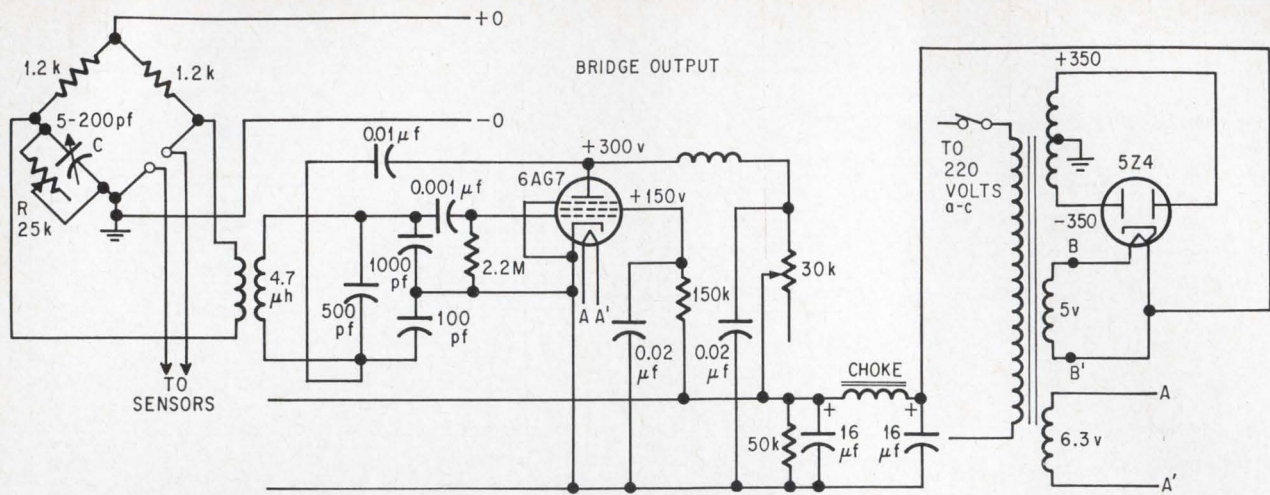

Bridge circuit. Sensors, whose capacitance depends on liquid level, being monitored, are placed in one arm of bridge circuit. As capacitance varies, so does the output of the unbalanced bridge.

over the electrodes and protected leads carry the signal from the oscillator to the bridge.

The bridge is first balanced for minimum output—a few microvolts—by adjusting C and R when the liquid is at the top of the electrodes. Tests were run with three lengths of electrodes—4, 7 and 15.5 centimeters—placed around the guide tube, whose outside diameter was 1.5 cm. The longer electrodes had the greatest detection sensitivity as the level of liquid changed—5 millivolts rms per millimeter change of level, compared with 2.6 and 3.4 mv per mm for the 4- and 7-mm long electrodes.

Liquids tested	Detection sensitivity (RMS) mv/mm
Double distilled water	4
Potassium hydroxide solution, pH 10	4.9
Potassium hydroxide solution, pH 8	4.9
Methyl alcohol	3.2
Ethyl acetate	0.7
Acetone (commercial)	2.3
Amyl acetate	0.7
AmI alcohol	1.9
Methyl ethyl ketone	2.5

Time delay stretched with new bias scheme

By Arthur L. Plevy

East Brunswick, N.J.

Time delays as long as half an hour occur when a Schockley diode is biased with small voltage-rated capacitors and large resistors. Incorporated in the power supply of a computer's printer, for example, this circuit delays the operation until the character drum reaches synchronous speed.

In conventional circuits, large capacitances produce the desired RC time constant because the timing resistor's size is limited by the holding current for the Schockley diode, D_1 . Capacitor size is further reduced by biasing the diode so that only 8 volts of the 50-volt breakdown potential is developed across the timing capacitor; usually, the the entire breakdown voltage is across the timing capacitor, requiring high-voltage capacitors.

The modified circuit, however, does not require a large capacitor to produce long time delays. When the anode of D_1 is tied to a 42-volt supply, C_1 need only supply the remaining portion (—8 volts) of D_1 's 50-volt breakdown voltage.

Resistor R_2 provides ample holding current and fixes the size of timing resistor R_1 ; hence, R_1 may be made as large as necessary to obtain the desired R_1C_1 time constant and C_1 may be made proportionally small. Diode D_1 is a 4E50.

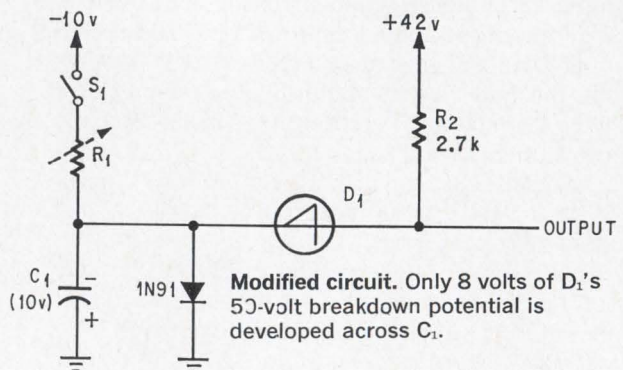

Modified circuit. Only 8 volts of D_1 's 50-volt breakdown potential is developed across C_1 .

Equivalent circuits estimate damage from nuclear radiation

Using device models, circuit designers can calculate the effects on components and then compute the over-all response of a circuit

By Joseph T. Finnell Jr., David D. Bertetti and Fred W. Karpowich

Missile System Division, Avco Corp., Wilmington, Mass.

Radiation from a nuclear weapons explosion can make even a simple, one-transistor amplifier behave as though gremlins were on the loose in the circuit. Although the effects can be explained by physicists' formulas, radiation-equivalent circuits give engineers a better picture of what happens.

The schematic representations are also in tune with the times. Until recently, the many studies of radiation effects on components were primarily research efforts. Now, the emphasis has shifted to practical circuit development, particularly when it comes to aerospace systems. Design times can be shortened and confidence in a circuit's survivability increased when an analysis is made of radiation models, in conjunction with radiation-effects tests.

Breadboards vs computers

Experienced designers of hardened circuits often find that breadboarding a design idea and testing it with a radiation simulator is more effective than doing rigorous design analysis, which can be so complex that a computer is required.

But it must be kept in mind that there is no laboratory substitute for the mix of radiations in a real weapons environment. Instead, the effects of neutrons and gamma radiation must be checked out in

separate test facilities. Special pulsed reactors are used to simulate the brief but strong fluxes of fast neutrons, and flash X-ray machines or linear electron accelerators are used to simulate gamma-ray doses.

Because the designer's chief concern is over-all circuit response to the radiation mix, a great deal depends on the designer's ability to correlate the data from the separate tests. Each type of radiation causes a variety of effects—some transient, some permanent—and a variety of responses. Over-all response stems from the interaction of the effects on different components.

In the analytical approach, the effects on each component are first estimated and then represented as components, current generators, and perturbations to existing components in the equivalent circuit. These estimates can sometimes be based on radiation-effects data gathered in previous research programs. But, for the most part, they must be based on new radiation-simulated experiments.

Since a circuit is a matrix of components, radiation effects represented in the components' equivalent circuits add up in matrix fashion. The complexity of a radiation equivalent circuit is evidenced by the schematic on page 74 of a common-emitter amplifier. This circuit shows how equivalent circuits for transistors, resistors, and capacitors can be combined.

Such a schematic can be rendered into a set of nodal or state-variable equations. The equations must be solved with analog or digital computers—a pencil and paper attack on the problem is a hopeless task, because inhomogenous and nonlinear elements crop up in the 20 or more simultaneous equations used in the solution.

Despite careful component selection and use of

A closer look

"Designing for the worst of worst cases—nuclear war" [Electronics, Aug. 21, p. 99] detailed the nature of a nuclear weapons environment. It also summarized the effects of radiation on electronic circuits and some of the techniques employed to offset them. In this article, a more detailed picture is presented of what has been learned about these effects on all types of electron components, and how they disrupt the operation of solid state circuits.

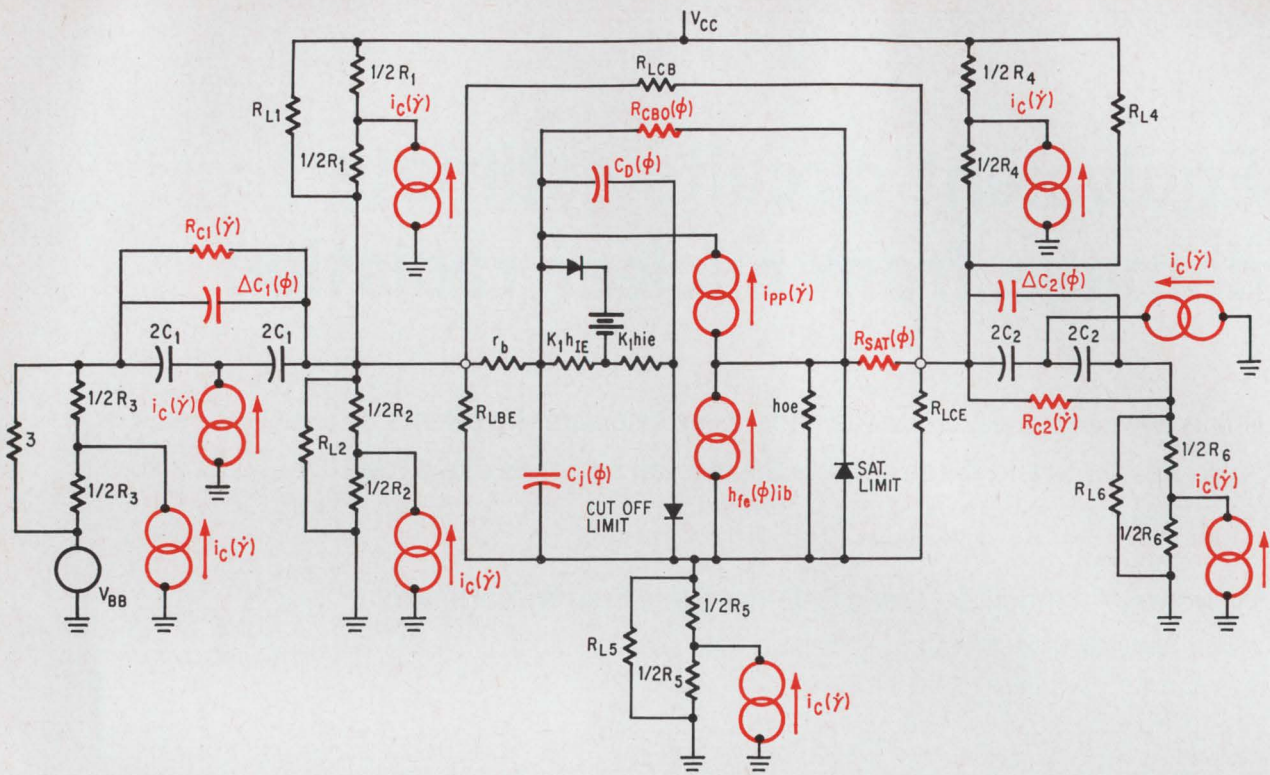

Radiation amplifier. Complex equivalent circuit, above, is needed to explain the effect of gamma radiation and neutron bombardment on the simple common-emitter amplifier, at left. Circuit parameters shown in color are functions of radiation. The radiation-induced photocurrents and Compton electron replacement currents cause components to act as miniature generators.

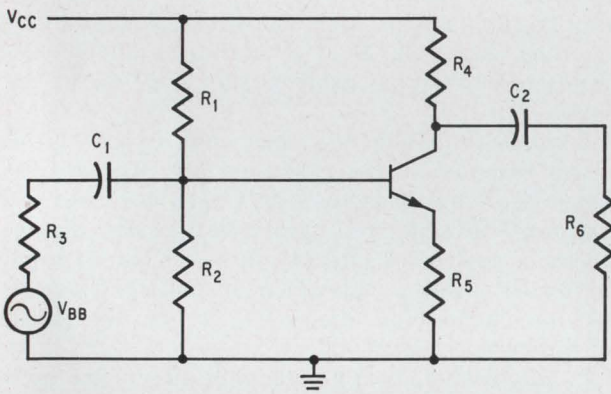

good design practice, such an analysis might indicate that a circuit could not withstand the expected radiation environment. In that case, other measures can be taken, such as the use of circumvention redundancy, gamma-ray sensing circuit desensitizers, or complete redesign—perhaps even to consider a different approach to the problem and eliminate certain types of circuitry.

Transient and permanent effects

High-energy gamma rays and neutrons—those with energies above 1 million electron volts (MeV)—are the most troublesome radiations in the weapons environment. Either kind can cause transient or permanent alteration of component characteristics, rendering a circuit inoperable.

Permanent change, of course, is an irrecoverable alteration in properties, such as occurs with dislocation of the crystal lattice in semiconductor devices. A typical transient effect is the generation of photocurrents. Some designers loosely define any effect lasting longer than a required recovery time

as permanent degradation—in a practical sense, a circuit that doesn't recover in time to do its job on a mission has failed.

The radiation spectrum from a nuclear explosion is rich in gamma rays with energies above 1 MeV. At that level, transient changes due to ionization of materials in and near the components can be severe. The gamma rays give up energy in the materials through formation of electron-hole pairs, photoelectric effects, and Compton effect (freezing, or scattering, of electrons). These effects generate photocurrents in semiconductors, change the conductivities of conductors and insulators, and create leakage paths in component packages. The absorption of large doses of gamma energy by the materials can severely overheat the components.

The charge imbalance created by the Compton effect can cause passive, as well as active, components to generate spurious current pulses in the circuit. Most of the freed electrons have energies in the million-electron-volt range, and many of them escape from the body of the component part. They

are replaced by electrons drawn from ground, generating a current pulse called the Compton replacement current. The shape of the Compton current pulse depends on circuit impedance to ground and the shape of the gamma pulse—that is, the rapidity with which the radiation intensity rises and falls.

Furthermore, destructive secondary effects often arise from the transient primary effects. For example, transistors will amplify the primary photocurrents, often to saturation. The circuit can be driven into a mode of operation that raises current or temperature levels beyond the safe operating margins of the components.

Bombardment of the materials with neutrons more energetic than 1 Mev can cause all the ionization ailments and then some. As the neutrons hit the atoms in the component materials, they produce crystal dislocations and other irrecoverable forms of damage. Only a portion of the neutron energy is lost in this fashion. Studies at the Sandia Corp. show that the degree of ionization depends on the energy given up by the neutrons.¹ As can be seen in the curve for silicon at the right, the percentage of neutron energy that goes into ionization rises with neutron energy.

Transients in transistors

Production of numerous hole-electron pairs in and near carrier depletion regions make each transistor and diode act like a tiny, additional power source in the circuit. The pairs are excess carriers whose net effect is generation of a primary photocurrent, I_{pp} , at the diffused junctions.

In transistors, I_{pp} is produced by the charge-segregating action of the base-to-collector and base-to-emitter junctions. If this occurs while the transistor is drawing normal circuit-operating power, the transistor amplifies part of the primary photocurrent, giving a larger, secondary photocurrent, I_{sp} .

As long as circuit operation remains linear, I_{sp} is roughly proportional to I_{pp} times transistor gain, β . The photocurrents are incremental changes in the transistor operating currents, I_{CO} and I_{BO} .

The primary photocurrent splits into two parts, as in the simplified model, at the right, of a transistor in a radiation environment. One part, I_{pp1} , flows into the circuit outside the transistor. The second part, I_{pp2} , flows into the transistor's emitter and is treated by the transistor as a base-drive current. Therefore, I_{sp} is a collector-to-emitter current

$$I_{sp} \approx \beta I_{pp2} \quad (1)$$

and total collector current, I_C' , is

$$I_C' \approx \beta I_{pp2} + I_{pp1} + I_C(0) \quad (2)$$

This relationship fails to hold true if the transistor current rises to saturation and no longer operates linearly. Intense ionizing radiations tend to drive transistors into saturation, where they remain for some time after the radiation pulse ends.

Creation of leakage paths in the transistor packaging (or in the passivation oxide on the silicon

crystal) is of less significance. Experience has shown that, as a practical matter, leakage won't make circuit operation worse if the transistors have already been driven into saturation by the photocurrents. The leakage varies with packaging materials. It is shown as three resistances in the transistor model, since it shunts the emitter, base, and collector connections, E, B, and C.

Primary photocurrent levels in nonsaturated transistors fall in the ranges tabulated on the following page. The ranges are not clear-cut; there are isolated cases of overlap. The values were measured while transistors were irradiated by linear electron accelerators. Generally, direct measurement using

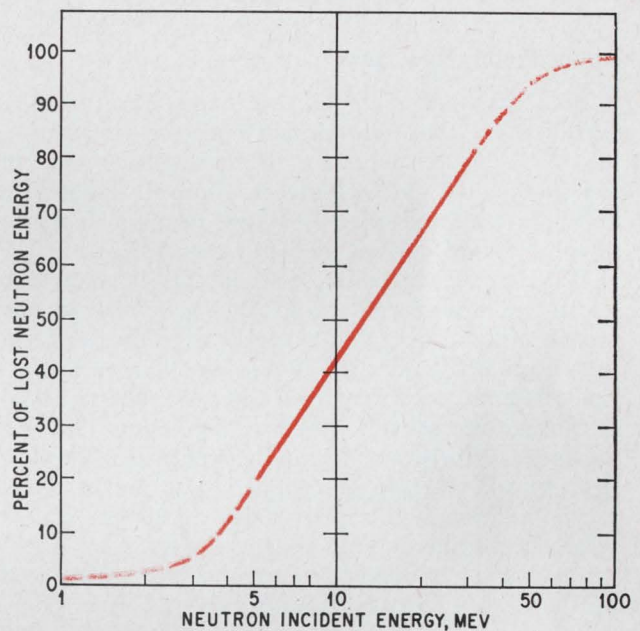

Silicon vs neutrons. Some of the energy lost by neutrons in silicon acts as ionizing radiation. The percentage of energy causing ionization increases with the incident energy of the neutrons.

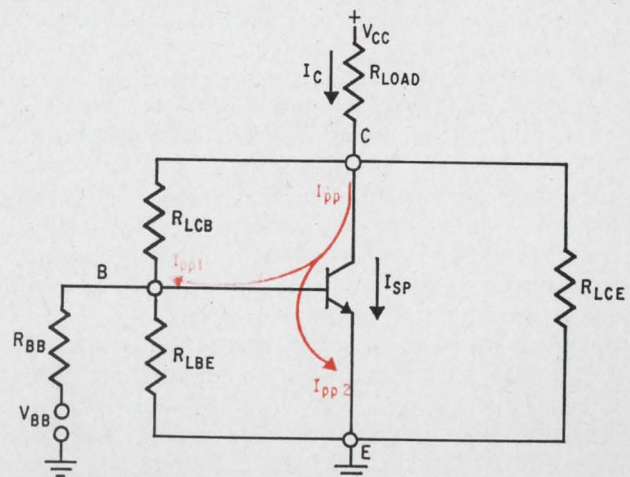

Irradiated transistor. Photocurrent produced in a transistor by ionizing radiation is amplified. The primary photocurrent splits two ways.

Primary photocurrents in transistors

Transistor class	Approximate photocurrent ($\mu\text{a per megarad/sec}$)
High-frequency switches	
low-power	1 to 10
medium power	10 to 100
High-frequency power switches	
P_c between 1 and 10 watts	50 to 500
P_c between 10 and 150 watts	500 to 5,000

a gamma-ray simulator (flash X ray or linear electron accelerator) is needed to determine how much primary photocurrent will be produced in a given transistor.

Further information on transient effects in transistors and diodes is contained in the TREE Handbook (transient radiation effects on electronics).²

High fluence, low gain

Bombardment is a good term for neutron irradiation because these atomic particles can break up a crystal lattice structure, causing displacements in crystals, called cluster defects. Neutron damage in solid state circuits usually shows up as a decrease in the forward current gain of transistors.

When neutrons collide with atoms in a crystal, energy is transferred from the neutrons to the atoms. If the energy transferred exceeds the level that normally binds the atoms into the crystal lattice, the atom will break free and move about. Some of these atoms move to interstitial positions, leaving vacancies at positions normally occupied in the lattice. In silicon, the interstitial atoms act as weak n-type doping, while the vacancy clusters act as stronger p-type doping (electron traps). In effect, the transistor is doped in a manner not anticipated by the device processors, and gain and other characteristics suffer.

The gain variation with neutron fluence is given by^{3, 4}

$$\frac{\beta}{\beta_0} = \frac{1}{1 + \frac{1.22}{2\pi} \frac{\phi\beta_0}{f_2 k}} \quad (3)$$

Ideally, the damage constant, K , would depend entirely on the semiconductor material, and the alpha cutoff frequency, f , would account for device geometry, doping levels, and material variations. In practice, K varies slightly in transistors of the same type, and widely in transistors of different types. Experimental measurements in reactors generally yield K values between 10^5 and 10^7 . Typically, a transistor will begin to lose gain rapidly when neutron fluence exceeds about 10^{12} n/cm² and will cease amplifying at about 10^{15} n/cm².

However, some specially made transistors are guaranteed to retain 15% or more of their initial gain at 10^{15} n/cm². These hardened transistors are doped so that minority carriers in the base have very short lifetimes, and the base width is made small enough to provide gain. Such devices have an f in the gigahertz range. Since carrier lifetime is shorter than in conventional transistors, creation

of lattice vacancies during neutron bombardment results in markedly less relative change in average lifetime. Therefore, the damage constant is high—about 10^7 n-sec/cm².

If the gain of such a hardened transistor is initially 100, one can predict with equation 3 that gain will be 34 at fluence of 10^{15} n/cm².

The gain loss due to dislocations is more or less permanent. At first, there is considerable chaos just after the pulse passes its peak. If in this state the transistor has any gain at all, it indicates the pulse of neutrons wasn't very powerful. The process of the lattice coming to equilibrium is called fast annealing.

The transient loss of gain may be many times as great as the permanent loss, and annealing time can be as short as 100 microseconds or as long as many milliseconds. Designers worry more about the transient than the permanent losses when a circuit must operate during or immediately after neutron exposure. The loss and recovery is difficult to calculate, so it is generally measured in a pulsed reactor whose neutron pulse output (of a few hundred microseconds) approximates the anticipated weapons environment.

Neutrons also cause permanent degradation of cutoff-collector current, collector-to-emitter voltage, collector-saturation voltage, and the equivalent circuit base resistances. Often, the changes are small and the effect on circuit operation inconsequential. But some transistors undergo large changes, so these characteristics, too, are generally checked out in a nuclear reactor.

Gamma heating

Gamma rays cause essentially the same lattice-displacement effects as neutrons, but these are far less troublesome in semiconductor devices than the heat generated by gamma irradiation. In fact, they are negligible in the mixed environment of a nuclear explosion.

The most dangerous gammas are the prompt ones—those emanating in less than a microsecond from the explosion rather than those radiating from the fireball or caused by neutron capture in atmospheric nitrogen. A circuit must be very close to an explosion to receive a million-rad dose of prompt gammas—so close that often the dominant damage mechanisms will be neutron bombardment, shock from the blast, and thermal radiation. Likewise, the direct heating of a semiconductor device can be fatal when the gamma dose exceeds 10^7 rads in less than a microsecond—but the size of the dose will be of no consequence if the circuit has already been destroyed or rendered inoperable by the other transient

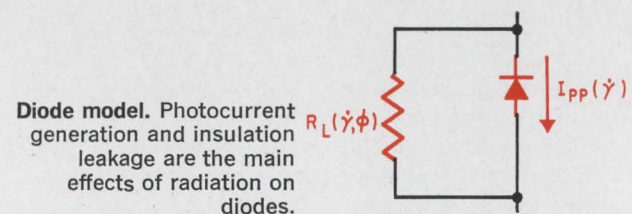

Definitions of terms

Term	Definition	Units
I_{pp}	Primary photocurrent in transistors and diodes	amps
γ	Gamma-ray dose rate	roentgen/second or rads/second (Si)
γ	Gamma-ray dose	rads
ϕ	Neutron fluence	n/cm ²
fluence	Time-integrated flux	particles/cm ²
flux	Rate of flow of particles or energy per unit area	particles/cm ² /sec
I_{sp}	Transistor secondary photocurrent	amps
β, h_{fe}	Transistor small signal forward current gain	(dimensionless)
β_o	Initial current gain	(dimensionless)
f_α	Transistor α cutoff frequency	hertz
K	neutron-damage constant	neutron-seconds/cm ²
I_{CBO}	Transistor cutoff collector current	amps
V_{CE}	Collector-to-emitter voltage drop	volts
V_{BE}	Base-to-emitter voltage drop	volts
$R_{(sat)}$	Collector saturation resistance	ohms
γ_b	T equivalent circuit base resistance	ohms
γ_e	T equivalent circuit emitter resistance	ohms
rad	Radiation absorbed dose (100 ergs/gram) referenced to the material in which absorbed eg. 10 ⁵ rads (silicon)	rads
roentgen	Radiation dose unit (83.8 ergs per gram deposited in dry air at STP)	roentgen
Curie	Radioactive source strength 3.7×10^{10} disintegrations per second	curie
$i_e(\dot{\gamma})$	Compton scattering current from electronic components as a function of gamma-dot	amps
ΔE	Energy absorbed from a gamma-ray field by a slab of material	ergs
E_o	Incident energy in gamma-ray field on surface of slab of material	ergs
$\gamma(E)$	Normalized gamma-ray spectrum—function of energy	fraction/unit E/cm ²
$\sigma(E)$	Material absorption cross-section—function of energy	cm ²
R_s	Capacitor shunt resistance	ohms
$\epsilon\epsilon_o$	Absolute dielectric constant	farads/meter
C	Capacitance	farads
σ	Conductivity	mho/meter
$R_s(\dot{\gamma}, \phi)$	Leakage or shunt resistance	ohms
i_b	Transistor base current	amps
h_{ie}	Hybrid parameters (common-emitter transistor)	ohms
h_{oe}	Hybrid parameters (common-emitter transistor)	mhos
h_{re}, h_{fe}	Hybrid parameters (common-emitter transistor)	(dimensionless)

and permanent effects. A prompt gamma dose of 10^7 rads will heat silicon to 130°C.

What is of primary concern to the designer is the cumulative heating of the semiconductor. Gamma energy that is converted to thermal energy, ambient temperature, normal power dissipation, and abnormal power dissipation as the result of transient photocurrents, can quickly add up to an operating temperature higher than the component was built to withstand. Or, in any event, it can produce the operating degradations generally associated with high component temperatures.

When the gamma pulse lasts a microsecond or less, the heating is assumed to be adiabatic—that is, the device's temperature rises instantaneously and there is no opportunity for heat to flow from the device to a heat sink. In the adiabatic case

$$\Delta T = \frac{\text{rads} \times 10^{-5}}{2.39 \times \text{specific heat}} \quad (4)$$

In the preceding equation, ΔT represents the temperature rise and specific heat of the semiconductor material.

In most cases where the gamma dose is intense enough to cause overheating, the circuit will also be driven into saturation by photocurrents and Compton currents. Therefore, the gamma heating in an operating circuit is augmented by I^2R heating at saturation.

As the duration of gamma pulses go beyond a microsecond, heating becomes less and less adiabatic. The temperature rise will be less severe at a given gamma dose since some of the heat will have time to flow out to the heat sink while the component is being irradiated. How much less heat depends on the width of the gamma pulse, flow rates of heat in the silicon, and the conductivity of the thermal path to the heat sink. Likewise, heating due to photocurrents will be more severe at saturation if the tran-

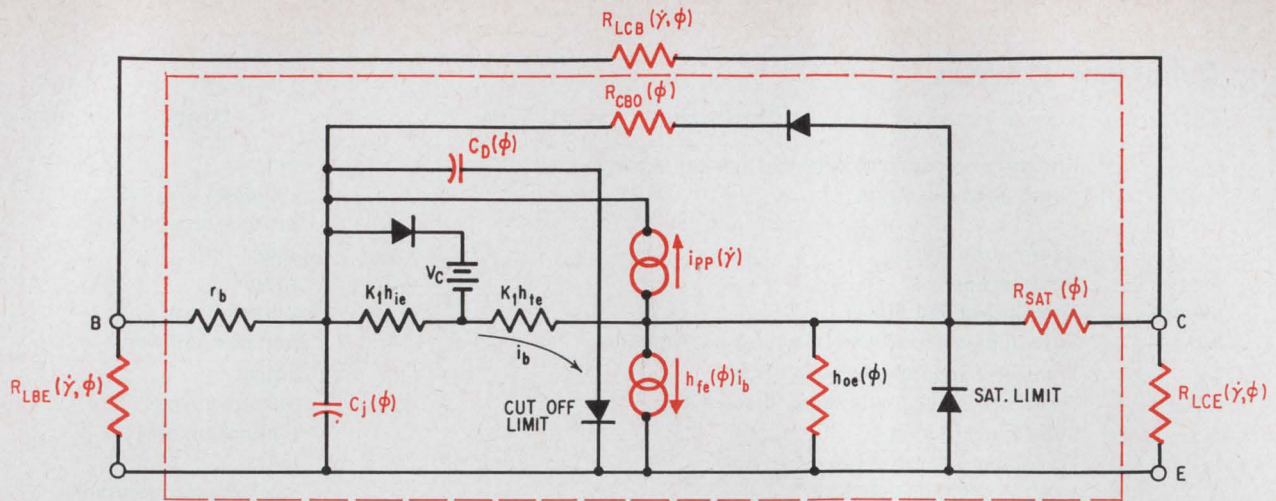

Transistor equivalent. Common-emitter equivalent circuit of npn transistor (dashed area) sorts out changes in characteristics caused by radiation and is accurate enough to be used in circuit-analysis applications.

sistor's storage time is much longer than a microsecond.

Semiconductor diodes are damaged in much the same ways as transistors.

During gamma irradiation, a primary photocurrent is produced by the charge-segregating action of the p-n junction, as indicated in the model on page 76. Of course, there is no secondary photocurrent—since diodes do not amplify—but diodes are subject to the secondary photocurrents generated by transistors in the circuit. And, as in transistors, leakage paths arise in the diode insulation.

Damaged diodes

Permanent damage from lattice displacements shows up mainly as shorter carrier lifetimes. The resulting changes in reverse characteristics are not well behaved. It has been observed in some cases that identical diodes, tested side by side in a reactor, exhibit increases or decreases in avalanche- or zener-breakdown voltage, reverse-leakage current, and breakdown or zener resistance.

Forward saturation resistance and leakage both increase. Slight changes may occur in junction capacitance and diffusion capacitance, but these

changes have negligible effects unless capacitance values are critical to circuit operating stability.

Semiconductor equivalent circuits

Although simplified models of transistors and diodes are sufficient to visualize effects, they aren't precise enough for design work. The equivalent circuits on this page are adequate engineering models for most cases.

The transistor is shown in a common-emitter configuration, with the primary photocurrent between the collector and base. K_1 is a dimensionless constant that mixes "hybrid" and "T" parameters for this application. It is found with

$$K_1 = \frac{(1 + h_{fe}) r_e}{(1 + h_{fe}) r_e + r_b} \quad (5)$$

After the variations in the conventional transistor parameters are found by experimentation in radiation simulators, the voltage and currents can be solved with the equivalent circuits.

Integrated circuits

Ionization-current effects are an order of magnitude greater in monolithic integrated circuits than in discrete circuits. The primary photocurrents, it must be remembered, arise in the junction area in discrete devices. Besides acting as junctions in transistors and diodes, p-n junctions are used for element isolation, for separating the elements from the silicon-crystal substrate, and for forming resistors and capacitors.

Moreover, as the photocurrents are generated, the combinations of isolation and substrate junctions create parasitic diode and transistor elements in the ic. Sometimes the substrate junction makes a nearby transistor act like a pnpn switch—a device that is very sensitive to ionizing radiation. The photocurrents can turn on the transistor and keep it on, a condition known as latchup.

A linear ic's transient response to radiation is dominated by secondary photocurrents. So the greater the gamma-dose rate (rads per unit time),

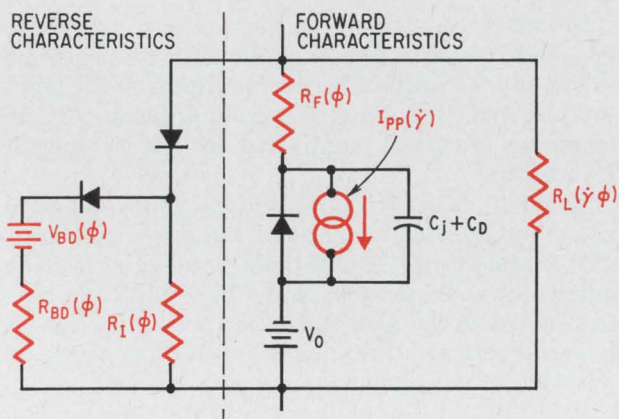

Diode equivalent. Forward and reverse characteristics of diodes are represented in this circuit-design model.

People

Bunker-Ramo Corp.'s Defense Systems division, formerly a leading maker of coded message systems for electronic warfare communications, is trying to regain the ground it's lost. A first step was taken this week when a manager was named for the communications department, without one for several months. The new man is **Jack J. O'Neill**, who at Airborne Instruments Laboratory oversaw the design and qualification of that company's first group of solid state microwave frequency synthesizers.



Jack J. O'Neill

O'Neill hopes to beef up the sales side of the department and generate new business. He says that the company has a funding program through which ideas can be investigated for three to six months. If an idea looks promising, a "feasibility model" can be built. "Then, when there's a demand for the product, we'll be there with a piece of equipment and not just an idea for development."

With the appointment of **Kenneth G. Harple** as director of development engineering, Systems Engineering Laboratories of Fort Lauderdale Fla., has taken a major step toward strengthening its position in the industrial control and data-acquisition markets, which presently account for 30% of its sales. The 38-year-old Harple is a well-known developer of industrial systems equipment.



Kenneth G. Harple

Systems Engineering, a growing computer firm in existence since 1962, began by developing data-acquisition equipment. It started making its own computers in 1965. Thus, unlike most systems companies, SEL now makes its own com-

reliable switches

FOR THE BOEING 727

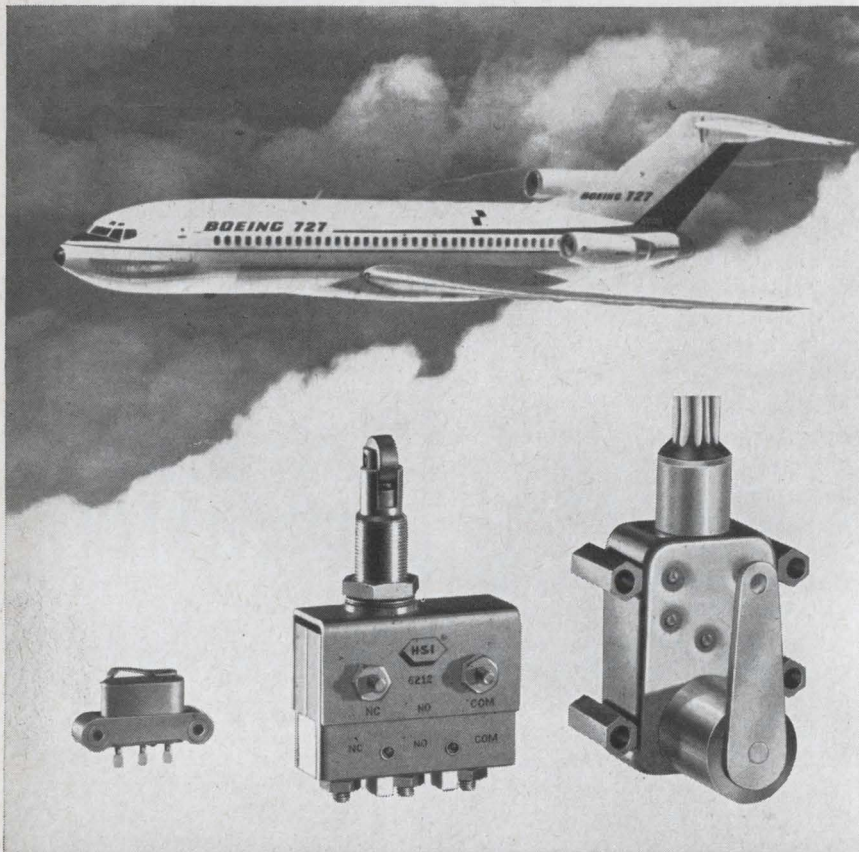

HSI sealed switches have successfully performed critical tasks on the Boeing 727 since the start of the program. That means faithful performance during thousands of flight hours.

The HSI Flap, Leading Edge Slat, and Landing Gear Switches have patented elastomer-bonded rotary seals and heliarc welded stainless steel enclosure. These features provide positive protection against severe environmental conditions of humidity, altitude and temperature.

The HSI hermetically sealed Engine Thrust Reverser Lockout Switches operate in ambient temperatures of -65° to $+660^{\circ}$ F. This capability comes from years of experience with high temperature applications. Furthermore, the one-piece blade design of these switches provides unusually high contact pressures making the switches insensitive to severe vibration conditions. Call HSI for answers to special switching problems. Send for data sheets.



HAYDON SWITCH & INSTRUMENT, INC.

Where Optimum Performance is Standard

1500 Meriden Road, Waterbury, Conn. 06720/Area Code (203) 756-7441

the longer the time that ic's are saturated and operate nonlinearly. Digital ic's also saturate, but the major concern is whether they change state falsely during irradiation. Flip-flops sometimes reset in a symmetrical manner—that is, regardless of the control signals applied during saturation, there is an equal probability that they will be in either of their two states when they come out of saturation.

Transistor gain loss due to neutron bombardment is about equal for a transistor in an ic and a discrete transistor with a similar geometry, base-region design, and cutoff frequency. The diffused resistors and capacitors used in ic's are much more vulnerable than their discrete counterparts because they are formed with p-n junctions. Leakage and other surface effects, however, are less pronounced in ic's than in discrete components—perhaps because the protective oxide on the silicon is more carefully controlled during the production of the circuit than during production of a discrete semiconductor device.

Fairly hard ic's are being produced by the silicon-dioxide isolation technique. Essentially, this separates the elements into discrete devices surrounded by dielectric. Radiation photocurrents are reduced by an order of magnitude back to the discrete-transistor range by elimination of isolation and substrate junctions. Without the extra junctions, parasitic elements and latchup cannot occur, and digital ic's are less likely to change state.

No significant further progress in ic hardening can be expected without more basic research in ic production techniques. For example, initial tests indicate that replacing silicon dioxide with silicon nitride for surface passivation and dielectric isolation substantially improves resistance to ionizing radiation. Both the International Business Machines Corp. and the Sperry Rand Corp. are developing techniques for silicon-nitride isolation.

Ionization increases a material's conductivity in most cases, so the obvious effect of irradiating a resistor is a lowering of resistance values. But don't count on it. The conductivity increases and the formation of leakage paths in the resistor package may be offset by other changes that add to bulk resistivity.

Carbon and resistive wire, for example, lose resistivity. Yet, some carbon-composition, carbon-film, and even some wirewound resistors show slight over-all increases in resistance. Perhaps the increases are due to structural changes. The damage mechanisms in resistive materials are not as well understood as those in other materials. This is partly because the effects are inconsistent and partly because resistors have been studied less than other components.

Resistor shunts

In a circuit, a decrease in a resistor's value has the effect of placing a shunt resistor in parallel with the actual resistor, as in the equivalent circuit at the right. Shunt values of 1 to 100 megohms have been observed at gamma-ray dose rates of 10^7 rads/second. Since parallel resistances lower than

Neutron tolerance of resistors

Resistor type	Mild damage threshold (n/cm ²)	Severe damage threshold (n/cm ²)
Carbon composition	10^{13}	10^{16}
Metal film	3×10^{16}	5×10^{17}
Carbon film	10^{15}	10^{17}
Oxide film	2×10^{12}	2×10^{16}
Precision wirewound ceramic	5×10^{17}	10^{19}
epoxy	10^{15}	10^{19}

a megohm can crop up in a circuit at higher dose rates, the designer should consider how they would affect circuit operation. If the shunts could cause problems, the resistor characteristics should be measured in a gamma-ray simulator.

In the equivalent circuit, the series resistor $\Delta R(\gamma\phi)$ accounts for any resistance increases that gamma or neutron radiation may produce. $R_s(\gamma\phi)$ represents increase in conductivity of the resistive material and leakage through the insulating material of the resistor substrate or packaging materials.

Neutron bombardment will permanently change resistor values, but the change is generally small or negligible at fluences below 10^{15} n/cm². Even so, a circuit requiring precise resistor values could be in trouble at fluences less than 10^{14} n/cm².

The permanent-damage thresholds tabulated above were obtained by measurements in fission-neutron flux, rather than a real fusion-fission neutron mixture, but are helpful in component selection. Insufficient data has been gathered on resistance variations to predict absolute changes in resistor values, so the designer must again measure changes experimentally and weigh the effect upon circuit operation.

Compton current

Absolute changes in the values of resistors—or capacitors, coils, and other passive components such as cables, batteries, etc.—generally perturb circuit operation less than the transient currents that can be generated in such components by the Compton effect. Like photocurrents, the Compton replacement currents are amplified by the operating

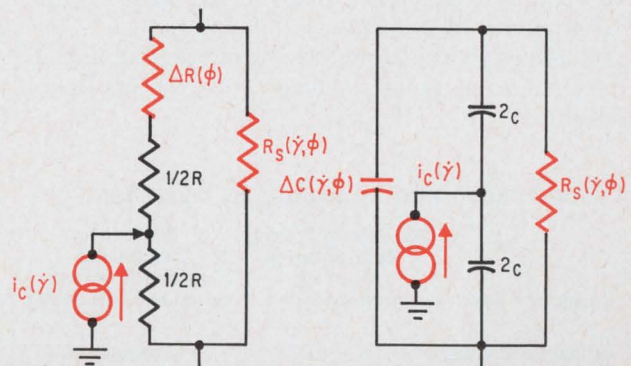

Resistor, capacitor. Changes in conductance and leakage, and Compton currents alter characteristics of resistors and capacitors.

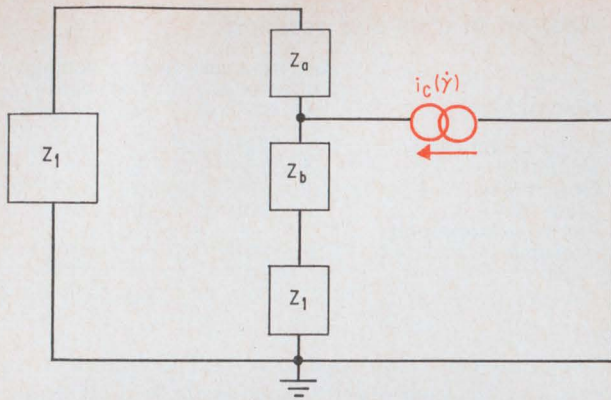

Compton currents. The replacement-current model of resistor indicates how electrons are drawn from ground to replace Compton electrons escaping from component.

transistors and contribute to nonlinearities in circuit outputs, saturation, and latchup (in monolithic transistors).

Assuming that the scattering of Compton electrons is uniform, the Compton current, $i_c(\gamma)$, is considered to be injected from ground into the center of the component, as in the resistor equivalent circuit and in the Compton current model shown above. Similar models are used for components other than resistors. In the model, V_1, V_2, V_3 are nodal voltages, Z_a and Z_b are the impedances of the two halves of the component body, and Z_1 and Z_2 are the circuit's impedance to ground from both ends of the component.

A ballpark estimate of the Compton current in resistors can be obtained with

$$i_c(\gamma) \approx 10^{-12} \gamma \quad (6)$$

where γ is the dose rate in rads per second.² One rad equals 100 ergs of absorbed energy per gram. Energy absorption varies with the material; hence the amount of gamma radiation in a rad also varies. The energy absorbed is calculated with

$$\Delta E = E_0 \int_0^{\infty} \gamma(E) \sigma(E) dE \quad (7)$$

Terms are defined on page 77.

To determine Compton current in capacitors, one can multiply γ by 10^{-11} to 10^{-10} . Precise evaluation of Compton currents in any component requires experiments in gamma-ray simulators.

Changes in the conductivity of irradiated materials can cause greater leakage in capacitors than in resistors.

Conductance and annealing in capacitors

Capacitor Type	Maximum leakage conductance mho/ μ fd/ megarad/sec.	Dielectric long-time annealing time constant (seconds)
Aluminum oxide	3×10^3	unknown
Tantalum oxide	10^2	10^{-4}
Ceramic (BaTiO ₃)	2	1
Glass and mica	10^4	1
Mylar	10^5	10^{-2} to 10^{-3}

A resistive material is essentially a conductor while a capacitor dielectric is essentially an insulator. Even though both might undergo an equal change in absolute conductivity, an insulator's relative change in conductivity could be many orders of magnitude greater, since its initial conductivity was nearly zero. Little ionizing radiation thus produces significant change in capacitor conductivity.

Conductive capacitors

The increase is considered by the circuit designer in much the same fashion as resistor leakage, and is shown as a shunt resistance, R_s , in the equivalent circuit on page 79 (R_s also includes radiation-induced leakage in the capacitor package). To calculate R_s as a function of gamma-dose rate, use

$$R_s = \frac{\epsilon \epsilon_0}{C \sigma} \quad (8)$$

The radiation-induced conductivity, σ , is found by measurement in a gamma-ray simulator. A thorough discussion of this transient effect and much data useful for capacitor selection has been published in the TREE Handbook.² The edge effects are assumed negligible in this equation. Radiation effects in the types of capacitors employed in solid state circuits, along with the effects on other components, are given on the facing page.

Conductivity rises approximately as fast as intensity rises in the radiation pulse. However, it doesn't drop immediately when the radiation subsides. The time required for conductivity to drop to an acceptable level is determined experimentally—it may be as long as 1 second.

Over-all recovery—or annealing—time depends on the dielectric's chemical purity and other factors that determine which recovery time constant predominates. Typical values are given below left, along with leakage conductance. Total maximum conductance per megarad of radiation is obtained by multiplying the tabulated conductance by the capacitance in microfarads.

Blowouts

Much of the data on permanent damage to capacitors was obtained in reactors providing a mixture of fission neutrons and gamma rays⁶. In some instances, reactor-caused damage was found in capacitors exposed only to gamma rays, but the reasons for the damage aren't clear. Some capacitors have failed spectacularly, with minor explosions or eruptions of the cans or cases of certain types of oil-filled, oil-impregnated, and wet electrolytic capacitors. The radiation decomposed the liquid and caused a buildup of gas pressure.

Test results indicate:

- Glass, mica, and ceramic capacitors are highly resistant to damage. After exposure in a reactor pile to 10^{15} n/cm² of fast neutrons and more than 10^8 rads of gamma rays, capacitance and dielectric loss factors show slight—only a fraction of a percent—permanent changes, or none at all. In addition, the thermal-neutron level in the reactor pile may be

Principle effects of nuclear radiation on components

Component	Change	Damage	Primary cause
Transistor			
Operating currents	Increase, due to photo-currents	Transient, but could contribute to permanent damage	Production of hole-electron pairs by gamma rays
Gain	Decrease, due to change in minority carrier lifetime	Transient and/or permanent	Crystal dislocations by neutrons, some of which are annealed
Temperature	Increase	Transient and/or permanent	Heating by gamma rays, R_{SAT} by neutrons
Leakage	Increase	Transient	Insulator conductivity changes from ionization and neutron damage
Diode			
Reverse characteristics	Shift	Transient and/or permanent	Due at least in part to neutron damage
Forward saturation resistance	Increase	Transient and/or permanent	Neutron damage
Leakage	Increase	Transient and/or permanent	Same as transistor
Integrated circuit			
Transistor and diode characteristics	Same as discrete components, generally larger	Same as discrete components	Same as transistors and diodes, larger photocurrents in monolithic IC's because of additional junction areas
Spurious effects	Transistor turn on (latchup) can occur, due to photocurrents	Transient	Substrate junction forms pnpn switch with nearby transistor
Resistor			
Resistance	Generally decreases (sometimes increases)	Transient, generally	Materials conductivity changes, due to ionization and neutron damage
Spurious effects	Compton current generation	Transient	Electron scattering by gamma rays
Capacitor			
Leakage	Increase	Transient, generally	Same as resistors plus electron trapping in dielectric
Spurious effects	Compton current generation	Transient	Same as resistors
Operation	Physical damage	Permanent	Gas evolution in liquid dielectrics by gamma heating
Vacuum tube			
Plate current	Increase	Transient	Secondary effect of Compton current generation by grids

10^{18} to 10^{20} n/cm² (a thermal neutron moves slowly and may have kinetic energy as low as 0.025 electron volt).

- Mylar capacitors and some types of polystyrene capacitors suffer little or no permanent damage from exposures to as much as 10^{15} n/cm² and 10^8 rads.

- Dry electrolytic aluminum and tantalum capacitors show minor permanent changes in capacitance and dissipation factors at 10^{14} n/cm² and 10^8 rads. The effects may possibly be caused more by the gamma dose than neutron fluence.

- Paper and some types of plastic capacitors can be severely damaged by gas evolution and dielectric changes. The tests exposed them for several days to approximately 10^{15} n/cm² of fast neutrons, 10^{18} n/cm² of thermal neutrons, and 10^8 rads. Long-time, gamma-ray soak tests in cobalt-60 piles, adding up to 10^8 or more rads, produce similar damage in some cases.

It is very difficult, if not impossible, to correlate accurately such test results with actual exposure to a nuclear explosion. Extent of the damage is apparently a function of the long exposure times. In contrast, an explosion would produce high-intensity gamma rays and fast neutrons for only a brief time.

Another significant difference is that the explosion spectrum outside the fireball contains hardly any thermal neutrons in comparison with the number of fast neutrons⁷. The number of thermal neutrons in conventional reactor piles exceeds the number of fast neutrons—at least in some of the cases cited. Thermal neutrons' low kinetic energy makes it unlikely that they will do any serious structural damage. However, thermal neutrons are readily absorbed by the nuclei of materials, making the materials radioactive. The half-lives of radioactive-insulating materials range from seconds to years. Emission of beta particles and gamma rays within the insulator keeps its conductivity higher than normal during that period. Since the conductivity change is persistent, it may be measured as permanent damage.

Vacuum tubes

Extensive studies have not been made of the vulnerability of vacuum tubes to ionizing radiations. However, degradation appears to be mainly transient effects of the Compton replacement current.

The grids are the chief source of Compton electrons scattered from the tube elements, so plate current increases as though a positive bias were applied to the grid. The higher conduction state persists until the replacement current can flow through the grid-bias network in the circuit. The amount of plate-current increase varies primarily with grid resistance and tube gain.

The Compton effect occurs whether the tubes are conventional glass-envelope types or ceramic-metal types. Much has been made of the radiation resistance of miniature ceramic-metal receiving tubes to radiation but this resistance shows up primarily in less damage from heat, neutrons, and physical shock.

Inductors and transformers, like resistors and capacitors, exhibit leakages and Compton currents.

The gamma-ray leakage effects in insulators, potting compounds, and printed circuit boards are similar to those in capacitor dielectrics. These effects are usually neglected by designers of hardened circuits in the early stages because they are negligible in comparison with other circuit perturbations caused by gamma rays. Fast neutrons also produce some leakage of a fairly permanent nature, and thermal neutrons produce the type of conductivity change discussed under capacitance.

References

1. F.M. Smits, "On the energy dependence of neutron damage in silicon transistors," Sandia Corp. SC-R-64-196, July 1964, Albuquerque, N.M.
2. D.C. Jones, editor, TREE Handbook (Transient Radiation Effects on Electronics), DASA 1420, Battelle Memorial Institute, July 1966, Columbus, Ohio.
3. J.R. Bilinski and R. Merrill, "Selecting transistors for radiation environments," Electronics, Dec. 25, 1959, p. 38.
4. G.C.M. Messenger and J.P. Spratt, "Effects on neutron irradiation on germanium and silicon," Proc. IRE, June 1958, p. 1038.
5. Donald Christiansen, "A challenge: to integrate and isolate," Electronics, March 20, 1967, p. 91.
6. J.F. Kircher and R.F. Bowman, "Effects of Radiation on Materials and Components," Reinhold Publishing Corp., New York, 1964.
7. Samuel Glasstone, "Source Book of Atomic Energy," Van Nostrand Publishing Co., Princeton, N.J.

Bibliography

- T.C. Helvey, "Effects of Nuclear Radiation on Men and Materials," T.F. Rider Pub. Co., New York, 1959.
- Samuel Glasstone, "Effects of Nuclear Weapons," U.S. Department of Defense and U.S. Atomic Energy Commission, Superintendent of Documents, Washington, 1957 (Revised 1962 and 1964).
- Henning L. Olesen, "Radiation Effects on Electronic Systems," Plenum Press, New York, 1966.

The authors



Joseph T. Finnell Jr., a 17-year veteran in military electronics, heads the section at the Avco Corp. that determines nuclear vulnerability of missile systems.



David D. Bertetti joined Avco's nuclear-effects section four years ago. He now heads the circuit design, analysis, and evaluation group of the section.



Fred W. Karpowich is studying transient-radiation effects. He designed hardened circuits at the Hughes Aircraft Co. and the Philco-Ford Corp. before joining Avco as a senior staff engineer.

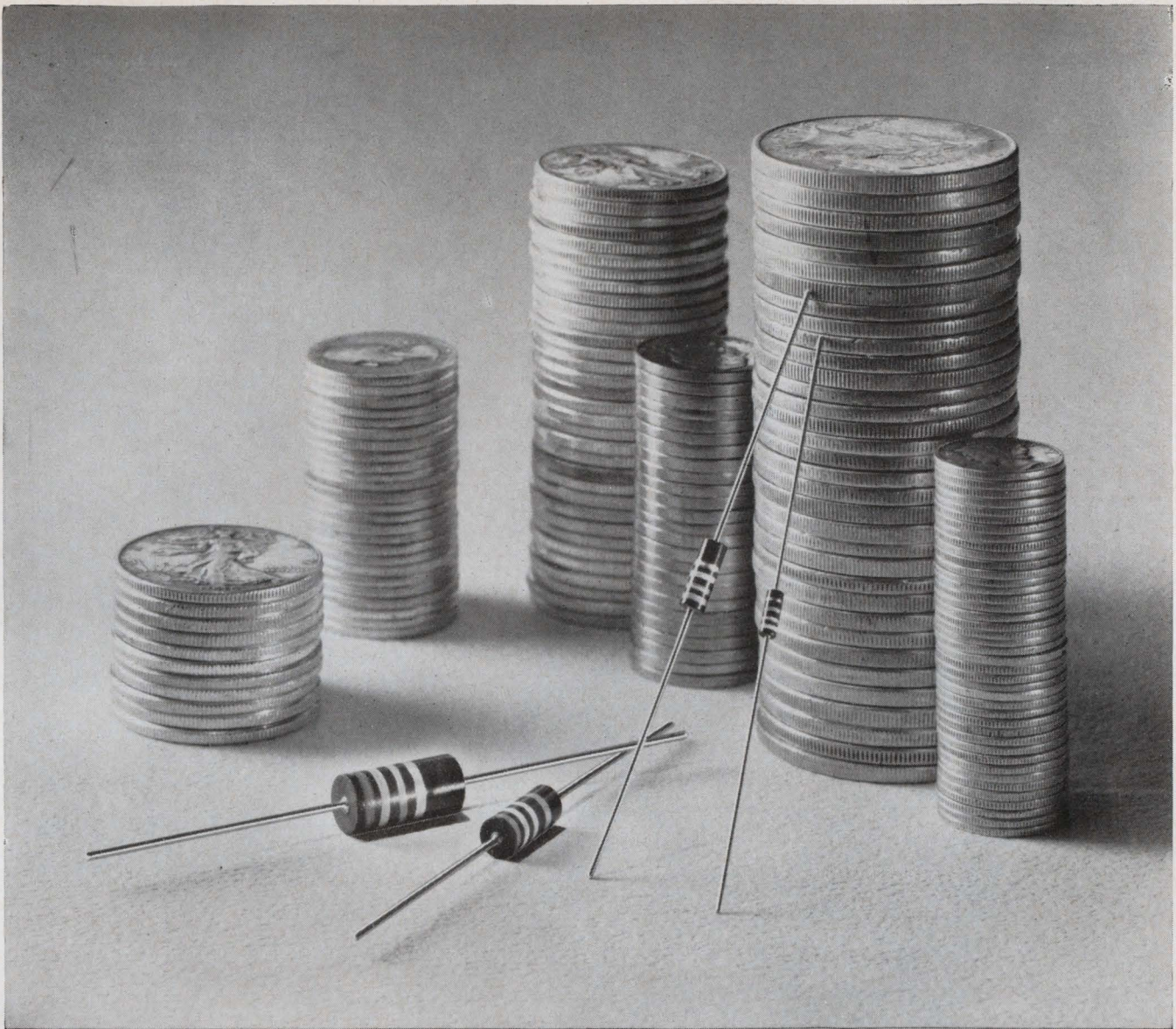

Quality Need Not Be Expensive

Some people would have you believe that to buy the best, you must pay the most. This is not necessarily true. Price is only a measure of value—never a substitute for it.

At Stackpole, the real value of any resistor is determined by a combination of its performance record and its price. Perhaps this is why so many of our customers continue to specify Stackpole resistors year after year to maintain top performance for established products and for their new ones, too. Such confidence and loyalty cannot be based on price alone.

Uniformity has become the accepted characteristic of Stackpole resistors. Unique production methods, coupled with in-depth experience in manufacturing and testing are your assurance that Stackpole resistors will give you absolute performance. The resistors you order today will be identical in every way to your last order.

Most leading manufacturers of electronic equipment have long recognized Stackpole resistors for reliability.

Whether it be the rugged demands of portable television or the critical tolerances of space age communication and tracking equipment, Stackpole resistors deliver the performance you expect—the kind of dependability that builds a reputation for your products.

Why continue to pay a premium for quality? Let us prove that you get value from Stackpole. Quality resistors, economically priced, are delivered promptly and backed up by our complete corporate facility. Next time, specify Stackpole. There's a family of fine resistors available in sizes of 2, 1, $\frac{1}{2}$ and $\frac{1}{4}$ watts. For samples and additional information, write: Stackpole Carbon Company, Electronic Components Division, Kane, Pa. Phone: 814-837-7000 — TWX: 510-695-8404.





**Good old,
reliable,
faithful,
trustworthy,
proven,
tested,
workable,
dependable,
consistent,
versatile,
Signetics
SP-600 series
is now
better than ever**

Guaranteed fan-out has been increased from 4 to 8.
And the operating range is now 0° C to +75° C.
Signetics SP-600 was the first DTL line in the industry to offer the convenience of the dual in-line silicone package. Find-out for yourself. Send for specs and reliability data based on two years of extensive testing. Write Signetics, 811 E. Arques, Sunnyvale, California 94086. Good old Signetics.

**SIGNETICS
INTEGRATED
CIRCUITS**



A SUBSIDIARY OF CORNING GLASS WORKS

SIGNETICS SALES OFFICES: Metropolitan New York (201) 992-3980; Upper New York State (315) 469-1072; Southwestern (214) 231-6344; Western Regional (213) 272-9421; Eastern Regional (617) 245-8200; Mid-Atlantic (609) 858-2864; Southeastern (813) 726-3734; Midwestern Regional (312) 259-8300; Northwestern (408) 738-2710.

DISTRIBUTORS: Compar at all locations listed below. Semiconductor Specialists, Inc. (312) 279-1000; Terminal Hudson Electronics (212) 243-5200; Wesco Electronics (213) 684-0880; Wesco Electronics (405) 968-3475; Hammond Electronics (305) 241-6601; Avnet Electronics Corp. of Massachusetts (617) 272-3060; Pioneer Standard Electronics Inc. (301) 427-3300.

DOMESTIC REPRESENTATIVES: Jack Pyle Company (415) 349-1266. Compar Corporation at the following locations: Alabama (205) 539-8476; Arizona (602) 947-4336; California (213) 245-1172; California (415) 697-6244; Colorado (303) 781-0912; Connecticut (203) 288-9276; Florida (305) 855-3964; Illinois (312) 775-5300; Maryland (301) 484-5400; Massachusetts (617) 969-7140; Michigan (313) 476-5758; Minnesota (612) 922-7011; Missouri (314) 428-5313; New Jersey (609) 429-1526; New Mexico (505) 265-1020; New York (518) 436-8536; New York (607) 723-8743; New York (716) 684-5731; New York (201) 471-6090; North Carolina (919) 724-0750; Ohio (216) 333-4120; Ohio (513) 878-2631; Texas (214) EM 3-1526; Texas (713) 649-5756; Washington (206) 725-7800.

INTERNATIONAL SALES: France, Germany, Italy, Belgium, Holland, Luxemburg, Spain—Sovcor Electronique, 11, Chemin de Ronde, Le Vesinet. (S.-&O.) France. United Kingdom, Ireland, Sweden, Denmark, Norway, Switzerland, Austria, Portugal—Electrosil Ltd., Lakeside Estate, Colnbrook-Bypass Slough, Buckinghamshire, Great Britain. Australia—Corning, 1202 Plaza Building, Australia Square, Sydney, N.S.W. 27-4318. Canada—Corning Glass Works of Canada, Ltd., Leaside Plant, Ontario, Canada (416) 421-150. Israel—Optronix, P.O. Box 195, Ramat-Gan, Israel 724-437. Japan—ASAHI Glass Co., Ltd., Corning Products Sales Dept. No. 2, 3-Chome Marunouchi, Chiyoda-ku, Tokyo, Japan.

Computer aid on the ocean floor

A 700-mile underwater telephone cable, linking Vietnam and the Philippines, was laid in eight days as a shipboard computer calculated critical equalizers spliced between repeated cable points

By Oswald R. Reh

U.S. Underseas Cable Corp., Washington

Typhoons twice howled across the cable ship's route, causing rough seas for many days, and once there was a hurricane, but the computer clicked merrily along, performing its programmed calculations despite the rolling, pitching, and yawing of the ship *Neptun*. A telephone cable had to be strung along the bottom of the South China Sea that would connect South Vietnam and the Philippines.

The war in Vietnam, with its increasingly heavier communication requirements between Saigon and the Philippines, placed a heavy premium on speed, and any technique that could save months in cable-laying was happily seized by the U.S. Underseas Cable Corp., assigned the task by the Air Force.

During the eight days of the mission, the computer solved two big problems. First, it determined the component makeup for the equalizers needed to counteract the electrical loss of each 10-part cable section. And it determined the component values for each equalizer.

The experience gained in laying the much-needed voice link between Vietnam and the United States' friendly ally, produced a technique that can be applied to any communication system where on-the-spot equalization, adjustment of signal strength and a delay-time equalization of a wide frequency band are required: high-speed data transmission, computer-controlled relay systems, missile-range test-

ing, satellite tracking, missile and submarine detecting, and tracking and destroy systems.

The cable link provides 60 telephone channels in each direction, making possible 60 simultaneous phone conversations. Each channel has a 4-kilohertz bandwidth. Multispeech transmission requires a wide frequency band but such a frequency range causes large electrical losses. Loss of signal strength is proportional to cable length; in a sea cable the problem is complicated by different ocean temperatures, water pressures, and cable stresses.

In laying sea cables such as this one, repeaters are spliced into the cable at specified intervals to compensate for the loss in signal strength. In the Vietnam-Philippines link, it was necessary to use 41 repeaters. The losses are adjusted against a predetermined figure based on an examination of the ocean terrain. Deviations from the expected values can be ascertained accurately during the cable laying. After every 10 repeaters, defined as an ocean block, an equalizer containing passive filters is inserted to compensate for any losses not overcome by the repeaters.

Splicing points

Determining the complicated equalizer circuits and equalizer component values is a time-consuming task if calculated with manual techniques, or even with the help of electrical calculators. In conventional cable-laying operations, adjustments of the equalizer must be determined by stopping the cable-laying operation while the calculations are being made. Besides slowing progress, halting the ship endangers the success of the entire installation, especially in the face of hazardous weather conditions.

The only way to meet the short schedule for laying the Vietnam-Philippines link, colorfully labeled the *Wetwash A* cable system, was to accomplish the entire equalization process aboard ship. Compli-

The author



Oswald R. Reh heads the technical center of U.S. Underseas Cable Corp. He supervises the electronic computer and data retrieval centers, and the electronic laboratory. He has had 10 years experience in the design and development of carrier-frequency equipment and underwater repeaters and equalizers.

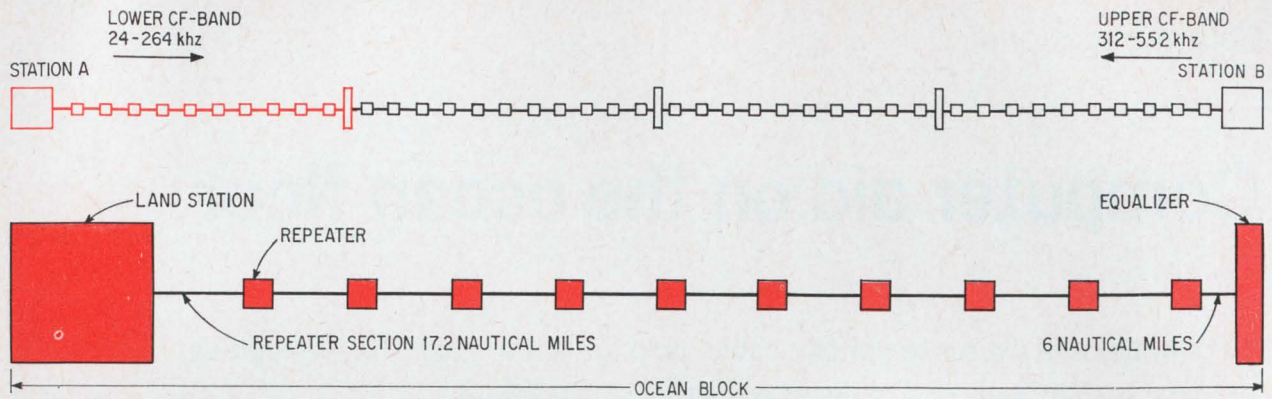

Battle plan. Between South Vietnam and the Philippines, the two land stations, 41 repeaters and three equalizers were laid in four ocean blocks.

cating the problem was the extra-ordinary length of the cable, twice any previously laid. It was obvious that a computer, small in size but capable of withstanding all sorts of weather-produced rigors, was an absolute necessity. It had to work with the utmost precision even as the ship rolled, pitched, and yawed in a typhoon, if need be. Equally important was the availability of a manufacturer's repair and adjustment services on a worldwide basis. Furthermore, the computer had to be easily programed to operate from special programs.

Many tried, one chosen

Many computers were carefully considered before an IBM 1620 was finally chosen. At the end of August 1964 the cable ship Neptun was berthed at Nordenham, Germany, and the 1,320-pound com-

puter was installed in a test room in the ship's fore bridge, one deck above the main level, and secured against the stormy seas by bottom plates firmly screwed into the steel deck. Its output-typewriter, with its movable carriage arranged to operate along the longitudinal ship's axis, had been checked while in operation to determine whether it would continue to function in heavy seas. A similar test was made on the paper tape read and the punch unit. There was no malfunctioning or interference in any of the three units.

The computer manufacturer established a frequency-stability requirement of ± 0.5 hertz for the power supply. But previous experience with a-c motor-alternators—the ship board supply source—indicated that a frequency stability of only ± 1.0 hz could be met. Fortunately, tests showed that the re-

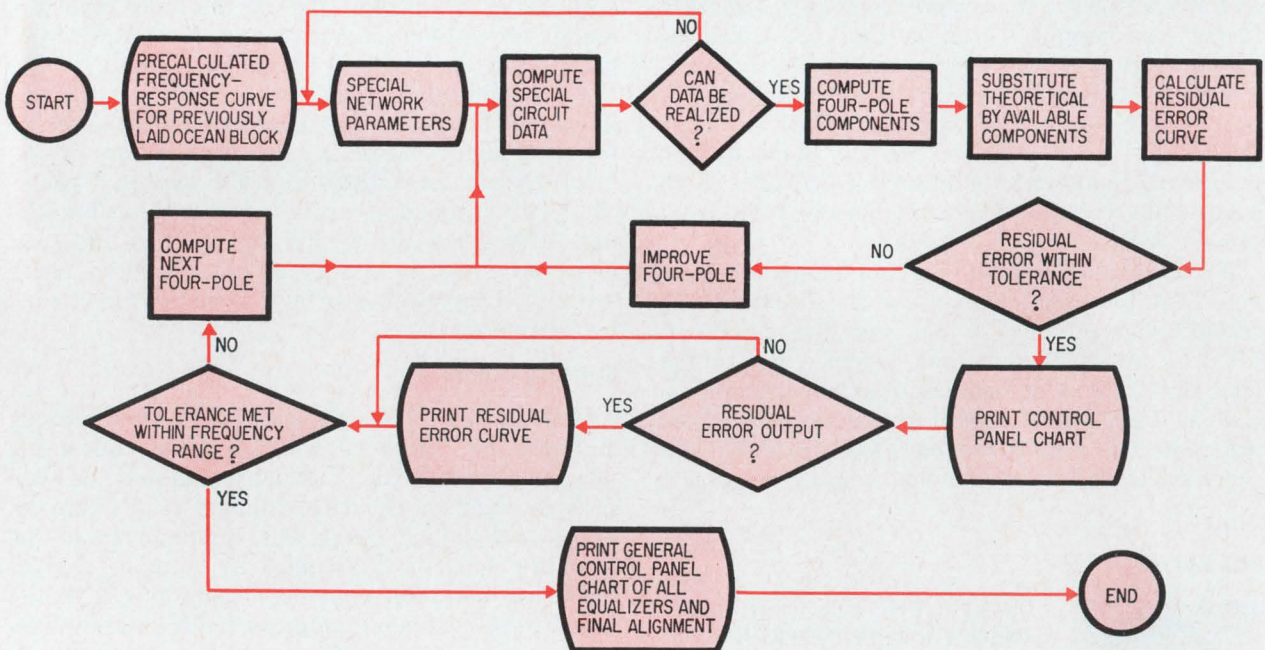

Equalization program. Component values for the bridged-T networks within each equalizer are computed by following this computer routine. To start, a frequency-response curve is prepared for the first ocean block laid. This is then compared with a desired frequency-response curve for the section. Special network parameter data is added to the deviations between the two curves and the computer determines whether the bridged-T networks can be made with the available components. If they can, the computer determines their values. If they can't the parameter data is readjusted. Process is repeated for each ocean block as it is laid.

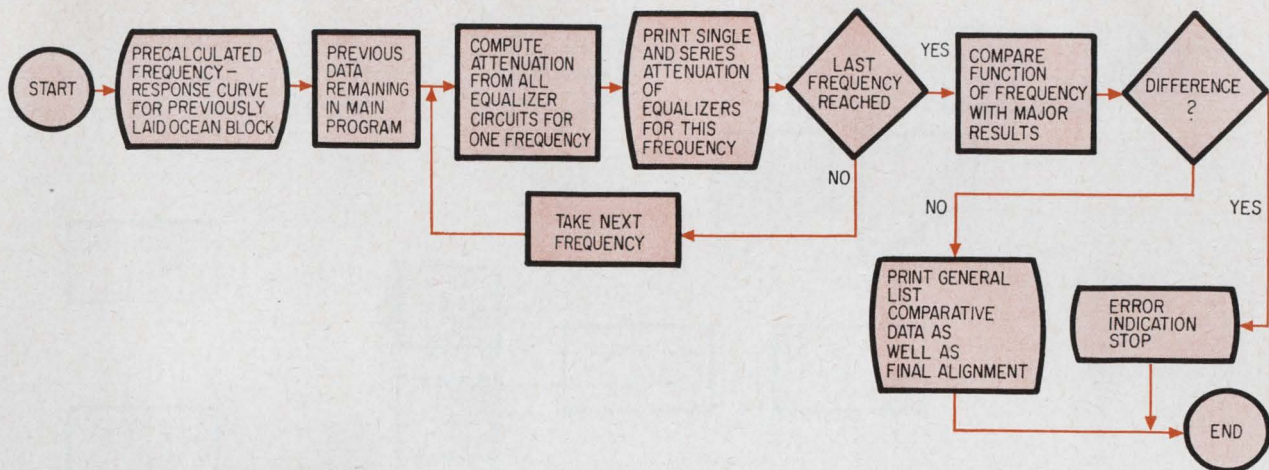

List program. All equalization data not erased from the main program when it concludes is compared against the desired frequency-response curve. Values are determined for the components based on the deviation.

quirement set by the computer manufacturer was conservative; the computer was found to calculate precisely even with frequency variations of ± 2 hertz.

The cable was divided into 42 parts, based on the best solution for noise factor and overload. Each part, called a repeater section, measured 17.2 nautical miles. Repeaters were connected between each section of the previous 17.2-mile cable length. At the end of 10 repeaters an equalizer was connected. Each 10-block repeater grouping formed what was designated an ocean block. There were 41 repeaters, three equalizers and four ocean blocks.

Computer aid

To design the equalizers, part of the cable already laid was tested continuously and the test data immediately stored in the computer and on punched tapes. Partial tests were performed on the block every half hour and a full test every two hours.

Two substantial curves were evaluated. One contained the measured data representing the frequency response curve of the entire ocean block just laid; the other specified the desired frequency response for the block. Then the computer processed the two curves to determine the necessary compensation. The compensation data was then used to synthesize the passive bridged-T networks that accomplish the equalization. Characteristics of the available passive components were also stored in the computer, so that the machine could compare the synthesized data with the characteristics of the components.

The complete equalizer contains about 20 bridged-T networks in cascade, the line and power separating filters, and two prefabricated adjustable cable-building-out networks. Each T-network is built with a similar design but has different component values. Because the equalizer contains no active networks, an equalizer section is shorter than a repeater section—12 instead of 17.2 nautical miles. Using the main computer program the engineer is able to simulate the frequency response of a bridged-T section.

Adding these sections in cascade between two

ocean blocks compensates for the loss in the previously laid block. A typical comparison of an uncompensated and compensated ocean block is at the bottom of page 88. The bottom curve represents the final residual deviation. A list of the calculated component values for all individual networks is typed out from the data provided by the computer. In addition, the frequency response of each bridged-T network can be obtained with the aid of the list program which calls upon the stored data available from the main program.

A correction program was prepared in the event the network components had to be modified or, an equalizer had to be changed. All previously calculated data was stored in the correction program so that it was not necessary to refeed this information or repeat calculations of the whole program.

The laying of the South Vietnam-Philippines sea cable started on November 19, 1964, at which time telecommunication was established over the cable between the terminal station and the test room aboard the cable ship. As the cable was laid out, it was tested from both sides from the ship and from the terminal land station.

Time to calculate

During the laying of the cable, the ship reduced its speed from six knots to three when reaching the



Cable ship. Neptun during the cable-laying operation. Cable is laid continuously from the front end of the ship.

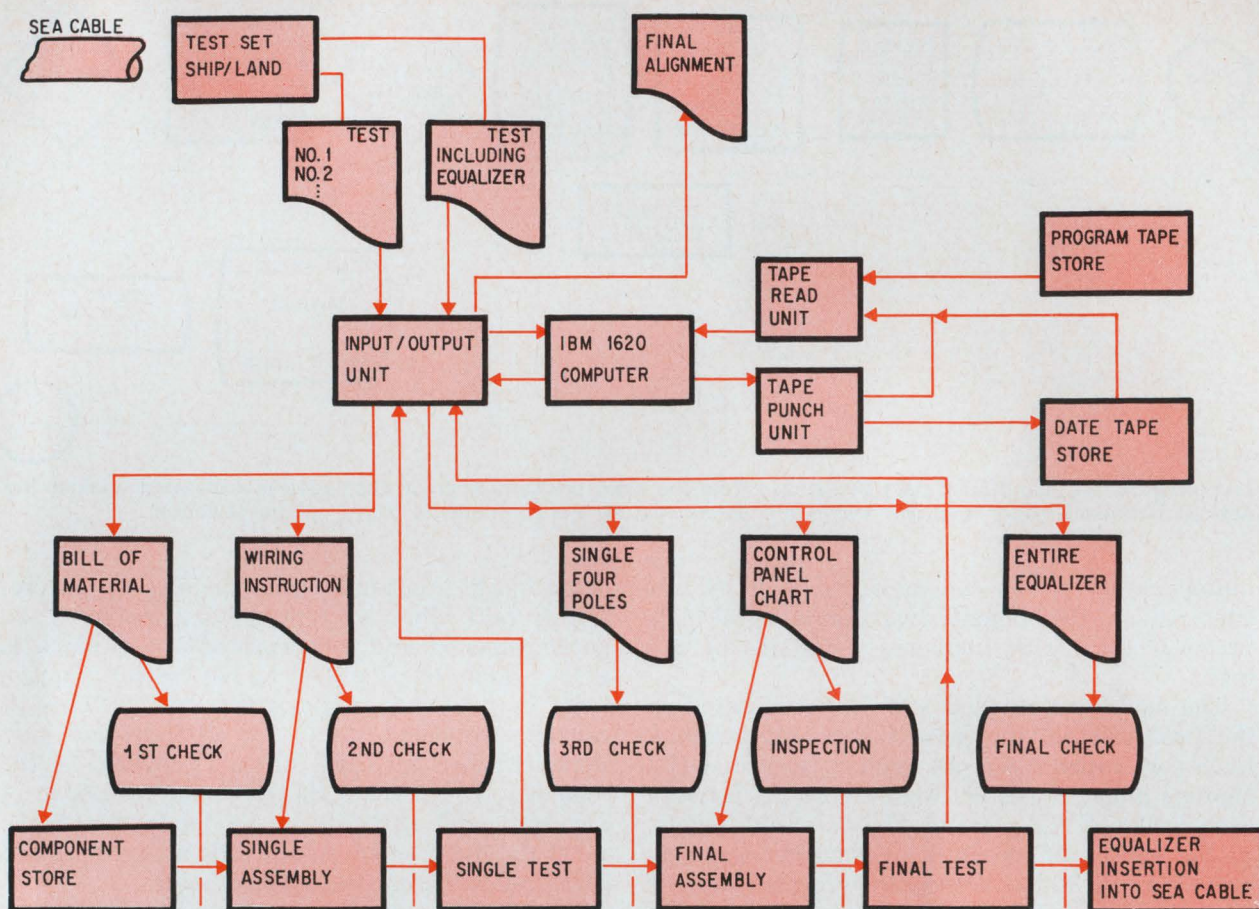

Testing procedure. Equalizers are run through a series of tests before they are inserted into the cable.

last third of the first ocean block. Thus there was enough time in which to make the calculations, assemble the equalizer, and test and splice it into the cable. At the beginning of this period of reduced speed, the computer successively processed the extrapolation, evaluated the tests, calculated the block characteristics on the ocean bottom and then set up the nominal equalizer curve.

The prefabricated repeaters were flown to all

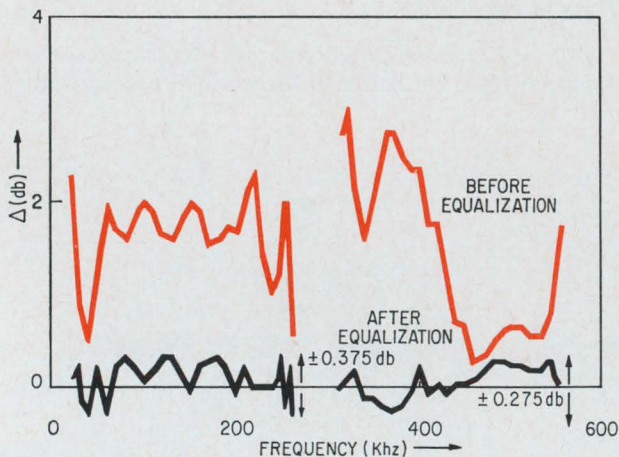

Achieving equalization. Upper curve represents the frequency response for the entire sea-cable link before equalization. Adding the equalizers results in the desired lower curve.

ports of call of the cable ship. As each repeater arrived, it was tested, spliced into the cable and stored in the holds of the ship. Subsections of the cable—the ocean blocks—were successively assembled and precise tests taken at every stage. All these tests—a series of attenuation measurements after the splicing in of each repeater—were stored on the paper tapes and evaluated by the computer.

As soon as a block containing 10 repeaters was completed, further information on the temperature of the subsection was determined. On several occasions the shipboard tanks, which contained the particular ocean block, were flooded and the block tested.

The ocean block completed first was tested at different temperatures by using water from the Atlantic, the Caribbean and the Pacific. When the water temperature was constant, the tank was flooded and the cable was allowed to reach a stable temperature. Then a variety of test data was taken. All evaluation of the test data was performed by the computer. This made possible a more precise calculation of the loss of signal strength in the cable after it had been laid.

When the Neptun reached the Philippine coast on November 27, 1964, eight days after it started, it had laid 700-nautical miles of sea cable without any interruptions and had written a new chapter in the history of computer-aided design for communications.



Guide to Machlett Electron Tubes

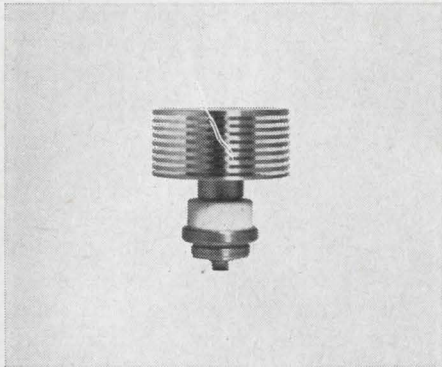

Planar Triodes.

Grid pulsed to 1 kw at 6 Gc. To 35 kw in pulse modulator service. For communications, radar beacons and navigation.

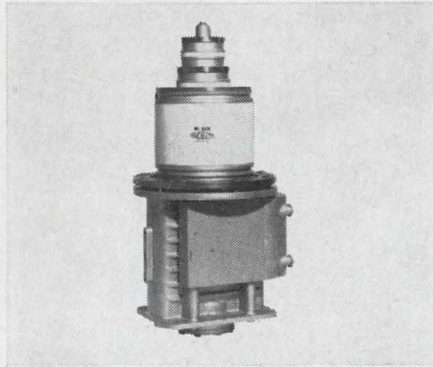

Magnetic Beam Triodes.

Pulsed ratings to 6 Mw with only 2.5 kw drive. CW ratings to 200 kW with only 0.7 kW drive.

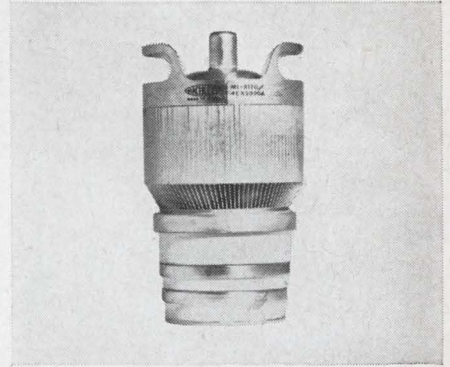

Heavy Duty Tetrodes.

Forced air cooled, water cooled and vapor cooled for broadcasting and communications.

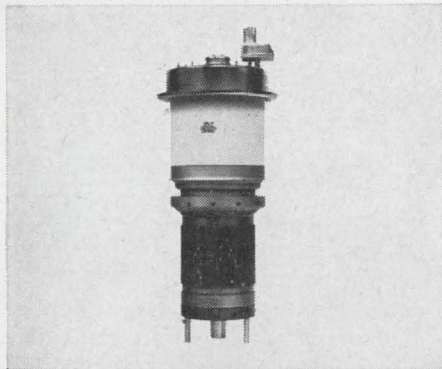

Pulse Modulators.

Shield grid triodes (oxide cathode) to 4.5 Mw, 80 kv peak. High voltage triodes (thoriated tungsten cathode) to 20 Mw with plate voltages to 200 kv peak.

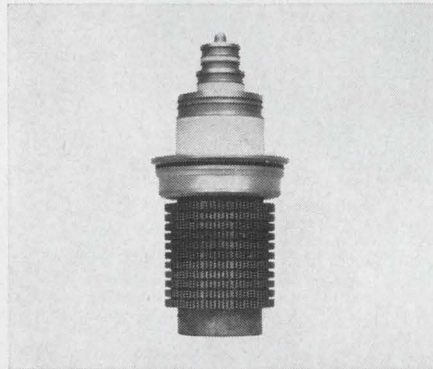

Heavy Duty Triodes.

Includes vapor cooled triodes, to 440 kW CW.



Vacuum Capacitors, Variable.

RMS amperes to 75A; voltage to 15 kv peak. Capacities from 5-750 pF to 50-2,300 pF.

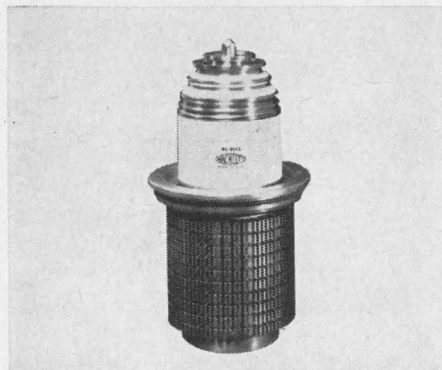

High Power Tetrodes.

Vapor cooled tetrodes to 350 kw CW for communications.

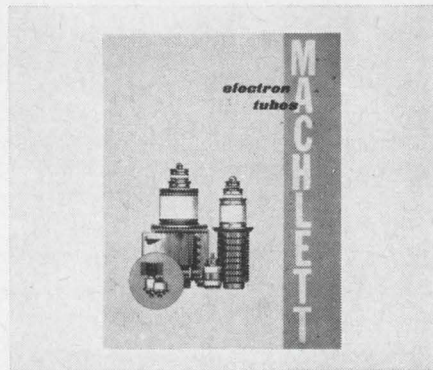

Send for latest condensed catalog

covering the entire line of Machlett electron tubes.
Write: The Machlett Laboratories, Inc.,
1063 Hope Street, Stamford, Conn. 06907

RAYTHEON

THE MACHLETT LABORATORIES, INC.

A SUBSIDIARY OF RAYTHEON COMPANY

It comes clean out of our test bath

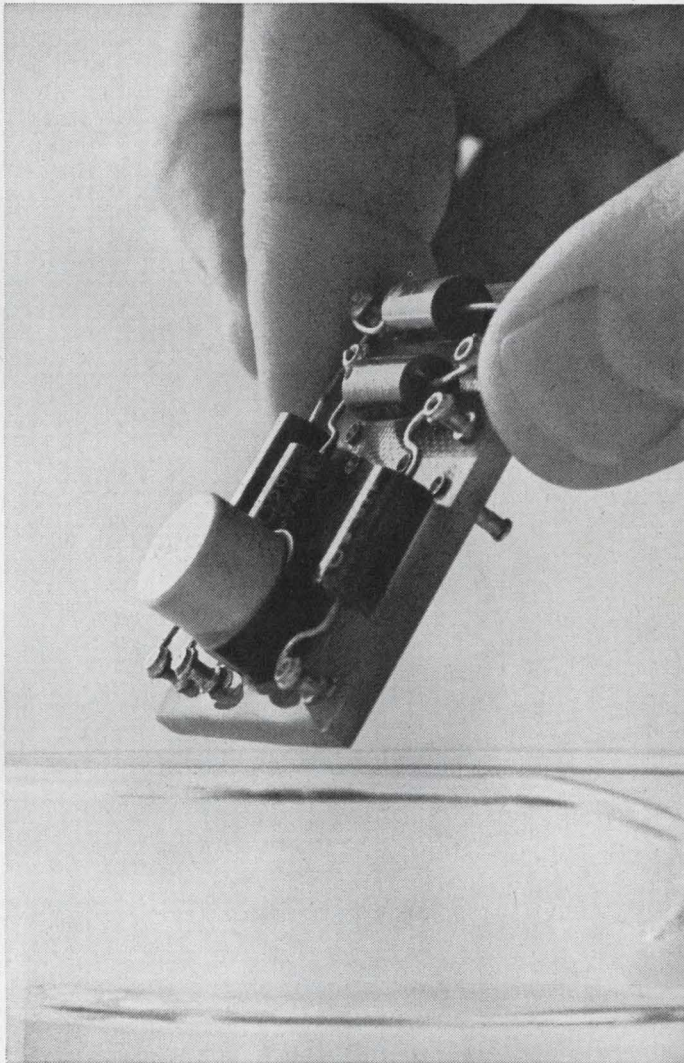
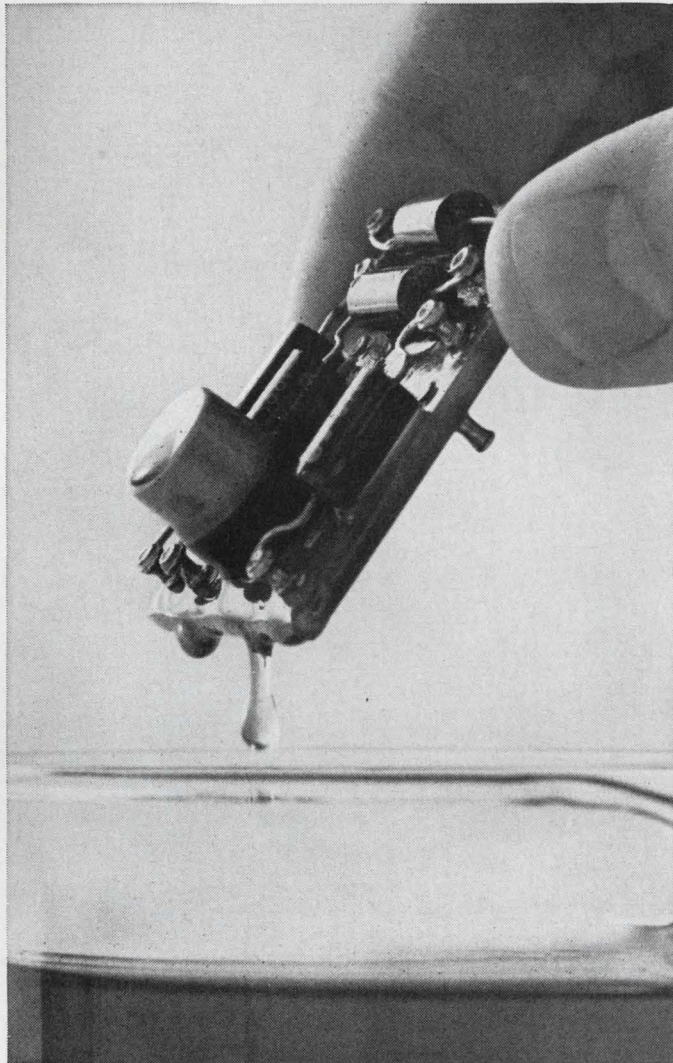

Temperature test your integrated or hybrid circuits in a 3M Brand Inert Fluorochemical Liquid and it'll drain clean, dry immediately and leave no residue.

Unlike conventional test bath fluids, with our Inert Liquids there's no costly cleaning stage to slow down production.

3M Brand Inert Liquids—FC-43, FC-75, FC-77, FC-78—also give you a wide liquid range so you can use them at both high and low temperatures, high dielectric strength for electrical insulation, compatibility to prevent adverse effects on sensitive materials, and non-flammability to make them safe.

With those properties and that kind of reliability—plus efficiency at removing heat—it's no wonder

our Inert Liquids work equally well as coolants. Test them for either application.

3M Chemical Division
Dept. KAX-107, St. Paul, Minn. 55101

Send me all the details about 3M Brand Inert Liquids.

Name _____

Company _____ Title _____

Address _____

City _____ State _____ Zip _____

Chemical Division **3M**
COMPANY



When it comes to electrical tapes, Mystik is king!

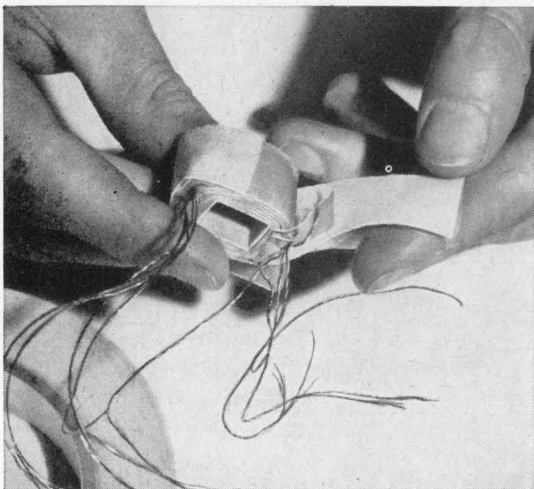

No doubt about it, Mystik leads the field in special-purpose tapes. Our extensive line of top quality products are perfect for hundreds of applications ranging from conventional industrial uses to the more sophisticated demands of the space age.

Mystik tapes are made in a wide range of materials including paper, plastic, cloth and glass cloth as well as many types of films and foils. They provide physical and performance characteristics of every description and are suitable for binding, shielding, strapping and insulating. Mystik pioneered tapes with heat-resistant silicone adhesives that grip like a vise even when exposed to high temperatures. Other new tapes are continually being developed to keep pace with the needs of the rapidly-expanding electrical industry.

We'll gladly prove our right to the "crown". Our local distributor will assist you in selecting the right tape for your application. He's in the Yellow Pages under "Tape" or write The Borden Chemical Co., Mystik Tape Div., 1700 Winnetka Ave., Northfield, Ill.



**BORDEN
CHEMICAL**

Machine looks, listens, learns

It employs a matrix-expansion technique, five-state memory units, and a "don't know" capability, to identify spoken or graphic inputs, differentiate between similar patterns, and eliminate any guesswork

By G. L. Clapper

International Business Machines Corp., Raleigh, N. C.

Capable of learning, responsive to the spoken word, but requires patient repetition to retain lessons—these phrases might have been lifted from the report card of some slow but willing student. They also describe a fast and willing machine that can learn to identify both graphic and spoken inputs, and that demonstrates the feasibility of three new techniques in adaptive pattern recognition.

Because the unit is adaptive, its organization makes no allowance for prior knowledge of the input data's exact nature. For example, if the design were used in a voice-controlled milling machine, it could learn to obey commands like "up," "down," "left," "right." But it could also, without any redesigning, learn to obey a Frenchman's "montez," "descendez," "à gauche," "à droite," or a Spaniard's "suba," "baja," "a la izquierda," and "a la derecha."

The machine is not designed to recognize any particular kind of inputs—be they 10 decimal digits, up to 16 arbitrary patterns, or 16 different syllables in any language. Rather it is shown the sequence of patterns or syllables one at a time, together with the desired outputs for each one. It then sets up its own decision criteria upon which to base recognition of further inputs.

The present model is limited in size and capability, but the principles embodied in it could be

incorporated in larger versions that might, for example, permit a computer to be programed by spoken instructions, or an unmanned spacecraft to be directed to alter its operation upon commands from a ground station.

To recognize both written and verbal inputs, the demonstration model employs:

- A relatively simple expansion of the input patterns that heightens the differences between similar patterns.

- A bank of five-state adaptive memory units that stores patterns for comparison with inputs.

- A parallel summation technique that enables the machine to make a "don't know" response, as well as "yes" or "no."

In the demonstration model, the input patterns are stored in a 3-by-5 matrix of flip-flops. This stored pattern is then expanded into a 7-by-5 matrix, with a technique independent of the size of the matrix. The same technique could be used to differentiate among more complex patterns in the input matrix of a larger machine.

Longer memory

The five-state, or quinary, adaptive memory units [see "Five states of learning," p. 98] learn faster and retain information longer than the infinite-state arrangements used in some previous adaptive pattern recognizers.

The decision techniques used elsewhere involve a threshold upon which a "yes" or "no" response must be made for every input pattern. But with the parallel summation method used in the demonstration model, all the previous experience of the machine is available instantaneously to decision circuits that can generate any one of the three possible outputs [see "Three-way decision," p. 101].

One earlier adaptive pattern recognizer, the Perceptron developed at Cornell University, contains

The author



Gene Clapper holds the title of IBM Fellow, the company's highest technical rank. Currently studying adaptive systems and speech recognition techniques, he has been with IBM since 1934, and has developed a large number of circuits, subsystems, and machines. He holds 60 U.S. patents.

an array of motor-driven potentiometers controlled by the difference between the actual output and the desired output. In another earlier unit, Stanford University's Adaline, a chemical cell's resistance is varied by plating or deplating metal on a carbon electrode.

Because both the potentiometers and the chemical cells, called Memistors, can have any resistance between their minimum and maximum values, they have, in effect, an infinite number of states. They therefore have an easy time learning the difference between two similar patterns, U and V, for instance, but a hard time discerning that A and A are two versions of one pattern.

Also, the Memistors take several seconds to change from one state to another, and can't be depended on to stay in a given state for longer than an hour or so. The quinary memory units, on the other hand, change states in a microsecond or less and will retain a state as long as electric power is available.

Third choice

In a pattern recognizer that depends on a single "yes-no" threshold, the machine must either discern or not discern a resemblance between every pattern presented to it and a learned pattern. Such an arrangement leads to somewhat arbitrary decisions when the input is near the threshold. And if the threshold has a tendency to drift, as is the case with the Memistor, these close decisions are more likely to be wrong even though the basic pattern has been thoroughly learned.

But in the present machine, the adaptive quinary memory units store all the previous experience of the machine. Input patterns gate weighted sums from the memory units to four three-way decision circuits, which indicate whether the summation is substantially positive ("yes"), negative ("no"), or nearly zero ("don't know"). The three states aren't stable, but simply indicate a sum of several stable

states of the adaptive memory units.

In contrast, an adaptive system using a serial-search method looks through records of all its past experience, one record at a time, before responding to any input. An example here would be the well-known checkers-playing computer program developed at the International Business Machines Corp. during the 1950's. Before making any move, the computer reviews prior games stored on magnetic tape or in a disk file to see if it ever encountered a similar situation, what it did at that time, and how the move turned out. As it plays more games, it accumulates more data; the searching time could eventually make the computer an exasperating slow player.

Spoon feeding

The demonstration pattern recognizer accepts graphic data written by stylus on a 3-by-5 front-panel array, and verbal inputs spoken into a microphone and passed to a binary encoder, or word-code generator. After the input is recorded as a pattern in the smaller internal flip-flop matrix and expanded in the larger one to show up in greater detail, it is applied simultaneously to four banks of memory units. Four decision units compare the enlarged pattern with previously learned patterns in the memory banks, and generate four binary signals that are decoded into one of 16 possible outputs identifying—or not identifying—the input.

To train the machine, the operator presents each input pattern in turn, manually selects the desired output for that input, and presses a button that conditions the memory banks.

With the memory completely cleared, as it is when power is first turned on, the operator might first trace a 1 on the write-in matrix, set a rotary switch to the appropriate output—putting a binary-coded decimal 1 on four lines to the four memory banks—and press the "condition" button. The operator can handle the figure 2 in the same way, and

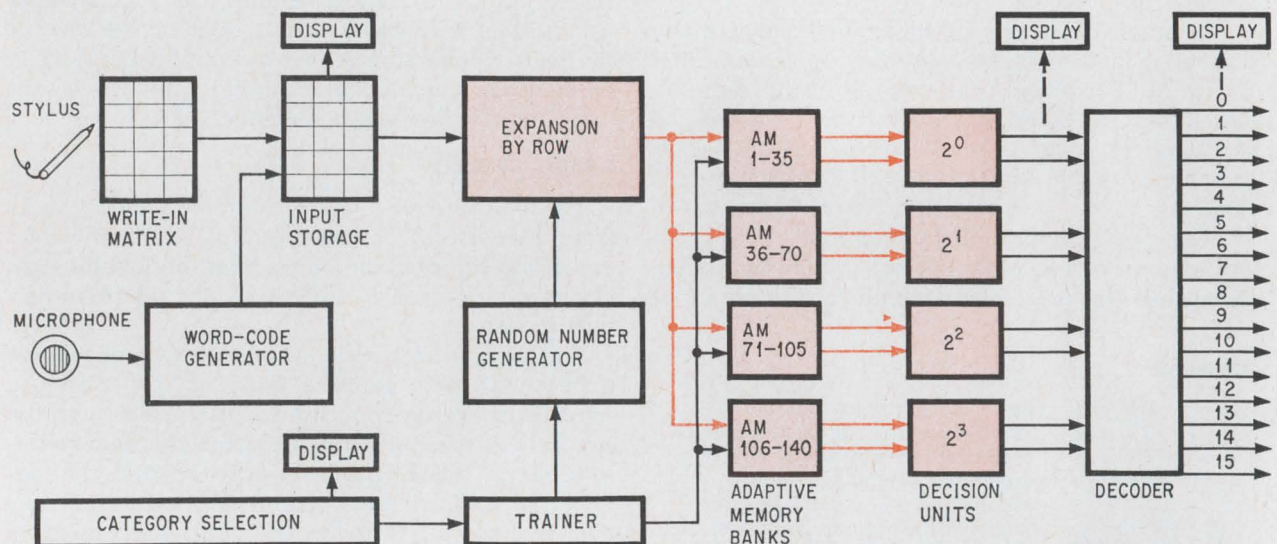

Graphics and voice. Both kinds of input set up patterns in the 3-by-5 input storage, which is expanded into a 7-by-5 matrix row by row. The expanded pattern gates weighted sums from the corresponding adaptive memory units to the decision units, which produce a binary output if they recognize the pattern.

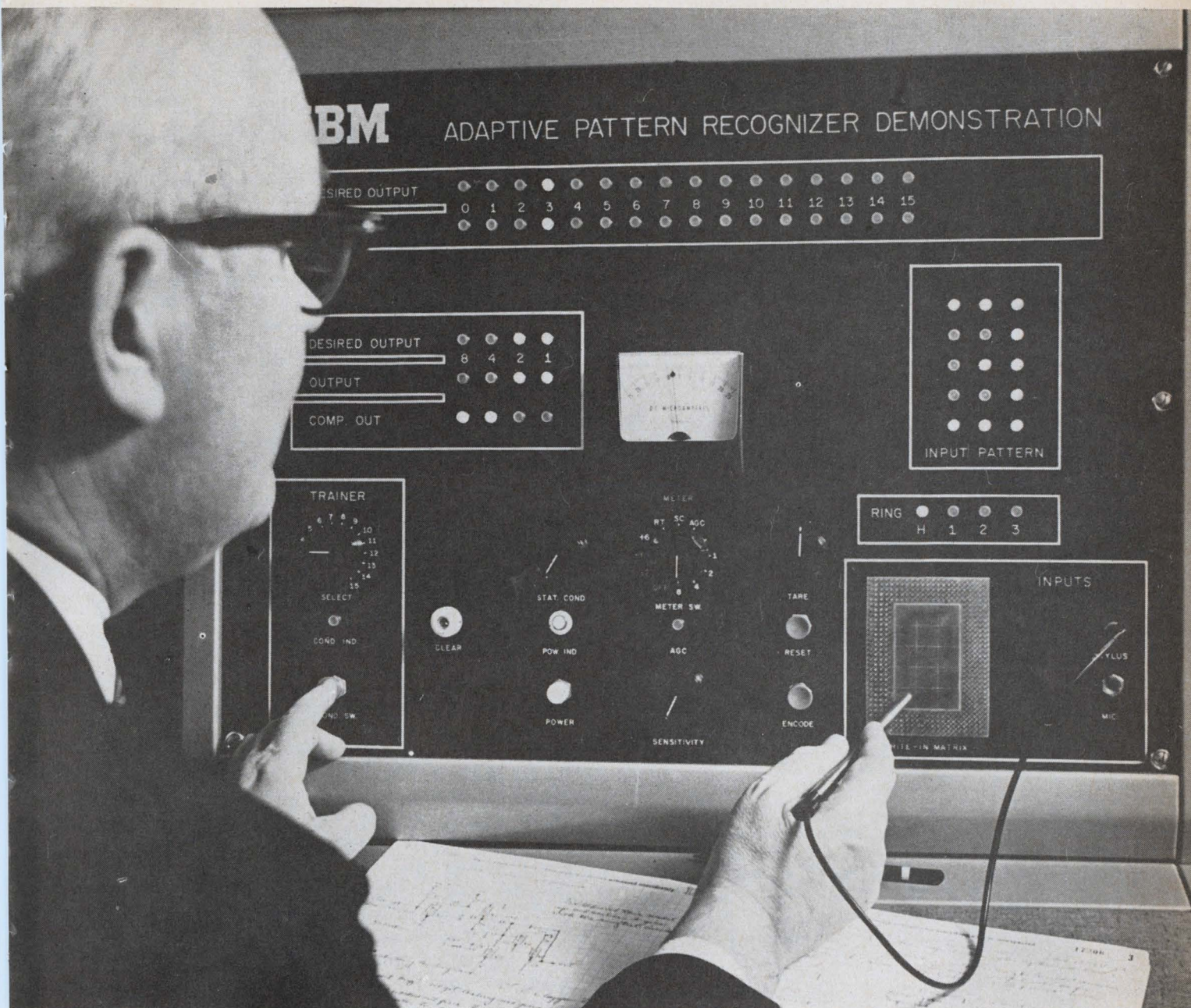

Pattern recognizer. Double row of lights at top show desired output and actual output. The author has entered the digit 3 on the write-in matrix at lower right; it appears in the matrix display at center right. He has also set the trainer at 3 and pressed the conditioning key, thus matching the actual to the desired output. The same signals are displayed in binary form at the left of the meter. The encode key blocks out the background noise when the microphone is not in use, the reset key clears the input matrix, and the clear terminal wipes out all previous training.

if he goes back to input 1, the machine will probably recognize it at this point without being further conditioned.

If, however, he then teaches a 3 to the machine, it may become confused when it again sees either the 1 or the 2, and the operator must then go back and retrain it for the earlier inputs.

For each new pattern presented during training, the machine generally has to be retrained for two or three previously learned patterns, particularly if they resemble the new input in some way. Distinguishing between 0 and 8 is always troublesome, for example, because when traced out on the 3-by-5

matrix the figures differ only in the presence or absence of the center bit—the cross-over of the 8. Three or four iterations are usually sufficient, though, to train the machine to differentiate between such pairs reliably thereafter, and a few more iterations can teach it all patterns in a set.

The input set can include variations of some or all the patterns if these are known in advance. And the machine can handle considerable variation from the original set once its training is complete.

In the case of sets without variations—the 10 decimal digits, for example, where a 2 always looks like a 2, a 6 like a 6, and so on—arbitrary small

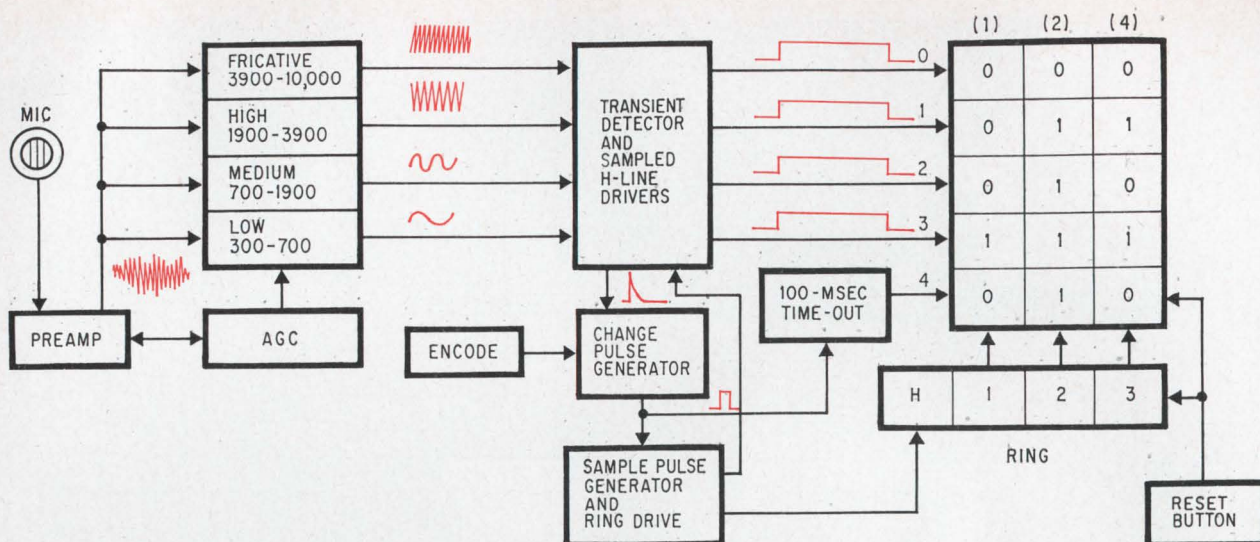

Four frequency bands. The spoken input "nine" sets up a pattern in the 3-by-5 matrix through a set of four filters. A timing circuit determines whether a speech segment exceeds 100 milliseconds.

differences between successive inputs of the same pattern are introduced. Without this technique, called statistical conditioning, the machine would have to learn the full set of input patterns without seeing anything less than the complete characters, a difficult task. With this conditioning, however, it learns that each digit is represented by one of several sets of identifying features, each set smaller than the one describing the complete character. Thus, the demonstration model could identify a pattern as a 1 just from seeing part of the down-

stroke and perhaps the base of the figure.

Statistical conditioning isn't necessary when dealing with verbal patterns, which are varied enough even when the same person does all the speaking.

Clipped sounds

Spoken inputs are encoded by the word-code generator; a set of four broadband frequency selectors generate on or off signals to indicate the presence or absence of speech components in each of the four frequency bands. Only the first three discrete sounds in a word are encoded—the rest of the word is ignored. On or off signals for the first three sounds in each of the four bands are stored in four rows of the 3-by-5 flip-flop matrix; the fifth row of flip-flops indicates whether the sound was short or long, turning on if the interval between "change" pulses exceeds 100 milliseconds. A change pulse indicates that at least one of the frequency selectors is detecting the beginning or end of a speech sound.

Input information stored in the matrix is expanded row by row by considering each row as a three-bit binary number. Each of seven combinations of three bits (all 0's are excluded) corresponds to a single bit in the expanded matrix, which therefore again has five rows, but with seven positions, or flip-flops, in each row. No more than one flip-flop in any row can be turned on at any one time.

During training, the states of the flip-flops in the 7-by-5 matrix adjust the states of the four banks of memory units to generate the desired output. After training, the expanded pattern causes the memory units to gate different amounts of positive or negative current onto common buses in accordance with their respective states; these states may therefore be regarded as current-regulating weights.

The buses, one pair for each of the four memory banks, transmit the total current to the four deci-

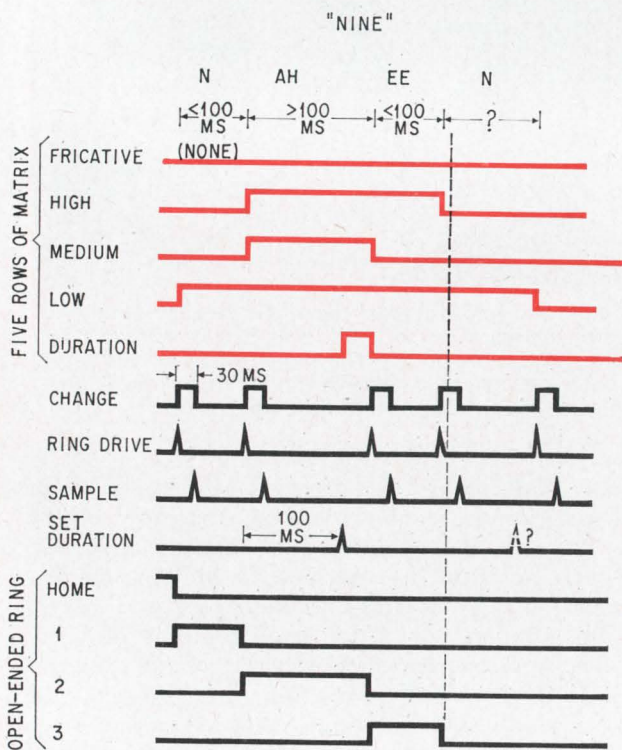

Binary frequency signals. The change pulse controls the setting of successive segments of the word "nine" into successive columns of the matrix, and is generated by the turning on and off of the various filter outputs.

sion units, which then generate the signals that represent whichever of the 16 patterns the machine recognizes. If it doesn't recognize the pattern, one or more of the four outputs will remain in a "middle" state halfway between the two binary levels, indicating indecision or lack of comprehension.

The four signals are decoded in a conventional decoding circuit to turn on an indicator lamp identifying the input pattern, if it's recognized. If the pattern can't be identified, two or more decoder outputs will be produced, but no lamp will turn on because the outputs' current comes from a constant source that is not sufficient for two lamps.

The input to the four frequency selectors is the amplified complex speech waveform from the microphone. An automatic gain control (agc) circuit keeps the amplitude of the signal within reasonable limits, and a sensitivity control screens out background noise.

The agc circuit also generates an interlock signal that squelches the fundamental excitation impulse at the beginning of each syllable. The speech waveform is a sort of reverse sawtooth, one peak to a syllable, with a fast rise time, slow decay, and a pulse train under each peak. Initial impulses are among the characteristics by which a person's voice can be recognized, but they add nothing to the meaning of what's said.

Its master's voice

The frequency selectors contain bandpass filters in four ranges. The highest-range filter is sensitive to fricatives—sounds formed when air passes through a small opening such as between the tongue and the roof of the mouth ("s"), or between the teeth and the lower lip ("f"). Fricatives may be voiced ("z," "v") as well as unvoiced. The next band covers the "high resonance" portion of the speech spectrum, differentiating "f" from "s" and aiding vowel discrimination. The other two bands cover the medium and low resonance portions of the speech spectrum, picking up the voiced part of fricatives and other vocal sounds. The low-frequency cutoff is the average fundamental frequency of the female voice and the average second harmonic of the male voice.

Unlike some more sophisticated speech analyzers, the word-code generator, a simplified version of an earlier design, doesn't distinguish or track formants, which are peaks of intensity plotted against frequency and which vary with time.

Consider the machine's handling of the spoken word "nine." Of four sound segments—n-ah-ee-n—the first three are retained in the matrix, as shown on the opposite page. The first sound, "n," is normally short and contains only low frequencies. The sound "ah" is long and contains low, medium, and high resonance, but no fricatives. The third sound is short, with high and low resonance; it's actually only a transition from "ah" to the fourth segment, "n," which is lost. If the word is pronounced "nnnnine," the same pattern would appear except that the bottom flip-flop in the first column would

turn on, reflecting the prolonged "n" sound.

Before the operator speaks, he must reset all the flip-flops in the 3-by-5 matrix with a pushbutton; the same reset pulse also returns an open-ended three-stage ring counter to its home position. The transitions at the rise and fall of the four binary signals generate square change pulses about 30 milliseconds wide, as in the timing chart at the bottom of the opposite page.

The rise of the change pulse as the first segment "n" is spoken generates a ring-drive pulse that advances the ring to its first position, gating the first segment into the first of the three columns in the matrix. The change-pulse fall generates a sample pulse that stores the state of each frequency selector output in the corresponding flip-flop of the first column.

The rise of subsequent change pulses advances the ring to its second and third positions, so that later frequency samples are stored in the second and third columns of the array.

Drawn or quoted

For graphic inputs, each of the 15 segments of the write-in array is wired to a flip-flop in the 3-by-5 internal matrix. A constant-current source connected to the stylus turns on the flip-flops as the stylus contacts the corresponding segments of the write-in matrix. A momentary contact with the wrong segment creates a spike in that segment's line to its flip-flop, a spike that a low-pass filter in the line suppresses.

The patterns produced in the 3-by-5 flip-flop matrix by corresponding graphic and spoken inputs—

0	1	2	4
1	1	2	4
2	1	2	4
3	1	2	4
4	1	2	4

1	03	12	22	32	47
2	07	14	27	31	47
3	07	14	26	34	47
4	05	15	27	34	44
5	07	11	27	34	47
6	03	11	27	35	47
7	07	14	24	34	44
8	07	15	27	35	47
9	07	15	27	34	46
0	07	15	25	35	47

Expanding by row. Each row of the matrix is treated as a binary number; the pattern in five rows thus is described by five numbers, each specifying the row and the appropriate binary number.

Other expansions

The row-by-row technique was chosen from a number of alternative methods of expansion as the most economical in terms of hardware and yet sufficient to identify the digits and similar patterns that the machine should recognize.

The 15 bits, considered as a group, can be arrayed in 2^{15} , or 32,768, different combinations—too large a number to implement at any reasonable cost. Furthermore, no two of these could be recognized as being “almost” alike, so that a system using this expansion could not generalize.

If the 15 bits are considered individually, the set of 10 decimal digits would require 150 descriptors, each of them either on or off, as shown below left. The diagram indicates that bits 1 and 15 are of no value in identifying any digit because they appear for all digits. Bits 2 and 9 aren't much better; they appear for all but one digit. And bits 3, 8, 12, and 14 appear in all but two representations. Furthermore, bits 5 and 11 uniquely describe the digit 1; no other digit has any unique descriptors. This leaves only five bits, or descriptors, out of 15 to identify nine of the

10 digits, and these five—4, 6, 7, 10, and 13—aren't sufficient to identify all those nine.

An expansion by column is analogous in every way to the expansion by row, except for its direction. In the diagram below right, the columns of the smaller matrix are numbered 0, 1, 2, and the rows are given the binary values 1, 2, 4, 8, and 16 to identify combinations. Three 3-digit descriptors are associated with each input pattern; the first digit identifies the appropriate column of the matrix and the second and third identify the bits turned on.

Thus the digit 1 is represented by descriptors 017, 131, 216. This means that in column 0 bits 1 and 16 are turned on, giving the combination 17; in column 1 all five bits are turned on, so that their binary identifiers add up to 31; and in column 2 only bit 16 is turned on. The rest of the diagram lists the descriptors in the column-by-column expansion—three for each of 10 decimal digits.

The column expansion includes 11 unique combinations, as opposed to nine in the row expansion; but these 11 still appear in

only seven of the 10 digits, the same number as in the row expansion. The descriptors 121 and 231, both appearing for six of the 10 digits, have the least descriptive power. This is somewhat better than in the row expansion, but that small advantage is offset by the three descriptors per digit in the column expansion, as compared to five for the row expansion.

The most important practical disadvantage in column expansion is that the technique would require more than twice as many of the adaptive quinary memory units— $3 \times 31 = 93$ —for each of the four banks than does row expansion— $5 \times 7 = 35$.

There are various other ways to expand the small matrix. A combined row and column method for example, is entirely possible; each digit would have eight descriptors, and the expanded matrix would provide very good discrimination and generalization. But it would require 128 memory units, and would thus be that much more expensive. Or the matrix could be expanded along its diagonals, or in a pattern similar to the knight's move in chess—relating cells that are one row and two columns apart, or two rows and one column.

1	2	3
4	5	6
7	8	9
10	11	12
13	14	15

1
2
3
4
5
6
7
8
9
0

1 2 - - 5 - - 8 - - 11 - 13 14 15
 1 2 3 - - 6 7 8 9 10 - - 13 14 15
 1 2 3 - - 6 - 8 9 - - 12 13 14 15
 1 - 3 4 - 6 7 8 9 - - 12 - - 15
 1 2 3 4 - - 7 8 9 - - 12 13 14 15
 1 2 - 4 - - 7 8 9 10 - 12 13 14 15
 1 2 3 - - 6 - - 9 - - 12 - - 15
 1 2 3 4 - 6 7 8 9 10 - 12 13 14 15
 1 2 3 4 - 6 7 8 9 - - 12 - 14 15
 1 2 3 4 - 6 7 - 9 10 - 12 13 14 15

Expanding by element. If each flip-flop were treated individually in matrix expansion, the various patterns would be difficult to distinguish because so many would share the same elements.

0	1	2
1	1	1
2	2	2
4	4	4
8	8	8
16	16	16

1
2
3
4
5
6
7
8
9
0

017 131 216
 029 121 223
 017 121 231
 007 104 231
 023 121 229
 031 121 228
 001 101 231
 031 121 231
 007 121 231
 031 117 231

Expanding by column. A five-bit binary number represents each column of the matrix. Three numbers thus describe the pattern in the three columns; each number specifies the column and the binary number in that column.

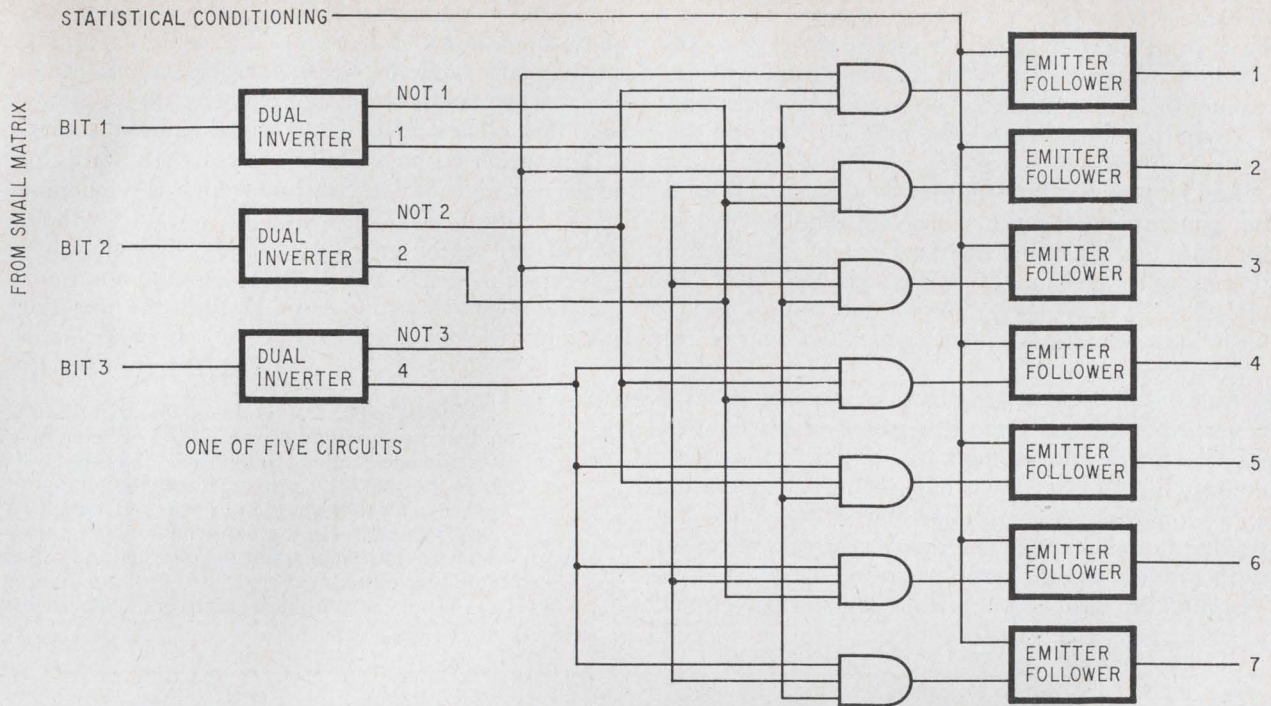

Decoder for expansion. The binary number in each row of the small matrix is decoded to set an individual flip-flop in the corresponding row of the expanded matrix. Statistical conditioning blocks some outputs at random.

for instance, a drawn “9” and a spoken “nine”—will generally differ. But with sufficient training the machine can learn to recognize both patterns as representations of the same thing, because both patterns are expanded and establish weights in the memory banks in the same way. The stored weights, however, will differ among sets of graphic digits, sets of spoken digits, and sets of both graphic and spoken digits.

The expansion of patterns from smaller to larger matrix is done row by row in the demonstration model. In the diagram on page 95, the rows of the smaller matrix are numbered 0 through 4, and the columns are given the binary values 1, 2, and 4 to identify combinations. Five two-digit descriptors are associated with each input pattern; the first digit identifies the appropriate row of the matrix and the second identifies the bits turned on.

Thus the digit 1 is represented by descriptors 03, 12, 22, 32, 47. This means that in row 0 bits 1 and 2 are turned on, giving the combination 3; in rows 1, 2, and 3 only bit 2 is turned on; and in row 4 all three bits are turned on. The rest of the diagram lists the descriptors in the row-by-row expansion—five for each of 10 decimal digits.

The total of 50 descriptors includes many that occur more than once, plus nine, shown in color, that are unique. These nine can describe seven of the 10 digits, namely 1, 2, 3, 4, 7, 9, and 0. All the descriptors are of some value in identifying digits; least valuable are 07 and 47, which each apply to seven out of the 10 digits—2, 3, 5, 7, 8, 9, 0 and 1, 2, 3, 5, 6, 8, 0, respectively.

Physically, the expansion process involves the driving of five three-bit decoders from the rows of the smaller matrix. The decoded outputs set the

flip-flops in the rows of the 7-by-5 matrix.

The expanded matrix contains fewer descriptor bits in a larger area, reducing the probability of descriptor overlap between patterns. The adaptive memory units are driven by the flip-flops in the expanded matrix on a one-to-one basis, a factor that combines with the wider separation of patterns to provide reliable recognition with relatively simple memory units.

Conditioned reflex

The inputs to the 35 units in the memory bank, top of page 99, are the 35 descriptor lines from the expanded matrix. The two condition drivers, for 0 and 1, are each driven by a three-way AND whose inputs come from the trainer input, the statistical conditioning unit, and from the opposing output of the balanced decision unit. For example, if the desired output from the bank is 1, the Condition 1 driver is activated only if the 0 output appears at the decision unit. The 0 output is on for either 0 decisions or “don’t know” conditions.

The pressing of the condition key on the console sets off a chain of events. First, a small current increment, or tare weight, is subtracted from all lines. The tare assures that additional weight beyond the minimum is added to the memory units as a margin of safety. If the total weight presented to the decision unit during training is just barely out of the “don’t know” condition, it will be substantially positive or negative during actual operation with the tare disconnected.

A gated multivibrator next produces master conditioning pulses to all eight condition driver gates—only four of which are open, under control of the input from the operator—adding weight to all

banks until the desired output appears. The feedback from the decision-unit output closes the condition driver gates when the correct output appears, automatically terminating the conditioning process.

If the operator desires, he may turn on the statistical conditioning unit for random conditioning. When he presses the condition key, a random-number generator gates two or three of the five descriptors into the expanded matrix. For any given conditioning pulse, it is not known which descriptors are effective, or how many; but all descriptors appear with approximately equal probability over a full training period.

The random-number generator is based on a zener diode biased just to the point of breakdown. As the bias voltage fluctuates slightly, the diode continually breaks down and recovers, generating a random voltage fluctuation that is amplified, integrated, and shaped. The result is a train of pulses with random widths and spacings. The pulse train is applied to a six-position shift register driven and

sampled by a 1-kilohertz clock pulse. Because the pulse-train input is random, the contents of the register are random; when sampled at any time, the last five positions of the register gate a random selection of descriptors into the expanded matrix.

The graph on page 102 indicates the number of trials required in a test during which the machine tried to attain 100% learning of a rigid (without variations) set of graphic symbols. The first test (black line) was made with the random-number generator switched off. After 12 runs the machine got into a vicious circle that prevented 100% learn-

Continued on page 100

Training logic. Trainer opens one of the two gates feeding the condition drivers. If the decision unit has made no decision or a wrong one, its output will also drive the gate. The statistical conditioning unit then feeds pulses through the open gate, adjusting the weights stored in the bank memory units until the correct output appears at the decision unit, at which point the gate automatically closes. The tare guarantees a margin of safety in the stored weight.

Five states of learning

The units of the pattern recognizer are novel two-transistor circuits with five stable states. An input line from one of the 35 flip-flops in the larger matrix is common to the four corresponding units in the four memory banks, and two conditioning input lines and two summation output lines are common to all the memory units in a single bank of 35.

The input line gates conditioning pulses that change the state of the quinary memory unit, and it also admits varying amounts of current to the summation lines, depending on the state of the unit.

Diodes D_3 and D_4 are associated with the conditioning gates, and diodes D_9 and D_{10} with the summation gates. The quinary trigger is a modified Eccles-Jordan flip-flop with three additional stable states created by diode pairs D_1/D_2 , D_5/D_6 , and D_7/D_8 , in color.

Reset. Momentarily turning off the -12-volt power resets the circuit; it therefore automatically assumes the reset state when power is first turned on. In this reset state, the middle one of the five, the two transistors have equal collector currents, so that A and B are at the same voltage—about -4.2 volts. The two emitters are at a higher level—about -1.6 volts—and the 36-ohm resistors establish a still higher level at the diode cathodes,

so that D_1 and D_2 are reverse biased.

There is, therefore, no cross-coupling between emitters, and each emitter impedance provides degenerative feedback. As the gain of each stage is somewhat less than unity, the circuit is stable. The net output weight is zero, because equal current flows to the summation lines, which are assumed to be at approximately the same voltage level.

The state of the input line alone has no effect on the balance of the summation lines. When the input line is at -11 volts, diodes D_9 and D_{10} decouple points A and B, so that equal resistances connect both summation lines to the input voltage. When the input rises to ground, diodes D_9 and D_{10} maintain the voltage at their anodes at a slightly higher level than that at A and B, so that equal currents again flow to the summation lines.

Adding weight. The leading edge of the pulse on the Condition 0 line, when the input gate is at ground, generates a positive transient at the base of Q_1 through conducting diode D_3 . This reduces the collector current in Q_1 , and the voltage at point A becomes more negative.

Simultaneously, the emitter voltage of Q_1 becomes more positive and D_1 turns on, cross-coupling the

emitters through the 36-ohm resistance. The voltage at A falls, and the voltage at B rises until it equals the voltage at the cathode of D_8 . Diodes D_7 and D_8 then both conduct, and a low-impedance inverse feedback path is established from collector to base of Q_2 . This feedback stabilizes the trigger with point A at -6.5 volts and B at -2.8 volts—a state designated as weight -1. The higher level at B reverse biases diode D_9 , so that when the input line rises, current flows to the W_0 summation line. But D_{10} is forward biased, taking current from the input through A to the -12-volt supply.

Another pulse on the Condition 0 line in the presence of an input gate reduces the current in Q_1 still further. Point A then drops to its lowest level, -9.5 volts, as Q_1 approaches cutoff and Q_2 approaches saturation, raising point B to -1 volt. The circuit is again stable, and the weight is -2. Maximum current flows to the W_0 lines, and minimum current to W_1 .

Opposite path. In the same way, applying pulses to the Condition 1 line in the presence of an input gate steps the circuit the other way. The first pulse passes through conducting diode D_4 , cutting off Q_2 . A increases while B drops until D_7 and D_8 again stabilize the circuit. A second pulse on the Condition 1 line brings the circuit to the reset state, and a third boosts A and drops B until D_5 and D_6 stabilize the circuit at another state

New from Sprague!

**5 Times the Resistance of
a Conventional Metal-Film Resistor
of Equal Size!**

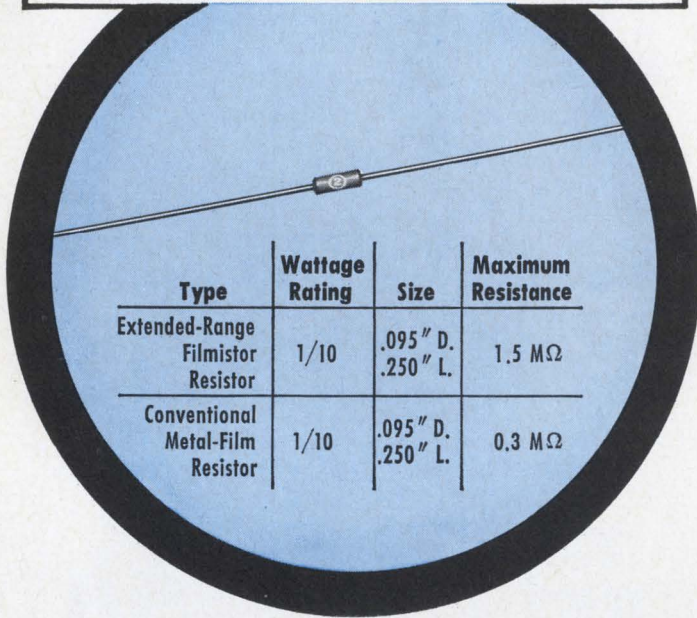

Type	Wattage Rating	Size	Maximum Resistance
Extended-Range Filmistor Resistor	1/10	.095" D. .250" L.	1.5 MΩ
Conventional Metal-Film Resistor	1/10	.095" D. .250" L.	0.3 MΩ

EXTENDED-RANGE FILMISTOR[®] METAL-FILM RESISTORS

**Substantial saving of space in all wattage ratings —
1/20, 1/10, 1/8, 1/4, 1/2, and 1 watt—with
absolutely NO SACRIFICE IN STABILITY!**

Extended-Range Filmistor Resistors now offer, in addition to accuracy . . . stability . . . reliability . . . resistance values in size reductions which were previously unobtainable. Size and weight advantages of Filmistor Resistors now make them ideal for applications in high-impedance circuits, field-effect transistor circuits, etc. Many designs which previously had to settle for the higher temperature coefficients of carbon-film resistors in order to obtain required resistance values can now utilize the low and controlled temperature coefficients of Filmistor Metal-Film Resistors.

Other key features are $\pm 1\%$ standard resistance tolerance, low inherent noise level, negligible voltage coefficient of resistance, and tough molded case for protection against mechanical damage and humidity.

For complete technical data, write for Engineering Bulletin 7025D to Technical Literature Service, Sprague Electric Co., 35 Marshall Street, North Adams, Massachusetts 01247.

SPRAGUE COMPONENTS

RESISTORS
CAPACITORS
TRANSISTORS
INTEGRATED CIRCUITS
THIN-FILM MICROCIRCUITS
INTERFERENCE FILTERS

PACKAGED COMPONENT ASSEMBLIES
FUNCTIONAL DIGITAL CIRCUITS
MAGNETIC COMPONENTS
PULSE TRANSFORMERS
CERAMIC-BASE PRINTED NETWORKS
PULSE-FORMING NETWORKS



*Sprague and '®' are registered trademarks of the Sprague Electric Co.

People

puters and peripheral equipment, combining them into systems tailored to customer needs.

Harple, believing too much burden has been put on the programmer, looks forward to developing instruments designed to simplify programming—in which tradeoffs between hardware and software have been considered—thus resulting in lower net cost to the user.

Harple will be rejoining SEL's Emil Borgers, executive vice president, for whom he worked three years ago at Scientific Data Systems Inc.

H. Brainard Fancher was sent to Paris three years ago by the General Electric Co. to manage GE's takeover of Compagnie des Machines - Bull and to rebuild the French concern's shaky financial base. Now, with Bull-GE on its feet, he has been recalled to Syracuse to become manager of the advanced systems and requirements operation of GE's Defense Electronics division.



H. Brainard Fancher

Fancher will direct the systems coordination of the division's six departments—aerospace electronics, heavy military, armaments, avionics, ordnance, and special information products (military computers)—plus its electronics research and advanced engineering laboratory. He will also supervise the division's operations abroad.

His new job reflects the Pentagon's increasing emphasis on complete systems packages, rather than individual products.

Had GE undertaken a systems engineering effort earlier, he believes, it might have been able to bid on the entire Nike-X system. Instead, the company collected only the order for radar, now being supplied by the heavy military department.

Fancher isn't entirely new to systems coordination. Just before his French mission, he managed GE's Apollo program, and that, he says, "is the biggest system yet."

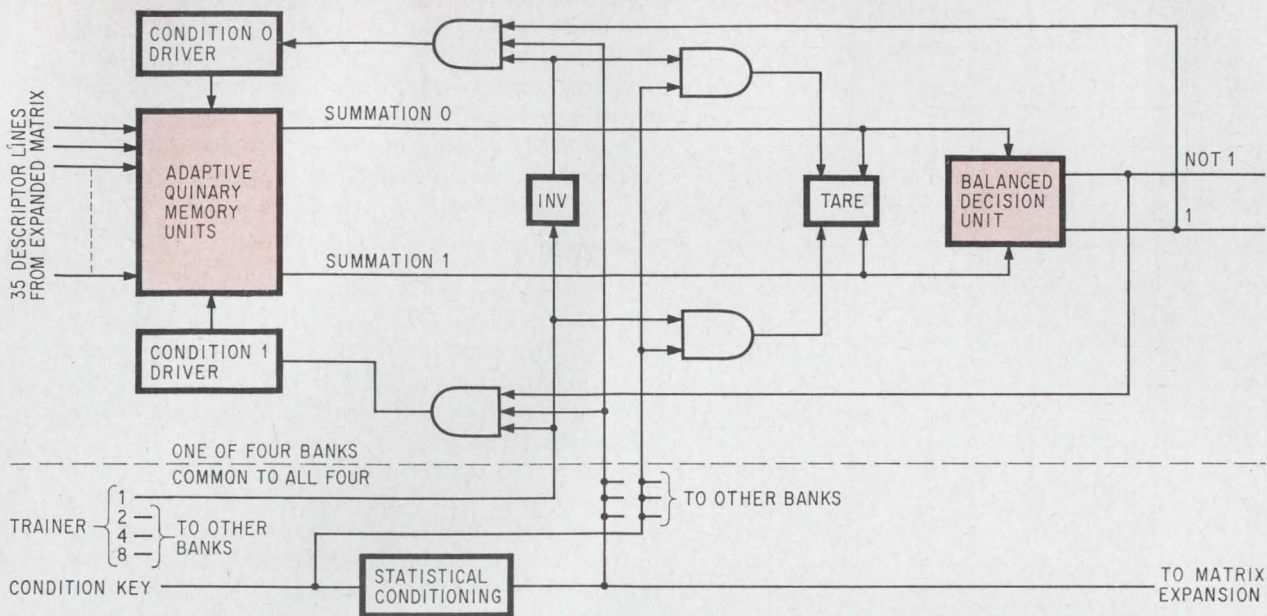

with weight +1. Finally, a fourth pulse on the line causes Q_2 to approach cutoff and Q_1 to approach saturation, stabilizing the circuit in its fifth stable state, in which the weight is +2.

Thus, the quinary memory unit can be adapted through its range and reversed as often as necessary. Conditioning pulses are applied to the whole bank of units during training; those units that are acti-

vated by inputs from the matrix expansion will respond. As these units change state, the weights change and the summation lines' balance is altered in the direction that produces the desired output.

NODE	N1	N2	N3 (RESET)	N4	N5
V_A	-9.5	-6.5	-4.2	-2.8	-1.0
V_B	-1.0	-2.8	-4.2	-6.5	-9.5
ΔV	-8.5	-3.7	0	+3.7	+8.5
WEIGHT	-2	-1	0	+1	+2

$\Delta V = V_A - V_B$ = DIFFERENCE BETWEEN COLLECTOR VOLTAGES

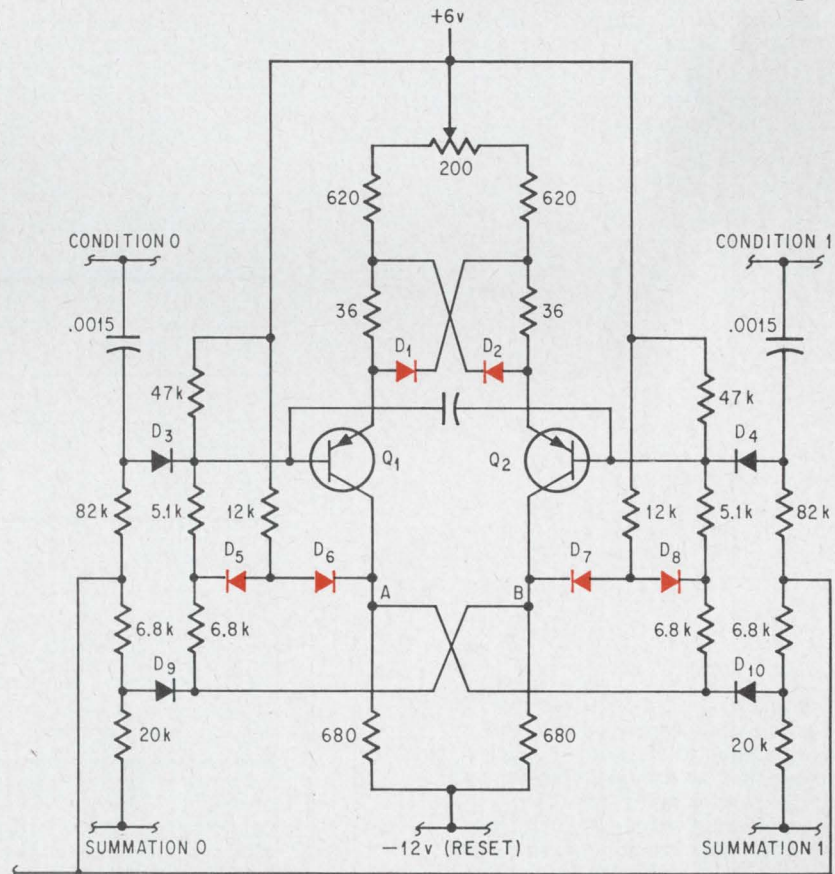

Quinary memory unit. The three diode pairs [color] give this modified Eccles-Jordan circuit three extra stable states for a total of five. The basic circuit connects the base of each transistor to the collector of the other through the 5.1K and 6.8K resistors.

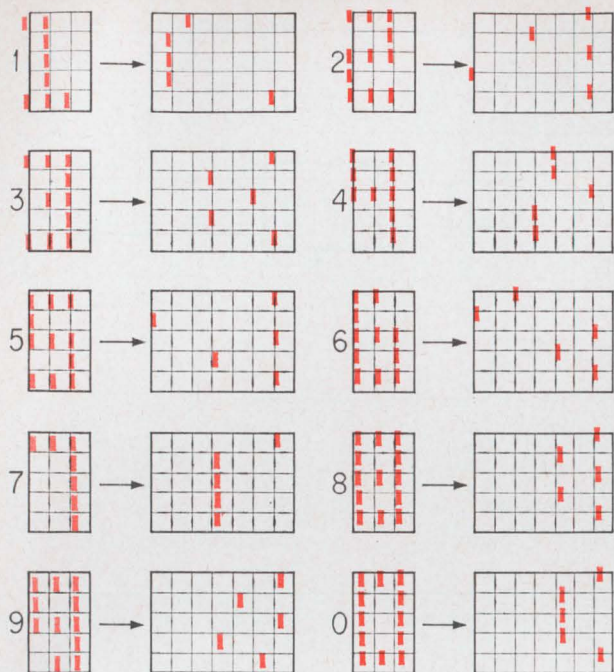

Expanded patterns. Each of the 10 decimal digits, entered graphically here, expands into a different, more distinguishable pattern in the large matrix. The distinction between 8 and 0 is the only one not much improved by expanding.

ing. It had most of the 16 patterns down pat, but was continually confused by a few similar pairs. The memory was then reset—the machine was made to forget everything. The random-number generator was switched on, and the same patterns were presented again, in the same order. This time as shown in color, the machine learned all of them perfectly in six trials.

A weighted answer

The diagram below shows the steps taken when the machine is presented with the digit 9 traced on the write-in matrix. Each segment touched by the stylus sets a flip-flop in the 3-by-5 matrix, so that the pattern of 1's in that matrix duplicates the traced-out pattern.

In the small matrix, the top row has a 1 in all three positions; the binary number 111 corresponds to the decimal number 7, so the seventh flip-flop in the top row of the large matrix (contains a 1) is turned on. Likewise, the second row contains the binary number 101, or 5, and the fifth flip-flop is set in the large matrix. In the same way, in the other rows, the seventh, fourth and sixth flip-flops are turned on. The descriptors for the input pattern are 07, 15, 27, 34, and 46.

The five flip-flops that have been set in the large matrix gate the corresponding five memory units

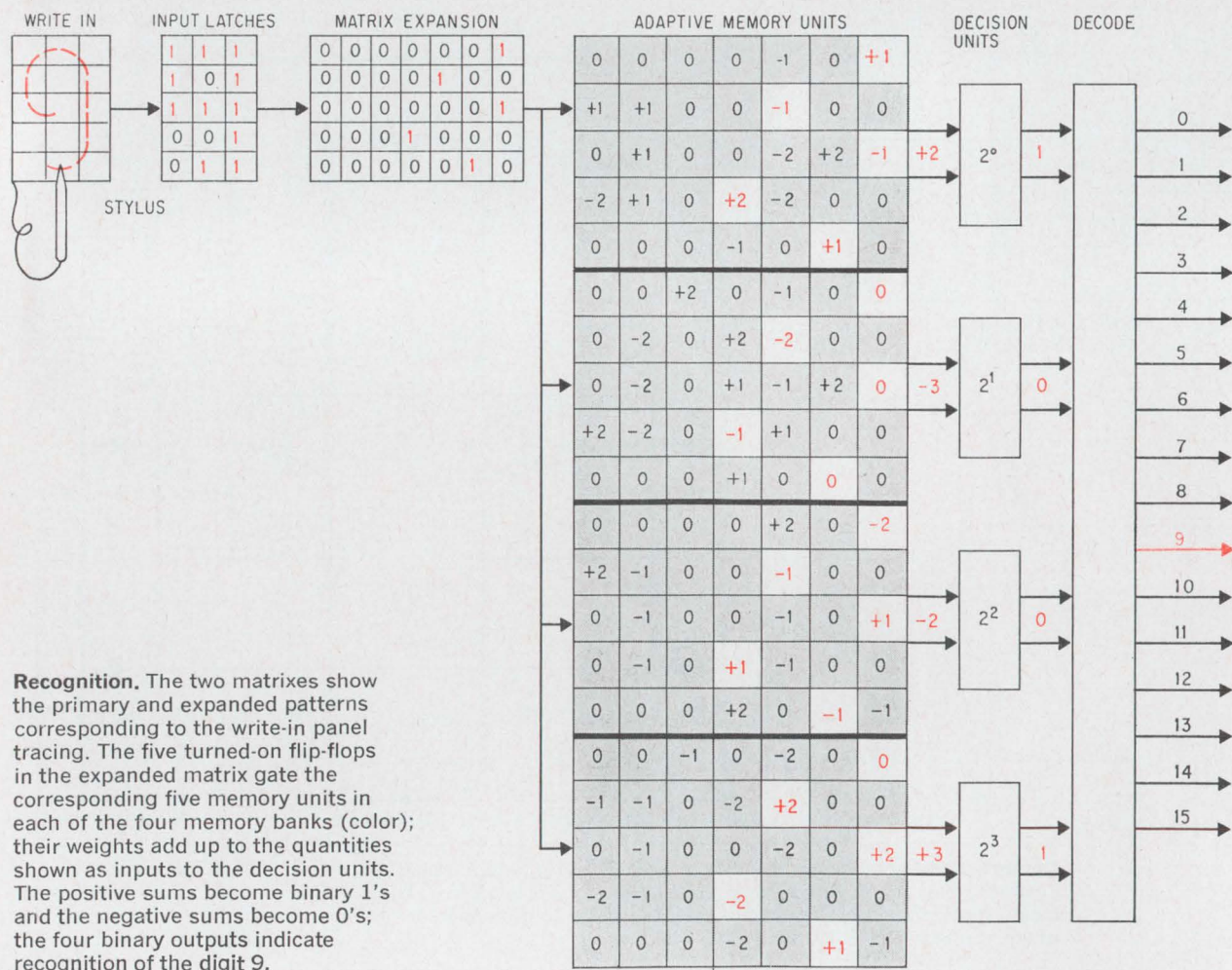

Recognition. The two matrixes show the primary and expanded patterns corresponding to the write-in panel tracing. The five turned-on flip-flops in the expanded matrix gate the corresponding five memory units in each of the four memory banks (color); their weights add up to the quantities shown as inputs to the decision units. The positive sums become binary 1's and the negative sums become 0's; the four binary outputs indicate recognition of the digit 9.

Three-way decision

The inputs to the balanced ternary decision unit are summation lines from the quinary memory units that the decision unit compares for balance or imbalance rather as a differential amplifier would. The circuit determines the relative voltage levels for the two lines without referring to a fixed threshold; the line with the more positive voltage determines the output.

No guess. When no input pattern is present, or when the descriptors don't fully describe the pattern, the voltages on the summation lines are equal. Transistors Q_3 and Q_4 both conduct equally, and the current in each is about 1.5 milliamperes, since Q_5 maintains the total current at about 3 ma. About 0.9 ma then flows in the base circuits of both Q_1 and Q_2 , saturating them.

Equal inputs turn on both the 0 and 1 outputs to indicate the "uncertain" or "don't know" condition. The positive and negative tolerances of the zone of equality are adjusted by the width potentiometer and the balance adjustment.

No hedging. A difference as small as 0.05 volt between the summation lines eliminates the uncertainty and generates a solid 0 or 1 output. If the voltage on the W_0 summation line is 0.05 volt more positive than the voltage on the W_1 summation line, Q_3 takes over nearly all the 3 ma. Because this maintains conduction in Q_1 and

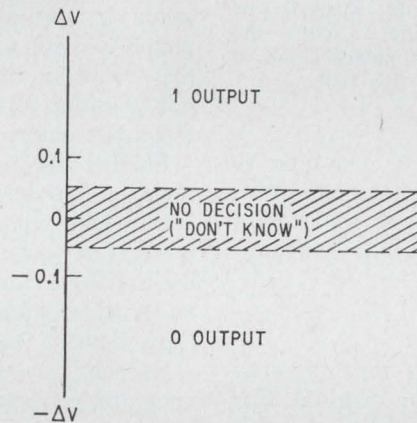
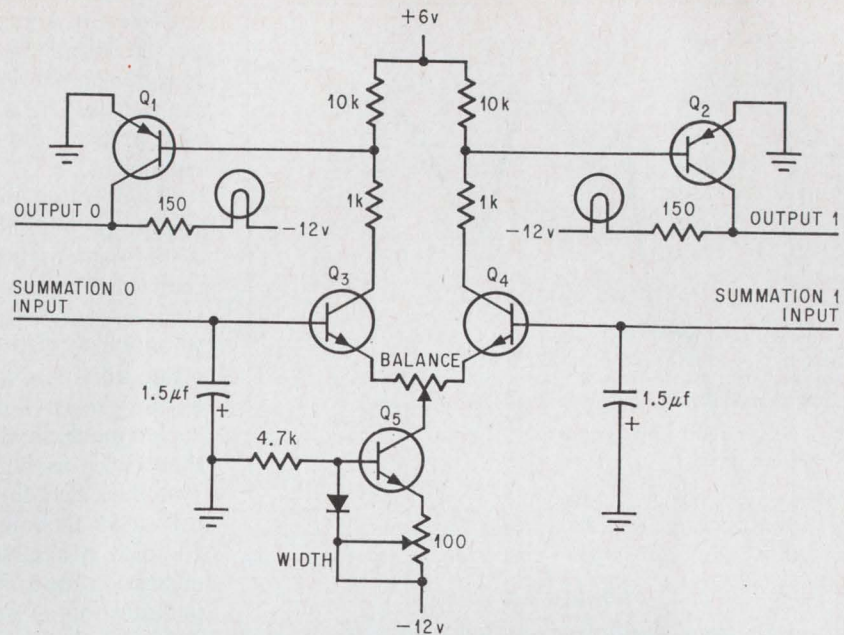

Ternary decision unit. Like a differential amplifier, this circuit measures the difference between two signals and produces a signal on one output or the other depending on the sign of the difference. If the two inputs are the same, both output signals are on.

turns off Q_2 , a true indication for 0 is given.

A single unit of weight difference from the memory bank provides a voltage difference of at least 0.1 volt, assuring a correct decision.

Furthermore, the balanced summation lines ensure that variations in power supply and other parameters will have little effect on the determination of the decision-unit output.

in each of the four memory banks. These units are shown unshaded in the diagram, with their respective weights—relative current-gating capabilities—in color.

Current corresponding to the weights of these memory units is added up on the summation lines common to all the memory units in each bank, and the sum is shown between the two lines leading to the decision units. Where the sum is positive, the output of the decision unit is 1; where the sum is negative, the decision unit produces a 0. The four outputs taken together present the binary number 1001, which, decoded, turns on the output 9.

In this example, the recognizer has been well trained; none of the memory banks produce zero current, or equal current on both buses of a pair. If any did, the decision unit would produce a "don't

know," for that memory bank, and there would be no recognition.

The operation can be outlined in a small table like that at the bottom of page 102. The left-hand column contains the descriptors for the digit 9; the entries in each row of the left half of the table are the weights from the unshaded squares in the diagram at the bottom of page 100, reading from bottom to top. These weights can then be added up column by column and the correct value of the input pattern deduced from the distribution of plus and minus signs in the sums, corresponding to 1's and 0's.

The right half of the table contains the weights for the digit 3. Similar tables can be made up for other digits, using the proper weights from the shaded squares. The same digit shapes are em-

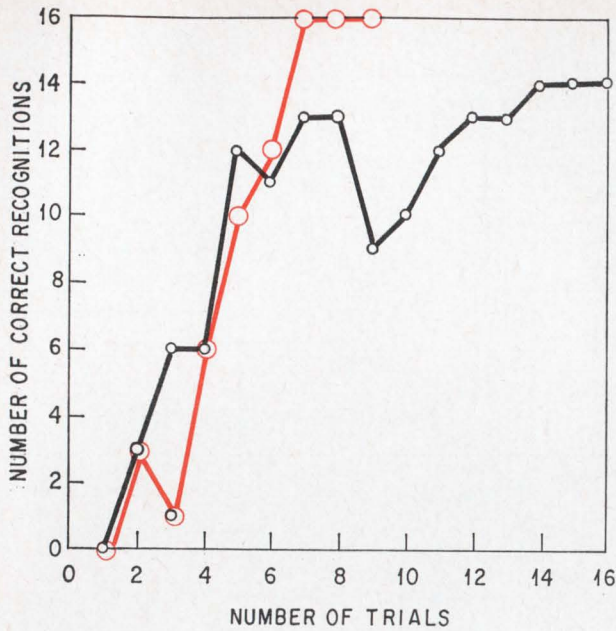

Statistical conditioning. The machine learned a set of graphic symbols perfectly in only six trials when it was statistically conditioned (colored line). With the random-number generator switched off (black line), it never got more than 14 of 16 right in this test.

ployed as were used in training the machine to arrive at the weights shown in the memory banks; these are indicated in the diagram at the top of page 100, along with their corresponding expansions.

Some confusion

Different shapes will be correctly recognized if they aren't too far removed from the original. For example, a 1 drawn as a single vertical line through the center column of the matrix will be recognized as a 1 using the weights in the diagram; but a similar line through the right-hand column looks more like a 7, and one through the left hand column looks like a 6, believe it or not, and the machine will identify it as such.

Tests with the demonstration model indicate the feasibility of building a similar device with a larger input matrix to handle more complex data, and with more binary decision units that can handle more patterns.

07	0	-2	0	+1	07	0	-2	0	+1
15	+2	-1	-2	-1	14	-2	0	+2	0
27	+2	+1	0	-1	26	0	0	+2	+2
34	-2	+1	-1	+2	34	-2	+1	-1	+2
46	+1	-1	0	+1	47	-1	-1	0	0
	+3	-2	-3	+2		-5	-2	+3	+5
9	1	0	0	1	3	0	0	1	1

Summing up. The stored weights shown in the diagram at the bottom of page 100 add up to produce the proper outputs for each digit.

A linear increase in the number of decision units would represent an exponential increase in the number of output categories. The present model, with four decision units, produces 16 outputs (recognizes 16 patterns). A machine with twice as many decision units would have 16 times 16, or 256, output categories.

Quadrupling the size of the input matrix would require perhaps four times as much logic hardware as the demonstration model contains, but less than four times as much control circuitry, power-supply volume, and mounting hardware. Assuming—conservatively—that a machine with twice as many decision units and four times as large an input matrix as the present unit would be eight times its size, such a machine could be packaged in a box no more than twice as high, wide, and long as the present system's. And the employment of the latest miniaturization techniques could doubtless fit the more complex system to the space occupied by the demonstration unit. For that matter, the present model includes lots of empty space.

Obviously the signals that turn on the indicator lights in the demonstration model could easily punch a card, print a figure, or close a relay. Or they could interrupt a computer program, and in so doing initiate some response by the computer to the input pattern.

Further, the machine's adaptive organization allows for component failure, a particularly important feature in systems that may incorporate large-scale integration techniques. A working version could be built with batches of LSI devices of which 10% were marginal or imperfect, and could learn to bypass those devices that fail.

Speech processing opens possibilities beyond computer programming, of course. Besides being able to adapt to any speaker, regardless of his language, dialect, or peculiar pronunciation traits, an identifier or verifier system based on these adaptive principles could learn to recognize a speaker by his individual vocal characteristics.

Bibliography

- H. L. Gelernter and N. Rochester, "Intelligent behavior in problem solving machines," *IBM Journal of Research and Development*, October 1958, p. 336.
- Arthur L. Samuel, "Some studies in machine learning using the game of checkers," *IBM Journal of Research and Development*, July 1959, p. 211.
- F. Rosenblatt, "Principles of Neurodynamics: Perceptrons and the Theory of Brain Mechanisms," Spartan Books, Washington, D.C., 1962.
- B. Widrow, "Generalization and information storage in networks of Adaline neurons," *Self-Organizing Systems*, Spartan Books, Washington, D.C., 1962; p. 435.
- Harold S. Crafts, "Components that learn and how to use them," *Electronics*, March 22, 1963, p. 49.
- G.L. Clapper, "Digital circuit techniques for speech analysis," *IEEE Transactions on Communications and Electronics*, May 1963, p. 296.
- J.S. Griffin Jr., J.H. King, Jr., and C.J. Tunis, "A pattern identification device using linear decision functions," *Computer and Information Sciences*, Spartan Books, Washington, D.C., 1963; p. 169.
- L.A. Kamentsky and C.N. Liu, "A theoretical and experimental study of a model for pattern recognition," *ibid.*, p. 194.
- F. Casey and G. Nagy, "Recognition of printed Chinese characters," *IEEE Transactions on Electronic Computers*, February 1966, p. 91.

**New
HF transmitters!
New
HF receivers!
New
HF catalog!**

Send now for catalog of this all-new SSB, HF radio line. Granger Associates, 1601 California Ave., Palo Alto, California 94304 / Russell House, Molesey Road, Walton-on-Thames, Surrey, England / 1-3 Dale St., Brookvale, NSW, Australia

HF transmitting and receiving systems

*Granger
Associates*

SHORT FORM CATALOG/JUNE, 1967

Send for yours.

18

These ~~14~~ Low-Cost Devices
Make RCA

the Triac Leader of the Industry

*And now we're introducing
the industry's first 40 amp Triacs!*

Now, RCA offers you the industry's broadest line of Triacs, with an unmatched choice of ratings and triggering characteristics in space-saving packages ...all at truly economical prices! Triacs are today's most modern, effective component for ac phase-control and load switching. Because they can perform the functions of two SCR's, Triacs make possible new economies in full-wave power circuit design and cost for industrial and commercial applications.

So for efficient, inexpensive solid-state control of motors, lighting, and heating, look to RCA, the Triac Leader. Your RCA Sales Representative will be happy to give you more details, including price and delivery. Also, ask him about RCA's complete line of SCR's. For additional technical data, write RCA Commercial Engineering, Section RN-102, Harrison, N.J. 07029. See your RCA Distributor for his price and delivery.

Current Rating I_T (rms)	Low Voltage (100V)	120V Line (200V)	240V Line (400V)	Package
2.5A ($I_{GT} = 3$ mA max)	40525	40526	40527	modified 3-lead TO-5
2.5A ($I_{GT} = 10$ mA max)	40528	40529	40530	modified 3-lead TO-5
6A		40429	40430	TO-66
6A		40485	40486	modified 2-lead TO-5
6A		40431 (with integral trigger)	40432	modified 2-lead TO-5
15A		40575	40576	TO-66
40A		TA2836 TA2838	TA2837 TA2839	press fit stud

*Priced in quantities of 1,000 and up.

RCA Electronic Components and Devices



The Most Trusted Name in Electronics

Sensitive-Gate Triacs under \$1.00*

Extremely high gate sensitivity...rms (on-state) current = 2.5A...and a price level that makes possible a new generation of controls for small appliances, induction motors, and sensing circuits. Maximum gate sensitivities of 3 mA or 10 mA are actually many times greater than that of conventional Triacs! This means simplified triggering circuits and reduced component costs. The 100V versions (40525 and 40528) sell for \$0.95*; the 200V types (40526 and 40529) are priced at \$0.98*; and the 400V units (40527 and 40530) are available at \$1.40*!

6A Triacs in 2-lead TO-5 to Control up to 1440 Watts

With the new 40485 and 40486 6A Triacs, RCA doesn't have to use an expensive press-fit package to control a lot of power. Both types employ the low-cost TO-5 case which can be easily mounted on heat spreaders using mass produced pre-punched parts and batch soldering techniques for improved heat-sinking ability. The 40485 sells for only \$1.50* and controls 720 watts. The 40486 can control 1440 watts and sells for \$1.98*. And reliability is assured with surge current protection up to 100A!

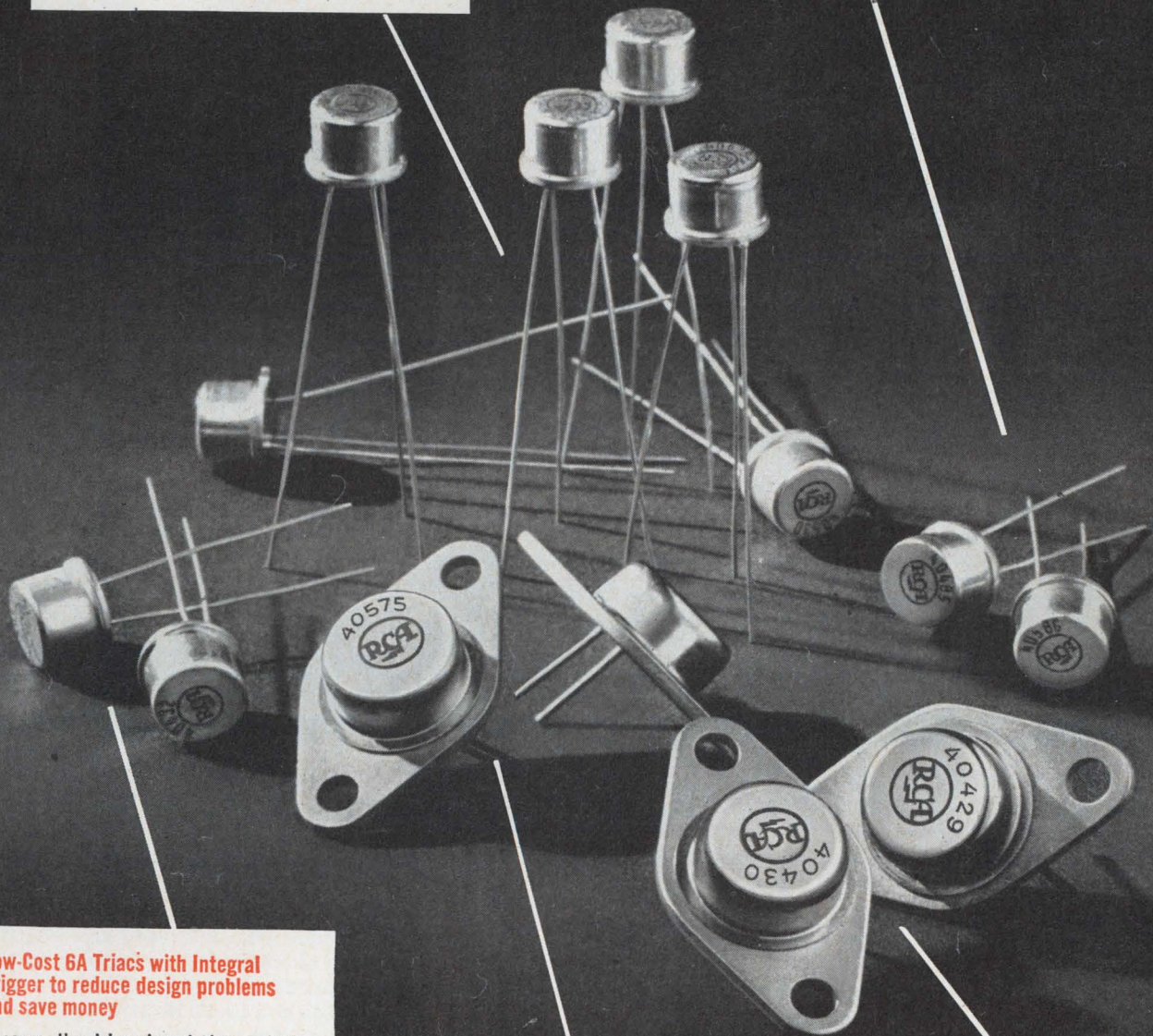

Low-Cost 6A Triacs with Integral Trigger to reduce design problems and save money

Because the triggering device and the firing characteristics of the 40431 and 40432 Triacs are coordinated inside a compact TO-5 case, you don't have to worry about designing in additional triggering components. You benefit further from reduced circuit and assembly costs, plus improved packaging densities! So if your ac-load control circuits require a trigger, why not have it built-in for you? The 40431 controls 720 watts at 120V and costs \$1.80*; the 40432 controls 1440 watts at 240V and costs only \$2.48*.

15A Triacs for Load Control up to 3600W

RCA developmental types 40575 and 40576 Triacs extend solid-state control way up into the kilowatt range. These powerful TO-66 units have surge current protection up to 100A, plus all of the other design benefits of RCA's lower current Triacs. Possible applications include power supplies, heating controls, motor drivers, and many other industrial and commercial usages.

6A Triacs in Popular TO-66 Package

Need full-wave control of up to 1440 watts in a TO-66 package? RCA 40429 and 40430 Triacs are your answer. Featuring surge current protection up to 80A, these devices are ideal for lighting, heating, and motor control circuits. The 200V 40429 costs \$1.50* the 400V 40430 only \$1.98*.

Tektronix sampling oscilloscope features DC-to-1 GHz bandwidth and split-screen storage

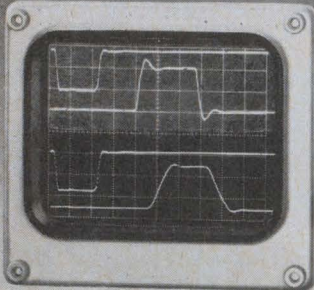

Before-after

With sampling and split-screen storage, you can compare your fast risetime input and output signals, before and after circuit modifications. Store the original waveforms on the upper half of the display and compare the new waveforms with the original.

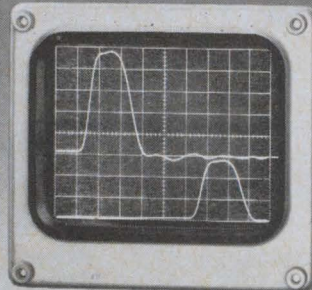

Low repetition rate

Analyze low repetition rate, fast risetime pulses with split-screen storage and dual-trace, 350-ps risetime sampling plug-ins. The display is two, 2-ns wide pulses from a 60-Hz generator. Signals can be stored for up to one hour.

TDR

Using the Type 281 Time-Domain Reflectometer Pulsar, the total length of the transmission line is stored on the upper half of the display. The lower display is a magnification of the transmission line discontinuity. (Waveform shown on oscilloscope.)

Type 281 Pulsar (order 015-0060-00) \$ 95
($T_{rise} \leq 750$ ps, ≈ 460 mV into 50Ω)

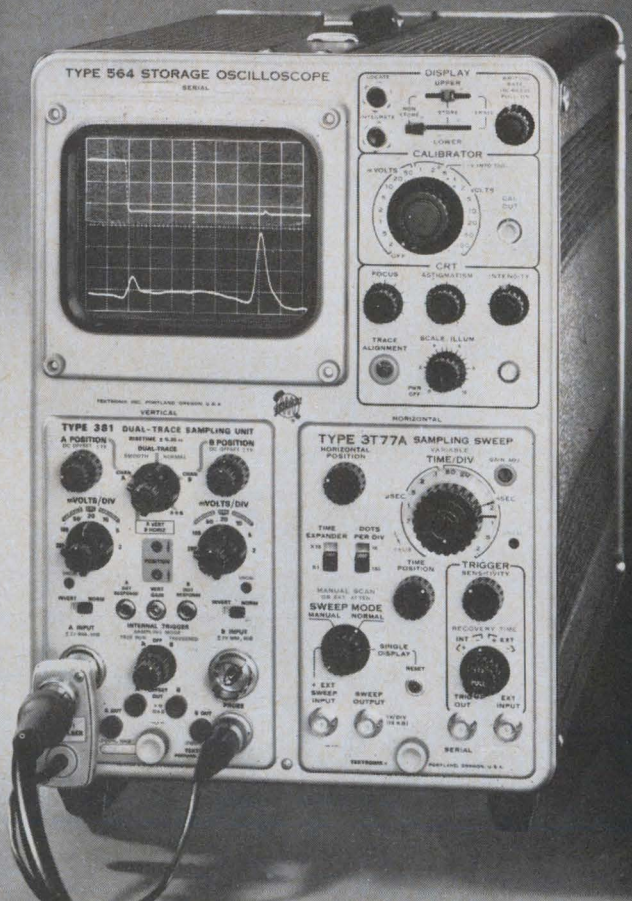

The Tektronix Type 564 split-screen storage oscilloscope with the Type 3T77A sampling time-base and the new Type 3S1 dual-trace sampling vertical is a DC-to-1 GHz measurement system with the unique capabilities of split-screen storage.

The Type 564 storage oscilloscope is virtually two instruments in one, offering all the advantages of a split-screen storage oscilloscope, plus those of a conventional plug-in oscilloscope. The contrast ratio and brightness of stored displays are constant and independent of viewing time, writing and sweep speeds, or signal repetition rates. The entire screen or either half can be used for storage and/or conventional displays. In the stored mode, either half of the screen can be erased independently of the other half.

The new Type 3S1 is a dual-trace sampling plug-in that has two identical amplifiers with 350-ps risetime and DC-to-1 GHz bandwidth. The $50\text{-}\Omega$ verticals feature a 2-mV/div to 200-mV/div calibrated deflection range and built-in delay

lines that provide internal triggering. A complete selection of probes is available, providing minimum high-frequency loading.

The Type 3T77A sampling time-base has a calibrated sweep range from $10\ \mu\text{s}/\text{div}$ to $200\ \text{ps}/\text{div}$, extending to $20\ \text{ps}/\text{div}$ with the X10 magnifier. It features internal or external triggering from 30 Hz to 1 GHz on pulses and from 100 kHz through 1 GHz with sinewaves. Time positioning provides a sweep delay range corresponding to at least one screen diameter. Manual scan and single display modes permit full use of the Type 564 split-screen storage capability.

For a demonstration, contact your nearby Tektronix Field Engineer or write: Tektronix, Inc., P. O. Box 500, Beaverton, Oregon 97005.

Type 564 Storage Oscilloscope	\$ 925
Type RM564 Rack-Mount Oscilloscope (7" high)	\$1025
Type 3T77A Sampling Time-Base Plug-in	\$ 690
Type 3S1 Dual-Trace Sampling Plug-in	\$1150

U.S. Sales Prices FOB Beaverton, Oregon



Conventional or storage
oscilloscopes

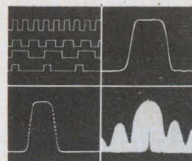

...with multi-trace, differential,
sampling and spectrum analyzer plug-ins

Probing the News

Integrated electronics

Microwave IC's come of age

Industry is gearing for volume applications in military, space, and commercial outlets; hybrid technology will give way to monolithic as mass markets develop

By Mark B. Leeds

Solid state editor

Integrated circuits are chipping away at the private preserves of microwave and other high-frequency tubes and components. And a number of IC trends are becoming increasingly apparent:

- Military and space systems, especially radar, are the biggest potential outlets at the moment, but consumer and commercial applications will be increasingly in evidence by the 1970's.

- Lower costs and greater reliability are the principal reasons for the IC push. However, the multifunctional characteristics of these assemblies promise a variety of additional operating advantages that should enhance their appeal.

- Hybrid techniques are now dominant, but monolithic technology is gaining ground and will eventually prevail as mass markets open.

- More and more systems manufacturers will compete directly with IC houses as erstwhile suppliers seek a share of development projects leading to prototype microwave equipment.

I. Something of value

Most of the money now being spent in the microwave field is on subsystems and equipment, rather than parts. Industry sources say outlays for discrete semiconductor components, hybrid and monolithic IC's, and integrated-equipment modules are running at an annual rate of \$40 million to \$60 million, with IC's accounting for only \$2 million to \$3 million of this total. But, as assemblies improve, the semiconductor portion of the microwave market

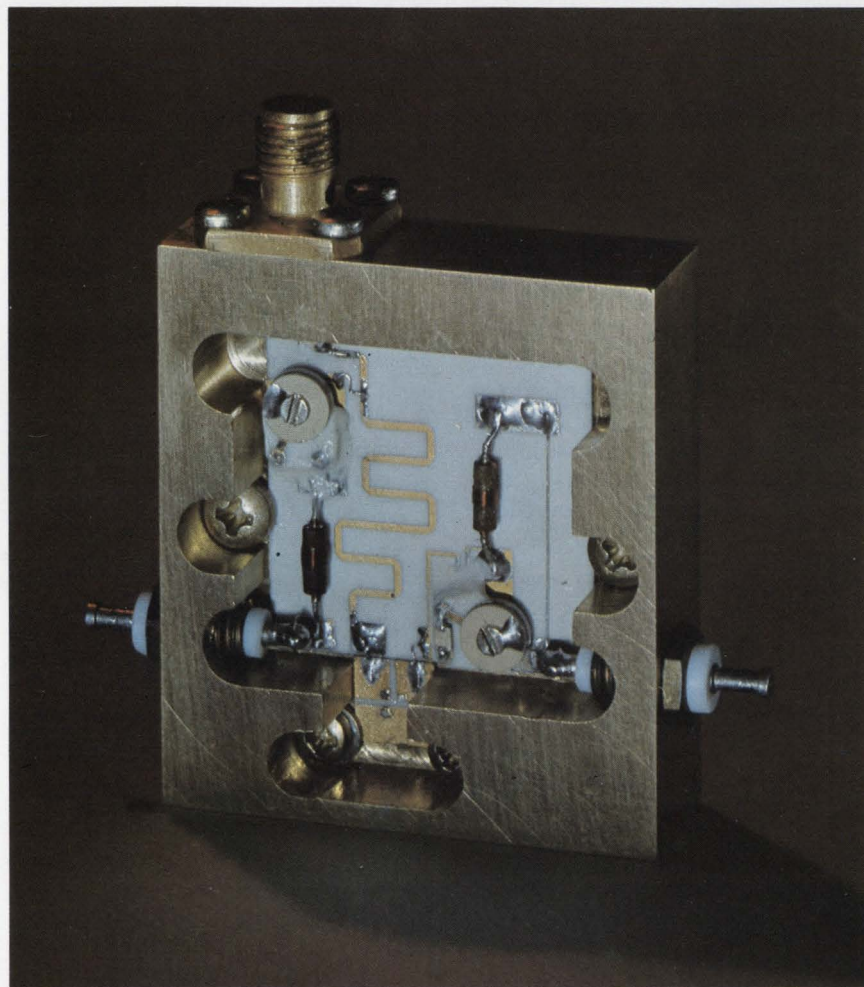

High powered. A hybrid 500-MHz oscillator built by Motorola produces a 2-watt power output. The device is mounted in a brass test fixture.

could reach \$350 million a year by the mid-1970's, according to Virgil L. Simmons, manager of microwave products at Texas Instruments Incorporated. He believes IC's will get an 85% slice of this pie.

As a result of its three years of

experience on the Air Force's MERA (microelectronics for radar applications) program, TI has a headstart on other semiconductor makers in the race for microwave IC markets. On the systems side of the fence, Microwave Associates Inc., which

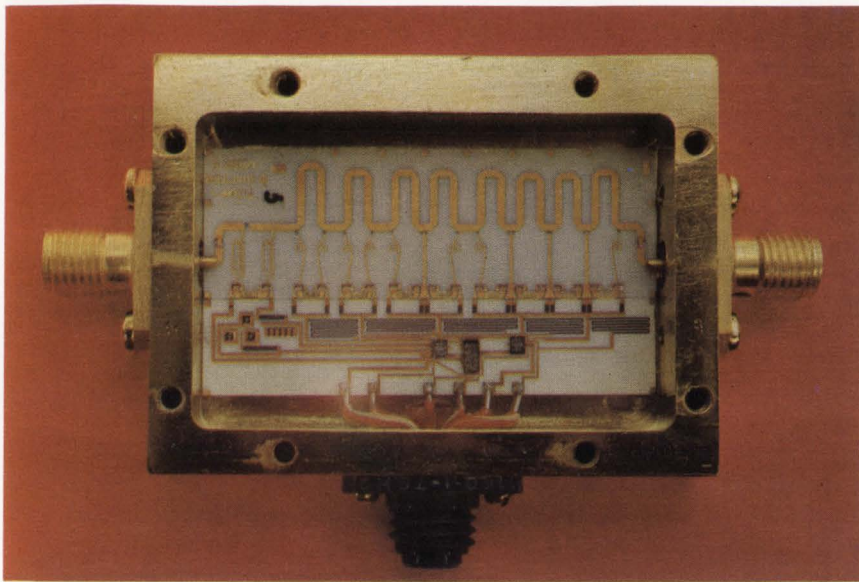

Complex. A four-bit S-band phase shifter made by Texas Instruments incorporates high-frequency driver and logic elements—the monolithic chips seen at the top center—as well as microwave switching diodes.

has a solid IC capability, holds a commanding lead. But coming up fast to give the top two a run for their money are Sylvania Electric Products Inc., a subsidiary of the General Telephone & Electronics Corp., and the Radio Corp. of America. Also in the running are such outfits as the General Dynamics Corp., TRW Inc., the Hughes Aircraft Co., the Bell Telephone Laboratories, and Motorola Inc. Overseas, Japan's Nippon Electric Co., Germany's Siemens AG, and France's Compagnie

Française Thomson Houston-Hotchkiss Brandt are among the firms that have assigned microwave IC's a high priority.

Role call. Circuits developed by TI for MERA are typical of the microwave assemblies being produced. Among these devices are S-band pulse power modules, transmit-receive switches, frequency quadruplers, X-band balanced mixers, local oscillator multipliers, and pulse modulators.

Other state-of-the-art microwave

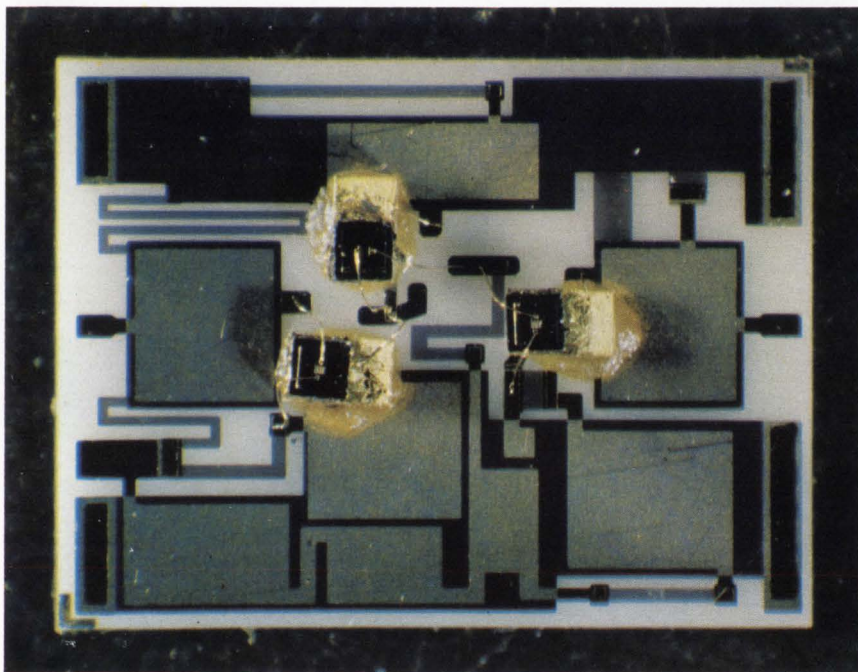

Starting point. Devices like the 500-MHz preamp from TI are bringing the Air Force's integrated phased-array radar program close to reality.

assemblies include radio-frequency and video amplifiers, circulators, and impedance-matching networks. Operating frequencies of microwave IC's run from as low as 300 megahertz through 94 gigahertz [Electronics, Aug. 21, p. 44]. Most devices work between 1 and 12 GHz; power levels vary from the submilliwatt range to 1 or 2 watts.

II. Market profile

Military and space projects in general and radar systems in particular provide the largest outlets for microwave IC's. "Radar will do for microwave IC's what computers did for digital devices," says Roger Webster, who heads Texas Instruments' microwave research and development program.

The outlook for phased-array systems is especially promising, says Richard Alberts, chief of the integrated avionics task force in the Electronic Technology Division of Avionics Laboratories at Wright-Patterson Air Force Base. He predicts that by the mid-1970's some 10,000 military aircraft may be equipped with phased-array radars, each using as many as 1,000 microwave IC modules.

Alberts also considers navigation satellites, global-communications systems, missile-guidance equipment, and electronic-countermeasures apparatus potential volume outlets. William Edwards, technical manager for microwave devices in the avionics labs at Wright-Patterson, says telemetry systems—most of which operate below 1 GHz—will be designed upward for the 1.5 to 2.3 GHz range, opening up another vast outlet for microwave IC's.

Thomas Hyltin, manager of advanced microwave development at TI, sees microwave IC's eventually supplanting infrared and ultrasonic devices in measurement systems.

Fallout. The MERA project has been good to TI. The company is now marketing some of the IC's and discrete components developed for the program to systems firms. In addition, as a result of early success, TI has snared a number of new development contracts. Among these awards are a solid-state transmitter and altimeter for the National Aeronautics and Space Administration, a portable radar for the Army, an airborne-intercept radar for the Navy, a communications satellite for the

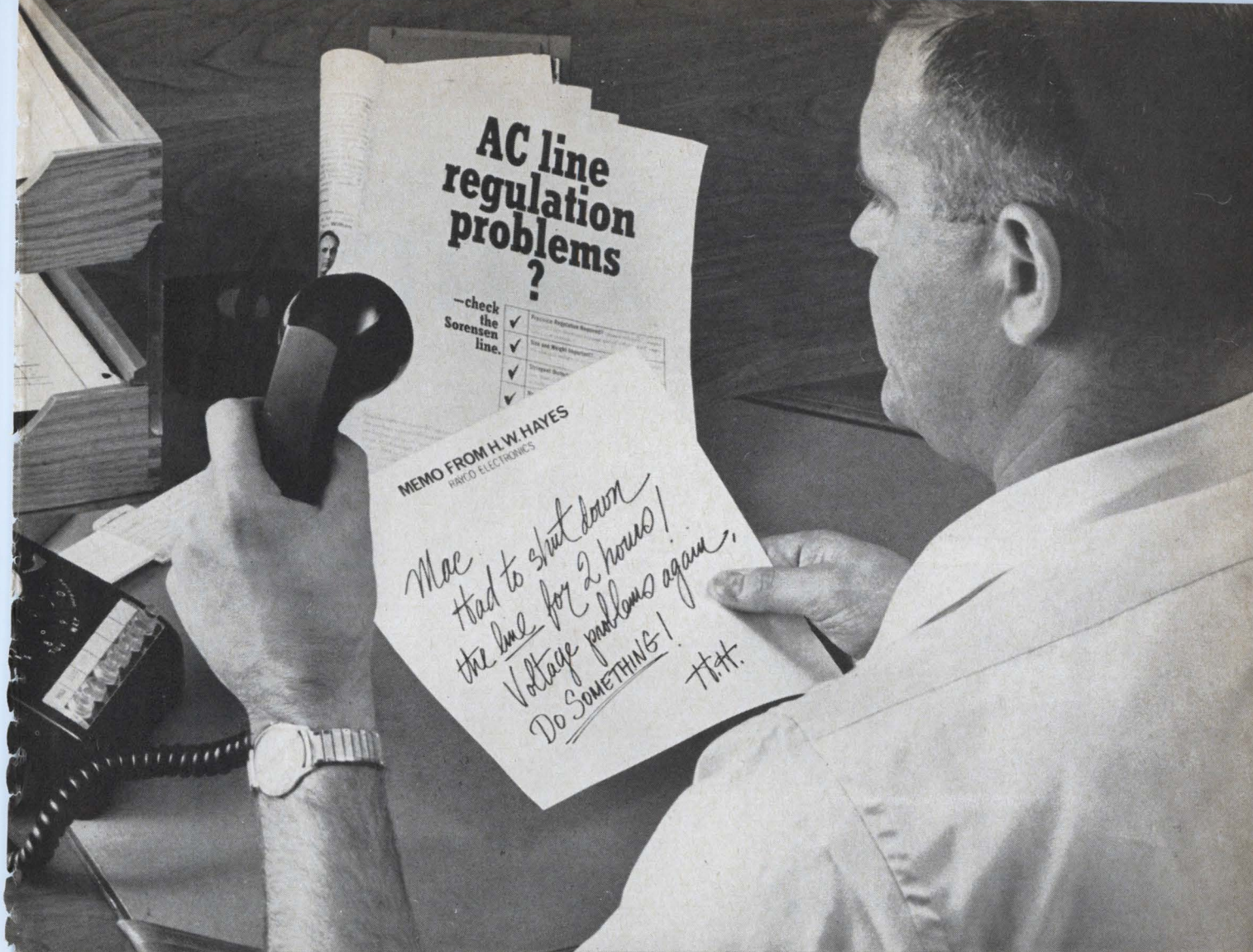

Call Sorensen

203-838-6571

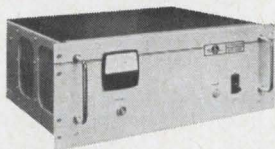

... for the solution to your voltage problems! As you know, AC line regulation is the single, most effective preventive maintenance measure you, or any other engineer can specify. Regulation reduces costly production line down-time, and insures precision laboratory instrument performance. Whether your problem is on the production line or in the laboratory, there are Sorensen regulators, available from 150 VA to 45 KVA, that will more than satisfy those "DO SOMETHING" demands.

The Sorensen ACR Series combines SCR regulation, printed circuit maintainability, with up to 60% size and weight reduction over conventional units. The 0.01 Series provides $\pm 0.01\%$ precision regulation for problems de-

manding the strictest accuracy and stability. Where fast response and high accuracy is important, models of the FR Series respond to line and load changes within 50 μ sec—considerably less than one cycle. Where size is not a factor, Sorensen's magnetic-amplifier S Series offers most effective, low-cost regulation. Each of Sorensen's 27 models have been expertly designed to solve specific voltage problems. We've been experts at solving regulation problems for over a quarter of a century.

For details on AC Line Regulators or DC Power Supplies, call or contact your local representative, or: Raytheon Company, Sorensen Operation, Richards Avenue, Norwalk, Connecticut 06856. Telephone: 203-838-6571; TWX 710-468-2940.



Circle 11 on reader service card

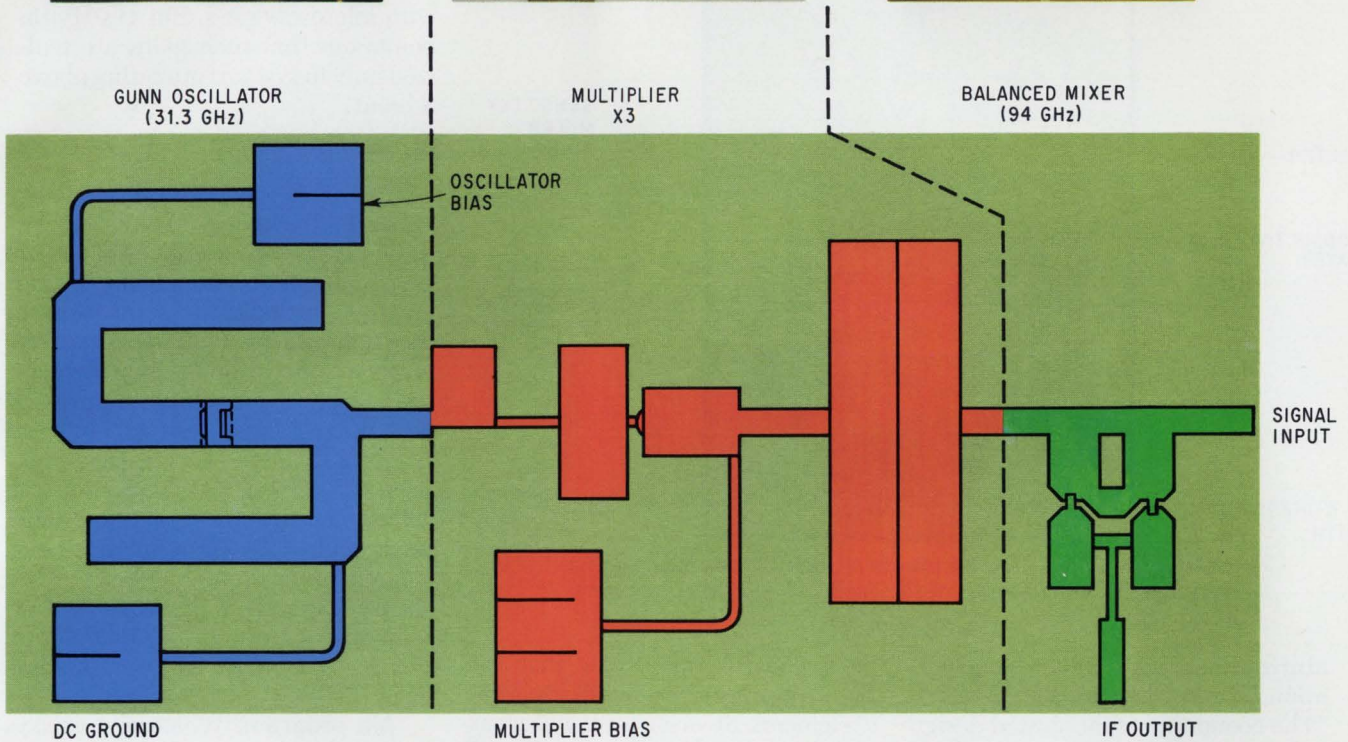
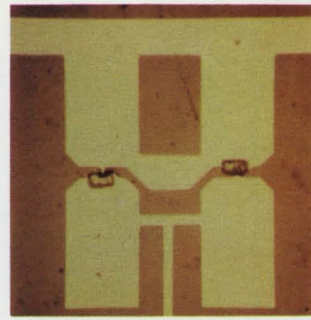
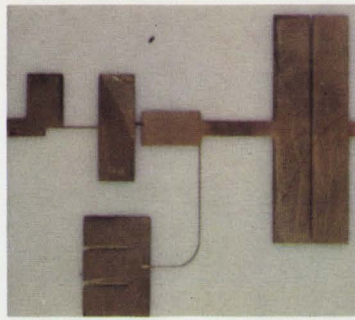
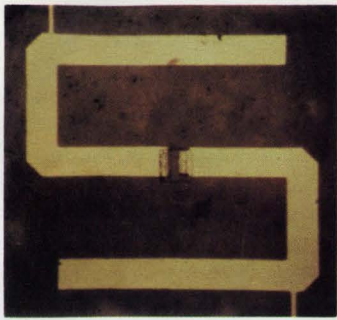

Three in one. This state-of-the-art device developed by TI for a 94-GHz receiver for the Air Force has three functions on a single monolithic chip. The circuit is fabricated on a 40-by-80-mil semi-insulating gallium-arsenide substrate.

Air Force, and advanced radar systems for the Marine Corps.

Executives at Microwaves Associates agree with the rosy assessment of the market potential for microwave IC's. But Richard T. Dibona, vice president for sales, cites telephony, industrial-surveillance gear, and airborne systems for commercial aviation as other applications. A. T. Botka, who heads the company's microwave-development effort, is optimistic about tying microwave IC assemblies to computers in high-speed data-processing applications like aerospace navigation and air-traffic control.

Motorola's Semiconductor Products division is tooling up to produce as many as 10,000 microwave IC's a week by 1969. Karl Wolters, who heads microwave development at the company's Government Electronics division, pinpoints collision-avoidance equipment and high-frequency

commercial-communications systems as potential outlets for the devices. At Sylvania, Arthur H. Solomon, chief of the microwave-components section, believes that point-to-point relay communications, data transmission, and closed-circuit television applications will prove lucrative. "The first extensive use of microwave IC's by nonmilitary customers will occur in Europe at telephone companies that don't have microwave links. The devices will be used for low-power, short-hop, low-density traffic voice channels," he says.

Overseas. But European interest in microwave IC's is not confined to telephony. Marcel Palazo, microwave manager at Thomson Houston's Radar and Aerospace division, says his company is working on devices for a variety of applications, including ground-based phased-array radar stations. In West Ger-

many, Siemens is turning out circulators, frequency multipliers, attenuators, and directional couplers with an eye to expanding its share in the communications business.

Despite the potential, a great deal depends on the course of action a company decides to take. A source at RCA, who anticipates "tremendous opportunities in such areas as marine radar, collision-avoidance systems, garage-door openers, and railroad-car identification systems," is disturbed that his company has not centralized its efforts.

"We have microwave IC facilities in a half-dozen areas," he says. "A decision on centralization is due soon, but I wish it had been made earlier since our technical capabilities rank us with the leaders."

III. Savings

"The prime motivation for going to microwave IC's is economy. Mini-

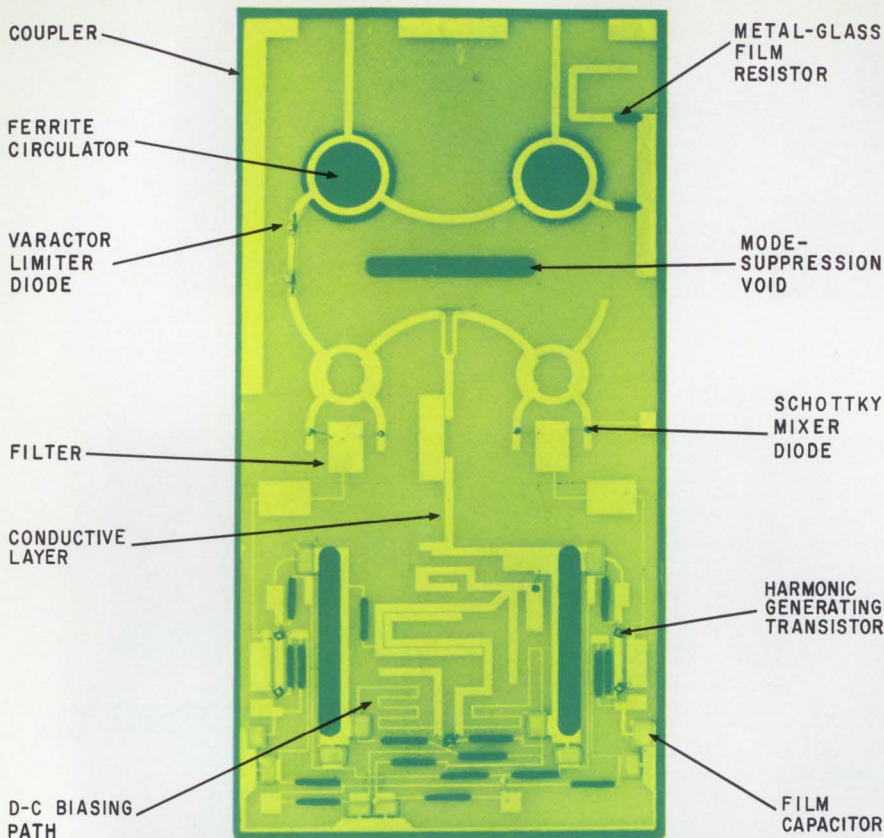

Multifunctional. Built by Microwave Associates, this hybrid device performs preamplification, mixing, and local oscillator functions.

aturization is a secondary consideration," says Motorola's Wolters. "The economics of integrated design mean that ic's will constitute up to 70% of all our microwave equipment in the next few years."

Maintenance and troubleshooting costs have proved the biggest headaches with radar. Systems that operate for only 10% of the lifetime of the equipment containing them are considered working wonders. As a rule of thumb, conventional radars break down an average of 100 times during their life span; each failure requires upwards of 10 hours of repair work.

A Government study, says π 's Simmons, pins the blame for 50% of all radar failures on less than 10% of the electronic and mechanical components. Among the weakest links are magnetrons, klystrons, connectors, and coupling. An integrated-design approach could circumvent critical shortcomings; π 's Hyltin claims that mean time between failures of microwave ic's will outstrip that of aircraft carrying the radar system.

Extras. Integrated design provides additional advantages. Simmons

cites phased-array radar that can both track and beam with the same ic elements. Steering is easily accomplished and such systems can furnish over-all area, rather than zone, coverage.

Since semiconductors don't have the narrow-response characteristics of tubes, broader bandwidth is possible. This, in turn, makes systems more versatile. In phased-array radars, ic modules are closer to the radiating element, thus minimizing power losses. Arthur S. Robinson, technical director of RCA's Missile and Surface Radar division, says

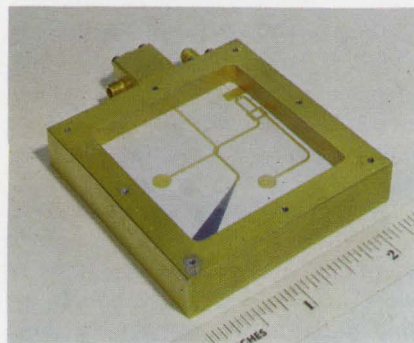

Test case. Experimental hybrid built by Sylvania has beam-lead diodes and ink-like film passive elements; it is designed for doppler-radar systems.

that when tubes are used, losses occur in the waveguide, duplexers, feeds, and phase shifters.

"Low-cost fabrication in quantity is a key consideration," says Marvin E. Groll, Sylvania's marketing manager for microwave products. "Automated production is, to a great extent, a reality with ic's. This isn't true, however, of waveguide systems." Size savings are also possible with microwave ic's. But π 's Hyltin points out that such gains are realized only in systems operating above S band.

IV. Way to go

Most of the microwave ic's now either in the works or still on the drawing boards are hybrid rather than monolithic. The main reason is that virtually any microwave function can be realized comparatively easily through hybrid techniques. The monolithic approach still doesn't lend itself to low-cost batch fabrication [Electronics, Sept. 4, p. 25]. Also, power dissipation represents a problem. Troublesome now, such difficulties are not considered insurmountable and the industry expects to be turning out volume quantities of monolithic devices probably as soon as the early 1970's.

Aid program. Webster at π says computers are being used as extensively for microwave ic design as for digital circuits. "We know the characteristics of the materials and geometries at high frequencies, so it's a snap to design the patterns and figure out the types, ingredients, dimensions, and location of the elements," he says.

"Even though microwave ic's are generally considered custom jobs," says Webster, "there are many similarities. Impedance levels as well as switching and amplifying requirements, for example, are common to most circuits. We know how specific materials and combinations of certain lengths will behave. We also know that to modify a function, we simply change a length or increase a doping level. There is getting to be less and less of the trial and error and adjustment that characterized past circuit design. And each design and element that is finalized becomes a sort of master print to be used again and again. Under the old rules, every circuit had to be dealt with ad hoc, even when off-the-shelf devices were

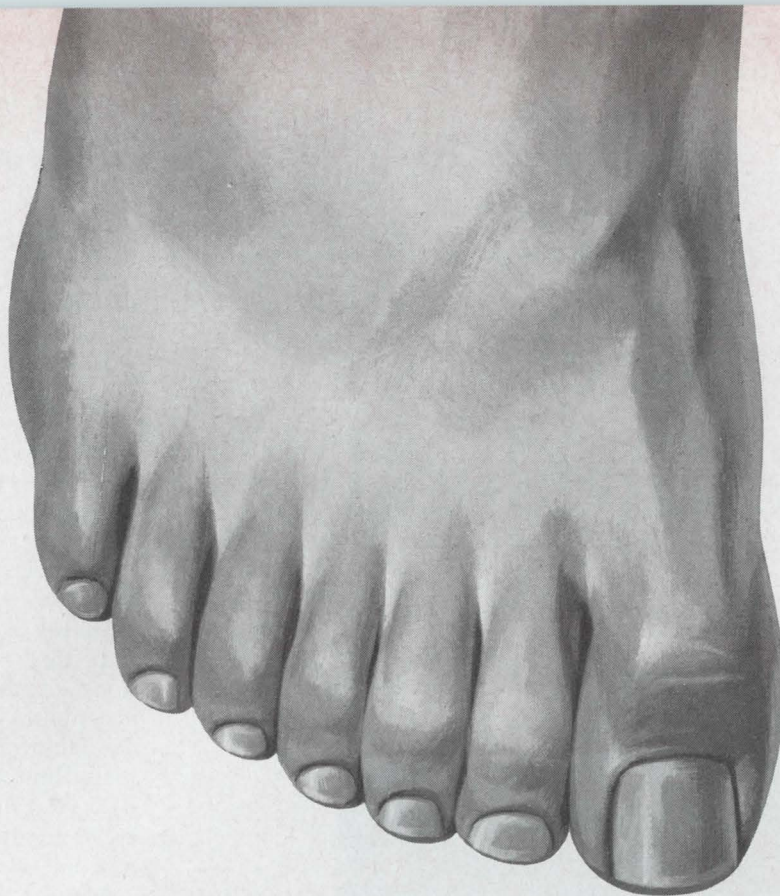

Beckman EiD takes a firm foothold in industrial counting.

Our new 200 kHz integrated circuit counters put us a step ahead of competitive models.

Seven compact counter/timer models run the gamut of applications: preset process control...frequency and normalized rate measurements...down to basic accumulation. Reliability? They *more* than measure up due to design/style factors like: Simplified front controls. Easily readable in-line display. Low (25W normal) power need. Closed-box, drip-tight, dustproof design with no cooling fan needed. High input sensitivity. Built to take rough work environments. And *all-integrated* circuits.

All models are available with data output in 1-2-4-8 binary-coded decimal form. Feeds directly into tape punchers or digital printers. For a convincing demonstration, contact our nearest regional office, listed at right. You'll find EiD's up front with what counts.

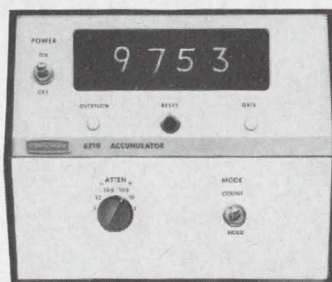

EiD more than
measures up.



INSTRUMENTS, INC.
ELECTRONIC INSTRUMENTS
DIVISION

2400 Harbor Blvd., Fullerton, Calif. 92634,
(213) 691-0841

7360 N. Lincoln Ave., Lincolnwood, Ill.
60646, (312) 583-1020

12051 Tech Rd., Montgomery Ind. Park,
Silver Spring, Md. 20904, (301) 622-2500

International Subsidiaries: Geneva;
Munich; Glenrothes, Scotland; Tokyo; Paris;
Capetown; London; Mexico City

Circle 111 on reader service card

Meet The Dividers!

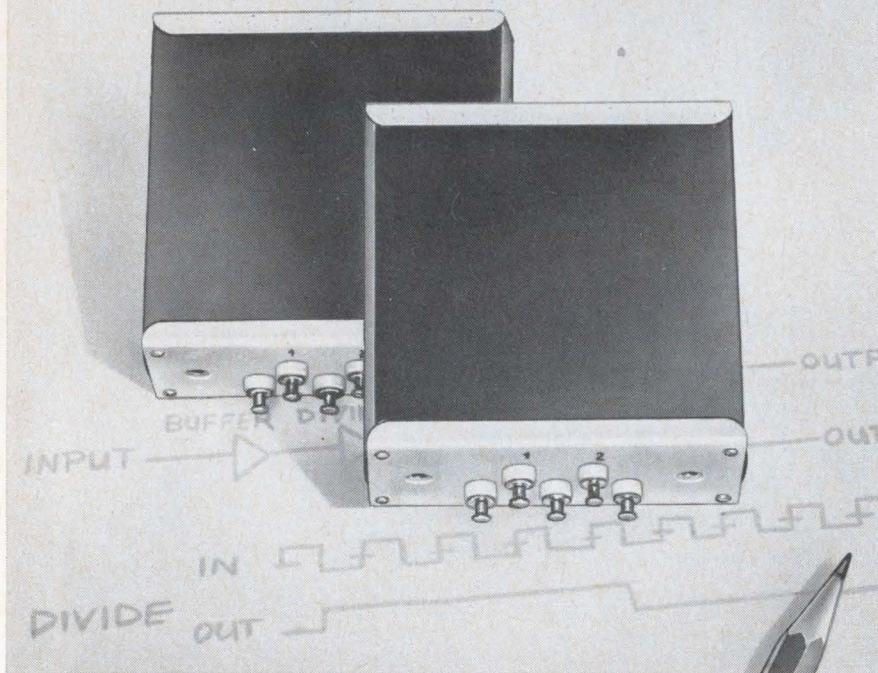

ICD SERIES INTEGRATED CIRCUIT DIVIDERS

They are new from International. Use them for crystal controlled time bases, scope calibrators, and clock sources.

International ICD units are totally integrated circuit frequency dividers. They are smaller than a pack of cigarettes (1" x 2¼" x 2⅜"). All have two separate outputs. They are packaged in nine types providing divide ratios 2 thru 10. No tuning or adjustment is required. The output pulse has the same stability as the driving pulse. Voltage required, 3.6 vdc ± 10%.

FREQUENCY RANGE

ICD-10 to 10 MHz.....\$19.95 ea.

ICD-2 thru ICD-9 to
2 MHz.....\$19.95 ea.

ICD Buffer (for feeding
more than one circuit)...\$ 9.95 ea.

WRITE FOR COMPLETE CATALOG.



CRYSTAL MFG. CO., INC.
10 NO. LEE • OKLA. CITY, OKLA. 73102

... both IC and systems firms
are now playing dual roles ...

being used."

Keys. Development of solid state discrete elements like microwave transistors, diodes, passive film networks, and related items that could be integrated, has opened up the field in the past few years. Transistors operating at 4 Ghz, for example, are now common. This is also true for mixing and switching diodes operating at even higher frequencies, permitting the use of multiplication techniques. Power-handling capacities are still lower than those of tubes, but combinations of active elements provide acceptable levels. Then, too, semiconductor elements are not as thermally limited as tubes. Thus, such devices can withstand proportionately greater average power levels and tolerate wide pulses.

Moving ahead. Microwave IC technology continues to gain ground rapidly. Typical of what's ahead is Microwave Associates' integrated Ku-band doppler-radar program for the Air Force. The project is exploring the feasibility of using large-scale-integration techniques in microwave applications. At RCA, engineers are paralleling Gunn diodes with an eye to achieving kilowatt outputs at 1 to 2 Ghz. Bell Lab researchers are on the verge of getting 1-watt outputs at 150 Ghz with limited space-charge accumulation devices. Interdigitated transistors handling 1 watt at 3 Ghz are being developed at TRW and the company expects to have a 25-watt, 1-Ghz unit operative before 1970.

At TI, Hytlin believes the millimeter range above 30 Ghz is ripe for IC conquest. He also predicts a new breed of digital elements operating at microwave frequencies for up to subnanosecond switching.

V. Power struggle

As a result of the heightened interest in microwave IC's, there is an inevitable blurring of the traditional roles played by systems manufacturers and IC makers. Eventually, there must be a direct confrontation. But for the moment, despite occasional skirmishes, an uneasy truce prevails. Perhaps the

main reason for the status quo is the Government, which is underwriting research and development efforts at both the systems and semiconductor levels.

When it comes to assembling functional blocks to build working equipment, the systems makers have the edge. But at the device level, the IC makers have the advantage. Although developments in the microwave area are generally linked to devices, the systems makers seem to be more skillful in exploiting the possibilities of new circuits. In effect, they have successfully reduced the component makers' edge.

As a rule, IC houses delay releasing the newest device developments until their own engineers have thoroughly grounded themselves on the ins and outs involved. This effectively serves to keep the state of the art at home base.

Systems firms can produce their own IC's, and their hybrid units are on a par with anything delivered by semiconductor outfits. But when monolithic devices become a fact of life, IC houses should be able to open a lead on the basis of both economy and technology. Monolithic production is an expensive proposition, beyond the reach of all but the most affluent corporations. Systems makers would have to develop volume markets to justify the vast outlays needed to get into production. It's unlikely that the microwave field can support any mass business until the 1970's.

Playing it cozy. The IC houses that don't have a background in systems work and lack operating units in the radar and communications fields generally avoid competing with their customers—both actual and potential. But the microwave field lacks giant customers like the International Business Machines Corp. that can create markets by themselves.

It is not unlikely that marketing and merchandising prowess may ultimately dictate which firms get the biggest slice of the microwave pie. For the moment, however, IC houses and systems makers appear content to quietly upgrade their competence in the others' specialties. Some companies are even reorganizing along marketing and production lines so they can work both sides of the street.

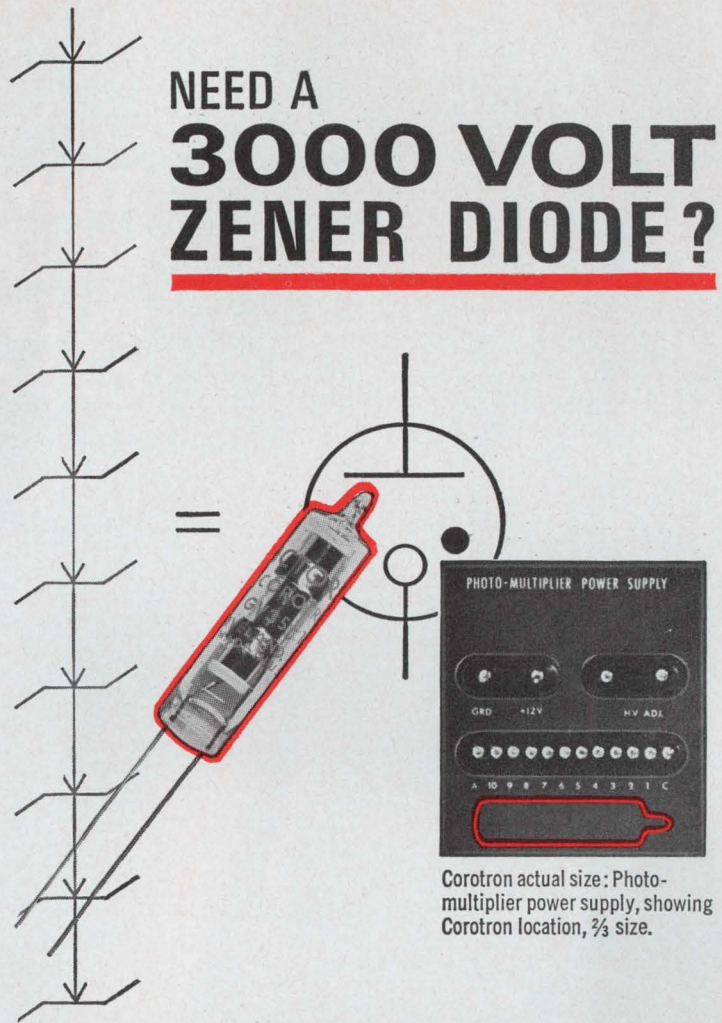

NEED A 3000 VOLT ZENER DIODE?

Corotron actual size: Photo-multiplier power supply, showing Corotron location, $\frac{2}{3}$ size.

You could string together several hundred zeners. Or you could specify *one* Victoreen Corotron. It is the gaseous equivalent of the zener with all the advantages of an *ideal* HV zener diode.

For space research and other rugged applications requiring absolute power supply stability, GV3S Series, shown, provide the ideal reference voltage anywhere in the range of 400 to 3000 volts. They enable circuitry to maintain constant high voltage regardless of battery source voltage or load current variations. Cubage and weight (GV3S Corotron weighs only 4 gm.) are important considerations. So is temperature variation (Corotrons operate from 200°C down to -65°C). Ruggedized versions withstand shock to 2000 G, vibration 10 to 2000 cps.

If you're trying to simplify circuits . . . to cut cost, size and weight . . . to upgrade performance—you need Corotron high voltage regulators. Models are available now from 400 to 30,000 volts. A consultation with our Applications Engineering Dept. will speed up the countdown.

8501-A



VICTOREEN INSTRUMENT DIVISION
10101 WOODLAND AVENUE • CLEVELAND, OHIO 44104
IN EUROPE: GROVE HOUSE, LONDON RD., ISLEWORTH, MIDDLESEX, ENGLAND

TRW METALLIZED POLYCARBONATE CAPACITORS



TRW
X463UW
10MFD 50V

... small enough to fit!

TRW 50-volt Metallized Polycarbonate Capacitors are made to squeeze into tight places. Imagine 10 microfarads measuring .547" x 1¼" long... the smallest wound capacitor on the market!

Short on size and long on reliability, the X463UW series meets all requirements of MIL-C-27287.
VOLTAGE—50V, 100V, 200V, 400V
CAPACITANCE— .001 through 10 mfd
TOLERANCE—available to $\pm 1\%$.

For data, write TRW Capacitor Div., Ogallala, Neb. Phone (308) 284-3611. TWX 910-620-0321.

TRW[®]

Bantam computers cutting into heavyweight territory

Ability to do specific jobs at reasonable cost—and programing problems of large, third-generation systems—opens rich market

For more than a decade big, fast, and costly processors have thoroughly dominated the computer scene. But the picture is changing. Bargain-priced, bantam weight machines will take the play away from supersystems at the Fall Joint Computer Conference next month in Anaheim, Calif.

In the vanguard of this upheaval are two companies not normally considered dominant figures in the data processing field—the Digital Equipment Corp. with an integrated-circuit takeoff on its PDP-8 series and the Hewlett-Packard Co. with its model 2115A, a stripped-down, economy version of the 2116A [Electronics, Sept. 18, p. 43].

Probably the main reason that small computers have captured the fancies of both users and manufacturers is the extreme difficulty experienced in programing the large, third-generation machines. Moreover, both groups are waking up to the fact that there is a place—and a growing one—for small computers that can do specific tasks efficiently at a reasonable cost. Adding further impetus is a year-old Air Force resolve to use off-the-shelf machines rather than custom designs for all but a few mobile and airborne applications [Electronics, Sept. 19, 1966, p. 201]. And integrated circuits have helped bring the cost of general-purpose computers below \$20,000.

I. Diminishing returns

Until now, the major trend in computer design has been to reduce the cost per calculation by increasing the size and speed of the computer. The International Business Machines Corp., for example, says it cost \$1 to process 35,000 program instructions in 1950; today, 35,000,000 instructions can be

processed for \$1. Theoretically, this gives machines the capacity to work on several problems at the same time. But the bigger the machines grew, the more important became precision scheduling of peripheral gear, such as tape transports, printers, punched-card input and output devices, and data transmission apparatus. Moreover, exactness must be automatic—a situation requiring complex operating-system programs that have proved difficult or impossible to write.

IBM Corp. has suffered the best publicized woes with software for the larger models of System 360. The program was completed at least two years late. At one time, the company had nearly 1,000 people writing it. When finally delivered, the program still didn't satisfy everybody, and it has already been changed two or three times. Regular revision will be necessary, probably as long as System 360 machines are in use.

Programs for operating systems have grown so big—IBM's has one million instructions — that they choke the computer memories, cutting down on the machine's ability to perform useful tasks. For example, the 360's operating system occupies almost 32,000 bytes of memory all of the time.

Identity crisis. As another source of discouragement, a big computer takes a lot of programing to make it a scientific problem solver for one user, a payroll accounting machine for another, an information retrieval system for a third, and a language translator for a fourth.

Time-sharing has further complicated programing by introducing complex coding and programing requirements to assure each user's privacy.

As a result of such difficulties, users have begun asking if it wouldn't be more economical to buy several small-sized general-purpose computers, each of which

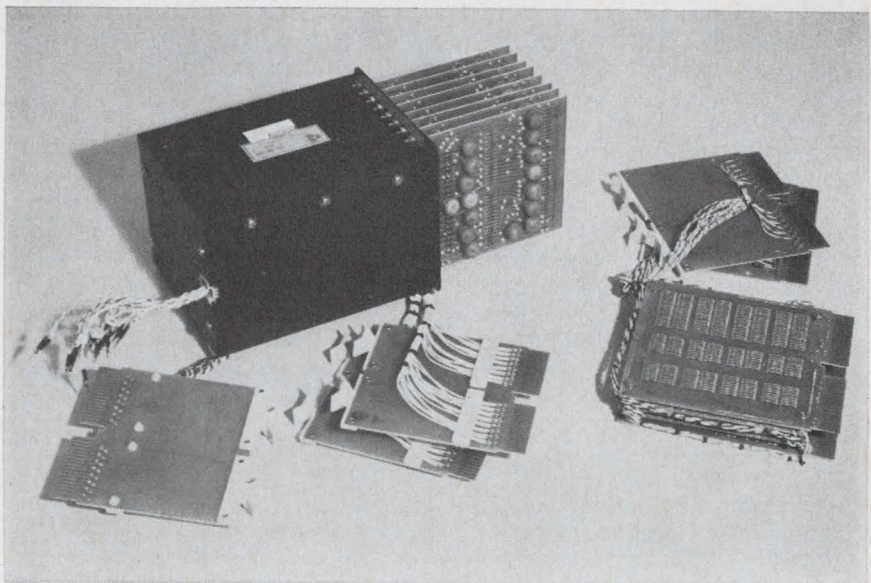

Squeeze play. Core stack memory for new Digital Equipment Corp. computer built with IC's is shown at right; it replaces the hardware at the left.

. . . the trend to time-shared systems will boost small computer sales . . .

could concentrate on a single problem, such as circuit design, payroll preparation, or inventory checks. More and more customers are saying yes, particularly since the availability and use of integrated circuits has brought the cost of small machines with acceptable speeds and capacity into the \$10,000 to \$20,000 range. Moreover, these smaller processors are comparatively easy and inexpensive to program.

Charles D. Ettinger, manager of small computer marketing at the General Electric Co., says that the trend to time-shared systems and remote batch processors will mean more rather than less business for the mighty mites. He believes that multiplant companies will want small machines for remote access to central systems as well as for

use as principal processors at outlying locations. Ettinger estimates that perhaps 5,000 new commercial users will be buying such equipment between now and 1970.

Job shopping. Other analysts peg the dollar value of the 1967 market in small computers at more than \$200 million. In addition to taking over conventional computer chores in scientific and research applications, the small new machines have created their own openings in process control, test instrumentation, and communications. Small computers are also being employed as satellites—either as controllers or buffers—in larger data processing systems.

II. Dead aim

With such a lure, the market, which is expected to grow to nearly

\$1 billion by 1970, is attracting new suppliers. For example, Hewlett-Packard, an instrument maker, was prompted to introduce a small general-purpose computer, the 2115A, that costs \$16,500 with a teleprinter. The company's new machine, which will be unveiled at Anaheim, is an adaptation of the special-purpose computer, designed for instrumentation systems, that was introduced last fall. The 2115A was intended to compete head-on with a small machine already doing very well—the PDP-8, an \$18,000 unit made by the Digital Equipment Corp., self-styled "IBM of small computers." The H-P machine uses the same kind of input and programing and produces the same kind of output as Digital Equipment Corp.'s model 8.

With the PDP-8 and another small machine—the PDP-8/S, a slower model of the 8 which carries a bargain-basement price tag of \$10,000—DEC claims a healthy percentage of the small-computer market. The company considers Honeywell Inc.'s Computer Control division, whose models DDP-416 and -516 sell in the \$20,000 range, and Hewlett-Packard its principal competitors.

Big deals. Unlike orders for large machines that typically dribble in one at a time, bookings for small machines can come in bunches. Theodore Helweg, vice president for marketing at Honeywell's Computer Control division, says his firm recently received an order for 150 machines from a communications concern. About the same time, the Digital Equipment Corp. reported an order for 200 machines from one of its customers in the communication field.

One-upmanship. Both Honeywell and Digital Equipment Corp. are looking worriedly over their shoulders at Hewlett-Packard because of the instrument company's traditionally strong marketing organization. Barely had H-P announced its plans to enter the general-purpose computer business with the 2115A when DEC hustled to trump its rival's ace with a new version of the model 8 that is faster, more powerful and costs only \$12,800 with teleprinter. [For a closer look at this new machine, the PDP-8/I—I for integrated circuits—see the box on this page.] The new machine

Family plan

Stockholders at the Digital Equipment Corp.'s annual meeting at the end of October were treated to a preview of the company's first computer built with integrated electronics: the PDP-8/I. The new machine is compatible with the company's model 8: it runs on the same programs and operates the same input-output equipment at about the same speed. But with a price tag of \$12,800, it costs \$6,000 less than the model 8 and \$4,000 less than the new machine announced this fall by the Hewlett-Packard Co.

The company started its family of small computers four years ago with the PDP-5 machine. It followed up with the PDP-8, which was faster and cheaper. The PDP-8/S, a slower, less expensive version of the PDP-8, came next.

The design of the 8/I typifies the new breed of small computers. It has minimal architecture. For example, the basic instruction set does not include multiply or divide instructions; instead, program subroutines perform these operations. If a buyer needs such capability, he can get the hardware at extra cost. In addition, the machine has no index registers except for a single special address in the main memory.

Until the model 8/I, DEC had stayed away from integrated electronics on the grounds that IC's were neither economic nor reliable enough. What changed the company's mind was the availability of transistor-transistor logic (TTL). The high speed of TTL allows the new computer to equal the performance of a PDP-8 machine—which operates on register-to-register transfers so that two or more transfers take place at the same time—even though the PDP-8/I uses a common bus for transfers, allowing only one transfer at a time. The common bus is necessary because of the limited number of inputs available in an individual TTL circuit.

Compared to the PDP-8 or the PDP-8/S, the new machine has somewhat greater capability. In operation, it is more serial than the 8 and more parallel than the 8/S. The 8/I has built-in controls for a paper-tape reader and plotter—something the earlier machines lacked.

And, although both the PDP-8 and the PDP-8/I have a basic memory of 4-k bits, the new computer has built-in wiring to handle an extra 4-k memory that can be plugged in. The earlier machine requires an external module.

Satisfied with the performance of the PDP-8/I, DEC may redesign the cheaper PDP-8/S with IC's to produce a no-trimmings computer that could sell for about \$6,000.

Would you believe

Speeds to 10 nanoseconds per bit.

Aperture time low as 0.2 nanoseconds.

Internal sample-and-hold and power supplies.

Prompt delivery.

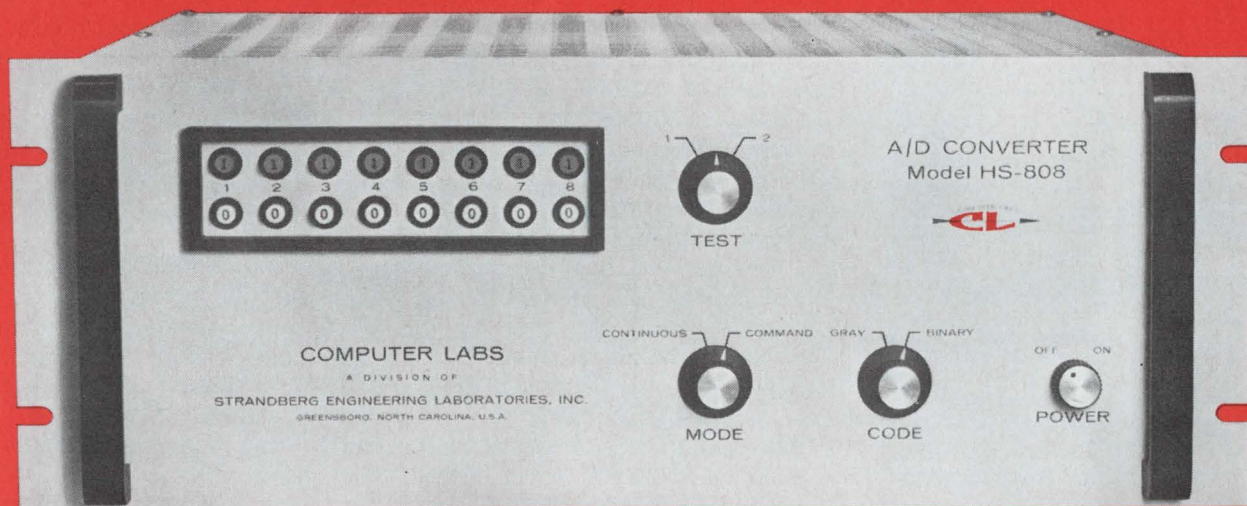

HS-808 A/D Converter 8-bit Conversion at 8 MHz

BITS	MODEL NO.	CONVERSION RATE (MAX.)	APERTURE	WEIGHT OF LSB.	ACCURACY	ANALOG BW FOR RATED ACCURACY	MAX. ANALOG BANDWIDTH	PRICE
4	HS-425	25 MHz	1.0 ns	128 mv	64 mv	12.5 MHz	15 MHz	\$5800
4	HS-406	6 MHz	3.0 ns	128 mv	64 mv	3 MHz	5 MHz	\$4200
5	HS-520	20 MHz	0.8 ns	64 mv	32 mv	10 MHz	15 MHz	\$6400
5	HS-505	5 MHz	2.5 ns	64 mv	32 mv	2.5 MHz	5 MHz	\$4800
6	HS-615	15 MHz	0.6 ns	32 mv	16 mv	7.5 MHz	15 MHz	\$7490
6	HS-604	4 MHz	2.0 ns	32 mv	16 mv	2 MHz	5 MHz	\$5500
7	HS-710	10 MHz	0.4 ns	16 mv	8 mv	5 MHz	15 MHz	\$7950
7	HS-703	3 MHz	1.5 ns	16 mv	8 mv	1.5 MHz	5 MHz	\$5900
8	HS-808	8 MHz	0.35 ns	8 mv	4 mv	4 MHz	10 MHz	\$8650
8	HS-802	2 MHz	1.0 ns	8 mv	4 mv	1 MHz	3 MHz	\$6400
9	HS-905	5 MHz	0.2 ns	4 mv	2 mv	2.5 MHz	10 MHz	\$9660
9	HS-901	1 MHz	0.5 ns	4 mv	2 mv	0.5 MHz	3 MHz	\$6800

Your Search is Over ...



(919) 292-6427 • 1109 VALLEY PARK DRIVE • GREENSBORO, N. C. 27403

A DIVISION OF
STRANDBERG ENGINEERING LABORATORIES, INC.

for tomorrow's technology today

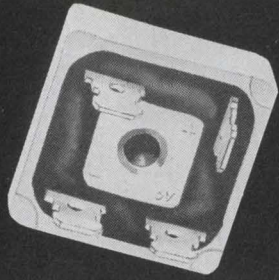

"ALPAC" A NEW CONCEPT!

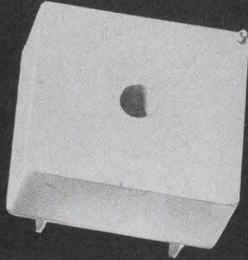

high current integrated rectifier circuits

"ALPAC" bridge rectifier circuits offer:

ALUMINUM CASE — A new power bridge rectifier circuit designed in a functional aluminum case.

HIGH CURRENT — Up to 25 amps average rectified current available from PIV ratings of 50 to 600 volts.

SMALL SIZE — Case size is 1.125"x1.125" x.406" max.

TERMINALS INSULATED FROM CASE — Unique 3-way-universal-terminals allow maximum installation flexibility.

"ALPAC" is specifically designed to simplify packaging and minimizing production costs. Economically priced to replace multiple stud rectifier usage, "ALPAC" reduces space requirements by one third with improved reliability.

Internally, "ALPAC" utilizes the Semtech high performance rectifiers, welded together for mechanical strength. The device is rated at a maximum thermal resistance of 1.5°C/Watt.

Technical bulletins describing the "ALPAC's" high current Bridge Rectifiers, Doublers, and Center Taps are available.

SEMTECH CORPORATION

652 Mitchell Road, Newbury Park, California 91320
(805) 498-2111/ from L.A. (213) 628-5392 TWX; 910-336-1264

Central: 140 No. La Grange Road, La Grange, Illinois 60525
(312) 352-3227 • Eastern: 116-55 Queens Blvd., Forest Hills,
N.Y., N.Y. 11375 (212) 263-3115 • European Sales: Bourmes AG,
Alpenstrasse 1, Zug, Switzerland (042) 4 82 72/73

... with LSI, an entire processor may be built on a single chip ...

will also make its official debut at the Fall Joint Computer Conference.

III. Best of the rest

Although virtually all other computer makers say they too are interested in the small computer business, most do not make equipment that meets the tough specification of very low cost. Scientific Data Systems Inc., for example, makes the Sigma 2, which comes close to being a small general-purpose machine. But while its price tag is only \$30,000, a company executive cautions that adding peripheral equipment can run the cost up to \$70,000 or \$80,000 for an installation. Other small computer makers contend the Sigma 2 has not been tough competition and say it accounts for less than 2% of the market. General Electric's model 115 "small computer" has a starting price of \$55,000; installations cost as much as \$275,000.

The Radio Corp. of America has a machine, the 1600, which meets the requirements for a small computer, but the company does not yet sell the machine as a separate product. The 1600 is used as a controller in other data processing systems or as a buffer in communications systems.

The Control Data Corp. which has always concentrated on the largest and fastest computers, typically those run by aerospace companies which have large staffs or computer experts to write their own programs, has also eschewed this part of the market. And IBM, which bestrides the worldwide computer market, has only fielded one entry that meets the low-priced limitation.

IV. New ballgame

But the three major outfits—DEC, CDC, and H-P are not likely to keep their preserve private for very long. During the next decade, the development of large-scale integration—the incorporation of thousands of gates on a single chip—will change not only the organization and shape of the next generation of computers but also the structure of the in-

dustry. It's conceivable that an entire processor could be built on a single slice of silicon the size of a half dollar.

Dan E. Cota, a member of the product planning staff at Scientific Data Systems, says large-scale integration may well be one of the technologies that will lead to small systems even cheaper than those now available. "Large-scale integration is suitable for logic and it may also be useful for memories," he says. "If this proves out, we could take a total design approach to new systems." Combining memory and logic in the same package, or even on the same slice, would distribute memory throughout the computer instead of restricting it to one portion.

But even before that happens, medium-scale integration—50 to 100 gates on a single IC—will radically affect computer designs. In addition, medium-scale integration products, some of which are already being marketed or built on pilot lines, will cut the costs of small computers even more sharply.

Logical contenders. It's inevitable that some of the semiconductor companies that build large arrays will enter the small computer field. Texas Instruments Incorporated has already built an experimental machine in its laboratory and is weighing its market potential. The Fairchild Camera & Instrument Co., which has pushed IC instrumentation in its instrument division, has a bevy of computer experts and could launch a line of equipment to follow Hewlett-Packard's lead.

Finally, some of the aerospace firms like the Autonetics division of the North American Rockwell Corp. with inhouse capabilities in both IC's and computer technology, are studying the possibilities of the small machines as diversification vehicles. What makes this area so much more attractive than the large general-purpose computer business is the premium placed on hardware. There is no need to develop the complex, expensive software packages which tripped a lot of earlier entries in the computer market.

No Comment.

LM 101

Voltage Follower

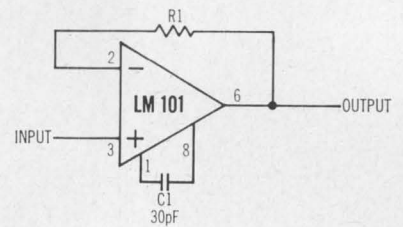

Inverting Amplifier with Balancing Circuit

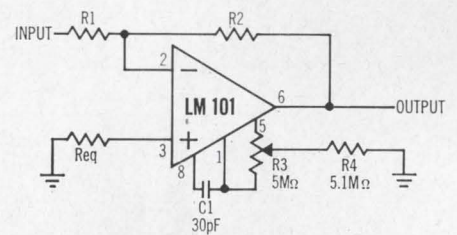

Unity Gain Inverting Amplifier

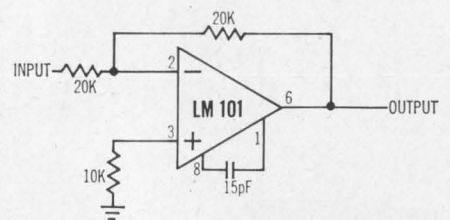

Voltage Comparator for Driving DTL or TTL Integrated Circuits

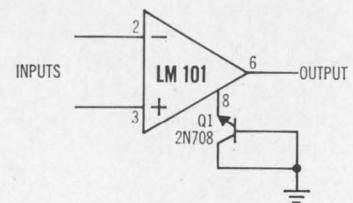



Searching for electronic components that are hard to describe and even harder to find?

Stop.

Let the Northern Plains Industrial Catalog search for you.

Northern's Industrial Catalog can locate a source for most any part or assembly. It is a unique find-it-in-a-hurry service of Northern Natural Gas Company that will quickly locate reliable suppliers, sub-contractors and sources for parts, components and sub-assemblies made to your exact specifications. In technical terms, the Northern

Plains Industrial Catalog is a computerized compilation of all industrial fabricators in the Northern Plains area—Iowa, Kansas, Minnesota, Nebraska, South Dakota and western Wisconsin. It's the source of information that can tell you where to buy wisely, profitably and quickly. And the service is free. So if you're interested in electronic

components, plastics, short run stampings, motors, precision machined parts, instruments, die castings or whatever, fill out the coupon. You'll receive complete information. And if you attach a sketch or specifications of your required components, Northern Natural Gas will send you a specially compiled list of qualified producers.

INDUSTRIAL CATALOG

Area Development Dept. E-1030

Northern Natural Gas Co., Omaha, Nebr. 68101



Dear Sirs: Please send Sources of Supply information on: _____

_____ Drawings enclosed.

NAME _____ TITLE _____

COMPANY _____

ADDRESS _____

CITY _____ STATE _____

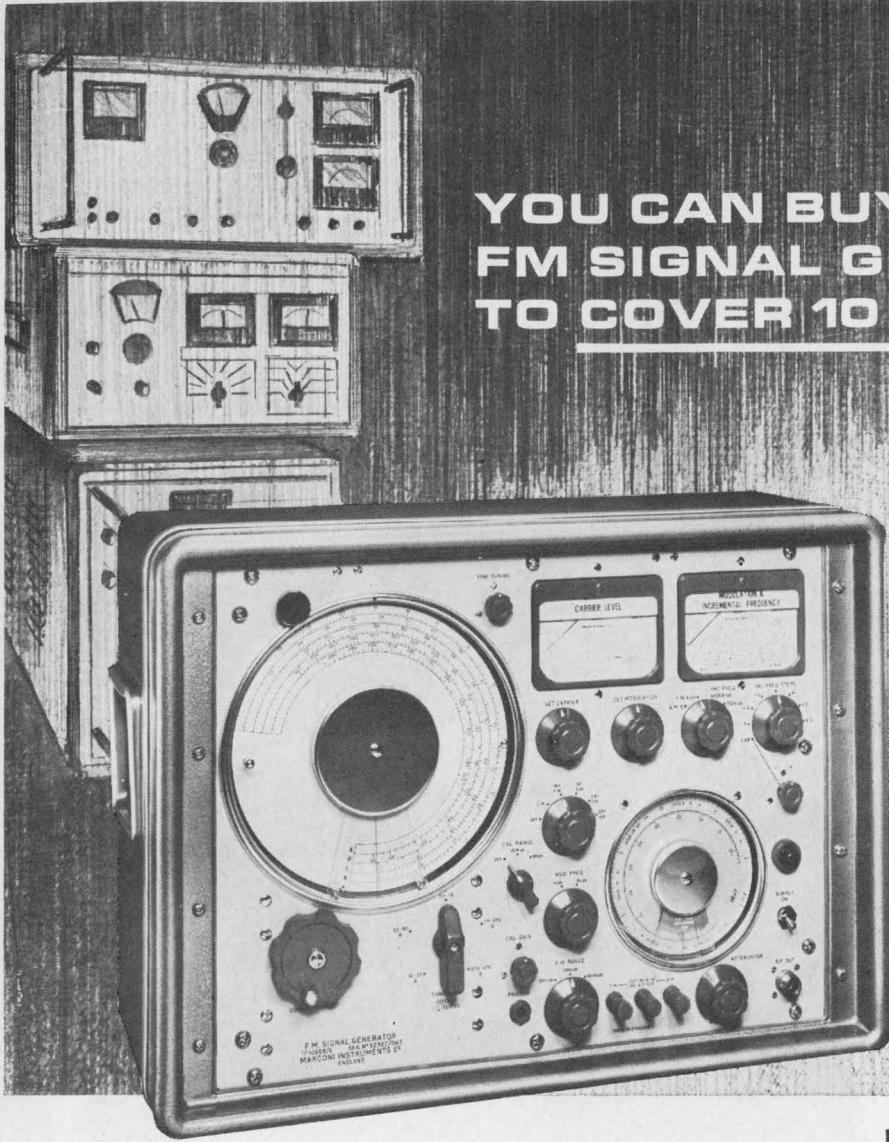

YOU CAN BUY **3**
FM SIGNAL GENERATORS
TO COVER 10 TO 470 MHz

1
... OR
MARCONI
FM
SIGNAL
GENERATOR
MODEL 1066B

The Marconi 1066B Series of FM Signal Generators are now considered standards of the industry for all RF and IF checks on FM equipment including telemetry, communications, sensitivity, bandwidth, and limiting of receivers, FM transceivers, etc. Outstanding features of these instruments are:

1066B/1 (6625-929-4277)

- No sub-harmonics
- Stepped and Continuously variable incremental tuning
- Internal or external modulation
- Output 0.2 μ V to 100 mV into 50 Ω
- FM on CW < 100 Hz

1066B/6 (6625-937-2801)

- All the features of 1066B/1 plus ...
- Built-in crystal calibrator: 10 mc & 1 mc
- FM deviation: up to \pm 400 KHz
- Modulation range: 30 Hz to 100 KHz
- Modulator distortion < 5% 215 to 265 MHz; < 10% elsewhere

Available Upon Request



THE SIG GEN BOOK
 This 28-page book presents detailed discussions on signal generators and receiver measurements including: source impedance of feeder connected receivers, coupling to loop antennas, signal-to-noise ratio, automatic gain control, plotting response characteristics, measurement of adjacent channel suppression and spurious response, etc.

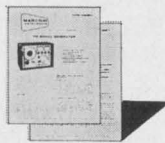

TECHNICAL DATA SHEETS
 Technical Data Sheets on the Model 1066B/1 and Model 1066B/6 Marconi FM Signal Generators detail all specifications, operation, applications, features and accessories available.

MARCONI INSTRUMENTS
 Division of English Electric Corporation

111 CEDAR LANE, ENGLEWOOD, NEW JERSEY 07631 • (201) 567-0607



Over 60% of all Heinemann hydraulic-magnetic circuit breakers produced each year are rather odd in one way or another.

By the usual standards, at any rate. But for us the far-out is all in a day's work. We're tooled up to manufacture the out-of-the-ordinary as a matter of routine.

The fact is, we have an extensive roster of options for you to work with when you want really tight overload protection. Current ratings in any integral or fractional value, from 0.010 to 225 amps. A choice of several time-delay characteristics or instantaneous trip. A selection of special-function internal circuits — relay-trip, shunt-trip, etc. A broad array of models, from one to six poles, from subminiature on up.

The cost of a job-matched Heinemann breaker will probably be a good bit less than you would expect. The reason is simple enough. 'Specials' are our specialty—60% every year.

If you've got a knotty protection requirement, get in touch with us. For a starter, try our Bulletin 302; it covers our entire line of breakers. We'll put a copy in the mail as soon as we hear from you. Heinemann Electric Company, 2626 Brunswick Pike, Trenton, N.J. 08602.

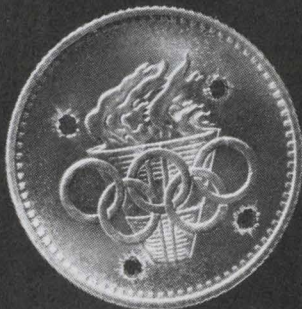

4 lives
3 forms
2 uses
1 crystal
0 voids



The **TOTALLY TOKIN TOTAL:**

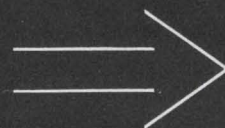
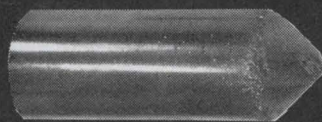

The Olympic Winner—

watchers were headed by TOKIN.

- '64 Olympics: Japan Broadcasting Corporation developed unique slow-speed video tape recorders to catch the winning moments beyond doubt. To get long life and super-sensitivity for their VTR recording heads, they chose **TOKIN** to make the tips. Just last year **TOKIN** began to produce them internationally.
- TOKIN** heads the heads with Ferrite Single Crystals. These **TOKIN** single crystals quadruple recording head life, vastly improve electrical characteristics because voidless ceramic materials with high electrical resistivity are used.
- TOKIN** single crystals can be produced along customer-specifications in (1) round ingot form, in (2) blocks and in (3) chips—and even cores. These extraordinary crystals head the heads in (1) VTR's and audio recorders, and work as well in (2) computers and data processing equipment.
- TOKIN** was the first to do it, stays in first place internationally: **TOKIN** manufactures nearly 100% of ferrite single crystals in Japan, stands almost alone among world-makers. (**TOKIN** also manufactures a complete line of head-materials including Sendust alloys.) And like everything else **TOKIN** takes

up, **TOKIN** single crystals are, start-to-finish, totally **TOKIN**.

5. Write:

Tohoku Metal Industries, Ltd.

4, 7-chome, Ginza-Higashi, Chuo-ku, Tokyo, Japan
 Telephone: Tokyo 542-6171
 Cable Address: TOHOKUMETAL TOKYO



Authoritative. Accurate. Current.

Computer programming makes its entire contents as current as the week it went to press.

Comprehensive. 2,000 pages, 126,000 items. Including a complete list of trade names.

Easiest to use. Organized for speed. Locate

products and their sources in one reference.

In wide use. An industry standard. Makes phone to phone discussions more efficient.

Valuable. EBG can help you save time. Make more profit for your company. Meet deadlines. Improve products. Use it often.

Electronics Buyers' Guide

A McGraw-Hill Market Directed Publication, 330 West 42nd Street, New York, N. Y. 10036

integrated product listings—
product sources and specifications in the same section.

color coded readouts—
yellow section for product, green section for manufacturers and trade names.

coming this fall...

The Black Box Explosion

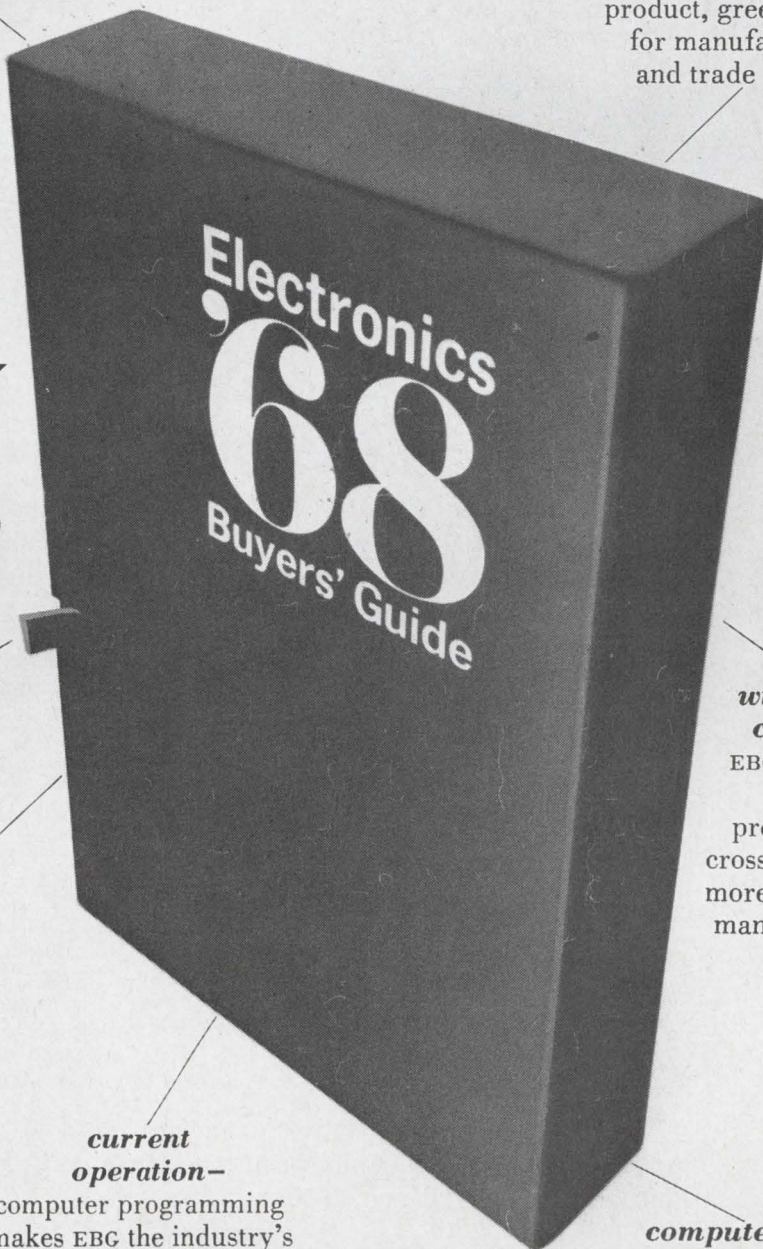

pull here

shelf mounting—
keeps an entire industry within arms length.

current operation—
computer programming makes EBG the industry's most up-to-date directory.

wide band coverage—
EBG lists over 4,000 products and cross references: more than 6,000 manufacturers.

computerized dimensions—
computer programming provides cross references, eliminates duplication.

Two new IRC metal films you should know about



This one saves board space

This one saves you money

These new IRC metal film resistors can solve many of your space and cost problems. Both offer IRC's superior metal film performance. Both meet or exceed the requirements of MIL-R-10509.

TYPE UC. An ultra-miniature unit that fills the gap between discrete resistors and microcircuits. It has stability and reliability of higher rated units, and a tolerance that most microcircuits can't match. Gold dumet leads, reliable high alumina substrate and rugged end cap termination.

TYPE CEA. Handles four different power ratings. You can combine your metal film needs to save money and simplify stocking. ΔR 's are all well within MIL limits. Rugged end cap termination.

$\frac{1}{2}W @ 70^{\circ}C \ 1\% \ \Delta R$
 $\frac{1}{4}W @ 125^{\circ}C \ 1\% \ \Delta R$

$\frac{1}{4}W @ 70^{\circ}C \ .5\% \ \Delta R$
 $\frac{1}{8}W @ 125^{\circ}C \ .5\% \ \Delta R$

CAPSULE SPECIFICATIONS

	Type UC	Type CEA
Resistance:	50 Ω to 10K	10 Ω to 1.5 meg.
Tolerances:	$\pm 1, 2, 5\%$	$\pm 1\%$
Temp. Coeff.:	$\pm 50, 100ppm/^{\circ}C$	$\pm 100ppm/^{\circ}C$
Power:	1/20W @ 100 $^{\circ}C$	$\frac{1}{2}$ and $\frac{1}{4}W @ 70^{\circ}C$ $\frac{1}{4}$ and $\frac{1}{8}W @ 125^{\circ}C$
Body Size:	.145" x .057" dia. max.	.281" x .100" dia. max.

Write for complete data and evaluation sample. IRC, Inc., 401 N. Broad St., Philadelphia, Pennsylvania 19108.



New Products

New television equipment

Tape, disk recorders make wider color splash

Companies aim at new industrial markets, medical research and education with simpler, smaller units; black-and-white set is \$600 under firm's prior low

By **Christmastime**, the Ampex Corp. will be marketing two new video-tape recorders for industrial, medical, and educational applications. Still too costly for the consumer market—one machine is priced at \$995 and the other starts at \$8,000—the VTR's are beginning to rival the familiar audio tape units in both size and simplicity of operation.

In addition to the Ampex entries, the MVR Corp. has unveiled a video-disk recorder for slow-motion playback. Based on equipment developed for instant replay of sports highlights on television, the new recorder is billed as a valuable tool in heart research, psychiatry, physics, highway-safety studies—anywhere events can be monitored continuously and data used for special analysis.

I. Priced lowered

The \$995 price for the Ampex VR-5000 is \$600 below the company's previous low for a black-and-white recorder. The company's other entry, the VR-7800, a sub-broadcast-quality color recorder, will be offered for \$8,000 to \$12,000, depending on optional features. It is intended primarily as a production machine for making master black-and-white or color tapes, and can be used in any closed-circuit tv application.

The VR-5000 includes deck, base, and video-control center, which enables the recorder to be connected to the antenna terminals of any tv set. Thus, the set can be used as a playback monitor. The recorder has its own built-in audio monitor and speaker system. With a 20 hertz-to-2.5 megahertz bandwidth, the recorder has a playback resolution of better than 280 lines.

Servotracked. It is equipped with a new servosystem to control timing and tracking of the rotating head. This system employs a d-c

motor, which has a printed-circuit permanent-magnet field and is driven by a pulse-duration modulated source. This is a departure from the hysteresis-synchronous motor normally used to drive the capstan and accounts for a time-base stability of 2 Mhz.

The VR-5000 weighs just under 65 pounds, and will record and play back a 1-hour program using a 10-inch reel of special 1-inch video tape.

The VR-7800 color recorder is by far the most sophisticated helical-scan recorder introduced to date. It is the first unit priced under \$50,000 that meets the Federal Communications Commission's 2,500-Mhz transmission requirements for black-and-white and for National Television Standards Code (NTSC) color, and the Electronic Industries Association standard covering broadcast requirements.

New generation. The 7800 is the first video recorder in the Ampex family to use monolithic integrated circuits—more than 70 circuits for servocontrol and video processing.

Its four-motor transport system—one for drum, one for capstan, and one for each of the two reels—is



For the record. Ampex VR-5000 tape unit, smallest in the company's line, weighs 64 pounds, can be used with any standard monitor or television set.

automatically switched by solid state circuitry. Unlike lower-priced VTR's, the 7800 has separate capstan and drum servos. The recorder can operate independently of the power-line frequency. It can also be synchronized to the line frequency externally, or internally by a 50- or 60-hz oscillator.

Editing circuits enable tapes to be electronically spliced, allowing any number of tape strips to be combined on a continuous reel. Another new feature is an electronic tension servo, which senses the tape condition and automatically takes up the slack or eases tension.

A color-correction feature that, until now, was used only on the \$100,000 VR-2000 studio recorder, has been included in the 7800 design. The customary separate audio and control channels, variable speed slow motion playback, and full remote control capabilities are included.

Like all recorders in the Ampex line, both the 5000 and 7800 have a video writing speed of 1000 inches per second, and a reel-to-reel tape speed of 9.6 ips. They both use 1-mil polyester base video tape and have a maximum recording time of one hour.

II. Football and psychiatry

The medical research market is a prime goal for the MVR Corp.'s 222S slow-motion playback unit, which was developed for football telecasts. The Mayo Clinic in Rochester, Minn., will use one unit to study fluoroscopic X rays of dogs' hearts. John T. Phan, designer of the unit, says the stop-action equipment can also create a three-dimensional effect. It would record a series of focused X-ray pictures in planes, each image taking eight fields or four frames. By progressively focusing the X ray from front to rear of a tumor it could record up to 100 frames. Since the eye retains an image for a split second, the recorder could play these frames back at a speed in which the eye would see a 3-D picture.

In psychiatric analysis, says Phan, instant playback would enable a patient to see his actions on a monitor.

Slow to slower. The 222S offers four modes of operation: real time of 26 continuous seconds; stop action; four forward slow-motion

speeds; and reverse motion at either full speed or any or all of the four slow-motion speeds.

The 222S also permits field-by-field analysis by holding an individual frame upwards of 100 hours. In this way, events can be recorded, held and analyzed, and then erased or transferred to another record such as a strip chart or x-y recorder.

The 222S has a price tag of \$25,000 for the basic black-and-white machine. With color capability added, the 222S will be priced about \$35,000 higher.

New tv equipment

Little Shaver convention-bound

Color television camera
of broadcast quality
weighs in at 23 pounds

All three major television networks will be sending Little Shavers to cover next year's political conventions. The Little Shavers aren't baby-faced reporters, but portable color-tv cameras developed by the Philips Broadcast Equipment Corp., a subsidiary of North American Philips Co. (Norelco).



Moving color. Optical simplicity helps make portable camera possible.

Called the PCP-70, Little Shaver is the first portable color camera of broadcast quality to be marketed. It uses the same optical and electronic equipment as its full-size studio counterpart, the PC-70. In their studio cameras, other manufacturers use four image tubes—one for each of the three primary colors and one for color registration. To split the incoming light four ways, requires four lenses, five mirrors, and a beam splitter. The PC-70 and the Little Shaver use one prism assembly and three Plumbicon image tubes. The fourth tube isn't needed, because of an unusual technique called contours out of green. The output of the green tube serves two functions: it supplies the green video signal and feeds a circuit that enhances the boundaries between colors, eliminating registration problems.

Like big brother. Because the PCP-70 has few parts in its optical path, the unit requires less light to produce a high-quality video signal. And because of its optical simplicity, Norelco engineers were able to repack big brother into the Little Shaver.

The PCP-70 has a smaller lens than the PC-70. The automatic, servocontrolled zoom and focus systems are omitted in the portable model. The lens, image tubes, and first preamplifier are contained in the 23-pound, shoulder-carried camera, with the rest of the electronics mounted in a 10-pound backpack. Total system weight is 44 pounds, with a cathode-ray tube viewfinder and a wiring harness making up the additional 11 pounds. With a longer harness the camera can be up to 75 feet away from the backpack electronics.

Compatible. What makes the Little Shaver particularly attractive to broadcasters is that it uses the same control equipment as the bigger, studio cameras. Capable of being operated up to 3,000 feet from the control console, using standard TV-81 cable, the Little Shaver is a natural for sporting events. The American Broadcasting Co. has ordered the camera to cover the 1968 Winter Olympic games. It is priced at \$41,450 minus control console. All three networks now use PC-70 consoles.

Philips Broadcast Equipment Corp., Paramus, N.J. [338]

When \$2.00* can buy solid-state reliability with zero offset voltage...



TO-72

who needs a mechanical chopper?

RCA's new 3N138 insulated-gate MOS transistor features extremely low feedthrough capacitance (0.25 pF max.)...works equally well with either positive or negative incoming signals!

This new full insulated-gate, N-channel, depletion type MOS transistor can offer performance advantages of mechanical choppers with none of their drawbacks. The inherent zero offset voltage (see chart) means that you have none of the tracking problems of matched bipolar devices, caused by temperature changes and extended operation. Compared to a mechanical chopper, the 3N138 offers the additional features of solid-state reliability, superior frequency response, lower driving power, and small size.

Among other important advantages, the insulated gate provides a very high value of input resistance (10^{14} ohms typ.). Forward transconductance is also exceptionally high (6000 μ mho typ.). So for outstanding performance and reliability in chopper and multiplex applications and industrial instrumentation and control circuits, ask your RCA Field Representative for complete information on the 3N138 MOS field-effect transistor. For additional technical data, including Application Note AN-3452, "Chopper Circuits Using RCA MOS Field-Effect Transistors," write RCA Commercial Engineering, Section EN10-2, Harrison, N.J. 07029. See your RCA Distributor for his price and delivery.

MAX RATINGS AND ELECTRICAL CHARACTERISTICS

DRAIN-TO-SOURCE VOLTAGE: $V_{DS} = +35$ volts max.
GATE-TO-SOURCE VOLTAGE: $V_{GS} = \pm 10$ Vdc max.

GATE LEAKAGE CURRENT:
 $I_{GSS} = 10$ pA max. @ $25^\circ\text{C } T_A$

DRAIN-TO-SOURCE "OFF" RESISTANCE:
 $R_{DS}(\text{off}) = 2 \times 10^8$ ohms min.

DRAIN-TO-SOURCE "ON" RESISTANCE:
 $r_{DS}(\text{on}) = 300$ ohms max. @ $V_{DS} = 0, V_{GS} = 0, f = 1$ KHz

FEEDTHROUGH CAPACITANCE:
 $C_{rss} = 0.25$ pF max.

*Price in 1,000 up quantities

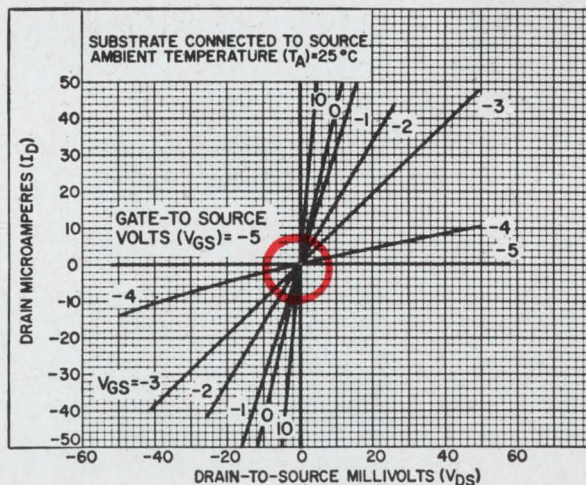

RCA Electronic Components and Devices



The Most Trusted Name in Electronics

Precise Measurement:

Versatile New
Solid-state
Test Receiver
from AIL



\$1350.00

What's your measurement problem: Noise figure? Gain? Attenuation? Selectivity?

The AIL High Precision Test Receiver provides the greatest accuracy, resolution and economy of any receiver you can buy.

For example, when used with AIL's Standard Noise Sources, you can measure low noise devices to an accuracy of 0.1 dB with a resolution of less than 1°K, traceable to NBS.

What's more, plug-in RF mixers and converters extend the useful range of the basic 30 MHz instrument from 40 MHz to 40 GHz.

There is also a continuously variable attenuator with an accuracy of ± 0.05 dB/10 dB that is calibratable at the NBS, providing simple series-substitution attenuation measurements at a cost of less than $\frac{1}{2}$ that of most competitive equipment.

See your nearby AIL Representative for complete information.

TYPE 136 RECEIVER SPECIFICATIONS

Post Amplifier

Center frequency	30 MHz
3-dB bandwidth	1 MHz (nom)
Input impedance	50 ohms (nom)
Full-scale sensitivity	-90 dBm
Overall IF and video gain	100 dB
Gain control range	50 dB (min)

Attenuator

Range	0 to 100 dB
Insertion loss	18 dB (max)
Accuracy	± 0.05 dB/10 dB, ± 0.3 dB (max for 100 dB change)
Resolution ($\frac{1}{2}$ smallest division)	0.01 dB

Overall Instrument

Measurement range and accuracy

IF	100 dB \pm 0.4 dB
RF	60 dB \pm 0.3 dB

Scale resolution

($\frac{1}{2}$ smallest div.)	Normal 0.05 dB Expanded 0.005 dB
--------------------------------	-------------------------------------

Video output

0.5 volt (100-ohm load)

Rise and fall time

1.5 usec (max)

Power required

115/230 vac, 50 to 400 Hz, 20 watts



AIRBORNE INSTRUMENTS LABORATORY
DEER PARK, LONG ISLAND, NEW YORK

709

Voltage Follower

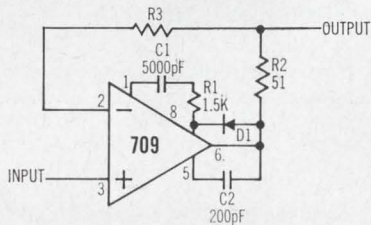

Inverting Amplifier with Balancing Circuit

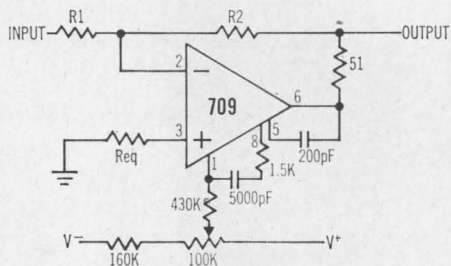

Unity Gain Inverting Amplifier

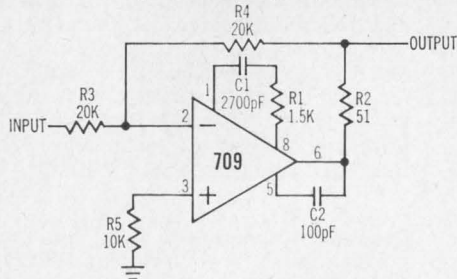

Voltage Comparator for Driving DTL or TTL Integrated Circuits

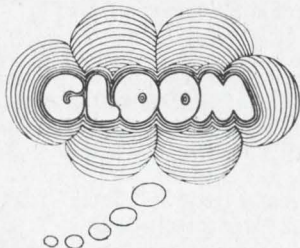

for comment, write:
2975 San Ysidro Way, Santa Clara,
California 95051, (408) 245-4320

National Semiconductor

New Components Review

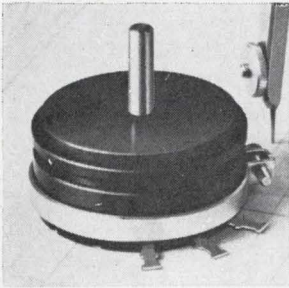

Single-turn pots 3103 and 3203 have 7/8-in. and 1 1/16-in. diameters, respectively. Essentially infinite resolution cermet elements come in resistance values of 1 meg, with resistance tolerance of $\pm 5\%$ and independent linearity of $\pm 0.5\%$. At $+50^\circ\text{C}$ power rating is 1.25 w for the 3103 and 1.5 w for the 3203. Beckman Instruments Inc., 2500 Harbor Blvd., Fullerton, Calif. [341]

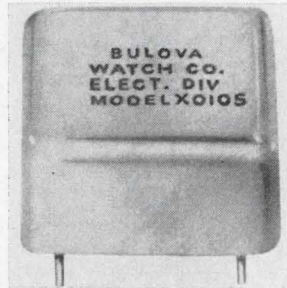

One-half-cubic-inch crystal oscillator model XO-105 is designed for industrial and military applications on p-c boards. Frequency range is 2 Mhz to 100 Mhz. Frequency stability versus temperature varies from $\pm 0.0005\%$ (in the range of $+20^\circ$ to $+30^\circ\text{C}$) to $\pm 0.005\%$ (for -55° to $+85^\circ\text{C}$). Electronics Div. Bulova Watch Co., 61-20 Woodside Ave., Woodside, N.Y. [342]

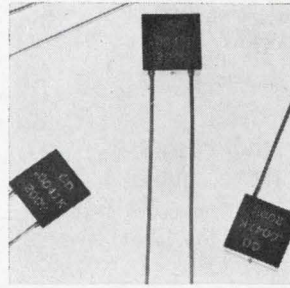

Molded ceramic capacitors TMM5 and TMM6, through advanced multilayer technology, are available from 10 to 100,000 pf. Units meet MIL-C-11015/18 and 19 for MIL Styles CK05 and CK06. They exceed the BX temperature characteristic requirement ($\pm 15\%$ at zero v d-c; $\pm 15\%$ - 20% at 100 v d-c). Cornell-Dubilier Electronics, 50 Paris St., Newark, N.J. [343]

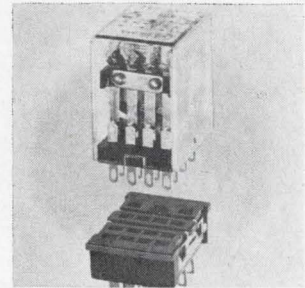

Four-pole relay series 67 is slightly more than 1 cu in. Each pole switches low-level to 3-ampere loads at least 100,000 times. In-line contact arrangement assures mechanical life to 100 million operations d-c, and 50 million a-c. The unit is suited for use in computers and data handling equipment. Sigma Instruments Inc., 170 Pearl St., Braintree, Mass. 02185. [344]

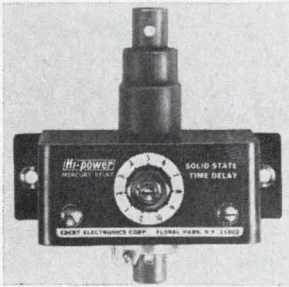

Hermetically sealed time delay relays rated to 60 kw have factory preset or adjustable delays on "make" of from 100 msec to 300 sec in 1-, 2-, and 3-pole models. Operating temperature is 10° to 65°C . Repeatability is $\pm 2\%$ at stated voltages and temperature range. The 50-amp TD-B-1 unit is illustrated. Ebert Electronics Corp., 130 Jericho Turnpike, Floral Park, N.Y. [345]

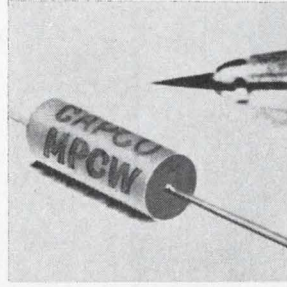

Metalized polycarbonate capacitors in the MPCW series are for filter and timing circuits. Ambient operating temperature range is -55° to $+125^\circ\text{C}$. Retrace after full-range temperature cycling is typically less than 1.5%. The series is available in 0.001 to 10 μf , in 50, 100, 200, 300 and 400 v d-c. Capco Capacitors, 5262 W. 34th St., Lubbock, Texas. [346]

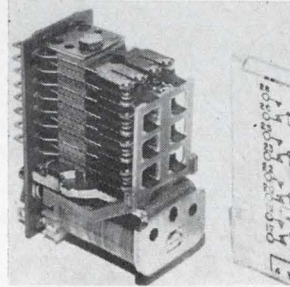

Multipole relay model R10 features an 8 Form C contact arrangement. Five different contact styles are offered, ranging from a crossbar dry-circuit type to a heavy-duty 5-amp type. Coil operating voltages range from 3 v d-c to 115 v d-c. Actuator displacement is 0.045 in. minimum with overtravel of 0.010 in. Parelco Inc., 16239 Colorado Ave., Paramount, Calif. [347]

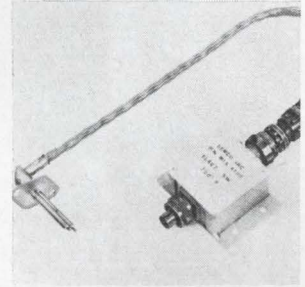

A high-temperature switch for airborne use is 1.25 x 2 x 2 in. and weighs approximately 8 oz. The standard units will switch up to 1.5 amps. Response time for 63% of step change is better than 100 msec. The unit operates under temperatures of -65° to $+250^\circ\text{F}$. It is rfi free per MIL-I-6181D. Scientific Engineering & Mfg. Co., 11505 Vanowen St., N. Hollywood, Calif. [348]

New components

Logarithmic diodes for analog computers

Operating on the same principle as a slide rule, diodes perform multiplication, division, and power functions

Development of analog computers has lagged behind that of digital machines largely because of the demands for accuracy and predictability placed on transistors. In analog computers, multiplication is carried out by the addition of the logs of the numbers that are to be

multiplied—much like a slide-rule approach. Transistor circuits that are used to accomplish this are very sensitive to temperature, interstage inaccuracies, and resistor ratios. Until recently, the same could be said about diodes.

Now the Computer Diode Corp.,

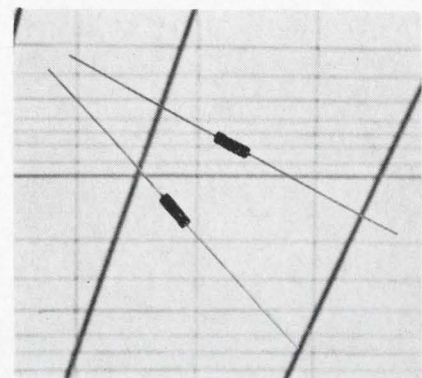

Nonlinear. Diodes with logarithmic I-V characteristics multiply in analog computers.

VICTORY sets
the pace
with

THERMISTORS

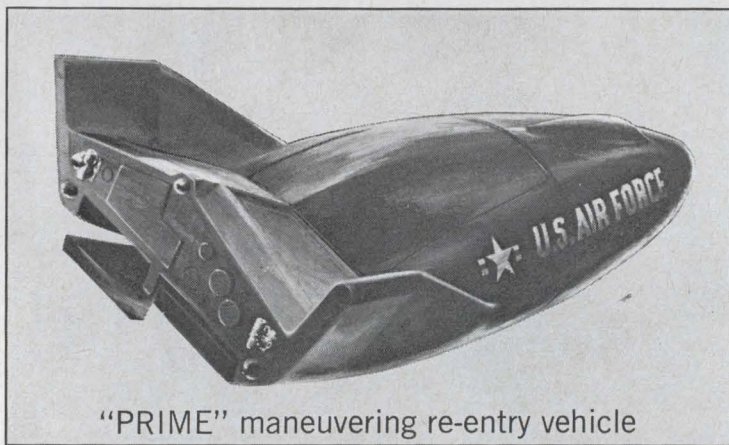

"PRIME" maneuvering re-entry vehicle

Designed by MARTIN MARIETTA for the U.S. Air Force, "PRIME" is a research vehicle which may lead to a generation of lifting body spacecraft which will fly home from space to landings at conventional airports. VECO was recently awarded the "PRIME" Achievement Award for its thermistor contribution to this successfully concluded Air Force program.

There is no denying that PRIME is "way out." However, VECO specializes in "down to earth" thermistor applications. VECO thermistors are being used more and more frequently in every-day products for home, office and industry.

Wherever PRECISE measurement, compensation and control of temperature is needed and where INSTANT RESPONSE is essential, engineers and designers are finding that VECO thermistors can do the job better, with greater reliability and often at less cost than conventional devices.

VECO's engineering staff is available to assist you in the application of thermistors to your products.

Write for Catalog MGP681

VECO First in Progress • First in Service

8673



VICTORY ENGINEERING CORP.

Springfield Ave., Springfield, N. J. 07081
Tel: 201-379-5900 TWX: 710-983-4430

by exercising unusually tight control over the alloying area, is producing units with logarithmic characteristics that are accurate and reproducible.

If the output of a diode is plotted on a semilog scale with forward voltage on the horizontal axis and the log of the current on the vertical axis, a curve is generated that is described by the equation: $V = A \log I + BI \pm C$, where V is the forward voltage and I is the forward current. The coefficient A determines the slope of the voltage versus log current output of the diode, B describes the ohmic component of the diode, and C is the point at which the curve crosses the horizontal axis.

The new diodes, designated the CODI LD series, bear out the equation to within ± 2 millivolts. The coefficients are repeatable from batch to batch.

To verify the accuracy of the diodes, a specialized computer is used to check the I versus V relationship at 800 points on the curve. These outputs are then reduced to provide the exact equation generated by the diode to determine deviations from the theoretical values. The temperature characteristics are also checked at three points: -55° , $+25^\circ$, and $+125^\circ$ C. Since the output of the diodes varies with temperature, performance must be determined for a specific temperature. If desired, diodes can be made to conform to a given curve across a specified temperature range.

Operating over a three-decade range from 10 to 10,000 microamps, the diodes are available in chip form, plastic packages, and DO-7 glass packages. They cost about \$1 each.

For applications requiring more complex equations, the engineer can request additional diode data. Upon request, the manufacturer will supply the deviation from the original equation. This data is obtained with the help of a computer whose output is fed to an automatic printer or data logger. During production the manufacturer uses an analog computer to obtain data on a go or no-go basis for a minimum of 1200 different current values along the log curve.

Computer Diode Corp., Fair Lawn, N.J. [349]

New components

Here's a switch —with resistors

Circuit-deck combines both in package for scopes, plotters, dvm's

It's an old story. A company's engineers find they can make a better component than they can buy. Once they've acquired the new capability they decide to market the component.

The Helipot division of Beckman Instruments Inc., best known for its potentiometers, got into the switch and resistor business after replacing a commercially available switch, to which discrete resistors were soldered, in a Beckman strip-chart recorder. The switch deck and discrete resistors were replaced with what the firm calls a circuit-deck, a combination of switch and resistor networks packaged in one small preassembled unit designated the Series 1390 precision cermet switch.

John Doering, Helipot's chief engineer for product design, says the circuit-deck can be used in any instrument in which resistors are used in connection with switches—such as oscilloscopes, x-y plotters, or digital voltmeters.

Spinoff. In developing the 1390, Beckman applied its experience in thick-film microcircuits, to switching applications. Elimination of discrete resistors, with their associ-

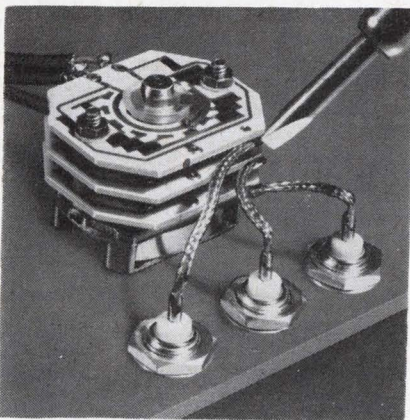

Switch plus. Wafer can have as many as 10 resistors screened on each side.

Low noise for highest sensitivity in this best-buy SWR meter

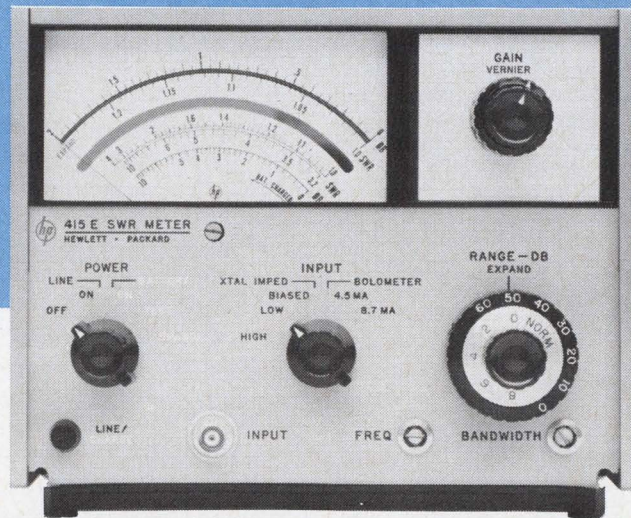

Because of its remarkably low 4 dB noise figure—a 6 to 10 dB improvement over other instruments of its type—you get the highest usable sensitivity with the Hewlett-Packard 415E SWR Meter. It gives you 0.15 μV rms for full-scale deflection at maximum bandwidth. Noise is at least 7.5 dB below full scale.

For wide range attenuation measurements, you achieve even greater accuracy with the high precision range attenuator—70-dB in 10- and 2-dB steps, accuracy ± 0.05 dB/10-dB step, ± 0.10 dB cumulative. Use "Expanded Scale" to get full-scale deflection for any 2-dB segment. This gives you highest resolution, linearity (± 0.02 dB) and accuracy (± 0.05 dB cumulative). Input frequency is 1000 Hz, adjustable, and bandwidth is variable from 15 to 130 Hz. Wide variety of inputs: low- and high-impedance crystal detectors, biased crystal and low- and high-current bolometers, with positive bolometer protection. Recorder and amplifier outputs. For field use, unit is optionally available with rechargeable battery pack. 415E, price \$350.

For more information call your local HP field engineer or write Hewlett-Packard, Palo Alto, California 94304; Europe: 54 Route des Acacias, Geneva.

HEWLETT  PACKARD

MICROWAVE TEST EQUIPMENT

04710

Now! TCXO's from Bulova!

Stability:
±0.5 PPM!



Now you can get Temperature Compensated Crystal Oscillators from Bulova, with all the quality and dependability that have made Bulova the leader in frequency control products. Our new Model TCXO-5 is just four-cubic-inches, consumes only 50 mW, and employs a computer-selected-and-optimized compensation network designed to maintain frequency stability over wide temperature ranges without the need for an oven (±0.5 PPM from -40°C to +70°C). Perfect for aerospace and military applications where power, space and weight restrictions are severe.

SPECIFICATIONS

Frequency Range:	2MHz to 5MHz
Frequency Stability:	±0.5 PPM from -40°C to +70°C
Output:	Sine Wave, 1VP-P into a 1000 OHM Resistive Load
Input:	50 mW
Size:	Just 4 cu. in.
Weight:	Only 5 oz.

Other frequencies, output wave shapes, output levels and load impedances can also be supplied.

Write today for more information about Bulova's new TCXO-5, or assistance with any Crystal Oscillator problem. Address: Dept. E-27.

Try Bulova First!

FREQUENCY CONTROL PRODUCTS

ELECTRONICS DIVISION
OF BULOVA WATCH COMPANY, INC.

61-20 WOODSIDE AVENUE
WOODSIDE, N.Y. 11377, (212) DE 5-6000

... permits variety of switch logic ...

ated individual design, assembly, and testing allows a cost reduction of at least 25%, Doering says.

Switches in the 1390 series consist of screened cermet resistors, switch pads, and interconnections fired on an alumina wafer that replaces the conventional switch deck. Screened capacitors are also offered in the series. A typical wafer may have five to 10 ¼-watt resistors screened on each side of the wafer; 10 wafers take up only 2½ inches behind the instrument panel.

Other advantages claimed for the circuit-deck are long life and good high-frequency performance.

According to the company, principal initial applications will be in digital voltmeters. The biggest attraction is the cost-saving achieved by eliminating discrete resistors, "plus the concentration of responsibility a user gets by buying an assembled package," says Doering. Custom designs, with specific ratios, capacitance values, resistance values, and logic are being offered.

No limit. Beckman says the ability to connect contacts on opposite sides of the rotor, plus the use of feedthroughs on the wafer, make just about any switch logic possible. Resistance ratios will remain stable within 0.01% after 1,000 hours of load life at 65°C, according to the company.

The circuit-deck can be provided with pin-type terminals to which flexible cables may have to be connected. Round pins coming off the switch can be made for direct mounting on a printed-circuit board. The switch can be wired in when the board is put through its solder operation.

Specifications

Range of resistor values	10 ohms to 1 meg-ohm
Resistance tolerance	±5% to ±0.2%
Ratio range	10,000:1
Ratio stability over temperature range	5 ppm/°C
Temperature coefficient of resistance	±300 ppm/°C
Power rating	2.5 w per side at 65°C
Range of capacitor values	10 pf to 270 pf
Contact rating	125 ma
Dielectric strength	1,000 v rms
Insulation resistance at 100 volts d-c	1,000 megohms

Beckman Instruments, Inc., Helipot Division, Fullerton, Calif. [350]

new products from Dynalectron

A whole family of basic timing instruments, the 2000 series, utilizing integrated circuits almost exclusively, combines to form various time code translator, reader, generator, tape search, and control systems.

The 2000 series concept means that the system is continuously expandable upward without obsoleting present 200 series system components, allowing the user to select a system that fits his requirements.

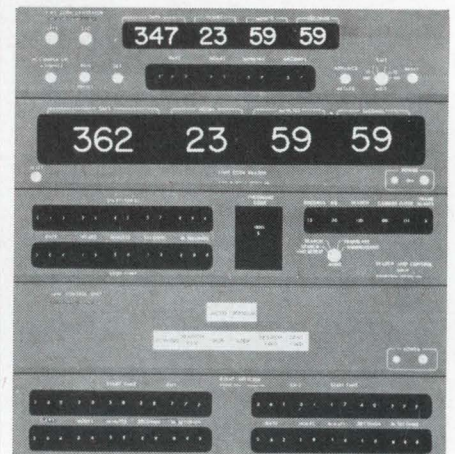

The most comprehensive system, shown here, is the Model 2506 Universal Time Code Translator / Reader / Generator / Search / Tape Control / Event Director Terminal, composed of the:

- Model 2004 Time Code Reader
- Model 2101 Time Code Generator
- Model 2901 Search and Control Unit
- Model 2910 Tape Control Unit
- Model 2920 Event Director and Control

For more information, write or telephone:

Sales Manager
Dynalectron Corporation
Instrument & Electronics Division
440 Hester Street
San Leandro, California
Telephone: (415) 569-5841
TWX: (910) 366-7373

DYNALECTRON CORPORATION 

Mylar[®] helped Maxwell Labs save 75% on size and weight in its new 5KV capacitor.

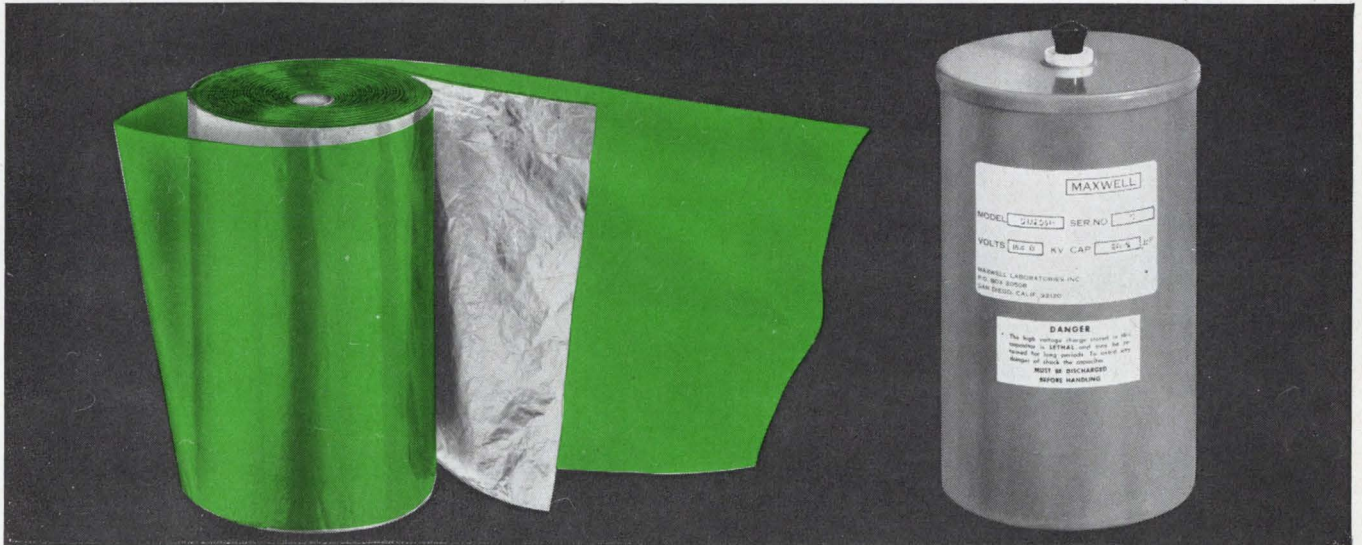

What would you like Mylar to do for you?

This new high-voltage capacitor of MYLAR* polyester film is about the size of a can of beans. Yet it stores enough energy to illuminate all the lights in the city of Washington, D. C., for a millionth of a second.

"We believe these new capacitors represent the first significant breakthrough this industry has seen in the last ten years", said Dr. Terence J. Gooding, President of Maxwell Laboratories, Inc., San Diego, California, developers of the capacitor.

Capacitor manufacturers in the past have frequently relied on paper impregnated with chemicals as a capacitor dielectric material. These units were often up to four times as large and bulky.

Where can you use the size and weight savings available with MYLAR? In aerospace? Other airborne uses? You name it. MYLAR can do it. Why? Higher dielectric strength in thinner

gauges than other materials. MYLAR also offers excellent resistance to most chemicals and moisture plus thermal stability from -60°C . to $+150^{\circ}\text{C}$.

MYLAR is manufactured by the Du Pont Company — leader in plastic-film technology. Du Pont offers more types and gauges of polyester films than any other film supplier.

Better find out more about MYLAR. Send the coupon for a free Fact File today. Or write: Du Pont Company, Room 4991C, Wilmington, Del. 19898.

*Du Pont registered trademark.

DU PONT MYLAR[®]
REG. U.S. PAT. OFF.

Du Pont Company
Room 4991C
Wilmington, Delaware 19898

I'd like to find out what MYLAR can do for me.
Please send me a Fact File.

Name

Company

City State Zip

The Hard Way to Make a Control System...

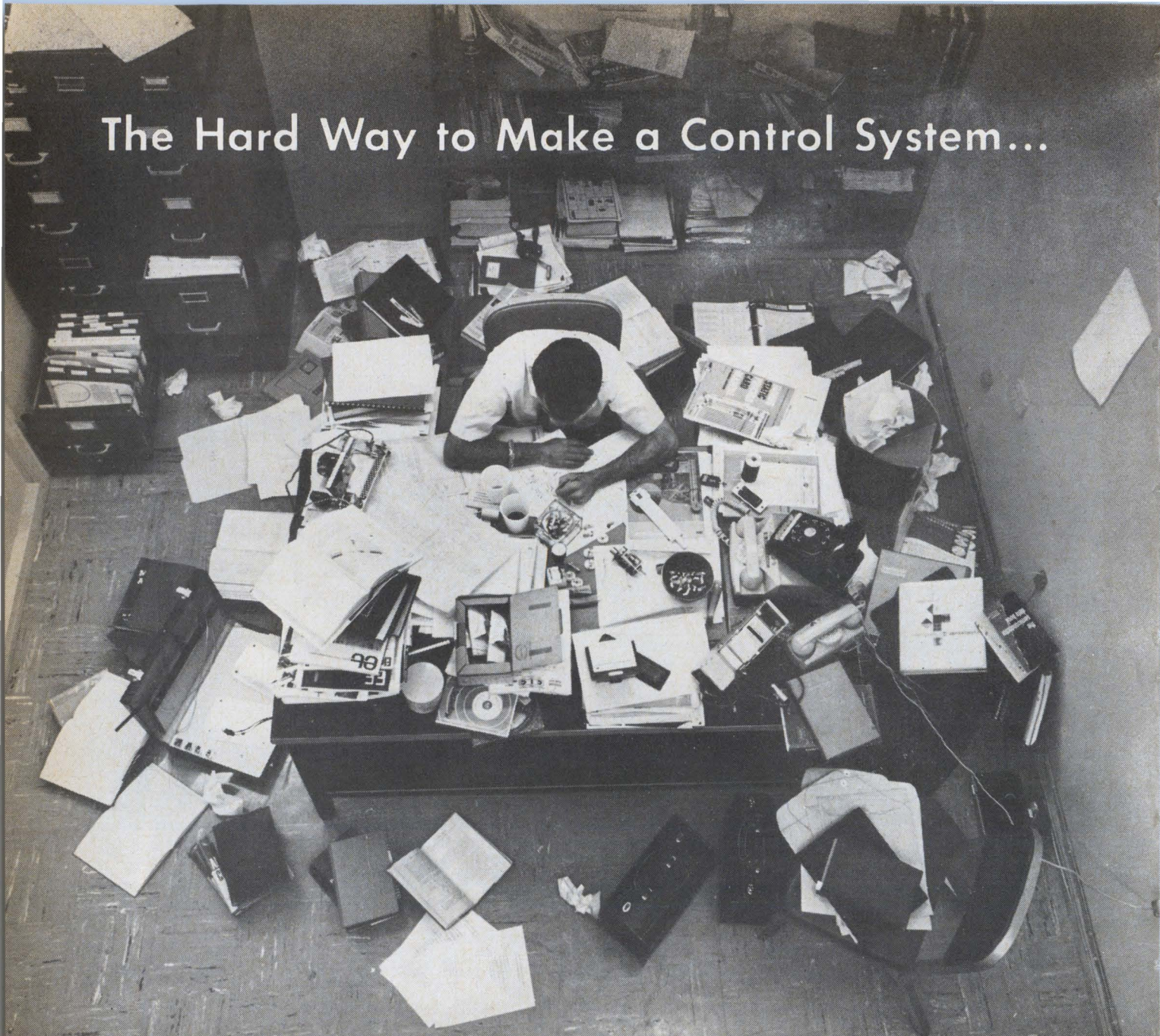

The Easy Way: Buy it from CIC...for less.

Why struggle with problems of component specifications, interface matching, system reliability? CIC manufactures ultra-reliable, long-life components for the precise measurement and control of displacement, pressure, flow, temperature, force, acceleration, velocity, etc. Our single source responsibility will provide you with a system of superior performance at lower cost.

Our engineering staff is available to handle your instrumentation and control requirements. Write or call (collect) Mr. J. Kristoffersen ... Now.



FREE BROCHURE!

Write for this booklet describing some of CIC's Instrumentation, Controls and Components capabilities.

CIC *Instrumentation & Controls Division*

COMPUTER INSTRUMENTS CORPORATION

70 MADISON AVE., HEMPSTEAD, N.Y. 11550/516-483-8200

Circle 134 on reader service card

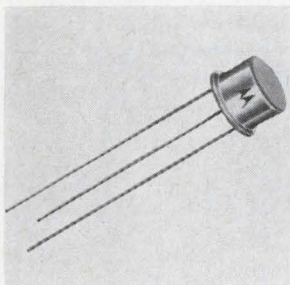

Eight germanium mesa transistors, manufactured by the selective metal etch process, provide direct replacement for Philco MADT devices in military and industrial communications equipment. All are in the TO-5 case. Frequencies range from 100 to 980 Mhz. Price (100 and up) ranges from \$1.05 to \$3.05. Motorola Semiconductor Products Inc., Phoenix, Ariz. [436]

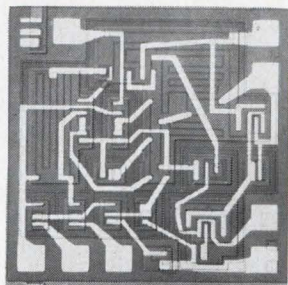

Improvements in major parameters of the μ A709 standard operational amplifier are found in the μ A709A, a direct plug-in replacement. Input offset voltage is 2 mv max.; input offset current, 50 na max.; input offset voltage drift, 10 μ v/ $^{\circ}$ C max.; input offset current drift, 0.5 na/ $^{\circ}$ C max. (+25 $^{\circ}$ to +125 $^{\circ}$ C). Fairchild Camera and Instrument Corp., Mountain View, Calif. [437]

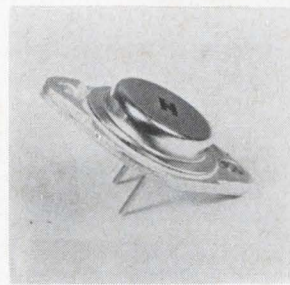

A 25-amp germanium power transistor, the HST3080 series, packaged in a TO-3 or TO-4 case, provides a low-cost, high-current unit capable of 106 w. Specs include: minimum gain of 10 at 25 amps, breakdown voltage (V_{CE0} , V_{CEX}) is 40-80 v. It is for use in military and industrial inverters, switches, etc. Hughes Semiconductors, 500 Superior Ave., Newport Beach, Calif. [438]

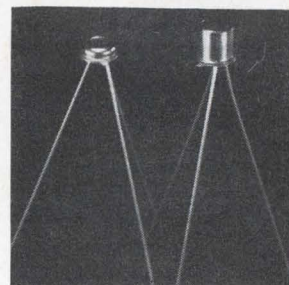

Four low-level, high-speed switching transistors—2N2432, 2N2432A, 2N3153, and 2N4138—are npn complements to the 2N2944. These devices feature low offset voltage (0.5 mv max.) and high emitter-base breakdown voltage (15 v min.). Unit prices start at \$12 in 1-99 quantities; from \$8 each in 100-999 lots. Crystalonics Inc., 147 Sherman St., Cambridge, Mass. [439]



Photodetector PIN-8LC is designed for high speed and for applications requiring a good spectral response at a laser wave length of 1.06 microns. The unit has an active area of 1 cm² and a minimum capacitance of 40 pf. Rise time to a light pulse is less than 5 nsec. Quantum efficiency is 30% at 1.06 microns. United Detector Technology, Box 2251, Santa Monica, Calif. [440]

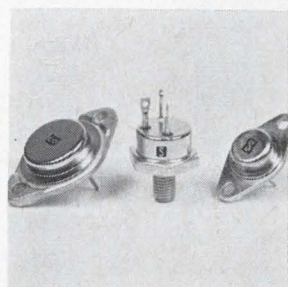

High-voltage npn silicon power transistors are offered up to 700 v in 3 different packages. The TO-3, TO-61, and TO-66 are characterized at current levels of 1, 2, and 3 amps. The TO-3 and TO-61 are rated at 100 w at 75 $^{\circ}$ C case temperature. The TO-66 is capable of 50w power dissipation at 75 $^{\circ}$ C. Solitron Devices Inc., 1177 Blue Heron Blvd., Riviera Beach, Fla. [441]

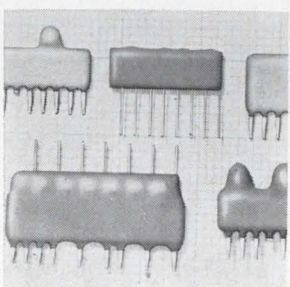

Hybrid circuit modules custom designed for the consumer, industrial, and military markets. Besides thick film deposition of resistors, capacitors, and circuitry on ceramic substrates, silicon transistors, and germanium and silicon diodes are included in the units. Costs start at less than 20 cents in quantity. Centralab Div., Globe-Union Inc., 5757 N. Green Bay, Milwaukee. [442]

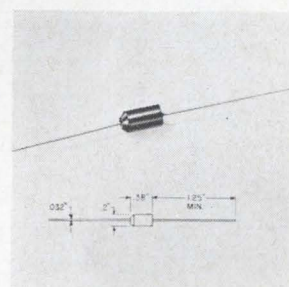

Silicon rectifiers with piv's of 1,600 to 6,000 v and a forward current of 150 to 500 ma—depending on piv—are in a 0.2 x 0.38 in. transfer molded package. Series RF160A-RK600A and RF-160B-RK600B offer a choice of 200 or 250 nsec recovery time. Price of the RJ400B (4,000 piv) is \$2.67 in 100 lots. Electronic Devices Inc., 21 Gray Oaks Ave., Yonkers, N.Y. [443]

New semiconductors

Jack-of-all-trades op amp

Multifunction unit challenges conventional devices; needs no extra circuitry for complex operations

The closest thing yet to a universal operational amplifier appears to be the Westinghouse Electric Corp.'s WC 306. A monolithic op amp, it was designed, not for high gain, but for versatility. Unlike other op amps—such as the popular 709—which are designed for a single

function, the new unit can perform complex operations without additional circuitry.

Instead of increasing gain or bandwidth, the 306 has both high and low impedance inputs and differential as well as single-ended outputs. The output flexibility is

achieved by using a vertical pnp transistor in a complementary pair configuration in the last stage. According to Bill Williams, head of Westinghouse's linear integrated-circuit group, "In many applications, one 306 will replace two or more 709's."

In recording instruments, where it's desirable to isolate a signal from ground, the 306 can be connected with both differential inputs and outputs to drive a recorder directly. In zero-cross detection, where a pulse output is required whenever a signal swings from plus to minus—or vice versa—only one 306 is needed. The amplifier satur-

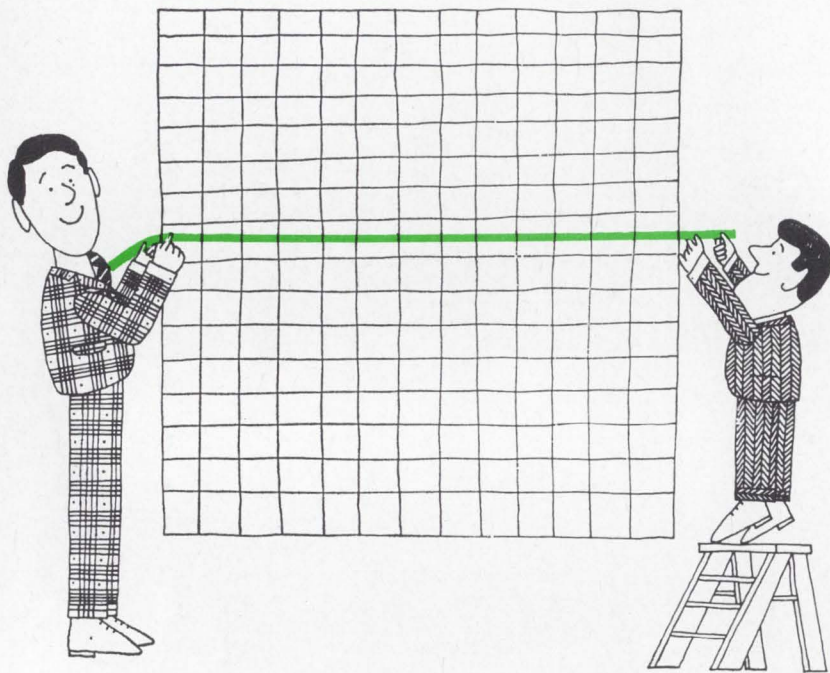

We'd like to hand you a line. It belongs to Mallory MOL film resistors.

It's a stability curve. And when you put it on its graph, it shows that Mallory MOL metal oxide film resistors change less than 5% on 10,000-hour load life. TC is ± 250 ppm/ $^{\circ}\text{C}$. All MOL's are 100% tested. Delivery is prompt. The price is right.

It all adds up to one thing: you get premium performance without premium price. That's the reason most major TV manufacturers use MOL's. For details, call or write Mallory Controls Company.

MALLORY

MALLORY CONTROLS COMPANY

a division of P. R. MALLORY & CO. INC.
Box 231, Frankfort, Indiana 46041

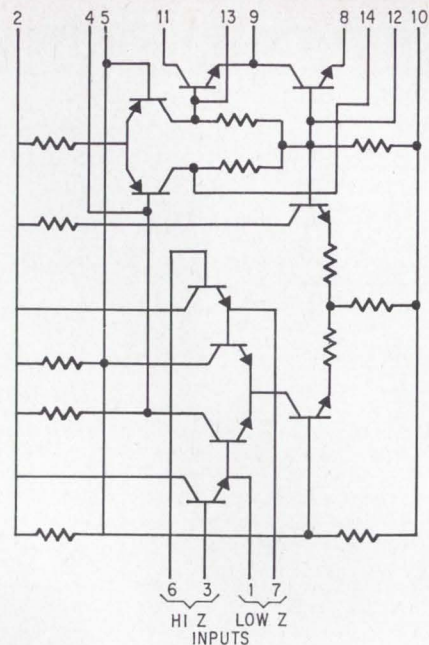

Real thing. Vertical pnp transistors are used in the output stage.

ates, causing it to switch, when its output is a few millivolts above ground.

Because the 306 has external connections that are not available on other op amps, it performs unusual functions. Pin 11 can be used as a sense-and-control amplifier input for series-voltage regulation. If pin 9 is grounded, the 306 can drive a low-current relay directly by connecting the relay power supply to pin 11. This operation between pins 9 and 11 is independent of the regular power supply, which is connected to pins 2 and 10.

If a wideband amplifier is needed, the low impedance input is used, providing 30 decibels of gain at 10 megahertz. Other circuits, such as a voltage comparator, and a window detector, can be implemented by the addition of an external resistor.

Packages include flat packs and dual in-line plastics, and the units are priced at \$6.60 each in lots of 50.

Specifications

Power supply	± 15 v
Input voltage	± 6.25 v
Operating temperature	-55° to $+125^{\circ}\text{C}$
Differential gain	2,000
Input offset voltage	10 mv max.
Frequency response	500 khz
Input impedance	300 kilohms
Output impedance	4 kilohms
Power dissipation	40 ohms
	450 mw

Westinghouse Electric Corp., Box 7377, Elkridge, Md. [444]

New semiconductors

Channel protects leads from bending

Hybrid transistor chips for microwave equipment operate up to 2.5 Ghz

A line of channel-packaged silicon transistors for thin- and thick-film, and stripline circuit applications has been developed by the KMC Semiconductor Corp. The units are available for uhf and vhf microwave circuitry in both amplifiers and oscillators. The transistor chips are mounted in a ceramic channel and then encapsulated in epoxy

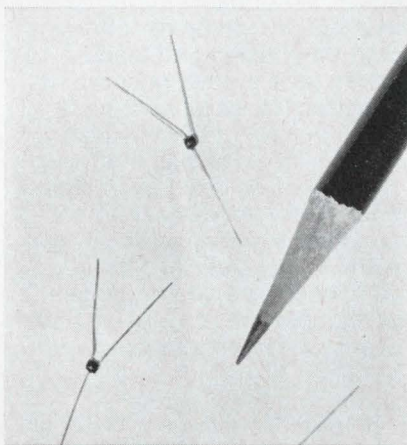

Protected. The three sides of the channel form a mold for epoxy.

avoid lead bending—at high frequencies, bent leads cause the device inductance to increase.

The amplifier group consists of 27 transistors that operate over a frequency range from 60 to 1,000 megahertz. Twelve of the units are low-noise devices with a maximum system noise figure of 1.4 decibels at 60 Mhz. All of the amplifiers are supplied with gold-plated Kovar ribbon leads.

The oscillator transistors consist of eight types, ranging in output power from 20 milliwatts at 2 gigahertz, to 60 mw at 2.5 Ghz. These are supplied with nonmagnetic silver leads for applications where yttrium iron garnet tuning is used.

KMC Semiconductor Corp., Parker Rd., Long Valley, N.J. [445]

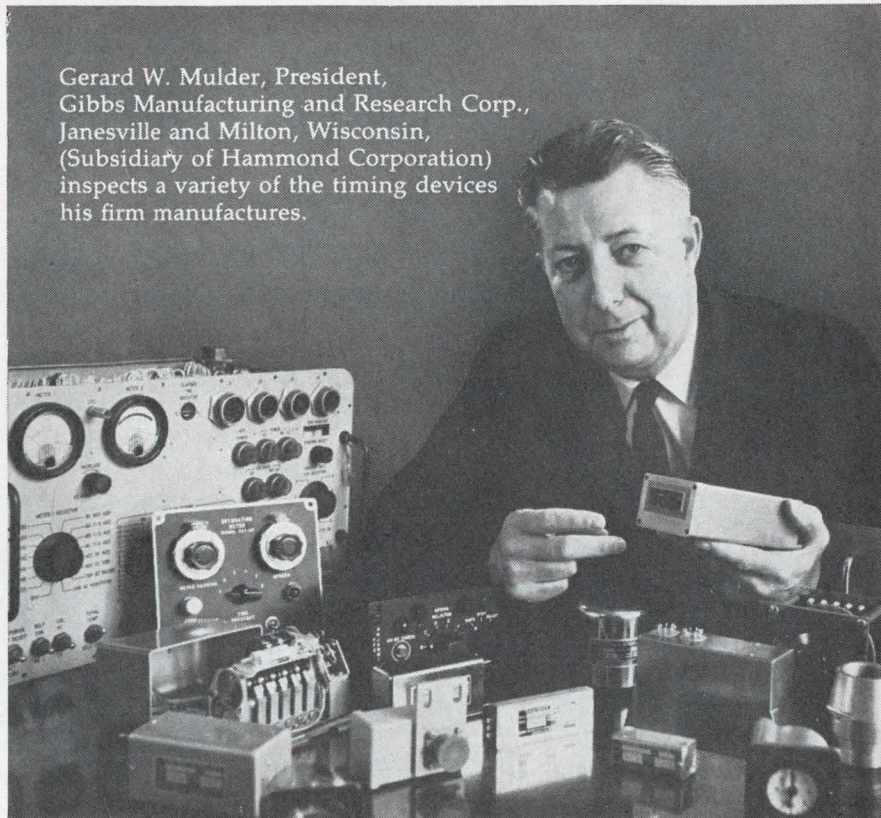

Gerard W. Mulder, President, Gibbs Manufacturing and Research Corp., Janesville and Milton, Wisconsin, (Subsidiary of Hammond Corporation) inspects a variety of the timing devices his firm manufactures.

It's Time To Investigate Wisconsin's "Profitable Difference"

"We've grown from 125 employees in 1961 to our current level exceeding 600," says Jerry Mulder. "And there has been no shortage of skilled, trainable labor. When your product line includes audio reverberation units and electronic, mechanical, electromechanical, and electrochemical timing devices for military, space, and commercial applications, you must attract a top-notch engineering staff. Ours equals those in the popular east and west coast 'brain centers.' Thanks to Wisconsin's excellent vocational and technical schools, perhaps the best in the nation, we have an ample supply of skilled technicians. Our female labor force is better than I've seen anywhere else and I've been an administrator for 22 years in six states. Gibbs will continue to expand in Wisconsin. We like it here!"

Our Director of Industry Development, John R. Frederick, can show you a lot of facts about Wisconsin's skilled labor force, male and female.

Call him collect at 608-256-3151 or write: Dept. F, P. O. Box 192, Madison, Wisconsin 53701.



WISCONSIN
POWER & LIGHT
An Investor Owned COMPANY

Clean Safe-
Clean Quick-
Clean Clean



Bausch & Lomb BALSONIC ULTRASONIC CLEANERS

Different size bubbles blast
away dirt of all sizes.

Remove soils of oil, dust, dirt, grease, fingerprints, lint, jeweler's rouge, abrasive, polishing and grinding compounds, plastic residues, metal chips, tarnish, corrosion from metal, glass, plastics.

Thorough cleansing action is assured by simultaneous multi-frequency output—the only small size ultrasonic cleaner to have this feature).

Choose Balsonic wherever small part cleaning is important. Conveniently packaged with proper solvent for either Metallurgical, Precision Parts, Surgical or Contamination Control applications.

Two sizes: Balsonic I. $7\frac{5}{8} \times 3\frac{1}{2} \times 2\frac{1}{2}$ in. tank. Balsonic II. $9\frac{1}{8} \times 7\frac{1}{4} \times 3\frac{3}{8}$ in. tank.

Use the coupon for a free demonstration and our new catalog 42-2221. Bausch & Lomb, 61446 Bausch St., Rochester, N.Y. 14602.

BAUSCH & LOMB

Bausch & Lomb
61446 Bausch St., Rochester, N. Y. 14602

- Please send me your catalog No. 42-2221 with complete information on your new Balsonic Cleaners.
- I would like a free demonstration of Balsonic Cleaners.

Name.....

Please Print

Title.....

Firm or Institution.....

Address.....

..... Zip.....

New semiconductors

Tv transistor handles 1,400 v

New device may help
clear way for low-cost,
all-solid-state sets

The first step in designing a low-cost, large-screen, all-transistor tv receiver would be to eliminate the power transformer, which accounts for a disproportionately large part of the set's cost. But this step can be taken only when semiconductor houses come up with cost-competitive high-voltage devices that can operate from a 120-volt supply.

The major problem here is that the horizontal output transistor should have a breakdown voltage rating of about 1,500 volts, but the highest voltage rating of currently available transistors, selling for \$6 each, is 700 volts.

However, in what appears to be a significant advance in fabrication technology, the Amperex Electronic Corp. has developed a transistor, designated the A705, with a collector-base voltage of 1,400 volts—something of a record. The company attributes the rating to special profiling of the crystal edges, plus a mesa collector structure.

Amperex is demonstrating its device to tv manufacturers in a line-operated, 23-inch, all-transistor feasibility model that employs the A705 as a power source to drive the flyback transformer directly. When operated at its maximum power, the transistor dissipates 8 watts with a maximum mounting base temperature of 95°C.

Amperex Electronic Corporation, Slattersville, R. I. 02876 [465]

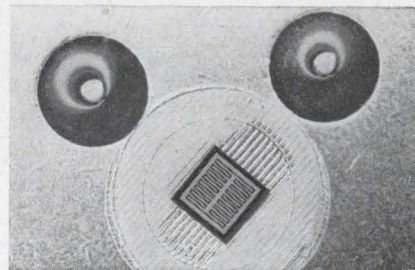

Minimight. Transistor handles high voltage in crucial television circuit.

Compact
electronics package?

COOL IT...

...with a small size, long life, high output AiResearch fan.

Garrett-AiResearch special purpose fans are individually designed and custom built to deliver more flow and greater pressure rise with a minimum envelope size.

Take a typical AiResearch small size fan: computer-optimized for required performance under all operating environments; our own motor, engineered and manufactured for a perfect match to its fan; and up to 40 percent more airflow than any other ventilating fan of similar input, size, and weight.

Next time you need a ventilating fan for a very special airborne or ground electronics enclosure specify AiResearch. Available for high temperature and cryogenic applications, with flow rates and power requirements as specified. AiResearch Manufacturing Division, Torrance Facility, 2525 190th Street, Torrance, California 90509.

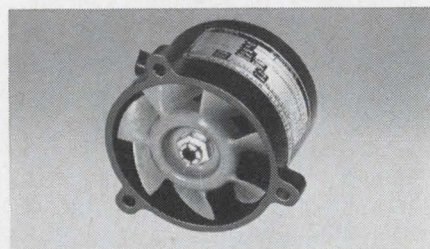
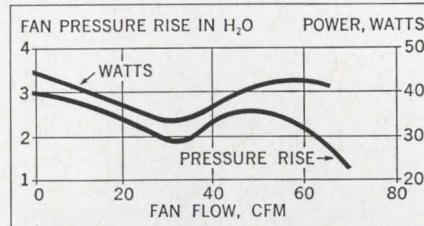

**AIRESEARCH
SPECIAL PURPOSE
FANS**

There always has to be a winner—and when it comes to all-purpose sweep signal generators, the Jerrold Model 900-C is a shoo-in.

Measure a *narrow* band circuit (sweepwidth down to 10 kHz) or check the *entire coverage* of broad band units such as mixers, amplifiers, or filters (sweepwidths up to 400 MHz). Design, test or measure a variety of VHF, UHF, narrow and wide band devices in the frequency range 500 kHz to 1200 MHz... and do it with incomparable ease and accuracy. Here is convenience only an all-purpose sweeper can provide.

The 900-C and ultra-reliable Measurement-by-Comparison techniques permit accurate and simple measurement of gain, loss, and VSWR. You can disregard variables such as nonlinearity of detectors, oscilloscope drift, and line voltage variations.

If you need more convincing, send for complete data—or contact us for a demonstration. Write Government and Industrial Division, Jerrold Electronics Corporation, 401 Walnut St., Philadelphia, Pa. 19105.

JERROLD

clean sweep!

IN TEST,
MEASUREMENT,
AND
DESIGN

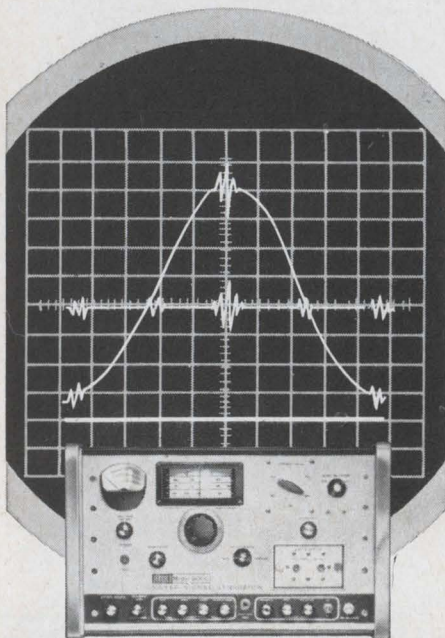

Meetings

Meeting on Electromagnetic Compatibility, Society of Automotive Engineers; Dallas Sheraton Hotel, Dallas, Oct. 31-Nov. 1.

Nuclear Science Symposium, IEEE; Statler Hilton Hotel, Los Angeles, Oct. 31-Nov. 2.

Asilomar Conference on Circuits and Systems, IEEE; Asilomar Hotel, Pacific Grove, Calif., Nov. 1-3.

Northeast Research and Engineering Meeting (Nerem), New England Section of IEEE; Sheraton-Boston Hotel, Boston, Nov. 1-3.

Product Assurance Conference, IEEE; Waldorf-Astoria, New York, Nov. 2-3.

Applied Superconductivity Conference and Exhibition, Atomic Energy Commission and University of Texas; Austin, Nov. 6-8.

Conference on Speech Communications and Processing, IEEE; Massachusetts Institute of Technology, Cambridge, Nov. 6-8.

Technical Conference, Society of Plastics Engineers, Nevele Country Club, Ellenville, N.Y., Nov. 6-7.

Reliability Physics Symposium, IEEE; Statler Hilton Hotel, Los Angeles, Nov. 6-8.

Symposium on Automatic Support Systems for Advanced Maintainability, IEEE; Colony Motor Hotel, Clayton, Mo., Nov. 7-9.

Analytical Symposium and Instrument Exhibit, American Chemical Society, and American Microchemical Society, Society for Applied Spectroscopy; Statler Hilton Hotel, New York, Nov. 8-10.

Western Conference on Broadcasting, Broadcasting Group of IEEE; Ambassador Hotel, Los Angeles, Nov. 9-10.

Symposium on the Application of Computers to the Problems of Urban Society, Association for Computing Machinery; New York Hilton Hotel, New York, Nov. 10.

Conference on Applications of Simulation Using the General-Purpose Simulation System, IEEE; New York Hilton Hotel, New York, Nov. 13-14.

Conference on Thermal Conductivity, Department of Commerce and National Bureau of Standards; Gaithersburg, Md., Nov. 13-15.

Engineering in Medicine and Biology Conference, IEEE; Statler Hilton Hotel, Boston, Nov. 13-16.

Computer Conference, American Federation of Information Processing Societies; Convention Center, Anaheim, Calif. Nov. 14-16.*

Short Courses

Precision radiometry—calibration and measurement, University of Michigan's School of Engineering, Ann Arbor, Mich.; Nov. 6-10; \$175 fee.

Seminar on value engineering, University of New Mexico's State Technical Services, Albuquerque, New Mexico; Nov. 13-17; \$125 fee.

Institute on the computer and hospital administration, The American University's Center for Technology and Administration, Washington; Nov. 28-Dec. 1; \$175 fee.

Call for papers

Colloquium in Packaging Electronics and Optics, Rochester Institute of Technology; Manger Hotel, Rochester, N.Y., Mar. 13-15, 1968. Nov. 22 is deadline for submission of abstracts to A. Robert Maurice, Extended Services Div., Rochester Institute of Technology, P.O. Box 3416, Rochester, N.Y. 14614.

Computer Conference, IEEE; International Hotel, Los Angeles, June 25-27, 1968. Jan. 15 is deadline for submission of digests of papers of Harold Peterson, c/o Rand Corp., 1700 Main St., Santa Monica, Calif.

International Conference on Communications, IEEE; Sheraton Hotel, Philadelphia, June 12-14, 1968. Jan. 15 is deadline for submission of papers to R.S. Caruthers, International Telephone & Telegraph Corp., 320 Park Ave., New York 10022.

* Meeting preview on page 16.



RETURN ON INVESTMENT?



CONSIDER your income as return on an investment made up of your education, accomplishments, and your total experience and you find that you capitalize out to a suprisingly large sum.

INVEST your talents in a company for immediate rewards with a sound plan for long-term growth.

MELPAR, INC. started with 35 employees in 1945 and has grown to over 3,000 highly qualified technical, support, and managerial personnel. And we are backed by the vast resources of the Westinghouse Air Brake Company.

THINK also about the enjoyment you can get from your investment. Don't squander your investment on unimportant work; receive a full measure of satisfaction and growth by working in areas of *advanced electronics, aerospace systems, and the physical and life sciences* ranging from *basic research to design and development* - always advancing the frontiers of technical knowledge and applications.

Our professional staff likes the return on its investment. While most positions require an advanced degree, or considerable directly related experience, there are also openings with equivalent growth potential for recent graduates.

READY TO INVEST?

WRITE IN COMPLETE CONFIDENCE TO:
Professional Investment Manager



MELPAR, INC.

(A SUBSIDIARY OF WESTINGHOUSE AIR BRAKE CO.)
7789 Arlington Blvd. • Falls Church, Virginia 22046

IMMEDIATE OPENINGS FOR: Physicists, Electrical Engineers, Programmers, Mathematicians, Mechanical Engineers, Designers-Ceramists, **IN THE AREAS OF:** Simulation and Training, Applied Electronics, Electronic Warfare, Avionics, Transportation Systems, Astro Systems, Electronic Research, Systems Analysis. **ALSO POSITIONS FOR:** Chemists, Biochemists, Virologists, Biologists, Veterinarians, in our Bio-Sciences Research Center.

an equal opportunity employer m/f

When you have an insulating problem that's "up in the air"

...ask LAPP.

LAPP ANTENNA INSULATORS

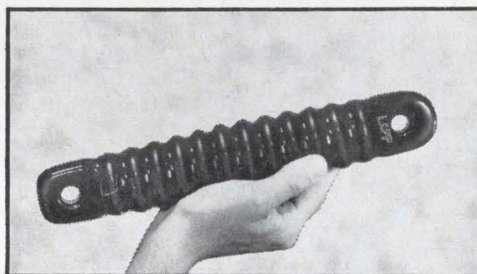

Shaped insulator

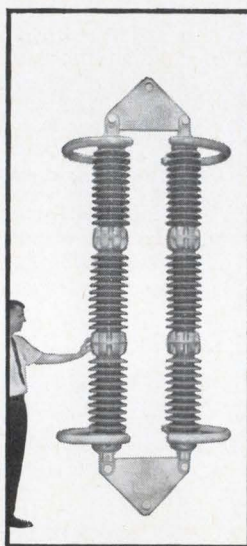

Double strain assembly



Rod-type with rain shield and corona ring

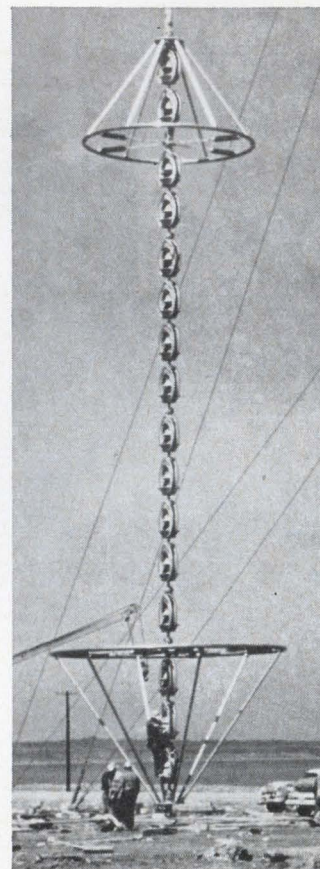

Special antenna insulator assembly with corona rings.

Lapp has been designing and producing antenna insulators for nearly a half century. We have delivered short ones, long ones, little ones, big ones, giant ones. Each met the customers' electrical and mechanical specifications with "room to spare".

Examples? The double-strain insulator assembly shown here tested to 240,000 lbs. ultimate strength. A similar triple yoke assembly tests to 360,000 lbs. Lapp has a compression cone guy insulator already designed that tests to 750,000 lbs! We also

have many smaller units and rod-type and shaped insulators.

Don't leave your antenna insulating problem "up in the air". Write or call Lapp Insulator Co., Inc., LeRoy, N. Y. 14482. We're down-to-earth people who get the job done.

Lapp

50
YEARS

New Instrument Review

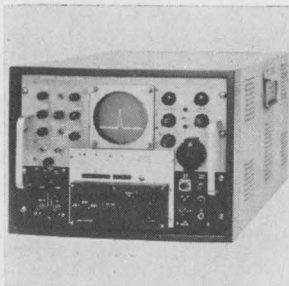

Dynamic range of better than 70 db distinguishes the LA-40A ssb spectrum analyzer. The unit uses a single tuning control to search for signals and has plug-in tuning heads with easy-to-read, digital type dials. Sweep rates and resolution are automatically optimized for calibrated widths from 0.5 to 100 khz. Specialty Electronics Development Corp., 70-31 84th St., Glendale, N.Y. [361]



Strain gauge pressure transducer RV22 uses IC techniques. Featuring a built-in amplifier, the unit gives a repeatability of 0.2%, hysteresis of 0.25%, and linearity of 0.25%. Maximum output at full scale pressure is 4 v into 400 ohms. Twelve ranges are available: from 0-15 lbs to 0-1,500 lbs. Price is under \$325. Dentronics Inc., 60 Oak St., Hackensack, N.J. 07601. [362]



Frequency selective voltmeter 3111, covering a range of 20 hz to 150 khz, is for use in telemetered supervisory control systems. Features include restored frequency and recorder outputs, 100-kilohm input impedance, and 600-ohm input circuits. Accuracy is ± 0.5 db over input levels of -100 db to +22 db. Rycom Instruments Inc., 9351 E. 59th St., Raytown, Mo. [363]



D-c voltage calibrator and electronic galvanometer VS11-G has a range of 0 to ± 11.1110 v d-c, resolution of 100 μ v. Input impedance is infinite at null and 200 kilohms off null. The output mode has an absolute accuracy of $\pm 0.01\%$ of setting. Output current is 30 ma; output impedance, 30 milliohms. Electronic Development Corp., 423 W. Broadway, Boston, Mass. [364]

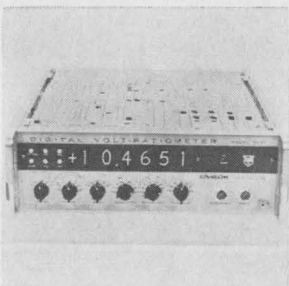

Digital volt-ratiometer model 4651 features 5-digit display and a sixth digit overrange, externally programmable front-panel controls, and accuracy within 0.001% of full scale $\pm 0.005\%$ of reading. Input impedance is greater than 10,000 megohms on a 10.9999 volt range. Balance time averages 50 msec. Cimron Division, Lear Siegler Inc., 1152 Morena Blvd., San Diego, Calif. [365]

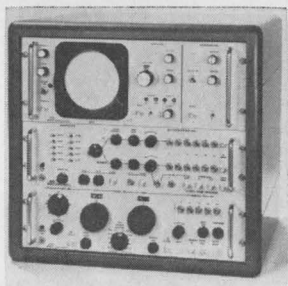

Sweep instrumentation test set TS-102 provides a lab-type 5-in.-scope display system, besides solid state sweep generation functions. The display unit provides vertical sensitivities of 1 mv/cm with band pass to 500 khz. Four sweep outputs are offered: video, 0 to 10 Mhz; i-f, 35 to 50 Mhz; vhf, 50 to 250 Mhz; uhf, 450 to 920 Mhz. Sweep Systems Inc., Box 616, Indianapolis. [366]

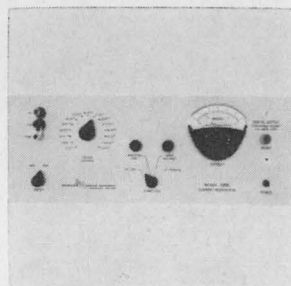

Current integrator model 1000 is for use with low energy particle accelerators. A wide span of input currents can be accommodated by its 15 scales that range from 2 na to 20 ma full scale. Accuracy is 0.02%. A chopper-stabilized input amplifier with a gain to 10^8 provides extremely low input impedance and eliminates drift. Brookhaven Instruments Corp., Box 212, Brookhaven, N.Y. [367]

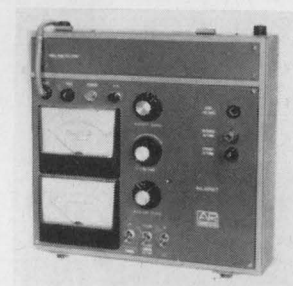

High-voltage test set 4030 has an output of 4,000 v a-c for dielectric strength testing and leakage current measurement. It is suited for manufacturing and quality control checks of components, wiring harnesses and motors. It has a 2-range kilovoltmeter and 3-range microammeter, both accurate to within $\pm 3\%$. Associated Research Inc., 3777 W. Belmont, Chicago. [368]

New instruments

Transceiver expands sonar jobs

Device designed to match variety of transducers for underwater ranging, sea-bottom profiling

Echo-sounding equipment aboard ships was—until quite recently—considered adequate if it merely told where the ocean bottom was at a given time.

More demanding tasks like acoustic ranging have now emerged—for expanded oceanographic studies,

cable-laying projects, antisubmarine warfare research, and harbor and river navigation.

As an aid to navigation, such as following a channel with the help of a recorder profile of the river bottom, acoustic ranging "is more reliable than radar—there's less clut-

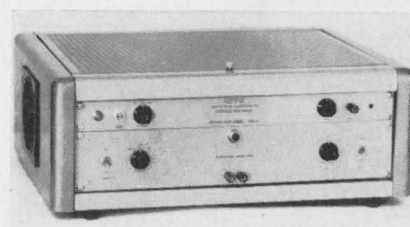

Sound center. Modular transceiver can match virtually all existing transducers.

ter to contend with," says George Lehsten, chief engineer of Alpine Geophysical Associates.

The company, which developed a series of acoustic transceivers for its own ocean study projects, has decided to sell the devices to other

The naked truth!

Now for the first time ever! The unpurgated Redcor/Module's complete 10-channel multiplexer facts are laid bare! A lascivious thrill will run down your spine when you learn of its voluptuous 100 kc throughput rate! Its luscious 5 psec settling time! Your blood will thunder through your veins, your mind reel, at the wildly exciting possibility of eliminating multiplexer

modulations and offset! All this and more are yours in a bold new data sheet, "Sex & Specs & our Multiplex", available to all red-blooded engineers at **no cost!** Engineers under 18 must have a note from mommy.

REDCOR 7800 DEERING AVENUE
CANOGA PARK,
CALIFORNIA 91304

(213) 348-5892 • TWX 910-494-1228

Circle 183 on reader service card

Join our Phoenix Profit Club!

Most clubs take pride in their exclusivity. But not ours. The only qualification for membership is a healthy profit-and-loss statement. And because we have a vigorous business climate, fast-growing markets, tax-free inventories, high worker productivity and low state income taxes, our membership is really zooming!

For latest edition of "THE PHOENIX STORY" write Stanton Allen, Manager, Economic Development Department, Room E-2, Chamber of Commerce, Phoenix, Arizona 85004

PHOENIX
ARIZONA

72 HOUR DELIVERY

ON THESE

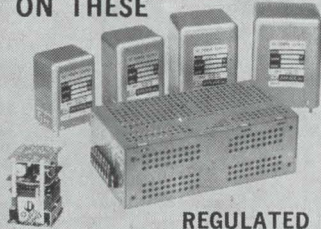

REGULATED DC POWER SUPPLIES

- Fully accessible, fully repairable
- Low Cost—Large quantity discounts
- 0.5 to 250 vdc coverage
- Combined regulation from 0.5% to 0.01%
- Temperature coefficient from 0.04%/°C to 0.001%/°C
- Stability—To 0.005%/Month
- Two year warranty
- Many optional modifications

See EEM for power supplies and voltage references



DYNAGE inc.
1331 Blue Hills Ave., Bloomfield
Conn. 06002 • (203) 243-0315

... records deepest water known ...

research groups.

Static field. "Outside of changing from tubes to solid state, very few design improvements have been made in this field since World War II," says Lehsten. "That's why we had to develop our own transceivers."

Called the Series 495, the transceivers can accurately match almost any acoustic transducer, regardless of impedance level, within a wide range. The company considers this feature especially attractive to companies retrofitting marine equipment because it means that transducers already mounted on ship hulls can be used and given additional power for underwater ranging.

According to the company, the versatility of the new transceivers will help to refine acoustic echo ranging as a form of navigation.

Lehsten, designer of the transceivers, says they will correctly match any device between 50 and 400 ohms, and yet deliver the full rated power automatically with no control or tap selection needed. This is accomplished in the transceiver by sensing the impedance match between it and the transducer. An error signal is fed back to the biasing networks of the driver transistors, to change the drive level applied to the output. This changes the drive impedance, which also affects the secondary impedance and thus matches the transceiver output impedance to that of the transducer.

Depth power. Another design feature is the use of a single frequency receiver section operating at the transmitted frequency, which can be set at a wide range. The bandwidth of the receiver section determines in part the actual transmitted frequency. This assures the maximum transfer of reflected energy without envelope distortion so prevalent with the more common heterodyning type systems currently in use. By using power levels of 1,000 watts or more, these units could record the bottom of the deepest water known.

The Series 495 devices are precision bathymetric transceivers, designed for standard sonar transduc-

ers and precision bathymetric recorders. There are four transceiver models—ranging from 800 to 1,400 watts output. The transducers should be capable of transmitting 12-kilohertz pulses or—for one of the models only—any other frequency between 3.5 khz and 39 khz. The transceivers may be used with any commercially available precision recorder requiring an input level of approximately 1 volt.

The Alpine transceivers are packaged for either bench or standard 19-inch rack installations. They are also available in self-enclosed cabinets for other types of installations. Only four cable connections are necessary to hook up the transducer and recorder.

All models operate on 117 ± 15 v a-c, 50-60 cycles. All have an input sensitivity of approximately 10^6 volts. They are convertible for use with other sound sources and detecting systems by means of plug-in, interchangeable amplifiers. A separate, balanced signal input connector is supplied for external signal sources of any characteristic impedance between 50 and 1,000 ohms. No bandwidth limitations exist between this signal source and the recorder, within the range of 5 hz to 50 khz, depending on the amplifier model.

Specifications

Model number 495	
Power consumption (w)	300
Power output (w)	800
Bandwidth	12 khz $\pm 1\%$
Nominal frequency (khz)	12
Frequency stability (hz)	10
Pulse lengths (ms)	0.2 to 15.0

Model number 495A	
Power consumption (w)	350
Power output (w)	1,200
Bandwidth	12 khz $\pm 1\%$ 34 khz $\pm 2\%$
Nominal frequency (khz)	12 34
Frequency stability (hz)	10 at 12 khz 30 at 34 khz
Pulse length (ms)	0.2 to 15

Model number 495A2	
Power consumption (w)	350
Power output (w)	1,400
Bandwidth	12 khz $\pm 1\%$ 34 khz $\pm 2\%$
Nominal frequency (khz)	12 34
Frequency stability (hz)	10 at 12 khz 30 at 34 khz
Pulse length (ms)	0.2 to 15

Model number 495B	
Power consumption (w)	350
Power output (w)	1,400
Bandwidth	12 khz $\pm 1\%$
Nominal frequency (khz)	12
Frequency stability (hz)	10
Pulse length (ms)	0.2 to 10 (to 20 with external capacitor)

Alpine Geophysical Associates Inc.,
Norwood, N.J. [369]

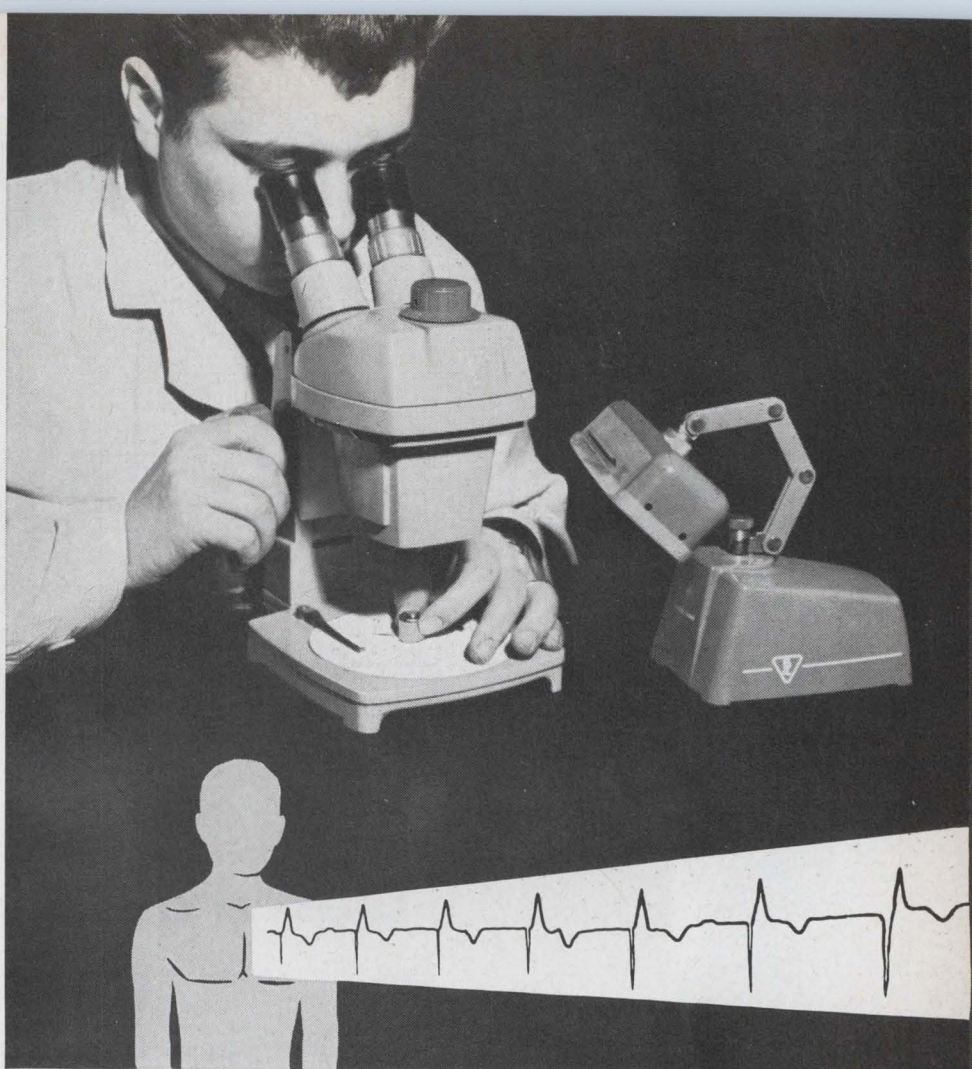

StereoZoom® helps Mallory provide "ZERO DEFECTS" cells for IMPLANTED HEART PACEMAKERS

To meet critical pacemaker requirements, Mallory Battery Company, a division of P. R. Mallory & Co., Inc. must provide batteries of absolute reliability over a specified length of time. A unique Certified Cell program assures "zero defects" output. Every component is tested singly and pre-selected within tight limits. Fall-outs are discarded. Each shipment is certified as produced to the highest level of quality under the present state of the art. To date, no premature failures have been reported.

StereoZoom plays a vital role in the many rigid cell inspections. Continuously variable magnification lets inspectors zoom easily, quickly, through the widest range of settings to the best one for each visual task. Flat fields give images of *full* edge-to-edge clarity and sharpness. Flexibility of mounting parts and stand allows complete freedom of movement.

StereoZoom optical quality fulfills the most critical requirements in the science laboratory, too. There are 24 complete models as well as selected components to choose from. Call your dealer or write for Catalog 31-15, Bausch & Lomb, 62347 Bausch Street, Rochester, New York 14602.

ADVANCING ELECTRONIC/OPTICAL INSTRUMENTATION

BAUSCH & LOMB 
Circle 143 on reader service card

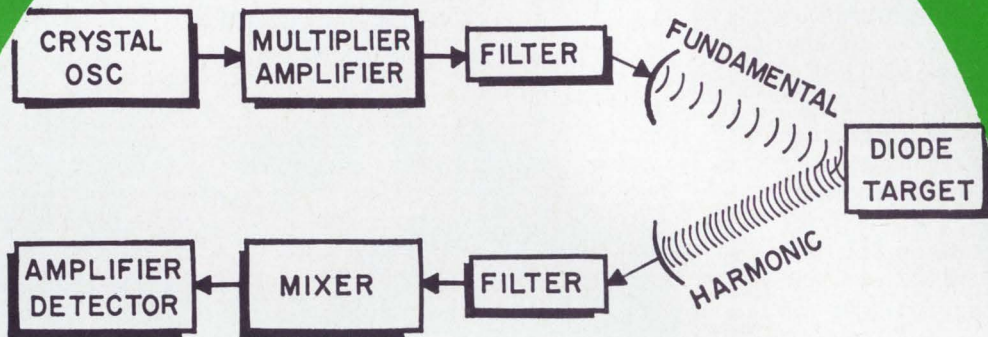

Can a diode in free space generate harmonics?

YES—and it's the basis of Dinade—a new communications & navigation system from Microlab/FXR!

Everyone knows that diodes generate harmonics—in a circuit! But perhaps you didn't know that diodes can be made to do this in free space—without any attached circuitry or power source.

Microlab/FXR has applied this principle to a new Diode Interrogation, Communication and Navigation System*. This is a harmonic radar system, consisting of a Diode Exciter/Receiver plus a passive diode antenna—or a self-focusing phased array where increased range is required—either modulated or unmodulated.

This new Microlab/FXR system can thus detect and communicate with any object (or person) to which the diode is attached. Perhaps even more important, it can positively

single out and identify any particular target from all others. Microlab/FXR's new system can well be the answer to heretofore unyielding problems connected with air/sea navigation, flight traffic control, rescue and recovery operations, IFF systems, etc. In other areas, the system can be used for everything from automobile traffic control to aircraft blind landing systems; from bird and animal migratory studies to human medical diagnostics.

Maybe these applications whet your appetite—maybe they fit in neatly with a project you're working on—maybe they give you a new idea for something we haven't thought of. If so, you'll want more information. Just circle the Reader Service Card. Better still, write us directly, at Dept. E-61.



MICROLAB/FXR

*patents pending

Livingston, New Jersey 07039 Phones: (201) 992-7700; (212) 721-9000

©1967

New Subassemblies Review

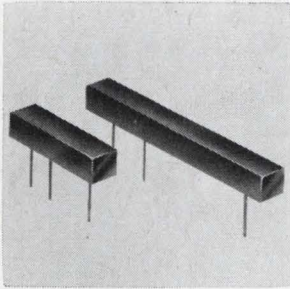

Delay lines in the SM series conform to applicable portions of MIL-D-23859A. Standard items range from 10 to 1,200 nsec at impedance levels of 100, 200, and 500 ohms. Operating temperature is -55° to $+125^{\circ}\text{C}$. They come in 2 sizes: $1 \times 0.32 \times 0.32$ in. and $2 \times 0.32 \times 0.32$ in., both with $\frac{1}{2}$ -in. leads. ESC Electronics Corp., 534 Bergen Blvd., Palisades Park, N.J. [381]

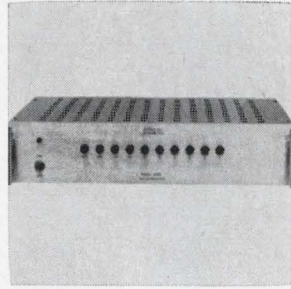

Model 10BP1 a-d converter employs IC logic. Bipolar inputs over a ± 5 -v range are converted to 9-bit, plus sign, binary output in 11 μsec . The maximum conversion rate is 90,000 words/sec with an accuracy of $\pm 0.1\%$ of full scale $\pm \frac{1}{2}$ least significant bit. Input impedance is greater than 2,000 ohms. Houston Magnetics Div., A.I.C. Corp., Box 207, Bellaire, Texas. [382]

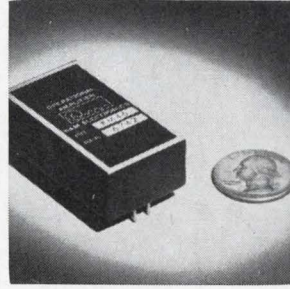

Battery-operated, FET operational amplifier model KM46 is suited for integrators; sample and hold circuitry; isolation amplifiers; low-noise, high-impedance a-c amplifiers; and general instrumentation amplifiers. Quiescent current at ± 9.5 v is 1.5 ma maximum; input impedance at d-c, 1×10^{12} ohms; offset current, 30 pa. K&M Electronics Corp., 102 Hobart St., Hackensack, N.J. [383]

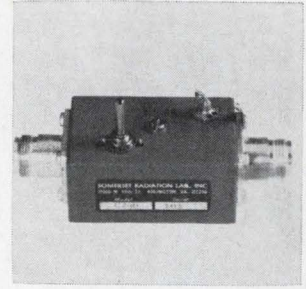

Transistor amplifier G260 has a frequency range of 55 to 65 Mhz. It can deliver 1 watt to a 50-ohm load with an input of 20 mw for a gain of 17 db. A single negative-ground power supply furnishing $+28$ v at 150 ma maximum is the only external d-c requirement. Size is $1.13 \times 1.38 \times 3.85$ in. Somerset Radiation Laboratory Inc., 2060 N. 14th St., Arlington, Va. [384]

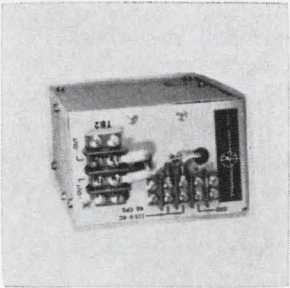

Power modules have been developed to meet the regulation, ripple and rfi requirements of all commonly available integrated circuits. Model IC5-25, measuring only $5\frac{1}{4} \times 3\frac{1}{2} \times 7\frac{1}{2}$ in. and weighing only 6 lbs., delivers 5 v d-c at 25 amps with regulation of 125 mv and rms ripple of 15 mv. Transistor Devices Inc., 65 Route No. 53, Mt. Tabor, N.J. 07878. [385]



Differential d-c amplifier A524-14 offers solid state design plus encapsulated construction for virtual immunity to severe airborne or missile-borne environments. Performance includes a zero stability of better than $0.5 \mu\text{V}/^{\circ}\text{C}$, linearity within $\pm 0.1\%$, and noise of 1 μv peak-to-peak. Common mode rejection is 120 db at 60 hz. Ectron Corp., 8070 Engineer Rd., San Diego, Calif. [386]

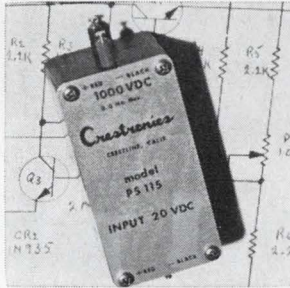

High-voltage d-c/d-c converter PS115 is a 3-w unit with an average efficiency of 75%. Conversion frequency is approximately 30 khz, which lends itself to good filtering for low output ripple (0.1%), and low conduction interference is less than 10 mv across a 1-ohm resistor in series with the input. Price is \$90. Crestronics, Box S, Crestline, Calif. 92325. [387]

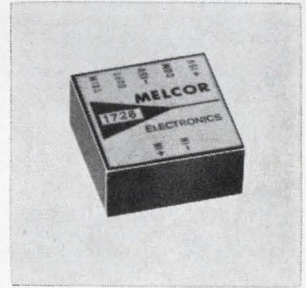

Bipolar, transistor, differential operational amplifier model 1726 features low voltage offset drift coefficient vs temperature of $5 \mu\text{V}/^{\circ}\text{C}$. It has high full-power bandwidth of 200 khz and high slewing rate of 12 v/ μsec . The unit is applicable in control instrumentation, computation, and data logging. Melcor Electronics Corp., 1750 New Highway, Farmingdale, N.Y. [388]

New subassemblies

IC servo loops control tape transport

Semiconductor techniques eliminate mechanical complexity; head remains stationary in automatic loading procedure

Semiconductor technology has revolutionized computers, but the revolution hasn't been drastic enough as far as computer tape transports are concerned.

That's the reasoning behind the decision of Texas Instruments Incorporated to bring out a new line

of tape transports. The major tenet of the design philosophy was to take advantage of TI's expertise in semiconductor electronics, and apply it to the transport.

"Central processors have been reduced perhaps 10 times in cost, 10-20 times in size, and speed has been

increased 10 times in the past decade, mostly by improved semiconductor techniques," says Project Manager Norman Gruzcelac. "Meanwhile, too much that is mechanical has remained in the tape transport, keeping complexity high and reliability low." Also, says Gruzcelac, mechanical systems cannot take advantage of upcoming advances in electronics.

In the new line, designated Model 959, no belts, gears, clutches, or brakes are used, and TI says no mechanical adjustments are needed for the life of the transport. Linear integrated circuits are employed in the capstan drive and reel electron-

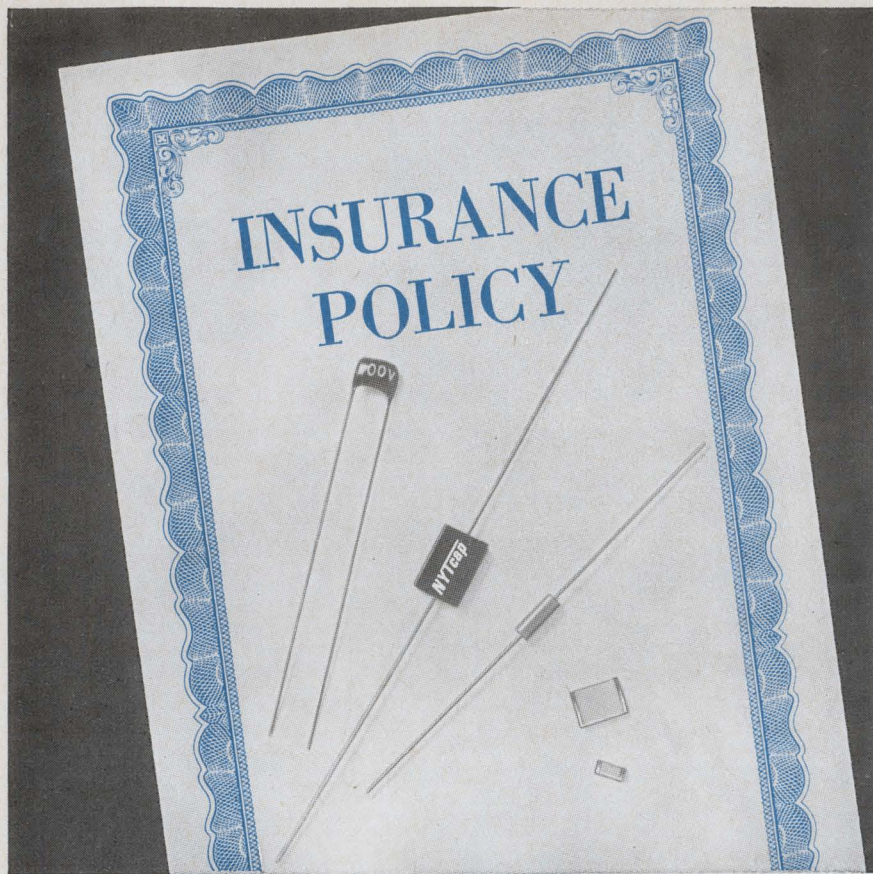

No small print

The Nytronics name on the package is all the insurance you need, to know your sub-miniaturized ceramic capacitors represent the highest standards of quality, stability, and capacitance-to-size-ratio. Available in four complete lines:

NYT-CHIP — An ultra-stable chip capacitor with tinned terminals, 0.170" x 0.065" x 0.070", with capacitance range of 4.7 pf through 220 pf, and 0.280" x 0.195" x 0.070" for 270 pf to 4700 pf. Temperature coefficient does not exceed ± 40 ppm/ $^{\circ}$ C over a temperature range of -55° C to $+125^{\circ}$ C. Working voltage 200 volts D.C.

NYT-CAP — An ultra high stability ceramic capacitor series packaged in a miniature molded epoxy tubular package 0.1" diameter by 0.250" in length, with capacitance range of 4.7 pf to 220 pf. The remainder of series in miniature, molded epoxy case 0.350" long by 0.250" wide by 0.1", with a range of 270 pf to 4700 pf. Temperature coefficient does not exceed ± 40 ppm/ $^{\circ}$ C over a temperature range of -55° C to $+125^{\circ}$ C. Working voltages 200 D.C.

DECI-CAP — A subminiature ceramic capacitor with an epoxy molded envelope 0.100" diameter by 0.250" long, axial leads, with capacitance range 4.7 pf to 27,000 pf, tolerance $\pm 10\%$. Unit designed to meet MIL-C-11015.

HY-CAP — Offers extremely high capacitance range .01 mfd. to 2.5 mfd. in $\pm 20\%$ tolerance. Voltage 100 WVDC, no derating to 125° C. Designed to meet MIL-C-11015.

Write or call for more information. In addition to ceramic capacitors, our inventory of other standardized high quality components includes inductors, delay lines, and resistors.



NYTRONICS[®]

...for Precision Electronic Components

550 Springfield Ave., Berkeley Heights, N. J. 07922 ■ (201) 464-9300 ■ TWX: 710-984-7977

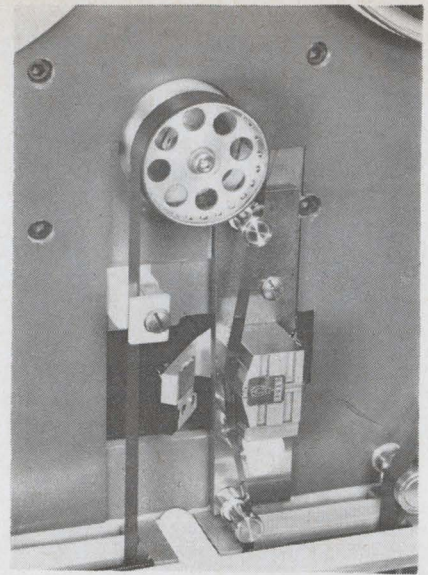

The unmoved. Tape head stays put, crosstalk shield swings away for loading.

ics, and digital ic's in the read-write electronics.

The design includes single-capstan drive, automatic loading, and quick-release transport hubs. There is no oxide contact except at the recording head, and the reel servosystem controls torque, to eliminate excessive tightening of the tape.

The two reel drives and the capstan drive are direct-coupled to d-c motors by operational amplifiers in ic form and by semiconductor circuitry in feedback loops.

Violin string. The use of operational amplifiers and servo loops coupled to the drive motors make for a smooth start for the tape. "Tape tends to act like a violin string," says Gruzcelac. "You can easily set up a standing wave in it, and get into all kinds of problems with lifting and twisting."

In the Model 959, the head need not be moved out of the way for tape loading. "Instead, we move the read-write crosstalk shield," says Gruzcelac. "This eliminates critical and complex mechanisms for accurately repositioning the head."

The tape must be accurately guided over its entire path from reel to reel, so that the tracks of data on the tape precisely match the individual magnetic air gaps on the head. Meeting these tolerances with a movable head is difficult. Repositioning of the crosstalk shield is much less critical.

Texas Instruments Incorporated, Industrial Products Group, P. O. Box 66027, Houston, Texas 77006. [389]

Don't despair because
the company's
educational program
wasn't planned for
your electronics
support people...

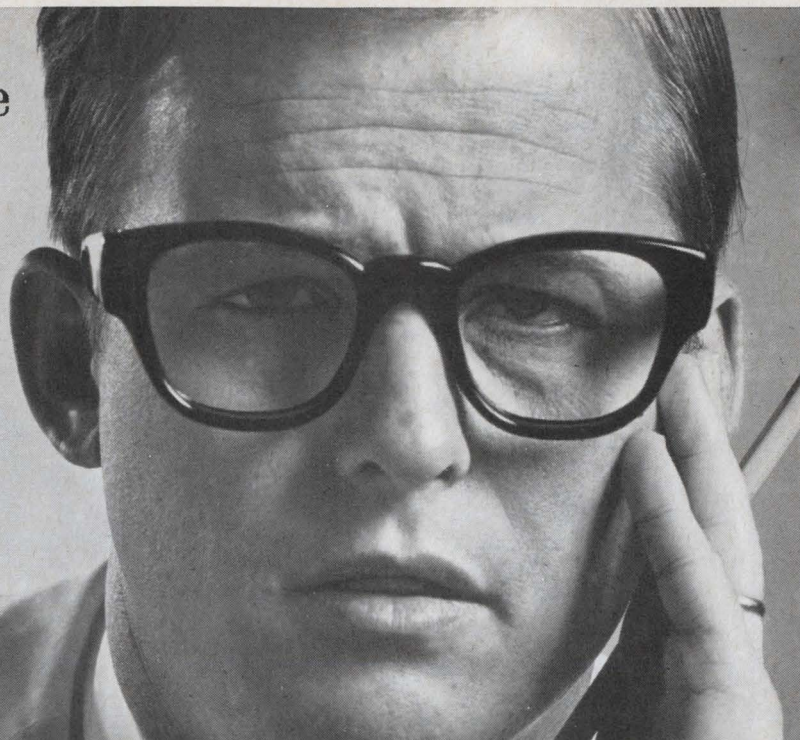

improvise

Look over your men. Pick out a few who are intelligent enough to profit from more education in electronics, ambitious enough to work hard to get it. Send us their names and addresses. We'll send them complete information about CREI Home Study Programs in Electronics, tell them how these programs have helped thousands of young men increase their value to their employers. We'll explain how they can study at home, at their own pace, on their own schedule without traveling

to classes. We'll give them the names of the more than 80 leading scientists and engineers who help us develop and update programs related directly to the needs of industry.

Yes, we'll do all that. If you're lucky some of your men may enroll. Why not give it a try? Fill out the coupon and get it in the mail today.



CREI Programs cover these specialized areas of advanced electronics:

- Communications Engineering • Aeronautical and Navigational Engineering • Television Engineering • Computers • Nuclear Instrumentation and Control • Automatic Control Engineering • Missile and Spacecraft Guidance • Radar and Sonar Engineering • Nuclear Engineering Technology • Industrial Electronics for Automation • Computer Systems Technology.

CREI THE CAPITOL RADIO ENGINEERING INSTITUTE

A Division of McGraw-Hill, Inc.
Dept. 1844E, 3224 Sixteenth Street, N.W.
Washington, D.C. 20010

Gentlemen: The men listed at right are high school graduates working in some phase of electronics. Please send them your FREE book, "How to Prepare Today for Tomorrow's Jobs" and complete information about CREI Home Study Programs.

And please send me the free brochure which tells how we can use CREI Home Study Programs to supplement our educational program for electronics personnel.

Name _____
Title _____
Company _____
Address _____
City _____ State _____ Zip Code _____





Name _____
Address _____
City _____ State _____ Zip Code _____
Name _____
Address _____
City _____ State _____ Zip Code _____
Name _____
Address _____
City _____ State _____ Zip Code _____
Name _____
Address _____
City _____ State _____ Zip Code _____
Name _____
Address _____
City _____ State _____ Zip Code _____

(Not enough room? Attach sheet of paper with additional names and addresses)

Celco

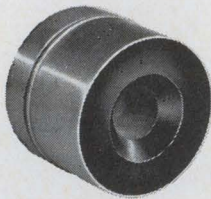
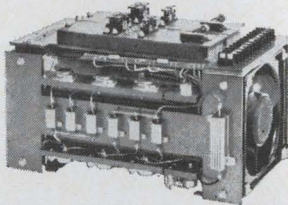
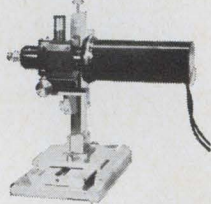
DEFLECTION COMPONENTS

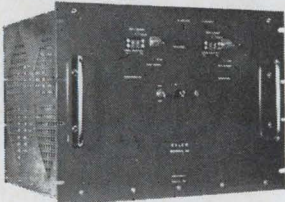
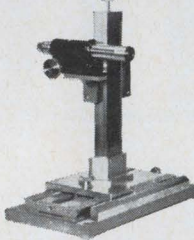
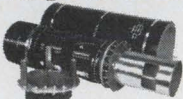
for the DISPLAY INDUSTRY

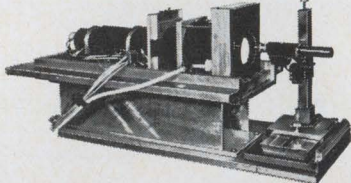
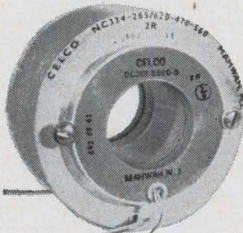
YOKES	AMPLIFIERS	INSTRUMENTS
<p>DEFLECTRONS Ultra High Resolution Yokes Type HD</p>  <p>For 40° Flat Faced Scanners, Computer Readouts, Side-Looking Radar, Mapping.</p>	<p>20V ALL SILICON DRIVERS Type DA-PPN-3</p>  <p>3, 6, 12 amp X-Y amplifiers matched to your yoke and response requirements. Available with regulated power supplies</p>	<p>DISPLAY MEASUREMENT LAB</p>  <p>Two-Slit CRT Spot Analyzer on X-Y Traverse quickly ascertains spot size, line width, and X-Y coordinates. Easily determines linearity and positional accuracies as well as phosphor characteristics.</p>
<p>PIN CUSHION CORRECTORS Electromagnetic</p>  <p>Straight Sides to 0.1%.</p> <p>Use with CELCO Micropositioner for optimum accuracy</p>	<p>40 VOLT DEFLECTION DRIVER All Silicon Type RDA-PP6N-1</p>  <p>With regulated Quadru-Power Supplies. 12 amp change in less than 9 μsec. 0.02% linearity.</p>	<p>X-Y TRAVELING MICROSCOPE Mounted on X-Y Traverse.</p>  <p>Line Straightness, spot positions and line positions measured with a high degree of repeatability. Use for aligning yokes, focus coils and field correctors.</p>
<p>TV CAMERA COILS for 3" Image Orthicons Type I.O.</p>  <p>Deflection Yoke, Focus and Alignment Coil Assemblies to meet your specs.</p>	<p>RASTER GENERATOR All Solid State Type 2 SG-1</p>  <p>Two Ramp Units in one panel. Ramps from 20 μsec to 100 msec. Adjustable dc offset. Compatible with CELCO Drivers.</p>	<p>CRT DEFLECTION SYSTEM</p>  <p>Contains all deflection, focus and corrective coils, micro-positioners for each, your CRT, complete shielding from all stray magnetic fields. Use for automating assembly lines, a reader of bubble-chamber photos.</p>
<p>MAGNETIC LENS for High Resolution CRT's Type NC</p>  <p>For correction of CRT distortions. Consists of static and dynamic focus and astigmatic coils.</p>		

Celco YOKES

Constantine Engineering Laboratories Company

MAHWAH, N. J.
201-327-1123
TWX 201-327-1435

UPLAND, CAL.
714-982-0215
TWX 714-556-9550

A state of the art frequency comparator featuring all silicon semiconductor design, the Model 103A makes short term frequency comparisons to 1 part in 10^{11} . Accuracy can be extended to 1 part in 10^{13} under controlled environmental conditions. □ The 103A accepts the widest range of test and reference frequencies of any comparator on the market today. Frequencies of 100 kHz to 5 MHz in 14 discrete increments are acceptable for both inputs independent of one another and in any combination. □ Seven data channels out for ultimate versatility are available. Front panel metering provides "stand alone" operation with no other readout devices required for most measurements. Here's one comparator you can use on the test bench as well as in the standards laboratory.

Stands alone. Announcing the Fluke/Montronics 103A Frequency Comparator. Now, with only one 17 lb. instrument you can make complete measurements of frequency comparison, relative phase, and short term stability. And even though the price is a modest \$1,995, the model 103A offers more features than any other comparator on the market today!

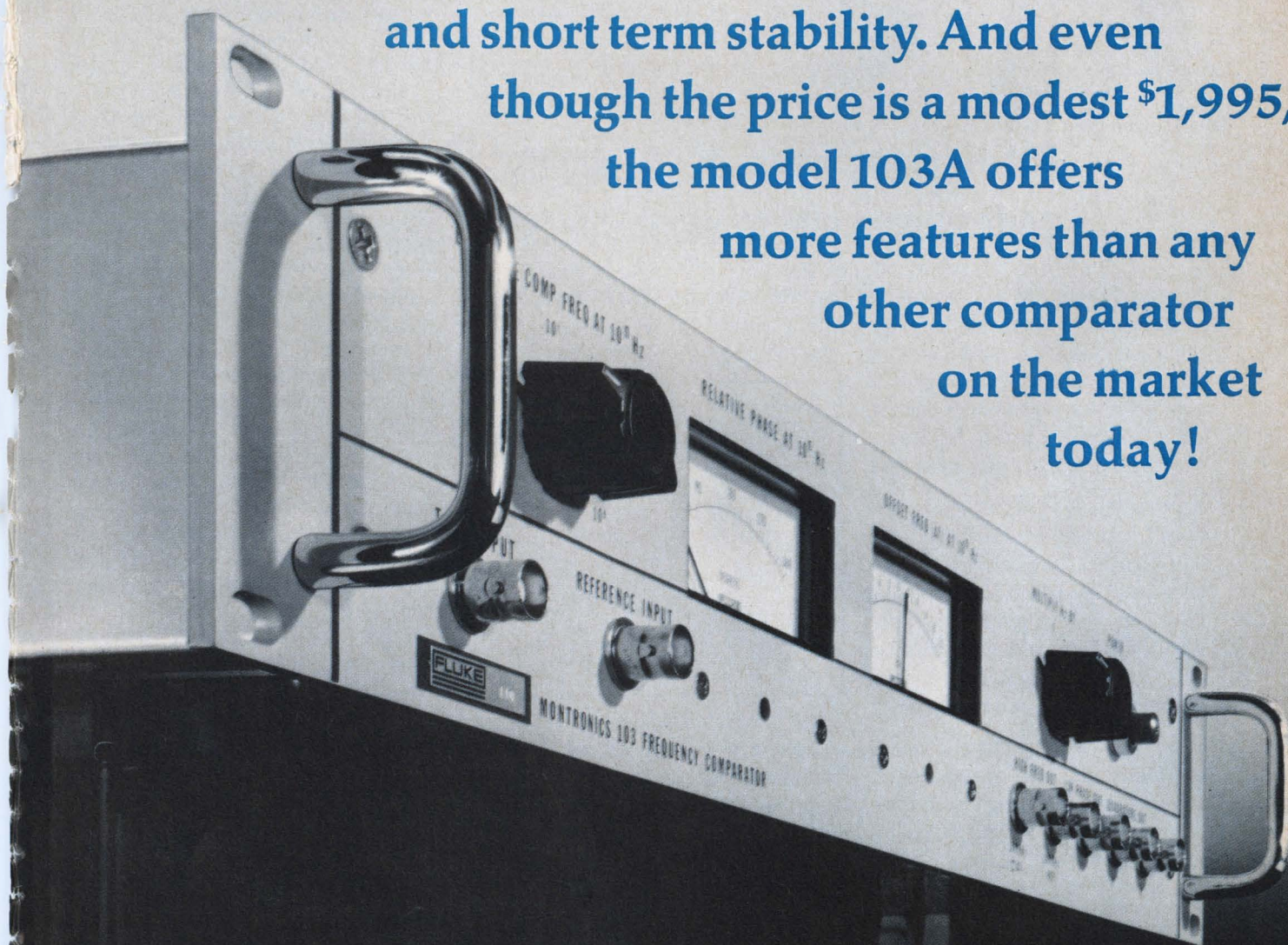

Montronics • Box 7428 • Seattle, Washington • Phone: (206) PR6-3141. TWX: (910) 449-2850
In Europe, address Fluke International Corporation, P.O. Box 5053,
Ledeboerstraat 27, Tilburg, Holland. Telex: 844-50237.



New Microwave Review

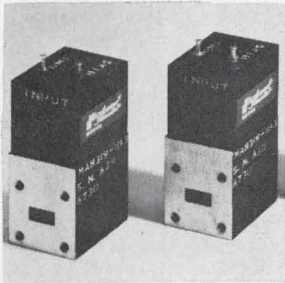

Compact Ka-band diode switch MA-8319-1Q3 is designed for positive receiver protection in radar systems or as a variable attenuator in agc systems. The unit operates from 33 to 35 Ghz over a bandwidth of 0.5 Ghz. Insertion loss is 1 db max. at +50 ma and isolation is 20 db min. at -50 v. Microwave Associates Inc., Burlington, Mass. 01803 [401]

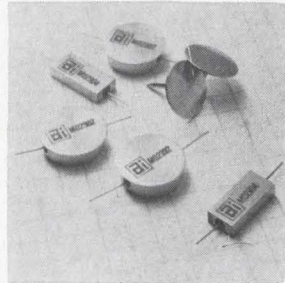

A shunt-mounted chip switch/attenuator is offered in the circular S0-30 style and the rectangular S0-31 case. Typical insertion loss at zero reverse voltage, 2 to 4 Ghz, is 1 db max.; 4 to 12 Ghz, 1.5 db max. Isolation at 50-ma forward current, 2 to 4 Ghz, is 50 db minimum; 4 to 12 Ghz, 55 db minimum. Alpha Industries Inc., 381 Elliot St., Newton Upper Falls, Mass. [402]

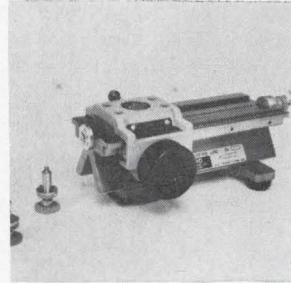

Coaxial slotted line 2400-04 has an outer conductor that is an accurately machined metal block with a 0.1378-in.-diameter bore. It is suited for precision measurements in miniature and subminiature connectors up through 36 Ghz. Over-all dimensions are 2.7 x 7.5 x 3.5 in. Weight is 1.5 lbs. Price is \$1,200. Alford Manufacturing Co., 120 Cross St., Winchester, Mass. 01890. [403]

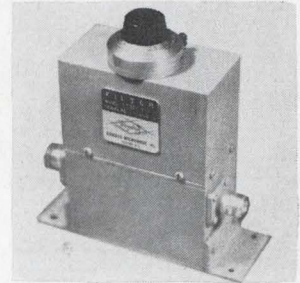

Bandpass coaxial filter G859 features one-knob tuning. A calibrated knob is directly coupled to a low-torque precision gear train to minimize backlash. The unit's range is 5.5 to 5.8 Ghz. Its 3-db bandwidth is 33 Mhz; 55-db bandwidth, 85 Mhz. Max. insertion loss is 2.9 db; vswr, 1.5:1 at output frequency ± 10 Mhz. Gombos Microwave Inc., Webro Road, Clifton, N.J. [404]

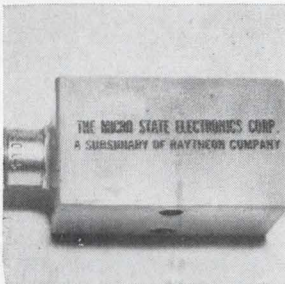

Octave-band limiters hold peak power of 250 w to 100 mw at 2 to 4 and 4 to 8 Ghz. They handle an average power of up to 5 w. Insertion loss across the bands is under 2 db. Recovery time is 100 nsec. Units measure 1 1/2 x 3/4 x 3/4 in. Uses include protection of tunnel diode amplifiers and mixers. Micro State Electronics Corp., 152 Floral Ave., New Providence, N.J. [405]

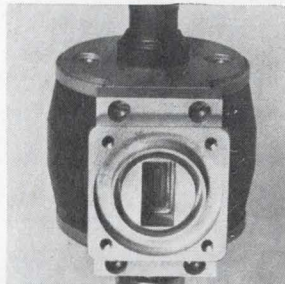

Pulsed magnetron BLM-143A, designed for use in ground radar systems and beacons, delivers a peak output of at least 1 kw over the range of 16 to 16.5 Ghz. Peak anode voltage is 3 kv; peak anode current, 1.6 amps; average input power (including heater), 8 w; load vswr, 1.3:1. Over-all dimensions are 2.625 x 2.375 x 3.422 in. Varian Associates, 8 Salem Rd., Beverly, Mass. [406]

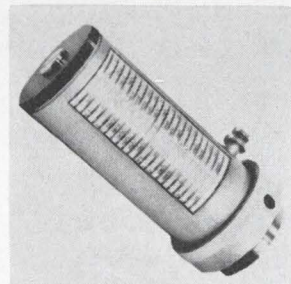

Direct-reading frequency meter 410-A12, for use with WR-75 waveguide, covers a range of 10,450 to 13,350 Ghz. It provides a 20% nominal absorption dip, with a loaded Q of greater than 7,000. Accuracy is 0.06% of dial reading, or 0.01% with correction chart. Price is from \$500 to \$600, depending on quantity. Microlab/FXR, Ten Microlab Road, Livingston, N.J. [407]

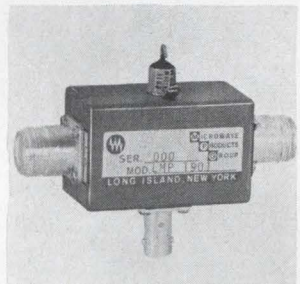

Miniature mixer preamps in the LMP series have an input frequency up to S band with a maximum noise figure of less than 6.5 db. Units measure 1 x 1 1/8 x 2 1/4 in. The r-f bandwidth is up to 10% of the input frequency. Output frequencies are up to 90 Mhz. Microwave Products Div., Consolidated Airborne Systems Inc., 115 Old Country Rd., Carle Place, N.Y. [408]

New microwave

Getting specific about frequencies

Improved circulator-isolator features specs that allow engineers to choose frequencies

An improved design for its Isoductor line of isolator-circulators allows Melabs of Palo Alto, Calif., to list absolute specs for both characteristic resistance, r_o , and characteristic inductance, l_o —enabling the design engineer to pick the operating frequency. The latest device

in the line will operate at any frequency from 200 to 400 megahertz depending on the type of external capacitor used.

The Isoductors were introduced several years ago as circulators minus their tuning capacitors. Melabs reasoned that users might want



Mounting. The Isoductor must be kept 1 inch or more from ferrous materials.

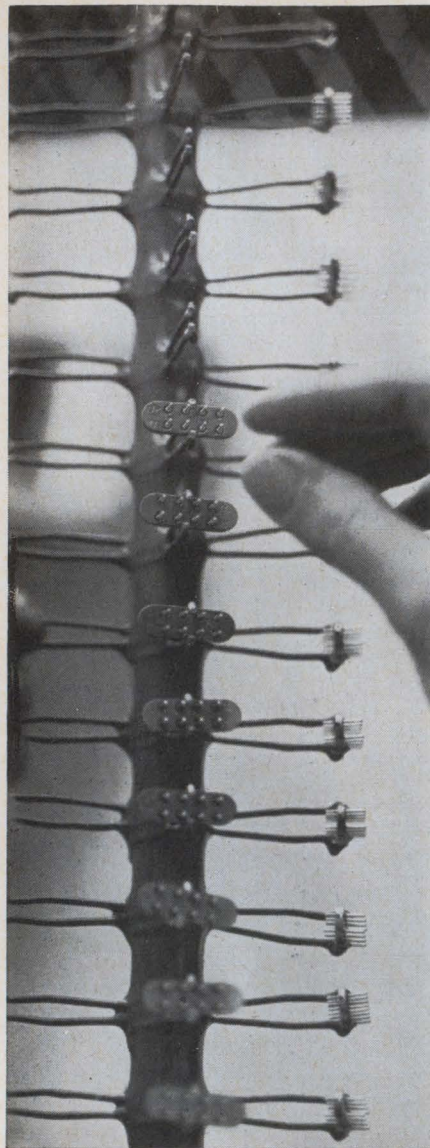

Pick a header... standard or custom

Then call Atlas—where reliability is a reality—whether you need custom headers to your drawings or any of more than 150 configurations of single-pin terminals for off-the-shelf delivery.

At Atlas a tape-programmed, six-head drilling machine reduces tooling time and total cost. An electron-beam welder bonds delicate parts with precision. And Helium Mass Spectrometers check for possible leakage.

In-house facilities such as these make it possible for us to manufacture and test to your specifications or MIL specs. For you that means unmatched quality and reliability. Challenge us today. Phone 215 666-0700. Or send for complete information.

ATLAS
CHEMICAL INDUSTRIES, INC.
Aerospace Components Division
Valley Forge, Pa. 19481

... device specified by its admittance ...

to choose their own values for the capacitors.

Circulators are three-port devices in which inputs to port 1 are outputs at port 2, but inputs to port 2 are blocked from port 1. Traditionally, these units are characterized by insertion loss and isolation, but the company found it difficult to draw up specifications on these parameters without knowing what external capacitors would be used; frequencies of operation could only be assured if the company specified a capacitor and it was used.

Easing doubts. Perry Vartanian, executive vice president of Melabs, says the new specs eliminate this constraint and make the device more understandable to designers, who apparently were somewhat wary of a component that could only be characterized in terms of something else. The new Isoductor, designated the LB-1, is completely characterized by its admittance,

$$Y = \frac{1}{r_0} + \frac{1}{j\omega l_0}$$

An external capacitor will resonate at the frequency of interest; adding a resistor (R_3 in the diagram) will define r_0 , which is equivalent to the resistance that will provide maximum isolation between the ports.

Internally, the Isoductor consists of a permanent magnet, a ferrite disc of low-loss material originally developed for microwave isolators and circulators, and a set of windings designed to give the desired nonreciprocal coupling to the electron-spin system of the ferrite-disc substrates.

Wide separation. The device can be used as a nonreciprocal phase

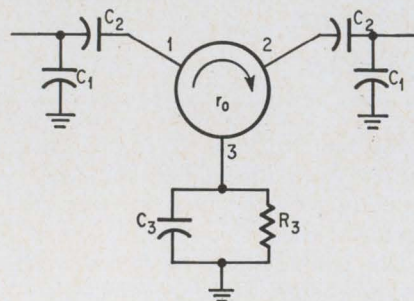

Tuning. External components R_3 and C_3 determine the operating frequency.

—EMPLOYMENT—

Optical Signal Processing Research

The Sperry Rand Research Center is seeking scientists with strong interests in optical processing and ultrasonic light modulation. Also individuals with experience in optical processing design and applications. Our research in this area includes wideband ultrasonic light modulation including transducer optimization and ultrasonic beam shape compensation as well as systems research signal optimization, range, doppler and angle processing.

These are unusually attractive research positions working with well-known professional people in our modern laboratories.

Please send resume in strict confidence to Mr. R. C. Davis, Employment Manager.



SPERRY RAND

RESEARCH CENTER

SUDBURY, MASSACHUSETTS 01776

An Equal Opportunity Employer

—SEARCHLIGHT SECTION—

RADAR AUTO-TRACK & TELEMETRY ANTENNA PEDESTALS 3 & 10 CM. SCR 584 AUTOTRACK RADARS. M-33 RADAR TPS-1D SEARCH. APS-45 TPS-10D HT. FINDERS. WX RADARS. FRN-32GGA. APS-1D APS-15B APS-27 (AMTI) SEARCH. ■ ■ ■ ARN-102 DOPPLER. DOZENS MORE. CARCINOTRONS. PFP'S. 25-5-1-2-3-6 MEGAWATT PULSE MODULATORS. CAVITIES. PULSE TRANSFORMERS. IF STRIPS. WAVEGUIDE. BENDS 200 MC. 1 KMC. 3 KMC. 6 KMC. 9 KMC. 24 KMC. RF PKGS.

RADIO RESEARCH INSTRUMENT CO.
550 5TH AVE., NEW YORK 36, N. Y. JU 6-4691

● CIRCLE 966 ON READER SERVICE CARD

X-band thermistor mount general microwave model X401 JETDS MX-3667/U.

New \$25.00 each, also misc other waveguide and coaxial line components, high temperature tantalum capacitors, multiterm pots, miniature pots, etc.

Write for List

E. U. BUTLER JR.

517 41st St. Sacramento, Calif. 95819

● CIRCLE 967 ON READER SERVICE CARD

New VACUUM PENCIL

for picking up miniature parts

\$7.50 ea.

Selected Distributors available.

PHILIP FISHERMAN COMPANY
7 CAMERON ST., WELLESLEY, MASSACHUSETTS

● CIRCLE 968 ON READER SERVICE CARD

—PROFESSIONAL SERVICES—

Donald C. Harder, Inc.

Magnetic Component Engineers

Reactors—Transformers—Filters

Serving the Research Laboratory

2580 K Street, San Diego, Calif. 92102

Phone (714) 239-8021

Photo contributed by Daniel J. Ransohoff



You can give her hope.

How? Can you find loving parents for her, give her good health, adjust her to the realities of normal living, remedy any physical or other problems troubling her? Probably not.

But you can do this: give the United Way. Support the regular community agencies which provide help for all, all at once, all year long — for the young and old, the ill and troubled, the poor and neglected, for members of the Armed Forces and their families, and for victims of disaster. Your voluntary United Way gift is your way of being a good neighbor and friend in your community. It is your way of saying you want to help make your community a better place for all families, including your own, through your United Fund or Community Chest.



27 million families benefit by child care, family service, youth guidance, health programs, disaster relief and services for the Armed Forces from 31,000 United Way agencies. Space contributed as a public service by this magazine.

... 25-db isolation with only 0.6-db power loss ...

shifter in feedback loops, or as a duplexer capable of separating signals 1 kilohertz apart. To date, however, the Isoductor has been employed principally as a load isolator. It provides 25-db isolation between a transistor amplifier and the following circuit, with a forward power loss of only 0.6 to 0.8 db. The designer can thus lay out individual transistor stages without worrying about interaction between the stages.

In another application, terminated Isoductors can be used as load isolators on each of two communications transmitters to reduce intermodulation distortion. Because of unwanted coupling between the two transmitters, energy from one gets into the other, producing undesirable third-order intermodulation products. Isoductors reduce these products by as much as 25 db, Melabs says, with negligible forward power loss.

The device could also act as a circulator or duplexer capable of separating signals on the basis of the direction of power flow. Thus it replaces the receive-transmit switch that is a large source of power loss in microwave systems. If transmitter, antenna, and receiver are connected to the three terminals, there is low loss from transmitter to antenna and about 20-db isolation from receiver to transmitter; for received signals the loss from antenna to receiver is only 0.6 to 0.8 db. Therefore, if any power is reflected from the antenna, it will not harm the receiver.

The LB-1 is the first of a series. Melabs plans other models to cover the 100-600 Mhz range at higher powers than the LB-1's rated 10 watts.

Specifications

Frequency	200-400 Mhz
r_o	250 ohms nominal
l_o	26.5 nanohenrys nominal
r_d (dissipation loss)	2,500 ohms minimum (corresponds to 1 db insertion loss)
Power	10 watts average (higher power available on special order)
Temperature	-35°C to +85°C
Price	\$89 in sample lots, lower in production quantities

Melabs, Stanford Industrial Park, Palo Alto, Calif. [409]

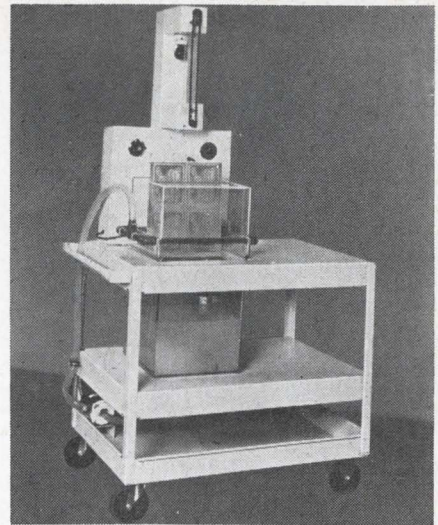

"fine line" etcher

for prototypes—limited runs

Model No. 201 (illus.), etches two 11" x 14" one-sided boards or one 11" x 14" two-sided board: **\$795** Pat. applied for

**ETCH YOUR OWN
P C BOARDS
AUTOMATICALLY**
(in less than 5 minutes)

from this →
to 11" x 14"

Shown Actual Size

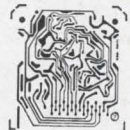

- No cooling or venting required!
- Etches as fine as .001"!
- Cuts costs in half—saves time!
- Complete photo processing instructions!
- Work is illuminated while etching!
- No patterning . . . minimum undercutting!

NOW IN USE BY:

AMP, Inc.
Ampex Corp.
Atomic Energy Com.
Bendix
Charles Brunning
Esso Research
General Dynamics
General Electric
IBM
ITT
Lear Siegler
Magnavox
Micro Switch
Owens-Illinois
Sonotone

Sprague Electric
Union Carbide
U.S. Air Force
Western Electric
Whirlpool
M.I.T.
Oklahoma State U.
Purdue Univ.
Washington Univ.
Univ. of Calif.
Univ. of Chicago
Univ. of Colorado
Univ. of Georgia
Univ. of Hawaii
Univ. of Penn.

CYCLO-TRONICS, INC.

3858 N. CICERO — CHICAGO, ILL. 60641
TELEPHONE: (312)-282-6141

Fast Recovery!

New, LEL IF Amplifiers, ITA-34, have 0.2 μ sec. recovery time and excellent pulse response. Ideal for a wide variety of microwave receiving system applications, they also feature high dynamic range and furnish both IF and detected outputs.

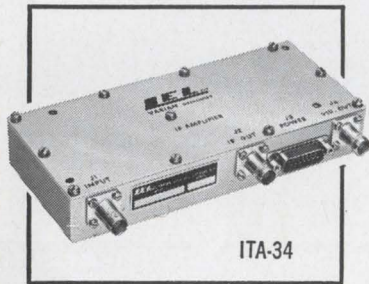

SPECIFICATIONS

C.F.	30 or 60 MHz
BW	3 or 8 MHz
Recovery Time	0.2 μ sec. (typ.)
IF Gain	
(into 50 Ω)	75 dB (min.)
Video Gain	
(into 1000 Ω)	80 dB (min.)
Input	50 ohms
Input	
(lin. operation)	-15 dBm (max.)
Output	
(lin. operation)	+10 dBm (max.)
External AGC range	50 dB (min.)
N.F.	7 dB (max.)
Weight	20 oz.
Dimensions	6 $\frac{7}{8}$ " x 1 $\frac{1}{8}$ " x 3"
Connectors	
(IF and Video)	BNC
(Power)	DA 15
Power required	-20 VDC @ 70 mA
Temperature	-55° to +70°C
Price	\$325

Fast Delivery!

(ONE WEEK)

More than 100 other standard IF Amplifiers are available many with such special characteristics as broad bandwidth, gain-and-phase-match, low noise, extremely low power drain.

Send now for complete data book including full specifications and performance curves.



AKRON ST., COPIAGUE, L. I., NEW YORK 11726
(516) AMityville 4-2200/(516) PYramid 9-8200
TWX Code 510-224-6692

New Books

Switched on

Large-signal transistor circuits
Donald T. Comer
Prentice-Hall Inc., 268 pp., \$10.50

Unlike many textbooks that describe transistor circuitry, this one is aimed at practical applications, and even an engineer familiar with the field can benefit from it. The reader can review, or learn for the first time, the basic elements of transistor physics, equivalent circuits, and graphical analysis that are needed to work with large-signal circuits. The author defines these as pulse, digital, or sweep circuits. They are also referred to as nonlinear, or nonsinusoidal circuits and find wide application in radar and digital computing. Only a few circuit design equations are given, but the book does offer a good physical insight into the circuit's operation.

To provide a broader base for studying practical switching circuits than the more conventional piecewise-linear, black-box, or graphical approaches, the author emphasizes an analysis of the transistor in the act of switching. Detailed static- and transient-switching characteristics of the transistor are considered, independent of particular circuit application.

In describing static-transistor switching the author uses the Ebers and Moll equations to define transistor operations in the cut-off, active, and saturated regions. These equations are often used in computer-aided transistor design.

For transient switching, the hybrid- π high-frequency circuit is described. This circuit enables the engineer to successfully predict active-region switching times.

Making use of the past

Modern Control Systems
Richard C. Dorf
Addison-Wesley Publishing Co., 387 pp., \$12.50

Too many books offer cut-and-dried, cookbook solutions to classical problems and reduce the adventure of discovery to a dusty heap of theorems. Richard C. Dorf believes that the best way to learn

is to reexamine the classical problems first, then consider new ways of solving them.

Dorf's book is primarily concerned with the control-system theory in the frequency and time domains. He deals mainly with linear systems but also describes some nonlinear systems. Each topic he treats, as well as the systems described in the examples, is dealt with in the light of the latest technology. Many of the topics, such as signal-flow graphs, sensitivity analysis, performance indices, the time domain, optimum control systems, and state variables are not usually found in a first text on control theory.

State variables, a relatively new technique for analyzing systems with equations that describe the system's stored energy, is a powerful tool because the equations are speedily solved by either an analog or digital computer. In an analog computer, only one integrating network is required for each first-order differential equation. Furthermore, state techniques are not restricted to systems that are described only by differential equations; they may also be used to analyze and design sequential machines, switching networks, and sampled data systems.

Several practical problems are given from electrical, mechanical, chemical, or industrial engineering areas, as well as from sociology, biology, and economics.

Recently published

Electronics for Scientists and Engineers, R. Ralph Benedict, Prentice-Hall, Inc., 635 pp., \$12.95

Basic instrumentation and control topics such as d-c amplifiers, servos, analog computers, feedback theory, data acquisition, recording and processing are described for scientists and engineers not in the electronics field.

Theory and Applications of Holography, John B. DeVelis and George O. Reynolds, Addison-Wesley Publishing Co., 196 pp., \$12.95

A probing description of various systems for those engaged in holography and related industrial research. Mathematics of holography is presented in a separate section for engineers not familiar with this field.

Handbook of Filter Synthesis, Anatol I. Zverev, John Wiley and Sons, Inc., 576 pp., \$19.95

This handbook explains filter performance to the electronics engineer. Design charts for crystal filters, coupled resonators, helical filters, and basic inductance-capacitance types are featured.

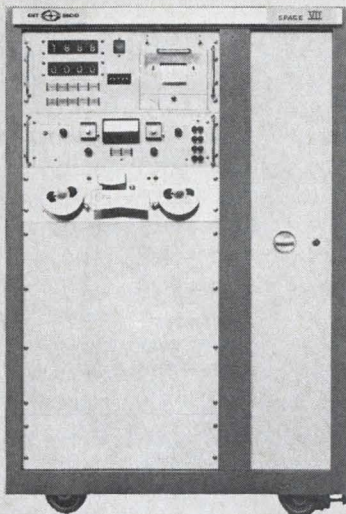

**IT TAKES A LOT
OF ADJECTIVES
TO DESCRIBE THE
SPACE VII...**

Adjectives like FAST, ACCURATE, FLEXIBLE, RELIABLE, VERSATILE, ECONOMICAL and MANEUVERABLE. If you doubt for one minute that a humble wiring system can live up to these labels, then try testing this tester for yourself. It was designed and developed (after thorough lab and field testing) especially to meet today's demand for speed, accuracy, versatility and economy. DIT-MCO's Space VII operates on the fully automatic tape input and printout concept. Design and construction are of the highest quality. The "total

speed" function of the Space VII gives you faster overall test time because of adaptation and hookup ease, rapid tape feed, speed of test plus speed of fault determination time, scan time, error recording and printout. With this advanced system you can test up to 2,000 terminations at a rate of more than 400 per minute! Electronic engineers who've tried it, call DIT-MCO's Space VII the best intermediate size testing system on the market. We won't disagree.



DIT-MCO INTERNATIONAL
A DIVISION OF XEBEC CORPORATION
5612 BRIGHTON TERRACE
KANSAS CITY, MISSOURI 64130
TELEPHONE (816) 363-6288 TELEX 42-6149

IT'S NO WONDER APPROXIMATELY 90% OF ALL MAJOR MANUFACTURERS IN THE COMPUTER AND AEROSPACE INDUSTRIES ARE SATISFIED USERS OF DIT-MCO SYSTEMS.

Circle 184 on reader service card

WITH INSERTS, THE SAVINGS ARE IN THE HOLE

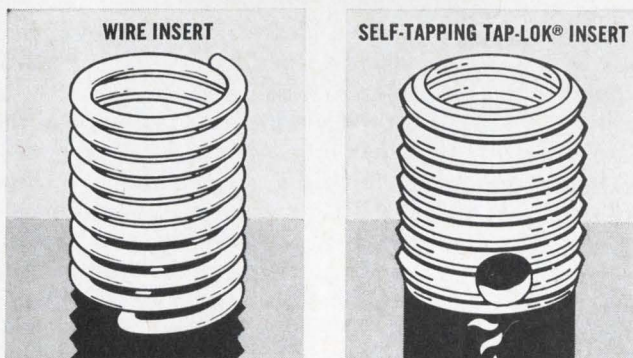

For the real bargain in inserts, look into the hole. You'll get a new view of what really counts—final installed costs. Check these approximate installation figures:

(Estimated Costs*)	Do Our Costs Agree With Yours? If Not, Fill in Your Own	(Estimated Costs*)
Wire-Type Inserts		Self-Tapping Tap-Lok® Inserts
Insert Cost .050¢	_____	Insert Cost .044¢
Drill Hole .070¢	_____	Drill Hole .070¢
Tap Hole .090¢	_____	Tap Hole Not Req.
Gage Hole .030¢	_____	Gage Hole Not Req.
Install Insert .080¢	_____	Install Insert .080¢
Remove Tang .050¢	_____	Remove Tang Not Req.
Per Finished Hole .370¢		Per Finished Hole .194¢

*Estimated cost for wire-type 4-40, .224" long, 25,000 quantity; Tap-Lok 4-40, .234" long, case-hardened steel, 25,000 quantity. Estimated average costs will vary with user, equipment, overhead, and labor rates.

Self-tapping Tap-Lok inserts eliminate three operations which alone amount to about triple the cost of the insert itself. With Tap-Lok you need only one inexpensive installation tool. Wire inserts require special taps, gages, and a tang removal tool. Tap-Lok inserts conform to MS 35914-101 thru 166. Write for data—Groov-Pin Corp., 1121 Hendricks Causeway, Ridgefield, N.J. 07657, (201) WH 5-6780.

FASTENER DIVISION **GROOV-PIN CORP.**

Circle 185 on reader service card

ELIMINATE WASTEFUL DRAWING-BOARD-TEDIUM!

Engineers and draftsmen should use their time creatively. Let STANPAT prepare any symbol, diagram, spec, detail, title block, or any other drawing that appears in your tracings repetitively. Simply apply the STANPAT in seconds directly to your drawing. It will be accurate . . . permanent . . . perfectly reproducible . . . and you will gain more creative time!

Drawing-board time should be used for creative problem-solving . . . not for repeated and re-repeated rendering of often-used elements. STANPAT changes draftsmen from drawing-machines to creative assets. But it has to be STANPAT if you want STANPAT's advantages: pre-printing on finest tri-acetate; crisp, clean reproduction even with microfilm, matte surface that thrives on erasures; flat-lying, easy-storing sheets; complete freedom from "ghosting".

Send for literature and samples today.
faithfully serving the engineer for a quarter century
STANPAT PRODUCTS INC.
Covert and Main Street, Dept. J-10
Port Washington, N.Y. 11050
Telephone: 516 883-8400



Circle 153 on reader service card

153

NEW

mini-mod

**I/C POWER
SUPPLY**

**80%
SMALLER!**

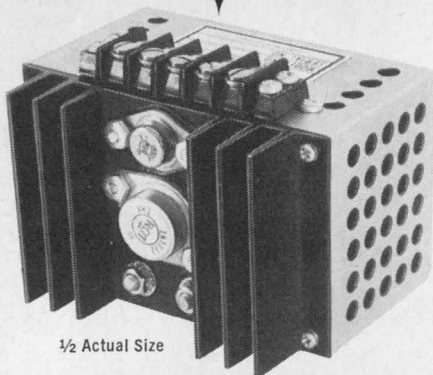

1/2 Actual Size

Powertec's new, ultra-miniature power supply is only 4"x3"x2 5/8" including heatsink.

Mini-mod is specifically designed for use in lightweight chassis with IC or other digital logic. Output voltages are available from 3 to 30 volts with .05% regulation.

INPUT: 115 Volts 47-440HZ

TYPICAL OUTPUTS:

3 V at 6 A

5 V at 5 A

15 V at 2 A

Mini-mod is currently available from stock. Detailed specifications and price are available upon request.

CUSTOM POWER SYSTEMS

Powertec's experts are capable of solving your most difficult power conversion requirements.

**FOR MORE INFORMATION
WRITE**

POWERTEC

9170 Independence Avenue
Chatsworth, California 91311

Technical Abstracts

MOST colorful

A developmental 15-inch transistorized color receiver
W.E. Babcock
Radio Corp. of America, Somerville, N.J.

Field effect transistors that can directly replace vacuum tubes, plus a high-voltage, developmental bipolar transistor, are the keys to an experimental solid state color tv set built around a new 15-inch picture tube. Though the transistors were chosen for performance rather than attractive prices, they could become low-cost items within a few years.

The design is based on standard vacuum-tube circuits where the substitution of metal oxide semiconductor transistors for the tubes requires only a reduction in supply voltage and minor adjustments in component values.

Commercially available dual-gate MOS transistors with regions of nearly constant gain for a wide range of bias voltages are used in an automatic gain control system in the radio-frequency and intermediate-frequency amplifiers. The r-f amplifier is set at a bias for constant gain, while the i-f amplifiers are biased at points where the gain changes rapidly with bias. As age voltage increases, the i-f gain drops rapidly but the r-f gain remains constant. The amount of agc delay can be varied over a wide range by adjusting the resistors in the network.

The vertical-deflection circuit is a four-stage multivibrator that includes feedback from the output circuit to trigger the multi. The horizontal-deflection circuit uses an advanced bipolar transistor that can withstand a collector-to-emitter pulse of 1,000 volts and normally operates with 750-volt pulses.

Presented at the 1967 International Electronics Conference, Toronto, Sept. 25-27.

Multiplicity

A PCM telemetry system utilizing multiple IC technologies
D.C. Fox
Autonetics Division, North American Aviation, Inc.
Anaheim, Calif.

Integrated circuits of all types—metal-oxide semiconductors, thin-

film resistive networks, hybrids, and linear and digital monolithics—each doing the job it does best, were used in an experimental pulse-code modulation telemetry system. The system, small enough to fit into an attache case, uses IC's exclusively and promises to be more reliable and less costly than existing systems.

The telemetry module can handle 48 channels of information and provides 10 bits of magnitude information for each channel. It is divided into three sections: multiplexer, amplifier, and analog-to-digital converter. Both differential and singled-ended inputs are used, and multiplexing is controlled by random or sequential addressing.

The system accepts positive or negative voltages on two different ranges: ± 5.11 volts and ± 51.1 millivolts full scale. After multiplexing these voltages by sequential switching, it amplifies, samples and holds, and then converts them to digital values for transmission on the data channel.

Metal-oxide-semiconductor IC's were picked for use in the multiplexer; the choice is excellent for low-level, low-offset multiplexing. The multiplexing section consists of five identical MOS circuits: four wired to perform an analog multiplexer function and the fifth to provide sequence or selection of the other four IC's.

Hybrid IC techniques were needed to achieve performance levels in the amplifier that are impossible with monolithics. The amplifier has an input impedance of 100 megohms and a common-mode rejection of 120 decibels. Nichrome resistors provide good tracking of resistance-ratios and temperature-coefficients. The hybrid process also results in lower costs for prototype development of the amplifier.

The third section of the system, the analog-to-digital converter, uses a 10-bit thin-film ladder network built with high-accuracy nichrome resistors, monolithic digital (transistor-logic) and dielectrically isolated linear IC's.

Presented at the International Telemetry Conference, Washington, Oct. 3-4.

THE NEW SEARCH TEAM

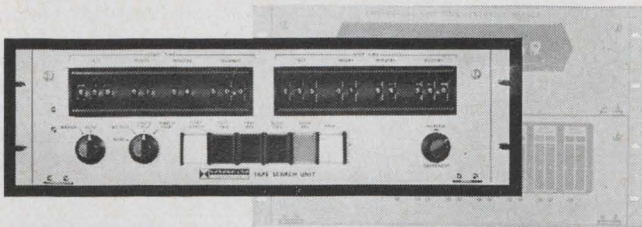

from CHRONO-LOG

Now, automatic tape search with the Series 24,000 Automatic Tape Search Control Unit and any Chrono-Log Time Code Reader or Reader/Generator. The new team provides automatic control of search, playback, editing and data reduction of analog magnetic tape recordings. . . .

- Uses a time code recorded with the data;
- Controls the tape drive to search for desired segments of data at high speeds;
- Plays back the segment at playback speed;
- Starts and activates external data reduction equipment;
- Recycles the tape drive at the end of the desired segment.

Chrono-Log manufactures a complete line of automatic tape search systems, time code generators and readers.

Write . . . or telephone (215) EL 6-6771



CHRONO-LOG CORP.

2583 WEST CHESTER PIKE, BROOMALL, PA.

Circle 186 on reader service card

Major Southern California Aerospace Company, located in the Los Angeles area, has immediate openings for:

TECHNICAL SPECIALIST

Will be responsible for the Systems Engineering that will functionally integrate a large, high-speed data processing laboratory with a space born sensor.

The position will involve developing criteria for integrating a variety of data into a suitable transmission format, specifying adequate error protection, setting overall performance requirements for the processing laboratory, and evaluating subsequent accomplishments.

Pertinent experience would include a direct background in both systems engineering and digital data processing.

SENIOR SYSTEMS ENGINEER

To direct System Design and Analysis of complex visual electro-optical aerospace systems. Will be in charge of a small group of analysts and technical specialists which translates overall requirements into engineering terms.

Should be familiar with optical systems, atmospheric effects and visual detectors such as phototubes, image orthicons and image dissectors.

Will work in the development of state-of-the-art improvements in detection techniques on programs of national significance.

Send resume, including salary requirements to:

P-3998, ELECTRONICS

255 California St., San Francisco Calif. 94111

an equal opportunity employer

TUNG-SOL PACKAGES LIGHT TO YOUR REQUIREMENTS

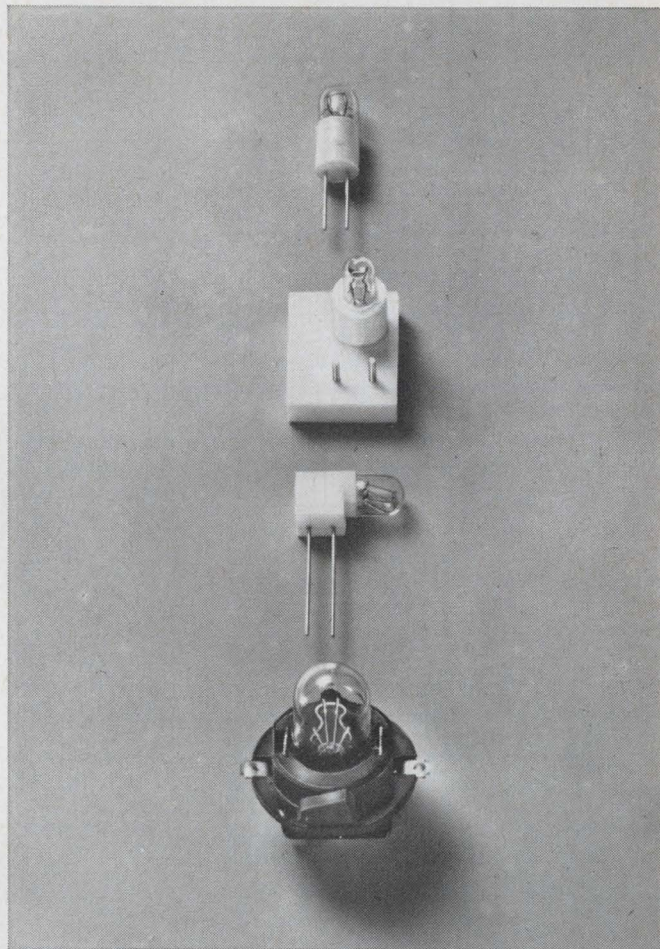

Special lamp assemblies are not necessarily expensive, especially if the configuration can be made compatible with molding techniques. By molding bases on miniature or subminiature lamps, Tung-Sol has pointed the way to substantial production advantages for numerous manufacturers of computers and other equipment.

Molded base lamps need no wired-in mounting receptacle—itsself a major production benefit. Elimination of the customary cemented-on metal base contributes to greater reliability.

Installation of Tung-Sol "packaged light" is simple and production shrinkage is reduced almost to nil. Some molded base lamps can be installed with automated equipment. Tung-Sol molded base lamps may help you produce a better product, cut costs, or both. Write for more information. Tung-Sol Division, Wagner Electric Corporation, One Summer Ave., Newark, N.J. 07104.

TUNG-SOL®

**WHERE BIG THINGS ARE DONE
WITH SMALL LAMPS**

® REGISTERED TRADEMARK WAGNER ELECTRIC CORPORATION

To provide you with a practical way of increasing your technical knowledge,

CREI now offers extension programs in Communications Engineering

Not simply courses, but complete programs in advanced electronics with Communications Engineering as a major elective. One program is for engineers who need updating, the other for high school graduates who want to move ahead in electronics.

CREI's industry-approved home study method permits you to study at your own pace, on your own schedule. Our free book gives full information and details on technical material covered. For your copy, use coupon below, or write: CREI, Dept. 1810E-6, 3224 Sixteenth Street, N.W., Washington, D.C. 20010.

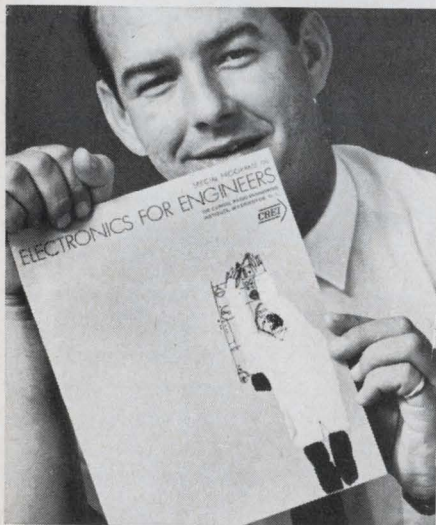

Founded 1927
CREI
 THE CAPITOL RADIO ENGINEERING INSTITUTE
 A DIVISION OF MCGRAW-HILL, INC.
 Dept. 1810E-6, 3224 16th St.,
 N.W. Washington, D.C. 20010

Accredited Member of the National Home Study Council

Please send me FREE book describing CREI Programs in Electronics and Major Elective in Communications Engineering.

I am interested in Updating Program for Engineers
 Regular Program for men working in electronics

Name _____ Age _____

Address _____

City _____ State _____ Zip Code _____

Employed by _____

Position _____

New Literature

Foam flux. Alpha Metals Inc., 56 Water St., Jersey City, N.J. A technical bulletin describes Reliafoam No. 811-13 flux, a rapid, high-rising foam flux for printed circuits and other electronic assemblies.

Circle 446 on reader service card.

Amplitude distribution analyzer. B&K Instruments Inc., 5111 W. 164th St., Cleveland, Ohio 44142, has available an eight-page bulletin on the model 161 amplitude distribution analyzer for statistical analysis of complex, random, nonperiodic, and transient waveforms from d-c to 20 khz. [447]

Memory modules. Electronic Products Division, Corning Glass Works, Raleigh, N.C. 27602. Reference file CE-5.03 provides applications and specifications for a line of digital glass memory modules. [448]

Indicating lights. General Electric Co., Schenectady, N.Y. 12305. Bulletin GEA-8266 details the CR103 type G transistorized indicating lights. [449]

Thermistor housings. Fenwal Electronics Inc., 63 Fountain St., Framingham, Mass. 01701, has published a 28-page catalog describing over 55 typical thermistor housings and compatible thermistor elements. It is available on letterhead request.

TR-limiter. Microwave Associates Inc., Burlington, Mass., has released a technical bulletin describing a TR-limiter that combines a gas TR tube and a solid state limiter in a single package to provide positive protection for standard crystal receivers. [450]

Tin-oxide resistors. Electronic Products Division, Corning Glass Works, Raleigh, N.C. 27602, offers a data sheet listing characteristics and applications for its half-watt, flame-proof tin-oxide resistors. [451]

Power supply. Borg-Warner Controls Division of Borg-Warner Corp., 825 Nash St., El Segundo, Calif. A data bulletin covers the model 50-7 general purpose a-c/d-c power supply. [452]

Wire and cable. Belden Corp., P.O. Box 5070A, Chicago 60680. A complete line of electronic wire and cable is illustrated and described in catalog 867. [453]

Time delay circuits. Potter & Brumfield Division of American Machine & Foundry Co., Princeton, Ind. 47570. A 12-page booklet features a variety of circuit diagrams for time delay relay applications. [454]

System power supplies. RO Associates, 917 Terminal Way, San Carlos, Calif. 94070, has issued a four-page brochure covering a line of system power sup-

plies for digital IC and analog applications. [455]

Coaxial components. Microlab/FXR, 10 Microlab Road, Livingston, N.J. 07039. Catalog 17A describes a line of miniaturized and 18 Ghz coaxial components. [456]

Turns-counting dials. Helipot Division, Beckman Instruments Inc., 2500 Harbor Blvd., Fullerton, Calif. 92634. Miniature digital turns-counting dials are described in data sheet 671074. [457]

Computer control cables. Gulton Industries Inc., 212 Durham Ave., Metuchen, N.J. 08840, has issued a comprehensive brochure that facilitates specifying of complex computer control cables. [458]

Microwave anechoic chambers. Emerson & Cuming Inc., Canton, Mass. 02021. A four-page folder, seventh in a series, describes recent advances in the design and construction of microwave anechoic chambers. [459]

IC logic cards. Datascan Inc., 1111 Paulison Ave., Clifton, N.J. 07013. A 115-page technical catalog on series 200 IC logic cards is available to qualified design engineers requesting on company letterhead.

Operational amplifier. National Semiconductor Corp., 2950 San Ysidro Way, Santa Clara, Calif. 95051, has published bulletin SC-104 describing and illustrating its LM201, an operational amplifier for commercial and industrial applications. [460]

Junction circulators. Raytheon Co., Foundry Ave., Waltham, Mass. 02154. A four-page bulletin describes a line of 12 basic high-power, waveguide junction circulators. [461]

Temperature controller. InstruLab Inc., 1205 Lamar St., Dayton, Ohio 45404. Data sheet 9500-34 describes the specifications for a miniaturized temperature control system. [462]

Color electrolytics. Cornell-Dubilier Electronics, 50 Paris St., Newark, N.J. 07101. A six-page brochure lists more than 250 wide-range color electrolytics by capacitance value. [463]

Attenuator set. Weinschel Engineering, Gaithersburg, Md., has issued a data sheet on precision attenuator set model AS-4 with a frequency range of d-c to 12.4 Ghz [464]

Microwave equipment. Narda Microwave Corp., Plainview, N.Y. 11803. A 152-page catalog covers a complete line of coaxial and waveguide devices and systems. Useful design information is included. Copies are available on letterhead request.

Our little black book has over 100,000 phone numbers.

You never had a black book like it. Over 1,500 pages. And those phone numbers!

More than 100,000 telling you who to call / where to go, for the over 4,000 different product categories listed and advertised in the yellow pages of the Electronic Buyers' Guide. There's never been a buyer's directory like it. The new '68 edition will be coming your way in November. Look for the book in the black box.

EBG for '68... bigger, better and more useful than ever before.

Electronics Buyers' Guide

A McGraw-Hill Market Directed Publication, 330 West 42nd Street, New York, N.Y. 10036



Is love the right word?

Sounds a bit soft when speaking of a machine — but Sharp's electronic desk calculator isn't at all ordinary and some people do speak of it softly, in loving tones. Beautifully engineered, superbly responsive, trim neat style... but not feminine...

Sharp 30B is absolutely silent!

Fits lovingly on many a desk and dutifully serves.

See its lovely features for yourself.



Model CS-30B:

*14 digit *Memory register *Error preventers
*Fraction device *Easy to operate *And maintain

 **SHARP**

HAYAKAWA ELECTRIC CO., LTD. Osaka Japan

U. S. Subsidiary: SHARP ELECTRONICS CORP. 178 Commerce Road Carlstadt, New Jersey

microwave problem?

talk to Andrew...the antenna systems specialist



Andrew microwave antenna systems are hard at work all over the world. Fixed, portable, and mobile installations, designed by Andrew, can be found wherever communications engineers demand the utmost in performance and reliability. ■ This new transportable 7 GHz system is a good case in point: used in a quick reaction microwave link, the unit packs broadband communications capability into a compact package. A 100 ft. aluminum telescoping mast pneumatically raises the 6 foot antenna, guy wires, and dual axis positioner in

less than 60 minutes. The flexible HELIAX® elliptical waveguide feeder goes up simultaneously, and the jacket includes control cables for the positioner. An automatic dehydrator-compressor, 1½ ton trailer, and AC power supply complete the package—all from Andrew. One source—one responsibility. ■ **Have a microwave antenna system problem?** Bring it to Andrew, most people do! Andrew Corporation, P.O. Box 42807, Chicago, Illinois 60642.

3-67





SQUELCH

RFI/EMI

**Let Hopkins scan, fix & qualify
your equipment to meet specs!**

Hopkins Engineering Co., with more than 20 years of experience in designing, developing and manufacturing power, communication and general purpose filters, now offers complete, expanded, RFI/EMI testing facilities... to scan, fix and qualify your equipment.

Hopkins new RFI/EMI testing services cover frequencies from 30 Hz to 10,000 MHz. Facilities are available for testing all sizes of equipment from miniature DC motors to giant central power distribution systems; and all types of circuits from simple relays to complex sophisticated space packages.

In Hopkins' air conditioned shielded enclosures, latest testing equipment is now ready to make a diagnosis for you. 'Round the clock testing service is available if required. All backed by two

decades of solving RFI/EMI problems with thousands of types of custom-made filters.

Hopkins experience in the RFI/EMI testing, prototype development and filter manufacturing can help you deliver equipment to meet the following MIL SPECS, and others:

MIL-I-6181D	MIL-I-16910C
MIL-I-26600	MIL-I-11748
MIL-Std-826	MIL-Std-461*
MIL-Std-462*	MIL-Std-463*

*Tentative

Tests to meet special customer-authored EMI specifications are scheduled daily. Save time. Hopkins will design, develop and manufacture prototypes and mass-produce RFI/EMI filters so that your equipment or component will meet any interference or operational requirement.

For measurements, analysis, corrective recommendations and filter hardware, try Hopkins service for a welcome change. Contact the local Hopkins representative in your area, or the Marketing Department...

HOPKINS
Engineering Company

12900 Foothill Boulevard, San Fernando, California 91342
Telephone (213) 361-8691-TWX 213-764-5998 Cable: HOP

A Subsidiary of Maxson Electronics Corporation

Meeting preview

Far-flung, ankle-deep

The fall edition of the American Federation of Information Processing Societies' semiannual Joint Computer Conference will, as usual, include sessions to interest members in all six of the sponsoring organizations. But the trouble is that because the meeting has to satisfy so many people, it cannot please everyone.

Compared to the computer conference sponsored by the IEEE, which provided an in-depth look at recent developments in computer hardware, this conference offers, at best, shallow treatment. Nevertheless, a number of interesting papers and sessions are scheduled for the conference, which will be held Nov. 14-16 in Anaheim, Calif.

Two papers to be given evidence the growing interest in the Fast Fourier transform technique, sometimes called the Cooley-Tukey algorithm. One, by L.B. Lesem, P.M. Hirsch, and J.A. Jordan Jr. of the International Business Machines Corp., describes the technique's applications to computer-generated holograms, and the other, by A.G. Larson and R.C. Singleton of Stanford Research Institute, describes a real-time implementation of the algorithm on a small computer.

In another paper, D.K. Hansom from the Univac division of Sperry Rand Corp., C.F. Chong from Ferroxcube Corp., and R. Mosenkis of Radio Corp. of America will describe a large plated-wire memory containing 100 million bits [Electronics, May 15, p. 101]. Both Chong and Mosenkis worked with Hansom at Univac where the memory was designed, leading to speculation about their present employers' interest in plated-wire technology. Ferroxcube is believed to be more interested in the technique than RCA.

In an attempt to repair the breach between the hardware and software designers, a tutorial session, "Software for Hardware Types," will be offered. The session includes at least one paper, by Albert B. Tonik of Univac, that should interest those familiar with hardware but mystified by software.

Newsletter from Abroad

October 30, 1967

Russians hint shrouded antenna silenced Venus-4

Western space experts now are largely convinced that a partly blocked antenna prevented the Soviet Union's Venus-4 instrument capsule from transmitting back to earth after it had landed on the planet.

The Soviet Academy of Sciences maintains that the soft landing—with parachutes—was successful. Data telemetered from the 843-pound capsule while it was dropping through the dense Venusian atmosphere indicated the rate of descent was 10 feet per second just before impact. **Thus the Russians feel sure the package would have kept on transmitting after it landed had the highly directional main antenna been clear.**

For telemetry, the Soviets used a pencil antenna working with a parabolic reflector 7.5 feet in diameter. The transmitter operated in the decimeter waveband.

Although Venus-4 went silent as it hit the planet, the shot rates as a stunning space achievement. As a result, Western observers say it's almost certain that the Russians will not mount a manned space spectacular next week to celebrate the 50th Anniversary of the Revolution. They may, however, try a recovery at sea with a Soyuz spacecraft carrying an animal. The Soviets presumably have been redesigning the Soyuz since its first test flight this spring ended in disaster [Electronics, May 1, p. 161].

Ground stations tender subject in Great Britain

Some sort of fuss now seems inevitable when Britain's Cable & Wireless Ltd. finally names—probably next month—a contractor for satellite communications terminals in Hong Kong and the Persian Gulf island of Bahrain.

The government-owned but commercially run communications company called for bids on two stations 16 months ago and insiders say the best tender came from the Nippon Electric Co. British telecommunications makers, though, apparently put strong pressure on the government to throw the business to one of them. Their pitch: export sales of British ground-station hardware would suffer if a Japanese company won the Cable & Wireless contract.

It's a good bet that Cable & Wireless, as a result, reworked its specifications so that it could pick a British contractor. The Marconi Co. most likely will get the job. Officials at Nippon Electric may ask the Japanese government to protest if the disguised "Buy British" maneuver costs it the job.

Matsushita readies 1,500-V transistor

Look for line-operated, all-transistor Japanese television sets with no power transformer sometime next year. Matsushita Electronics Corp. will have the kingpin component for such sets, a high-voltage transistor for the horizontal output stage, in quantity production by next February.

The horizontal output transistor has a collector-base rating of 1,500 volts. It has the same mesa-collector, planar-emitter structure found in the high-voltage transistor introduced earlier this month by the Amperex Electronics Corp. [Electronics, Oct. 16, p. 47]. Both Companies are affiliates of Philips' Gloeilampenfabrieken and both based their high-voltage transistors on a Philips' design.

Matsushita Electric Industrial Co., partner with Philips in Matsushita Electronics, already has prototypes of 19-inch sets designed around the

Newsletter from Abroad

1,500-volt transistor. The sets also have an 800-volt transistor in the vertical output stage and a 300-volt transistor in the audio output stage. Both are triple-diffused silicon mesa units developed by Matsushita.

Matsushita has yet to set a price for its 1,500-volt transistor. But company officials say they'll at least match Ampere's price of "about \$2.50."

German MD's to try computer network

A nationwide computer network to aid West German doctors in making diagnoses may be in the offing.

The country's medical association will start trials with one computer early next year. **If the tryout is successful, the association will expand the system to include as many as 24 computers spotted throughout West Germany** so that all its 50,000 member doctors could be tied into the network. In the U.S. thus far, computer diagnosis has been evaluated in hospitals and medical research centers but has not been used in actual practice.

Besides helping doctors make diagnoses, the computers will prepare diets for patients suited for their specific ailments. The system also will be used to evaluate data generated by mass medical checkups.

Consortiums form for Symphonie

French and German electronics companies have teamed up on a strictly national basis in their quest for the prime contract in the \$40 million binational Symphonie telecommunications satellite project [Electronics, Sept. 4, p. 208]. About two-thirds of the money will go for electronics hardware.

The French group vying for the lead role in electronics consists of Compagnie Francaise Thomson Houston-Hotchkiss Brandt, its subsidiary-to-be CSF-Compagnie Generale de Telegraphie sans Fil, and the Societe Anonyme de Telecommunications. German companies that will act in concert for Symphonie are AEG-Telefunken, Siemens AG, and Rohde & Schwarz.

No matter who wins, the losing group figures to pick up considerable business in Symphonie subcontract work. The French and German governments agreed that the project's work would be farmed out equally in the two countries. So the losers will have an inside track—although not an absolute guarantee—for their country's share of the business.

Symphonie's airframe, however, looks like a winner-take-all proposition. The two competing consortiums are binational so there'll be no need for subcontracts.

Britain may build 400-foot antenna

Britain's famed radio astronomer Sir Bernard Lovell quite likely will get his 400-foot fully steerable antenna [Electronics, May 1, p. 162]. **Funds for the design of the dish—which will be the world's largest—were earmarked this month by the government's Science Research Council.**

H.C. Husband, the consulting engineer picked by the council to design the antenna, says it will cost about \$14 million. The site of the big dish—still not selected—will be "far" from Jodrell Bank. The two antennas will be linked by microwave so that they can operate as an interferometer.

Jodrell Bank's 250-foot antenna is now the world's largest. It will be eclipsed, though, in about 2½ years by a 328-foot antenna now under construction near Bonn. The big British dish could be in service in about five years if the council decides to fund it.

SEMICONDUCTOR NEWSBRIEFS

PUBLISHED BY MOTOROLA SEMICONDUCTOR PRODUCTS INC.

Dual Op Amp Leads Parade Of Five Money-Saving Integrated Circuits

Prices as low as \$3.50 (100-up) have been announced for a series of five I/C Op Amps that are now available in the Unibloc 14-pin dual in-line plastic package. Heading the series is Motorola's new dual operational amplifier (MC1435P), a single monolithic chip that contains two op amps in one package and is capable of providing a theoretical open-loop voltage gain of more than 36,000,000!

Significantly, the 6,000 gain in each of the MC1435's two amplifiers will provide usable gain for any practical application, without a need to cascade. And, there's gain to spare, for stability in feedback configurations, with a minimum of external components.

Other low-cost linear circuits in the group include four different single-function op amps. All five circuits operate over the 0 to +75°C temperature range; and, all are completely specified for industrial and consumer applications. Here are some highlight specifications to prove that Motorola offers "The Most I/C Op Amp for the Least Money:":

Device Type	Open-Loop Gain (Typ)	Temp. Drift	Output Voltage Swing (Typ)	Output Impedance Ohms (Typ)	Price (100-Up)
MC1435P	6,000 ea. ampl.	$\pm 3 \mu\text{V}/^\circ\text{C}$	$\pm 3.6 \text{ V}$	1.7 K	\$4.50
MC1430P	5,000		$\pm 5.0 \text{ V}$	25	3.50
MC1431P	3,500		$\pm 5.0 \text{ V}$	25	4.00
MC1433P	60,000	$\pm 8 \mu\text{V}/^\circ\text{C}$	$\pm 13.0 \text{ V}$	100	6.00
MC1709C	45,000	$\pm 3 \mu\text{V}/^\circ\text{C}$	$\pm 14.0 \text{ V}$	150	6.00

For details circle Reader Service # 309

Featured In This Issue:

2 ns MECL II R-S Flip-Flops Page 2
 ZenGard Transient Suppressors Page 3
 Tiny Micro-T Plastic Transistors Page 5

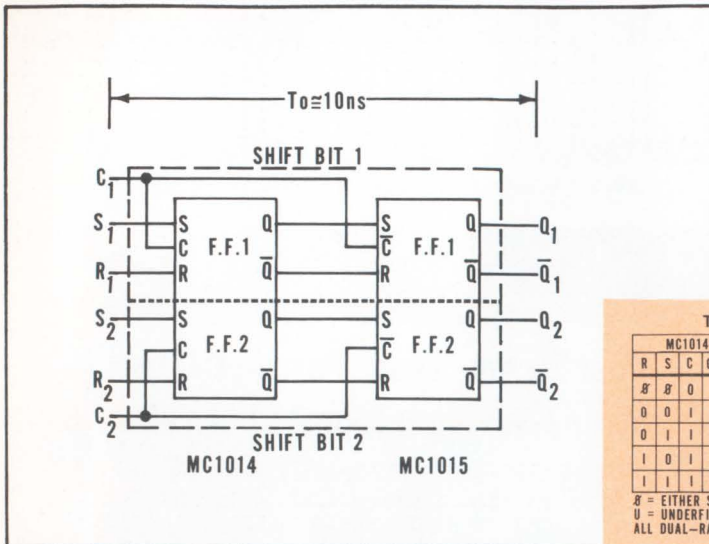

Logic diagram and truth table show how MC1014 and MC1015 are connected to form two Master-Slave shift register elements.

TRUTH TABLES

MC1014				MC1015			
R	S	C	Q _{n+1}	R	S	C	Q _{n+1}
0	0	0	Q	0	0	0	Q
0	0	1	Q	0	0	0	Q
0	1	1	1	0	1	0	1
1	0	1	1	1	0	0	1
1	1	1	U	1	1	0	U

0 = EITHER STATE MAY BE PRESENT
U = UNDEFINED LOGIC STATE (COMMON TO ALL DUAL-RAIL INPUT R-S FLIP-FLOPS)

MECL II Dual R-S Flip-Flops Combine To Achieve Two Gating Levels; 2 ns Prop. Delay Increase

Two new additions to the growing MECL II line of integrated circuits MC1014 and MC1015P, may be used as positive-gated and negative-gated R-S Flip-Flops, respectively. The two levels of gating are accomplished with only 2 ns increase in propagation delay. As a result, a single phase, clocked Master-Slave type of shift register may be obtained as shown.

The MC1014P, in addition to teaming with MC1015P for shift register functions, is also useful as a dual storage element. It contains two dc Set-Reset Flip-Flops with a positive clock input provided for each flip-flop. The counterpart, MC1015P, operates with a negative clock input. Both circuits exhibit a typi-

cal propagation delay of 5.0 ns, operating over the 0 to +75°C temperature range. Both provide typical power dissipation of 125 mW at an operating frequency of 80 MHz. Minimum dc fan-out of 25 for each output is guaranteed. Prices for the MC1014P and MC1015P are \$4.25 (1,000-up), in the 14-pin dual in-line plastic package.

The MECL II family of logic integrated circuits now includes 27 functional elements in the limited temperature range MC1000P series and a comparable number in the full temperature range MC1200F series. All of these circuits are fully compatible with the MECL 300/350 series types.

For details, circle Reader Service # 310

MDTL Presettable Decade Counters Feature 20 MHz Operation

A new series of MDTL circuits, types MC938F, MC838F and MC838P, all offer individual direct-sets for each stage as well as a common reset and buffered inputs (a standard MDTL loading factor of 1). These monolithic ripple counters operate in excess of 20 MHz at ± 20% of the nominal 5.0 V power supply.

The three new devices are composed basically of four MC950 pulse-triggered binaries. All have standard MDTL inputs and use active pull-up devices in the outputs to increase capacitive drive capabilities. Typical dc noise immunity is better

than 1.0 volt.

All three new circuits are fully compatible with the Motorola MC930/830 series MDTL and Motorola MC500/400 series MTTL.

Circuit Type	Package	Temp. Range	Price (100-Up)
MC938F	14-Pin Ceramic Flat Pack	(-55 to +125°C)	\$18.00
MC838F	14-Pin Ceramic Flat Pack	(0 to +75°C)	10.00
MC838P	14-Pin Unibloc Plastic	(0 to +75°C)	6.70 (1,000-up)

For details, circle Reader Service # 311

Differential "In" and "Out" I/C Ideal For Wide-Band Amplifier Applications

Motorola's new MC1520, a monolithic Op Amp integrated circuit, provides both differential input and differential output characteristics. Because of the latter capability, this new circuit exhibits an extremely good common-mode rejection ratio of 90 dB (typ) — making it ideal for use in instrumentation, communication and computer equipment.

The MC1520 also provides a high differential gain of 74 dB (max) — numer-

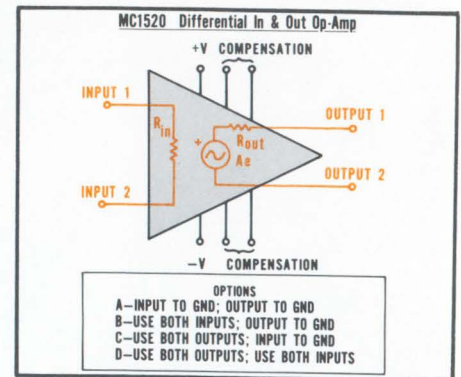

New linear I/C boasts differential outputs as well as differential inputs . . . making it a good universal operational amplifier.

ically 7,200 — and, as a result, is also a good general purpose operational amplifier. It is particularly useful in wide-band applications requiring large output-voltage swings at high frequencies, especially those calling for differential outputs. The MC1520's gain of 7,200 compares with gains of less than 1,000 for comparable circuits.

Other outstanding typical characteristics of the MC1520 are:

- Wide Closed-Loop Bandwidth — 10 MHz
- High Input Impedance — 2 MΩ
- Low Output Impedance — 50Ω
- Full Output Voltage Swing to Greater than 1 MHz

Available in both the TO-99 10-pin metal can and TO-91 ceramic flat pack, the MC1520G is 100-up priced at \$10.00; and the MC1520F is \$15.00 (100-up).

For details, circle Reader Service # 312



One ounce of ZenGard protects against kW "spikes"

New ZenGard Transient Suppressors Provide 12 kW Surge Protection

The MPZ5 series of ZenGard suppressors are designed to protect transistors, SCR's, rectifiers and other sensitive components in danger of destruction from circuit transients above their ratings. They can easily absorb up to 12 kW for 0.1 ms in applications as 14 V military automotive ignition, 28 V aircraft equipment and 110 V ac line-operated circuits. They are more-than-equal replacements for mechanically or electrically-limited selenium cells, silicon carbide varistors, RC networks and electro-mechanical relay systems.

Besides providing sharp, controlled reverse breakdown characteristics, the new series exhibits clamping factors as low as 1.25 — a figure of merit which means

Electrical Characteristics for MPZ5 Transient Suppressors (At $T_C = 25^\circ\text{C}$):

Type Numbers	Nominal Operating Voltage		Clamping Factor C_F^*	Maximum Zener Voltage $P_W = 1 \text{ ms}$		Minimum Zener Voltage	
	$V_{OP(DC)}$	$V_{OP(RMS)}$		$V_Z @ I_{ZT}$	I_{ZT}	$V_Z @ I_Z$	I_Z
MPZ5-18B MPZ5-16A	14	10	1.25 1.5	20V 24V	200A	16Vdc	0.4Aoc
MPZ5-32C MPZ5-32B MPZ5-32A	28	20	1.25 1.4 1.56	40V 45V 50V	100A	32Vdc	0.2Aoc
MPZ5-180C MPZ5-180B MPZ5-180A	165	117	1.14 1.25 1.39	205V 225V 250V	20A	180Vdc	0.03Aoc

$$*C_F = \frac{V_Z(\text{MAX})}{V_Z(\text{MIN})}$$

lower overshoot voltage and less chance of component degradation and burn-out — and is less temperature and age-sensitive than conventional stacked cells. Costs can also be reduced by allowing the safe use of lower voltage-rated rectifiers.

Weighing only 1 ounce and occupying less than 2 cubic inches, the devices feature low leakage ($50 \mu\text{A max @ } V_R$) which affords negligible power losses. They are oxide-passivated for top reliability and performance and will operate over a -65 to $+175^\circ\text{C}$ range.

Non-standard voltages, tight-tolerance and higher power units (200 kW units have been supplied) can be developed for specific requirements.

For details, circle Reader Service # 313

SME Transistors Replace "Old-Workhorse" MADT Types

Eight new germanium SME (Selective Metal Etch) mesa transistors — including 2 popular JAN types — are now available in volume quantities to provide a leading second-source for MADT® devices in military and industrial communications equipment.

The SME process, an exclusive Motorola development, is considered a breakthrough in germanium mesa devices. Higher-frequency, lower-noise

performance is obtainable due to complete freedom of transistor geometry and much better definition and closer spacing of emitter/base areas to gain optimum device performance.

In addition to meeting exact parameter-by-parameter specs, the inherent flexibility of the advanced SME process makes it possible to achieve nearly identical key MADT parameter distributions. Thus the user can now count on second-source direct replacement availability for essentially all MADT-type sockets.

Motorola's MADT replacement types are furnished in the popular TO-5 case (with "tab" removed) which meets all EIA-specified dimensions of the older, TO-9 package, including exact lead configurations.

Type	Use	Power Gain @ 200 MHz (min)	NF (max)	$V_{CE(SAT)}$ @ $I_C = 10 \text{ mA}$ (max)	F (max)
2N502	VHF ampl.	8 dB	10 dB	N.A.	500 MHz
2N502A JAN2N502A	VHF ampl.	10 dB	7 dB	N.A.	620 MHz
2N502B JAN2N502B	VHF ampl.	10 dB	7 dB	N.A.	620 MHz
2N1499A	HF switch	N.A.	N.A.	0.20 Volt	100* MHz
2N1742	VHF ampl.	14 dB	5.5 dB	N.A.	980 MHz
2N2048	HF switch	N.A.	N.A.	0.14 Volt	150* MHz

* f_t (min)

For details, circle Reader Service # 314

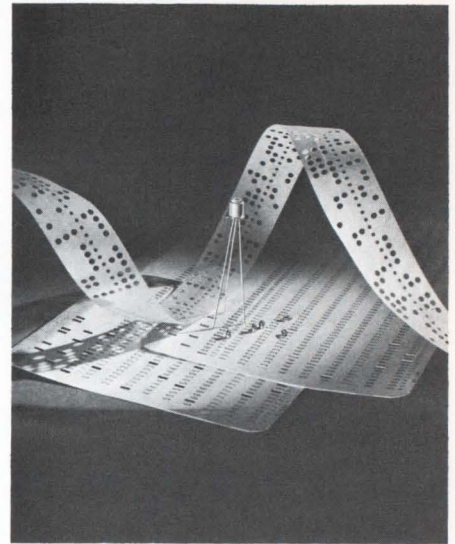

Fast Photo Sensors Aid Light-Activated Designs

A tiny photo detector — type MRD200 — and a sensitive photo-transistor — type MRD300 — now provide opportunities to simplify light-activated designs!

Functional and compact (only 0.060" diameter), the MRD200, two-terminal unit serves where small size and high density positioning is required such as high-speed tape and card readers and rotating shaft information encoders.

It displays linear characteristics over the dynamic range — ideal for reading film sound tracks. Maximum t_{on}/t_{off} is only $6.5 \mu\text{s}$ allowing faster reading than any mechanical contacts. And, its extremely narrow field of view minimizes cross-talk.

With equally fast rise/fall time, the MRD300 utilizes a TO-18 case with external connections for added control and excels in applications where high sensitivity is essential. It responds to modulation well above the audio spectrum providing a useful means of data transfer from laser light sources.

Both units operate from 1 to 50 Volt power supplies and are compatible with most transistor circuits. Low leakage permits use in direct-coupled designs for low-signal-level operation.

Type	Radiation Sensitivity mA/mW/cm^2 (typ)	Illumination Sensitivity $\mu\text{A/lum/ft}^2$ (typ)	Dark Current μA (max)
MRD200	0.5	5.0	0.025
MRD300	1.6†	10†	

†Base open

For details, circle Reader Service # 315

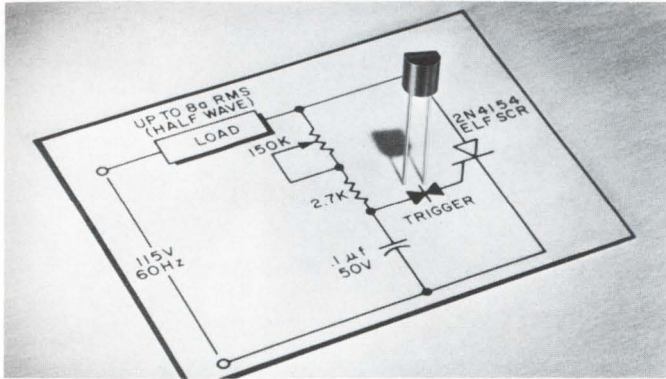

Low-cost MPT28/32/36 silicon plastic bilateral triggers now make it possible to use all solid-state design in economy power control circuits.

New Bilateral Triggers Trigger New Low-Cost Power Control Designs

Another layer of cost has been peeled from already-economical, all-solid-state power control circuitry with the introduction of the MPT 28/MPT32/MPT36 series of silicon bilateral triggers.

These 28-, 32-, and 36-volt (nom) devices are housed in the Unibloc plastic package — well-known for its rugged,

Trigger Type	$V_{BR}†$ (nom) Volts	$I_{BR}‡$ (typ) μA	$\Delta V†$ (typ) Volts	I_{pulse} (max) Amps
MPT28	28			
MPT32	32	20	10	2
MPT36	36			

† ± 4 volts, both directions
‡ Both directions

void-free case integrity that has consistently withstood 3,000-hour severe environmental testing. The new series furnishes symmetrical switching characteristics, low 50 μA (max) switching current, which reduces capacitor size . . . and a large, 10-volt (typ) switch-back voltage which allows higher energy pulses-to-gate for faster "turn-on," lower

switching losses and reliable thyristor operation.

In addition, use of these lower voltage, solid-state devices in place of short-lived, high-breakover-voltage neon triggering devices affords broader conduction angle control plus easier triggering of less sensitive thyristors through higher pulse current.

And exclusive Annular construction ensures stable operation over a -40 to $+100^\circ C$ operating temperature range.

How can you best use them in consumer/industrial designs . . . at below-25¢ volume prices?

Tie this new bilateral trigger series together with more than 270 different thyristors now available from the industry's broadest up-to-35-Amp line including these preferred 8-Amp Motorola favorites: 50 to 400-volt TRIACS, 50 to 600-volt THERMOPAD plastic SCR's and the ever-popular, metal "can," 25 to 600-volt ELF SCR's.

For details, circle Reader Service # 316

800 mA SCR's Spark New Economy Designs

With prices pegged substantially below 40¢ in volume quantities, the 2N5060-63 SCR series is sure to be a boon to the designer of low-level, power controls.

Housed in the rugged Unibloc plastic package, these 30 to 150-volt units can be plugged directly into existing TO-18 pin circles without confusing lead crossing. Only 200 μA is necessary to trigger these devices — making them ideal for low-level sensing and triggering designs.

Low-power consumer/industrial/military applications are virtually limitless: military fuzes (squib-firing and safety circuits), flame detectors, automatic warning systems, lamp and relay drivers,

fractional H.P. motor controls, sensing, detecting and process controls, vending machines, touch switches, ring-counters, shift registers, flip-flops, gate drivers for larger SCR's, ad-infinitem!

The exclusive Annular construction affords stable, reliable operation over a wide -65 to $+125^\circ C$ operating temperature range.

Other features are: 6-A peak surge rating, 1.7-V peak forward "on" voltage and 5 mA max. holding-current, at $25^\circ C$.

TYPE	I_F (AMPS)	V_{EXM}/V_{RXM} (VOLTS)	PRICE (100-Up)
2N5060	0.8	30	\$.51
2N5061		60	.55
2N5062		100	.64
2N5063		150	.85

For details, circle Reader Service # 317

Low-cost, Complementary Chopper Designs With New Plastic MOSFETS

Low-level, low-frequency complementary chopper designs at a low, low cost . . . that's the essence of the story about Motorola's new plastic-encapsulated MOSFET types — MPF159-160. But then, what more could one want?

Low-level (low-power) complementary chopper applications? They've been almost impossible to accomplish with bipolars because bipolars exhibit excessive leakage. MPF159-160 boast an I_{GSS} value in the picoamp region. Low-cost? The 100-up price for these devices in the Unibloc plastic package (that meets MIL standards) is just \$2.75 — about one-third the cost of comparable metal "can" types.

The two new devices are both silicon, type C, triode-connected field-effect transistors that utilize the MOS process. MPF159 offers an R_d "on" rating of 100 ohms, while the complementary p-channel device, MPF160, provides 200 ohms of drain-source resistance in the "on" condition. Both are 15-volt devices that provide 200 mW of continuous power dissipation.

Other ratings for the two devices are:

Characteristic	Symbol	Max. Rating	Unit
Gate Reverse Current	I_{GSS}	100	pA
Zero-Gate Voltage Drain Current	I_{DSS}	10.0	nA
Input Capacitance	C_{iss}	3.0 4.0	pF (MPF159) pF (MPF160)
Reverse Transfer Capacitance	C_{rss}	1.0	pF (Both)

For details, circle Reader Service # 318

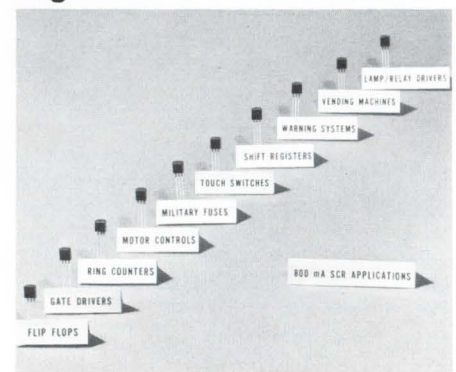

When you think "low-level power control," think 2N5060-63 SCR's. They're naturals for virtually all low-cost, high-volume designs.

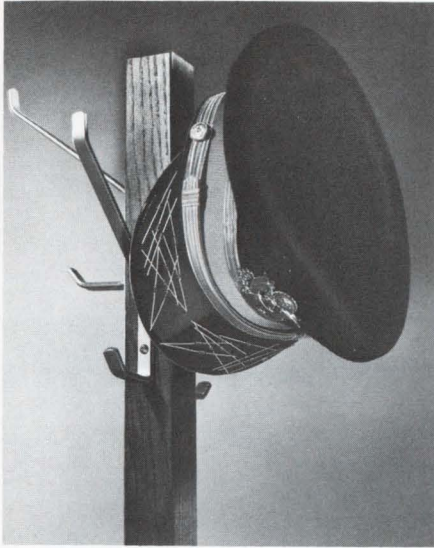

"Surmetic" First Plastic Rectifier To Count Cadence To MIL-S-19500/228D

Now — the most popular, industry-accepted standard in plastic rectifiers — the Surmetic — is the first of its kind to meet rigid military requirements! . . . an above-and-beyond "call to reliability duty" that you can expect in your consumer/industrial designs, too.

Motorola doesn't have a special production line for mil-type Surmetic rectifiers . . . Rather, identical devices for both military acceptance as well as your particular requirements are from the same production runs — your assurance that all quality designed into the Surmetic is available to all users.

You get these important design advantages too:

- Improved HV avalanche characteristics through advanced die fabrication
- Superior lead and seal capabilities through double nail head construction
- Excellent reliability through high-temperature passivation

And a minimum guard-band of 20% on all voltages means that I_R will be maintained at 120% of PIV — an automatic safety factor which assures you that units rated at 400 volts, for example, are actually capable of 480 volts operation!

The complete line of Surmetic rectifiers covers a reverse voltage range of 50 to 1000 volts. They are rated to carry a full amp at 75°C and 30-amp surges.

Type	V_{RM} (Volts)	I_O @ 75°C (Amps)	I_R (A)	I_{FM} (SURGE) (Amps)	Prices (100-up)
JAN1N3611	200	1	5	30	\$.99
JAN1N3612	400	1	5	30	1.30

For details, circle Reader Service # 319

Unibloc "Micro-T" Debut Spurs New High-Density Concepts

The advent of Motorola's Micro-T molded Unibloc plastic transistors now provides the ultra-small devices you've needed to make those high-density, miniaturized equipment design dreams come true. Besides being roughly only one-tenth the volume of standard plastic or TO-18 transistors, the Micro-T's leads radiate from the center of its body, making it particularly well suited to "drop in" automatic strip-line PC board mounting.

The new Micro-T also lets you design circuits having discrete device performance while achieving the component densities and space reductions approaching that of integrated circuits. In addition, its unique structure allows for a wide latitude of mounting flexibility and circuit-layout design. For example, it makes an ideal device for use in thick-film and unitized circuit assemblies.

The first Micro-T transistors available are Motorola PNP/NPN complementary MMT3903-06 silicon Annular switching and amplifier types. They feature a host of premium specs including BV_{CEO} 's of as high as 40 V min., C_{ob} of only 4.0 pF max., current gain speed in two ranges — 100 μ A to 1 mA, and 1 mA

For details, circle Reader Service # 320

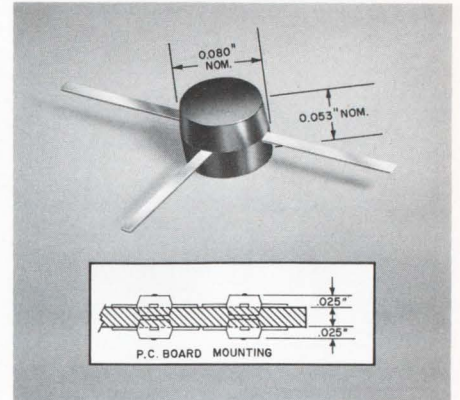

Micro-T Unibloc plastic transistors make high-performance ultra-miniature designs economically practical.

to 10 mA — with saturation voltages as low as 0.2 V at $I_C = 10$ mA. They dissipate a full 225 mW at $T_A = 25^\circ\text{C}$ and operate over a wide junction temperature of from -55 to $+135^\circ\text{C}$.

Prices are moderate too — only \$1.60 for the MMT3903 and MMT3905 and \$2.00 for the MMT3904 and MMT3906 — in 100-up quantities.

Surmetic-20 Gives Body Blow To Zener Diode Prices

The new 1/2-watt Surmetic 20 zener diodes now place reliable, economical, voltage regulation within the reach of every circuit designer.

Priced as low as 36¢ (10% tolerance, 5,000-up), the 1N5221-81 units will replace more than 450 older, more costly DO-7 devices from 2.4 to 200 volts . . . and give an extra "capability cushion" besides.

Surmetic-20's are conservatively rated at 500mW under normal mounting conditions. Production-line units have demonstrated "no-failure" resistance to greatly overstressed, 1-watt, 1,000-hour testing. In addition, nanoampere reverse leakage current ratings indicate cleanliness of the passivated junctions and assure low-power drain and sharper knees in all applications.

As a result of flame and distortion-proof silicone polymer packaging, a 200°C operating temperature and repeated defiance of 50-day moisture resistance tests (5 times the exposure period required in standard mil-type case integrity tests), it can be designed with

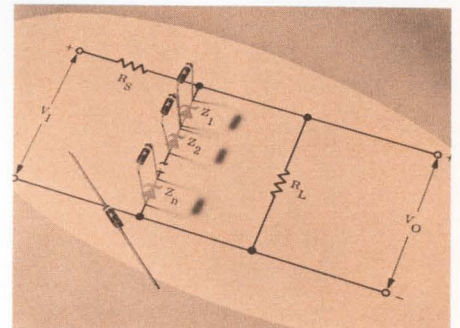

Their low-cost makes it economically practical to employ Surmetic-20 zener diodes in multiple arrays ("strings") to provide greater design flexibility.

more confidence — and less heat sinking — into virtually all high-temperature, high-humidity environments.

Both demanding industrial and military circuits which require solid-state devices to be completely spec'd (Surmetic 20's are 100% oscilloscope-tested and characterized at 4 critical points including $i_{z(surge)}$), or non-critical commercial-type applications are a natural for ultra-economical Surmetic-20 types.

For details, circle Reader Service # 321



ADE GERMANIUM POWER-SWITCHING TRANSISTORS

— Double "Brute-Power" Capability Over Alloy Types

It's almost like having two power transistors for the price of one! Motorola's new Alloy-Diffused-Epitaxial (ADE) die structure boosts peak power-switching capability to nearly twice that of conventional alloy units, yet carries a low price tag.

The MP2200A-2400A switching transistors are ideal for core driver, power conversion and HV switching applications where high power capability—80 to 120 V min @ 8 A—is needed at low cost. In addition, high current/gain (25 min @ 8 A), low saturation voltage (0.6 V @ 25 A) and good switching speed (9 μ s t_{on} @ 10 A typ) advantages rank them as efficient, solid-state servants in "brute-power" designs. They are available in TO-41 or TO-3 all-aluminum cases.

Type	V _{CE} Volts (sus)	I _C Amps (Cont)	V _{CE(sat)} Volts (max)	h _{FE} @ I _C (min)	Price (100-up)
MP2200A	80	25	0.6	25	\$2.25
MP2300A	100			@	2.45
MP2400A	120			8 A	2.60

For details circle Reader Service # 322

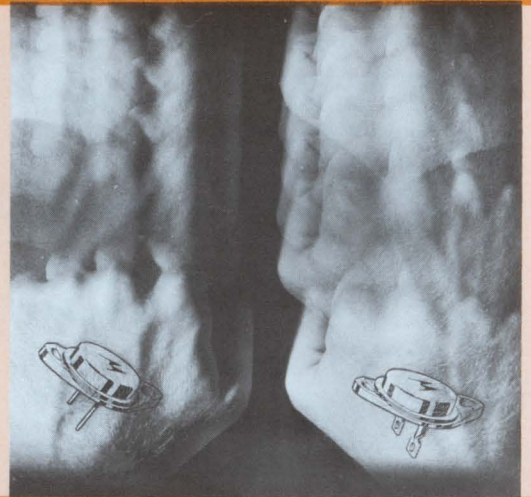

TIGHT-VOLTAGE-TOLERANCE REFERENCE DIODES

— Spec'd To $\pm 2\%$ Limits, 0.0005%/°C; Yet Cost 30% Less!

You can now specify either a ± 0.2 V ("A" type, $\pm 2\%$) or a ± 0.4 V (non-suffix, $\pm 4\%$) tolerance over the nominal 9.4-volt rating for tight voltage range considerations in critical test equipment, meter, satellite and instrumentation designs with Motorola's 1N2163 reference diode series. And where economy is a factor (where *isn't* it!) you can realize savings up to 30% over published prices for comparable units. These 750 mW units feature maximum voltage change spec'd over test temperature range and temperature coefficients guaranteed over three operating temperatures.

For details circle Reader Service # 323



Type Number	Max ΔV_z (Volts)	Test Temperature (°C)	Temperature Coefficient (%/°C)	Price (100-up)	
				Std.	"A" Types
1N2163,A	0.033	0, +25, +70	0.005	\$ 2.50	\$ 2.60
1N2164,A	0.086	-55, 0, +25, +75, +125	0.005	3.40	4.15
1N2165,A	0.115	-55, 0, +25, +75, +125, +185	0.005	4.25	5.50
1N2166,A	0.007	0, +25, +70	0.001	5.10	6.10
1N2167,A	0.017	-55, 0, +25, +75, +125	0.001	6.50	8.30
1N2168,A	0.023	-55, 0, +25, +75, +125, +185	0.001	8.95	12.00
1N2169,A	0.004	0, +25, +70	0.0005	12.75	18.80
1N2170,A	0.009	-55, 0, +25, +75, +125	0.0005	18.00	27.80
1N2171,A	0.012	-55, 0, +25, +75, +125, +185	0.0005	26.20	33.50

SENSITIVE GATE SCR's

— Reduce Triggering Requirements to μA Levels

Only 100 μA (@ $T_c = 25^\circ C$) is needed to turn on the new 2N4212-16 series of SCR's — a current level many orders of magnitude less than that needed by conventional SCR's and one that virtually eliminates the necessity for elaborate pre-triggering (using transistors or high output triggers). This low-level sensing capability also minimizes the complexity of amplifier stages needed to fire larger power SCR's. The 1.6 amp family is packaged in the space-saving, hermetic TO-5 case and includes both premium and economy units.

Type	V _{max} Volts	I _{max} (Surge) Amps	Max at 25°C		Prices (100-up)
			I _{GT}	I _{HX} (R _{GK} = 1 k)	
2N4212	25	15	100 μA	3.0 μA	\$1.80
2N4213	50				2.00
2N4214	100				3.30
2N4215	150				4.10
2N4216	200				5.40
MCR1906-1	25	15	1 mA	5.0 μA	1.05
MCR1906-2	50				1.10
MCR1906-3	100				1.25
MCR1906-4	200				1.35

For details circle Reader Service # 324

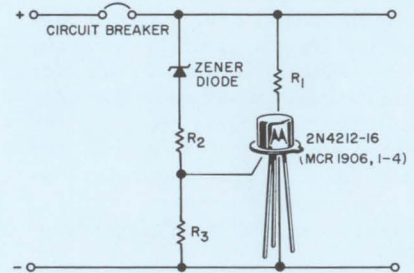

SCR Crowbar Over-Voltage Protection for DC Operation

UNIBLOC PLASTIC UNIJUNCTION TRANSISTORS

— Combine Low Price And High Performance . . . With Availability

You can select from two narrow-range eta spreads with the 2N4870-71 series UJT's, reducing the necessity of tight tolerance resistor/capacitor selection and two valley current characteristics, allowing wider latitude in sawtooth oscillator and frequency divider circuit design. And, ultra-low leakage, resulting from the Annular structure, reduces pulse-width variations. In addition, their low (2.5 V) typical emitter saturation-voltage allows greater output to the following circuit stage — particularly useful in triggering applications.

Use them in consumer/industrial applications such as timers, lamp dimmers/flashers, sawtooth generators, motor-speed controls, fuse circuits, pulse generators, multivibrators, oscillators . . . ad infinitum!

Type	Package	Peak Point Current (Typ)	Emitter Reverse Current (Typ)	Intrinsic Standoff Ratio		Price (100-up)
				Min.	Max.	
2N4870	TO-92 UNIBLOC PLASTIC	1 μA	0.05 μA	0.56	0.75	\$.64
2N4871				0.70	0.85	\$.68

For details circle Reader Service # 325

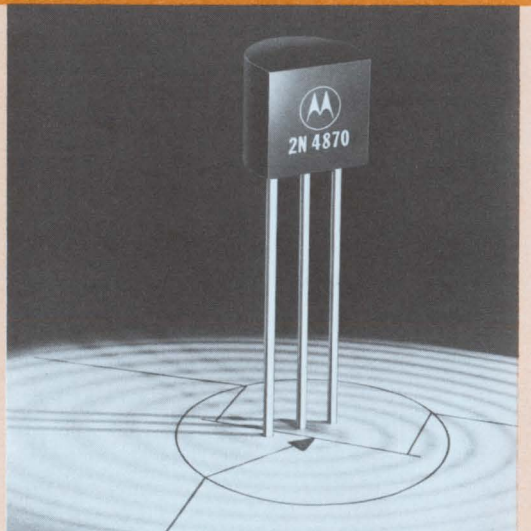

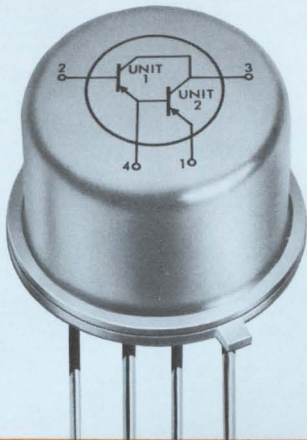

1-AMP PNP DARLINGTON AMPLIFIERS

— Provide High Current Gain Even at Cryogenic Temperatures

The designer is assured of a minimum gain of 15,000 at -55°C and gains up to 60,000 at $+25^{\circ}\text{C}$ (typ) with two new PNP Darlington amplifiers—making them highly suited for very-low-temperature designs—types 2N4974 and 2N4975. They operate over a wide dc current range from $1\ \mu\text{A}$ to 1.0 A with characteristics specified at 8 separate points over the complete operating current range. Both units carry a high P_D rating of 800 mW at 25°C .

Motorola's patented annular semiconductor structure assures unusually low leakage currents— $I_{CBO} = 10\ \text{nA}(\text{max})$ at $V_{CBO} = 30\ \text{V}$. They have a maximum noise figure of only 6.0 dB at 1.0 mA and a typical f_T of 275 MHz at 20 mA. Typical gain specifications for these PNP Darlington amplifiers are:

TYPE	-55°C	$+25^{\circ}\text{C}$
2N4974	15,000	60,000
2N4975	10,000	30,000

For details circle Reader Service # 326

HIGH-GAIN 2N4416 — VHF/UHF JFET

— Fits 8 Out Of Every 10 Sockets!

There's little doubt that most designers will find this new n-channel JFET so versatile that it will soon become the most useful device in the "designer's tool box."

Even though the 2N4416 is characterized as a VHF/UHF amplifier, it will work equally well in low-noise, high-gain amplifiers from dc to above 400 MHz. At 100 MHz, noise figure is specified at 2.0 dB and power gain is 18.0 dB at the same frequency. In addition, the device features input capacitance of 4.0 pF at 1 MHz and transconductance of 4,000 μmhos at 400 MHz.

Motorola's 2N4416 JFET is available now in the TO-72 (4-lead TO-18) package, with isolated chip. The 100-up price is \$3.35.

For details circle Reader Service # 327

GERMANIUM VHF AMPLIFIER TRANSISTORS

— Break 2 dB Noise-Figure Barrier — 1.6 dB max. at 200 MHz!

Low-noise, low-price and high power-gain make the MM5000 PNP VHF amplifier transistor series a natural choice for the value vs. performance conscious engineer. The units also feature an f_T of 800 MHz min., and a collector-base capacitance of only 0.6 pF max. They are fabricated using Motorola's exclusive Selective Metal Etch process, which permits greater freedom of geometry design. The result . . . better definition and closer spacing of emitter/base areas to provide optimum performance characteristics. Case type: TO-72.

Type	Low Noise @ 200 MHz	Power Gain @ 200 MHz	Prices (100-up)
MM5000	1.6 dB max	24 dB min	\$4.75
MM5001	2.0 dB max	22 dB min	2.80
MM5002	2.2 dB max	20 dB min	2.00

For details circle Reader Service # 328

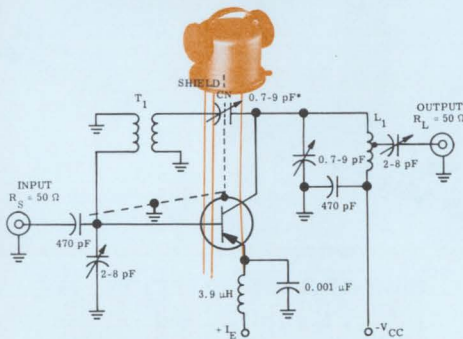

MM5000-MM5002 - POWER GAIN AND NOISE FIGURE TEST CIRCUIT

NOTE:

If coupon is missing use magazine's Reader Service numbers to order literature on items described in NEWSBRIEFS

For Fast Action!

. . . on delivery of literature for items described in this publication — fill out this coupon, fold as indicated and drop in the mail.

(NO POSTAGE IS REQUIRED)

FOLD HERE

FIRST CLASS
Permit No. 2565
PHOENIX
ARIZONA

BUSINESS REPLY MAIL
No postage stamp necessary if mailed in the United States

POSTAGE WILL BE PAID BY

Semiconductor NEWSBRIEFS
Motorola Semiconductor Products Inc.
P. O. Box 13408
Phoenix, Arizona 85002





NPN/PNP HIGH-VOLTAGE SILICON HIGH-FREQUENCY TRANSISTORS

— Offer An Outstanding Combination of Key Parameters

Combining leakage currents in the nanoamp range with low saturation voltages and dc betas (β_{FE}) up to 200 at $I_C = 10$ mA — all this at very high f_T 's — Motorola's NPN 2N4924-27 and PNP 2N4928-31 complementary high-voltage silicon Annular transistors provide the peak-efficiency parameters you need to avoid expensive "overspecing" often encountered with devices of this type.

Packaged in the TO-39 case, they dissipate up to 5 watts at $T_C = 25^\circ\text{C}$. Both polarity types are available in production quantities to serve a broad scope of high-voltage, high-frequency amplifier applications.

NPN 2N4924-27 and PNP 2N4928-31 Silicon Annular Transistors

Types		BV _{CEO} @ 10 mA (V)	I _{CEO} @ V _{CB} (A)			V _{CE(sat)} @ 10 mA max. (V)		f _T @ 20 mA; 20 V (MHz)		Prices (100-up)	
NPN	PNP		NPN	PNP	(V)	NPN	PNP	NPN min/max	PNP min/max	NPN	PNP
2N4924	2N4928	100	0.1	0.5	50	0.25	0.5	100/500	100/1000	\$1.35	\$2.70
2N4925	2N4929	150	0.1	0.5	75	0.25	0.5	100/500	100/1000	1.65	3.30
2N4926	2N4930	200	0.1	1.0	100	1.00	5.0	30/300*	20/200	1.95	3.95
2N4927	2N4931	250	0.1	1.0	150	1.00	5.0	30/300*	20/200	2.10	4.50

*f_T @ I_C = 10 mA

For details, circle Reader Service # 329

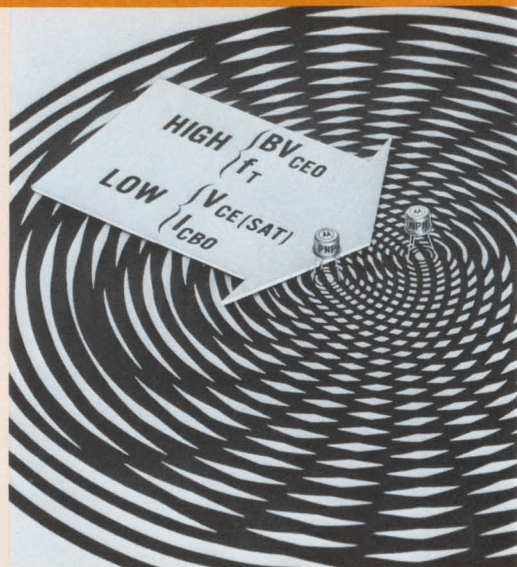

HIGH-EFFICIENCY POWER VARACTOR MULTIPLIERS

— Boost Frequencies Eight Times in a Single Step!

With the advent of four new step-recovery power multipliers (varactors), the microwave designer can say goodbye to the expensive prospect of two, three, and sometimes four multiplication steps in order to reach regions as high as 6 GHz. Motorola types MV1816B-17B . . . and their tighter tolerance "1" versions (with superior thermal resistance) multiply a frequency 8 times — e.g. from 800 MHz to 6400 MHz — in a single step, with a minimum 20-25% efficiency. Other significant parameters for the MV1816B-17B are:

Device Type	P _{in} (W)	Eff. % (min)	f _{in} /f _{out} (MHz)	θ _{JC} (°C/W max)	C _r @ 6 V 1 MHz (pF)	BV _R @ 10 μA (Volts, min)
MV1816B	3	20	300/2400	23	2.4 - 3.6	75
MV1816B1		25		15		
MV1817B	1	20	800/6400	35	0.8 - 1.2	35
MV1817B1		25		25		

These universal devices can be employed in a wide range of local oscillator and transmitter designs requiring a variety of frequencies and multiplication steps. Both types are available in "pill" and "pill/prongs" packages.

For details, circle Reader Service # 330

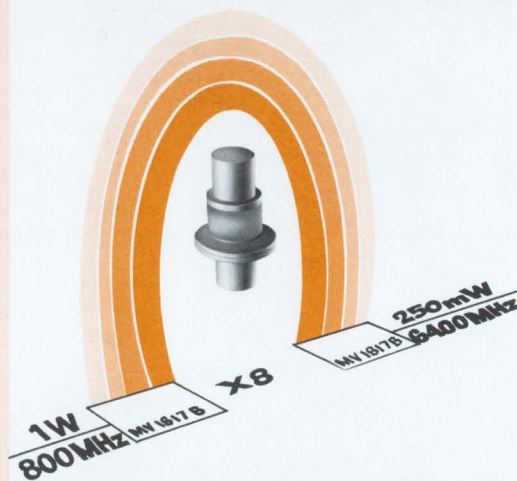

Published by Motorola Semiconductor Products Inc.

The circuitry shown external to Motorola products is for illustrative purposes only, and Motorola does not assume any responsibility for its use or warrant its performance or that it is free from patent infringement.

MECL II, MTTL, MDTL, ADE, Micro-T, Unibloc, Surmetic, THERMOPAD, ELF, ZenGard used in this publication are trademarks of Motorola Inc. Annular semiconductors are patented by Motorola Inc. Motorola Inc. has applied for patents on the "Selective Metal Etch" (SME) transistor process. MADT is a registered trademark of Philco Corp.

**SEMICONDUCTOR
NEWSBRIEFS**

COPYRIGHT 1967

Tear Along Perforated Line and Drop in Mail (No Postage Required)

To expedite the delivery of the literature you have requested, we would appreciate that you CLEARLY PRINT your name and mailing address below:

NAME, TITLE _____

COMPANY (DIV.) _____

ADDRESS _____

CITY _____

STATE (ZIP) _____

SEAL HERE

Please circle the Reader Service number of item(s) you are interested in receiving:

E					
309	313	317	321	325	329
310	314	318	322	326	330
311	315	319	323	327	
312	316	320	324	328	

Do you wish a Motorola Field Representative

to contact you? VISIT PHONE

Phone No. _____ Area Code _____

NOTICE: Requests for literature on items described in this issue cannot be honored after Feb. 15, 1968.

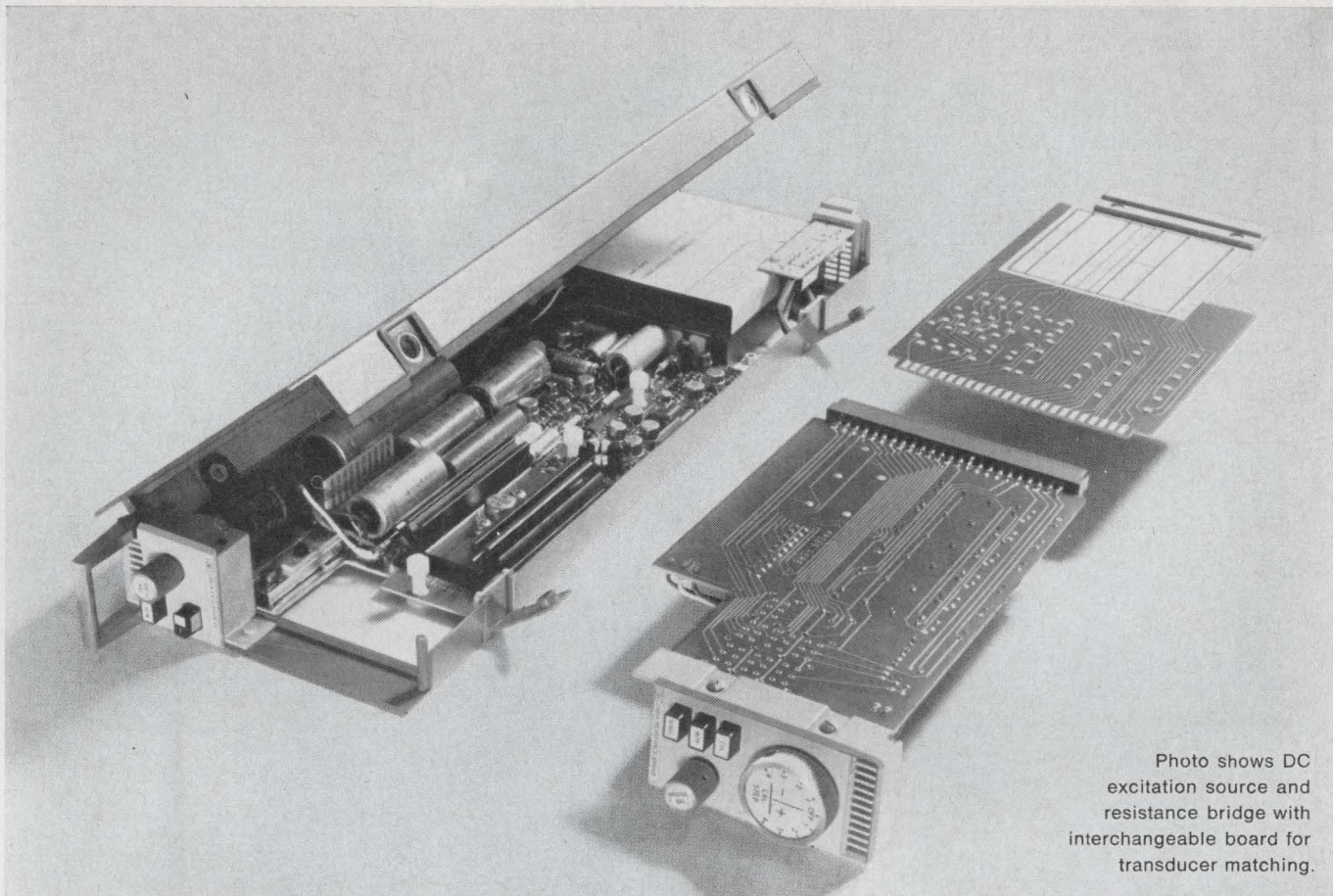
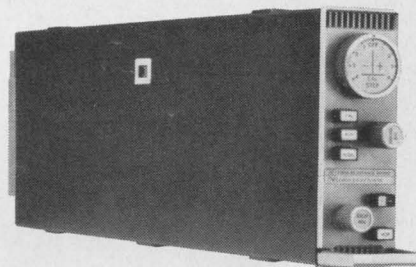

Photo shows DC excitation source and resistance bridge with interchangeable board for transducer matching.

Plug-together Signal Conditioners



with high performance, low-cost adaptability

A floated, guarded DC excitation source provides switch-selectable constant-voltage and constant-current operating modes, plus a unique mode for linear output from single active arm bridges. Exceptional environmental stability saves man-hours maintaining large systems in calibration.

Resistance bridge module provides bridge completion, balancing, calibration and normalizing functions. Minimum cost adaptation to transducers is afforded through a detachable board for mounting components for a specific transducer.

The excitation source may be used on a per-channel basis for maximum isolation, or with up to five transducers using inex-

pensive excitation couplers for each channel... or many transducers can be excited from an external power supply, and you can have local regulated level control. Plug-together design allows change from shared to individual channel excitation. Price for excitation and conditioning: from \$160 to \$360 per channel (for rack-mounted, cabled system) depending on configuration.

For information on the 2480 Series or compatible data acquisition instrumentation call your local HP field engineer or write Hewlett-Packard, Palo Alto, California 94306; Europe: 54 Route des Acacias, Geneva.

HEWLETT  PACKARD

SIGNAL CONDITIONERS

06706

West Germany

Horning in

The West Germans, it turns out, have a decided knack for satellite communications ground terminals.

Three years ago, they put into service at Raisting in Bavaria their first satellite ground station. The antenna at the time was rated as the most-advanced design in commercial use [Electronics, Nov. 16, 1964, p. 175]. Now for their second satellite terminal, scheduled to be completed in mid-1969, the Germans again will try something new.

All large satellite ground stations built so far carry transmitting and receiving equipment on the moving structure that keeps the massive antenna aimed at the satellite. The new Raisting installation will have its transmitter and receiver mounted in the pedestal, off the moving antenna structure.

Double-jointed. Like its predecessor, Raisting II has a combined Cassegrain-and-horn design. But instead of a single bend in the horn, there will be two so that the horn can handle antenna movements in both azimuth and elevation. In one bend, radio-frequency energy bounces off a flat reflector onto a parabolic reflector. It focuses the energy onto the director of the big antenna dish.

Two bends mean two rotating joints; but the antenna designers say this complication is more than offset by the advantages of fixed receiving and transmitting equipment. Maintenance, obviously, is easier on fixed gear. No slip rings are needed to feed power to the transmitter and the receiver. And keeping the helium-cooled receiver supplied with helium becomes less of a problem.

Home made. To build Raisting I, West Germany had to lean heavily on hardware supplied by U.S. man-

ufacturers. But Raisting II will have little not made in Germany. Siemens AG, which is managing the project for the government-run West German telecommunications system, will build about 70% of the electronics for the new ground station. Some 30% will come from AEG-Telefunken. About the only noteworthy hardware that may have to be imported is the refrigeration system to cool the receiver.

Fried. Krupp will build the dish and its support structure.

For the receiver, Siemens designed a parametric amplifier cooled with gaseous helium rather than liquid helium. This makes for a less-expensive receiver although the noise temperature is rather

high—about 15°K. Receiver gain will run about 58.5 decibels over a band from 5,925 to 6,425 megahertz.

For the transmitter, Siemens has decided on a water-cooled traveling-wave tube with output power of between 2 and 3 kilowatts. Antenna gain in the transmit direction will be just under 62 db.

De-iced. After their experience with Raisting I, government telecommunications officials decided to forego a radome for the new antenna. In rainy weather, a film of water forms on the Raisting I radome and makes for poor reception.

Bavarian winters being what they are, though, an unprotected dish would ice up. So Siemens

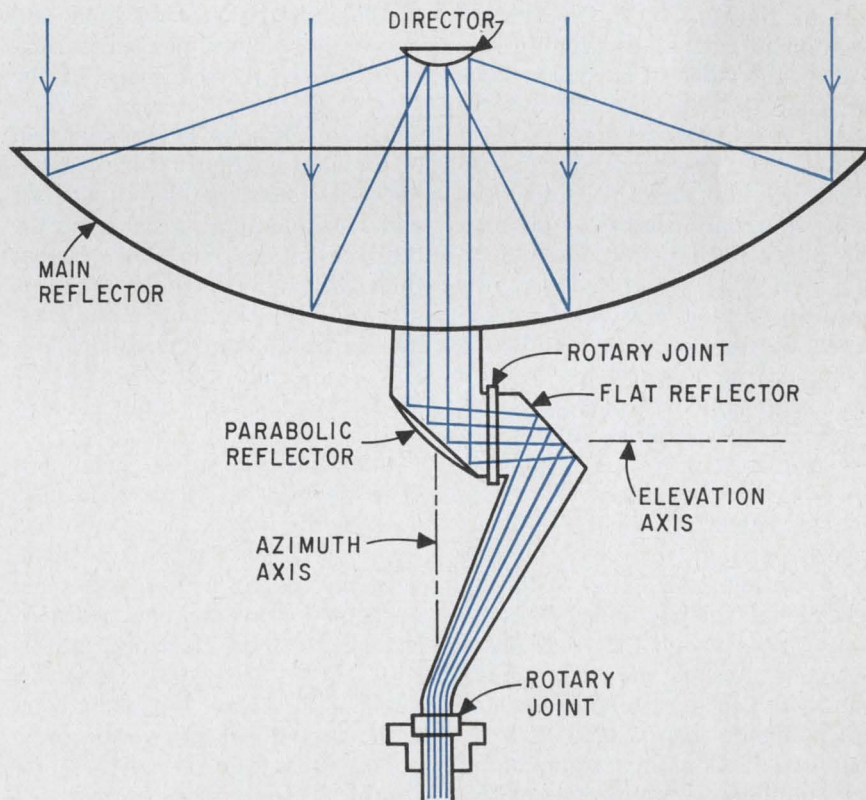

TO DIPLEXER, RECEIVER AND TRANSMITTER

Around the bends. Horn that feeds Cassegrain antenna has two bends and two rotating joints. The double-jointed layout makes it possible to keep the transmitter and receiver off the moving portion of the antenna for a satellite communications ground terminal.

plans to fit the underside of the dish with infrared heaters. They'll radiate between 250 and 300 kw of heating power to keep the antenna reflecting surface free of ice.

Besides doing away with the radome to hold down attenuation, Raisting II's designers increased sensitivity by setting the dish diameter at 91.5 feet, 9.5 feet more than for Raisting I. The second terminal was designed to work with Intelsat-3 satellites, which will have slightly lower power flux per channel (although more channels) than the predecessor satellites that the older terminal was built for. Raisting I, however, is currently being modified so that it can handle communications via the Intelsat-3 satellites scheduled to be launched next year.

Simple answer

Any time a television repairman has to fiddle with the video intermediate-frequency amplifier in a set, the bill runs high. Changing a component means realigning the coils in the video i-f strip, a tedious job that can take a skilled technician 20 minutes or more to do.

Some set designers say crystal filters are the answer. Unlike the coils commonly used in i-f circuits, the filters need no tuning. Others maintain that integrated circuits, because of their low stray capacitance, are the way to i-f amplifiers that need no adjustment. A third approach, now being tried at the applications laboratory of Standard Elektrik Lorenz AG, is simply to lower the i-f frequency.

Less critical. Hansjuergen Mosel, who's heading the work at the West German subsidiary of the International Telephone & Telegraph Corp., points out that the lower frequency makes the ratio of the bandwidth to the center frequency much higher than usual. As a result, variations in the parameters of key amplifier components—particularly the transistors—have little effect on the i-f response curve.

At Standard Elektrik, the experimental video i-f amplifiers have a center frequency of 14 megahertz.

The video carrier is at 17 Mhz and the sound carrier at 11.5 Mhz. Conventional i-f amplifiers in West German sets operate at 36 Mhz and have the same 5.5-Mhz separation between the video and sound carriers. (In the U.S., the i-f center frequency is 45 Mhz and the bandwidth 4.5 Mhz.)

Stagecraft. In the three-stage, 14-Mhz i-f amplifier, only the first stage has a feedback input for automatic gain control; the other two use plastic-encapsulated transistors with high internal shielding. The capacitive feedback is so low that neutralization is not necessary, says Mosel.

At the amplifier input and in the second and third stages, the frequency-selective elements are symmetrically damped two-circuit bandpass filters. Because of the symmetrical damping, frequency detuning between the two circuits of each filter has a negligible effect on the response curve. And because of the loose capacitive coupling between stages, small variations in the characteristics of the input and output transistors have practically no influence on the shape of the curve.

The result is an i-f amplifier that needs no adjustment if close tolerances are held on the capacitors, coils, and damping resistors in the filter circuits. Printed coils, rather than adjustable ferrite core types, are used in the amplifier. Total amplification is about 80 decibels and the output voltage across the 2.7-kilohm load resistor is roughly 2 volts.

Interference. Mosel, who last year devised a circuit that does away with coils in the i-f and discriminator stages in tv sound channels, says some further work must be done before the new video i-f amplifier can be designed into tv sets. The 14-Mhz center frequency lies in a shortwave broadcast band used, among others, by ham radio operators, and this raises the problem of shielding the i-f circuit.

If the shielding isn't onerous, Standard Elektrik expects to develop a hybrid-circuit package combining both a tv tuner and a video i-f amplifier.

Great Britain

IC time at ICT

Britain's biggest computer maker, International Computers and Tabulators Ltd., has compiled an admirable track record in recent years. Among West European computer firms, ICT stands out as the sole company that, in its domestic market, has managed to best the International Business Machines Corp.

The company turned the trick with second-generation transistorized computers. But ever since IBM started delivering third-generation integrated-circuit machines in 1965, the industry has wondered when ICT would follow suit. The answer came this month as ICT announced it would be ready to deliver a large multiaccess computer—designated the 1906A—by late 1969.

The machine's central processor—built around emitter-coupled logic (ECL) packages—will handle up to 1 million instructions per second, and transfer up to 5 million characters per second to the peripheral equipment. System prices will range from \$1.5 million to \$4 million. Performance and price puts the 1906A in much the same class as IBM's 360/65.

Officials at ICT predict 40 sales in the domestic market, plus another 40 or so overseas.

Fast logic. The company opted for emitter-coupled logic because it felt ECL's speed would make possible a massive computing capacity at the right price. About three years ago, ICT developed thick-film hybrid ECL circuits with a switching time of 3 nanoseconds. Using these circuits, it put together a prototype processor to prove out the design. Later, ICT scouted around for a volume producer of ECL, settling on Motorola Inc.

Motorola developed a monolithic equivalent of the hybrid logic that has the same switching time. Although the monolithic's noise margin is somewhat lower than the hybrid's, it isn't enough to affect the machine's performance. The

British firm describes the first production IC's as "superb" and says they'll be much cheaper than hybrids in the long run.

At the outset, the IC packages will be imported from the U.S. However, ICR will undoubtedly line up a British supplier as a second source, most likely Ferranti Ltd. Motorola and Ferranti are negotiating for British production of the ECL packages.

The central processor circuits are so fast, says ICR, that they could be paired with a memory having a 100-nsec cycle time. But a memory this fast would be too costly, so the 1906A core memory will have a 750-nsec cycle time. The memory will be arranged for multiple access for up to eight words at a time, however, to get an effective cycle time close to 100 nsec.

The store width is 50 bits and its capacity will range up to 4 million words.

Curbed crosstalk. The company says that despite the high speed, some computer makers have shied away from ECL because of troubles with crosstalk in the densely packed wiring of the circuit. This was solved at ICR by integrating ground lines and logic transmission lines in multilayer printed-circuit boards.

The processor will be made up of from 60 to 70 boards, each carrying up to 200 IC packages. Only about 0.1-inch thick, the boards will contain up to a dozen layers, two of them carrying ground connections.

Japan

Slow color

Thirty seconds is more than enough to show a pro football quarterback tossing a touchdown pass to a sure-handed receiver. And so U.S. television networks aren't bothered at all by the 30-second limit on the disk-recording equipment they use for playback of colorcast sports events in slow-motion [see story p. 125].

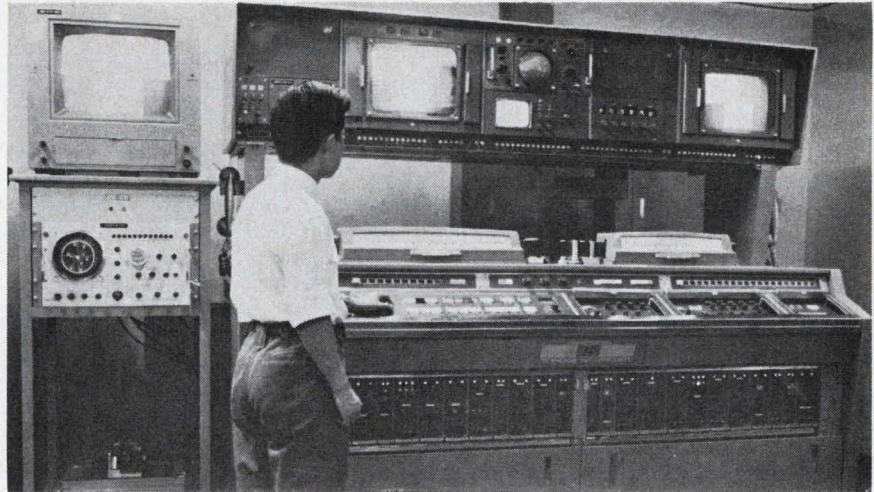

Fast or slow. Color video tape recorder plays back at normal speed or one-fifth speed for slow-motion.

But 30 seconds isn't long enough for Nippon Hoso Kyokai (the Japan Broadcasting Co.), whose viewers like long slow-motion replays of sumo matches, the stylized wrestling contests popular in Japan. So NHK has come up with a color video tape recorder that can play back at normal speed or one-fifth speed. The slow-motion playback by the recorder can start anywhere on the tape and last for hours. But NHK of course doesn't go to extremes.

Adapted. The slow-motion recorder is a standard four-head broadcast-type unit, to which two sets of playback heads and additional circuits are fitted. The standard playback heads operate in the usual manner for normal speed.

Both standard and slow-speed heads rotate at 240 revolutions per second. But the slow-speed heads are slightly offset so that four consecutive tracks of the tape are reproduced during one revolution of the head assembly. During the next four revolutions, the heads are electronically switched off, and on the sixth revolution they reproduce the next four tracks on the tape.

Two auxiliary memory units are used for slow-motion operation. Each has a stationary drum wound with enough tape to reproduce one field. Inside the drum are heads rotating at 60 revolutions per second for recording and playback. The units are similar to helical-scan home-video recorders, except that the tape doesn't move.

Quartets. The two memory units are for even and odd scan fields of the TV signal. Four groups of four tracks from the original tape are recorded as one field on one memory. The next group of four tracks is recorded as one field on the other memory. Each field is reproduced five times while the other field is being recorded.

The color subcarrier is separated from the brightness of the reproduced slow-motion signal by passing it through the resolver circuit, which corrects the phase of the signal, and is then again added to the brightness signal. Correction of the phase of the color subcarrier signal only, without processing the brightness signal, provides broadcast-quality color reproduction, Japan Broadcasting says. In this respect, the unit differs from other color video tape recorders, which process the entire color signal.

By the numbers

Controls makers in Japan find themselves in much the same situation their American counterparts suffered through some three years ago. The agonizing is over when to go to market with direct digital control equipment.

At the automation show put on this month by the Japan Electric Measuring Instruments Association, it became clear that most of the country's controls makers think

the age of direct digital control is nearly at hand. Yokogawa Electric Works Ltd., Fuji Electric Co., Tokyo Shibaura Electric Co. (Toshiba), and Hitachi Ltd. all had DDC hardware to show. But DDC equipment was conspicuously missing at the precinct of Hokushin Electric Works Ltd. At the previous automation show two years ago, Hokushin had the competition agape with a display of DDC hardware developed jointly with the Fischer & Porter Co.

Too much too soon. Hokushin, competitors say, leaped into the market too soon. Although the DDC equipment worked, a field test at a refinery of the Mitsubishi Oil Co. proved more than anything else that Hokushin's DDC hardware could replace conventional analog controllers. But limited to proportional-integral-derivative control (PID)—known as Type 1 DDC—the Hokushin approach turned out to be an expensive way of doing what analog equipment can do.

In the U.S., Fischer & Porter has had mixed success with the Hokushin DDC hardware. One system was tried out first at a Canadian paper plant and later moved to a New England rubber plant. In both cases, the equipment was turned back to Fischer & Porter.

Meanwhile, the Union Carbide Corp. tried a system and found it worked well in a pilot plant having 75 control loops. A full-fledged system to control "more than 200" loops will go on-stream in a month or so at a Union Carbide plant. Fischer & Porter built the equipment, based on Hokushin's design.

Sophisticated. Hokushin currently is querying potential DDC customers to find out what they really want. Meanwhile, the company's competitors have decided that the future for DDC lies in Type 2 systems, a decision most American DDC makers and users arrived at two to three years ago. In these, the computer not only handles PID control but also implements advanced control schemes like feed-forward that can signal changes long before conventional PID equipment could react. Thus with Type 2 DDC, the payoff comes not from lower initial control system cost but

from gains in output of plants and improvements in product quality.

At the moment, Yokogawa Electric rates as the front-runner among Japanese DDC systems makers. The company has two systems in operation at chemical plants, plus orders for a half-dozen more. Fuji Electric has two systems—both small—in operation. Hitachi and Toshiba still are looking for their first DDC customers. Only Yokogawa and Hokushin have special-purpose DDC central processors. The others have based their entries on small general-purpose computers.

Backup. Yokogawa's system relies heavily on integrated circuits in the arithmetic and logic circuits. All-in-all, there are about 1,600 diode-transistor-logic packages, supplied by the Nippon Electric Co.

Although a prototype system with no backup equipment stayed on-line 99.90% of the time during a nine-month field test at a pilot fermentation plant, Yokogawa engineers added some partial duplication to cut the down time for subsequent systems. They have standby arithmetic control circuits, memory current drivers, and amplifiers. In Yokogawa's view, complete duplication would be a waste of money.

France

Traffic talk

The automobile telephone has not achieved wide popularity either in Western Europe or the United States. So far it has been used chiefly by business executives or government officials. In all of Paris, for example, only 225 mobile phone subscribers are tied into the government-run system. And in the New York metropolitan area, the figure is a mere 800.

Significant strides, though, seem imminent in Western Europe. A system that can handle 400 subscribers is about ready to go into service in Madrid. Barcelona expects to have a 400-subscriber system on the air by the spring of 1968. And West German telephone officials are thinking about a nation-

wide automobile telephone network that could handle up to 100,000 subscribers.

Credit Le Matériel Téléphonique, a French subsidiary of the International Telephone & Telegraph Corp., for the spurt of activity. The company's new automatic mobile telephone equipment has been selected for Madrid and Barcelona and probably will be the West German choice.

Grouped. Like the improved mobile telephone service equipment used by the Bell System in the U.S., LMT's equipment ties automobile phone subscribers into the telephone network by microwave radio. The main difference between the two lies in the terminal equipment that links the transmitter-receiver to the telephone switching circuits in the central exchange. The U.S. equipment acts as a number of independent subscriber circuits. The French equipment functions as a group of four trunk lines, one for each radio channel.

The advantage over independent circuits, LMT says, is that a terminal operating as a group of trunk lines doesn't have to duplicate line-concentrators, registers, and translators that exist in the central exchange. However, the trunk-line arrangement alone doesn't cover call metering and special services, so LMT adds to the trunk switch a pseudo line switch.

Well spaced. In the Madrid installation, calls to cars are broadcast from a central station with a 250-watt transmitter for each of the four channels. Calls from cars are picked up by five receiving stations spotted to cover the city. The system operates in the 156—174 megahertz band. Transmissions are frequency-modulated and the channels are spaced 20 kilohertz apart.

The transceivers in subscribers' cars have 10-watt transmitters. When a subscriber lifts the phone off the hook to call, the transceiver unit searches automatically for a free channel.

LMT's vehicle equipment is less complex than Bell's, which can handle eight radio channels. Also, the LMT equipment has no provision for making calls through an operator, as Bell's does.

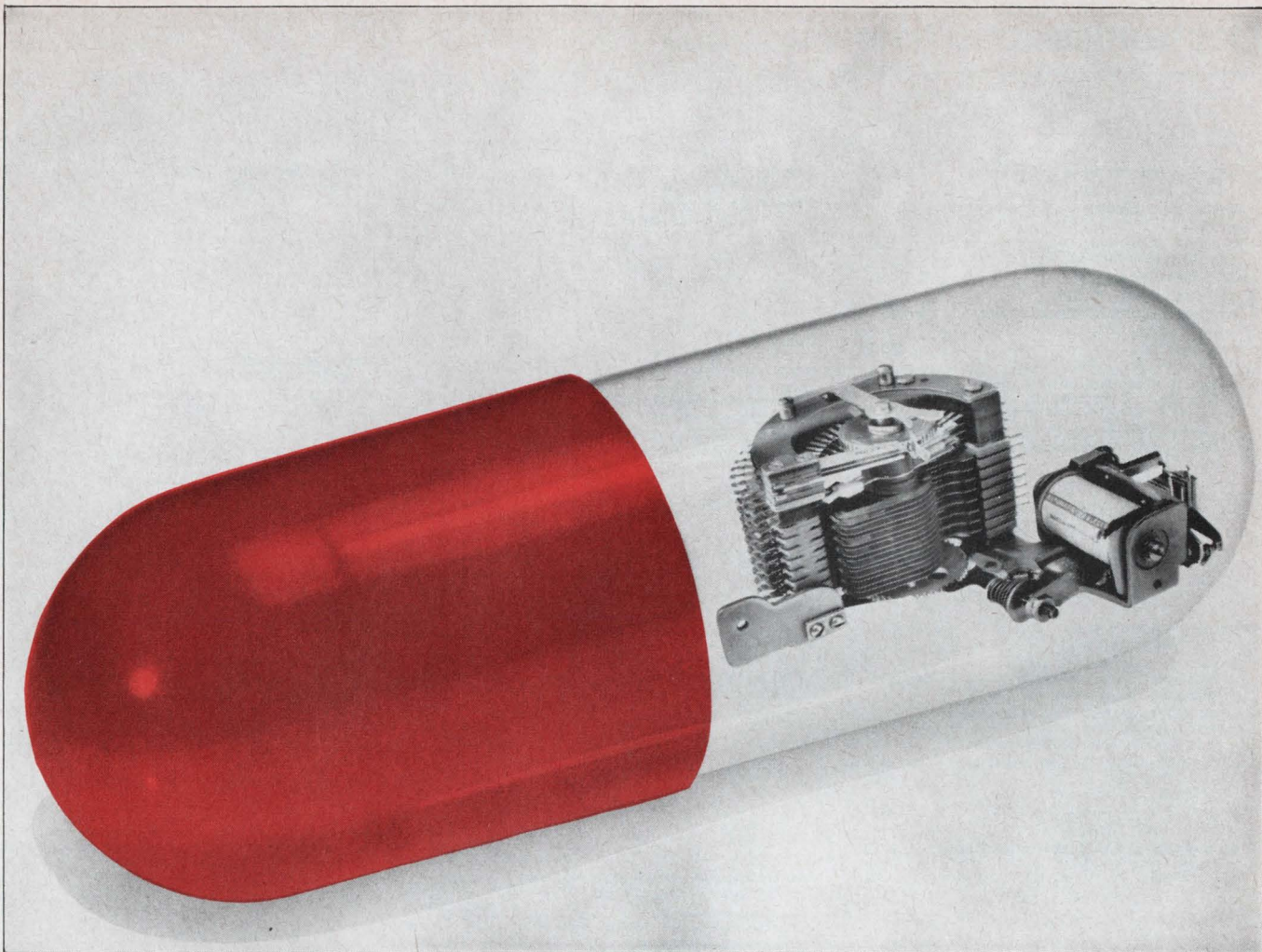

Remedy for nightmares: AE's Type 45NC stepping switch with "shorting" levels.

Many of today's complex switching circuits look like an engineer's nightmare. Why not simplify them? You can replace whole groups of components with an AE Type 45NC "stepper."

This switch has normally closed ("shorting") levels. It's designed so that pairs of contacts *open* successively when the rotor is stepped.

The Type 45NC can solve almost any circuit-transfer or testing problem.

It's ideal for self-interrupted hunting, and you don't need auxiliary relays.

You get one or two electrical levels of either 26 or 52 point normally-closed contacts. For extra versatility, you can specify addi-

tional levels of *normally-open* contacts—on the same switch.

Contacts are gold-plated phosphor bronze. Contact resistance: a maximum of 50 to 100 milliohms, measured at 6 volts 100 milliamperes.

When you specify AE rotary stepping switches, you get the benefit of our continuous research—in design, in metals and insulating materials. All this plus *positive positioning* — a unique AE design

feature that locks the rotor and makes overthrow impossible.

Find out more about AE rotary stepping switches—an economical, rugged and reliable way to simplify switching circuits. There's a lot of helpful application information in our new reference circular 1698-L. To get your copy, just ask your AE representative. Or write to the

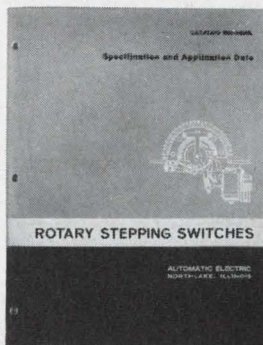

Director, Relay Equipment Sales, Automatic Electric, Northlake, Illinois 60164.

AUTOMATIC ELECTRIC
SUBSIDIARY OF
GENERAL TELEPHONE & ELECTRONICS **GT&E**

Electronics advertisers

October 30, 1967

Airborne Instruments Laboratory Campbell-Mithun, Inc.	128	Dynage, Inc. F. W. Prella Co.	142	Jerrold Electronics Corp. Mohr & Co., Inc.	14
Airco Speer Electronic Components Hazard Adv. Co., Inc.	49	Dynalectron Corp. Dawson MacLeod & Stivers	132	Lapp Insulator Co. Wolff Associates	140
Airpax Electronics, Inc. Welch, Mirabile & Co., Inc.	59			L. E. L. Div. of Varian Associates Snow & Depew Adv., Inc.	152
Allen-Bradley Co. Fensholt Adv. Agcy.	39, 40	Electronic Associates, Inc. Gaynor & Ducas, Inc.	38		
Amphenol Corp., Connector Div. Marsteller, Inc.	54, 55	Electronics Buyers' Guide Plansboard, Inc.	123	Machlett Laboratories, Div. of Raytheon Co.	9
Andrew Corp. Fensholt Adv., Inc.	158			Fuller & Smith & Ross, Inc.	
Atlas Chemical Industries, Inc., Aerospace Components Div.	150	Fairchild Semiconductor, Inc. Faust/Day, Inc.	20, 21	Mallory & Co., P. R., Mfg. Div. Aitkin-Kynett Co.	136
Harris D. McKinney, Inc.		Fluke Manufacturing Co., John Bonfield Associates	15	Marconi Instruments McCarthy, Scelba & Dibiasi Adv. Agcy., Inc.	120
Automatic Electric Co., Sub. of General Telephone & Electronics Corp.	173			Melpar, Inc. Arthur J. Lamb, Inc.	139
Marsteller, Inc.		Garrett Corp., Airesearch Mfg. Div. J. Walter Thompson Co.	138	Microlab/FXR Frank Best & Co., Inc.	144
		General Radio Co. Horton, Church & Golf, Inc.	2nd Cover	Minnesota Mining & Manufacturing Co., Chemical Div.	89
		Granger Associates West Associates	103	Motorola Semiconductor Products, Inc.	161 to 168
Bausch & Lomb, Inc. Wolff Associates, Inc.	138, 143	Groov-Pin Corporation Feeley Adv. Agcy., Inc.	153	Lane & Bird Adv., Inc.	
Beckman Instruments, Inc., Electronic Instrument Div.	64, 111			National Semiconductor Corp. Jay Chiat & Associates	12, 13
Hixson & Jorgensen, Inc.		Hayakawa Electronics Co., Ltd. Dai-Ichi International, Inc.	157	North Atlantic Industries, Inc. Murray Heyert Associates	41
Bendix Corporation, Flight & Engine Instruments Div.	42	Haydon Switch & Instruments, Inc. Reynolds & Foster, Inc.	8	Northern Natural Gas Co. Bozell & Jacobs, Inc.	119
MacManus, John & Adams, Inc.		Heinemann Electric Co. Thomas R. Sundheim, Inc.	121	Nytronics, Inc. The Stukalin Adv. Agcy.	146
Borden Chemical Co., Mystik Tape Industrial Div.	90	Hewlett Packard, Colorado Springs Div. Tallant/Yates Adv., Inc.	1		
Conahay & Lyon, Inc.		Hewlett Packard, Dymec Div. Lennen & Newell, Inc.	17	Pacific Measurements, Inc. Jack Herrick Adv., Inc.	7
Bourns, Inc., Timpot Div. Lester Company, The	63	Hewlett Packard, Frequency & Time Div. Lennen & Newell, Inc.	36	Phoenix Chamber of Commerce Jennings & Thompson Advertising	142
Bulova Watch Co., Electronics Div. Frank Best Co., Inc.	132	Hewlett Packard, Loveland Div. 3rd Cover, 2 Tallant/Yates Adv., Inc.	6	Powertec, Inc. Frost, Shaffer, Gauthier	154
		Hewlett Packard, Microwave Div. Lennen & Newell, Inc.	131		
		Honeywell Computer Control Div. Franklin P. Folts, Inc.	47	Radio Corporation of America 4th Cover, 51, 104, 105, 127	
		Hopkins Engineering Co. Ray Gage, Inc.	16	AI Paul Lefton Co.	
Capitol Radio Engineering Institute Henry J. Kaufman & Associates	147, 156			Redcor Corporation Smith-Klitten, Inc.	142
Celanese Corporation of America, Celanese Plastics Div.	53	International Crystal Mfg. Co. Robert V. Freeland & Associates	112		
West, Weir & Bartel, Inc.		I R C, Inc. Gray & Rogers, Inc.	124	Semtech Corporation Burruss Advertising	118
CELCO, (Constantine Engineering Labs., Co.)	148	ITT Semiconductors Div. Neals & Hickok, Inc.	176	Signetics Corp., Sub. Corning Glass Works	84
Stano Advertising				Cunningham & Walsh, Inc.	
Chrono-Log Corporation Hill Associates	155				
Clifton Precision Products Co., Litton Industries Div.	37				
Ivey Advertising, Inc.					
Computer Instruments Corp. Dickerman Advertising, Inc.	134				
Computer Labs. Wrenn Studio	117				
Continental Connector Corp. Dunwoodie Associates	60				
Control Data Corp., Analog-Digital Systems Div.	52				
Barnes-Champ Advertising					
Cyclo-Tronics, Inc. Bernard J. Hahn & Associates	151				
Dale Electronics, Inc., Sub. of Lionel Corp.	56				
Swanson, Sinkey, Ellis, Inc.					
Delco Radio, Div. of General Motors Corp.	18, 19				
Campbell-Ewald Co.					
Digital Equipment Corp. Kalb & Schneider, Inc.	22				
Dit-Mco International, Div. of Xebec Corp.	153				
Martin Fromm & Assoc., Inc.					
DuPont de Nemours Co., Mylar Div. Batten, Barten, Durstine & Osborn, Inc.	133				



Advertising sales staff

- Siliconix, Inc. 24, 175
Graphics West
- Sorensen Operation, Raytheon Co. 11
James Advertising, Inc.
- Sprague Electric Co., The 5, 10
Harry P. Bridge Co.
- Stackpole Carbon Co., 83
Electronic Components Div.
Meek & Thomas, Inc.
- Stanpat Products, Inc. 153
Morton Advertising, Inc.
- Sylvania Electric Products, Inc., 27 to 34
Electronic Tube Div.
Doyle, Dane, Bernbach, Inc.

- Tektronix, Inc. 106
Hugh Dwight Adv., Inc.
- Telonic Instruments 61
Jansen Associates, Inc.
- Texas Instruments Incorporated 62
Industrial Products Group
Robinson-Gerrard Incorporated
- Tohoku Metal Industries, Ltd. 122
Hakuho, Inc.
- Torrington Mfg. Co., Air Impeller Div. 35
Wilson, Haight & Welch, Inc.
- TRW Electronics Capacitors Div. 114
Fuller & Smith & Ross, Inc.
- Tung Sol Division, 155
Wagner Electric Corp.
E.M. Freystadt Associates

- Victoreen Instrument Co., The 113
Palm & Peterson, Inc.
- Victory Engineering Corp. 130
Black-Russell-Morris

- Westinghouse Electric Corp., 6
Electronic Tube Div.
McCann/ITSM
- Wisconsin Power & Light Co. 137
Ralph Timmons

Classified Advertising

F.J. Eberle, Manager

- PROFESSIONAL SERVICES 150
- EMPLOYMENT OPPORTUNITIES 150

EQUIPMENT

(Used or Surplus New) For Sale 150

LEGAL NOTICE

ADVERTISERS INDEX

- Butler, E.V. Jr. 150
- Fishman, Philip, Co. 150
- Radio Research Instrument Co. 150
- Sperry Rand Research Center 150

■ For more information on complete product line see advertisement in the latest Electronics Buyers' Guide

Frank E. LeBeau [212] 971-6464

Advertising sales manager
 Wallis Clarke [212] 971-2187
 Assistant to sales manager
 Donald J. Austermann [212] 971-3139
 Promotion Manager
 Atlanta, Ga. 30309: Michael H. Miller, 1375 Peachtree St., N.E. [404] TR 5-0523
 Boston, Mass. 02116: William S. Hodgkinson
 McGraw-Hill Building, Copley Square [617] CO 2-1160
 Chicago, Ill. 60611: Robert M. Denmead, J. Bradley MacKimm, Ralph Hanning, 645 North Michigan Avenue, [312] MO 4-5800
 Cleveland, Ohio 44113: William J. Boyle, 55 Public Square, [216] SU 1-7000
 Dallas, Texas 75201: Richard P. Poole, 1800 Republic National Bank Tower, [214] RI 7-9721

Denver, Colo. 80202: Joseph C. Page, David M. Watson, Tower Bldg., 1700 Broadway, [303] 255-5484

Detroit, Michigan 48226: Ralph Hanning 856 Penobscot Building [313] 962-1793

Houston, Texas 77002: Kenneth George, 2270 Humble Bldg., [713] CA 4-8381

Los Angeles, Calif. 90017: Ian C. Hill, John G. Zisch, 1125 W. 6th St., [213] HU 2-5450

Minneapolis, Minn. 55402: J. Bradley MacKimm, 1104 Northstar Center [612] 332-7425

New York, N.Y. 10036
500 Fifth Avenue
Donald R. Furth [212] 971-3615
James R. Pierce [212] 971-3616
Jeffrey M. Preston [212] 971-3617

Philadelphia, Pa. 19103:
Warren H. Gardner, Jeffrey M. Preston,
6 Penn Center Plaza,
[215] LO 8-6161

Pittsburgh, Pa. 15222: Warren H. Gardner,
4 Gateway Center, [412] 391-1314

Portland, Ore. 97204: James T. Hauptli,
218 Mohawk Building, 222 S.W. Morrison
Street, Phone [503] 223-5118

Rochester, N.Y. 14534: William J. Boyle,
9 Greylock Ridge, Pittsford, N.Y.
[716] 586-5040

St. Louis, Mo. 63105: Robert M. Denmead
The Clayton Tower, 7751 Carondelet Ave.
[314] PA 5-7285

San Francisco, Calif. 94111:
James T. Hauptli, 255 California Street,
[415] DO 2-4600

London W1: Edwin S. Murphy Jr.,
34 Dover Street, Hyde Park 1451

Paris: Pierre Braude, European Director
Iena Commercial Bldg., 33 rue Galilee
Phone: 553-47-79

Milan: Robert Saidel
1 via Baracchini Phone: 86-90-656

Frankfurt/Main: Dieter Rothenback
Elsa-Brandstroem Str. 2
Phone: 72 01 81

Geneva: Mike Zeynel
1, rue du Temple Phone: 31 95 60

Tokyo: Nobuyuki Sato, 1, Kotohiracho
Shiba, Minato-Ku [502] 0656

Osaka: Ryoji Kobayashi 163, Umegae-cho
Kita-ku [362] 8771

Business department

Wallace C. Carmichael, Manager [212] 971-3191
 Stephen R. Weiss, Production Manager [212] 971-2044
 Thomas M. Egan, Assistant Production Manager [212] 971-3140
 Dorothy Carmesin, Contracts and Billings [212] 971-2908

Circulation and research

Milton Drake, Manager [212] 971-3485
 Isaaca Siegel, Assistant Circulation Manager [212] 971-6057
 David Strassler, Assistant Research Manager [212] 971-6058
 Chloe D. Glover, Research Associate [212] 971-6057

Electronics buyers' guide

George F. Werner, General Manager [212] 971-2310
 Ray Smyth, Eastern Regional Manager [212] 971-6538
 Regina Hera, Directory Manager [212] 971-2544
 Thomas M. Egan, Production Manager [212] 971-3140

VCR* FET performance

in a voltage-tunable oscillator

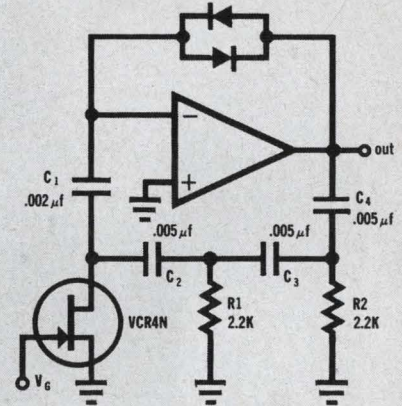

Siliconix assumes no responsibility for the circuit shown, nor do they represent or warrant that it does not infringe any patents.

Output frequency varies between 6 Kc and 18 Kc as V_G is varied from zero volts to pinchoff. The range can be shifted by changing C_1 , C_2 , and C_3 , and broadened by substituting VCR FETs for R_1 and R_2 . The diodes maintain proper amplifier gain throughout the entire frequency range and eliminate the VCR matching problem.

Interested? Build this and other VCR circuits with the VCR FET Designer's Kit DK6. You get 6 VCR FETs (\$30 value) for just \$19.50 from your distributor.

More information? Write us or check the inquiry card.

* VCR: Voltage Controlled Resistor - a new family of FET devices offering variable resistance ranges on the order of 10,000 : 1.



Siliconix incorporated

1140 W. Evelyn Ave. • Sunnyvale, CA 94086
Phone (408) 245-1000 • TWX: 910-339-9216

The Predictables.



When ITT people ship your Series 930 DTL order you get on-time delivery.

More than 97% of your Series 930 DTL orders get delivered on time. How's that for predictability? We offer the same 15 circuit functions in the same packages as those people you've been having delivery problems with. Doesn't that justify a change?

To see how little trouble DTL buying can be, try the ITT "Predictables." Order off the shelf from your distributor or direct from your factory representative. Our shipping people may have to work late, but your receiving people won't.

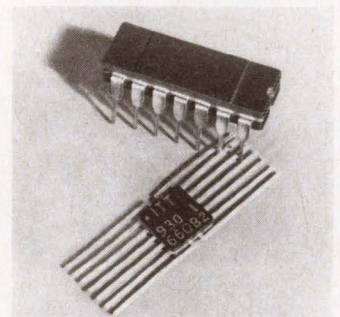

Integrated circuits **ITT**

FACTORIES IN WEST PALM BEACH, FLORIDA; PALO ALTO, CALIFORNIA; LAWRENCE, MASSACHUSETTS; HARLOW AND FOOTSCRAY, ENGLAND; FREIBURG AND NURENBERG, GERMANY

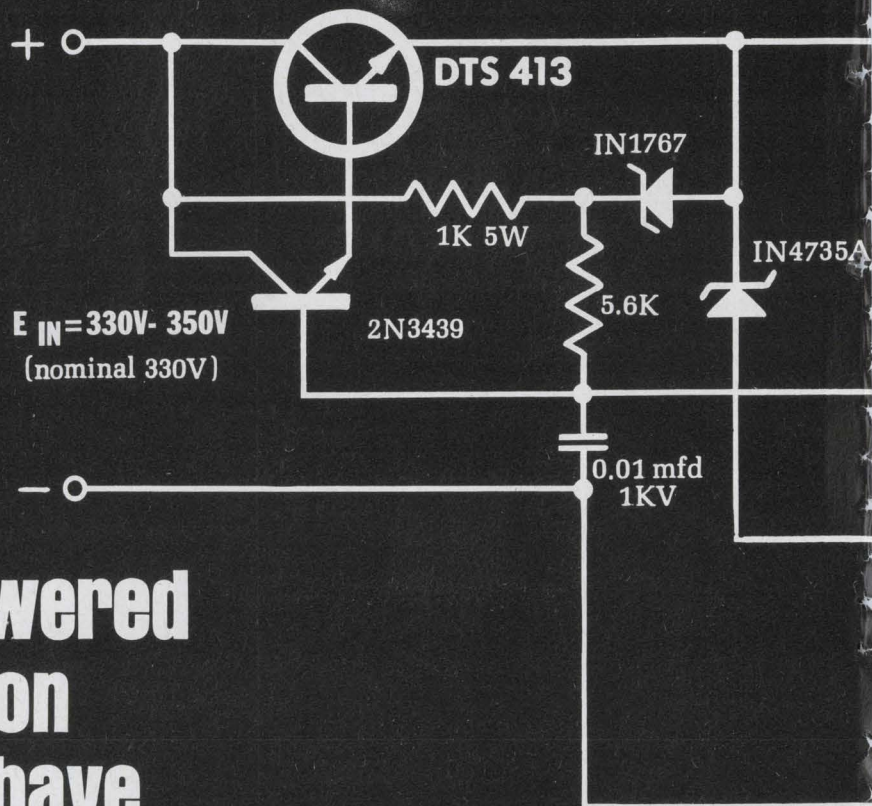

High-powered regulation doesn't have to carry a high-powered price!

The simple DC regulator shown supplies 290 volts to a load of 50 to 600 milliamperes. Regulation is better than $\pm .05$ percent with an input voltage variation of 15%. Delco high voltage silicon makes this possible with just one series transistor—the DTS-413—priced at just \$3.95 each in 1000-and-up quantities.

This circuit also can be scaled to the capabilities of any of the other cost saving Delco DTS transistors, including the new DTS-424 and DTS-425. And no matter which Delco high voltage transistor you use, reduction of weight, size, and component cost is part of the bargain. Circuit complexity and number of components are reduced and so assembly costs go down, too. And fewer components mean higher reliability.

Right now, Delco silicon power transistors are adding these benefits in such high energy circuits as: DC-DC converters, ultrasonic power supplies, VLF class C amplifiers, off-line class A audio output and magnetic CRT deflection (several major TV manufacturers use them in big screen horizontal and vertical sweep circuits).

How soon can you get Delco silicon power transistors? How soon do you need them? With our experience and new plant facilities, samples or production quantities can be shipped promptly. Call one of our distributors or a Delco sales office now.

For full details on the DC regulator circuit, ask for application note number 38.

Application of Delco high voltage silicon power transistors: a DC voltage regulator.

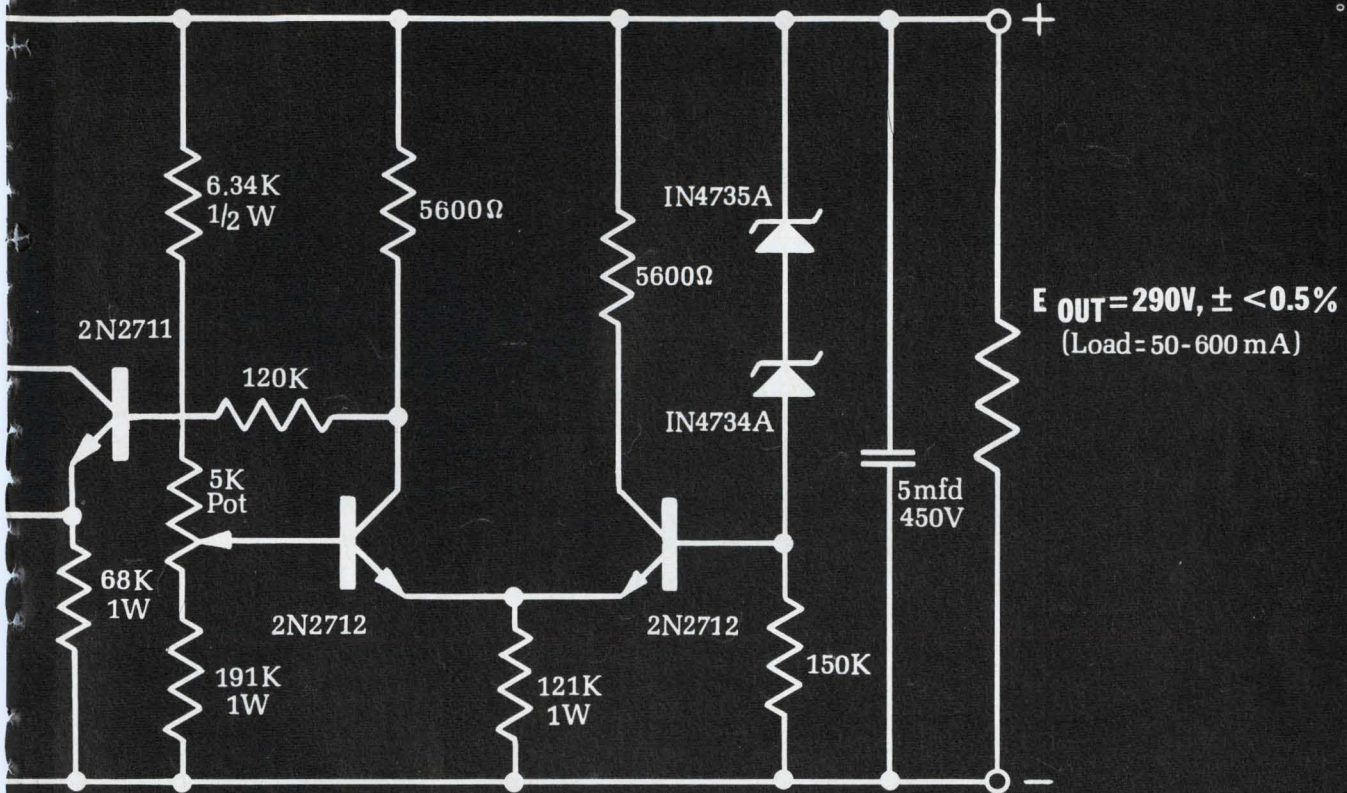

TYPE	V _{CEX}	V _{CEO} (sus) min.	I _C max.	h _{FE} min. V _{CE} =5 V @ I _C	P _D max.	PRICE 1000-and-up QUANTITIES
DTS-413	400V	325V	2.0A	15 @ 1.0A	75W	\$3.95
DTS-423	400V	325V	3.5A	10 @ 2.5A	100W	\$4.95
DTS-424	700V	350V	3.5A	10 @ 2.5A	100W	\$7.00
DTS-425	700V	400V	3.5A	10 @ 2.5A	100W	\$10.00
DTS-430	400V	300V	5.0A	10 @ 3.5A	125W	\$17.49
DTS-431	400V	325V	5.0A	10 @ 3.5A	125W	\$25.00

NPN silicon transistors packaged in solid copper TO-3 case.

Field Sales Offices: Union, New Jersey* 07083 Box 1018 Chestnut Station (201) 687-3770; Detroit, Michigan 48202 57 Harper Avenue (313) 873-6560; Santa Monica, Calif.* 90401 726 Santa Monica Blvd. (213) 393-1465; Syracuse, New York 13203 1054 James Street (315) 472-2668; Chicago, Illinois* 60656 5151 N. Harlem Avenue (312) 775-5411; General Sales Office: 700 E. Firmin, Kokomo, Ind. 46901 (317) 459-2175

*Office includes field lab and resident engineer for applications assistance.

DELCO RADIO

DIVISION OF GENERAL MOTORS • KOKOMO, INDIANA

WIN A 1970 CAR FROM FAIRCHILD:



Please enter my name in your New Product sweepstakes.

NAME _____

TITLE _____

COMPANY _____

CITY _____ STATE _____ ZIP _____

Void wherever prohibited, licensed, taxed, or in any other way restricted by law. Employees of Fairchild Camera and Instrument Corporation, its advertising and sweepstakes agencies and their families are not eligible.

FAIRCHILD SEMICONDUCTOR SWEEPSTAKES
P. O. Box 68 Los Angeles, California 90051

Now that we have your attention, we have a short announcement to make:

We're introducing our 1970 product line. All monolithic integrated circuits—MSIs, LSIs and new linears. There will be a new one every week for the next 52 weeks. In stock. At Fairchild distributors. Complete with data sheets and reliability information. And, they will be available in volume. (The first four are on the opposite page.)

Any week we fail to announce a new product, we'll hold a drawing. The winner gets a 1970 car. To keep. Any model he chooses (up to \$4,000) or the equivalent in cash. Fill in the coupon and return it to us. We'll enter your name in the sweepstakes. Enter now. By 1970 you'll need a new car, anyway.

FAIRCHILD

FAIRCHILD SEMICONDUCTOR / A Division of Fairchild Camera and Instrument Corporation SEMICONDUCTOR 313 Fairchild Drive, Mountain View, California 94040, (415) 962.5011 ■ TWX: 910.379.6435

9300 FOUR-BIT UNIVERSAL REGISTER

1. Fairchild will introduce a new integrated circuit each week for the next 52 weeks. This is number

The Fairchild 9300 is the first of a new line of highly versatile digital elements. It is an MSI (Medium Scale Integration) device which means greater complexity in less space, fewer external connection requirements and improved reliability. At the same time, the 9300 is extremely flexible and can be used in a number of applications. For example, it can function as either a high speed shift register, a high speed counter or a high speed storage element. It features 20 MHz shift frequency, type D input (obtained by tying together the J and K inputs), gated synchronous parallel input, Q and Q output, and complete compatibility with CCLS elements. The 9300 comes in a hermetic, ceramic dual in-line package with a 16-lead configuration. It is available in both military and industrial temperature ranges (-55°C to +125°C and 0°C to +70°C). The 9300 is available in volume quantities. Fairchild distributors have it in stock now. Write for complete specifications, applications information and descriptions of other Fairchild MSI elements.

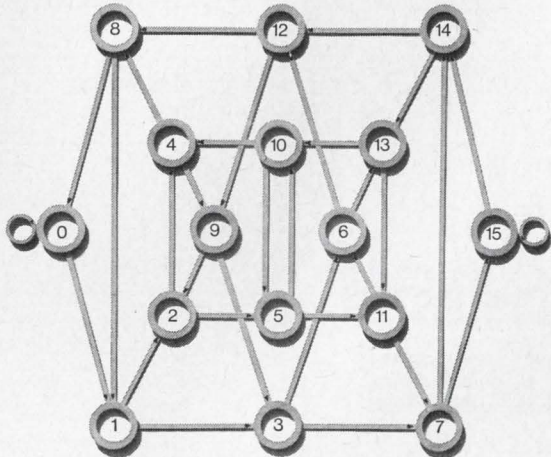

FAIRCHILD

FAIRCHILD SEMICONDUCTOR / A Division of Fairchild Camera and Instrument Corporation SEMICONDUCTOR UNIT, 311 Fairchild Drive, Mountain View, California 94035 (415) 962-5011 • TWX 910 370-8415

Circle 190 on reader service card

9304 DUAL FULL ADDER

2. Fairchild will introduce a new integrated circuit each week for 52 weeks. This is number

Fairchild's 9304 is a highly flexible MSI (Medium Scale Integration) device with extremely fast carry propagation delay (typical 8 nanoseconds). It provides greater complexity in less space, fewer external connection requirements and improved reliability. Separate carry inputs allow the use of two adders—individually or together. The 9304 is fully compatible with Fairchild CCLS devices. It's also part of our family of system building blocks. Others are shift registers, counters, decoders, interface devices, etc. It is applicable in any digital logic system. Its versatility means high volume production resulting in low unit cost. In addition to a dual full adder, the 9304 can also be used as a parity checker, an exclusive OR circuit, or for a number of other useful logic functions. It comes in a 16-pin hermetic dual in-line package. It is available in both military and industrial temperature ranges (-55°C to +125°C and 0°C to +70°C). The 9304 is at your Fairchild distributor now. Write for complete specs, application information and descriptions of our other MSI devices.

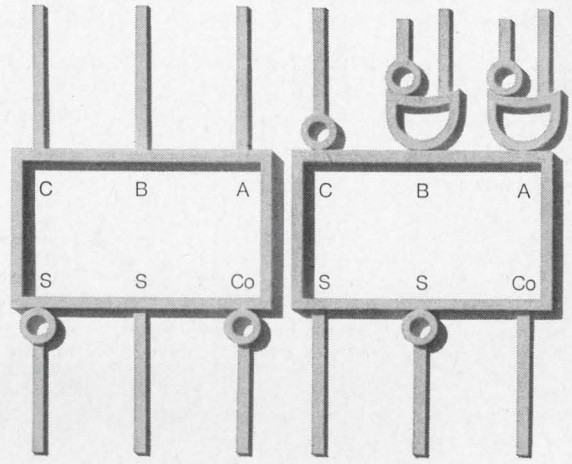

FAIRCHILD

FAIRCHILD SEMICONDUCTOR / A Division of Fairchild Camera and Instrument Corporation SEMICONDUCTOR UNIT, 311 Fairchild Drive, Mountain View, California 94035 (415) 962-5011 • TWX 910 370-8415

Circle 191 on reader service card

9020 DUAL J-K FLIP-FLOP

3. Fairchild will introduce a new integrated circuit each week for 52 weeks. This is number

The 9020 is a CCLS device in a dual in-line package. It consists of two J-K flip-flops with a common clock, separate J, K and K inputs and a common JK input. The joint JK input eliminates the need for gating clock waveforms and can result in simplified logic designs and minimized clock skew problems. The K input also allows the 9020 to perform as a dual type D flip-flop by tying the J and K inputs together. Clock loading is reduced by a single clock buffer. The 9020 is fast (50MHz) and flexible. It comes in a 16-pin hermetically sealed package. It's available in both military and industrial temperature ranges (-55°C to +125°C and 0°C to +70°C). It can be operated as a type D flip-flop or as a standard JK. The 9020 is available in volume quantities now. Fairchild distributors have it in stock. Write for complete specifications, applications information and descriptions of our other new products.

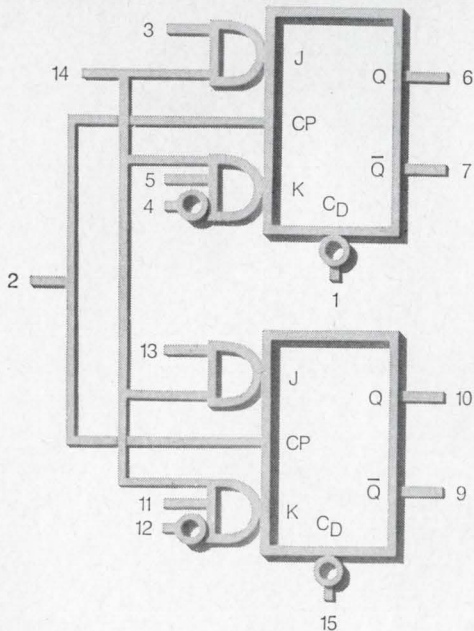

FAIRCHILD

FAIRCHILD SEMICONDUCTOR / A Division of Fairchild Camera and Instrument Corporation SEMICONDUCTOR UNIT, 311 Fairchild Drive, Mountain View, California 94035 (415) 962-5011 • TWX 910 370-8415

Circle 192 on reader service card

9301 ONE-OF-TEN DECODER

4. Fairchild will introduce a new integrated circuit each week for 52 weeks. This is number

The 9301 is a CCLS multi-function decoder in a 16-pin hermetic dual in-line package. It's part of our new family of system building blocks. (Others are shift registers, counters, adders, etc.) It is applicable in any digital logic system. The 9301 is designed to give added flexibility to Fairchild's Medium Scale Integration (MSI) devices. (MSI already offers greater complexity in less space, fewer external connection requirements and improved reliability.) As an example of its many applications, the 9301 can serve as an input/output between our universal register (9300), memory cell (9003) and dual full adder (9304). It can also be used as an expandable digital demultiplexer, minterm generator, and as a decoder for any BCD code. It comes in both military and industrial temperature ranges (-55°C to +125°C and 0°C to +70°C). The 9301 and other MSI devices mentioned above are available in volume. Fairchild distributors have them in stock now. We also have a comprehensive literature package that discusses, in depth, all the advantages of Medium Scale Integration. Write for your free copy today.

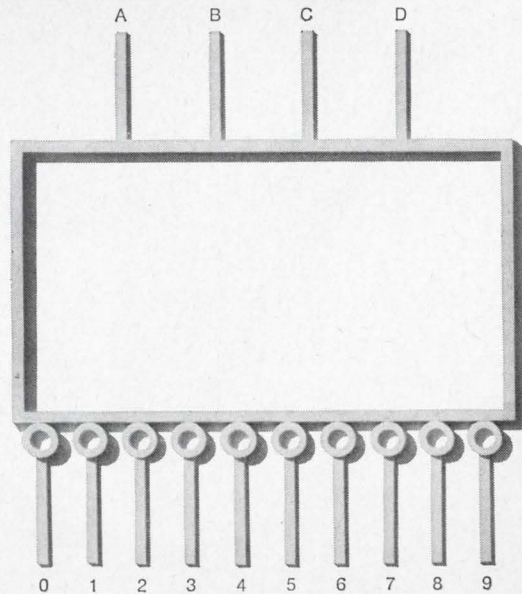

FAIRCHILD

FAIRCHILD SEMICONDUCTOR / A Division of Fairchild Camera and Instrument Corporation SEMICONDUCTOR UNIT, 311 Fairchild Drive, Mountain View, California 94035 (415) 962-5011 • TWX 910 370-8415

Circle 193 on reader service card

When you sell 650 PDP-8/S computers in the 8 months since it was introduced, you develop a little confidence, and you start doing things differently.

(The PDP-8/S is a full, general purpose, 4096 12 bit word core memory, FORTRAN-speaking, expandable digital computer complete with ASR-33 teletype and software. It sells for \$10,000 each. Generous quantity discounts.)

For one thing, you think about stocking the computer, like other instrument makers stock voltmeters, even if nobody has ever done that before. And that's exactly what we've done. Effective now, small quantity orders of the PDP-8/S are available off-the-shelf. Instantaneous delivery. Larger quantities still require a short delivery schedule.

And secondly, we've put at least one in every field office we have — 22 of them. If you must have the computer that's in the field office, you back up your car open your trunk, and take it. We'll send the field office a replacement. That way, it

becomes off-the-shelf instantaneous delivery not only in Maynard, Mass., but around the country.

Mail and phone orders will be filled promptly, too.

Gentlemen:

- Enclosed find \$10,000.
Send computer.
- Send sales engineer.
- Just send free books, now.
Maybe computer later.



Name _____

Title _____

Company _____

Address _____

off-the-shelf computers



Editorial

The battle lines are drawn

A deafening hue and cry over community antenna television, better known as CATV, is going to be heard during the next 12 months.

Technical men and businessmen now recognize that there is more to CATV than piping commercial television over the mountains to backwoods villages, that the brightest potential comes once the coaxial cable has been laid into every home in the country. Then a whole universe of new possibilities opens up: picturephone, computers in the home, newspaper delivery by facsimile, entertainment retrieval systems, and whatever else—needing large bandwidth for transmission—the imagination can conjure up.

The cacophony is going to come from several different directions. Most broadcasters want to kill CATV because they see it as a face-to-face competitor. They see the new medium as a parasite living off the broadcaster program fare. But the telephone companies see CATV as a superb way to increase their services—via picturephone-type equipment, for one example—and their revenues. And the operators of CATV systems want to take their systems into the 100 major markets the Federal Communications Commission has frozen them out of, to originate their own programs, and to sell advertising on their systems.

Meanwhile, CATV has divided the FCC into a handful of bitterly opposing camps. The FCC's Broadcast Bureau naturally supports the broadcasters' contention that CATV is better off dead because it would change the status quo of broadcasting. At the Common Carrier Bureau, staff members lean towards the telephone companies and support their view that CATV cables are just an extension of wired carrier services.

And the CATV task force, which the agency set up last year to handle a growing backlog of CATV cases, sees itself as the defender of an infant industry that ought to be allowed to survive.

If the staff of the FCC is at odds over CATV, the commissioners are even more sharply divided: Three of them now believe that CATV ought to be given a chance to grow. Two believe that the cable medium should be killed off quickly—as pay television was—before it damages the structure of broadcasting in the U.S. And two others, who are ostensibly noncommitted, wish CATV would go away. Until this summer, the FCC hoped that Congress would solve the problem for the commissioners by passing a copyright law that would put most of the CATV systems out of business.

Now it is clear that even if Congress passes such legislation—and it is doubtful it will come this year—CATV will not die. For one thing, big corporations have moved into it, supplementing or replacing the tiny “momma-and-poppa” systems (so-named because they were often family affairs run by a husband and wife) that started the business. Companies such as Time Inc., Westinghouse Electric, General Telephone & Electronics, and General Instrument have a big stake in CATV these days and these companies are willing to pay a copyright fee to broadcasters for the use of programs and even to pay an additional fee for the right to retransmit broadcasters' signals. But the big CATV operators also talk about wanting the broadcasters to share advertising revenues with them in payment for CATV's extension of a television station's audience.

Broadcasters are the strongest foes of CATV, but there is no unanimity among them about the new medium. Although the National Association of Broadcasters bluntly calls CATV operators parasites, fully 35% of CATV systems are owned by broadcasters—some local and some national—like Cox Broadcasting, Westinghouse, and NBC. CBS has started a study of CATV with the intent of eventually acquiring some systems and the American Broadcasting Co. is only waiting the outcome of its merger plan with ITT, now under scrutiny by the Justice Department and the FCC, before it moves into CATV.

While NAB calls the CATV operators parasites for re-broadcasting television's programs, other broadcasters are indignant about CATV systems' plans to originate their own material. And that leads to another schism at the FCC. The protesting broadcasters have almost convinced the Broadcast Bureau at the FCC to recommend that the agency order CATV broadcasters to stop originating shows. But in October, at a regional meeting of CATV operators, FCC Commissioner Nicholas Johnson urged the CATV men to originate more of their own programs.

The argument that CATV should be relegated to the backwoods communities behind the mountains is also obsolete. The major cities of the U.S. need it even more because reflections from new high-rise buildings are ruining tv reception. In New York City, for example, one wonders why the FCC doesn't oppose the construction of the proposed World Trade Center, which everyone agrees will damage television reception for 2 million to 3 million viewers, if it insists on keeping CATV out of the city.

The rapid acceptance of color telecasting has made cable transmission even more desirable because color tv has tighter requirements. With the new amplifiers, filters and transmitting techniques installed on the cable, CATV systems can produce better quality than the old kind of radiation broadcasting.

Unhappily, CATV's role as a supplement to television appears to be the best way to pay for the installation of coaxial cable around the U.S.—even though television programming may be the least important user of CATV in the future. So the television aspects have to be pushed. But CATV is too important to be killed off as a sop to broadcasters.

DIFF AMP — HIGH Z_{IN}

Take Two Resistors

Add one Dual FET

Combine with a CL Diode

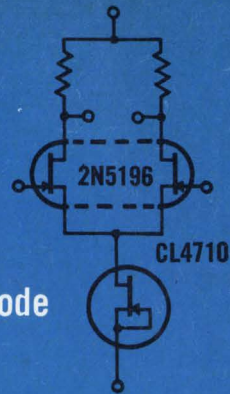

Type	Offset	Tracking	I_G
2N5196	5 mV max	5 $\mu\text{V}/^\circ\text{C}$	15 μA max
2N5197	5	10	15
2N5198	10	20	15
2N5199	15	40	15
2N5195	5	10	15

SELECT THE FET DUAL FOR YOUR DIFF AMP

TRACKING FROM 5 $\mu\text{V}/^\circ\text{C}$

A dual matched FET combined with a current limiter diode is all you need for a high impedance diff amp. Input currents are less than 15 μA . . . even with trans-conductances over 1000 μmhos . The matching parameters of the dual FETs are the most important for diff amp operation—several guaranteed limit ranges are offered for a trade off between cost and performance. Select the optimum dual for your application by using the Siliconix "Diff Amp Designer's Kit." Start with

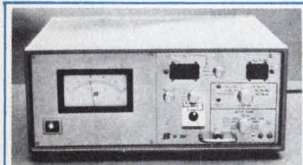

NEW LOW COST FET TESTER

The SI200 Semiconductor Tester features plug-ins for expandable test capability, simplicity of operation, and low cost.
 Price: SI200 Tester — \$960
 Price: SI201 (DC & g_m) Plug-in Module — \$1335

the most closely matched pair, the 2N5196 . . . check operation . . . then downgrade to lesser matched units until the minimum acceptable performance is reached.

The CL diode — a two terminal FET with the source and gate connected — is the constant current supply. This avoids the complexity of the bipolar limiter. These diodes are available for current sources ranging from 220 μA to 4.7 mA. The CL diodes in the Designer's Kit offer typical currents for diff amp designs.

Get your Siliconix "Diff Amp Designer's Kit," DK7, from your distributor. It contains four dual FETs, the 2N5196 through 2N5199, and two CL diodes for \$84.50. For literature on these and other FETs, just write or check the inquiry card.

the most closely matched pair, the 2N5196 . . . check operation . . . then downgrade to lesser matched units until the minimum acceptable performance is reached.

The CL diode — a two terminal FET with the source and gate connected — is the constant current supply. This avoids the complexity of the bipolar limiter. These diodes are available for current sources ranging from 220 μA to 4.7 mA. The CL diodes in the Designer's Kit offer typical currents for diff amp designs.

Get your Siliconix "Diff Amp Designer's Kit," DK7, from your distributor. It contains four dual FETs, the 2N5196 through 2N5199, and two CL diodes for \$84.50. For literature on these and other FETs, just write or check the inquiry card.



Siliconix incorporated

1140 W. Evelyn Avenue, Sunnyvale, California 94086
 Telephone (408) 245-1000 TWX: 910-339-9216

Franchised Distributors

ALABAMA Cramer Electronics, Inc. Huntsville (205) 536-4493	Oakland (415) 834-3311 Electronic Supply, Inc. Riverside (714) 683-8110	Chicago (312) 279-1000 Milgrays Elec., Inc. Hyattsville (202) 864-6330	Bergenfield (201) 384-3643 Kierulff Elec., Inc. Albuquerque (505) 268-3901	Dayton (513) 278-5861 Oil Capitol Elec. Corp. Tulsa (918) 836-2541
ARIZONA Kierulff Electronics, Inc. Phoenix (602) 273-7331	COLORADO Kierulff Elec., Inc. Denver (303) 825-7033	MASS. Cramer Electronics, Inc. Newton (617) 969-7700	NEW YORK Summit Dist., Inc. Buffalo (716) 884-3450	PENNSYLVANIA Milgrays Elec., Inc. Philadelphia (215) 228-2000
CALIF. Hollywood Radio & Elec. Hollywood (213) 466-3181 Menlo Park (415) 322-3431	CONNECTICUT Cramer Elec., Inc. Hamden (203) 288-7771	MICH. Semiconductor Spec., Inc. Detroit (313) 255-0300	Milgrays Electronics, Inc. New York City (212) 989-1600 East. Semiconductor Sales, Inc. Syracuse (315) 455-6641	TEXAS Sterling Electronics, Inc. Austin (512) 452-0271 Dallas (214) 357-9131 Houston (713) 666-4061
Kierulff Electronics Los Angeles (213) 685-5511 San Diego (714) 278-2112 Elmar Electronics, Inc. Mountain View (415) 961-3611	FLORIDA Perrott Associates, Inc. Clearwater (813) 446-2535 Orlando (305) 275-1132 West Palm Beach (305) 585-7761	MINN. Semiconductor Spec., Inc. Minneapolis (612) 866-3434	NORTH CAROLINA Kirkman Elec. Winston-Salem (919) 724-0541	Houston (713) 228-1465 Washington Elec. Seattle (206) 682-8981
	ILLINOIS Semiconductor Spec.	MISSOURI Semiconductor Spec. St. Louis (314) 521-8866	OHIO Alpine Industries, Inc.	
		NEW JERSEY Tech. Elec. Dist.		