

Electronics®

Timers with integrated circuits: page 70

Special report on Japanese technology: page 77

Survey of Japan's electronics industry: page 81

December 13, 1965

75 cents

A McGraw-Hill Publication

Below: Microwave antennas dominate Tokyo's skyline, page 99





**PIONEERS IN
MINIATURIZATION**

"SPECIAL" (CUSTOM BUILT) FILTERS

TO YOUR SPECIFICATIONS

**ILLUSTRATED ARE
TYPICAL SPECIAL FILTERS**

RANGE OF FREQUENCIES ON SPECIAL UNITS

IS FROM 0.1 CYCLE TO 400 MC.

Over thirty years of experience in the design and production of special filters have resulted in UTC being a first source for difficult units. Present designs both military and commercial incorporate a wide variety of core structures, winding methods, and capacitors to provide maximum performance, stability, and reliability. Fully experienced, top engineering talent backed by complete environmental testing and life testing facilities assure the highest standard in the industry. Full analysis and evaluation of materials are conducted in UTC's Material and Chemical Laboratories. Rigid quality control measures coordinated with exhaustive statistical findings and latest production procedures results in the industry's highest degree of reliability.

**MILITARY AND COMMERCIAL TYPES FOR
EVERY PHASE OF THE ELECTRONICS ART**

POWER TRANSFORMERS • AUDIO TRANSFORMERS • INDUCTORS • PULSE TRANSFORMERS • ELECTRIC WAVE FILTERS • LUMPED CONSTANT DELAY LINES • HIGH Q COILS • MAGNETIC AMPLIFIERS • SATURABLE REACTORS • REFERENCE UNITS

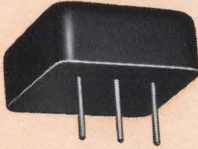

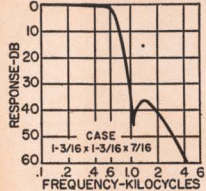

RESPONSE-DB
FREQUENCY-KILOCYCLES

560 ~ Telemetering low pass filter. Available from 400 ~ to 70 KC. $\pm 7.5\%$ bandwidth flat to 1 db. Attenuation greater than 35 db beyond the 2nd harmonic of $\pm 7.5\%$ frequency. Impedance 47K ohms. MIL-F-18327B. Wt. 0.8 oz.

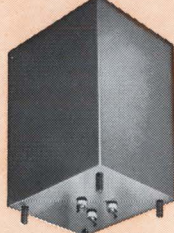

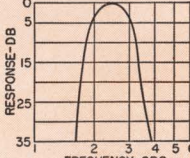

RESPONSE-DB
FREQUENCY-CPS

Low frequency band pass filter. Designed for 2.5 cps center frequency. At 2 to 3 cps within 3 db. At 1.5 cps and lower, and 4 cps and higher, greater than 30 db. Source and Load 10K ohms. Size: 4 x 4-11/16 x 6". MA MIL case, MIL-F-18327B.

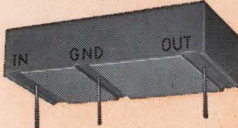

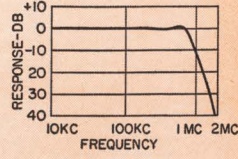

RESPONSE-DB
FREQUENCY

High frequency low pass filter. Zero to 700 KC within 1 db. 1.95 mc to 10 mc 40 db minimum. Source and Load 1000 ohms. Molded flat construction for printed circuit applications. Size: 1 x 2 x 1/2"; Wt: 1 oz. MIL-F-18327B.



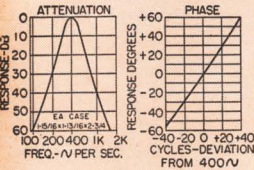

ATTENUATION
PHASE
RESPONSE-DB
RESPONSE DEGREES
CYCLES-DEVIATION FROM 400/V

Band pass 400 cycle Gaussian filter. Linear phase response in pass band. Attenuation 380 cps to 420 cps within 0.5 db. 2nd harmonic down 25 db, 3rd harmonic down 45 db. Source and load 5K ohms. MIL-F-18327B Wt., 0.9 lbs.

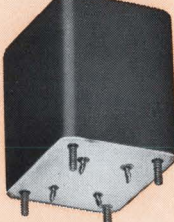

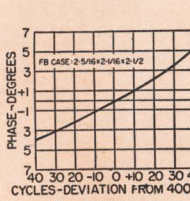

PHASE-DEGREES
CYCLES-DEVIATION FROM 400/V

Minimum phase shift 400 cycle band pass filter. Within ± 1.5 db 370 to 430 cycles, greater than 45 db beyond 1100 cycles. 1K ohms to 100K ohms. MIL-F-18327B; 1 lb.



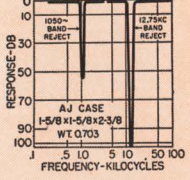

RESPONSE-DB
FREQUENCY-KILOCYCLES

Band reject filters (two shown). The 1050 ~ filter has 50 db attenuation and is only 3 db at 950 and 1150 cycles. The 12.75 KC filter has more than 100 db attenuation and is only 3 db at 10.8 and 15 KC. Source and load 600 ohms, both are MIL-F-18327B.

Write for catalog of over
1,300 UTC HIGH RELIABILITY
STOCK ITEMS
IMMEDIATELY AVAILABLE
from your local distributor.



UNITED TRANSFORMER CORP.

150 VARICK STREET, NEW YORK 13, N. Y.

PACIFIC MFG. DIVISION: 3630 EASTHAM DRIVE, CULVER CITY, CALIF.
EXPORT DIVISION: 13 EAST 40th STREET, NEW YORK 16, N. Y. CABLE: "ARLAB"

Electronics

December 13, 1965
Volume 38, Number 25

Page 4	Readers Comment
8	People
14	Meetings
16	Meeting Preview
23	Editorial
25	Electronics Newsletter
51	Washington Newsletter
114	Reprints
157	New Products
223	New Books
226	Technical Abstracts
235	New Literature

Electronics Review

Page	33	Bootstrap calibration	36	Squeegee-printed transistors
	34	Four in space		
	34	War hero—the helicopter	38	Telltale hearts
	35	Project Hindsight	38	In the driver's seat
	35	Birds eye viewed	40	Ultraviolet steel gauge
			42	Printing in patches
			43	The radar gap

Probing the News

125	France joins the space age club
128	Hong Kong adds quality to its bargain line
134	Cleanliness is next . . . to Mars
142	Money available—with technical advice

Electronics Abroad

237	Micron transistors	239	Printer catching up
238	Fallen Starfighters	240	Eyes west
238	Computer push	240	No Nadge verdict
238	Electronic quiz	241	Around the world
238	Stop and go		

Technical Articles

Integrated circuits	70	Off-the-shelf IC's in timer Diode transistor logic in timer for space applications saved time and money Alvin A. Lampell, Airborne Instruments Laboratory
Circuit design	74	Designer's casebook <ul style="list-style-type: none">● Modified decade counter eliminates components● Tunnel diode sensor protects regulator from short circuit● Isolating transistor improves one-shot
Special report	77	Japanese technology The new push for technical leadership No longer content with following U.S. technology, the Japanese are stressing research
	81	When you're second, you try harder Japan's semiconductor industry offers new components and ways to use them
	90	Japan seeks its own route to improved IC techniques Building on U.S. technology, the Japanese have digital circuits, now are pushing linear ones
	99	Bidding for world leadership in solid state microwave gear Japan has the densest network in the world
	106	After a lull, numerical control is in demand Sales are double this year, as the Japanese concentrate on application work rather than design
	110	Manual process control makes way for computers Japanese are accepting computers for direct digital control and integrated hierarchies

Title R registered
U.S. Patent Office;
© copyright 1965
by McGraw-Hill, Inc.
All rights reserved,
including the right to
reproduce the contents
of this publication,
in whole or in part.

Electronics

Editor: Lewis H. Young

Senior editors

Technical: Samuel Weber
News: Kemp Anderson Jr.

Senior associate editors: John F. Mason, George Sideris

Department editors

Advanced technology: Joan Blum
Avionics: W.J. Evanzia
Circuit design: Michael Elia
Computers: Wallace B. Riley
Consumer electronics: Richard Lipkin
Electronics review: Stanley Zarowin
Instrumentation: Carl Moskowitz
Manufacturing: George Sideris
Military electronics: John F. Mason
New products: William P. O'Brien
Solid state: Jerome Eimbinder
Space electronics: Peter R. Sigmund
Special projects: Richard M. Machol

Regional editors

Boston: Thomas Maguire, editor; Robin Carlson
Los Angeles: William B. Wallace, Walter Barney, editors; June Ranil
San Francisco: Laurence D. Shergalis, Edmond G. Addeo, editors; Mary Jo Jadin

Copy editors

Howard Rausch, Sally Powell

Graphic design

Art director: Saul Sussman
Assistant art director: Donna M. Griffiths
Editorial production: Ann Mella
Production editor: Arthur C. Miller

Editorial secretaries: Claire Benell, Mary D'Angelo, Lynn Emery, Lorraine Fabry, Kay Fontana, Lorraine Longo, Carolyn Michnowicz

McGraw-Hill News Service

Director: John Wilhelm; **Atlanta:** Fran Ridgway; **Chicago:** Bruce Cross, Louis S. Gomolak; **Cleveland:** Arthur Zimmerman; **Dallas:** Marvin Reid; **Detroit:** N. Hunter; **Los Angeles:** Michael Murphy, Ron Lovell; **San Francisco:** Margaret Ralston; **Seattle:** Ray Bloomberg; **Washington:** Arthur L. Moore, Charles Gardner, Herbert W. Cheshire, Seth Payne, Warren Burkett, Warren Kornberg

McGraw-Hill World News Service

Bonn: John Johnsrud, John Gosch; **Brussels:** Arthur Erikson; **London:** John Shinn; **Mexico City:** Wesley Perry; **Milan:** Bruce Bendow; **Moscow:** Donald Winston; **Paris:** Dan Smith; **Rio de Janeiro:** Leslie Warren; **Tokyo:** Marvin Petal, Charles Cohen

Circulation manager: Hugh J. Quinn

Reprints: T.M. Egan

Publisher: C.C. Randolph

Electronics: December 13, 1965, Vol. 38, No. 25

Printed at 99 North Broadway, Albany, N.Y.
Second class postage paid at Albany, N.Y.

Subscriptions are solicited only from those actively engaged in the field of the publication. Position and company connection must be indicated on orders. Subscription prices: United States and Possessions and Canada, \$6.00 one year, \$9.00 two years, \$12.00 three years. All other countries \$20.00 one year. Single copies, United States and Possessions and Canada 75¢. Single copies all other countries \$1.50.

Published every other Monday by McGraw-Hill Inc. 330 West 42nd Street, New York, N.Y. 10036. Founder: James H. McGraw, 1860-1948.

Subscribers: The Publisher, upon written request to our New York office from any subscriber, agrees to refund that part of the subscription price applying to copies not yet mailed. Please send change of address notices, subscription orders or complaints to Fulfillment Manager, Electronics, at the address below. Change of address notices should provide old as well as new address, including postal zone number if any. If possible, attach address label from recent issue. Allow one month for change to become effective.

Postmaster: Please send Form 3579 to Fulfillment Manager, Electronics, P.O. Box 430, Hightstown New Jersey 08520

Readers Comment

Cathodic patent question

To the Editor:

I read with interest the article on "Regulating bias on a ship's hull" [Aug. 9, p. 84], and would like to call to your attention two U. S. A. patents, numbers 2,021,519 and 2,221,897, issued in 1935 and 1940 respectively, which cover substantially the same system described.

This development, which was conducted in part with a U. S. Navy contract, was applied to both naval vessels and lighter-than-air craft.

The patents were licensed to the American Telephone & Telegraph Co., and the system is used for the protection of buried cables and pipe lines.

I agree, with the authors of your article, that this approach should be a rewarding one for the protection of metallic components operating in the sea or other corrosive environment.

H. S. Polin

Director
Laboratoire de Recherches
Physiques,
Geneva, Switzerland

The author replies:

Polin's patents are representative of a number issued over the last 50 years embracing the concept of impressed current cathodic protection, incorporating various manifestations of feedback principle to obtain potential control.

The attainment of a maintenance-free system of high-current output with high-loop gain has been far more recent, and is partly a result of the availability of reliable and efficient magnetic amplifiers and silicon controlled rectifiers.

A problem in the past has been the short life or high cost of anodes and an inherent unreliability in potential sensing devices due to polarization of the reference half-cell. The current Lockheed cathodic protection systems have features which overcome these problems. A patented lead-platinum bielectrode is used as the anode for ship systems. It possesses a very high current capacity, low driving voltage, very long life, an ability to repair

Did you know Sprague makes...?

SILICONTROL® SCR GATE DRIVES

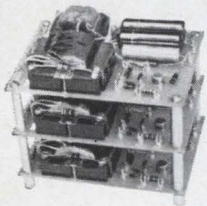

For balanced SCR firing in 3-phase a-c or d-c power control. Pulse rise time of 1 to 3 microseconds to meet requirements of high-current-rated SCRs.

ASK FOR BULLETIN 85,520A

Circle 277 on reader service card

VOLTAGE-SENSITIVE SWITCHES

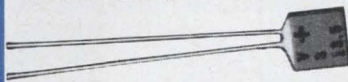

Unique semiconductor device which remains in the "open" state until a specified actuating voltage is reached. When "breakdown" voltage is applied, switch closes almost instantaneously, providing a low-impedance conductive path between terminals. Breakdown voltages from 7 to 200 V.

ASK FOR BULLETIN 93,000

Circle 278 on reader service card

TRIGGER TRANSFORMERS FOR SCR CIRCUITS



A better, less-expensive way to trigger SCRs. Will accommodate large SCR gate impedance differences. 3-winding or 2-winding designs for full-wave or half-wave applications.

ASK FOR BULLETIN 40,225.2

Circle 276 on reader service card

MAGNETIC LOGIC DEVICES

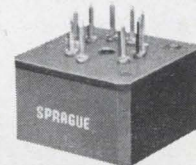

Core-diode and core transistor magnetic shift registers and magnetic counters for switching and storage applications in computer, logic, and similar circuitry.

ASK FOR BULLETIN SERIES 42,000

Circle 279 on reader service card

INDISTOR® R-L DELAY NETWORKS



Save space by replacing separate inductors and resistors. Guaranteed L/R ratio. Available in fully molded or epoxy-dipped cases.

ASK FOR BULLETIN
SERIES 45,000

Circle 280 on reader service card

DYNACOR® BOBBIN CORES

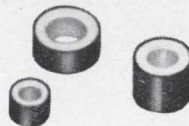

Logical flux values in popular physical sizes are stocked in production quantities for fast delivery. Value engineered for quality with economy.

ASK FOR BULLETIN SERIES 50,000

Circle 281 on reader service card

DYNACOR® TAPE CORES



Square loop tape cores manufactured with high permeability alloys, designed for use in critical non-linear magnetic components. Applications in magnetic amplifiers, saturable reactors, d-c to d-c and d-c to a-c converters and specialty transformers.

ASK FOR BULLETIN SERIES 51,000

Circle 282 on reader service card

MOLDED-CASE PULSE TRANSFORMERS

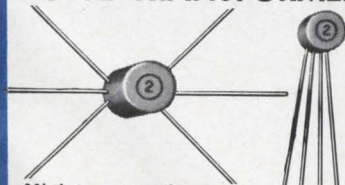

Miniature transformers in nanosecond, medium, and high-inductance designs. Tough molded cases for increased protection against physical damage and severe atmospheric conditions.

ASK FOR BULLETIN 40,225A

Circle 283 on reader service card

MOLDED-CASE SHIELDED R-F INDUCTORS

Fully shielded, ultra-tiny, yet performance is comparable to that of larger units. Inductance values from 0.1 to 12,000 uH. Molded for positive protection against humidity and handling. Meet requirements of MIL-C-15305.

ASK FOR BULLETIN SERIES
41,800

Circle 284 on reader service card

For complete technical data on any of these products, write for applicable Engineering Bulletin(s) to Technical Literature Service, Sprague Electric Company, 35 Marshall Street, North Adams, Massachusetts 01248.

455C-4100

SPRAGUE®
THE MARK OF RELIABILITY

Sprague and *®* are registered trademarks of the Sprague Electric Co.

Automatic Frequency-Response Recording System



For fast response studies of filters, networks, amplifiers, transducers, and other devices operating in the audio range

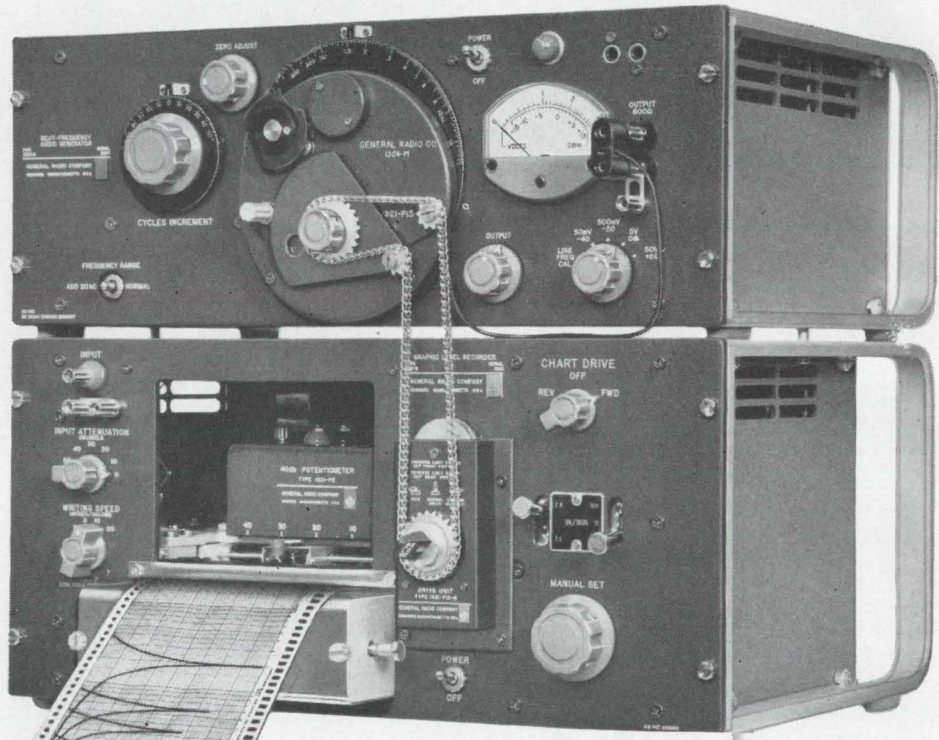

Type 1350-A
Generator-Recorder Assembly,
complete, \$2055 in U.S.A.

**Easy to Use . . . Accurate . . .
Provides a Permanent Chart Record**

Here is an all-solid-state, servo-type recorder that plots the rms value of ac voltage logarithmically on a linear dB scale. It is coupled mechanically to a beat-frequency audio generator whose frequency characteristic over the audio range is flat within ± 0.25 dB. To use this automatic recording system, connect the output of the generator to the device you are testing and apply the device's output to the recorder . . . Flick a switch and set the system into motion; the recorder and generator operating in synchronism provide you with a response curve of the device under test in a few seconds.

Call us for a trial demonstration and see for yourself what this recording system can do for you.

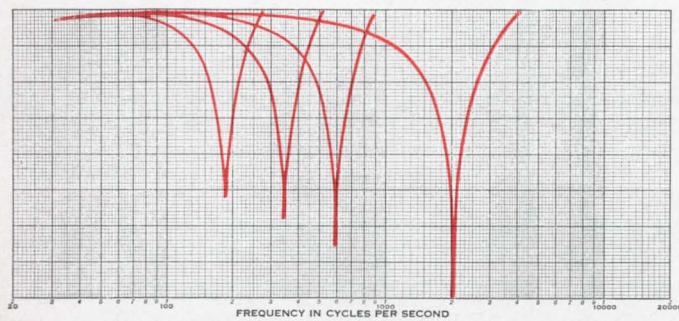

Recording of transmission characteristics of an adjustable notch filter for four different frequency settings. This plot is a permanent ink recording on 4-inch-wide chart paper. Dynamic recording range is 40 dB (20- and 80-dB dynamic ranges also available). Recorder chart speed and pen writing speed can be set over ranges of 2.5 to 75 in/min and 1 to 20 in/s, respectively.

IN CANADA: Toronto 247-2171, Montreal (Mt. Royal) 737-3673
IN EUROPE: Zurich, Switzerland - London, England



GENERAL RADIO COMPANY

WEST CONCORD, MASSACHUSETTS

BOSTON (W. Concord) 646-0550 NEW YORK, N. Y., 964-2722 (Ridgefield, N. J.) 943-3140 CHICAGO (Oak Park) 848-9400 PHILADELPHIA (Ft. Washington) 646-8030 WASHINGTON, D.C. (Rockville, Md.) 946-1600 SYRACUSE 454-9323 DALLAS ME 7-2240 SAN FRANCISCO (Los Altos) 948-8233 LOS ANGELES. 469-6201 ORLANDO, FLA. 425-4671 CLEVELAND 886-0150

itself if damaged, and is relatively inexpensive. Additionally, the problem of unreliable reference electrodes has been solved by using a patented rejuvenation circuit which maintains laboratory accuracy of the silver-silver chloride half-cell.

E. L. Littauer
O. G. O'Brien

Lockheed Aircraft Service Co.
Ontario, Calif.

Facing reality

To the Editor:

When are the integrated circuit promoters going to face reality? Vasil Uzunoglu's discussion [Nov. 15, p. 114] of inductorless integrated circuitry ignores a basic fact: virtually all requirements for frequency-sensitive circuits are dictated by the specific frequency. A tuning mechanism is required to bring the circuit into alignment, yet the vast microcircuit industry has not come up with such a technique. Instead, it insists that the circuit user must learn to live with the glittering junk the industry attempts to pass off as a useful linear circuit.

And it will have to come up with more than that voltage-sensitive capacitor that was so highly touted in those early days before someone got around to asking where the alignment voltage was to come from.

Yet, there is a type of component that might eventually be developed if the solid state people will lift their collective heads out of the Boolean sandbox long enough to look around them. They just might develop some sort of adaptive memory element such as the learning machine people have been searching for without marked success. Such an element could be in-

corporated as the alignment control in inductorless microcircuits and simultaneously find a large market with the adaptive machines people.

But until such components can be developed in a form compatible with integrated technology, stop cluttering up your magazine with "solutions" to the inductor problem.

A. J. Cote Jr.

Silver Spring, Md.

The author replies:

As its title implies, the object of the article was to make a review and analysis of the six possible methods to achieve bandpass characteristics without an inductance. The tuning of a stage to a required frequency was not the subject and for fixed tuned stages, such as intermediate-frequency, the alignment within limits can be incorporated on a microelectronic block.

Also, the article points out clearly the difficulties associated with the methods in every case. For example, the notch filter feedback method suffers from instability, the digital filterings from complexity and fabrication difficulties, etc. No claim was made that in these methods lies the final solution to realize bandpass characteristics on microelectronic blocks. An awareness of the difficulties with the present techniques can open new horizons and lead to new investigations.

As a matter of fact, I am pleased to learn that the use of adaptive memory elements may be a solution to the problem of tuning inductorless circuits.

Vasil Uzunoglu

Scientist
Arinc Research Corp.
Annapolis, Md.

New from Sprague!

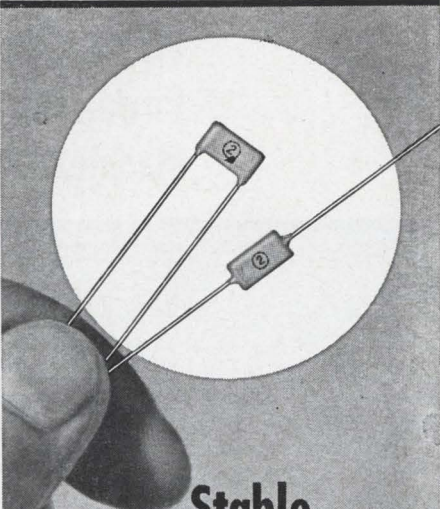

**Stable
Ceramic Capacitors
for Stable Circuits
All the Way
from -55 C to +125 C**

 Sprague's new temperature stable Formulation 067 Monolythic® Capacitors are guaranteed not to deviate from room temperature capacitance by more than +10, -15% over the wide temperature range from -55 C to +125 C.

 Layer-built construction produces reliable units with high capacitance values in small physical size. Alternately sprayed layers of ceramic dielectric and metallic electrodes are fired as a single piece into one homogeneous block. A 0.56 μ F capacitor is only .500" x .500" x .235" thin!

 Absence of anti-resonant points up to 1000 mc makes Monolythic Capacitors uniquely suited for d-c to high-frequency applications.

 Voltage rating, 100V @ 85 C or 50V @ 125 C. Available in axial-lead as well as radial-lead configurations.

For complete technical data, write for Engineering Bulletin 6205 to the Technical Literature Service, Sprague Electric Co., 35 Marshall St., North Adams, Mass. 01248.

45C 5138

SPRAGUE
THE MARK OF RELIABILITY

*Sprague' and '®' are registered trademarks of the Sprague Electric Co.

SUBSCRIPTION SERVICE

Please include an Electronics Magazine address label to insure prompt service whenever you write us about your subscription.

Mail to: Fulfillment Manager
Electronics
P.O. Box 430
Hightstown, N.J. 08520

To subscribe mail this form with your payment and check new subscription renew my present subscription

Subscription rates: in the U.S.: 1 year, \$6; two years, \$9; three years, \$12. Subscription rates for foreign countries available on request

CHANGE OF ADDRESS

ATTACH
LABEL
HERE

If you are moving, please let us know five weeks before changing your address. Place magazine address label here, print your new address below.

name _____

address _____

city _____

state _____

zip code _____

World's Highest Power Tetrode— Machlett's ML-8545



The Machlett ML-8545 general-purpose, vapor-cooled tetrode delivers 16% more power with 25% less plate voltage (plate modulation service) than the closest competitive tube. It is capable of 300 kW continuous output as a Class C amplifier or oscillator at frequencies to 50 Mc. Maximum plate input is 420 kW. Applications include: High-power broadcast and communications; all-purpose rf generation; particle acceleration. For details on the ML-8545 and the ML-8546 water-cooled version, write: The Machlett Laboratories, Inc., Springdale, Conn. 06879. An affiliate of Raytheon Company.

MACHLETT

ELECTRON TUBE SPECIALIST

People

"Marketing industrial electronic products requires an entirely new set of techniques," says **Daniel M. Zinn**, Gulton Industries, Inc.'s new assistant to the vice president.

"The industrial user operates under different rules than does the military," says Zinn. "For example, industrial users buy right to the specification, with no exceptions. And, perhaps most importantly, they must be shown that technological advances do pay off with results. They are more reluctant at present to accept technological advancement than is the government."

Gulton has started to reorganize its resources to increase its share of the industrial electronics market. Its instrumentation group has been almost entirely relocated in Hawthorne, Calif.

In his new position, Zinn will coordinate the technologies of the corporation's nationwide divisions and subsidiaries. He is on an extended tour of Gulton's facilities to acquaint himself both with the company's products and personnel.



"Those who follow are always behind." These words, expressing **Robert H. Rediker's** philosophy, are on a printed motto he will take to his new job as professor of electrical engineering at the Massachusetts Institute of Technology.

Rediker, a leader in the field of solid state physics, headed a team at MIT's Lincoln Laboratory that obtained coherent light emission from gallium arsenide in 1963. That work coincided with similar developments by teams from the General Electric Co. and the International Business Machines Corp. The work of the three groups initiated the



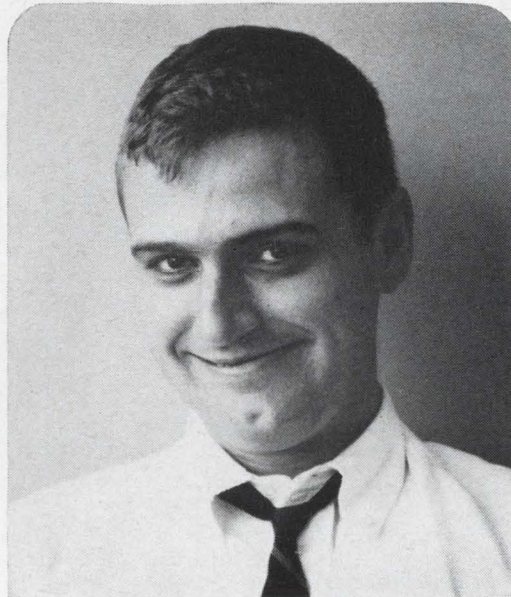

There's Ed Maloney

inside every Bendix rectifier.

In today's semiconductor business, who still talks about the personal touch? Ed Maloney does . . . Sure he's got high-reliability rectifiers . . . and yes, he meets military specifications . . . and of course, he provides fast delivery on 300 different part numbers.

But . . . Ed says there's a lot more to it than that. As Manager of Silicon Rectifier Production, he firmly believes that personal integrity must be built

inside every Bendix rectifier.

He watches 100% high temperature testing like a hawk; he's right on top of the smooth flowing process; he's checking into things from the crystal stage all the way to shipping.

You can't afford not to have a guy like this on your side. Place Bendix rectifiers in your equipment! You'll feel better with them inside.

TYPES MEETING MIL SPEC	AT 150°C	
	I _o AMPS	PRV VOLTS
USN1N124A,26A,28A	1	200-600
USAF1N1199-1206	12	50-600
JAN1N1202,R,04,R,06,R	12	200-600
JAN1N1614,R-16,R	5	240-720
JAN1N4458,R,59,R	5	960, 1200



Bendix Semiconductor Division
HOLMDEL, NEW JERSEY



Baltimore (Towson), Md.—(301) 828-6877; **Chicago**—(312) 637-6929; **Dallas**—(214) 357-1972; **Detroit**—(313) JO 6-1420; **Holmdel, N. J.**—(201) 747-5400; **Los Angeles**—(213) 776-4100; **Miami Springs, Fla.**—(305) 887-5521; **Minneapolis**—(612) 926-4633; **Redwood City, Calif.**—James S. Heaton Co., (415) 369-4671; **Seattle**—Ray Johnston Co., Inc., (206) LA 4-5170; **Syracuse, N. Y.**—(315) 474-7531; **Waltham, Mass.**—(617) 899-0770; **Export**—(212) 973-2121, Cable: "Bendixint," 605 Third Ave. N. Y.; **Ottawa, Ont.**—Computing Devices of Canada, P.O. Box 508—(613) TA 8-2711.

Now you can

Digitize

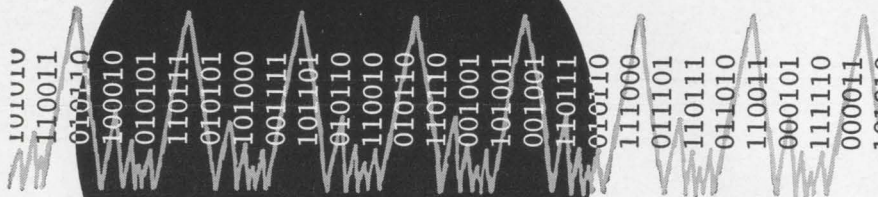

at a 10mc
Rate

with the

VIDEOVERTER[®]

**10 million 6 bit words
per second**



This all solid state "Video" Speed Analog to Digital Converter provides a new generation of ultra high speed measurements at 0.5% accuracy. Parallel output words are obtained at 100 nanosecond intervals. Here is a proven design that uses a delay line digitizing technique and "recognizes" high frequency pulses.

Epsco Analog to Digital Converter capability covers the entire spectrum of accuracy and speed.

Standard Units include:

Model TWV-744 — Six Bit Videoverter operates at 10 Mc.

Model TWV-745 — Seven Bit Videoverter operates at 5 Mc.

Model MSA-8 — Eight Bit 1 Mc Analog to Digital Converter.

Model AS-2 — Ten Bit integrated circuit Analog to Digital Converter operates at 50 Kc.

DATRAC II — Ten to fourteen Bit Analog to Digital Converter operates at 25 Kc.

Compatible Digital to Analog Converters are available for all Models.
Special Units are also available.



Write for
Technical Literature.

411 Providence Highway, Westwood, Mass. 02090 Tel. (617) 329-1500

technology of semiconductor lasers.

Since then, Lincoln's applied physics group, headed by Rediker, has been one of the most persistent in extending the semiconductor laser technology. The group has achieved laser action in indium arsenide, indium-gallium arsenide and indium antimonide, and extended it to all three types of excitation: injection in pn junctions, electron-beam pumping and optical pumping.

Rediker has also made major contributions to the development of magnetically tuned semiconductor lasers, to the discovery of laser action in lead salts, pressure tuning of these lasers to coherent radiation far into the infrared, and to the development of optically excited and electron-beam excited bulk semiconductor lasers.

In addition to teaching duties, Rediker will supervise the research efforts of graduate students. He intends to continue his own work in semiconductor development.

He says, "I hope to be doing work in what is going to be important: tomorrow's research today, not today's research tomorrow."

The appointment of **Finn J. Larsen** once again places an electronics specialist in the post of deputy director of defense research and engineering.



Larsen, until recently a vice president of Honeywell, Inc., will have a more restricted role than his predecessor because of a recent reorganization of the department that centralizes electronics programs under Thomas Rogers as deputy director for electronic and information systems.

Larsen will have considerable responsibility for the over-all management of the \$7-billion annual military research and development effort. He will be second in command to the recently appointed director, John Foster.

At Honeywell, Larsen directed planning, sales and the advanced development of avionics, space, weapons and reconnaissance systems.

Get Trouble-Free Fuse Protection in Wet Locations with a . . .

Another
outstanding
development
by the makers
of BUSS Fuses

PICTURE
APPROXIMATELY
ACTUAL
SIZE

TRON

In-the-Line WATERPROOF FUSEHOLDER

FOR USE ON:

- Mobile Power Supply Units
- Military Field Applications
- Electronic Components at Missile Sites
- Surveillance Equipment
- Fire and Police Call Systems
- Marine Equipment
- Communications Equipment
- Street or Highway Lighting Standards
- Sub-surface Junction Boxes Supplying Lighting or Equipment Circuits
- Oil Field Equipment
- Yard Lights
- Portable Outdoor or Construction Equipment
- Mine Equipment or
- Any circuit operating in exposed locations.

Watertight construction; resistance to damage by weather, water, salt spray or corrosive fumes permit use of TRON fuseholders in exposed locations where safety and long life are of vital importance.

For Protection of Circuits of 600 Volts or Less

TRON Waterproof Fuseholders fill the need for a watertight holder that is easy to install to give fuse protection to circuits in exposed locations.

Crimp-Type Tubular Terminals Available in Many Sizes

The crimp-type tubular terminals on TRON fuseholders are available in sizes to take many sizes of solid or stranded wire.

If desired, Load-side terminals can take one size wire, while Line-side terminals take another size wire.

A crimpable insulating sleeve covers each terminal. This provides a good surface for taping after crimping. When properly taped the crimped terminal is completely insulated and waterproof.

CAN BE USED AS TAP-OFF CONNECTOR

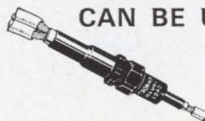

TRON Waterproof Fuseholders can also be used as Tap-Off connectors by having the Line-side terminal large enough to permit the two ends of the Line-wire to be crimped into it. This eliminates costly line connections and labor.

Two Models Available

Both rated at 30 amps. at 600 volts or less

The TRON HEB Fuseholder takes fuses 13/32 inch diameter by 1 1/2 inches long.

The TRON HEH Fuseholder takes fuses 13/32 inch by 1 3/8 inches long.

Write for BUSS Bulletin SFH-11

INSIST ON



BUSS QUALITY

BUSSMANN MFG. DIVISION, McGraw-Edison Co.
St. Louis, Mo. 63107

Fairchild invented Dual in-line packaging for manufacturers of commercial equipment. Dual in-line is a little larger than military-aerospace type packages. 

It is also a lot easier to work with. (Insert it by hand or by machine.) Its leads have

(Dual in-line actual size.)

  dimensional tolerances to fit holes drilled to commercial standards. Use standard circuit boards. Flow solder it. In fact, handle it the way you would any discrete component. 

Dual in-line 

saves you trouble in the field, too: it has an all-ceramic body to prevent accidental shorts. Leads can be probed from the top, where they are visible to the serviceman. And, should you ever



have to replace a circuit, a pair of pliers and a soldering iron are all the equipment you need. We have a complete line of logic functions available in Dual in-line. Your distributor has them in stock. Or, write for brochure.

FAIRCHILD
SEMICONDUCTOR

Obviously from Sprague!

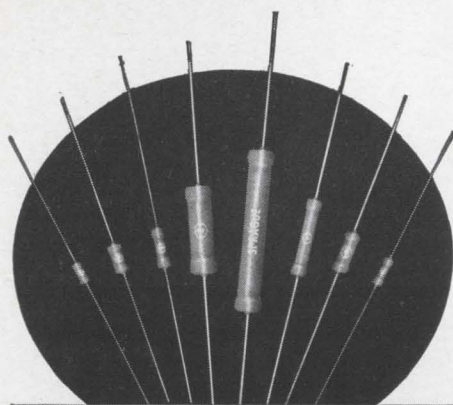

ACRASIL®

**... the precision/power
wirewound resistor
with more
PLUS features!**

Silicone Encapsulated—Seals resistance element. Provides exceptional protection against severe environmental conditions as well as physical damage.

Wide Application—Standard and non-inductive windings. Equally suited for printed wiring boards, custom packaging, and point-to-point wiring.

Close Resistance Tolerances—Standard tolerances to $\pm 0.05\%$.

Wide Range of Ratings— $\frac{1}{4}$ watt to 10 watts. Resistance values from $.05\Omega$ to $66K\Omega$.

Minified Sizes—Smaller than other conventional wirewound resistors.

Excellent Stability—Under extended load life and environmental operating parameters, Acrasil Resistors show exceptionally small change in resistance values.

Outstanding Reliability—Fully meet electrical performance requirements of MIL-R-26C, as well as individual customer high reliability specifications.

For complete technical data, write for Engineering Bulletin 7450 to Technical Literature Service, Sprague Electric Company, 35 Marshall St., North Adams, Mass.

SPRAGUE®
THE MARK OF RELIABILITY

*Sprague® and ® are registered trademarks of the Sprague Electric Co. 45 R-185-63

Meetings

American Association for the Advancement of Science, AAAS; University of California, Berkeley, Dec. 26-31.

International Symposium on Differential Equations and Theory of Systems, AFOSR, Brown University and the University of Puerto Rico; University of Puerto Rico, Dec. 27-30.

Astrodynamics Symposium, American Astronautical Society; University of California, Berkeley, Dec. 29.

Solid State Physics Conference, Institute of Physics and The Physical Society; Renold Building, Manchester, England, Jan. 4-7.

Sealab II Symposium, U.S. Navy; Statler Hilton Hotel, Washington, D. C., Jan. 11-12.

Conference on Electronics in Publishing, American University; International Inn, Washington, D.C., Jan. 17-20.

Instrumentation for Process Industries Conference, Texas A&M University; College Station, Tex., Jan. 19-21.

Conference on Symmetry Principles at High Energy, AFOSR, AEC, NASA; Univ. of Miami, Coral Gables, Florida, Jan. 20-22.

Phonon Interaction in Solids Conference, Princeton University; Princeton, N. J., Jan. 20-21.

Helicopter Conference, Helicopter Association of America; Inn of Six Flags, Arlington, Tex., Jan. 23-26.

Aerospace Sciences Conference, Statler-Hilton Hotel, New York, N. Y., Jan. 24-26.

AE-4 Electromagnetic Compatibility Conference, SAE; General Dynamics/Convair, San Diego, Calif., Jan. 25-26.

National Electronic Representatives Association Marketing Conference, ERA; Riviera Hotel, Palm Springs, Calif., Jan. 26-30.

American Society of Testing and Materials Spring Meeting, ASTM; Shoreham and Sheraton Park Hotels, Washington, D.C., Jan. 30-Feb. 4.

International Symposium on Information Theory, AFOSR, IEEE; University of California, Los Angeles, Jan. 31-Feb. 2.

Integrated Circuits Seminar, IEEE, Basic Sciences Committee; Stevens Institute of Technology, Hoboken, N.J., Feb. 2.

Winter Convention on Aerospace & Electronics Systems, IEEE; International Hotel, Los Angeles, Feb. 2-4.*

Solid State Circuits Conference, IEEE, University of Pennsylvania; Sheraton Hotel, Philadelphia, Feb. 9-11.

Radioisotope Applications in Aerospace, AFSC and Atomic Energy Commission; Sheraton-Dayton Hotel, Dayton, Ohio, Feb. 22-24.

Offshore Exploration Conference, OECON; Lafayette Hotel, Long Beach, Calif., Feb. 22-24.

Call for papers

Audio Engineering Society Convention, AES; Hollywood Roosevelt Hotel, Los Angeles, April 25-28. Jan. 28 is deadline for submission of abstracts on all aspects of audio engineering to John C. Baumann, Papers Chairman, Ampex Corp., 8467 Beverly Blvd., Los Angeles, 90048.

Symposium on Electron and Laser Beam Technology, IEEE, University of Michigan; University of Michigan, Ann Arbor, Apr. 6-8. Jan. 15 is deadline for submission of 50- and 500-word abstracts on the physics of electron, ion, and light beams, and the application of energy beams to micro-miniaturization and thin films (integrated-circuit construction), to Dr. G. I. Haddad, Electrical Engineering Department, University of Michigan, Ann Arbor, Mich.

International Electronic Circuit Packaging Symposium, EDN; Sports Arena, Los Angeles, Aug. 23-24. Feb. 1 is deadline for submission of a two-page abstract on electronic system packaging, problems and materials to the Papers Committee, Seventh IECPS, Box 155, Englewood, Colo., 80110.

*** Meeting preview on page 16**

Here's how to cut the time and cost of data reduction

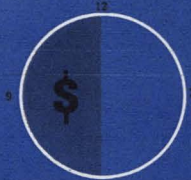

by 50 percent

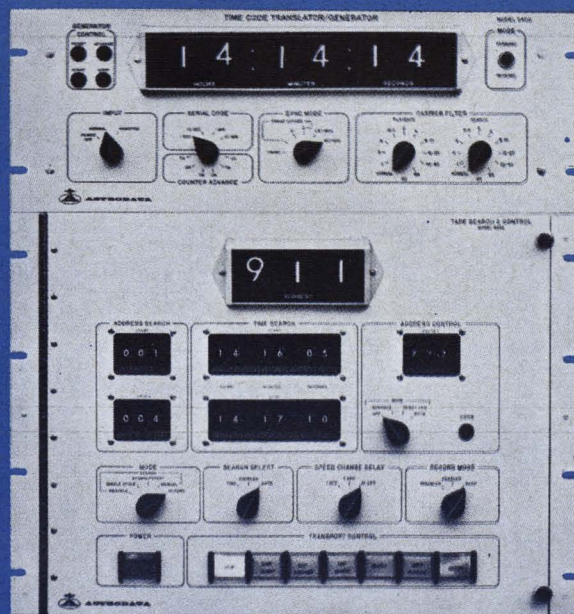

Faster set-up, more automatic control, immediate feedback of test results. Wherever data is gathered and searched on magnetic tape, the Model 5600 Tape Search System can provide these advantages. First, because it combines Time Code generation and translation of time/ID information into one compact, programmable unit.

MULTIPLE OPERATIONS

You have complete control over the RECORD, SEARCH, and PLAYBACK of magnetic tape transports. In RECORD, the unit provides both automatic and manual control; and generates serial time codes for mag tape transports and oscillographs. In SEARCH and PLAYBACK, the 5600 translates and uses previously recorded time/ID data as a reference in programming the tape transport. This means you can check back over your test results immediately, providing unusual flexibility in planning or re-designing experimentation, and rapid correlation of data.

MULTIPLE ECONOMIES

The Model 5600 allows numerous economies lacking in conventional tape search procedures, particularly in applications with numerous, repetitive data runs. In bio-medical applications, for example, separate generation and translation systems usually mean high equipment costs, laborious set-up, and delays in interpretation of up to one day or more.

IRIG "B" TIME CODE: Model 5600 generates and translates IRIG Format B time codes, modified to include BCD seconds, minutes and hours, and the 3-digit identification code.

SELECTABLE ASTRODATA "A" TIME CODES: Four speeds are available for output to oscillographs. Rates range from a time frame of 1 second to 10 min.

FOUR MODES OF SEARCH: Searching may be accomplished by RECYCLE, SINGLE CYCLE, SEARCH/STOP, MANUAL SEARCH. The search select may be set to TIME, ID ADDRESS, or combined TIME-ID ADDRESS.

WIDE ANGLE SUPER NIXIE DISPLAYS: Accumulated time-of-day or elapsed time in hours, minutes and seconds, along with ID data programmed into the time code, appears on the front panel with polarized filters for maximum visibility. Up to three remote displays can be connected.

CARRIER FILTERS: Ten band-pass filters are selectable from two front-panel rotary switches. One switch selects the proper filter for tape playback speed; the other selects the proper filter for search speeds. Extra switch positions permit by-passing a filter or inserting external filter via connector.

SYNCHRONIZATION MODE (ERROR BY-PASS): This enables operator selection of by-passing 0, 1, 2, 3, or consecutive time words decoded erroneously without reflecting these errors in the output register.

SINGLE-CYCLE NOISE REJECTION: Noise or dropout of a single cycle or less occurring on the input will not affect the decoding process.

For complete technical information, contact your nearest Astrodata representative or write direct on your company letterhead.



ASTRODATA

P. O. Box 3003 ■ 240 E. Palais Road, Anaheim, California ■ 92803

IEEE in Los Angeles

New developments in electronic technology will be discussed at the winter convention on Aerospace and Electronic Systems of the IEEE. In addition, government officials will also provide details on current programs and policies.

A concurrent symposium, sponsored by the Air Force Systems Command, will take place during the convention which will be held Feb. 2 to 4 in Los Angeles. For this symposium the sessions are classified; special clearances will be required. Tactical defense problems will be examined in sessions on tactical avionics and missiles, battle-field systems, and underseas warfare. The use of equipment and systems in Vietnam will be reviewed.

Computers. The man-computer interaction in the design process will be emphasized in the computer session. J. F. Reintjes and M. L. Dertouzos, both professors at the Massachusetts Institute of Technology will give a talk on computer-aided design of electronic circuits. The capabilities of present laser designs and the potential of parametric laser oscillators, optical pumping systems, continuous-wave ruby, and ion gas lasers will be examined in depth by, among others, speakers Robert Miller of Bell Telephone Labs and Dieter Roess of Siemens & Halske AG, Germany.

Communications will receive special attention in both classified and unclassified discussions. In a session on deep space communications, Willard Patton will outline some component problems in a microwave deep-space communications system. In the session on communication satellites, Lt. General Alfred Starbird, director of the Defense Communication Agency will discuss the military's communication satellite problem. Maj. General Robert Meyer of Stratcom and Col. Mitchell Goldenthal of Satcom will examine the Army's role in global communications.

The space program will also be discussed in sessions on the scientific exploration of the planets and the Apollo Saturn equipment.

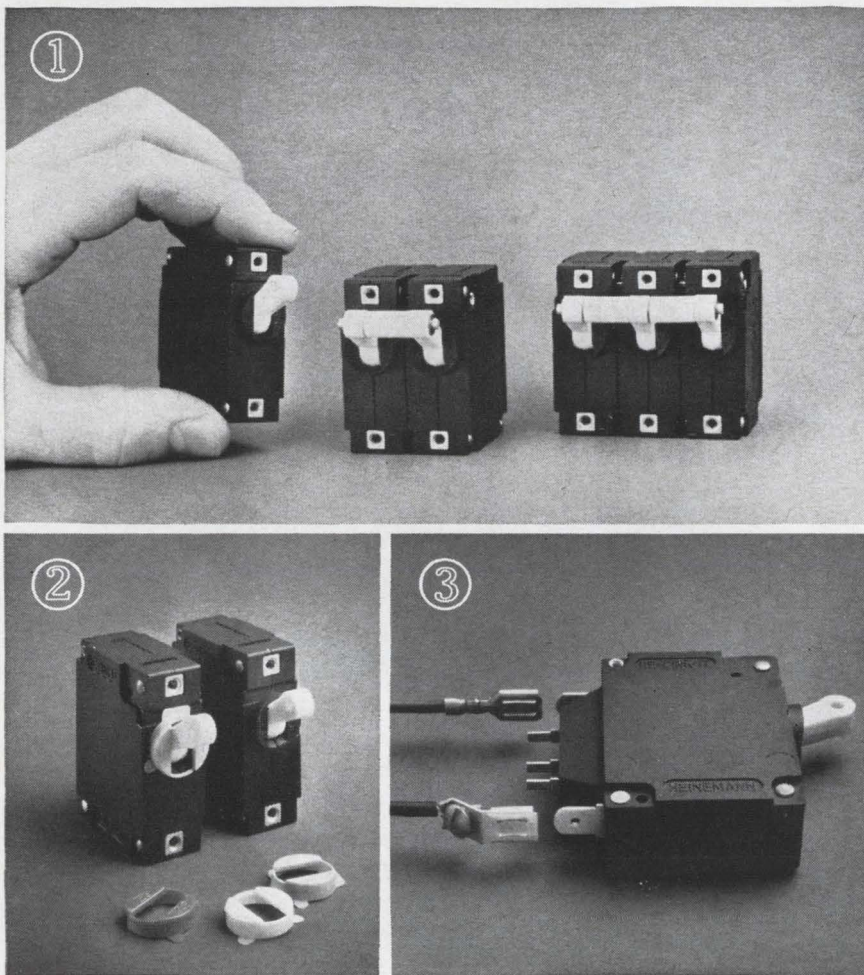

Three nice features and a surprise in Heinemann's new Series JA circuit breakers:

1. Natural shoulder packaging. The slim, Ivy League JA weighs in at just 2.5 ounces per pole, including hydraulic-magnetic actuating element, silver-alloy contacts and an uncommonly efficient arc-quenching device.
2. Pizazz—The JA is the first breaker with snap-on color-coding caps that you can mix or match for functional or decorative purposes. Also included: a very dressy white handle.
3. Convenience. The JA's 'universal' terminals are made to accept soldered, crimped-type, or screw-type connections; you can use whichever you're tooled for—or overstocked with.
4. Economy. This is the surprise. The JA actually costs less, model for model, than our Series AM12 breakers, which it can replace to your advantage. The JA is available in current ratings from 0.100 to 20 amps, at up to 250V AC or 50V DC. With a choice of time-delay or non-time-delay response. Special-function internal circuits, too. Bulletin 3350 will give you full technical data. Write, wire or shout for a copy.

Heinemann Electric Company

2600 Brunswick Pike, Trenton, N. J. 08602

Why Vector for MOL telemetry?

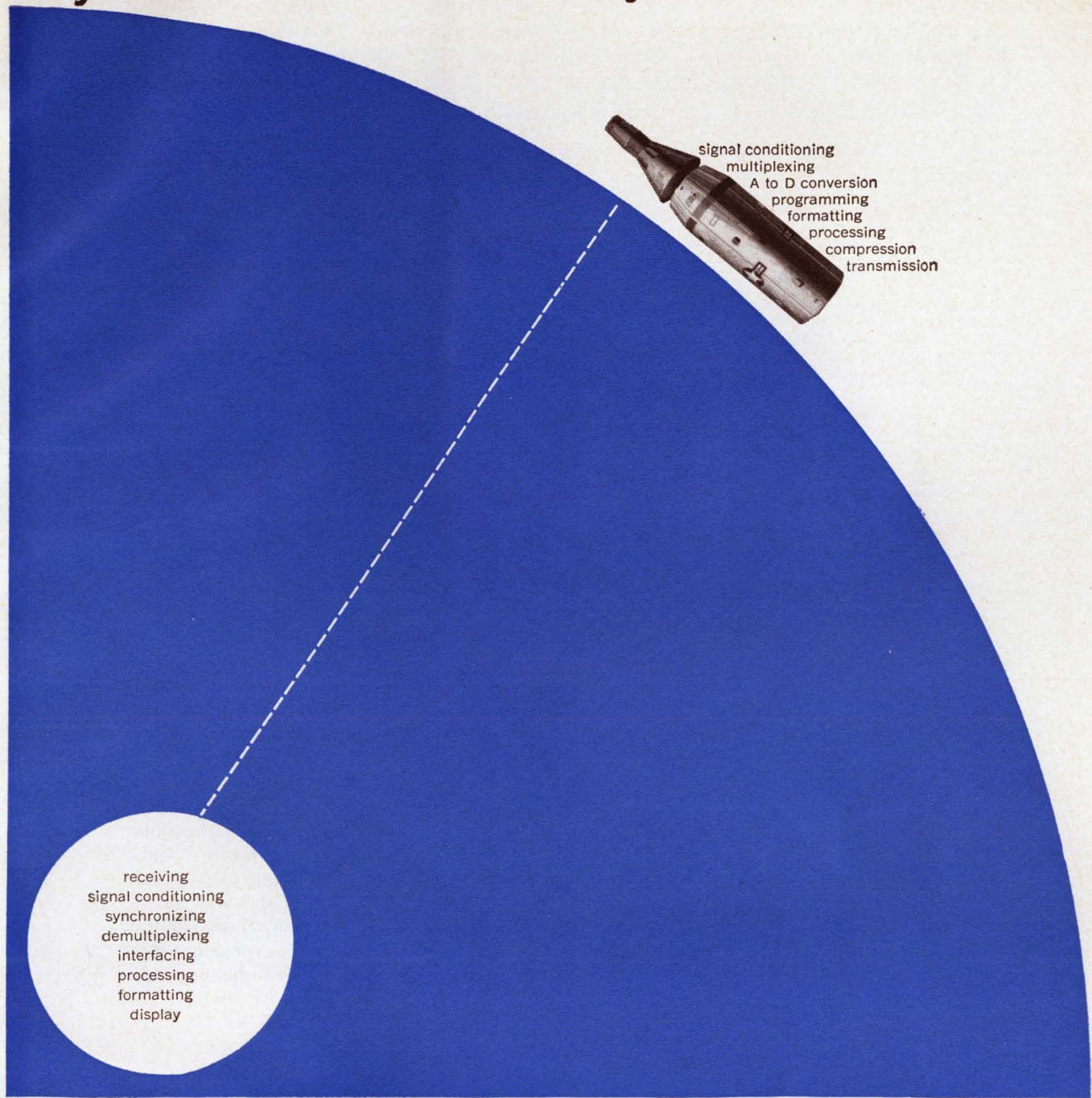

Proved competence in microtelemetry.

Vector pioneered in microtelemetry with the world's smallest production-model VCO — only .109 cubic inch, shock tested in excess of 20,000 G's.

Produced by the most advanced microelectronic circuit techniques, Vector components and systems have the high reliability characteristics which can come only from using *true* microcircuit design and production methods.

A family of multiplexers and A to D converters already exists. Vector

also has design experience in signal conditioners, processors, synchronizers and demultiplexers. From this firm base, Vector offers complete follow-through — from systems design to hardware production — with the highest possible reliability.

Vector telemetry components and systems are used on a wide variety of

space projects, including Saturn, Gemini, and Apollo.

Existing, proved micro-hardware... system design and follow-through capability... experience — good reasons why Vector is uniquely qualified to fill MOL requirements for airborne and ground-based data acquisition, handling and processing systems.

Vector DIVISION OF UNITED AIRCRAFT CORPORATION
SOUTHAMPTON, PENNSYLVANIA



EAGLE *Cycl-Flex*® TIMERS/COUNTERS

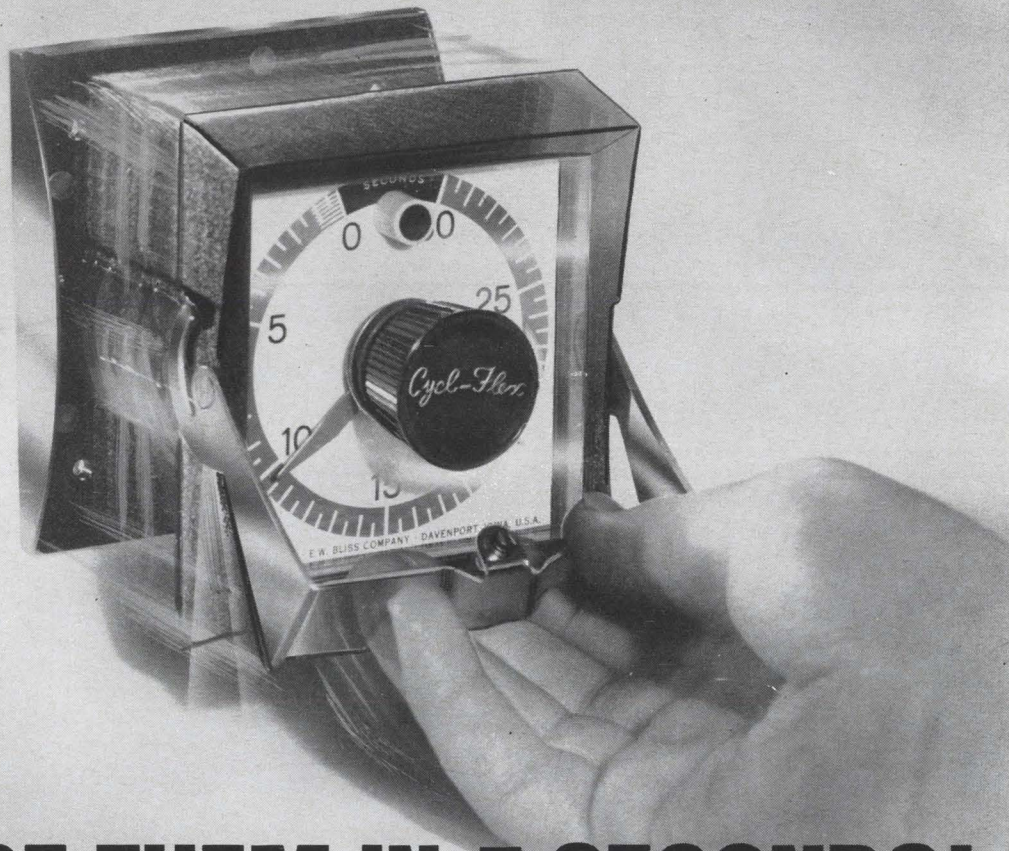

REPLACE THEM IN 5 SECONDS!

Cut down-time and increase production with Eagle Cycl-Flex time and count controls. You can remove them, check them and replace them in 5 seconds or less...no tools needed!

- Cycl-Flex plug-in timers can be controlled to within 0.5% of the dial range.
- Front-panel mounting makes them easy to install and set.
- Long cycling life—through extensive quality control and life testing programs.
- A synchronous motor and toothed clutch, produced by a special Eagle process, assure totally accurate settings and performance.

Add all these features together. Then add Eagle's special consultation, development and design services...and custom production of all types of units.

Compare. You'll choose Eagle.

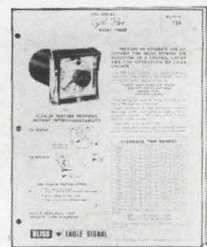
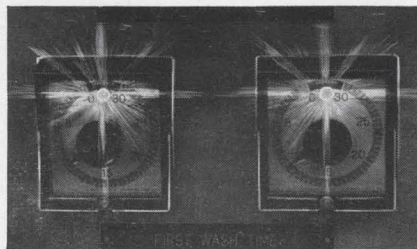

NEW—Now standard on all Cycl-Flex timers, a built-in pilot light, to indicate, even from a distance, that the timer is operating.

For full details on Cycl-Flex timers, write for Bulletin 125, Eagle Signal Division, E. W. Bliss Company, Federal Street, Davenport, Iowa.

BLISS  **EAGLE SIGNAL**
A DIVISION OF THE E. W. BLISS COMPANY

Electro-Mechanical, Electronic, Solid State Timing/Counting/Programming Controls General Purpose, Medium Power Relays

NEW EAGLE RELAYS

COMPARE
Better Life Characteristics

COMPARE
Higher Reliability

COMPARE
Fewer Parts

COMPARE
More Design Flexibility

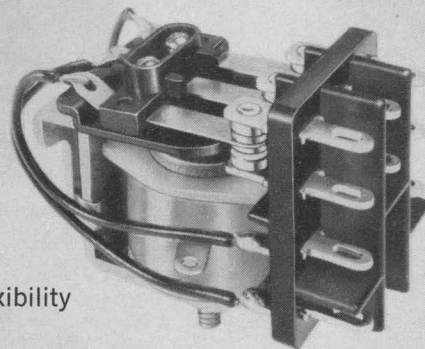

Eagle 25AA
General Purpose
Relay (Actual Size)

COMPARE
Lower Pull-in Voltages

COMPARE THEM!

New Eagle relays... more than 3,000 types... are the best you can get anywhere. Be crafty. Check the specs and the product. Convince yourself.

One example: Gold-plated contacts are *standard* on every general purpose Eagle relay. And on medium power relays, silver cadmium oxide contacts are standard, since they deliver the best possible current-bearing characteristics in this power range.

Check some more. Note the sturdy designs... the ratings that exceed all other competitively-priced units... the precise engineering and inventive use of materials. They're all what you'd expect from Eagle—leaders in time/count control devices.

If you've ever dealt with Eagle you'll expect more, and you'll get it. We're talking about unequalled service... service that frankly has never before been available from any relay manufacturer.

Compare. You'll choose Eagle.



Part of the "big" picture... more than 3,000 types: plug-in with dust covers; dual latching; hermetically sealed; custom-engineered styles.

Get full details in our new, 16-page color catalog. Send for your free copy to Eagle Signal Division, E. W. Bliss Company, Federal Street, Davenport, Iowa.

BLISS  **EAGLE SIGNAL**

A DIVISION OF THE E. W. BLISS COMPANY

Electro-Mechanical, Electronic, Solid State Timing/Counting/Programming Controls General Purpose, Medium Power Relays

FROM TRANSISTORS TO TRIGGERS...

NEW MOTOROLA TYPES TO FIT YOUR TOUGHEST DESIGN JOBS

all new... all oriented to your needs!
in this handy "applications brochure... yours for the



all described "unlimited" asking!

SILICON BILATERAL TRIGGER...MT-32 (32V±4V)

... For an economical, highly reliable device for use in Thyristor and other triggering circuits

- Symmetrical V-I characteristics
- High pulse-current — 2 Amps
- Packaged in miniature DO-7 "glass" hermetic encapsulation — $P_D = 150 \text{ mW}$

VOLT/AMP. CHARACTERISTICS

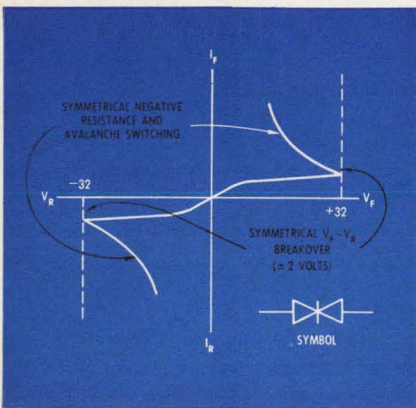

LOW-VOLTAGE, FAST SWITCHING, EPITAXIAL 4-LAYER DIODES

Series M4L3052, 53, 54

- Low breakover voltages: 8-12 volts
- Low junction capacitance: typically 35 pf @ 8-12 V_F
- Fast switching speeds: typically $t_{ON} = 50 \text{ nsec}$, $t_{OFF} = 100 \text{ nsec}$
- Packaged in DO-7 "glass" case ($P_D = 150 \text{ mW}$)

All this at new low prices!

TYPICAL CHARACTERISTICS

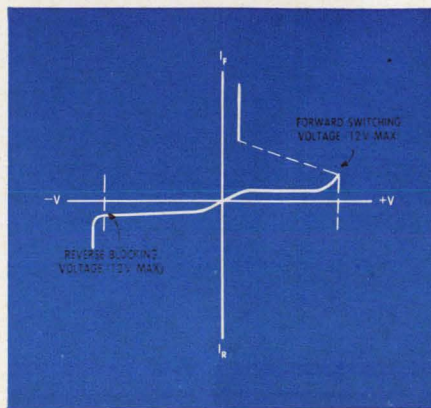

"NO COMPROMISE" LOW-COST PLASTIC SILICON TRANSISTORS

... with UNIBLOC* Performance and Reliability Features!

- NPN/PNP for complementary circuit design
- Complete "h" parameters specified
- Gain specified from 100 μA to 100 mA
- High voltage — 40 volts (min)

*Trademark of Motorola Inc.

PNP — 2N3905-6

NPN — 2N3903-4



CHOOSE FROM 3 NEW RTL INTEGRATED CIRCUIT LOGIC COMPLEMENT LINES

... to best fit your particular
performance/cost
requirements!

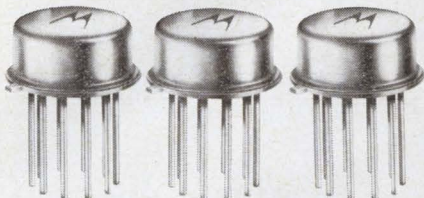

- Fan-out capability up to 5
- 12 nsec — typical propagation delay
- 15 mW/NODE Dissipation
- MC900G series — designed for MILITARY extreme environmental applications. Operating Temp. Range: -55°C to $+125^{\circ}\text{C}$
- MC800G series — for reliable operation in INDUSTRIAL logic applications. Operating Temp. Range: 0 to $+100^{\circ}\text{C}$
- MC700G series — value priced for broad INDUSTRIAL/COMMERCIAL applications. Operating Temp. Range: $+15^{\circ}\text{C}$ to $+55^{\circ}\text{C}$ — choice of 19 circuit functions.

✓ (New, comprehensive technical brochures are available describing the complete MC900G, MC800G, and MC700G series ... check coupon below for your copies.)

... for saturated switching

OPTIMIZED "FOUR-H" GEOMETRY — FOR MEMORY DRIVER DESIGNS TO 1½ AMPS!

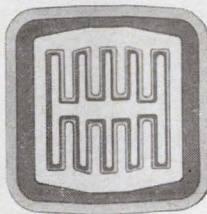

Optimized "Four-H"
Geometry

PNP 2N3762 Series



NPN
2N3734-37 Series

Featuring:

- High speeds — $f_T = 330$ mc (NPN), 220 mc (PNP)
- High current — to 1.5 A
- $C_{ob} = 7$ pf (NPN), 12 pf (PNP)
- h_{FE} — specified from 10 mA to 1.5 A
- Low $V_{CE(sat)} = 0.7$ V @ 1.0 A

... for non-saturated switching

1800 MC CURRENT-MODE SWITCHES NPN-2N3959 & 2N3960

CURRENT-GAIN — BANDWIDTH PRODUCT

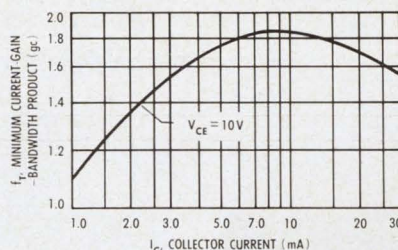

TYPICAL PERFORMANCE FOR THE 2N3960

Featuring:

- 1800 mc — frequency response
- Specified 12 volt (min) BV_{CEO}
- Low $C_{ob} = 2.5$ pf (max)
- Low $r'_b C_c = 20$ psec (typ) TO-18 Pkg.

12-AMP SILICON RECTIFIERS (50-1000V) MR1120-MR1130

... filling your needs for
high-performance,
medium-current rectification
at an economical price!

- 12 amps @ 150°C
- High surge-current @ elevated temperatures — 300 amps @ 150°C
- Low forward voltage drop — 0.55 V (average)
- Available in standard or reverse polarity

CURRENT VS. TEMPERATURE DERATING CURVE

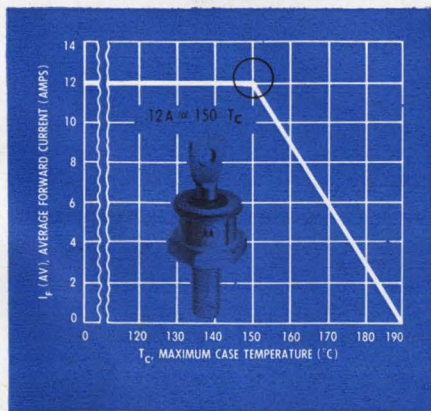

To receive your copy of *APPLICATIONS UNLIMITED* and the following design aids, just fill out coupon below and drop it in the mail to us.



MOTOROLA
Semiconductor
Products Inc.

5005 EAST McDOWELL ROAD, PHOENIX, ARIZONA 85008

Please print

NAME _____ TITLE _____

JOB FUNCTION _____

COMPANY _____ DEPT. NO. _____

ADDRESS _____ PHONE _____

CITY _____ STATE _____ ZIP _____

Send to:

MOTOROLA SEMICONDUCTOR PRODUCTS, INC.
BOX 955, PHOENIX, ARIZONA 85001

- RTL Integrated Circuit Brochures
 Zener Selection Guide
 Silicon Rectifier Selection Guide
 Silicon Annular Transistor Selection Guide
 Germanium Power Transistor Selection Guide

KEPCO PBX MODULES

REGULATED  DC SUPPLY

**6 BRAND NEW PROGRAMMABLE SUPPLIES
OFFER MORE PRECISE REGULATION
GREATER POWER AND HIGHER
OPERATING TEMPERATURES**

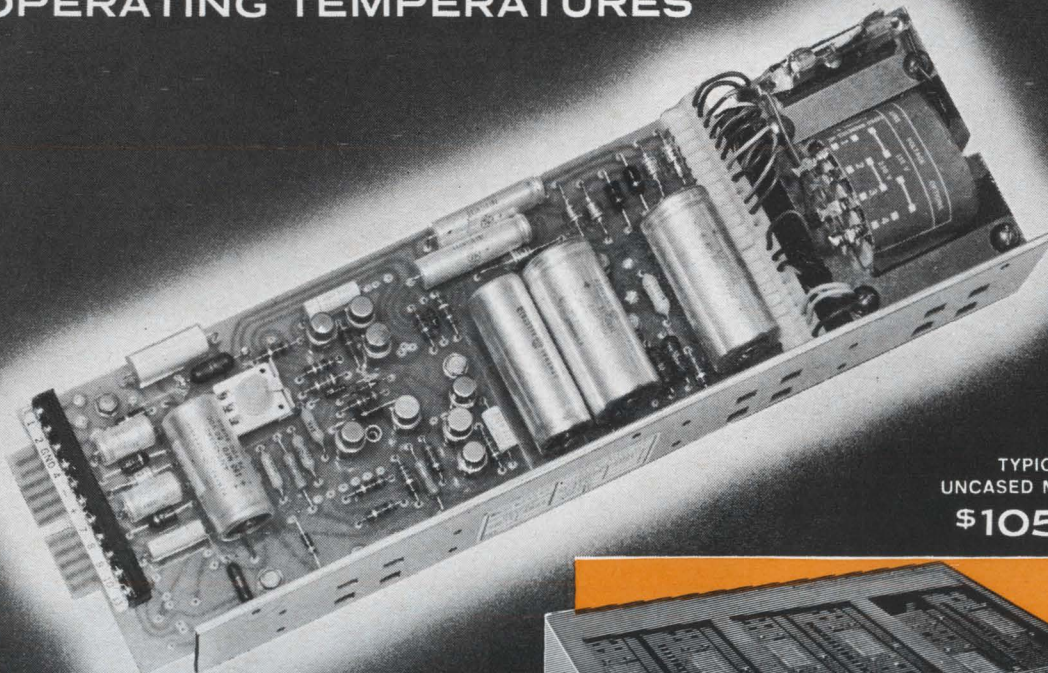

TYPICAL
UNCASED MODULE
\$105.00

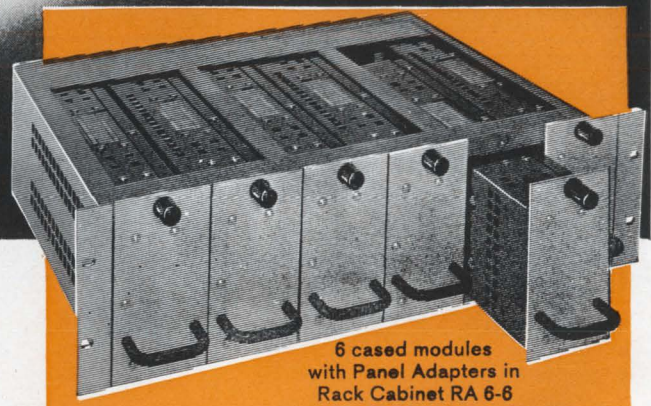

6 cased modules
with Panel Adapters in
Rack Cabinet RA 6-6

In introducing the all silicon PBX Group, Kepco has packed *more power and more features* into a low cost power supply module than ever before. Designed to complement the popular PAX Group, the new PBX modules share the same hardware, rack enclosures and mounting flexibility.

- **PACKAGE:** Identical to the popular PAX plug-in modules
- **POWER:** Twice the PAX rating
- **REGULATION and STABILITY:** 0.01%
- **RIPPLE:** Less than 0.1 mv rms
- **HIGH TEMPERATURES:** Up to 71°C
- **CURRENT LIMITING:** Now so sharp, it's practically automatic crossover current regulation
- **PROGRAMMING:** By resistance, voltage or current. High speed capability available.

0.01% REGULATION and STABILITY

MODEL	DC OUTPUT		RIPPLE (MAX) RMS MV	MAX. * INPUT AMPS
	VOLTS	AMPS		
PBX 7-2	0-7	0-2	0.1	0.6
PBX 15-1.5	0-15	0-1.5	0.1	0.7
PBX 21-1	0-21	0-1	0.1	0.5
PBX 40-0.5	0-40	0-0.5	0.1	0.5
PBX 72-0.3	0-72	0-0.3	0.1	0.5
PBX 100-0.2	0-100	0-0.2	0.1	0.5

*At 125V AC

See our complete Catalog in

eem Sec. 4000 **PAGES 791-826** **eBG**



For complete specifications write for PBX Brochure #146-1130

KEPCO, INC. • 131-38 SANFORD AVENUE • FLUSHING, N.Y. 11352 • (212) 461-7000 • TWX #212-539-6623 • Cable: KEPCOPOWER NEWYORK

Editorial

Westernizing Japan

Japanese developments in electronics are moving almost as fast as the trains on the new Tokaido line, the railroad the Japanese are so proud of because it is the world's fastest. They still lag behind the United States, as most Japanese will frankly admit, but they are racing to catch up. That's the really significant inference of our special report on Japanese electronics (pp. 77-112).

After reading Yasuo Tarui's survey of integrated circuit activity (p. 90), it's hard to believe the first development started only 18 months ago. And this without benefit of a gigantic military or space program to subsidize the work. One of the biggest government research projects supporting integrated circuit activity is for \$80,000, a sum puny by U.S. standards. Yet six companies are sharing in the award to develop six different IC equipments.

Semiconductor production is the nucleus of Japan's electronics industry. Takuya Kojima and Makoto Watanabe have surveyed not only some unusual Japanese devices but how some of their associates use components in circuits (pp. 81-87). While the technology may not be impressive to a student of advanced semiconductor phenomena, nearly every U.S. consumer-products company uses Japanese devices—an impressive fact.

In solid state microwave technology, Japan may well be on a par with the United States. Its terrain and economy have encouraged use of wireless communication instead of coaxial lines so that Japan today has the densest network in the world, as Isoa Someya reports on page 99. Solid state systems save installation and construction costs, keenly important in a country whose resources are sharply limited.

Because the Japanese desire greatly to be considered an advanced people, they tend to take a gamble on the new even before it is proven. This has been particularly true in industrial plants, many of which were destroyed during World War II. Rebuilding from scratch during the post war boom, which accelerated sharply from 1960 to 1964, many manufacturers installed industrial electronics instead of con-

ventional electrical or mechanical controls. Japanese companies have shown far more willingness to change to electronics than their counterparts in U.S. industry. Today, even in the face of a recession, Japanese industry is buying more numerically controlled machine tools (p. 106) and computers for process control (110) than ever before.

Progress has created a demand for a lot of new products too: radio, television and tape recorders. Now the fads are air conditioners, central heating and hot water heaters. At Sanyo Electric Co. Ltd., a major appliance manufacturer, executive managing director Kaoru Iue explains the pressure: "In the summer, the average Japanese has always come home after work, taken off his clothes and sat nude in front of a fan to keep cool. Thousands of Japanese who have traveled to the U.S., now believe that is no way for an advanced people to behave—so they want air conditioning. In the same way, Japanese housewives have learned the desirability of having hot water in the morning, after centuries of doing all the morning chores in cold water."

All this activity and dynamism in Japan poses a considerable threat to the U.S. electronics industry, clearly the world's leader. The Japanese are particularly attuned to the infant markets of Asia and Africa and have serious designs on maturing markets in Europe. For several years now, they have been raising havoc in certain parts of the U.S. electronics market.

But the most serious threat to U.S. electronics firms may be something the Americans are doing themselves. Manufacturer after manufacturer is buying Japanese consumer products with the U.S. company's nameplate riveted on at the end of the production line. If U.S. manufacturers continue to abandon their engineering and production for Japanese products, they are headed for oblivion because they cannot compete with the purely merchandising organizations such as Sears, Roebuck & Co. and Montgomery Ward which buy Japanese products too. These merchandisers own outlets through which they can retail the Japanese products; the manufacturers must resell the goods to independent retailers who then have to compete in price with the Montgomery Wards and Sears stores.

The two things the Japanese fear most are the fast rate of development of U.S. technology and U.S. automation. To offset the phenomenal progress the Japanese are making, U.S. companies will have to pour more effort and money into product development and automation of production facilities. This is no time for American companies to be complacent.

These P&B relays are immediately available at factory prices from your electronic parts distributor



CD-38

SOLID STATE TIME DELAY—You get excellent timing characteristics in these knob-adjustable solid state relays. Timing range: 0.6 to 60 seconds. AC or DC models. Internal DPDT relay rated at 10 amperes, 115V AC resistive. For continuous duty over temperature range of -40°C to $+55^{\circ}\text{C}$.

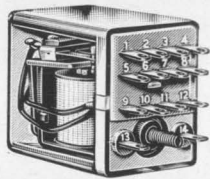

KHP

COMPACT FOUR-POLE RELAY—Small, rugged 4PDT relay designed to meet exacting requirements of data processing, computer and process control applications. Rated at 3 amperes at 30V DC or 115V AC resistive. Solder terminals. Special sockets have printed circuit or solder lug terminals. Also available hermetically sealed.

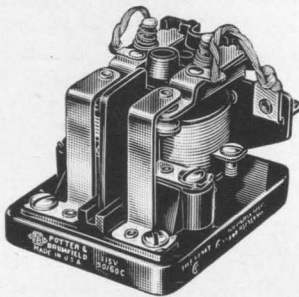

PR

POPULAR 25 AMPERE POWER RELAY—Compact, heavy-duty power relay listed by U/L and CSA. Screw terminals and rugged construction suitable for industrial application requiring reliability and long life. AC or DC models.

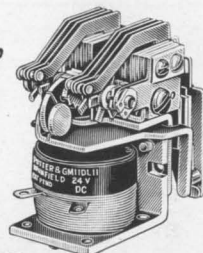

GM

VERSATILE IMPULSE/SEQUENCING RELAY—Unusual single-coil relay can be used to latch, step, count and switch in sequence. Switching occurs during drop-out for greater reliability. AC or DC models. Contacts rated for 3 amperes. Can also be furnished with uni-directional printed circuit boards having 10 or 12 switch positions.

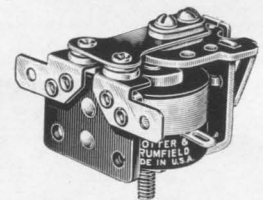

KR3-H

SMALL RELAY SWITCHES 20 AMPERES—Three KR3-H relays will fit in space required for most other 20-ampere relays. Mechanical life exceeds one million operations and twin contacts are rated at 20 amperes at 115V AC, 60 cycles resistive or 28V DC, 1 HP 115/230V 60 cycles. Contact terminals will accept $\frac{1}{4}$ " quick-connects or solder connections. Contact arrangement: SPST-NO-DB.

...and there are 60 other types to choose from!

Chances are, you'll save both time and money when you order standard P&B relays from an authorized distributor. You'll get speedy service at factory prices. Your P&B distributor has available more than

60 basic relay types totalling 627 coil voltages and contact arrangements. All are shown in our new Stock Catalog 100 . . . free from your electronic parts distributor. Ask for a personal copy today.



POTTER & BRUMFIELD

Division of American Machine & Foundry Company, Princeton, Indiana
Export: AMF International, 261 Madison Avenue, New York, N.Y.

Electronics Newsletter

December 13, 1965

Satellite-to-home broadcasts weighed

The National Aeronautics and Space Administration is showing increased interest in satellites that can broadcast radio signals directly to home receivers.

The agency has requested industry proposals for studies of such direct-broadcast satellites. It is considering orbiting one or more such satellites late in this decade or in the early 1970's. The satellites would be able to broadcast programs throughout the world. Operating in the f-m mode, they would relay voice broadcasts to home or car radios equipped with directional antennas.

NASA officials believe that direct television-broadcast satellites could also be orbited by 1977, using a Snap-8 nuclear-power supply with 35 kilowatts of power.

High cost of money: who gets hurt?

When the Federal Reserve Board increased the cost of borrowing money this month to a 35-year high, its action hit particularly hard at two kinds of companies: those whose consumer products are sold largely on installment, such as television receivers, and those planning rapid expansion. One result of the increase in banks' discount rates—to 4.5% from 4%—may be to make small-business investment companies more attractive sources of loans [see p. 142]. SBIC's raise money through the sale of stock, so are not affected by the change in bank rates.

The FRB says its move was designed not to slow down business expansion but to prevent the expansion from increasing too fast.

U. S. airlines seek microwave network

United States airlines are in the market for a nationwide network for microwave communications. The network, expected to cost about \$50 million, is planned by the commercial airlines' own communications company, Aeronautical Radio, Inc. (Arinc). Bids are due April 1. The airlines currently use the Bell System's bulk leased-wire communications service, called Telpak.

The commercial airlines' move to their own communications network was prompted by two factors that threaten the future of Telpak. Critics of the bulk-wire service are battling it in court, contending that it's unnecessary and discriminates by offering lower rates to large users; in addition, the massive investigation of the entire Bell System, announced recently by the government, may result in the Federal Communications Commission's ordering substantial rate boosts for bulk users.

Arinc estimates it would cost the airlines \$12 million a year to operate their own communications network. Without Telpak, the airlines would have to spend about \$65 million a year for telephone and teletype service. With Telpak, the charge for this year is estimated at \$48 million.

Soviet fails again to land on the moon

The Soviet Union failed in its fourth attempt to gently land a package of instruments on the moon. Soviet scientists indicated, however, that further efforts are planned.

The crash landing on the moon, it is believed, was caused not by mechanical trouble aboard the spacecraft, Luna 8, but by unexpected characteristics of the moon. Some space experts in the United States suspect that the moon's surface may not be reflecting the spacecraft's radar properly. The radar is used to keep track of the distance between

Electronics Newsletter

the moon and the craft; the retrorockets are triggered by radar signals as the spaceship approaches the moon's surface.

A new role for the F-111

At first it was simply the TFX, for tactical fighter experimental. Then it became a two-service plane and its name was changed to F-111A for the Air Force and F-111B for the Navy. **Now the Pentagon has given it a new role—reconnaissance—and a new name—RF-111A.**

The General Dynamics Corp. has received a \$12-million contract to develop the new version of the variable swept-wing aircraft outfitted with the latest in electronic sensors. **No production commitment has been made yet.**

Defense Secretary Robert S. McNamara is said to favor further modifications to convert the plane into a strategic bomber. If that happens the name will be changed again—to B-111.

Read diode's power and efficiency lifted

Silicon p-n-i-n diodes are being pushed to higher power and efficiency levels. Bernard C. De Loach Jr. and Ralph L. Johnston of Bell Telephone Laboratories have increased the power of the Read oscillator to 147 milliwatts from 19, and its efficiency to 5% from 1.5%. The continuous-wave output has a frequency of 5.3 gigacycles.

Messerschmitt wins space contract

Two familiar names in German aeronautics—Junkers and Messerschmitt—have won a contract that puts them solidly into the space industry. Junkers Flugzeugund Motorenwerke AG, now a subsidiary of Messerschmitt AG, has been chosen as the major contractor for an international satellite called HEOS. The satellite is a project of ESRO, the European Space Research Organization, and has the backing of eight European countries. The contract, for development and production of the satellite, totals \$6.5 million.

When HEOS goes up in the second half of 1968, **it will investigate the far fringes of the earth's atmosphere in a highly eccentric orbit that will take it about 150,000 miles from the earth.**

Other members of the industry group of which Junkers is the head, are: the British Aircraft Corp.; Etudes Techniques et Constructions Aérospatiales, in Belgium; and Societe National D' Etude et de Construction de moteurs D'Aviation, in France.

A boost for PAL

Britain's Television Advisory Committee has made its recommendation on the color system it would like to see adopted. The recommendation, made to Postmaster General Wedgewood Benn, the final arbiter for Britain's tv networks, **is that West Germany's PAL system should be used with a 625-line horizontal scan.** PAL is a modification of the United States' NTSC system which Britain favored earlier.

Addendum

The Air Force will seek bids soon on a major contract covering operations and maintenance of facilities at its Western Test Range at Vandenberg, Calif. Among other things, the contract will cover operation and upkeep of data-collection and communications systems, radars and displays and launch equipment.

Obviously photography is the neat way to capture information and record data

You would like to try it. (You have heard that photographic processing is now so fuss-free and compact that it can go on all by itself in unmanned spacecraft.)

But photo-technology may not be your game. And your needs are special.

Wouldn't it be nice to talk them over with some fellow engineers who live photo-technology day in and day out?

You don't have to turn into any more of a photo-technologist yourself than you want to be. New developments can make such a carefree attitude realistic.

Tell us what you want to accomplish. If we think you're over-optimistic we'll tell you. Otherwise, we'll invite you to Rochester for conversations with the two or three men best qualified to tell you exactly what to do or whom

to see for the results you seek.

We have quite an assemblage of photo-engineers to draw on.

We are, after all,

Kodak

Call or write Eastman Kodak Company, Special Applications, Rochester, N.Y. 14650, 716-325-2000, Ext. 5129.



**Who cares about
component innovations?**



At General Electric, engineering is the most important factor in electronics. This engineering excellence means you get the best in component reliability and performance.

**Who cares if you improve
your circuit designs?**



Constant attention to new and improved electronic circuit designs results in better quality, lower price, and new market growth for your business and ours.

Who cares about all your component needs?

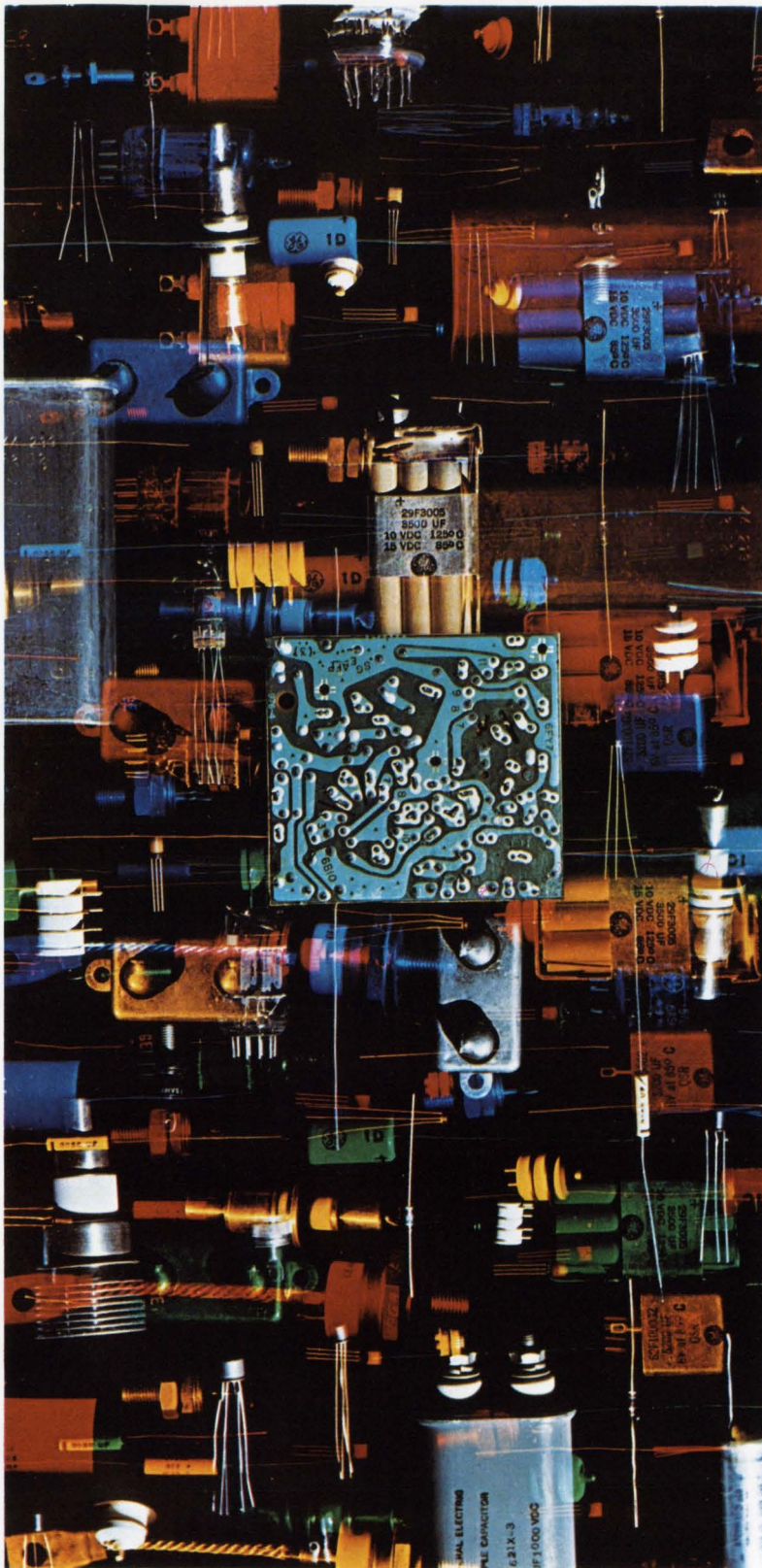

You can choose from more than 6,000 different G-E electronic components from capacitors, semiconductors and tubes to instruments, batteries and integrated circuits.

General Electric cares

(so do you; that's why
we're out to do
things your way)

We may not offer everything you want from one supplier. But, we do come a little closer than anyone else.

This means more than just being your number one source for a full range of electronic components. Our experience, facilities, and engineering competence—both as a producer and major user—combine to give you unmatched design capability and component reliability.

You're also assured of continuing product innovation—like Triac, the new low-cost SCR, Compactrons, Blackhawk capacitors, and nickle-cadmium batteries, just to name a few.

How do you benefit from this continuing partnership in electronics? Ask the people who represent us, your G-E engineer/salesman or distributor.

900-02

Progress Is Our Most Important Product

GENERAL  ELECTRIC

SPECIFYING MODULES?

5 points to check
— and 3 questions for your supplier

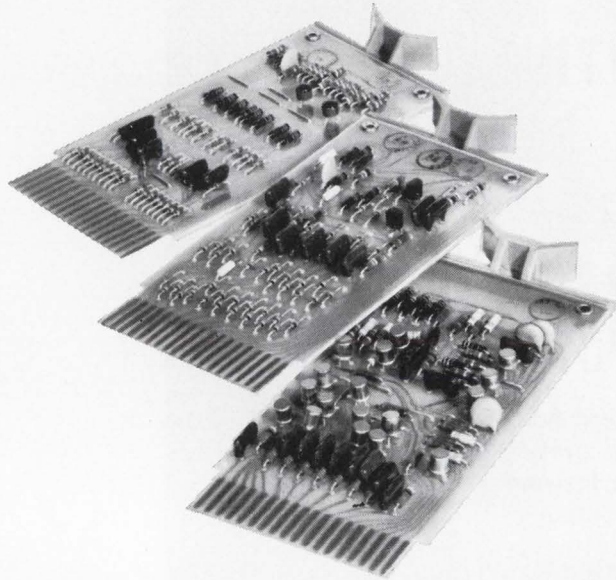

1. NOISE IMMUNITY

FLIP CHIP Modules use DTL clamped logic, provide a threshold value of 1.2-1.5 volts of noise immunity.

2. DRIVING CAPABILITY (Fan Out)

Based on 1 ma = 1 unit load, FLIP CHIP gates have a typical fan out of 18 unit loads; flip-flops have a typical fan out of 15 unit loads.

3. COST

FLIP CHIP gates cost out at about \$4.00 per gate — mounted, tested, and ready to go. A built in design feature permits additional diode inputs to be added at an average cost of 60¢ each.

FLIP CHIP flip-flops run about \$11.00 each and provide multiple functions (JK, RS, T, and RST). Since the same flip-flop can be used in a variety of applications — counters, shift registers, jam transfer buffers, BCD counters — inventory can be held to a minimum, reducing costly spares.

4. SPEED

Two frequency ranges are offered in our standard FLIP CHIP line:

- R Series — up to 2 mc
- B Series — up to 10 mc

Both series are fully compatible with our earlier line of System Modules.

5. RELIABILITY

FLIP CHIP Modules are rigidly tested and warranted for 10 years. Printed specifications are included with each module.

What is the breadth of my suppliers' line?

You need only one supplier when you select Digital. FLIP CHIPS take you from input to output. Logic level converters standardize incoming and outgoing signals. Digital has a complete line of: interface modules — including relay drivers, lamp drivers, bus drivers, Schmitt triggers, A-D and D-A modules, and mounting hardware and power supplies. All the equipment necessary to build a complete system.

What kind of delivery can I expect?

You get off-the-shelf delivery on all standard items. If it's any easier, order through the latest Allied Electronics catalog.

Can I get systems design help?

Digital applications engineers, located in major cities throughout the United States and in Canada, Europe, and Australia, are experienced professionals who can understand your problem and recommend the equipment to solve it.

Our 202 page FLIP CHIP Module Catalog has been called the standard reference work on digital logic for the industry. It's a valuable manual on logic circuit design and yours for the asking. For your free copy, just call any Digital Equipment office: DIGITAL EQUIPMENT CORPORATION, Maynard, Massachusetts 01754. Telephone: (617) 897-8821.

DIGITAL
MODULES • COMPUTERS

Specifications

Frequency range: 10 to 500 Mc (MHz) in six bands: 10 to 18.5 Mc; 18.5 to 35 Mc; 35 to 65 Mc; 65 to 125 Mc; 125 to 250 Mc; 250 to 500 Mc.

RF gain: 30 db (10 to 125 Mc);
27 db (125 to 250 Mc);
24 db (250 to 500 Mc).

RF bandwidth: >700 Kc (10 to 150 Mc);
>1.4 Mc (150 to 500 Mc).

RF output:

Range: up to 15 volts across external 50-ohm load.

Impedance: 50 ohms

Calibration: 0.2 to 3 volts f.s.;
1.0 to 10 volts f.s.; 2.0 to 30 volts f.s.
(increments of approx. 5%).

Accuracy: ± 1.0 db of f.s. (10 to 250 Mc);
 ± 1.5 db f.s. (250 to 500 Mc).

Leakage: Effective shielding is greater than 40 db.

RF input

Level: (for 10 volt output into 50 ohms);
 ≤ 0.316 volts (10 to 125 Mc);
 ≤ 0.446 volts (125 to 250 Mc);
 ≤ 0.630 volts (250 to 500 Mc).

Impedance: 50 ohms

AM range: reproduces modulation of driving source 0 to 100% up to 5 volt maximum carrier output.

AM distortion: <10% added to distortion of driving source.

FM range: reproduces modulation of driving source except as limited by RF bandwidth.

FM distortion: negligible distortion added to distortion of driving source for deviations and modulation frequencies <150 Kc.

Incidental AM: <10% added to modulation of driving source at 150 Kc deviation.

Power: 105 to 125 v or 210 to 250 v,
50 or 60 cps, 150 w.

Mounting: cabinet for bench use;
by removal of extruded strips suitable for 19" rack mounting.

Price: \$1200.
F.o.b. factory.

For your application, contact your local Hewlett-Packard field engineer or write Hewlett-Packard, Green Pond Road, Rockaway, N. J. 07866; Europe: 54 Route des Acacias, Geneva.

Data subject to change without notice.

Now, BOTH in one instrument

HIGH POWER, LOW NOISE

—the HP 230A 10 Mc to 500 Mc Power Amplifier

The Hewlett-Packard Model 230A is the ideal RF amplifier for both high and low-level applications. With a typical noise figure of 6 to 8 db, the instrument provides up to 30 db gain and a maximum power output of 5 watts.

Typical Applications include:

SIGNAL GENERATOR POWER AMPLIFIER — Provides up to 15 volts output from standard VHF signal generators for receiver testing, watt and voltmeter calibration, antenna testing, and attenuation measurements. May also be used to drive antennas for remote systems testing such as aircraft ILS.

RECEIVER PRE-SELECTOR — When used as a pre-selector with conventional communications receivers, fractional microvolt sensitivities are attainable.

TUNED SELECTIVE FILTER — Provides a convenient means for the selective amplification of RF signals in the 10 to 500 Mc range with excellent rejection of undesired frequencies.

HARMONIC AMPLIFIER — May be used to amplify desired harmonics in the output of signal generators and frequency synthesizers thereby extending their useful range.

FREQUENCY COUNTER PRE-AMPLIFIER — As a pre-amplifier for conventional frequency counters, such as the -hp- 5245L, will provide a 15 to 30 times improvement in input sensitivity. Remote, off-the-air frequency measurements of FM broadcast and communication transmitters may be readily performed.

RF MILLIVOLTMETER PRE-AMPLIFIER — Used as a pre-amplifier for RF millivoltmeters, such as the -hp- 411, the 230A will provide 15 to 30 times improvement in sensitivity.

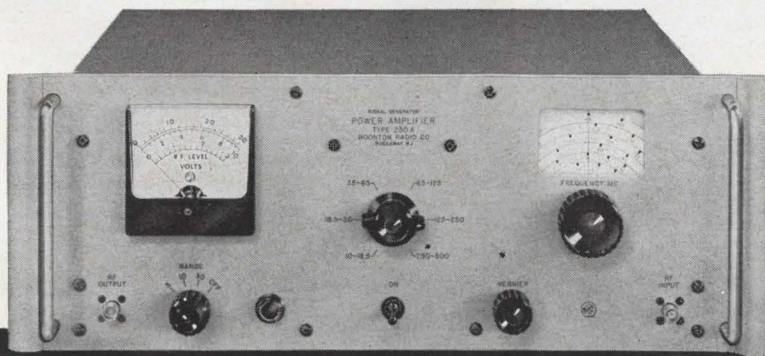

HEWLETT  **PACKARD**
An extra measure of quality

FONER VIBRATING SAMPLE MAGNETOMETER

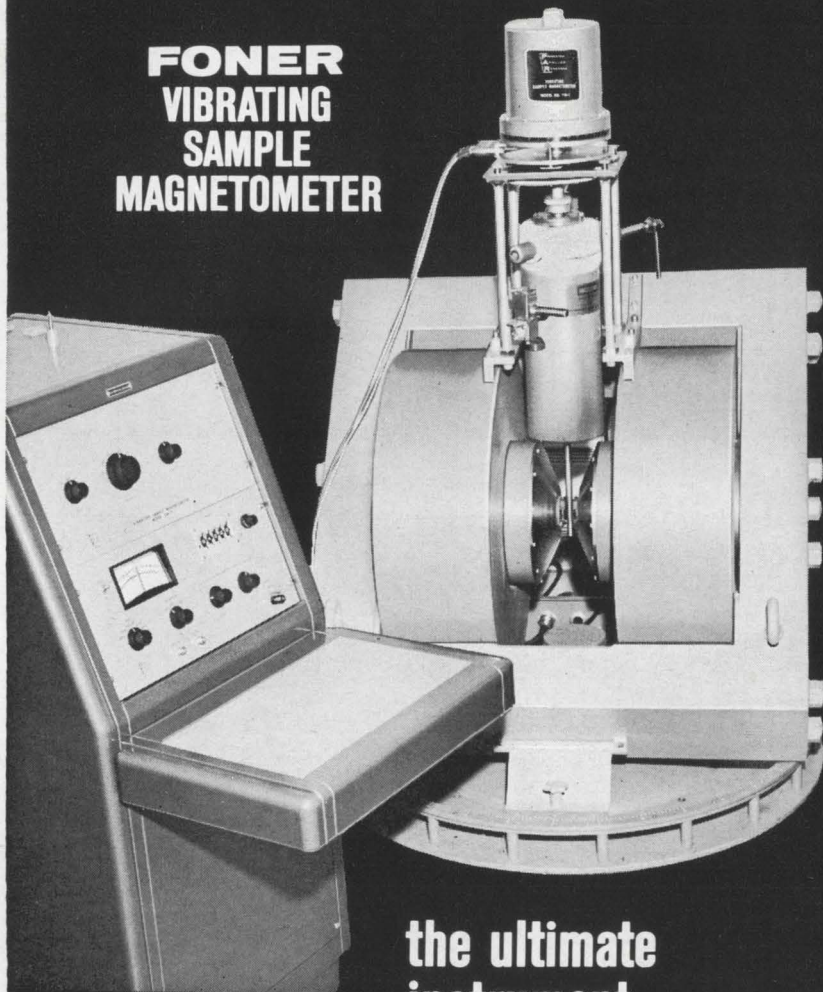

the ultimate
instrument
for investigating
magnetic
properties
of matter

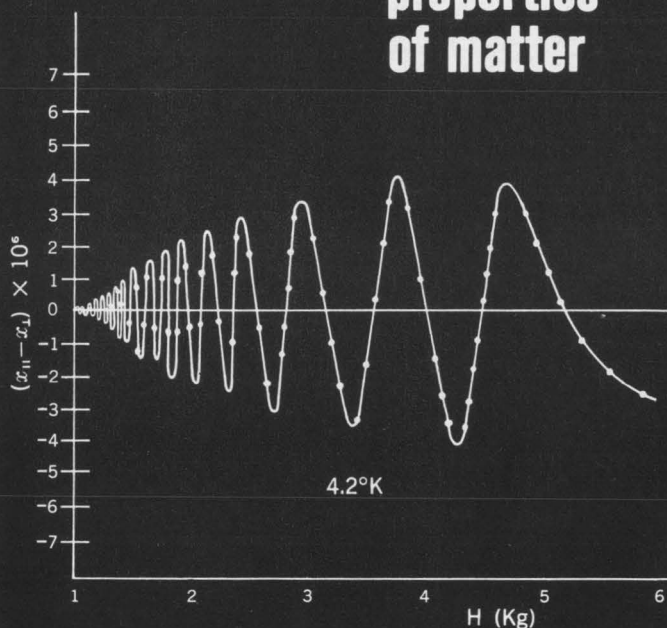

Typical deHaas-Van Alphen Effect

In studies of the structure of matter, magnetic properties have long been of paramount importance in providing information of a fundamental nature. This has been true in such widely diverse fields as the study of free radicals in bio-chemical systems, the study of the deHaas-Van Alphen effect in metallic crystals at low temperatures and investigations of the nature of the bonds in intermetallic compounds. The limitations imposed by classical methods of magnetic measurements, those of low sensitivity and of high field homogeneity, have however made precise meaningful measurements difficult and slow and hence have restricted their ultimate useful employment.

The development by Foner of a versatile and sensitive Vibrating Sample Magnetometer* and its commercial availability through PAR now make possible the extension of magnetic measurement techniques both to experiments requiring sensitivities and resolutions heretofore unobtainable, and to routine measurements which require simple set up procedures and quick sample changes. With this magnetometer, permanent and/or induced magnetic moments may be precisely measured in a uniform magnetic field as a function of temperature, field, crystallographic orientation, or time. This is done by placing a small sample of the material whose magnetic moment is to be determined in a sample holder located at the end of a vibrating rod and vibrating it perpendicular to the magnetic field of the magnet. The resulting oscillating dipole field induces an AC voltage in a pair of stationary pick-up coils mounted securely to the pole faces of the magnet. The induced voltage is measured electronically in a system whose signal-to-noise ratio is near the limit set by the Johnson noise of the pick-up coils. From the magnitude of this measured voltage, the magnetic moment of the sample is deduced.

An extremely wide range of magnetic moments can be measured with high precision and the instrument has a simple calibration procedure, exhibits very high stability, and minimizes most sources of error. Cryogenic techniques may be used to measure moments over an extended range of temperature down to the liquid helium range. Magnetic moment measurements of Ferromagnetic, Paramagnetic, Diamagnetic, Ferrimagnetic, Antiferromagnetic, Metamagnetic and Superconducting materials have been made utilizing this system. Various versions of this instrument have now replaced most of the classical methods for magnetic moment measurements in numerous laboratories throughout the world. Price \$12,500. Your inquiries on specific magnetic measurement problems are invited.

*Manufactured exclusively by PAR
under license in U.S. Patent No. 2,946,948.

Write for Bulletin No. 116 to:

PAR PRINCETON APPLIED RESEARCH CORP.
Dept. D
Box 565, Princeton, N. J. Tel. (609) 799-1222

Space electronics

Bootstrap calibration

The Air Force wants to know if it's possible to precisely define a satellite's orbit from ground radar data and then use that same orbit as a standard by which to calibrate the same radars.

"We sometimes call it bootstrap calibration," says Charles W. Hunter, a mathematician at Air Force Electronic Systems division, Hanscom Field, Mass.

The project, being done for the National Range Division, is not just an exercise in mathematical acrobatics. One objective is to improve the accuracy of ballistic missiles by reducing errors in the missile-range radars which track them. The other is to determine the position of orbiting satellites more accurately. "Five times more accurately than is now possible," says Hunter, project manager at ESD's directorate of aerospace instrumentation.

In orbit. Next June, the first of two satellite payloads designed to test the feasibility of the calibration technique will ride down the Western Test Range atop an Atlas booster. It will go into an equatorial orbit aboard the OVI-7, one of a series of vehicles being launched for the Air Force Office of Aerospace Research.

In August of 1966, another calibration payload will ride piggyback on an Atlas-Agena down the Western Test Range and then inject itself into a polar orbit. This project will be accomplished by the Air Force Space Systems division.

The satellites will carry transponders tuned to most of the radars on the missile ranges [Electronics, March, 8, p. 108].

Ground work. Meanwhile, ESD and the Mitre Corp., Bedford, Mass., will be modifying existing computer programs for a limited reduction of the radar data acquired from each of the two satellites.

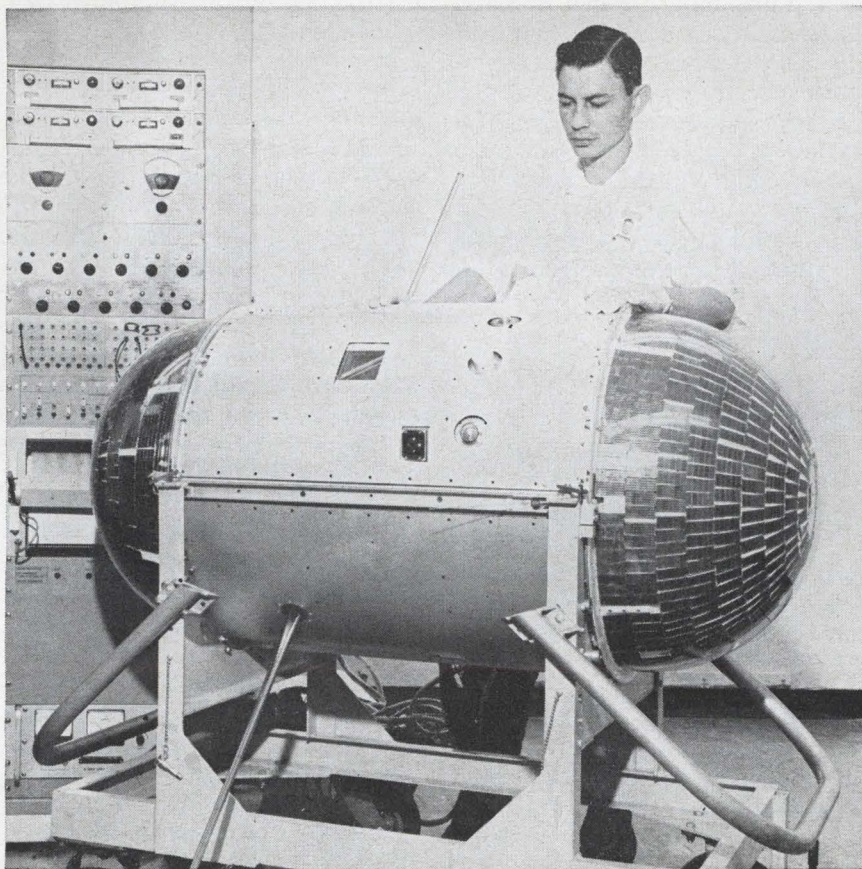

Aerospace research satellite will carry transponders that may be able to calibrate radars on the missile ranges. General Dynamics Corp. built the satellite which the Air Force will launch in June.

A comparative analysis center will be set up in Bedford. It is hoped that the final phase of the analysis, to determine if the technique is feasible, will start in December of 1966.

Says Maj. John Musterman, chief of the Metric Systems division at Bedford: "This over-all analysis will, we hope, tell us if self-calibration will work or if it is necessary to stick to the old system of optical beacons. If feasibility is proven, the analysis should also tell us that range radars should be calibrated before each shot, or once a month, or what."

Satellite gear. The Eastern Test Range will track the first satellite on its calibration runs next June. The calibration experiment will be one of five aboard the OVI-7 experimental satellite, built by the

General Dynamics Corp. The satellite will go into a 550-nautical-mile high orbit, and will be gravity-gradient stabilized. It will carry a transponder for Glotrac radars and one for C-band radars. The outputs from these will go into a diplexer and then to a single antenna. It will not be possible to include a transponder for the Mistran radars because it would require too much power—about 150 watts, compared with 42 watts for Glotrac and 25 for the C-band transponders.

The second satellite, scheduled for an August launch, will be a P-11 made by the Lockheed Missiles and Space Co., a division of the Lockheed Aircraft Corp. It will orbit at an altitude of 500 nautical miles. The P-11 has its own propulsion unit and is spin-stabilized. Solid-fuel rocket engines will allow the

satellite to launch itself from an orbiting spacecraft into the prescribed orbital path.

The P-11 will carry six antennas. It will have an S-band and a C-band transponder, also a uhf and vhf telemetry transmitter. The P-11 will carry a transponder for an S-band space-to-ground link of the type planned for the manned orbiting laboratory. The P-11 will also have a command and control link to turn the uhf and vhf equipment on and off. Lockheed will integrate the systems for this project.

Four in space

The most complex space feat ever attempted is under way with the orbiting of the two-man spacecraft, Gemini 7. The rendezvous mission's most delicate phase was scheduled to begin Dec. 13 when another two-man capsule, Gemini 6, is launched.

During its 26 hours in orbit, Gemini 6 will try to catch up with the first spacecraft, sidle up to it—probably as close as 30 feet—and then literally fly rings around it for about two orbits of the earth.

Gemini 7's astronauts haven't been idle during their nine-day wait in orbit. Frank Borman and James Lovell have conducted a series of experiments, including the first attempt to use a laser beam to carry voice signals between a spacecraft and the ground.

Tight fit. The first big problem will be timing at the launching of Gemini 6. The National Aeronautics and Space Administration will have only 47 minutes—a record for brevity—in which to shoot the capsule through its keyhole in the sky.

For most of its catch-up sprint, Gemini 6 will be guided by earth-bound radars and computers. For the last 250 miles, however, Astronauts Walter Schirra and Thomas Stafford will be able to control it, aided by on-board radar and a digital computer. Such rendezvous maneuvers are considered essential for Project Apollo, whose goal is to land Americans on the moon by 1970.

On target. The astronauts in

Gemini 6 will measure their distance from Gemini 7 by transmitting radar pulses and measuring the magnitude of the return signal voltage or the time of the signal's return. Bearing will be plotted by interferometry.

When the spacecraft are in the same orbit they will share a single ultrahigh frequency channel for communications. Telemetry from both will be displayed at ground stations in real time. The craft will not communicate directly with each other; voice messages will be relayed by ground stations. Because the two craft will be on adjacent command frequencies, the astronauts in one will turn off their receivers to avoid interference from commands sent to the other spacecraft from the ground.

Ground radars will track both spacecraft simultaneously. This will be possible because the ships' transponders will return radar pulses at different intervals—three-microsecond intervals for Gemini 7 and five-microsecond for Gemini 6.

Laser experiment. For the laser experiment, Lovell aims a six-pound laser transmitter at ground receivers in Hawaii, Ascension Island and White Sands, N.M. The transmitter, developed by the Radio Corp. of America, is 3 by 6 by 8 inches. Its four gallium-arsenide injection lasers pulse 100 times per second while the astronaut is trying to make contact with the ground; after contact is made, he switches to 8,000 pulses per second, and this higher pulse rate is modulated to carry the astronaut's voice to the ground.

The lasers can deliver 16 watts of light power at 9,000 angstroms. With a telescopic sight, Lovell aims them at another beam coming from an argon-gas laser mounted on the receiver on the ground. The receiver, 30 inches in diameter, contains a collector and focusing unit, with a photomultiplier at its focal plane.

Another experiment on Gemini 7 constitutes the first test of an electroencephalograph (EEG) in space, to check for changes in Lovell's brain-wave patterns. Four electrical leads run from Lovell's head to a signal conditioner, which

amplifies the waves; the waves are then recorded on tape aboard the spacecraft for comparison with other EEG's in a brain-wave library being developed by NASA.

Military electronics

War hero—the helicopter

The combat performance of the 1st Air Cavalry division has so impressed Defense Secretary Robert S. McNamara that he declared, during his recent trip to South Vietnam, his intention to form other helicopter-borne divisions. Before the end of the year, the Army will give McNamara a specific proposal for converting one, and possible two, of its existing divisions into air mobile units. The plan calls for heavy procurement of helicopters and their avionics. The new purchases will follow closely on the heels of last summer's order for a 50% increase in the number of helicopters for transport and reconnaissance.

These increases, plus the need for additional and replacement helicopters in Vietnam, have already led to contracts for increased production of the Bell UH-1 and the Boeing CH-47. Within Vietnam itself a buildup in helicopter strength from 800 to 1,400 will be completed by the end of the year and doubtless hundreds more will be assigned there in 1966.

Two designs. On top of this, the Defense Department has recently given the go-ahead for development of two new types of helicopters—a light observation helicopter (LOH) and an armed helicopter known as AAFSS (advanced aerial fire support system).

The Hughes Tool Co. is developing the LOH as a replacement for the O-1 (Bird Dog) fixed-wing plane and the OH-13 (Sioux) and OH-23 (Raven) helicopters. The total buy probably will exceed 2,000.

Bids for the avionics package for the LOH are now being evaluated and a contract award is expected next month. The package will contain radio transceivers in the uhf,

vhf, and f-m bands, an f-m monitor receiver for the pilot, an intercommunication system, and an ADF (automatic direction finder) for navigation. The console will weigh 40% less than existing equipment with these capabilities, and may use integrated circuits.

The Lockheed Aircraft Corp. is developing the AAFSS as a replacement for about 400 armed versions of the UH-1D, originally a small transport chopper that was converted into an armed helicopter by attaching weapons to it. Now the AAFSS is being designed from the outset as an attack helicopter.

The AAFSS will be equipped with station-keeping equipment but the design of the airframe is too far along to include terrain-avoidance radar. The Army is working on terrain-avoidance radar and hopes to have such equipment ready for the STAAS (surveillance and target acquisition aircraft system), the follow-on to the Mohawk fixed-wing plane.

May use IHAS. The Army is footing part of the bill for development of the Navy's integrated helicopter avionics system (IHAS), being developed by the Teledyne Systems Corp. IHAS will use microcircuits and a small computer to provide automatic navigation, terrain-avoidance radar and station-keeping features. This system, or parts of it, augmented by fire-control features, may be used in AAFSS.

Other Army aviation projects include a ground-based command and control system for use when planes are in action; an air traffic regulation system, compatible with the Air Force and the Navy craft, for flight over friendly territory; and a system to control the terminal flight phase, when aircraft approach an airfield's traffic pattern.

Project Hindsight

Pentagon engineers, studying the genesis of military inventions made over the past two decades, have reached tentative conclusions that, if confirmed, may lead to profound changes in the management and financing of weapons research.

The project chief, Chalmers W.

Sherwin, sees four recommendations as likely results of the study:

- Creation of "program oriented" laboratories similar to the electronics lab at the Massachusetts Institute of Technology.

- Greater stress on research aimed at specific end-products of immediate value to the military.

- Less emphasis on individual research projects by "some professor who's got a good idea."

- More flexibility for the contractor in apportioning military funds, with less control from Washington.

Genealogy. The engineers in Project Hindsight found evidence to support the notion that necessity is the mother of invention; not vague, long-range necessity, they emphasized, but specific, immediate needs.

Eight out of ten inventions in the development of systems seem to have been achieved at the local level to solve an immediate problem in a program under contract, the study says. This is the kind of invention that comes as a result of a research group's discovery that it cannot fulfill its contract without a new kind of device or material.

Furthermore, Sherwin's group continues, 85% of military inventions seem to have been made in the course of an organization's study in a broad area, rather than an individual researcher's work on a single narrow project.

Yet these "one-shot" projects receive 50% to 75% of the research money spent by the Defense Department, the report says.

Case histories. Project Hindsight was created in response to congressional criticism of the way in which the Pentagon has spent \$10 billion on defense research since 1945. Sherwin, deputy director of research and technology in the Defense Department, organized the study around five case histories: the development of the Bullpup and Lance missiles, the 105-millimeter howitzer, the C-141 aircraft and the SPS 48 radar. Lance, for example, includes more than 120 inventions.

The Pentagon engineers traced the development of each system to see where, how and why each in-

vention came about. More than 1,000 interviews have been conducted so far. Eventually, Sherwin hopes to trace the development of every invention that has found its way into a U. S. weapons system.

The outlook. Would his recommendations result in less federal funds for independent research? No, says Sherwin, but they would focus defense spending more sharply on military needs, leaving more basic science support to the National Science Foundation.

As for the new laboratories, Sherwin says the first probably would be two electrochemistry labs to specialize in basic-materials problems that have been encountered in recent research on energy conversion.

"We'll want to build a capability in one place," he explains, "with top scientists and graduate students, rather than fund a bunch of guys doing independent research."

Advanced technology

Bird's eye viewed

The biological system of animals performs pattern recognition so brilliantly that some scientists have attempted to construct electronic systems with properties resembling those of living organs. Such systems would be invaluable in signal analysis—for example as radar target discriminators.

The photograph shown below, for

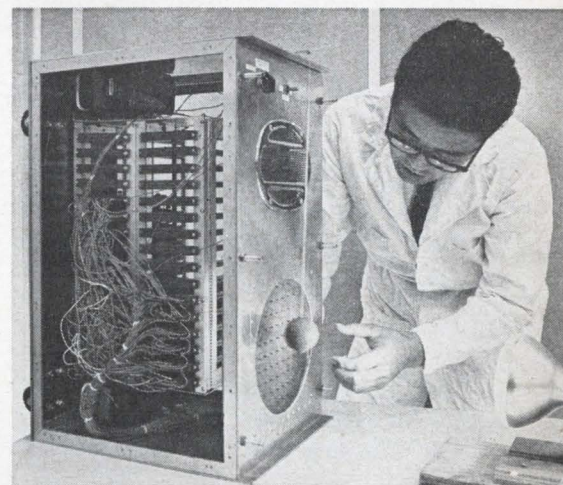

instance, is an analog of a pigeon's eye. It's not sophisticated enough to recognize a crust of bread, but it does have the remarkable property of detecting motion in a single specific direction.

The eye, built at the Astropower Laboratory of the Douglas Aircraft Co. Missile and Space Systems division, is made up of photodiodes and special-purpose circuits connected in a manner that closely resembles the cones and neurons in an actual pigeon's eye. Since biologists are by no means sure of the function of each neuron, the electronic analog is necessarily only approximate. Still, it works. When a ball is passed from left to right through a beam of light that shines on the photodiodes, the device will produce an output, manifested as a beep on a loudspeaker. But when the ball swings back, the speaker is silent.

Cones, neurons, and ganglia. To design an electronic structure that did not violate what was known about the biological structure, the Astropower staff, under Sam S. Viglione, worked closely with Richard L. Binggeli of the University of Southern California Medical School's anatomy department. Binggeli is studying the retinas of vertebrates.

In the real pigeon's eye, impulses from rods and cones, the sensors in the pigeon retina, are transmitted through a network of bipolar nerve cells, called ganglia, when the cells are stimulated at a certain threshold. The impulses travel through the optic nerve to a part of the brain. About 30% of all the ganglia are direction-sensing; each stimulates a different part of the brain. What Astropower has built is a single ganglion, with its associated inputs.

There are a number of cells, called amacrine, in the eye which apparently have no direct route to the brain. They may connect two cones, or two bipolar cells. Biologists have postulated that these cells act as inhibitors, that is, although one cone may be stimulated by a moving object, an adjacent one might not be if connected to the first through an amacrine. Similarly, if a bipolar cell were

stimulated simultaneously by a cone and a nearby amacrine, the impulses would cancel each other out, and the cell would not fire. Astropower simulated the action of the amacrine with an inverter circuit combined with diodes so arranged that the triggering sequence for the bipolar circuits was only correct when the ball moved from left to right.

Building a model. The bipolar cell circuitry consists of a Kirchhoff adder, an integrator (a resistance-capacitance element), a multivibrator or blocking oscillator, and a function generator. The adder sums inputs from a number of diodes—in the eye a number of cones may be stimulated at the same time. The output from the adder goes to the integrator, which has a capacitive function; in the eye, a bipolar cell might not fire from a single stimulus, but a second and third stimulus, at later points in time, might push the potential over the threshold level.

The multivibrator simulates the slow decay of the potential across the bipolar after it has fired, the so-called refractory recovery period; and the function generator is inserted in a feedback loop between the multivibrator and the integrator so that the multivibrator produces a standard pulse output, like the pulses in the real eye. The width and amplitude of the pulses are always the same; the spacing of the pulses is a function of the spacing and amplitude of the impulses to the entire circuit.

It's a long step from the electronic eye to whole pattern recognition. But Binggeli reports that he's already getting feedback from the Astropower model. "I'm learning what questions to ask," he says. And, perhaps, what patterns to look for.

Manufacturing

Squeegee-printed transistors

Screen printers, which now have a firm base in the printing of passive networks for hybrid integrated cir-

cuits, may soon be used for large power transistors. One supplier of printing equipment hopes to convince transistor manufacturers that one swipe of a squeegee blade across a printing screen can do the work of several photoetching processes.

Affiliated Manufacturers, Inc. (AMI) of Whitehouse, N.J., has found that it can print etching resist on silicon wafers with a pattern tolerance of one mil (0.001 inch). Dots as small as one mil in diameter, which require even tighter tolerances, have been printed experimentally on other materials. The resolution is still far too crude for small, high-speed transistors (see related story on p. 237) but it is good enough for etching the electrodes of large devices, contends Alex F. Sopru, AMI's engineering manager.

The resist used is a tar-based wax, called apiezon, that is often used to prepare printed circuit boards for etching. The wax is softened with solvents, forced through holes in a printing screen with a squeegee, and dried. The holes in the screen are made by etching a film supported on a fine wire mesh. The wax hardens, the substrate exposed in the resist can be etched. For electrodes, the substrate would be a thin film of metal on the silicon wafer. As a final step, the wax is dissolved.

The new process would eliminate three additional steps semiconductor manufacturers now use between application and removal of a photosensitive resist: putting a mask on the resist, exposing the resist and developing it.

Green ceramics. Meanwhile, screen printers are further refining hybrid circuit printing techniques, according to Sopru. One method that he predicts will catch on fast is automatic printing of film resistors and other passive-network parts on long, flexible tapes of green alumina ceramic. Green ceramic is ceramic that has been pressed, but not fired. The tapes look like strips of shiny, white cardboard.

At present, the passive networks are usually printed on individual, fired substrates that often vary in

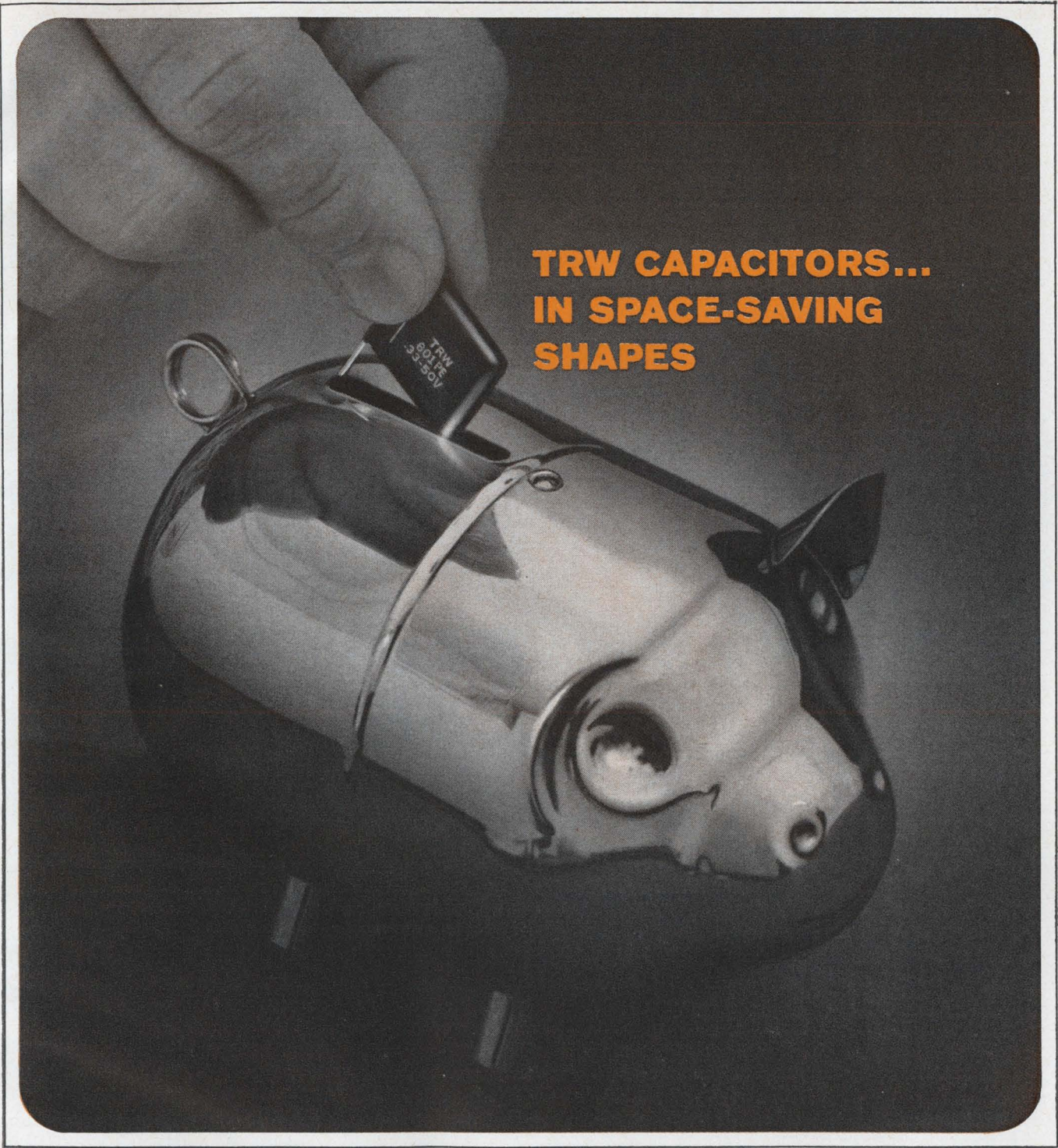

**TRW CAPACITORS...
IN SPACE-SAVING
SHAPES**

14-60

The 601 PE... a particular shape for a particular need.

Design with Mylar reliability in the size and shape of a disc! The slim, compact type 601 PE is tailored for printed circuits in military or industrial applications.

In all you will find more than 200 design variations of reliable TRW Capacitors. Round or oval cross-sections. Axial

or radial leads. Dipped, tape-wrapped, or metal enclosed cases. Essentially all these constructions are available in film-foil, in metalized Mylar* and polycarbonate dielectric.

In a tight spot? There's a TRW Capacitor to help you. Contact TRW Capacitors, Box 1000, Ogallala, Nebraska.

*Du Pont Trademark

TRW CAPACITORS

size and are not as smooth as the tapes. Soprú says the printers and other production machines can do a faster, more precise job when tapes are used. The tapes can run from the printer into a firing furnace. The only problem is that the resistor characteristics also depend on the firing temperature, so special inks are needed.

Machine soldering. Another method that is catching on, according to Soprú, is machine soldering of active-device leads into holes in the ceramic substrate instead of hand-soldering them to conductors on the top side of the substrate. The trick is to get the conductive inks into the holes so the solder will stay in the holes and form a good joint between the conductor and the lead. Solder won't wet bare ceramic.

This is being done, Soprú says, by having the screen printer form a little puddle of ink over the hole. Then a vacuum, drawn under the substrate, sucks the ink into the hole. The same method can be used to connect conductor patterns that have been printed on the top and underside of the board.

Resistors can be printed on the bottom of the substrate and devices such as packaged transistors can then be mounted on the top. This technique avoids the practice of bending the transistor leads under the substrate so that the lead ends can be soldered to a conductor pad near the hole.

Medical electronics

Telltale hearts

A device that in three minutes can detect heart defects in children has been developed by the Humetrics division of the Thiokol Chemical Corp. Called a PhonoCardioScan (PCS), the portable instrument can be operated by a nurse or technician.

The PCS was designed for school heart-test projects. Physicians stress that early detection of heart abnormalities improves chances of cure. When the PCS

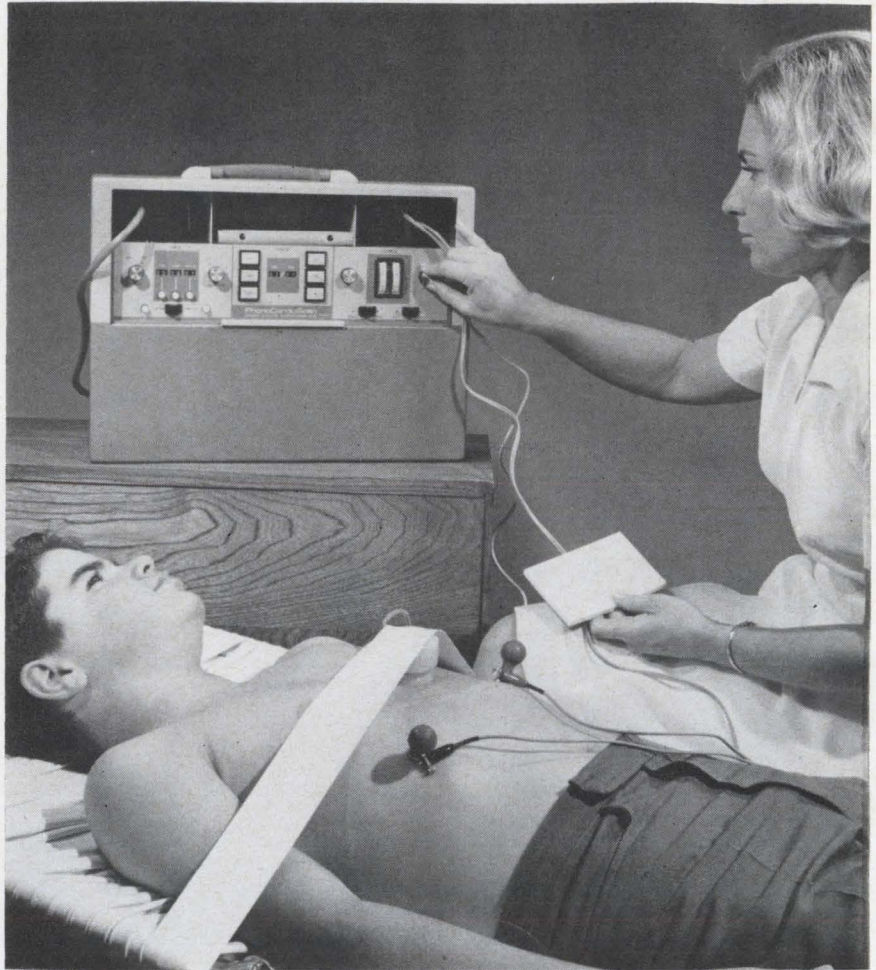

Portable instrument checks child's heart in three minutes.

notes suspicious sounds, the youngster is sent to a doctor.

The PCS' logic circuits were designed, with the aid of a computer, to recognize the sounds characteristic of abnormal hearts. Heart sounds from many patients were recorded on tape and patients were also examined by cardiologists. The sounds were then analyzed for normal and abnormal patterns.

How it hears. The PCS picks up two types of heart information. Suction-cup electrodes register the electrical potential of the heart to time the heart sound within a cycle. A microphone, placed on four designated areas on a patient's chest, picks up sounds of contraction, expansion and valve motion.

Analog information from several cardiac cycles is examined beat by beat. The PCS registers on one digital counter the number of cycles examined and on another digital counter those cycles whose sound

patterns are considered outside the normal, according to the information programed. If more than 6 out of every 10 cycles are abnormal, the patient is sent on for further examination.

A second group of counters presents the PCS operator with additional information on every beat. If this data varies with the main counter's, the cycle can be thrown out and the process begun again.

Industrial electronics

In the driver's seat

No matter what they look like or how they operate, every function of the high-speed trains of the future will depend on electronics, according to a \$515,000 survey for the

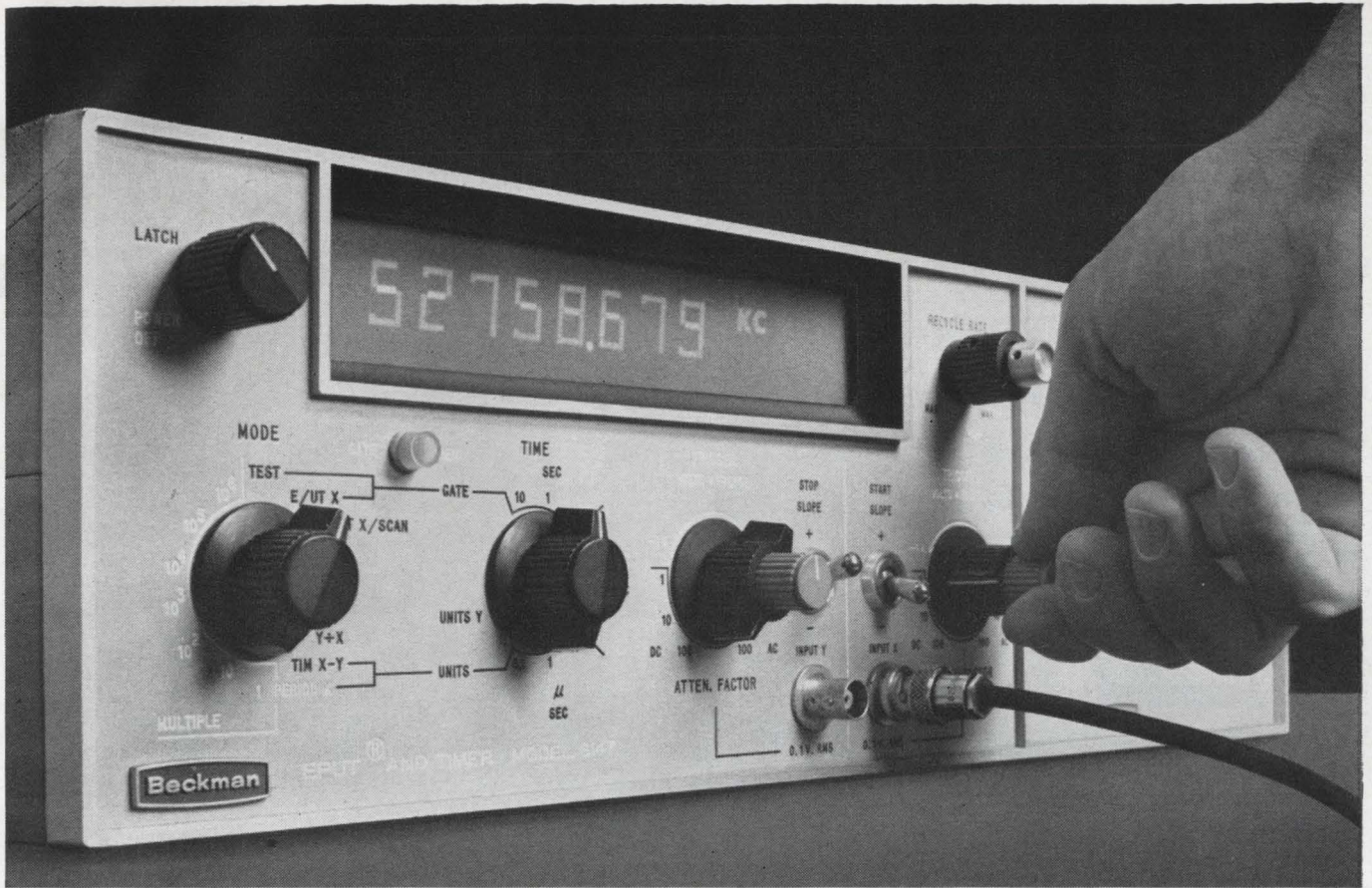

The only *solid-state* counters available? If any electronic counters can be considered *all* solid-state, they're the Beckman 6100 Series. These 2.5, 25, and 50-mc counters use *no* vacuum tubes in any form—even the digital display is solid-state. This spells superior reliability and value backed by these unparalleled benefits: Electroluminescent display guaranteed against catastrophic failure for *three years*. More plug-ins—*nine*—for greater versatility. Plug-ins do *not* just add basic functions but expand and add capabilities (trigger controls and time interval function are available on basic counters). Plug-ins include frequency extenders to 3 gc, integrating DVM, mode expander/preset, and preamplifier. *Active* storage provides BCD output data during next sampling. All these benefits *plus* Mil ratings at no extra cost. Plus standard functions of frequency, period, multiple-period average, ratio, multiple-ratio average, time interval, and random count measurements; automatic decimal point positioning and unit of measurement display. Prices of basic instruments start at \$1,960 and plug-ins from \$440. For your best value in counting, ask your Beckman Berkeley representative for a demonstration of a *truly* solid-state electronic counter—the 6100 Series.

Beckman[®]

INSTRUMENTS, INC.

BERKELEY DIVISION

RICHMOND, CALIFORNIA • 94804

INTERNATIONAL SUBSIDIARIES: GENEVA, SWITZERLAND; MUNICH, GERMANY; GLENROTHES, SCOTLAND; PARIS, FRANCE; TOKYO, JAPAN; CAPETOWN, SOUTH AFRICA

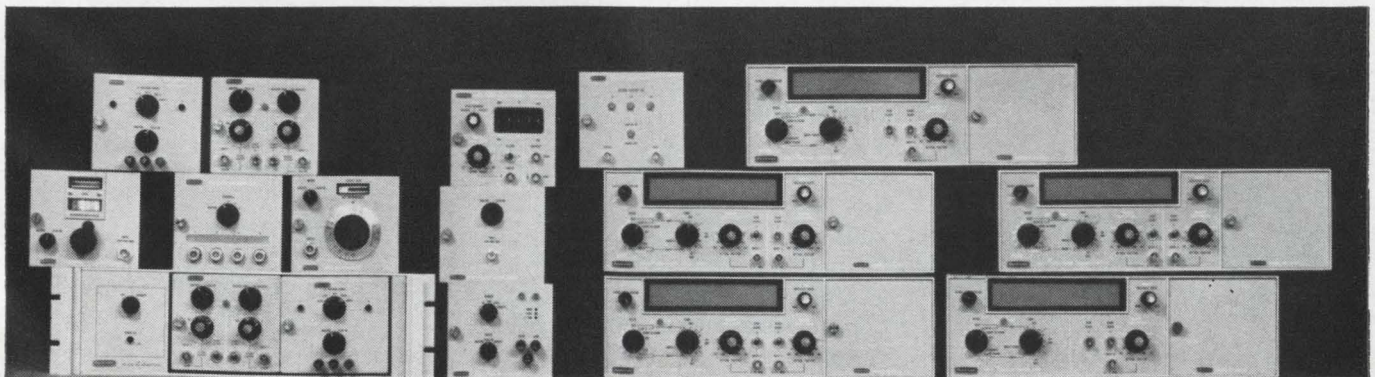

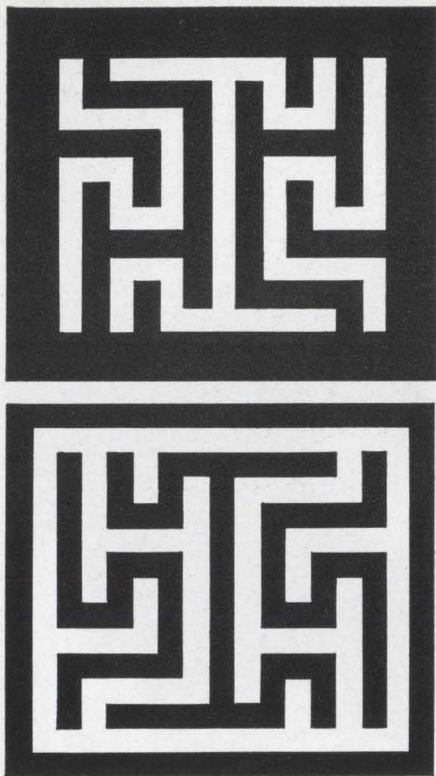

Patterns for the future

are being set at General Micro-electronics. Following a philosophy of "device to systems design," GME has experienced unparalleled growth in the electronics industry. This growth has increased our demand for creative people who can contribute professional or technical talent in the areas of:

- Component and Systems Design
- Advanced Circuit Design in such areas as Input/Output Conversion, Memory and High Speed Digital Circuits
- Integrated Circuit and Semiconductor Device Engineering
- Semiconductor Materials R & D

Resumés or letters outlining your interests and background should be addressed to:

Technical Staffing

GENERAL MICRO-ELECTRONICS, INC.
A Subsidiary of The Pyle-National Co.
2920 San Ysidro Way, Santa Clara, California

An Equal Opportunity Employer.

Commerce Department, made by the Massachusetts Institute of Technology.

In fact, completely automatic electronic controls for high-speed ground transportation—200 to 300 miles an hour—will have to be well on the way to development before any decisions on system design can be made, the study said.

The study pinpointed areas in which new research and development efforts are needed. Congress has authorized a three-year, \$90-million program for high-speed ground transportation development, with about two-thirds of it for R&D.

Requirements for which electronic techniques have not been perfected, the study said, include: over-all computer control of the system; keeping of real-time tabs on each vehicle; speed control of each vehicle for safe headways and emergency stops; switching controls to feed vehicles into the high-speed guideway or to transfer passenger-carrying capsules from one vehicle to another without slowing; and a completely computerized system for scheduling and for reservations, ticketing, billing and accounting.

Choice question. Electronics may figure in choice of a power source and a decision on whether the high-speed vehicles should roll on steel or rubber wheels, skim on cushions of air, or float in magnetic suspension above the guideway.

A linear-induction motor—essentially a rotary-principle motor with the guideway itself serving as the stationary energy-power source—probably would be easiest to adapt to automatic control, the report said. Some developmental work has been done by the Westinghouse Electric Co. and the General Motors Research Laboratory at Santa Monica, Calif. And the use of silicon controlled rectifiers has made variable-frequency power supplies feasible at high-power levels, offering a possible means of acceleration and deceleration. But linear-induction motors are still largely theoretical, and the MIT study said extensive new research is needed into all potentially promising power systems.

Some groundwork is being done on automatic control systems. At least four companies are developing systems tailored to lower-speed, more conventional railroad and rapid-transit systems [Electronics, July 26, 1965, pp. 71-96]. They are the Westinghouse Air Brake Co., General Electric Co., Westinghouse Electric Co. and General Railway Signal Co. Some of their techniques may be adaptable upward, officials have said. But the demands of the high-speed system envisioned in the university study is expected to far exceed present-day control devices.

Computer aided. "At the high speeds now encountered only in air transport," the report said, "there is overwhelming evidence to suggest that . . . these command and decision functions must necessarily yield in large part to automation through computer control."

The MIT study recommended that a computer system be developed to handle not only reservations but also scheduling—putting new vehicles into service automatically to meet increased demand. This would require knowledge of the position and of every vehicle in the system; and once such a process was started, it might eventually be possible to evolve completely free scheduling—adding vehicles only when demand arose.

The study recommended establishment of a nonprofit research organization to coordinate R&D activities.

A high-speed ground transportation system could be constructed within 15 years, if intensive R&D efforts were begun now, the study said.

Instrumentation

Ultraviolet steel gauge

In steelmaking, one of the biggest causes of waste has been the inability to measure accurately the width of the hot steel strip as it passes through the mill. Conventional gauges are based on infrared

sensors; because the outer edge of the steel cools faster than the middle, it emits less infrared—sometimes too little to be picked up by the detector.

The Granite City Steel Co. of Granite City, Ill., says it has solved the problem by changing to ultraviolet measurement with a width gauge that provides its own light source. The noncontacting gauge, developed by Gulton Industries, Inc., is just as accurate as conventional instruments—with error of only $\frac{1}{16}$ inch per 80 inches of strip width—but is unaffected by temperature variations in the steel.

Scanning. As the steel passes over the ultraviolet light source, the gauge's scanning mechanism sweeps over the metal 20 times a second. Each time the scanner crosses an edge of steel strip, which is either blocking or unblocking the light behind the strip, the scanner generates narrow pulses defining the location of the edge. Filters screen out the infrared radiation. Simultaneously, a high-speed counter and a shaft-driven pulse generator convert the time between pulses into a digital quantity whose magnitude corresponds to the strip width.

The scanner consists of two optical systems, synchronized sequentially. The two scanners and the pulse counter are on a common shaft; this assures that the digitizing accuracy will be independent of any variations in the scanning speed. The width measurement is displayed digitally at a control console and compared with a preset width. This comparison generates an analog signal that can be used to control the mill. The scanning-and-display process takes 0.01 second.

This speed is important because the company receives orders for steel strip in a variety of widths, and any delay in adjustment of the width can result in expensive waste.

Easy to operate. Besides reducing waste of time and steel, the ultraviolet gauge requires little maintenance and needs to be calibrated only once—when it is installed. That's because it has only one moving part, a rotating shaft that whirls

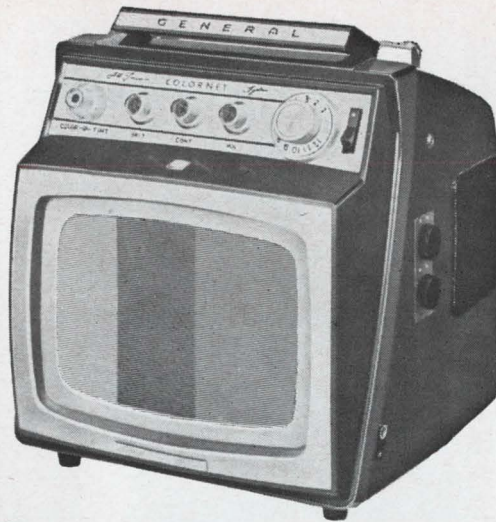

Weight: 18 lb.
Dimensions: 11" x 10" x 9-5/8"

Revolutionary one-gun 9" portable **color TV set** developed by **YAOU Electric Co., of Japan**

One of the big news stories in consumer electronics this year was Yaou's successful commercial production of its unique "colornet" color TV set. The all-solid-state system uses a line sequential system in combination with a 7-1/2" single-gun color tube, "colornetron," developed jointly by Yaou and Kobe Kogyo Co., Ltd. The result is an advanced TV color receiver with many attractive features:—

1. single-gun color tube with post focusing system gives **bright, natural color reproduction** and makes **adjustment and operation very easy**
2. ingenious combination of three interval APC circuit, offset subcarrier demodulator, and storage counter circuit **eliminates color drift**
3. low switching frequency and full utilization of beam current results in **stable performance and bright picture screen without "crawling"**
4. low switching frequency drastically **reduces interference from spurious radiation**
5. phosphorescent materials are applied to the picture tube vertically, so **color purity is not affected by terrestrial magnetism**, and the set **can be moved at will without necessitating readjustment**
6. elimination of convergence circuit meant that **servicing is no more difficult than for a black and white set**
7. with post accelerating system, deflection power is very small and deflection yoke and other components the same as for black and white sets, so **production cost of the set can be kept very low**
8. all-transistorization (47 transistors, 25 diodes, 16 thermistors, and 3 high voltage rectifiers) keeps the set **compact and light weight**
9. **power consumption is only 30 watts (DC-20 watts)**—1/10 that of a conventional vacuum tube color TV set
10. **receiver can be operated on DC 12V battery**

This revolutionary portable color TV set is only the latest example of the creative ingenuity built into every Yaou product. No wonder Yaou's electric and electronic consumer line has gained a reputation for quality and originality, along with reasonable prices.

 **YAOU**

(Outside of the United States & Canada,
Yaou products are marketed under brand name of "  **GENERAL** ")

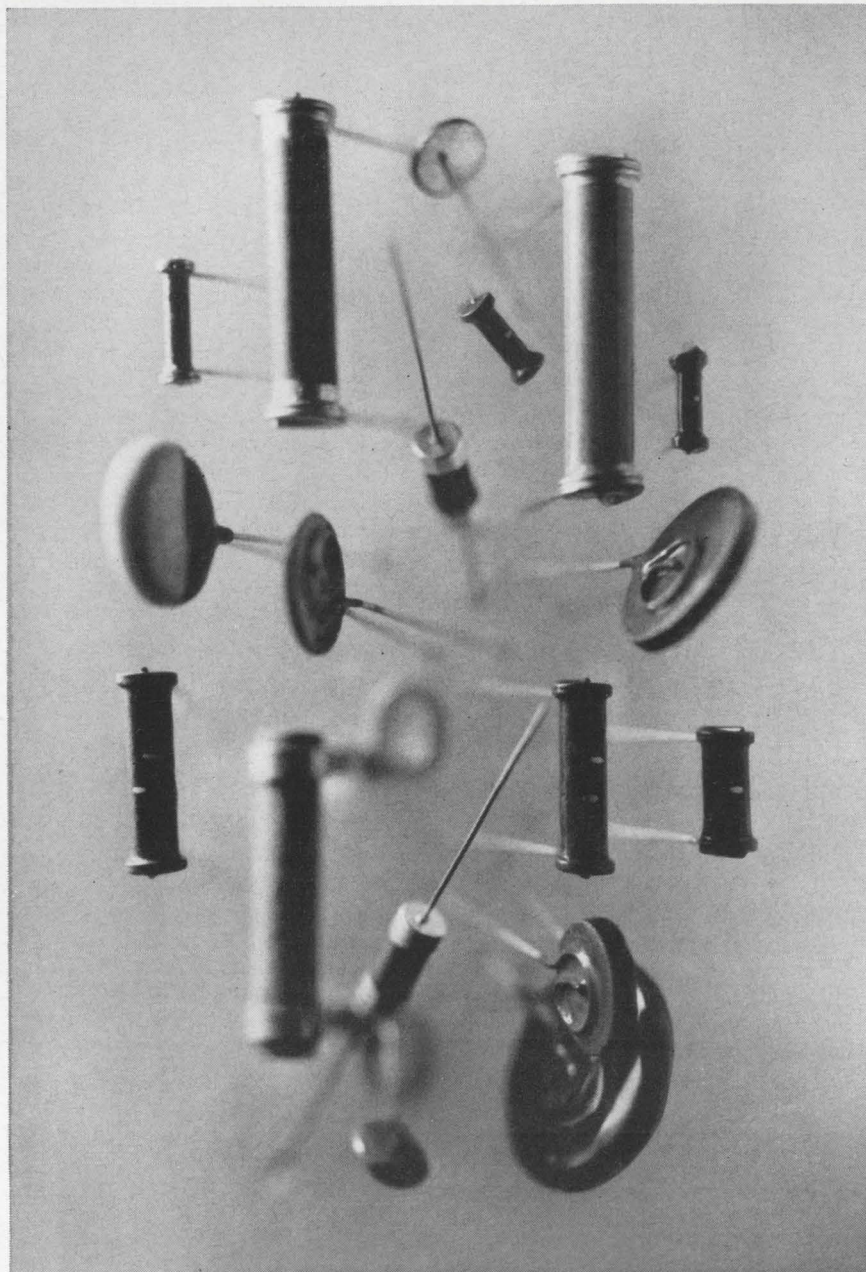

Varistors come get 'em

We make 99 standard silicon carbide varistors and stock them for immediate off-the-shelf delivery. Values range from 0.25 through 3.00 watts; sizes from 0.500" x 0.090" through 1.50" x 0.155" in discs. You'll find a full range of sizes in rod varistors just as available. Prices from \$0.08 to \$1.00. Send for complete technical data and see how economically, how quickly we can help you solve arc-suppression, voltage-regulation and -control problems with CARBORUNDUM® varistors. Varistors Dept. ELS-12, Electronics Division, The Carborundum Company, Niagara Falls, N. Y.

CARBORUNDUM

the two optical scanners' lenses at 1,200 revolutions a minute.

The gauge can also be checked to zero between strips. Conventional gauges have to be reset or recalibrated for each width, while production is interrupted.

The steel company declines to discuss savings, but Gulton says they should allow Granite City to amortize the machine's \$60,000 cost in less than six months. The company already has decided to install an ultraviolet scanner at an automated mill under construction at Granite City.

Computers

Printing in patches

A computer program developed by Bell Telephone Laboratories uses a cathode-ray tube in printing, providing a fast way to set a page of type.

The program, still experimental, displays, on the face of the crt, lettering in any type font, or other designs or patterns.

An electron beam traces irregular patches on the screen. The patches are assembled into letters. To the eye the display appears only as an irregular dancing spot zig-zagging widely across the screen; but a camera using time-exposure produces negatives and pictures of the lettering. Negatives can be quickly converted to a printing plate.

Previous use. Cathode-ray tubes have previously been used in text displays, but only where printed output was not needed. And the displays have been limited to a relatively small number of characters of a single size and style. Two systems have been used; in one a short sequence of instruction for each individual letter directs the electron beam to trace the outline of that letter. In the other a mask or stencil with the letters cut out shapes the beam by passing it through the appropriate part of the stencil; the beam is then deflected to the proper point on the screen. Either

way, the display is limited to one particular shape of the letter generated by the instructions or cut into the stencil.

Present-day electronic typesetting techniques are generally limited to automatic hyphenation and justification (margin-straightening) using typesetting machines controlled by computer-generated paper tape.

Simple to use. To use the new technique, an operator types on a keyboard in much the same way as on a standard typewriter. The new program can display text in any alphabet, simply by assembling the patches in the proper order for the characters desired. The program can also display musical scores, line drawings, mathematical equations, or any other graphic output. With this technique, the "type" can be "set" for a printed page much faster than by any other method, and the printing plate then made from the photographic negative by conventional techniques.

Bell is working on clearer displays of more shapes, and on a special-purpose computer for operating the display. Eventually it may be possible for a reporter to file a news story, editors to edit it, and the printing plate to be made for it, without once writing it on paper.

Avionics

The radar gap

At 4:18 p.m. on Saturday, Trans World Airlines Flight 42 bound from San Francisco and Eastern Airlines' 3:30 shuttle from Boston were just two of almost a hundred blips on the radar scope in the air route control center at John F. Kennedy International Airport. The two blips were on a collision course, but nobody in the control center was concerned. According to the flight plans of the planes, they were separated in the air by 1,000 feet of altitude which doesn't show on the two-dimensional radar. At 4:20 p.m. the blips met; but one blip even-

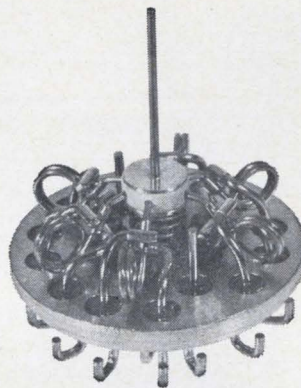

WHERE THE WEDGE-ACTION* IS!

These contacts provide the highest confidence level ever established by an electromechanical relay

Electro-Tec's wedge-action contact design has been proving itself for over 8 years in 6PDT operations — establishing a dry-circuit confidence level of 90% based on a failure rate of only .001% in 10,000 operations. It's been available for over a year for 2PDT operations. Our new 1/2-size crystal can wedge-action relay will be available soon in production quantities. In all wedge-action relays, each precious-metal contact combines a long contact wipe area with a high contact force. This combination gives you low, low contact resistance, stable within 15 to 20 milliohms over 100,000 operations. It gives you extreme shock, vibration, and acceleration immunity. Gives you a critical-application relay that outperforms spec. requirements. (Test data available on request.) Competitively priced.

*U. S. Patent No. 2,866,046 and others pending.

Request Literature on Wedge-Action Relays



Electro-Tec Corp.

SLIP RINGS • RELAYS • SWITCHES

P. O. BOX 667 • ORMOND BEACH, FLA.
(904) 677-1771 • TWX 810-857-0305

Manufacturing facilities: Ormond Beach, Fla. • Blacksburg, Va.

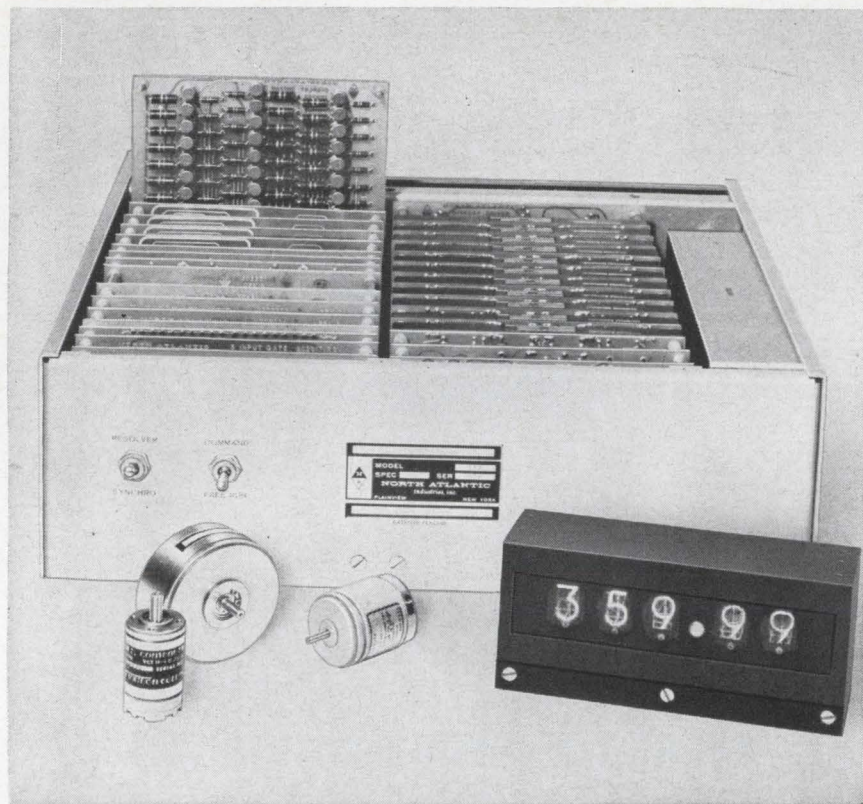

how to convert resolver and synchro angles to digits (and vice versa)

North Atlantic now brings you a new family of solid-state analog-to-digital and digital-to-analog converters for resolver and synchro data. They offer a major advance in conversion accuracy in modern navigation, simulation, data processing and measurement systems.

Typical of these new instruments is the Model API-5450 shown here. It provides both continuous and command conversion of both resolver and synchro angles, accommodates all line-to-line voltages from 11.8 to 90 volts at 400 cps. Output data is in decimal digits and is presented both as a Nixie-tube display and a five-digit printer output with supplementary print command. Accuracy is 0.01° and update time is less than 1 second.

All instruments in this family are designed to MIL-T-21200 and feature all solid-state circuitry and precision transformers—there are no motors, gears, or relays. Their flexible plug-in modular circuit design permits a wide range of variations to suit your specific requirements. For example:

- 18 bit or 10 second accuracy and resolution
- binary, BCD, or decimal inputs/outputs
- multiplexed channels
- multi-speed inputs/outputs
- high conversion speeds
- other signal frequencies

Your North Atlantic representative has complete application information. He'll be glad to help you solve interface problems in measurement and data conversion. Simply call or write.



NORTH ATLANTIC industries, inc.
TERMINAL DRIVE, PLAINVIEW, L. I., NEW YORK • Overbrook 1-8600

tually disappeared—and U. S. commercial air service suffered its 15th midair collision in the past 16 years.

No 3-D radar. In the aftermath of Saturday's crash, the question again arose why the Federal Aviation Agency does not have three-dimensional radar to warn ground controllers that assigned altitude separations have vanished. It was a familiar question because it had arisen five years earlier in 1960 when TWA and United Airlines planes collided over Staten Island, N. Y., killing 134 people.

Right after that accident, the FAA rushed work on 3-D radar, building a giant 14-story antenna to test a system designed by Maxson Electronics Corp. in Great River, N. Y. But that effort died because the system could not measure altitudes closer than 1,000 feet, the minimum separation between planes the FAA will permit.

As a result, FAA quietly dropped its plans for 3-D radar, claiming that no system was accurate enough. Instead, it adopted a program of installing beacon transponders that transmit altitude information and aircraft identification in digital form to the ground.

Only for jets. The FAA's system is scheduled to be operational by 1970. Today, only jet aircraft carry beacons, and not until 1969 will all jets have the kind compatible with FAA's system. The Eastern plane, a piston-powered Constellation carried no beacon.

When the FAA dropped its program in 1961 to install 3-D radar, its experts believed that controllers had to have altitude information with an accuracy greater than radar could provide. The controllers wanted to measure altitude separations as small as 100 feet, but the smallest even the best military height finders could measure was 1,000 feet. Even the best 3-D radar developed for the military could distinguish a separation of only 500 feet.

At the time, radar accuracy and speed of coverage were limited by mechanical antennas. Today, electronic scanning with phased arrays may supply the agency's required accuracy at a speed it wants.

LOW COST HI-VOLTAGE

NPN SILICON
TRANSISTOR

300 VOLT VCER
HFE > 40 IC = 20 MA VCE 10V
5 WATTS 25° C CASE

TRS 301 LC
TO-5 PACKAGE

70¢

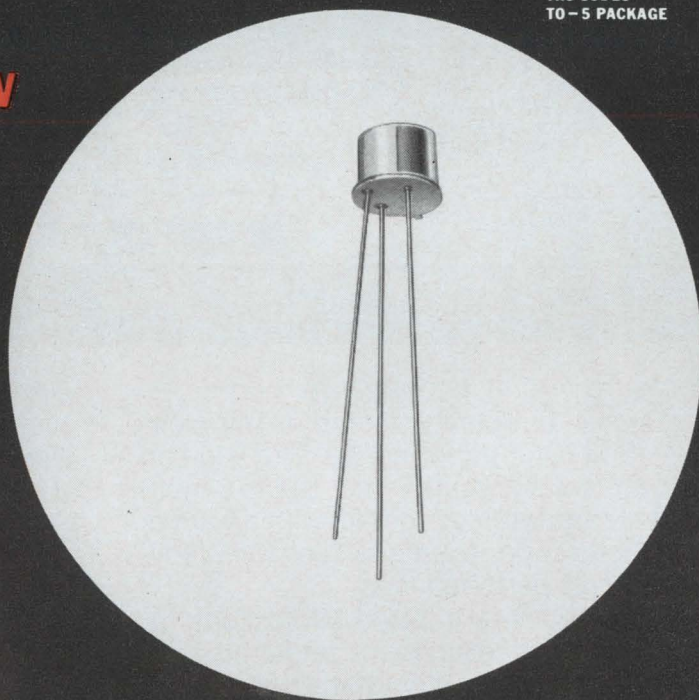

INDUSTRO

TRANSISTOR CORPORATION

35-10 36th Ave., Long Island City, N. Y. 11106 • Phone (212) 392-8000

For complete specifications
contact any Industro
distributor or
sales office

**NPN SILICON TRANSISTORS
ALSO AVAILABLE
THRU 800 VOLTS**

REPRESENTATIVES: Argus Associates, Inc., P. O. Box 68, Warminster, Penna., 215-675-4131 • Cantronics, Ltd., P. O. 296, Downsview, Ontario, Canada, 789-4664 • Dorado Elec. Reps., 13615 Victory Blvd., Van Nuys, Calif., 213-873-4124 • Geartner Associates, Inc., 235 Lincoln Road, Miami Beach, Fla., 305-531-0200 • Al Hubert Associates, P. O. Box 143, Brookline, Mass., 02145, 617 CO 2-0027 • J. R. Sales Eng'g Co., 6446 W. Bloomingdale Ave., Chicago, Ill., 312-889-6662 • Machine & Products (European Export), 52 Wall St., New York, N. Y. WH 4-4370 • Melvin Sales, 113 Camino Real, Millbrae, California, 415-697-6922 • Packard Associates, 6434 Maple Avenue, Dallas, Texas, 214-357-5713 • W. J. Stulgis Co., Inc., 698 W. Crockett St., Seattle, Washington, ATwater 2-7870 • Western Elect. Components, 4301 Birch St., Newport Beach, Calif., 714-540-1322 • White Sales Co., P. O. Box 8432, Minneapolis, Minnesota, 929-5710

Searching for Clues to Microcircuit Reliability?

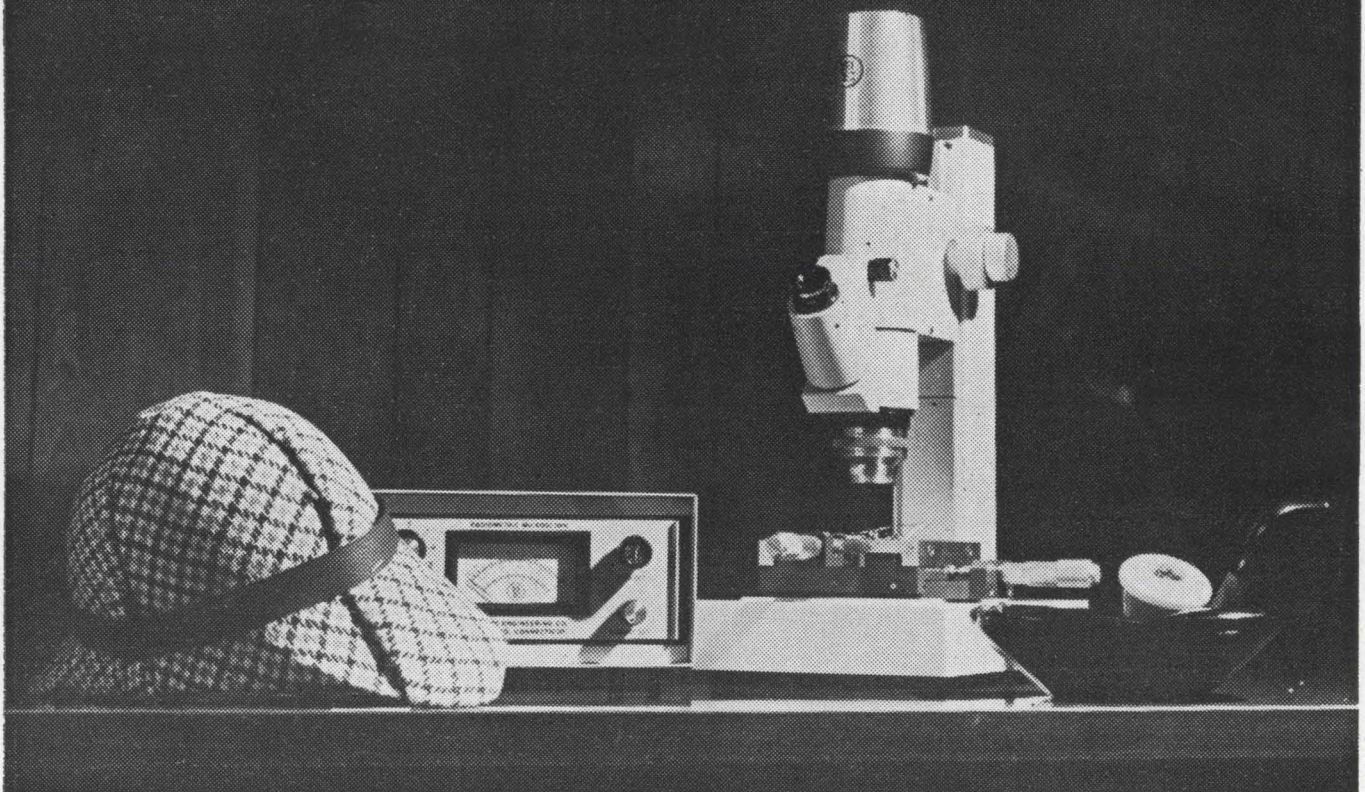

Measure circuit temperature.

Excessive temperatures rob a microcircuit's reliability and performance. But you can track down microcircuit "hot spots" non-destructively and without contact with a Barnes Infrared Microscope, a unique tool for studying microcircuit performance.

There's a Barnes Infrared Microscope for practically every measurement situation. It's easy to use — features simultaneous viewing while measuring — direct temperature readout — $\frac{1}{2}^{\circ}\text{C}$ temperature sensitivity at ambient. It's ideal for checking circuits of low power dissipation and handles target areas down to 0.0003 inch in diameter too.

Choose the Barnes microscope with an infrared detector matching your requirements.

Need microsecond response for high speed scanning, and measuring thermal transients? Use a cooled infrared detector in a stainless steel dewar. Gives 8-hour operation without attention. Troublefree life. How about special flexibility at lowest cost? Try our unique thermistor bolometer detector. Works without coolants. Operates anywhere, at any angle — even upside down.

With a full line of accessories and scanning stages, Barnes has the right Infrared Microscope to improve your microcircuit's reliability. Better investigate these new tools today. Phone, write or TWX our Product Sales Department for further information and a demonstration.



30 Commerce Road • Stamford, Connecticut 06902
Telephone: (203) 348-5381 • TWX: (203) 327-0840

TOTAL
RESPONSE . . . by *Air Products*

**makes
the
difference**

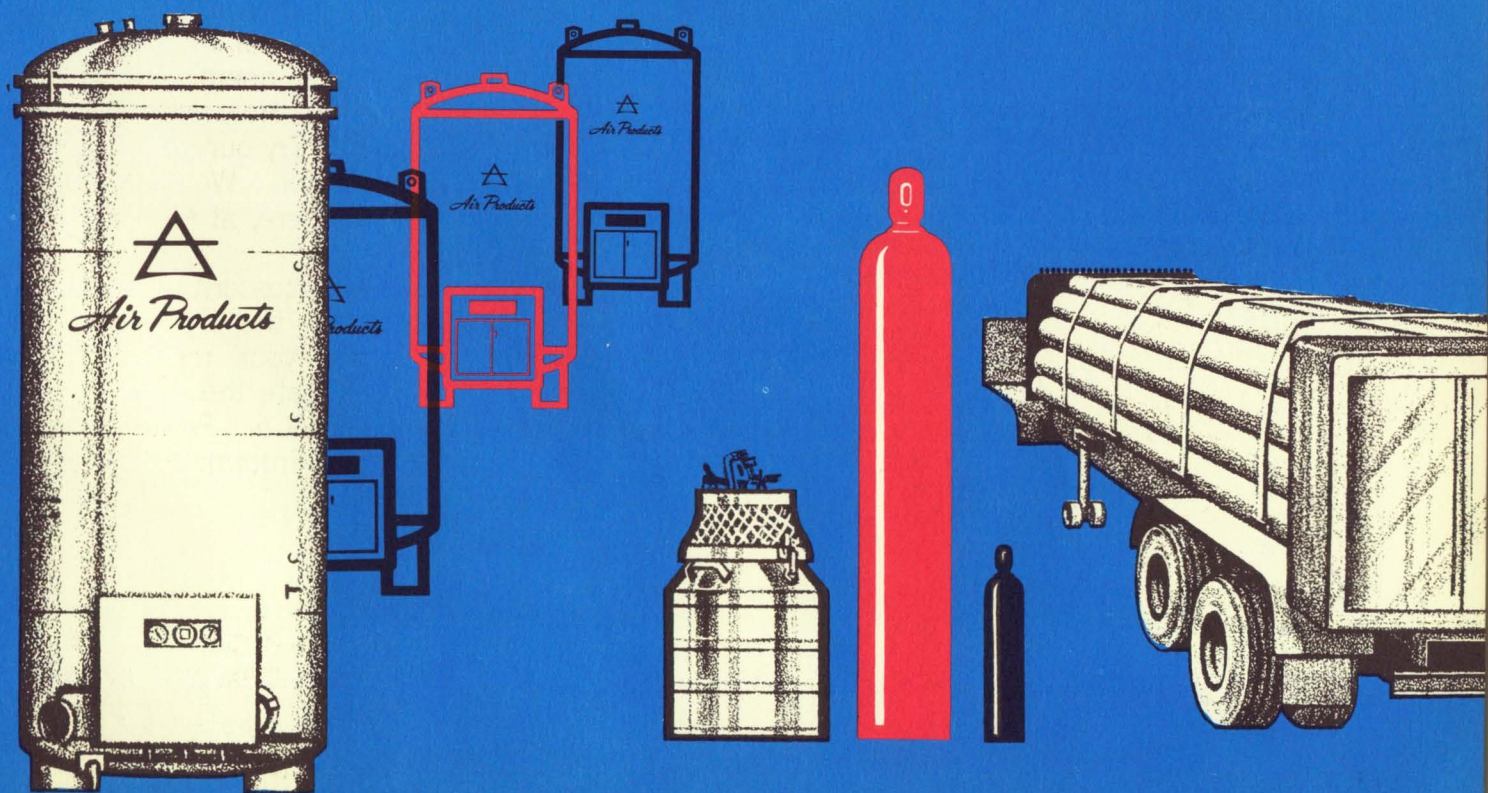

Air Products

**RESEARCH AND DEVELOPMENT
DESIGN AND ENGINEERING
FABRICATION AND CONSTRUCTION
PLANT OPERATIONS
PRODUCT DISTRIBUTION**



APPLIED R & D: Air Products total response literally begins here — at modern, recently expanded research and development laboratories, where scientists, chemists and engineers are assigned to projects ranging from explorations for improved products and processes of the future . . . to solutions of current customer problems.

In cryogenics — the science of the supercold in which Air Products continues to play a major pioneering role — typical projects extend from development of improved systems for production, distribution and storage of cryogenic liquids and gases . . . to more efficient and economical methods for Air Products customers to utilize these products. Still other projects are aimed at investigating and developing totally new dimensions of technology and service to our customers.

From these efforts have come such key developments as: Oxy-fuel lances — pioneered by Air Products — that promise to double steel production rates . . . Special oxygen processes for the copper refining industry . . . High-purity annealing gases that protect and improve the quality and versatility of steel and other metals . . . Special applications of gas atmospheres in float-glass manufacturing processes . . . Development of a complete line of specialty gases . . . The world's most advanced liquid nitrogen in-transit food refrigeration system . . . N₂-ON-SITE automatic plants to supply ultrahigh purity nitrogen.



DESIGN AND ENGINEERING: Heightened creativity in design and engineering is a key aspect of Air Products response to the demands of rapidly advancing cryogenic technology.

Moving from initial concept to final detailed specifications, Air Products design and engineering groups tailor their efforts to the individualized requirements of each customer.

Dramatically illustrating the creativity factor involved in these projects is the frequent need to develop entirely new design concepts for component equipment that would otherwise be unavailable.

Successful development of such components, and their optimum integration into total systems, is greatly facilitated by Air Products depth of experience in operating its own nationwide network of industrial gas production plants. Each plant figuratively serves as a "field laboratory" in which new design concepts can be tested under day-to-day operating situations. This experience proves invaluable in designing the equipment or systems that may serve your future requirements.

TOTAL RESPONSE by *Air Products* ...

MEANS TOTAL RESPONSE . . .

TO YOUR INDUSTRIAL GAS REQUIREMENTS

Yes, Air Products **total** response makes a big difference. A difference in efficiency. A difference in economy. A difference in full satisfaction of your requirements for industrial gases **when** and **where** needed in the purities and quantities specified.

Today, in fact, Air Products stands almost alone in its field as a source

of completely integrated capabilities. Whether your need is for a single cylinder of gas, or tonnage quantities delivered by pipeline from an on-site production plant . . . for specialized gas handling and utilization equipment, or for problem-solving research and development . . . Air Products has the capabilities that do the job, do it right, do it best!



FABRICATION AND CONSTRUCTION

— Translating engineering concepts into physical components and systems presents a major challenge to corporate versatility. A challenge to which Air Products responds with a quarter century's experience in fabricating equipment for its own and customer use. Many exclusive fabrication techniques developed by Air Products testify to outstanding competence in the manufacture of equipment ranging in size from the miniature to the massive.

Complementing this fabrication capability is proven leadership in construction of major plant facilities for the production of industrial gases. Critical-path scheduling and other computerized programs optimize work flow during successive stages of construction, reducing costs and assuring on-time start-up.

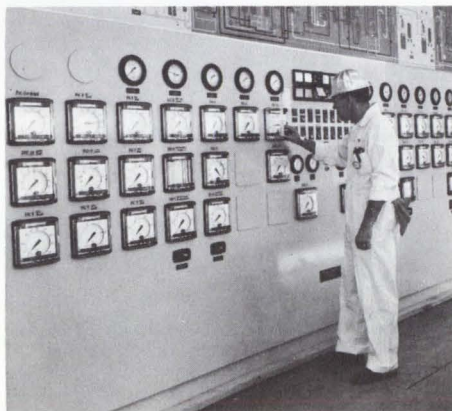

PLANT OPERATIONS — Technological and safety factors require outstanding competence in the operation of a modern cryogenic process plant. This level of competence is exemplified by the trained operating teams that provide reliable product supply from industrial gas production facilities operated by Air Products.

In each instance, Air Products operating capability gives an added measure of confidence that critical supply commitments will be met. In addition, the availability of highly skilled operating personnel meets the demands of increasingly automated equipment — with resultant maximization of plant efficiency.

Safety, a prime requisite in all phases of cryogenic technology, is a further by-product of the skills of Air Products operating specialists. Continuing feedback of information and data from each Air Products plant facility creates, in addition, a vast knowledge-reservoir drawn upon by all Company groups in fully satisfying customer needs.

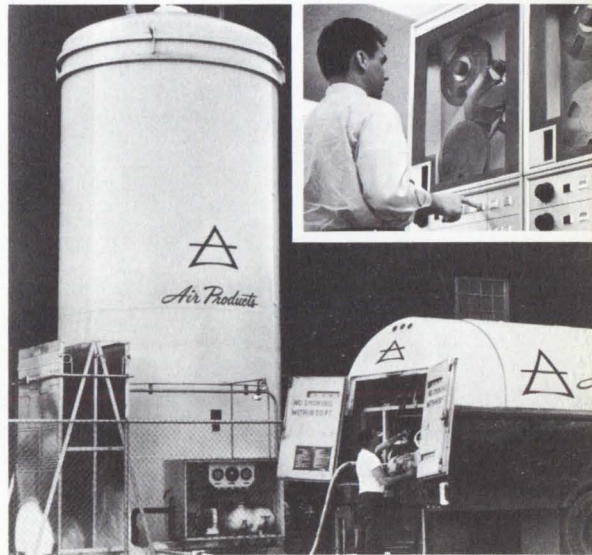

PRODUCT DISTRIBUTION — Nerve center of Air Products distribution network is a computer-control center. Here, distribution specialists program each customer's product demand patterns, relate total requirements to plant production, and schedule rail and highway transports for optimal product distribution.

Though seemingly complex, this computer-controlled response has been refined to standard operating procedures that provide product availability when and where needed.

Economy, another vital aspect of Air Products distribution leadership, is underscored by the world's most modern fleets of tank-trucks, tank-trailers, and railway tank-cars, for the deliveries of bulk quantities of liquefied gases. Cylinder trucks and tube trailers distribute gaseous products.

Operating from Air Products nationwide network of production plants and distribution centers, these rolling fleets make on-time, every-time deliveries to meet your every industrial gas requirement.

MAKES THE DIFFERENCE

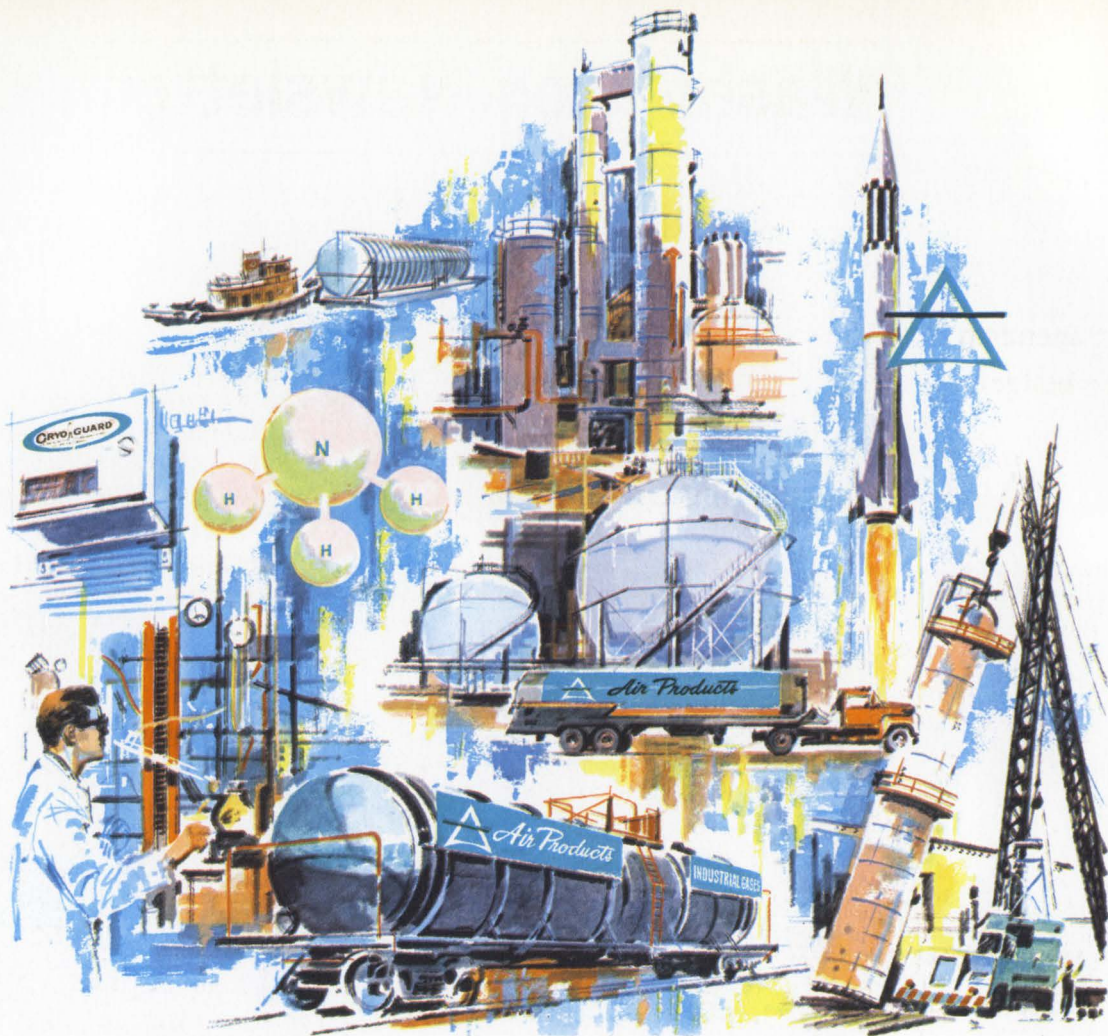

GASES IN TONNAGE QUANTITIES: Air Products — pioneer of the on-site concept of industrial gas production — builds a cryogenic production facility at or near the customer's location . . . economically supplies gases in tonnage volumes via direct pipeline.

GASES IN BULK QUANTITIES: Small to medium volume demand for industrial and medical gases is most economically supplied by bulk liquid deliveries to storage units installed on your property by Air Products. Liquid content is automatically vaporized and drawn off as a gas when needed. In addition, tube-trailers provide bulk deliveries of gaseous product.

GASES IN CYLINDER QUANTITIES: To customers requiring gases in cylinder quantities, Air Products means assurance of full-line product selection. Nationwide fleets of cylinder trucks and trailers speed deliveries of these gases from Air Products production plants and distribution centers. Added value: An Air Products analysis of your gas applications, and programming your most economical supply pattern.

RARE GASES: Deliveries of argon, neon, krypton and xenon — in the quantities and purities you require — are backed by the famed Air Products service that helps customers select and apply gases most efficiently and economically.

ANNEALING GASES: Air Products has adapted its on-site production leadership to the tonnage-volume supply of hydrogen and ultrahigh purity nitrogen gas mixtures that protect and improve the quality and versatility of steel and other metals.

SPECIALTY GASES: Air Products proprietary techniques in gas blending — plus the industry's most advanced quality control program — underscore a line of more than 100 specialty gas products including: research gases, gas mixtures, calibration gas standards, doping gases, zero gases, biomedical gases, and industrial and forming gas atmospheres.

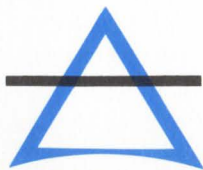

Air Products and Chemicals
INC.

ALLENTOWN, PENNSYLVANIA

Washington Newsletter

December 13, 1965

Military spending expands budget . . .

The war in Vietnam has ruined President Johnson's efforts to hold this fiscal year's spending below \$100 billion. Government outlays in fiscal 1966, ending next June 30, will be \$5 billion to \$7 billion higher than the \$99.7 billion total originally projected. **The President is likely to seek as much extra spending as possible in the current year, through supplementary appropriations, to take some of the inevitable pressure off what is shaping up as an enormously tight budget for fiscal 1967.**

Military spending alone for fiscal 1966 will climb between \$3 billion and \$4 billion from the \$49 billion that was estimated last January.

The big question now is the size of the additional buildup that Johnson will announce in January when he makes his requests for spending for 1967.

Unofficial expectations are that, for 1967, military costs will climb yet another \$3 billion to \$4 billion, to \$55 billion. Minimal additional increases in what is being called a "lean" and "disciplined" budget should push the over-all total to a record \$110 billion.

So 1967 will not be a year for initiating programs.

. . . slowing progress on Nike X system . . .

It is increasingly likely, for instance, that the government will back away again from a clear-cut commitment to build and deploy the Nike X antimissile missile defense system. President Johnson and Defense Secretary Robert S. McNamara must reach a decision soon in drawing up a new defense budget for submission to Congress next month.

But the rising cost of the Vietnam war and the inflationary potential of increasing government spending generally are known to be causing Johnson serious concern. These two problems are strong arguments against approval for production of Nike X now, particularly since there is such controversy both inside and outside the government on the need for the system.

The expectation is that production will be postponed for another year, or that only a modest start will be made so as not to constitute a firm commitment to eventually build the entire system. McNamara has long indicated doubts about how effective Nike X would be against a Soviet attack and about the high cost—\$20 billion—for such a defense. But he has shown considerable interest in a more modest version, costing \$6 billion to \$10 billion, for protection against a Communist Chinese missile threat.

Now, however, approval of even this less-ambitious system appears doubtful because of the budgetary climate. As a reflection of this, Nike X advocates have begun to talk up a still more limited possibility—a pinpoint defense system to protect the United States' intercontinental missile sites. The problem is the high cost of tooling up to achieve such limited production.

. . . and keeping rein on NASA spending

Similarly, the National Aeronautics and Space Administration's budget for fiscal 1967 will be held tightly to programs already under way. That is the word coming out of conferences now being held by NASA and the Bureau of the Budget. NASA wants a \$5.6-billion budget for fiscal

Washington Newsletter

1967. The Budget Bureau wants to hold it to \$5.1 billion.

NASA has planned to start a round of post-Apollo programs in fiscal 1967 as funding for current programs begins to taper off. This is contingent, however, on the agency's keeping its over-all budget at the \$5.3-billion level, at which it has been running for the past couple of years. Now, NASA sources say they are not sure whether the White House will approve any of the new programs. **NASA has definitely been told that there will no across-the-board long-range money;** funds must be earmarked for specific projects to stand a chance of approval.

The major program NASA wants to start next year is Project Voyager, to land unmanned instrument packages on Mars by 1971. The estimated cost is \$1.5 billion. Congress authorized \$48 million this year for study purposes, but hasn't officially approved the program in its entirety. Such approval would require \$150 million to \$200 million more in next year's budget. **NASA also wants to move forward on programs to extend Project Apollo,** whose goal is to land men on the moon by 1970. The space agency won't know for two to three weeks which of these will be approved, if any.

Whether NASA's budget for fiscal 1967 dips slightly below this year's level or not, **spending during fiscal 1967 will hold at about \$5.6 billion,** about the same as this year's because spending lags behind new appropriations and contract-letting.

Research projects to be catalogued

The attention of government specialists in handling scientific and technical information is beginning to turn to the need for information on projects that are still under way; earlier efforts concentrated on completed projects.

The Federal Clearinghouse for Scientific and Technical Information will begin publication early next year of a catalog of all current physical research, both basic and applied, supported by the government.

The listing, to be distributed to industry twice a month, will come out of the Smithsonian Institution's Science Information Exchange, which already has a catalog of about 12,000 projects.

For internal, research-management purposes, NASA is seeking proposals by Dec. 20 on an automated program-management and information system. The program will give NASA the ability to call any current research projects out of the system for a look or for meshing with other parts of the space program. NASA also has an agreement with the Defense Department under which the two agencies exchange reports of research projects.

Bigger civilian role for science weighed

Are the United States' scientific resources being "economically employed to achieve our vital national goals"? **A research subcommittee of the powerful House Committee on Government Operations will begin hearings on that question in January.**

The subcommittee's chairman, Henry S. Reuss (D., Wis.), agrees with Gov. Edmund G. Brown of California and Sen. Gaylord Nelson (D., Wis.) that a national effort might be justified, applying research-and-development techniques to water, sewerage, transportation, crime and civilian industrial technology.

Did you ever wish someone would combine the best cleaning features of fluorocarbon solvents and water detergents?

Someone did! It's called FREON® T-WD 602.

FREON T-WD 602 solvent* is a clear, stable dispersion of water in FREON® TF that combines the cleaning power of water detergents with the unique properties of FREON fluorocarbon solvents. It cleans organic and inorganic soils at the same time...and cleans better than water detergents alone. Here's why:

Lower surface tension—Water has a surface tension of 72 dynes per centimeter. With a detergent, this drops to approximately 30. But FREON T-WD 602 has a surface tension of only 19.5 dynes! It easily penetrates even the most microscopic pores and crevices to dissolve and wash away contaminants that water and detergents can never reach...and its high density floats particulate matter away.

Quick drying—A system using FREON T-WD 602 speeds up production. Parts come out clean, dry and ready to handle. No extra drying procedures are needed.

Leaves no residue—Parts cleaned in FREON T-WD 602 followed by a FREON TF vapor rinse dry without leaving any residue.

Can be re-used—You can renew the FREON T-WD 602 bath just by letting it settle, skimming off soils and replacing with an equal volume of water. FREON T-WD 602 is ideal for cleaning complex assemblies where a com-

bination of organic and inorganic soils exists. It is one of a group of "tailored" solvents for special cleaning problems based on FREON TF. For more information, mail the coupon.

*Process and composition patents applied for.



BETTER THINGS FOR BETTER LIVING
...THROUGH CHEMISTRY



Du Pont Co., Room 3309-A
Wilmington, Delaware 19898

Please send complete information on
 FREON T-WD 602; the other FREON
"tailored" solvents. I am interested in
cleaning _____

Name _____ Title _____

Company _____

Address _____

City _____ State _____ Zip _____

In Europe, mail to: Du Pont de Nemours International S.A.,
"Freon" Prod. Div., 81 route de l'Aire, Geneva, Switzerland



THREE NEW RTV SILICONE RUBBER DEVELOPMENTS

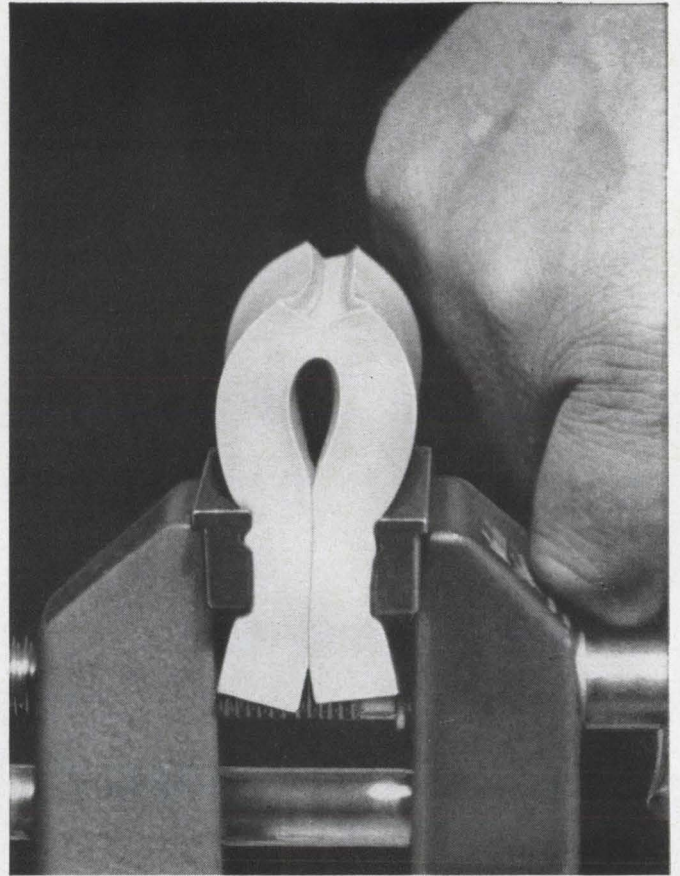
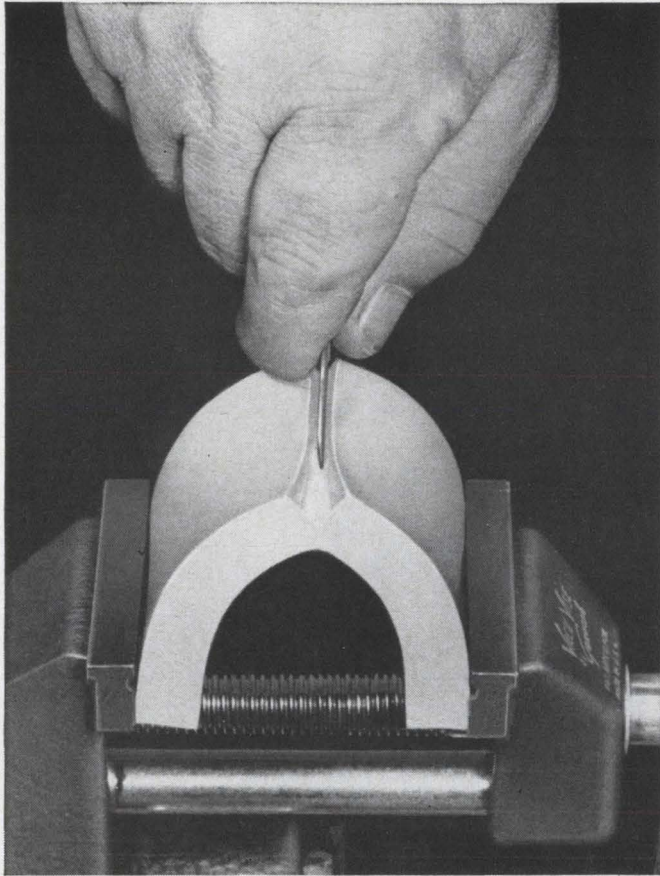

RTV-7 foam for shock and vibration damping at extreme temperatures

RTV-7 foams to five times its original volume to provide mechanical support. Even at temperatures as low as -65°F or as high as 350°F , it retains the flexibility needed to absorb severe shock and vibration . . . assures continuous protection for electronic components and electrical apparatus.

Mixed with a curing agent, RTV-7 liquid silicone rubber foams and cures on the spot. In 10 minutes flat. Density can be varied to meet specific requirements.

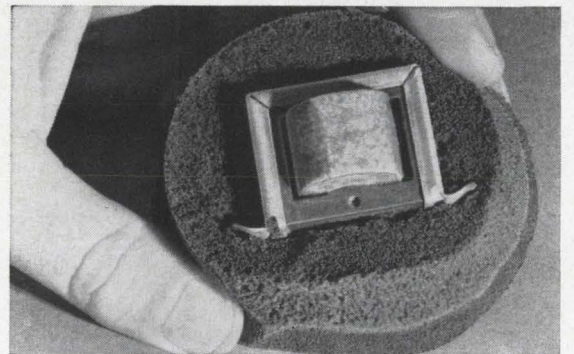

AUTHORIZED DISTRIBUTORS OF RTV INDUSTRIAL SEALANTS

ALABAMA
Argo & Company
Birmingham

ARIZONA
Electrical Specialty Co.
Phoenix

CALIFORNIA
Electrical Specialty Co.
Los Angeles
Electrical Specialty Co.
South San Francisco
R. V. Weatherford Co.
Glendale

COLORADO
Electrical Specialty Co.
Denver

CONNECTICUT
R. H. Carlson Co., Inc.
Greenwich

D. C.
Read Plastics, Inc.
Washington

FLORIDA
Gulf Semiconductors, Inc.
Coral Gables
Gulf Semiconductors, Inc.
Winter Park

ILLINOIS
Allied Radio Corp.
Chicago
Federal Insulation Corp.
Chicago
J. J. Glenn and Co., Inc.
Chicago

INDIANA
Hyaline Plastics Corp.
Indianapolis

IOWA
Plastic Supply, Inc.
Des Moines

KENTUCKY
General Rubber &
Supply Co.
Louisville

MASSACHUSETTS
Northeast Chemical Co.
Boston

MICHIGAN
F. B. Wright Co., Inc.
Dearborn

MICHIGAN (cont'd)
Ren Plastics Inc.
Lansing

MINNESOTA
D. A. Schultz Company
Minneapolis

MISSOURI
D. A. James Company
St. Louis
Regal Plastic Supply Co.
Kansas City

NEBRASKA
Regal Plastic Supply Co.
Omaha

NEW JERSEY
Smooth-on Mfg. Co.
Jersey City

NEW YORK
Punt, Inc.
Floral Park
Queen City Rubber Co.
Buffalo
Adhesive Products Corp.
New York
Chamberlin Rubber Co.
Rochester
Syracuse

OHIO
Philpott Rubber Co.
Cleveland
Parkway Products, Inc.
Cincinnati

OREGON
Electrical Specialty Co.
Portland

Ultra-high strength RTV-630: slash it, flex it double...it never tears

By far the toughest two-part RTV silicone rubber ever developed, General Electric's RTV-630 has a tear strength of 100 psi — die B. *That's more than twice the tear resistance of any other RTV.*

Three physical properties comparable to those of heat cured rubber are the basis for RTV-630's uncommon toughness.

- Hardness measures 55-70 durometer.
- Tensile strength registers as high as 850 psi.
- Elongation ranges between 300% and 400%.

The overall strength and durability of General Electric's newest RTV are complemented by its superior reversion resistance. By its rapid curing time. And by its outstanding thick section cure capabilities.

Proven in Plastics Processing and Flexible Mold Applications

Already used for prototypes and in extended runs for plastic parts fabrication, RTV-630 has consistently demonstrated superior performance under rigorous production conditions.

In thermoforming reinforced plastic parts for space vehicles, RTV-630 was successfully used as a male punch die. Subjected to 5000 psi at 350°F, it has performed more than *six times longer* than previously used materials without any visible signs of fatigue or deterioration.

In multi-cavity molding of epoxy parts for electronic modules, RTV-630 molds lasted *twice as long* as molds made with conventional RTV's.

Now the toughest RTV in existence, RTV-630 also promises to be important in other applications. In potting and encapsulating. Molded functional parts. Pressure bag and matched die molding of reinforced plastics. Conveyor belts. And release coatings.

7 common properties of all G-E RTV silicone rubbers

- Extreme temperature resistance.
- Room temperature cures.
- Chemical resistance.
- Ozone, weather and age resistance.
- Strong bonds.
- Excellent dielectric.
- Minimum shrinkage.



Ready-to-use RTV-102 cartridge pack speeds production line sealing

No catalyst, no mixing, no priming needed. RTV-102 sealant is ready to go, ready to speed sealing jobs. Provides tough, flexible rubber seals for radio chassis, terminal connectors, other electrical and electronic applications. Ideal for hard-to-reach spots. Sets in minutes. Cures in hours. Won't sag, shrink, crack, harden or peel.

General Electric's new cartridge pack comes with white (RTV-102) and translucent (RTV-108) compounds. In six and 12 ounce sizes for hand or air powered caulking guns.

PENNSYLVANIA
Smith of Philadelphia, Inc.
Philadelphia
Speck-Marshall Co.
McKees Rocks

TEXAS
Lawrence Electronic Co.
Dallas
Houston Industrial
Supply Co., Inc.
Houston

WASHINGTON
Electrical Specialty Co.
Seattle

WISCONSIN
R. J. Wittenburg Co.
Milwaukee

For complete information on these newest G-E RTV compounds, ask your nearest distributor as listed, or write to Section N12167, Silicone Products Department, General Electric Company, Waterford, New York.

GENERAL  ELECTRIC

CLARE *MILITARY-TYPE*

Meet the most rigid design requirements

Circuit designers working to military standards of reliability will find that CLARE Military Type Relays are precise components of unusual flexibility, capable of long-life operation under a wide variety of contact loads. They offer the designer exactly the relays he needs—standard, extra sensitive, latching, miniaturized—with sensitivity ranging from 40 to 250 mw. All meet

stringent requirements of shock, vibration and linear acceleration, in ambient temperatures ranging from -65°C to $+125^{\circ}\text{C}$. Terminals are designed for 0.2" grid spacing. Terminal types include plug-in, solder hook, straight lead and formed lead. Mounting styles may be plain, side plate, stud or ear bracket. Relays are available with soldered or welded (W) cases.

Versatile Contact Capability • Gold-plated contact areas provide consistently low contact resistance. Bifurcated contacts, with high contact pressures and overtravel for proper wipe, provide reliable operation at high or low level.

Long Mechanical Life • Contacts and armature are only moving parts... obviating mechanical failure and assuring consistent trouble-free, long-life operation.

High Sensitivity • Consistently high sensitivity (while still maintaining wide contact gaps and high contact forces) is made possible by coils and magnetic parts of maximum size.

CLARE Quality • A continuous testing program, with feedback to product engineering, quality control, and production functions, results in standard production relays of constantly improving quality. It also provides reliability data of immediate value to the customer. Clare Military Type Relays meet the rigid specifications of MIL-R-5757D... plus the even more stringent requirements of the Clare Quality Assurance Program.

	F	FW	One-Coil LF One-Coil LFW	Two-Coil LF Two-Coil LFW	SF	SFW	HF
Contact Arrangement	2 Form C (dpdt)						
Contact Rating— High Level (NOTE 3)	2.0 amp res @ 28 VDC, 125°C 1.0 amp res @ 115VAC, 125°C			2.0 amp res @ 28 VDC, 125°C 0.5 amp res @ 115 VAC, 125°C		2.0 amp res @ 28 VDC, 25°C 1.0 amp res @ 28 VDC, 125°C 0.3 amp res @ 115 VAC, 125°C	
Contact Rating— Low Level	10 μ a @ 10 mv.			100,000 miss-free operations monitored at every operation for a maximum drop of .5 mv.			
Contact Resistance— Before Life	50 milliohms max @ 6v, 100 ma						
Contact Resistance— After Life	100 milliohms max @ 6v, 100 ma						
Maximum Operate Time (including bounce)	5.0 ms		8.0 ms	6.0 ms		8.0 ms	5.0 ms
Nominal Must-Operate Sensitivity	250 mw		50 mw	100 mw (per coil)		40-200 mw (Note 1)	160 mw
Nominal Operating Voltage	6.3-110vdc		3.2-110vdc (continuous duty)	3.2-54vdc (continuous duty)		6.3-110vdc	5.0-48vdc
Coil Resistance	35-10,000 ohms		40-9100 ohms	15-4400 ohms (per coil)		35-10,000 ohms	40-3500 ohms
ENVIRONMENTAL CAPABILITIES (Temperature Range: -65°C to $+125^{\circ}\text{C}$)							
Shock ($\frac{1}{2}$ sine wave 11 \pm 1 ms pulse)	65 g		100 g			65 g	65 g
Vibration	.125" double amplitude or 20 g (Note 2)		.250" double amplitude or 20 g (Note 2)			.125" double amplitude or 15 g (Note 2)	.250" double amplitude or 20 g (Note 2)
Linear Acceleration	100 g						

- NOTES: { 1. SF and SFW Relays are available in four ranges of sensitivity—40-60 mw, 61-80 mw, 81-120 mw, 121-200 mw.
2. Whichever is less and depending on mounting style.
3. 100,000 miss-free operations monitored at every operation for a maximum drop of 10% of source voltage.

RELAYS

.....with a wide range of relay types built for 100,000 miss-free operations!

F/FW* STANDARD

Non-polarized • Single-side stable • Single coil operation
High speed relays with operate and release time of 5 ms max. Operate at a power of 250 mw approx. Have mean mechanical life of 50,000,000 operations at 30 cps. Dimensions of Type F soldered enclosure are: .800" wide, .396" deep and .875" high. FW (welded) enclosures are .900" high.

SF/SFW* SENSITIVE

Non-polarized • Single-side stable • Single coil operation
High-sensitivity versions of F/FW relays. Identical in dimensions, similar in construction but capable of operating as low as 40 mw. Four models available with varying operating sensitivities (see Note 1, Table of Electrical Characteristics).

LF/LFW* LATCHING

Polarized • Bi-stable • Single or double coil operation
Magnetic latching relays. Dimensions identical to Type F/FW relays. Two permanent magnets incorporated in the dynamically balanced armature provide latching forces to hold contacts in either stable position. One-coil relays operate at approximately 50 mw, two-coil at approximately 100 mw per coil.

HF MINIATURIZED

Non-polarized • Single-side stable • Single coil operation
Half-size relays with same dimensions as F/FW relays except height (.410" max.). With standard 26.5 vdc coil, has resistance of 1250 ohms, must-operate sensitivity of 160 mw and power requirement of 560 mw at nominal voltage. Also available with special 26.5 vdc coil, resistance of 700 ohms, must-operate sensitivity of 290 mw and power requirement of 1000 mw.

*W indicates welded enclosures.

For complete information contact your nearest CLARE Sales Engineer

CALL— NEEDHAM (Mass.): (617) 444-4200 • GREAT NECK, L.I. (N.Y.): (516) 466-2100 • SYRACUSE: (315) 422-0347 • PHILADELPHIA: (215) 386-3385 • WASHINGTON: (202) 393-1337 • ORLANDO: (305) 424-9508 • CHICAGO: (312) 262-7700 • MINNEAPOLIS: (612) 920-3125 • CLEVELAND: (216) 221-9030 • XENIA (Ohio): (513) 426-5485 • CINCINNATI: (513) 891-3827 • MISSION (Kansas): (913) 722-2441 • DALLAS: (214) 741-4411 • HOUSTON: (713) 528-3811 • SEATTLE: (206) 725-9700 • SAN FRANCISCO: (415) 982-7932 • VAN NUYS (Cal.): (213) 787-2510 • TORONTO, CANADA: C. P. Clare Canada Ltd. • TOKYO, JAPAN: Westrex Co., Orient

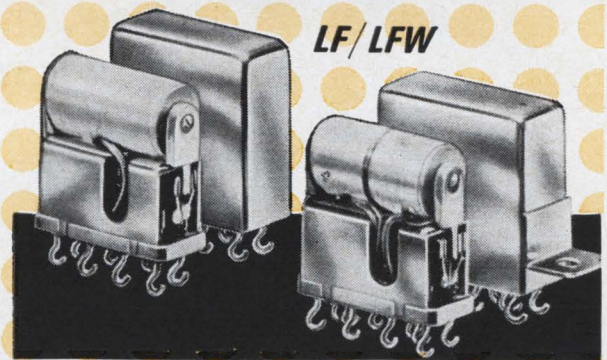
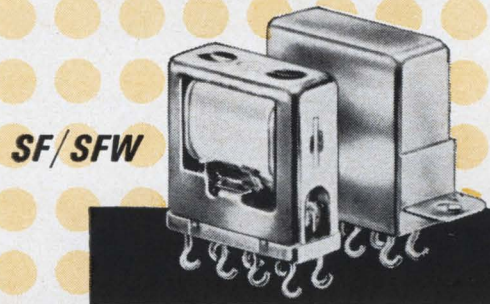
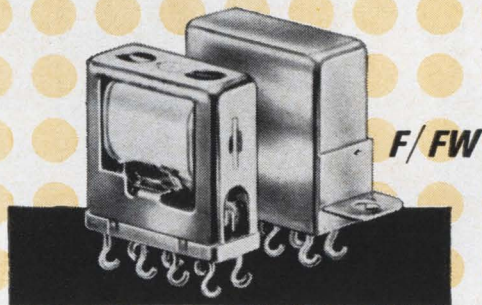

Write Group 12N7C. P. CLARE & CO.
3101 Pratt Boulevard Chicago, Ill. 60645



relays and related control components



Great editorial is something he takes to a meeting

(What a climate for selling!)

Electronics magazine helps engineers make decisions. It keeps a vital audience of technical men informed on what is new, different and changing in their highly complex world.

These key men are influential in purchasing a wide range of products and services. For example: nearly 80% buy or specify electronic components; nearly 80% buy or specify electronic equipment.

More than 65,000 engineer-subscribers here and abroad depend on the great editorial of Electronics to help them do their jobs effectively. They read Electronics carefully, and pass along their copies to 119,000* additional readers.

You can sell these important customers and prospects when they are most responsive, by advertising in Electronics.

*ELECTRONICS SUBSCRIBER PROFILE

Electronics

A McGraw-Hill *Market-Directed* Publication
330 West 42nd Street, New York, N.Y. 10036



MEMBER: AUDIT BUREAU OF CIRCULATIONS, AMERICAN BUSINESS PRESS

We want to thank

the microwave engineering community for its immediate and enthusiastic acceptance of our new **Modular Microwave Signal Generators & Sources. Polarad** generator / source sales are soaring, & everyone who adopts the PEI modular rack / stack (or "more instrumentation for your instrument dollar") Philosophy Becomes a Logical Prospect for **Modular Spectrum Analyzers, Modular SSB Analysis Systems**, and the World's Finest RFI Equipment. Want More Signal Capability per Dollar?

Call Your Local Polarad Sales Engineer or Call Us Directly at (212) EX 2-4500 for a Demo or a Quote.



Model 1107/1108

Signal Generators
3.80-11.0 GC
+3 dbm to -127 dbm
(+10 dbm uncalibrated)



Model 1205

Source
0.95-2.40 GC
Varies from 50 to 320 mw depending on frequency.

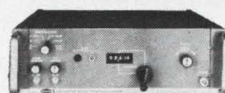

Model 1206

Source
1.95-4.20 GC
Varies from 50 to 230 mw depending on frequency.

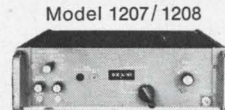

Model 1207/1208

Sources
3.80-11.0 GC
Varies from 25 to 200 mw depending on frequency.

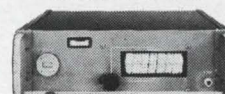

Model 1509/1510

Doublers
10.0-21.0 GC
0 dbm to -100 dbm; max. input
200 mw; conversion loss < 18 db.

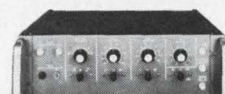

Model 1001

Modulator
Sufficient level to modulate all modular generators and sources.
Pulse, Square Wave & Sawtooth FM.
Pulse width: 0.2-10 μ sec.
Repetition rate: 10 to 10,000 pps.
Sync delay: 0 and 2-2,000 μ sec.



Model 3815

Phase-Lock Frequency Stabilizer
Stabilization of any oscillator—BWO, VTM, or Reflex Klystron, up to 12.4 GC.



World Leader in
Microwave
Instrumentation

POLARAD
ELECTRONIC INSTRUMENTS
A Division of Polarad Electronics Corporation
34-02 QUEENS BOULEVARD
LONG ISLAND CITY, NEW YORK 11101

Circle 59 on reader service card

MALLORY

MTA molded electrolytics outperform many metal case capacitors



The MTA is a different kind of aluminum electrolytic. Its plastic case is molded in one piece around the capacitor element. Its price is exceptionally attractive. And its performance and quality beat cardboard and plastic case miniatures, and even many metal case models. It's already being used by leading manufacturers of entertainment and commercial electronic equipment. Here are some results of evaluation testing done recently.

Low temperature stability is good for a miniature aluminum capacitor. Capacity retention, even at -30°C ,

is more than ample for most uses.

High temperature tests at 65°C and at 85°C , show that DC leakage, dissipation factor and capacitance stability are comparable with much higher priced units. DC leakage of polar models is less than 0.03 microamperes per mfd-volt.

Long-term reliability tests indicate that the MTA may set a new standard of value in its class. At 85°C , there hasn't been a single failure of any kind in 1 million piece-hours of life test. At 65°C , there has been only *one* failure in $2\frac{1}{2}$ million piece-hours.

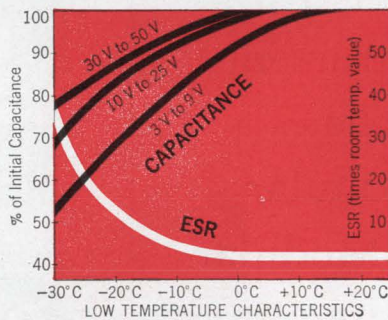

CIRCLE 105 ON READER SERVICE CARD

Miniature 5-Watt Control

Only $\frac{3}{4}$ " in diameter, this Mallory wire-wound control is rated 5 watts at 35°C ambient... can be derated linearly to zero watts at 105°C .

Resistance range is 1 to 25,000 ohms for non-linear tapers. Non-linear tapers can be supplied on order, with resistance range depending on taper.

Two styles are available: VW, with $\frac{3}{8}$ " bushing and $\frac{1}{4}$ " shaft; and SC, with $\frac{1}{4}$ " bushing and $\frac{1}{8}$ " shaft. Can also be supplied in military types as QVW and QSC. Special mounting

arrangements can be provided to your specifications.

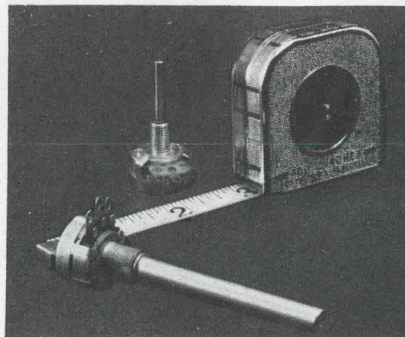

CIRCLE 106 ON READER SERVICE CARD

MOL Film Resistors rated full wattage at 70°C

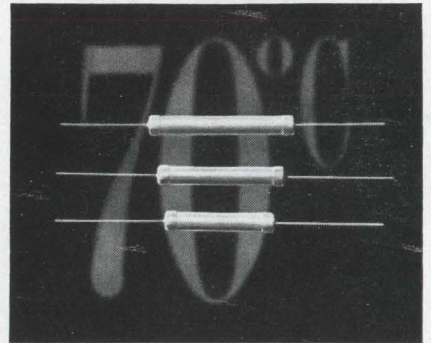

We are now rating MOL metal oxide film resistors for full wattage at 70°C ambient. Even at this new higher temperature, these resistors maintain the superior stability which has made them the choice of all major television manufacturers.

In a typical load-life test at 70°C , 125% of rated load was applied on a cycle of 15 minutes on and 15 minutes off. After 200 hours, resistance change of 7-watt MOL resistors averaged less than 5%.

The MOL line has superior stability on all counts. Temperature coefficient is only ± 250 PPM/ $^{\circ}\text{C}$. Humidity tests at 95% R.H. for 100 hours at no load showed less than 0.04% change in resistance.

A wide range of resistance values is available in 2, 3, 4, 5 and 7 watt sizes.

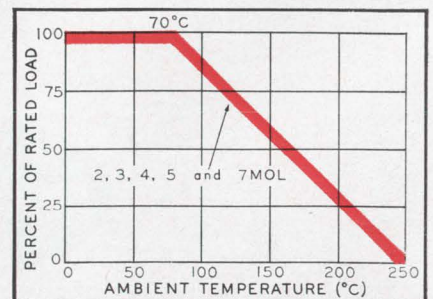

CIRCLE 107 ON READER SERVICE CARD

DESIGNER'S FILE

P. R. MALLORY & CO. INC., INDIANAPOLIS, INDIANA 46206

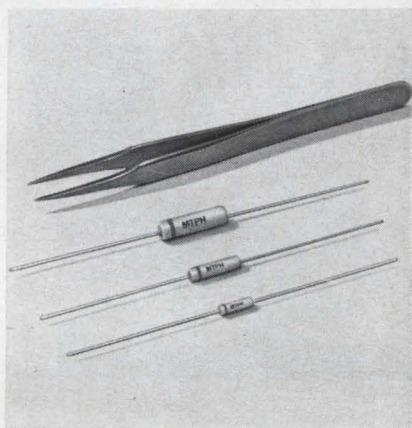

MTPH tantalum capacitors record zero failures in 3,700,000 test hours

Quality control and long term testing of MTPH miniature wet slug tantalum capacitors shows a reliability level amply high for the most demanding applications. In 3.1 million piece-hours of testing at rated voltage at 85°C, there have been zero failures, either catastrophic or DC leakage degradation.

These capacitors are manufactured in the same "white room" facilities that we use for producing a similar line for Minuteman II for Autonetics Division of North American Aviation. Reliability programs under Minuteman specifications have been in continuous operation at this facility for over two years.

The MTPH has considerably higher rating per unit volume than other wet slug, solid or foil tantalum capacitors. Maximum C-V product ranges up to 170,000 mfd-volts per cubic inch. Its small case size makes it applicable for use with thin films and integrated circuits. Ratings are from 450 mfd, 6 volts to 6.8 mfd, 50 volts; case sizes are 0.115" dia. by 0.400", 0.145" dia. by 0.590", and 0.225" dia. by 0.775".

CIRCLE 108 ON READER SERVICE CARD

"Zero defects" program produces high-reliability Certified Mercury Cells

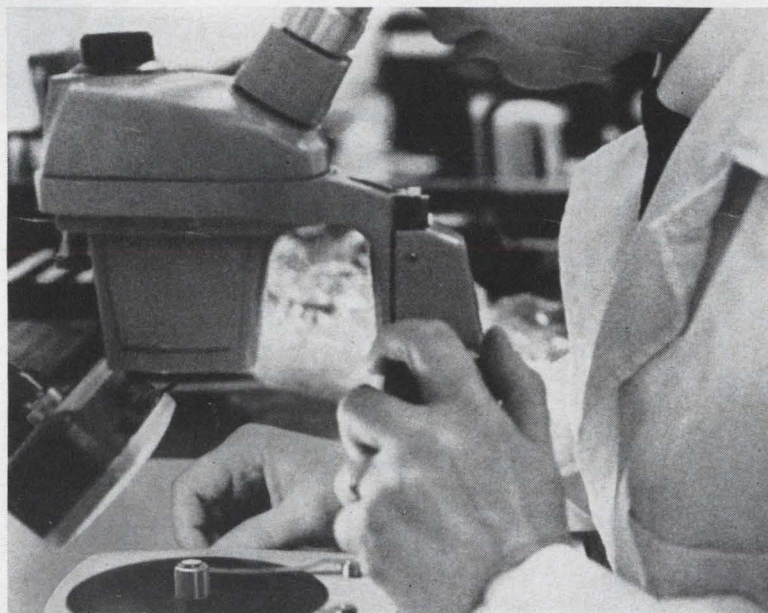

One of many inspection operations on the Mallory Certified Cell line.

For battery applications where maximum reliability is required, such as implanted heart pacemakers, we are producing Certified Mercury Cells in a special, completely separate manufacturing facility. The Certified Cell line, unique in battery manufacturing, uses the most advanced methods of screening and quality control to assure "zero defects" output. Of the many thousands of cells produced on this line, there has not yet been a single report of premature failure. As a result of the Certified Cell program, the mean life of cells used in heart pacers has been increased by about 50%.

All manufacturing operations are performed by trained technicians. Every component... anode and

cathode pellets, containers, seals... is individually tested and pre-selected and only those which come within tight limits of optimum specification values are used. Fall-outs are discarded and not re-worked.

Complete physical and electrical tests are made on each cell during and after assembly. Complete test data are kept in permanent record for each production lot. Each shipment is individually certified to have been produced to the highest level of quality that is possible under the present state of the art.

A broad range of Mallory Mercury Cells can be supplied under the Certified Cell program.

CIRCLE 109 ON READER SERVICE CARD

spectrum analysis

with your  oscilloscope

*provides phase lock
and 100 MHz dispersion*

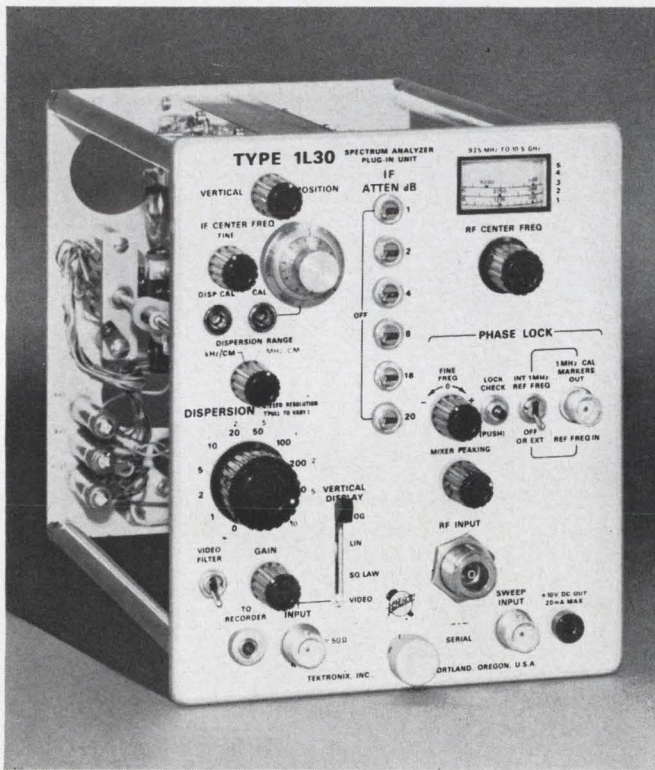
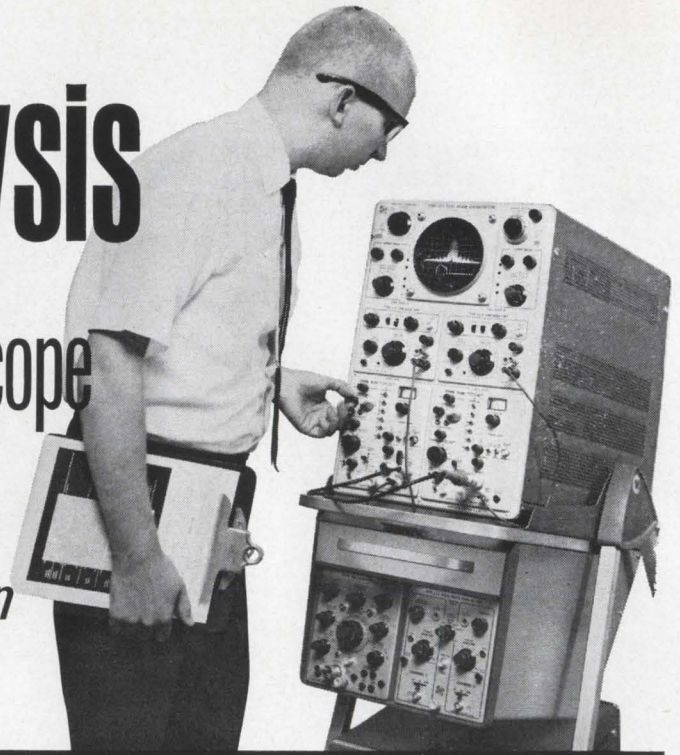

TYPE 1L20 10 MHz · 4.2 GHz	TYPE 1L30 925 MHz · 10.5 GHz
--------------------------------------	--

These new spectrum analyzer plug-in units can be used in all Tektronix oscilloscopes that accept letter-series plug-ins. They provide a rapid and accurate method for display and analysis of energy distribution over a wide range of frequencies. *Type 1L10 with similar features covering frequency range from 1 MHz to 36 MHz also available.*

phase lock — Permits stable displays at 1 kHz/cm dispersion by locking the frequency of the RF local oscillator to the internal 1-MHz crystal-controlled reference, or to an external standard frequency.

calibrated dispersion — Screen width calibrated from 1 kHz/cm to 10 MHz/cm in 1-2-5 sequence permits direct readings of displayed frequencies. For ease of operation, resolution is coupled to dispersion and varies from 1 kHz to 100 kHz. Can be uncoupled for optimized displays.

display flatness — ± 1 dB over 100 MHz dispersion.

recorder output — A front-panel connector provides a dc-coupled analog output of the spectral display for chart recorders or other uses.

other characteristics	Type 1L20	Type 1L30
Frequency Range	10 MHz—4.2 GHz	925 MHz—10.5 GHz
Minimum Sensitivity	110—90 (-dBm)	105—75 (-dBm)
Incidental FM	With Phase Lock, less than 300 Hz on fundamental.	
Dial Accuracy	$\pm(2 \text{ MHz} \pm 1\% \text{ of rf input frequency})$	
IF Attenuation	51 dB ± 0.1 dB/dB in 1-dB steps	
IF Gain	50 dB, variable	
Display	Log, linear, square law, video	
Price	\$1995.00	\$1995.00

Type 3L10 for Tektronix 560-Series Oscilloscopes provides 1 MHz to 36 MHz spectrum analysis capability.

U.S. Sales Prices, f.o.b. Beaverton, Oregon

For more information or a demonstration, call your Tektronix field engineer.

Tektronix, Inc.

new

LODEX*

**PERMANENT
MAGNETS**

Lodex*, General Electric's new permanent-magnet material, can be formed economically into the precise shape and size for your application.

Expensive form grinding or high-temperature treating are eliminated because this material is pressed into its final shape.

Lodex magnetic material consists of elongated single-domain particles dispersed in a lead matrix. This makes it possible to produce magnet shapes to extremely close physical tolerances and to maintain close magnetic uniformity.

Lodex magnetic material is already being used in many products:

Battery-powered Motors—provides the stator field flux for truly portable appliances such as automatic movie cameras or electric tooth brushes.

Hearing Aids—is contributing to miniaturization of newer hearing aids by providing a force field for diaphragm movement in a compact package.

Precision Meters—provides uniform magnetic fields in the air gap, making it especially suited for core meters.

Reed Switches—provides highly uniform magnetic performance with high-density packaging.

Other applications include automotive speedometers and gauges, speakers, relays, thermostats, microphones, timing motors, and light meters. There are many others.

Contact your G-E Sales Engineer to discover how this innovation in magnetic materials can help solve your design and application problems. **Magnetic Materials Section, Edmore, Mich.**

731-03

*Trademark of the General Electric Company.

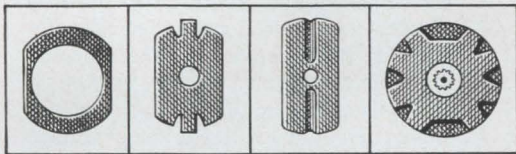

**design intricate
magnet shapes
economically**



GENERAL  ELECTRIC

CEC goes all-out with temperature instrumentation

Long noted for its leadership in the measurement fields of pressure, velocity and acceleration, CEC has now extended its capability even further with the release of a broad line of precision temperature transducers and signal conditioning equipment.

These advanced instruments include Thermocouple Temperature Probes, Thermocouple Reference Junctions, Integral Bridge Resistance Temperature Transducers, and Precision, Single-Element, Platinum Resistance Temperature Transducers.

All of the above readily meet the most stringent industrial and military specifications, and all are fully compatible with the specialized requirements of modern instrumentation systems. For unique applications requiring non-standard equipment, CEC can also furnish custom-designed components or complete instrumentation systems to comply with specialized temperature measurement requirements.

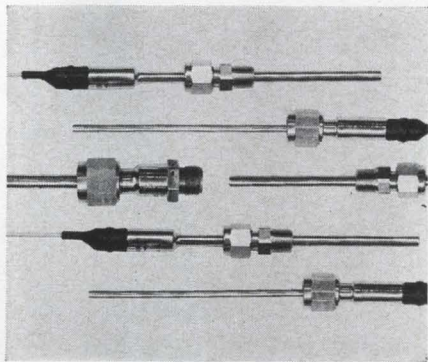

Precision Thermocouple Temperature Probes

CEC Precision Thermocouple Temperature Probes are manufactured from premium-grade thermoelectric materials and highest quality hardware. Their rugged design and precision construction assure the greatest practical accuracy, making them the logical choice for laboratory, industrial, field and airborne applications where temperatures of gases or liquids are to be measured, monitored or controlled.

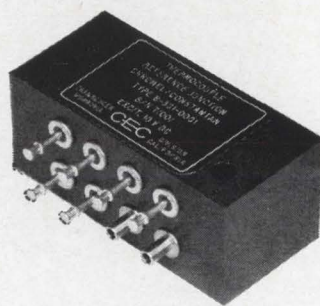

Type 8-301 Thermocouple Reference Junction

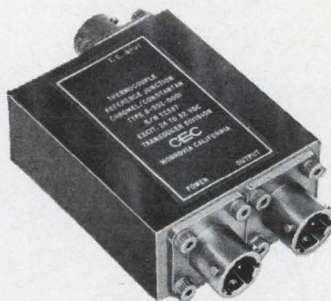

Type 8-302 Thermocouple Reference Junction

The 8-301 and 8-302 are basically the same type of Thermocouple Reference Junction. The bridge circuitry of both is similar to that used in CEC's high-precision, full-bridge resistance thermometers. They are available for use with all commonly supplied thermocouple elements.

They share other common advantages, too. A sealed, anodized aluminum housing provides protection against 100% humidity and altitude environments, enabling them to withstand the stresses encountered in missile and airborne applications. And, a copper sleeve over the compensator assembly assures uniform temperature throughout the bridge assembly, thus virtually eliminating transient error.

They differ in type of electrical connections, in voltage requirements and size. The 8-301 contains its own internal regulator and operates from an unregulated 28 v d-c power supply. The 8-302 uses a precise, regulated 10 v d-c power supply, weighs less than 6 ounces and is self compensating.

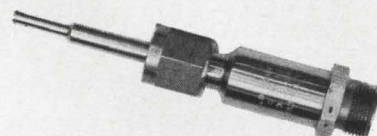

Type 4-550 Integral Bridge Temperature Transducers

CEC's Integral Bridge resistance temperature transducers contain all electrical circuitry required to produce direct voltages proportional to the temperature being measured. These probes combine a four-arm bridge, as well as the sensing element, in the thermometer stem, thereby providing a linear voltage output without drift. Transducers for immersion in both liquids and gases are standard, and all designs can be easily modified to meet user requirements for temperature range, immersion length, mounting provisions and electrical connector.



Type 4-502-0001 Resistance Temperature Transducer

The Type 4-502-0001 is a wire-wound, four-terminal, strain-free, open-element platinum transducer. With a range of -320°F to $+500^{\circ}\text{F}$, it is designed for highly accurate temperature measurements of liquids, gases and cryogenic fluids. Construction features include coils that are wound on platinum tubes to minimize thermal strain effects, and a non-inductive coil that prevents the sensing of stray field effects.

For all specifications and facts about CEC's new family of precision temperature measuring instruments, call or write for CEC Bulletin Kit #7064-X8.

CEC
Transducer Division

**CONSOLIDATED
ELECTRODYNAMICS**

A SUBSIDIARY OF BELL & HOWELL/PASADENA, CALIF. 91109
INTERNATIONAL SUBSIDIARIES: WOKING, SURREY, ENGLAND
AND FRIEDBERG (HESSSEN), W. GERMANY

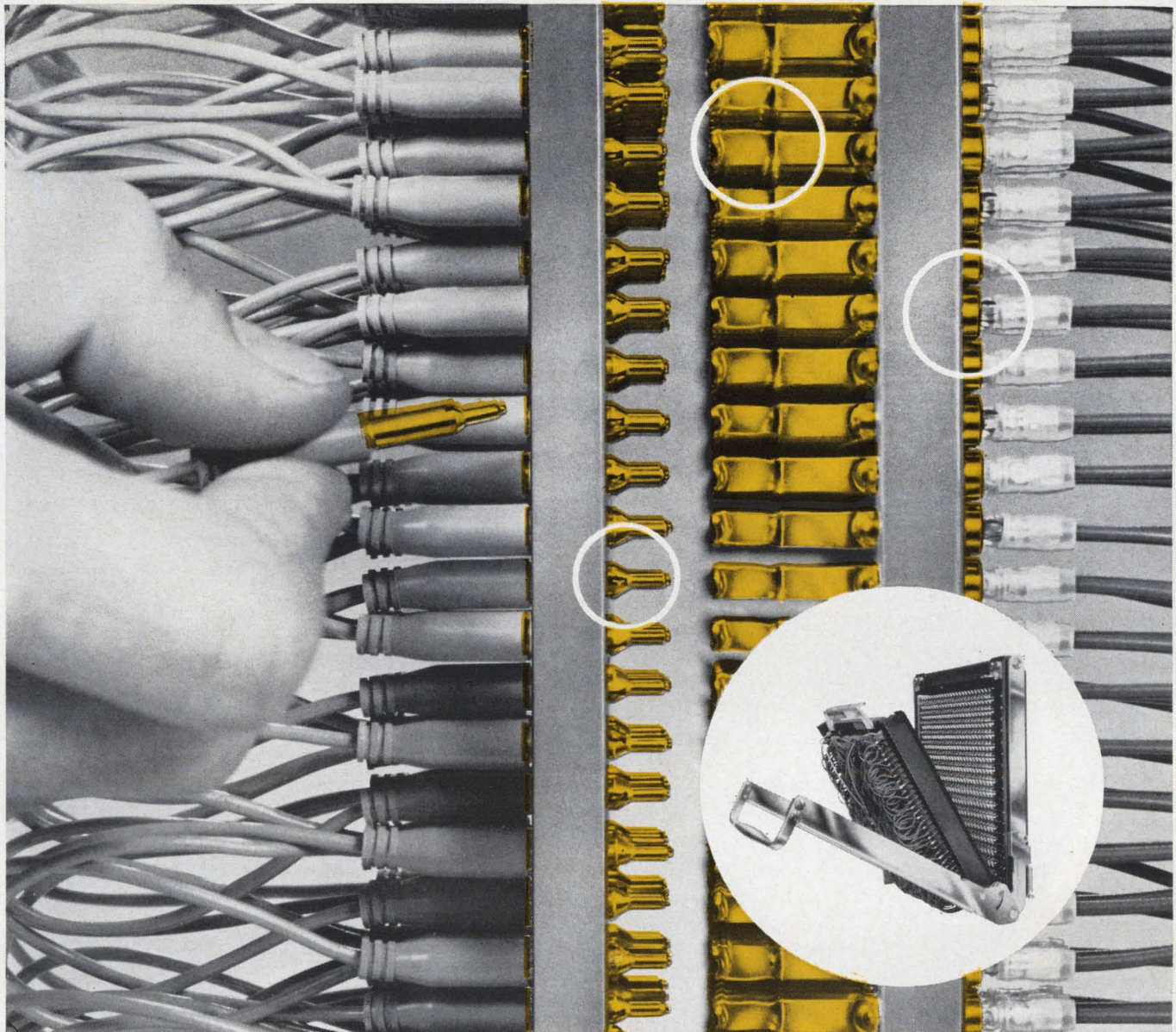

Zero in on quality

There's not even the hint of a "miss" in this A-MP★ Patchcord Programming System!

Patchcord Programming Systems are comprised of a series of metallic contact junctions. The electrical performance of these systems is determined by the sum of the mechanical properties of these junctions.

Check ours out . . . feature by feature . . . and one fact is outstanding: it's quality-built at *every point* for overall *reliable* performance.

Ours is a modern, compact, lightweight system designed with fewer moving mechanical parts and is quality-controlled to maintain precision tolerances, resulting in increased reliability.

All contacts are gold-over-nickel plated. This, coupled with our patented double-wiping action that pre-cleans contact springs and patchcord pins, assures positive, reliable connections everytime.

Twin-Detent Patchcords, in manual or semi-permanent types, incorporate a specially designed, wholly contained spring-member that

locks the cord to board and prevents program failure by accidental dislodgement. Patchcords can be easily hand-removed to facilitate program changes.

As for rear board wiring, precision crimped LANCELOK★ contacts provide maximum electrical performance and positive retention in the board through a unique locking lance design.

These are just highlights. All of them add up to the quality you look for to assure reliable performance. Get all the details you need by writing today for complete information.

★Trademark of AMP INCORPORATED



A-MP★ products and engineering assistance are available through subsidiary companies in: Australia • Canada • England • France • Holland • Italy • Japan • Mexico • West Germany

GUDEBROD LACING TAPE CAN SAVE YOU MONEY—



**HERE'S
WHY-**

1 SPECIAL FINISHES SPEED HARNESING

Gudebrod has Lacing Tape that almost laces itself—the worker guides it instead of having to fight it. *Work goes fast!*

2 BETTER HARNESSES —FEWER REJECTS

Gudebrod Lacing Tape makes proper ties that do not slip. *Saves money on assembly! Saves costly rejects!*

3 WORKER SAFETY APPRECIATED

Gudebrod Lacing Tape is easy on the hands, feels good to work with . . . so the work goes better, is faster. *Saves money on harnessing time!*

4 GUDEBROD CABLE-LACER another money saver

Handle holds bobbin of lacing tape, feeds tape as needed, grips it for knotting. Speeds harnessing. Has paid for itself in a day. *Another money saver.*

Gudebrod Lacing Tape is engineered for the job it has to do—saves money where it counts—in the harness room. More than 200 different tapes in the Gudebrod Line—Write for our Product Data Book!



GUDEBROD BROS. SILK CO., INC.

FOUNDED IN 1870

Electronics Division



12 SOUTH 12th STREET, PHILADELPHIA, PENNSYLVANIA 19107

Area Code 215, WA 2-1122

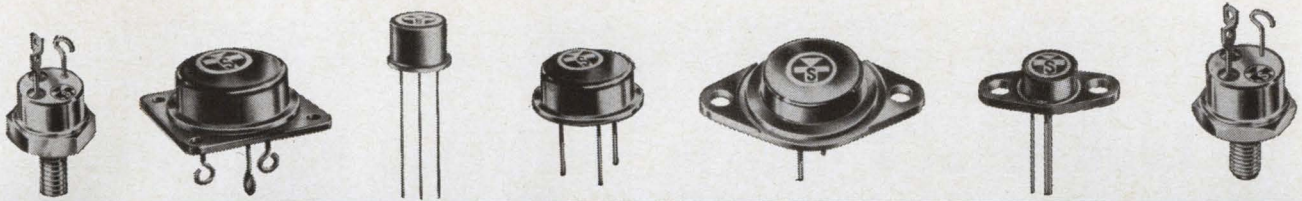

INTERROGATOR

PNP SILICON TRANSISTORS—76 TYPES IN 9 PACKAGES

Question: Why not PNP in your design plans?

Greater efficiency, greater reliability, overall savings.

A broad line of PNP SILICON POWER TRANSISTORS is available, from 8.75 watts to 85 watts of power capability, in a wide variety of package types. V_{CE0} ratings range from 40 volts to 120 volts, with saturation resistances as low as 0.3 ohms @ $I_C = 1$ Amp., and minimum h_{FE} of 10 @ $I_C = 3$ Amps., and 20 @ $I_C = 1$ Amp. These PNP types can be used as complements to Silicon Transistor Corporation's existing NPN silicon power transistors, and are supplied in the 2N3163 through 2N3208 series, and also in other series custom-designed to meet specific requirements. To satisfy virtually any power circuit design, these characteristics are available in the following packages: TO-5, 7/16" D.E.S., TO-8, TO-37, TO-53, 11/16" D.E.S., TO-3, and the isolated collector versions of the TO-53 and 11/16" D.E.S. For more information, be the interrogator yourself—and question.



EAST GATE BLVD., GARDEN CITY, NEW YORK 11532, 516 Pioneer 2-4100. TWX 510-222-8258

REGIONAL OFFICES:

CHICAGO, ILL. 60625, 5555 NORTH LINCOLN AVE., 312-271-0366-7, TWX 910-221-1304
LOS ALTOS, CALIF. 94022, 1 FIRST ST., 415-941-2842.

Questions and Answers. PNP.

Collector Voltage V_{CE0} -Volts	Use Current* I_C -Amps	Max. Current I_C -Amps	TYPE		
			TO-61	TO-53	TO-3
40	1.0	3.0	2N3163	2N3167	2N3171
	2.0	5.0	2N3175	2N3179	2N3183
	3.0	5.0	2N3187	2N3191	2N3195
60	1.0	3.0	2N3164	2N3168	2N3172
	2.0	5.0	2N3176	2N3180	2N3184
	3.0	5.0	2N3188	2N3192	2N3196
80	1.0	3.0	2N3165	2N3169	2N3173
	2.0	5.0	2N3177	2N3181	2N3185
	3.0	5.0	2N3189	2N3193	2N3197
100	1.0	3.0	2N3166	2N3170	2N3174
	2.0	5.0	2N3178	2N3182	2N3186
	3.0	5.0	2N3190	2N3194	2N3198

*Use Current: That collector current level at which the gain and saturation voltages are specified



Look what's new in electronic hardware

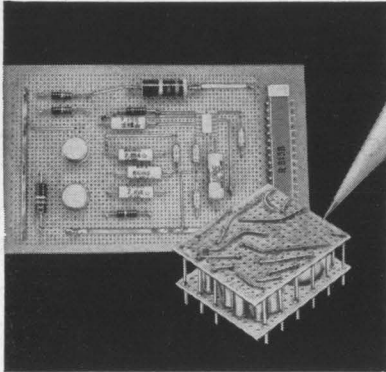

New Micro-Miniature Pre-Punched Insulating Board and Terminals — New Micro-Vectorbord is perfect as a holding matrix for making cordwood modules, and for mounting integrated circuits and discrete components. Dense small hole grid patterns and micro-miniature Push-In terminals, connectors, etc., permit high component densities. Made of epoxy glass in 4 grid patterns: 1/64" to 1/32" thick. Copper cladding if required. Frames for stiffening and mounting in card guides. Plumbords with edge mounted Miniature Elco Varicons available 9-52 contacts spaced .05 centers.

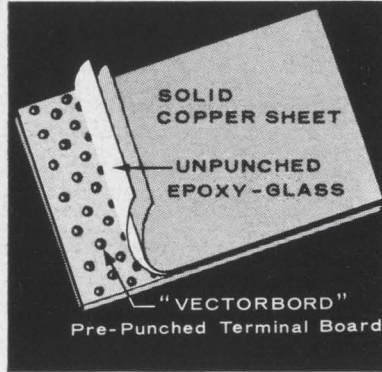

Patented

Copper Covered Sheets of Holes — COPPCO Vectorbord utilizes unpunched sheets of 2 oz. copper bonded to pre-punched insulating board with an adhesive liner of thin unpunched epoxy glass. The result is a sheet of holes with an unperforated copper surface. The inherent utility of pre-punched holes is immediately available for terminals or component leads below the unpunched copper and glass liner layers. Yet holes never interfere with etching conductor paths or areas wherever required. Available off-the-shelf on one or two sides of epoxy glass Vectorbord.

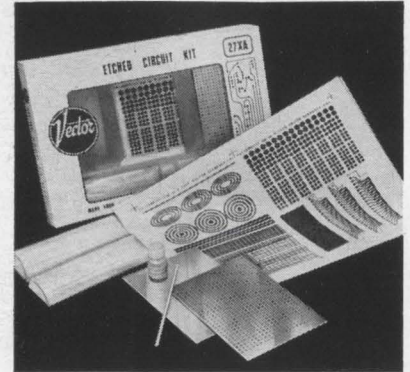

New Do-It-Yourself Resist Patterns for Etching Prototype Circuits in Minutes — New pattern sheets of Vector's Rub-On-Resist have lines from 1/64" to 1/8" and transistor pads for .05" and .1" center-to-center layouts. Easy-to-Use Vectoresist eliminates sticky tapes and photographic techniques for making prototype etched circuit layouts. Junctions do not undercut in etching because application pressure fuses joining pieces. Kit 27XA (\$5.95) has 1 all-purpose Vectoresist sheet and everything else except hot water for making 2 etched circuit boards in minutes.

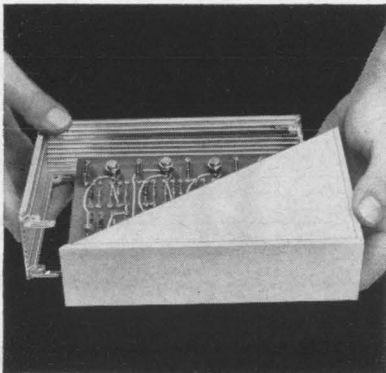

Patent pending

New Expandable Cases — New extruded aluminum Frame-Loc Rails are now available in wide size range to make sleek handsome circuit cases (or chassis) virtually any size or shape. Longitudinal grooves accommodate circuit boards on various center spacings. Circuits on etched cards requiring RFI shielding, or those employing bulkier components can be readily packaged. Complete "RF tight" cases with or without mounted shielded connectors, or case parts only are available with all hardware for plug-in rack, or chassis mounting.

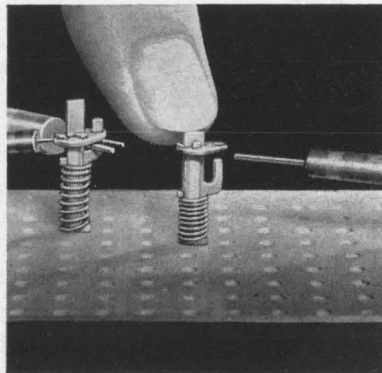

Patent pending

Solderless Side Entry U-Clip Terminal — New Solderless U-CLIPS with less than .002 ohms resistance for instant "Push-In" use in 1/16" or 3/32" holes for testing or breadboarding circuits and components. A unique "side entry" slot for component wires is uncovered by finger pressure on a plunger permitting leads to be conveniently "laid in" rather than threaded through the terminal. Contact reliability is achieved by the possibility to criss-cross leads over a 270° range. Terminals may be used again and again.

Vectorize your breadboarding and profit 3 ways!

SPEED — With Vector hardware experimental circuits are assembled in minutes... without soldering.

DELIVERABILITY — Prototypes made with Vector hardware are handsome enough to deliver for customer approval.

SAVINGS — Experimental circuits made with Vector hardware can be quickly disassembled and the low cost components used over and over without clean-up.



Technical Articles

Off-the-shelf integrated circuits for versatile and accurate timer: page 70

More and more engineers are finding that it is cheaper to use off-the-shelf integrated circuits, particularly if the equipment is digital, than discrete components. In a precision timer for space applications, IC's saved time and money and made the finished product more reliable.

Special Report : Japanese technology

The new push for technical leadership: page 77

The Japanese are not content with following U. S. technology. Today, most companies are stressing research, even though they still depend heavily on government laboratories and universities for basic studies.

When you're second, you try harder: page 81

In one decade, Japan's semiconductor industry has become the world's second largest. But quantity is not its only accomplishment. The Japanese have developed some unusual devices and interesting ways to use semiconductors in circuits.

Japan seeks its own route to improved IC techniques: page 90

Though the integrated circuit work started only 18 months ago, the Japanese have made great strides to catch up with U.S. technology. After developing digital devices for computers, they shifted emphasis to linear units because there is greater potential in the products most important to Japanese electronics producers.

Bidding for world leadership in solid state microwave: page 99



With the densest microwave network in the world, the Japanese have much to gain by going to solid state systems. Every city in Japan has a skyline of microwave antennas. For our cover, we zeroed in on one, with Tokyo as a background.

After a lull, numerical control is enjoying new popularity: page 106

Sales in numerical control doubled this year. There's a preference for less expensive, point-to-point systems. Finding applications is more important than designing systems.

Manual process control makes way for computers: page 110

Worried by rising labor costs, many Japanese are looking to computer control to run plants in steel, chemical, petroleum, paper, cement and electric industries. Two concepts are direct digital control and integrated hierarchies.

**Coming
December 27**

- First European electronics market report
- More on error control in communications
- Processing radar optical signals

Off-the-shelf integrated circuits for versatile and accurate timer

Monolithic diode transistor logic circuit chosen to meet stringent requirements for airplane and spacecraft applications

By Alvin A. Lampell

Airborne Instruments Laboratory,
Division of Cutler-Hammer, Inc., Deer Park, N.Y.

As the availability of digital integrated circuits increases, engineers rely less on custom-made circuits. They are learning how to fit off-the-shelf IC's to system requirements. As a result, they are saving time and money.

For example, the engineers at Airborne Instruments Laboratory faced the problem of designing an accurate and versatile spacecraft timer that met stringent requirements. They chose IC's and the timer met the requirements with high reliability.

The primary goal of the laboratory, a division of Cutler-Hammer, Inc., was to develop a preprogrammed source of delays ranging from 2 seconds to 10 minutes or more. But the specifications also called for a minimum accuracy of repeatability of 99% (the time delay obtained with a specific dial setting should be repeated within 1% if the setting is changed, then reset) and a maximum variation of 5% for delays up to 60 seconds for temperatures ranging from -20° through $+70^{\circ}\text{C}$. With these requirements in mind, the engineers were required to cull carefully the available commercial IC's.

Signetics circuit used

The unit finally selected was a monolithic diode

The author



Alvin A. Lampell is in the special projects section of Airborne Instruments Laboratory's space systems department. He joined Airborne in 1959.

transistor logic circuit, the SE124G, manufactured by Signetics Corporation. The SE124G, a flip-flop circuit, is packaged in a ten-lead flat-pack, approximately $\frac{1}{4}$ -inch square and $\frac{1}{16}$ -inch thick.

The timer circuit, comprising three SE124G integrated circuits and 22 discrete components, is on page 71. As shown by the dotted lines, one or two of the integrated circuits can be eliminated if a narrower range of time delays is acceptable. Additional IC's provide longer delays. For example, four IC's provide delays up to 20 minutes; five provide delays up to 40 minutes. Adding IC's to the basic 3-IC system also increases the time span over which variations from temperature changes can be held to 5%. With 4 IC's, the limit is 2 minutes; with 5 IC's, it's doubled.

In one application, the timer IC's, the signal-processing input circuitry and the signal-receiving output circuit are housed in a single module shown on page 71. Most of the equipment's IC cases (each $\frac{1}{4}$ -inch square by $\frac{1}{8}$ -inch thick) are stacked and welded to form a cordwood assembly for compactness. The module is potted with an alumina-filled epoxy to improve its ability to withstand shock, and to assure improved temperature distribution through the entire unit. Only about one-third of the space in the module is occupied by the timer IC's and their associated discrete components. The timer unit measures $1\frac{5}{8}$ -inch square by 1-inch high, but because of a 1-inch potentiometer protrusion, the total depth is $2\frac{5}{8}$ inches. The photograph on page 71 shows a small module, within the larger module, which contains timer IC's plus other IC's not associated with timing. A second small module, also within the larger module but not visible in the photo, contains other non-timing IC's.

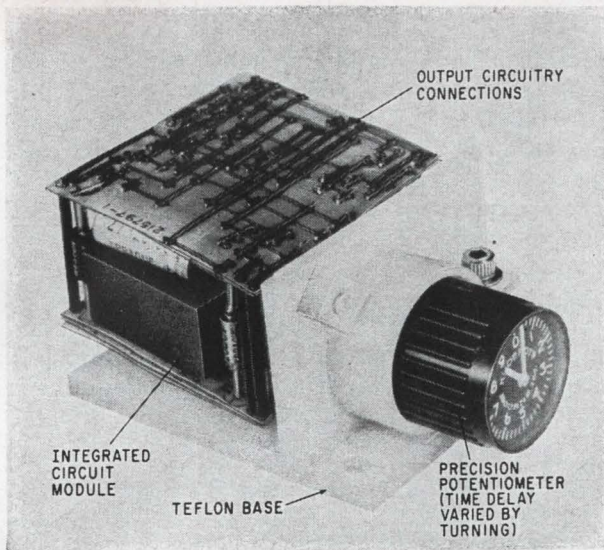

Timer package also includes components and integrated circuits not associated with the timing function. The timer circuitry occupies only one-third of the package.

Operation of the timing circuit shown below starts with a negative-going pulse (pulse changing from +4 volts to slightly-above-ground voltage) applied at the input designated "set." This sets all three of the flip-flop integrated-circuits to zero. The base of Q_1 , an n-p-n transistor, becomes more negative, Q_1 turns off and D_4 is back biased.

A constant charging current is supplied to C_1 by the constant-current generator circuit consisting of Q_2 , R_5 , R_6 , D_5 (1N643) and R_7 (resistor R_7 is a 1,000-ohm potentiometer). As a result, the voltage across C_1 increases linearly with time until the voltage at the emitter of Q_3 , the unijunction transistor, is sufficient to turn it on. The rate at which C_1 is positively charged is determined by the setting of the potentiometer, R_7 . As the potentiometer arm is moved toward the +24-volt-connection point, the voltage on the base of Q_2 increases, the charg-

ing rate decreases, and the delay increases.

After C_1 has been sufficiently charged, Q_3 is triggered and C_1 is rapidly discharged through R_8 , R_9 and the emitter-to-base-one junction of Q_3 . Transistor Q_4 is turned on by the conducting unijunction transistor and supplies a pulse to IC_2 , changing its flip-flop setting from the zero to the one state.

As the discharge current from C_1 flowing through Q_3 decreases, Q_3 drops out of conduction. Capacitor C_1 starts to charge again and the entire cycle is repeated.

For a delay system with n IC's in the feedback network, 2^n charging cycles are required to obtain the desired delay interval. In this case, two integrated circuits are being used, therefore C_1 must be charged and discharged four times before C_1 turns on, ending the delay period.

At the end of the second charging cycle, the pulse supplied by Q_4 changes the IC_2 flip-flop circuit from one to the zero state and the IC_3 flip-flop circuit goes from the zero to the one state. At the end of the third cycle, IC_2 changes from the zero to the one state. Finally, at the end of the fourth cycle, the pulse supplied by Q_4 changes both IC_2 and IC_3 from the one to the zero state, causing IC_1 to change from the zero to the one state, and thereby turning on Q_1 . The conducting Q_1 , in turn, clamps C_1 to ground.

An expression for the current supplied to charge capacitor C_1 can be derived by examining the base circuitry for Q_2 which is in the diagram on page 73. Once this current is known, the time required to charge C_1 can be determined. The portion of the circuit to be replaced by a Thévenin equivalent circuit is inside the box formed by the broken lines. The same circuitry is shown in the center diagram where the Thévenin equivalent circuit is represented by R_{eq} .

The Thévenin equivalent resistance, R_{eq} , is actually three resistances, R_x , $(R_p - R_x)$, and R_6 in

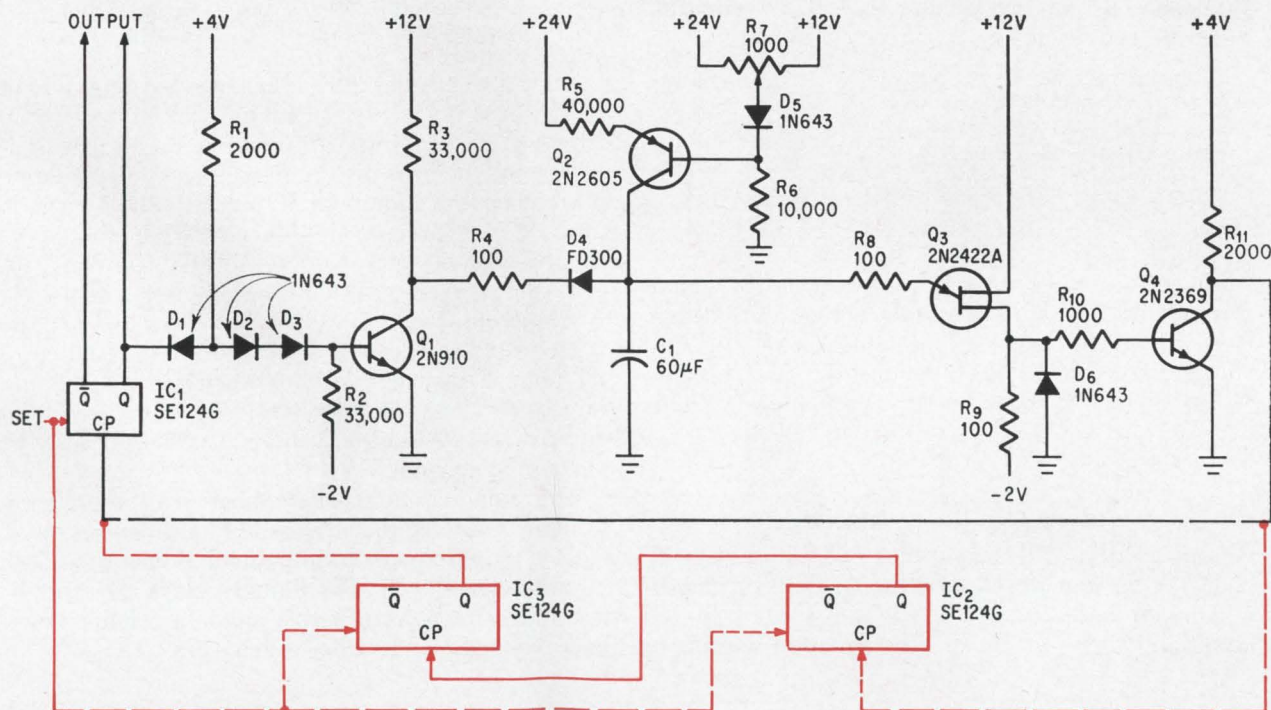

Timing circuit provides delays up to 10 minutes. If shorter delays are satisfactory, one or both of the integrated circuits (shown connected with broken lines) may be eliminated.

parallel. The expression for R_{eq} is

$$R_{eq} = \frac{\frac{R_x(R_p - R_x)}{R_p} (R_6)}{\frac{R_x(R_p - R_x)}{R_p} + R_6} \quad (1)$$

where R_p = total potentiometer resistance, and R_x = resistance between potentiometer and the +12-volt supply.

Because $R_x(R_p - R_x)/R_p$ is equal to or less than 500 ohms and R_6 is much larger than R_x (in this case 10,000 ohms) equation 1 reduces to

$$R_{eq} \approx \frac{R_x(R_p - R_x)}{R_p} \quad (2)$$

Using nodal analysis, the Thévenin equivalent voltage for the portion of the circuit contained within the broken lines on page 73 is:

$$V_{eq} = \frac{\left[\frac{(24 - 12)R_x}{R_p} + 12 - V_F \right] 10000}{10000 + \frac{R_x(R_p - R_x)}{R_p}} \quad (3)$$

where V_F is the forward voltage drop of diode D_5 .

Using the same approximations that led to equation 2, equation 3 reduces to

$$V_{eq} \approx \frac{(24 - 12)R_x}{R_p} + 12 - V_F \quad (4)$$

The equivalent circuit on page 73 represents the charging circuit for capacitor C_1 . The current flowing in this circuit is the emitter current of transistor Q_2

$$I_e = \frac{24 - V_{BE} - V_{eq}}{R_5 + (R_{eq}/\beta)} \quad (5)$$

where $V_{BE} = Q_2$ base-to-emitter voltage and $\beta = Q_2$ current gain.

For the 2N2605, β is typically equal to or greater than 50 at a temperature of 25°C and a collector current of 10 microamperes.

Because R_5 is much greater than R_{eq}/β , equation 5 can be rewritten as

$$I_e \approx \frac{24 - V_{BE} - V_{eq}}{R_5} \quad (6)$$

From equations 4 and 6

$$I_e \approx \frac{24 - V_{BE} - \left[\frac{(24 - 12)R_x}{R_p} + 12 - V_F \right]}{R_5} \quad (7)$$

Since V_{BE} and V_F are approximately equal throughout the entire operating temperature range, they effectively cancel. Eliminating V_F and V_{D1} , and substituting $R_5 = 40,000$ ohms, $I_c = I_e/a$, and V_p equal to $(12 R_x/R_p) - 12$ in equation 7 yields

$$I_c \approx \frac{24 - \left[\frac{12R_x}{R_p} - 12 \right]}{40,000\alpha} \approx \frac{24 - V_p}{40,000\alpha}$$

where I_c is the collector current of Q_2 and also the charging current for C_1 , α is the Q_2 current gain in a common-base circuit. V_p is substituted in the equation solely to make the equation easier to

handle. The subscript P denotes that V_p is a function of the potentiometer setting.

The circuit is designed so when Q_2 conducts, capacitor C_1 charges until its top electrode reaches a voltage which is sufficient to trigger Q_3 , the unijunction transistor. The charging current is the output of the constant-current generator, given in equation 8.

The charging circuit

A simplified representation of the charging circuit is on page 73. The voltage across the capacitor is given by the expression

$$V_c = \frac{1}{C} \int_{E_c(0^+)}^{E_c(t)} i dt \quad (9)$$

Solving equation 9 yields

$$I_c t / C_1 = E_c(t) - E_c(0^+) \quad (10)$$

where $E_c(t)$ is the voltage across C_1 after a time t and $E_c(0^+)$ is the voltage initially across C_1 .

The initial voltage across C_1 is

$$E_c(0^+) = V_{D4} + V_{CE(SAT)} + I_c R_4 \quad (11)$$

where V_{D4} is the voltage drop across D_4 and $V_{CE(SAT)}$ is the saturation voltage for Q_1 .

Since the maximum value of I_c is only about 0.3 milliamperes, the $I_c R_4$ product will be no more than 0.03. This is small enough to permit dropping the $I_c R_4$ component from equation 11. Therefore, the expression for $E_c(0^+)$ is simplified to

$$E_c(0^+) = V_{D4} + V_{CE(SAT)} \quad (12)$$

Unijunction transistor

The voltage required to turn on the unijunction transistor is given by

$$V_{pp} = V_{BB}\eta + V_D \quad (13)$$

The following definitions apply to the equations given above:

V_{pp} = peak-point (turn-on voltage)

V_{BB} = total base supply voltage

η = intrinsic standoff ratio (ratio is constant with temperature and V_{BB} variations)

V_D = forward voltage drop for unijunction diode.

The current that flows in the charging circuit of C_1 must be greater than the peak-point current (the current at which the unijunction transistor is triggered). It must also be less than the sustaining current so the unijunction transistor will turn off after it is triggered. In this circuit, I_c should be greater than 20 microamperes—the peak-point current (the current at which the unijunction transistor is triggered). It must also be less than the sustaining current so the unijunction transistor will turn off after it is triggered. In this circuit, I_c should be greater than 20 microamperes—the peak-point current for Q_3 —but less than 8 milliamperes, the sustaining current.

The unijunction-transistor portion of the timing system is also depicted in the circuit on page 73. This is the arrangement to be used if one integrated circuit is employed. For longer delays, D_6 and R_9 are added to the circuit to provide a reliable reference voltage to which C_1 discharges.

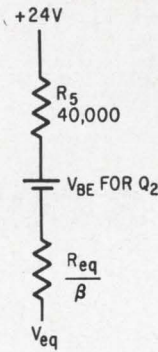
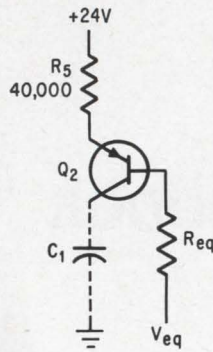
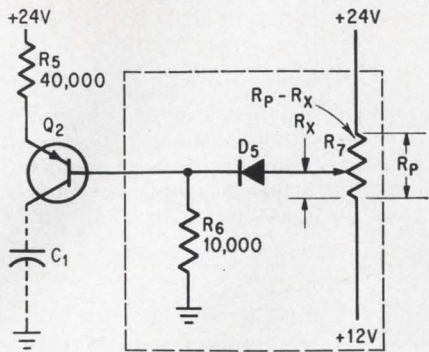

Base circuitry for Q₂ in the timer circuit on page 71 is shown in diagram at left. In the center diagram the base circuitry has been replaced by a Thevenin equivalence resistance and voltage. The constant current supplied to charge C₁ is generated by the circuit shown at the right.

To provide an expression for delay time, equation 10 can be rewritten

$$t = \frac{[E_c(t) - E_c(0^+)] C_1}{I_c} \quad (14)$$

Since the voltage across C₁ is equal to V_{pp} when Q₃ fires, V_{pp} = E_c(t). Therefore, from equation 13, E_c(t) = V_{BB}η + V_D. From equations 8 and 12

$$t = \frac{[(V_{BB}\eta + V_D) - (V_{D4} + V_{CE(SAT)})] C_1 (40,000\alpha)}{24 - V_p} \quad (15)$$

The unijunction diode voltage drop, V_D, is approximately equal to the sum of V_{D4} and V_{CE(SAT)}. Equation 15 reduces to

$$t = \frac{V_{BB}\eta}{V_s - V_p} K_1 \alpha \quad (16)$$

where K₁ = 40,000C₁ and V_s = supply voltage.

Using partial derivatives to account for the variations due to changes in V_s, V_{BB}, α and V_p

$$\Delta t = K_1 \left[\left(\frac{\alpha_0}{V_{S0} - V_{P0}} \right) \Delta V_{BB} + \left(\frac{V_{BB0}}{V_{S0} - V_{P0}} \right) \Delta \alpha - \left[\left(\frac{V_{BB0} \alpha}{(V_{S0} - V_{P0})^2} \right) \right] \left[\Delta V_{S0} - \Delta V_p \right] \right] \quad (17)$$

where the subscript 0 indicates time t₀.

A 60-microfarad capacitor was chosen for C₁; this value is adequate for the time delay range required. The capacitor exhibited a positive linear temperature coefficient between -55 to +85°C. A slight improvement in the accuracy of the timer can be obtained if the 40,000-ohm resistor R₅ has a negative temperature coefficient to offset the effects of temperature changes on C₁.

The value of α for Q₂ varies with temperature and is typically from 0.995 through 0.98. The value of the standoff ratio η for Q₃ is typically between 0.62 and 0.75.

If the +24-volt and +12-volt power supplies have 1-percent variations and α varies by 0.015, t will vary by about ±5 percent.

Separate +4-volt and -2-volt sources are required to bias the integrated circuits. The circuits could be operated with applied voltages of +4 volts and ground, however the units would then be less immune to noise. If a slight increase in package size is permissible, the +4-volt supply may be obtained from the +12-volt supply by

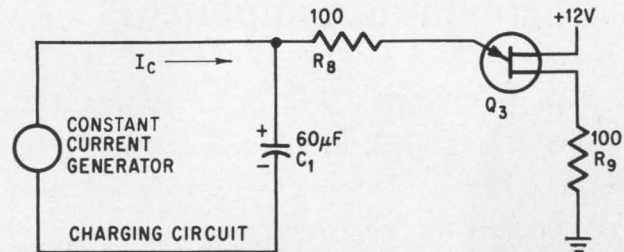

Unijunction-transistor stage: capacitor C₁ is charged until the firing voltage for the unijunction transistor is reached.

means of a zener diode. This would not affect the timer accuracy.

There is a practical limit to the maximum time delay obtainable with the basic circuit (excluding IC₂ and IC₃). Repeatability also decreases rapidly as the leakage currents of C₁ and D₄ approach the level of the charging current I_c.

Components with low-leakage characteristics should be selected for C₁ and D₄. In this application, an RL series capacitor, made by International Telephone and Telegraph Corp., with a d-c leakage current of 0.4 microamperes at 25°C and 1.2 microamperes at 125°C was selected for C₁. For D₄, a FD300 diode made by the Fairchild Semiconductor Division of the Fairchild Camera & Instrument Corp. was selected. The FD300 has a leakage current of only three microamperes at 150°C with a reverse voltage of 125 volts. To further minimize the effect of the leakage currents, the timing system should be designed for a minimum value of charging current.

Resistors R₄ and R₈ protect transistors Q₁ and Q₃, respectively, from current surges; R₁₀ limits the base current of Q₄ to a safe value. Variable resistor, R₇, is a ten-turn clock-face potentiometer, model number 3600, manufactured by Bourns, Inc. If the space requirement had been more critical, the Bourns model 330, a microminiature potentiometer, could have been used. In this case, some repeatability accuracy would be sacrificed.

The timer system has been employed in several airborne applications and has provided the 99% repeatability desired. In one application, it has been slightly modified to generate linear sweeps for display.

Designer's casebook

Designer's casebook is a regular feature in Electronics. Readers are invited to submit novel circuit ideas, packaging schemes, or other unusual solutions to design problems. Descriptions should be short. We'll pay \$50 for each item published.

Modified decade counter eliminates components

By Phil Ward

Texas Instruments, Inc., Dallas, Tex.

Because the binary-coded decimal counter shown below has no capacitively coupled feedback circuits, it increases the operating speed of the circuit. By using a simple wiring change and adding a single diode, D_5 , the circuit returns to its initial state at the count of 10 rather than 16. The modifications are shown by the heavy lines.

The wiring change involves breaking the trigger input lines on stage 4 and connecting side A to the 2^0 output of stage 1, and side B to the 2^2 output of stage 3. Negative-going trigger pulses from stage 1 do not affect stage 4 until it has been flipped by a negative-going pulse from stage 3.

Stage 4 is flipped for the first time at the count of eight, and causes the counter to hold the binary number 1000. In this count, stage 4 has the 1 output. The ninth pulse forces the 2^0 output of stage 1 to go positive and makes the counter read 1001. Therefore the circuit operates as an ordinary binary counter up to and including the count of nine. While the circuit is holding the count of nine, the 1 output of the fourth stage, through diode D_5 , reverse-biases the trigger gate of stage 2 so that it will reject the next pulse from stage 1. How-

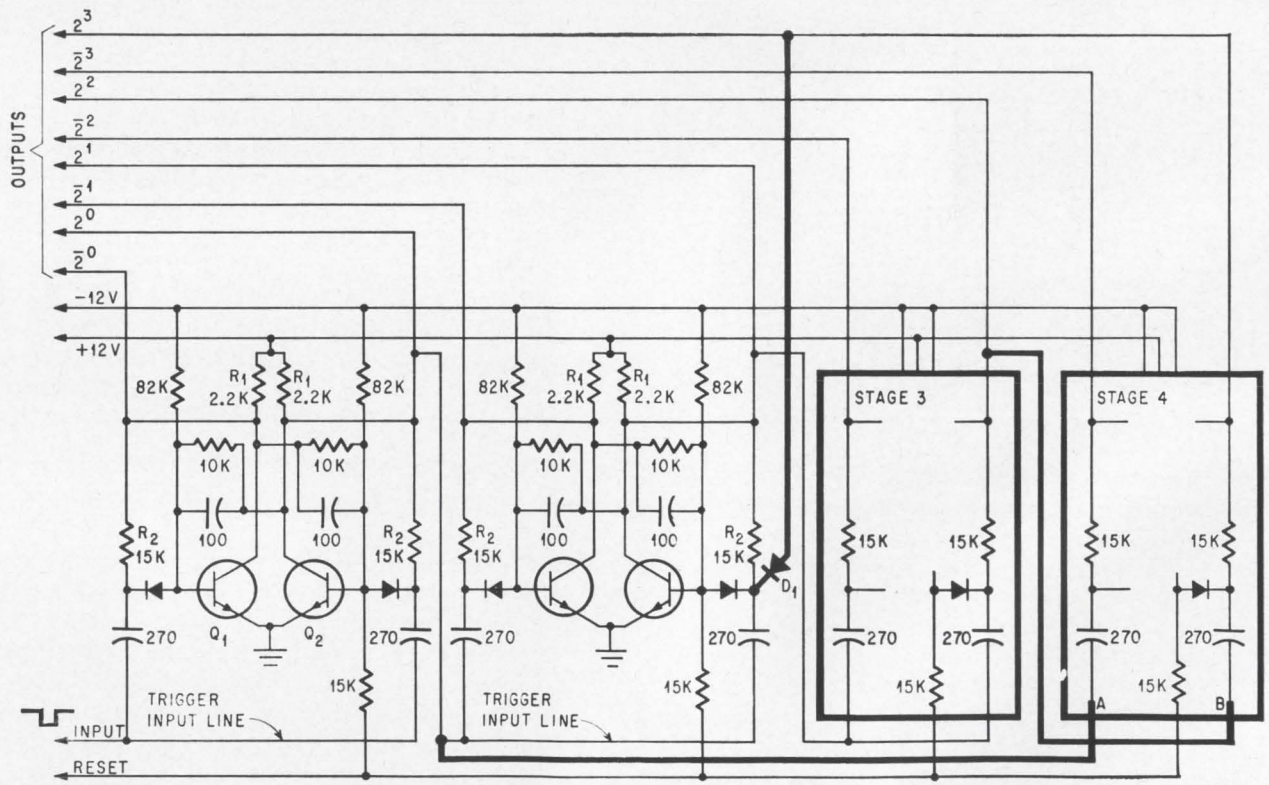

Decimal counter operates at the maximum repetition rate of the flip-flop stages. Heavy lines in the schematic indicate the changes that have been made in the basic circuit.

ever, the tenth pulse still forces the output of stage 1 to reset to 0, and this negative pulse resets stage 4. The outputs of stage 1 to 4 now read 0000 and the binary-coded decimal cycle begins again.

This method of advancing the count reduces the number of circuit components. It also permits the binary-coded decimal counter to operate at the maximum repetition rate of the basic flip-flop and

its trigger circuit. Decade counters which use capacitively coupled feedback require time delays to allow the feedback pulses to advance the count properly and to permit transient counter states to subside. This circuit uses no feedback pulses so no transient counter states occur. The only critical requirement is that the collector load resistors, R_1 , be small compared to the trigger circuit resistors, R_2 .

Tunnel-diode sensor protects regulator from short circuit

By Jack Takesuye

Motorola Semiconductor Products, Inc., Phoenix, Ariz.

Short-circuit protection, excellent regulation and fast response to changing load conditions are provided by the series regulator shown below. With an input voltage ranging from 30 to 40 volts d-c, the

output at a full load of 3 amperes will be held to within 99.05% of 28 volts. With an input voltage of 35 volts, and a load current varied from 0 through 3 amperes, the output voltage will be maintained within 99.85% of 28 volts. When switching from half-load to full-load, the response time—the time for the output voltage to return to within 10% of its initial value—will be less than 4 microseconds.

The basic circuit, at the right in the schematic, is subject to short-circuit overload. Under normal conditions, output voltage is regulated by the series pass-transistor, Q_1 . The drive for Q_1 is obtained by sampling the output voltage of the regulator with the voltage divider R_1 , R_2 and R_3 . This sampled

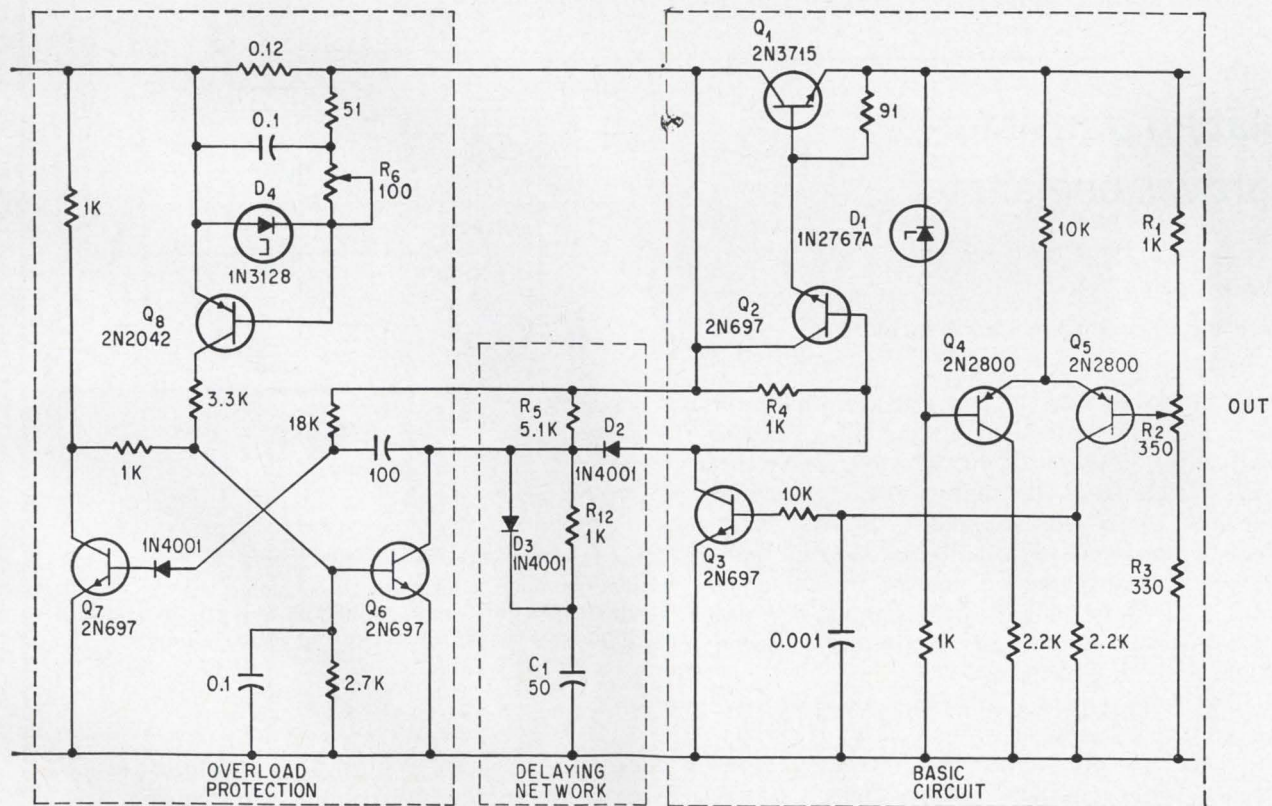

Regulator includes an overload circuit—to protect the series pass-transistor, Q_1 , against damage from short-circuited loads—and a delaying network to prevent oscillations when connected to a capacitive load. The network does not increase the response time under varying load conditions.

voltage is compared to the reference voltage provided by the zener diode D_1 . The difference between the two voltages is amplified and drives Q_1 to minimize the difference. If the output terminals are short-circuited, Q_1 is driven fully on in an attempt to maintain constant output voltage.

Under these conditions, Q_1 will operate at maximum collector-to-emitter voltage and collector current, and can be damaged from excessive heating or secondary breakdown. If secondary breakdown does occur, Q_1 cannot be protected by fusing because transistor failure may occur in a few microseconds; the fuses will not open quickly enough.

To protect Q_1 from damage, an overload-sensing circuit consisting of tunnel diode D_4 and transistor Q_8 , is used to trigger a monostable multivibrator, which removes the drive from Q_1 . This turns off the regulator circuit until the multivibrator resets. If the overload still exists, the regulator is again turned off. This type of protection would be adequate for resistive loads, but for large capacitive loads, the surge current charging the capacitor also would cause the overload protective circuit to turn the regulator off. If the capacitor is discharged by a shunt load, the overload would trigger again after the regulator turned on. This could result in a low-frequency oscillation. To eliminate this problem, the drive to the series pass-transistor can be

applied slowly, minimizing the surge current. However, a simple RC-delays network would degrade the response time (full to half load) of the regulator.

To slowly apply drive to the series pass-transistor and maintain good response time of the regulator, the delaying network is added to the circuit. The voltage to drive Q_1 builds up slowly because C_1 must be charged through R_4 and R_5 . This results in a slow-rising voltage at the collector of Q_3 and minimizes the surge current when the regulator is turned on. Once the capacitor C_1 is charged, diode D_2 is back biased and decouples the delaying network from the regulator circuit; therefore, no loss in response time is noticed from full-load to half-load steps.

Potentiometer R_6 in the overload protection circuit is adjusted to turn off the regulator when the load current exceeds 3.5 amperes. This keeps the load line within the safe limit of the operating characteristics of the series pass-transistor, Q_1 .

The overload problem in series-regulator voltage supplies can be solved by many unique circuits. Various factors such as cost, reliability and performance determine the type of overload protection that should be used. The protective circuitry in this design increases the reliability of the series-regulator supply without degrading its performance capabilities.

Isolating transistor improves one-shot

By Jozek Kalisz

Institute of Nuclear Research, Warsaw, Poland

Several improvements in one-shot multivibrator performance are obtained by adding transistor Q_1 , as in the circuit at the right. The triggering circuit is isolated from the timing circuit, allowing the duration of the output pulse to be fully independent of the input pulse amplitude. In the conventional triggering method, shown by the components in the dotted lines, a 50% change in pulse duration may occur as trigger amplitude is varied from one through eight volts.

Another improvement is that the minimum triggering voltage is reduced from 0.25 to 0.1 volts. Furthermore, the circuit provides increased input impedance while reducing recovery time. Fast recovery is obtained by allowing C_1 to discharge through the low-impedance, base-to-emitter path that appears when Q_1 and Q_2 conduct. Isolating the trigger input from the timing-circuit R_2C_2 also

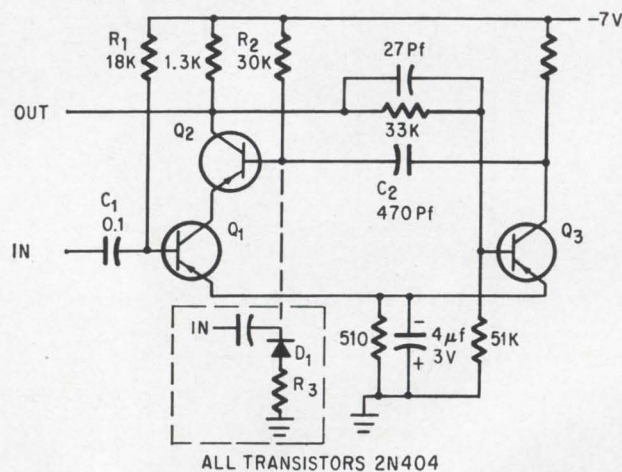

Trigger inputs at the base of Q_1 are isolated from timing elements R_2C_2 , reducing the pulse-width variations and improving trigger sensitivity and recovery time.

reduces the variation in output pulse width caused by temperature, because R_3 and temperature-sensitive diode D_1 no longer shunt R_2 .

Except for the addition of transistor Q_1 , the circuit has the same number of components as a standard one-shot multivibrator.

日本の技術

Japanese technology

The new push for technical leadership

No longer content with improving on U.S. developments, Japanese engineers are now stressing research. One reason is the increased cost of labor

By Lewis H. Young

Editor

In 1960, when this magazine last took an in-depth look at electronics in Japan [Electronics, May 17, 1960, pp. 53 to 100], we found an industry built almost entirely on cheap labor. Research was meager. The principal products were low-priced transistors, components and radios. The best customers were bargain stores.

Today's vibrant Japanese industry is growing as rapidly as any in that country. High-speed production lines spew forth television sets, radios and tape recorders, and workers apply the private brand names of American electronics manufacturers as well as such American retail giants as Sears, Roebuck and Co. and Montgomery Ward & Co. Silicon transistors are slowly appearing, and engineers are installing facilities to produce integrated circuits.

But the biggest change is the new accent on research. At company after company, engineers talk about developing new concepts, rather than improving on American technology. Money, long scarce, is beginning to arrive from surprising places: The Bell Tele-

phone Laboratories, for instance, is financing work at the University of Tokyo on time-division electronic switching for telephone exchanges.

A glamor industry

Electronics' importance to the Japanese economy is far greater than one would guess from its annual sales of \$2.5 billion to \$3.0 billion. The technology offers Japan everything she needs in order to attain her national goals:

- Economic growth. The electronics industry is expanding nearly 15% a year, and that's just a start. With relatively little capital necessary, compared with steel or chemicals, electronics companies are springing up all over the country and existing concerns are constantly adding facilities.

- Exports. Despite a year-long recession, exports of semiconductors, components, radios, television sets, tape recorders and microwave equipment continue to climb, bolstering the country's balance of international payments. Record sales have been reported by the Sony Corp., which exports 63% of its production; also by the Nippon Electric Co. and Sanyo Electric Co., other big exporters.

- Long-range potential. Although the United States is Japan's best customer, with Western Europe a poor second, the new countries of Africa and Asia have gargantuan appetites for communications equipment and consumer products, which are Japanese specialties. These countries still lack money to buy such goods, but the Japanese are confident that they have the inside track for the time when the demand materializes, Japan has already sold solid state microwave equipment to Pakistan, Indonesia and India, and maintains good relations with many of these new countries.

- Prestige. Because electronics is an advanced technology, the Japanese think it can help them attain the reputation of being an advanced country. After shutting themselves off from the rest of the world for nearly 300 years, until 1850, the Japanese became known as copiers when they rushed to catch up. The desire to be considered advanced—which approaches the dimensions of an obsession in some quarters—is one reason the Japanese grasp any new technological idea that comes along, even if they see no immediate application or benefit. An example is the way Japanese companies plunged into color television in 1960—and, in many cases, were burned.

- Productivity. Electronics technology offers the capability of developing the automatic control equipment necessary to keep Japanese industries competitive with those in other parts of the world.

Tough nut to crack

"To compete in world markets, Japan will have to become a highly automated, high-efficiency producer," says Masahiro Shimizu, president of Hokushin Electric Works, Ltd., a producer of instruments, process controllers and computers for automation. Shimizu and other progressive executives recognize the nutcracker in which Japan's

electronics industry is being squeezed.

From the south—Taiwan and Hong Kong—comes the threat of cheap labor—the same asset that Japan once used against the United States. From the east comes pressure by the superior technology of the United States. But the Japanese figure to be a tough nut to crack.

Salaries in Japan have risen sharply in the past five years—about 10% a year, with a 13% jump in 1965. A production worker starts at nearly \$168 a month if you add fringe benefits; that's hardly competitive with the \$15 a month paid in Taiwan or \$30 a month in Hong Kong. And these increases will probably continue.

Electronics technology in the United States is still superior to Japan's, but the Japanese have been able to shorten development schedules by using the results of U.S. experiments and omitting the procedure that U.S. engineers had found to be unproductive. Evaluating the current status of Japanese electronics, Ichiro Isaka, chief engineer of the Electronic Industry Association of Japan, says: "In consumer products, Japan is number one in the world because of its high production rates and low costs. Our microwave equipment competes on even terms with U.S. products. But we are way behind in the study of integrated circuits."

Being second to the U.S. in technology is more than a matter of embarrassment to the Japanese. It is expensive, because Japanese companies must pay royalties to the U.S. owners of patents the Japanese want to use.

Fujitsu, Ltd., is an exception because it will not sign a licensing agreement with a foreign company. This producer of computers, numerical control for machine tools, components and semiconductors prefers to develop its own devices and procedures even though it may enter a market late as a result. More typical, however, is the Nippon Electric Co., which has a long list of licensing arrangements: with Honeywell Inc., for data-processing equipment; with the International Telephone and Telegraph Corp. for communications equipment; with the Western Electric Co. for telephone equipment; with Varian Associates for microwave tubes and linear accelerators; and with the Fairchild Instrument & Camera Co. and General Electric Co. for semiconductor processes.

An American who has lived in Japan for many

Electronics makes the Japanese appear advanced.



years noted another change recently. He said: "When I first came to Japan in 1954, Japanese consumer products were made badly. The only saving grace was that you could get them repaired. Today, Japanese appliances are beautifully made, but when something goes wrong there's nobody to fix them." Most good servicemen have given up repair work for employment in factories where they work shorter hours and earn more pay.

But clearly the biggest change is the new accent on research. One of the greatest incentives to this approach is the desire to become independent of U. S. patents.

More development than research

The biggest deterrent to effective research in Japan is management's inability to evaluate the importance of such studies. Sanai Mito, managing director of the Central Research Laboratory at the Hayakawa Electric Co. explains: "Now companies realize how important research is, but we are just half-way. Management is too hasty. Though they claim they understand research, they want quick results. To get quick results you have to go into development work, not research."

As a result, the accomplishments of Japanese laboratories are heavier on development than on research. At Matsushita, Tetsujiro Nakao, senior managing director, puts the case strongly: "Development is important, but if we ignore fundamental research we will be in trouble." Yet the Central Research Laboratory recently completed the design of a home video tape recorder, a project more akin to an engineering department than a research facility. Nako says his company spends about 3.8% of sales income on research and development; last year's sales totaled about \$616 million. "At least 15% of the total R&D budget is earmarked for basic research," he added proudly.

The growth of research facilities and the formation of new ones in the past five years, clearly shows Japan's intent. The list of expanded facilities and new ones is imposing:

- Just four years ago Hayakawa, which manufactures Sharp-brand tv sets, tape recorders and other consumer products, organized its first central research laboratory, even though the company itself started in 1923.

- Sanyo Electric Co., another appliance maker, officially recognized the importance of research when it chartered a central laboratory in December, 1961, after a small group had operated as a technical department for three years at the company's headquarters. The laboratory staff has increased to 230 people and is expected to expand to 300 as the proper personnel is found.

- The central research laboratory at Hitachi, Ltd., has increased from 600 to 1,400 people over the past five years—and is still growing. The present goal is a staff of 1,500.

- In 1960, the research facility at Mitsubishi Electric had 600 to 700 employees; today the number is 1,500.

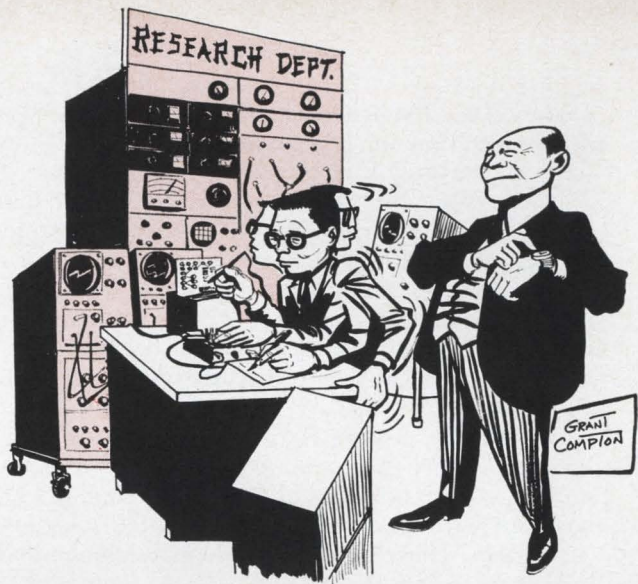

Management is still too hasty; can't wait for research.

Even though Japanese companies have increased their expenditures for R&D dramatically, there is still a serious shortage of funds for that purpose. The Japanese recognize that they must compete with the United States and bewail the giant appropriations for military and space research in America. By contrast, Japan's space program is budgeted around \$7 million for 1965—and that is nearly double last year's figure.

To stretch R&D funds, the government and companies have evolved practices designed to minimize duplication of effort. A lot of fundamental research is performed at government laboratories, and the results are available to all companies.

When word of a truly significant development reaches Japan, the first research is likely to be done at a government laboratory. In 1955, development of numerical control for machine tools started at the Government Mechanical Laboratory near Tokyo. The first Japanese-designed computer was built in prototype at the Electrotechnical laboratory.

Many microwave developments started at the Electrical Communications Laboratory of the Nippon Telegraph and Telephone Public Corp., which the government owns. Much broadcasting equipment has been designed at the research laboratories of Nippon Hoso Kyokai, the government-controlled Japan Broadcasting Co.

When developments are completed at a government laboratory the results are given or sold to Japanese electronics companies. Almost every Japanese computer company owes its technical start in data processing to the development of the Mark IV computer, the first machine built at the government's Electrotechnical laboratory. A few months ago, the Electrical Communications Laboratory gave the solid state design for a 15-gigacycle microwave repeater, which had been designed and tested at the laboratory, to the Nippon Electric Co. to manufacture for the telephone company.

When a government lab charges a royalty, the fee is often microscopic. Toshiba paid only \$1,500 for the design of a two-tube color camera, developed by the research laboratory of the Japan Broad-

casting Co., for televising the Olympics held in Tokyo last autumn. The payment included technical help in starting production.

Universities also help the Japanese to get more research per dollar. Although government professors are prohibited from receiving payment for outside activities, many faculty members secretly ignore the ban and work for private companies as consultants, buttressing the technical effort.

There is a legal way to use the universities too; it's called a *kenkyusei*, or research student. A company can send a graduate engineer to a university for one or two years to perform research under university supervision and take some courses. The cost is \$300 per year plus the student's full salary. This year, Tokyo University registered about 30 *kenkyusei*.

One complaint heard often about Japanese educational practices is that too much money is spent on elementary and secondary schools and not enough on colleges and universities. Japan can boast of a literacy rate of nearly 100%, even though the language is exceedingly complex with nearly 2,500 characters (compared with English's 26).

In contrast, Japan's colleges have unattractive, rundown physical plants that are overflowing with students. Even in new facilities, such as those built to replace the bombed-out electrical engineering building at Osaka University, the structures are stark and unadorned, with unpainted concrete walls on the inside.

Changes in research

Because the facilities are so bad, most of the research carried out at universities is theoretical, requiring a minimum of equipment. At the University of Tokyo, for example, sitting in a ramshackle frame building, Prof. Takashi Isobe studies correlation techniques and pattern recognition. His most recent work has been to develop a new method of measuring the dynamic characteristics of a control system.

Across the campus, in a slightly sturdier building, Prof. Jin-Ichi Nagumo studies self-organizing systems and learning machines, and develops simple devices for medical electronics, such as a direct-coupled pacemaker.

But conditions are changing. More money for experimental equipment is becoming available. Some of it comes from surprising places. The Bell Telephone Laboratories, for example, is financing work on time-division electronic switching at the University of Tokyo. Money is coming from Japanese companies too, as more of them are sending their R&D staffs back to college to keep up with American technology, because so many faculty members have gone to the United States for graduate study.

Despite Japanese efforts to husband their research resources, there is still plenty of duplication. The reason is that Japanese companies tend to play follow-the-leader. Half a dozen companies, for instance, are striving to develop continuous-

wave Gunn-effect oscillators for microwave applications. Also, after word spread that the aggressive Sony Corp. was building an electronic calculator, two appliance makers—the Hayakawa Electric Co. and the Yaou Electric Co.—rushed the development of similar calculators too.

The greatest research effort is going into integrated circuits and electronic switching for telephone exchanges. Still, a catalog of other Japanese research is impressive.

At the Nippon Electric Co., which many Japanese credit with conducting the best industrial research in Japan, projects range from computer developments to quantum electronics.

The NEAC L-2 computer, built at Nippon Electric's Central Research Laboratory, is the basis of the company's new model 500 commercial machine. It has a 10-megacycle clock rate and three memories: wire, core, and a read-only "eddy-card" memory made of square holes in a copper plastic sandwich. In the experimental machine, Nippon Electric has built an index register of 15 words with tunnel diode circuitry to increase speed. The machine's add and subtract time is 0.5 microsecond, with fixed-point arithmetic and 1.4 microseconds with floating point; times for multiplication are 1.9 to 7.7 microseconds for fixed point and 2.4 to 7 microseconds for floating point.

Most of Nippon Electric's work with integrated circuits (see p. 90 for a survey of all integrated-circuit work in Japan) is being done at the company's semiconductor division. But the lab is trying to develop integrated circuits—double NOR logic units—for delta-modulation communication equipment.

In another project, a researcher at NEC has studied voice analysis and built a machine that accepts numbers, given orally, for dialing a telephone.

One of the Mitsubishi Electric Corp.'s top-priority research projects is the development of three-dimensional radar for Japan's defense agency. Says one Mitsubishi engineer: "It's the only development we can give the U. S."

Details are classified, and the company says only that the system uses a phased-array antenna. If it works, and the tests should be completed by next summer, Mitsubishi's system will be the most accurate radar in the world and have the longest range.

Matsushita's Wireless Research Laboratory has almost as many projects under way as the company's Central Research Laboratory. Its emphasis is on new materials and components. About a year away from commercial use is a cubic boride material for the recording heads of tape recorders. Its hardness is 1,000 on a Vickers scale, compared with 600 for ceramic materials; its permeability at 100 cycles per second is 3,000, far better than the 1,600 of ordinary head materials. Its one flaw is a higher coercive force than that found in conventional materials, so present work is aimed at reducing this force, the company says.

Closer to production is a cadmium-sulfide p-n

junction for photovoltaic cells. This material is less expensive than silicon, which has been used the same way, but cadmium sulfide's efficiency when generating power is slightly lower. Current generated is 15 milliamperes per square centimeter at 0.4 volt with a load and 0.5 volt on open circuit.

At Sanyo's central laboratory, work on injection electroluminescence shows promise because Sanyo scientists see a potential for high efficiency and brightness in the single crystals of zinc telluride which they are using.

Despite the surge of recent research, Japan's greatest strength still lies in her ability to perform high-quality development of products based on American technology. Visitors from the United States continually find examples of ingenious engineering. Last month at one of Sanyo's laboratories, for example, an experimental silicon controlled rectifier was controlling a refrigerator's motor. Changing the frequency of electricity doubled the running speed of the 40-watt motor, producing the same cooling effect as with an 80-watt motor.

To assess the technical contribution of the electronics industry in Japan, the editors of *Electronics* have asked several Japanese experts to report on their specialties, emphasizing those developments which are peculiarly Japanese. From these reports, which appear on pages 81 to 112, an engineer can assess Japanese technology. Those segments of technology selected are:

1. Discrete semiconductor devices, which are essential ingredients in most products (see below).
2. Integrated circuits, because the Japanese are emphasizing linear devices and racing to catch up with the United States (p. 90).
3. Solid state microwave, because the Japanese have the densest networks in the world and boast that their equipment is as good as anybody's (p. 99).
4. Industrial electronics, because the Japanese are pushing hard for automation to offset rising labor costs. One report covers numerical control of machine tools (p. 106); the other, process control by computer (p. 110).

Japanese technology

日本の技術

When you're second, you try harder

In one decade, Japan's semiconductor industry has become the world's second largest. Pioneering engineers, a variety of unusual devices, and breakthroughs in miniaturization techniques account for phenomenal growth

By Takuya Kojima and Makoto Watanabe

Electrical Communications Laboratory,
Nippon Telegraph and Telephone Public Corp., Tokyo

Large scale production of semiconductor devices is the nucleus of the Japanese electronics industry. More than 400 million transistors were produced last year, making Japan's semiconductor industry the second largest in the world, trailing only the United States. Yet quantity is not the industry's sole accomplishment. Japanese engineers have created some unusual devices such as the passivated mesa transistor, a bidirectional twin transistor, the Esaki diode, and a double-diffused pnp transistor of unique structure.

All this has happened in the last decade. The dominant force behind such rapid growth has been

Japan's pioneering in the transistorizing of consumer products such as a-m and f-m radios, tape recorders and television sets, now small enough to be called microsets.

The structure of the Japanese industry helped too. All the makers of semiconductor devices in Japan—and the total number is less than 20—also manufacture consumer products, other electronic equipment or both. Because they are in the same company, information flows rapidly between device builders and equipment designers.

Most of the semiconductors made in Japan are germanium devices, and go into consumer prod-

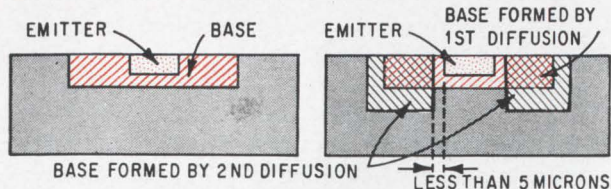

Nippon Electric Co.'s multiple diffused base transistor (left) compared to a conventional planar transistor at right. By widening the base area with a second diffusion, NEC reduces base spreading resistance, thus increasing maximum frequency

ucts. New consumer products, however, require better quality devices. Thus, the transistorization of large television reviewers, with screens up to 19 inches, demands high-frequency transistors and high-power devices. Communication and industrial equipment also needs special-purpose devices of high quality. Although silicon technology is new in Japan, its spread has been rapid and most semiconductor suppliers produce both germanium and silicon devices.

Challenge of higher frequencies

As in the United States, there is great pressure in Japan to produce higher-frequency devices. For example, television makers want transistors capable of operating up to 1,000 megacycles for ultrahigh-frequency receivers. For this application, Japanese suppliers offer both germanium and silicon devices.

To boost operating frequency, Japanese firms are trying either to minimize the base spreading resistance of their devices or to minimize the collector capacitance. The reasons become evident from the equation for maximum frequency of oscillation of a transistor:

$$\frac{1}{4\pi} \left[\frac{1}{r_{bb'} c_c \tau_{ec}} \right]^{1/2} \quad (1)$$

where $r_{bb'}$ is the base spreading resistance, c_c is the collector capacitance and τ_{ec} is the carrier transit time between emitter and collector. The base spreading resistance and collector capacitance degrade performance. Base spreading resistance not only decreases the power gain and output power but also degrades the noise figure.

To lower this resistance in silicon transistors, firms have introduced some novel device structures. For example, the Nippon Electric Co., Japan's biggest microwave equipment manufacturer, uses a multiple base diffusion process to add another area

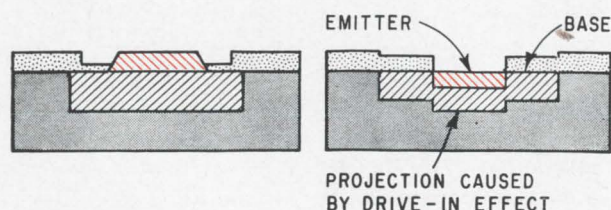

Emitter mesa transistor built by the Nippon Electric Co. (left) withstands drive-in effect which had destroyed conventional mesa transistor (right).

of impurities in the 2SC288, 2SC289, and 2SC272 devices (shown above). After the usual diffusion has formed a conventional base area, a second process diffuses impurities just outside the emitter area, widening the base thickness and reducing the base spreading resistance. The $r_{bb'}c_c$ product of the 2SC288 is only 3 picoseconds; the base resistance is less than $\frac{1}{3}$ that of a conventional transistor.

NEC also achieves a low base spreading resistance with a second approach called emitter mesa structure and shown in the figure below. This structure reduces the drive-in effect in which impurities in the base region are driven toward the collector area, forming a small projection in the collector junction plane.

Though the effect is more pronounced in a silicon mesa transistor, where the impurity is gallium, than in a planar transistor where the impurity is boron, it becomes critical in any high-frequency transistor. That's because a high-frequency device has an extremely narrow base width which is a bottleneck in the base region between the area immediately beneath the emitter junction and the area outside the junction. The bottleneck causes an appreciable increase in the base resistance and disturbs the uniform carrier flow in the base area.

In the emitter mesa structure, a mesa formed by a vapor etching process prior to diffusion, offsets the drive-in effect. The height of the mesa is just enough to compensate for the depth of the projection that would be formed in the junction plane by the drive-in phenomenon. Thus an ideal flat junction structure results.

There is one other advantage of the emitter mesa structure: it eliminates unwanted parasitic capacitance and carrier injections around the vertical outside edge of the base. Although these can be ignored in an ordinary device, they are appreciable in a high-frequency transistor whose emitter width is 5 microns or less. The parasitic capacitance decreases the high-frequency amplification factor in the small-current region of the emitter; the excess carrier injection at the edge decreases the current amplification factor in the large-current region of the emitter. By using the emitter mesa structure, NEC increases the gain by 3 db throughout the range of emitter current and decreases noise by 0.5 db.

From the equation for the maximum frequency of oscillation of a transistor (above), it is clear that frequency can also be increased if collector capacitance is reduced. In the base mesa transistor, designed by NEC, the geometry lowers this characteristic. In the structure (p. 83), the base area is defined by a deposited layer of silicon dioxide. Since only a small region of the base is needed to make contact with the metallization of the electrode, the capacitance of the metallized portion to the collector is negligible. Such low collector capacitance makes the device well-suited for application in wideband-amplifiers—and especially in amplifiers with automatic gain control because

Building a base mesa transistor

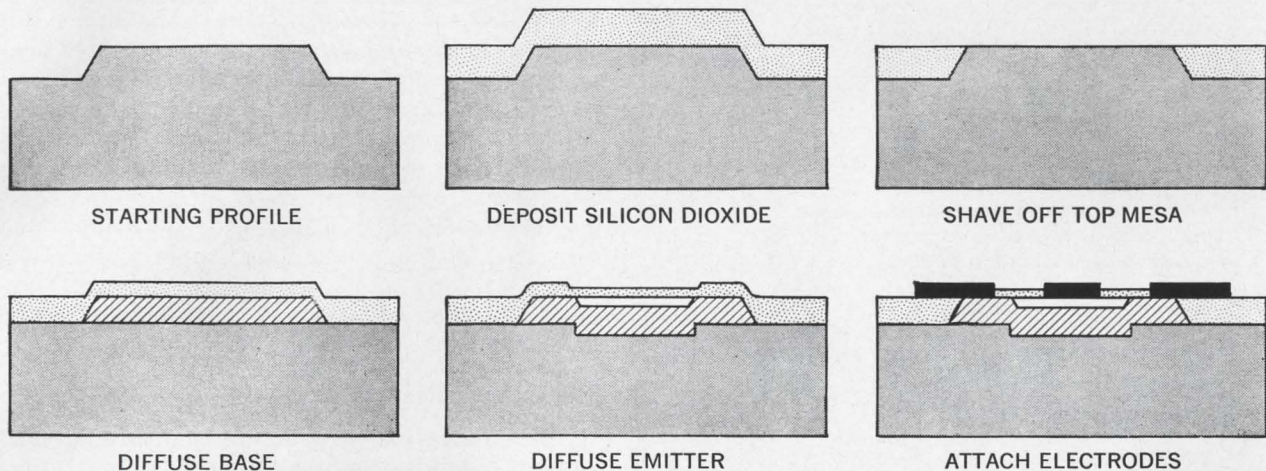

circuit capacitance changes less with changes in voltage stemming from the gain control.

It seems clear that all three techniques—multiple diffused base, emitter mesa, and base mesa—could be applied to one device, to produce even better transistors capable of handling higher frequencies.

At the Matsushita Electronics Corp., the semiconductor producer of the big Matsushita Industrial Electronics Co., another approach to reducing collector capacitance has been taken with extended base planar transistors. A highly doped area just beneath the extended base electrode shields the electrode from the collector. In the Matsushita 2SC562 series, the base-to-collector capacitance is as low as 0.15 picofarads.

Minimum base-to-collector capacitance eliminates several bothersome effects. By definition, in an extended base electrode device, a metallized contact to the base is extended along the silicon dioxide layer on top of the collector bulk semiconductor region for easier bonding of the base lead wire. If the device has an extremely small base area, the parasitic capacitance between the extended base electrode and the collector bulk semiconductor region is comparable to the capacitance of the intrinsic collector junction. Such a high capacitance makes it impossible either to increase the power gain of the transistor in ultra-high-frequency ranges or to stabilize transistor operation at lower frequencies where capacitance can cause feedback. In addition, if the intermediate frequency stage of an amplifier is equipped with automatic gain control, high capacitance causes the bandpass characteristics to change with the gain of the transistor.

Most of the high-frequency devices Matsushita has developed are going into television sets. The 2SC562 is used in the control stage of television i-f amplifiers with forward gain control. The 2SC563 goes into the output stage of i-f amplifiers. And the 2SC593, with a power gain of 20 db at 450 Mc and a cutoff frequency more than 1,500 Mc, is for uhf tuners.

Because silicon devices cost considerably more

than germanium ones, there is still a lot of interest in germanium devices in Japan, even for high-frequency applications. Japanese engineers use mesa, planar and alloyed diffused types of germanium transistors in high-frequency applications. One example is the 2SA448, a double-diffused pnp transistor, shown on page 84, developed by the Sony Corp. The mesa surface is divided into two steps of equal area, separated by a space of only one micron. One step is the base contact metallization region; the other is the emitter contact metallization region.

Even though high precision is required in manufacturing, the fabrication of the 2SA448 is relatively simple. First, a coating of silicon dioxide is deposited uniformly over the entire face of a germanium wafer. Then gallium is deposited on the oxide coating and diffused through it to form the emitter layer of p+ material. Trenches in the SiO₂ are formed by a photolithographic process. The p+ material below these trenches is etched out to form deeps whose bottoms reach to the p- material. Then the SiO₂ layer is removed, leaving a surface of alternating p+ and p- stripes. At this point, the device is a p- wafer with parallel ribbons of p+ material along its upper surface.

In the next step, the base diffusion of n-type material takes place. A layer of n-type material forms at the base of the trenches and under the p+ ribbons because the diffusion constant of the n impurity is 1,000 times that of gallium which was the p+ impurity. But, because the quantity of n impurity is much smaller than that of gallium, the p+ region stays a p+ region. Aided by geometry, the n impurity extends further into the p- region at the bottom of the trenches than under the p+ region. Since the n layer under the p+ layer is the base region of the finished device and the n layer at the bottom of the deeps is the base lead attachment region, the finished transistor has a thin base and low base spreading resistance.

After the second diffusion, a shadow evaporation process forms the aluminum base and emitter con-

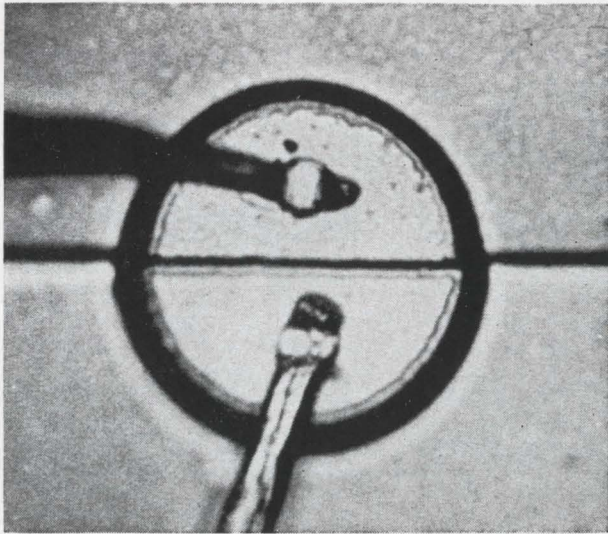

One micron or less separates the emitter electrode (top) and base electrode (bottom) of Sony's double diffused germanium pnp transistor. Used for high-frequency applications, it can be fabricated easily.

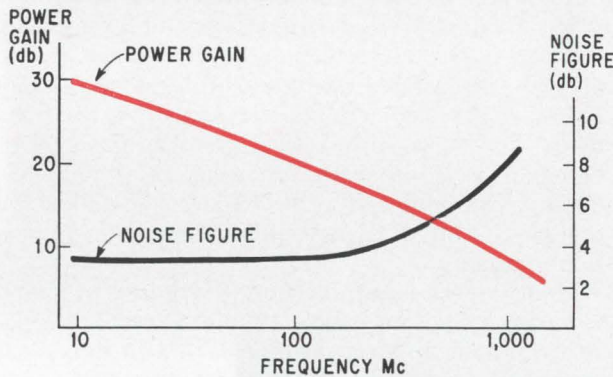

How Sony's germanium transistor, 2SA448, performs at high frequency. Its performance is good up to 1 gigacycle.

tact regions. In this process, the entire base and emitter contact regions are metallized with only about a micron spacing between them. No precision positioning is required since the step in the structure provides a built-in mask.

Finally, the wafers are diced and individual pellets mounted on tabs for mesa masking and mesa etching. Mounting, lead attachment and sealing are conventional.

Built this way, Sony's 2SA448 has a power gain of 8 db at 1 gigacycle. Noise figure at this frequency is 7 db in the common emitter connection.

Power transistors

The considerable effort to produce high-frequency devices has not been duplicated with high-power units. Though many companies make power transistors, both silicon and germanium, most are conventionally designed.

Epitaxial or triple-diffused silicon power transistors are manufactured with capacities ranging from 10 to 150 watts—not exceptional when compared with devices made in the United States with power ratings up to 300 watts. Currently the

2SD137 made by Kobe Kogyo has the highest collector breakdown voltage of any device made in Japan: 300 volts. Recently, both Kobe Kogyo and Toshiba (Tokyo Shibaura Electric Co.) started manufacturing overlay transistors which have higher power capability in the high-frequency range.

In entertainment and industrial applications, alloy drift and diffused base germanium transistors are still used almost exclusively. In audio-frequency amplifiers, horizontal deflecting systems for tv picture tubes, and regulated power supplies, they have proven to be free of secondary breakdown. Many people wonder whether silicon will ever replace germanium for such applications.

The passivated mesa

Although the planar structure is clearly the most widely used for silicon transistors, it has one serious limitation: the breakdown voltage of the collector is low. After examining the probable causes of this limitation, Hitachi Ltd., has developed an improved passivated mesa transistor which has a better collector junction.

In Japan, as in the United States, the causes of collector breakdown in planar structure are not clear. Partially, it's caused by geometry: the electric field is concentrated at the corners of the diffused area. Some researchers believe that a large amount of impurities in the base region cause surface breakdown. The surface of the base has a greater concentration of impurities than the region adjacent to the horizontal collector junction because diffusion produces a graded layer with a higher concentration of impurities near the surface.

At other times, a poor silicon-silicon dioxide interface seems the cause. Or, if the silicon-silicon dioxide surfaces are separated by an n^+ surface layer, breakdown can occur too.

Hitachi's new process produces a mesa structure that has a high collector breakdown voltage, low noise figure, small leakage current, and a high current amplification factor in the small current region.

The process is applied to a completed mesa transistor. After silicon dioxide is deposited on the transistor by the thermal decomposition of organic oxysilane, a thin film of lead is deposited onto the oxide layer. Finally, the device is exposed to high temperature so the lead and silicon dioxide can combine to form a protective glass whose composition is lead oxide and silicon dioxide.

Many kinds of transistors treated this way are available for entertainment and industrial applications. For example, the Hitachi 2SD190 is a silicon device with a BV_{cbo} of 300 volts; the 2S280H is a twin transistor for low-level differential amplifiers and it has an excellent reliability record.

Hitachi claims the process can be applied to other semiconductor devices, too.

Beginning of field effect devices

Among Japanese engineers, the field effect transistor is still a novelty whose application is very limited. Only five companies supply them at pres-

ent: Toshiba, Hitachi, Fujitsu, Kobe Kogyo and Mitsubishi. Typical of these devices is the Toshiba 2SJ13, a p-channel junction FET with a transconductance of 3.5 milliohms. The Mitsubishi 3SK15 series is a depletion mode metal oxide semiconductor device for general purpose use. The Hitachi 3SK11 is a depletion mode n-channel MOS fabricated by a technique called field cooling process.

Depletion mode, enhancement mode and even nonuniform channel MOS devices can be made by the field cooling process. A small quantity of movable impurities, such as sodium ions, are impregnated in the silicon dioxide layer. An electric field applied between the gate and bulk crystal at high temperature causes the impurities to drift through the oxide layer, changing the surface potential of the silicon appreciably. When the surface channel has reached the desired conductance, the field is removed and the device is cooled, fixing the impurities in the oxide layer.

Making the Esaki diode

Unquestionably the best known Japanese semiconductor development is the Esaki or tunnel diode, invented by Leo Esaki at the Sony Corp. in 1957. After a resounding acceptance, particularly be-

cause of its apparent high speed, the tunnel diode turned into a big disappointment. One reason was the incorrect use of the device in circuits. It is a diode and cannot replace transistors or other multi-lead devices. But another reason was reliability. Initially, every manufacturer fabricated Esaki diodes by a conventional alloy-etching process. It produced a diode whose structure resembled a boulder balanced on a point, and the device was not very rugged.

In addition, performance requirements were in conflict with each other. For a high cutoff frequency, the junction diameter has to be about 5 microns or less; but for high reliability, the final junction diameter cannot be smaller than the initial junction diameter before etching. It turned out that a 5-micron diameter area—needed for high-frequency cutoff—was too small for lead attachment.

Because the Esaki diode was a truly Japanese development, Japanese companies continue to work with it. To build more reliable devices, some of them have switched to a mask technique. At Sony, where the device was developed, a process called the bridge technique was developed, using a combination of evaporated mask and etching methods.

In the new Sony process, after a germanium slice

Applications of passivated mesa transistors

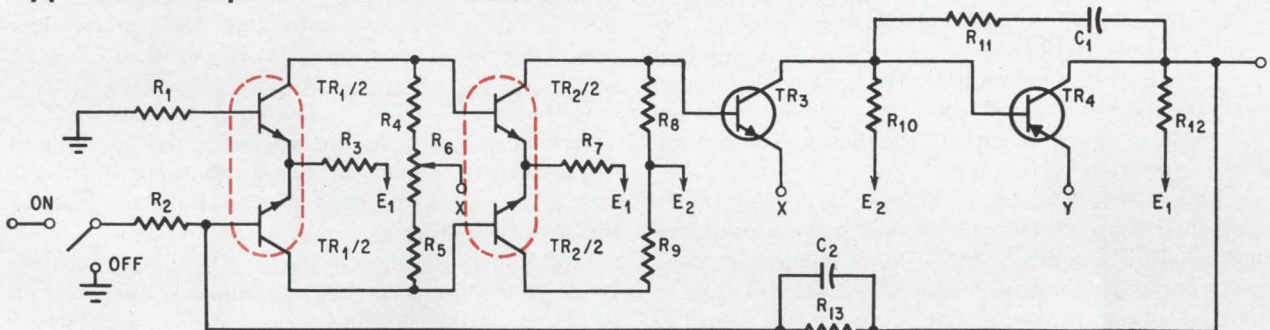

Low-drift differential amplifier uses two pairs of twin passivated mesa transistors. Voltage gain is 40 db; drift is 10 microvolts per degree centigrade.

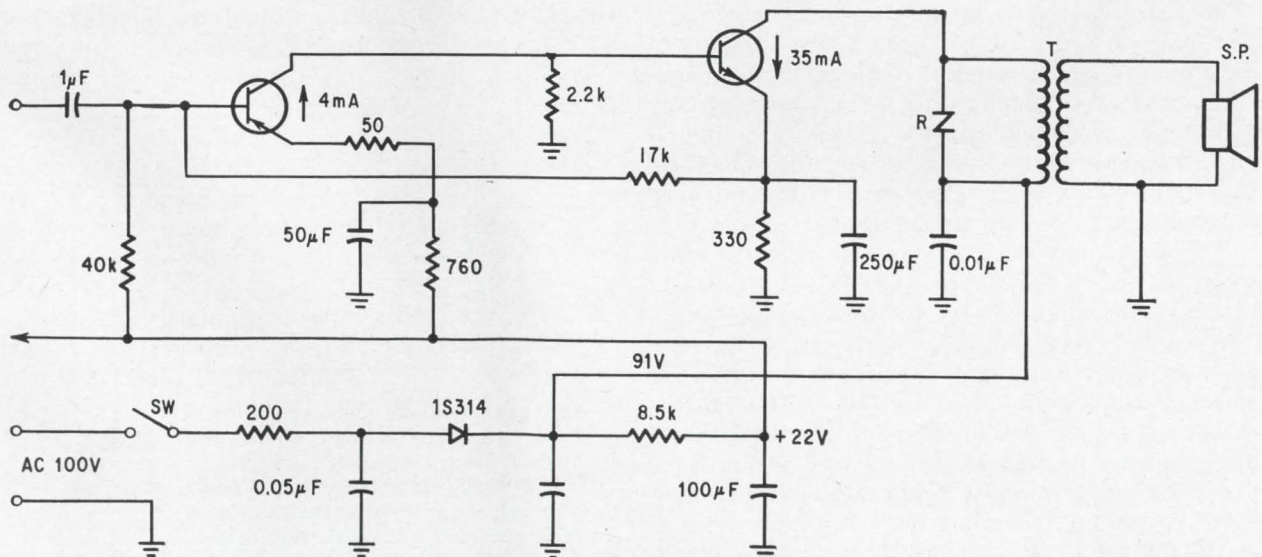

In the output stage of a home radio, a high voltage passivated mesa transistor is protected by a silicon varistor.

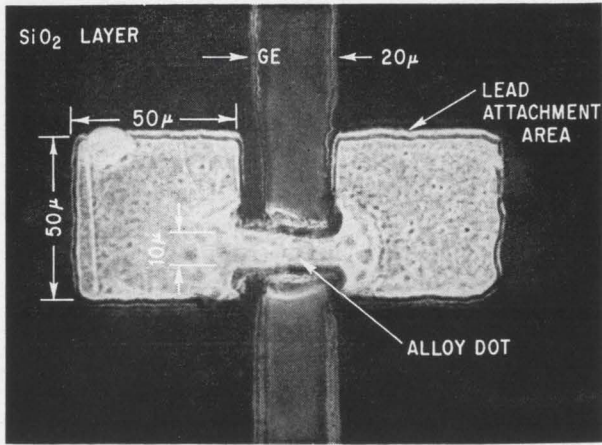

In Sony's new method of fabricating tunnel diodes, a dot of alloy material bridges the trench between two metallized areas. The result is a more rugged device.

has been coated with silicon dioxide, a trench about 20 microns wide is cut in the oxide coating by photolithographic etching. Then two regions, 50 microns by 50 microns, on each side of the trench are metallized. An alloy dot bridges the two metallized areas over the trench, forming a junction at the bottom of the trench and ohmic contacts to the two metallized regions. A final etching process brings the diode to the desired characteristics of peak current and peak-to-valley current ratio.

In a diode made this way, the etched junction is only slightly smaller than the original junction. But the junction does not have to contribute to mechanical support; rather, the ohmic contact region supports the junction.

Besides being stronger, the new diode has better electrical characteristics. One which Sony produces has a cutoff frequency of 10 to 21 gigacycles, self resonant frequency of 14 to 22 gigacycles, and a capacitance-to-peak current ratio of 0.1 to 0.25 picofarads per milliampere.

Other high-frequency diodes

Because of Japan's interest in and use of solid state microwave, there has been a lot of activity in developing high-frequency diodes for communication systems. Among the first Japanese semiconductor developments was the Kita diode or silver-bonded diode developed at the Electrical Communications Laboratory of NTT, and now manufactured by Nippon Electric Co.

The Kita diode has outstanding characteristics when used as a parametric amplifier, up-converter or frequency multiplier at microwave frequencies. The reason is the small capacitance of the depletion layer, typically less than 0.5 picofarads, and a low series resistance, less than 10 ohms. Although the device was first developed in 1954, its greatest applications have appeared in the past two or three years. Now new ones are being discovered in high-speed switching, clamping and clipping.

Making the diode is relatively easy; the big difference is in the method of bonding. In a conven-

tional diode gold wires are used. In the Kita device, the tip of a silver whisker, containing a small amount of gallium, contacts a bulk crystal which has been highly doped with n type germanium or silicon. Applying a large current pulse produces a very small area of p+ material on the crystal, completing the fabrication of the diode.

As an indication of Japanese activity producing a variety of diodes:

- Nippon Electric Co. produces high frequency zener diodes with low junction capacitance.

- Fujitsu Ltd., the Nippon Electric Co., and the Mitsubishi Electric Corp. make silicon diffused varactors for solid state microwave systems of 2, 4 and 6 Gc. The Mitsubishi MVE6006 can deliver an output of 3 watts at 4 Gc when used as a frequency tripler. That's the highest output at this frequency of any Japanese diode.

- The New Japan Radio Co., Ltd., Fujitsu Ltd., and the Sanyo Electric Co. make variable-capacitance diodes with a retrograded junction, a device which is also called a hyper-abrupt junction diode. These devices are used as a tuning element which covers a wide frequency range and as a modulator in f-m communications systems.

- Fujitsu Ltd., has also developed a new gallium-arsenide light emitting diode that throws a narrow beam of noncoherent light through a transparent window at the top of the mounting. It has been used in a micromanipulator which accurately positions tools driven by a pulse motor.

Special purpose devices

A look at some of the special purpose devices developed in Japan helps understand both the spread of Japan's semiconductor industry and its electronics industry.

One unusual device is the V-203, a bidirectional twin transistor, built by the Nippon Electric Co. for balanced modulators. A unique junction structure and a controlled epitaxial technique produces symmetrical characteristics (see circuit below).

Another device is a high-speed four-layer diode developed by Mitsubishi. A two-terminal silicon device, it has a breakover voltage of only 3 volts and

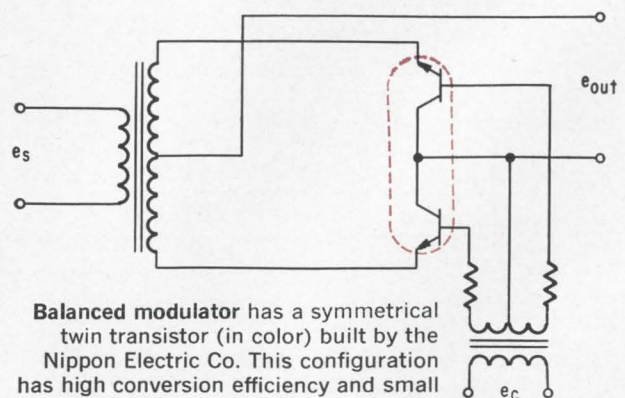

Balanced modulator has a symmetrical twin transistor (in color) built by the Nippon Electric Co. This configuration has high conversion efficiency and small carrier leakage because the saturation resistance and voltage are appreciably smaller than those of diodes used in conventional modulators.

a switching time of 20 nanoseconds. Most probably application is in fast digital circuits.

And still another new device is the gate-turnoff silicon controlled rectifier produced by Toshiba. Labeled the M8392, it has a turnoff gain of 8; that is, a gate current of 500 milliamps can turn off a current of 4 amps.

Power handling devices

Although both power equipment manufacturers and transistor makers make power handling devices—silicon rectifiers, silicon controlled rectifiers, and silicon symmetrical switches (bidirectional four-layer diodes)—the development effort doesn't begin to compare with that in the United States. In general, scr's, for example, are expensive and are not yet used widely. Until recently, Japanese scr's did not have the large current-carrying capacities of those available in the U. S. and Europe.

The situation is changing and some new devices supply the strongest evidence. A new scr developed by Nippon Electric Co. uses a silicon slice $1\frac{1}{2}$ inches in diameter; it's the biggest scr developed in Japan. Called the V-179, it has a mean forward current of 700 amps, repetitive peak reverse voltage of 2,350 volts, and a surge current rating of 9,000 amps.

One not so large is the CJ-021 built by Hitachi for ac-dc conversion in a 2,200 kilowatt electric locomotive. Ratings of this scr are: a peak reverse voltage of 1,200 volts and a mean forward current of 390 amps. Because so much of Japan's extensive railroads net is electrified, there is likely to be an increased use of scr's for conversion and speed control as the manufacturing volume increases and decreases the cost.

Hitachi has one other interesting scr, the CR-93VE, a small high speed device. It takes only 3 microseconds to turn on 1,000 amps, and 6 microseconds to turn off 10 amps. But it can handle 1,000 amps only for short surges.

Silicon symmetrical switches are a specialty of the Shindengen Electric Manufacturing Co. which makes several series of them. Its KXB series contains two terminal bidirectional switches with breakover voltages of 100 to 200 volts. The K17B-10 and K17B-20 have a rating of 150 amps, bidirectional rms current and the K5B can handle 12 amps.

Another supplier is Hitachi, whose FR-01 is a 5-layer switch with one control gate electrode. A control current, either positive or negative, of 100 milliamps can fire the switch in either direction, regulating an rms current of 16 amperes.

High-voltage rectifiers

Still a small part of the Japanese semiconductor industry is the manufacture of high-voltage rectifiers, capable of handling reverse voltages of 3,000 and 4,000 volts. The Hitachi HO3-DA has a peak reverse voltage of 3,000 volts and a rated mean forward current of 470 amps. A device made by the Sanken Electric Co. has a breakdown voltage exceeding 4,000 volts; mean forward current is 150

A neat packaging idea

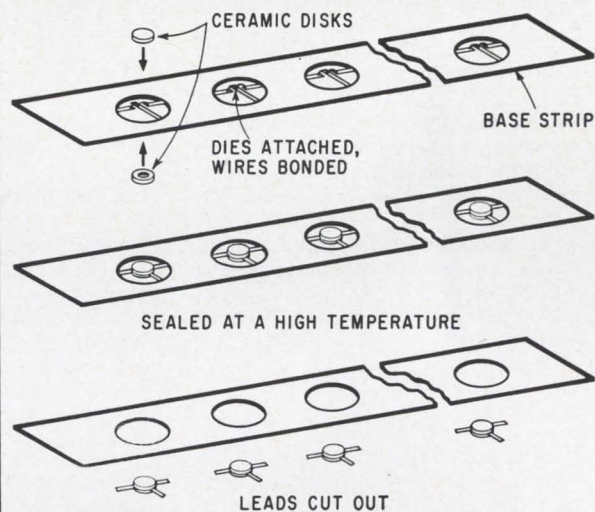
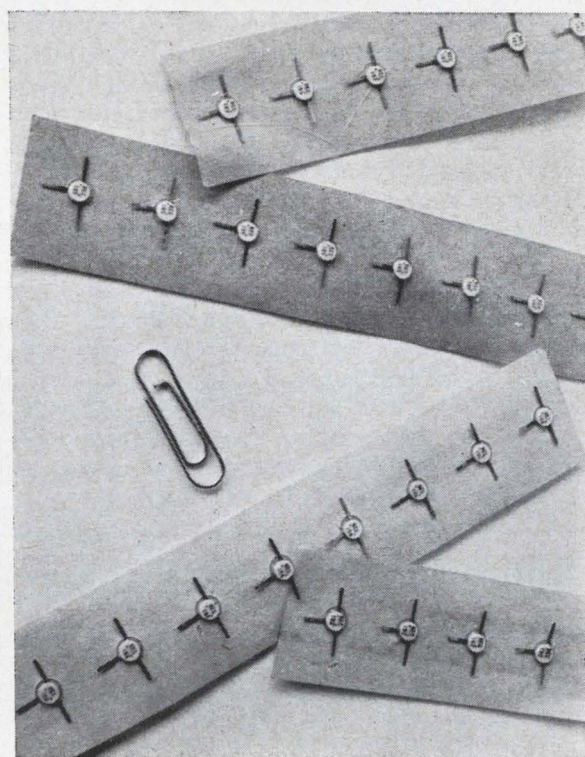

At the Nippon Electric Co., miniature high-frequency transistors are assembled on rolls of Kovar material to simplify manufacturing and handling. The transistors are mounted in tiny ceramic headers called Micro Disks which also minimize parasitic capacitances and inductance created by conventional single-ended packages.

Assembly is simple and automated. Leads are stamped from a continuous flat strip of Kovar. Silicon dies are mounted on the collector leads and interval leads are attached between the base and emitter and the leads on the strip. Tiny ceramic disks, recessed like an ashtray in the center are coated with low-melting glass, then attached from both sides of the strip. When the assembly is heated, the glass melts and a hermetic seal is formed. The leads are cut out from the strip and the devices separated from each other for final testing.

milliamperes and the forward voltage drop is only one volt when maximum forward current flows.

Shindengen makes an avalanche rectifier diode, the S5Z-50, with a reverse surge power rating of 2.5 kilowatts for 10 microsecond pulses. In the S5Z series, peak reverse voltages range from 400 to 1,200 volts; mean forward current is about 20 amps.

Any survey of the Japanese semiconductor industry would not be complete without mentioning several processing techniques which have been developed.

Many of the high voltage devices made in Japan receive a special surface treatment called ONV, which means oxidation by nitrogen dioxide vapor. The treatment, developed at the Electrical Communications Laboratory, consists of two processes: cleaning the silicon surface in an atmosphere of hydrogen fluoride and nitrogen dioxide; and oxidizing at a low temperature. Such treatment raises breakdown voltage, minimizes leakage current and

steps up the surge power rating.

Though germanium devices far outnumber silicon devices produced by Japanese semiconductor makers, more research effort is being applied to silicon technology because it is newer. For example, the Oki Electric Co. has perfected a simple process for depositing polycrystal silicon.

The company has made a tiny diode with an upper ohmic contact formed by depositing polycrystal silicon. The polycrystal material is deposited in a window cut into oxide masking. During fabrication, it acts as an impurity source for diffusing the p-n junction beneath it, and afterwards as a protective coating and contact to the completed junction. This technique supplies a rigid, reliable contact that is simple; no ball or fancy contact structure is required as it is with many kinds of silicon diodes.

Another application of silicon polycrystal produces isolated silicon islands in integrated circuits

Some Japanese uses of semiconductor components

I. Switching the horizontal deflection of a tv tube

Two transistors connected in series are the essential components in a circuit (at right) designed to switch the horizontal deflection of a television tube. One has a relatively low breakdown voltage but switches at high speed; the other has a high breakdown voltage but sacrifices high frequency characteristics for a wide area of safe operation. The first has a grounded emitter, the second a grounded base connection.

To switch on the circuit, a signal is applied across the base and emitter of the first transistor, causing a base current to flow equivalent to

$$I_B = \frac{E_2}{R_B}$$

If I_B is large enough to turn on the second transistor, a deflection current flows equivalent to

$$I_D = \frac{1}{L_D} (E_1 + E_2) t$$

where

I_D = yoke current in amperes

L_D = yoke inductance in microhenries

E_1 and E_2 are power supply voltages in volts

t = time in microsecond after second transistor turns on

When an off signal is applied to the first transistor, the charge stored in the base of the second transistor flows through resistance R_B until it disappears. Not until the stored charge completely disappears is the switching complete.

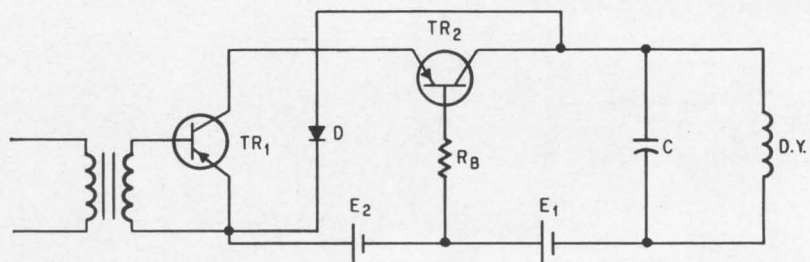

Transistors switch horizontal deflection of TV tube

II. Esaki diodes in a pcm system

Possibly because the Esaki or tunnel diode was developed by a countryman, Japanese engineers have retained a fondness for it even though many U.S. engineers became disenchanted with the device a long time ago. Properly used, this high-speed device has some clear advantages. For example, the Nippon Telegraph and Telephone Public Corp. has just designed Esaki diodes into three switching circuits (see below and p. 89) for a 24-channel pulse code modulation communications sys-

tem. By using this device, NTT not only reduced the size of the equipment, but decreased power consumption by nearly two-thirds, to 67 watts from 220 watts. The three are: a temporary memory, a pulse shaping circuit, and a voltage comparator.

The temporary memory is equivalent to a bistable flip-flop circuit.

The pulse shaping circuit, like a Schmitt trigger, converts a sine-wave to a pulse train.

In the voltage comparator, when incoming signal exceeds a specified level, an output pulse of definite amplitude appears at the output.

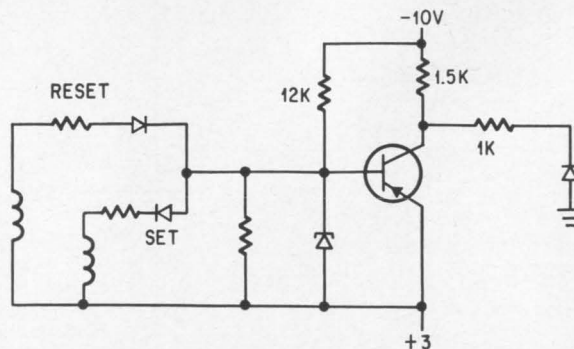

Temporary memory is equivalent to a bistable flip-flop circuit.

in a process similar to Motorola's EPIC process—but simpler.

In Motorola's process, a silicon crystal is etched to a waffle-like pattern and then oxidized. Polycrystal is deposited over the waffle-like face; the bulk of the single crystal material is removed by grinding and lapping until the waffle-like projections are a group of oxide-isolated islands supported by polycrystal silicon.

In the Oki process, the starting material is a two-layer structure of thin silicon single crystal on a polycrystal bulk. In the etch that produces the waffle-like structure, the single crystal is cut down to the supporting polycrystal. The structure is then oxidized and polycrystal silicon deposited just as it is in the EPIC process. But the original polycrystal silicon is removed, leaving a group of oxide-insulated islands supported by polycrystal silicon. What makes this process simpler is that the polycrystal material is removed easily.

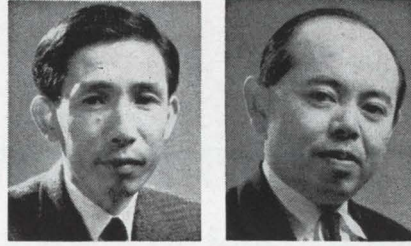

The authors

After receiving his Ph.D from Osaka University, Takuya Kojima (left) started his engineering career by developing tubes for wideband amplifiers. He switched to semiconductor devices in 1955 and now heads solid state engineering work at the Electrical Communications Laboratory.

Ever since he graduated from the University of Tokyo in 1953, Makoto Watanabe (right) has had an interest in semiconductors. As a staff engineer at the Electrical Communications Laboratory, he develops high frequency germanium and silicon devices.

Pulse shaping circuit, like a Schmitt trigger, converts incoming sinewave signal to a pulse train.

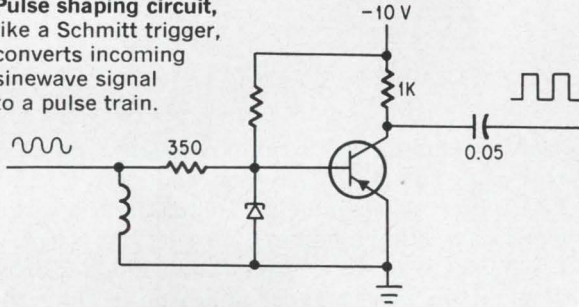

In voltage comparator, when incoming signal exceeds a specified level, an output pulse appears at the output terminal.

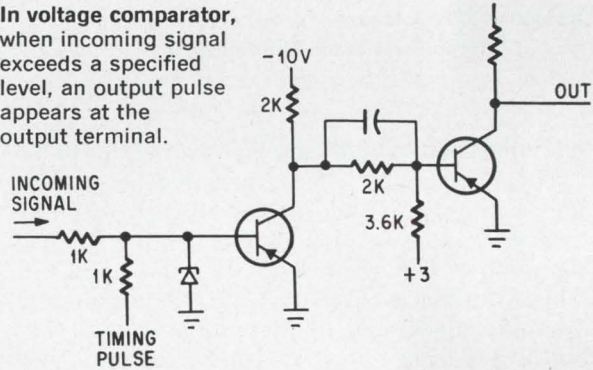

III. Esaki diodes in a memory matrix

One attraction of the Esaki diode has always been its high speed. At the Electrical Communication Laboratory of NTT, engineers have used the tunnel diode to design a high speed memory matrix whose cycle time is under 50 nanoseconds.

The peak current through the diode is one millampere and the capacitance connected in parallel with it is 50 picofarads. Thus a driving pulse with a rise time of 3 nanoseconds can deliver a read-

out pulse of 80 millivolts on the sense line. The capacitance in parallel to the diode matches the rise time of a memory cell with that of the driving pulse and stabilizes the operation against external noise.

Two silicon diodes and a load resistance form a load line (see circuit diagram below), which is connected between a bias line and a word line of the matrix.

In the static condition, the operating point is at one of two points

on the voltage-current curve, depending on whether a zero or a one is being stored. When information is read out, a negative pulse or value $-V_1$ is impressed on the word line, causing a small noise to appear in the sense line. The size of this noise is large if a one is stored, small if a zero is stored.

A zero is written when a positive pulse is applied to the word line while a negative pulse is applied to the digit line.

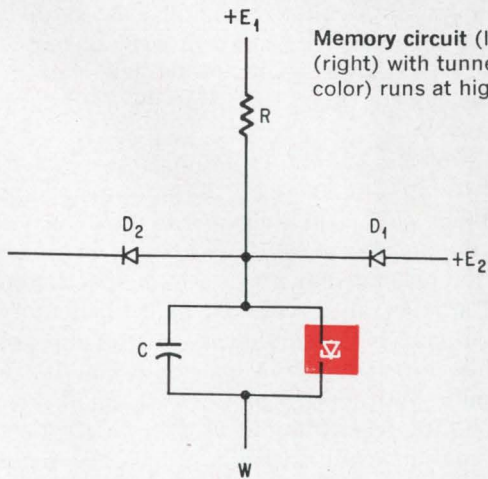

Memory circuit (left) and matrix (right) with tunnel diode (in color) runs at high speed.

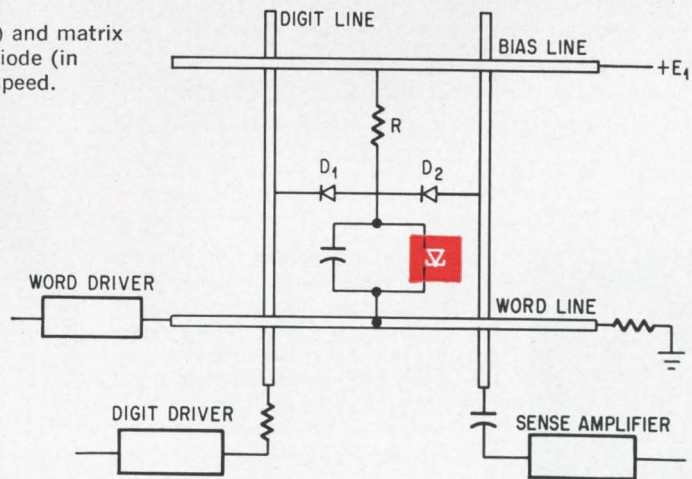

Japan seeks its own route to improved IC techniques

Encouraged by the government, Japanese electronics companies, building on U. S. technology, are coordinating research, revising processing techniques and shifting their emphasis to linear circuits

By Yasuo Tarui

Electrotechnical Laboratory
Ministry of International Trade and Industry

When integrated circuit activity started in Japan last year it followed almost exactly the pattern established by the United States. Initially, the biggest effort was to develop digital circuits for use in computers. This year, however, the emphasis has shifted to linear circuits because their potential seems more applicable to the products most important to Japanese industry—consumer, communications and industrial equipment.

The beginning of Japanese activity can be traced directly to the International Business Machine Corp.'s introduction of the System 360 series of computers, which incorporate hybrid integrated circuits. Because Japanese makers of general-purpose machines, six in all, have barely been holding their own with IBM, it was clear they had to have IC equipment if they were to continue to compete with any success. IBM has already installed more than 30% of all the computers in Japan. The move to integrated circuits was natural for the six Japanese computer companies because they also manufacture semiconductors.

By the autumn of 1965, Fujitsu Ltd., Hitachi Ltd. and the Nippon Electric Co., the big three of the

Japanese computer industry, were ready with computers using integrated circuits (page 93).

Five other semiconductor companies have developed monolithic integrated circuits too. At present, in Japan as in the United States, diode-transistor logic is the most popular approach to computer design. Of the eight major producers, only the Sony Corp. and the Matsushita Electrical Industrial Corp., are not computer makers. But, it can be seen in the table on page 91 that not all the development work has been digital; a number of amplifiers have also been produced.

Government programs

The six computer companies are being helped and encouraged by the Japanese government. For example, the Ministry of International Trade and Industry (MITI) has made available about \$80,000 in research grants to them for the development of special integrated circuits. Ostensibly, the grant is to cover half the direct costs of a project. In reality, the Ministry's estimate is invariably low and the grant rarely covers more than one-third the cost of the research.

All the projects in this program (page 92) are scheduled to be completed by the spring of 1966. One advantage of coordinating research this way is to reduce duplication of effort. Thus one company works on the general register of a high-speed computer and another on a low-cost control memory. A third company is developing the arithmetic and control units for a desk-type calculator; a fourth, the arithmetic and control units for a small-sized computer; a fifth, the arithmetic unit of a high speed computer; and the sixth, a read-only memory tester. The research accomplished in each project will be

The author



Yasuo Tarui has worked with semiconductors ever since he joined the Electrotechnical Laboratory. Today he is a strong advocate of integrated circuits. In October, he received his Doctor of Engineering degree from the University of Tokyo for research on the measurement of transistor parameters.

available to all the companies.

Producers are also being encouraged by the Microcircuit Technical Committee of the Japan Electronic Industry Development Association. Chairman of the committee is Noboru Takagi, a professor at the University of Tokyo; Tsuneo Momota of MITI's Electrotechnical Laboratory is the vice chairman. Because of their affiliations, they can disseminate technical information widely.

In September 1964, a new element was introduced into the Japanese integrated circuit picture when Kyodo Electronics Laboratory Inc., was formed by an American semiconductor specialist, Bernard Jacobs, and five Japanese component companies. Only Jacobs has had any background in semiconductor production. The five are: Toko Inc., a maker of coils and other electronic components; the Nippon Chemical Condenser Co., electrolytic and nonelectrolytic capacitors; the Koden Electronics Co., radio direction finders and loran systems; the Pioneer Electronics Corp., speakers and hi-fi components; and the Alps Electric Co., switches and television tuners.

Among integrated circuit producers in Japan, Kyodo is the only company that has not been producing transistors and other semiconductor devices. Last summer, it perfected its first product, a hybrid flip-flop that operates at a repetition rate of 25 megacycles. By 1966, it expects to offer a complete line of integrated circuits in Japan and the United States.

I. Examining Japanese products

Though many of the integrated circuits developed in Japan thus far closely resemble those available in the United States, there are some that are unusual. In addition, a lot of new processing techniques have been perfected, some to improve on U. S. technology and, some, frankly to avoid patents that cover procedures developed in the U. S. A closer examination of the unusual Japanese products show a decided bias for linear circuits.

Negative feedback amplifier

At the Nippon Electric Co. (NEC), a group of four engineers headed by Toshio Kurosawa has developed a negative feedback-type amplifier with a bandwidth of 10 megacycles. Some idea of potential applications can be deduced by the fact that two of the engineers are specialists on telephone carrier equipment; Kurosawa and the fourth engineer are semiconductor specialists.

In designing this amplifier, the NEC group recognized that absolute values of resistance are difficult to reproduce in an integrated circuit. But they capitalized on the fact that resistance ratios can be maintained because the geometry of elements on the same chip can be matched, even if absolute values of resistivity or depth of diffusion cannot be maintained. Thus, controlling the gain by the ratio of resistance produced their stable

Integrated circuit manufacturers

Company	Digital circuits	Linear circuits
Nippon Electric Co.	DTL	Low-level 3-stage amplifier for hearing aid
	TTL	
	CTL	Low-level 2-stage direct-coupled amplifier ($f_c=2, 7$ Mc)
	MOS transistor gate	3-stage direct-coupled wideband amplifier ($f_c=25$ Mc) Feedback amplifier
Hitachi Ltd.	ECL MOS transistor gate 8-bit shift register	Separated collector Darlington amplifier
Fujitsu Ltd.	modified DCTL (resistors on SiO_2)	audio-frequency amplifier (thin film)
	DTL	i-f amplifier
	ECL	
Mitsubishi Electric Corp.	TTL, DTL	2-stage direct-coupled wideband amplifier ($f_c=3$ Mc)
	Synchronizing signal-distributor Pulse amplifier (resistors and capacitor on SiO_2)	
Oki Electric Industry Co.	TTL	
	DTL	
	MOS transistor gate flip-flop	
Toshiba	DTL	a-f amplifier
Sony Corp.		2-stage direct-coupled wideband amplifier ($f_c=12$ Mc)
		i-f amplifier
Matsushita Electronics Corp. (a joint venture of Matsushita Electric Industrial Co. and Philips Gloeilampenfabrieken, N.V., Netherlands)		hearing aid (gain, 80 db)

DTL—Diode transistor logic
TTL—Transistor transistor logic
CTL—Complementary transistor logic
ECL—Emitter coupled logic
MOS—Metal oxide semiconductor
DCTL—Direct coupled transistor logic

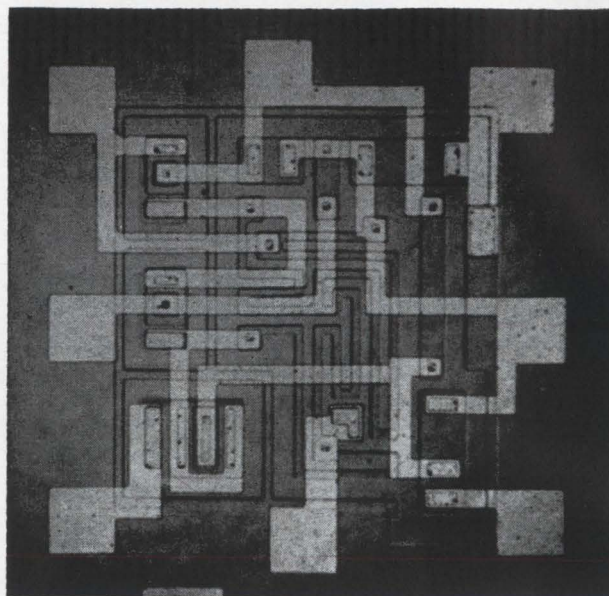
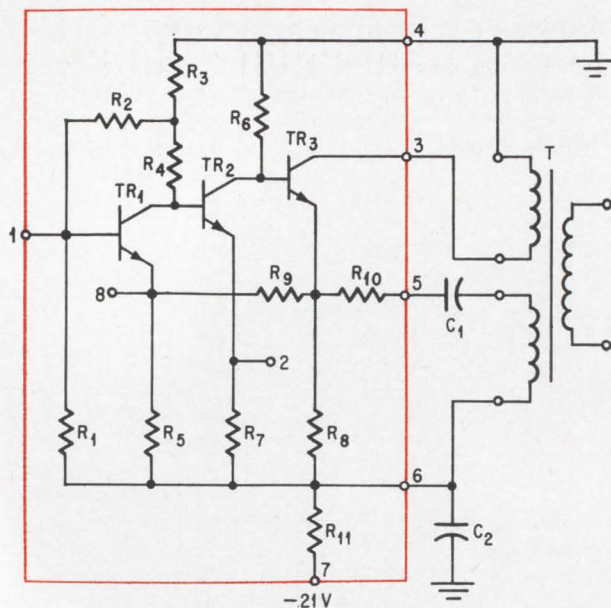

Negative feedback amplifier (photo and circuit diagram) for possible telephone-carrier applications is produced by the Nippon Electric Co. Because it depends on ratios of resistance rather than absolute values, the amplifier is stable and its performance consistent.

constant-gain amplifier. The circuit diagram and a photo of the chip are above.

A series-parallel feedback circuit reduces power consumption by stabilizing the d-c bias setting at a low current and improves impedance matching. Low value resistances in the feedback circuit reduce random fluctuations in resistance.

Several IC amplifiers of this design showed con-

sistent performance in tests. The gain of any one was within 0.3 decibel of the gain of any other amplifier. And the gain proved to be independent of temperature; since all the resistances change by the same percentage, the ratio of critical resistances in the feedback circuit does not change.

Examining the gain-frequency curves, nearly o-shaped, it is seen that there are two cutoff fre-

Government-aided research projects . . .

Company in charge	Equipment	Abbreviated specification (typical function)	Company in charge	Equipment	Abbreviated specification (typical function)
Fujitsu Ltd.	Arithmetic unit of high-speed computer	By CML—memory capacity; 512 words (18 bits+sign per word, 16 instructions) clock frequency of 8 Mc. (16 megacycle 2-phase) add time: 1 μ sec	Tokyo Shibaura Electric Co. (Toshiba)	Processor of small-size computer (business machine)	By DTL—memory capacity of 8 words, each word consisting of 14 units of 5 bits each to give 13 decimal digits. add and subtract time: 3 millisec multiply and divide time: 100 to 300 millisec
Nippon Electric Co.	Low-cost control memory	By CTL, transistors and diodes—memory capacity 16 words with 18 bits per word access time: 250 nsec cycle time: 500 nsec nondestructive reading	Oki Electric Industry Co.	Arithmetic and control units of a symplified portable computer (desk-type calculator)	By thin-film integrated circuits augend subtrahend register: 10 digits multiplicand multiplier register: 9 digits multiplication register: 10 digits memory register: 2 registers of 10 digits each. Operable at room temperature and high humidity, compact size
Mitsubishi Electric Corp.	Arithmetic and control units of small-size computer	By DTL—memory capacity of 4,096 words with 18 bits per word add time: 20 μ sec divide time: 140 μ sec	Hitachi Ltd.	Read-only memory tester	By ECTL, transistors and diodes, read cycle: 40 nsec memory capacity: 512 words of 54 bits per word

Japanese computers with integrated circuits

	Nippon Electric Co.	Hitachi Ltd.	Fujitsu Ltd.
Computer	NEAC 2200 series model 500	HITAC 8000 series model 8500	FACOM 230 series model 60
Word length	6 bits/character	32 bits/word	42 bits/word
Number of instructions	about 50 with variants	144	—
Main memory	wire	wire (scratch pad memory)	—
Capacity	33 k~524 k characters	66 k~524 k Bytes	128 k words
Cycle time	0.188 μ s/character	0.84 μ s/Bytes	0.92 μ s/word
Operation speed*			
decimal add (fixed)	9.9 μ s (5+5 digits)	1.92 μ s	1.15 μ s
decimal multiply (fixed)	110 μ s (5+5 digits)	12.1 μ s	4.1 μ s
Family of integrated circuit	CTL	ECTL	TTL
propagation delay	5 ns	20 ns/pair	10 to 15ns
Clock frequency	6 Mc	—	8.7 Mc
Serial or parallel	parallel	parallel	parallel

* Only representative values out of many available operations; comparison of operation speed appears to be for different conditions.

quencies when no feedback is applied—a cutoff frequency being a corner in the gain-frequency curve. The first is caused by the collector capacitance of the second transistor; the second by a combination of collector capacitance and the cutoff of the current amplification factor of the last stage.

When used as an audio amplifier, the circuit has these characteristics:

Gain	36 db
(600 ohm input and output impedances)	
Overload point	17 dbm
Amplifier noise figure	52 db at 1 kc
Gain-frequency characteristic	0.15 db
between the range of 0.2 kc and 3.4 kc	
with reference to 0.00 db at 1 kc	

Improved Darlington circuit

Some of the disadvantages of a standard Darlington circuit have been eliminated in a linear integrated amplifier developed by Hitachi. In their modification of the Darlington circuit, useful to above 10 Mc, the Hitachi group has minimized input stray capacitance, output stray capacitance and collector capacitance. At the same time, it has tried to maximize amplification, f_T , of the transistors and to keep the current amplification factor of the transistor in the last stage small.

With this design, the phenomenon known as the Miller effect is dissipated. In a conventional Darlington circuit, in which the collectors of all three transistors are connected, a very high capacitance—equal to the base-to-emitter capacitance multiplied by the gain—is reflected back to the input terminal. Because the Darlington circuit has a high impedance at low frequencies, the reflected capacitance (the Miller effect) reduces bandwidth greatly. In narrow-band amplifiers, the feedback capacitance also reduces gain and tends to cause instability. In addition, the Darlington circuit norm-

ally has a high collector-to-emitter threshold voltage so it cannot be switched when operated at low power supply voltages.

The large output-to-input feedback capacitance of the circuit (caused by the inclusion of the base-to-collector capacitance of the first transistor) produces the Miller effect. The Hitachi design eliminates that problem by a separate connection for one transistor. Hitachi's separate-collector Darlington and the standard Darlington are compared on page 94.

In the manufacture of the Hitachi circuit, a three-step process produces a high concentration of boron in a smooth silicon dioxide surface. The process starts with the box diffusion of boron at 1,100° to 1,200° C for 20 minutes. A second diffusion is performed for seven and a half hours in wet oxygen at 1,200° C. In the third step, all silicon dioxide is removed and the diffusion repeated under the same conditions for an additional seven and a half hours.

For ohmic contacts and interconnections, the Hitachi researchers deposit a silver-aluminum layer. The silver layer is evaporated to a thickness of 50 to 100 angstroms while the surface temperature of the wafer is held to 500° C. The layer of aluminum is evaporated to a thickness of 5,000 angstroms while the surface temperature is maintained at 250° C. This procedure produces a very fine-grain evaporated layer which is bonded well to the substrate. The separate-collector Darlington circuit has been used in an intermediate-frequency amplifier (p. 94) and its gain-frequency characteristic measured at 455 kc. and at 10.7 Mc. Under the latter conditions, the gain-frequency curve is asymmetric, indicating a small amount of instability. The analysis on page 94 shows that stability can be improved by decreasing the feedback

Using Hitachi's modified Darlington circuit . . .

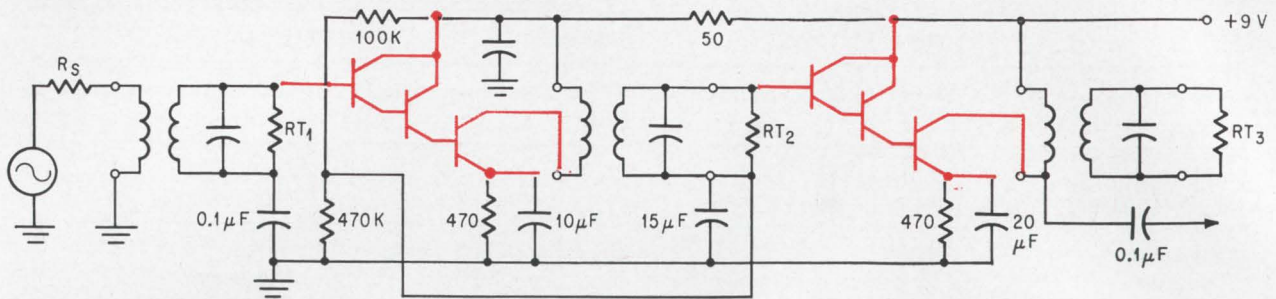

Separate-collector circuit is used in an i-f amplifier. No high capacitance is reflected back to the input with a Darlington configuration, and the circuit has greater bandwidths.

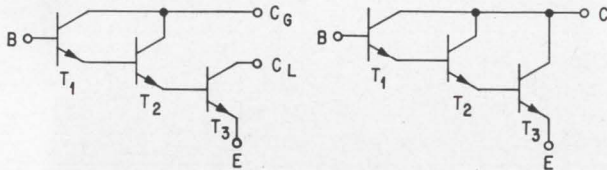

Conventional Darlington circuit (right) in which all three transistors have a common lead and Hitachi's separate-collector circuit.

At 10.7 Mc, gain-frequency curve of i-f amplifier is asymmetric, indicating a small amount of instability. Feedback capacitance is too high.

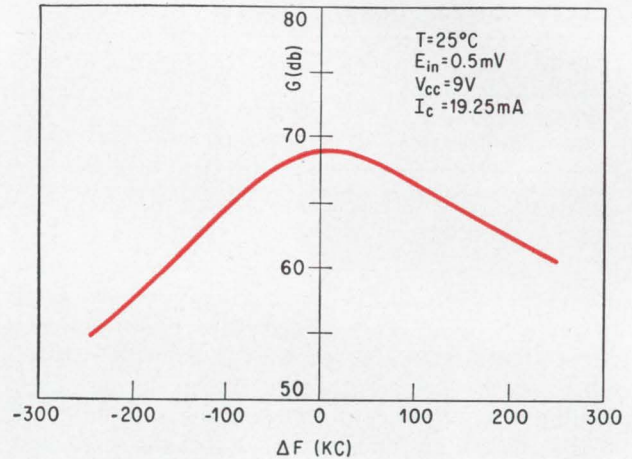

capacitance and increasing the cutoff frequency of the forward transconductance.

Synchronizing-signal distributor

Two chips make up a circuit that distributes a synchronizing signal to many cameras in a television studio. A group at the Mitsubishi Electric Corp. developed the circuit with help from Nippon Hoso Kyokai, the Japan Broadcasting Corp. One chip is the input section; the other, the output (photographs of the chips and corresponding circuits are on p. 95).

In the input section there are terminals for a delay circuit, should one be needed. Following the delay circuit is an emitter-follower output stage with a Darlington connection for maximum input impedance. Diodes were added to speed up the circuit by extracting turn-off base current. An impedance of about 10 kilohms is measured at the input.

The output section also uses a Darlington connection in the output stage to obtain high d-c current gain.

When the two chips are connected in a signal-distributing circuit, the transient transfer characteristics are:

	in nanoseconds
Rise time	20 to 30
Fall time	40 to 60
Leading-edge propagation time	70 to 90 nsec
Trailing-edge propagation time	100 to 160 nsec

These measurements were made with the delay line terminals shorted, at a pulse repetition frequency of 15.75 kc, pulse width of 5 msec, and input pulse height of -4 volts.

An 8-channel synchronizing-signal generator has been assembled with the two-chip circuit technique.

MOS shift register

Already producing metal-oxide-semiconductor transistors, Hitachi has extended its discrete-device fabrication techniques to build an 8-bit shift register on a single chip with MOS devices. Hitachi has already placed 96 MOS transistors and 32 MOS diodes on a chip 2 mm by 1.8 mm.

Another company experimenting with MOS integrated circuits for computer devices is the Nippon Electric Co. At its central research laboratory, NEC has built a very small-capacity MOS memory—8 MOS transistors on a chip packaged in a TO-5 can. NEC researchers are still a long way from their goal of 400 MOS transistors (or 100 bits of memory) on a single chip that would be capable of a 5- to 10-Mc clock rate. The first experimental units, 2 bits in a TO-5 can, have an access time of 50 nanoseconds; researchers want a cycle time of 100 to 200 nanoseconds.

Optoelectronic devices for logic

At the Semiconductor Research Institute of Tohoku University, in Sendai, investigators are

developing optoelectronic integrated circuits to perform logic functions. Headed by Professor Junichi Nishizawa, the group has discovered that roughening two parallel faces of a gallium arsenide laser-diode prevents the light from leaving these faces and redirects it, thereby increasing the light output from the other two sides faces. Now, they are studying the interaction effects of a single crystal with two diodes, one with roughened surfaces.

In such an arrangement, the researchers have observed an interesting quenching of the light output in one direction. When a diode is biased with a current greater than its threshold current, the light emitted in one direction varies with changes in current through the other diode. By harnessing this dependency, the group expects to make a device capable of on-off logic.

Another research program at Sendai has produced an optoelectronic isolator with a 1.7 Gc cut-off frequency. The device consists of a gallium-arsenide laser diode and a silicon p-i-n photodiode. An electric signal is converted to light in the laser diode; the light is detected by the photodiode which acts as a transformer with good isolation.

From this research might come a direct current-to-gigacycle frequency isolator for optoelectronic logic, and a transformer with good isolation for integrated circuits.

In the experimental device, a 20-millivolt a-c signal of 1.5 Gc is superimposed on the 12-ampere-pulse current to the laser diode, which operates at liquid nitrogen temperatures. The pulse has a duration of 1 microsecond and a repetition frequency of 50 cycles per second. The output of the photodiode is detected with a local oscillator, whose frequency is 1.51 Gc, and then amplified.

The over-all current-transfer ratio is 13%, with an optical fiber between the laser diode and the photodiode. The cutoff frequency is limited by the photodiode now, but researchers believe that improved diodes will be available soon with cutoff frequencies of about 10 Gc.

II. New processing techniques

While most of their production techniques for integrated circuits are based on technology devel-

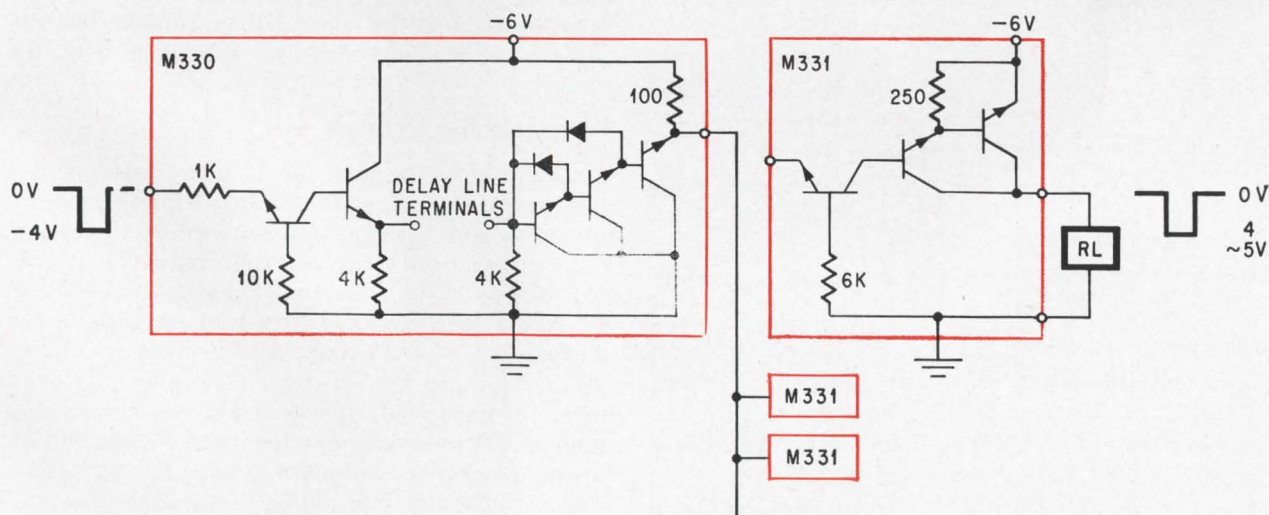
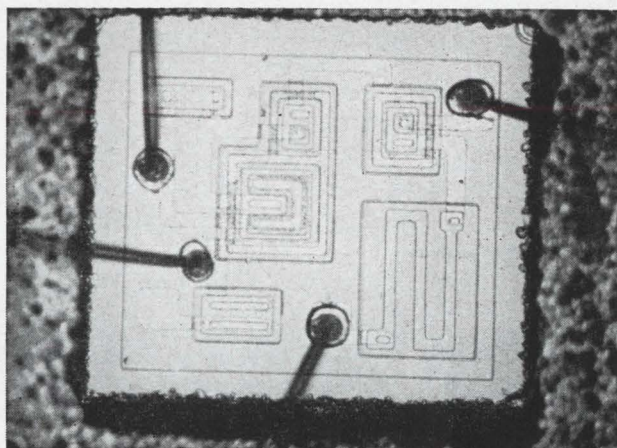
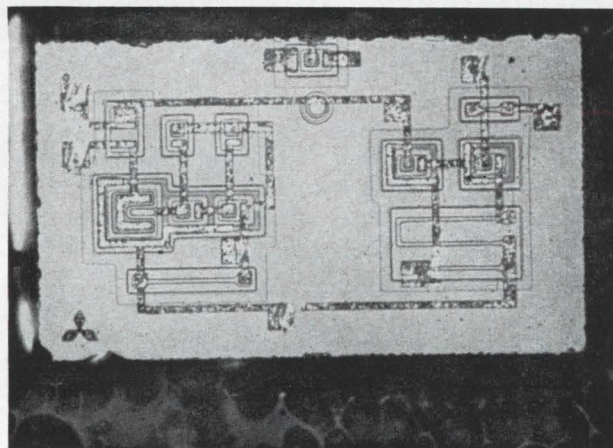

Synchronizing signal is distributed to several television cameras by this integrated circuit composed of two chips (photos). One chip (circuit diagram in box at left) is input section, other is output. Additional output chips for more cameras can be added in parallel.

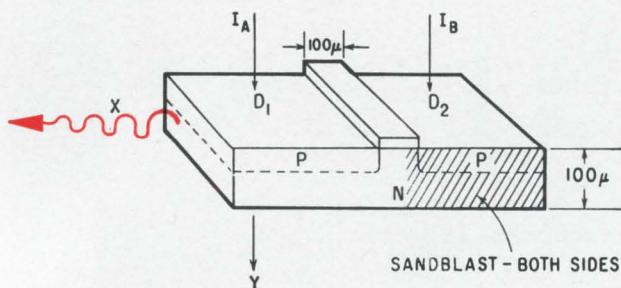
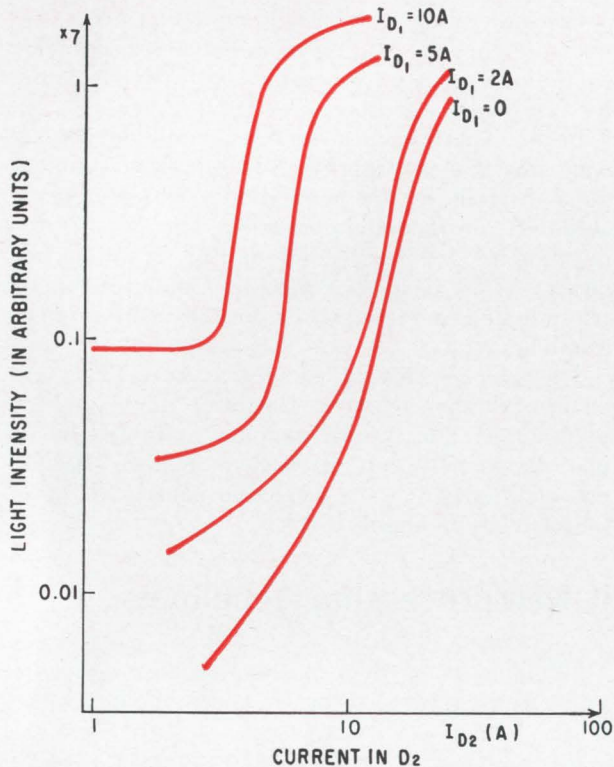

Roughening two parallel faces of a laser diode by sandblasting redirects the light to the other sides. Light transmitted in the Y direction by diode D_1 depends on current carried by diode D_2 as shown by the curves.

Oki's improved method of isolation

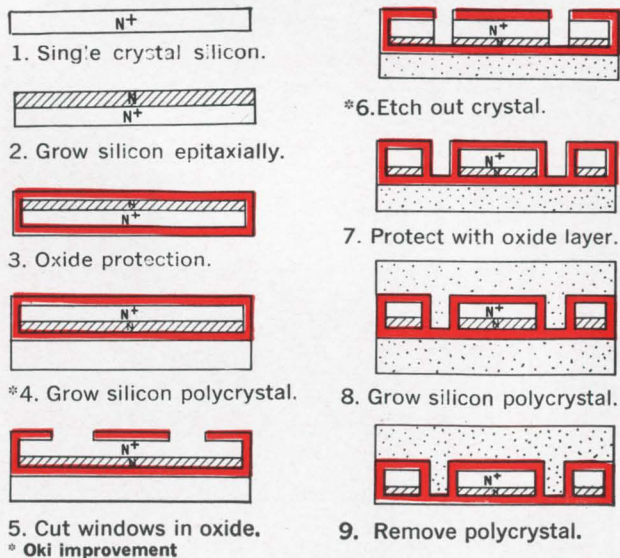

5. Cut windows in oxide.
* Oki improvement

oped in the United States, in a number of cases the Japanese have made what are sometimes minor-sounding but important changes. One Japanese company, for example, has developed better methods of dielectric isolation.

Isolating the devices on an integrated circuit is essential. Of the two known methods, dielectric isolation is far superior to reversed-diode isolation. In the U.S., a method of fabricating dielectrically isolated integrated circuits was published in the Proceedings of the IEEE in January, 1965 by D. A. Maxwell, R. H. Beeson and D. F. Allison. Now Toshimichi Sakata and Mamoru Ikegami of the Oki Electric Co. have improved on the original U.S. method.

Though slight, the difference between the two processes is significant. To appreciate the difference, it is necessary to have a general understanding of the U.S. process. In it, mesa-like projections of polycrystalline silicon are formed on a substrate of single crystal silicon by photolithography; the surface of the silicon wafer is oxidized; polycrystalline silicon is deposited to fill in the valleys and cover the mesas; finally, the chip is flipped over and the original wafer is removed by grinding and polishing until only oxide-insulated islands supported by the deposited polycrystalline silicon remain. Removing the original wafer is difficult.

Oki's improved method is shown, step-by-step, below at left. Polycrystalline silicon is deposited for support before the photolithography process forms the mesas. During the formation of the mesas, all silicon between the mesas is removed. Then the procedure is the same as that in the American method: valleys are filled in and the mesas covered with a deposit of polycrystalline silicon.

When the first polycrystalline layer is removed, the silicon islands in which the semiconductor devices are fabricated are exposed.

Of significance in the improved method is the fact that silicon dioxide film separates the semiconductor islands from the polycrystalline layer that has to be removed. As a result, it is much easier to remove the layer than to remove the silicon single crystal which is contiguous with the islands.

Vapor selective etching

Sakata and Ikegami have also developed a method of selective etching capable of sharp resolution for some fabricating of dielectric isolation. With this procedure, it is possible to etch deeply in the vertical direction and minimize the etch in the horizontal direction without any etching of the silicon-dioxide passivation layer.

Windows are cut in the silicon-dioxide layer, using conventional photomasking and etching methods. Then a second silicon wafer is placed on top of the etched surface and the polycrystalline underside of the first wafer is heated to about 1,200° C in an atmosphere of hydrogen and hydrogen chloride (see top page 97).

Heating causes the silicon under the windows to

vaporize and deposit on the cooler wafer above them. In this way, silicon is etched in the vertical direction with high resolution. The amount of side etching necessary to finish the design is three to five times less than the amount required with conventional methods.

Toshiba's preferential epitaxial growth

Toshiba (Tokyo Shibaura Electric Co.) developed a method of forming n-type islands in p-type silicon substrate to make transistors and silicon controlled rectifiers [Electronics, April 5, 1965, p. 185]. Now the technique has been applied to integrated circuits so that, exclusive of regions masked by a layer of silicon oxide, silicon is grown epitaxially on substrates.

The process starts when the substrate is oxidized thermally. Next, windows are etched through the oxide film at the places where islands of n-type material are desired. Anhydrous hydrogen chloride, which does not attack the oxide film, etches moats into the substrate. The moats are filled epitaxially with n-type silicon single crystals into which planar structures are fabricated.

Experience shows the process works best when a buried n-type collector layer is formed. Toshiba's method cuts the time to fabricate isolation to about 30 minutes, an important reduction compared to the 10 to 30 hours required to produce islands of isolation by conventional diffusion processes.

A transistor built this way has a cutoff frequency above 130 megacycles; maximum collector voltage is 60 volts and maximum collector current is 500 milliamperes. At 100 ma, the current amplification is more than 20.

In diodes made this way, the p-n junction has

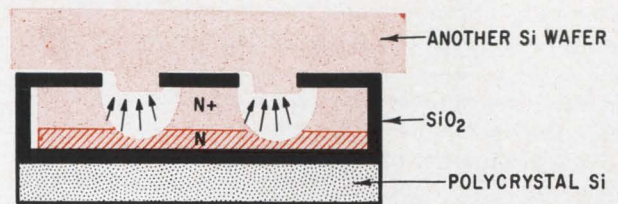

In vapor-selective etching process at Oki Electric, heat is applied to polycrystal support material so temperature gradient exists. This causes silicon to evaporate through windows cut into the oxide layer and deposit on a second silicon wafer above the windows.

reversed-bias characteristics, low leakage current and hard zener breakdown.

Chromium-silicon thin-film resistors

Trying to produce high resistivity for hybrid integrated circuits and thin-film circuits, Saburo Iikawa and Tatsuya Enomoto of the Mitsubishi Electric Corp. developed chromium-silicon resistors with resistance high enough to be used in communications receivers.

The thin film is evaporated from a tantalum boat containing a mixture of powders—60% (by weight) silicon and the rest chromium. Chemical analysis of the evaporated film shows a composition of 80% silicon and 20% chromium by weight.

Electrically, the sheet resistance can be controlled to values between 1,000 and 10,000 ohms per square. So far, Mitsubishi has used resistors made of films with a resistivity of 5,000 ohms per square; temperature coefficient has been minus 100 parts per million per degree centigrade.

To make terminations on the resistor, Mitsubishi

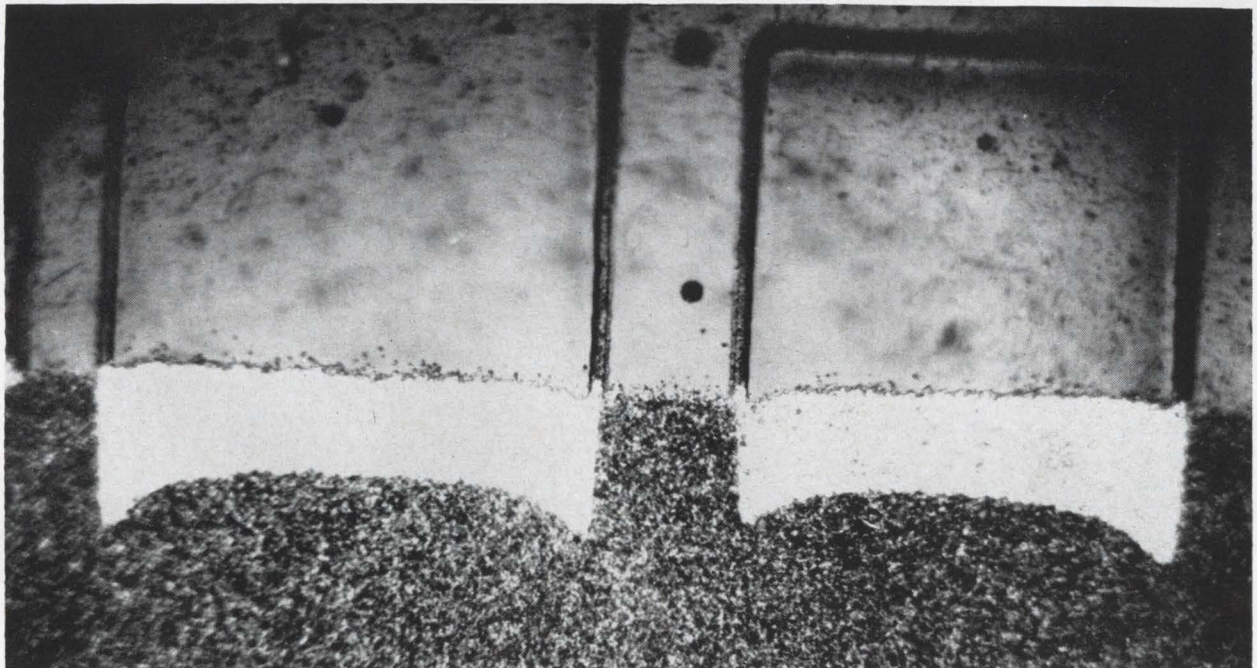

Islands of n-type material (here stained with gold) are formed in p-type material by Toshiba's masked epitaxial process. Hydrogen chloride etches moats which are filled epitaxially with n-type silicon single crystal.

evaporates chromium and then a mixture of chromium and copper. The outer surface of the termination is pure copper.

These resistances are relatively stable. In one test, the resistance changed only 0.08% after a power dissipation of 2 milliwatts per square millimeter for 1,000 hours at 85° C. After 3,000 hours of this test, change in resistance was still less than 1%.

The first use of these devices was in hybrid circuits for a portable transceiver used by railroad workers on the New Tokaido railway line. In these circuits, the chromium-silicon resistors supplied the high resistance; nickel-chromium films made up small resistance and tantalum oxide films were capacitors (see circuits at right).

Tantalum photoetching

Normally tantalum thin-film circuits cannot be deposited directly onto semiconductor chips because the silicon dioxide layer would be removed when the tantalum layer is etched. Ichiro Miwa and Takeo Nishimura at Hitachi developed a simple and accurate method of fabricating tantalum thin-film circuits and recently modified it for use on the oxidized silicon surface of other semiconductor materials.

The Hitachi researchers found that Kodak Photoresist would protect the oxide coating long enough during the tantalum etching. Thus KPR is spread over the semiconductor material; then removed by photolithographic means wherever tantalum is to be applied.

Fabricating tantalum circuits by the Hitachi method depends on the selective etching of tan-

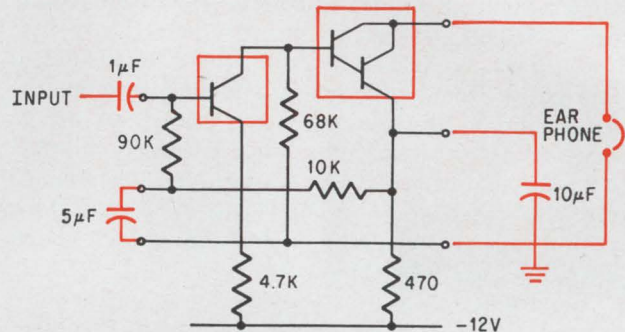
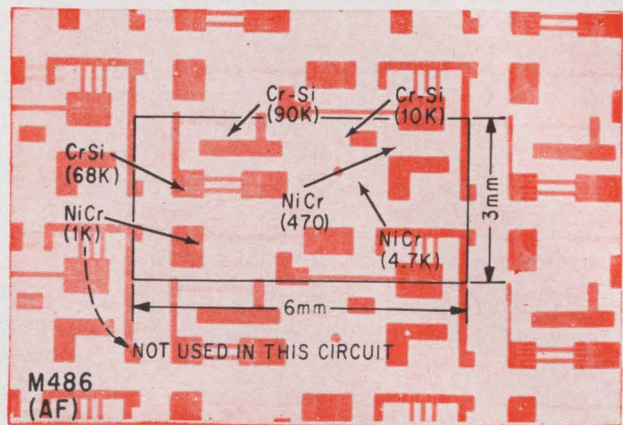

Stage of an audio amplifier (in photo and circuit diagram) using Mitsubishi's chromium-silicon resistors with resistance up to 68,000 ohms. In this thin-film circuit, smaller resistances are made by nickel-chromium resistors. Transistors and other parts shown in dotted boxes are not a part of the film circuit.

Japanese integrated DTL NAND gates

Company*	Maxi- mum fan-in	Maxi- mum fan-out	Average Propa- gation delay (ns)	Power dissi- pation (mw)	Operating tempera- ture (°C)
Nippon Electric Co.	more than 6	6	15	15	-15~125
Fujitsu Ltd.	3	6	15	35	0~75
Tokyo Shibaura Electric Co. (Toshiba)	3	5	15	10	-30~125
Mitsubishi Electric Mfg. Co.		5	35	10	0~75
Oki Electric Industry Co.		10	30	15	0~75
Hitachi Ltd.	6	6	20	20	0~65

* Only these six companies are producing general-purpose digital computers.

talium and tantalum oxide. Aqueous alkaline solutions will dissolve the oxide but not tantalum; acids will dissolve tantalum but not its oxide. Thus tantalum oxide is used as a mask when etching tantalum with acids.

A typical circuit would be made this way:

- After a tantalum film is deposited on an insulating substrate, its surface is electrolytically anodized until specific sheet resistivity is obtained.

- Kodak Photoresist is applied to the film. A photolithograph etch removes tantalum oxide and layers of tantalum from all places that are not to be used for resistors, capacitors or conductors. First, an alkaline solution dissolves the oxide layer; then an acid solution dissolves the exposed tantalum.

- The oxide layer covering conductors is then dissolved with an aqueous solution.

- A conductive film, which forms the conductors and counterelectrodes for the capacitors, is deposited over the entire surface.

- A photolithographic process dissolves the unnecessary portions of the conductive film.

Though KPR is known to have inferior resistance to active etchants, it can protect the silicon dioxide film because the film is subjected to the active solutions for a very short time. There is a small variation in the time required to etch tantalum from different parts of the circuit. It is only during this variation period that KPR is required to protect the silicon dioxide film.

Bidding for world leadership in solid state microwave gear

With problems uniquely suited to solution by microwave, the Japanese are making big advances in solid state equipment using such components as the tunnel diode, Kita diode, hyperabrupt diode and mesa transistor

By Isao Someya

Electrical Communication Laboratory
Nippon Telegraph and Public Corp.

Japan has many of the problems that microwave is best-suited to solve—communications needs of a dense population (about half that of the United States squeezed into an area smaller than Montana), a combination of mountainous terrain and narrow streets that make coaxial cable difficult to install and maintain, and expensive and limited natural power. Japan also had an “advantage”—a chance to start fresh after 80% of its telephone service had been destroyed during World War II.

For these reasons, the country chose microwave and today has the densest system in the world. Japan's first solid state microwave system went into operation in 1962, an 11-gigacycle system that connected television studios to telephone exchanges a short distance away. The system required only 10% as much power as would a comparable tube setup, and construction costs were halved. Because of these savings, Japan developed solid state systems and today boasts that her solid state microwave gear is as good as any in the world.

Although Japanese engineers borrow heavily from United States technology, they have made significant contributions in the microwave field,

primarily with the application of Japanese-developed components such as the tunnel diode and the Kita diode. Since there are no military programs to prime the research pump in Japan, most of the development has been done at the Electrical Communication Laboratory of the government-owned Nippon Telegraph and Telephone Public Corporation. Its laboratory is comparable, in a modest way, to the Bell Telephone Laboratories. More recently, development work of this type has also been carried on in the research laboratories of a few private companies; the Nippon Electric Co., Fujitsu Ltd., Hitachi Ltd., Mitsubishi Electric Corp. and Toshiba (Tokyo Shibaura Electric Corp.).

Once a development is perfected, the Electrical Communication Laboratory (ECL) turns the design over to one or more manufacturers. The Japanese success in competing in the international market is evident in the sales of microwave equipment to the governments of Mexico, Taiwan, and Indonesia.

Solid state research in the microwave field in Japan can be traced to 1955 when the concept of the parametric amplifier was proposed independently at ECL. From this proposal came the development of variable capacitance diodes (varactors) and silver-bonded or Kita diodes. Mesa transistors with gain-bandwidth products of several hundred megacycles were developed in 1959. Today in Japan, parametric amplifiers are used mainly in over-the-horizon systems of medium capacity operated by private users such as railroads and utility companies. NTT has used these amplifiers in a 2-Gc over-the-horizon system that connects the southern island of Kyushu to Okinawa. And the applications

continued on page 102

The author



Isao Someya is chief of the director's office at the Electrical Communications Laboratory in charge of planning. He is a 1938 graduate of Tokyo University and earned his doctorate degree from the university in 1951.

Spreading microwave network crowds the Japanese landscape

Japan owns the densest network of microwave links in the world; its five major islands are crisscrossed by microwave routes, as the map below shows. Around key cities such as Tokyo and Osaka, communication lines are so numerous that links interfere with each other. This year, when Japan's telephone company found it had to increase capacity between Osaka and Nara, it installed a 15-Gc system because engineers feared interference from the 12 two-way, 11-Gc links between Osaka and Kyoto. Because of this congestion, the Japanese are working hard to develop solid state microwave equipment with greater capacity.

Easily the biggest user of microwave in Japan is the Nippon Telegraph and Telephone Public Corporation (NTT)—a government-owned company. Other private users include the railroads—which include many independent lines—and public utilities, such as electric companies, gas producers and distributors, and water suppliers. Almost every railroad has its own private microwave link and so does every utility—a characteristic of big Japanese companies is to perform many services themselves.

Japan's dependence on microwave can be traced to the damage done in World War II when nearly 80% of the country's telephone service was wiped out by bombings and fire. When rebuilding, the Japanese chose the newest type of communication and what for

them was the most economical—microwave. Because of the mountainous terrain, installing microwave antennas and repeaters was far less expensive than laying coaxial cable. Japan National Railways, for example, puts relays on mountains to reflect beams into stations in valleys. Also, digging up the crowded and narrow streets in Japanese cities is expensive and far more trouble than the government believes it is worth. One characteristic of any Japanese city is the skyline of microwave antennas (see cover) that blossom like the chimney pots of another continent.

Communication explosion

In 1954, there were only 2.5 million telephones in Japan, which had a population of nearly 90 million people. Ten years later, Japan could boast 8.6 million telephones and 5.5 million subscriber lines. Today, the telephone company cannot fill 1.3 million applications for new telephones. The demand has risen sharply, despite imposing requirements for a new telephone. A new subscriber pays not only a connection fee of 300 yen (about 84 cents) and an equipment charge of 10,000 yen (\$28), but he also must buy a debenture for 150,000 yen (\$420). If the subscriber holds the bond for its full 10-year life, he earns 7.3% interest a year.

NTT has begun a four-year program to catch up with the demand for telephone service. By 1970 it expects to have 15 million phones

on its line.

During the same period, television broadcasting has grown rapidly so that there are 350 local broadcasting stations scattered over the country. The Tokyo headquarters of the three networks, the government-owned Nippon Hoso Kyokai (Japan Broadcasting Co.) and two that are privately owned, originate programs which have to be carried throughout the island by microwave. In Tokyo, NTT has no cable connecting the network stations to telephone exchanges. Programs leave the station via microwave too, usually on an 11-Gc carrier aimed at the nearest telephone exchange.

Forced to higher frequencies

Although NTT has some local lines—2 Gc, 6 Gc, 11 Gc and 15 Gc—its basic lines operate at 4 Gc. As traffic has filled these, the telephone company has been forced to higher frequencies. In 1961, a 6-Gc line was installed between Tokyo and Osaka, a distance of 350 miles, and 11-Gc lines were installed about the same time for short-haul traffic.

Private users of microwave operate at 2, 7, 8, and 13 Gc. They are mostly line-of-sight systems, and a few over-the-horizon systems, with a capacity ranging from 60 through 240 telephone channels. Since traffic volume on these private lines is generally small and there is no interference problem, most of them use passive relays with large metal reflectors. NTT, however, uses the most sophisticated equipment.

When NTT completed its first broadband 4-Gc system in 1954, the telephone company was the first in the world with a traveling wave tube in a commercially-operated repeater. In the United States, American Telephone and Tele-

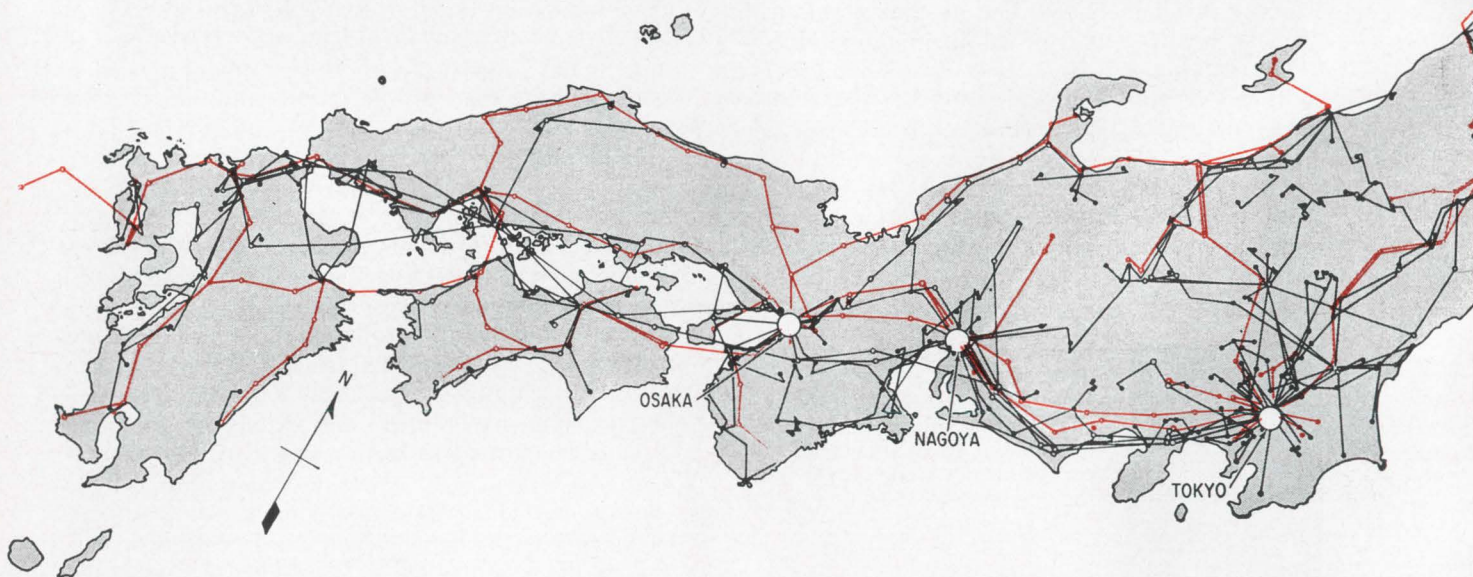

graph completed a 4-Gc system earlier, but with triodes rather than twt's.

NTT's pioneering line, designated SF-B1, connected Tokyo and Osaka with 10 relay stations along the route. In each heterodyne repeater were two traveling wave tube stages to get the required power output. They heterodyned the received signal down to 70 Mc, amplified it, then heterodyned it up to the carrier frequency at which it would be transmitted. To avoid feedback, transmitter and receiver frequencies in one repeater varied by about 200 Mc.

Since that first system went into operation, three other 4-Gc systems have been developed. The latest, SF-B4, still uses vacuum tubes. It can carry color television transmission over a distance of 1,550 miles. Most of the radio frequency channels of the 4-Gc sys-

tem now carry television signals. All four radio-frequency channels allotted to the 4-Gc band were being used by 1961, so NTT was forced to a 6-Gc system.

With the 6-Gc system, NTT can carry as many as 1,800 telephone channels, compared to only 960 in the 4-Gc line. The first system, the SF-U1, had a capacity of 1,200 telephone channels on each radio carrier. In 1964, an improved 6-Gc system, the SF-U2, was installed between Tokyo and Osaka with a capacity of 1,800 telephone channels.

For local networks where there is no demand for television transmission, NTT has a 2-Gc line with a bandwidth of only 150 Mc. The system uses lighthouse tubes with an output of about 5 watts. By the end of 1965, however, an improved solid state 2-Gc system will be in service.

In NTT's second 11-Gc system, developed in 1962, the only tube is a klystron in each transmitter and receiver; everything else is solid state—transistors or diodes. The SF-T2 was designed for short-haul telephone circuits. Its predecessor, SF-T1, was primarily for branching or entrance microwave systems, connecting to a 4-Gc or 6-Gc system. Both were intended for short-distance transmission, because rain severely attenuates 11-Gc signals.

In its complex and diverse system, NTT uses two kinds of repeater: the heterodyne type for long-distance transmission and the baseband type for short distances with few relay stations, so that any distortion buildup will be held to a minimum.

If the microwave system has a lot of branching, NTT uses a baseband system because it is easier to insert or remove groups of channels on a baseband signal. If the signal has to pass through many repeaters, however, the repeated detection and remodulation introduces distortion, so long-range systems use the heterodyne repeater. Also, there generally is no branching on a long range system.

In the baseband repeater, the output of the i-f amplifier is detected to produce a signal which is a replica of the multi-channel baseband signal fed into the first relay station. This baseband signal modulates the repeater's transmitter as it sends the signal over the next relay span. Such a signal covers a range of frequencies from the audio range to about 5 Mc for a 1,200-channel repeater—maximum frequency is equal to the number of channels times the 4,000-cycle bandwidth per channel.

Five companies supply most of the microwave equipment used in Japan: the Nippon Electric Co., Fujitsu, Ltd., Hitachi, Ltd., Toshiba (Tokyo Shibaura Electric Corp.) and Mitsubishi Electric Corp.

This year, Japan's spreading microwave network ran into serious trouble when the height limitation on buildings was raised. Previously, fear of earthquakes has kept buildings under 10 stories. Now some networks have been cut off by new skyscrapers in Tokyo and Osaka. The problem is so serious that it may force NTT to install coaxial cable to replace microwave systems. Because new buildings have blocked microwave stations—best publicized was the blocking of Japan National Railways' headquarters in Tokyo—the Japanese Diet subsequently passed a law allowing a microwave user to stop construction of a new building for as long as five years if the construction cuts off a microwave system.

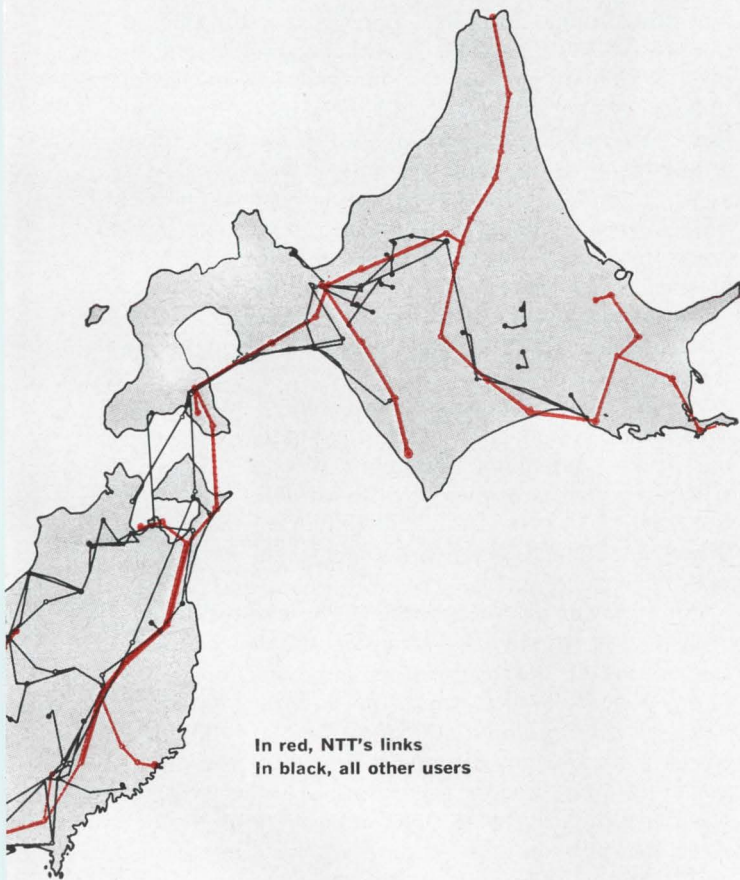

In red, NTT's links
In black, all other users

NTT's microwave network

System	Total length (kilometers)
Line-of-sight	
2 Gc	925
4 Gc	8,481
6 Gc	3,798
11 Gc	246
Over-the-horizon	
2 Gc	573
Total	14,033

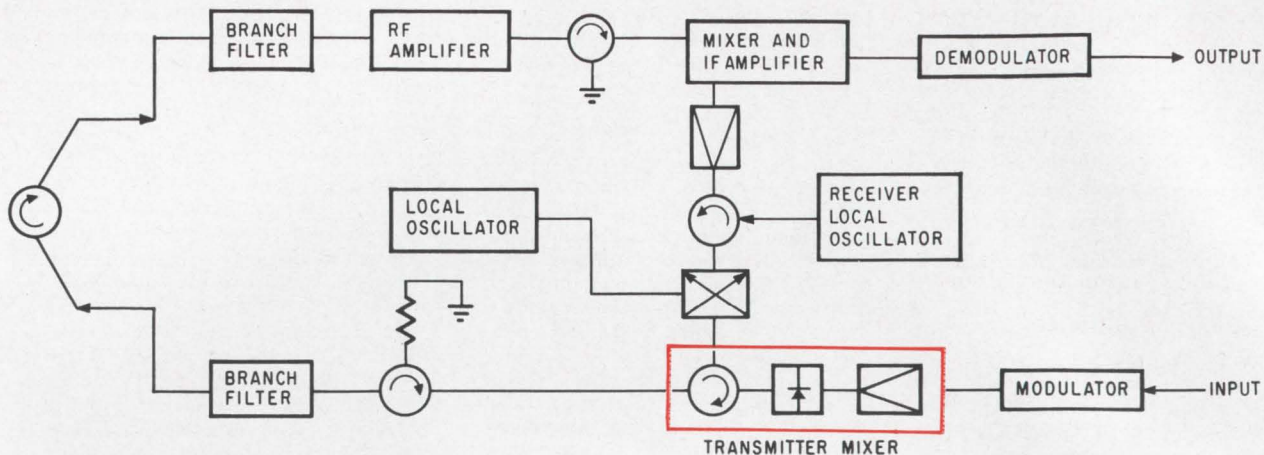

New baseband repeater for solid state 2-Gc system. Transmitter-frequency mixer (color) supplies 300-mw output.

are increasing as the microwave networks grow. Last March, NTT tested a new all-solid state 2-Gc system. First units of this UF-B4 system are being installed now, and are scheduled to be operating before the end of the year. Designed for short telephone circuits where branching is frequent, the UF-B4 generally uses a baseband repeater (see block diagram above) but can also use a heterodyne repeater for long-distance systems.

One of the most interesting parts of the repeater is the transmitter-frequency mixer, which supplies the 300-milliwatt output of the transmitter. A local oscillator of the frequency-multiplier type delivers about one watt to the mixer. In the transmitter converter, a 70 Mc carrier that has been frequency-modulated by the baseband signal is heterodyned against the transmitter's local oscillator to produce the transmitter output signal. Power loss of about 5 decibels in the transmitter mixer accounts for the difference between the one-watt frequency-multiplier output and the 300-milliwatt transmitter output.

As a baseband system, the modulator is connected to the last i-f amplifier, which is sometimes called the post-i-f amplifier, so that the signal is amplified to the high level required at the transmitting mixer. When the mixer is to be used as a heterodyne repeater, the output of the receiver main i-f of half the repeater is connected to the last i-f amplifier of the transmitter of the other half. In this configuration, the receiver demodulators and transmitter modulators are not used.

The power consumption of a repeater in this 2-Gc system is about 100 watts. The standard repeating span is about 31 miles. If the span loss is large, NTT inserts a tunnel-diode amplifier with a gain of 15 db and a noise figure of 5 db on the front-end of the receiver. In the 70 Mc modulator, hyperabrupt junction diodes are the modulating elements.

Low-noise amplifiers

While one section of ECL is designing systems, another section works on components. One major area of research has been in low-noise amplifiers.

At present, the laboratory considers only the parametric amplifier, operating at room temperature, and tunnel-diode amplifiers practical for broadband microwave systems. Maser and parametric amplifiers, which operate at the temperature of liquid helium, are so expensive and difficult to maintain that NTT considers them unsuitable for first-stage amplifiers of broadband systems.

So far in NTT's networks, parametric amplifiers have been used commercially only in the over-the-horizon system between Kyushu and Okinawa. The amplifiers are placed in the front ends of the receiver for this link's two operating bands: 900 Mc for television and 2-Gc for multichannel telephone transmission.

A similar amplifier has been designed for a 4 Gc broadband system (see figure next page) that can handle 960 telephone channels. The d-c biasing voltage, which is applied to the varactor diode, is fed through the circulator and polyiron non-reflecting termination. Coaxial lines are tuned by inserting dielectric plungers.

Pump power for the amplifier, 10 to 20 milliwatts at 12 Gc, is supplied by a tripler which multiplies the output of the transmitter local oscillator. As pump power changes, variations in gain characteristics of the amplifier are small (see p. 103). Because of the design, automatic control of the pump power is unnecessary; this simplification is made possible primarily by the characteristics of the device: an optimum self-bias voltage for the diodes and suitable detuning of the resonance circuit. These characteristics eliminate variations in the bandpass characteristics.

In 1963, research started on an 11-Gc parametric amplifier built with silver-bonded diodes. These diodes are a unique Japanese development, devised by Shoichiro Kita at ECL in 1955. Many types of these devices are now made in Japan for parametric amplifiers, microwave switches, transmitter converters for repeaters and i-f limiters. Because of its Kita diodes, the 11-Gc amplifier had a very low noise figure: 3 db measured for sideband reception at room temperature and 0.7 db at 85°.

The other low-noise amplifier favored by the

Japanese is a tunnel-diode type. This amplifier is not suitable for systems operating with relatively high input lines, because its saturation level is low. This restriction can be removed if tunnel diodes with high negative conductance are chosen.

For example, in the receiver of a 4-Gc broadband system, a tunnel-diode amplifier has a noise figure only slightly worse than a parametric amplifier. But it has one big advantage: it can amplify microwaves without requiring pump power.

Frequency multipliers

When the Japanese became acquainted with variable capacitance diodes or varactors, they began using them in frequency multipliers.

NTT uses such a frequency multiplier as a local oscillator when the required output power of the oscillator is low and the frequency is 6 Gc or less. Under these operating conditions, the solid state multiplier has a higher efficiency (defined as the ratio of microwave output to the d-c power input) than the conventional klystron oscillator. In addition, NTT has found that the longer life of a diode and the elimination of complicated automatic frequency control circuits simplify maintenance. In the SF-U2 system—NTT's second-generation 6-Gc system—only the local oscillator is solid state. Its output is only 20 dbm (20 db above 1 milliwatt or 100 milliwatts). But in the newest 6-Gc system, the SF-U3—scheduled for field test in 1966 and for installation in 1967—all vacuum tubes are replaced by transistors.

The local oscillator in this new system (see block diagram p. 104) has a crystal oscillator, transistor amplifiers and multipliers. Operating at a frequency between 55 and 59 Mc, the crystal oscillator is an overtone type.

The input to the frequency multiplier has a frequency-modulated noise component. Because its frequency deviation is multiplied by a factor of 108, parasitic oscillations have to be suppressed and noise reduced in the crystal oscillator and power amplifiers that follow. To reduce undesired harmonics and noise, a narrow bandpass filter—composed of two stages of cavity resonators operating in the H_{021} mode—has been inserted in the output of the multiplier. The loaded Q of the filter is about 8,000 and its insertion loss is about 2 db.

ECL also has developed a new frequency multiplier for the new all-solid state 4-Gc system. In this multiplier, the overtone crystal oscillates at 114 Mc. This signal is amplified to about 30 watts before two tripler stages increase the frequency to 1,025 Mc.

The last two multiplier stages are doublers. They are made with a special varactor diode, the ECL 1242, which has an output of 2.5 watts at 4 Gc (see table p. 105 for its characteristics). Thus, the power range of the multiplier varies from an input of 30 watts at 114 Mc to an output of 2.5 watts at 4.1 Gc.

Improvements in solid state i-f amplifiers have made it possible to design better solid state re-

peaters. A solid state i-f amplifier was used first in 1961 in the first-generation 11-Gc system. Its bandwidth was large enough to amplify 600 telephone channels. Better transistors and transistor circuitry boosted this capability to 1,800 telephone channels and such an amplifier is now in production. ECL also has almost completed work on an

Low noise parametric amplifier

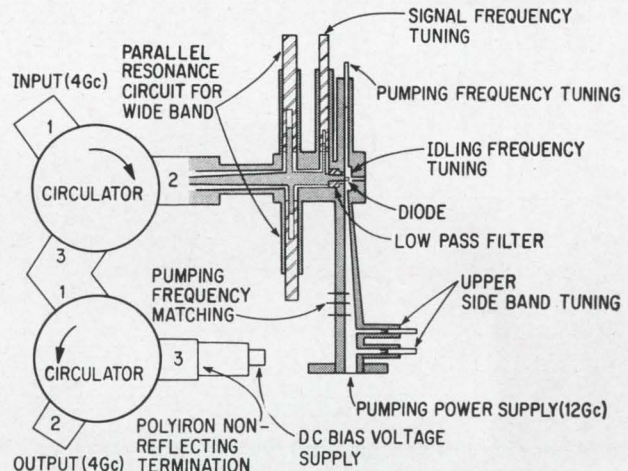

In parametric amplifier for 4-Gc system, d-c biasing voltage is fed through the circulator and polyiron non-reflecting termination. Pump power is supplied by a tripler which multiplies the output of the transmitter local oscillator.

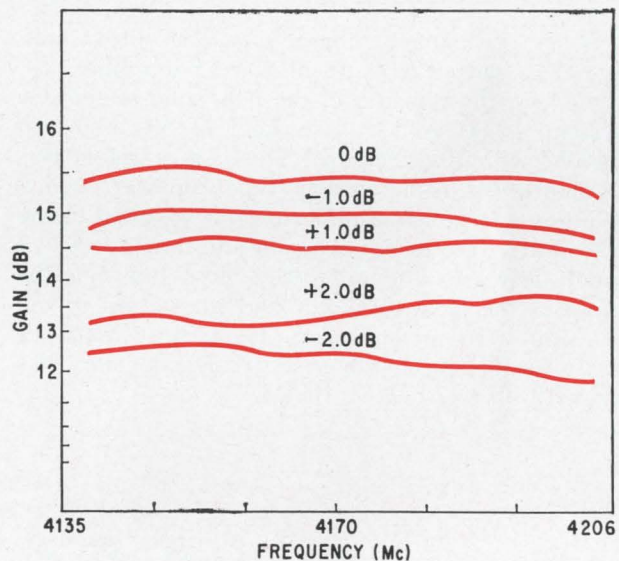

When pump power changes, variation of gain in parametric amplifier for 4-Gc system is small.

Characteristics of low noise amplifiers for 4 Gc system

Variable	Parametric amplifier	Tunnel diode amplifier
Gain.....	15 dB	15 dB
Band-width..	60 Mc (0.2 ^{dB} down)	200 Mc (0.2 ^{dB} down)
Noise figure.	2.5 dB	4.8 dB
Diode.....	MS-4104	MA-4604A

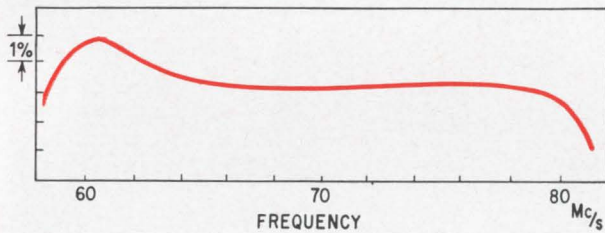
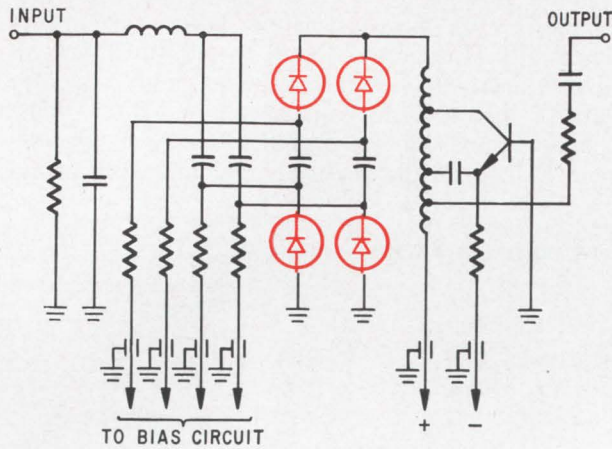

Frequency modulator (top), with four abrupt junction diodes (shown in color) in tuning circuit has linear output. Linearity, bottom, is within 1% over range of 70 Mc \pm 8

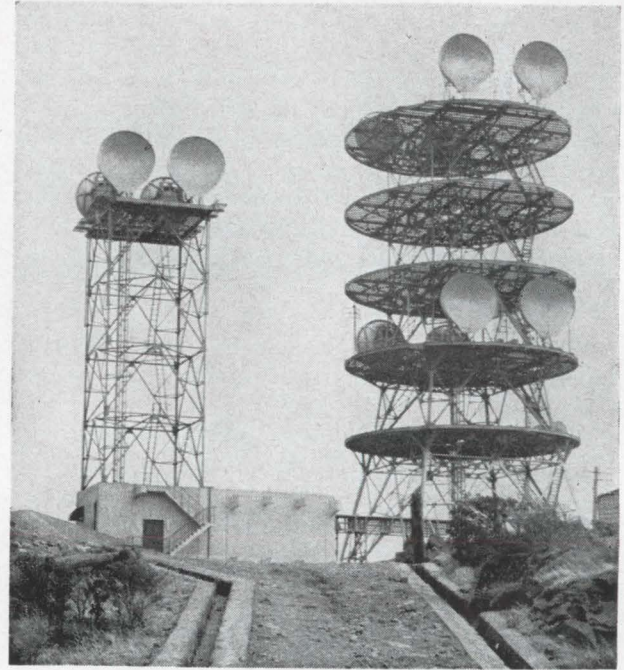

Microwave repeater stations, like this one at Futago Yama, dot the hilltops of the Japanese countryside. Inside the building is a heterodyne repeater.

improved amplifier that can handle 2,700 telephone channels—more than quadrupling capacity in 4 years.

A key performance characteristic is output voltage. The output voltage of the i-f amplifier, designed for the repeater of the new solid state 4-Gc system, is 90 volts into a load of 500 ohms in parallel with 10 picofarads. This is a desirable performance for a heterodyne-type repeater, which requires a large i-f amplifier output supplied to the transmitter frequency mixer. In addition, a large i-f input decreases the microwave loss between the input of the local oscillator and the output of the transmitter frequency mixer. The new i-f amplifier has a frequency characteristic which deviates less than 0.2 db at 70 Mc \pm 10 Mc.

Another component that has made an important contribution to microwave technology in Japan is the hyperabrupt junction diode, which has made possible solid state frequency modulators.

The useful characteristic of a hyperabrupt junction diode is the value of n in the equation for junction capacitance:

$$C_j = \frac{C_k}{(\phi - V)^n}$$

where C_j = junction capacity

C_k = a constant

V = bias voltage supplied to diode

ϕ = contact potential

Usually, n is larger than $\frac{1}{2}$ and sometimes is as large as 5 or 6.

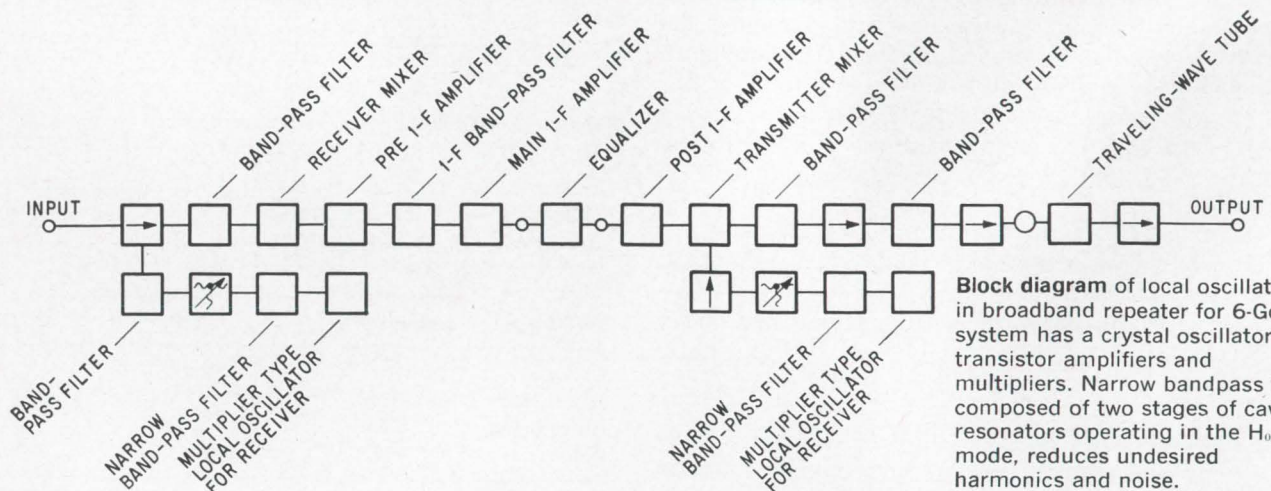

Block diagram of local oscillator in broadband repeater for 6-Gc system has a crystal oscillator, transistor amplifiers and multipliers. Narrow bandpass filter, composed of two stages of cavity resonators operating in the H_{021} mode, reduces undesired harmonics and noise.

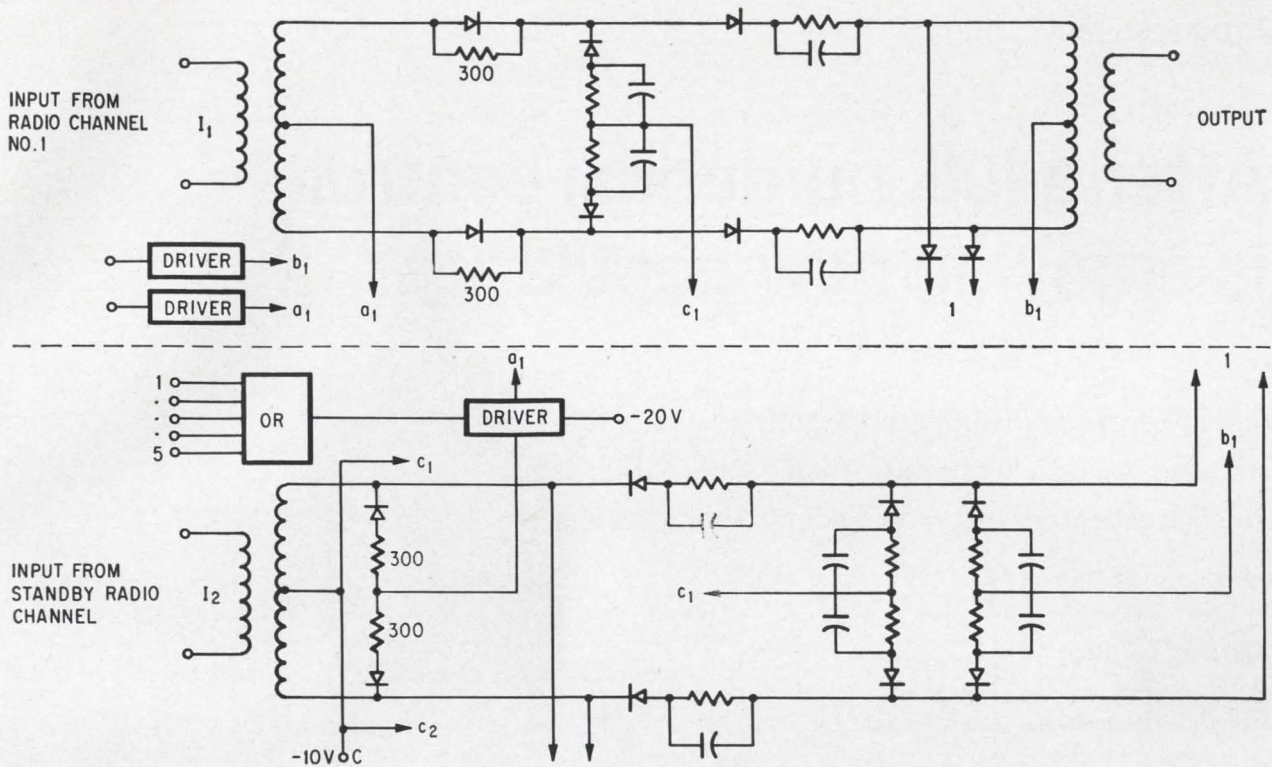

Switching circuit with Kita diodes has transition time of 15 to 20 nanoseconds for break and 40 nanoseconds for restoration. That is more than adequate, even for high-speed data transmission of 1,000 to 2,000 bands for which a transition time of 40 microseconds is required.

If a diode with an n value of about 2 is placed in the tuning circuit of the modulating oscillator and its bias voltage is controlled by the input signal, its linearity is good enough so the oscillator can modulate a super multi-channel signal. Under these conditions, the variation of differential modulation is less than 1% in the range of $70 \text{ Mc} + 4 \text{ Mc}$. Sensitivity is more than 10 Mc per volt.

Also, when several diodes are connected in parallel and are given different bias voltages to compensate for the characteristics of each, linearity can be improved to cover a broader range of frequency deviation. One modulator designed this way used 4 hyperabrupt junction diodes (see figure p. 104) and its variation of differential modulation was less than 1% in the range of $70 \text{ Mc} \pm 8 \text{ Mc}$ (see figure below circuit on p. 104).

Solid state switching

Traditionally, the reed relay has been used for switching an r-f channel to a protection channel when there is equipment failure or severe fading. The transition time of these mechanical devices is 1 to 2 milliseconds. Since this time is barely satisfactory for the transmission of 50-band telegraphy, it is clearly unsatisfactory for high-speed data transmission. Therefore, ECL has developed a solid state unit, using Kita diodes, for the 11-Gc system and the unit can be used in the new 15 Gc system, too. The actual design goes back to 1959, even though it has been used only recently.

When such a switching circuit (see figure above)

Specifications for varactor diode in high power multiplier

Variable	Specification	Condition
Breakdown voltage V_B	60v	
Capacitance C_j	3~6 pf	at bias volt - 6v
Cutoff frequency f_c	< 50 Gc	"
Thermal resistance θ	> 15 °C/w	

is used in the receiving side of a broadband telephone system, the distortion introduced by the diodes which are positively biased, must be kept small. The impedance ratio of reverse-biased diodes to positive-biased diodes determines the quantity of cross talk between switched channels.

The insertion loss of this circuit is less than 0.6 db. The transition time is about 15 to 20 nanoseconds for break, 40 nanoseconds for restoration. These times, which include the operation times of the driving circuits, are more than adequate because the transmission of high-speed (1,000 to 2,000 band) data requires a transition time of about 40 microseconds.

To extend solid state in microwave, researchers in Japan are concentrating on developing power transistors and varactor diodes that can handle the higher frequencies at higher powers. The biggest obstacle is not system design, but lack of understanding of the diffusion technology for producing such devices.

After a lull, numerical control is enjoying new popularity

Activity peaked in 1960, then fell off. Now systems are being installed at a rate that is more than double earlier sales.

The newest entry is a low-cost point-to-point system

Kazuto Togino

Government Mechanical Laboratory
Ministry of International Trade and Industry

It is a Japanese trait to embrace the newest in technology even if its application and benefit are not immediately obvious. That is one explanation of the enthusiastic acceptance of numerical control of machine tools in 1955. Development activity peaked in 1960 and then slumped sharply as interest waned. The recent resurgence of interest in numerical control is based, this time, on the economy that such systems can generate for the buyer.

The clearest picture of what's been happening can be gained by examining the sales figures for the two kinds of numerical control: so-called point-to-point systems in which the numerical input information moves a tool from one specified point to another by the shortest possible route; and continuous contouring, in which the numerical instructions direct the cutter to move along some predetermined path.

In 1964, 36 point-to-point systems were sold, almost three times the number sold in the five preceding years. That represents a sales volume of about \$360,000. This year, sales are running nearly

120% ahead of last year. Japan's metalworking firms should buy 75 to 80 such systems, about \$750,000 worth.

Sales of continuous-contouring systems are enjoying growth too. Last year, 21 systems were sold at a value somewhere near \$1 million; 34 such systems had been sold in the previous five years. This year, sales are up 100% and control makers should deliver 40 or more systems, worth nearly \$2 million.

Despite the rapid growth, numerical control remains a small business in Japan, probably well under \$3 million for 1965. In fact, it is so small that one company, Fujitsu Ltd., dominates the field. Industry experts estimate that Fujitsu's share of the numerical control business ranges from a conservative guess of 70%, to the company's own claim of 90%.

Fujitsu's Japanese competitors are Nippon Electric Co., Toshiba (Tokyo Shibaura Electric Co.), Hitachi Ltd., Mitsubishi Electric Corp., and Yaskawa Electric Mfg. Co. But Fujitsu sees the stiffest competition coming from the United States. Several Pratt & Whitney Tape-O-Matic machine tools equipped with numerical point-to-point systems, have already been imported into Japan.

Even of more concern to Japanese producers is the current patent situation on numerically-controlled machines with automatic tool changers, like Kearney & Trecker's Milwaukee-Matic. Though a few machines of this type have been built in Japan (by Hitachi Ltd., Niigata Iron Works, and the Matsuura Manufacturing Co.), many foreign patents now registered in Japan may block their future manufacture.

In many ways, the Japanese again have followed

The author



Since 1949, Kazuto Togino has been on the staff of the Government Mechanical Laboratory. An electrical engineer with an interest in machine tools, he designed the numerical control system for a large precision-boring machine. His Ph.D is from Tokyo University. Currently, as head of the Systems Research Section, he is studying automation systems for applications ranging from production to traffic control.

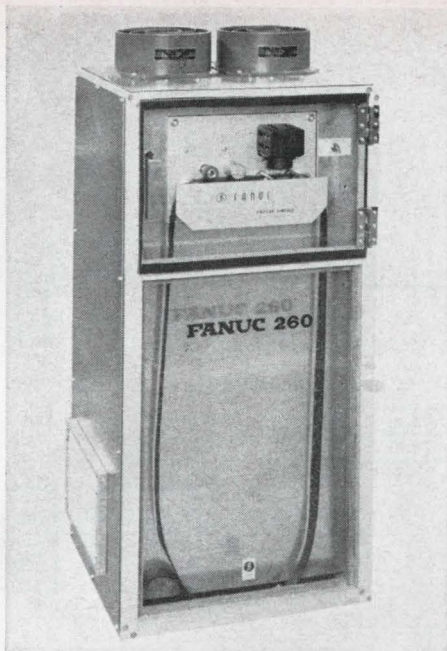

Small and compact, Fanuc 260 numerical control has an attractively low price—\$6,500.

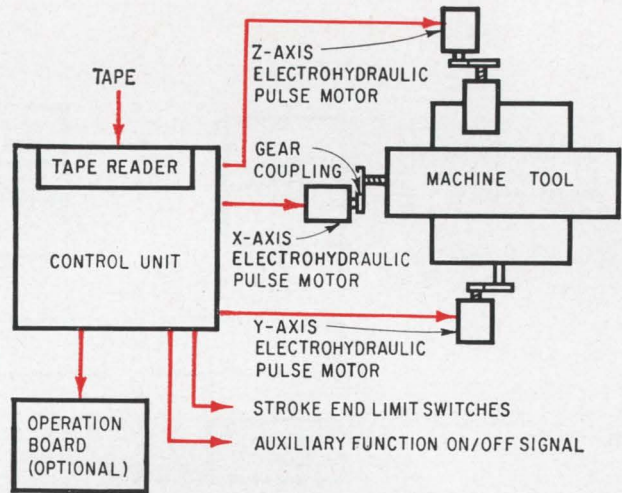

Main parts of Fanuc 260 are a transistorized control system and the electrohydraulic pulse motors that serve as digital-to-analog converters and power drives for feed screws

the lead of U.S. industry. There is an obvious preference for the less expensive point-to-point systems, just as there is in the U.S. In addition, Japanese control makers are concentrating more on finding new applications for numerical control and selling it than in engineering new systems—as are their American counterparts. New design plays a minute role these days.

Fanuc 260

Japan's newest system is Fujitsu's Fanuc 260 and it is responsible for the boom in point-to-point systems. Small, compact and low in price, selling for about \$6,500—it is supposed to be able to do 80% of the ordinary machining operations. All transistorized, it was introduced last year and production began last spring.

The two major units in the Fanuc 260 are shown in the block diagram above: a control unit and one electrohydraulic pulse motor for each dimension. The motor serves two functions—it is a digital-to-analog converter and it supplies power to drive the

tool in one dimension. A three-dimensional machine has three such motors.

The electrohydraulic pulse motor has been responsible for Fujitsu's strong patent and market position in Japan. When it is used in numerical control, no feedback system is required to measure where the tool is at any instant. Most numerical control systems require a position-measuring transducer and a feedback link to tell where the tool is before another numerical instruction can be followed.

Although Fujitsu's pulse motor, shown below, was invented in 1956, it is used in almost all Fujitsu's numerical control systems, and its operation is still interesting.

Operating through a gear train, an electric pulse motor drives a spool-type, four-way valve to run a hydraulic motor that is connected to the feed screw of a machine tool. The motor rotates 1.5° for each electric pulse it receives. Normally the gear ratio through which it drives and the pitch of the feed screw are selected so that the tool moves 0.01 mm

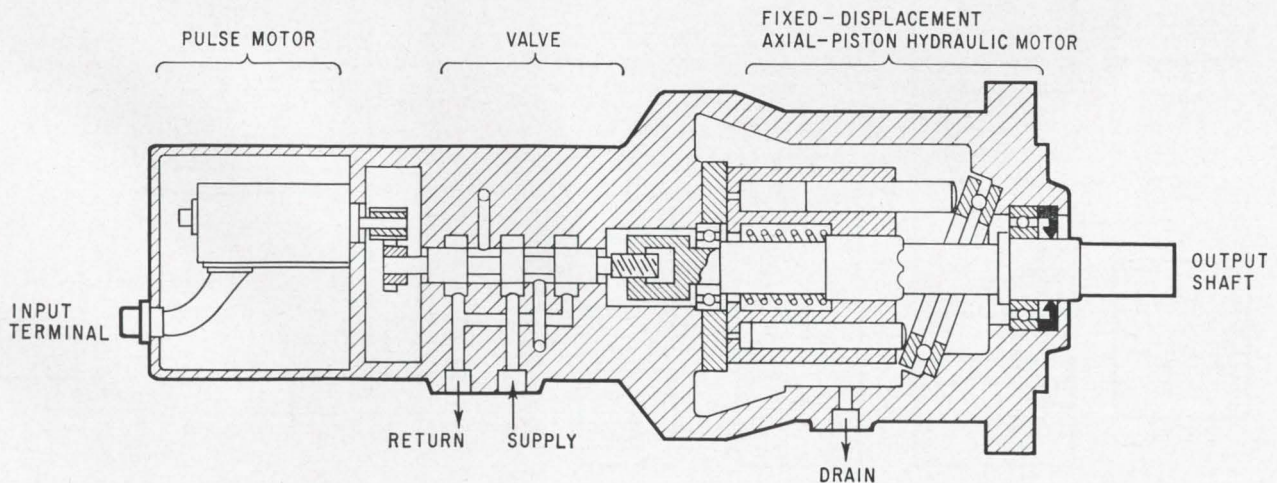

Fujitsu's electrohydraulic pulse motor is principal reason for the company's strong position in numerical control. A single pulse rotates the motor exactly 1.5° ; the output is geared so that a single pulse feeds 0.01 mm.

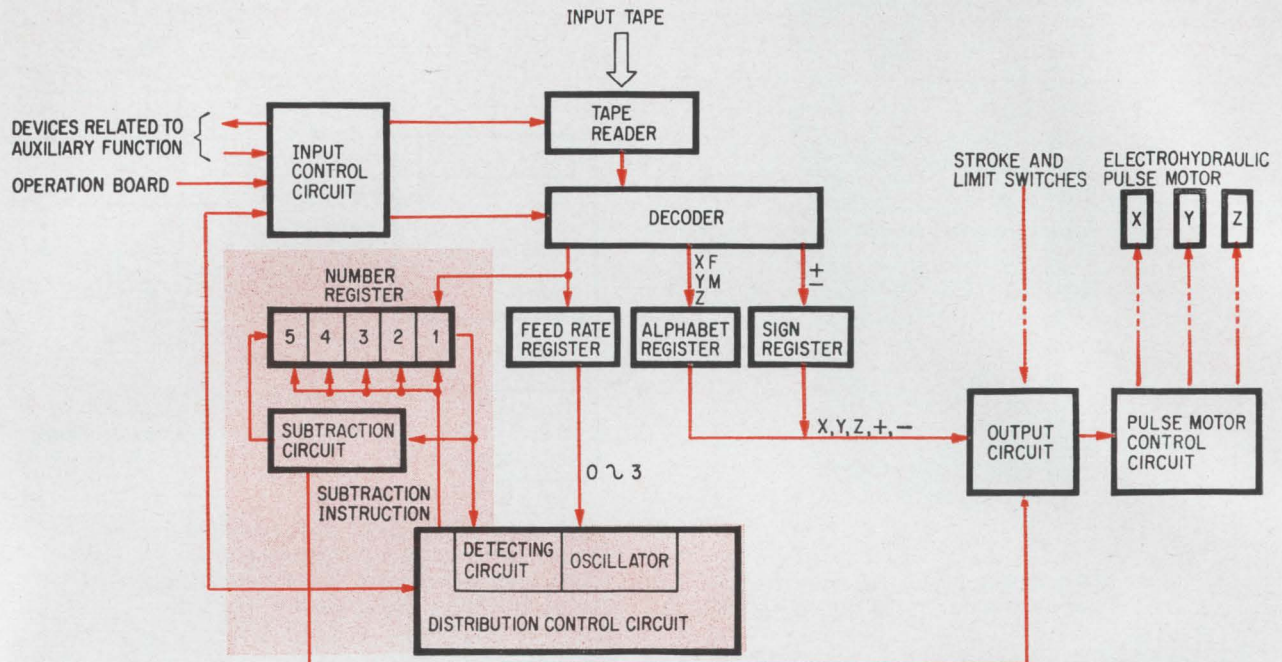

Typical Fujitsu numerical control system has no feedback circuit to report where the tool is. Feed information subsystem (in color) goes into a number register; each pulse from the oscillator empties one number from this register into a subtraction circuit, until a zero detecting circuit finds the register is empty.

for each pulse fed into the motor by an oscillator.

The motor starts instantaneously at pulse rates up to 2,000 per second; its maximum continuous pulse rate is 6,000 per second. That means it can drive the feed of a machine tool as fast as 3,600 mm/min. On the driving end, motors are available with outputs ranging from 0.4 to 6 horsepower.

The output position of the fixed-displacement hydraulic motor is fed back mechanically through a special nut. In this way, the actuator output shaft continually follows the low-power pulse motor.

In the control unit there are five main subsystems: a punched-paper tape reader; a central command unit that carries out control functions and

computing; a magnetic drive circuit to actuate the clamp magnetics of the pulse motors and the switching relays; a pulse motor drive circuit that excites and rotates the pulse motors; and a power supply.

At the start of operation, the input control circuit activates the paper tape reader (see figure above). Coded data from the tape is distributed by the decoder and stored either in a sign register, an alphabetic register, a feed register or a number register. Direction of the movement is in the sign register; which axis (x, y or z) is in the alphabet register; the speed of feed is in the feed register; and how far to move the feed is in the number

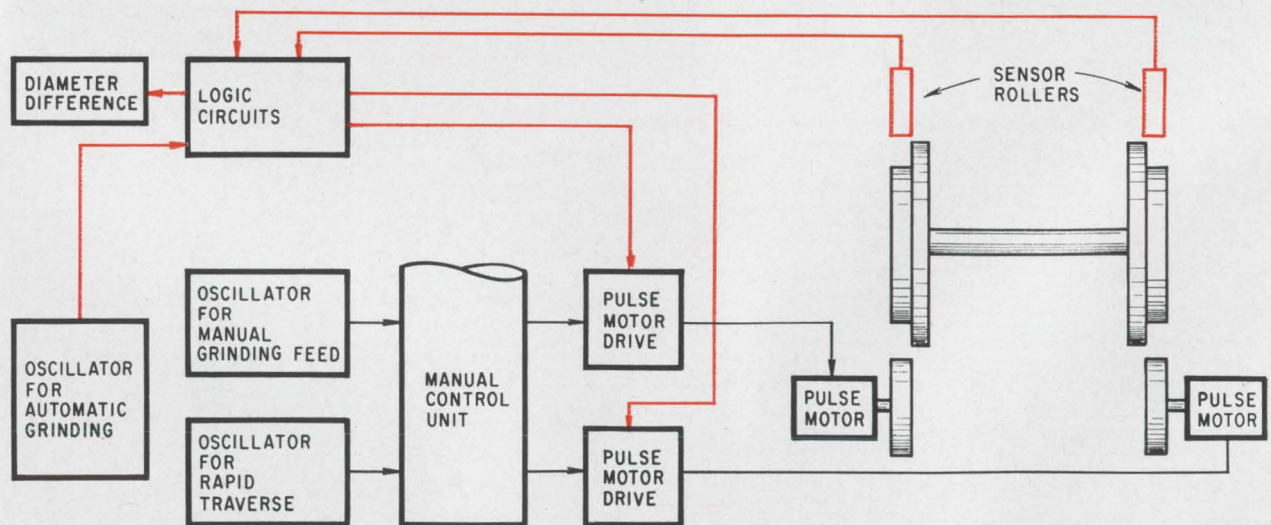

Truing of wheels is manually controlled in wheel grinder used by Japan National Railways on new Tokaido line. But diameter of wheels on the same axles are matched by automatic grinding (controls shown in color). In the 75-ton wheel grinder, four identical systems grind eight wheels of a car.

register (shown as a five-unit device).

Data stored in the alphabet and sign register goes into the output circuit to direct the tool movement along the proper axis. Movement is along only one axis at a time. Meanwhile, data in the feed-rate register feeds a pulse oscillator in a distribution control circuit to regulate the frequency of the drive pulse to the electrohydraulic pulse motor.

The same distribution control circuit empties the number register into a subtraction circuit, one number at a time every time the oscillator produces a pulse—thus moving the feed screw. The content of the number register is continually checked by a zero-detecting circuit in the distribution control circuit. When the contents become zero, the pulse distribution stops.

Of the more than 100 numerical control systems sold in Japan, the most technically interesting are a fully automatic camshaft grinder and a railroad wheel grinder. The controls of both were supplied by Fujitsu.

Wheel grinders

Two punched-paper tapes run the Fanuc 280 control system of a camshaft grinder which produces automobile camshafts completely automatically. One tape contains the profile of the cams; the other has sequence information to position each of the several cams on the shaft at the proper angle.

The numerical control positions the grinding wheel so it touches the cam profile at the point where the valve lifter is intended to touch. To do this, the wheel is raised in the y-direction while it is pushed forward in the z-direction (see below). Since the cam profile is determined by the cam rotational angle and the lift is a function of the cam angle, simultaneous control of three dimensions is required: θ (the cam angle), y and z.

To program the machine, it's necessary to plot a curve describing the position of the grinding wheel at every point. Then this curve is divided into many tiny straight lines. Next, numerical values describing each increment are punched into the cam profile tape.

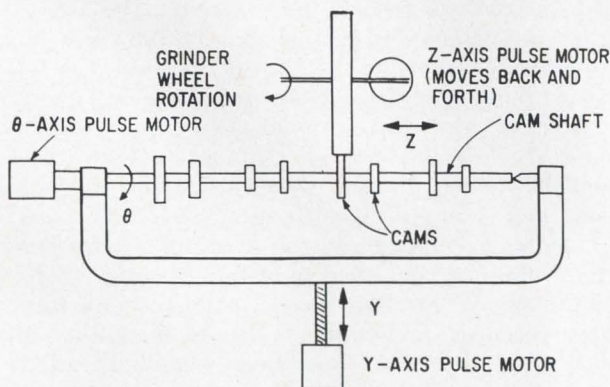

Three-dimensional control required by automatic cam grinder. Dimension θ positions the cam; dimension y feeds the grinder in and out; dimension x selects the cam.

On Japan's new Tokaido railroad, the 125 mile-per-hour high-speed line between Tokyo and Osaka, the high speed wears grooves in the wheels. If the brakes are applied hard while the train is running at high speed, flat spots form on the wheels as they skid along the track. Only grinding can true the wheels back to their required shape and roundness because they are made of metal which has been heat treated to increase the hardness. To speed the wheel grinding operation and keep costs down, Japan National Railways has installed a grinder with numerical control (see bottom p. 108).

Though the wheel grinder is a 75-metric-ton machine that grinds eight wheels at a time, the fundamental principle of control is the same as that in the Fanuc 260 described previously. A separate Fujitsu electrohydraulic pulse motor feeds each grinding wheel. Grinding of the two wheels on the same axle (the eight wheels are on four separate axles) are synchronized, though machining front and rear axles of a truck is controlled independently and is performed while the truck is still mounted on the coach.

Just as the electrohydraulic motor of the Fanuc 260 positioning system is run by pulses from an oscillator, so are the motors of the grinder. But there are two separate oscillators for each motor: one for fast traverse (moving the grinding wheel into position), and the other for feeding the grinding wheel as it cuts. The frequency that directs fast traverse can be changed at the control panel.

Truing of each wheel is performed by manually operated control. An operator feeds the grinders until the wheel in the worst shape on each axle has been trued. Then an automatic control takes over to match the wheels on each axis.

For matching, the right wheel of each axle is considered the standard. A sensor rolls over each wheel while a photoelectric coder connected to it generates pulses—1,000 for a complete revolution of the sensor. Signals from the coders on the right and left wheels are fed to a difference counter at the same time the coder on the right wheel feeds a preset counter. When the latter reaches 17,400, corresponding to two revolutions of a wheel whose diameter is the standard 870 mm, the count in the difference counter represents how much the wheels differ in diameter. If the difference is plus, the left grinding wheel is fed forward; if minus, the right wheel advances.

A low-cost binary display on the control panel tells the operator how much the diameters of each pair of wheels differ. From this information he can decide which grinding feed rate to use.

Now the railroad has one grinding machine in its yards outside Osaka. In November, the average speed on the run was increased to 103 miles per hour from 80, and wheel wear is expected to increase. JNR will need to set up another wheel grinder in its Tokyo yards and since the numerically controlled unit built by Kishou Seizo Kaisho Ltd. has worked so well, JNR will probably get another just like it!

Manual process control makes way for computers

High labor costs, potential work force shortage, and expanding production encourage new technology

By Atsunobu Ichikawa

Professor, Tokyo Institute of Technology

Faced with sharply rising labor costs, a potential labor shortage and expanding production, Japanese industrialists are slowly replacing manual process control with control by computer.

Like many other technical innovations, the concept of computer control was borrowed by the Japanese from the United States. It was adopted after the first installation had been completed at the Texaco Co.'s Port Arthur (Tex.) refinery in 1958.

Today, computer control is moving in two directions in Japan: direct digital control and integrated control. Direct digital control, also borrowed from the U.S., was endorsed last month when Hokushin Electric Works Ltd. introduced a new low-cost DDC machine of Japanese design [Electronics, Nov. 29, 1965, p. 132].

At the other extreme, some Japanese companies are installing hierarchies of computers for integrated control. Nippon Kokan Kabushiki Kaisha, a big steel producer, will install 15 to 17 computers at its new Fukuyama works—now under construction—to control production, scheduling, management and processes in the plant. The machines will be used on three levels: off-line planning, off-line scheduling and process control.

The author



Atsunobu Ichikawa is a chemical engineer who has specialized in the dynamic response of processes and their control. He has a doctorate from the Tokyo Institute of Technology and has also attended Princeton University and Case Institute of Technology.

Since the Japanese first embraced computer control, 50 such systems have been installed at plants producing steel, petroleum, chemicals and electricity. Most of these machines were built to American designs. Of the nine supplying control computers, seven have licensing agreements with U.S. companies. Hitachi Ltd.'s HITAC 4010 is the RCA 3301 built under license. The Yamatake-Honeywell Keiki Co. is a joint venture that produces process control computer [though the Nippon Electric Co. produces Honeywell modified general-purpose computers]. And Mitsubishi TRW is a joint venture that used to build TRW process control computers until the Thompson-Ramo-Wooldridge Co. went out of the business. Now Mitsubishi executives are trying to decide what computer to use in its future control systems.

Only Hokushin and Fujitsu Ltd. have no ties to U.S. computer makers. Hokushin's new DDC controller, an integrated circuit machine that costs about \$20,000, was developed jointly with the Fischer & Porter Co., the U. S. instrument company. Toshiba's first control computer, the Tosbac 3300, was Japanese designed. But Toshiba now has a licensing agreement with the General Electric Co. to build its process control computers.

Another new Japanese-designed process computer is Fujitsu's Facom 270 series with three models: models 10 and 20 have discrete components; model 30 will have integrated circuits.

The biggest Japanese user of computers for control is the iron and steel industry. At least 15 machines are controlling basic oxygen converters, blast furnaces, and rolling mills. In the utility industry, 14 machines have been installed and 11 more are on order. Nearly all 25 are for monitoring operations, as opposed to control. Chemical and petroleum processors have installed more than 10

computers to control processes ranging from cement-making to the manufacture of ethylene and vinylchloride.

Because of the complexity of most processes, it is difficult to pin down all the savings resulting from computer control. For example, installing a computer in the control loop requires a better understanding of the process; this understanding often leads to better process equipment which improves the output of the plant. Integrated digital control, a large computer monitoring other computers which control processes, would seem to allow optimization on a large scale that would be impossible by manual control.

Although many of the computer control installations in Japan are duplicates of those in the United States, a few are unique because of differences in process or differences in computer philosophy.

Three such installations are control of a basic oxygen converter, automatic control of a cement kiln and sequential control of a batch fermentation process.

Controlling the oxygen converter

Making steel in a basic oxygen converter is one of the most significant improvements in metallurgy in a decade: it cuts the time to convert a batch of iron to steel from about 10 hours in an open hearth furnace to less than one hour. During the first part of the process, pure oxygen blows through molten steel, burning out impurities such as sulphur and phosphorous. During the last part or finishing portion, carefully calculated amounts of ferroalloys, carbonizing agents and other additives are injected to produce the quality of steel desired.

The critical part of the process is determining how long to blow oxygen through the melt, and what temperature to heat the steel at the end of the oxidizing. The computer makes both calculations and also predicts the proper amounts of additives to bring the steel to the desired mix.

In Japan, an oxygen converter was brought under real-time computer control for the first time in 1963. A HOC 300 computer, built by Hokushin Electric Works Ltd., controlled the process at the

Kawasaki Works of Nippon Kokan Kabushiki Kaisha.

Because the mathematical model that relates the variables which might affect the process is so essential in computer control, it was designed first. The model was derived through an extensive theoretical and experimental study of the company's existing plants by an off-line computer. The model that evolved from this exhaustive study is

$$y_{e,0} = y_{m,1} + \Delta y_{e,-1} \\ = y_{m,0} + f(u_1 v_0 - v_1)$$

where

$$u = u \left\{ \sum_1^h (y_{m,n} - y_{en}) \right\}$$

$$v_0 = v \{ x_0^1, x_0^2, \dots, x_0^n \}$$

$$v_1 = v \{ x_1^1, x_1^2, \dots, x_1^n \}$$

y_e = control objective of variable y

y_m = measured value of variable n

In this formula, certain key variables are established as control objectives and designated by the letter y . Other variables which affect these objective variables are designated by $x^1 \dots x^n$. Thus, in this formula, the superscript is not a raising to the power, merely a way of describing the variables. The variables have a subscript which refers to a batch of material entered into the converter. Thus any variable with the subscript 0 refers to the charge currently in the converter; any other suffix i refers to the i th previous charge. The function v was derived theoretically and then refined by statistical analysis on actual data.

The computer determines the target value (or desired value) of a variable $y_{e,0}$ from this mathematical model and from data measured and stored while previous charges of iron were being processed. Function u is a moving average of deviations from previous charges. The deviation represents the difference between the predicted value and the actual value. The term $(v_0 - v_1)$ is an adjustment.

To control the oxygen converter, the computer receives data on 144 variables.

Each time the computer recognizes a critical

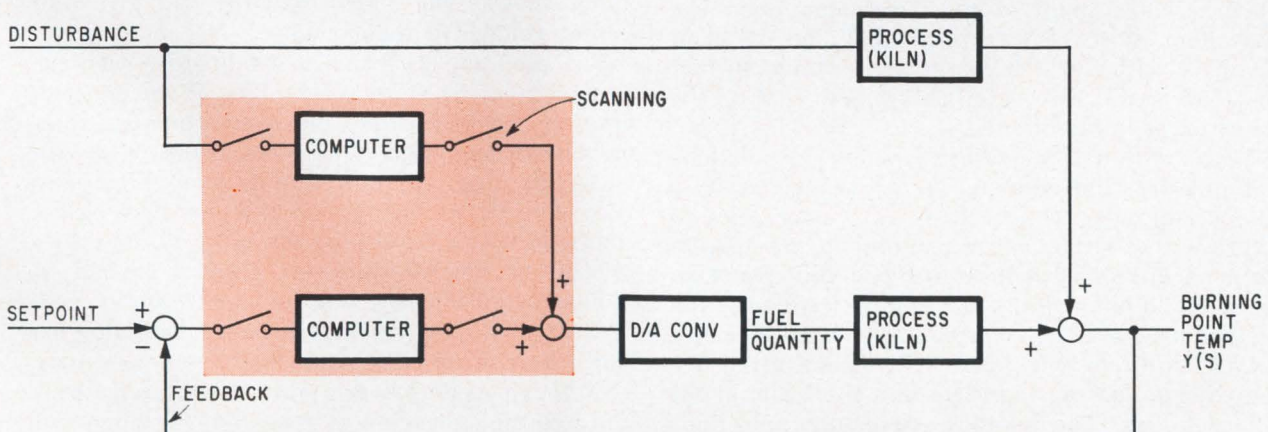

Feedforward concept (in color) is combined with feedback in control of cement kiln. Computer calculates size of input to bring process variable to setpoint.

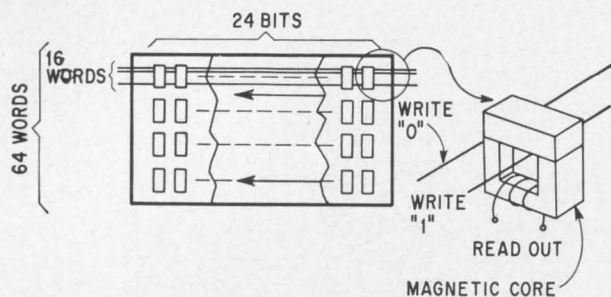

Square cores are used in memory of fixed program of Codal 3061, developed by Hitachi with the Ajinomoto Co. To change the program, cores are rewired by hand.

input, which is related to each control equation, it examines the variables in the equation to see if they have been renewed and stored. If so, the computer resolves the equation. One such variable is the composition of the charge as measured by an X-ray instrument. In this way, succeeding computations have no errors introduced by earlier analysis.

At any time, an operator can ask to see variables needed to guide the steelmaking process, such as hot steel temperature and end-point temperature. A priority interrupt stops any computation and displays these variables on call.

The management of Nippon Kokan believes the installation has been a total success after two years of operation. The computer reached several control objectives with an accuracy far greater than that experienced when skilled operators ran an oxygen converter.

The company believes the computer control paid for itself within a year by saving 100 charges that would not have met specifications unless the control had intervened. In addition, the company says it is using smaller amounts of expensive ferroalloy material because the computer calculates the required amounts accurately.

Making cement

There are two companies in Japan making cement under computer control. The installations of an RW-300 computer at the Kumagaya plant of the Chichibu Cement Co. and the TRW-330 machine at the Nanyo plant of the Tokuyama Soda Co. were joint efforts of Mitsubishi TRW and the plant involved. Although the computer is similar to that installed at the Riverside (Calif.) Cement Co., the approach is quite different.

Both the Riverside and the Japanese installations optimize by "hill climbing"—measuring variables, calculating output; then changing the variables to improve the output and repeating the calculation until an optimum point is reached. But the Japanese could not stabilize the kiln by feedback—the method used at the California installation—because they used a different process. Riverside mixed dry ingredients and roasted them in a short kiln about 330 feet long. The Japanese companies mix their ingredients as a slurry, then fed the stream into much longer kilns, nearly 500 feet long at Chichibu and more than 600 feet at Tokuyama. Because the

Japanese kilns are so much longer, the roasting process requires far more heat than the U.S. method and has a time constant of four hours compared to one. The time constant is the number of hours between changing a variable and measuring the effect of that change.

If feedback stabilization is applied to the long Japanese kilns, the process tends to "hunt" and never stabilizes because the time constant is too long. Thus the Japanese applied a combination of feedforward and feedback in critical control loops (see p. 111). Because the technique requires additional memory, the Japanese computers had memories twice as large as the California installation—32,000 words compared to 16,000.

Improving flavor

In Japan, as many restaurants and homes serve monosodium glutamate for seasoning as serve salt. Ajinomoto Co., Inc., a leading manufacturer of the seasoning, uses a type of direct digital control to set up the sequence for a fermentation process in a pilot plant at its Kawasaki works. The company soon will extend the sequence control to its production lines where it is now using a relay sequence control on some lines.

Ajinomoto's fermentation process is a batch type reaction in which enzymes produce complex chemicals. It requires strict sequencing of operations. Before the process starts, steam is introduced in each part of the reactor to sterilize it. Then an enzyme strain is placed in a sterilized medium and air is fed to it under strict conditions. Improper manipulation of any one of many valves that regulate the process can produce harmful microbes or kill the useful ones.

When Ajinomoto decided to adopt computer control, the company concluded that none of the machines available was reliable enough to control its critical process. So Ajinomoto, working with Hitachi Ltd., developed a special computer—the Codal 3061.

One interesting feature of the Codal 3061 is the read-only memory that stores the fixed program. It has square magnetic cores, as the figure above shows. The cores are large and give high output voltage to reduce noise.

The program is stored on 64 boards; each has a capacity of 64 words of 24 bits. When the program is changed, excite wires are threaded manually inside and outside the cores. If the excite wire is outside, that core corresponds to a zero; if the wire is inside, it corresponds to a one. Because the computer uses a fixed program memory, its cost—\$25,000 to \$30,000—is lower than if it had an ordinary core memory of equivalent size.

During the past six months, this computer has had a time availability of 99.90%.

Although engineers are enthusiastic about computer control, the current recession in Japan will prevent some prime users from automating—particularly steel and chemical plants, industries which suffer from overcapacity.

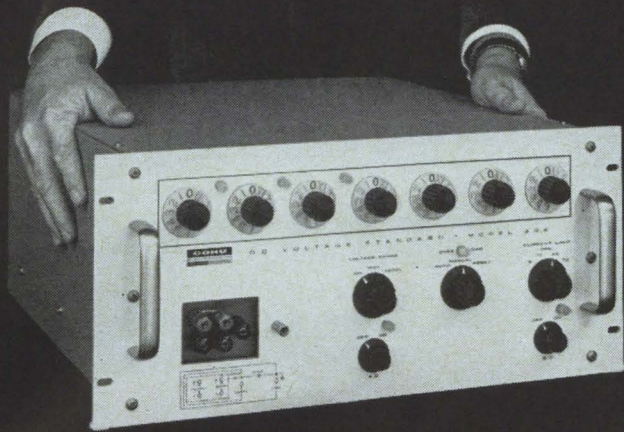

Meet the DC voltage standard with:

STABILITY WITHIN 15 PPM

... for 7 days, 25 ppm for 6 months.

Recorded stability history available representing
1344 hours of data logger time.

0.003% ACCURACY

... ensured by temperature-controlled precision
Zener reference.

IMMEDIATE DELIVERY

... the COHU Model 304 is off-the-shelf ... hundreds of units
already in use ... like the entire family of
COHU DC voltage standards.

... and voltages from 0 to 1222.2221 in 3 ranges;
steps as small as 1 μ v.



Box 623
San Diego, Calif. 92112
Phone 714-277-6700

How to make more precise measurements, eliminate maintenance problems:

**“Use the Below Coupon To
Order Editorial Reprints
From Electronics!”**

Fill in, cut out the coupon, insert in envelope
and mail to:

Electronics Reprint Department
330 West 42nd Street, New York, N.Y. 10036

Reprints Available:

(Price: 50¢ each unless otherwise noted.)

- Key no. **R-82** Computer Time Sharing, 20 pages
- Key no. **R-80** The Packaging Revolution In Microelectronics (2 part series, 32 pages.) \$1.00.
- Key no. **R-79** MOS Integrated Circuits Save Space and Money, 16 pages.
- Key no. **R-78** The Overlay Transistor, 4 color special feature, 15 pages.
- Key no. **R-77** Cold Cathode Tubes (3 part series, 28 pages).
- Key no. **R-76** Automated Trains: Who's On The Right Track? 16 pages.
- Key no. **R-75** Biotelemetry (2 Part series, 16 pages).
- Key no. **R-74** Unijunction Transistors, 24 pages.

Reprint order form

(See the above list, please order by key number.)

To help expedite mailing of your reprints, please send cash, check, or money order when you order.

Send me reprint(s) of key no(s) at ¢ each.

Name

Number & Street

City, State, Zip Code

Get the extra capability, greater reliability, and longer useful life of Rohde & Schwarz!

Since 1933, Rohde & Schwarz' group of unusually creative engineers have been designing electronic instruments that are truly unique. These instruments are constantly ahead of what is considered to be the state-of-the-art. They are more precise. They are easier to use and read. Many perform extra functions. Some do jobs never done before. All are constructed with uncompromising quality—drastically reducing maintenance requirements. As a result, they do not become obsolete as fast as ordinary instruments—they provide more years of useful life. As you might expect, you pay a little more initially for some of these—but an investment in Rohde & Schwarz saves you plenty in the long run!

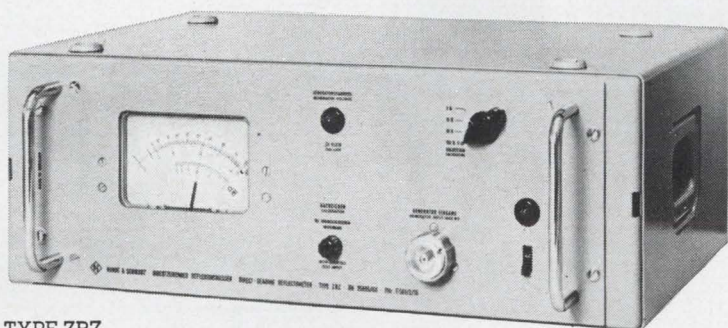

TYPE ZRZ

For more information CIRCLE 80 ON READER SERVICE CARD

Now! Read reflection coefficients and attenuations DIRECTLY!

The Rohde & Schwarz Type ZRZ Reflectometer is a modern, accurate, and dependable instrument for measuring reflection coefficients from 0.5% to 100%, and attenuations from 0.05 dB to 5 dB. Read-out is direct and instantaneous from the built-in scale; no calculations or interpolations are required. Outputs for a slave meter and a recorder increase the unit's versatility, and its low test voltage makes it ideally suitable for semiconductor circuits.

ADDITIONAL FEATURES:

- Frequency range 30-1000 MHz
- Broad-band, no tuning required
- Signal generator is only external accessory required
- Automatic voltage control, signal generator voltage can vary by factor 2:1
- Fully transistorized

An ideal RF Power Generator for use with Slotted Lines and other measuring instruments!

This Rohde & Schwarz VHF Power Signal Generator features seven subranges, covering from 25 to 480 MHz. Typical power output is between 500 and 800 milliwatts which can be attenuated as much as 40 dB when required. Each range has its own scale, calibrated directly in frequency.



TYPE SLSV

FEATURES:

- Frequency calibration accuracy $\pm 1\%$
- Frequency drift less than 5 parts in 10^5 within 15 minutes after 2 hours of operation
- Switch selected square wave modulation

For more information CIRCLE 81 ON READER SERVICE CARD

Here's a multi-purpose receiver for monitoring radio reception, and interference, and making lab measurements. It's a complete transmission test set, using a built-in tracking generator with 30 mv fixed output. It combines a selective microvoltmeter with RF preselection. And it covers 25 to 900 MHz with just 3 plug-in RF units. AC and battery operation.

OTHER FEATURES:

- Measuring range 0 to 120 dB referred to $1\mu V$
- Narrow ($\pm 12\frac{1}{2}$ kHz) and wide (± 60 kHz) bandwidths
- Has built-in tracking calibrating oscillator, eliminating need for calibration charts
- Accuracy is ± 1.5 dB
- Linear (20 dB) and logarithmic (40 and 60 dB) scales
- Indicates RMS, quasi-peak, and peak values (with slide-back voltmeter)
- Provides AM and FM demodulation

Monitor VHF and UHF with One Receiver! Covers 25 to 900 MHz!



TYPE ESU

For more information CIRCLE 82 ON READER SERVICE CARD

Like getting several generators for the price of one! 2.3 to 7.0 GHz

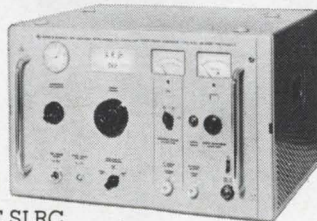

TYPE SLRC

For more information CIRCLE 83 ON READER SERVICE CARD

Just one knob tunes across the complete frequency band of 2.3 to 7.0 GHz in the Type SLRC Power Signal Generator. Measure over this entire range without changing Generators. Perfect for antenna ranges and radar systems; 2 and 4 terminal networks; narrow band resonators; and as a signal source for VSWR indicators.

FEATURES:

- Digital scale; single range, single tuning
- Large power output—3 watts maximum, more than 1 watt over greater part of the range
- External pulse modulation provided
- Can be synchronized from frequency synthesizer Type XUC
- Continuously variable attenuator has 100 dB range
- Carefully shielded for measurements at low power outputs

Rohde & Schwarz, 111 Lexington Ave., Passaic, N.J., 07056 Phone: PRescott 3-8010

Inquiries outside the U.S.A. should be directed to: Rohde & Schwarz, Muehldorfstrasse 15, Munchen 8, West Germany.

BEEP BEEP BEEP BEEP BEEP BEEP BE

3SK11

ac amp.

3SK12

Switching

3SK13

dc amp.

MOS N-CHANNEL TYPE

This family utilizes a hermetically sealed four-lead package which is similar in shape to the JEDEC TO-18.

ELECTRICAL CHARACTERISTICS ($T_a=25^\circ\text{C}$)	3SK11			3SK12			3SK13			
	min	typ	max	min	typ	max	min	typ	max	
V_{DSX} ($I_D=10\mu\text{A}$, $V_{GS}=-10\text{V}$)	20	—	—	20	—	—	20	—	—	volts
I_{DSS} ($V_{DS}=6\text{V}$, $V_{GS}=0$)	0.5	2.0	6.0	0.5	2.0	8.0	0.5	2.0	6.0	mA
V_{GS} ($I_D=50\mu\text{A}$, $V_{DS}=6\text{V}$)	—	—	-8	—	—	-8	—	—	-8	volts
Y_{fs} ($V_{DS}=6\text{V}$, $V_{GS}=0$, $f=1\text{kc}$)	400	750	1500	300	750	—	400	750	1500	μU
I_{GSS} ($V_{DS}=0$, $V_{GS}=-6\text{V}$)	—	—	1.0	—	—	50	—	—	1.0	μA
C_{is} ($V_{DS}=0$, $f=1\text{mc}$)	—	3.6	—	—	3.6	—	—	3.6	—	pF
$R_{DS(on)}$ ($V_{DS}=0.1\text{V}$, $V_{GS}=0$)	—	—	—	—	0.6	2.0	—	—	—	$\text{k}\Omega$
$R_{DS(off)}$ ($V_{DS}=0.1\text{V}$, $V_{GS}=0$)	—	—	—	50	—	—	—	—	—	$\text{M}\Omega$
t_{on} ($V_{DD}=6\text{V}$, $R_L=100\Omega$)	—	—	—	—	—	50	—	—	—	$\text{m}\mu\text{s}$
t_{off} ($R_{gs}=50\Omega$)	—	—	—	—	—	50	—	—	—	$\text{m}\mu\text{s}$
ΔI_{DSS}^* ($V_{DS}=6\text{V}$, $V_{GS}=0$, $t=0.5$ hour)	—	—	—	—	—	—	—	+0 -20	—	μA
NF ($V_{DS}=6\text{V}$, $I_D=0.5\text{mA}$, $f=1\text{kc}$, $R_g=10\text{M}\Omega$)	—	6	—	—	—	—	—	6	—	db

*Initial Drift

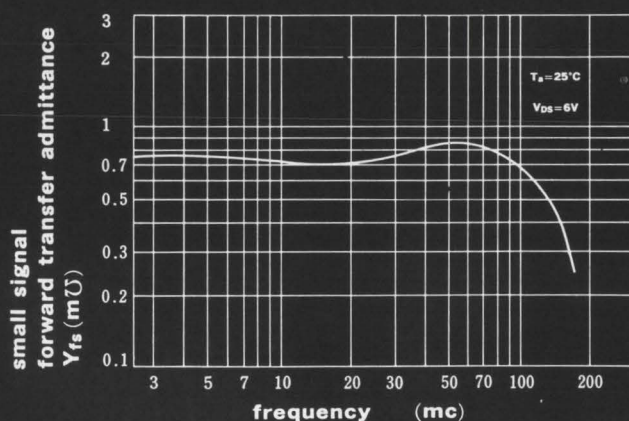

MAXIMUM RATINGS ($T_a=25^\circ\text{C}$)

V_{DSX}	20 volts
V_{GSX}	+2 -20 volts
V_{GS} (peak) ...	± 20 volts
I_D	10mA
P	100mW
T_{ch}	150°C
T_{stg}	-55~150°C

Now you know what the Hitachi Field Effect Transistors are all about.



HITACHI SALES CORPORATION: 333, N. Michigan Avenue, Chicago 1, Ill., U.S.A. Tel: 726-4572/4 / 666, 5th Avenue, New York, N.Y. 10019, U.S.A. Tel: 581-8844 / 12715, S. Daphne Avenue, Hawthorne, Calif., U.S.A. Tel: 757-8143 HITACHI, LTD., DUESSELDORF OFFICE: Graf Adolf Strasse 37, Duesseldorf, West Germany Tel: 10846

DTL

INTEGRATED CIRCUITS

IMMEDIATE AVAILABILITY

- GMe's Epitaxial DTL Family provides optimum performance at low cost per function.
- High noise immunity: Typ. 1 volt at 25°C.
- High speed: Typ. 17 nsec./ Fan-out: 8 minimum.
- Low Power Dissipation: Typ. 18 mw per gate function.
- Single and double power supply operation available.
- Dual source availability: Interchangeable on a pin for pin basis with Signetics parts.
- Available from all GMe distributors.



General Micro-electronics Inc.

Subsidiary of The Pyle-National Company

2920 SAN YSIDRO WAY • SANTA CLARA, CALIF. 95051
TWX: (408) 737-9961 PHONE: (408) 245-2966

GENERAL MICRO-ELECTRONICS, INC./DTL CROSS REFERENCE CHART		
GME CATALOG NUMBER	COMPETITIVE EQUIVALENT	DESCRIPTION
254G4	SE101	4-Input NAND/NOR GATE*
254G3	SE102	3-Input NAND/NOR GATE*
254G6	SE105	6-Input Gate Expander
254DA	SE106	Dual 5-Input Gate Expander
264P	SE110	3-Input Power Gate*
264D4	SE111	Dual 4-Input Power Gate
264E3	SE112	Dual 3-Input Power Gate*
264D3	SE113	Dual 3-Input Power Gate
264D2	SE115	Dual 2-Input NAND/NOR Gate
263DG	SE116	Dual 4-Input NAND/NOR Gate*
264B	SE124	RST Binary Element
264L	SE150	2-Input CLOCK/CAPACITIVE Line Driver
264B4	SE155	Dual 4-Input CLOCK/CAPACITIVE Line Driver
264E4	SE156	Dual 4-Input CLOCK/CAPACITIVE Line Driver*
264B3	SE157	Dual 3-Input CLOCK/CAPACITIVE Line Driver
264SS	SE160	One-Shot Multivibrator
264G9	SE170	Triple 3-Input NAND/NOR Gate
263Q2	SE180	Quadruple 2-Input NAND/NOR Gate
263Q	SE181	Quadruple Inverter
264D5	CS700	Dual 3-2-Input NAND/NOR Gate
264DR	CS701	Dual 3-2-Input NAND/NOR Gate
264MB	CS704	RST Binary Element
254D3	CS705	Dual 3-Input AND Gate
254DD	CS709	Dual 3-Input Gate Expander
264T2	CS727	Triple 2-Input NAND/NOR Gate* *Expandable

Did da Vinci do the same old thing, day in, day out?

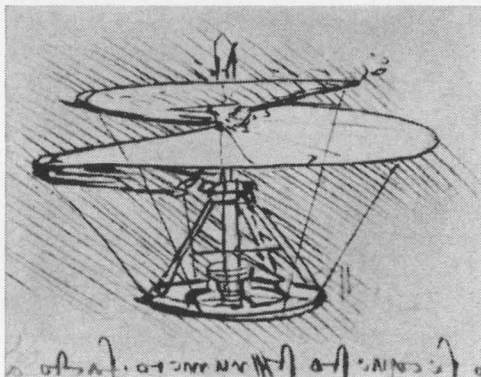

Leonardo's aerial screw or helicopter

Why should you?

An EE with six to ten years' experience (and maybe an advanced degree or two) has no business wasting his time on repetitive projects.

That's not the way we work at Sylvania/Mountain View. Our engineers work on one-of-a-kind problems. Originals that call for original solutions.

Our engineers work on a variety of activities. See right for some current openings. (But the list is only partial for the work we do in electronic warfare, electronic countermeasure systems, including intelligence systems, reconnaissance and anti-intrusion systems.)

One thing all our work has in common though—it calls for engineers who like to feel their capabilities are being challenged with each new project.

You can be assured of some pretty pleasant and convenient surroundings, too. Mountain View is 40 minutes south of civilized San

Francisco (and a good 400 miles away from Los Angeles). For educational advancement, Stanford and other prominent universities are located nearby.

If you would like more specific information about the "different" kinds of work you might do at Sylvania/Mountain View, send a resume to Manager—Professional Staffing, P. O. Box 188EL, Sylvania Electronic Systems—West, Mountain View, California. He'll see that you get a prompt, frank (and confidential) reply.

Transmitters/Transceivers

Design and develop a wide variety of compact, wide band, versatile transmitters and sophisticated small automated ECM systems.

Work emphasizes solid-state RF circuits and equipment design in all frequency ranges with challenges in all types of circuit and equipment design problems.

Receivers

Design and develop solid-state circuitry for all types of receivers involving IF, RF, low noise, video, DC amplifier design. Applications

will include latest solid-state and microwave components in both linear and non-linear circuits.

Signal Processing

Design and development of solid-state circuitry for low-noise, high-gain analog equipment and state-of-the-art digital techniques for use in complex signal analyzers, threat recognition, logic and decision circuitry.

Microwaves

Design and develop microwave components for experimental electronic warfare systems. Advanced solid-state components design such as tunnel diode oscillators and amplifiers, varactor devices.

Antennas

Design and develop broadband compact antennas such as horn and log periodic antennas of low frequency to millimeter range for ECM tracking and direction finding systems.

Optics

Investigate devices and techniques for modulation and demodulation of lasers for application in optical systems. Design and evaluation of optical receiving systems both coherent and incoherent in the visual and infrared regions.

GTE

GENERAL TELEPHONE & ELECTRONICS
Total Communications from a single source through

SYLVANIA ELECTRONIC SYSTEMS

An Equal Opportunity Employer

244-B

Leach's new power contactors are smaller and lighter than any power contactors meeting MIL-R-6106E. The model 9123, for example, measures only 3.305" x 3.73" x 2.532" and weighs less than 1.10 pounds.

True balanced armature design lets them take up to 50g shock and 25g vibration with a contact opening of less than 10 microseconds.

As for contact pressure, it's over one pound per contact. Together with contaminant-free construction, they easily comply with the minimum current requirements of MIL-R-6106E.

Contacts are attached directly to the header terminals to eliminate internal wiring. Not only that, the contacts utilize a "double-break" feature. Arcs are extinguished faster on contact break providing less contact erosion and longer contact life.

RELAY DIVISION: 5915 Avalon Boulevard, Los Angeles 3, California. Phone: (213) 232-8221 Export: LEACH INTERNATIONAL, S.A.

These new units are available in three contact ratings, all meeting the latest revised requirements in the aircraft and aerospace industries. The 9324, is the smallest, lightest, 3-phase, 20 amp AC contactor on the market. The 9123 (MS 27997) is a 25 amp AC or DC unit. The 9124 (MS 27222) will carry a 50 amp AC or DC load. And most important, special mountings are included to make them interchangeable with larger MS "top hat" contactors.

The full story on these extraordinary power contactors is in our new brochure. Write for it and compare the specs with the power contactors you're now using.

LEACH CORPORATION

**This very ordinary
looking little device can
switch a 50 amp power load and
withstand 25g vibration. That's
quite extraordinary**

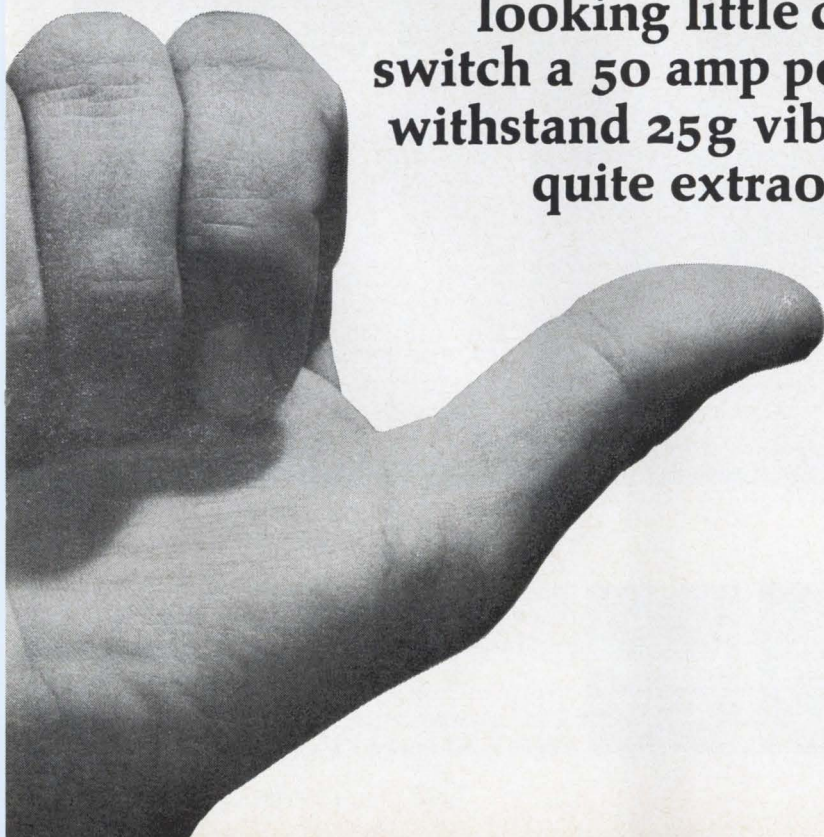

HOW TO GET A COMPONENTS CUSTOMER— AND KEEP HIM!

Be inventive, be bold, be pioneering. Give a free hand to Japan's most advanced research staff, and see if they don't come up with exciting achievements in the whole components field.

Establish a flawless system of production marked by rigid quality control. Check and check, and double-check all components, long before they're shipped to market.

Become Japan's largest, most respected manufacturer of a broad spectrum of components. Guarantee

the quality of your products. Guarantee their on-time delivery to any part of the world.

And when you get a customer, satisfy him. Talk his language. Know his needs.

Matsushita is all these things to its many customers throughout the world. Matsushita makes 28% of all electrolytics exported from Japan, 26.4% of all aluminum capacitors, 34.7% of all tantalum capacitors. Plus an uncommon range of electrical and electronic parts.

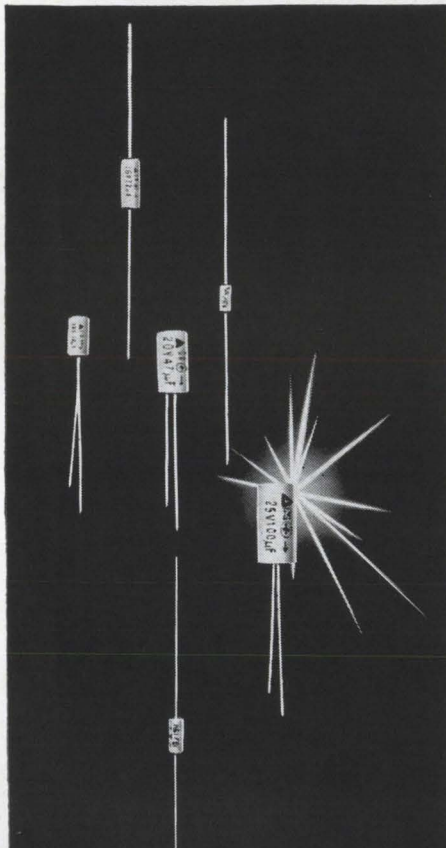

30% MINIATURIZED SOLID TANTALUM CAPACITORS
 Operating Temp. -55°C to $+85^{\circ}\text{C}$
 Working Voltage 3.15 to 35V DC
 Capacitance 0.047 to $470\mu\text{F}$

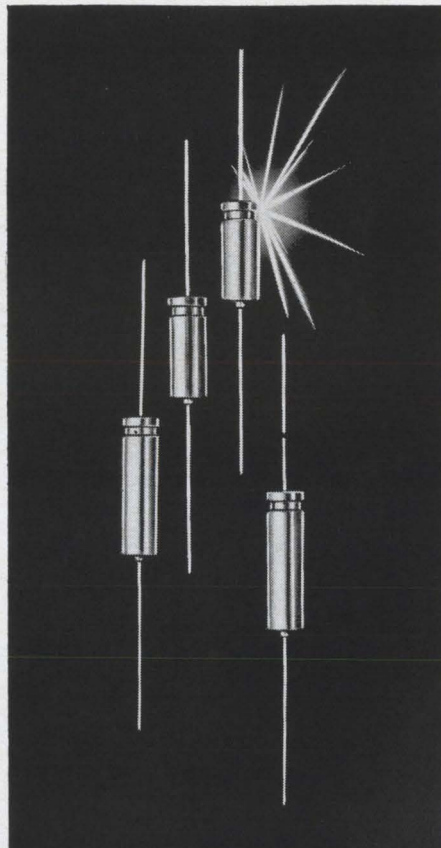

HIGH RELIABILITY ALUMINUM ELECTROLYTIC CAPACITORS
 Operating Temp. -55°C to $+125^{\circ}\text{C}$
 Working Voltage 3 to 50V DC
 Capacitance 1 to $100\mu\text{F}$

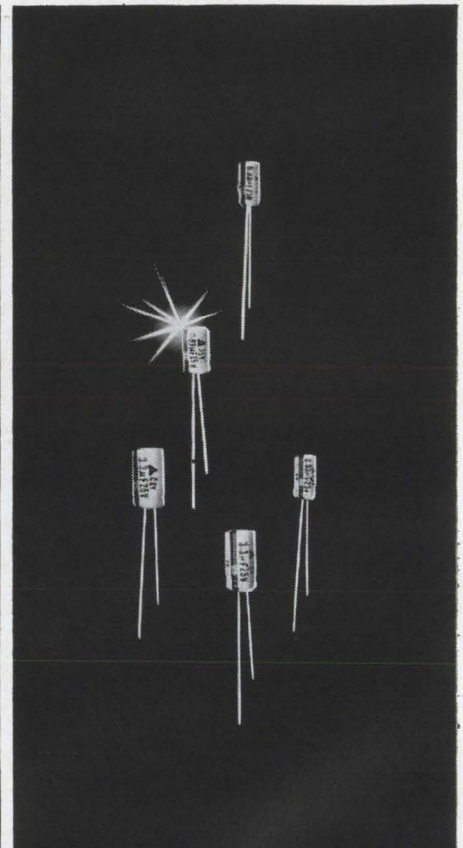

ALUMINUM SOLID CAPACITORS
 Operating Temp. -40°C to $+85^{\circ}\text{C}$
 Working Voltage 6 to 25V DC
 Capacitance 0.047 to $4.7\mu\text{F}$

For complete information and catalogues, write to (please mention "Electronics"):
 Matsushita Electric Corporation of America
 Pan-Am Building, 200 Park Avenue, New York,
 N. Y. 10017, U.S.A.
 Matsushita Electric(Hamburg) G. m. b. H.
 2 Hamburg 36, Jungfernstieg 40, F. R. Germany



Electronic Components Division
 Matsushita Electric
 Kadoma, Osaka, Japan

Japan's Largest Producer of Electronic and Electrical Home Appliances
MATSUSHITA ELECTRIC



**HIDDEN*
QUALITY**

MODEL 630 V-O-M



Standard
Of the
Industry

PRICE†
\$49.50

EXCLUSIVE TRIPLETT BAR RING
SHIELDED MOVEMENT

FUSED
SIMPLE TO
REPLACE
MULTIPLIERS
OR SHUNTS

HEAVY INSULATED CASE

EASY TO CHANGE
STANDARD BATTERIES

HIGH FLUX
MAGNET,
SPRING
BACKED
JEWELS
—FOR
RUGGEDNESS

SPARE FUSE

COMPLETELY WIRED CIRCUIT

FACTS MAKE FEATURES:

- 1** Popular streamlined tester with long meter scales arranged for easy reading. Fuse protected.
- 2** Single control knob selects any of 32 ranges—less chance of incorrect settings and burnouts.
- 3** Four resistance ranges—from .1 ohm reads direct; 4½ ohm center scale; high 100 megohms.

Attention to detail makes the Triplet Model 630 V-O-M a life-time investment. It has an outstanding ohm scale; four ranges—low readings .1 ohm, high 100 megs. Fuse affords extra protection to the resistors in the ohmmeter circuit, especially the XI setting, should too high a voltage be applied. Accuracy 3% DC to 1200V. Heavy molded case for high impact, fully insulated.

† 630A same as 630 plus 1½% accuracy and mirror scale only \$59.50

TRIPLETT ELECTRICAL INSTRUMENT COMPANY, BLUFFTON, OHIO

THE WORLD'S MOST COMPLETE LINE OF V-O-M'S.
AVAILABLE FROM YOUR TRIPLETT DISTRIBUTOR'S STOCK.



**FINEST
OF ITS KIND**



Portable

\$349.50

True Dynamic Mutual Conductance

**MODEL 3444
TUBE ANALYZER**

FACTS MAKE FEATURES:

- 1** The only tube tester under \$1,000 that is simple and fast to operate, and will measure tube characteristics at known readable potentials.
- 2** The only tube tester under \$1,000 that is simple and fast to operate, and provides readings to:
 - (a) Plot tube characteristic curves.
 - (b) Measure grid current at known potentials.
 - (c) Compare cutoff characteristics of dual tubes.
- 3** The only tube tester under \$1,000 that is simple and fast to operate, and reads directly in micromhos with a self checking Gm circuit.

This superb unit speedily and accurately solves the most perplexing tube analysis problems. Measures true Gm without any compensating factors; using proper value DC electrode potentials. Checks PLATE current cutoff. Checks GAS under actual operating conditions. Checks RECTIFIERS under load. Checks THYRATRON firing voltage and grid currents. Checks DUAL section tubes with only one lever movement. Provides SHORTS and leakage measurements from 0-10 megohms using a filtered DC supply of 85 volts. Case: Wood, gray leatherette covered, 15¾" x 18¾" x 7¾".

TRIPLETT ELECTRICAL INSTRUMENT COMPANY, BLUFFTON, OHIO

THE WORLD'S MOST COMPLETE LINE OF V-O-M'S.
AVAILABLE FROM YOUR TRIPLETT DISTRIBUTOR'S STOCK.

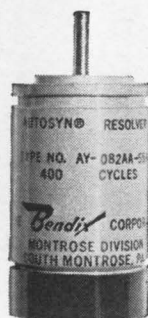

(Actual size)

The newest, finest Bendix Autosyn Synchros won't carry much weight.

Unless you consider the 1.3 ounces typical of the new Size 08 Autosyn® Synchros "much". Which most engineers don't. And which, when coupled with the fact that the 16 new Size 08 Synchros boast a maximum diameter of just 0.750 inch, is enough to influence almost every weight- and size-critical design on the drawing boards.

But subminiaturization is only one of the talents Bendix Autosyn Synchros offer you. All sizes (08, 10, 11, 15 and 22) are available in stainless steel or aluminum housings, for instance. Some are accurate and stable at operating temperatures as high as 800° F, which makes them ideal for use in supersonic aircraft. Others are

built for increased radiation resistance. And hundreds more are specifically designed for aircraft instrument applications.

There's certain to be an Autosyn Synchro that's right for your needs. To find out which one, call us at 717, 278-1161, in Montrose, Pennsylvania. Or write for our new 42-page catalog.

Montrose Division



Inside story of the new look in series regulators

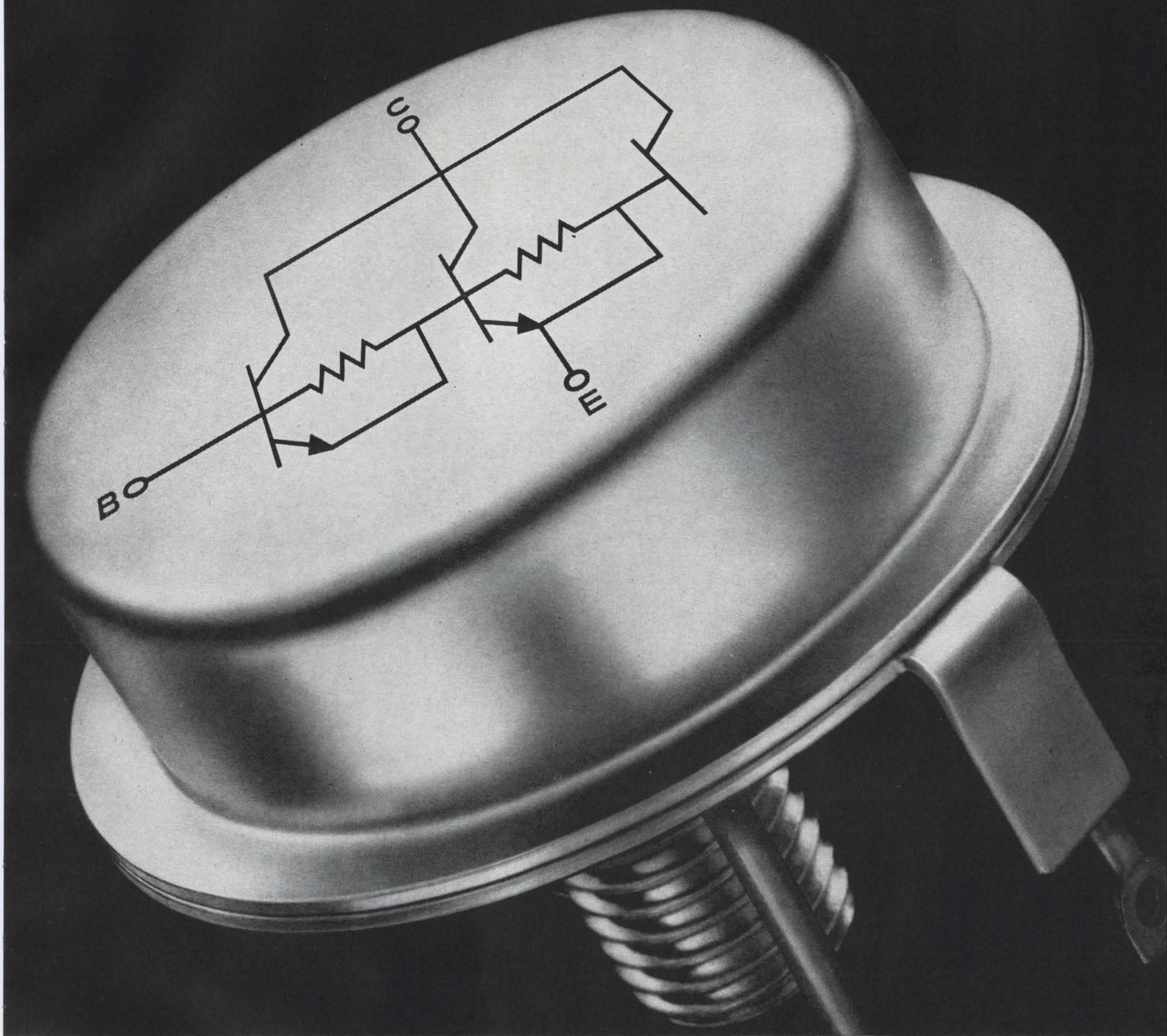

Westinghouse power integrated amplifiers eliminate a complete driver stage.

Save space, improve reliability, cut costs with Westinghouse power integrated amplifiers. Types 2N2233 and 2N3477 provide exceptionally high gain at high power levels— $h_{FE} = 400$ at 10 amps I_c , $V_{CE} = 200$ volts and $P_D = 150$ watts. Single and double ended packages provide complete design flexibility. Check these exclusive features:

- Hard soldered junctions eliminate thermal fatigue.
- Large emitter-base area puts an end to secondary breakdown.
- True monolithic construction stops runaway leakage.

SINGLE ENDED	DOUBLE ENDED	V_{CE}	h_{FE}
2N2226	2N3470	50	100
2N2227	2N3471	100	@
2N2228	2N3472	150	10A
2N2229	2N3473	200	
2N2230	2N3474	50	400
2N2231	2N3475	100	@
2N2232	2N3476	150	10A
2N2233	2N3477	200	

You can be sure if it's Westinghouse



And, of course, reliability is assured by the exclusive Westinghouse Lifetime Semiconductor Guarantee.* For full information call your Westinghouse salesman or distributor, or write to the Westinghouse Semiconductor Division, Youngwood, Pennsylvania.

*Westinghouse warrants to the original purchaser that it will correct any defect or defects in workmanship, by repair or replacement f.o.b. factory, for any JEDEC-type silicon power semiconductor during the life of the equipment in which it is originally installed, provided said device is used within manufacturer's published ratings and applied in accordance with good engineering practice. This warranty is applicable to devices of the stated types shipped after March 9, 1964, until further notice. This warranty shall constitute a fulfillment of all Westinghouse liabilities in respect to said products. This warranty is in lieu of all other warranties expressed or implied. Westinghouse shall not be liable for any consequential damages. SC-2050

Circle 123 on reader service card

FOR THE FIRST TIME :

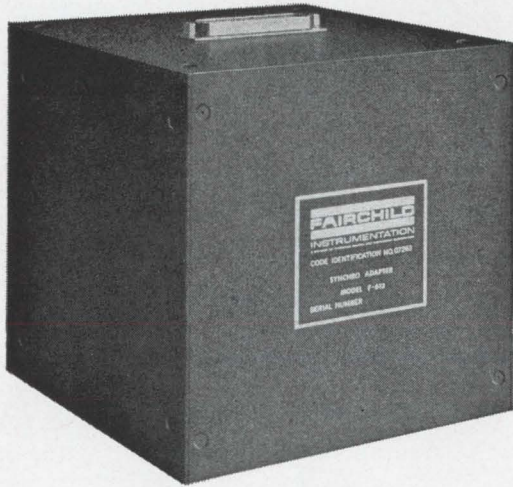

SIZE: 250 cubic inches
THE F-613 SYNCHRO ADAPTER MODULE FOR USE WITH
THE F-615 A/D CONVERTER

SYNCHRO TO DIGITAL CONVERSION— INTEGRATED CIRCUIT RELIABILITY

Now data systems designers can convert synchro or resolver signals to digital output with Fairchild's new F-613 and F-615 microcircuit modules. Integrated circuitry gives these modules exceptional reliability, small size and low cost—ideal for airborne and ground support instrumentation as well as industrial controls and navigation systems. The block diagram below illustrates how the F-613 and F-615 combine to convert synchro or resolver voltages to digital output.

Add synchro conversion to your own data system. Building block construction permits the systems designer to add only the functions he needs to his existing system. For example, the F-613 module may be used with any suitable A-D converter.

Check these design features:

Operating Temperature Range:
-54°C to 71°C

Resolution: 13 Bits (when used with
F-615 A-D Module)

Accuracy: +0.05% ±½ least
significant bit (standard) higher
on request

Designed to meet
MIL-E-5400, Class 2

TYPE	DESCRIPTION OF OTHER MICROSERIES 600 MODULES
F-611-5	Microplexer, Basic 5-Channel Multiplexer
F-612	Microstrobe, Sample and Hold
F-614	Microadapter, AC-DC Adapter
F-624	Microadapter, Digital-AC Adapter
F-625	Microverter, Basic Digital-DC Converter
F-632	Microregulator, Reference Voltage
F-633	Microregulator, Line Voltage
F-634	Microadapter, Digital-Synchro Adapter

MICROSERIES F-613/F-615 SYNCHRO TO DIGITAL CONVERSION SYSTEM

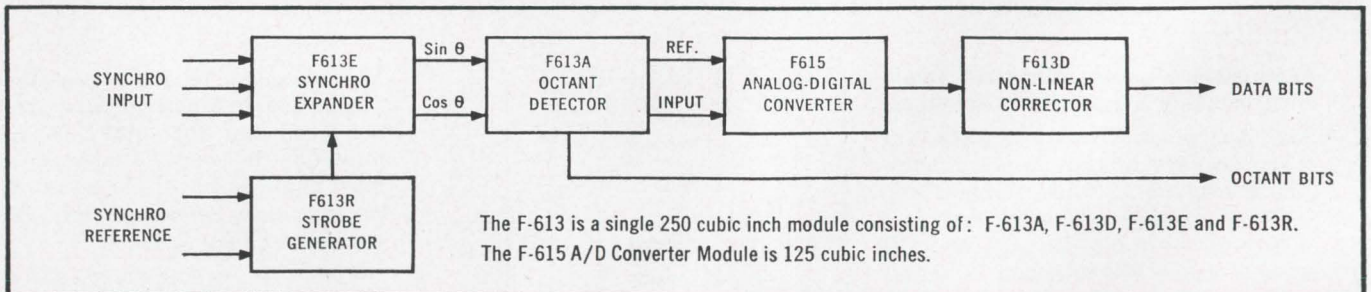

FAIRCHILD
INSTRUMENTATION

Probing the News

Space electronics

France joins the space age club

The successful launch of its first satellite was technically unimpressive but it became a membership card in the world's most exclusive organization

By Robert Farrell

Paris News Bureau

The 88-pound satellite that roared into orbit from its launch pad in the Algerian Sahara Nov. 26 was not a complete technical success, but it was a resounding political coup. It made France a member of one of the most exclusive and costly clubs in the world—the space age club. There are only two other members—the United States and the Soviet Union.

The A-1 satellite's main purpose—to test the French-developed, three-stage Diamant booster—was accomplished: the booster worked well. Transmission from the satellite, however, was almost a flop: one of the satellite's four antennas apparently was damaged during powered flight. This lack of transmission almost spoiled the second purpose of the launch—to test France's two satellite ground station networks, called Diane and Iris. Diane consists of tracking stations at the Hammaguir launch base in the Sahara and Pretoria, South Africa. Iris has telemetry and control stations at Hammaguir, Pretoria, Ouagadougou in West Africa, and in Beirut, Lebanon.

During the first orbit, neither Iris nor Diane picked up a signal. On the second pass, Hammaguir picked up a faint noise—enough to know the A-1 was in orbit. The equipment on board the satellite—for the most part silent—consists of a radar transponder and two transmitters; one is a beacon and the other is for telemetry. Batteries on board were supposed to keep the

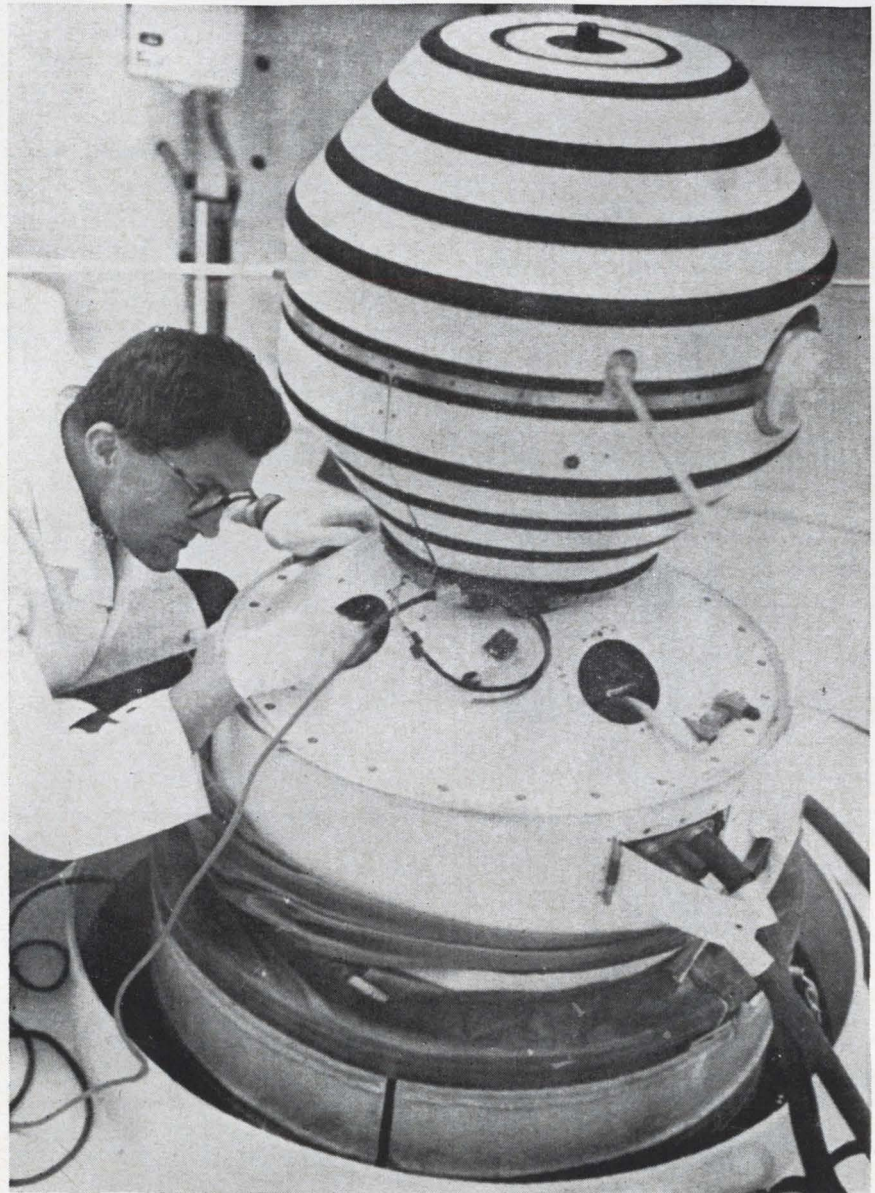

Transmission from France's first satellite was late, weak and short-lived, but it proved that the Diamant booster worked—and well.

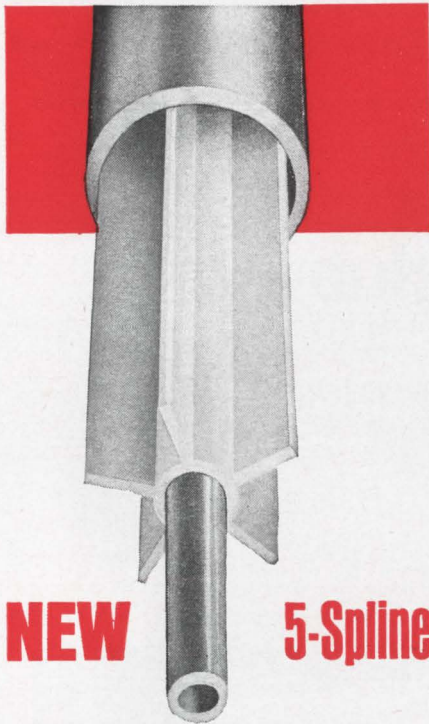

NEW

5-Spline

Coaxitube

**50-ohm Semi-flexible
Air-Dielectric Coaxial Cable**

This new Precision product is a unique semi-flexible coaxial cable for low-loss RF transmission. Five linear splines of Teflon* support the center conductor within a seamless aluminum or copper tube—achieving essentially an air-dielectric coaxial cable, light in weight and mechanically strong. Can be supplied with a jacket of vinyl or Teflon. **Let's discuss how you might use it.**

*Du Pont Trademark

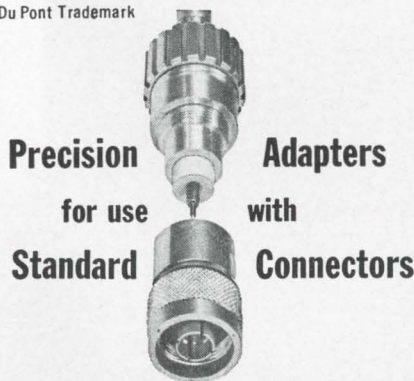

With this special adapter designed by Precision's engineers, Coaxitube can be terminated in standard UG connectors—with no deviation of electrical characteristics.

YOUR BEST DECISION:



PRECISION
TUBE COMPANY, INC.
North Wales, Pa.
Phone: (215) 699-4806—Telex: 083-381

equipment going for 15 days. The orbit was intended to last a year, and probably will since the 330-mile perigee and the 1,090-mile apogee keep it above atmospheric drag. The period of revolution is 108 minutes.

I. Space budget

France's space program, of course, is modest by comparison with programs in the United States and Soviet Union. France currently is spending only 1 percent of the amount the U.S. is spending, and no man-in-space project is planned.

In 1962 when France's civil space program got under way, the Centre National d'Etudes Spatiales (CNES)—the French equivalent of the U.S. National Aeronautics and Space Administration—had a budget of approximately \$18 million. This year, the CNES budget is up to \$57 million and in 1966 will total \$74 million.

Actually, CNES officials complain that they are getting about 40 percent less than they are requesting. Gen. Robert Aubiniere, CNES boss, considers an annual \$100-million budget to be a minimal one. The space agency, in fact, has been forced to limit its programs because of the budget squeeze.

Still, it's misleading to judge French space efforts entirely by the CNES budget. Because France has military ambitions, including the development of long-range, ground-to-ground strategic missiles and Polaris-type missiles for nuclear submarines, there is a good deal of military fallout on the French civil space effort.

CNES Diamant launcher is an example. The rocket is being financed almost entirely by the French defense ministry. So, the development of this \$100-million CNES booster has not cost the space agency any budgetary headaches. Yet it's the Diamant that has enabled France to proclaim itself number three in space.

II. Space plans

France, however, does not intend to confine its space effort to national programs. It is participating in the European space launcher project by building the second stage of the Europa rocket. It is also working on a satellite program

with NASA. The first one, designated FR-1, was scheduled to be launched Dec. 6 by a NASA Scout booster from Vandenberg Air Force Base, Calif.

The FR-1 satellite, designed and developed by CNES, is France's first scientific satellite. Scheduled to be launched into a near-polar orbit, the FR-1 was designed to measure the effects of the earth's magnetic field on very-low-frequency propagation. The experiment was to involve continuous radiation of signals from two ground stations, one in France and the other at Balboa, Panama. The satellite antenna system was to assist in tracking vlf signal propagation along the flight path and in measuring signal strength direction and signal-noise ratio.

Three more satellites will be launched from Hammaguir powered by Diamant boosters. In Janu-

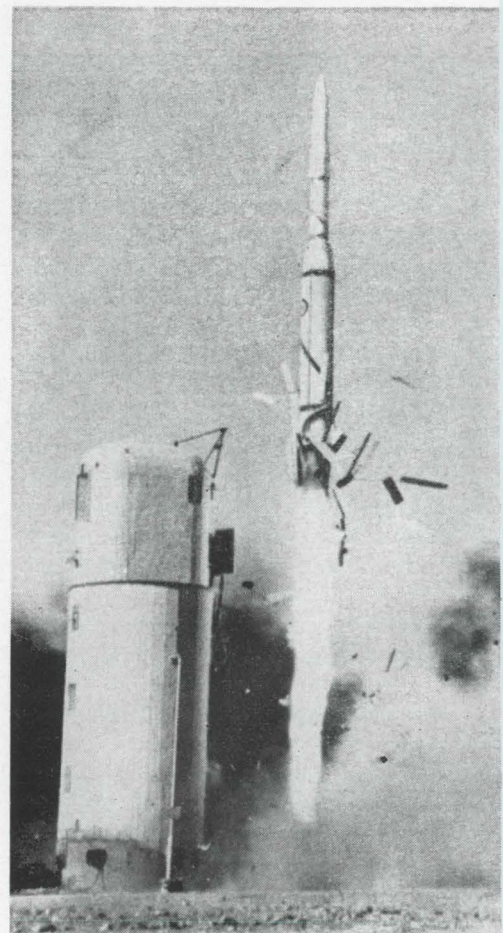

France's A-1 satellite, launched Nov. 26, should stay up about a year. The satellite succeeded in one mission and flopped in another. The booster worked well, but the transmission in flight was poor, apparently because of a damaged antenna.

ary, the 80-pound D-1 satellite will go up—the first French scientific satellite orbited by a French booster; later, the D-1B; and in mid-1967 the 175-pound D-1D.

After mid-1967, the French will shift their space shots to a new \$60-million launch center now under development in French Guiana, in South America. This base, which will employ some 25,000 people, will not be completely finished until 1969 [Electronics Nov. 1, p. 159].

In all, the French have orbited one satellite and scheduled four more flights. In addition, the French hope to work out a new agreement with NSA for launching a meteorological satellite with a NASA booster sometime in 1967 to 1968.

III. Market

As might be expected, the bulk of the electronics business is handled by French electronics companies such as Compagnie Francaise Thomson-Houston and the Compagnie Generale de Telegraphie Sans Fil (CSF). One of the reasons for the French effort is to keep its companies proficient in advanced technology.

Initially, the French leaned on a U.S. supplier for such satellite components as silicon cells but now these items are being developed by Societe Anonyme de Telecommunications.

U.S. companies are involved if they have French affiliates, such as the International Telephone and Telegraph Corp.'s wholly-owned subsidiary, Laboratoire Central des Telecommunications (LCT). They can also sell to France if they develop equipment so superior that the French have no recourse but to buy from the U.S.

When France moves its space activities to French Guiana, there may be more opportunity for U.S. business. Although CNES has already ordered its two big tracking radars from Thomson-Houston—similar to the Radio Corp. of America's AN/FPQ-16 missile range standbys—two digital computers must still be purchased and two new telemetry stations must be outfitted.

France hopes the favorable location of the site for launching will attract many foreign users.

LOOK WHAT YOU CAN DO WITH THIS

Aeme  Electric

POWER SUPPLY

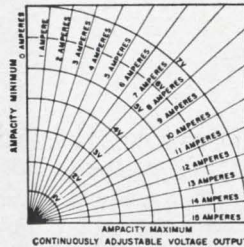

Here is a power supply designed to be a laboratory or production line work horse. Circuitry is simple, components are rugged—it is unsophisticated in design—no flashing lights, bells or buzzers. It will provide a dependable D.C. output continuously variable over a range from 0 to 7 volts with maximum ampacity of 15. Ripple less than 2%. Priced right.

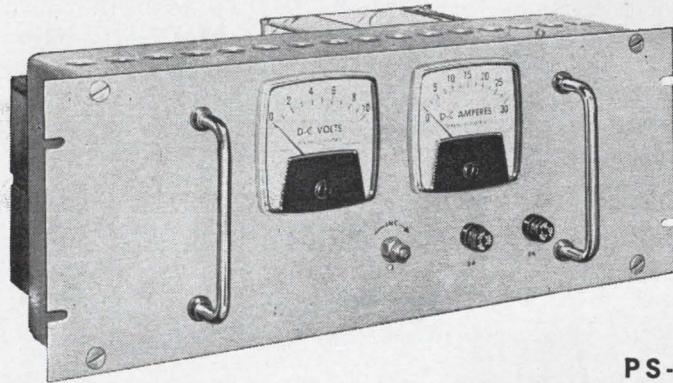

PS-57350

CONSTRUCTION AND COMPONENT FEATURES OF THE PS-57350 POWER SUPPLY

Input voltage range 100 to 130 volts: constant voltage transformer provides $\pm 1\%$ line regulation: continuously adjustable autotransformer regulates input voltage to isolated stepdown transformer: continuous duty solid state rectifier: computer grade, electrolytic filter capacitors: easy reading D.C. voltmeter: easy reading D.C. ammeter: two external input line fuse holders: size of panel 19" x 7" x 10"

OR CHOOSE FROM THESE STOCK MODELS

Catalog Number	D. C. OUTPUT			Max. Ripple	Max. Line	Reguln. Load
	Volts	Amps	Watts			
PS-57360	23-28	2	56	1%	$\pm 1\%$	2%
PS-57361	23-28	3	84	1%	$\pm 1\%$	2%
PS-57362	48-54	4	216	1%	$\pm 1\%$	2%
PS-57363	24, 24	15/2	360/48	1%	$\pm 1\%$	2%
PS-57364	24, 125	2/0.5	48/62.5	1%	$\pm 1\%$	2%
PS-57365	24, 125	1/3	24/375	1%	$\pm 1\%$	2%
PS-1-6757	0-45	0/2.5	112.5	-1%	$\pm 1\%$	5%
PS-39600	0-50	0/5	250	-1%	$\pm 1\%$	3%

Catalog 175 illustrates and gives specifications on 42 other stock model Power Supplies. Write for a copy.

Aeme  Electric

Engineers and Builders of...

3112 WATER STREET, CUBA, NEW YORK

Canadian Representative: Polygon Services, Ltd.
50 Northline Rd., Toronto 16, Ont.

SAA-3932-3221

REGULATED POWER SUPPLIES
STATIC POWER RECTIFIERS
VOLTAGE STABILIZERS
VOLTAGE REGULATORS

Hong Kong adds quality electronics to its bargain basement line

Growth comes from production of components, television parts, and better products at new American plants

By David Roads

McGraw-Hill World News

Hong Kong, for years a producer of cheap single-band transistor radios, is tuning into a wider electronics business wavelength. Pressed by the cheap sets of Taiwan and sparked by American interest, the old bargain-basement Colony is humming with talk of diversification, new markets, and im-

proved and better-looking products. Though the growth rate this year will fall short of doubling—it has doubled annually for the past four years—businessmen are pleased that the increase will come as much from manufacture of more sophisticated products as from the inexpensive radios, which last

year brought in \$16 million.

The brightest news in Hong Kong has been the success of the component producers. At the Department of Commerce and Industry, assistant trade officer F. S. L. Young predicts exports of semiconductor devices will hit \$7 million in 1965.

Businessmen are pleased, too, by the news that the United States has become its biggest electronics customer, picking up slack caused by a new United Kingdom surcharge of 15%.

I. Easy to read

United States companies moving to Hong Kong have gone there for several reasons. The Colony is one of the freest places in the world. Export and import licenses can be obtained in a matter of hours. It has British laws, written in English, making it easy for American executives to understand the few regulations the Colony imposes on manufacturers. And then there are the bargains in labor, components, and investment.

The Japanese transistor radio manufacturers, who preceded the Americans to Hong Kong by eight years, went there to bypass import quotas imposed by Commonwealth countries.

Among U.S. companies that have moved to Hong Kong are Arvin Industries, the Fairchild Semiconductor division of the Fairchild Camera & Instrument Co., the Oak Electronics Co., and the Ampex Corp. And rising smartly in the suburbs of Kowloon, a ferry ride across the bay from the island of Hong Kong, is the nearly com-



Transelectronic Ltd., plant being built in the Hong Kong suburb of Kowloon is one example of how the island's electronics industry is maturing. The new company will produce quality radios—over a million the first year, management hopes.

What's new about joining metals to glass or ceramic?

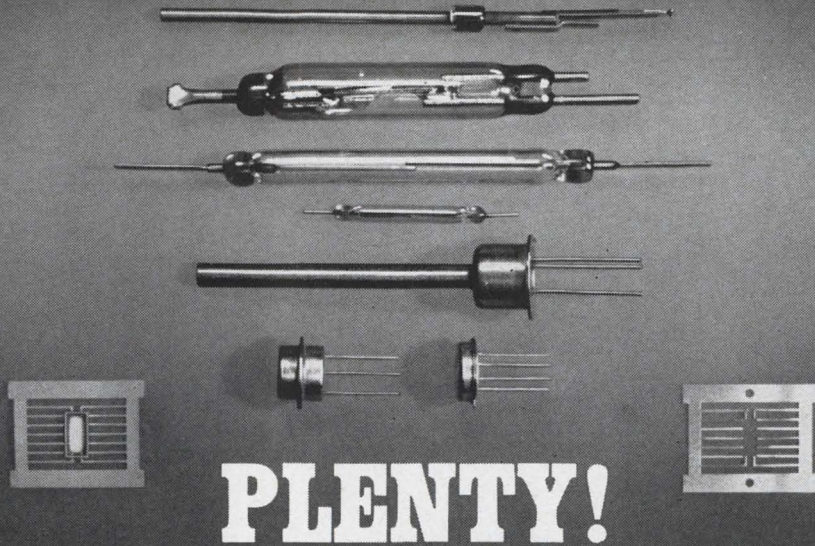

If you haven't been calling Carpenter.

Fact No. 1. Carpenter offers you the widest selection of glass sealing alloys available today. This increases your opportunity to meet expansion characteristics more precisely. It strengthens the possibility of doing it with the most economical alloy . . . or one that is easier to fabricate.

Fact No. 2. Our long-term experience as a producer of glass sealing alloys enables Carpenter to evaluate your project more thoroughly . . . with more flexible thinking. This includes help in the selection of the glass or ceramic itself.

Fact No. 3. Carpenter's production techniques—particularly as a leader in vacuum melting—give you quality which can also reduce component costs, and assure predictable performance from heat to heat and shipment to shipment.

Fact No. 4. Rigid quality controls insure more uni-

form physical and mechanical properties. For example, our ability to control grain size in strip gives you better forming characteristics . . . permits deep drawing without "earring".

Fact No. 5. As the developer and patent holder of the world's first gas-free glass sealing alloy, Carpenter offers you improved glass sealing characteristics. And you get them without any change in thermal expansion behavior.

Fact No. 6. Because no other company offers you such diversified experience in the field of glass sealing alloys, you have everything to gain by calling Carpenter. Why not do it today? Contact your Carpenter Representative for qualified assistance. Or, if you prefer, write for our 72-page booklet on "Alloys for Electronic, Magnetic and Electrical Applications". The Carpenter Steel Company, 170 W. Bern Street, Reading, Pa.

Carpenter steel
IN A WORD, CONFIDENCE

ELECTRONIC, MAGNETIC AND ELECTRICAL ALLOYS • HIGH TEMPERATURE ALLOYS • TOOL AND DIE STEELS • STAINLESS STEELS • SPECIAL-PURPOSE STEELS • TUBING AND PIPE • FINE WIRE SPECIALTIES

A date to jot down:
Feb. 3-8 1966
PARIS
 (at the Porte de Versailles)

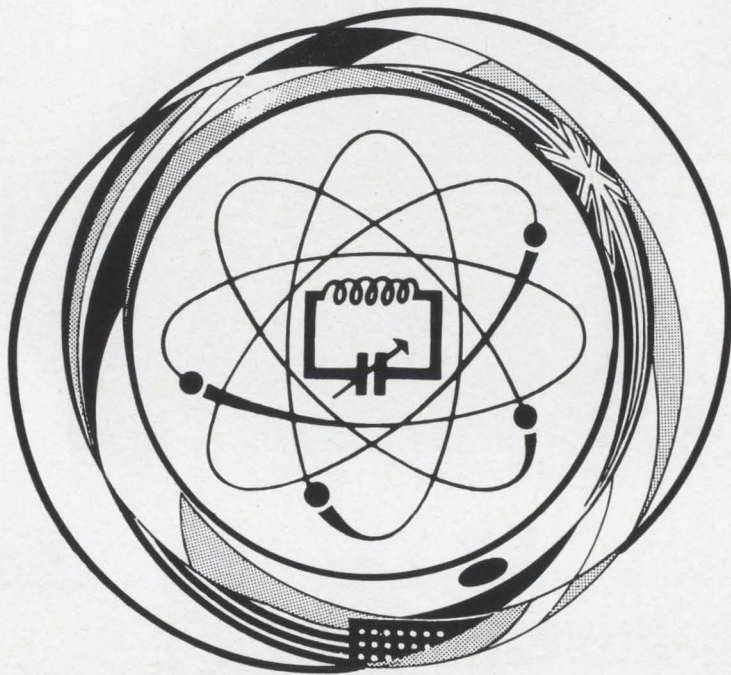

Electronic industry's first world-wide reunion of 1966 at the international exhibition of

ELECTRONIC COMPONENTS

and at the International
Audio Equipment Show

The latest advances in electronic technology: components, tubes and semi-conductors; measurement and control equipment, audio-equipment. For information and literature, please write to: S.D.S.A. 16 rue de Presles—Paris 15° tel: 273 24 70 Official carrier: Air France, Overseas Trade Show Department, 683 Fifth Ave.—New York, N. Y. 10022

PUBLIC SERVICE
 PARIS



For official invitation, fill out and return the attached form to: **S.D.S.A. Relations Exterieures**
16 rue de Presles—Paris 15° France

Name

Firm

Address

pleted home of Transeletronics, Ltd., the new Asian joint venture of the International Telephone and Telegraph Co. and the Zenith Radio Corp. Token production of radio sets is scheduled to start this month; next year the plant is expected to produce over a million sets.

Happy. Many Hong Kong residents see Tranelectronics as new evidence of the maturing of the electronics industry. The sets will be engineered by Zenith—in fact, Zenith will have a design engineer at the plant. Usually, radios are fabricated to circuits supplied by a components supplier.

Fairchild, which started production late in 1963, moved this autumn to larger quarters because its output of semiconductor devices has grown so rapidly. Oak's plant, in production a little more than a year, has already moved into the black, way ahead of schedule. Arvin came to the mainland in 1964. Exports of television parts, such as very high frequency tuners, produced primarily by Oak Electronics, may reach \$2.5 million this year, up from \$170,000 last year.

Growth ahead. Most component producers in Hong Kong can see only increasing business ahead. Many, like a subsidiary of the Sprague Electric Co. expect to supply a lot of parts to the Philco Corp.'s new television and radio plant in Taiwan, when it starts producing late in 1966.

The component men reflect the talk of radio assemblers in Hong Kong who now import almost all their components from Japan but who would like to buy them locally. A few small suppliers have already started producing such components as capacitors, coils, transformers, loudspeakers and printed circuit boards.

Although the assemblers have eyed the Fairchild operation in Hong Kong longingly, nobody is yet buying Fairchild's semiconductor devices. One reason is that Fairchild makes only silicon transistors and the assemblers use germanium. Said a radio executive, "Unless a silicon device is designed especially for a radio application its signal-to-noise ratio is bad."

II. Fallout easing

The other reason is price. Many

of Hong Kong's radio producers buy transistor fallouts from Japanese companies — devices that haven't met the semiconductor manufacturer's specifications. Even after sorting, the units cost only two or three cents a piece.

But this too is changing. E. P. Wethey, president of Transelectronics Ltd., has been studying the operation of other Hong Kong radio assemblers and he notes, "More and more companies are buying components against specifications instead of buying fallouts."

Still, radio production is the backbone of Hong Kong's electronics industry today. In 1964, the industry produced nearly 4 million sets, valued at \$16 million. In the first seven months of 1965, 3 million sets were produced worth \$9 million.

The decline in gross income from sales of radios—and a sharp reduction in average price to \$3 a set this year from \$4 a set last year—illustrates Hong Kong's chief problem. Competition from Taiwan has cut prices sharply, particularly for the pocket-sized, single-band radio, which has been Hong Kong's strength.

Less expensive. Because Taiwan labor is clearly cheaper [Electronics, Nov. 1, 1965, p. 114] many electronics companies in Hong Kong are now developing more sophisticated sets, 7- to 10-transistor units with several bands, a-m/f-m sets, and some shortwave units. And some of the firms are building handsomer, more attractive radios.

International Service Corp. Ltd., which started producing radios just four years ago and grew to nearly \$2 million sales in 1964, felt the pinch so sharply, it was forced to take in contract work. For 1966, however, its president, George M. Baker plans some new products. One is a waterproof radio for yachting enthusiasts and beach parties. Then, too, he'll be putting a line of multiple-band sets in teak cabinets instead of cheap plastic. Later he may add stereo receivers in teak cabinets. In addition he's adding production of f-m radio sets.

III. Gathered forces

Wireless Products Ltd., the second largest producer of radios in the Colony, fared better—enjoying

Circle 131 on reader service card →

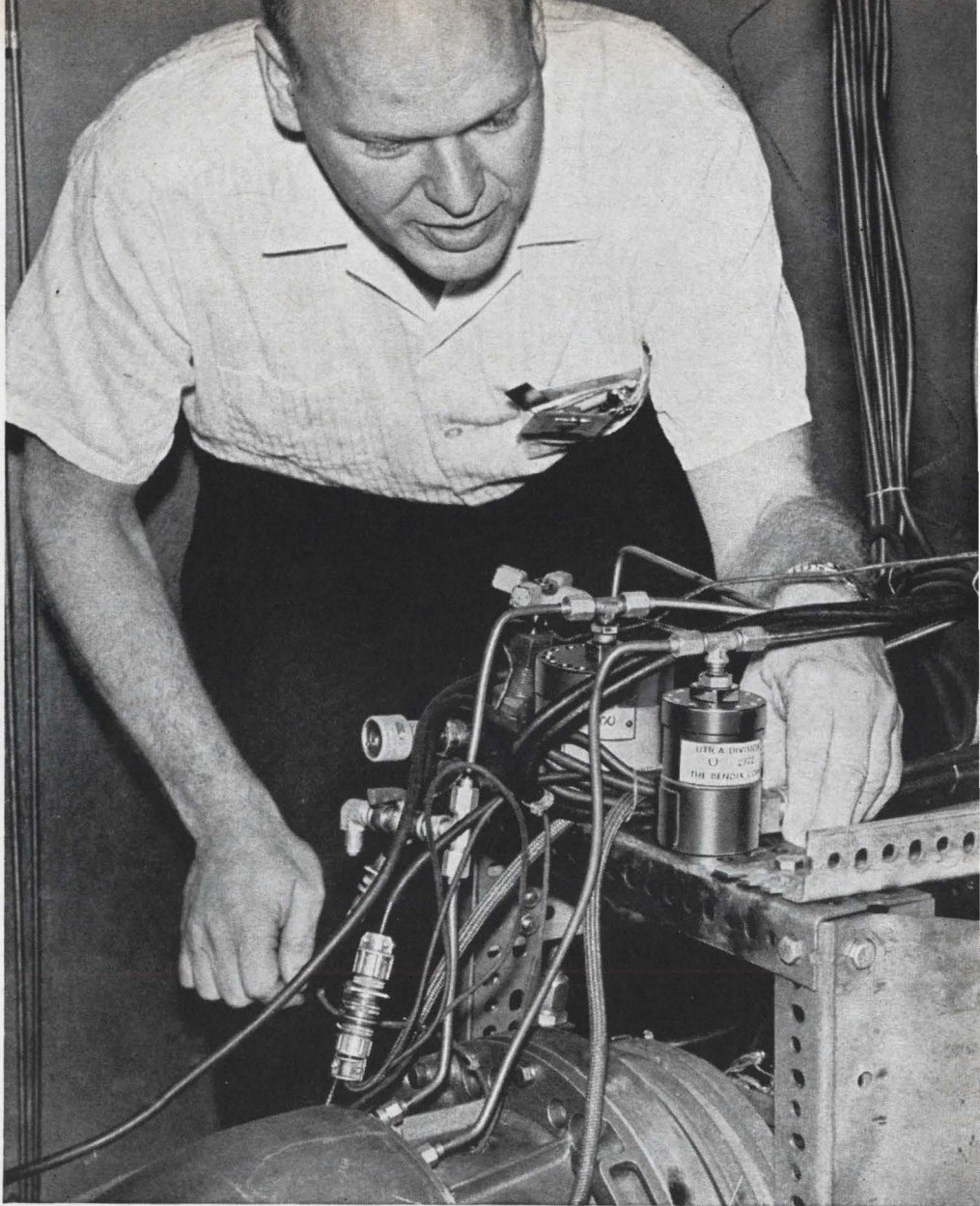

Taber Teledynes® used for reliable tests of Bendix turbine starter

Installed on a test stand at The Bendix Corporation's Utica Division, the two Taber TELEDYNE® Pressure Transducers shown above are used to measure pressures for oscillographic recording so that temperature, time, voltage, current, pressure and speed of an air turbine starter can be correlated.

Bendix test engineers say, "Taber transducers are chosen here because they provide the high degree of accuracy and reliability required for our type of work."

Regularly selected for numerous in-flight, ground support and test applications, Taber TELEDYNE® Bonded Strain Gage Pressure Transducers offer: high overpressure protection, long life, high reliability, infinite resolution, excellent stability and low sensitivity to temperature, shock and vibration.

For detailed information, write: Aerospace Electronics Division, Taber Instrument Corp., Section 158, 107 Goundry St., N. Tonawanda, N. Y.

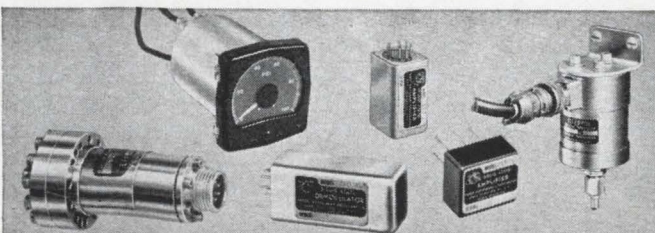

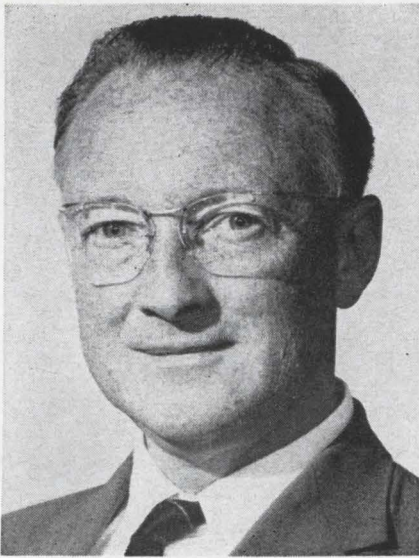

E.P. Wethey, president of Trans-electronic Ltd., says the Hong Kong market for quality components is growing.

substantial increase in sales. Last month it moved to its own eight-story building from scattered lofts in two buildings. In its new plant the company has the capacity to produce 180,000 radios a month. This year, its sales should approach \$4 million. Only last month, the company chartered an airplane to fly 80,000 radios to Kayson's International Ltd., an importer in Los Angeles, an indication of how good its business is.

The shipment indicated another change in Hong Kong electronics: the U.S. has become its biggest customer by far. As recently as 1963, the United Kingdom ranked as the biggest buyer when it imported 46.7% of Hong Kong's electronics output; U.S. companies bought 36.6%.

This year, United Kingdom imports fell sharply because of a reduction in demand and the 15% surcharge imposed in March to protect the British pound sterling. In the first seven months of 1964, the U.K. bought 731,000 Hong Kong radios, worth \$3.3 million. In the same period this year, the country imported only 457,000 sets at a value of \$2.06 million. Meanwhile, from January through July, U.S. companies bought nearly 2 million sets, costing \$6.1 million.

New markets. Obviously, Hong Kong radio producers would have been in serious trouble if some new markets had not developed, particularly in Canada, Southeast Asia, the Middle East and Africa.

With apparently dim prospects in hand, why did IT&T and Zenith pick Hong Kong for its new plant? Wethey, who surveyed many other locations including Portugal and Taiwan, lists a handful of advantages:

- Hong Kong is near a good source of components in Japan and a components industry is building up in the Colony. That's important since the expense of components accounts for nearly three-fourths the cost of a radio.

- Export and import licenses can be obtained quickly. Wireless Products Ltd.'s president, A. I. Cappon, who has been in the radio-manufacturing business in the Far East for 12 years commented: "Hong Kong is the only place where you can build radios before lunch and have them on a boat before supper."

- Its few laws are written in English.

- Labor is cheap. A female worker receives about \$1 a day for the first three months, advancing to \$1.13 per day eventually. Even though skilled technicians are in short supply, they earn only between \$2.09 and \$2.61 a day.

- Local banks are the most generous in the world. "They'll even lend you an umbrella," quipped one executive. Hot money from all over Asia flows into them looking for investment opportunities.

IV. At their mercy

One advantage Transelectronics has over other Hong Kong producers is a built-in sales force. Zenith and IT&T will take all of its production. Other companies do business with the hundreds of buyers that flock to Hong Kong looking for bargains. Commerce Department's Young explained, "We are at the mercy of buyers. We have to give them what they want." What the bargain lookers want has led to some questionable practices. For example, because the buyers relate the price by the number of transistors in a set, a few manufacturers use transistors as diodes, just to boost the total. You can find single-band pocket transistor radios with anywhere from 6 to 12 transistors; sometimes as many as four of them with only two of their three leads connected.

To shake off such buyers, the In-

DELCO RADIO SEMICONDUCTORS AVAILABLE AT THESE DISTRIBUTORS

EAST

BINGHAMTON, N. Y.—Federal Electronics, Inc.
P. O. Box 1208/PI 8-8211
PHILADELPHIA 23, PENN.
Almo Industrial Electronics, Inc.
412 North 6th Street/WA 2-5918
PITTSBURGH 6, PENN.—Radio Parts Company, Inc.
6401 Penn Ave./361-4600
NEWTON 58, MASS.—Greene-Shaw Company
341 Watertown Street/WO 9-8900
CLIFTON, N. J.—Eastern Radio Corporation
312 Clifton Avenue/471-6600
WOODBURY, L. I., N. Y. 11797
Harvey Radio Company, Inc.
60 Crossways Park West, Phone (516)-921-8700
BALTIMORE 1, MD.—Radio Electric Service Company
5 North Howard Street/LE 9-3835

SOUTH

BIRMINGHAM 5, ALA
Forbes Distributing Company, Inc.
2610 Third Avenue, South/AL 1-4104
WEST PALM BEACH, FLA.—Goddard, Inc.
1309 North Dixie/TE 3-5701
RICHMOND 20, VA.—Meridian Electronics, Inc.
1001 West Broad Street/353-6648

MIDWEST

KALAMAZOO, MICH.—Electronic Supply Corporation
P. O. Box 831/381-4623
INDIANAPOLIS 25, IND.
Graham Electronics Supply, Inc.
122 South Senate Avenue/ME 4-8486
CLEVELAND 1, OHIO—The W. M. Pattison Supply Co.
Industrial Electronics Division
777 Rockwell Avenue/621-7320
CHICAGO 30, ILL.—Merquip Electronics, Inc.
4939 North Elston Avenue/AV 2-5400
CINCINNATI 10, OHIO—United Radio, Inc.
7713 Reinhold Drive/241-6530
KANSAS CITY 11, MO.—Walters Radio Supply, Inc.
3635 Main Street/JE 1-7015
ST. LOUIS 17, MO.

Electronic Components for Industry Co.
2605 South Hanley Road/MI 7-5505
TULSA, OKLAHOMA 74119—Radio, Inc.
1000 South Main Street/(918)-587-9124
MINNEAPOLIS, MINNESOTA 55413
Northwest Electronics Corporation
336 Hoover St., N. E./ (612)-331-6350

WEST

DALLAS 1, TEXAS—Adleta Company
1907 McKinney Ave./RI 2-8257
HOUSTON 1, TEXAS—Harrison Equipment Company, Inc.
1422 San Jacinto Street/CA 4-9131
SAN DIEGO 1, CAL.
Milo of California, Inc.
2060 India Street, Box 2710/232-8951
LOS ANGELES 15, CAL.—Radio Products Sales, Inc.
1501 South Hill Street/RI 8-1271
LOS ANGELES, CAL. 90022—Kierulff Electronics
2585 Commerce Way/OV 5-5511
MOUNTAIN VIEW, CAL.—Kierulff Electronics
2484 Middlefield Road/968-6292
DENVER, COLO.—L. B. Walker Radio Company
300 Bryant Street/WE 5-2401
SEATTLE 1, WASH.—C & G Electronics Company
2600 2nd Ave./Main 4-4354
PHOENIX, ARIZ.—Midland Specialty Co., Inc.
1930 North 22nd Ave./258-4531
ALBUQUERQUE, N.M.—Midland Specialty Co., Inc.
1712 Lomas Blvd., N.E./247-2486
TUCSON, ARIZ.—Midland Specialty Co., Inc.
951 South Park Ave./MA 4-2315

Ask for a complete catalog

DELCO RADIO

DIVISION OF GENERAL MOTORS • KOKOMO, INDIANA

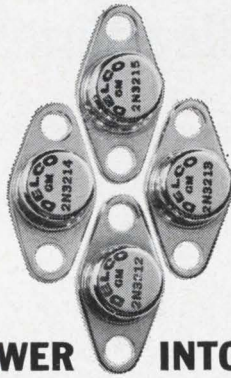

HOW TO CRAM BIG POWER INTO A LITTLE SPACE

Consider this family of miniature Nu-Base† transistors. Delco Radio's 2N3212, 13, 14 and 15 in the TO-37 case. They'll help you pack high current, high voltage, and fast switching in a small circuit package. And our SPAC‡ process gives them excellent parameter stability over a wide range of environmental conditions.

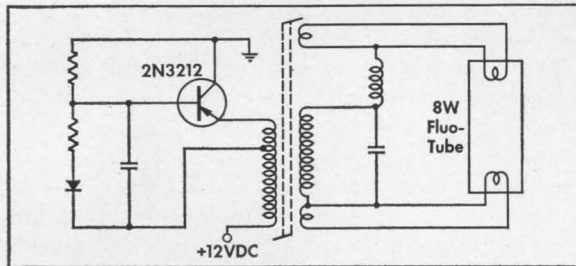

Battery-operated fluorescent light supply: A basic transistorized blocking oscillator forms the heart of this 8-watt portable fluorescent light.

Each of these Delco devices is rated 5 amperes, maximum continuous collector current. Their VCEO ratings, shown on the chart, make them especially useful where high voltages and high currents are encountered. In switching applications, they combine relatively low satu-

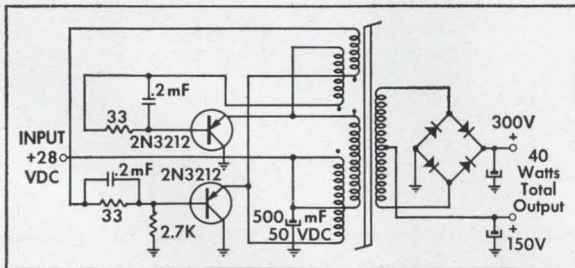

40-watt DC to DC converter gets an efficiency of 90 percent from the low saturation resistance of the miniature Delco 2N3212.

ration resistance and high speed for excellent efficiency and reliability.

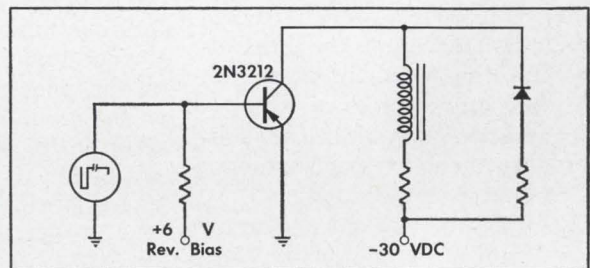

Print-out hammer driver: The high gain of this miniature TO-37 Nu-Base transistor enables it to switch 7 amperes of collector current at short duty cycles (10-15%).

In Delco Nu-Base construction, the husky element has built-in protection from current "hot spots" to assure freedom from secondary breakdown over the operating range.

These units will dissipate over 5 watts at 71°C case temperature, and operate over a range of -65° to 110°C. They lend themselves easily to automatic insertion.

Get in touch with one of our sales offices or your Delco semiconductor distributor. More data, prices and application information on this big little transistor will soon be on its way.

TYPE	2N3212	2N3213	2N3214	2N3215
Vcbo	-100	-80	-60	-40
Vceo @ Ic=20ma	-80	-60	-40	-30
hFE @ 3A	30-90	30-90	30-90	25-100
Vce (sat.) @ Ic=5A	-0.5v	-0.5v	-0.5v	-0.5v
Vce (sus.) @ Ic=3A	-80	-60	-40	-30

Conditions for Vce (sus.) { Pulse Width=1.4ms
Duty Cycle = 4%
Inductance = 6mh

Operating temperatures = 110°C max., -65°C min.; max. storage temperature = 125°C.

†Delco's name for non-uniform diffused base germanium transistors.

‡Surface Passivation and Ambient Control.

FIELD
SALES
OFFICES

UNION, NEW JERSEY*
Box 1018 Chestnut Station
(201) 687-3770
SYRACUSE, NEW YORK
1054 James Street
(315) 472-2668

DETROIT, MICHIGAN
57 Harper Avenue
(313) 873-6560
CHICAGO, ILLINOIS*
5151 N. Harlem Avenue
(312) 775-5411

SANTA MONICA, CALIFORNIA*
726 Santa Monica Blvd.
(213) 870-8807
General Sales Office:
700 E. Firmin, Kokomo, Ind.
(317) 457-8461—Ext. 2175

*Office includes field lab and resident engineer for applications assistance.

DELCO RADIO
Division of General Motors
Kokomo, Indiana

ternational Service Corp. reorganized its sales staff. Explained president Baker, "We have to get away from the buyer who comes here seeking shirts, rattanware, plastic flowers and radios. We are setting up a chain of distributors who handle only electronics.

It's free. Because of Hong Kong's free enterprise system, its nearness to Communist China, and its flood of refugees, the electronics industry has a little of the aura of a television spy story. An entrepreneur can open business with only a \$1,000 investment and one customer. At some plants, quality control consists of turning the finished radio on and off.

Officially, 25 factories have registered with the government to produce transistor radios in the Colony, 12 others are unregistered. Ten companies produce components and two others fabricate sub-assemblies such as television tuners and computer memory cores.

At Galli's, the fine old restaurant in the Peninsula Hotel, where electronics executives gather over stingers and curry, rumors make up most of the conversation. Fear of competition from Communist China, rising wages, shrinking component supplies are usual topics.

V. Tv on way?

One other rumor that created a lot of talk is that somebody is producing television sets in the Crown Colony. Until recently, the rumor was not taken seriously. Almost everybody agreed that Hong Kong had to produce something small and easy to ship. A television set seems too bulky for long-distance export. But now, at least two companies have pilot production started. One is an independent, N. Mings and Co., owned by J. K. Li, who fled from the China mainland nearly 10 years ago. The other is a joint venture of the Japanese Sanyo Electric Co. and Chinese interests.

Li is assembling Sylvania kits for sale in Malaysia and Indonesia. Sanyo is assembling the same set its parent builds in Japan.

George Baker, who also serves as president of the Hong Kong Radio and Electronics Association, says, "It is only a matter of time until Hong Kong makes miniature television sets and tape recorders."

Space electronics

Cleanliness is next . . . to Mars

When Voyager makes its trip it must be 'clean'.

How to test sterilized components without recontaminating them is the big question at JPL

By Walter Barney

Los Angeles Regional Editor

The first earth creatures to land on Mars may be bacteria—but not if the National Aeronautics and Space Administration can help it. The Voyager capsule scheduled to land on the planet in 1971 will not get off the ground until NASA can offer odds of 10,000 to 1 that no living organism is on board. NASA's stakes are high—the scientific success of the whole Mars program depends on keeping the spacecraft "clean." The scientists must be sure that any bacteria encountered is indigenous to Mars and not imported from earth.

To achieve this state of purity, a large army of technicians at the California Institute of Technology's Jet Propulsion Laboratory, which is in charge of NASA's lunar and

planetary programs, is devising means of sterilizing the spacecraft. Their problem is how to do it without damaging the electronic equipment. Ranger moon probes 3, 4 and 5 were sterilized—and all three missions failed.

Subsequent Rangers, launched without being sterilized, completed their missions successfully and crashed on the moon—bacteria and all. Since it is believed the moon has no bacteria of its own—at least on the surface—contaminating it doesn't matter. Mars, on the other hand, is believed to contain some form of life, thus making sterilization of the vehicle essential.

I. How to sterilize

There are several ways to destroy

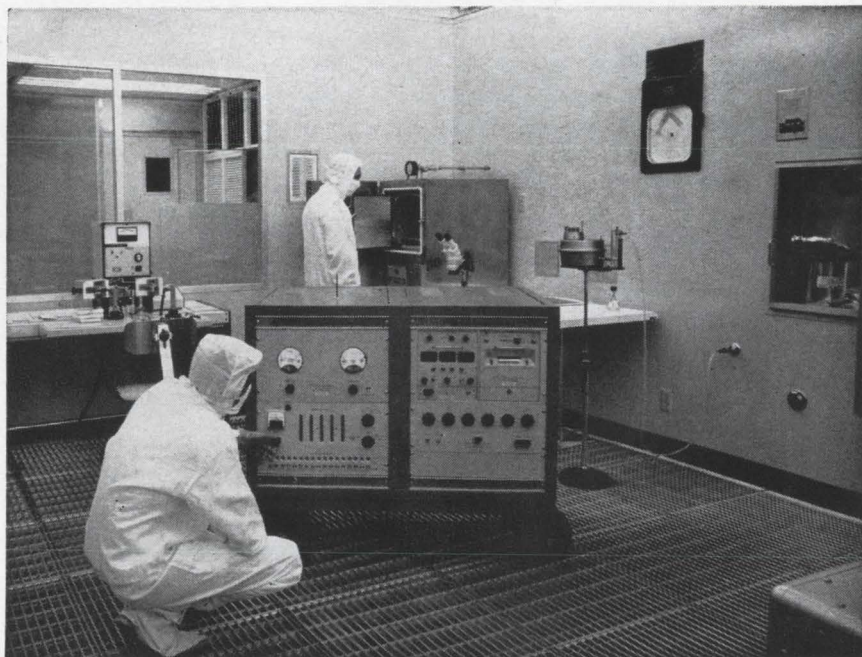

Voyager components, after sterilization, will be assembled in this bio-clean room at JPL, one of the first in the U. S. to meet NASA's strict requirements.

**μA711 Dual Comparator
as a Sense Amplifier**

The μA711 is built around an entirely new approach to integrated linear circuits. It eliminates the tolerance problems encountered in designing sense amplifiers for coincident current memories. Using external precision resistors the threshold can be adjusted over a wide range almost independently of integrated circuit characteristics. Excellent threshold stability over the full military temperature range is inherent in this design approach. You can also use the μA711 as a dual sense amplifier for biax memories where the outputs are separated by the strobes.

Other applications include a double-ended limit detector as used in GO/NO-GO test equipment, or a window discriminator for nuclear pulse-height discriminators. Your distributor has the μA711 in stock, or write for complete data sheet and application information. **FAIRCHILD SEMICONDUCTOR**

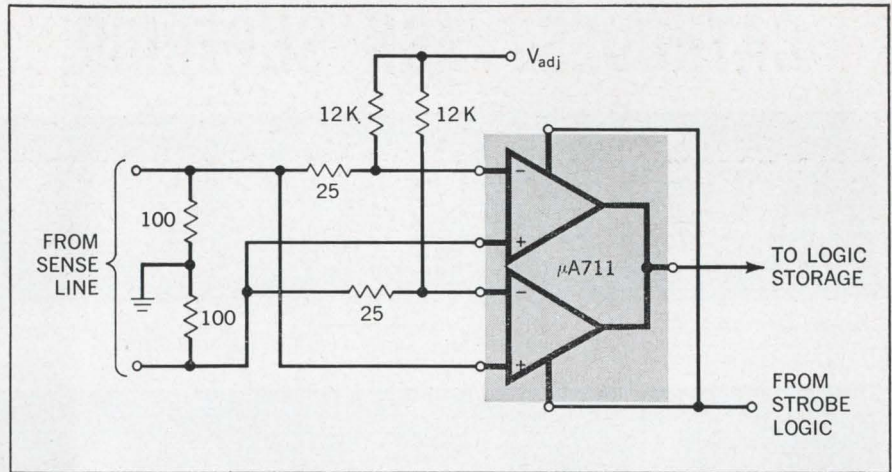

μA711 Features:

- Independent strobing of both channels.
- Outputs can be OR'ed directly.
- Compatible with all popular integrated logic forms.
- Guaranteed over full temperature range (-55°C to 125°C).
- Pulse stretching easily accomplished on output.

Typical Characteristics:

High accuracy	1mV
Fast response time	40 nsec.
Large input voltage range	±5 volts
Low power consumption	130mW
Fast strobe operation	12 nsec.

FAIRCHILD INTEGRATED SENSE AMPLIFIER

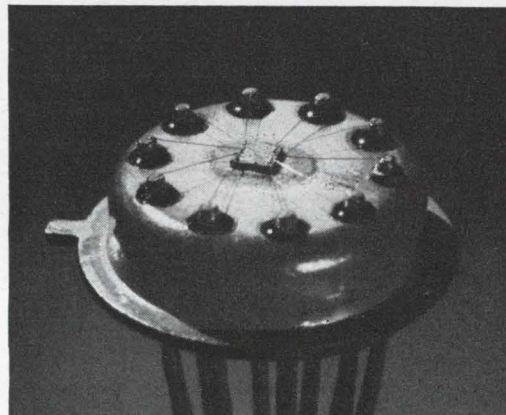

WHAT'S THE LATEST IN DISC CATHODES? ASK SUPERIOR.

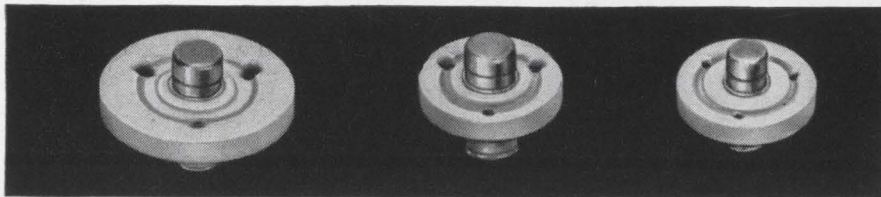

Full power for 6.3 volt-600 ma heater applications

Full power, narrow-neck for 600 ma heater applications

1/4 power for 450 ma heater applications

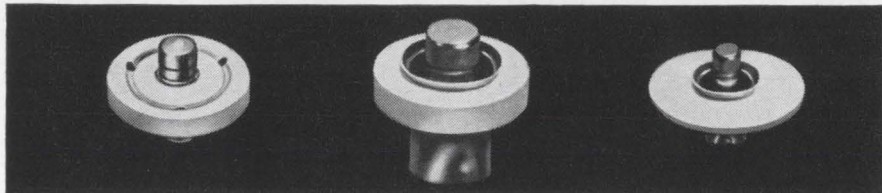

1/2 power for 300 ma heater applications

Shielded full power for better temperature uniformity in 600 ma heater applications

Shielded low power for 12.6 volt 85 ma heater applications

Widest choice of disc cathode designs

There are three basic types of Superior disc cathodes. Each has its own advantages. All feature close control of the E-dimension (distance between top of cap and top of ceramic), flare at the shank opening to facilitate assembly, shadow groove in the ceramic to inhibit electrical leakage and are available in wide choice of both cap and shank materials. Available in 0.121", 0.100" and 0.090" outside diameter shanks. Ceramic diameters can be either 0.490" or 0.365", with either round or triangular center hole.

New shielded disc cathodes—Full power and low power

In the full power design the emitter is separated from the ceramics by a shield which minimizes the conducting X-section from the shank to the ceramic. In the low power design, the slender shank, thermal shield and thin ceramic permit low heater power consumption and fast rise time. The shield also acts to eliminate leakage if sublimation takes place.

Widest choice of disc cathode materials

Superior's disc cathodes feature separate nickel cap and shank alloys. Hence you may choose the most suitable material for each. The Cathaloy® series, developed and controlled by Superior Tube Co., offers alloys with high strength, high activity, low sublimation, freedom from interface impedance, or any desired combination.

Cathaloy A-31. Approximately twice as strong as tungsten-free alloys at high temperatures.

Cathaloy A-33. Combines the high emission of active alloys with freedom from sublimation and interface impedance.

Cathaloy P-51. More than 100% stronger than X-3014 at high temperatures.

X-3014. Powder metallurgy pure nickel for resistance to sublimation. Suggested for shanks.

X-3015. Special shank alloy for strength with resistance to sublimation and for non-emitting characteristics.

Nickel 220, Nickel 225, Nickel 230 and Nickel 233. Suggested for caps requiring normal emission with rapid activation.

Driver Harris 599 and 799. Provide rapid activation plus high level d-c emission. For caps only.

For your copy of our Catalog 51, write Superior Tube Company, 2500 Germantown Ave., Norristown, Pa.

Superior Tube

The big name in small tubing

NORRISTOWN, PA. 19404

West Coast: Pacific Tube Company, Los Angeles, California

Johnson & Hoffman Mfg. Corp., Carle Place, N.Y.—an affiliated company making precision metal stampings and deep-drawn parts

bacteria. Radiation and chemicals will do it partially, but only heat will kill all of them to produce real sterilization—the complete absence of life.

The staff at JPL is working toward the goal of a bacteria-free capsule in four steps:

- Hardware that can withstand the rigors of intense heat will be used; some components will have to be developed and all must undergo rigid testing.

- Before using heat, another sterilizing agent must eliminate as many bacteria as possible.

- The spacecraft will be sterilized by heat.

- After the heat treatment, recontamination must be prevented.

Heat resistant. Warren H. Lockyear of JPL is conducting a program to establish a list of electronic parts for Voyager that can withstand heat. Since NASA has not yet decided on the experiments Voyager will carry, the program concentrates on those parts likely to be widely used in any Voyager spacecraft.

In March, JPL will have completed testing about 5,000 heat-sterilized capacitors—consisting of 23 types. Already, Lockyear's program has shown that sterilized tantalum capacitors will not operate dependably for the 10,000 hours demanded of Mars equipment. Resistors and diodes have completed 4,000 hours of testing, and potentiometers 3,000 hours. Their acceptability can not, of course, be determined until the full 10,000 hours has been completed.

In the test, the parts must demonstrate ability to survive not only heat treatment at various temperatures and time cycles, but decontamination with chemicals—specifically ethylene tetraoxide (ETO), a gas used to reduce the number of organisms on the spacecraft before the final heat treatment.

Although ETO kills life wherever it finds it, it cannot penetrate all parts of a system. The gas is being considered for surface decontamination because Lockyear's studies indicate that ETO decontamination can reduce the number of organisms on board to 10⁸ before sterilization by heat.

Time and temperature. The heat treatment itself has two variables: time and temperature. Basically,

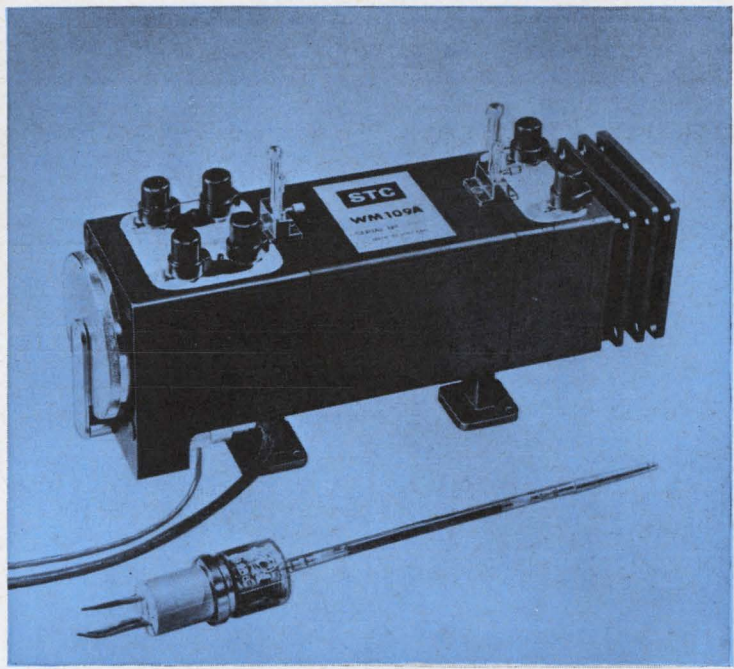
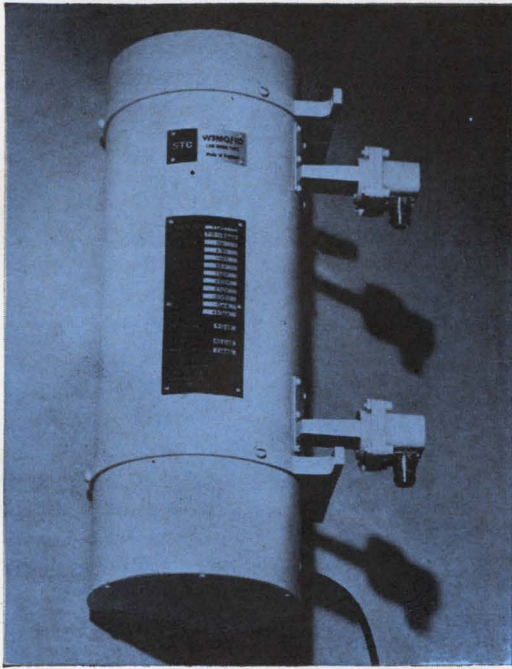

Travelling-wave tubes

During the past year, STC have added to their extensive range of travelling-wave tubes the new high performance types: W3/2G and the W3MQ Series.

Magnetically screened versions of the W3MQ Series of low-noise packaged tubes have now been introduced. These may be operated efficiently in close proximity to one another or to extraneous ferro-magnetic materials. The new tubes can be supplied for wide-band operation, or for narrow-band operation with a lower noise factor. They can be fitted with coaxial or waveguide r.f. input and output connections, as specified by customers.

Abridged data for a selection of STC travelling-wave tubes are given in the adjacent table.

ABRIDGED DATA

Type	Frequency Gc/s	Max. Power Output	Gain dB	At output of	Typical Noise Factor dB
W3/2G	10.7 to 13.2*	12 W	43	5 W	26
W3MQ/1D†	7.0 to 11.5	15 mW	38	Small Signal	9
W4/2G	7.0 to 8.5	15 W	45	5 W	26
W4/1G	7.0 to 7.8	11 W	40	5 W	26
W5/1G	5.85 to 7.2	11 W	38	5 W	26
W5/2G	5.85 to 7.2	25 W	42	10 W	28
	7.2 to 8.2	18 W	42	7 W	28
W7/4G	3.6 to 5.0	12 W	46	6 W	27
W9/2E	2.5 to 4.1	10 mW	40	Small Signal	8
W9/3E	2.5 to 4.1	0.1 mW	15	Small Signal	16
W10/3E	2.7 to 3.7	3 mW	24	Small Signal	6.8

*With possible extension to 15 Gc/s. †Packaged tube. Magnetically screened.

USA enquiries to:
ITT Electron Tube Division,
Box 100, Easton, Pennsylvania.

Other countries contact:
STC Valve Division, Brixham Road,
Paignton, Devon, England.

Standard Telephones and Cables Limited

Subsidiary of International Telephone and Telegraph Corporation





AMELCO'S PROCESS CONTROL PERMITS OPTIMUM GEOMETRY FOR HIGHEST PERFORMANCE

ADVANCED mask-making and photo-etching techniques have resulted in a series of Field Effect Transistors with transconductance high in relation to other parameters.

$$g_m/2\pi C_{is} = 80 \text{ Mc} \quad g_m/I_G = 2 \times 10^7 \quad g_m/I_D = 2$$

In amplifier applications this means type 2N2967 will provide more gain at higher frequencies with less power supply drain and less transducer loading. Noise Figure is less than 1.5 db at 100 cps. (Other types offer pinch-off voltage of 1.7 volts where power supply voltage is limited.)

For switching applications type 2N2966 offers $R_{OFF}/R_{ON} = 4.5 \times 10^7$ and $C_{DG} = 1.3 \text{ pf}$ maximum. In addition, pinch-off is controlled within the range of 4 to 6 volts. Thus spikes from the driving source are reduced and offset due to resistance effects are minimized.

These types are available from stock.

	2N3966	2N3967
g_m	—	1600-2400 μmhos
R_{on}	220 Ω	—
C_{is}	6.0 pf	5.0 pf
C_{DG}	1.3 pf	1.3 pf
I_G	0.1 nA	0.1 nA
V_P	4-6 V	2-5 V
	PRICE	
1 - 99	\$12.00	\$10.50
100 - 999	\$ 8.00	\$ 7.00



AMELCO SEMICONDUCTOR

DIVISION OF TELEDYNE, INC.
1300 TERRA BELLA AVE., MOUNTAIN VIEW, CALIFORNIA

Mail Address: P. O. Box 1030, Mountain View, Calif./Phone: (415) 968-9241/TWX: (415) 969-9112/Telex: 033-914

REGIONAL OFFICES

Southwest

3216 West El Segundo Blvd.
Hawthorne, California
(213) 772-6341

Northwest

1300 Terra Bella Avenue
Mountain View, California
(415) 968-9241

East

P. O. Box 1927
Paterson, New Jersey 07509
(516) 334-7997

Northeast

543 High Street
Westwood, Massachusetts
(617) 326-6600

Midwest

650 West Algonquin Road
Des Plaines, Illinois
(312) 439-3250

2428 West 22nd Street
Minneapolis, Minnesota
(612) 374-1969

the lower the temperature, the more time required for sterilization; the higher the temperature the more likely that reliability of the parts will be affected. There is some evidence, however, that prolonged heating at low temperatures is also damaging to parts, so low temperatures themselves would not be the answer to safe sterilization, even if the tedious procedure of prolonged heating were tolerable otherwise.

To establish thermal death-time curves, JPL borrowed a concept from the food canning industry, which has long used heat as a means of destroying bacteria. Canners have established a series of decimal reduction times, called "D values"; these are the times required to bring about a 90% reduction in the number of living cells. The D values vary for different organisms and different temperatures.

II. Reliability factors

Exactly what happens to an electronic component when it is heated is not completely known. Certain elements tend to boil off and settle elsewhere, as they would in a chemical solution. The heat causes a relaxation of the molecules and a change in the stress of the basic materials, producing a change in electrical characteristics. "Sterility and reliability are opposite sides of the same coin," says Gordon Kautz, who is in charge of JPL's sterilization program.

JPL's overriding preoccupation is that the Voyager capsule meet the sterility requirements. The lab would rather have a mission fail, than succeed and contaminate the planet. But the men responsible for the Voyager program at JPL do not want to be so conservative, that they will unnecessarily increase the difficulties and costs. In addition to developing hardware capable of withstanding the rigors of sterilization, JPL wants to learn more about sterilization techniques, with the idea of reducing those rigors.

Kautz's program had to take into account the equipment, procedures and controls needed to make sterile capsules, the monitoring and control of subassembly vendors, the ability to assess contamination during assembly and testing, the capability and control of the sterili-

zation ovens, and the thermal lag characteristics of the assembled capsule.

The entire sterilization cycle is a series of type-approval and flight-acceptance tests. Type-approval tests are stiffer than those used for flight equipment, the environment being most severe at the lower stages of assembly. For type-approval, the entire system gets three cycles of 53 hours at 135°C; subsystems get six 60- to 70-hour cycles, and piece parts, six 96-hour cycles.

The same procedures are applied to decontaminate with ETO: flight acceptance consists of one 24-hour cycle at 40°C, while type-approval requires three 24-hour cycles at 50°C for systems, and six 24-hour cycles at 50° for subsystems and piece parts. The type-approval tests are followed by careful testing to see how reliability has been affected.

III. How to make a capsule

Testing of flight equipment poses a real dilemma for reliability engineers. After the most elaborate type-approval testing and flight-acceptance testing, there would still be the prospect of flying the space capsule itself without testing it after the heat treatment. The failure of the three Rangers points to the necessity of some sort of testing after sterilization.

It has been suggested to NASA that the capsule be tested after sterilization, and then given a second heat treatment. This, however, invites risk because heating a component a second time could be asking for trouble.

If the post-sterilization heating approach is accepted—NASA will eventually make the decision—the capsule will not require the expensive “superclean room” for assembly that would be needed if the capsule got only one heat treatment. After the two heat treatments, final assembly could be performed under less expensive conventional clean-room conditions.

JPL has proposed that subsystems be manufactured in a normal working environment having cleanliness standards consistent with the production of reliable space hardware. Detachable coupons—small hunks of material that pick up bacteria—would be attached to the

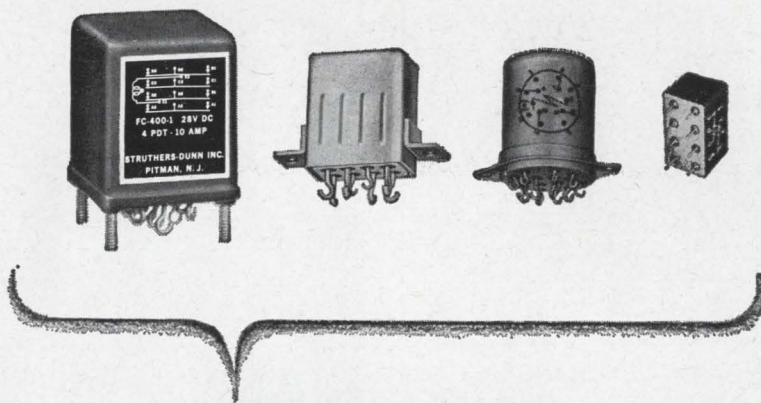

When you think about MIL-Spec relays...

Every manufacturer meets specifications.

Every one has Quality Control.

Every one tests and re-tests.

Every one talks reliability.

Every one has production controls.

Every one seals his relays.

Every one has a “broad line.”

Every one has a clean room

(And every clean room is clean).

Every one tries to price competitively.

Every one offers fast service.

Every one has catalogs.

So why should you specify

Struthers-Dunn relays, particularly . . . ?

BECAUSE... Struthers-Dunn has made more types of relays, including MIL-Spec relays, for more years than anyone else. Because Struthers-Dunn has learned more and is farther ahead in total capability. Because you can buy with more confidence. We have bulletins, too. Send for them. Write us at Pitman, N. J.

STRUTHERS-DUNN

Pitman, New Jersey

PIONEERS IN RELAY RELIABILITY



SALES ENGINEERING OFFICES IN: Albuquerque • Atlanta • Belmont, Calif. • Boston • Buffalo • Charlotte • Cincinnati • Clearwater, Fla. • Cleveland • Clifton • Dallas • Encino • Englewood • Glen Ellyn, Ill. • Houston • Kansas City • Las Vegas • Memphis • New York • Phoenix • Pittsburgh • St. Louis • St. Paul • Salt Lake City • Richardson, Tex. • Seattle • Southfield • Wichita • Wilmette. Canadian Licensee: Renfrew Electric Co., Ltd., Toronto. Export Dept.: 1505 Race St., Philadelphia, Pennsylvania 19102, U.S.A.

ONLY TRYGON HR-B Series POWER SUPPLIES give you all these features

- All silicon —60°C operation
- Constant voltage/constant current
- .01% regulation; 0.5 mv ripple
- Up to 300 watts—voltages to 160V.
- Remote sensing—remote programming
- TRYLINK® precision current mode
- Automatic overvoltage protection option
- Half Rack Size—Bench or rack mount

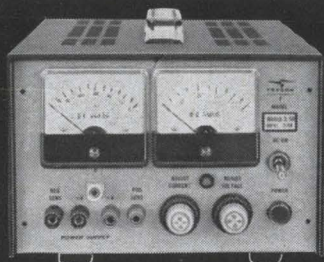

Looking for a challenging engineering opportunity with growth potential? Contact D. Hauptman at Trygon. An equal opportunity employer.

TRYGON
ELECTRONICS, INC.
Roosevelt, N.Y. 11575

Please rush me your new 52-page Power Supply Handbook—FREE

Name _____

Title _____

Company _____

Address _____

City _____ State _____ Zip _____

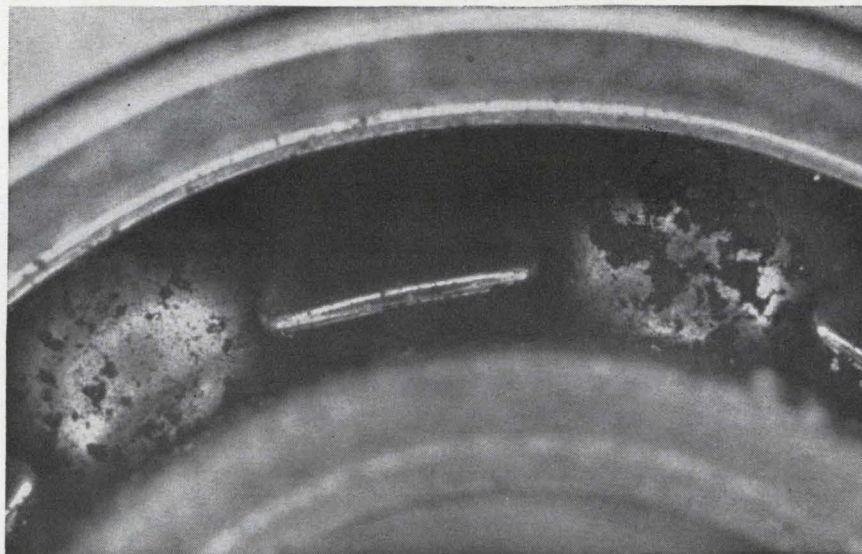

Heat damage to capstan bearing of a tape recorder subjected to 145°C during three 36-hour heat cycles.

subsystems, where they would remain until final assembly. They would then be removed and the amount of bacteria determined.

Completed subsystems would get flight-acceptance tests, including the ETO cycle and a dry heat cycle equal to the final sterilization cycle. Thus the equipment would be internally sterile and certified for assembly into the capsule.

The initial capsule assembly would also be in a normal working environment, but monitoring would be stricter, and personnel practices more rigid.

The completed capsule would be tested and then disassembled to the subsystem level; all surfaces would be decontaminated with ETO. That step marks the transition into the controlled bio-clean environment in which final assembly would be performed.

Says Kautz: "This plan accomplishes the objective of enabling us to perform the more difficult phases of assembly and of all the environmental tests under reasonably normal working conditions. If environmental testing had to be performed under the bio-clean conditions of final assembly, a manifold increase in time and cost would be incurred." The superclean-room assembly, Kautz estimates, would double the cost of manufacture; the other method would add only 15% or 20% to the cost.

IV. A year's work

While NASA deliberates on whether to use one or two heat

treatments, JPL continues compiling the list of sterilizable piece parts and its work on the efficiency and effects of ethylene tetraoxide. This work must be finished by January, 1967. JPL is also trying to create better and more reliable techniques for the collection and evaluation of microbiological data.

One of the more vexing problems concerns the failure of a subsystem whose individual components may have survived heat sterilization. At a recent conference Wayne E. Arens of JPL described the failure of a tape recorder—heat had caused the tape to give off hydrochloric acid which combined with the magnesium frame to form crystals of magnesium chloride. These crystals caused a capstan failure after only five days of life testing. Additionally, the presence of some oxygen in the dry nitrogen atmosphere caused rust to form on some bearings.

American bacteria. NASA, of course, can only control bacteria that would emigrate from the United States. Although the Russians have announced that they are sterilizing their spacecraft at 105°C, some JPL scientists have expressed skepticism as to whether heat is being applied for the necessary 336 hours. If Zond 2, the Russian probe that failed at the time of Mariner 4's spectacular success, hit Mars much of NASA's work may be useless. Since speculation on that subject is fruitless, NASA and JPL will continue to work on a bacteria-free Voyager.

THESE CIRCUIT PROTECTORS ARE ENTIRELY MAGNETIC TRIP

Hermetically sealed AP Protectors meet or exceed MIL-C-39019. They repeatedly rupture 300A 250V AC, 500A 125V AC, 500A 50V DC, have magnetic time delay, but open a 1000% overload in 4 milliseconds. There is no trip at 100G shock or 20G vibration, carrying rated current. Available 10 MA to 20A, with a wide variety of circuit combinations, delay curves and auxiliary signal circuits. Ask for bulletin 16E-4.

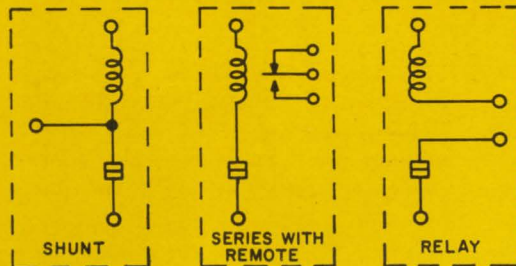

AP113

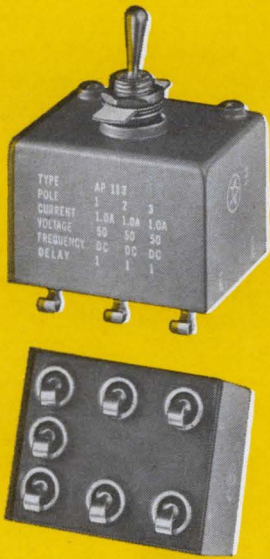

AP4

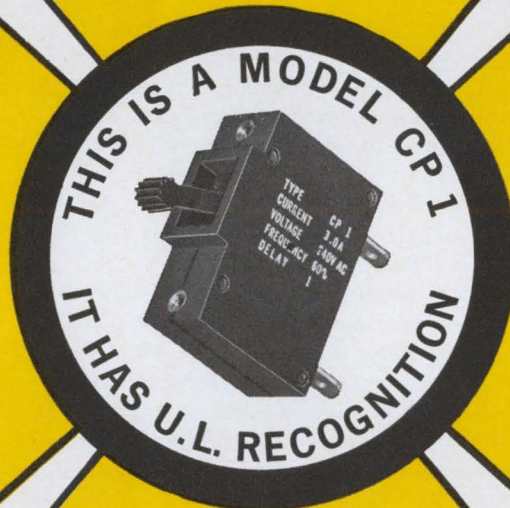
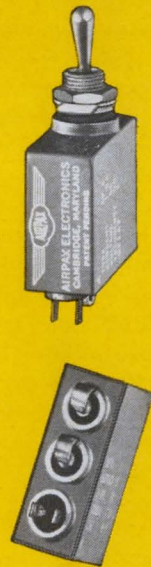

AP12



AP114



Money available—with technical advice

Small-business investment companies have adopted a more cautious approach to borrowers in the electronics industry. Many offer engineering and scientific help along with business hints

Like a once-scratched puppy eyeing the neighborhood alley cat, small-business investment companies are reacting more cautiously—but with continuing fascination—to advances from electronics concerns. The big change is an intensified interest by SBIC's in companies' technical problems. More and more of these investors retain scientists and engineers to help company engineers.

In 1961, the electronics industry received more than 20% of all SBIC loans. Today, four years and hundreds of bankruptcies later, the proportion has dropped below 10%, according to Stanley M. Rubel Jr., a Chicago financial consultant and publisher of an SBIC evaluation service. But with outstanding loans totaling \$50 million to \$60 million, SBIC's are still a major—and increasingly influential—source of funds for electronics companies.

The intensity of investor enthusiasm varies with experience and, to some extent, with geography. The president of a Chicago-based SBIC declares, "New electronics companies and those in related fields find it almost impossible to get financing in the Midwest." At the same time Merylyn E. Doleman, vice president of the Bank of America in San Francisco and a specialist in electronics and aerospace industries, says, "SBIC interest is very high in electronics because a sound product and sound management can still compete successfully against heavy competition."

I. How they manage

The words "good management" are crucial. Many potential inves-

tors agree with James V. Sidell, president of Financial Investors of Boston, Inc., when he says: "Most management in electronics companies are rather artistic types, not business people. They are so involved in their theories that they can't or won't deal with business problems."

With increasing regularity, SBIC's try to assume some management role in companies in which they invest but avoid exercising direct control. "What we do exercise," says George Quist, president of an SBIC subsidiary of the Bank of America, "is the benefit of our business experience, and we keep ourselves available for consultation."

Shared ownership. In 1960, Narinder Kapany formed Optics Technology, Inc., in Palo Alto, Calif., to produce medical-electronics equipment, notably an ophthalmoscope laser for welding detached retinas. Kapany and his associates negotiated a \$500,000 loan from a local SBIC, Draper, Gather and Anderson. The company was divided into three parts: 49% of the stock went to Kapany and his associates, 49% to the SBIC, and 2% was put in trust with the stipulation that if the company succeeded—as it has—Kapany's group would receive these shares and controlling interest.

Kapany and his group now hold 51% of the stock in a thriving company. Since that initial financing five years ago, Optics Technology has borrowed from three other concerns.

"We are highly pleased with our relationships with investors," says Kapany. "Investors have been able to understand the long-range goals

of the company. They . . . offer business counsel when asked for it, but do not interfere with the management otherwise. Most of the decisions made at our board meetings have been unanimous."

Shared acumen. In September, 1964, Cyber-tronics, Inc., a New York company that leases data-processing equipment, borrowed \$800,000 from the Small Business Investment Co. of New York. With the money came some business advice. During the ensuing 15 months, Cyber-tronics' sales have soared from \$837,000 to more than \$3 million, and the company has appointed a new vice president for finance—Donald Glickman, a former vice president of the investment company.

The Electronics Capital Corp. of San Diego, Calif., the biggest SBIC, has scientists and engineers on its board of directors; these men often help companies solve technical problems while other specialists concentrate on management and marketing. Electronics Capital's investments are almost entirely in scientific engineering companies.

The second-largest SBIC, the Boston Capital Corp., retains a technical consultant, Charles S. Draper, head of the department of aeronautics and astronautics at the Massachusetts Institute of Technology.

Shared responsibility. Despite the trend toward greater participation in the technical field, most SBIC's still make a point of avoiding giving advice about products. "I wouldn't know one black box from another," says Grogan Lord, president of the Texas Capital Corp. "We just attempt to be a financial partner."

One of Texas Capital's successful investments is in AirBorn Connectors, Inc., a Dallas producer of

A nationwide roundup by Electronics correspondents in New York, Washington, Boston, Atlanta, Dallas, Chicago, Cleveland, San Francisco and Los Angeles

"ACTIVE"...

ERIE Definition of Advanced Component Capability



SUBMINIATURE MONOBLOC CERAMIC CAPACITORS

High capacitance to volume ratio. Hermetically sealed in glass; precision molded; and phenolic dipped types.



MINIATURE HERMETICALLY SEALED BUTTON MICA CAPACITORS

For -55°C. to $+200^{\circ}\text{C.}$ applications.



SUBMINIATURE BROAD BAND R. F. I. FILTERS

Eliminate RF noise in 10 KC to 10 KMC frequency range.



HIGH RELIABILITY TUBULAR and DISC CERAMIC CAPACITORS

General Purpose; Temperature Compensating; and High Stability types.



MINIATURE CERAMIC and GLASS TRIMMERS

Precision trimmers with capacitance and terminal arrangements to suit need.



MINIATURE FILM CAPACITORS

Designed for filter, bypass, coupling and blocking applications.



SUBMINIATURE DIFFUSED SILICON RECTIFIERS

High forward conductance, low-leakage currents and reliable performance.



MINIATURE BYPASS CAPACITOR SYSTEMS FOR TRANSMITTING TUBES

Effective capacitive bypassing and coupling or filtering of all signals in 10 to 3000 megacycle range and beyond.

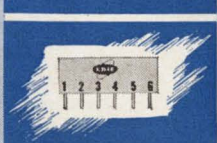

SUBMINIATURE INTEGRATED NETWORKS

Compact modules of resistor-capacitor networks with 2, 4, 6 or 8 leads... with or without semiconductor elements.

THE term "ACTIVE" in the Erie organization identifies a total program encompassing the research, development and production of Advanced Components Through Increased Volumetric Efficiency for aerospace, military and commercial equipment.

Project "ACTIVE" now brings to electronics and avionics a series of high performance, subminiature components designed for applications where every cubic inch of space and every ounce of weight is critical to successful equipment performance.

These Erie components have been and are being designed into the circuitry of such demanding systems as Gemini, Apollo, Minuteman, Nike X, Telstar, Polaris... commercial computers, oscilloscopes... and many other applications where size, weight and dependable performance are vital. While the advanced products illustrated at left are in quantity production, a number of components are still in the concept stage, while others are at final evaluation ready for production.

Consider the problem-solving advantages Erie ACTIVE components can offer you in your quest for reliable, subminiature components. We suggest ERIE as your quality source. A collect call or letter to your nearby representative... or to Erie headquarters is all that is needed as the "first step."

ERIE

TECHNOLOGICAL

PRODUCTS, INC.



Formerly
Erie Resistor
Corporation

644 West 12th Street
Erie, Pennsylvania

Erie's Project "ACTIVE"
Advanced Components through Increased Volumetric Efficiency

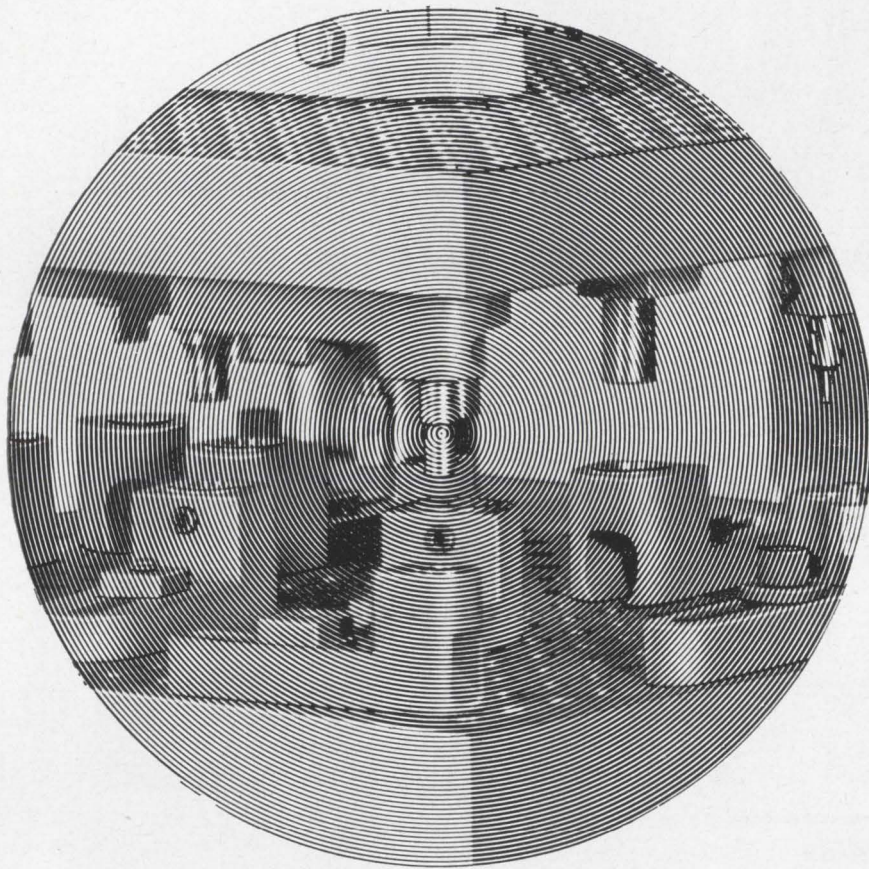

Punching Problems Disappear with Di-Acro

You can't miss! The Di-Acro 44 page book on the art of punching shows you every operation from stylus control with a turret punch press to hand punching with a single station model. Plus 500 standard and "standard special" dies from stock. See your distributor or write us.



DI-ACRO

A Division of Houdaille Industries, Inc.

4512 Eighth Ave., Lake City, Minn. 55041

precision-engineered electronic connectors. In 1961, the SBIC loaned \$250,000 to AirBorn at 7% interest; Texas Capital also received an option to buy 60,000 shares of AirBorn's common stock—about 23% of the outstanding shares. The strongest management influence exerted by Texas Capital was to try—unsuccessfully—to persuade AirBorn to make an acquisition.

In general, says Rubel, the SBIC specialist in Chicago, the SBIC "asks for a position on the board of directors, and from there provides counsel to the company in . . . financial administration or internal control. Some SBIC's also provide general management or business consulting," he adds.

II. Causes of caution

Why are investors so cautious in dealing with electronics companies? Besides the fact that many were burned in the years 1962 through 1964, there's this basic reason: a big portion of SBIC loans go to new, unproven concerns that cannot raise money elsewhere. Such companies are high risks in any industry, and particularly so in an intensely competitive field such as electronics, where technology is increasing the tempo of obsolescence.

Some investors are veering away from new companies altogether. "We can't evaluate a company right at its inception," says B. J. Brooks, secretary of the Continental Capital Corp. of San Francisco, "because at that stage it has mostly engineering problems. We're not electronics men, we're businessmen."

Continental Capital prefers to deal with a company that has been in business a year or two. "We no longer finance an idea, we finance growth," says Brooks. He prefers that his investments go for such purposes as diversification, retooling, or stepping up of a promising research project.

The law. Yet it is the new, unproven companies for whom the Small Business Investment Act was written in 1958. Its chief sponsors, incidentally, were two senators who have risen to higher office: Lyndon B. Johnson of Texas and Hubert H. Humphrey of Minnesota.

The act was designed to help

Hi-Q engineers will work hand-in-glove with you



to meet your specific capacitor requirements!

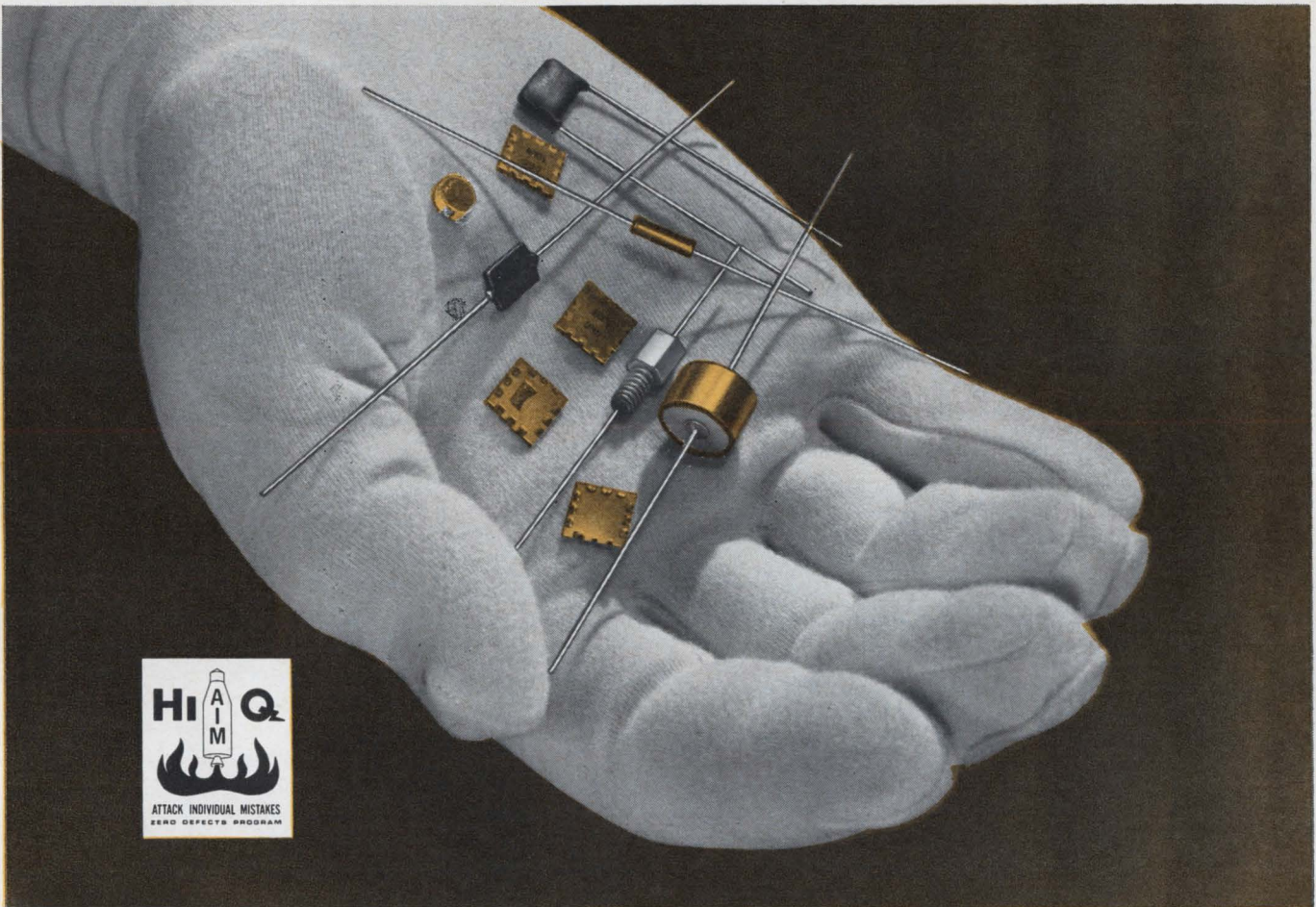

In a fast moving industry where "state-of-the-art" is almost yesterday's news, the ability to achieve technical and design advances almost overnight demands close teamwork with the end user.

Hi-Q is geared—from design to production—to the constant development and introduction of new ideas generated by customer requirements. It is a significant fact that most of the many "state-of-the-art" advances from Hi-Q have actually originated with a customer need, rather than from "blue sky" engineering of products (with the hope there may be a place for them). Whether your need demands a technical advance as dramatic as our introduction of CERALAM, or the kind of

HI REL procedures necessary to qualify for projects like Minuteman, Hi-Q engineers will not only solve it, but put the answer into production and make delivery in any quantities you need. It's that ability to turn "blue sky" engineering into "nuts and bolts" deliveries that finally makes Hi-Q outstanding in its field.

Call us.



AEROVOX
CORPORATION
OLEAN, N. Y.

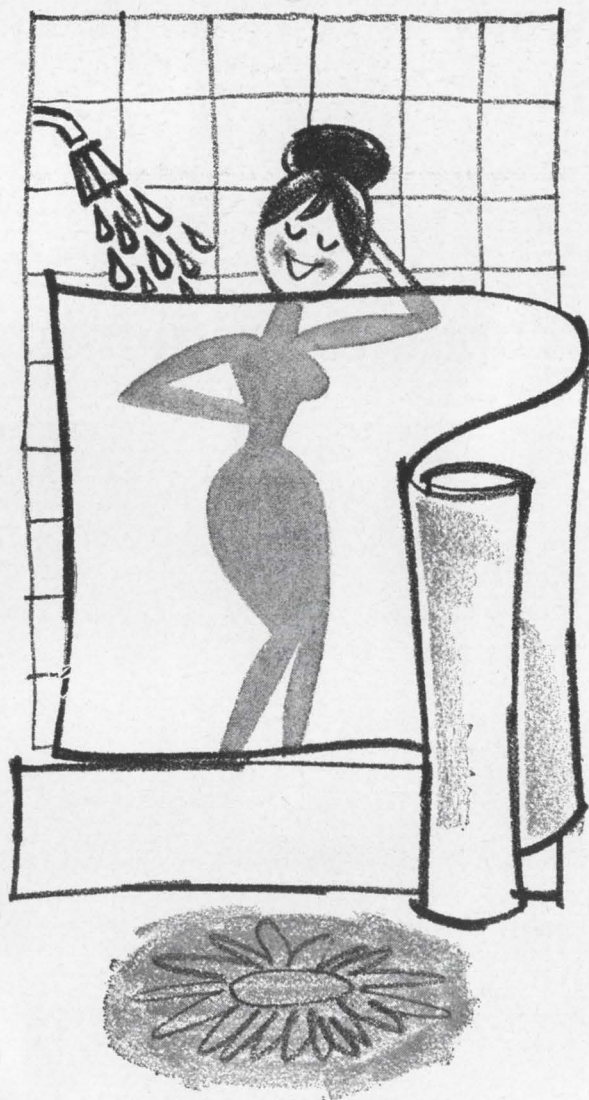

**Need a clear polyester film
for electrical grade labels?
"SCOTCHPAR"
is the answer to your needs**

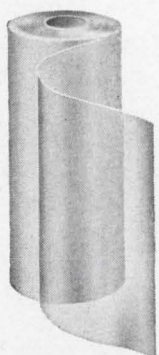

Good taste prevents us from illustrating how completely transparent "Scotchpar" can be! The point we wish to make, however, is that this versatile electrical grade polyester film can be produced in various degrees of transparency . . . from sparkling clear to satin white. And our ability to customize "Scotchpar" goes below the surface . . . we can also make internal modifications of basic polyester to suit most of your specific electrical needs. Contact: 3M Co., Film & Allied Products Division, 2501 Hudson Rd., St. Paul, Minn., Dept. ICL-125.

Scotchpar[®] electrical grade
BRAND polyester film

"SCOTCHPAR" IS A REG. T.M. OF 3M CO.



small businessmen who were unable to produce venture capital or to negotiate long-term loans. It permitted the establishment of small-business investment companies to advance funds—long-term loans or equity capital—to small companies which, because of the high risk, could not get money from usual sources.

To be eligible for a charter from the government's Small Business Administration, an SBIC must raise a minimum of \$300,000 on its own. Half of an SBIC's operating capital may be borrowed from the SBA at 5½% interest.

The law places few limits on an SBIC's operation; the most important is a requirement for diversification—no more than 20% of its operating capital may be invested in one company. Loans are made for a minimum of five years and may run as long as 20 years. Interest rates usually are between 7½% and 10%.

An SBIC can—and often does—invest by purchasing stock in a company. But it cannot own a majority of the outstanding shares for long—usually the limit is 18 months.

Who is eligible for an SBIC loan? A small company, which the law defines as one whose assets are under \$5 million, whose net worth does not exceed \$2.5 million, and whose average net income after taxes for each of the preceding two years was not more than \$250,000.

The gamble. Another cause of SBIC caution is the rapidly changing technology of electronics. Marvin A. Marder, president of Adams Street Capital, Inc., of Chicago, explains: "Before the small company can turn around with a new product it may be superseded" by an improvement.

Another drawback is the heavy government influence. "They depend to a great extent on sales . . . to the government," says a Chicago SBIC official, "and the U. S. government is a somewhat unpredictable and capricious buyer."

Still another problem is the traditionally short life-span of an electronic product. James W. Howard, president of Growth Capital, Inc., of Cleveland, explains: "One technological change, such as a shift from semiconductors to molecular

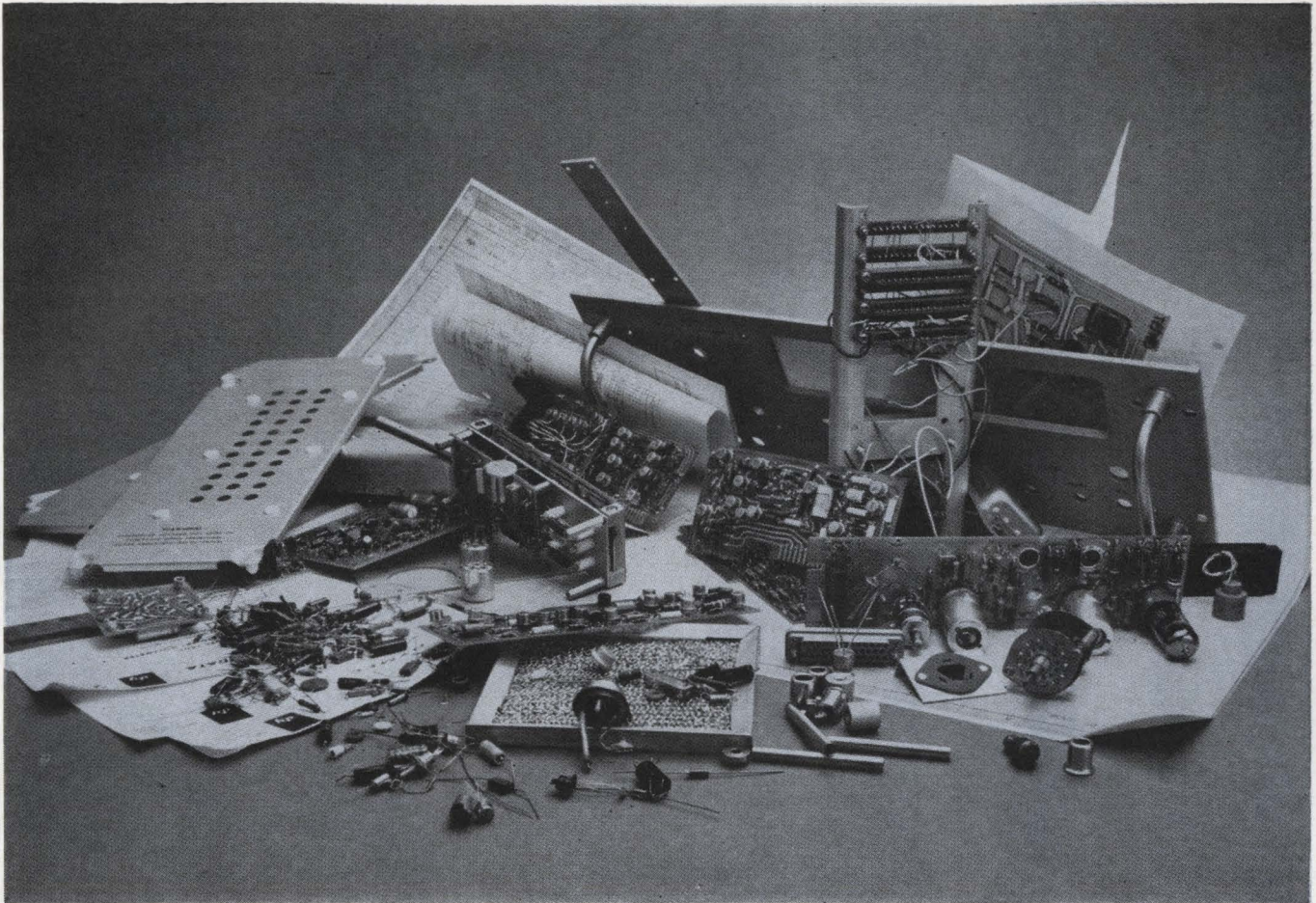

135 REASONS WHY

The 2401C Integrating Digital Voltmeter is your best buy. The Hewlett-Packard 2401C DVM keeps improving and improving. Just about everybody in the hp organization...engineers, test personnel, production line people...and, of course, marketing people, who know what you want and who want to offer it...keep making this instrument better.

That's why the 2401C has been changed 135 times since it became the world's first DVM to use the integrating principle...lets you make low-level measurements in the presence of extreme noise.

Some changes you've seen: A sixth digit to get maximum use out of the instrument's built-in 300% over-ranging capability. Optional autoranging at 6 msec per range, the fastest available. Integration around zero with a reversing counter...no zero foldover, even with positive/negative-going noise on the signal you want to measure. Improved accuracy of 0.01% of reading $\pm 0.005\%$ of full scale ± 1 digit.

And a lot of changes you haven't seen: New, advanced components for increased performance and/or reliability. New engineering to keep the 2401C ahead in performance. New production techniques to keep the price in line (there has never been an increase in price). The 2401C offers tested and proved RFI performance. It has a Federal stock number for easy specification, too.

Nobody at Hewlett-Packard lets this DVM rest...it just keeps getting improved. That's why it's so far ahead. If you have a measurement problem, involved with getting accurate dc measurements (0.1-1000 v full scale) in the presence of a frustrating amount of noise, you shouldn't let the 2401C rest, either. You should have it on your bench. Your Hewlett-Packard field engineer will put it there...and put it through its paces. Or you can write for complete specs (though a lot of the 135 changes aren't spec'd) to Dymec Division of Hewlett-Packard, 395 Page Mill Road, Palo Alto, California 94306, Tel. (415) 326-1755; Europe: 54 Route des Acacias, Geneva.



The machine costs \$3950. Ask for a demonstration.
Data subject to change (135 so far) without notice.
Price f.o.b. factory.

**HEWLETT
PACKARD**  **DYMEC
DIVISION**

This 20-joule High-Q CAPACITOR has inductance of ONLY 1 NANOHENRY

- Q is 250 at 5 mc
- 0.1 microfarad
- 20 kilovolts

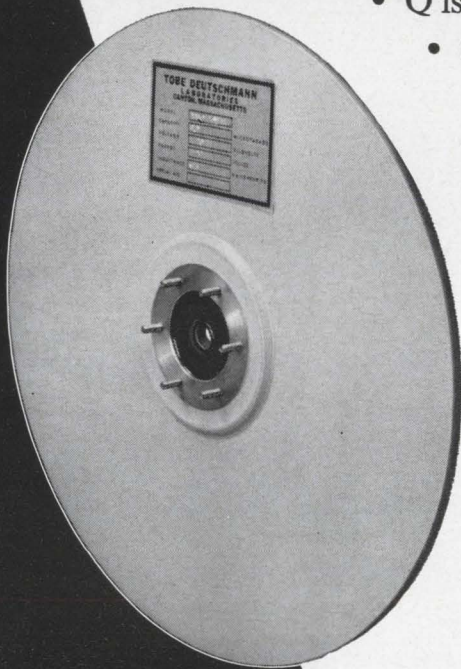

\$172

The Model ESC 247B coaxial disc capacitor is one of a series whose inductance is essentially that of the terminal. Its coaxial construction results in maximum self-inductance of only one nanohenry for any capacitance from 250 pf to 0.5 μ fd.

Capacitors in this configuration can be furnished in 50kv rating or, at lower voltage, to 500 joules. They can also be constructed to operate at high repetition rates.

Units available at ratings to 50 kv will permit coaxial mounting of spark-gap switches. The through-hole in the center of the terminal permits efficient installation of circuit components.

Ask for Bulletin EB365-20; it gives detailed information about the physical structure and electrical characteristics of coaxial disc capacitors.

And write or call us whenever you have a special or unusual requirement for capacitors, discharge switches, or low-impedance pulse-forming lines.

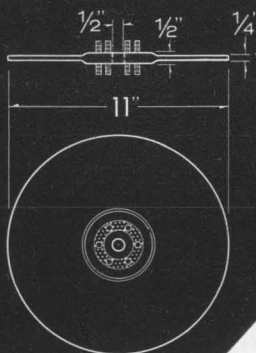

TOBE DEUTSCHMANN

LABORATORIES

CANTON, MASSACHUSETTS 02021 Telephone (617) 828-3366

components, can completely obsolete the product and technological advantage of a small company."

III. The bright side

Despite their wariness, SBIC's have a lot to offer electronics companies. Perhaps the most attractive advantage is their ability to negotiate a tailor-made loan; most lending organizations are not that flexible. They also can offer business advice that young engineers often need.

An SBIC with strong interest in electronics may also bring a rich background to a new business. Stan Keller, controller of Data-pulse, Inc., of Inglewood, Calif., says Continental Capital of San Francisco provided valuable contacts with other segments of the electronics industry for his manufacturer of test equipment. "They are on the lookout for other companies with similar objectives," he explains, and "this can be helpful, specifically in cases of possible merger or of acquisition of production rights."

What they look for. One of the Midwest's successful SBIC's is the Vanguard Venture Capital Corp. of Chicago. Perhaps significantly, Vanguard's president, Kenneth Arenberg, is an engineer.

"A balanced management team is the key," he says. "We place a greater emphasis on the people involved than we do on a technical breakthrough."

The president of an Atlanta SBIC, who asked that his company not be identified, recently discussed frankly the lessons of a brief career that "hasn't been profitable" but that he believes is "on the right track at last."

"In the first place," he says, "we'll never sponsor a brand-new company again. I'll insist that they have at least three years of experience."

Secondly, he will insist on business experience among top management.

And thirdly: "We'll insist the firm set out on a course of carrying out one or two—and only one or two—well-defined projects." Never again, he vows, will his company invest in an engineering company that has a dozen projects under way "with little hope of any of them ever reaching fruition."

Now—
all seven

MIL-R-27208A

and

MIL-R-22097B

potentiometers

WIREWOUND (MIL-R-27208A)

RESISTON® CARBON (MIL-R-22097B, Characteristic B)

(units shown actual size)							
	MIL-SPEC STYLE RT10 Bourns TRIMPOT® Model 220	MIL-SPEC STYLE RT12 Bourns TRIMPOT® Model 224	MIL-SPEC STYLE RT11 Bourns TRIMPOT® Model 3010	MIL-SPEC STYLE RT22 Bourns TRIMPOT® Model 3250	MIL-SPEC STYLE RJ11 Bourns TRIMPOT® Model 3011	MIL-SPEC STYLE RJ12 Bourns TRIMPOT® Model 3051	MIL-SPEC STYLE RJ22 Bourns TRIMPOT® Model 3251
Resistances	10Ω to 30K	10Ω to 100K	10Ω to 100K	10Ω* to 50K	20K to 1 Meg	20K to 1 Meg	20K to 1 Meg
Power Rating	1.0W	1.0W	1.0W	1.0W	0.25W	0.25W	0.50W
Humidity-Proof	YES	YES	YES	YES	YES	YES	YES

*MIL Spec shows following min. T.R.: RT10, 100Ω; RT22, 50Ω

These seven potentiometers not only meet the specs, they beat the specs. All seven have higher operating temperature, lower end resistance, better shock and vibration performance, lower temperature coefficient, higher dielectric strength and higher insulation resistance than the specs call for.

Where MIL-R-27208A sets a maximum operating temperature of 150°C for wirewound units, for example, Bourns gives you 175°C. And where MIL-R-22097B, Characteristic B, asks for 125°C in carbon units, Bourns gives you 150°C. In every important parameter, Bourns surpasses the requirements.

All seven models exceed MIL-STD-202B, Method 106, for cycling humidity. In addition, all units have solid electrical

grade-A nickel, gold-plated pins suitable for soldering or welding. Carbon models have the exclusive Bourns RESISTON® film elements, and wirewound units feature the virtually indestructible Bourns SILVERWELD® termination. To be sure of specifications, don't MIL-SPECulate—SPECify Bourns!

Write now for qualification data, technical literature.



BOURNS

BOURNS, INC., TRIMPOT DIVISION
1200 COLUMBIA AVE., RIVERSIDE, CALIF.
PHONE 684-1700 · TWX: 714-682 9582
CABLE: BOURNSINC.

If it's TRIMPOT®, it's BOURNS

bla

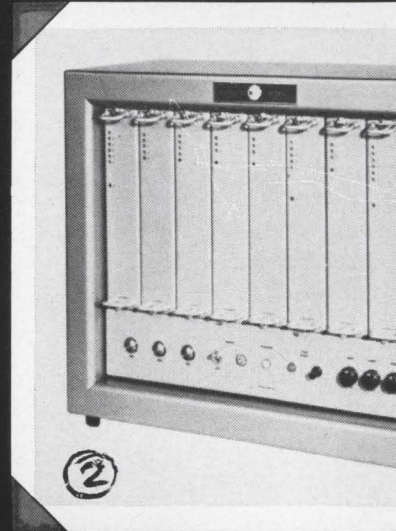
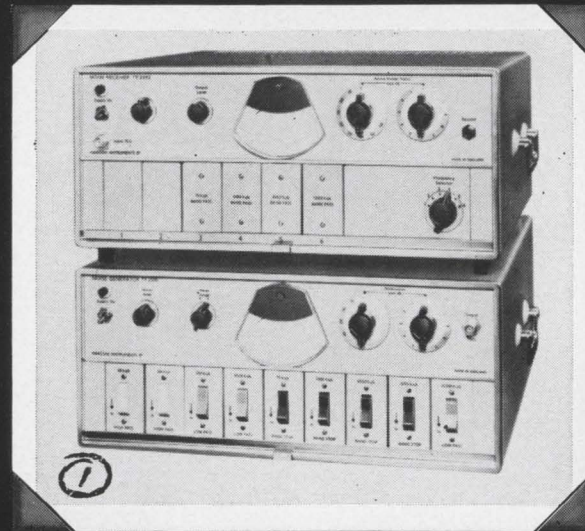

4 More from Marconi

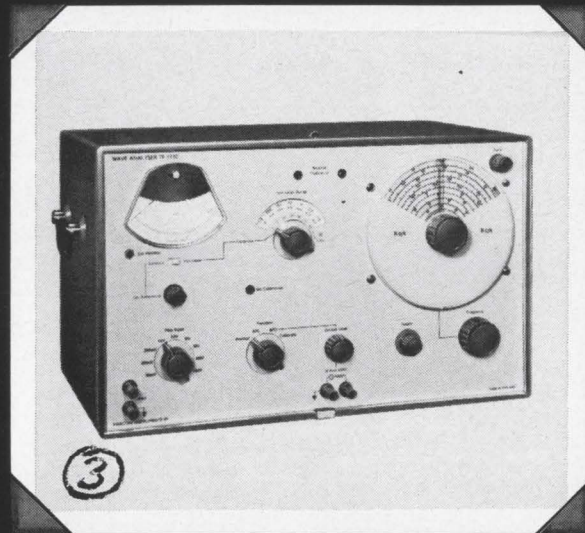

The **LEADERS** in Test Equipment for Multi-Channel Communication

1 Transistorized Noise Loading Test Set 2700 Channels Model 2090

- Generates noise flat to ± 1 db from 12 kc to 12.388 mc
- Band limiting and Slot filters to 2700 channels for CCIR, CCITT and DCA recommendations.

2 Autospec Automatic Single-Path Error-Correcting Telegraph Equipment

- Suitable for one-way or both-way circuits
- 1000:1 reduction of printed character error rate or more
- Alternative speeds include:

45.45 Bauds	60 W.P.M.
50 Bauds	66 W.P.M.
75 Bauds	100 W.P.M.

3 Transistorized Wave Analyzer Model 2330

- 20 cps to 50 kc with BFO output flat 0.05 db
- Measures down to $3\mu V$
- Relative amplitudes to -75 db

4 Two-Channel Noise Meter Model 2330

- Test ple lat
- Ch out
- Pro dep to

MARCONI INSTRUMENTS

Division of English Electric Corporation

111 CEDAR LANE • ENGLEWOOD

Main Plant: St. Albans, England

no matter how di
It's Better with Sp

To whatever you direct
talents whether military
Sperry semiconductors
ment it. Take our new li
Base Oxide Passivated S
tors for example (and
do). Through planar tec
Epi-Base units exhibit l
base breakdown voltage

BIG = 200 small

BIG: Big performance, big economy.

small: 5/8" diameter size.

200: CTS Series 200 composition variable resistor for numerous limited space industrial and commercial applications.

NEW: New straight and concentric tandems.
New solder lug terminals.

High Dependability CTS Composition Element: Proven over the years in all kinds of environments. Over 1 billion elements made; over 300,000,000 now in active service.

Resistance Range: 200 ohms through 5 megohms.

Availability: 3-6 weeks in quantity. CTS has the industry's largest output of controls.

New Constructions

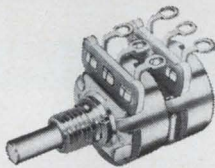

Straight Tandem
Solder Lug Terminals

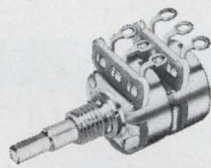

Concentric Tandem
Solder Lug Terminals

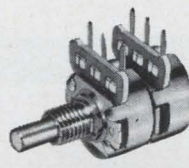

Straight Tandem
P. C. Terminals

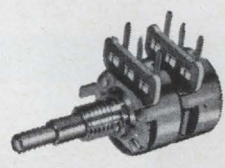

Concentric Tandem
P. C. Terminals

Sample constructions showing Series 200 versatility
(Many other combinations available.)

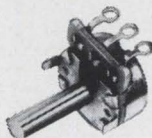

Basic 200 Control
Ear Mounted



Rear Extended Shaft
Bushing Mounted

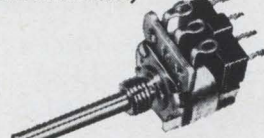

ND On-Off Switch
Bushing Mounted

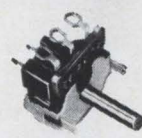

Q On-Off Switch
Ear Mounted

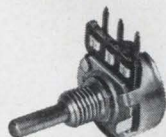

Basic 200 Control
Bushing Mounted

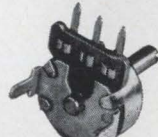

Rear Extended Shaft
Ear Mounted



Mounted with Shaft
Perpendicular to
Panel

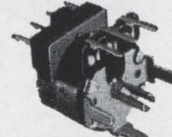

ND On-Off Switch
Shaft Perpendicular
to Panel

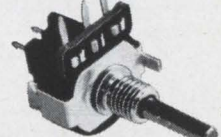

Q On-Off Switch
Bushing Mounted



Founded 1896

CTS CORPORATION
Elkhart, Indiana

Sales Offices and Representatives conveniently located throughout the world.

Principal Products

Variable Resistors
Selector Switches
Loudspeakers
Trimming Potentiometers
Fixed Resistor Micromodules
& Microelectronic Circuitry
Crystals, Filters,
Oscillators & Ovens

Subsidiaries

CTS of Asheville, Inc., Skyland, N.C.
CTS of Berne, Inc., Berne, Indiana
CTS of Paducah, Inc., Paducah, Ky.
Chicago Telephone of California, Inc.,
South Pasadena, Calif.
CTS of Canada, Ltd., Streetsville, Ontario
CTS Microelectronics, Inc., Lafayette, Ind.
CTS Research, Inc., Lafayette, Ind.
CTS Knights, Inc., Sandwich, Ill.

You need a pushbutton switch. 

Bill, at the next board, needs a toggle switch. 

Sam's looking for placard indicators. 

Joe wants a switchlite. 

Harry wants a hermetically-sealed switch. 

Here's the easy way to get all the answers at once!

Just check the bingo card in this book for any or all of the Control Switch catalogs listed below. Or send us a card of your own.

If you get all of our catalogs you'll have it made.

First, because these catalogs cover a combination of switch types and switchlites that no other manufacturer can offer. So you get a concentrated reference.

Second, because some switch manufacturers don't make *any* of the switches we make. So Control Switch catalogs save wild goose chases.

Third, because we make only quality switches. For computers, aircraft, missiles, control panels, and such. So our catalogs (and your nearest Control Switch distributor) save time screening out switches that haven't got it.

Here's the list. Check the Reader Service Card number at the left for the catalogs you want.

- #245 *Condensed Switch Catalog 100*
- #246 *Basic Snap-Action Switch Catalog 110*
- #247 *Toggle Catalog 180*
- #248 *Indicator Light Catalog 120*
- #249 *Hermetic Switch Catalog 130*
- #250 *Switchlite Catalog 220*
- #251 *Pushbutton Catalog 190*



CONTROL SWITCH DIVISION
1420 Delmar Drive, Folcroft, Pennsylvania 19032



Who's charmed the untamable thermosets*
into behaving in extruded form?

THIOKOL PANELYTE. That's who.

Do the narrow limitations of high compression molding with thermosetting plastics put a crimp in your design flexibility? Forget it.

Now, because of Thiokol's unique thermoset extrusion process, you can think thermosets for any structural and functional component. Complex profiles, undercuts and other unusual configurations impractical to mold are producible through this newly developed system.

A wide variety of resins can be utilized to

meet the most stringent requirements—phenolic, melamine, urea, diallyl phthalate, epoxy. Extruded profiles up to six inches in diameter and in long continuous lengths can be produced. The dies required cost only a fraction as much as a high compression mold. Economically, the system lends itself to volume production.

Call or write Thiokol Panelyte for full information about its revolutionary thermoset extrusion process. See Yellow Pages for nearest representative.

Thiokol
PANELYTE
INDUSTRIAL

*As manufactured by
York Industrial Plastics, Inc.

THIOKOL CHEMICAL CORP., PANELYTE INDUSTRIAL DIVISION, N. ENTERPRISE AVE., TRENTON, N. J. 08600

“We demand minimum size plus maximum reliability. That’s why we use capacitors of Mylar®”

says Worthington C. Lent, Vice President,
Telephone Development & Operations,
Lear Siegler, Inc.

Central telephone office equipment must be designed as compactly as possible. At the same time, this equipment must be reliable for a service life of many years. So Lear Siegler uses capacitors of MYLAR*. And nothing but capacitors of MYLAR in the R-635 Voice-Frequency Repeater. The extremely high dielectric strength of MYLAR means smaller capacitors. The extremely high stability of MYLAR means long-term reliability.

Other dielectric materials could have been used but anything else that would meet specifications would cost much more than capacitors of MYLAR, according to Lear-Siegler, Inc.

If size, reliability and price are important to you, check the ways capacitors of MYLAR could help you improve your designs. For some interesting technical data, write Du Pont Co., Room 3241-A, Wilmington, Delaware 19898. (In Canada, write Du Pont of Canada Ltd., P. O. Box 660, Montreal, Quebec.)

only DU PONT makes

MYLAR®
POLYESTER FILM

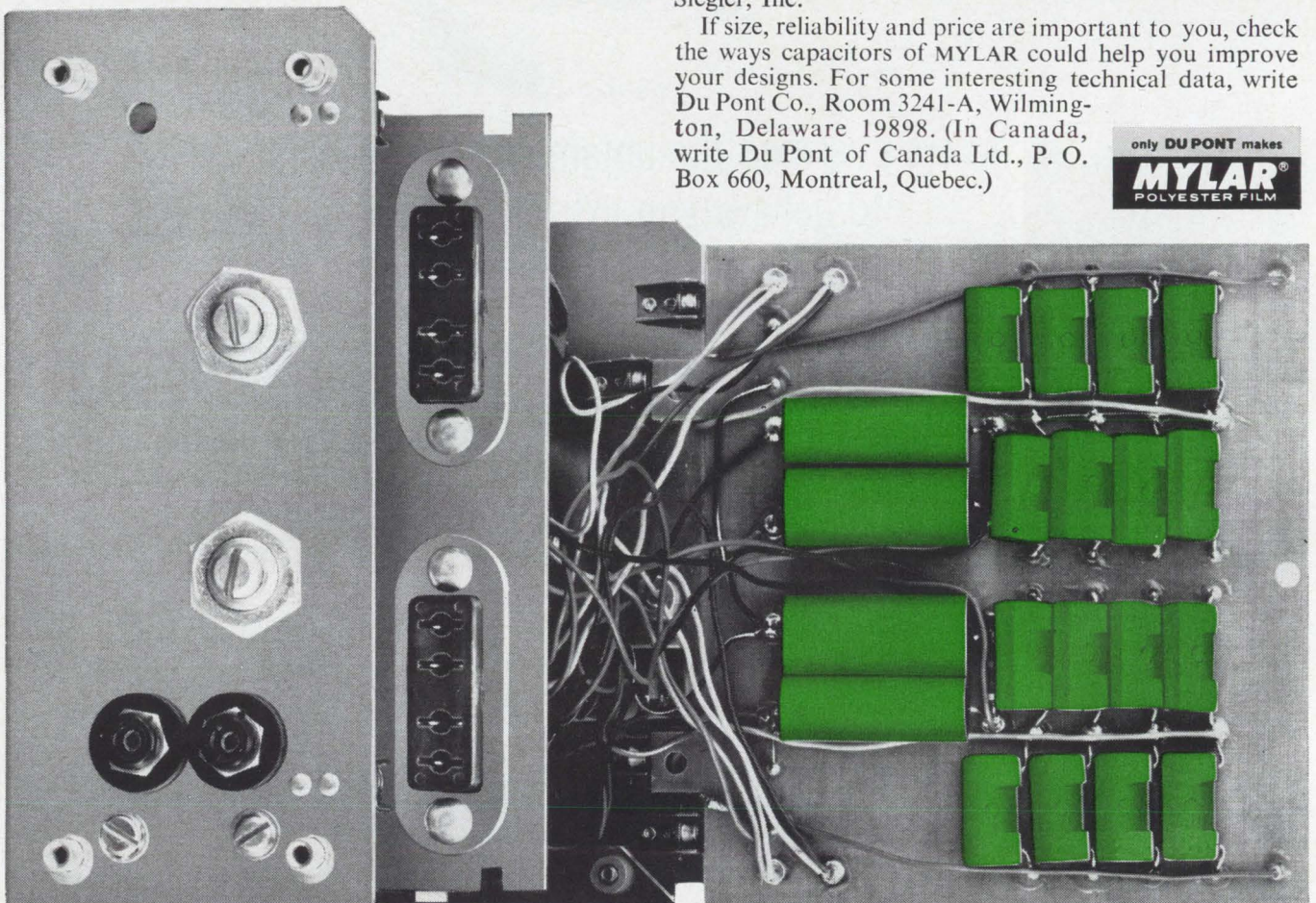

20 capacitors of MYLAR* polyester film are used in the R-635 Voice-Frequency Repeater manufactured by the Electronic Instrumentation Division of Lear Siegler, Anaheim, California.

*Du Pont's registered trademark for its polyester film.



BETTER THINGS FOR BETTER LIVING... THROUGH CHEMISTRY

Microwave oven for industrial processing

System will benefit laboratories concerned with processing research, quality control and small-batch production

A test cavity that uses a magnetron has been specifically designed for the job of evaluating a production process using microwave heating.

This unit is an accurately instrumented and controlled microwave oven intended for laboratory use in applications where rapid reduction of moisture content by microwave heating is important. It will find application in laboratories in the food-processing, chemical, lumber, and textile industries. Other uses include the accelerated curing of glues, resins, and polymers; establishment of production processes where heating by microwave energy is to be employed; and chemical titration. It is claimed that any laboratory involved in processing research, as well as quality control and small-batch production, can use the system.

The test cavity and power pack are mounted in a common console. The PPS-2.5 power pack produces 2.5 kilowatts at 2,450 Mc, and power output is continuously variable from 500 watts to the 2.5-kw maximum rating. The unit is 31½ inches high, 14 inches wide, and 28 inches deep, and operates on 220-volt a-c power. The PPS-2.5 power pack may also be supplied separately to allow coupling to special fixtures as required. Microwave power output is available through standard 3.40" x 1.70" (WR-340) waveguide.

The TCS-2.5 test cavity is of the multimode variety, and includes an integral scale for continuous monitoring of sample weight during processing. It can accept specimens with maximum dimensions of 24 x 18 x 16 inches. Specimens are placed on a balance pan which is the floor of the cavity. Weight, from 200 to 2,000 grams, is read from a meter below the cavity door.

The multimode type of design

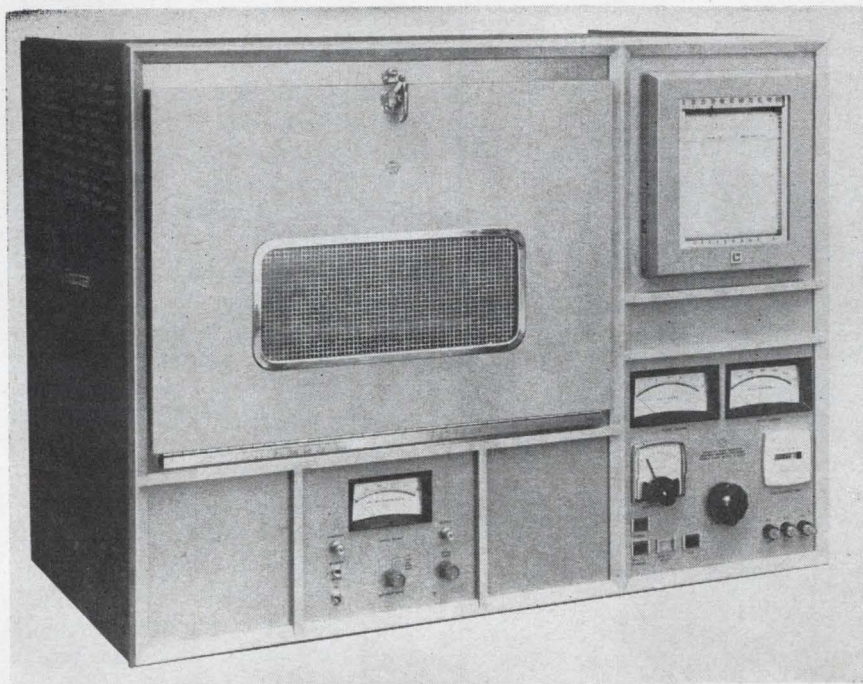

was chosen by Eimac to insure optimum coupling of r-f to almost any sample form that might be placed in the cavity. The multimode design, according to Eimac, is best for batch processing.

The system can be provided with a strip chart recorder for a permanent record of test variables. Proportional control of the excitation cycle is possible with an accessory, and optional controls are available for cavity temperature and humid-

ity control. Eimac is planning similar units with input powers up to 250 kilowatts.

Specifications

A-c power required	220 v at 20 amps
System dimensions	Combined units measure 31½ x 28 x 42½ in.
Total weight	270 pounds
Price	\$4,350 (excluding options)
Delivery	90 days

Eimac division of Varian Associates, 301 Industrial Way, San Carlos, Calif., Circle 349 on reader service card.

Stable oscillator in a small package

Model 676 fixed-frequency, non-temperature-controlled oscillator offers a 4- to 25-Mc output in a ⅓-cu in. package.

Frequency stability is $\pm 0.006\%$ maximum from -55° to $+90^{\circ}\text{C}$. Output is d-c coupled into a 100-pf

load. Input is +10, +5 v d-c. The unit has a low silhouette form factor and is encapsulated in a low-density, high-strength semirigid foam. It is designed for 10 to 2,000 cps 20 g vibration, rfi per Mil-I-6181, environment per Mil-E-5400, and is suitable for in-flight missile applications.

Monitor Products Co., 815 Fremont Ave., S. Pasadena, Calif. [350]

A new twist on handling light-- from Bulova

Now... scan, chop, twist—with a tuning fork!

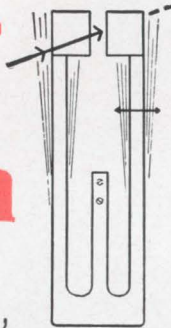

Bulova's American Time Products division has a patent pending on an important innovation in tuning forks: By affixing to the fork's tines a pair of vanes which can be slotted, notched or pierced as desired, the fork can be made to chop light or similar energy beams—making possible optical effects never before achieved.

Bulova fork light choppers offer great advantages over motor-driven types: There are no wearing parts—no lubrication is required—operational life is many times longer! Forks handle light more efficiently. They are smaller and lighter than any other chopper. Example: A 2 cu. inch package can chop 1,000 times per second!

And Bulova keeps coming up with important improvements. Among the latest—forks can now be supplied with peak-to-peak tine excursions of $\frac{3}{8}$ " at 200 cps.

In addition, Bulova has recently patented torsional tuning forks. Each tine twists about its own axis independently, in opposite phase. This eliminates rate change

due to attitude or acceleration, and results in the most constant and uniform movement known. Bulova torsional forks can be used for any number of scanner variations—in spectrophotometers, automatic star tracking units and densitometers. Write for information. Address: Dept. E-19.

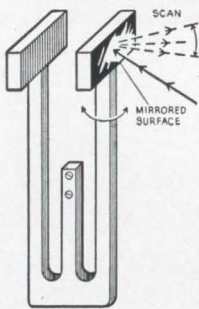

BULOVA AMERICAN TIME PRODUCTS

Electronics Div. of Bulova Watch Co., Inc.
61-20 Woodside Avenue, Woodside,
New York 11377 (212) DE 5-6000

New Components and Hardware

Switch handles 5 amps, 200 volts

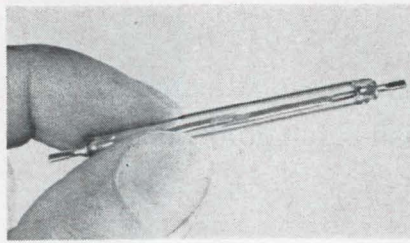

Raising the level at which current can be switched reliably has long been a goal of switch manufacturers. Now, the AB Svenska Elektronik, a subsidiary of the L. M. Ericsson Corp. in Sweden, claims to have increased the amount of switching current to 5 amps from the earlier maximum of 2 amps.

Dry reed switches have been used as relays in electronic computers, calculating machines and telephone exchanges. The dry reed switch—which can be operated either electromagnetically, or by a permanent magnet, or by a combination of the two—is enclosed in a gas-tight capsule; the magnetic field operates directly upon the reeds to ensure fast and reliable operation. However, the most serious limitation of the switch has been the amount of current it could safely pass.

Svenska tried standard electroplated rhodium on the reeds and found that the contact resistance varied significantly with use, and from switch to switch. They tried diffusing gold; but found that the incidence of "contact stick" increased. Finally, to overcome these difficulties, they developed a proprietary technique of triple-plating rhodium on the reeds.

Not only has the amount of current the switch can handle been increased: the switch can handle a 200-volt inductive load—five times greater than before. At 50% of full load, the contact resistance varies only 1 ohm in 8 million operations. It also takes about 8 million operations before one failure (5 msec contact stick) occurs.

Svenska says that the switch, which will be sold only to the American market immediately, of-

fers the manufacturer an off-the-shelf component that has higher reliability and lower cost than any other comparable unit available today. The reed relay will cost less than \$.50 in lots of 500,000 (comparable switches cost \$2.00) and can be delivered 30 days after receipt of order.

Specifications

Contact type	Spst—normally open
Operating time, approx.	1 msec
Operating rate, maximum	350 cps
Initial contact resistance	
Average value, below	25 milliohms
Maximum value	50 milliohms
Contact ratings	
Switching current, max.	5 amps
Switching voltage, a-c/d-c max.	200 volts
Switching power, max.	100 va
Life expectancy, to first failure, (minimum)	500 x 10 ⁶ operations
Pull-in	80-110 ampere-turns
Drop-out	78-48 ampere-turns
Breakdown voltage d-c	900 volts
Insulation resistance	10 ¹² ohms
Capacitances	
Between reeds in air	0.5 pf
Between one reed and coil	1.2 pf
Vibration and shock, any direction	40g
Mounting position	Any

The Ericsson Corp., 100 Park Ave., New York 17, N.Y. [351]

Over/under-voltage metering relays

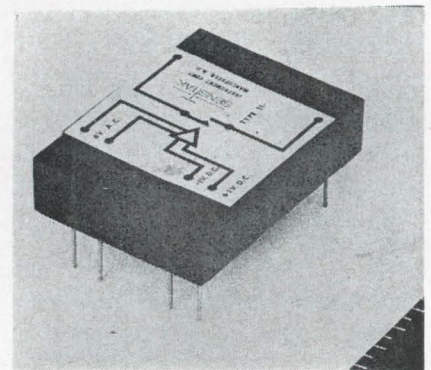

A family of solid-state over-voltage and under-voltage metering relays is announced. The relays combine a silicon, solid-state, operational amplifier and a reed contactor. The contacts will carry 15 watts a-c or

d-c. Primary power requirements are 8 v a-c at 20 ma. Signal requirements to close contacts are 1 v, 1 ma \pm 1%.

There are four types of relays available. Models 11A and 11B are latching relays, whose contacts will remain closed if the signal voltage approaches the operating point. Models 12A and 12B are on/off relays. The 11A and 12A will cause contact closure when the signal voltage exceeds 1 v. The 11B and 12B will cause contact closure when the signal voltage drops below 1 v. Signal voltage up to 500 v may be used with an appropriate external series resistor. The signal voltage may be d-c, rectified a-c, or rectangular pulses. With rectified a-c signals the relay will operate on the rms value; with rectangular pulses, on the peak value.

The relays are epoxy-encapsulated and are temperature-compensated from -20° to $+70^{\circ}$ C. They can be installed on p-c boards or standard chassis assemblies. Prices start at \$15.45, single unit, with discount on quantity; delivery from stock. Sensitivities down to 10 μ a are available on order.

Sensitak Instrument Corp., 531 Front St., Manchester, N.H., 03101. [352]

Hermetically sealed time delay switch

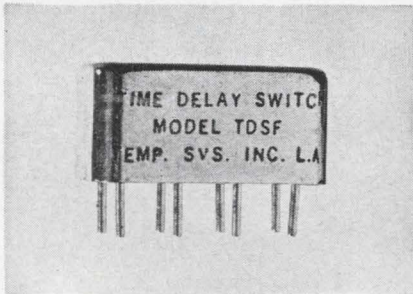

Model TDS-230 spst time delay switch is a solid-state, hermetically sealed package in a half crystal can. It is ideally suited for applications requiring high reliability and repeatability.

The unit is rated for 0.15 ampere continuous without heat sink. The use of an external timing resistor permits time delay ranges of 0.01 to 90 seconds with nominal ratios of 10:1 span within the range. Repeatability exceeds 1%. The switch is designed to meet ground and

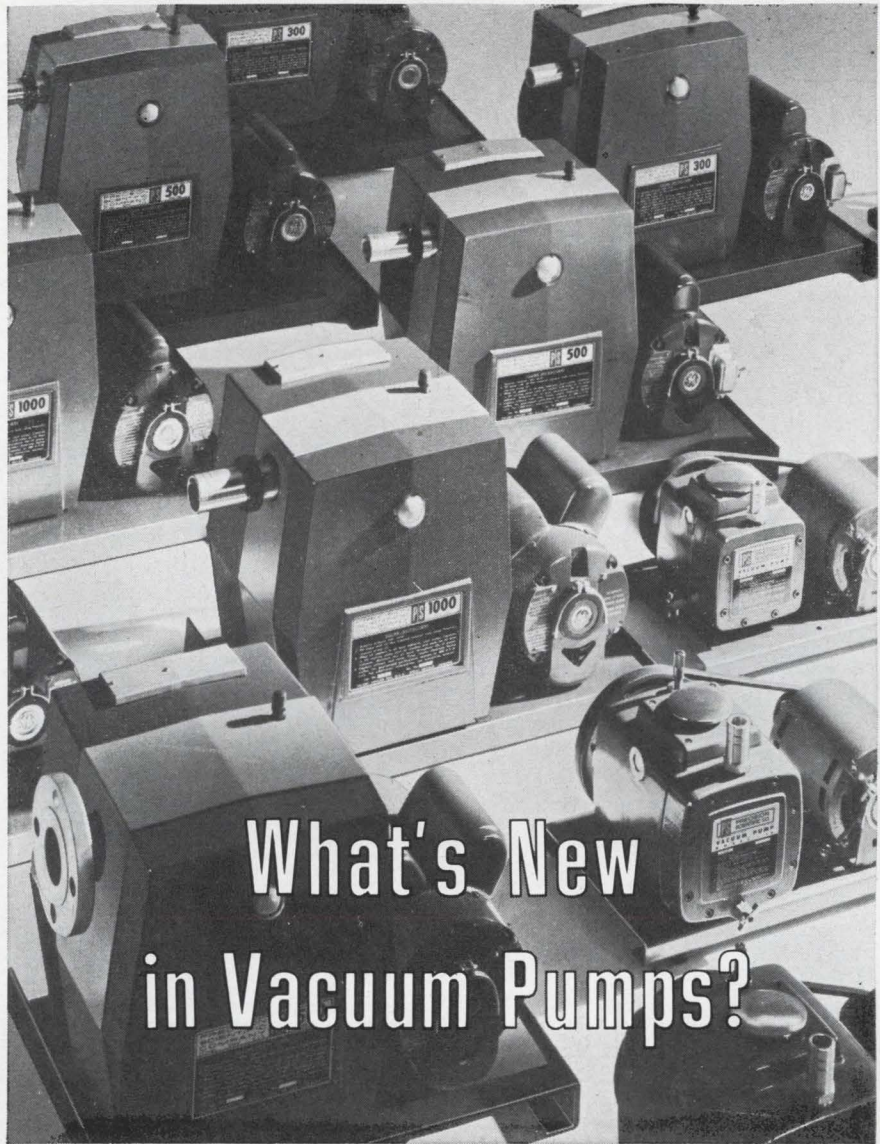

Precision Scientific Introduces Newest, Broadest Line in Industry!

Now you can have your choice of 12 brand new, internal vane vacuum pumps, plus a new, full range line of high vacuum fittings. Available in both single and two stage models, with capacity ranges from 25 to 1500 liters/minute, at prices ranging from \$100 to \$1500. Guaranteed ultimate vacuum runs to 0.1 micron of mercury. And, perhaps best of all, these pumps are quieter, smaller and more efficient than any on the market today!

You get superior service always from a job-rated model just right for your needs. Consult your Precision Scientific Distributor or write today for new 24-page Bulletin 650, just off the press.

Since 1920 • The finest in Quality Laboratory Apparatus



3737 W. Cortland Street, Chicago, Illinois 60647
Local Offices in New York • Chicago • Los Angeles

how to get your Pulse Generator "made to order" from TI



"Special" Pulse Generators are made to order at TI. Modular construction allows assembly of the right building blocks to meet your requirements. Now, "specials" cost you no more, frequently cost less than conventional pulse generators.

For example, the 6613 is an economical general-purpose unit with PRF from 15 cps to 15 mc, priced at only \$950. Another model, the 6325, is a ten-channel, word-bit programmable unit operating up to 25 mc. The single unit does the job of ten discrete generators, at half the cost, and fits in a cabinet 23 in. wide, 38 in. high, 18 in. deep.

TI Pulse Generators give you outstanding performance: PRF's to 100 mc, fast rise and fall times, variable pulse width and delay, variable rise and fall times, plus and minus outputs, pulse mixing, programmed and random word generation. You have your choice of portable or rack-mounting cases.

When you need special pulse generator performance, choose one of the thousands of standard pulse generator combinations from Texas Instruments. For more information, contact your nearest TI Authorized Representative or write to the Industrial Products Group in Houston.

INDUSTRIAL
PRODUCTS
GROUP



TEXAS INSTRUMENTS
INCORPORATED
P. O. BOX 66027 HOUSTON, TEXAS 77006
118 RUE DU RHONE GENEVA, SWITZERLAND

New Components

space-borne environments and is protected against line transients and reverse polarity.

The unit price in quantities of 1 to 9 is \$35 each and delivery can be made from stock to one week after receipt of order.

Temperature Systems, Inc., 1871 S. Orange Drive, Los Angeles 19, Calif. [353]

Tiny, glass-sealed high-megohm resistors

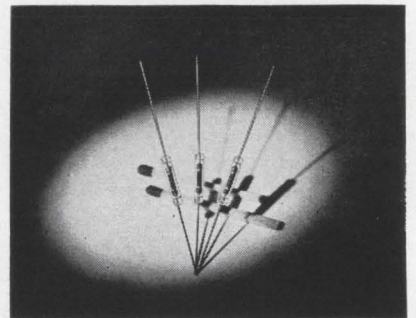

A new resistor line, series HR600, is now available in resistances from 10^8 to 10^{14} ohms. This miniature, hermetically glass-sealed resistor (said to be smaller than any other manufactured) operates at voltages up to 1,000 v, temperatures up to 150°C . It is available in tolerances of 2%, 5%, and 10%, and offers good long-term stability.

The HR600 measures only 0.526 in. long x 0.110 in. in diameter. Pyrofilm Resistor Co., 3 Saddle Road, Cedar Knolls, N.J. [354]

Feed-through seal has 37-pin connector

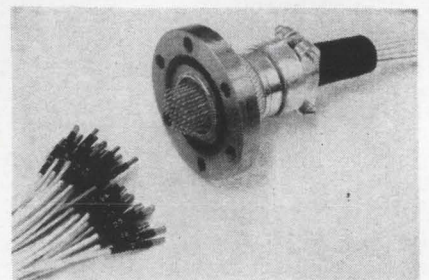

A low-cost, 37-pin electrical feed-through seal is announced for use in high-vacuum systems, test cham-

bers, and other equipment items. It is suited for quick electrical connections between instrumentation and the many types of electrical and electronics equipment to be energized while in vacuum or other atmospheres. The large number of identified pins, per feed-through, now makes it possible to provide wiring for numerous circuits economically.

The connector is mounted in a standard 2 $\frac{3}{4}$ -in.-o.d. stainless-steel vacuum flange. The wire used on the connector is 20-gauge standard, polyvinyl-chloride insulated, glass-braid overlay. The external wires are prewired into the connector cap and number-coded. Inside wires, also provided, are fitted with individual connector contacts, and are also number-coded. The rating of each pin and wire is 7 $\frac{1}{2}$ amps and 1000 v d-c, at sea level. The entire assembly is helium-leak-tight to 5×10^{-10} standard cc per sec.

The new feed-through, designated the model V4-137, is priced at \$250.

Materials Research Corp., Orangeburg, N.Y., 10962. [355]

Banana-type terminal socket

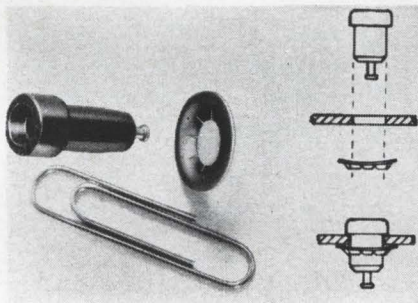

The banana-type terminal socket illustrated is said to be the only one completely molded into high-temperature diallyl phthalate. The push-on-type banana jack offers high dielectric strength and low moisture absorption for critical test-equipment requirements. The jack is installed simply by drilling a 0.265-in.-diameter hole, and attaching the jack with a push-on fastener. There are no nuts or lock washers needed. A slight taper in the body facilitates installation. Over-all length is $\frac{1}{8}$ in.

The socket is normally supplied

how to get your A-D Converter "made to order" from TI

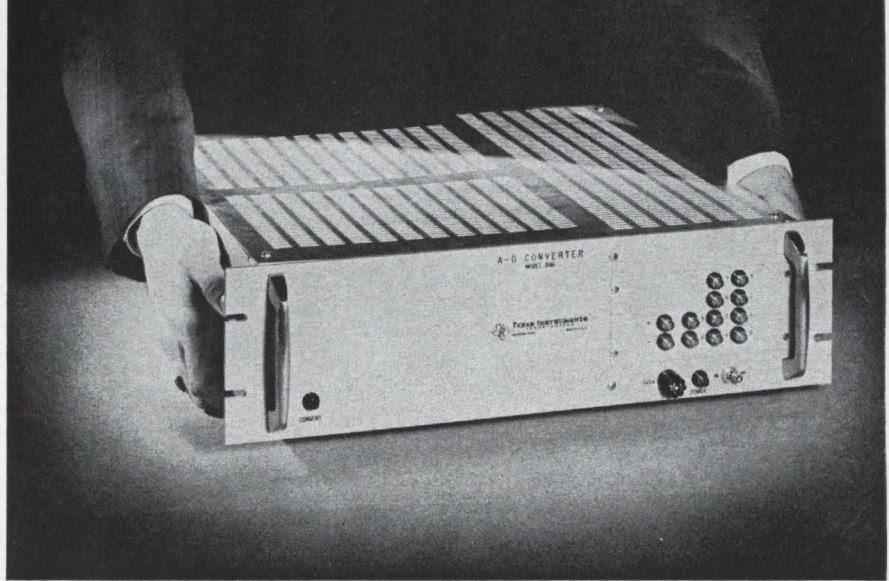

For your choice of more than 10,534 TI converters, just select the input/output functions that meet your requirements. Then you get an A-D Converter composed of carefully engineered, field-proven functional modules that exactly fit your job . . . "made to order" from TI.

With Series 846 Converters, you'll get speed as high as 69,000 conversions/sec including built-in sample and hold. You'll get accuracy to 0.025% of full scale and high input impedance (100 megohms) for single-ended or differential units. And for low-level conversion, you get high common-mode rejection.

You can also have your choice of TI Multiplexers from 32 different models. Multiplexers can be furnished to accommodate 10 to 160 channels at sampling rates to 50,000 channels/sec. Four channel-select versions are offered: addressable, addressable/sequential, sequential or direct channel-select.

When you need an A-D Converter or Multiplexer, choose one of the "made to order" instruments from Texas Instruments. For more information, contact your nearest TI Authorized Representative or write directly to the Industrial Products Group in Houston.

INDUSTRIAL
PRODUCTS
GROUP



TEXAS INSTRUMENTS
INCORPORATED
P. O. BOX 66027 HOUSTON, TEXAS 77006
118 RUE du RHONE GENEVA, SWITZERLAND

751

Easy to Operate
 Easy to Carry
 Excellent Reproduction



Broadcast Use Video Tape Recorder System BV-120 chain

WFM-1
 TIS-1 | PV-120U

Comprising Videocorder PV-120U
 TV Signal Integrated Stabilizer TIS-1
 Waveform Monitor WFM-1

RESEARCH MAKES THE DIFFERENCE
SONY

For further information, please contact:
 SONY CORPORATION SONY CORP. OF AMERICA SONY OVERSEAS S.A.
 351 Kitashinagawa-6 516 W. Florence Ave. Baarerstrasse 73, Zug
 Shinagawa-ku, Tokyo, Japan Inglewood, California, U.S.A. Switzerland

New Components

Cadmium-plated; gold plating is also available. A complete range of colors is standard for coding. Prices range upward from 6½ cents each, depending on quantity. Mounting tools for hand or machine mounting are available.

Electronic Molding Corp., 38 Church St., Pawtucket, R.I., 02860. [356]

Time delay relays for industrial use

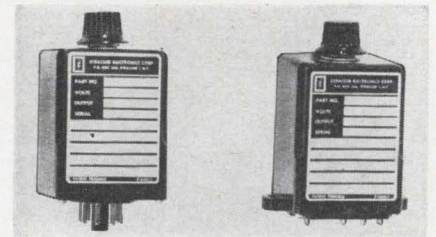

A series of highly accurate, solid-state time delay relays has been introduced for industrial application. The DDR series is available in a variety of enclosures and adjustable timing ranges from a fraction of a second to six minutes. Units can operate from a-c or d-c voltage sources.

The timer is designed to offer delay upon de-energization. Life expectancy is 10 million mechanical operations, with a repeat accuracy of ±2% and a reset time of 50 msec. Output contacts are dpdt and are rated for 10 amps resistive load.

Syracuse Electronics Corp., P.O. Box 566, Syracuse 1, N.Y. [357]

Thermal timing relays mount on p-c boards



Series JT thermal time-delay relays are designed for mounting on printed-circuit boards. Four pins

New F-111 uses 50 miles of wire jacketed with Kynar.*
Why? Primarily because KYNAR is tough. Its mechanical strength and abrasion resistance make it possible to use thinner jacketing without compromising performance. Result: savings in space...savings in weight amounting to several hundred pounds per plane. Wire jacketed with cross-linked KYNAR is described in MIL-W-81044.

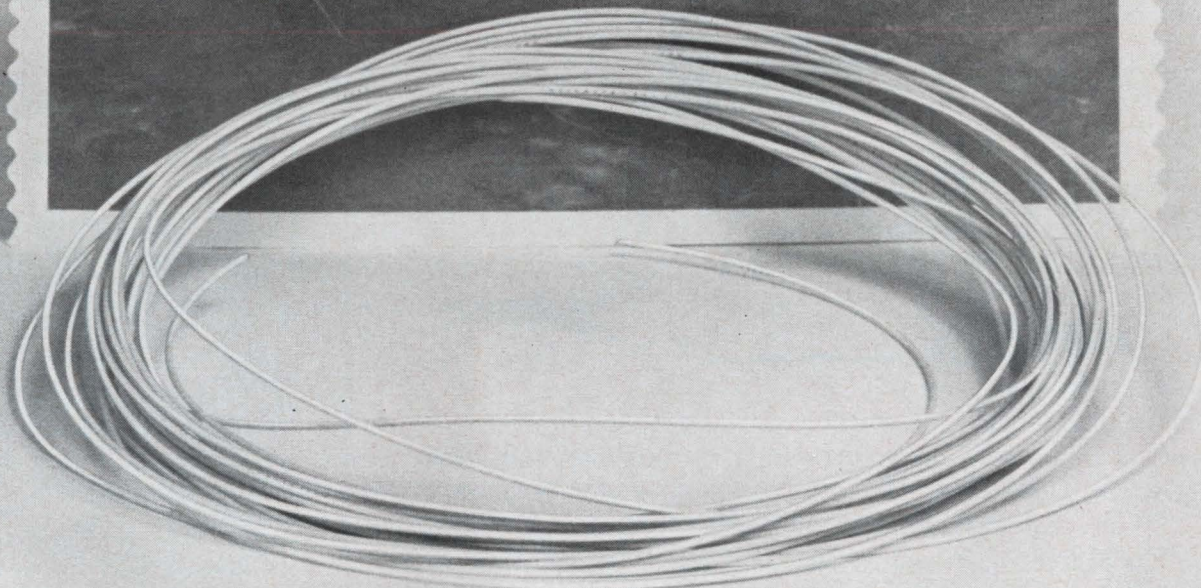
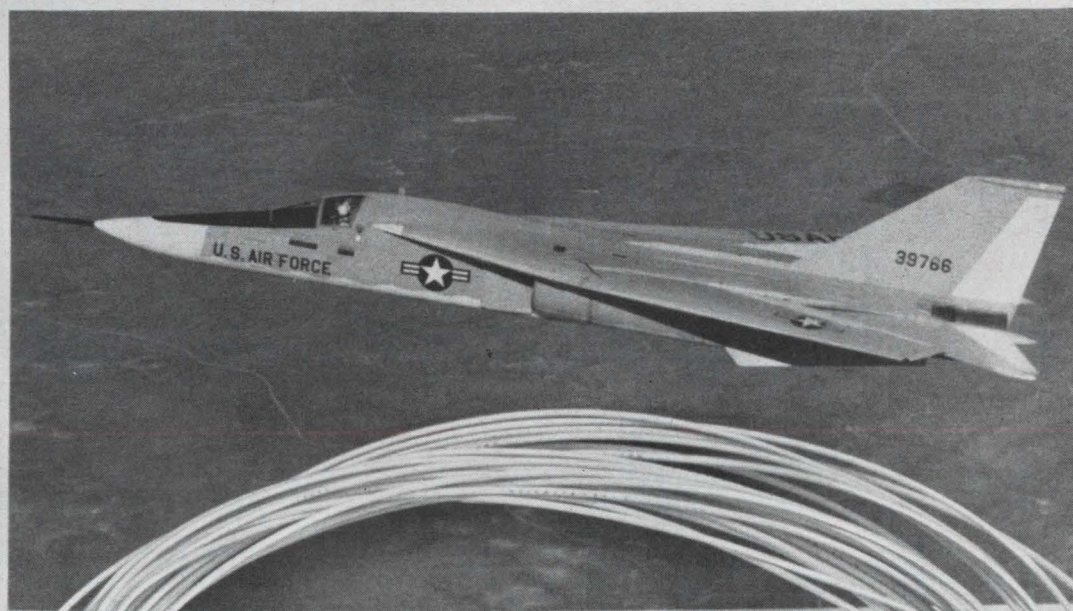

If you have a problem with space, weight, cut-through, abrasion or temperature, consider using wire insulated and/or jacketed with KYNAR. For detailed information, write Pennsalt Chemicals Corporation, 3 Penn Center, Philadelphia, Pa. 19102.

Kynar...the fluoroplastic that's tough!

*Registered trademark of Pennsalt Chemicals Corporation for its vinylidene fluoride resin.



CHEMICALS ■ EQUIPMENT

*Supply Problem for Precision Metals
got you stumped?*

*use Hamilton's
theory of
probability
to solve it:*



This is where complete production facilities count! Chances are Hamilton's capabilities are the answer . . . as they have been for hundreds of others . . . whether it's high strength, non-magnetic foil only 90 millionths of an inch thick . . . precision strip for contacts to work accurately at temperatures up to 1500°F . . . or permalloy sheets .006" thick with only a $\pm .0001$ " variation. The Precision Metals Division of Hamilton Watch has the unique precision production facilities to do the almost "impossible". □ What can you lose? Before you give up, ask us. Invest a postage stamp and ask for the brochure on Precision Metals. You will receive facts and information that you can use.

PRECISION METALS DIVISION
HAMILTON
WATCH COMPANY
LANCASTER PA.

New Components

on the base of the relay serve as terminals and also attach the relay to the board. The units are fully compensated for ambient temperature variation and will operate in any plane. They are intended for use in communications equipment, industrial control, and other commercial applications.

Delay intervals from 2 seconds to 3 minutes are available and are factory set. Timing tolerance is $\pm 15\%$. Heater voltages of 6.3, 28, 115, and 230 v are standard, and relays will operate interchangeably on a-c and d-c. Contacts are single-pole, single-throw, either normally open or normally closed. Contact rating for resistive loads is 5 amps to 125 v a-c; 3 amps to 250 v a-c; 1 amp to 32 v d-c. The enclosing case is of stainless steel and is approximately $\frac{3}{4}$ in. square and $2\frac{1}{4}$ in. long.

Price is \$5 to \$10, depending on time-delay range and quantity. G-V Controls Inc., Okner Parkway, Livingston, N.J. [358]

Rotary switch has dual concentric shaft

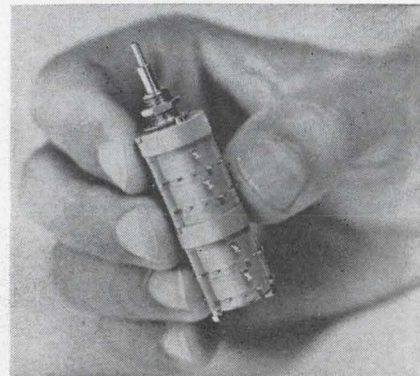

A totally enclosed, explosion-proof microminiature rotary switch, series 2505, features a dual concentric shaft that permits one set of poles to be rotated independently of the other. Up to three decks maximum are available on the outer shaft with a total of eight decks over-all. The switch is available in combination of shorting and non-shortening decks.

The new series is built to exceed the requirements of MIL-S-3786B. Electrical rating carries 8 amps

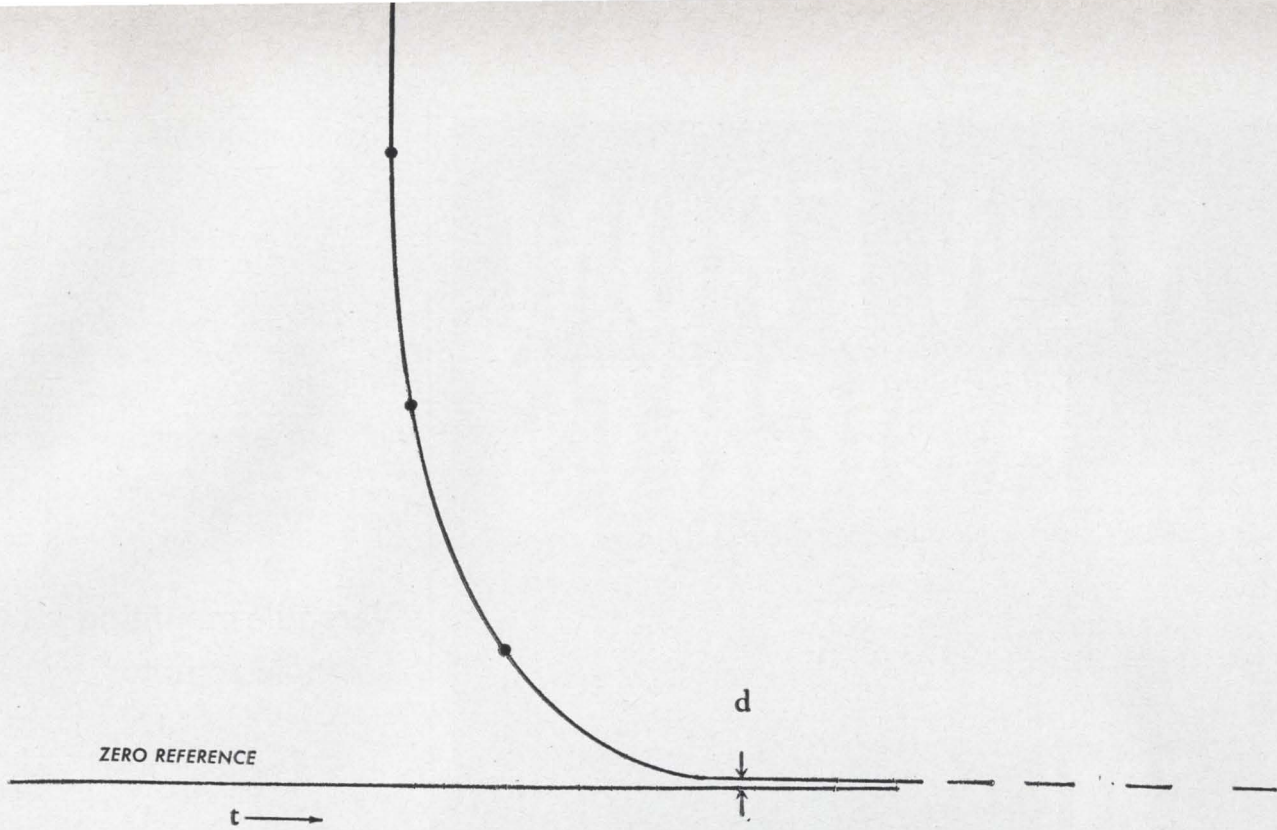

d is the dynamic response of a CELCO deflection yoke

It is 0.1% in 5 microseconds

Need a faster response for your display?

Use a DYNAYOKE[®]



Constantine Engineering Laboratories Company

YOKES

FOCUS COILS

DEFLECTION AMPLIFIERS

NEW FROM KNIGHTS



new low price
proportional
control ovens
for precise
control of
temperature
environment
for crystals
and components.

Four new proportional control ovens — 952 thru 955 Series — eliminates usual noise problems associated with thermostat controlled ovens. Temperature remains constant without deviations due to thermostat on-off cycling found in other devices. Models 952 and 953 are designed primarily for crystals and small components. The larger Models 954 and 955 are for large components, oscillators, etc. and can be supplied with 4, 7, or 9 pin internal sockets. Standard operating temperatures are 65°, 75° and 85°C ± 5°C. Other temperatures and closer tolerances are available. At constant ambient temperature oven stability is ± .025°C max.

Standard input voltage is 28VDC. Other voltages available on special order.

For detailed information request Bulletin 952-5 from your CTS Knights representative or from the main office.



CTS Knights, Inc.

of Sandwich, Illinois
(formerly The James Knights Co.)
a subsidiary of CTS Corporation, Elkhart, Indiana



New Components

continuous, makes and breaks ¼ amp 115 v a-c resistive, ¼ amp 28 v d-c resistive, and ⅛ amp 28 v d-c inductive. The switch measures ½ in. in body diameter. Torque is 5 to 12 in.-oz.

Series 2505 is available in 30°, 36°, and 45° indexing or combinations of any two.

Janco Corp., 3111 Winona Ave., Burbank, Calif. [359]

Versatile mounting solenoid actuator

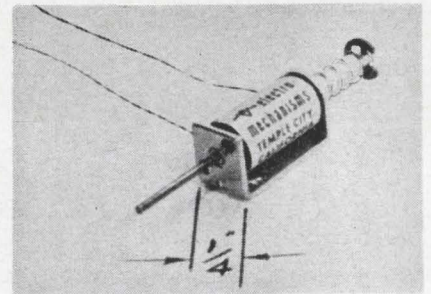

A solenoid actuator has been developed that features compact size, low cost and versatile mounting. It is designed for push or pull operation and is available as a stock item for 6, 12, 24 or 48 volts. Size of the unit permits mounting side by side on ¼-in. centers. Frame length is approximately ½ in.

The unit delivers 14-oz pull when closed and has a maximum stroke of 5/16 in. Low duty cycle coils deliver up to twice this force. The unit operates at very high speed due to its low inertia. Price of the model SP-25 ranges from 68 cents to \$2.58 depending on quantity, features, etc.

Electro-Mechanisms, Inc., 5040 Sereno Dr., Temple City, Calif. [360]

Tiny capacitors are voltage variable

Voltage variable capacitors are being offered in a smaller-than-normal glass package. The Micro Caps feature high Q and high transconductance at high frequencies. A wide range of capacitances is available. Piv is 60 volts. The units are



No matter how big the ferrite piece,
**WHEN MECHANICAL AND ELECTRICAL
 SPECS ARE TIGHT ... SPECIFY STACKPOLE**

Stackpole makes them all:

Toroids over 6.000" OD x .500" Long

Cup Cores 2.500" OD x .960" O Hgt.

Rods to 1.000" D x 2.812" Long

Sleeves to 4.050" OD x 2.500" long

Rectangular Solids of nearly 6" Length x 4.175"

Width x .750" Thick.

But gross size isn't Stackpole's only claim to fame in ferrites. As one customer put it, "Your ferrite cores are more consistent from order to order than any of your competitors."

Over 30 grades. Isn't that what you're looking for?



STACKPOLE
 ELECTRONIC COMPONENTS DIVISION
 ST. MARYS, PENNSYLVANIA

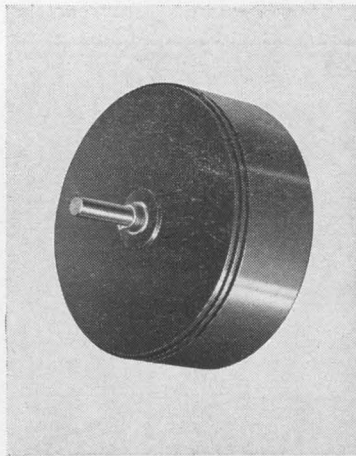

This is a new Optical Encoder.

It provides its own internal data storage.
It needs no amplifiers.
It's about two years ahead of the field.

DATEX 03-506 OPTICAL ENCODER SERIES

- High Output—No Amplifiers
- Automatic Internal Storage
- High Speed—Long Life
- Low Voltage, Low Temperature, Long Life Lamp
- Variety of Output Codes
- Military, Commercial Applications

Through the selection of unique, state-of-the-art sensors, a high output is obtained directly from the DATEX optical encoder without the use of amplifiers, eliminating the need of buffering and DC amplification problems.

The DATEX optical encoder is a true switch, not a signal generator. This feature, coupled with carefully engineered circuitry, automatically provides a store or lack of each bit output, eliminating subsequent bit dropout.



The use of an optical sensor system allows operational speed to 1000 rpm and life limited essentially by the mechanical bearings. With a non-contact optical sensor, slow speeds may run to almost any degree with virtually no change of wear.

The use of low voltage, low temperature lamps results in an expected lamp assembly life of 40,000 hours or more. The assembly is easily removed for normal maintenance. Output codes available as standard include binary, gray, 8421 BCD and Data.

Digital Instrumentation and Control for Science and Industry

This is a new Data Packet.

It tells about a breakthrough in encoder performance; explains the simplicity, high output signal, long life and storage capability of Datex's new Optical Encoders. It's yours for the asking.

DATEX
GIANNINI CONTROLS CORPORATION
1307 S. MYRTLE AVE., MONROVIA, CALIF. 91017

New Components

especially designed for use in military field communications equipment, parametric amplifiers, frequency multipliers, and automatic frequency control. They are available in 5%, 10% or 20% tolerances, with both medium and high Q. Price ranges from \$2.50 to \$28 in 100 lots.

Easton Corp., 25 Locust St., Haverhill, Mass. [361]

Thin, rectangular cermet trimmer

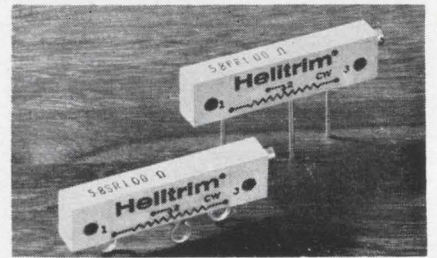

Model 58 is a thin rectangular trimming potentiometer offered with either printed circuit pins or solder lugs. It is the industry's only trimmer with a slim RJ12 style plastic housing and terminals staggered in RJ11 configuration. The unit is less than 0.200 in. thick and requires only two-thirds the board space of an RJ11 trimmer.

The pot features a cermet resistance element with essentially infinite resolution and standard resistances from 10 ohms to 2 meg-ohms. Power rating is 1 watt at 85°C, and the total operating temperature range is -65° to 175°C. Price is \$5.50.

Helipot division of Beckman Instruments, Inc., 2500 Harbor Blvd., Fullerton, Calif., 92634. [362]

Solid-state switch handles high power

A solid-state switch now in production combines high power capability and broadband operation. Model DS-650 spst switch can handle up to 100 watts c-w power—average or peak—and operates in a frequency range from 100 to 600 Mc. Isolation

COMPONENT COMMENTS *From Speer*

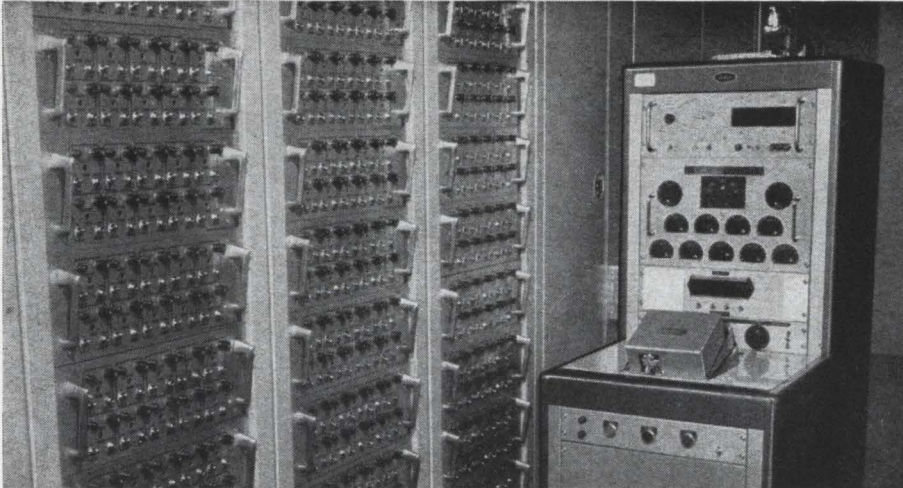

In order to accommodate the 10,000-hour failure-rate level determination load life test (shown above) as well as the other special tests required by MIL-R-39008, Speer recently added 28,000 square feet of quality control and inspection facilities to its Bradford, Pennsylvania, resistor plant.

How to be sure that a resistor will shape up to MIL-R-39008

The problem, as we see it, is twofold. First: how can the resistor manufacturer be sure? And second: how can you, the purchaser, be sure?

First things first. The new MIL-R-39008 "Established Reliability" specification is a challenge to the manufacturer to achieve higher standards of accuracy and reliability than were required by the earlier MIL-R-11 military specs. Not only are the MIL-R-39008 tests more extensive and more exacting; they're also decidedly more time-consuming. (Example? Up to 630 million unit test hours are required to extend qualification to the lowest of the new failure-rate levels. With MIL-R-11, failure-rate level determination was not even required.)

We at Speer had a sneaking suspicion that we possessed the broad background and the resistor know-how to achieve these new standards of accuracy and reliability. And now, at last, we've completed sufficient long-term life testing to determine that our 5-stripe resistors can indeed "shape up" to MIL-R-39008's rugged military standards.

So far, so good. But how do we now assure *you* of our resistors' Established Reliability? Five colorful stripes aren't adequate assurance. Neither are glowing adjectives.

So we've decided to do more—and that's why each shipment of our 5-stripe resistors comes to you with a lot quality certificate to document its performance. Automatically generated data from each test group is maintained for detailed reference.

If you'd like to pursue this subject of Established Reliability still further, we invite you to send for our technical article entitled "How the New 'Tri-Service' Specification MIL-R-39008 Applies to Resistors." To get a copy, use the coupon.

SPEER CARBON COMPANY

St. Marys, Pennsylvania
Speer Carbon Co. is a Division of Air Reduction Company, Inc.

- Rush "How the New 'Tri-Service' Specification MIL-R-39008 Applies to Resistors."
- Rush "The Jeffers Inductor Handbook."
- Arrange for me to receive reprints of "Component Comments."

Name _____

Title _____

Company _____

Address _____

City _____

State _____ Zip _____

Our inductor capabilities are an open book

We have just discovered that our Jeffers Electronics Division is not a group to be trifled with.

In a recent issue of "Component Comments," we presented a feature on "The Speer Resistor Handbook." When our Jeffers associates got wind of this, they reminded us, a trifle tartly, that "The Jeffers Inductor Handbook" is equally fascinating.

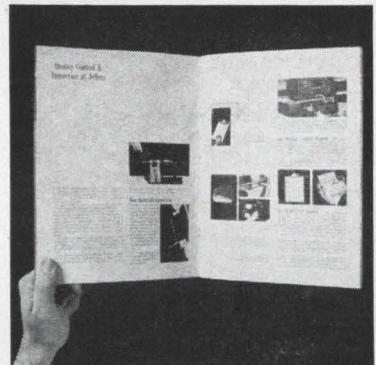

Interior view of our free, 16-page, lavishly illustrated "Inductor Handbook."

And so it is. This colorful 16-page brochure takes you through the entire Jeffers inductor plant—from the automated manufacturing operation and the application engineering services to the Established Reliability Program and the comprehensive Quality Control & Inspection Program. (Did you know, for example, that there are continuous patrol checks at every manufacturing step?) You'll also learn how our standard catalog inductors have performed under MIL-C-15305 test conditions.

As you can see, our Jeffers Division's inductor capabilities are an open book. If you'd like a copy, just mail us the coupon.

a new recording concept

[AND HERE'S WHAT IT WILL DO]

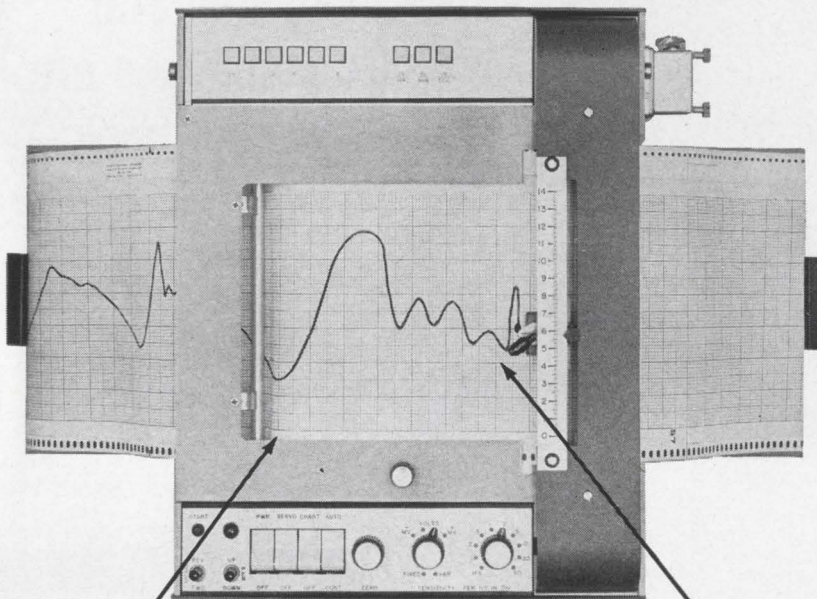

THE AXIS PERFORMS AS

- A STRIP CHART
- X For X-Y
- T-Y (Sequencing Chart)
- PROGRAMMING CHART
- PROGRAMMABLE CHART
- PULSE CHART DRIVEN

THIS AXIS IS the highest quality servo available in any type multi-range potentiometric recorder today.

Dollar for dollar, this new OMNIGRAPHIC™ RECORDER will deliver more functions, more features and more conveniences than any other recorder ... or any other **two** recorders on the market today. Examples: Continuous or automatic advance feed for recording on Z-fold continuous 8½" paper or on a 7" x 10" paper grid with perforations for easy tearing to 8½" x 11" file size; push button speed control provides 18 selections from 2"/sec. to .05"/hr., or a 144,000:1 range; .15% accuracy; ⅓ sec. f.s. pen response; 20 voltage ranges; and infinite input resistance.

The OMNIGRAPHIC™ RECORDER is unique. It is a new concept in graphic recording. The cost is far less than you may imagine.

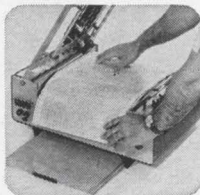

Ease of loading

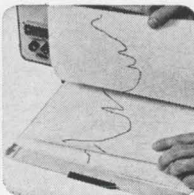

Z-fold paper

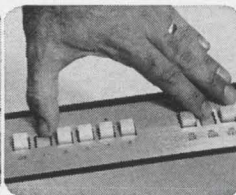

Push button selection

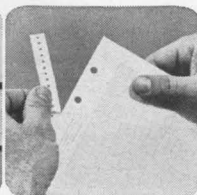

Tears to std. chart size



houston OMNIGRAPHIC corporation

a subsidiary of houston instrument corporation
4950 Terminal Ave. / Bellaire, Texas 77401
(713) 667 7403 / cable HOINCO / TWX (713) 571 2063

IN EUROPE: Houston Instrument N.V. Keizersgracht 450, Amsterdam, Holland, Tel. (020) 238138

New Components

at 100 Mc is typically greater than 42 db, at 500 Mc it is greater than 31 db.

The DS-650 will switch (10% to 90% points) at speeds as high as 200 nsec when used with a suitable driver. Insertion loss across the entire bandwidth is less than 0.5 db; on vswr is typically below 1.7; impedance is 50 ohms nominal. Size (excluding connectors) is 4.75 x 2.3 x 1.0 in. and weight is 15 oz. Standard connectors include type N female for r-f and type BNC for control unit.

Sanders Associates, Inc., 95 Canal St., Nashua, N.H. [363]



Mercury plunger relay is highly reliable

A mercury plunger relay measuring only 3 in. high x 1⅞ in. wide x 1⅞ in. deep is now available with quick-connect terminals. The Mini-Relay is rated to control loads up to 20 amps at 120 v a-c and it can safely handle 2,300 w of incandescent lamps.

Using liquid mercury-to-mercury contacts within a hermetically sealed shatter-proof tube, the Mini-Relay provides silent reliable operation. With no parts to wear out or stick or corrode, the unit permits millions of makes and breaks without service or repair.

The basic operating principle of a mercury plunger relay provides two separate pools of mercury,

electrically isolated from each other. With the activation of the coil, a plunger is immersed in the lower pool, displacing the mercury upwards until it makes contact with the mercury in the upper pool, thus completing the circuit. Deactivation of the coil releases the plunger, allowing the mercury level to drop, breaking the circuit. The liquid contact surface is continuously renewed on each make, and arcing is kept to a minimum, assuring long life and trouble-free operation.

The MiniRelay is constructed with all terminals in the front for easy accessibility and simple installation.

Ebert Electronics, Floral Park, N.Y. [364]

Worm-gear-actuated adjustment pot

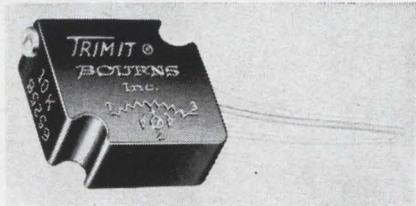

A 1/2-in.-square, worm-gear-actuated adjustment potentiometer has been developed for industrial and commercial uses. According to the maker, the wirewound model 3257 Trimit pot is the lowest-priced 1/2-in.-square unit available. Cost is \$2.36 in 100-piece quantities.

The fact that it has only twelve parts contributes to the 3257's overall reliability yet keeps the cost low. Despite its price, the 3257 has features that allow it to be used in moderately rugged environments.

These features include an idling mechanism that prevents damage from forced adjustment at the end of wiper travel; a temperature range from -65° to +105°C; fused Silverweld termination, which eliminates the chief cause of potentiometer failure; and shock and vibration capabilities of 20 g and 10 g, 2000 cps, respectively.

Resistance range is 10 ohms to 20,000 ohms; resistance tolerance, ±10%; power rating, 0.25 w at 25°C; size, 1/2 x 1/2 x 0.22 in.

Bourns, Inc., 1200 Columbia Ave., Riverside, Calif. [365]

COMPARE PHYSICAL SIZE CAPACITANCE AND COST

YOU'LL SPECIFY

RMC MAGNACAPS

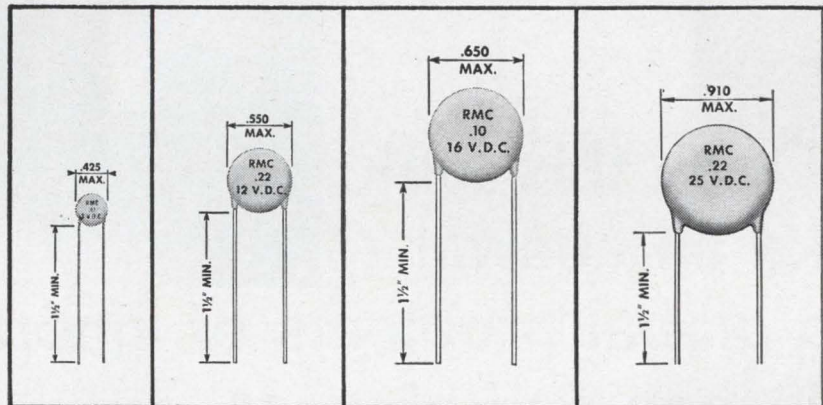

GENERAL SPECIFICATIONS

CAPACITANCE: Within tolerance @ 1KC, 0.05 vrms max. and 25°C.

TEMPERATURE COEFFICIENT: M-3—Z5R, Y5S, X5S, M-12, 16 and 25—Z5T, Y5T, X5U.

LIFE TEST: 250 hours @ rated voltage and maximum temperature.

BODY INSULATION: Durez phenolic—vacuum wax impregnated.

LEAD STYLES AVAILABLE: Long leads—#22 AWG tinned copper and kinked lead plug-ins for printed wire circuits.

■ For their size RMC Magnacaps offer the ultimate in the development of capacitance with acceptable temperature stability. Considering their small size and their proven reliability you'll find that Magnacaps are very economical.

Type M3 and M12 "MAGNACAPS" offer an extremely high efficiency ratio and are recommended for applications with lower operating voltages. The M3 type is available with a capacitance range of .05 mf to 2.2 mf. M12 Magnacaps cover the range from .05 mf to 1.0 mf. Their use as emitter bypass components is particularly suggested, as they retain their proper impedance characteristics well into the radio frequency range.

M16 and M25 "MAGNACAPS" offer an economical general purpose component for wide application with a capacitance range of .01 mf to .22 mf. Their conservative design rating, and high value of insulation resistance (10 megohms at rated voltage) has made these units particularly popular in mobile or portable battery operated equipment.

For additional information, write on your letterhead.

DISCAP
CERAMIC
CAPACITORS



RADIO MATERIALS COMPANY

A DIVISION OF P. R. MALLORY & CO., INC.

GENERAL OFFICE: 4242 W. Bryn Mawr Ave., Chicago 46, Ill.

Two RMC Plants Devoted Exclusively to Ceramic Capacitors

FACTORIES AT CHICAGO, ILL. AND ATTICA, IND.

Does this look like an answer to global problems of ignorance, disease and physical deprivation?



Not yet. But we're getting closer.

Behind this movement is a simple statistic with startling implications for all of us—*If you count all the scientists and engineers since the beginning of recorded history, ninety percent are alive today!*

We are now in the midst of the result—an incredible explosion of information from every corner of the globe. And somewhere within this explosion will be the ultimate answers to mankind's oldest, and newest problems.

The challenges are many. First, to understand the nature of this giant intellectual force. Then, to find the best way to collect it, classify it, store it... and distribute it appropriately

and instantly to the people who need it.

In this light, you might consider today's Xerox products early and primitive steps along a difficult but fascinating path. You'd be right. Yet, has anyone taken these steps before us?

Your degree and background may be more appropriate to our advanced work than you imagined. We're as interested in talking with communication systems specialists as electromechanical designers, organic chemists as much as program analysts. This list is as broad as it is long. Maybe broader. You'll find several specific (and urgent) openings outlined at the right. If they suggest a possible community of interest, send us your resume. An equal opportunity employer (M&F).

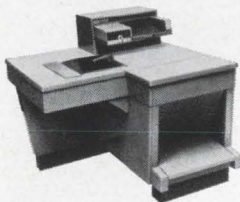

The Xerox 914 Copier revolutionized the office copying industry when it was introduced in 1959... and really started us on our way.



Less than 3 years later, the 813 further extended low-cost, quality office copying. One-seventh the volume of the 914, it does just about everything the 914 does except copy solid, 3-dimensional objects.



Another revolution. An electro-mechanical-chemical-optical device called the 2400 because it produces 2,400 copies per hour directly from an original document. No stencil or "master" of any kind. You press a button,

XEROX

TOP PHOTO: LDX (Long Distance Xerography) scans, transmits and reproduces images over distances limited only by the transmission medium. Something like it may print the morning paper at your breakfast table some day, or help you manage a global business.

XEROX, 914, 813, 2400 AND LDX ARE TRADEMARKS OF XEROX CORPORATION

Does this look like an answer to your career problems?

ELECTRONIC DEVELOPMENT ENGINEERS. Experimental design, fabrication, and testing of CRT displays, character generation, and control equipment. BSEE required with experience in electronic circuit design, solid state logic, display, communications and/or packaging.

ELECTRONIC ENGINEERS. To work in the development of peripheral equipment of data processing systems. BSEE required with design experience in the area of solid state digital data processing equipment in both systems and circuits.

INFORMATION SYSTEMS ENGINEERS. For system configuration study and synthesis leading to detailed specification of information storage and retrieval equipments, computer peripheral equipments, and data systems terminals. BSEE required with at least 5 years experience in design, development and/or systems in digital information processing display, communications, and/or microfilm systems.

DEVELOPMENT ENGINEERS. To work in Discreet and Integrated Circuit Packaging. BSEE with experience in such areas as standard circuit packaging, logic configurations, circuit selection for logic and linear applications, and component applications.

These positions are in Rochester, New York. Send resume, including salary history to Mr. John J. Foley, Xerox Corporation, Department EL-12, P.O. Box 1540, Rochester, N. Y. 14603.

XEROX

An Equal Opportunity Employer (M&F)

New Semiconductors

Silicon transistors offer fast switching

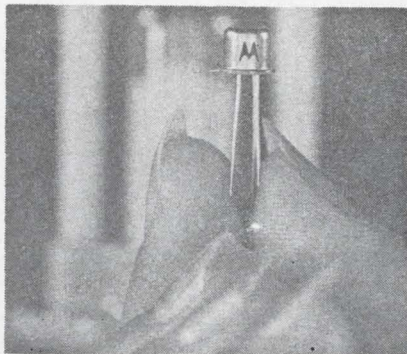

Silicon annular npn transistors, types 2N3959 and 2N3960, are designed for high-speed nonsaturated switching applications.

New "narrow base profile" techniques permit base thicknesses on the order of only 0.1 micron in volume production transistors. Previously, base regions this thin could not be fabricated without prohibitive loss of yield. This production problem had limited gain-bandwidth (f_T) to approximately 1,200 Mc with an adequate breakdown voltage rating. Using the narrow base profile, the 2N3960 offers a typical f_T of 1,800 Mc combined with a collector-base breakdown voltage of 20 v minimum and a collector-emitter breakdown voltage of 12 v minimum.

Both the 2N3959 and 2N3960 feature gain-bandwidth products specified at collector current values of 5, 10, and 30 ma. Guaranteed minimum f_T values at collector current of 10 ma are 1,300 Mc for the 2N3959 and 1,600 Mc for the 2N3960.

Input and output capacitance for both devices are 2.5 pf maximum. The collector-base time constant is 25 psec maximum for the 2N3959 and 40 psec maximum for the 2N3960, measured at collector current of 10 ma and collector-to-emitter voltage of 10 v d-c.

The high gain-bandwidth products, low capacitances and low base spreading resistances of these new devices provide exceptionally high speed in current mode logic circuits. In this type of circuitry,

the transistors offer typical turn-on delay and rise time values of 2 nsec when measured at a collector current of 30 ma and an output voltage of 1 v.

Prices for the 2N3959 are \$10.50 for 1 to 99, \$7 for 100 to 999; for the 2N3960, \$13.10 for 1 to 99, \$8.75 for 100 to 999.

Motorola Semiconductor Products, Inc., Box 955, Phoenix, Ariz., 85001. [371]

Silicon rectifiers conserve space, cost

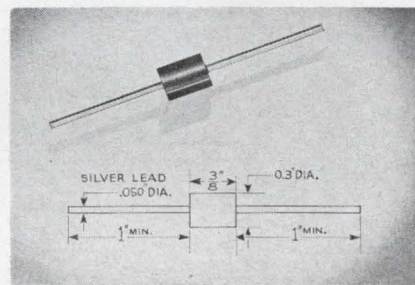

Axial-lead silicon rectifiers are being supplied with a forward current of 3 amps and a surge rating of 300 amps. The body is insulated.

Replacing stud rectifiers mounted on heatsinks or metal stacks, the molded HIB type can be mounted on component boards, allowing space and cost savings.

The units are suitable for d-c motor controls, power tools, welding equipment, radio transmitters and battery chargers, as well as military power supplies requiring large forward currents and high surge currents. Price of the 800-piv units is \$1.75 each for 1 to 99 pieces.

Electronic Devices, Inc., 21 Gray Oaks Ave., Yonkers, N.Y. 10710. [372]

Silicon diode bridge rectifiers

A series of molded, single-phase, full-wave bridge rectifiers is comprised of hermetically sealed silicon diodes completely encapsulated in a ten-sided configuration that permits snap-on addition of heat sinks.

Available in current ratings of 6,

New Semiconductors

10 and 12 amps in voltage ratings from 50 to 400 piv, the rectifiers feature a highly efficient heat sink for extra margin performance, when desired. The heat sink is offered separately for snap-on application to the 6- and 10-amp units, and is an integral part of the 12-amp units. Under fan cooling, 12-amp units operate at 15 amps.

Considering the volt/ampere rating, the bridge rectifiers are small in size, measuring only $1\frac{5}{8}$ in. across the top flat surface, and $\frac{5}{8}$ in. high. With heat sink added, the diameter increases to $2\frac{3}{4}$ in. Mounting is accomplished by means of one 8-32 screw through a hole in the center of the encapsulation. Since the rectifier is electrically insulated, it can be mounted directly to metal chassis.

All 15 devices in the series, and optional heat sinks, are available from stock, at prices ranging from \$2 to \$5 in production quantities. Alpha Components Corp., 4222 Glencoe, Venice, Calif. [373]

Power transistor in TO-46 package

A 2-amp silicon planar npn power transistor is being manufactured for military, industrial, and commercial applications. It will provide customers with the latest state-of-the-art construction for medium-power transistors. The new transistor can be used as power supplies for computers, medium-power amplifiers, compact lightweight airborne equipment, and medium-power switching applications.

Features include collector-to-base breakdown voltages from 60 to 180 v d-c; collector-to-emitter sustaining voltages from 40 to 120 v; gains from 50 minimum to 150 maximum and saturation voltage (collector to emitter) of 0.35 v maximum. The transistor has a thermal resistance of $25^{\circ}\text{C}/\text{watt}$ and a dissipation of 4 w at 100°C case.

The family series are MHT5001 through MHT5005 and are priced from \$5 to \$10 at 100 quantity. Availability is from stock. Solitron Devices, Inc., 1177 Blue Heron Blvd., Riviera Beach, Fla. [374]

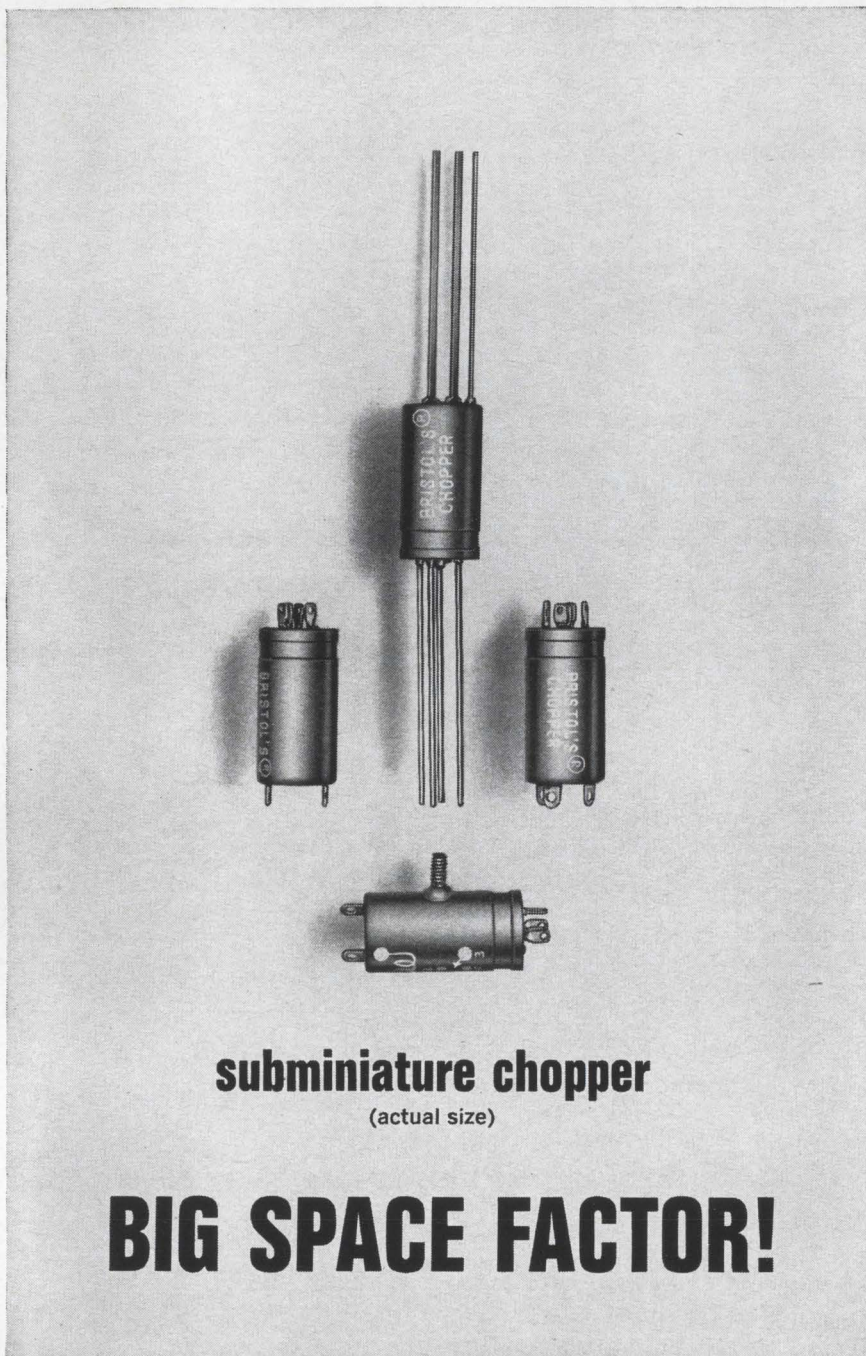

subminiature chopper

(actual size)

BIG SPACE FACTOR!

You'll always find room for this chopper—no matter how crowded you are for component space. And no matter what mounting you have, there's a style to fit it. All you need—for maximum precision and reliability—is 0.1 cubic inch. Bristol F Series Subminiature Chopper also gives you: complete shielding—welded construction—airborne environmental ratings—lowest noise level.

Write **The Bristol Company**, Aircraft Components Division, 152 Bristol Road, Waterbury, Conn. 06720. A subsidiary of American Chain & Cable Company, Inc.



S.12

AUTOMATIC CONTROLLING, RECORDING,
LOGGING AND TELEMETERING INSTRUMENTS
SUPERVISORY CONTROL SYSTEMS



World-Wide Service with manufacturing
plants in Canada, Mexico, England, France, Italy,
South Africa, Australia and the United States

Objective:

**To pierce the night
and spot the enemy
with a compact
surveillance
system.**

**Achieved by another
American Optical development:**

**Wide-angle
reconnaissance
lens system
smaller than
a bread box.**

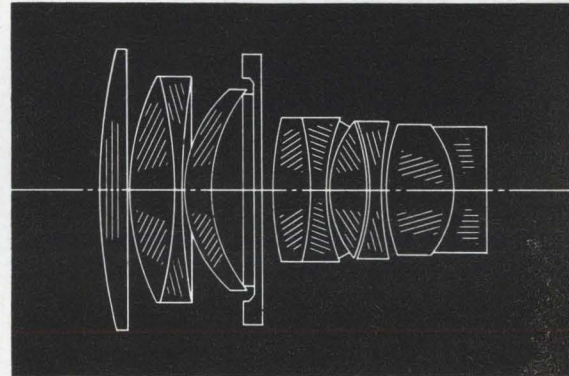
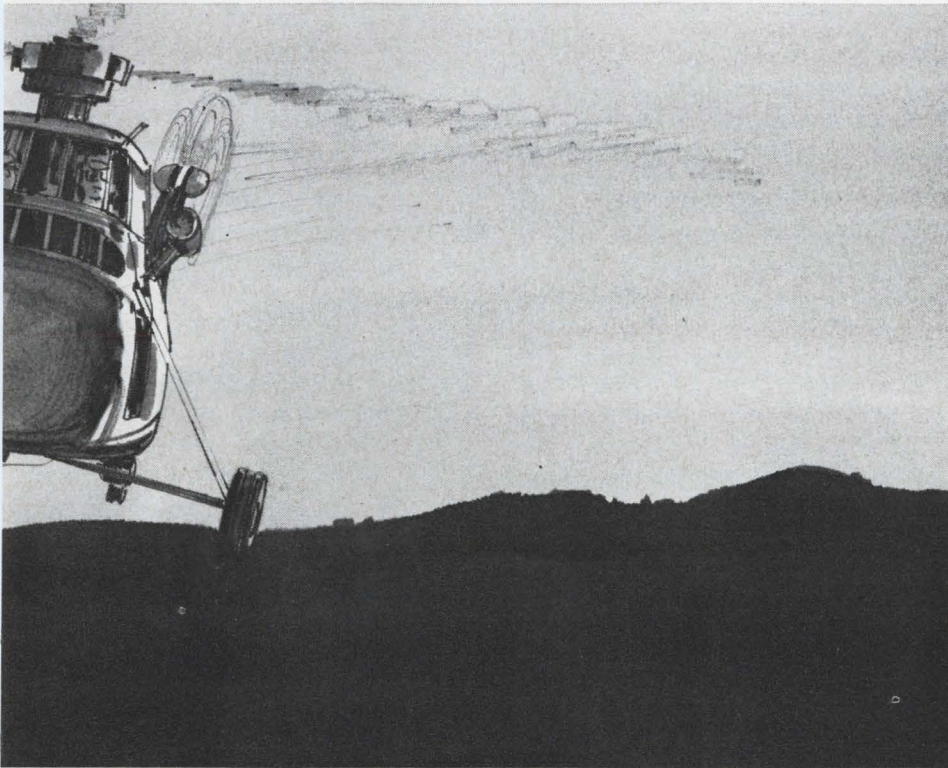

Passive observation of terrain, under the cover of darkness, is essential for up-to-date intelligence. To accomplish this task, airborne systems further require minimum weight and space characteristics. Combining its recent innovations in fiber optics and optical design, American Optical produced the compact but powerful 136 Hytar lens system. Speed : $f/0.8$ (adjustable to $f/16$ for daytime

operation) ; range : 7 ft. to infinity ; field angle : 40° . The 8-lb., shock-resistant package can be tucked neatly into the underbelly of a helicopter or mounted in any tactical orientation.

Let American Optical contribute to the solution of your problem. For 132 years we have been advancing optical technology. Our capabilities include materials research, instrument development and production, and systems integration. For help with your optical problem, consult the leader in optics. Write American Optical Company, Space-Defense Division, Dept. 400, Southbridge, Massachusetts 01551.

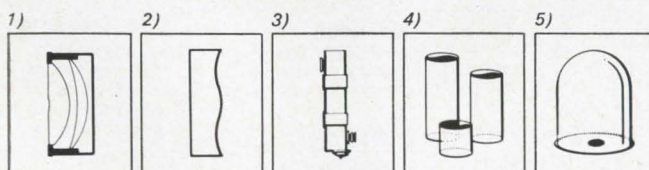

Investigate these other AO products: 1) Custom Optics, 2) Aspheric Lens, 3) Sights, 4) Laser Glass, 5) Thin Film Coatings



AMERICAN OPTICAL COMPANY

SPACE-DEFENSE DIVISION—SOUTHBRIDGE, MASSACHUSETTS

Circle 175 on reader service card

Yes,
there is an
a.c. Pot
that gives
you
 $\pm 0.01\%$
linearity
and
20-ohm
output
impedance



Vernistat,
of course

Write for data.

PERKIN-ELMER

Electronic Products Division
751 Main Ave., Norwalk, Conn.

New Instruments

Faster, clearer frequency comparisons

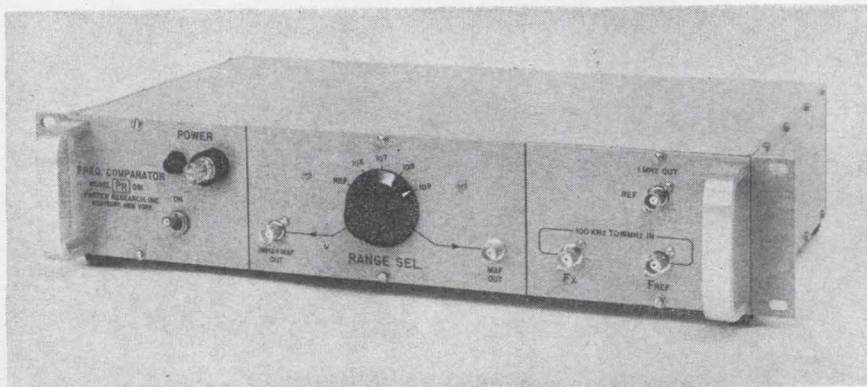

A comparator that provides a rapid, economical method for the precise calibration of frequency sources has been developed by Parzen Research, Inc. The model 091 comparator was designed to work with standard frequency or period counters, extending their capabilities beyond their usual measurement range. Besides providing far greater resolution than a conventional frequency counter, the comparator simplifies frequency comparisons as contrasted with use of the standard frequency signals broadcast by the National Bureau of Standards.

According to the manufacturer, model 091 provides quick, unambiguous measurements in standards rooms, on production lines, and at field stations. It can be used to align the time bases of frequency counters and time code generators with primary standards, check the stability of frequency sources, and collect data on the long-term drift in input signals.

Parzen's multiple-input frequency comparator accepts any of 21 commonly used frequencies between 100 kilocycles and 10 megacycles on both the reference and unknown frequency input channels. No auxiliary equipment, switching, adjustments, or special connections are required to operate at the different frequencies, so the two input channels can be used interchangeably.

For each pair of input signals, the comparator generates two output signals. One, a train of fast-

rise time pulses, corresponds to the error-expanded frequency of $1 \text{ Mc} \pm M\Delta f$, where M is a multiplication factor referred to 1 Mc and Δf is the frequency difference between the converted input signals. This pulsed output is fed to a standard frequency counter for display. The difference $M\Delta f$ can be expanded for greater resolution through a front-panel range switch. This changes the multiplication factor M by 10, 100, or 1,000.

The second signal, an audio-frequency output, corresponds to the term $M\Delta f$. With a period counter, it can be used for a high-resolution display of the amount of error. However, this output does not indicate which of the two sig-

Specifications

Frequencies	100.0, 111.1, 125.0, 142.9, 166.7, 200.0, 250.0, 333.3, and 500.0 kc; 1.0, 1.5, 2.0, 2.5, 3.0, 4.0, 5.0, 6.0, 7.0, 8.0, 9.0, and 10.0 Mc. 0.25 to 3 volts rms.
Input level	
Frequency difference range	10^0 to 10^6
Output frequency range	$1 \text{ Mc} \pm 5 \text{ kc}$, where 5 kc is the range of the multiplied difference ($M\Delta f$) between the reference and unknown frequencies, which can be read directly in parts in 10^9 .
Resolution (with 1-Mc digital frequency counter)	± 1 part in 10^9 for 1 second count ± 1 part in 10^{10} for 10 second count ± 1 part in 10^{11} for 100 second count
Frequency range ($M\Delta f$ output)	0 to 1 kc
Level ($M\Delta f$ output)	1 volt peak-to-peak
Resolution ($M\Delta f$ output)	Better than ± 1 part in 10^{10} for 1 second and for 1 period

**NEED 14-BIT A-TO-D CONVERSION AT 200 KC?
OR 8-BIT AT 1 MC? ADAGE HAS IT!**

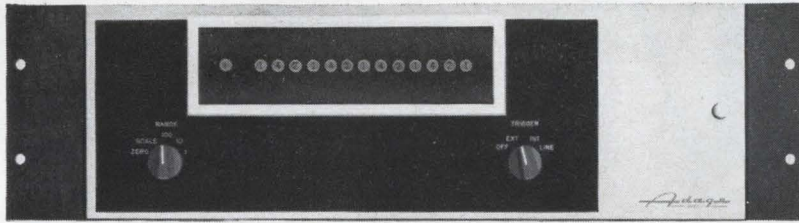

The high-speed, high-resolution VT13-AB and ultra high-speed VT7-AB are the latest additions to the Adage VOLDICON™ line of voltage digitizers. Based on a novel design combining techniques of successive approximation and parallel threshold decoding, the VT13-AB accomplishes a 14-bit analog-to-digital conversion in less than 4 microseconds. The 8-bit VT7-AB performs a complete conversion in under 800 nanoseconds.

Other Voldicon models include:

VS Series A-to-D Converters

2 μ sec. per bit conversion time
14-bit binary or 16-bit BCD
 $\pm .01\%$ accuracy

D-to-A Converters

$\pm 150v$ output
 $\pm .01\%$ accuracy
14-bit resolution

And look at these other Adage data systems components!

Series VMX™ Multiplexers

100,000 samples per second
 $\pm .002\%$ offset spread; .01% gain spread — no adjustments required
Systems-organized flexible programming

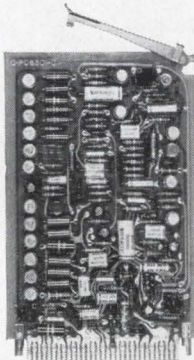

Sample-and-Hold Amplifier, Model SA3

Tracks within .01% in 10 μ sec. for FS input step change
100 nanosec. aperture
100 μ sec. recovery from 10X FS overloads

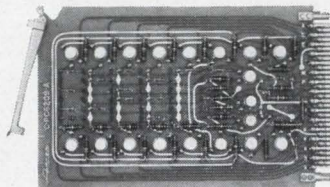

Operational Amplifier, Model OP3

Over 5 MC gain-bandwidth product
Approximately 100 pico-amps leakage current
Less than 30 μ v offset drift

HZA™ Isolation Amplifiers

100,000 megohms input impedance
 $\pm 150v$ input voltage range
1 part in 1,000,000 gain accuracy
Single-ended and differential with 120 db common mode rejection

Digital Logic

Designed for analog/digital system requirements
Compatible modules for digital control, decoding, formatting and interfacing

AC Signal Conditioners

.01% of final value achieved within 15 cycles of lowest frequency
 $\pm .05\%$ accuracy

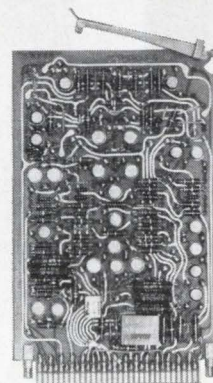

Next time, get a quote from Adage — for components or complete systems. We think you'll like our prices, too. Call or write I. R. Schwartz, Vice President, 617 783-1100.



1079 Commonwealth Avenue, Boston, Massachusetts 02215

Adage, Inc. welcomes employment inquiries from professional engineers.

World's Most Accurate C/R Bridge

100kc—1 mc

0.1% ACCURACY

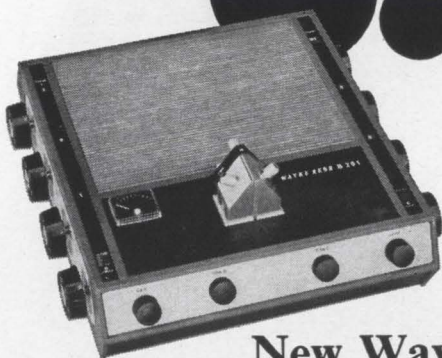

New Wayne Kerr B201 Bridge

Designed for highly precise, simultaneous in-circuit measurement of capacitance and conductance over an extremely wide range—from 0.001pF—10,000pF and from 0.01 μ Mho—100mMho—the B201 Bridge is invaluable for checking capacitors and components of printed circuits and/or encapsulated assemblies.

A four-figure digital readout provides excellent discrimination enabling the B201 to be used for the observance of minute changes in component values or alterations in the constants of lines, filters, aerials, equalizing circuits and a variety of passive 2- or 3-terminal networks. A built-in level control simplifies evaluation of semi-conductors and other non-linear devices.

An all solid state design, the B201 is portable and completely self-contained with battery and rectifier unit housed internally.

SPECIFICATIONS

Measurement Ranges: 0.001pF—10,000pF; 0.01 μ Mho—100 mMho in six ranges.

Frequency Range: 100kc—1mc (plug-in Source and Detector units for 100kc or 1mc).

Accuracy: $\pm 0.1\% \pm 1$ minor division (4th significant figure).

Discrimination: ± 1 minor division or better.

Price: \$1500. FOB Montclair, N.J.

B601 BRIDGE. For wide range, precise measurement of L,C,R; transistor admittance, (with adaptor) from 15 kc—5 mc $\pm 1\%$.

Wide Frequency Range: 15 kc to 5 mc.

High Accuracy: $\pm 1\%$ generally.

Extreme Versatility: Transformer Ratio-Arm circuit provides 2- and 3-terminal measurements balanced or unbalanced. Simultaneous display of R and X on separate dials.

Price: \$800. FOB Montclair, N.J.

For literature and detailed specifications, write:



Wayne Kerr CORPORATION

18-C Frink St., Montclair, N.J. 07042 • Phone (201) 746-2438
INNOVATIONS IN INSTRUMENTATION

New Instruments

nal frequencies is higher. With either output, the frequency difference is shown as parts in 10^{10} , 10^9 , 10^8 , 10^7 , or 10^6 . This process is accomplished in seconds on the standard counters.

The Parzen comparator also furnishes a precise one-megacycle output signal that may be used as a reference time base for the frequency and/or period counter.

The model 091 comparator operates from either a 115-volt a-c supply or a 22- to 30-volt d-c source. Both a-c and battery connections can be made at the same time; the instrument will automatically transfer to the battery if the a-c voltage drops too low, or if the a-c supply fails entirely.

Parzen Research, Inc., 48 Urban Ave., Westbury, L.I. N.Y. 11590 [381]

Accurate and stable a-c voltage standard

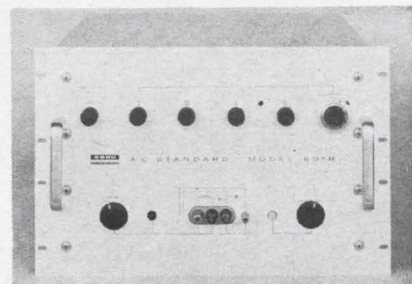

An a-c voltage standard now in production offers a basic output voltage accuracy within 0.05% and 7-day voltage stability within 0.01%. Model 601B provides a sinusoidal output at frequencies of 60, 400, and 1,000 cps; the frequency is accurate to within 1.0%. Output voltage from 1 v to 501 v is adjustable in 0.1-v steps, and between 0.1-v steps by a multiturn potentiometer having a 100- μ v adjustment resolution. By using the 601B to drive a ratio transformer, output voltages lower than 1 v can be obtained.

Output harmonic distortion is less than 0.3%, and the noise and hum is less than 0.05% of setting. Line regulation is better than 0.01% for 10% a-c line-voltage change. Other design features in-

INSTRUMENTATION'S
MOST POWERFUL
BABY

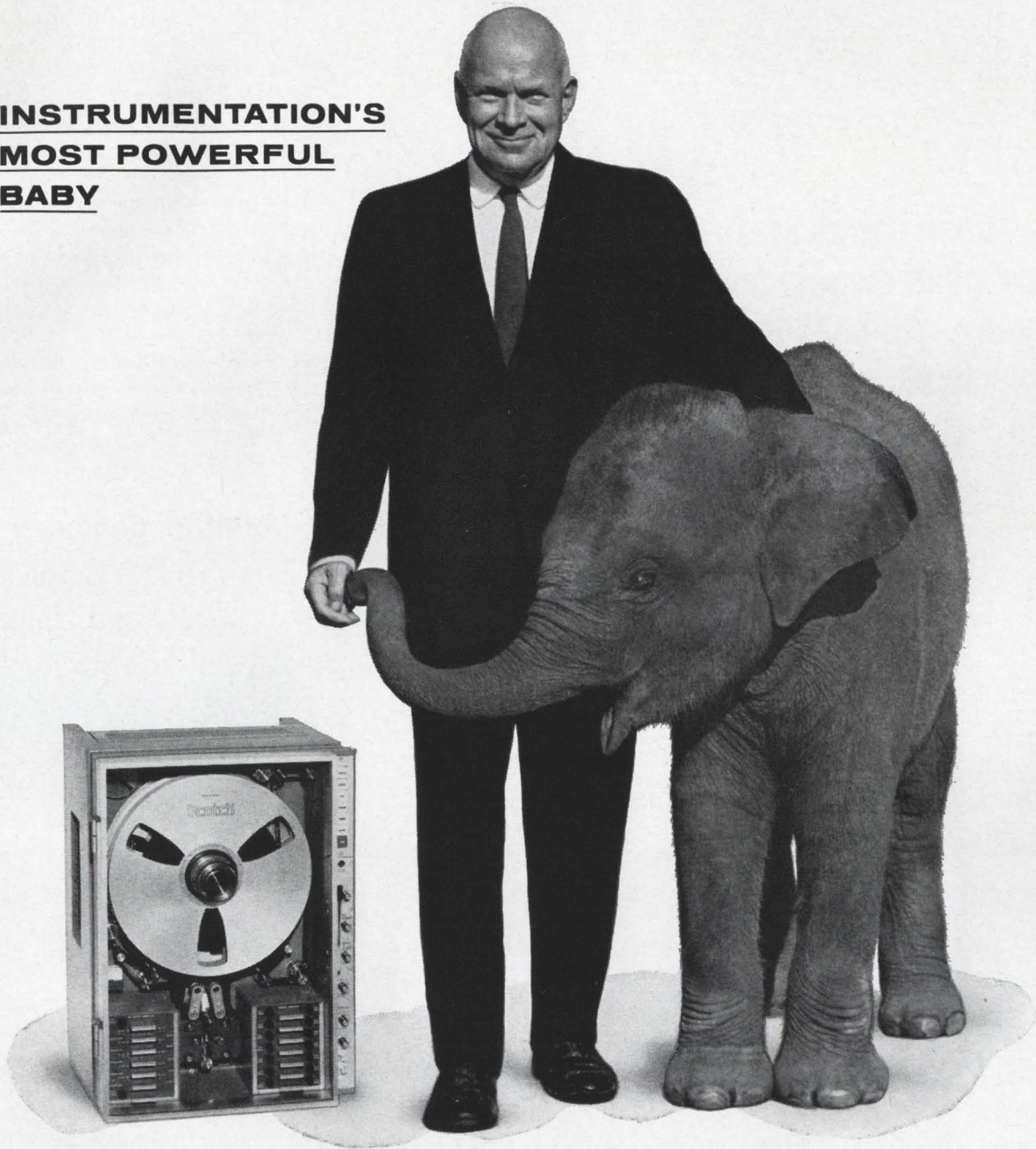

2.0 MEGACYCLES OPTIONAL

FOURTEEN 1.5-mc CHANNELS IN FOUR CUBIC FEET

Our new PC-500 Coax stands alone among compact field recorders, another working proof of Mincom's leadership in wideband instrumentation. Only twenty-four inches tall, this beautifully designed package contains the industry's highest performance per cubic foot — seven or fourteen 1.5-mc record channels, 14-inch reels, seven switchable speeds from $1\frac{7}{8}$ to 120 ips, two selectable reproduce-monitor channels. PC-500 is IRIG-compatible with all standard playback systems, including Mincom's TICOR II. Record on PC-500 with a 200-kc reference signal, on playback take advantage of TICOR II's unequalled $\pm 0.5 \mu\text{sec}$ time base comparison between events. Solve your basic problems in multi-channel wideband field recording by writing for PC-500 specifications.

Revere-Mincom Division **3M**
COMPANY
300 SOUTH LEWIS ROAD • CAMARILLO, CALIFORNIA 93010

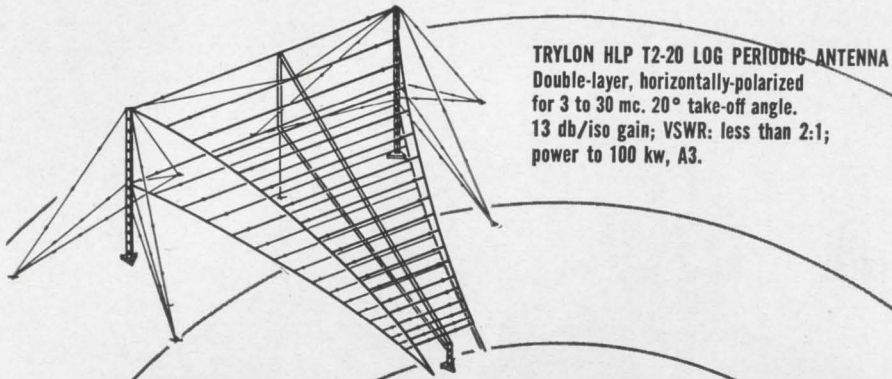

TRYLON HLP T2-20 LOG PERIODIC ANTENNA
 Double-layer, horizontally-polarized
 for 3 to 30 mc. 20° take-off angle.
 13 db/iso gain; VSWR: less than 2:1;
 power to 100 kw, A3.

**Three things make a good antenna system:
 design competency; fabrication proficiency; and
 economy—which is the sure result of integrating
 the electrical and the structural problems as a
 single responsibility of the TRYLON group.**



Elverson, Pa. 19520 (215) 942-2981 — International Division, 750 Third Avenue, New York, N.Y. 10017, U.S.A.
 Circle 300 on reader service card

**Ever need plug-in power supplies in a hurry?
 Send for our 1965 catalog.
 It lists 62,000 different types.
 The one you need will be shipped in 3 days.
 (We've never failed to make good on this promise)**

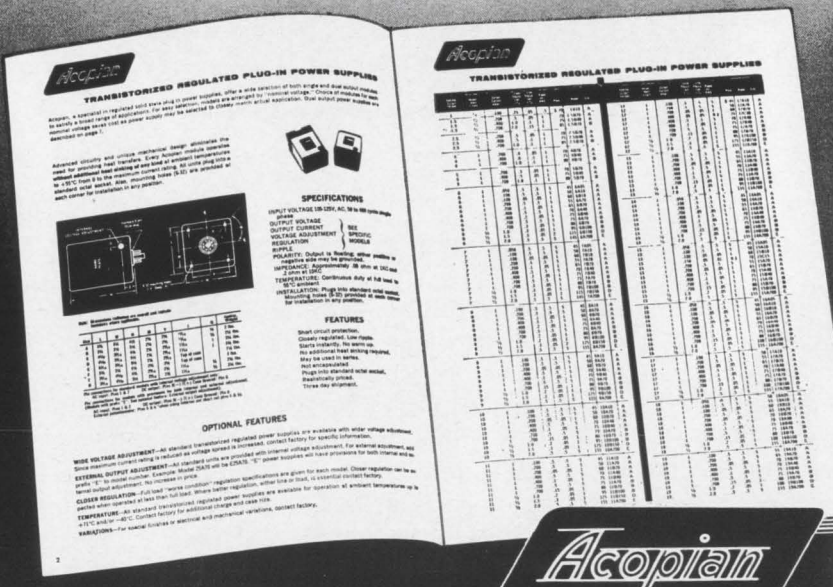

Acopian Corporation, Easton, Pennsylvania, (215) 258-6149

New Instruments

clude overload protection, and isolated and guarded output achieved with a case-within-a-case system of shielding.

Output power capability up to 25 w enables the 601B to be used for many general-purpose applications, such as the calibration of low-impedance, dynamometer-type instruments. Other applications for which it is suited include gyro and servo system design and testing and evaluation of magnetic properties. It is a basic component in a-c/d-c calibration consoles. Price is \$4,500; delivery from stock. Cohu Electronics, Inc., Box 623, San Diego, Calif., 92112. [382]

**Multifunction timer
 has variable range**

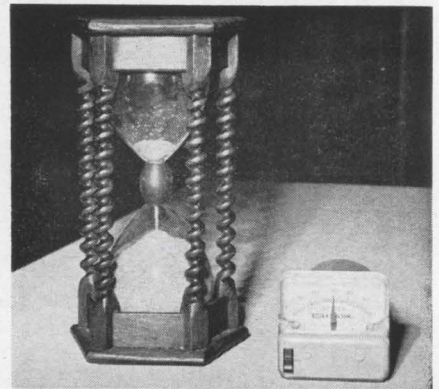

A multifunction timer now in production has a high visibility meter-type display. Said to complement cybernetically designed instrumentation and machinery, the model 179 series is available with continuously variable timing ranges from 6 seconds up to 60 hours. Settings can be made easily and accurately with a vernier thumb wheel.

The versatile unit may be used as either a delay timer, an interval timer, or a combination of both merely by varying the connections made at the easily accessible 9-point terminal board on the rear of the timer. Timing accuracy is 0.5% of full scale. Reset time is instantaneous. Model 179's switching contacts are rated at 10 amps 125/250 v a-c.

Another feature is the unit's one-

piece, high-impact, molded plastic housing, which provides an effective dust cover and a unique terminal board.

Eagle Signal division, E.W. Bliss Co., Davenport, Iowa. [383]

Shaft position pulse transducer

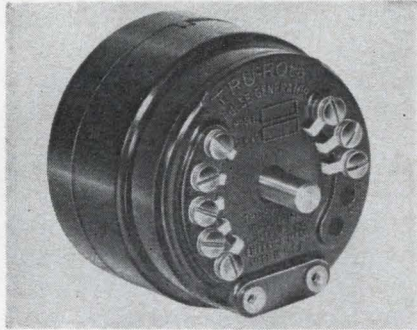

This rotary pulse generator produces two channels of quadrature signals, which may be used to produce up to 3,000 equidistant bi-directional pulses per shaft revolution. Use of high-impact-resistant polycarbonate housing increases ruggedness and reduces price.

The instrument is available with internal amplifier/shaper to produce amplified square waves in quadrature. Applications are in any system that measures or controls position or speed, including machine tools, tape recorders, process machinery, batch weighing, and material cut-off.

Price is \$125 for the basic rotary pulse generator; \$175 for the rotary pulse generator with amplifier.

Trump-Ross Industrial Controls, Inc., 265 Boston Road, N. Billerica, Mass., 01862. [384]

Pulse generator can be programed

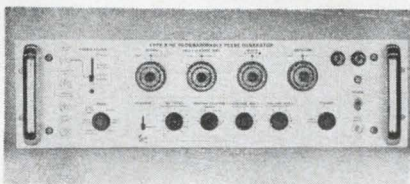

A programmable 10-Mc, 10-v pulse generator, type R116, is primarily intended for application where a

FANUC 260



Revolutionary and high performance Numerical Control System for straight cut and positioning

The FANUC 260 is a numerical control which performs by means of Electrohydraulic Pulse Motors (EHPM), according to numerical instructions punched on tape

Outstanding Features

- ◇ Small in size: 32.28 (H) x 15.76 (W) x 13.78 (D) inches
- ◇ Very inexpensive . . . one-third the price of conventional models
- ◇ Feedback mechanism is unnecessary
- ◇ Feed rate can be easily changed
- ◇ Numerous optional equipment are available
- ◇ Highly dependable

Specifications

Min. resolution:	0.0004 inch/pulse
Max. command dimension:	39.371 inch
Travel instruction:	Travel amount of each axis (incremental) and direction
Number of controlled axes:	3
Feed Rate:	Rapid traverse (F0) 94.492 inch/min. Cutting feed rate (F1) } 0.196~39.371 inch/min. (F2) } (adjustable manually) (F3) }
Tape read-in by photoelectric tape reader:	200 steps/sec.
Tape used:	8-channel 1 inch wide tape (codes used are in accordance with the E.I.A. standard)
Pulse motor:	Selection is made at will from among the following motors according to the demand of the machine: Electric pulse motor type 109, EHPM type 1/5-SS, 1/2-SS, 1-SS, and 3-SS.
Alarm signal:	When a fault is found in checking the tape input signal, the alarm lamp lights up and the operation is stopped.
Ambient temperature:	32°~104°F
Power supply:	110 ± 10 V (50/60 cps) single phase 1 kVA

For more detailed information, write our **Export Agents:**

C. ITOH & CO., G.m.b.H.
(P.O. Box 4507)
Berliner Allee 47,
Dusseldorf, W. Germany
Phone: 10726

C. ITOH & CO., LTD.
London Office
Kempson St., London W.C. 2
Phone: AVENue 9461/10

C. ITOH & CO., (AMERICA) INC.
5th Floor, ITT Bldg.
320 Park Ave., New York 22, N.Y.
Phone: PLaza 1-4330



FUJITSU LIMITED
Communications and Electronics

Marunouchi, Tokyo, Japan

TRANSISTORISED OSCILLOSCOPES 1Mc/s to 100 Mc/s

FOR LABORATORIES •

340 A

Cabinet (340 A) or Rack-Mounting (340 AR) model

The unit includes : 1 vertical amplifier

1 horizontal amplifier

1 calibrator 0.2 mV at 100 V at 1 Kc/s Accuracy : 2%

1 delay line 120 nsec

1 cathode-ray tube

1 power supply

The unit can be equipped with :

1 set of time-base plug-in units : BT 210 and BT 110

1 set of plug-in vertical amplifier

P 1100 and P 280 - Soon available ; P 110 - DP 100



340 AR



• PORTABLE

345 A

Vertical amplifier

Bandwidth : 0.9 Mc/s Deviation coefficient : 50 mV/div

Sweep system : free-running or triggered

Sweep coefficient : 1 s/div to 0.2 μ sec/div

Magnifier X5 : 0.04 μ sec/div

Cathode-ray tube

Diameter : 7 cm - Acceleration voltage : 3.8 kV

Power requirements

a) Mains supply : 110/220 v - 50 to 400 cps

b) DC. 7.2-10 v and 10-12 v

Power consumption : 2.25 A approx.

349 C

Vertical amplifier

Bandwidth : 0-2.5 Mc/s Deviation coefficient : 50 mV/div

" 8 cps - 2.5 Mc/s " " 10 mV/div

Sweep system

Sweep coefficient : 10 msec/div to 2 μ sec/div

Triggering : automatic, internal + or - external sync.

External triggering : minimum voltage : 10 V peak-to-peak

Horizontal amplifier

Bandwidth : 0-50 Kc/s Deviation coefficient : 7 V/div

Cathode-ray tube Diameter : 7 cm

Power requirements

Mains supply : 110/220 V - 50 cps or DC : 5 V to 9 V

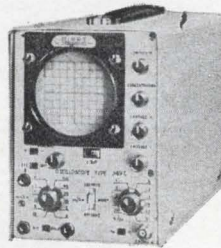

INTER PLANS



BT 210

2 identical time-bases
5 sec/cm
to 10 nsec/cm
As delaying sweep:
Max delay : 100 sec

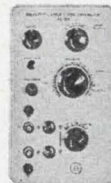

DP 100

0-100 Kc/s
100 μ V/cm



BT 110

one single time-base
5 sec/cm
to 10 nsec/cm

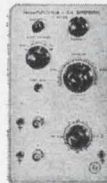

P 110

0-10 Mc/s
1 mV/cm



P 1100

Bandwidth
0 - 100 Mc/s
Rise-time 3.5 nsec
5 and 50 mV/cm



P 280

2 identical amplifiers
0 - 80 Mc/s
Rise-time 4.5 nsec
5 and 50 mV/cm

OTHER PRODUCTS : GENERATORS, OSCILLOSCOPES CAMERAS,...

RIBET-DESJARDINS

Measure and Control Department - 13-17, rue Périer MONTRouGE/PARIS-TÉL : 253 24-40

New Instruments

variety of pulse amplitudes, polarities, shapes, and other parameters are required in rapid sequence, as in systems and production testing. All functions are programmable; in addition, the unit can be operated from calibrated front-panel controls for applications that do not require external programming.

Calibrated and programmable parameters include trigger source, period, delay or burst time, width, amplitude, mode, d-c offset, rise time, fall time, and polarity. Switch-range, as well as variable control, is programmable for all functions.

Rise time and fall time range from 10 nsec to 110 μ sec maximum, amplitude from 0.4 v to 10 v, width from 50 nsec to 550 μ sec, delay or burst time from 50 nsec to 550 μ sec, period from 100 nsec to 11 msec, and d-c offset from +5 to -5 v, all continuously variable. Rise time and fall time are independently variable when on the same range.

Special programmable operating modes include delayed single pulse that provides normal pulse output after the selected delay time; double pulse output for two pulses per pretrigger output, with one pulse delayed in time by a variable amount with respect to the other; burst output with a burst of output pulses for each applied external trigger; and gated output that provides pulse outputs for the duration of the applied gate.

Complete programming capability requires 21 bits and 7 analog lines. Characteristics of the type R116 make it suitable for semiconductor and general-purpose applications.

The pulse generator mounts in a standard 19-in. rack and measures 4 $\frac{1}{4}$ in. high and 18 $\frac{1}{8}$ in. deep. Net weight is approximately 23 lb. Price is \$1,550; availability, approximately 60 days.

Tektronix, Inc., P.O. Box 500, Beaverton, Ore., 97005. [385]

Analog x-y plotter offers high stability

High stability and frequency response are credited to the Plot-automatic model 800A, a new 11 x 17-

CONSIDER COLORADO

. . . *transportation gateway* . . . East or West. North or South. Inter-State. Intra-State.

Air, rail, truck or bus, consider Colorado, the distribution center for a 13 state area. The state is served by 7 Class I railroads, on 3,671 miles of track within our borders. It's served by 75 transcontinental truck lines, five of which are headquartered in the state. Four of the five are among the largest in the nation. Also, Colorado boasts the second busiest general aviation and the 12th busiest commercial airport in the nation, with 8 commercial airlines making 269 scheduled flights per day. Throughout the state there are a total of 36 public use and 80 civic airports to keep all Colorado in commuting distance of the nation.

If transportation is a consideration in your business, consider industrial Colorado for your expansion or relocation. Complete information is available from Dwight E. Neill, Director, Division of Commerce and Development, 15 State Services Building, Denver, Colorado.



Everyone's talking about

Delevan's

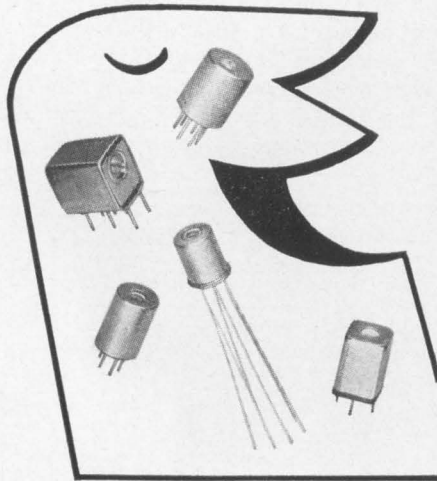

BROAD RANGE OF SHIELDED COILS & TRANSFORMERS

Here's why!

- 1 Only Delevan offers 12 mechanical designs from which to choose depending upon the environmental characteristics required to satisfy a specific need.
- 2 Standard RF and IF transformers offering similar electrical characteristics for all designs including standardized 30 MC, 10.7 MC and 455 KC, IF transformers. Also tunable units in RETMA values from .1 uh to 10 mh.
- 3 A wide pricing range from \$5.00 for units used in HIGH REL. space programs to as low as \$1.00 for commercial applications.

The industry's widest selection

12 MECHANICAL DESIGNS

Delevan Electronics Corp.

Subsidiary of American Precision Industries Inc.
270 Quaker Road, East Aurora, N. Y. 14052

New Instruments

in. analog x-y plotter. The all-transistor unit provides automatic plots of voltage/voltage or voltage/time functions, from a wide variety of d-c voltage inputs.

New servo-amplifier design gives the unit full-scale accuracies of 0.15% (both axes) and repeatability of 0.1%. Recording period is 1,500 sec, with a carriage sweep of 0.01 through 2.0 in. per sec. The 16 voltage ranges include 0.5 through 500 mv per in. and 1 through 50 v per in., with continuous vernier on all ranges. A constant input impedance of 1 megohm is provided.

Other features include a new nonclog vacuum paper hold-down system, temperature-compensated zener bridge reference circuit, easily replaceable ink cartridge, and maintenance-free, sealed, follow-up potentiometers. The Plotomatic 800A is available in either table or rack-mount models. Price for either model is \$1,885; availability, 30 days after receipt of order. Data Equipment Co., 2126 S. Lyon St., Santa Ana, Calif. [386]

Easy-to-operate unit measures vibration

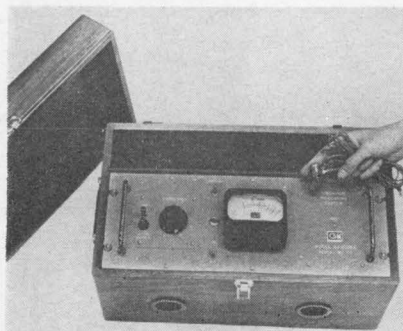

A portable, low-level vibration measuring system has been introduced. The model KA-9908A can be operated by unskilled personnel after only a few minutes' instruction. Voltage output terminals permit monitoring of vibration wave form on an oscilloscope or other auxiliary equipment. Charge amplifier construction maintains factory calibration with any cable length up to 250 ft.

The system is available with

SEMI-CONDUCTOR AUTOMATIC SELECTOR

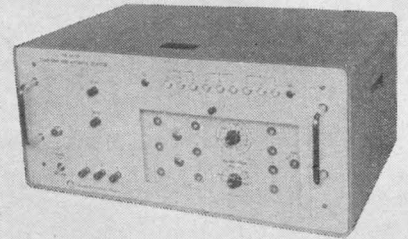

MODEL TMS-101 TRANSISTOR AUTOMATIC SELECTOR SPECIFICATION

Item	continuously variable value		
		I _C	I _E
BV _{CB0}	20~50V	10~30μA	
BV _{EB0}	3~10V		10~30μA
LV _{CE0}	10~40V	1~5 mA	
hFE	10~200V		1~5 mA
	accuracy ± 3%	stability ± 3%	

REMARK.

BV_{CB0} fixed in condition of 50 ≥ A > B > C ≥ 20V
LV_{CE0} fixed in condition of 40 ≥ A > B > C ≥ 10V
hFE fixed in condition of 200 ≥ a > b > c ≥ 10

EACH JUDGEMENT

BV_{CB0}, BV_{EB0}, LV_{CE0}: Good when less than setting current value.

hFE: Bad except a.b.c in condition of 200 ≥ a > b > c ≥ 10

TOTAL JUDGEMENT

9 combinations of good A.B.C and good a.b.c are. Aa. Ab. Ac. Ba. Bb. Bc. Ca. Cb. Cc. Accordingly, total of combination makes 10 classification with inferiority.



MODEL DMS-101 DIODE AUTOMATIC SELECTOR SPECIFICATION

Item	continuously variable value	
I _R	V _R 0~50V	I _R 0.1~1μA
V _R	I _R 2~20μA	V _R 0~75V
V _{F1.2}	I _{F1.2} 250μ~2mA	V _{F1.2} 0.5~1V
V _{F3.4}	I _{F3.4} 2~10mA	V _{F3.4} 0.5~1V
	stability ± 3%	accuracy ± 3%

JUDGEMENT

I_R, V_R: Good when more than setting current value.

V_{F1-4}: Good when the difference between upper and lower limits of V_{FN} is within setting range.

OTHERS; DMS-102, TMS-102, 103, 104, 105, 106.



MINATO ELECTRONICS CO., LTD.

Address. 10, Nishikubo-hachiman-cho,
Minato-ku, Tokyo, Japan.

Tel. (431) 2762. 2733

The Hughes/NASA Syncom stands still at 6875 mph to talk to a billion people.

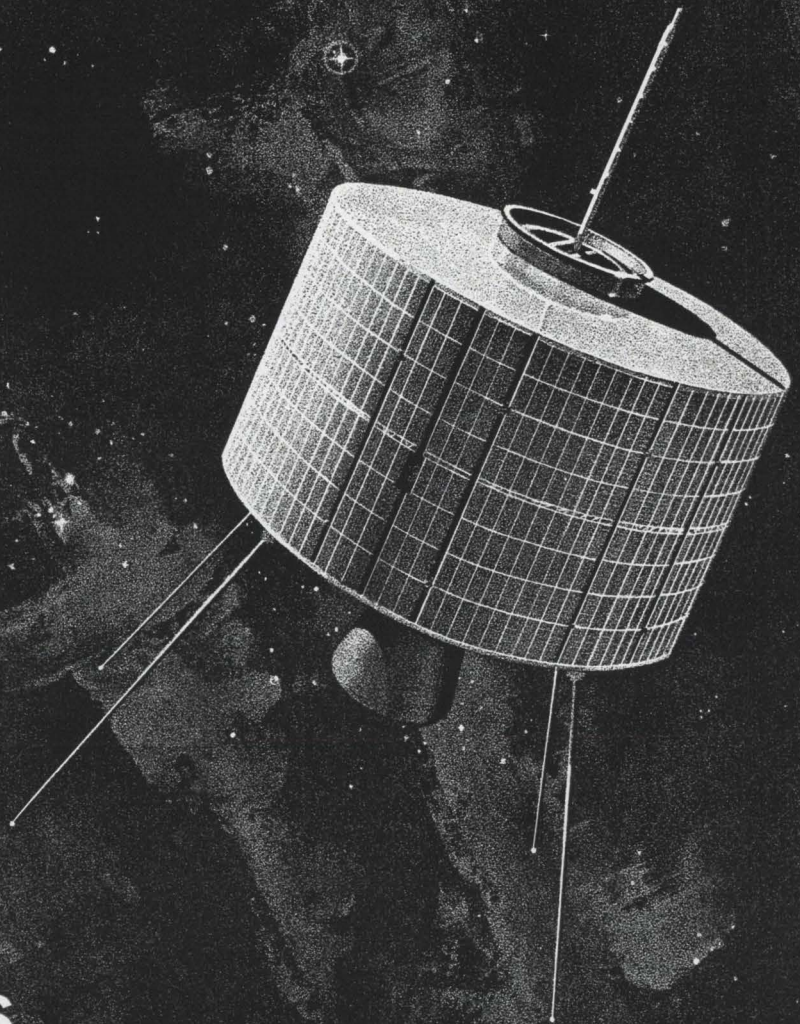
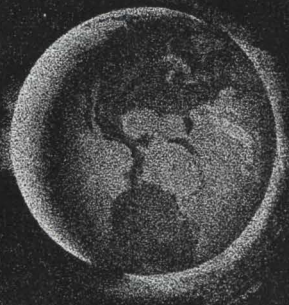

CIRCUIT DESIGNERS... is your appointment in space with Hughes?

Today, Hughes is one of the nation's most active aerospace/electronics firms: Projects include: F-111B PHOENIX Guided Missile System, TOW Anti-Tank Missile, SURVEYOR Lunar Spacecraft, SYNCOM, POLARIS, VATE, Hard Point Defense and others.

This vigor will assist the qualified engineers and scientists towards more and better opportunities for both professional and personal growth.

Many immediate openings exist. The engineers selected for these positions will be assigned to the following design tasks: the development of high power airborne radar transmitters, the design of which involves use

of the most advanced components; the design of low noise radar receivers using parametric amplifiers; solid state masers and other advanced microwave components; radar data processing circuit design, including range and speed trackers, crystal filter circuitry and a variety of display circuits; high efficiency power supplies for airborne and space electronic systems; telemetering and command circuits for space vehicles, timing, control and display circuits for the Hughes COLIDAR (Coherent Light Detection and Ranging).

If you are interested and believe that you can contribute, make your appointment today.

For immediate consideration, please airmail your resume to:

Mr. Robert A. Martin
Head of Employment
Hughes Aerospace Divisions
11940 W. Jefferson Blvd.
Culver City 11, California

Creating a new world with electronics

HUGHES

HUGHES AIRCRAFT COMPANY

AEROSPACE DIVISIONS

An equal opportunity employer.

U. S. CITIZENSHIP REQUIRED

CEI MADE THE BEST 1-2 GC FREQUENCY EXTENDER



NOW WE MAKE A BETTER ONE

The solid state FE-1-2A, CEI's latest YIG-tuned frequency extender, covers 1-2 gc in a single band, converting signals to a 160 mc (or optional 21.4 mc) IF compatible with other CEI equipments. Improvements over the earlier FE-1-2 include: more compact size (now just 3½" tall); a spring steel tape dial for easier and ultra-precise tuning; plus other features . . . at no increase in price. Reliable and easy to operate, the FE-1-2A

incorporates a four-section YIG preselector for low oscillator radiation and high image rejection. The preselector is tracked electronically throughout its range, thus avoiding complex mechanical drives.

For details on this and other CEI products, please write:



COMMUNICATION ELECTRONICS INCORPORATED

6006 Executive Boulevard, Rockville, Maryland 20852, Phone (301) 933-2800

Circle 302 on reader service card

New Instruments

seven full-scale overlapping ranges, from 0.01 to 10 g rms. It has a frequency response of $\pm 6\%$ from 20 cps to 5 kc and $\pm 10\%$ from 10 cps to 10 kc, both relative to 50 cps. Output sensitivity is 100 mv/g $\pm 3\%$ into auxiliary equipment with 1 megohm minimum input impedance. The system operates from a power source of 110 v a-c, 40 w.

Model KA-9908A is approximately 20½ in. long x 11½ in. deep x 12 in. high.

Gulton Industries, Inc., 212 Durham Ave., Metuchen, N.J. [387]

Sweep generators have wide tuning range

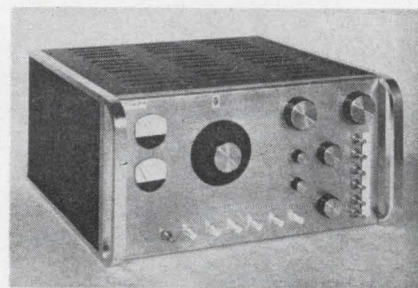

Models HS-80 and HS-85 sweep generators are high-power, wide-tuning-range units that provide more than 5 watts of leveled output over the frequency range of 200 Mc to 1 Gc. Each unit offers a choice of four modes of operation: swept r-f, modulated swept r-f, c-w, and modulated c-w.

Silicon transistors are used in all circuits except the high-voltage circuits, which use vacuum tubes. The elimination of vacuum tubes wherever possible has added to the reliability and useful life of the instruments, minimizing required maintenance. Both instruments contain a built-in attenuator, which enables the user to adjust the output signal from 4 to 85 db in 1-db steps and a vernier attenuator covering 0 to 4 db.

These units also have provisions for accepting up to six single-frequency or harmonic plug-in markers for accurate frequency identification. High-power sweep generators have wide applications in testing and aligning high-power,

90% of all Japanese ITV cameras use COSMICAR lenses.

COSMICAR
INDUSTRIAL TV LENSES



For your vidicon, image orthicon and professional movie cameras, Cosmicar lenses are available in focal lengths from 12.5mm up to 1000mm.

New zoom lenses are now available.



ICHIZUKA OPTICAL CO., LTD.

2-568, SHIMOOCHIAI, SHINJUKU-KU, TOKYO

CABLE ADDRESS: "MOVIEKINO TOKYO"

nonlinear circuitry such as varactor frequency multipliers and high-power transmitters. These instruments also provide sufficient power to drive a multiple test station system or an extremely lossy system.

Price per unit is \$2,500; delivery, 30 days.

Texscan Corp., 51 S. Koweba Lane, Indianapolis, Ind. [388]

Temperature programmer is self-contained

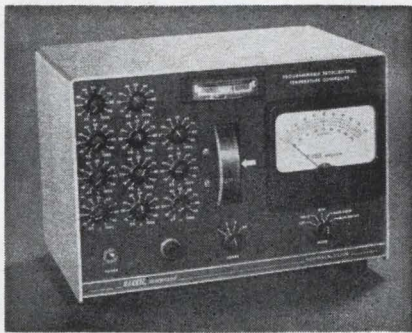

This temperature programmer allows the generation of any arbitrary function of temperature without the use of cams or complicated curve followers. The TP-200 series uses a principle of electronic function generation said to be completely new to the field of temperature control. The desired temperature function is generated by use of a large number of straight line segments of varying slopes, controlled by function dials right on the face of the instrument. Any arbitrary temperature function can be approximated to any desired degree of accuracy by this technique.

The outstanding feature of the programmer is that any new function can be programmed in less than 5 minutes without the use of any external equipment or conversion charts. The function is set up right on the face of the instrument, using the built-in meter which reads directly in desired temperature. Programs may be started at any point or may be interrupted as desired. A front-panel drum dial indicates the progress of the program at all times. The program progress is synchronously governed, so that programs are exactly repeatable.

In addition to providing a means of programming temperature, the TP-200 will also provide built-in mon-

Send today for this FREE G-E catalog

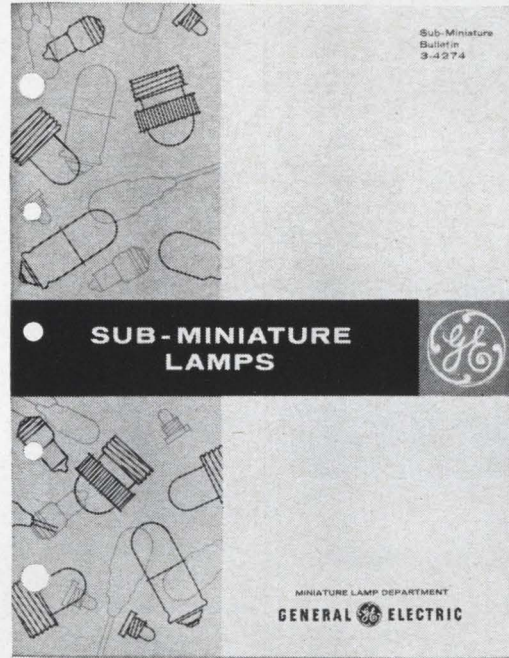

Mail the coupon below and have at your fingertips complete data on General Electric's full line of sub-miniature lamps.

They're designed for use where space is limited, reliable service a "must", long life essential and light output vital.

Twenty pages of data cover 197 lamps ranging from 1.3v to 60v., in 6 bulb sizes up to 1/4 inch in diameter. Includes 18 drawings with detail dimensions plus 4 pages of fundamental design information.

All bulbs are cross referenced for federal stock and military standards numbers. Folder size, universal punched to fit binders.

CLIP AND MAIL

TO: General Electric Company, Miniature Lamp Dept. M5-11,
Nela Park, Cleveland, Ohio 44112.

Send me a copy of Sub-Miniature Lamp Bulletin 3-4274.

(Please Print)

Name _____

Title _____

Company _____

Division _____

Address _____

City _____

State _____ Zip Code _____

We manufacture _____

I'd like a G-E representative to contact me

Progress Is Our Most Important Product

GENERAL  ELECTRIC

the DA 410



Frequency Response Analyzer

Measures frequency response from 0.001 to 1000 cps

- performs servo analysis automatically—with speed, accuracy and ease of operation never before achieved . . .
- provides results from 1 to 1½ cycles of test frequency .001 to 1 cps, 2 secs. from 1 to 1000 cps
- displays phase and amplitude on direct digital readout
- achieves 40 db of noise and harmonic rejection
- accurate to 1% in amplitude and 1° phase
- carrier and dc operation
- has No drift adjustment
- high-speed, automatic operation
- self-check, self-calibrating
- all solid state, only 7"x17"x16" in size
- weighs just 38 lbs.
- and costs but \$6840.00
- options for automatic operation, point-to-point, printout, etc.

Write for Bulletin DA410



Quality by Design

Weston Instruments, Inc.

WESTON-BOONSHAFT AND FUCHS
Hatboro, Pennsylvania 19040

New Instruments

itoring of the actual temperature conditions at the load. A 4½-in. panel meter provides a continuous visual indication of the actual temperature, while an edgewise meter monitors the deviations between the actual temperature and the desired program, and provides a visual alarm whenever the two differ. External recording of temperature programming is available as an optional accessory, as is an alarm amplifier that provides a relay closure for remote alarm whenever actual and programed temperatures differ.

TP-200 programers may be used to program systems using mechanical or CO₂ refrigeration or thermoelectric cooling, in addition to standard oven or furnace heaters. Cabinet styles are available for either bench or surface mounting. Harrel, Inc., 16 Fitch St., E. Norwalk, Conn., 06855. [389]

Delay measuring set offers high accuracy

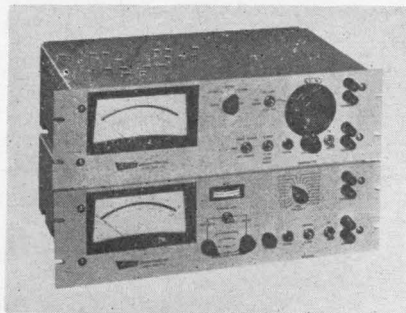

High order accuracy, compact construction and solid-state design throughout are major features of a new transmission delay measuring set. Accuracy of the model 460 delay set is $\pm 5 \mu\text{sec}$, and the total delay that can be measured unambiguously is 4 msec. The unit utilizes carrier frequencies variable from 500 cps to 50 kc. It is capable of both absolute and relative measurements. Readings are direct in milliseconds and the set is adaptable to either closed- or open-loop measurements.

The company explains that precision determination of electrical

we are your best bet
for electronic materials

"What did you say?"

**"WE SAID, WE ARE
YOUR BEST BET
FOR ELECTRONIC
MATERIALS!"**

We are a primary fabricator and supplier of high purity metals and alloys, compound semiconductors and thermoelectric cooling materials.

PHONE AREA CODE 509 747-6111

TWX 509-328-1464 Telex 032 610

IMMEDIATE SHIPMENT BY AIR PRE-PAID

COMINCO PRODUCTS, INC.

electronic materials division

818 West Riverside Ave.,
Spokane, Washington 99201

5603

Circle 303 on reader service card



CAPACITORS

**All Welded
Construction!!
Miniature
Electrolytic
Capacitors**

Other Products:

Paper Capacitors, Metallized Paper Capacitors, Aluminum Electrolytic Capacitors, Tantalum Electrolytic Capacitors, Plastic Film Capacitors, Ceramic Capacitors, Mica Capacitors & Filstar (Noise Suppressors).

**NIPPON COMMUNICATION
INDUSTRIAL CO., LTD.**

Head Office: 260, Kitamikata, Kawasaki, Japan
Cable Address: KAWASAKI NICOMM

MHW
International
CORPORATION

Sole Sales Rep: (USA & Canada Area)
301 Sylvan Ave., Englewood Cliffs, New Jersey 07632
Tel. 201-567-9222 N.Y. Tel. 212-244-0695

Circle 304 on reader service card

delay is a critical parameter in telephone communications engineering. The compact model 460 transmitter and receiver units can be stacked together for local input-output, or separated for remote inputs and outputs. Each contains its own power supply for plug-in operation, on 115 v a-c.

The transmitter and receiver units together occupy a total of only 10½ in. of panel space on a standard 19-in. rack. The new instrument is designed to provide for precision measurement of delay in transmission lines, filters, networks and other linear active or passive elements.

Acton Laboratories, Inc., 531 Main St., Acton, Mass. [390]

Cavitation meter has instant response

Cavitation can be regarded in general terms as the formation followed by a rapid collapse of small cavities into a liquid phase. It can be produced not only by intense acoustic fields, but also by other means, such as high-speed ship propellers, underwater sparks, heated wires, exploding capsules, rapidly rotating rods, venturi tubes, vibrating blades, etc. This would explain the interest in accurate cavitation intensity measurements.

A cavitation meter, model CVM-3a, has been developed which gives an instantaneous indication of the true amount of energy released during the cavitation of liquid media. It gives readings proportional to the amount of noise produced during bubble collapse after reduction of the transducer signal contribution.

Characteristics of this meter include: response time less than 1 second; extended frequency range (up to 600 kc); analog d-c output; light weight (9 lb); and compactness (8¼ x 9½ x 12¼ in.). Each meter is calibrated with the carbon tetrachloride decomposition technique.

An important application will be the monitoring of cavitation intensity in ultrasonic baths during cleaning operation.

Macrosonics Corp., 1001 Roosevelt Ave., Carteret, N.J. [391]

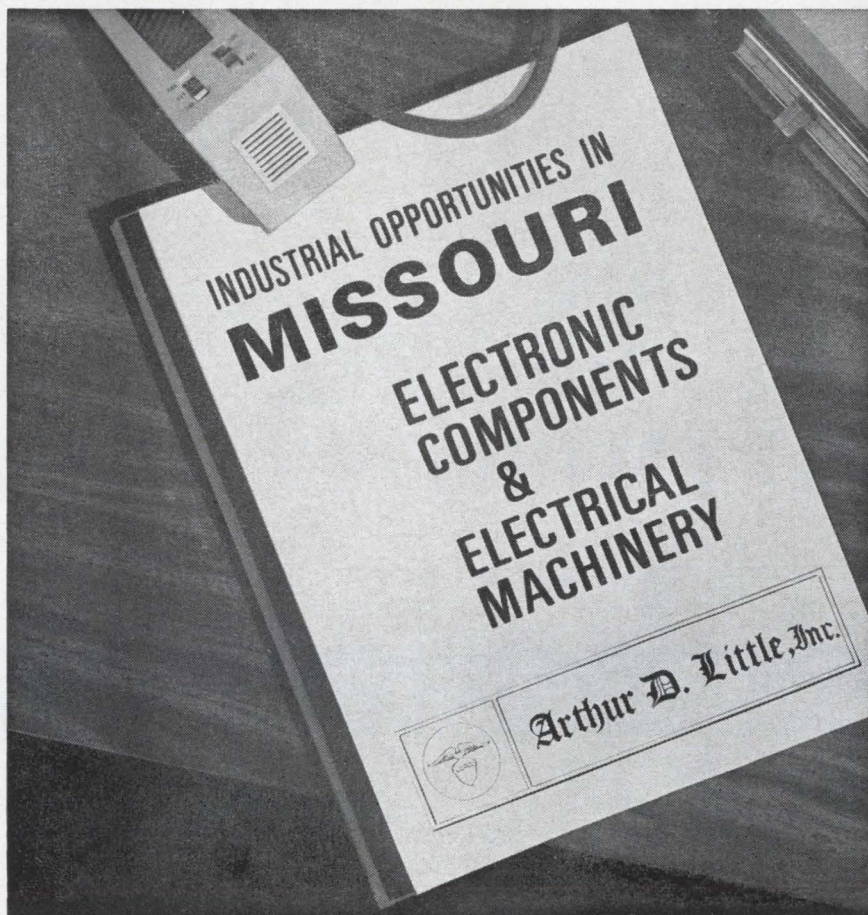

WRITE, WIRE OR PHONE FOR THIS **FREE** ARTHUR D. LITTLE REPORT

Informative and candid, this study by Arthur D. Little, Inc., presents an analysis of the Electronic Components and Electrical Machinery Industry. It reports on business structure, consumption, employment trends, location and market aspects, marketing opportunities, industry forecast, and equipment suppliers.

This revealing report is bound in book form and will be sent to you promptly. Just attach coupon to your letterhead.



MISSOURI

KEEP MISSOURI IN THE CENTER OF YOUR THINKING

Mr. Henry C. Maddox, Director
Missouri Division of Commerce and Industrial Development
Jefferson Building, Dept. E12-13-5, Jefferson City, Mo.
Phone No. 314-636-7185

PLEASE SEND ME A COPY OF THE ELECTRONIC COMPONENTS AND ELECTRICAL MACHINERY REPORT

Name _____ Title _____

Company _____

Street _____ City _____ State _____

HERE'S AN OPPORTUNITY

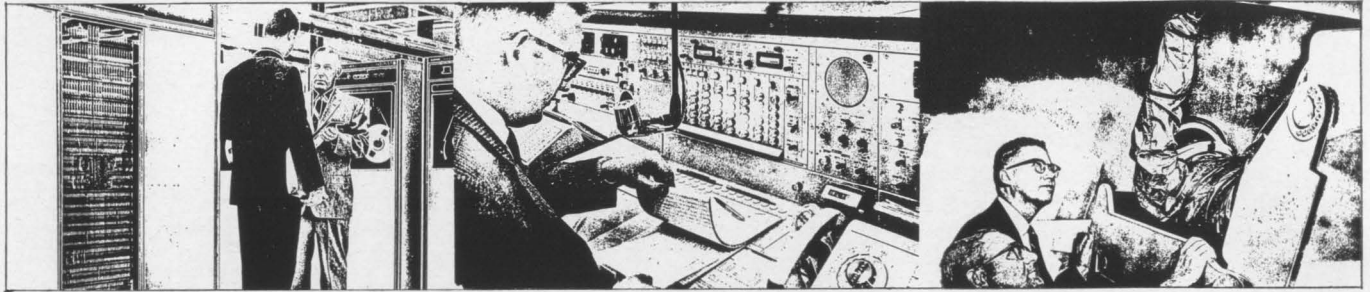

TO IMPROVE YOUR FUTURE

... Both professionally and personally. Every project at Collins is the most demanding in its area of industry, and we need professionals to continue the growth this level of quality has created. Living and working conditions — and compensation — are commensurate with these standards. These listings are current.

SEND RESUME FOR PROMPT INFORMATION

MICROWAVE SYSTEMS ENGINEERS—Electrical engineers with experience in microwave communication systems, design, or wire line carrier design. B.S.E.E. preferred. Must be willing to travel. (Dallas)

INDUSTRIAL ENGINEERING—These men will have a wide range of industrial engineering experience. They will be involved in standard data application, cost estimating, utilization studies, layout facilities planning, work measurement and cost reduction. (Cedar Rapids and Newport Beach)

INDUSTRIAL ENGINEERING, MECHANICAL ENGINEERING OR INDUSTRIAL MANAGEMENT GRADUATES—Experience in any of the following areas: manufacturing planning and methods, facilities planning, work measurement, cost reduction and control systems and procedures, tool and equipment design, computerized manufacturing techniques, quality engineering. (Dallas and Newport Beach)

FIELD SUPPORT ENGINEERS—Openings for field engineers with installation and

check-out experience in one or more of the following: high density microwave systems, toll terminal equipments, cable and open wire multiplex monopulse tracking techniques, phase locked loop receivers, parametric amplifiers, Cassegrain feeds, tropospheric scatter systems, solid state data systems. Most openings are single status with minimum of one year at location. (Dallas)

MECHANICAL ENGINEERS—B.S.M.E. for equipment and systems design. Duties will include machine design, hydraulic circuit design, stress and dynamic analysis, hydraulic and pneumatic design, electronic packaging and production processes. (Dallas and Newport Beach)

CRYSTAL FILTER ENGINEERS—To work in the challenging field of crystal filter development and/or crystal development. Minimum requirement B.S. degree but prefer M.S. or Ph.D. Two to four years minimum experience. (Newport Beach)

PRODUCTION ENGINEERS—These men

should have a background in flight director systems, gyroscopic devices or general electronics manufacturing. This area involves final development, tooling up and development of processes required for manufacture of newly designed avionics products. (Cedar Rapids and Newport Beach)

ELECTRICAL ENGINEER (Test Equipment)—This supervisory position involves the application of advanced techniques in product testing. Background should include utilization of programmed tape control and real time computer control technology and automatic test stations. (Cedar Rapids and Newport Beach)

RF SYSTEMS ENGINEERS—B.S.E.E. with experience in RF Systems including receivers, transmitters, and antennas in the VHF-UHF frequency range. Of specific interest is experience in phase locked loop receivers, high power transmitters, tracking (monopulse) antenna systems, and tracking system analysis. (Dallas)

COMMUNICATION / COMPUTATION / CONTROL



COLLINS RADIO COMPANY
An equal opportunity employer

New Subassemblies and Systems

The power that won't fail

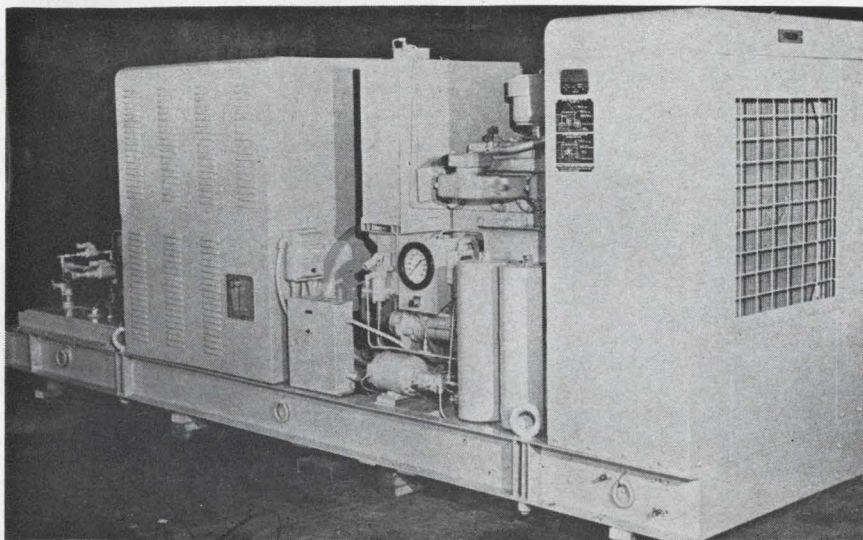

The 100-kw no-fail power system consists of (left to right) hydraulic motor, synchronous motor and alternator, and accumulators for hydraulic fluid, all in cabinet; diesel engine starter system, diesel engine and radiator.

Last month's massive power failure in the Northeast pointed up sharply the need for instantaneous backup power to prevent even momentary blackouts of such critical electronic equipment as computers, radar, data-transmission systems and aircraft landing aids. Coincidentally, the Fermont division of the Dynamics Corp. of America has announced a system that is specifically designed to provide just such backup power.

Fermont's electronically controlled "No-Fail" power system not only takes over automatically when commercial power fails, but also cuts in whenever frequency or voltage varies beyond preset tolerances.

Under normal operating conditions, the No-Fail power system operates as a buffer between the primary power source and the equipment to which it is supplying power. Commercial power drives a synchronous motor that is directly coupled to an alternator. The alternator supplies the equipment with power and closely regulates voltage and frequency.

When commercial power fails, or becomes irregular beyond tolerable limits, a solid-state frequency sensing device at the alternator's output activates a constant-speed servo-

mechanism. The servo system keeps the rotor of the generator turning at a constant rate by releasing high-pressure hydraulic fluid at a controlled rate into a motor. The frequency-sensing device also starts up a diesel engine and, when it attains operating speed, the engine is automatically coupled to the motor-alternator shaft by an over-running clutch. Power for the alternator is then supplied by the diesel engine and the hydraulic motor shuts off.

While the system is operating on emergency diesel power, the moni-

Specifications

Rated power	10 kw to 250 kw with 0.8 PF (as specified)
Output	Any standard operating voltage and frequency, single or three phase
Voltage Regulation	$\pm 1\%$ from no-load to full load $\pm 1/4\%$ at constant load
Voltage transient	$\pm 5\%$ deviation < 1 sec during 50% load change
Frequency regulation (Engine)	Isochronous, $\pm 1/2\%$ at constant load
Frequency regulation (Transition from utility to engine power)	$\pm 1/4$ cycle
Frequency regulation (motor drive)	Synchronous with commercial power frequency
Price	Depends on size and other variables, ranges from \$15,000 to \$150,000
Delivery	From 90 to 180 days

"Get Acquainted" Offer

If you'll tell us more about yourself through the confidential resume below, we'll know where to send you this booklet telling more about ourselves.

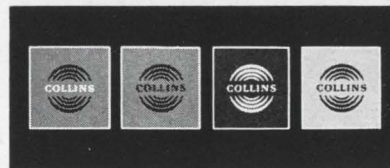

Send resume to Manager,
Professional Employment,
Collins Radio Company

Cedar Rapids, Iowa
Dallas, Texas
Newport Beach, California

CHECK LISTINGS

Name _____ Home Address _____ Phone _____

City & State _____

Present Position, Company _____

Primary Experience Area _____ No. of years _____

Education: EE _____ ME _____ Math _____ Physics _____ Chemistry _____

Bus. Adm. _____ Other _____ PhD _____

Degree: BS _____ MS _____ school, date _____ school, date _____

Please attach any pertinent information

CHRISTIE D-C POWER

ZERO
TO
40
VOLTS
CONTINUOUS

SCR

VOLTAGE-CURRENT REGULATED

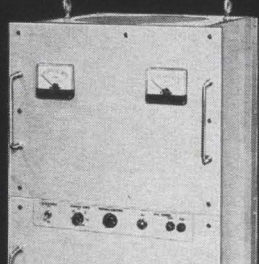

75
150
300
600
AMPS

- 30 mv. Ripple
- Fits Relay Rack

- 0.1% Regulation
- To MIL & RFI Specs

CHRISTIE ELECTRIC CORP. Since 1929

3400 West 67th Street Los Angeles California 90043
Circle 305 on reader service card

New Subassemblies

tor circuit in the control console continuously monitors the commercial power. When commercial power is found to be stable over an adjustable period (15-60 minutes), a synchronization circuit adjusts diesel engine speed, synchronizing it with the power frequency. The commercial power breaker is then closed and the diesel engine shuts off.

The No-Fail 100-kw unit (see picture) is 15½ ft. long, 4 ft. deep, and 6 ft. high; weight is 8,800 lb.

Fermont Division, Dynamics Corp. of America, 141 North Ave., Bridgeport, Conn., 06606 [401]

Educational tv system fits tight budgets

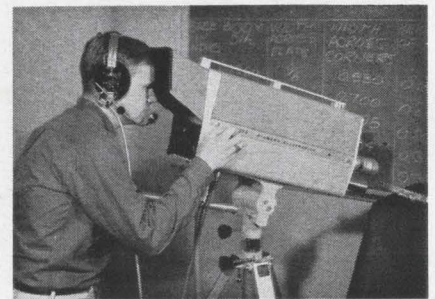

A closed-circuit educational tv system recently introduced is priced within most school budgets. It uses modular components to allow developing the nucleus of a high-performance system that can be expanded as needs and funds allow.

A "starter" camera-monitor chain can be purchased for \$1,500. This can be used for teacher training and for image magnification within a classroom.

A basic system costs approximately \$11,000, compared with about ten times as much for the usual studio arrangement. The package includes two viewfinder cameras, another camera for use with film chains, microscopes and similar equipment, a projector, two monitors and all controls. Screen images are up to 2½ times clearer than home tv, according to the manufacturer.

Designed primarily for educational use, the new system meets all broadcast requirements and EIA

SHIZUKI CAPACITORS

Injection Polypropylene Resin Molded Metallized Lacquer Film Capacitors
(-30°C +85°C)

For Transistorized TV set Electronic Timers

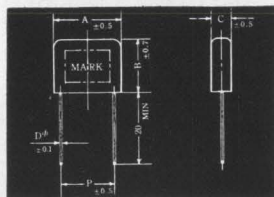

50 volts D.C. Working unit: mm

TYPE	CAP	A	B	C	D	P
PML-0.47/50	*0.47 µF	14.0	14.0	5.0	0.6	10.0
PML-0.5/50	0.5 µF	14.0	14.0	5.0	0.6	10.0
PML-0.68/50	*0.68 µF	19.5	16.0	5.5	0.6	15.0
PML-1.0/50	*1.0 µF	19.5	16.0	5.5	0.6	15.0
PML-1.5/50	*1.5 µF	24.0	19.0	6.5	0.7	19.0
PML-2.0/50	2.0 µF	24.0	19.0	6.5	0.7	19.0
PML-2.2/50	*2.2 µF	24.0	19.0	6.5	0.7	19.0
PML-3.3/50	*3.3 µF	30.0	20.0	7.0	0.7	25.0
PML-6.8/50	*6.8 µF	31.0	23.0	10.0	0.8	25.0

* STANDARD

◊ Lacquer Film Capacitors ◊ Polyester Film Capacitors ◊ Metallized Paper Capacitors for Motor running, fluorescent ballasts ◊ Noise Suppression Capacitors ◊ Ignition Capacitors ◊ Miniature Electrolytic Capacitors



SHIZUKI ELECTRICAL MFG. CO., LTD.

HEAD OFFICE: TAISHA-CHO, NISHINOMIYA JAPAN
CABLE ADDRESS: "CAPACITOR" NISHINOMIYA
TOKYO FACTORY: 10-7, ARAJUYUKU, OTA-KU, TOKYO

DIGITAL INDICATOR

NEW TYPE
RK-E 1

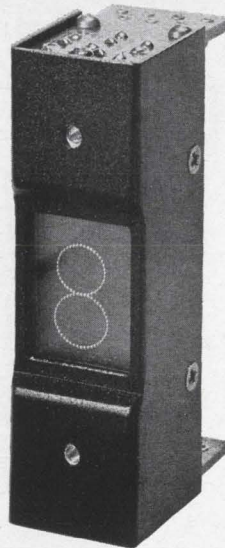

- Long Life!
- Economical!
- Small!
- Clear!

SPECIFICATION

- CHARACTER HEIGHTS 0.55"
- LAMP VOLTAGE 6.3V, 12V
- SIZE 2.56"×0.79"×1.26"

OKAYA MUSEN CO., LTD.

2-2 Kamidori Shibuya, Tokyo, Japan
Tel: (400) 8511

Circle 306 on reader service card

Engineers interested in developmental aviation have 3 ways to go at Lockheed-California.

Subsonic.



Lockheed's company speedometer spans speed regimes from 0 mph through Mach 12. And the opportunities for engineers interested in programs encompassing these regimes were never more diverse.

In subsonic airborne systems, Lockheed is taking a fresh look at basic problems. For example, it is deeply involved in STOL and V/STOL short-haul transports for mass travel between major cities. In addition, a Lockheed five passenger rigid rotor helicopter prototype is now flying. In the future: heavy-lift helicopters capable of transporting 24,000 or 40,000

Supersonic.

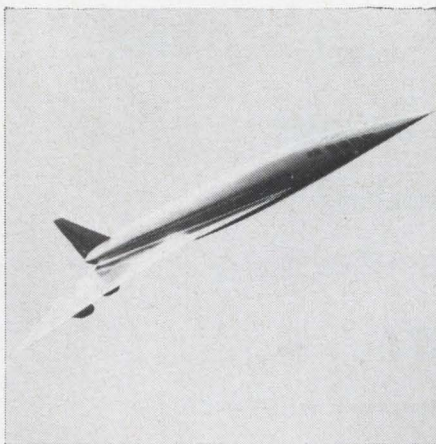

pounds for 100 or 200 miles. And under parallel development—advanced rotary-wing craft able to stop, fold, or start blades in forward flight.

Lockheed's supersonic efforts are also expanding. Its SST program alone is a major and growing endeavor. It reflects the unprecedented experience Lockheed engineers have gained in Mach 3, high altitude, titanium aircraft.

Manned hypersonic test and cruise vehicles, using the SCRAMJET approach, are under development at Lockheed. They point to the day when high priority passengers and cargo

Hypersonic.

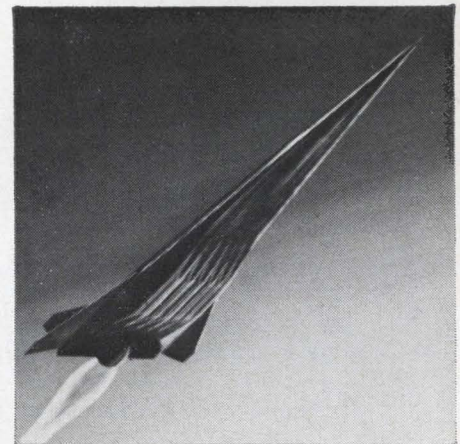

can travel at Mach 12 speeds to any place on earth.

A large number of engineering positions are now open in sub-, super-, and hypersonic speed efforts. For information concerning specific opportunities write: Mr. E. W. Des Lauriers, Professional Placement Manager, Dept. 1512, 2404 N. Hollywood Way, Burbank, California. An equal opportunity employer.

LOCKHEED-CALIFORNIA CO.

A DIVISION OF LOCKHEED AIRCRAFT CORPORATION

KLIXON
CIRCUIT BREAKERS

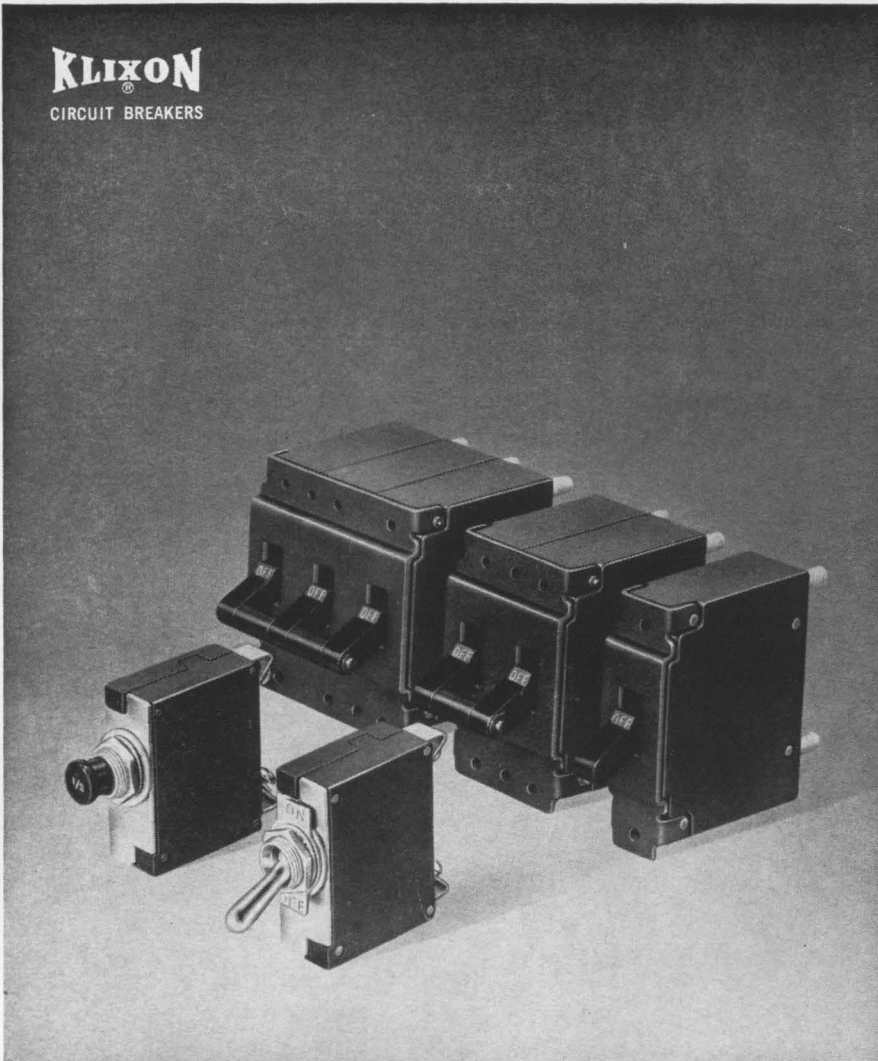

When magnetic circuit breakers are needed for high-reliability protection

...TI DELIVERS!

Name your specifications! Ratings from 0.050 to 50 amp. 2, 3 or 4 terminals. Internal circuits for series, shunt, calibrating tap or relay trip. Remote indication or control. Toggle or push-pull actuation. One, two or three poles. 20% lower voltage drop. 50% higher rupture capacity. All these options are included among the 202 standard types of KLIXON® brand Magnetic Circuit Breakers. All available for off-the-shelf delivery from stock.

Bulletin CIRB-1 contains complete technical information on TI magnetic circuit breakers. Write for your free copy today.



METALS & CONTROLS INC.
5012 FOREST ST., ATTLEBORO, MASS.
A CORPORATE DIVISION OF
TEXAS INSTRUMENTS
INCORPORATED

New Subassemblies

RS-170 standards. Key components are two new viewfinder cameras with horizontal resolution of either 650 or 800 lines. They are said to be the first viewfinder cameras to use silicon transistors throughout (both camera and viewfinder) for picture reliability and stability. Silicon transistors are not affected by the temperature changes that cause picture shrinkage, fading and blurring in conventional units. Input power changes of up to 30 v and temperature variations of 125°F will not cause noticeable picture degradation (change in size, contrast or resolution).

Diamond Electronics, Lancaster, Ohio. [402]

Medium-power-load servo repeater

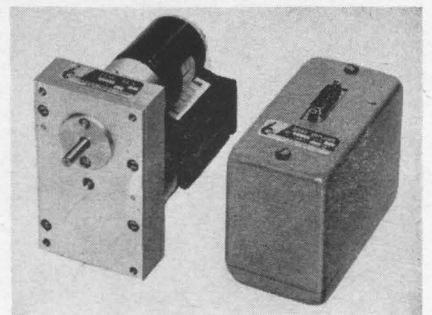

Model 893A/GT-879A servo repeater makes up a medium-power, high-accuracy synchro follower combination designed for a wide variety of heavy-duty industrial and military applications. The self-contained, fully engineered package consists of a solid state a-c servo amplifier that requires just a 117-v, 60-cps power supply, and a mechanical gear train which includes a 10-w servo motor with integral a-c tachometer, precision gearing and feedback control transformer with coupled output shaft.

No additional equipment is needed for this fully integrated servo system. Everything has been included to provide a light-weight, power-packed, long-life servo module. The system follows 60 cps, 3-wire synchro data and affords a top unloaded output shaft speed of 100 rpm max and a stall torque

ELECTRO

...EXACTLY THE POWER SUPPLY YOU NEED!

Conservatively-rated components... overload protection.
Top quality construction, long life... guaranteed one year.



1.



2.

1. Need good but not super regulation? ...you can save \$250 to \$650.

Electro "NFB" Power Supply . . . one of the industry's lowest cost-per watt-output, priced at only \$250. Regulation: 13% at maximum output; 0-32 vdc up to 15 amperes; . . . Low dc impedance: 0.3 ohms, no load to full load. (Rack model NFB1 . . . \$275.)

2. Need low ripple, high voltage: ...Electro has both for only \$150.

Electro "EFB" . . . a low cost power supply delivering up to 128 watts, with top-load ripple less than 0.1% at only \$150. Low cost-per-watt-output. Two ranges, continuously variable 0-32 vdc up to 4 amperes; 0-16 vdc to 8 amperes. Regulation: 1.25 volts for each ampere of load current change between 0-4 amperes in 32 volt range; 1.0 volt for each ampere of load change between 0-8 amperes in 16 volt range. (Rack model EFBR . . . \$175.)

3. Need others?

. . . 18 standard models, 6 to 500 vdc from \$27.50 stocked at your electronic distributor; custom designs for O.E.M. and special applications.

Write for complete line catalog

5185



Since 1936—Pioneers in Low Voltage DC Power Supplies
• Proximity Switches • Magnetic Pickups • Tachometers
• Pres-Con Controls • Dynamic Micrometers

ELECTRO PRODUCTS LABORATORIES, INC.
6125-F HOWARD, CHICAGO, ILL. 60648 • 312/775-5220

A CVC advance in thin film evaporation techniques...

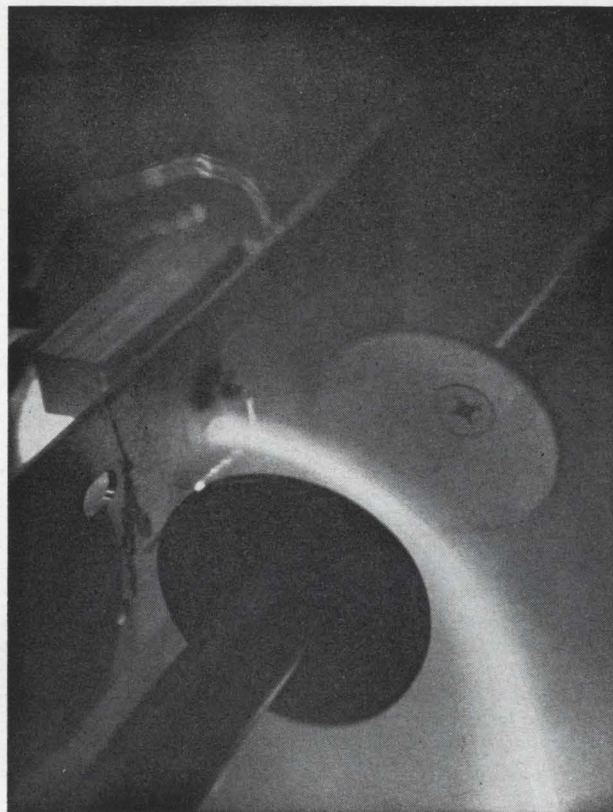

CVC's Electron Beam Gun with new Adjustable Beam Deflection

Now you have maximum control over beam spot position to reach multiple sources—allowing you to evaporate a number of materials in a single cycle.

Simply mount the CVC Electron Beam Gun to the chamber through a specially designed feed-through ring that seats on the baseplate. The beam is directed into the chamber and deflected downwards to the evaporant by means of an external control system. This gives you important advantages.

- More working space and flexibility within the chamber.
- Longer filament life.
- No water cooling.
- Simple, convenient mounting.

Write us now for the latest literature on this highly adaptable evaporation package.



Consolidated Vacuum Corporation

ROCHESTER, N. Y. 14603 • A SUBSIDIARY OF BELL & HOWELL
International Subsidiaries: Woking, Surrey, England
& Friedberg, West Germany



DROPS

varactor prices

AS MUCH AS 65%!

"INCREDIBLE" you might say, knowing that AEL quality has always been outstanding in the industry. The fact is, not one iota of quality is missing, we assure you.

"JUST A FEW TYPES" you might suppose. Wrong . . . price reductions are effective on the most complete line of varactors in the industry.

"HOW DO THEY DO IT?" you might ask. Ultra-refined cost cutting production techniques and tremendous volume have replaced expensive slow hand operations.

"HOW FAST CAN I GET AEL VARACTORS?" A good question. AEL gives you speedy stock to two-week delivery every time.

"TELL ME MORE ABOUT AEL VARACTORS" Okay . . . read on . . .

- Types available . . . standard double ended cartridge and pill (or button) package.
- Frequency range . . . packages with cut-off frequencies up to 180 Gc.
- Breakdown voltages . . . 160 V max.
- Junction capacitance . . . 0.1 pf to 16 pf or higher.

"GREAT . . . BUT WHAT ABOUT MY CUSTOM REQUIREMENTS?" As always AEL continues to provide any type of state-of-the-art varactor to meet your exact specifications.

"IS LITERATURE AVAILABLE?" Absolutely. Send for our new technical bulletin and schedule of new sizzling low prices . . . at once.



American Electronic Laboratories, Inc.
P. O. BOX 552, LANSDALE, PENNSYLVANIA 19446 • PHONE: (215) 822-2929

Circle 308 on reader service card

Meet the Miniature SLIDE REGULATOR from Matsunaga

(Valuable Voltage Transformer)

Small as a cigarette pack, these regulators are manufactured on an automated line. Quality is uniform from unit to unit, performance high and durable. Extensively used in copying machines, electric computers and other office machines. For detailed information please write today.

25VA	0.5A
Input	50V or 117V
Output	0 ~ 117V

MATSUNAGA
MANUFACTURING CO., LTD.

No. 7, 2-chome, Himonya, Meguro-ku, Tokyo

New Subassemblies

of 350 oz-in. Price of the servo repeater is approximately \$980; delivery, 4 to 6 weeks.

Industrial Control Co., Central Ave. at Pinelawn, Farmingdale, N.Y. [403]

Nanosecond tapped delay line

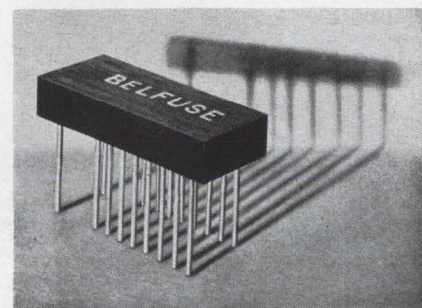

A miniature, nanosecond delay line has been announced. The encapsulated unit has a total delay of 15 nsec with taps every nanosecond, and a rise time of less than 5 nsec.

Designed for printed circuit mounting, the delay line is available in three impedance values of 93 ohms, 200 ohms or 500 ohms. With a size of only 1.5 x 0.5 x 0.25 in., the delay line is suitable for many computer applications where high-reliability delay elements are required.

Price in production quantities is under \$8; delivery, from stock to 2 weeks.

Bel Fuse, Inc., 198 Van Vorst St., Jersey City, N.J. [404]

Multiplexers handle 8 to 128 channels

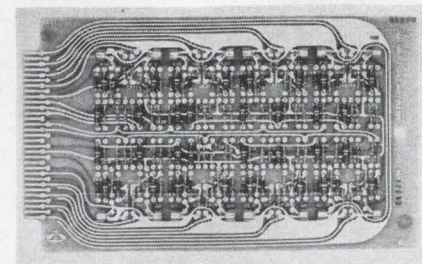

Series 970 solid-state multiplexers are designed to handle as few as 8 channels, as many as 128 channels. Eight switches are constructed on

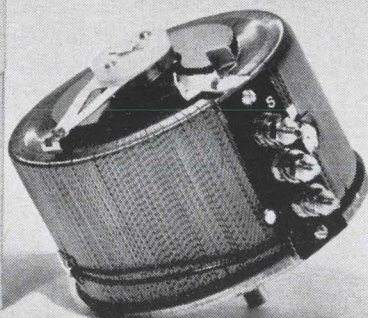

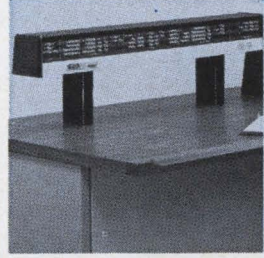
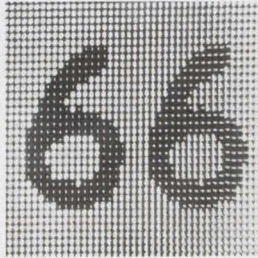
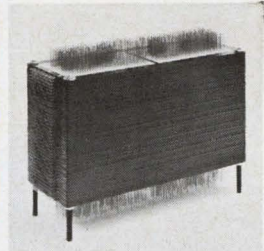
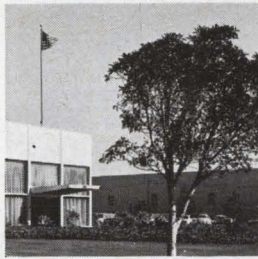
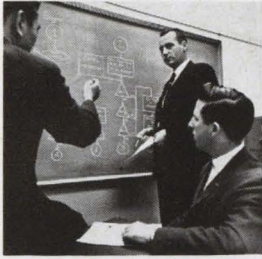
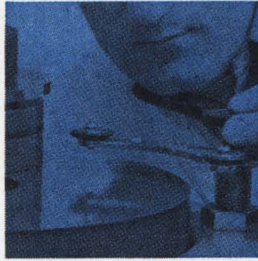
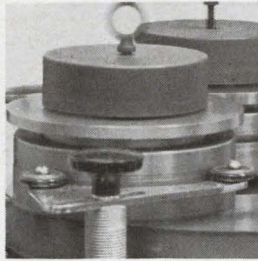

**NCR
ELECTRONICS
DIVISION
HAS BIG
PLANS FOR
1966.
HOW
ABOUT
YOU?**

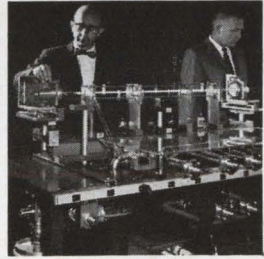
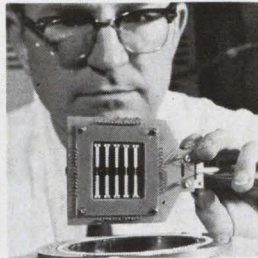

You can go on waiting for your digital systems future to come—or you can join NCR Electronics Division. At NCR, the key word is now. Advanced hardware on the drawing board, on the production line and on the market tells you that NCR means real-time opportunity. Look into NCR Electronics Division and you'll see accomplishment—like the NCR 315 RMC Rod Memory Computer with the all thin-film main memory. You'll see business automation being created for more than 120 countries. And you'll see a chance to combine a good living with the good Southern California life. Investigate these opportunities now and make it a happy new year.

The National Cash Register Company



ELECTRONICS DIVISION
2816 W. El Segundo Blvd., Hawthorne, California
Telephone: Area Code 213-757-5111
An equal-opportunity employer

- ADVANCED PRODUCT PLANNING SPECIALISTS
- ADVANCED MECHANISMS SPECIALIST
- MAGNETIC RECORDING SPECIALISTS
- ADVANCED MEMORY-RESEARCH SPECIALISTS
- ADVANCED SYSTEMS SPECIALISTS
- ELECTRONIC PRODUCT ENGINEERING
- PACKAGING
- BUSINESS PROGRAMMING
- SOFTWARE PROGRAMMING
- DESIGN AUTOMATION PROGRAMMING
- SYSTEMS FORMULATION
- LOGIC DESIGN
- POWER SUPPLY DESIGN
- MECHANISMS DESIGN
- TEST ENGINEERS AND TEST TECHNICIANS

ARRANGE NOW FOR AN INTERVIEW IN YOUR AREA
Confidential interviews will be held soon in various parts of the country. Openings above are in Los Angeles. Additional openings in Dayton, Ohio, for mechanical, electrical and chemical engineers, physicists, chemists (MS or PhD level). Send resume immediately to Bill Holloway, Technical Placement, or call collect.

REMEMBER RESE

FOR MAGNETIC CORE MEMORIES

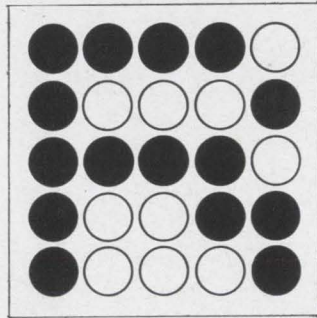

RESE ENGINEERING INC.

A and Courtland Streets, Philadelphia, Pa. 19120 (215) GL5-9000

Circle 309 on reader service card

Top Quality at a price
you can afford!



S-6N SRP-13G

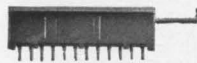

PM-182Z



S-10A



PB-MJ-18P

True to our traditional precision, we are offering the jamproof products to every part of the world, including the PM-182Z Push Switch for transceivers, the S-6N and S-10A Slide Switches for transistor radios, the SRP-13G Micro Rotary Switch, the PB-MJ-18P Micro Jack as shown above, the Multi-Connector for print board, the IFT OSC for transistor radios, etc.

Ask our catalogue without obligations

FUJI DENPA INDUSTRY CO., LTD.

No. 3-23, 5-chome, Higashikojima, Ota-ku, Tokyo, Japan
Tel. Tokyo (742-4531-2)

Primo

Super High Sensitivity
**SOUND LEVEL
METER MICROPHONE**
(DYNAMIC TYPE)



DM-1332

Specifications

- Frequency Response:
20~16,000c/s ± 1.5 dB
- Impedance: 100 Ω $\pm 10\%$
- Sensitivity: -80dB ± 2 dB
- Dimensions: 35 ϕ x220mm
- Weight: 7.30gm.

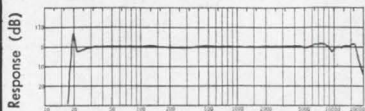

For catalog write to

PRIMO COMPANY LTD.

2043 MURE, MITAKASHI, TOKYO, JAPAN
TEL. 0422-3-3121 (Calling from Tokyo)

Circle 310 on reader service card

New Subassemblies

a single plug-in card module for channel expansion in groups of eight, to be added at any time. The versatile units will accept single-ended inputs, differential inputs or three-wire inputs consisting of a differential input and guard shield.

For single-ended operation, a high-input-impedance buffer amplifier is provided. Gain is adjustable from 1 to 20, so that input signals as low as ± 500 mv full scale are amplified to ± 10 v. at the output. With an internal impedance less than one ohm, the amplifier can deliver a full 10 ma to the multiplexer load.

For differential inputs, an input resistance of 100 megohms is maintained, and amplification is available external to the unit.

Stepping rate of the series 970 multiplexers is selectable from 0 to 20,000 channels per sec. Optional provisions are available for random channel selection from external signals, or sequential scanning by internal programing.

The entire multiplexer is packaged compactly in a standard 19-in. rack frame, occupying only 7 in. of vertical panel space. Included in the unit are decoder modules, a control module, a buffer amplifier (for single-ended operation), and a plug-in power supply. Input filters can be supplied on request. Astrodata, Inc., 240 E. Palais Road, Anaheim, Calif. [405]

Solid-state laser is versatile

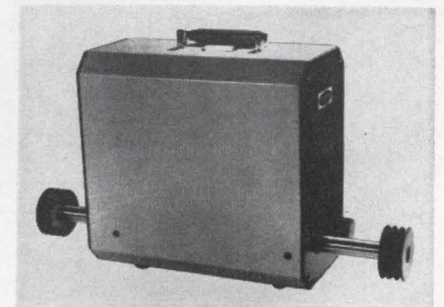

A solid-state laser system now on the market consists of a single cavity laser head and a matching 3,000-joule power supply.

The versatile LH5 laser head can be used with a wide variety

INSTANT AVAILABILITY

on **HARDWARE ...**
HARDWARE ... and more
HARDWARE



You name it . . . we have it in stock . . . for instant delivery!

Included in the **CAMBION®** line — more than 100 handles designed to meet any type of space limitation, environment, surface configuration and means of attachment: kollet knobs, snap-lock battery holders, captive panel screws, shaft locks, thumb screws, component clips, standoffs, brackets, rivets, tube clamps, spacers — the most complete inventory of electronic parts, hardware and accessory items available to you in quantity at any time.

Exclusive **CAMBION DIAL-A-PART** round-the-clock service places the complete **CAMBION** line at your disposal — immediately. For the parts you need — when you need them — call **DIAL-A-PART**, (617) 876-2800. Cambridge Thermionic Corporation, 401 Concord Ave., Cambridge, Massachusetts 02138. Man . . . have we got hardware!

CAMBION®
 "DIAL-A-PART" SERVICE

Standardize on **CAMBION** . . . the guaranteed electronic components
 Circle 340 on reader service card

Orion
 Speaker *New product:*
 "Violist"
 Model: MF-40
 Size: 4"
 Rated power: 5W
 Frequency range: 60c/s-15,000c/s
 Magnet weight: 8.4oz

- We manufacture various kinds of speakers for:**
1. Radio & TV,
 2. Taperecorders,
 3. Autos,
 4. Public Addresses,
 5. Outdoors,
 6. Intercom.
 7. Electric Guitars,
 8. High-Fidelity Systems.

Please write for further information to:
 -The oldest manufacturers in Japan-
TONEGEN ELECTRIC CO., LTD.
 37, I-chome, Furuichi-Minamidori, Joto-ku, Osaka, Japan.
 Cable Address: TONEGEN OSAKA

TM® CRIMP
 MINIATURE CONNECTORS

TM CRIMP PLUG TM CRIMP JACK

Exploded views before crimping

NEW TM CRIMP MINIATURE CONNECTORS are comprised of only 3 basic parts for rapid assembly: (1) the connector body, (2) center contact, and (3) crimp sleeve. They provide an outstanding performance wherever they are used. Prove it yourself by specifying them when maximum reliability is a positive requirement.

TM CRIMP CONNECTOR FEATURES:

- low cost, yet high quality
- low VSWR
- high cable retention strength
- quick and uniform assembly
- weatherproof heat shrink tubing (supplied)
- also available in aluminum

TYPICAL MATED PAIR USING RG-223/U CABLE

IMPORTANT: Now available is GRFF's new 24-page Connector Catalog! Write or call for your free copy.

TNC **TM®** **GM**

Connectors shown above are actual size
 Comprehensive descriptive literature is available on all of the outstanding GRFF connector types shown above. **Non-standard applications solved quickly and efficiently!**

General RF Fittings, Inc.
 702 BEACON ST./BOSTON MASSACHUSETTS 02215
 Telephone: 617 267-5120

**IT'S
A
FACT**

America's principal
defense contractors,
computer builders,
instrumentation
manufacturers and
electronic systems
developers use more
Metal Removal Company
solid carbide circuit
board drills and
routers than all other
makes combined.

For more information,
may we send you our
Catalogs D63 and E65
... and name of
nearest distributor?

**SOLID CARBIDE
CIRCUIT BOARD
TOOLING**

THE METAL REMOVAL COMPANY
1859 West Columbia Avenue • Chicago, Illinois 60626

Plants Located in CHICAGO • LOS ANGELES • SAN JUAN

**MASTER TOOL AND WHEEL MAKERS
FOR THE WORLD**

Circle 200 on reader service card

To order reprints: Fill in, cut out coupon below, insert in envelope and mail to: **Electronics Reprint Dept., 330 W. 42nd Street, New York, N.Y. 10036**

Reprint order form

For listing of reprints available see the Reader Service Card.

The Packaging Revolution In Microelectronics

Send me reprints of Key no. R-80 & 81 at 50¢ each.

For reprints of previous special reports fill in below:

Send me reprints of Key No.(s) @¢ each.
(For prices, see Reader Service Card)

Name

Number of street

City, State, Zip Code

New Subassemblies

of straight flashlamps. The crystal holders can be adapted to accept crystals from 1/4 in. to 3/4 in. in diameter and 1 1/4 in. to 6 5/8 in. in length. The holders can accommodate crystals with dielectric coatings, roof top prisms and other reflector techniques.

Although supplied with a ruby laser rod, the LH5 head can also be operated with crystals of neodymium in glass, calcium tungstate, calcium fluoride, and other laser materials.

Using the standard 2,000-joule lamp and LR3 ruby, the LH5 system delivers 10 joules at room temperature and 20 to 25 joules when cooled with liquid nitrogen.

The double open-ended design facilitates use of external mirrors, cavity lengthening and Q switching, all of which can be accomplished without modification to the laser head.

Designed particularly for use with the LH5 laser head, the LPS12 power supply operates from nominal 110 v lines (110-125 v, 60 cycle). Pulse-forming networks match the output pulse shape to the characteristics of the flashlamp in use. Output can be varied from 0 to 3,000 joules in a 1.5-nsec pulse length. When the laser is Q switched, the pulse length can be shortened to 0.8 msec. Charging time for 2,000 joules is 5 seconds. Raytheon Co., Laser Advanced Development Center, 120 Second Ave., Waltham, Mass. [406]

Power supply has high input-output isolation

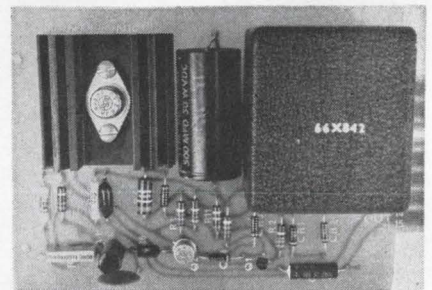

Silicon regulated d-c power supplies are available with high input-output isolation. The RW series offers

NIFEGON



servo-
components
with
built-in
quality

Servo components are not all alike, in spite of the fact that international standards dictate identical external appearance. The difference is in the component — reliability and life expectancy — two characteristics which depend solely on quality. The Nifegon trademark symbolizes precision servo components with built-in quality.



SYNCHROS

(for torque applications and servo system)

Sizes 11, 18 and 23 — 2", 3" and 5" respectively.



RESOLVERS

(compensated and uncompensated)

Sizes 11 and 18 — 2"



SERVOMOTORS

Size 11



MOTOR-GENERATORS

Size 11



GEARHEADS

Size 11

SVENSKA ACKUMULATOR AKTIEBOLAGET

JUNGNER

INSTRUMENTFABRIKEN · STOCKHOLM

Riddargatan 17 • Stockholm 14 • Sweden
Telephone: Sweden 22 23 40 • Cables: NIFE
Telex: 1592

Circle 311 on reader service card

Two electrifying reasons for coming home with us to Paris:

1. The Electronic Components Exhibit.
2. Paris.

The first may turn out to be an excuse, although it's the largest exhibition in the world, but that's up to you. Either way, Air France (official carrier for the exhibit) will joyously jet you nonstop to Paris from New York, Los Angeles or Montreal direct from Chicago or Washington, D.C. And we'll start your Paris orientation in the air, from the memorable French cuisine to the matchless comfort and service. We want you to feel at home when you get to Paris. That's why you'll find an Air France Welcome Service desk at the exhibit. We'll be happy to show you around when you arrive: Let us arrange all the details of your stay before you leave. Fares? There are none lower. Cargo Service? None better. For complete information, clip and mail the coupon below.

AIR FRANCE

E-12-3

Overseas Trade Show Department

AMN-CG

683 Fifth Avenue

New York, N.Y. 10022

Please send me, free, the detailed technical brochure and admission card for the 9th International Exhibition of Electronic Components

Name _____

Company _____

Address _____

City _____ State _____ Zip Code _____



AIR FRANCE
THE WORLD'S LARGEST AIRLINE
à Votre Service

Circle 201 on reader service card

MORE

Value IN METERS

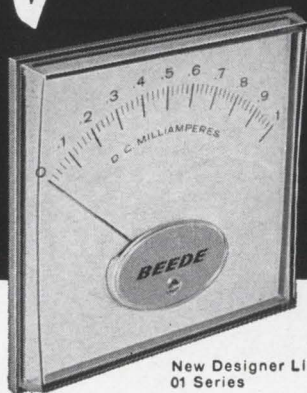

New Designer Line
01 Series

FROM BEEDA



Edgewise Model E-25

Traditional Style Model 16

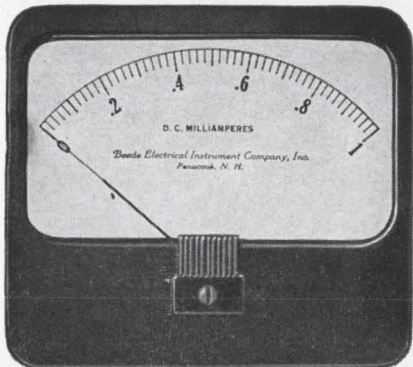

Quality.... Beede's quality control program insures meter performance to customer's specifications.

Delivery... Dependable promises every time so that you can set and meet your production schedule.

Style..... A variety of styles for every need from our new "Designer Line" to the traditional case styles.

Price..... Realistic, competitive prices on every style.

D.C. current sensitivities from 20 microamps; D.C. voltage sensitivities from 3 millivolts.

Write for our new illustrated brochures giving full specifications on our complete line.

BEEDA

ELECTRICAL INSTRUMENT CO., INC.
PENACOOK, NEW HAMPSHIRE

Area Code: 603-753-6362 TWX: 603-753-4727

New Subassemblies

a combination of excellent regulation and stability with less than 0.1 pf input to output capacitance. The units are designed for use in instrumentation, control systems, strain gages, and other d-c power uses where precision, stability, and isolation are critical parameters.

The supply is wired on an epoxy glass card that may be used in card racks or chassis-mounted. Over-all size is 4½ x 6½ x 1¾ in. Discrete voltages to 30 v d-c are available with ±5% adjustment by multiturn potentiometer. Output power is 4 watts. Regulation is 0.01% line, 0.05% load; ripple and noise, less than 1 mv peak-to-peak. Temperature coefficient is 0.005%/°F. Price for 1 to 9 is \$89 each; availability, stock to four weeks. Scintillonics, Inc., Box 701, Fort Collins, Colo. [407]

Variable-bandwidth crystal filter

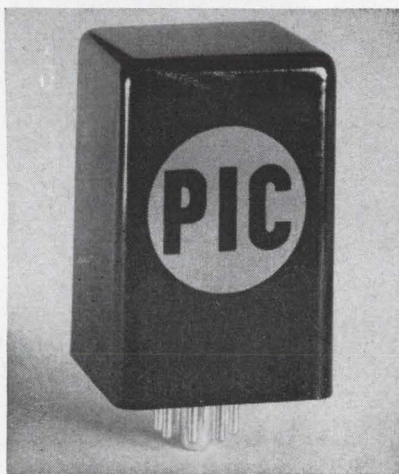

The transistorized version of the CF-T voltage-controllable, variable-bandwidth, active crystal filter requires lower power—only 13 v d-c at 10 ma. A two-stage filter provides improved skirt selectivity at the narrowest bandwidth and at the -60 db points. Ratio of widest pass band to narrowest pass band is greater than 40 to 1. Center frequency may be specified from 5 kc to 1 Mc. Bandwidth is adjusted by d-c or a-c control voltage.

The filters are useful for spectrum analyzer, frequency synthesizer or other applications where

IDX Antenna

Presenting

a complete line
of TV Antennas
and Accessories.

TV COMMUNITY RECEPTION UNITS ALL PREPARED!

Matching Transformers



DM-73



DUM-37H

Directinal Couplers



DDC-172



DDC-274

Distributors



DD-772



DD-734

UHF-VHF Transistor Converter for every home use

covers
470MC-770MC
both for
black/white
& color TV

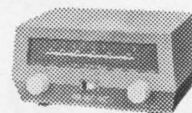

Model UC-310

All Band Transistor Booster
best for black/white
and color TV, and
FM radio, as well.

20 dB gain

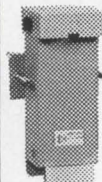

Model TAX-233C

For further informations,
please write to:

KANSAI TELEVI KOGYO CO., LTD.

No. 6, Irie-dori 5-chome,
Hyogo-ku, Kobe, Japan.

Tel. (68)-1361-6 Kobe
Cable "KANTELKO KOBE"

NEW ZELTEX AMPLIFIER WITH FETS!

- New, Smaller Package
- Lower Cost
- Improved Performance

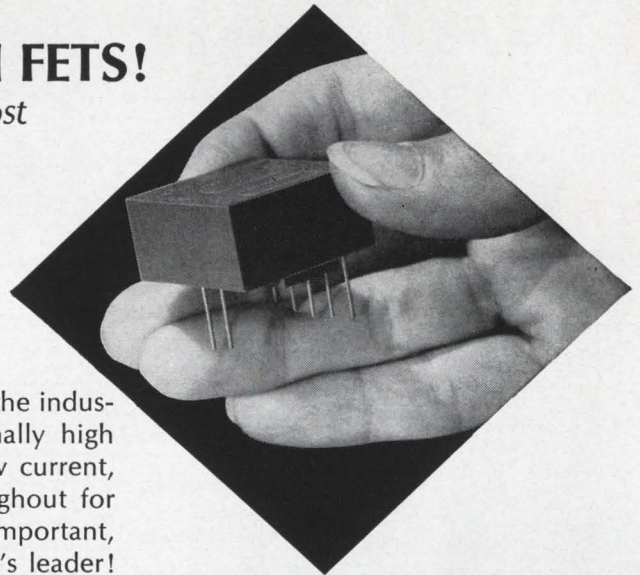

More FET amplifier news from Zeltex—true economy with the industry's most outstanding performance! Featuring exceptionally high differential and common mode input impedance with low current, this new Zeltex amplifier utilizes silicon transistors throughout for utmost reliability. Where performance, cost and size are important, the Model 132 offers the industry's best from the industry's leader!



ZELTEX, INC.

1000 Chalamar Road, Concord, California
 Phone: (415) 686-6660
 The broadest spectrum of Amplifiers
 and Computer Elements

Check these key specifications:

Input Current: 100 picoamp
 Voltage Gain: 100,000
 Voltage Drift: 20 μ volt/ $^{\circ}$ C
 Input Impedance: 10,000 meg
 Slew Rate: 10 ν/μ sec

Model 132 Differential Operational Amplifier with Field Effect Transistors...

Also available in a 0.4 in. high enclosure, this remarkable new Zeltex FET Amplifier is available virtually from stock. For complete information, write or phone today.

Circle 313 on reader service card

OKI BWO 50BW10 covers 44-54Gc in a single tube with typical power output of 100MW

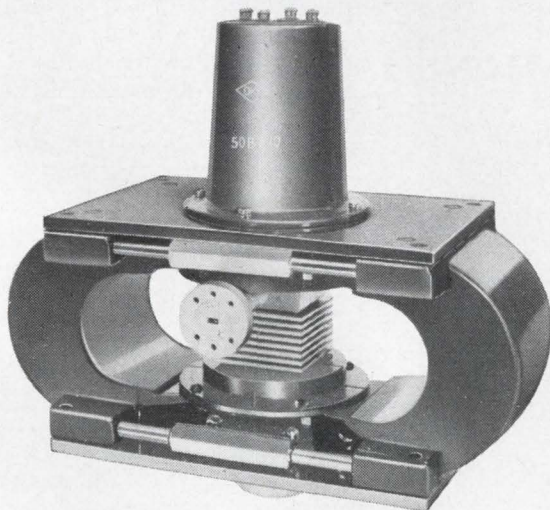

Soon available up to 100GC!!

Here are the superb capabilities of OKI BWOs:

- * Electronic tuning of 10,000Mc
- * High output power—20mW min.
- * Long life—2,000 hours expected and one year warranted
- * FM modulation at high repetition rate over full tuning range
- * Easy AM modulation
- * Low noise

OKI Model	Freq. (Gc)	Power output (mW)		Delay line voltage (V)	Cathode current (mA)
		MINIMUM	TYPICAL		
* BA47F	43.5-51.5	30	100	3600 max.	33 max.
* BA50G	46-53.5	30	100	3600	33
** 50BW10	44-54	20	100	3500	40
* BA55B	51-59	20	100	3600	33
* BA60C	55-65	20	100	3600	33
** BA47H	46-52	150	500	4000	65
** BA50H	48-54	150	500	4000	65

* Forced air cooled.

** Water cooled. Water cooling is required for operation at cathode current of over 30mA at typical operation.

OKI
 electric industry
 co., ltd. TOKYO JAPAN

Authorized Distributor: **BUTLER ROBERTS ASSOCIATES INC.**

Head Office: 500 S.E. 24th Street, Ft. Lauderdale, Florida

New York Office: 202 East 44th Street, New York 17, New York

West Coast Rep.: Frank R. Thomas, P.O. Box 1377, Santa Barbara, Calif.

Tel: Area 305: 523-7202

Tel: Area 212: 682-2989

Tel: Area 805: 962-5917

NATVAR TUBING AND SLEEVING

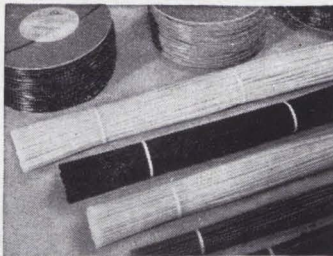

For a Wide Range of Military Electronic and Electrical Uses	General Purpose Extruded Vinyl Tubing	Natvar 241	MIL-I-631C, Type F, Form U, Grade A, Class II, Category 1.
		Natvar 261	MIL-I-631C, Type F, Form U, Grade A, Class I & II, Category 1.
	Low Temperature Extruded Vinyl Tubing	Natvar 361	MIL-I-631C, Type F, Form U, Grade B, Class I & II, Category 1.
		Natvar 362	MIL-I-7444B, Type I, II & III, Range I, II & III.
		Natvar 363	MIL-I-22076.
	High Temperature Extruded Vinyl Tubing	Natvar 461	MIL-I-631C, Type F, Form U, Grade C, Class I & II, Category 1. U/L Approved for 105°C Continuous Operation.
		Natvar 400	U/L Approved for 105°C Continuous Operation.
		Natvar 500	Specially Formulated for Use in Transformer Oil.
	Natvar Coated Fiberglass Sleeveings	Vinyl	MIL-I-21557 (Grade A Only) and MIL-I-3190B.
		Isolastane (Polyurethane)	MIL-I-3190B.
		Silicone Rubber	MIL-I-18057A (Grade A Only).

Natvar is synonymous with quality throughout the world. Among the many outstanding insulations now serving the needs of the military and industry are Natvar extruded tubings and coated sleeveings.

These are made to perform in a wide range of temperatures from -68°C to 180°C and above, and to meet the electrical and mechanical requirements of applicable military and industry specifications. In addition, most have superior resistance to oil, alkali and flame; excellent flexibility, and exceptional toughness and ability to withstand abrasion.

The specially compounded formulations used in Natvar extruded tubings and coated sleeveings are subjected to systematic and rigorous quality control from raw materials to finished product. The name Natvar is your guarantee of quality and uniformity.

Shipments of standard items can be made the same day from distributor's or factory stock. Samples are available on request.

Natvar Products

- Varnished cambric—sheet and tape
- Varnished canvas and duck—sheet and tape
- Varnished silk and special rayon—sheet and tape
- Varnished papers—rope and kraft—sheet and tape
- Varnished, silicone varnished and silicone rubber coated Fiberglass—sheet and tape
- Slot cell combinations, Aboglas®, Isoplex®
- Teraglas®
- Acryliglas® sheets, rolls, tapes
- Isolaglas® sheets, rolls, tapes
- Epoxy coated glass sheets, rolls, tapes
- Isolaglas® sheet and tape
- Isolastane® sheet, tape, tubing and sleeving
- Vinyl coated and silicone rubber coated Fiberglass tubing and sleeving
- Extruded vinyl tubing and tape
- Styroflex® flexible polystyrene tape

We will be very happy to supply information on any of our products on request.



NATVAR CORPORATION

FORMERLY THE NATIONAL VARNISHED PRODUCTS CORPORATION

Telephone 201-388-8800 TWX 201-381-8056 Cable Address NATVAR, Rahway, N. J.
201 RANDOLPH AVENUE • WOODBRIDGE, NEW JERSEY
Circle 204 on reader service card

To order reprints: Fill in, cut out coupon below, insert in envelope and mail to: **Electronics Reprint Dept., 330 W. 42nd Street, New York, N.Y. 10036**

Reprint order form

For listing of reprints available see the Reader Service Card.

A Look at Japanese Electronics Technology

Send me reprints of Key no. R-83 at 50¢ each.

For reprints of previous special reports fill in below:

Send me reprints of Key No.(s) @ ¢ each.

(For prices, see Reader Service Card)

Name

Number of street

City, State, Zip code

New Subassemblies

bandwidth must be adjustable and controllable. Price for 1 to 4 pieces is \$95 each.

Polyphase Instrument Co., Bridgeport, Pa. [408]

Miniature f-m tuner offers high stability

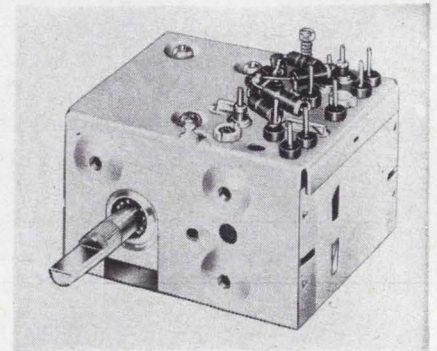

The FM-9 tuners are three-gang variable condenser models with three transistors mounted inside the package. Approximate dimensions are 2½ in. wide x 2¼ in. deep x 2 in. high, excluding shaft extensions.

Power requirement is 12 v at 8 ma negative ground, with positive ground and other operating voltages available. Input impedance is 300 ohms balanced, 75 ohms unbalanced. Double-tuned i-f transformer works into a 60-ohm load output shunted by 55 pf.

Tuners can be customized to meet circuit requirements and chassis compatibility.

Oak Mfg. Co., Crystal Lake, Ill. [409]

Tiny 1-Mc oscillator is crystal-controlled

A 1-Mc, microminiature, crystal-controlled oscillator now being offered is believed to be the smallest available commercially. Model S2967, designed for printed-circuit-board mounting, is intended primarily for use in communication and navigation equipment.

The crystal, which is an integral part of the unit, is in a cold-welded holder. Cold welding, because it eliminates solder and attendant

flux and heat, permits substantial increases in the stability and reliability of crystals.

Specifications of the model S2967 are: aging, 3 parts in 10^8 per day; size, 0.75 x 1 x 0.562 in. Cost is less than \$50 per unit in lots of 100 or more.

Reeves-Hoffman division of Dynamics Corp. of America, 400 W. North St., Carlisle, Pa., 17013. [410]

Fifty-millisecond delay line



Model 81-43 delay line is a 50-millisecond unit, which is adjustable from 48 to 51.75 msec in steps of 0.25 msec. It is designed for geophysical exploration devices. Bandwidth is 800 cps (down 3 db); amplitude response, ± 1 db from 100 cps to 600 cps; phase response, ± 0.25 msec from 100 cps to 600 cps; impedance, 5000 ohms; insertion loss, approximately 8 db; peak signal amplitude, 1 v rms, d-c test voltage, -200.

The unit is supplied in three cases (complete with carrying handles), each of which requires 17 x 10 x 5 in. Delay lines with similar specifications or multitapped units can be built to exact customer requirements.

ESC Electronics Corp., 534 Bergen Blvd., Palisades Park, N.J. [411]

Instrumentation-type wide-band amplifier

A solid-state differential amplifier is available with gain settings from 10 to 1,000. Type ADV-1 delivers an output of 100 ma at ± 20 v. The unit is designed to amplify small signals from low-impedance

NEON or INCANDESCENT SUB-MINIATURE INDICATOR LIGHTS

MEET OR EXCEED ENVIRONMENTAL AND OPERATIONAL REQUIREMENTS OF MIL-L-6723 AND MIL-L-3661

Miniaturization is made possible by the wide selection of Dialco Sub-Miniature Indicator Lights for mounting in 15/32" or 17/32" clearance hole. Among the features offered are: Watertight construction; resistance to vibration and corrosion; high-heat plastic or glass lenses; anti-rotation (locked) construction; phenolic insulation of military specification grade.

Neon assemblies accommodate T-2 lamps in two types: NE-2D (MS25252) for 105-125V AC-DC; and High Brightness NE-2J for 110-125V AC only. In DIALCO units, the current limiting resistor is built-in (U.S. Pat. No. 2,421,321).

Incandescent assemblies accommodate T-1 $\frac{3}{4}$ lamps in voltages from 1.35 to 28V—with life ratings to 50,000 hours.

SAMPLES ON REQUEST—AT ONCE—NO CHARGE.

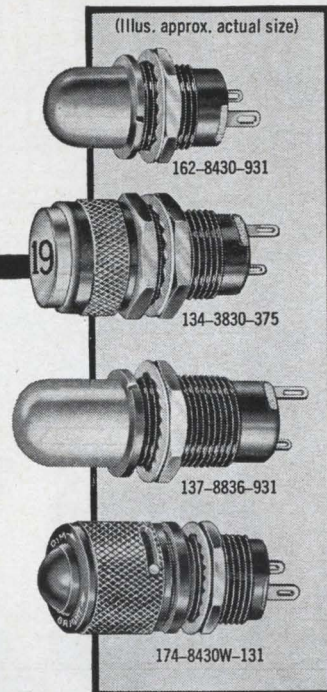

WRITE FOR CURRENT CATALOG

DIALCO

Foremost Manufacturer of Indicator Lights

DIALIGHT CORPORATION

60 STEWART AVENUE, BROOKLYN, N.Y. 11237 212 HYACINTH 7-7600

Circle 314 on reader service card

WE'VE SIMPLIFIED PHOTOCCELL-LAMP DESIGN

New Clairex® PHOTOMODS® combine selected photoconductive cells and lamps into one compact module ready for use as noiseless pots, circuit isolators, automatic gain controls and for numerous other control applications. 11 standard PHOTOMODS are now available combining hermetically sealed CdS and CdSe photocells coupled to 5000 hour lamps rated at 6, 12, 24, and 120 volts. Custom PHOTOMODS are also available based on your specific control and signal circuit parameters.



For additional design data request technical bulletin ITD 465.

CLAIREX

"The LIGHT Touch in Automation and Control"

CL-105

8 West 30 Street, New York, N. Y. 10001, 212 MU 4-0940

LAM-O-LUME

PURE FUSED QUARTZ

HIGH INTENSITY XENON OR
ULTRA-VIOLET LIGHT SOURCE

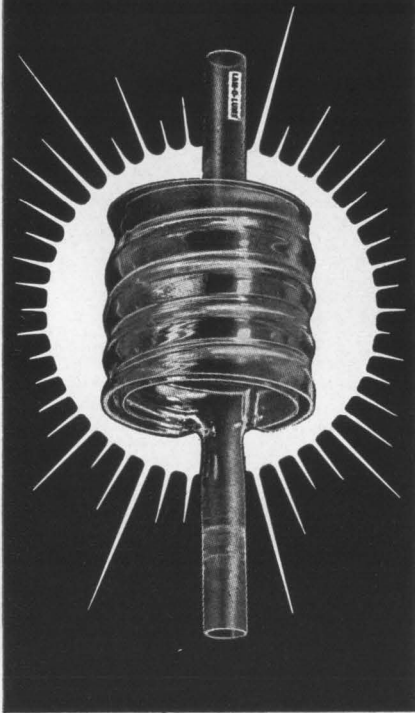

This unitized, dimensionally accurate, pure fused quartz envelope (coil), of rugged design, provides an excellent source for Xenon high intensity lighting or ultra-violet irradiation. The LAM-O-LUME can be supplied as a plain envelope or as a completed tube with electrodes and rare gas.

FOR XENON SERVICE, which provides light intensities brighter than the sun, for outdoor lighting, photography, etc., the unitized THERMAL AMERICAN LAM-O-LUME power supply comes complete with built-in capacitors and trigger circuit; provides 600 joule output with operating range between 1000 and 1800 volts; delivers 35-50 lumens per watt second and a life of 10,000 flashes at rated input.

FOR ULTRA-VIOLET LIGHT SOURCE for irradiation, laboratory heat exchangers, laser pumping, etc., the LAM-O-LUME power supply is available with standard 400 watt average capacity.

Write for details.

42



New Subassemblies

sources, such as thermocouples and strain gauges. It is well suited to many instrumentation-system uses, for data acquisition, and for general laboratory use.

The ADV-1 has a self-contained power supply. Active components are reliable silicon devices used to achieve low drift, low noise and fast recovery from overloads. Other principal features are high gain accuracy and high common-mode rejection. Eight ADV-1 amplifiers, assembled in a rack adapter, can be mounted in a standard 19-in. rack, using only 5 1/4 in. of vertical panel space.

This amplifier will be available beginning in December. It is priced at \$495.

Fairchild Instrumentation-West, 844 Charleston Road, Palo Alto, Calif. [412]

Breadboarding system can hold 33 modules

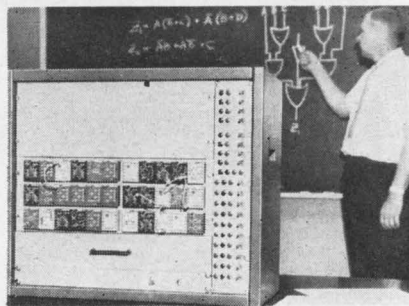

A breadboarding system has been developed that is fast and easy to use and accommodates up to 33 encapsulated plug-in circuit modules, each comprised of from one to four standard digital circuits. Faster, more positive plug-in is provided by means of longer floating power pins on the circuit modules. The system, known as Facilogic laboratory kit K6001, consists of a pre-wired bench cabinet, an 18-switch panel, a power supply, a complete set of patchcords, and 33 plug-in circuit modules.

All standard circuits are available, including NAND, NOR, AND, and OR logic. Blank modules are available for special circuits. Breadboard modules correspond directly to a complete line of encapsulated circuit modules and standard cards,

Your
name
goes
here

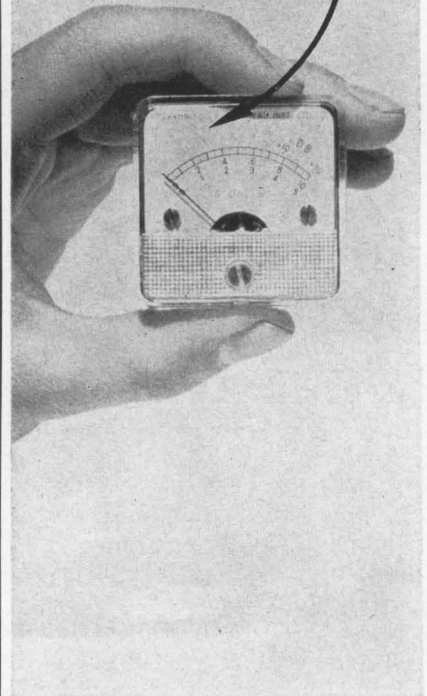

The names of thirty-nine firms from New York to Johannesburg appear on Kyoritsu Electric's clear plastic panel meters.

Kyoritsu of Japan manufactures quality electrical instruments to order exclusively for export. Kyoritsu guarantees prompt delivery at reasonable, competitive prices.

Available in popular DC and AC panel meter styles, sizes and rating... clear plastic, black bakelite, long scale, or edgewise. Volts, amps, microamps, milliamps.

For our illustrated general catalog write to:



Kyoritsu

KYORITSU ELECTRICAL INSTRUMENTS WORKS, LTD.
5-22, 2-chome, Nakane, Meguro-ku, Tokyo

which are available from stock. Thus, prototype systems and test equipment may be breadboarded, debugged, and later constructed of corresponding standard in-stock encapsulated circuit modules and cards, with significant savings in time and cost.

The Facilogic modular breadboarding system is available on a special free tryout leasing basis that provides a 30-day in-plant trial at no charge.

Roback Corp., 1525 Buck Road, Huntingdon Valley, Pa. [413]

Plug-in amplifier is rated at 2.5 watts

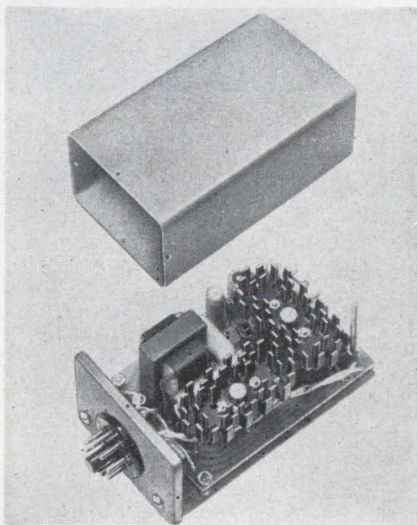

A solid-state linear amplifier, model MA25C, is designed for multitone audio signaling systems. Its 2.5-w rating is sufficient to drive 10 single-channel resonant reed decoders (RDI or MD2C) simultaneously.

Gain is adjustable from 0 to 47 db. Input impedance is 600 ohms, balanced and isolated for direct connection to standard telephone lines. Minimum output load impedance is 200 ohms. With an input of 0.022 v rms per tone, minimum output is 5 v rms per tone.

Power required is 24 v d-c at a maximum of 350 ma. Operation is class B, so current drain is proportional to power output. The amplifier weighs only 10 oz and is available from stock at the following prices: 1-9, \$69; 10-24, \$61.50; production lots of 100-499, \$54. Delivery, 4 to 6 weeks. Bramco Controls Division, Ledex, Inc., College and South Sts., Piqua, Ohio. [414]

HIGHER DENSITY PACKAGING

with Netic & Co-Netic Magnetic Shielding Foils

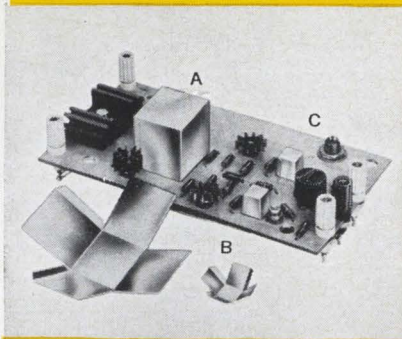

Higher density packaging . . . minimum magnetic interaction . . . no critical orientation . . . by enclosing magnetically sensitive components A, B, & C in Netic or Co-Netic.

Saves Space, Time, Money, Weight

Cuts easily to any outline . . . saving valuable time and weight, minimizing waste and tooling costs. Ideal for shielding hard-to-get-at components. Thicknesses from .002".

EXPLORER IV



Permanently Pre-annealed Netic and Co-Netic are shock insensitive, non-retentive. They have innumerable military, scientific, laboratory and commercial uses demanding permanent, trouble-free protection against magnetic fields.

MAGNETIC SHIELD DIVISION

Perfection Mica Company

1322 N. ELSTON AVENUE, CHICAGO, ILLINOIS 60622

ORIGINATORS OF PERMANENTLY EFFECTIVE NETIC CO-NETIC MAGNETIC SHIELDING

Circle 316 on reader service card

LAMP-LIGHTED push-button switch

Lamp-Lighted Push-Button Switch designed to Sub-miniaturization requirement

MLB-2085



Button

Stroke: 4.5 mm MAX
Lamp: 6V. 12V. 18V
Color: Red, Blue

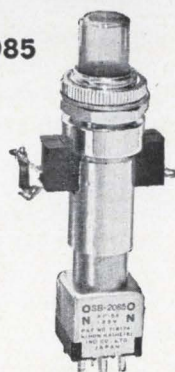

Switch

Rating: 5A. 125V. A.C.
Dielectric-strength: Over one minute at A.C. 1,000V



NIHON KAIHEIKI IND. CO., LTD.

1-5-14, Minami-Magome, Ota-ku, Tokyo, Japan

Agents:

in East Coast of U.S.A.:

DAVID RIEMER COMPANY

473, Broadway, New York 13, N.Y., U.S.A.

in France:

COMPAGNIE GENERALE DE PHYSIQUE

42, Boulevard de la Bastille, Paris-XII, France

Transformer for

MICROPHONE

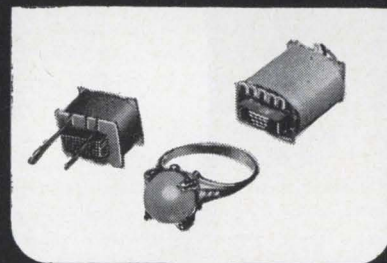

Q+Q

YOUR assurance of best quality and quantity
The secret 2-Q's behind every Nishimura products



Nishimura Musen-Denki Co., Ltd.

21, Owada-cho, Shibuya-ku, Tokyo, Japan



Qualified Electronics Technicians

(Where do you find them?)

Many Companies will tell you the best source is their present staff of technical personnel. These men have the necessary aptitude and ambition . . . can be readily up-graded through a planned electronics training program.

Since 1934 Cleveland Institute has developed such programs for hundreds of leading companies . . . has provided thousands of men with practical, useable knowledge of electronics theory and fundamentals. These men understand the "why" of electronics . . . can install, maintain, troubleshoot, and repair the sophisticated equipment you're using today, and will be using in the years ahead. Learn how CIE can "tailor" an Electronics Training Program to your specific needs. Its effectiveness and economy will amaze you. Send coupon today for FREE brochure. Cleveland Institute of Electronics, Dept. E-13, 1776 E. 17th St., Cleveland, Ohio 44114.

SEND COUPON TODAY

Cleveland Institute of Electronics

Dept. E-13, 1776 E. 17th St., Cleveland, Ohio

Gentlemen: I am interested in learning more about your Electronics Home Study Programs. Please send complete information.

Name _____

Title _____

Company _____

Address _____

City _____ State _____ Zip _____

Accredited Member, National Home Study Council.

New Microwave

Antenna withstands reentry temperature

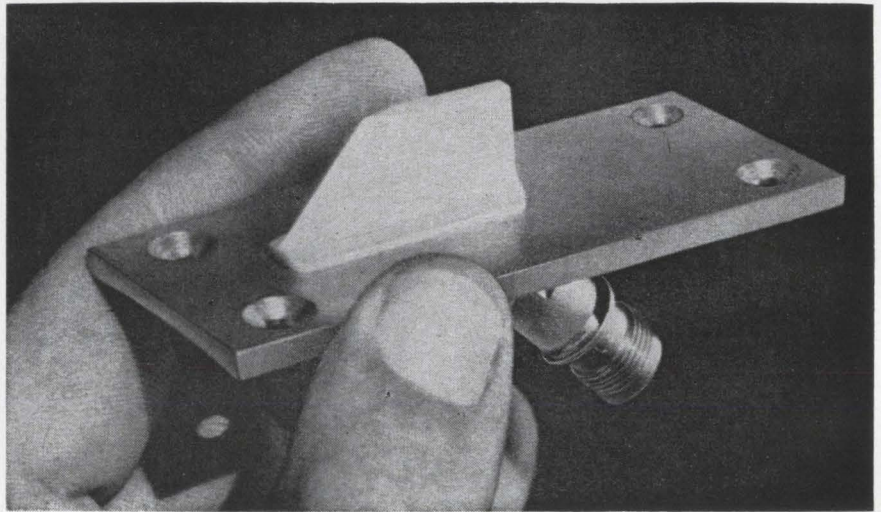

A fin-shaped beacon antenna, weighing only three ounces, can withstand the intense heat encountered when missiles and space vehicles reenter the atmosphere. The antenna, designated DM AQ4 by its developers, Dorne and Margolin, Inc., is capable of withstanding 800°F continuously and 1,200°F for five minutes.

The stainless-steel blade antenna is covered with an ablative material known as Imidite 1850, and has a stainless-steel base plate for mounting. Several antennas can be mounted around the circumference of a space vehicle to provide nearly spherical coverage; the number required for this purpose depends on the diameter of the vehicle. A vehicle whose diameter is 13.5 inches, for instance, needs only two antennas on opposite sides for spherical coverage. For such an arrangement, power-matched dividers must be connected to each antenna to maintain constant load.

The DM AQ4 is designed for C band, having a frequency range from 5,400 to 5,900 megacycles and a voltage standing wave ratio less than 2.0. For any 250-megacycle band within this range, however, vswr is less than 1.5.

At an altitude of 30,000 feet and a speed of mach 3, the antenna drag is 2.9 pounds. At 70,000 feet and the same speed, the drag decreases to 0.1 pound.

The antenna was developed for the GAR-9, an air-to-air missile, and meets both MIL-E-5400, general airborne electronic equipment specification, and MIL-E-5272C, environmental test specification.

Cost of the DM AQ4 is \$625. Delivery is within 60 days.

Specifications

Antenna load impedance	50 ohms
Connector type	TNC
Dimensions	
mounting base	3.38 x 1.5 inches
antenna height	0.60 inch

Dorne and Margolin, Inc., Westbury, N.Y. [421]

Crossguide couplers come in 48 models

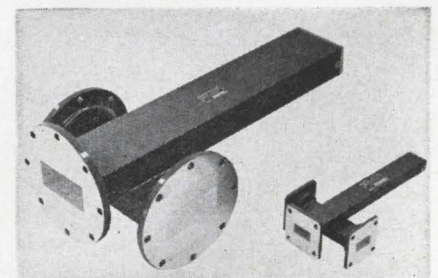

Both unterminated and terminated crossguide directional couplers are offered in 48 standard models to provide 20, 30, or 40 db coupling over the frequency range of 2.60 to 40.0 Gc. Other coupling values are

available on special order. The compact, light, and relatively inexpensive units feature excellent vswr coupling and directivity characteristics.

The unterminated crossguide coupler is used to sample incident and reflected power simultaneously. The crossguide coupler with the secondary arm terminated serves many applications where a sampling of only incident power is required.

Minimum directivity of all models is 20 db with a coupling sensitivity of ± 1.5 db maximum over the waveguide range. The vswr of any arm is 1.05 maximum.

Waveline, Inc., Caldwell, N.J. [422]

Full-bandwidth waveguide isolators

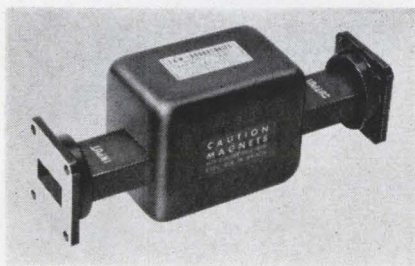

Nine new high-isolation, full-bandwidth waveguide isolators cover the frequency range from 3.95 to 26.5 Gc. Typically, model X910LI features 40 db isolation, 1.0 db insertion loss and vswr of 1.10 across the full X-band.

Units are designed for critical system and laboratory applications where higher than average isolation is required. Minimum length and volume are achieved by use of improved solid-state techniques.

E&M Laboratories, 7419 Greenbush Ave., North Hollywood, Calif. [423]

Light-weight, Ku-band coaxial magnetrons

Light-weight, coaxial magnetrons are announced for operation at Ku-band frequencies. The units—the QKH1302, 1325, and 1368—are designed for airborne radar applications requiring high efficiency, frequency stability, and small size. They will meet the most rigorous

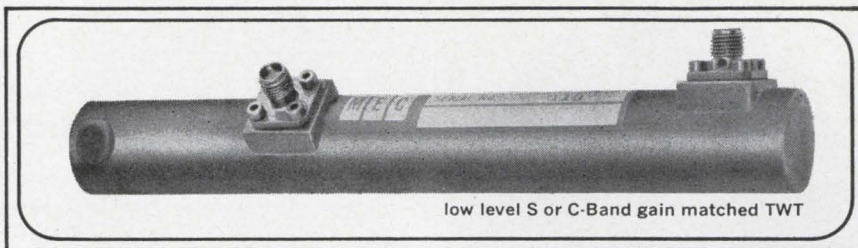

miniaturized

twts

for

those

who

think

small

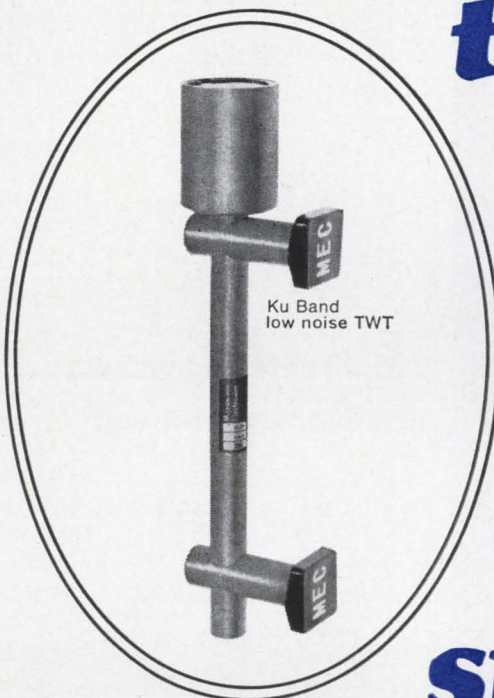

What is small? Merely $\frac{1}{3}$ to $\frac{1}{2}$ the size and weight of tubes built just a year ago.

Available? Yes, we're delivering miniature low-noise, low- and medium-power TWTs in quantity for military systems.

Why small? To anticipate urgent requirements for reduced size and weight in military, airborne and other applications where component density is critical.

But not small in performance. Noise figure, gain, power output and other performance characteristics are equal to or better than their bigger and heavier ancestors. And all MEC miniature tubes have PPM focusing, full magnetic shielding, military environmentalization and rugged metal-ceramic construction.

What's next? Contact MEC's representative in your area for details, or drop us a line in Palo Alto.

Exceptional opportunities on our technical staff for qualified scientists and engineers. An equal opportunity employer.



Microwave Electronics

3165 Porter Drive
Palo Alto, California

a division of Teledyne, Inc.

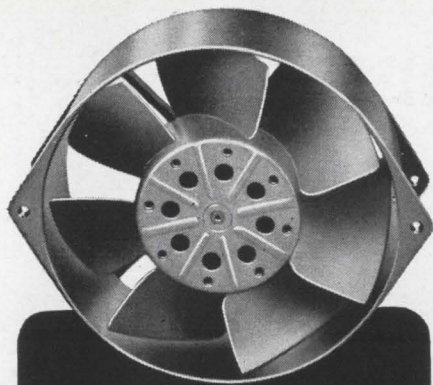

New

5 1/2"

SHADED-POLE

Model 6500

PAMOTOR

Axial Fans

- Free air delivery in excess of 300 cfm at 3000 rpm
- Over 20,000 operational hours without maintenance
- Outstanding performance at moderate cost (under \$30.00 for single units)
- Only 2" deep
- 110 v or 220 v operation
- Stocked for immediate delivery

Write for technical data on the Model 6500 and other PAMOTOR axial fans to:

PAMOTOR, INC.
312 SEVENTH STREET • SAN FRANCISCO, CALIF.

New Microwave

airborne environmental conditions.

The QKH1302 is tuned mechanically over the 16.6- to 17.1-Gc frequency range. The QKH1325 operates at a fixed frequency of 16.5 Gc, and the QKH1368 at a fixed frequency of 17.2 Gc. Peak output power for the QKH1325 is 65 kw; for the other two units, 35 kw.

The coaxial magnetrons have integral stabilizing cavities incorporated in the resonant structure of the tubes. This design is said to be responsible for lower push-pull figures, longer tube life, and higher reliability than in conventional magnetrons.

Microwave & Power Tube division, the Raytheon Co., Foundry Ave., Waltham, Mass. [424]

Millimeter-wave bwo delivers up to 1 watt

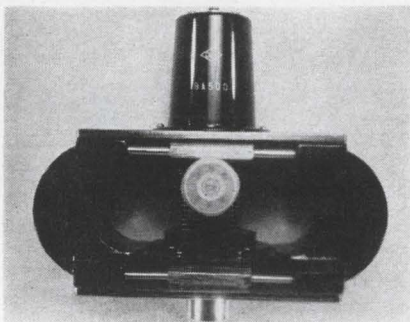

A line of backward-wave oscillators now available cover the millimeter frequency range from 44 Gc to 100 Gc, with a power output from 400 mw to 1 watt, over a wide bandwidth. They are available for either air or water cooling operations.

Model 50BW10 has a center frequency of 50 Gc and is electronically tunable from 46.8 to 54.35 Gc. The delay line voltage rating is 2,000 to 4,000 v d-c; delay line current, 60 ma d-c; anode voltage, 1,080 v d-c; Wehnelt voltage, -300 v d-c; anode current, -0.5 ma d-c; heater voltage, 6.3 v a-c; heater current, 1.0 amp a-c. The unit is priced at \$3,100.

These bwo's are finding increased application in satellite ground stations, space communications, maser pumps and many other

MITSUMI COMPONENTS

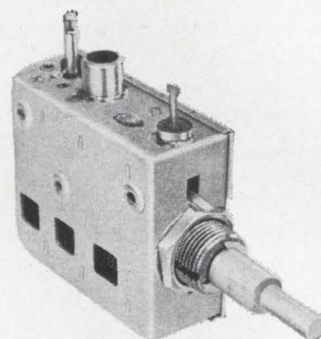

UHF U-AS11

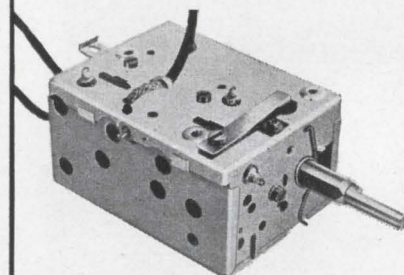

VHF V-AS11

NEW TRANSISTOR TV TUNER

The characteristics of Mitsumi transistor TV tuner are high sensitivity, small spurious radiation and high durability.

The tuner is available for both VHF and UHF. It has a unique fine adjustment mechanism and is superior in humidity characteristics and temperature characteristics.

Main Products

Polyvaricon • IFT • Oscillator coil • Antenna coil • Composite coil • Special coil • Micro motor • Synchronous motor • Variable resistor • Trimming potentiometer • FM tuner TV tuner • Various sockets • CdS photoconductive cell.



MITSUMI ELECTRIC CO., LTD.

New York office: 11 Broadway, New York, N.Y. 10004, U.S.A. Phone: HA-5-3085, 3086.
Main office: 1056, Koadachi, Komae-machi, Kitatama-gun, Tokyo, Japan.
Phone: Tokyo 415-6211/23

If you ever want your power sources to get off the ground, read on:

When it comes to power sources and frequency multipliers we are tempted to say: We offer more of what you go to solid state for—excellent stability, high reliability and high efficiency in remarkably small, lightweight packages.



Take our P8004 Ku-band power source. This gives you a 16.5 Gc output frequency with 6mw output power in just 25

cubic inches, weighing 22 oz. Stability is crystal-controlled as part of the high reliability and long-life design. Input power requirements are unusually low.

For telemetry systems, the P8003 S-band power source gives you 20mw output power at a 2.2Gc output frequency, in 12 cubic inches weighing 8.5 oz.

As an example of broad bandwidth and high efficiency, consider the P8405 VHF multiplier: x3 multiplication factor, 360 to 420 mc output frequency, for a 15% bandwidth and greater than 42% efficiency. 12 watts output power.

Our unrelenting effort to achieve maximum reliability in our power sources gets an assist from this fact: we utilize our own demonstrably reliable varactors.



We pride ourselves, in addition, on a quick reaction to your custom-design requirements. Give us a try. For detailed information and prompt technical help, call, write or wire Russ Wright, or at least send in the Reader Service Card. (Phone: 215-855-4681.)

SOLID-STATE PRODUCTS OPERATION

PHILCO

A SUBSIDIARY OF *Ford Motor Company*
LANSDALE DIVISION • LANSDALE, PA.
In Canada, Don Mills Road, Don Mills, Ontario, Canada

Measuring Frequency?

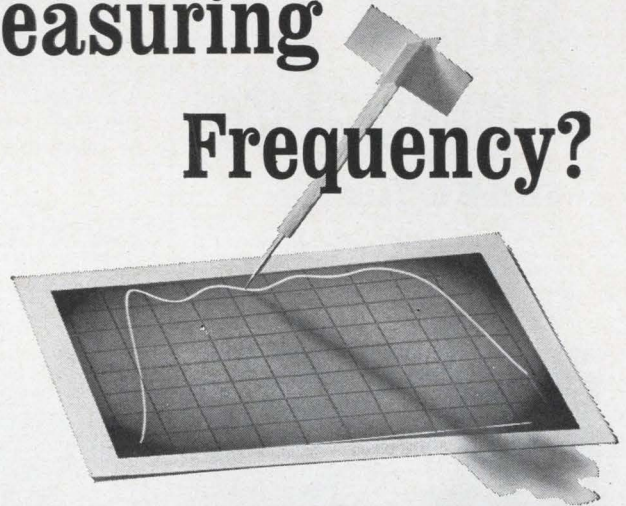

Quit Guessing ...

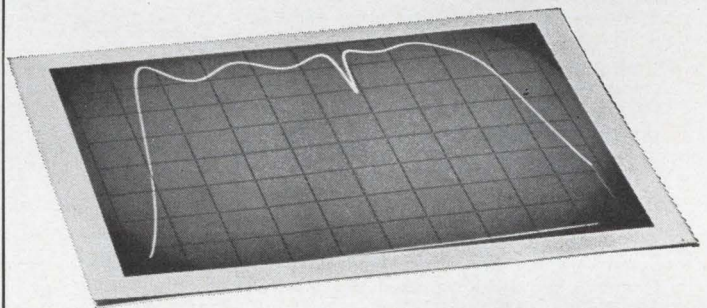

... for only \$195⁰⁰!

Now, for the first time, a Wavemeter capable of indicating frequency to 0.2% accuracy on a direct-reading dial is available at a price under \$200. It's the new Telonic Model TWM.

50 Mhz to 4 Ghz

An absorption type meter, the instrument has a tuning range of 1 full octave covering all frequencies from 50 Mhz to 4 Ghz. Insertion loss is held to 0.5 db and VSWR at 1.5/1. The TWM passes signals through a matched transmission line, the sample being absorbed by the cavity at resonance and causing a 2 ± 1 db power dip in the line.

Pre-Calibrated

Simple to use, the TWM has a pre-calibrated 5:1 vernier dial that needs no interpolation or extrapolation. **The setting you make is the frequency you read.** Considering convenience, accuracy, range and price, the TWM Wavemeter is a natural for every engineer who wants to be frequency-sure. Full specifications available on request.

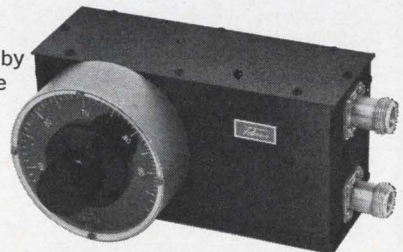

ENGINEERING CO.

A DIVISION OF TELONIC INDUSTRIES, INC.
480 Mermaid St., Laguna Beach, California 92651
Tel: (714) HY 4-7581 TWX: 714 673-1120

MEASURE

Surface Temperature

DIRECTLY

Model 380T provides fast temperature readout even in locations not previously accessible. Accuracy is $\pm 1\%$ of scale range.

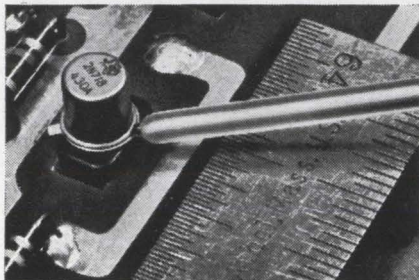

Small Probes make Point Contact Measurement.

Model 380T is already serving industry in the following areas: Electronic Design Engineers: Determine heat dissipation of components and need to use heat sinks. Quality Control Engineers: Measure temperature levels before encapsulation to improve mean time between failures (MTBF). Research Engineers: Run temperature profiles on semiconductor wafers. Metallurgical Engineers: Define substrate deposition parameters for thin film techniques.



RFL MODEL 380T Direct Reading ELECTRICAL THERMOMETER

FEATURES

Small Mass — Fast Response Probe
Improved Resolution — $5\frac{1}{2}$ inch scale

Taut Band Suspension Meter

Battery Powered
Portable Unit weighs 4 lbs.

Customer Specifies Scale Range

Price: \$245.
net f.o.b., Boonton, N.J.

For more information write or call
John Carson: (201) 334-3100 (collect)



Boonton,
New Jersey

07005

EST. 1922

Radio Frequency Labs., Inc.

New Microwave

uses in the expanding millimeter-wave field.

OKI Electronics of America, 202 E. 44th St., New York, N.Y. [425]

Pulsed type amplatron delivers up to 3 Mw

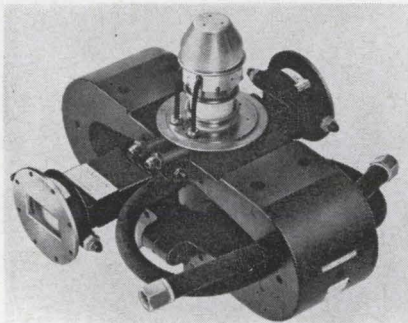

An S-band, pulsed type Amplatron, the QKS1110, is rated for outputs up to 3.0 megawatts. When used with a modulator having proper load line characteristics, it covers its frequency range of 2.9 to 3.1 Gc without electrical or mechanical adjustment. Peak power ranges from 0.7 to 3.0 megawatts, while average power is 20 to 30 kilowatts. Pulse duration can be varied from 2 to 100 μ sec.

Efficiency of the 115-lb, liquid-cooled tube is rated between 68% and 74%. The integral magnet tube employs waveguide with UG54A/U couplings for both input and output.

Raytheon Co., Microwave and Power Tube division, Waltham, Mass. [426]

Grid-pulsed twt designed for X-band

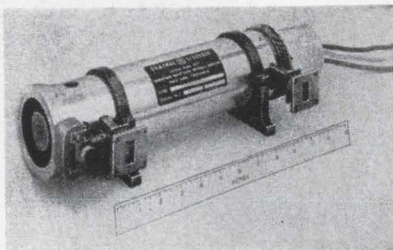

A 10-kw, grid-pulsed traveling-wave tube now available weighs 14 lb and measures 15.5 in. long. The air-cooled type ZM-3280 has

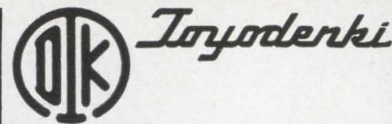

Automation of
drawing process!!

Figures and letters can be
written automatically also!

DIGITAL COMPUTING RECORDER

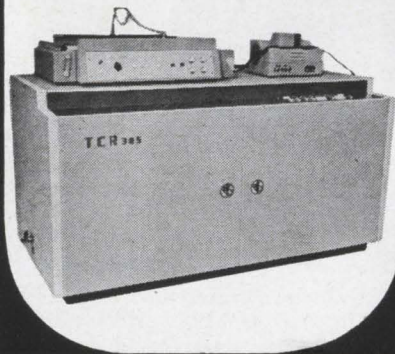

This equipment performs the reading out and numerical operation by the output perforated tape of digital electronic computer.

In other words the drawing process is done automatically not only for quadratic curves but also for letters and figures.

This equipment is controlled completely by digital signals. As a consequence there are no drift, variation of gain etc. at all.

Stabilized and high accuracy records can be obtained at high speed.

This equipment has the following diversified uses.

1. Preparing design drawings in tapes.
2. Preparation of drawings for data of machines subjected to numerical control and automatic control equipment.
3. Preparation of weather charts and topographical drawings.
4. Preparation of drawings for test data.

TOYO DENKI SEIZO K K

(Toyo Electric Mfg Co., Ltd)

Main Office No. 7 5 chome Yaesu
Chuo-ku Tokyo Japan
Cable Address YOHDEN TOKYO
Telephone Tokyo (272) 4211

Interdepartmental
MEMO

TO: ELECTRONIC GROUP
Ever hear of a 3600 RPM
Inductor Motor?
We've got it!

Signed: *Electromechanical
Group*

Send for your copy
of new HSI catalog.



**HAYDON SWITCH &
INSTRUMENT, INC.**

1500 MERIDEN ROAD, WATERBURY, CONN. 06720

Circle 321 on reader service card

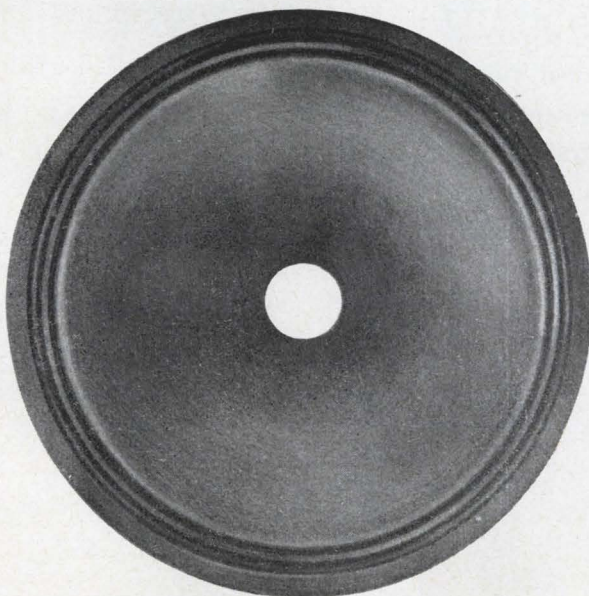

TOYO CONES

We can serve you various types of
"Cones Paper" with high quality.

TOYO CONE PAPER CO., LTD.

184, 2-Chome, Nakano-Cho, Miyakojima-Ku, Osaka, Japan Phone: Osaka 351-7791

Tokyo-Office 5-17-7, Nukui-Machi, Nerima-Ku, Tokyo, Japan Phone: Tokyo 992-3152

Circle 322 on reader service card

MIAL

polystyrene capacitors outperform micas and other film capacitors ...cut costs, too!

MIAL'S sealed polystyrene capacitors surpass all film capacitors in life span...reliability...freedom from drift...insulation resistance (more than 500,000 megs) and "Q" factor. MIAL offers the widest range of "polys" in production quantities.

Capacitance, 20 pF to 600,000 pF; capacitance tolerance from $\pm 0.3\%$ to $\pm 20\%$; temperature coefficient, N100 and N150 ± 50 PPM/°C; Voltage, 33 VDCW to 1000 VDCW.

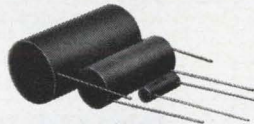

MIAL 602
High Reliability Precision Type



MIAL 603
Printed Circuit Mounting—
High Reliability Precision Type



MIAL 610
Sub-Miniature



MIAL 611
General Purpose N150



MIAL 612
Printed Circuit Board Mounting



MIAL 613
Axial-Lead Close Tolerance



MIAL 614
Radial Lead Close Tolerance



MIAL 615
End Lead Close Tolerance



MIAL 616
Axial Lead

Polystyrene
Capacitors

MIAL

Write today for new complete catalog. Gives environmental, electrical and mechanical characteristics, charts and dimensions.



MIAL
U. S. A., I N C.

165K FRANKLIN AVENUE, NUTLEY, N.J. 07110 • (201) 667-1600-1601

Circle 213 on reader service card

213

NEW INDUSTRIAL CERAMICS

Kyocera



Kyocera's two factories with fully modernized production facilities are always ready to manufacture ceramics as precise in dimension and strict in surface conditions as present day technology permits.

For micro-miniaturization, for especially smooth surface, for highly developed metallized products, for **BETTER PERFORMANCE** and **RELIABILITY**, take advantage of Kyocera's advanced manufacturing technics and unique metallization methods.

For Further Information, please contact

Marubeni-Iida(America)Inc.

Los Angeles Branch 530 West Sixth Street Los Angeles 14, Calif. MAison 8-6271
Chicago Branch 1181 Merchandise Mart Chicago 54, Ill. Tel. 467-6993
New York Branch 42nd Floor, Pan American Bldg. 200 Park Ave., New York, N.Y. Whitehall 973-6500



KYOTO CERAMIC CO., LTD.

11, Haramachi, Nishinokyo, Nakagyo-ku Kyoto, Japan.

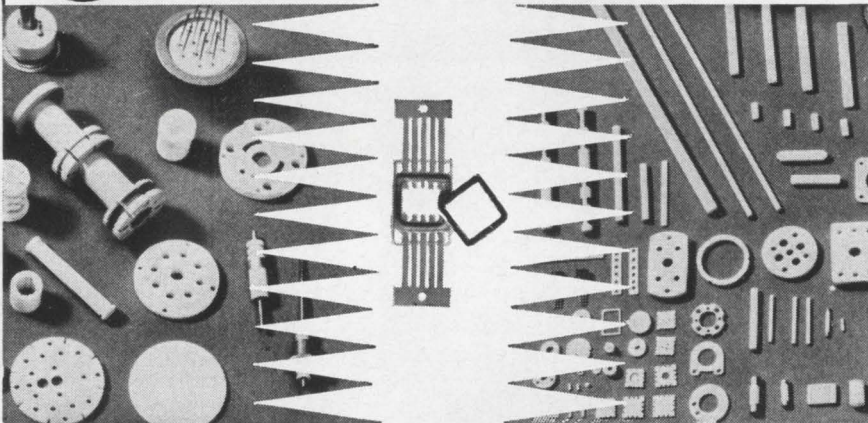

Circle 323 on reader service card

Telrex



"— with a MATERIAL DIFFERENCE!"

The Choice of the Discriminating Communication Engineer . . . the Man who Never Settles for Anything Less than THE-VERY-BEST!

telrex "BEAMED-POWER" ANTENNAS and ANTENNA SYSTEMS

Provide optimum performance and reliability per element, per dollar. Antennas from 500 Kc to 1500 Mc. Free PL88 condensed data and pricing catalog, describes military and commercial antennas, systems, accessories, Towers, Masts, Rotators, "Baluns" and transmission line data.

ANTENNAS Communication and TV Antennas
 SINCE 1921 **telrex** LABORATORIES
 Asbury Park 41, New Jersey, U.S.A.

MICRO TUBE

New smallest, high voltage rectifier tube for TV or measuring instrument

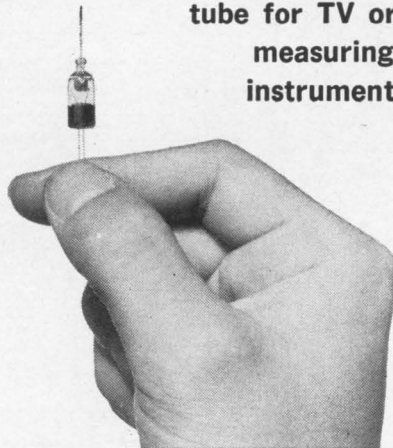

BUSINESS LINES

- Time delay relay tube (6N030 etc.)
- High voltage rectifier tube (5642)
- Pencil tube (6562, 5794, 5876, etc.)
- Geiger Müller tube (GM-10 etc.)
- Microtube (1DK1, 1SK2, 5642B, etc.)
- CdS (Glass sealed)

ELECTRON TUBE DIVISION

TAIYO ELECTRONICS CORP.

No. 22, 5-chome, Higashi-Togashi, Shinagawa-ku, Tokyo, Japan Tel. (782) 4176-8

Circle 324 on reader service card

New Microwave

a gain of 40 db. Output exceeds 10 kw from 8.5 to 9.6 Gc. Typical operation is at 22.5 kv and 4.7 amps cathode current.

The twt is particularly designed to meet the stiff demands of airborne and tactical surface systems. For example, it has met a shock test of 80 g and a vibration of 10 g in accordance with Curve I of MIL-E-5400.

A liquid-cooled version, type ZM-3281, is also available. General Electric Co., Schenectady, N.Y. [427]

Spdt diode switch covers 2 to 6 Gc

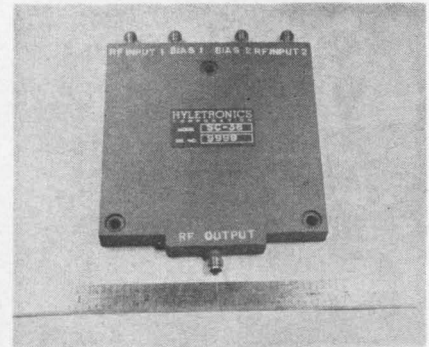

Model SC-38 is a single-pole, double-throw diode switch that operates over the frequency band from 2 to 6 Gc with insertion loss averaging 1.5 db and isolation a minimum of 40 db. Switching speeds in the nanosecond range have been measured.

Applications of this switch include switching one receiver between two antennas. Delivery of model SC-38 can be made 30 days from receipt of order.

Hyletronics Corp., 185 Cambridge St., Burlington, Mass. [428]

Compact twt amplifier features low noise

Model HL-701 is a traveling-wave-tube amplifier containing a solid-state power supply, and designed for the 2.0- to 4.0-Gc band. Size is 3½ x 5 x 15 in.; total weight is less than 11 lb; and power con-

DRAMATIC REDUCTION

formerly 77" h. x 33" w. x 33" d.

now only

29" h x 17" w x 17" d

(5 KW Audio
Power Amplifier)

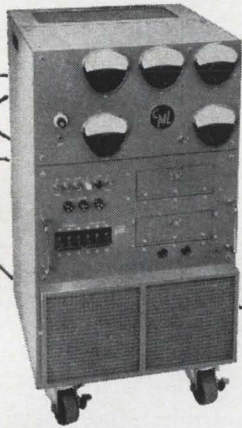

All other models similarly reduced... (but in size only!) For instance, 10 KW Model, formerly 78" h. x 78" w. x 36" d., now only 48" h. x 34" w. x 24" d. CML Audio Power Amplifiers produce tremendous power in the smallest packages. Wide frequency range. Low distortion. Ideal for CW and pulsed operation,

acoustic testing, vibration testing, plasma tubes, ion propulsion engines. Perfect for marine installations. All units with wide range of output impedance taps. Air-cooled and vapor-cooled units. Full power available into low power factor loads. Call or write today for details.

CML, Inc.

A subsidiary of Tenney Engineering, Inc.
350 Leland Avenue • Plainfield, New Jersey
(201) 754-5502 • TWX: 201-756-2064



Circle 325 on reader service card

NCC CAPACITORS

POLYESTER FILM CAPACITORS

Type MXT.



In Plastic Tube.
Capacitance

Range: .001 MFD to .22 MFD.
Voltages: 100v, 200v, 400v, 600v DC.

Type MFL.



dipped Flat Shape.
Capacitance

Range: .001 MFD to .47 MFD.
Voltages: 35v, 50v, 100v, 200v DC.

Type MFK.



dipped Flat Shape.
Non-Inductive Construction.

Capacitance
Range: .01 MFD to .22 MFD.
Voltages: 100v, 200v, 400v, 600v DC.

METALLIZED POLYESTER FILM CAPACITORS

Type FNX-H

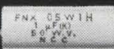

Mylar Wrapped Semioval
With Epoxy End Seal.

Capacitance
Range: 1 MFD to 10 MFD.
Voltages: 50v DC.

SOLID TANTALUM CAPACITORS

Type TAS.

Sealed with Epoxy Resin.



Capacitance

Range: 1 MFD to 220 MFD.
Voltages: 3v, 6v, 10v, 15v, 20v, 25v,
35v DC.

Type TAX.

MIL-C-26655A Hermetically Sealed.

MATSUO ELECTRIC CO., LTD.

HEAD OFFICE: 3-chome, Sennari-cho, Toyonaka-shi, Osaka, Japan.
Cable Address "NCC MATSUO" OSAKA

Circle 326 on reader service card

MEETS MS-16108,
Rev.F, MIL-STD-242B!



U.S. Pat. No. 2,704,357

TOUGHEST METAL-CLAD TIP JACK ON THE MARKET!

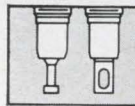

TWO TERMINAL
TYPES:

105-200-220 Series
— Type "A" (Turret)
105-200-211 Series
— Type "C" (Eyelet)

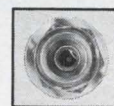

CLOSED ENTRY
CONTACT
DESIGN:

Excludes entry
of Tip Plug .085",
or larger!

These high reliability metal-clad tip jacks are built to take it! Molded of tough, low-loss polyamide, they're designed to withstand severe environmental temperature, vibration and salt spray conditions. Closed entry contact design excludes entry of tip plug .085" or larger—prevents accidental contact damage caused by careless probe insertion. Heavy, nickel-plated brass jacket. Gold-plated, beryllium copper contact spring. Current Rating: 5 Amps. Voltage Breakdown: 8,000 Volts DC. Capacity to 1/8" Panel: 3.8 pf. Furnished with 1/4"-32 nut and lock washer—available in 10 attractive colors molded to Federal Standard 595.

CUTAWAY
VIEW



111-300
SERIES

40 AMP. BINDING POST—Designed for fast, easy installation with high reliability. Molded of low-loss polyamide with silver-plated brass stud and self-captivated thumb nut. Rated at 40 amps, 7,000 Volts DC breakdown. Insulation resistance greater than 200 megohms after MIL-T-5422B test. Capacity to 1/8" Panel: 3.5 pf. Six standard colors to Federal Standard 595.

DETAILED CATALOG AVAILABLE—In addition to connectors, Johnson also manufactures other quality electronic components. Write for our Components Catalog 984.



E. F. JOHNSON COMPANY

3034 TENTH AVE. S.W. • WASECA, MINNESOTA 56093

Circle 215 on reader service card

215

telephone quality components

There is no higher standard for switching components. Specify famous Stromberg-Carlson . . . known to telephony since 1894.

RELAYS: Types A, B, BB, C and E. All standard spring combinations are available. Send for Bulletin T-5000R3.

KEYS: Broad selection of push-button, cam and twist types. Send for Bulletin T-5002R2.

HANDSETS: High-efficiency instruments; standard or with switch assemblies. Send for Bulletin T-5017R.

Full-line data on request.



114 Carlson Road • Rochester, N.Y. 14603



Circle 327 on reader service card

FERRITE CORE

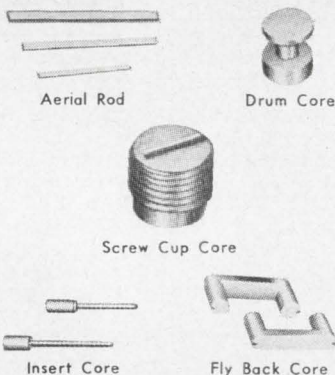

- For 1. Antenna Core
2. I.F.T.
3. EI-Core and EE-Core
4. Pot Core
5. Fly Back Trans Core
6. Deflection Yoke Core
7. Ring Core, etc.

*For catalog write to:

NIPPON FERRITE IND. CO., LTD.
21, Ichigaya, Sanai-cho, Shinjuku-ku, Tokyo, Japan
Phone: 269-0105 ~ 8 Cable: "NIPPON FERRITE"

216 Circle 216 on reader service card

TAIYO OHM FIXED COMPOSITION RESISTOR

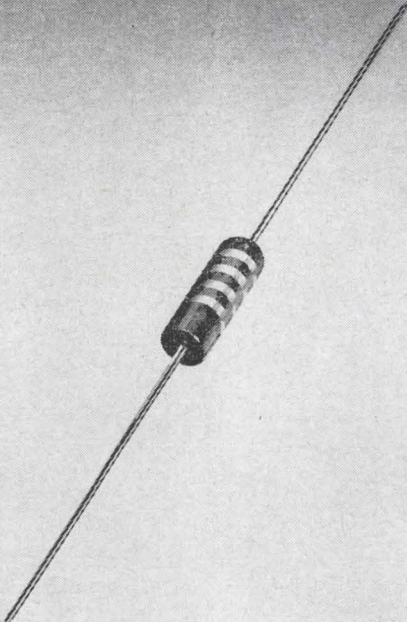

TAIYO DENKI CO., LTD.

1-12, 3-chome, Sunamichi,
Sakai C., Osaka, Japan.
Phone: Sakai-3-6841

Circle 328 on reader service card

New Microwave

sumption is less than 22 watts. It is equipped with an advanced ppm tube furnishing a noise figure as low as 10 db, 1 w c-w power output, and a small signal gain of 35 db. Similar units can be supplied with other twt's covering octave bandwidths up to 12.4 Gc.

Typical applications include electronic countermeasures, reconnaissance, augmentors and buffers. The unit may be supplied to meet MIL Spec requirements for parts, construction, and reliability. The compact configuration allows installation of multiple units in a very small space, with each unit covering a different octave across the microwave spectrum.

Availability is 45 days after receipt of order, and price in quantities of 1 to 5 is \$4,950. Huggins Laboratories, 999 E. Arques Ave., Sunnyvale, Calif. [429]

Reflex klystron uses low resonator voltage

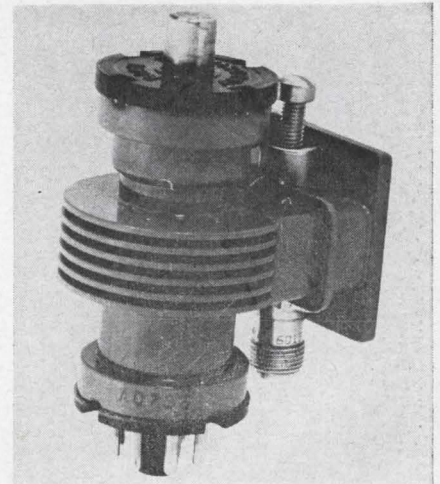

The VA-300 reflex klystron oscillator requires only 100 volts for its resonator. It has been designed for reliable local oscillator or low-power transmitter service in microwave relay systems.

The tube produces an average output of 15 mw. It has an external cavity design that provides exceptional frequency stability in 300-Mc bands between 5.86 and 7.85 Gc. Modulation characteristics are excellent and free from anomalies. The output is routed through a fe-

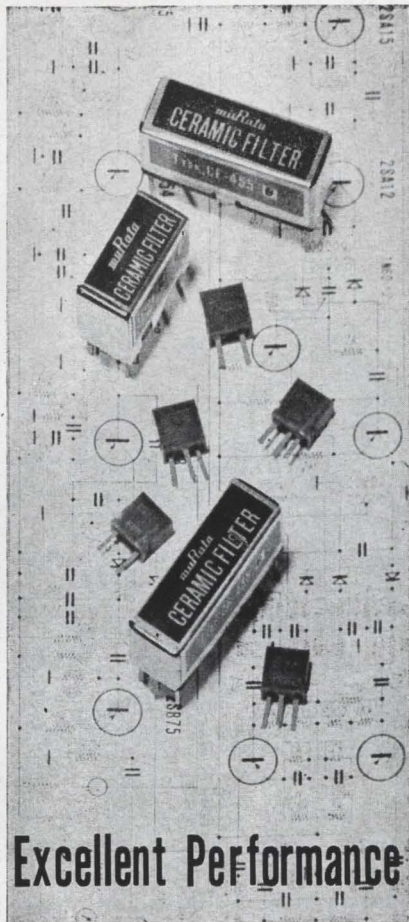

Excellent Performance

CERAMIC FILTER

Murata offers four types ceramic filters: Series, By-pass and Ladder.

Compactness, no alignment and no tuning, flatness of temperature characteristic and negligible aging characteristics are their major features.

Combining economy with these features, Murata ceramic filters are designed to provide effectual operation which can not be attained by usual IFT.

muRata

**MURATA
MFG. CO., LTD.**

Nagaoka-cho, Kyoto, Japan
Cable Address: MURATA KYOTO

MURATA CORP. OF AMERICA

440 PARK AVE. SOUTH, NEWYORK

male TNC coaxial connector. Dimensions are 2.375 x 3.75 x 1.75 in.

Varian Associates, 611 Hansen Way, Palo Alto, Calif. [430]

Microwave amplifiers use tunnel diodes

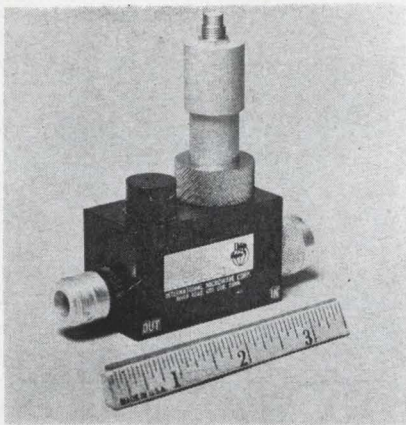

Tunnel-diode amplifiers are announced for the television and communications industry at prices previously available only in large production quantities. Amplifiers are available with 10% bandwidth between 5.9 and 7.2 Gc, 15 db minimum gain and 5 db noise figure. They can be provided with type N coaxial connectors or CPR 137G waveguide flanges. The amplifiers utilize germanium tunnel diodes as the active elements. Prices for the coaxial units are \$750 each; waveguide units are \$850 each; delivery, 60 days.

International Microwave Corp., River Road, Cos Cob, Conn., 06807. [431]

YIG bandpass filters for S- to K-band use

A line of four yttrium iron garnet bandpass filters has been announced for S- to K-band operation.

Models Y-1001, 2001, 4001, and 8001 are voltage tunable over their frequency ranges. Frequency range for the Y-1001 is 1 to 2 Gc; the Y-2001, 2 to 4 Gc; the Y-4001, 4 to 8 Gc; and the Y-8001, 8 to 12 Gc.

Shape factor is 30 to 3 for all units, and bandwidth is 20 Mc. The devices measure 6 x 2 x 2 in., weigh 8 to 10 oz, and have in-line connections.

MicroState Electronics Corp., 152 Floral Ave., Murray Hill, N.J. [432]

SINCLAIR'S YAGI ANTENNAS

RUGGED RELIABILITY... WHEN IT COUNTS!

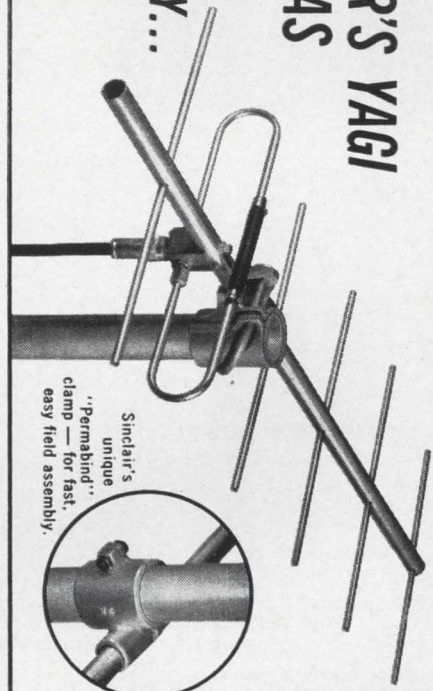

Sinclair's unique "Permand" clamp — for fast, easy field assembly.

Sure, most UHF-VHF yagi antennas function effectively — when the weather's good! It's when the wind starts to howl and the weather turns from bad to worse that the unmatched rugged reliability of a Sinclair yagi really counts. Every standard Sinclair yagi is designed to withstand 110 mph winds with a 1/2" radial ice coating. An integral part of this rugged construction is Sinclair's unique "Permand" clamp that makes for fast, permanent field assembly.

Standard Sinclair yagis are available in a wide frequency range from 30Mc. to 470Mc. . . . gains from 6.5db to 17.0db . . . power ratings up to one KW. Send coupon today for complete FREE literature and prices.

SINCLAIR RADIO LABORATORIES, INC.
523 FILLMORE AVENUE DEPT. 101 TONAWANDA, NEW YORK

FREE LITERATURE

TO: SINCLAIR RADIO LABORATORIES, INC.
Dept. 101 523 Fillmore Avenue
Tonawanda, New York 14152

Name: _____
Title: _____
Company: _____
Address: _____
City: _____
State: _____ Zip: _____

THINK RATS

... for electrical power.

Garrett-AiResearch Ram Air Turbine Systems (RATS) give you auxiliary electrical power from 150 watts to 30 kw.

Externally or internally stored RATS provide power on demand—full-time or intermittent loading—speed control within $\pm 5\%$ of the rated electrical frequency.

Think RATS for reliable electrical power for countermeasures, communications, control, guidance, weapons systems, and other aircraft and missile needs. Operate over a broad environmental range. Low weight. Low drag. Backed by AiResearch single-source responsibility and service.

For design and application data on RATS for electrical, hydraulic, pneumatic, and mechanical power, write: AiResearch Manufacturing Company, 9851 Sepulveda Blvd., Los Angeles, California 90009.

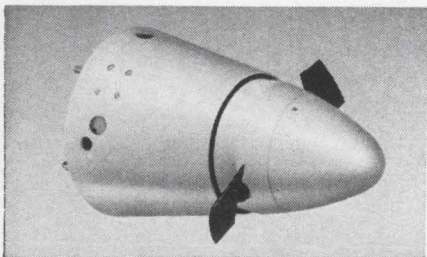
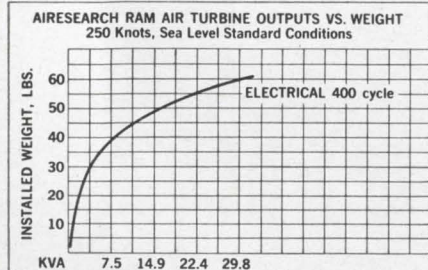

**AIRESEARCH
RAM AIR TURBINE
SYSTEMS**



New Production Equipment

Pneumatic probes for circuit testers

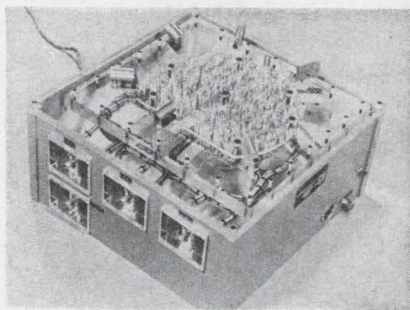

Probes push up through plenum chamber to contact circuit board. Board (not shown) is mounted above the array of probes.

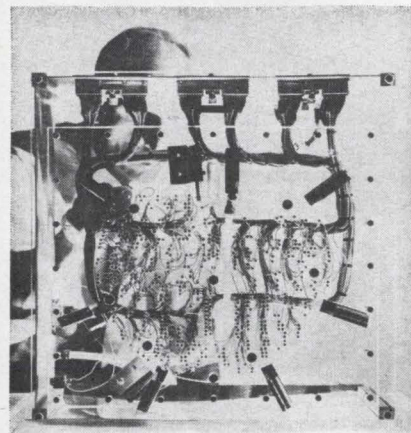

View through transparent chamber shows wiring harness between probe and multipin connectors, for connection to an automatic circuit analyzer.

An instrument that can make immediate, automatic contact with every part of a circuit-board assembly for testing purposes is being made by the McKee Automation Corp. It serves as a connector that allows test signals to be applied to any combination of contact points anywhere on the circuit board, so automatically programed circuit analyzers can be used for step-by-step analysis of the assembly.

McKee originally designed this fixture for high-speed check-out of circuit boards of the Mark 46 torpedo system. Now the company will custom-build similar fixtures for checking out other types of boards.

The fixture shown has some 600 test probes. These are mounted in a movable plate in a plenum chamber made of transparent plastic. The contact ends of the probes extend through the chamber top. When air pressure in the chamber is increased by means of a solenoid valve that is actuated by a signal from the check-out system, the plate carrying the probes rises. This brings the probes in contact with the test board, which is mounted above the probes.

Each probe is spring-loaded to maintain contact pressure against test points of varying heights on the board.

The probes can be arranged in a special pattern for a specific board assembly, or they can be set to mate with contact points on a

standard grid pattern. Center-to-center spacing between contact points can be as little as 0.1 inch.

Because the probes are spring-loaded, the same probe array could be used to test both unassembled and assembled boards. For example, the probes could contact plated-through-hole lands on the unassembled boards, for wiring-continuity tests. After assembly, the probes could contact the solder joints under the board for circuit tests.

McKee Automation Corp., 7315 Greenbush Ave., North Hollywood, Calif. [451]

Pocket wiring tool strips and cuts

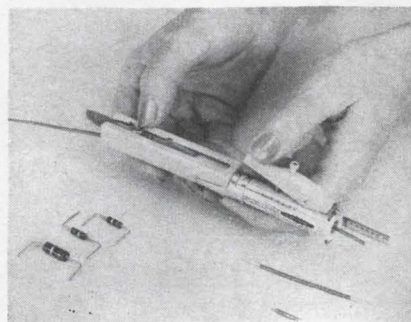

Engineered to serve all circuit wiring functions except actual soldering, the Snip-N-Strip cuts jumper

Test & Measuring Equipment
 Data Recorders
 Data Processing Equipment
 Power Supplies
 Communications Systems



The Boxer® Fan fights failures by keeping components cool in these and many other systems and electronic enclosures.

Standard size rugged metal housing resists breakage to assure system reliability.

Long life. Air bearing model endures 20 to 30 years; sleeve bearing model some 5 years; stainless steel ball bearing model has life in between. Commercial and mil spec types available. Accepts many inputs. dc to 400 cps, 28 to 230V models. Range of outputs. From 70 to 195 cfm, flip fan to reverse airflow direction. Accessories. Screen and filter available in standard and slim-line

(1/8 inch) types; also finger guards and cord sets. Available. Six widely used models are distributor stocked for immediate delivery. Sales reps throughout the US and in Canada.

IMC Magnetics Corp., only producer of the high-reliability fan used in the MINUTEMAN'S guidance computer, is the single-source specialist for airmovers.

EAST
 Baltimore, Md.: D & H Distributing Co., Inc. (301) 539-6525
 Binghamton, N.Y.: Stack Industrial Electronics. (607) RA 3-6326
 Boston, Mass.: De Mambro Radio Supply Co. (617) AL 4-9000
 Cambridge, Mass.: Electrical Supply Corp. (617) UN 4-6300
 Clifton, N. J.: Eastern Radio Corp. (201) 471-6800
 Farmingdale, L. I., N.Y.: Arrow Electronics, Inc. (212) JA 6-0300, (516) MY 4-6800
 New Haven, Conn.: Connector Corp. of America, (203) SP 7-2513
 Philadelphia, Penn.: Simco Electronics, Inc. (215) 229-1880, (609) 964-8400
 Pittsburgh, Penn.: Cameradio Company Industrial Electronics, (412) 391-4000

SOUTH
 Atlanta, Ga.: Ack Radio Supply Co., (404) 375-6246
 Birmingham, Ala.: Ack Radio Supply Co., (205) FA 2-0588
 Greenville, S. C.: Carolina Radio Supply Co., Inc. (803) 239-5125

Greensboro, N. C.: Carolina Radio Supply Co., Inc. (919) 273-8669
 Huntsville, Ala.: Ack Radio Supply Co. (205) 825-2341

MIDWEST
 Cincinnati, Ohio: Newark Herrlinger Electronics Corp., (513) GA 1-5282
 Chicago, Ill.: Newark Electronics Corp. (312) ST 2-2844
 Dayton, Ohio: ESCO, Inc. (513) 298-0191
 Detroit, Mich.: Newark Ferguson Electronics Corp. (313) JO 4-5490
 Minneapolis, Minn.: D. A. Schultz Co. (612) FE 9-7701
 Milwaukee, Wis.: Electronic Expeditors, (414) 871-3000
 St. Louis, Mo.: Target Sales Corp. (314) JA 1-3800

WEST
 Austin, Tex.: 4-M Co., (512) ALPINE 5-3131
 Dallas, Tex.: All State Electronics, Inc. (214) RI 1-3281

Denver, Colo.: Newark-Denver Electronic Supply Corp., (303) SK 7-3351
 Houston, Tex.: Busacker Electronics & Equipment Company, Inc. (713) JA 6-4661
 Gardena, Calif.: Bell Electronic Corp., (213) FA 1-5802
 Inglewood, Calif.: Newark Electronics Corp., (213) OR 8-0441
 Los Angeles, Calif.: Kierulff Electronics, (213) OV 5-5511
 Menlo Park, Calif.: Bell Electronic Corp., (415) DA 3-9431
 Palo Alto, Calif.: Penco Electronic Corp., (415) DA 6-3366
 San Diego, Calif.: Bell Electronic Corp., (714) BR 8-4350, Kierulff Electronics, (714) 278-2112
 Salt Lake City, Utah: Newark-Denver Electronic Supply Company, (801) EM 3-6107
 San Antonio, Tex.: Busacker Electronics & Equipment Company, Inc. (512) CA 3-5517
 Seattle, Wash.: Seattle Radio Supply, Inc., (206) MA 4-2341
 Tempe, Ariz.: JMC Magnetics Corp., Arizona Division, (602) 967-7851

CANADA
 Ottawa, Ont.: M. J. Howard Co., Ltd., PA 8-2991

imc Magnetics Corp., Marketing Division: 570 Main Street, Westbury, New York 11591. Telephone: (516) 334-7070. TWX (516) 336-3319.

Circle 330 on reader service card

NOBLE COMPONENTS

MAIN PRODUCTS: VARIABLE RESISTOR • ELECTRONIC SWITCH • CAPACITOR • CR COMPOSITE PARTS • FIXED RESISTOR • COIL • IFT • POWER RESISTOR

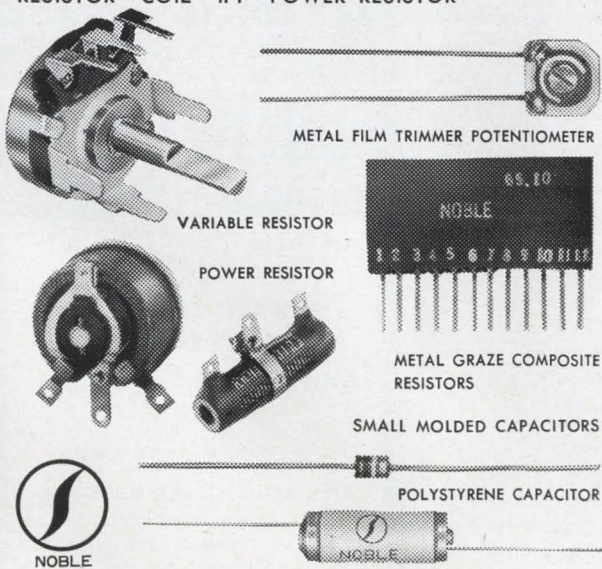

TEIKOKU TSUSHIN KOGYO CO., LTD.

335, NISHINAKA-MACHI, KARIYADO, KAWASAKI-CITY, JAPAN
 PHONE: NAKAHARA 3-3171~8 TELEX: 286-55

RELAY COMPONENTS OF THERMOSET PLASTICS

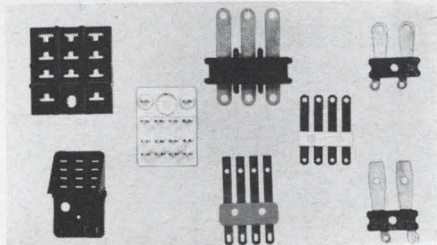

Precision relay component molding of DAP, Phenolics, Alkyds to specification. Long or short runs. Insert molding. We offer you the savings of low mold costs due to our specialized machines and techniques. Complete resources for material selection aid, design and engineering of the mold, tooling molding, quality control. Close tolerances. On time deliveries. Write or call for sample work or a quotation today.

Send for **FREE** brochure.

938-7671
 Area 312



DIVISION OF THERMOTECH INDUSTRIES, INC.
 1202 South Fifth Street, Hopkins, Minn.

HOW'S YOUR THERMISTOR IQ?

Want to learn more about these versatile, precision sensors? Here's FREE literature to help you.

CAPSULE THERMISTOR COURSE BOOK

Ten quick, painless lessons on precision thermistors, their characteristics, and how they are used. Illustrates basic thermistor circuits, compares thermistors with other sensors, gives typical circuit design calculations, etc.

Ask for F.E.I. CAPSULE THERMISTOR COURSE BOOK.

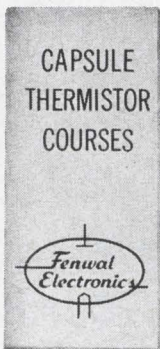

THERMISTOR FACT FOLDER

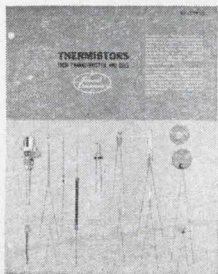

An illustrated booklet which describes various thermistor types, including F.E.I. ISO-CURVE* interchangeable thermistors, and how to apply them in measurement and control circuits.

Ask for F.E.I. THERMISTOR FACT FOLDER.

*MADE UNDER PAT. 3109227 AND OTHERS. ISO-CURVE IS A TRADEMARK OF F.E.I.

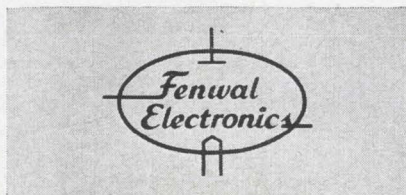

63 FOUNTAIN STREET, FRAMINGHAM, MASS.

Production Equipment

wires and component leads to measure length; strips insulation; and tailors lead bends. It contains a retractable surgical-steel knife blade, and fits the pocket with a convenient clip.

The tool is constructed of tough lightweight glass-filled nylon plastic, and has, at one end, a trigger-actuated set of quadrilateral shear blades, which cut conductors cleanly without distorting stranded types. An adjusting setscrew on the trigger provides for partial closing of the shears for insulation stripping operations. A sliding scale on the side of the tool gives an accurate, quickly adjustable length gage, and can be locked in position by means of the pocket clip.

Both stripping and cutting operations can be performed from either direction. For cutting and preparing a quantity of jumper leads, the conductor is fed through the tool from the opposite end. Thus, when the tool is used to work on leads inside equipment, the cut ends and insulation scraps are contained inside the Snip-N-Strip instead of flying into inaccessible parts of the equipment.

At the opposite end of the Snip-N-Strip is mounted a latching carrier for interchangeable and replaceable scalpel blades of standard type. A receptacle beside the blade gives a convenient means of inserting component leads to produce neatly tailored bends and turns. The measuring rule, reversible in any of four directions and extensible at either end, is used for accurate measurement of component lead bends. List price is \$9.95. James Electronic Tool Co., P.O. Box 1482, Palo Alto, Calif. [452]

System controls resistor quality

A system has been developed that will permit automated manufacture of tantalum thin-film resistors. Initially, tantalum film is deposited on a glass substrate to obtain a resistance about 25% below the final value. The surface is then subjected to controlled anodization, which forms a layer of tantalum oxide, progressively increasing the effec-

Metronix

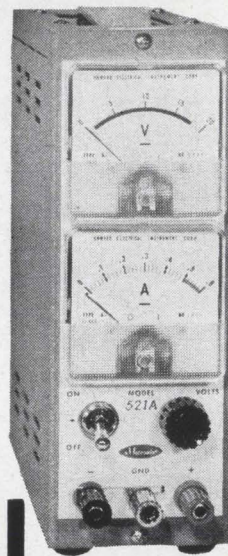

REGULATED DC POWER SUPPLIES

MODEL
521A

RIPPLE: 3mVp-p

MODEL	VOLTS	AMPS	REGULATION (line or load)
521A	1~18V	0.5A	± 20mV
541A	1~35V	0.25A	± 20mV
543	1~35V	0.5A	± 20mV
531B	0~35V	1A	± 10mV
535C	0~35V	5A	± 3mV

Metronix corp.

76, CHOFU-CHIDORI-CHO, OTA-KU, TOKYO, JAPAN

Circle 332 on reader service card

INNOVATION
INNOVATION
INNOVATION
INNOVATION



In
**Electrical
Electronics
Engineering**

EXHIBITS (4 days only)

Monday - Thursday
11:30 A.M. - 9:30 P.M.
NEW YORK COLISEUM

TECHNICAL SESSIONS

Monday - Friday
NEW YORK HILTON
MARCH 21-25

Members \$2. Non-Members \$5.



**IEEE
EXHIBITION**

Circle 333 on reader service card

Rohm CARBON FILM RESISTORS POWER SUPPLY

TYPE-RD

A coated conformal carbon film resistor with resistance tolerance $\pm 1\%$ to $\pm 10\%$. It is as perfectly designed for commercial electronics as for high precision industrial work.

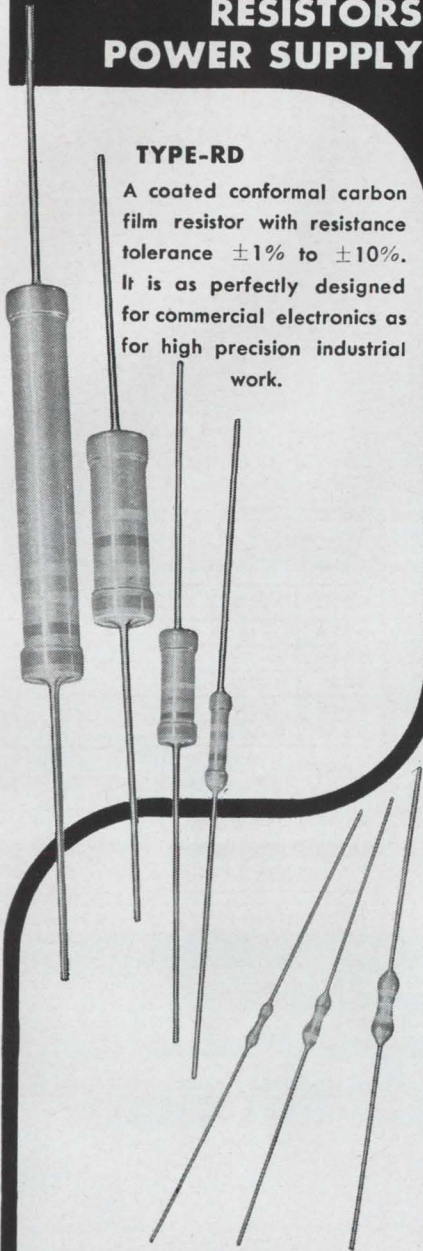

TYPE-R

A miniature carbon film resistor, especially suited for transistor circuits, with resistance tolerance only $\pm 5\%$ to $\pm 10\%$. This remarkable item is mass-produced and can be supplied in large volume at low cost.

Rohm

TOYO ELECTRONICS
INDUSTRY CORPORATION

P.O. Box 103 Central Kyoto, Japan
Cable: Rohm Kyoto

tive resistance until the desired value is obtained.

The system insures that every resistor is manufactured within the programed tolerances, eliminating subsequent classification. Each resistor can be individually checked upon completion without disturbing those in the batch that are still in process.

Elements of the system include a programable constant-voltage power supply of 120, 250, or 500 v, along with an automatic resistor test instrument and a high-speed reed relay scanner. The scanner permits the measurement and control of each individual resistor in a programed sequence. The system accommodates twenty substrate resistive elements simultaneously, although the techniques are applicable to systems of up to several hundred elements.

Prices will be quoted on an individual basis, due to variation in manufacturing parameters.

Marquette Electronics, 925 East Abert Place, Milwaukee, Wis., 53212. [453]

Hand-operated machine makes bends in leads

A machine to produce precision bends in resistor, diode and other component leads is designed to fill the gap between the needle-nose plier and mass production-bending techniques. Model 100A Lead-bender is manually operated and produces uniform and accurate lead bends in a variety of configurations. Axial lead components as large as $\frac{1}{2}$ in. in diameter can be accommodated by the machine without body damage or damage to the leads, while production rates of up to 600 per hour are possible.

Bends for 0.5-, 0.6-, 0.7- and 0.8-in. printed-circuit centers can be made with standard, easily interchangeable dies. Dies for Military-NASA type, commercial, and offset-double bends, as well as single bends for perpendicularly mounted components, are stock and considered standard. Custom bends for these and other hole spacings can be supplied to customer specification.

D. Vel Research Laboratories, Inc., 555 Bedford Road, Bedford Hills, New York, 10507. [454]

YOU CAN SPLIT LOGS, hairs, votes, and some heat-shrinkable tubings, BUT YOU CAN'T SPLIT

FLEXITE SHRINKDOWN



PLASTIC TUBING

when properly selected from these four grades and applied according to Markel recommendations:

1

HT-105, Flexible Class A (105°C) Shrinkdown
Extruded tubing similar to Flexite HT-105; outstanding dielectric properties; adaptable for many uses; it shrinks at less than 200°F.

2

SD-105, Semi-Rigid Class A Shrinkdown
For uses where greater mechanical strength and rigidity are needed, and over components sensitive to higher than 200°F temperatures.

3

PO-135, Flexible Class B (130°C) Shrinkdown
Thermally stable tubing of specially formulated polymers; excellent electrical, chemical and oil resistance. Shrinks at 235°F. Meets MIL-I-23053 (wep), Class I.

4

TE-250, Flexible Class C (250°C) Shrinkdown
Of modified polytetrafluoroethylene; offers exceptional electrical, thermal, and chemical-resistance properties. Shrinks at 621°F.

Markel customers are saving many dollars and much valuable time with these magic tubings that shrink 50% in diameter with the flash of a heat gun—adding a sheath of mechanical and electrical protection over terminals, connectors, cables, components, and other irregular shapes. Let's see how this idea could serve you; write for technical data and samples.

L. FRANK **MARKEL** & SONS

ONE SOURCE FOR EXCELLENCE
Insulating Tubings and Sleeveings
High Temperature Wire and Cable
NORRISTOWN, PENNSYLVANIA 19404



We can deliver
power as you like it...

and we've recently
proved it again!

Shipment of the prototype power converter for IMP, NASA/Goddard's Interplanetary Monitoring Platform, is the latest in a long line of satellite power system achievements by Space Craft, Inc.

Since IMP's mission includes the measurement of fields, the system requires a power supply which generates no significant magnetic field. In response to this requirement, Space Craft designed and built a non-magnetic power converter. It converts DC to RF through a 1 Mc oscillator and demodulates back to DC at four output voltages. Voltage regulation is better than $\pm 0.05\%$.

Thus IMP takes its place among more than a score of power conversion contracts successfully completed or under way at Space Craft, Inc. These systems have combined conversion efficiencies as high as 86% with minimum weight, minimum volume and maximum reliability.

When you have specialized power problems, go where the experience is...

SPACE CRAFT, INC.

8620 SO. MEMORIAL PKWY. / HUNTSVILLE, ALA. 35802

Circle 335 on reader service card



New 20 pg. Catalog makes it
Easy to Select

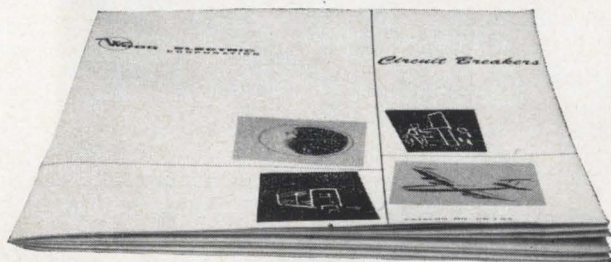

the right Thermal or Magnetic
Circuit Breakers

Write for your
FREE COPY



**WOOD ELECTRIC
CORPORATION**

244 Broad Street, Lynn, Mass. (617) LY8-5313

Automatic Distortion
Analyzer for
Audio Labs and Production

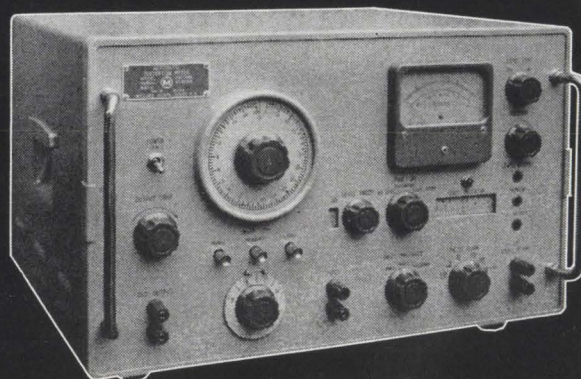

Model MAK-655A

FEATURES:

- **FREQ. RANGE:** 20-20,000 c/s in 106 steps, 2-5-10 sequence, automatic (1 step per sec.) or manual selection.
- **LOW DISTORTION OSCILLATOR,** with marker output; 30-dB output level control, automatic or manual.
- **DISTORTION METER:** 0.3% - 30% f.s. in 5 ranges; input -60 to +20 dBm, overall, or 40-dBm range, automatic; recorder output, 0.4V max.; X-axis 0-3V DC.
- **APPLICATIONS:** Audio distortion and response measurements; signal and noise level meter, etc.

• Catalog sheet on request:



MEGURO DENPA SOKKI K.K.

(Meguro Electronic Instrument Co., Ltd.)
2658, 5-chome, Kamimeguro, Meguro-ku, Tokyo, Japan
TEL: 711-7191-7 Cables: MEGURODENPA TOKYO

New Books

Laser operation

Optical Masers
George Birnbaum
Academic Press, Inc., 306 pp., \$9.50

The principles of laser operation—in particular, the atomic processes associated with laser action and their relation to device configuration—are discussed in this book. The major topics are consistent with the building blocks of an optical maser: materials, pump and resonator. The three types of laser materials now in use—crystal, gas, and semiconductor—are described in separate chapters. Optical pumping is discussed in a brief chapter. Several introductory chapters cover the theory of maser operation, from both the steady-state and transient viewpoints. These chapters include derivations of the rate and gain equations and a comprehensive discussion of optical resonators. The final chapters discuss the radiation characteristics of the source, such as coherence and mode patterns, and a short review of laser applications in the fields of communications and spectroscopy. There is also a chapter treating nonlinear effects, using both the quantum picture of multiple photon absorption and the wave picture of harmonic generation.

But the quality of the treatment is uneven. This is not so much the fault of the author: Almost all the books written in a new multidiscipline field that is growing at an exceedingly fast rate have this shortcoming. As is often the case, the book excels in those areas where the author has contributed original research. This applies to the first few chapters. For instance, a chapter on spectral line shape is concise and to the point; in particular, the distinction made between homogeneous and inhomogeneous broadening is very well done in terms of Lorentz and Gaussian distributions. The chapter on optical resonators is also good, with excellent photographs of radiation patterns for rectangular and circular modes. The chapter on multiple-photon processes is another asset because this material is not usually found in texts on optical

masers. Furthermore, one of the chapter's outstanding points is the clear distinction made between parametric interaction processes such as harmonic generation (which leaves the atomic system in its initial state) and Raman- or Stokes-type emission processes.

Other chapters fall below standard. An example: the chapters on output of optical maser radiation characteristics and optical maser applications. In the former, the important subject of spatial coherence, for all practical purposes, is ignored. There is either confusion in the author's mind or poor exposition in pointing out the difference between coherence lengths parallel to and coherence lengths normal to the direction of propagation. It also appears that some of the material in this chapter was not thoroughly studied before it was incorporated in the book; the material on photon correlation contains entire lines taken verbatim from one of the quoted references. In the chapter on applications, the development is so sketchy that its usefulness is questionable.

In spite of its shortcomings, this book will be valuable to anyone engaged in laser research. Because it is written in the language of the atomic physicist, the book may be difficult for electronic or microwave engineers. But those concerned with applications and desiring greater understanding of the laser will find it a useful guide to appropriate papers in the technical literature.

Henri Hodari

National Engineering Science Co.
Pasadena, Calif.

Elementary network theory

Physical Networks
R. S. Sanford
Prentice-Hall, Inc., 516 pp., \$12.95

Various types of linear one-dimensional physical systems are discussed at an undergraduate level. Using the concepts of "through" and "across" variables and the generalized definitions for basic ideal network elements, this volume treats the network theory from a unified point of view. Besides electrical networks, other types of lumped-parameter linear systems are examined; these include mechanical, hydraulic, acoustical, and

THERMOELECTRIC COOLERS

Standard line...
for immediate delivery!

MODULE 3950-1

For spot cooling—especially in electronic components. Heat pumping capacity 6.8 watts; voltage 2.6 VDC; current 7 amps DC. Module mounted between aluminum plates for mechanical strength, uniform junction temperatures.

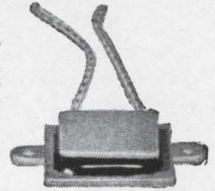

MODULE 3951-1

Similar in configuration to 3950-1, but with higher 20-watt heat pumping capacity. Voltage 6.4 VDC; current 7 amps DC.

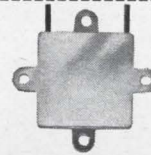

MODULE 3952-1

Very low current requirements (1500 milliamps), high heat pumping capacity (2000 milliwatts)—yet very small (.786" sq. x .196" thick) and light (less than 1/4 oz.). Ideal for hot spot problems in circuits with low available power.

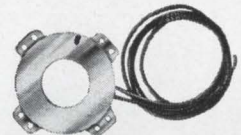

MODULE 3953-1

New annular ring provides high 20 watt heat pumping capacity (68 BTU's per hour). Runs on low 6.5-7.0 amps current rating. Cold plate diameter is 1 7/8" with an ID of 7/8". Four mounting tabs are located at 90° increments on the base plate. Tabs include one 6-32 machine screw feed through hole. Modules specially intended for cooling in a variety of unusual circuit applications.

ASSEMBLY 3970-1

Complete TE cooling system: cold plate, heat sink, fan and bracket. High 40-watt heat pumping capacity, low 7-amp DC current load. Unit measures only 4 3/4" x 5" x 4 1/2".

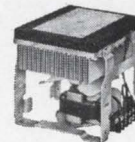

COLD PLATE 7200-1

Newest laboratory device offers researchers a large area cold surface 6" x 3" down to -15°C — yet draws only 1 amp on standard 110-115 VAC, 60 cycle current!

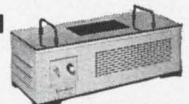

Send for complete data now!

CAMBION®

"DIAL-A-PART" SERVICE

Standardize on CAMBION...
The Guaranteed Electronic Components
CAMBRIDGE THERMIONIC CORPORATION
401 Concord Avenue, Cambridge, Mass. 02138
Tel: (617) 876-2800

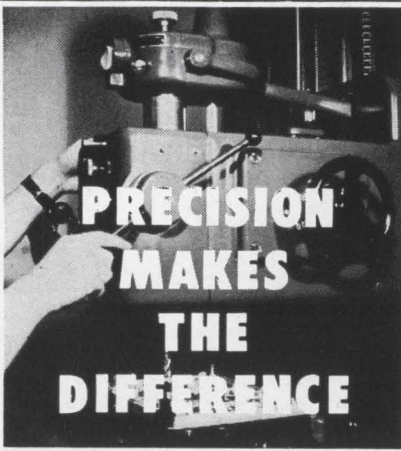

When the creative brains and experienced hands of AIWA, Japan's leading electronic sound engineering expert, are combined with the Swiss-born precision machine tools capable of microscopic precision processing, the outcome is self-evident—Precision-Engineered Audio Equipment. Yes, every AIWA product is engineered with that precision of micron accuracy. When you choose AIWA, you are certainly assured of dependable performance derived from that precision, which makes the difference.



TP-704

AC/DC Operation Solid State 5" Tape Recorder

Compact, light weight design, easy to carry, with self-contained batteries and built-in DC converter, 2 speeds 3-3/4 & 1-7/8 ips. High power output more than 800 mW. High-impact plastic with diecast frame. Dimensions 10-3/8 x 12 x 3-5/8" (263 x 304 x 92 mm). Weight 11 lbs. (4.9 kg).

The Sign of Quality

AIWA

AIWA CO., LTD.
TOKYO-CHICAGO

EXCLUSIVE DISTRIBUTOR IN U.S.A.

Semtron International Co., Inc. • 4215 West 45th Street,
Chicago, Illinois 60632
Service Depot • 4529 South Tripp Ave.,
Chicago, Illinois 60632

EXCLUSIVE DISTRIBUTOR IN EUROPE

Celone Limited • 5 Kanalstrasse, Glattbrugg,
Zurich, Switzerland

New Books

thermal systems. Its wide range of engineering topics and many practical examples make the book suitable as an introductory textbook for the electrical engineer; it also has some value as a reference for system engineers in other fields.

The first half discusses the general concept of the network approach and basic principles of linear-system analysis; the balance deals with more advanced topics, including the working principles of various types of transducers involving electromechanical, electrical-hydraulic, and hydromechanical systems, from the point of view of combined networks, and the analysis of closed-loop systems. Several special topics are included: the stability consideration of feedback systems, the principle of modulation, equalizer design, root-locus analysis, and the use of analog computers. Although this is a fairly wide range, the discussion of each topic lacks thoroughness.

The style is pedantic; theorems are stated without proof. Most principles and methods are illustrated only by special examples. Nonetheless, the book gives a more balanced discussion of various physical systems than do many circuits textbooks. The discussion of various types of transducers, for example, is very thorough. Nonelectrical engineers who wish to obtain a group of the network approach, will find this a useful reference.

C.H. Tang

Raytheon Co.
Wayland, Mass.

Recently published

The Chemistry of Diamond-Like Semiconductors N.A. Goryunova, Edited by J.C. Anderson, The M.I.T. Press, 236 pp., \$10

Electrical Circuits, L.A. Manning, McGraw-Hill Book Co., 567 pp., \$12

Space Communications Systems, R.F. Filipowsky, E.I. Muehldorf, Pentice-Hall, Inc., 575 pp., \$14.90

Modern Radar, Analysis, Evaluation, and System Design, R.S. Berkowitz, John Wiley & Sons, 660 pp., \$19.50

Atomic and Space Physics, A.E.S. Greene, P.J. Wyatt, Addison-Wesley Publishing Co., 619 pp., \$18.75

Computer Control & Industrial Processes, E.S. Savas, McGraw-Hill Book Co., 400 pp., \$16

Industrial Management in the Atomic Age, A.L. Parsegian, Addison-Wesley Publishing Co., 374 pp., \$10.75

**6 BIT A TO D CONVERTER
15,000,000 CONVERSIONS PER SECOND**

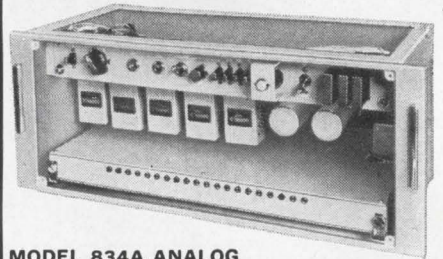

MODEL 834A ANALOG TO DIGITAL CONVERTER

Well-suited for telemetering or process control
Long life and high stability
All solid state, silicon semi-conductors

SPECIFICATIONS

Method: successive comparison.
Digital output: B.C.D. 12 bit parallel. Stability: $\pm 0.2\%/6$ months. Conversion time: approximately 240 μ s. Operating temperature: -10°C to $+50^{\circ}\text{C}$. Width: 480 mm. Height: 199 mm. Depth: 2250 m/m. AC input: 100/110/220/240V $\pm 10\%$ 50 or 60 c/s.

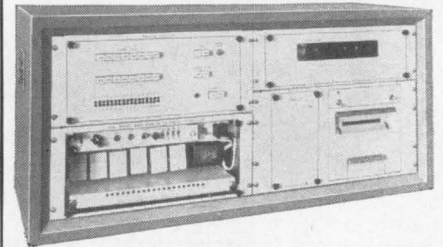

MODEL 198C DATA LOGGING SYSTEM

All solid state
Random access analog scanner
High reliability and accuracy
Operates over large temperature ranges
Low cost

SPECIFICATIONS

Scanning capability: 16 channels. Scanning speed: up to 5 channels per second. Accuracy: 0.1%. Output: printing paper tape. Logging cycles: 10 seconds to 1 hour (specify on ordering). AC input: 100/110/220/240V $\pm 10\%$ 50 or 60 cps (specify on ordering).



MODEL 507C DIGITAL VOLTMETER

All solid state and high speed.

SPECIFICATIONS

Measuring range: (1) 0.001 to 1.599 volts
(2) 0.01 to 15.99 volts
(3) 0.1 to 159.9 volts
(4) 1 to 1,599 volts

Accuracy: 0.1% of full scale. A/D conversion time: 600 μ s. Max. repetition rate: 1 kc. Reading mode auto: 100 c/s repetition rate.

Digital output:

4 digit decimal $10C_1$, parallel code connectable to the line printer Operating temperature: 0 to 40°C . Width: 480 mm. Height: 199 mm. Depth: 350 mm. Weight: approx. 13 kg. AC input: 100/110/220/240V 50 or 60 cps.

CHUO ELECTRONICS CO., LTD.
No. 21 Motohongo-machi Hachioji-shi,
Tokyo, Japan

Mitsubishi Photo-Conductive Cells For Long Life

As with all Mitsubishi electronic components, these photo-conductive cells are made from only the finest materials—and manufactured under a quality control program which assures you of continuous, trouble-free performance. Mitsubishi Three Diamonds mark, Japan's most famous product symbol, is your guarantee of top quality components.



PZC-3107

A miniature slug type, cadmium sulfide, low voltage cell. Especially applicable to camera equipment. Hermetically sealed, moisture proof and long lived.



PZC-7103

Especially applicable to automatic relays and automatic switching equipment, this moisture proof cell is designed for a power application of approximately 0.3 W.



PZE-3101G

A glass sealed, slug type, selenic cadmium cell, designed for photoelectric measuring devices, control circuits, non-contact relays etc.

PHOTO-CONDUCTIVE CELLS

Specifications		PZC-3107	PZC-7103	PZE-3101G
Max. Rating	Voltage (V)	100	200	50
	Power (W)	0.03	0.3	0.01
	Temperature (°C)	-75~+60	-75~+60	-40~+40
Max. Dimension	Thickness (inch)	0.12	0.32	0.52
	Diameter (inch)	0.37	1.10	0.26
	100 lux	5 KΩ	1.6 KΩ	70 KΩ
Resistance (at 25°C)	10 lux	20 KΩ	8 KΩ	—
	1 lux	80 KΩ	40 KΩ	—
	Dark (after 30 sec)	1 MΩ	5 MΩ	1,000 MΩ



MITSUBISHI ELECTRIC CORPORATION
Head Office: Mitsubishi Denki Bldg., Marunouchi, Tokyo. Cable Address: MELCO TOKYO

Circle 338 on reader service card

SOMETHING MISSING?

SMK may have it...
if it's an electronic component
for every type of communication
and industries.

Write immediately for information.



SG-1016



S-H-5001



X-L-0316



S-I-8007



S-I-8008



MICRO SWITCH

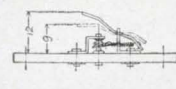
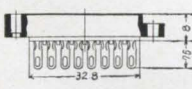
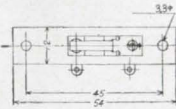
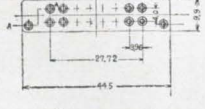
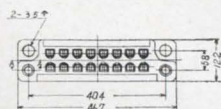

SHOWA MUSEN KOGYO CO., LTD.
5-5 6-CHOME, TOGOSHI, SHINAGAWA-KU, TOKYO,
JAPAN CABLE: "SHOWAMUSEN"

print electronic components ...efficiently

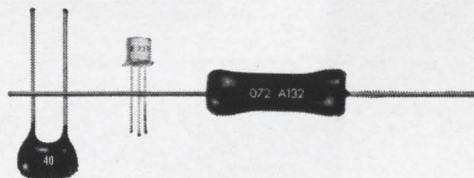

Clear, easy to read identification on small parts can be applied efficiently at speeds equal to your production with a Matthews Off-set "In-Line" Rotary Printer.

Standard printers work equally well on round, flat, or contoured surfaces, with the parts handling section designed for each part. Special inks available for various surface conditions. Inquire today for photos with sample.



JAS. H. MATTHEWS & CO.
Industrial Marking Products Division
6788 PENN AVENUE • PITTSBURGH, PA. 15206
MARKING METHODS SINCE 1850

NEW MAGNETIC RELAY plugs into your PC board!

NO Springs, NO Wiring,
NO Sockets, NO Soldering,
NO Mechanical Linkage

Printact®

Standard Series G
Latching Series LS/LD

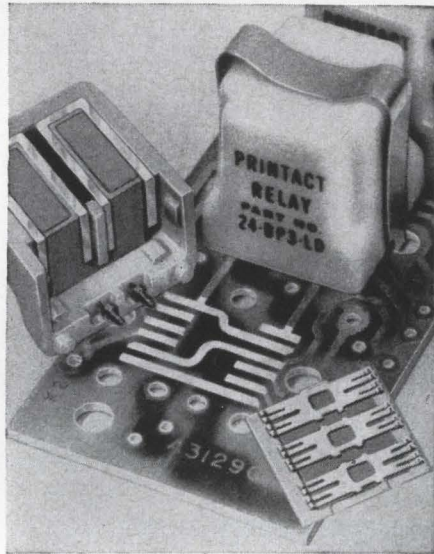

(actual size)

Plated Conductors on Your PC Board are the Fixed Contacts

Save SPACE, MONEY and MANHOURS with these new small, lightweight, highly reliable Standard and Latching PRINTACT Relays.

Available with Bifurcated Palladium or Gold Alloy contacts for more than 10 million cycle 2 or 3 pole switching. Handles up to 3 amp. res. loads. Coils for 6, 12, 24 and 48 vdc at 500 mw. Operating temperature -30°C to $+95^{\circ}\text{C}$. Operate time 7 ms. The little gem is an 0.8 oz. $\frac{7}{8}$ " cube.

Quality features include: double-break contacts; balanced armature, enclosed housing, plug-in application; encapsulated coil; self-wiping contacts and inherent snap-action—and the cost is lower than you think!

Executone

MAIL COUPON TODAY

PRINTACT RELAY DIVISION
47-37 Austell Place
Long Island City, N.Y. 11101

- Send Printact data and prices.
 Have your local rep. call.

Name _____ Title _____

Firm _____ Tel. # _____

Address _____

City _____

Technical Abstracts

Small package, high power

High-performance experimental power triodes

By J.E. Beggs and N.T. Lavoo
General Electric Research and
Development Center, Schenectady, N.Y.

A tenfold increase in plate current, transconductance, gain-bandwidth product and power output is provided by new experimental planar triodes developed for microwave frequencies. The increased performance capabilities over that of commercially available triodes of comparable size and weight result from design modifications utilizing new structural materials and improved tube assembly and processing techniques. The L-65/Y1430 triode—the smaller of the two tubes discussed in the paper—is approximately $1\frac{1}{4}$ ounces. The larger tube, the L-64/Y1498 triode, is $1\frac{5}{8}$ inch long by $1\frac{1}{2}$ inch in diameter.

The cathodes supply a current of 1 ampere, corresponding to an emission-current density of 1.6 amperes per square centimeter. Extremely rugged control-grid structures have fine detail, yet are capable of conducting the large displacement currents that flow during high-power operation of the tube. This combination results in exceptionally high transconductances on the order of 0.3 to 0.7 mhos, in small triodes that can provide an output of 1 kilowatt or more at 1 gigacycle and a few milliwatts at 20 Gc.

In the L65 tube, 50 watts of drive and a plate voltage of 2.1 kilovolts produce a continuous-wave power output of one kilowatt and a plate efficiency of 67%. The power gain is 13 decibels. By increasing the anode voltage, 1 kw of output power is obtained with 20 db gain at an efficiency of 41.5%. An output capacitance of only 4 picofarads together with the high transconductance permits a theoretical gain-bandwidth product of 12 Gc. When tested in a triple-tuned circuit centered at 1.3 Gc, a gain-bandwidth product of 7.45 Gc was measured. Under typical conditions the gain was 15.5 db and the three db bandwidth was 167 Mc.

The L64, is very similar in con-



Experimental triode type L65/Y1430, right, supplies c-w power levels 20 times greater than the widely used 2C39 triode. Design improvements have also resulted in unusually high gain-bandwidth products for the L-65.

struction to the L65, but because of its larger size is capable of higher output power. At 1.3 Gc, it has been tested with an input pulse of 500 microseconds and a duty factor of 0.07. Under these long-pulse conditions, a gain-bandwidth product of two Gc was measured in a triple-tuned circuit. Typically the gain is 21 db and the three db bandwidth is 144 Mc. Under large-signal, broadband conditions, five-kw peak output power is obtained with a gain of 17 db and an efficiency of 33%.

Other construction features contributing to high performance of the triodes include a water-cooled molybdenum anode to permit high-power operation, close spacing between control grid and cathode to reduce electron transit time, and thoroughly degassed components and high vacuum within the tube.

Presented at the International Electronics Devices Meeting, Washington, October 20-22 1965

Logical design with IC's

Cobweb cellular arrays
Robert C. Minnick,
Stanford Research Institute,
Menlo Park, Calif.

Logical design with integrated circuits should produce the desired output with a minimum of interconnection—minimum component count is secondary.

The cobweb cellular array offers

a technique for logical design with integrated circuits improving on the previously reported cutpoint array. A cutpoint array is a rectangular group of cells, each with two inputs and two outputs and each capable of performing one of six logical functions plus the "1", "0" and flip-flop functions. Switches within the cells define the logical function; these switches may be photoresistors, flip-flop circuits, or conductor breaks.

However, cutpoint arrays tend to require a large number of cells—even though a minimum component count is not a concern, they often require connections from edge to edge of the same array through back-panel wiring. Often they do not have enough edge terminals for the required back-panel connections, and faulty cells in an array are not easily isolated.

The cobweb array is similar to the cutpoint array, but has more connections between cells on one substrate and more switches within the cells. The circuitry within the cell is the same, and the logical functions generated are the same. With the cobweb array there are 1½ to 3 times as many edge terminals for outside connections; and at the same time connections from edge to edge of the same array can be made equivalently through the greater complexity of the individual cells. A 3-bit adder can be built with 30 cobweb cells, but requires 49 cutpoint cells; the number of cobweb cells for a shift register is 25, five greater than with cutpoints, but with a complete elimination of edge connections. And a typical generalized logic function drops from 36 cells to 18, with elimination of edge connections.

Faulty cutpoint cells, when found, can be removed from the array and replaced. This is not feasible with cobweb cells because of the complex design.

Presented at the Fall Joint Computer Conference, Las Vegas, Nov. 30-Dec. 2

Wideband amplifier

The reflex repeater, a direct r-f to r-f repeater
Phillip E. Tucker, Lockheed Missiles and Space Co., Sunnyvale, Calif.

Although the reflex-amplifier concept has been known for many

Semiconductor Integrated Circuits

MICROPACK

μPC 3 (THREE-STAGE AMPLIFIER)

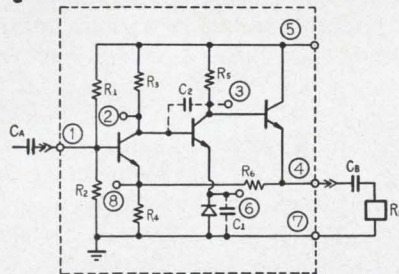

EQUIVALENT CIRCUIT

ELECTRICAL CHARACTERISTICS

($T_a = 25^\circ\text{C}$, $V_{cc} = 24\text{V}$, $R_L = 1.2\text{ k}\Omega$, otherwise specified)

Item	Conditions	Min	Typical	Max	Unit
Voltage Gain	$P_o = 0\text{ dbm}$, $f = 50\text{ kc}$	20	21	22	db
Max Output Voltage	$f = 50\text{ kc}$, $KF = 10\%$	4.5			V
Cutoff Freq. (-3 db)	$P_o = 0\text{ dbm}$, $R_L = 600\Omega$		20		Mc
Cutoff Freq. (-0.5 db)	$P_o = 0\text{ dbm}$, $R_L = 600\Omega$		10		Mc
2nd Harmonic Distortion	$P_o = 0\text{ dbm}$, $f = 3\text{ Mc}$	-60	-65		db
3rd Harmonic Distortion	$P_o = 0\text{ dbm}$, $f = 3\text{ Mc}$		-75		db
Input Impedance	$f = 50\text{ kc}$		1.5		k Ω

μPC 4 (POWER SUPPLY VOLTAGE REGULATOR 12V, 2A)

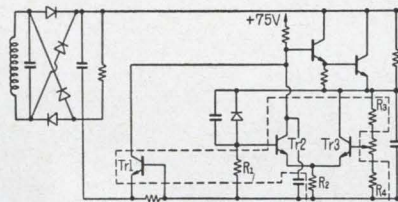

Note: Elements within the dotted line are integrated circuits.

ELECTRICAL CHARACTERISTICS

Output Voltage Change (Supply Voltage $\pm 10\%$) $\pm 3\text{mV}$
(Output Current 0~2A) $\pm 20\text{mV}$
($-10 \sim +25 \sim +65^\circ\text{C}$) $1\text{mV}/^\circ\text{C}$

Output Voltage 12V
Output Current 0~2A

Sensitivity Approx. 30mV
Ripple 3mV p-p

LOGIC CIRCUITS

Complete Line of DTL for Computers

- μPB 1 Single NAND
- μPB 2 Dual NAND
- μPB 3 R-S Flip-flop
- μPB 4 Half Shift Register
- μPB 5 Half Adder
- μPB 6 Buffer Amplifier
- μPB 7 Dual NAND
- μPB 8 R-S Flip-flop
- μPB 9 AND-OR
- μPB 10 J-K Flip-flop
- μPA 20 Gate Expander

Products for today—
Innovations for tomorrow

NEC

Nippon Electric Company Limited
P. O. Box 1, Takanawa, Tokyo, Japan

Nippon Electric New York Inc. Room 3721, Pan American Bldg., 200 Park Avenue, New York 17, N.Y.

05
x7 1
8 ÷ 4
236
+ 9

**DON'T LET YOUR STAFF
READ THIS AD!**

If they do, they're bound to try and revolutionize your whole office. Because this is the *new* SHARP COMPET 20... a desk calculator that operates faster than any conventional motor-driven or relay type.

Developed after years of research, the SHARP COMPET 20 is indispensable in the office, the factory or the laboratory.

So... make your own decisions. Make a point of testing the *new* SHARP COMPET 20 electronic desk calculator NOW!

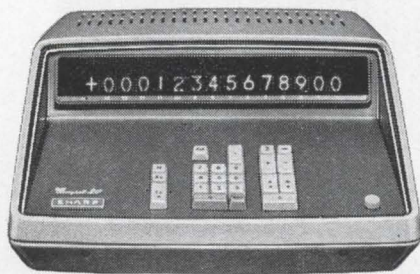

model CS-20A



SHARP COMPET

ELECTRONIC DESK CALCULATOR

HAYAKAWA ELECTRIC CO., LTD.

OSAKA, JAPAN

CABLE ADDRESS: LABOMET OSAKA

TELEX: HAYAKAWA OS3428

Technical Abstracts

years, it has not been used to any great degree. Applications, for the most part, have been limited to video or the low end of the very high frequency range. These early systems were designed for point-to-point relay of television, and were in ground-based installations only. Reflex amplifiers with traveling-wave tubes are now being designed; such systems have wide bandwidth, high gain, and multiple signal handling capability.

In the basic reflex system, an input signal at frequency f_1 is passed through a bandpass filter and amplified by a twt. On leaving the twt, the signal is routed through a second filter to the mixer for frequency translation. At the output of the mixer, either the upper or lower sideband is selected by filtering and the signal (now at frequency f_2) is fed back to the twt and amplified. The amplified f_2 output from the twt is then transmitted.

Other radio repeaters use a "back-to-back," or heterodyne, configuration. With the back-to-back repeater, the received signal is first demodulated and then used to modulate a separate transmitter. With the heterodyne repeater, the received signal is translated to an intermediate frequency, amplified, and then again translated, this time to a radio frequency suitable for transmission. Both of these repeaters have been used in point-to-point systems and in satellite communications applications.

In his paper, the author discusses the merits of each repeater system and how a reflex repeater can provide wideband capability, increased reliability, system and component simplicity, duplex and multiple access capability, and flexible operation.

In a discussion of laboratory tests on a typical 7-Gc reflex repeater system, the writer tells how the operation of a reflex repeater is essentially that of a linear amplifier, and why the distortion products which result from this type of operation are extremely low.

Presented at the National Telemetering Conference, Houston, Tex., April 13-15

Brings you up-to-date on modern digital techniques using semiconductor devices



PULSE, DIGITAL, AND SWITCHING WAVEFORMS

Devices and Circuits for

Their Generation and Processing

By **JACOB MILLMAN**, Prof. of Elec. Engrg., Columbia Univ.; and **HERBERT TAUB**, Prof. of Elec. Engrg., The City College of N. Y.

958 pages, 6 $\frac{3}{8}$ x 9 $\frac{1}{4}$, 803 illus., \$18.00

Here is a practical treatment of the essential information needed to work creatively with pulse, digital, and switching circuits. Designed to be of maximum value to the practicing engineer, this book provides you with working descriptions of active and passive devices and circuit configurations for the generation and processing of pulse-type signals.

Principal emphasis on use of transistors and other semiconductor devices

Semiconductor and tube circuits are treated side by side throughout, with principal emphasis on transistors. Circuits are first analyzed on a physical basis, with mathematics used to express quantitative relationships only after clear understanding of the circuit's behavior is established. Commercially available device characteristics are employed for optimum application usefulness.

The book presents methods for generation of very narrow (nanosecond or microsecond) pulses, and also wider (millisecond or second) gates or square waves. It also includes other waveforms—a step, an exponential, a pulse code, a staircase, and a precisely linear ramp. Its discussions of processing show how to make a waveform perform a useful function by transmitting the signal... amplifying it... selecting a portion of it in voltage... choosing a section of it in time... combining it with other signals to perform a logic operation... and employing it to synchronize a system. The book explains these processes in the detail necessary for rapid and easy application.

ALSO OF SPECIAL INTEREST

COMMUNICATION NETS: Stochastic Message Flow and Delay by **L. Kleinrock**. Provides material on the many varieties of flow and transportation nets, showing their similarities and differences. Special emphasis on methods for solving problems of optimum channel capacity, digital computer simulation, dependent traffic, routing performance, priority discipline, and more. **206 pp., 66 illus., \$12.50**

**SEE THESE AT YOUR BOOKSTORE
OR MAIL COUPON
FOR 10-DAY FREE EXAMINATION**

McGraw-Hill Book Co., Dept. 23-L-D13
330 West 42 Street, New York, N.Y. 10036

Send me book(s) checked below for 10 days on approval. In 10 days, I will pay for book(s) I keep, plus few cents for delivery costs, and return unwanted book(s) postpaid. **SAVE MONEY:** we pay delivery costs if you remit with coupon; same examination and return privilege.

- Millman & Taub—Pulse Digital, and Switching Waveforms, \$18.00**
 Kleinrock—Communication Nets, \$12.50

NAME (print) _____

ADDRESS _____

CITY _____

STATE _____

ZIP _____

For prices outside U.S. write McGraw-Hill Intl. N.Y.C. 23-L-D13

QUALIFICATION FORM FOR POSITIONS AVAILABLE

ATTENTION: ENGINEERS, SCIENTISTS, PHYSICISTS

This Qualification Form is designed to help you advance in the electronics industry. It is unique and compact. Designed with the assistance of professional personnel management, it isolates specific experience in electronics and deals only in essential background information.

The advertisers listed here are seeking professional experience. Fill in the Qualification Form below.

STRICTLY CONFIDENTIAL

Your Qualification form will be handled as "Strictly Confidential" by Electronics. Our processing system is such that your form will be forwarded within 24 hours to the proper executives in the companies you select. You will be contacted at your home by the interested companies.

WHAT TO DO

1. Review the positions in the advertisements.
2. Select those for which you qualify.
3. Notice the key numbers.
4. Circle the corresponding key number below the Qualification Form.
5. Fill out the form completely. Please print clearly.
6. Mail to: Classified Advertising Div., Electronics, Box 12, New York, N. Y. 10036.

COMPANY	PAGE#	KEY#
ATOMIC PERSONNEL INC. Phila. 2, Pa.	232	1
COLLINS RADIO COMPANY Cedar Rapids, Iowa	190-191	2
ELDORADO ELECTRONICS Concord, Calif.	128*	3
ELECTRONICS COMMUNICATIONS INC. St. Petersburg, Fla.	231	4
GENERAL ELECTRIC CO. Heavy Military Electronics Dept. Syracuse, New York	230	5
GENERAL ELECTRODYNAMICS CORP. Garland, Texas	234	6
KAISER ALUMINUM & CHEMICAL CORP. Ravenswood, W. Va.	232	7
LOCKHEED CALIFORNIA CO. Div. of Lockheed Aircraft Corp. Burbank, Calif.	193	8
LOCKHEED MISSILES & SPACE COMPANY Div. of Lockheed Aircraft Corp. Sunnyvale, Calif.	130*	9
NATIONAL CASH REGISTER Electronics Div. Hawthorne, Calif.	197	10
PHILADELPHIA NAVAL SHIPYARD Phila., Pa. 19112	232	11
RCA SERVICE COMPANY Camden, New Jersey	127*	12
RIXON ELECTRONICS INC. Silver Springs, Md.	127*	13
SYLVANIA ELECTRONICS SYSTEMS WEST Mountain View, Calif.	118	14
XEROX CORP. Rochester, New York	172-173	15
Box E 150	232	16

* These advertisements appeared in the November 29th issue.

(cut here)

Electronics QUALIFICATION FORM FOR POSITIONS AVAILABLE

(cut here)

(Please type or print clearly. Necessary for reproduction.)

Personal Background

NAME

HOME ADDRESS

CITY ZONE STATE

HOME TELEPHONE

Education

PROFESSIONAL DEGREE(S)

MAJOR(S)

UNIVERSITY

DATE(S)

FIELDS OF EXPERIENCE (Please Check)

12/13/65

- | | | |
|--|--|---------------------------------------|
| <input type="checkbox"/> Aerospace | <input type="checkbox"/> Fire Control | <input type="checkbox"/> Radar |
| <input type="checkbox"/> Antennas | <input type="checkbox"/> Human Factors | <input type="checkbox"/> Radio-TV |
| <input type="checkbox"/> ASW | <input type="checkbox"/> Infrared | <input type="checkbox"/> Simulators |
| <input type="checkbox"/> Circuits | <input type="checkbox"/> Instrumentation | <input type="checkbox"/> Solid State |
| <input type="checkbox"/> Communications | <input type="checkbox"/> Medicine | <input type="checkbox"/> Telemetry |
| <input type="checkbox"/> Components | <input type="checkbox"/> Microwave | <input type="checkbox"/> Transformers |
| <input type="checkbox"/> Computers | <input type="checkbox"/> Navigation | <input type="checkbox"/> Other |
| <input type="checkbox"/> ECM | <input type="checkbox"/> Operations Research | <input type="checkbox"/> |
| <input type="checkbox"/> Electron Tubes | <input type="checkbox"/> Optics | <input type="checkbox"/> |
| <input type="checkbox"/> Engineering Writing | <input type="checkbox"/> Packaging | <input type="checkbox"/> |

CATEGORY OF SPECIALIZATION

Please indicate number of months experience on proper lines.

	Technical Experience (Months)	Supervisory Experience (Months)
RESEARCH (pure, fundamental, basic)
RESEARCH (Applied)
SYSTEMS (New Concepts)
DEVELOPMENT (Model)
DESIGN (Product)
MANUFACTURING (Product)
FIELD (Service)
SALES (Proposals & Products)

CIRCLE KEY NUMBERS OF ABOVE COMPANIES' POSITIONS THAT INTEREST YOU

1 2 3 4 5 6 7 8 9 10 11 12 13 14 15 16



Engineering career opportunities

**Tie your career
to the world's
most advanced
radar/sonar
systems...
at G.E.!**

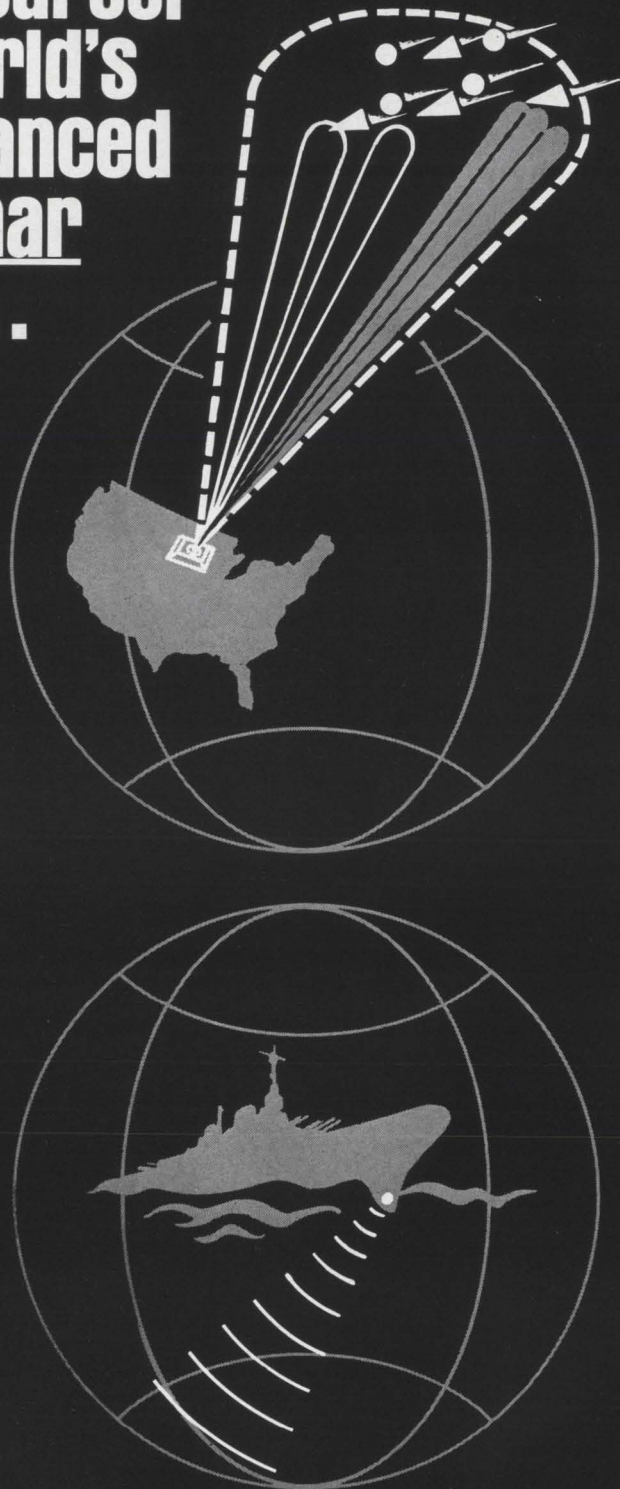

**Investigate your career now
in missile-defense radar; ad-
vanced sonar engineering at
General Electric.**

G.E.'s Heavy Military Electronics Dept.—whose capabilities include the design, development and fabrication of the world's largest and most advanced ASW and radar systems—announces long-term career openings for continuing contributions to large military contracts.

HMED offers you stability based on its broad capability for handling large programs and the experience that goes with front-rank performance on this decade's most advanced projects. Your growth is tied to that of a lean, highly professional engineering group backed by top-flight facilities—both within HMED and throughout General Electric.

At G.E., you'll be treated as a professional who's expected to handle well-defined, delegated responsibility. In most instances you'll deal directly with your customer's organization.

You will be given every opportunity to develop yourself professionally through continuing Company-taught courses and advanced tuition-paid study at nearby Syracuse University. And, in the course of your work, you'll have access to information developed by other G.E. facilities throughout the country.

WHY NOT MATCH YOUR EXPERIENCE AND CAREER DESIRES AGAINST THESE REQUIREMENTS?

SONAR: Advanced Sonar Engineers; Array Beamformer and Signal Processing Development Engineers; Digital Logic Engineers; Sonar Solid-state Circuit Design; Transducer Development; Solid-state Transmitter Development; Pattern Recognition Analysis; Adaptive Filtering Research; Display Development; Propagation Analysis; Sonar Subsystem Development.

RADAR: Monitor and Control Analysis Engineers; Digital Control Eqpt. Engineers; Microwave Component Design Engineers; Consultant, Circuit Design and Development; Instrumentation Circuit Engineers; ME's for Signal Processing Modules; Consultant, Array Radar Subsystem Requirements.

INVESTIGATE NOW! For full information, send a résumé of your experience in confidence to J. L. Wool, Professional Placement, Heavy Military Electronics Dept., Section 122, General Electric Co., Court St., Syracuse, New York.

177-65

An Equal Opportunity Employer

GENERAL



ELECTRIC

FOR INFORMATION

*about
employment
opportunities
advertising
contact the
McGraw-Hill
office nearest you*

ATLANTA, 30309

1375 Peachtree St., N.E.
404-875-0523

BOSTON, 02116

607 Boylston St.
617-262-1160

CHICAGO, 60611

645 No. Michigan Avenue
312-664-5800

CLEVELAND, 44113

55 Public Square
216-781-7000

DALLAS, 75201

1800 Republic Nat'l. Bank Tower
214-747-9721

DENVER, 80202

1700 Broadway, Tower Bldg.
303-255-2981

DETROIT, 48226

856 Penobscot Building
313-962-1793

HOUSTON, 77002

2270 Humble Bldg.
713-224-8381

LOS ANGELES, 90017

1125 West Sixth Street
213-482-5450

NEW YORK, 10036

500 Fifth Avenue
212-971-3594

PHILADELPHIA, 19103

Six Penn Center Plaza
215-568-6161

PITTSBURGH, 15222

4 Gateway Center
412-391-1314

ST. LOUIS, 63105

7751 Carondelet Avenue
314-725-7285

SAN FRANCISCO, 94111

255 California Street
415-362-4600

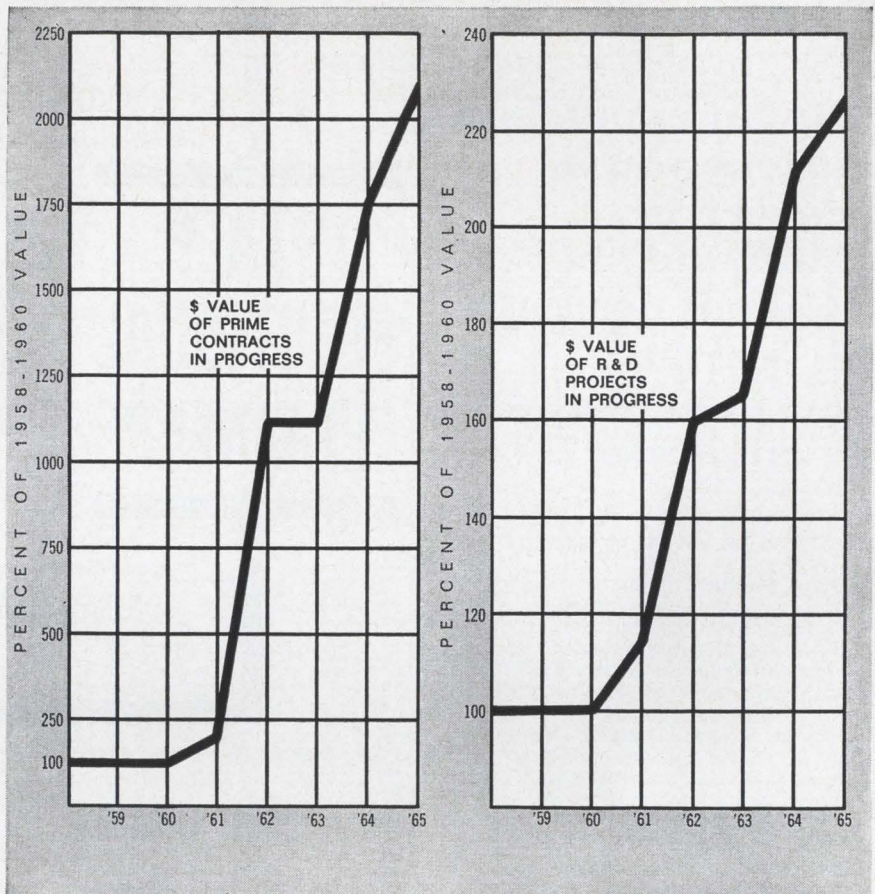

2 REASONS WHY THERE'S MORE ENGINEERING OPPORTUNITY AT ECI

Where there's engineering excitement there's engineering opportunity. Two key indicators — prime contracts in progress and R&D work in progress — prove that exciting things are happening at Electronic Communications, Inc. ECI has generated these remarkable activity increases by building a solid, successful reputation in airborne systems, multiplexing, space instrumentation and other areas of military and aerospace communication. You can get aboard this upward trend immediately if you are qualified in:

RF ENGINEERING — aggressive new programs are now under way in the design and development of microminiature transmitters and receivers. Positions require at least a BS degree, with a minimum of three years experience, and sound knowledge of transmitter and/or receiver design theory.

SPACE INSTRUMENTATION PROJECT ENGINEERING — you'll need in-depth technical ability, plus six years experience in data handling, control, or analog instrumentation.

THIN-FILM CIRCUIT DESIGN — involving theory and application of thermodynamics, mechanics of materials and electronic component design in the development of microelectronic circuitry. BS or MS in EE or physics required.

SYSTEMS INTEGRATION — you must be thoroughly grounded in aircraft electrical systems and be familiar with interface problems involved in installation of airborne communications equipment. Prior systems integration or field installation experience is most desirable.

If you are qualified, send your resume, in confidence, to Duane Meyer, ECI, Box 12248E, St. Petersburg, Fla., or call him collect at (813) 347-1121. (An equal opportunity employer.)

ELECTRONIC COMMUNICATIONS, INC.

ST. PETERSBURG, FLORIDA



*Electrical and
Electronic Engineers:*

Naval expansion offers you a career in ship and shore system design, research, development and evaluation

Starting salaries up to \$10,619 depending on experience.

Many exciting opportunities for engineers are being created by the expansion of the Philadelphia Naval Shipyard, the major facility for new ship construction on the East Coast, and expansion of the activities of the Office of Industrial Manager, Fourth Naval District. These are career Civil Service positions with regular salary increases and generous benefits including 15-26 days of vacation, 13 days of sick leave, 8 holidays, inexpensive health and life insurance, and an unusually liberal retirement plan.

Electrical and electronic engineers are offered a variety of challenging assignments in every phase of ship and system design ranging from electrical power and light to fire control, communications, radar, and instrumentation, etc. Also offered are laboratory assignments in research and development of stress, sound and vibration, measuring equipment and their application; assurance engineering and reliability engineering covering the field of shipbuilding systems and equipment; and development, design, instrumentation, and installation planning of electronic systems for U. S. Naval activities ashore.

Philadelphia and its suburbs offer housing accommodations for every taste. This historic city has museums, libraries, spacious parks, 27 colleges and universities, and is within an hour's drive of excellent ocean beaches and famous mountain resorts.

If you have a degree in engineering, send a resume or Standard Form 57 (available at any Post Office) to the Industrial Relations Office, Code 175-F



**Philadelphia
Naval Shipyard**
Philadelphia, Pennsylvania 19112
An Equal Opportunity Employer

KAISER ALUMINUM and CHEMICAL CORPORATION

Ravenswood Works Ravenswood, West Virginia

STAFF ELECTRICAL ENGINEER

Permanent position in aluminum reduction plant Engineering Division. Responsible for major electrical engineering projects including design of new facilities and alterations to existing equipment. Must provide technical and administrative supervision for engineers and draftsmen.

Applicants must have the following minimum qualifications: B.S. in E.E., 10 years experience in responsible engineering work, good working knowledge of high voltage AC power distribution (138 KV), metering, relaying, switching, etc. Adequate working knowledge of high voltage, high current rectifier stations including mercury arc and solid state rectifiers, DC bus systems, high current metering systems and safety requirements.

Minimum salary \$12,000.

Salary commensurate with experience.

Location: Mid-Ohio Valley.

Excellent benefits including relocation assistance.

Send resume in complete confidence to Mr. Carl A. Dunlap

KAISER ALUMINUM & CHEMICAL CORPORATION

P. O. Box 98

Ravenswood, West Virginia

An equal opportunity employer

CHIEF ENGINEER METALLURGIST

Recent experience in Semi-Conductor and/or Precious Electrical Contact Fabrication.

These positions offer excellent growth opportunities, as well as attractive benefits including profit-sharing, stock options, life and medical insurance.

Send resume including

Salary Requirements To:

Box E 150, 125 W 41 St, NYC 36



E. E.'s

for FEE-PAID Positions
WRITE US FIRST!

Use our confidential application for professional, individualized service . . . a complete national technical employment agency.

ATOMIC PERSONNEL, INC.
Suite 1207L, 1518 Walnut St., Phila. 2, Pa.

PROFESSIONAL SERVICES

GIBBS & HILL, Inc.

Consulting Engineers

Systems Engineering

Operations Research • Development

Field Studies • Design • Procurement

Power • Transportation • Communications

Water Supply • Waste Treatment

393 Seventh Avenue

New York 1, N. Y.

ADDRESS BOX NO. REPLIES TO: Box No.

Classified Adv. Div. of this publication.

Send to office nearest you.

NEW YORK, N. Y. 10036; P. O. Box 12

CHICAGO, Ill. 60611; 645 N. Michigan Ave.

SAN FRANCISCO, Cal. 94111; 255 California St.

SELLING OPPORTUNITY WANTED

Canadian Representative established 20 years, desires line of high precision wire wound resistors and rotary switches. RA-8041, Electronics.

BOOKS

Technical Manuals signal corp etc. Worlds largest list free. Quaker Electronics, Hunlock Creek, Pa., 18621

EMPLOYMENT OPPORTUNITIES

The advertisements in this section include all employment opportunities—executive, management, technical, selling, office, skilled, manual, etc.

Look in the forward section of the magazine for additional Employment Opportunities advertising.

— RATES —

DISPLAYED: The advertising rate is \$52.00 per inch for all advertising appearing on other than a contract basis. Contract rates quoted on request. Effective Jan. 1966, rate is \$60.00 per inch.

An advertising inch is measured $\frac{7}{8}$ " vertically on a column—3 columns—30 inches to a page. Subject to Agency Commission.

UNDISPLAYED: \$2.70 per line, minimum 3 lines. To figure advance payment count 5 average words as a line. Box numbers—count as 1 line.

Discount of 10% if full payment is made in advance for 4 consecutive insertions. Not subject to Agency Commission.

Send new ads to:

ELECTRONICS

Class. Adv. Div., P.O. Box 12, N.Y., N.Y. 10036

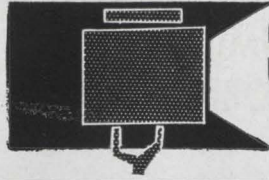

SEARCHLIGHT SECTION

• CLASSIFIED ADVERTISING • BUSINESS OPPORTUNITIES
• USED OR SURPLUS EQUIPMENT

TEST EQUIPMENT

For over 20 years specializing in top brands only. Write for our latest listing. We buy complete inventories.



ELECTRONIC SALES
1413 Howard Street, Chicago, Illinois 60626
Telephone ROgers Park 4-0600

CIRCLE 955 ON READER SERVICE CARD

ELECTRON TUBES

KLYSTRONS • ATR & TR • MAGNETRONS
SUBMINIATURES • C.R.T. • T.W.T. • 5000-
6000 SERIES
• SEND FOR NEW CATALOG A2 •
A & A ELECTRONICS CORP.
1063 PERRY ANNEX
WHITTIER, CALIF.
696-7544

CIRCLE 956 ON READER SERVICE CARD

SMALL AD but BIG STOCK

of choice test equipment
and surplus electronics

Higher Quality—Lower Costs
Get our advice on your problem

ENGINEERING ASSOCIATES
434 Patterson Road — Dayton 19, Ohio

CIRCLE 957 ON READER SERVICE CARD

REFERENCE BOOK

"TRANSISTOR CIRCUIT ANALYSIS"—
Joyce and Clarke

Presents the basic methods of analysis involved in the understanding and design of junction transistor circuitry. Limiting the transistor models employed to a few easily interrelated ones. Write for free brochure. \$10.75.

Addison-Wesley, Reading, Mass. 01867

CIRCLE 951 ON READER SERVICE CARD

EQUIPMENT SALE

H.P. TEC., G.R. ETC. Practically new
Decade Boxes, Pulse Gen's, VTVM's,
Audio Osc.—Counter's, etc.

EASY-UP, INC.

2425 Bradley Road, Rockford, Ill.
Ph. 877-5288

CIRCLE 953 ON READER SERVICE CARD

Standardized

**BATTERY
HOLDERS**

KEYSTONE ELECTRONICS CORP.
49 BLEECKER ST., N.Y., N.Y. 10012

FREE
CATALOG

CIRCLE 954 ON READER SERVICE CARD

SEARCHLIGHT Equipment Locating Service

No Cost or Obligation

This service is designed to help you, the reader of SEARCHLIGHT SECTION, to locate used or rebuilt equipment not currently advertised.

HOW TO USE: Check the ads in this SEARCHLIGHT SECTION to see if what you want is advertised. If not, print clearly the specifications of the equipment and/or components wanted on the coupon below, or on your own letterhead.

THIS IS A SERVICE TO OUR READERS. THIS PUBLICATION DOES NOT BUY, SELL OR STOCK EQUIPMENT OR MATERIALS OF ANY TYPE. Your requirements will be brought promptly to the attention of the used equipment dealers advertising in this section. You will receive replies directly from them.

Obviously, the list of such advertisers is limited by comparison with the over 65,000 subscribers to **electronics**, all directly engaged in the electronics industry. A small 'EQUIPMENT WANTED' advertisement in the SEARCHLIGHT SECTION will bring your needs to the attention of ALL who read **electronics**. The cost is low . . . just \$27.25 per advertising inch—7/8" x 2-3/16"

SEARCHLIGHT EQUIPMENT LOCATING SERVICE

CLASSIFIED ADVERTISING

c/o **electronics**, P.O. Box 12, New York, N. Y. 10036

Please help us to locate the following used equipment:

.....
.....
NAME TITLE COMPANY
STREET CITY STATE ZIP CODE.....

12/13/65

AUTOTRACK ANTENNA MOUNT

360 degree azimuth, 210 degree elevation sweep with better than 1 mil. accuracy. Missile velocity acceleration and slewing rates. Amplidyne and servo control. Will handle up to 20 ft. dish. Supplied complete with control chassis. In stock—immediate delivery. Used world over by NASA, USAF. TYPE MP-61 B. SCR-584. NIKE AJAX mounts also in stock plus several airborne trackers.

SCR 584 AUTOMATIC TRACKING RADARS

Our 584s in like new condition, ready to go, and in stock for immediate delivery. Ideal for telemetry research and development, missile tracking, satellite tracking, balloon tracking. Used on Atlantic Missile Range, Pacific Missile Range, N.A.S.A. Wallops Island, A.B.M.A. Write us. Fully Desc. MIT Rad. Lab. Series, Vol. 1, pps. 207-210, 228, 284-286. Compl. inst. Bk. avail. \$25.00 each.

AN/GPG-1 SKYSWEEP TRACKER

3 cm. automatic tracking radar system. Complete package with indicator system. Full target acquisition and automatic tracking. Input 115 volts 60 cycle. New. In stock for immediate delivery. Entire System 6' long, 3' wide, 10' high. Ideal for infrared Tracker, Drone Tracker, Missile, Tracker, R. & D.

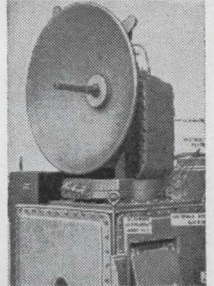

PULSE MODULATORS

MIT MODEL 9 PULSER

1 MEGAWATT—HARD TUBE

Output 25 kv 40 amp. Duty cycle, .002. Pulse lengths .25 to 2 microsec. Also .5 to 5 microsec, and 1 to 5 microsec. Uses 6C21. Input 115v 60 cycle AC. Mfr. GE. Complete with driver and high voltage power supply. Ref: MIT Rad. Lab. Series, Vol. 5, pps. 152-160.

2 MEGAWATT PULSER

Output 30 kv at 70 amp. Duty cycle .001. Rep rates: 1 microsec 600 pps. 1 or 2 msec 300 pps. Uses 5948 hydrogen thyratron. Input 120/208 VAC 60 cycle. Mfr. GE. Complete with high voltage power supply.

MIT MODEL 3 PULSER

Output: 144 kw (12 kv at 12 amp.) Duty ratio: .001 max. Pulse duration: .5, 1 and 2 microsec. Input: 115 v 400 to 2000 cps and 24 vdc. \$325 ea. Full desc. Vol. 5, MIT Rad. Lab. series, pg. 140.

250KW HARD TUBE PULSER

Output 16 kv 16 amp. duty cycle .002. Pulses can be coded. Uses 5D21, 715C or 4PR60A. Input 115 v 60 cycle ac. incl. H.V. pwr supply \$1200 ea.

5949 THYRATRON AGING RACK

Compl. Chatham Electronics Console incl. 15 kv power supply & PFN's. \$1800.

MICROWAVE SYSTEMS

E-4 FIRE CONTROL SYSTEM

Hughes Aircraft X Band. Complete. In stock.

C-BAND RADAR

250 KW output, C-band, PPI indicator, 5C22 thyratron modulator. Antenna hi gain parabolic section. Input 115 volts 60 cycle AC. complete \$2750.00.

300 TO 2400MC RF PKG.

300 to 2400 MC CW. Tuneable. Transmitter 10 to 30 Watts. Output. As new \$475.

500KW "L" BAND RADAR

500 kw 1220-1359 mcs. 160 nautical mile search range P.P.I. and A Scopes. MTI. thyratron mod. 5J26 magnetron. Complete system.

PHILCO MICROWAVE LINKS

C Band Microwave Link terminal bays and repeater bays in stock. New \$1500 each or \$2500 per pr.

100—800MC. CW SOURCE

150 watts CW nominal output 115 V 60 Cy AC input. \$1600.

100KW 3CM. RADAR

Complete 100 kw output airborne system with AMTI, 5C22 thyr. mod. 4J52 magnetron, PPI. 360 deg az sweep, 60 deg. elev. sweep, gyro stabilizer, hi-gain rcvr. Complete with all plugs and cables.

M-33 AUTO-TRACK RADAR SYSTEM

X band with plotting board, automatic range tracking, etc. Complete with 1 megawatt acq. radar.

INFRARED SOURCES

Collimated radiation simulator and transistorized temp. controller. Temp. range, 200-600 degree C. Absolute Accuracy ±3 degree C. Type AN/USM. \$1975 New.

3KW RCA PHONE & TELEG XMTR

2—30 MC. 10 Autotone channels plus MO. Input 220 vac. 50/60 cycles.



**Radio-Research
Instrument Co.**

650 6th Ave. New York 36, N.Y.
Tel. JUdson 6-4691

CIRCLE 952 ON READER SERVICE CARD

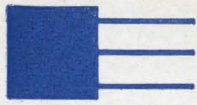

"BLUE CHIP" TRANSFORMERS for printed circuit applications FROM STOCK!

Available in five case sizes (.10 to 1.2 cubic inches) with 62 new power ratings, Blue Chip transformers provide maximum flexibility for electrical and mechanical transistor circuit applications. Blue Chip transformers meet Mil-T-27B, Grade 5, Class S requirements. Typically the smallest size Blue Chip has a frequency response of ± 2 db, 300 to 100,000 cps. Maximum distortion of 10% at 30 milliwatts, 300 to 100,000 cps. Distortion on all types—10% or less. Write for your copy of complete electrical and mechanical specifications on Blue Chip transformers.

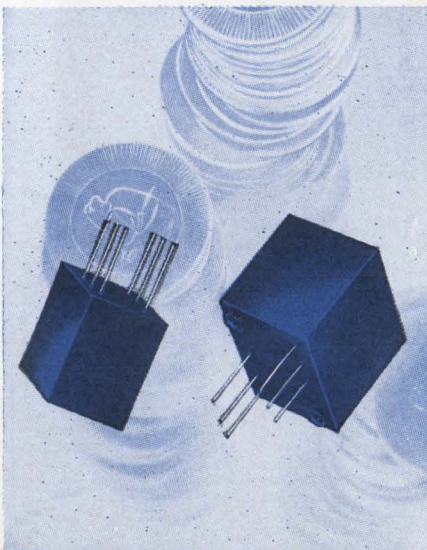

ADC PRODUCTS INC.

6325 CAMBRIDGE ST. ■ MINNEAPOLIS 26, MINNESOTA

New Literature

P-c board relay. James Electronics, Inc., 4050 N. Rockwell St., Chicago, Ill., 60618, offers a two-page data sheet describing the single-throw series Micro-Scan relay for printed-circuit-board application.

Circle 461 on reader service card.

Tantalum capacitors. Tansitor Electronics, Inc., West Road, Bennington, Vt., has released an engineering bulletin on its custom-made type CM tantalum capacitors. [462]

Materials technology. The Carborundum Co., Niagara Falls, N.Y. A semiannual publication, Advanced Materials Technology, features in its current issue silicon carbide whiskers, plus articles on high-temperature thermistors, graphite, Zirconium powders and ceramic bonding. [463]

Two-axis accelerometer. Kearfott Division, General Precision, Inc., Little Falls, N.J., offers a catalog data sheet on the model C70 2414001 inertial two-axis accelerometer. [464]

Microwave components. PRD Electronics, Inc., 1200 Prospect Ave., Westbury, N.Y., 11590, has available a two-page data sheet describing waveguide and coaxial microwave components. [465]

Rfi filters. Lundy Electronics & Systems, Inc., Glen Head, N. Y., has available an 18-page catalog entitled "LossyLine EMI Absorptive Filters." [466]

Silicon semiconductors. Raytheon Company, Components Division, 191 Spring St., Lexington, Mass. Key specifications for more than 500 silicon semiconductors are listed in a new condensed catalog. [467]

Analog computation. Electronic Associates, Inc., West Long Branch, N.J. A 12-page booklet describes the basic principles of analog computation and briefly explains how this versatile, problem-solving technique can be used to increase engineering efficiency. [468]

Nickel-cadmium batteries. Sonotone Corp., Elmsford, N.Y., 10523, has issued a four-page technical brochure, BA-125, on its line of sealed nickel-cadmium battery cells. [469]

Quartz pressure transducer. Kistler Instrument Corp., 8989 Sheridan Drive, Clarence, N.Y., 14031, has released bulletin 157465 describing a subminiature quartz pressure transducer, which contains an internal accelerometer that virtually eliminates vibration sensitivity. [470]

A-c motors and rotating devices. Rotating Components, Inc., 1560 Fifth Ave., Bay Shore, N.Y., offers a new catalog

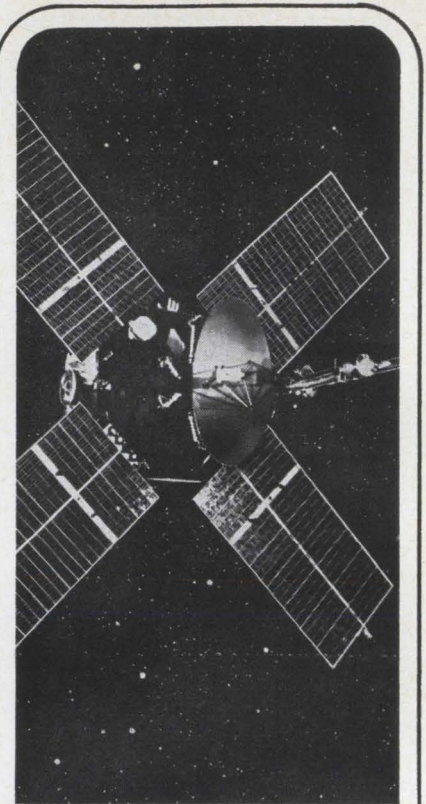

Mariner IV looked at Mars thru a GEC vidicon . . .

New projects and programs have created more opportunities and challenges at GEC. With excellent lab and support facilities, we are expanding our scope and depth in our four divisions. We seek a professional for the following assignment in our Electronic Tube Division.

DEFLECTION YOKE DESIGN ENGINEER

Practical design engineer with considerable experience and sufficient knowledge of magnetic field theory to originate novel design concepts. Salary open. Degree not mandatory; experience and know-how is: Write: Fred Cason, Mgr Prof Emplymt, Box 798, Garland, Texas 75041

**GENERAL ELECTRODYNAMICS
CORPORATION**
AN EQUAL OPPORTUNITY EMPLOYER



nichicon

**The Largest Maker
of Capacitors
in
Japan**



**You Know A Great Deal About
Electronic Equipment
And That's Why You Know
Capacitors Are So Valuable**

Nichicon provides you with the best from Japan because Nichicon has the experience built up from many years of research. One of our major customers abroad is R.C.A., The Magnavox Company. Nichicon products are mainly for overseas markets.

Main Products: Electrolytic, Ceramic, Tantalum, Plastic Film, Paper, MP and Mica Capacitors.

Nichicon Capacitor Ltd.

HEAD OFFICE: Nakagyo-ku, Kyoto, Japan
CABLE ADDRESS: CAPACITOR KYOTO

that includes, in addition to its line of fans, blowers and motors, the complete line of Sangamo precision motors. [471]

Test/measuring/control equipment. Industrial Instruments, Inc., 89 Commerce Road, Cedar Grove, N.J., 07009, has released a 42-page catalog dealing with equipment for test, measuring and control applications. [472]

Transmission measuring facility. Radio Engineering Laboratories, 29-01 Borden Ave., Long Island City, N.Y., 11101, has available a technical data sheet on its solid-state transmission measuring facility. [473]

Thermal writing recorder. Consolidated Electrodynamics Corp., 360 Sierra Madre Villa, Pasadena, Calif. A four-page bulletin describes a low-cost, portable, two-channel thermal writing recorder. [474]

Microphotography facility. HLC Engineering Co., Anderson & Roesch Sts., Oreland, Pa., 19075. A microphotography facility for low-cost, in-house production of microelectronic photomasks and similar photographic applications is described in a six-page technical bulletin. [475]

Linear motion potentiometers. Computer Instruments Corp., 92 Madison Ave., Hempstead, N.Y. Catalog IMP263A presents the comprehensive range of the company's latest precision film potentiometers, including the new model 110 with stroke to 60 in. [476]

Microwave power measurement. Hewlett-Packard, 1501 Page Mill Road, Palo Alto, Calif., 94304. Application Note No. 64 is an 80-page, up-to-date reference on the subject of microwave power measurement. [477]

Power supplies. Elasco, Inc., 33 Simmons St., Boston, Mass. A 20-page catalog includes eight series of standard models and introduces 800 new power supplies. [478]

Slotted sections. PRD Electronics, Inc., 1200 Prospect Ave., Westbury, N.Y., 11590, has available a two-page data sheet describing waveguide and coaxial slotted sections for precision vswr and impedance measurements. [479]

Video switching system. Cohu Electronics, Inc., Box 623, San Diego, Calif., 92112. The 9000 series video switching matrix system is described in technical data sheet 6-382. [480]

Piezoelectric data. Clevite Corp., Piezoelectric division, 232 Forbes Road, Bedford, Ohio. A comprehensive piezoelectric data book is available to electronic device, and system designers. [481]

Multiplex receiver. Dayton Electronic Products Co., 117 E. Helena St., Dayton, Ohio, 45404, has issued a data sheet on the S/6 logical solid-state multiplex receiver for the broadcast industry. [482]

NEW

For LEM-MOL-APOLLO-SATURN

BIT ERROR RATE MONITOR

Compares*serial data bits, DC to 2 MC

Accumulates, stores, and displays bit errors

Direct 3 or 4 digit display of bit error rate

Internal data delay compensation: 0 to 5 bits

Printer output: 1-2-4-8 BCD

Bit matches selectable in place of bit errors

Wide application as general purpose comparator

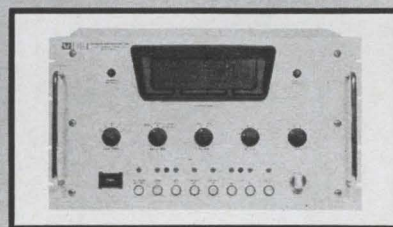

The DEI Bit Error Rate Monitor provides a means of comparing two serial NRZ data bit streams on a bit by bit basis. It accumulates the number of negative or positive comparisons over a bit interval selectable 10^3 to 10^7 bits or on a continuous basis. Provision is made for processing code forms other than NRZ. The number of bit errors (or bit matches) are presented on a visual digital display while simultaneously presented in BCD form as a printer output.

The BA-102 Series can be used in conjunction with PCM serial simulators to measure bit error rate of PCM processing systems. Operation is provided at bit rates from DC to 2 megacycles with data I/O threshold adjustable from +7 to -7 volts.

The power supply is self-contained and input/output connections are provided on both the front and the rear of the unit. A built-in delay to compensate for delay of the processing system under measurement is also provided.

For additional information write for Bulletin BA-102.



DEI
RESEARCH
DEVELOPMENT
MANUFACTURING

Defense Electronics, Inc.

Rockville, Maryland

(301)762-5700

TWX: 710-828-9783

WHAT ONE INSTRUMENT...

can be used to accurately test the frequency response of quartz crystals,

meeting the rigid requirements of stability, flatness, adjustability and frequency identification necessary for this precise operation?

can measure the dynamic impedance of a power supply at any frequency from 20 Hz to 3000 MHz,

or at several frequencies in that range, providing an instantaneous oscilloscope presentation of the supply's impedance characteristics?

can provide complete frequency transmission characteristics of telephone or other transmission lines

for equalizing operations, materially reducing testing time, supplying total frequency coverage, and eliminating correlation errors between first and last test readings?

What instrument that does all this can also determine filter passbands, compare input characteristics with phase/amplitude transmission, test relative inputs and outputs of an RF network, and perform many test functions in the lab or in production that by other methods took too much time and supplied incomplete data?

The answer is Telonic's **SM-2000 SWEEP GENERATOR**, a basic control unit that accepts 22 different plug-in oscillator heads covering 20 Hz to 3000 MHz in both wide and narrow frequency segments for a wide variety of applications. It is the most time-saving, versatile instrument you'll find on any test bench.

MORE APPLICATIONS-

On request, Telonic will be glad to send you an Application File Folder covering all techniques mentioned here in detail, in addition to many other applications for swept frequency measurements. Your request also places your name automatically on our mailing list to receive further application notes for the file.



60 North First Avenue, Beech Grove, Indiana
Tel: (317) 787-3231 TWX: 810-341-3202

International Leader in Swept Frequency Instrumentation.
Representatives in all major cities in the U.S.
and throughout the world.

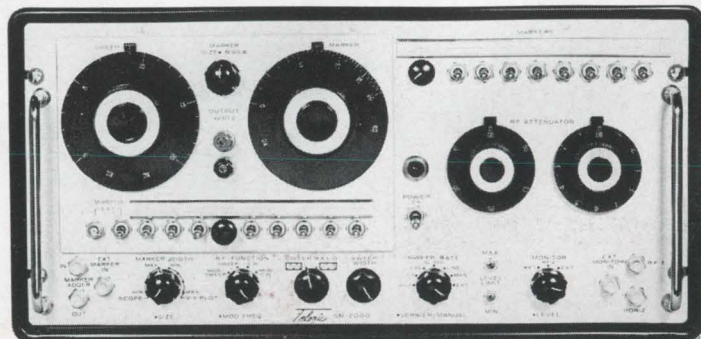
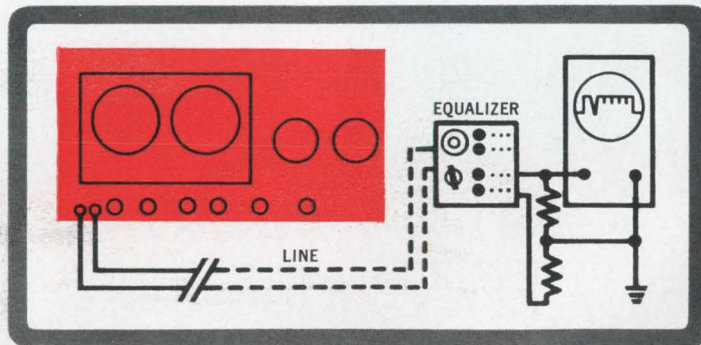
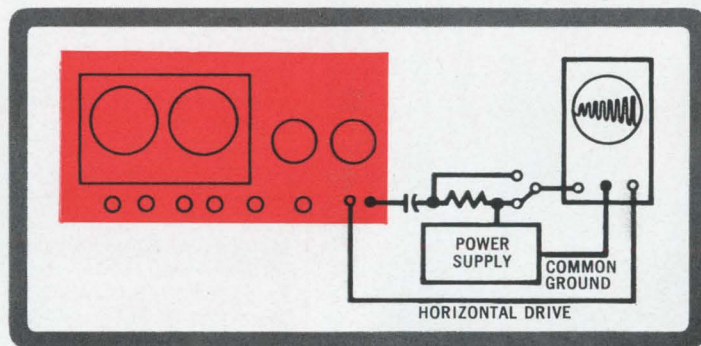
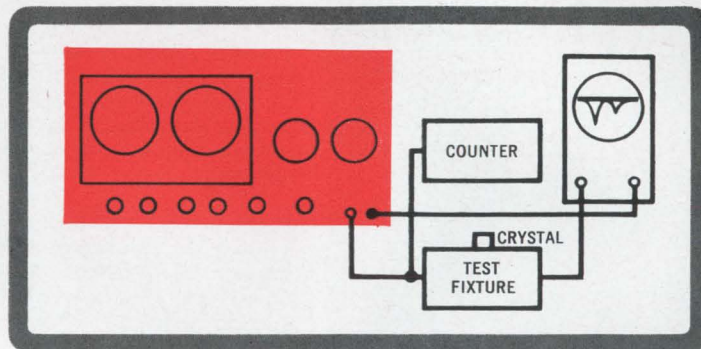

Electronics Abroad

Volume 38
Number 25

West Germany

Micron transistors

A research group at Telefunken AG in West Germany has apparently cracked open one of the barriers to the production of higher-frequency semiconductor devices. The barrier has been inaccuracy of dimensions at extremely small device sizes. Small transistors, diodes and integrated circuits can operate faster than big ones, but only if they are shaped precisely.

Telefunken has worked out a method called optical masking that is similar to the conventional photo-etching process but about 10 times as accurate. Lines as narrow as 0.3 micron have been developed in etching resist, and lines 0.4 micron wide have been etched in silicon dioxide. The thinnest line achieved with other techniques is 0.1 or 0.2 mil, or about 2½ to 5 microns, according to Hans-Juergen Schuetze, head of the Telefunken research group. A micron is 0.000039 inch.

Windows. The Telefunken group projects directly onto the silicon wafer an optical image of the pattern to be etched—the windows through which silicon-device junctions and metal-film electrodes are formed.

Optical masking will soon be tried in the United States by the Microelectronics division of the Hughes Aircraft Co., under a development contract with the United States Air Force. Rainer Zuleeg, a native of Germany who heads device research at Hughes, received a preview of the technique last summer at the Telefunken laboratories in Ulm, while on a visit to Germany. With the masks, Zuleeg hopes to make multichannel field-effect transistors (FET's) that will operate at one gigacycle per second. Zuleeg's group previously had developed a 100-channel FET that operated at 300 megacycles

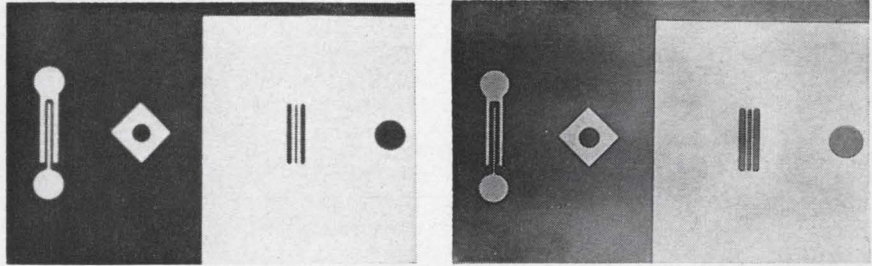

Submicron transistor patterns produced by optical masking. At left is a metal-film masking image; at right, pattern etched in silicon dioxide. Transistor's emitter line and base stripes are 0.65 micron wide, the wavelength of red light

per second [Electronics, Nov. 30, 1964, p. 46]. He now plans to shrink the channel structure, use 1,000 channels and thus boost frequency.

As a favor to Schuetze and his coworker, K. E. Hennings, at the recent Electron Devices Meeting in Washington, Zuleeg read a paper they had written about their method.

High-speed logic. Schuetze says high-speed, nanowatt logic circuits and high-capacity semiconductor memories can be made more economically by optical masking. Telefunken will be producing IC's with the technique in about a year, according to Richard Epple, head of device development at the company's plant in Heilbronn. Schuetze also anticipates applications in microwave transistors and microwave diodes.

Noncontact lenses. The usual method, contact masking, has inherent resolution problems, Schuetze says. First, light shining through the mask is diffracted, undermining the developed resist. Also, the mask and substrate cannot be aligned accurately.

Projecting the masking image through lenses above the substrate eliminates the diffraction problem. The two images are aligned by remagnifying the substrate image so that it appears to be in the same plane as the masking image.

Mike or camera. For patterns that are small but extremely precise, Telefunken projects the masking image through a microscope objective (lens) called a planopo-

chromate. For larger patterns but lower precision, high-resolution camera lenses are used. Carl Zeiss of Oberkochen helped to develop the lenses.

With an objective, lines 0.3 micron wide can be developed in resist over an area 0.2 millimeter square, or 0.6 micron over 0.5 mm square, or 1 micron over 2 mm square.

Camera lenses produce 3-micron lines over a 20-mm square area. Schuetze thinks the camera lenses will prove most popular because they give a better ratio of image area to resolution, and can be used for large etching patterns. He hopes to obtain 1-micron lines over a 1-inch square area, with lenses being developed.

Step and repeat. An inch square is big enough to cover most of a silicon wafer. Usually, many devices—1,000 or more transistors, for example—will be made in a wafer. This requires repetitive patterns, such as the contact masks now made on photographic film by step-and-repeat cameras.

Repetitive images can be prepared for the camera-lens method in the same way. Repetitive images can be developed on the silicon wafer with the microscope method. Line width is 1 micron over a 1-inch square when the repeating is done mechanically. Schuetze thinks he can cut this to 0.5 micron if the masking images have a resolution of 0.3 micron and if the repeater is guided electronically.

Such precise masks must be

made of thin-metal film on glass. The metal is etched with patterns that are reduced from large artwork and developed in very thin layers of resist on the metal film.

Fallen Starfighters

The pride of the new Luftwaffe—but clearly not its joy—is the F-104 Starfighter, 500 of which have been built in Germany under license from the Lockheed Aircraft Corp. Last month the Luftwaffe's 10th birthday was marred by the grounding of all Starfighters following three crashes in a week and 22 so far this year. Each plane will be thoroughly tested before it is allowed back into the air.

Unlike a previous controversy, this one has not implicated the plane's electronic systems, which account for more than half of the \$1.75-million cost of each aircraft. This time, critics—such as the influential newspaper *Die Welt*—are calling for more electronics in the form of more advanced, automatic testing gear.

A complex plane. The hassle last year centered on the inertial guidance system, the LN-3, made by Litton Industries, Inc. This time, it is charged that the Luftwaffe's ground maintenance and testing procedures and equipment are inadequate to keep the complex Starfighter in good operating order.

The German Air Force might be less sensitive to such attacks were the accident rate the same in the air forces of other members of the North Atlantic Treaty Organization. But only 4 of 130 Starfighters in the Dutch Air Force have crashed, 2 of Belgium's 100 and none of Denmark's 29.

Computer push

Siemens & Halske AG, West Germany's biggest electronics company, plans a \$125-million push to expand its puny—6% to 7%—share of the domestic computer market.

The first step will be creation of a \$10-million computer-development center in Munich; then \$5 million will be spent to expand Sie-

mens' manufacturing plants in that city. Most of the rest will be spent on development, production and distribution.

The International Business Machines Corp. is estimated to have installed 70% of the computers in use in West Germany. Another United States company, the Remington Rand Corp., is a poor second with 7% to 8%.

Link with RCA. The German company has sold fifty 4004-model computers, which it manufactures and sells under a cross-licensing agreement with the Radio Corp. of America. The 4004 is Siemens' name for the RCA Spectra 70.

Siemens plans to increase the share of domestically produced components for the 4004 computer—to 70% from 30%.

Canada

Electronic quiz

The trouble with intelligence tests is that many psychologists disagree on the definition of intelligence. Furthermore, some test results are affected by differences in the subjects' reading ability, cultural experience and emotional state.

An Ottawa psychologist, John P. Ertl, thinks he may be on the way to an electronic solution. His system requires no overt response, dealing as it does directly with the subject's brain. But Ertl cautions: "We are not measuring IQ (intelligence quotient) as such, but rather the neurological efficiency on which all intelligence depends."

Timing the waves. Ertl's system is based on the fact that when the brain reacts to any stimulus, it emits electrical signals. It is further dependent on two hypotheses: that a specific point in each wave train represents information-processing activity in the brain, and that the speed with which these information-processing signals follow the stimulus is proportional to that vague attribute called intelligence.

With financial support from the Ontario Mental Health Foundation,

Ertl has worked out a way to stimulate the brain and measure the brain's response time. He has compared his electronically derived cores with those obtained on standard IQ tests and found a 0.8 correlation; 1.0 is perfect correlation..

Light stimulus. The subject is stimulated by flashing a bright light in his eyes. These flashes occur at random, but average about one every three seconds. The brain signals are picked up by an electrode on the subject's head.

One technical problem was to select the weak signals—about 50 microvolts—from a noisy background. Ertl's system picks out and amplifies the information-processing signals with the help of an Enhancetron—a device made by the Nuclear Data Co. that samples such waves at as many as 1,024 points and enters these measurements in its memory. The Enhancetron extracts weak signals from backgrounds of nonfilterable random electrical noise by an electronic overaging technique.

After 100 measurements, the enhancetron displays the waveshape—representing the average of these measurements—on an oscilloscope. From the display, the operator can measure the interval between the stimulus and the information-processing signal.

One of this system's major potentials is still to be demonstrated. Ertl hopes it will provide a valuable way to detect mental retardation earlier than is now possible.

Great Britain

Stop and go

London bobbies will soon have a couple of computers helping them try to unsnarl that city's traffic. Late next year the British Ministry of Transport will test a closed-loop control system in a six-square-mile section of London that copes with a quarter of a million cars a day.

If the \$1.4-million experiment is successful, computerized traffic control will be extended to other

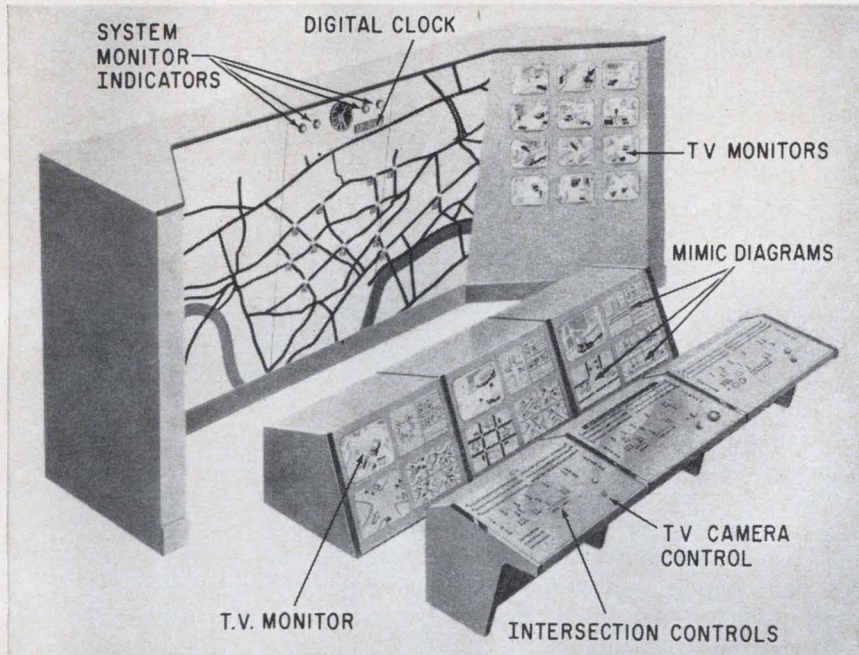

Traffic control. Artist's conception of wall map, tv monitors, and mimic diagrams showing details of intersections. Three control consoles are in foreground.

parts of the city. The electronic hardware, \$560,000 worth, is being supplied by the Plessey Co. Besides computers, the equipment includes data-transmission gear, control and display units, detectors and traffic lights.

Self governing. The London system will be a closed-loop feedback control; that is, the flow of vehicles will be determined automatically, based on traffic conditions. Other systems—for example in Munich and Los Angeles—compare traffic flow with a series of preset computer programs and select the most appropriate program.

London's vehicle-actuated controls will be subject to override by a computer in the central office and by manual controls.

Double check. The system will have two computers, one in the central processor, the other in a data-scanner unit. The scanner will collect information from vehicle detectors and rearrange it into a format intelligible to the central processor. Either computer will be able to check the other.

The computers will be along the lines of Plessey's XL type of digital machine. About 100 of these are being used in air-traffic control. Each computer has a 24-bit 4,096-

word core memory, expandable to 65,536 words. The core store's cycle time is about 2.5 microseconds. Magnetic-drum backing stores will compile data for traffic analysis and for storing programs.

Traffic detectors will be pneumatic and inductive loops. The pneumatic detectors—rubber tubes embedded in the road surface will measure the vehicles speed; the inductive loops, installed under the road surface, will sense the passage of vehicles and the backing up of traffic.

Outstations. At each traffic light a "data outstation" will convert data received from the central processor into an output that will control traffic-light switches. The outstation will also scan the condition of traffic lights and transmit the information to the central control office. The outstations, made with integrated circuits for high reliability, will be housed in weatherproof cabinets adjacent to the curb.

Television cameras installed at major intersections will allow the traffic picture to be monitored on screens at the central office. There will also be a wall-map display of the area showing whether each light is red or green.

Should the line with the central

office be broken, as in a partial power failure, the lights will be able to operate independently.

Japan

Printer catching up

Fast computers have at least one built-in problem: they outrun their printing units. One way to reduce computer waiting time is to write the output on tape, to be printed later; but this still results in some delay.

Now the Tokyo Shibaura Electric Co. (Toshiba) has developed an electrostatic printer that operates as fast as most Japanese digital computers. The printer, built at Toshiba's Central Research Laboratory, grinds out information at 152 lines a second, with 130 characters to a line; that's almost 20,000 characters a second. Tsutomu Honma, leader of the development group, says the speed has been increased experimentally to 250 lines a second.

In the United States, Stromberg-Carlson's 4020 is believed to be the fastest electrostatic printer. Made by the Stromberg-Carlson division of the General Dynamics Corp., the 4020 prints 3,600 lines a minute. But the company also manufactures a microfilm printer that produces as many as 20,000 lines a minute.

In quintuplicate. Toshiba has another advantage over other electrostatic printers: it can make as many as five copies, each as sharp as the original. Other printers of this type make only one copy. The Toshiba unit can print more than 100 different characters, a bigger variety at a faster speed than one developed by Hitachi, Ltd. [Electronics, March 22, p. 187] because it loses no time bringing a rotating type-wheel into position.

For each of the 130 character positions on a horizontal line, the Toshiba printer has five stylus electrodes. Opposite this row of 650 electrodes are 130 counter electrodes; between the two rows of electrodes travels a web of paper that has been coated to retain

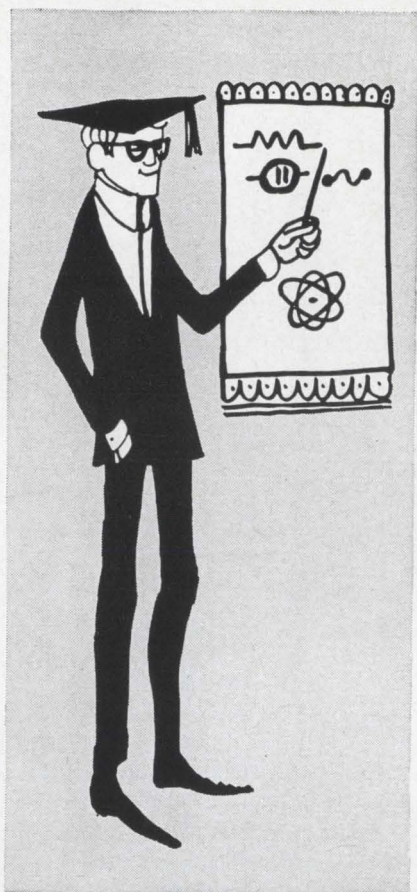

workability

(pre-production training)

WESTern PENNSylvania has a time-tested and proved-in-use plan by which adaptable, productive people with a variety of industrial aptitudes will be trained in advance in whatever skills are needed for YOUR particular operation, usually at no cost to you. For details—and information on 100% financing of industrial plants at low, low interest

rates . . . financing of equipment and machinery . . . loans for working capital . . . and WESTern PENNSylvania's favorable tax climate—send coupon, wire or call collect.



WEST PENN POWER

an operating unit of ALLEGHENY POWER SYSTEM

Area Development Department, Room 560
WEST PENN POWER—Greensburg, Pa. 15602
Phone: 412—837-3000

In strict confidence, I'd like details about WESTern PENNSylvania's: Pre-Production Training Favorable Tax Climate Financing Plans Industrial Properties and Shell Buildings

Name _____
Title _____
Company _____
Address _____
City _____ State _____
Code _____ Phone _____

electrostatic charges. The paper passes through the printer at 2.3 feet per second, and seven voltage pulses are applied between selected styluses and counter electrodes as the paper advances the 2.7-millimeter height of each symbol, producing the equivalent of a matrix five dots wide and seven dots high. The characters are formed from a pattern within this 35-dot matrix. Each character is 1.8 millimeters wide, and there is a 1.35-millimeter space between lines.

The limit. The paper is charged electrically at points corresponding to the energized styluses. After charging, the paper is developed with toner powder in the conventional manner, but not fixed. Toner from the coated paper is transferred, under pressure, to as many as five webs of ordinary paper to produce up to five copies. The print-out paper is fixed with heat, then cut into page-size sheets and stacked. The speed of cutting is the ultimate limit of the printer's overall speed, Honma says.

Page forms can be printed if desired, although they are not fitted to the experimental printer. Ability to use ordinary paper for the final print-out holds down the cost. The intermediate print-out, on coated paper, is not fixed, and the paper can be reused until it falls apart.

The printer is still experimental. It will not be connected to a computer before spring, Toshiba says. Meanwhile the company will continue to improve it, simulating a computer's output by using electrical signals. Toshiba, besides spending its own money, is aided by a research grant from the Japanese Ministry of International Trade and Industry.

France

No Nadge verdict

The timetable called for a \$280-million contract to be awarded early this month by the North Atlantic Treaty Organization, but the program—called Nadge for NATO Air-Defense Ground-Environment—has been derailed. Insiders at

NATO's annual ministerial meeting blame faulty project definition.

NATO knows what it wants technically, but bidders say the goals are impossible under the organization's price limits.

Bidders complain that Nadge was defined several years ago, with no subsequent provision for increasing costs. One says: "Nadge marks the first time such a vast international undertaking has been attempted on a fixed-cost basis."

Three choices. Details of the disagreement between bidders and NATO have not been disclosed, but sources close to the competition agree that the organization will have to make one of three moves:

- Relax the technical requirements demanded from bidders.
- Increase the ceiling beyond \$280 million.
- Kill the Nadge program.

The three competing consortiums are led by the International Telephone and Telegraph Corp., Westinghouse Electric Corp. and Hughes Aircraft Co.

Czechoslovakia

Eyes west

The small countries of Eastern Europe constitute a growing market for automatic air-traffic control systems, says Zdenek Zacek of the Czech transport ministry.

His own country ranks second only to the United States in air traffic, Zacek told an aeronautics symposium last month in Washington. With 13 major airports crammed into a country about the size of Louisiana, Czechoslovakia claims to have the highest air-traffic density in Europe.

Automation by '72. Eleven of these airports are being equipped for all-weather landing systems, Zacek says, and the Czech government is studying automation of air-traffic control. By 1968 the manufacture of hardware is expected to begin in Czechoslovakia, he says, and in 1972 he expects an automated system to be in operation.

Most of the radar systems, both

primary and secondary, are being made in Czechoslovakia, but those for the automated system will probably be imported, he adds. The Czech air ministry, and those of other countries in the Soviet bloc, will look to the West for these and for computers, Zacek predicts.

Soviet systems. Why won't the Czechs buy this equipment from the Soviet Union? Zacek says the Russian equipment available does not meet Czech specifications.

The Soviet Union is known to have installed improved gear in recent years for ground control at its own civilian airports, but nothing that could be called automatic beyond the usual air-route radio channels. But little is known about Soviet aviation equipment because it all comes under military secrecy. Aeroflot, the national airline is a branch of the Soviet air force which, in turn, is part of the Red Army.

Around the world

Great Britain. A two-year study of ways to apply pneumatic fluid logic to digital control systems has won support from the British Science Research Council. The research will be conducted at Birmingham University. A principal goal is the development of simple digital feedback servomechanisms for controlling machine tools.

Soviet Union. The Russians have transmitted Secam color-television programs from Moscow to Paris via their Molnya-1 communications satellite. The experimental broadcast arrived in Paris strong and clear. The Russians also have promised to do something about the high prices of color-tv sets in the Soviet Union.

Sweden. The Swedish Post Office Board says it will invest about \$40 million over the next seven years to "automate" postal service. Mail-sorting machines, probably of West German manufacture, will be tested, the agency says, and electronic accounting machines will handle postal savings and money orders. Parcels will be sorted semi-automatically.

Ballantine AC-DC Digital Voltmeter

Model 355

Price: \$590



Measures Full Scale AC to 10 mV

Measures AC & DC from 0 to 1000 V

1/4% Accuracy f.s. for AC & DC Voltages up to 500 and for mid-band AC Frequencies

NEW The only Digital Voltmeter of its type in the U.S.A.

Ballantine's new Model 355 is a versatile, economical digital voltmeter . . . ideal for production line and quality control applications.

You'll find it useful in place of analog instruments in reducing personnel errors, in speeding up production. Its accuracy and reliability, so typical of Ballantine equipment, should start saving you time and money in its first day of operation.

The Model 355 features a servo-driven, three-digit counter with over-ranging . . . combines many virtues of both digital and analog voltmeters in one small, compact, economical package. Its large, well-lighted readout with illuminated decimal point, mode and range information, allows fast, clear readings, while the indicator can follow and allow observation of slowly varying signals. The position of the last digit can be interpolated to the nearest tenth, thus avoiding the typical "± 1 digit" restriction of a fully digitized display. An optional foot-operated switch retains voltage readings and enables you to cut the time between successive readings materially. Another aid in reducing personnel errors is provided by an over-range indicator that signals excessive input or voltage of the wrong polarity.

PARTIAL SPECIFICATIONS

Voltage Range	AC	DC	Accuracy in % of Full Scale	
	0 to 1000	0 to 1000	AC	DC
Full scale, most sensitive range	10 mV	100 mV	1 mV to 500 V	1/4%, 50 Hz to 10 kHz 1/2%, 30 Hz to 50 kHz 1%, 50 kHz to 250 kHz
	30 Hz to 250 kHz	DC		
Optional Model 600 Resistors	are available for measuring current directly in volts		Power Requirements	115/230 V, 50-60 Hz, 5 1/2 W
			Relay Rack Version	Model 800 rack mounting kit is optional

Write for technical data sheet

Member Scientific Apparatus Makers Association

— Since 1932 —



BALLANTINE LABORATORIES INC.

Boonton, New Jersey

CHECK WITH BALLANTINE FIRST FOR DC AND AC ELECTRONIC VOLTMETERS/AMMETERS/OHM METERS, REGARDLESS OF YOUR REQUIREMENTS. WE HAVE A LARGE LINE, WITH ADDITIONS EACH YEAR. ALSO AC/DC LINEAR CONVERTERS, AC/DC CALIBRATORS, WIDE BAND AMPLIFIERS, DIRECT-READING CAPACITANCE METERS, AND A LINE OF LABORATORY VOLTAGE STANDARDS FOR 0 TO 1,000 MHZ.

Electronics advertisers

December 13, 1965



ADC Products Inc. John Gompper & Associates	234	Chuo Electric Ltd. Standard Advertising Inc.	224	General Electric Company, Silicone Products Dept. Ross Roy Inc.	54, 55
AMP Incorporated Garceau, Hargrave & McCullough Inc.	65	Clairex Corporation Michel Cather Inc.	205	General Electrodynamics Corp. Evans Young Wyatt Adv.	234
Acme Electric Corporation Scheel Adv. Agency	127	Clare & Company, C.P. Reincke, Meyer & Finn Adv.	56, 57	General Micro-Electronics Jack Herrick Advertising Inc.	40, 117
Acopian Corporation Mort Barish Associates Inc.	180	Cleveland Institute of Electronics Carr Liggett Advertising Inc.	208	General Radio Company K.E. Morang Company	6
Adage Inc. Fuller & Smith & Ross Inc.	177	Cohu Electronics Inc. Erwin Wasey, Ruthrauff & Ryan Inc.	113	General R-F Fittings Co. Inc. Van Christo Associates	199
Aerovox Corporation, Hi-Q Division Lescarboura Advertising Inc.	145	Collins Radio Company Tracy-Locke Company Inc.	190, 191	Gudebrod Bros. Silk Co. Inc. Lee Ramsdell & Co. Inc.	66
Air France Fuller & Smith & Ross Inc.	201	Cominco Products Inc. McKim Productions Limited	188	Hamilton Watch Company Beaumont, Heller & Sperling Inc.	164
Airpax Electronics Inc. Welch, Mirabile & Company Inc.	141	Colorado, State of Buchen Advertising Inc.	183	Hayakawa Electronics Co. Ltd. Dai-ichi International Inc.	228
Air Products & Chemicals Inc. Arthur Falconer Associates Corporation	47 to 50	Communication Electronics Inc.	186	Haydon Switch & Instrument Inc. Cory Snow Inc.	213
Airesearch Mfg. Div. of Garrett Corporation J. Walter Thompson Company	218	Consolidated Electrodynamics Corporation Hixson & Jorgensen Inc.	64	Heinemann Electric Company Thomas R. Sundheim Inc.	16
AIWA Company Ltd. Diamond Zasshi Adv. Co. Ltd.	224	Consolidated Vacuum Corporation Wolff Associates Inc.	195	Hewlett Packard Company Lennen & Newell Inc.	1, 147
Amelco Semiconductor, Div. of Teledyne Inc. Sturges and Associates	138	Controls Company of America The Harry P. Bridge Company	154	Hitachi Ltd. Dentsu Advertising Ltd.	116
American Electronic Laboratories Inc. Benn Associates	196	Datex (Div. of Giannini Controls Corp.) Faust/Day Inc. Advertising	168	Houston Omnigraphic Corporation Cooley & Pate Inc.	170
American Optical Company Fuller & Smith & Ross Inc.	175	Defense Electronics Inc. H. Durand Associates	235	Hughes Aircraft Company Foote, Cone & Belding Inc.	185
Astrodata Inc. Bonfield Associates Inc.	15	Delco Radio Division of General Motors Corporation Campbell-Ewald Company	132, 133	IMC Magnetics Corporation Monad Advertising Design	219
Ballantine Laboratories Lang-Lawrence Advertising Inc.	241	Delevan Electronics Corporation Clayton A. Stahika Advertising Company	184	I E E E Exhibition Alpaugh Advertising	220
Barnes Engineering Company Diener & Dorskind Adv.	46	Di-Acro Corporation Charles E. Brown Advertising	144	Ichizuka Optical Company Ltd. Matsushita Inc.	186
Beckman Instrument Inc. Berkeley Division Hickson & Jorgensen	39	Dialight Corporation H.J. Gold Co. Advertising	205	Industro Transistor Milchar Advertising Co. Inc.	45
Beede Electrical Instruments Co. Inc. S. Gunnar Myrbeck & Company	202	Digital Equipment Corporation Kalb & Schneider Inc.	30	Japan Electronics Instrument Co. Eastern Promotions	244
Bendix Corporation, Montrose Division MacManus, John & Adams Inc.	122	DuPont de Nemours & Co. Inc. E.I. Batten, Barton, Durstine & Osborn Inc.	53, 156	Johnson Company E.F. Firestone Advertising Inc.	215
Bendix Corporation, Semiconductor Division MacManus, John & Adams Inc.	9	Eastman Kodak Company The Rumrill Company Inc.	27	Jungner AB Instrumentfabriken Drevas ABS Gumelius Annonsbyra	201
Bliss Company, Eagle Signal Division Feeley Advertising Agency Inc.	18, 19	Electro Products Laboratories Inc. C.M. Gotsch, Advertising	195	Kansai Televi Kogyo Co., Ltd. Osaka Koken Co. Ltd.	202
Boonton, Div. of Hewlett Packard Co. George Homer Martin Associates	31	Electro Tec Corporation McClellan & Associates Inc.	43	Kepeco Inc. Weiss Advertising	22
Bourns Inc. Allen, Dorsey & Hatfield Inc.	149	Epsco Incorporated L.K. Frank Company Inc.	10	Kyoritsu Electrical Instrument Works, Ltd. AMO, Advertising & Marketing Organization	206
Bristol Company, The Chirurg & Cairns, Inc.	174	Erie Technological Products Co. Inc. Altman-Hall Associates	143	Kyoto Ceramic Company Ltd. Daiko Advertising Inc.	214
Brush Instruments Div. of Clevite Corp. Carr Liggett Adv. Inc.	3rd Cover	Fairchild Semiconductor Corp. Faust/Day Inc. Advertising	12, 13, 135	Leach Corporation Jay Chait & Associates	119
Bulova American Time Products Ted Gravenson Inc.	158	Fairchild Semiconductor Corp. Johnson & Lewis Inc.	124	Lockheed-California Company McCann-Erickson	193
Bussmann Mfg. Co. Div. of McGraw Edison Co. Henderson Advertising Company	11	Fenwal Electronics Inc. Larcom Randall Advertising Inc.	220	Machlett Laboratories Inc. Fuller & Smith & Ross Inc.	8
CML Inc. Keyes, Martin & Company	215	Fuji Denpa Industry Co. Ltd. Eastern Promotions Inc.	198	Mallory & Company Inc., P.R. The Aitkin-Kynett Company	60, 61
CTS Inc. Burton Browne Advertising	153	Fujitsu Limited Fuji Agency	181	Marconi Instruments Armand Richards Advertising Agcy.	152
CTS Knights Inc. Burton Browne Advertising	166	General Electric Company, Electronic Components George R. Nelson Inc.	28, 29	Markel & Sons, L. Frank George Moll Advertising Inc.	221
Cambridge Thermionic Corporation Chirurg & Cairns, Inc.	199, 223	General Electric Company, Magnetic Materials Div. George R. Nelson Inc.	63	Matsushita Electric Dentsu Advertising	120
Carborundum Company The Rumrill Company	42	General Electric Company, Miniature Lamp Dept. Batten, Barton, Durstine & Osborn Inc.	187	Matsunaga Manufacturing Co. Ltd. Asia Advertising Agency Inc.	196
Carpenter Steel Company Beaumont, Heller & Sperling	129			Matsuo Electric Co., Ltd. Fuji Agency	215
CELCO Stano Advertising	165				
Christie Electric Corporation Len Woolf Company Advertising	192				

Executive, editorial, circulation and advertising offices: McGraw-Hill Building, 330 West 42nd Street, New York, N.Y., 10036. Telephone (212) 971-3333. Teletype TWX N.Y. 212 640-4646. Cable: McGrawhill. N.Y. Officers of the Publications Division: Shelton Fisher, President; Vice Presidents: Joseph H. Allen, Operations; Robert F. Boger, Administration; John R. Callahan, Editorial; Ervin E. DeGraff, Circulation; Donald C. McGraw, Jr., Advertising Sales; Angelo R. Venezian, Marketing. Officers of the Corporation: Donald C. McGraw, President; L. Keith Goodrich, Hugh J. Kelly and Robert E. Slaughter, Executive Vice Presidents; John J. Cooke, Vice President and Secretary; John L. McGraw, Treasurer. Title R registered U.S. Patent Office; © copyright 1965 by McGraw-Hill, Inc. All rights reserved, including the right to reproduce the contents of this publication, in whole or in part.

Electronics advertisers

December 13, 1965

Matthews & Company, Jas. H. W.S. Hill Company	225	Radio Corporation of America Al Paul Lefton Company	4th Cover	Tobe Deutschmann Laboratories Engineered Advertising	148
McGraw-Hill Book Co. Inc.	228	Radio Engineering Laboratories Arthur Falconer Associates Corp.	151	Tonegen Electronics Co. Ltd. Sun-Gain Shia, Ltd.	199
■ Meguro Electric Instrument Co. Ltd. General Advertising Agency	222	■ Radio Frequency Laboratories Inc. J.A. Brady & Company	212	Toyo Cone Paper Co. Ltd. Sanko Sha Advertising Agency	213
■ Metal Removal Company, The Advertising Producers Associated Inc.	200	■ Radio Materials Company Div. of P.R. Mallory Co. Edro Advertising Inc.	171	Toyo Denki Seizo K.K. Diamond Publishing Co. Ltd.	212
Metronix Corporation Standard Advertising Inc.	220	Rese Engineering Inc. Joseph Gering/Graphic Design Associates	198	■ Toyo Electronics Industry Corporation Dentsu Advertising	221
M. I. A. L., U. S. A. Inc. Keys, Martin Company	213	■ Ribet-Desjardins Inter-Plasn	182	Triplett Electrical Instrument Co. Burton Browne Advertising	121
Microwave Electronics Corporation Bonfield Associates Inc.	209	Rohde & Schwarz Inc. Ted Gravenston Advertising	114, 115	Trygon Electronics The Wexton Company Inc.	140
Minato Electronics Co. Ltd. Diamond Zasshi Adv. Ltd.	184	S.D.S.A. Publi-Service	130	■ Trylon Inc. George Moll Adv. Inc.	180
Minnesota Mining & Mfg. Company, Mincom Div. Reach, McClinton & Co. Inc.	179	Sanborn Company, Div. of Hewlett Packard Co. Culver Advertising Inc.	2	United Aircraft Corporation, Vector Department Div. Cunningham & Walsh Inc.	17
Minnesota Mining & Mfg. Company, Scotchpar Division Klau-Van Pietersom-Dunlap Inc.	146	Shizuki Electrical Mfg. Co. Ltd. New Asia Trading News Agcy.	192	■ United Transformer Corporation Philip Stogel Company Inc.	2nd Cover
Missouri Commerce & Industrial Div. Frank Block Associates	189	Showa Musen Kogyo Co. Ltd. Nippon Advertising Agency Inc.	225	Vector Electronic Company Inc. Van Der Boom, McCarron Inc.	68
■ Mitsubishi Electric Corporation Hakuhodo Inc.	225	■ Silicon Transistor Corporation A.D. Adams Advertising Inc.	67	Wayne Kerr Corporation Josephson, Cuffari & Company	178
■ Mitsumi Electric Company, Ltd. Sanko Tsushinsha Ltd.	210	Sinclair Radio Laboratories Inc. John E. Hayes Company Inc.	217	Westinghouse Semiconductor Division ITSM	123
Motorola Semiconductor Products Inc. Lane and Bird Advertising Inc.	20, 21	Sony Corporation Standard Advertising Inc.	162	Weston-Boonschaft & Fuchs Arndt, Preston, Chapin, Lamb & Keen Inc.	188
■ Murata Mfg. Co. Ltd. Daiko Ltd.	217	Space Craft Inc. Neals & Hickok Incorporated	222	West Penn Power Company Fuller & Smith & Ross Inc.	240
National Cash Register Company Allen, Dorsey, Hatfield Inc.	197	Speer Carbon Company Hazard Advertising Company	169	Wood Electric Corporation L.K. Frank Company Inc.	222
Natvar Corporation, The Sanger-Funnell Inc.	204	Sperry Semiconductor Div. of Sperry Rand Corporation Armand Richards Advertising Agency	150	Yaou Electric Co. Ltd. Hakuhodo Incorporated	41
Nichicon Electronics Co. Ltd. Dai-Ichi International Inc.	235	Sprague Electric Company The Harry P. Bridge Company	5, 7, 14	Xerox Corporation Deutsch & Shea Inc.	172, 173
Nihon Kaiheiki Ind. Co. Ltd. Eastern Promotions, Inc.	207	Stackpole Carbon Company Meek and Thomas Inc.	167	■ Zeltex Inc. Sturges and Associates	203
Nippon Communication Industrial Co. Standard Advertising Inc.	188	Standard Telephone & Cables Limited Div. of ITT Brockie, Haslam & Company	137		
Nippon Electric Company Ltd. Hakuhodo Incorporated	227	Stromberg-Carlson Corporation The Rumrill Company Inc.	216		
Nippon Ferrite Industrial Co. Ltd. General Advertising Agency	216	Struthers-Dunn Inc. The Harry P. Bridge Co.	139		
Nishimura Musen-Denki Co. Ltd. Nichiden Adv. Ltd.	207	■ Superior Tube Company Gray & Rogers Inc.	136		
North Atlantic Industries Inc. Murray Heyert Associates	44	Sylvania Electric Inc. Lennen & Newell	118		
		■ Syntronic Instruments Inc. Burton Browne Advertising	244		
Okaya Musen Co. Ltd K.K. Kyoei Kokoku Sha	192				
■ Oki Electric Industry Co. Ltd. Standard Advertising Inc.	203	TRW Electronics Fuller & Smith & Ross Inc.	37		
		Taber Instrument Corporation Harold Warner Advertising Inc.	131		
Pamotor Inc. Harry P. Bridge Co., The	210	■ Taiyo Denki Company Ltd. Sanko Sha Advertising	216		
■ Pennsalt Chemicals Corporation The Aitkin-Kynett Company	163	Taiyo Electronics Corporation Standard Advertising Agency	214		
■ Perfection Mica Company, Magnetic Shield Div. Burton, Browne Advertising	207	Teikoku Tsushin Kogyo Co. Ltd. Dentsu Advertising Ltd.	219		
Perkin Elmer Corporation Gaynor & Ducas Inc.	176	■ Tektronix Inc. Hugh Dwight Adv. Inc.	62		
■ Permag Corporation Schneider Allen Walsh Inc.	244	■ Telonic Engineering Company Jensen Associates	211		
Philco Corporation Lansdale Division Batten, Barton, Durstine & Osborn Inc.	211	■ Telonic Industries Inc. Jansen Associates	236		
■ Polarad Electronic Instruments Keys, Martin & Company	59	Telrex Laboratories George Homer Martin Associates	214		
Potter & Brumfield Div. of American Machine & Foundry Co. Grant, Schwenck & Baker Inc.	24	Texas Instruments Incorporated Industrial Products Group Robinson-Gerrard Inc.	160, 161		
■ Precision Tube Company Inc. George Moll Advertising Inc.	126	Texas Instruments Incorporated Metals & Controls Inc. Horton, Church & Goff, Inc.	194		
Precision Scientific Company Tri-State Advertising Company	159	Thermal American Fused Quartz Company Knip Associates	206		
■ Primo Company Ltd. General Advertising Agency	198	Thermotech Industries Inc. Anderson-Madison Adv. Inc.	219		
Princeton Applied Research Corp. Mort Barish Associates	32	Thiokol Chemical Corporation MacManus, John & Adams Inc.	155		
■ Printact Relay Division of Executone Inc. J.A. Richards Advertising	226				

Classified advertising

F.J. Eberle, Business Mgr.	
EMPLOYMENT OPPORTUNITIES	230-232
EQUIPMENT (Used or Surplus New) For Sale	233

Classified advertisers index

A & A Electronics Corp.	233
Addison-Wesley	233
Atomic Personnel Inc.	232
Easy-Up Inc.	233
Electronic Communications Inc.	231
Engineering Associates	233
General Electric Co.	
Heavy Military Electronics Dept.	230
Kaiser Aluminum & Chemical Corp.	232
Keystone Electronics Corp.	233
Norman Electronic Sales	233
Philadelphia Naval Shipyard	232
Radio Research Instrument	233

■ For more information on complete product line see advertisement in the latest Electronics Buyers' Guide

WHICH DEFLECTION YOKE FOR YOUR DISPLAY ?

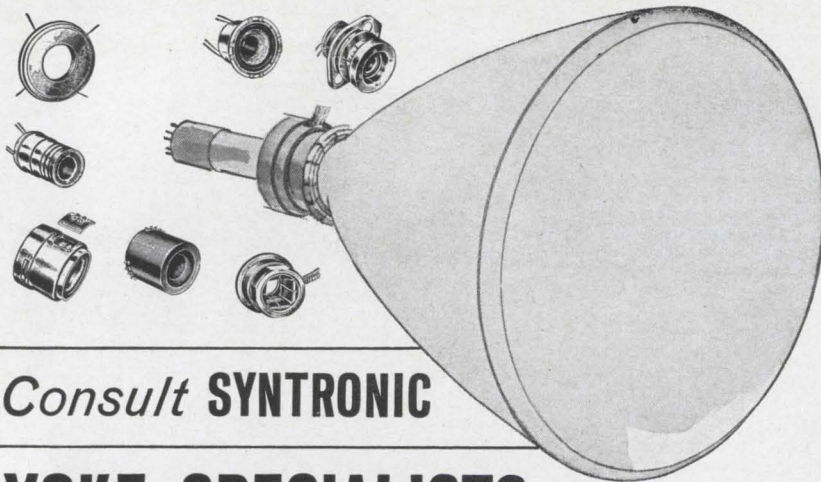

Consult **SYNTRONIC**

YOKE SPECIALISTS

Syntronic's team of experts knows more about yoke design, engineering and quality control than anyone else. A solid 10-year record of leadership—acknowledged throughout the industry. Benefit from it.

syntronic INSTRUMENTS, INC.
100 Industrial Road, Addison, Illinois
Phone: Kingswood 3-6444

Circle 342 on Reader Service Card

NEED MAGNETS? YOU CAN'T MISS WHEN YOU CALL PERMAG

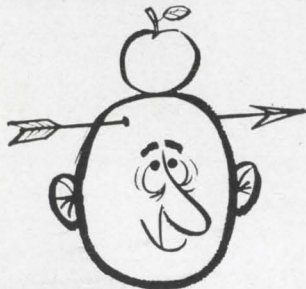

We stock all sizes, all shapes, all grades, for all uses . . . all ready for 24-HOUR DELIVERY. Including soft magnetic materials—now available for the first time in small, less-than-mill-run quantities. Also, magnets engineered and fabricated to your needs. Write for catalog and data sheets.

PERMAG PACIFIC CORP. 5441 W. 104th St.
Los Angeles, Calif. 90045 / Phones: Area Code
213 776-5656, 213 670-7060 / TWX: 213 670-0408

PERMAG CENTRAL CORP. 5301 D. Otto Ave.
Rosemont, Des Plaines, Illinois 60018 / Phone:
Area Code 312 678-1120

PERMAG CORP. 88-06 Van Wyck Expressway
Jamaica, New York 11418 / Phone: Area Code
212 OLYMPIA 7-1818 / TWX: 212 479-3654

JEIC SOUND LEVEL METER



THE MOST USED IN JAPAN

Measuring Range: 35 dB to 130 dB
Conforms to JIS C-1502 Standard or
IEC Standard.

JEIC is the representative manufacture
of all kinds of sound and vibration
measuring instruments in Japan.

JAPAN ELECTRONIC INSTRUMENT CO., LTD.

2-445 Nakameguro, Meguro-ku, Tokyo, Japan
Phone: Tokyo 719-6411

Circle 343 on Reader Service Card



Advertising sales staff

Gordon Jones [212] 971-2210
Advertising sales manager

Atlanta, Ga. 30309: Gus H. Krimsier,
Michael H. Miller, 1375 Peachtree St. N.E.,
[404] TR 5-0523

Boston, Mass. 02116: William S. Hodgkinson
McGraw-Hill Building, Copley Square
[617] CO 2-1160

Chicago, Ill. 60611: Robert M. Denmead,
J. Bradley MacKimm
645 North Michigan Avenue,
[312] MO 4-5800

Cleveland, Ohio 44113: Paul T. Fegley, 55
Public Square, [216] SU 1-7000

Dallas, Texas 75201: Richard P. Poole, The
Vaughn Building, 1712 Commerce Street,
[214] RI 7-9721

Denver, Colo. 80202: Joseph C. Page, David
M. Watson, Tower Bldg., 1700 Broadway,
[303] AL 5-2981

Detroit, Michigan 48226: Paul T. Fegley
856 Penobscot Building
[313] 962-1793

Houston, Texas 77002: Kenneth George,
2270 Humble Bldg.,
[713] CA 4-8381

Los Angeles, Calif. 90017: Ashley P.
Hartman, John G. Zisch, 1125 W. 6th St.,
[213] HU 2-5450

Minneapolis, Minn. 55402: J. Bradley
MacKimm 1104 Northstar Center
(612) 332-7425

New York, N. Y. 10036:
Donald R. Furth [212] 971-3615
Frank LeBeau [212] 971-3615
George F. Werner [212] 971-3615
500 Fifth Avenue

Philadelphia, Pa. 19103: William J. Boyle,
Warren H. Gardner, 6 Penn Center Plaza,
[215] LO 8-6161

Pittsburgh, Pa. 15222: Paul T. Fegley,
4 Gateway Center, (412) 391-1314

Portland, Ore. 97204: James T. Hauptli,
Pacific Building, Yamhill Street,
(503) CA3-5118

St. Louis, Mo. 63105: Robert M. Denmead
The Clayton Tower, 7751 Carondelet Ave.
[314] PA5-7285

San Francisco, Calif. 94111:
James T. Hauptli, 255 California Street,
[415] DO 2-4600

London W1: John W. Patten, Edwin S.
Murphy Jr., 34 Dover Street,
Hyde Park 1451

Milan: I, via
Baracchini Phone: 86-90-617
86-90-656

Frankfurt/Main: Gerd Hinske, 85
Westendstrasse Phone: 77 26 65 and
77 30 59

Geneva: Michael R. Zeynel, Joseph Wuensch,
1, rue du Temple
Phone: 31 95 60

Paris VIII: Denis Jacob, 17 Avenue
Matignon ALMA-0452

Tokyo: Nobuyuki Sato, 1, Kotohiracho
Shiba, Minato-Ku (502) 0656

Osaka: Kazutaka, Miura, 163, Umegee-cho,
Kita-ku [362] 8771

Nagoya: International Media Representatives,
Yamaishi Bldg., 13, 2-Chome,
Oike-cho Naka-ku

Hugh J. Quinn: [212] 971-2335
Manager Electronics Buyers' Guide

David M. Tempest: [212] 971-3139
Promotion manager

Milton Drake: [212] 971-3485
Market research manager

Wallace C. Carmichael: [212] 971-3191
Business manager

Theodore R. Geipel: [212] 971-2044
Production manager

Another Brush Innovation in Recording:

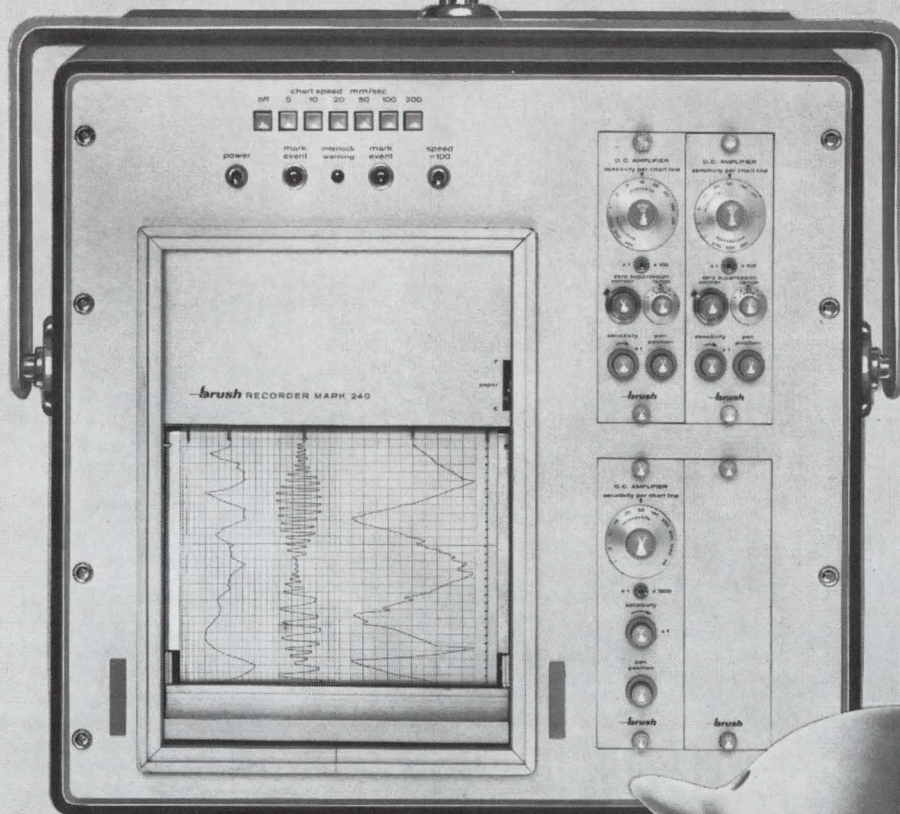

The Brush Mark 240

**If you can't record it
with this recorder,
chances are
it didn't happen!**



What we've done is this:

We took our famous Mark 200 Recorder and made a 'compact' version for general purpose and medical requirements. Performance? The new 240 will do everything the Mark 200 will do. And as Aerospace people will tell you, that's plenty: System linearity better than 1/2%. Pressurized fluid writing system assures incredibly crisp traces on low cost chart paper. Presentation is true rectilinear and there's push-button choice of 12 chart speeds.

Cost? The Mark 240 runs about

half as much as a Mark 200. Still, you have a choice of either four 40 mm analog channels, two 80 mm channels, or a combination* of two 40s and one 80. (You can also have 8-channel event-marker modules). There's a choice of 17 plug-in pre-amplifiers, too. High gain d-c units, straight-through couplers and strain-gage and demodulator types. The Mark 240 is just 17 1/2" high x 19" wide x 20 1/2" deep. Mount it vertically or horizontally in standard 19" racks to RETMA specs, on table-top carts or you name it!

If your kind of recording calls for the utmost in resolution, precision and recording flexibility, ask your Brush representative for complete details about the new Brush Mark 240. There's nothing else like it . . . anywhere! Brush Instruments Division, Clevite Corporation, 37th & Perkins, Cleveland, Ohio 44114. *Just out! Three information-packed booklets on strain recording, temperature recording and techniques of low-level recording. Write us today for your copies. They're yours for the asking!*

*see photo

CLEVITE
brush INSTRUMENTS DIVISION

TYPICAL QUANTUM-EFFICIENCY CURVES

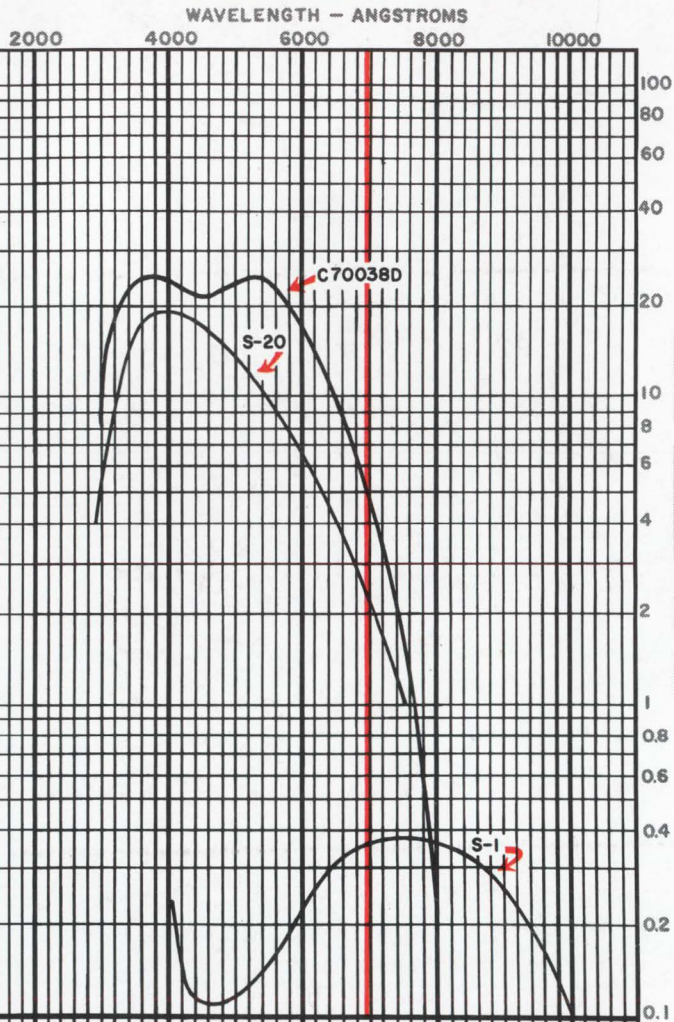

RCA-C70038D

Typical QE of 5.5% at 6943Å

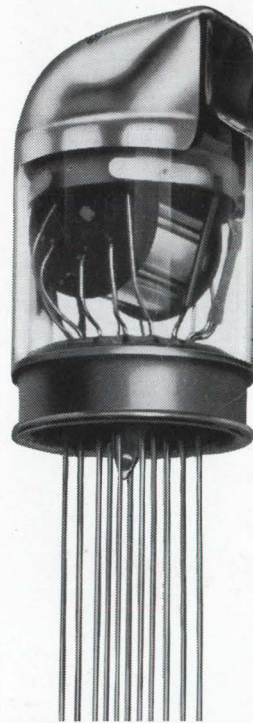

New dormer-window photomultiplier offers high performance and high speed for red and near-infrared LASER-beam detection

C70038D is new! Designed to detect low-level light in relatively high background brightness, it provides a quantum efficiency $2\frac{1}{2}$ times that of conventional multialkali (S-20) photocathodes at 6943 angstroms. C70038D, a 10-stage, developmental photomultiplier, achieves this advantage by introducing to the industry a multialkali photocathode deposited on a reflective substrate.

This new design approach provides excellent improvement in QE—as much as 250% when detecting ruby laser radiation. C70038D offers a typical QE of 25% at 5500Å; 5.5% at 6943Å (values greater than 8% have been obtained). Combine these features with high anode sensitivity and a rise time of 2.3 nsec at 1500 volts, and you have the high-speed, high-performance photomultiplier you need for LASER-beam detection systems in the red and near-infrared regions of the spectrum.

In addition, this dormer-window type unit can be used in star tracking, stellar navigation, surveillance systems, guidance systems, range finding, mapping, and communications.

Talk with your RCA representative about C70038D. Ask him, too, about the wide range of other RCA LASER-beam detectors as outlined in PIT-704, "RCA Near-Infrared LASER-Beam Detectors." For your copy, as well as technical data on C70038D, write: RCA Commercial Engineering, Section L19Q-2, Harrison, N. J.

RCA ELECTRONIC COMPONENTS AND DEVICES



The Most Trusted Name in Electronics