

# Electronics.

**Survey of passive microcomponents: page 48**  
**At last, solid-state gear for the military: page 63**  
**Communications and control on Gemini: page 71**

May 3, 1965

75 cents

A McGraw-Hill Publication

Below: field-testing new transistorized communications, page 63





# DI-T200™ SERIES

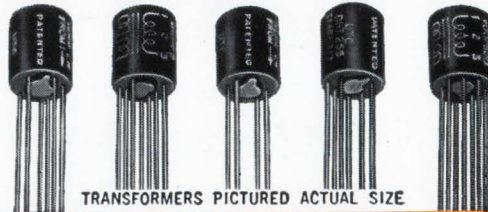

## ULTRAMINIATURE TRANSISTOR TRANSFORMERS & INDUCTORS

TYPICAL DI-T200 PERFORMANCE

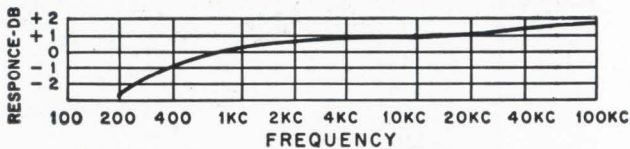
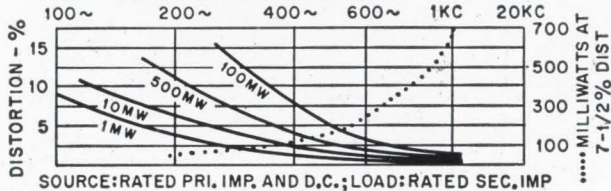

Type No.	Pri. Imp.	DCma† in Pri.	Sec. Imp.	Pri. Res.	Mw Level	Application
DI-T225	80 CT 100 CT	12 10	32 split 40 split	10	500	Interstage
DI-T230	300 CT	7	600 CT	20	500	Output or line to line
DI-T235	400 CT 500 CT	8 6	40 split 50 Split	50	500	Interstage
DI-T240	400 CT 500 CT	8 6	400 split 500 split	50	500	Interstage or output (Ratio 2:1:1)
DI-T245	500 CT 600 CT	3 3	50 CT 60 CT	65	500	Output or matching
DI-T250	500 CT	5.5	600 CT	35	500	Output or line to line or mixing
DI-T255	1,000 CT 1,200 CT	3 3	50 CT 60 CT	110	500	Output or matching
DI-T260	1,500 CT	3	600 CT	90	500	Output to line
DI-T265	2,000 CT 2,500 CT	3 3	8,000 split 10,000 split	180	100	Isol. or interstage (Ratio 1:1:1)
DI-T270	10,000 CT 12,000 CT	1 1	500 CT 600 CT	870	100	Output or driver
DI-T273	10,000 CT 12,500 CT	1 1	1,200 CT 1,500 CT	870	100	Output or driver
DI-T276	10,000 CT 12,000 CT	1 1	2,000 CT 2,400 CT	870	100	Interstage or driver
DI-T278	10,000 CT 12,500 CT	1 1	2,000 split 2,500 split	620	100	Interstage or driver
DI-T283	10,000 CT 12,000 CT	1 1	10,000 CT 12,000 CT	970	100	Isol. or interstage (Ratio 1:1)
DI-T288	20,000 CT 30,000 CT	.5 .5	800 CT 1,200 CT	870	50	Interstage or driver
DI-T204	Split Inductor (2 wds)	§ .1 Hy @ 4 maDC, .08 Hys @ 10 maDC, DCR 25Ω §§ .025 Hys @ 8 maDC, .02 Hys @ 20 maDC, DCR 6Ω				
DI-T208	Split Inductor (2 wds)	§ .9 Hys @ 2 maDC, .5 Hys @ 6 maDC, DCR 105Ω §§ .2 Hys @ 4 maDC, .1 Hys @ 12 maDC, DCR 26Ω				
DI-T212	Split Inductor (2 wds)	§ 2.5 Hys @ 2 maDC, .9 Hys @ 4 maDC, DCR 630Ω §§ .6 Hys @ 4 maDC, .2 Hys @ 8 maDC, DCR 157Ω				
DI-T216	Split Inductor (2 wds)	§ 4.5 Hys @ 2 maDC, 1.2 Hys @ 4 maDC, DCR 2300Ω §§ 1.1 Hys @ 4 maDC, .3 Hys @ 8 maDC, DCR 575Ω				

†DCma shown is for single ended usage (under 5% distortion—100mw—1 KC)... for push pull, DCma can be any balanced value taken by 5W transistors (under 5% distortion—500mw—1 KC) DI-T200 units have been designed for transistor application only... not for vacuum tube service. U.S. Pat. No. 2,949,591 other pending. Where windings are listed as split, ¼ of the listed impedance is available by paralleling the winding. §Series connected; §§Parallel connected.

- ➔ DUMET LEADS  
(gold plated, weldable and solderable)
- ➔ STRAIGHT PIN TERMINALS  
(printed circuit application)
- ➔ HIGHEST PERFORMANCE  
for size in the industry
- ➔ METAL ENCASED  
(Grade 4, Ruggedized)

**ALL STOCK UNITS MIL TYPE TF4RX  
Class "S" Available on Special Order**

High Power Rating..... up to 100 times greater.  
Excellent Response..... twice as good at low end.  
Low Distortion..... reduced 80%.  
High Efficiency..... up to 30% better... compare DCR.  
Moisture Proof..... hermetically sealed to MIL-T-27B.  
Ultraminiature Size..... 5/16 Dia. x ¾" H, 1/15 Oz.

The unique structural design of the DI-T200 series transformers and inductors provides the excellent electrical characteristics, high reliability and wide application possibilities inherent in the UTC DO-T family of miniaturized units. The DI-T200 series units employ the same high quality design found in UTC's DO-T, DI-T, and PIP lines. This unique transformer structural concept affords unprecedented power handling capabilities coupled with extremely small size. Further, the high degree of reliability has been dynamically proven in the field. These characteristics are basic in the structure, which is ruggedized, hermetically sealed, employing a completely rigid bobbin, eliminating stress and wire movement. The turns are circular in shape rather than square, eliminating turn corner stress, and effecting uniform wire lay. The coil wire and external lead are rigidly anchored terminal board fashion, employing no tapes and brought out through strain relief. The curves illustrated indicate the superior performance of these units compared to similar size units now on the market.

The leads are uninsulated 1" long, .017 Dumet wire, spaced on a .1" radius circle to conform to terminal spacing techniques of the "TO-5" case semiconductors and micrologic elements.

**IMMEDIATE DELIVERY  
FROM STOCK**

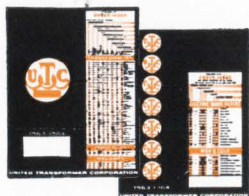

## UNITED TRANSFORMER CORP.

150 VARICK STREET, NEW YORK 13, N. Y.

PACIFIC MFG. DIVISION: 3630 EASTHAM DRIVE, CULVER CITY, CALIF.  
EXPORT DIVISION: 13 EAST 40th STREET, NEW YORK 16, N. Y. CABLE: "ARLAB"

# 2X10<sup>-11</sup> Accuracy\*

from a new  
compact,  
solid-state  
atomic  
standard

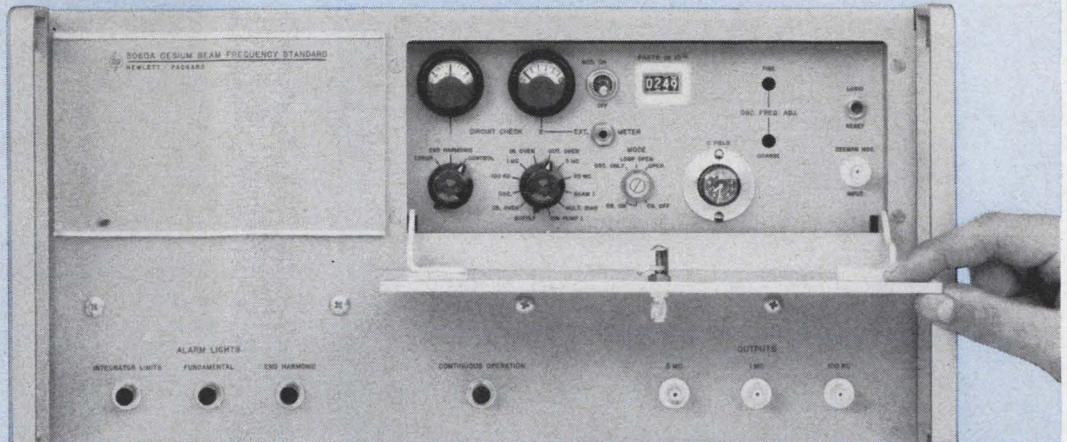

Long-life Cesium 133 resonator—plus:  
Reference to A<sub>1</sub> or UT<sub>2</sub> time scale  
Closed-loop self-checking control circuitry  
Highly stable quartz oscillator  
Only 8¾" high, 65 lbs.

Here's a true primary atomic standard which offers unprecedented features in an easily portable package. Reliability assurances include automatic continuous output monitoring and a rugged, spectrally pure, high precision quartz crystal oscillator which may be operated independently of the cesium beam resonator. The resonator itself has a guaranteed operating life of 10,000 hours.

The 5060A Frequency Standard operates from standard ac power or directly from a 28 v dc source. Especially useful is the provision for output readjustment for periodic changes of the time scale itself. For instance, internationally agreed UT<sub>2</sub> adjustments may be made with a simple component change.

Never before such a combination: Accuracy, reliability, ruggedness, portability, easy time scale adjustment for changing requirements. Check the specifications against your military, industrial or scientific requirements. Call your Hewlett-Packard field engineer, or write for complete information on the hp 5060A, Hewlett-Packard, Palo Alto, California 94304, Tel., (415) 326-7000; Europe: 54 Route des Acacias, Geneva; Canada: 8270 Mayrand Street, Montreal.

<b>Accuracy:</b>	± 2 x 10 <sup>-11</sup>
<b>Long-term stability:</b>	± 1 x 10 <sup>-11</sup> (for the life of the cesium beam tube)
<b>Short-term stability:</b>	rms fractional frequency deviation for 1 second averaging: $\frac{\Delta f_{rms}}{f} \leq 1 \times 10^{-10}$
<b>Signal-to-noise ratio (5 mc):</b>	At least 87 db at rated output; output filter bandwidth approx. 125 cps
<b>Harmonic distortion (5 mc, 1 mc and 100 kc):</b>	Down more than 40 db from rated output
<b>Output frequencies:</b>	5 mc, 1 mc, 100 kc sinusoidal, 100 kc clock drive
<b>Output voltages:</b>	1 v rms into 50 ohms, clock drive suitable for hp frequency divider and clocks
<b>Time scale adjustments:</b>	Adjustable in increments of 10 x 10 <sup>-10</sup> by changing a component in the frequency synthesizer; automatic monitor to indicate proper operation; A <sub>1</sub> or UT <sub>2</sub> time scales supplied to order
<b>Cesium beam tube life:</b>	10,000 hours guaranteed (operating)
<b>Power:</b>	115 or 230 v ac ± 10%, 50 to 1000 cps, or 22 to 30 v dc; approx. 50 w operating
<b>Size:</b>	16¾" wide, 8¾" high, 16½" deep, 65 lbs.
<b>Price:</b>	hp 5060A Cesium Beam Standard, \$15,500

\*Absolute: hp model 5060A is a true primary standard whose output frequency is uniquely defined by basic physical properties of the cesium atom. The specified accuracy is achieved without reference to frequency calibration sources.

**HEWLETT**  **PACKARD**  
An extra measure of quality

9039

# Get a record you can *clearly* read — even at 5 KC

... from the one system supplied complete with your choice of amplifier

Now you can have all the Sanborn advantages of a DC-5 KC optical oscillograph supplied as a complete, integrated package ready to record — plus clearer, higher resolution recordings made possible by improvements in optical system design and chart papers. Put eight traces on the 8" ultra-violet-sensitive chart of a standard "4500" system — with any trace across the full chart width and positioned by convenient front-panel controls. Or record up to 25 channels of high frequency information with optional versions. Save valuable time by recording all frequencies up to 5 kc with a single set of galvanometers driven by amplifiers incorporating frequency boost and compensating circuits, thus eliminating an "inventory" of different galvanometers and the time required to install and align a new set for each recording requirement. Make signal connections quickly and conveniently to front-panel or rear input connectors, and have complete operational control with amplifier front panel basic controls for each signal. Change system sensitivity from 2.5 mv/inch to 625 mv/inch by easily changing plug-in 8-channel amplifier modules (choice of four). Load paper in daylight . . . select any of 9 chart speeds by pushbutton or control them remotely . . . see fully developed traces a few seconds after recording . . . use system in mobile console, rack mount or portable cases.

Ask your local Sanborn Division/Hewlett-Packard sales office for technical data and expert application assistance. Offices in 47 U.S. and Canadian cities, and major areas overseas. Sanborn Division, Hewlett-Packard Company, Waltham, Mass.

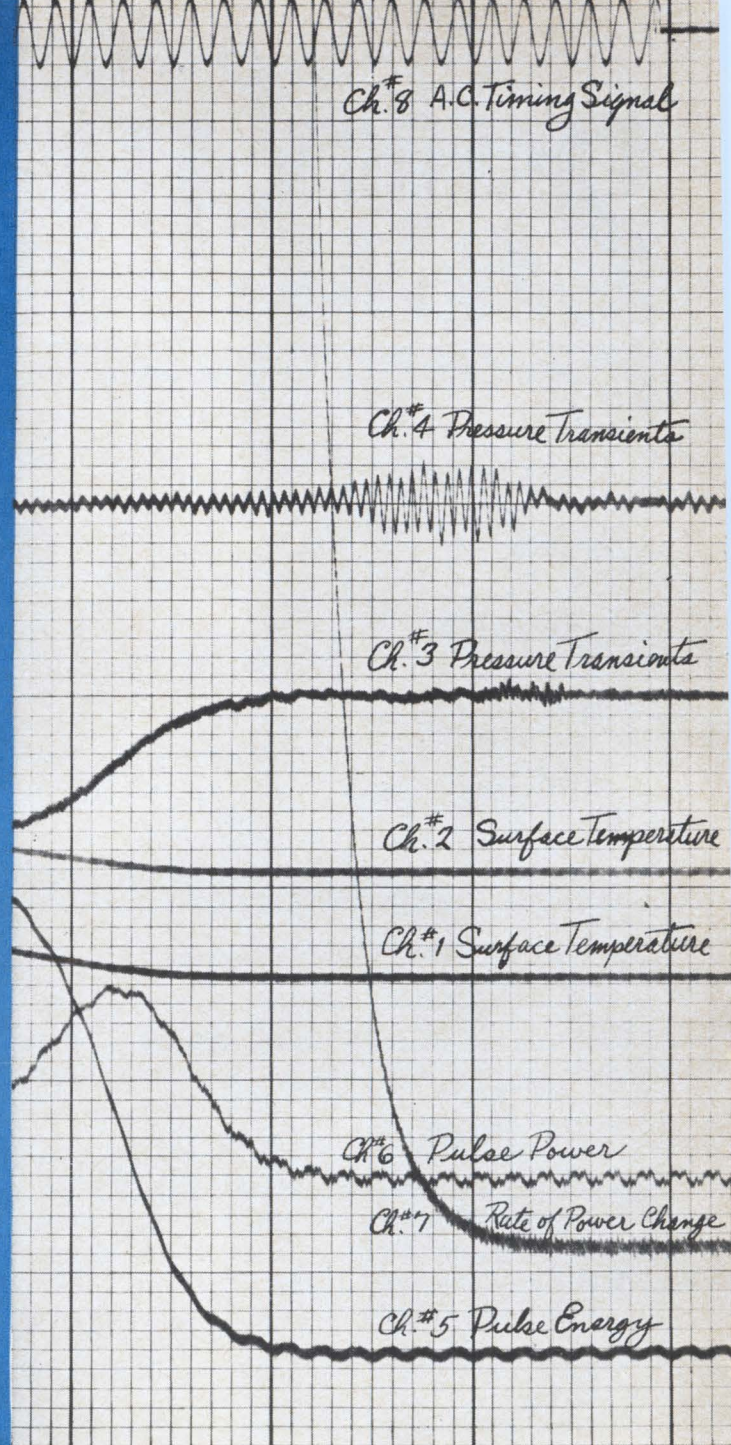
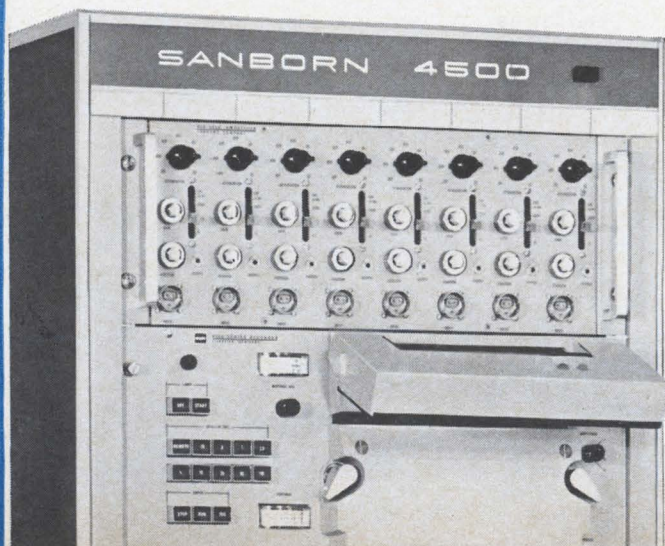

## Specifications — 4500 Series Optical Oscillographs

<b>Sensitivity</b>	625 mv/1", 50 mv/1", or 2.5 mv/1", depending on amplifier chosen.
<b>Frequency Response</b>	DC to 5 KC (-3db) at 4" p-p
<b>Common Mode Performance</b>	Rejec. ratio at least 140 db at DC, max. c.m. voltage $\pm 500$ v (with Medium Gain Amplifier)
<b>Linearity</b>	1½ % of full scale (8 inches)
<b>Gain Stability</b>	Better than 1%, 0° to 50°C, 103 to 127 (line) volts
<b>Noise</b>	0.02" p-p, max.
<b>Chart Speeds</b>	Nine, 0.25 to 100"/sec.
<b>Prices</b>	Complete 8-channel system in cabinet, with galvanometer driver amplifiers, \$6950; with medium gain amplifiers, \$8530 (F.O.B. Waltham, Mass.)

**HEWLETT  
PACKARD**  **SANBORN  
DIVISION**

# Electronics

May 3, 1965

Volume 38, Number 9

Page 4	Readers Comment
8	People
10	Meetings
15	Editorial
17	Electronics Newsletter
37	Washington Newsletter
119	New Products
145	New Books
147	Technical Abstracts
153	New Literature

## Electronics Review

Page 27	Russia's Telstar	30	Northeast passage
28	Light on a quarrel	32	No smear
28	Neutron movies	33	Powerful modulator
29	Rings for the laser	34	The FCC steps in
30	Spotting a twister	35	Antidote to a bug

## Electronics Abroad

155	Electronic reflexes	157	Scratch one consortium
155	Answers from aloft		
156	Progress on display	158	CATV in the Alps
157	Color tube unmasked	158	Emphasis on exports
157	On the plantation	158	Around the world

## Probing the News

103	Overseas defense market grows
105	Patent predicament
108	Realistic space flight—on the ground

## Technical Articles

### I. Design

<b>Microelectronics</b>	48	<b>A broader choice of components for silicon integrated circuits</b> More than a dozen alternatives to the familiar diffused resistor and capacitor are available R.M. Burger and R.P. Donovan, Research Triangle Institute
<b>Circuit design</b>	60	<b>Designer's casebook</b> FET in bridge circuit gates a 300-kc signal; photoconductors chop d-c signal levels; unijunction transistor latches relay with short pulses

### II. Applications

<b>Military electronics</b>	63	<b>Finally, the armed forces get solid state communications. (Cover)</b> Lack of money and a sense of urgency held back advances W.J. Evanzia, Avionics editor
<b>Space electronics</b>	71	<b>Gemini's electronic firsts</b> Inertial guidance system with versatile computer guides astronauts
	77	<b>Telemetry that's compact and reliable</b> Highly redundant pulse code modulation system transmits data Bernard N. Bohm, Electro-Mechanical Research Inc.
	88	<b>Retrieving data from Gemini</b> An inside look at the telemetry transmitter which has to operate in severe environments R.G. Erdmann, RCA
	83	<b>The capsule is no isolation booth</b> Line-of-sight and over-the-horizon communications connect astronauts and the ground R.E. Perkins and C.V. Wolfers, McDonnell Aircraft Corp.

# Electronics

**Editor:** Lewis H. Young

## Senior editors

**Technical:** Samuel Weber

**News:** Kemp Anderson, Jr.

**Senior associate editors:** John F. Mason, George Sideris

## Department editors

**Advanced technology:** Joan Blum

**Avionics:** W.J. Evanzia

**Circuit design:** Michael Elia

**Components:** Michael F. Tomaino

**Computers:** Wallace B. Riley

**Consumer electronics:** Richard Lipkin

**Instrumentation:** Carl Moskowitz

**Manufacturing:** George Sideris

**Military electronics:** John F. Mason

**New products:** William P. O'Brien

**Solid state:** Jerome Eimbinder

**Space electronics:** Peter R. Sigmund

**Staff writer:** Stanley Zarowin

## Regional editors

**Boston:** Thomas Maguire, editor; Robin Carlson

**Los Angeles:** William B. Wallace, editor; June Long

**San Francisco:** Laurence D. Shergalis, editor; Mary Jo Jadin

**London:** Derek Barlow, editor

## Copy editors

Howard Rausch, Sally Powell, Walter Barney

## Graphic design

**Art director:** Saul Sussman

**Assistant art director:** Donna M. Marchyn

**Editorial production:** Ann Mella

**Production editor:** Arthur C. Miller

**Editorial secretaries:** Claire Benell, Mary D'Angelo, Lynn Emery, Kay Fontana, Carolyn Michnowicz, Lorraine Rossi, Lorraine Werner

## McGraw-Hill news service

**Director:** John Wilhelm; **Atlanta:** Fran Ridgeway; **Chicago:** Bruce Cross;

**Cleveland:** Arthur Zimmerman; **Dallas:** Marvin Reid;

**Detroit:** Donald MacDonald; **Los Angeles:** Michael Murphy,

Ron Lovell; **San Francisco:** Margaret Ralston, Ed. Addeo;

**Seattle:** Ray Bloomberg; **Washington:** Arthur L. Moore, Glen Bayless,

Charles Gardner, Herbert W. Cheshire, Seth Payne

## McGraw-Hill world news service

**Bonn:** Richard Mikton; **Brussels:** Arthur Erikson; **London:** John Shinn;

**Mexico City:** Wesley Perry; **Milan:** Bruce Bendow;

**Moscow:** Donald Winston; **Paris:** Dan Smith;

**Rio de Janeiro:** Leslie Warren; **Tokyo:** Marvin Petal, Charles Cohen

**Circulation manager:** Hugh J. Quinn

**Reprints:** T.M. Egan

**Publisher:** C.C. Randolph

**Electronics:** May 3, 1965, Vol. 38, No. 9

Printed at 99 North Broadway, Albany, N.Y.  
Second class postage paid at Albany, N.Y.

Subscriptions are solicited only from those actively engaged in the field of the publication. Position and company connection must be indicated on orders. Subscription prices: United States and Possessions and Canada, \$6.00 one year, \$9.00 two years, \$12.00 three years. All other countries \$20.00 one year. Single copies, United States and Possessions and Canada 75¢. Single copies all other countries \$1.50.

Published every other Monday by McGraw-Hill Inc. 330 West 42nd Street, New York, N.Y. 10036. Founder: James H. McGraw, 1860-1948.

**Subscribers:** The Publisher, upon written request to our New York office from any subscriber, agrees to refund that part of the subscription price applying to copies not yet mailed. Please send change of address notices, subscription orders or complaints to Fulfillment Manager, Electronics, at the address below. Change of address notices should provide old as well as new address, including postal zone number if any. If possible, attach address label from recent issue. Allow one month for change to become effective.

**Postmaster:** Please send Form 3579 to Fulfillment Manager, Electronics, P.O. Box 430, Hightstown New Jersey 08520

## Readers Comment

### Beefing up IEEE Sessions

To the Editor:

I wholeheartedly agree with your editorial [March 8, 1965, p. 15] about IEEE technical sessions. Yours is the answer to the present state of affairs regarding IEEE "tutorial" sessions. As a design engineer, I need to understand in everyday engineering language how to apply new ideas to new practical applications and new products.

As a member of AAAS, I think your point of studying its policy is very well taken.

Charles H. Stern

Flotronic Products Inc.  
Fort Lauderdale, Fla.

### Case for thin films

To the Editor:

I recently read your coverage of the Solid State Circuits Conference [March 8, 1965, p. 125] and concluded that not one exponent of thin films spoke up.

If one assumes that all micro-electronic approaches offer only the highest quality products, then the crux of the cost problem is reduced to three points: testing, trimming, and assembly and packaging. Only packaging received any attention at SSCC.

If yield is so low that it is necessary to test 400 devices to find 80 good ones, the circuits will be costly. For example, one system designer recently received quotations for large quantities of transistor chips to be used with thin film circuits. The chips cost less than 20¢ each in large quantities. However, after incoming inspection to weed out the rejects, the actual cost was about \$1.80, no less than that of a standard pack.

Another limitation is trimming. How does one trim a complex micro-electronic network? Today some people sandblast. In a network of, say, 20 series and parallel resistors and capacitors, how are the culprits found? Trimming is actually a barometer of a particular fabrication technique's limitation. An approach which demands a trim-

# New from Sprague!

For extreme size reduction and unusual capacitance stability . . .

## COMPARE!

The tubular polycarbonate film capacitor and the rectangular oil-impregnated paper capacitor are both rated 10  $\mu$ F, 100 VAC, 400 cy.

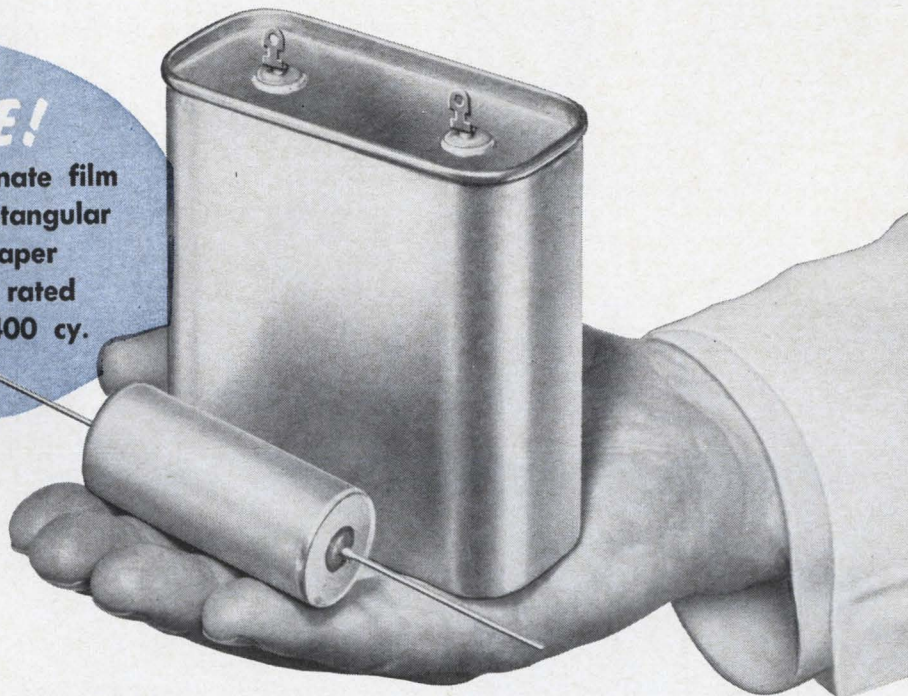

## FILMITE® 'K' POLYCARBONATE FILM CAPACITORS

● New Filmite 'K' Polycarbonate Film Capacitors are more than 13 times smaller than paper capacitors of equivalent capacitance value and voltage rating!

● Polycarbonate film dielectric provides exceptionally high capacitance stability over the entire temperature range, due to inherently low coefficient of expansion of polycarbonate film and a dielectric constant which is nearly independent of temperature.

● Filmite 'K' Capacitors exhibit almost no capacitance change with temperature—dramatically better than polyester-film types, they even surpass polystyrene capacitors.

● Low dissipation factor (high  $Q$ ) makes these capacitors extremely desirable where high current capabilities are required, as in SCR commutating capacitor applications.

● Low dielectric absorption (considerably lower than that of many other commonly-used film dielectrics) over a broad frequency/temperature spectrum makes Filmite 'K' Capacitors ideal for timing and integrating.

● Extremely high insulation resistance, especially at higher temperatures. Superior to many other commonly-used film dielectrics.

● Close capacitance tolerances—available to  $\pm 0.25\%$ !

● Filmite 'K' Capacitors are excellent for critical applications including tuned circuits, analog and digital computers, precision timing and integrating circuits because of the unusual properties of the polycarbonate film dielectric.

Type 260P Filmite 'K' Capacitors are metallized, utilizing non-inductive construction. They feature special self-healing characteristics, in the rare event of capacitor dielectric breakdown. Designed for operation at full rated voltage over the temperature range of  $-55\text{ C}$  to  $+105\text{ C}$ , these metal-clad capacitors are hermetically-sealed and are available with both standard and weldable wire leads or solder tabs in a variety of mounting styles.

Types 237P and 238P Filmite 'K' Capacitors are of high-purity foil construction, and are hermetically sealed in metal cases. Operating temp. range,  $-55\text{ C}$  to  $+125\text{ C}$ .

For complete technical data on Type 260P and on Type 237P and 238P Capacitors, write for Engineering Bulletins 2705 and 2700, respectively, to Technical Literature Service, Sprague Electric Company, 35 Marshall Street, North Adams, Massachusetts.

### SPRAGUE COMPONENTS

CAPACITORS  
TRANSISTORS  
RESISTORS

INTEGRATED CIRCUITS  
THIN-FILM MICROCIRCUITS

PULSE TRANSFORMERS  
INTERFERENCE FILTERS  
PULSE-FORMING NETWORKS  
TOROIDAL INDUCTORS  
ELECTRIC WAVE FILTERS

CERAMIC-BASE PRINTED NETWORKS  
PACKAGED COMPONENT ASSEMBLIES  
BOBBIN and TAPE WOUND MAGNETIC CORES  
SILICON RECTIFIER GATE CONTROLS  
FUNCTIONAL DIGITAL CIRCUITS

**SPRAGUE®**  
THE MARK OF RELIABILITY

\*Sprague' and '®' are registered trademarks of the Sprague Electric Co.

**Obviously from Sprague!**



**Sprague Filmistor® Resistors equal or surpass precision wirewounds in accuracy... stability... reliability... yet they're smaller in size!**

Other key features include:

- Low, controlled temperature coefficients.
- Low inherent noise level.
- Negligible voltage coefficient of resistance.
- Tough molded shell for positive protection against mechanical damage and humidity.
- Available in 5 wattage ratings— $\frac{1}{10}$ ,  $\frac{1}{8}$ ,  $\frac{1}{4}$ ,  $\frac{1}{2}$ , and 1 watt.

For complete technical data, write for **Engineering Bulletin 7025B to Technical Literature Service, Sprague Electric Co., 35 Marshall St., North Adams, Mass.**



® 'Sprague' and ® are registered trademarks of the Sprague Electric Co.  
45R-179-63-RL

ming station will never result in the economic fabrication of a multiplicity of components all interconnected, ready to assemble, package, and ship.

Thin films are useful now, even with inserted diodes and transistors, for low (microwatt) and high (tens of watts) power devices, low and high frequency (100-mega-cycle) devices, and linear as well as digital circuitry. They provide thermocouples, strain gages, and heaters, as well as other transducers and sensors.

With capacitors and crossovers deposited, assembly of thin film circuits, even with inserted silicon chips, involves about as many man-made joints as so-called integrated circuits.

Martin A. Karp  
Alpha Microelectronics Co. Inc.  
Beltsville, Md.

#### Integrating a name

To the editor:

Writing in the Proceedings of the IEEE, Mr. P. E. Haggerty, president, Texas Instruments Incorporated, says about microelectronics: "Because the real change produced by this new technology lies in integration in circuit and function, rather than the small size implied by 'micro,' the author prefers the term 'integrated electronics' rather than 'microelectronics.'"

Integrated electronics, is however, a long term. Why not call it INTEGRONICS?

I think dropping "elect" in electronics is good because phenomena other than electrical (optical and thermal) are used more and more in integrated circuits.

A. Lyden  
Aktiebolaget Atomenergi  
Studsvik, Sweden

#### Production changes

To the Editor:

In your March 8 issue [p. 48] you quoted Gerry Luecke of Texas Instruments as saying at the Solid State Circuits Conference that all a user needs is a guarantee of a device's electrical specifications.

A guarantee that if at time  $t = 0$  you put a specified signal into the circuit you will get a specified signal out is obviously desirable. However, this is something users

can check for themselves, if necessary on a 100% basis. What a user cannot be continually checking is that these electrical characteristics will hold at some future time, after the device has been subjected to operational environmental conditions. Qualification tests can be performed on the original items and approval for use granted. But, as Jack Fort of the National Cash Register Co. says, if the production techniques are changed, then these qualification tests are invalidated and must be repeated.

It is difficult to understand a manager of Texas Instruments making such a statement.

Neville Lewis  
Canadian Westinghouse Company Ltd.  
Hamilton, Ontario

■ Gerry Luecke's main point was that the manufacturer should not be prevented from improving his product. Mr. Luecke said that changes in integrated-circuit production techniques will be made only after very extensive testing and evaluation. He also notes that this practice by the integrated-circuit manufacturer does not differ from the one now used by systems manufacturers, who, he says, often make many changes—some unpublicized—as they receive reports on their equipment's performance.

#### Flying low

To the editor:

In the article "Flying Low" [March 8, 1965, p. 43], some misleading claims are made for a pulse altimeter.

An altimeter, by definition, measures the vertical distance from the aircraft to the ground. This is not the distance the pilot wants to know when descending. He needs to know the distance along his present or future path to the ground. Only this will tell him when to pull up.

Particularly in hilly terrain or where obstacles such as television antennas are located, the altimeter is not enough.

It was to overcome such difficulties that terrain-following and avoidance radars were developed.

A. C. Wesley  
Ferranti, Ltd.  
Edinburgh, Scotland



# Militarized

# Variac®

AUTOTRANSFORMERS  
for 350- to 1200-cycle applications

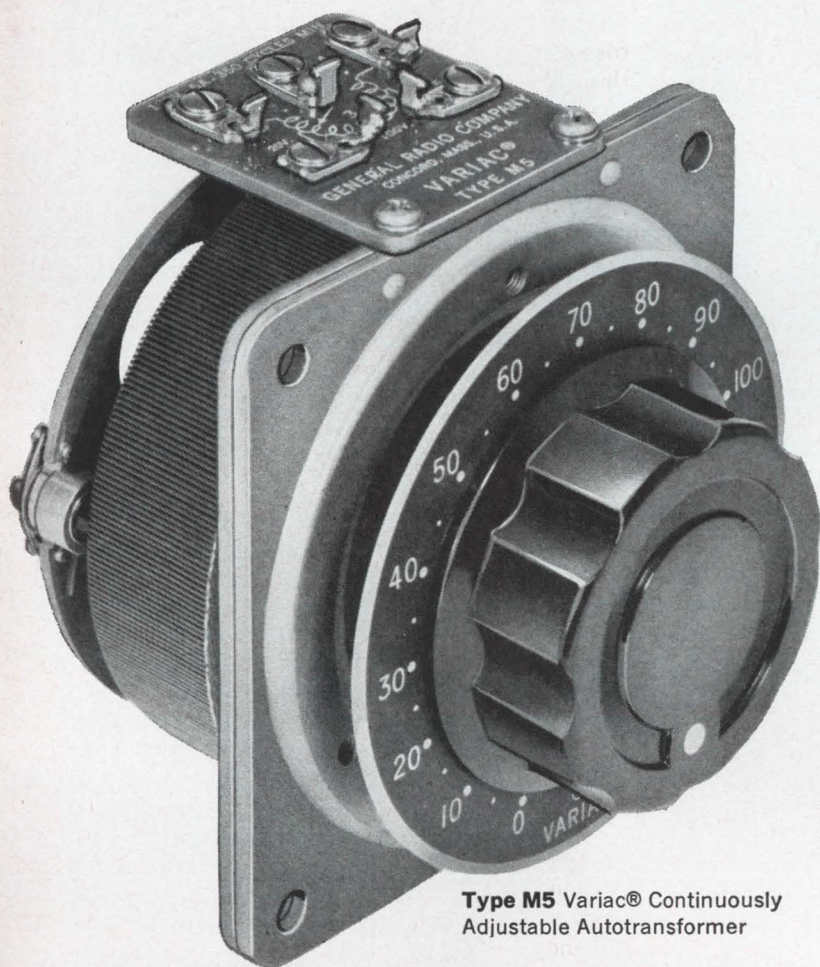

**Type M5 Variac®** Continuously Adjustable Autotransformer

- ★ Approximately 60% lighter in weight than their 60-cycle equivalents.
- ★ Built to withstand shock, vibration, and extreme environments . . . meet many military specifications.
- ★ Moisture-fungicide protected.
- ★ Core completely enclosed by two cup-shaped winding forms of molded phenolic, not fiber or tape wrap-arounds — precision molded grooves insure positive positioning of turns.
- ★ DURATRAK brush contact surface prevents track deterioration and permits momentary overloads up to 1000% without damage.
- ★ Terminal board equipped with both screws and soldering lugs — imprinted with terminal numbers, wiring diagram, and nominal voltage between taps.
- ★ Large radiating surface — protects brush and track from heat damage.
- ★ Counterbalanced rotating parts hold setting under shock and vibration.
- ★ Low-loss, high-silicon steel, strip-wound core.
- ★ Brush designed for constant and correct contact pressure.
- ★ Resin-impregnated glass cloth insulation between coil and base.
- ★ Winding taps concealed for protection from damage.
- ★ 2-ampere model (Type M2) has over 400 turns for applications requiring high resolution.
- ★ Overvoltage taps standard on all models.
- ★ Ganged and motor-driven models available.

**Continuously Adjustable Output Voltage from 0-120 volts or 0-140 volts**

TYPE	RATED INPUT VOLTAGE	LINE-VOLTAGE CONNECTION				OVERVOLTAGE CONNECTION		NET WEIGHT POUNDS	PRICE
		OUTPUT KVA AT MAXIMUM OUTPUT VOLTAGE	RATED OUTPUT CURRENT AMPERES	OUTPUT VOLTAGE RANGE	MAXIMUM OUTPUT CURRENT AMPERES	OUTPUT VOLTAGE RANGE	*RATED CURRENT AMPERES		
<b>M2</b>	120	0.37	2.4	0-120	3.1	0-140	2.4	2	<b>\$15.50</b>
<b>M5</b>	120	0.94	6	0-120	7.8	0-140	6	3½	<b>18.50</b>
<b>M10</b>	120	1.56	10	0-120	13	0-140	10	6½	<b>35.00</b>
<b>M20</b>	120	3.12	20	0-120	26	0-140	20	13	<b>54.00</b>

\*Rated current should not be exceeded for the overvoltage connection.



Write for the Variac Bulletin.

IN CANADA: Toronto 247-2171, Montreal (Mt. Royal) 737-3673  
IN EUROPE: Zurich, Switzerland — London, England



## GENERAL RADIO COMPANY

WEST CONCORD, MASSACHUSETTS

BOSTON NEW YORK, N. Y., 964-2722 CHICAGO PHILADELPHIA WASHINGTON, D. C. SYRACUSE DALLAS SAN FRANCISCO LOS ANGELES ORLANDO, FLA. CLEVELAND  
(W. Concord) 646-0550 (Ridgefield, N. J.) 943-3140 (Oak Park) 848-9400 (Ft. Washington) 646-8030 (Rockville, Md.) 946-1600 454-9323 FL 7-4031 (Los Altos) 948-8233 469-6201 425-4671 886-0150

## 10 X More Power With Water-Cooled UHF Planar Triodes

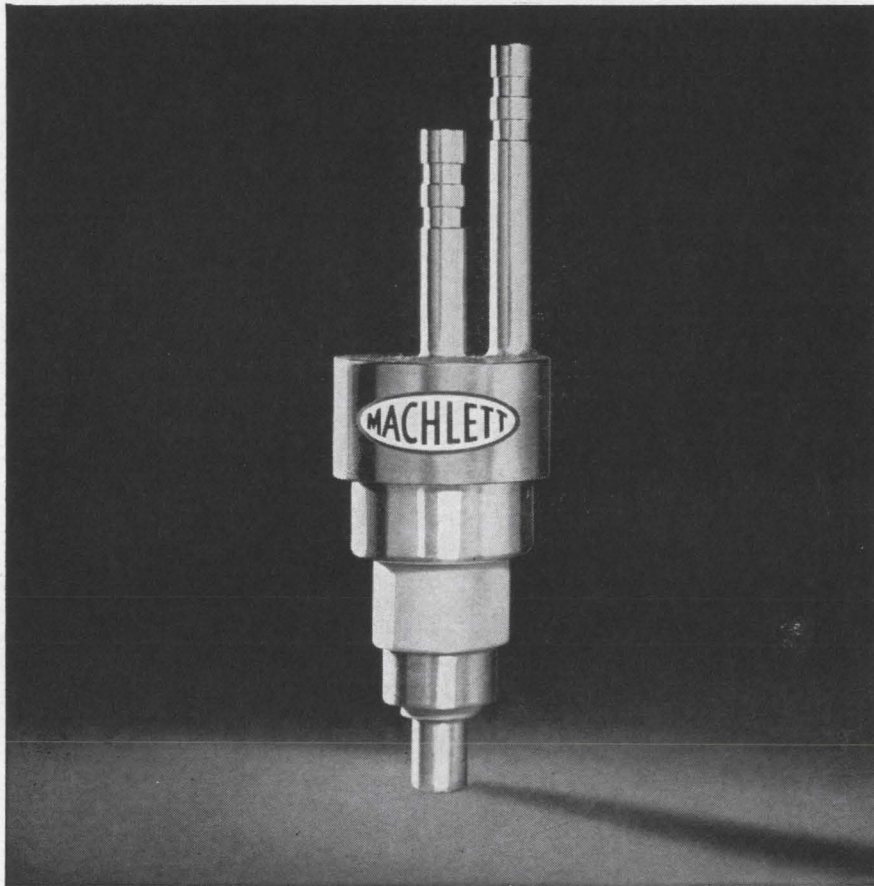

Machlett Laboratories has developed a simple, yet unique water cooling device for UHF planar triodes which permits CW output powers up to 10 X higher than previously attainable. Plate dissipation capability on one tube, the ML-7815, with water jacket, exceeds 400 watts. Comparable figure for forced-air-cooled ML-7815 is 100 watts; same tube with anode cover is 10 watts. Water cooling also makes possible operation at high cathode current densities—eg., a variation of the ML-7289 with water jacket is rated at 2 kV with 400 mA cathode current; a standard ML-7289 is capable of 1 kV and 125 mA cathode current. Water jackets are currently available on special ML-7289, ML-7698, ML-7815, ML-7855, ML-8403 and ML-8533. Write the Machlett Laboratories, Inc., Springdale, Conn. 06879. An Affiliate of Raytheon Company.

**MACHLETT**  
ELECTRON TUBE SPECIALIST

## People

**Arthur Lowell** used to be the Marine Corps colonel in charge of the avionics division of the Navy's Bureau of Weapons. As such, he was one of the earliest proponents of microelectronics and was responsible for much of the original planning for the Integrated Light Avionics System (ILAS) and Integrated Helicopter Avionics System (IHAS) and the microelectronics concerned with each of them.



He was recently appointed assistant to the president and acting executive director of the research and engineering department of Autonetics, a division of North American Aviation, Inc., a post in which he can continue his attempts to put microelectronics into hardware economically.

"After we do a good job of making microelectronic computers," he says, "the natural follow-on will be the implementation of microelectronics in as many weapon systems as we can." He is referring to radar and communications systems already in Autonetics' product line.

"In the 1940-50 period, we were first developing electronics in weapons," he says. "In the 1950-60 period we were improving the performance of this capability. In the years 1960 to 1970, I see an era of making the equipment work reliably and providing it at a cost the customer can afford."

Lowell received much of his technical training in the Marine Corps, from which he retired in 1963. He worked on solid state electronics at Johns Hopkins University's Applied Physics Laboratory and went on to Rensselaer Polytechnic Institute, where he received his master's degree in 1949—all on a service-sponsored program.

A native Californian and a graduate of the University of California, Lowell was president and general manager of General Microelectronics, Inc., a subsidiary of the Pyle-National Co., before accepting the Autonetics position.

*We grow our oscillators small!*

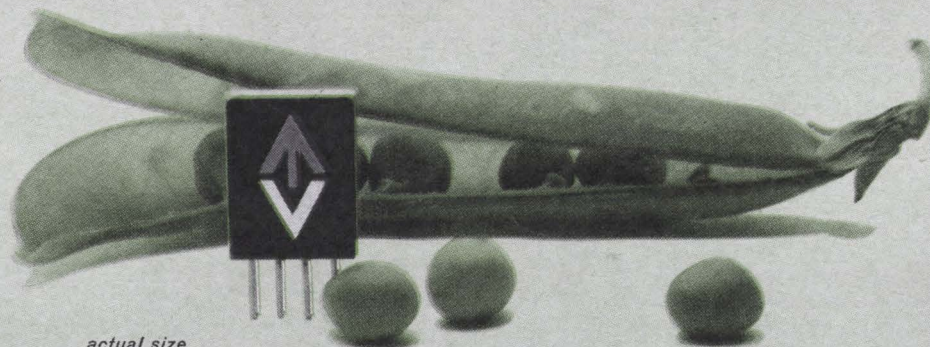

*actual size*

## **A TRULY MICROMINIATURIZED SOLID STATE VCO**

**Voltage Controlled Subcarrier Oscillator Vector Model MMO-11**

**Built to the highest reliability specifications using the most advanced thin film and integrated circuit techniques. ■ MTBF figure is 400,000 hours.**

**Designed to meet the severest environmental specifications ■ Flight proven on one major program to 10,000 g shock for three milliseconds.**

**Also available: Mixing amplifiers built with same microcircuit techniques, and mounting assemblies for complete system integration.**

**Weight: 0.13 ounces ■ Size: 1.00" x .722" x .150"**

**Power Requirements: Unregulated 28V DC**

**IMMEDIATE DELIVERY FROM STOCK**

**Vector** DEPARTMENT OF **NORDEN** DIVISION OF UNITED AIRCRAFT CORPORATION  
SOUTHAMPTON, PENNSYLVANIA Telephone 215 EL 7-7600

**U  
A**

# Battery

## 150 Volts/inch<sup>3</sup>

## 20 Yrs. Shelf Life

1. How would I keep a capacitor charged for up to 20 years?
2. Is it *really* possible to pack 150 volts/cu. in. into a battery?
3. Where can I get a *solid* electrolyte battery whose mass and center of gravity will not change with time or use?
4. Can I find a battery which will endure short circuits (for hours) and recover to its original open circuit voltage within seconds?
5. Is it possible to obtain high voltage batteries in almost any configuration?
6. Where can I find a battery which will behave like this . . .

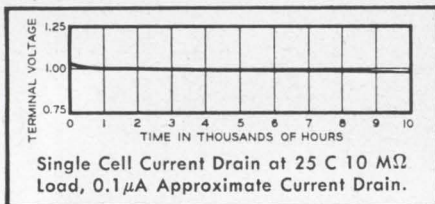

. . . and which has a total available charge of 1500 microampere-hours or 5 coulombs per cell?

**The answers to these questions are:**

1. *Using Sprague Solid Electrolyte Batteries.*
2. *Yes indeed!*
3. *Sprague Electric.*
4. *Yes.*
5. *Yes.*
6. *Sprague Electric. For complete technical data, write for Engineering Bulletin 11,101 to Technical Literature Service, Sprague Electric Co., 35 Marshall Street, North Adams, Massachusetts 01248*

# SPRAGUE®

THE MARK OF RELIABILITY

® and ® are registered trademarks of the Sprague Electric Co.

## Meetings

**Rocky Mountain Bioengineering Annual Symposium**, IEEE, USAF Acad., Fitzsimmons Gen. Hospital, et al; Brown Palace Hotel, Denver, **May 3-4.**

**Annual Technical Conference**, ASQC; Biltmore Hotel, Los Angeles, Calif., **May 3-5.**

**American Astronautical Society Annual Meeting**, AAS, IIT Research Institute; Conrad Hilton Hotel, Chicago, **May 4-6.**

**Packaging Industry Annual Conference**, IEEE; Milwaukee Inn, Milwaukee, Wis., **May 4-6.**

**"Post-Apollo Missions" Meeting**, AAS; The Conrad Hilton Hotel, Chicago, **May 4-6.**

**ICA Annual Conference**, ICA; Hilton Hotel, Pittsburgh, **May 4-7.**

**National Telemetry Conference**, NTC; Prudential center, Boston, **May 10-12.**

**Institute on Electronics and Automation in Publishing**, Amer. Univ.; International Inn, Wash., **May 10-13.**

**Power Instrumentation Symposium**, Power Industry Div. of ISA; Commodore Hotel, New York City, **May 12-14.**

**Solid State Quantum Electronics**, Univ. of Wisconsin; Madison, Wis., **May 13-14.**

**Design Engineering Conference**, ASME; New York Coliseum, New York, **May 17-20.**

**Society of Photographic Scientists and Engineers Annual Conference**, SPSE; Sheraton-Cleveland Hotel, Cleveland, **May 17-21.**

**Aerospace Fluid Power Systems and Equipment Conference**, SAE; Statler-Hilton Hotel, Los Angeles, **May 18-20.**

**Digital Equipment Computer Users Society Spring Technical Meeting**, DECUS; William James Hall, Harvard University, Cambridge, Mass., **May 20-21.**

**Electronic Reliability Conference**, IEEE; Carnegie Foundation Building, N.Y.C. **May 21.**

**Computing Meeting**, NYU; Stony Brook, L.I. Campus, **May 21.**

**Microelectronics Annual Symposium**, St. Louis Section of IEEE; Chase Park Plaza, St. Louis, Mo., **May 24-26.**

**International Television Symposium**, IEEE/SEV/ASE; Pavillon of Montreux, Montreux, Switzerland, **May 24-29.**

**IFIP Congress '65**, IFIP/IEEE; New York Hilton, N.Y.C., **May 24-29.**

**Armed Forces Communications and Electronics Association Annual Convention**, AFCEA; Sheraton-Park Hotel, Wash., **May 25-27.**

**Bicentennial Space Symposium and National Conference**, NASA, St. Louis Bicentennial Commission; Chase-Park Plaza Hotel, St. Louis, **May 26-28.**

**Symposium on Analysis Instrumentation**, ISA; Sheraton-Mt. Royal Hotel, Montreal, **May 26-28.**

**Cybernation, Automation and Human Responses Annual Conference**, ICR; Americana Hotel, N.Y.C., **May 27-29.**

**Biomedical Computer Applications Conference**, BIO/New York Academy of Sciences; Waldorf-Astoria, N.Y.C., **June 3-5.**

**IEEE Annual Communications Convention (Including GLOBECOM VII)**, CTG/IEEE; University of Colorado, Boulder, Colo., **June 7-9.**

**National Electronic Packaging and Production Conference (NEP/CON'65)**, EPP; Long Beach Arena, Long Beach, Calif., **June 8-10.**

**Broadcast and TV Receivers Conference**, G-BTR/IEEE; O'Hare Inn, Des Plaines, Ill., **June 14-15.**

**Midwest Symposium on Circuit Theory**, G-CT/IEEE; Colorado State University, Ft. Collins, Colo., **June 14-15.**

## Call for papers

**Joint Computer Conference**, AFIPS; Las Vegas, Nov. 30-Dec. 2. **June 15** is deadline for submission of completed draft copy and 150-word abstract to Mr. Robert Gray, Secretary, Program Committee, 1965 FJCC, P. O. Box 49, Santa Monica, Calif. 90406.

**Physics of Failure in Electronics**, IIT Research Institute, Rome Air Development Center; IIT Research Inst., Chicago, Nov. 16-18. **June 25** is deadline for submission of 4 copies of 300- to 500-word abstract and 50-word summary and author's biography to Morton Goldberg, IIT Research Institute, 10 West 35 St. Chicago 60616.

# ASTRODATA

## ADVANCED SOLID STATE AMPLIFIERS FOR YOUR CONTROL AND INSTRUMENTATION APPLICATIONS



ASTRODATA advanced design instrumentation amplifiers raise state-of-the-art standards to higher levels for measurement... conditioning... monitoring... indicating... control.

For custom designs, Astrodata's extensive experience provides a well-qualified capability for satisfying your specific performance needs.

**Model 884 Wideband (dc to 100 kc) Floating, Guarded Amplifier...**

**Model 885 Wideband (dc to 10 kc) Differential, Isolated Amplifier...**

high-gain/performance amplifiers for low-level, wideband systems at lowest cost. Completely transistorized, these state-of-the-art amplifiers use field-effect transistors in place of mechanical choppers to achieve lowest drift rate, freedom from microphonics and maximum reliability. Gain range to 3000 and a continuously adjustable 10-turn vernier control are provided as standard features. Two differential models with  $\pm 10$  ma or  $\pm 100$  ma output current from a low impedance can drive long lines, A to D converters, multiplexers, galvanometers or tape recorders. Transfer characteristic is optimized to provide wide frequency response with minimum overshoot, fastest settling and overload recovery times, and minimum phase shift. Common mode rejection is greater than 120 db with up to  $\pm 300$  volts dc or peak ac common mode voltage.

All models have built-in power supplies, feature drift less than  $1 \mu\text{V}$  per week, wideband noise less than  $4 \mu\text{V}$  rms, linearity better than 0.02%. Can be used either separately or in the same rack module with Model 1155 Universal Signal Conditioning Unit or Model 890 Electronic Filter to form complete, isolated signal conditioning channels.

**Model 885-135 Differential Amplifier** to drive multiplexers, tape recorders and A to D converters.

GAIN RANGE: 1 to 3000  
INPUT RESISTANCE:  
100 megohms  
BANDWIDTH: dc to  
10 kc  
OUTPUT:  $\pm 5$  volts at  
 $\pm 10$  ma  
DRIFT:  $\pm 1 \mu\text{V}$  for  
40 hours  
TEMP. COEFF:  
 $\pm 0.2 \mu\text{V}/^\circ\text{F}$   
NOISE:  $2 \mu\text{V}$  rms

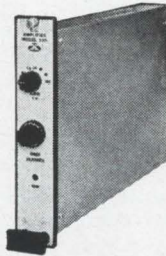

**Model 885-235 Differential Amplifier** to drive data systems, long lines and galvanometers.

GAIN RANGE: 3 to 3000  
INPUT RESISTANCE:  
100 megohms  
BANDWIDTH: dc to  
10 kc  
OUTPUT:  $\pm 10$  volts  
at  $\pm 100$  ma  
DRIFT:  $\pm 1 \mu\text{V}$  for  
40 hours  
TEMP. COEFF:  
 $\pm 0.2 \mu\text{V}/^\circ\text{F}$   
NOISE:  $2 \mu\text{V}$  rms

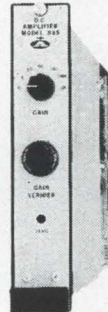

**Model 1155 Universal Signal Conditioning Unit**

Uses plug-in circuit cards to supply excitation or bias, attenuation, circuit completion, balancing, filtering and calibration. Used with low-level or high level signals from thermocouples, strain gages, resistance temperature sensors, thermistors, potentiometers and voltage sources. Can function separately or in same rack module with Models 884 or 885 Amplifiers or Model 890 Filter to provide complete conditioning, calibration and normalizing of transducer signals.

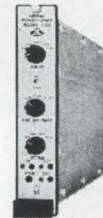

**Model 141-102 Wideband DC Utility Amplifier** to drive galvanometers and fulfill wideband dc amplifier requirements.

GAIN RANGE: 1 to  
25  
INPUT RESISTANCE:  
>10 megohms  
OUTPUT:  $\pm 10$  ma  
at  $\pm 10$  volts  
COMMON MODE  
REJECTION: >60 db  
at all gain settings

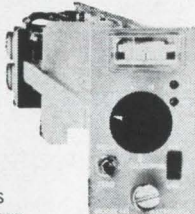

FREQUENCY RESPONSE:

RESPONSE:	$\pm 1/2\%$	$\pm 3.0\%$	-3 db point
FIXED GAIN POS:	dc to 20 kc	dc to 100 kc	500 kc

**Model 120 Nanovolt Amplifier** gives you high-gain/low-noise amplification for seismic transducer signals, cryogenic studies, thermocouple or strain gage signals.

GAIN RANGE: 200 to  
1,000,000  
BANDWIDTH: dc to  
100 cps  
NOISE:  $0.05 \mu\text{V}$  rms  
INPUT RESISTANCE:  
1 megohm  
OUTPUT LEVEL: 0 to  
 $\pm 5$  volts at  $\pm 5$  ma

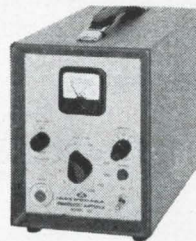

**Model 121Z Nanovoltmeter** provides  $0.1 \mu\text{V}$  full scale bridge balance detector or thermocouple indicator for standards and calibration work, in the field and in laboratories.

FULL SCALE RANGES:  
 $\pm 0.1 \mu\text{V}$  to  
 $\pm 100$  mv  
INPUT RESISTANCE:  
1 megohm  
ZERO SUPPRESSION:  
 $\pm 0.5 \mu\text{V}$  to  $\pm 5$  mv  
AMPLIFIER OUTPUT:  
Gain 30 to 3 million,  
delivers  $\pm 5$  volts  
at  $\pm 5$  ma  
Overload Indicator



Contact your Astrodata engineering representative for a demonstration... or write today for technical literature giving complete specifications.



**ASTRODATA INC.**

P.O. Box 3003 • 240 E. Palais Road, Anaheim, California • 92803

TEL. (714) 772-1000 • TWX 714-776-3760 • FAX • TELEX 06-78828 • CABLE ADDRESS - ASTRODATA, Anaheim

# New products from TI to help you

## N-channel FET's provide low-noise amplification beyond 200 mc

You can improve RF amplifier performance by using new TI N-channel field-effect transistors. Two 2N3822's used in the 200 mc cascode amplifier shown in Figure 1, gave 12 db gain and only 2.2 db noise at 200 mc. Cross modulation was less than one percent when a 1000  $\mu$ v, 200 mc signal and a 200,000  $\mu$ v, 150 mc signal were combined.

The new series, numbered 2N3821, 22 and 24, offers  $y_{fs}$  as high as 4500 min at 100 mc. Noise figure is typically 3 db at 10 cps. Gate leakage is typically 10 picoamps, and maximum input capacitance is less than 6 pf. Other advantages include zero offset voltage (in chopper applications) and high input impedance.

Dual N-channel FET's, typed TIS25-27, are available in a low-profile TO-5 package.

Circle 150 on the Reader Service Card for data sheet.

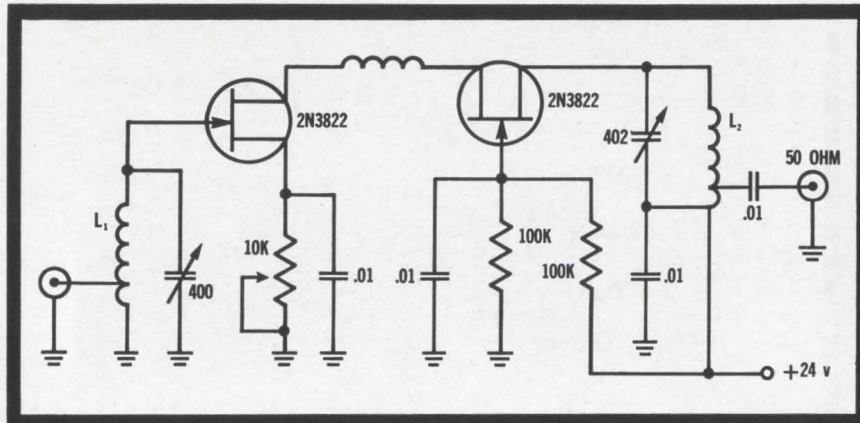

Figure 1. 200 mc cascode RF amplifier uses new TI N-channel FET's

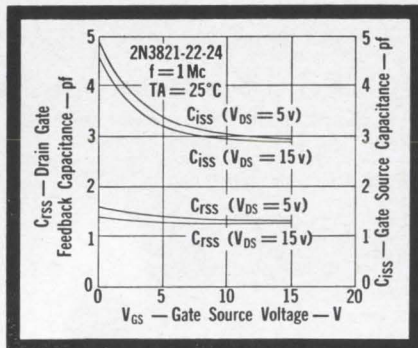

Figure 2. Important capacitance curves for 2N3821, 22, 24 transistors

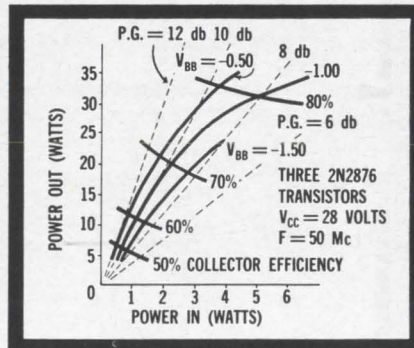

Figure 3. Performance curves for 50 mc amplifier shown in Figure 4

## 5 db gain at 150 mc, 10 watts output at 50 mc from new TI silicon transistors

High efficiency and high power output are characteristics of two silicon planar epitaxial power transistors from TI. As shown in Figure 4, they may be paralleled for even higher output.

JEDEC registered as 2N2876 and 2N2631, the new transistors are available in an isolated 7/16-inch stud package and a short-lead TO-5 respectively. Power output for the 2N2876 is 10 w at 50 mc and 3 w at 150 mc. The 2N2631 is rated 7.5 w at 50 mc and 3 w at 150 mc.

Applications include military communications equipment, SonoBouys, citizens band transmitter driver or output stages up to 200 mc, and high-speed switching up to 2 amps.

Circle 151 on the Reader Service Card for data sheet.

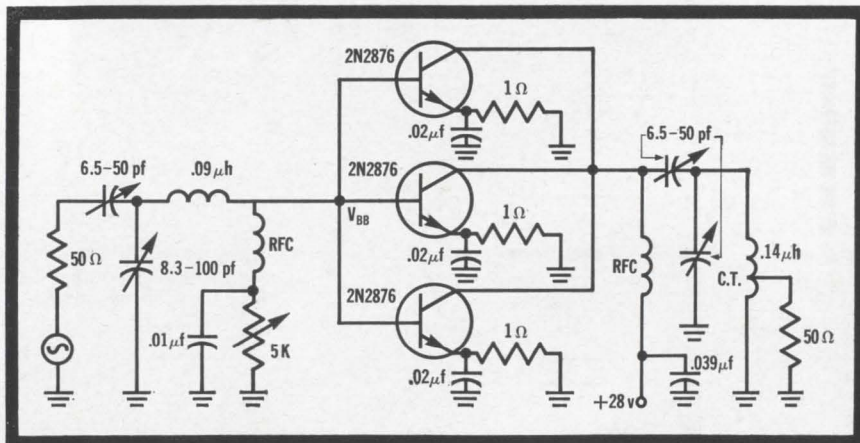

Figure 4. 30w, 50 mc amplifier uses three 2N2876 transistors. (See Figure 3)

## Double-anode regulators reduce cost of transient protection

New one-watt, double-anode TI regulators provide zener regulation in both forward and reverse direction yet are priced competitively with single-anode units. Result: a sharp reduction in circuitry costs in many applications, such as the one shown in Figure 5.

For both forward and reverse transient protection and bidirectional clipping applications, one double-anode regulator replaces two single-anode units, reducing component cost, simplifying circuitry and reducing parts inventories. The new devices also can be used in both for-

TI cannot assume any responsibility for any circuits shown or represent that they are free from patent infringement.

# improve performance and reduce costs

ward or reverse single-anode applications at no cost penalty.

The new TI regulators, designated 1N4831-60, are rated from 9 to 150 v. Other characteristics include a sharp zener "knee", low dynamic impedance, and an operating temperature range of  $-65^{\circ}$  to  $175^{\circ}\text{C}$ . They are packaged in a fully insulated, cylindrical glass package that measures only 0.150 by 0.360 inches.

Circle 152 on the Reader Service Card for data sheets.

## New gated symmetrical switch permits simpler control circuits

Now you can cut circuitry essentially in half by using a TIC20-23 silicon gated symmetrical switch instead of two conventional SCR's.

These new full-wave devices feature high voltage capability (to 300 v), high power capability (600 w, 1500 w peak), and high current capability (6 amps below  $75^{\circ}\text{C}$ ). Gated operation reduces RF interference.

Circuits, such as the light dimmer circuit shown in Figure 6, provide 5 to 95 percent a-c power control with a single device. The TIC20-23 series may also be used in high-sensitivity phase control circuits.

The gated switches are available in either an automotive press fit package or a  $\frac{1}{4}$ -inch stud package. Circle 153 on the Reader Service Card for data sheet.

## New picosecond switching diodes

Recovery times of less than 100 psec, offset voltage  $V_F=0.3$  v typical at 0.1 ma, and high reliability are among features of TIXD27-28 switching diodes announced by TI.

Extremely high speed and high conductance at low voltage and current make these new devices ideal for demanding application such as the oscilloscope sampling circuit shown in Figure 7.

Reliability studies on the new units indicate that metal-silicon barrier diodes give exceptional reliability and uniformity of parameter.

Circle 154 on the Reader Service Card for data sheets.

## Noise figure for new UHF mixer diode is 10 db typical at 890 mc

The new TIXV304 metal-silicon barrier mixer diode makes possible low-noise UHF TV front ends with exceptionally uniform characteristics.

The metal-silicon barrier construction makes possible better circuit performance and higher reliability at no price penalty over older point contact devices.

The TIXV304 is packaged in the proven Moly/G<sup>®</sup> diode package. Circle 155 on the Reader Service Card for data sheet.

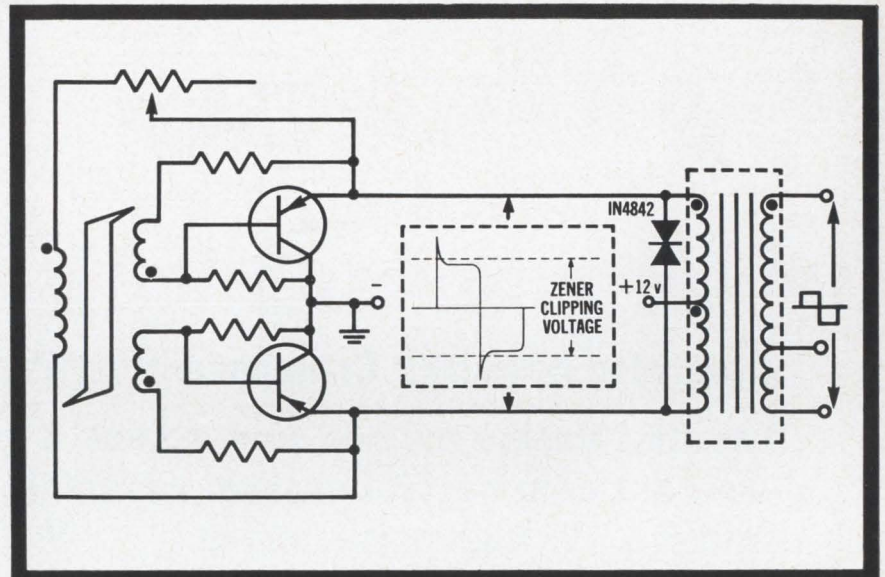

Figure 5. One 1N4842 double-anode regulator protects both transistors by clipping transients in this dual-transformer inverter

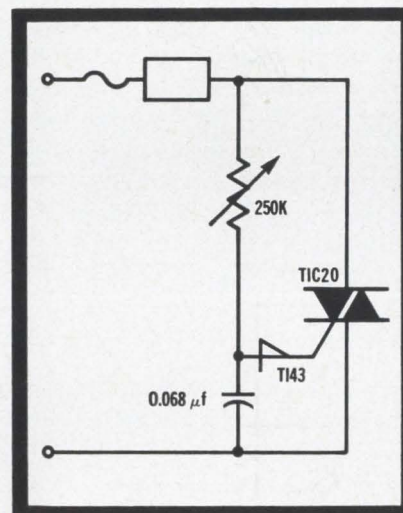

Figure 6. Simple light dimmer employs TI gated symmetrical switch

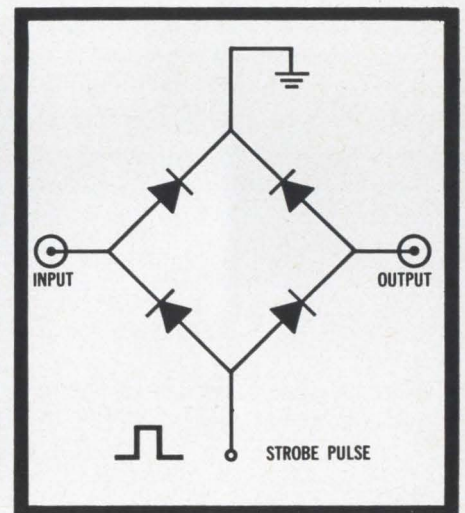
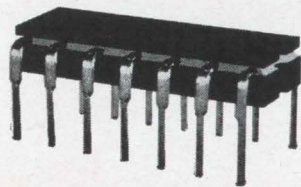

Figure 7. Oscilloscope sampling gate uses TIXD27 metal-barrier silicon diodes



**TEXAS INSTRUMENTS**  
INCORPORATED  
13500 N. CENTRAL EXPRESSWAY  
P. O. BOX 5012 • DALLAS 22, TEXAS



# THIS IS CT<sub>μ</sub>L!

**The first microcircuit family for commercial computers**

- (1) Integrated NPN-PNP Complementary Transistor Micrologic™**
- (2) The first design method that attains 3 nsec per logic decision with low-cost commercial system assembly techniques. Large signal swings—3V. High noise immunity—.5V.**
- (3) A new package designed specifically for handling ease and economy.**

**Fastest Decision Rate vs. System Cost** Now Complementary Transistor Logic—potentially faster than any other logic form—is economically practical for commercial computers. Fairchild CT<sub>μ</sub>L for the first time combines both NPN and PNP transistors in a monolithic, Silicon Planar Epitaxial microcircuit. This circuit approach allows systems designers to attain delays per logic decision as low as 3 to 5 nanoseconds...rise times of 5 to 15 nano-

seconds...binary counting rates of 30 to 40 mc. Yet the unique CT<sub>μ</sub>L package can be used with all low-cost, proven commercial system assembly techniques. Other key CT<sub>μ</sub>L features: high noise immunity and high fan-out at high speed; wide power supply tolerances; the ability to drive heavy loads at high speeds. Temperature range: +15°C to +55°C.

For complete specifications, write for the comprehensive six-page data sheet.

## CT<sub>μ</sub>L SPEED

Typical Propagation Delay Test Set-Up  
(16" open transmission lines)

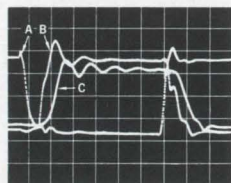
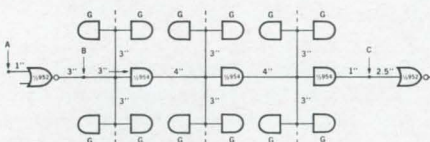

**t<sub>pd</sub> WAVEFORMS  
AT FAN-OUT =  
5 PER NODE,  
16" OPEN  
TRANSMISSION  
LINE**

VERT = 1.0V/cm

HORIZ = 20 nsec/cm

This test configuration may have as many as 8 logic levels for an average propagation delay of 2.6 to 3.1 nsec per logic decision. The t<sub>pd</sub> measurements are taken at +1.0V from inverter to inverter.

## CT<sub>μ</sub>L PACKAGE

The CT<sub>μ</sub>L package accommodates low-cost commercial assembly methods, including

- flow soldering
- two-sided printed circuit boards
- manual or automatic insertion
- loose drill tolerances
- wide printed circuit lines

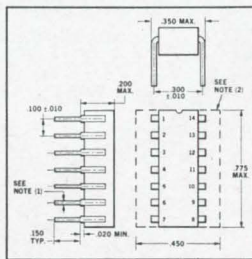

1. Leads are a modified hexagon in cross section. Board-drilling dimensions should equal your practice for a conventional .020 inch diameter lead.

2. Max. envelope for all planned packages of this design family.

## CT<sub>μ</sub>L PRICES

	1-24	25-99	100-999 mixed type	same type
Dual 2-Input Inverter Gate—CT <sub>μ</sub> L 952	\$7.50	\$6.00	\$5.25	\$5.00
2-2-3-Input AND Gate—CT <sub>μ</sub> L 953	7.50	6.00	5.25	5.00
Dual 4-Input AND Gate—CT <sub>μ</sub> L 954	7.50	6.00	5.25	5.00
Single 8-Input AND Gate—CT <sub>μ</sub> L 955	7.50	6.00	5.25	5.00
Buffer—CT <sub>μ</sub> L 956	7.50	6.00	5.25	5.00
Dual Rank Flip-Flop—CT <sub>μ</sub> L 957	14.00	11.20	9.80	9.40

**FAIRCHILD**  
SEMICONDUCTOR



---

Editorial

---

## Europe: a changing market

A subtle but significant change is taking place in the European electronics industry. Leisurely, easy-going Europe is rapidly turning into a dog-eat-dog competitive arena. That the continent is no longer a soft touch for any American-made product or service was clear to visitors, at the international electronic components show last month in Paris.

There are two principal reasons for the change: the faltering of the economic booms in many countries, and the resurgence of nationalism.

When United States electronics companies opened plants in Europe in the late 1950's, most of them were welcomed. They were bringing payrolls and industrialization, and feeding a seemingly insatiable hunger for products of all kinds.

In those years and in the early 1960's, Europe experienced the greatest industrial expansion in history. Production rapidly outstripped the labor supply; for the first time, millions of consumers had enough money to buy automobiles, radios, phonographs and television sets.

But that picture has changed considerably in the last 12 months. Booms and letdowns have created economic ills, and every country seems to be seeking the same remedy: exports. The resulting competition is so fierce that it threatens to sweep away the cartels that have propped electronics prices and held back new technology in Europe.

In Britain, the boom spurred purchases of consumer goods so sharply that prices climbed and British products had trouble competing in the international market. Imports jumped so far ahead of exports that the pound sterling, the monetary base, nearly collapsed. Britain's answer to her problem has been loud and clear: export. The closest and most likely target is the European mainland.

In West Germany prosperity continues, but for electronics companies there is a serious soft spot: the market for radios, phonographs and black-and-white television is nearly saturated. To keep factories busy, electronics companies

are looking for new markets, and they are peering most hungrily at other countries in Europe.

Italy's economic boom ran out of steam last year. Business is bad, and electronics companies are seeking European exports to make it better.

Nearly everybody sees France as a customer. President de Gaulle's military program has stimulated electronics progress sharply. But France's financial resources are limited; so while de Gaulle orates about the grandeur of France, his military is looking for bargains regardless of their national origin.

De Gaulle's nationalism takes a pragmatic approach. He won't let a foreign company operate in France unless the company brings something—capital, technology or products—that French concerns lack.

Some other countries have been less business-like in pursuing economic nationalism. Britain, for example, has cooled to foreign companies interested in setting up operations there. And more and more buyers follow a buy-British policy regardless of price and delivery date.

Competition, however, is bending the walls that nationalism erects. In the turbulent marketplace that is Europe today, nobody can disregard price and delivery for very long. That is what makes Europe an attractive target—so attractive that even countries behind the Iron Curtain, such as Poland, East Germany and Hungary, are anxious to participate.

The Japanese, too, have decided that now is the time to invade the European market. They started in West Germany last year and had a near-disaster because they did not offer adequate service or application information. In France and elsewhere in Europe, the Japanese will not make that mistake again.

And that illustrates clearly how to succeed in Europe despite today's blood-curdling competition. European electronics companies, although eager for business, are vulnerable. Their product lines have been designed mainly to suit the producer, not the customer. That leaves huge gaps.

Many European companies are reluctant to tailor their products to a user's need. Too often they hold back new products and technology until they've made what Americans would consider a fantastic profit on the old. Few electronics concerns in Europe have staffs of application engineers ready to tackle a customer's problem. They prefer to act as suppliers, and leave the designing to the buyers.

Thus, despite the change, conditions are right for a company with imaginative product planning, helpful application engineering, aggressive marketing, the right price and quick delivery.

Not everybody can qualify.

**This P&B relay switches 20 amperes,  
costs only \$3.90\* each, is available  
from leading parts distributors...**

**and it's this small**

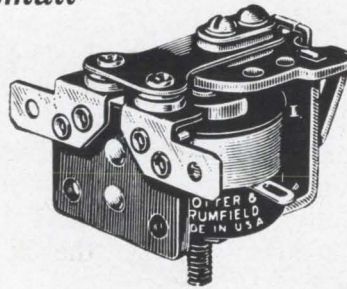

Here is a real space-saving power relay—ideal for applications where limited space is a factor. *Three* KR3 relays will fit in the space required for *one* 20-ampere relay of most other makes. The KR3 occupies only little more than one and a half cubic inches.

Installation is simple, too. Standard KR3 relays have a convenient stud and mounting tab—and the contact terminals will accept  $\frac{1}{4}$ " quick-connects or solder connections.

Field-proved for more than a year, the KR3 is available for immediate

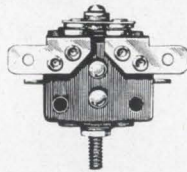

shipment from authorized P&B distributors. Tests show mechanical life will exceed one million operations . . . and the twin contacts are rated at 20 amperes at 115V AC, 60 cycles resistive or 28V DC, 1 HP 115/230V 60 cycles.

Relays ordered from the factory can be supplied in clear, high-impact polycarbonate case with octal plug.

For complete information, call your nearest P&B sales representative or write direct. Remember . . . you can buy cheaper relays but you cannot buy P&B quality for less.



#### ENGINEERING SPECIFICATIONS

##### GENERAL:

Insulation Resistance: 1000 megohms.  
Expected Life: 1 million mechanical operations, min.  
Breakdown Voltage: 500V rms 60 cycles bet. all elements.  
Temperature Range | AC and DC: -45°C min.  
Open Relay | AC: +70°C max.  
DC: +85°C max.

##### CONTACTS:

Arrangements: SPST-NO-DB (1 Form X) only.  
Rating: 20 amps @ 115V AC, 60 cycles resistive,  
or 28V DC; 1 HP 115/230V 60 cycles.

##### COILS:

Voltage: DC: to 110V  
AC: to 230V  
Power: DC: 1.2 watts min.  
AC: 2.0 volt-amps.  
Resistance: 16,500 ohms maximum.  
Duty: Continuous.

##### MOUNTING:

Open: One 6-32 stud and  $\frac{1}{4}$ " locating tab on  $\frac{7}{16}$ " centers.  
Enclosed: Octal socket.

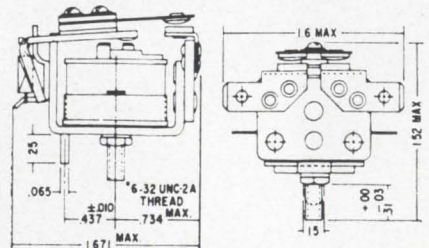

\*Unit price for 6 to 115V AC models.  
Quantity discounts available.

RIDE THE AMF MONORAIL AT THE NEW YORK WORLD'S FAIR



## POTTER & BRUMFIELD

Division of American Machine & Foundry Company, Princeton, Indiana  
In Canada: Potter & Brumfield, Division of AMF Canada Ltd., Guelph, Ont.  
Export: AMF International, 261 Madison Avenue, New York, N.Y.

---

# Electronics Newsletter

---

May 3, 1965

## Pentagon may lift defense spending

Observers in Washington are predicting that the Pentagon will boost military spending within 30 days because of the accelerated action in South Vietnam—even though on April 26 Defense Secretary Robert S. McNamara said, “We don’t have plans to increase procurement above the previously established level. Experts in Washington say the Pentagon has been financing the Vietnam war by borrowing money from other accounts, which are running dry.

A member of the Armed Services Committee, Sen. John Stennis (D., Miss.) says the war in Vietnam is “unprogramed”—meaning that funds haven’t been budgeted. He adds, “We’re going to push for appropriations for Vietnam.” The Senate Preparedness subcommittee staff is checking to see if the supplies’ drain has hurt over-all combat readiness.

The first electronic equipment purchased is likely to be for sea surveillance and ship-to-shore and ship-to-air communications.

## IBM modifies 360 again

Computer makers are talking about the changes International Business Machines Corp. is making in the System/360. Three models announced 13 months ago have been made obsolete before the first machines could be delivered. And two others, announced only last March, have also just been replaced.

IBM says it always expected to make changes in System/360 from time to time, although clearly, the company was not satisfied with the memory capability of the original machines. In the most recent move, three models were added to the line: the 65, 67 and 75. There are now 13 models of the System/360.

The 65 and 75 are essentially the same as the original 60, 62 and 70, but with substantially faster memory cycle times, plus the ability to interleave memory accesses—i.e., to fetch one word while storing another. The new models cost less, too. The model 65 has double the memory capacity of the 60; the 67 is the same as the 65 with the addition of special time-sharing equipment; it replaces the models 64 and 66 announced in March.

Customers who ordered models 60 and 70 for delivery on the original schedule will get them, because they are now in production. They will be field-converted to the new models as soon as hardware becomes available, and the old models will be discontinued.

## RCA unit to make printing gear

Within days after the Radio Corp. of America’s plans to acquire the publishing firm Prentice-Hall, Inc., collapsed, RCA announced formation of a Graphic Systems division, which will develop and produce sophisticated electronic equipment for the printing industry.

One of the first products of the new division, says Stanley W. Cochran, vice president and general manager of the unit, will be a system that will accept textual material, pictures, charts and advertisements and arrange them for printing.

A keyboard operator will feed textual material into the system and an optical scanner will collect data on illustrations. A computer will digitize all the data, organize it and produce a “page map,” showing the make-up of the page. The system will then produce page proofs and

---

# Electronics Newsletter

---

make a photographic film master from which a printing plate can be made by a separate process.

## Million-dollar IC order placed

Scientific Data Systems, Inc., which is developing a computer with all integrated-circuit logic, has placed the largest single order ever made by a computer manufacturer for integrated circuits. The order for custom-built diode-transistor logic circuits, valued at more than \$1-million, went to the Fairchild Semiconductor division of the Fairchild Camera & Instrument Corp. The circuits will be used in several SDS computers, including the SDS 92, the first commercial computer to use integrated circuits.

## European industry wants own NASA

A NASA for Europe has been proposed by Jean Delorme', president of Eurospace, an organization of 120 European aerospace companies. He called for a fivefold increase in European space expenditures, to \$1 billion a year from the present \$170 million. The United States' annual space budget is about \$5 billion.

Delorme', of France, said a body similar to the U. S. National Aeronautics and Space Administration could coordinate space projects and avoid duplication. His proposal received wide support from the other Eurospace delegates, who met last week in Philadelphia.

The group also supports the idea of a worldwide telecommunication system of about 12 medium-altitude satellites that would supplement the Communications Satellite Corp.'s system.

## Pentagon studies microwave link

A new microwave communications system for United States forces in Japan is awaiting approval by the Pentagon. The system would be part of the over-all program to establish a global military network [Electronics, April 19, p. 133], and would replace several obsolete links in the Kanto Plain area in Japan.

The network would be the final portion of the Pacific Area Communications System (PACS), an updating project managed by the Electronic Systems division at Hanscom Field, Mass. The other two PACS subsystems are Project Wet Wash, the troposcatter link between Vietnam and the Philippines, which is now operational, and communications improvement in the Hawaiian area.

## NASA nulls tv for Gemini

NASA's Manned Spacecraft Center is evaluating television systems for possible use on Gemini. Though there is no official program to put tv on the craft, interest in viewing U.S. astronauts in real time has been increasing because of Russia's success.

The cameras themselves are no problem; rugged vidicons developed for Saturn weigh about two pounds and transmit at a standard 30 frames per second. Gemini would have to carry an additional transmitter, however, to handle the broad bandwidth of television.

## Arinc will give Motorola's course

Arinc Research Corp. will take over the one-week integrated-circuit course formerly given by the Semiconductor division of Motorola, Inc. [Electronics, Jan. 25, p. 18]. Arinc will give its first course June 21-25 in Washington.



# PLASTICOTE<sup>®</sup> WIRE & CABLE

by

## CHESTER

**CHESTER CABLE CORP.**

A Subsidiary of Tennessee Corporation

**CHESTER, NEW YORK**

(See reverse side)

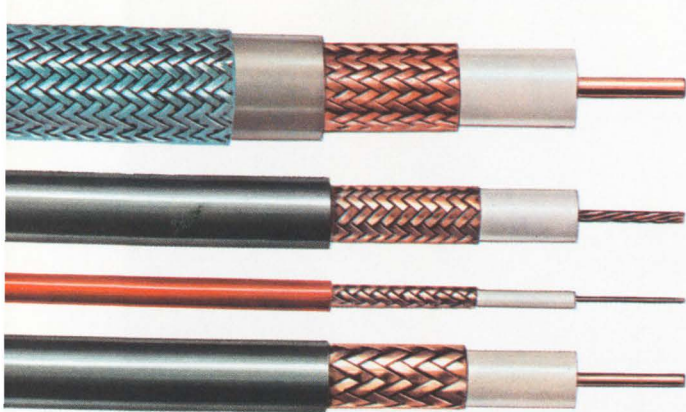

**COAXIAL CABLE** — Chester Cable Corp. offers a complete line of coaxial cable for military and commercial applications. Manufactured in accordance with MIL-C-17, JAN-C-17 and commercial specifications. Constructions include solid, air-spaced and foam dielectrics with conventional braid shields or flat copper tape shields, having PVC or polyethylene jackets. Custom designed constructions of triaxial cable and high frequency-high voltage cable are also available.

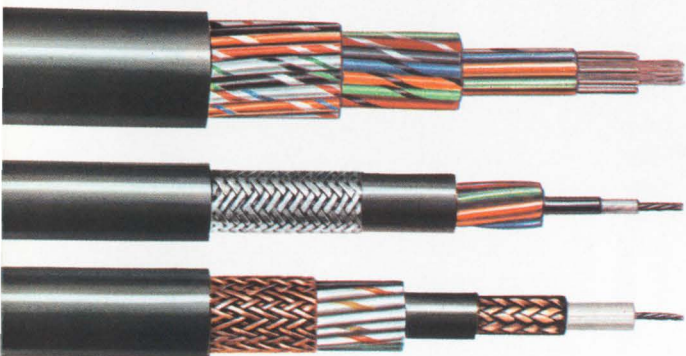

**MULTI-CONDUCTOR CABLE** — Wide range of custom designs available, manufactured in accordance with such industry standards as MIL specs., U/L, CSA, IPCEA, EIA, IMSA, ASTM, etc.

Chester Cable Corp. is a preferred source for quality electronic and electrical cable, insulated and jacketed with thermoplastic materials such as polyvinylchloride, polyethylene and nylon. Custom designs of shielded or unshielded cable include: Control Cable • TV Camera Cable • Missile Cable • Intercom Cable • Computer Cable • Special Hi-Voltage Cable and Parallel Bonded Ribbon Cable.

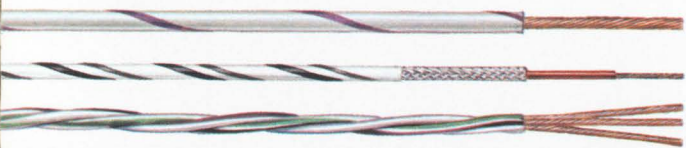

**MIL-SPEC WIRE** — Made in accordance with specifications MIL-W-16878 (Types B, C & D), MIL-W-76B (Types LW, MW & HW) and MIL-W-5086A for electronic systems. Available in single or multiple constructions, shielded or unshielded, with or without nylon or PVC jackets.

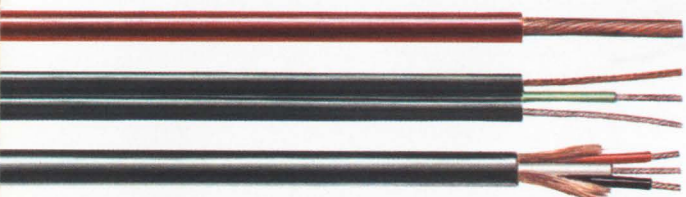

**WIRE AND CORD FOR THE APPLIANCE INDUSTRY** — U/L and CSA approved, 60°C — 80°C — 90°C — 105°C appliance wiring material — SVT, SJT, ST cord, SJTO & STO oil-resistant cord, SJT & ST oil-proof cord, SPT cord with or without individually insulated ground wire. Used for washers, dryers, refrigerating, air conditioning, vending, heating, X-ray and other electrical and electronic equipment.

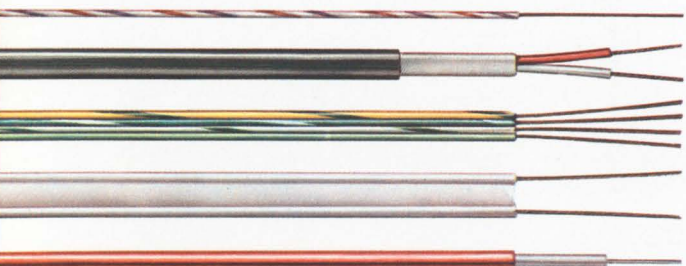

**RADIO AND TV CIRCUIT WIRE AND CABLE** — U/L and CSA approved, 60°C — 80°C — 90°C — 105°C appliance and radio circuit wire, microphone cable, shielded and unshielded audio circuit wire, twin lead antenna wire, phonograph cable, parallel-bonded color convergence ckt. cable, braided hook-up wire, hi-anode wire, hot chassis lead, balun-coil wire, shielded constructions with spiral, braided, aluminum-Mylar tape and conductive materials; all available in Thrif-T-Bond® tinned over-coated conductors.

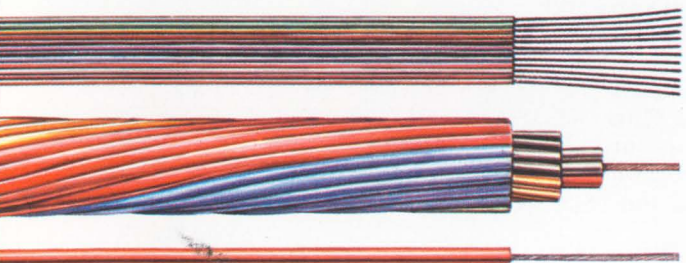

**MISCELLANEOUS WIRE AND CABLE**—Machine Tool Wire • Bus Drop Cable • Flexible Test Lead Wire • Municipal Signal Cable • Low Energy Circuit Control Cable • Station Control Cable • Inter-Office Communication and Signaling Cable • Deep-Well Submersible Water Pump Cable • Gas Tube Sign and Oil Burner Ignition Cable • Intercom Cable • Gasoline and Oil Resistant Wire • Computer Cable • Uninsulated Bus Wire • Parallel and Jacketed Cord • Braided Ground Strap, and special custom designed cable for your applications.



Write or phone for further information.

**CHESTER CABLE CORP., A Subsidiary of Tennessee Corporation, CHESTER, NEW YORK 10918**

Phone: 914 - 469-2141 • TWX: 914 - 469-7011

Printed in U.S.A.

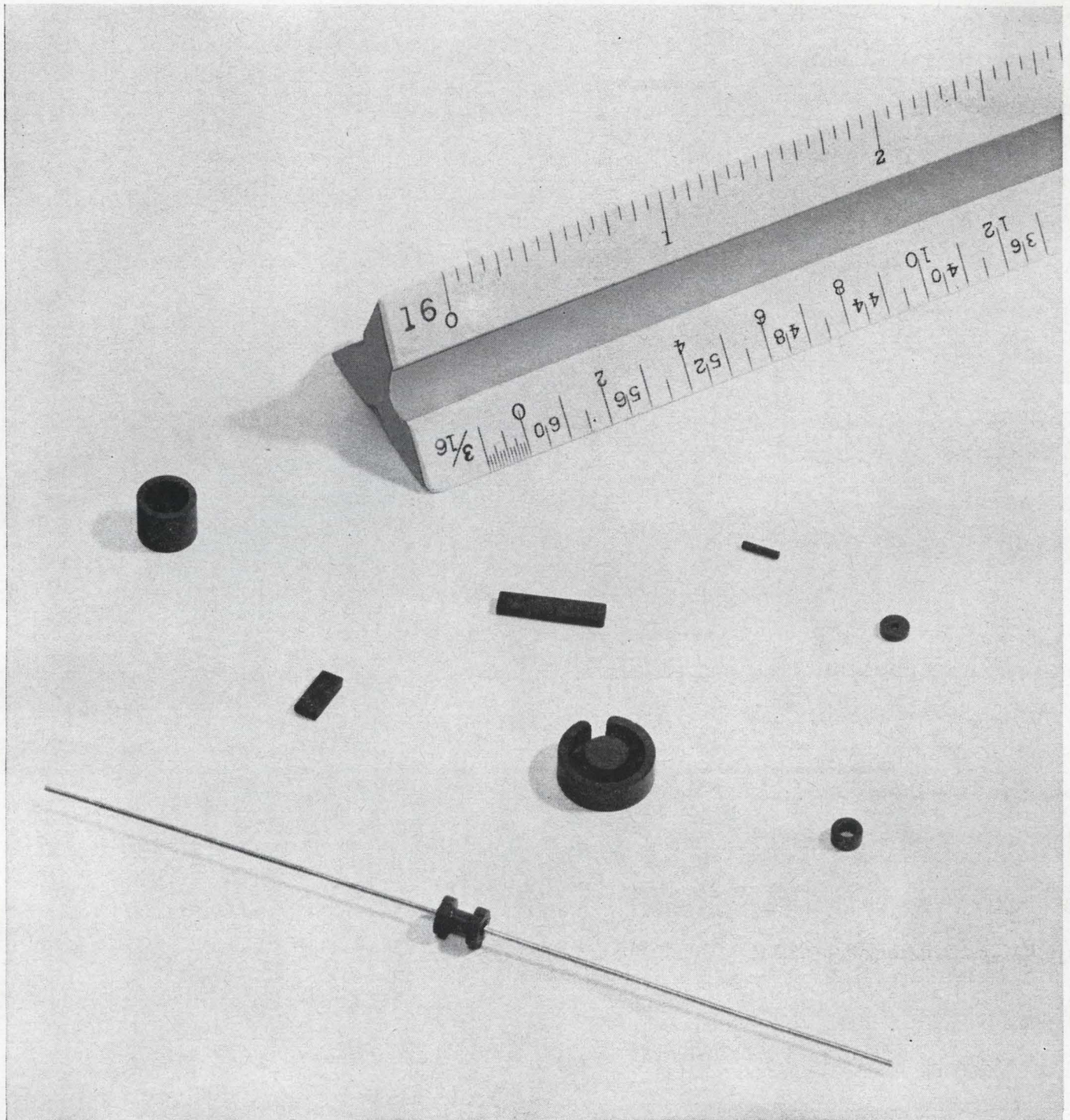

*No matter how small the ferrite piece,*  
**WHEN MECHANICAL AND ELECTRICAL SPECS ARE TIGHT...  
 SPECIFY STACKPOLE**

Stackpole makes them all:

- Toroids down to .120" OD
- Cups as small as .250" OD x .130 Hgt.
- Bobbins smaller than .080" OD
- Cores of .031" D x .170" Long
- Coil forms below .060" D x .187" Long
- Sleeves to .075" OD x .028" ID
- Rectangular Solids smaller than .120" x .120" x .218"

But subminiature size isn't Stackpole's only claim to fame in ferrites. One customer put it this way, "Your ferrite cores are more consistent from order to order than any of your competitors."

Over 30 grades. Isn't that what you're looking for?



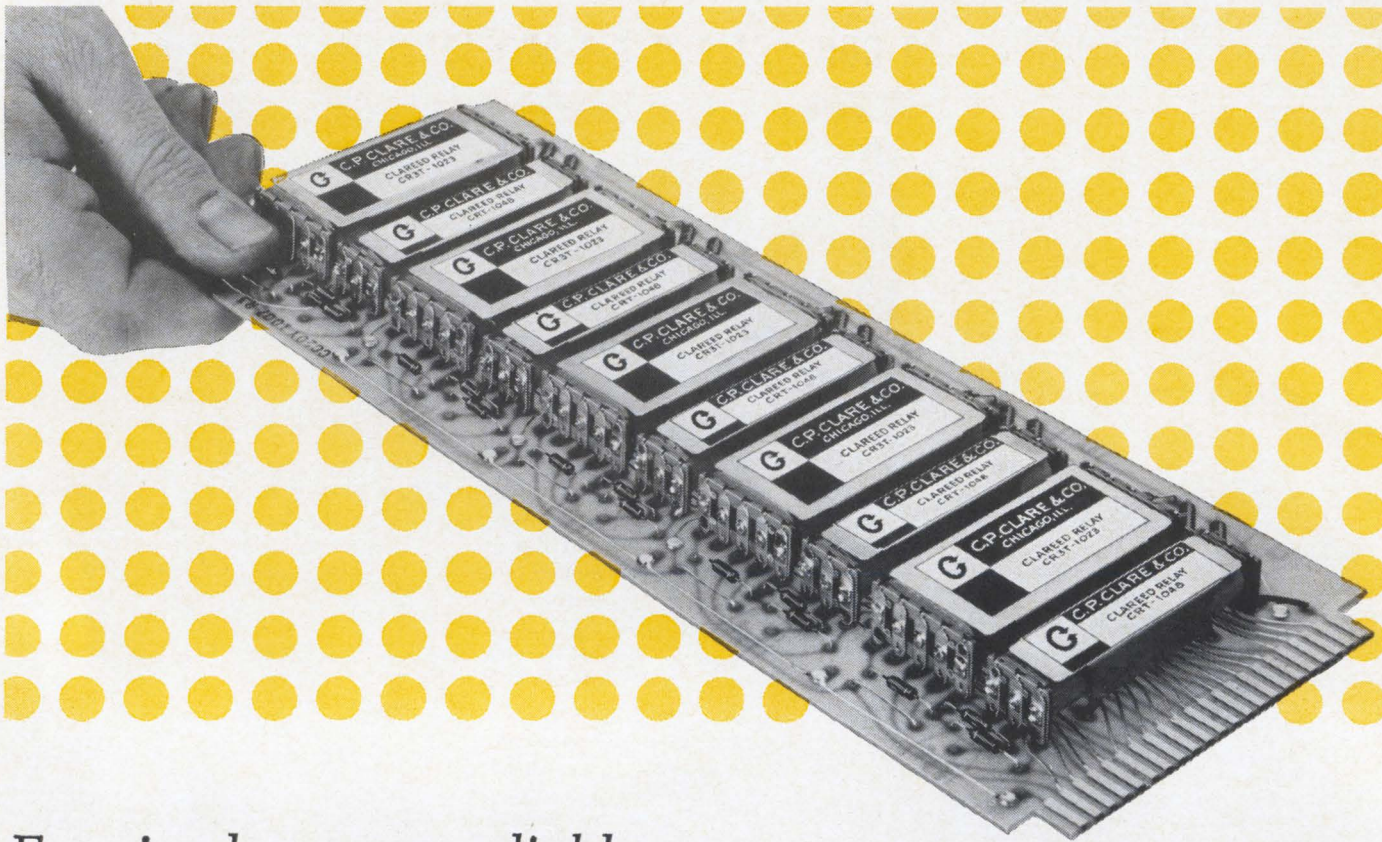

For simpler, more reliable  
digital control circuits... **CLAREED**®

# **CONTROL MODULES**

*pre-packaged counting, selection and logic devices*

■ Counting, selection and logic switching problems are readily solved with Clareed Control Modules. Pre-packaged (or custom-designed if your problem is a new one), these modules combine speed, simplicity, and reliability ...at lower cost than comparable solid state circuitry, and without unnecessary design delay.

**Counting.** Pre-packaged printed circuit board modules in wide variety, for assembly to perform as decimal ring counters, radix <sup>(n)</sup> counters, bi-directional counters, shift registers, etc. Typical applications include scanning systems, digital clocks, data tracking and data transmission systems.

**Selection.** Pre-packaged printed circuit board modules in wide variety, for interconnection to perform as selection matrices. Typical applications include more versatile equivalents of traditional cross-bars, selection matrices capable of individual memory, and check-out matrices which can be operated with all contacts either normally open or normally closed. (Combining these Selection Modules with Clareed Counting Modules, the designer can readily provide a wide variety of scanners.)

**Logic.** Pre-packaged units for printed circuit board assembly in custom-designed logic modules, which efficiently perform such logic functions as AND, inclusive OR, exclusive OR, NAND, NOR, exclusive NOR, etc. These standard Clareed units, in Clare-customized systems, provide master control circuitry which greatly reduces complexity and cost of digital control systems.

Take a look at these Clareed advantages! You'll see how this versatile switching concept can fit into your plans for industrial or commercial systems.

- multiple input and output capabilities, making possible logic at both input and output
- switching capabilities from low level up to 15 va, ac or dc, automatically available at all points without additional output circuitry
- complete isolation between input and output. The output is the contact closure
- immunity to transient and external noise
- data handling speeds up to 120 bits per second, 250 bits as special
- modular printed circuit board construction compatible with modern electronic assembly techniques...meets the requirements of almost any application



## TYPICAL CLAREED CONTROL SYSTEM APPLICATIONS

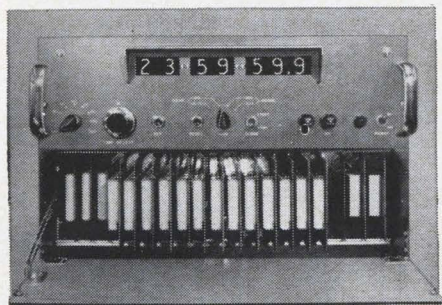

*Digital Clocks* using Clareded Control Modules as ring and binary counters, illustrate a variety of solutions for basic counting circuits in application for timed events, testing and systems control. Counting is performed by flux operated flip-flop elements; switching in the high-rate counter is done by Clare mercury-wetted contacts. This design provides:

- Greenwich time output
- elapsed time output
- local and/or remote visual readout
- local and/or remote control
- 7 digit capability

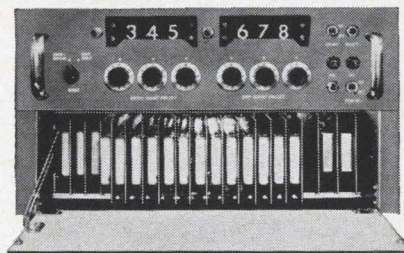

*Industrial Preset Counters* demonstrate production counting and control applications which provide a wide range of switching functions. Clareded flip-flop Modules are the basic switching elements used to provide this more versatile control. This design provides:

- low-cost anti-coincidence circuit for multi-channel operation
- preset 3 digit or 6 digit capability
- multi-channel input
- batch mode operation
- preset unit and batch operation
- special packages available to meet NEMA general purpose, explosion-proof, gas-tight, and water-tight enclosure requirements

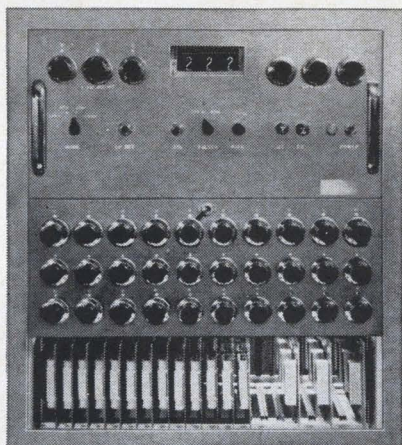

*Scanners* exemplify flexible sub-systems for instrumentation sampling, data logging and control systems requiring multiplexing. In the example shown, the driver is a three-decade counter composed of Clareded flip-flops; the control section uses flux and contact logic to control the driver and provide strobe drive to the matrix. A broad range of scanning options is possible:

- scan rate up to 100 crosspoints per second
- any number of crosspoints
- any number of poles per crosspoint
- special crosspoints for low level scanning
- contact forms A, B, C, or D at any crosspoints
- sequential scan with stop and recycle modes
- random scan of any 10 points in any sequence

Clareded Control Modules can be applied to the switching requirements of most systems. Proven Clareded solutions span many completely different application areas, including:

- machine tool numerical control
- telephone peripheral equipment
- engine test cell scanning systems
- psychological testing equipment
- process counting and recording
- missile checkout systems
- supervisory control and alarm annunciator systems

What's more important is how can Clareded Control help with your switching problems? Take another look at the Clareded advantages. Then, ask your Clare engineer how these plus features apply to your system. Write for Manual 400, Clareded Control Modules, or ask for specific data on Clare Industrial Preset Counters, Digital Clocks and Scanners. C. P. CLARE & CO., Group 05N4, 3101 Pratt Boulevard, Chicago, Illinois 60645.



relays and related control components

# FROM GUDEBROD—A CONSULTANT'S REPORT

SURVEY of HARNESS  
TYING OPERATION  
for  
*Your COMPANY*

Area Code 215, WA 2-1122 • TWX 215-869  
**ROS. SILK CO., INC.**  
FOUNDED IN 1870  
*Silk Division*  
PHILADELPHIA, PENNSYLVANIA  
**OFFICES •**  
NEW YORK, NEW YORK  
25 West 34th Street, Area Code 212  
BURBANK, CALIFORNIA  
1636 Ontario Street, Area Code 818 • 248-088  
sylvania 19464

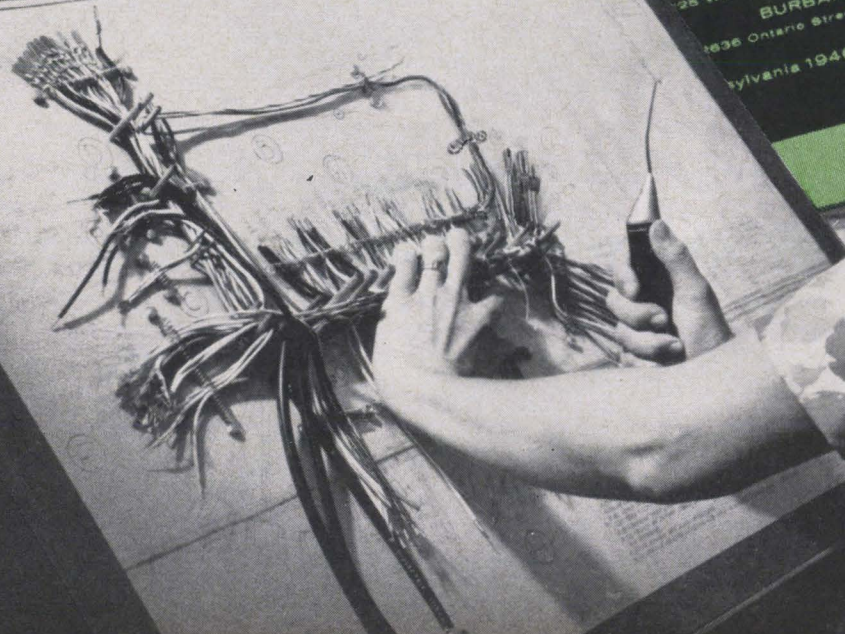

... so that you may improve your harnesses  
... while you save money, too!

**GIVE YOUR HARNESS OPERATION  
A FULL REVIEW ... with this  
Gudebrod Survey (AT NO COST TO YOU, OF COURSE)**

"Improve" is the guide-word of the electronics field—but has your harness operation kept pace? If you could improve your harness product—and save money at the same time—wouldn't you be interested? Where do you go for help in achieving this desirable situation? To Gudebrod—there is no comparable source for such help in the industry. That's why management at the Gudebrod Electronic Division is offering to make a Consultant's Report on your harness department operation. With self-interest they believe that improving the state of the art in the industry will improve their own business atmosphere. So—why not take advantage of Gudebrod's wealth of tape engineering experience and knowledge—there is no cost or obligation attached to it!

#### STANDARDS

To improve your standards specifications, Gudebrod can suggest tapes for high or low temperature use, for fungistatic qualities, for burnproof features, for vacuum use, as well as for material specifications and for tensile strength. The more than 200 types of flat tape in the Gudebrod line are specially designed, not only to meet various specifications but to facilitate the tying operation. Production quantities of tape especially for your use can be made if necessary. With this intimate knowledge of lacing tape, the recommendations contained in the Gudebrod Consultant's Report will help your Standards Engineer—to improve your product and to save money.

#### METHODS

In designing lacing tapes to meet various specifications, the Gudebrod research and de-

velopment operations have kept in mind the basic idea of producing tapes that "tie themselves." The originator of the flat braided tape which did so much to improve wire harnessing and at the same time tremendously increase the safety factor for workers, Gudebrod continues to pioneer in the use of better materials, and in a closer regard for specifications. Taking advantage of the "tie-ability" of Gudebrod tapes is important to your Methods Engineer. The recommendations contained in the Gudebrod Consultant's Report will help your Methods Engineer to improve your product and save money.

#### PRODUCTION

Implementing the requirements of the Specifications and Methods Engineers in economical operation is the problem of the Production Engineer. Gudebrod can show how to use the Cable-Lacer, how to take advantage of dispensing packages, cut lengths, special rigs and other labor speeding and easing means. Whether your harness work is custom or production there are ways of improving your operations that may not have occurred to you—that's why the recommendations contained in the Gudebrod Consultant's Report will help your Production Engineer—in improving your product—in saving money.

#### SURVEY AND CONSULTANT'S REPORT —FREE

Here is all you have to do—write or phone Gudebrod. At your convenience a Gudebrod representative will complete a survey working with your Standards, Methods and Production Engineers. This will be reviewed by engineers at the Gudebrod Home Office. Written recommendations will be prepared and sent to you. There will be absolutely no cost or obligation. Why not get your Consultant's Report under way—get in touch with Gudebrod today.



**GUDEBROD BROS. SILK CO., INC.**

FOUNDED IN 1870

*Electronics Division*



12 SOUTH 12th STREET, PHILADELPHIA, PENNSYLVANIA 19107  
Area Code 215, WA 2-1122

Circle 25 on reader service card

**NEW:**

# Digital Thermometer/Temperature Controller

## 0.1°C accuracy\* from -192.0°C to +999.9°C

*features:*

- High absolute accuracy
- Direct reading
- Easily calibrated
- Fully automatic operation
- Outputs for control, recording, or telemetry
- Modular construction
- High reliability

The PAR Model DTS-1 offers a new order of reliability, convenience, and accuracy in laboratory and process control thermometry. The unit operates by comparing the resistance of a sensor element of platinum (the material whose characteristics define the International Temperature Scale) with an internally generated reference function which employs a unique resist-

ance analog network\*\* that precisely duplicates the temperature-versus-resistance change of platinum. This method allows an absolute accuracy\* of 0.1°C to be achieved. A modified self-balancing Kelvin bridge eliminates sensor lead resistance errors, permitting precise remote temperature monitoring.

In addition to the direct visual readout, measured temperature information is available in binary coded or 10-line decimal form for printer or computer input as well as in pulse code modulated form for telemetry applications. For temperature control or strip-chart recording applications, an analog signal is provided which is proportional to the difference between the measured temperature and the desired temperature

selected by front panel thumb-wheel switches.

All circuits use solid state components except the comparator amplifier where two miniature nuvistor tubes are used to obtain high input impedance and the reference function generator where mercury-wetted relays are used. The entire Kelvin bridge, including the resistance analog network, is isothermally enclosed to assure a high degree of accuracy and good long-term stability. Rugged modular construction, utilizing printed circuit boards, contributes to reliable performance and extended service-free life.

Price: \$3,950.00 (excluding probe). Write for Bulletin #118.

\*Subject to operating range of actual sensor used.

\*\*Patent Pending

**PAR** **PRINCETON**  
APPLIED RESEARCH CORP.  
Dept. D  
Box 565, Princeton, New Jersey

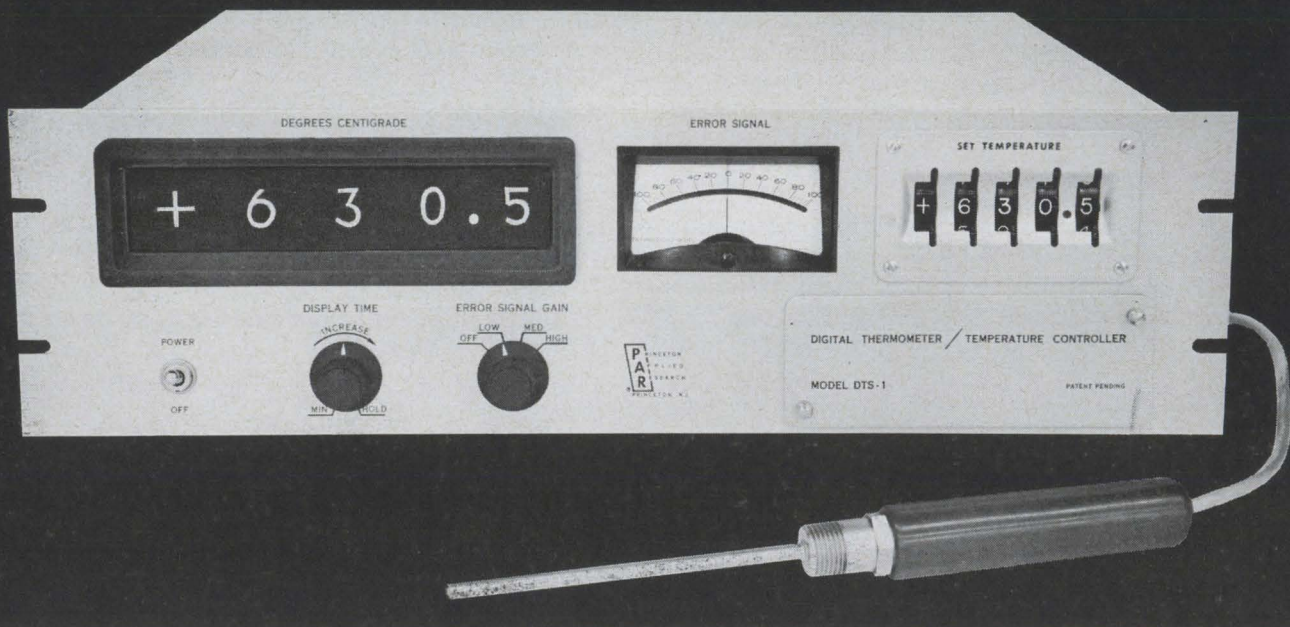

## Communications

### Russia's Telstar

The Soviet Union's first communications satellite, which was launched late last month, appears to be a resounding success, but Russian scientists emphasize that Molnya 1 (Lightning) is only an experiment. They say much more is being planned.

Up to now, Russians have roundly criticized Western space attempts, calling the Communications Satellite Corp.'s Early Bird premature. Lightning 1 seems rather sophisticated for a first try, but apparently has nothing that Telstar or Early Bird don't have.

**Mostly over Russia.** Lightning 1 is in an exaggerated elliptical orbit. Its apogee is nearly 25,000 miles over the Northern Hemisphere and its perigee is 310 miles over the Southern Hemisphere; most of its 11-hour, 48-minute orbit is over the Soviet Union. While it is over Russia, it's high enough to have both Moscow and Vladivostok in its sight.

Lightning 1 works on two modes: one-way television communications, and the multichannel two-way telephone, radiophoto, and telegraph communications. The satellite's power comes from solar cells and chemical energy cells.

Lightning 1 uses a 625-line, 25-frames-per-second television system, which the Soviets say simplifies ground-control problems. The television relay operates on the principle of linear amplification of ground signal, which the Soviets point out permits the television image to be retransmitted to ground without delay and with minimum distortion. Lightning 1's antenna operates over an extremely narrow angle, pinpointing the image. Ground stations are the usual complex system of parabolic antennas, which are moved to



Photo by radio

Technicians in Russia monitor tv reception from Lightning 1.

track Sputniks in accordance with computer command. A mixing system on ground permits the television image to be received along with sound. Special measuring impulses permit continuous control of television.

**More communications.** Although Russian scientists didn't announce how many telephone conversations could be carried at one time by Lightning 1, the Soviets hinted that it could be used for communications between any two points in the Soviet Union, although so far it has only linked Moscow and Vladivostok.

The early telecasts to and from Vladivostok were seen by millions. Films were shown first; live broadcasts followed. Lightning 1 contains equipment described by the Soviets as telegraph-compressing gear, which presumably records in-

formation when the satellite is out of range, then dumps when over Soviet territory.

**Moscow calling.** Lightning 1 may lead to an eventual solution of Soviet Union's vexing long-distance communication problems. In recent years the Soviets have been vacillating between installing cross-country coaxial cable or building relay stations.

Constructing relay stations would be a tremendous job. There are thousands of miles of swamps, forests and uninhabited wilds that the system would have to cross. Even medium-sized cities, such as Yakutsk in Central Siberia, are connected to Moscow by telephone for only a few hours a day because they must share the existing facilities.

Now it appears that two Lightning satellites could give un-

interrupted communication for that region.

The system also has military value for the Soviets, by taking some of the load off conventional ground systems in populated sections. It could even provide an important communications link to Red China.

---

### Military electronics

---

#### Light on a quarrel

The electro-optical space surveillance system designed and built by the Radio Corp. of America for the Air Force at Cloudercroft, N. M., contains some of the most complex applications of fiber optics to date. And therein lies a problem: they are so sophisticated that the optical performance of the entire system, in the Air Force's view, is not exactly 20-20.

Relations between RCA and the Electronic Systems division of the Air Force, which manages the project, aren't too clear either. When the feasibility project was partially halted earlier this year [Electronics, March 8, p. 17], the Air Force maintained that there was a contract dispute. No, said RCA, active development work stopped because "The tests there are completed and we are writing our reports now." Apparently the parties are negotiating over which is to pay for the tests and for additional development work, which the Air Force feels is needed.

**Fiber bundles.** The \$5-million project has been designated the FSR-2. It is a passive system, which uses sunlight reflected from a target in space as the source of energy, and the motion of the target, relative to the fixed-star background, for detection. The surveillance telescope picks up the light energy with a mirror. Fiber optic bundles dissect the light into 12 equal, square formats and then distribute the 12 images to the faceplates of 12 image-orthicon camera heads. With the aid of a computer, this combination is used

to monitor electronically the telescope's field of view.

If it can be perfected, the system will be totally automatic and will become part of the Space Detection and Tracking System (Spadats). Its data would be transmitted to the North Atlantic Air Defense headquarters at Colorado Springs, Colo.

**No fringe benefits.** Reportedly, one of the basic problems posed by the fiber optics has been fringing at the ends of the fibers, which reduces the useful area at the end of the fiber. One solution might be to thicken the end, so that even with fringing, there will be more useful area at the end. Studies are also being made into techniques for bending the fibers and avoiding image degradation caused by heat in the system, controlling temperature during fabrication of the fibers, using better glass, and making many fibers at once.

The fiber bundles are made from 400 sub-bundles, each containing 18,000 individually clad fibers. The

sub-bundles are fused in an oven to form solid glass bars 20 inches long, each containing about seven million fibers; these bars are reheated and bent against forming tools into their final shapes. Twelve bundles are epoxy-cemented into a single assembly that has 234 inches of coherent optical path length and 460 cubic inches of glass, and contains 86 million individual fibers.

---

### Advanced technology

---

#### Neutron movies

Scientists at the Atomic Energy Commission's Argonne National Laboratory have been using very intense neutron beams to take still radiographs through lead shields for nuclear fuel studies. Now they can make moving pictures with a neutron image intensifier tube developed by the Rauland Corp., a

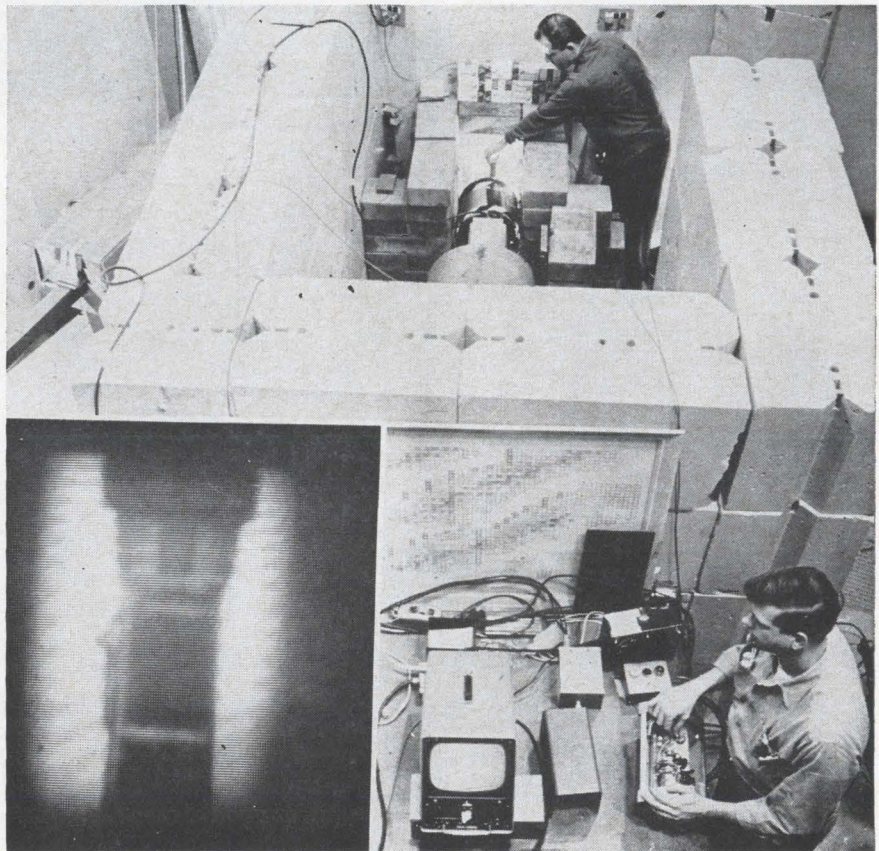

**Neutron radiograph** of a flashlight (insert) is made through a lead shield by Argonne lab technicians. New tube allows moving radiographs to be taken.

subsidiary of the Zenith Radio Corp. Images are projected on a television screen safely away from the reactor's radioactive field.

For the atomic scientist, the development means he can see the action inside a nuclear fuel chamber; for the biologist, it means he can observe carbon-hydrogen compounds, such as chromosomes in human cells, as they affect the growth of an organism; for the quality-control engineer it means he can conduct nondestructive tests in materials that x-rays either couldn't penetrate to or couldn't detect.

**Separate gates.** The key to neutron radiography is the ability of slowed-down thermal neutrons to pass through such elements as uranium, lead, plutonium or bismuth. On the other hand, the neutrons are absorbed in varying degrees by hydrogen, carbon, lithium and boron. In general, materials that block x-rays pass neutrons, and materials that pass x-rays block neutrons.

In early neutron radiography, developed two years ago at Argonne, an object was placed in front of an intense beam of thermal neutrons, which are generated only by large reactors or particle accelerators. A thin screen of a material that could be made radioactive by the neutrons was placed behind the object and exposed to the beam. The screen, with a radioactive "image" on it, was then placed against a photographic plate and the film was exposed by the radioactive atoms in the screen.

**Like a tv tube.** The image intensifier tube was developed by Rauland researcher Wilfrid F. Niklas. His tube resembles a tv picture tube, but it has "screens" at both ends. An image created by a stream of neutrons is converted into light when the neutrons impinge on a chemical mixture at the input screen. When the light strikes another screen directly behind the neutron-sensitive screen, a small stream of electrons is produced; these electrons are energized and diverted onto a small fluorescent screen at the other end of the tube.

At Argonne, tv neutron radio-

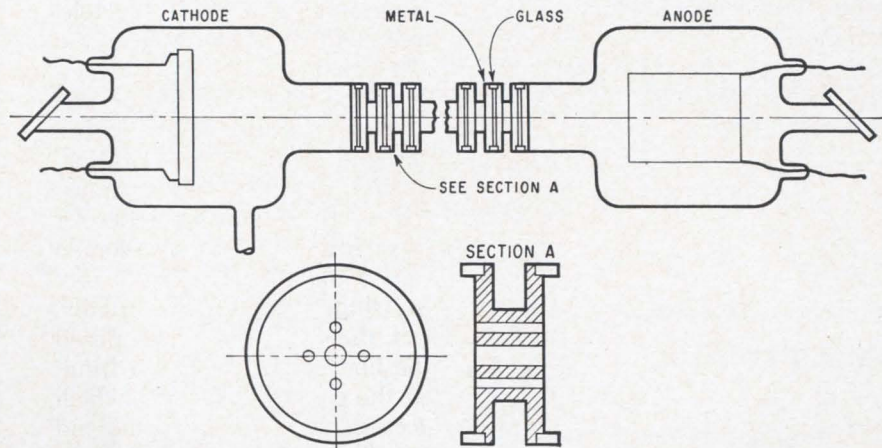

**Laser discharge tube** with rings of metal. New design is expected to permit high-power lasers.

graphs are being used to observe the results of heating irradiated nuclear fuels to a point where they begin to expand and eventually burst their containers. Previously, measurements had to be taken at various intervals during the experiment. Now the activity can be continuously monitored and recorded while the observer is safely outside the radiation field of the reaction.

### Rings for the laser

When 20,000 watts are supplied to a gas laser system, the quartz or Pyrex discharge tube is destroyed by heat. One of the limits on power is heat dissipation, and neither Pyrex nor quartz is a good heat conductor. A possible solution—building the tube with alternate rings of quartz and metal—was outlined last month by Roy Paananen of the Raytheon Co. at the Second Conference on Laser Technology in Chicago [Electronics, April 19 p. 17]. Metal-quartz tubes with continuous output have been used successfully at both Raytheon and the Bell Telephone Laboratories.

**Glass rings.** The tube is made with spool-shaped copper segments cemented to glass insulating rings. Each segment of the tube is self-adjusting in potential because it is electrically "floating"; that is, each segment is electrically as well as physically isolated so that the voltage drop occurs over the areas between the spool-shaped segments.

Generally, input power is limited by thermal conduction inadequacies of the quartz or Pyrex. Even with water cooling at the rate of 2 gallons per minute, the upper limit of power input is about 20,000 watts.

At Bell, E. F. Labuda, E. I. Gordon and R. C. Miller have experimentally determined the limiting length-to-bore ratio for the metal sections to be about 50:1. However, as that ratio is approached, bits of metal ring sputter, or split off. Larger refractory metal discs, cooled by thermal radiation through a quartz envelope, reduce the sputtering problem. The Bell scientists have already demonstrated laser output densities off one watt per cubic centimeter at a current density of about 40 milliwatts.

**Work in Germany.** Research on arcs through metal tubes by German physicists indicates that an input of 10 kw per centimeter of tube is possible. In laser work, 100 cm is a reasonable length for a discharge tube, so that at 0.1% efficiency, an output of 1 kw is theoretically attainable.

Commenting on output/input ratio, Paananen noted that efficiencies two to three times as great as the maximum obtainable at present can be expected from argon lasers with large-bore discharge tubes, but that these configurations are not necessarily those which give the most power. He says that ceramic tubes also possess great thermal conductivity and that re-

search in this area is in progress now at other companies. He also predicts that c-w neon lasers at about 3,400 angstroms, ultraviolet, are forthcoming.

---

### Weather

---

#### Spotting a twister

On Palm Sunday, 250 persons died in 37 twisters that tore through six states in Tornado Alley, a slice of the Great Plains that stretches from the Texas Panhandle to Wisconsin. Another 2,500 were injured

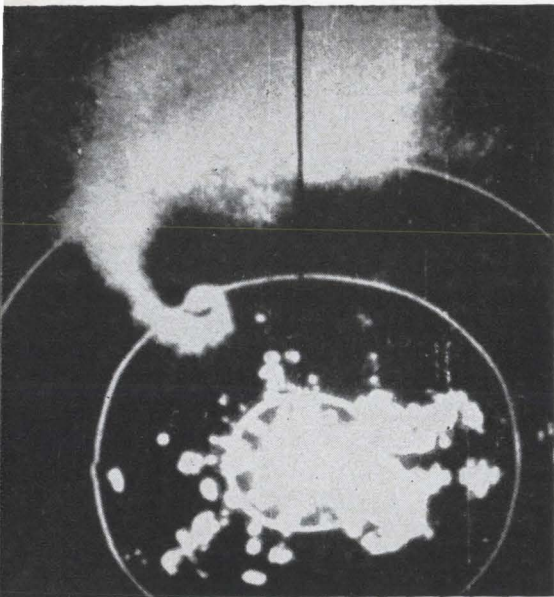

Hook of a tornado as it appears on radar scope.

and damage was estimated at \$240 million. Weathermen are now conducting an investigation to find out why the human toll was so high.

The Weather Bureau says radar operators spotted the telltale little hooks that indicates tornadoes between 20 minutes and four hours before the twisters ripped into towns—but people just didn't take heed.

**Calm public.** "The trouble is," says Allen Pearson, head of the Weather Bureau's emergency warning service, "the people didn't believe the warnings."

Unfortunately, the storm warning network isn't as sophisticated or automatic as the detection system. The task of getting warnings to the people depends on telephone, teletype, local radio and television stations and civil defense alarms. The Weather Bureau concedes that there were some problems in getting the warnings to the news media. It is investigating the time lag.

Earlier efforts by Civil Defense officials to promote development of automatic electronic warning devices in homes and factories have so far been unsuccessful. Devices for automatically turning on radios to broadcast warnings have proven either too costly or unreliable. Another warning device, plugged into a wall outlet and triggered by small variations in power output, also failed to catch on.

**Springtime watch.** From mid-April to the end of June, Weather Bureau radar observers watch their screens closely, hunting for early signs of a twister. The most powerful tool for detecting the tornado's hook is a 500-kilowatt radar set called the WSR-57, a \$300,000 piece of equipment that has a range of 250 nautical miles. But a twister has to be within 100 miles for the operator to spot the hook. The bureau currently has 31 of these radars in operation around the country, with six more on order from the Raytheon Co. To blanket the entire nation with WSR-57's, the Weather Bureau would need 40 more sets, at an investment of \$1.2 million. So far, Congress hasn't allocated the funds.

**Seeing the storm.** The WSR-57 operates in the S band, between 2,700 and 2,900 megacycles, the frequencies that suffer least from attenuation in penetrating weather. To make the sets "see" weather even better, the radars use linear polarization to enhance the displays.

Many of the other 67 weather radar installations around the country use obsolescent instruments, which have been acquired from the Defense Department as surplus gear.

The most pressing need for ad-

ditional radar units is in the Southeast, where current installations are too far apart, the bureau believes. Most of the radar installation in Tornado Alley are spaced 200 miles apart, so detection times are generally small.

---

### Industrial electronics

---

#### Northeast passage

Traffic is gradually choking the Northeast. By 1980, if drastic action is not taken, the highways between Boston and Washington will become nothing but elongated parking lots. High-speed rail transportation may be one answer; another, given in a study prepared for the Commerce Department by Cornell University's Aeronautical Laboratory, may be these developments:

- An automatic urban transit system that would electronically guide small electric cars through city streets and park them;
- A semiautomatic intercity highway system in which larger cars would be able to cruise safely at more than 100 miles per hour;
- A semiautomatic super freightway for the exclusive use of huge trucks.

Only the freightway idea is given specific application by the report. The first link would be an experimental 100-mile strip between Camden, N. J., and the Thomas E. Dewey Thruway in New York. The trucks would be barred from other highways in the area—such as the heavily traveled New Jersey Turnpike—thus increasing the passenger car capacity of the other routes.

Since getting onto the freightway would be a little like jumping onto a merry-go-round in full swing, matters of judgment would be left to a computer. At an interchange, a driver would insert a punched card into a slot, giving essential information about his vehicle and its destination. The computer would control signals to guide the truck down an access highway and onto the freightway so that it could enter the traffic smoothly. Through a



## TRW CAPACITORS STAY PUT



14-55A

### STABILIZED for a lifetime...to $\pm 1\%$

How do we build stability into our close tolerance capacitors? By selecting the finest basic materials. By manufacturing in highly specialized facilities with controlled processes. By inspection-testing to top reliability standards. By really caring! Result? *Stability*. The kind that won't quit. The kind of stability you need for all critical circuits requiring long term  $\pm 1\%$  tolerance.

- **VERY SMALL SIZE**—Ideally suited for high density requirements.
- **QUICK DELIVERY**—Fast schedules...all types...any quantities.
- **CASE STYLES**—Tape-wrapped, dipped or hermetically sealed.
- **CAPACITY RANGE**—As low as .001 mfd to  $\pm 1\%$ .

\*Du Pont registered trademark

- **MANY MIL TYPES AVAILABLE**—Type 683 Mylar\* to MIL-C-19978 (CQ)... Type 643UW Mylar to MIL-C-27287 (CTM)
- **RELIABILITY**—Proven by data from millions of test hours.
- **MICA and CERAMIC REPLACEMENT**—Many close tolerance types cost less than mica, are more stable than ceramic ...in values above .001 mfd.

For complete information phone, wire or write  
TRW Capacitor Division,  
112 West First Street, Ogallala, Nebraska.  
Phone: 308-284-3611.  
TWX: 308-526-7816.

FORMERLY  
**GOOD-ALL**

**TRW CAPACITOR DIVISION**  
THOMPSON RAMO WOOLDRIDGE INC.

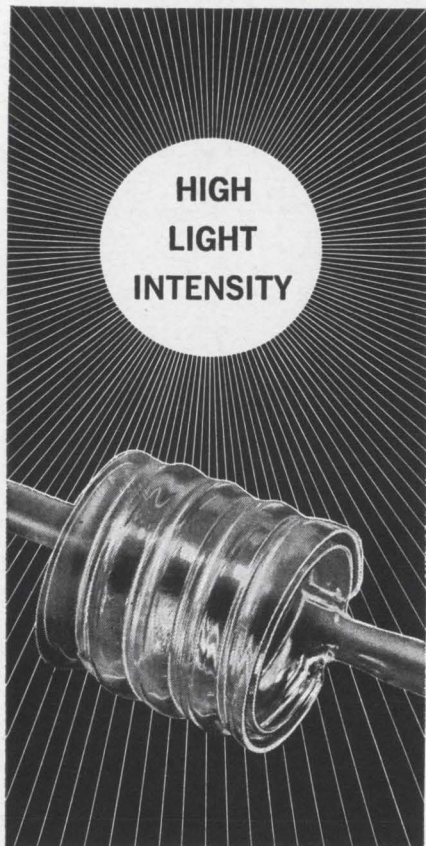

# LAM-O-LUME

## PURE FUSED QUARTZ LAMP ENVELOPE

The envelope features rugged, unitized construction of great dimensional accuracy, that is produced by centering a cylindrical quartz tube within a second tube of larger diameter. The annular space between the tubes becomes a helical coil as a special high temperature burner fuses inner and outer tubes together along a narrow helical path.

Excellent for outdoor lighting, Ultra-violet irradiation, laboratory heat exchangers, laser pumping, photography and Xenon lamps to provide light intensities many times brighter than the sun.

Comes in lengths up to 30 inches and in diameters of greater than 1 inch, has high chemical purity, low thermal shock, and operates indefinitely up to 1050°C.

Write for details.



## Electronics Review

system of sensors, the computer would keep track of distances between trucks and activate control devices to adjust speed. The trucks would run on their own power.

Cornell estimates that such a strip would cost between \$400 million and \$500 million.

**Zippering along.** For intercity passenger car travel, the study suggests development of cars that would cruise at 100; presumably they would travel on a highway similar to the freightway.

For city and suburban driving, the study suggests development of a small, electrically powered car which it dubbed the Urbmobile. Once this overgrown golf cart moved onto a city street, it would come under automatic control. Careful regulation of spacing would permit roads to carry up to 7,200 cars an hour—three or four times as many as a current urban expressway can.

Two forms of spacing are outlined: one in which the cars were coupled into "trains," and one in which each car occupied a space which is electronically controlled.

**Close spacing.** The continual coupling and uncoupling of a train makes it inferior to electronic spacing, the study says, but, on the other hand, close spacing will require a high degree of electronic sophistication and will be quite expensive. Therefore, the first such system will probably use trains, however unwieldy, the study concludes.

Lest electronics manufacturers be dreaming of a traffic bonanza, the study cautions: "Public acceptance of an automatic guidance system will be more readily gained with a mechanical, rather than an electronic device, because of the general lack of public confidence in the reliability of electronic devices."

## Avionics

### No smear

Any amateur home-movie buff knows what can happen when he

tries to shoot a fast-moving scene: the picture may smear. With experience, he learns to avoid smear by panning—swinging the camera in the same direction as the target, so that the angular speeds of the camera and the target match.

Designers of photographic equipment for reconnaissance planes have the same basic problem, although it's more complicated.

**Adjust the speed.** Some reconnaissance cameras operate with the shutter continuously open; therefore a simple way to avoid smear would be to adjust the rate at which the film passes behind the lens so that it matches the angular speed of a point on the ground. In effect, the film itself would be panned, rather than the camera. The camera system would have to adjust itself for the ratio between velocity (V) of the craft and its altitude (H).

A fully automated system that computes this ratio, adjusts the film movement and periodically repositions the camera to look ahead, leapfrogging from one scene to another, has been developed by F. H. Kierstead, a scientist at the Goodyear Aerospace Corp., a subsidiary of the Goodyear Tire and Rubber Co. The system, undergoing tests by the Air Force, can operate from satellite altitudes down to 1,000 feet.

The first step in adjusting the film's speed and the nodding motion of the camera occurs in a vidicon, which converts the photographed image into an electrical signal. That signal is fed to a tube which stores the information. Then a nutation generator, which deflects the electron beams without changing their polarization, feeds one signal through a deflection amplifier and into the storage tube and another simultaneously into a phase discriminator. The signals from the vidicon and the storage tube are compared, providing separate information on fore-aft (longitudinal) error and left-right (lateral) error. The longitudinal data is integrated to produce a V/H signal that drives a servo and repositions the camera, so the image coming through the lens matches the stored signal. The V/H signal

is fed simultaneously to a servo that adjusts the craft's rudder to correct for drift.

**Picture scanning.** Conventional television techniques are used to transfer signals of the scene, as viewed by the vidicon, to the storage tube. A raster generator scans the vidicon and the storage tube synchronously, and modulates the storage tube's read-in beam with the vidicon's output. Once the information is stored, the potentials within the storage tube are adjusted for readout.

Correlation is performed by a second scanning of the vidicon and the storage tube, but this time the readout beam of the storage tube is modulated with the vidicon. The output of the storage tube is used to measure the error: the highest output indicates the least error and the condition for the least smear.

### Solid state

### Powerful modulator

The difficulty in shrinking the size and weight of a pulse modulator by turning to solid state devices lies partly in the semiconductors' susceptibility to damage from high inverse voltages and fast transients. Engineers at the Ling Electronics division of Ling-Temco-Vought, Inc., at Anaheim, Calif., licked the problem by choosing silicon controlled rectifiers to replace hydrogen thyratrons as switches, because the scr's are capable of handling higher power than most other solid state devices—and then by developing circuitry to protect the scr's against the transients.

The result, they say, was a pulse modulator rated at 65 megawatts peak and 75 kilowatts average output, much greater than that of other solid state systems.

James A. Ross, vice president of engineering at Ling, says the design concept holds out hope for "unlimited super-power levels far beyond conventional gas tube pulse modulators."

In the LTV modulator, each scr

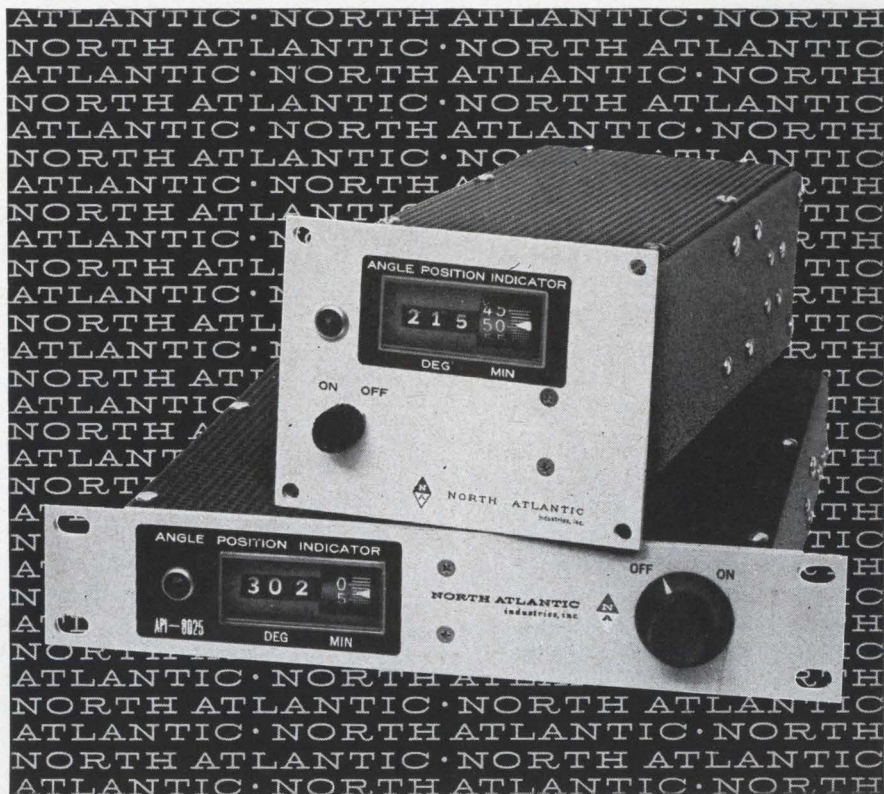

## how to measure resolver or synchro position with 30 second repeatability

In both production test and ground checkout systems, North Atlantic's high performance Angle Position Indicators provide exceptional operator ease and precision in the measurement of synchro and resolver position. Features include digital readout in degrees and minutes, 30 second resolution, continuous rotation, plug-in solid-state amplifier and power supply modules. Due to the design flexibility of these units, they can be readily provided with a variety of features for specific requirements. Typical units in this line incorporate combinations of the following features:

- Single Synchro or Resolver Input
- Dual Synchro or Resolver Inputs
- Retransmit Synchro, Resolver, Potentiometer, or Encoder
- 2-Speed Synchro Input
- Multi-frequency Inputs
- DC Input
- 0-999 Counter

#### BASIC SPECIFICATIONS

Range.....	0°-360° continuous rotation
Accuracy.....	6 minutes (standard)
Repeatability.....	30 seconds
Slew Speed.....	25°/second
Power.....	115 volts, 400 cps
Size.....	API-8025 1 3/4" h x 9 1/2" w x 9" d
	API-8027 3 1/2" h x 4 7/8" w x 9 3/4" d



Your local North Atlantic representative has complete data on the API line. Call him today or write direct for technical literature.

**NORTH ATLANTIC industries, inc.**  
TERMINAL DRIVE, PLAINVIEW, L. I., NEW YORK • OVerbrook 1-8600

# Trygon RS Series:

---

# 71°C all- silicon power supplies

---

## for high-reliability systems!

---

71°C without derating, external heat sinking or forced air—3½" rack height—hermetically-sealed rectifiers—temperature stabilized reference diodes and semiconductors—computer grade filter capacitors—all for extreme reliability! Constant voltage/constant current, with automatic mode crossover. Seven models, from \$359. Write today for complete specs. Dept. E-30.

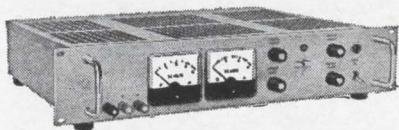

**TRYGON®**  
**POWER SUPPLIES**  
Roosevelt, L. I., N. Y. (516) FReeport 8-2800

## Electronics Review

---

switches parallel pulse lines into a common load. The small, lightweight device needs no heater power, and, therefore, reduces input power and cooling requirements.

**Divides and combines.** A single low voltage power supply is fed to 18 parallel-connected charging assemblies, which can be adjusted to charge up to the same peak voltage. Each of the assemblies is in turn connected to 24 parallel pulse-forming networks. The output of the pulse networks are put together in 18 combining transformers with high primary-to-secondary turns ratios. The transformers, whose secondaries are connected in parallel, transfer the combined pulses to a single 1:12 ratio pulse transformer, which can then apply a 256-kilowatt pulse at 256 amperes to a klystron load.

Although the system's final output is at very high voltage, components in front of the primary of the combining transformers operate at a relatively low potential. So far, after 2,200 operating hours, there have been no network capacitor failures and only 10 scr failures.

Modulators of this design can not only be used in present-day land-based radars, linear accelerators, industrial and medical x-ray generators, but will make possible lighter high-power radar for aircraft and satellites.

---

## Consumer electronics

---

### The FCC steps in

The Federal Communications Commission made it clear late last month that it will keep community antenna television (CATV) on a tight rein.

Specifically, the FCC took these actions:

- Claimed jurisdiction over all CATV systems. There is no question about the commission's authority to regulate CATV systems using microwave facilities, because they must have FCC licenses to broadcast. However, only about a

fifth of the systems use microwave. The others use only cables, and have previously been regarded by the FCC as free from federal control.

- Slapped a restriction on microwave CATV systems, requiring them to broadcast as many local programs as they can carry, and forbidding them to duplicate those programs with imported signals from distant stations within 15 days before or after the local broadcasts.

- Proposed to make the same rule effective for the cable CATV systems. FCC Chairman E. William Henry indicated that this action will be taken within a matter of months.

- Launched a broad inquiry into possible further regulations for all CATV systems. For example, it is virtually certain that CATV's which originate their own programming will be regulated just as licensed commercial broadcasters are now. This, Henry concedes, gets very close to a system of outright licensing for all CATV operators. Eventually, licensing seems sure to come.

**Legislative support.** Some congressmen and some CATV men—such as Irving B. Kahn, the Teleprompter Corp. president—feel that the commission should have waited for legislation authorizing it to regulate CATV. Henry says the commission would welcome such legislation, but makes it plain that the agency can't wait. The industry has come to regard federal regulation as inevitable; it, too, is ready for legislation, which would avoid litigation and a long period of uncertainty.

CATV is a low-investment, high-profit operation. It's so attractive that there are now about 1,300 CATV systems, compared with 550 only five years ago. CATV gets its product free: the tv signals that it picks up from licensed stations. The signals then are carried by cable or microwave into the homes of fee-paying customers. The buyer of CATV services gets more variety in programs, and generally more dependable signals.

**Commercial fears.** In the view of many commercial tv broadcasters, CATV threatens the whole tv struc-

ture. The FCC shares this concern. In addition, it feels CATV may harm ultrahigh frequency broadcasting. Multichannel uhf was helped by passage of the law requiring that all tv sets be equipped to receive uhf signals. As a result, engineering work is under way to perfect transmitting and receiving equipment for uhf. This work, of course, would be in vain if CATV choked off uhf before it took hold.

### Antidote to a bug

If you think your martini may be bugged, you can always go on the wagon—but you needn't do anything so drastic. You can also employ a gadget developed by Dectron Industries, Inc., that neutralizes "bugged" olives by jamming any radio transmissions emanating from such eavesdropping devices.

It was Dectron, of Santa Monica, Calif., that developed the snooping "olive" in the first place.

The countermeasure, called the Antibug, fits into a shirt pocket and jams radio frequencies over a 200-megacycle bandwidth. "This will more than cover all the known radio-frequency bugs," says Steven W. Netolicky, president of Dectron. "One of our problems," he adds, "is to hold down the Antibug's bandwidth."

**Ten-hour day.** The Antibug Mark I is 3 $\frac{3}{8}$  inches high, 1 $\frac{1}{2}$  inches wide and  $\frac{5}{8}$  inch thick. It operates for 10 hours on a standard four-volt nickel-cadmium battery.

The Antibug can jam only radio transmission; it's ineffective against hidden tape recorders, telephone taps and other direct-wire connections. However, it works well against all miniature transmitters, spike mikes, telephone bugs and other eavesdropping devices.

**Total jamming.** One difficulty with the Antibug is that it tends to reveal its presence by jamming every radio in the room. However, Netolicky notes, in an atmosphere where bugging is suspected, a potential victim might not be very embarrassed at being caught protecting himself.

The Antibug's circuitry is relatively simple, and discrete components are used.

## Will the real \$5 integrated chopper please stand up

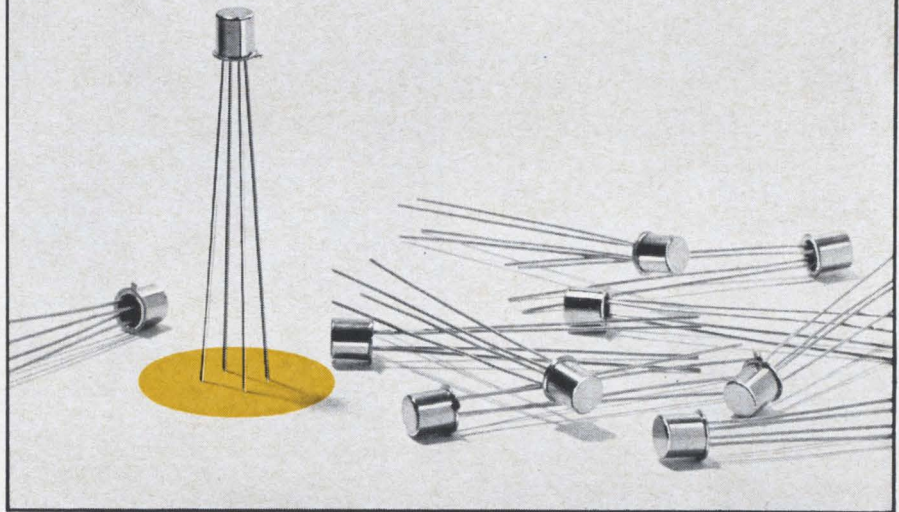

GET MORE VOLTS PER DOLLAR WITH CRYSTALONICS 3N105-107

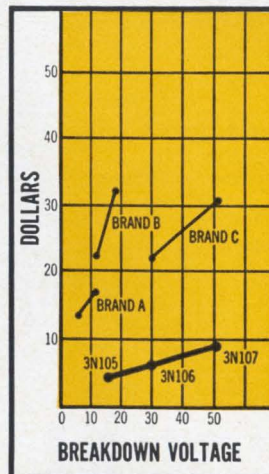

And will anyone who thinks all integrated choppers are expensive please sit back and read this. New twists in our exclusive **Silicon Epitaxial Junction Process** now enable us to sell **dual-emitter devices at matched-pair prices.**

For general industrial use, we offer the 3N105-107 for \$5-8 in 100 quantities. Also, we're second source for the "incomparable" 3N90-95 series. For the ultimate in performance, we offer the 3N100-104, again at competitive prices. All are available **off the shelf** from Crystalonics or your local distributor.

If you'd still rather pick a pair, we also have the broadest line of single choppers. We can supply them in bulk, or in pairs matched to  $\pm 50$  microvolts. For the choppers you'd like to specify, call Crystalonics. Our Applications Engineers will be happy to help you.



**Crystalonics, Inc.**

147 SHERMAN STREET • CAMBRIDGE 40, MASS. • TEL: 617-491-1670  
6715 HOLLYWOOD BLVD. • HOLLYWOOD 28, CALIF. • TEL: 213-463-6992

# TEST YOUR EPITAXIAL CONTROLLED RECTIFIER IQ!

For IR 35, 70, 100, 150 average ampere types

See answers at bottom of page

**QUESTION 2:** IR epitaxial controlled rectifiers will withstand \_\_\_\_\_ reverse voltage transient in the reverse avalanche region (providing power dissipation rating is not exceeded).

- A - 1500 volts
- B - unlimited
- C - 120%

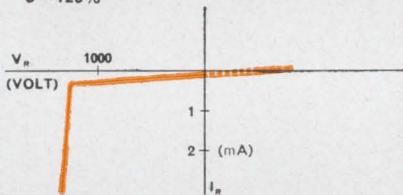

TYPICAL REVERSE VOLTAGE CHARACTERISTICS

IR epitaxial controlled rectifiers actually tested for more than 100,000,000 (10<sup>8</sup>) turn-on operations by voltage breaker, without failures.

**QUESTION 3:** Forward voltage transient capability of IR epitaxial controlled rectifiers is limited to \_\_\_\_\_ (providing power dissipation and di/dt are within ratings).

- A - infinite voltage
- B - full rated forward blocking voltage
- C - 120% of rated voltage



V-I CHARACTERISTICS

IR offers the highest di/dt in the industry. di/dt = 300 amperes per microsecond maximum to 300 amperes peak in 35, 70, 100 and 150 ampere ratings (with sufficient gate drive).

**QUESTION 1:** Turn-off time \_\_\_\_\_ with increase in the reverse recovery current.

- A - increases
- B - unaffected
- C - decreases

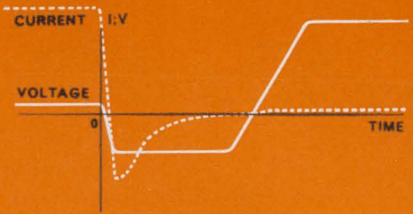

TURN-OFF ACTION

IR epitaxial controlled rectifiers provide very fast turn-off time—20 and 30 microseconds maximum in 35 and 70 ampere types, 30 microseconds in 100 and 150 ampere types.

**QUESTION 4:** dV/dt can turn on a controlled rectifier because of \_\_\_\_\_ generated in the device.

- A - localized heating
- B - capacitive displacement current
- C - impurities



IR epitaxial controlled rectifiers are available with dV/dt greater than 200 V/μ sec. in 35, 70, 100, 150 ampere types; 1000 V/μ sec. in 35, 70 ampere types.

**QUESTION 5:** The limiting factor to high temperature operation of epitaxial controlled rectifiers is \_\_\_\_\_.

- A - melting of the solder
- B - localized hot spots
- C - thermal self-firing



IR epitaxial controlled rectifiers provide highest temperature capability... 150°C maximum for 35 and 70 ampere devices.

**QUESTION 6:** The blocking of forward voltage is accomplished by the \_\_\_\_\_ in a PNP SCR.

- A - center junction
- B - cathode junction
- C - anode junction

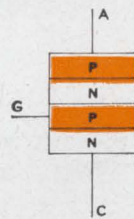

PNPN SCR

IR voltage ratings go up to 1300 volts in 35, 70, 100 and 150 ampere types—the highest in the industry.

**QUESTION 7:** With International Rectifier's new SCR Calculator you can determine \_\_\_\_\_.

- A - SCR rating and number required
- B - R-C imposed dV/dt
- C - phase shift range



If you do not yet have this compact time-saving SCR Calculator, send check or money order for \$1.00 to International Rectifier Corp., 233 Kansas Street, El Segundo, California.

Only International Rectifier offers these premium parameters. All ratings—35, 70, 100 and 150 average ampere—are available in production quantities, at standard prices. IR epitaxial controlled rectifiers open areas of application

heretofore impossible. For further information and application assistance, contact your local International Rectifier sales office or write to International Rectifier Corp., 233 Kansas Street, El Segundo, California.

WORLD'S LARGEST RECTIFIER SPECIALISTS



# INTERNATIONAL RECTIFIER

INTERNATIONAL RECTIFIER CORP., EL SEGUNDO, CALIF., PHONE OR 8-6281 • CABLE RECTUSA • REGIONAL OFFICES IN NEW YORK CITY, CH 4-0748 • FORT LEE, N. J., WI 7-3311 • SYRACUSE, N. Y. HE 7-8495 • CAMBRIDGE, MASS., UN 4-6520 • ARDMORE, PA., MI 9-3667, GR 3-3932 • SILVER SPRING, MD., JU 9-3305 • MIAMI, FLA., 445-5201 • CHICAGO, ILL., OR 6-4090 • CLEVELAND, OHIO, 734-4100 • DAYTON, OHIO, 223-7691 • HUNTINGTON WOODS, MICH., LI 8-1144 • ST. LOUIS, MO., TE 8-6333 • MINNEAPOLIS, MINN., 920-1200 • RICHARDSON, TEX., AD 1-2504 • LOS ANGELES, CALIF., 750-0550 • IN CANADA: TORONTO, ONT., 421-5970 • MONTREAL, QUE., 861-0562

EUROPEAN GENERAL SALES OFFICE: 38 AVENUE DES ARTS, BRUSSELS 4, BELGIUM • TELEPHONE: 111774

Answers: 1-C; 2-B; 3-A; 4-B; 5-C; 6-A; 7-A; B and C.

---

# Washington Newsletter

---

May 3, 1965

## Cutting the strings on research dollars

New directions are being charted in the financing, distribution and choice of projects for scientific research sponsored by the government. Policy-making scientists, exploiting their influence with Congress and the Administration, are pushing for:

- **A major expansion in the role of the National Science Foundation.** Currently, to obtain funds, scientists in some basic research projects must justify their work to agencies with specific missions, such as the Defense Department and the National Aeronautics and Space Administration.

- **A more even geographical distribution of federal research dollars.** Both Congress and the Administration appear more receptive to the long-standing complaint of the Midwest that California and New England are unfairly favored.

- **Added emphasis on federally supported applied research,** as distinct from the basic scientific efforts that have received heavy emphasis in recent years.

## Navy gets to work on F-111B bugs

The Pentagon has named a trouble-shooter to try to work the bugs out of the Navy version of the TFX fighter plane, the F-111B.

Rear Adm. W. E. Sweeney will manage the Navy version, as deputy to Air Force Brig. Gen. John L. Zoeckler, manager of the over-all program. Sweeney will tackle the development problems that have kept the F-111B in the research and development phase: keeping weight within acceptable limits for carrier use, and integrating the Phoenix air-to-air missile with the plane.

Charles M. Herzfeld, deputy directory of the Defense Department's Advanced Research Projects Agency, is taking over as director on July 1, succeeding R. L. Sproul. Herzfeld is the agency's director of missile defense.

## Johnson seeks more Eastern trade

The Johnson Administration would like a more permissive policy on trading with Communist countries—particularly the Eastern European satellites.

Whether the products of American technology should be exported is a crucial concern to electronics companies. A 12-man special Presidential committee on U.S. trade relations with Eastern European countries and the Soviet Union has gone to work, and will report to the President by June. It is headed by J. Irwin Miller, chairman of the Cummins Engine Co., and includes James B. Fisk, president of Bell Telephone Laboratories.

The Administration clearly wants a recommendation for increased trade with the East bloc. But even if it gets one, Congress may balk. Rising tensions over fighting in South Vietnam have produced a climate in which the legislators—traditionally skeptical—may be unwilling to sanction more trade. **Some companies that have been exporting to Communist countries have stopped, fearing that publicity would hurt their public image.** One Presidential adviser puts it this way "U.S. government policy is less of a barrier to East-West trade than public and business attitudes."

---

# Washington Newsletter

---

## Power plant needed for small A-sub

President Johnson has given permission for the Navy to go ahead with plans for a nuclear-powered deep-diving research vessel—and now all that is needed is the power plant, which will have to be small. The job of developing the package belongs to Vice Adm. Hyman G. Rickover and his Division of Naval Reactors.

**Government engineers feel that electronic equipment for the submarine presents no real difficulties, but the design of the power plant is another matter.**

The Bureau of Commercial Fisheries already has a shallow-diving, high-speed nuclear sub for oceanography in early planning stages. That vessel is to be equipped with electronic sounding and tracking equipment for chasing schools of fish, as well as instruments for measurement of salinity, pressure, temperature and other factors related to marine life. It is expected to cost at least \$30 million, and the General Dynamics Corp. has just completed feasibility studies which indicate that present electronic and shipbuilding techniques can do the job, if the power plant problem can be solved.

The Navy sub will carry mineralogical equipment for the Bureau of Mines, as well as gravitometric and communications equipment. No feasibility studies or cost estimates have been made.

## High costs shrink radio telescope

**Construction is under way at Sugar Grove, W. Va., of a teacup version of the big dish radio telescope which the Navy canceled in 1962, after estimates of its cost zoomed to more than \$200 million from about \$60 million.**

The telescope will have a mesh dish 150 feet in diameter, compared with the 600-foot version that was planned. Even so, the new one, which can be pointed to any spot in the sky, will be as large as any now in use in the United States.

It will be used for basic research in radio wave propagation and to improve military communications techniques. The big dish was to have been primarily an intelligence collector, picking up portions of radio communications that left the atmosphere and bounced off the moon. But the advent of intelligence-gathering satellites and soaring costs undermined its potential usefulness.

**The Navy, uncertain how much of the work it will do itself, hasn't yet awarded any of electronics contracts.**

## Stellar guidance to be tested again

**Another experimental flight of the stellar inertial guidance system that is being developed for the Air Force will be made late this month or in early June.**

In the first feasibility flight, a Polaris A-1 missile carrying the system was destroyed 73 seconds after launch when it veered off course, but not because of the guidance system.

The system locked onto the star Polaris and tracked it properly before the flight was aborted.

Developed by General Precision, Inc., the system originally was intended for the mobile medium range ballistic missile, but that program was canceled when Congress refused to continue funding it. Though the system hasn't been assigned to a particular missile yet, feasibility flights will be made in August and October.



# You can cool with air...

*(if you have a lot of space)*

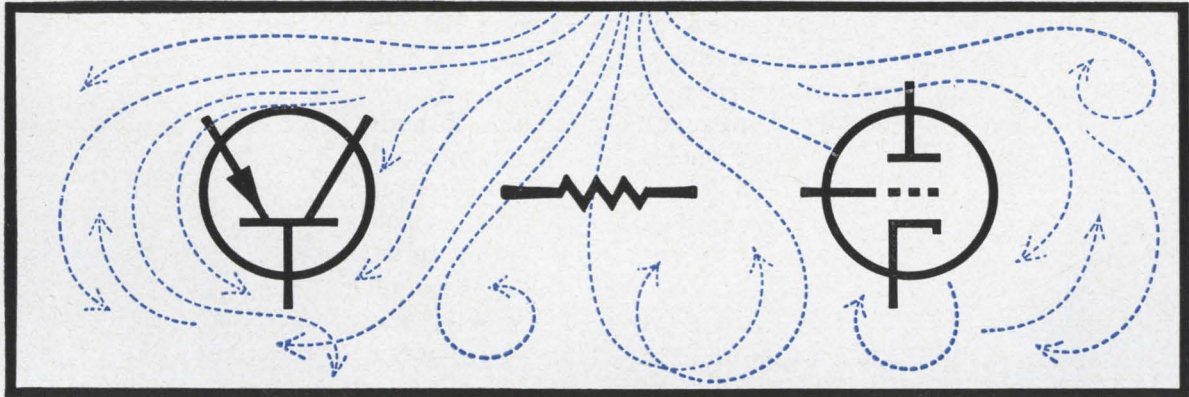

**OR**

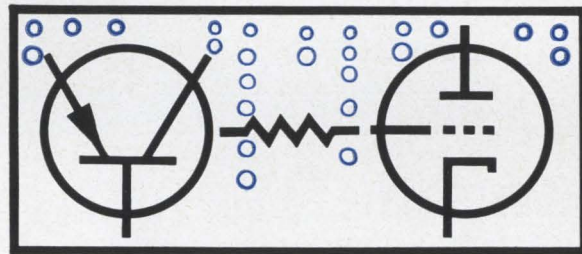

## use FREON<sup>®</sup> dielectric coolants

*(if you don't)*

FREON carries heat away hundreds of times better than air. Close-packed assemblies can operate efficiently at safe temperatures. FREON compounds have outstanding characteristics as heat transfer media either by boiling or by convection.

These inert coolants will work for you in your high-density electronic equipment—wherever you have a reliability problem from “hot spots” in power tubes, transistors, resistors, transformers, packaged electronics, etc. FREON coolants can make your design more compact—at low to moderate cost, while improving reliability through close thermal control.

These five FREON dielectric coolants range in boiling point from +38.8°F. to +237.0°F., offering a wide range of use:

FREON-114	CClF <sub>2</sub> CClF <sub>2</sub>	B.P. + 38.8°F.
FREON-113	CCl <sub>2</sub> FCClF <sub>2</sub>	B.P. +117.6°F.
FREON-215	CCl <sub>2</sub> CF <sub>2</sub> CF <sub>2</sub>	B.P. +165.0°F.
FREON-112	CCl <sub>2</sub> FCClF <sub>2</sub>	B.P. +199.0°F.
FREON-214	CCl <sub>2</sub> CF <sub>2</sub> CF <sub>2</sub> Cl	B.P. +237.0°F.

Send the coupon for complete technical information based on our 33 years' experience with cooling problems.

**DU PONT** **FREON<sup>®</sup>**  
dielectric coolants

Better Things for Better Living . . . through Chemistry

Du Pont Company  
Room 2658A  
Wilmington, Delaware 19898

Please send me complete technical information on FREON dielectric coolants.

Name \_\_\_\_\_

Address \_\_\_\_\_

City \_\_\_\_\_

State \_\_\_\_\_ Zip \_\_\_\_\_

Offer good in U.S.A. only.

# A NEW FACTORY-AGED XENON FLASHTUBE FOR HIGH ENERGY LASER PUMPING . . .



## GUARANTEED UP TO 500 FLASHES (in a cavity)

The new EG&G pre-fired, factory-aged FX-47B Linear Xenon Flashtube has a guaranteed life of 500 shots when operated in a cavity at 4 kJ, 1.4 ms and cooled with dry nitrogen. In addition, it has a test bench demonstrated life of up to 300 shots at 10 kJ, 3.8 ms, when operated in free air with air cooling. This exceeds, by at least one order of magnitude, the 10-to-50 shot life of the equivalent non-aged tube.

EG&G's exclusive aging process achieves this significant increase in xenon tube life by strengthening the quartz envelopes, preconditioning the electrodes, and by the elimination, before shipment, of any tube that gives the slightest indication of premature failure.

The new FX-47B is priced at \$65, from stock, and is the first aged tube of its kind available commercially.

The overall EG&G xenon flashtube line is the broadest in the industry. It encompasses linear, helical, bifilar, annular, pi-shaped, internally triggered and custom designs having energy inputs from one joule/pulse up to many thousands of joules/pulse.

All EG&G xenon flashtubes feature: unique electrode design, resistance to thermal-electrical-mechanical shock, highest quality quartz envelope with uniform concentricity, in both bore and O.D., and large-area end-cap construction which permits more efficient heat dissipation.

### SPECIFICATIONS

Max. Input/Flash	{ 4 kJ @ 1.4 ms 10 kJ @ 3.8 ms
Operating Voltage Range	1 to 3 KV (DC)
Light Output/Flash	40,000 HCPS @ 10 kJ
Outer Diameter of Quartz Envelope	15 mm
Arc Length	6.5 inches
Overall Length	9 <sup>13</sup> / <sub>16</sub> inches

For complete information on the FX-47B and other EG & G flashtubes, request Data Sheet 1002. Edgerton, Germeshausen & Grier, Inc., 160 Brookline Avenue, Boston, Massachusetts 02215. Phone: 617-267-9700. Cable address: EGGINC, Boston.



## Kodak reports on:

**Murphy and the flowing curtain . . . optimism about fine temperature differences . . .  
the proper way to make connections**

### Pour the package over the product

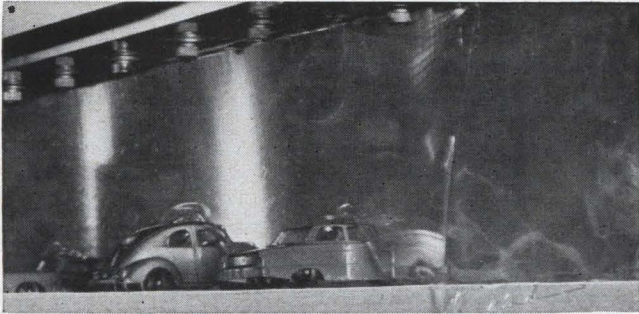

—and it just might prove practical for real ones, too. Call it the EASTOFLOW System. Recognize it as a great leap forward we are sponsoring in that most contemporary art form, packaging. Just pour the package over the item as a bubble-free liquid curtain of a suitable thermoplastic, pull it skin-tight by a short suck, and trim the congealed excess. What a way to keep track of a large-value, small-size electronic item, mounted on its own punched card for inventory control!

*An enthusiast named John Murphy, who can be reached at Eastman Chemical Products, Inc., Kingsport, Tenn. 37662 (Subsidiary of Eastman Kodak Company), knows better than to let anybody sign a lease for an EASTOFLOW Machine unless likely to wind up better off for having done so.*

### Cholesterol for engineers

D.C.B., a chemist of ours and an extremely busy man, took a day off. Mrs. B., a clever girl enjoying a fine run of good fortune on a nationally televised contest, had reached the stage of competing for a substantial prize in Florida real estate. He kept her company to New York for the shot at the big one. But to make good use of his hour aloft, he took along *Scientific American* to catch up on science as an aspect of modern culture. There, in the August 1964 issue, he found an article on the cholesteric state of matter. Suddenly a question answered itself. Suddenly he understood why our Eastman Organic Chemicals Department had been getting inquiries lately for the esters of cholesterol.

A fellow giant no less respected than Kodak was permitting one of its scientists to disclose in the magazine certain exciting physical properties of the esters of that greasy stuff which has lately become familiar by name to middle-aged males who live well. The new-found properties offer little apparent cause for worry. On the contrary, the author sounds broadly optimistic about the usefulness of the remarkable sensitivity to fine temperature differences that is seen in the color of the light reflected by layers of the esters. Though cholesteryl esters are old stuff, new visions arise of coatings that show temperature anomalies difficult at best to find with complex instruments, of simple nondestructive test methods that reveal structural unsoundness through singularities in heat flow.

So it came to pass that Mrs. B., calmed and comforted by a husband beside her engrossed in his *Scientific American*, went

on and won the big house and lot in Florida. Further did it come to pass that we can now offer 3-Chlorocholest-5-ene (EASTMAN 9562, "Cholesteryl Chloride"), Cholesteryl Acetate (EASTMAN 2391), Cholesteryl Myristate (EASTMAN 9693), Cholesteryl p-Nitrobenzoate (EASTMAN 9697), Cholesteryl Nonanoate (EASTMAN 9669), and Cholesteryl Propionate (EASTMAN 4742). Orders may be placed with Distillation Products Industries, Rochester, N. Y. 14603 (Division of Eastman Kodak Company).

Now where do you get directions for the use of these esters? You don't. At least not yet. Finding the directions for use we assume to be what your employer might be paying you to do. Least of all do we offer assurance of success. You and the firm we avoided mentioning are up against a hard fact of life. That the author got clearance to yield to the blandishments of *Scientific American* is no accident. The big company, even as our own, has to publish enough to make itself attractive to the scientific community, whence will come its future strength. Yet the old sense of property, the basis of the firm's very existence, inhibits it from tossing to the four winds those few nuggets of practical information for which much gold has been traded.

*Meanwhile we keep thinking of more and more cholesteryl esters and wondering whose move is next.*

### Artwork for electronics

The following information will strike some as dull, some as confusing, and some as useful enough to make partial amends for often afflicting the reader with windy pseudo-intellectual irrelevancies:

We have worked out the proper way to prepare "artwork" economically for printed circuits connecting pad locations on some standardized grid configuration. It employs KODAGRAPH AUTOPOSITIVE Film, ESTAR Thick Base, EA7, a product which disposes for good and all of any lingering question about dimensional stability.

First you prepare a single master negative that carries the circuit-board outline, terminals, register and identification marks, and all possible circuit pads. From this, working in ordinary room light, you print photographically a stock of artwork blanks. Whenever you want to make a new set of connections, you take one of your blanks and lay down in tape or ink on the matte back of the film blank whatever connections you want. You see all the circuit pads as light blue, but the camera that will reduce the circuit to its real size will see only the pads you color red. No light table required. No register problem because the whole layout, including the grid of pads, is on the same piece of film.

*All is spelled out in fine detail—even the formula for making up the etch bath that leaves emulsion on the film base only where wanted—in a pamphlet we call "Instant Artwork." Free from Eastman Kodak Company, Reprography Products Division, Rochester, N. Y. 14650. Actually the method is not limited to printed circuits. It is useful for all kinds of standardized charts. "Imagination is the main factor in its versatility," says our pamphlet. Whoever wishes to lift this unexceptionable sentiment and apply it to his own product should feel free.*

**This is another advertisement where Eastman Kodak Company probes at random for mutual interests and occasionally a little revenue from those whose work has something to do with science**

**GOOD NEWS REPORTS:**



**MARIETTA, GEORGIA:**

**"Two 10-channel, type S-II Dynograph® recorders operating continuously since installed, May, 1964. No difficulties."**

**SCOVILLE, IDAHO:**

**"Fourteen six-channel Type S-II instruments, used on 24-hour-day basis on tests up to eight weeks, provide most accurate data. No test data lost. No problems."**

**LOS ANGELES, CALIFORNIA:**

**"Eighty channels on Type S-II Dynograph recorders operating perfectly. No artifacts evident in six months on high sensitivity product check-out certification tests. Customer delighted."**

This reliability and fine performance is typical of the solid-state Beckman Type S-II Dynograph Recorder. Representatives all over the country report the same thing, again and again.

Just as importantly, users find recorded data is the most accurate and best recorded of any direct-writing oscillograph. Servo feedback from every pen tip gives a locked-in trace. Between-channel time comparisons are of the highest accuracy – across 8 channels pen traces are within .010" of a straight line. Type S-II specs assure sensitivity of 1mv/div to 5v/div; differential and

floating input; system accuracy to 0.25%; and linearity of  $\pm 0.25\%$  full scale. The zero weave paper and the pressurized ink supply assure fine readability and no paper drift at all speeds.

Over 30 input couplers allow the conditioning of virtually any input signal, so you can adapt the Dynograph Recorder to your changing requirements at very little cost.

This combination of reliability, accuracy and flexibility comes only with a Beckman Dynograph Recorder. For more information contact your local Offner Division Sales Engineering Representative, or write for Data File 722.

**Beckman®**

INSTRUMENTS, INC.

**OFFNER DIVISION**

SCHILLER PARK, ILLINOIS • 60176

INTERNATIONAL SUBSIDIARIES: GENEVA, SWITZERLAND; MUNICH, GERMANY;  
GLENROTHES, SCOTLAND; PARIS, FRANCE; TOKYO, JAPAN; CAPE TOWN, SOUTH AFRICA



# in the groove

Enlarged approximately 33 times

All Daystrom Squaretrim® pots have **locked-in linearity**. That's because of our exclusive technique for winding resistive wire elements. First, an insulated mandrel is locked in a winding lathe and the insulation is scored with a precision tool. Then, resistance wire is tightly wound into the spiraled grooves. Result: the encased units withstand extreme vibration and shock, offer superior resolution and guaranteed performance . . . we call it "locked-in linearity."

These Squaretrim pots are serving

in many critical military and commercial applications where reliability and small size are important. Daystrom potentiometers use an aluminum case for highest heat dissipation and RF shielding.

Send for full information. Contact your nearest Weston distributor for technical data, prices and evaluation units. For a copy of our catalog, write: Weston Instruments, Inc., Archbald, Pennsylvania 18403. Phone: (717) 876-1500. In Canada: Daystrom Ltd., Cooksville, Ontario.

Only Weston's exclusive wire-in-the-groove offers **LOCKED-IN LINEARITY**

## From Weston's broad trimmer line



actual  
size

**Series 200** — 3/8" Squaretrim, 0.150" thick, slotted or Allenhead adjustment screws, flexible leads. Operation: from -55 to 150°C. Resistance: 10Ω to 50k. Rating: 1w @ 50°C in still air.



**Series 300** — 1/2" Squaretrim, 0.187" thick, slotted or Allenhead adjustment screw, flexible leads. Operating temperature from -55 to 150°C. Resistance from 10Ω to 50k. Rating: 1w @ 50°C in still air.

QUALITY BY DESIGN



**WESTON INSTRUMENTS, INC.**

Archbald, Pennsylvania 18403

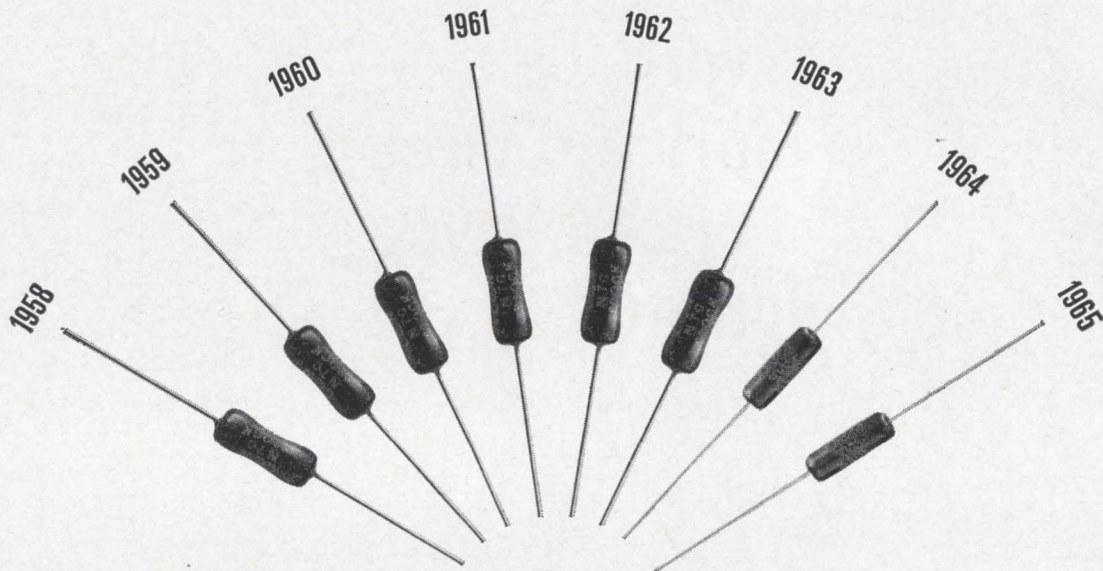

## The eighth year of significant improvements in CORNING® precision resistors

You'd never know it just by looking at them, though. Our engineers don't even have tail lights to change from year to year.

But on the little things inside, they're tigers.

Take TC, for example. Back in 1958, our CORNING N-Insulated Series of resistors went on the market with a TC of  $\pm 500$  ppm. Not too bad, not too good.

We went to work on it and whittled the TC down to  $\pm 300$  ppm in our 1960 model. In 1961, we'd squeezed TC down to  $\pm 200$  ppm—it was getting tougher.

Then, in the 1962-63 versions of CORNING RN-Resistor types, we screwed the TC down to  $\pm 150$  ppm.

And last year, in the CORNING NA-Resistor styles, we held TC to  $\pm 100$  ppm. But TC isn't everything.

Soon we will announce a major advance in the over-all stability and performance of CORNING precision resistors—once again improving our basic glass tin oxide component, which already holds well-established benchmarks for long, flat load-life performance.

Actually, we made a big interim improvement in that stability with the CORNING NA-Resistor. Look at the Design Tolerances we've assigned to the Characteristic D NA-Resistor— $\pm 1.9\%$ /20,000 hours for the NA55D and NA60D;  $\pm 3.2\%$ /20,000 hours for the NA65D, and  $\pm 4.3\%$ /20,000 hours for the NA70D—all calculated within 3 sigma limits.

These Design Tolerances include the 1% purchase tolerance and all  $\Delta R$  due to TC and load-life drift.

With CORNING NA-Resistors you know the parameters of its performance under load.

### PHYSICAL CHARACTERISTICS

Mil Type	Corning Type	Wattage	Resistance (ohms)	
			Min.	Max.
RN55D	NA55D	$\frac{1}{8}$	51	150K
RN60D	NA60D	$\frac{1}{4}$	10	249K
RN65D	NA65D	$\frac{1}{2}$	10	500K
RN70D	NA70D	$\frac{3}{4}$	51	1 Meg.

Order from your nearby Corning distributor, or write for full technical data to Corning Glass Works, 3913 Electronics Dr., Raleigh, N. C.

**CORNING**  
ELECTRONICS

**a termination  
for every  
application....  
wire lead,  
printed circuit,  
or shaft type  
trimming potentiometers**

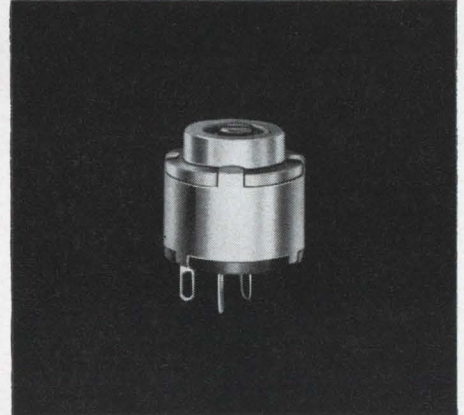
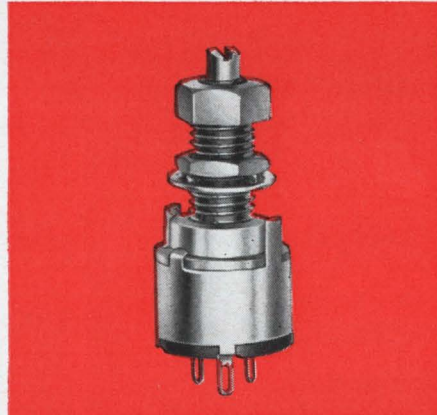
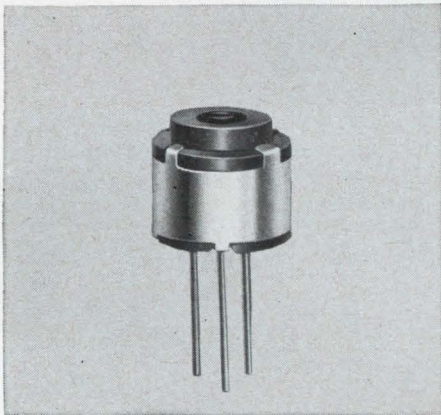

## **CLAROSTAT** SERIES 63

### COMPOSITION ELEMENT TRIMMING POTENTIOMETERS

One of the great things about this great series of trimmer pots is the choice of configurations which lets you mate the same electrical performance and mechanical quality to several requirements. Whether you need the Series 63 specs for a printed circuit, wired circuit, or with a shaft, you still know you're getting the best there is. Available in resistance ranges from 100 ohms to up to 1 megohm, the Series 63 pots are rated for .25 watts dissipation at 70°C. Working voltage is 350VAC, and breakdown voltage is 750VAC (terminals to ground). Mechanical construction of the Series 63 pot trimmers includes features such as carbon-to-carbon and metal-to-metal contacts for increased reliability, longer life, and lower noise. Gold plated mounting terminals are located for a .1" grid configuration, and mechanical and electrical rotation are 295°. Write for prices or further information.

# CLAROSTAT

CLAROSTAT MFG. CO., INC., DOVER, NEW HAMPSHIRE, U.S.A.

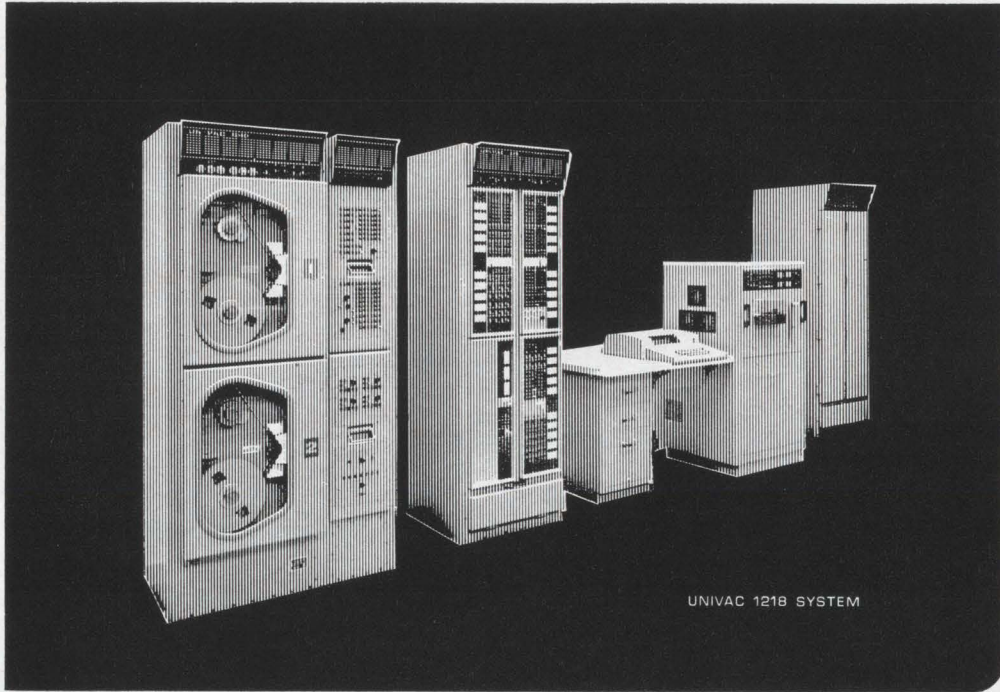

UNIVAC 1218 SYSTEM

**UNIVAC\***  
uses **CTC** memory  
test systems

to test  
memory modules  
for  
military  
computers

... those who build the  
most reliable digital systems  
standardize on  
CTC test equipment

\*UNIVAC DIVISION OF SPERRY RAND CORPORATION





# Technical Articles

---

**A broader choice  
of components for silicon  
integrated circuits:  
page 48**

In the fabrication of integrated circuits, resistors and capacitors are usually built by one or two diffusion methods, thus restricting what the designer can do. If he runs into limitations, there are more than a dozen alternatives to the more familiar method; these can increase the flexibility of integrated circuits.

**Finally, the armed  
forces get solid state  
communications:  
page 63**



The military is just beginning to use transistorized communications equipment in quantity. For a long time, strategic projects like missiles took higher priority and many communications officers could not see the full potential of the transistor. All that is changing, though, and the military is moving full speed ahead to transistorize field communication gear. The Pentagon sees cost reductions as well as improvements in reliability, performance and service.

**Communications  
in Project Gemini:  
page 71**

The first manned Gemini flight was a whopping success and there are five more coming up, one later this month. In Part 2 of a special report—Part 1 appeared April 15—the communications and control systems are examined.

- Gemini's electronic firsts: page 71
- Telemetry that's compact and reliable: page 77
- Retrieving data from Gemini: page 83
- The capsule is no isolation booth: page 88

---

**Coming  
May 17**

- A new look at multiplier design:  
using a coaxial cavity
- Improving delay lines with an  
optical technique
- Television cameras in space
- An industrial application of the laser

# A broader choice of components for silicon integrated circuits

When the familiar diffused resistors and capacitors can't provide the performance needed in an integrated circuit, more than a dozen alternatives are available

By Robert M. Burger and Robert P. Donovan

Solid State Laboratory, Research Triangle Institute, Durham, N.C.

**The limitations**—some temporary, some fundamental—of available resistors and capacitors in silicon integrated circuits present a challenge to circuit and system designers as well as to semiconductor materials and process engineers. An understanding of these limitations permits more intelligent choice and use of such circuits than when the circuits are treated as black boxes with fixed specifications.

The resistors and capacitors of a circuit can be made of silicon through various diffusion processes and by employing junction effects. In addition, compatible types of resistors and capacitors can be fabricated on the silicon crystal as thin films made with many different materials and several processes. Each of these materials has performance advantages and drawbacks. Some are

widely used, some are rarely used, and some are still in development.

## Designer's choice

The ranges of resistance and capacitance available in today's integrated circuits are limited, particularly in most diffused resistors and capacitors, which cannot yet be made to the precision required for some applications and are temperature-sensitive. These components, however, will continue to be used in most circuits in the foreseeable future because they are more economical than thin-film types. Diffused resistors and capacitors are made by the same processes used for fabricating the active devices—the transistors and diodes—of integrated circuits.

Resistors and capacitors with greater precision, lower temperature coefficients and broader ranges of values can be made by the deposition of thin films on the oxide layer that protects the active devices diffused into the silicon crystal.

Thin-film resistors are used in only a small percentage of integrated circuits, but their use will increase as designers strive to produce better circuits.

One recent report<sup>1</sup>, for example, cites how the speed of a logic circuit was increased by substituting thin-film Nichrome resistors for diffused resistors. The increase in speed was attributed to elimination of the pn-junction isolation capacitance associated with diffused resistors and to better design of the active devices diffused into the silicon.

In another recent study<sup>2</sup>, a buffer amplifier was made in two ways, one with diffused resistors and the other with sputtered tantalum thin-film resistors. The tantalum resistors had a temperature

## The authors



Robert M. Burger has been doing research in semiconductors since he obtained his doctorate in physics at Brown University in 1955. Besides directing the Solid State Laboratory at the Research Triangle Institute, he is adjunct associate professor of electrical engineering at Duke University.



Robert P. Donovan served four years as an Air Force fighter pilot after graduating from the Massachusetts Institute of Technology. Then he went to the University of Pennsylvania for a master's degree in physics in 1959. He and co-author Burger worked at the Westinghouse Electric Corp. before joining the institute.

## Types and properties of silicon resistors

Type	Maximum reasonable $\rho_s$ (ohms/square)	Typical tolerances	Minimum TCR (ppm/°C)	Advantages	Disadvantages
<b>Bulk</b>  n-or p-type silicon	$10^4$	$\pm 30\%$	high ( $>10^3$ )	Easy to build, certain interconnections internally made	Very high TCR, poor tolerance, additional isolation often required
<b>Diffused-layer</b>  n-type silicon diffused p-type	500	$\pm 10\%$	200	Good dimensional control, flexible in size and shape, junction isolation possible by operating voltages	Dependent on large area p-n junction for isolation, capacitance of isolating junction added to circuit
<b>Epitaxial</b>  p-type epitaxial n-type silicon n-type diffused	$2 \times 10^3$	$\pm 15\%$	200	nearly homogeneous impurity distribution	Same as for diffused layer resistor, geometry must be defined by additional diffusion and values limited to the impurity concentrations obtainable by vapor deposition
<b>Vapor-deposited</b>  n-or p-type silicon	$2 \times 10^3$	?	100-150	d-c isolation is independent of operating voltage and polarity, less capacitive coupling than junction-isolated resistors	Adherence and uniformity poorer than epitaxial layer, capacitance of MOS structure added to circuit Same as for epitaxial layer
<b>Field-effect</b>  n-type silicon p-type	$10^8$ (resistance)	?	high	Same as reverse-biased, junction resistor, established technology	Restricted operating ranges, TCR may be high without some form of temperature compensation, d-c and a-c resistances may be quite different
<b>Series or parallel combinations</b>  p diffused n-type silicon Series n+ diffused n-type silicon Parallel	500	$\pm 30\%$	low	reduces TCR	Analysis is difficult and reproducibility poor
<b>Reverse-biased Junction</b>	$10^3$ to $10^{10}$ (resistance)	?	high	high values of resistance, small area	Control is not yet demonstrated Same as field effect
<b>Compensated impurity</b>	High ( $>10^4$ )	?	low ( $<300$ )	high sheet resistivity with low TCR	Fabrication technology is not presently available

coefficient of resistance (TCR) of  $-200$  parts per million per degree centigrade, compared with  $+2,000$  ppm per degree for the diffused resistors. Distributed capacitance at zero bias was  $0.04$  picofarads per square mil and  $0.3$  pf respectively. That, plus other factors such as process tolerance that is three times as tight, reduced from  $\pm 15\%$  to  $\pm 5\%$ , resulted in superior performance for the amplifier using the thin-film resistors.

Although thin-film resistors require several more processing steps than diffused resistors, some researchers contend they can lower circuit costs by improving manufacturing yield. This is attributed to the elimination of wide variation in diffused resistor values, elimination of junction shorting and resistor isolation areas, and reduction of circuit area since films can be made with higher sheet resistivity than diffused silicon.

Thin-film capacitors are rarely used at present in silicon integrated circuits. They are difficult to design, difficult to make, and pose reliability problems such as possible shorting between electrodes through pinholes in the dielectric. Discrete capacitors will probably continue to be used in microelectronics systems unless some other way is found to overcome the shortcomings of integrated-circuit capacitors.

There is a third alternative: circuits in which resistors and capacitors are eliminated or reduced to a minimum. Circuits redesigned to eliminate passive components may require more transistors and diodes, but these components are readily made in silicon. This is often a more rewarding approach than attempting, for example, to make resistors more linear.

Such redesign may actually reduce circuit cost. In integrated circuits, passive components cost more than active components—the reverse of the cost situation in discrete-component circuits. Integrated passive components require a larger area of the silicon than the active components and integrated-circuit cost depends directly on how many circuits can be produced in a given area of silicon. Major advances in present technology, or new techniques, would be needed to make economical, reliable diffused resistors as small as transistors.

Considerable research is being done on other ways of circumventing passive-component use. Phonon and photon coupling are examples. These show a trend toward the early concepts of molecular electronics, the realization of electronic functions through optimum use of materials properties.<sup>22</sup>

Attractive as these alternatives are, integrated circuits must depend at present upon the formation of passive components in the silicon crystal or on top of it.

## I. Resistors

Diffused silicon resistors and Nichrome thin-film resistors are preferred because they satisfy most requirements. The type selected depends on design factors such as resistance value, tolerance, operating potential, power, TCR, available area, isolation

method and the V-I curve desired.

Diffused resistors have characteristic sheet resistivities from  $10$  to approximately  $400$  ohms per square, and TCR's of up to  $\pm 2,000$  ppm per degree centigrade. One significant advantage of diffused resistors is their ability to "track"—that is, the values of two resistors formed by the same diffusion on the same chip will maintain a fixed ratio despite a large TCR.

Metal-film resistors can be made with sheet resistivities up to several thousand ohms per square and with TCR's on the order of  $100$  ppm per degree. The TCR is negligible for most applications.

A resistor is any device with two active terminals in which voltage and current are closely in phase. The V-I characteristic is traditionally a reasonably straight line, but it need not be. In many cases, a nonlinear V-I curve is preferred and in such cases it is customary to speak of d-c resistance ( $V/I$ ) and a-c resistance ( $\Delta V/\Delta I$ , or voltage change divided by current change). Other characteristics of nonlinear V-I curves, such as the locations of cliffs and plateaus, may be of more interest than the resistance.

### Silicon resistors

Silicon is not a very good material for making resistors. Silicon's sheet resistivity is limited and its high temperature coefficients better suit it for use as a thermistor. Nevertheless, diffused silicon resistors are more popular than other types because of processing economy. Only suitable photoetching masks are needed to make acceptable resistors at the same time transistors are being made. The most common diffused silicon resistors are those formed in a diffused layer by the planar process. A number of other types have been proposed and will also be described. Properties of the various types are given in the table on page 49 and are described below:

**Bulk resistors** are made by providing ohmic contacts between two points of a homogeneous, uniformly doped crystal of silicon material. Tolerance depends on how well the geometry of the resistor is controlled by such methods as lapping, etching, and scribing.

High-resistivity silicon has a large TCR. A temperature change of  $50^\circ\text{C}$  may change the resistance value by a factor of  $10$  or more. At lower resistivity, with acceptable TCR, the obtainable values of resistance are low.

A fundamental problem of bulk resistors is that additional isolation steps are usually necessary to decouple the resistors from other elements in the silicon block. When an isolating junction is not required, distributed capacitive coupling is reduced; this can be advantageous in high-frequency devices.

**Diffused layer resistors** are formed by including an appropriate pattern in the photoetching mask to define diffusion areas. The resistor may be diffused at the time the base region or emitter regions of the transistor are diffused.

The equivalent circuit of a diffused resistor must

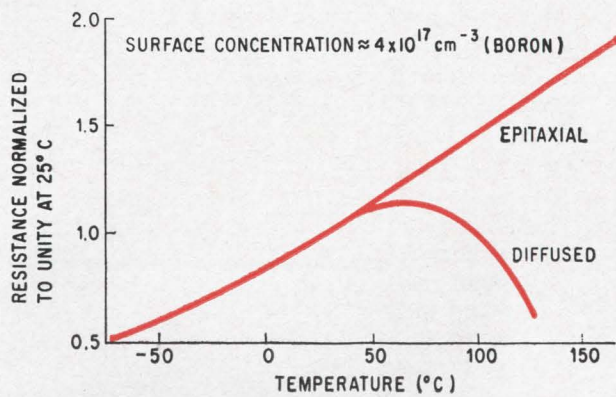

Temperature dependence of an epitaxial-layer resistor, compared with that of a diffused-layer resistor.

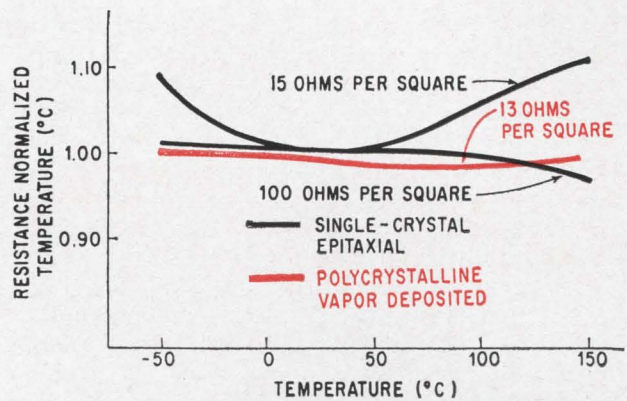

Thinner, higher-resistivity epitaxial layer (100 ohms) has a more uniform temperature coefficient than thicker layer. Note similarity of 100-ohm curve to that for a polycrystalline deposited-silicon resistor (color).

include the capacitance and rectifying properties of the p-n junction created by the diffusion. One possible schematic for such a resistor is shown below. The distributed parameters are represented by a large number of lumped components.

The junction defining the diffused region provides d-c isolation between the resistor and the substrate as long as the polarity of the substrate voltages keeps the junction reverse biased. When the operating voltages are not properly polarized, additional isolation steps are necessary.

The thinness of this type of resistor enables an acceptable TCR to be obtained with practical values of sheet resistivity. Introduction of additional impurities, of both n- and p-type, may further reduce the TCR while maintaining a practical sheet resistivity. This is the compensated impurity resistor.

**Epitaxial layer resistors** are made by using diffused-through barrier junctions to shape a desired region of the epitaxial layer. Contacts are alloyed to the surface of the epitaxial region and the resistance is controlled by the geometry, as with diffused resistors. The major difference between the two is the near-uniformity of the impurity distribution of an epitaxial layer. The temperature dependence of a diffused boron resistor and an epitaxial boron resistor of similar surface concentrations is compared in the curves above, left.

In very thin epitaxial resistors the large density (density, in this case, means number of crystal dislocations, or defects, in a given area or volume of crystal) of crystal dislocations at the interface

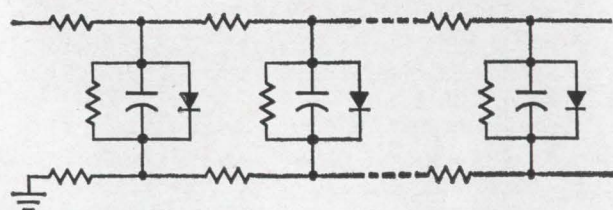

Capacitance and rectifying properties of the p-n junction are indicated in this equivalent circuit for a diffused resistor.

between the epitaxial layer and the substrate is an important, although little understood, factor. Conduction in a high-dislocation region is probably different in detail from that in a dislocation-free region<sup>3</sup>. Evidence to support this conclusion is presented in the figure above, right, showing the temperature dependence of resistance of two similarly doped epitaxial resistors which vary only in thickness. The thin layer has a higher sheet resistivity and a smaller TCR, probably because it has more crystalline defects than the thicker layer. The conduction is limited by scattering from imperfections or structural defects rather than by phonon or impurity scattering. No quantitative data exists relating resistance to structural defects.<sup>4</sup>

**Vapor-deposited silicon resistors** could be classified with the thin film resistors except that the material used is polycrystalline silicon. The deposition process is similar to that used to obtain monocrystalline epitaxial layers. The resistors can be isolated by forming them on top of the silicon-oxide layer that passivates the base crystal of silicon. The layers exhibit a TCR slightly lower than that obtained with similarly doped diffused resistors. As with thin-film resistors, additional process steps are necessary, including etching to define the geometry.

For satisfactory performance, a polycrystalline resistor has to be thicker than a diffused or an epitaxial resistor. Since the resistor structure is no longer monocrystalline, more inhomogeneities and local defects are present. The influence of the lack of uniformity is diminished as the layer thickness grows. Included in the resistance vs temperature curves above, right, is one for a vapor-deposited (on a ceramic substrate) polycrystalline resistor with sheet resistivity,  $\rho_s$  about 13 ohms per square. Compare this with the curves for the 15 ohms per square epitaxial resistor. Phosphorus is the doping impurity of both resistors.<sup>5</sup>

In general, the large density of grain boundaries in vapor-deposited polycrystalline silicon resistors results in lower TCR values than for similarly doped epitaxial layers. TCR's of approximately

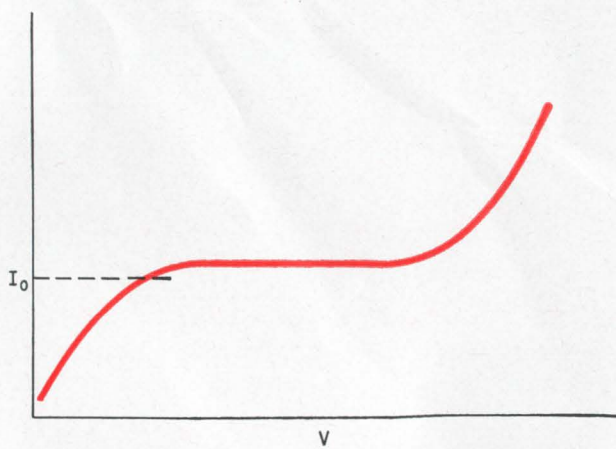
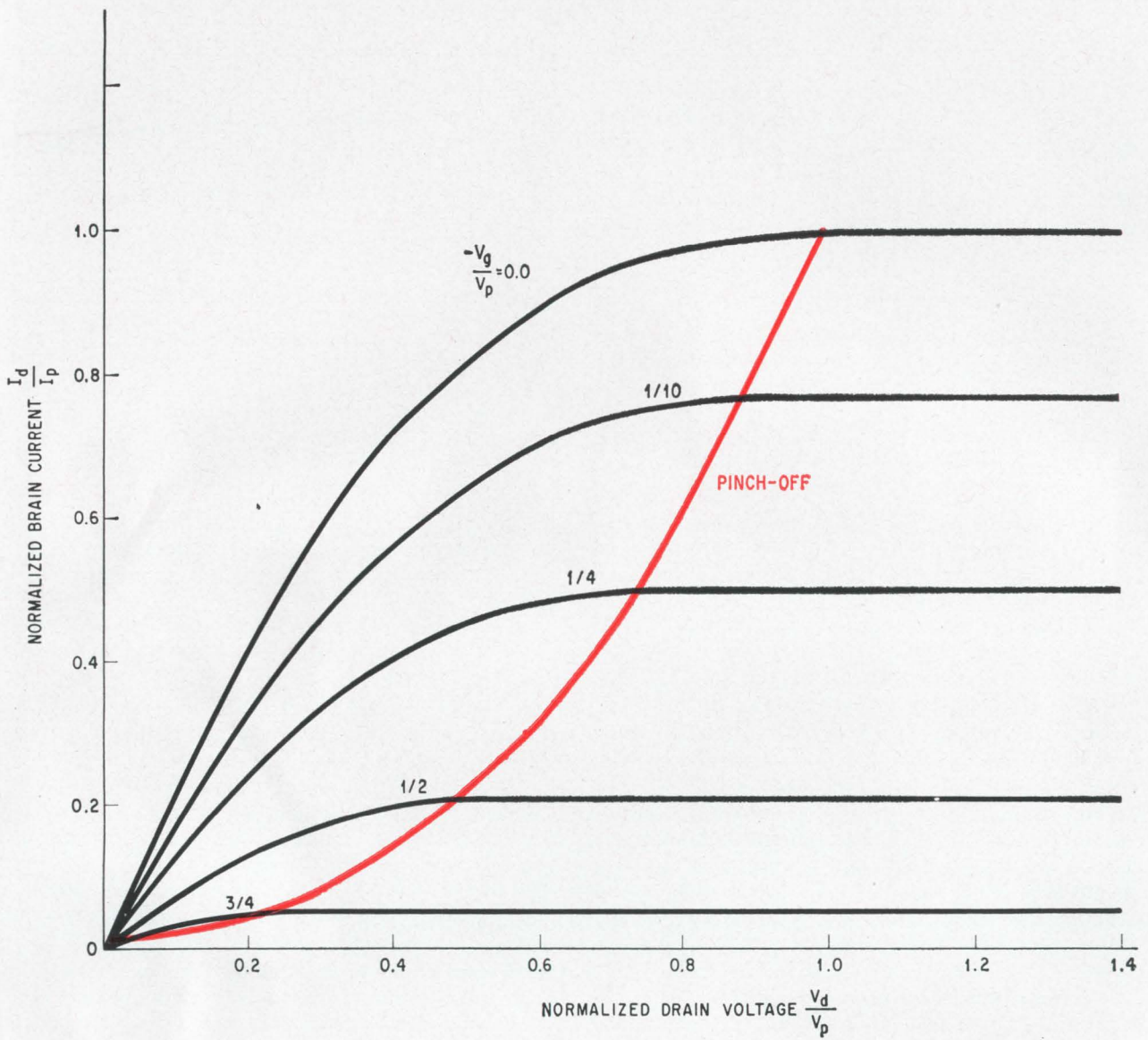

Normalized drain current versus voltage characteristic of field effect resistors (top) is nonlinear. Using only the region below pinch-off, (color line) the curve for channel resistance as a function of gate bias is derived at lower right. Overall V-I curve of this type of resistor shows essentially constant current between pinch-off and breakdown.

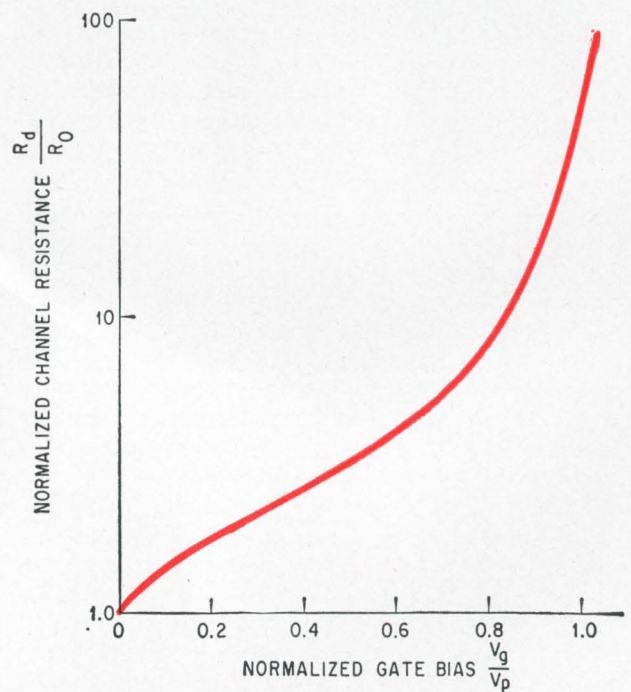

150 ppm/° C over the temperature range of -50° to 150° C have been observed on polycrystalline silicon layers.

The best TCR seen in single crystal layers (except for extremely thin layers where the effect of dislocations is dominant) is  $\geq 220$  ppm per degree centigrade. The mechanism that reduces the TCR of a thin epitaxial resistor (100 ohms/square) below that of a thicker epitaxial resistor (15 ohms/square), as illustrated on page 51, is probably the same as the mechanism that lowers the TCR of the polycrystalline layers.

Inherent advantages of vapor-deposited resistors are good isolation irrespective of polarity and the use of a material compatible with the oxidized silicon substrate.

**Field effect resistors** have a nonlinear V-I characteristic. In this design the channel region of a junction field-effect structure or of a surface field-effect structure is employed as a resistor.

The channel resistance is plotted as a function of gate voltage, at lower right, page 52. Gate voltage is normalized to pinch-off voltage, and resistance is normalized to zero current-zero gate bias channel resistance. This curve applies only to that part of the drain V-I characteristic in the linear region below pinch-off as indicated at top of page 52. The V-I curve of this type of resistor is shown at lower left. Between the pinch-off and breakdown voltages the current is reasonably constant. In some places where linear resistors are customarily used, a device with this property would be more convenient. The field-effect resistor takes much less room than a conventional one, but it cannot be fabricated during the same diffusions as for diodes and bipolar transistors. The lack of production compatibility is a major deterrent to widespread use of field-effect resistors in circuits made with bipolar transistors. It should be noted that, with a sufficient potential gradient, any silicon resistor with junction isolation can exhibit current saturation as shown here.

Junction resistors also have a nonlinear V-I characteristic. The V-I curve of a diode, as shown at right has several regions of interest. In region A (forward biased) the curve is steep so that the a-c resistance is small. In region B (reverse biased, below breakdown) the curve is flat and the a-c resistance is high. In region C (reverse breakdown) the curve is again steep, but the voltage drop is much greater than in region A.

The difficulty of reproducing the cliff location—the steep portion of the curve—makes region C difficult to use in integrated circuits. The slope in the B region and the size of the current are nearly impossible to hold. If control of the junction leakage by impurity doping or surface treatment can be achieved, a useful type of resistor is possible. The voltage drop in region A is about 0.7 volt, a characteristic that is put to extensive use. Several such voltage drops can be put in series to achieve slightly higher voltage drops.

Other silicon resistor types are possible. Only the diffused resistor is used extensively.

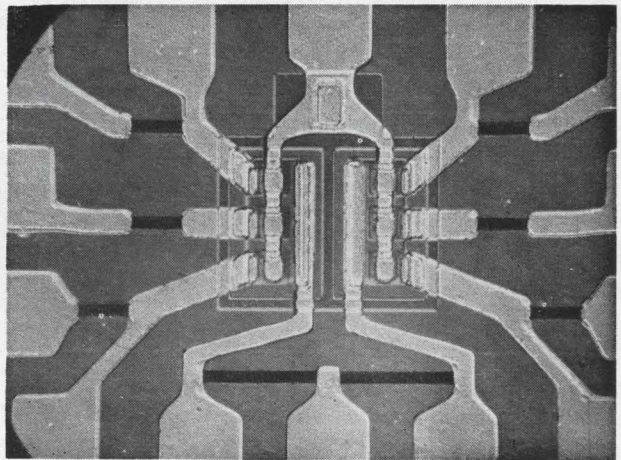
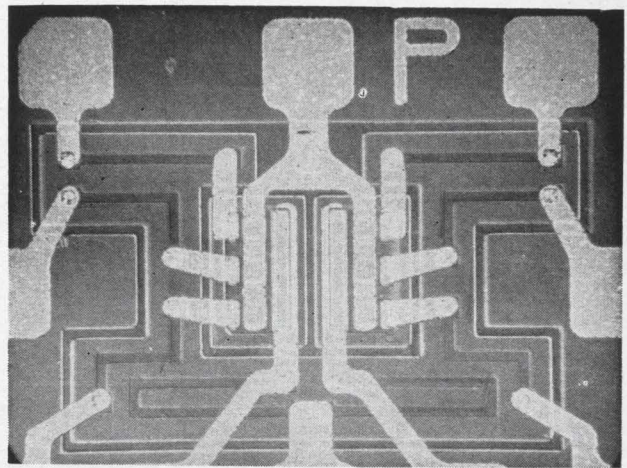

**Silicon integrated circuit** made with diffused resistors (top) and sputtered tantalum thin-film resistors (bottom). The resistors, about 0.001 inch wide, are the lines seen between the large aluminum electrodes to the right and left of the active devices in the middle of the circuit chips (Philco Corp.).

### Thin-film resistors

Although Nichrome is generally used for thin-film resistors, the resistive properties of many other materials have been intensively studied and used. Thin-film resistors can be made from metals, semiconductors and cermets (mixtures of metals

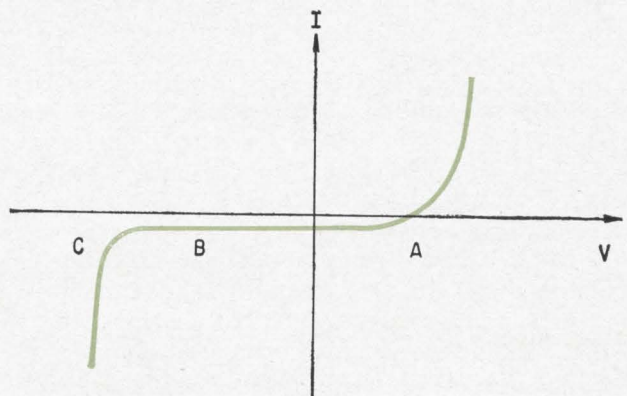

**V-I curve of a diode** indicates why a junction resistor is nonlinear. However, it is difficult to control the location or slope of the curve at A and C.

## Materials for thin-film resistors

Materials	Range of sheet resistivity (ohms/square)	Deposition Method	TCR (ppm/°C)	Comments
Nichrome	10-10 <sup>4</sup>	vacuum evaporation, sputtering	±500	very compatible, good stability, now used on silicon integrated circuits
Silicon chromium	10 <sup>3</sup> -10 <sup>4</sup>	vacuum evaporation	±250	compatible, now used on silicon integrated circuits
Silicon monoxide-chromium	200-10 <sup>4</sup>	vacuum evaporation	±250	compatible, abrasion resistant
Tantalum (oxide, nitride)	10-10 <sup>4</sup>	sputtering	±200	must be heat treated for stabilization
Rhenium	10-10 <sup>4</sup>	vacuum evaporation	±500	no data on silicon substrate, high temperature operation
Carbon	10-10 <sup>7</sup>	vapor plating, vacuum evaporation	High	poor reproducibility and stability, no data with silicon substrate
Nickel	20-10 <sup>5</sup>	electroless deposition	±250	compatible, easy to prepare, no data on silicon substrate
Tin oxide	10-5,000	vapor plating	±250	stable, normally requires substrate at high temperature during deposition
Various metals	Low-unstable at high R	all methods	100-3,000	most metals exhibit a low sheet resistivity, are easily deposited

and ceramics). The observed properties of several thin-film materials are given in the table above.

As films, these materials do not have the resistivity of their bulk forms because of the different conduction mechanisms in thin films. Resistivity is a function of both the composition and physical nature, such as the grain structure, of the film. The films can be affected by heat treatment, which encourages agglomeration or other structure-changing phenomena. The sheet resistivities and TCR's given are meaningful only for the processes cited.

Materials other than Nichrome may come into wider use in silicon integrated circuits when a reproducible sheet resistivity on the order of a megohm per square becomes possible. The improvements that can result from using other materials or different processes are minor at present. Higher values of resistance, lower TCR's, and improved tolerances will, however, result from relatively straightforward advances in technology.

Thin-film resistors for silicon integrated circuits can be deposited on the silicon chip by plating, vacuum evaporation, sputtering or silk-screening. The latter process results in a thick-film resistor, around one micron thick, rather than the 0.1 micron which is characteristic of the other processes.

**Nichrome resistors** have received the most acceptance, partly because of the tenacity with which chromium adheres to silicon oxide. Nichrome is a nickel-chromium alloy which has a higher resistivity than pure chromium. Silicon-chromium and silicon-monoxide-chromium have also been investigated.

Nichrome resistors have been fabricated by an inversion-etch process because direct etching is

difficult. The resistor areas are defined by openings in a previously deposited metal or photoresist layer. The unwanted material is then removed by dissolving the predeposit.

Tantalum resistors are made by sputtering, a technique that uses energetic ions to dislodge atoms from a source location, after which the metal deposits on the circuit substrate. Sputtering is used primarily because of the difficulties of evaporating refractory metals, such as tantalum. The apparatus is arranged so that a conductive contact can be made to the tantalum deposits without breaking the vacuum and before any oxidation occurs. Gold is a suitable material for contacts.

Oxidizing the tantalum film produces a protective coating whose formation also influences resistivity by thinning the unoxidized film. Heating the film in air to a temperature above the anticipated operating temperature of the circuit is adequate for stabilization. The sheet resistivity must be determined after aging to allow for the change caused by oxidation.

Plated resistors can be formed by the electroless deposition of nickel. Electroless nickel plating has often been used to form ohmic contacts to both p- and n-type silicon surfaces. Recently, techniques for electroless deposition of nickel on smooth glass microscope slides were perfected and their extension to deposition on silicon substrates covered with silicon dioxide appears direct. This technique could be used to form the required resistors, contacts and interconnections simply by varying the thickness of the layers.

Plating eliminates the vacuum equipment and processing which are expensive and difficult to



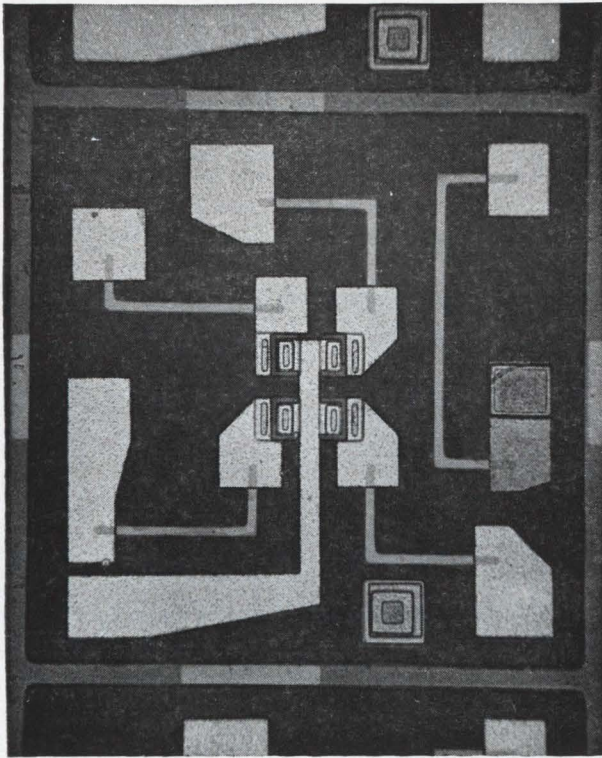

**Nichrome** is the material generally used for thin-film resistors. The Nichrome resistors (the lines branching out from the active devices in the center) of this circuit were deposited through masks, not etched (Raytheon Co.).

control. Variations in the vacuum are probably partially responsible for the nonreproducibility sometimes encountered with evaporated or sputtered thin-film resistors.

### High resistivity

Only by making metal films extremely thin (less than 100 angstrom units or 0.01 micron) does the

sheet resistivity rise to values greater than 1,000 ohms/square. In doing so, the added control problems lead to poor reproducibility and unsatisfactory performance. Generally, the maximum practical limit of metal-film sheet resistivity is about 200 to 600 ohms per square.

An obvious technique for increasing resistance without decreasing the film thickness is to raise the resistivity of the film by mixing the metal with an insulator. This composition film is called a cermet. A large number of combinations are possible, the most common being either oxidation of a metal whose oxide is a nonconductor or the simultaneous evaporation of a metal and an insulator such as silicon oxide.

The lower curve below shows that contemporary cermet resistors are quite stable—unlike earlier cermet resistors. The sheet resistivity of these particular resistors is 250 ohms per square. Cermet films<sup>6, 7</sup> can be made with much higher values of sheet resistivity, but the control problems become difficult and the reproducibility poor. Consequently, high sheet resistivity values are still not practical for cermets.<sup>8</sup>

A recent report<sup>9</sup> describes a variation of the cermet resistor which is described as a binary conducting glass. It involves evaporation of chromium and subsequent heat treatment to diffuse it into the silicon dioxide. Low thermal coefficients of resistance and practical sheet resistances to 10,000 ohms per square are reported. These have been applied successfully to the fabrication of micro-power integrated silicon amplifiers.<sup>10</sup>

Tin-oxide resistors can also assure high sheet resistivity. Values as high as 5,000 ohms per square have been reported. Experimentally produced tin-oxide antimony-oxide films are stable up to 500°C in a nuclear environment.<sup>11</sup>

A fabrication technique is to spray a solution con-

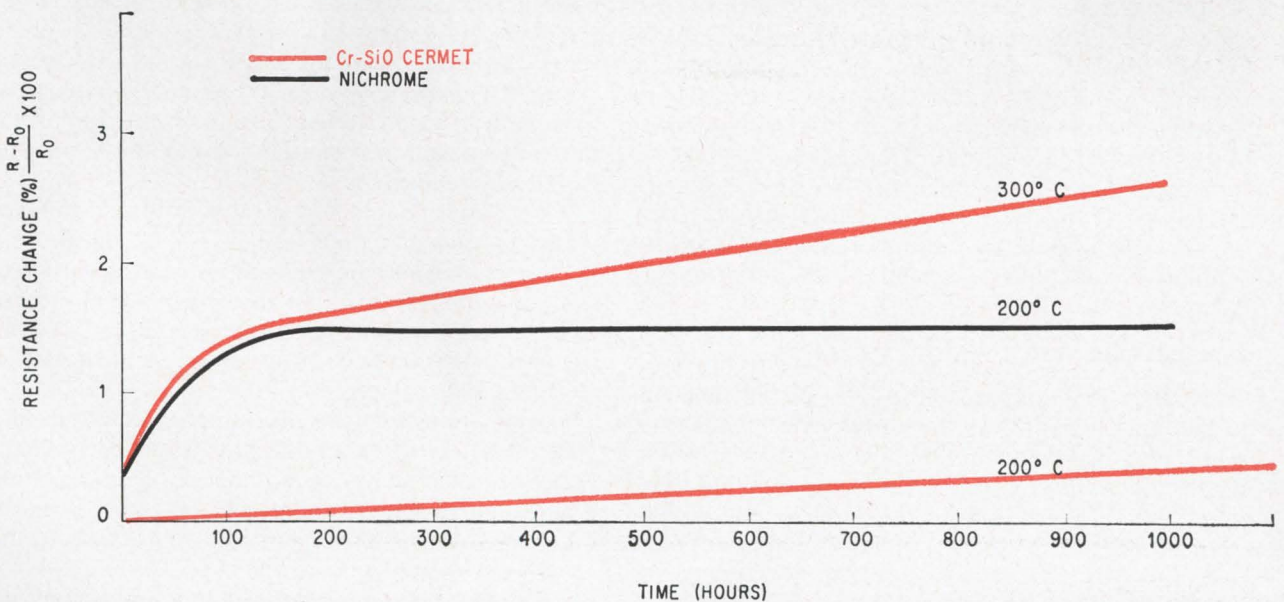

Stability of cermet-film resistors compares favorably with that of Nichrome film resistors.

## Electrical properties of thin-film dielectrics

Dielectric	Capacitance (pf)	Capacitance ( $\mu\text{f}/\text{in}^2$ )	Dissipation factor (1 kc)	Breakdown voltage (volts)	Thickness (angstrom units)
<b>Thermally grown</b>	350	0.36	0.035	10	900
SiO <sub>2</sub>	225	0.23	0.0005	20	1,200
TiO <sub>2</sub>	350	0.36	0.030	15	?
	300	0.31	0.190	30	?
<b>Vacuum deposited</b>					
SiO	320	0.34	0.008	20	1,400
ZnO	300	0.31	0.035	10	1,100
CeF <sub>3</sub>	3,000	3.10	0.28	2	?
	500	0.52	0.065	10	?
ZnS	200	0.21	0.030	30	500
B <sub>2</sub> O <sub>3</sub> + SiO	30	0.031	0.030	30	4,400
Al <sub>2</sub> Si <sub>2</sub> O <sub>7</sub>	?	0.3-0.5	0.5 (at 1 Mc)	80-100	1,000-2,000
<b>Vacuum-deposited and oxidized</b>					
	400	0.42	0.007	10	830
Ti-TiO <sub>2</sub>	680	0.70	0.027	15	1,250
Nb-Nb <sub>2</sub> O <sub>5</sub>	480	0.50	0.035	10	1,800
	400	0.42	0.050	35	2,100
<b>Cathode-sputtered</b>					
Ti-TiO <sub>2</sub>	1,200	1.25	0.050	5	?
Nb-Nb <sub>2</sub> O <sub>5</sub>	2,000	2.09	0.010	5	700
Ta-Ta <sub>2</sub> O <sub>5</sub>	2,000	2.08	0.020	5	?
	1,000	1.04	0.010	20	?

taining tin and antimony salts onto a hot substrate, leaving a thin film deposit. However, the substrate temperature during deposition is quite high, 700° to 1,200° C, which may be unsuitable for some integrated-circuit applications.

## II. Capacitors

Among the factors that must be considered in capacitors for silicon integrated circuits are capacitance per unit area, isolation, polarization of the capacitor, dynamic range, dissipation factor, temperature coefficient and cost. Available techniques offer different tradeoffs on these factors, but the basic problem of capacitance per unit area is a limitation common to all designs and has restricted the use of capacitors in integrated circuits.

Only small capacitances are now possible in monolithic circuits. A maximum practical size is between 100 and 200 picofarads with a tolerance of  $\pm 20\%$ . Capacitors 50 pf or smaller have been included in a few purchasable devices.<sup>21</sup>

The three types of capacitors which are available are the silicon junction capacitor, the metal-oxide-semiconductor (MOS) capacitor, and the thin film capacitor.

### Junction capacitor

To date, junction capacitors—those that use the capacitance existing at the interface between two types of silicon crystal, such as a p-n junction—have enjoyed a small edge in popularity over the other types. The reason is the same as the reason diffused resistors are preferred—no additional processing steps are required for building them into a silicon integrated circuit.

The capacitance per unit area obtainable for the

full range of practical p-n junctions is shown on page 57 for both the step junction and the graded junction. Important in p-n junction capacitors are d-c reverse bias and the dependence of capacitance upon the actual reverse voltage. As a coupling capacitor, for example, the capacitance variation with the a-c signal may introduce intolerable distortion. On the other hand, the change in capacitance with bias can be used for tuning if the signals are small.

A typical emitter junction in an integrated device exhibits a capacitance of 10<sup>5</sup> pf per square centimeter while that of a base-collector junction is one order of magnitude less. A capacitor made from an emitter junction will have a voltage breakdown of approximately six volts, which limits its applicability. Additional problems are introduced by the required isolation between the capacitor structure and the substrate. Without isolation, the amount of parasitic capacitance can be comparable to that of the desired capacitor.

The dissipation factor of the diffused junction capacitor depends upon the resistance of the capacitor electrodes, the leakage current of the junction, and the a-c losses in the silicon. While there is little data available on actual structures, Q's between 10 and 300 have been observed in the range of 0.1 to 1 megacycle.<sup>12</sup>

Design innovation can be employed to circumvent some of the inherent disadvantages of junction capacitors. For example, it is possible to obtain a capacitor which will operate with either polarity by using a transistor-like junction structure with no base connection. The zero-bias capacitance is large but decreases rapidly with applied voltage of either polarity. Contacts can be designed for minimum

series resistance, and isolation such as the recently introduced dielectric-isolation technique decreases parasitic coupling.<sup>18</sup>

### MOS capacitor

The metal-oxide-semiconductor (MOS) capacitor benefits from the inherent compatibility of the capacitor materials and production method the silicon monolith. The capacitor structure consists of a diffused silicon layer bottom plate, the silicon-dioxide dielectric, and a metal conductor top plate.

It should be recognized that silicon oxides, as manufactured in any silicon-integrated-circuit process, are probably not stoichiometric compounds; that is, the ratio of silicon to oxide varies from process to process and even throughout the same structure. Impurities and structural differences may also affect the oxide properties. The large amount of contemporary research on oxide properties will result in improved quality of the oxide layer.

In all capacitor structures a compromise must be reached between the breakdown voltage of the oxide and the capacitance per unit area available within the structure. In a typical case using a 500-angstrom-unit oxide film, a capacitance of 50 nf per square centimeter and a breakdown voltage of 80 volts is obtainable. An oxide thickness of 1,000 angstrom unit with a capacitance of 10 to 30 nf per square centimeter is more common.<sup>14</sup>

An extra processing step is required to get the right thickness in the silicon-dioxide dielectric layer on top of the silicon since the oxide layer normally present is too thick. While it is possible to obtain a large dependence of capacitance on voltage with the MOS structure, it can also be designed so that this dependence is minimized and is below that of a junction capacitor. This control of the capacitance variation with voltage can be a design advantage.

The bottom plate of an MOS capacitor should consist of an emitter type diffused layer to take advantage of its low sheet resistivity. Parasitic capacitance between this diffused layer and the other portions of the silicon structure depend on the design. The dissipation factor of an MOS capacitor depends upon the series electrode resistance of the integrated-circuit structure. Leakage resistance can be greater than  $10^9$  ohms.<sup>15</sup>

### Thin-film capacitors

Thin-film capacitors more closely resemble conventional discrete capacitors than do MOS or junction capacitors. Generally, a thin-film capacitor consists of a dielectric layer between metallic electrodes.

One disadvantage of using thin-film capacitors is that several additional processing steps are required—deposition of the films and photoengraving to obtain the geometrical resolution required for precision capacitors. Another disadvantage is the danger inherent in introducing new materials into the silicon structure. Surface cleanliness, interlayer diffusion and differences in thermal coefficients of expansion of the materials can contribute to unreliability.

However, the thin-film structure can be arranged to overcome some of the electrical problems of the junction and MOS structures. A thick passivating oxide on the substrate, for example, will give good isolation between the capacitor and the remainder of the integrated circuit.

There is also the possibility of significantly increasing the amount of capacitance in a given area, by making the capacitors of several layers of dielectric between several layers of electrode material. Success in making such multi-layer thin-film capacitors have been reported only recently.<sup>20</sup>

At present, the type of circuits that can be in-

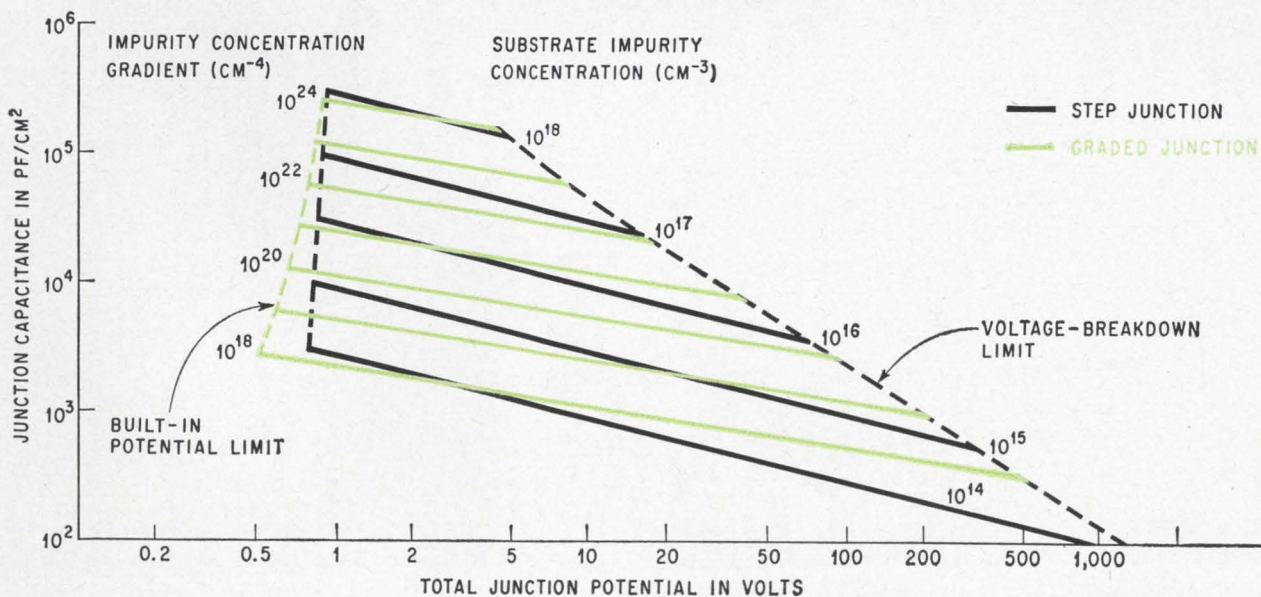

Capacitance per square centimeter for capacitors made from linearly graded junctions and step junctions diffused in silicon crystal.

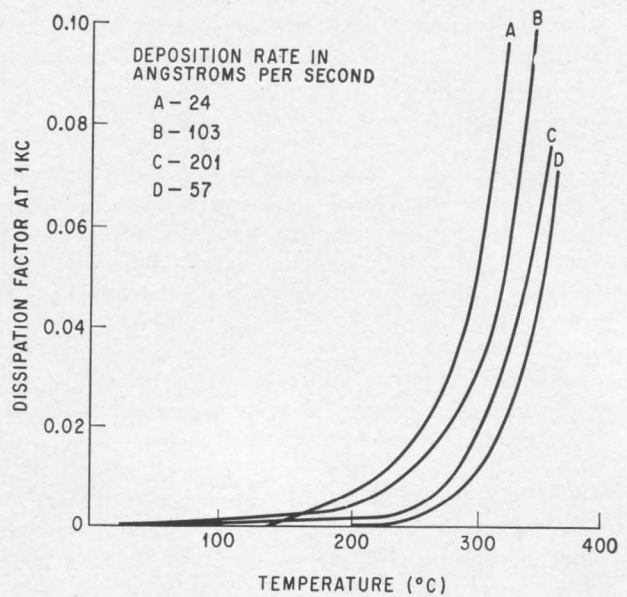
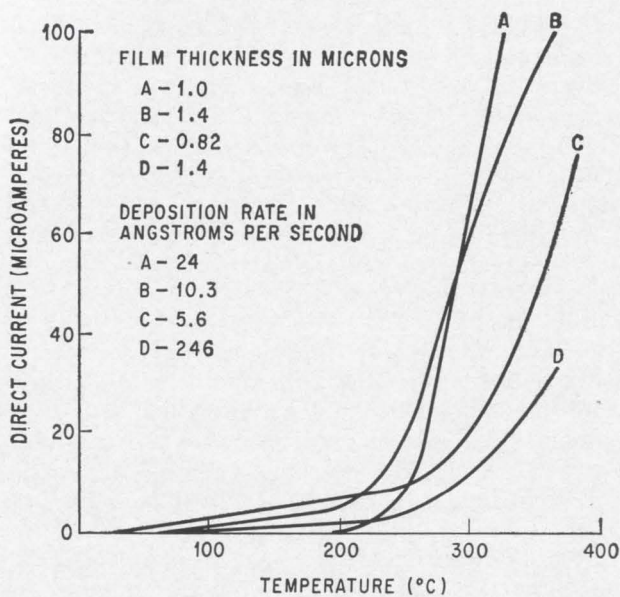

Silicon monoxide films are not only sensitive to temperature, their characteristics also vary according to film thickness and deposition rate. The curves at left indicate effect of deposition rate on dissipation factor, while at right the effect of deposition rate and thickness on leakage current is shown.

egrated is severely restricted by the capacitance available in a given area. Improvements will require research to understand oxide behavior, in multilayer construction and in better processing techniques.

#### Thin-film dielectrics

A typical thin-film capacitor has a capacitance value of 10 nanofarads to 1 microfarad per square centimeter; in the physical size compatible with

integrated circuits the range of capacitance is the same as that of MOS or junction capacitors—on the order of hundreds of picofarads.

Breakdown voltage is typically 50 volts, temperature coefficient is 150 to 250 ppm per degree centigrade, and the dissipation factor is on the order of 0.01 at one kilocycle.

These characteristics are given for specific materials in the table on page 56.

Silicon monoxide (SiO) is the material most often

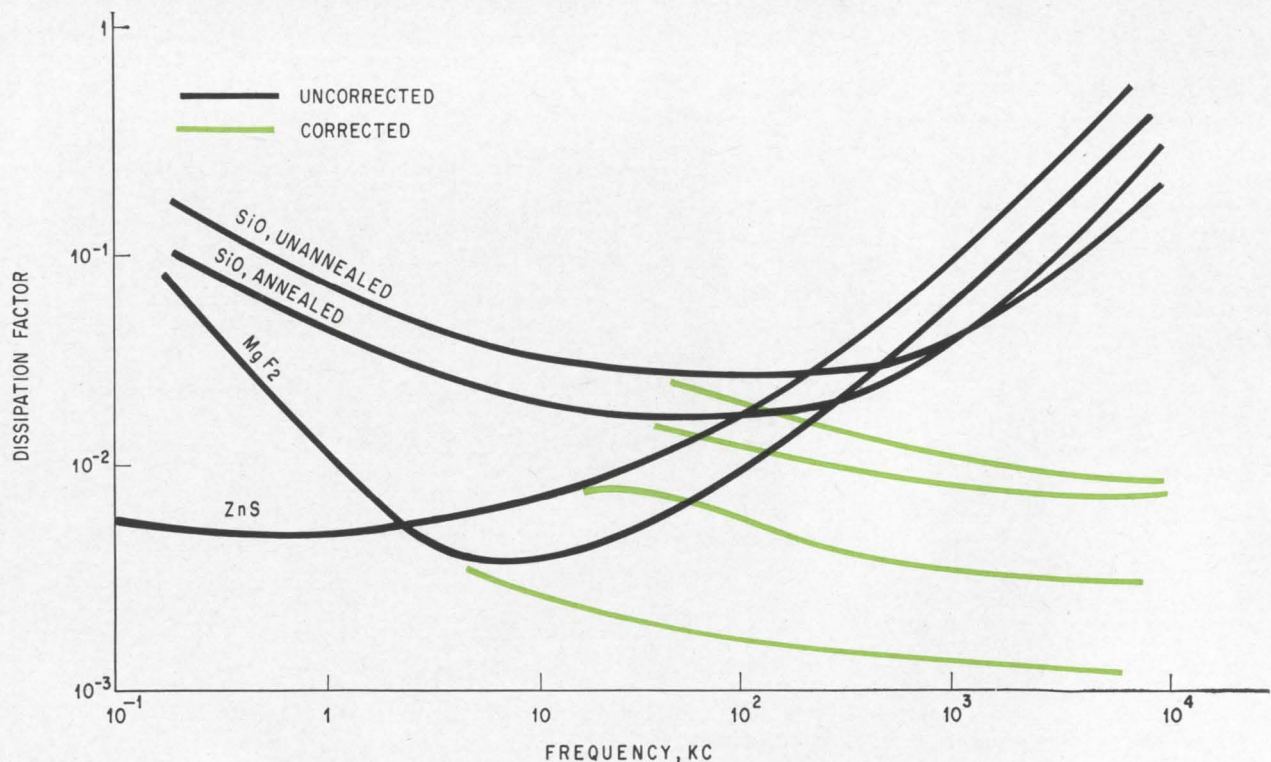

Dissipation factor of 1,000-picofarad thin-film capacitors. The colored portions of the curves are values corrected for electrode lead and plate losses.

used for thin-film capacitors. In some cases, it is converted to silicon dioxide during deposition. The usual difficulties of thin-film structures, such as pin-hole defects, characterize such capacitors.<sup>16</sup>

Only one of the materials listed possesses a significant advantage over thermally grown silicon dioxide. This is a tantalum oxide which has six times as much capacitance per area as silicon dioxide. Even so, a capacitor made of this material must still be much larger than the active elements of an integrated circuit.

### Dissipation factor

The two major dissipative mechanisms of thin-film dielectrics are migration of charge carriers and the friction associated with dipole alignment under the influence of the applied field. Since the dissipation factor of a dielectric is determined by placing the material in a capacitor, there is the added loss due to any series resistance of the electrodes.

To separate the ohmic lead and plate losses from the true dielectric losses, the electrical resistance of the leads and plates must either be kept negligible or be independently determinable. To find the effect of lead and plate losses one can assume that their constant ohmic loss is in series with an ideal capacitor. Then the dissipation factor of this series capacitance-resistance arrangement is given by the equation:

$$D = \omega R_s C$$

where  $\omega$  is  $2\pi f$  and  $f$  is frequency,  $R_s$  is the series resistance and  $C$  is the capacitance. Data for such an arrangement demonstrates that the higher resistivities of the electrode material clearly yield larger dissipation factors (the distributed characteristics of the capacitance and resistance are not taken into account).

The deposition rate of silicon monoxide affects its dissipation factor. (The evaporated dielectric is probably a complex compound, but is referred to as silicon monoxide for simplicity since silicon monoxide is the source material.) Increasing the deposition rate from low values (<10 angstrom units per second) to high values (30 to 100 angstrom units per second) increases the dissipation factor by an order of magnitude. The curve is not necessarily smooth in between those values.<sup>18</sup>

The dissipation factor of silicon monoxide is very sensitive to temperature changes. The figures on page 58 indicate typical influences of temperature on the dissipation factor and leakage current of silicon monoxide. However, the dissipation factor is acceptable for most applications below 100°C.<sup>19</sup>

A general characterization of dissipation factor for thin film dielectrics as a function of frequency is shown at left. It typically decreases with increasing frequency. Measured values of dissipation factor are corrected for lead and plate losses to indicate the dielectric loss.<sup>17</sup>

In general the dissipation factors of thin-film capacitors depend upon the geometry of the electrodes, the deposition rate of the dielectric, temperature cycling, frequency of the applied voltages

and dielectric thickness. Therefore, to achieve an acceptable dissipation factor for thin film capacitors, a qualitative design based upon experience must be used. Data for the dielectric of the capacitor similar to the data presented for silicon monoxide can be used to establish a starting point and to anticipate general trends for the dissipation factor as a function of the various process parameters.

Since both plates of a thin-film capacitor can be good conductors, dissipative losses are primarily in the dielectric and correspond to those given in the table.

The breakdown voltages listed for the materials are functions of the method of deposition and should be considered only ballpark figures.

### References

1. N. Fuschillo, D. Householder, J. Kroboth, T.E. Pardue, "High Speed DTL Logic," 1965 International Solid-State Circuits Conference, Feb. 17, 1965.
2. T.V. Sikina, "A Buffer Amplifier Using Tantalum Film and Silicon Integrated-Circuit Techniques," 1964 National Electronics Conference, Oct. 1964.
3. Texas Instruments Incorporated, "First Quarterly Reports for Semiconductor Resistive Element," July 1-Sept. 30, 1961, NObsr-85406, SR-0080302, ST-90607, Dallas, Tex., Oct. 15, 1961 (U) AD 270 011.
4. Texas Instruments Incorporated, "Fourth Quarterly Report for Semiconductor Resistive Element," Apr. 1-June 30, 1962, NObsr-85406, SR-0080302, ST-9607, Dallas, Tex., June 30, 1962 (U) AD 278-729.
5. Texas Instruments Incorporated, "Third Quarterly Report for Semiconductor Resistive Element," Jan. 1-March 31, 1962, NObsr-85406, SR-0080302, ST-9607, Dallas, Tex., April 15, 1962 (U) AD 274 965.
6. M.V. Sullivan and J.H. Eigler, "Electroless Nickel Plating for Making Ohmic Contacts to Silicon," J. Electrochem. Soc. 104, April, 1957, pp. 226-230.
7. Diamond Ordnance Fuze Laboratories "Microcircuitry by Chemical Deposition," E.L. Hebb, TR-1052, DA 5906-01-014, Washington, June 22, 1962 (U) N62-16070.
8. Halex Inc., "Physics of Thin Resistive Films," E.R. Olson and G.V. Vajda, Scientific Report No. 2, Contract No. AF 33(616)-6685, El Segundo, Calif., Dec., 1959 (U) AD 230 381.
9. C.Z. Leinkram and W.S. Corak, "Electrical Characteristics of a New Type of Thin-Film Resistor," Proc. IEEE 53, March, 1965, p. 300.
10. C.P. Hoffman and M.N. Giuliano, "Micropower Molecular Amplifiers for Infrared Search-Track System Application," Solid State Design 6, March, 1965, p. 24.
11. P.R. Mallory and Co., Inc., "Resistors, Fixed, Precision High Temperature, Radiation Resistant," R.A. Najmon, WADD Tech. Report 60-801, April, 1961, Contract No. AF 33(616)-6164, Indianapolis, Ind. (U) AD 262 063.
12. Pacific Semiconductors, Inc., "PSI High-Q Varicap Data Sheet," Hawthorne, Calif.
13. Electronics Vol. 37, No. 17, June 1, 1964, p. 23.
14. G.R. Madland, presentation at DOD-AGED Microelectronics Conference, May, 1963, Durham, N.C.
15. H.G. Rudenberg, J.R. Johnson, and L.C. White, "Titanium Oxide and Silicon Oxide Capacitors for Microminiature Functional Circuits," Solid State Design, Vol. 3, Aug. 1962, p. 27.
16. Melpar, Inc., "Eighth Quarterly Report on Molecular Circuit Development," Feb. 15 to May 15, 1962, Contract No. Now 60-0632-C, Falls Church, Va. (U) AD 275 283.
17. F.S. Maddocks and R.E. Thun, "Properties of Evaporated Film Capacitors," J. Electrochem. Soc. 109, Feb., 1962, pp. 99-103.
18. Stanford Research Institute, "Dielectric Thin Films With Increased Breakdown Strength," S.W. Chaikin and A. Gilbert, Technical Report II, Dec. 1, 1961 to May 30, 1962, Contract No. DA-36-039-SC-87460, Menlo Park, Calif., July, 1962.
19. G. Sidall and B.A. Probyn, "Vacuum Deposition of Electronic Components," Radio and Electronic Components, May, 1961.
20. R.S. Clark, "Sputtered SiO<sub>2</sub> Capacitors Compatible with Integrated Circuits," (paper presented at AIME Mtg., Boston, Sept., 1964).
21. For example, Texas Instruments series 51 blocks, Signetics binary element
22. Electronics Vol. 37, No. 21, July 27, 1964, p. 54, 58.

### Acknowledgments

Much of this information has been based on material from reports prepared for the Research and Technology division, Air Force Avionics Laboratory, Wright-Patterson Air Force Base, under Contract AF 33(657)-10340. R.A. Evans, L.K. Monteith and J.R. Hauser, of the Research Triangle Institute contributed information or assistance for the preparation of this article.

# Designer's casebook

Designer's casebook is a regular feature in Electronics. Readers are invited to submit novel circuit ideas, packaging schemes, or other unusual solutions to design problems. Descriptions should be short. We'll pay \$50 for each item published.

## FET in bridge circuit gates a 300-kc signal

By F.J. Murphree and Jesse Bealar  
U.S. Navy Mine Defense Laboratory, Panama City, Fla.

A field effect transistor is used as a low-leakage gate in a bridge circuit to provide an output of pulsed oscillations (tone bursts) from a continuous-

wave input of 300 kilocycles per second.

In usual FET-gate circuits, the gate of the FET is biased at 0 volts and the bridge is balanced so that minimum output occurs when the signal frequency is applied to the input. The FET resistance increases when a unidirectional pulse is applied to its gate; required pulse polarity depends on the type of FET channel used. The bridge becomes unbalanced and the gate lets through a c-w output signal for the duration of the gating pulse. With two such bridge circuits in tandem, as shown below, the signal leakage in the off condition is reduced to 60 decibels below the voltage level through the gate in the on condition. A 300-

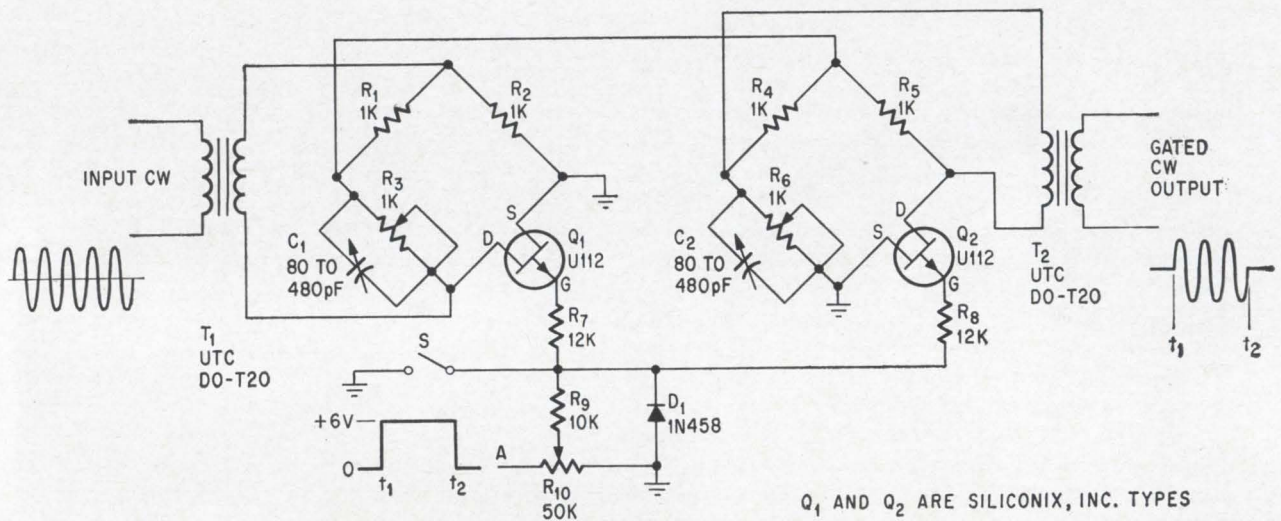

Q<sub>1</sub> AND Q<sub>2</sub> ARE SILICONIX, INC. TYPES

FET bridge circuits in tandem act as a low-leakage gate with on-off ratio of 60 decibels.

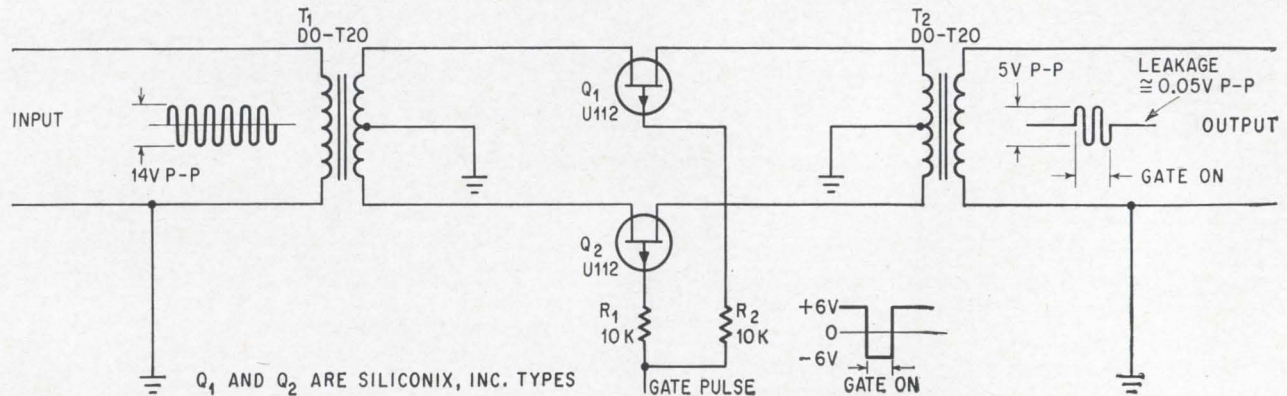

Q<sub>1</sub> AND Q<sub>2</sub> ARE SILICONIX, INC. TYPES

Simpler FET gate circuit has on-off ratio of 50 decibels.

kilocycle signal sees an insertion loss of about 20 decibels when the gate is in the on condition.

The circuit is adjusted as follows:

A continuous a-c signal is applied to the input terminals of  $T_1$ . Switch  $S_1$  is closed and the individual bridge circuits are balanced by adjusting  $R_3$  and  $C_1$ , and  $R_6$  and  $C_2$ , respectively. After the bridges are balanced,  $S_1$  is opened and a pulse is applied between A and ground (across potentiometer  $R_{10}$ ). Potentiometer  $R_{10}$  is adjusted to obtain the required output voltage level during the gate pulse. Each bridge can be rebalanced, if necessary, to obtain lowest leakage.

The input signal during the balancing should not exceed 0.25 volts because harmonics generated by the FET's may obscure the null at the fundamental frequency. Harmonics that are present in the input signal or generated by the FETs can be eliminated by a bandpass filter at the output of the gate circuit.

Balancing adjustments are unnecessary since d-c voltages are not used in the circuit. If long gate pulses are required, the FET's could be replaced by Raysistors.

To minimize leakage between the input and output, the external ground circuit must be given special attention to obtain maximum on-off ratio at the gate.

Another gate circuit that provides a pulsed c-w output from a c-w input is also shown. Although the on-off ratio of this gate circuit is only approximately 50 db, it has several advantages over the tandem bridge gate: fewer components resulting in lower cost, higher reliability, smaller packages and lower insertion loss (about 15 db with output load of 510 ohms). Also, it requires no adjustment.

These circuits were developed to reduce signal leakage of a commercial tone burst generator when used in sonar experiments in the gated off condition.

## Photoconductors chop d-c signal levels

By Warren Moore

Texas Instruments Incorporated, Houston, Texas

**The chopper circuit** shown below was designed for the amplifier of a sensitive potentiometer recorder. Chopping the d-c signal voltage with photoconductors, instead of with mechanical contacts, eliminates the stray interference from the a-c line, minimizes heat dissipation, and yields reliability.

The photoconductors have low resistance when illuminated; otherwise their resistance is high. Because neon lamps respond rapidly to ignition voltage, they are used to illuminate the photoconductors. Each photoconductor is illuminated by its

own neon lamp. Diodes  $D_1$  and  $D_2$  short-circuit the lamps on alternate half-cycles.

Switching is symmetrical because two photoconductors chop the input d-c instead of only one.

The ignition voltage for the neon lamps in this circuit is between 100 and 120 volts and the extinction voltage is about 75 volts.

When the line voltage is lower than the extinction voltage of one lamp and not as high as the ignition voltage of the other, both lamps are off.

The resistance of illuminated photoconductors can vary from 400 to 4,000 ohms because they have high temperature coefficients. However, this variation in resistance is not a major problem because the chopper's output is connected to an amplifier that has an input impedance of 150,000 ohms. This also means that the chopper's efficiency is high and that temperature does not pose a serious problem.

The neon lamps are usually placed close to the photoconductors for maximum light transfer. But

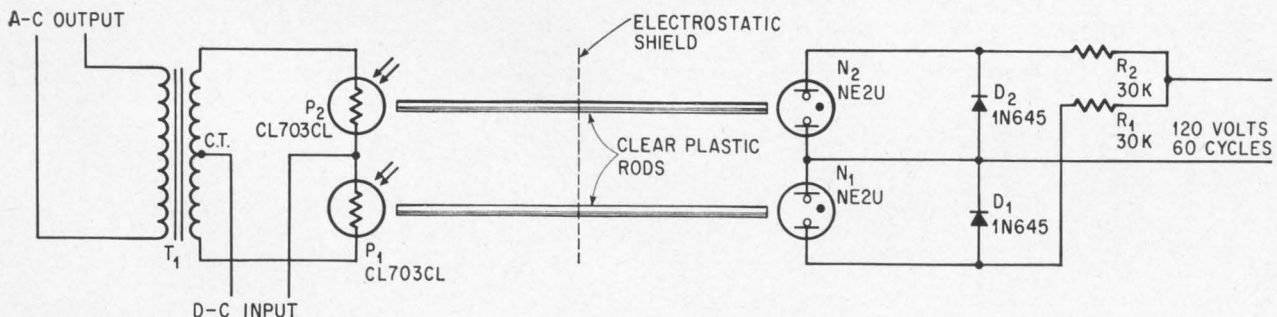

Photoconductor is turned on and off by its neon lamp during alternate half-cycles of input a-c line frequency.

the photoconductors, because they operate at the microvolt level, must be electrostatically shielded from the neon lamps, which operate at about 100 volts. In other photochoppers, a conductive glass lets the light through but shields the electric field. But here, the lamps and photoconductors are placed far apart to reduce shielding problems. Light is conducted from the lamps to the photoconductors through clear plastic or glass rods.

Another problem is due to the leads of the photoconductors; when combined with copper, these make an excellent thermocouple, introducing extraneous voltages. These thermal emf's are about  $40 \mu\text{V}/^\circ\text{C}$ . Since the amplifier is detecting microvolts, the connection of copper leads of the circuit and the Kovar leads of the photoconductor are encapsulated in epoxy to assure that the junction is isothermal.

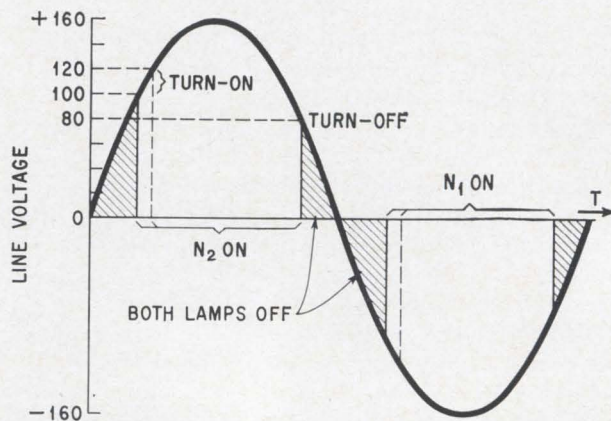

Ignition voltage of neon lamps varies (jitters) and must be considered when the phase of the output a-c is important.

## Unijunction transistor latches relay with short pulses

By Steven E. Summer

High Energy Physics Laboratory  
City College Research Foundation, New York

The relay in the circuit shown below latches on with a set pulse and is unlatched by a reset pulse. The set and reset pulses are +12 volts in amplitude and 100 microseconds duration. This circuit can maintain continuous control during the time between a set and a reset pulse.

The heart of the circuit is the unijunction transistor  $Q_3$ . A set pulse at terminal A causes  $Q_1$  and  $Q_2$  to conduct heavily. The current increase

in  $R_3$  raises the emitter voltage of  $Q_3$  above its firing voltage  $V_p$ . The ujt fires and because  $R_4$  has a low resistance,  $Q_3$  remains on, or latches. The voltage from base-one to ground (about three volts) drives  $Q_4$  into conduction, which saturates  $Q_5$ . When  $Q_5$  is saturated, the 12-volt, 0.25 amp relay is actuated.

A positive 12-volt reset pulse at terminal B raises  $Q_3$ 's base-one voltage above its emitter voltage; this back-biases the emitter-base-one junction. The ujt emitter current drops to less than its peak-point current  $I_p$  and  $Q_3$  switches back to the off state.

The unijunction transistor, in the conducting state, is biased at about 75% of  $V_p$  by  $R_4$  and  $R_5$ . The peak-point voltage is given by  $V_p \cong \eta V_{bb} + 0.7$  where  $\eta$ , the intrinsic standoff ratio, varies from 0.47 to 0.62 for a 2N1671. Since  $V_p$  may vary in this circuit from 6.3 to 8.7 volts, the emitter of  $Q_3$  should not be biased at more than 6 volts.

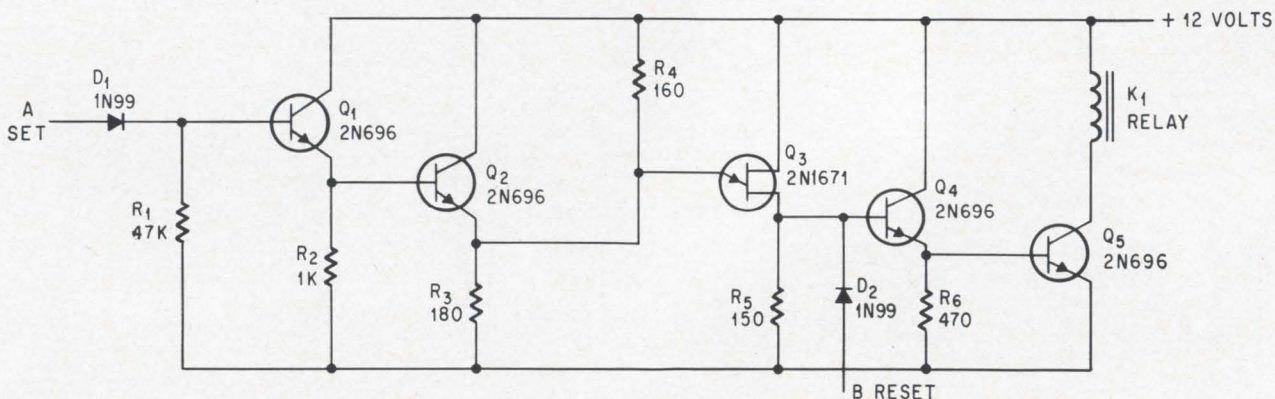

Relay is latched on or off in accordance with the state of the unijunction transistor. Ujt is driven into either stable state by a separate set and reset pulse.



# Finally, the armed forces get solid state communications

Ten years of development were required before the military began to enjoy the benefit of transistors, as lack of money and of a sense of urgency contributed to the slow advance of the required technology

By W. J. Evanzia

Avionics editor

**Transistors were supposed** to revolutionize communications equipment, but outside of Dick Tracy, the revolution has been slow. Despite the bright forecasts of 1955, the technology has lagged—especially in military communications. The Pentagon didn't have the money for research and didn't press for it, and the result is that only now, after 10 years of development, is solid state equipment beginning to move out to troops in the field.

## Low priority, high inventory

Communications wasn't very high on the priority list in the mid- and late 50's; the military, which had to stay within its budget, was concerned with other projects thought to be more important. And since the services already had large stockpiles of communications gear, which included everything from man-pack radios to teletypes, any abrupt change in equipment was economically difficult. (Because new field equipment requires large investments of time and money, the military generally does not replace old gear until minimum useful life has been obtained. New equipment is phased in and replaces the old on a year-by-year basis). Of equal importance was the fact that many military communications officers failed to see the full potential of the transistor. (They now talk about a "transistor gap" between where we are and where we should be.) The Navy, for instance, did not feel the need of transistorized communications since it already had large inventories of communication equipment; according to one naval engineer "The Navy bridged the transistor gap by not doing anything."

The fundamental problem was reliability. The very nature of a military mission prohibits using untried or experimental devices in the field. Early

research and development on transistors was put off because Bell Telephone Laboratories was doing that work. It was not until the Minuteman program came along in mid-1958, with its high acceptance standards and quality control techniques, that solid state components got the needed push.

Now that the reliability of semiconductor devices can be proved, the added concept of cost effectiveness is accelerating the change from tubes to all kinds of solid state devices, including integrated circuits. Cost effectiveness is a program wherein the total cost of equipment, from conception to termination, including research, design, development, production, and maintenance, is made the lowest possible.

The Department of Defense indicates that solid state components (transistors, thin films, and integrated silicon circuits) can reduce the overall cost of equipment as well as increase its reliability, performance, and serviceability.

## Performance counts

For the military, performance is paramount. The chart at the bottom of page 64 indicates the relative stress placed by military and commercial buyers on operational parameters. Performance itself has two dimensions: present and future. The military must know if the equipment of today will perform as well in future combat operations.

It wasn't until the early 60's that good r-f transistors started to appear. Until then, transistors were used principally in digital equipment; because of their limited power and frequency capability, they were unsuitable for communications gear. Since there were few large contracts for communications equipment available in the mid-fifties, manufacturers could not justify the high develop-

ment cost of transistorizing sets. Reliability was also poor. Transistors and diodes were being used in missile control circuits; but even though the specifications for these units were more rigorous than those being used in other systems, several missile failures were laid directly to semiconductors. Minuteman, more than anything else, changed that, and helped make transistors and reliability synonymous.

### The development cycle

When new equipment is actually introduced, it has already been through a long process. The requirements sent in from the field must be evaluated, prototypes field-tested, procurement data compiled and production established, installation begun, and logistics and personnel training accomplished. The result is that many sets in use today represent a design philosophy of five years ago.

For instance, development started on the SCR-508, a vhf-fm tank radio set in 1940. When the United States entered the war, the set was ready. It remained with the Army field forces until about 1951, when it was finally replaced by the AN/GRC-3-8 family. These in turn were in the field until about 1962, when the AN/VRC-12 was introduced.

The military is trying to shorten this cycle by project and commodity management, in which schedules are made for the entire life cycle of the equipment. Once engineering development of complex equipment starts, the schedule calls for a maximum of four years for it to go through all the stages leading to a field-tested piece of equipment.

Like the Army, the Navy replaces its communications gear on a 10-year cycle. They estimate that it takes 3 to 5 years to develop a piece of equipment, another 1½ to 2 years to get it into production, 6 months to get it out to the fleet, and another 6 months to install it. The AN/ARC-27, an h-f radio transceiver, was installed in naval aircraft in 1950. More than 10 years later it was replaced by the AN/ARC-52. Both of these sets are vacuum-tube types. Just now, the AN/ARC-51, a partially transistorized uhf set, is replacing the AN/ARC 13-15 of World War II vintage.

### Signaling the changes

The Army Electronics Command at Fort Monmouth is specifically charged with assuring that the troops in the field have the most modern communications and surveillance equipment, and with de-

veloping the specialized and advanced gear the Army will need in the future.

The Electronics Command's laboratories are responsible for development of both ground and airborne radio equipment. Much of their effort is directed toward designing hardware; in this part of their activity they are primarily interested in a least-risk type of operation—that is, exploiting new developments that have already proven workable. But because the communications field and related technologies are advancing at such a rapid rate, they also have an active research effort.

### Microelectronic research

One such area of applied research and exploratory development is integrated circuits. Army field personnel continue to ask for smaller and lighter packages. They want higher performance, greater reliability, and a reduction in logistic requirements.

Researchers at Monmouth are interested in developing families of linear integrated circuits that would find use in such items as man-pack, vehicular and miniaturized helmet radios for field communications. In fact, a prototype version of the helmet radio [Electronics, Nov. 1, 1963 p. 10] using only silicon integrated circuits, except for bypass capacitors and coils, has already demonstrated the general feasibility of integrated circuits in field communication equipment. The present helmet radio receiver, which uses miniature discrete component technology and weighs less than nine ounces, clips to the standard army helmet. The hand-held transmitter is approximately 7½ by 2½ by 1½ inches. Two-channel operation (with plug-in crystals) provides ranges of either one mile or 500 yards. Delco Radio division of the General Motors Corp. now has a contract to deliver a number of these sets, which have been undergoing service tests and have not yet been adopted for standard field use.

A frequency synthesizer may occupy one-third to one-half of the total volume of a man-pack single sideband communication transceiver. Effective use of integrated circuitry could cut both size and cost and improve performance and reliability. One stable frequency reference with digital integrated flip-flop dividers can take the place of the 15 to 18 crystal oscillators that might normally be required. Accordingly, the Electronics Command is working to develop the necessary very high-speed silicon integrated circuits, using dielectric isolation techniques to achieve propagation delays of 3 to 5 nanoseconds per gate.

### Present miniaturized sets

The AN/PRC-25 is a vhf man-pack radio set that is now being used in the field. It weighs only 17 pounds 3 ounces, and replaces three sets (AN/PRC-8-9-10) that cover a frequency range of 20 to 55 megacycles. The PRC-25 is an f-m receiver/transmitter that operates in the 30- to 76-megacycle range and provides 920 channels spaced at 50 kilocycle intervals, with a power output of 2 watts.

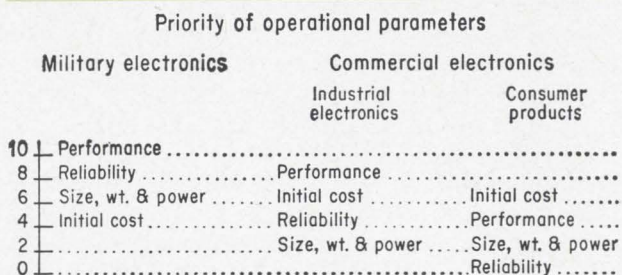

**Comparison of military and commercial electronic requirements.** The need for high performance outweighs all other considerations in military gear.

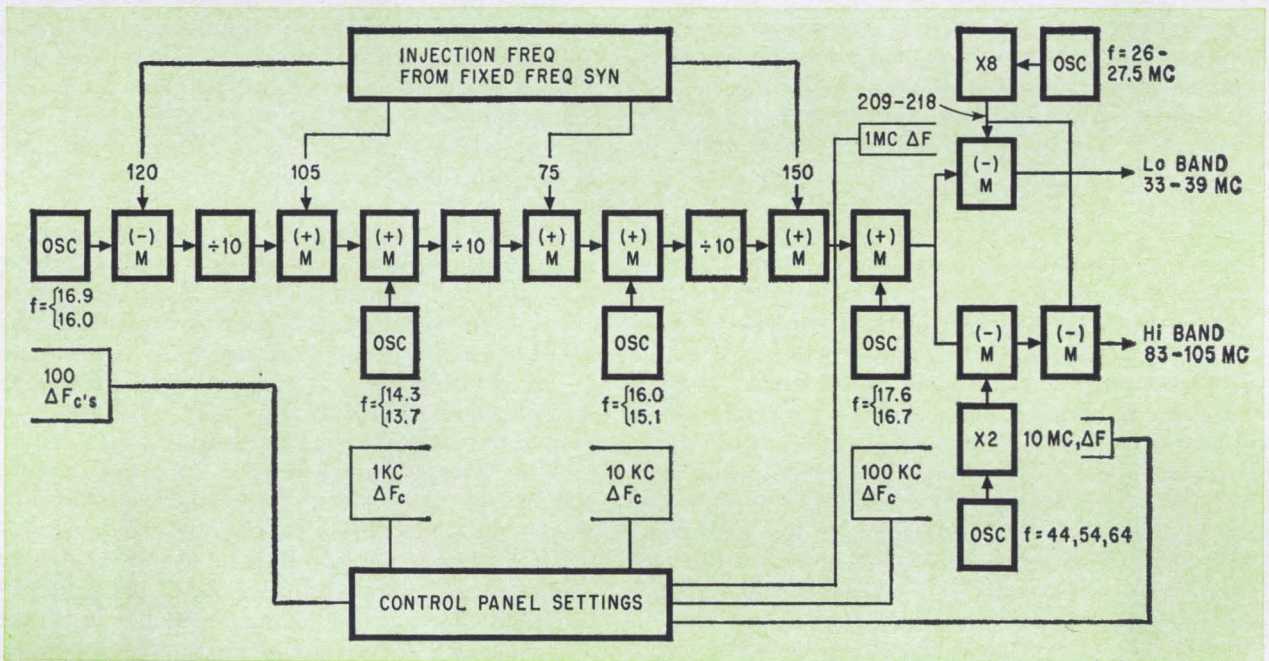
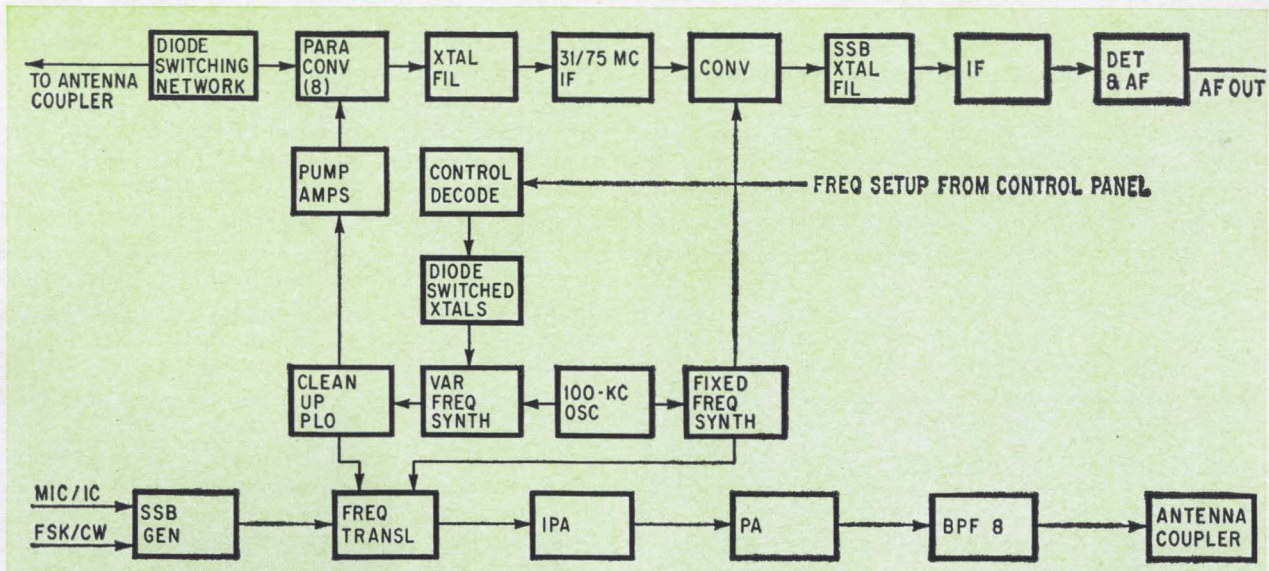

Separate control panel switches set up the operating frequencies for the AN/ARC-104. The system has two frequency synthesizers: a fixed frequency synthesizer which provides the mixing signals for the receiver section, and a variable frequency synthesizer which sets up the fixed injection signals (lower diagram). In the VFS, 100-cycle, 1-kc, 10-kc 1-Mc, and 10-Mc knobs on the control panel activate crystal oscillators. The oscillator signals are then mixed with the injection signals to give high- and low-band coverage.

Stable frequencies are generated for both the transmitter and receiver by a frequency synthesizer.

The unit is transistorized throughout, with the exception of one tube in the transmitter power output stage. A future version will be completely solid state. With 25 modular plug-in sub-assemblies, the set is easy to service.

Man-pack and vehicular versions are now being made by the Surface Communications division of the Radio Corp. of America in its Cambridge, Ohio, plant.

#### For use on wheels

The AN/VRC-12, designed especially for use in vehicles or tanks, is also now in the field. Weighing

only 90 pounds, it replaced three pieces of equipment which weighed 200 pounds each.

This set also operates in the 30- to 76-megacycle band. It is frequency-modulated and has a power output of 35 watts. The equipment it replaces operates in the 20 to 55 Mc band and has a power output of only 15 watts maximum. The VRC-12, all transistorized except for the output stage, is now being made by the Magnavox Corp. in Fort Wayne, Indiana.

#### Some future gear

Almost ready to be sent into the field is the AN/PRC-62, a man-packed, single-sideband (SSB) set designed for use by combat and combat support

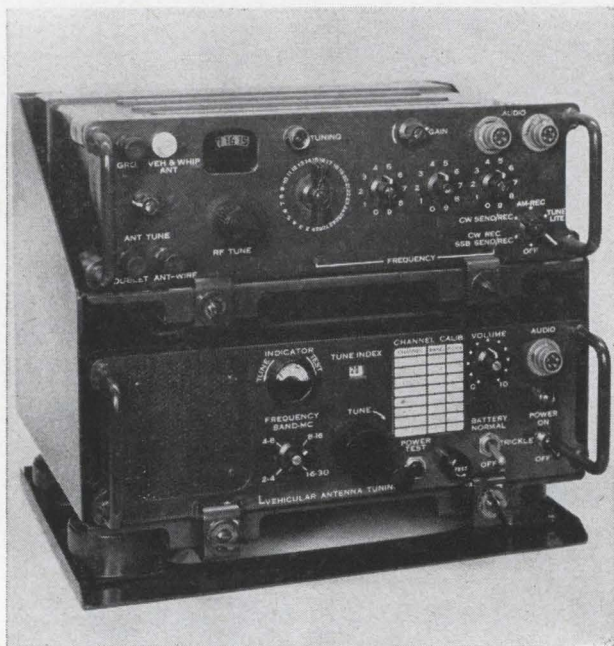

The Army's AN/PRC-62 will be of two types—vehicle (shown above) and man-pack. It will be all transistorized except for the transmitter output stages.

troops at the company, battalion or division level. It is scheduled to replace the AN/GRC-9 (1945 design), which takes three men to carry and covers only a 2-to 12-megacycle range.

Transmitting at 20 watts PEP (peak envelop power), the new set will be able to operate in any one of three modes; transmit/receive SSB voice, transmit/receive c-w Morse, and SSB transmit/a-m receive. It will cover the h-f band of 2 to 30 megacycles and will use a frequency synthesizer to generate transmit/receive frequencies every 1000 cycles over the band. The set will be completely transistorized except for the output stage.

Two versions of the PRC-62 will be made—vehicle and man-pack. The man-packed unit with the transceiver attached to its battery power will only be about 12 inches wide, 17 inches high and 4 inches deep and weigh approximately 34 pounds. RCA is also developing this unit in Camden, N. J.

### To replace 100 sets

The Army has high hopes for the experimental AN/PRC-70, a man-pack, high-frequency radio covering a range of 2 to 76 megacycles (74,000 channels) with a power output of more than 20 watts. The transceiver will be able to operate in a c-w mode as well as SSB, f-m and a-m. A vehicular version is also in development. Integrated circuits are expected to play a major role in this unit, a 30-pound transceiver which is to replace over 100 types of radio sets now operating in the field. The military first became interested in this kind of transceiver back in 1961, but it was not until late 1964 that they awarded development contracts. Fifteen months have been scheduled for develop-

ment, after which the unit will be field-tested for a year. The services now expect the set to be operational in the late 1960's. The Avco Corp. in Cincinnati, and the General Dynamics Corp. Electronics division in Rochester now have development contracts.

### New Navy radio

With the design of the AN/ARC-104 in June 1962 [Electronics, Oct. 25, 1963, page 75] came naval aviation's first really clean break from tube technology to solid state. The transceiver was to have as much integrated circuitry as possible; 65% was the design objective.

Initial design called for the set to be all solid state, but that goal proved impossible. Still, the AN/ARC-104 is representative of what the naval avionic people think that the design of a high frequency communications set should be. It is a 400-watt PEP, 2- to 30-megacycles, 280,000 channel, SSB (upper sideband only) radio, that also operates a-m-e (carrier plus upper sideband only) so that it is compatible with existing aviation communication sets. The ARC-104 will meet all the environmental requirements of MIL-E-5400 Class II equipment. The complete set will weigh 30 pounds and be less than one cubic foot in volume. Plug-in self-testing modules will make maintenance work on the set relatively easy. R&D work is being done at RCA in Camden.

It was soon found that power transistors had not been developed enough to operate over the entire 2- to 30-megacycle spectrum. Transistor second breakdown effect [Electronics, June 15, 1964, p. 66] limited to practical frequency range to 10 to 12 Mc at high power. Therefore, the experimental unit will have a pair of 4CX 350 tetrodes in its final stages. Also, one extremely low noise section in the receiver's front end required the use of a nuvistor. Technical requirements for the ARC-104 called for extremely low noise (greater than 10 db signal-to-noise ratio), flat frequency characteristics (band-pass filters flat with  $\pm \frac{1}{2}$  db), and wide dynamic range. If they had not been so high, it would have been possible to achieve a completely solid-state device with no moving parts.

### Too much noise

Frequencies for the AN/ARC-104 are generated by a synthesizer of unique design. Original specifications called for 100-cycle separation between channels, and RCA had proposed a straightforward "divide by n" counter using metal oxide semiconductor field-effect transistors [Electronics, Oct. 25, 1963, p. 75]. Later, separation requirements were changed to 100 cycles, and new problems arose. The FET's could not meet the stability requirements at high temperatures, and spurious frequency modulation (or noise) occurred at the output of the phase comparator. This noise was the sum of 1/f noise, jitter in the counter, ripple at the phase-comparator output and narrow bandwidth in the feedback loop. That loop contained a special

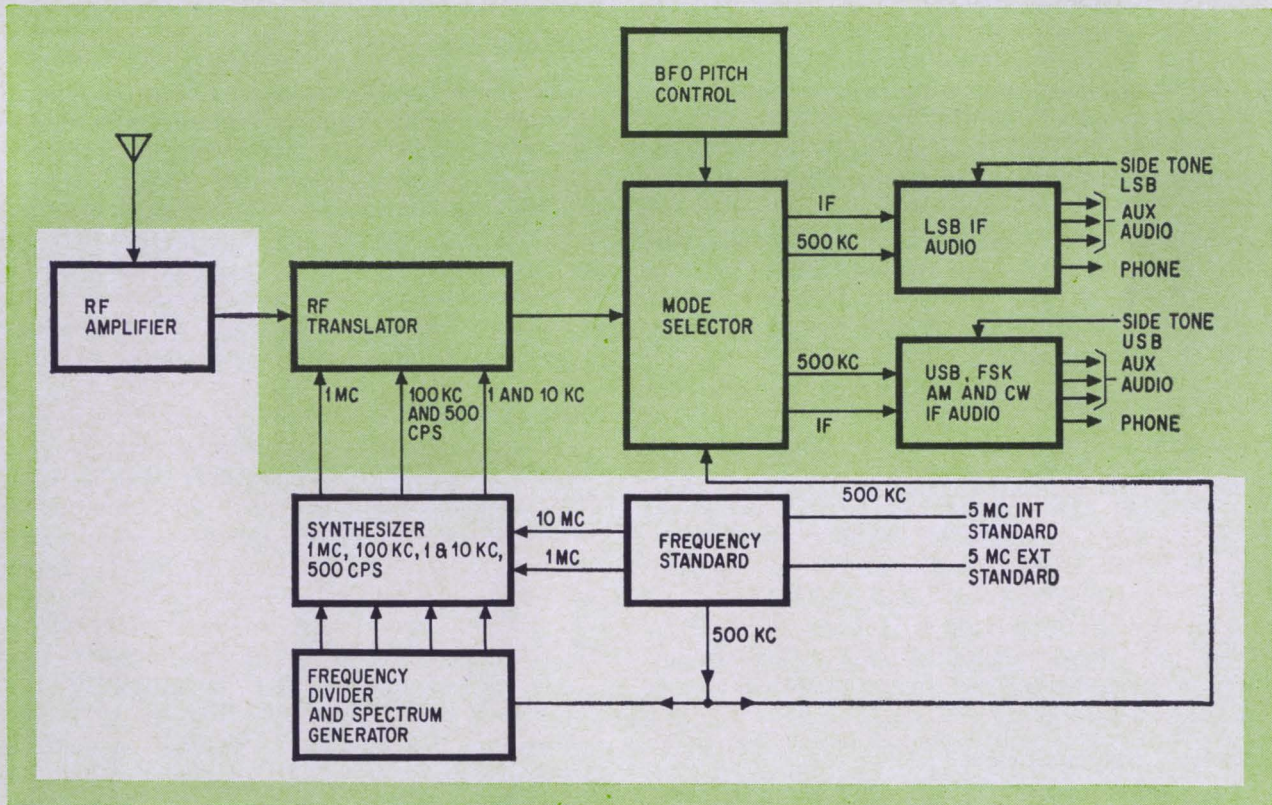
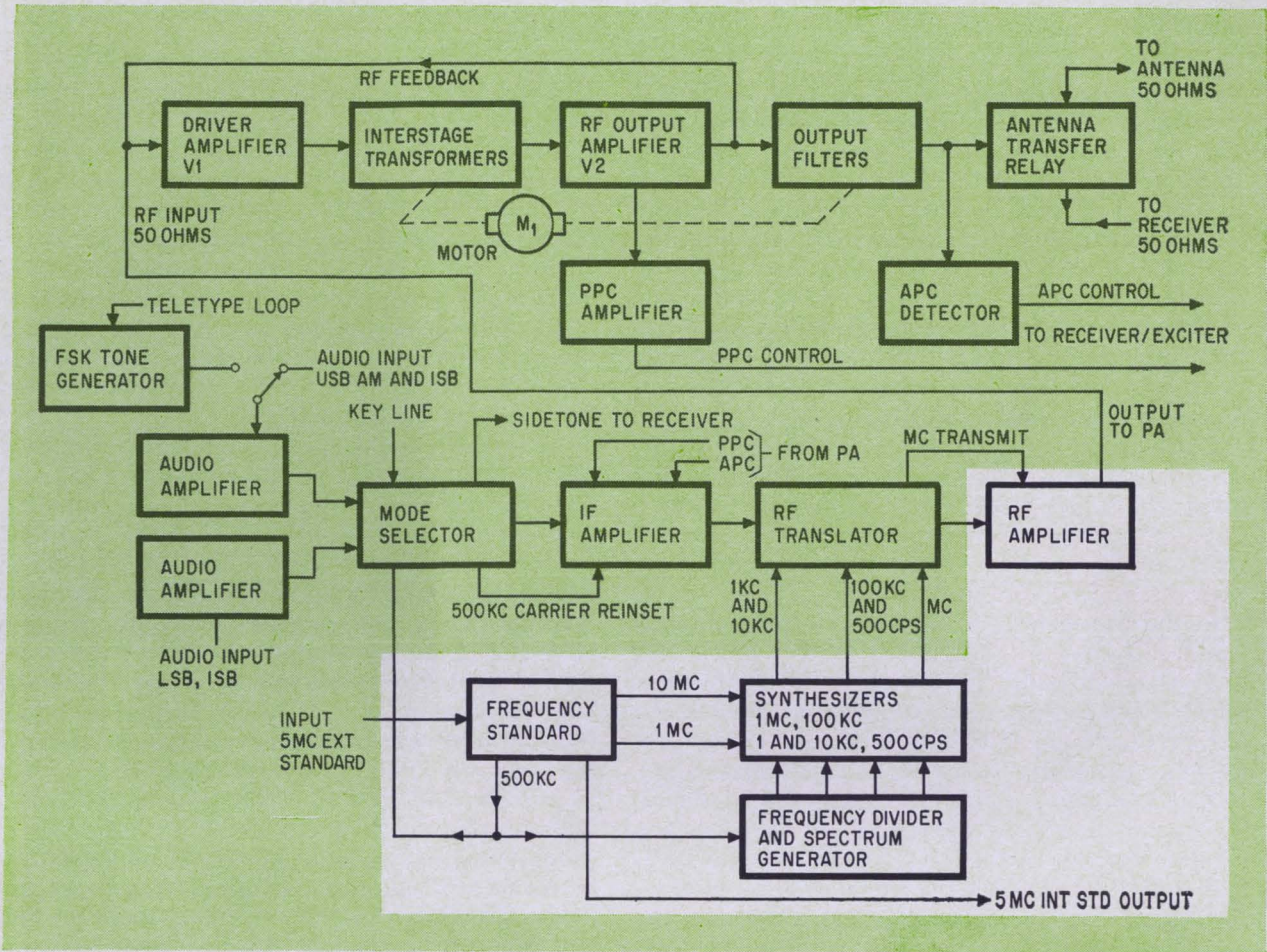

**Commonality of components** in the AN/WRC-1 helps to reduce cost. Four stages in the exciter (top) are identical to those in the receiver (outline in color). In both the exciter and receiver (bottom), the translator-synthesizer modules perform the translation from intermediate frequency to any one of 56,000 discrete output radio frequencies (r-f to intermediate in receivers), by using injection frequencies provided by the synthesizer. The frequency standard is stable to 1 part in  $10^8$  per day

low-pass filter between the output of the phase comparator and the voltage-controlled-oscillator. The filter was supposed to remove the 250-cycle ripple coming out of the phase comparator, but it so reduced the gain bandwidth product of the loop that it was only able to correct the very low frequencies. Unity gain was approximately 3 cps; therefore noise, such as microphonics, (about equal to 500 cps) would pass through unfiltered. While these conditions could be tolerated in a voice only (a-m) type of communication set, they were intolerable in a phase stable (SSB) unit.

Consequently, the entire design of the synthesizer was reinvestigated and a new design resembling the Stone and Hastings Naval Research Laboratory circuit adopted. [Electronics, May 18, 1964, p. 71]. A microelectronic linear circuit replaced the old digital design.

In the transceiver, a 100-kilocycle pulse from a standard frequency oscillator is used to phase-lock a crystal oscillator (fixed frequency synthesizer) which takes the place of the low pass filter in the old circuit design. The output of the variable frequency synthesizer is fed to an additional phase-locked oscillator, called the clean-up oscillator, whose function is to reduce the noise sidebands coming from the VFS. This further increases circuit stability and raises the signal-to-noise ratio by filtering out signals higher than 5 kc away from the carrier frequency.

Unique to this receiver is the high dynamic range—the ratio of the strength of signal outside the pass band to a signal within the band before cross modulation will take place. The required dynamic range of the ARC-104 is 120 db; in some tests it has already exceeded this by 20 db. In one demonstration, signals in the pass band of only 2 to 3 microvolts were not affected by other signals outside the pass band greater than ten volts, until the noise signal was less than six kilocycles away from the band edges. Only then did cross-modulation affect intelligibility. Parametric amplifiers of the up-converter type are used in the front end to obtain low-noise amplification and improve the dynamic range.

Prototypes of the ARC-104 are scheduled to be delivered in fiscal year 1966, at which time environmental and on-board aircraft testing will begin. The first sets will probably be put aboard multi-engined aircraft like the P3A Orion antisubmarine warfare plane. However, it will also be carried on attack aircraft where there is a requirement for SSB voice communications. Because of the size and weight advantage of the 104, a model will also be made for helicopters.

### Surface fleet equipment

The AN/UCC-1, a shape carrier frequency telegraphic set, was one of the earliest pieces of miniaturized surface Navy communications equipment in the fleet readiness category. Work began about 10 years ago. American Scientific Co. of Alexandria, Va. is now producing a transistorized set, while

Honeywell, Inc. is developing an integrated circuit version.

The AN/WRC-1, now being produced in quantities, is all solid state except for two tubes in the transmitter final (8116), another in the receiver (6B26), and one in the exciter (6AN5WA). It is a 100-watt, h-f, SSB/a-m voice, frequency-shift keying, c-w set designed to operate in the 2- to 30-Mc band. A frequency synthesizer provides transmit/receive frequencies every 500 cps across the band. General Dynamics Electronics division in Rochester is making the equipment.

To reduce problems of maintenance and parts replacement, the receiver and transmitter are completely modularized, and about 80 percent of the modules used in the receiver are identical to those used in the transmitter. Each module is self-contained and can be tested and maintained as a unit. No adjustments are necessary when the modules are installed into the equipment.

New components and some equipment redesign have resulted in an "A" series which will have transmit-receive frequencies every 100 cycles across the band, for a total of 280,000 channels.

The AN/SRR-19, a new low-frequency receiver, will use what the Navy calls a modest mix. That is, its circuitry will include about 30 nuvistors and between two and three hundred transistors and diodes. Development is by National Radio in Malden, Mass. It is scheduled for fleet introduction in fiscal 1966.

### Air Force role

The Rome Air Development Center sets standards and evaluates communications requirements for the Air Force.

The Air Force's concern with miniaturization is evidenced by emphasis on the development of two new sets, the AN/PRC-65 and the AN/PRC-66. Both are ground-to-air equipment intended for use by paratroopers and forward air controllers, and at emergency landing fields. Both sets take advantage of the latest in integrated circuitry and transistors.

The AN/PRC-65 will be first microminiaturized Air Force communications equipment to go into the field. Last May, the Rome center awarded a contract for the development and production of the unit to Simmonds Precision Products Inc. of Tarrytown, N. Y. Since this is a hurry-up program, some cordwood construction has been authorized. Modules and discrete components are encapsulated. The package is only 50 cubic inches in volume and will weigh less than 6 pounds, including batteries. The battery pack is separable from the electronics package; so that operating efficiency in cold climates may be improved by placing the batteries under clothing for warmth.

The AN/PRC-65, an a-m set, operates in the 100- to 156-Mc region. Its output stage, using a 2N3375 power transistor, gives minimum power of 2 watts. Channel switching is made easy with a printed circuit digital switch—a thumbwheel rotary switch,

whose axis is shifted 90 degrees from that of conventional types. Switch contacts are made by feelers from the rotary drum to a printed circuit board. The set contains about 25 easily replaceable sub-modules of monolithic, hybrid, and discrete transistor circuitry. The synthesizer has both field effect transistors and thin-film microcircuits; thin-film circuits are also used in the r-f input section.

The greatest savings in size is the design of the frequency synthesizer. It uses hybrid thin-film techniques, contains R-C filters but no tuned circuits or inductors, and occupies only one cubic inch of space. The vhf synthesizer in the PRC-65 provides 1,120 channels, spaced every 50 kilocycles over the entire frequency range.

### Double-duty oscillator

The synthesizer contains a phase-shift voltage controlled oscillator (VCO), which can tune over a

Microcircuit AN/PRC-25 at left, which weighs only six pounds will do the same job as the 40-pound, AN/PRC-41 on right.

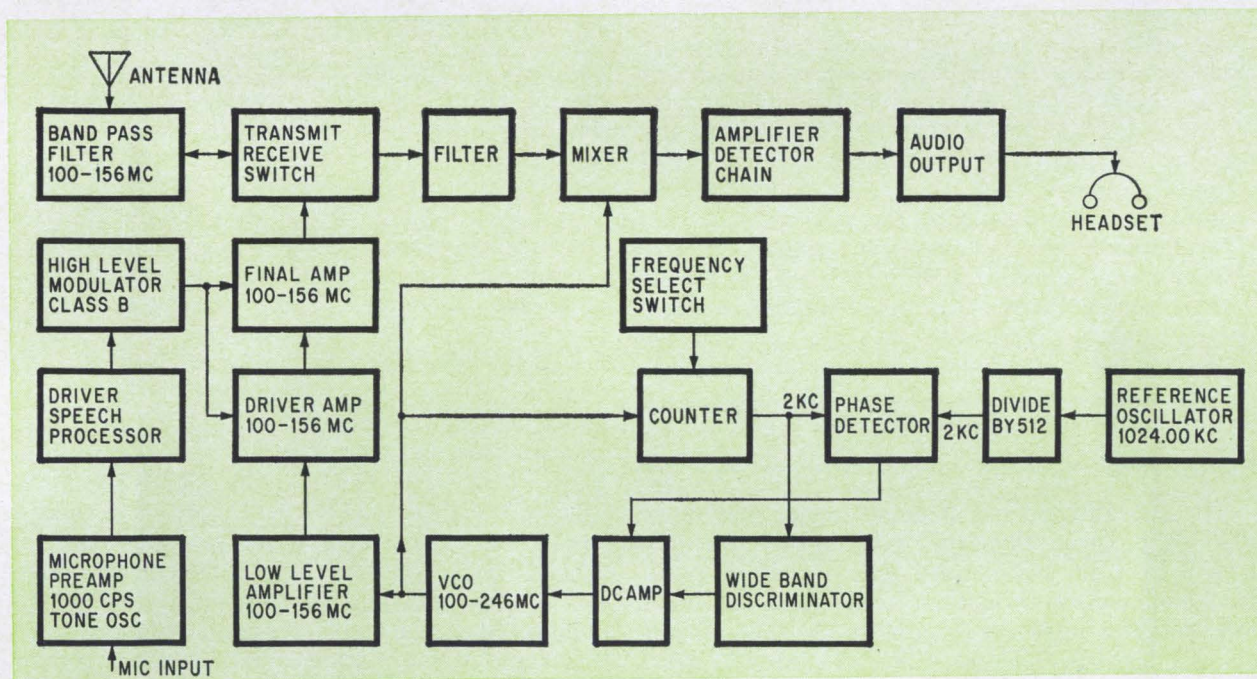
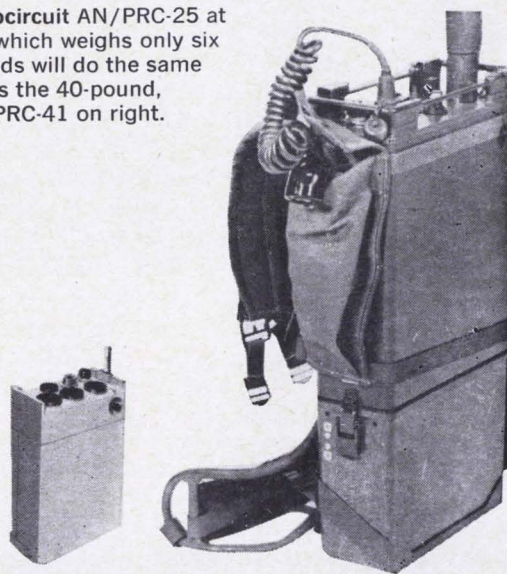

AN/PRC-65 transceiver block diagram. Broadband r-f amplifiers require no tuning adjustments.

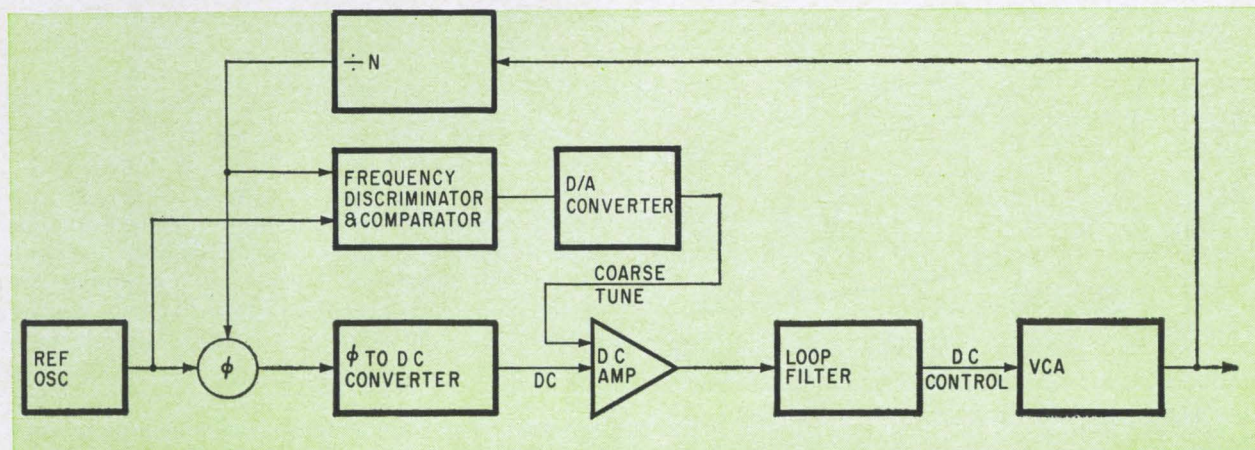

A digital synthesizer of the type used in the AN/PRC-65. The phase-locked servo loop stabilizes the voltage-controlled-oscillator settings between 100 and 250 Mcs.

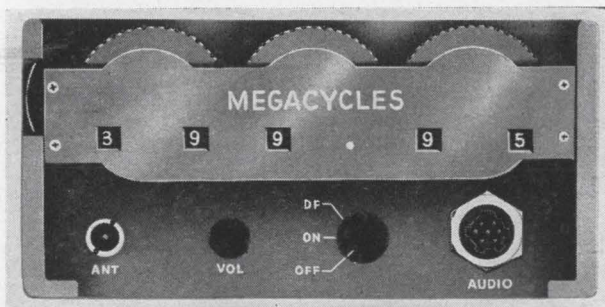

Digital switches like that of the AN/PRC-66, shown above, will set up transmit/receive frequencies in less than 5 seconds.

3-to-1 frequency range. This VCO serves as both a transmitter-exciter and a receiver local oscillator. The VCO frequency is held fixed with crystal accuracy through a phase-locked loop which compares it with a signal derived from a crystal oscillator. Feedback in the servo loop is in digital form.

The output of the VCO passes through a digital pulse counter that forms part of the feedback loop. Because a change in the frequency selector switch causes a corresponding change in the division ratio of the pulse counter, a change will occur in the feedback frequency. This change varies the VCO output frequency, and causes the transceiver to assume the value set up by the selector.

A simple module change can extend the frequency range down to 2 Mc or up to 500 Mc. It was originally feared that near channel interference would be a problem, but new design and packaging techniques enabled Simmonds to exceed the cross modulation specification of 66 db; they have now demonstrated 90 db.

### Longer road

The AN/PRC-66 has a much longer and more difficult program than the -65, but like the -65, it will be used by forward air controllers, paratroopers, and other combat communication team members for two-way ground-to-air line-of-sight communications. The program was started in April

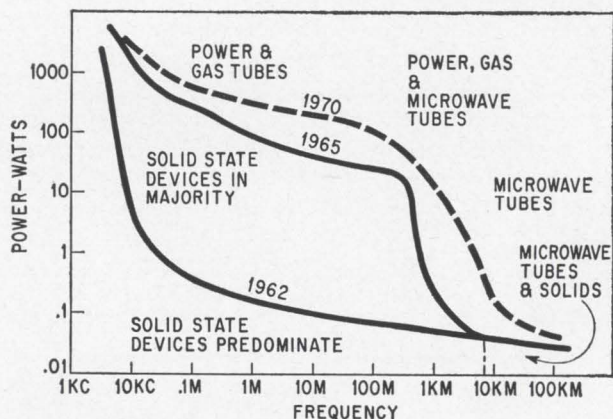

Comparison of tubes and solid state devices. It is evident that there are some areas where it will be a long time before solid state can replace tubes.

of 1964 and will run for about two more years. It will use the very latest advances in thin-film and integrated circuits and operate over a band of 225-400 Mc, with 3,500 transmit/receive channels. Power output and receiver sensitivity is approximately the same for the PRC-66 and the PRC-65 (3 microvolts for 10 db S + N/N, 2 watts output). Packaging requirements for the PRC-66 are the same as for the PRC-65—both must be waterproof and completely portable. The set without battery will be 1.5 x 4 x 6 inches, and weigh less than 7 pounds. Collins is also making a version of the AN/PRC-66 for the Marine Corps.

The contract for the development and production of the PRC-66 was awarded to the Canadian Commercial Corporation, which in turn subcontracted to Collins Radio in Canada. However, the Collins plant in Cedar Rapids, Iowa, is making the equipment.

### Limits on use

Despite rapid advances in the transistor art over the past few years, there are many areas in communications that are still restricted to tube technology. This is specially evident in the area of uhf high-power transistors. It is still difficult to get a transistor to operate reliably much over 100 megacycles at 10 watts of power. In 1962, 0.1 watt at 1 megacycle was about the limit. Transmitter second breakdown effect is still a big problem. So are cooling and intolerance to momentary faults (voltage spikes, arcs, etc.). These drawbacks can still limit transistor use in transmitter power amplifier stages. Also, because transistors are inherently nonlinear devices, they require special handling in linear high power operation.

In receivers too, there remains some circuit functions where tubes can still do a better job than solid state components. Primarily, this is in receiver front ends, where high dynamic range and low signal-to-noise ratios are important considerations, and in some automatic gain control circuits. One military communications research engineer put it this way: "As far as transistors in military communications receivers go, we're at the same level in technology as we were when the screen grid was introduced to the vacuum tube. One of the big problems is getting manufacturers to make a transistor of high enough quality. They feel that the market would be too narrow, and that only the military would be interested." The graph at left indicates the area of power vs. frequency where solid state devices and tubes predominate.

Still, it is clear that the Army, Navy and Air Force are going to solid state (transistors, thin films and integrated circuits) technology as rapidly as possible. Distance measuring equipment, tactical air navigation, uhf data links, beacon warning systems, and uhf air rescue sets are already being designed in transistor-microelectronic versions. The size and weight reduction, inherent reliability and eventual cost reduction all make complete miniaturization attractive and necessary.



## Gemini's electronic 'firsts'

Astronauts control flights, aided by a versatile digital computer, inertial-guidance system and a core memory with nondestructive readout. Conclusion of a 2-part report

**When Astronauts** Virgil I. Grissom and John W. Young took their historic three-lap flight around the earth, they were accompanied in the Molly Brown by three electronic "firsts":

- The first general-purpose digital computer known to have been used in a manned spacecraft.
- The first inertial-guidance system in a manned United States spacecraft.
- The first core memory with nondestructive readout to be used in a space application.

These electronic advances permitted manual control of a U. S. spaceship for the first time. But design requirements and time limits required the use of proven technology throughout the system. Project Gemini may well be the last major space system to use all-discrete components, for example. The International Business Machines Corp. supplied the computer and was responsible for the system integration.

### Manual vs. computer control

The inertial guidance system is organized around the interface between astronaut and computer; that is, the astronauts' ability to control the spacecraft manually through most of the mission, while being assisted by the computer in the solution of guidance problems.

Some part of the inertial guidance system is active during all phases of the Gemini mission—ascend, orbital maneuvering, rendezvous and reentry.

During ascent, the computer generates data for a redundant set of controls in the autopilot for the complete vehicle, including the spacecraft and both rocket stages. In this phase, control is from the ground. If the astronaut feels that oscillations are building up alarmingly in amplitude or frequency, he can override the ground control and switch in the redundant controls to straighten the path of ascent. In the event of a major deviation in course, the astronaut may not have time to switch over manually; in this case the switching is done automatically [Electronics, April 5, p. 94]. In either case the redundant controls "fade in" to avoid too sudden a change.

If this control transition takes place, the com-

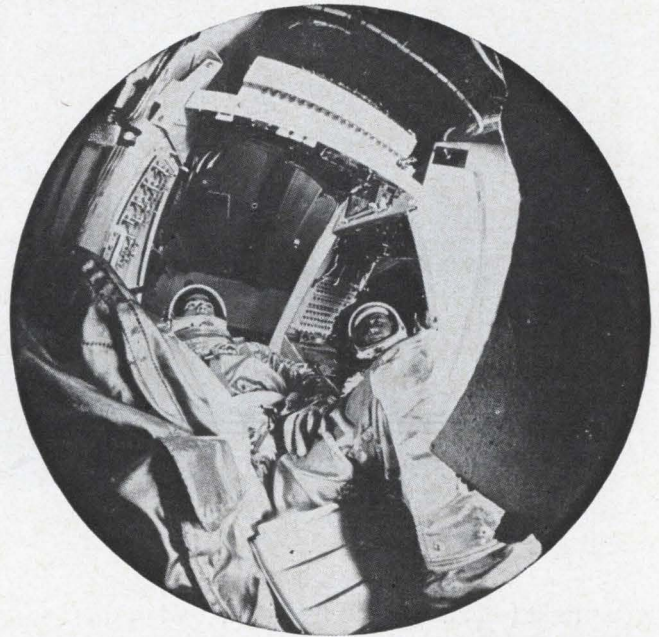

puter controls the steering of the second stage during the remainder of the ascent. After the second engine cuts off, both the second stage and the spacecraft are in orbit; but after separation, to keep the two parts from following one another too closely, a slight additional thrust is given the spacecraft, so that it enters an orbit that is significantly different from that of the second stage.

For the rest of the mission, the computer in the spacecraft displays the thrust required for each maneuver, including the start of reentry. Then the astronaut manually executes the thrust in accordance with the computed requirements.

While maneuvering in orbit, the spacecraft will come within radar range of the target prior to rendezvous. In this phase, data from the ground will provide information on the relative positions of the spacecraft and the target, an Agena D rocket. The inertial platform will indicate the spacecraft's attitude so that the astronauts can aim it in the right direction. Finally, the computer will calculate the thrust required to bring the spacecraft into radar range. During the first manned Gemini mission, there was no rendezvous; the astronauts checked out the maneuverability of the spacecraft as if they were about to attempt rendezvous.

During rendezvous, the on board radar [Electronics, April 5, p. 110] will provide the initial velocity differential. The spacecraft will have been



**Astronaut enters data** into Gemini computer, using manual data-insertion unit. Display portion of the unit appears at left of keyboard.

brought from an orbit intersecting that of the target into an orbit very nearly the same, but with slightly greater velocity. As the spacecraft approaches the target, the velocity differential must be reduced, until just before contact it is nearly zero.

### Components for inertial guidance

To accomplish all this, the inertial guidance system uses—in addition to the general-purpose computer—an inertial measuring unit supplied by the Aeronautical division of Honeywell, Inc.; a manual data-insertion unit designed by the International Business Machines Corp.; and an incremental-velocity indicator built by Lear Siegler, Inc. All work was performed under contract to the McDonnell Aircraft Corp.

There is also a control panel by which the astronauts communicate with the system. There are four switches on the control panel. They control, respectively, power on-off, mode selection, start, and reset error. The astronaut selects the proper mode for the computer depending on which phase of the mission is in progress. During countdown, for example, he uses the prelaunch setting; during rendezvous maneuvers he uses the rendezvous mode. There are also modes to use during ascent, orbital maneuver and reentry.

After entering data from the insertion unit, the astronaut presses the start button. During any computation, if an error occurs, a computer-malfunction light will turn on. The astronaut will turn

it off with the reset-error button. If the light comes on again immediately, he will know that the error is permanent.

The manual data-insertion unit consists of a keyboard and a set of seven electro-mechanical dials similar in appearance to an automobile odometer (photo above). With the decimal keyboard, the astronaut can enter addresses and data into the computer. The dials allow him to verify the data before loading it into the memory, and to read data stored previously in the memory.

### Operating the computer

To get data into or out of the computer, the astronaut first presses a key that clears a transistor register, which acts as a buffer in the insertion unit. He then uses the keyboard to enter two decimal digits that are loaded into the buffer in binary-coded decimal form; these digits also appear on the readout device for verification. The two digits represent an address in the computer memory. He must wait one-half second after entering each digit, to allow for worst-case mechanical delay within the unit.

If the astronaut wishes to read out the contents of this address, he presses the "readout" button. The data, stored in memory as a binary number, is converted to binary-coded decimal, enters the buffer, and appears as a five-digit display on the dials. For entering data into the selected address, such as a desired change in velocity, he continues

to enter digits one at a time until five more have been entered, making a total of seven. He then presses the "enter" button; this causes the digits to pass from the buffer, be converted to binary, and be stored.

If the astronaut discovers an error during this procedure, he can press the "clear" button and start over. If the computer discovers an error made by the astronaut, it automatically clears the readout unit; such an error might be an invalid address or an attempt to store more than five digits.

After entering appropriate data into the computer's memory, the astronaut can press the start button and the computer will process the data according to whichever mode it is in (ascent, rendezvous, etc.). The keyboard and the display dials can be operated and observed conveniently by one astronaut. If a computation calls for a change in velocity, this computer output appears on the incremental-velocity indicator, which is in front of the other astronaut. The use of this indicator is best illustrated by an example.

Suppose that Gemini is required to change orbits. The astronaut knows the velocity change that is required, having previously computed it or having been given the figure by ground control.

He enters this figure by means of the keyboard, places the computer in catch-up mode, and begins computation. The computer picks up the spacecraft's orientation from the inertial platform. On the three dials of the incremental velocity indicator, the computer indicates the thrust in each of the three principal directions that will produce the required change in velocity. If the spacecraft happens to be pointing in the proper direction, the total thrust required will be shown in the fore-aft dial on the incremental-velocity indicator. The up-down and left-right dials will read zero. If the spacecraft is not oriented properly, lateral or vertical thrusts will also be indicated. The astronaut must turn the spacecraft into the proper orientation, or attitude, before starting the thrust.

After reading the thrust requirement on the incremental velocity indicator, the astronaut will decide whether to attempt the desired maneuver. He makes several lesser appraisals first; for example, is there enough fuel to try for rendezvous now? or should he wait until the capsule has drifted closer? This decision is easy, because the capsule's fuel supply is indicated in terms of total available acceleration. This is similar to having the gasoline gauge in an automobile calibrated in miles rather than in gallons.

Then, as the astronaut operates the thruster control, the computer continually recalculates the additional thrust required and corrects the indicator accordingly; the readings are therefore driven toward zero. When they reach zero, the spacecraft will have changed its speed to achieve the desired orbit, which is in the same plane as the original orbit.

The incremental-velocity indicator is used this way for any velocity change in any maneuver.

## Preventing gimbal lock

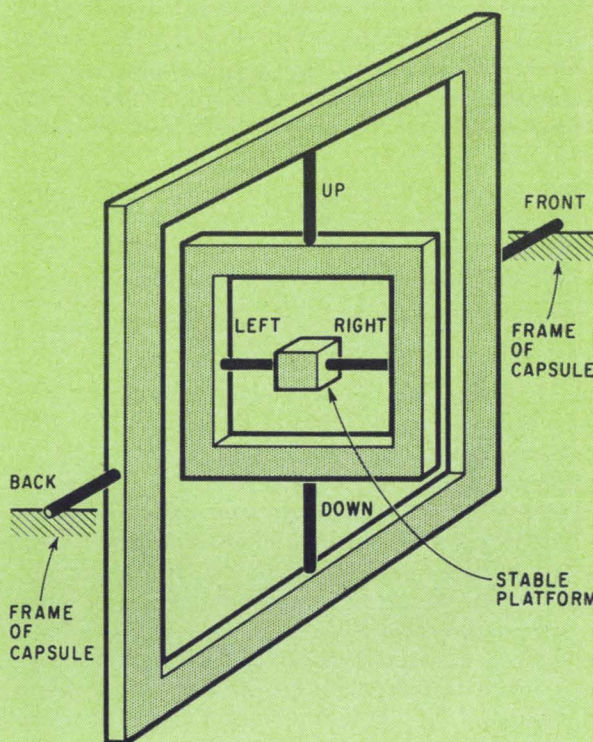

Since there are only three major axes in space, three gimbals might be considered sufficient to hold the platform stable. With only three, however, gimbal lock is a danger.

Consider the spacecraft moving uniformly through space with the three gimbal axes mutually perpendicular. Assume that the order of the axes is as shown in the diagram above, and that the spacecraft turns 90° about the axis of the center gimbal, the up-down axis in this figure.

The spacecraft is now moving in the same direction as before, but sliding sideways. Now the axes of the inner and outer gimbals are parallel, and there is no axis in the original direction of the outer gimbal. Therefore the spacecraft cannot be maneuvered about this axis without causing the platform to tumble; the stable element is no longer stable—it no longer serves as a reference for navigation. This condition is called gimbal lock.

One way to avoid this condition without restricting the capsule's maneuverability is to mount the platform on four gimbals, as described below, with an arrangement such as the servo system described to prevent gimbal lock.

## Inertial measuring unit

The inertial measuring unit consists of three gyroscopes and three accelerometers, one pair for each major axis (front-back, up-down and left-right). Each gyroscope and each accelerometer, with its associated controls, has a thermostat and heater to keep the temperature constant and minimize thermal drift.

The assembly is mounted within a set of gimbals to maintain stability during flight (see panel above). The innermost gimbal is free to rotate 360° about

a left-right axis, allowing the platform to remain steady when the capsule pitches or somersaults. The next gimbal outward rotates only 15° either way from its normal position, about a front-back axis, and is used with a servo system to control the outermost gimbal. The third gimbal rotates 360° about an up-down or yaw axis, holding the platform steady as the capsule turns left or right. The fourth outermost gimbal rotates 360° about another front, back or roll axis, and is driven by the servo system in such a way that the second gimbal tends to remain perpendicular to the third. This arrangement is required if gimbal lock is to be avoided.

### Digital computer's inputs

Three inputs to the digital computer are the angles of the various gimbal axes; they give an indication of the capsule's attitude. For a digital input—*analog-to-digital* converters were avoided because of their additional size and weight—a resolver is used on each gimbal axis. This small synchro is connected so as to provide a 400-cps voltage whose phase is compared with a reference 400-cps voltage. This new technique has since been used in other space systems. Resolvers were designed for this application by the Kearfott division of the General Precision Equipment Corp., of Little Falls, N. J.

Each time the reference voltage crosses zero from positive to negative, a counter is started. Each time the resolver's output voltage crosses zero in the same direction the counter is stopped, the count is transferred to the digital computer, and the counter is reset. The counter's input is a pulse of four megacycles per second generated by the basic computer clock. One cycle of a 400-

cps voltage takes 2.5 milliseconds; one counter pulse occurs every 250 nanoseconds. Therefore, as the phase difference of the two voltages approaches 360°, the number of counter pulses approaches 10,000. This requires a straight binary counter with 14 positions, since  $2^{14} = 16,384$ . The maximum counter value, therefore, is 10,000 and its precision is 0.01%.

Another input to the computer is the acceleration in each of the three major directions, measured by the accelerometers on the stable platform. Three electronic packages, one for each axis, provide a pair of pulse trains, each of which varies in frequency with the acceleration. Nominal frequency for constant velocity is 1,800 cps; this varies from 0 to 3,600 cps, depending on positive or negative acceleration. These limits are approached only during reentry and during the early stages of ascent, respectively. Details are given in the box at the bottom of this page.

The power supply for the entire inertial guidance system, including the computer, is supplied by the Engineered Magnetics division of Gulton Industries, Inc., under subcontract to Honeywell Inc. It provides three regulated d-c voltages and two regulated a-c voltages.

### The computer's versatility

The Gemini computer is an amazingly flexible instrument. It is a general-purpose computer that can be programmed for any of a wide variety of mission profiles and other tasks, not necessarily related to space exploration. The program can be loaded only on the ground, but that is primarily because there are no arrangements for loading programs in the spacecraft.

As a stored-program computer, its list of in-

## How acceleration is measured

Each accelerometer is a standard Honeywell 116 pendulous type consisting of an unbalanced cylinder floating in fluid. Gimbals at the ends of the cylinder, along its axis, are mounted in precision jewel bearings with augmented suspension; this causes a continual dithering of the gimbals within the bearings. In this way the gimbals are kept in contact with the bearings only a tiny fraction of the time, and are therefore restrained by bearing friction only during that time. This reduces the accelerometer's threshold and increases its range.

Two coils, attached to the cylinder, operate in a permanent magnetic field. An iron slug, also attached to the cylinder, varies the coupling in a stationary coil as the cylinder moves. The output of a 3,600-cps oscillator is fed to the ends of the stationary coil and grounded at a center tap.

When acceleration is zero, the cylinder remains in its null position and is held there by the coils in the magnetic field. The iron slug is in its neutral position.

A standard rebalance circuit samples the two equally loaded 3,600-cps pulses, and uses their equality to drive two pulse generators at 1,800 cps; they are synchronized with the master 3,600-cps and out of phase with each other. The two 1,800-cps pulse trains are

fed into the digital computer, where one continually adds 1 to a counter and the other continually subtracts 1. Thus the counter oscillates about zero. From time to time the computer program samples the counter, notes the zero or near-zero value, and acts accordingly—by doing nothing.

When positive or negative acceleration occurs, the cylinder rotates in the fluid, the iron slug moves with respect to the coil, and one side of the circuit becomes more heavily loaded, inductively, than the other. The rebalance circuit uses this information to increase the frequency of one pulse generator and to decrease the frequency of the other, in such a way that the sum of the two frequencies is 3,600. Now the value of the counter in the computer departs from zero one way or the other, depending on the direction of acceleration, and the computer program transfers to the appropriate subroutine.

Meanwhile, the rebalance circuit also takes the difference between the two pulse trains and generates a pulsed signal to one of the coils on the cylinder. This signal acts to pull the cylinder back toward its equilibrium position. The greater the acceleration, the greater the pull toward neutral.

The range of acceleration measured by this device is approximately  $\pm 10g$  or 10 times the force of gravity at the earth's surface in either direction.

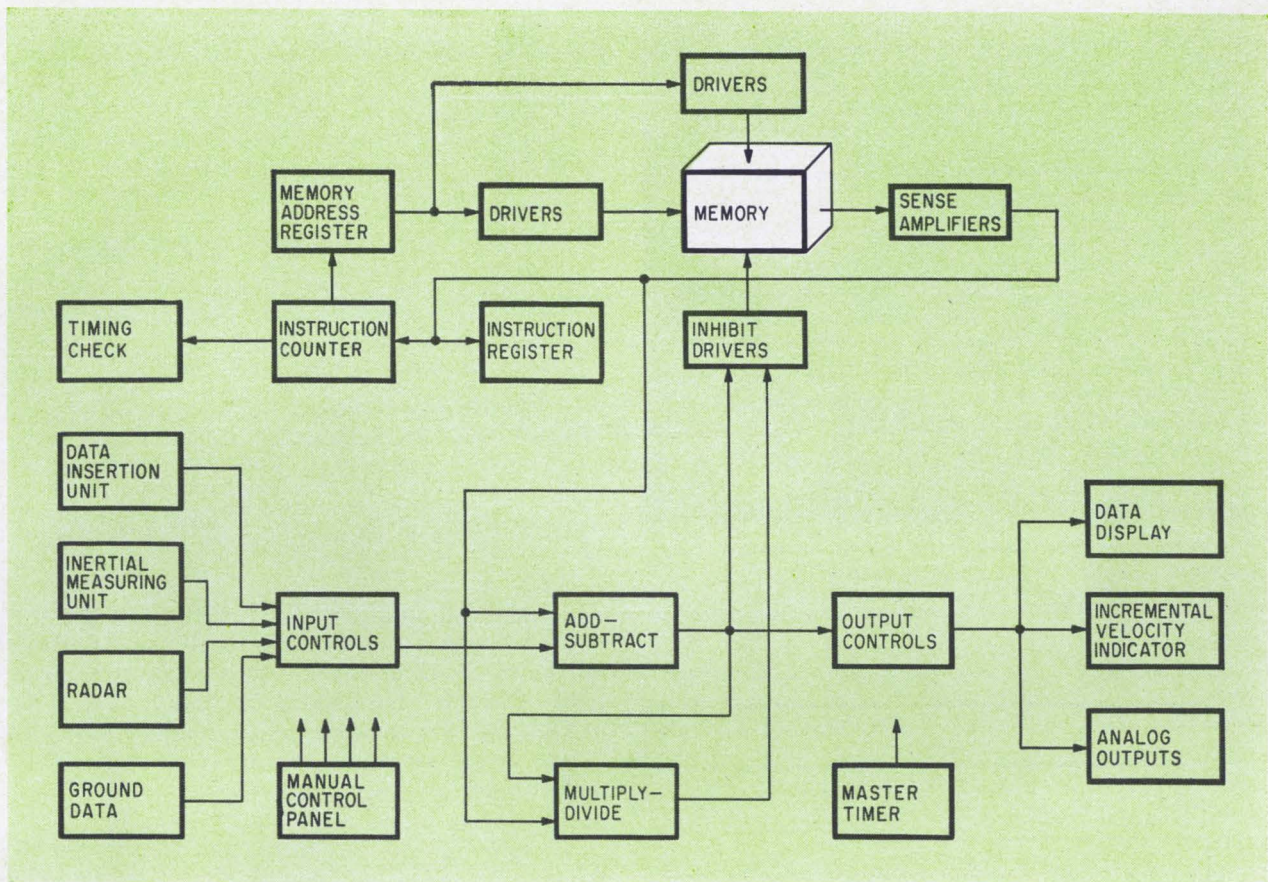

**Data flow in Gemini's computer.** All data and instructions originate in memory. Control of inhibit drivers by add-subtract unit and multiply-divide unit prevents writing of "ones"; all cores are first set to zero when writing. Nondestructive readout memory does not require regeneration.

structions is stored in its memory in the same way as data, and can be operated on as data if circumstances require it.

As a serial computer, it works on binary data one bit at a time. This design reduces its complexity at some sacrifice in speed.

As a fixed-point computer, it works on the binary equivalent of ordinary numbers like 2, 17, 773440, or 3.1416, as opposed to floating-point numbers like  $3.9 \times 10^8$ .

As a single-address machine, every instruction in its program contains one address.

As a synchronous machine, the computer has a timer that defines a fixed interval of time between successive operations.

Other characteristics of the machine are shown in the panel on page 76. The circuitry, using silicon-planar epitaxial transistors in diode-transistor logic, is packaged in over 500 individually potted modules. The modules are attached to multilayer boards consisting of alternate layers of glass-epoxy and printed circuitry. There are 15 layers of printed circuitry, with heat-transfer plates on each side to radiate heat out of the assembly. The total thickness is about  $\frac{5}{8}$  inch. Thermal paths are critical, since the computer operates during reentry when external temperatures are at a peak.

The computer is limited to 1.3 cubic feet, and cannot weigh more than 59 pounds excluding the

power supply; its power consumption is 90 watts average. It is noteworthy that the computer's size and weight could have been reduced only 20% by using integrated circuitry instead of the discrete-component type that was available when the project was started.

Because of size and weight restrictions, there is no redundancy in the computer. However, reliable operation has been obtained by stringent screening, selection and burn-in of components and by designing circuits to operate under worst-case conditions of tolerance and end-of-life. The mean time to failure has been estimated at 2,700 hours.

Five glass delay lines, with delays ranging from 27 to 120 microseconds, are used as registers and accumulators in the computer. They are ultrasonic delay lines, sometimes called glass memories, with piezo-electric transducers at the input and output. The units, made by the Corning Glass Works' Electronic Products division are about 3 by 0.5 inch.

### Memory design

The memory in the Gemini computer is the non-destructive readout type, built of two-aperture ferrite cores called MARS, for Multi-Aperture Reluctance Switch. In a nondestructive readout memory, the data remains intact in any location after having been read out to the computer.

Many computers have destructive readout, in

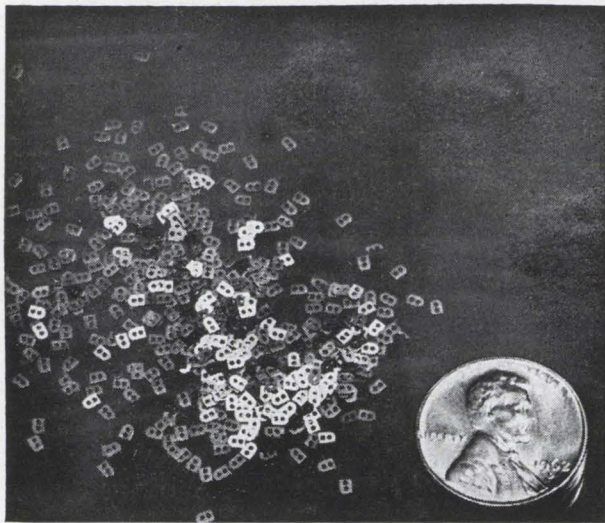

**Ferrite memory cores** used in the Gemini computer measure less than one-tenth of an inch in length. There are over 150,000 of them in the computer.

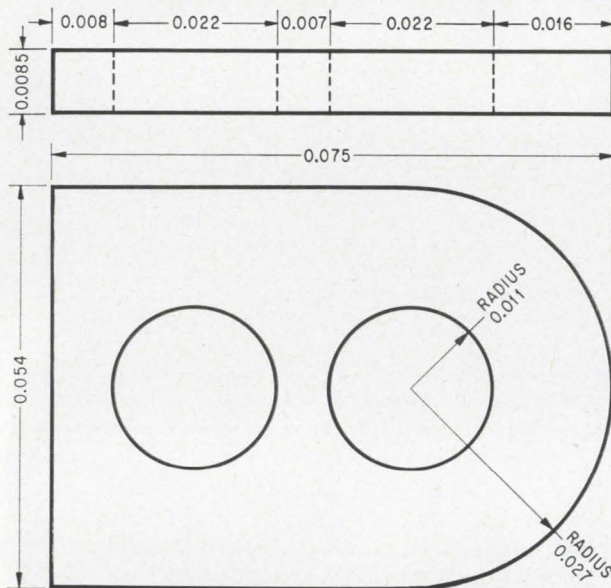

**Dimensions of MARS cores**

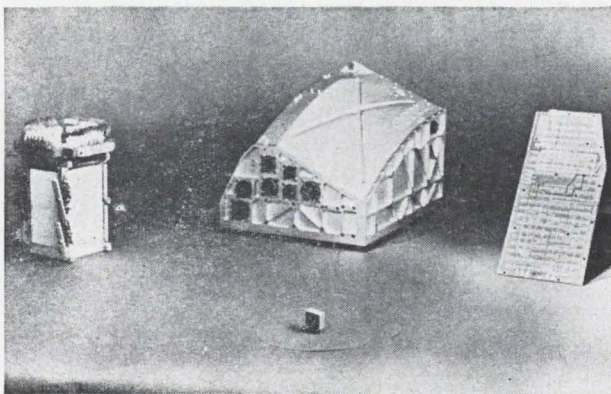

**Gemini's computer** (center) carries out guidance calculations for the Gemini spacecraft. Its memory, measuring approximately 4 by 4 by 7 inches, is shown at the left. In the foreground is an example of the type of microcircuit used; these are interconnected with printed wiring planes similar to that shown at the right.

## Computer's general characteristics

Logic blocks, And-Or-Invert; levels 0 and +8 volts  
Arithmetic execution times:

Add, subtract, transfer	140 microseconds
Multiply, full precision	420 microseconds
Divide, full precision	840 microseconds

Memory characteristics:

39 bits per word, 4,096 words, random access, non-destructive readout
Memory cycle time, 8 microseconds
Instructions (read only), 13 bits or 1 syllable.
Data (read or write) 26 bits or 2 syllables
Typical assignment, 1,500 data syllables, 9,288 instruction syllables

Component count: 12,899

Environmental specifications: Shroud, 0° to 200° F.  
Cold plate, 60° to 80° F.  
Pressure, atmospheric to vacuum.

which the data in memory is destroyed in the process of being read out; in these machines, data taken out must be regenerated if it is to be used again later. Thus, in the Gemini computer, use of the MARS core for nondestructive readout saves the circuitry that would be required for regeneration. This in turn saves weight and power, both of which are critical in a spacecraft application.

As shown in the diagram at the left, the MARS device is a ferrite tablet with two holes of about equal size. The two holes provide three legs for flux paths.

Each individual core can be switched in two microseconds. Circuit delays extend the computer's memory cycle to eight microseconds, either for reading or for storing. The memory is made up of 39 planes, each consisting of an array of 64 by 64 ferrite cores.

The MARS cores in the Gemini computer's memory provide sense voltages that are usable from -20° to about +70° C. As the temperature increases, the sense pulses denoting a "one" decrease in height faster than the spurious "zero" pulses, to the extent that a threshold-detection system would fail. To remedy this, an area detector was devised. It generates a current proportional to the sense-voltage, and applies it to a gated integrator. At the appropriate time in the memory cycle, the gate is opened and the output of the integrator drives a current detector. This also gives a better "one-to-zero" ratio.

The low temperature extreme is established by the transistor circuit requirements. It is really not a problem because the computer is mounted on a "cold plate", which is heated to a constant temperature and serves as a temperature reference for conditioning the computer.

Whenever, they have had a choice between manual and automatic control, astronauts have elected to do it themselves. The control system for Gemini gives them more manual control than on any previous U. S. space flight. And future computers are almost certain to further this trend.

# Telemetry that's compact and reliable

A highly redundant pulse code modulation system met NASA's requirements for a system to work almost perfectly for a 356-hour orbital flight

By Bernard N. Bohm

Electro-Mechanical Research, Inc., Sarasota, Fla.

**Telemetry equipment** for real-time data acquisition from the Gemini space capsule is severely restricted in weight, size, and power consumption, yet it must function with extremely high reliability. The National Aeronautics and Space Administration wanted a system that would operate with a 93.8% probability of success for a mission time of 357 hours, allowing only 5% for each sample rate to fail. Electro-Mechanical Research, Inc. (EMR), operating under a subcontract from the McDonnell Aircraft Corp., came up with a package that packed 133,000 parts into a total volume of 3.6 cubic feet and had a 94.3% probability of success over 356 hours of operation.

That reliability is equal to a mean time between failures of 6,080 hours, or more than eight months.

## Pulse code modulation

EMR worked for three years to perfect this pulse code modulation (pcm) system. The engineers could not use integrated circuits, since there was insufficient data to qualify them on grounds of reliability. Their method was redundancy plus reliability of components.

The system is untended. Its first test was a 2,500-mile suborbital flight Jan. 19, on which it worked perfectly.

More important, the system also worked satisfactorily on the first manned flight last month—both

in the transmission from space and the reception on the ground.

## Commutator train

The pcm system samples, encodes and transmits some 6,400 measurements each second from the electrical signals that are produced by 269 separate sources. The measurements are made sequentially and are transmitted over a 240-megacycle f-m radio link to the ground. The sampling rates for individual signals, which may be thought of in commutator form, vary from one sample every 2.4 seconds for slowly varying temperature measurements to 640 samples per second (sps) for the astronauts' heartbeats.

Data channels consist of high-level (high voltage) analog, low-level analog, bilevel, bilevel pulse and digital data. The master frame has 160 words, 16 of which are in a prime frame that contains the sub-commutated channels. Master frame channels are wired together to provide logic drives for super-commutation (more common contacts in a given period of time) of the high-sample-rate data.

The high sample rates of 640 sps, 160 sps and 80 sps monitor the astronauts' physical condition. Rates of 40 sps, 20 sps and 10 sps monitor functions pertaining to launch and navigation. The low rates of 1.25 sps and 0.416 sps are primarily for housekeeping functions, such as internal temperatures and voltages. A total of 96 basic frames completes a full data field of 2.4 seconds, during which every source is monitored at least once.

## Package deal

The multiplexer-encoder is housed in three different packages—a programmer, a high-level multiplexer and a low-level multiplexer—not including the three separate transmitters and a recorder-reproducer [Electronics, Aug. 24, 1964, p. 84] that make up the entire data-transmission system. The three transmitters are solid-state units capable of a minimum output of 2 watts at 240 megacycles.

## The author



As Gemini project manager at EMR, Bernard N. Bohm is responsible for meeting all program objectives for spaceborne telemetry components. Previously, he worked in missile and fire control systems management and as an engineer in radar and communications projects.

One of two transmitters located in the reentry capsule is used for the transmission of the pcm real-time output bit stream; the other is used for recorder-playback transmission. A third transmitter, located in the adapter section of the spacecraft, is used as a spare.

The remote multiplexers shown in the block diagram above, located in various portions of the spacecraft and in the adapter section, accept analog signals in both the 0- to-20-millivolt range (low level) and 0- to-5-volt range (high level). High-level multiplexers also process bilevel signals obtained from relays and solenoids by multiplexing in parallel binary form. All three types of units derive their power from a common supply in the programmer.

### Data processing

The programmer directly processes high-level, low-level and bilevel data from sources in its immediate vicinity, including serial binary data obtained from the guidance computer and the spacecraft time-reference system. All analog data is converted to the 8-bit binary code, time-multiplexed with the binary data and necessary synchronizing codes, and transmitted upon request of the astronaut or the digital command system at the serial bit rate of 51,200 bits per second.

To avoid losing important data when no ground station is in contact with the spacecraft, data is recorded on a magnetic tape. Such data is dumped

while the spacecraft is in orbit over selected ground stations, and the tape may be used again.

### Fail-safe

The initial step toward the achievement of high reliability is the establishment of maximum permissible failure rates for each subsystem. The predicted failure rate for the actual design is then compared with the maximum permissible failure rate. From this point, the system design is improved to the point where its predicted reliability meets the required goal. Although simple in theory, such improvement must be accomplished within the constraints imposed by available components and by volume, weight, power requirements, cost, and schedule.

The first design approach used a system with conventional military standard parts and no redundancy. The estimated reliability of this system was about 70%, which was far too low to be considered.

Next, quad redundancy, which will be described below, was considered. Although a fully quad-redundant system was judged almost 97% reliable, it could not meet volume, weight and power limitations.

### Priority on redundancy

To derive as much reliability as possible from the redundancy techniques, while conserving weight and volume, subsystems and circuits were

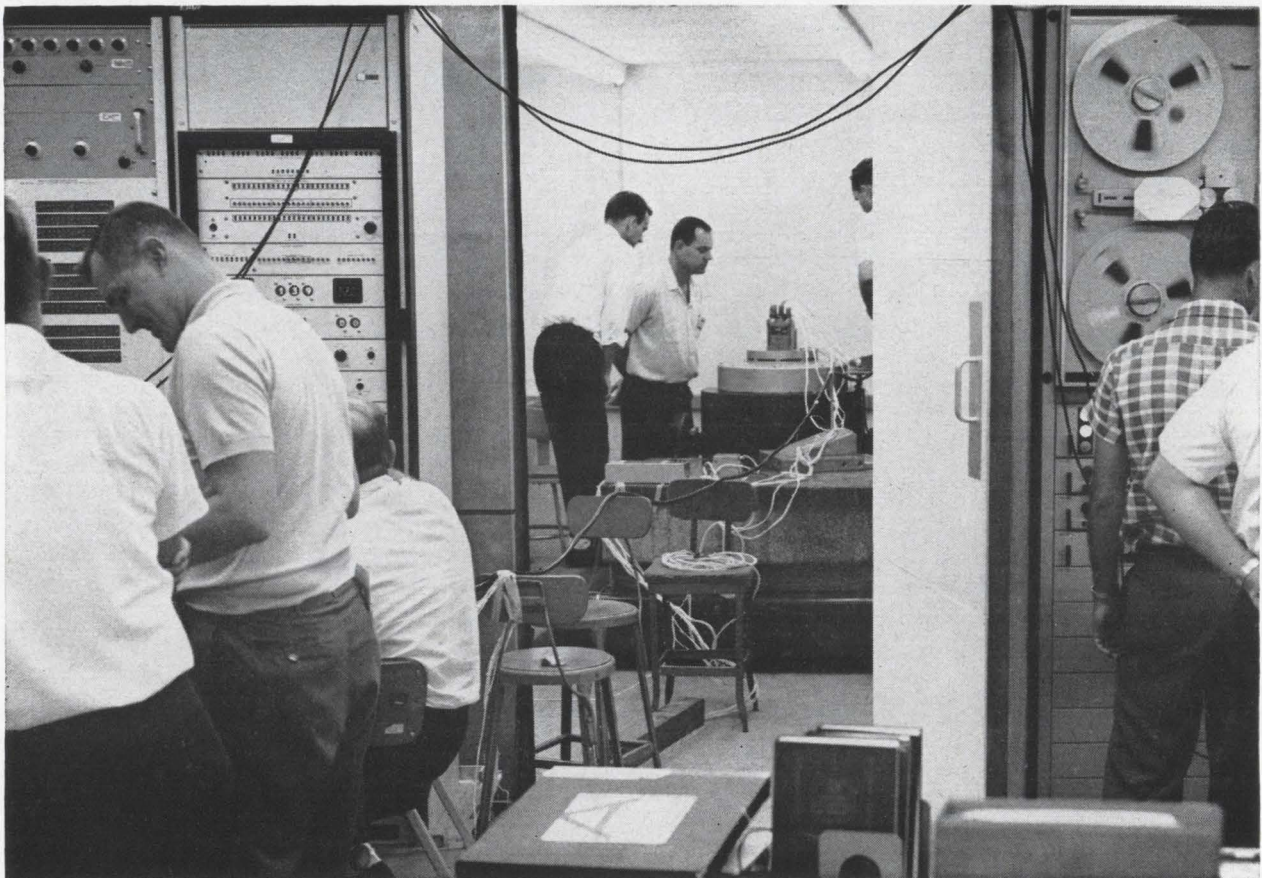

Vibration tests in progress on Gemini equipment (far room) are monitored and recorded for playback and analysis.



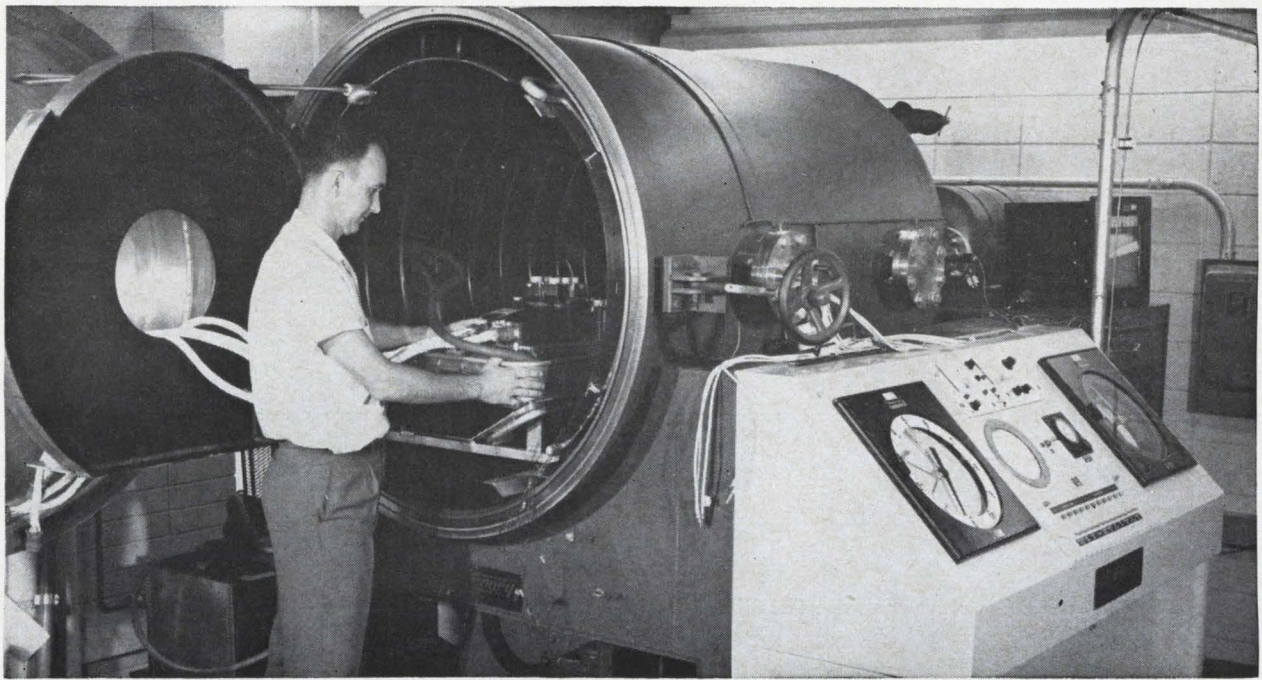

Spaceborne data-transmission equipment is given extensive environmental tests under temperature extremes at low pressure.

studied to determine which ones affected reliability most. Redundant and nonredundant modules performing the same function were developed and tested; nonredundant  $n$  gates, for example, had failure rates almost 20 times greater than their quad-redundant counterparts used in critical logic circuits.

Circuits performing critical system functions were given priority for redundant design. Redundancy was then employed in the less critical circuits until the available volume, weight and power limitations were reached. The overall system was reassessed and found to be approximately 84% reliable—still short of the goal.

### Parts reliability

A program was then initiated to improve the reliability of the basic parts—transistors, metal-film resistors, and critical capacitors—in all circuits. Parts were subjected to temperature preconditioning and power burn-in at rated dissipation. Part parameters were measured prior to and after power burn-in, and the difference between the readings was used to screen each lot of parts statistically. This process not only eliminated infant-mortality parts but enabled potential failures—reliability risks—to be weeded out.

The attack on parts reliability did the trick. To-

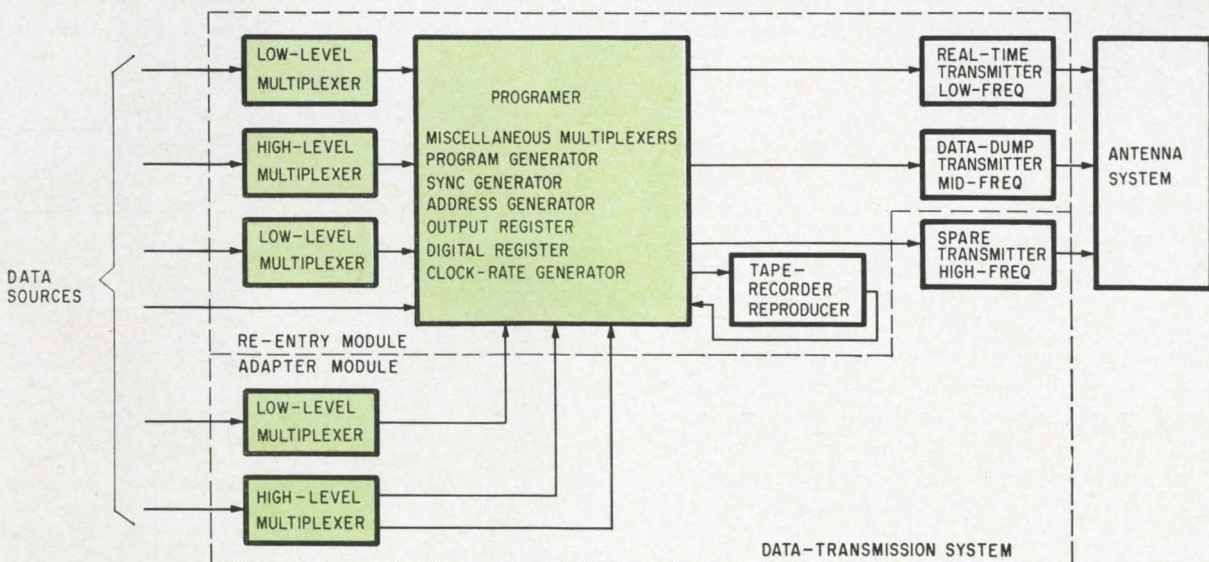

Data-transmission system takes information from sensors, encodes it and prepares a pulse-code modulation signal (in colored blocks) for transmission to the ground or for storage on tape to be dumped in orbit or after reentry.

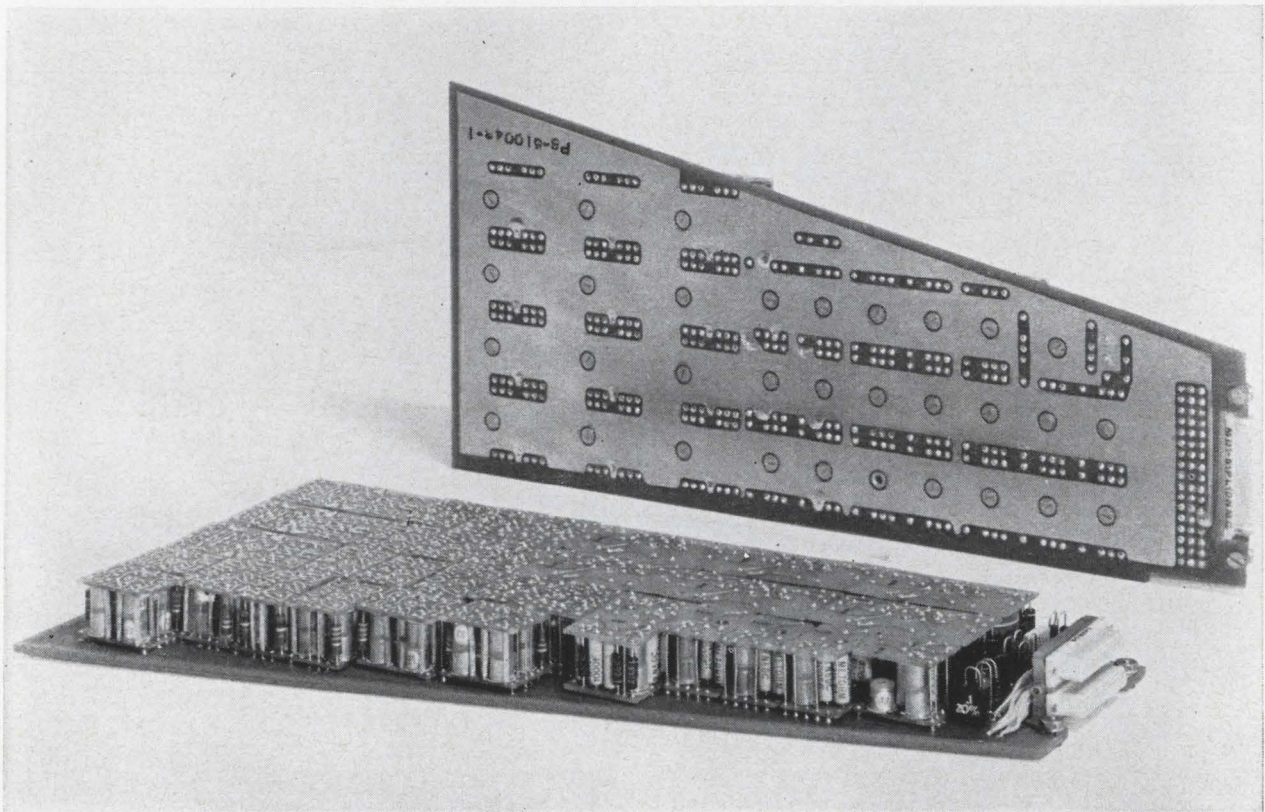

**Multilayer board construction** of a programmer subassembly shows the high-density packing possible with the cordwood technique. Density is 37,000 discrete components per cubic foot.

gether with the redundancy, it yielded an estimated system reliability of 94.3% for a system that met the volume, weight and power requirements.

### Redundant circuits

In quad redundancy, each transistor and its associated passive components are replaced by a group of four transistors and associated parts in a series-parallel arrangement. The redundant block offers two parallel paths, so that if any transistor fails to turn on because of a failure in that circuit, an alternate path is provided for the current. Each current path, however, contains two active elements. If a transistor turns on permanently owing to the failure of some component, the other transistor in the current path can still be turned off to interrupt the current flow. Thus, no single failure can cause a system malfunction.

The typical channel configuration in the drawing at right illustrates the use of both series and quad redundancy. Second-tier switches are series redundant to protect the system from a shorted transistor, and the third-tier switches are quad-redundant to protect both a group of data channels and the system from a faulty transistor. The switch-tier configuration also permits the parallel excitation of groups of first-tier switches for the word gate, greatly reducing the complexity of the arithmetic and also reducing system power consumption. Experience to date with the Gemini telemetry, the OSO-2 (orbiting satellite observer) and

Celestee (an orbiting astronomical observatory experiment) indicates the reliability of quad-redundant circuits.

The design problems with quad-redundant circuits are more difficult than with nonredundant circuits. It is hard to obtain good operating safety margins for all possible failure modes of individual parts. This problem is compounded by requirements for reduced system power, which, along with the redundancy, has reduced the power available to individual parts to a low level.

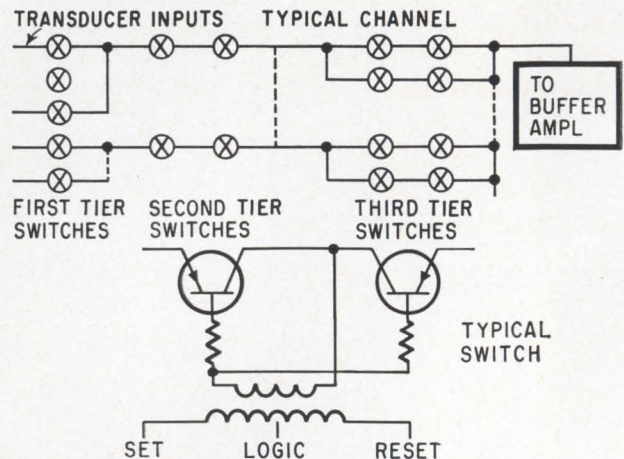

**High-level analog** commutator channel uses quad redundancy to protect both the transducers and the system in case of single-switch failure in either on or off condition. The switch at bottom is typical for the channel.



The high-level multiplexer, showing polyurethane foam encapsulant used for individual assemblies. The complete unit is at center.

### Cooperative effort

EMR has worked closely with transistor manufacturers over the past four years in developing new devices with useful parameters in the 100- to 300-microampere collector current range. An example is the low power dissipation, fast-switching 2N2412 produced by Texas Instruments Incorporated, which is used in all the counters and logic circuits for complementary logic. The NS749 was developed by the National Semiconductor Corp. for EMR to use in original OSO quad-redundant circuitry and then was selected for similar application on Gemini. It has high gain and low saturation voltage to provide low power dissipation and permit the construction of logic-circuit trees. A special version of the NS749, which has a higher speed, is now used for particular applications in Gemini logic.

### Low-power circuits

Low-power circuits reduce the stresses applied to parts and also the threat to system reliability from thermal surge encountered during reentry. The spacecraft cooling system is inoperative during vehicle reentry, and on-board electronic systems must withstand radiant heating from the vehicle skin, in addition to the heat they generate by themselves.

Concern for minimum power dissipation pervades the entire circuit design. Micropower cir-

cuits virtually eliminate dissipative elements and minimize the number of passive components. In the quad circuits, transistors with complementary characteristics are used. For example, the output of an npn transistor provides base-drive current to a subsequent pnp transistor, and the output of the pnp is used to supply base-drive current to a subsequent npn.

Further, an npn transistor is used as an active variable-resistance collector load for a pnp transistor and vice versa. The quiescent currents are small, but the transient currents available for the pulses are relatively large.

### Paperwork

All circuits are designed to minimize the number of reactive components. Rigorous circuit design can thus be accomplished on paper to ensure that the equipment will continue to operate despite variations in the component parameters. This design process does not require approximations or experiments. Minimizing the number of reactive elements, particularly differentiating or speed-up capacitors, also reduces the susceptibility to externally generated noise pulses and to disturbances arising from capacitive or common-impedance coupling within the system itself. This, in turn, permits operation at low power levels with maximum noise immunity.

The construction techniques adapted for the data-handling system have resulted in a density of

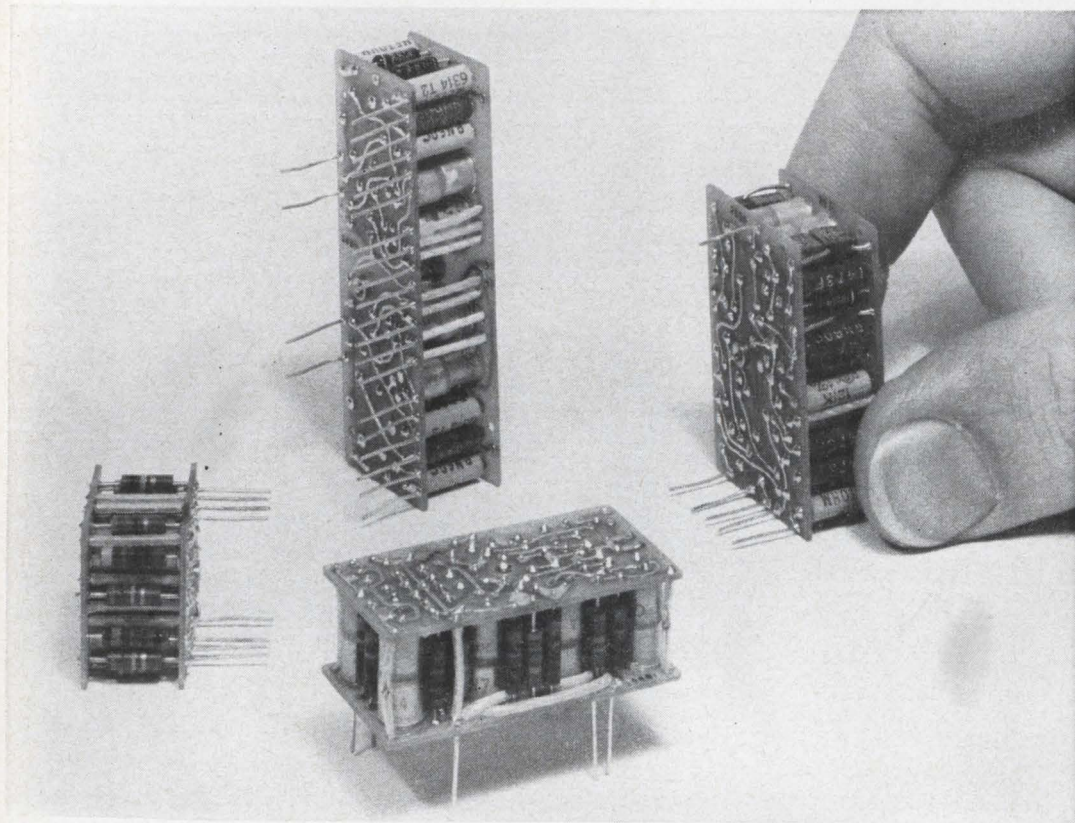

**Cordwood construction** of the circuit modules before encapsulation.

37,000 parts per cubic foot—one of the highest densities for any system made up almost entirely of discrete components. The equipment was one of the first to use small circuit modules of cordwood construction mounted on master multilayer boards that serve as interconnection matrices, as shown in the photograph above. Each subassembly is interchangeable with another of like type to facilitate unit assembly and spares support. Requirements of weight, vibration and shock resistance and operation in salt water determined the unique encapsulation approach.

All circuit assemblies are embedded in urethane foam—the lightest possible form of cushioning—for rigidity prior to unit assembly. The entrance wiring harness is encapsulated in Sylgard—a tough, rubberlike, translucent plastic made by the Dow Corning Corp.—to support the individual wires and to dampen vibrations.

The aluminum housing mounts a pressure relief valve that permits the assembly's internal pressure to follow closely any changes in ambient pressure.

#### **Testing for reliability**

In addition to other screening processes, all transistors are x-rayed. Components are monitored throughout each stage of the assembly process. Modules are examined and operated both before and after encapsulation and the critical signal conditioning modules are aged under power for 100 hours.

A completed system is operated for 15 hours as soon as it leaves the production line.

A major problem is how to determine that an op-

erating encapsulated circuit is actually fully redundant. Since a single component failure in such a system does not inhibit the system's operation, it is extremely difficult to ensure that all parts have survived the hazards of the manufacturing process. Thus, the order of construction and the actual placement of interconnections were chosen with extreme care. Wiring proceeded so that the various parallel current paths remained separate as long as possible.

During the final assembly test, about 80 percent of the included parts could still be checked individually before the module was transformed into a complete redundant entity.

#### **Automatic testing**

The manufacturing test program is automated to reduce human error, expedite routine procedures, and ensure a clear record of all test results. For example, an automated test station thoroughly tests each system before shipment. This test set performs in less than five minutes all the functions necessary for a complete bench verification of the pcm system.

For qualification with a permanent printed record, it can step through a series of approximately 11,000 measurements and print out the results at the rate of one every 2.5 seconds. Both manual and automatic modes of operation are provided. In the automatic mode, the system will stop as it records an out-of-tolerance condition.

Other specialized test instruments monitor module operation at check points along the assembly lines.

# Retrieving data from Gemini

A telemetry transmitter, operating under the worst conditions imaginable, sends vital data about the astronauts, their craft and the space atmosphere

By R. G. Erdmann

Communications Systems Division, Radio Corp. of America, Camden, N. J.

**It would be difficult** to devise a more tortuous environment for a transmitter than a manned spacecraft orbiting the earth. Yet a reliable flow of data is necessary for the success of Project Gemini and other space missions.

Sharp increases in temperature jeopardize frequency stability and require the use of thermistors and sensistors to compensate critical circuits. The Gemini capsule used heat sinks of beryllium oxide, soldered to the chassis, to dissipate heat into the vacuum outside.

Heavy vibrations necessitate structural supports and potting of resins. Some circuits cannot tolerate full potting without large losses of power; for Project Gemini, a system of selective potting was developed.

Electromagnetic and radiofrequency interference make thin magnetic shielding necessary, as well as special finger stock to insure good r-f contact.

Weightlessness creates some unusual problems. Dust, crumbs, droplets of perspiration, even loose screws float about freely and often find their way into electronic gear unless the packages are sealed.

## Analyzing the data

Project Gemini is only as useful as the data it generates is reliable. Much of this information—about the men, the machines and the space environment—must be obtained and analyzed while

the spacecraft is in flight. All data is converted to digital form and sent to earth via a radio telemetry link at about 50,000 bits a second.

Sometimes it is necessary to record data and then send it quickly during a pass above a ground station. A special recorder [Electronics, Aug. 24, 1964, p. 84] performs the function of a memory onto which information can be written slowly, but which can be read out into the telemetry transmitter at 22 times the recording rate.

The transmitter, shown in the diagram on page 84, has performed reliably in Gemini flights. Because pulse-coded modulation (pcm) equipment was not ready for the first unmanned flight, data was sent back using frequency modulation with 10 f-m subcarriers (f-m/f-m). This mode of transmission was possible because the equipment has low intermodulation, which prevents interference between the various data channels.

In the second shot, pcm/f-m was used and the high-speed-readout tape recorder operated successfully with the transmitter. Radio-frequency signals were consistent until the transmitter fell below the optical horizon of the receiver location.

The transmitter operates in the frequency range from 225 to 260 megacycles and has a nominal power output of 2.5 watts with a minimum of 2.0 watts under all normal environmental conditions. Even under thermal surge, power output is typically 2 watts or greater. Its frequency stability is specified at  $\pm 0.01\%$ , but is usually much better.

It normally operates over a range of input voltages of from 18.0 to 30.5 volts, but will perform for short periods with as high as 36 volts. Frequency modulation is used for inputs of 25 cycles to 150 kilocycles and the distortion is less than 3% for modulation deviation up to  $\pm 150$  kc. The power input is less than 20.5 watts. The transmitter is 40 cubic inches in volume and weighs less than 41 ounces.

The transmitter uses a reactance-modulated

## The author



R. G. Erdmann is responsible for design and development of the Gemini transmitter and the vhf transceiver for the lunar excursion module (LEM) for Project Apollo.

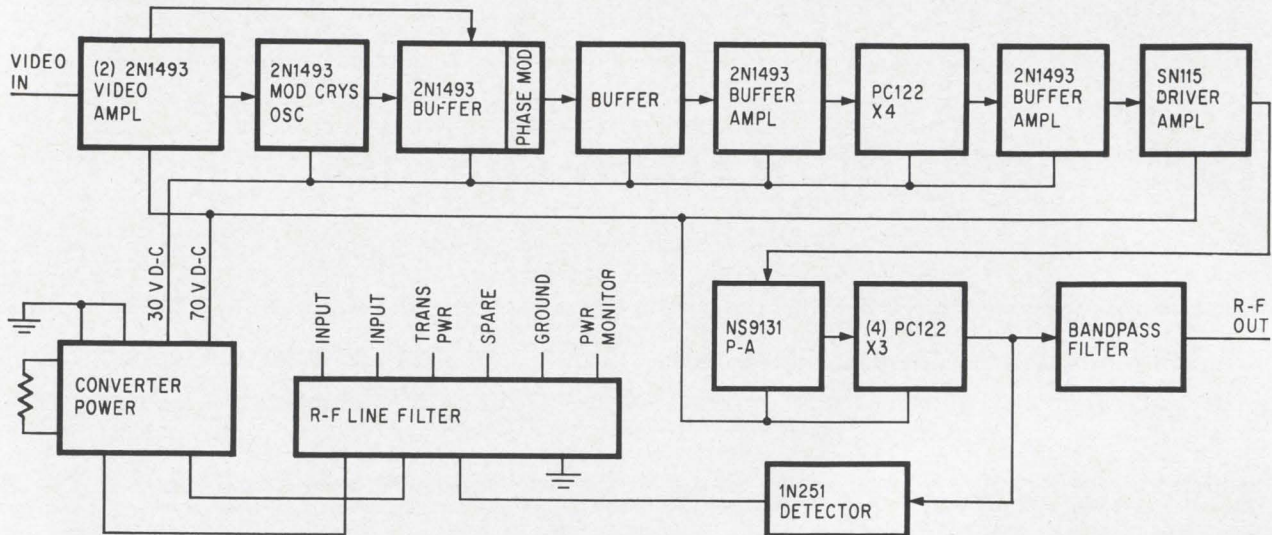

Stages of the transmitter show that modulation is introduced through the video amplifier to both a modulated crystal oscillator and phase modulator. The detector (lower right) produces an output-level indication that is telemetered to the ground.

crystal oscillator driving a buffer amplifier that also contains a phase modulator. This stage is followed by an amplifier chain, which increases the power level and multiplies the oscillator frequency to the desired output frequency. The chain comprises two varactor multipliers (diode frequency multipliers), one operating at low power level and the other operating at the final frequency and high power level.

A two-stage video amplifier produces high input impedance and raises the level of the incoming video or data sufficiently to drive the modulation circuits. A bandpass output filter reduces unwanted multiplier frequencies. The solid-state power converter fully regulates the transmitter's supply voltages (30 volts for the low-level stages and 70 volts for the high). It also isolates the transmitter chassis ground from the spacecraft ground, preventing ground-loop currents in the wiring system from interfering with the flow of data and other signals.

A multiple-section filter removes r-f from the leads through the main power connector to prevent interference in other spacecraft equipment. Incoming stray disturbances are prevented from interfering with transmitter operation. Test signals indicating transmitter input voltage and power output are telemetered back to the ground.

### Modulation without distortion

A reactance-modulated crystal oscillator insures frequency stability during extreme environmental exposure for long periods of time. The circuit also handles low-frequency modulation combined with corrected phase modulation for the high-frequency portion of the modulating signal. For successful operation, this combination of circuits requires low distortion at the point of cross-over from one mode of operation to the other; but the technique results in low spurious output.

The combination of phase modulation and frequency modulation is necessary because of the large frequency deviation of the carrier required in this application ( $\pm 150$  kc peak for a maximum modulation band of 150 kc). Distortion in the frequency-modulated oscillator rises rapidly with modulation frequency. A frequency-modulated oscillator is thus usable only to about 8,000 cycles deviation unless additional frequency multiplication is used in the transmitter design.

The solution used in this application is a phase modulator followed by a correction network to produce frequency modulation.

To obtain adequate linearity down to the lowest frequency of modulation to be used, the Gemini transmitter employs three cascaded stages of inductive-capacitive networks phase-shifted by varactor diodes. The varactor diodes are paralleled to keep the bias swing sufficiently low for minimum distortion.

Distortion at the cross-over point of the combined modulator is a combination of distortion of both the frequency-modulated oscillator and the phase modulator. Consequently, the distortion contributed by each part of the circuit must be lower than the desired total. It is also important in the crossover network to use circuits that roll off smoothly and do not produce transients in the modulator. The circuit, when tested with sine- and square-wave inputs throughout the passband, showed no discontinuities. Thus complex waveforms could modulate the carrier without distortion.

An important advantage in this type of modulator is low incidental frequency modulation owing to the inherent stability of a crystal oscillator besides the long-term carrier stability gained by using a crystal as a reference.

### Direct coupling saves space

A novel circuit technique is the use of a direct

coupling in the video amplifier to eliminate bulky tantalum coupling and bypass capacitors. Besides saving space and weight, this innovation permits use of a low-frequency passband down to about 5 cycles. The passband could be extended to 0 cycles with minor redesign of the circuit. The schematic of the amplifier is shown at the right. Negative feedback stabilizes the amplifier's operation. This feedback also maintains the distortion of these circuits to values between 0.45% and 1.8% in the range between 200 and 100,000 cycles.

Another circuit innovation suppresses third-harmonic currents in the collector circuits of the high-power stages. In the usual design for third-harmonic suppression, a trap circuit is placed in the collector path as shown below left. The space needed for this added circuit was not available in the Gemini transmitter. The solution was to load the power-amplifier stage with a multiplier stage. While performing its normal function of tripling the input frequency, this stage also presents the proper input impedance to suppress third-harmonic current in the power-amplifier collector. The drawing (below, right) shows the equivalent circuit of the multiplier indicating that third-harmonic current flow is attenuated in the power-amplifier collector circuit. In effect a trap circuit was obtained with no extra components.

### Temperature compensation

Initial calculations of the heating that is expected to be encountered in reentry showed that the transmitter must be designed to work at an ultimate temperature of better than 100°C. The circuits of the high-power portion were designed and tested at temperatures in excess of 110°C and the low-power stages were designed and tested to 125°C. Even though the circuits are capable of operation at these temperatures without destruction, some degradation of performance occurred during the test. This was particularly noticeable in the class C stages, which are self-biased. In these drive stages, the change in gain at high temperatures not only reduces the available r-f signal for amplification, but also affects the self-bias. In addition, the varactor multipliers require a relatively constant drive to maintain constant input

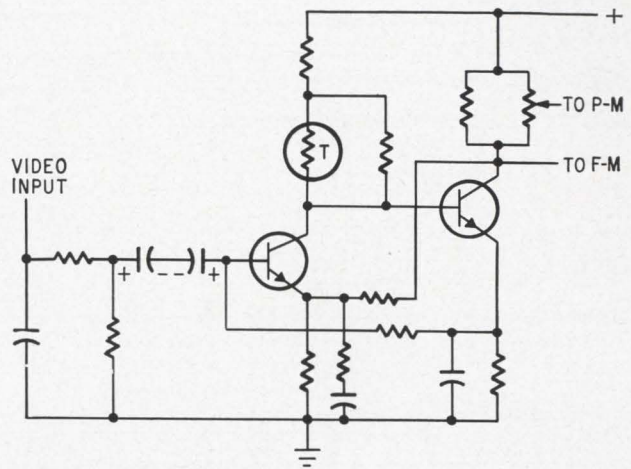

Video amplifier is direct-coupled, eliminating bulky capacitors.

and output impedance. Any change in their impedance usually results in a loss of power owing to mismatch.

To overcome these problems, temperature compensation is used in the crystal oscillator, the video amplifier, the varactor-modulator tuned circuits and in the multiplier chain-drive circuits. The reliability-assurance test model, which was overstressed on temperature, showed remarkable stability with temperature.

### Power conservation

Initially, the high-level r-f circuits employed ceramic trimmers that exhibited appreciable losses at high frequency. These capacitors were replaced with small air-dielectric capacitors having low r-f losses but constructed to withstand high breakdown voltage. This capability is important because corona breakdown is experienced on many applications in a near-vacuum environment. The use of these capacitors added a penalty, however. Since the capacitance range of dielectric capacitors is smaller than ceramic types, it was necessary to add extreme capacitance in parallel with each to obtain the required value of capacitance. This restricted the transmitter's tuning range to some extent and complicated the procedure for large

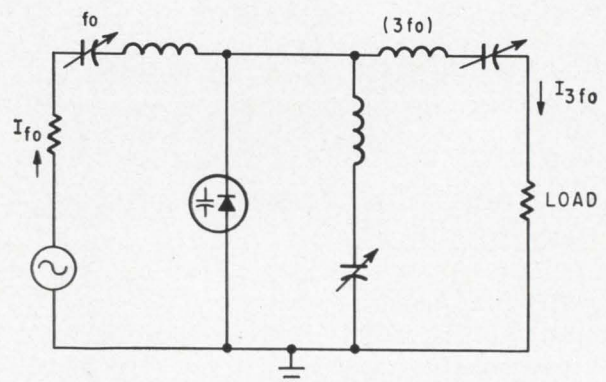
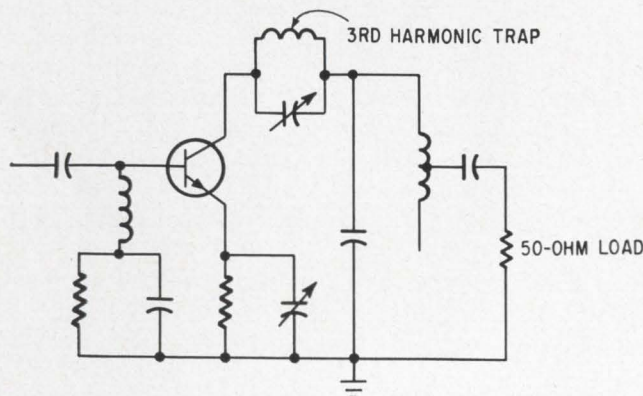

Trap circuit (left) is customarily used but is replaced in the telemetering device by varactor multiplier circuit (right).

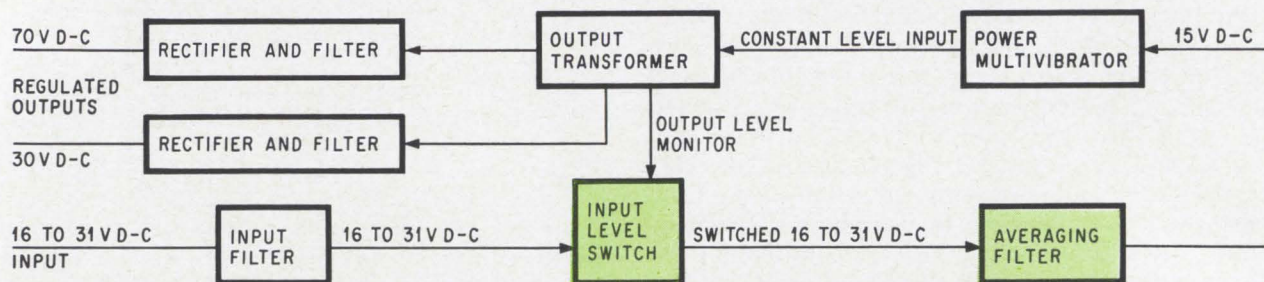

**Power converter** changes low-voltage direct current to higher values, regulates voltage to the equipment, and prevents line surges. Units in color prevent damage to transmitter from overvoltage.

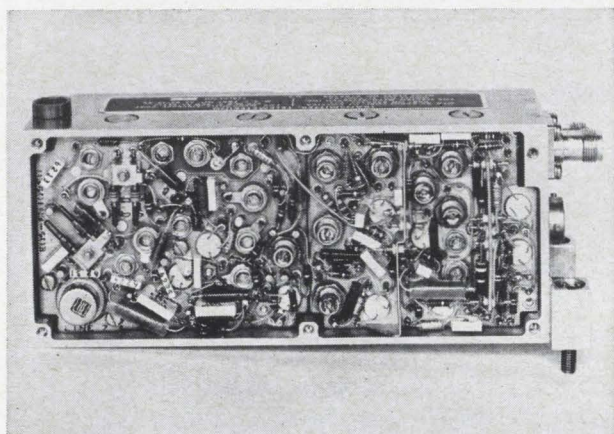

**Underside of transmitter chassis** shows compact construction. Power unit is mounted on the opposite side.

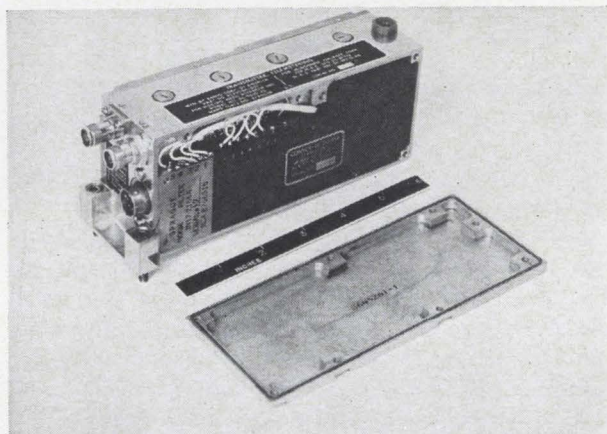

**Finger stock**, visible around edge of the cover, and an O-ring (visible as a black line) provide rfi and moisture seal. Power converter can be seen in the transmitter case.

frequency changes. Nevertheless, the results are impressive as shown by the data in the table below.

A fully regulating power converter, shown in the diagram above, permits operation over a wide input voltage range and eliminates all transients on the supply lines. The converter uses a preregulator circuit plus feedback to control the output of a power oscillator; this steps up the voltage to 70 volts for the high-level transistors and delivers a constant 30 volts for the low-level transistors. With the feedback feature, output is practically constant over the environmental range of operation, and the output voltage to the transmitter is independent of line-voltage variations.

The power converter's switching rate on the preregulator varies from about 200 cycles at low line-voltage input to about 3,500 cycles at high line input, and the power oscillator runs at about 2,000 cycles. Both frequencies fall within the modulation bandwidth of 25 cycles to 150 kc and there-

fore must be attenuated. Some additional circuit filtering is required in the r-f stages, particularly in the oscillator-modulator as well as in the multiplier chain. These circuits are bypassed with tantalum capacitors to remove any effects of line-conducted ripple.

Since limitations on space and weight make it impossible to encase the power converter fully, its proximity to video and sensitive r-f circuits initially produced hum. The use of a thin shield confined the magnetic field sufficiently to attenuate induced voltages to tolerable values.

### Selective potting

Besides saving weight, selective potting reduces the effect of stray capacitance on high-frequency circuits. Stray capacitance in varactor multiplier circuits diverts pumping current from the power amplifier to the diode-ground circuit, reducing the over-all efficiency of the r-f circuits to an intolerable value. Partial or selective potting permits supporting components like chokes and diodes with long wire leads to avoid vibration without introducing undesirable dielectric loss between electrically sensitive points. A urethane compound is used that retains its strength at temperatures of about 100°C and does not strain the components at low temperatures. Low-loss foam potting is employed for lower-frequency circuits.

Instability of removable subassemblies and se-

### Comparison of ceramic and air trimmers

	Ceramic	Air
Transmitter output watts.....	2.5	2.5
D-C watts input.....	9.2	7.7
Driver d-c watts input.....	2.8	2.2
Total d-c watts input.....	12.0	9.9



vere resonances in the r-f chassis owing to lack of stiffening members required redesign to eliminate vibration. The solution was to provide a heavy tie-down cover to which the chassis was attached by posts. The added weight contributed to the unit's thermal inertia, extending the allowable time of the heat pulse encountered in thermal-surge periods. Other vibration studies showed that any structure free of sine-wave vibration-multiplication effects is also free of random vibration effects. It was also determined that the effect of random vibration was less severe than the sine-wave resonance that produces drumming, or reinforcement of vibration in a periodic fashion.

### Dissipating heat

The chassis of the r-f units are made of copper and tin-plated aluminum. This plating permits soldering all ground lugs and heat sinks for good electrical and thermal bonding. Because restrictions and water-tight construction require precision fit, the frame and covers are machined out of solid aluminum stock. The covers, connectors and filters are sealed with O-ring gaskets. Beryllium-oxide heat sinks, which are soldered into the chassis, reduce the interface temperature drop between the transistors and the chassis. Good heat-transfer techniques cannot rely on radiation conduction alone in a vacuum environment.

The heat problem is complicated by the condition known as thermal surge, encountered when a spacecraft reenters the atmosphere. The wall of the spacecraft is intensely heated by friction between the air and the skin of the craft. During thermal surge, this heat is radiated to the transmitter. The main cooling system is jettisoned prior to reentry, while the cabin system is required for higher-priority purposes and the transmitter's cold plate is left without cooling flow. Although total reentry from retrofire to water impact takes only 18½ minutes, specifications require the transmitter to operate without heat removal for up to one hour.

Thermal surge starts when the transmitter is in a hard vacuum so the equipment must have built-in means for dealing with the heat pulse by conduction and radiation. Heat must, therefore, be stored within the transmitter and transferred by conduction from one point of the equipment to another. The walls of the transmitter had to be designed to radiate back the heat from the spacecraft's heated walls. The over-all situation calls for construction with uniform low thermal drop within the transmitter and polished surfaces on outside of the transmitter case.

The mechanical design provides excellent conductive paths within the transmitter structure. Heat generators such as transistors and diodes often have a metal case for the conduction of heat as well as the electrical contact of one of the elements. A special type of mounting is used, that insulates the device electrically but conducts heat. A material with a low interface drop is beryllium oxide—a material now familiar to the space-elec-

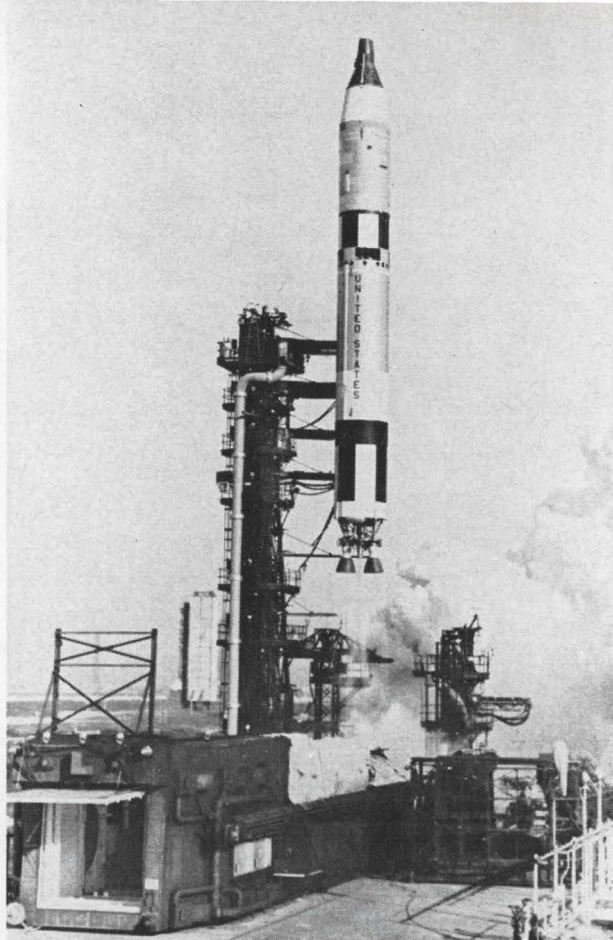

Titan 2 launch vehicle boosts second Gemini test flight in which the telemetering transmitter performed satisfactorily.

tronics engineer. Beryllium oxide is a good electrical insulator, yet has a thermal resistance almost as low as that of aluminum. The beryllium-oxide wafers are plated and soldered into the chassis.

The heat sink for devices such as the r-f power-output transistor of the multiplier chain is a copper block bolted directly to the prime heat storage and transfer point—the corner of the frame that is closest to the cold plate attachment.

The thermal inertia of the cold plate is negligible. Thus, the normal operating temperature of the transmitter is kept low by minimizing thermal drops to the cold plate.

When the heat generators are pumping heat into the storage areas of the transmitter, low thermal resistance used throughout the construction prevents any hot spots from developing. Heat is stored in the covers, chassis and other hardware and in heavy components like the d-c-to-d-c power converter, and the bandpass and power lead filters, all of which are filled with potting compound.

A challenging mechanical design problem is the need for a watertight seal that will also provide good r-f shielding—without taking much space. The solution is an O-ring design with tight tolerances on the case and covers, as well as a small hacksaw-like finger stock r-f interference spring that fits in a space less than a few thousandths of an inch thick.

A watertight and rfi-tight screwhead was developed for this application.

# The capsule is no isolation booth

Line-of-sight and over-the-horizon communications insure constant contact between the Gemini astronauts and NASA's network of ground stations

By Robert E. Perkins and Charles V. Wolfers

McDonnell Aircraft Corp.

**Astronauts in an orbiting Gemini** spacecraft are anything but alone. They are in constant touch with ground crews by communications gear providing two-way voice contact and ground-to-capsule data linkage. To insure voice contact with NASA's worldwide network of ground stations, the spacecraft has two separate ultrahigh frequency transceivers for line-of-sight contact and a high frequency transceiver for communicating beyond the horizon. The latter device will also help in recovery operations if the spacecraft misses the planned recovery zone.

NASA wanted an audio system which was 99.9% sure of working for a two-week period. It also had to be simple and light. Even with these requirements, engineers managed to put a uhf transceiver with a 3-watt output into a 100-cubic-inch package.

With such a volume and power, it would seem natural that the equipment would be fully tran-

sistorized—but it isn't. Both the h-f and uhf final power stages use tubes. Three years ago, when the Gemini equipment was designed, there were no transistors which would satisfy the requirements.

## Loud and clear

Voice communications involve one difficulty beyond simple signal transmission: the signal must be understood by the human ear. Voice processing is used to improve intelligibility by the most efficient use of the available signal power. Consonant sounds contribute more heavily to intelligibility than do vowel sounds, though vowel sounds have about 12 decibels more power. Consonant power can be boosted by peak clipping; if the vowels are peak clipped (limited), the effective average level of the speech will be increased. For example, without clipping, the average modulation is 35% with peaks of 100%; for 12 db of clipping the average is 70% with 100% peaks. Clipping the voice 12 db is thus equivalent to increasing transmitter power by 6 db. This is the optimum amount of clipping for maximizing talk power and intelligibility. Greater amounts of peak clipping will reduce intelligibility by causing the voice to sound unnatural.

## Audio controls

The amplifiers used are completely transistorized. The microphone amplifiers are capable of accepting signal levels of  $-80$  dbm (decibels below one milliwatt) and delivering 3 dbm to the transmitter modulators. These amplifiers have 40 db of automatic volume control, which provides a fixed drive level to the transmitter modulators, where the signal is peak-clipped 12 db. The automatic volume control also maintains a fixed intercom volume level regardless of astronaut speech level or sound transmissibility changes caused by variations in pressure.

Even though the microphones are designed to cancel noise, they cannot reject annoying breath

## The authors



Robert E. Perkins is the group supervisor for the Gemini communications and radar systems at McDonnell Aircraft Corp. He has also worked on the telemetry system for Project Mercury and the tracking and timing systems for Gemini.



Charles V. Wolfers, the section manager for electronics on Gemini, held a similar position on Project Mercury. He is responsible for system design and technical management of the communications and guidance systems.

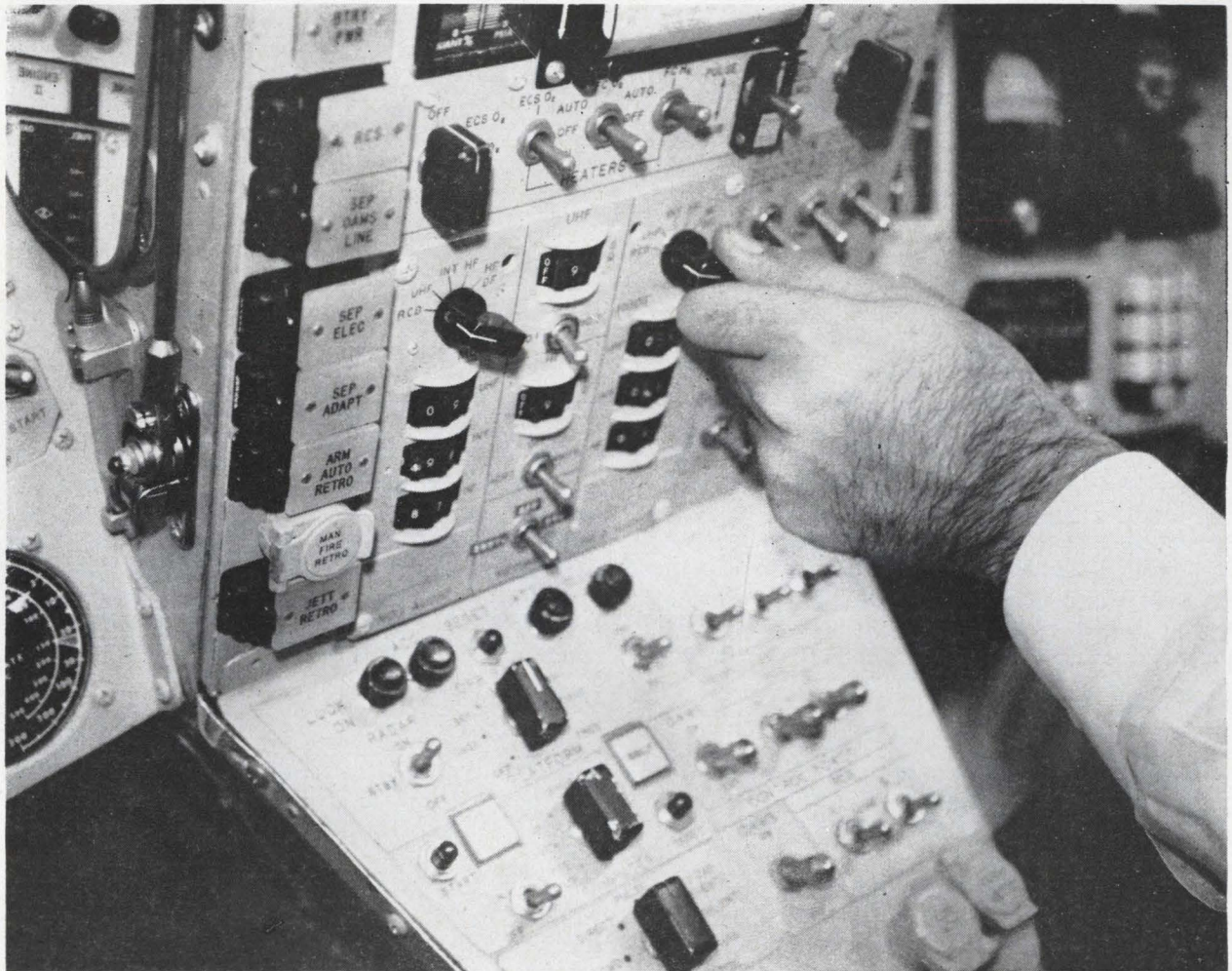

Transmission mode is selected on Gemini's voice control center by test engineer.

noises. To minimize these noises, there is an automatic 12 db reduction in gain when the intercom position is selected.

For hands-free operation of the transmitters, a voice-operated keying circuit called VOX may be used. This provision enables the astronauts to keep the transmitters in the low power (standby) mode with an r-f carrier being sent only when voice is present. During a period of great activity, such as rendezvous, when both men are occupied by control and navigation tasks, the VOX circuit is especially important. This circuit has a fast (10 millisecond) attack time to prevent loss of an initial word, and a slow release for pauses in speech to prevent loss of last syllables. Push-to-talk keying is used during launch because the noise could continuously activate the VOX.

Both transceivers are equipped with a squelch circuit, which reduces the sensitivity of the receiver. Without squelch, constant background noise would be very fatiguing for the astronauts, who will be in orbit for periods of up to 336 hours. The receiver squelch is controlled over a sensitivity range of approximately 20 microvolts input; it may be turned off when maximum range is required.

A single unit called the voice control center,

which is centrally located on the cabin control panel, as shown above, provides the necessary controls and central audio distribution for both transceivers.

The volume adjustments are divided into two groups so that either astronaut may simultaneously monitor h-f, uhf or intercom communications. The astronauts share center panel controls which adjust squelch (noise threshold), select transmitters, and select push-to-talk or VOX keying. In this way, cabling and connectors, as well as weight and volume, are kept at a minimum.

### The special problems of space

A particularly stringent environmental requirement for the equipment concerns temperature. The voice system is located in the equipment compartment outside the pressurized cabin, which exposes the box to a hard vacuum of  $10^{-8}$  pounds per square inch absolute during orbit, and to water immersion during recovery.

Leakage, a problem in the operation of high voltage equipment at hard vacuum, has been eliminated here by foam encapsulation of the transmitter and power supply.

Heat transfer poses a much tougher problem.

The spacecraft has an active fluid cold plate system which provides a temperature-controlled heat sink during orbit. All equipment outside of the cabin must be designed to transfer heat by conduction to the cold plate, which means that internal high-dissipation components must be thermally bonded to the base plate.

To further complicate the thermal design, the uhf voice transceiver must operate without coolant during reentry because of the high ambient temperature. This means that for a period of 40 minutes, the equipment must operate with wall temperature (inside the outer skin) of 200°F or greater. These temperature extremes create several problems for the equipment designer; for example, all of the components used must be rated at 257°F, and thermal bonding must permit rapid distribution of heat to prevent localized hot spots. However, the effectiveness of this solution is limited by the low thermal mass. It was necessary to gold-plate the exterior of the case to reduce the radiant heat from the spacecraft walls. Temperature reduction was 25°F.

### Regulating the power

The spacecraft power system of fuel cells and batteries has a wide range of voltage inputs which require regulation within the electronic equipment. Weight is a serious design constraint, and since power is proportional to weight, conventional regulating techniques (series or shunt) are not satisfactory. To satisfy the requirement of high efficiency, the majority of the regulators are of the switching type and use pulse width techniques, in which the regulator pulse width is made proportional to the input voltage. This type of regulator provides a nearly constant dissipation over large voltage ranges.

To compound regulator design problems, it was necessary to consider noise generation and high voltage transients. Noise generation is a common problem with switching converters, particularly those which use a switching regulator. It became necessary to incorporate considerable filtering. The filtering, however, provides a bonus in that it also protects the equipment against spikes of up to  $\pm 75$  volts. The h-f and uhf voice transceivers employ magnetic amplifier controlled silicon controlled rectifiers which vary the conduction angle of the switching voltage as a function of input voltage.

Equipment must also be designed to resist the severe vibration of 8.8 G's root-mean-square. It was found necessary to encapsulate modules with 2- to 4-pound (per cubic foot) foam to provide structural integrity without adding much weight. Metal stiffeners around the modules would have been too heavy. The h-f, uhf and voice control center are foam-encapsulated.

### Updating the capsule.

Gemini's command system, unlike that of Project Mercury, is an assist device which the crew may operate manually as time or flight situation dictates. The spacecraft contains a preprogramed digital

computer used for inertial navigation. However, for impact within a predetermined recovery zone on reentry, or for rendezvous with a target vehicle, the navigational system requires updating of several orbital parameters from the ground at various times during the mission.

The system operation design concepts are fairly straightforward and employ conventional logic design. A message with predetermined format is sent from ground transmitters to the spacecraft digital command system. (DCS). This message may actuate equipment, or it may be a stored-program message which is data for the navigation computer or the time reference system, which then counts down for firing of the retro rockets.

After decoding, the message is stored in a buffer register and the applicable system is notified by the DCS that a message is available. Within a given length of time, the computer or time reference system (TRS) shifts the message out of the DCS at its own clock rate (500 kilocycles per second for the computer and 8.192 kc for the TRS).

### Message confidence

The required data rate for information transfer to the spacecraft is based on the longest message and the maximum number of updates over any one ground station. The maximum word length, which is a time reference system update, is 24 bits. The message must contain address bits to determine whether the information goes to the computer or the TRS. The data rate chosen was 200 bits per second.

With the relatively low data rates required, it is permissible to use a coding scheme to minimize the chance of random noise introducing errors into the system. This coding scheme involves sub-bit coding of each information bit; each sub-bit must be recognized in a certain logical order before a binary one or zero is accepted. The more sub-bits into which each bit is divided, the smaller the probability of accepting an incorrect message.

System efficiency and capacity are thus sacrificed for higher confidence in the validity of an accepted message. After channel capacity, the probability of accepting an invalid message, and the data rate had been weighed, a five-bit code was selected.

### Modulating the data

The type of coding and relatively slow data rate influenced the type of modulation used. Phase shift keyed f-m was chosen because it uses a 1000 cycle reference signal which simplifies the detecting equipment aboard the spacecraft.

With this method, the digital data phase-modulates a 2000-cycle subcarrier. A zero phase represents a one bit and a 180 degree phase represents a zero bit. The 1000-cycle reference signal and the 2000-cycle phase-modulated signal are then linearly summed and the combined signal frequency-modulates the transmitter.

A bonus of this system design is that an active filter with the narrow bandwidth of 20 cycles per

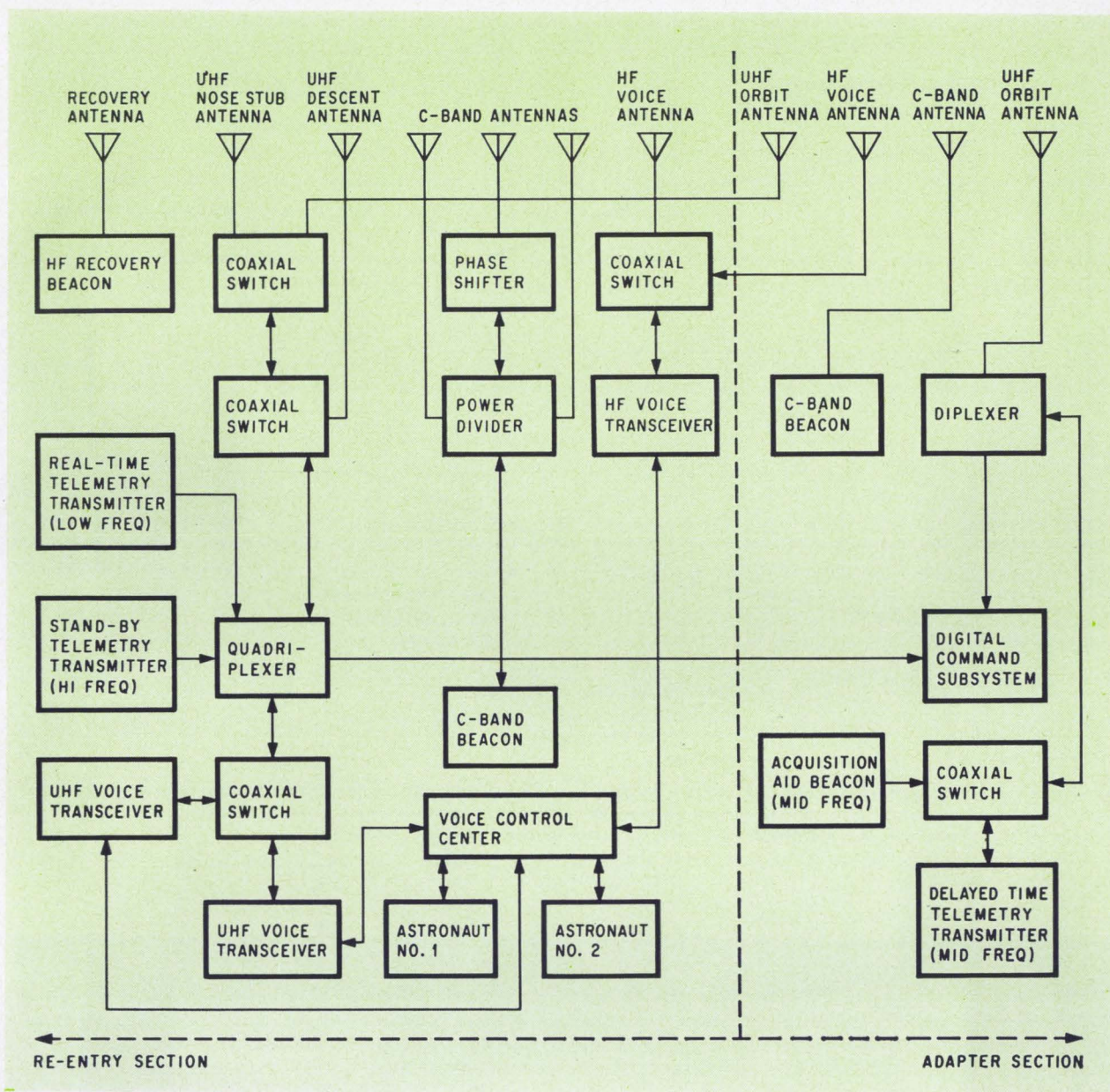

**Block diagram** of entire communications system. Coaxial switches allow each astronaut to select antennas as well as transmission mode. All controls are in the voice control center.

second is used, providing a great deal of signal to noise improvement (approximately 24 db for the reference tone). The data channel uses a matched filter which provides an improvement of 7.5 db.

The remainder of the system is logic circuitry necessary to decode the messages, transfer incoming messages, and activate real time commands.

### Antenna system

Antennas were designed to serve all radio equipment, with emphasis on performance and simplicity. Common use of a single antenna by several radio systems promotes aerodynamic simplicity during launch and reentry mission phases. However, in orbit, duplicate antennas positioned around the vehicle provide optimum radiation coverage

and high reliability. The locations of the various antennas are shown above. Ground antenna systems with high gain and accurate tracking capability allow mechanically simple, nondirectional spacecraft antennas to be used effectively. The clean vehicle geometry and the high vacuum in orbit, and the relatively few radio frequencies needed for spacecraft communication also simplify the electrical design. On the other side of the ledger is the mechanical design efficiency needed to tolerate environments experienced during launch, orbit, reentry, and time in the ocean.

### Tracking the ship

The tracking system's C-band antennas must be used during launch and reentry, as well as during orbital flight; therefore slot antennas are used

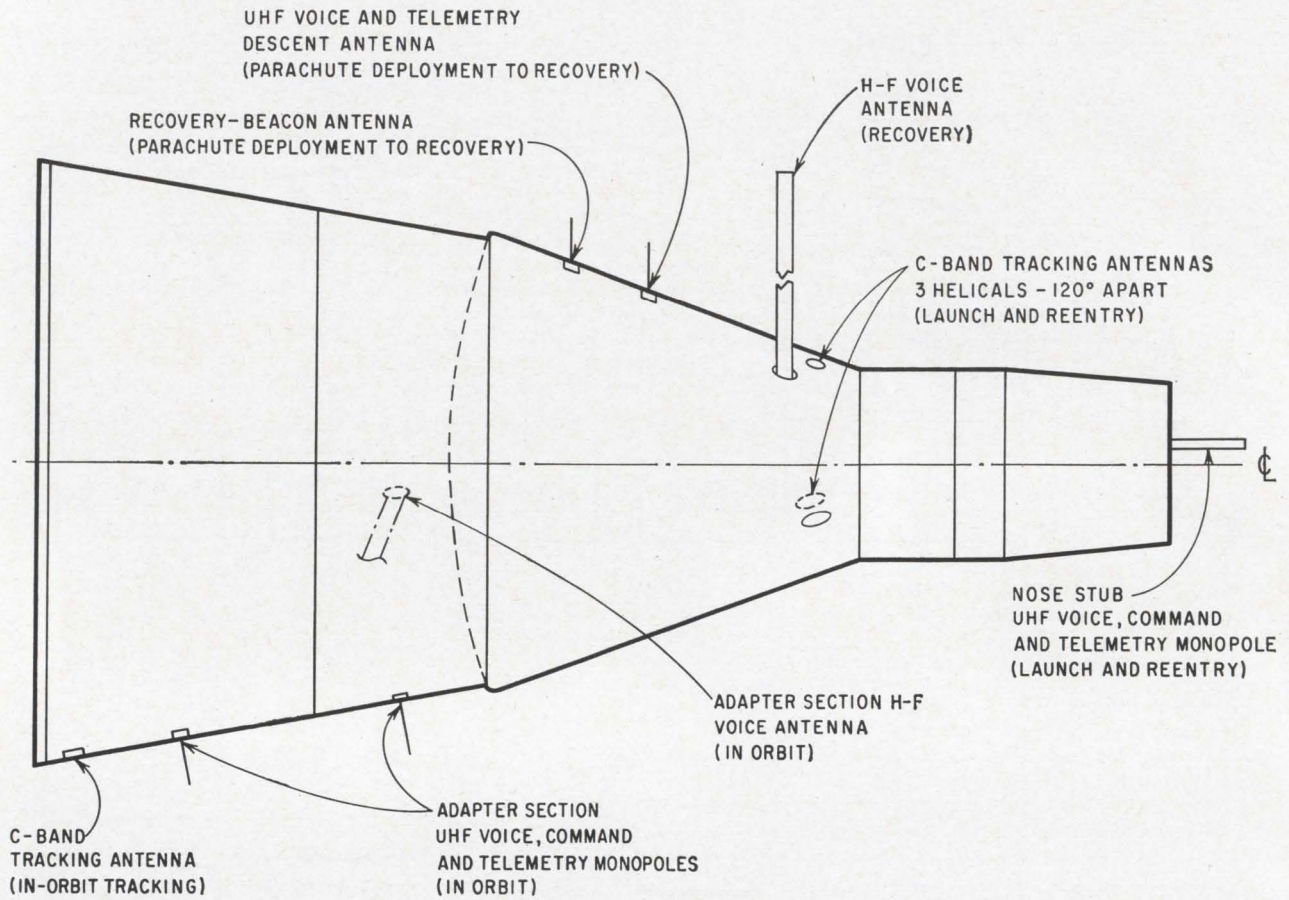

**Antennas** for each communication function are located on the Gemini capsule for optimum coverage during launch, orbit, reentry or recovery. The correct antennas are switched in during the various phases of the mission; in case of a malfunction, the astronaut may switch to one of the redundant antennas.

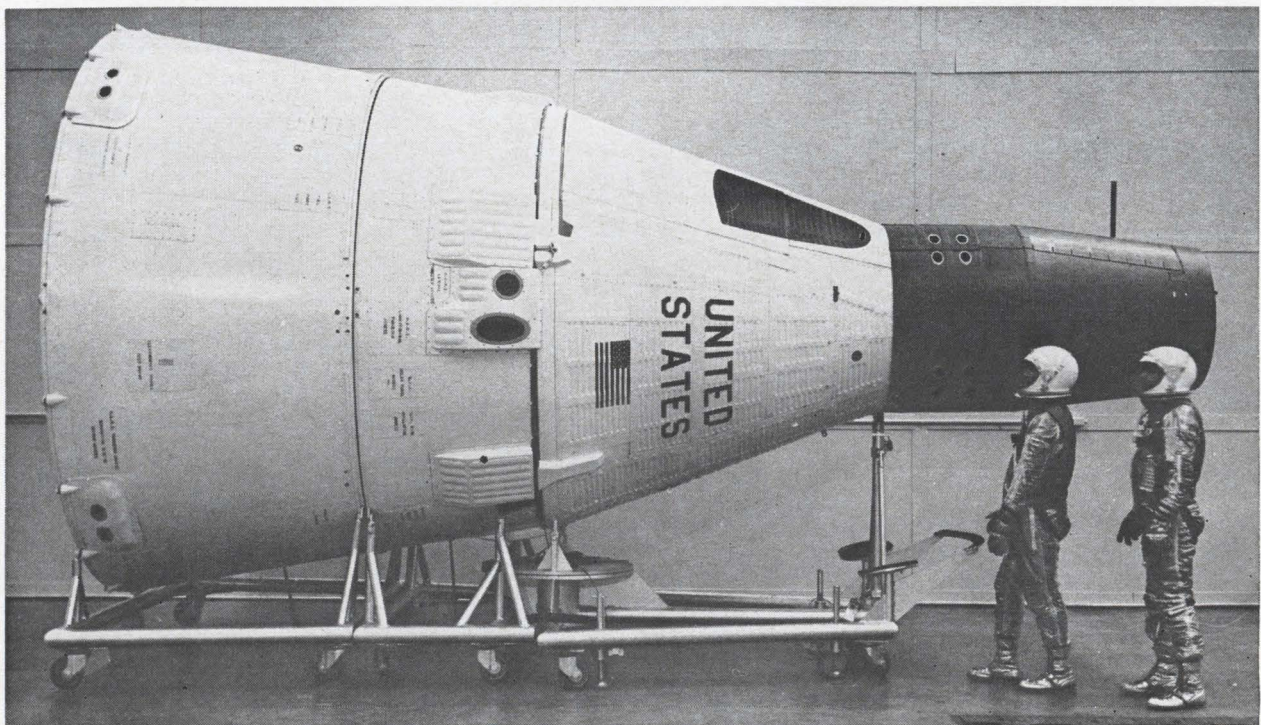

**Astronauts Virgil I. Grissom and John Young inspect Gemini spacecraft.** The reentry module, containing communications equipment, is sandwiched between adapter and nose sections, which are jettisoned before reentry.

## The skin of their teeth

The laser's bigtime communications debut will be out of this world. The National Aeronautics and Space Administration has requested proposals for a laser transmitter which could be used on the Gemini spacecraft—possibly on about the eighth manned mission, GTA-10.

You can't get communications much more sophisticated than a laser, but this device will be fairly crude. NASA wants a self-contained transmitter without electrical or mechanical connection with the capsule. The astronaut would aim it with his teeth, which would clamp onto a "bite board" and provide stabilization.

The bite board will be two inches long, made of acrylic plastic, imprinted to fit the astronaut's teeth. The transmitter will also have an eyepiece, for aiming, angled so that it fits right against the user's eye. On either side of the transmitter will be a handle with a trigger; for reasons of safety, only when both triggers are pulled will the device operate.

The laser beam will pass through the capsule window, so the device will be usable only if the capsule is in the right attitude.

The laser is valuable for communications because it is more highly collimated and more easily focused than a microwave beam, and can carry much more information because of its wide bandwidth. But modulating the signal to be carried on the beam is difficult, as is overcoming problems from the cloud cover, dust, and haze of the atmosphere, which attenuate the beam. The Gemini experiment would collect data on the effects of the atmosphere on a coherent beam, and evaluate equipment for acquiring and tracking a ground receiver via a laser. No real data would be transmitted; only a fixed signal.

NASA wants the system to be pulse frequency modulated, rather than voice-modulated. Specifically, the laser will be of the gallium arsenide type, with an output wavelength which shifts no more than 50 angstroms. Pulse must be stable in amplitude, duration (100 nanoseconds) and rise time; carrier frequency must be stable to 0.1%. NASA would like 10 watts peak pulse power, but will settle for five. The transmitter must be capable of operating for 10 minutes over ranges of up to 1,000 nautical miles.

The receiver will be mounted on a Nike-Ajax pedestal, with an argon gas laser used as a ground beacon. The receiver's detector will be an RCA 7102 photomultiplier near the focal plane of a 30-inch Dall Kirkham collecting system mounted on the pedestal.

NASA's Manned Spacecraft Center will receive three transmitters under the contract. The first is to be delivered to the center no later than June 15, and a second to the McDonnell Aircraft Corp. by July 9. A Gemini spacecraft transmitter and backup are to be delivered no later than September 1. The transmitter must have dimensions similar to those of the 0.04-cubic-foot nuclear emulsion package scheduled for Gemini Titan 7 and Gemini Titan Agena 8. That's so both devices fit the same slot and either can be taken on a given Gemini flight.

NASA has already tested a handheld GaAs pulsed laser transmitter aboard an F-100 jet fighter at White Sands Missile Range, in New Mexico. [Electronics, Feb. 22, p. 48]. A pilot transmitted voice over a beam 0.1° wide. He also tracked another GaAs laser flashing at 10 cps next to the receiver. The beacon's flash rate varied when the voice signals were received on the ground.

which can tolerate the elevated temperatures and are immune to damage from high mach air flow. Three cavity-mounted helical antennas imbedded in mica-filled quartz are spaced symmetrically around the small conical end of the cabin. They provide good omnidirectional coverage when spacecraft is in the launch or reentry attitude (nose up). Because of interference nulls caused by pattern overlap, one of these circularly polarized units is phase shifted approximately 180° at a high rate by a ferrite phase shifter. In this way ground radars can track the vehicle with greater accuracy at angles which are affected by these overlapping antenna patterns. If it were not for critical time considerations when Gemini separates from the launch vehicle, there would be no need for high-speed phasing; however this is the point when it must be decided whether orbital flight or immediate reentry is indicated by the success of the powered flight trajectory.

Once in orbit, the C-band slot antenna at bottom center of the adapter section is used because of superior omnidirectional coverage at orbital attitude. An additional advantage is that all power is concentrated at the horizons not divided three ways as in the helical array.

### Uhf communications

Uhf voice, command and telemetry are also covered by more than one antenna. For launch and re-

entry, a monopole mounted on the capsule's nose is multiplexed to all uhf on-board systems. It is a stainless steel teflon sheathed rod kept rigid by spring tension on a ball and socket joint. This element is broadband enough to accommodate efficiently frequencies from 230 to 450 Mc. It will withstand reentry heating without retraction and if struck by parachute cables will flex without damage to itself or the parachute rigging.

Although the astronaut may choose to use the nose stub antenna, other antennas are provided for optimum horizon coverage at orbit attitude. Two jack-in-the-box beryllium copper monopoles, for voice, telemetry, and command receiver equipment, are installed in the adapter section. These units erect when the spacecraft separates from the booster. Lightweight, minimum-strength design is possible since these units are used only during orbit.

Each of the dual receivers of the command receiver package is connected to a separate antenna—one to the nose stub, and one to an adapter monopole. This arrangement—in effect only during orbit—is designed to make certain that a ground command of immediate importance will not be lost in the pattern null of either antenna.

### High-frequency masts

There are two retractable h-f voice antennas on-board—one used during orbit, the other during re-

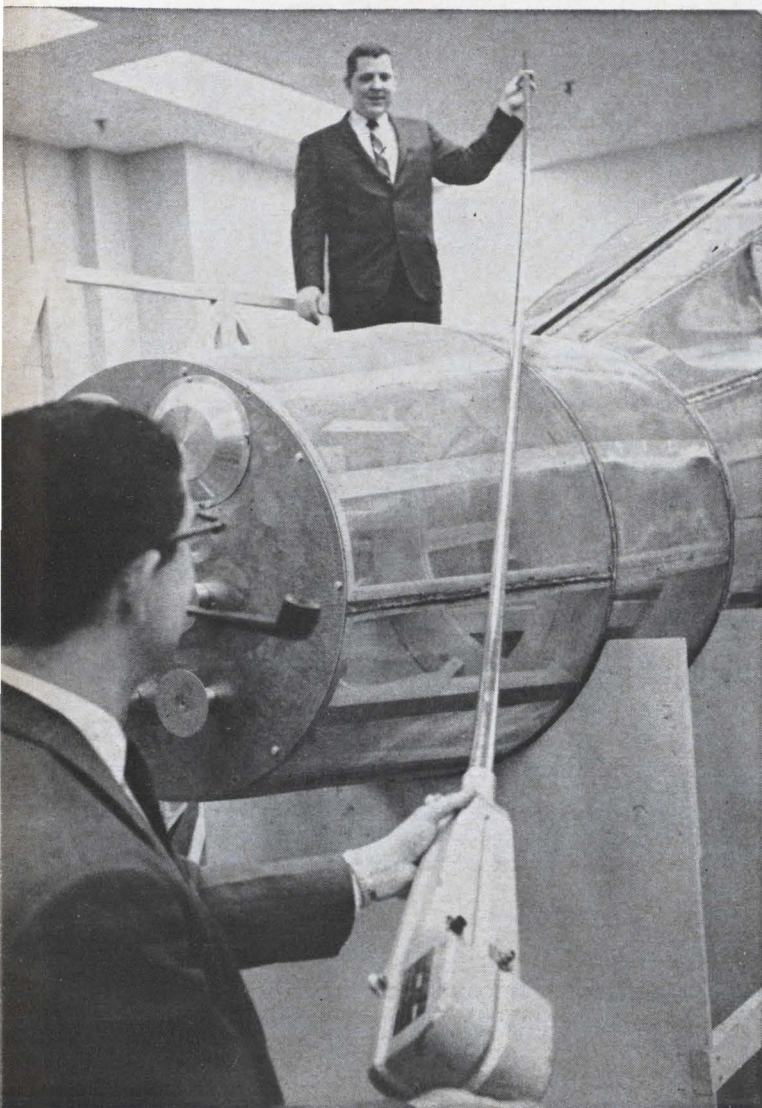

Fully extended, the h-f voice antenna is 13 feet long. In background is full-scale wire mockup of spacecraft, which is used to measure antenna impedance and voltage standing wave ratio.

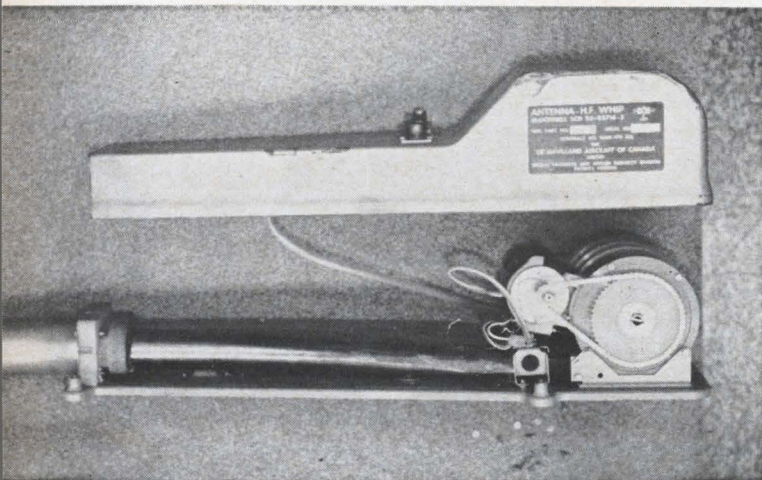

High-frequency voice antenna forms into a tube as it unwinds from chain-driven drum.

covery. The recovery antenna is a motor-driven self-forming steel tube, laminated and wound flat on a drum, as shown at the left below. The elements emerge and uncoil to form a 13-foot monopole at right angles to the spacecraft's axis. A recovery antenna of this type—though very small and light for its height—presented numerous design problems. The strength required for the high sea does not suggest the use of self-forming elements 13 feet long, and the flexible elements are extremely difficult to seal against water which causes severe electrical losses. The cassette, where the antenna is electrically driven, is beneath the water line, but dynamic air pressures at launch and re-entry prevent a water-tight seal until spacecraft impact. To solve this problem, a water-activated chemical valve seals the assembly at impact. A rubber covering, which is stowed concentrically, is extended to cover the antenna two feet from its base to provide a seal above water. To insure strength, the assembly uses six overlapped laminated elements.

The retractable h-f antenna on the adapter section for orbital communication is similar to the recovery antenna except that since it does not have to withstand wind and sea currents, it is constructed of only three laminated elements and it does not have the water seals. It was thought originally that the recovery antenna could be used during orbit, retracted for reentry, and then extended again for recovery; but it was decided to use two separate antennas so as to better protect the recovery antenna. The retracted recovery antenna is protected from reentry heating by a flush mounted plug. This plug prevents heat gases from entering the antenna case to cause damage to either the rubber covering or the drive mechanism.

### Finding the ship

After reentry, there is a period of time from drogue chute deployment to touchdown and recovery when the uhf voice and telemetry systems can no longer use the nose stub or adapter monopole antennas, all having been previously jettisoned. At this point self-erecting whip antennas in the parachute cable troughs come into play.

One of these elements serves the radio recovery beacon from time of main chute deployment; the other is diplexed simultaneously to uhf voice and telemetry transmitters. In the normal flotation attitude of the spacecraft, these antennas are essentially vertical and can withstand water, wave impact, and high wind without difficulty. Should the onboard recovery beacon or electrical power supply fail prior to recovery, one of these antennas can be disconnected from inside the cabin, and the astronaut's self-powered life raft uhf beacon connected to it.

Reprints of this report are available. See the reader service card at the back of this issue.

© copyright 1965, Electronics © A McGraw-Hill Publication



# MICRO SWITCH announces a new concept in the design and construction of keyboards and control panels

It's called **KB**

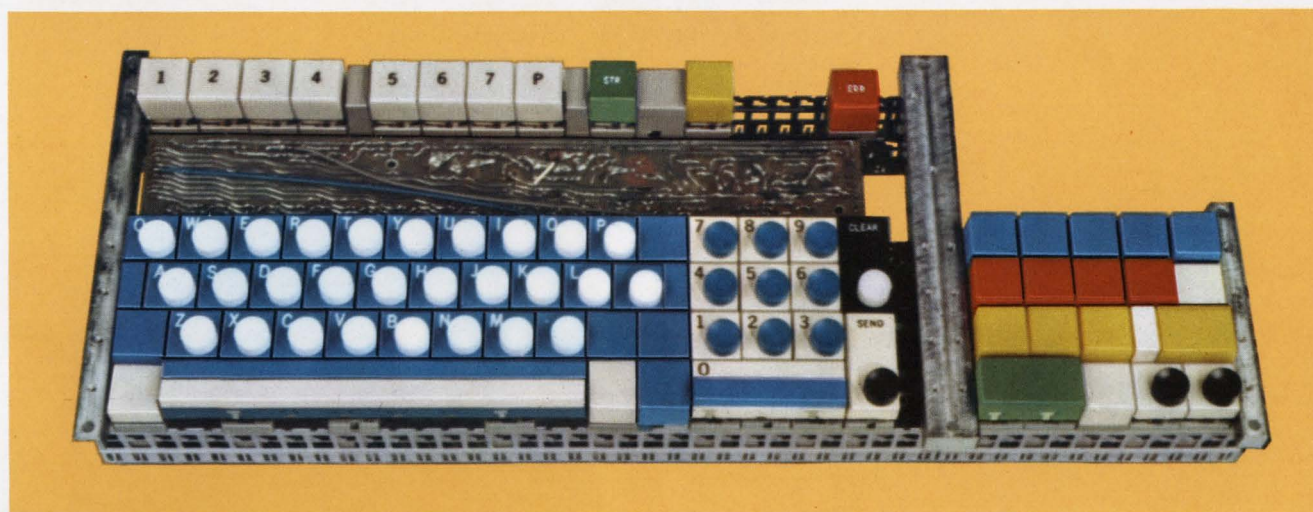
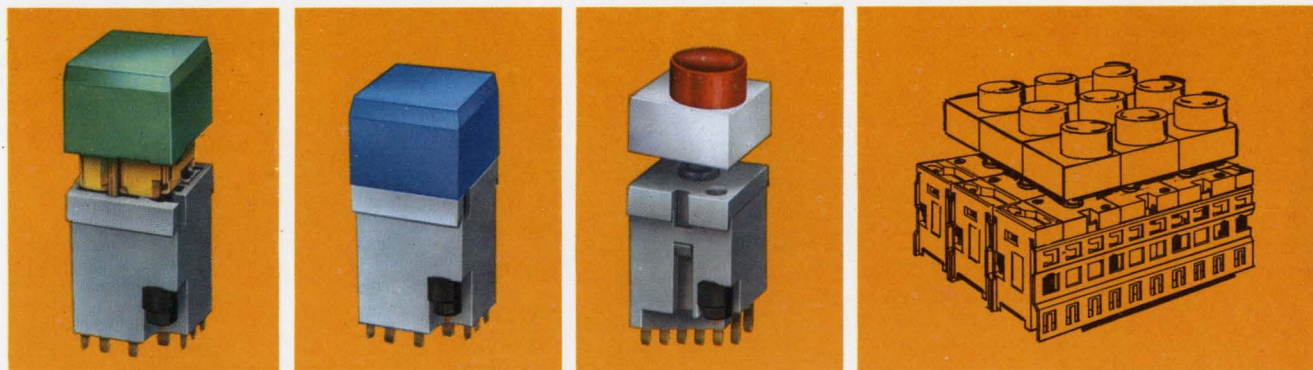

For the first time KB gives you complete freedom to create truly customized panels—gives you a new set of components making it practical to design a special man/machine interface for each individual keyboard.

our components  
 are special for you to  
 order a special.

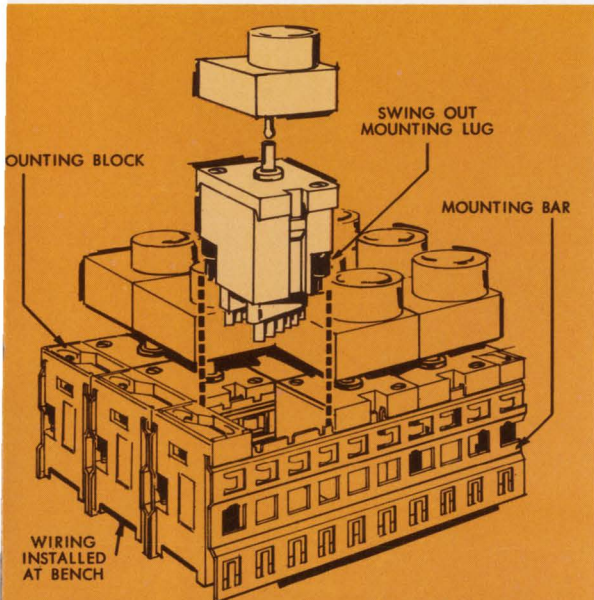

**Matrix is assembled at the bench**—mounting bars and mounting blocks are assembled in single rows with only a screwdriver. Rows simply snap together into a multiple-row matrix. And at the bench the matrix is completely assembled. All assembly, encoding and wiring is done conveniently before the keyboard is installed.

Finished matrix fits in *one panel cutout*—requires no additional supporting members. Actually strengthens the panel.

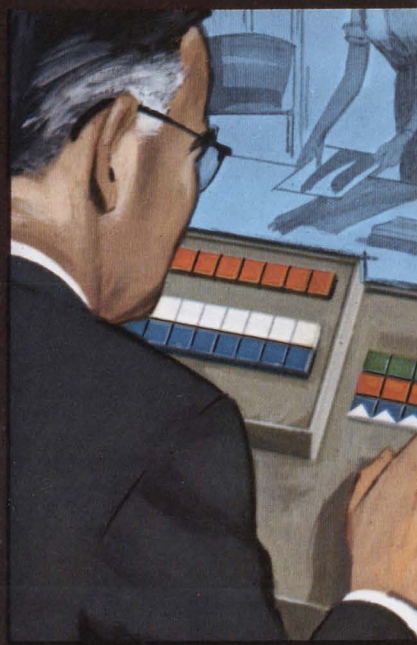
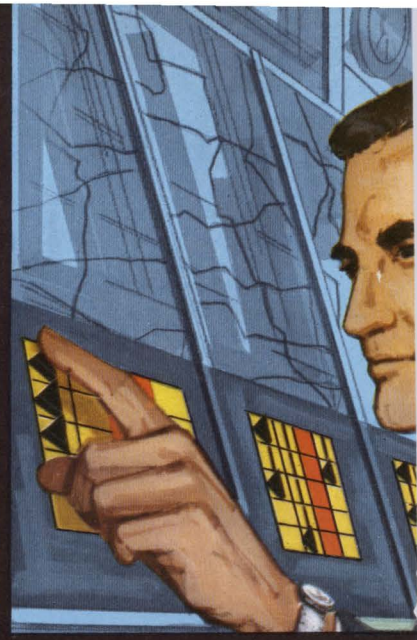
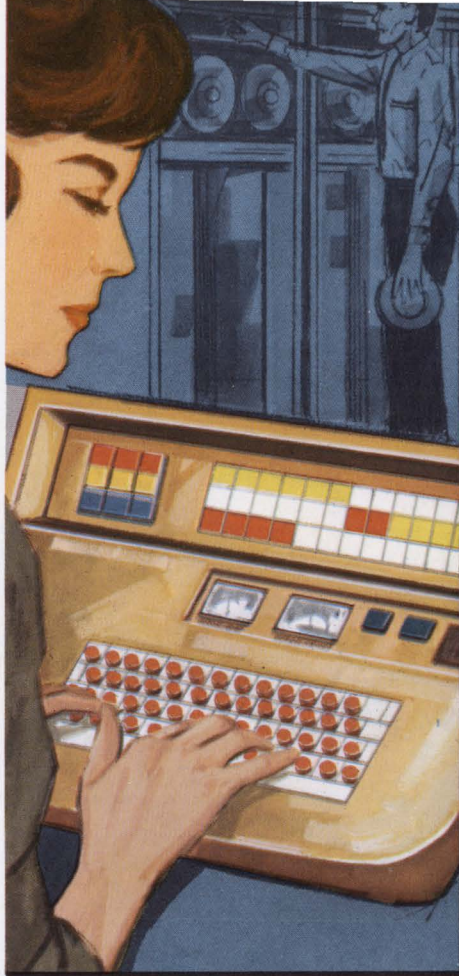

KB allows you to arrange encoding switches, power switches, and indicators in a compatible array to solve your own man/machine interface problem.

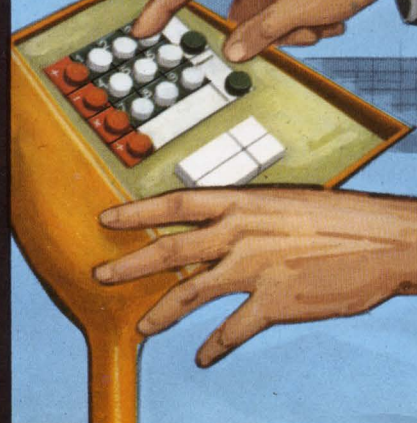
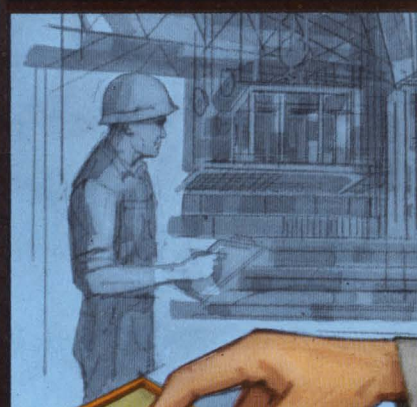
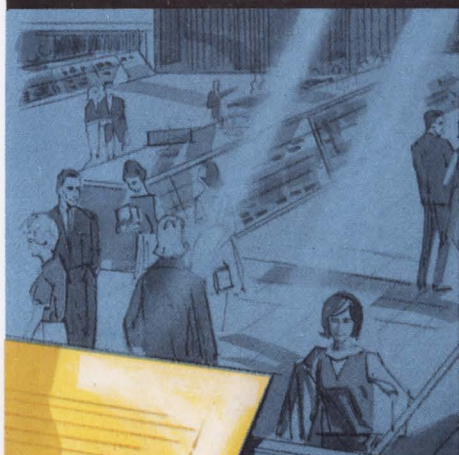

## Think what new KB can save you...

in engineering time, tooling costs, assembly costs, component costs, panel space and weight—what it can save in maintenance time and expense.

Call a MICRO SWITCH Branch Office for a demonstration of KB.

# MICRO SWITCH

FREEPORT, ILLINOIS 61033

A DIVISION OF HONEYWELL

IN CANADA: HONEYWELL CONTROLS LIMITED, TORONTO 17, ONTARIO

**HONEYWELL INTERNATIONAL**—Sales and service offices in all principal cities of the world. Manufacturing in United States, United Kingdom, Canada, Netherlands, Germany, France, Japan.

ANOTHER **UNIQUE** INSTRUMENT FROM ROHDE & SCHWARZ



## MEASURE DIELECTRIC LOSSES AT MICROWAVE FREQUENCIES

**NEW R/S Materials  
Characteristics  
Test Assembly**

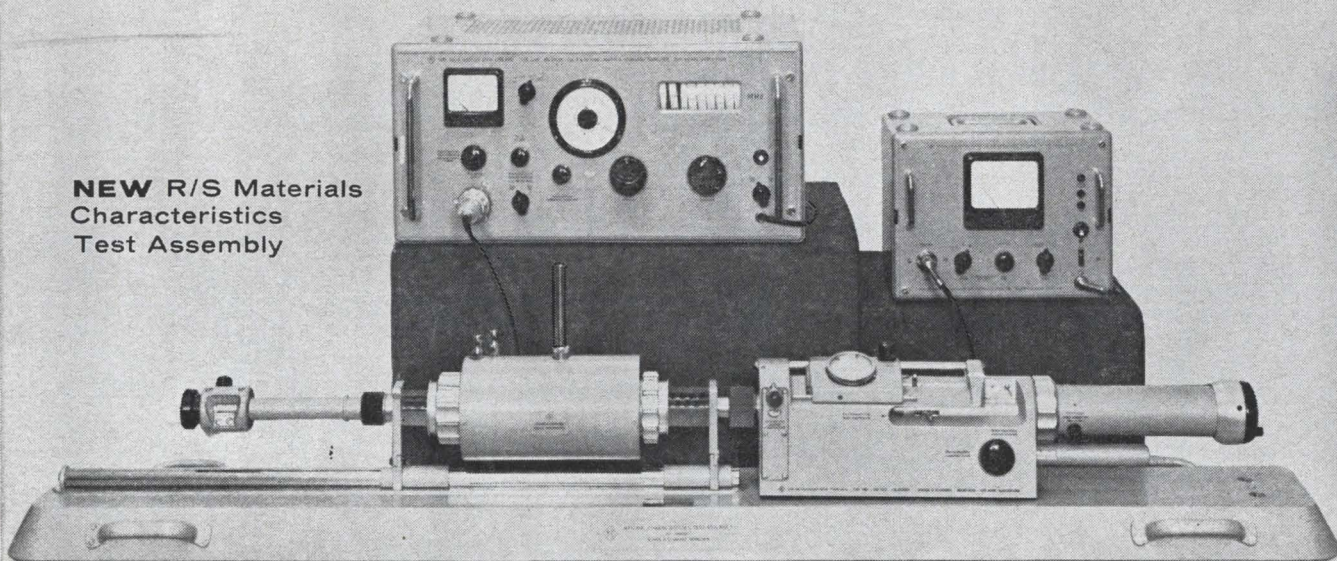

### Unique Design Allows:

- **CONTINUOUS FREQUENCY MEASUREMENTS** — Over a wide range from 30 mc to 7000 mc.
- **CONTINUOUS COVERAGE** — Over a wide temperature range from  $-60^{\circ}\text{C}$  to  $+240^{\circ}\text{C}$ .
- **FLEXIBILITY** — Modular Building-Block Concept — add modules at any time.
- **ECONOMY** — Buy only modules as needed, and only for applications as required.

The R/S Test Assembly measures dielectric constants and dissipation factors of: • **INSULATORS** • **FERRITES** • **SOLID AND LIQUID MATERIALS**

The following coaxial modules, which are completely compatible with each other, comprise the Test Assembly:

- A **STANDING WAVE DETECTOR** — for the desired frequency range, including an **INDICATOR** — for the evaluation or indication of the output voltage of the slotted or non-slotted line.
- A **SIGNAL GENERATOR** — of suitable frequency, power and stability.
- **COAXIAL CONTAINERS** — for operation at room temperature, and for accurate temperature control of the specimens over a wide range.
- A **CALIBRATED ADJUSTABLE SHORT** — a coaxial line, with sliding short, which serves to set the open-and short-circuit conditions . . . also used as a specimen container.
- A **BASE PLATE** — for accurate arrangement of all components mechanically associated with each other.

Fulfilling all the requirements for a universal measuring arrangement, the Test Assembly has been designed and produced to guarantee system performance.

*Complete technical information  
on this unique test assembly  
is available on request.*



**ROHDE & SCHWARZ**  
ELECTRONIC MEASURING EQUIPMENT FOR THE UNCOMPROMISING  
111 Lexington Ave., Passaic, N. J. • PRescott 3-8100

Inquiries outside the U.S.A. should be directed to: Rohde & Schwarz, Muehldorfstrasse 15, Munchen 8, West Germany.

# Announcing

An exciting program that adds new dimensions to your understanding of the ideas, discoveries, and achievements of science

## The HALL OF SCIENCE Book Club

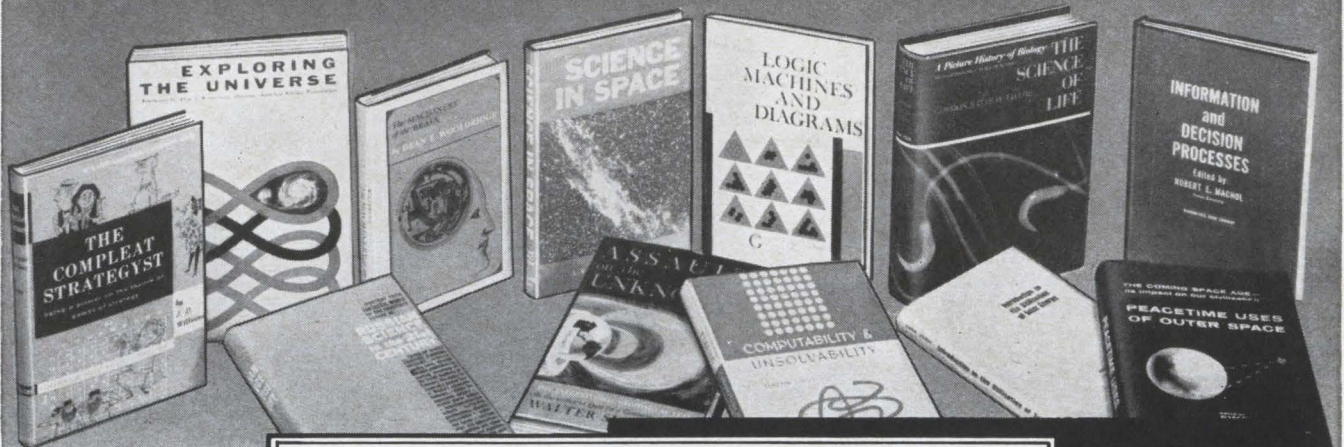

### Special Introductory Offer

- |   |   |   |
|---|---|---|
| <p>1. <b>THE COMPLETE STRATEGIST.</b> J. D. Williams. Fascinating game theory and its uses. Publisher's price \$5.95. Club price \$5.05</p> <p>2. <b>EXPLORING THE UNIVERSE.</b> Louise Young, ed. Science through the ages and how it relates to other fields. Pub. price \$7.50. Club price \$6.40</p> <p>3. <b>RUSSIAN SCIENCE IN THE 21st CENTURY.</b> S. Gousschev, M. Vassilief. Predictions by 29 top Soviet scientists. Pub. price \$4.95. Club price \$4.20</p> <p>4. <b>THE MACHINERY OF THE BRAIN.</b> Dean E. Woodridge. How the brain works—and whether computers may work the same way. Publisher's price \$5.95. Club price \$5.05</p> | <p>5. <b>SCIENCE IN SPACE.</b> L. V. Berkner, H. Odishaw, eds. Leading scientists' ideas on vital research using space vehicles. Publisher's price \$9.00. Club price \$7.65</p> <p>6. <b>ASSAULT ON THE UNKNOWN.</b> Walter Sullivan. Comprehensive account of the international Geophysical Year. Pub. price \$8.50. Club price \$7.25</p> <p>7. <b>LOGIC MACHINES AND DIAGRAMS.</b> Martin Gardner. Methods for solving problems in formal logic. Pub. price \$5.00. Club price \$4.25</p> <p>8. <b>COMPUTABILITY AND UNSOLVABILITY.</b> Martin Davis. Simple treatment of computability theory. Publisher's price \$8.95. Club price \$7.60</p> | <p>9. <b>THE SCIENCE OF LIFE.</b> G. R. Taylor. Lavishly illustrated history of biology. Pub. Price \$9.95. Club price \$8.45</p> <p>10. <b>INTRODUCTION TO THE UTILIZATION OF SOLAR ENERGY.</b> A. M. Zarem, D. Erway. Converting solar energy. Publisher's price \$14.00. Club price \$11.90</p> <p>11. <b>INFORMATION AND DECISION PROCESSES.</b> Robert Machol, ed. Decision processes discussed by mathematicians. Publisher's price \$6.50. Club price \$5.50</p> <p>12. <b>PEACETIME USES OF OUTER SPACE.</b> Simon Ramo, ed. 12 authorities chronicle the increasing impact of space technology on our lives. Publisher's price \$6.95. Club price \$5.90</p> |
|---|---|---|

**YOU ARE INVITED TO TAKE**

any book  
for only

**\$1.00**

with Charter Membership

VALUES FROM \$4.95 to \$14.00

YOU ARE INVITED to join a new club program, *The Hall of Science Book Club*. It has been designed for those who want to keep alert to the pace and impact of science's breakthroughs. To demonstrate the savings the new club makes available, you may take any book shown above for only \$1.00!

This special club, planned to bring you a new value in reading and reference service, helps keep you abreast of the important—the intriguing—the newsworthy events in the broad realm of science. Books offered through the program will cover a wide range of interests: from game theory to evolution; from the probings of man's consciousness to exploration of outer space; from reports on current research being done today to speculation on what tomorrow holds in store. All offerings will be selected on the basis of their practical, popular, and professional appeal.

**How the Club operates.** Periodically you will receive free of charge the Club's official announcement, as issued. This will give advance notice of the next month's feature selection, as well as a number of alternate choices available. If you want the featured book, you do nothing; it will be mailed to you. If you want an alternate . . . or if you want no book that month, simply return the card conveniently provided for this purpose.

We ask you to agree only to take four books over a two year period. Out of the large number of titles offered during this time, there surely would be at least four you would want to add to your permanent library anyway. By joining the Club you save yourself the bother of searching and shopping, and save at least 15 per cent from the publisher's price.

How to start a Charter Membership on a trial basis

Send no money now. Just check any two books you want—one for only \$1.00, and one as your first Club selection—in the coupon below. Take advantage of this special introductory offer now, and get two books for less than the regular price of one. (If coupon is detached, write to the Hall of Science Book Club, Dept. L 5365, 330 W. 42nd St., New York, N. Y. 10036).

**MAIL THIS COUPON TODAY!**

330 West 42nd Street, New York, N. Y. 10036  
The Hall of Science Book Club

L5365

Please enroll me as a member of the Hall of Science Book Club. I am to receive the two books whose numbers I have printed in the two boxes at the right. You will bill me for my first selection at the special club price and \$1 for my new membership book, plus local tax, if any, and a few additional cents for delivery costs. (The Club assumes this charge on prepaid orders). Forthcoming selections will be described to me in advance and I may decline any book. I need take only four selections or alternates in two years of membership. (This offer good in U.S. only).

MY \$1 CHOICE

MY FIRST SELECTION

Name ..... (please print)

Address .....

City..... State..... Zip Code.....

**NO RISK GUARANTEE:** If not completely satisfied, you may return your first shipment within 10 days and your membership will be canceled. L 5365

# Cinch capabilities in micro-electronic interconnection can solve your packaging problems

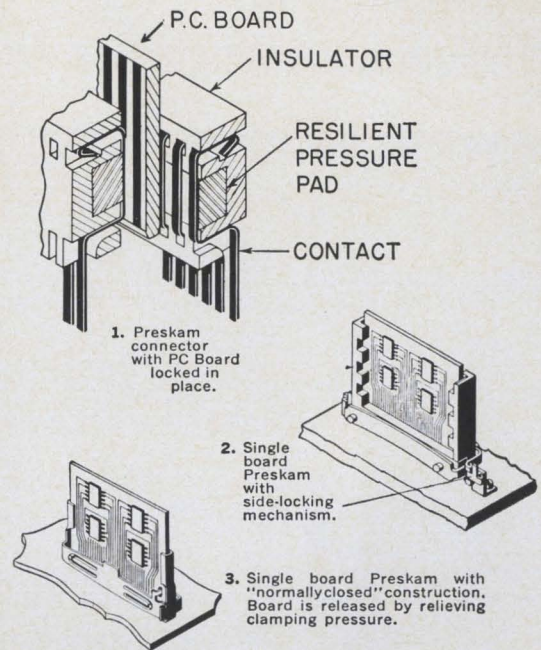
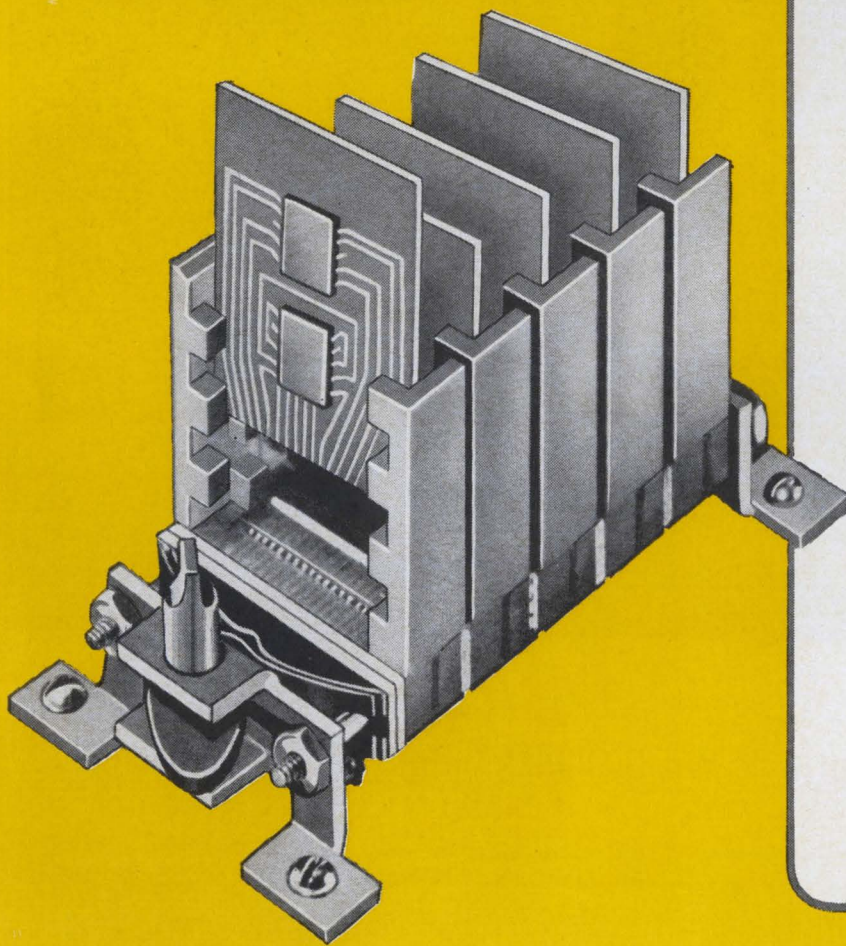

Ask Cinch about the new Preskam\* System that permits connections that don't dwarf the circuits they join.

Either a board or male connector is dropped into place and then a cam actuated insulating bar clamps the board into the connector. High uniform contact pressure is maintained over an up to 70% greater contact area than in conventional connection means.

Contacts are on 25-mil centers and boards can be as little as 100-mils apart. Multiple boards may be controlled by the same locking device.

With contact disengagement before board insertion or withdrawal, the most fragile thin glass or ceramic substrate is undamaged even from repetitive insertions.

RELATE YOUR PRODUCT PLANNING TO THE STATE-OF-THE-ART INTERCONNECTION SYSTEMS WHICH ARE AVAILABLE FROM THE CINCH RESEARCH AND DEVELOPMENT PROGRAM. ASK CINCH FIRST: THEY MAY HAVE ALREADY SOLVED YOUR INTERCONNECTION PROBLEM.

Write Cinch Manufacturing Company, at 1026 South Homan Avenue, Chicago, Illinois 60624.

CM-6505

\*Patent Pending



**CINCH**

DIVISION OF UNITED-CARR

**A. King McCord,  
President, Westinghouse Air Brake Company, says,**

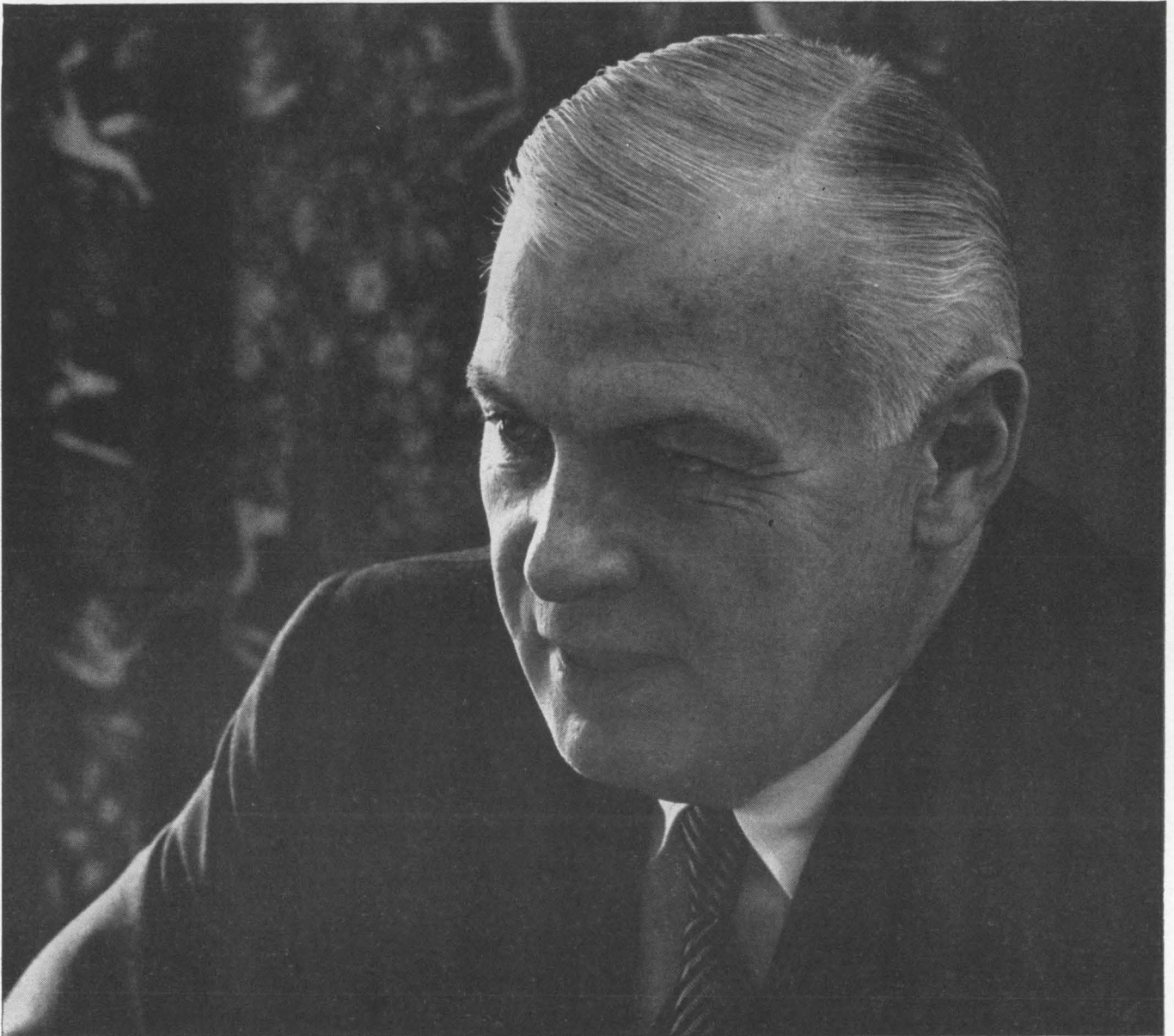

**“We’ve introduced the world to WABCO with Industrial Advertising.”**

“We gave *seven* individual companies a single corporate identity—virtually overnight. We let customers in thirty major markets know that Westinghouse Air Brake now ranks among the world’s most skilled and diversified suppliers—of earthmovers, drilling equipment, compressors,

automatic signal and control systems, electronic guidance detection and communications equipment, control valves, hydraulic and pneumatic cylinders, and—that’s right—air brakes. We told the story fast and inexpensively to hundreds of thousands of purchasing influences, with Industrial Advertising.”

***Advertising cuts the cost of selling . . .***

**ASSOCIATION OF INDUSTRIAL ADVERTISERS**



271 Madison Ave., New York, N. Y. 10016

# INSULTITE

heat-shrinkable tubing

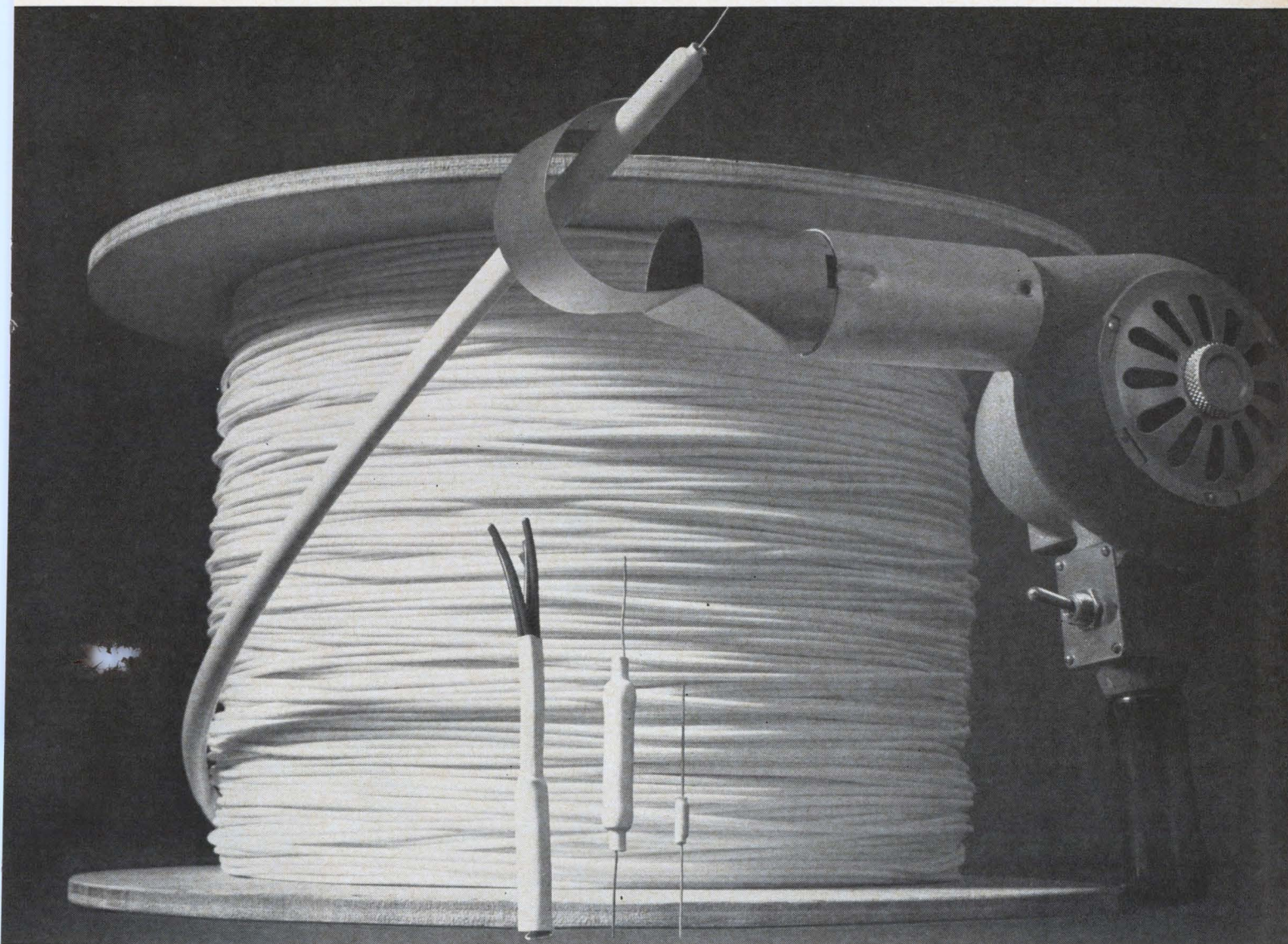

## first of the INSULRAD family of irradiated polyolefins from E.C.C.

Now there's an important new source of heat-shrinkable tubing—INSULTITE from Electronized Chemicals Corporation.

INSULTITE meets competitive heat-shrinkable tubing requirements spec for spec — *outperforms* other shrinkables in volume resistivity, longitudinal change, water absorption, and resistance to solvents.

INSULTITE is the answer wherever skin-tight packaging or encapsulating covers

are needed. Apply heat: INSULTITE molds itself around smooth or irregular shapes to form a tight protective jacket.

INSULTITE is available in standard colors and sizes and is supplied in four-foot or specified lengths . . . competitively priced, and available now. For more information on this new product fill out and return the coupon at right or call Electronized Chemicals Corporation, Burlington, Massachusetts — 617-272-2850.

Yes, I'd like to learn more about INSULTITE.

- Send literature  
 Send samples  
 Have a sales engineer call.

NAME .....

COMPANY .....

ADDRESS .....

CITY ..... STATE .....



**ELECTRONIZED CHEMICALS CORPORATION**

a subsidiary of **HIGH VOLTAGE  
ENGINEERING**

# Why most telemetry installations specify Panoramic instruments



**TMI-1b/120 Indicator**—spectrum presentation of 18 IRIG channels showing slight preemphasis of higher channels. Log scan, log amplitude.

Look at the test and monitoring instruments on any FM/FM telemetry system. Chances are they're Panoramic. Field-proved reliability makes them the most-used instruments in the industry. Consider, too, that Panoramic offers analyzers and calibrators covering the broadest range up to 200 kc, including new channels 19-21, F-H, constant bandwidth channels and specials.

**Customized needs**—Modular construction permits low-cost modification to meet special needs. Singer Applications Engineers are thoroughly familiar with telemetering system requirements, whether for extended frequency range subcarrier indicators, calibrators for non-standard systems, unique spectrum monitoring or surveillance units. Chances are we have already built some sets to meet your special needs.

**Reliability and design integrity**—Long-term reliability, with virtually no down-time, is assured by careful, conservative design and 100% QC checkout as per MIL-Q-9858. Reliability is further assured by our 15 years of leadership in the design and construction of telemetry test equipment.

**For complete details and applications assistance, contact your nearest Panoramic representative or the address below.**

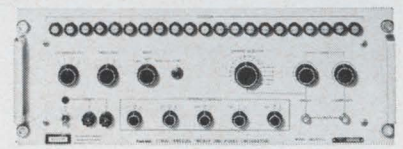

TMC-421

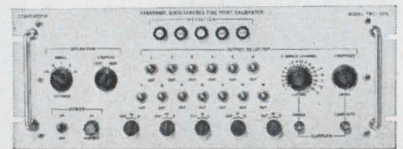

TMC-505

**Models TMC-421 and TMC-505**

simultaneous 21-point and 5-point calibrators used for discriminator calibration and as  $\pm 0.002\%$  frequency standards.

**WIDEST OFF-THE-SHELF AVAILABILITY**

Model Number	Subcarrier Spectrum Analyzers	Model Number	Subcarrier Calibrators
TMI-1b TMI-1b/120 } Militarized TMI-1b/200 TMI-4/120 TMI-4/200 TMI-23 TMI-23/200	350 cps to 85 kc, log and lin scan 350 cps to 120 kc, log and lin scan 350 cps to 200 kc, log and lin scan 350 cps to 120 kc, log and lin scan 350 cps to 200 kc, log and lin scan 12.5 cps to 120 kc simultaneous log and lin scan 12.5 cps to 200 kc simultaneous log and lin scan	TMC-421 TMC-411E TMC-505	Simultaneous 21 point calibrator Simultaneous 11 point calibrator Simultaneous 5 point calibrator  (Both instruments provide 0.002% long term accuracy, automatic transient free sequencing. They are fully transistorized, 7" high. Modification for special channels readily available.)
		TMC-3/21	3 point calibrator for all channels 1-21 and A-H. 0.02% accuracy (0.002% optional)

NOTE: Also available — seven Panadaptors for interference analysis and monitoring of receivers; four Spectrum Analyzers, RF through microwave.



## THE SINGER COMPANY METRICS DIVISION

915 PEMBROKE STREET  
BRIDGEPORT, CONNECTICUT

Design and production of PANORAMIC • SENSITIVE RESEARCH • EMPIRE • GERTSCH instruments for measurement

\*A Trademark of THE SINGER COMPANY



# Probing the News

Military electronics

## Overseas defense market grows

A special office in the Defense Department is helping U.S. companies sell military products overseas; the market for electronics may hit \$300 million this year

By William L. Smith

Washington News Bureau

As defense spending in the United States levels off, sales of military electronic equipment to foreign countries is on the rise. Of the estimated \$1.1 billion in military products that will be exported this year, \$300 million will be for electronics. In 1962, all U. S. military

exports amounted to only \$300 million.

Helping these sales grow is the job of Henry J. Kuss, Jr., whose office in the Pentagon was created four years ago, and whose lengthy title is deputy assistant secretary of defense for international logistics

negotiations. Kuss, who had specialized in U. S. and NATO supply problems since his service in the Navy in World War II, has tried to help the electronics industry make more sales, and hopes to be even more helpful in the future.

“Expanding electronics exports



International trade fairs brought in only \$42 million in export sales last year, but they get companies into business overseas. Both the Commerce Department and the Defense Department can supply information about such fairs. Here, Electronics Associates, Inc., shows its analog computer at a Commerce exhibit in Zurich.

is probably the most confusing problem we face," Kuss says, adding that the industry is difficult to define for Defense Department purposes since electronics tends to get lost in large systems. But he indicates that industry cooperation with his staff helps, and that more of it would be heartily welcomed.

### I. Three market approaches

There are three ways a U. S. company can reach overseas markets:

- By selling components and subsystems to U. S. prime contractors, such as to General Dynamics Corp. for the F-111;
- By selling an entire system overseas, such as an air defense system or a radar installation;
- By selling a subsystem or components for a system that a foreign government is putting together.

Kuss says that though the first approach obviously brings in money, it isn't a good way to make an impression in a market.

**Company reps.** The second and third approaches are the best, he believes. They represent an active selling approach, and that's what is needed. The drawback is that they both cost money. Company representatives are a must and costly sales promotions are helpful.

Big companies have the easiest time promoting electronic equipment in key foreign military markets, Kuss admits. He cites the case of the Bendix Corp., which opened its own promotion campaign in Europe at considerable cost and has now evidently made a good profit on it. Other big companies are having similar success. All are selling entire systems as well as major chunks of others.

But Kuss thinks the small company can compete on a direct basis as well. The military itself assembles big systems in foreign countries, whereas in the U. S., the prime contractor system is used; therefore equipment sold on a sub-contract basis in the U. S. can be sold directly to the military abroad.

When a new market emerges overseas, it's usually a big one. If a country decides to outfit its army with communications gear, it must do it from scratch. Repeat orders are often big. The U. S. Army sometimes buys similar equipment



These Lockheed Aircraft Corp. F-104's, which are going to Japan, were part of the company's \$50.6 million in sales to foreign governments last year. F-104's were also sold to Germany, Canada, the Netherlands, Italy and Belgium.

for one battalion or less. Such a contract could be profitless.

### II. Joint production

Kuss points out that the U. S. and foreign military establishments have cooperated in the production of military equipment in the recent past; foreign buyers and manufacturers have become familiar with U. S. electronic equipment and are anxious to use it again. Examples include joint production of the twin-place F-104 jet and the Bell helicopter with West Germany, of the M-60 tank with Italy, and of the Naval Tactical Data Display systems with France, Germany and Italy. And these are just a few.

Kuss is against using licensing arrangements. Too often, he says, the U. S. government helps a manufacturer to finance development of military equipment and then licenses it to a foreign company. The foreign company then makes windfall profits the U. S. company or government has no share in.

### III. Where the market is

Kuss says that 80% of the foreign military market for U. S. electronics and other goods is in Australia, Canada, France, Germany,

Italy, Japan, Switzerland and Britain. The demand is for every phase of military electronic equipment.

In Belgium, India, Iran, the Netherlands, Norway, Saudi Arabia, Spain and Sweden, representing another 10%, the demand is for radar, other detection equipment and more sophisticated communications.

For the final 10%, the demands vary sharply from country to country, with needs mostly based on existing production lines.

**Payments.** Defense Dept. officials are in close touch with foreign needs and are eager to get the word to manufacturers interested in the business. They say that about 70% of the orders being placed by foreign governments are paid for on a progress basis—as work moves along—just as in the U. S. Another 20% can be easily backed by loans guaranteed by U. S. banks, insurance companies and the Export-Import Bank. For the other 10%, from countries which are less developed and present a real credit risk, the Defense Dept. has \$1.5 billion in credit guarantees to be used over the next 10 years.

These guarantees will be issued only in support of U. S. foreign

policy and, with respect to developing countries, only where payments will not interfere with the country's economic development.

#### IV. Expositions

Kuss wants to give the electronics industry every help in taking a shot at the market. He hopes a major shot can be fired during the government's proposed International Aerospace and Science Exposition, which is tentatively scheduled for the summer of 1966 at Dulles International Airport outside Washington, D. C.

The purpose of the show is to give U. S. manufacturers of aeronautic, aerospace and related equipment a display case for selling to foreign markets. The focus will be on major pieces of equipment, but Kuss hopes to get at least one or two days set aside for components and subsystems, with the emphasis on electronics. He indicates that the success of getting special time for electronics will depend in large part on the industry's making a coordinated effort to prove it has something special to sell.

**Continuous effort.** The government has made several efforts to get better foreign exposure for electronic equipment. Under federal sponsorship, more than 100 companies unveiled exhibits April 21 at London's International Engineering Exhibition, and most of them were electronics makers.

As in past U. S.-sponsored international shows, the emphasis was on getting new and smaller firms into the export market.

The fairs aren't hard to get into. Either Defense or the Commerce Dept.'s Bureau of International Commerce has the answers. All the manufacturer has to do is pay for getting the equipment to and from the export point, and assure that someone will be there to show it.

In actual sales, trade fairs and similar U. S. exhibitions overseas don't bring in large amounts of business. Last year about \$42 million in export sales were racked up by such shows, while total U. S. exports hit \$26 billion. But their prime purpose isn't sales; the government merely wants to get companies' feet wet in the export market.

## Government

# The patent predicament

A presidential panel is seeking ways to streamline the U.S. system and standardize international procedures on protection of investors' rights

By Warren Kornberg

Washington News Bureau

**It takes three to four years** to patent an invention in the United States—an intolerable interval, in the opinion of many inventors, attorneys and officials of the U. S. Patent Office.

Patent Commissioner Edward J. Brenner questions whether the patent system can be remedied appreciably without starting from scratch—or even whether it ought to be. He notes that the system is basically unchanged from its original form in 1836. The Secretary of Commerce, John T. Connor, adds: "The system was designed to bring innovation to an essentially agrarian economy."

While Brenner strives to make the existing procedures work, a presidential commission was recently appointed to review the basic patent system with an eye to strengthening it. Besides its concern with the U. S. system, the commission—with representatives of industry, universities, the legal profession and the government—will consider ways to strengthen and standardize international patent controls.

### I. A burgeoning backlog

When Brenner took over the Patent Office last year, he found a backlog of 200,000 patent applications. A total of 87,000 applications was received in 1964, but only 75,000 were processed; that added to the deficit.

He instituted administrative reforms and thinks he has reversed the trend toward bigger backlogs. He expects 89,000 applications to be received this year and 100,000 to be processed. Eventually, the streamlined procedures may cut the

delay time to 2 to 2½ years, he says.

But speed has been gained at the price of thoroughness. A patent attorney for an electronics company alleges: "The office is currently making hasty searches, increasing the risk of successful challenges in court." Legal challenges on patent rulings are already 60% to 70% successful. Such challenges are generally based on the premise that an alleged invention isn't really new.

Electronics companies submit almost one-third of the applications processed by the Patent Office.

The problem even seems to defy automation. Less than 1% of the search mechanism is computerized. Even maximum automation would save only about 20% of the examiners time, Brenner says.

**Is this search necessary?** Everybody seems to agree on the reason for the delay: a policy of thorough search by the Patent Office of all of the world's technical literature and prior developments to assure that the application does describe a patentable innovation.

The commission will consider elimination of the search prior to issuing a patent. In effect, this would change the role of the Patent Office to one of publishing patent applications; a search would be deferred until a patent is challenged.

The Common Market has adopted such a deferred-search policy, Brenner says. The market consists of six of Europe's most industrialized countries: Belgium, the Netherlands, France, West Germany, Italy and Luxembourg.

Such a policy creates uncertainty about the validity of a patent; but,

from  
**BURR-BROWN**  
a new  
operational  
amplifier  
with low drift  
and high  
input impedance

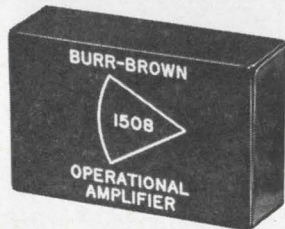

The latest addition to the popular Burr-Brown operational amplifier family is model 1508. It's an all-silicon solid-state differential input unit which approaches FET and chopper-stabilized performance without the attendant cost. You will find it particularly useful in high impedance circuits and integrators requiring extremely low current drift. It is also excellent for voltage reference applications drawing from standard cells. And, it is small... a modular 1.8" x 1.2" x 0.6.

**TYPICAL PERFORMANCE @ 25°C**

Input Impedance	
differential	1.0 Mohms
common mode	500 Mohms
Current Drift	$\pm .05$ na/°C
Voltage Drift	$\pm 10$ $\mu$ v/°C
D.C. Gain	96 db
Unity Gain Bandwidth	1.0 Mcps
Rated Output	$\pm 10$ V (min) @ 20 ma

The Burr-Brown 1508 is immediately available at \$110 in unit quantity... \$99 in quantities of ten. Connectors and accessories are also in stock.

**FOR COMPLETE TECHNICAL INFORMATION** on the 1508... or, for prompt assistance with your operational amplifier application, wire, write or phone Burr-Brown today.

**BURR-BROWN**

RESEARCH CORPORATION  
INTERNATIONAL AIRPORT INDUSTRIAL PARK  
BOX 11400, TUCSON, ARIZONA 85706  
PHONE: 602-294-1431 • TWX: 910-952-1111

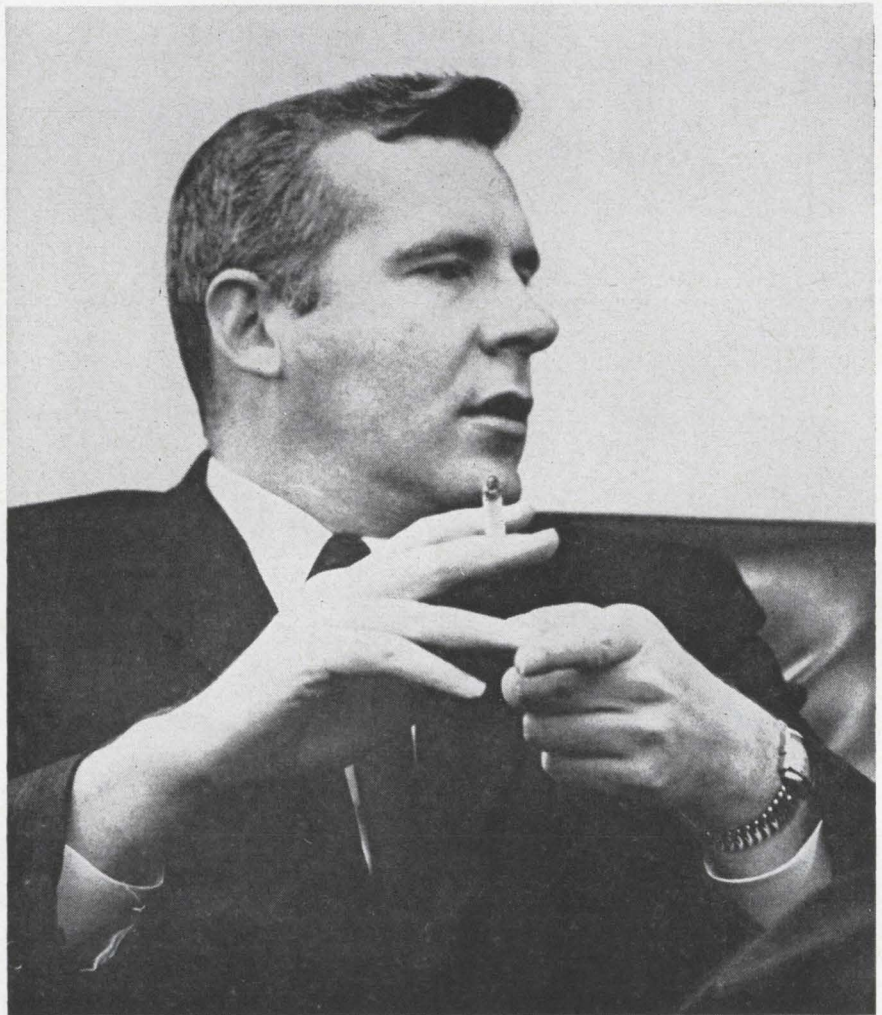

**Patent Commissioner Edward J. Brenner** discusses problems of modernizing a 19th-century institution to meet 20th-century needs.

Brenner asks, is the validity any more certain during the years in which an application is being processed? The biggest change, he notes, would be to shift the cost of the search from the public to the party who is seeking a patent.

It now costs the government about \$100 to make a patent search. But even under the present procedure, companies sometimes spend \$1,000 on a backup search prior to marketing the product, to guard against a court challenge that may require a more extensive search that can cost as much as \$10,000.

## II. International protection

As international trade increases, so does the need for protecting patent rights. The latest country to acknowledge that fact is the Soviet Union, which says it is ready to join the Paris Convention for the Protection of Industrial Property, an international accord that in-

cludes general patent rights [Electronics, April 5, p. 185].

The Paris Convention affords only minimal protection. It commits member countries to provide the same protection to a foreign inventor that the inventor's country gives to its own patent holders. The inventor must also file separately in each country where he seeks patent rights.

**Need for uniformity.** One deterrent to international patent pacts is the absence of uniformity in searches. While the Common Market favors deferred search, the Scandinavian countries are moving toward a common system based on prior search.

In its reappraisal of the U. S. patent system, the presidential commission will have to consider these international differences. "The closer patent systems are to being about the same," says Brenner, "the better are the possibilities of cooperation."

## ONCE UPON A TIME!



A man went to a clothier to buy a suit. The clothier said his suits cost \$1500. each! The man was appalled. The clothier explained that every item in his suits was specially procured and custom tailored to fit the personality of each customer. Sometimes the wool came from Australia, sometimes Scotland... sometimes the bone for buttons came out of the African Congo, sometimes the jungles of India... sometimes the "horsehairs" for the lapels were taken from Yak tails in the Himalayas, sometimes from Buffalo beards in Canada. No two customers were ever provided with identical suits, but the suits cost \$1500 each.

■ The man was very much impressed and was about to order a suit when the question of delivery occurred to him. "But I need this suit for my daughter's wedding," he explained. "And when is that?" the clothier asked. "The day after tomorrow," the man replied. "Don't worry," the clothier said — "you'll have it!" ■ High reliability semiconductor users have been in the position of



the man who wanted to buy a suit. They've been asked to pay enormously high prices for customized reliability assurance programs, and they've been promised deliveries that have been patently impossible under conventional reliability assurance procedures.

■ Now Motorola offers a program that changes all that. The new Motorola Meg-A-Life II Program takes the high cost and long delivery time out of high reliability semiconductor device procurement. It offers: three levels of superior quality assurance... Mil-type or

equivalent devices as source material, plus special screens and tests, with periodic screen effectiveness re-verification... dependable delivery schedules from 2 to 4 weeks... certificate of compliance assurance... options for flexibility—and moderate costs for any size order! ■ Want to know how it's all possible? Circle the reader service card for an illustrated brochure describing the Motorola Meg-A-Life II Program in detail. Or write: Dept. TIC, Box 955, Phoenix, Arizona 85001.

**MOTOROLA Semiconductors**

# the **BEEDE** **MAG-B** movement

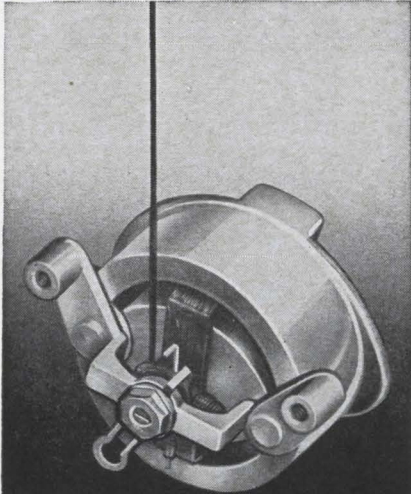

**extra-high  
TORQUE  
DURABILITY**

You get extra-high torque durability and ruggedness with the new Beede Magcentric B Movement. The MAG-B's extra-high torque is engineered and built-in to overcome resistance and friction forces. The solid ruggedness of the MAG-B Movement is specially made to easily take rough abuse in the field and shipping.

You get more high torque durability and ruggedness, for your dollar, with the Beede MAG-B than any other movement on the market.

#### The new **BEEDE MAG-B** features:

- High torque for durability
- Large air gap
- Sturdy mechanical construction
- Simplicity of positive mechanical design
- Self-shielded jewel and pivot movement
- Maximum in-operation ruggedness
- High quality at a competitive price

If your standard is providing dependable equipment to your customers, the Beede MAG-B Movement is your best buy.

The MAG-B Movement is another example in the continuing Beede program to provide you with the finest meter movements available . . . at prices you want to pay.

**BEEDE**

ELECTRICAL INSTRUMENT CO., INC.  
PENACOOK, NEW HAMPSHIRE

Area Code: 603-753-6362/TWX: 603-753-4727

Space electronics

## Realistic space flight — on the ground

Student space pilots get so carried away by the "view" from their simulator that they lose track of time

By Ronald P. Lovell

Los Angeles News Bureau

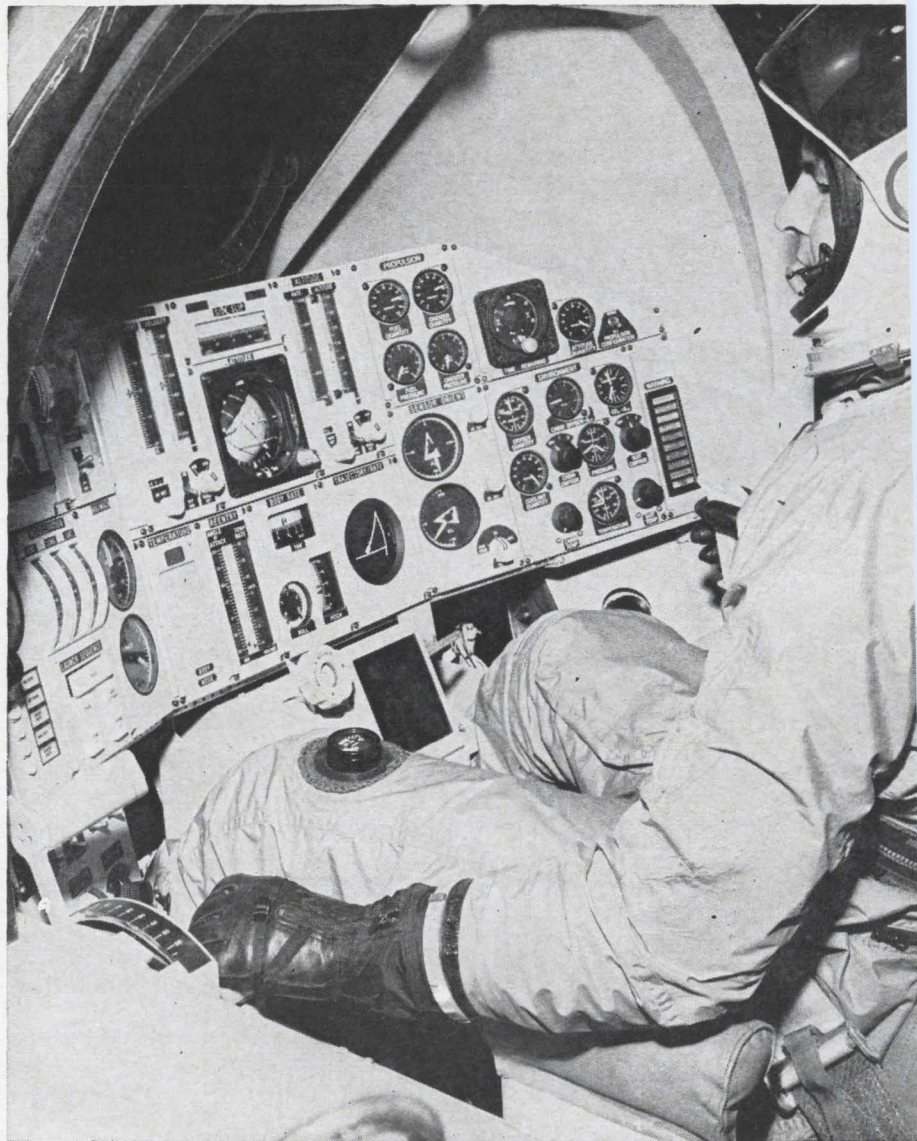

Pilot flies his own space mission, making decisions and carrying them out with the simulator's controls. Sometimes he "gets back" safe and sound, sometimes he doesn't. Here, Maj. John Prodan banks his spacecraft to the right and looks through a 12-inch window in front of him for the Agena satellite with which he plans to rendezvous. Prodan handles thrust with his left hand and attitude with his right.

**Air Force Maj. John Prodan** watched a dial on the instrument panel of his spacecraft tick off the seconds. The 10-ton craft held at a constant altitude. Engine burn-out took place in a split second, and the vibration eased up and stopped. He was in orbit.

Through his 12-inch window, Prodan saw a grey-black sky and a thousand stars. Had he been headed 40 degrees to the left, the morning sun would have been a ball of blinding light. Two minutes and 15 seconds later, he rolled the craft and saw the earth. Ten degrees to the right and a half mile away, he spotted the Agena satellite. Prodan reached for the throttle and started the complicated procedure that he hoped would bring him into rendezvous.

Only one hour before, Prodan's wife had been driving him through the sun-baked California desert. She had waved good-bye when he got out of the car and promised to meet him for lunch at the club, if there were no problems at home.

The major was not in orbit; he was in the new \$5.6-million space-flight simulator at the Air Force Aerospace Research Pilot School at Edwards Air Force Base. Prodan, chief of the school's simulation branch, and his eight students in class 64-B fly several missions a week like this one, without ever leaving the ground.

This isn't the only spacecraft simulator in the country, but, according to Prodan, none are as elaborate as this one. "No other simulator is as realistic or has the visual and motion capabilities this one has," he says. A pilot who has used the simulator a number of times said, "I can't imagine anything closer to a real space flight than this. When you look out that window it's so real you lose track of time and normal thinking."

The unit, which was built by the Link division of General Precision, Inc., is built so that the instructor can program a variety of flight problems for the students to solve. The student "flies" the craft, and on his first few flights usually does something that in a real mission would mean disaster.

### I. Flexibility

The unit, called the T-27, does not simulate one specific space-

## Mallory Film Resistors

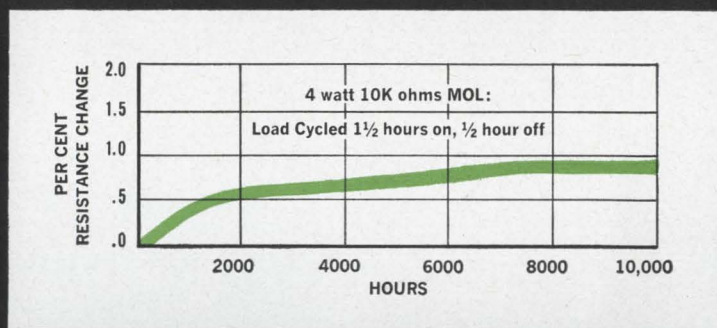

## How's this for quality in film resistors?

Premium performance *without* premium price is what you get with Mallory MOL metal oxide film resistors. For instance:

**Load Life Stability.** Resistance change is less than 1% after 10,000 hours of load life test . . . full load on 1½ hours, off ½ hour. Temperature coefficient is low: ±250 PPM/°C.

**Humidity Stability.** After 100 hours at no load at 95% humidity, average resistance change is less than +.04%. After 1000 hours at 95% humidity at 100% load, average resistance change was ±0.7%.

**Flame Resistance.** No flame or emission of molten material even at 315% overvoltage.

You can get MOL resistors in 2, 3, 4, 5 and 7 watt ratings, in a broad range of resistance values. 2-watt values go from 30 to 500,000 ohms. For complete data, write or call Mallory Controls Company, a division of P. R. Mallory & Co. Inc., Frankfurt, Indiana 46041.

# MALLORY

## Increase your skill and earning power as an ELECTRONICS TECHNICIAN

Whatever your past experience in electrical or electronics fields, you can easily master the skills and techniques that spell success in these areas today. Everything you need to know is in a unique 3-book Library that treats in detail basic fundamentals of electronics study. You gain a working knowledge of the mathematics required for solving everyday problems in modern electronics — including television, radio, and other fields. Arithmetical processes, logarithms, trigonometry, and algebra are explained in simple, non-technical language.

Up-to-date concepts of *electron physics* . . . the nature and behavior of resistors, inductors, and capacitors . . . theories of magnetism . . . the characteristics of inductance and capacitance—and other subjects essential to a mastery of electronics are explained in detail. Finally, modern techniques for *designing new circuits* as well as analytical methods of correcting electronic problems of circuit design are presented.

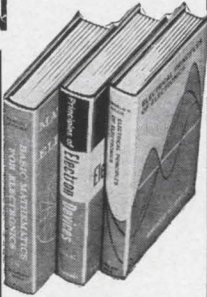

### LIBRARY CONTAINS

Gillie's *Principles of Electron Devices*  
Cooke's *Basic Mathematics for Electronics*

Gillie's *Electrical Principles of Electronics*

## BASIC ELECTRONICS LIBRARY

Practical guidance on topics like these . . .

- Shows how to use the slide rule to simplify many mathematical operations
- Treats transistor multivibrator design and theory in detail
- Tells how to solve parallel circuits by the total circuit method
- Explains how to find the effective value of current or voltage
- Examines the circuit combinations with non-sinusoidal waveforms
- Shows how to apply Kirchhoff's Laws to analyze circuit conditions
- Considers the semiconductor diode and vacuum diode in terms of their operational similarities
- Analyzes tank circuits, using both vector algebra, and the principles of conductance, susceptance, and admittance
- And much, much more!

**SAVE \$7.30!** Purchased individually, the total price of these books would be \$32.25. Under this special offer, the complete Library is available for only \$24.95, a saving of \$7.30

3 Volumes  
1787 pages  
1125 illus.  
\$24.95

### EASY TERMS:

\$6.95 in 10 days, then \$6 a month for 3 months

**10 DAYS' FREE EXAMINATION**  
Convenient Mail Service  
Direct from McGRAW-HILL

McGraw-Hill Book Co., Dept. 11-FL-53  
327 W. 41st St., N. Y. C. 10036

Send me the Basic Electronics Library for 10 days' examination on approval. In 10 days I will send \$6.95 then \$6.00 monthly until \$24.95 is paid. Otherwise I will return books postpaid. (If you remit in full with coupon, plus local tax, refund and return privileges still apply.)

Name .....  
Address .....  
City ..... State ..... Zip Code.....  
Company .....  
Position .....

For price and terms outside U. S.  
Write McGraw-Hill Int'l., N. W. C. 11-FL-53

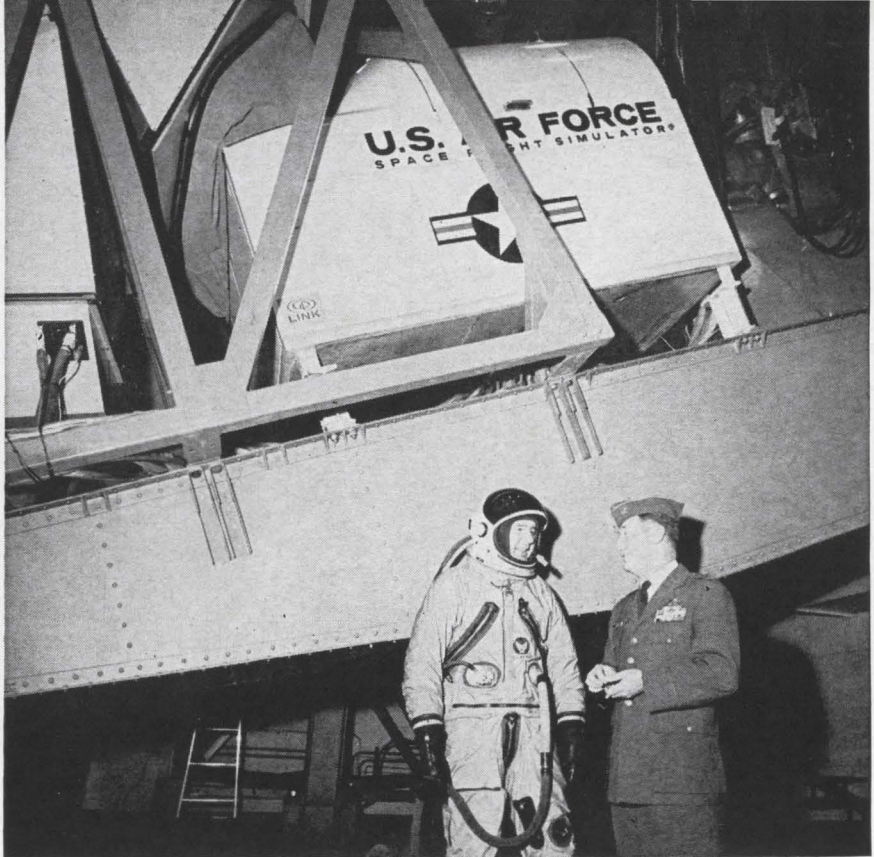

Prodan and school commandant Col. C.E. Yeager chat while waiting for the spacecraft to be brought into boarding position. The 15-ton mechanism makes the cockpit vibrate like the Titan II.

craft, but can be programmed for any system. It can behave like a low lift-over-drag type like Mercury, Gemini and Apollo, or a high lift-over-drag vehicle like the canceled DynaSoar. Booster characteristics are similar to those of Titan II and III.

The T-27 carries out all elements of space flight: boost, orbit, rendezvous, docking and reentry. The unit's extensive computer system does most of the work. When the pilot starts a roll, pitch or yaw maneuver, for example, the action is transmitted to two computers which solve the equation of motion and instruct the motion system, the visual display and the instruments in the cockpit.

**Computer complex.** A hybrid unit, the computer system consists of a Link Mark II digital simulation computer, two analog computers built by Electronic Associates, Inc., and the interface equipment needed to integrate the digital and analog output.

The Mark II is a parallel-process machine designed specifically for aerospace vehicle simulation. Its capacity is 65,000 words in drum and core memories; access time is one microsecond.

The Mark II has a data preselect

band in which 32 sets of initial conditions are stored to permit simulation of various mission phases, without going through the whole flight when, for example, only rendezvous is wanted. The instructor may also select and store conditions of any point in the mission on a separate control panel, so he can continue the flight but return to a trouble spot later. Or he can "freeze" the mission at any time to ask questions and make corrections. The instructor's panel is linked to the pilot's cockpit by an intercom system and contains a television screen which shows the pilot in action.

The T-27 has three other major subsystems—visual/optical, environmental, and cockpit control and motion.

### II. Visual display

The fantastic world that the pilot sees through the 12-inch window is an electronic trick. The window is actually a high resolution television system, and the thousand stars are a thousand colored ball bearings imbedded in a 27-inch sphere. The ball bearings vary in size from 0.375 inches to 0.031 inches to simulate stars from minus 1.6 magnitude to the fifth magni-



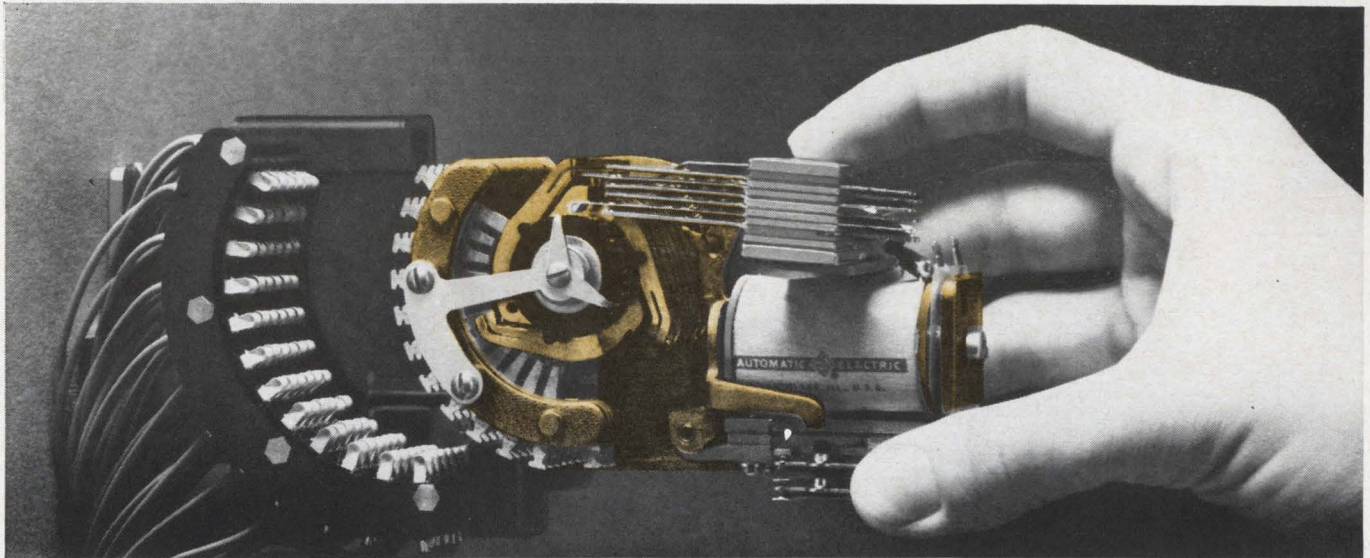

Give any switch

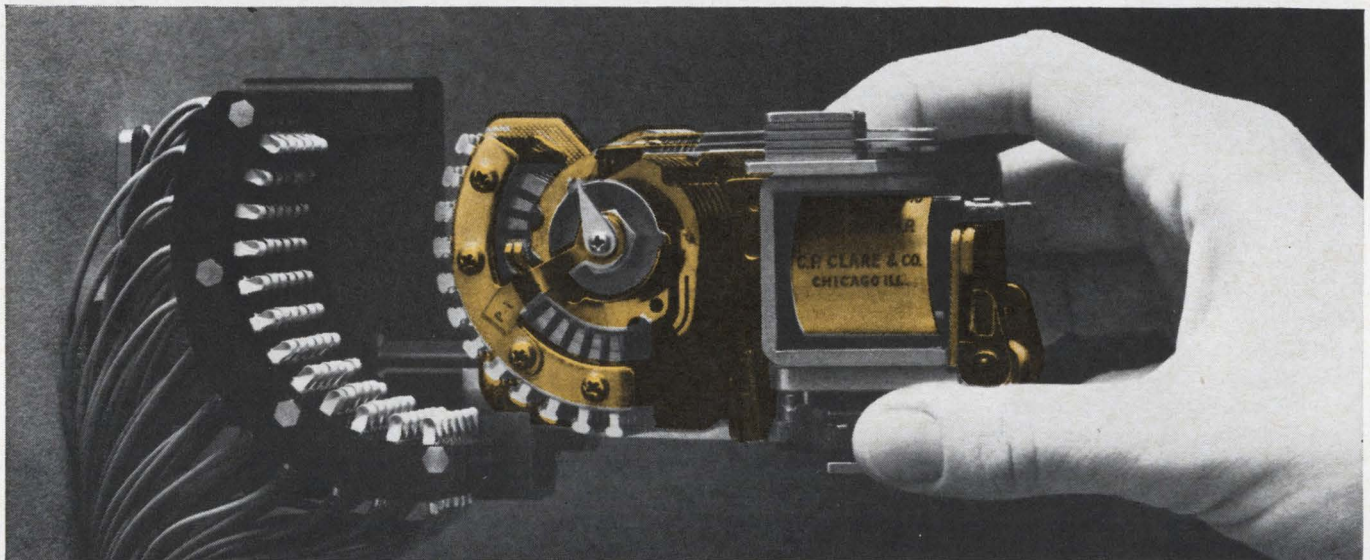

a plug

Either switch plugs into AMP's new Stepping Switch Connector in less than a minute. Best of all, there's no messy soldering, no cold solder joints, nor cramped working space to contend with. To quickly insert or remove a stepping switch requires only the turn of a jackscrew.

And original production benefits are even greater! Contacts can be crimped by automatic machine or hand tool onto individual leads or on a wire harness. Snap-in contact design makes assembly quicker and facilitates wiring changes. Contact reliability is assured by redundant contact areas plated with tin or gold over nickel. A positive guide assures alignment of switch and connector contacts. Most standard stepping switches can be used with this advanced technique, opening new avenues for packaging design.

Look at these time-and-money-saving features:

Plug-in versatility for stepping switches (Connector or stepping switch can be chassis mounted)

- Simplifies preventative maintenance
- Automatic machine or hand crimping of contacts simplifies manufacture of harness assembly
- Connector harness can be pre-tested before assembly into equipment
- Crimp-on, snap-in contacts permit easy insertion, modification, or removal of harness leads
- Gold over nickel or tin plating available
- Multiple areas of contact assures reliability

This remarkable new concept provides design versatility and high-speed production capability for anyone who uses stepping switches. To find out more about it, write today.

\*Trademark of AMP INCORPORATED



AMP\* products and engineering assistance are available through subsidiary companies in: Australia • Canada • England • France • Holland • Italy • Japan • Mexico • West Germany

# Ballantine DC/AC Voltmeter/Ohmmeter

Model 345  
Price: \$350

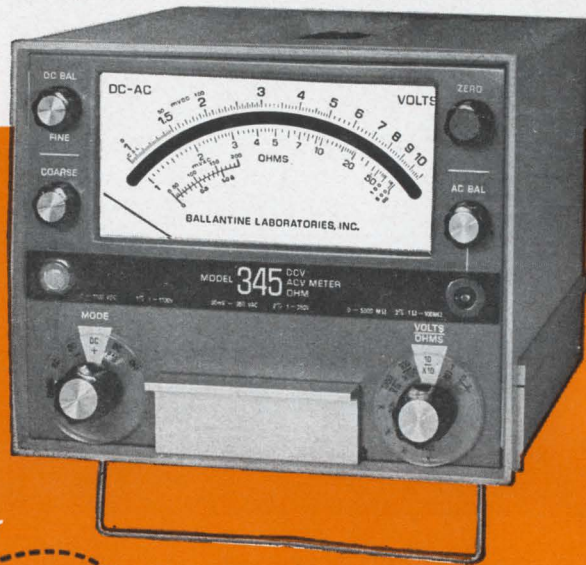

Unrivalled Accuracy and High Resolution

Log Indicator; single Decade Voltage Scale

Internal Calibration for dc and ac Ranges

**NEW!**

Measures 0 —  $\pm 1,100$  V dc;  
0 — 350 V ac ( $\frac{20 \text{ Hz}}{1000 \text{ MHz}}$ ); 0 — 5,000 M $\Omega$

Ballantine's Model 345 DC/AC Voltmeter/Ohmmeter is a multi-purpose instrument for use in the laboratory and on the production line.

It features a single, 5-inch, mirror-backed logarithmic scale and decade switching for both ac/dc volts and ohms measurements . . . and assures you of unrivalled ease, speed, accuracy and resolution in making these measurements. Its logarithmic scale, for example, permits an accuracy specification of 1% of indication for dc; 2% of indication for ac; and 3% of indication for ohms.

Since there are no wrong scales to read, errors in reading are reduced greatly. Because of the instrument's decade switching, you can make more measurements without the need for range switching.

The Model 345's accuracy is maintained for power line voltage changes of  $\pm 20\%$ , so necessary for use on the production line. Because its built-in ac and dc reference standards enable you to check its accuracy in a few seconds, there's no need of removing it from service.

## PARTIAL SPECIFICATIONS

### OHMMETER

Resistance Range . . . . . 0 to 5,000 M $\Omega$   
in nine ranges

Accuracy . . . . .  $\pm 3\%$  of indication 1 $\Omega$  to 100 M $\Omega$ ;  
above 100 M $\Omega$  not specified

### DC VOLTMETER

Voltage Range . . . . . 0 to  $\pm 1,100$  V  
in five ranges

Accuracy . . . . .  $\pm 1\%$  of indication from  
1 V to 1,100V;  $\pm 1.5\%$  of indication  
 $\pm 1$  mV, below 1 V

### AC VOLTMETER

Voltage Range . . . . . 0 to 350 V in five ranges

Frequency Range . . . . . 20 Hz to 1,000 MHz

Accuracy . . . . . 50 Hz to 100 MHz,  $\pm 2\%$  of indication from 1 V to 350 V; 0-1V,  
 $\pm 2\%$  of indication  $\pm 5$  mV; 100 MHz—1,000 MHz,  $\pm 10\%$  of indication  $\pm 5$  mV

Write for brochure giving many more details

Member Scientific Apparatus Makers Association

— Since 1932 —



**BALLANTINE LABORATORIES INC.**  
Boonton, New Jersey

CHECK WITH BALLANTINE FIRST FOR DC AND AC ELECTRONIC VOLTMETERS/AMMETERS/OHMMETERS, REGARDLESS OF YOUR REQUIREMENTS. WE HAVE A LARGE LINE, WITH ADDITIONS EACH YEAR. ALSO AC/DC LINEAR CONVERTERS, AC/DC CALIBRATORS, WIDE BAND AMPLIFIERS, DIRECT-READING CAPACITANCE METERS, AND A LINE OF LABORATORY VOLTAGE STANDARDS FOR 0 TO 1,000 MHz.

tude. The sphere is illuminated by highly collimated light. It is movable in all directions; as the pilot pitches down, for example, the sphere is rotated in the opposite direction. A disk installed at the bottom of the sphere represents the horizon and cuts off the light source when the pilot has moved the capsule toward the horizon.

The approximately 2,000-pound display system on top of the simulator contains beam splitters, lenses and mirrors which project three images—target, the earth and the stars—on the viewing window.

A model of an Agena satellite is used for practicing rendezvous. The Agena is in a separate room, linked to the spacecraft via closed circuit television. Completely maneuverable, the model can pitch and yaw on two outer gimbals and roll with an internal gimbal.

The model is always under scrutiny by a servo-controlled camera, with a zoom lens, mounted on a track. Upon command from the computer, the camera can be moved to vary the range from 5 feet to 30,000 feet.

### III. The environment

The simulator authentically duplicates cockpit vibration, sound generation, cockpit air conditioning, pressure suit temperature and pressure control. The sounds of each of the various rocket stages, attitude thrust jets, and jettison separation are provided by equipment in the master control station and connected with the rest of the system through the interface junction panel. Static, cosmic noise, solar noise, and galactic noise is inserted directly into the communication system.

**Cockpit controls.** The cockpit contains a control volume with rudder pedals or a side arm attitude controller. In addition to primary controls, the interior includes a modular designed main instrument panel, sectional console panels, a seat and auxiliary equipment. When practical, actual spacecraft instruments are installed on the pilot's panel. Normally, instruments on the panel indicate such things as velocity, rendezvous, side slippage, altitude propulsion, cabin environment, reentry, the launch sequence, electrical loading, life support, and fuel remaining.

# MOTION MEASUREMENT REPORT

# CEC

## REPORT NUMBER 2

### New "pea-size" piezoelectric accelerometer features detachable cable

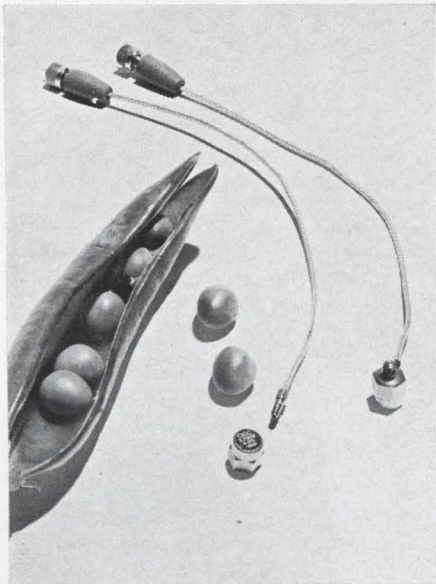

Up until the introduction of CEC's new 4-275 Piezoelectric Accelerometer, cable deterioration had been the major problem with the use of such miniaturized instrumentation. Frequent cable replacement had proved extremely costly to users, both in time and money — particularly since the entire unit had to be returned to the manufacturer for repair.

Not so with the 4-275. This accelerometer is so conveniently designed that a worn cable may be easily removed and a new one attached by the user in a matter of minutes. Compare this to the days required for factory replacement, and the saving becomes significant indeed.

To simplify matters even further, each 4-275 shipped includes at no extra cost an extra cable, a connector wrench, and a special adapter for mating with standard cables.

However, economy and convenience are not the only advantages offered by this new CEC accelerometer. Its "compliant rod" construction mechanically isolates the sensing element from the case. And its performance characteristics are outstanding as you will note from the specifications.

Two models of the 4-275 are available. The 0001 without stud for conventional adhesive mounting; and the 0002 with stud for screw mounting. Both models come with the free cable replacement kit.

Obviously, the 4-275 Piezoelectric Accelerometer is the ideal answer for a wide range of applications, both aerospace and industrial—from thin section vibration testing to acoustical testing.

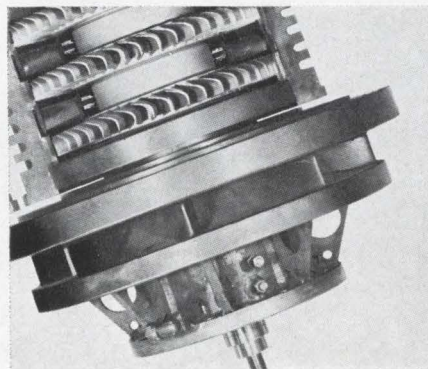

#### Specifications:

- Basic voltage sensitivity — 5.5 mv/g nominal.
- Capacitance — 420 pf nominal.
- Mounted natural frequency — 100 kc nominal (58 gms)
- Frequency response —  $\pm 5\%$  from 4 cps to 15,000 cps.

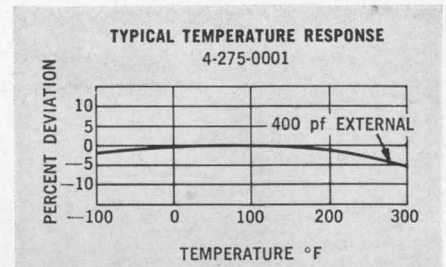

- Cross-axis sensitivity — less than 5% in any axis.
- Accelerometer charge sensitivity — 2.3 pcmb/g nominal.
- Acceleration range—vibration, 2000 g sinusoidal; shock, 2000 g 75  $\mu$ sec half sine wave pulse.
- Linearity —  $\pm 2\%$ .
- Temperature response — (see typical curve).
- Insulation resistance — 1000 megohms minimum over the rated temperature range.
- Response to acoustic noise of 140 db — less than 1 mv rms in reference to random noise of 75 cps to 10,000 cps.
- Humidity — epoxy sealed.
- Weight — 1.8 grams maximum, excluding cable.
- Instrumentation adaptability — compatible with CEC miniature electronics and other signal conditioning devices.

For all the important facts about the new 4-275 Piezoelectric Accelerometers, call your nearest CEC Sales and Service Office, or write for Bulletin CEC 4275-X3.

## CEC

Transducer Division

**CONSOLIDATED ELECTRODYNAMICS**

A SUBSIDIARY OF BELL & HOWELL/PASADENA, CALIF. 91109  
INTERNATIONAL SUBSIDIARIES: WOKING, SURREY, ENGLAND  
AND FRIEDBERG (HESSSEN), W. GERMANY

## IBM 12-pole wire contact relays give you 200 million operations ...at 45¢ per pole

Low price. High performance. Plug-gable. Fast delivery. And more.

Solderless connections, multiple coils, compactness and standardized mountings give you...lower manufacturing costs...lower initial product costs...lower product servicing costs.

IBM 12-pole relays start at \$5.40, 4-poles at \$2.90, latch relays at \$8.45. (Even less in quantity.) And, they're available for fast delivery.

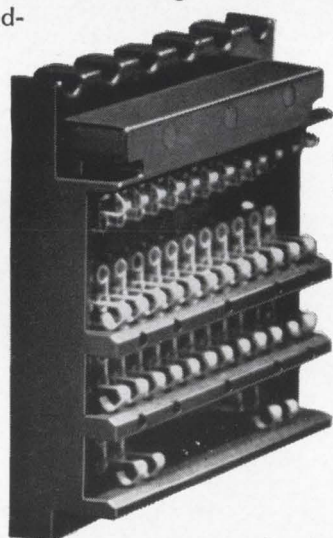

Use these IBM wire contact relays for counting logic switching, shift registers...communications, process control data processing, and many others.

Here's what you get with an IBM relay (shown here 1/3 larger than actual size): Long life—up to 200 million operations; high operate speed—as fast as 4 ms; fast release time—under 5ms; versatile contact

arrangements—4, 6 and 12 PDT, Form C, 4 and 6 PDT latch; maximum reliability—1 error per over 400 million contact closures at 48 VDC is attainable; variable coil voltages—up to 100 VDC; contact rating—3 amp steady state.

Send for your copy of our wire contact relay catalogue; IBM Corporation, Industrial Products Division, 1000 Westchester Ave., White Plains, N.Y. 10604.

Overseas, contact your local IBM World Trade Corporation office.

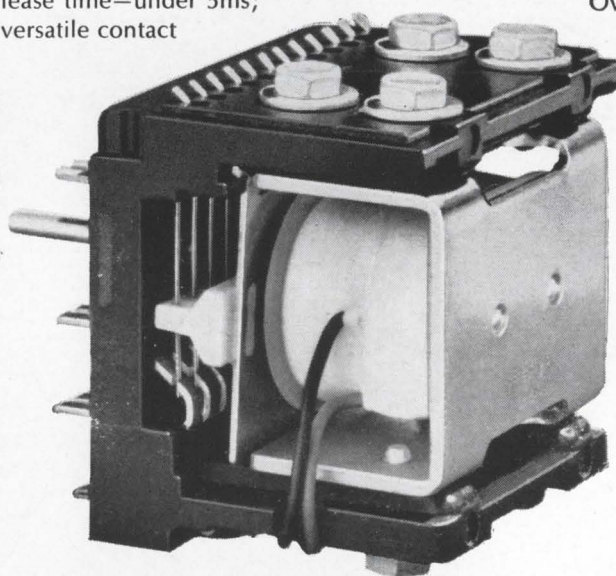

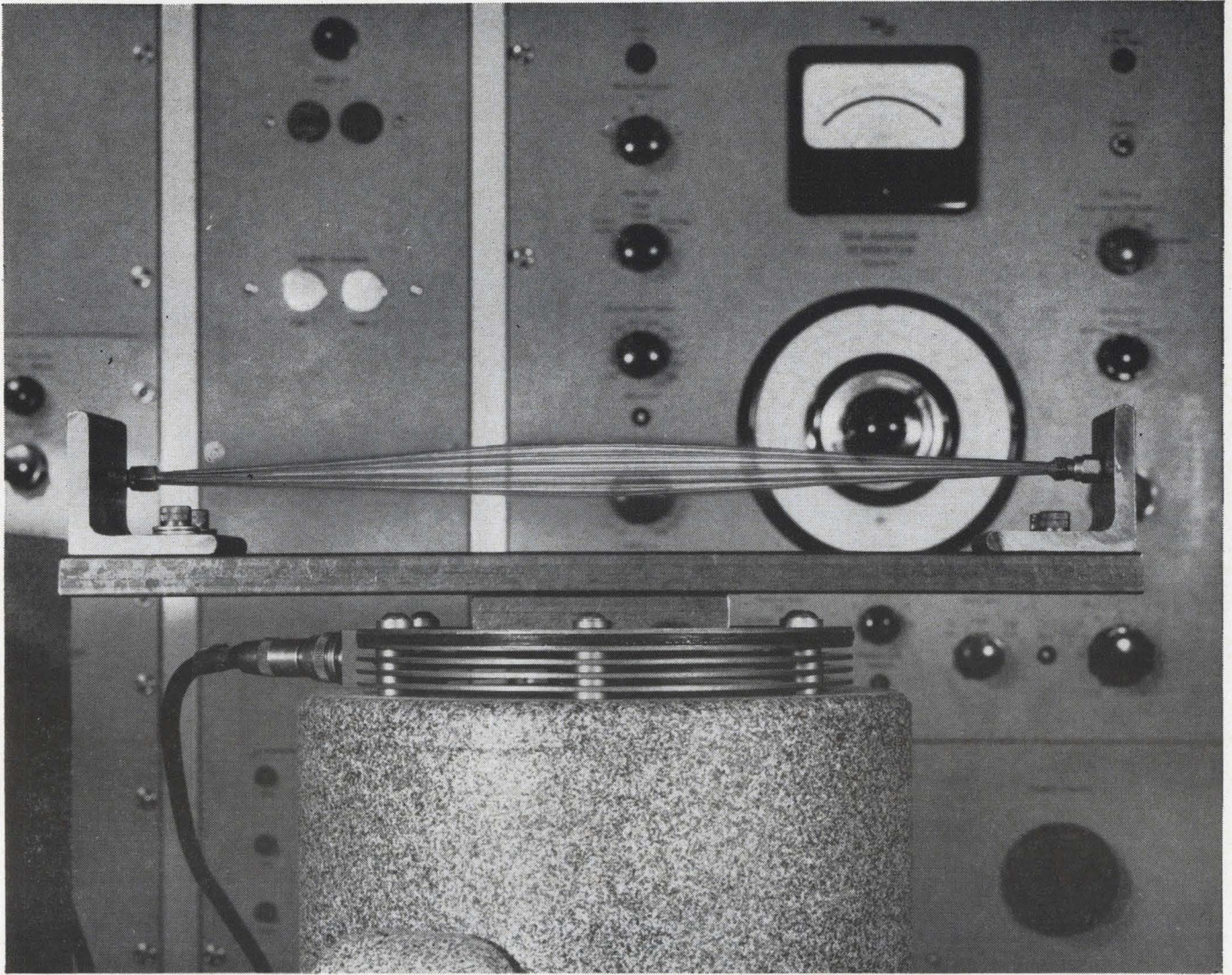

**This miniature coaxial cable of ours was vibrated at resonance 7 hours before the sheath cracked. The best competitive cable lasted 55 minutes.**

While flexibility is not the only consideration when you are specifying miniature coaxial cable, freedom to form to the needs of the application is a compelling factor in your choice. Think, for a moment, in terms of low noise amplifiers, microwave transmission, high speed computers and the wide range of black box requirements.

Here, then, is your answer. Miniature coaxial

cable with a silver plated Copperweld inner conductor, a TFE Teflon dielectric and solid, practically indestructible copper sheath, in standard, 50 ohm impedances, diameters of .070" and .141", lengths from 12' to 200'. Or, special diameters for your special needs.

Let us know if we can help you. Bulletin MC-1 with full details is yours for the asking.

**PHELPS DODGE** ELECTRONIC PRODUCTS  
NORTH HAVEN, CONNECTICUT



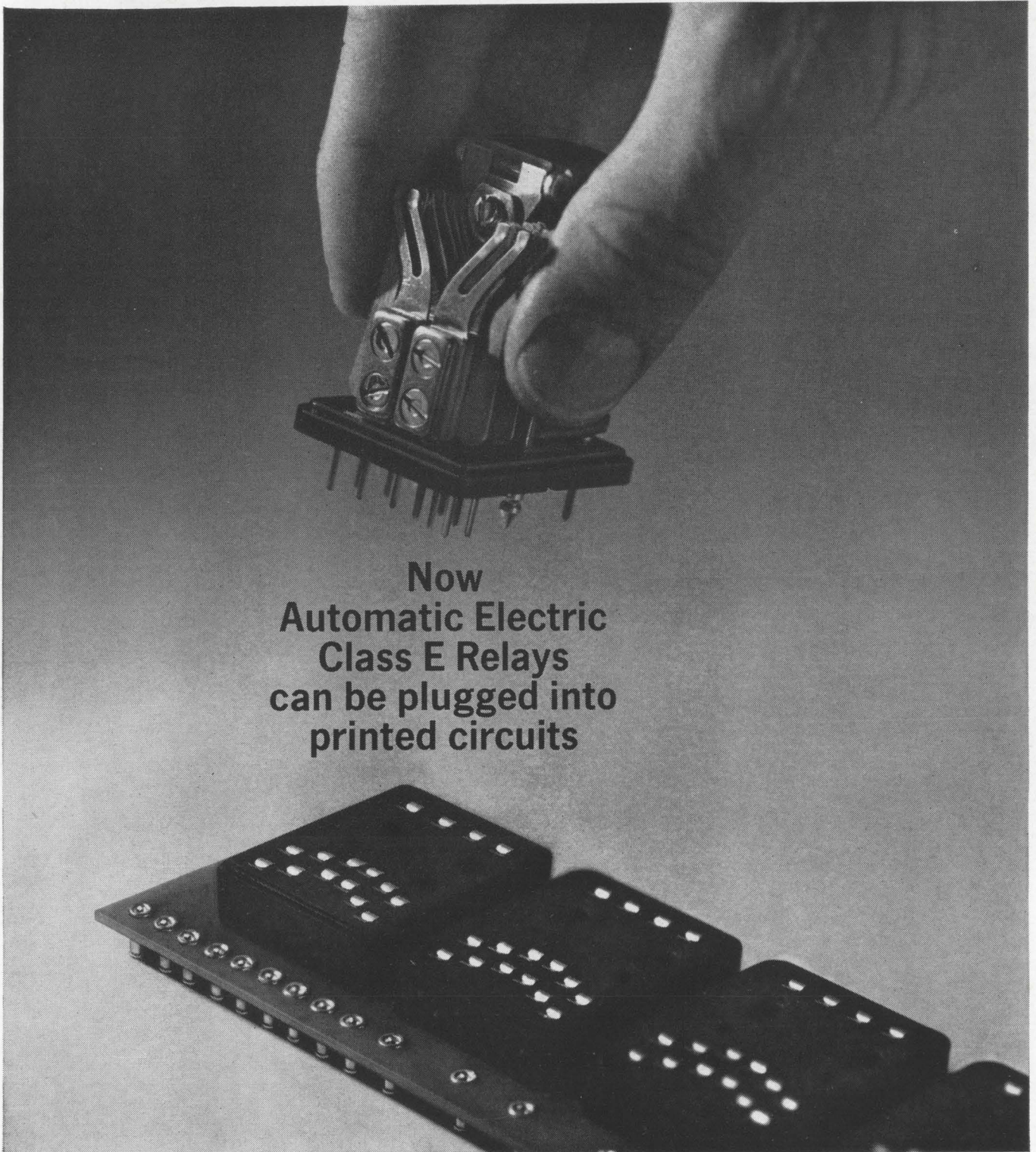

Now  
Automatic Electric  
Class E Relays  
can be plugged into  
printed circuits

Photographed in the laboratories of Pockard Instrument Company

See the special socket? It's a handy new convenience. You can attach the socket to the circuit—and insert a Class E taper-tab relay later on.

This new method can simplify packaging, shipping and inventory. You don't have to ship a printed-circuit board with the relay in place. Ship them separately—with all the resultant benefits.

At the receiving end, it's easy to insert the complete series ETA assembly with its plastic dust cover. Remove it anytime, quickly. The socket stays in place.

Want some helpful details? Just drop us a line, and ask for AE's Product News on the ETA socket.

**Widest Mounting Choice**

In addition to this new ETA socket with printed-circuit terminals,

other Class E relay sockets are available with dual taper-pin and taper-tab terminals. And the relays themselves can have conventional solder, taper-tabs, or wrapped-wire terminals, or pins for plug mounting.

This amounts to the industry's widest selection of Class E relay connections—another good reason to check Automatic Electric for *all* your relay needs. Write the Director, Relay Control Equipment Sales, Automatic Electric, Northlake, Illinois 60164.

**AUTOMATIC ELECTRIC**  
SUBSIDIARY OF  
**GENERAL TELEPHONE & ELECTRONICS GTE**

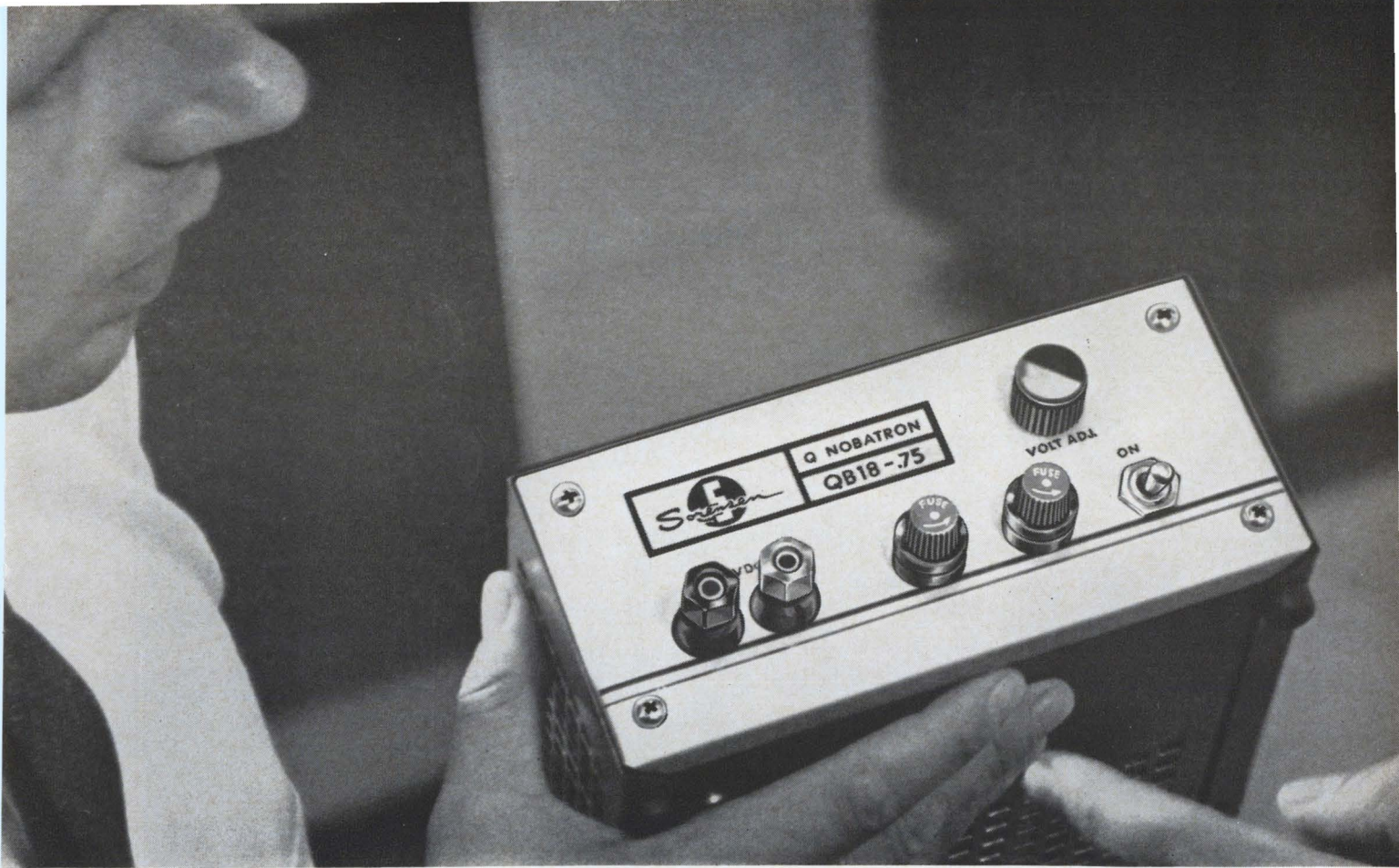

## "Only \$98?"

Yes! Sorensen's QB Series (transistorized DC power supplies) are available off-the-shelf for as little as \$98. Every one of the 24 models in this line provides:

- Constant current (Regulation  $\pm 0.01\%$ , line and load combined)
- Voltage regulation  $\pm 0.01\%$  (line and load combined)\*
- Extended voltage range, 2:1
- RMS ripple less than 300 microvolts
- Transient response 25 microseconds or less
- Temperature coefficient 0.015% /°C
- Drift typically less than 0.025% for 8 hours
- Output impedance as low as  $25\mu$  ohms +  $0.3\mu$ h
- No turn-on, turn-off overshoot
- Remote sensing
- Programmability
- Series or parallel operation

\*Regulation for 6-volt models  $\pm 0.02\%$

For complete specification and application information on the QB Series, and all other Sorensen products, send for the new 140-page **Controlled Power Catalog and Handbook**. Contact your local Sorensen representative, or write Sorensen, Richards Avenue, South Norwalk, Conn. Or, use reader service number 200.

### ELECTRICAL SPECIFICATIONS

MODEL NUMBER	OUTPUT VOLTAGE RANGE (VDC)	MAXIMUM OUTPUT CURRENT (AMPS.)	PRICE	MODEL NUMBER	OUTPUT VOLTAGE RANGE (VDC)	MAXIMUM OUTPUT CURRENT (AMPS.)	PRICE
QB6-2	5-9	2	\$ 98	QB28-2	18-36	2	\$160*
QB12-1	9-18	1	98	QB50-1	40-60	1	160*
QB18-.75	13-26	.75	98	QB6-15	5-9	15	215*
QB28-.5	18-36	.5	98	QB12-8	9-18	8	215*
QB6-4	5-9	4	108	QB18-6	13-26	6	215*
QB12-2	9-18	2	108	QB28-4	18-36	4	215*
QB18-1.5	13-26	1.5	108	QB50-2	40-60	2	215*
QB28-1	18-36	1	108	QB6-30	5-9	30	285*
QB50-.5	40-60	.5	108	QB12-15	9-18	15	285*
QB6-8	5-9	8	160*	QB18-12	13-26	12	285*
QB12-4	9-18	4	160*	QB28-8	18-36	8	285*
QB18-3	13-26	3	160*	QB50-4	40-60	4	285*

\*Optional volt and ammeters \$30



Circle 117 on reader service card

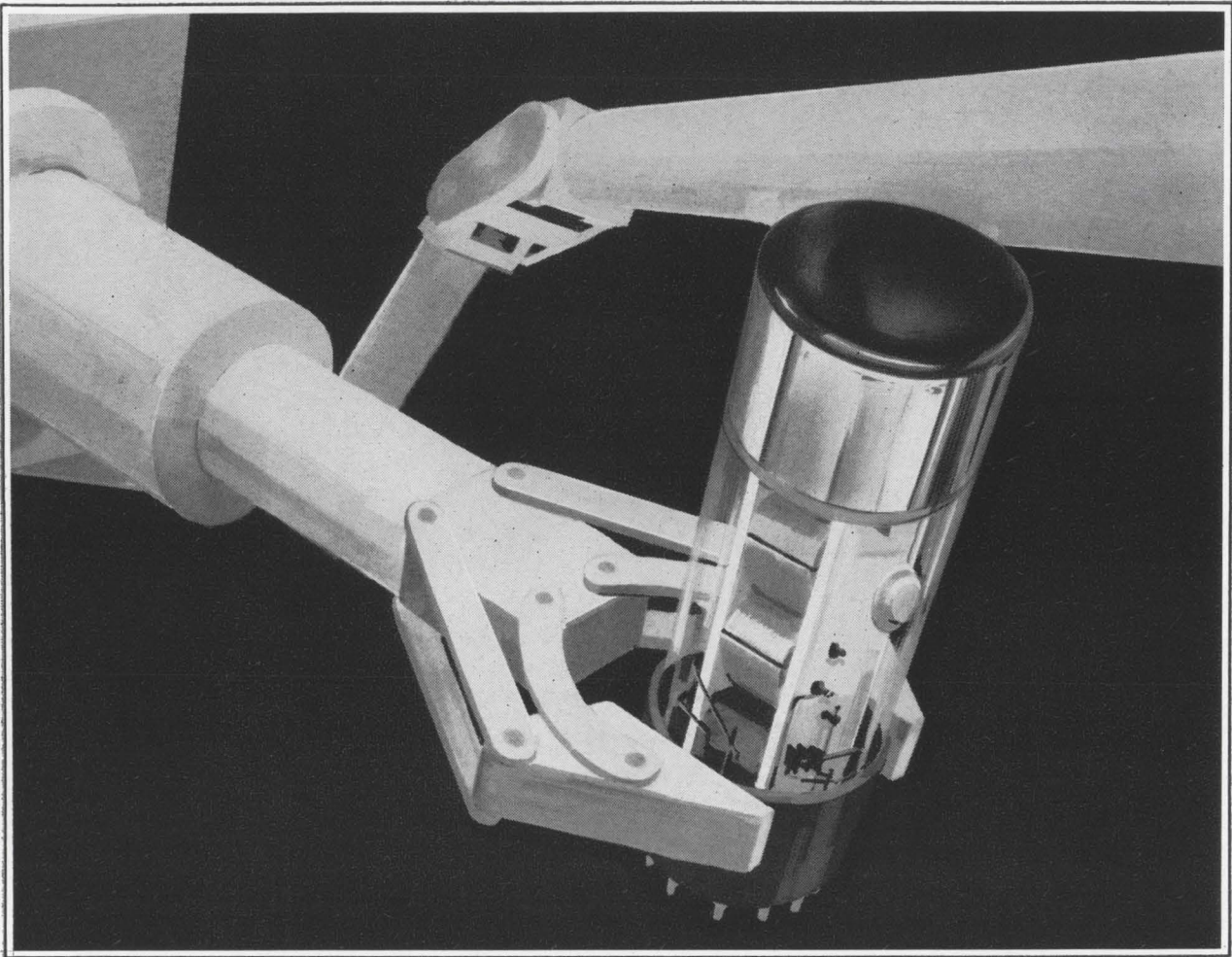

## **THIS PHOTOMULTIPLIER IS NOT FOR SALE!**

The last thing you want for scintillation counting is a radioactive PMT. Fairchild-DuMont has built such tubes, but not to sell. They are part of a continuous research program to upgrade the performance of DuMont PMTs. A radioactive tracer, Cesium 137, introduced into otherwise typical PMTs permits quantitative measurements of cesium disposition in the tube. These studies have led to improvements in processing which yield a tube with superior gain stability. The new radioactive tracer technique is but one of numerous developments resulting from DuMont's program of extensive product research and improvement.

Whether your application calls for a PMT of standard type, a special modification or a wholly new design, you can confidently make DuMont your preferred source. That applies also to CRTs, Storage Tubes, Power Tubes and Ionization Gauges. Describe your requirements to your distributor, or write Fairchild-DuMont Laboratories Tube Division, 750 Bloomfield Ave., Clifton, N.J.

Selected career engineering opportunities are available. An equal opportunity employer.

**FAIRCHILD**

**DU MONT LABORATORIES**  
ELECTRONIC TUBE DIVISION



# Digital voltmeter ignores common-mode noise

Solid-state device attains accuracy of 0.005% and remote rate of 15 readings a second with 140-db rejection at all frequencies

As military and industrial electronics become more sophisticated, measurements are faster, more precise and—as an unfortunate corollary—more subject to common-mode noise. To alleviate the noise problem, the Hewlett-Packard Co. has introduced a solid state digital voltmeter that achieves common-mode noise rejection of 140 decibels at all frequencies, with 1,000 ohms unbalance, without resorting to speed-reducing input filters.

Model 3460A is both integrating and potentiometric. It is, in fact, an automated, integrating, guarded differential voltmeter. Its readout is five digits, with a sixth for over-ranging. Maximum resolution on the lowest range is 10 microvolts. Input impedance is 10 megohms on all ranges. The instrument can provide readings as fast as 15 a second, with accuracy of  $\pm 0.005\%$  of reading ( $\pm 2$  counts).

The unknown input voltage is continuously applied through an input attenuator to a voltage-to-frequency converter, where a train of pulses is generated whose frequency is proportional to the input voltage. The use of a voltage-to-frequency converter to obtain integration minimizes the effects of hum and noise superimposed on a d-c signal. The converter lends itself readily to guarded construction, reducing common-mode noise.

To obtain high accuracy and speed, the 3460A employs two precise sampling periods per reading. During the first sampling period, the pulses generated by the converter are entered into the four most significant counting units. This is a coarse approximation (up to 0.3%) of the input voltage. During this coarse sample, the converter is used alone, with no feedback. At the end of the first sampling period, the count is stored in counting units and is transferred to a digital-to-analog converter. The conversion accuracy of the d-to-a



converter is 0.002%. The converter's analog output is compared with the input voltage. The error signal—the difference between the input voltage and the d-to-a converter analog output—is then applied to the voltage-to-frequency converter.

Then the voltage-to-frequency converter assumes the task of a null meter, measuring the difference voltage by converting it into a train of pulses whose frequency is proportional to the difference voltage. The pulses generated during the second sample period are entered into the least significant counting units. Since all the counting units are reversible, the second reading can be added or subtracted from the first reading depending upon the direction of the error of the first reading. In this way, the input voltage is integrated.

If the pulses counted during the second sample period exceed 99, there is an overflow and the fourth digit is changed accordingly. At the end of the second sample period, the counts contained in all the counting units are transferred to the display tubes for digital indications directly in volts measured.

The reference supply, a prime determinant of the instrument's accuracy and stability depends upon an aged zener diode that is tem-

perature-compensated. The instability of the reference supply is less than 0.001% per month.

The 3460A is designed for fully automatic operation within a data-acquisition system. Measurement function, voltage range and sampling rate can all be externally selected. In addition, binary-coded decimal output voltages are produced for each measurement and for indication of measurement function, voltage range and polarity for recording. A complete printed record of the output information can be obtained with a digital recorder.

## Specifications

Voltage accuracy:	$\pm 0.005\%$ of reading $\pm 2$ digits from $+ 10^0$ to $40^0$ C
Ranges:	Full scale presentation of $\pm 1.00000$ , $\pm 10.000$ , $\pm 100.000$ and $\pm 1000.00$ v (up to 20% over-ranging)
Reading rate:	Remote—maximum of 15 independent readings per sec Local—maximum of 3 independent readings per sec to 1 independent reading per 5 sec
Input impedance:	10 megohms $\pm 0.3\%$
Polarity selection:	Automatic
Range selection:	Automatic, remote or manual
Common mode rejection	160 db at d-c
Size:	5 in. high x 16 in. wide x 21 $\frac{3}{8}$ in. deep
Price:	\$3,600 (standard unit)
Availability:	60 days after receipt of order

Hewlett-Packard Co., 1501 Page Mill Road, Palo Alto, Calif.  
Circle 350 on reader service card

### Narrow Sweeps for the Sharpest Filters

#### 20 cps - 200 kc

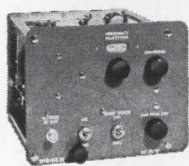

P-141A  
PLUG-IN

**RESIDUAL**

< .2 cps

**DRIFT**

< 3 cps in 1 min;  
15 cps in 5 min

Price: \$475.

#### 100 cps - 2.0 mc



P-130E  
PLUG-IN

**RESIDUAL**

< 1 cps

**DRIFT**

< 30 cps in 1 min;  
120 cps in 5 min

Price: \$375.

#### 2 mc - 32 mc

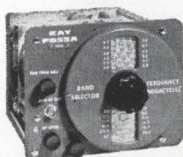

P855-A  
PLUG-IN

**RESIDUAL**

5 cps below 5 mc;  
10 cps below 35 mc

**DRIFT**

± .0005% for 1 min;  
± 0.1% for 3 hrs

Price: \$595.

#### 141-D Sweep and Marker Generator

#### 20 cps - 200 kc

**RESIDUAL** < .1 cps

**DRIFT** < 2 cps in 1 min;  
6 cps in 5 min

Price: \$1295.

### Prices slashed on miniature inductors

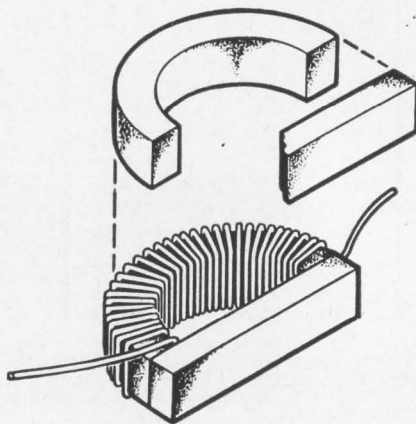

The Cambridge Thermionic Corp. claims to have cut in half the cost of making miniature inductors by modifying the shape of the inductor. The company uses a D-shaped core (see diagram) instead of the usual toroidal structures. The cost reduction is due to simplified technique used in winding wire around the core.

In the conventional toroid, wire has to be threaded into the center of the O cord and wound evenly up and around the doughnut shape. This requires complicated wire-winding techniques that add to the cost of the inductor.

Cambridge eliminates the toroid and uses a special wire-winding machine that winds the wire around the curved half segment of the D cord with a continuous spool of wire. A metal bar is then bonded to the wire-wound half segment, completing the inductor element. This technique has been used for winding large power transformers, but apparently has not occurred to toroid makers before this.

Company spokesmen say the magnetic field generated around the wound half segment continues around the D core in a continuous rotary path, similar to the magnetic field generated around a toroid structure. The new D cores obtain a repeatability of inductance values significantly better than other inductor core structures—cup cores, E or I cores—according to the manufacturer.

The D structure was originally

developed to make low-cost inductors for the RCA Signal Corps micromodule program—to be incorporated into portable radio receiving sets and helmet receivers worn by soldiers. The microelement inductors are available commercially in a range of fixed inductance values. Coil and wire winding can be purchased unmounted (part No. 3641), or mounted on a ceramic substrate (part No. 3365).

#### Specifications

Dimensions:	0.25 by 0.2 in.
Fixed inductance range:	0.01 $\mu$ h to 100 $\mu$ h
Temperature range:	-55° to +85° C
Price:	unmounted assemblies—79 cents ea. in quantities of 500 to 999 substrate mounted—\$3.40 ea. in similar quantities.

Cambridge Thermionic Corp., 445 Concord Ave., Cambridge, Mass. [351]

### Gasket improves rfi shielding

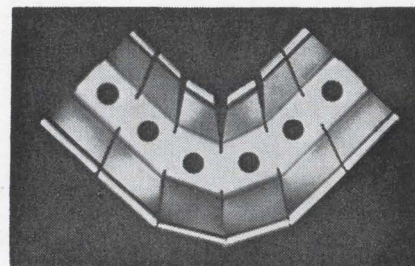

A new electronic gasket meets the demand for higher attenuation and is expected to permit design simplification of structures to be shielded from radio-frequency interference. Three mechanical problems in the assembly and maintenance of finger strip gaskets are solved by the new design: soldering is completely eliminated, prefabricated 90° corners are available for rectangular openings, and a new spring fastener permits easy assembly or disassembly in the field. The new spring fastener has a head thickness of only 0.004 in., permitting solid compression of the new gaskets to improve attenuation. The fasteners and gaskets are installed with a pencil butt, and

# 20 cps - 1000 mc Plug-ins



1500: BASIC SWEEP & MARKER RACK

## TYPICAL PLUG-INS

Model	Center Freq.	Sweep Width		Model	Center Freq.	Sweep Width	
P-141	20 cps-200 kc	20 cps-20 kc	\$475.	P-867	220-470 mc	20 kc-30 mc	\$200.
P-130	100 cps-2 mc	200 cps-2 mc	375.	P-123	100-1 kmc	Octave	335.
P152-A	10 kc-20 mc	10 kc-20 mc	375.	Model	Freq. Marker		
P-855	2-32 mc	20 cps-800 kc	595.	PM-7631	6 Pulse + Ext.		150.*
P-856	10-120 mc	40 cps-1 mc	595.	PM-932	30 Pulse		150.*
P-860	2-220 mc	10 kc-30 mc	595.	PM-861	Harmonic and CW Osc.		150.*

\*PLUS MARKERS

# SWEEP STEEP SKIRTS

AND  
AUDIO  
TAPE  
COMM.  
VIDEO  
VHF  
UHF

### ■ VOLTAGE CONTROLLED OSCILLATORS

### ■ MARKERS

- Pulse
- RF Turn-off
- Harmonic
- CW Birdie

### ■ SWEEP

- 0.2 to 60 cps
- Log and Linear
- External Input
- Manual Control

The basic rack contains a variable, sawtooth sweep generator, a fast-acting AGC, frequency-marker control and output circuits, RF output circuits with precision attenuators, a calibrated output meter, an accurate RF detector, and carefully regulated power supplies.

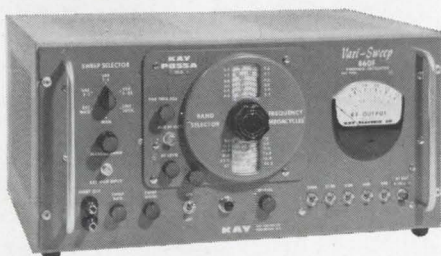

860F Racks for Sweeps Only Price: \$450.

1500 Racks Price: \$565.

## WIDE SWEEPS for the WIDEST TUNERS



P123-A PLUG-IN

100 - 1000 mc

Full Octave Sweep Width

### Sweep at Once

500-1000 mc  
300-600 mc, etc.

### Full 0.5 V rms into 50 ohms

A real Octave Sweep with Excellent Full-Width  
Frequency Linearity (Excellent narrow sweeps, too!)

Price \$335.

# KAY ELECTRIC COMPANY

Maple Avenue, Pine Brook, Morris County, N. J.

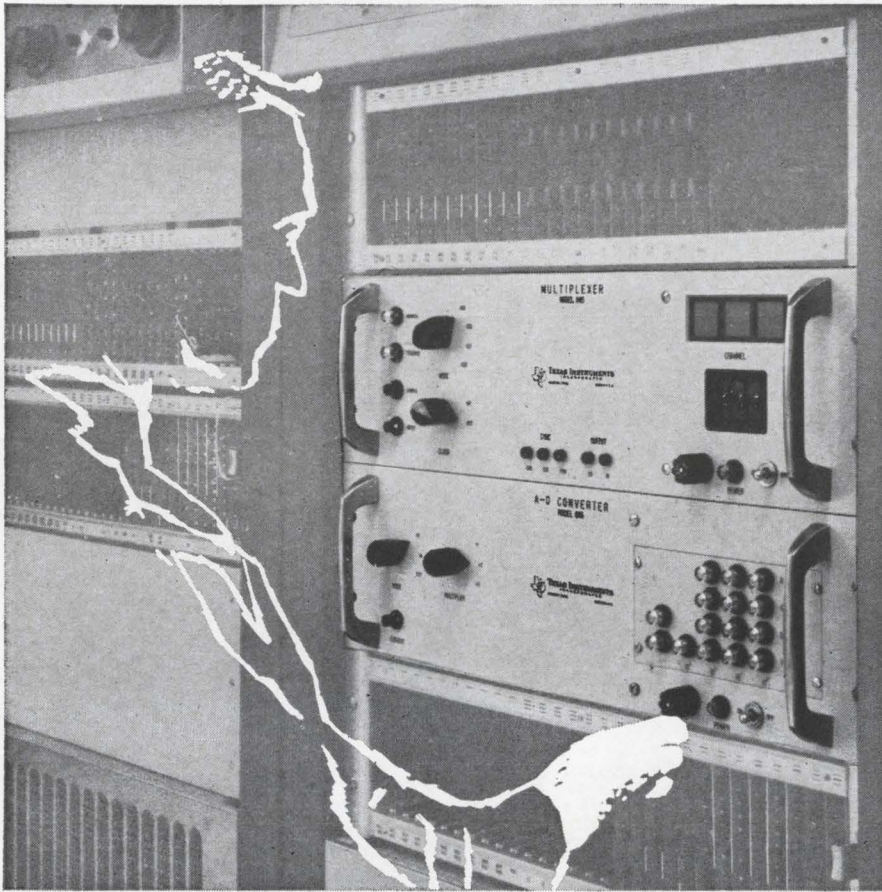

## Accurate Data Sampling and Conversion at 50 KC plus

**Model 846 A-D Converters**, in straight binary or BCD code, include an integral sample and hold circuit with 100 nanosecond aperture and automatic zero stabilization. Accuracy at 50 kc is 0.025% full scale . . . *sample and hold included!* Offered in a wide choice of input specifications, logic levels and output codes, plus D-A conversion option.

**Model 844/845 Multiplexers** feature 0.01% linearity with low dynamic crossfeed, fast settling time and variable sample duration. Choose from addressable, sequential, direct channel select, or combined addressable/sequential—all accommodate input levels to  $\pm 10$  volts. Basic capacities of 10 and 16 channels can be expanded tenfold with plug-in PC cards.

Ask a TI Application Engineer for further information on digital data handling equipment for your specific needs; one model must meet your requirements!

INDUSTRIAL  
PRODUCTS  
GROUP



**TEXAS INSTRUMENTS**  
INCORPORATED  
P. O. BOX 66027 HOUSTON, TEXAS 77006  
7 RUE VERNONNEX GENEVA, SWITZERLAND

692

## New Components

are removable without damage with a knife blade. Test results of the new design show attenuation in excess of 107 db on a variety of surfaces, and with a number of different fasteners. The gasket withstood over 60,000 compressions without failure in an accelerated life test.

Instrument Specialties Co., 244 Bergen Blvd., Little Falls, N.J. [352]

## Wire connector eliminates soldering

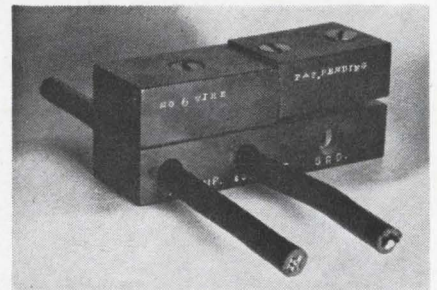

A new principle provides a unique, sure method of connecting wires in a positive, dependable terminal contact, according to the manufacturer. This wire connector is usable wherever wire ends meet. It eliminates the use of lugs, the soldering and annealing of wires; it is fireproof and waterproof, and severe jarrings and vibrations cannot disturb the contact. Extensive tests have proved that the strength of wire bonding is equivalent to 95-lb pressure. The new device connects two or more conductors using clamping members of an insulating material (Melamine), which resists fire and shock. The clamping members are grooved to varying diameter wire sizes; each variation means a variation in the wire connector size. Each connector is coded to insure correct joining. The clamping members are actuated by a spring screw passing through the center of the body. The spring screw causes a tension on the connection. Wire and terminals need no advance preparation—just strip and clamp, and the connection is made. The speedy, cost-saving wire connector can be

used on every wire diameter, including strand wire.

Loudin Electrical Co., 5 Willowbrook Place, Stamford, Conn. [353]

## General purpose relay has fewer parts

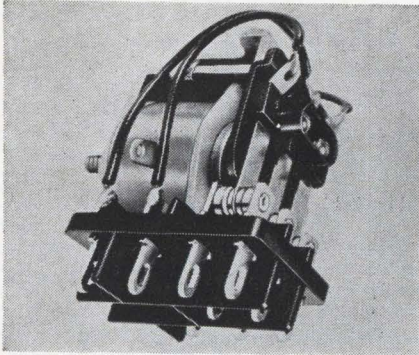

The open frame, continuous duty 25AA relay is said to offer greater reliability and better performance than other competitively priced relays, mainly because it has fewer parts than competitive relays. Some types have up to eleven fewer parts. Gold-plated contacts are standard, allowing longer shelf life and eliminating oxidation of contacts. Other advantages of the relays include: lower pull-in voltages (d-c, 70% of nominal voltage; a-c, 75% of nominal voltage); better life characteristics and improved design flexibility.

These general purpose relays are for heavy-duty spdt, dpdt or 3 pdt switching on a-c or d-c inputs. Rated loads are 5 or 10 amps at 115 v a-c. The units weigh two ounces. They incorporate mountings standard with industry: 6-32 tapped hole or 6-32 stud, both with a locating tab.

The a-c version has operating voltages of 0.5 to 250, a current range of 0.005 to 10 amps, and a temperature range of  $-55^{\circ}\text{C}$  to  $+72^{\circ}\text{C}$ . The d-c version has operating voltages of 0.2 to 130; current range, 0.005 to 10 amps; and temperature range,  $-55^{\circ}\text{C}$  to  $+85^{\circ}\text{C}$ . Coil voltages on the a-c range from 6 to 230, and on the d-c from 6 to 110.

The relays have a mechanical life expectancy of over 20 million operations under an extremely fast duty cycle of 350 times per minute. Eagle Signal Division, E.W. Bliss Co., Davenport, Iowa. [354]

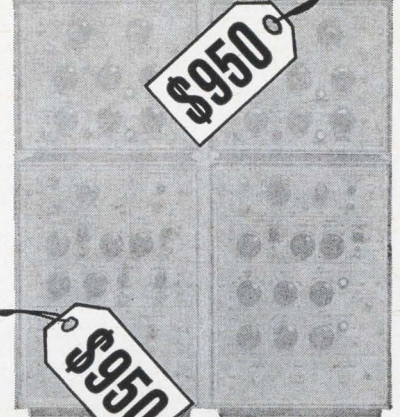
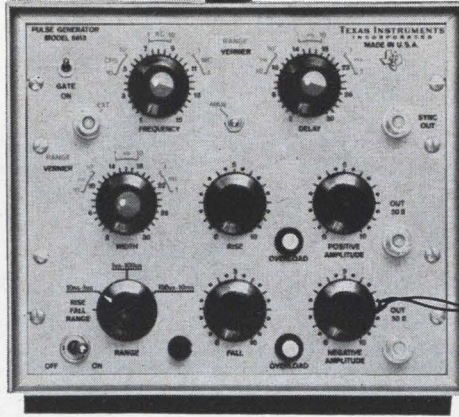
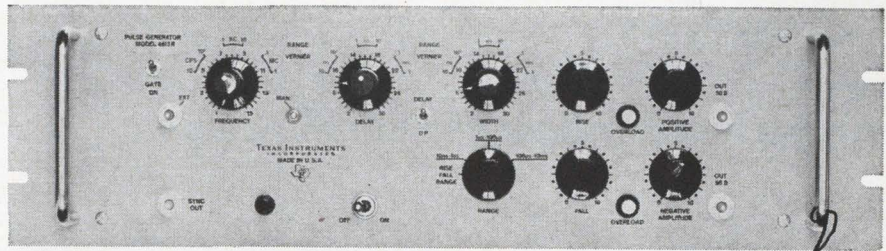

\$950

\$950

# more general-purpose features, higher performance and quality with TI's 6613 pulse generator

The Model 6613 General Purpose Pulse Generator fills the need for a low-cost, high-quality test instrument with exceptional performance specifications. It is a general purpose instrument ideal for most pulse applications such as testing integrated circuits, digital circuit design, system design and checkout, testing of diodes and transistors.

The 6613 provides coincident positive and negative pulses determined by an internal clock generator or external source, with rep rate variable in 6 steps. Pulse width and delay are also variable in 6 steps. Amplitude is variable from near zero to 10 volts, with overload protection provided. Solid-state circuitry is utilized throughout. The compact unit measures  $8\frac{1}{2}$  in. high,  $8\frac{1}{2}$  in. wide, 12 in. deep and weighs only 10 lb.

## SPECIFICATIONS

### Clock Pulse Repetition Frequency

15 cps to 150 cps	15 to 150 kc
150 to 1500 cps	150 kc to 1.5 mc
1500 cps to 15 kc	1.5 mc to 15 mc

### Delay

30 to 300 nano-sec	30 to 300 microseconds
300 nanoseconds to 3 microseconds	300 microseconds to 3 milliseconds
3 to 30 microseconds	3 to 30 milliseconds

### Width

30 to 300 nano-sec	30 to 300 microseconds
300 nanoseconds to 3 microseconds	300 microseconds to 3 milliseconds
3 to 30 microseconds	3 to 30 milliseconds

### Pulse Amplitude—10 v into 50 ohms

**Rise and Fall Times**—variable: less than 10 nanoseconds to 1 microsec, 1 microsec to 100 microseconds, 100 microseconds to 10 milliseconds, minimum rise time typically 8 nanoseconds

INDUSTRIAL  
PRODUCTS  
GROUP



**TEXAS INSTRUMENTS  
INCORPORATED**

P. O. BOX 66027 HOUSTON, TEXAS 77006  
7 RUE VERNONNEX GENEVA, SWITZERLAND

712

## New Instruments

# Remote head enhances sampling scope

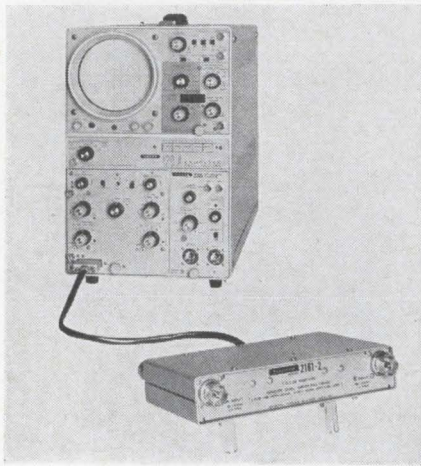

High-frequency measuring equipment does not lend itself easily to substantial reduction in size. General Applied Science Laboratories, Inc., has tackled this problem by separating the input circuitry of high-speed Lumatron 120A sampling oscilloscopes and providing a remote sampling head.

The model 2161 remote sampling head is compact and can be brought up close to the circuit under test. This eliminates the distortion of nanosecond pulses that occur when the pulses are fed to the scope through the normal length of coaxial cable. The pulses are amplified in the remote head so they are not affected by feeding to the scope over long coaxial lines, and the scope display is a truer picture of the fast pulse being measured.

The samplers in the remote head are of the feed-through variety and display a signal that does not necessarily terminate at the oscilloscope. The combination of the remote and feedthrough features of the model 2161 allows the user to break into a coaxial connection in the circuit under test and to insert the head without disturbing the circuit.

The company says the new unit is useful in display and measurement of fast semiconductors, fast tunnel diodes, fast diode-stored charge and fast signal phase-shift in Lissajous mode.

### Specifications

Rise time and frequency response:	less than 0.1 nsec, 10% to 90% equivalent to d-c to 3,500 Mc bandpass
Noise and smoothing:	less than 4 mv with smoothing control at minimum; less than 1 mv with smooth control at max
Sensitivity:	2 mv/cm to 200 mv/cm calibrated in 1-2-5 steps
Dynamic range:	$\pm 1$ v
Triggering:	external pre-trigger required approximately 70 nsec before signal
Input impedance:	50 ohms
Price:	\$1,590

General Applied Science Laboratories, Inc., Merrick and Stewart Avenues, Westbury, L.I., N.Y. [381]

## Solid-state clocks with decimal display

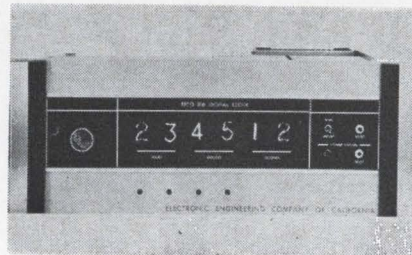

Two new precision digital clocks provide accurate time of day as a decimal display, and in binary-coded-decimal form. Types 815 and 816 provide parallel logic levels; in addition, the 816 provides serial readout. They provide direct time codes to data logging or data recording systems, computers, strip chart recorders, printers, etc. Both models feature all-solid-state design with no mechanical devices such as motors, relays, or stepping switches. Both units are synchronized to power line frequency, or may be supplied with an internal frequency source. In addition to the time codes, six square wave pulse rate outputs are simultaneously available. Each model includes a power failure indicator which remains on until a power failure reset is pressed. Both units measure 19 in. wide, 15 in. deep, 7 in. high, and weigh 32 lb. Prices start at



## Silicone Greases are available from these distributors

### ARIZONA

ELECTRICAL SPECIALTY COMPANY  
120 South 29th Street, Phoenix  
R. V. WEATHERFORD COMPANY  
9310 North Central Avenue, Phoenix

### CALIFORNIA

ELECTRICAL SPECIALTY COMPANY  
2820 East 12th Street, Los Angeles  
158-168 11th Street, San Francisco  
R. V. WEATHERFORD COMPANY  
6921 San Fernando Road, Glendale 1  
3240 Hillview Avenue, Palo Alto

### COLORADO

ELECTRICAL SPECIALTY COMPANY  
2026 Arapahoe Street, Denver 5

### DISTRICT OF COLUMBIA

READ PLASTICS, INC.  
317 Cedar Street, N.W., Washington 12

### FLORIDA

GULF SEMICONDUCTORS, INC.  
129 Almeria Avenue, Coral Gables 34

### ILLINOIS

FEDERAL INSULATION  
549 West Randolph Street, Chicago 7  
J. J. GLENN & CO., INC.  
605 West Washington Boulevard, Chicago 7

### INDIANA

HYALINE PLASTICS CORP.  
1019 North Capitol Street, Indianapolis

### KENTUCKY

GENERAL RUBBER & SUPPLY COMPANY  
3118 Preston Highway, Louisville 40213

### MASSACHUSETTS

NORTHEAST CHEMICAL COMPANY  
581 Boylston Street, Boston 16

### MICHIGAN

F. B. WRIGHT COMPANY, INC.  
9999 Mercier Street, Dearborn

### MINNESOTA

D. A. SCHULTZ COMPANY  
801 S.E. 8th Street, Minneapolis

### MISSOURI

D. A. JAMES COMPANY  
911 St. Charles Street, St. Louis 1  
REGAL PLASTIC SUPPLY COMPANY  
1735 Main Street, Kansas City

### NEW YORK

QUEEN CITY RUBBER COMPANY  
825 E. Ferry Street, Buffalo, N. Y.  
CHAMBERLIN RUBBER COMPANY  
455 East Main Street, Rochester 14604  
210 Marcellus Street, Syracuse 4  
PUNT, INC.  
160 Woodbine Court, Box 99, Floral Park

### OHIO

THE PHILPOTT RUBBER COMPANY  
2077 East 30th Street, Cleveland 15  
PARKWAY PRODUCTS, INC.  
1230 West Seventh Street, Cincinnati 45203

### OREGON

ELECTRICAL SPECIALTY COMPANY  
2360 N.W. Quimby Street, Portland 10

### PENNSYLVANIA

SMITH OF PHILADELPHIA  
Second and Somerset Street, Philadelphia 33  
SPECK-MARSHALL COMPANY  
P. O. Box 110, Nichol Avenue, McKees Rocks, 15136

### TEXAS

HOUSTON INDUSTRIAL SUPPLY COMPANY, INC.  
P. O. Box 52507, 1902 Bell Avenue, Houston 52  
LAWRENCE ELECTRONIC COMPANY  
P. O. Box 20676, 3422 Cridelle, Dallas 20

### WASHINGTON

ELECTRICAL SPECIALTY COMPANY  
2442 First Avenue, South, Seattle

### WISCONSIN

R. J. WITTENBURG COMPANY  
1338 West Atkinson Avenue, Milwaukee 53206

GENERAL  ELECTRIC

# A HALF-TON OF SPECIAL FIELD COIL NEEDS A LOT OF HEAT DISSIPATION

(And G-E Silicone dielectric grease does  
the job with half the volume of non-silicone  
heat transfer agents)

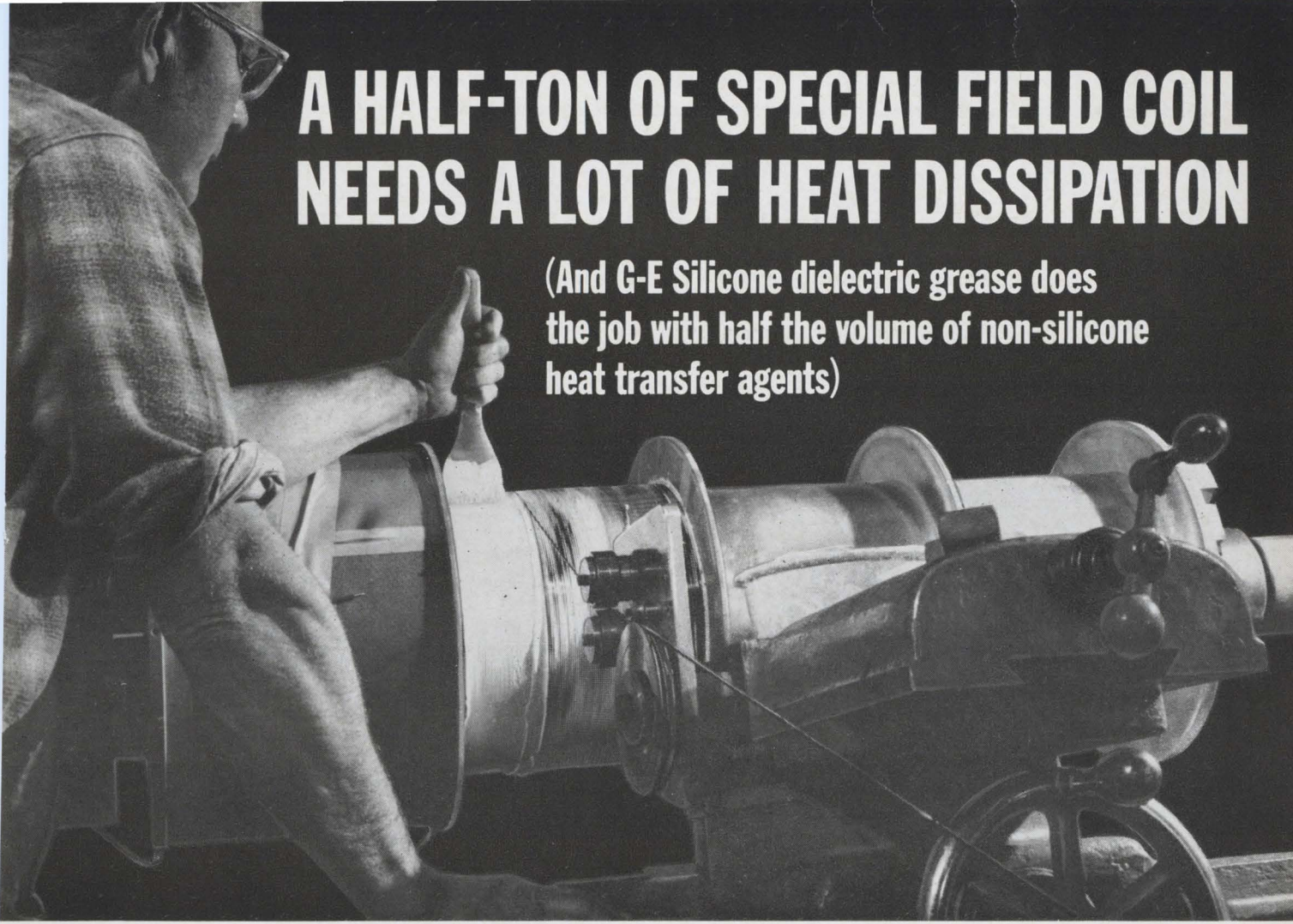

This Klystron tube used for vital radar defense is over four feet in height and is supported by a special field coil weighing more than a half-ton. To protect the coil from its own heat, G-E Insulgrease® Dielectric Compound G-640 is applied to the coil windings to assure dissipation of the heat as rapidly and as efficiently as possible, even under the most adverse conditions. To attempt to duplicate this high level of effectiveness and reliability would take *more than twice the volume* of a non-silicone heat transfer agent!

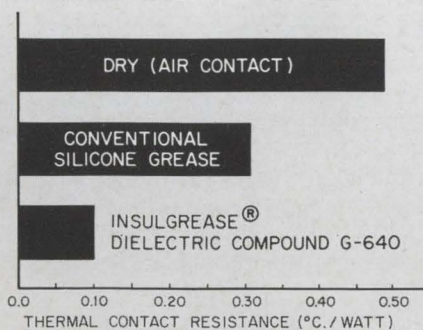

Data taken on a silicon power transistor mounted directly on an anodized aluminum plate. Mounting torque = 15 in.-lbs. Resistance measured as a function of the interface compounds between transistor case and mounting surface.

## THERMAL CONTACT RESISTANCE.

The high thermal conductivity of G-E Insulgrease Dielectric Compound G-640 is reflected at left in its thermal contact resistance. Most conventional silicone greases offer improved thermal contact resistance over that of air. G-640 offers a still greater improvement with a value of 0.09°C/watt. G-E silicone greases are also water repellent and high temperature (over 400°F) resistant. Chemically inert, they are highly compatible, non-corrosive and will adhere to almost anything.

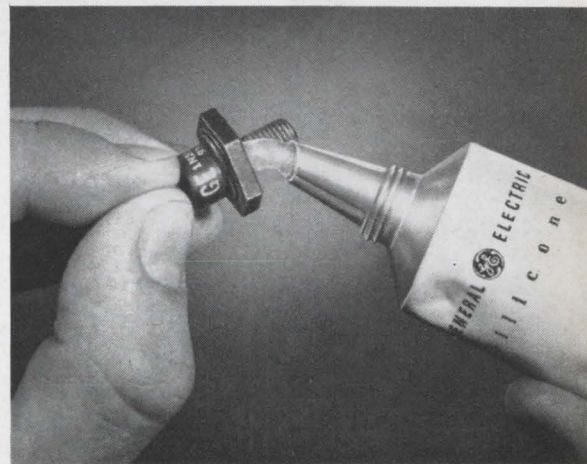

**G-E silicone dielectric greases, available from the distributors shown on the opposite page, offer you countless ways to insulate and protect electric circuits and components. Get your free sample — and a copy of our informative new data book, S-21 — and see. There are greases compounded for insulation, and for lubrication, and for general purpose use. Write on your letterhead, mentioning your application, to Section N4142, Silicone Products Dept., General Electric Company, Waterford, New York.**

**GENERAL  ELECTRIC**

Circle 125 on reader service card

# SMALLEST HIGH VOLTAGE POWER PACKS

Announcing Additions to the Widely-Used PC 1 HV-M Series Power Packs  
New Ratings . . . Most Items Available From Stock  
Rated Output Voltages from 1000 to 75,000 Volts

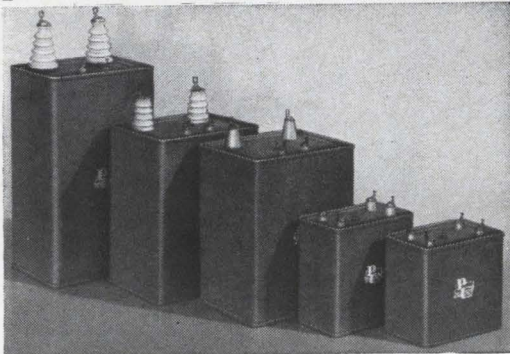

A welcome development in power packs — highest quality materials, smaller packaging, long life and high reliability — features commonly found only in power packs of much larger size and much higher cost.

Compact "M" Series Power Packs Give You:

- Choice of rated output voltages from 1000 to 75,000 DC
- Choice of rated output currents of 1.5, 5 and 10 milliamperes
- Choice of input voltages of 118, 220, 230 and 240 volts AC
- Input frequency range 50 to 500 CPS
- Output ripple 190 RMS at rated load and voltage with 60 CPS input
- Wide ambient temperature range
- Variable output from 0 to rated voltage
- Hermetically sealed

Write today for complete information, including technical data, on these amazing new compact power packs.

**Plastic Capacitors, INC.**

2620 N. Clybourn • Chicago 14, Ill.  
DI 8-3735

Custom  Engineering at  
Production Prices

Circle 203 on reader service card

## New Instruments

\$2,000, depending on options; delivery, 30 to 45 days.  
Electronic Engineering Co. of California,  
1601 E. Chestnut Ave., Santa Ana, Calif.  
[382]

## High-stability current source

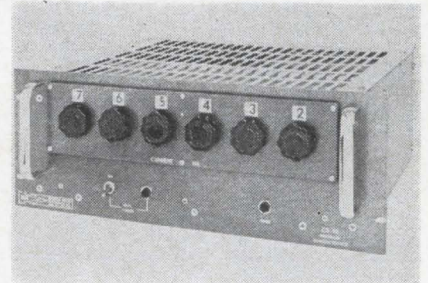

A precision d-c source is available for testing semiconductors and in other applications that require up to 1,000 ma. The unit has a long-term stability (100 hours) of better than 100 ppm at a maximum load of 12.5 v. Typical performance is 50 ppm. The equipment offers excellent performance at low current levels. Features include: high reliability, all-solid-state design, temperature controlled references, window in-line read-out, low temperature coefficient, programable, thorough shielding with low ripple, plug-in modules, and ease of operation. Applications include: testing of semiconductors, gyro torquers, meters, clutches, torque motors, solenoids, magnetic cores, batteries, precision light filaments, potentiometers, and resistors. Price is \$995.

North Hills Electronics, Glen Cove, L.I., N.Y. [383]

## Temperature controller weighs only 70 grams

Designed for electronics systems that demand highly stabilized temperatures—radar equipment, precision optics or parametric amplifiers—the Klixon 4CT proportional temperature controller weighs only 70 grams and has a silicon controlled rectifier output rather than a relay output. It is corrosion-

**TRYLON HLP T2-20 LOG PERIODIC ANTENNA**  
Double-layer, horizontally-polarized for 3 to 30 mc. 20° take-off angle.  
13 db/iso gain; VSWR: less than 2:1; power to 100 kw, A3.

**Three things make a good antenna system: design competency; fabrication proficiency; and economy—which is the sure result of integrating the electrical and the structural problems as a single responsibility of the TRYLON group.**

Elverson, Pa. 19520 (215) 942-2981 — International Division, 750 Third Avenue, New York, N.Y. 10017, U.S.A.



resistant, solid state and sealed in steel. Accurate temperature control is achieved by supplying power to the load in varying amounts according to temperature. As the temperature falls below the set point, more power is supplied to the load. As temperature approaches the set point, power to the load is decreased. A thermistor sensing unit, usually mounted in a remote location from the basic controller, provides a varying signal to the magnetic amplifier. The amplified signal triggers an SCR that modulates the alternating current, half-wave output, for a narrow proportioning band of 3° C. This proportionally controlled power output applied to the heater provides temperature stabilization within  $\pm 0.05^\circ$  C under fixed ambient conditions. The 4CT controller is equipped with glass-sealed, solder-type terminals and a choice of two mounting brackets. Three basic sensors are available: a surface sensing element with its own mounting bracket, an immersion probe for liquid or air temperature sensing, and a cylindrical probe for insertion in a solid mass. The sensors may be mounted in a remote location.

Metals & Controls, Inc., a division of Texas Instruments, Inc., Attleboro, Mass. [384]

### Unit converts frequency to d-c

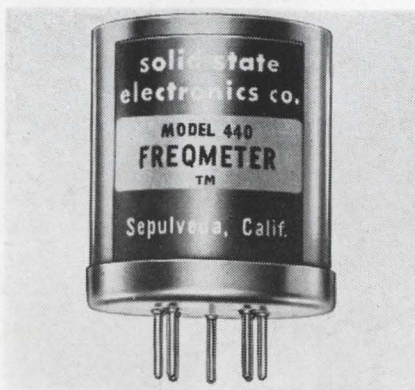

The Freqmeter is a completely solid-state unit that will linearly convert frequency or repetition rate of signals to a proportional d-c voltage. This is accomplished with four standard models over an input frequency range extending from 0 to 100 kc (model 410, zero to 100

*Over a barrel  
for magnetic metals?*

*use the  
theory of  
probability  
to solve your problems*

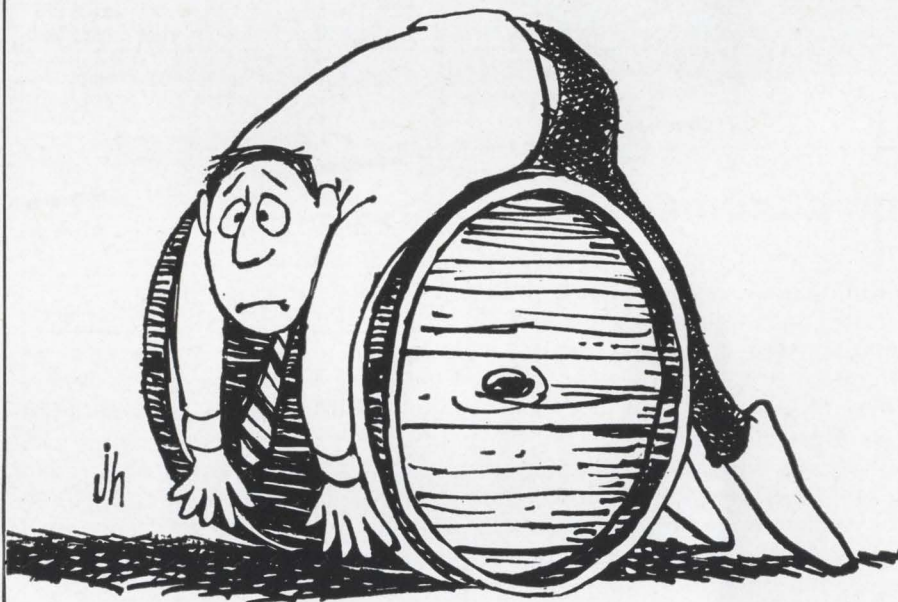

This is where experience counts! Chances are Hamilton has the answer for you . . . as we have for hundreds of others . . . whether it is ultra-thin foil, close-tolerance strip and wire or magnetic and high-temperature metals for computers, strain gages, delay lines, springs, diaphragms and an endless number of other applications. The Precision Metals Division of Hamilton Watch has the metallurgical "know-how" and the unique precision production facilities to do the almost "impossible!" What can you lose? Before you give up . . . ask us. Invest a postage stamp and ask for the brochure on Precision Metals. You will receive facts and information that you can use.

PRECISION METALS DIVISION  
 **HAMILTON**  
 WATCH COMPANY  
 LANCASTER, PA.

# RADIO & ELECTRONIC COMPONENT SHOW

## OLYMPIA LONDON 18-21 MAY

Sponsored by the  
Radio & Electronic Component Manufacturers' Federation



### BIG BUSINESS in small pieces

British radio and electronic equipment is world-famed.

But it can never be better than the components that go into it.

Fresh techniques in the component industry, new materials, more sophisticated test instruments and smaller-than-ever micro-miniaturisation are all to be seen at the Radio and Electronic Component Show at Olympia — Britain's only major electronic show this year — from May 18th to 21st.

It is the biggest, widest-interest show of its kind. Three hundred exhibitors demonstrate the scientific and engineering progress which has rocketed component exports 13 per cent this year.

A record 50,000 visitors from 70 countries saw the last component show. This year's exhibition, 20 per cent larger and even more comprehensive in scope, is the show that every buyer, engineer and scientist must see.

#### Exhibits include . . .

**. . . components, accessories, valves, cathode-ray tubes, semi-conductors, instruments, test gear, materials, machinery and tools for:**

- Professional and scientific electronic equipment
- Process control, industrial electronics and automation
- Nucleonic and atomic power control apparatus
- Civil and military ground and air equipment
- Medical and biological electronic and allied apparatus
- Radar and navigational aids
- Guided missile and spacecraft equipment
- Electronic computers and data handling equipment
- Telecommunications equipment
- Radio and television receivers
- Tape recorders, record reproducers, film equipment
- Amplifiers, tuners and "hi-fi"
- Measuring instruments and test gear

An **I E L** Exhibition

Further details and free personal invitation card from:

**INDUSTRIAL EXHIBITIONS LIMITED 9 ARGYLL STREET LONDON W1 ENGLAND**

### New Instruments

cps; model 420, zero to 1 kc; model 430, zero to 10 kc; model 440, zero to 100 kc). The Freqmeter output is virtually insensitive to supply voltage, temperature, input amplitude or waveforms, and will function properly when driven with sine, square and triangular waves, pulses, etc. This unit will also indicate the average frequency of random signals. The output may be used to drive meters, galvanometers, recorders, oscilloscopes, computers, digitizers or other indicating devices. No warmup time is required. Applications of the Freqmeter include: frequency measurements, frequency discrimination, vibration analysis, radiation monitoring, frequency control harmonic analysis, speed control, vco stabilization, frequency recording telemetering, count rate measurements, f-m deviation, detection, tachometry and flow rate measurements. Solid State Electronics Co., 15321 Rayen St., Sepulveda, Calif. [385]

### Universal controller features high gain



Model 50 indicating proportional controller is a universal, high-gain unit for controlling power up to 60 kw. Unlike other controllers that require an operator to monitor the process continuously when changing the control point, this controller has a spring return switch. In the up position, the 10-turn vernier dial potentiometer can be set to a new control point as indicated by the meter. In addition, the high-

gain amplifier has feed-back adjustment that aids in compensating for time lags in the control system. The controller is suitable for temperature control application since it may be provided with calibrated probes containing thermistors, single crystal silicon carbide elements, or platinum wire for an over-all temperature span of  $-100^{\circ}\text{C}$  to  $+500^{\circ}\text{C}$ . The controller consists of a bridge circuit and solid-state amplifier, a firing circuit and a silicon controlled rectifier heat sink assembly. For loads up to 220 v, 12 amps, the unit is mounted in one cabinet that may be used on a bench or mounted on the wall. For loads above 220 v, 12 amps, the heat sink is mounted in a separate case. Price of the model 50 universal controller is \$110 to \$700 depending on the amount of power required. Delivery is 10 days.

Radio Frequency Laboratories, Inc.,  
Boonton, N.J. [386]

### Oscillator covers 0.35 cps to 52 kc



Model 420C provides simultaneous sine and square waves from 0.35 cps to 52 kc, with less than 1% harmonic distortion and 1 db amplitude variation. Both outputs are independently controlled in amplitude, and can be connected for floating or chassis-ground operation. A front-panel switch allows choice of either balanced or single-ended sine output, which is a continuous waveform without discontinuities typical of synthetic wave generators. Frequency calibration is  $\pm 2\%$ . Applications include testing of servos, geophysical instruments, timing controls, as well as vibration tests, low-frequency triggering, and transient response measurements. Price is \$410. Krohn-Hite Corp., 580 Massachusetts Ave., Cambridge, Mass. 02139. [387]

# G.E. now has an exclusive, new glow lamp that fits incandescent sockets... part of a full line of glow lamp indicators

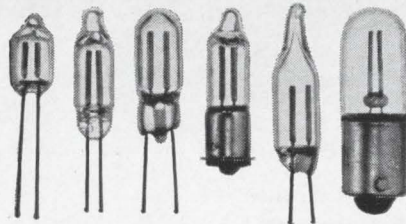

## to fit all your needs.

Now—for the first time—you have your choice between an incandescent indicator or our new  $\frac{5}{8}$ " based glow lamp that fits in the same size socket. It's priced in line with its incandescent counterpart and it's exclusive with G.E.!

Advantages of this new design—designated A1G and A1H—include:

- greater resistance to shock and vibration than a filament lamp of equal size
- elimination of a transformer when operated in series with a resistor on 110-120 volts
- standard item, readily available
- available in high and low brightness types

This new design is only one of a full line of more than 23 indicator glow lamps ranging in size from the tiny  $\frac{1}{2}$ " to  $3\frac{1}{2}$ " M. O. L. Illustrated above (actual size) are six of the most popular, smaller lamps.

*Want the last word in glow lamps?* It's yours in the brand-new, 1965 edition of G-E's 117-page Glow Lamp Manual.

Send for it now on your company letterhead. It's only \$1.00. (No purchase orders for less than \$5, please.)

Additional technical data available in Glow Lamp Bulletins 3-5022 and 3-4335, free as usual. Write to: General Electric Co., Miniature Lamp Dept. M-16, Nela Park, Cleveland, Ohio 44112



*Progress Is Our Most Important Product*

**GENERAL  ELECTRIC**



**4BT-2 Tiny-Stat Thermal Switch**  
Smallest, fastest!  
Weighs 0.2 gram

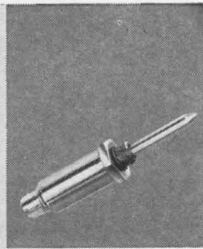

**Probe-Type Thermal Switch**  
Anticipates rapid temperature change.

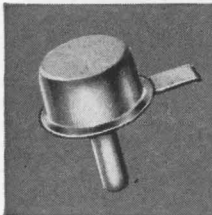

**3BT-2 Tiny-Stat Thermal Switch**  
Transistor-size. Shock & vibration resistant

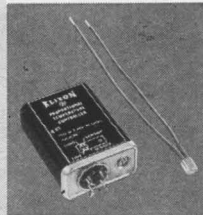

**4CT Solid State Controller**  
Stabilizes temperature at  $\pm 0.05^\circ\text{C}$ .

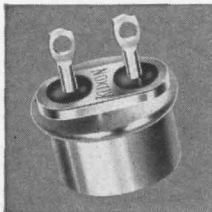

**M1 High Capacity Thermal Switch**  
Up to 7 amps, 30 volts Extra High Reliability (EHR)

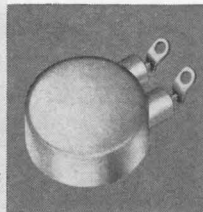

**M2 Narrow Diff. Thermal Switch**  
 $2^\circ$  to  $5^\circ\text{F}$  differential in  $0^\circ$  to  $250^\circ\text{F}$  range.

## RELY ON TI

### FOR TEMPERATURE CONTROL

**TI Precision Thermal Switches . . .** identified by the trusted KLIXON® trademark . . . is the only line that brackets all these characteristics: control within  $\pm 0.05^\circ\text{C}$ ; narrow differential; extremely fast response; large electrical capacity; subminiature size; open or close on temperature rise; single or double throw switching; automatic or manual reset; all-welded hermetic sealing; immersion probe sensing; tamperproof calibration; EHR (extra high reliability) series.

**Wide-range application!** KLIXON Precision Thermal Switches are now performing control or warning functions in thousands of industrial and military installations.

For complete information write today for a FREE copy of the KLIXON Thermal Switch Fact File.



**METALS & CONTROLS INC.**  
5005 FOREST ST., ATTLEBORO, MASS.  
A CORPORATE DIVISION OF  
**TEXAS INSTRUMENTS**  
INCORPORATED

## New Semiconductors

### MOS integrated circuits for commercial use

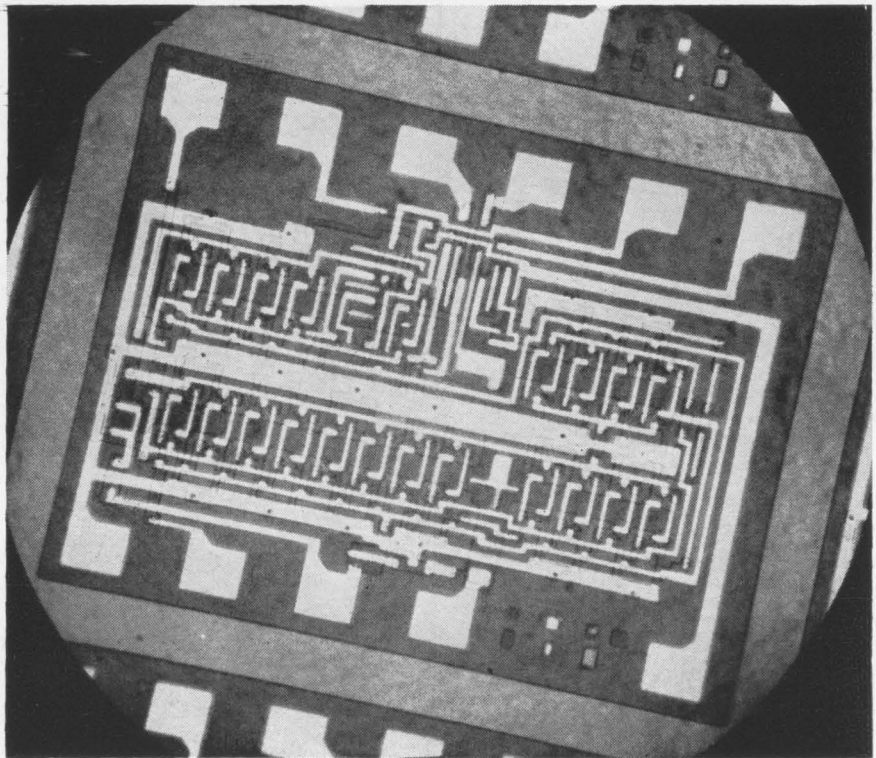

The General Instrument Corp. recently announced a major commitment in microelectronic circuits for consumer and commercial equipment. As a first big step, the company has announced the MEM501, a monolithic integrated circuit containing 110 metal oxide semiconductor (MOS) transistors and 48 resistors.

The MEM501 and subsequent integrated circuits planned for later this year will make it economically feasible to use microelectronic circuits in commercial equipment, according to Herman Fialkov, group vice president and head of the semiconductor products operation. Fialkov lists cash-register computers, adding machines, automobile speed controls and computers for sports scoreboards as commercial applications in which the MEM501 can be used.

The MEM501 wafer measures only 0.07 by 0.06 inch. It contains three shift registers, which share a common supply voltage. The shift registers can be used independently or connected in series

to form a 21-bit shift register.

The MEM501 requires 100 milliwatts of power from the battery supply; about six times this power would be needed to operate a 21-bit shift register built with 21 flip-flop circuits in which each integrated circuit was separately packaged.

The 21-bit shift register operates at up to 500 kilocycles. It is contained in a 10-lead TO-5 package and sells for \$74.50. Its operating temperature range is from  $-55^\circ$  to  $+85^\circ\text{C}$ . A military version, priced at \$97.50 and capable of operating from  $-55^\circ$  to  $+125^\circ\text{C}$ , is also available. Shipping of high-volume quantities of both commercial and military types will begin in June, the company says.

#### Specifications

Power consumption	$< 100$ mv
Supply voltage	$-22$ volts $\pm 10\%$
Output supply voltage	0 to $-22$ volts
Shift pulse amplitude	0 to $-10$ volts
Shift pulse frequency	d-c to 500 kc
Shift pulse rise and fall times ( $t_r$ , $t_f$ )	$< 100$ nsec
Shift pulse input impedance	6 pf, 50 kilohms
Input swing	0 to $-10$ volts

Output swing (no d-c load)	0 to -12 volts
Input capacitance	2 pf
Output impedance	2 kilohms at ground 10 kilohms at -10 volts
Operating temperature	-55° to 125°C, military -55° to 85°C, commercial

General Instrument Corp., 600 W. John St., Hicksville, N.Y. [371]

## Single junction silicon varactors

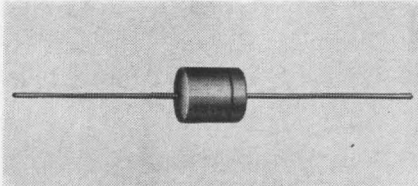

A line of single junction, high capacitance silicon varactors is now available for designers of communications equipment. Part numbers VH-310 and VH-311 are both rated at 1,000 pf at -4 v, 50 Mc with a Q of 30, and their maximum voltage ratings are 100 v and 50 v respectively. Other features of the units include: insulated body, axial leads, body size only 0.375 in. diameter by 0.435 in. long, and complete conformance to MIL-S-19500. The varactors are available in small quantities from stock to 2 weeks, and in production quantities within 3-4 weeks.

Solitron Devices, Inc., 256 Oak Tree Road, Tappan, N.Y. 10983. [372]

## Power transistor delivers 1 w at 1 Gc

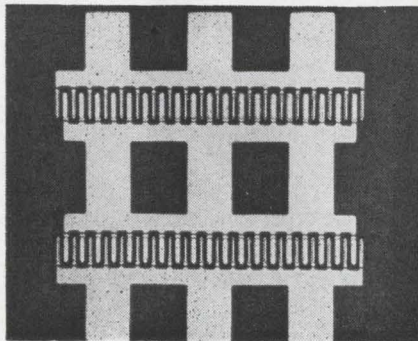

A high-frequency microwave power transistor now available can deliver a full watt output at a fundamental frequency of 1,000 Mc with guaranteed 40% efficiency. The MT1038

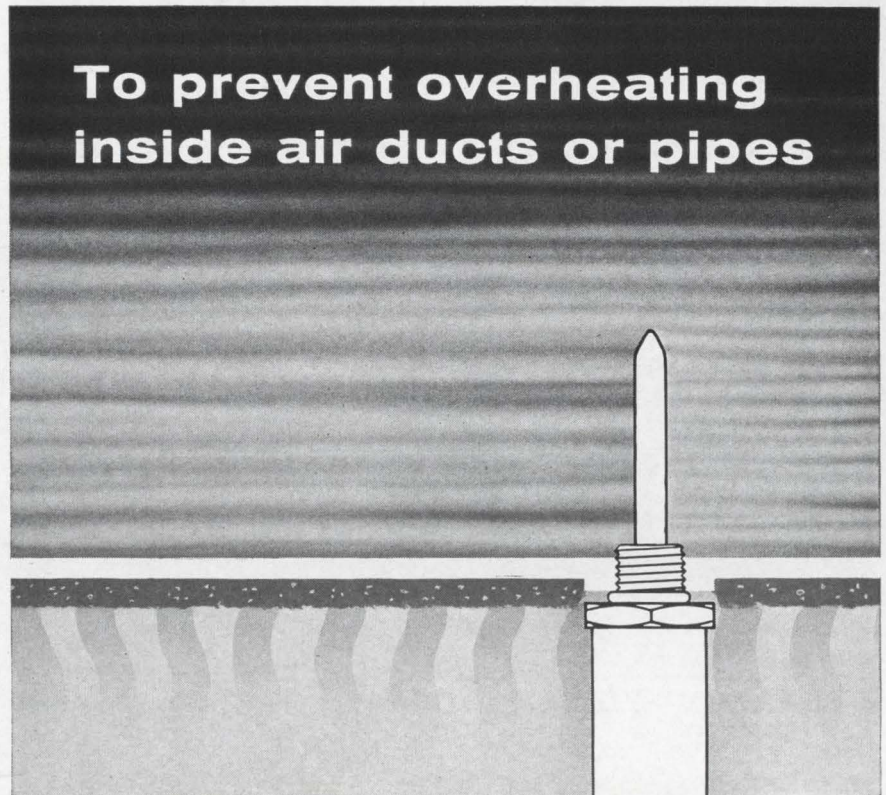
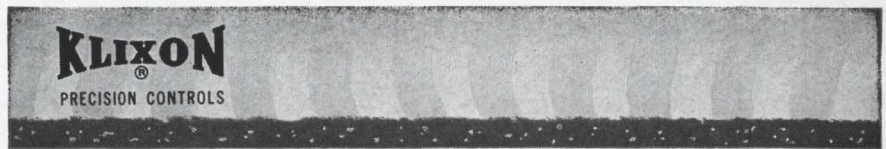

## RELY ON T<sup>1</sup> FOR TEMPERATURE CONTROL

**The Garrett Corporation does!** This leading manufacturer of aerospace heat transfer equipment uses KLIXON® 2PT probe-type thermal switches in the heating/cooling system of one of today's most advanced commercial aircraft. Inserted in the system's air duct, the 2PT functions as a high limit switch to prevent the cabin from overheating.

**Why specify 2PT?** Many reasons. Its temperature differential is within 1°F. Its rod-and-tube mechanism provides temperature anticipation under conditions of rapid rise. Its hermetically sealed construction preserves tamperproof calibration. It passes all applicable environmental tests of MIL-STD-202. Its operating range is 150° to 525°F. Its operating life is 100,000 cycles at full load.

For complete information about 2PT and other probe-type thermal switches, write for Bulletin PRET-13. We'll also send you the "Tunnel of Horrors" booklet which describes our testing procedures.

**KLIXON**  
CONTROL PLANTS IN  
Attleboro, Mass • Versailles, Ky.  
Richmond Hill, Ontario  
Holland • Italy • Australia  
Argentina • Brazil • Mexico



**METALS & CONTROLS INC.**  
5005 FOREST ST., ATTLEBORO, MASS.  
A CORPORATE DIVISION OF  
**TEXAS INSTRUMENTS**  
INCORPORATED

# AUTOMATIC **TESTER** FOR BOTH **NICKEL-CADMIUM** AND LEAD-ACID BATTERIES

**FULLY PROGRAMMED** — automatic turn-off or charger activation

**AUTOMATIC READ-OUT** — displays ampere-hours

**UNIVERSAL** — 12 and 24 volts, 3 to 100 ampere-hours

**PORTABLE** — only 11½ pounds

**SELF-POWERED** — no a-c required

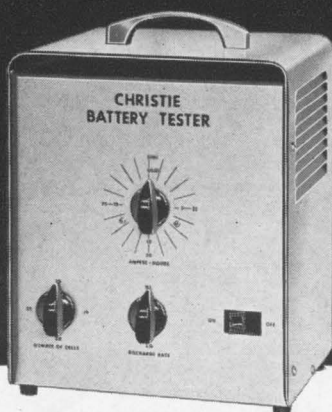

**CHRISTIE ELECTRIC CORP.** ..... Since 1929

3400 W. 67th Street, Los Angeles, California 90043

Circle 204 on reader service card

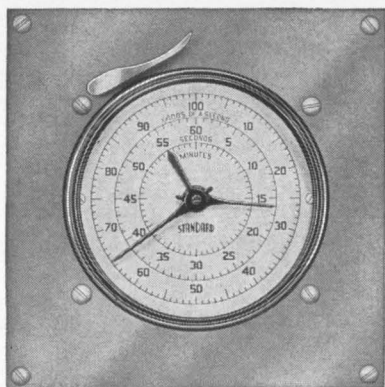

## THE ONE TIMER WITH ALL THE FEATURES

- Portable, Panel or Wall Mounting
- Scale Divisions from 1/1000 sec. to 1/5 sec.
- Totalize from .360 sec. to 60 min.
- Accuracy range from  $\pm .0002$  to  $\pm .1$  sec.

Since 1932 Standard Electric Time Company has been developing and manufacturing units for the precise measurement of elapsed time. Accuracy, rugged construction and long life are Standard features.

For full details request free 20 page catalog No. 257.

Model	Scale Divisions	Totalizes	Accuracy
S-100	1/5 sec.	6000 sec.	$\pm .1$ sec.
S-60	1/5 sec.	60 min.	$\pm .1$ sec.
SM-60	1/100 min.	60 min.	$\pm .002$ min.
S-10	1/10 sec.	1000 sec.	$\pm .02$ sec.
S-6	1/1000 min.	10 min.	$\pm .0002$ min.
S-1	1/100 sec.	60 sec.	$\pm .01$ sec.
MST-100	1/1000 sec.	6 sec.	$\pm .001$ sec.
MST-500	1/1000 sec.	30 sec.	$\pm .002$ sec.

**THE STANDARD ELECTRIC TIME COMPANY**

89 LOGAN STREET • SPRINGFIELD, MASSACHUSETTS

## New Semiconductors

is a silicon planar epitaxial device designed to operate both as an oscillator and as a large signal vhf or uhf class C amplifier. Available in the standard TO-46 three-lead package, the MT1038 reaches typical circuit efficiency of 50%. Under in-house laboratory conditions, the device has achieved extremely high fundamental frequency levels with these sample results: 1,500 Mc, 350 mw; 2,000 Mc, 200 mw; and 3,000 Mc, 10 mw. It has a maximum storage temperature of 200°C and an operating junction temperature of 175°C. Price for the MT1038 in 1-99 quantities is \$250 each. Fairchild Semiconductor, 313 Fairchild Drive, Mountain View, Calif. [373]

## Silicon transistor breaks power barrier

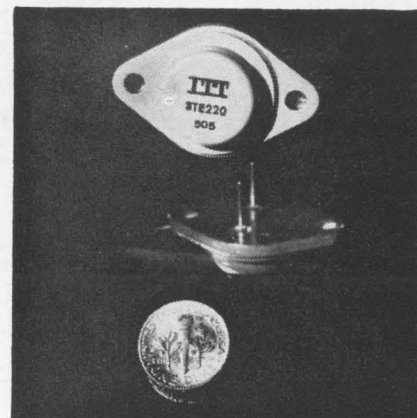

Claimed to be the world's most powerful r-f transistor, the 3TE220 is capable of developing 50 w r-f power output at 150 Mc. The silicon interdigitated power transistor is of the planar epitaxial type, with stabilization resistances for unmatched long-term stability, safe operating area and Class AB operation, along with its state-of-the-art power output. Designed for output use in high-gain Class B and C r-f amplifiers, the device has the emitter electrically connected to the case to permit exceptionally high-gain performance. Lower feedback between the input and output of the transistor is also made possible by this feature. The 3TE220 can develop 30 w at 28 v. It provides 7 db gain in a 40-v circuit and per-

mits maximum collector current of 2.5 amps. Collector-base voltage is 80 v; collector-emitter voltage, 80 v; emitter-base voltage, 4 v; total power dissipation, 100 w; storage temperature,  $-65$  to  $+200^{\circ}\text{C}$ ; junction temperature,  $175^{\circ}\text{C}$ . Packaged in a JEDEC TO-3 configuration, the device can be used singly to replace multiples of lower-power devices. Prices for the 3TE220 are \$275 for 1-99, and \$193 in quantities of more than 100.

ITT Semiconductor, 1801 Page Mill Road, Palo Alto, Calif. [374]

## Zener diodes operate at 1 ma

A line of 6.2-v temperature-compensated zener diodes with temperature coefficient ranging from  $0.01\%/^{\circ}\text{C}$  to  $0.0005\%/^{\circ}\text{C}$  and designed for 1-ma operation is announced. The diodes have single chip construction with alloy back contact to assure sharp knee, low-noise performance with long-term stability. They are furnished in the EIA DO-7 package. Delivery on quantities to 250 is being made on two-week schedules.

TRW Semiconductors Inc., 14520 S. Aviation Blvd., Lawndale, Calif. [375]

## Transistors switch 20-amp current

A high-current converter demonstrates the switching features of a new 20-ampere silicon planar transistor. The converter operates from a 12-v, 20-amp d-c power supply. A pair of triple-diffused 2N3597 transistors switch the 20-amp current at over 50 kc. The manufacturer says the 20-amp switching capability is unique in a silicon planar device. In addition, the high frequency permitted by the transistor allows reduced size of the converter package. Finally, the company claims that the use of silicon devices allows an increase in high-temperature ratings at currents previously impossible without the paralleling of the switching transistors.

Semiconductor Products Group, Honeywell, Inc., Division, 2755 4th Ave. S., Minneapolis 8, Minn. [376]

PLACE THE STYLUS, PUNCH A HOLE ○ PLACE THE  
STYLUS, PUNCH A HOLE □ PLACE THE STYLUS, PUNCH A HOLE △  
PLACE THE STYLUS, PUNCH A HOLE ○ PLACE THE STYLUS, PUNCH A HOLE ○ PLACE,

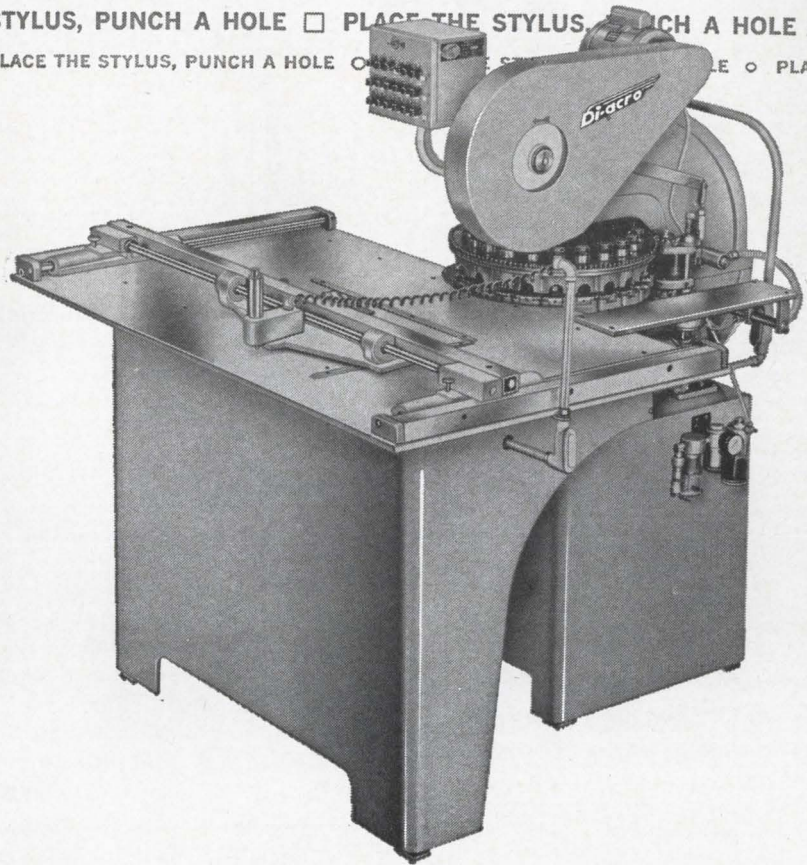

# FASTER THAN A HOLE A SECOND!

This is a brand new turret punch press. Electrically linked to a floating stylus. Trace the template, touch the button — punch your holes.

The feather-touch stylus floats on recirculating ball bearings. Accurate within  $.005$ " of the template. Eighteen punch and die sets always ready, always perfectly aligned. Change

setups fast as you can drop in a new template.

Capacity: up to 2" dia. hole in 14 ga. steel blank up to 19"x24". Over 500 standard and "special" punches and dies from stock. Custom shapes to your order.

Call your Di-Acro distributor for the big 44-page Punching Catalog. It's brand new, too!



## DI-ACRO

A Division of Houdaille Industries, Inc.  
455 Eighth Avenue, Lake City, Minnesota 55041

Di-Acro manufactures a complete line of benders, rod parters, brakes, press brakes, press brake dies, shears, notchers, rollers, punch presses, layout machines, spring winders and punches and dies. Write for catalog.



## GRAPHIC VISUAL CONTROL

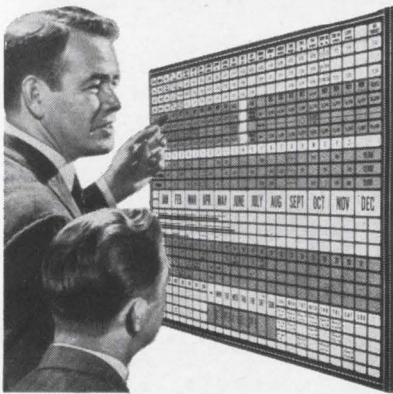

### You SEE How To Get Things Done With The BOARDMASTER System

You see a Graphic Picture of your operations, spotlighted in color. You have facts at Eye Level. Saves time, cuts costs and prevents errors.

Ideal for Production, Maintenance, Scheduling, Inventory, Sales, Traffic, Personnel and many other uses.

Simple and flexible tool. You write or type on cards and post on board. All cards are interchangeable.

Compact and Attractive. Made of Aluminum. Over 1,000,000 in use.

Complete Price **\$49<sup>50</sup>** Including Cards

**FREE** 24-Page BOOKLET No. C-10 Mailed Without Obligation

Write Today for Your Copy

**GRAPHIC SYSTEMS**

925 Danville Road • Yanceyville, N.C.

Circle 205 on reader service card

# MICO

## NEW SIX-RATIO STANDARD ENGRAVER

CAT. NO. 259

FOR LIGHT AND MEDIUM DUTY WORK

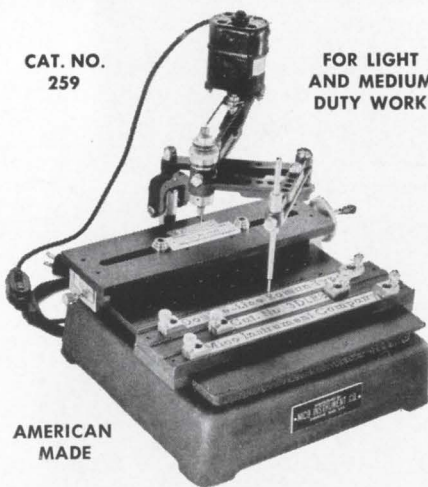

AMERICAN MADE

- Engineered for ruggedness and simplicity.
- Six pantograph ratios—from 1.5:1 to 4:1.
- Ball-bearing spindle uses 1/8" shank cutters and has true .250" micrometer depth control.
- Sturdy one-piece ratio studs anchor in ESNA stop-nuts for quick locking of pantograph arms.
- Master copy and work right-side up—in full view of operator. Raising stylus raises cutter.
- Attachments available for increasing versatility.

Send for bulletins and prices

**MICO INSTRUMENT CO.**

77 Trowbridge St.

Cambridge 38, Mass.

134 Circle 134 on reader service card

## New Subassemblies and Systems

### Laser for the classroom

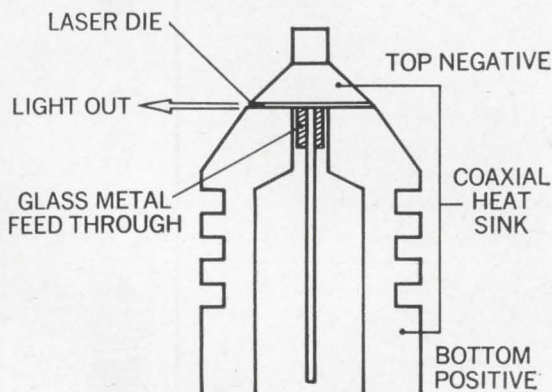
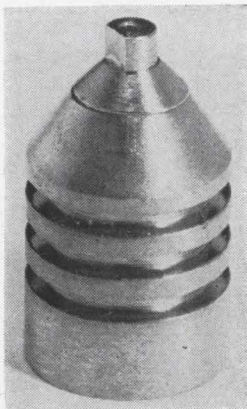

Coaxial heat sink welded to Korad's new GaAs room temperature laser.

Everybody is talking about the laser, but how many people have one? Although it has enormous potential, the instrument is so far pretty much a laboratory device, except for a few practical applications in eye surgery and welding. Now the Korad Corp., a subsidiary of the Union Carbide Corp., has marketed a gallium arsenide laser system that operates at room temperature and is, with its power supply, portable by one man. The system, consisting of a GaAs diode and a pulser, costs \$3,500 for the 4-watt version and \$2,200 for a 1½ watt version.

Korad's laser operates between 10 and 1,000 cps, too low for voice communications, but it is the forerunner of a 15-20 kilocycle system which will find use in military communications. Korad has operated such a system, nitrogen-cooled, over 12 miles.

The present commercial system is likely to find its greatest use in the classroom. Fred Burns, a Korad project manager, says 10 to 20 of them will go to schools which want to demonstrate laser principles without spending too much money. The system could also be used by companies that want a low energy source with precise control—for example, to evaporate minute amounts of material.

Key to room temperature operation was the design of a heat sink. A large heat dissipating area was required of the diode holder; but to achieve the ideal square wave

pulse, the holder had to be kept small in order to hold its capacitance to a minimum. Korad solved the dilemma with a copper core, and mounted the diode near the apex.

The GaAs crystal is produced by standard techniques, although the doping concentration is considerably higher than on crystals manufactured for cryogenically cooled devices. End faces of the crystal are polished parallel surfaces, which permit emission from both ends of the crystal. This results in loss of power, but the difficulty of polishing one triangular end, providing for internal reflection at one end and laser emission from the other, would increase the cost.

Robert Sehr, senior scientist at Korad, reports that a model of the new laser has been operated at 100 cps with an output of two watts for seven hours, with no detectable degradation of power. The infrared output falls within one of the atmospheric "windows" — wavelength values that pass through the atmosphere with little loss.

#### Specifications

Pulse duration	10—1000 pulses per second
Pulse frequency	50 nanoseconds
Spectral output	8650—8750 angstroms
Linewidth	13 angstroms
Efficiency	0.2%

Holder diameter (base)	0.38 inch
Holder height	0.62 inch

Diode width	0.006 inch
Diode length	0.010 inch
Diode height	0.0035 inch
Korad Corp., 2520 Colorado Ave., Santa Monica, Calif. [401]	



## Deflection amplifier drives crt yoke coils



Model 1476 solid state deflection amplifier is a dual channel power amplifier designed to drive the horizontal and vertical yoke coils of a cathode-ray tube. Applications are in radar and computer displays. Features include a self-contained blower, automatic thermostatic cut-out for thermal overload, all silicon transistors and a plug-in preamplifier. Power input is  $\pm 20$  v d-c, 6.5 amps maximum and 115 v, 400 cps, 0.15 amp for the blower. Input impedance is 10,000 ohms nominal; signal amplitude,  $\pm 3$  v; output current,  $\pm 3$  amps; step response time, 400  $\mu$ sec max at 1 amp; small signal sine wave response, flat within 3 db, d-c to 10 kc with 1 mh yoke load at  $\pm 250$  ma; dynamic linearity,  $\pm 0.5\%$  max for 95% of sweep input up to  $\pm 3$  amps; d-c linearity,  $\pm 0.5\%$  max for  $\pm 3$  amps; fly back or recovery time, 600  $\mu$ sec max. Melcor Electronics Corp., 1750 New Highway, Farmingdale, L.I., N.Y. [402]

## Coincident-current core memory systems

Advanced design, coincident-current, core memory systems are announced. Three models are available: the CC100 with read/write cycle time of 1  $\mu$ sec, word size to 16,384 words and bit length of 4 to 60 bits; the CC200 with read/write cycle time of 2  $\mu$ sec, word size to 16,384 words and bit length from 4 to 60 bits; and the CC500 with read/write cycle time 4.8 to 10  $\mu$ sec, word size to 16,384 words,

## "A GUY COULD GET KILLED IN HERE"...

... this place is like a roller-skating rink! What's all the traffic? I had to *fight* my way into the instrument room!

*Oh, hello, Rip! Yes, we're doing a rush business here today! Every instrument in the joint's been in and out of here at least twice. Particularly amplifiers — just can't get 'em back here fast enough to meet all the requests!*



Amplifiers? Any special types really hot right now?

*Dunno. All my data-acquisition types have been out for about a week now. And all my audio amplifiers are down the hall in Dept. 23. Video amplifiers have been on the most-wanted list, too. And here are three requests for RF amplifiers I can't even fill until tomorrow at the earliest!*

What you need are more amplifiers like Krohn-Hite's DCA-10 — a stable ten watts, tenth-percent distortion, wide band!

*We're always using the DCA-10's you sold us — as audio amplifiers, mainly. But how about the other applications I've got to fill?*

But nothing! You're short on data-acquisition types? Look — the DCA-10's direct-coupled, goes all the way down to dc. Only 0.2% distortion at 0.1 cps. Perfect on data circuitry. And talk about video amplifiers — the DCA-10 is one in disguise! No droop on a step function from a DCA-10, as you'd get from a capacitor-coupled amplifier! And with a megacycle bandwidth, you get a rise time in the order of 0.1 microseconds.

*Yeah, the top end of a megacycle would serve the needs of many of the requests for RF amplifiers.*

Now you're thinking Krohn-Hite! Actually, there's really nothing like it for the money — frequency response flat within a db all the way up, stable dc level, too, and low hum and noise.

*You certainly don't have low hum and noise!*

What do you expect — *I'm a rep!* Just one more thing — when you need 20 watts push-pull — two DCA-10's cascaded, one in the unity gain position, will give it to you. For *more* power, its big brother, the DCA-50 gives 50 watts single-ended or 100 watts push-pull, up to 500kc, with the *same* clean specs of the DCA-10. Now, anything else I can tell you about the DCA-10?

*Yeah — price and delivery on twenty!*



**KROHN-HITE  
CORPORATION**

580 Massachusetts Avenue, Cambridge 39, Mass.  
Area Code 617 491-3211

*Pioneering in Quality Electronic Instruments*

A design file  
of microelectronic  
materials, processes,  
techniques, and  
special circuits

## MICROELECTRONIC CIRCUITS AND APPLICATIONS

By JOHN M. CARROLL

352 pages, about 800 illustrations of  
circuits, devices, and applications  
\$9.75

Here are the full facts and technical data on microelectronics. In this book you'll find a vast fund of information on the design and application of circuits, and the materials and processes used to fabricate them. All major approaches to microminiaturization are covered, including micromodules using discrete components, thin-film circuits, and monolithic semiconductor circuits. New semiconductor devices especially applicable to microelectronics are described along with many special and unusual circuits. Containing more than one hundred articles that first appeared in *Electronics*, the book reflects current developments in microelectronic materials, processes, and practical applications.

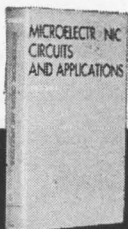

BUY THIS BOOK  
AT YOUR BOOKSTORE  
OR MAIL THIS COUPON

McGraw-Hill Book Co., Dept. 23-L-385  
330 West 42 Street, New York, N. Y. 10036

Send me John M. Carroll's  
MICROELECTRONIC CIRCUITS AND APPLICATIONS for 10 days on approval. In 10 days I will remit \$9.75 plus a few cents for delivery costs, or return book postpaid. SAVE MONEY: we pay delivery costs if you remit with coupon. Same examination and return privilege.

NAME (print) \_\_\_\_\_

ADDRESS \_\_\_\_\_

CITY \_\_\_\_\_

STATE \_\_\_\_\_

ZIP CODE \_\_\_\_\_

For prices outside U. S., write McGraw-Hill Intl., N. Y. C. 23-L-385

### New Subassemblies

and bit length 4 to 36 bits. These systems are available for commercial use or to military specification. Addressing can be random access, sequential noninterlaced or sequential interlaced. Other special optional features are available, such as indicator lights, parity check and counters.

Lockheed Electronics Co., 6201 East Randolph St., Los Angeles, Calif., 90022. [403]

### Power modules squeeze costs

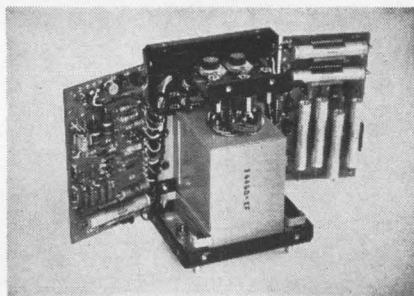

These power modules are intended to beat the military cost squeeze and represent units capable of meeting the full military component, workmanship and environmental requirements of MIL-E-4158, MIL-E-5400, MIL-E-16400, MIL-E-5272 and MIL-T-21200. An independent testing laboratory's certification of compliance is available for representative units. The new model types include: MS-10P05 (output 10 to 20 v d-c at 0 to 50 ma); MS124 (output 11 to 12 v d-c at 0 to 4 amps); MS248 (output 23 to 24 v d-c at 0 to 8 amps); and MS602 (output 59 to 61 v d-c at 0 to 2 amps). Units are also available for intermediate voltages and current ratings. Input can be 108 to 132 v a-c, 50 to 440 cps either single or three phase. Models are designed for operation at  $-55^{\circ}\text{C}$  to  $+75^{\circ}\text{C}$  full ratings, no external heat sinking. Ripple is less than 800  $\mu\text{V}$  rms, line regulation better than  $\pm 0.01\%$ , load regulation less than 0.05%. Transient response is less than 50  $\mu\text{sec}$  and units have particularly low drift characteristics including a temperature coefficient of better than

0.01%/°C. Models are available from stock or within an extremely short delivery cycle. Prices start at \$220 each.

Electronic Research Associates, Inc., 67 Sand Park Road, Cedar Grove, N.J. [404]

### Magnetic amplifiers resist radiation

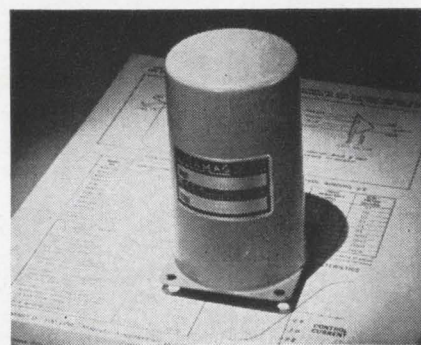

A series of low-cost, solid state magnetic amplifiers provide excellent resistance to radiation. They will withstand 1,000% overloads and also be operated into a dead short without damage. The mag-amps also offer optimum reliability to shock, vibration and moisture. Available at either 50 or 60 cps, the Ultomag 100 line magnetic amplifiers are economically priced due to design and production techniques that eliminate extensive trimming and testing. Applications are universal for both military and industrial users. Units can be used in almost any application where vacuum tubes or transistors are required. Life of this magamp line is ten years. The units provide up to 43 db polarity reversible gain with zero stability better than 1%. Power requirements are 115 v a-c  $\pm 10\%$ , 50 or 60 cps. Range of operating temperature is from  $-5^{\circ}\text{C}$  to  $+55^{\circ}\text{C}$ , storage temperature from  $-55^{\circ}\text{C}$  to  $+85^{\circ}\text{C}$ . Case dimensions are 2.53 in. diameter 4.31 in. high. Unit cost is \$69.50 up to five units. Delivery is from stock to four weeks.

Military & Computer Electronics Corp., 900 N.E. 13th St., Ft. Lauderdale, Fla., 33304. [405]

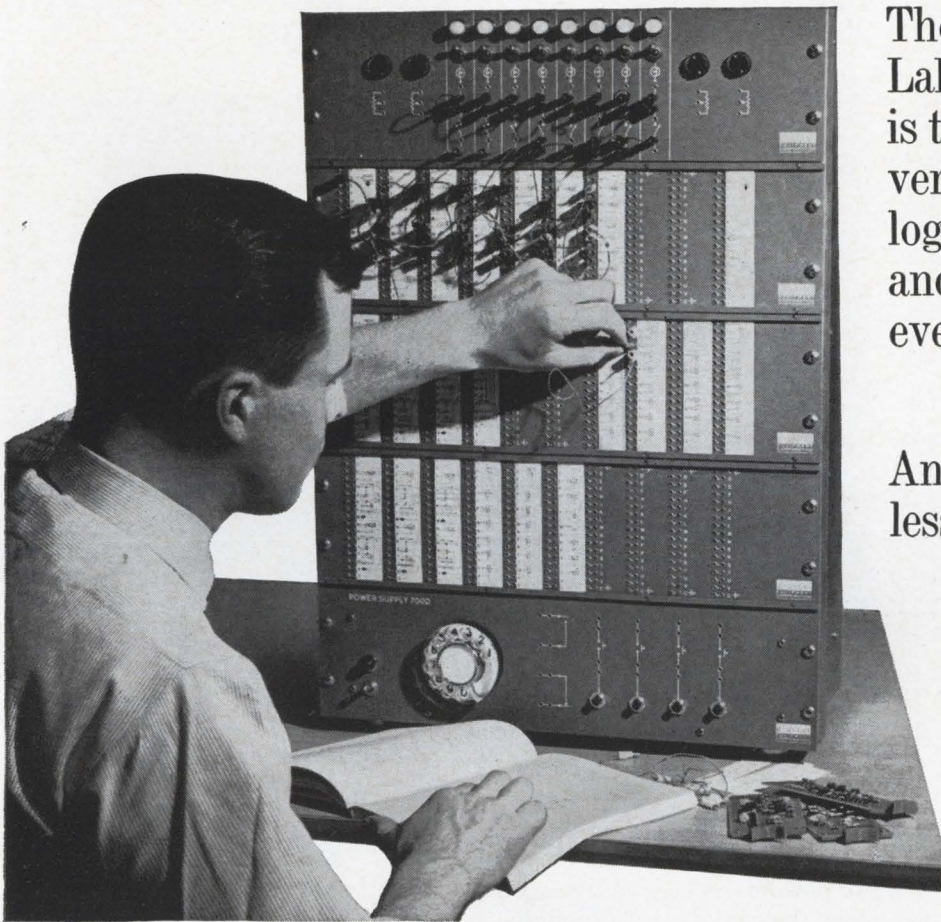

The Digital Laboratory System is the most versatile digital logic design tool and training device ever made.

And it costs less than \$1000.

With the Digital Laboratory System, you or your technicians can build operating digital systems...complete with logic elements, power supply, controls, indicators and mounting hardware. The plug-in FLIP CHIP™ logic modules are the same used in production digital equipment, including Digital's own remarkable PDP-8 Computer.

You quickly learn to build digital testers, simulators, or breadboard systems using front-mounted logic-circuit diagrams and patch cords. Plug in additional FLIP CHIP modules to build more sophisticated systems. Connect more standard digital panels to construct systems with expanded computing capability.

The Digital Laboratory System is an excellent training device, too. Students, technicians, or staff members who want to familiarize themselves with digital techniques can learn quickly using our free workbook.

It contains detailed experiments in 2- and 3-hour laboratory sessions.

For a demonstration, call any Digital Equipment office or the main office:  
DIGITAL EQUIPMENT CORPORATION,  
Maynard, Massachusetts 01754.  
Telephone: 617 897-8821.

MAYNARD, MASS. • Washington, D.C. • Parsippany, N.J. •  
Los Angeles • Palo Alto • Chicago • Ann Arbor • Pittsburgh •  
Huntsville • Orlando • Carleton Place, Ont. • Reading, England •  
Munich, W. Germany • Sydney, Australia.

**digital**

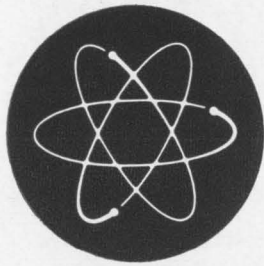

## LOOK AT LOCKHEED IN AGE ELECTRONIC SYSTEMS

Lockheed Missiles & Space Company has immediate need in Aerospace Ground-support Equipment Electronics for qualified engineers able to meet the following qualifications:

Must be able to project AGE systems from concept to point of sale. Will develop specifications and reports, direct technical proposal activity, lead other engineers, and improve or correct their concepts into a workable and saleable hardware system.

AGE systems include launch base equipment, computer controlled data processing systems, and digital hardline command systems.

Requires knowledge of magnetic interference problems, space systems testing experience, and perhaps some digital systems background plus, of course, a degree in Electrical Engineering. Ideally, we are looking for technical level supervisory types who would rather apply their technical knowledge in a practical manner.

Please write Mr. K. R. Kiddoo, Professional Placement Manager, Lockheed Missiles & Space Company, 462 Industrial Relations Building, Post Office Box 504, Sunnyvale, California.

**LOCKHEED**  
MISSILES & SPACE COMPANY  
A GROUP DIVISION OF LOCKHEED AIRCRAFT CORPORATION

*An equal opportunity employer*

## New Microwave

### VTM needs no special handling

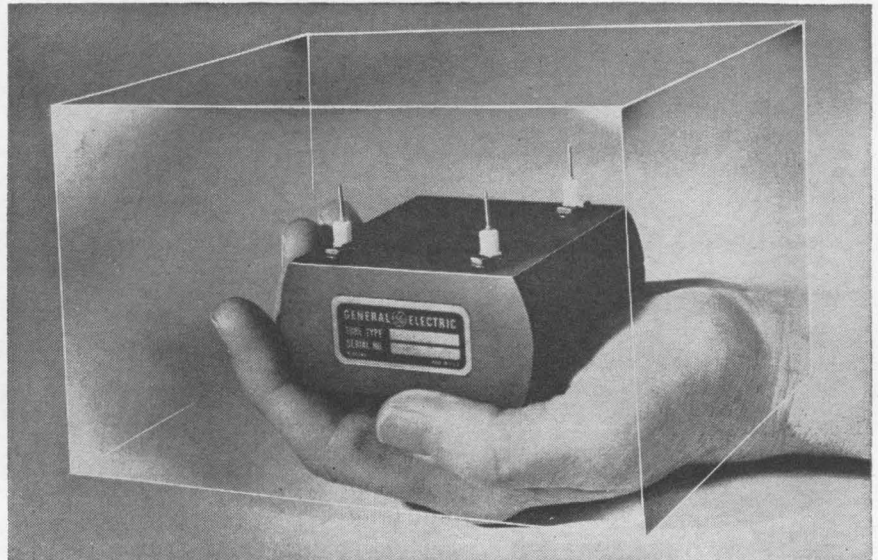

Shielded voltage tunable magnetron comes in a small package. Sketched-in cube represents space taken by a conventional VTM enclosed in its protective screen cage.

Put a voltage-tunable magnetron on the steel deck of a ship or a steel workbench—or just touch it with a stainless steel screwdriver—and you might as well throw it out. If not handled by trained personnel with special tools, a VTM can easily become degaussed and hence unusable. The VTM must be kept away from all magnetic materials. One way is to enclose it in a screen cage; but since the cage itself could degauss the VTM, the sides must be kept several inches from the tube. The usual size of a VTM with protective package is 250 cubic inches.

Using the tube is thus a ticklish business. But the General Electric Co. has developed a method of shielding VTM's from magnetic effects that can cause noise, linearity or power degradation so that the tube can be put in a 15-cubic-inch package. Further, the unit can be handled with no more care than is necessary for any electronic component.

The new package is also shielded from radio-frequency interference, and feed-through capacitors in the case attenuate any stray radiation normally present in connecting leads.

The shielded unit is made pos-

sible by simplified magnetic circuitry and application of new magnetic materials (both proprietary) which protect the VTM but do not upset the magnetic properties within the enclosure. The new magnetic circuits also are less sensitive to temperature change so that frequency-correction circuits may be simplified.

Engineering samples of a one-watt, 2000- to 4000-megacycle tube, designated ZM-6222, are available in 60 days. Other VTM's covering the range from 250 to 4000 megacycles in octave bands will be available in the future.

General Electric Co., Schenectady, N. Y. [421]

### Telemetry transmitter produces 8 w at S-band

A telemetry transmitter has been introduced that produces 8 w of c-w output power at S-band—2.2 to 2.3 Gc. The EM4567 transmitter has a volume of 98 cu in., and weighs 8 lb. All specifications are met in severe missile launch environment, including  $-40^{\circ}\text{C}$  to  $+85^{\circ}\text{C}$  temperature ranges. Modulation frequency response is flat

$\pm 1$  db, 5 cps to 800 kc. Over-all efficiency is 15%. This transmitter is a hybrid, that is solid state except for a vacuum tube oscillator stage. Frequency stability is improved by adding an afc servo loop referenced to an ultrastable crystal oscillator. Afc and correction are fed back to the cavity oscillator through a varactor diode. The transmitter will load into fluctuating mismatches. This is important since missile antenna match fluctuates due to ionization, proximity to launch equipment and other loop factors. Matching is made possible by using a circulator with three ports, one port internally terminated in a resistive load which absorbs any power reflected by the mismatch. The package can be pressurized to 30 psi absolute and will maintain this within 75% for one year.

Eitel-McCullough Inc., San Carlos, Calif. [422]

### Voltage-tunable bwo operates at 8-12.4 Gc

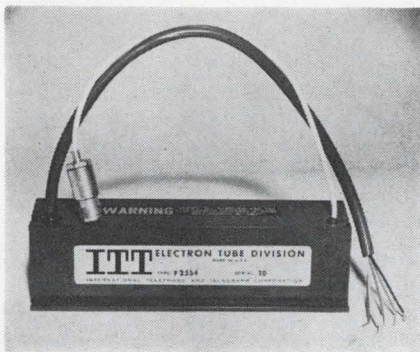

The F-2554 backward-wave oscillator is voltage-tunable in the 8- to 12.4-Gc range, with minimum power output of 10 mw. With permanent-magnet focusing, the highly stable device can be used as a swept signal source in signal generators, as a master oscillator for frequency-diversity reception or as a local oscillator in radar or countermeasure receivers. Typically, operating potential is 450 to 2,000 v and cathode current is 10 ma. Heater power is 6.3 v at about 1 amp. Spurious output is 40 db minimum below signal. The tube is 6 in. long by about 1½ in. square. It weighs about 1 lb, 10 oz. ITT Electron Tube Division, Box 104, Clifton, N.J. [423]

## LITTLE CHOPPER



## BIG PERFORMER

Where component space is limited—Bristol's Subminiature Chopper offers:

- 0.1 cu. in. size
- complete shielding
- radiation resistance
- airborne environmental ratings
- lowest noise level

Write for detailed spec sheet. **The Bristol Company**, Aircraft Division, 152 Bristol Road, Waterbury, Conn. 06720.  
A subsidiary of American Chain & Cable Company, Inc. 4.7

**BRISTOL** . . . engineers for precision, builds for reliability



To order reprints  
from Electronics  
fill in, cut out  
coupon below,  
insert in envelope  
and mail to:

Electronics Reprint  
Dept.

330 West 42nd Street  
New York, N. Y. 10036

**Reprint order form**

For listing of reprints available see  
the reader service card

To help expedite mailing of your  
reprints please send cash, check  
or money order with your order.

For reprints of the latest  
Special report:

Electronics 35th Anniversary  
Special Section

Send me . . . . reprints of key  
no. R-72 at 50¢ each.

For reprints of previous special  
reports fill in below:

Send me . . . . reprints of key no.(s)  
..... at . . . . ¢ each.

For prices see the reader service  
card.

Name .....

Number & Street .....

City, State .....

Zip Code .....

**New Production Equipment**

**Binding cables at high speed**

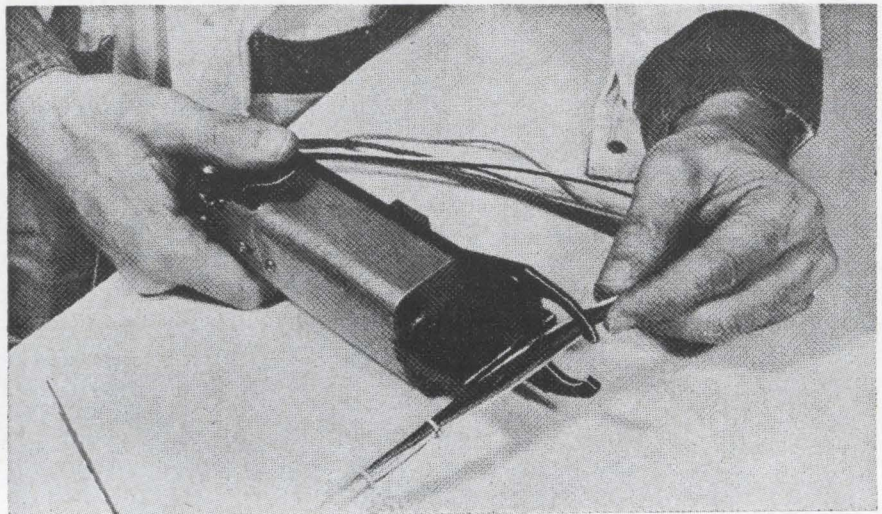

A hand tool has been developed that laces up cable wiring harnesses at an eye-popping speed—one tie in three seconds. The price is also an eye-popper, \$975, but the company claims the tool is so much faster than hand lacing that it will pay for itself in five to seven months, then show a fat profit.

Prospective customers are advised, however, that they will have to wait about five months to get one. The tool is in production at the Wire-Wrap division of the Gardner-Denver Co., but the initial production is earmarked for sale to the Western Electric Co., which makes harnesses by the thousands for telephone and military equipment. Western Electric gets preference because it devised the lacing technique, though its prototype used a rotary motor. Gardner-Denver redesigned it for pneumatic operation to make it less expensive.

The device, called the 14W2, looks like an ungainly pair of pliers. The inside of the jaws are grooved, so that a circular path is formed when they are closed. The operator puts the open jaws of the tool around the cable and then presses a throttle button. This actuates an air-driven mechanism which closes the jaws and then feeds a rod of 1/8-in.-diameter polyvinyl chloride into the groove.

The rod runs through the groove and back into the body of the tool,

so that it encircles the cable. The loop is drawn to a preset tension, then cut off and the ends fastened together with a small steel staple. Since tension, not loop diameter, determines where the rod is cut, the tool is self-adapting to any cable diameter up to the inside diameter of the jaws.

The present model will bind cable up to one inch in diameter. The manufacturer plans a larger model.

To use the 14W2 at top speed, the operator must lift the cable a half inch or so above the work table. A simple wiring aid has been devised to do this. Conventionally, the wires of a harness are routed around pins on a layout board. Gardner-Denver just fastens small sheet-metal straps across pairs of pins, and puts a few extra pair under long runs of wire.

This aid would also make hand lacing, or lacing with preformed plastic ties, easier, since laces have to be slipped between the wire and the table.

**Specifications**

Length	12 inches
Weight	3 3/4 pounds
Cable capacity	up to 1-inch diameter
Cycle time	3 seconds
Staple capacity	150
Recommended air pressure	80 to 100 psig

Gardner-Denver Co., Wire-Wrap division, Grand Haven, Mich. [451]

## Semiconductor dicer keeps yield high

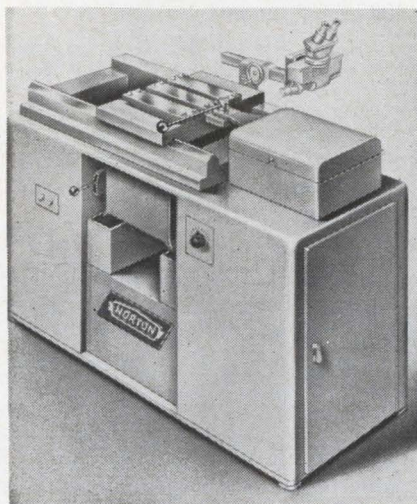

Model 311 dicing machine provides new cutting concepts for the semiconductor processing industry. It produces square-sided dice as small as 0.015 in. with yields of 95%. Applications include dicing planar-type transistors, integrated circuits and all other wafers with deposited geometries. Cutting blades as thin as 0.001 in. are used in combination with a very fine abrasive, producing cuts of 0.002 to 0.003 in. wide with surfaces having a lapped quality. The breaking operation associated with scribing is eliminated completely. Cracked or partial wafers can also be diced with minimum loss. While the technique will be first used with silicon wafers, the machine works equally well with germanium, arsenide compounds and ceramics. The technique permits dicing through silicon dioxide layers and other coatings with the same minimum kerf loss. Square sides are produced with minimum chipping. Square-sided dice, as opposed to those with slope sides produced by other commercial methods, facilitate either automatic or manual handling. With the model 311, the dice remain on the mounting block after cutting for inspection. Tedious separation of loose dice is eliminated. The dice close to the edge of the wafer are not damaged by this cutting technique. Model 311 can cut three wafers up to 1 3/8 in. in diameter at one time. Norton Co., Machine Tool Division, Worcester, Mass., 01606 [452]

**MODULAR SOLID STATE**

**DATA RECORDERS**

**SS 822**  
**\$1295<sup>00</sup>**

**2 CHANNEL**  
Two Channel Performance

**SS 844**  
**\$1985<sup>00</sup>**

**4 CHANNEL**  
Features: 1/4" tape, 10 1/2" reels, two inputs per channel, Electro Dynamic Braking.

**WRITE ...**

for complete catalogue and specifications

IPS	RESPONSE	WOW	S/N
15	± 2db 30-30,000 cps	0.06%	57
7 1/2	± 2db 30-20,000 cps	0.09%	56
3 3/4	± 3db 30-10,000 cps	0.18%	50 db

**CROWN INTERNATIONAL, Box 1000, Elkhart, Ind., U.S.A.**

Circle 206 on reader service card

NEW  
602A

**602A** **\$290**

**FREQ. RANGES:** 20 cps to 20 kc, 20 cps to 500 kc, 20 cps to 5 mc.

**OUTPUT SPECTRUM:** 20 cps to 20 kc — -1 db, 20 cps to 500 kc — -3 db, 500 kc to 5 mc — -8 db.

**OUTPUT LEVEL:** (open circuit), 20 kc range — 3 volts, 500 kc range — 2 volts, 5 mc range — 1 volt.

**OUTPUT IMPEDANCE:** 500 ohms ± 10% calibrated to work into open circuit.

**MAXIMUM LOAD:** (on direct output) no limit.

**OUTPUT STEP ATTENUATOR:** X1.0, X0.1, X0.01, X.001, and X.0001.

**Accuracy:** ± 3% to 100kc, ± 10% to 5 mc

**Output Impedance:** 200 ohms ± 1%

**SPECTRAL DENSITY:** Approximate spectral density (mv/√cps) for 1 volt rms output, 20 kc band — 5, 500 kc band — 1.2, 5 mc band — 0.4.

**AMPLITUDE PROBABILITY DISTRIBUTION:** Symmetrical non-clipped Gaussian waveform all ranges.

**OUTPUTMETER:** 0-5 volts rms.

**OPERATING TEMP.:** 0 to 50° C.

**POWER:** 115/220 volts ± 10/20 volts, 50 to 1,000 cycles ac.

**PANEL COLOR:** Clear anodized brushed aluminum.

**DIMENSIONS:** 5 1/2" high x 8 3/4" wide x 11" deep.

**SHIPPING WEIGHT:** Approx. 10 lbs.

**ELGENCO INC.**  
**NOISE GENERATORS**  
1562 EUCLID AVENUE  
SANTA MONICA, CALIF. 90404  
PHONE 451-1635 (AREA CODE 213)

Send FREE file folder full of Noise Generator Info

Circle 141 on reader service card

To order reprints: Fill in, cut out coupon below, insert in envelope and mail to: **Electronics Reprint Dept., 330 W. 42nd Street, New York, N.Y. 10036**

### Reprint order form

For listing of reprints available see the Reader Service Card.

Communications on Gemini

Send me ..... reprints of Key no. R-73 at 50¢ each.

For reprints of previous special reports fill in below:

Send me ..... reprints of Key No.(s) ..... @ ..... ¢ each.  
(For prices, see Reader Service Card)

Name .....

Number of street .....

City, State, Zip code .....

# Silicone encapsulant improves zener diodes

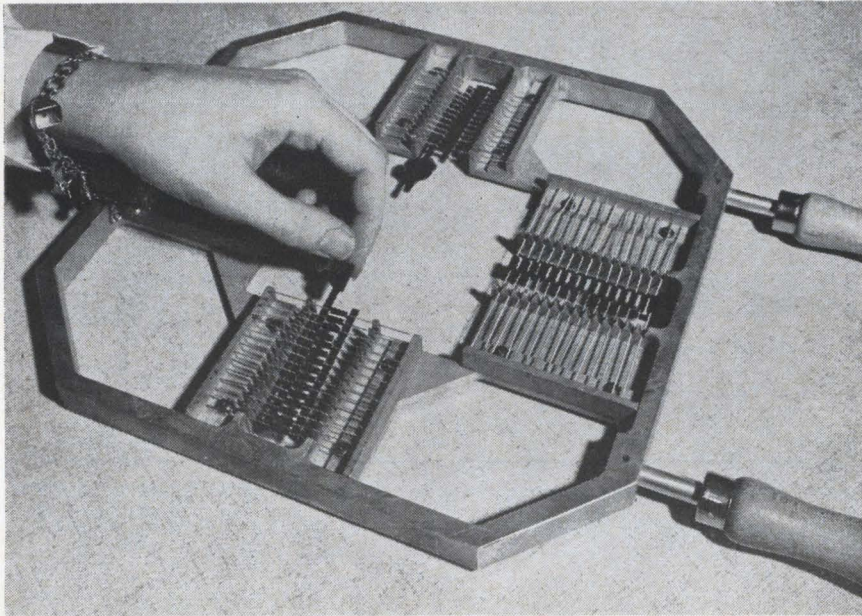

**Zener diodes**, encapsulated in thermosetting silicone plastic, are removed from fixture after coming off assembly line. Assembly of the silicone plastic diode lends itself readily to automation; yields are higher than with designs requiring more complicated production techniques.

A silicone plastic encapsulating material has enabled North American Electronics, Inc., to quadruple the power-dissipation capabilities of its zener diodes without increasing size or mass. The zeners are encapsulated in the model 304 molding compound, made by the Dow Corning Corp., rather than in the hollow glass package commonly used.

North American says processing the silicone package is simpler than making it with glass. By the end of the year the company expects to produce silicone-encapsulated units on a completely automated assembly line. It expects to turn out 400 zeners a minute.

Conventionally designed avalanche diodes in a standard JEDEC DO-7 glass package 0.100 inch diameter and 0.265 inch long are usually rated at 250 milliwatts. The silicone-encapsulated zeners are rated at one watt dissipation at 75° C. In addition, the new semiconductor package is stronger thermally and mechanically than conventional glass-encapsulated units. It is rated at 250° C, according to Arthur Bruno, division manager at North American.

In addition, the molding tempera-

tures are considerably lower than those required for sealing glass packages (about 325° F compared to about 850° F), permitting leads to be soldered to the junction. The spring-loaded contact made by the S-band whisker in conventional zener construction is a common source of trouble. High melting temperatures of glass also require refractory metals, such as molybdenum, to be used in double heat-sink type diodes. These metals are poor conductors. In contrast, the low processing temperatures of the silicone plastic never melt the junction, solder or lead coatings. The silicone package also eliminates cracking caused by the differential thermal contraction between metal and glass during cooling; a problem with glass packages.

The new silicone-encapsulated zeners are resistant to flame, acid and solvents, and can be cleaned in the same manner as glass. Dielectric strength and moisture-absorption rates are equivalent to those of glass. The new diodes pass all the tests required of hermetically sealed devices and meet MIL-S-19500 specifications. They have been repetitively cycled from

the temperature of liquid nitrogen to 300° C without failure.

Zener or avalanche diodes are widely used as voltage-limiting devices and to provide reference voltages in electronic circuits. The new silicone-encapsulated units are available with over-all ratings from 2 to 200 volts.

Leads may be either of 0.020-inch-diameter silver or gold-plated Dumet. This compares with the minimum 0.030-inch-diameter silver leads required by the heat-sink type of high-power dissipation diode.

The silicone molding compound is also used for encapsulating diodes made by Motorola Semiconductor Products, Inc., and Thompson Ramo Wooldridge, Inc.

### Properties of 304 molding compound

Molding temperature	270° to 320°F
Thermal conductivity, cm <sup>2</sup> /sec/cm <sup>2</sup> /°C/cm x 10 <sup>-4</sup>	9.2
Dielectric constant, 1 Mc	3.60
Dissipation factor, 1 Mc	0.002
Electric strength, volts/mil	380
Volume resistivity, ohm/cm	5 x 10 <sup>14</sup>
Insulation resistance, ohms,	
at 23°C	4 x 10 <sup>14</sup>
at 250°C	5 x 10 <sup>10</sup>

Dow Corning, Midland, Mich. [441]

## Electrical insulation has polyester base

Polyteraglas electrical insulation is suitable for use in applications up to 155° C, where some degree of stretch is required. It consists of a woven fabric comprising polyester warp yarns and continuous filament glass fiber filler yarns. The fabric is coated with a heat resistant (Class F) polyester resin. Polyteraglas stretches to conform to irregular surfaces, while the polyester coating retains its dielectric strength even under considerable elongation. It has excellent resistance to high humidity and exceptional tear resistance. Polyteraglas of 0.008 in. and 0.010 in. thicknesses is available in rolls approximately 36 in. wide and 25 yds or 50 yds long; tapes 3/8 in. wide or wider; and sheets 36 in. by 36 in. and 24 in. by 36 in. Natvar Corp., 211 Randolph Ave., Woodbridge, N.J. 07095. [442]



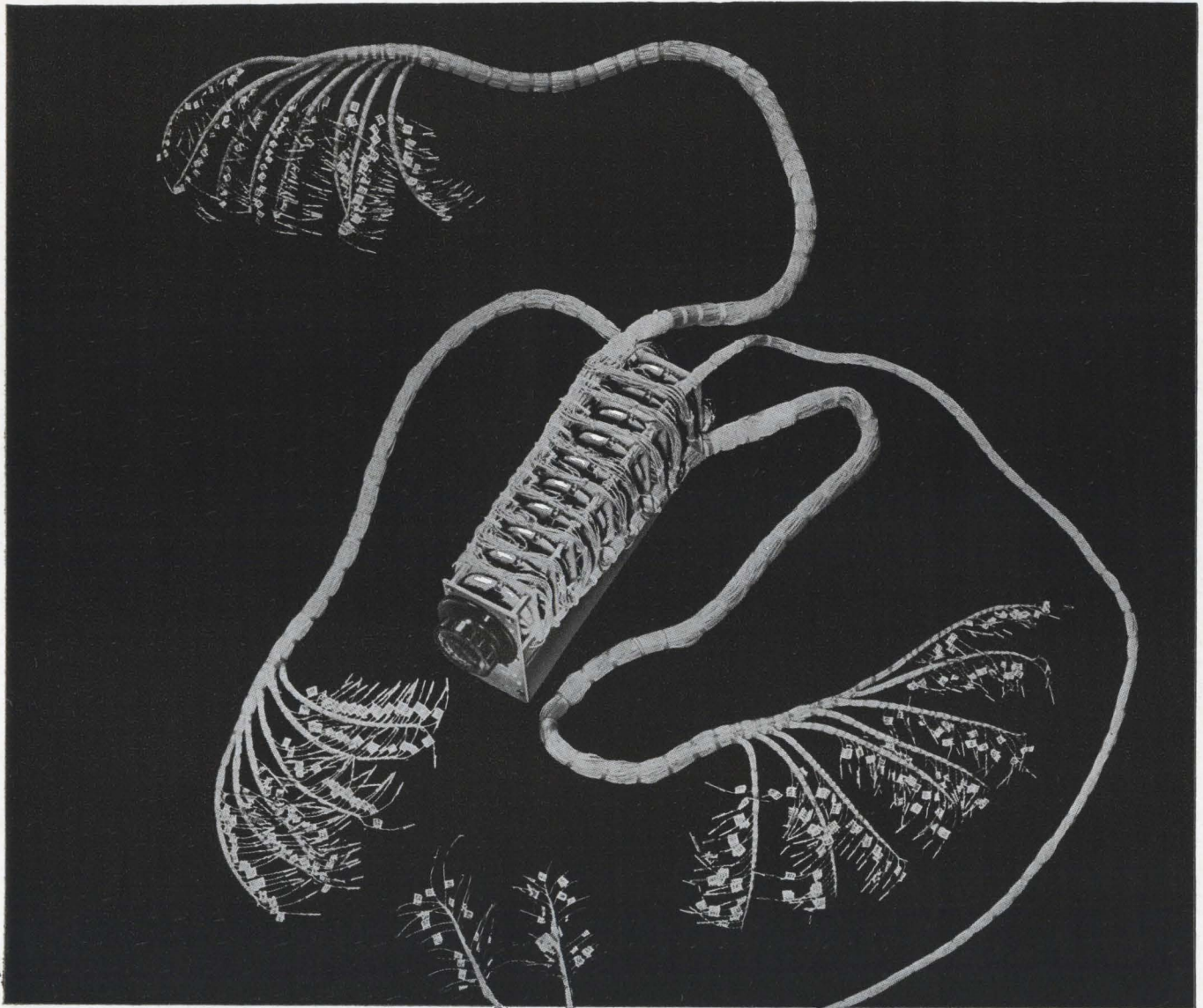

## No application is beyond the reach of a Daven switch

Whatever the application, whatever the performance level, there is a Daven rotary switch to fill your need. All are fully described in the brand new Daven switch catalog—available now. Included is everything you should know to order rotary switches: standard, special, miniature, subminiature...military or commercial. All the characteristics and special features are here.

All the code numbers and ordering information. All concise, clear, comprehensive.

Wherever precise switching is required, the reliable performance of Daven rotary selector switches has made them the standard of the industry.

**Write for Catalog S-84 today!**



**DAVEN**   
LIVINGSTON, NEW JERSEY  
(201) 992-4300 • TWX 201 992-7356 • Cable: DAVEN LIVINGSTON N J

936

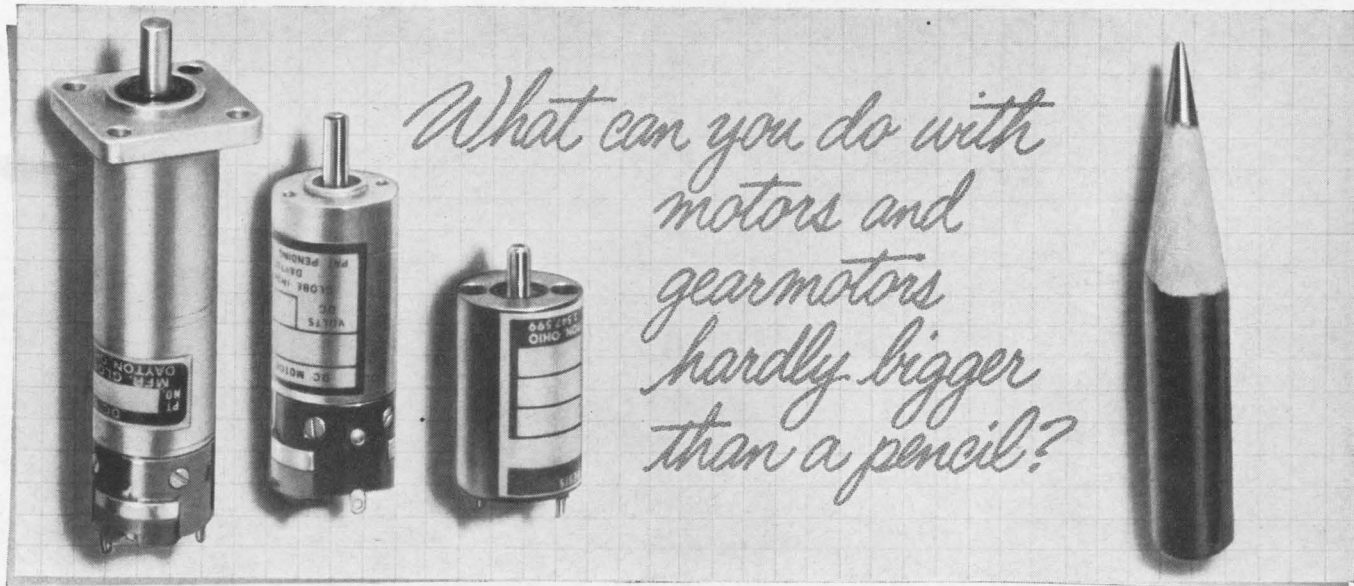

*What can you do with  
motors and  
garmotors  
hardly bigger  
than a pencil?*

You can figure on designing more compact products. As a matter of fact Globe has developed 2 new MIL spec motors—one for a.c. called Type CC, and one for d.c. named VT. Both motors are only  $\frac{5}{8}$ " in diameter, weigh  $1\frac{1}{2}$  ounces. Type VT uses a system of planetary gearing that multiplies torque up to 50 oz. in.

Choices for designers are fantastic; we have 83 standard gear ratios. Type VT can be wound for any voltage up to 50 v.d.c., and we can furnish them with speed governors. Type CC is a hysteresis synchronous motor. And if you need a smaller or larger power unit, come to the can-do manufacturer. Request Bn. 58.

**TYPE VT**—Produces .0025 HP in the 8,000 to 17,000 rpm range. Size:  $\frac{5}{8}$ " x  $1\frac{3}{8}$ " long. 1.48 oz. To 50 v.d.c. Planetary gearing in 83 ratios.

**TYPE CC**—Produces .07 oz. in. max. sync. torque. Size:  $\frac{5}{8}$ " x  $1\frac{3}{8}$ " long. 1.5 oz. 26 v.a.c. (115 v.a.c. with series capacitor), 2 or 4 poles, 400 cycles.

**GLOBE**

Globe Industries, Inc., 2275 Stanley Avenue  
Dayton, Ohio 45404, U.S.A., Tel.: 513 222-3741

Circle 208 on reader service card

# BIG AMPS

## SMALL SIZE

### in AC and DC Circuit Breakers

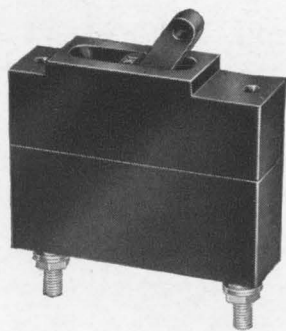

Now 60 to 100 amps in a 2.53" x 0.76" x 2.0" package. Other models with ratings from  $\frac{1}{4}$  to 50 amps . . . no change in package size.

Write for Circuit Breaker Catalog



**WOOD ELECTRIC  
CORPORATION**

244 Broad Street, Lynn, Mass. (617) LY8-5313

**8½" X 11" X-Y  
RECORDER**

**HR-96-T  
\$1050**

<p><b>0.25% ACCURACY</b> 10 in/sec Pen Speed 1 mv/in to 10 v/in Stepped attenuators</p>	<p>5 sec to 15 min full scale selectable time base Zener Reference Voltages Electric Pen Lift</p>
---	---

HR96Z Without Time Base \$995.

**houston  
OMNIGRAPHIC  
corporation**

a subsidiary of houston instrument corporation  
4950 Terminal Ave. / Bellaire, Texas 77401  
(713) 667 7403 / cable HOINCO / TWX (713) 571 2063

## New Books

### Transistor specifications manual

Transistor Specifications Manual  
Howard W. Sams Engineering Staff,  
Howard W. Sams & Co., Inc.,  
159 pp., \$2.95

This reference guide to commercially available transistors is not as complete as the Datadex Transistor Reference Book, which was reviewed in the April 5 edition of Electronics. And the Datadex edition was criticized for containing some out of date material and for its omission of more recent information.

The more obvious failing of the Transistor Specifications Manual is in its listing of manufacturers for various transistor types. The manufacturers column in the transistor listing often shows companies still supplying types that have not been in their line for some time. For example, RCA dropped the 2N561 from its line a couple of years ago, but it is the only manufacturer listed for this type. However, Cleveite and Bendix, both of which have been supplying this type since 1963, are not listed.

The manual does contain a good transistor outline section which should prove useful to both design and standards engineers.

Siliconix, KSC Semiconductor Corp., TRW Semiconductors and several other transistor manufacturers are omitted from the list of 52 American and foreign manufacturers whose types are shown.

A section on old type numbers vs. new type numbers is so incomplete that it might well have been omitted.

Current gain values are given, but the collector current at which they are measured is not given. This makes the values meaningless. Also, the column for frequency response does not indicate if the frequencies are in kilocycles or megacycles per second.

The lead and terminal identification section is a big asset. It is separate from the outline section and provides quick reference to basing information.

But all things considered, the Datadex manual, despite its shortcomings, is a better buy.

—Jerome Eimbinder

### Microelectronics

American Microelectronics Data Annual, 1964-65  
G.W.A. Dummer and J. MacKenzie Robertson, editors  
The Macmillan Co., 941 pp., \$22.50

The editors have gathered the data sheets of more than 40 companies that produce microelectronic circuits or equipment associated with this field and reproduced them in this 8½" by 11" volume.

The biggest disadvantage of this type of publication is that it is often out of date by the time it comes off the press. For example, this volume contains over 50 pages describing RCA micromodules. However, the preface contains a note stating that after the volume had gone to press RCA announced that their micromodules were no longer available.

While publication of this sort of material in a single volume is useful to the user of integrated circuits, its value is considerably diminished by the fact that the microelectronics field is such a rapidly changing one. Probably a more practical approach would be to publish this information in loose-leaf form and to issue periodic mailings.

—J. E.

### Recently published

**Energetic Processes in Follow-up Electrical Control Systems**, A.A. Bulgakov Macmillan Co., 126 pp., \$6.00.

**Switching Theory: Volume 1, Combinational Circuits**, Raymond E. Miller, John Wiley & Sons, Inc., 351 pp., \$12.95.

**Electronic Amplifiers for Automatic Compensators**, D.Y. Polonnikov, Macmillan Co., 324 pp., \$12.00.

**Basic Theory of Space Communications**, Frederick J. Tischer, D.Van Nostrand Co., Inc., 463 pp., \$11.75.

**High-Intensity Ultrasonics Industrial Applications**, Basil Brown and John E. Goodman, ILIFFE Books Ltd., 235 pp., \$7.70.

**Cybernetics, or Control and Communication in the Animal and the Machine**, Norbert Wiener, M.I.T. Press, 212 pp., \$1.95.

**Fundamentals of Semiconductor Devices**, Joseph Lindmayer and Charles Y. Wrigley, D.Van Nostrand Co., Inc., 486 pp., \$11.95.

**Planning the Local UHF-TV Station**, Patrick S. Finnegan, Hayden Pub. Co., Inc., 296 pp., \$10.00.

**Handbook of Satellites and Space Vehicles**, R.P. Haviland, D.Van Nostrand Co., Inc., 457 pp., \$15.75.

**Stress: A Problem-Oriented Computer Language for Structural Engineering**, Dept. of Civil Engineering, M.I.T., M.I.T. Press, 388 pp., \$12.50.

# Quick Reaction Capability that Counts



JANUS  
Model B100-82  
Forward-Backward  
Counter Module with Display

## HERE'S WHY:

These 1-mc Forward-Backward Decade Counters may be applied quickly and easily to systems and products requiring reliable high-speed bi-directional counting.

**JANUS Model B100-80 Series Forward-Backward Counters Provide:**

**SPEED:** Accept pulses to 1-mc in either direction.

**QUICK REVERSING TIME:** Less than two microseconds.

**RELIABILITY:** All transistorized, silicon circuitry throughout.

**LOW COST:**\* \$115.00 (or less) for units with display. \$46.50 (or less) for units without display. Less costly than making them yourself.

**FAST DELIVERY:** From stock.

Available (with or without display) individually or in quantity for use in high speed counter applications where quality, low-cost and reliability are important.

Write for Technical Literature.

**The Next Time You Need Counters Count on JANUS**

\*Price (FOB Newton, Mass.)  
even lower in large quantity.

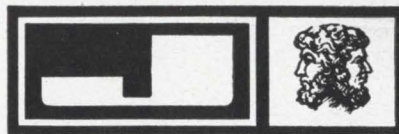

**JANUS CONTROL CORPORATION**  
HUNT ST., NEWTON, MASS. TEL. 926-1037

## A NEW INSTRUMENT FOR THE FAR ULTRAVIOLET

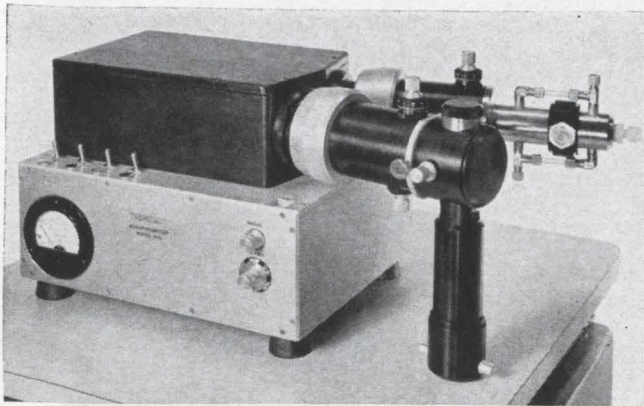

### TROPEL MODEL N-2 MONOCHROMATOR equipped with

#### Model BNH-1 Discharge Tube & Model S-2 Reflectometer

The Model N-2 Monochromator is an improved normal incidence grating instrument which produces exceptionally intense and pure spectra. The N-2 design features a compact vacuum chamber (total volume, 0.25 cu.ft.), and a high speed four inch diffusion pump, a six speed motor driven wavelength scanning system, and manually controlled scanning. The newest addition to the Model N-2 line of accessories is Tropel's Differential Pumping Chamber, a unique device which enables operation of the Monochromator with a windowless light source, at pressures as low as  $8 \times 10^{-6}$  Torr. Basic instrument—\$6950.00

• Write for brochures describing the new  
Model N-2 Monochromator and accessories

**TROPEL, INC.** • 52 WEST AVE. • FAIRPORT, N. Y.

CONSULTANTS & DESIGNERS OF OPTICAL SYSTEMS  
MANUFACTURERS OF PROTOTYPE LENSES & INSTRUMENTS

Circle 210 on reader service card

Around the world ...

## KYORITSU Measuring Instruments

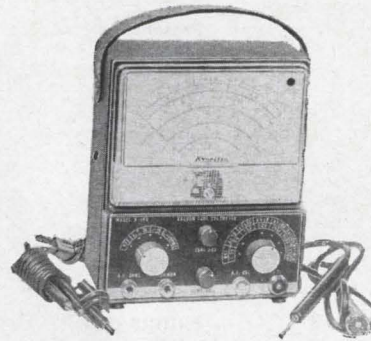

K-142

Vacuum Tube Voltmeter  
(190x170x105 m/m)



VR-2P VU Meter  
(42x42x37 m/m)



P-60 6" Meter



# Kyoritsu

ELECTRICAL INSTRUMENTS WORKS, LTD.

120, Nakane-cho, Meguro-ku, Tokyo, Japan

Cable address: KYORITSUKEIKI TOKYO

Telex: TK 2849

Direct Inquiry Welcomed

Circle 211 on reader service card

### PROFESSIONAL PERSONNEL REQUISITION

## Immediate Opening at Marquardt for Senior Solid State Physicist

Ph.D. with minimum of three years experience to conduct fundamental and applied research studies. Must be capable of independent work. Direct experience required in one or more of the following areas: photoconductivity, electroluminescence, ferroelectricity, thin films or crystal physics.

*U.S. Citizenship Required  
Send complete resumes to  
Professional Personnel,  
Department 135,*

THE *Marquardt*  
CORPORATION

16555 Saticoy St., Van Nuys, Calif.  
AN EQUAL OPPORTUNITY EMPLOYER

### Planning to change your address?

Use the form below to indicate a change of address. Because our issues are addressed in advance, please try to allow at least 5 weeks for change of address to become effective. Attach the address label from your most recent issue in the space provided below.

[Please print the following information for proper service]

Title or position .....

Name .....

Chief job responsibility .....

Company and Div .....

Product or Service ..... Approx. No. of employees .....

Address .....

City ..... Zone ..... State or Prov. ....

Mail to: Fulfillment Manager, **Electronics**  
P.O. Box 430, Hightstown, N.J. 08520

\*Paste present mailing label or address  
from wrapper or envelope here.

## Technical Abstracts

### Multiprocessor democracy

Multiprocessing with floating executive control  
Jack J. Pariser  
Hughes Aircraft Co.,  
Fullerton, Calif.

A multiprocessor consists of a number of interconnected computers, with one executive computer controlling the operation. The executive responds to interruptions and assigns all input-output operations. The slaves carry out routine computations and subsidiary routines. Such systems allow real-time control of problems.

If one of the slave computers should fail, the system can usually continue to operate with somewhat reduced capacity. This kind of reduction is sometimes called graceful degradation. But if the master computer should fail, the entire system goes out until the master is repaired or one of the slaves can be made to take over.

In the Hughes H-3118 multiprocessor system, the executive function is designed to float between several individual processors. All the processors are identical, but only one can hold the executive function at any given time. Any processor can take over the executive function at its option, provided the preceding holder is not performing an executive routine. If such a routine is in progress, the slave either accepts another subsidiary assignment from the executive, or waits until the end of the routine to take over. Interrupts are routed to all processors and all processors have access to input-output controllers, but only the executive processor can respond to interrupts and call input-output assignments.

This implementation of the system in several identical packages for each major function is referred to as modular construction. The modular concept is extended to all parts of the system.

The memory is built in several banks which are physically separate but logically form a single large array with a common addressing scheme. The failure of a single bank creates a gap in the series of

available addresses, but does not take out the whole system.

Presented at the IEEE International Convention, New York, Mar. 22-26

### Lunar mapping

Application of a photometric technique for mapping the moon  
M.E. Andursky  
Systems division, The Bendix Corp.,  
Ann Arbor, Mich.

Lunar contours can be located and identified with a television sensor, taking advantage of the moon's unique characteristics of scattering and reflecting solar radiation. The reflectance of the lunar surface to incident light is characterized by a peaked back-scatter in the direction of the source. The shape of this characteristic depends almost entirely on the three directional angles in aspherical geometry. Diffuse surfaces obeying the Lambertian distribution law produce a directional reflectance or albedo (ratio of reflected to incident light) depending only on the emittance angle, but the directional reflectance of the lunar surface is the product of the albedo and a function of the three angles which is known as the lunar photometric function. This function was found to be exhibited by a synthetic material used in conjunction with a diffuse white backing from which simulated lunar surfaces were fabricated.

Experimental data came from three types of sensors: 1) directly with a photometer; 2) by photography using Royal Pan and Royal X Pan film as the sensor and reading the resultant densities with a microdensitometer against a calibrated step wedge; and 3) through a vidicon television system where the display monitor was photographed and the resultant densities measured.

Using the vidicon television system, the following accuracy capabilities were reported: Source angle,  $\pm 50^\circ$ ; sensor angle,  $0^\circ$  to  $50^\circ$ ; photometry precision,  $\pm 5\%$  to  $\pm 10\%$ ; apparent source angle accuracy,  $\pm 5^\circ$  to  $\pm 10^\circ$ .

Presented at the Third Symposium on the Remote Sensing of Environment, Ann Arbor, Mich., Oct. 14-16, 1964.

# YOU CAN SPLIT LOGS, hairs, votes, and some heat-shrinkable tubings, BUT YOU CAN'T SPLIT

## FLEXITE SHRINKDOWN



### PLASTIC TUBING

when properly selected from these four grades and applied according to Markel recommendations:

# 1

**HT-105, Flexible Class A (105°C) Shrinkdown**  
Extruded tubing similar to Flexite HT-105; outstanding dielectric properties; adaptable for many uses; it shrinks at less than 200°F.

# 2

**SD-105, Semi-Rigid Class A Shrinkdown**  
For uses where greater mechanical strength and rigidity are needed, and over components sensitive to higher than 200°F temperatures.

# 3

**PD-135, Flexible Class B (130°C) Shrinkdown**  
Thermally stable tubing of specially formulated polymers; excellent electrical, chemical and oil resistance. Shrinks at 235°F. Meets MIL-I-23053 (wep), Class I.

# 4

**TE-250, Flexible Class C (250°C) Shrinkdown**  
Of modified polytetrafluoroethylene; offers exceptional electrical, thermal, and chemical-resistance properties. Shrinks at 621°F.

Markel customers are saving many dollars and much valuable time with these magic tubings that shrink 50% in diameter with the flash of a heat gun—adding a sheath of mechanical and electrical protection over terminals, connectors, cables, components, and other irregular shapes. Let's see how this idea could serve you; write for technical data and samples.

L. FRANK **MARKEL** & SONS  
SINCE 1922

ONE SOURCE FOR EXCELLENCE  
Insulating Tubings and Sleeveings  
High Temperature Wire and Cable  
NORRISTOWN, PENNSYLVANIA 19404



Engineering career opportunities

**Tie your career  
to the world's  
most advanced  
radar/sonar  
systems...  
at G.E.!**

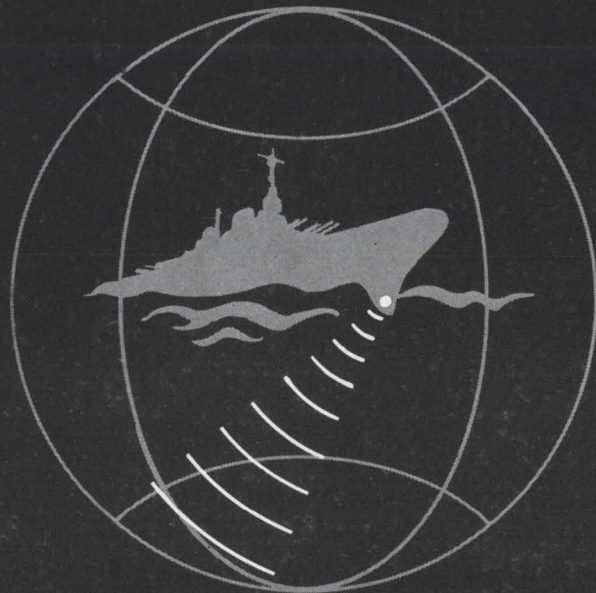
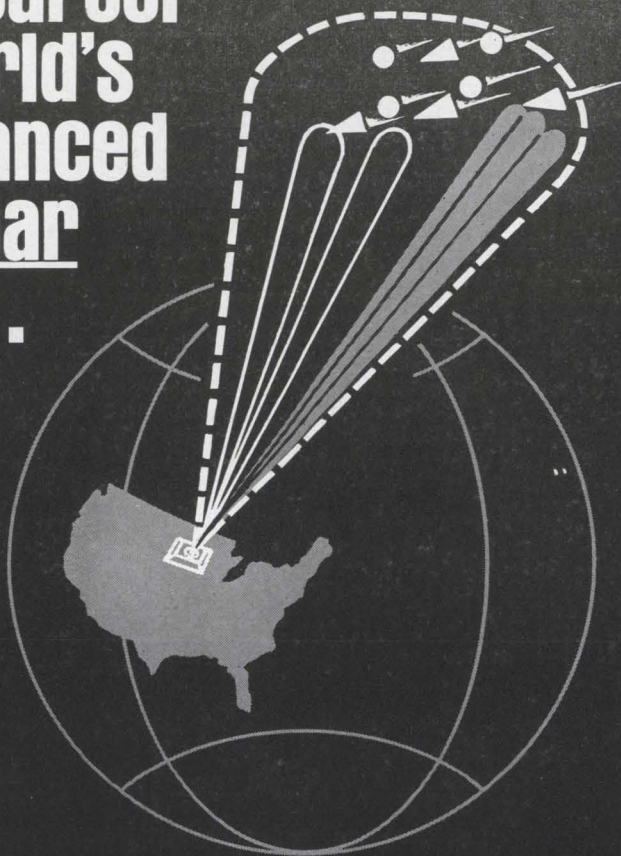

**Investigate your career now in missile-defense radar; advanced sonar engineering at General Electric.**

G.E.'s Heavy Military Electronics Dept.—whose capabilities include the design, development and fabrication of the world's largest and most advanced ASW and radar systems—announces long-term career openings for continuing contributions to large military contracts.

HMED offers you stability based on its broad capability for handling large programs and the experience that goes with front-rank performance on this decade's most advanced projects. Your growth is tied to that of a lean, highly professional engineering group backed by top-flight facilities—both within HMED and throughout General Electric.

At G.E., you'll be treated as a professional who's expected to handle well-defined, delegated responsibility. In most instances you'll deal directly with your customer's organization.

You will be given every opportunity to develop yourself professionally through continuing Company-taught courses and advanced tuition-paid study at nearby Syracuse University. And, in the course of your work, you'll have access to information developed by other G.E. facilities throughout the country.

**WHY NOT MATCH YOUR EXPERIENCE AND CAREER DESIRES AGAINST THESE REQUIREMENTS?**

**SONAR:** Advanced Sonar Engineers; Array Beamformer and Signal Processing Development Engineers; Digital Logic Engineers; Sonar Solid-state Circuit Design; Transducer Development; Solid-state Transmitter Development; Pattern Recognition Analysis; Adaptive Filtering Research; Display Development; Propagation Analysis; Sonar Subsystem Development.

**RADAR:** Monitor and Control Analysis Engineers; Digital Control Eqpt. Engineers; Microwave Component Design Engineers; Consultant, Circuit Design and Development; Instrumentation Circuit Engineers; ME's for Signal Processing Modules; Consultant, Array Radar Subsystem Requirements.

**INVESTIGATE NOW!** For full information, send a resume of your experience in confidence to J. L. Wool, Professional Placement, Heavy Military Electronics Dept., Section T-48, General Electric Co., Court St., Syracuse, New York.

177-65

*An Equal Opportunity Employer*

**GENERAL  ELECTRIC**

# THE BUSINESS PRINCIPLES OF AN AEROSPACE INDUSTRY

These statements of policy were presented at an Engineering Forum by Vice President of Engineering at McDonnell, Mr. Kendall Perkins. If you, as an engineer are encouraged to follow these principles in your work, you will gain. If you are successful in the pursuit of these goals, the Nation will gain.

"... Organizations, like people, have personality and character. The things which make an organization distinctive are the ways in which it differs from other organizations. These generally stem from subtle differences in the principles which guide it and the practices it has learned to follow. What then are the guiding principles at McDonnell?

"We believe it is a good business principle, for example, to give high priority to anticipating and doing our best to meet the needs of the customer—those needs which are really sound and will not change tomorrow. This often means passing up the easy-to-get contract, or the quick and easy solution to a problem, or even the approbation of a customer representative who may have become oversold on a particular project or a particular solution to a problem. Anticipating real and lasting customer needs often means creating something the customer hasn't yet asked for and doesn't yet want to buy—and then developing it and presenting it in such a way that the need becomes sufficiently apparent and pressing to open the door to a contract.

"We're not always right in what we believe the customer should have but we've found that timely and energetic effort to find what he needs, and to find an optimum solution, pays off handsomely in the long run. It was this principle which led us to start work on a manned orbiting spacecraft more than a year before the NASA asked for bids on Mercury. The same principle led us to undertake the design of an unusually versatile, high performance fighter for the Navy more than a year before our first Navy contract for Phantom II's. Thus it might be said that our largest current contracts have stemmed from the practice of anticipating customer needs. We still look forward to sizable production contracts for products conceived several years ago and actively developed since.

"We believe it is a good business principle to give high priority to meeting the needs of the individuals who make up our organization. This means many things in addition to a fair salary. It means treating people as they should want to be treated—with fairness and understanding. It means

defining responsibilities and necessary constraints, but not blocking initiative. It means opportunities for personal development by training, and freedom to transfer to other kinds of work. It means opportunities to contribute to attainment of worthy objectives. It means opportunities to advance to positions of responsibility and recognition, depending primarily on such contributions. It means the fairest and most thoughtful attention to adjustments in position and salary.

"We're not always right in our treatment of people but it's not for lack of trying at all levels. Our record has been outstanding in that we have close to the highest morale and close to the lowest percentage of terminations in the aerospace industry.

"We believe it is a good business principle to effectively foster cooperation between people. It may sound corny to talk about team action as much as we do. But nowhere in industry is there so great a need for cooperation—internal and external—as in the aerospace industry. Few other industrial products are as complex or as dependent upon such advanced engineering as a manned spacecraft or high performance aircraft. Few require so many kinds of engineering talent interacting toward the solution of so many kinds of problems. Few products require reconciling so many requirements expressed by so many people in so many documents. In short, there is a demand for effective coordination in the thinking of great numbers of people unmatched in any other industry.

"There is no such thing as an expert in all phases of an airplane, a missile, or a spacecraft. Successful systems of this complexity are developed only by employing the combined efforts of a team of people engaged in a wide variety of engineering and other activities. Technical areas are as far apart as chemistry and UHF radiation, hypersonic aerodynamics and gyroscope design, exotic high temperature materials and computer technology. No single brain can firmly grasp all these areas. Hence there is no substitute for an effective team—one whose members have learned to work together in harmony and mutual respect. The man who would lead

such teams must be capable of grasping what is told by others and appreciating the implication, but he must be modest enough to depend on the abilities and judgment of others and delegate responsibility whenever he safely can. Advanced systems development cannot be successfully run in a high-handed manner.

"I feel we have been successful at McDonnell in creating a harmonious atmosphere and minimizing non-constructive controversy. I believe we have built a team where there is a real sense of pride in group accomplishment and, at the same time, recognition of individual accomplishment. There is acceptance of necessary constraints without undue loss of individual spontaneity. We in management do our level best to provide a climate where these things can happen.

"The process of fully considering inputs from, and working in close harmony with so many other people calls for a type of organization and a set of skills and habits not ordinarily taught in school. It calls for keeping our viewpoints as broad as we can. It calls for changing our minds when the logic of the situation demands. It calls for keeping the best interest of the customer and the company ahead of our own immediate desire. It calls for recognizing that the other fellow's opinion can validly differ from our own without signifying either poor judgment or questionable motives on his part. It calls for keeping our heads when those about us are losing theirs and blaming it on us. It calls for these and many other practices in good human relations.

"We believe it is a good principle to make important decisions with the most meticulous care. In comparing our company with others it strikes me that we are more careful than most about reaching our decisions. We have learned the importance of examining all alternatives, digging up all the pertinent facts, fully analyzing results, and being objective and thorough in our judgments. This has tended to become a habit, exasperating at times, but well worth it on balance. It began when the company was formed and, in my opinion, has had more to do with our success than any other single practice."

Engineers, Scientists, Physicists and Mathematicians with energy, enthusiasm, and great creativity are needed for projects in the national interest underway at McDonnell. If you would like to work where the business principles outlined above are corporate policy and where the pursuit of excellence is a permanent corporate goal, we urge you to complete and mail the brief resume form below.

**MCDONNELL** An Equal Opportunity Employer.

Mail This Form To: W. R. Wardle, McDonnell Employment, Dept. V-53, Box 516, St. Louis, Mo., 63166

Name \_\_\_\_\_ Home Address \_\_\_\_\_  
 City & State \_\_\_\_\_ Phone \_\_\_\_\_ Age \_\_\_\_\_  
 Education: BS \_\_\_\_\_ MS \_\_\_\_\_ Ph D \_\_\_\_\_ Major Field: \_\_\_\_\_  
 Date \_\_\_\_\_ Date \_\_\_\_\_ Date \_\_\_\_\_  
 Primary Experience Area: \_\_\_\_\_ Present Position: \_\_\_\_\_  
 \_\_\_\_\_ Number of Years \_\_\_\_\_ I would like to receive application form



St. Louis Bicentennial Space Symposium and Fifth National Conference on the Peaceful Uses of Space, May 26-27-28, 1965

For information, write: Box 7133, St. Louis, Missouri 63177

CIRCLE 951 ON READER SERVICE CARD

# IBM

## MEMORY AND SEMICONDUCTOR ENGINEERS

**Assignments:** Excellent opportunities are available with IBM in East Fishkill, New York, and Burlington, Vermont. Professionals can enjoy the exceptional scientific environment, the long-range security with a growing division of a growth company, and opportunities for advancement. There are openings in the following fields:

**Memory Development Engineering:** Opportunities for experienced engineers in the design and development of high-speed memories, high-frequency small-signal amplifiers, magnetic devices, high-performance read-only memories, microswitch transmission lines, and high-current fast-pulse semiconductor circuits. Additional openings are available on a junior level for graduate engineers with an interest in memory development.

**Process Engineering:** Experience in semiconductor device development, pilot line or manufacturing engineering, to work on development of individual components, device design, diffusion, silk screening, printed circuits, plastic encapsulants, or materials and processing.

**Integrated Circuit Development and Packaging Engineering:** Openings for engineers experienced in the design of integrated circuit modules with familiarity in high-temperature processes and materials. Assignments are also available in the field of packaging of high-speed electronic circuitry.

**Qualifications:** B.S. or advanced degree in Electrical Engineering, Mechanical Engineering, Physics, Metallurgy, Chemistry, Chemical Engineering.

**Locations:** These positions will be in Poughkeepsie and Fishkill, New York, and in Burlington, Vermont. Liberal benefits plan and in-plant graduate program.

**Please Write:** If you would like to explore these and other opportunities in greater depth, write, outlining your interests and qualifications, to: R. L. Barnard, Dept. 554E1, IBM Corporation, East Fishkill Facility, Route 52, Hopewell Junction, N. Y.

# IBM

An Equal Opportunity Employer

## ELECTRONIC ENGINEERS

Positions for BS, MS, Ph.D in: Solid State Circuit Design, Information Theory, Instrumentation, Systems Design, Lasers.

SAN FRANCISCO BAY AREA

## LAWRENCE RADIATION LABORATORY

University of California

Research in:

- CONTROLLED FUSION
- BIO-MEDICINE
- APPLICATIONS OF NUCLEAR EXPLOSIVES

FOR information about our programs and opportunities, write:

**DAN McGEE**

LRL M18-45

P.O. BOX 808

LIVERMORE, CALIF.

U. S. Citizenship Required

An equal opportunity employer



## E. E.'s

for FEE-PAID Positions  
WRITE US FIRST!

Use our confidential application for professional, individualized service . . . a complete national technical employment agency.

**ATOMIC PERSONNEL, INC.**

Suite 1207L, 1518 Walnut St., Phila. 2, Pa.

ADDRESS BOX NO. REPLIES TO: Box No. Classified Adv. Div. of this publication.

Send to office nearest you.

NEW YORK, N. Y. 10036: P. O. Box 12

CHICAGO, Ill. 60611: 645 N. Michigan Ave.

SAN FRANCISCO, Cal. 94111: 255 California St.

### SELLING OPPORTUNITY AVAILABLE

European Manufacturer of semiconductors for entertainment field seeks aggressive distributors in U.S.A., Canada and Latin America. Reply to Box RW-6104, Electronics.

## PROFESSIONAL SERVICES

**GIBBS & HILL, Inc.**  
Consulting Engineers

Systems Engineering

Operations Research • Development

Field Studies • Design • Procurement

Power • Transportation • Communications

Water Supply • Waste Treatment

393 Seventh Avenue

New York 1, N. Y.



Engineers and Scientists  
are invited to  
inquire about the  
professional openings  
available immediately with  
General Electric  
on the Apollo Program

# apollo

# apollo

## PROGRAM

### HUNTSVILLE, ALABAMA

Experience required in the following areas:

<p><b>Systems Design Engineer</b> BSEE</p>	Conceptual, functional and preliminary design of electrical subsystems and hardware of ground support equipment for launch vehicles. Should include computer applications, digital circuitry or control systems design.
<p><b>Systems Engineers-Power</b> BSEE</p>	Analysis of power requirements of stage and missile systems and/or launch complex areas. Conceptual, functional, preliminary design of ESE equipment as applied to launch missile stages.
<p><b>Systems Interface Engineers</b> BSEE</p>	Experience in design and evaluation of complex electrical GSE with interface coordination experience. From available documentation analyze, formulate, and document the various interfaces (vehicle/GSE, GSE/GSE) and formulate functional circuit schematics.
<p><b>Electrical Engineer-Reliability Analysis-BSEE</b> (Also for Cocoa Beach, Fla.)</p>	Design, test or analysis of electrical systems, with at least two years in failure mode and effects analysis, determination of criticality numbers, or development of math models. Coordinate analytical effort with design and test personnel.

### HOUSTON, TEXAS

Experience required in the following areas:

<p><b>Crew Systems Engineer</b> BSAE, ME</p>	Analysis of systems required for support and operational use of spacecraft crew; in development of specifications, test plans and requirements for crew systems; and knowledge of crew capabilities and limitations.
<p><b>Engineer, Failure Data (or Analysis)</b> BA/BS, Math, Physics or Engr'g.</p>	Analyze failure and use data for parts and materials. Perform assessments of parts and materials reliability. 5-10 years experience in defense industry parts and materials qualification testing and analysis. Familiarity with mathematics of test data report handling (plot trends).
<p><b>Engineer-Cryogenics Fuel Cell</b> BSME/ChE.</p>	3 to 5 years experience in work involving Cryogenics, Fuel Cells and associated systems. This should include systems design and analysis. Provide technical assessment of design of Apollo SC systems emphasizing reliability.

### DAYTONA BEACH, FLORIDA

Experience required in the following areas:

<p><b>Computer Programmers</b> BS Math, Engineering</p>	Large scale computer programming of applied math and engineering problems. Experience in technical data processing and/or information systems desired.
<p><b>Documentation Specialists</b> College Degree (Also for Cocoa Beach, Fla., if design exper. strong.)</p>	Analyze, determine and define Apollo engineering documentation standards and practices requirements necessary to achieve Department objectives. Five years in Engineering Documentation; familiarity and experience in DOD policies; contract; specifications and technical manuals, regulation and writing; plus actual knowledge of large systems preferably missile and/or aircraft.
<p><b>Engineer-Operational Analysis</b> BSME, AE, CE, IE</p>	Develop systems management procedures and system analysis of launch facilities and equipment. Minimum 2-3 years experience preferably in similar aerospace program. Must deal with customers, know and be able to document all functions, authorities, responsibilities of organization and information flow. Require familiarity with AFSC 375 series system and government documents.

*contact* **MR. D. D. SMITH / PROFESSIONAL & TECHNICAL RESOURCES**  
G.E. / Apollo Support Dept. / Room 1107-S / Box 2500 / Daytona Beach, Fla. 32015

**APOLLO SUPPORT DEPARTMENT**  
Missile & Space Division

**GENERAL  ELECTRIC**

An equal opportunity employer.

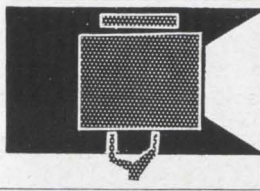

# SEARCHLIGHT SECTION

• CLASSIFIED ADVERTISING • BUSINESS OPPORTUNITIES  
• USED OR SURPLUS EQUIPMENT

## ROTRON COOLING FAN

Computer pullouts. Like new. 'Muffin Fan. In-audibly cools amplifiers, tuners, power supplies, etc. Lengthens tube and equipment life—improves their performance. 4 11/16" sq. x 1 1/2" deep, 100 cfm. For 110-120 v. 60 cycle AC. 1 1/4 lbs. \$8.50 each. Quantity discount available.

**MARS SALES** P. O. Box 72832, Los Angeles, Calif. 90016

CIRCLE 956 ON READER SERVICE CARD

**New**  
for picking up miniature parts

**VACUUM PENCIL**

**PHILIP FISHMAN CO.**  
7 CAMERON ST., WELLESLEY, MASSACHUSETTS

CIRCLE 958 ON READER SERVICE CARD

## FREE...CATALOG BARRY ELECTRONICS

512 BROADWAY NEW YORK 12, N.Y. 212-WALKER 5-7000 TWX-571-0484

CIRCLE 959 ON READER SERVICE CARD

### ELECTRON TUBES

KLYSTRONS • ATR & TR • MAGNETRONS  
SUBMINIATURES • C.R.T. • T.W.T. • 5000-6000 SERIES  
• SEND FOR NEW CATALOG A2 •  
**A & A ELECTRONICS CORP.**  
1063 PERRY ANNEX WHITTIER, CALIF. 696-7544

CIRCLE 960 ON READER SERVICE CARD

*Your Inquiries to Advertisers Will Have Special Value . . .*

—for you—the advertiser—and the publisher, if you mention this publication. Advertisers value highly this evidence of the publication you read. Satisfied advertisers enable the publishers to secure more advertisers and—more advertisers mean more information on more products or better service—more value—to YOU.

## SYNCHROS • GENERATORS INVERTORS • SERVOS

- 23TR6 Torque Receiver . . . . . \$32.50
- 23TX6 Torque Transmitter . . . . . 32.50
- 23CX6 Control Transmitter . . . . . 32.50
- 1 F Motor 115/90 V. 60 Cy. . . . . 24.95
- 1 G Generator 115 V. 60 Cy. . . . . 24.95
- 1 HDG Differential Gen. . . . . 24.95
- 5 G Navy Ord. Size 115 V. 60 Cy. . . . . 24.95
- 5 F Navy Ord. Size 115 V. 60 Cy. . . . . 24.95
- 6 G Navy Ord. Size 115 V. 60 Cy. . . . . 29.50
- 7 G Navy Ord. Size 115 V. 60 Cy. . . . . 39.50
- Bendix Invertor E-1617-1, 24V. Input, 115V. 400 Cy. 3 Ph. s50 V.A. Output. . . . . 25.00
- Jack-Heintz Invertor E-1617-1, 24 V. Input Output 115/230 V. 1/3 Ph. 400 Cy. 2250 V.A. . . . . 75.00
- General Electric E-1823-120/208 V. 400 Cy. Generator 60 KVA. . . . . 250.00
- Jack-Heintz Invertor E-1725-1 24 V. Input, Output 115/230 V. 1/3 Ph. 400 Cy. 2250 V.A. . . . . 75.00
- Westinghouse, Generator 120/208 V. 3 Ph. 400 Cy. . . . . 75.00
- Pioneer Instrument Invertor 12123-1A Input 24 V. Output 115 V. 3 Ph. 400 Cy. . . . . 25.00
- Elinco Generator PM2. . . . . 18.95
- Deihl FPE49-7 Servo Motor & Tach. . . . . 29.95
- Deihl PM Motor 27.5 VDC. . . . . 4.95

## AC MOTORS • DC MOTORS FANS-BLOWERS • RESOLVERS GEARED MOTORS • ACTUATORS

LARGE STOCK OF ROTATING DEVICES  
ALL ITEMS F.O.B. OAKLAND  
Send for Free Catalog  
(ON COMPANY LETTERHEAD PLEASE)

**ELECTRO GADGET SUPPLY**  
Doolittle & Langley Streets  
Oakland Airport Oakland, Calif.  
Phone 562-6641

CIRCLE 954 ON READER SERVICE CARD

## AUTORACK ANTENNA MOUNT

360 degree azimuth, 210 degree elevation sweep with better than 1 mil. accuracy. Missile velocity acceleration and slewing rates. Amplidyne and servo control. Will handle up to 20 ft. dish. Supplied complete with control chassis. In stock—immediate delivery. Used world over by NASA, USAF. TYPE MP-61 B. SCR-584. NIKE AJAX mounts also in stock plus several airborne trackers.

## SCR 584 AUTOMATIC TRACKING RADARS

Our 584s in like new condition, ready to go, and in stock for immediate delivery. Ideal for telemetry research and development, missile tracking, satellite tracking, balloon tracking. Used on Atlantic Missile Range, Pacific Missile Range, N.A.S.A. Wallops Island, A.B.M.A. Write us. Fully Desc. MIT Rad. Lab. Series, Vol. 1, pps. 207-210, 228, 284-286. Compl. inst. Bk. avail. \$25.00 each.

## AN/MPQ-29 SKYSWEEP TRACKER

3 cm. automatic tracking radar system. Complete package with indicator system. Full target acquisition and automatic tracking. Input 115 volts 60 cycle. New. In stock for immediate delivery. Entire System 6' long, 3' wide, 10' high. Ideal for infrared Tracker, Drone Tracker, Missile, Tracker, R. & D.

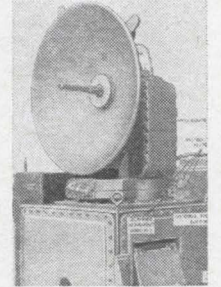

## PULSE MODULATORS

**MIT MODEL 9 PULSER**  
**1 MEGAWATT—HARD TUBE**  
Output 25 kv 40 amp. Duty cycle, .002. Pulse lengths .25 to 2 microsec. Also .5 to 5 microsec, and 1 to .5 microsec. Uses 6C21. Input 115v 60 cycle AC. Mfr. GE. Complete with driver and high voltage power supply. Ref: MIT Rad. Lab. Series, Vol. 5, pps. 152-160.

**2 MEGAWATT PULSER**  
Output 30 kv at 70 amp. Duty cycle .001. Rep rates: 1 microsec 600 pps, 1 or 2 msec 300 pps. Uses 5948 hydrogen thyratron. Input 120/208 VAC 60 cycle. Mfr. GE. Complete with high voltage power supply.

**MIT MODEL 3 PULSER**  
Output: 144 kw (12 kv at 12 amp.) Duty ratio: .001 max. Pulse duration: .5, 1 and 2 microsec. Input: 115 v 400 to 2000 cps and 24 vdc. \$325 ea. Full desc. Vol. 5, MIT Rad. Lab. series, pg. 140.

**250KW HARD TUBE PULSER**  
Output 16 kv 16 amp. duty cycle .002. Pulses can be coded. Uses 5D21, 715C or 4PR60A. Input 115 v 60 cycle ac. incl. H.V. pwr supply \$1200 ea.

**5949 THYRATRON AGING RACK**  
Compl. Chatham Electronics Console incl. 15 kv power supply & PFN's. \$1800.

## MICROWAVE SYSTEMS

**E-4 FIRE CONTROL SYSTEM**  
Hughes Aircraft X Band. Complete. In stock.

**C-BAND RADAR**  
250 KW output, C-band, PPI indicator, 5C22 thyatron modulator. Antenna hi gain parabolic section. Input 115 volts 60 cycle AC, complete \$2750.00.

**300 TO 2400MC RF PKG.**  
300 to 2400 MC CW. Tuneable. Transmitter 10 to 30 Watts. Output. As new \$475.

**500KW "L" BAND RADAR**  
500 kw 1220-1350 mcs. 160 nautical mile search range P.P.I. and A. Scopes. MTI, thyatron mod. 5325 magnetron. Complete system.

**PHILCO MICROWAVE LINKS**  
C Band Microwave Link terminal bays and repeater bays in stock. New \$1500 each or \$2500 per pr.

**100—800MC. CW SOURCE**  
150 watts CW nominal output 115 V 60 Cy AC input, \$1600.

**100KW 3CM. RADAR**  
Complete 100 kw output airborne system with AMTI, 5C22 thyr. mod. 4152 magnetron. PPI. 360 deg az sweep, 60 deg. elev. sweep, gyro stabilizer, hi-gain revr. Complete with all plugs and cables.

**M-33 AUTO-TRACK RADAR SYSTEM**  
X band with plotting board, automatic range tracking, etc. Complete with 1 megawatt acq. radar.

**INFRARED SOURCES**  
Collimated radiation simulator and transistorized temp. controller. Temp. range, 200-600 degree C. Absolute Accuracy ±3 degree C. Type AN/USM, \$1975 New.

**3KW RCA PHONE & TELEG XMT**  
2—30 MC. 10 Autotone channels plus MO. Input 220 vac. 50/60 cycles.

**Radio-Research Instrument Co.**  
550 5th Ave. New York 36, N.Y.  
Tel. JUdson 8-4691

CIRCLE 952 ON READER SERVICE CARD

**EDMUND CATALOG**  
SCIENCE  
MATH  
OPTICS

**EDMUND SCIENTIFIC CO.**  
BARRINGTON, N. J.

# FREE CATALOG! NEARLY 4,000 BUYS FOR INDUSTRY

## OPTICS! SCIENCE! MATH! GIANT 148 PAGES

Many on-the-job helps . . . Quality Control Aids! Write for this completely new, 1965 Catalog. New items, new categories, new illustrations. 148 easy-to-read pages packed with hundreds of charts, diagrams, illustrations. A treasure-house of optical and scientific information . . . unusual bargains galore. Optics for industry, research labs, design engineers, experimenters, hobbyists! Instruments for checking, measuring—to speed work, improve quality, cut production costs. We give you facts: what it is—how it works—where it's used!

### COMPARATORS, MAGNIFIERS, MICROSCOPES

Hard-to-get war surplus bargains—ingenious scientific tools—imported—domestic. Thousands of components: lenses, prisms, wedges, mirrors, mounts—accessories of all descriptions. Dozens of instruments: magnifiers, stereo microscopes, telescopes, binoculars, infra-red equipment, photo attachments. Shop by mail. No salesman will call. Use the Catalog of America's greatest Optics—Science—Math Mart. Known for reliability. Mail coupon below for catalog "EX". No obligation.  
**EDMUND SCIENTIFIC CO.**  
Barrington, N. J.

**MAIL COUPON FOR FREE CATALOG "EX"!**

**EDMUND SCIENTIFIC CO., Barrington, N. J.**  
Please send FREE Giant 148-page Catalog "EX"

NAME .....

ADDRESS .....

CITY ..... ZONE..... STATE.....

CIRCLE 953 ON READER SERVICE CARD

## New Literature

**Integrated-circuit sockets.** Augat Inc., 33 Perry Ave., Attleboro, Mass. Catalog 364 contains an eight-page illustrated description of integrated-circuit sockets and accessories. Circle 461 on reader service card

**Subminiature toggle switches.** C&K Components, Inc., 103 Morse St., Newton, Mass., 02158. A catalog sheet deals with the series 7200 dpdt subminiature toggle switches that combine maximum performance, dependability, and durability with minimum weight and small size. [462]

**All-silicon power supply.** Nexus Research Laboratory, Inc., 480 Neponset St., Canton, Mass., 02021. Bulletin PB-051 covers the NPS-30, a miniature, reference grade regulator designed to supply power to a few amplifiers in small analog systems. [463]

**Soldering irons.** American Electrical Heater Co., 6110 Cass Ave., Detroit, Mich., 48202, offers a catalog entitled "Soldering Irons Designed Expressly for Miniature, Subminiature and Micro-miniature Electronics Fields." [464]

**Capacitors.** Components, Inc., Smith St., Biddeford, Maine, has released 3 four-page catalogs covering its solid tantalum Minitan modular, Minitan H series, and Minitan cordwood capacitors. [465]

**Optics brochure.** Perkin-Elmer Corp., Main Ave., Norwalk, Conn. An eight-page brochure details company capabilities in optical components, devices, systems, consultation, design and engineering. [466]

**Driver/decoder modules.** Industrial Electronic Engineers, Inc., 7720 Lemon Ave., Van Nuys, Calif., 91405, has available an engineering data sheet on new solid state driver/decoder modules for use with rear-projection readouts. [467]

**Integrated display console.** Aerospace Systems Division, Defense Electronic Products, Radio Corp. of America, 8500 Balboa Blvd., Van Nuys, Calif., offers a brochure on the type 6320 integrated display console. [468]

**D-c gearmotors.** Globe Industries, Inc., 1784 Stanley Ave., Dayton, Ohio, 45404. Bulletin E-2029 gives design data plus dimensions on CMM and CLL p-m gearmotors rated to 1,000 oz.-in. output. [469]

**Relays.** Guardian Electric Mfg. Co., 1550 W. Carroll Ave., Chicago 7, Ill. Bulletin B2, describes series 1200, 1210, 1220, 1210N and 1200/1200 general purpose relays. [470]

**Overvoltage load protector.** Dressen-Barnes Electronics Corp., 250 North

Vinedo Ave., Pasadena, Calif. A technical bulletin explains and lists application data on the new overvoltage load protector for industrial, commercial and military fields. [471]

**Combination isolator.** Barry Controls, 700 Pleasant St., Watertown, Mass., 02172. Bulletin 2.26 describes the series 2K isolators that provide excellent protection from both vibratory and shock inputs in a single, compact isolation element. [472]

**Components.** Waldom Electronics, Inc., 4625 W. 53rd St., Chicago, Ill., 60632. Catalog 6F5 is a 40-page listing of terminals, hardware and components for the electronic and electrical industries. Prices are included [473]

**X-ray diffraction systems.** General Electric Co., 5504 S. Brainard Ave., La-Grange, Ill., offers a catalog covering a line of basic x-ray diffraction systems for fast and accurate laboratory and production line identification of compounds and chemical substances. [474]

**Radio relay equipment.** Selenia Telecommunications, P.O. Box 7083, Rome, Italy, has available a data sheet on the SRL-23A all solid state radio relay equipment. [475]

**Signal sensors.** Kearfott Division, General Precision Inc., Aerospace Group, Little Falls, N.J., has available a data sheet on three signal sensors that are designed to activate a relay when an input signal reaches a preset value. [476]

**Tiny chopper.** Solid State Electronics Corp., 15321 Rayen St., Sepulveda, Calif., has published a bulletin on the model 6 silicon Microchopper, said to be the smallest ever devised. [477]

**R-f coaxial plugs.** ITT Cannon Electric, 3208 Humboldt St., Los Angeles, Calif., 90031, offers a catalog describing subminiature r-f coaxial plugs. [478]

**Vhf oscillator.** Boonton division, Hewlett-Packard, Co, Green Pond Road, Rockaway, N.J., 07866. A technical data sheet illustrates and describes the model 3200A vhf oscillator designed for general purpose laboratory use. [479]

**Piezoelectric ceramic composition.** Piezoelectric division, Clevite Corp., 232 Forbes Road, Bedford, Ohio. Technical paper TP-21 contains specifications for PZT-4 piezoelectric ceramic composition. Included are performance curves based on laboratory testing. [480]

**Microwave tubes.** Hughes Microwave Tube Division, P.O. Box 90427, Los Angeles, Calif., 90009, is offering a short-form catalog on its lines of traveling-wave tubes and backward-wave oscillators. [481]

## COMINCO high-purity metals

Available forms in 99.999% and/or 99.9999% purities	ALUMINUM	ANTIMONY	ARSENIC	BISMUTH	CADMIUM	COPPER	GOLD
BARS	X	X	X	X	X	X	
SHEETS	X				X	X	X
WIRE	X				X	X	X
POWDER		X	X	X	X		
SHOT		X		X	X	X	
ROD	X			X	X	X	
RIBBON							
PREFORMS	X				X	X	X
SALTS					X		
Available forms in 99.999% and/or 99.9999% purities	INDIUM	LEAD	SILVER	TELLURIUM	THALLIUM	TIN	ZINC
BARS	X	X	X	X	X	X	X
SHEETS	X	X	X			X	X
WIRE	X	X	X			X	X
POWDER	X	X	X	X	X	X	X
SHOT	X	X	X			X	X
ROD	X	X	X			X	X
RIBBON	X	X				X	
PREFORMS	X	X	X			X	X
SALTS	X						

### COMINCO PRODUCTS, INC.

ELECTRONIC MATERIALS DIVISION  
818 West Riverside Ave., Spokane, Wash. 99201  
Phone 509 747-6111 Telex 032 610

5609

TWX 509-328-1464

Circle 212 on reader service card



### NEW! ELECTRONICS SLIDE RULE WITH INSTRUCTION COURSE

Professional, all-metal 10" slide rule . . . designed specifically for engineers and technicians. Comes with four lesson AUTO-PROGRAMMED Instruction Course. Carries special scales to speed solution of reactance and resonance frequency problems. Has handy decimal point locator plus widely use formulas and conversion factors not found on any other rule. Can be used for conventional computation, too. Made to our rigid specs by Pickett, Inc. Rule, AUTO-PROGRAMMED Instruction Course and top-grain leather case . . . just \$14.95. Satisfaction warranted or your money back. Cleveland Institute of Electronics, 1776 E. 17th St., Dept. E-105, Cleveland, Ohio 44114.

#### SEND COUPON TODAY

### Cleveland Institute of Electronics

1776 E. 17th St., Dept. E-105, Cleveland, Ohio 44114

- Send FREE brochure only . . . without obligation.  
 Send Electronics Slide Rule with Instruction Course and leather case. I'm enclosing \$14.95.

Name \_\_\_\_\_ (Please Print)

Address \_\_\_\_\_ County \_\_\_\_\_

City \_\_\_\_\_ State \_\_\_\_\_ Zip \_\_\_\_\_

A leader in Electronics Training . . . since 1934

**ANDREW**



**SIMPLIFIES  
INSTALLATION PLANNING**

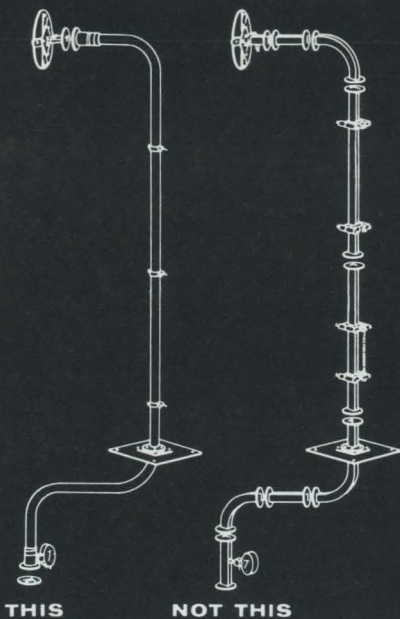

**HELIAX® ELLIPTICAL  
WAVEGUIDE** Better than  
rectangular at half the cost!

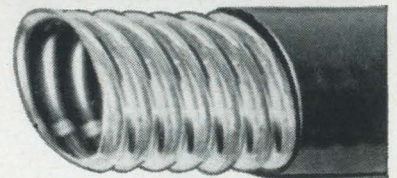

**Continuous lengths . . . flexible.** HELIAX elliptical waveguide eliminates the echo distortion caused by the numerous bends, twists, and flange joints of a conventional waveguide run. Attenuation is also reduced\*. HELIAX flexibility simplifies planning and handling. Installation requires only unreeling, attachment to tower, and connection to equipment. Write today, or ask your Andrew sales engineer for complete information on this new Andrew waveguide development!

\*At 6700 Mc, HELIAX elliptical waveguide loss is 1.5 db/100 ft, compared to 1.9 db/100 ft. for rectangular waveguide.

**Andrew**  
CORPORATION  
P. O. BOX 807 • CHICAGO, ILLINOIS U.S.A. 60642

**28 YEARS OF ENGINEERING INTEGRITY**  
EUROPEAN OPERATIONS: ANDREW CORPORATION, HOJSGAARDS—ALLE 02, HELLERUP, DENMARK

# Electronics Abroad

Volume 38  
Number 9

## Yugoslavia

### Electronic reflexes

An artificial hand with built-in reflex action has been developed by Prof. Rajko Tomovic of the University of Belgrade's electrical engineering department. Unlike most prosthetic limbs, which require the user to control every movement, this device contracts automatically to conform to the shape of the object to be grasped.

Even for someone with the use of both hands, picking up something is not as easy as it sounds. The fingers must adapt to the shape of the object, and the hand must be clenched with enough power to hold the object but not to crush it. A human hand does this automatically; Tomovic's hand does it in two steps.

**Reflex switches.** The "reflexes" are governed by 10 microswitches on the palm, thumb and fingertips. When the user wants to lift something, he presses a switch on the inside of his forearm. As soon as any one of the microswitches touches the object, it automatically contracts the hand until all fingers are in contact with the object. In other artificial hands, the user must make a separate effort to perform this task.

Since any microswitch activates the whole hand, the user must land more or less on target or he will find himself grasping empty air.

To lift the object, the user must tighten the grip, which is controlled by varying the power supply that the battery delivers to the motor. The user exercises control by flexing his biceps, activating a sensitive element that is fitted into an elastic armband. The tighter the contraction, the tighter the grip. If he does not flex the biceps, gripping power is one-tenth of that available. Pressing the forearm switch releases the grip.

**Electronic nerves.** The microswitches are stimulated by transistorized logic circuits that are activated by a magnetic d-c servomotor with d-c amplifiers. All driving mechanisms are positioned in

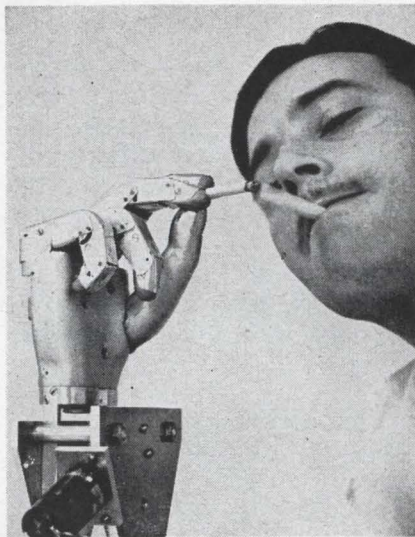

Artificial hand is steadier than the cigarette the user is lighting. Motor is in cylindrical tube at bottom. In use the hand has a plastic cover.

the hand, except the servomotor and the electronic circuitry. The motor is attached to the forearm; the circuitry and the nickel-cadmium battery are housed in separate external units.

The output circuit, which controls the motor, is constructed as a bridge so that power consumption is low when the system is at rest.

The amplifier's output stage acts as a relay feedback system when the object is to be released, and returns the system to its initial position.

The servomotor includes a worm-gear, whose shaft is in the middle of the hand, perpendicular to the palm. A cam disk rotates on the same shaft. The rotation is transformed into straight-line motion by two metal slides, one of which

moves perpendicular to the direction of the fingers and the other parallel to the finger. The sliding action pulls the fingers.

**Room for improvement.** Dr. Hilda Gross of the University of California at Los Angeles, where Tomovic is a visiting lecturer, evaluated the hand in a study financed by the office of vocational rehabilitation of the United States Department of Health, Education and Welfare. She said preliminary results were encouraging, but mentioned several problems. Finger joints work well in small, delicate tasks, she said, but opening a bottle or a faucet is still too much for them.

She suggested some electronic and mechanical changes to increase stability, reduce size and weight, and make it easier to use. The hand is being modified in Yugoslavia. When this work is completed, the Pupin Institute will join the Ritzoldi Institute of Bologna, Italy, in manufacturing the hand—probably early next year.

Mass production may also cut the price from the present \$1,200 level.

## Great Britain

### Answers from aloft

Starting July 1, all planes flying 25,000 feet or more above Britain must carry transponders that automatically identify the flight and give its altitude and other information.

Synchronized neatly with that deadline is an announcement that a British-French consortium has introduced a versatile secondary radar system that meets both civil and military demands for identification. Secondary radar supplements primary radar, which obtains range and bearing.

The new system, called Secar,

was developed jointly by the Marconi Co., a subsidiary of the English Electric Co., and by the Compagnie Française Thompson Houston.

Secar is suitable for use with any primary radar system, the manufacturers say. The system will be in operation June 10 to 21 at the Paris International Air Show.

The United States also has a program to require beacon transponders by 1970 on all military and commercial aircraft flying above 18,000 feet [Electronics, April 19, p. 40].

**Q & A.** In the secondary radar system, ground stations transmit interrogation signals that are received by a transponder on an aircraft. The transponder automatically sends back a coded reply. The ground also sends a control pulse by a beam characteristic that is different from that of the queries.

A high-speed switching system in the Secar antenna allows both types of output pulse to be sent from a single antenna and transmitter.

Secar performs both passive and active decoding. Passive decoding compares an incoming reply with a preselected signal stored in the decoder memory. If the reply code is unknown, Secar turns to active decoding; the operator isolates the unknown response with a stroboscopic marker, and this response is analyzed by decoding circuits and displayed alphanumerically.

If the pilot flips a switch indicating he's in some kind of trouble, Secar's decoding circuits give audio and visual alarms and an automatic response on the plan-position indicator (PPI).

**Screening the replies.** All aircraft replies are represented on the PPI together with the associated signals from primary radar. The operator controls two types of alphanumeric display: one for identifying the plane, the other for noting its altitude.

The British program, which ultimately will be extended to lower-flying planes, requires transponders that meet specifications of the International Civil Aviation Organization. Sweden, France, Belgium,

Switzerland and Ireland also plan to adopt secondary radar requirements soon.

### Progress on display

The Labor government's new Ministry of Technology made a splash at the Institute of Physics and the Physical Society exhibition in Manchester last month by sponsoring two dozen devices and processes.

The office administers 10 research establishments and aids 50 others with grants; it is also the sponsor department for the electronics, computer, telecommunications and machine-tool industries.

It was the first time in its 49-year history that the show had been held outside of London. The change of scene held attendance down, but not the quality of the exhibits. Perhaps stimulated by the new ministry's interest, exhibitors showed more genuinely new items than usual, and there were fewer outright commercial exhibits.

**Frequency converter.** An upper-sideband frequency converter, shown by the Plessey Co., makes use of barrier capacity with applied junction voltage in a semiconductor diode. It converts a signal frequency of 70 megacycles per second to 7.5 Mc.

A klystron oscillator, the power source, modulates the barrier capacity of two silicon varactor diodes placed in two output arms of a three-decibel coupler. Pump power is fed through an input arm, and the desired sideband is extracted at a third output arm. Filters allow the current to flow only at the three frequencies of interest—the signal frequency, pump frequency and upper sideband frequency.

**New film memory.** One highlight of the show was a new type of random-access magnetic film memory, shown by the Plessey Co. At low cost per bit, it gives a nondestructive readout at read-cycle times that are comparable to those obtained with core stores, and write times faster than those obtained with drums.

Other exhibits that received con-

siderable attention in Manchester:

▪ A technique for deposition of glassy or amorphous films, even on cold surfaces, was introduced by Standard Telephones and Cables, Ltd., a subsidiary of the International Telephone and Telegraph Corp. By exciting inorganic gas molecules with radio frequencies, the system causes materials to be deposited at low ambient temperatures on glass, plastic and metal. Purity of the gas is maintained because, unlike methods that use heat to sustain the chemical reaction, the STC method requires no electrodes and permits the reaction tube to remain cold.

STC uses a quartz reaction tube. A low-power r-f generator, operating at one megacycle per second, is coupled either inductively or capacitatively to the gas stream. The gases are metered separately and fed simultaneously into the tube, where deposition occurs in the glow-discharge region at 2 to 10 microns an hour.

▪ A liquid composition meter that uses immersed r-f resonators was shown by the National Physical Laboratory. It gives continuous measurement of mixtures of ethanol and water, needed for on-line computer-control studies of a chemical process.

A double resonator is inserted into a special nonconducting section of pipe carrying the mixture. One resonator is constructed from a fixed inductor and a capacitor; the sealed-in dielectric of the capacitor is a reference mixture that could have the mean composition of the measuring range. The second resonator is totally immersed in the liquid to be measured.

A variable-frequency oscillator is continuously swept over its full range. When it is correctly coupled to the resonators, the oscillator's grid current decreases sharply as the oscillator passes through either resonant frequency. The current waveform is amplified and converted into a square wave, which then operates a flip-flop circuit. The output from the flip-flop can either be smoothed to give an analog output or used as a gating waveform to control a counter.

France

Color tube unmasked

After nearly a year of sketchy reports, the Compagnie Francaise de Television (CFT) has demonstrated the color-television tube that it says can be manufactured for one-third less cost than conventional shadow-mask tubes. CFT seems to have solved the technical problems that caused the scheduled introduction to be canceled 14 months ago and says production will begin soon.

The new tube employs a wire grill with 450 spaces instead of an expensive shadow mask containing thousands of tiny holes. The grill presents less obstruction to the electrons coming from three cathode-ray guns; together with a technique for adjusting the electrons' speed, the grill allows the tube to utilize 90% of the electrons, compared with the 10% to 15% used by shadow-mask tubes.

**Economies.** This efficiency reduces power requirements considerably because the new tube can obtain good brightness with much less current than is needed in shadow-mask tubes. It also permits the use of circuits that are only slightly more costly than those for black-and-white tv.



New color-tv tube is studied by CFT engineers. Dark border on tube contains electrodes that adjust electrons' speed.

Shadow masks also have been eliminated by two Japanese companies, the Sony Corp. and Yaou Electric Co. They employ versions of the Lawrence tube, which uses one electron gun to sample the reds, blues and greens sequentially. The CFT tube, with three guns as in the shadow-mask versions, presumably presents the three colors simultaneously; this results in better picture detail.

**Production plans.** CFT, which owns patents on the Secam color-tv system, is a joint venture of Compagnie Generale de Telegraphic Sans Fil and Compagnie de St. Gobain, a major manufacturer of glass and chemicals.

Henri de France, inventor of Secam, helped to develop the maskless tube. He says small production lines are being set up with the help of Selenia of Italy, a subsidiary of the Raytheon Co. De France concedes that CFT and Selenia have not yet developed mass-production methods, but says he expects full-scale production to be possible within a year.

A CFT spokesman says a "big set" with the new tube and its associated circuitry will probably cost less than \$300. The biggest saving in production is the elimina-

tion of the shadow mask, which requires a complex, expensive and precise manufacturing process.

Two permanent adjustments will be made at the factory, de France says. The speed of the electron beam will be regulated by brightener electrodes—metallic strips—on the outside of the tube. And the voltages around spaces in the grill will be adjusted so that each space "steers" the beam that passes through it.

The new tube has a flat face, making it easier to see the picture from the side.

Scratch one consortium

The Raytheon Co., which was the latest entry in the race for a \$279-million NATO contract, has become the first known to have withdrawn. The contract is for an air-defense ground-environment network, called Nadge.

Karl M. Schwarzkopf, Raytheon's Paris representative, says his company made its decision after officials of the North Atlantic Treaty Organization rejected suggestions for changes in procurement procedures. He declines to elaborate, but another Raytheon official says the company was dissatisfied with the way the program was defined.

Other members of the Raytheon-led consortium were Ferranti, Ltd., of Britain, Sintra of France and Brown-Boveri & Cie of Switzerland. Other contenders are groups led by the Hughes Aircraft Corp., Litton Industries, Inc., and the Westinghouse Electric Corp.



Henri de France looks pleased as he discusses new color-tv tube. De France invented Secam color system.

Brazil

On the plantation

The coffee plantation may soon have an answer to the genteel tea-taster: an electronic bean-selector.

Two young engineers in Rio de Janeiro have developed a device that performs the final process in grading—separating the good dark beans from the green ones—faster

and less expensively than people can.

The inventors, Frank Gevert and Alberto Barroso de Souza, met while working at the International Business Machines Corp. plant in Rio. Last year they formed Tecnostral Ltda. to manufacture and sell the machine, called the Solotron T-5. By early this year 70 Solotrons had been sold and 24 units were being produced monthly at a plant in Rio. "We built the first one in my back yard," Gevert recalls.

**A row of beans.** The early stages in bean selection are still done mechanically in the new process; these are grading the beans by size and density, and feeding the survivors into the Solotron. The beans are marched single file, by electromagnetic vibrators, into an inspection chamber where two photoelectric cells examine each bean against a colored background.

If the bean's color falls within a preset range, it is passed onto a conveyor belt; if it is too light or too dark, a signal activates an electropneumatic valve that separates the rejected bean and ejects it onto another belt for discard.

Wide-range a-c and d-c voltage stabilizers permit the Solotron to operate at 160 to 260 volts—a necessary flexibility in a country where voltage varies widely. Gevert and Barroso de Souza are now working on a frequency stabilizer, because in Brazil's backland coffee country the frequency also varies.

**Easy to operate.** Any unskilled operator who understands coffee can operate the Solotron. By turning switches, he can adjust the chromatic reference background and test the photocell's sensitivity on the five independent tracks.

The machine handles four bags of coffee an hour, double the capacity of all-mechanical methods, Gevert says. The production cost is said to be one-half that of competitive systems, and maintenance and operating costs 20% as high.

All parts are manufactured domestically, Gevert says, except one type of transistor imported from the United States and roller bearings purchased in Sweden.

---

## Switzerland

---

### CATV in the Alps

In the shadow of the Alps, nature has had little competition from television. Since Feb. 26, however, residents of the area around Lucerne have been receiving clear pictures from six stations over a community antenna tv system (CATV).

Even the nearest station, with a transmitter atop Rigi peak overlooking the valley, had been plagued by echoes. With CATV, West German tv comes through sharp and clear from the Black Forest, 62 miles to the northwest.

**Exit echo.** The echoes are eliminated by a 65.6-foot-high antenna system erected on a mountaintop 492 feet above the new housing development of Würzenbach. The tower contains five antennas: four for tv and one for f-m radio. The antenna system was developed by the Swiss subsidiary of Siemens & Halske AG of West Germany.

The signals travel a mile and a quarter to a distribution center, along a coaxial cable that contains several line amplifiers. From there they go to subscribers' homes. The company expects ultimately to have 2,000 subscribers.

Two other Swiss communities are experimenting with CATV. There are only about half a dozen CATV systems in Europe, compared with about 1,500 in the United States.

---

## East Germany

---

### Emphasis on exports

Add another contender in the scramble for international television markets. Now that half of East Germany's families own tv sets, state planners are seeking foreign markets for the unsold supply.

Until now, only about 5% of the country's tv output has been exported, compared with 16% for all consumer products. But with 642,-

000 sets a year rolling off assembly lines, only to clog dealers' shelves, foreign sales seem to be the logical goal.

A 21-inch set without ultrahigh frequency costs \$512 in East Germany.

**Components.** The government also seems to be stressing improvement in electronic components. A group of plants and institutes has been given the task of developing components for industrial electronics and for electronic data-processing systems.

One unit, the Manfred von Ardenne Research Institute, is responsible particularly for electron-beam and ion-beam technology and equipment for thin-film manufacturing techniques. Two other members of the component group are the Dresden Institute for Molecular Electronics, and the Electronic Computing Machines and High Vacuum plants of VEB, whose initials stand for the German words for People's Own Company.

Zebeina, a plant in Dresden, recently began mass production of a standard line of plug-and-socket connectors intended for computers, control equipment, switch panels and other low-voltage applications. East Germany still has to import most of its sophisticated components; much of the supply comes from West Germany.

---

## Around the world

---

**China.** Electronics technology in Communist China is 5 to 10 years behind the West's, according to a Danish electronics engineer who recently participated for two months in industrial exhibitions there. The engineer, H. Kongsted, says 30,000 Chinese engineers and technicians attended the Danish exhibitions in Peking, Shanghai and Wuhan.

**Poland.** The Polish section of a four-nation coaxial cable is reported to be completed. The 1,750-mile link will carry television programs and telephone calls between Poland, the Soviet Union, Czechoslovakia and East Germany.





*Him say, "When reliability counts, count on Mylar®."*

There'll be no signaling from your computer (or its operators) if you make certain that all your tapes are on a base of "Mylar"\*. That's because "Mylar" is strong (a tensile strength of 20,000 psi), stable (unaffected by

temperature or humidity changes) and durable (no plasticizer to dry out or become brittle with age). No wonder it has been the most used tape base for the past ten years. Remember: When reliability counts, count on "Mylar".

**DUPONT**  
DU PONT DE NEMOURS & CO.  
 Better Things for Better Living  
 ...through Chemistry

only **DUPONT** makes  
**MYLAR®**  
 POLYESTER FILM

\*Du Pont's registered trademark for its polyester film.



■ AMP Incorporated	111	Krohn-Hite Corporation	135
Garceau, Hargrave & McCullough Inc.		Stern/Frank Advertising Inc.	
■ Andrew Corporation	154	Kyorigutsu Electrical Inst. Works Ltd.	146
The Fensholt Advertising Agency		Nichiden Adv.	
Astrodata Inc.	11	Machlett Laboratories Inc., The	8
Bonfield Associates Inc.		Fuller & Smith & Ross Inc.	
Automatic Electric Company	116	Mallory & Company Inc. P. R.	109
Kudner Agency Inc.		The Aitkin Kynett Company	
■ Ballantine Laboratories	112	■ Markel & Sons, L. Frank	147
Lang-Lawrence Advertising Inc.		George Moll Advertising Inc.	
Beckman Instruments Inc. Offner Division	42	Marquardt Corp.	146
Erwin Wasey, Ruthrauff & Ryan Inc.		Grant Adv. Inc.	
Beede Electrical Instruments Company Inc.	108	McGraw Hill Book Company Inc.	98, 136
S. Gunnar Myrbeck & Company		Mico Instrument Company	134
Bristol Company, The	139	■ Microswitch Div. of Honeywell	95, 96
Chirurg & Cairns Inc.		Batten, Barton, Durstine & Osborn Inc.	
■ Brush Instruments, Div. of Clevite Corporation	3rd Cover	Motorola Semiconductor Products Inc.	107
Carr Liggett Adv. Inc.		Lane and Bird Advertising Inc.	
Burr-Brown Research Corporation	106	North Atlantic Industries Inc.	33
N. A. Winter Adv. Agency		Murray Heyert Associates	
■ Chester Cable Corporation	19, 20	■ Phelps Dodge Electronic Products Corp.	115
Lewis Advertising Agency		Smith, Dorian & Burman Inc.	126
■ Christie Electric Corporation	132	Plastic Capacitors Inc.	126
Len Woolf Co. Advertising		Sander Rodkin Adv. Agcy. Ltd.	
■ Cinch Manufacturing Company	99	Potter & Brumfield Div. of	
Stral Advertising Company Inc.		American Machine & Foundry Co.	16
Clare & Company, C. P.	22, 23	Grant, Schwenck & Baker Inc.	
Reinke, Meyer & Finn Adv.		Princeton Applied Research Corporation	26
■ Clarostat Mfg. Co.	45	Mort Barish Associates	
Lescarboura Advertising Inc.		Radio Corporation of America	4th Cover
Cleveland Institute of Electronics	153	Al Paul Lefton Company	
Carr Liggett Advertising Inc.		Rohde & Schwarz Inc.	97
Cominco Products Inc.	153	Armand Richards Advertising Agency	
McKim Productions Limited		■ Sanborn Co., A Div. of Hewlett Packard Company	2
Computer Test Corporation	46	Culver Advertising Inc.	
Technical Marketing		■ Singer Company, Metrics Division	102
Consolidated Electrodynamics Corporation	113	Hepler & Gibney Inc.	
Hixson & Jorgensen Inc.		■ Sorensen Inc.	117
Corning Electronic Div. of Corning Glass Works	44	Fuller & Smith & Ross Inc.	5, 6, 10
The Rumrill Company Inc.		Sprague Electric Company	
Crown International	141	The Harry P. Bridge Company	
Frank Crowley Advertising		Stackpole Carbon Company	21
Crystalonics Inc.	35	Meek and Thomas Inc.	
Impact Advertising Inc.		Standard Electric Time Company	132
Daven, Div. of McGraw Edison	143	William Schaller Co. Inc.	
Keyes, Martin & Company		TRW Electronics	31
Di-Acro Corporation	133	Fuller & Smith & Ross Inc.	
Charles E. Brown Adv.		Texas Instruments Incorporated, Industrial Products Group	122, 123
■ Digital Equipment Corporation	137	Robinson-Gerrard Inc.	
The Rumrill Company Inc.		Texas Instruments Incorporated Metals & Controls Inc.	130, 131
DuPont de Nemours & Co. Inc. E. I.	39, 159	Horton, Church & Goff Inc.	
Batten, Barton, Durstine & Osborn Inc.		Texas Instruments Incorporated Semiconductor-Components Division	12, 13
Eastman Kodak Company	41	Don L. Baxter Inc.	
The Rumrill Company Inc.		Thermal American Fused Quartz Company	32
Edgerton, Germeshausen & Grier Inc.	40	Knipf Associates	
Reach, McClinton & Co. Inc.		Tropel Inc.	146
Electronized Chemicals Corporation	101	Harry M. Clar & Associates	
Kenyon & Eckhardt Inc.		■ Trygon Electronics	34
Elgenco Incorporated	141	Carpenter, Matthews & Stewart Inc.	
Lewco Advertising		■ Trylon Inc.	126
Fairchild Scientific Instruments, Dumont Laboratories Div.	118	George Moll Adv. Inc.	
The Roger & Wilbur Co. Inc.		■ United Transformer Corporation	2nd Cover
Fairchild Semiconductor Corp.	14	Philip Stogel Company Inc.	
Johnson & Lewis Inc.		Vector Department of Norden Div. of United Aircraft Corporation	9
■ General Electric Company Miniature Lamp Dept.	129	Cunningham & Walsh Inc.	
Batten, Barton, Durstine & Osborn Inc.		Weston Instruments Incorporated	100
■ General Electric Company, Silicone Products Dept.	124, 125	Basford Incorporated	
Ross Roy Inc.		Wood Electric Corporation	144
General Radio Company	7	L.K. Frank Co. Inc.	
K. E. Morang Company			
■ Globe Industries Inc.	144		
Odiorne Industrial Adv. Inc.			
Graphic Systems Inc.	134		
Caswell Adv. Agency			
Gudebrod Bros. Silk Co. Inc.	24, 25		
Lee Ramsdell & Co. Inc.			
Hamilton Watch Company	127		
Beaumont, Heller & Sperling Inc.			
■ Hewlett-Packard Company	1		
Lennen & Newell Inc.			
Houston Omnigraphic Corporation	144		
Cooley & Pate Inc.			
■ IBM Corporation, Industrial Products Div.	114		
Marsteller Inc.			
Industrial Exhibitions Ltd.	128		
Walkley Hodgson Limited			
International Rectifier Corporation	36		
Communication Associates			
Janus Control Corporation	145		
L. K. Frank Co. Inc.			
■ Key Electric Company	120, 121		
Josephson, Cuffari & Company			

## Classified advertising

F. J. Eberle, Business Mgr.	
Employment Opportunities	148-151
Equipment	
(Used or Surplus New)	
For Sale	152

## Classified advertisers index

■ A & Electronics Corp.	152
Atomic Personnel Inc.	150
■ Barry Electronics	152
Edmund Scientific Co.	152
Electro Gadget Supply	152
Engineering Associates	152
■ Fishman Co., Philip	152
General Electric Co.	
Heavy Military Electronics Dept.	148
Missile & Space Div.	151
International Business Machines	150
Lawrence Radiation Laboratory	150
Mars Sales	152
McDonnell	149
■ Radio Research Instrument	152

## Advertising sales staff

**Gordon Jones** [212] 971-2210  
Advertising sales manager

**Atlanta, Ga. 30309:** Gus H. Krimsier, Michael H. Miller, 1375 Peachtree St. N.E., [404] TR 5-0523

**Boston, Mass. 02116:** William S. Hodgkinson McGraw-Hill Building, Copley Square, [617] CO 2-1160

**Chicago, Ill. 60611:** Robert M. Denmead, J. Bradley MacKimm 645 North Michigan Avenue, [312] MO 4-5800

**Cleveland, Ohio 44113:** Paul T. Fegley, 55 Public Square, [216] SU 1-7000

**Dallas, Texas 75201:** Richard P. Poole, The Vaughn Building, 1712 Commerce Street, [214] RI 7-9721

**Denver, Colo. 80202:** Joseph C. Page, David M. Watson, Tower Bldg., 1700 Broadway, [303] AL 5-2981

**Houston, Texas 77025:** Kenneth George, Prudential Bldg., Halcombe Blvd., [713] RI 8-1280

**Los Angeles, Calif. 90017:** Ashley P. Hartman, John G. Zisch, 1125 W. 6th St., [213] HU 2-5450

**New York, N.Y. 10036:** Donald R. Furth [212] 971-3615  
Frank LeBeau [212] 971-3615  
George F. Werner [212] 971-3615  
500 Fifth Avenue

**Philadelphia, Pa. 19103:** William J. Boyle, Warren H. Gardner, 6 Penn Center Plaza, [215] LO 8-6161

**San Francisco, Calif. 94111:** James T. Hauptli, 255 California Street, [415] DO 2-4600

**London W1:** John W. Patten, Edwin S. Murphy Jr., 34 Dover Street, Hyde Park 1451

**Milano:** Ludovico Greco, 1 via Baracchini Phone: 86-90-617

**Frankfurt/Main:** Gerd Hinske, 85 Westendstrasse Phone: 77 26 65 and 77 30 59

**Geneva:** Michael R. Zeynel, Joseph Wuensch, 2 Place du Port 244275

**Paris VIII:** Denis Jacob, 17 Avenue Matignon ALMA-0452

**Tokyo:** Nobuyuki Sato  
Shiba, Minato-ku (502) 0656

**Osaka:** Kazutaka, Miura, 163, Umegae-cho, Kilita-ku [362] 8771

**Nagoya:** International Media Representatives, Yamagishi Bldg., 13, 2-Chome, Oike-cho Naka-ku

**Hugh J. Quinn:** [212] 971-2335  
Manager Electronics Buyers' Guide

**David M. Tempest:** [212] 971-3139  
Promotion manager

**Milton Drake:** [212] 971-3485  
Market research manager

**Richard J. Tomlinson:** [212] 971-3191  
Business manager

**Theodore R. Geipel:** [212] 971-2044  
Production manager

■ For more information on complete product line see advertisement in the latest Electronics Buyers' Guide

# New Brush Mark 842

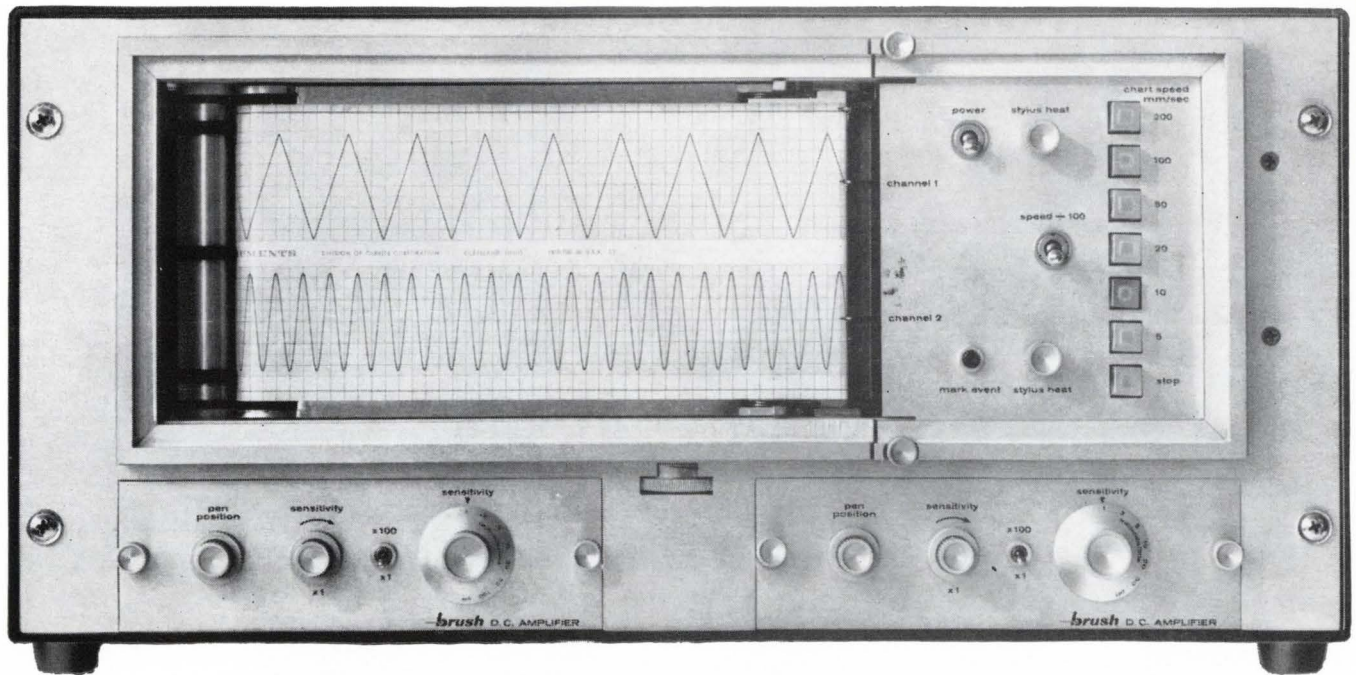

## Highest useable frequency response of *any* direct writing recorder

**Here's the Recorder some people thought was years away . . . a completely self-contained system for general purpose or specialized requirements.**

Useable frequency response . . . 75 cps full scale; flat to 150 cps at reduced amplitude.

$\frac{1}{2}\%$  Linearity . . . assured by *tangent-correction*.

Plug-in preamplifiers . . . design your own recorder.

Complete simplicity . . . push a button and it's "go" .

All solid state electronics.

And new high-torque penmotors permit greater stylus pressure without loss of accuracy . . . assure uniform accurate recording of high speed transients. Rugged styli deliver crisp, clear traces on heat sensitive paper. Wide "off-the-shelf" selection of plug-in modular preamplifiers, lets you match a Mark 842 system to *your* specific recording requirements. Variety of mounting possibilities, including RETMA standard. Simple, reliable, flexible

. . . designed to fill your needs for years to come. Complete details on request. Brush Instruments Division, Clevite Corporation, 37th & Perkins, Cleveland, Ohio 44114.

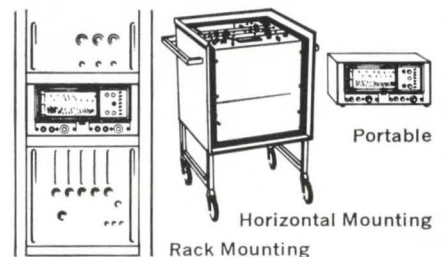

# CLEVITE

**brush** INSTRUMENTS DIVISION

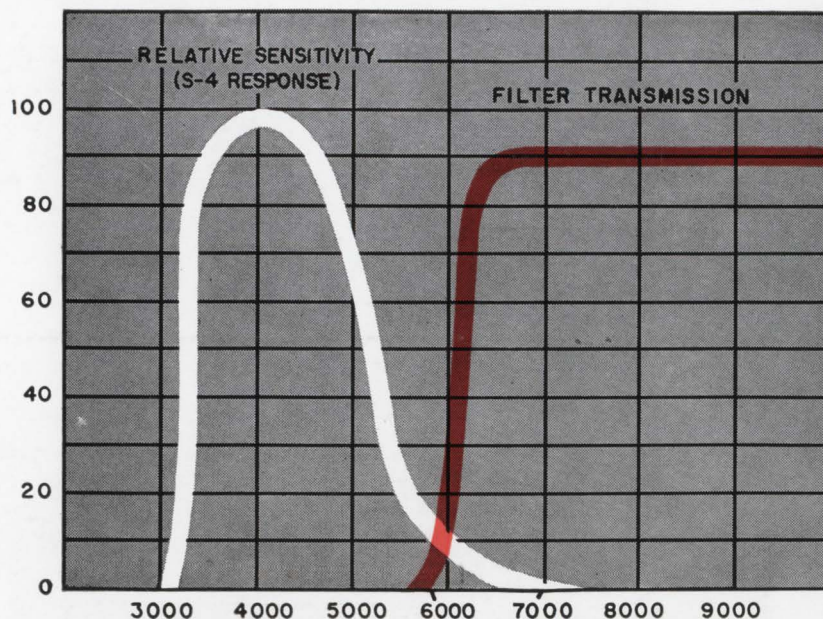

\*The anode current comprising the "white" portion of this ratio is measured with a tungsten light source operated at a color temperature of 2870°K. The anode current comprising the "red" portion of this ratio is measured under conditions identical with the "white" measurement except that the light input is transmitted through a specially selected red filter as shown above.

## "Red-to-White" Ratio\* Controlled Above 5800 Angstroms

Now! RCA introduces three new photomultipliers with sensitivity ratings controlled above 5800 angstroms. A particularly desirable characteristic for radiation detection and measurement in the red region of the spectrum, this specified "red-to-white" ratio\* is 5% or greater for RCA-4471; and 7% or greater for RCA-4472 and 4473. The 4471 and 4472 have all the desirable features and characteristics of the 931A as well as a higher luminous sensitivity rating, while the 4473 has all the desirable features and characteristics of the 1P21 as well as a higher luminous sensitivity rating. The 4471 and 4472 are unilaterally interchangeable with the 931A and the 4473 is unilaterally interchangeable with the 1P21.

Recommended for critical applications for detecting and measuring extremely low levels of light, these three RCA photomultipliers are excellent for use in such applications as flame, spark, and arc spectroscopy; in color printing processes; and in flying spot scanners.

Complete data are available from your RCA representative. See him about these and other RCA light-sensitive devices. Or, for information on specific types, write: RCA, Commercial Engineering, Section EL9Q-1, Harrison, N.J.

ALSO AVAILABLE THROUGH  
YOUR RCA INDUSTRIAL  
TUBE DISTRIBUTOR

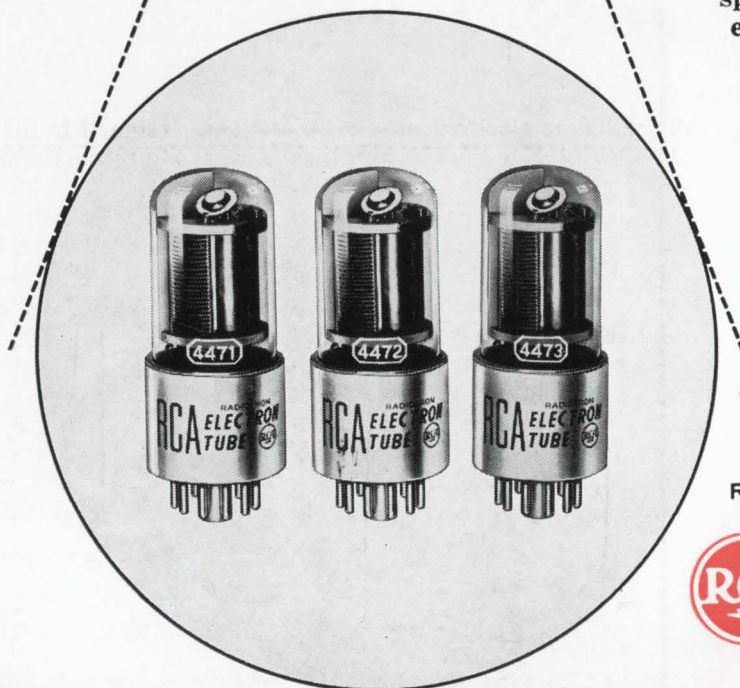

RCA Electronic Components and Devices



The Most Trusted Name  
in Electronics