

Electronics®

A repertoire of display circuits: page 60

Three computers run a steel mill: page 80

What's wrong with telemetry tape recorders: page 90

January 25, 1965

75 cents

A McGraw-Hill Publication

Below: Pattern for making a new thin-film circuit, page 67

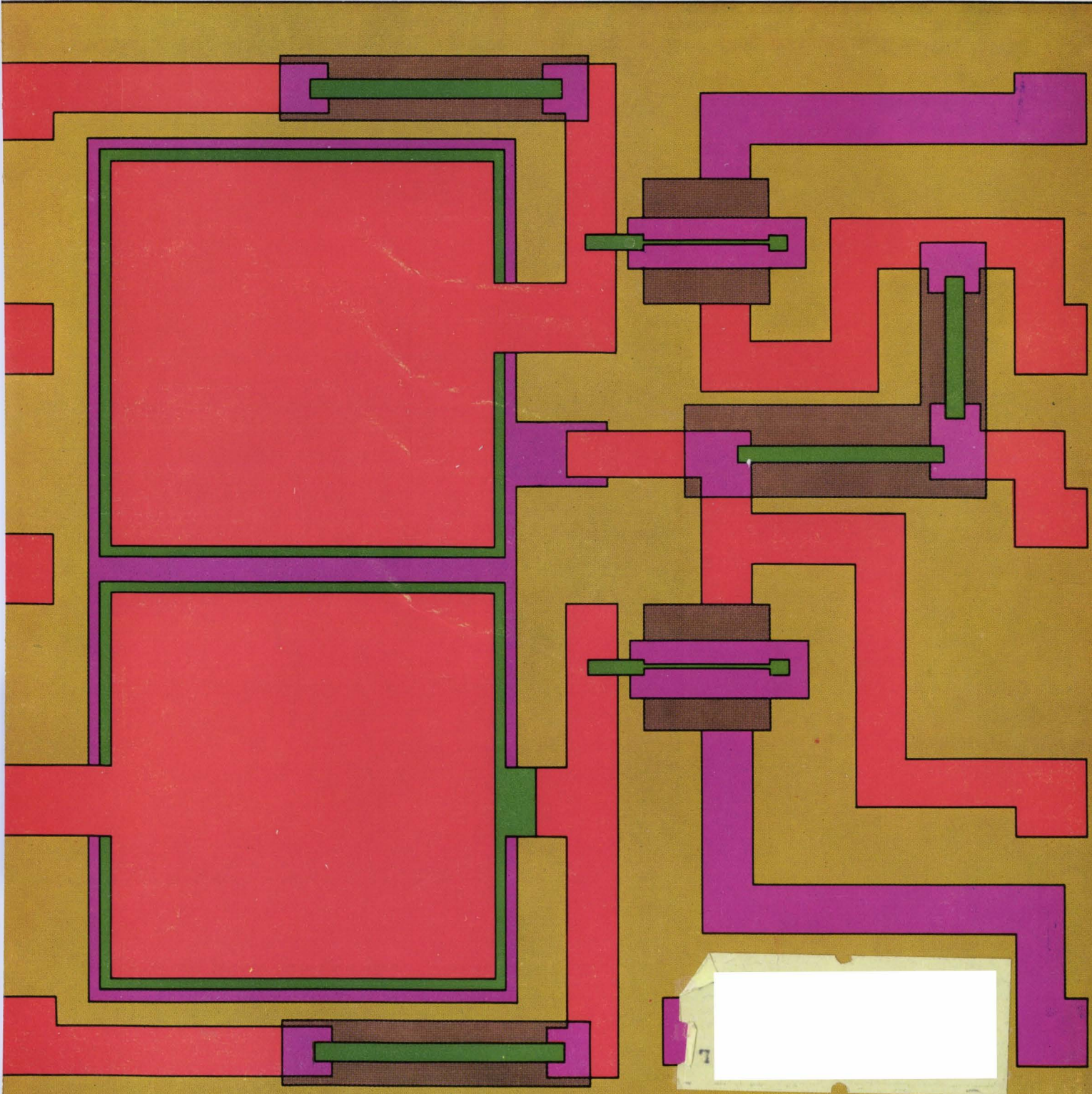



DC Voltmeter

- Four ranges, 1.5, 15, 150, and 1500 volts, full scale
- Minimum reading is 0.005V.
- 100-megohm input resistance
- Additional open-grid input up to 150V. Grid current less than 10^{-10} A.
- Accuracy $\pm 2\%$ of reading above one-tenth full scale ($\pm 0.2\%$ of full scale below).

AC Voltmeter

- Four ranges, 1.5, 15, 150 and 1500 volts, full scale.
- Minimum reading is 0.1V
- Probe input impedance is 25 megohms in parallel with 2pF. Above 150V, a 10:1 internal divider provides input impedance of 25 megohms in parallel with 30pF. For high-voltage measurements above 0.5Mc/s or those requiring low input capacitance, an accessory Type 1806-P2 10:1 Range Multiplier is available. Input of Multiplier is 2500 megohms in parallel with 2pF.
- Accuracy at 400 c/s, $\pm 2\%$ of reading from 1.5V to 1500V, $\pm 3\%$ of reading below 1.5V.
- Frequency Range — Probe resonant frequency is above 3Gc/s. When probe is used with accessory Type 1806-P1 Tee Connector in a coaxial line, error is less than ± 3 db to 1.5Gc/s; VSWR is less than 1.1 below 1Gc/s.

Ohmmeter

- 0.2 ohm to 1000 megohms in four ranges with center-scale values of 10 ohms, 1 kilohm, 100 kilohms, and 10 megohms.
- Test voltage never exceeds 1.5V; maximum current is 43mA (into short circuit).
- Accuracy $\pm 5\%$ of reading from 1 to 10 on scale.

and then some —

- Taut-band meter movement
- Excellent calibration stability — the heart of the instrument is an extremely stable hybrid amplifier. There is so much feedback that rundown in tube transconductance or transistor current gain to half initial value will not affect accuracy.
- $\frac{5}{8}$ " diameter probe with numerous attachments for access to hard-to-reach circuit points.
- Storage socket and reel for probe and its cable are built into the instrument.
- Storage compartment for accessories in cabinet model.
- Available in a convenient flip-tilt case for portability or as a rack-mounted version.
- Price for either model, \$490 (in U.S.A.); 1806-P2 10:1 Range Multiplier, \$20; 1806-P1 Tee Connector, \$35.



1806-A
Electronic Voltmeter
in flip-tilt case

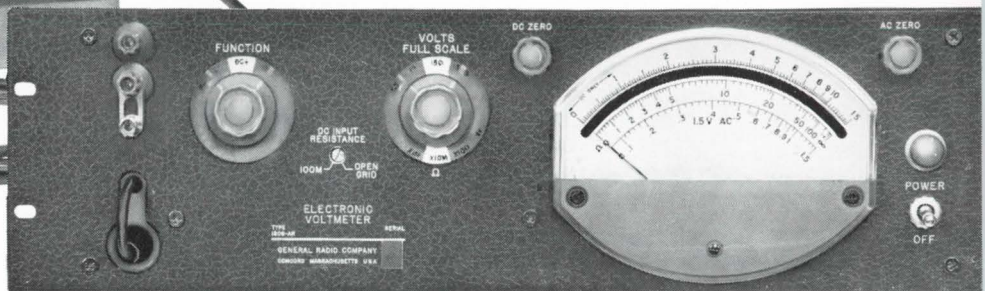

1806-AR Electronic Voltmeter for relay-rack mounting

Write for Complete Information

IN CANADA: Toronto 247-2171, Montreal (Mt. Royal) 737-3673
IN EUROPE: Zurich, Switzerland — London, England



GENERAL RADIO COMPANY

WEST CONCORD, MASSACHUSETTS

NEW YORK, N. Y., 964-2722
(Ridgefield, N. J.) 943-3140

CHICAGO
(Oak Park) 848-9400

PHILADELPHIA
(Ft. Washington) 646-8030

WASHINGTON, D.C.
(Rockville, Md.) 946-1600

SYRACUSE
454-9323

DALLAS
FL 7-4031

SAN FRANCISCO
(Los Altos) 948-8233

LOS ANGELES
469-6201

ORLANDO, FLA.
425-4671

CLEVELAND
886-0150

Circle 900 on reader service card

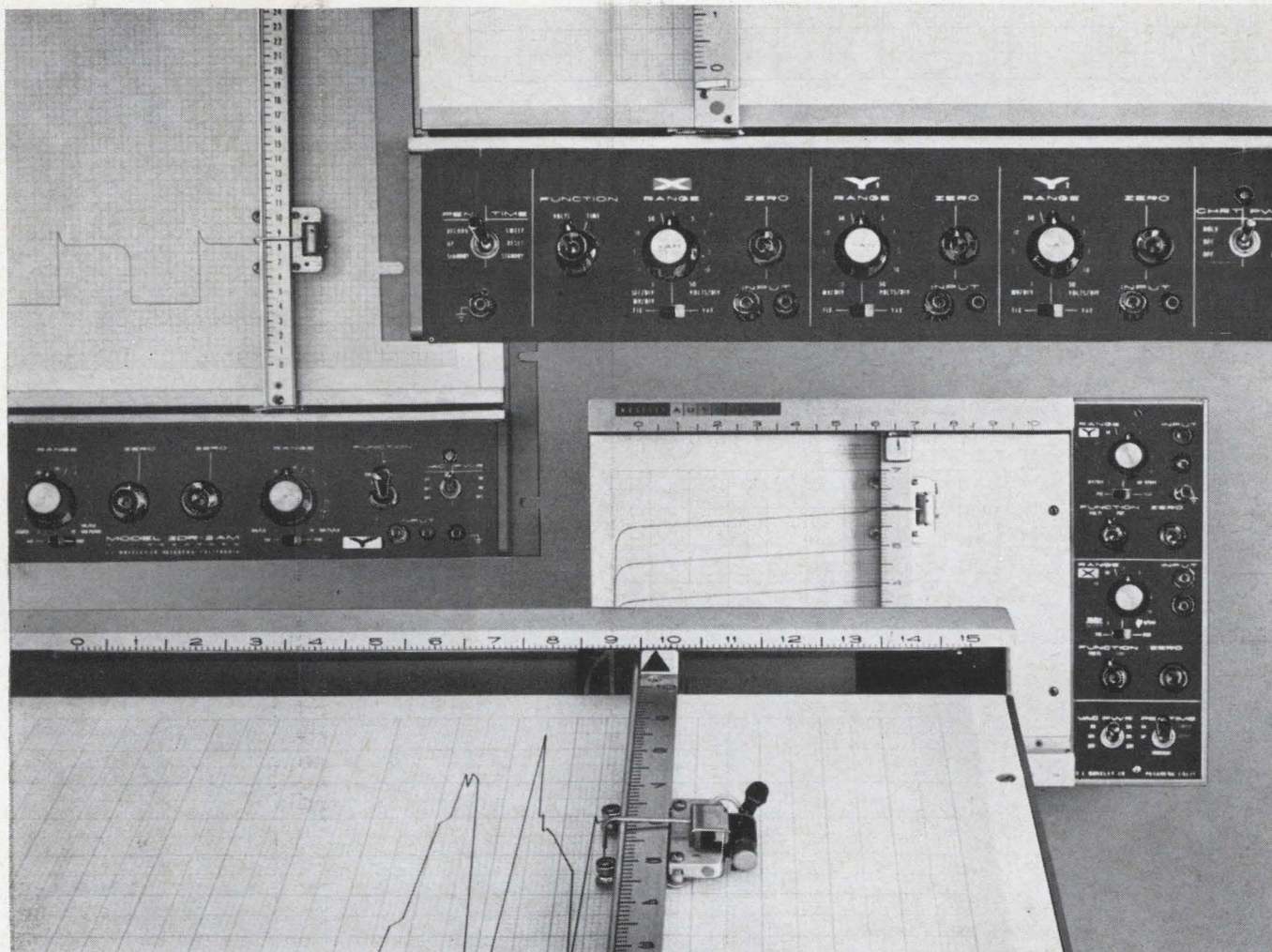

You can do your best plotting with Moseley servo-recorders. Moseley offers 52 models of x-y recorders as well as a line of flexible strip-chart recorders and today's most complete line of accessories. Check the

for the RECORD X-Y RECORDERS

brief specs here, then call your hp field engineer for a demonstration of the model most useful to you. Write for complete data to Hewlett-Packard/Moseley Division, 433 N. Fair Oaks Ave., Pasadena, Calif.

Model	Characteristics	Price
7050A	8½" x 11" x-y basic systems recorder, single range, all solid state	\$ 975
135C	8½" x 11" recorder, dc input, 10 fixed ranges each channel and continuously variable	\$1190
135	8½" x 11", compact portable, desk or rack mount 16 ranges and time sweep	\$1650
135A	Similar to 135, but has one megohm input impedance on 11 ranges	\$1650
7030A	8½" x 11" x-y recorder, 100 microvolts/in. sensitivity, portable or rack mount; AUTOGRIP*; 1 megohm input impedance on all ranges, floating and guarded, high common mode rejection	\$1795
136A	Two-pen x-y ₁ -y ₂ version of 135A	\$2650
6SA	10" x 10" rack mount recorder with automatic chart advance, up to 120 charts on single roll; one megohm input on 16 ranges each axis	\$3150
7	32" x 32" x-y recorder, ideal for plotting table; vertical or horizontal mounting	\$3950

Model	Characteristics	Price
2D-4 (bench) 2DR-4 (rack)	11" x 17" recorder, dc input, 10 fixed ranges and continuously variable	\$1490
2D-2 (bench) 2DR-2 (rack)	11" x 17" recorder, accepts dc inputs 16 ranges on each axis; built-in time sweep, all solid state	\$1950
2D-2A (bench) 2DR-2A (rack)	Similar to 2D-2, except provides one megohm input resistance on 11 ranges	\$1950
2D-3 (bench) 2DR-3 (rack)	Similar to 2D-2, omits built-in time base; ideal for computer use, accepts ± 100 v computer reference	\$2050
7590A	11" x 17" x-y nuclear plotting system, null detector, character printer	\$1985
7000A	11" x 17" recorder, ac or dc inputs on each axis, resettable time sweep; AUTOGRIP*; 1 megohm input impedance on all ranges, floating and guarded, high common mode rejection	\$2575
2FRA	11" x 17" two-pen x-y ₁ -y ₂ recorder, built-in time base	\$3575

*T. M. Pat. Pend.

**HEWLETT
PACKARD**  **MOSELEY
DIVISION**

9871

Have you thought about microwave mixing...

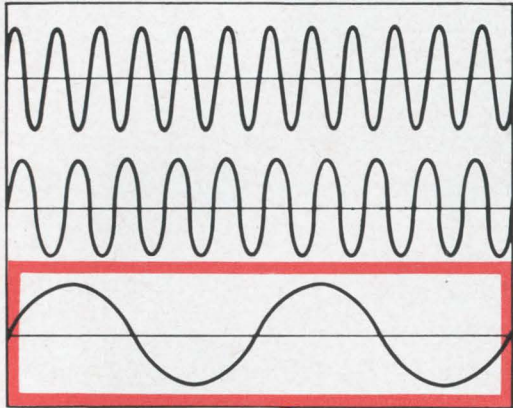

with Hot Carrier Diodes?

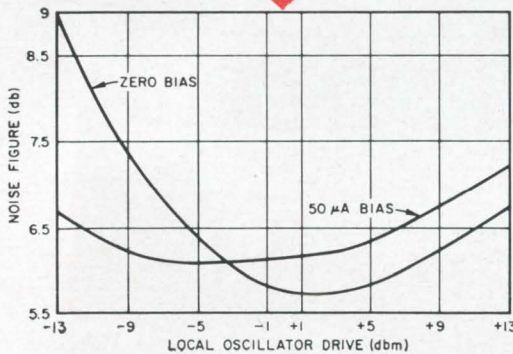

- Improved receiver sensitivity
- Higher reliability
- Wider dynamic range

Through advances in metal-silicon technology, **hp associates** has developed a diode ideal for microwave mixing applications. The Hot Carrier Diode generates less thermal noise than a resistor to allow improvement in receiver sensitivity over present designs. Conversion loss and noise figure are predictable from measurements of basic diode parameters to provide ease of matching for balanced mixer applications as well as tracking over a wide temperature range. The controlled area deposited junction provides a much more reliable, physically more rugged device than any existing point contact diodes used for these applications. Controlled surface junction also provides wider usable dynamic range without introducing excess spurious noise. This particular series of devices is usable broadband to about 3 gc and narrow band to 6 gc, with devices soon to be announced to 12 gc.

SPECIFICATIONS hpa 2150

Test Frequency: 2000 mc

Conversion Loss, L_C : 6 db max

(IF impedance, 100 Ω ; RF load impedance, 50 Ω)

Output Noise Ratio, t : 1 max

Local Oscillator Drive Power, P_O : -1 to ± 5 dbm (zero dc bias)

-10 to ± 20 dbm (20 μ a dc bias)

IF Impedance: 50 Ω min; 200 Ω max (impedance controllable by L. O. Drive Power without degradation of noise)

RF Impedance: 1.5 max (VSWR)

Forward Current, I_F : 50 ma min ($V_f = 1$ volt)

Capacitance, C_O : 1 pf max ($f = 1$ mc); $V_R = 0$

Breakdown Voltage, B_{VR} : 5 volts min

Price: 1 to 99, \$22; 100 to 999, \$14.70

Specifications at $T = 25^\circ C$; units are in small glass package 0.160" long and 0.070" in diameter.

Write for Application Note #3 "The Hot Carrier Diode", and Application Note #6 "The Hot Carrier Microwave Mixer Diode", for complete specifications and technical design information.



hp associates 620 PAGE MILL ROAD,
PALO ALTO, CALIF. 94304, (415) 321-8510
An Affiliate of Hewlett-Packard Company

Electronics

January 25, 1965
Volume 38, Number 2

Page 4	Readers Comment
8	People
10	Meetings
15	Editorial
17	Electronics Newsletter
47	Washington Newsletter
113	New Products
145	New Books
146	Technical Abstracts
151	New Literature

Electronics Review

Page 33	Honeywell's come-back	35	For blind readers
		36	Quick look
33	Tiger in paper mill	36	Crystal thermometer
34	Must they tell?	38	Make mine dry
35	More efficient amplifier	38	Irradiated circuits
		40	Party-line radio

Electronics Abroad

153	Baker's computer	155	Microwave for industry
153	Color-tv sweepstakes		
154	Antisub weapon	156	More radios
155	War of the watches	156	Economic espionage

Probing the News

101	Air Force's \$30-million ash heap
102	Accidents are his business
106	Our Man in Europe

Technical Articles

I. Design

Circuit design	60	Reliable repertoire of display circuits Basic circuits process signals for cathode-ray tubes and indicator lamps A.E. Popodi, Westinghouse Electric Co.
Microelectronics	67	Thin-film capacitance elements: Which one is best for your purpose? Any circuit requirement can be met by choosing the proper material and the right fabrication method F. W. Schenkel, Johns Hopkins University
Solid state	73	Stable, differential amplifiers designed without choppers New compensation technique produces long-term stability in a product used often D.F. Hilbiber, Fairchild Camera & Instrument Corp.
Circuit design	76	Designer's casebook Rise time adjustment independent of fall time; adding a component reduces circuit recovery time; silicon controlled switch used in pulse circuit

II. Application

Industrial electronics	80	Computer trio runs the works at big British steel mill Echelon of machines does everything from filing orders to running machinery J. Tudor Jones, English Electric Co.
Instrumentation	90	Wideband tape-recorder users object to standards An engineer charges that standards borrowed from audio recorders are inadequate for telemetry V.A. Ratner, Defense Electronics Inc.

Title R registered
U.S. Patent Office;
© copyright 1965
by McGraw-Hill, Inc.
All right reserved,
including the right to
reproduce the contents
of this publication,
in whole or in part.

Electronics

Editor: Lewis H. Young

Senior editors

Technical: Samuel Weber

News: Kemp Anderson, Jr.

Senior associate editors: John F. Mason, George Sideris

Department editors

Advanced technology: George V. Novotny

Avionics: W.J. Evanzia

Circuit design: Michael Elia

Communications: Alexander A. McKenzie

Components: Michael F. Tomaino

Industrial electronics: Louis S. Gomolak

Instrumentation: Carl Moskowitz

Manufacturing: George Sideris

Military electronics: John F. Mason

New products: William P. O'Brien

Solid state: Jerome Eimbinder, G.G. Tirellis

Space electronics: Joel A. Strasser

Staff writer: Leon H. Dulberger

Regional editors

Boston: Thomas Maguire, editor; Robin Carlson

Chicago: Cletus M. Wiley, editor; Leslie Krimston

Los Angeles: William Wallace, editor; June Long

San Francisco: Laurence D. Shergalis, editor; Mary Jo Jadwin

London: Derek Barlow, editor

Copy editors

Howard Rausch, Sally Powell, Stanley Zarowin

Graphic design

Art director: Saul Sussman

Assistant art director: John C. Wright, Jr.

Editorial production: Ann Mella

Production editor: Arthur C. Miller

Editorial secretaries: Claire Benell, Mary D'Angelo, Lynn Emery, Kay Fontana, Carolyn Michnowicz, Lorraine Rossi, Lorraine Werner

McGraw-Hill news service

Director: John Wilhelm; Atlanta: Fran Ridgeway; Chicago: Bruce Cross;

Cleveland: Arthur Zimmerman; Dallas: Marvin Reid;

Detroit: Donald MacDonald; Los Angeles: Michael Murphy,

Ron Lovell; San Francisco: Margaret Ralston, Ed. Addeo;

Seattle: Ray Bloomberg; Washington: George Bryant Jr., Glen Bayless, Charles Gardner

McGraw-Hill world news service

Bonn: Richard Mikton; Brussels: Arthur Erikson; London: John Shinn;

Mexico City: Wesley Perry; Milan: Bruce Bendow;

Moscow: Donald Winston; Paris: Dan Smith;

Rio de Janeiro: Leslie Warren; Tokyo: Marvin Petal, Charles Cohen

Circulation manager: Hugh J. Quinn

Reprints: T.M. Egan

Publisher: C.C. Randolph

Electronics: January 25, 1965, Vol. 38, No. 2

Printed at 99 North Broadway, Albany, N.Y.
Second class postage paid at Albany, N.Y.

Subscriptions are solicited only from those actively engaged in the field of the publication. Position and company connection must be indicated on orders. Subscription prices: United States and Possessions and Canada, \$6.00 one year, \$9.00 two years, \$12.00 three years. All other countries \$20.00 one year. Single copies, United States and Possessions and Canada 75¢. Single copies all other countries \$1.50.

Published every other Monday by McGraw-Hill Inc. 330 West 42nd Street, New York, N.Y. 10036. Founder: James H. McGraw, 1860-1948.

Subscribers: The Publisher, upon written request to our New York office from any subscriber, agrees to refund that part of the subscription price applying to copies not yet mailed. Please send change of address notices, subscription orders or complaints to Fulfillment Manager, Electronics, at the address below. Change of address notices should provide old as well as new address, including postal zone number if any. If possible, attach address label from recent issue. Allow one month for change to become effective.

Postmaster: Please send Form 3579 to Fulfillment Manager, Electronics, P.O. Box 430, Hightstown New Jersey 08520

Readers Comment

Causing ripples

To the Editor:

Although the article about the high-current converter [Designer's casebook, Nov. 30, p. 41] had some merit, it contained a half-truth: that low output ripple was obtained by a high-frequency inverter. Although it is true that a square-wave oscillator produces hardly any ripple after rectification, this holds true only if the input has no ripple.

In the design shown, the ripple in the input should be approximately 12 volts. This will show up as a 120 cycle ripple in the same proportion in the output of the inverter.

It appears to me that at the working output frequency the choice of the diodes was poor because excessive switching losses will result.

H.B. Farensbach

ETCA Co.
New York, N.Y.

■ The author replies:

The percentage of 120 cycle ripple voltage which does appear in the output is satisfactory for this thermoelectric application and permitted me to eliminate the filter choke. As for the choice of diodes, I recognize that the design can be optimized by selecting some other diode but here again the diode package is satisfactory.

Allan L. Wennerberg

Whirlpool Corp.
St. Joseph, Mich.

Parking violation?

To the Editor:

After reading "Farewell to free time on city parking meters," [Dec. 28, p. 72] I am appalled that a consulting engineer should think that the only way to detect the presence of two tons of metal at a distance of two feet requires five transistors, three diodes, one relay, 36 resistors and capacitors, an optical filter, and an infrared detector. It is incredible that a magazine that editorially decries the inability of American engineers to design cheap and simple devices for the

In Volume Production!

The NAND/NOR Gate shown here is one of a series of CERACIRCUIT DTL Logic Modules.



a compatible line of DTL Logic

CERACIRCUIT[®] THIN-FILM MICROCIRCUITS

5 Mc DTL LOGIC CIRCUITS

The basic member of the Sprague series of DTL Logic Modules is the UC-1001B NAND/NOR Gate (see schematic), with typical propagation time delay of 10 nsec per stage over a temperature range of -55°C to $+125^{\circ}\text{C}$. Other DTL Logic Ceracircuits include UC-1002B SCT Flip-Flop, UC-1003B Buffer-Driver, UC-1004B Exclusive OR/Half-Adder, UC-1005B 8-Diode Gate, and UC-1006B 5-Diode Gate.

To facilitate contact packaging and assembly

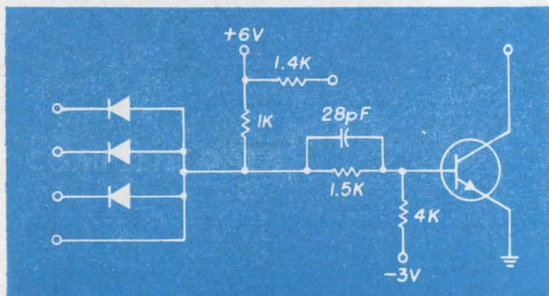

Circuit schematic, UC-1001B NAND/NOR Gate.

on printed wiring boards, all 5 Mc DTL Ceracircuit Modules are encapsulated in one standard case, 1.0" wide x 0.4" high x 0.2" thick.

CUSTOM-TAILORED CERACIRCUITS

Ceracircuit Ceramic-base Microcircuits provide the circuit designer with highly desirable features—component familiarity, design versatility, increased reliability, circuit economy. Thin-film hybrid ceramic technology permits wide ranges of resistance and capacitance values, holding close tolerances without the usual high-cost penalties. Each passive component is deposited on a single ceramic substrate, keeping its identity and allowing conventional design procedures.

WRITE FOR COMPLETE DATA

For information on Ceracircuit DTL Logic Modules, or custom Ceracircuits to satisfy your specific requirements, write to Technical Literature Service, Sprague Electric Co., 35 Marshall Street, North Adams, Massachusetts 01248

SPRAGUE COMPONENTS

THIN-FILM MICROCIRCUITS
INTEGRATED CIRCUITS
TRANSISTORS
CAPACITORS
RESISTORS
43M-4157 RI

PULSE TRANSFORMERS
INTERFERENCE FILTERS
PULSE-FORMING NETWORKS
TOROIDAL INDUCTORS
ELECTRIC WAVE FILTERS

CERAMIC-BASE PRINTED NETWORKS
PACKAGED COMPONENT ASSEMBLIES
BOBBIN and TAPE WOUND MAGNETIC CORES
SILICON RECTIFIER GATE CONTROLS
FUNCTIONAL DIGITAL CIRCUITS

SPRAGUE[®]
THE MARK OF RELIABILITY

*Sprague' and '®' are registered trademarks of the Sprague Electric Co.

db db db db
FOR MAXIMUM GAIN
 \$\$\$\$
AT MINIMUM COST...

You Can't Beat MADT^{*} Communications Transistors

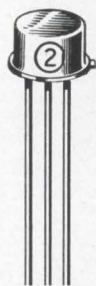
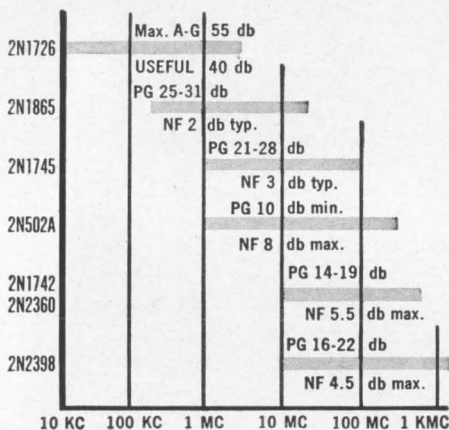

MADT Communications Transistors are now available in production quantities from Sprague Electric. For complete information on these and other MADT High-Performance Amplifier Transistors, write to Technical Literature Service, Sprague Electric Co., 35 Marshall St., North Adams, Massachusetts.

*Trademark of Philco Corp.

45T-4111



Sprague and '2' are registered trademarks of the Sprague Electric Co.

nonmilitary market should publish such an affront to intelligence. The five-minute car-wash establishments all over the country achieve the desired detection with a hinged rod, connected to a valve to turn on the rinse water when a car is in position.

But we are, no doubt, fortunate that it was an infrared specialist who was given the problem and not a nuclear scientist.

Robert E. Salzman
 Pittsburgh, Pa.

▪ The author replies:

Mr. Salzman has either ignored or failed to grasp the motion-detector requirement. His presence detector would be useless for this application. To visualize the mechanical trip-rod of a car-wash mounted on or near a parking meter is laughable.

A road-pad of the traffic-signal type was considered several years ago for parking meters. Like the photocell, it was wide open to undesired triggering.

Incidentally, the General Dynamics Corp. has purchased the patent rights to the infrared detector after evaluation by them. Commercial applications will be handled by Stromberg-Carlson, a subsidiary of General Dynamics.

W.E. Osborne
 Pomona, Calif.

Deliberate omission

To the Editor:

G.C. Riddle's comment [Dec. 14, p. 4] that I omitted the conventional zener-diode feedback in my article "Operational trigger for precise control" [Nov. 2, p. 50] needs a reply.

Purposefully, this older circuit was not discussed. The article was designed to inform readers of the many advantages available in new small positive feedback and latching methods that we have proven operationally successful during the past year. They reliably obtain hysteresis of one millivolt with one nanoampere input current change, and repeatabilities of fractions of the above.

Here are some additional specific superiorities of resistive positive-feedback over zener negative-feedback:

▪ Two resistors and a pot are

usually less expensive than two zeners.

▪ The resistive positive-feedback method cannot provide a truly fixed amount of hysteresis for combating noise or other problems since this varies with amplifier gain and zener characteristics.

▪ Leakage of most zeners makes the setpoint relatively unstable compared to the nanoampere stability of the operational-trigger system.

▪ The zener nonsaturating method is not as satisfactory for efficiently driving an output relay.

▪ Finally, these methods, along with Carter-Princeton's patent-pending "Ultra-Comparator"™ circuitry allow a simple five-transistor "amplifier" to do the whole job of amplifying the one-picowatt signal levels up to one-watt coil drive while maintaining one-millivolt hysteresis and essentially zero setpoint drift.

I hope these comments make the intent of my article somewhat clearer.

Peter Lefferts
 Senior design engineer
 Carter Products, Inc.

Noisy figures

To the Editor:

In the article "How to measure FET noise" by Joel Cohen [Nov. 30, pg. 62], the author gives the equation for noise figure as

$$N.F. = 20 \log \frac{N_T + N_R}{N_R}$$

and states that

$$N_T = E_{in} + I_{in} R_s$$

N_T and N_R must be added algebraically since they are uncorrelated.

The correct expression is

$$N.F. = 20 \log \left[\frac{N_T^2 + N_R^2}{N_R} \right]^{\frac{1}{2}}$$

I believe.

The expression for N_T is correct since the correlation coefficient between E_{in} and I_{in} is about 1. The exact expression is

$$N_T = [E_{in}^2 + I_{in}^2 R_s^2 + 2\delta E_{in} I_{in} R_s]^{\frac{1}{2}}$$

where δ is the correlation coefficient.

E.G. Fleenor
 Lockheed Missiles and Space Co.
 Sunnyvale, Calif.

slash semiconductor testing costs

with

- faster programming – simplified digital switching
- absolute device protection – programmable clamps and limiters
- individually programmable test times – 50 milliseconds to 5 secs
- more accurate testing – 0.5% accuracy

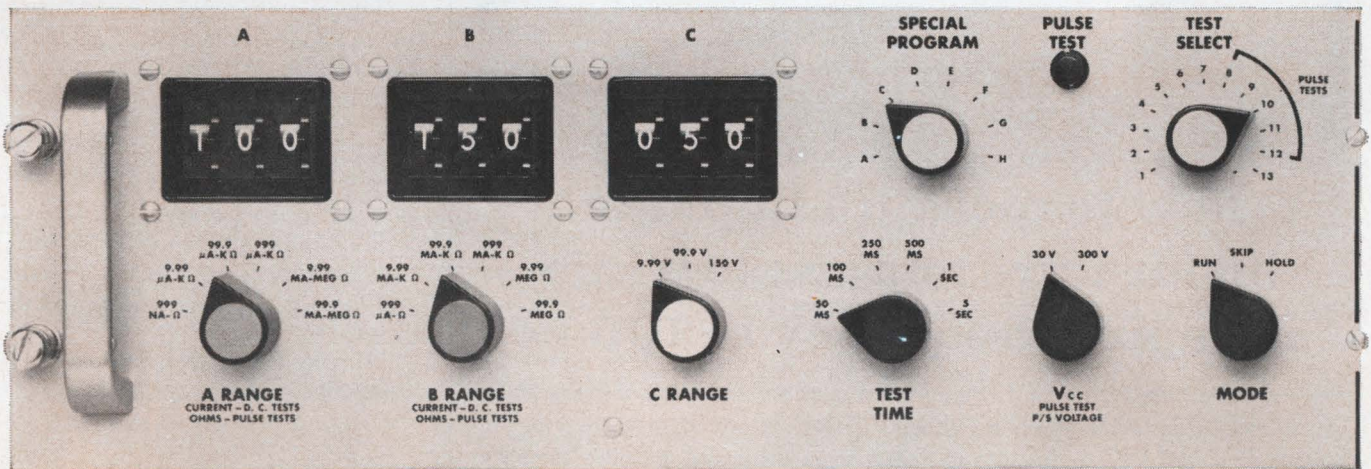

The Model 658 Transistor/Diode Test System provides: digit-switch programming from 1 nanoamp to 2 amps with readout from 0.3 nanoamp; d-c and pulse testing; tests in any random sequence. The 658 is expandable up to 48 tests. Testing modules fit in a separate drawer holding eight units; rack enclosures are available. Using digit-switches you can read test results directly. With the 658, you get *socket control*—shortest lead lengths from device to test circuit. Test sockets are interchangeable. You cannot find a more flexible, economical system.



write for information

INDUSTRIAL
PRODUCTS
GROUP



TEXAS INSTRUMENTS
INCORPORATED

P. O. BOX 66027 HOUSTON, TEXAS 77006
7 RUE VERNONNEX GENEVA, SWITZERLAND

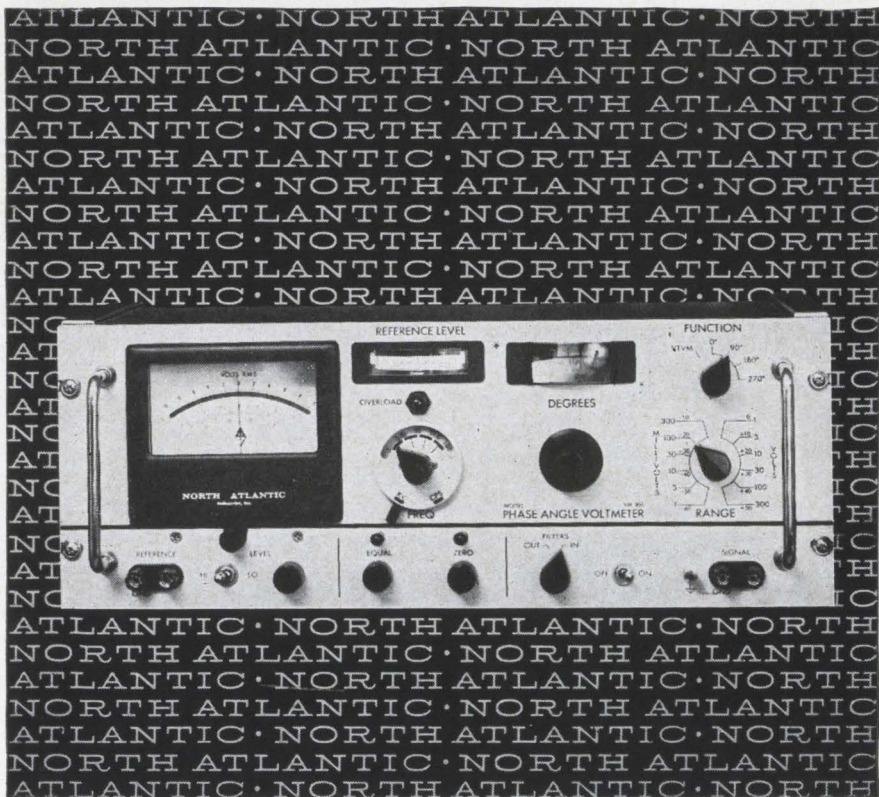

how to measure in-phase, quadrature and angle while sweeping frequency to 100 kc

North Atlantic's latest addition to the PAV line of Phase Angle Voltmeters* enables you to make measurements while frequency is varying over half-decades without recalibration. The VM-301 **Broadband Phase Angle Voltmeter*** provides complete coverage from 10 cps to 100 kc, and incorporates plug-in filters to reduce the effects of harmonics in the range of 50 cps to 10 kc with only 16 sets of filters. Vibration analysis and servo analysis are only two of the many applications for this unit. Abridged specifications are listed below:

Voltage Range.....	1 mv to 300 volts full scale
Voltage Accuracy.....	2% full scale
Phase Dial Range.....	0° to 90° with 0.1° resolution (plus 4 quadrants)
Phase Accuracy.....	0.25°
Input Impedance.....	10 megohms, 30μf for all ranges (signal and reference inputs)
Reference Level Range.....	0.15 to 130 volts
Harmonic Rejection.....	50 db
Nulling Sensitivity.....	less than 2 microvolts
Size.....	19" x 7" x 10" deep
Price.....	\$1990.00 plus \$160.00 per set of filters

North Atlantic's sales representative in your area can tell you all about this unit as well as other Phase Angle Voltmeters* for both production test and ground support applications. Send for our data sheet today.

*Trademark



NORTH ATLANTIC industries, inc.
TERMINAL DRIVE, PLAINVIEW, L. I., NEW YORK • OVERbrook 1-8600

People

Diversification is the forte of **C. Gordon Murphy**, recently named to the new post of vice president, program and management, of the Data Systems division of Litton Industries, Inc.



"You get business in the military area by doing a good job on programs for existing customers . . . while also researching follow-on business in new areas," Murphy says.

The executive, who was program manager for Syncom satellites at the Hughes Aircraft Co., says his responsibilities go beyond marketing; he is setting up teams composed of program, preliminary design and marketing men to examine new areas of business. The teams will look into command-and-control applications for data-processing products in reconnaissance and undersea warfare.

Murphy holds a master's degree from Harvard University.

Last week the United States Junior Chamber of Commerce named **James E. Mercereau** one of the ten most outstanding young men in the nation. The 34-year-old physicist was honored for his work in cryogenics.



The Ford Motor Co. scientist is currently directing the construction of a supersensitive magnetometer that will be launched into space to detect minute changes in magnetic forces. He is also investigating the application of cryogenics technology to computer designs in an effort to improve computer efficiency.

Mercereau joined Ford's engineering and research staff in June, 1962. He had been an assistant professor at the California Institute of Technology and was a consultant to the Aerospace Corp.

Air Navigational Aids and Machlett's UHF Planar Triodes

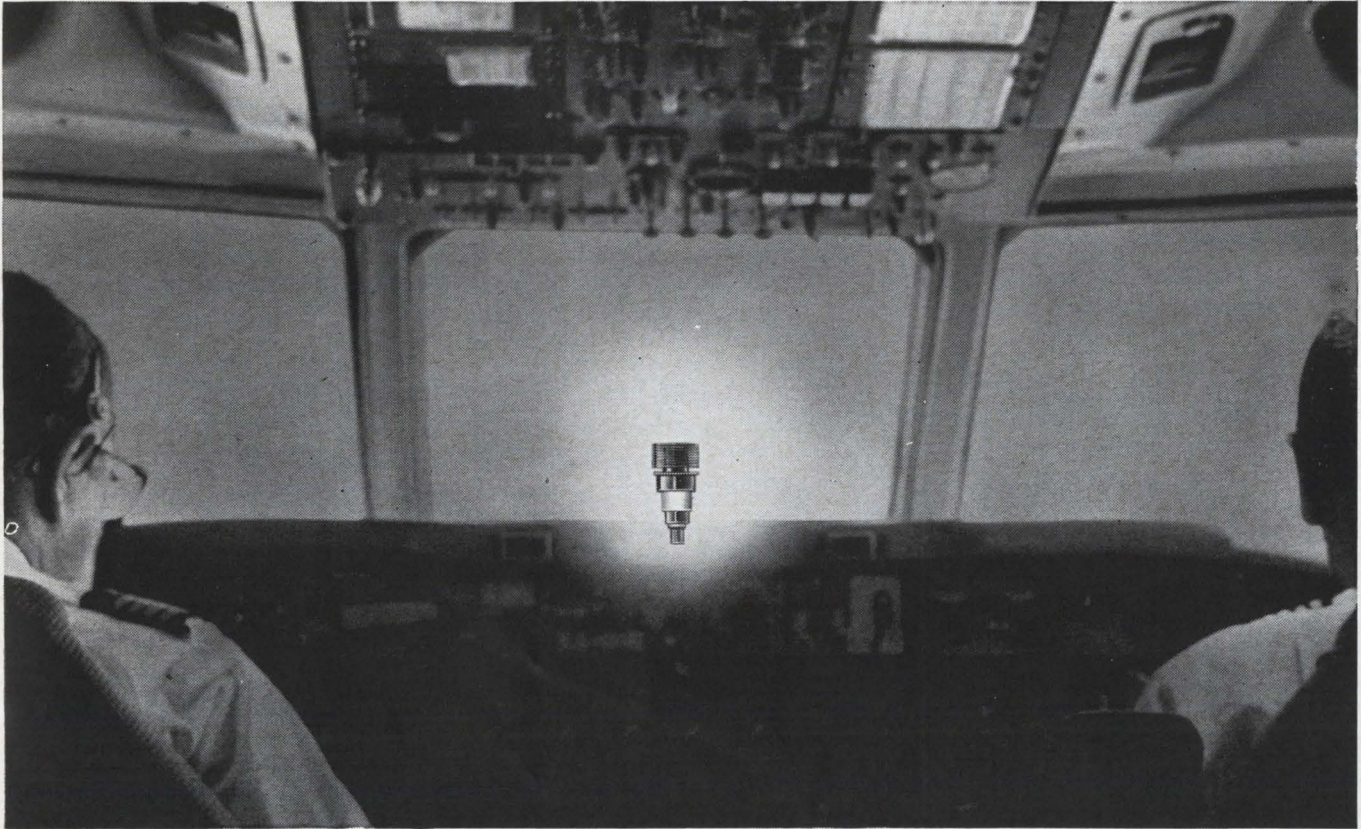

Control of today's commercial air traffic demands the most reliable navigational aids. Machlett UHF planar triodes have been selected to play a vital role in DME and transponder equipment aboard most of the nation's airliners. The demonstrated superiority of the tubes in this application is typical of the capability and competence of the Machlett organization. Whether your needs can be met from our broad-range inventory of high power/high voltage triodes or tetrodes, UHF planar triodes, X-ray tubes, vidicons, or you require assistance in research or design development, write your "Electron Tube Specialist," The Machlett Laboratories, Inc., Springdale, Conn. An Affiliate of Raytheon Company.

MACHLETT

ELECTRON TUBE SPECIALIST

Best way to check coaxial-cable attenuation, return loss

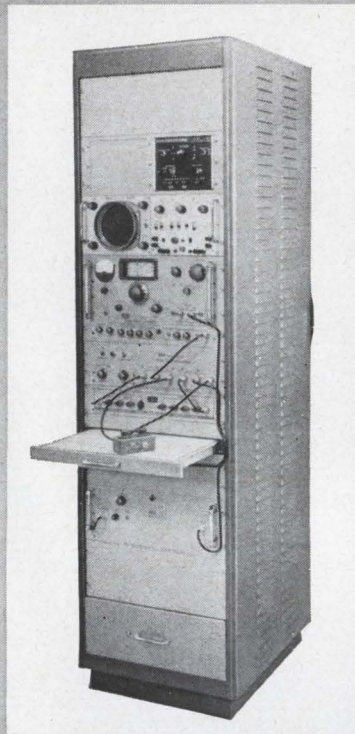

JERROLD CABLE TEST SET model 1900

\$5,850⁰⁰

For fast and extremely accurate quantitative measurements of return loss (VSWR), nominal impedance, and attenuation in coaxial cables, you should have a Jerrold Cable Test Set. The Model 1900 is a complete rack-mounted and enclosed unit consisting of a Model 900-B Sweep Signal Generator, Model FD-33 Comparator, Model AV-50R Attenuator, Model SCA-213C-5BR Amplifier, two RF Bridges (Models KSBV-5B and KSBV-57B), a set of miscellaneous attenuator pads, standard terminations, cable set, jacks, and plugs. The oscilloscope and the Moseley-type translator illustrated here are optional, as are a Model SD-8A Slow-Speed Sweep Driver.

In addition to its capabilities in checking coaxial cable, the Model 1900 Test Set is of course an ideal means of testing impedance, gain, attenuation, and VSWR of all electronic components.

Write for complete technical literature.



JERROLD ELECTRONICS

Industrial Products Division
Philadelphia, Pa. 19132

In Canada: Jerrold Electronics, 60 Wingold Ave., Toronto 19, Ont.
Export: Rocke International, 13 E. 40th St., New York 10016

**SWEEP GENERATORS • PRECISION ATTENUATORS
AMPLIFIERS • COMPARATORS**

Meetings

Fundamental Phenomena in the Material Sciences Annual Symposium, Ilikon Corp.; Sheraton Plaza Hotel, Boston, Jan. 25-26.

Integrated Circuits Seminar, IEEE; Stevens Institute of Technology, Hoboken, N.J., Jan. 28.

Northwestern University Science Symposium, NU; Pick-Congress Hotel and Thorne Hall of Northwestern University, Chicago, Jan. 28-29.

Winter Power Meeting, PEEC/IEEE; Statler-Hilton Hotel, New York, Jan. 31-Feb. 5.

Institute on Information Storage and Retrieval, The American University; Willard Hotel, Washington, Feb. 1-4.

On-Line Computing Systems Symposium, UCLA Extension Service, Informatics, Inc.; University of California Los Angeles, Feb. 2-4.

Winter Convention on Military Electronics, PTGMIL & L.A. Section of IEEE; Ambassador Hotel, Los Angeles, Feb. 3-5.

Electrical/Electronic Trade Show, Electrical Representatives Club, Electronic Representatives Assn.; Denver Auditorium Arena, Denver, Feb. 15-17.

Solid-State Circuits International Conference, University of Pennsylvania, IEEE; University of Pennsylvania and Sheraton Hotel, Philadelphia, Feb. 17-19.

Annual West Coast Reliability Symposium, ASQC, UCLA; Moore Hall, University of California, Los Angeles, Feb. 20.

Particle Accelerator Conference, AIP, NSG/IEEE, NBS, USAEC; Shoreham Hotel, Washington, Mar. 10-12.

ISA National Conference on Instrumentation for the Iron and Steel Industry, ISA; Pick-Roosevelt Hotel, Pittsburgh, Mar. 17-19.

Management Conference on Operations Research, Systems Engineering and Electronic Data Processing, University of Pennsylvania, Philadelphia, Mar. 17-19.

IEEE International Convention, IEEE; N.Y. Coliseum and New York Hilton Hotel, New York, Mar. 22-25.

Society of Motion Picture and Television Engineers Semiannual Conference and Exhibit, SMPTE; Ambassador Hotel, Los Angeles, Mar. 28-Apr. 2.

Electron Beam Annual Symposium, Pennsylvania State University, Alloyd

Corp.; Pennsylvania State University, University Park, Pa., Mar. 31-Apr. 2.

Electronic Parts Distributors Show, Electronic Industry Show Corp., New York Hilton and Americana Hotels, New York, Mar. 31-Apr. 4.

IEEE Seminar on Space Vehicle Reliability, IEEE; Airport Marina Hotel, Los Angeles, Apr. 2.

National Packaging Exposition, AMA; McCormick Place, Chicago, Apr. 5-8.

Cleveland Electronics Conference, Cleveland Electronics Conference, Inc., IEEE, ISA, CPS, Western Reserve University, Case Institute of Technology; Cleveland Public Auditorium, Cleveland, Apr. 6-8.

Conference on Impact of Batch-Fabrication on Future Computers, PGEC/IEEE; Thunderbird Hotel, Los Angeles, Apr. 6-8.

IEEE Region 3 Meeting, Robert E. Lee Hotel, Winston-Salem, N.C., Apr. 7-9.

Electronic Components International Exhibition, FNIE, SDSA, Parc des Expositions (Fair Grounds), Paris, Apr. 8-13.

IEEE Region 6 Annual Conference, Nuclear Rocket Development Station, Las Vegas, Apr. 13-15.

Telemetry National Conference, AIAA, IEEE, ISA; Shamrock-Hilton Hotel, Houston, Tex., Apr. 13-15.

Call for papers

Annual Conference on Nuclear & Space Radiation Effects, G-NS/IEEE; University of Michigan, Ann Arbor, Mich., July 12-15. **Feb. 1** is deadline for submitting 200-400 word abstract to S. C. Rogers, Radiation Effects Dept., 5312, Sandia Corp., Albuquerque, N. M.

Antennas and Propagation International Symposium, IEEE; Sheraton Park Hotel, Washington, Aug. 30-Sept. 1. **May 15** is deadline for submitting, in triplicate, both a 400-600 word summary and a 50-100 word abstract to R. J. Adams, Chairman, Technical Program Committee, 1965 International Symposium on Antennas and Propagation, Code 5330, U. S. Naval Research Lab., Washington, D. C., 20390.

DALE**RELIABILITY**TOTAL CAPABILITY IN
PRECISION RESISTANCE

*Here's
what the
excitement's
about...*

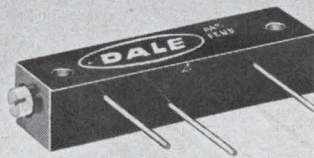

One watt at 70° makes Dale 2100 Series highest-rated commercial wirewound T-pot

Check the case dimensions of Dale's new 2100 Series—it's a direct, and competitively-priced replacement for several frequently specified wirewounds with lower power ratings. In both construction and performance, the 2100 is Dale-designed to be the commercial counterpart of RT-11, MIL-R-27208A. Normally an unsealed unit, it can be sealed for just a few cents more—giving you a humidity-proof trimmer equal to the Mil-Spec in all areas except temperature. Right now, you can simplify your design, standards and inventory problems by putting the 2100 Series to work on jobs which you may now be assigning to as many as three *different* trimmers. The price is right—and the delivery is fast.

Write for Catalog B

SERIES 2100 SPECIFICATIONS

Case Dimensions:	.31 high	.28 wide	1.25 long
Standard Models:	2187—Printed Circuit Pins, 21 AWG Gold Plated 2188—Stranded Vinyl Leads 2189—Solder Lug, Gold Plated		
Power Rating:	1 watt at 70°C, derating to 0 at 125°C		
Oper. Temp. Range:	-65°C to 125°C		
Adjustment Turns:	25±2		
Standard Tolerance:	±10% standard (lower tolerances available)		

DALE**DALE ELECTRONICS, INC.**

1300 28th Avenue, Columbus, Nebraska

A subsidiary of THE LIONEL CORPORATION

Also Sold by Dale Electronics Canada, Ltd., Toronto, Ontario, Canada



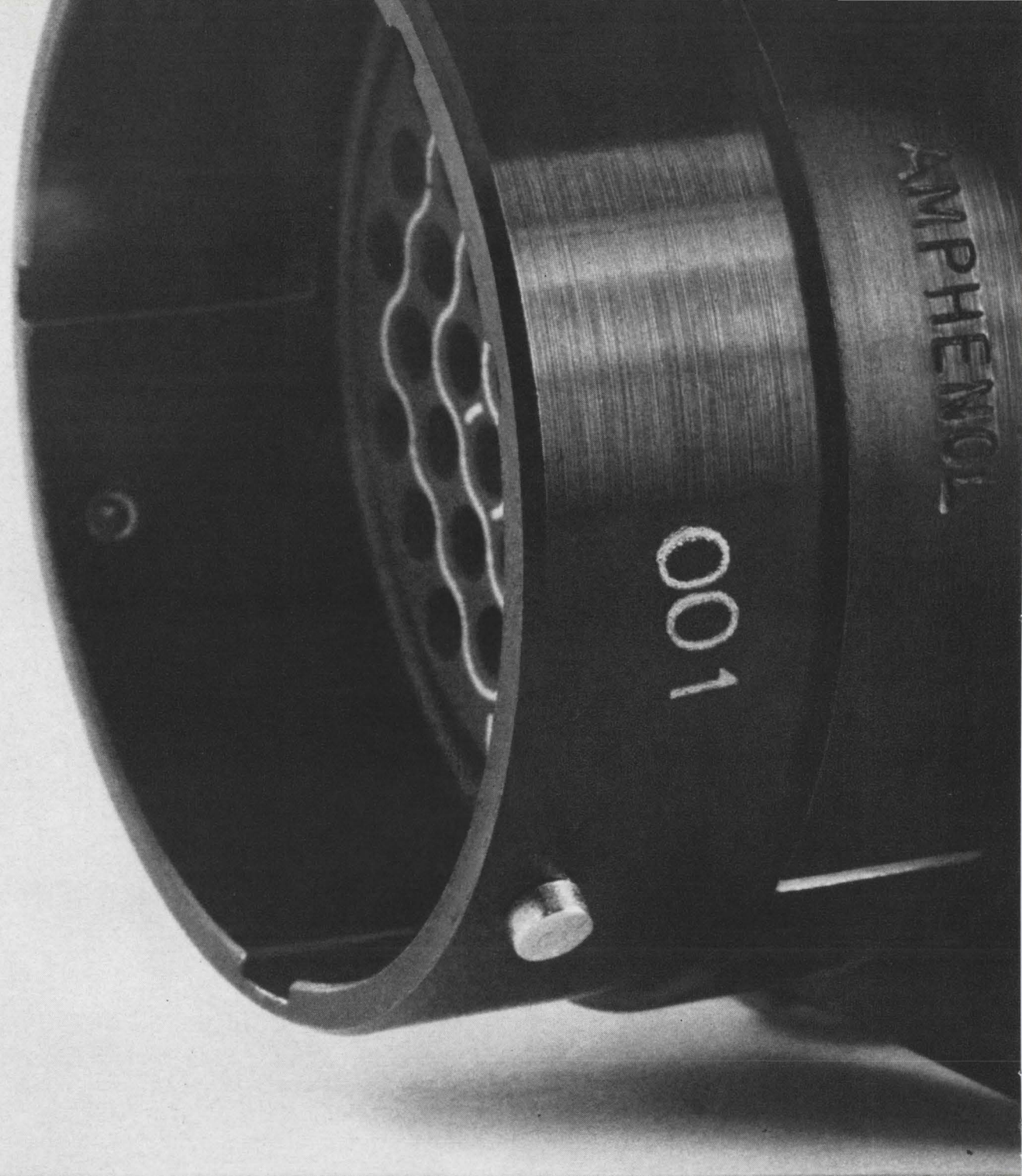

***Now Amphenol introduces
connector traceability
—by the number***

The "001" tells you this Amphenol 48 Series connector was assembled with a group of 1,472 other MIL-C-26500 connectors on Thursday, December 10, 1964.

All 48 Series connectors assembled on one day in the same production run are stamped with an identical number. We call it a Specific Control Number, or SCN. It's your reference



to a *complete recorded history* of the part and all others made during that particular production run.

This Amphenol SCN system assures complete traceability of every component part in every stage of production. We can start with a single contact and trace up to the complete connector, or trace back from a connector to a part.

In fact, we can give you the documents the day you get the connectors . . . a ready portfolio of check-out information when you need it during design, or breadboarding, or test model inspection.

If "001" *should* malfunction, (statistically, only half a chance in ten million!), all that's needed is to check the connectors marked "001". It's a

real time saver if you're dealing with thousands of connectors in a jet aircraft, missile, submarine, or computer.

Amphenol's is the only *documented* reliability you get with a connector. So why settle for somebody else's confidence limits? Ask an Amphenol Sales Engineer. Or write the *Amphenol Connector Division, 1830 South 54th Avenue, Chicago 50, Illinois.*

Amphenol **CONNECTOR DIVISION**

AMPHENOL-BORG ELECTRONICS CORPORATION

Specify Amphenol . . . the leading name in cable, connectors, rf switches, potentiometers, microelectronics

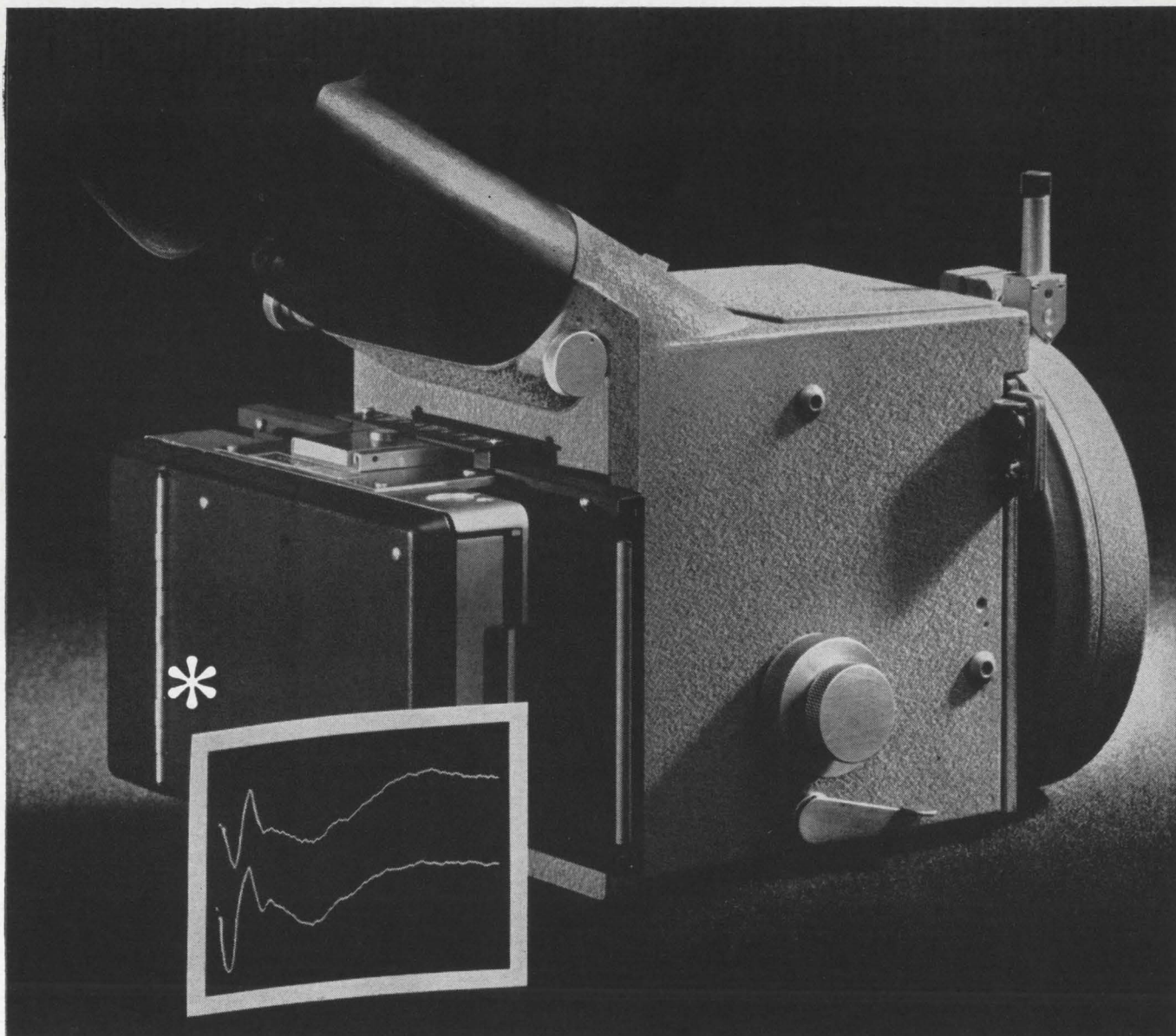

FAIRCHILD SCOPE CAMERA AIDS EYE RESEARCH

Use as clinical tool illustrates versatility of Type 450-A camera; Polaroid Land Back and Film provide immediate record

Electroretinography is but one of the scientific frontiers where Fairchild Oscilloscope Cameras are providing high precision recording of displayed phenomena. Among the features which contribute to this high performance are: • helical rack and pinion mechanism for pinpoint focusing and image reduction • heavy duty synchro-shutters • jam-proof lever for positive tripping of shutter. • Object-to-image ratio is continuously adjustable from 1:1 to 1:0.85, permitting recording of full 6 x 10 cm field on Polaroid Land film in 0.9 actual size. With the new Polaroid Land Film Pack Adapter prints — developed outside the camera — are available in 10 seconds. • Accessories include data chamber for writing in test identification for recording simultaneously with CRT display. If your work requires precision recording of oscilloscope displays, call your local Fairchild Field Engineer or write for complete data on the Type 450-A and other Fairchild Oscilloscope Cameras. Fairchild Scientific Instrument Dept., 750 Bloomfield Ave., Clifton, N.J. ("Polaroid"® by Polaroid Corp.)

* Traces show reaction of human eyes to a short light stimulus. The retinae electric potential is picked up with contact lens electrodes, fed to scope and recorded by Fairchild Oscilloscope camera fitted with Polaroid Back. Sequence is initiated by synchro-shutter of camera. Polaroid print is reproduction of one of thousands made at New York Medical College by G. Peter Halberg, M.D., Associate Clinical Professor of Ophthalmology.

FAIRCHILD

DUMONT LABORATORIES
SCIENTIFIC INSTRUMENT DEPARTMENT

Editorial

Sense and nonsense

A report published this month by Arthur D. Little, Inc., a respected research firm, carries an unpleasant implication for engineers: more unemployment by 1970. This is inferred from two conclusions that Little reaches, one valid and the other—in our opinion—fallacious.

After repeating what many people have been saying for the past six months—that defense procurement will slide about 15% in the next five years—the report makes two other interesting points: that the giant engineering complex is vanishing from American industry, and that big defense companies cannot diversify successfully except by acquisition.

If that second conclusion is correct, thousands more engineers now working in military electronics will be unemployed by 1970. Fortunately, Little's thinking on diversification is erroneous.

Little bases its conclusion on past experience. It notes correctly that many military-oriented companies have tried to diversify and failed dimly. Therefore, Little concludes that military-oriented companies cannot diversify, except by the acquisition route.

Nonsense. There are many reasons why diversification attempts have failed. Defense companies have tried to invade fields about which they knew nothing; airplane builders, for example, have made canoes and house trailers. Then too, some companies have tried to employ the same engineering, manufacturing and marketing approaches that had been successful in government work.

The handbook on how to succeed in civilian business should start with one rule in big bold letters: Develop commercial approaches and use them.

A company cannot compete in civilian markets

if its engineering is terribly expensive, if its manufacturing costs are weighted down with reliability overhead of the kind that government work demands, and if its marketing repertoire is limited to selling only one customer—the government.

One success story has been written by the Hawker-Siddely Group, Ltd., a British company that used to produce only military aircraft and engines. Today it also has a thriving industrial-control business, engineered by the same men who used to work on engine test instruments and aircraft instruments.

Little's conclusion about engineering complexes, however, deserves serious consideration.

The end of the boom in military spending marks the end of the gigantic engineering complex that employs thousands or tens of thousands of engineers in one company on one project. Only the government can afford such munificence. Civilian endeavors cannot afford engineering of anywhere near such magnitude.

Clearly that's bad news for engineers. No matter how you figure it, a lot of them are going to be out of jobs in the next five years. Those who will remain employed are the engineers who are doing truly engineering work—not technician work with a fancy title—with broad-based knowledge that they increase regularly.

The electronics industry is going to see the end of narrow specialization by engineers; it's simply too uneconomic. Certainly there will be some specialization in broad areas such as microwave, communications, microcircuitry and consumer products. But the civilian economy cannot afford very many specialists in acceleration testing of communication equipment, nor experts in insulation for miniature transformers, nor designers of klystron-tube assemblies.

Today some engineers hold jobs that technicians should have. Others are doing work that draftsmen should be doing. And not enough engineers are concerned about their own careers.

If the electronics industry is to avoid a glut of engineers, steps have to be taken now. Companies that have been thinking about diversifying ought to start doing something about it. And engineers ought to take stock by asking themselves some searching questions: What am I learning? Is my job truly engineering? Where can I advance?

In the final analysis, each engineer has to watch out for his own career.

Performance

that
speaks
for
itself



System Accuracy:
 $\pm 0.071\%$ RMS

Total Rotor Null:
0.2 mv/volt

Signal to Noise
Ratio: 74 db min.

Components
Interchangeable
without losing system accuracy

Clifton Amplifier-Resolver Combination

Let's skip the hot air and talk about the performance of this "state-of-the-art" Amplifier-Resolver Combination built for military airborne use.

This Combination is designed for systems requiring interchangeability of resolver or amplifier without adjustment or trimming. System accuracy of $\pm 0.071\%$ RMS is obtained under any combination of voltage, temperature, and frequency within the given ranges. Voltage range is 0 to 26 VRMS. Frequency range: 380-420 cps. Tempera-

ture range -25°C to $+95^{\circ}\text{C}$. Input impedance is 100 k ohms $\pm 1\%$. Total rotor null is 0.2 mv/v of input and fundamental nulls are .05 mv/v. Interaxis error is 3 minutes maximum. Calibration error, 2.5 minutes max. The ratio of the actual output voltage to the undesired output voltage at 20 volts level is 74 db min.

The Resolver is a compensated Clifton Size 11 with the stator as the primary winding. Stator tuned impedance 13.8 k ohms. Stator nominal Q—6.1. Rotor peaking frequency: 40 kc minimum. Weight is 5.5 oz. maximum. Temperature range -55°C to $+125^{\circ}\text{C}$.

The Dual Channel Booster Amplifier is 1.84" x 1.63" x .75". Power requirements +30 VDC ± 2 VDC @ 25 ma. max.; -30 VDC ± 2 VDC @ 35 ma. max. Ripple 10 mv max. Weight 2.5 oz. Temp. range -55°C to $+125^{\circ}\text{C}$. A single channel amplifier 1" x 1.63" x .75" is also available.

'Nuff said? For price and delivery contact any of our sales offices or representatives. Clifton Precision Products, Division of Litton Industries, Clifton Heights, Pa., Colorado Springs, Colo.

cppe **CLIFTON** PRECISION PRODUCTS
DIVISION OF LITTON INDUSTRIES



Electronics Newsletter

January 25, 1965

Industrial seminar barred by IEEE

Company-sponsored "industrial seminars" will be missing from technical meetings at this year's show of the Institute of Electrical and Electronic Engineers. The IEEE says it won't allow the seminars to be conducted as part of its meetings.

Seminars are a subtle form of new-product promotion, although they're heralded by their sponsors as a source of technical information. The institute says the seminars "aren't in keeping with the IEEE charter as a professional technical organization." Another reason for the ban may be that seminars siphon off audiences from the IEEE technical sessions.

The IEEE concedes that it cannot prevent companies from leasing facilities near its meetings, so the seminars probably will continue.

Producer assails MOS FET tests

Radiation tests on insulated-gate field-effect transistors by the Navy have stirred up a fallout of criticism by Melpar, Inc., a producer of MOS FET's. In the tests at the Naval Research Laboratory, conventional MOS FET's suffered permanent damage when exposed to 10^6 rads.

Melpar, a subsidiary of the Westinghouse Air Brake Co., says the Navy should have included thin-film devices in its tests. Charles Feldman, manager of Melpar's physical electronics research laboratory, says thin-film MOS FET's withstand a radiation dose of 2×10^8 rads without degradation.

Advanced studies of bomber begin

Development of a new bomber that may replace the B-52 has entered the advanced study phase, although Defense Secretary Robert S. McNamara is still not convinced that the Air Force needs the craft.

In fiscal 1965 Congress voted \$52 million for avionic and propulsion studies, and the fiscal 1966 budget is expected to earmark about the same sum.

The plane, called the Advanced Strategic Manned Aircraft, is being designed to fly at treetop altitudes at speeds up to 2,000 miles an hour. It may carry the Sram air-to-ground missile [Electronics, March 6, pp. 46, 47] that President Johnson mentioned in his defense message to Congress.

Secret 'spy' trial ends in Sweden

A Swedish electronics dealer charged with espionage awaits a verdict due Feb. 1 in Stockholm. He's accused of selling between \$60 million and \$80 million of electronic equipment to the Soviet Union from 1958 to 1961 and of trying to obtain military information for Russia from a university library.

The trial, which started Jan. 2 and ended Jan. 18, was held behind closed doors. Under Swedish law, espionage trials may be conducted in secret if the court decides that disclosure of testimony would jeopardize security. The prosecution did disclose that the defendant, Johan Uno Norman, had been blacklisted by the United States for two years for failing to prohibit the sale of electronic equipment to Russia.

The prosecution has asked that Norman be given a "relatively hard" sentence to demonstrate publicly the seriousness of such transactions. The

Electronics Newsletter

maximum penalty is life imprisonment under a new Swedish law that puts certain business transactions in the same category as direct military espionage.

Improved Ranger to re-shoot moon

Electronic improvements have been made on the Ranger 8 spacecraft that will be launched during about Feb. 17 to photograph the moon.

Engineers at the Radio Corp. of America have substituted triode intermediate-power amplifiers for the tetrode amplifiers used on the Ranger 7. The two-element tube was susceptible to bandwidth drift when the temperature rose to 100° C and remained there for more than an hour. In addition, the new amplifiers are more resistant to vibration.

The sensitivity of the vidicon camera has been increased, according to its producer, RCA, and **an improved focusing technique is expected to result in sharper pictures.**

Ranger 9, the final spacecraft in the moon-probe series, is scheduled to be launched in mid-March.

ABC tries Secam for color-tv tape

A hybrid color-television system is being tested for studio use by the American Broadcasting Co.

ABC is transcoding the NTSC color signal, used by United States broadcasters, into the French system, called Secam, for video-tape recording. Then ABC transcodes it back to NTSC for broadcasting. The advantage: Secam's color signals can be recorded on black-and-white video-tape recorders. About \$10,000 of additional circuitry would be required to convert each black-and-white so it can handle NTSC color signals. Since ABC's affiliated stations use hundreds of recorders, the savings could be considerable.

ABC and Columbia Broadcasting System, Inc., use film for their delayed color broadcasts.

In Europe, meanwhile, American interests are trying to convince broadcasters there to adopt the NTSC system for color broadcasting [see p. 153].

Arinc may conduct Motorola course

Arinc Research Corp. is negotiating to take over the one-week integrated-circuit course for technical management now given by Motorola Semiconductor Products, Inc., a subsidiary of Motorola, Inc. Arinc would pay a commission to Motorola for each person who enrolled.

Motorola will give the course for the last time April 5 to 9 in Paris. Classes will be conducted in English, French and German; tuition, usually \$450, has been cut to \$300.

Arinc hasn't set a price for its one-week course, but it's expected to be about \$500. And the company doesn't plan to continue Motorola's \$900 two-week engineering course or the \$3,900 three-week course in engineering assembly.

Addenda

An unmanned Gemini spacecraft completed its second suborbital flight Jan. 19, assuring a go-ahead for a two-man flight in April or May. . . . Transistorized ignition systems are being used as standard equipment on the Studebaker Corp.'s top-of-the-line Daytona. Other auto makers offer transistorized ignition as optional equipment.

This month's Highlight

TRANSISTORS

Fastest high-speed switch also ideal low-level amplifier

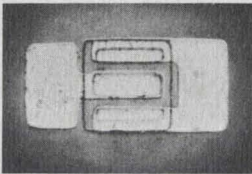

Sylvania's remarkable 2N2784 transistor has proven even more versatile than was originally thought. Billed as the "World's Fastest Silicon Switch" (which it still is!), the unit's characteristics in both test and actual use demonstrate its effectiveness in low-level amplification as well.

Reliability testing completed to date (see 2000-hour test chart) indicates that the 2N2784 has a demonstrated failure rate of between 0.0 and 0.77%/1000 hours. The 0.77% figure is at the 90% confidence level when tested under maximum stress conditions of 300 milliwatts operating life or 200°C storage.

This built-in reliability, along with high degrees of radiation resistance and low-level amplification, particularly suits the 2N2784 for such aerospace applications as satellites and space probes. Other characteristics designed into this transistor help explain its success in instrumentation and industrial computers: high switching speed ($T_{on} + T_{off} = 12$ nanoseconds), 1 Gc minimum gain band-

width, low saturation voltages (typ 0.2 volts). It has an unusually high beta figure at microamperes with only gradual falloff beyond 10 milliamperes.

Still other important characteristics are:

	Min	Max		Min	Max
H_{FE}	40	120	$I_{CBO}(150^\circ C)$		5 μA
$V_{CE(sat)}$.26 V	$V_{CE0}(sust)$	6.0	V
C_{ob}		3.0 pf	BV_{EBO}	4.0	V
C_{TE}		2.0 pf	T_S		5.0 ns

This outstanding performance stems from advanced device design and refined photolithographic techniques plus Sylvania's skills in epitaxial technology. Unusually small junction sizes and spacings as well as low capacitances result in the improved frequency responses for both switching and amplifier applications. The same transistor may also be used as a video amplifier, linear amplifier, airborne microwave receiver, and a non-sat high-speed flip-flop.

The 2N2784 is available in TO-18, TO-46 and TO-51 co-planar packages.

OPERATING LIFE @ $I_C = 30$ MA, $V_C = 10$ V (300 mw)
0 Hours vs. 2000 Hours

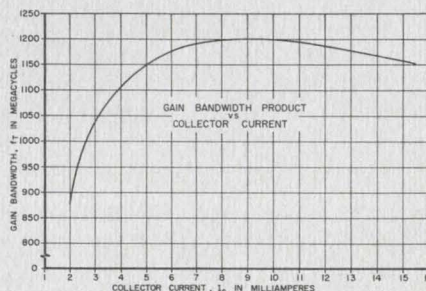
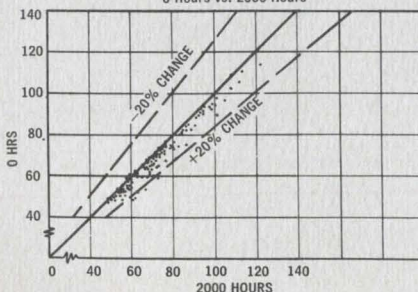

CIRCLE NUMBER 300 ON READER SERVICE CARD



in capsule

transistors — world's fastest silicon switch, plus Sylvania's expanded line of PNP core drivers...

color picture tubes — revolutionary new tube for television manufacturers...

receiving tubes — the economics of low B+ types in color television...

integrated circuits — twelve versatile units for a world of applications...

silicon rectifiers — inherently greater surge capacity in Sylvania's SPR's...

cathode ray tubes — how rear window CRT's can work for you...

readouts — final step toward fully solid state display systems...

rectifiers — a new controlled avalanche unit that withstands 1000 amp surges...

photoconductors — extra reliability of Sylvania's new 1-2 line...

...all in the first issue of IDEAS, Sylvania's magazine for component and circuit designers.

Color television

Sylvania's new color bright 85[®] picture tube

How valid the claims?

Last June Sylvania made extraordinary claims about a new picture tube for color television. "A major breakthrough," said Gene K. Beare, President of Sylvania. Other claims were made: 43% brighter in monochrome, redder reds, whiter whites, superior color registration, improved contrast, more vivid images... and so on. Now, eight months later, how valid the claims?

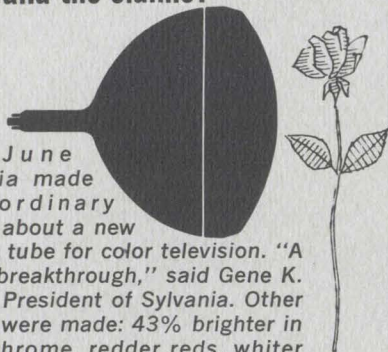

It has been proven that the color bright 85 tube is all that Sylvania claimed eight months ago, and maybe more. The proof is in the acceptance—by Sylvania's OEM customers, in sales of Sylvania's own TV sets, and in actual tests with almost 10,000 consumers.

The major factors in the big swing to Sylvania color picture tubes are a new red-emitting phosphor (europium-activated yttrium vanadate YV04:Eu) as well as a unique screening technique where phosphors are "dusted" onto the tube's faceplate.

The red phosphor, containing the rare-earth element europium, is found in small deposits in a few known locations. Developed at GT&E Laboratories, the new phosphor has proven itself more stable than standard industry sulfides. Because it is both truer and brighter than the standard red sulfide, now the blue and green phosphors are used in their natural, undeadened states. The result is a substantially brighter picture.

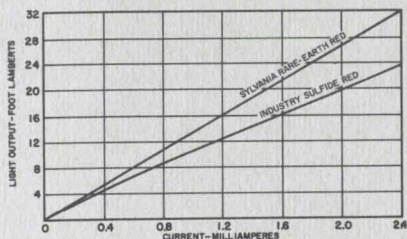

When viewing black and white, the color bright 85 tube is 43% brighter, on the average, than other currently available color tubes. The heightened brightness makes for a sharper, more vivid picture with better contrast. More color tints are also possible. Viewing in normally lighted living rooms and dealer showrooms is now a thing of the present.

When the set is turned off the tube shows an attractive white face, not the usual greyish-yellow screen. Also, because the europium phosphor is white-

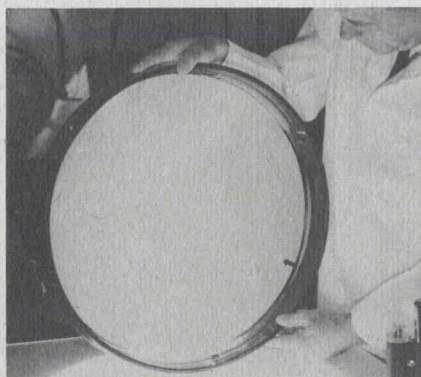

Engineer examines a new phosphor dot "screen."

bodied, the normal unwanted filter actions are greatly reduced.

One of the major accomplishments of the color bright 85 tube is the fidelity in color values over wide ranges of brightness. The reds in Sylvania's tube keep their natural hues, not shifting to orange-reds in the highlights of the picture.

Adding it all up, it's apparent why, in color picture tubes, the trend is to Sylvania.

CIRCLE NUMBER 301 ON READER SERVICE CARD.

more election results color bright 85 tube the winner

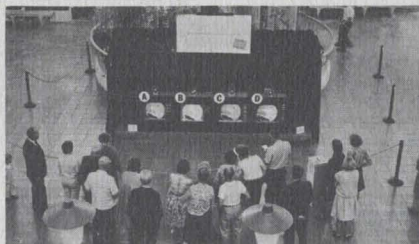

The returns are in from another election. This time 9,789 consumers voted in six major cities. The results show that television sets equipped with color bright 85 picture tubes are the overwhelming choice in an impartial test of men and women coast to coast.

Asked to compare the picture performances of four current-model color sets of comparable retail value, the sets with the Sylvania picture tubes were picked conclusively over other brands. Tests were performed in New York, Chicago, Los Angeles, Detroit, Philadelphia and Boston.

All brand identification was concealed. Each set received the same signal through the same antenna with the same amount of line current. Controls were adjusted for optimum performance of each set and all operating conditions were verified electronically.

Color bright 85 tubes had the brightest color picture according to 76.1% of all tested. Sixty-eight percent also picked it as having the clearest picture; 66.6% said it had the best overall color performance; 60.2% chose it as having the most pleasing colors; 50.1% thought color bright 85 tubes had the "reddest" red color. In black and white, Sylvania scored as follows: 77.7%—brightest picture, 71.2%—best overall performance, 70.4%—"blackest" black and "whitest" white. We think you'll agree—Sylvania's big difference is impressive.

CIRCLE NUMBER 301 ON READER SERVICE CARD.

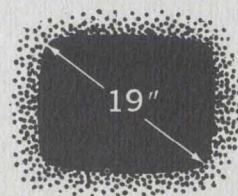

Now, a 19" rectangular color bright 85 tube

Sylvania has just introduced the newest picture tube in the color bright 85 series, a 19" 90° rectangular model.

Like its two predecessors in the series, the new 19" tube is a direct-viewed three gun shadow mask type for use in color television receivers. Other color bright 85 tubes available are the 21" 70° round and the 25" 90° rectangular tubes.

This tube uses the yttrium vanadate europium-activated phosphor for high brightness and optimum rendition. It is compact too, having an overall approximate length of 18" and weighing just 24 pounds, including its bonded safety shield. The picture area is approximately 180 square inches.

Because of the gun assembly and design, the external neck components and associated circuitry are compatible with the 25" tube thereby simplifying TV set design.

Each electron gun incorporates a long life heater-cathode assembly featuring a unique shielded cathode and highly reliable tungsten-rhenium heater.

CIRCLE NUMBER 321 ON READER SERVICE CARD.

damping, deflecting, demodulating at low cost with low B+ tubes

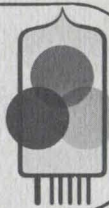

Receivers operating at voltages in the B+ range (250-270V) will become a major factor in bringing color TV to mass markets. Circuit engineers are now engaged in designing these units because manufacturers can cut production costs while offering quality sets at reduced consumer prices. Versatile multifunction tubes are still another means to the same end.

Now Sylvania's new color TV receiving tubes make possible circuit power reductions from the standard 400 volts to 270 volts.

The new tubes are all designed for low B+ operation and include special purpose and multifunction types. Under development for several years, there are types for deflecting, damping, demodulating and rectifying.

There are many ways in which the TV set manufacturer can realize cost savings. For example: (1) series string operation, (2) the multifunction nature of some of the tube types, (3) more economical filter circuits, and (4) possible elimination of the power transformer.

All in all, significant savings can be had. We suggest you ask your Sylvania sales engineer about these new tubes.

CIRCLE NUMBER 302 ON READER SERVICE CARD.

rectifiers

Sylvania's controlled avalanche series takes 1000-amp surges

A controlled avalanche rectifier that will withstand extremely high surge currents is one of two new silicon diffused molded lines from Sylvania. The controlled avalanche series, designed primarily for high surge applications, such as power supplies, is capable of handling 1000-amp PIV surges.

Both new molded rectifier lines have a power dissipation of one watt, one microamp leakage at PIV, and forward conduction of 1.2 amperes (at one volt, typ.).

The standard package for both units is the bullet-shaped injection molded type. Because the cathode lead is at the pointed end, polarity is easily identifiable. Overall dimensions of this molded package are 0.375" (max.) long with a 0.200" (max.) diameter. With standard leads, overall length is 2.375" min.

More complete information on performance and characteristics of these two new series is included in the curves and chart shown here.

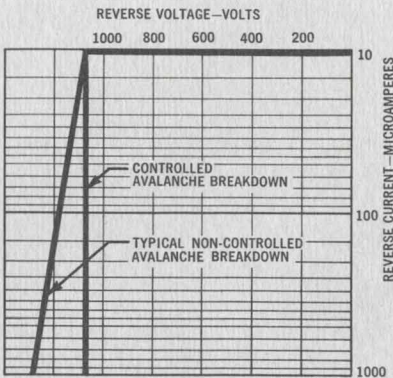

CIRCLE NUMBER 303 ON READER SERVICE CARD

CONTROLLED AVALANCHE RECTIFIER 1 Ampere, Molded Package (Readings at 25°C)						
ELECTRICAL CHARACTERISTICS	SR 6587	SR 6588	SR 6589	SR 6590	SR 6591	Unit
Peak Reverse Voltage	200	400	600	800	1000	Volts
RMS Input Voltage	140	280	420	560	710	Volts
Max. DC Forward Voltage Drop @ 1a	1.0	1.0	1.0	1.0	1.0	Volts
Max. DC Rev. Current @ PRV	1.0	1.0	1.0	1.0	1.0	μA
Max. DC Rev. Current @ 100°C	50	50	50	50	50	μA
ABSOLUTE MAXIMUM RATINGS						
Max. Peak Rev. Working Voltage	200	400	600	800	1000	Volts
Max. Peak Forward Current	1.0	1.0	1.0	1.0	1.0	Amps
Max. Fwd. Peak, Non-Recurrent Surge	50	50	50	50	50	Amps
Max. Fwd. Peak, Recurrent Surge	20	20	20	20	20	Amps

NEW 1-AMPERE RECTIFIER Molded Package (Readings at 25°C)			
ELECTRICAL CHARACTERISTICS	SR 6592	SR 6593	Unit
Peak Reverse Voltage	800	1000	Volts
RMS Input Voltage	560	710	Volts
Max. DC Forward Voltage Drop @ 1a	1.0	1.0	Volts
Max. DC Rev. Current @ PRV	1.0	1.0	μA
Max. DC Rev. Current @ 100°C	50	50	μA
ABSOLUTE MAXIMUM RATINGS			
Max. Peak Rev. Working Voltage	800	1000	Volts
Max. Peak Forward Current	1.0	1.0	Amps
Max. Fwd. Peak, Non-Recurrent	30	30	Amps
Max. Fwd. Peak, Recurrent	10	10	Amps

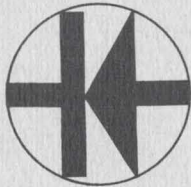

silicon power rectifiers

SPR's to 450 amps, with 80% greater surge capability

The best surge capability available today in high power silicon rectifiers is found in Sylvania's broad line of single junction types which range from 75 to 450 amperes and up to 1200 volts. For example, the 450-amp unit can withstand repeated 12,000 amp surges for 4 milliseconds and 6000 amp surges for 10 milliseconds.

Featuring a unique "Thermal Cap" construction, these rectifiers allow up to 80% greater surge capacity over standard type rectifiers. "Thermal Cap" permits fuses and cutouts to act before destruction levels are reached. In recent tests Sylvania high power rectifiers took four times as long as competitive devices to reach 200°C, while being tested at nearly 100% overload conditions with no forced air conditioning.

Exclusive "Thermal Cap" construction also lowers thermal excursion, increases short time and adds long surge capability by absorbing heat in the on-cycle and dissipating it in the off-cycle

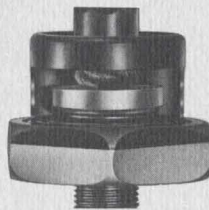

through the top lead. This is done by the addition of a copper slug heat sink on top of the silicon wafer.

These rectifiers offer many advantages to design engineers. They're available in both positive and negative polarity, either stud or flange-mounted. They can reduce the number of paralleling reactors as well as the size and weight of assemblies. They offer longer life through cooler operation.

With Sylvania's 450-amp silicon rectifier you also get the largest current-carrying capacity available in a single junction. The same unit is capable of 850 amps (typ) water-cooled and PIV's to 1200 volts. It can withstand 2000 amps dc (air-cooled) or 4500 amps dc (water-cooled) in 3 phase YY continuous operation. And, very importantly, it economically replaces two 240-amp rectifiers.

Sylvania's full line of silicon rectifiers presently includes over 500 types from which to choose, beginning with 3-amp devices. All are immediately available in quantity.

CIRCLE NUMBER 304 ON READER SERVICE CARD

Typical Maximum Ratings

Ampere Line	Peak Reverse Voltage	Average Rectified Current	Peak Forward Surge 1 Sec.	Peak Forward Surge 4 msec.	Junc. Temp.	Thermal Resistance Per Watt Between Junction & Base	Torque	Storage Temperature	Reverse Current
160	50 to 1000V	160A	650 A av. 2040 A peak	5000A	190°C	.3°C	60 lb/ft min.	-65°C to +150°C Short period 200°C	40 ma rated PRV Tj = 150°C
240	50 to 1200V	240A	1100 A av. 3500 A peak	7500A	190°C	.2°C	60 lb/ft min.	-65°C to +150°C Short period 200°C	50 ma rated PRV Tj = 150°C
450	50 to 1200V	450A	1650 A av. 5100 A peak	12000A	190°C	.1°C	60 lb/ft min.	-65°C to +150°C Short period 200°C	50 ma rated PRV Tj = 150°C

readouts

Sylvania's EL Systems now fully solid state



Sylvania's new line of solid-state SCR translators are the final step toward fully solid-state readout systems.

Specifically designed for use with EL (electroluminescence), the new switching matrices can translate into displayed numbers a 1-2-4-8 BCD input from a frequency counter or a computer. Built with a unique combination of diode logic and silicon controlled rectifiers, the switches consume little power, working from a 6-volt dc logic source. Some sources are positive true and the others negative true.

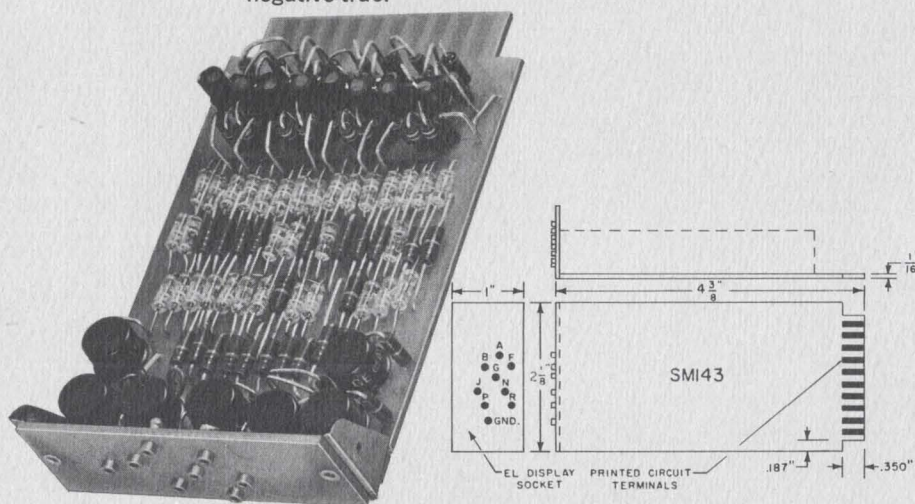

The new SM-142 and SM-143 operate from +6V and serve an EL readout displaying seven-segmented numerals ranging in height from 1/2" to 1 1/2". The SM-142 consists of the basic translator and switching circuitry for seven signal inputs. The SM-143 has additional flip-flop storage (or memory) circuits; i.e., as the unit counts, the readout continues to display the most recently computed numbers. The storage feature reduces SM-143 inputs to four data lines plus one strobe and one erase.

Like long-life EL, these translators have the same dependable solid-state reliability. They are of a modular design (see photo) and are rugged, built to withstand shock and vibration.

CIRCLE NUMBER 305 ON READER SERVICE CARD

Sylvania's integrate

Integrated circuits must have a basic combination of characteristics to suit a specific job. Until recently, this always meant costly custom-designed, custom engineered circuits, each one virtually an expensive "original."

Sylvania engineers have created a set of basic circuits, categorizing them into four families, each of which is capable of suiting a wide range of applications. The theory behind this approach is to make available sets of circuits providing the best price performance ratio for each range of application.

SINGLE PHASE TRIGGERED FLIP FLOP (MP) SF 30 • (MS) SF 31 (GSIP) SF 32 • (GSIS) SF 33

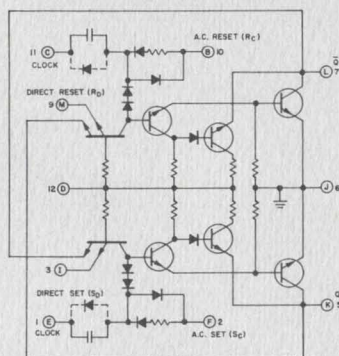

DUAL 3-INPUT OR EXPANDER (MP) SG 170 • (MS) SG 171 (GSIP) SG 172 • (GSIS) SG 173

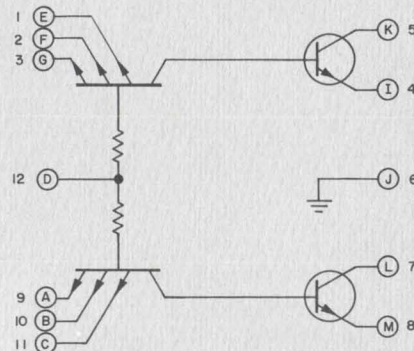

EXPANDABLE EXCLUSIVE OR GATE (MP) SG 110 • (MS) SG 111 (GSIP) SG 112 • (GSIS) SG 113

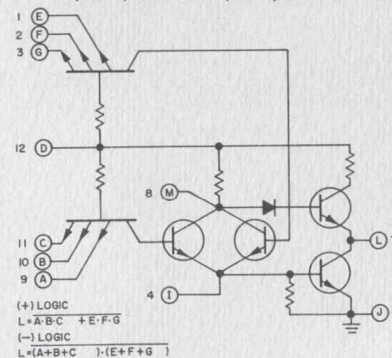

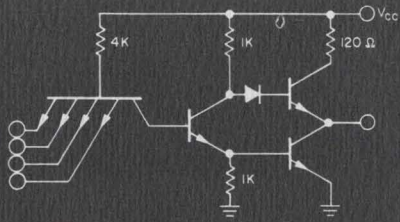

greater logic capabilities and high performance, at low cost

The result is a series of 4 Sylvania Universal High-level Logic families. Each family consists of the 12 circuits shown, categorized for 2 full Military and 2 Fixed Plant application ranges. Each series includes 9 gates and 3 flip flops. These circuits are produced using buried layer, monolithic planar epitaxial construction with Sylvania's advanced fine line technology. Sylvania integrated circuits can substantially lower the can count in many computer designs. This is due to versatility and the range of circuit functions available, combined with the basic

high drive capability.

Operating on a single power supply, the 12 types have a fanout capability of 6 to 20, typical switching speeds of just 10 nanoseconds, noise immunity of 1.0 volt (25°C) and average power dissipation per stage of 15 milliwatts. They also withstand radiation effects measuring as high as $10^{14}n/cm^2$.

All of these circuits are available off-the-shelf in either a hard glass flat package or a 12 pin TO-5 package, both hermetically sealed to $1 \times 10^{-8}cc/sec.$, 100% verified with radiflo testing.

TYPICAL CHARACTERISTICS				
Circuit Category	Temperature Range	Fanout	Noise Immunity @ Room Temp.	Propagation Delay Time
Military—Prime (MP)	-55°C to 125°C	15	1.0V	12
Military—Standard (MS)	-55°C to 125°C	7	1.0V	12
Ground System & Industrial—Prime (GSIP)	0°C to 75°C	12	0.9V	12
Ground System & Industrial—Standard (GSIS)	0°C to 75°C	6	0.9V	12

CIRCLE NUMBER 306 ON READER SERVICE CARD

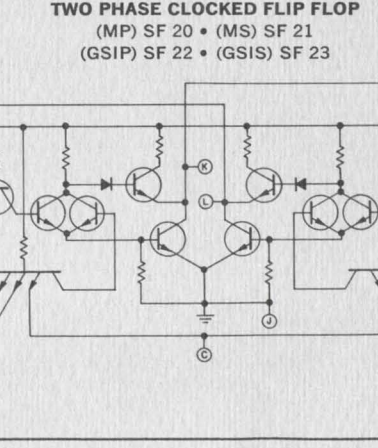
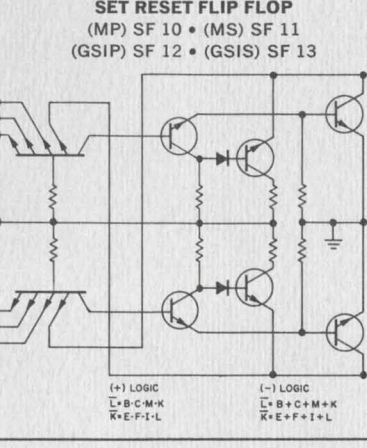
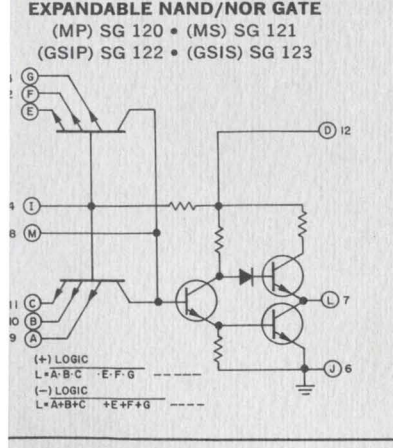
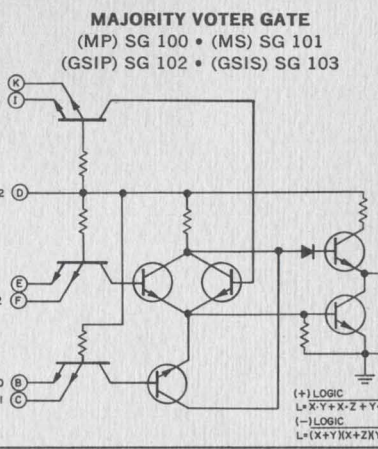
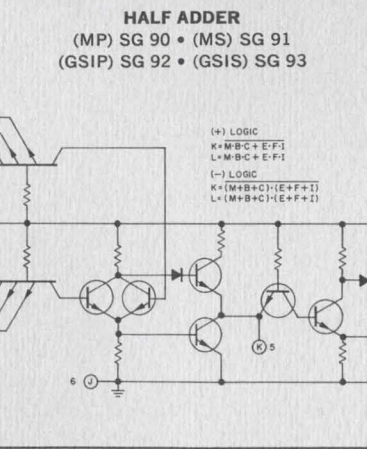
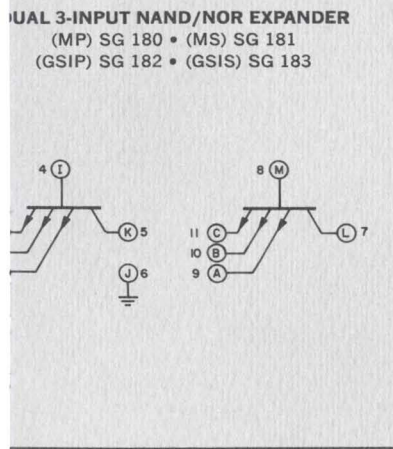
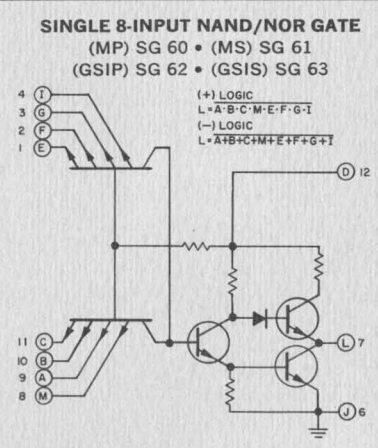
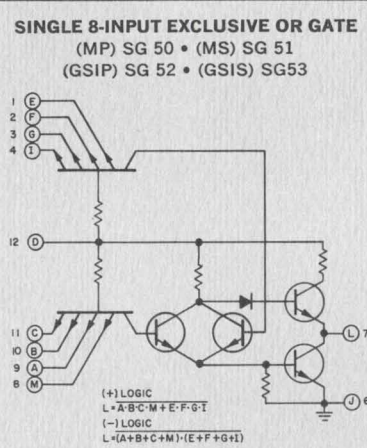
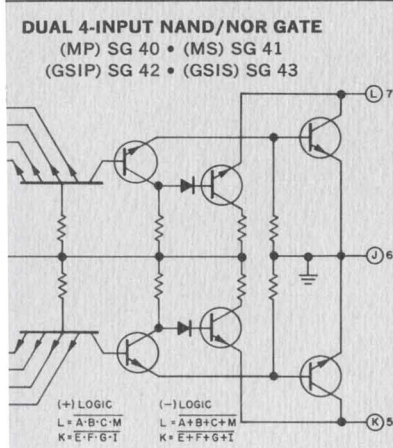

transistors

Sylvania's new PNP silicon Core Drivers in "single H" construction

Medium current PNP Core Drivers, complementary to Sylvania's NPN transistors, are new additions to the Semiconductor Division's line. "Single H" in construction, the new 2N2904 through 2N2907 series supplements the Sylvania "double H" high current Core Driver family. Versatile, they can also be used as medium power amplifiers.

The new "single H" transistors with their higher operating frequency and lower capacitance greatly enhance the Sylvania PNP Core Driver line. Typically, an h_{FE} of 100 can be attained at 150 ma I_c and collector-to-emitter breakdowns run to a high of 60 volts. Leakage currents are low at just 10 nanoamps. Operating frequency is high at 200 megacycles.

The value in complementary pairs is well known by circuit designers. For example, when Sylvania complementary types 2N2907 PNP and 2N2222 NPN "single H" Core Drivers are designed into a circuit, fewer circuit components are needed. Hence, both a simplified circuit and a component savings result.

As for packaging, the 2N2904 and

2N2905 types are available in TO-5 and TO-51 co-planar, while the 2N2906 and 2N2907 are supplied in TO-18 and TO-51 packages.

"Double H" Core Drivers

Sylvania's unique "double H" epitaxial units have large area, low capacitance designs that are extremely efficient in current handling. This makes for an unusually flat beta, high even in the higher current region.

Leakage currents are very low, and speed is excellent, too. Tested in 2N1132B circuitry, the new Sylvania 2N3081 exhibits typical T_{on} of 10 ns, T_{off} of 15 ns, compared to 2N1132B maximum limits of 45 ns and 35 ns.

Extremely tight manufacturing controls, plus far advanced epitaxial, planar and photolithographic techniques, are Sylvania strong points that make this design — and performance — possible. There's a choice of packages in these "double H" units, the TO-51 co-planar and the TO-5 with collector connected to case.

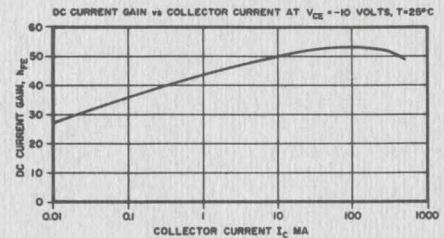
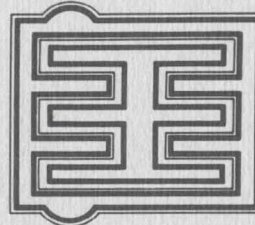
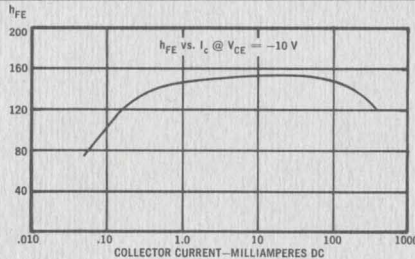
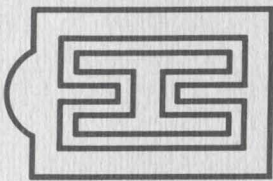

CIRCLE NUMBER 307 ON READER SERVICE CARD.

Product Manager's Corner

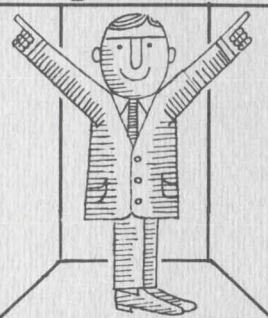

integrated circuits

planned marketing vs. "fall-out barrel" techniques

By this imposing headline we mean: knowing our process and product capability, as well as planning a marketing program based on this knowledge as opposed to "catch-as-catch-can" pricing based on random availability.

I believe the component industry has damaged its reputation through the practice of dumping accumulated inventories and fallout product on the market at distress prices.

In addition to the obvious problem that cheap money drives good money out of circulation, customers frequently end up with higher assembled circuit costs resulting from added handling costs. Furthermore the end products have frequently been of lower reliability than what was practically achievable at the cost level. Finally there has always been the ultimate problem of inability to quote continuing delivery.

The new categorization of Sylvania's microcircuit product line presents an answer to the designer's dilemma of how to pick integrated circuits with a satisfactory cost-performance ratio. All our integrated circuits are made from the same process to the same quality standards and tested to the same military-type environmental and electrical stresses.

The Sylvania process design has a predictable distribution that can be categorized into a practical application spectrum. On this basis we are presenting four categories of Sylvania Universal High-level Logic circuits. These are:

- Military-Prime (MP) • Military-Standard (MS) • Ground System & Industrial-Prime (GSIP) • Ground System & Industrial-Standard (GSIS)

The GSIP and GSIS categories are designed for Fixed Plant and Military Ground System applications.

These products are in continuous production!

Products which do not meet this controlled spectrum are classified as unusable.

The customer now has a choice of fan out, temperature range and price without compromise of performance or reliability. He is assured of continuing supply and he is protected from rising prices with unit volume increase.

I believe Sylvania's approach to planned marketing will help maintain the reliability reputation of integrated circuits and integrated circuit equipment, solve the designer's dilemma and deliver optimum performance per dollar invested.



Harry Zuhler

photoconductors

extra reliability in a T-2 cell

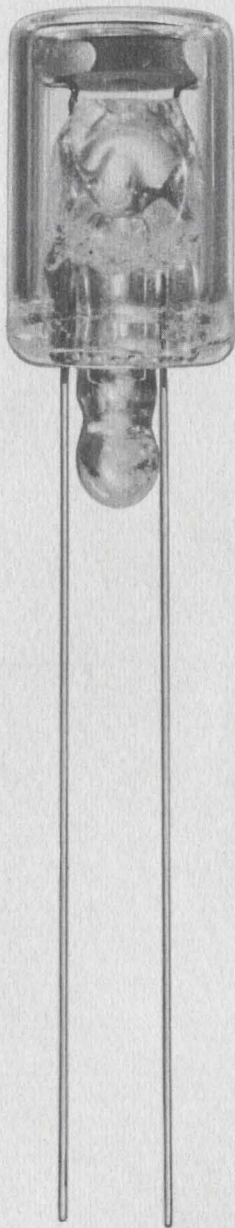

resulting moisture, the blue dot on the cadmium sulfide wafer changes to pink. This happens in the presence of just 0.02% moisture.

Ideal for a wide range of critical applications, the new T-2 offers long life, electrical stability and mechanical ruggedness — performance characteristics adding up to the highest quality unit available in the industry today.

There are seven types in the line covering the broad range of 1,500 to 100,000 ohms light-resistance at 2 foot-candles. Dark-resistance is at least 100 times the light-resistance value.

Dissipation for each cell is 50 milliwatts at 25°C, giving a moderate power-handling capability. This ideally suits the cell for direct operation of electromechanical actuators and indicators of 1.0 to 2.0 milliamps sensitivity.

Thermal stability is further assured with the T-2's light-sensitive cadmium sulfide wafer. This material has a medium-fast response time and a spectral response that peaks in the visible range.

Among T-2 photoconductor applications are industrial process control, aerospace use, electronic instrumentation, automatic aperture control in cameras, light meters, tachometers, headlight dimmers, automatic TV brightness controls and studio-type remote volume controls.

T-2 PHOTOCONDUCTOR DATA

Photo-conductor Type No.	Cell Voltage ^{1,2} Volts	Light Resistance ³ Ohms	Dark Resistance ⁴ ohms	Cell Dissipation Milli-watts (At 25°C)	Ambient Temperature Range-°C (Note 1)
8318	300	40,000	10.0	50	-40 to +70
8474	150	1,500	0.15	50	-40 to +70
8475	200	3,000	0.3	50	-40 to +70
8476	300	6,000	0.6	50	-40 to +70
8477	300	12,000	1.2	50	-40 to +70
8478	300	24,000	2.4	50	-40 to +70
8582	300	100,000	10.0	50	-40 to +70

NOTES:

1. Absolute maximum values.
2. Measured with cell in complete darkness at a pulse rate of 100 pps, 100 μ sec. duration. Voltage in excess of the rated value may damage the cell. Max. DC or AC peak voltage is limited by max. dissipation and min. dark resistance rating.
3. Illumination 2 FC. Color temperature 2870°K for all. Measured after 60 minutes minimum exposure to approximately 50 FC illumination (ambient room light).
4. Minimum. Measured in complete darkness at least 10 seconds after removal of 2 FC illumination.

Just as you wouldn't shovel snow in a bathing suit, you wouldn't use an ordinary photoconductor in extreme humidity.

Sylvania has come up with an answer to a principal cause of photoconductor malfunction. The newest line of cells from Sylvania, the ¼-inch T-2 series, has the most positive protection yet devised against moisture. Not only does it have a true hermetic seal for long life and stability at humidity and temperature extremes...each cell also has double-barrelled protection with its own advance warning system — the famous Sylvania Blue Dot. In the event of damage to the all-glass envelope and

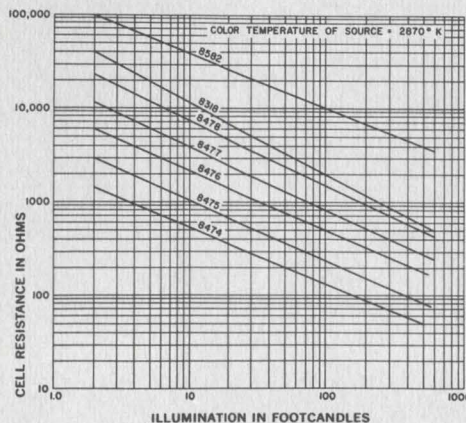

CIRCLE NUMBER 308 ON READER SERVICE CARD

LITERATURE CHECK LIST

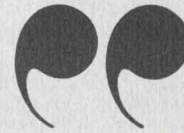

For copies of Sylvania publications listed here, circle indicated number on Reader Service card.

Silicon Power Rectifiers—describes complete line available of over 500 field-proved types, 3 to 450 amps, up to 1200 volts, in 7 packages. (SM3902)

CIRCLE 311

T-2 Miniature Photoconductive Cells — performance characteristics and application information on ¼" high-reliability photoconductive cells. (ET-2979)

CIRCLE 312

NPN Germanium Alloy Transistors—oval-shaped units for high stacking density; describes 8 typical circuits. (SM3929)

CIRCLE 313

Automatic Display Systems—description of Sylvania electroluminescent and gas-glow alphanumeric data display systems. (ET-2975A)

CIRCLE 314

Microwave Diode Product Guide—summary performance characteristics for mixer and detector diodes, tunnel diodes, and varactors. (9135P363)

CIRCLE 315

Low B+ Tubes for Color TV—characteristics of new tubes for color television designed for operation at low B+ voltages. (ET-2969)

CIRCLE 316

Rectangular Color TV Picture Tube, Tentative Engineering Data—characteristics and ratings of Sylvania's new 25" rectangular color bright 85 picture tube. (ET-2966)

CIRCLE 317

Sylvania Integrated Circuits, Typical Systems Functions — typical applications which demonstrate advantages of Sylvania Universal High-level Logic. (SM2971)

CIRCLE 318

PNPN Silicon Epitaxial Planar Switches —characteristics, curves and typical applications; circuits for new 3-terminal bistable silicon switches. (SM1979)

CIRCLE 319

Guide to Sylvania Industrial and Military Cathode Ray Tubes—typical specifications for Sylvania's complete line of oscilloscopes, radar indicators, video recorders, industrial monitors, receiver check tubes and flying spot scanners. (ET-3914)

CIRCLE 320

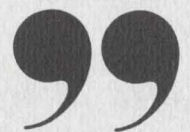

CRT's

Double duty through a rear window

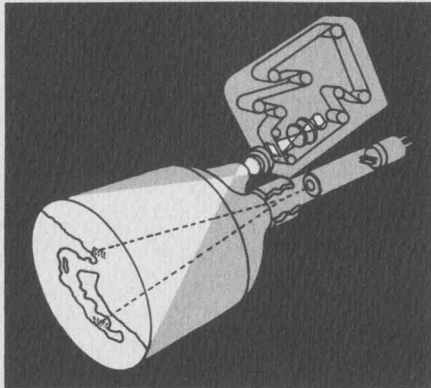

At a remote U.S. radar installation a static map of the island chain is seen on the CRT screen. Suddenly two fast-moving images enter the picture, streaking toward the North American heartland. Are the blips friend or foe?

This not-impossible occurrence could happen. Aircraft position data being displayed on this particular tube, a rear window CRT, is easily assessed in a real-time relationship that is vital if interception is needed. The static map is projected from a window at the rear of a Sylvania tube. The airborne blips originate from an outside source. Together the two images are both meaningful and accurate.

Optical projection of overlay information for comparator applications is one of two principal uses for Sylvania rear window cathode ray tubes. The other main use is for simultaneously photographing the screen's electron image.

In the projection technique, the static background can emanate from a conventional slide or motion picture (see cut) projected through an aperture, actually an optically flat "rear window" sealed to the funnel of the CRT. The dynamic data may be transmitted to the tube's phosphor screen from a radar scanner, a computer or other sources.

Sylvania's rear window tubes also allow for simple recording of data that appear on the screen without interference to front viewing. Both still and

motion picture photography are possible.

Cathode ray tubes with the rear window feature have been proved effective in showing and/or recording troop movements, aircraft positions, altitudes, distances, pressure measurements and other telemetering uses. One of these CRT's, Sylvania's 19" round SC-3875, also features highly sensitive character writing deflection plates which can produce alphanumeric symbols. The symbols are positioned with the tube's main deflection yoke.

The SC-3875's high-resolution electron gun uses an ion trap to eliminate ion blemishes. Its optical viewing window has a useful diameter of 2½ inches, sufficiently large for a wide variety of projectors or cameras.

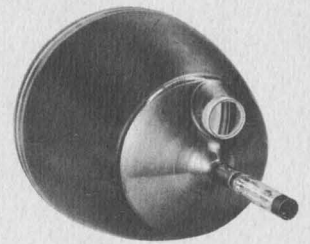

CIRCLE NUMBER 309 ON READER SERVICE CARD

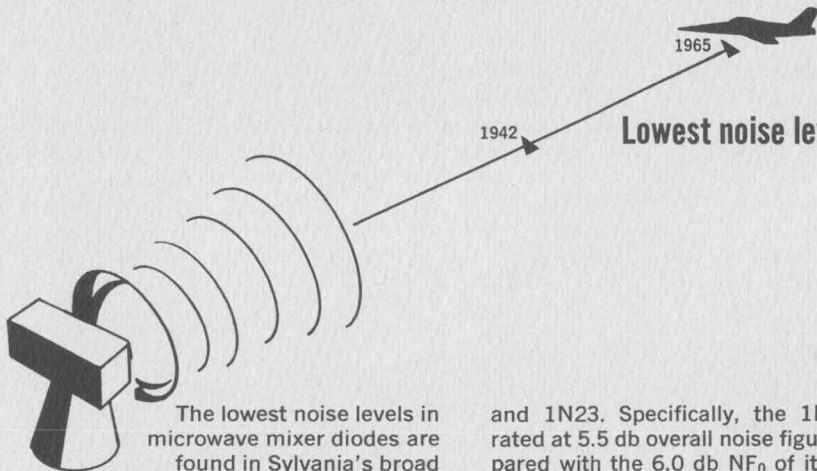

microwave diodes

Lowest noise level yet in Sylvania's new mixer diode series

The lowest noise levels in microwave mixer diodes are found in Sylvania's broad new line. These improved noise figures are significantly lower by 0.5 to 2.0 db in S through Ku bands. They are the results of new epitaxial silicon techniques. Pioneers in the science of epitaxy, Sylvania has applied its experience in semiconductor research and fabrication to produce the most important new mixer diode development in recent years.

Included in this new series are the latest versions of the well-known 1N21

and 1N23. Specifically, the 1N21G is rated at 5.5 db overall noise figure, compared with the 6.0 db NF_0 of its immediate predecessor, the 1N21F. Similarly, the 1N23G is also improved by 0.5 db.

Another of these devices, the premium broadband 5282F, is designed to operate from 12.4 to 18 Gc. The pulse burnout characteristic of this diode remains at 1 erg even though the NF_0 , measured at 16 Gc, has been improved by a full 0.5 db over the best unit previously available.

Still other new units, the "B" versions

of the MicroMin 1N831 and 1N832 diodes can improve the performance of strip transmission line systems.

Here's how nine new epitaxial microwave mixer diodes compare in noise level with those available until now:

Freq. Band	New Type	NF_0 , db*	NF_0 , db*	Standard
S	1N21G	5.5	6.0	1N21F
S	1N831B	6.5	7.0	1N831A
S	1N3655B	6.0	7.0	1N3655A
X	1N23G	6.5	7.0	1N23F
X	1N832B	7.0	7.5	1N832A
X	D5221E	7.0	8.3	D5221C
S	D5223E	7.5	9.5	D5223C
Ku	1N78F	7.5	8.0	1N78E
12.4-18.0	D5282F	7.5	8.0	D5282E

* $NF_{1\text{r}} = 1.5$ db

CIRCLE NUMBER 310 ON READER SERVICE CARD.

SYLVANIA

SUBSIDIARY OF
GENERAL TELEPHONE & ELECTRONICS GTE

NEW CAPABILITIES IN: ELECTRONIC TUBES • SEMICONDUCTORS • MICROWAVE DEVICES • SPECIAL COMPONENTS • DISPLAY DEVICES

Report from

**BELL
LABORATORIES**

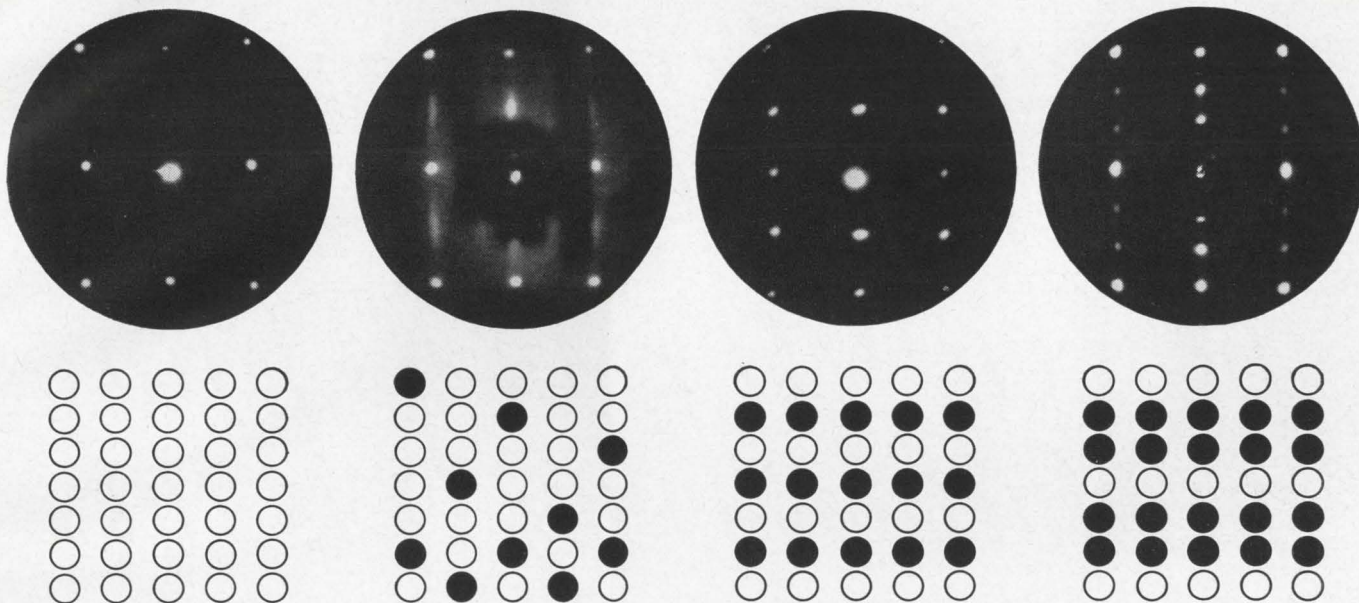

Adsorption of oxygen on crystalline nickel surface produces sequence of diffraction patterns shown in upper row. These patterns can be accounted for by the surface atom arrangements in lower row (nickel as open circles, oxygen as filled circles). Clean nickel surface is represented at far left. As oxygen atom concentration increases from left to right, streaks appear (left center), implying random oxygen positions. At $\frac{1}{2}$ oxygen coverage (right center), surface is ordered and streaks have coalesced into sharp spots halfway between original spots. At $\frac{2}{3}$ oxygen coverage (right) a triply periodic pattern and atomic arrangement occur.

A closer look at the surfaces of solids

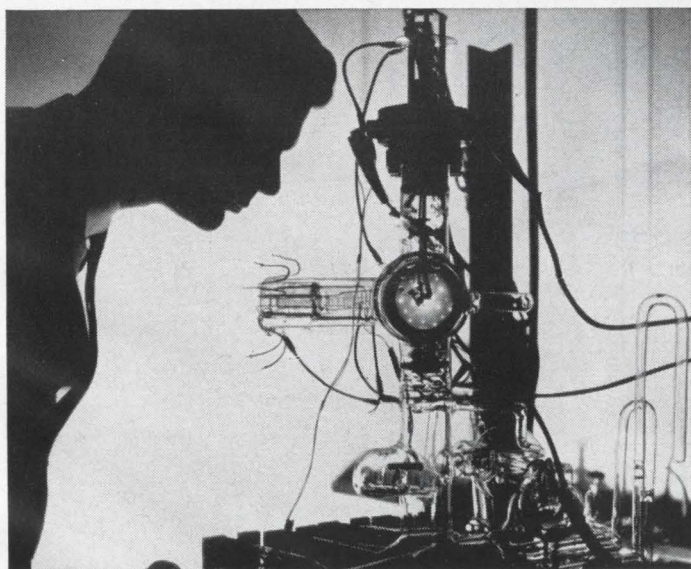

Low energy electron diffraction equipment showing spot pattern on phosphor screen at center. In this ultrahigh vacuum apparatus electrons are diffracted at the target crystal which can be seen in front of the screen. They are then accelerated to produce visible spots. Electron energy at the crystal surface is variable from near zero to several hundred electron volts.

What does a surface really look like on an atomic scale? What happens when a gas interacts with an atomically clean, crystalline surface? With recently improved apparatus (left) based on the scattering of low energy electrons into preferred directions (diffraction), it is now possible to answer such questions in considerable detail.

As an example, scientists at Bell Laboratories have recently observed the intriguing sequence of surface structures illustrated above when oxygen gas interacts with a nickel surface. Structures have been identified and transitions among them studied as functions of gas pressure and temperature on several crystallographic faces of a number of metals, semiconductors and insulators.

Other types of results concern the formation of faceted pits and pyramids at surfaces, nucleation and growth in monolayers and multilayers, and the vibrations of surface atoms. We are working toward fundamental knowledge of surfaces comparable to present knowledge of the bulk properties of crystals.



Bell Telephone Laboratories
Research and Development Unit of the Bell System

This is Vitro Electronics' Telemetry Receiver • It is Type 1037A • It is not new It is thoroughly field-proven • It is in its fifth production run • It is the standard for comparison

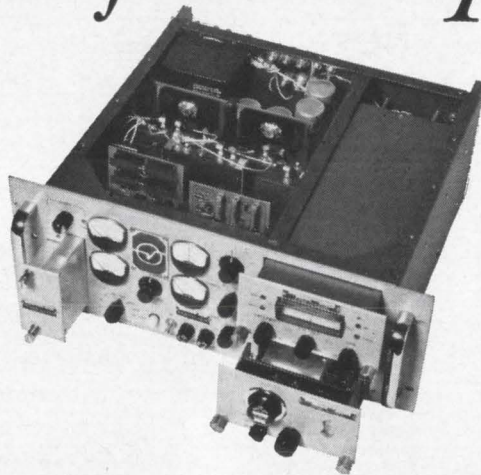

The 1037A is still the only advanced type telemetry receiver that is in full production with a long and successful history of field-proven performance and reliability. The 1037A offers a wide choice of off-the-shelf plug-in RF tuners covering a range of 55-2300 mc and the most versatile group of IF demodulators available which include true phase with long or short loop, linear phase for special PCM applications, phase tracking, high capture ratio, phase lock, FM and AM for all known telemetry formats. Integral plug-in predetection converters and spectrum display units optional. Improved adjacent channel rejection and optimum combination of RF nuvistors and solid state design avoid the dynamic range problems inherent in solid state RF tuner designs.

Vitro Electronics is also the only manufacturer with a complete line of off-the-shelf solid state pre- and post detection combiners, dual diversity receivers, up and down converters, multicouplers, preamplifiers, etc.

*For a complete new catalog or additional details please write to
Vitro Electronics, 919 Jesup-Blair Drive, Silver Spring, Maryland.*

VITRO CORPORATION OF AMERICA • 90 PARK AVENUE • NEW YORK, N. Y. 10016

Vitro

a remarkable **NEW POWER SUPPLY** from Deltron

THE HIGH PRECISION "DUET"

\$168⁰⁰

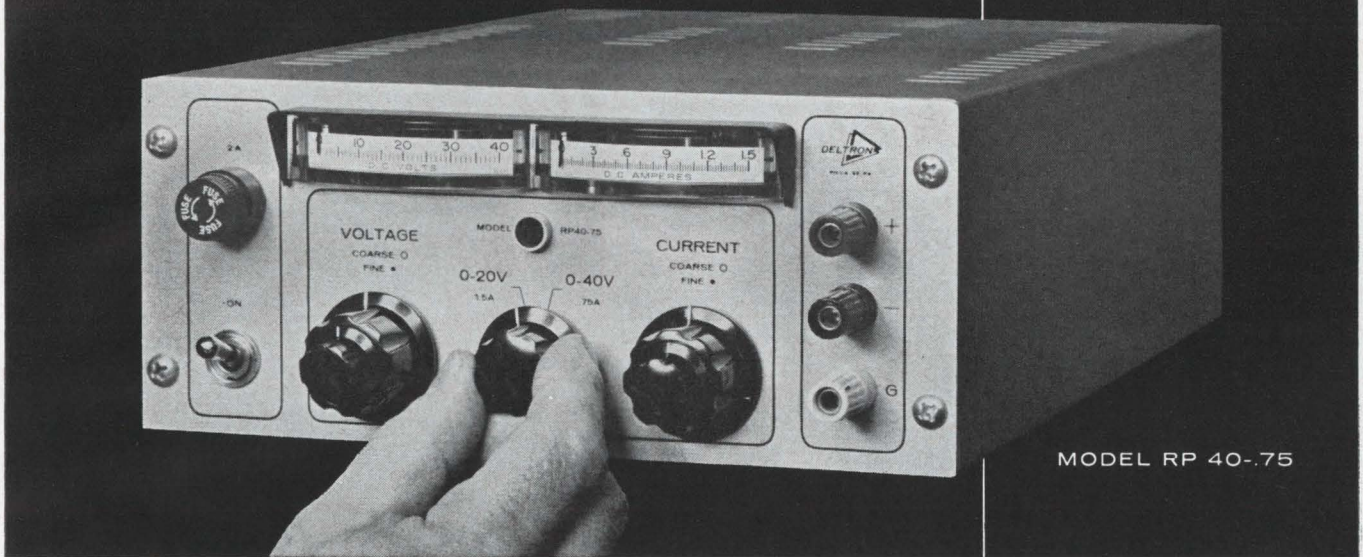

MODEL RP 40-75

"DUET" twin amplifier controls
voltage or current with automatic electronic crossover

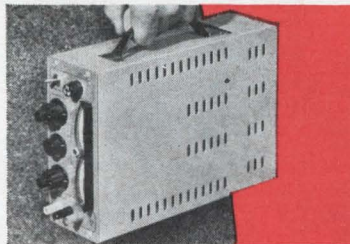

Built-in handle makes it easy to carry the "Duet". It's about half the size of an average briefcase.

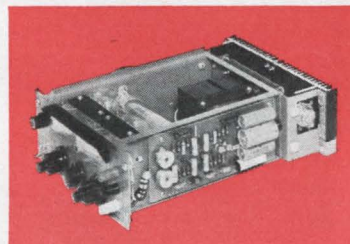

Examine for yourself the superior design, workmanship, and components in the "Duet".

- Dual output range:
0-40 V at 0.75 amp . . 0-20 V at 1.5 amps.
- 0.01% regulation.
- Ripple — less than 200 microvolts.
- All specifications are *guaranteed* without any need for external programming resistors.
- No overshoot on turn-on . . turn-off . . or power interruption in either voltage or current mode.
- Automatic series and parallel operation without complicated connections.
- Half-rack size . . permits rack mounting as singles or duals . . as well as portable use.
- One free demonstration will prove the "DUET" superior in PERFORMANCE . . QUALITY . . and PRICE . . to any other on the market.

16 OTHER RP MODELS AVAILABLE
... IN A WIDE RANGE OF RATINGS

For more information . . or to arrange a demonstration, write to..

Deltron inc.

FOURTH AND CAMBRIA STREETS, PHILADELPHIA 33, PENNA.
PHONE: (215) 739-1101 TWX: (215) 569-8686

CONSIDER YOUR HARNESSING OPERATION...

SURVEY of HARNESS
TYING OPERATION
for
YOUR COMPANY



GUDEBROD BROS. SILK CO., INC.
FOUNDED IN 1870
Electronics Division

Area Code 215, WA 2-1122 • TWX 215-589-8551

12 SOUTH 12TH STREET, PHILADELPHIA, PENNSYLVANIA 19107

• BRANCH OFFICES •

BOSTON, MASSACHUSETTS 02111
115 Chauncey Street, Area Code 617, HA 6-6347

CHICAGO, ILLINOIS 60654
1382 Merchandise Mart, Area Code 312, DE 7-3026

NEW YORK, NEW YORK 10001
225 West 34th Street, Area Code 212, LA 4-8888

BURBANK, CALIFORNIA 91504
2636 Ontario Street, Area Code 213, 848-3988
TWX 213-848-7891

PLANT: Pottstown, Pennsylvania 19464

Would you like to save money while improving the product?

TO FIND OUT HOW
—here is what you
need—and it's FREE

Have you considered that your company may be overlooking the possibility of achieving savings on harness operations while, at the same time, the product is improved? Gudebrod engineers have been making recommendations to companies like yours *with just such results!* Here's how it is done:

FOR THE STANDARDS ENGINEER

As electronic engineering becomes more and more sophisticated, as the use of electronic equipment becomes more widespread, the specifications, even for lacing materials, become more exacting. Gudebrod engineers can suggest the right tying tape for your particular requirements. The two hundred plus types of tape in the Gudebrod line are specially designed for specific purposes and each one of these tapes is engineered for efficiency in the tying operation as well. Our engineers will be happy to work with *your* Standards Engineer to save money while improving the product.

FOR THE METHODS ENGINEER

Gudebrod has engineered its entire tape line with the basic idea of producing tapes that "tie themselves." Easy, safe handling,

non-slip knots, trim harnesses have been kept in mind—features that speed the harnessing operation. In addition, there are dispensing packages, cut lengths, bobbins, color identification—custom designed for the lacing job. Gudebrod engineers will be pleased to work with *your* Methods Engineer to save money while improving the product.

FOR THE PRODUCTION ENGINEER

Gudebrod has a lacing tool, the Cable-Lacer, the first hand tool specifically designed to ease and speed harness tying. No longer need cable lacing be a hand wearing, hand tearing chore. The Cable-Lacer has paid for itself in as little as one day—you can benefit from the savings every day thereafter. A Gudebrod engineer would welcome an opportunity to demonstrate the Cable-Lacer—and to work with *your* Production Engineer to save money while improving the product.

HARNESS OPERATION SURVEY—FREE

Consider then, this offer by Gudebrod to work with your Standards, Methods and Operating Engineers in suggesting how to save money on harness operations while you improve your product. A Gudebrod engineer will make, at your convenience, a complete survey of your harness materials, methods and production. It will be a thorough-going review well worth while—and there will be absolutely no cost or obligation. Why not write or phone today requesting *your* survey?



GUDEBROD BROS. SILK CO., INC.

FOUNDED IN 1870



Electronics Division

12 SOUTH 12th STREET, PHILADELPHIA, PENNSYLVANIA 19107

Area Code 215, WA 2-1122 • TWX 215-569-8551

NSC MICRO CONCEPT
 REVOLUTIONIZES LOW LEVEL
 DIFFERENTIAL AMPLIFIERS

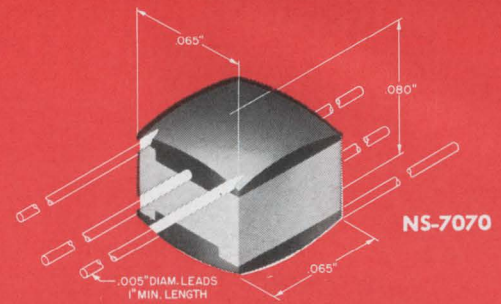
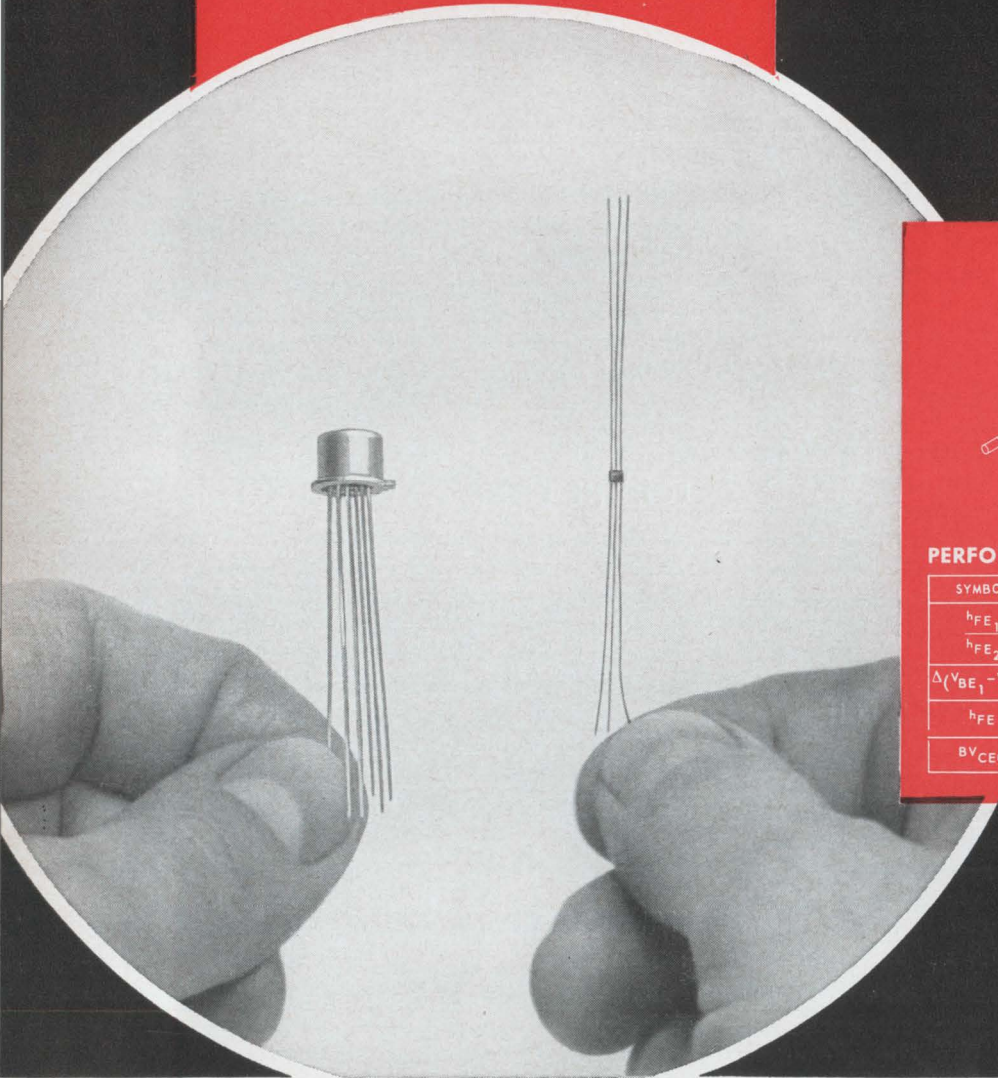

PERFORMANCE CHARACTERISTICS

SYMBOL	TEST CONDITIONS	MIN.	MAX.
$\frac{h_{FE1}}{h_{FE2}}$	$I_C = 10\mu A, V_{CE} = 5V$.9	1.0
$\Delta(V_{BE1} - V_{BE2})$	$I_C = 10\mu A, V_{CE} = 5V, T_A = -55^\circ C \text{ to } +125^\circ C$	-	$10 \mu V/^\circ C$
h_{FE}	$I_C = 10\mu A, V_{CE} = 5V$	100	-
BV_{CEO}	$I_C = 1mA, I_B = 0$	45	-

NOW...DIFFERENTIAL AMPLIFIERS 1/150 THE SIZE OF TO-5

● New NSC micro differential amplifiers operate at low level, with all parameters specified at 10μ amp. These microminiature double-ended six terminal devices offer more flexible circuit layout. Rugged .005" dia. gold-plated leads handle easily, can be conventionally soldered or welded. Naturally NSC makes conventional differential amplifiers. Write for Catalog Sheets NS 7070-7001. Before specifying silicon transistors or integrated circuits in standard or microminiature packages, be sure to investigate NSC's wide product line. Ask for New Composite Catalog on all NSC devices.

NSC
 NATIONAL SEMICONDUCTOR CORPORATION
 DANBURY, CONN.

Electronics Review

Volume 38
Number 2

Industrial electronics

Honeywell's comeback

Few eyebrows were raised when Honeywell, Inc., bounded back into the process-computer business with a small, fast, efficient machine. But there were some gasps at the price tags—\$55,000 to \$70,000. These are near the low end of the industry's price spectrum, which extends to \$320,000.

Honeywell, a force in electronic data-processing and the biggest name in process instrumentation, had had disappointments in the process-computer field. Industry had taken to earlier, higher-priced Honeywell computers like a street urchin takes to soapy water. Honeywell had withdrawn, temporarily, from designing process-control computers.

New language. Now Honeywell is back with a system that, according to its specifications, is the most complete on the market in its price range. It includes a multiplexer, analog-to-digital and digital-to-analog converters, an input-output typewriter and a paper-tape punch and reader; also a new programming language, Contran, that's said to cut programing time by more than 50%.

The H-21, for \$50,000, has a six-microsecond memory cycle using magnetic ferrite cores. Capacities range from 2,048 to 16,384 words; 4,096 is standard. Half the memory locations are directly addressable with a single instruction. Indirect addressing and indexing are included.

The H-22, at \$70,000, has a 1.75-microsecond cycle with the same size memories.

Both computers use 20-bit words; the 19th bit is for parity checking, the 20th is a memory-guard bit.

Guarding the memory. The memory-guard bit allows process-companies to compile new programs

while their systems are controlling on-line. The guard bit acts as a "hardware lock" on memory locations, preventing a programmer from writing in such a location. Other computers on the market depend on the programmer's memory for this safety factor. This is why on-line compiling is a problem.

Both main frames can be connected to additional high-speed input-output peripheral equipment such as magnetic drum memories and magnetic tape stations. But the H-21 time-shares its eight extras, while the H-22 uses eight parallel input channels. Transfer rates are 83 kilocycles time-shared and 71 kilocycles on each parallel input.

Cutting the cost. Honeywell gives two reasons for the low price.

One is the interface system, called a Magnetik Coupler. It uses large, rugged magnetic ferrite cores, $\frac{3}{8}$ inch in outside diameter, to perform logic and decoding between the input-output equipment, the digital multiplexer and the computer main frame.

With simplified and standardized wiring, and by cementing the cores to the backs of the interface connectors, Honeywell's Special Systems division has completely eliminated transistors and diodes and their circuit boards from interface work.

The second reason is time-sharing of the control and arithmetic registers in the main frame. This reduces the number of circuit boards and components used, and shortens manufacturing time. Every capacitor and resistor in the main frame is a thin-film component instead of discrete. This also results in lower production costs.

A year to develop. Kenneth Harple, chief development engineer, is responsible for the design of both Honeywell systems. Work started early last year; the first systems will be delivered in the last quarter of this year. Ten systems have already been sold: two for iron foundries, one for testing electronic

equipment, one for monitoring a power-generating plant, another for a textile-finishing mill and others for use in batching and blending.

Both systems accept 50 analog inputs for 12 analog outputs and 100 digital inputs for 50 digital outputs with the 4,096 word memory. Multiplexer speed is 200 analog points per second and 360,000 open or closed digital indications each second.

Analog-to-digital conversion is reported to be accurate to 99.95% of full scale.

Add time with the H-21 is 12 microseconds and multiply time using two 18-bit words is 54 microseconds. For the H-22 systems the figures are 4.8 μ sec to add and 25 μ sec to multiply. Both systems have 16 levels of priority interrupt, with up to 144 input lines connected to each level.

Slashing programing time. Contran is said to reduce programing time as much as 50% while allowing the programmer to write all his programs at the compiler level.

Programs are now written as much as possible in either Fortran or Algol and then finished in assembler language at the compiler level. Contran eliminates both steps. The new program has a built-in executive routine that decides when to run the program and what memory locations to assign. It automatically supervises the transfer of data from drum memories to the main frame's core memory, something that neither Fortran nor Algol can accomplish.

Even though Contran begins at the compiler level, it uses simple instructions, such as "analog in," to make the programmer's work easier.

Tiger in the paper mill

Until mid-January, even its competitors were disappointed at the International Business Machines Corp.'s failure to perfect complete

computer control of a papermaking machine. They noted that 10 of the 13 existing installations were by IBM, and charged that repeated failures were causing the paper industry to lose faith in computer control [Electronics, March 23, p. 27].

But on Jan. 12 a new leaf was turned. The Harding-Jones Paper Co. announced that its rag paper mill in Middletown, Ohio, was under complete closed-loop control with an IBM 1710 process-control system. C. M. Jones, the paper company's president, declared, "It's an economic and technical success."

Now criticism of IBM is taking a more conventional tack. "They could sew up the market," says one rival.

Gruntled or not, competitors credit IBM with another "first." "They've proved they've got the hardware and that their approach to control works," concedes one computer maker.

Logging the data. All along, IBM's approach to controlling papermaking has been to throw a computer onto the process as a data-logger and let the computer decide what needs to be controlled. Other computer-makers have approached the problem from the opposite side; they study the process, then tell the computer what to control."

Most paper companies have small technical staffs. Their understanding of what a computer can do is even smaller. And everybody's understanding of the papermaking process was, until two weeks ago, largely guesswork. These were the reasons why three 1710 systems were yanked out of mills and returned to IBM. The dissatisfied users were Potlatch Forest Industries, Inc., the Fitchburg Paper Co. and an unidentified company.

Robert Walker, a member of the engineering team at Fitchburg—a subsidiary of Litton Industries, Inc.—sums up the economic and technical problems: "We couldn't program the actions of the people working the machines. Papermaking is an art, not a science." Because papermaking couldn't be programmed, the systems proved too

expensive for the mills.

But Jones disagrees. "A mill our size can't afford a research department and we have a small technical staff. But, we felt [in December, 1963] that the 1710 system might serve two purposes—saving time while improving quality and mathematically defining the papermaking process. Our suppositions proved to be true."

Output up 7%. Jones says production of rag paper has increased 7% and quality has improved because of computer control. Rag paper is an industry term for expensive bond and ledger papers. The rag-paper machine produces about 19 tons a day—600 feet per minute of 72-inch-wide rolls. In the 1710 control system, 38 sensors spotted along the length of the machine measure such variables as raw stock consistency, flows, temperatures and speeds of the multi-sectioned machine's drive motors. This feedback, in closed loops, is used to automatically adjust the machine's operation.

The control computer is a 1620 with 20,000 characters of main memory and two million characters of additional memory contained in an IBM 1311 disk file.

Used as a data-logger at first, the 1710 collected the best operating combinations for making each grade of paper. These are now used as operating standards.

Contracting

Must they tell?

The General Accounting Office and the Hewlett-Packard Co. are nearing a showdown on the long-undecided question of the government's right to examine defense contractors' cost-of-production records in negotiated contracts. And the electronics industry is waiting for the decision.

The government office and the contractor are doing battle in a San Francisco District Court. The case involves the sale in 1959 of \$2 million in electronic gear to the Air Force. Hewlett-Packard cooperated in a 1962 audit of the transaction but balked when the GAO

asked for information on the cost of production. In October of 1963 the government sued.

What's pertinent? The basis for Hewlett-Packard's stand is that it did not supply the Air Force with similar data when the four contracts at issue were negotiated. The Air Force accepted the company's catalog price, less discounts that ranged from 9% to 32%. So, says the company, cost was never a factor in the negotiations and cost information wasn't directly pertinent to the audit.

Comptroller General Joseph Campbell doesn't acknowledge any such limitation. He insists that Congress gave his office a mandate to "examine such of the contractor's records as would permit a valid evaluation of the reasonableness of the prices charged without regard to the factors considered or ignored by the contractor in establishing those prices."

Campbell is basing his position on a 1951 law which gives his office the authority to look at any "directly pertinent" records any time up to three years after final payment by the government.

In 1962, Congress passed a bill which required defense contractors to supply cost data except when "the price negotiated is based on adequate price competition, established catalog or market prices of commercial items sold in substantial quantities to the general public."

Keeping it confidential. In 1962 when the hassle started, David Packard, the company president, spelled out his objections to disclosing cost information in a letter to Campbell.

"The electronic industry," he wrote, "is a very competitive one and we consider the H-P cost data as to specific instruments to be highly confidential. H-P would be most unhappy if such information became available to our competitors in any manner. The nature of the duties of the General Accounting Office are such that information developed by its audits is often made public through reports to Congress and is frequently given wide dissemination to various

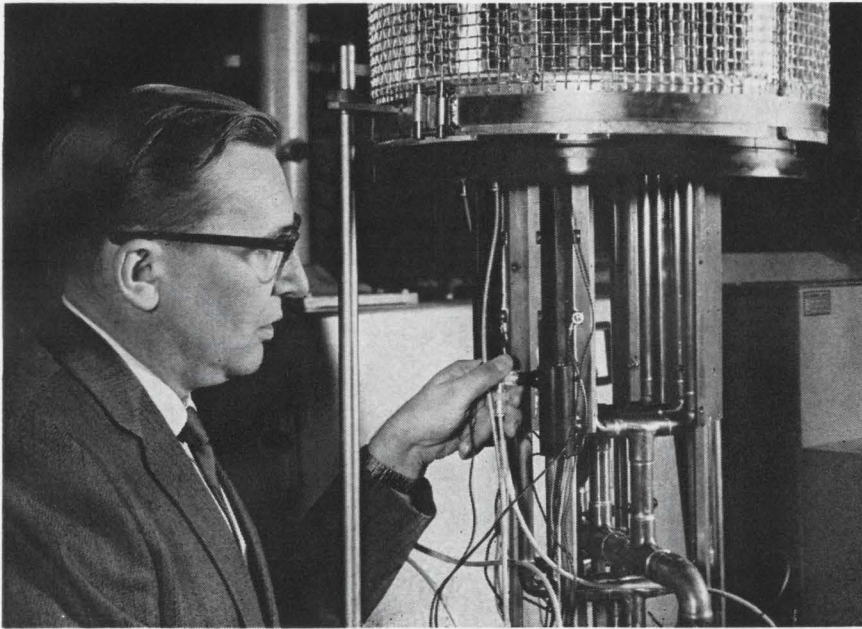

Satellite traveling-wave tube with 40% efficiency is tested in environmental chamber at RCA by Max J. Schindler, designer of the tube.

governmental contracting agencies. Preservation of confidentiality is not possible under such circumstances.”

Appeal expected. During recent weeks government and company lawyers have been trying to iron out some questions of fact. If they succeed, the federal judge will be able to rule in a summary judgment procedure that would avoid a lengthy trial, and a decision may come in February.

It's believed that the definitive answer is still some years away. Whatever the decision, either the GAO or Hewlett-Packard will appeal.

Electronics firms are watching the developments closely. Some have refused to supply the General Accounting Office with cost data pending the outcome of the suit.

Space electronics

More efficient amplifier

A traveling-wave tube 30% to 60% more efficient than existing models has been described by the Radio Corp. of America. It uses a variable, programmed magnetic field as its focusing system instead of the usual constant field.

Amplifier tubes in space satellites have efficiencies of 25% to 30%. RCA says its tube, developed by Max J. Schindler of its Electronic Components and Devices division, has efficiencies of 40% including heater power.

The National Aeronautics and Space Administration and companies competing for contracts have expressed interest but declined to comment on the RCA tube. RCA says it's working on another tube that uses similar technology but with two collectors instead of one. This tube can attain efficiencies of 50% to 55%, according to the company.

Closer alignment. To achieve its 40% efficiency, the RCA tube's focusing system corrects the additional defocusing forces near the tube's output. Mechanical alignment of the periodic magnets is more precise than in existing tubes.

By decreasing the collector voltage, the RCA tube increases the difference in potential between the helix and the collector, thereby improving efficiency. Collector voltages are 40% of helix voltages, according to RCA; earlier tubes' collector voltages are about 57% of helix voltage.

The attenuator has shorter tapers than usual, keeping it farther from the tube's output. This cuts re-

duces the interception of the beam with the helix, and increases efficiency of the interaction.

New plating. To reduce losses, the tungsten helix is plated with copper without the usual nickel base. This results in thinner, more uniform plating and eliminates the cracking and increased resistivity that result from alloying of nickel and copper. To reduce heat loss, the helix is supported by beryllia rods instead of alumina rods.

The RCA tube has a ceramic-metal envelope instead of glass. This allows the use of smaller magnets, which are mounted close to the helix. The metal tube is smaller and has thinner walls than the glass version. It weighs 25 ounces, about one-third as much as the glass tube that's flown on the Relay satellites.

The new tube operates in the four-gigacycle range with outputs of 5 to 20 watts. It has a flat bandwidth of 3 to 4.6 Gc. Its efficiency exceeds 30% at 2.5 to 3.5 Gc. It has a saturated gain of 40 decibels, a noise figure of below 23 decibels and a life expectancy of six years.

Medical electronics

For blind readers

Ever since Louis Braille's blind students first ran their fingertips over raised dots in 1829, the sightless have been able to read. But they've been limited to publications printed in braille.

Recently a 12-year-old California girl, Candy Linvill, has been reading ordinary books despite the fact she has been blind since she was two. She's been using an electronic aid invented by her father, John Linvill, head of the electrical engineering department at Stanford University. The device permits the blind to read any printed matter, as long as the letters are in a conventional typeface and at least as large as those on this page.

Vibrators. What Candy is reading are vibrations from an 8-by-12 array of piezoelectric bimorph reeds, each about the size of a pencil point, which are activated

by photocells. She moves a small optical probe across the page, and the probe picks up signal variations caused by the light reflected from black print on white paper. These signals cause the reeds to vibrate at 200 cycles a second, in a pattern corresponding to the shape of the letters.

The reed array is 1 by 1¼ inches—a convenient size to be felt by the fingertips. Tests indicate it's possible to read about 20 words a minute after 15 hours' practice; at that point the rate levels off, though it may rise again when the reader learns to recognize entire words instead of individual letters. Adept readers of braille sometimes attain speeds of 100 words a minute.

The Linvill device uses about eight photocells to span the height of each letter, and five for the width.

Sound used. The piezoelectrical reeds, which produce a mechanical force when voltage is applied, is not the first attempt to make print sensible to blind persons. A group in Britain developed the Optophone, in which letters were converted into sounds by photocells. This device and others have permitted reading speeds of up to 30 words a minute. Air jets have also been used for tactile sensation, but these require a large area.

Work is currently under way on a contract from the Office of Naval Research, seeking a way to apply the reeds to the development of a tactile sensor system. No practical application is seen yet, but the Navy is interested in providing another communication channel for a man whose eyes and ears may be fully occupied.

Under the new system, the visual field would be mapped into an electroluminescent display, eliminating unnecessary detail and reducing the information so that it could be comprehended by touch.

Each photocell, in an array of several hundred, would view a small spot on the luminescent image, and would activate reeds; these would form a tactile image. Such a device could be hand-held, or even worn on the head and sensed through the forehead.

Behavioral studies are under way

to determine just how detailed an image would be necessary.

Avionics

Quick look

This week a Navy photo-reconnaissance aircraft is scheduled to fly over Stamford, Conn., at 40,000 feet to photograph the city. Ten seconds after the cameras click, observers at a nearby ground station are expected to have in their hands high-quality aerial pictures that were transmitted from the plane.

Currently, photo-reconnaissance planes must return to their bases before aerial pictures can be processed and examined, but a photo-transmission system, developed by Columbia Broadcasting System, Inc., is designed to close the time gap between picture-taking and viewing of the film on the ground.

Mating equipment. The test flight over Stamford will mark the first time high-resolution gear on both the plane and the ground is mated. Previous tests without the mated equipment have been made over 200-mile transmission links; in these cases lower resolution pictures were obtained. The high-resolution equipment scans at 20 line pairs per millimeter (a line pair consists of one sweep of the scanning beam and a return). Later, a lower-resolution (4 line pairs per millimeter) real-time viewer will be added to the ground equipment so that observers will be able to observe a continuously moving picture of the aerial scene.

The airborne station in this week's test will contain a conventional 70-millimeter aerial camera, a film processor, a photoscanner to scan the processed film and a transmitter to send the photoscan signals. Transmission will be in the S-band (video bandwidth is 2.2 megacycles at 2.250 gigacycles). On the ground, a receiver will pick up the transmitted analog signal and feed it to a recorder-processor that will reproduce the picture for viewing.

Eliminates smear. Because the system's speed can be adjusted to

match the speed of the sensor, it will work well with side-looking radars and infrared photography. The system can also be programmed to correct for distortions in the radar or infrared picture caused by brightness or smear.

The heart of the system is a photoscanner developed by CBS. It scans the picture a complete line at a time. Conventional flying spot scanners, on the other hand, scan a picture element by element. Instead of a phosphor-coated flat plane, as used in a cathode-ray tube, the line scanner uses a phosphor-coated drum, which spins inside the tube. The drum, which is rotated by a magnetic coupling, serves as both an anode and a heat sink for the phosphor coating. The reduction in heat permits a brighter picture than is possible in a conventional cathode-ray tube.

The program is under the direction of Anthony DiPentima, director of intelligence search systems for CBS.

Instrumentation

Crystal thermometer

Quartz crystals may replace the special equipment and the carefully controlled environment of a standards laboratory ordinarily needed to obtain precise measurements of temperature.

A new instrument, developed by the Dymec division of the Hewlett-Packard Co., puts the temperature-sensitive properties of piezoelectric crystals to work. And the design of the instrument provides for direct digital readout of temperature.

Computer determines cut. Hewlett-Packard uses specially cut quartz for the piezoelectric crystal in its temperature sensors. The special cut, developed through computer calculations to determine best characteristics, results in a highly linear and very sensitive correspondence between resonant frequency and temperature. The cut crystals have a temperature sensitivity of 35.4 parts per million per degree centigrade.

Sensor probes. Two configura-

LAMBDA EXCLUSIVE

ALL SILICON $\frac{1}{4}$ RACK

MULTI-CURRENT-RATED™

POWER SUPPLIES

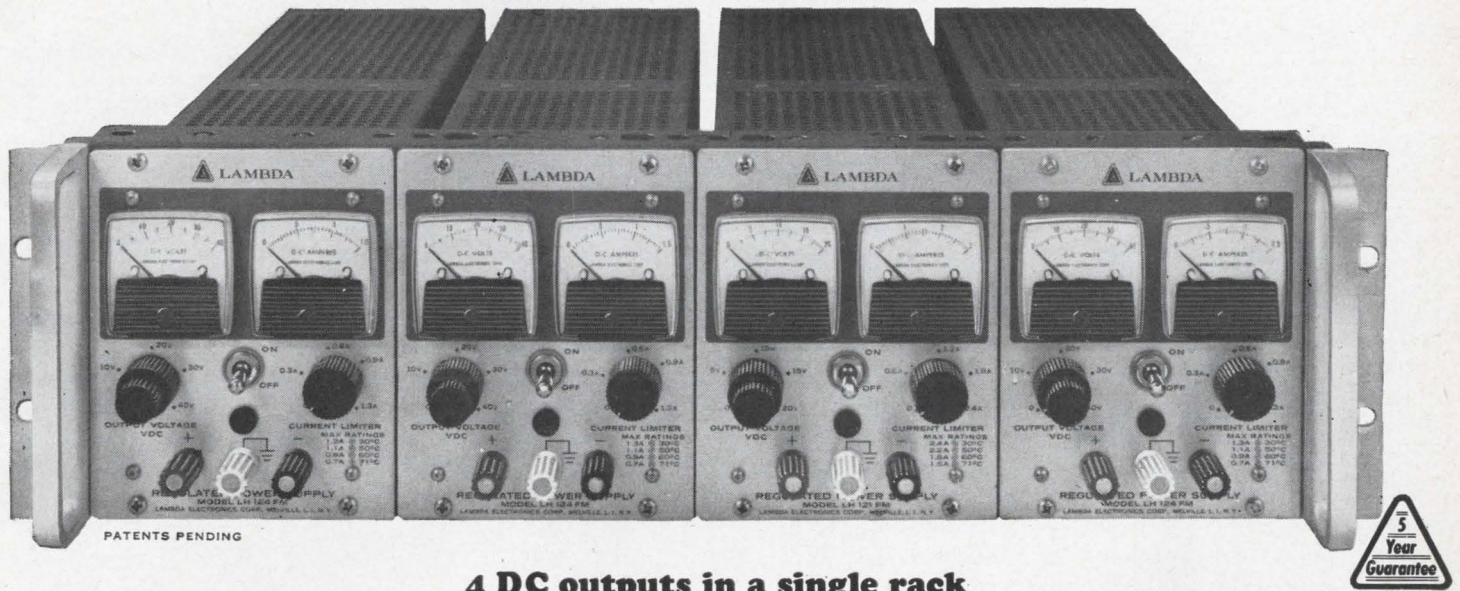

4 DC outputs in a single rack

- LH series models available up to 60 VDC, up to 9 amps in $\frac{1}{4}$ & $\frac{1}{2}$ rack models.
- Meets RFI Spec.—Mil-I-16910.
- Modular-Subrack design for bench, chassis and rack use.
- Regulation—.015% or 1 MV (line or load)
- Ripple—250 microvolts rms. 1MV P-P
- AC Input — 105-135 VAC, 45-480 CPS.
- $\frac{1}{4}$ rack: LH 118, 121, 124, 127— $5\frac{3}{16}'' \times 4\frac{3}{16}'' \times 15\frac{1}{16}''$
- $\frac{1}{2}$ rack: LH 119, 122, 125, 128— $5\frac{3}{16}'' \times 8\frac{3}{8}'' \times 15\frac{1}{16}''$

Model	Voltage Range	CURRENT RANGE AT AMBIENT OF: (1)				Price (2)
		30°C	50°C	60°C	71°C	
LH 118	0-10VDC	0-4.0A	0-3.5A	0-2.9A	0-2.3A	\$175.00
LH 119	0-10VDC	0-9.0A	0-8.0A	0-6.9A	0-5.8A	\$289.00
LH 121	0-20VDC	0-2.4A	0-2.2A	0-1.8A	0-1.5A	\$159.00
LH 122	0-20VDC	0-5.7A	0-4.7A	0-4.0A	0-3.3A	\$260.00
LH 124	0-40-VDC	0-1.3A	0-1.1A	0-0.9A	0-0.7A	\$154.00
LH 125	0-40-VDC	0-3.0A	0-2.7A	0-2.3A	0-1.9A	\$269.00
LH 127	0-60VDC	0-0.9A	0-0.7A	0-0.6A	0-0.5A	\$184.00
LH 128	0-60VDC	0-2.4A	0-2.1A	0-1.8A	0-1.5A	\$315.00

(1) Current rating applies over entire voltage range. DC OUTPUT Voltage regulated for line and load.

(2) Prices are for non-metered models. For metered models and front panel controls, add suffix (FM) to model number and add \$25.00 to the price. For non-metered chassis mounting models, add suffix (S) to model number and subtract \$5.00 from the non-metered price.

SEND FOR LAMBDA CATALOG



LAMBDA ELECTRONICS CORP.

515 BROAD HOLLOW ROAD • MELVILLE, L. I., NEW YORK • 516 MYRTLE 4-4200

SALES OFFICES AND REPRESENTATIVES CONVENIENTLY LOCATED IN MAJOR CITIES

LA-158

Circle 37 on reader service card

tions of the instrument have been developed: one with a single sensor probe for measuring temperatures of a single location with respect to absolute zero, and the other with two sensor probes that measure temperature differences between two locations. The instruments may be calibrated to read in centigrade or fahrenheit.

The single-probe design has a readout resolution of 0.001°C or $^{\circ}\text{F}$; the two-probe design, measuring differential temperatures, has a resolution of 0.0001° . In comparison, usable sensitivity of good quality platinum resistance and thermistor systems is about 0.01°C or $^{\circ}\text{F}$.

Oscillator output. The temperature-probe crystal controls an oscillator operating at a nominal frequency of 28.2 megacycles. Variation of 1°C at the probe crystal will shift the oscillator output by 1,000 cycles per second. The probe-controlled oscillator's output is compared to a reference oscillator with a fixed output of 28.2 cps and the error is a measure of the probe temperature. Fixed output of the reference oscillator is controlled by a temperature-stabilized crystal. This is the only part of the system that requires temperature control and it can be accomplished in a small, portable chamber.

For differential measurements, two active probes are used and the difference between the outputs of their respective oscillators is the temperature measurement. One of the probes is also compared to the reference oscillator. The probes can be located up to 250 feet from the other equipment.

Digital readout of the instruments makes them especially suitable for chemical processing plants where temperatures must be closely controlled and some operations are temperature-sequenced.

Consumer

Make mine dry

Electronic devices that automatically turn off a home clothes drier when the laundry is dry are starting to gain in popularity although



Button senses moisture of laundry in home clothes drier. When the laundry is dry, circuit turns off drier.

they've been around since 1961. Practically all major drier producers are expected to offer such sensors on their machines this year and one electronics company has just developed an improved moisture-sensing device.

Driers without electronic moisture-sensors have timers that turn off a machine. But a housewife must guess at the time cycle. Generally, 4% to 6% of the weight of dry garments is moisture. If a batch of laundry is over-dried, garments may shrink, shed lint and feel rough.

In 1961, the Maytag Co., which produces its own sensing devices, first used them in its top line of machines. Now the middle-price models have them too.

On the upswing. Last year, two other drier makers started featuring the shut-off device, the Hamilton Manufacturing Co. and the Whirlpool Corp. (under the Kenmore label, the house brand of Sears, Roebuck & Co.). Hamilton buys its systems from the Control Corp. of America and Whirlpool buys its from Texas Instruments, Inc.

TI says four other manufacturers are planning to use its moisture-sensing device this year.

The Control Corp. has introduced a moisture-sensor that is simpler and cheaper than its predecessor; the new one works on the

same principle as the TI device. The new device differs in two ways: it no longer is necessary to directly measure the electrical resistance of the clothes to determine the amount of moisture, and a single button replaces the long brass strips that encircle the inside of the drier's drum or the brass fingers that are mounted on each of the drier's baffles, or fins.

With conventional devices, the strips or fingers are connected with slip rings to a circuit, so that the clothes are one leg of a voltage divider. As the clothes dry, their resistance increases, until, at a preset level, a triggering circuit stops the drier.

Button, button. The button sensor is a small conductor that is connected to the grounded drum through a capacitor. The under-grounded side of the capacitor is connected to a wiper contact on the outer side of the drum. Each time the drum revolves, a charge of 160 volts is applied through the wiper to the capacitor. As the wet clothes pass over the sensor, the capacitor is discharged to ground. The amount of residual charge on the capacitor is picked off through the wiper on every revolution of the drum just before the capacitor is recharged. As the clothes dry, more residual charge is left on the capacitor after each turn of the drum. When the charge reaches a preset level, a circuit is triggered, turning off the drier.

The Control Corp.'s engineering director, Paul Williams, estimates that apart from the installation, which is simpler, the new system will cost \$12, \$3 less than the earlier device. And Hamilton is expected to be the first customer for the new system.

Texas Instruments' device costs about \$10 for the circuitry alone; the brass sensor strips and installation are extra.

Manufacturing

Irradiated circuits

Irradiation is becoming a favored technique for stabilizing and standardizing the electrical characteris-

How GRC tiny die castings & plastic moldings help POLAROID deliver top camera performance

12 GRIES small parts in 5 materials provide higher value for POLAROID'S newest, smallest, lightest camera

Parts shown approx. 1/5 larger than actual size

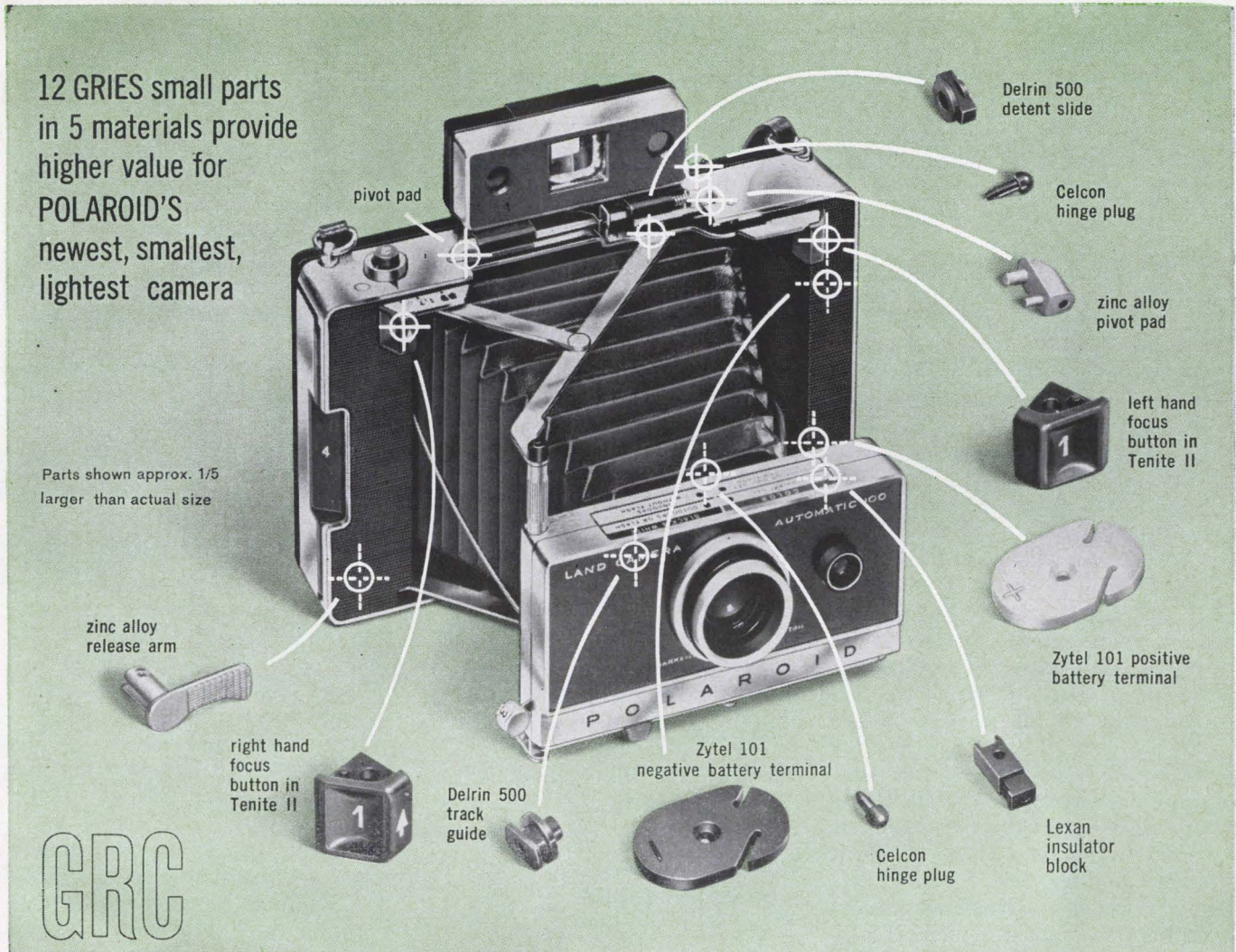

color pictures in 60 seconds! Black and white pictures in just 10. The new Polaroid Color Pack Camera.

Product ideas make profits. But before ideas become over-the-counter realities, creative engineering must take a long, hard look at design, materials and methods. To achieve high performance, Polaroid took every opportunity to get the most value out of every component. They looked for design and production advantages everywhere... right through to simpler, more economical final assembly.

How about your products? How many new ways can you engineer higher value into them? Put your present products—or new product ideas—to the test. Find out today how GRC engineering skills, higher value concepts, and special methods can benefit you.

Write today for these helpful guides to achieving higher value in small parts... full information and demonstration samples of GRC services.

GRIES REPRODUCER CORP.

world's foremost producer of small die castings & plastic moldings • 151 Beechwood Avenue, New Rochelle, N. Y. • (914) NEW Rochelle 3-8600

GRC SPECIAL METHODS produce tiny zinc alloy die castings and plastic moldings in engineering thermoplastics by exclusive automatic single cavity techniques. Parts have great design flexibility, are highly uniform and precise. Automatic assembly is facilitated, secondary operations and production steps are reduced.
Maximum sizes: zinc alloy—2" long; ½ oz.
 —plastics—1¾" long; .05 oz.
No minimum sizes

GRIES

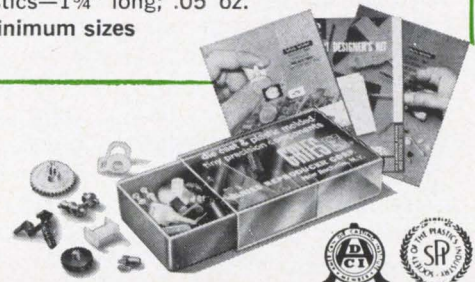

tics of integrated circuits, after the circuits have been made and sealed in packages. One company's entire production of integrated circuits is being irradiated. Others use the process only for selected types and applications.

The technique is considered especially valuable for conditioning a circuit to withstand space radiation. The irradiated circuit's performance won't be changed much by the relatively small amount of additional radiation it encounters in space.

Handled in bulk. The process has been used for several years to modify transistors and diodes [Electronics, Feb. 17, 1961, p. 28; July 20, 1962, p. 66]. The devices, placed on a conveyor belt that passes under an accelerator beam, are subjected to three million electron volts of energy. The dosage is controlled by varying current, scan width and conveyor speed.

This process is used by Electronized Chemicals Corp., a subsidiary of the High Voltage Engineering Corp., which makes particle accelerators. Electronized Chemicals says that it is processing discrete components in lots of 40,000 to 50,000 and that irradiation is used by five of the seven major semiconductor manufacturers. The names of the customers were not disclosed.

The radiation reduces minority carrier lifetime. Like chemical doping, electron bombardment creates additional conduction paths in semiconductor crystals. But instead of injecting impurities, bombardment causes dislocations in the crystal lattice. When a diode is switched from on to off, the current moves more swiftly back through the material before the next switching pulse.

Less beta, more speed. In a transistor, this atomic displacement also changes the current transfer ratio. The electron bombardment increases leakage and reduces beta, the current gain, which is the ratio of emitter current to base current. Some applications require a lower beta. In other cases, beta is sacrificed for higher switching speed.

Bombardment also speeds the turn-on time in power transistors and silicon controlled rectifiers and

reduces noise level in zener diodes.

Sensitive circuits. Irradiation of integrated circuits requires special processing. "They are sensitive devices," says John F. Kean, who heads semiconductor processing at Electronized Chemicals. "We have found that repeated passes under the beam at a low dosage level is the best way to provide the cumulative radiation effect and yet avoid self-annealing from heat absorption." Integrated circuits are placed on dry ice during the process, and the cold is conducted into the silicon by the circuit leads.

One manufacturer pays 37 cents for irradiation of each of his circuits to get a stable, standard beta measurement; the circuit sells for \$250. Another producer irradiates his eight-transistor integrated circuits to obtain a more uniform level of gain throughout the network.

Experimental attempts have been made to irradiate the silicon wafer itself, before it is fabricated into circuits. But heat generated by manufacturing processes has a tendency to anneal out the effects. New manufacturing techniques, however, may make it possible to irradiate the silicon wafers. Laser processing of the circuits, for example, might be fast enough to make thermal effects negligible.

Communications

Party-line radio

The Army has field-tested a new radio system that can serve up to 48 subscribers on a party-line basis on the ground or in the air.

The network, developed for the Army by Motorola Communications & Electronics Inc., a subsidiary of Motorola, Inc., is designed to replace many field-communication systems that use telephone wires. A phone network is impractical for field communications because wires are broken easily and take time to install.

Used in test. The radio system, called AN/USC-3V, was tested at Fort Hood in Texas during December. The system operates in the very-high frequency range and was

used for all mobile communications, including air-to-ground contracts with helicopters.

The usual range for the system is about 10 miles, but it can transmit voice, teletype-writer and facsimile signals satisfactorily up to 30 miles.

System capacity. The system requires two 90-kilocycle bands, representing a wide slice of radio spectrum, but its central switchboard serves 12 radio-telephone subscribers simultaneously with two-way service. By going to party-line, the capacity can be quadrupled. At the central radio switchboard 16 wire-line subscribers can be connected into the radio network.

The radio transmission is multiplexed by frequency division. The system uses single-sideband modulation six kilocycles wide, which is narrower than other systems using frequency modulation with 50-kilocycle channels.

Narrow-band single-sideband transmission requires extremely accurate frequency control. The system uses crystal oscillator units that warm up from 40°C in five minutes to a frequency accuracy of five parts in ten million.

Motorola declines to give details on the oscillator, except to say that the crystal is an AT-cut quartz element, with gold-plated electrodes deposited on optically polished surfaces and sealed in glass. The temperature in the oven surrounding the crystal is set to within 0.1°C of the critical turnover point at which crystal frequency begins to vary greatly with temperature change. The oscillator's transistor circuit uses zener-diode output regulation and a buffer stage to separate the transmitter circuits from the control, improving stability.

Lower power. To avoid overloading the central-control receiver circuits when a mobile unit is nearby, an automatic control reduces the mobile station's output power.

The frequency control of each subscriber station generally is automatically synchronized with the master frequency of the central station. In case of damage to the central-control receiver, it is possible for the subscriber stations to talk among themselves.

BREADBOARD

with this solid state operational amplifier

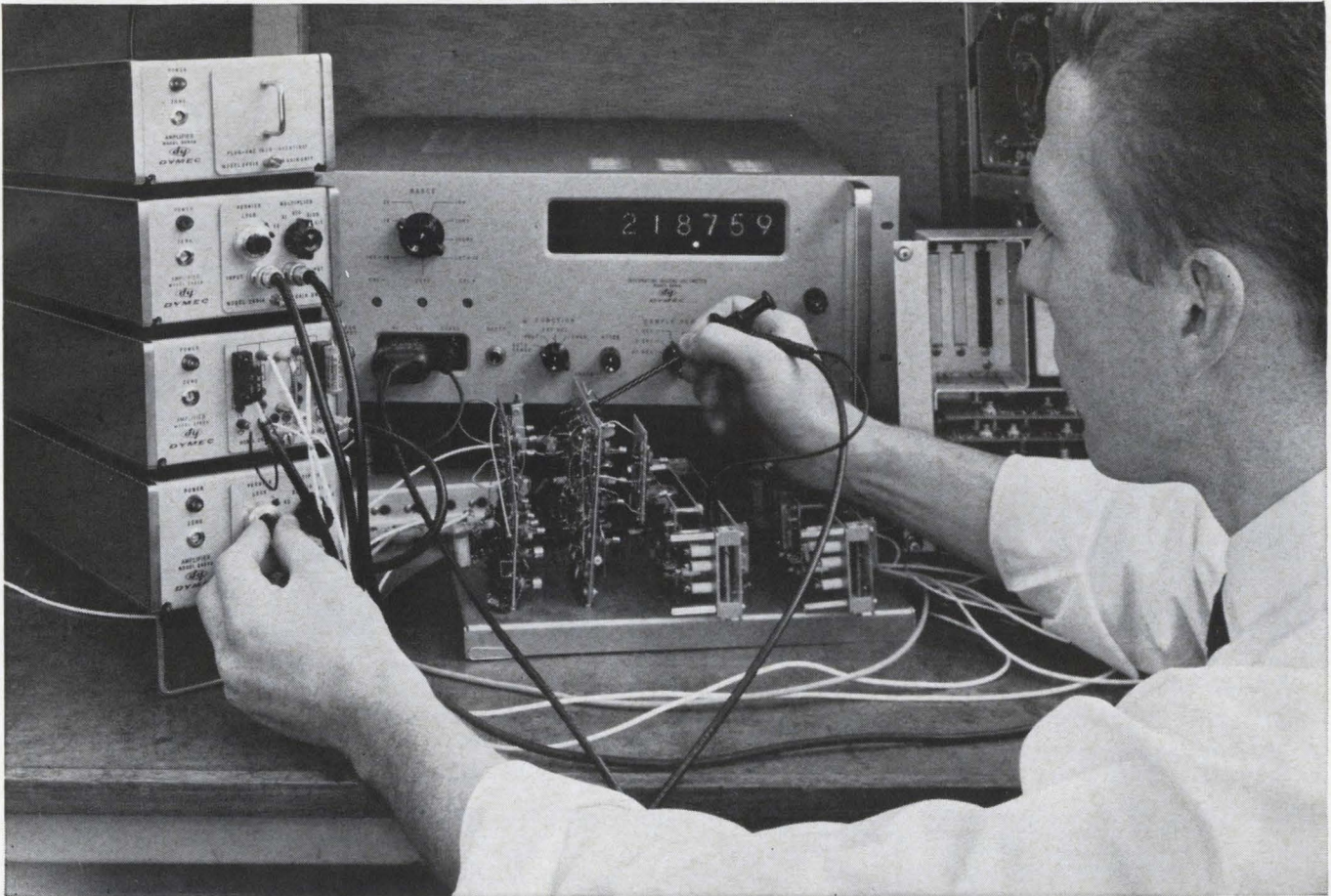

Use the DY-2460A as an active element of your newly designed circuits...

AMPLIFIER ■ SUMMER ■ HIGH IMPEDANCE ISOLATOR ■ INTEGRATOR ■ INVERTER

Check out new design concepts and ideas in a hurry with the DY-2460A DC Amplifier as a circuit element. This wideband, solid state instrument is ready-made for a wide variety of circuit applications which will save you time and effort.

The low-cost DY-2460A is designed for general purpose use. Amplitude and phase response are properly controlled beyond unity gain to permit a variety of feedback networks. A self-contained power supply in each instrument provides highest isolation when operating a group of amplifiers at different potentials. A non-synchronous photoconductive chopper eliminates all effects of ac pickup.

Plug-in design of the 2460A increases its versatility. A patch unit plug-in brings input, output, summing point and feedback circuit to the front panel; other plug-ins

provide switchable gains in steps from 1 through 1000, vernier adjustment through 11,000, and a high-accuracy plus-one configuration with greater than 10^{10} ohms input resistance.

The 2460A will supply an output of ± 10 v peak at 10 ma. Zero drift is less than $1\mu\text{v}$ per week, noise less than $4\mu\text{v}$ peak to peak.

Ask your Dymec/Hewlett-Packard field engineer for all the details on how the DY-2460A can make your breadboarding easier.

Price: DY-2460A Amplifier, \$445. DY-2461A-M1 Data Systems Plug-in, \$85; DY-2461A-M2 Bench-use Plug-in, \$125; DY-2461A-M3 Patch Unit Plug-in, \$75; DY-2461A-M4 Plus-one Gain Plug-in, \$35.

Data subject to change without notice. Prices f.o.b. factory.

DYMEC
A DIVISION OF HEWLETT-PACKARD COMPANY

DEPT. E-1, 395 PAGE MILL ROAD, PALO ALTO, CALIF. • PHONE (415) 326-1755 TWX 415-492-9363



These Specifications show why CINCH-GRAPIK leads the Industry in Multilayer Circuitry

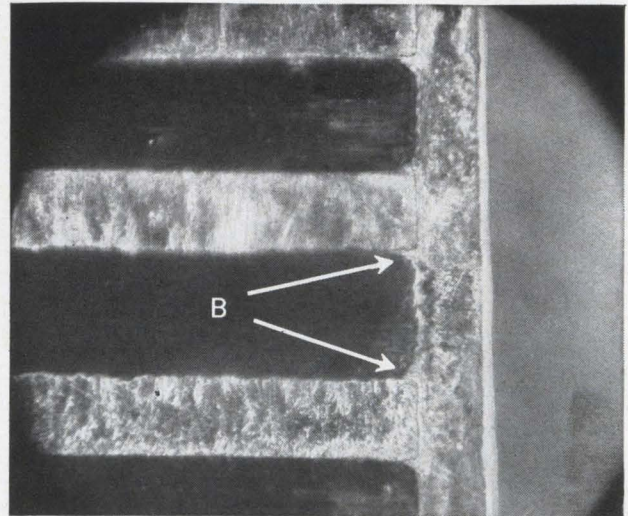
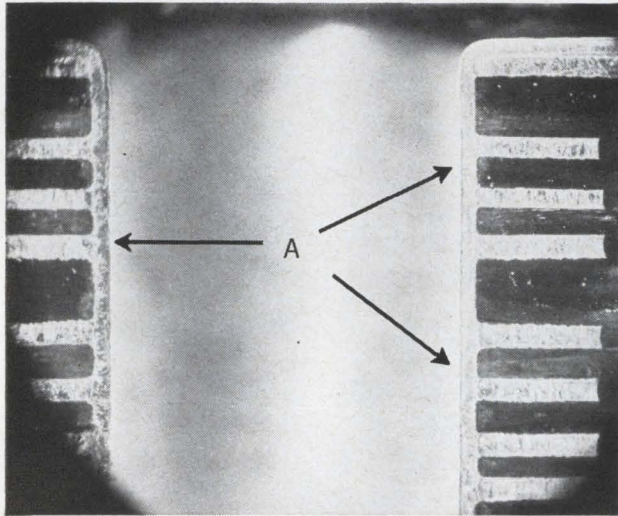

These potted cross-section microphotos (approx. 60x and 215x) demonstrate CINCH-GRAPIK's superior multilayer characteristics. (A) High density, uniform wall thickness throughout the entire length of the hole. (B) High reliability, full contact interface connection between individual layers and the plated wall.

- | | | | | | | | |
|---|---|--------|-----------|------|------------|----------|------------|
| <p>MATERIAL: Epoxy glass type GE per MIL-P-13949B. Insulation between layers shall be a minimum of .004. Greater thickness may be acquired depending upon cost requirement.</p> | <p>ENVIRONMENTAL: During a continuous four hour test at $+150 \pm 5^{\circ}\text{C}$ no evidence of blistering, delamination or other deterioration shall occur.</p> | | | | | | |
| <p>COPPER FOIL: Copper may be one ounce or two ounce per MIL-P-13949B ¶ 3.2.1 and ¶ 6.2c.</p> | <p>SOLDERABILITY: Shall be capable of withstanding a dip or wave soldering operation of a maximum of 10 seconds ± 1 second at a temperature of $500 \pm 5^{\circ}\text{F}$ with no evidence of blistering, delamination or other deterioration.</p> | | | | | | |
| <p>THICKNESS: Finished board thickness per MIL-P-13949B ¶ 3.2.2 Table I Class I. Depending upon total thickness and number of layers, a closer tolerance of $\pm .005$ can be held.</p> | <p>RESOLDERABILITY: Shall be capable of withstanding the removal and replacement of any individual module for a minimum of ten heating operations with no harmful effects when using a 371/2 watt soldering iron and exercising reasonable care.</p> | | | | | | |
| <p>WARP AND TWIST: The finished board shall not exceed 1% warp or twist. Measurement shall be made in accordance with Federal Spec. LP406.</p> | <p>REGISTRATION: Registration of layers, pattern to board outline, or layer to layer shall be $\pm .005$ from true center or true location.</p> | | | | | | |
| <p>UNIFORMITY: All laminated boards of corresponding thickness and/or lot will be of uniform texture, finish and specified properties.</p> | <p>DRILLING: All holes shall be $\pm .003$ from true center when using the artwork as a guide or from grid location when using a coordinate system.</p> | | | | | | |
| <p>INSULATION: Resistance between any two conductors shall not be less than 50,000 megohms with 100 volts D.C. applied for one minute.</p> | <p>CONDUCTOR WIDTH: Minimum nominal conductor width on inner layers .008 and .012 on outer layers. Tolerances: $\pm .002$ on inner layers and $\pm .004$ on outer layers.</p> | | | | | | |
| <p>DIELECTRIC VOLTAGE: Minimum dielectric withstanding voltage between two conductors shall be 1000 volts A.C. peak or D.C., applied for one minute.</p> | <p>HOLE SIZE: Minimum finished hole size .018 with a ratio of 33% hole diameter to thickness of finished board. Hole tolerance $\pm .003$.</p> | | | | | | |
| <p>DIELECTRIC CONSTANT: Average, maximum at one megacycle, 5.8.</p> | <p>PLATING MATERIAL THICKNESS:</p> <table border="0" style="margin-left: 20px;"> <tr> <td>Copper</td> <td>.001 min.</td> </tr> <tr> <td>Gold</td> <td>.0001 min.</td> </tr> <tr> <td>Tin-Lead</td> <td>.0005 min.</td> </tr> </table> <p>When specified, the boards can be nickel-gold plated.</p> | Copper | .001 min. | Gold | .0001 min. | Tin-Lead | .0005 min. |
| Copper | .001 min. | | | | | | |
| Gold | .0001 min. | | | | | | |
| Tin-Lead | .0005 min. | | | | | | |

REV. JUNE '63



200 South Turnbull Canyon Road, City of Industry (Los Angeles), California 91744 • Phone (213) ED 3-1201.
Offices in 22 Principal Cities throughout United States, Canada, England and Australia listed under Cinch Mfg. Co,
or United-Carr Incorporated • Cinch • Cinch-Monadnock • Howard B. Jones • Ucinite • Palnut



“Jimmy, what is a Spectrophotometer?”

Jimmy learned his lesson well today at one of the North Carolina *Industrial Education Centers*. He's one of over 25,000 students attending the 20 Centers established by the State—representing an investment of over \$52,000,000. Tailored to the needs of industry, such specialized training is paid for by the State. The student contributes his time at no cost to industry.

North Carolina has the nation's largest farm population and hard work is no stranger to them, just as they understand the rights of property ownership. Mechanization continues to free a large number of these industrious people. Interested? Write Governor Dan K. Moore for a copy of “Greater Opportunity for Industry in North Carolina” . . . free (and confidential), of course.

GO NORTH CAROLINA
where good government is a habit

ANNOUNCING items 3 & 4 in the Fluke '65 Pacesetter Line. Either one of these two new solid state differential voltmeters will make your measurement with ease and accuracy

Completely portable... use rechargeable battery or line power... 0 to 1100 volt range... dc accuracy $\pm 0.03\%$, ac, $\pm 0.2\%$... will withstand 1100 v on any range without damage... in-line, automatic decimal point readout... 1 mv full scale null sensitivity... reference stable to 50 PPM/year.

When John Fluke sets out to introduce a new line of solid state differential voltmeters (plus several other goodies that we'll announce a bit later), you can count on top performance and the best value per dollar invested. If it's a Fluke, it's got to work!

No Ground Loops

New Series 871 & 873 dc and ac/dc solid state differential voltmeters, respectively, are avail-

able in either 50-440 cps, 115/230 volt line powered only or combination line and battery powered models. You can expect 30 hours' operation before the batteries need recharging. One of the great advantages of battery operation is the elimination of measurement inaccuracies caused by ground loops. Worth noting too, performance isn't degraded one bit while the batteries are being recharged.

Twice the Range

Range of the new instruments, 0 to 1000 volts ac or dc with 10% overranging, is more than twice that of earlier Fluke voltmeters. Input impedance is infinite at null up to 11 vdc for true potentiometric measurements and an excellent 10 megohms above 11 vdc.

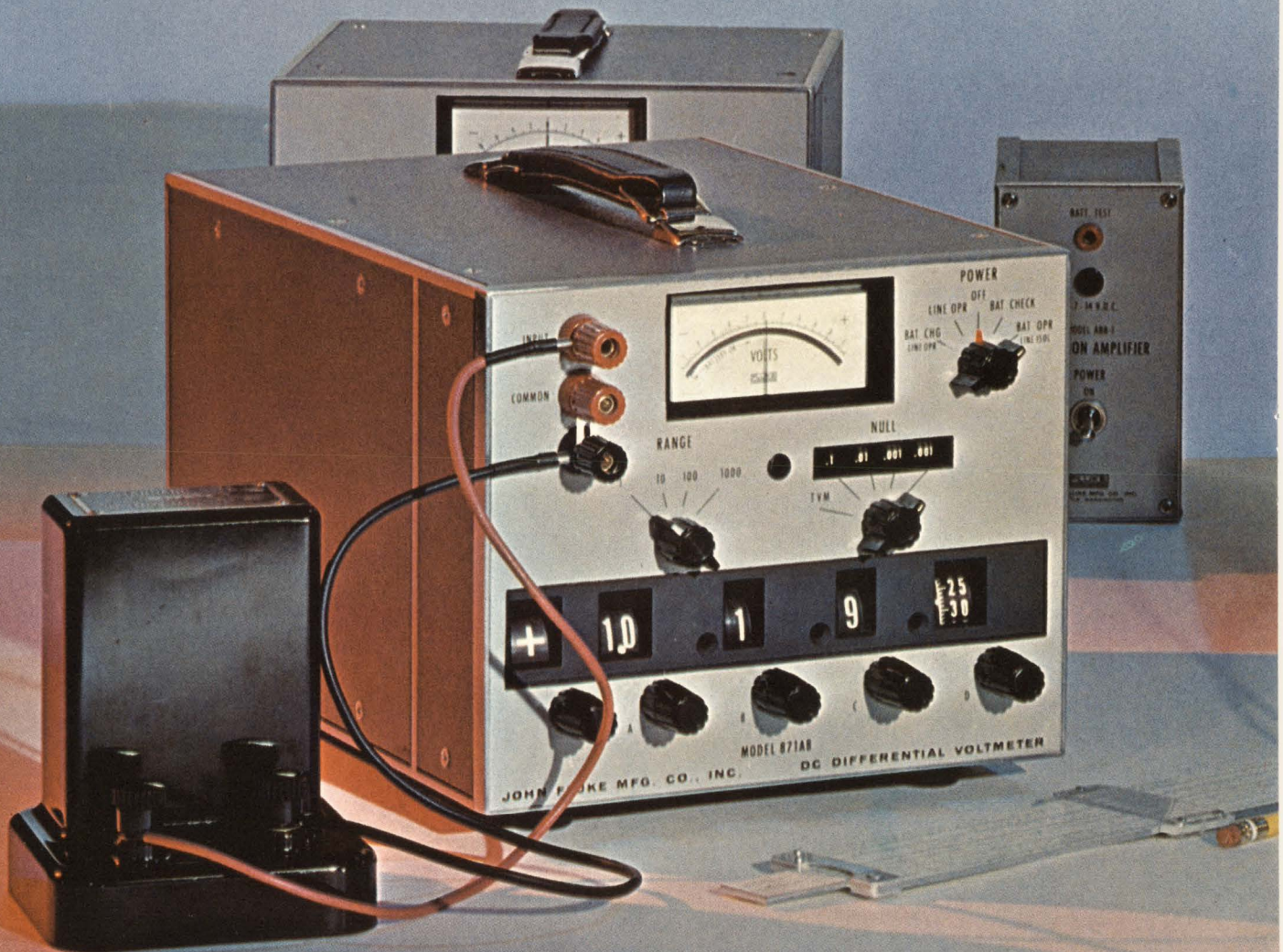

Special Zener Processing

DC accuracy is $\pm 0.03\%$. AC accuracy from 20 cps to 10 kc is $\pm 0.2\%$ of input, and $\pm 0.3\%$ over the 10 cps to 20 kc range. Fluke processes each zener diode reference to prove 0.005% per year stability. Ratio stability of Fluke resistors is 0.0025% per year. T. C. for reference and critical resistors is 0.0005%/°C and 0.0004%/°C respectively. You can simply neglect voltmeter instability in making measurements.

Perfect Null

Five digit readout with automatic decimal point and mode indicator insures quick accurate readings. Perfect null is obtained by using a precision single turn pot at the output of the Kelvin Varley divider.

Only 14 Pounds with Batteries

These completely portable voltmeters weigh a scant 13 pounds in the line power only version and 14 pounds with battery power too. Size is 7" high x 8½" wide x 11¾" deep. Instruments are equipped with resilient feet and tilt-up bail for field and bench use. Attaching metal handles allows half-rack or side-by-side mounting. The enclosed cabinet keeps dirt and dust out.

As Conventional Voltmeters

In the conventional voltage mode, accuracy is 3% of range.

Mil Spec Testing

One thing more, the Fluke development program includes Mil-spec shock, vibration and temperature testing. Our stated specs are the same ones you'll get in the instrument we deliver to you.

Prices

Price of the Series 871 DC Differential Voltmeter is \$565 for the line powered model and \$695 for the battery and line powered model. Series 873 AC/DC Differential Voltmeters are priced at \$785 and \$1035.

Now It's Your Turn

For complete information and/or an immediate demonstration, call your nearby Fluke engineering sales representative (listed in EEM) or address John Fluke Mfg. Co., Inc., Box 7428, Seattle, Washington 98133. Phone: (206) 776-1171. TWX: (910) 449-2850. Cable: FLUKE.

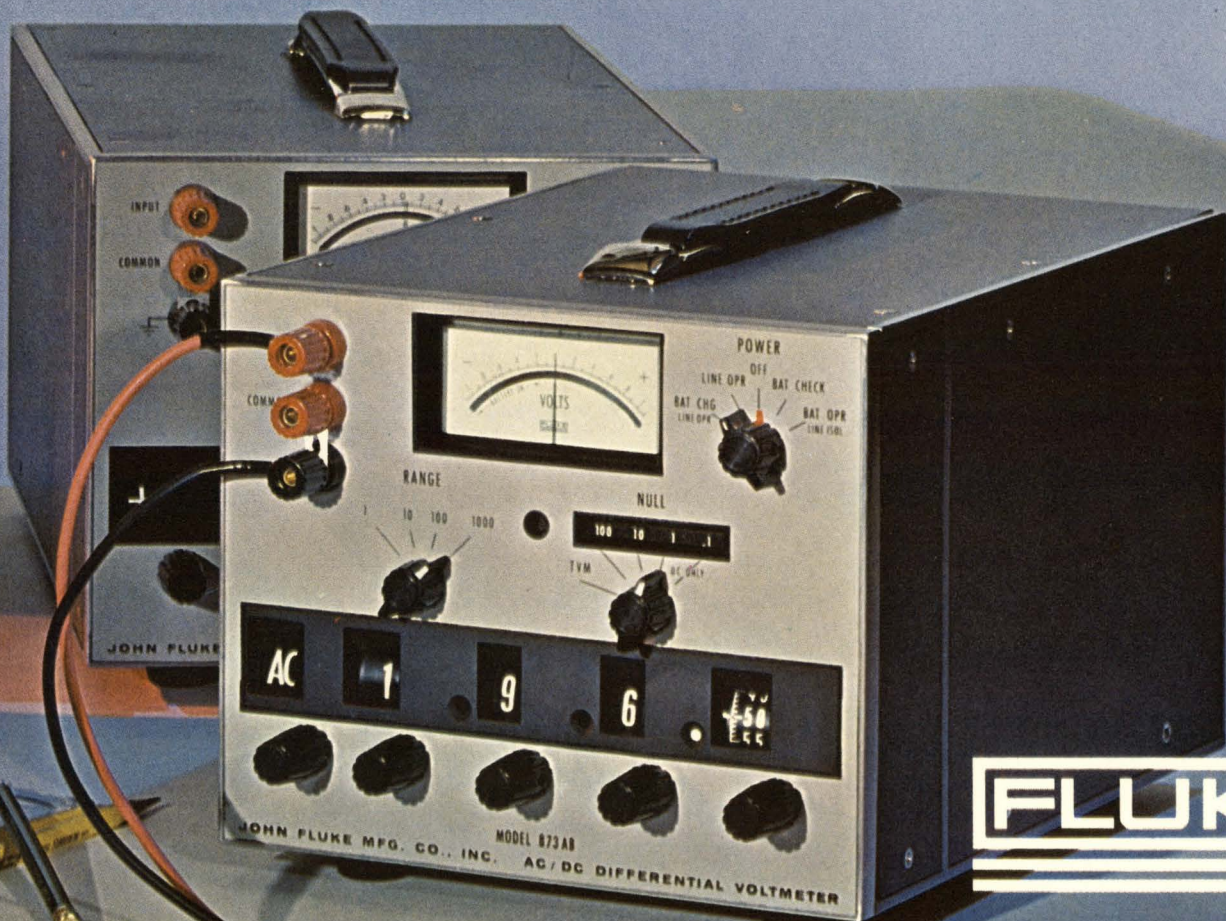

FLUKE

KAY

small-to-miniature

PRECISION ATTENUATORS

dc to 1000 mc

These highly precise new rotary and in-line miniature attenuators provide an accurate and fixed amount of loss in circuits operating in the dc to 1000 mc range. All units are quality-manufactured throughout, with custom switches, solid silver contacts and 1% tolerance carbon film resistors.

For Complete Information Write

KAY
ELECTRIC COMPANY
PINE BROOK, MORRIS COUNTY, N.J.

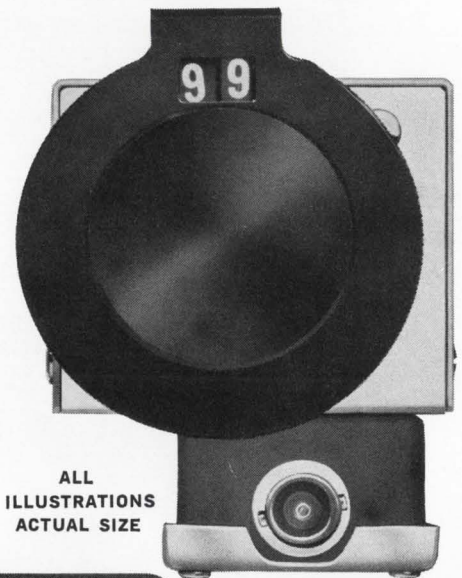
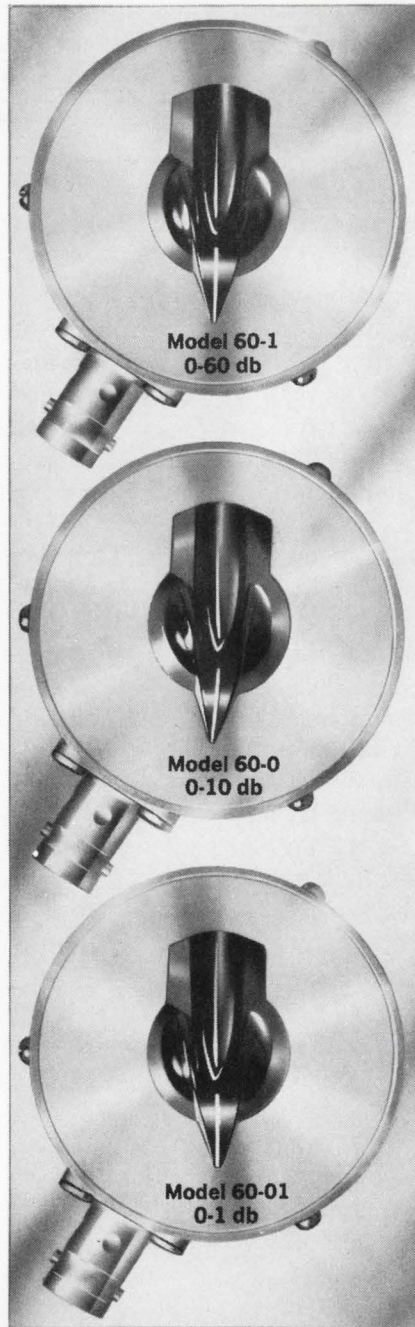

ALL
ILLUSTRATIONS
ACTUAL SIZE

Model 50-0
0-99 db



Model 90-0
0-101 db

SPECIFICATIONS	Model 60-1 0-60 db, 10 db Steps	Model 60-0 0-10 db, 1 db Steps	Model 60-01 0-1 db, 0.1 db Steps	Model 90-0 0-101 db, 1.0 db Steps
Attenuator Steps:	0, 10, 20, 30, 40, 50, 60 db	0, 1, 2, 3, 4, 5, 6, 7, 8, 9, 10 db	0, .1, .2, .3, .4, .5, .6, .7, .8, .9, 1 db	0-101 db in 9 steps
Impedance:	50 ohms	50 ohms	50 ohms	50 ohms
Freq. Range:	dc to 1300 mc	dc to 1300 mc	dc to 1000 mc	dc to 1000 mc
Typical Accuracy:	± 2% at 30 mc, ± 5% at 1000 mc	± .2 db to 300 mc ± .3 db to 100 mc	Within ± 10% at 1000 mc	0.6 db from 250 to 500 mc, 1.5 db at 1000 mc
Typical VSWR:	1:1.1 to 300 mc, 1:1.3 at 1000 mc	1:1.1 to 300 mc, 1:1.3 at 1000 mc	Less than 1.4 at 1000 mc	1.2:1 to 500 mc, 1.4:1 500 to 1000 mc
Insertion Loss:	Negligible to 300 mc 0.1db to 500 mc 0.2db to 1000 mc	Negligible to 300 mc 0.1db to 500 mc 0.2db to 900 mc	Negligible to 300 mc 0.1db to 500 mc 0.2db to 900 mc	0-db at low freq. app. 0.6db at 500 mc app. 1.0db at 1000 mc
Nominal Power Rating:	½ watt	1 watt	1 watt	1 watt
Dimensions:	2" dia., 2½" long	2" dia., 2½" long	2" dia., 2½" long	6¼" x 13/16" x 1¼"
Price:	\$79.	\$79.	\$79.	\$110.

Model 50-0 0-99 db Same Electrical Specifications as Model 90-0 Price: \$225.

Washington Newsletter

January 25, 1965

Major investments for electronics

President Johnson's defense program calls for three new developments requiring a heavy investment in electronic equipment. Johnson sketched his program in a special message to Congress last week and will fill in details when the defense budget is made public this week.

The new developments: an advanced version of the Polaris missile with twice the accuracy and payload of the Polaris A-3; a new short-range attack missile, called the Sram, for use on strategic bombers and possibly tactical bombers, and a system for reporting the arrival of missiles at their targets.

Defense spending is sliding. Defense expenditures for fiscal 1966 would drop to \$49 billion, down slightly from earlier unofficial predictions. The Pentagon is now estimating that spending for fiscal 1965, ending June 30, will total about \$49.3 billion, down nearly \$2 billion from fiscal 1964.

The new Polaris will take advantage of microminiaturization in electronic components. **Its development will require an estimated \$800 million and an additional \$1.2 billion will be spent on production of the missiles and on modification of submarines to accommodate them.**

The missile has been known as the Polaris B-3. The Pentagon now has dubbed it the Poseidon, after the Greek god of the sea.

Project-definition work on the Poseidon will begin soon. The Lockheed Missile & Space Co., a division of the Lockheed Aircraft Corp., will be the system integrator. In addition to improved guidance, the missile probably will have a multiple warhead that could be maneuvered during the reentry.

Sram will be designed to knock out anti-aircraft defenses near targets. It would have a range of about 100 miles and an accuracy probability within a matter of feet.

Secrecy surrounds the planned development to have missiles report back on their arrival and detonation at targets. Use of television, infrared and sonar-like techniques have been suggested, however.

Johnson also plans to delay production of the Nike-X antimissile missile. Another \$400 million will be spent on its development in the new fiscal year and an additional \$100 million on other developments associated with it.

McGovern alters his conversion bill

Military-oriented industries would get help in broadening product lines for civilian uses under a bill introduced by Sen. George McGovern (D., S. C.). **The measure would set up a committee on economic conversion and diversification to study economic problems caused by the declining military budget.**

McGovern agreed to drop a stumbling block to a similar bill he introduced last year—a requirement that defense contractors establish long-range plans for conversion to civilian work. The Administration and industry called the provision an invasion of contractors' rights.

The commission would be headed by the Secretary of Commerce, and would include the Secretaries of Defense, Labor and the Treasury, chairmen of the Atomic Energy Commission and the Council of Economic Advisers, and the administrator of the NASA.

White House support of the bill improves its chance of approval this year.

Washington Newsletter

Pentagon relaxes classification rules

Engineers will soon get more technical information on research projects from the Pentagon. Military leaders have approved procedures intended to relax security classifications on scientific data.

The new procedures replace regulations that often conflicted with other security-classification rules. Defense chiefs concede that the former regulations allowed lower-echelon officials too much leeway in restricting information.

About 200 defense officials now have the authority to classify information as "top secret"; under the former rules, about 400 people had this authority. Also, classification must be on a paragraph-by-paragraph basis, preventing an official from taking the easy way out and classifying an entire document that contains only a few sensitive sections. A monitoring system will be established to prevent over-classification by some officials.

However, the Pentagon keeps its "for official use only" rubber stamp, which is used to block the release of information on grounds other than security.

Electronics' role in transit project

President Johnson's transit program depends largely on research in electronics and other sciences. He will ask Congress for \$20 million to advance railroad technology; half of this would go into research for trains that travel up to 250 miles an hour. "At these speeds," says one government official, "electronic backups are going to be needed all along the way for safety."

The President envisions a billion-dollar, high-speed system between Washington and Boston. The Massachusetts Institute of Technology has a contract to coordinate research and development.

Techniques being mentioned include computer control of traffic flow and switching, and grouping of passengers going to the same destination so their car can be separated automatically from the rest of the train with a minimum loss of time.

Pentagon adopts quartz standard

The Pentagon has adopted standards established by the North Atlantic Treaty Organization for quartz-crystal units used in communication equipment.

Standardization of equipment is a continuing policy of NATO and covers most military equipment used by its members. The Department of Defense has parallel programs under way for its own services.

The Pentagon will continue to watch for improvements in quartz crystals to make certain the standardization policy doesn't prevent the use of improved components.

Producers of quartz crystals say it is too early to assess the economic effect of the Pentagon move.

Addenda

Maj. Gen. George P. Sampson, retiring deputy director for defense communications systems of the Defense Communications Agency, may be named a director of technical operations for the Communications Satellite Corp. . . . The Air Force plans to award a contract to study the way a bat uses its echo-location mechanism to track down insects for food. The information will be used to improve the military's theoretical understanding of radar and sonar.

This is DEI's Solid State Receiver

It's new

Tunes in the range of 100 to 2300 mc

Superior performance characteristics

The TR-711 is virtually spurious free

Sets the standard for comparison

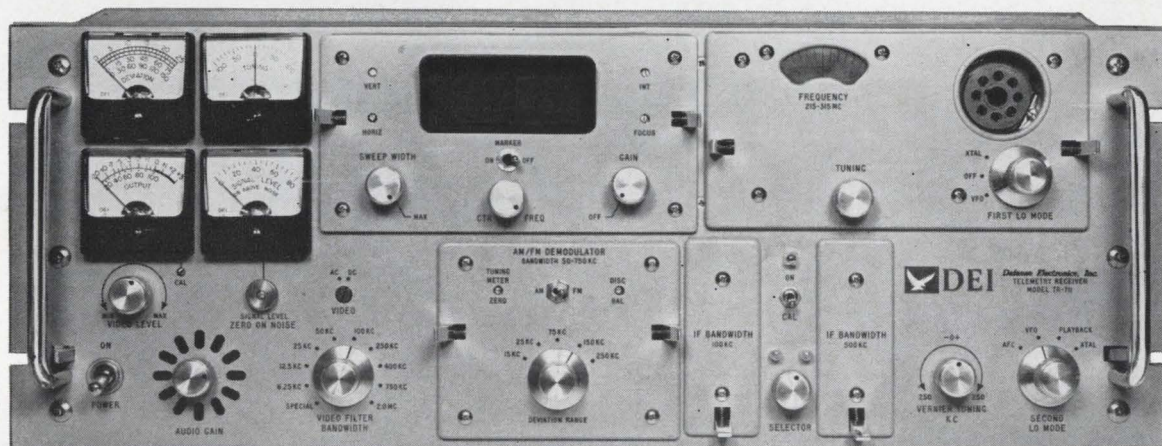

The TR-711 Receiver is modular in construction and can be supplied with a complete complement of plug-in modules including RF tuning units from 100 to 2300 mc, IF amplifiers with 10 kc to 3.3 mc bandwidths, AM, FM, and phase demodulators, and plug-in spectrum display unit, oscilloscope, predetection up and down converter, or high capture ratio discriminator. Any combination of plug-in modules can be utilized, thus providing unlimited receiving combinations adaptable to any known or projected telemetry system.

Characteristics and accessories are described in Bulletin TR-711.

Defense Electronics, Inc.
Rockville, Maryland



DEI
RESEARCH
DEVELOPMENT
MANUFACTURING

ROCKVILLE, MD. (301) 762-5700, TWX: 301-427-4660; SHERMAN OAKS, CALIF. (213) 872-2870, TWX: 213-732-2742; COCOA, FLA. (305) 632-5442; INT'L., ROCKVILLE, MARYLAND.

These **6** recent semiconductor developments from Motorola... are changing today's computer performance standards! ...ARE THEY WORKING FOR YOU?

The World's Smallest Transistor Junction Yields Motorola's "0-pf"* Transistor

... and the fastest micro-power switching ever!

Here's a new annular transistor with capacitance values so low that other circuit values (wiring, stray capacitances, etc.) have become the circuit speed limiting factors. Typical C_{ob} or C_{ib} rating is only 0.7 pf maximum for the 2N3493. Thus, in applications in the micro-power region ($\cong 100 \mu A$), switching speeds in the 1 megacycle range are easily attained... making possible circuits that are 50 to 100 times faster than those using conventional devices!

For information check Motorola type 2N3493 silicon NPN annular transistor.

New 175 Volt (BV_{CEO}) Annular Transistors Add a New Dimension to Circuit Design

... with no sacrifice in gain, saturation, or frequency performance!

New annular process silicon epitaxial transistors exhibiting voltages up to 175 volts... also offer saturation voltage lower than most non-epitaxial silicon transistors now available!... high gain ($h_{FE} - 100$ to 300)... and high frequency (200 mc) performance, too! Truly, the circuit designer can literally "throw away the book" when designing high voltage transistor circuits using these new types.

For information check Motorola PNP types 2N3494-97 & 2N3634-37 and NPN types 2N3498-2N3501.

New Low-priced MECL* Integrated Circuits Spur New Computer Design Activity

... with circuit prices as low as \$1.95!

Now it's economically practical to take advantage of the added equipment features made possible by designing and building electronic equipment with integrated circuits (i.e. smaller size, lower weight, lower power, higher reliability, etc.). A complete computer complement of high-speed (6 nsec propagation delay) integrated circuits designed and priced for immediate commercial use is available in the new Motorola low-cost MECL MC350 series of devices. This new MECL line, priced from \$1.95 to \$7.60 (100 up) now makes it practical, from both an economic and performance viewpoint, to build commercial integrated circuit computers today!

For information check Motorola type MC352-MC361 MECL integrated circuits.

I'm interested in these new Motorola computer semiconductor developments! Please send me complete technical data on the following products:

- | | |
|---|--|
| <input type="checkbox"/> No. 1 — "O-pf" Transistor | <input type="checkbox"/> No. 4 — PNP/NPN High-speed, High-voltage Pairs |
| <input type="checkbox"/> No. 2 — PNP/NPN High Voltage Annular Transistors | <input type="checkbox"/> No. 5 — 3 Amp/60 mc Annular Transistors |
| <input type="checkbox"/> No. 3 — Low-cost MECL Integrated Circuits | <input type="checkbox"/> No. 6 — High-speed, broad-range over-metallized transistors |

NAME _____
TITLE _____
COMPANY _____
DIVISION _____
ADDRESS _____
CITY _____ STATE _____ ZIP _____



MOTOROLA
Semiconductors

298-1

BOX 955 • PHOENIX, ARIZONA 85001 • A SUBSIDIARY OF MOTOROLA INC.

The First Low-Storage, High-Voltage PNP/NPN Silicon Transistor Pair

... open a new era in complementary core driver circuit design!

A Motorola process breakthrough which permits for the first time production of gold-diffused (low-storage-time), high-voltage silicon PNP transistors, yields PNP devices with characteristics that closely match those of the most advanced NPN transistors in the industry. Now these 1-amp PNP types simplify design of complementary transistor circuits for memory driving ... because they offer both **high speed** (for advanced thin-film and core memories) and **high voltage** (for driving a greater number of series-driven magnetic elements).

For information check Motorola PNP types 2N3467-68 and complementary NPN types 2N3252-53 and 2N3444.

New 60 mc Silicon Transistors Feature Current Gain Specified Up to 3 Amps

... making the "ideal" core driver transistor!

Here are new transistors that combine the two "most wanted" parameters desired for core driving applications ... high speed and high current. Packaged in the "solid metal header" T0-5 package for high power dissipation, these devices offer the circuit designer a compact "power package" capable of a big work load ... **within a small package!**

For information check Motorola NPN types 2N3506-07 silicon annular transistors.

*O-pf and MECL are Trademarks of Motorola Inc.

New Over-metallized Annular Transistors Feature Low-Capacitance Internal Design

... offer the best high-speed/broad-range switching combination!

New fabrication techniques for making electrical connection to extremely small emitter, base, and collector areas of high frequency silicon annular transistors have made possible breakthroughs in speed/current performance of logic transistors. Today Motorola has new devices with such variable performance capabilities as 700 mc — f, ... 100 mA collector current rating ... 30 nsec turn-off time ... specified current gain from 1 mA to 100 mA ... **all in a single PNP transistor type!**

For information check PNP types 2N3546 & MM2894 (T0-18 package) or NPN types 2N3508-9 (T0-46 package).

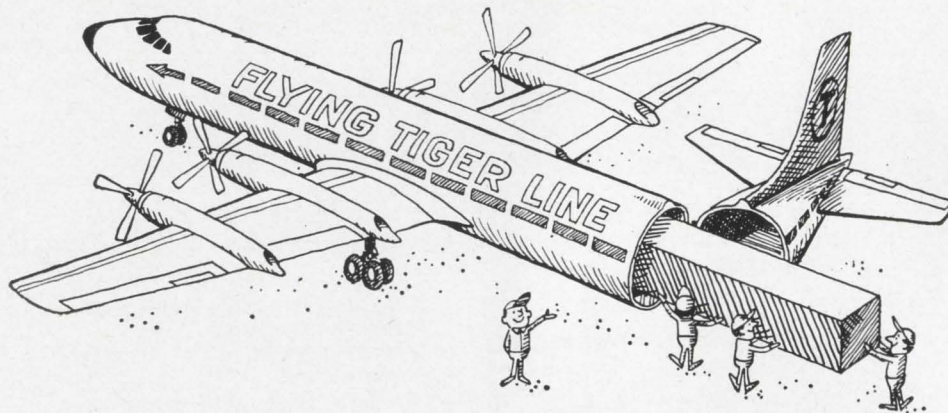

FLYING TIGER FLIES THE OUTSIZE CARGO

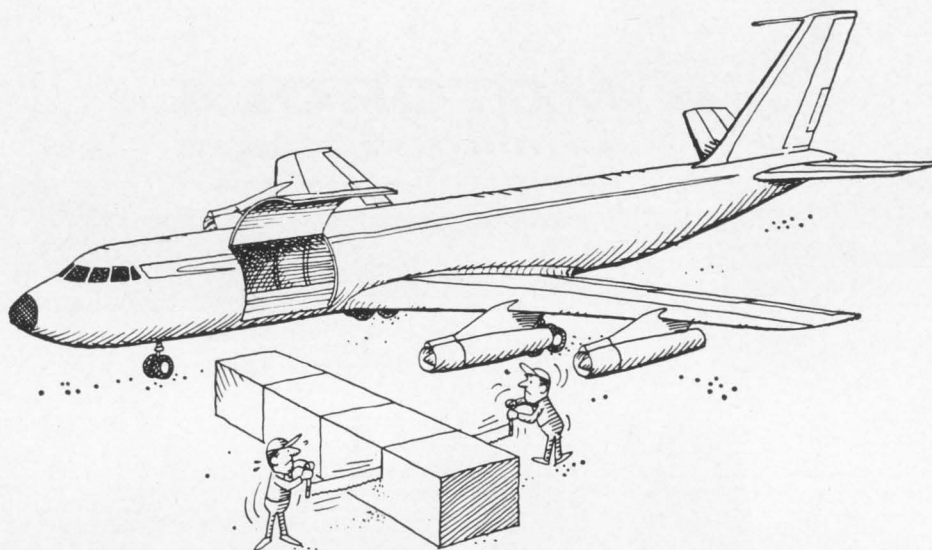

JET FREIGHTERS WON'T TAKE OR CAN'T HANDLE

You'll find passenger airlines which also carry cargo aren't very accommodating when you have a large single piece of freight. On all-cargo jets, for example, most draw the line at anything over 7 ft. wide, 10 ft. long, or 6 ft. 8 in. high. But not Flying Tigers. It's everyday routine for our Swingtail-44s to get that really big shipment of yours aboard, which side-loading jet cargo

freighters won't or can't physically handle.

Next time you have an airfreight shipment, out-size or any size, trust it to the airline that will carry **all** your freight. The one that will get it to over 2,500 U.S. markets, thanks to "Skyroad," Tigers' combined air/rail/trucks system. Or to anywhere in the world by charter. Flying Tiger ... the world's largest scheduled all-cargo airline.

the airfreight specialist

FLYING TIGER LINE





New microcircuit module now available



Hamilton Standard has developed a new microcircuit modular packaging technology. New, low-cost, hermetically sealed modules permit the interconnection of integrated and thin-film hybrid circuits, or a combination of both, in a protected all-welded assembly. Up to ten discrete wafers provide a maximum of 360 interconnections.

Fifteen standard modules including digital and linear circuits are avail-

able for evaluation or for production quantities. Special circuits also are easily adapted to the modular package. Flexible automation permits the economical production of limited quantities. Electron-beam welding assures high reliability and strength without the use of organic materials.

Delivery of standard circuits for evaluation is approximately 30 days. Mail the coupon for specifications of modules, and for more information.

**Attention: Sales Manager,
Electronics Department
Hamilton Standard
Division of United Aircraft Corporation
Broad Brook, Connecticut**

Please send the list of standard circuits available for evaluation and the new microcircuit module brochure.

NAME _____
TITLE _____
COMPANY _____
ADDRESS _____
CITY _____
STATE _____ ZIP CODE _____

Hamilton Standard DIVISION OF UNITED AIRCRAFT CORPORATION

**U
A**

ELECTRONICS • ATTITUDE CONTROLS • STABILIZATION SYSTEMS • ENVIRONMENTAL CONTROLS • FUEL AND AIR INDUCTION CONTROLS • ELECTRON BEAM MACHINES • PROPELLERS • STARTERS • TURBOMACHINERY • GROUND SUPPORT EQUIPMENT • INDUSTRIAL VALVES • OVERHAUL AND REPAIR

YOU CAN RELY ON



3BT-2 Tiny Stat Thermal Switch

This transistor-size, hermetically-sealed, snap-action thermal switch combines high resistance to shock and vibration with extremely fast response. Weighs only 0.4 gram. Rated at 1 amp, 115 v-ac/30 v-dc, 10,000 cycles. Temperature setting range, 0° to 350°F.

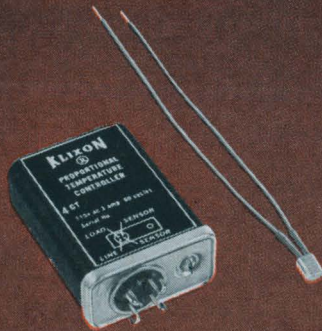

4CT Solid State Proportional Controller

This combination of thermistor sensor (surface element or immersion probe), magnetic amplifier and silicon controlled rectifier stabilizes temperature at $\pm 0.1^\circ\text{F}$. Reliability is high... no moving parts. Rated up to 3 amp, 60 or 400 cycle, 115 v-ac. Response within one cycle. Calibration range, -65° to 600°F .



M1 High Capacity Thermal Switch

This highly reliable, hermetically-sealed, snap-action thermal switch is designed for applications with electrical loads up to 7 amp, 30 v-ac/dc. Qualified under MIL-E-5272C and MIL-T-5574A. Ambient temperature range, -320° to 500°F . Minimum differential, 9°F .



4BT-2 Tiny Stat Thermal Switch

The smallest, lightest, fastest snap-action thermal switch ever made. Only $\frac{3}{32}$ " thick. Weighs only 0.2 gram. Responds five times faster than its nearest equivalent. The ideal replacement for thermistors and their electronic switching circuitry. Same electrical and environmental characteristics as 3BT-2.

TI

FOR TEMPERATURE CONTROL

NO OTHER LINE OF THERMAL SWITCHES OFFERS SUCH DIVERSIFIED CAPABILITIES!

Check these characteristics! Control within tenths of a degree. Narrow differential. Extremely fast response. Large electrical capacity. Subminiature size. Open or close on temperature rise or fall. Single or double throw switching. Automatic or manual reset. All-welded hermetic sealing. Immersion probe sensing. Tamperproof calibration. EHR (extra high reliability) series.

TI Precision Thermal Switches . . . identified by the trusted KLIXON® trademark . . . meet various combinations of the above requirements with eleven precision types . . . six are described at the left. Freedom from design limitations as well as savings in engineering and procurement time are yours when you evaluate these thermal switches first.

Wide-range application! KLIXON Precision Thermal Switches are now performing control or warning functions in rate gyros, accelerometers, crystal ovens, electronic tube ovens, computers, transistor circuitry, heater blankets, missile batteries, servo-mechanisms, aerial cameras, radar equipment, missiles and aircraft.

For complete information, write for your FREE copy of the TI-KLIXON Thermal Switch Fact File. We'll also send you the "Tunnel of Horrors" booklet which describes our testing program.



METALS & CONTROLS INC.
5001 FOREST ST., ATTLEBORO, MASS.
A CORPORATE DIVISION OF
TEXAS INSTRUMENTS
INCORPORATED

2PT Probe-Type Thermal Switch

Rod-and-tube mechanism provides temperature anticipation under conditions of rapid change. Temperature differential within 1°F. Rated at 2 amp, 125 v-ac/30 v-dc. Operating temperature 150° to 525°F. Slow make-and-break action. Ask about our complete probe-type series.

M2 Narrow Differential Thermal Switch

This hermetically sealed, snap-action thermal switch has a differential range of 2° to 5°F at 0° to 250°F. Ambient temperature range, -65° to 450°F. Electrical rating, 2 amp, 30 v-dc/120 v-ac 250,000 cycles, 3 amp, 30 v-dc 50,000 cycles.



Him say, "When reliability counts, count on Mylar®."

There'll be no signaling from your computer (or its operators) if you make certain that all your tapes are on a base of "Mylar"*. That's because "Mylar" is strong (a tensile strength of 20,000 psi), stable (unaffected by

temperature or humidity changes) and durable (no plasticizer to dry out or become brittle with age). No wonder it has been the most used tape base for the past ten years. Remember: When reliability counts, count on "Mylar".

DU PONT
REG. U.S. PAT. OFF.
 Better Things for Better Living
 ... through Chemistry

only **DU PONT** makes
MYLAR®
 POLYESTER FILM

*Du Pont's registered trademark for its polyester film.

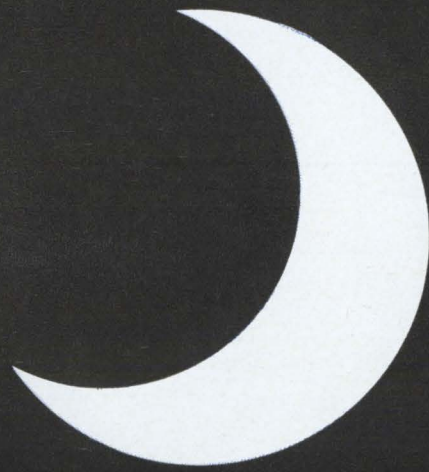

Which air cargo service gets priority during peak night rush hours?

Air Express.

During night rush hours—when it's vital—Air Express receives priority after air mail on every scheduled U.S. airline. On every flight!

What's more, your shipments get priority in the morning and afternoon, too, when you use Air Express.

And with good reason. Air Express is a joint venture of all 39 scheduled airlines and REA

Express. That's why Air Express can deliver to any of 21,000 U.S. cities by sunset tomorrow. And why you're assured of 2 hour pickup at your end and superfast delivery at your customer's end.

Service? Door-to-door. All with just one call, one waybill. Yet, you'll find Air Express is often your cheapest way to ship. Frequently cheaper

than even surface carrier.

So, if you ship from 5 to 50 pounds anywhere in the U.S.A., you're missing a bet unless you check Air Express. Call your local REA Express office next time and see. And remember: there is only one Air Express.

Air Express outdelivers them all ... anywhere in the U.S.A.

Air Express
Division of REA Express



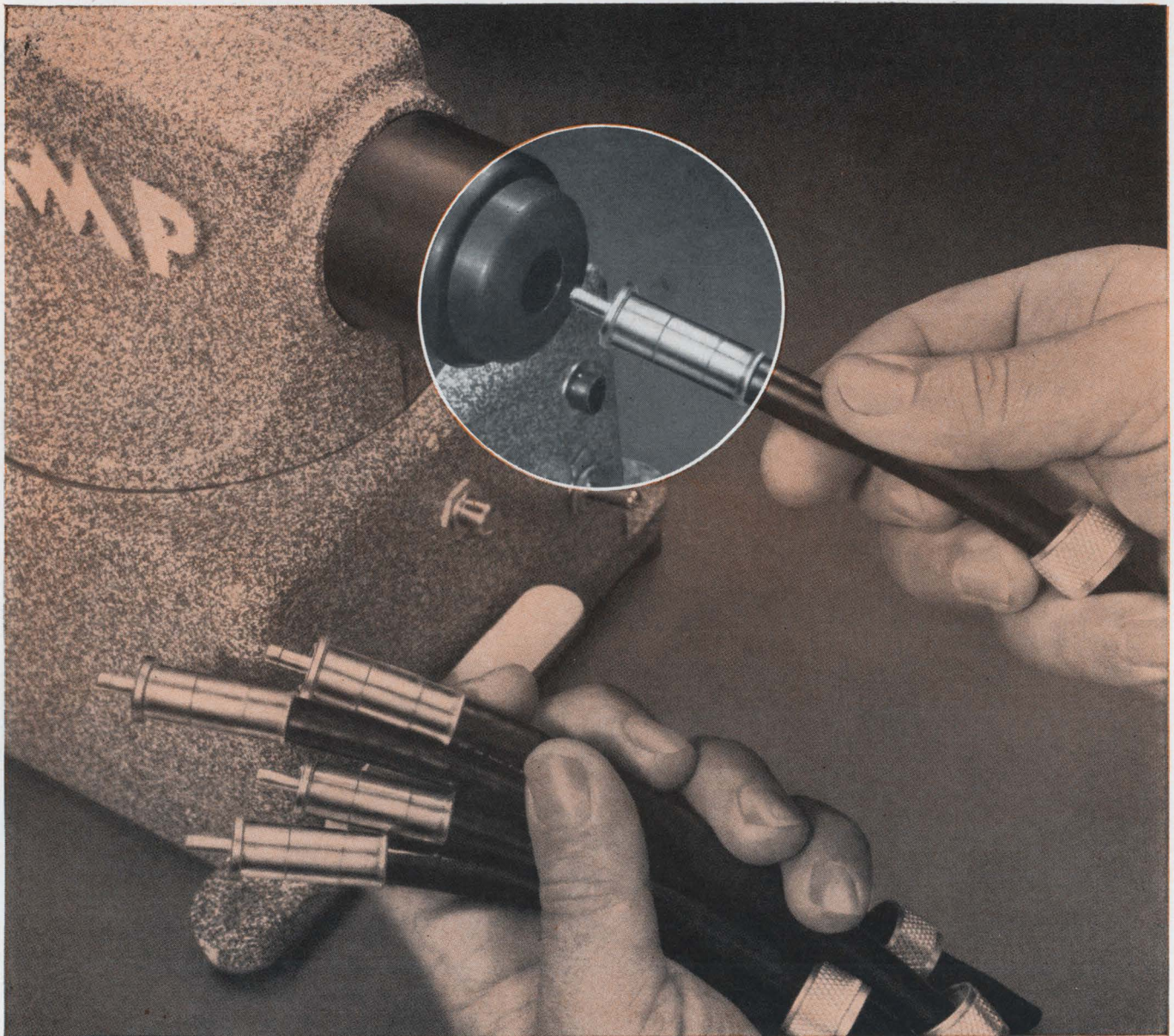

Solder would only spoil it

Besides, who would want to go through all the motions of soldering when this plug can be crimped in a single step? In fact, it's the *only* UHF plug for which one-crimp application tooling has been specifically designed. Think of what this means in terms of production savings!

Whether you use a hand tool or bench-mounted machine to attach the plug to the conductor, you'll get one-step, precision controlled crimps everytime. Braid, center conductor, and insulation support are crimped simultaneously. And the controlled crimping process assures high resistance to braid pull-out as well as maximum conductivity. Without solder.

The A-MP* UHF plug is a non-constant impedance type, comparable to the popular PL-259 and ideally suited to circuits requiring up to 500 volts, operating at frequencies up to 500 MC. Exceptionally low VSWR, low assembly cost and excellent

braid retention are a few of its advantages. Its uses are so numerous, they can only be suggested here:

- Antennae to radio receivers
- Ship-to-shore communications
- Control and guidance systems
- Government and public wire services
- PA systems
- Electronic signaling devices

Make connections the easy way with AMP's new UHF Series Connector Plug. To be *really* convinced, write today for complete information.

*Trademark of AMP INCORPORATED



A-MP* products and engineering assistance are available through subsidiary companies in: Australia • Canada • England • France • Holland • Italy • Japan • Mexico • West Germany

Technical Articles

**Reliable repertoire
of display circuits:
page 60**

Here is a collection of simple, efficient circuits that can be adapted to meet the special requirements of any display system. With more and more applications—both military and industrial—demanding complex display of information, signal processing has become an integral part of display work.

**Which thin-film
capacitance element
is best?
page 67**

Thin-film circuitry is winning broader acceptance, so more emphasis is being placed on choosing the right material and fabrication process to make the capacitor. There are three basic methods and at least seven materials to choose from.

**Computer trio
runs the works
at British steel mill:
page 80**

At the Park Gate Iron and Steel Co. three computers do everything from filing to filling orders. One does paper work and planning, another coordinates mill operations and the third runs the steel-cutting shears.

**A controversy
over wideband
tape recorders:
page 90**

An engineer charges that the standards which evolved with audio magnetic-tape recording no longer fit wide-band machines used in telemetry. He asks for new standards, new definitions, and new methods of measuring variables that have significance, instead of variables associated with audio work.

**Coming
February 8**

- A laser video link
- More new optoelectronic devices
- A universal package for microelectronics
- The electronics in navigation satellites

Reliable repertoire of display circuits

Designers can capitalize on the versatility of the cathode-ray tube and indicator lamp with these basic circuits

By A. E. Popodi

Westinghouse Defense and Space Center, Westinghouse Electric Corp., Baltimore

Satellite and missile tracking radar systems collect vast amounts of information, much of which must be conveyed quickly to an observer. An efficient, reliable and rapid way of transferring information is by visual display.

Visual presentation techniques include status, pattern and cathode-ray tube displays. Circuit designers need a dependable repertoire of simple, efficient circuits that can be adapted to meet the special requirements of any display system. The basic circuits described here have demonstrated their reliability in varying environmental conditions over extended periods of time. All of them will be

useful to engineers in the design of any display system.

Signal processing has become an integral part of display systems. For example, conventional video displays of radar information are presented simultaneously with computer-controlled alphanumeric symbols. In most cases, random access operation as well as high resolution and high bandwidth are required. Presently, these objectives can be achieved only with cathode-ray tube displays.

Two groups of circuits are required to operate cathode-ray tubes. These are the power supply group and the signal processing group. In the power supply group are the regulated power supplies, the circuits that cut off the crt beam during the retrace interval (blanking and unblanking circuits), and all those circuits that protect the display tube screen from failures in the deflection system.

In the signal processing group are video amplifiers, video switches, limiting and threshold cir-

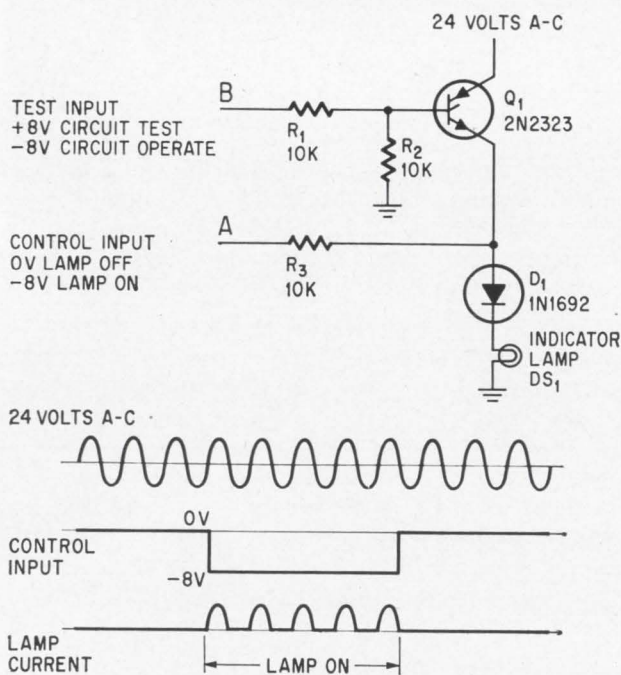

Lamp driver in a status-type display is turned on by applying a signal to a silicon controlled rectifier. One terminal of the driver circuit can accept a test signal to show if the circuit is working. DS₁ is a type 313.

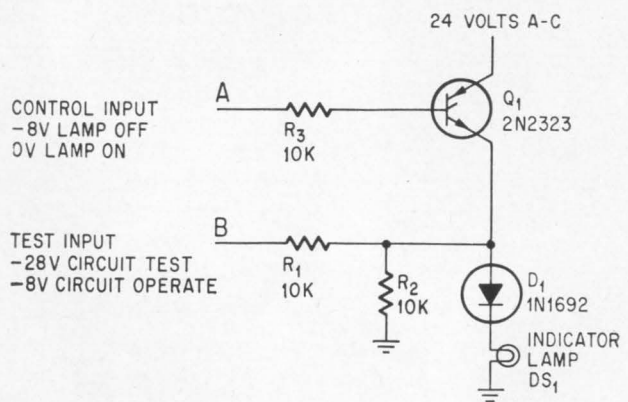

Control pulse that rises to a positive potential may be required to turn on an indicator lamp in a display system where negative pulses are commonly used to give a lamp indication. DS₁ is a type 313.

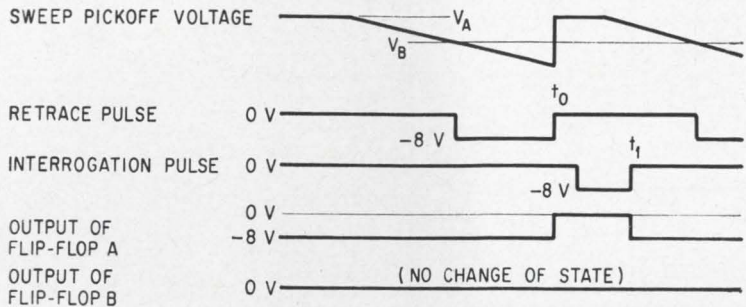
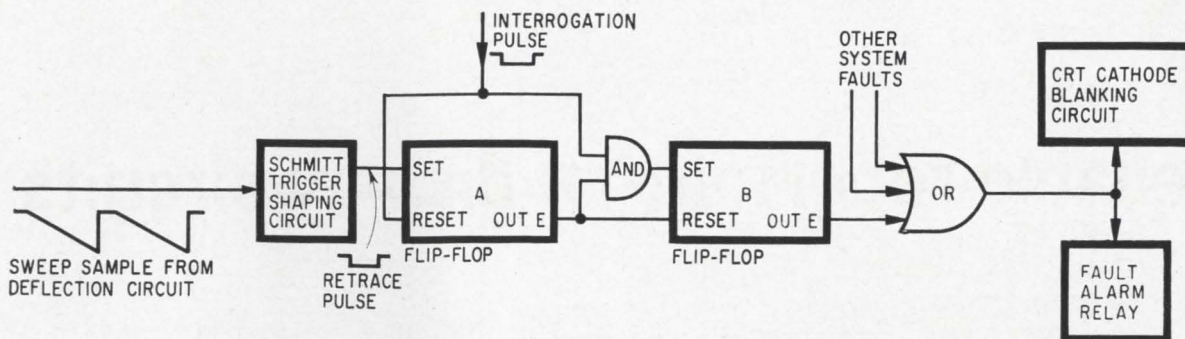

Cathode-ray tubes must be protected against screen damage caused by circuit failures. A missing retrace pulse activates a circuit (blanking circuit) that prevents electron-beam flow from the grid to the screen. The fault automatically clears when the next retrace pulse appears and the electron beam is unblanked. The timing diagram describes the operation of the crt-protection circuit. A retrace pulse can be derived at any point V_B from a pickoff voltage whose amplitude is V_A .

cuits, sweep generators and deflection amplifiers.

Lamp-driver circuit

Status and pattern displays generally require less bandwidth and resolution than cathode-ray tube displays. Status displays, where lights indicate a specific condition or fault, are characterized by large numbers of identical indicators. These are usually incandescent lamps or electroluminescent devices. Often, the incandescent lamps must be switched rapidly without relays or excessive loading of the control source. A simple lamp-control circuit with one silicon controlled rectifier and only five components per lamp is shown on page 60, left.

The control signal is applied at input terminal A (in this example the logic pulse is $-8v$) and a test signal may be applied to terminal B. If the voltage at the test terminal is -8 volts, the circuit is in the operating condition and the scr can be turned on by applying the control signal. A control signal of -8 volts forward biases the gate electrode with respect to the cathode and the scr fires during the positive half cycle of the a-c input voltage. During the negative half cycle, the scr is extinguished, but it will refire at the next positive half cycle as long as the $-8-v$ control signal is applied. In applications where the circuit is off for long periods, it is desirable to test the operation of the indicator circuit. A $+8$ volt signal applied at the test terminal will fire the scr and the indicator lamp will ignite even though the control signal is in the off condition (0 volts).

The circuit at the right on page 60, shows a driver that must turn on a lamp with a positive pulse.

Protection circuit for crt's

Indicator cathode-ray tubes as well as video storage tubes must be protected against failures in

the deflection circuits to avoid permanently damaging the tube screen by burning of the phosphor.

A typical protection technique is to charge a storage capacitor with a pickoff voltage obtained from the crt deflection circuit. In case of a sweep failure, the capacitor voltage discharges to zero volts. Usually, this voltage change is used to cut off the crt either by driving its cathode positive or by turning off the high-voltage power supply. But, large storage capacitors are required and the protective action is too slow for many applications. Problems also arise with this technique in circuits where several, widely separated sweep frequencies exist or where there are long periods without sweep.

A better crt protection circuit is the sweep monitor, shown in the block diagram above. The sweep monitor detects a single sweep failure. It operates independently of sweep speeds and does not require additional circuits for protection during periods of intentional sweep inactivity. The monitor resets itself when the failure condition disappears.

The monitor consists of a shaping circuit, two flip-flops and an AND gate. The circuit is controlled by two inputs: a retrace pulse, which is a derivative of the pickoff voltage from the sweep circuit, and an interrogation pulse, derived from the sweep trigger. Neither the duration nor the starting time of the interrogation pulse is critical. But, the interrogation pulse should be terminated before the start of the next sweep retrace. The output of flip-flop B is the input to an OR gate having other fault functions as inputs. The output of the OR gate controls the crt blanking circuit by driving the tube beyond cutoff.

The timing diagram describes the operation of the sweep monitor for a failure-free condition. A

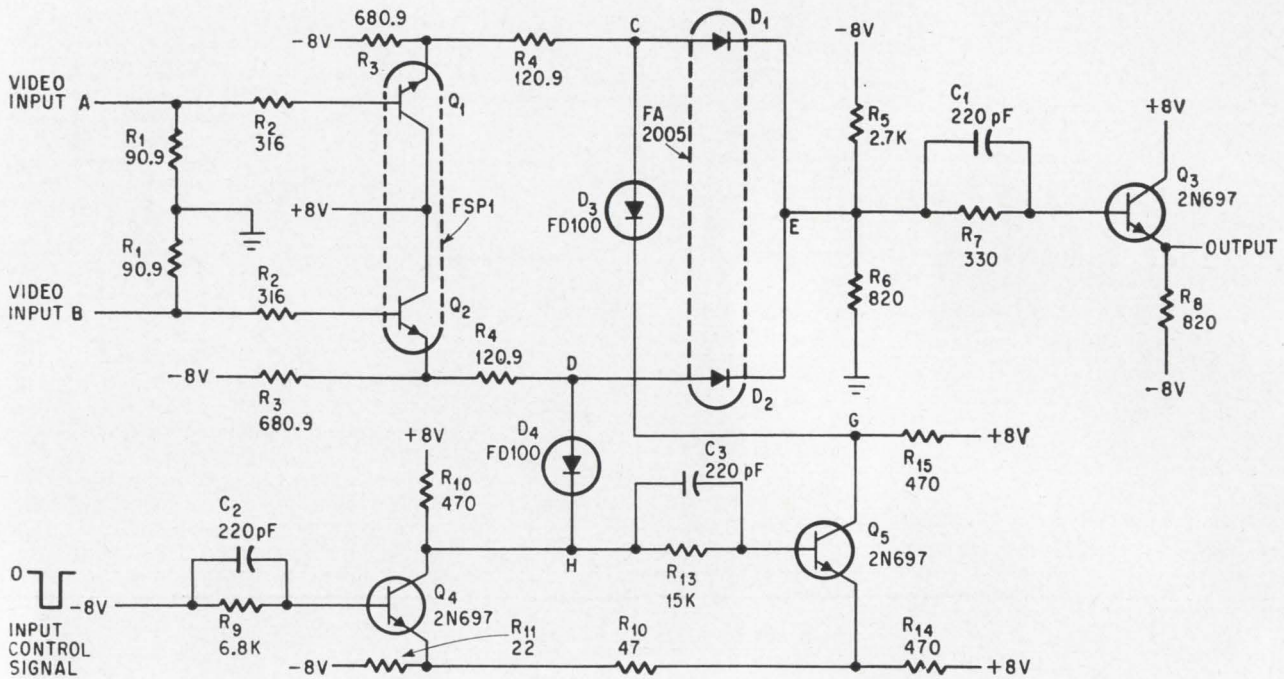

Electronic switch allows simultaneous display of two signals on one crt screen. The switch instantaneously samples each signal and modulates the crt beam so that separate waveshapes appear on the screen.

sample of the sweep voltage is fed into the shaping circuit which produces a positive pulse at the end of the sweep period (t_0). The positive-going edge of the sweep voltage sets flip-flop A, whose output changes from -8 volts to zero volts. At t_1 the positive, trailing edge of the interrogating pulse resets flip-flop A and its output reverts to -8 volts. Therefore, the waveform at the output of flip-flop A is a positive-going pulse, starting at t_0 and ending at t_1 . This pulse and the interrogation pulse are applied to flip-flop B through the AND gate. Because the AND gate does not have two negative inputs, it gives no output, and flip-flop B cannot change state.

In the fault condition, characterized by a missing retrace pulse, flip-flop A remains in its reset state and its output remains at -8 volts (no output pulse). Flip-flop B can now be set at the end of the interrogation pulse; its output indicates a fault. If the fault continues, further interrogation pulses will have no effect on the state of flip-flop B. Only a reset pulse can change its state. The fault indication can be removed only when the next retrace appears. This provides the automatic reset for the sweep monitor.

A Schmitt trigger circuit performs the shaping of the sweep input voltage.

Balanced video switch

In many applications, video signals from different sources are presented on a common display by rapidly switching from one input channel to another. Only an electronic switch can perform this job. The most important requirement of an electronic switch is transient-free operation. Opening or closing a switch produces transients and in an

electronic switch these transients can appear as false output signals.

Because these switching transients are generally of short duration, false outputs can be avoided by blanking the cathode-ray tube (the tube beam is cut off during the switching transient).

Another undesirable condition that can occur at the output is a difference in the d-c voltage levels between two switch channels. This difference in voltage levels, termed a pedestal, must be kept as small as possible with respect to the video signal. The pedestal is a function of switch channel balance and is also dependent on the d-c operating potentials of the switch.

The electronic switch shown in the circuit diagram above uses a matched pair of diodes as switches. Each diode, D_1 and D_2 , conducts an equal amount of bias current, regardless of the video signal current. The switch-output d-c level is then constant for both channels of the switch. Matched diodes also provide identical output current over a wide variation of supply voltage and temperature.

For single-pole, double-throw operation, the video signals are connected to input terminals A and B. The push-pull amplifier, consisting of transistors Q_1 and Q_5 , provides out-of-phase gating voltages that are applied at points C and D in the circuit. The resistor network in the base circuit of the output driver transistor Q_3 , provides the bias current for the signal diode D_1 or D_2 , whichever is conducting.

When the gate voltage at circuit point G is $+4$ volts and point H is at -4 volts, diode D_3 is cut off and D_4 conducts. Therefore, signal diode D_1 is forward biased and conducts signal current, and

D_2 is cutoff. If the switch position is reversed, the same bias current flows through diode D_2 , and D_1 is cut off.

With perfectly balanced switch channels and identical video input signals to each channel, the output voltage level at E does not change. A diode package is available for D_1 and D_2 with the forward voltage drop between diodes matched to 10 millivolts over a temperature range of -25°C to $+75^\circ\text{C}$. A matched pair of transistors in a single TO-5 case is available for Q_1 and Q_2 with approximately the same temperature characteristics.

This electronic switch accepts a positive video signal having an amplitude of 2 volts. The input-to-output deviation from linearity at this level is less than 1% and the amplitude loss is about 3 db. The output pulse rise time across a 90-ohm load is 25 nanoseconds. The control signal is a -8 volt pulse. The switching transient is of 50 nanoseconds duration and has an amplitude of 0.5 volts and the pedestal is 20 millivolts maximum.

This switch can also operate with a small sinusoidal input having a maximum peak amplitude of 0.5 volt. Reversing the connections of signal diodes D_1 and D_2 and also reversing the polarities of the bias voltages allows negative video pulses to be switched.

Pulsed oscillator

Alphanumeric display symbols may be derived from combinations of circles, half-circles or ellipses. The pulsed oscillator shown in the circuit diagram above, can be used to form alphanumeric display symbols with transient-free oscillations. Immediately after the start gate is applied, the first cycle of oscillation has sinusoidal waveform and full amplitude. Because terminating the pulse oscillation is generally less critical, the turn-off transient can be tolerated if it is short compared to one period of the oscillation frequency.

The pulsed oscillator circuit consists of an oscillator transistor Q_2 , a tuned circuit L-C₁-C₂ with

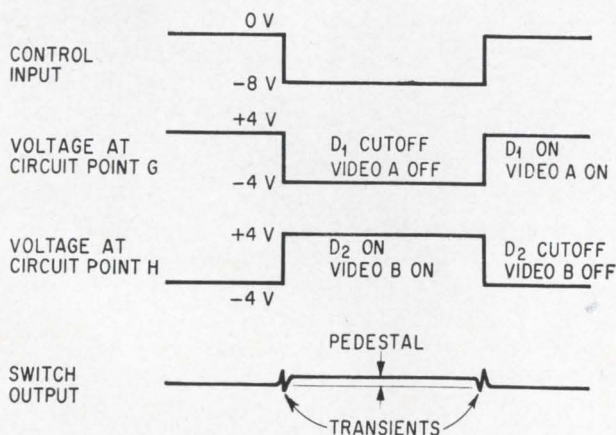

False signals can appear at the switch output due to spike voltages caused by switching pulse transients. Blanking the crt beam during these intervals eliminates the effects of such transients. Any imbalance in the switch channels causes a change in the output d-c voltage level, commonly referred to as a pedestal.

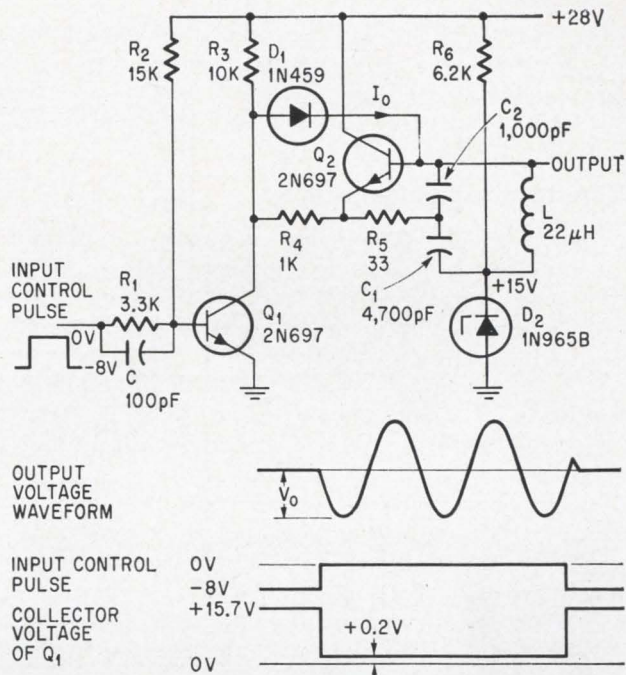

Pulsed oscillators used in display systems must provide a gated sinusoidal signal free of turn-on transients. The turn-off transient time should be significantly less than one period of the oscillation frequency.

capacitive feedback, feedback resistor R_5 and clamping diode D_1 . Tuning coil L is at a positive d-c potential of 15 volts, established by zener diode D_2 and resistor R_6 . Resistor R_4 connects the emitter of oscillator transistor Q_2 to the collector of switching transistor Q_1 . When the control input pulse (0 volts) turns on Q_1 , power is applied to the oscillator because the collector of Q_1 is approximately at ground potential. Diode D_1 is back-biased and Q_2 oscillates.

When Q_1 is cut off by a -8v control pulse, the collector voltage of Q_1 rises towards $+28$ volts until diode D_1 starts to conduct at about $+15$ volts. This places damping resistor R_3 across the tuned circuit, causing its oscillation to decay rapidly. At the same time, the Q_2 emitter supply voltage is removed. The d-c clamping current I_0 flowing in the coil, is determined by resistor R_3 . I_0 is selected according to the relationship $V_0 = I_0 \omega L$, where V_0 is the required a-c peak voltage of the oscillator and ω is the frequency of oscillation of the tuned circuit in radians. Constant coil current during quiescence assures that every gated burst starts with the same amplitude V_0 , independent of transistor characteristics, as shown in the voltage wave-shapes associated with the circuit diagram.

The pulsed oscillator can operate at any frequency. Its upper limit is determined mainly by the rise and fall time of the collector voltage of switching transistor Q_1 .

Summarizing the advantages of this pulsed oscillator circuit: it has high output voltage; sinusoidal oscillation starts with full amplitude and stops within less than one cycle; it does not pro-

duce d-c transient voltages; the initial amplitude of the oscillator output voltage is determined only by resistor R_3 and not by transistor characteristics; both transistors are nonconducting during off periods.

Threshold and limiting circuit

Video-signal processing requires amplitude selection such that video inputs below a given voltage level (threshold) and above some other voltage level (limit) are rejected. An ideal threshold and limiting device should have

- Independent adjustment of threshold and limiting levels.
- Adjustment of either level without a false output when there is no video input.
- Threshold and limit level controls calibrated as a percentage of maximum input video amplitude.
- A feature that prevents setting the threshold level above the limiting level.
- A wideband response beginning at d-c.

A practical circuit that meets these requirements, is shown in the diagram below.

Positive video signals are applied at the input A of resistor voltage divider R_1 - R_2 . The tap of the voltage divider B is connected to the output stage which consists of the Q_4 and Q_5 emitter followers. The other side of the divider C is connected to a voltage V_{TH} of low source impedance, provided by emitter follower Q_1 . V_{TH} is adjustable from zero volts to some negative voltage, depending on the maximum video input voltage level. Limiting diode D_1 is connected to another low impedance source V_{LIM} provided by emitter follower Q_2 . V_{LIM} can be adjusted from zero volts to some positive volt-

age by varying potentiometer R_8 .

The video output circuit comprises two emitter followers Q_4 and Q_5 . Because the threshold voltage, V_{TH} , is always negative when the video input is zero, point B will also be negative, and this causes Q_4 to be cut off. The emitter of Q_4 is also negative; this cuts off transistor Q_5 and the video output at its emitter is zero. As the video input increases positively, point B becomes positive and Q_5 starts to conduct, producing a video output. If the input becomes even more positive, diode D_1 begins to conduct and keeps point B from rising further. This establishes the limit level.

The graph associated with the circuit diagram shows the output-input voltage relationship for the case where $R_1 = R_2$ in the voltage divider, and where the threshold limit $V_{TH} = 0\%$ of video input (all video input below the limit voltage level passes) and $V_{TH} = 50\%$ of the video input (all video input signals below 50% of the maximum video input voltage are rejected). If the threshold level V_{TH} is zero, the most positive potential which point B can reach is some voltage V_1 , which is also the maximum required limiting potential V_{LIM} for this case. If the threshold control is set to 50% of the maximum input signal, then the maximum video output is equal to V_2 which is half the limit voltage when $V_{TH} = 0\%$. Therefore, the maximum limiting level is not constant but is a function of the threshold potential.

The maximum limiting voltage is controlled by the threshold voltage through the voltage divider consisting of R_3 , R_4 , R_5 and R_6 . As V_{TH} becomes more negative, the base of Q_3 becomes less positive, and the maximum limiting voltage is reduced.

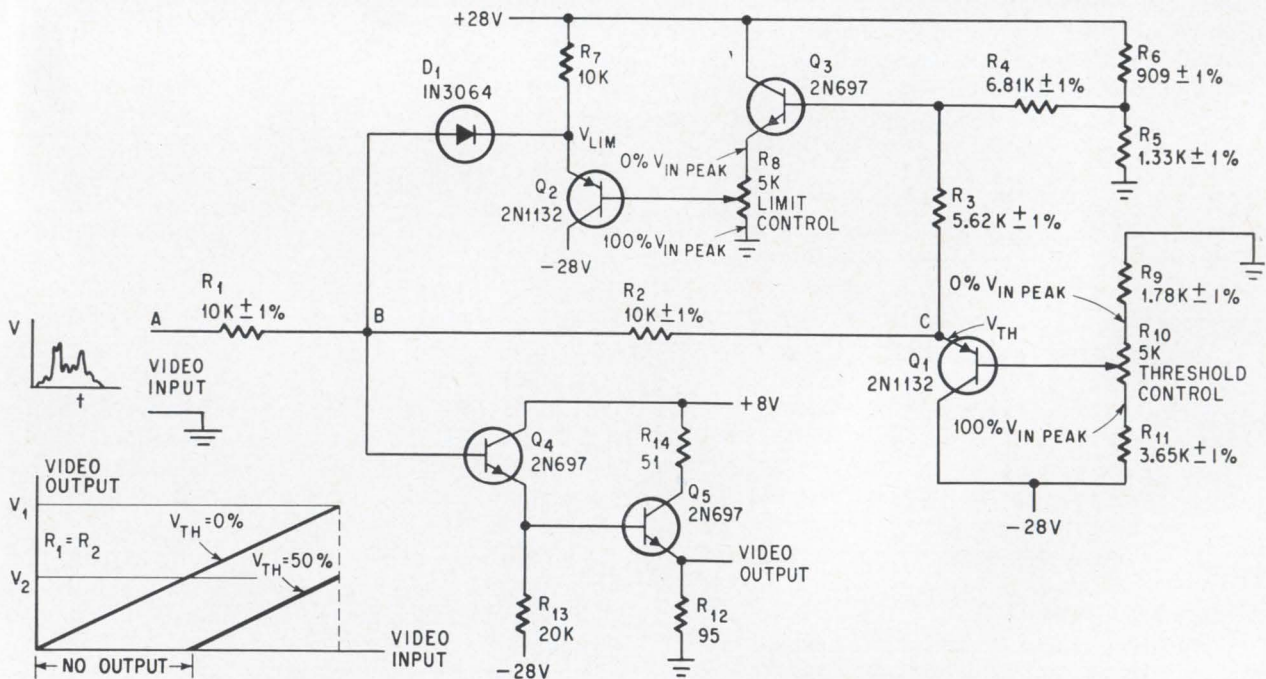

Threshold and limit circuit selects amplitudes of video signals in display systems. Video input signals with amplitudes above the threshold level (adjusted by R_{10}) and below the limit level (adjusted by R_8) will appear at the output. Threshold and limit voltage levels are set as a percentage of the maximum video input amplitude.

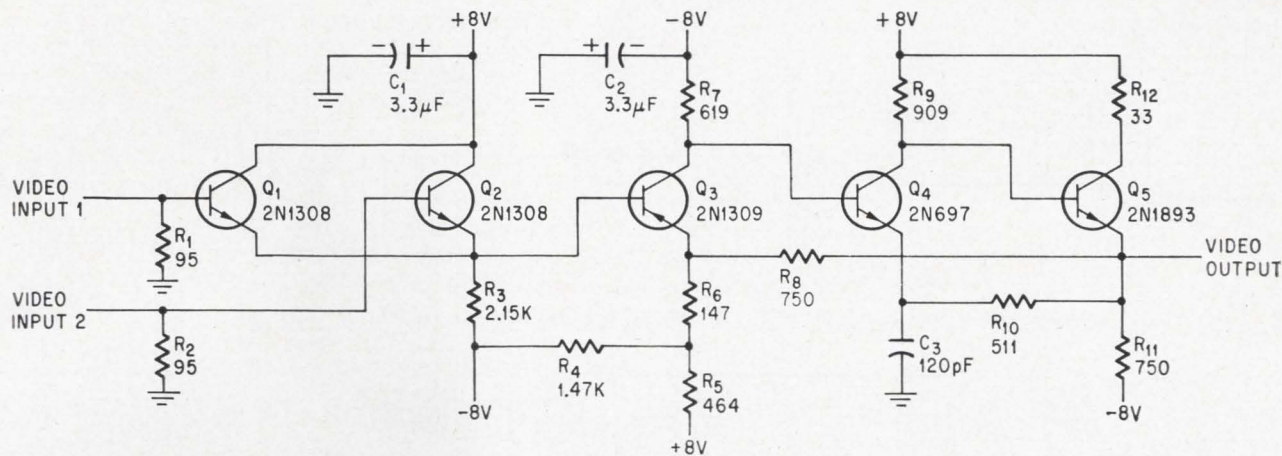

Video selector provides an output for the larger amplitude of either of two input signals.

Transistor Q_3 serves as a driver for the limiting control potentiometer and is required only in wide-band applications.

Both threshold and limit controls can be calibrated as a ratio (in percent) of the maximum video input voltage. For example, consider the extreme condition where both controls are set to 50%. All video inputs smaller than 50% of the peak video will be suppressed due to the threshold level and all video inputs greater than 50% of the peak video will be rejected due to the limit level. Actually, all video inputs are rejected.

Because only a variable d-c voltage is required to set both levels, the circuit can be operated remotely.

Video-selector and line driver

Sometimes the largest of several video signals combined in one channel must be selected to provide an output signal while all other video signals are simultaneously rejected. A circuit that performs this function can also mix two pulse trains of equal amplitudes and different frequencies. But in either application, maximum isolation must be maintained between the video sources.

A dual-input video-selector capable of driving a 95-ohm load is shown in the diagram above. Both video inputs are positive with amplitudes ranging between 0 volts and +2.5 volts. The larger of the two input signals produces positive output. Isolation between the video signals is obtained by back bias of the base-emitter junction of that transistor (Q_1 or Q_2) with the lower video input amplitude applied to its base. The output stage, consists of transistors Q_3 , Q_4 and Q_5 , and employs negative feedback provided by R_8 . Resistor R_{12} in the collector circuit of the output stage acts as a current limiter in case the output terminal is accidentally shorted to ground.

The circuit gain is about 3 db and the output pulse rise time is 80 nanoseconds with a 95-ohm load.

This circuit can accept only positive-going video signals. For negative video input signals, Q_1 and

Q_2 must be pnp-type transistors and the transistors in the amplifier stage should also be changed accordingly.

Unblinking and intensity control

Video information and alphanumeric symbols are frequently presented on a common display tube on a time-sharing basis. Symbol repertoire can be increased and operator error reduced by allocating different light intensities to different symbols. Beam intensity can be controlled by the potential on the grid or cathode of the display tube. Generally, the video signal that controls beam intensity is applied to the grid, and the cathode is used to introduce the blanking signals. Since cathode circuits are usually quite simple, it is advantageous to control symbol intensity at the cathode.

In the circuit on page 66, top, the unblinking level is variable and is a function of two logic control inputs (symbol intensity gate 1 and symbol intensity gate 2). The cathode of the crt is connected to the emitter follower Q_2 (circuit output). When transistor Q_1 is cut off, the base of Q_2 goes positive until Q_2 becomes saturated and clamps the crt cathode to the +70 volt supply. This cathode potential will cut off the crt beam.

When a positive-going gate pulse saturates Q_1 , the base of Q_2 is placed at a potential established by a clamping diode D_3 and emitter follower Q_3 . The clamping voltage at the base of Q_2 is controlled by the resistor network consisting of R_7 , R_8 , and R_9 . Transistors Q_4 and Q_5 are on-off switches.

With this circuit, two different crt electron-beam intensities are provided. The beam intensity depends on whether transistor Q_4 or Q_5 is turned on. Transistor Q_4 applies a +15 volt pulse, or Q_5 applies a +10 volt pulse, to the cathode of the crt. The five volt difference can be observed in the distinct change in intensity levels of the individual signals on the crt screen. The lower cathode potential resulting when Q_5 conducts (symbol intensity level 2) produces the greater display intensity.

The output rise time is about 0.5 microseconds

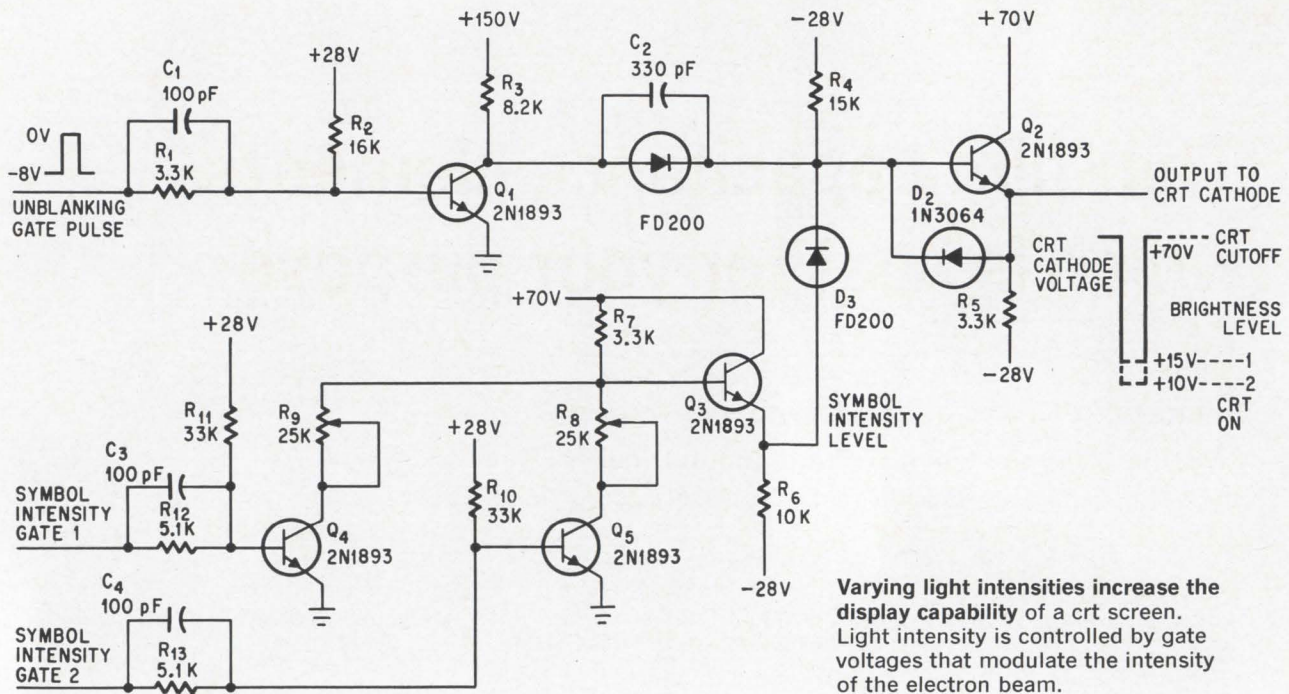

for a maximum voltage swing from +10 to +70 volts with a 15 pf capacitive load at the emitter of Q_2 and $R_5 = 3,300$ ohms.

Focus-coil regulated current

The magnetic focus coil for a cathode-ray tube requires a regulated d-c current supply of several hundred milliamperes. The regulation requirements vary from fractions of a percent to several percent, depending on the particular application. The current must be regulated because the focus coil resistance varies with temperature. In many cases,

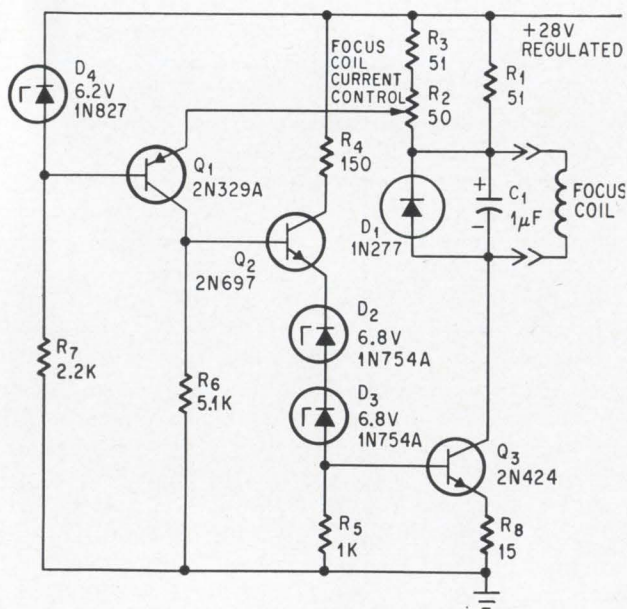

Magnetic coil that focuses the crt electron beam must be energized by a regulated d-c current because coil resistance varies with temperature.

a constant-current device, such as a transistor, can provide sufficient regulation. However, for closer regulation additional gain must be provided.

In the regulated-current supply shown at left, potentiometer R_2 samples the focus-coil current. The voltage across R_2 drives grounded-base amplifier Q_1 . The base voltage of Q_1 is established by R_7 and temperature-compensated zener diode D_4 having a reference voltage with a temperature coefficient of 0.001% per degree centigrade. Emitter follower Q_2 drives output transistor Q_3 . Diode D_1 protects Q_3 from excessive transient voltages that occur when the current in the coil is interrupted. Resistor R_4 limits the power dissipation in Q_2 when the coil is disconnected from the collector of Q_3 . Capacitor C_1 stabilizes the regulation. R_2 can be located to provide remote control of the focus coil current.

This regulator has a current range of 220 to 270 ma and a regulation of better than 0.5% between 25°C and 65°C.

Acknowledgement

The author acknowledges the assistance of O. McAteer, R. H. Casey, C. Haslbeck, F. Lori and C.R. Pearman.

The author



Alfred E. Popodi is a Fellow Engineer with the Westinghouse Electric Corp. in Baltimore. He holds a master's degree in electrical engineering.

Thin-film capacitance elements: which is best for your purpose?

Knowledge of materials and fabrication processes helps designer to meet any circuit requirement

By F.W. Schenkel

Applied Physics Laboratory Johns Hopkins University, Silver Spring, Md.

The trend toward thin-film components in miniaturized circuitry puts added emphasis on the choice of materials. The most stable thin-film elements, for example, aren't always consistently reproducible. The most reproducible may also be the most expensive. The most economical may not be stable enough.

Researchers are constantly studying materials to help designers select the most appropriate for various thin-film applications. This article summarizes some of the most useful findings on the advantages and disadvantages of six materials most commonly used for capacitance elements in thin-film circuits. It also cites information available on new materials still under investigation, materials that promise to extend circuit operation to higher temperatures and higher voltages.

First some questions

Before deciding on a capacitance material, the engineer should analyze his needs. Are close tolerances required? What are the frequency requirements? Is the circuit designed for high-speed operation? Is the available space severely limited? In what temperature range will the circuit operate? What fabrication process is available? How much money can be spent?

To find the capacitance material that comes closest to meeting these needs, the engineer must know more than the physical and electrical characteristics of the available materials. He can find much of this information in the table on page 68. He also has to know how each material behaves during and after deposition on a thin-film substrate.

The basic capacitor formula

Analysis of capacitance elements for a thin-film circuit begins with the basic capacitance formula.

The capacitance formed by an insulator separated by two parallel plate conductors is expressed by

$$C = 8.842 \times 10^{-8} \frac{KA}{d} \quad (1)$$

where C is the capacitance in microfarads, K is the dielectric constant of the material, A is the area of the capacitor in square centimeters, and d is the thickness of the dielectric in centimeters.

When designing a microelectronic circuit, the designer tries to keep the area, A , as small as possible, choosing a material whose dielectric constant, K , is large. It is desirable to keep the thickness of the material, d , to the minimum required to handle a given voltage. When high capacitance is required, the dielectric material is deposited in multilayers.

The quality factor of a capacitor, Q , represents the rates of energy stored to energy dissipated. The higher the Q , the longer the energy can be stored.

The dissipation factor^{1, 2} is a reciprocal of Q , and is expressed as:

$$D = \omega CR \quad (2)$$

where ω equals the angular frequency, C equals the capacitance in farads, and R equals the equiv-

The author



Frederick Schenkel is supervisor of research and development for thin-film microelectronic components in the Applied Physics Laboratory of Johns Hopkins University. He has worked on designing thin-film devices, photosensitive elements, image intensifiers and camera tubes.

alent series resistance. R is determined by the lead wires, the counter electrodes and the nature of the dielectric material.

Power losses in a capacitor are associated with the factors that make up the resistance, R. Experimental data shows that capacitor losses are independent of frequency up to about 100 kilocycles. In this range, the biggest loss is in the dielectric. Dielectric loss is related to the material's chemical and atomic structure, and to changes in the material caused by the migration of ions. At frequencies near 100 kilocycles, dissipation is a function of counter-electrode resistance and depends largely on the dimensions and the materials used for lead wires.

Choosing a substrate

After tentatively selecting a capacitance material based on physical and electrical characteristics, the designer must decide how the material will be deposited onto a substrate, and whether the deposition process used is compatible with the material selected. Vapor plating is probably the least expensive, but vacuum deposition or wet chemistry usually results in closer tolerances. The capacitance element should form a tenacious chemical bond that will not deteriorate with time, or in the presence of an electrical field. Adhesion, or the strength of the bond between the film capacitor and the substrate, varies widely for different substrates.³

How thin-film elements are made: the 3 basic production methods

Three different processes produce thin-film elements that have greater reliability than discrete components. They are vapor deposition, wet chemistry and vapor plating [table below].

All three manufacturing processes should be considered before the engineer chooses a dielectric material for a particular thin-film circuit application.

All three processes eliminate most mechanical interconnections except those between substrates and between elements or chips that are added after the deposition. A wide range of component values is available; with them, it is possible to approach the values obtainable with discrete components.

Vacuum deposition

Vacuum deposition is done by depositing the circuit element on a substrate in vapor form in a vacuum. Vacuum-deposition processes are the most versatile, and can be used to make active elements such as thin-film field-effect transistors as well as passive elements.

While these active elements are far from perfect, they hold great promise for microcircuits. Most thin-film circuits still require that the active elements be in chip form, and added to an inactive substrate containing the passive elements. A hybrid circuit can be made from an active substrate that contains transistors and diodes on which

Thin film capacitance materials, and their characteristics

Dielectric material	Cap. per in ² in μ f	Dissipation factor at 1 Kc	Operating potential in volts	Break-down potential in volts	Temp. coef. ppm/°C	Dielectric constant	Counter electrode	Freq. limit in Kc	Cap. range in μ f	Amb. Temp. limit (°C)	Fabrication process
Silicon monoxide	0.09	0.1%	35	50	110	6	Alum. or Copper	b	10 ⁻⁶ to 10 ⁻¹	125	Vac. Dep.
Silicon dioxide	0.03	0.1%	35	50	a	4	Alum. or Copper	b	10 ⁻⁶ to 10 ⁻¹	c	Vac. Dep.
Tant. pentoxide	1.00	1.0%	20	25	300	25	Tant. and Alum.	10	10 ⁻⁶ to 1	c	Wet Chem.
Titanium oxide	1.00	1.0%	35	45	a	100	Tit. and Alum.	1000	10 ⁻⁶ to 1	125	Wet Chem.
Aluminum oxide	0.55	1.5%	10	15	a	10	Alum.	b	10 ⁻⁶ to 10 ⁻¹	c	Wet Chem.
Alumina silicate	0.064	0.3%	100	150	300	6-7	Alum.	500	10 ⁻⁶ to 10 ⁻¹	150	Vapor Plat.

a—accurate figures have not been established.

b—actual limits have not been established. Theoretically this material can be used in a circuit that operates at thousands of megacycles.

c—temperature limit has not been established, but it is probably not much higher than 125 deg C.

Adhesion is a function of the oxide layer formed between film and substrate. A well-formed oxide layer usually provides an excellent chemical bond. Good adhesion of the film to a substrate also depends upon the affinity of the film material for oxygen. Contamination of the substrate, even a few atomic layers thick, can prevent the formation of a good oxide layer and reduce adhesion.

Film adhesion problems also can arise as a result of the migration of alkali ions from the substrate. This condition can be accelerated in the presence of an electric field; it can even cause reactions with some metallic films that can completely disintegrate the capacitive element.

Various substrates minimize these adhesion prob-

lems. Circuit fabricators use nonalkali substrates such as Corning Glass 7059, a glass sheet such as Corning Microsheet 0211, and sometimes a glazed ceramic. Alkali containing substrates are usually coated with silicon monoxide before deposition of capacitance and other thin-film elements. The silicon-monoxide film acts as a buffer and prevents attack upon the film elements that is caused by presence of an alkali. The substrates are also protected from contamination by chemical cleaning, which is usually followed by baking the substrate in a vacuum, or by ionic bombardment,⁴ or both. It is important that the substrate be cleared of microscopic dust particles.

passive elements are deposited. Completely thin-film circuits are expected to find their way into the market soon. Capital investment in vapor-deposition equipment is already high.

Wet chemistry

Wet chemistry is used most often for producing circuit elements of tantalum or titanium. It employs vacuum deposition, or a sputtering technique, to form a base-metal layer. This metallic base layer is processed further by anodizing predetermined areas to form resistors and dielectric films. Capacitance elements are formed by coating the dielectric films with a metallic layer, such as aluminum, which has good electrical conductivity.

This approach has one major disadvantage: It requires the work to be transferred from a vacuum system to a chemical bath and then back to a vacuum system. This need can be overcome if reactive sputtering techniques are used instead of anodizing the tantalum or titanium film.

The wet-chemistry process can be useful if bulk active elements are to be added to the thin-film elements. The process often employs a vacuum-deposition technique for forming electrodes or combines photoresistive masking techniques with an electroplating process.

Vapor plating

Vapor plating works on the principle of decomposing a chemical compound by the action of heat to form a vapor that is then deposited on a substrate to form the circuit elements. Vapor-plating facilities require far less set-up time and capital expenditure than other techniques. A metal halide, such as aluminum chloride or tin chloride, is often used. During this process the substrate, upon which the oxide film of the metal is formed, is maintained at high temperature. Vapor plating is also useful for the interaction of reactive gases with other volatile compounds to form semiconducting films.

The two most common methods employ hydrogen reduction and thermal decomposition. Hydrogen reduction has been used in the formation of epitaxial films of silicon from silicon tetrachloride. Thermal decomposition, such as is used in the formation of tin-oxide films, employs an inert carrier gas such as argon.

A pyrolytic process for depositing conductive tin-oxide films on airplane windshields has been used for many years to melt ice. This process is used to fabricate resistors and resistor networks. Considerable effort is being expended to develop similar oxide films for capacitor dielectrics.¹

Reference

1. D. Peterson, "Evaluation of vapor-plated oxide films for capacitor dielectrics," IEEE Transactions, component parts, pp. 119-122, September, 1963.

Selecting a dielectric material

Silicon monoxide, silicon dioxide and tantalum pentoxide are the most widely used dielectric materials for thin-film applications. Titanium oxide is coming into greater use because of its higher dielectric constant. Anodized dielectrics, as formed by the tantalum or titanium wet-chemistry process, produce component polarity. For good reproduction of dielectric constant in titanium oxide from unit to unit, still further refinement of process control is necessary. This refinement is expected to be achieved soon.

Silicon monoxide

Silicon monoxide is one of the most commonly used materials in thin-film capacitance elements. The capacitor plates, or counter electrodes, used with this material are usually made of aluminum or copper, both of which exhibit good conductivity. By carefully controlling the vacuum-deposition process, it is possible to make silicon-monoxide capacitors whose tolerances are consistently within 2%. However, it is common for circuit fabricators to work with tolerances of 10%.

Work performed with silicon monoxide indicates the importance of proper heat treatment of capacitance elements made with this material. The graph at the top of page 70 plots capacitance as a function of temperature, both before and after the material was subjected to a heat-treatment cycle. In this case, the capacitor was unprotected and data was taken in air at one kilocycle per second. It is clear that the temperature change in capacitance increases rapidly prior to heat treatment. After proper heat treatment, the capacitor can be operated up to 165°C with negligible change in capacitance.

The second graph on page 70 shows the dissipation factor of the capacitor as a function of operating temperature after heat treatment for an aluminum-silicon monoxide-aluminum capacitor. The curve was taken at a frequency of one kilocycle. The top graph on page 71 gives the variation in dielectric constant as a function of operating temperature for an aluminum-silicon monoxide-aluminum capacitor, taken at various frequencies.

Dielectrics exhibiting a high temperature coefficient of capacitance are also characterized by a large dissipation factor.⁴ Because the temperature dependency between dissipation factor, dielectric

constant and capacitance are interrelated, it is necessary to determine a heat-treatment schedule that yields the greatest possible reduction in the dissipation factor. Experiments have shown that heat treatment for 45 minutes at 450°C improves capacitor dissipation by a factor of 30 to 50.

Leakage characteristics for a typical silicon-monoxide capacitor indicate that when the capacitor is operating at 20 volts the leakage current of a random sampling of capacitor elements is 10^{-7} amperes or less for a surface area of 12 square millimeters.

Tantalum pentoxide

Tantalum films are widely used for low-speed circuits. Tantalum capacitors achieve a capacitance range comparable to those attained with the vacuum-deposited, silicon-monoxide type. Tantalum has an advantage because of its higher dielectric constant: It can pack more capacitance into much smaller areas.

These capacitors consist of a layer of sputtered tantalum. One part is anodized to tantalum oxide, the other part of the layer remains tantalum and is used as one of the counter-electrodes. Aluminum can be evaporated over the tantalum oxide to form the second counter electrode.

One limitation of tantalum capacitors is their poor performance at frequencies above 10 kilocycles. This is due to the rapid increase in dissipation factor as a result of the high series resistance inherent in tantalum. Extension of the useful frequency range of this capacitance element requires the use of a good conductive underlay, such as aluminum, along with the tantalum counter electrode. A better approach is to use a capacitor of aluminum and aluminum oxide. However, this requires a larger device because the dielectric constant of aluminum oxide is only 10, compared with 26 for tantalum oxide. Aluminum-oxide capacitors exhibit dissipation factors of about 2% at one megacycle.

The graphs on page 71 show how capacitance and dissipation factors change with temperature⁵ for tantalum oxide and aluminum oxide. The leakage current of a tantalum capacitor is different for voltage applied in the forward (anodization) and reverse directions. The voltage is from 20% to 50% higher in the forward direction for a given current.

In addition, silicon-monoxide or dioxide dielectrics do not suffer from polarization, as do anodized dielectrics such as tantalum.

Titanium oxide

Titanium oxide is attractive as a material for thin-film capacitance elements because of its high dielectric constant. This compound can be deposited using a method similar to that for tantalum. Like tantalum capacitors, titanium-oxide capacitors are most useful in low-speed circuits.

Aluminum silicate

Capacitance elements fabricated by vapor-plating techniques may become popular because of

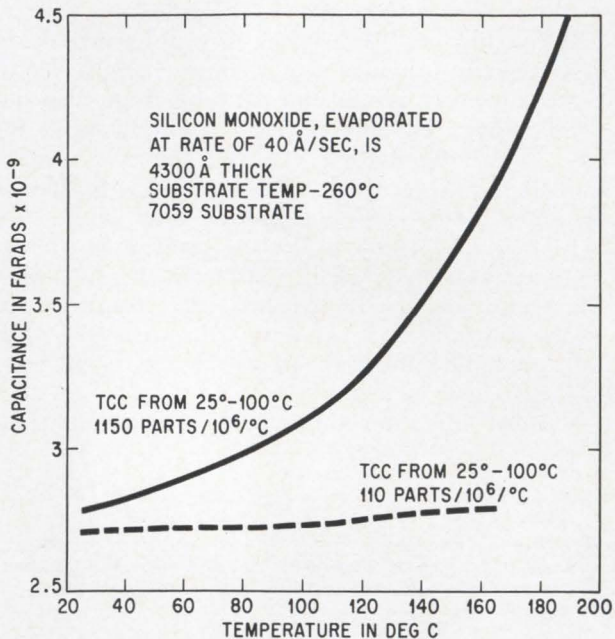

Capacitance as a function of temperature for silicon monoxide. The broken line shows that silicon-monoxide capacitors can be operated up to 165°C, with negligible change in capacitance after a heat treatment at 400°C for 30 minutes.

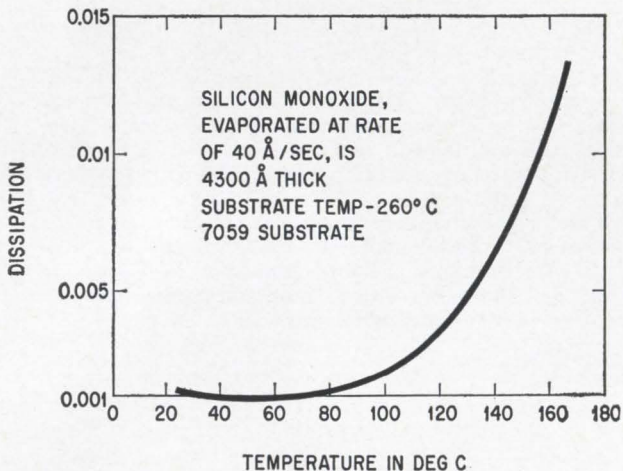

Dissipation factor as a function of temperature for an unprotected aluminum-silicon monoxide-aluminum capacitor. Measurements were taken in air at one kilocycle per second after heat treatment.

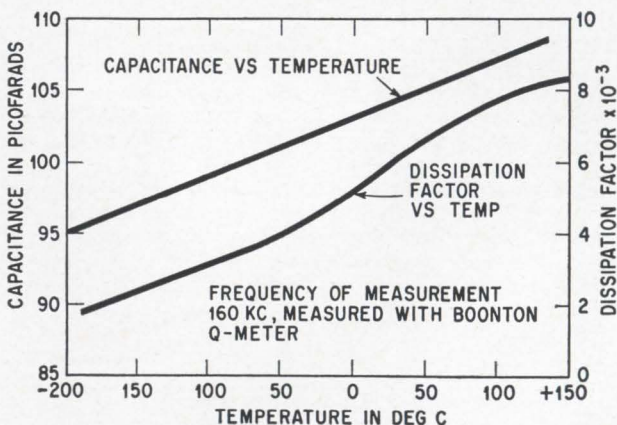

Capacitance and dissipation factor increase with temperature for an aluminum-oxide capacitor.

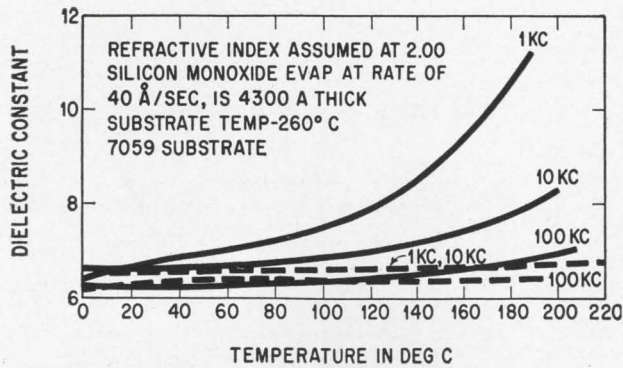

Dielectric constant as a function of temperature for an unprotected aluminum-silicon monoxide-aluminum capacitor. Measurements were taken in air. Broken lines show relative stability of dielectric constant after it was heat-treated at 400°C for 30 minutes.

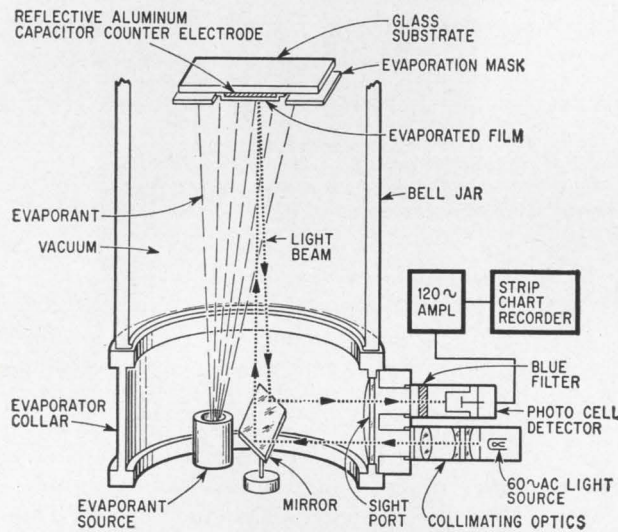

Two-beam interferometer is used to measure thickness of a thin-film component.

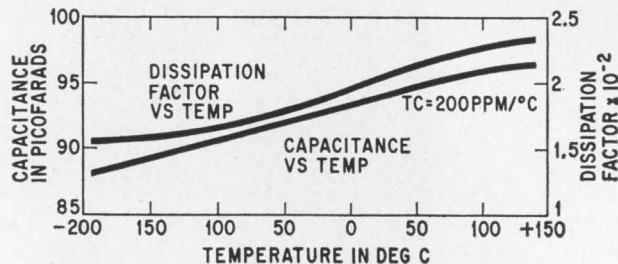

Dissipation factor and capacitance increase rapidly with temperature for a tantalum capacitor.

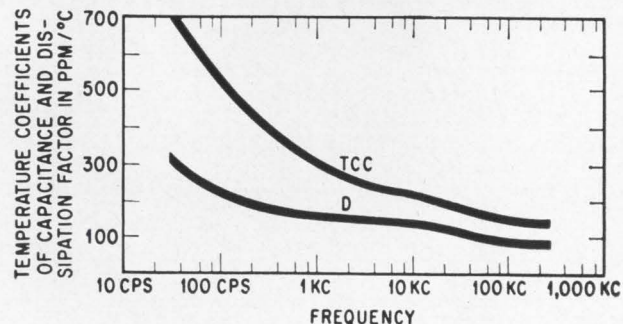

Temperature coefficient of capacitance and dissipation decline as frequency rises. Capacitance is alumina silicate.

their low cost. One such element makes use of an alumina-silicate dielectric film and aluminum counter electrodes. The graph at the bottom of this page shows the temperature coefficient of capacitance and the dissipation factor³ as a function of frequency for an alumina silicate dielectric. This data was taken at about 25°C. Low-leakage capacitors with alumina-silicate dielectrics have been produced with leakage current less than 10^{-8} amperes at 150 volts for 100-picofarad capacitors. The dielectric breakdown is about 150 to 175 volts. A typical capacitance would be about 100 picofarads per square millimeter. One major advantage of this capacitor is its high breakdown potential.

New capacitive elements are constantly being studied. The rare-earth oxides—neodymium oxide and dysprosium oxide—offer interesting prospects for attaining higher dielectric constants, higher temperature ranges and higher resistance to voltage breakdown.

A more reliable amplifier

A thin-film amplifier with two silicon-monoxide capacitors is shown on page 72. Its evaporated interconnections make the circuit more reliable than wired or soldered circuits, and its low mass makes it relatively immune to radiation damage. The circuit has been used for pulse amplification. Its configuration is similar to circuits using vacuum tubes. Besides the capacitors, the circuit contains chromium and rhenium resistors and two thin-film field-effect triodes.

Measuring the film

A two-beam interferometer is used to measure the thickness of the dielectric film during deposition. It requires less maintenance than crystal-type thickness monitors, and consumes less space in the vacuum chamber. However, its usefulness is limited to transparent films. The diagram at the left shows the basic components of such an instrument.

Here's how it works. A collimated beam of light is passed through a view port in the vacuum system. The beam is reflected by a mirror and strikes a glass substrate at a predetermined point where the dielectric film is to be deposited.

Reflected light from the substrate, after passing through a color filter, strikes a cesium-antimonide photocell detector. In this case, the substrate is coated with an aluminum film in the form of a capacitor counter-electrode. The aluminum film is highly reflective and gives off an intense light beam.

The phototube detector is equipped with a narrow-band interference filter that passes only light energy having a wavelength of 4,300 angstroms. The detector's output is fed into a 120-cycle tuned amplifier that drives a recorder. The interference pattern formed by the reflective light from the upper and lower surfaces of the dielectric film changes during the course of evaporation. When this happens, the detector sees a cyclic variation in the blue reflectivity. The interval between two maximums and two minimums will correspond to

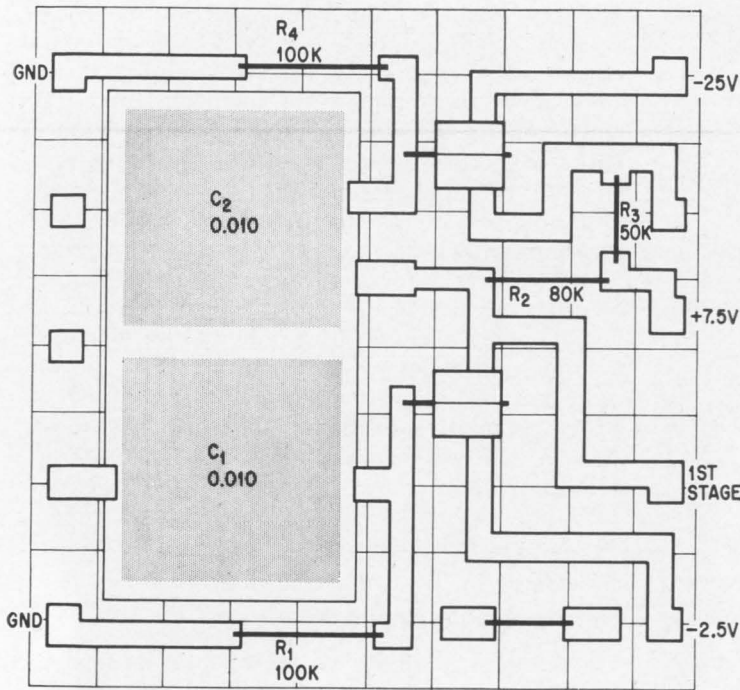

Thin-film amplifier incorporates two silicon-monoxide aluminum capacitors, two thin-film triodes and several chromium and rhenium resistors. Evaporated interconnections offer increased reliability; low mass has greater resistance to radiation damage.

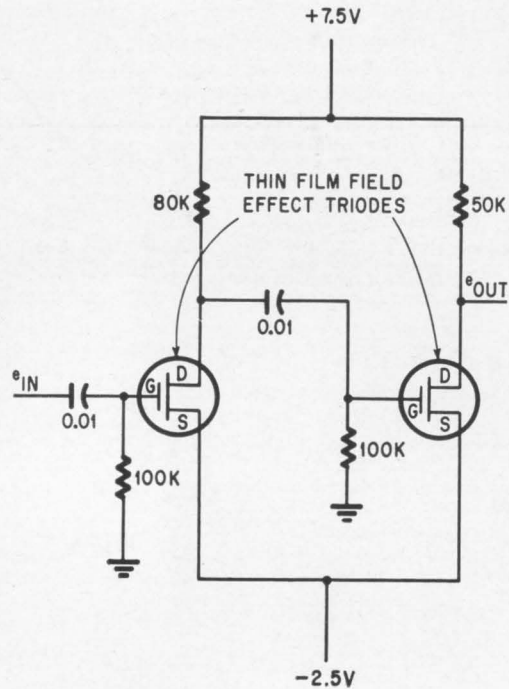

a change in film thickness of $\lambda/2n$, where n equals the refractive index and λ equals the wavelength.

The blue region of the spectrum was chosen because the photocell detector attains peak response in the blue, at 4,400 angstroms. Most of the background light from the evaporation source is concentrated in the red portion of the spectrum. The blue-sensitive detector discriminates against background-light radiation that originates from the evaporation source.

Advantage is taken of the large differences in thermal time constants between background light and the light-source filament. The light source and evaporation sources are energized with 60-cycle alternating current. However, because of the large differences in mass, the 120-cycle modulated light radiation from the evaporation source is small compared with that of the tungsten-filament lamp. As a result, the detector sees only the radiation from

the interferometer light source.

The two-beam interferometer is useful for obtaining the optical thickness of an evaporated film during deposition. The geometric thickness is determined by measurements made outside the vacuum system, using a multiple-beam interferometer.⁶ The refractive index is determined from measurements of the optical and geometric thicknesses. The

refractive index can be considered to be constant for films more than 2,000 angstroms thick.

Data has been compiled on the effect of the evaporation rate on the dielectric constant and refractive index. This data shows that the dielectric constant remains unchanged when the film evaporation rate is more than 15 angstroms per second. At film thicknesses of less than 2,000 angstroms, and evaporation rates of less than 15 angstroms per second, a transition phase into a silicon-dioxide film takes place.

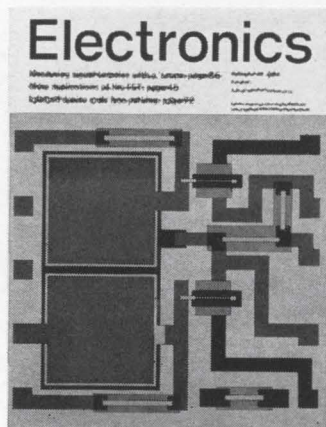

The cover

Pulse amplifier, built for the Navy, contains thin-film active and passive elements. It's more reliable than soldered circuits, and more immune to radiation damage.

Acknowledgment

The author thanks William Liben for his comments and John Tanski and Dean Pappas, for helping to make and measure the films. The work described in this article was performed under contract NOW-62-0604-c by the Bureau of Naval Weapons.

References

1. M. Gevers and F.K. DuPre, "A remarkable property of technical solid dielectrics, Philips Technical Review 9, 91 1947.
2. D.A. McLean, Journal of the Electrochemical Society Vol. 1, p. 108 (1961).
3. P. Benjamin and C. Weaver, "Adhesion of metal films to glass," Proceedings Royal Society, London, A254,177, 1960.
4. L. Holland, "The cleaning of glass in a glow discharge," British Journal of Applied Physics, Vol. 9, pp. 410-415, October, 1958.
5. T.B. Sikina, High-Density Film Microcircuits, Electronic Reliability and Microminiaturization, Pergamon Press, Vol. 1, 1962.
6. S. Tolansky, Multiple-Beam Interferometry, Clarendon Press, 1948.

Stable differential amplifier designed without choppers

New compensation technique provides long-term stability.

Signal drift is reduced to less than 1 microvolt per °C

By David F. Hilbiber

Fairchild Semiconductor Division of Fairchild Camera & Instrument Corp. Mountain View, Calif.

The differential amplifier is certainly the simplest circuit that will provide stable d-c gain. Although the differential amplifier is attractive because of its simplicity, it does have performance limitations. The circuit has this major shortcoming: both the quiescent input current and the transistor emitter-to-base voltage are affected by temperature. Drift or error signals are generated by the unequal temperature coefficients of the two transistors' base-to-emitter voltages and from d-c voltage drops across the source impedance.

It is possible to select matched pairs of transistors to reduce such errors. Changes can be controlled in this way to less than 10 microvolt/°C. However, for a temperature spread of ±50°C, drift can still be as high as ±0.5 millivolt from V_{BE} variations alone. For a system that is 99% accurate, the signal voltage must be greater than 50 millivolts. Since the output of many low-level transducers, such as noble metal thermocouples and wire strain gages, is considerably less than this value, extremely accurate matching is required.

A circuit design technique has been developed in which accumulative drifts caused by all elements of an amplifier may be reduced to a minimum. With this method, it is possible to obtain drift signals considerably less than 1 microvolt/°C. This has also been observed by R. D. Thornton and A. H. Hoffait, W. E. Earle and the author.

C. T. Sah has shown that for a variety of transistors, base-to-emitter voltage is uniquely related to collector current. This relationship is almost the same as the one derived by William Shockley for the idealized one-dimension p-n junction. That is, $I_C = I_S[\exp(qV_{BE}/kT) - 1]$ (1)

where q is the electronic charge, k is Boltzmann's constant, and T is the temperature in degrees Kelvin. I_S is the emitter-to-base junction saturation current, normalized to include the base region trans-

port factor. The saturation current is:

$$I_S = CT^\beta \exp(-E_G/kT) \quad (2)$$

where E_G is the semiconductor energy gap, C a constant relating to area and impurity concentrations and β is a constant determined by the minority carrier mobility and associated parameters. By combining equations 1 and 2, the expression below may be stated in the form of a Taylor series relating V_{BE} to the temperature and collector current.

$$V_{BE} = \frac{kT_o}{q} \left(\ln \frac{I_C}{I_o} + A_o \right) + \frac{k}{q} \left[\ln \frac{I_C}{I_o} + \left(A_o - \beta + \frac{E_{Go}}{kT_o} \right) \right] (T - T_o) - \frac{\beta k}{qT_o} \frac{(T - T_o)^2}{2} + \dots + \frac{\beta k}{q} \frac{(-1)^{n-1}(T - T_o)^n}{n(n-1)} + \dots \quad (3)$$

where I_o is an arbitrary reference current level,

$$A_o = \ln [I_o/I_S T_o]$$

$I_S(T_o)$ is the saturation current at $T = T_o$.

The basic circuit of the differential amplifier is shown on page 75. The circuit is adjusted for balance by varying R_E so $V_{out} = 0$ when $V_{in} = 0$. The

The author



David F. Hilbiber is the head of the linear integrated circuits section of Fairchild's Research and Development Laboratory. He has been with the company since 1959. He was previously with the International Business Machines Corp. and the Missiles & Space division of the Lockheed Aircraft Corp.

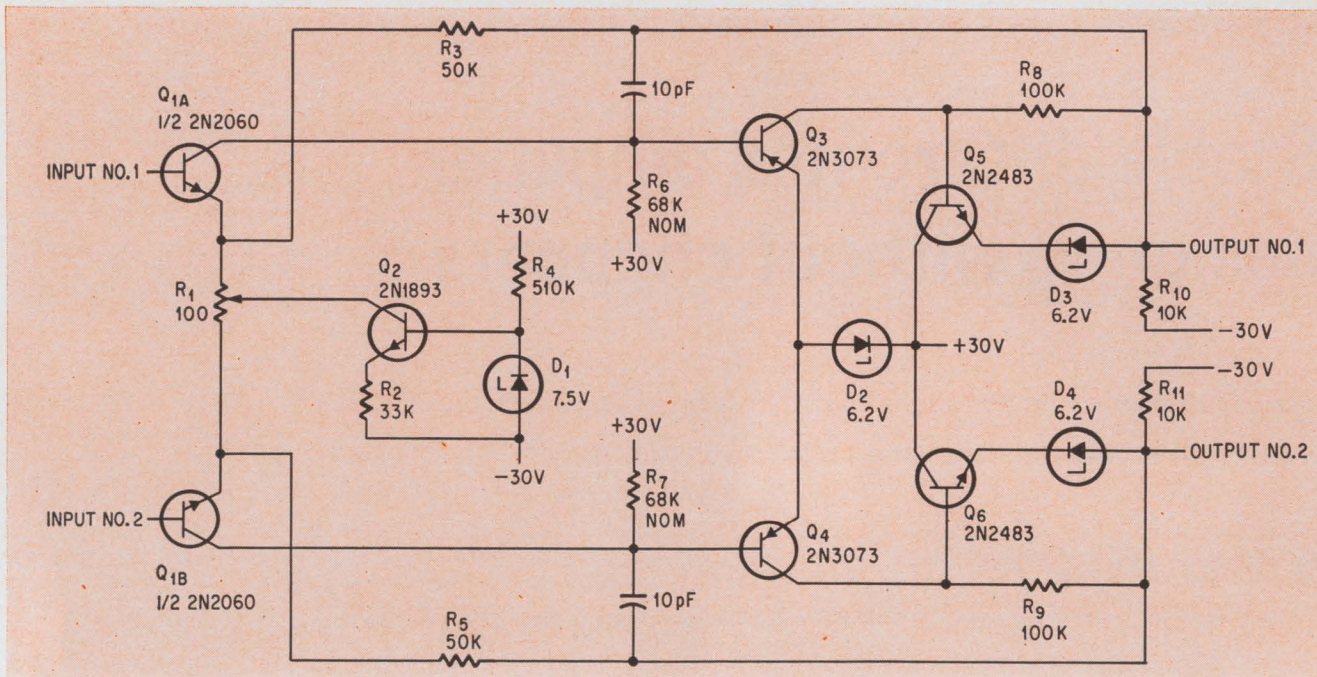

following input loop equation can then be written:

$$(V_{BE1} - V_{BE2}) + R_E(A_1 I_{C1} - A_2 I_{C2}) = 0$$

where $A_1 = m \left(1 + \frac{1}{h_{FE2}} \right)$

$$A_2 = (1 - m) \left(1 + \frac{1}{h_{FE2}} \right)$$

Using the expression previously developed for V_{BE} , the input loop equation can be rewritten as

$$\left[\frac{kT_o}{q} + (A_{o1} - A_{o2}) + R_E(A_1 I_{C1} - A_2 I_{C2}) \right] + \frac{k}{q} \left[\ln \frac{I_{C1}}{I_{C2}} + (A_{o1} - A_{o2}) \right] = 0 \quad (4)$$

Since the constant β is independent of operating levels and is very nearly equal for all transistors of a given type, then all second and higher order terms of the expansion fall out. Thus $(K/q)(A_{o1} - A_{o2})$ is the net differential temperature coefficient of base-to-emitter voltage. However, this term can also be considered to include the effect of varying drops across R_E with temperature resulting from changes of h_{FE} . The circuit balance may be made independent of temperature by choosing

$$\frac{k}{q} \left[\ln \frac{I_{C1}}{I_{C2}} + (A_{o1} - A_{o2}) \right] = 0$$

Since $\frac{k}{q} (A_{o1} - A_{o2}) = \frac{\Delta V}{\Delta T}$ as just mentioned,

then we may choose a ratio of collector currents:

$$\frac{I_{C2}}{I_{C1}} = \exp \left(\frac{q}{k} \cdot \frac{\Delta V}{\Delta T} \right) \quad (5)$$

in order to achieve the desired temperature independence.

A practical example is demonstrated with the amplifier shown above. This amplifier provides a stable voltage gain of 1,000, determined by the ratio of $(R_1 + R_3 + R_5)/R_1$. Transistor Q_2 is operated as a current source biasing the input stage. The collector currents of Q_{1A} and Q_{1B} are a function of the base currents of Q_3 and Q_4 , respectively, and the currents through R_6 and R_7 . Diode D_2 is chosen to provide a positive temperature coefficient of voltage to compensate for the emitter-to-base voltages of Q_3 and Q_4 , thus maintaining essentially a constant voltage across R_6 and R_7 . Transistors Q_5 and Q_6 operate as emitter followers to provide additional output drive capability. Diodes D_3 and D_4 are used to maintain the quiescent collector currents of Q_3 and Q_4 essentially constant with respect to temperature variations. All of the resistors that are used in this circuit are made of metal film, with a ± 50 parts per million temperature coefficient of resistance.

With the input terminals returned to ground, the amplifier differential voltage was set at zero at 19°C. The amplifier was then observed to have an output of -850 millivolts at +80°C, and +540 millivolts at -22°C. This is equivalent to -13.6 microvolts per °C referred to the input. Since the terminal labeled output No. 2 was considered the common terminal, this implies that the collector current of Q_{1A} increases more rapidly with temperature than does the collector current of Q_{1B} . Hence the temperature coefficient of V_{BE1A} is greater than that of V_{BE1B} . Since the first-order temperature coefficient may be reduced by increasing collector current, then either I_{C1A} must be increased, or I_{C1B} decreased. This change is done easily by adjusting either R_6 or R_7 , or both. Since the voltage drops across these resistors are very nearly equal, then:

$$I_{C1A} \times R_6 = I_{C1B} \times R_7 \text{ or}$$

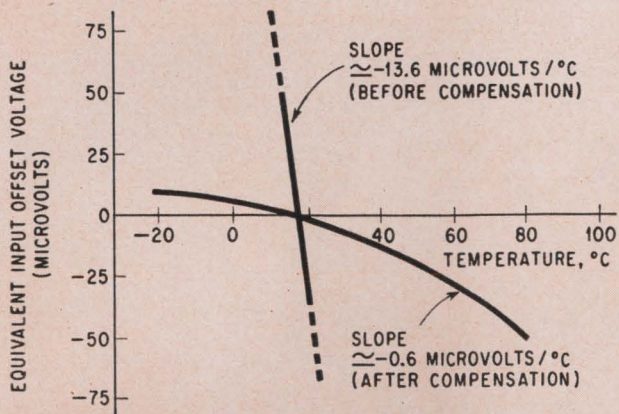

Graph shows how compensation reduces temperature's effect on the equivalent input offset voltage.

◀Differential-input feedback amplifier has closed-loop voltage gain of 1,000, which is determined by the ratio $(R_1 + R_3 + R_5) / R_1$. Adjustment of R_7 reduces circuit drift to a minimum. Amplifier is designed by the techniques discussed in this article.

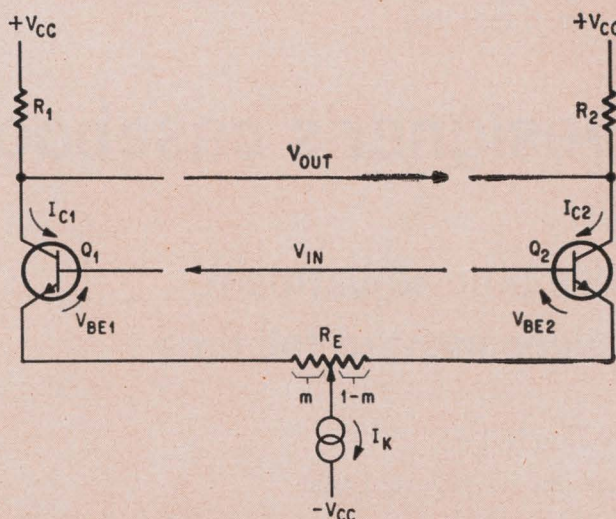

Diagram of basic differential-input, differential-output amplifier. Resistor R_E is adjusted so that V_{OUT} equals 0 when V_{IN} equals 0.

$$\frac{I_{C1A}}{I_{C1B}} = \frac{R_7}{R_6}$$

Thus, (5) may then be alternately expressed as,

$$\frac{R_7}{R_6} = \exp\left(\frac{q}{k} \cdot \frac{\Delta V}{\Delta T}\right) \quad (6)$$

where the measured $\Delta V/\Delta T$ is 1.36×10^{-5} determined by temperature cycling.

Therefore, to properly compensate the amplifier,

$$\begin{aligned} \frac{R_7}{R_6} &= \exp\left[\left(\frac{1.602 \times 10^{-19}}{1.38 \times 10^{-23}}\right) \cdot (1.36 \times 10^{-5})\right] \\ &= 1.1708. \end{aligned}$$

In accordance with the R_7/R_6 ratio just determined, it was decided to increase the value of R_7 by 11.6 kilohms (originally R_6 and R_7 were both equal to 68 kilohms). The nearest practical value of 11 kilohms was chosen. The amplifier was then re-zeroed at 19°C and observed to have outputs of -50 millivolts and $+10$ millivolts at $+80^\circ\text{C}$ and -22°C , respectively. This is equivalent to -0.6 microvolts per $^\circ\text{C}$ referred to the input. Although the drift was reduced by a factor of 22, it could have been reduced to almost zero by the addition of 600 ohms to R_7 to achieve the desired calculated value.

A plot of input-offset voltage (change of measured differential output voltage referred to input) as a function of temperature is shown above.

Temperature extremes

Although it is possible to have equal offset voltages at both temperature extremes, the nonlinearity of the curve imposes a minimum value of equivalent input drift that can be attained with the amplifier. Experience has shown that this nonlinearity arises primarily from nonideal tracking of base currents of the first two stages, and to a somewhat

lesser degree, from unequal temperature coefficients of the resistances in the stages. By proper selection of transistors with essentially linear h_{re} characteristics with respect to temperature, it is possible to reduce this nonlinearity to a magnitude of 5 to 10 microvolts for a 100°C range.

Although drift may be arbitrarily small by this compensation technique, the effort will be justified only if the stability of the amplifier is of the same order. Stability refers to the ability of the amplifier to hold a preset voltage. To determine long-term stability, 10 amplifiers using the circuit shown on page 74 were life-tested at rated supply voltages and at a temperature of $22^\circ\text{C} \pm 3^\circ\text{C}$. The output of nine units remained within a 25-millivolt envelope for 1,200 hours. The 10th unit showed a slow systematic drift of about 35 millivolts during this time, beginning to stabilize at the end of the test.

However, stability was not of the same nature when the amplifiers were immersed in a liquid bath; the output in this case remained within ± 2 millivolts for all 10 units for a 24-hour period.

Wideband noise for this circuit is approximately 5 microvolts peak-to-peak referred to the input, for source impedances less than 350 ohms. Hence, the total error voltage appearing at the output resulting from temperature, time and noise contributions is indeed comparable. Further, the magnitude of this error signal is sufficiently small so that the differential amplifier is compatible with a system with an accuracy of 0.25% to 0.5%, 5 millivolts full scale and operating over a range of 100°C .

Two important aspects that also affect the differential amplifier-voltage have not been discussed. These are Seebeck effect voltages and packaging. Nevertheless it may be concluded that the differential amplifier is capable of a level of performance comparable to state-of-the-art chopper stabilized amplifiers using the design techniques presented.

Designer's casebook

Designer's casebook is a regular feature in Electronics. Readers are invited to submit novel circuit ideas, packaging schemes, or other unusual solutions to design problems. Descriptions should be short. We'll pay \$50 for each item published.

Rise time adjustment independent of fall time

By Don N. Lee

Datapulse Inc., Inglewood, Calif.

A circuit that can generate pulses with independently adjustable linear rise and fall times can be a valuable tool in the worst-case design of pulse circuits.

A linear pulse-rise time is obtained by charging a capacitor from a constant current source. Discharging the same capacitor through a constant current sink produces linearity of the pulse falling

edge. The value of the constant currents determines the slope of the rise and fall time.

The voltage across a capacitor is given by:

$$v = \frac{Q}{C} = \frac{1}{C} \int i dt$$

When the charging current is constant this equation reduces to:

$$v = \frac{i}{C} \int dt$$

and performing the simple integration

$$v = \frac{i}{C} t.$$

The resulting equation shows that the voltage rise across the capacitor is a linear function of time when the charging current is constant.

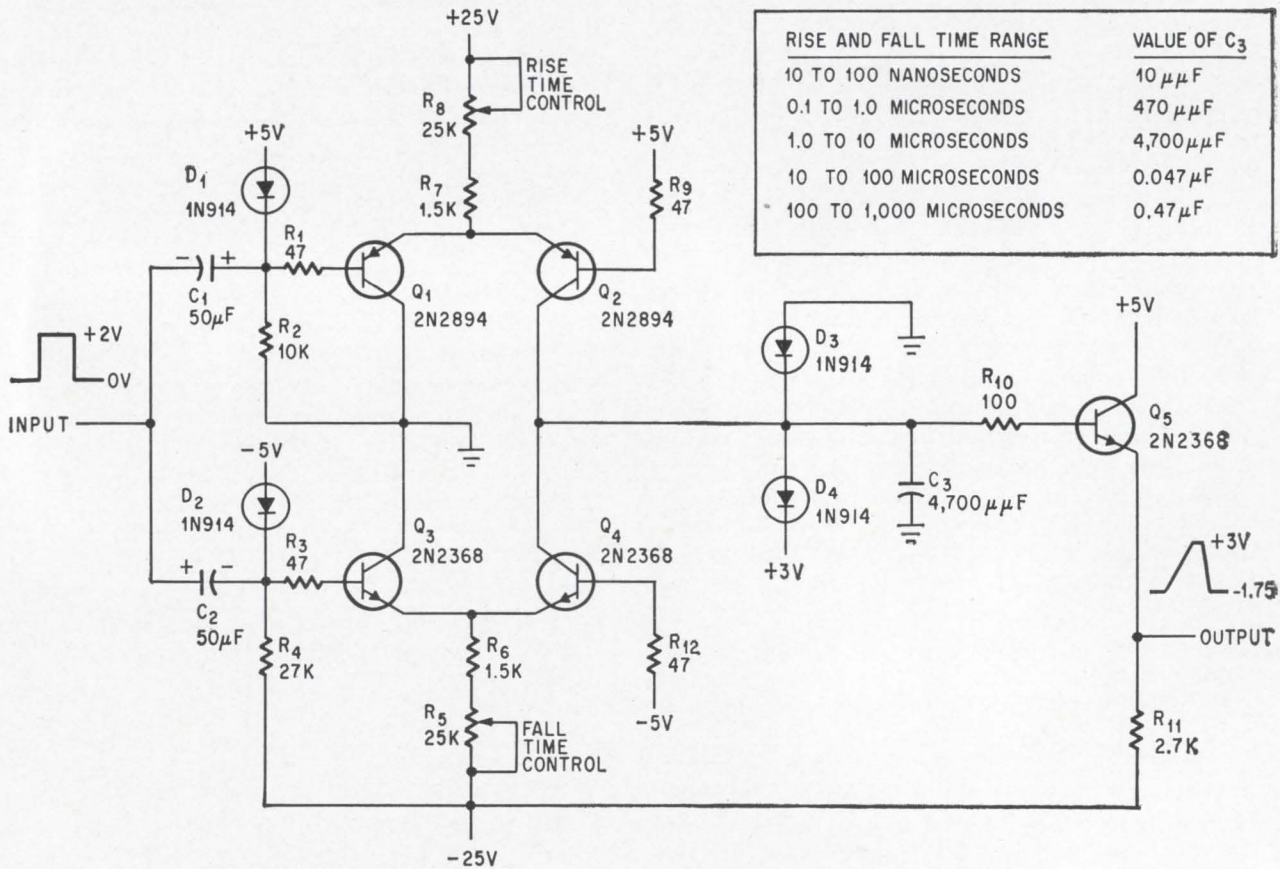

Rise time is determined by the value of the collector current of Q₂, fall time by Q₁ collector current. The value of capacitor C₃ controls range of rise and fall times as indicated in the table.

A simple constant current source is shown in the circuit diagram at right. The emitter current i_e is given by

$$i_e = \frac{V_1 - V_{be}}{R_1}$$

where V_{be} = forward base-to-emitter voltage drop of Q_1 .

From the fundamental relationship between transistor collector and emitter current

$$i_c = \alpha i_e, \text{ then}$$

$$i_c = \frac{\alpha(V_1 - V_{be})}{R_1}$$

where α the Q_1 common base current gain ≈ 1 .

Since V_{be} is generally negligible compared to V_1 the equation above reduces to

$$i_c = \frac{V_1}{R_1}$$

The collector current is constant and independent of both the collector load and the collector voltage. A constant current source and a constant current sink of this type are required to alternately charge and discharge a capacitor. The result is a pulse having linear and independently adjustable rise and fall times.

In the circuit diagram at left, transistors Q_1 and Q_2 (pnp types) form the constant current source that charges capacitor C_3 . Each transistor shares a common emitter resistor. Transistors Q_3 and Q_4 (nnp types) form the constant current sink that discharges C_3 .

In the current source consisting of Q_1 and Q_2 , the base of Q_1 is biased more negatively than the base of Q_2 by the forward voltage drop across D_1 . This causes Q_1 to conduct and Q_2 to be cut off. In the current sink consisting of Q_3 and Q_4 , the forward voltage drop across D_2 causes the base of Q_3 to be more negatively biased than the base of Q_4 . Transistor Q_3 is cut off and Q_4 conducts. The collector voltage of Q_4 is clamped to ground by D_3 which prevents Q_4 from going into saturation.

The voltage at the collector of Q_4 is equal to the forward voltage drop of D_3 and is approximately -0.75 volts. This voltage is coupled to the Q_5 emitter-follower. The voltage across R_{10} and the base-to-emitter junction of Q_5 establishes the output voltage at approximately -1.75 volts with respect to ground.

The circuit operation is initiated by $+2$ volt input pulse. This pulse is applied simultaneously to the bases of Q_1 and Q_3 causing Q_1 to be cut off and Q_3 to conduct. As Q_1 turns off, Q_2 turns on, and as Q_3 turns on, Q_4 turns off.

The voltage rise across C_3 is linear because the charging current supplied by the Q_2 collector is constant. This collector current depends, essentially, on the voltage at the base of Q_2 and the

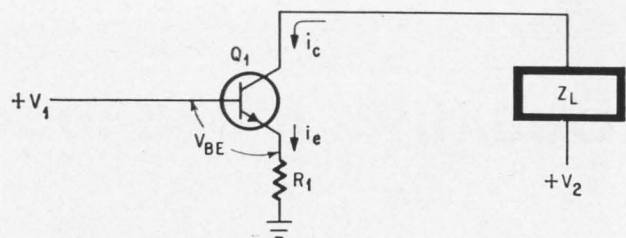

Collector current is independent of Z_L and V_2 in the constant current source.

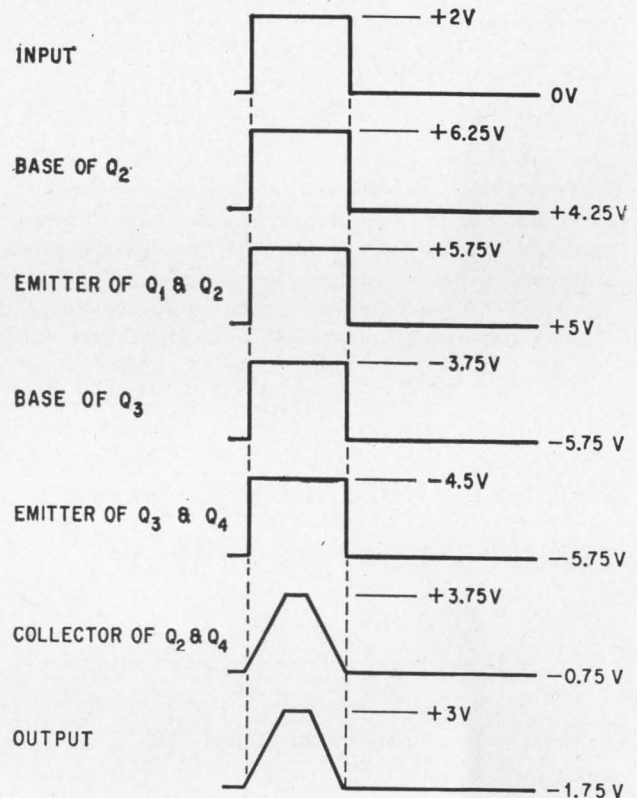

Voltage waveshapes describe operation of circuit with independently adjustable linear rise and fall time.

resistance in its emitter circuit. It is independent of both the collector load and the collector voltage.

When the voltage across C_3 rises to $+3$ volts, it is clamped at that voltage by D_4 . The capacitor voltage is coupled through R_{10} and the Q_5 emitter follower to the output. The output voltage at this time is approximately $+3$ volts.

When the positive input voltage is terminated, Q_2 and Q_3 turn off and Q_1 and Q_4 begin to conduct. The linear discharge of C_3 is now controlled by the collector current of Q_4 which effectively acts as a constant current sink. When the voltage across C_3 discharges to ground potential, diode D_3 clamps C_3 at this potential and the circuit returns to its original state.

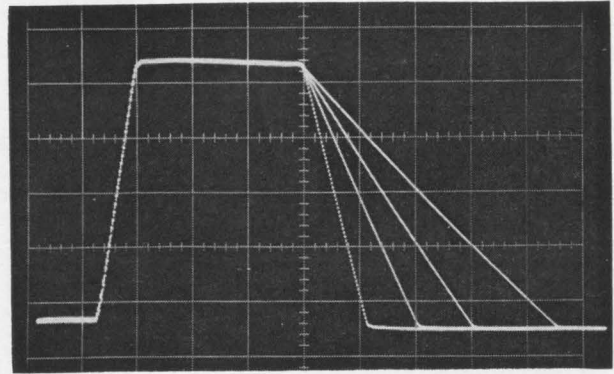
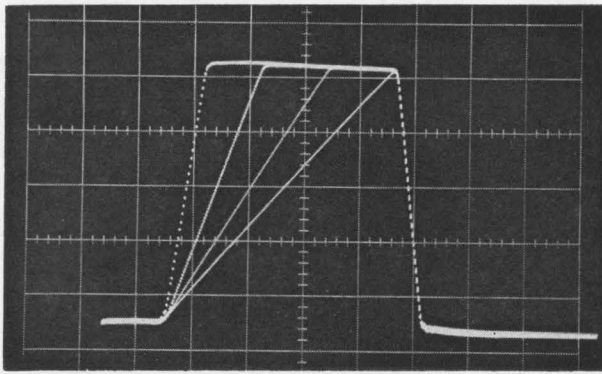

Variable rise time and constant fall time obtained from circuit is shown above, left, in multiple exposure photograph. Constant rise time and variable fall time obtained from same circuit is in photo above, right. Vertical scale is one volt per centimeter. Horizontal scale is 50 nanoseconds per centimeter. Photos taken on Tektronix 661 sampling scope.

the collector currents of Q_2 and Q_4 are independent of each other, the rise and fall times are also independent. For the component values shown, the rise and fall times can be adjusted from less than one microsecond to more than 10 microseconds. If it is desirable to vary continuously the rise and fall times over a range of greater than 10 to 1, the val-

ues of R_6 and R_8 should be increased.

The voltage waveforms pertinent to the circuit operations are shown on the preceding page.

Typical photographs of output waveforms obtained with this circuit are shown above. These are multiple exposures showing the pulse output having independently variable rise and fall times.

Adding a component reduces recovery time

By L.C. Radzik and J.J. Curtis

International Business Machines Corp., Endicott, N.Y.

Because speed, performance and size were most important, a delay circuit in a computer had to be redesigned to reduce its recovery time with a minimum of added components. The addition of only a single component reduced the recovery time 75%.

The original circuit was the same as shown below except that capacitor C_1 had a value of 500 picofarads and capacitor C_2 was not used. The recovery time was reduced from 2 to 0.5 microseconds by changing the value of C_1 and inserting C_2 in the circuit.

Before the modification, a positive voltage input to the base of Q_1 turned it on. The falling Q_1 collector voltage coupled a negative voltage to the junction of diodes D_1 and D_2 , which was approximately equal to the voltage change at the collector. Diodes D_1 and D_2 were reverse-biased by this negative voltage until C_1 was able to discharge through R_3 . When this happened, Q_2 con-

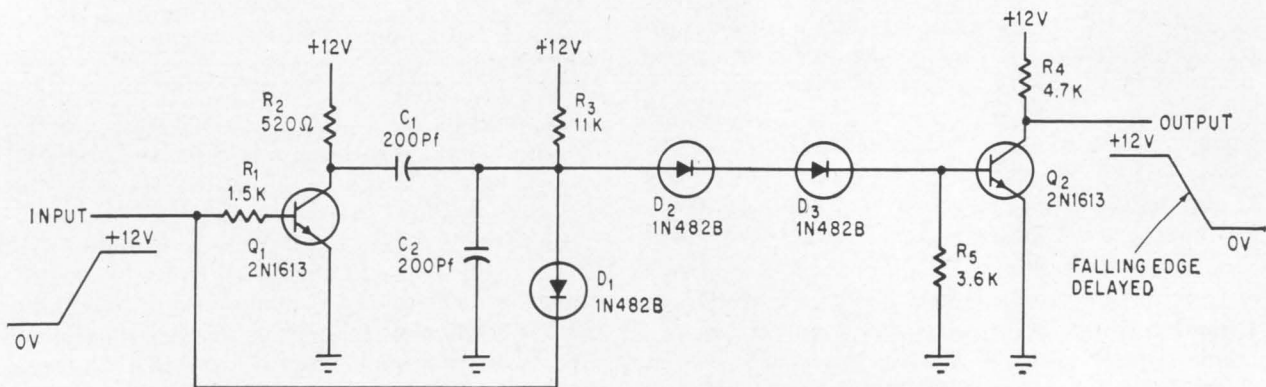

Capacitor C_1 was reduced from 500 to 200 picofarads and C_2 was added. The result was a reduction in recovery time to 0.5 μ sec from 2 μ sec with the same 2-microsecond delay time.

ducted. This delayed the voltage rise at the input. The component values shown in the diagram produced a delay time of two microseconds. When the input signal fell, both Q_1 and Q_2 turned off.

For the circuit always to provide the same delay, C_1 must recharge to +12 volts. The time necessary for C_1 to recharge is the circuit-recovery time. The charge path of C_1 (through R_2 and D_1) produces a recovery time that is approximately equal to the delay time (two microseconds).

The modified circuit operates similarly. However, the voltage coupled to the junction of diodes D_1

and D_2 is approximately equal to $\frac{C_1(\Delta V_{C1})}{C_1 + C_2}$, where

ΔV_{C1} is the change in the collector voltage of Q_1 . The negative voltage swing is less than that in the original circuit, and the time constant for the delay is $(C_1 + C_2) R_3$ instead of $C_1 R_3$.

The recovery time is still determined by the values of C_1 , R_2 and D_1 , and can be reduced by minimizing the values of C_1 and R_2 . The required delay time can then be achieved by adjusting the value of C_2 .

Silicon controlled switch can generate pulses

By H. H. Wieder

Naval Ordnance Laboratory, Corona, Calif.

A versatile and inexpensive pulse generator can be built with a pnpn silicon controlled switch.

In the circuit shown at right, a relaxation oscillator comprises the scs type 3N86, series resistors R_3 and R_4 , and capacitor C . The oscillator output frequency can be adjusted by the variable resistor R_4 or by the value of the fixed capacitor C . A delay line is connected to anode A of the scs. A negative step function is impressed on the delay line when the scs conducts. The duration of the negative pulse generated across R_5 (output) is twice the electrical length of the delay line. The peak amplitude of the pulse is about half the value of the d-c potential applied to anode A, and is also a function of the voltage at the anode gate G_A .

The pulse generator is free-running when the cathode gate G_C is open-circuited. The pulse-repetition rate is controlled by the frequency of relaxation and can be adjusted from 1 to 500 pulses per second by the variable resistor R_4 ; the pulse duration and amplitude are independent of the repetition rate. The pulse generator can be operated in the gated mode by the application of a negative pulse of arbitrary duration to G_C . For the circuit component values shown, the required cathode gate pulse amplitude is -1.5 v and the gate current is $50\mu A$.

For 500 pulses per second repetition rate with 20-v peak and 5 μsec duration, an HH-4000 delay line ($Z_o = 4,000$ ohms) was used with $R_5 = 3,900$ ohms. Source currents drawn by the circuit are:

Circuit current	Free-running	Gated
anode current	460 μa	70 μa
anode gate current	18 μa	-43.5* μa
cathode gate current	0	50 μa

*current flows between anode and anode gate.

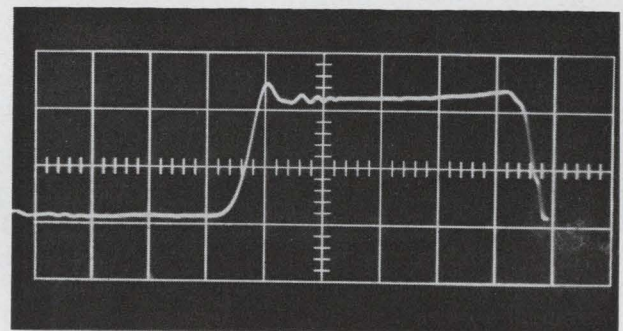

Pulse output across $R_5 = 3.9$ kilohms, pulse duration of 5 μsec , 500 pps, 20 v amplitude with HH-400 delay line. Horizontal scale is one microsecond per division.

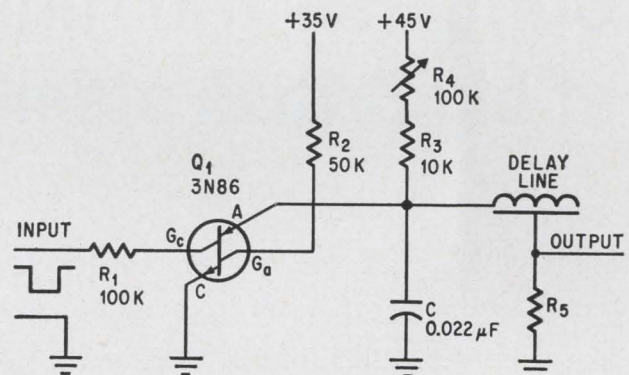

Generator can be operated in the gated mode by applying negative pulses at the cathode or can be free-running when this gate is open-circuited. The value of resistor R_5 must match the impedance of the delay line selected.

Higher pulse amplitudes are obtainable with an scs such as the 3N82 which has a breakover voltage of 100 v. The maximum pulse repetition rate is determined by the total current through the pnpn junction, which must be less than the holding current (2.0 to 5.0 ma). The holding current is the average value of the cathode pulse current that maintains the scs in conduction.

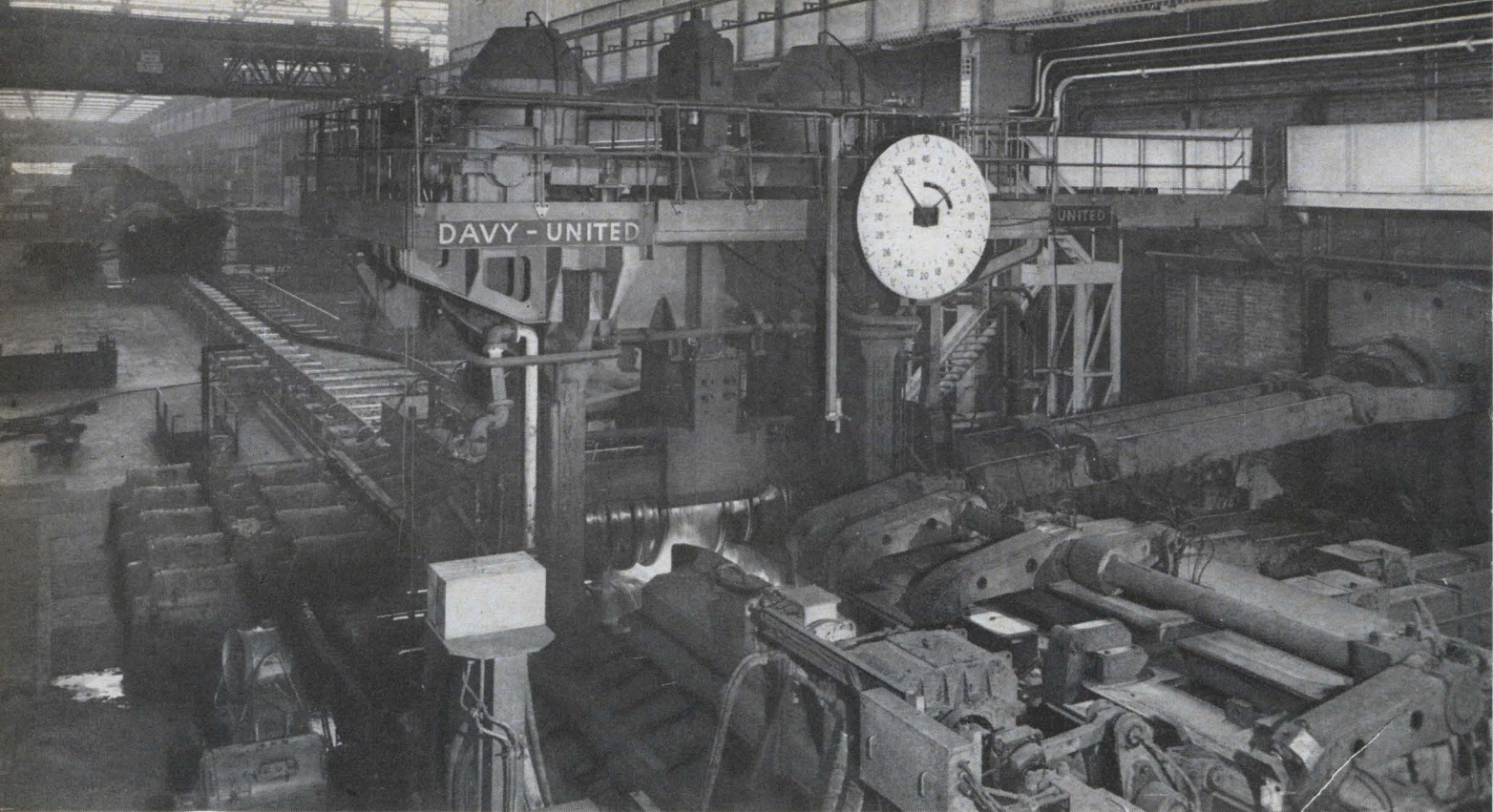

In the steel mill, oxygen is used to clean blooms (foreground) that are rolled according to computer-generated instructions. These long rods are then cut in the bloom shear (left center).

Industrial electronics

Computer trio runs the works at big British steel mill

Multimillion-dollar steel mill takes orders from 3 boss computers that will do everything from filing to filling orders for 800,000 tons of steel

By J. Tudor Jones

English Electric Co., Stafford, England

A British steel mill is being run by a computer chain-of-command. A blue-collar unit takes orders from a white-collar unit that, in turn, is answerable to an executive machine that's likely to flip its logic circuits if anything goes wrong at a lower echelon.

Such an integrated setup, using three English Electric-Leo KDN2 computers, is now operating at

the Rotherham works of the Park Gate Iron & Steel Co., a subsidiary of Tube Investments, Ltd.

The executive machine handles accounting and over-all production scheduling, the white-collar computer coordinates the operations of the various mills and the blue-collar unit is used for on-line, real-time process control.

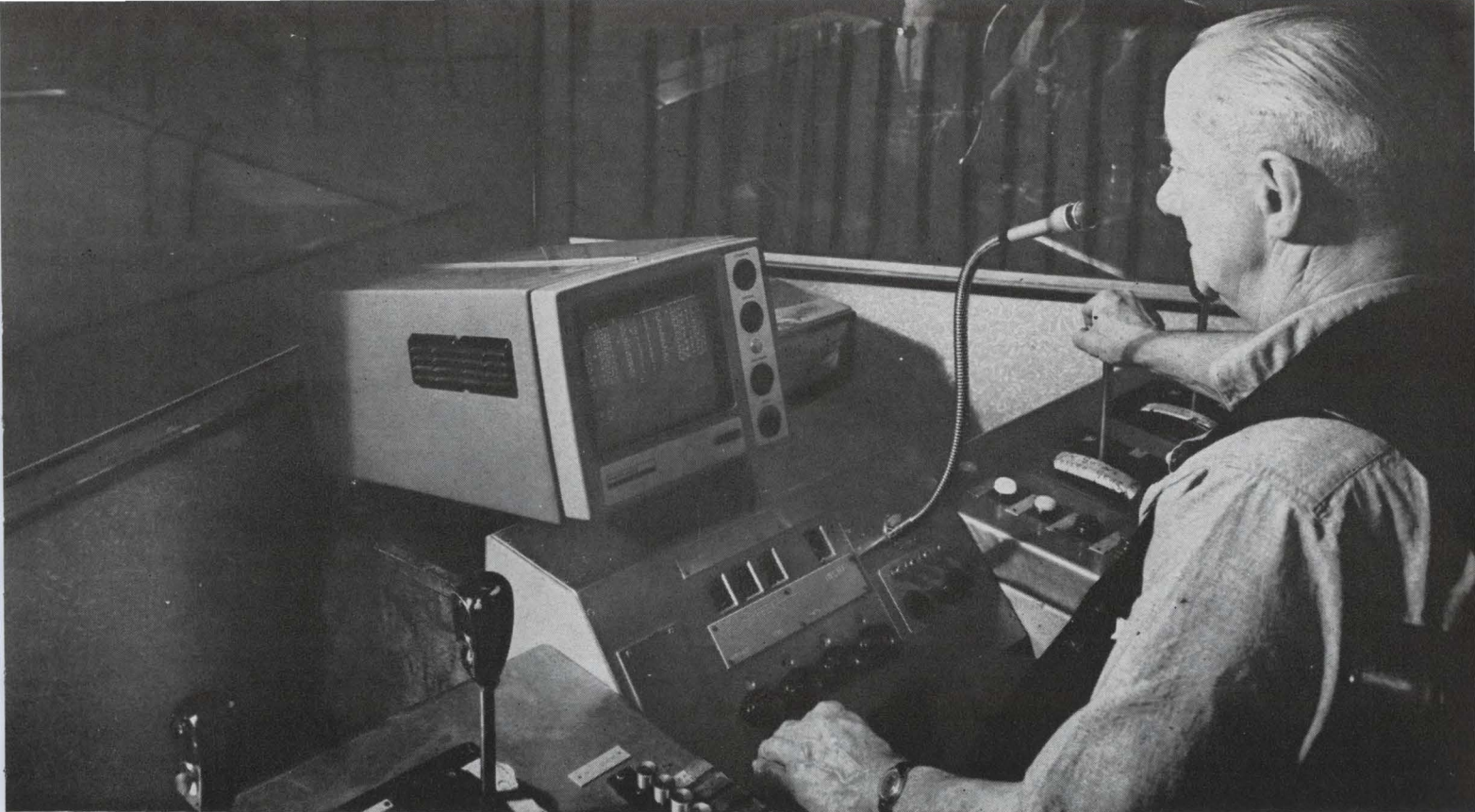

Operator controls cutting of blooms after reading computer-generated instructions on the face of the cathode-ray tube display.

Automated artisans

Until recently, steelmaking was considered the province of artisans whose techniques changed over the years. The planning and organization of production in a steelworks relied on man's skill to get acceptable, though far from ideal, standards of production.

The steel industry got its first computers in the late 1950's for off-line production control. They increased the plants' efficiency. The first on-line computers were used early in the 1960's for both real-time process and cutting control.

On-line production control made it possible to link a planning computer to a process computer for steelmaking. Computers took over starting with the incoming order, through the mill, to final shipment and billing.

Computer team for efficiency

When the Park Gate Iron & Steel Co. spent a total of \$88 million to expand its facilities it wanted the best in automation. After prolonged study it decided that an integrated three-level system of computer control, in the areas indicated in color on the following page, was worth the money.

The planning computer controls all off-line production for the steelmaking departments, the primary mill and the finishing mills.

The primary mill forms a single path through which all material must pass so Park Gate needed fast reliable communications in that area. A computer for production coordination directs primary mill operations.

In the bloom mill, an automatic programmer, not a true computer, automatically controls the rolling operations. It is linked into the production coordination system.

Because the third computer directs the flying shear, it has increased the process yield. It also helps to identify products.

Seeing the big picture

Steel production is complicated. A wide variety of steels, rolled into many different shapes and sizes, can be ordered in small quantities. For economic production and efficient use of the steel-making furnaces, individual orders are grouped, if possible, into 70- to 100-ton quantities of similar specification. These quantities are produced in a sequence that minimizes changes of the rolling profile in the finishing mills. Delivery dates are more easily met.

But the steel produced does not always meet the Park Gate's specification. This means the form of control used must be flexible. It has to allow for reallocation of out-of-specification steel and for variable yields from successive processes without seriously jeopardizing over-all plant scheduling.

The fast data-handling abilities of a computer meet these requirements. The computer "sees" the entire steelworks in perspective and quickly solves problems.

Production scheduling is based on a review of outstanding orders, stocks, work in progress and so on. In the past, many clerks had to search for the data in a massive filing system. Now, serial processing of presorted data on magnetic tape is the

From iron ore

PRODUCTION



PRODUCTION

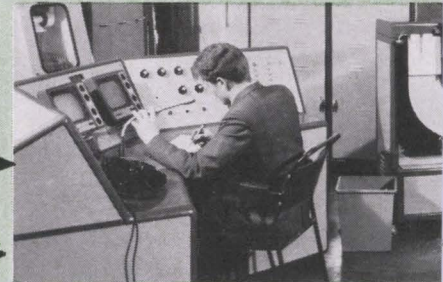

WORK SCHEDULES

BLOOM MILL PROGRAM

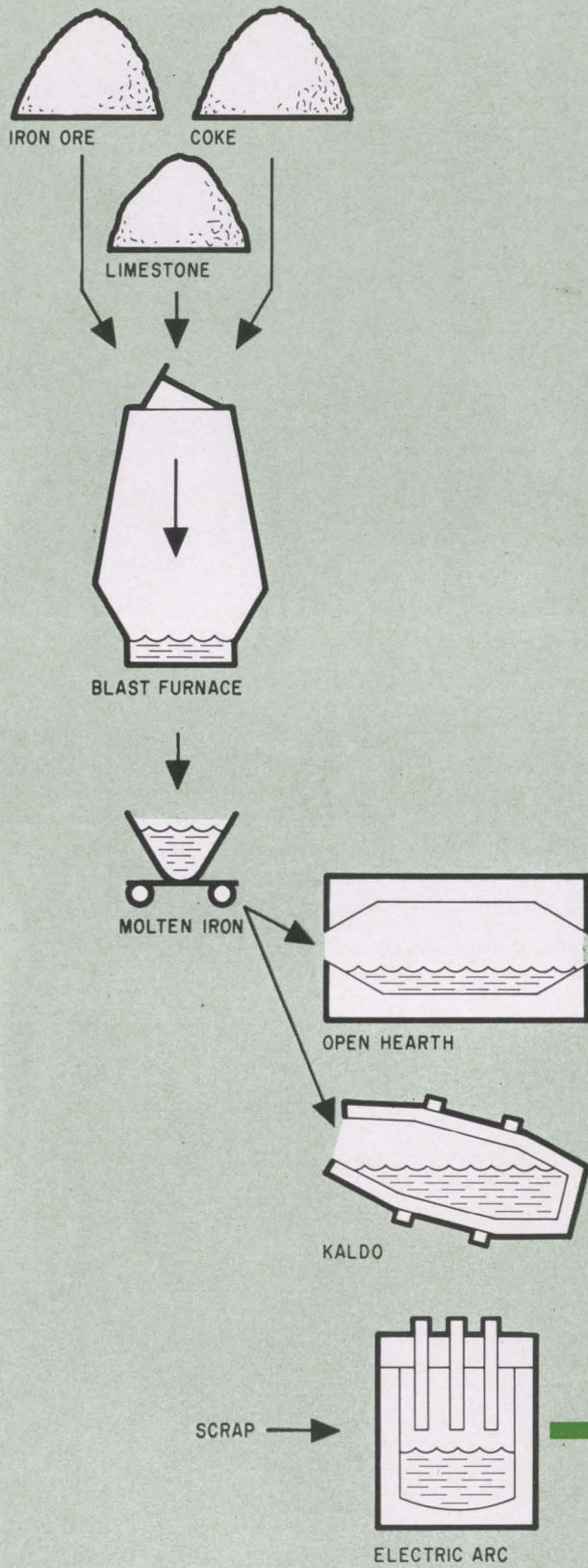
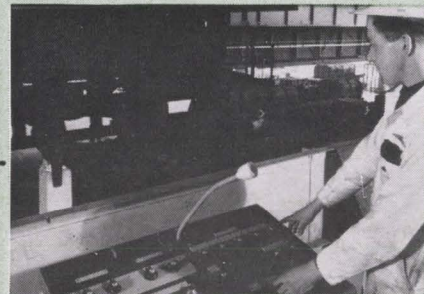
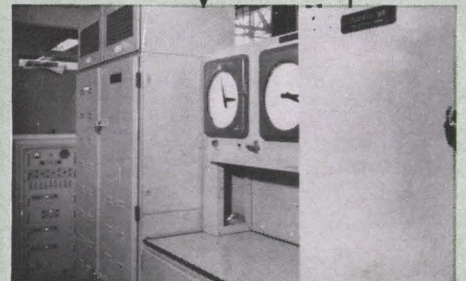

to finished steel

PLANNING

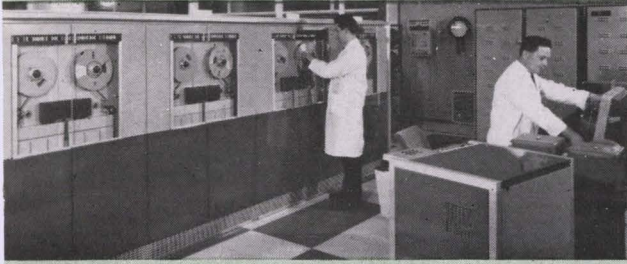

BILLING &
REPORTS

COORDINATION

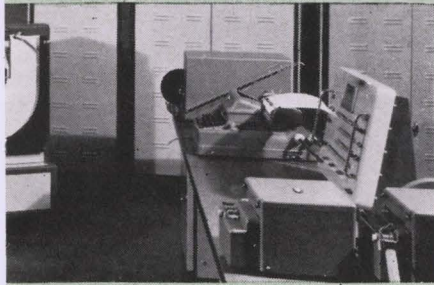

PRODUCTION
REPORTS

FINISHING MILLS

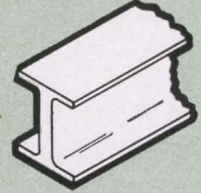

BEAM

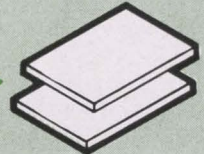

PLATE

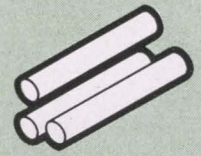

ROD

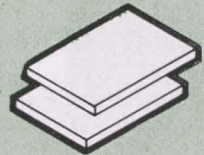

TIN PLATE

BILLET
SHEAR
COMPUTER

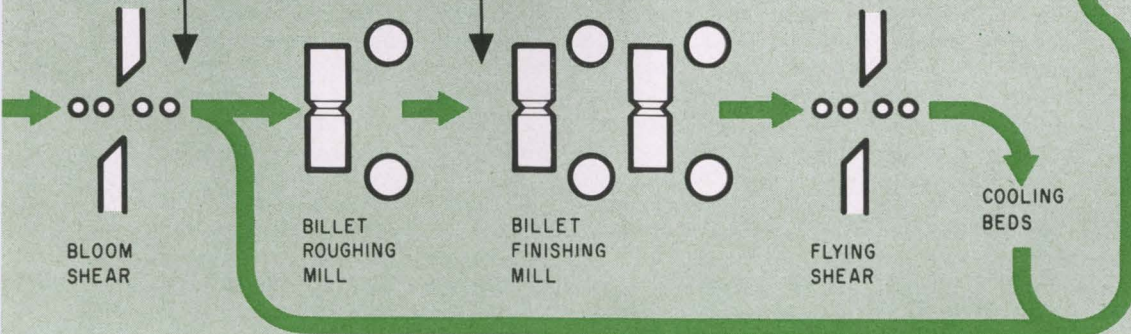
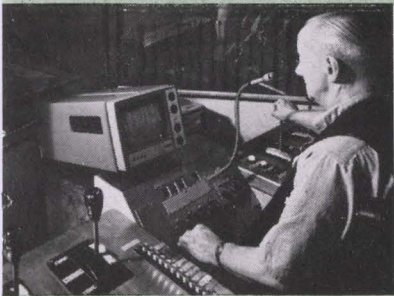

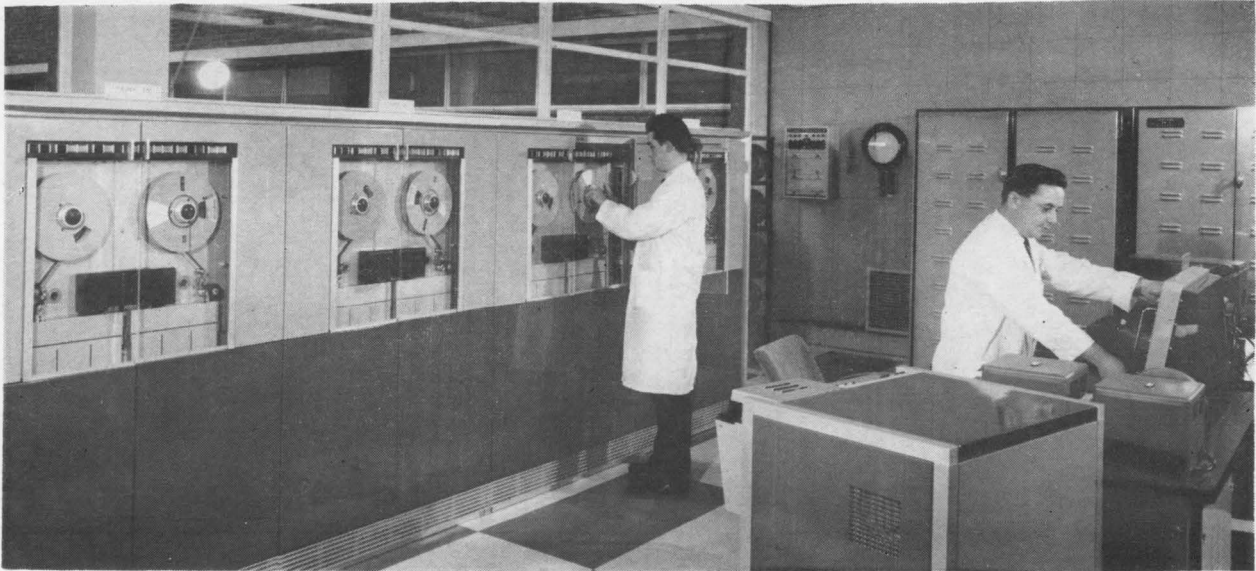

Executive computer, above, handles over-all production scheduling and other management functions such as making up reports.

filing system that is the basis for production scheduling at Park Gate.

Incoming orders are cleared of extraneous material by the sales department and then punched into paper tape. The data goes into the computer; there it is sorted into a standard sequence that merges with existing files. The sorted orders are combined into cast quantities for the various steel-making processes. Rolling schedules for the different mills are also printed out.

After the steel has been made and analyzed, the analysis is checked against the original orders by an experienced employee. Where necessary, casts

are reassigned to orders for which they are more suitable and another attempt is made to meet the original specification. The allocation information is fed back to the computer every two to four hours through punched paper tape to update all relevant files. The allocation data is also used to make Pit tapes. These identify the ingots and indicate how each, stored in the reheating furnaces, is to be treated.

Executive system

The executive system is seen above on the right. Incoming orders and other prepared documents are

From iron ore to finished steel

Steel's basic raw material is iron ore, generally an iron oxide mixed with varying amounts of impurities. The ore is usually transported from open-pit mines to the steelworks. Here it is dumped, along with coke and limestone, into tall blast furnaces where it is reduced to basic iron. The diagram on the preceding pages shows the step-by-step process that turns raw materials into finished steel products. The mixture goes down the furnace stack and molten iron is tapped from the base of the furnace.

This molten iron usually contains about 4% carbon and perhaps up to 1% phosphorous, silicon and sulphur; a composition too brittle for most uses. The ore must be refined further in a steelmaking process.

For usable steel, impurities in molten iron are reduced to specified percentages. For special steels, alloying elements are added as well.

Large ladles of molten ore go to the steelmaking shop. There the liquid ore is purified by oxidizing in either open hearth or Kaldo (lancing the molten metal with oxygen) steel-making processes. Scrap steel, from various rolling processes, is melted in an electric arc furnace. The steel produced by each of these processes is brought to a specified composition and temperature, then the furnaces are tapped and the molten steel dumped into huge ingot molds where casts, weighing about five tons each, are made.

The molds are transferred to the primary rolling mill where they are

reheated in furnaces known as soaking pits. Then the ingots are passed back and forth, about 17 times, through a rolling mill. Square steel rods, called "blooms" or rectangular-shaped "slabs" are produced.

The blooms or slabs are then passed through a de-surfacer where defects are burned off with oxygen. Next, a bloom shear cuts off below-par material at the ends (the nose and tail). Blooms that will not be turned into billets, smaller rods, are cut to the required length. However, most of the steel continues to the billet mill.

The billets are cut to specified lengths by a flying shear, then sent to one of three cooling beds. This is the last stop in the primary mill.

After inspection and surface treatment the billets are transferred to finishing mills and turned into plates, rods, bars or beams.



Girls punch incoming orders into tapes that are then taken next door and read into the executive computer using tape reader, right foreground, in photo at left.

transcribed onto punched paper tape in the data-preparation room, a section of which is shown in the photograph on this page. An original tape is punched for each document. The tape and the document are sent to an automatic keyboard verifier. There a second operator produces a master tape. If the character punched on the original tape is verified when the second operator depresses a key, a new character is punched on the master tape. If the character is not verified, the punching of the master tape is stopped. This allows the point of error to be identified and corrected.

The off-line executive computer is an English

Electric-Leo Computers Ltd. KDN2 connected to four KDF6 magnetic tape stations. Each station has a 40,000 characters-per-second transfer rate with forward writing and forward-and-reverse reading ability. A full tape holds over 9 million bits. Data is protected by using a 16-track tape that allows double recording and reading of each character and parity checking.

The computer's core memory holds 24,576 words. The mean instruction time is 175 micro-seconds. Data input comes from parity-checked eight-channel punched paper tape read by a 1,000-character-per-second photoelectric reader.

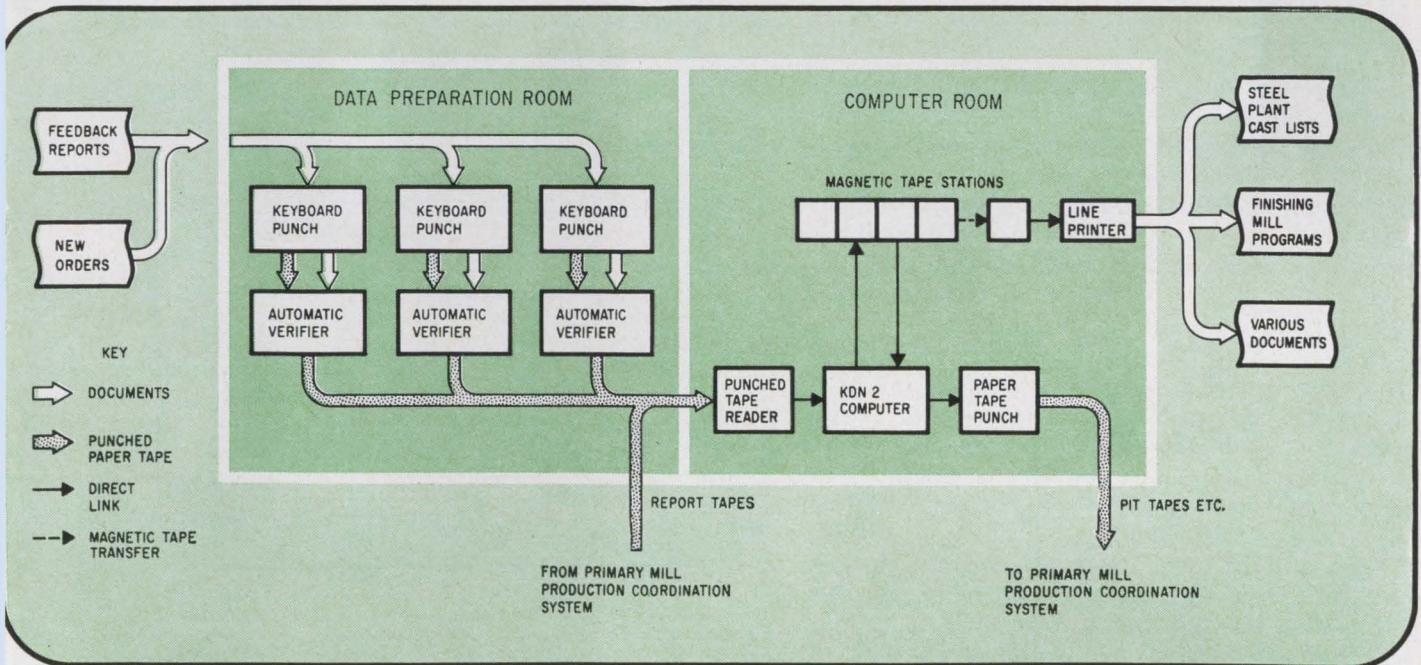

New steel orders and data from mill are combined in executive computer at production planning center and turned into reports, schedules and invoices.

Data output to the on-line white collar computer is either by eight-channel punched paper tape, produced on a 110 character per second punch, or by printed cards or schedules. For this printed data an English Electric-Leo 1040 line-printer, not directly connected to the computer, is used. It prints from magnetic tape at a speed of 1,000 lines per minute.

White-collar machine

The second KDN2 computer links the planning system and the process controls, diagram below, right. It also interconnects mill operators and the automatic mill controls with the man who supervises work in the primary mill, the production controller.

This production coordination system performs all routine duties in the primary mill area. It sends instructions to individual operators and to the automatic controls, and collects feedback data. This white collar system tells the production controller (man, not machine), when there's trouble, and provides a means of implementing his decisions.

At the primary mill, operations start when a pit tape comes from the planning computer. The tape is fed into the coordination computer by the production controller when the ingots in a reheating furnace are ready to be withdrawn.

As each ingot is taken from the reheating furnace an operator, called a heater, signals this information to the white collar computer by using switches on one of seven data-input desks. A photograph of a desk is on the next page. The computer matches the ingot's identity with the pit tape identification. The computer also sends the ingot number and processing requirements to individual mill-operator displays, in "pulpits," located along the rolling line.

Electronic writing

The pulpit operator reads this information in tabular form on the face of a cathode-ray tube. The electronic writing system, supplied by Marconi Ltd., reduces paper work in the primary mill area to a minimum. There are two tabular formats: one for the four displays in the bloom mill, the other for four displays in the billet mill. Both formats are duplicated on the production controller's console shown above.

A display lists rolling instructions and identifies the ingot at each processing station by means of an arrow. This arrow moves up one line on the display as each operation is completed. A completion signal is fed back to the coordination computer. The computer follows the progress of each ingot through the mill.

Whenever an ingot is taken from the reheating furnace, or passed from bloom to billet mill, this information is added at the bottom of the appropriate display. When an ingot leaves the bloom mill or billet mill area, its data line is removed from the top of the screen; all lower lines move up

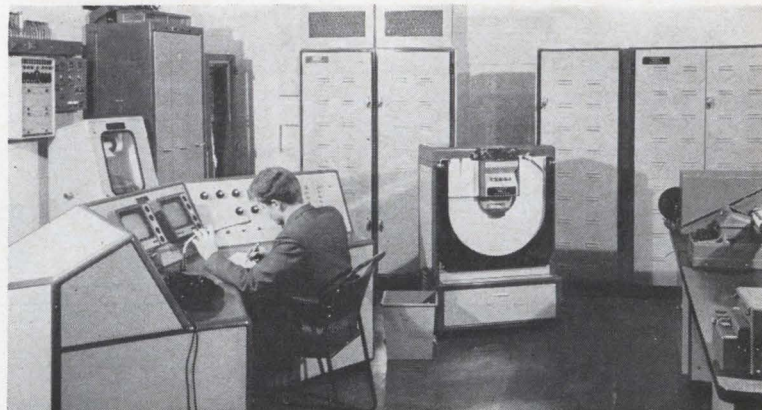

Control of the steelworking process is the prime job of the white-collar computer (right) shown here in the production coordinating center.

one line in position.

The display can include special instructions, or queries from the computer based on unexpected feedback data from operators. The correct time is always shown on the display.

The tabular display system is controlled by the production coordination computer. This machine also sends data and instructions to the billet-shearing computer and to the bloom mill automatic programmer.

Feedback of data may be either automatic or manual. For example, bloom-weight feedback is automatic but data on the length of bloom after it is cut must come from an operator who uses keys, pushbuttons or rotary switches to signal the computer.

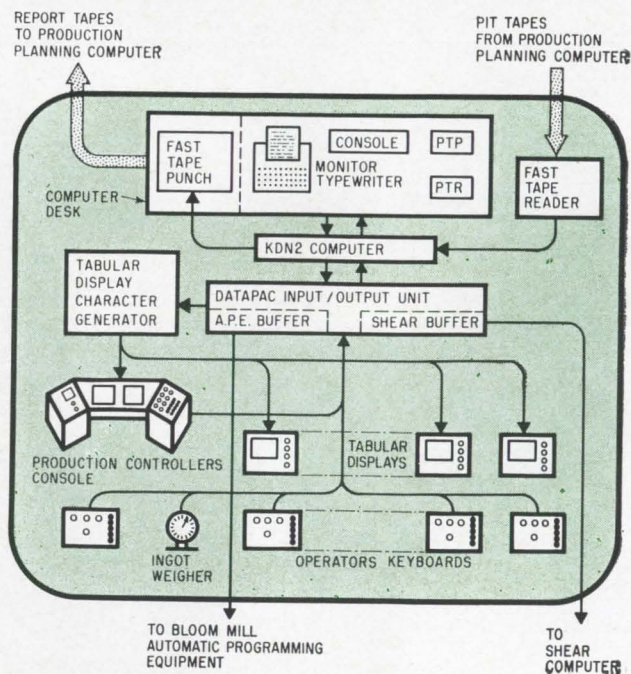

White-collar computer generates voltages that write messages on the operator displays located in the mill area.

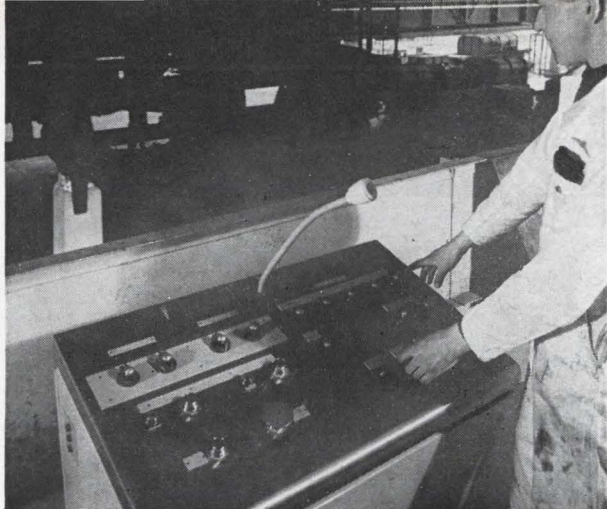

Reheat-furnace operator signals coordination computer that ingots are leaving furnace on way to rolling mill.

Generating a number

Information to be displayed is transferred from the computer to the display's ferrite core memory. The memory, holding 4,096 six-bit characters, is scanned every 20 microseconds and a character is read out to a decoding matrix. Here the six-bit coded signal is converted to an instruction pulse on an output line.

The letter-number generator receives this instruction and develops the necessary X and Y analog waveforms to deflect the spot on the cathode-ray tube to write the chosen character.

The appropriate character is produced when the X and Y signals form each character as a series of straight lines, each lasting one microsecond. For each character, the electron beam is clamped to the center. The first two movements of the beam are blanked out as the beam moves to the point on the tube where the letter will start. The blanking signal is removed for 16 microseconds as the beam draws the required character. It retraces its path if less than 16 straight lines are needed.

The display units use an 8.5 inch rectangular screen. This screen size allows characters that are easily viewed under both pulpit and production-control-center lights. The cathode-ray tubes have a medium persistence phosphor that eliminates objectionable flicker as each character is generated 12 times per second.

In the pulpit

In each of the control pulpits, special data-input keys and switches are directly linked to the coordination computer through the input/output equipment. The bloom-shear operator in his pulpit is shown on page 81. He receives his cutting instructions from a tabular display unit.

The operator positions the bloom for cutting by manually controlling the roller table drives. As he makes each cut he sets the length on the rotary switches in front of him, sets the "cut complete" key in the keystrip near his left hand and presses the "data input" pushbutton.

During its scanning cycle, the computer notes that data is to be collected from the bloom shear cubicle and interrogates the message keys and cut-length switches. The computer accepts this information and automatically releases the latched-in message key and updates the tabular display.

Central control

While the computer handles routine situations, anything unexpected is referred by the computer to the production controller for decision. The production controller's console allows him to directly address the computer and, through it, the display system. This is done with message input keys and data input switches.

To supplement this link, the production controller also has direct audio communications with all control pulpits and other key points. The microphone, speaker and channel-selecting switches of the main audio communication system as well as a works telephone are provided on the console. The communications system was supplied by Marconi International Marine Ltd.

A continuous production log and record of all messages to and from the computer is maintained on a monitor typewriter.

The production coordination system is also linked to bloom-mill programmer and the shearing computer. The KDN2 merely sends the next rolling program number to a buffer unit; the number is accepted by the programmer when needed. A single bit code is fed back to the computer to call the next rolling program number while one program is still in progress.

Two-way information transfer is provided between the coordination and shearing computers. For this, two 18-bit buffer registers are used, one for each transfer direction. A special marker is set when either computer wishes to communicate with the other.

Automatic bloom-mill programmer

Ingots are reduced to blooms when they are passed back and forth through the bloom mill. The distance between the rollers is lessened for each pass and the manipulators that guide the work-piece are repositioned as the steel thickness is reduced.

The speed of the mill and specific roller tables is adjusted as the reduction takes place. The succession of different settings of roll separation, manipulator position and mill and table speeds is the rolling program. Since blooms and slabs will undergo more rolling and changes in size further down the line, less than a hundred rolling programs are needed in the bloom mill.

A pass is 24 bits

The programmer has a ferrite-core memory that uses 24 bits to define each pass setting of roll separation, manipulator position, drive speeds and has a capacity for 100 programs, each of 21 passes. The selected program and the pass in progress are

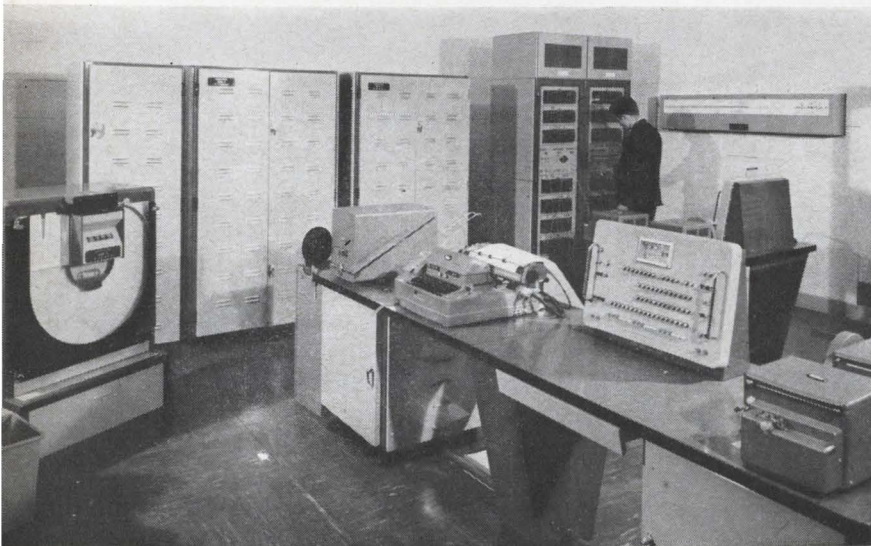

Production controller adjusts the billet-cutting computer during system checkout.

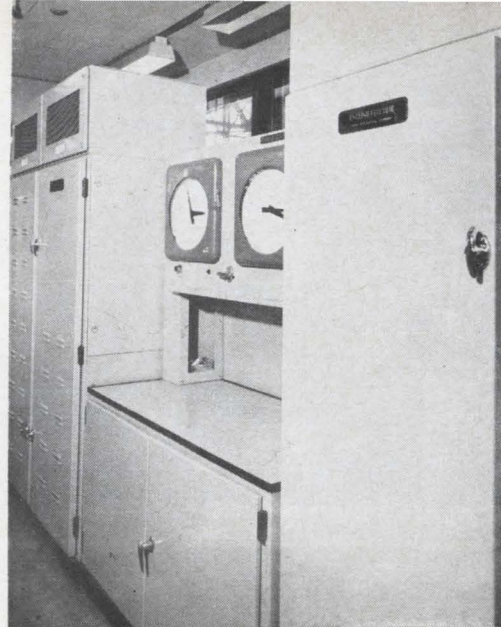

Bloom-mill programmer is housed in kitchen-like cabinets in room near the rolling line.

defined by planes in the core memory. The intersection of these planes gives the 24-bit setting for that pass.

The rolling programs may be set into the memory either on a pass-by-pass basis, using a special keyboard built into the programmer, or for high-speed mill operation, may be punched into paper tape and read into the Bloom-mill programmer by means of a tape reader.

Incorrect pass-setting information could cause accidents in the mill area, so special precautions are taken. All information is parity checked. The programmer unit has a double read/write cycle so that the pass setting is only transmitted to the bloom-rolling equipment when two successive readings coincide.

The bloom-mill operator can, if necessary, select the required rolling program. Once he makes his selection, the complete rolling sequence takes place automatically. Successive operations are directed by feedback information from infrared-sensitive photocells and mill load-cells. The bloom-mill operator monitors the operation. He can take over from the automatic programmer in case of an emergency.

Tilting or rotating the workpiece 90° is necessary several times during each rolling program but because of the difficulty isn't performed automatically. This rotation is handled by the operator when an indicator, controlled by the automatic programmer, lights up.

Blue-collar system

The billet-shearing system, using the third KDN 2 (photo above, left), maintains contact with the billet-rolling process, receiving continuous feedback. Calculations and direct control signals are derived from this feedback information. The shearing system insures that the billets, as rolled, are cut to ordered lengths with a minimum of waste.

Infrared measurements

Inside the billet mill are two finishing mills. The first handles the rough sizing of the billet and the second performs the finishing operation. However, since the billet will be cut as it emerges from the finishing mill, it is necessary to take measurements as the rough-sized billet is carried toward the finishing mill. From these measurements the final length of the finished billet is predicted.

The rough ingoing billet is measured by 72 coarse-pitched infrared sensitive photocells that detect the passing of the tail-end of the billet, photo on p. 89. The nose-end is detected by 10 fine-pitched photocells. The number of photocells energized (when the nose is in the fine cell range and the tail just clears a coarse cell) gives the length of the rough billet to the nearest four inches. Improved accuracy, to nearest inch, is automatically obtained by computer extrapolation.

The elongation that takes place in the finishing mill is measured as the nose of the billet emerges. The lengthened billet travels over a measuring roller that has a toothed-wheel connected to an electronic pulse generator.

Sixteen pulses are generated for every inch of outgoing billet and a count of these pulses, as the tail-end clears successive coarse cells, gives a measure of the elongation. Measurements of elongation are continuously taken until the tail end of the billet enters the finishing stands. The readings are then averaged for greater accuracy. Once the ingoing length and the elongation taking place are known, their product is an accurate prediction of the final billet length.

Information on the orders to be cut, number required, length and allowance, together with any special requirements for extra sample lengths to be left on certain billets is transmitted directly from the coordination computer to the shear com-

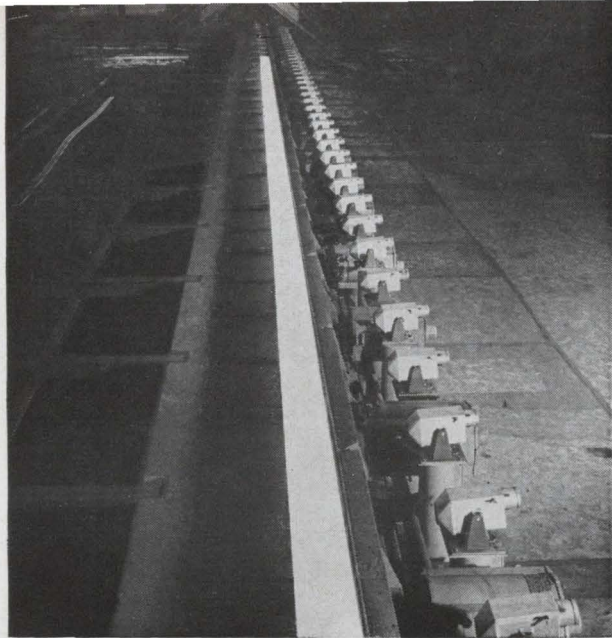

Hot billets are sized as they whiz past 72 infrared-sensitive photocells. Data goes to billet-cutting computer.

puter. From this information and the predicted final billet length, the shear computer is able to determine the cutting length. The shear computer then transmits cutting instructions to the shear control system.

Identifying billets

The second function of the shear computer is to identify cut billets that have been grouped and directed to one of three cooling beds by a cooling-bed operator. He sets a switch that tells the computer which of the beds has been used.

The ingot-identification data originally transmitted by the coordination computer, together with the length and number of billets actually cut is then printed out on one of three teleprinters mounted alongside the cooling beds. This enables a steelworker, the stamper, to identify each group of billets and to end-stamp each billet accordingly.

Mimic display

On the wall of the central control room a photocell-mimic display checks on the photocells that are measuring the rough and finished billets. Indicator lights all along the wall map of the mill go on as individual photocells are energized. The lights show the progress of each billet and it is easy to spot a faulty photocell.

Each of the 72 coarse-pitch photocells uses a silicon diode mounted at the focal plane of a lens system that, with its associated amplifier, is mounted in a special self-aligning plug-in module.

To keep the module cool, the photocell case is enclosed in a box fitted with a self-contained blower. The blower cuts down dirt accumulation on the lens by maintaining a flow of air across the front of the lens.

Beneath the metal skin

The executive computer is, naturally, in the cen-

tral office building some distance from the mill area. This location provides better environmental conditions for the magnetic-tape operation. Distance from the works presents no difficulty; communications are routed over a pneumatic tube system. Even with these better surroundings, full air-conditioning with temperature and humidity control is provided for the executive machine.

It was decided that the best place for the two on-line computers was in the billet mill motor-room area even though there were some disadvantages.

The on-line computers are surrounded by high-power equipment so it was necessary to minimize the effects of electrical noise, both air-borne and cable-borne.

All computer-system cables are well separated physically from the normal power cables. There is a separate ground system for the computer and its peripherals, and careful screening of all appropriate cables. The production control center is inside a bonded metal skin. These precautions, extreme as they seem, were well justified. By eliminating the normal pick-up hazards the system had a trouble-free start-up.

In operation

With an integrated, three-level control system it is impossible to begin simultaneous operation at all levels.

Computer control was progressively widened during the first half of 1964 and may grow even further in the future. Production planning operations dealt first with the primary-mill requirements. Next came production scheduling for the various finishing mills. Scheduling control of the entire steelworks went into operation last month.

The shearing system depended on the planning and coordinating systems' working first. Initially the shear computer was used to log outputs from the billet-measuring system and to help calibrate the photocell system. The shearing system is now operating full-time.

The bloom mill automatic programmer had a major advantage in that it could operate independently of any computer system. It was working soon after the bloom mill began operations. Aiming at the best possible rolling, a number of programs have been tried and rewritten in the light of operating experience. Further improvements in the nature and timing of the programs will continue for some time.

The author



J. Tudor Jones has specialized in electronics for the steel industry since he joined the Metal Industries division of the English Electric Co. in 1948. He now heads a team of engineers developing computer systems for steelworks.

Wideband tape-recorder users claim obsolete standards impede technology

System engineer charges that standards borrowed from audio recorders are inadequate for different generation of instruments used in telemetry

By V.A. Ratner

Director of the Systems Division of Defense Electronics, Inc., Rockville, Md.

Terms such as flutter used to define magnetic tape-recorder performance no longer have the same meaning; test techniques, such as measuring third-harmonic distortion, now have no relation to the performance actually required; factors with little importance influence the design of final equipment disproportionately; and advertisements confuse the system engineer by quoting lists of specifications that the recorder can not meet simultaneously.

These complaints illustrate the unhappy situation of wideband—one megacycle and up—magnetic-tape recorders today. Obsolete standards and methods of measurement are impeding the progress of telemetry and its applications.

Most specifications in use today originated with audio recorders. When the audio tape recorder moved to telemetry work, it made sense to borrow and extrapolate these standards, even though it meant stretching them to the limit. Extending the standards even further for wideband recorders—particularly with increasing use of predetection techniques and serial pulse-code modulation—has made today's standards hopelessly inadequate.

In fact, recorder requirements have changed so drastically, that we cannot rely solely on recorder manufacturers to solve these problems. The makers are too far removed from the application of the instrument and they have proprietary interests that can distort critical requirements. Rather, the solution must come from systems engineers and users who can work with the entire telemetry system and can judge the components impartially.*

Audio throwbacks

Many of the terms that developed with audio

recording no longer have a place in wideband recording. They've been replaced by new parameters. For example, the old approach to flutter—signal distortion caused by variations in longitudinal tape speed—no longer provides a basis for comparing recorders. Other vital comparisons can be made by considering such variables as bias frequency, amplitude stability, phase response and intermodulation distortion. But manufacturers do not specify or measure these variables in the same way; therefore the system engineer cannot compare different makes.

If we examine flutter, we find that the old Inter-Range Instrumentation Group (IRIG) standards measured it out to 10 kilocycles—more than adequate for an audio recorder or even a simple post-detection telemetry system. But a new machine whose tape runs at speeds of 120 inches per second can have appreciable velocity variation beyond 10 Kc.

High-frequency flutter, which has in the best machines a random frequency distribution, is caused by scrape components—friction between irregularities on the surfaces of the tape and the tape-guiding mechanism—and the violin effect—a mechanical resonance that causes the tape to vibrate like a violin string between the supports.

This type of flutter, sometimes higher than 20 Kc, can produce unsuspected modulation of the recorded data, introducing recording errors of several percent, even when the anticipated recorded error may only be 1%.

Wideband operation has also changed the interpretation of signal-to-noise ratio. In an audio recorder, over-all signal-to-noise ratio indicated a device's performance. But this is not the case in wideband machines. Today's standards must consider the spectral distribution of noise.

In a wideband recorder using constant current recording, the noise spectrum rises sharply at the

* In September the Inter-Range Instrumentation Group (IRIG) and a committee of the Aerospace Industries Association distributed a new proposed standard to end users and recorder manufacturers. But adoption is probably at least two years away.

high frequency end. Behind this phenomenon are two causes: a partial erasure of short wave lengths and the equalization circuitry that produces a flat frequency response. Yet the shape of the noise spectrum is more important than signal-to-noise ratios when the systems engineer chooses f-m center frequencies and channel bandwidths.

Another throwback to old audio techniques is setting third-harmonic distortion at 1% as the normal level of recording. This specification has no relation to the requirements of the recording system; yet to achieve it, other more important specifications are compromised.

This would not be worth mentioning if recorder parameters could be adjusted for top performance without hurting others. Unfortunately, there are variations in the specifications because of production tolerances in recorder heads and circuits, and these variations cannot be easily compensated for. System engineers generally lack the necessary information to establish the best recording parameters. In the end, a system engineer has to assume that the recording system is close to optimum whether it is or not.

Trade-offs for improvements

Still, there are some recorder specifications that can be optimized at the expense of less-important ones. Related and interdependent parameters are record level, bias level and frequency, harmonic distortion, intermodulation distortion, signal-to-noise ratio, frequency response and phase response.

An example of a possible trade-off: if the record current is increased and the bias decreased to maintain a flat frequency response, the harmonic distortion, intermodulation distortion and signal-to-noise ratio increase. But the relationship between these variables is so complex that a systems engineer must learn to specify them at more than one point.

And manufacturers still tend to emphasize the factors that make for good audio recorders. System performance is often optimized simply by adjusting the recorder for minimum noise and distortion over the region of interest. Then other variables—record level, bias, equalization—have to be adjusted as part of the system operating procedure. This approach leads certain specifications to assume greatly magnified importance with respect to others. A few even contribute to severe degradation of data.

One variable that has assumed added importance in wideband recorders is the bias frequency. With the audio recorder, the application dictates a bias frequency about five times the highest frequency to be recorded. The practice has carried over to wideband recorders—and led to problems.

In the audio recorder, the bias frequency chosen was not important. But it is important to the user in wideband recorders because serious radio frequency interference can develop with bias frequencies of 7 or 8 Mc. The bias oscillator must be a high-powered device and the radiation it emits is difficult to contain at such high bias frequencies;

thus it requires extra precautions to suppress the radiation of bias signals in the wideband recorder.

In addition, because the telemetry receiver's intermediate frequencies are usually either 5 or 10 Mc, the bias frequency could fall within the passband of the receiver intermediate frequency, creating still another system problem. Fortunately, the typical 7-Mc bias is nearly halfway between the two frequencies that are usually selected as the intermediate frequencies.

However, a choice of bias frequency may not always be as fortunate, particularly if predetection techniques are being used. In this event, bias frequencies and radio frequency interference suppression have to be considered when setting up the performance specifications of the magnetic recorder.

What to measure

Tape-recorder manufacturers have borrowed not only the semantics of audio recording but also test and measuring techniques. And these techniques have proved equally inadequate when applied to wideband recorders. Even the old IRIG measuring techniques do not really indicate recorder quality.

Currently there are no accepted standards for measuring the key parameters (see chart on pages 92, 93). Each manufacturer measures and defines these parameters differently. The lack of standardization makes it difficult, if not impossible, to compare recorders solely on the basis of quoted specifications. The effects of slight differences in the specifications are hard to evaluate and the methods of measurement are very important.

Take noise, for example: the signal-to-noise ratio may appear to be poor in a wideband measurement, but the noise level may be very low in the narrower band of interest.

Flutter offers a different dilemma. The old IRIG standard calls for flutter to be measured at 52.5 Kc over a 10-Kc bandwidth at a tape speed of 60 inches per second. But 52.5 Kc is completely

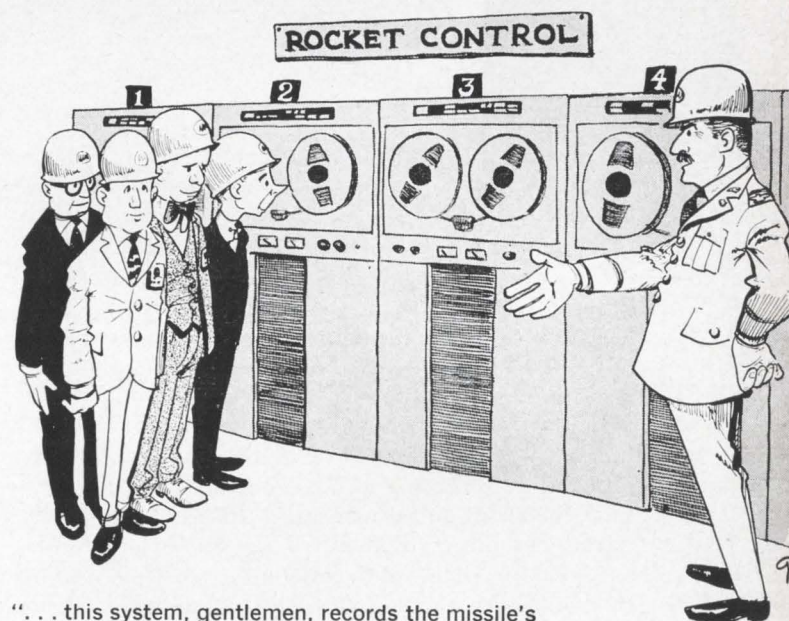

"... this system, gentlemen, records the missile's speed, trajectory and temperature, and it provides music for the cafeteria."

Comparison of wideband recorder specifications

SPECIFICATION	RECORDER (A)	RECORDER (B)	RECORDER (C)	RECORDER (D)	COMMENTS
Frequency response	400 cps to 1.5 Mc, ± 3 db at 120 ips, referenced to midpoint	400 cps to 1.5 Mc, ± 3 db at 120 ips, referenced to 1 Kc	400 cps to 1.5 Mc, ± 3 db at 120 ips, referenced to 150 Kc	400 cps to 1.5 Mc ± 3 db at 120 ips, unspecified reference	This specification is affected by adjustment of other parameters
Signal-to-noise ratio	25 db rms—rms using 18 db/octave bandpass filter at 120 ips	20 db at 120 ips (no bandpass filter)	25 db using 18 db/octave bandpass filter at all speeds	25 db rms	Varies with speed on some machines. No limitation on spectral distribution of wideband noise
Harmonic distortion	Less than 1% third harmonic at 1 Kc with 0.5% second harmonic	Less than 1% third harmonic at 1 Kc at 60 ips	Total less than 2%, 1% third harmonic at 150 Kc at 120 ips	Less than 1% third harmonic at 1 Kc	Defines "normal" record level to which all other specs are referenced, yet reference point can vary
Intermodulation distortion	Unspecified	Unspecified	Individual products less than 1% with any combination of 2 signals recorded at $\frac{1}{2}$ "normal" record level	Unspecified	This parameter very important in predetection applications. Interpretation can vary depending on whether individual products, total distortion or first order products only are measured
Phase response	Best square wave with specified amplitude response	Unspecified	Unspecified	Linearly increasing phase with increasing frequency across passband	Extremely difficult to measure using conventional test equipment. Spec should read: "envelope-delay variation across passband, is x-microseconds maximum"
Flutter	Less than 0.25% cumulative from 0.2 cps to 10 Kc at 120 ips	Less than 0.25% peak-to-peak cumulative from 0.2 cps to 10 Kc at 120 ips	Less than 0.1% peak-to-peak cumulative, dc to 200 cps and 0.5% dc to 10 Kc at 120 ips or 60 ips	Cumulative peak-to-peak at 60 ips: 0.2% from d-c to 10 Kc	At 120 ips considerable flutter may occur above 10 Kc. Flutter at lower speeds is greater and generally unspecified.
Input	0.25v rms minimum 1,000 ohms	0.5v peak-to-peak minimum, 10,000 ohms	0.35v rms minimum 10,000 ohms	1 v peak-to-peak 1,000 ohms	Standardized levels and impedance terminations are needed
Output	1 v rms across 75 ohms	1 v rms across 100 ohms	1 v rms across 50 ohms	1 v peak-to-peak across 91 ohms	Standardized levels and source impedance are needed.

out of the passband of some recorders.

Typical of the measurement confusion in industry are the different ways to determine the variations in signal propagation time (envelope delay). Envelope delay is used as a measure of phase-shift differential over the passband of a recorder. These variations are difficult to measure with conventional test instruments; therefore each manufacturer recommends a different way to determine this variable. None of the available methods is satisfactory because the fixed delay between the recording and reproducing heads is many times longer than the delay to be measured. In addition, flutter introduces errors that are of the same magnitude as envelope delay and cannot be separated from the delay. As a result, we find ourselves with no equipment capable of making the measurement of time delay over the full bandwidth of the recorder.

Probably the worst problem facing the systems engineer is how to make a comparison of magnetic-tape recorders from specifications advertised by equipment manufacturers. One practice of manufacturers is to quote a set of specifications (such variables as frequency response, signal-to-noise ratio and distortion) that have been measured by optimizing one variable at a time; the recorder cannot meet all the specifications simultaneously.

On a single setting

Every manufacturer should specify the performance of an instrumentation recorder in such a way that all the specs can be achieved by a single setting of all controls and adjustments.

Choosing a recorder is further complicated by the lack of agreement among manufacturers on standards and terms or specifications. Even where

SPECIFICATION	RECORDER (A)	RECORDER (B)	RECORDER (C)	RECORDER (D)	COMMENTS
Bias frequency	7 Mc	Unspecified	10 Mc	Unspecified	Bias frequency falling in the rf passband of associated equipment can be disastrous to system performance.
Metering	Average reading, rms calibration	Unspecified	peak from average	Unspecified	Peak-to-peak sensing with standardized constants is needed
Time displacement error	Unspecified	± 0.25 ms at 120 ips	± 0.5 μ sec at 120 ips	± 0.2 μ sec at 60 ips	A key specification for low-mass capstan arrangements
Tape-speed accuracy	$\pm 0.2\%$ of selected speed	$\pm 0.2\%$ of recorded speed	$\pm 0.15\%$ record and playback	Unspecified	Comparison of inter-machine and intra-machine figures is invalid
Head life	Unspecified	1,000 hours	1,000 hours at 120 ips	Unspecified	Interpretation should include speed, type of tape, head contact, etc.
Track dimensions	IRIG standard	IRIG standard	IRIG standard	IRIG standard	IRIG standard dimensions were developed for low-frequency machines and may not be optimum for minimum crosstalk, best time correlation, etc., on wideband machines.
Dynamic skew	± 0.1 μ sec at 120 ips for adjacent tracks on same head stack	± 0.5 μ sec at 120 ips for adjacent tracks on same head stack	± 0.3 μ sec at 120 ips for adjacent tracks on same head stack	± 0.15 μ sec at 120 ips for adjacent tracks on same head stack	Should be expanded to include nonadjacent tracks and inter-stack skew as well. Time interval should be stated. Generally worsens at lower speeds.
Instantaneous amplitude stability	Unspecified	Unspecified	Unspecified	Unspecified	Due to "tape bounce" on the heads this spec is vital in some applications.

Note: Such items as reel capacity, tape dimensions, tape speed, etc. are well standardized among all manufacturers.

there is agreement in principle, there is no agreement in specifics.

Take recorder input impedances: all manufacturers recognize the need for lowering input impedance, but no two have standardized on any given value.

In a wideband recorder, input and output impedances are far more important than they are in audio recorders or in post-detection telemetry. The former practice was to employ bridging techniques so the recorder had a high-input but a low-output impedance. This allowed the machine to drive a reasonable amount of cable while still maintaining good frequency response. At frequencies up to 1.5 Mc, however, such bridging techniques are not feasible. If predetection techniques or pulse-code modulation are employed, the system usually has lines terminated in their

characteristic impedances. For these machines, standardized input/output impedances are essential.

Impact of predetection

An examination of predetection techniques is worthwhile at this point because their use has grown beyond missile telemetry. The techniques are being used now in any application where the cost of repeating a test is so great that the loss of data cannot be tolerated.

In certain kinds of predetection recordings, particularly f-m/f-m data (where a radio frequency carrier is modulated by a subcarrier or a group of subcarriers of different frequencies), flutter can contribute an error of several percent. Variations in tape velocity produce time-base modulation of the recorded signal, simultaneously introducing

errors in frequency, phase, amplitude and time displacement. The only known method of compensating for all errors is reproducing the signal with an inverse time-base modulation.

Undesirable frequency modulation of the individual subcarriers is significant and requires compensation by a standard discriminator-subtraction technique.

Canceling the error

This technique uses a reference tone that is recorded on the tape at the same time as the data. On playback, an error signal is developed. When the error signal is inverted and recorded over the information in question, it subtracts the effects of this frequency shift.

This approach reduces the frequency-modulation errors that were predominant in early telemetry systems. But in many types of predetection recording, secondary effects, for which such compensation does not correct, also contribute to inaccuracies. Additional difficulties arise when a reference signal is mixed with the predetection signal. When the full 1.4-Mc bandwidth is used, there is no place in the spectrum for the reference tone. The probable solution—although not completely satisfactory—is to restrict system bandpass by using an amplifier with a narrower intermediate frequency for the recording.

Discrimination techniques do not work for jitter on pulse-type signals, a phenomenon introduced by the time-base modulation of flutter. Although several methods have been proposed to reduce the effect of jitter—mainly an inverse time-base modulation of the reproduced data using electrical, mechanical or ultrasonic delays which are variable—none have been implemented because of the difficult requirement for delay variations: several hundred microseconds at rates exceeding 10 Kc.

Such a delay immediately rules out a mechanical device that would need physical displacements in the order of inches to operate at high rates. Ultrasonic devices have the additional difficulty of achieving 1.5-Mc bandpass. Although an electronic delay line with active isolation can be theorized, it is impractical to build because of the large number of sections needed to produce a delay variation of several hundred microseconds.

Potential solutions

Another electronic approach involves a cathode ray tube. Theoretically, the tube is capable of true flutter compensation and is being evaluated.

To solve the jitter problem, one group of engineers has even suggested physical movement of the recorder-reproduce heads by servo control. But the rate of change is too great for this technique, too.

The answer may lie in reducing the variable time delay needed. If the frequency response of the servos can be increased to several hundred cycles per second, from only few cycles per second now, the range required for the variable delay line would indeed be reduced. One way to accomplish

this might be by the use of a low-mass capstan in the tape drive.

The difficulty in just correcting the error due to flutter illustrates the magnitude of the problem facing systems engineers. Even if the flutter error were completely corrected, over-all improvement would not be significant because of other systems errors that approach or exceed the size of the flutter error. Recorder noise, for example, can contribute as much as a 5% error in wideband signals. Incidental frequency-modulation in receiver and translator oscillators can also introduce errors as big as 5% for very narrow-band signals. Spurious translator signals at -30 decibels can contribute a 3% error when they fall in the passband of a sub-carrier channel.

Call for action

Obviously a great deal of standardization, evaluation and investigation is needed to clarify the wideband recorder situation. The systems engineer is in the best position to recognize the present limitations because he has more experience than the manufacturer applying wideband recorders to predetection recording of telemetry signals. A committee formed to study this problem should be composed of IRIG members, recorder manufacturers and, most importantly, systems engineers from companies that have integrated wideband recorders into a telemetry system and aren't prejudiced toward specific equipment.

The committee must:

- Redefine performance specifications so they apply to the full scope of wideband recorder capabilities and accurately describe performance.
- Standardize both test methods and performance specifications to enable a uniform comparison of competing instruments.
- Establish specifications and test techniques for characteristics, such as phase response, that have lately become important to magnetic recorders.
- Develop the specialized instrumentation necessary to measure each specified variable.
- Set a uniform time-displacement error specification and test methods for low-mass capstan recorders.

A solid foundation of consistent standards, available to all researchers, manufacturers and systems engineers is essential if magnetic recording technology is to advance.

The author



Victor A. Ratner is director of the Systems division at Defense Electronics, Inc. He is responsible for the development of predetection-recording and diversity-combining techniques for telemetry applications. He has written papers on diversity reception and pulse-code modulation telemetry and has a patent pending for a diversity combiner.

Let's talk facts about trimmer capacitor reliability

Only JFD gives you these design advantages...in the industry's broadest product line—over 500 standard models

Widest choice of drive mechanisms—
All seven are engineered for greatest tuning linearity without reversals and for the ultimate in repeatability. Anti-backlash designs exceed Mil-C-14409B requirements.

Versatile choice of five dielectric materials to satisfy the most varied design parameters.

Matched metalizing—Exclusive JFD metalizing processes form a homogeneous bond between dielectric and metal parts. There are no air gaps to widen tolerances and distort actual capacitances.

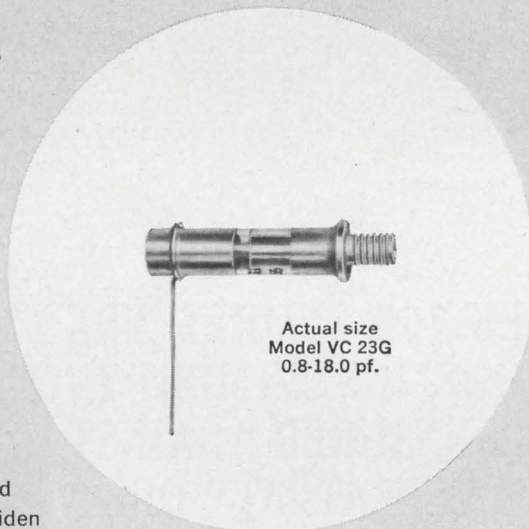

Industry's most comprehensive and advanced construction variations assure you the degree of reliability your application requires.

High level shock and vibration resistance—A plateau of 90 g's is common... by far the industry's highest. This is insured by continuous monitoring in JFD's shock and vibration laboratories.

High reliability of each individual unit is assured through the industry's most exacting quality control program.

That's why more JFD trimmer capacitors meet or exceed Mil-C-14409B than all other makes combined. JFD trimmer capacitors have been specified in the Apollo, Gemini, Minuteman and L. E. M. programs where high reliability is a must.

SEND FOR JFD CATALOG C-64



Components Division

JFD ELECTRONICS CORPORATION, 15th Ave. at 62nd St., Brooklyn, N. Y. 11219
 JFD NORTHEASTERN, Ruth Drive, P. O. Box 228, Marlboro, Mass. 07152
 JFD NEW YORK-NORTHERN, Damiano Pl., P. O. Box 96, New Hartford, N. Y. 13503
 JFD MID-ATLANTIC, 313 E. Broad St., Palmyra, N. J. 08065
 JFD MID-ATLANTIC-MARYLAND, P. O. Box 7676, Baltimore, Maryland 21207
 JFD MIDWESTERN, 6330 W. Hermione St., Chicago, Illinois 60646
 JFD MIDWESTERN-OHIO, P. O. Box 8086, Cincinnati, Ohio 45208
 JFD WESTERN, 9 Morlan Place, Arcadia, California 91006
 LCC STEAFIX, 128 Rue de Paris, Boite Postale 51, Montreuil-sous-Bois, Seine, France
 JFD ISRAEL LTD., Industrial Area B, Bldg. 23, Azur, Israel
 DUCON CONDENSER PTY., LTD., Christina Road, Villawood, N.S.W., Australia
 MURATA MANUFACTURING CO., LTD., Nagaoka Otokuni, Kyoto, Japan
 STANDARD TELEPHONE & CABLES LTD., Footscray, Sidcup, Kent, England

Variable Trimmer Piston Capacitors ■ Metalized Inductors ■ LC Tuners ■ Ceramic Fixed and Variable Capacitors ■ Fixed and Variable Distributed and Lumped Constant Delay Lines

If your scopes are more than three years old, you have **T.O.*** and it's costing you money.

*Technological Obsolescence

FAIRCHILD SERIES 765 SCOPES ARE T.O.-RESISTANT. YOUR INVESTMENT IN ONE MAIN FRAME IS INSURED AGAINST T.O. THROUGH THE VERSATILITY OF 22 PLUG-INS—AND MORE ARE ON THE WAY.

If you're doing advanced work with aging oscilloscopes, you are probably taking longer than you should to make less precise measurements than you need.

The Fairchild Solid State Series 765 main frame has unmatched value and add-on versatility. With it you keep abreast of the state-of-the-art with a minimum of capital investment. Buy one main frame at \$595, then add the plug-ins you need—for example, multi-trace displays, 100mc high gain amplifiers, raster displays, spectrum analyzers—as you need them. All the signal circuitry is in the plug-in; none is in the main frame.

22 plug-ins are now available for Series 765 main frames. Equally important, Fairchild research is continually developing new ones to keep even the first 765 up to date. So, instead of buying costly special purpose scopes, you merely add appropriate plug-ins as your instrumentation needs change.

Two examples of Fairchild versatility are shown on the next page. If you need these (or other) capabilities and your present scopes don't have them, T.O. is costing you money. It's both good engineering and good management to call in your Fairchild Field Engineer for a demonstration. Fairchild Scientific Instrument Dept., 750 Bloomfield Ave., Clifton, N.J.

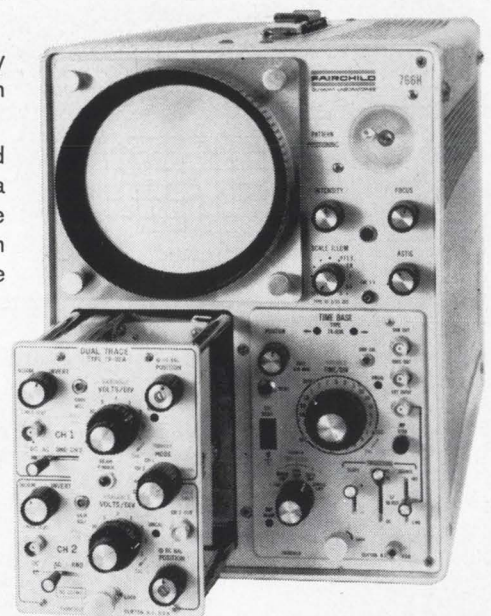

How Fairchild Scopes help curb **T.O.***

With three new plug-ins, Series 765 doubles as spectrum analyzer

For just \$820 any Fairchild Series 765 oscilloscope becomes an accurate spectrum analyzer. Three new plug-ins are available to cover a frequency range from 10cps to 500kc. When used with the type 777 dual beam scope, two analyzer plug-ins provide two simultaneous spectrum displays on the same CRT.

PLUG-INS	TYPE 74-91	TYPE 74-92	TYPE 74-93
Center Freq. Range	10cps to 20kc	35cps to 100kc	150cps to 500kc
Dispersion (sweep width) continuously variable	100cps to 6kc	500cps to 30kc	2.5kc to 150kc
Resolution Bandwidth (continuously variable)	10cps to 100cps	35cps to 250cps	150cps to 2kc
Sensitivity	40 μ v/cm	40 μ v/cm	40 μ v/cm

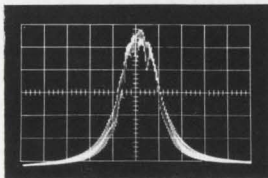

80kc carrier modulated at 35cps; maximum analyzer resolution.

New dual trace plug-in offers 100mc bandwidth, 10mv/cm sensitivity

Owners of Series 765 scopes who find a need for bandwidth beyond the range of any existing direct reading scope do not have to buy a costly sampling scope. A Type 79-02A 100mc dual-trace plug-in for \$1,200 provides the widest available bandwidth in conventional instruments. As a single trace amplifier, the 79-02A offers sensitivity of 1mv/cm with bandwidth greater than 50mc. Rise-time is 3.5ns. in dual trace 100mc operation.

Ask for complete data on these new Fairchild plug-ins

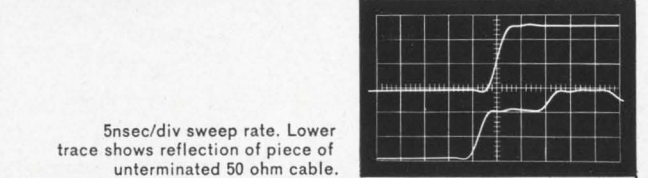
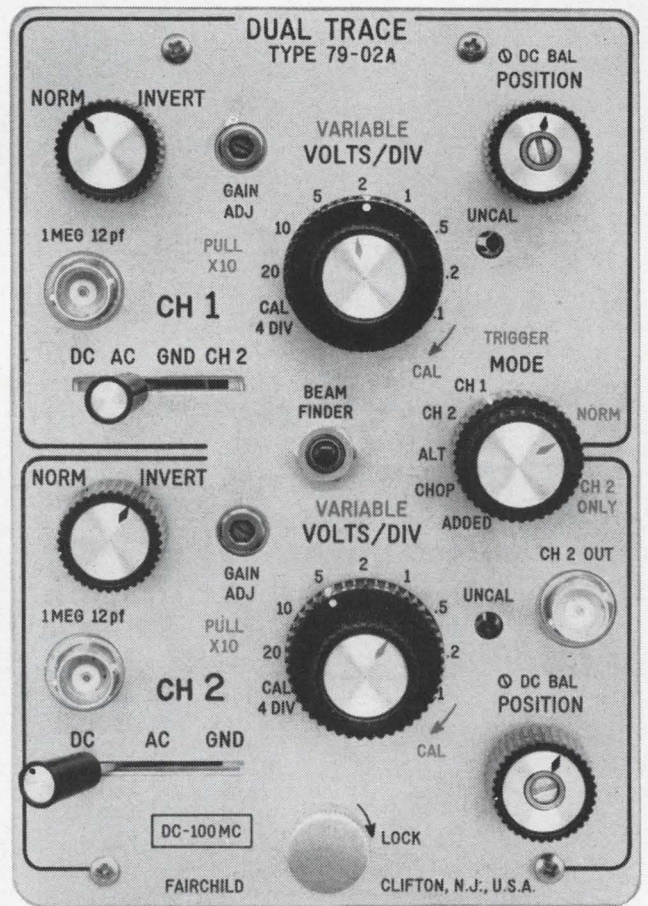

5nsec/div sweep rate. Lower trace shows reflection of piece of unterminated 50 ohm cable.

*Technological Obsolescence



FAIRCHILD

DU MONT LABORATORIES
SCIENTIFIC INSTRUMENT DEPARTMENT

New Modular Telegraph Relays



eliminate up to 54 spare parts

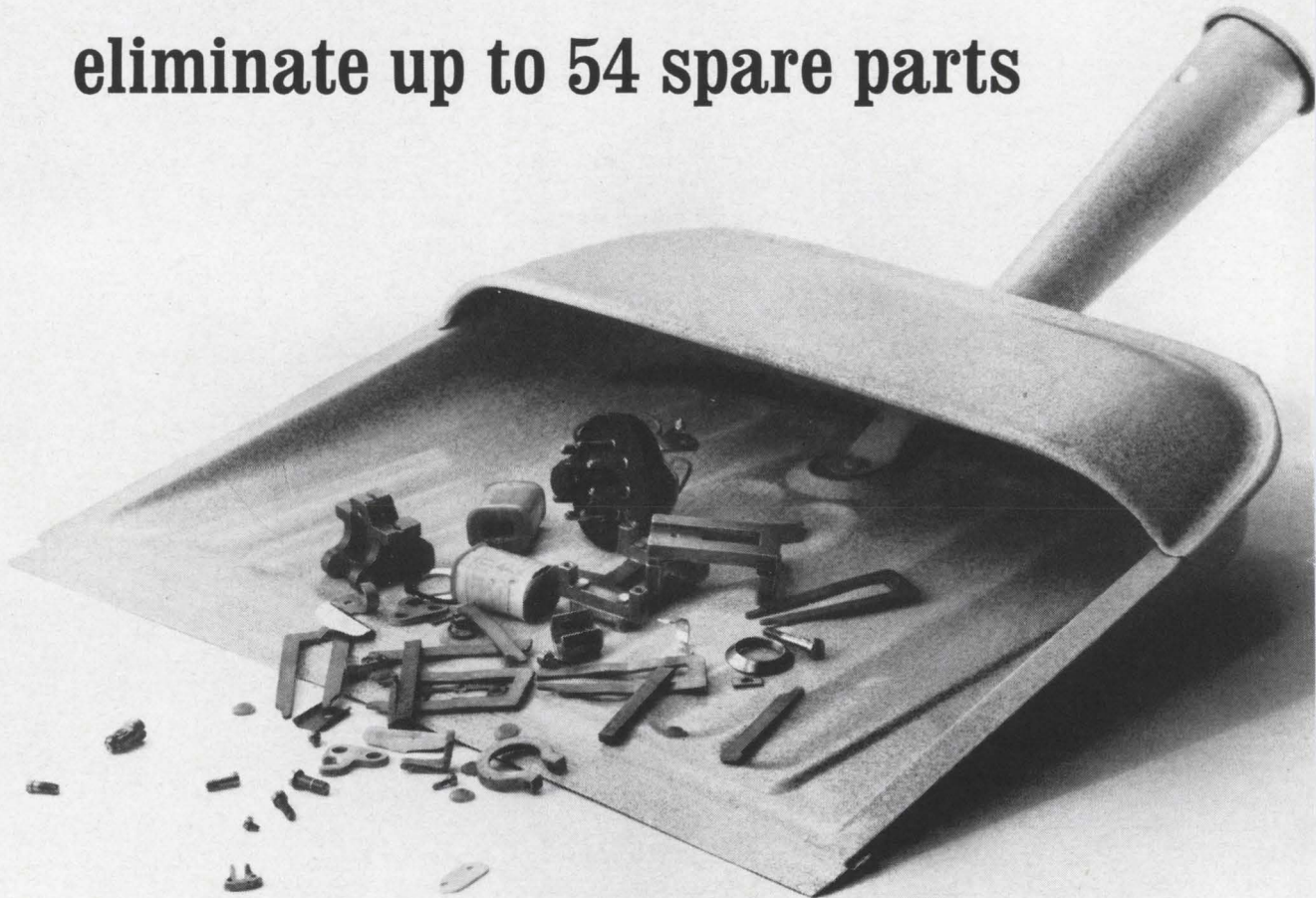

Radiation Solid State Units require only 3 different modules

Eliminate maintenance and adjustment, gain unlimited service life, and carry your inventory in your pocket!

Look inside the case of a new Radiation Solid State Modular Relay. You'll never find more than three different parts. You'll also notice the "checker" construction—a new concept in telegraph relay design. These modules are used in various combinations to duplicate any mode of operation presently handled by electromechanical units.

Inventory headaches are now a thing of the past. With conventional electromechanical units, you have to stock up to 54 parts. With new Radiation Solid State Relays you stock only three different modules. That's all!

Design Features . . .

Welded solid state circuitry is transfer molded to form rugged checkers which are exceptionally resistant to vibration and environmental extremes. Neutral relays consist of one Oscillator module and one Keyer module. Polar relays consist of two Oscillators and two Keyers. Add a Latch module and you have a Universal relay.

The stacked checkers and base are connected with either printed circuit cards or wiring, and inserted into the case. Should a module be damaged, it can be replaced quickly and easily. Pin connections are programmable, and any base wiring can be selected with simple changes.

Electrical Characteristics . . .

New Radiation Modular Relays are completely solid state—there are no moving parts. Thus, they eliminate the

need for maintenance and adjustment. Inputs are essentially resistive, and they do not induce transients in the line. The relays operate on current supplied by the input signal, and provide isolation of 50 megohms at 500 v dc. Conductive and radiated RF interference is 30 db better than standard electromechanical types (MIL-I-26,600). Radiation Solid State Relays operate at speeds to 2,400 bits/second with less than 1% distortion, and have been tested to show 56,000 hours MTBF. There are other features!

Radiation Modular Relays are available now in production quantities. Send the coupon for detailed information. We will also be glad to arrange for evaluation samples. Radiation Products Division, Dept.EL-01, Melbourne, Florida. Telephone: (305) 723-1511.

Relay Type	Base — Model Number — Price			
	Octal	202	255	
Polar	9228 \$ 95.00	9229 \$110.00	9230 \$110.00	
Neutral	9238 \$ 56.00	9239 \$ 65.00	9240 \$ 65.00	
Universal	9218 \$110.00	9249 \$120.00	9250 \$120.00	
Oscillator Module	Part No. 509972G1			\$23.40
Keyer Module	Part No. 509971G1			\$27.50
Latch Module	Part No. 509970G1			\$23.80
(All prices quoted for quantities of 1 to 49 items.)				

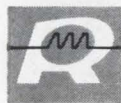

RADIATION PRODUCTS DIVISION
A DIVISION OF RADIATION INCORPORATED

Melbourne, Florida 32902

Gentlemen: Please send details on the new Radiation Modular Solid State Telegraph Relays.

Name _____ Title _____

Firm _____

Address _____ City _____ State _____ Zip _____

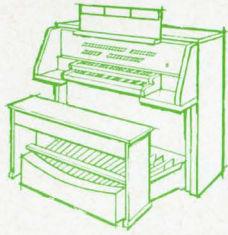

1. In electronic organs using tuning capacitors, maintenance of correct pitch is directly dependent on capacitor reliability.

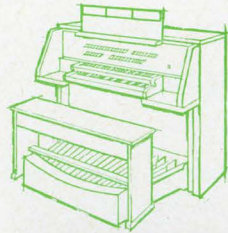

2. That's why the Hammond Chord Organ relies on 95 capacitors of "Mylar".

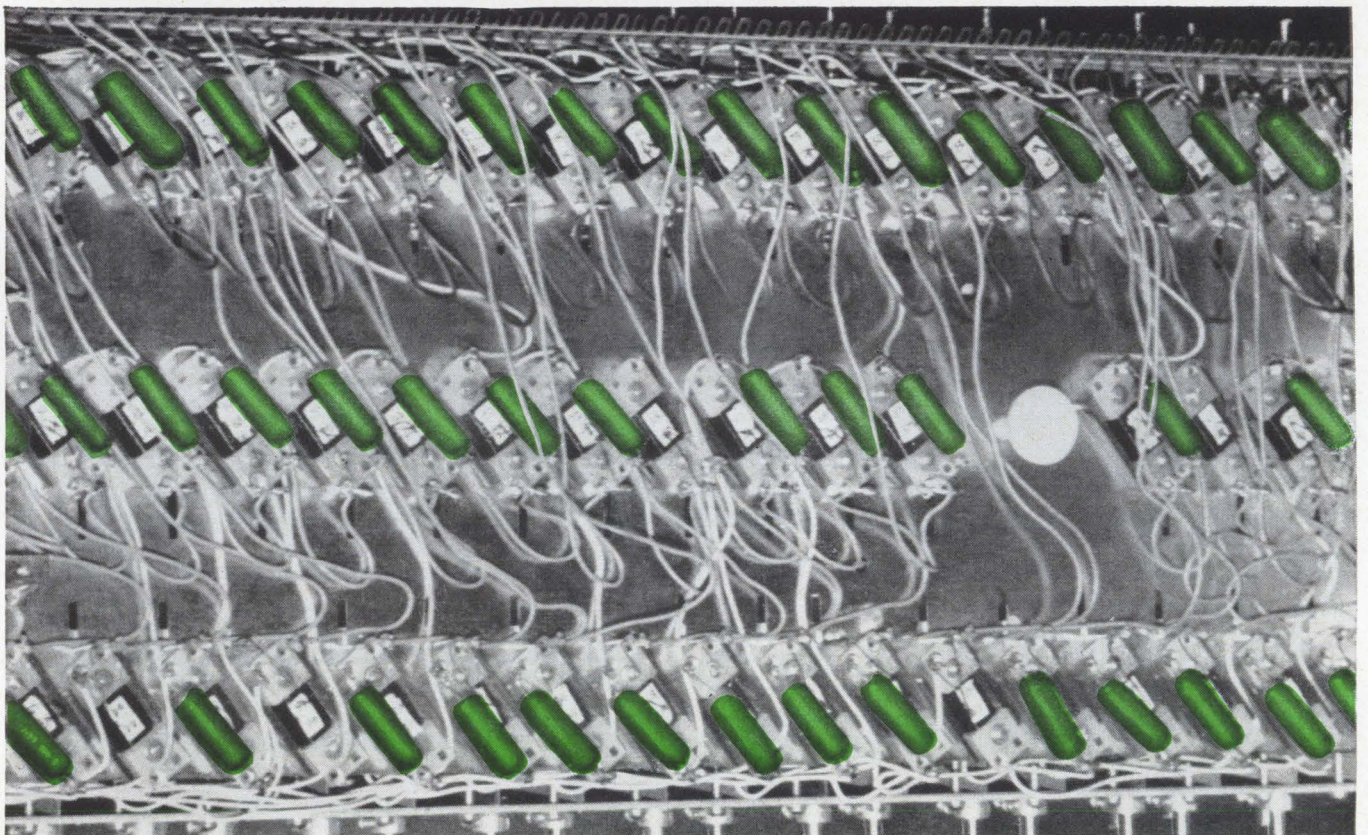

This is a section of Hammond's exclusive tone wheel generator from the Grand 100 organ. 94 capacitors of "Mylar" in sizes of .1 and .25 microfarads are used here, with 56 others in the amplifier and other circuit locations.

Until capacitors of "Mylar" were developed, the usual electronic organ capacitor dielectric was paper. In unusually humid situations, paper dielectrics can absorb moisture, causing them to leak, change capacitance and interfere with the operation of the organ.

Hammond Organ Company avoided these problems by enclosing paper capacitors in metal cans. This was expensive and bulky. Then Hammond engineers switched to capacitors of "Mylar". End of problem.

Today Hammond uses capacitors of "Mylar" in all organs for many purposes. There are 150 capacitors of "Mylar" in the Grand 100, where tuning is controlled by Hammond's exclusive tone wheel generator. In this case the additional benefit of small size was instrumental in

the decision to choose capacitors of "Mylar".

Not only do capacitors of "Mylar" give Hammond consistent reliability plus substantial savings in space . . . *but they cost no more, and often less, than paper capacitors.*

Reliability—proved in use by Hammond for 10 years, proved in 23,000,000 unit hours of intensive Du Pont sponsored independent testing—is just one important advantage of capacitors of "Mylar". For complete data that may help in your design problems, write Du Pont Co., Rm. 2310-A, Wilmington, Delaware 19898. In Canada: Du Pont of Canada, Ltd., P. O. Box 660, Montreal, Quebec.



BETTER THINGS FOR BETTER LIVING...THROUGH CHEMISTRY

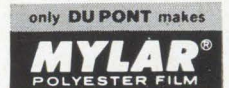

*Du Pont's registered trademark for its polyester film.

Probing the News

Military electronics

Air Force's \$30-million ash heap

With the early-warning system at the Eglin Air Force Base completely destroyed by fire, the Pentagon must decide whether and how it will be replaced

Opening-day hoopla is traditional with the military. One can always count on some ribbon-cutting, key-swapping or bottle-breaking along with the brass bands and welcoming speeches.

But any plans the Air Force may have had for April 15, the scheduled take-over date for a \$30-million radar installation at Eglin Air Force Base, went up in smoke on Jan. 5 when fire destroyed the 13-story, block-square complex.

I. Gap in defense

The giant sensor, designated the AN/FPS-85, was to be primarily

an electronic watchdog in northern Florida guarding against sneak missile or satellite attacks from the south. The Bendix Corp.'s Radio Systems division, Towson, Md., was the prime contractor for the space detection and tracking radar.

The system was to have been part of the North American Air Defense Command at Colorado Springs and there's little doubt that the fire leaves open a gap that the Eglin station would have closed. A military-industry team headed by Col. Thomas O. Wear, director of the 496L systems program office, which had manage-

ment responsibility for the radar project, is preparing to advise the Pentagon on what to do next.

Should the Pentagon want a replacement the team will be expected to advise defense officials whether they should redesign the system or try to rebuild it, salvaging as much equipment as possible.

Air-conditioning saved. Although some air-conditioning equipment on the ground floor of the complex is believed salvageable, the rest of the system was virtually destroyed. More than 25,000 radar elements, consisting of transmitters, receivers and antennas, were

Fire destroys 13-story phased-array radar that was to provide an early-warning system for enemy missiles or satellites approaching from the south.

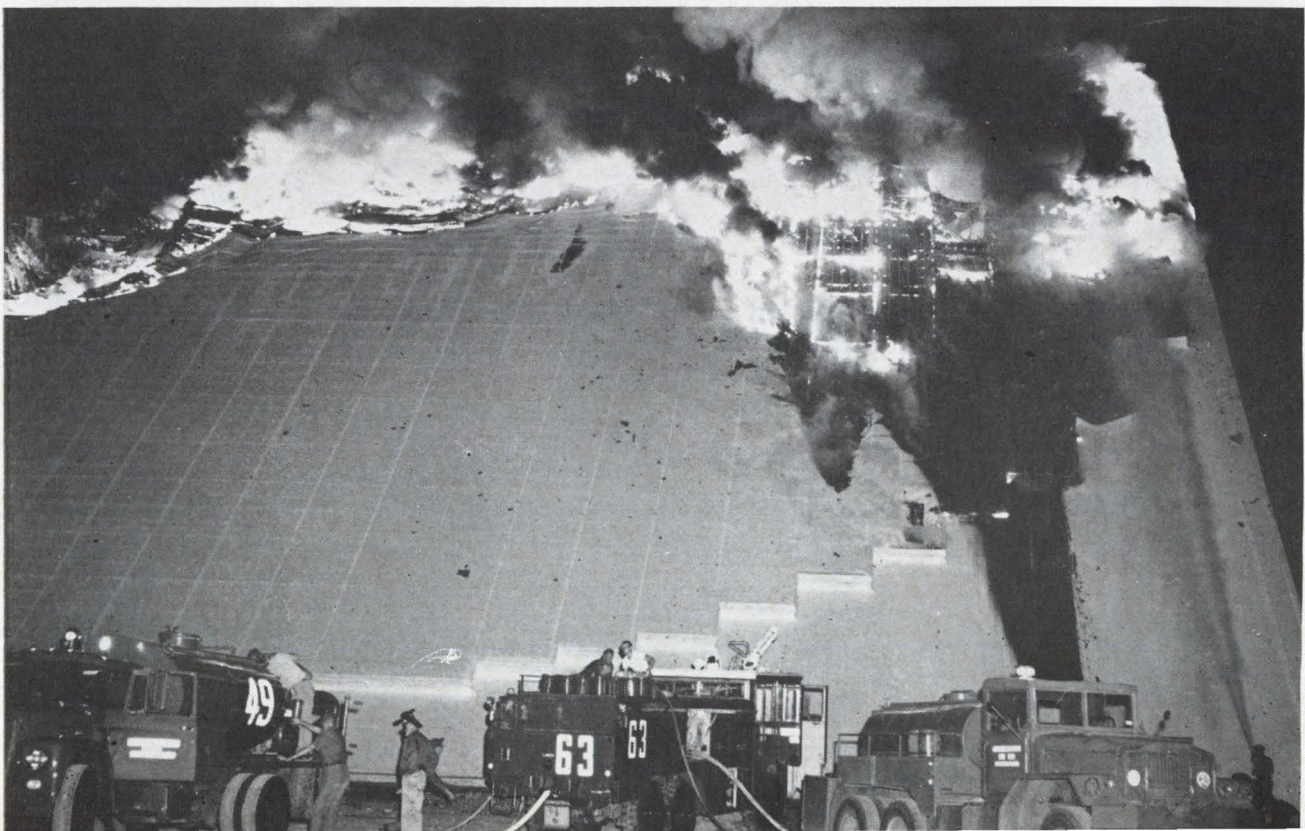

ruined by the heat. The steel skeleton is still standing, but is so warped that it probably could not be used to support the electronically steered precision phased array.

Design decision. If the Pentagon decides to rebuild the system using basically the same design, one Air Force source estimated that the project can be completed within eight months, working three shifts a day, without overtime or premium pay. The original \$30-million price tag should be slashed considerably because the research and development will not have to be repeated.

One phased-array expert says no revolutionary techniques have been developed in the ultrahigh frequency band in which the FPS-85 operates. However, new beam-steering techniques have evolved that could be applied to the system. Also, advances have been made in components engineering since the original design was frozen. It's likely, the expert says, that the team will recommend that the Pentagon improve the performance of the system, using the same basic design.

II. How did it happen?

The fire broke out at 3:15 p.m. The radar is some 25 miles away from the base headquarters in a sandy, pine-covered, desolate section of the air base. The nearest water for fighting the blaze was eight miles away and had to be trucked in. The pumping apparatus lacked the pressure to shoot the water up to the top portions of the building. Fire-fighters worked into the night extinguishing the flames.

The Air Force sealed off the area immediately after the flames were extinguished and would say only that there had been a fire. However, Electronics was told that the blaze originated in a transmitter. A witness, who asked that he not be identified, said a high-voltage arc ignited a plywood cover around the transmitter. Even though the plywood had been treated with a fire-retardant chemical, the intense heat from the spark apparently ignited the wood.

Losers, all. Another source familiar with the structure said the fire apparently was fed by a huge

amount of computer paper and by wood beams that separated and supported the many offices in the large building.

The Air Force announced that a team, headed by Lt. Gen. Leighton I. Davis, commander of the National Range Division of the Air Force Systems Command, is investigating the probable cause of the fire.

At the time of the fire, the radar had not been officially turned over to the Air Force. The system was in the "equipment installation and test phase," an Air Force aide said, and Bendix had the structure insured for an undisclosed amount of money.

Said another Air Force source:

"Everyone will lose on this: Bendix, its insurance company and the government."

III. Role of the system

Aside from its primary role as a watchdog for enemy missiles, the FPS-85 was designed for three other functions. When the automatic system was first proposed, the North American Air Defense Command said the radar was being built to detect, track and catalog unknown satellites. The system's other tasks: monitoring known satellites for additional orbital information, and keeping under surveillance satellites now in orbit.

Industrial electronics

Accidents are his business

Engineer checks out simulator that tests driver's reactions to hazards on highways

By Arthur Zimmerman

World News Bureau

Joe Poticny slammed on the brakes and twisted the steering wheel hard right. Brakes squealed, horns blared, lights flashed and his Plymouth headed for a broadside collision with another car.

But there was no crash that day

early this month. All action stopped, and the scene froze a split-second before the inevitable collision.

"Okay Joe, let's call it a day," said the voice from a loudspeaker mounted in the car. Joseph Poticny,



Back-seat driver's view of street scene projected on screen of automobile simulator system.

an electronics engineer, climbed out of the driving-simulator car in which he had just completed another prelude to a "fatal" accident.

Accidents are Poticny's business at the Goodyear Tire & Rubber Co.'s aerospace facility in Akron, Ohio. As manager of the simulator project, he is checking out an elaborate test system that will be used by the United States Public Health Service to find out how drivers react to dangerous situations.

I. Journey to nowhere

The Goodyear simulator, financed by a \$60,821 grant from the Public Health Service, will be used to check how drivers react under all kinds of road conditions and under many handicaps—drunkenness, fatigue, emotional upset.

Another simulator for long trips on superhighways, is being built by the Radio Corp. of America at its Defense Electronic Products division in Bethesda, Md. RCA has a \$136,183 grant.

The Goodyear system uses a real Plymouth and a 12-by-18-foot model of the streets around the plant. The car "travels" in and out of trouble all day without ever leaving its position in front of a high-gain, ellipsoidal projection screen. Other equipment includes a closed-circuit television system and two analog computers similar to those used in aircraft simulators that Goodyear built for the Navy.

Car is wired. The Plymouth, whose wheels barely touch the floor, is instrumented so that five kinds of data signals, representing the driver's handling of the car, are transmitted to the computers.

The signals are used to position the tv camera on the terrain model, where the camera represents the automobile. The camera's-eye view of the street scene is sent to a tv projector that enlarges the scene 87 times to life-size and displays it on the screen in front of the driver. A view of the street from inside the car shown at the beginning of this article.

Precision potentiometers translate the position of the accelerator, brake and clutch into varying voltage signals that are fed to the analog computers. Microswitches indicate the positions of the gear-shift. Rotary switches also are used on the brake and accelerator

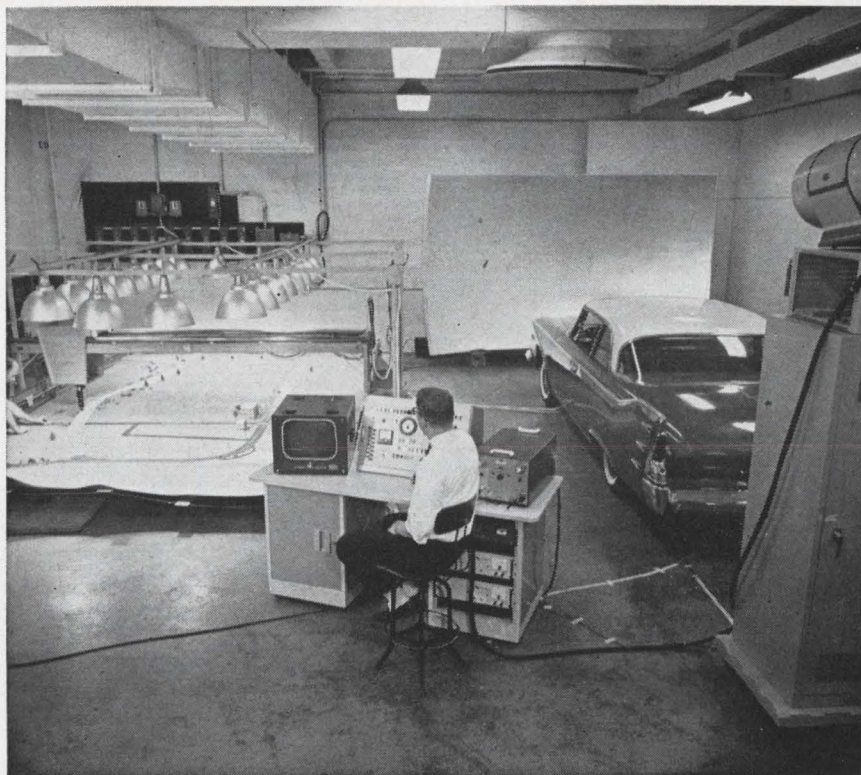

Goodyear driving simulator in action. The model at left is of the streets around the Goodyear plant in Akron, Ohio.

pedals to indicate light, medium or heavy braking or acceleration. The accelerator is instrumented because, in a crisis, some people step on it instead of the brake.

Another potentiometer is mounted on the end of the steering-wheel shaft.

Two computers. The computers were designed and built by Goodyear. One is programmed to reproduce any portion of the automobile engine's performance curve, based on the Plymouth's horsepower and torque characteristics. Accelerator data is fed to this computer to calculate speed data; this is fed to the second computer together with brake, clutch and gear-shift signals. These yield acceleration and deceleration data. The resulting signals are then fed to servomotors that move an overhead bridge on which the vidicon camera is transported over the model terrain.

The system's response time to the driver's actions is limited only by the servomotors' response times, in milliseconds.

II. Electronic 'engine'

Besides feeding speed data to its computer colleague, the engine-dynamics computer also sends sig-

nals back to the test car to simulate the effects of an engine in operation. The signals operate the speedometer and a transistorized generator that makes sounds like a car engine. "Leave off the sound," says Poticny, "and the test driver becomes confused."

The sound generator also responds to engine torque, vehicle speed, gear-shift positions, and deceleration due to braking. If the vehicle is in "motion", as shown by the moving scene on the projection screen, applying the brakes cause the engine sound to "slow down". Also, the forward motion slows down and the speedometer needle unwinds, based upon the computer's calculation of the vehicle's speed.

Traveling cameras. The vidicon camera travels forward and back along an overhead bridge, and from side to side along a carriage attached to the bridge. It also rotates up to 360° as the steering wheel is turned.

The camera, hanging from the bridge, views the model terrain through a prism as far above the model road, proportionately, as a life-size driver's eyes are above a real road. This is a fixed-focus op-

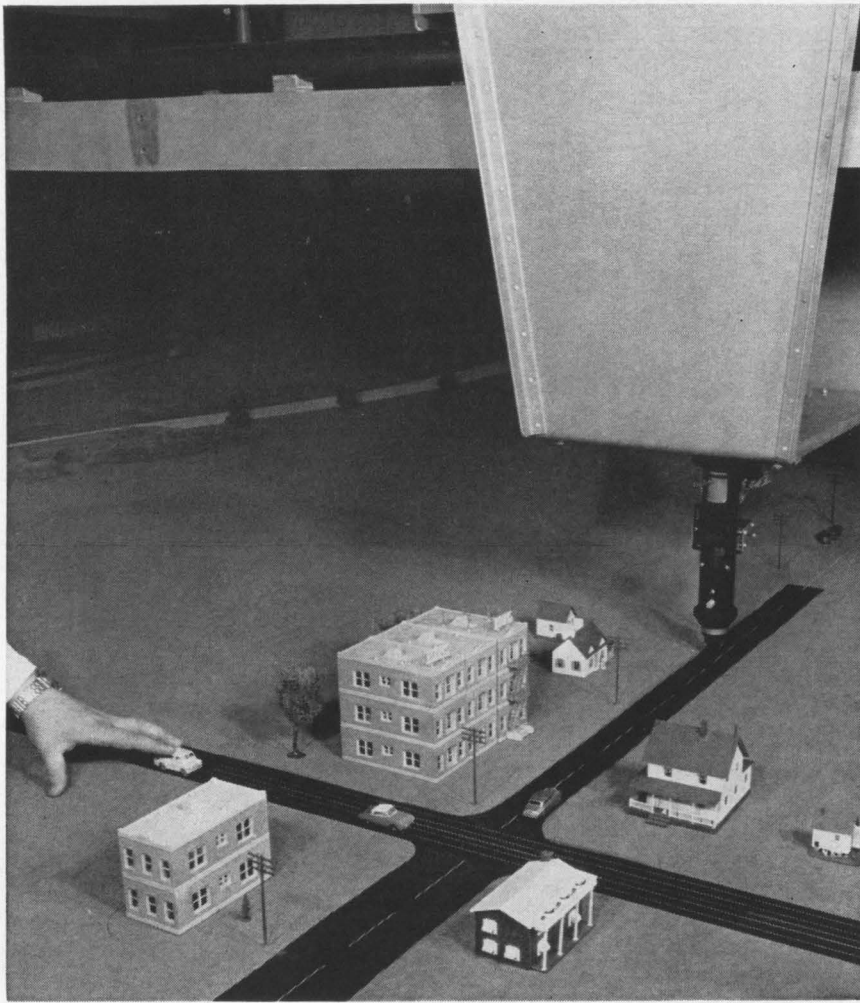

Simulator puts tv camera in the driver's seat on model street. Height of viewing prism is proportional to that of a real driver's eyes above a road.

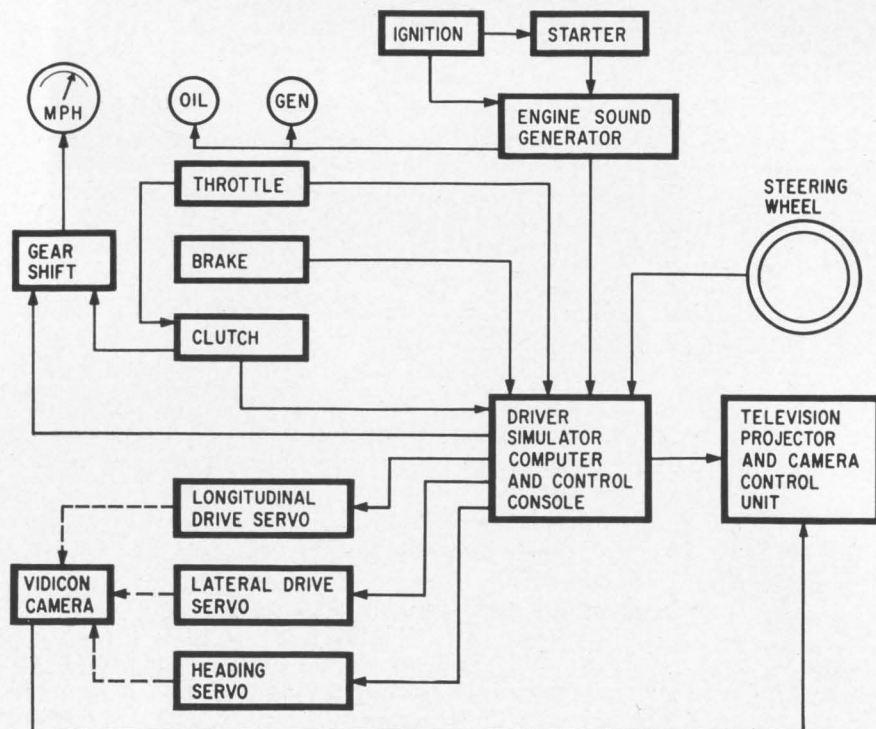

System depends on analog computers to drive the engine-sound generator, the oil and generator indicator lights, and position the tv camera for projecting the street scenes onto the ellipsoidal screen.

tical system with a depth of field from 1½ inches to infinity—proportionately the same scale as in ordinary driving. A driver does not usually focus on objects closer than 12 feet, Poticny explains.

The vidicon views of the terrain are displayed on the screen and on a monitor on the control console. The console also is fitted with jacks to provide for oscillographic recording of data from all five position-sensors.

Talking to the driver. The supervisor at the console has radio contact with the test driver. He can give him instructions to turn at a certain corner, for instance. This allows the supervisor to put the driver into a "hazardous" situation, such as coming upon a car stalled just beyond a corner or one darting out of a side road. When such a hazard occurs, the test car's horns and headlights, connected electrically to collision sensors, blare and flash to create additional confusion. That's when a driver might step on the accelerator instead of the brakes.

The big screen. To assure the accuracy of the test data, high-quality display of the terrain on the projection screen is necessary. A battery of overhead lamps is used to simulate daylight, overcast or nighttime conditions.

Goodyear also has a follow-on contract to evaluate the simulator's results. The results, if validated, will be used to establish criteria and specifications for a combination city-turnpike simulator, which would add car motions, vibrations and acceleration and deceleration effects to its repertoire of stimuli for the driver. It could also widen the display angle from the present 50°, and simulate longer-distance driving by increasing the size of the terrain model. A 180° viewing angle would give the effect of peripheral vision, an important factor in actual driving.

III. Other simulators

Other simulators are driver-training types such as the Drivo Trainer developed by the Rockwell Manufacturing Co. The system closest to Goodyear's is one owned by the Liberty Mutual Life Insurance Co. It uses a small terrain model and a light source that reflects the model onto a rear-projection screen.

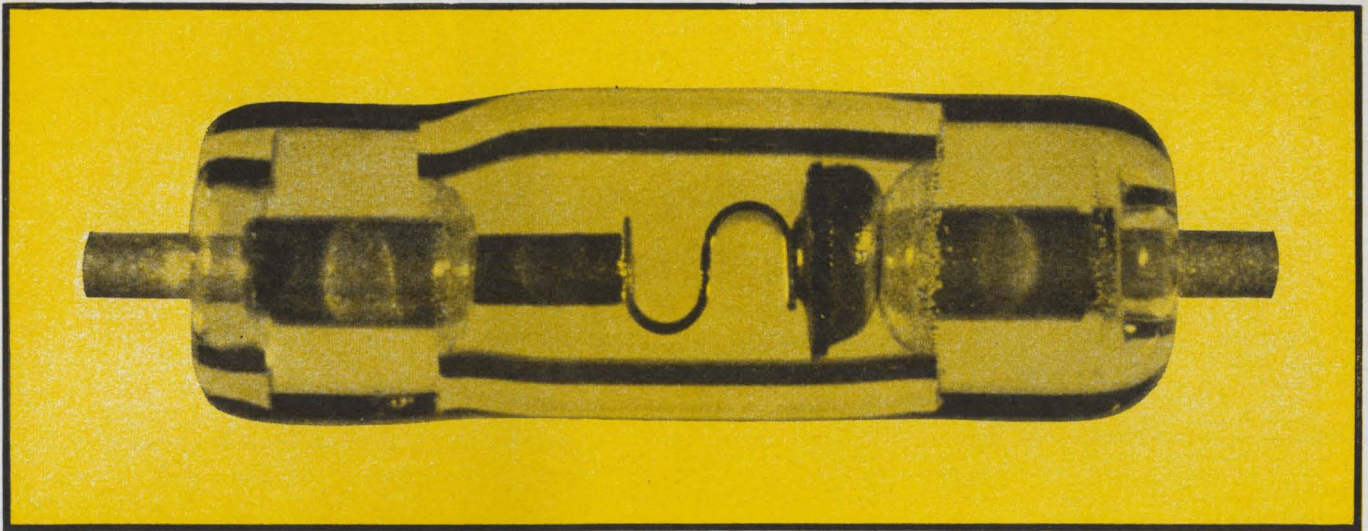

SIMPLEST, MOST EFFICIENT . . .

Two Terminal Solid State Switch
ITT SEMICONDUCTORS FOUR-LAYER DIODES

HOW THEY WORK

These epitaxial planar diodes have two stable states; the ON or low impedance state, and the OFF or high impedance state. To turn the diode ON, voltage across its terminals must exceed the switching voltage (V_s). The diode can be turned OFF by reducing the current through it below the holding current (I_h).

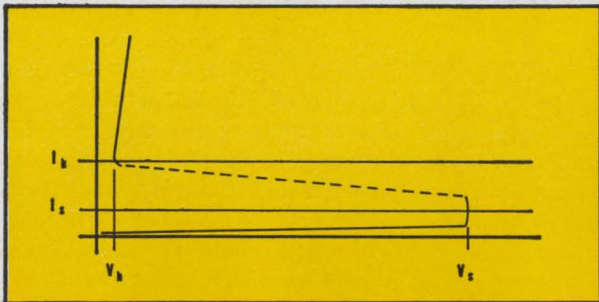

Above are shown the V-I characteristics of a typical four-layer diode. V_s is the point at which the diode breaks down and switches to the ON state where current is limited only by the external circuit impedance.

I_h is the minimum current which must be passed through the diode to keep it in the ON state. Below this value the diode switches abruptly to the OFF state. Switching times are below a microsecond, depending on circuit configurations.

HOW THEY'RE USED

Simple, inexpensive, multivibrators, flip-flops or one-shots using four-layer diodes can be designed for a variety of switching applications, including logic circuits, pulse generators and amplifiers, relay and memory drivers, binary counters and square wave generators. A typical free-running, or astable, multivibrator circuit is shown below. In this circuit the two sides are arranged so that current automatically switches from one side to the other without the need for an external trigger. To accomplish this, the supply voltage must be made higher than the switching voltage (V_s) of the four-layer diodes D_1 and D_2 .

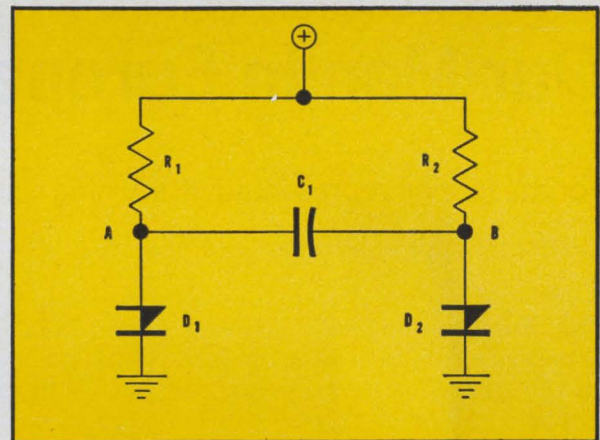

If it is assumed that D_1 is conducting, point A will be at ground. The current through R_1 must exceed the holding current (I_h) of D_1 . As C_1 charges through R_2 , the voltage at B will increase until it reaches the switching voltage of D_2 . At that moment, D_2 will switch ON and point B will go to ground. The stored charge across C_1 will drive point A negative, turning OFF D_1 , before starting to charge in the opposite direction. As C_1 charges, point A will rise to the switching voltage of D_1 and the process repeats itself all over again.

The switching frequency depends upon the time constants of R_1C_1 and R_2C_1 and on the ratio of the supply voltage to the switching voltage of the four-layer diodes. The circuit will operate symmetrically if all these factors are symmetrical, or it can be made to stay on one side longer than on the other if either of the time constants or the four-layer diode switching voltages are made unequal.

Write for additional circuit information on monostable, bistable and polarity sensitive multivibrator circuits. Ask for bulletin E-506.

SALES OFFICES

BOSTON
500 Broadway,
Lawrence, Mass.

CHICAGO
6261 W. Grand Avenue
Chicago 39, Illinois

LOS ANGELES
9911 Inglewood Avenue
Inglewood, California

METROPOLITAN NEW YORK
120 Prospect Street
So. Orange, N.J.

PHILADELPHIA
P. O. Box 83
Cherryhill, N.J.

ITT SEMICONDUCTORS
ELECTRONICS WAY, WEST PALM BEACH, FLORIDA
A DIVISION OF INTERNATIONAL TELEPHONE AND TELEGRAPH CORPORATION



Business Abroad

Our Man in Europe

For the foreign representative, learning a new set of business rules is as important as learning the language

The European market's growing importance puts increasing emphasis on the American electronics company's foreign representative. His job contrasts with its United States equivalent as markedly as a Parisian sidewalk cafe differs from a hamburger stand in Duluth.

The most obvious difference is language. The West European market consists of 14 countries and nearly as many languages. Harold Landau, the Raytheon Co.'s marketing director in Europe, Africa and the Middle East, is based in Rome. A recent week found him in Lebanon on Sunday, Rome on Monday, Milan on Tuesday morning and London that night, Bonn on Wednesday and Thursday and Paris on Friday. He saved Spain for the following week.

It's true that English is spoken almost everywhere. One Brussels-based marketing man says, "Broken English is the international language for electronics." But nationalism and increasing competi-

tion from European companies make it helpful for an American to be able to talk with a foreign prospect in the customer's own language.

Besides the languages spoken on the Continent, it's necessary to know the difference between British English and American English. "Continental agents generally learn their English from the British," explains a U.S. rep in Stockholm. "This difference sometimes leads to misunderstandings and costly delays."

I. It just isn't done

Protocol differs from country to country. A rep in London must master the art of the soft sell. In Paris, nationalism can destroy a salesman who knocks French products or President de Gaulle's policies. In West Germany, generally considered the country whose business climate most resembles that in the U.S., the Bundestag (lower house of parliament) ejected repre-

sentatives of the Lockheed Aircraft Corp. late in 1963 for lobbying too vigorously.

Selling in Europe follows a fixed procedure, frustratingly slow to an American but effective once it's mastered.

You simply don't phone a company or government official for an appointment. You start with a detailed letter asking for a meeting. If you get an appointment, some homework is important.

"I always manage to have some hard information to give him," says a Belgian representative of a U.S. concern. "I also check to see if he has published any technical papers so I can get the conversation going on a topic that interests him."

Don't call me . . . The next step is an invitation for lunch—from the prospective customer, never from the salesman. In Europe it's bad form to ask someone to lunch when you're new in his country. The Belgian rep says: "Depending on how receptive the customer is, I may wait until we've worked together six months or so before I do the asking. Even then, a dinner date is rare."

So is weekend entertaining. "Back home I negotiated some of my best contracts on the golf course," says the vice president in charge of European defense sales for a big U.S. company. "Here my business golfing is confined to other Americans who work with organizations like NATO"—the North Atlantic Treaty Organization.

Before a U.S. company is invited to bid on a contract, its foreign representative may visit the government office 5 to 10 times. Sometimes a contract is a result of negotiations that were carried on for two years or more.

In class-conscious countries such as Great Britain, there's also the problem of social acceptability. The rep must be acceptable to a wide range of people with different backgrounds, attitudes and accents.

II. Decisions, decisions

The foreign representative usually ranks higher in his company than does his counterpart in Washington. Far from headquarters, in a country where he is his company's expert, he often has the authority to make decisions on the spot and to make commitments for

New High-reliability aluminum electrolytics at new economical price

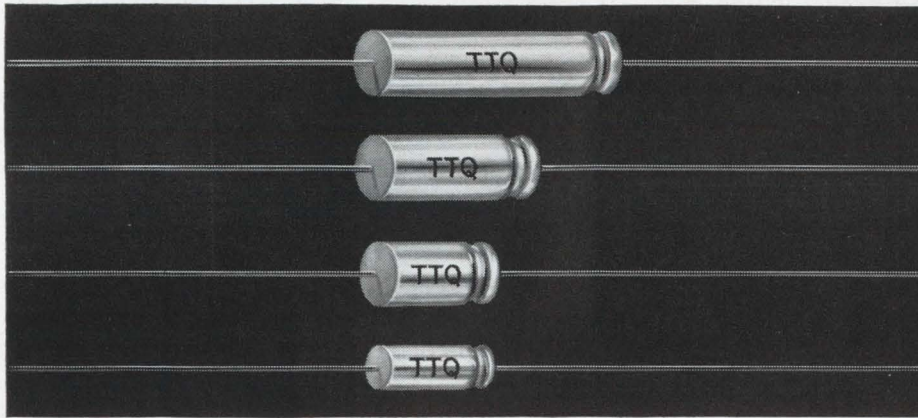

If you think you have to pay a big premium for high reliability in an electrolytic capacitor, the new Mallory type TTQ has some pleasant surprises for you.

The TTQ is a different kind of miniature aluminum electrolytic. One thing that makes it different is the extra care we take in manufacturing it, using special electrolytes for good high and low temperature performance, and all-welded construction to assure reliability under vibration and shock conditions. And another is the quality control production and sampling tests it gets . . . which can be as much or as little as you decide you need for your specific reliability requirements. Our Quality Control Department maintains a record of test data on each lot.

The result: Type TTQ capacitors have an expected life of 10 years or more when operated at normal temperatures within rated conditions. Their DC leakage and equivalent series resistance are exceptionally low and stable.

The TTQ comes in an aluminum case with special rubber end seal, with Mylar* or thermoplastic sleeve if desired. Temperature range is -40°C to 85°C . Ratings are 300 mfd, 3 VDC to 2 mfd, 150 VDC. Seven case sizes from $\frac{1}{4}$ " diameter, $\frac{1}{16}$ " long to $\frac{3}{8}$ " diameter, $1\frac{1}{2}$ " long. For data, write to Mallory Capacitor Company, Indianapolis, Indiana 46206—a division of P. R. Mallory & Co. Inc.

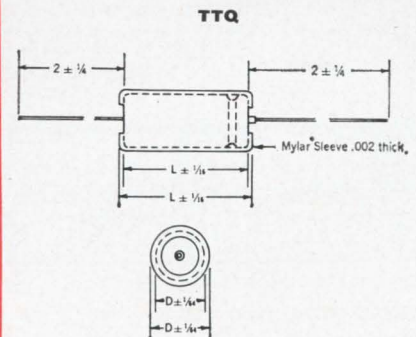
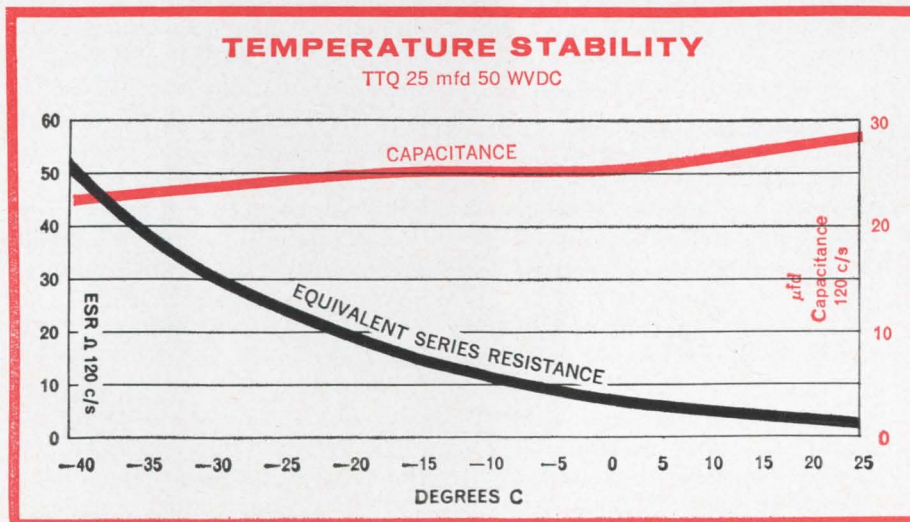
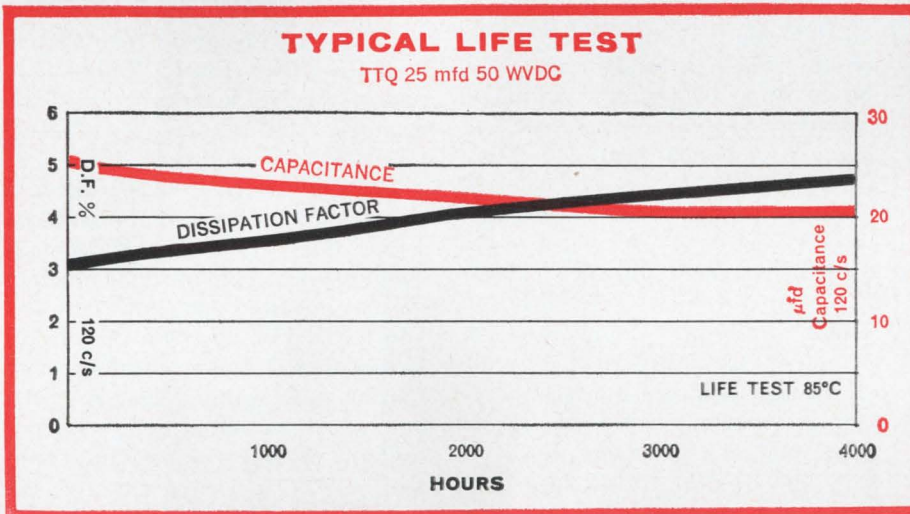

*Du Pont trademark



COMMUNICATIONS PROBLEMS



SEND YOUR
UHF-VHF
PROBLEMS
TO SINCLAIR

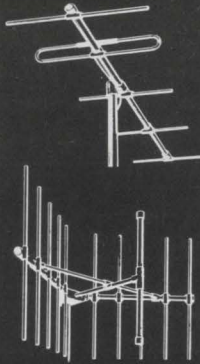
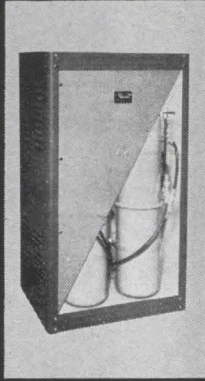

MULTICOUPLERS — use one antenna to simultaneously transmit and receive up to 24 systems . . . with high isolation between channels, low insertion loss and low maintenance costs. Multi-couplers for the 30MC to 10KMC range — specials to meet unusual problems.

DUPLEXERS — for the ultimate in isolation between Tx and Rx for dual simplex or full duplex operation. Separation as low as 0.5 MC at full power load of 250 watts. Perfect for base or repeater station or mobile operations. Frequency ranges from 30 MC to 960 MC — as small as 2" x 4" x 6".

ANTENNAS — a complete line — Isorays . . . Yagis . . . Ground Plane . . . Corner Reflectors . . . Base Station . . . Mobile — for frequency ranges from 30 MC to 470 MC. Gains from 0 db to 20 db. Rugged enough to withstand 125 mph winds with 1/2" ice coating — small enough to fit in a rear view auto mirror.



Also, a complete quality line of Band Pass and Reject Filters, Mounting Accessories and Antenna Hardware. Clip the coupon, attach to your letterhead, and we'll send complete details.

SINCLAIR RADIO LABORATORIES, INC.

523 FILLMORE AVENUE, DEPT. P
TONAWANDA, NEW YORK

IN CANADA: 21 TORO ROAD
TORONTO, ONTARIO

Name _____ Title _____

Company _____

Address _____

City _____ State _____

his company back in the U.S.

He needs more technical knowledge than his stateside colleague. A rep in Bonn says 90% of his time is spent giving technical advice and making technical comparisons. He also has to evaluate competitive systems from many countries that involve different technical approaches to a problem.

For these reasons, the foreign representative is often a technical specialist. One engineer joined a U.S. company in Belgium after a career in the U.S. Navy's missile program. He says selling in Europe depends almost entirely on convincing a prospect that one company's product is superior technically. There's relatively little personal contact outside the customer's office.

He recalls the days when he was on the other side of the ocean and on the receiving end of the sales pitch. "In Washington I was wined and dined several times a week, but here the game just isn't played that way."

Wider range. Technical competence is also necessary because the foreign rep usually handles a larger range of products than his colleague in the U.S. One Swedish company, AB. Nordiska Elektronik, which represents 24 American electronics concerns, stresses in its sales pitch the fact that its product line is one of the broadest in Europe. "It's obvious that no one American company can offer the best in all components and equipment," says its managing director, U.S.-born Stephen J. Finta Jr.

III. Special considerations

The best or cheapest system isn't always the one bought by a European military establishment. Now that less U.S. money is available for foreign countries' weapons systems, this nation has less say about the criteria for awarding contracts.

One rep, in Paris, ticks off several reasons he has encountered recently: "One country feels the need to plow its money back into its own economy. A small country can't afford the costly bidding procedures that we're accustomed to in America. Then there's the 'not-invented-here' stigma."

Government programs also involve economic and political con-



Business in Paris. U.S. rep entertains a purchasing official at Maxim's restaurant.

siderations. NATO has worked into its plans for an air-defense system a requirement that a bidder analyze how its country would be affected if the bidder won a NATO contract.

Security. Security clearance, a one-shot procedure in the U.S., is a multiple problem in Europe. A Belgian rep explains: "The fact you're cleared in one country means you have to be all the more careful in another country. For security reasons, we won't even show the outside of classified gear to a potential customer in another country."

Nordiska Elektronik, the Stockholm-based rep concern, has an additional security problem because of its dealings with Finland, which has close relations with the Soviet bloc. The company sells U.S.-made defense equipment to Norway and Denmark, both members of NATO, but keeps it out of Finland. Sweden, although nonaligned politically, has a Western-oriented defense establishment and is considered trustworthy with U.S. military gear.

Smuggling. Sometimes a knowledge of the rules helps a foreign rep know when they can be broken. One describes how he engages regularly in a practice that technically comes under the heading of smuggling.

"What are you going to do," he asks, "when you arrive at an airport late at night with some electronic instrument you want to show someone the next day? The cus-

toms men who handle this kind of gear have long since gone home. The only ones on duty are the suitcase-slappers. So I wave my American passport in their faces and dart by, shouting, "Nothing to declare!"

"I've yet to be caught," he adds, "but heaven help me if I am."

Remote control. Many American companies find that one rep can't drum up enough business to pay for his keep in Europe—at least \$50,000 a year for salary, travel expenses, office space and so on. One trend is to send abroad one "heavy-weight" from the home office to direct a team of nationals recruited among retired military officers who know their way around their own country's defense offices.

Another trend is the business arrangement with local company—either as a licensee or as a partner in a joint venture.

Many reps frown on licensing. "They're all right as a one-shot arrangement or as a bridge to something better," says one. "Otherwise your company is just selling its brains for inadequate returns."

"Forming a subsidiary jointly with a foreign concern is a sounder practice," this Paris rep continues. "This can get you over a lot of preliminary hurdles. It gives the U. S. firm a European name to present. This may not sound like much to an outsider, but as a European I can tell you it can make a lot of difference."

When a foreign government buys a weapons system from a company that's partly owned by a domestic concern, the government knows that some of its money will stay in the country and some jobs will be created at home.

IV. The gay life

A Rome rep complained recently that la dolce vita is much tamer than the Washington expense-account life that's considered mild by some U. S. standards.

Finta, the 30-year-old bachelor who founded Nordiska Elektronik in Sweden, says high-life entertaining is out. Even at Christmastime, there are no gifts, no lavish parties, no big dinners at posh restaurants. "Scandinavians don't expect this," he explains, "and would look at it suspiciously."

Even in Paris, no rep will admit

Unapproached in measuring accuracy and display versatility . . .

AFTER 5 YEARS (10 years in 1970) STILL THE INDUSTRY'S FINEST SYSTEM OF DUAL-TRACE SCOPES

Designed to grow with your needs with the addition of new Plug-ins.

analab 1120/700

The Analab Type 1120/700 has consistently proved itself for accurate *quantitative* measuring of signal amplitude, rise time, pulse duration, frequency, and phase.

Use it as a precision AC & DC voltmeter, phase meter, time-interval meter, analog waveform indicator . . . thanks to Analab's precision Null-Balance Readout.

Call or write your local rep for specifications on the 1120/700, 701, and the full line of Analab scopes, camera systems and accessories.



Analab DIVISION OF BENRUS
18 Marshall Street, South Norwalk, Connecticut

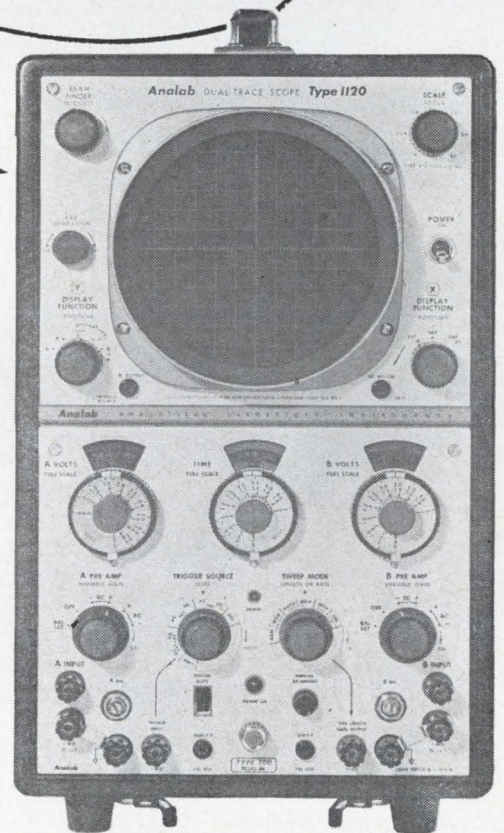

NEW . . . Type 701 SAMPLING AND SWEEP PLUG IN
. . . Extends frequency measuring capabilities to 5000 MC. Permits more than 80% of all H-F scope measurements with a single instrument.

not tomorrow...

not the next day...



but
the day
after that!

Acopian guarantees that any of their 62,000 different single or dual output plug-in power supplies will be shipped in three days! Request detailed 12-page catalog and price list from Acopian Corp., 927 Spruce Street, Easton, Pennsylvania, or call collect (215) 258-6149.

introducing a customer to girls. One does concede, however, that he sometimes takes clients—"if they seem the type"—to where the action is, then bows out early. What happens then? "If they need me to lead them by the hand in Paris . . ."

Entertaining. For Italians, lunch is a family affair; business entertaining in the afternoon is done mostly with other Americans. "I see someone in the military every day," says a Rome rep. I manage to have two business lunches a week, one with an American type, one with an Italian military man. Lunch is not lavish—the tab comes to about \$8 total. We usually eat in some restaurant off the Via Veneto.

"Evenings are a different story. About once a week we entertain one or two couples. We have a leisurely dinner and, in the season, we take them to the ballet or opera."

Expensive gifts? "I've never come across anyone in Italy who has even hinted that he wanted one. It's just the reverse. They sometimes insist that dinner be Dutch treat."

Entertainment steps up in the summer, when nationals are away but visitors from the home office arrive in swarms. "When they have gone," a Paris rep complains, "it often takes me six months to repair the damage they've done through ignorance of European attitudes and business methods."

Job surplus. Despite the glamor of working abroad on an American income, the rigid requirements hold down the number of foreign reps. The salary is good—about \$15,000 to \$20,000 a year plus allowances for living abroad—and the experience is considered helpful for a career later in the U. S.

Yet there seems to be a shortage of top-flight electronics engineers willing and able to work in Europe. H. Glen Wood, director of European operations for the Martin Marietta Corp., says: "Many electronics engineers don't see the opportunities over here."

It's not a requirement, but an easy-to-remember name is an advantage. Finta hit the jackpot in Sweden, where one of the most popular television shows is The Flintstones. The show's title in Sweden is "The Flinta Family."

McGraw-Hill
BOOKS

Just Published

INTEGRATED CIRCUITS Design Principles and Fabrication

Prepared by the Engineering Staff,
Semiconductor Products Div., Motorola
Inc.

Provides valuable information on how to put integrated circuits to work for you in a wide range of practical applications. From initial material processing through device packaging and reliability testing, all phases and aspects of integrated circuits are treated. Acceptor doping . . . hole-electron spin asymmetry . . . recombination and generation . . . the gaussian distribution . . . diffusion time . . . sheet resistance . . . and many other subjects are covered. 370 pp., 298 illus., \$12.50. Payable \$6.50 in 10 days, and \$6 in one month

OPTOELECTRONIC DEVICES AND CIRCUITS

Just Out. Treats the theory, operation, and application of optoelectronic systems. By S. Weber, *Electronics*. 368 pp., 473 illus., \$15.00. Payable \$7 in 10 days, \$8 in one month

MATHEMATICAL BAFFLERS

An entertaining and stimulating collection of 125 recreational problems. Includes the best from Litton Industries' Problematical Recreation Series. By A. Dunn, *Litton Industries*. 200 pp., illus., \$6.50

MICROWAVE FILTERS, IMPEDANCE-MATCHING NETWORKS, AND COUPLING STRUCTURES

Just Out. Shows how to design microwave devices for a wide variety of practical uses. By G. Matthaei, L. Young & E. Jones. 1079 pp., illus., \$22.50. Payable \$8.50 in 10 days, and \$7 for 2 months

10 DAYS' FREE EXAMINATION
Convenient Mail Service
Direct from McGraw-Hill

McGraw-Hill Book Co. 04-L125
327 W. 41st St., New York, N. Y. 10036
Send me book(s) checked below for 10 days on approval. In 10 days I will remit for book(s) I keep plus few cents for delivery costs, and return unwanted book(s) postpaid. (If you remit with coupon, plus local tax, we pay delivery costs—full refund and return privilege.)
 Motorola—Integrated Circuits, \$12.50
 Weber—Optoelec. Devices & Circs., \$15.00
 Dunn—Mathematical Bafflers, \$6.50
 Matthaei—Microwave Filters, Impedance-Match. Ntwks. & Coup. Struc., \$22.50
 Check here if you wish to pay on terms
Name
Address
City State..... Zip.....
Code.....
Company
Position
For price and terms outside U.S.
write McGraw-Hill Int'l., N. Y. 10036 04-L125

Relay News

from ELECTRICAL INDUSTRIES,

NEW **E-I** HERMETICALLY SEALED RELAY HEADERS

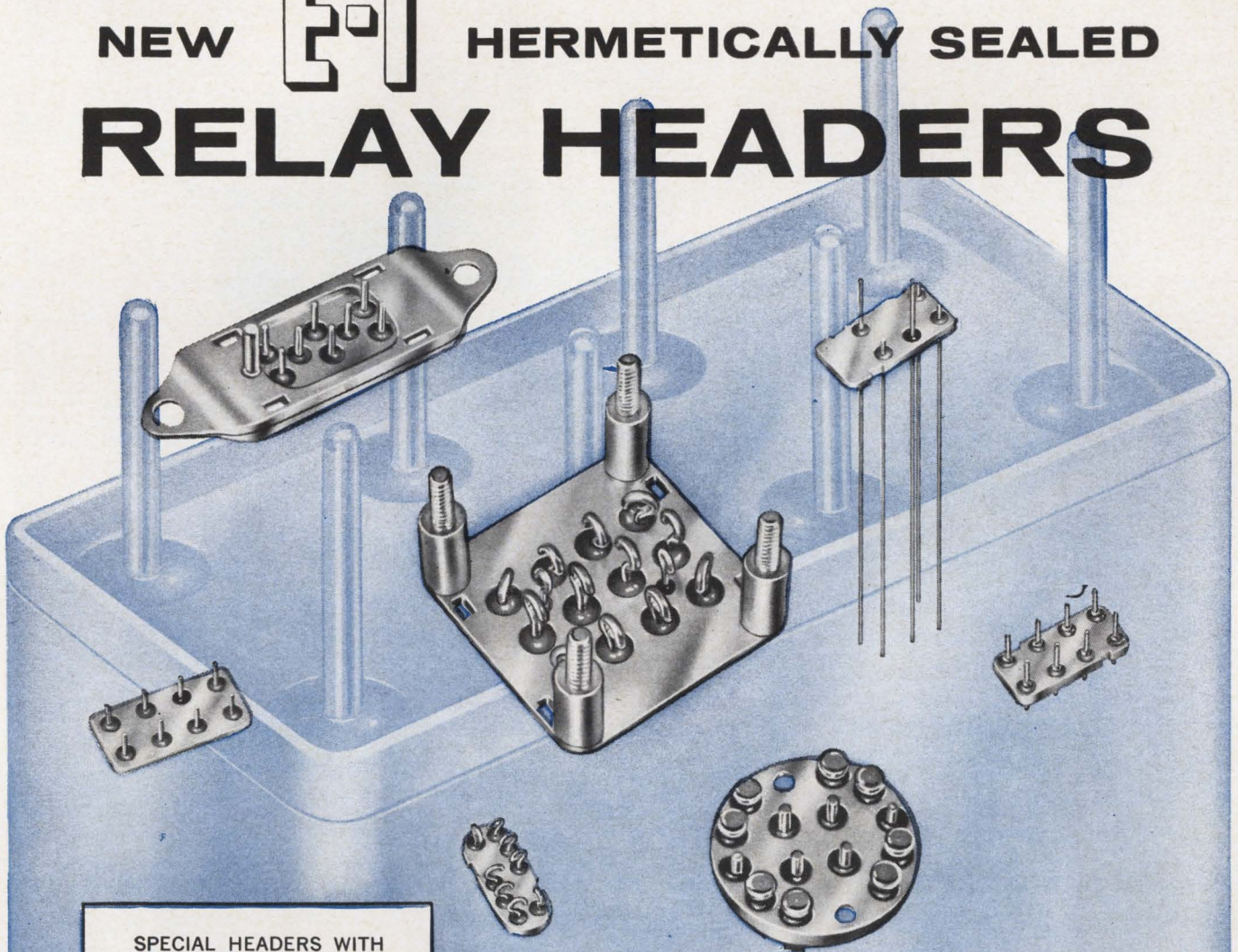

SPECIAL HEADERS WITH
SPADED WIRE LEADS
can be supplied at lower cost
than with round type leads

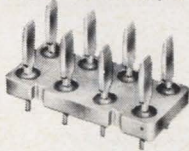

MODULAR TYPE HEADER
SUITABLE FOR
HELI-ARC WELDING

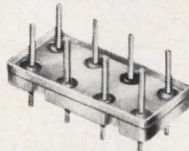

- Available in a Wide Range of Configurations
- Header Thicknesses down to .050 Inches
- Increased Torque Resistant Wire Available

E-I headers, featuring ruggedized compression seals, can be produced to your exact specifications to meet practically any type of relay application. In many cases, standard E-I tooling can be utilized at a considerable saving. Brazed contacts are available if required. Standard finishes available include hot solder dipped, electro-tin, nickel and gold. Special plating on order. Call or write E-I for quotations on your specific requirements!



ELECTRICAL INDUSTRIES

691 CENTRAL AVENUE, MURRAY HILL, NEW JERSEY

Division of Philips Electronics & Pharmaceutical Industries Corp.

PATENTED IN THE U.S.A., NO. 3,035,372; IN CANADA, NO. 523,390; AND IN THE UNITED KINGDOM, NO. 734,583; OTHER PATENTS PENDING.

NEW ZENER DIODE IN SOLID POLYSIL PACKAGE

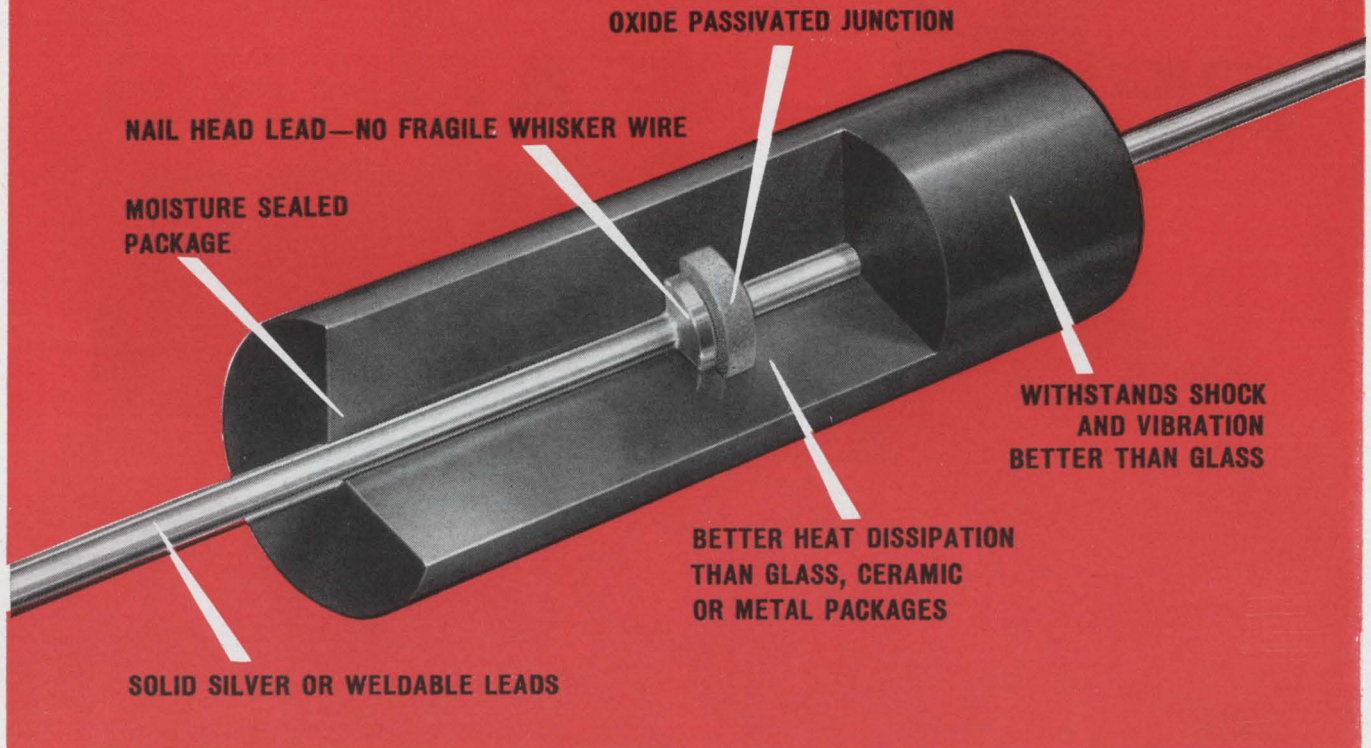

NEW CAPABILITY FOR ZENER DIODES

Solid POLYSIL package overcomes limitations of glass

POLYSIL is a new molding and sealing material developed by IRC. Its application to NAE Zener Diodes provides improved characteristics and greater capability than can be obtained with a glass package.

The solid package construction completely surrounds all internal parts, resulting in greater thermal and mechanical strength and more dependable performance. Polysil Zeners dissipate higher wattage than glass packages in the same physical size. The first 1 watt zener in a DO-7 package, Polysil Zeners have been tested to 250°C without catastrophic failure.

Write for samples, literature and prices. North American Electronics, 71 Linden Street, West Lynn, Massachusetts.

CAPSULE SPECIFICATIONS

MIL: Designed to meet MIL-S-19500
WATTAGES: To 1 watt @ 75°C
DIMENSIONS: DO-7 (.265" long x .10" dia.)
JEDEC TYPES: 1N702A thru 1N745A
 1N746A thru 1N759A
 1N761A thru 1N769A
 1N821 thru 1N827
 1N935 thru 1N939B
 1N941 thru 1N945B
 1N957B thru 1N992B
 1N4323 thru 1N4358
LEADS: Solid silver. Dumet available
 SEE ELECTRONIC ENGINEERS MASTER FOR
 COMPLETE CATALOG DATA ON ALL
 IRC PRODUCTS



NORTH AMERICAN ELECTRONICS
 DIVISION OF INTERNATIONAL RESISTANCE COMPANY

Molded h-f transistor handles high power

Packaging technique is based on a method of molding a cap around an exposed ceramic heat sink

What is claimed to be the first high-frequency, high-power transistor to be successfully encapsulated by transfer molding methods is now in production. A key factor in the year-long development of this transistor is the void-free package using a special silicone molding compound formulated by engineers at the Dow Corning Corp.

The new device is an npn, triple-diffused silicon planar type with isolated collector. Designated PT3690 by the manufacturer, it is rated at 10 w at 150 Mc (testing is now under way at frequencies as high as 400 Mc). At 2.5 grams, it is one-third the weight of comparable metal enclosed transistors. The cost of the devices is also lower, the company says. The inexpensive encapsulation technique is based on a method of molding a cap around an exposed ceramic heat sink. One reason for the low cost of the new device is that the manufacturing yield of encapsulated

transistors is a near-perfect 98 percent.

Total dissipation at case temperature of 25°C is 20 w. Thermal resistance (junction to case) is 8.75°C/w. The new package has proved to have excellent reliability during rugged environmental testing. Devices have been subjected to 1,000 hours storage at 200°C, and tested for moisture resistance and thermal shock resistance in cycles from +200°C to -55°C. Tests were conducted in accordance with MIL specifications, maintaining electrical and mechanical integrity, according to the manufacturer.

Applications lie in the fields of mobile, aircraft, commercial, business and public service communication systems where rugged transistors providing high power at high frequencies are much sought after. The manufacturer anticipates the PT3690 transistor will have an almost infinite useful lifetime. It is

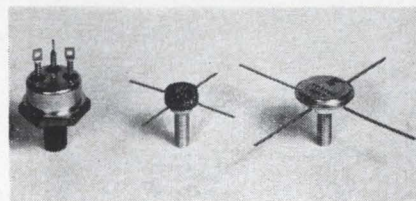

Silicone-encapsulated transistor (center) is rated at 10 w at 150 Mc. Weighing only 2.5 grams, it is approximately 1/3 of the weight of comparable metal-cased transistors beside it.

available with or without attached stud. Price in quantities of 1-99 is \$27.50 each; 100 and up, \$20 each. TRW Semiconductors Inc., a subsidiary of Thompson Ramo Wooldridge Inc., Lawndale, Calif.

Circle 349 on reader service card

High reliability metal film resistor

The EER-1/8 is said to constitute a major breakthrough in the state of the resistor art. Conforming to the RN60 size of MIL-R-10509E and the RNR60 size of MIL-R-55182, this specially constructed and molded resistor offers four times the wattage rating (1/2 w at 125°C) due to its thermal design. The EER-1/8 measures 0.128 in. in diameter by 0.398 in. long and has 0.025-in. diameter tinned copper leads 1 1/2 in. long. Reliability is enhanced by screening tests of 100% of the units as a part of the manufacturing procedure. Screen testing includes short time overload, temperature coefficient, and six hours of burn-in. Range coverage is from 50 ohms to 250,000 ohms, with tolerances from ±0.1% to ±5%, and temperature coefficients of ±25 ppm/°C, ±50 ppm/°C, and ±100 ppm/°C. Prices range from \$4.64 to 97 cents (including all screen testing).

American Components, Inc., 8th Ave. & Harry St., Conshohocken, Pa.

Circle 350 on reader service card

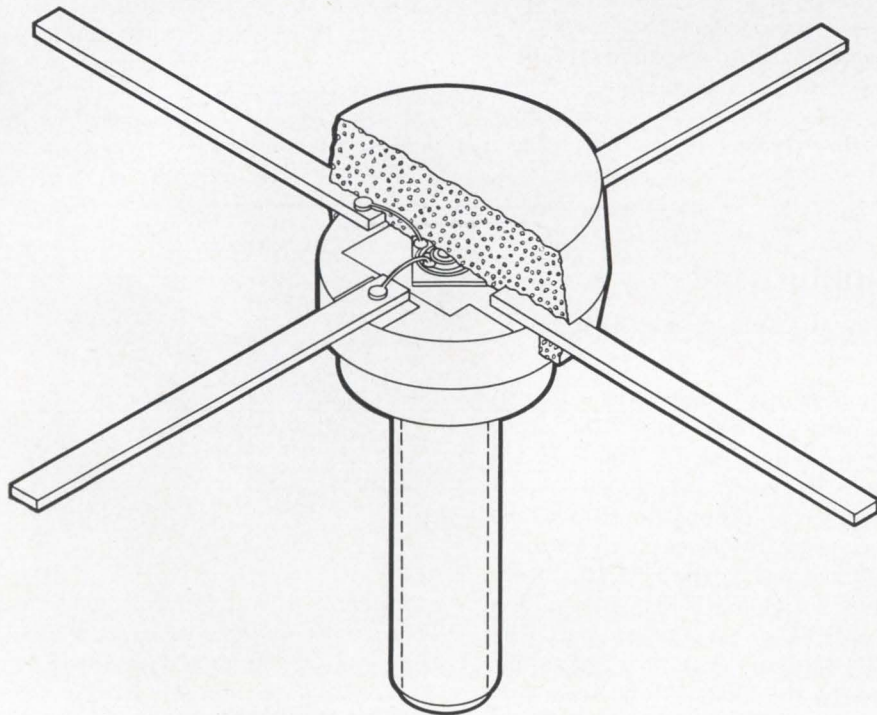

Cutaway drawing shows how silicone molding compound completely seals leads and protects junctions of new lightweight, high-performance transistor.

NEW DELTRANS SAVE SPACE & WEIGHT



from Delevan TUNABLE COILS AND TRANSFORMERS

Miniature coils and transformers packing a big load of features into a mighty small package. DELTRANS provide electrical characteristics equal or superior to units which are three times their size. DELTRANS were designed specifically for rigid Apollo requirements. Their capability to meet these requirements has been proven through exhaustive environmental testing. Use DELTRANS in applications demanding the utmost quality, reliability within minimum space and weight factors. Available for 30MC and 10.7MC IF usages in various voltage and impedance ratios. All units mounted on .100" grid spacing, using .020" terminals. Custom units for usage at other frequencies can be designed into this packaging.

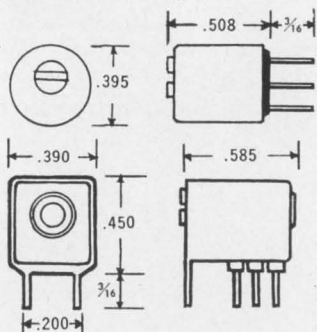

- Minimize coupling problems
- No moisture failures
- Low cost with high quality

Units are priced approximately \$3.00 in 1,000 piece quantities.

Environmental performance of Deltrans is substantiated by tests conducted in an approved laboratory. Test reports are available on request from:

TRANSFORMER DIVISION Delevan Electronics Corp.

Subsidiary of American Precision Industries Inc.
270 Quaker Road, East Aurora, N. Y. 14052

New Components and Hardware



Variety of jobs ahead for two-color crt's

A combination of color and compactness is featured in the model 2C48 two-color, thin cathode-ray tube. The two colors are drawn by two separate guns on a 4-by-8-in. screen. The tube is only 2½ in. deep. The company says this breakthrough in the field of crt's suggests a wide variety of experimental uses such as in the fields of sampling and measuring sets of related data where two traces are intertwined. Appropriate circuitry allows two separate inputs to be shown in time registry in two colors on the screen. Phase and phase

shift comparisons, dual performance characteristics, input versus output wave shapes, or friend or foe on radar scope display may all be shown with circuitry modification. Temperature variations over an area, 3-D radar or sonar display, or bar graphs where color hues vary with urgency of attention are a few other possible uses. The tube is available in a wide variety of sizes and shapes. It features both ruggedness and brightness, and it may be provided with any two basic phosphors.

Video Color Corp., 729 Centinela Ave., Inglewood, Calif. [351]

Multiturn pot with interlock switch

A multiturn potentiometer with off-position interlock switch for motor speed controls and variable speed drives has been announced. Model T580 is a precision 10-turn pot coupled to an interlock switch which operates within the first 10° clockwise rotation (representing less than 0.3% of total resistance). The unit measures 0 to 100 ohms through 0 to 300,000 ohms per section. The interlock switch is spdt, providing for normally open and/or normally closed interlock circuit re-

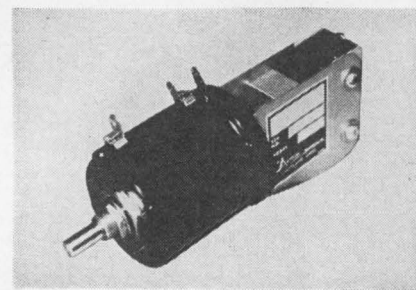

quirements. Model T580 uses a ¼-in. shaft and mounts by means of a ⅜ in.-32 bushing. Turns-counting dials, particularly suitable for use with the T580, will be supplied when specified. Two scales on the dial indicate number of whole turns

How do you take a picture of something you can't see?

Transient oscilloscope traces in the sub-nanosecond range move too fast for the human eye. How can you study them?

Use Polaroid 10,000-speed Land film. It's fast enough to make clear, high-contrast pictures of the most fleeting traces. And the results are fast, too.

Your pictures are fully developed in 10 seconds. If you are studying sequential traces, you can click off a full roll (8 exposures) in 20 seconds. Simply let the film stay in the camera back for 2 seconds, then pull the tab,

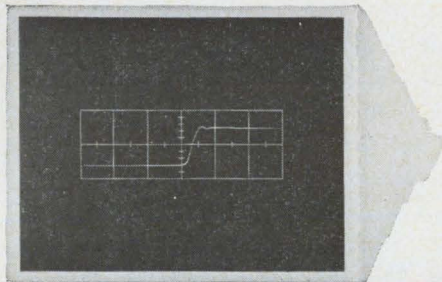

repeating the process for each exposure. Strip away the negative and you've got eight finished pictures.

The catalog name for this film is Polaroid PolaScope Type 410. It's panchromatic, responds best to blue phosphors such as P-11. The film's extreme sensitivity lets you use small camera apertures and low beam intensities too, so your trace pictures are really sharp.

Try Type 410 Land film the next time you need oscilloscope pictures. And see.

POLAROID ©

Polaroid 10,000-speed Land film.

Circle 115 on reader service card

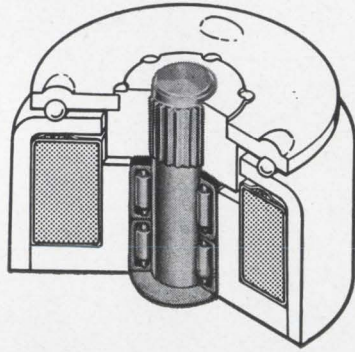

100 MILLION ACTUATIONS

This is a Ledex Endurance Engineered rotary solenoid.

Life expectancy without any field relubrication is 50 million cycles—100 million when you apply our Lube 2 every 10 million cycles.

A precision needle bearing, plus special materials, heat treatments and surface finishes make the difference.

Six sizes are available, with torque output from 12 to 445 ounce-inches.

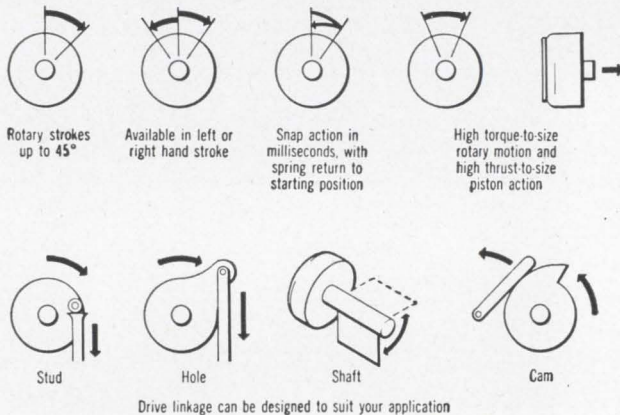

Ledex rotary solenoids are used to step, turn, pull, push, index, hammer, punch or trigger—wherever there's a need for fast, remote action.

Have an actuating problem? Longlife requirements? We'll design a solution for you. Write or phone 513-224-9891. Let's talk it over.



32-page catalog describes endurance engineered, standard and stock model rotary solenoids. Ask for C-264.

Ledex Inc.
123 Webster Street, Dayton, Ohio 45402



New Components

and hundredths of a turn completed, respectively. A vibration-proof lock is included. Nominal dimensions are: diameter, $1\frac{13}{16}$ in.; depth, 1 in.

Avtron Mfg., Inc., 10409 Meech Ave., Cleveland, Ohio, 44105. [352]

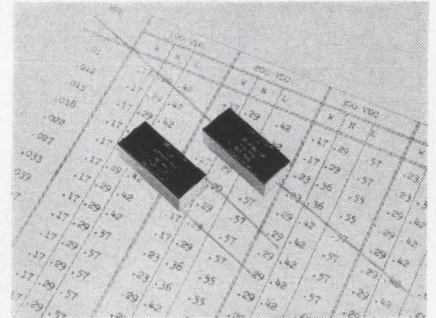

Tiny capacitors offer high stability

A line of subminiature capacitors that are totally epoxy-resin encapsulated utilizes Deltafilm LP (metalized polycarbonate) as the dielectric. The LP7 series possess excellent capacitance stability and insulation resistance over the operating temperature range. They operate at 125°C without voltage derating. The capacitors are available with axial or radial leads and are rated for both a-c and d-c voltages. They are said to be ideal for use in conventional and printed-circuit applications or wherever operational reliability and economy of space are paramount considerations. Units are available in voltage ratings of 100, 200, 300 and 400 v d-c from 0.01 to 5.0 μ f. Case dimensions range from 0.17 in. by 0.29 in. by 0.42 in. to 0.56 in. by 0.72 in. by 1.75 in.

Dearborn Electronic Laboratories, Inc., P.O. Box 3431, Orlando, Fla., 32802. [353]

Heat sinks available in choice of designs

The basic 700 series heat sinks are announced for press-fit rectifiers, scr's and transistors. As shown in the photograph, the designs offered solve a wide range of application

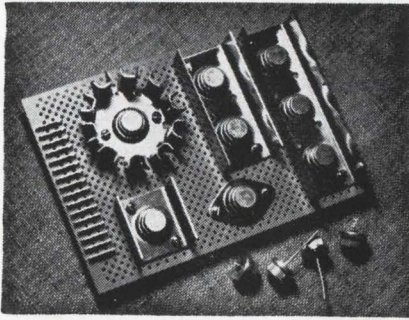

problems, among which the following are typical: 1) dimensions suitable for circuit board use; 2) medium to high power levels; 3) tandem units for common-base circuit applications such as rectifier bridge assemblies. Other features include the following: the only tools required for installing the rectifiers are a drill press and a $\frac{9}{16}$ in. socket; the rectifier can be removed and replaced without damaging the heat sink; a multistrand wire can be captivated during the insertion process and used as a more reliable case electrode.

Daedalus Co., 129 $\frac{1}{2}$ Rosecrans Ave., Manhattan Beach, Calif., 90266. [354]

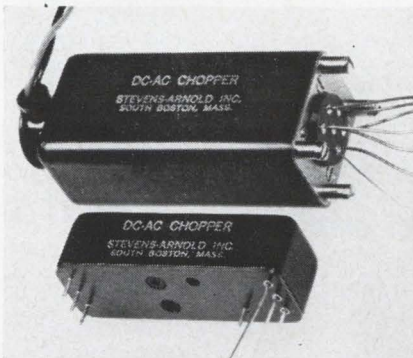

Low-noise choppers with a-c and d-c drives

Two basic additions have been made to a line of low-noise choppers. The first has printed-circuit board packaging with pins for solder-in connections. For plug-in connection printed-circuit board mounting jacks can be added. The second addition consists of new types designed specifically to reduce thermal noise to a minimum, and these are supplied either for printed-circuit board or vertical mounting, as illustrated. Reduction of thermals is accomplished by substituting copper leads externally for the usual pin type plug-in base,

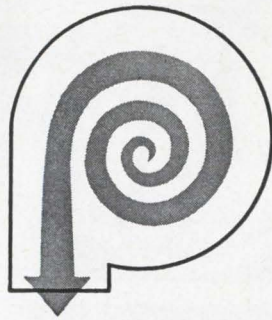

GLOBE A. C. CENTRIFUGALS COOL WITH SLINGSHOT FORCE

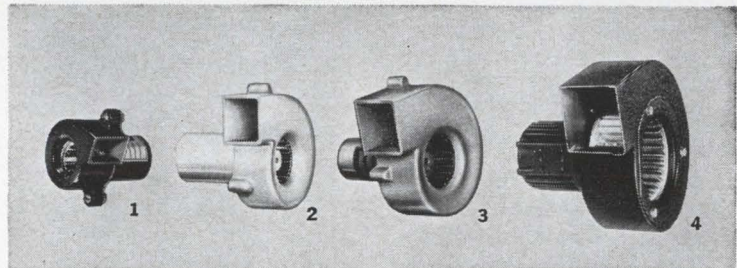

PERFORMANCE

- 1 1" wheel. 115 v.a.c., 400 cps. Overall length 2.48". Weight 4 oz. Part Number 19A565.
- 2 1 $\frac{1}{2}$ " wheel. 115 v.a.c., 400 cps. Overall length 3.30". Weight 16 $\frac{1}{4}$ oz. Part Number 19A690.
- 3 2" wheel. 115 v.a.c., 400 cps. Overall length 3.77". Weight 18 $\frac{3}{4}$ oz. Part Number 19A694.
- 4 3" wheel. 115 or 208 v.a.c., 50 or 60 cps. Overall length 6" max. Weight 3 $\frac{1}{2}$ lb. Part No. 19A1540.

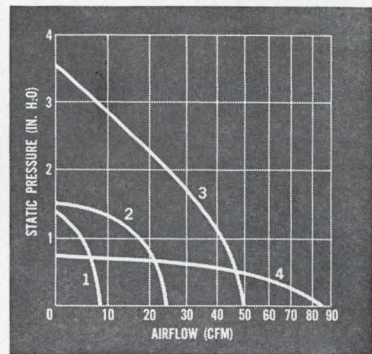

For economical cooling and pressurization, obtain a Globe proposal the next time you need standard or special centrifugal blowers. Globe makes single and double styles, for military or commercial applications. We also make a.c. and d.c. vaneaxial, tubeaxial, and multistage blowers and fans. Request Bul. CB. **Globe Industries, Inc.**, 2275 Stanley Avenue, Dayton, Ohio, 45404, U.S.A., Tel.: 513 222-3741.



MELPAR GROWTH

Creates
Immediate
Openings

SYSTEMS DESIGN

Development and analysis of complete digital computer system requirements for command and control applications. Requirements include experience in the analysis of real-time man-machine systems.

PROGRAMMING

Symbolic and machine language programming of real-time computer-controlled man-machine systems. Requirements include experience on CDC 160, CDC 160A, DDP 24, PB 250, PB 440, SDS 910, or SDS 920 series equipments.

LOGIC DESIGN

Design, development, and system integration of interface and special-purpose computer equipments. Requirements include experience with solid-state digital logic circuits and computer interface equipments.

MICROWAVE RECEIVER DESIGN

Specific problems include parametric amplifiers, varactor techniques, microwave filters, ultrastable programmable oscillators, and dual and triple channel balanced receivers for monopulse and guard antenna gating. Degree in EE or Physics required.

Write to Clarence Endsley
Manager
Professional Placement

MELPAR INC

A SUBSIDIARY OF WESTINGHOUSE AIR BRAKE COMPANY

3484 ARLINGTON BOULEVARD, FALLS CHURCH, VIRGINIA

(A Suburb of Washington, D. C.)

An equal opportunity employer

SPECIAL DETECTION SYSTEMS
BIOLOGICAL AND CHEMICAL

SIMULATION AND TRAINING

SPECIAL PURPOSE DATA
PROCESSING

ELECTRONIC WARFARE
SYSTEMS

MICROELECTRONICS

ORDNANCE DEVICES

COMMUNICATIONS

TEST AND
EVALUATION

SPACE SCIENCES

LIFE SCIENCES

New Components

plus special construction internally. Both these features result in a superior chopper which has demonstrated thermal noise as low as 8 nv per °C. There are drive systems for a-c input and for d-c input. A 60-cycle a-c drive has a chopping rate of 60 cycles and is available in both vertical and p-c board mountings. In the vertical types only, there are frequency doubling types where a 60-cycle input gives a 120-cycle chopping rate. For d-c drive from a 12-v d-c source, 83-cycle and 94-cycle chopping rates are available using a p-c board mounted d-c/a-c conversion unit with a transistorized multivibrator circuit.

Stevens-Arnold, Inc., 7 Elkins St., South Boston 27, Mass. [355]

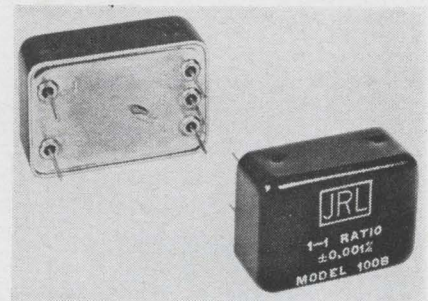

Standard resistors for printed circuits

A miniature resistance standard has been developed for printed circuit applications. A 5-terminal can, with dimensions of $1\frac{3}{8}$ in. by $5\frac{7}{8}$ in. by $\frac{1}{2}$ in. high, mounts either one 4-terminal or two 2-terminal resistors. Fifth terminal is case, which may thereby be grounded, guarded or floated. Accuracies are to $\pm 0.002\%$ absolute, 0.001% ratio. Temperature coefficients are to 1 ppm/°C absolute, 0.5 ppm/°C differential. Hermetically-sealed, oil-bath construction provides electrostatic shielding and closely matched environment for resistor pairs, as well as lowest thermal resistance to internally generated heat, and highest decoupling of external destabilizing influences such as environmental contamination and soldering irons.

Julie Research Laboratories, Inc., 211 W. 61st St., New York, N.Y. [356]

5 MILLION CORREEDS

are behind this booklet

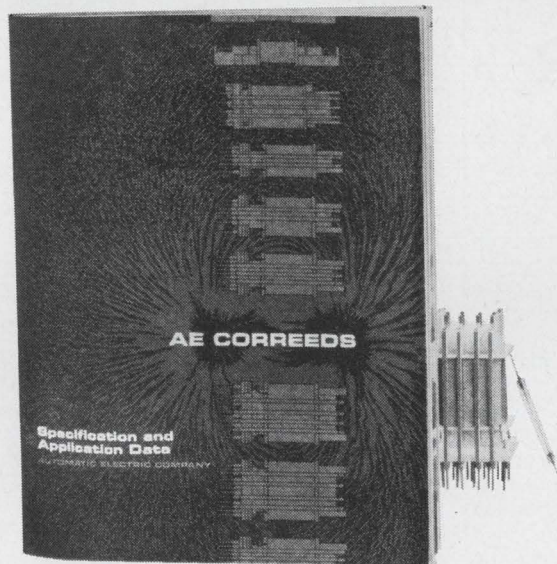

get your copy free

Learn why AE Correeds are your best route to the speed, long life and reliability of dry reed switching. This booklet gives you facts based on more than 5 years' experience in applying 5 million Correeds.

It tells how functional, rugged design protects your circuits against trouble—with straight, unstressed contact terminals that make Correeds virtually immune to changes in sensitivity, and prevent strain or fracture in the reed-capsules—with efficient shielding that permits high-

density mounting without magnetic interference—with sturdy molded coil bobbins that provide unusual structural strength.

AE CORREEDS Specification and Application Data also shows you how to put Correeds to work for you. It includes specifications, diagrams, mounting data and ordering information. To get your free copy, ask your AE representative for Circular 1051. Or, write to the Industrial Products Div., Automatic Electric Company, Northlake, IL. 60164.

AUTOMATIC ELECTRIC

SUBSIDIARY OF
GENERAL TELEPHONE & ELECTRONICS **GTE**

New Instruments

Tape-recording head reduces crosstalk

The design of these multichannel tape-recording heads incorporates a new type of compound shielding and a unique core design to reduce write-to-read cross-feed and inter-channel crosstalk by approximately one half while increasing electrical efficiency and life. Modular construction permits tight packaging resulting in more channels per inch of tape. The new design is incorporated in the manufacturer's 40-304000 series magnetic heads for instrumentation and computer recorders. The low core loss greatly reduces current requirements and doubles output at high frequencies. For a typical IRIG format, crosstalk rejection of 50 db or greater can be expected at frequencies up to 500 kc and recorded wavelengths as great as 30 mils (1 kc at 30 ips). Innovations in the new head structure allow for nearly double the normal gap depth and permit the use of wear-resistant materials where tape and head come in contact. Because of this, effective life is doubled. Contour of the recording surface is such that performance degradation through wear is

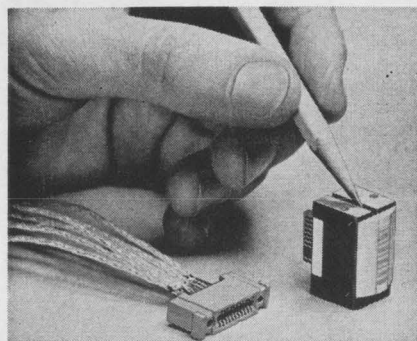

negligible. A slot built into the base of the new head contains a lapped surface which is an extension of the gap line. Precision mounting surfaces in all three axes are perfectly aligned with this gap surface. Thus, the head can be quickly and accurately installed simply by butting these precision surfaces against locator pins and fastening the head in place. Designed for user convenience, the new head is equipped with two p-c board connectors to permit quick disconnect and eliminate soldering directly on the head.

Brush Instruments Division, Clevite Corp., 37th and Perkins, Cleveland, Ohio. [381]

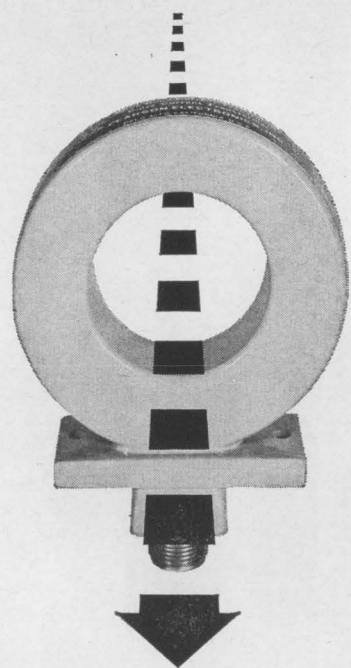

Wide Band, Precision CURRENT MONITOR

With a Pearson current monitor and an oscilloscope, you can precisely measure ac and pulse currents from milliamps to thousands of amperes, in any conductor or beam of charged particles, at any voltage level up to a million volts, at frequencies up to 35 mc or down to 1 cps.

The monitor is completely isolated, physically and electrically, from the circuit. It is a current transformer capable of highly precise measurement of both amplitude and waveshape. The one shown above, for example, offers high accuracy in output amplitude (+1%, -0%), 1 cps to 35 mc bandwidth, fast rise time (20 nanoseconds), and low droop (0.5% per millisecond).

Whether you want to install a Pearson current monitor around a conductor or a klystron, or measure the beam current in a particle accelerator, it's likely that one of our off-the-shelf models (ranging from 1/2" to 10 3/4" in ID) will do the job. If not, we'll make one that does. Send us your name and you'll have data sheets in a few days.

PEARSON ELECTRONICS INC
4007 Transport St., Palo Alto, California

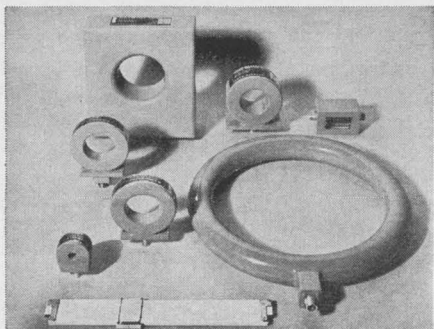

Modular, solid-state frequency comparator

The model 104 frequency comparator can make high-resolution measurements of both the short-term and the long-term stability of precisely generated frequencies. It also permits meaningful information to be obtained from noisy input signals. This state-of-the-art unit has been developed to monitor the outputs of atomic frequency standards and precision quartz crystal oscillators. Applications are found in standards and calibration laboratories' work, frequency and time monitoring, frequency source research and development, ultra-stable circuit evaluation, production testing, and navigation and tracking systems. Model 104 ac-

cepts reference and unknown frequencies of 1, 2.5, and 5 Mc in any combination without switching. Inputs of 100 kc as well as other frequencies can be added on special order. The bandwidth for all frequencies is $\pm 1/2\%$. Utilizing well-established error multiplication techniques, the comparator provides detailed analyses of the frequency, phase, time, and noise characteristics of frequency sources. In the instrument is a frequency discriminator, which produces a d-c output proportional to the sign and magnitude of the difference between the reference frequency and the unknown frequency. The frequency deviation can be indicated directly by a panel meter and an external single-channel chart recorder. Resolution of the frequency deviation readings

New from Sorensen... 40 volts at 10 amps in a constant current power supply for \$325.00

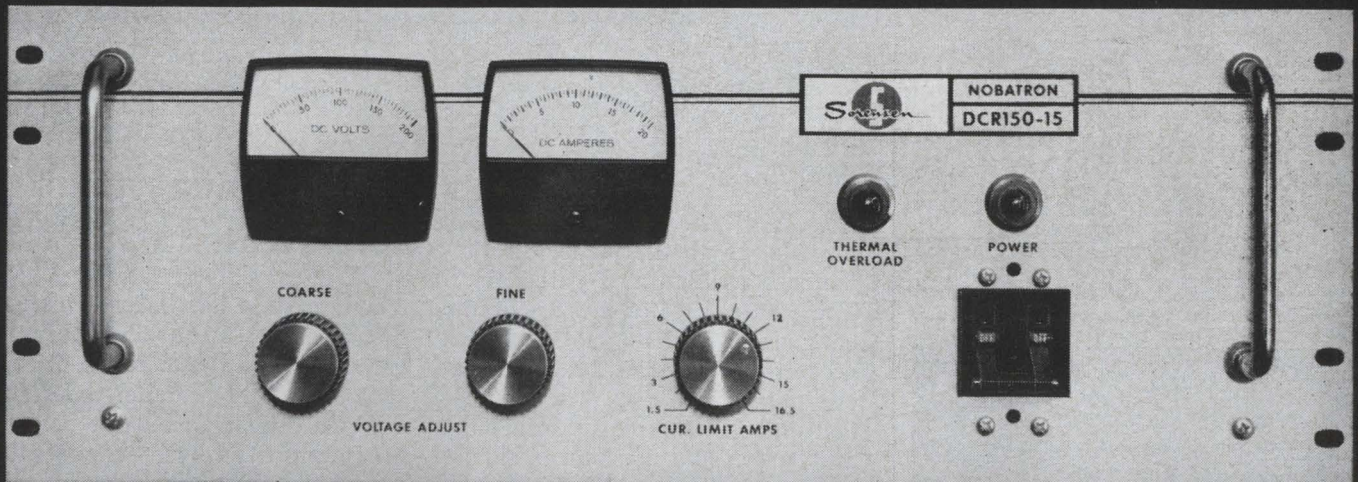

Now... 19 DCR supplies from 0-400 to 0-2400 watts

1. 19 SILICON CONTROLLED RECTIFIER SUPPLIES AVAILABLE... Delivery in 30 days or less.
2. LOW PRICES... Starting at \$325 (Voltmeter and Ammeter included with no increase in price)
3. COMPACT PACKAGING... 7" or 5 1/4" Rack Height
4. HIGH EFFICIENCY
5. CONSTANT VOLTAGE REGULATION... with continuously adjustable current limiting.
6. CONSTANT CURRENT REGULATION... with continuously adjustable voltage limiting.
7. AUTOMATIC CROSSOVER... full automatic transition from constant voltage to constant current operation, or from constant current to constant voltage operation, at any operating point.
8. REMOTE PROGRAMMING... Voltage and Current
9. REMOTE SENSING... At distances up to 200 feet
10. SERIES OR PARALLEL OPERATION
11. VOLTAGE REGULATION... (as low as $\pm 0.1\%$ or 15 mv) Line and Load combined
12. CURRENT REGULATION... As low as ± 15 ma
13. LOW RIPPLE... 0.5% + 50 mv (RMS)
14. UNITIZED CONTROL CIRCUITRY... for easy maintenance
15. COARSE AND FINE CONTROLS... for Voltage Output

For complete data on the DCR series and other Sorensen products, send for the new, 140-page "Controlled Power Catalog and Handbook." Write to: Sorensen, Richards Avenue, South Norwalk, Connecticut. Or use Reader Service Card Number 200.

DCR ELECTRICAL AND MECHANICAL SPECIFICATIONS:

MODEL NUMBER	VOLTAGE RANGE (VDC)	VOLTAGE REG. (LINE & LOAD COMBINED)	OUTPUT CURRENT (AMPS.)	CONSTANT CURRENT RANGE (AMPS.)	CURRENT REG.	RMS RIPPLE	TRANSIENT RESPONSE	PACKAGE SIZE (INCHES)			WEIGHT (LBS.)	PRICE
								WIDTH	HEIGHT	DEPTH		
DCR 300-1.25	0-300	$\pm 0.1\%$ or 60mv	0-1.25	0.125 to 1.37	± 15 ma	0.5% + 50mv	30msec	19	5 1/4	15	52	\$325
DCR 150-2.5	0-150	$\pm 0.1\%$ or 30mv	0-2.5	0.25 to 2.75	± 15 ma	0.5% + 50mv	30msec	19	5 1/4	15	52	325
DCR 80-5	0-80	$\pm 0.1\%$ or 30mv	0-5	0.5 to 5.5	± 15 ma	0.5% + 50mv	30msec	19	5 1/4	15	56	325
DCR 40-10	0-40	$\pm 0.1\%$ or 15mv	0-10	1 to 11.0	± 20 ma	0.5% + 50mv	30msec	19	5 1/4	15	55	325
DCR 300-2.5	0-300	$\pm 0.1\%$ or 60mv	0-2.5	0.25 to 2.75	± 15 ma	0.5% + 50mv	30msec	19	5 1/4	18	77	525
DCR 150-5	0-150	$\pm 0.1\%$ or 30mv	0-5	0.5 to 5.5	± 15 ma	0.5% + 50mv	30msec	19	5 1/4	18	77	525
DCR 80-10	0-80	$\pm 0.1\%$ or 20mv	0-10	1.0 to 11.0	± 20 ma	0.5% + 50mv	30msec	19	5 1/4	18	77	525
DCR 60-13	0-60	$\pm 0.1\%$ or 15mv	0-13	1.3 to 14.3	± 20 ma	0.5% + 50mv	30msec	19	5 1/4	18	77	525
DCR 40-20	0-40	$\pm 0.1\%$ or 15mv	0-20	2.0 to 22.0	± 25 ma	0.5% + 50mv	30msec	19	5 1/4	18	77	525
DCR 300-5	0-300	$\pm 0.1\%$ or 60mv	0-5	0.5 to 5.5	± 15 ma	0.5% + 50mv	30msec	19	7	18	95	710
DCR 150-10	0-150	$\pm 0.1\%$ or 30mv	0-10	1.0 to 11.0	± 20 ma	0.5% + 50mv	30msec	19	7	18	95	710
DCR 80-18	0-80	$\pm 0.1\%$ or 20mv	0-18	1.8 to 19.8	± 25 ma	0.5% + 50mv	30msec	19	7	18	98	710
DCR 60-25	0-60	$\pm 0.1\%$ or 15mv	0-25	2.5 to 27.5	± 25 ma	0.5% + 50mv	30msec	19	7	18	100	710
DCR 40-35	0-40	$\pm 0.1\%$ or 15mv	0-35	3.5 to 38.5	± 35 ma	0.5% + 50mv	30msec	19	7	18	102	710
DCR 300-8	0-300	$\pm 0.1\%$ or 60mv	0-8	0.8 to 8.8	± 20 ma	0.5% + 50mv	30msec	19	7	18	115	825
DCR 150-15	0-150	$\pm 0.1\%$ or 30mv	0-15	1.5 to 16.5	± 25 ma	0.5% + 50mv	30msec	19	7	18	115	825
DCR 80-30	0-80	$\pm 0.1\%$ or 20mv	0-30	3.0 to 33.0	± 30 ma	0.5% + 50mv	30msec	19	7	18	120	875
DCR 60-40	0-60	$\pm 0.1\%$ or 15mv	0-40	4.0 to 44.0	± 40 ma	0.5% + 50mv	30msec	19	7	20	130	900
DCR 40-60	0-40	$\pm 0.1\%$ or 15mv	0-60	6.0 to 66.0	± 60 ma	0.5% + 50mv	30msec	19	7	20	131	925



A UNIT OF RAYTHEON COMPANY

Circle 121 on reader service card

THE MARK OF QUALITY



Ultra-sensitive relays

HELPFUL DATA FOR YOUR CIRCUITRY IDEA FILE

The circuit drawing below indicates just one of the hundreds of ways many manufacturers utilize Micropositioner® polarized relays to solve complex control problems.

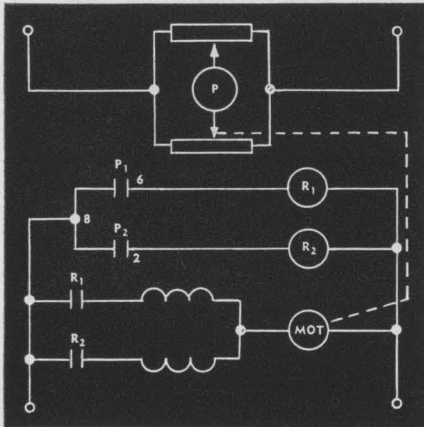

SERVOMECHANISMS APPLICATIONS

Many remote positioning applications can be solved by utilizing the Barber-Colman Micropositioner ultra-sensitive relay either as a null detector or a differential relay. In the circuit shown above, movement of the transmitting potentiometer introduces an error signal in Micropositioner coil P, which in turn energizes the positioning motor until balance is restored. Secondary relays R₁ and R₂ operated by the Micropositioner handle larger loads. This circuit can also be applied to synchronization . . . or the Micropositioner can be utilized in the output of an electronic servo control.

Among the many applications for this simplified servo control relay are positioning of antenna rotators and tuning condensers . . . aerial camera mounts . . . valves . . . test cell apparatus.

If your projects involve servomechanisms, why not make a test with a Micropositioner designed for circuits similar to that shown above? Write for Engineering Bulletin No. 9.

BARBER-COLMAN MICROPOSITIONER® POLARIZED D-C RELAYS

Operate on input power as low as 40 microwatts. Available in three types of adjustment: null seeking . . . magnetic latching "memory" . . . and form C break-make transfer. Also transistorized types with built-in preamplifier. Write for new quick reference file.

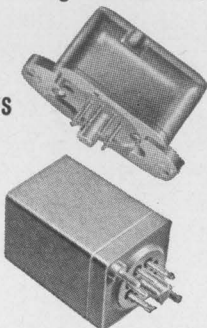

BARBER-COLMAN COMPANY

DEPT. A, 1259 ROCK STREET, ROCKFORD, ILLINOIS

New Instruments



provided by the frequency discriminator is as high as 1 part in 10¹¹. The phase-detector system of the comparator offers a resolution greater than 1 part in 10¹² for 1-second observation time. The modular instrument is completely solid state and uses silicon semiconductors exclusively. Price is \$6,450.

Parzen Research, Inc., 48 Urban Ave., Westbury, L.I., N.Y. [382]

Sweeping oscillator and frequency marker

The Multi-Sweep 159-B is a wide-range, video/vhf sweeping oscillator and frequency marker that provides a full 1 to 300 Mc of swept-frequency output by electronic frequency-modulating techniques. It also features a sweep width which is continuously variable from 300 Mc to less than 200 kc. The new oscillator provides a linear frequency sweep, flat automatic-gain-controlled output, and a complete marker system. Eight fixed markers are available at cus-



tometer specified frequencies and circuits are provided for an externally controlled variable marker. The unit may be swept at repetition rates above 20 kc, or be driven by an external varying d-c signal to function as a voltage-controlled oscillator. Fine-touch, smooth vernier and center frequency control are provided by a direct-reading digital frequency dial, which also adapts the 159-B for use as an i-f/vhf os-

cillator with continuously variable center frequency and sweep width. Kay Electric Co., Maple Ave., Pine Brook, Morris County, N.J. [383]

H-f measuring system covers d-c to 15 Gc

A new system has been developed that measures frequencies over the entire range of d-c to 15 Gc. It consists of a 50 Mc counter-timer and a 15 Gc transfer oscillator plug-in. Measurements over the entire range retain counter accuracy. This is achieved with a combination of afc and phase lock for c-w signals. Phase lock holds over a ±0.01% shift of the measured signal. Fine tuning without afc is provided to determine a-m and f-m modula-

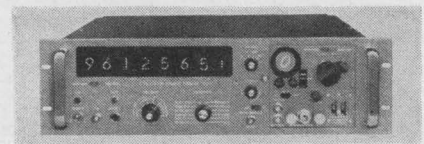

tion characteristics and measure pulsed r-f frequency. A simple operating technique of transfer oscillator requires only 1) tuning for zero beat on built-in scope, 2) setting of harmonic number with pre-set switches, and 3) answer is read directly in digital readout element of counter. The entire system measures only 5¼ in. high, and the front plug-in feature of the basic counter accommodates interchangeable function modules to increase the versatility of the counter. Price is \$4,450.

Systron-Donner Corp., 888 Galindo St., Concord, Calif. [384]

Sine programmer has fail-safe feature

An automatic sine programmer, which can fulfill the multilevel programming requirements of MIL specifications, has been announced. Model N671 contains four channels which can be independently controlled to effect crossover between displacement, velocity and accel-

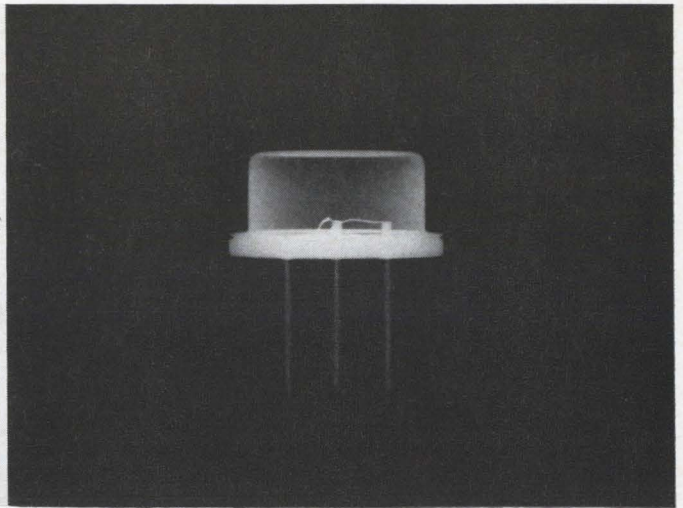
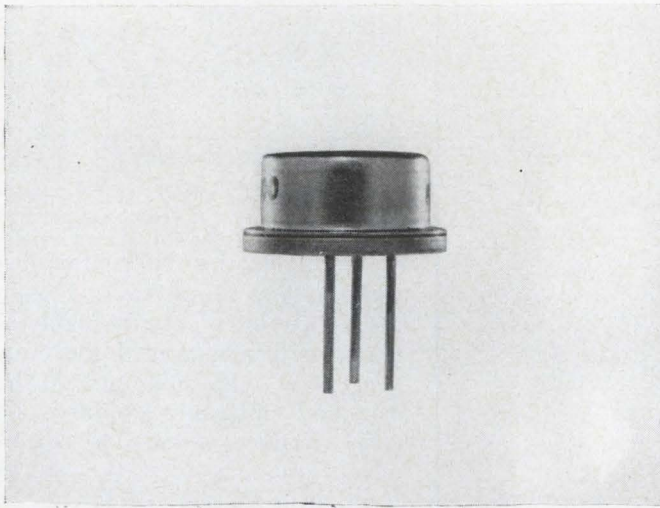

Meeting MIL specs?

***Ansco film lets you
see the reliability***

If you've invested millions in an in-plant reliability program, you should include Superay® 'H-D' Industrial X-ray film. Why? Because it can show up best the tiniest imperfection in your electronic components. This ultra-fine grain Class I film has very high contrast and microscopic definition throughout the entire KvP range. It's designed for high definition radiography and the ultimate in image quality.

For the X-ray "reliability" your components deserve, ask your GAF Representative about Ansco Superay 'H-D' Industrial X-ray films. Or write: X-ray film Dept., Box E125



GENERAL ANILINE & FILM CORPORATION

140 WEST 51 STREET • NEW YORK 10020

MODULES POTTED IN

TIMONIUM

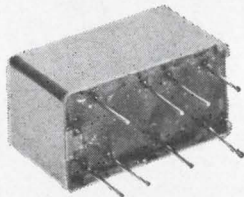

LEVEL DETECTOR

An extremely sensitive and relatively fast acting circuit similar to a Schmitt Trigger. Differences of a few millivolts between input and reference voltages can be detected at switching speeds in excess of 2 Mc. Hysteresis of the circuit is 2 or 3 millivolts. 2.0 in. long x 0.7 in. wide x 0.8 in. high. Available in silicon (EM3051) or germanium (EM2651).

- Standard digital module families to 250 KC and 2 MC
- Power supplies
- Special function boards
- Specialized designs at "off-the-shelf" cost and delivery

EMC
ELECTRONIC
MODULES
CORPORATION

1949 GREENSPRING DRIVE • TIMONIUM, MD.
Clearbrook 2-2900 TWX-301-252-0723

New Instruments

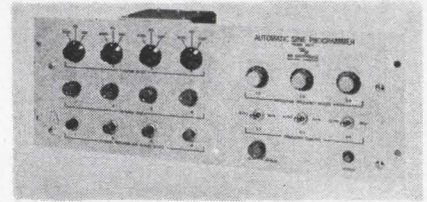

eration. A total of 81 control level combinations is possible. Transistorized circuitry permits highly accurate determination of the crossover point with minimum hysteresis and optimum stability. The N671 employs a fail-safe feature, which prevents alteration in the position of the servo relays in the event of a power failure. This protects the specimen from overtesting and possible damage caused by attenuated signals resulting in a demand for increased drive to the exciter. Frequency response of the programmer is flat over its range of 5 to 10,000 cps. The unit is used in conjunction with the N576 automatic vibration exciter and the N499 vibration meter.

MB Electronics, Division of Textron Electronics, Inc., 781 Whalley Ave., New Haven, Conn., 06508. [385]

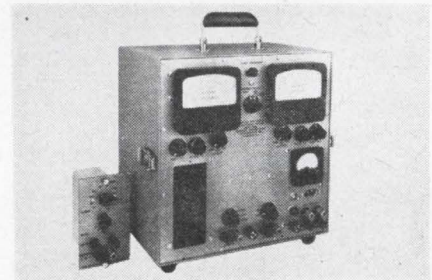

Instrument measures complex admittance

Model 100B complex impedance-admittance meter featuring model 100-PA-1002 front-end plug-in, now makes possible the direct measurement and continuous locus plotting of parallel equivalent conductance and susceptance for an unknown having one terminal grounded. The instrument can avoid circulating ground currents during such measurements. This is particularly important in the low-level calibration of sonar and

Make a connector's connecting pins thinner and shorter and you make the whole connector thinner, shorter, lighter.

Engineers of the world; meet the Bendix family of dependable thinner, shorter, lighter "Pancake" connectors.

They are the smallest, lightest off-the-shelf connectors currently available.

If you engineer for aerospace, Bendix® Pancakes can reduce your design's total connector length up to 50% and weight up to 60% over other production connectors.

And, in most installations, Pancake connectors give better performance: Provision for as many as 135 contacts in one Double-Density connector.

Increased resistance to contact pin bending. Greater contact retention. Temperature capabilities to 392°F continuous operation. Improved electrical characteristics through rigid, glass-filled epoxy inserts. And reduced failure through fewer components and increased materials capability.

They come in 9 sizes with both crimp and solder terminations. Straight plugs, wall mounts and jam nut receptacles

come with and without strain relief clamps. Box mounts and hermetic seal shell types are also available.

Your Bendix representative can give you 19 legitimate advantages of the totally new Pancake connectors over old-fashioned types; among them, proven dependability.

Or you can write us in Sidney, N.Y., for details.

And decide for yourself.

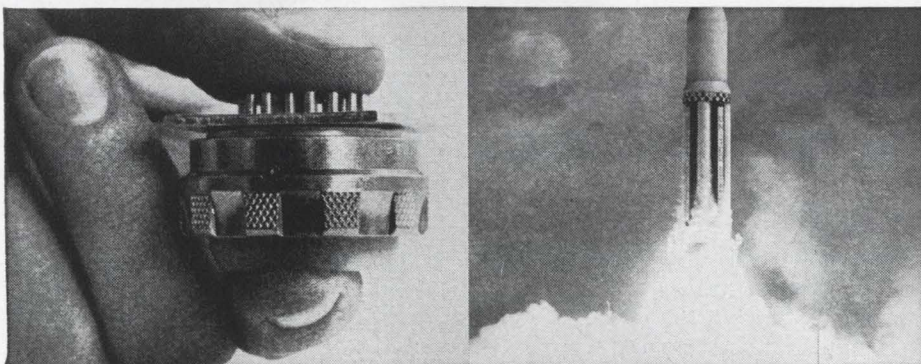



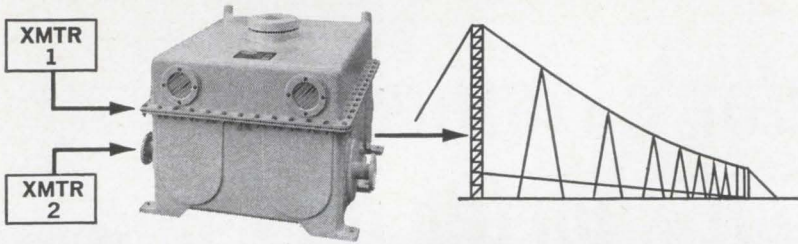
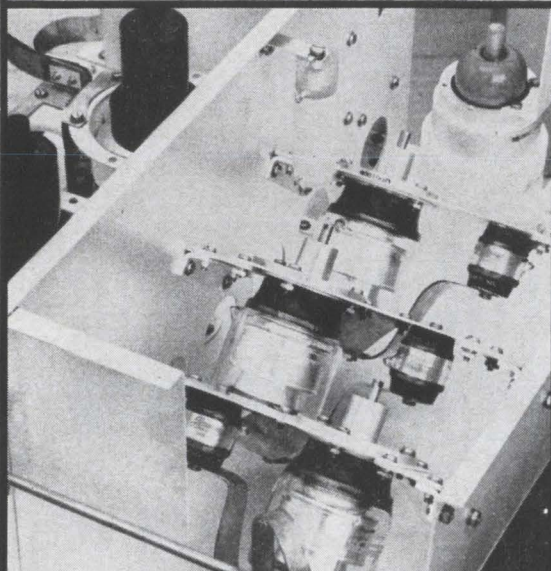

New Pancake connectors are half the size and weight of the miniature Pygmy® to let you reduce your weight requirements in critical aerospace designs.

Scintilla Division



	Type UCSV 250 Capacity 125 to 250 PF Voltage 10 KV PK Current (16 mc) 40 Amps RMS
	Type JCSF 80 Capacity 80 PF Voltage 10 KV Current (16 mc) 30 Amps RMS
	Type CVDA 1000 Capacity 25 to 1000 PF Voltage 7.5 KV Current (16 mc) 125 Amps RMS
	Type UCSX 1000 Capacity 25 to 1000 PF Voltage 7.5 KV Current (16 mc) 45 Amps RMS

NEW H-F MULTICOUPLER USES JENNINGS VACUUM CAPACITORS TO ACHIEVE HIGH Q

Jennings vacuum capacitors are used in the reactive filter network of Granger Associates Model 520F multicoupler. The multicoupler connects two h-f transmitters to a single broadband antenna, permitting both to transmit simultaneously without interference or interaction and without significant insertion loss. The high frequency range of 2 to 32 megacycles is divided into two channels, separated by an extremely narrow open band, to accommodate each transmitter. Jennings capacitors provide the low dissipation factor and high Q characteristics which make this close channel operation possible.

In addition the vacuum capacitors offer extra high voltage and current ratings at high ambient temperatures to provide a very comfortable margin of safety.

A high degree of reliability was required because the capacitors are used under oil in a sealed enclosure. Jennings vacuum capacitors met these requirements with ease. No field problems have ever occurred which could be related to either electrical or mechanical fault in the Jennings capacitors.

This proven application is only one of the hundreds in which Jennings vacuum capacitors have solved difficult circuit design problems. For any capacitive problem involving high power rf generating devices examine the advantages of Jennings capacitors. They have an unequalled record of exceptional performance in all sections of high power transmitters, dielectric heating equipment, antenna phasing equipment, electronic equipment from cyclotrons to electron microscopes.

At your request we will be happy to send more detailed information about our complete line of vacuum capacitors.

RELIABILITY MEANS VACUUM | VACUUM MEANS

Jennings[®]

JENNINGS RADIO MFG. CORP., 970 McLAUGHLIN AVE., SAN JOSE 8, CALIF., PHONE CYpress 2-4025

New Instruments

ultrasonic transducers as well as filters, amplifiers and other components which are connected to a pre-established ground point. Specifications include 12 full-scale admittance ranges from 10 micromhos to 50 millimhos; frequency range, 100 cps to 200 kc; voltage across unknown, 3 v rms. Meters on model 100 B read directly in micromhos of conductance and susceptance. The instrument includes d-c outputs for providing X-Y or strip chart recordings.

Dranetz Engineering Laboratories, Inc.,
11 Washington Ave., Plainfield, N.J.
[386]

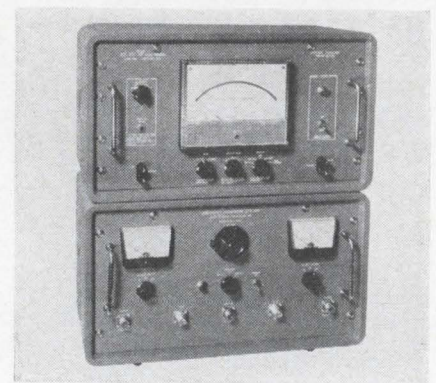

Direct-reading phase meter

This instrument, type 306-5, can be used for phase measurement from 10 cps to 200 Mc. It can also be used to plot phase vs frequency curve, phase vs amplitude curve, amplitude vs frequency curve, and unknown impedance curve on a Smith chart. Sensitivity is excellent; the meter can respond to signals down to 50 mv. Essential elements of the instrument are a matched pair of uhf mixers, a pair of video amplifiers, two voltmeters, a step variable coaxial step attenuator, and a wide-band phase meter. With a local oscillator, the 306-5 converts two input r-f signals into two signals at audio or video frequencies with their phase angles identical to that between the two r-f input signals. In addition, the amplitudes of the two output signals are proportional to those of the two r-f input signals. These two

before you specify frequency agile magnetrons consider these facts

There are 4 important reasons why it pays to come to Raytheon when you need rotary/spin-tuned magnetrons for simple, reliable frequency agile radar.

- 1 Only Raytheon can deliver rotary tuned magnetrons *entirely designed and produced in the United States.*
- 2 Only Raytheon has made operating RTM's at UHF, L, S, X, and Ku-Bands (see table).
- 3 Only Raytheon can provide ready adaptation of rotary tuning to many existing system-proven tubes, eliminating the delay and expense of basic tube design and permitting rapid retrofit into existing systems.
- 4 Only Raytheon has proven field experience with megawatt L-band RTM's in an operational system.

Raytheon rotary tuned magnetron capability

Band	Type No.	Bandwidth	Power Level
UHF	QKH1342†	50 Mc	2 Mw
L	QKH1014*	100 Mc	1 Mw
S	QKH1034†	150 Mc	4 Mw
X	QKH1299*	500 Mc	200 Kw
Ku	QKH1168†	500 Mc	80 Kw

*in small quantity production
† operating models built, additional development anticipated

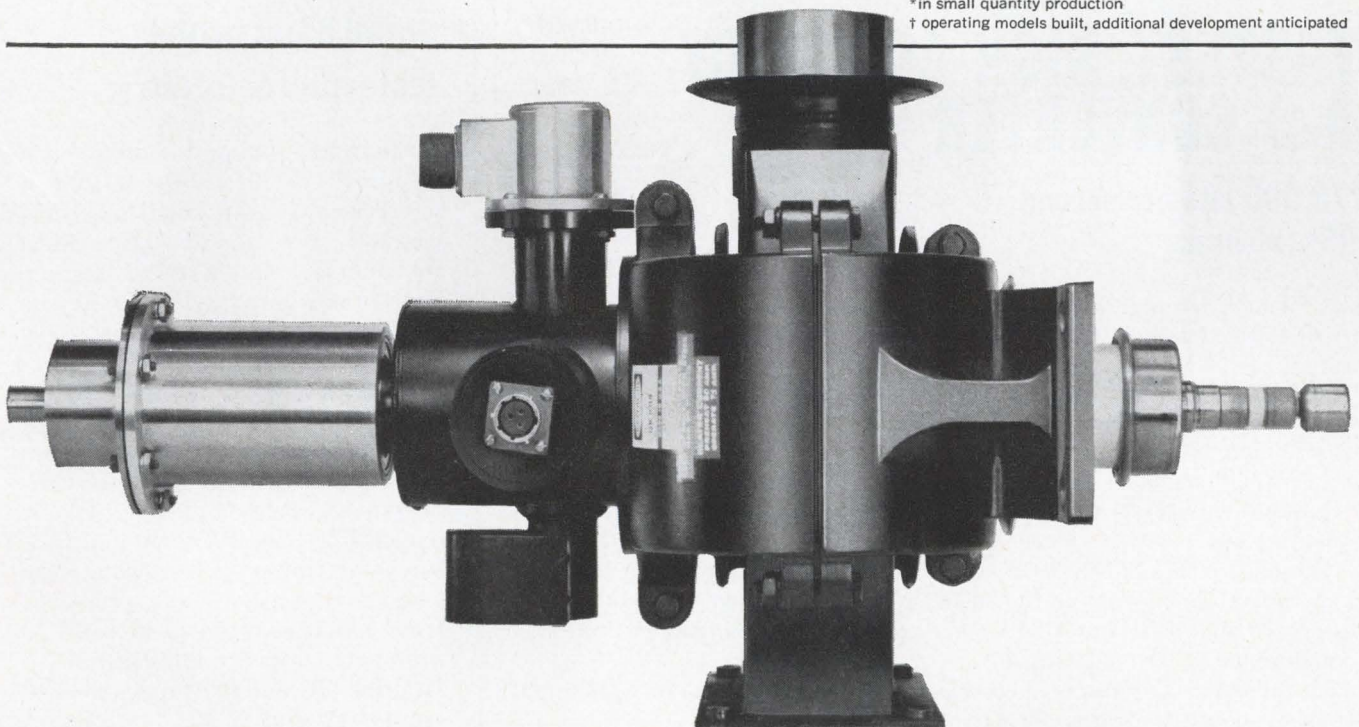

To put this unique capability to work on your specific problem, contact your nearest Raytheon sales office. Or write, Raytheon Company, Microwave and Power Tube Division, Waltham, Massachusetts 02154.

ECONOMICAL

AVAILABLE

ACCURATE

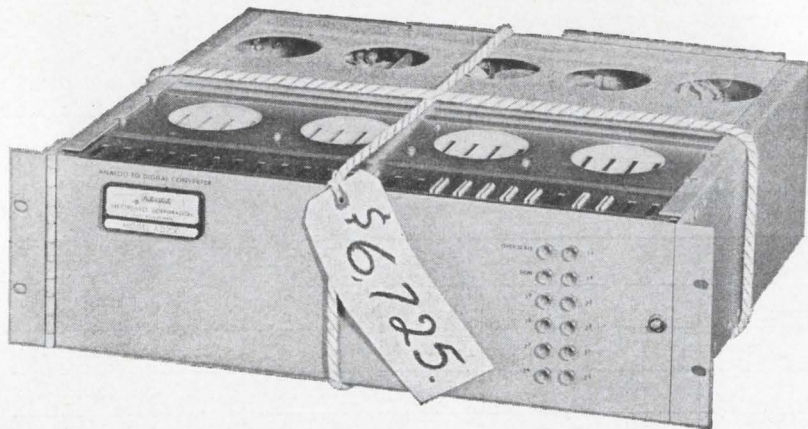

**PRICED RIGHT--
OFF-THE-SHELF--
FASTEST, HIGH-ACCURACY
A-D CONVERTER**

**770,000 bits per second ...
.05% accuracy**

This fastest, high accuracy Analog-to-Digital Converter provides 770,000 bits per second and accuracy to .05%. Yet Interstate's Model AD-200 costs less than many slower, less accurate converters. And it's available off-the-shelf.

Model AD-200 is a high-speed, highly accurate 11-binary-bit converter featuring optional sample-and-hold circuitry and internal clock. Accuracy is increased by maximum drift of less than 1 bit in 30 days. System oriented impedance is 10 megohms with an input of ± 10 V.

Its performance features and low price make the AD-200 your best converter buy.

A complete series of MX-300 Multiplexers, with from 16 to 96 analog inputs, is available to interface with Model AD-200 for full system integration. These high-speed multiplexers provide accuracy to .01%... sampling range up to 75 kc ... and sequential or random scan.

For full details on this fast, high-accuracy A-to-D Converter and Multiplexer series, write direct or use reader service card.

 **Interstate** ELECTRONICS CORPORATION
707 EAST VERMONT AVENUE, ANAHEIM, CALIFORNIA
A SUBSIDIARY OF INTERSTATE ENGINEERING CORPORATION
Telephone: (714) 772-2222, TWX (714) 776-0280 • Worldwide Representatives

New Instruments

audio signals are then applied to the wide-band phase meter, which in turn will read the phase angle between the two r-f signals directly in degrees on the 7-in. panel meter. For phase measurement, the relative accuracy is $\pm \frac{1}{2}^\circ$ from 0 to 360° ; and the absolute accuracy is $\pm 1^\circ$ or $\pm 2\%$. Resolution is less than 0.1° . Price is \$1,425.

Ad-Yu Electronics, Inc., 249 Terhune Ave., Passaic, N.J. [387]

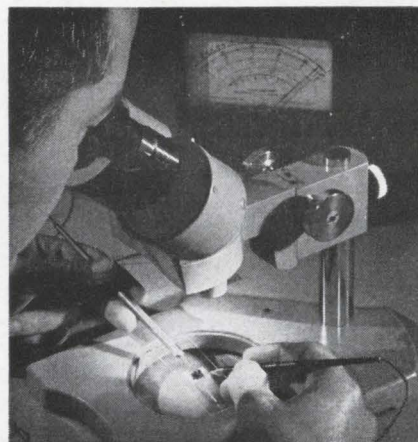

**Small hand probe
tests microcircuitry**

A new line of probes has been designed specifically for testing of microcircuitry and small electrical contacts. The microProbe is ideal for microscopic electrical testing. The probes are styled to fit the hand, with a light, flexible, out-of-the-way lead wire, and are supplied with a newly designed phone tip to fit the user's favorite meter or instrument. Banana plug adapters are supplied with every probe. MicroProbes are colored red, black, or gold for easy identification. Features of these instruments are: small size, ease of use, tip sizes from 0.005 in. to 0.040 in., and 20 different tip configurations—straight, 45° and 90° angles, forked points, ground hooks, and loops. The microProbes are offered as individual instruments of the user's selection or in assembled kits for specific requirements.

Circon Component Corp., Santa Barbara Municipal Airport, Goleta, Calif. 93017. [388]

Laminated plastic tubing

at its very best



all shapes and sizes



instant stock

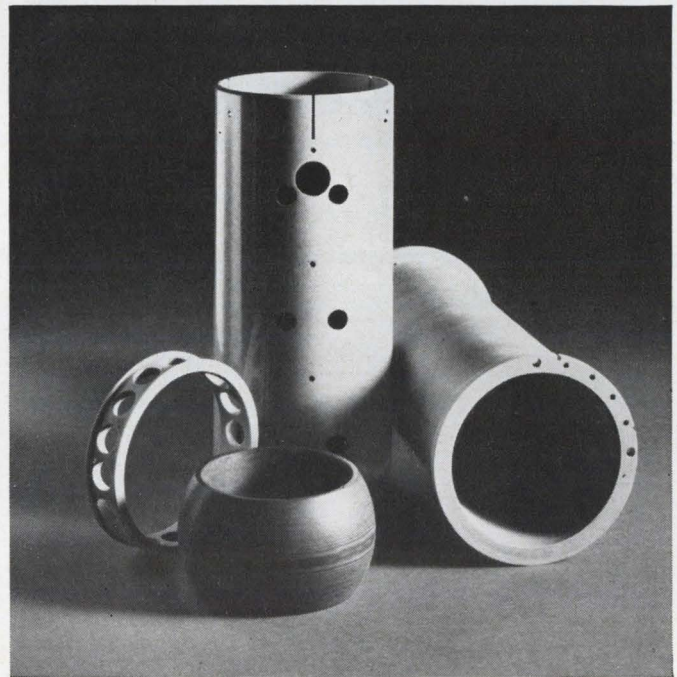

fabricated

We're not the only people in the laminated plastics industry making tubing.

But we make one whale of a lot of it.

We've so many mandrels you can get practically any diameter, shape or wall thickness you want—in every commercial grade.

And we stock so many finished tubes we can often fill your order

from our inventory. This saves you time if you do your own machining, gives us a flying start if we fabricate for you.

Some say our tubing department—manufacturing, fabricating—is the largest in the land. Could be. At any rate, we don't think anyone makes or fabricates more or better tubing.

Ask for Synthane tubing by name. Look up Synthane tubing in the

tubing section of the Synthane catalog—yours for the asking. Synthane Corporation, 36 River Road, Oaks, Pennsylvania.

You furnish the print...we'll furnish the part

SYNTHANE

CORPORATION **S** OAKS, PENNA.
Synthane-Pacific, 518 Garfield Avenue, Glendale 4, California

**VISUAL
INDICATING**

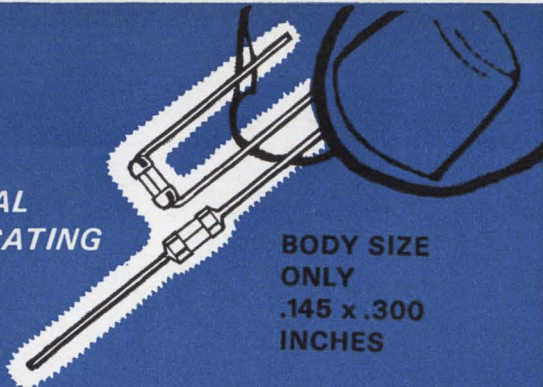

**BODY SIZE
ONLY
.145 x .300
INCHES**

BUSS Sub-Miniature PIGTAIL TRON FUSES

For use on miniaturized devices,— or on gigantic multi-circuit electronic devices.

Glass tube construction permits visual inspection of element.

Smallest fuses available with wide ampere range. Twenty-three ampere sizes from 1/100 thru 15 amps.

Hermetically sealed for potting without danger of sealing material affecting operation. Extreme high resistance to shock or vibration. Operate without exterior venting.

BUSS

Write for BUSS
Bulletin SFB

BUSSMANN MFG. DIVISION, McGraw-Edison Co., St. Louis, Mo. 63107

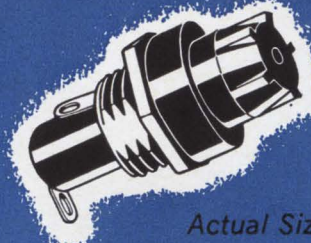

Actual Size
Only 1-5/8 inches long...
Extends just 29/32 inch
behind front of panel

BUSS Space Saver Panel Mounted Fuseholder

• Fuseholder takes 1/4 x 1 1/4 inch fuses. Converts to 9/32 x 1 1/4 inch fuses simply by changing screw type knob. Holder is rated at 30 ampere for any voltage up to 250.

• Also available in military type which meets all requirements of MIL-F-19207A.

BUSS

Write for BUSS
Bulletin SFH-10

BUSSMANN MFG. DIV., McGraw-Edison Co., ST. LOUIS, MO. 63107

BUSS: 1914-1964, Fifty years of Pioneering

Circle 131 on reader service card

Circle 131 on reader service card

To order reprints from Electronics

Fill in, cut coupon below, insert in envelope and mail to:

Electronics reprint dept.

330 West 42nd Street, New York, N. Y. 10036

Reprint order form

For listing of reprints available see the reader service card

To help expedite mailing of your reprints please send cash, check, or money order with your order.

For reprints of the latest special report:

Electronics Markets 1965

Send me reprints of Key no. R-67 at 50¢ each.

For reprints of previous special reports fill in below:

Send me reprints of Key no. (s) @ ¢ each

For prices see the reader service card.

Name

Number and Street

City, Zone No., State

New Semiconductors

Rectifier-multiplier bank modules offered

Series 45508 and 45509 high-voltage, rectifier-multiplier bank modules are announced. Within each series there are peak reverse voltage ratings of 1000, 2000, 3000, and 4000 v per rectifier section with a max d-c reverse current at 25°C at rated prv of 0.1 μ a max for the 45508 and 0.2 μ a max for the 45509. Other important parameters are:

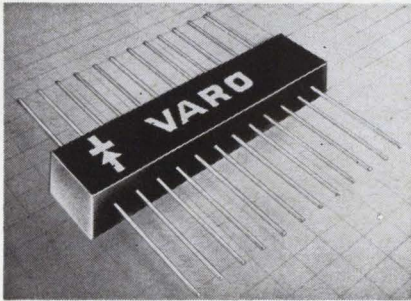

shunt capacitance, C_s , 4000 v of 0.25 pf max for the 45508 and 0.15 pf max for the 45509. Both series of devices are available in a single section (0.125 in. by 0.125 in. by 0.250 in. on the 45508, and 0.100 in. by 0.100 in. by 0.250 in. for the 45509) or with as many as 16 rectifier sections per module. These devices are designed principally for high-voltage power supplies and for image intensifier applications. Varo Inc., Special Products Division, 2201 Walnut St., Garland, Texas. [371]

Vacuum-deposited CdSe photocell

A low-cost, cadmium selenide photoconductive cell, type NSL-3531,

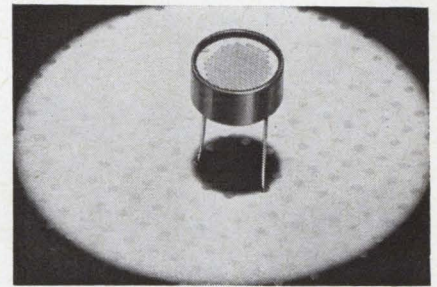

has been introduced. The plastic enclosed unit is a high-sensitivity, vacuum-deposited type measuring 1,700 ohms at 1.0 footcandle, 20 ohms at 100 footcandles. Minimum dark resistance is 2 megohms. Maximum voltage rating is 80 v peak a-c or d-c; maximum power dissipation, 0.2 w. The photocell is potted in clear high temperature epoxy. Maximum case diameter is 0.520 in.; height, 0.250 in.; leads are 0.017 in. diameter, 1.5 in. long.

National Semiconductors Ltd., 230 Authier St., Montreal 9, Canada. [372]

....New Developments in Electrical Protection

GMW FUSE
and HWA
FUSEHOLDER



FUSE SIZE
ONLY .270 x .250
INCHES

BUSS
VISUAL
INDICATING

Sub-Miniature FUSE-HOLDER COMBINATION

For space-tight applications. Fuse has window for inspection of element. Fuse may be used with or without holder.

Fuse held tight in holder by beryllium copper contacts assuring low resistance.

Holder can be used with or without knob. Knob makes holder water-proof from front of panel.

Military type fuse FM01 meets all requirements of MIL-F-23419. Military type holder FHN42W meets all military requirements of MIL-F-19207A.

BUSS

Write for BUSS
Bulletin SFB

BUSSMANN MFG. DIVISION, McGraw-Edison Co., St. Louis, Mo. 63107

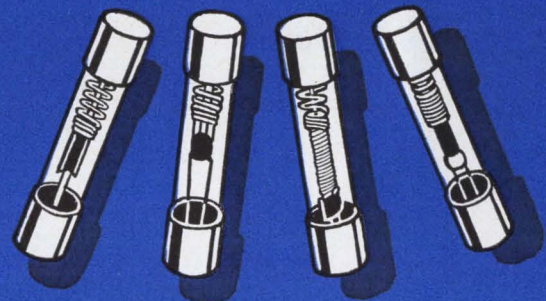

FUSETRON dual-element Fuses

time-delay type

"Slow blowing" fuses that prevent needless outages by not opening on motor starting currents or other harmless overloads—yet provide safe protection against short-circuits or dangerous overloads.

BUSS

Write for BUSS
Bulletin SFB

BUSSMANN MFG. DIVISION, McGraw-Edison Co., St. Louis, Mo. 63107



For Audio . . . For
the Sharpest Filters

KAY

141-D

Sweep & Marker
Generator

Voltage Controlled
Oscillator

20 cps — 200 kc

The 141-D provides a complete measurement system, including—logarithmic, linear and manual sweeps, or a calibrated cw signal; sharp “crystal”, pulse-type frequency markers and precision step attenuator.

The instrument adapts the accepted techniques of rf swept frequency alignment to audio and ultrasonic bandpass measurement and adjustments. In addition, the highly stable response curve developed by the 141-D, and the parallel display provided by its manual control, give easier, more accurate checks of high-Q filters and sharp slope devices.

SPECIFICATIONS

Center Frequency Range: 20 cps to 200 kc.
Sweep Width: 20 cycles to 200 kc.
Sweep Modes: 0.2 to 25 cps, line lock, manual, external input.
Output Level: 5 volts rms into 600 ohms.
Flatness: ± 0.5 db over widest sweep.
Markers: Nine crystal pulse-type markers, at customer specified frequencies.
Detector: built-in synchronous detector.
Price: \$1295. plus markers.

KAY

ELECTRIC COMPANY

Maple Avenue, Pine Brook, Morris County, New Jersey

New Subassemblies and Systems

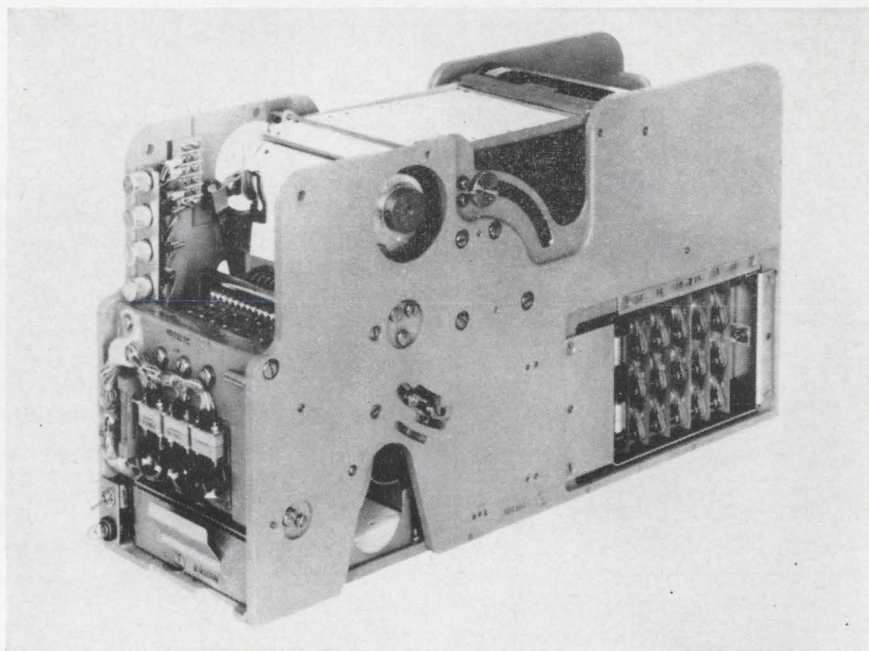

High-speed printer for military use

A new printer is capable of printing up to 10 lines per sec in a 26-column format with 64 characters available per column in a parallel mode. Serial, character-at-a-time printing allows a minimum print speed of 10 characters per sec. A typical message will provide an average speed of 80 characters per sec. A new drum design permits the use of only 13 print hammers (which is half the usual number), increasing reliability and reducing system costs. The drum is quickly replaceable (less than 30 sec) to facilitate various drum formats. New elastomeric torsion bearing print hammers are utilized to pro-

vide long life expectancy. The HSP-3604 printer and its associated basic electronics is packaged for mounting in a container only 5.4 in. in width, 8.8 in. in height, and 15.8 in. in depth. Incorporation of basic electronics allows the flexibility of either a serial or parallel print mode. Solid-state circuitry mounted on keyed plug-in printed-circuit boards is used throughout. The HSP-3604 is approved to meet applicable portions of MIL-E-16400, MIL-T-21200 and MIL-Q-9858, and is further supported by quality assurance documentation and field service support programs. Potter Instrument Co., Inc., 151 Sunnyside Blvd., Plainview, N.Y. [401]

Tv sync generator features small size

A new television sync generator (shown with a conventional field sync generator in the background) is said to be the smallest yet available. Model FR-2 is 1¾ in. high, 8½ in. wide, and 9¼ in. long. Weight is 4 lb. Featuring a self-contained, solid-state regulated power supply, the micrologic sync

generator is used to produce standard EIA synchronizing, blanking, and drive signals. The binary counter circuitry utilizes the micrologic elements, and the FR-2 has afc circuitry with an optional provision for a crystal controlled oscillator. The unit can be strapped to operate at 525, 625, 875, 945, or 1029 lines per frame. Front panel test points are provided for ease of adjustment. The generator can be supplied with panels for mounting

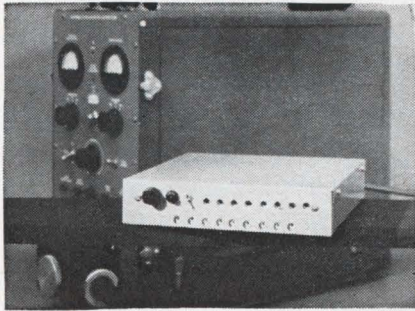

either one or two units into a 1¾ in. high space in a 19-in. rack. DuMont Laboratories, Divisions of Fairchild Camera and Instrument Corp., 750 Bloomfield Ave., Clifton, N.J. [402]

All-silicon circuit i-f preamplifiers

New i-f preamplifiers, model 4573 at 60 Mc and model 4623 at 30 Mc, use an all-silicon circuit having a gain of 35 db and maximum noise figure of 4.0 db over the range of -20°C to +65°C. Available versions of amplifiers offer bandwidth from 0.5 Mc to 10 Mc, with phase-matched pairs also available. Operation is linear from noise to -35 dbm with respect to input, and passband ripple is ½ db or less. Adjustment allows gain setting down to 20 db. The amplifier weighs 5 oz and is packaged in a cast-aluminum case measuring 1½ in. by 1½ in. by 3⅞ in. RS Electronics Corp., 795 Kifer Road, Sunnyvale, Calif., 94086. [403]

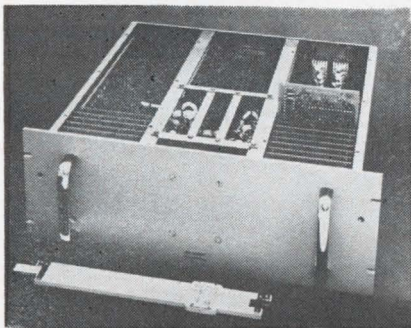

Core memory for severe environments

A new high speed core memory has been introduced. The severe environment memory system (SEMS-HR) is a printed-circuit, rack-

Ballantine DC/AC Voltmeter/Ohmmeter

Model 345
Price: \$350



Unrivalled Accuracy and High Resolution

Log Indicator; single Decade Voltage Scale

Internal Calibration for dc and ac Ranges

NEW!

**Measures 0 — ±1,100 V dc;
0 — 350 V ac (20 Hz to 1000 MHz); 0 — 5,000 MΩ**

Ballantine's Model 345 DC/AC Voltmeter/Ohmmeter is a multi-purpose instrument for use in the laboratory and on the production line.

It features a single, 5-inch, mirror-backed logarithmic scale and decade switching for both ac/dc volts and ohms measurements . . . and assures you of unrivalled ease, speed, accuracy and resolution in making these measurements. Its logarithmic scale, for example, permits an accuracy specification of 1% of indication for dc; 2% of indication for ac; and 3% of indication for ohms.

Since there are no wrong scales to read, errors in reading are reduced greatly. Because of the instrument's decade switching, you can make more measurements without the need for range switching.

The Model 345's accuracy is maintained for power line voltage changes of ±20%, so necessary for use on the production line. Because its built-in ac and dc reference standards enable you to check its accuracy in a few seconds, there's no need of removing it from service.

PARTIAL SPECIFICATIONS

OHMMETER	DC VOLTMETER
Resistance Range 0 to 5,000 MΩ in nine ranges	Voltage Range 0 to ±1,100 V in five ranges
Accuracy ±3% of indication 1Ω to 100 MΩ; above 100 MΩ not specified	Accuracy ±1% of indication from 1 V to 1,100V; ±1.5% of indication ±1 mV, below 1 V
AC VOLTMETER	
Voltage Range 0 to 350 V in five ranges	
Frequency Range 20 Hz to 1,000 MHz	
Accuracy 50 Hz to 100 MHz, ±2% of indication from 1 V to 350 V; 0-1V, ±2% of indication ±5 mV; 100 MHz—1,000 MHz, ±10% of indication ±5 mV	

Write for brochure giving many more details

Member Scientific Apparatus Makers Association

— Since 1932 —



BALLANTINE LABORATORIES INC.
Boonton, New Jersey

CHECK WITH BALLANTINE FIRST FOR LABORATORY VACUUM TUBE VOLTMETERS, REGARDLESS OF YOUR REQUIREMENTS FOR AMPLITUDE, FREQUENCY, OR WAVEFORM. WE HAVE A LARGE LINE, WITH ADDITIONS EACH YEAR. ALSO AC/DC LINEAR CONVERTERS, CALIBRATORS, WIDE BAND AMPLIFIERS, DIRECT-READING CAPACITANCE METERS, AND A LINE OF LABORATORY VOLTAGE STANDARDS 0 TO 1,000 MC.

SCR Thunderbolt MARK 10



NOW

It's Delta's new Mark 10 SCR Capacitive Discharge Ignition System. It's the true electronic solution to one of the major problems of engine operation.

You read about it in the Oct. 5 edition of *ELECTRONICS*. Now it is the standard of the industry.

The Mark 10, using Silicon Controlled Rectifier Switching, provides brand new levels of engine performance and economy. Unaffected by extremes of temperature and operating conditions, the Mark 10 installs quickly and easily without re-wiring. It operates on any 12 volt negative ground system.

ASSEMBLED UNITS AT \$49.50	MARK 10 DELTAKIT \$39.95
---	---

from dealers
or factory

available Jan. 15
ONLY from factory

Dealer and distributor inquiries invited.



**DELTA
PRODUCTS, INC.**

P. O. BOX 974
GRAND JUNCTION, COLORADO

New Subassemblies and Systems

mounted version of miniature high reliability core memories developed for military applications. The SEMS-4R is designed for ship-board, ground, mobile and industrial applications. Three operating temperature ranges are offered: -40°C to $+85^{\circ}\text{C}$, -20°C to $+65^{\circ}\text{C}$ or 0°C to $+50^{\circ}\text{C}$. The system meets MIL-E-16400E, MIL-E-4158B, MIL-Q-9858 and Mil standard 810 for ground support equipment. Access time is 1 μsec . Cycle time is 4 μsec . The 40-lb system has a capacity of 8,192 words of 40 bits.

Electronic Memories, Inc., 12621 Chadron Ave., Hawthorne, Calif. [404]

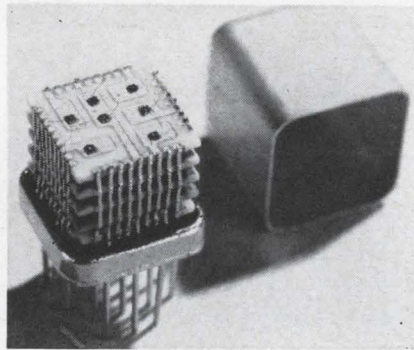

Hermetically sealed microcircuit module

An interconnection-packaging system has been developed that is compatible with thin film as well as semiconductor integrated circuits. The microcircuit module is a hermetically sealed interconnection-packaging system that employs electron beam welded microconnections of demonstrated high reliability. The structure is free of any polymeric materials and compatible with 125°C operating temperatures. The module is a parallelepiped with 20 external leads on 0.075-in. centers which protrude from a glass-to-metal header at the base of the structure. It is composed of standard notchless micro-wafers which support discrete and deposited electronic components as well as monolithic circuits. The basic element is a 0.310 in. square wafer with a standard edge termination pattern for interconnection

within the microwafer stack. Each wafer is provided with 36 terminations and the stack can consist of any combination of from 1 to 10 microwafers. The module assembly can be soldered or welded directly to a p-c board or supplied with a specially designed socket. Fifteen standard modules are available for evaluation and testing.

Hamilton Standard, Broad Brook, Conn. [405]

Controlled speed drive in compact design

Compact design, wide range speed control and low cost are featured in the new Motomatic model E-150 variable speed drive system. The motor delivers 1 in.-oz of continuous torque in a speed range of 10 to 10,000 rpm at a speed stability of better than 3%. Typical applications for this motor are various instrument drives and portable battery operated equipment. The system, which can be operated directly from the 115 v 60-cycle line, utilizes advanced transistorized circuitry, assuring high efficiency and reliability. The unit includes the motor and compact transistorized amplifier and can be supplied with accurate electronic speed indicator and various gear ratios.

Electro-Craft Corp., 1600 South Second St., Hopkins, Minn. [406]

Analog division magnetic modules

Completely solid-state units now available perform analog division. Accuracy is 1% or better over numerator and denominator ranges of 20 to 1. The numerator consists of an a-c input signal, while the denominator is a d-c control signal. The new units make it possible to avoid complex and cumbersome circuitry previously employed in the solution of analog equations and in trigonometric function conversion. Additional features are the high reliability characteristic of magnetic devices, adaptability to

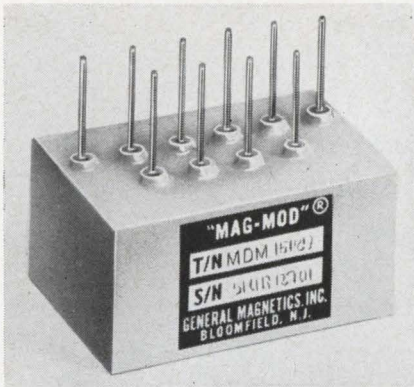

any signal frequency from 60 cps to over 100 kc, and operation over wide ambient temperature ranges and under severe environmental conditions. Small physical size makes them ideally suited for printed circuit use.

General Magnetics, Inc., 135 Bloomfield Ave., Bloomfield, N.J., 07003. [407]

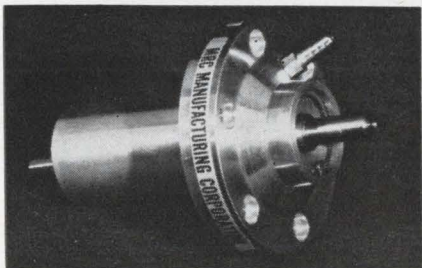

Rotary vacuum seal is leak-proof

This rotary vacuum seal allows the transmission of rotation up to 2,000 rpm to a vacuum system, without impairing the vacuum in any way. It has been proven leak-proof by helium mass spectrographic tests at speeds up to 2,000 rpm and is currently in continuous use in vacuum systems held at 10^{-7} torr. The patented dual seal design of the model V4-100 is responsible for its performance. Double ball-bearing construction is used to insure smooth performance and long-wear life. There is a provision for internal pump-out in the body of the rotary seal for high vacuum applications. Generally, however, for vacuums down to 10^{-5} torr, it is not necessary to pump-out between "O" rings in the body. Price of the V4-100 is \$125.

Materials Research Corp., Orangeburg, N.Y., 10962. [408]

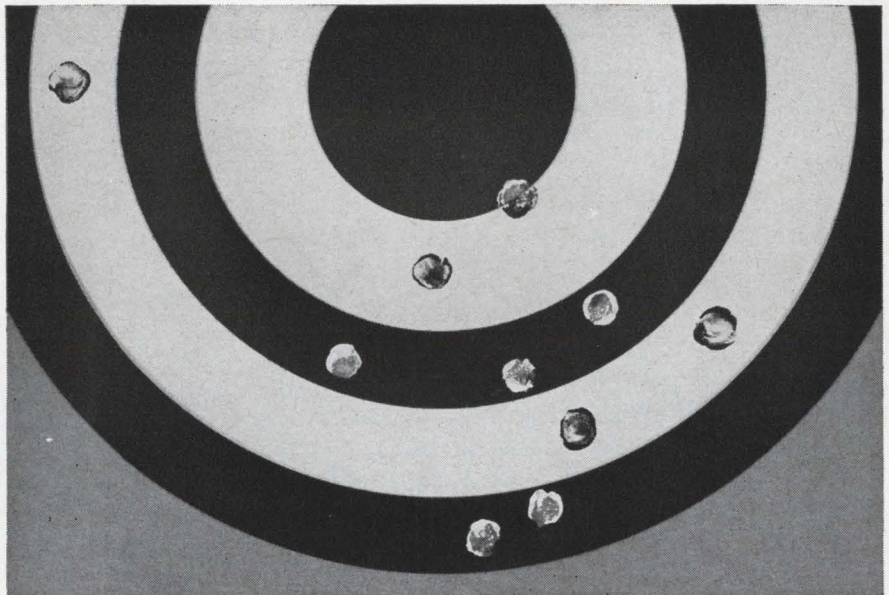

NO NEAR MISSES

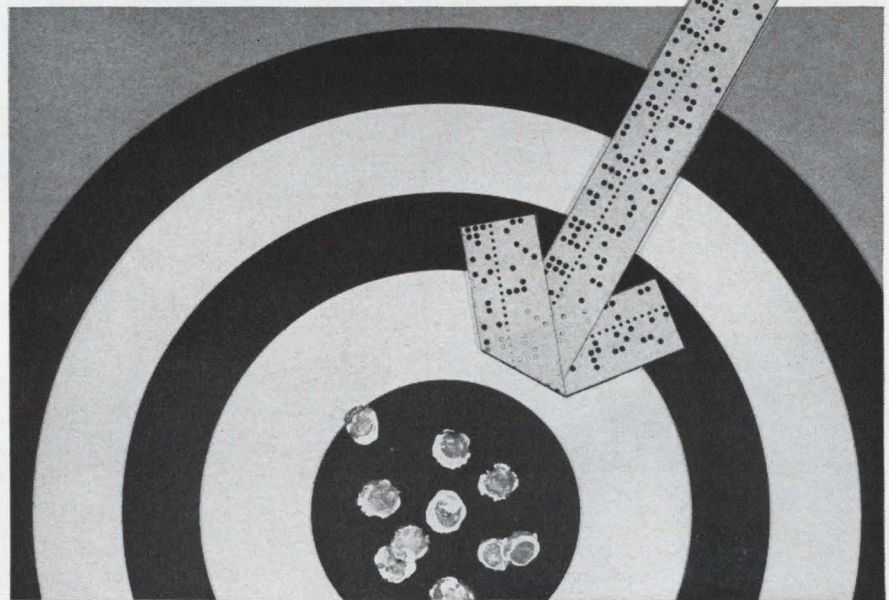

with computerized filter and transformer design

On-target design—with no false starts and no near misses—is one big advantage you get in Genisco filters and transformers designed with the help of computers.

You get faster solutions because computer designs are achieved in minutes instead of hours—and you get on-time delivery and lower shipping costs because Genisco plants are spotted in key market areas.

Computer design also means greater accuracy and the elimination of guesstimation. You never have to settle for the first solution when you're pressed for time because our computer method investigates several design approaches almost instantaneously.

Trial-and-error prototype costs are cut out because designs are automatically "performance tested" before production starts. And price quotations are fast and accurate. There's never any guessing about costs with Genisco computer design of filters and transformers.

Zero in on this new filter and transformer design capability. Write for complete information today.

Genisco

TECHNOLOGY CORPORATION



INSTRUMENTS DIVISION
(Wave Filters)
9036 Winnetka Ave.
Northridge, California
(213) 341-4320

CEECO DIVISION
(Wave Filters & Transformers)
3223 W. Armitage Ave.
Chicago 47, Illinois
(312) 327-3130

TRANSONIC DIVISION
(Transformers)
808 16th Street
Bakersfield, California
(805) 327-5701

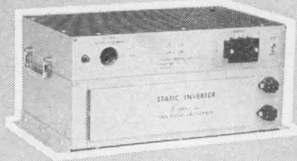

500 Watt Model . 500 GCWD Shown PRICE \$1195

HIGH POWER DC TO AC INVERTERS RUN SENSITIVE INSTRUMENTATION SUCH AS VIDEO TAPE RECORDERS FROM BATTERIES

Recommended for operating following broadcast recorders in remote areas, moving vehicles, boats or aircraft:

AMPEX - MACHTRONICS - DAGE - SONY

Used by U.S. Government and Defense Contractors for running sensitive equipment in the field from batteries.

INPUT	11-15 and 22-30 Volts DC, Selectable
OUTPUT	115 volts \pm 5%, sinusoidal
FREQUENCY	60 \pm .03 CPS
CAPACITIES	500 watts, 1000 watts and up.
OPTIONS	Rack or Portable
FEATURES	All transistorized, high efficiency

WRITE FOR CATALOG OF TOPAZ INVERTERS AND FREQUENCY CHANGERS



TOPAZ INCORPORATED
3804 HOUSTON STREET
SAN DIEGO, CALIF. 92110

Circle 203 on reader service card



250 Microvolts to 1000 Volts dc in a New, Low Cost Voltmeter!

Emcee Model 1115 dc voltmeter offers wide range, 21 overlapping scales, and an internal calibration source—and sells for only \$250! The "Polyvolter" measures very high and very low voltage, from 250 microvolts to 1,000 volts full scale.

A full scale accuracy of \pm 1% is maintained on all scales above 2.5 millivolts and \pm 2% below that level. Accuracy is assured by dc chopper amplifier and taut-band meter movement.

Polyvolter features internal calibration source of 2.0 millivolts \pm 0.5% . . . zero adjustment for null indication . . . all solid state.

For information, write to



emcee electronics, inc.

1202 ARNOLD AVE., NEW CASTLE, DEL.

New Microwave

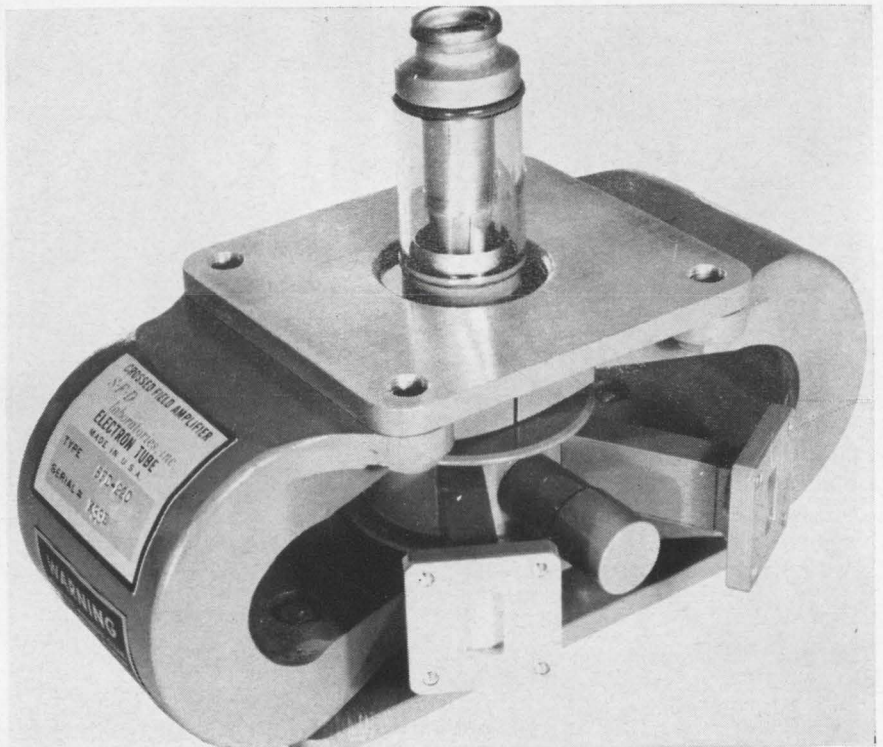

Crossed-field Ku-band amplifier

The new SFD-220 offers the highest power and highest gain of any Ku-band crossed-field amplifier, according to the manufacturer. The 100-kw tube is a continuous-cathode device designed for use as the final amplifier in Ku-band coherent radar transmitters. It is forced-air cooled and features ceramic input and output windows. The tube weighs approximately 10 lb including its integral permanent magnet and requires no heater supply. This, plus a typical efficiency of 30

to 35% makes it particularly useful for airborne or aerospace applications. The SFD-220 offers 20 db gain, and possesses the phase stability needed for frequency agile systems. Conservatively rated at 100 kw, it has been operated as high as 200 kw. Frequency range is 16.0 to 17.0 Gc; peak voltage range, 13.5 to 15.5 kv; peak current range, 18 to 25 amps; pulse length, 0.05 to 3 μ sec; duty cycle, 0.001; dimensions, 8½ in. by 5⅝ in. by 4⅞ in. S-F-D Laboratories, Inc., 800 Rahway Ave., Union, N.J. [421]

Transistor oscillator for 1.55 to 1.95 Gc

Part number 9511-1003 is a transistor oscillator with a manual tuning range of 400 Mc at a frequency of 1.55 to 1.95 Gc. Power output is 20 mw minimum; power input requirement, 28 v d-c at 15 ma max; frequency stability vs temperature, 5 ppm/°C. Modulation sensitivity is 2 Mc/v typical (voltage tunable 10 Mc with 2 db power variation).

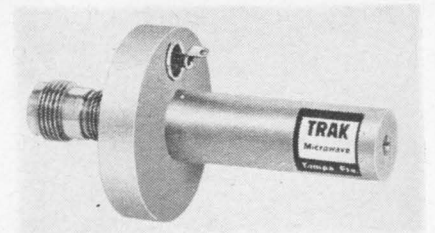

It is 3 in. long, 1.375 in. maximum diameter. Weight is 2 oz.

Trak Microwave Corp., Tampa, Fla. [422]



Model 11 * diameter 1"
 * number of turns 11
 * protrusion from panel 7/8"
 * numbers snap into the window as each turn is completed * base price in 1-9 quantities, \$7.75.



Model 30 * diameter 1 13/16"
 * number of turns 10
 * protrusion from panel 1"
 * numbers snap into the window as each turn is completed * base price in 1-9 quantities, \$5.75.

Read to 1/1000 Turn Accuracy

With New Spectrol Dials for
Potentiometers and Other Rotating Devices

Model 25 A new turns-counting dial with DIGITAL readout for multi-turn applications * 3-digit dial reads to 1099 (11 turns) * 4-digit dial reads to 9999 (100 turns) * fine calibrations allow setting to 1/1000 of a shaft turn * 2 to 1 gear ratio between setting knob and device shaft allows extremely fine settings * diameter 1 13/16" * standard 11-turn, 3-digit dial price, 1-9 quantities, \$14.25 * standard 100-turn, 4-digit dial price, 1-9 quantities, \$19.75.

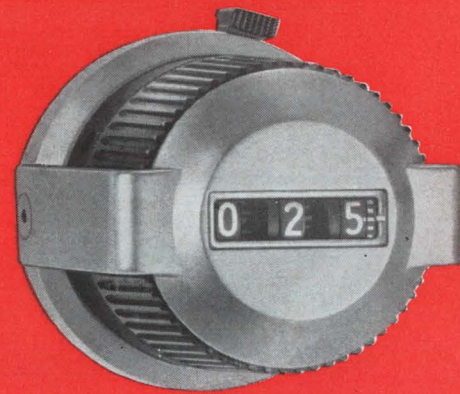

Spectrol Multidial® turns-counting dials offer these unique features: **Finely marked scale graduations** enable the operator to read settings with high accuracy. **Easy installation.** No disassembly, extra panel drilling or mounting hardware required. **Easy locking** with a finger touch that grips or releases without disturbing the setting. Settings are unaffected by vibration or shock. **Universal application** to any type of multi-turn potentiometer or other device. **Attractive satin chrome finish** with black plastic turning knob. Available for 1/4", 3/16" and 1/8" diameter shafts.

Call your nearest Spectrol distributor for immediate off-the-shelf delivery at factory prices, or write for complete specifications.

SPECTROL ELECTRONICS CORPORATION

1704 South Del Mar Avenue
San Gabriel,
California

Adams Court
Plainview, L. I.
New York

P. O. Box 130
Brampton
Ontario

AC VOLTAGE STANDARD

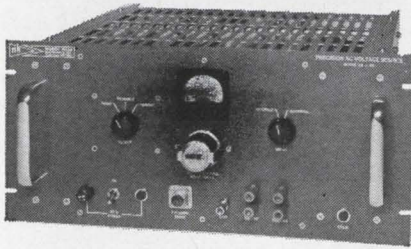

MODEL VS-60

by

NORTH HILLS

- Digital Readout
- Solid State-all Silicon
- Short circuit proof
- Tuning fork frequency control

Designed for AC calibration; gyro spinmotor, wheel, and pickoff supply; servo design and magnetic testing.

- Regulation 0.005%
- Stability 0.01%
- 25VA
- 50 ~ to over 10KC

In use in Polaris program and by leading companies for operational and test applications.

Send for FREE bulletin describing this and precision DC sources, voltage standards, galvanometers, bridges, potentiometers, etc.



**NORTH HILLS
ELECTRONICS, INC.**
Glen Cove, N. Y. 11542
Code 516, ORiole 1-5700

Circle 209 on reader service card

Major Supplier of INDIUM

Dimensions and weights of Standard (99.99%) and 59 (99.999%) Grade Indium shapes available as follows:

Ingots - 321.5 tr. oz. (this size in Standard Grade only), 100 tr. oz., 10 tr. oz. **Sheets** - maximum width of 5 in., minimum thickness of 0.002 in. **Wire** - minimum diameter 0.01 in. **Ribbon** - minimum thickness 0.005 in., maximum width 0.75 in. **Powder** - several sizes from -100 to -325 mesh. **Shot** - approximate diameter $\frac{1}{8}$ in. **Indium Compounds** - sulphate, chloride, oxide and hydroxide in crystal or solution form. Wide range of sizes of **Preforms** available in Standard and 59 Grades INDIUM and custom alloys based on these grades. Fabricated shapes include discs, spheres, squares, rectangles and washers. Very close tolerances maintained. Enquiries invited for special shapes, sizes and analyses.

COMINCO PRODUCTS, INC.
ELECTRONIC MATERIALS DIVISION,
818 West Riverside Ave., Spokane, Wash. 99201
Phone 509 747-6111 Telex 032 610
5606 TWX 509-328-1464

New Production Equipment

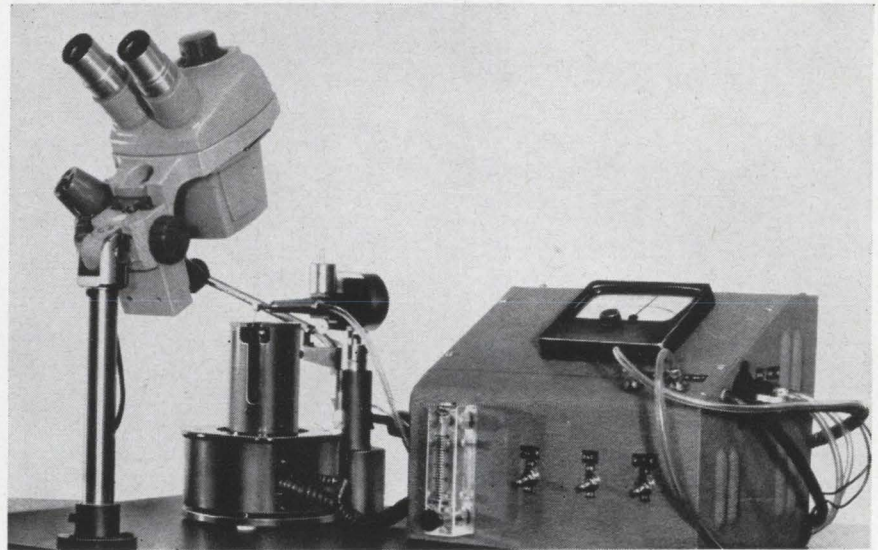

Semiconductor-die bonding equipment

Model DB semiconductor-die bonder is designed for laboratory and short-run production applications. The versatile, low-cost, bench-top unit measures 18 in. by 24 in. and provides facilities for supporting and heating the header to which the die is to be bonded; holding and manipulating the die; delivering and containing the forming gas; and for illuminating the work area and viewing it under variable magnification. Setups can be changed quickly for a variety of jobs. The work column has a low-friction Teflon base and is easily moved by hand on the surface plate. Heat is supplied by Calrod units, with the work-surface temperature automatically maintained at any desired point 0 to 600°C.

The forming-gas-delivery tube is attached to the work column. Adapters are available for various headers. Dice are picked up from a glass slide by vacuum probe. The vacuum control button is conveniently located in the Z-motion knob. The vertical range of the probe is $\frac{1}{4}$ in. at high reduction plus $\frac{1}{4}$ in. coarse set-up adjustment. Bonding pressure is variable. The work area is illuminated by a Bausch & Lomb Nicholas lamp, and the Stereozoom optics provide 20X to 40X magnification. Controls provided include a flowmeter for the forming gas, closed-loop temperature control (0 to 800°C), and push button switch in the Z-knob for the vacuum probe.

Axion Corp., New Fairfield, Conn. [451]

Wafer heater unit for silicon processing

A new unit-heating concept for the epitaxial processing of semiconductor silicon produces higher quality wafers at a savings of up to 40% in furnace fixtures. Known as the Wilson wafer heater, the unit consists of a quartz-encapsulated graphite disk exactly the size of the silicon wafer being processed.

This eliminates the silicon build-up and outgassing common with quartz-graphite plate heaters, a condition that produces sputtering, uneven surface finish, and contamination of the wafers. Processed at temperatures in excess of the 1250°C operating point of the r-f furnaces used in silicon processing, the heater's graphite has been completely outgassed, and the quartz hermetically sealed. The localized heat provided by the individual

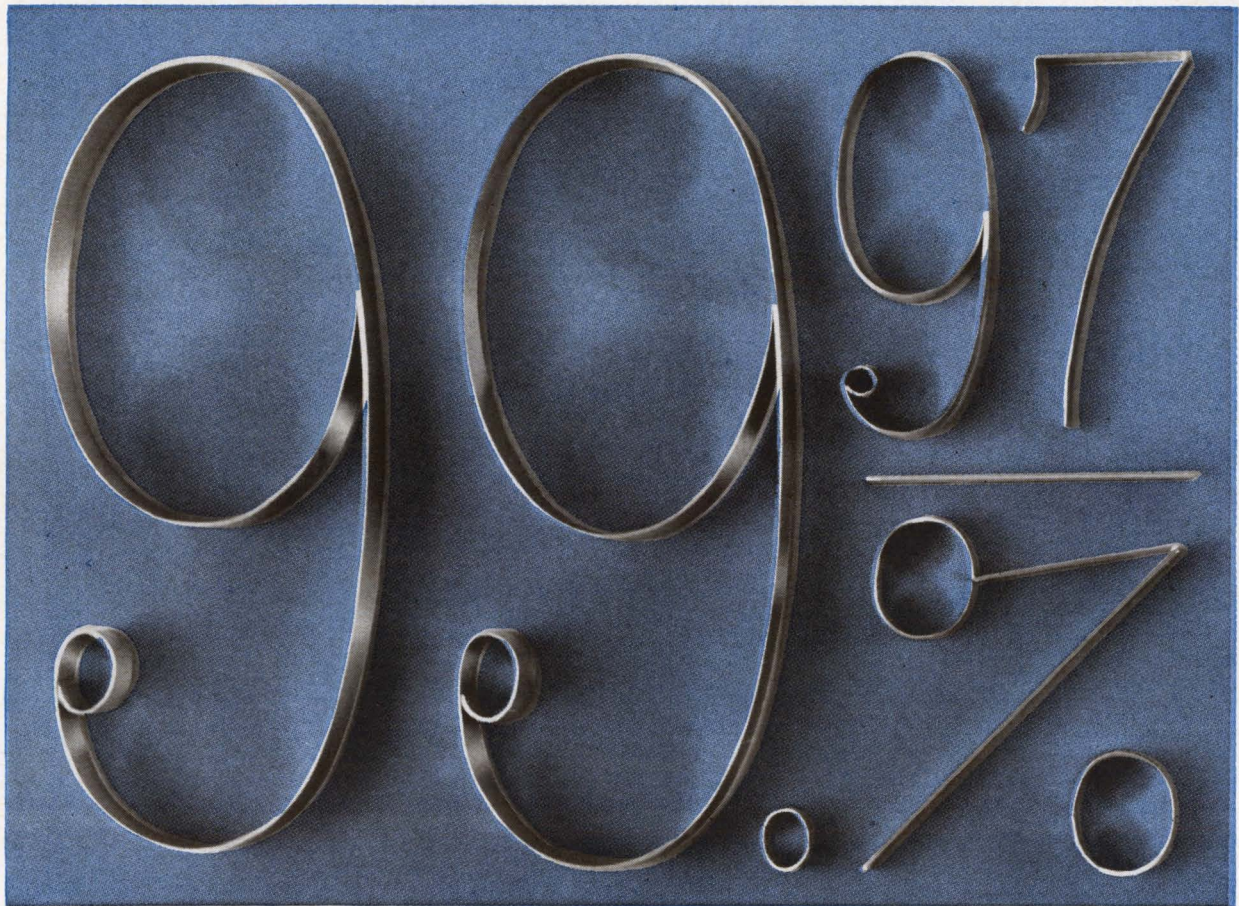

Just how pure do you need your nickel strip?

When Metals for Electronics says "High-Purity Nickel" we mean 99.97% pure—at no additional cost!

No non-metallic inclusions. No gas. We keep them out. That's how we achieve 99.97% purity. The result is nickel with 20 to 30% higher conductivity and lower sublimation coefficient—the ideal nickel for electronic tubes, transistor caps, transducers and nickel-cadmium batteries.

UNIFORMITY. Of course, all this talk about purity isn't worth a darn unless it's combined with uniformity. You get it with MfE High-Purity Nickel. H-P nickel is by its very nature uniform and therefore the choice for any use where uniform structure and coil-to-coil uniformity is vital, such as magnetostrictive applications.

IF THAT ISN'T SUFFICIENT REASON to specify high-purity nickel, how about this: it's available in continuous coil sizes, up to 200 lbs. per inch of width—with **no welds** and in a variety of standard arbor diameters. **You** specify the temper or hardness. High-Purity nickel is extremely workable because of its low base hardness, ductility, and low rate of work hardening. It meets existing specifications for pure nickel, such as ASTM B162, F3, and F239 and military specifications: MIL-N-19153 and MIL-N-46025.

NEW NEED. Metals for Electronics, Inc., pioneered the development of high-purity, high performance nickel strip from nickel powder in response to a growing need for this versatile material. As a subsidiary of Chas. Pfizer and Co., Inc., Metals for Electronics, Inc. adheres to its high-quality manufacturing standards and attention to customer requirements.

WE WELCOME your inquiries for High-Purity Nickel and other nickel alloy strip and ribbon.

Metals for Electronics, Inc.

a subsidiary of

CHAS. PFIZER & CO., INC.

235 E. 42nd St., N. Y. 10017



**ENGRAVE
EVERYTHING
FROM
6 FT. PANELS
TO TINY
NAMEPLATES**

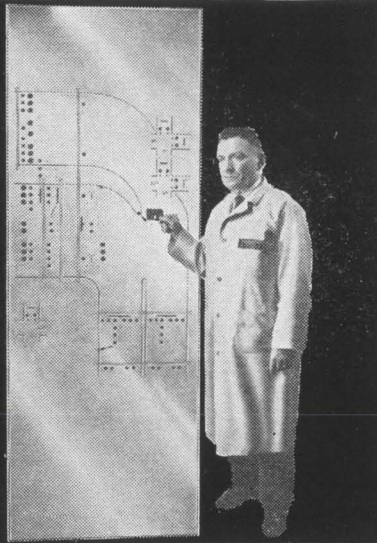

**Tracer-guided arm guides the worker—
makes everyone a skilled engraver.**

Convenient—It's right in the plant when and where you need it.

Accurate—Positive depth of cut with automatic depth regulator. 15 accurate ratios.

Speedy—Self-centering work holder cuts set-up time in half.

Ask for complete, illustrated catalog EE-14

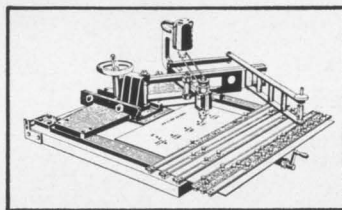

new hermes engraving machine corp.

154 WEST 14th ST., NEW YORK 11, N. Y. Chicago, Atlanta, Dallas, Los Angeles, Montreal

**New Production
Equipment**

graphite disks also means the furnace can be operated at a lower ambient temperature, a condition critical to successful epitaxial processing. The heaters are currently available in 1, 1¼, and 1½-in. diameters. Other suggested applications of the unit-heating concept are in specialized brazing techniques, including those using hydrogen or other atmospheres with which the inert quartz will not react.

C. K. Wall Co., 303 Claremont Ave., Montclair, N.J. 07042. [452]

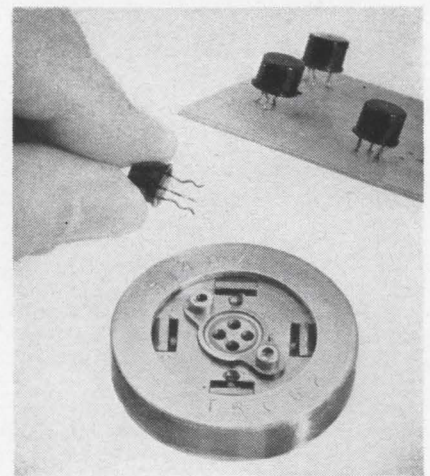

**Lead cutting
and joggling die**

A new transistor lead-cutting and joggling die eliminates need for transistor pads between transistor and p-c board. The die cuts three or four leads to a predetermined length and joggles in a single operation. The transistor can be snapped into standard hole patterns and remains in place with 1/8-5/32 air gap, regardless of p-c board position. This permits easy cleaning of the board without entrapment problems normally associated with pads. Transistor leads can be hand or wave soldered without necessity of the extra operation of trimming after soldering. The die head is interchangeable with all crimping die heads used with models 300, 300B, or 300BT power units.

Pico Crimping Tools Co., 9832 Jersey Ave., Santa Fe Springs, Calif. [453]

SERVO NEWS

**HIGH PERFORMANCE
VERNITRON SERVOMOTORS**
now available from inventory in 7 frame sizes...

150 models
200

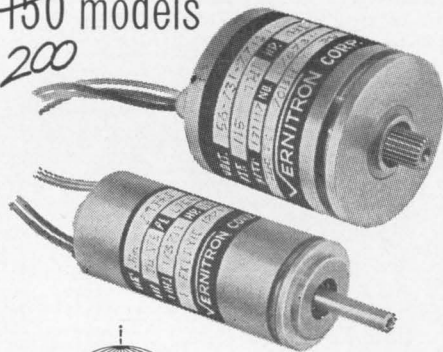

At the Vernitron Servomotor plant, military specifications are the starting point in performance. "Meet or exceed" is the word of the day—every day—for every size and model motor.

Modifications of housing, shaft, windings, torque and speed are regularly accommodated to handle special requirements. No matter what your specific Servomotor needs may be—at Vernitron they are treated with the utmost regard, from design to finished hardware.

Write, wire, phone now for complete price, delivery and specification data; ask for the new Vernitron Catalog.



**THE QUALITY NAME
IN PRECISION
SERVO COMPONENTS**

FARMINGDALE DIVISION: 46 Gazza Blvd., Farmingdale, N.Y. (516) MY4-5002
TWX: 516-248-9525

TORRANCE DIVISION: 1752 S. Crenshaw Blvd., Torrance, Calif., (213) FAirfax 8-2505
TWX: 213-328-1802

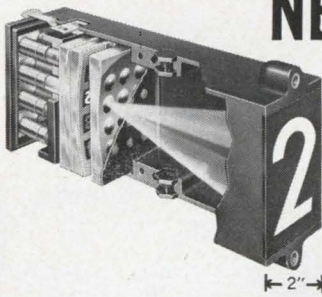

NEW...IEE

**REAR-PROJECTION
READOUT
DISPLAYS 2" HIGH
CHARACTERS
READABLE FROM
OVER 50 FT.**

Requires Minimum Panel Space (mounts on 2" centers)

The new Series 360 IEE readout provides display characters up to 2" in height. These indications are clearly legible from over 50 ft. and meet human engineering requirements for distant viewing. Despite the jumbo characters, the device is only 3" H, 2" W, 7 3/4" D.

The new readouts operate on the same principle as other single-plane IEE readouts: each is a miniature rear-projector using 12 incandescent lamps, film with up to 12 messages (one per lamp), lenses, and a non-glare viewing screen.

Smaller IEE readouts offer maximum character heights of 5/8" and 1". A larger model displays 3 3/8" high characters.

IMPORTANT FEATURES OF ALL IEE REAR-PROJECTION READOUTS:

- SINGLE-PLANE PRESENTATION for visual crispness, wide-angle readability. Only the message that's "on" is visible.
- INFINITE DISPLAY VERSATILITY including colors, symbols, numbers, letters, words—anything that can be put on film.
- 12 MESSAGE POSITIONS PER READOUT that may be displayed individually or in combination.
- MOST READABLE CHARACTERS that meet any Mil Spec or commercial requirement.
- EASY OPERATION direct from straight decimal input or through low current driver/decoder for conventional binary codes.

SEND TODAY FOR COMPLETE INFORMATION



INDUSTRIAL ELECTRONIC ENGINEERS, INC.

7720 Lemona Avenue • Van Nuys, California

Phone: (213) 787-0311 • TWX (213) 781-8115

Representatives in Principal Cities

©1965 IEE

Circle 204 on reader service card

Don't let the price tag fool you!



**This is a genuine, full-quality
Elgeet-Olympus STEREO microscope**

Distortion-free optics, brilliant imagery. Ideal for quality control, inspection and assembly of miniature parts and circuits. Magnification: 8X to 40X. A complete range of coated achromatic optics is available. For details, write Elgeet Optical Co.,

Inc., 830 Smith Street, Rochester, New York 14606.

Circle 205 on reader service card

**SYNCHRON[®]
MOTORS**

INTEGRITY
in
Name—Product—Policy

HANSEN MANUFACTURING CO., INC., Princeton, Indiana
SINCE 1907

Circle 141 on reader service card

141

FAMOUS ENCAPSULATING TECHNIQUES

with hull

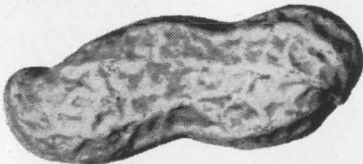

... and by **HULL**

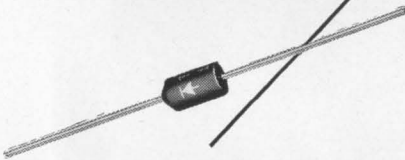

Now it's fashionable to claim *second* place. You can see we go a step further and show you *why* we're only *second* in encapsulating.

Hull encapsulating techniques are for components like diodes, resistors, delay lines, chokes, capacitors, pulse transformers. Our processes are direct encapsulation by transfer molding, by vacuum potting, and by continuous dispensing.

The "Hull Package"

We provide you a whole package (engineering, compound selection, design of molds and fixtures, Hull-developed encapsulating presses, and the working set-up).

And, we provide specific field-proved equipment: Vacuum units for potting and encapsulating with short pot life resins. The Blendmaster series of continuous metering, mixing and dispensing systems. And, of course, Hull transfer molding presses—standard or custom made.

Write for Bulletin P963, "Hull Direct Encapsulation Equipment." HULL CORPORATION, 5031 Davisville Road, Hatboro, Pa. 19040. Or, phone: (215) 675-5000.

H-3R



New Materials

Self-amalgamating insulating tape

Corona damage, the primary cause of degradation and subsequent failure of electrical cable splices and terminations, is virtually non-existent in the new Irrathene SPT tape. Irrathene SPT is claimed to be a major breakthrough in insulation technology. Corona stress tests, which completely broke down the leading butyl and polyethylene base tapes in less than 20 hours, left Irrathene SPT unharmed after more than 1,000 hours. This self-amalgamating insulating and jacketing material offers, for the first time, the low-loss properties and stability of polyethylene, corona resistance approaching silicone rubber, electrical and physical stability at temperatures up through 130°C, and resistance to moisture, weathering, ozone and tracking to allow continuous outside exposure without a protective covering. It remains flexible at temperatures below -40°F, but will not melt or flow after several days at 260°F.

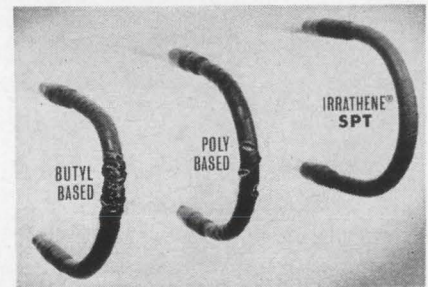

Irrathene SPT is a self-sealing plastic-like elastomer which is not affected by tension or stretching in application. It fuses into a homogeneous mass from its own compressive force and self-amalgamating nature. The tape is available in standard rolls (3/4 in. by 20 mil by 36 ft) at prices ranging from \$1.19 to \$1.69 per roll depending on quantity lots. Custom sizes are available on request.

General Electric Co., Insulating Materials Department, 1 Campbell Road, Schenectady, N.Y., 12306. [441]

Bimetallic powder inhibits oxide growth

A new bimetallic powder designed for wide application in the electrical-electronic field has been developed. Called Silcopowder, the silver-coated copper powder is suitable for use in a number of applications in which solid silver or materials with high silver content are now being used. It can also be used to upgrade base metal powders by inhibiting oxide formation and increasing or maintaining electrical conductivity over long periods of time. The new material, for example, is expected to be useful in the electrical contact field, as a substitute for fine silver powder where the Stokes Press method of pressing contacts is employed. Another anticipated application is in the area of conductive epoxies, where Silcopowder is an appropriate substitute for silver powder or flake

now used as the conductive particle.

Handy & Harman, 850 Third Ave., New York City 10022. [442]

Fast-curing, flexible one-component coating

A new one-component, polyurethane system, HumiSeal type 1A20, conforms to all the requirements of MIL-I-46058A (PUR). It is said to be one of the fastest curing polyurethanes now being commercially used in conformal coatings for printed circuit assemblies. Besides having excellent electrical properties, flexibility and exceptional abrasion resistance, films based on HumiSeal type 1A20 have excellent resistance to trichlorethylene for cleaning printed-circuit boards, and can be soldered through without spattering for easy repairs.

Columbia Technical Corp., Woodside, N.Y., 11377. [443]

**NOW IN PRODUCTION... CORES FOR THE DEFLECTION YOKE
AND TRANSFORMER SYSTEMS OF THE NEW 90° COLOR C.R.T.**

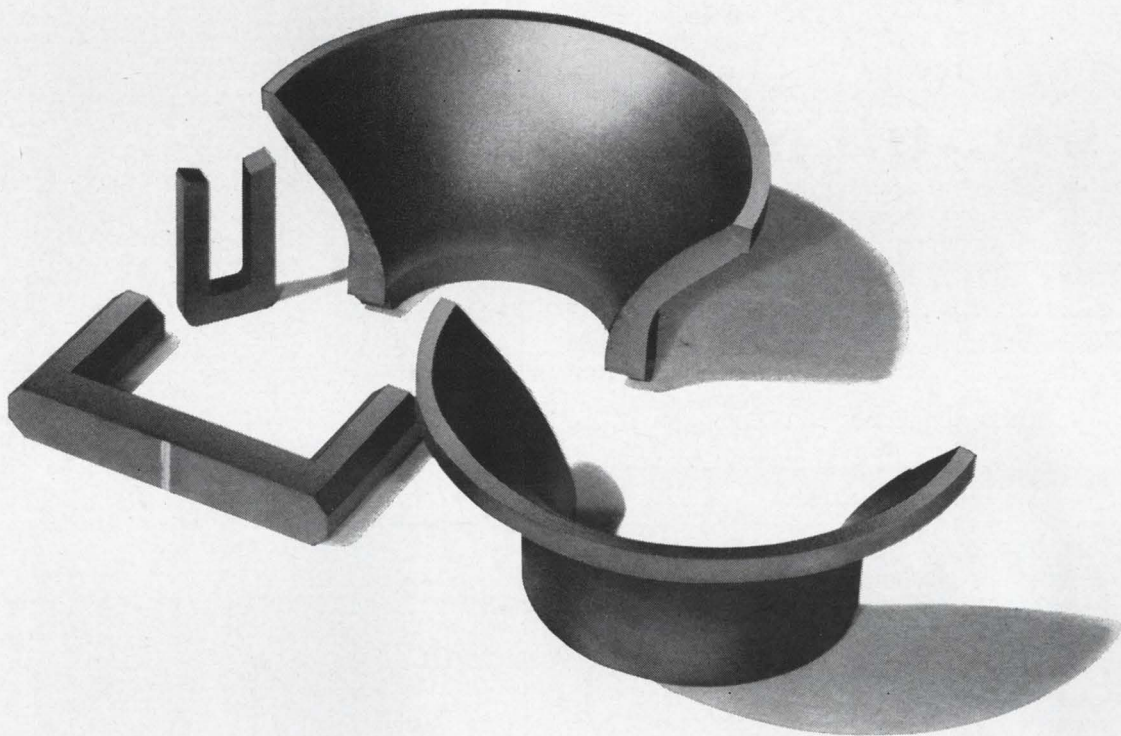

Stackpole, pioneer of ferrites for commercial applications, introduces Ceramag[®] deflection yoke and transformer cores and cores for the convergence system of wide-angle color television tubes. Production quantities of these highly uniform, fully dependable units are available for prompt delivery. They offer the same high standards

of quality and performance that have made Stackpole the foremost name in ferrites. This is why every major U. S. television manufacturer specifies Stackpole. For samples or additional technical information, write: Stackpole Carbon Company, Electronic Division, St. Marys, Pa. Phone: 814-834-1521 — TWX: 814-826-4808.



STACKPOLE
ELECTRONIC COMPONENTS DIVISION

DON'T BREAK YOUR VACUUM!!

VAC·U·LOK

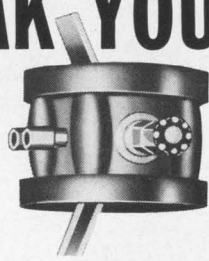

ROTARY TRANSFER LOCK rapidly loads and unloads vacuum chambers without affecting the vacuum — brings true automation to vacuum processing.

Evaporation, sputtering and testing in vacuum can now be put on a production line basis. Less contamination means more reliability.

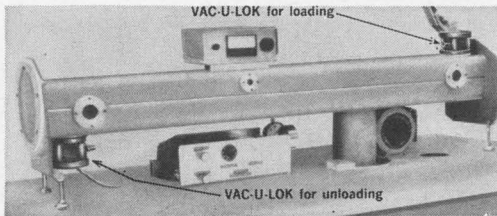

VAC-U-LOK...

- ★ eliminates repeated pumpdown and bakeout
- ★ maintains constant pressure and temperature
- ★ improves quality of deposited films

VACUUM PROCESSES, INC.

P. O. Box 523 • Richardson, Texas 75081 • 214 ADams 5-8960

Circle 206 on reader service card



Plant City, only 20 miles east of Tampa, RIGHT NOW offers more advantages for industrial locations than other Florida areas. Why?

FIRST — In the direct growth pattern of rapidly expanding Tampa Bay area. Low cost sites... Don't wait... Investigate now.

SECOND — More convenient to ALL Florida markets. Closer by actual miles.

THIRD — Two major railroads, a superb highway network including new Interstate 4. All utilities, including natural gas. Plus approved FAA airport adjacent to municipal, active industrial park.

FOURTH — Favorable construction costs and financing.

FIFTH — Excellent local labor market. Full educational, civic and cultural advantages. WRITE TODAY for surveys and facts. All contacts in strict confidence.

DICK PREWITT, General Manager
INDUSTRIAL DEVELOPMENT COMMITTEE
P. O. Box 1509-A PLANT CITY, FLORIDA

City MOST Convenient to ALL Florida

Find the product... Fast!

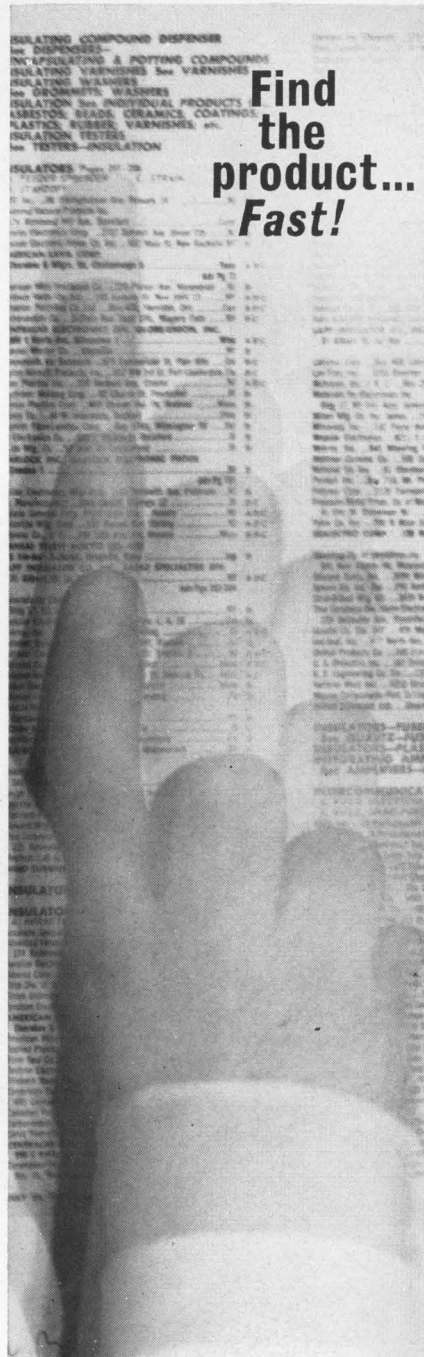

It's quick and easy to locate any of the thousands of electronic and allied products in your **Electronics Buyers' Guide**. All are listed clearly and unmistakably, cross-indexed with end use terms synonyms and newly devised terms. And, all advertisers in the EBG are carefully cross-referenced to their catalog-advertisement. EBG has the most complete, accurate and authentic product listings in the industry!

Electronics Buyers' Guide

A McGraw-Hill Publication
330 West 42nd Street,
New York, N. Y. 10036

New Books

Microcircuits—tardy report

Solid Circuits and Microminiaturization. Proceeding of conference held at West Ham College of Technology, London, June, 1963. A Pergamon Press Book, The Macmillan Co., 1964, 346 pp., \$8.50.

It is regrettable that, even in these days of high-speed automation, 18 months can pass before conference papers find their way into print. Although this book is nicely designed and bound, the papers would have been much more valuable a year ago, unbound and in almost any legible form.

Many of the papers are on the grosser aspects of solid circuits, such as applications and discussion of a product line. A few dig into the basic technology: electron-beam etching, a tunable solid-circuit filter for an i-f amplifier and the role of thin-film circuits, among other fields.

All in all, it's a handy reference to the state of the art as of 1½ years ago.

Computers

Electronic Data-Processing Systems: a Self-Instructional Programmed Manual

Leeland R. O'Neal
Prentice-Hall, Inc., 1964,
408 pp., \$10.

Readers who have some knowledge of the subject can safely skip various parts of this book; quizzes help them to determine how much they know and can omit from study. Up to 123 pages can be jumped over.

The author seems to assume that the reader is intelligent and able to fill in for himself material that has not been presented, or else that he's able to make some good guesses.

The areas covered are the external aspects of data processing: flow charts, programing, operator's console. The book is well written and concludes with a two-hour comprehensive examination. It is recommended for the courses suggested by the author: basic EDP, basic programing, management training or a course for computer operators.

Microelectronics

Introduction to Integrated Semiconductor Circuits.

Adi J. Khambata
John Wiley and Sons, Inc., 1963,
233 pp., \$7.50

An introduction to integrated semiconductor circuits, this is intended to be a book time-saving first treatment of the subject for engineers and managers, it collects material scattered in the literature. This in itself is not an outstanding accomplishment. On the other hand, few books have been published in this field that are better.

The book presents the history of microelectronics, and includes an introduction to the systems concepts that are unique to integrated circuits. It also contains a discussion of the fabrication processes that produce semiconductor diodes, transistors, resistors and capacitors. Thin-film techniques, used to produce passive elements, also are described. The section devoted to fabrication provides sufficient background for the reader to grasp the material given in later chapters.

There is an excellent discussion of integrated-circuit characteristics and design considerations. The treatment of circuit geometry and parasitics is particularly valuable as it is in these areas that the integrated circuit differs most from the discrete-component circuit.

Multichip and thin-film circuits are treated briefly. Emphasis is placed on the differences between these approaches and the monolithic approach.

In the area of mechanical packaging the book lacks development. Little is said about heat dissipation and interconnection. These subjects are essential first considerations for both engineering and management when integrated circuits are introduced into an equipment design.

The principal value of the book is for familiarization rather than reference.

Francis T. Lynch
Defense & Space Group
Burroughs Corp.
Paoli, Pa.

Recently published

Capacitors, Magnetic Circuits and Transformers, Leander W. Matsch, Prentice-Hall, Inc., 350 pp., \$16.00.

Proceedings of the 1964 Institute in Technical and Industrial Communications, Colorado State University, 134 pp., \$6.00.

ONE OF 25 NEW 3 WATT MINIATURE POWER SUPPLIES

from transformer
electronics
Company

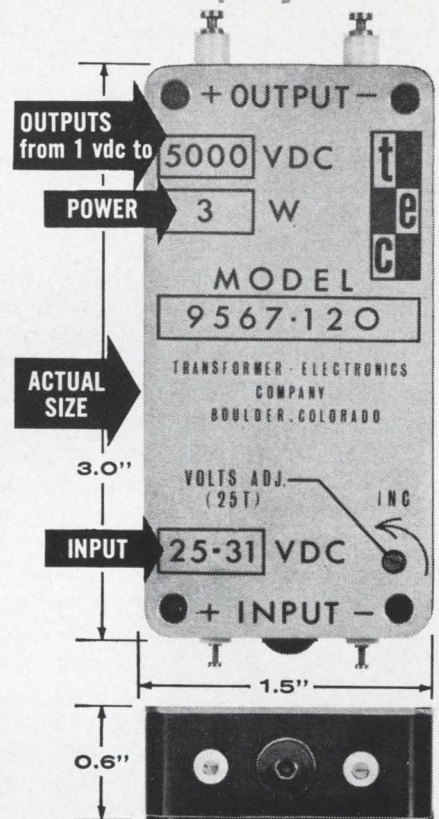

THE 9567 SERIES fulfills many requirements where DC-DC and DC-AC voltage conversion is required. Predominant features are: light weight (4 oz.) . . . low cost (prices start at \$150.00) . . . all silicon semiconductors . . . black anodized aluminum case . . . silicon rubber encapsulation . . . transient, reversed polarity and short circuit protection . . .

INPUT: 25-31 VDC (output regulated to 0.25%)

OUTPUTS: 1.5 VDC to 5000 VDC
± 15 VDC to ± 100 VDC
(dual output)
1.5 VAC to 1000 VAC (3
to 5 kc)
(adjustable ± 10%)

POWER: 3 WATTS

TEMPERATURE: — 55 to 100°C

FOR ADDITIONAL INFORMATION CONTACT:

**TRANSFORMER
ELECTRONICS
COMPANY**

BOULDER INDUSTRIAL PARK
BOULDER, COLORADO
TWX 303 443-2561 • PHONE (303) 442-3837

**POWER SUPPLIES • INVERTERS
CONVERTERS • TRANSFORMERS**

Multiple display

Digital television message generator.
V.E. Hupp and H.F. Horsman, United Aircraft Corporate Systems Center, Farmington, Conn.

Developed for the United States Air Force 433L global weather system, the generator accepts digital data input in real time and presents a character display on conventional television sets at multiple locations.

Digital input is accepted simultaneously from four parallel 100-wpm teletypewriter lines; up to 26 desired messages of up to 136 characters each are selected and stored. Unwanted characters can be deleted to shorten the message. Six characters are selected from storage and converted to video signals by a character generator that produces 52 stroke segments. The signals are then modulated, multiplexed and displayed on three tv channels, two messages per channel, at a large number of separate locations. The required strokes for all alphanumeric and special symbols are generated continuously.

The main storage of the message generator is a magnetic drum, which also stores preselected identifiers and deletion data.

With the all-solid-state character generator, scan conversion tubes are not needed; micrologic is used almost exclusively. The video output drivers are the only circuits requiring standard transistors for driving power.

Presented at the Society for Information Display (SID) National Symposium, Washington, Oct. 10.

Memory-element alloy

Ni-Fe-Nb-Ag, A new square-loop alloy for magnetic memory elements, E.M. Tolman, Bell Telephone Laboratories, Inc., Murray Hill, N.J.

An alloy for magnetic-storage elements, with a coercive force of 1 oersted and a rectangular hysteresis loop of 0.95 squareness ratio is composed of 79.4% nickel, 16.6% iron, 3.0% niobium and 1.0% silver. Flattened wire, (0.003 by 0.00025 inch) is drawn down to 0.060-inch diameter, with an anneal at 900° C in hydrogen, then drawn to 0.0011-

inch diameter, flattened at the 0.0011-inch diameter size, and annealed again.

Annealing of Ni-Fe alloy is ordinarily accompanied by a drastic drop in the squareness ratio and a deterioration of the hysteresis loop; to counteract these undesirable effects, silver was added, giving a material which develops an increased coercive force on annealing (through precipitation hardening).

By using niobium rather than molybdenum, samples were obtained that retained their loop squareness up to higher temperatures, allowing a coercive-force reduction to about 1.5 oersteds.

By combining the results of adding silver and niobium, an alloy was created with the desired heat stability of the hysteresis loop and the coercive force was reduced to the desired 1-oersted range. The alloy possessed a switching coefficient of 0.3 oe- μ sec.

The retention of magnetic anisotropy achieved by adding Nb and Ag to the basic alloy is attributed to the presence of dislocations anchored in the slip planes. These dislocations are believed to result from the interaction between lattice strains arising from the over-size foreign atoms (Nb and Ag) and strains generated by plastic deformation.

Presented at the 10th Annual Conference on Magnetism and Magnetic Material, Minneapolis, Nov. 16-19.

High-resolution spot

Nanosecond beam intensification for cathode-ray tubes
Herman Schmid, Stanford Electronics Laboratories, Stanford University Calif.

An experimental cathode-ray tube produces a high-resolution spot with only a small driving voltage. The new gun structure can display a single pulse of 10 volts in one nanosecond. The tube is operated with an accelerating potential of 24 kilovolts and the spot size is approximately 0.004 inch for normal viewing brightness. The dynamic range of spot brightness for typical applications is in the order of 20 decibels for single

events, and 30 db for repetitive events. The tube can be used for r-f pulse intensification up to 3-Gc carrier frequency, in which case the structure acts as a detector.

Although the tube was developed for a specialized need, it should have many applications in wide-band oscilloscopes, high-resolution systems, and fast-writing storage tubes.

The display can be observed with the naked eye, and can be photographed with standard Polaroid film, 3000 ASA speed. Faster films can record pulses as short as several hundred picoseconds.

A special modulating grid produces the wide-bandwidth structure. Pulses are applied to a coaxial line that enters the tube through the base. The cathode and modulating grid form part of the center and outer conductor of the line. Heater leads are brought out through openings of the coaxial line with wideband inductances.

In most applications the tube would use a raster scan, providing simultaneous display of the three parameters on the X, Y, and Z axes.

Presented at the Electron Devices Meeting, Washington, Oct 29-31.

Switching at C- and S-band

High-power, SPDT, fast ferrite switch
R.E. Willoughby,
Sperry Microwave Electronic Co.,
Clearwater, Fla.

A single-pole, double-throw, cut-off type ferrite switch has been developed for operation at C- and S-band frequencies. It is believed that this is the first device of this type to be operated at a truly high-power level. High-power performance is achieved by the novel approach of operation *above* the onset threshold for subsidiary resonance absorption. This technique appears promising for use in the development of other high-power devices. The C-band unit is designed for a peak power level of one megawatt with an insertion loss less than one decibel. Both units display a switching time of 150 microseconds.

The device consists essentially

Technical Abstracts

of a three-port waveguide junction with a section of reduced-sized ferrite-loaded waveguide at two of the ports. The characteristics of the reduced-area sections are such that microwave energy in the frequency range of interest is propagated if no magnetic biasing field is applied. Upon application of the biasing field, the effective permeability of the ferrite is reduced, causing the loaded waveguide to be cut off. The structure is matched so that if the magnetic field is applied to one section and not the other, a minimum input voltage standing wave ratio is obtained, and there is a maximum transfer of energy to the unbiased port.

Switching is accomplished by applying the magnetic biasing field to one ferrite-loaded section and simultaneously removing the magnetic field from the other. The technique of using cut-off waveguide to create the "off" condition provides isolation greater than that obtained by switching circulators, for example.

Presented at the 10th Annual Conference on Magnetism and Magnetic Materials, Minneapolis, Nov. 16-19.

Optoelectronic connections

Cadmium-telluride light-emitting diode
C.G. Kirkpatrick and R.G. Warren,
Autonetics, North American
Aviation Inc., Anaheim, Calif.

The use of light from optoelectronic devices could eliminate wires used in connecting microcircuits in computers and data processors. This would simplify manufacturing, improve reliability, increase speed and reduce costs. One light source that is commercially available is the gallium-arsenide diode. Now a cadmium-telluride p-n junction light-emitting diode that is four times as efficient as the gallium-arsenide type has been developed.

The new diode is made from single crystals of cadmium and tellurium. The single crystals of cadmium telluride are grown by the Bridgman technique—melting and slow cooling. Using this method, six-millimeter diameter crystals have been grown. By doping the

MEASUREMENT SYSTEMS/COMPONENTS

WRITE NOW!

If you buy, specify or work with systems for the measurement of **PRESSURE, FORCE, ACCELERATION, VIBRATION or DISPLACEMENT**, you will need a copy of the new, complete Omega catalog. This catalog describes the latest innovations in the measurement systems field, and includes a quick-reference chart relating specific measurement applications to the appropriate components.

For your specific application problems, for general information or for future reference, this catalog is a must! For your free copy write, telephone, TWX or use the reader service number below.



D DRESSEN-BARNES ELECTRONICS CORP.
OMEGA INSTRUMENTS DIVISION

B 2599 N. FAIR OAKS AVE. / ALTADENA, CALIF. 91002
TELEPHONE: (213)797-1832 / TWX: 213-499-2556

Circle 207 on reader service card

TWEEZERS

SUPER FINE TWEEZERS FOR PRECISION WORK A REVOLUTIONARY NEW TWEEZER

It firmly grips and holds the most delicate objects. Object can't slip because of special diamond grip. Gripping points lined with diamond-powder (fine grit). The diamond particles are firmly welded to stainless steel metal. These tweezers are used for micro-fine work and micro surgery.

No. 770. Blades taper gradually to very fine point—length 4¼ inches. Stainless steel—non magnetic. **\$10.00 each**

No. 774. Blades taper sharply from body to very fine points length 4¾ inches. Stainless steel—non magnetic. **\$8.50 each**

No. 772. Angled superfine points—Points on 45° angle. Length 4¼ inches—Stainless steel—non magnetic. **\$10.00 each**

No. 777. Curved, superfine points length 4¾ inches. Stainless steel—non magnetic. **\$10.00 each**

I. KASSOY INC. 30 WEST 47th ST., N. Y. 36, N. Y.

For additional types of tweezers—see circular

Circle 147 on reader service card

NIMS NATIONWIDE IMPROVED MAIL SERVICE PROGRAM

For Better Service
Your Post Office
Suggests

That You Mail Early In The Day!

Zeeners or Zayners

No matter how you pronounce it, nearly everyone agrees that when it comes to Zener Diodes, Motorola is the first choice. And for three good reasons: industry's broadest line; proven reliability; largest ready-for-shipment inventory anywhere. Call your Motorola distributor for local, super-fast service.

FREE SELECTION CHART: Write Dept. TIC-ZZ, Motorola Semiconductor Products, Inc., Box 955, Phoenix, Arizona 85001.

Circle 208 on reader service card

Technical Abstracts

cadmium-telluride compound very slightly with indium, 12-millimeter diameter crystals have been grown. Contact is made to the cadmium telluride by alloying indium or gold antimony dots onto the surface of the material.

P-n junctions were fabricated by diffusion with phosphorous and by alloying with antimony.

The forward-current characteristics of the diffused-junction diode shows a knee at about 600 millivolts. The reverse characteristics show the beginning of a sharp breakdown at about 38 volts. Current pulses of five amperes for approximately 80 nanoseconds have resulted in luminescence. The wavelength of emitted light has been determined, by the use of both broad- and narrow-band filters, to be about 8,000 angstroms.

Presented at the Electron Devices Meeting, IEEE, Washington, October 29-31.

Product mixer

A backward-diode product mixer
Robert M. Knox, Collins Radio Co.,
Cedar Rapids, Iowa

A backward-diode mixer has been operated at two gigacycles in the product mode. The product mode of operation is made possible by the unique feature of the diode—the nonlinear region of the current-voltage characteristic occurs within 0.1 volt of the origin. In this mode, each input signal operates as the local oscillator for the other, with the conversion gain of one signal proportional to the power level of the second signal. The net result is that the intermediate-frequency output power level is proportional to the product of the powers of the two input radio-frequency signals.

The theory that has been developed for the backward diode as a product mixer results in simplified relationship between conversion loss and noise figure as well as between input and output power. The theoretical results are verified for signal levels below -20 dbm (dbm = decibels below a milliwatt).

Presented at the National Electronics Conference and Exhibition, Chicago, Oct. 19-21.

introducing DIGI^{EC} DIGITAL THERMOMETER

Digital
Display of
Temperature



Accurate to
0.15°

Featuring:

- Thermistor Based Instrument—
- Over 15 types of Interchangeable Probes
- Four Integral and Selectable Input Temperature Channels
- Portable or Rack Mounts

Options:

- Provision for linear analog output
- BCD output for printer or computer

Typical Specifications:

	Model 500	Model 501
Range:	59.0°F to 122.0°F	000.0°C to 100.0°C
Least Significant Digit:	0.1°F	0.1°C
Repeatability:	0.05°F	0.05°C

Narrow Range Models Available
(20.00°C or 40.00°F-Span)
accurate to 0.05°C.

UNITED SYSTEMS CORPORATION
918 Woodley Road, Dayton 3, Ohio (513) 254-3567

Stocking Reps Throughout the United States, England and Canada

IMAGE INTENSIFIER ENGINEERS

BS in electrical engineering or physics, plus minimum of five years experience required to develop devices incorporating photo emitters, secondary emitters, fiber optics, channel multipliers and phosphorous screens for low light level surveillance systems.

TRANSMITTER OR RADAR ENGINEER

BS or MS in electrical engineering or physics, plus minimum of five years experience required in the electrical design of high-power transmitters, pulse modulators and RF heating generators and the application of power tubes in such equipment. Experience in the design of power tubes is not essential.

X-Ray Tube Engineer

BS or MS in electrical engineering or physics, plus minimum of five years experience in x-ray tube design, manufacture, applications or related activities. Machlett offers high wages and excellent fringe benefits. Submit resumes and salary requirements to Mr. R. F. Toner, The Machlett Laboratories, Inc., 1063 Hope Street, Springdale, Conn. Machlett is an affiliate of Raytheon Company.



ELECTRON TUBE SPECIALIST

An equal opportunity employer

ELECTRONIC ENGINEERS

Two important, new opportunities with



TEXAS INSTRUMENTS INCORPORATED

Within commuting distance from Boston. Outstanding opportunities to contribute to important new areas of electronic controls design . . . to advance your career in a rapid-growth company . . . to earn the highest professional recognition.

Project responsibilities. Two men will be selected to work on development of solid state control systems for applications in aerospace, appliance, other industries. Both projects offer project-type responsibility.

Circuit Design Experience. Applicants should have BS or MS in electrical engineering plus 1-4 years' experience, preferably in design of low frequency or power type circuits.

Liberal benefits. As a Tier you will receive full program of company benefits including company-paid educational assistance, retirement, profit-sharing. Advantages of Boston are a short drive away.

Send confidential letter or resume to Mr. T. M. Fowler, Employment Director, Dept. 846.

METALS & CONTROLS INC.

34 Forest Street . Attleboro, Mass.

A Corporate Division of

TEXAS INSTRUMENTS INCORPORATED

An equal opportunity employer



E. E.'s

for FEE-PAID Positions
WRITE US FIRST!

Use our confidential application for professional, individualized service . . . a complete national technical employment agency.

ATOMIC PERSONNEL, INC.

Suite 1207L, 1518 Walnut St., Phila. 2, Pa.

ADDRESS BOX NO. REPLIES TO: Box No. Classified Adv. Div. of this publication.

Send to office nearest you.

NEW YORK, N. Y. 10036: P. O. Box 12

CHICAGO, Ill. 60611: 645 N. Michigan Ave.

SAN FRANCISCO, Cal. 94111: 255 California St.

SELLING OPPORTUNITIES WANTED

Manufacturers Rep Available in Los Angeles. Can provide complete coverage to increase your sales volume and improve your profit. Balboa Industries, 15336 Roscoe, Van Nuys, Calif.

Mfrs' Exports Reps with excel. world-wide connect., on their toes around the clock, are eager to boost your sales. Aacor International, 198 Broadway, New York 8, N.Y.

Electronic Engineers

ARE YOU LOOKING FOR A CHALLENGE?
A CHANCE TO DO BASIC DESIGN WORK?
THEN JOIN HALLICRAFTERS

We have the position IF you have the background. Applicants must have B.S. or M.S. in Electrical Engineering, at least 3 years' experience in one or more of the following fields:

Solid State circuit design. Logic and/or linear circuits; Microwave equipment design. Receiver and/or transmitters; Countermeasures equipment design. Conceptual and/or hardware experience highly desirable.

Excellent salary, working conditions and all fringe benefits. Send your resume in strict confidence to: Mr. C. A. Wlot.



hallicrafters

1000 S. Kostner, Chicago, Ill.

An Equal Opportunity Employer

CHANGE JOBS PROFITABLY

Does one of these demanding descriptions fit you?

■ **SECTION MANAGER, TRANSMITTERS.** To direct aggressive development programs for state-of-the-art miniaturized RF transmitters. He should have ten years of experience in the design and engineering supervision of military communications equipment; it should have given him personal drive, demonstrated leadership ability, unusual technical understanding and keen administrative insight.

■ **SENIOR STAFF ENGINEERS, RECEIVERS.** Leadership capability sufficient for immediate assumption of key roles in vigorous development programs for solid-state micro-miniature receivers. Positions require six to eight years of experience and in-depth knowledge of receiver design fundamentals.

■ **PROJECT ENGINEERS, SPACE INSTRUMENTATION.** Technical ability of the very highest order is required. Six to eight years experience, preferably data handling, control, or analog instrumentation.

■ **DESIGN ENGINEERS, RF CIRCUITS.** With knowledge of state-of-the-art device and circuit technology. At least three years experience covering HF, VHF, UHF, or microwave applications.

If you qualify, your present job is not good enough. You can increase your personal satisfaction and professional rewards by contacting Electronic Communications, Inc., today.

ECI has built a solid, successful reputation in airborne communications, multiplexing and space instrumentation. The Company offers pleasant living conditions and unusual educational and cultural opportunities in St. Petersburg, Florida. And it offers you a chance to participate in further growth through technological contribution. Call collect Duane Meyer (813) 347-1121, or send him your resume at ECI, Box 12248B, St. Petersburg, Florida 33733. (An equal opportunity employer.)



ELECTRONIC COMMUNICATIONS, INC.
St. Petersburg, Florida

LABORATORY TEST EQUIPMENT

HEWLETT-PACKARD

151A High-Gain Amplifier, DC to 10 mc.	\$75
200 CDR Audio Oscillator	\$160
X281A Waveguide to Coax Adapter	\$115
330B Distortion Analyzer	\$345
S380A Calibrated Variable Attenuator	\$95
400A V.T.V.M. 10 cycles to 1 megacycle	\$50
400C V.T.V.M. 20 cycles to 2 megacycles	\$65
400D V.T.V.M. 10 cycles to 4 megacycles	\$145
410HR V.T.V.M. 10 cycles to 4 mc. (1% acc.)	\$185
410B AC-DC V.T.V.M. & Ohmmeter, to 700 mc.	\$145
415B SWR Indicator, 70 db range	\$135
430B Microwave Power Meter	\$95
430C Microwave Power Meter	\$145
450A Stabilized Amplifier	\$95
506A Optical Tachometer Head	\$85
520A High Speed Decade Scalar	\$265
521C Counter with 220 kc unit	\$450
612A Signal Generator	\$975

GENERAL RADIO

544B Megohm Bridge	\$245
648A Auxiliary Light Source (Strobolux)	\$125
724B Precision Waveform, 16 kc to 50 mc.	\$85
1570 Auto. Volt Regulator	\$195
1211A Unit Oscillator, 0.5 to 50 mc.	\$145
1605AR Impedance Comparator	\$475
1490B Decade Inductor, 11.11 h (0.001 h steps)	\$145
1304B Audio Generator	\$595
1521A Graphic Level Recorder	\$745
1432N Resistor Decade, Total 11,111 ohms	\$265
1432Q Resistor Decade, Total 1,111,000 ohms	\$65
1532B Strobolum	\$135
1700B Motor Speed Control	\$90

TEKTRONIX

107 Square-Wave Generator, 400 kc to 1 mc.	\$115
112 Differential D-C Coupled Amplifier	\$75
161 Pulse Generator	\$50
162 Waveform Generator	\$50
53/54K Fast Rise, Hi-Gain Plug-in Unit	\$95

KEPCO TRANSISTORIZED SUPPLIES

SC-18-4M: 0-18 V, 0-4 A, 0.1% regulation	\$225
SC-32-5: 0-32 V, 0-5 A, 0.01% regulation	\$185
SC-32-10: 0-32 V, 0-10 A, 0.01% regulation	\$225
SC-32-15: 0-32 V, 0-15 A, 0.01% regulation	\$275
SC-150-1: 0-150 V, 0.1 A, 0.01% regulation	\$185
2SC-32-1.5: Dual 0-32 V, 0-1.5 A, 0.01% reg.	\$175
2SC-100-0.2: Dual 0-100 V, 0-0.2 A, 0.01% reg.	\$165
SR-12-50: 13 V, 0.50 A, 1% regulation	\$395
SC-3672-0.5: 36-72 V, 0-0.5 A, 0.1% reg.	\$135
SC-3672-1M: 36-72 V, 0-1 A, 0.1% reg.	\$195
PSC-10-2: 7.5-12.5 V at 2 A, 0.02% reg.	\$195
PSC-20-2: 17.5-22.5 V at 2 A, 0.02% reg.	\$195

LAMBDA DC POWER SUPPLIES

28: 200-235 V, 0-100 MA, 6.3 @ 3A, 1%	\$35
28M: 200-235 V, 0-100 MA, 6.3 @ 3A, 1%	\$45
29M: 100-200 V, 0-100 MA, 6.3 @ 3A, 1%	\$65
C281: 125-325 V, 0-200 MA, 6.3 @ 10A, 0.25%	\$95
C481M: 125-325 V, 0-400 MA, 6.3 @ 15A, 0.25%	\$165
50R: 0-500 V, 0-500 MA, 6.3 (2) @ 5A, 0.5%	\$195
LA50-03A: 0-34 V, 0-5 A, Transistor'd, 0.05%	\$185
LT-2095M, 0-32 V, 0-2 A, Transistor'd, 0.15%	\$175
LT-2095AM, 0-32 V, 0-2 A, Transistor'd, 0.15%	\$195

RECORDING INSTRUMENTS

BARNES DEV. CO: Type 4 Data Recorder	\$750
SANBORN: Model 356-5480 Oscillograph	\$1,450
CONSOLIDATED ELEC: Mod. 5-114P3, 18-chn	\$975
BRUSH ELEC: Model BL-262, 2-channel	\$245
ESTERLINE-ANGUS: Model AW, 5-0-5 MA	\$135

MILITARY TEST SETS

AN/UPM-10 Radar Test Set	\$775
AN/URM-43B RF Power Meter, 0 to 600 mc.	\$95
TS-118A/AP RF Wattmeter, 20 to 1,400 mc.	\$195
AN/URM-79 Freq. Met., 100 kc to 20 mc., 0.01%	\$695
OS-8E/U Oscilloscope, portable, 2 mc bandwidth	\$165
TS-47/APR Test Oscillator, 40 to 500 mc.	\$65
AN/PRM-10 Grid Dip Oscillator, 2 to 400 mc.	\$110
FR-4/U Frequency Meter, 100 kc to 100 mc.	\$595
FS-15C/AP Fluxmeter, 1200 to 9600 Gauss	\$25
TS-731/URM Summation Bridge, 1 kmc to 4 kmc	\$65
AN/USM-24 Oscilloscope, 1.5 cps to 8.5 mc.	\$350
AN/UPM-11A Radar Range Calibrator	\$250

MISCELLANEOUS ITEMS

KROHN-HITE: Model 340A Servo Design Filter	\$65
ELECTRO PULSE: Mod. 2120A Pulse Generator	\$275
ELECTRO PULSE: Mod. 4120A Pulse Generator	\$125
SERVO CORP: Model 1100C Servo Analyzer	\$475
KINTEL: Model 301R DC Voltage Standard	\$450
STATHAM INST: TC-5B/2-3 Temp Chamber	\$375
KINTEL: Mod. 453 Scan, programming device	\$950
KINTEL: 451 Digital V.I. System	\$750
BECKMAN: Mod. 5914, In-line, 4 digit Readout	\$175
BRUSH: Model BL-262 2-Chan. DC Amplifier	\$245
BECKMAN: Model 5630-37 Predet. Counter	\$125
BECKMAN: Model 7350 R 100 kc counter	\$495
BECKMAN: Model 7360 1 MC Counter	\$695
SORENSEN: Model 300S Voltage Regulator	\$85
SORENSEN: Model 1000S Voltage Regulator	\$125
SORENSEN: FCD3P 1000-MI Freq. Changer	\$1,450
GERTSCH: PT-IR Ratiotran	\$145
BALLANTINE: Model 300E VTVM	\$165
EMPIRE DEVICES: AT-106MB Attenuator	\$350
RATHEON: Weld Power System HPT/2/1.5/1	\$395
PANORAMIC: LP-1 Sonic Analyzer	\$495
PANORAMIC: G-2 Sonic Response Indicator	\$175
B&K INSTS: 2603 Voltmeter/Amplifier	\$495
ELECTRO INSTS: DXM-031 Digital Clock	\$565
ELECTRO INSTS: A-12 DC Amplifier	\$285
TENNEY: Air Cooling Simulator	\$5,000
ELIN CO: Prec. DK-106R-13 400 Cy. OSC	\$165
HARRISON: 700A Power Sup. 0-315V, 1.5A	\$275
DUMONT: 304H Scope, 5" Crt.	\$95
G.E. CO: 112L318G1 Inst. Stn. Console	\$1,250
BOONTON: 260 A Q Meter	\$675
HICKOCK: 1700 Lab Tube Analyzer	\$450
BEHLMAN: 161-C-2 400 cy. source	\$295
ELECTRO SCIENTIFIC: 250 DA Impedance Bridge	\$325
FREED: MOD. 1010-A Comparison Bridge	\$150

ELECTRONICRAFT, INC.

P.O. BOX 13, BINGHAMTON, N.Y. 13902
Phone: 607-724-5785

CIRCLE 951 ON READER SERVICE CARD

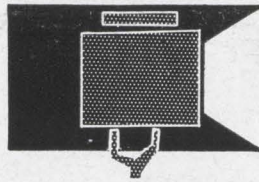

SEARCHLIGHT SECTION

• CLASSIFIED ADVERTISING • BUSINESS OPPORTUNITIES
• USED OR SURPLUS EQUIPMENT

STEPPING SIGMA HERMETICALLY
SWITCHES KURMAN SEALED
SENSITROLS WARD LEONARD
STRUTHERS N. AUTOMATIC
DUNN ELECTRIC
ROTARY LEACH
RACHET CLARE
ALLIED STOCK OF
LEDEX RELAYS
CLARE IN THE
LEACH WORLD
MINIA
SIGMA
NORTH
ELECTRIC
DORMEYER
TELEPHONE
TYPE
KURMAN
STEVENS
ARNOLD
CONTACT
MERCURY
SOLENOIDS
ADVANCE
ALLEN BRADLEY
POTTER
BRUMFIELD

LARGEST STOCK OF RELAYS IN THE WORLD

PRODUCTION QUANTITIES
MOST MAKES IN STOCK

Send for Latest Catalog

Universal RELAY CORP.

42 WHITE ST. NEW YORK 13, N. Y. WALKER 5-6900

CIRCLE 952 ON READER SERVICE CARD

FREE...CATALOG BARRY ELECTRONICS

512 BROADWAY 212-WALKER 5-7000
NEW YORK 12, N.Y. TWX-571-0484

CIRCLE 953 ON READER SERVICE CARD

RADAR AUTO-TRACK & TELEMETRY ANTENNA PEDESTALS 3 & 10 CM. SCR 584 AUTOTRACK RADARS. M-33 RADAR TPS-1D SEARCH. APS-45 TPS-10D HT. FINDERS. WX RADARS. FPN-32GCA. APS-10 APS-15B APS-27 (AMT) SEARCH. APN-102 DOPPLER. DOZENS MORE. CARCINOTRONS. PFN'S. 25.5-1-2-3-6 MEGAWATT PULSE MODULATORS. CAVITIES. PULSE TRANSFORMERS. IF STRIPS. WAVEGUIDE. BENDS 200 MC. 1 KMC. 3 KMC. 6 KMC. 9 KMC. 24 KMC. RF PKGS.

RADIO RESEARCH INSTRUMENT CO.
550 5TH AVE., NEW YORK 36, N. Y. JU 6-4691

CIRCLE 954 ON READER SERVICE CARD

FREE Catalog OF THE WORLD'S FINEST ELECTRONIC GOV'T SURPLUS BARGAINS



HUNDREDS OF TOP QUALITY ITEMS - Receivers, Transmitters, Microphones, Inverters, Power Supplies, Meters, Phones, Antennas, Indicators, Filters, Transformers, Amplifiers, Headsets, Converters, Control Boxes, Dynamometers, Test Equipment, Motors, Blowers, Cable, Keys, Chokes, Handsets, Switches, etc., etc. Send for Free Catalog - Dept. E-5.

FAIR RADIO SALES
2133 ELIDA RD. • Box 1105 • LIMA, OHIO

CIRCLE 955 ON READER SERVICE CARD

LAMBDA	Power Supplies-Regulated	
C-481-M	350V @ 400 M A	60.00
O-280-M	200V @ 200 M A	49.50
C-881-M	350V @ 800 M A	65.00

BOONTON RADIO TYPE 245 D	195.00
Signal Generator Calibrator	

Electro-Pulse Model 4120 A	Variable Pulse Generator	75.00 ea
----------------------------	--------------------------	----------

Hewlett-Packard Model 212 A	Pulse Generator	195.00
-----------------------------	-----------------	--------

Hewlett Packard Model 434 A	Calomimetric Power Meter	850.00
-----------------------------	--------------------------	--------

Kay Electronic Complete (3 units)	Vibralyzer Model 651 A	750.00
-----------------------------------	------------------------	--------

Dumont	Pulse Generator MODEL 404	150.00
--------	---------------------------	--------

MARCONI INSTRUMENTS VTVM	MODEL TF 1041 B	185.00
--------------------------	-----------------	--------

HEWLETT PACKARD Model P 530A	Frequency Meter	59.95
------------------------------	-----------------	-------

FARRAND OPTICAL Grating MONOCHROMATOR	ULTRAVIOLET VISIBLE 103420	295.00
---------------------------------------	----------------------------	--------

FXR UNIVERSAL RATIO METER	MODEL B 811 A	250.00
---------------------------	---------------	--------

GERTSCH MODEL TN-I TUNED NULL INDICATOR	PHASE SENSITIVE	475.00
---	-----------------	--------

BAIRD-Atomic Model GP-4	Transistor Tester	250.00
-------------------------	-------------------	--------

Marty's Mart

1236 Market St., San Francisco 3, California
Phone: Underhill 3-1215

CIRCLE 956 ON READER SERVICE CARD

★ MINIATURIZATION ★
SALE [180,000 SEMICONDUCTORS
150,000 RESISTORS
100,000 ELECTROLYTICS
AND TANTALYTICS]
WE BUY SURPLUS SEMICONDUCTORS
TRANSISTORS UNLIMITED COMPANY
462 Jericho Turnpike
Mineola, L. I., N. Y. (516) 747-7221

CIRCLE 958 ON READER SERVICE CARD

BOX #'s are Confidential...

WE WILL NOT DIVULGE THE NAME OF ANY classified advertiser using a box number. For readers who wish to protect their identity when answering box number ads, we suggest you send replies direct to Classified Manager of this publication. Enclose a not listing the concerns which you would not want your letters to reach.

New Literature

Rotary switches. Shallcross Mfg. Co., Preston St., Selma, N.C., 27576. Series 2 (1¾ in.) and series 4 (2½ in.) precision rotary switches are described comprehensively in the new 24-page catalog RS100. [461]

Component identification printing. Markem Machine Co., Keene, N.H., 03431. Three new bulletins contain helpful information for anyone concerned with identification printing of electronic components. They give technical data on cleaning components before printing, flash curing imprints and meeting permanency specs. [462]

Line and load regulation. Dressen-Barnes Electronics Corp., 250 N. Vinedo Ave., Pasadena, Calif. A technical booklet defines terminology, problems and solutions relating to power supply line and load regulation. [463]

Motor speed control systems. Electro-Craft Corp., 1600 Second St. South, Hopkins, Minn., has published two data sheets on the series E-600 and E-150 motor speed control systems. [464]

Frequency to d-c converter. Solid state Electronics Corp., 15321 Rayen St., Sepulveda, Calif., offers a bulletin describing the series 400 M panel-mounted visual Freqmeters. [465]

Reactance slide rule. Boonton Electronics Corp., 500 Pomeroy Road, Parsippany, N.J., 07054. A slide rule, designed for rapid calculation of the resistance and either Q or dissipation factor of capacitors and inductors, is available on letterhead request.

Antenna equipment. Andrew Corp., P.O. Box 807, Chicago, Ill., 60642. Catalog 23 presents in 96 pages what the manufacturer claims is the widest selection of antenna system equipment ever offered. [466]

Wire-wound resistors. Kelvin, 5919 Noble Ave., Van Nuys, Calif., has available catalog sheets on high-reliability, precision wire-wound resistors, together with supporting test data. [467]

Peak power meter. PRD Electronics, Inc., 202 Tillary St., Brooklyn, N.Y., 11201, is offering a data sheet describing its 668 peak power meter. [468]

Modular servo accelerometers. Gulton Industries, 212 Durham Ave., Metuchen, N.J., has issued a bulletin describing modular servo accelerometers which are said to offer flexibility of design parameters without affecting the proven performance characteristics or high reliability of the transducers. [469]

Transfer function computer. Wayne Kerr Corp., 22 Frink St., Montclair, N.J., 07042. An eight-page, illustrated bulletin covers the model SA-100 transfer function computer and four accessory instruments. [470]

Silicon rectifiers. Semiconductor Products Group, General Instrument Corp., 600 W. John St., Hicksville, L.I., N.Y. A six-page brochure contains characteristics, ratings, mechanical data, application notes and testing procedures for the company's Glass-Amp silicon rectifiers. [471]

Dipped mica capacitors. The Electro Motive Mfg. Co., Inc., Willimantic, Conn., has released its 1965 catalog No. 102 that gives design engineers 22 pages of technical data on EI-Menco dipped mica capacitors. [472]

Rack and panel connectors. Amphenol Connector Division of Amphenol-Borg Electronics Corp., 1830 S. 54th Ave., Chicago, Ill., 60650, has available catalog RP-1, a 32-page brochure on rack and panel connectors. [473]

Silicon digital modules. Cambridge Thermionic Corp., 445 Concord Ave., Cambridge, Mass., 02138. Catalog No. 82 contains technical data on the new Cambion line of silicon, 2-Mc digital modules. [474]

Digital computer. Digital Electronics, Inc., 2200 Shames Drive, Westbury, N.Y., offers a new brochure describing the features and capabilities of the Digiacc 3080 educational and general-purpose digital computer. [475]

Components. Jan Hardware Mfg. Co., Inc., 38-01 Queens Blvd., Long Island City 1, N.Y. A new 16-page condensed catalog contains detailed information on more than 250 electronic components. [476]

Microwave sweep oscillator. Micro-Power Inc., 20-21 Steinway St., Long Island City, N.Y. A new mailing piece covers the model 220 microwave sweep oscillator that has a range of 500 Mc to 40 Gc with wide range, plug-in oscillator units. [477]

Circuit-card mounting hardware. Scanbe Mfg. Corp., 1161 Monterey Pass Road, Monterey Park, Calif. A low silhouette guide slot combined with a positive locking connector mounting foot and a variety of guide extensions are the key to a system of circuit card support described in a new catalog. [478]

Compact digital computers. Data Machines, Inc., 1590 Monovia Ave., Newport Beach, Calif. A 12-page brochure gives detailed specifications for the 610 series of low-cost, compact digital computers. [479]

Vhf admittance bridge. Wayne Kerr Corp., 22 Frink St., Montclair, N.J., 07042, has published a four-page bulletin on the model B-801 vhf admittance bridge, a portable instrument designed for extremely accurate measurements on antennas, cables, and transmission lines and for other applications. [480]

RFI-EMC

Assignment: Involves theoretical and experimental development of suppression techniques from circuit to system level. Requires experience in RFI measurement and interference control techniques. Statistical correlation experience and knowledge of digital logic and circuits is desirable.

Location: These openings are at the Data Systems Division in Kingston, New York, approximately 100 miles north of New York City.

Please write: Outline your qualifications and interests to:

D. B. Calkins, Dept. 554A4
IBM Corporation
Box 390
Poughkeepsie, N. Y.

IBM

An Equal Opportunity Employer

Distinctively Styled



1½ in. AM-1 (actual size)

high torque, self-shielded panel meters

Clean, modern styling... easy scale readability... sizes 1½ to 4½". High torque mechanism gives 1% linearity, 2% accuracy and sensitivity to 20 ua. Magnetic system completely shields external field influences, permitting bezel-to-bezel mounting on any material without interaction or effect on calibration. Choice of colors or finishes, custom dials—ASA/MIL 4-stud mtg.

AMMON

AMMON INSTRUMENTS, INC.
345 Kelley Street, Manchester, N. H. 03105

A COOL 400 V



Delco Radio's new DTS 413 and DTS 423 power transistors, are conservatively rated at 75 and 100 watts. Our standard TO-3 package assures low thermal resistance (junction to heat sink 1.0°C per watt) for cool power. The silicon element gives you high voltage protection, high frequency response and low saturation voltage.

The price is low (less than 3¢ a volt for sample quantities) for two reasons: special inter-digitated geometry of the devices and our unique 3D* process for high yields.

Now you can reduce current, the size of other components, and increase efficiency in high energy circuits. Vertical and horizontal TV outputs, for example.

Your Delco Radio Semiconductor distributor has these two new power transistors on his shelf. Call him today for data sheets, prices and delivery.

*Triple sequential diffusion

RATINGS	DTS 413	DTS 423
VOLTAGE		
V _{CEO}	400 V (Max)	400 V (Max)
V _{CEO} (Sus)	325 V (Min)	325 V (Min)
V _{CE} (Sat)	0.8 (Max)	0.8 (Max)
	0.3 (Typ)	0.3 (Typ)
CURRENT		
I _C (Cont)	2.0A (Max)	3.5A (Max)
I _C (Peak)	5.0A (Max)	10.0A (Max)
I _B (Cont)	1.0A (Max)	2.0A (Max)
POWER		
	75 W (Max)	100 W (Max)
FREQUENCY RESPONSE		
f _t	6 MC (Typ)	5 MC (Typ)

FIELD SALES OFFICES

UNION, NEW JERSEY*
Box 1018 Chestnut Station
(201) 687-3770
SANTA MONICA, CALIFORNIA*
726 Santa Monica Blvd.
(213) 870-8807

DETROIT, MICHIGAN
57 Harper Avenue
(313) 873-6560
SYRACUSE, NEW YORK
1054 James Street
(315) 472-2668

PALO ALTO, CALIFORNIA
201 Town & Country Village
(415) 326-0365
CHICAGO, ILLINOIS*
5151 N. Harlem Avenue
(312) 775-5411

General Sales Office:
700 E. Firmin, Kokomo, Ind.
(317) 452-8211—Ext. 500

DELCO RADIO
Division of General Motors

*Office includes field lab and resident engineer for applications assistance.

The Netherlands

Baker's computer

Hard on the heels of their biggest American competitor, Dutch bakers are blending electronics with biscuits. But their recipe calls for a smaller amount of computer control than in a system used by the National Biscuit Co. in Chicago.

At the Royal Verkade Manufacturing Co. in Zaandam, a blending and mixing system gives tight quality control over the ingredients used in the enormous quantity of baked products turned out daily.

The Dutch system, made by EMI Electronics, Ltd., of Britain, does one job that Nabisco's doesn't: it controls mixing time, while Nabisco's [Electronics, Apr. 20, p. 82] controls only the batching.

Manual control. But the Nabisco system, made by the Foxboro Co., has other advantages. It uses a 4,096-word core memory for precise control of deliveries of flour, salt, milk powder and other ingredients for a batch of, for example, Saltine crackers or Fig Newtons. The Foxboro M97600 digital computer then compares the amounts delivered to the mixers with the required quantities stored in its memory for the various recipes.

In the Dutch system, amounts of all ingredients are hand-set on a recipe panel, using rotary switches. A simple computer of AND and NOR circuits performs time-sharing of the various pumps and scales between storage hoppers and mixing machines, and keeps track of the amounts used.

Controlled delivery. Signals from the weight scales and flow generators are compared to a-c demand signals set by the rotary switches. The ingredients are delivered, under computer control, to the proper mixing machine, and mixing time is controlled by the computer. Accuracy of batching is said to be 99%—about the

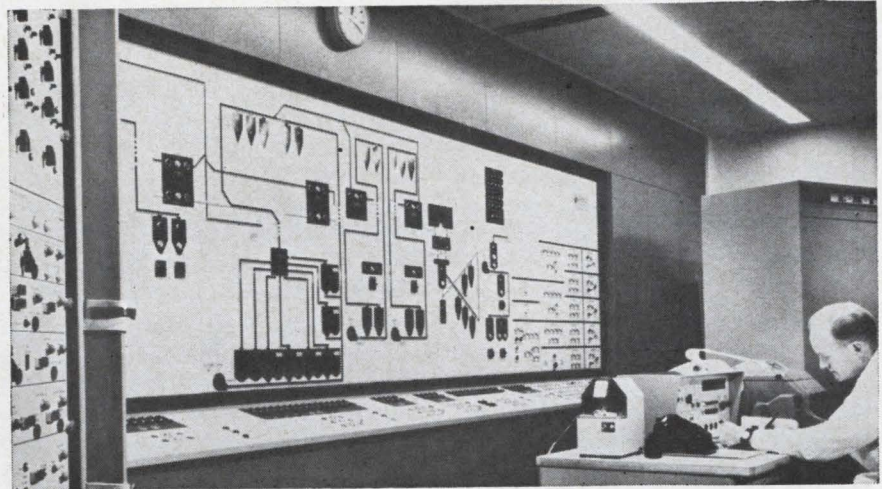

Bakery control center at Royal Verkade Manufacturing Co. Mimic shows ingredient flow. Milk powder, flour and other ingredients pour out of storage bins (pointed rectangles at top of board) into mixing bins (bottom of board), all under computer control.

same as in the Nabisco system.

Royal Verkade doesn't store recipes on punched tape because recipes don't change often enough. They're all set up by hand on the rotary switches, following typewritten schedules.

A teleprinter records the amount of each ingredient used, mixing time and other information.

Austria

Color tv sweepstakes

Nineteen sixty-five will probably be the year in which Western Europe agrees—or fails to agree—on a system of color television.

The first big test will come March 20 in Vienna, when the International Radio Consultative Committee (CCIR) meets to recommend a system for all Europe. Any clear-cut recommendation it makes is likely to be adopted by the European members of the International Telecommunications Union, an agency of the United Nations.

If no agreement is reached, it's possible that two countries will go it alone with different systems—France with her Secam and Britain

with the United States' NTSC. Each of the three contending systems—NTSC, Secam and West Germany's PAL—has some advantages and disadvantages.

The French lobby. The busiest politicking is being done by the French, who have made Secam a matter of national pride. Secam is the only color system that seems to have the all-out support of any government.

Opponents have even charged France with tailoring her foreign policy to fit Secam's campaign. The most recent report comes from the German-American Trade News, which says France has offered to buy more oil from the Soviet Union if Russia will support Secam. Secam is owned by Compagnie Française de Télévision.

Advocates of rival systems concede that Secam seems to have overcome NTSC's early lead in the color-tv sweepstakes. Even Britain, a strong proponent of NTSC, is said to be wavering.

NTSC counterattack. In the U.S. and Japan, a campaign for NTSC is gaining momentum. The Electronic Industries Association, in New York, is planning a double-barreled campaign: a technical presentation for the Vienna meet-

ing, and a nontechnical brochure for management in the broadcast industry. One exporter, R.C. Auriema Jr., explains: "This is a battle on the management level as well as on the technical level. People in this industry who go to Europe should be well-informed on this subject and get the NTSC message across."

Auriema Sr., head of Ad. Auriema, Inc., declares that NTSC has the almost-complete support of the Russians, Germans, Italians and Dutch.

The U.S. system is being demonstrated throughout Europe by the Radio Corp. of America, which owns most of the patents on NTSC receivers. RCA receives a 1.75% royalty on the factory cost of each receiver made. An RCA mobile van arrived in Moscow this month to demonstrate the NTSC system after appearances in London, Helsinki and Stockholm. George H. Brown, RCA's vice president of research and engineering, says the Soviets lean toward NTSC.

PAL's problems. The West German system also has been demonstrated throughout Europe, particularly in the East. But PAL doesn't seem to have the single-minded support from Bonn that Secam receives from Paris. In fact, the German representative to the Vienna meeting is reported to be neutral on which system should be chosen.

Like Secam, PAL eliminates NTSC's sensitivity to phase errors that cause reception of incorrect hues. This technical advantage is particularly important when transmitting in mountainous areas where reflections of the signal cause the shift in hue.

With the two European systems there is no need to adjust hue manually when changing stations, or to correct for phase error. In fact, Secam and PAL receivers have no hue-control knob.

Experience. NTSC's big advantage is experience. The system has been in commercial use for more than 11 years, and three million receivers are already equipped with NTSC gear. Its receivers are the least complex, and cheapest, of the three systems, and it's less sensi-

tive to transmission noise.

PAL's color signal is transmitted by a variation of the NTSC quadrature modulation, which averages out any shift in hue from line to line. However, the PAL receiver is more expensive than the other system's.

Secam, using frequency modulation for its chrominance signal, transmits pictures of fixed saturation and hue, and can be recorded on standard black-and-white video recorders. But the French system achieves these advantages at the expense of some vertical color resolution. Secam is more susceptible to noise than is NTSC, and less compatible with black-and-white signals. Its subcarrier signal is visible on black-and-white receivers.

High stakes. The stakes in the race are huge. Besides royalties, there's the prospect of selling components, and the longer-range hope that whichever system is adopted in Europe is likely to gain acceptance in the rest of the world.

However, there may not be a single clear-cut winner. The choice of a color isn't necessarily a matter of either-or. Experiments are being conducted in some countries with the use of the Secam signal in a broadcasting studio and for tape-recording. The signal is then trans-coded to the stronger NTSC signal for transmission. In the U.S., the American Broadcasting Co. is testing such a systems'.

France

Antisub weapon

The French Navy thinks its new magnetometer, claimed in Paris to be the best in the world, will be a potent weapon for detecting enemy submarines.

Magnetometers have long been used to search out submarines in shallow water. The French instrument is said to be much more sensitive and precise than other models. More important, it contains far fewer mechanical parts, making it easier to operate and maintain, according to Navy officials.

The magnetometer, which will

go into operation this year, uses a new technique for such devices: the measurement of the magnetic resonance frequency of cesium vapor, a highly corrosive substance that is kept in a glass vacuum tube. Studies for the new equipment were started in 1959 by Prof. J.P. Mosnier of the Ecole Normale Supérieure. Further development was carried out by the Compagnie Générale de Télégraphie Sans Fil (CSF).

U.S. versions. In the United States two companies, Texas Instruments, Inc., and Varian Associates, are working on magnetometers similar to the CSF device. However, the U.S. companies are said to be using different gases—helium in the case of TI and rubidium vapor for Varian.

The French magnetometer will cost about \$15,000, French Navy spokesmen say. A civilian version of the CSF magnetometer has been in use since July, 1963, for precise electromagnetic charting of France. This is being carried out by the Compagnie Générale de Géophysique as one study in the International Geophysical Year.

Two converted B-17's have flown about 50,000 miles for the mapping, which is nearly completed. Each plane tows its magnetometer 300 to 500 feet behind it.

Magnetic interference. The navy cannot tow its instrument because sub-hunter planes often turn in tight circles during a search. But putting the magnetometer so close to the plane subjects the instrument to the plane's magnetism; this problem is intensified by the new instrument's increased sensitivity. Instead, the apparatus will be mounted in a plastic boom extending from the tail of the plane. There's another problem: As a plane circles, it changes altitude, and the strength of the earth's magnetic field varies with altitude.

Navy technicians think they've overcome these obstacles, but aren't saying how.

Space study. Another version of the new magnetometer will be utilized in the space program in November when the French hope to launch a large liquid-fueled rocket, the Vespa, from Algeria.

At a height of about 125 miles, 200 kilograms of TNT will be exploded. One purpose is to determine the effect of such a blast on the earth's magnetic field.

The sensitivity of the civilian and space instruments is plus or minus one gamma. A gamma is 10^{-5} gauss. The dynamic range of the civilian instrument is 20,000 to 70,000 gauss, and turnover effect is two gamma. No such technical information is available on the navy version.

The magnetic resonance frequency of a vapor such as cesium is proportional to the intensity of the magnetic field in which the vapor is placed. The resonance can be detected by optical pumping—illuminating the system with circularly polarized light and observing to what extent this light is absorbed by the different energy levels of the atom.

Switzerland

War of the watches

The Swiss watch industry is planning to fight back against electronic assaults from the United States and the Soviet Union. Its goal is to make the Bulova Watch Co.'s successful new electronic timepiece, the Accutron, obsolete.

Presumably that would also downgrade the new Russian watch, named Slava (for glory), which has been described in *Izvestia*. A Bulova spokesman says that from the description the Slava sounds like a copy of the Accutron, but Bulova holds patents for the Accutron throughout the free world.

Funds from Bulova. Adding insult to the proposed injury, the Swiss are using Bulova money to help finance their new Horological Electronics Center near Neuchatel in western Switzerland. Bulova is a member of the Swiss Federation of Clock and Watch Manufacturers, which is footing the bill for the research facility. The center has \$1.5 million worth of equipment and a staff of 40, including physicists, chemists and electronics engineers.

The director, Roger P. Wellinger,

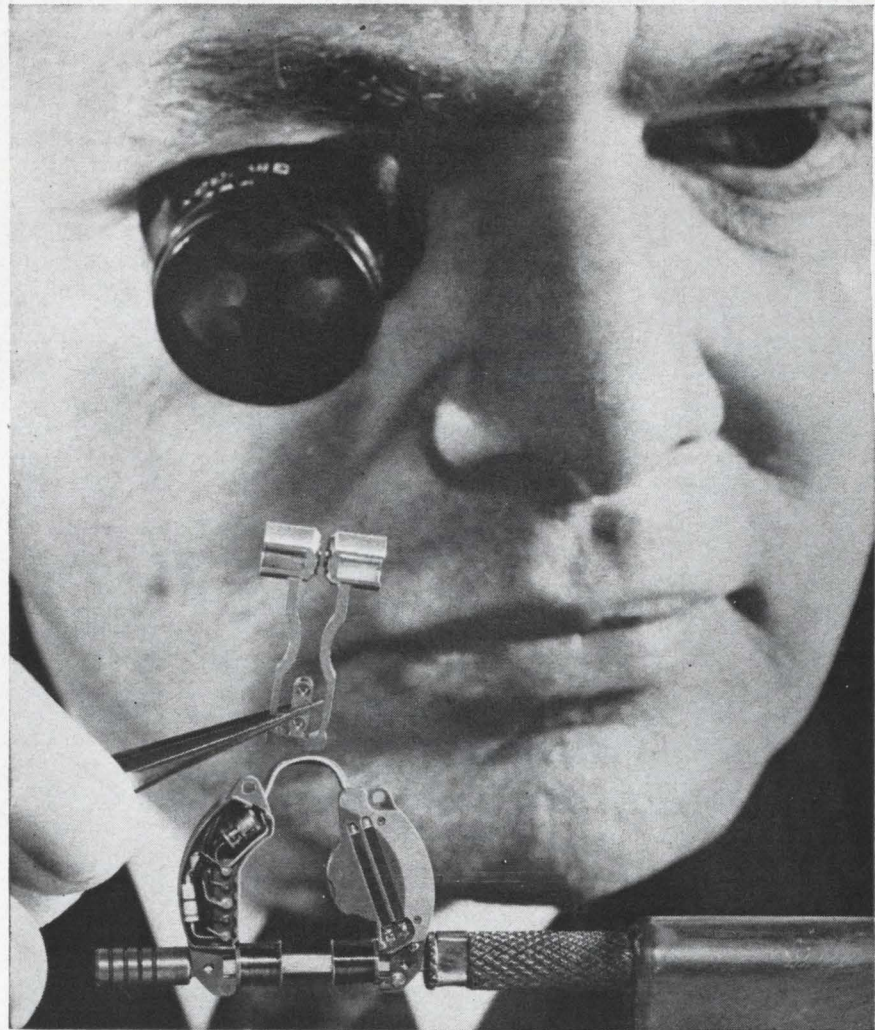

Tuning fork being placed onto transistorized circuit of an Accutron.

was manager of camera and power-tube engineering at the General Electric Co. The staff includes Max Hetzel, inventor of the Accutron.

Much of the work is top secret, but the researchers are known to be exploiting the nanowatt instead of the microwatt for the watch's low-power needs. This approach has resulted in the development of a nanowattmeter—an electronic panel 19 inches long and 8 inches high. When attached to a standard milliwattmeter, it can test components that use very low power.

The Accutron replaces the hair-spring and balance wheel of a conventional watch with an electromagnetic tuning fork whose vibration is controlled by a transistorized circuit.

New look. The Swiss electronic watch would probably give the industry a facelift. Researchers are

talking about a "dial" that looks like a television screen, with numbers depicting the time, such as 3:28.

If the Swiss succeed, they may still be able to hitch onto the boom that has resulted in the sale of 250,000 Accutrons since 1960. But any new watch that may emerge from the Swiss research center is probably still three years away, Wellinger says.

Great Britain

Microwave for industry

Microwave heating has been confined pretty much to cooking applications [*Electronics*, Sept. 7, p. 111]. Now it has found two industrial tasks, on an automobile as-

sembly line and in the production of fireproof safes. Both applications are being pioneered by Elliott-Automation, Ltd.

In the auto industry, polyurethane foam moldings are being cured by microwave at one plant of the British Motors Corp. Two other microwave installations are operating at Fiat plants in Italy, and a third is planned in Japan. Each installation costs about \$75,000.

A spokesman for British Motors says the system "cut production time drastically," from six minutes per molding down to 45 seconds, with fewer than 1% rejections. The new system is also said to reduce waste.

In auto production, as in fireproofing of safes, continuous-wave magnetrons are used at 2,450 megacycles. The power for radiation into a cavity 8 by 24 by 30 inches is 4.5 kilowatts.

Making safes safer. Modern safes are made fireproof by surrounding them with plaster of paris. Water of crystallization in the plaster prevents heat from penetrating the safe. The big problem in construction is to dry out the free water from the plaster without removing the water in bond.

Conventionally this is done by drying the plaster slowly for several weeks. With microwave heating, used at the Chubb & Sons Lock & Safe Co. in London, the plaster is placed in a fan-ventilated cavity resonator.

When microwave power is applied, the center of the mold dries faster than the exterior. When the free water is extracted, there's no further increase in the plaster's temperature. A reflectometer detects this change in the plaster's dielectric condition, and switches off the power.

Soviet Union

More radios

The Riga Radio Plant, largest of its type in the Soviet Union, is being expanded to double its present capacity by the end of 1965. Forty production lines now turn

out 500,000 radios a year, also radio-phonographs and commercial communication equipment such as telephones and telegraph gear. The plant also makes specialized equipment for Aeroflot, the Soviet airline, and presumably for the military.

Visvald I. Birkenfeld, the plant's director and chief engineer, says Riga Radio will begin producing fully transistorized f-m radios this year. It will also begin making telephone switchboards of the "automatic secretary" type, and is developing self-answering and conversation-taping instruments for regular industrial use, he adds.

Birkenfeld concedes that the Soviet Union lags far behind the United States in telephone equipment. But he points out that the Russian industry is more concentrated—Riga Radio makes 80% of Russia's telephone receivers—and says this makes research more efficient.

Exports to England. Riga Radio's chief exports are the Latvia and Spidola radios, which are sold in 43 countries, mostly in Asia and Africa. The newest customer is Britain, which was added to the list last year.

A visitor to the plant sees printed circuits, automatic soldering lines and other refinements. He also notes a huge poster proclaiming: "Our motto: to live and work as Communists."

About 6,000 of the 10,000 employees are women. The average wage is \$100 a month—slightly above the average for factory workers in Russia.

West Germany

Economic espionage

When the definitive history of the cold war is written, one of its most intriguing volumes will deal with economic espionage. The latest prominent casualty is Lorenz Cosmann, a 43-year-old electronics engineer sentenced to 2½ years in prison for supplying East Germany with technical information about companies in West Germany.

As a sales engineer for Siemens

& Halske AG, Cosmann was able to get information about computers and data-processing techniques being developed for some of the Federal Republic's largest companies. He sent microfilm to the East, showing equipment for customers of Siemens and of the International Business Machines Corp. He is also said to have passed along data about another company's work with laser beams.

No military value. The information seems to have been militarily innocuous. The espionage was aimed only at boosting the technological level of East German industry, which is said to be at least three years behind the Federal Republic in the application of computers.

Cosmann already had served 15 months in prison at the time of his conviction. He had been held "for investigation." This period is subtracted from his sentence; if the sentence is also shortened by one-third for good behavior, he could be released in May.

Comrades in captivity. Cosmann is a victim of Germany's Nazi past and its Communist present. He spent most of World War II in a concentration camp, where he met many men who were later to become leaders of Communist East Germany. At his trial he admitted sympathy with the Communist cause.

Cosmann was described by his attorney as an idealist anxious to bridge the gap between the two Germans. His relatively light sentence indicates that the plea may have carried some weight with the court.

Cosmann's idealism paid off—he received \$13,750 for the data he supplied, plus considerable expense money. This helped him live in a playboy style that could not have been supported by his \$450 monthly salary at Siemens' sales office in Cologne.

Cosmann's conviction points up gaps in the western alliance's embargo on sales of certain technical equipment to the East. He told the court, and was not contradicted, that East Germany was buying embargoed equipment from France and other countries.

ADD 2N1722 & 2N1724

TO A GROWING PLANAR LINE...



SILICON TRANSISTOR CORPORATION'S TRIPLE DIFFUSED PLANAR SILICON POWER TRANSISTORS

2N1722 in the TO-53 package, and 2N1724 in the TO-61 package, are the latest. These, and all our triple-diffused, planar, silicon power transistors, have high frequency, high gain and high reliability characteristics, plus Silicon Transistor Corporation's overall quality and service. Use them in high frequency, linear amplifiers, for high speed switching, and converter and inverter circuits operating at 50 to 100 KC. Low leakage and stable electrical characteristics are inherent in the planar process.

	Package	Pc @ 100°C	Ft	VCEO	hFE
2N1722	TO-53	50 watts	10 MC	80	20 @ 2A
2N1724	TO-61	50 watts	10 MC	80	20 @ 2A
2N2657	TO-5	1.25 watts	20 MC	60	—
2N2658	TO-5	1.25 watts	20 MC	80	—
2N2877	TO-59 (1/16" DES)	30 watts	30 MC	60	20 @ 1A
2N2878	TO-59 (1/16" DES)	30 watts	50 MC	60	40 @ 1A
2N2879	TO-59 (1/16" DES)	30 watts	30 MC	80	20 @ 1A
2N2880	TO-59 (1/16" DES)	30 watts	50 MC	80	40 @ 1A

For complete information and specifications, write to:



CARLE PLACE, LONG ISLAND, NEW YORK, 516-Pioneer 2-4100. TWX 516-248-9085

REGIONAL OFFICES: CHICAGO, ILL. 60625, 5555 NORTH LINCOLN AVE., 312-271-0366-7. TWX 910-221-1304
 LOS ALTOS, CALIF. 94022, 1 FIRST STREET, 415-941-2842. HUNTSVILLE, ALA. 35807, POST OFFICE BOX 1467

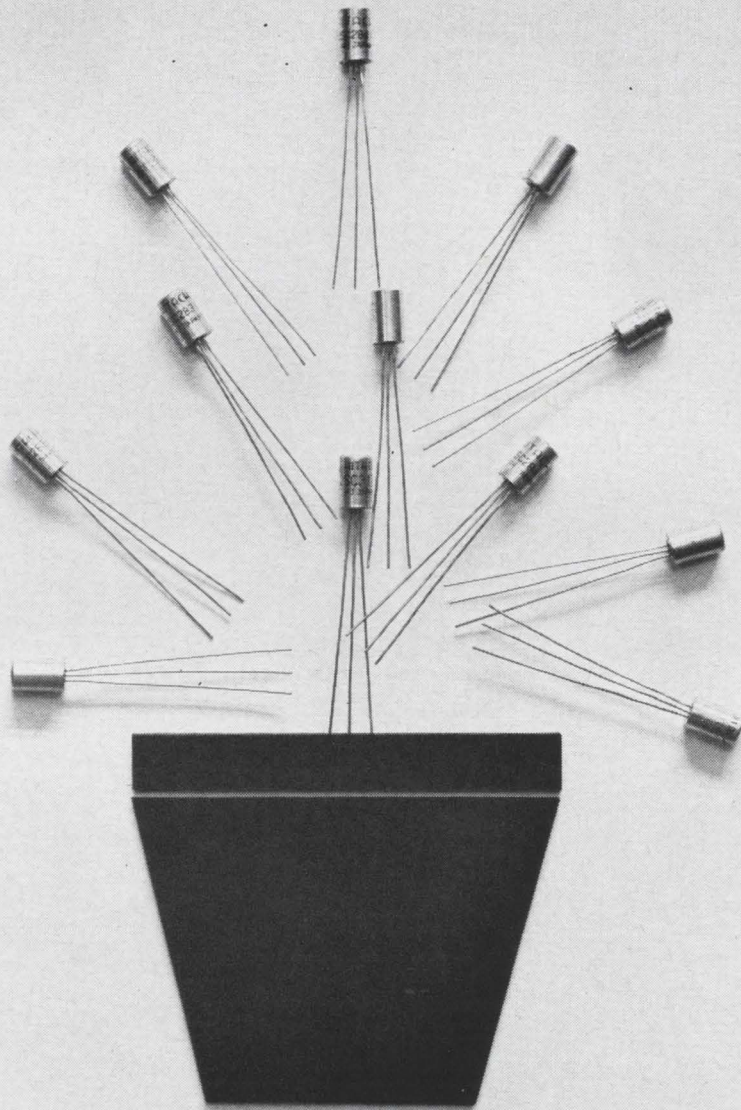

Tree of plenty

And Hitachi invented the way to make it grow. The fruits of this invention are called PM-type silicon transistors. Hitachi is now the only electronics manufacturer in the world that can produce such transistors by the millions! ■ This transistor family began as an idea. That idea was to develop Planar-type transistors that could eliminate surface contamination and retain optimum efficiency. This was achieved. The PM transistor was developed. But, only on a small scale. And it remained at this stage until Hitachi took over the task of mass production. ■ This proved to be almost as difficult as the original conception. But by the pains-taking development of a special sealing technique the problem was solved . . . mass production was possible for the first time. ■ The windfall of advances this brings to the electronics field are considerable: a transistor that is dependable due to longer lasting efficiency . . . a high collector inverse voltage . . . a small collector saturation current . . . current gain that does not drop off in low current operation . . . and, most important, a cost rate that makes it financially more than practical. ■ This is our tree of plenty . . . this is how to enjoy its benefits. Write to the addresses below.



HITACHI SALES CORPORATION: 333, N. Michigan Avenue, Chicago 1, Ill., U.S.A. Tel: 726-4572/4 / 666, 5th Avenue, New York, N.Y. 10019, U.S.A. Tel: 581-8844 / 12715, S. Daphne Avenue, Hawthorne, Calif., U.S.A. Tel: 757-8143
HITACHI, LTD., DUESSELDORF OFFICE: Graf Adolf Strasse 37, Duesseldorf, West Germany Tel: 10846

Electronics advertisers

January 25, 1965



■ AMP Incorporated Garceau, Hargrave & McCullough Inc.	58	■ Genisco Technology Corporation Getz and Sandborg Inc.	135	■ Pearson Electronics Inc.	120
■ Acopian Corporation Mort Barish Associates Inc.	110	■ Globe Industries Inc. Odiorne Industrial Advertising Inc.	117	Hal Lawrence Incorporated	
■ Air Express Div. of REA Express Ketchum, MacLeod & Grove Inc.	57	■ Gries Reproducer Corp. Harold Marshall Advertising Company Inc.	39	■ Plant City Clayton and Mohler Advertising Inc.	144
■ Ammon Instruments Inc. Culver Advertising Inc.	151	■ Gudebrod Bros. Silk Co., Inc. Lee Ramsdell & Co. Inc.	30, 31	■ Polaroid Corporation Doyle, Dane, Bernbach Inc.	115
■ Amphenol-Borg Electronics Corp., Connector Division Marsteller Inc.	12, 13	■ Hamilton Standard, Div. of United Aircraft Corp. Cunningham & Walsh Inc.	53	■ Radiation Inc. G.M. Basford Company	98, 99
■ Analab Instruments Kameny Associates	109	■ Hansen Mfg. Co. Inc. Keller-Crescent Co.	141	■ Radio Corporation of America Al Paul Lefton Company	4th Cover
■ Automatic Electric Co. Kudner Agency Inc.	119	■ Hewlett-Packard Associates Lennen & Newell Incorporated	2	■ Raytheon Company Fuller & Smith & Ross Inc.	127
■ Ballantine Laboratories Inc. Lang-Lawrence Advertising Inc.	133	■ Hewlett-Packard Company, Moseley Division Lennen & Newell Incorporated	1	■ Silicon Transistor Corporation A.D. Adams Advertising Incorporated	157
■ Barber Colman Company Howard H. Monk & Associates Inc.	122	■ Hitachi, Ltd. Dentsu Advertising Ltd.	158	■ Sinclair Radio Laboratories Inc. John E. Hayes Company Inc.	108
■ Bell Telephone Laboratories N.W. Ayer & Son Incorporated	27	■ Hull Corporation The Mitchener Company	142	■ Sorensen, Inc. Fuller & Smith & Ross Inc.	121
■ Bendix Corporation Scintilla Division MacManus, John & Adams Inc.	125	■ Industrial Electronic Engineers Inc. Gumpertz, Bentley & Dolan Advertising	141	■ Spectral Electronics Corporation Bonfield Associates Inc.	137
■ Brush Instruments, Div. of Clevite Corp. Carr Liggett Advertising Inc.	3rd Cover	■ International Business Machines Benton & Bowles Inc.	151	■ Sprague Electric Company The Harry P. Bridge Company	5, 6
■ Bussmann Mfg. Co. Div. of McGraw-Edison Co. Henderson Advertising Company	130, 131	■ ITT Semiconductors West, Weir & Bartel Inc.	105	■ Stackpole Carbon Company Meek and Thomas Inc.	143
■ Cinch-Graphik Div. of United Carr Reach, McClinton & Company	42	■ Interstate Electronics Corporation Jones, Maher, Roberts Advertising	128	■ Sylvania Electric Products Inc. Kudner Agency Inc.	19 to 26
■ Clifton Precision Products Co. Div. of Litton Industries Ivey Adv. Inc.	16	■ JFD Electronics Corporation Michel Cather Inc.	95	■ Synthane Corporation Arndt, Preston, Chapin, Lamb & Keen, Inc.	129
■ Cominco Products, Inc. McKim Production Limited	138	■ Jennings Radio Manufacturing Corp. L.H. Waldron Advertising	126	■ Texas Instruments Incorporated Metals & Controls Inc. Horton, Church & Goff Inc.	54, 55
■ Dale Electronics Inc. Swanson, Sinkey, Ellis Inc. Advertising	11	■ Jerrod Electronics Corp. Irving Gould Advertising Inc.	10	■ Texas Instruments Incorporated Industrial Products Group Robinson-Gerrard Inc.	7
■ Defense Electronics Inc. GLM Associates Inc.	49	■ Kassoy, I Harmony Impressions	147	■ Topaz Incorporated The Workshop	136
■ Delco Radio Division of General Motors Corporation Campbell-Ewald Company	152	■ Kay Electric Company Josephson, Cuffari & Company	46, 132	■ Transformer/Electronics	145
■ Delevan Electronics Corporation Clayton A Stahlka Advertising Company	114	■ Lambda Electronics Corporation Michel Cather Inc.	37	■ United Systems Inc. Advertising & Merchandising Inc.	148
■ Delta Products Inc.	134	■ Ledex Inc. Yeck and Yeck	116	■ Vacuum Processes Inc. McCrary Advertising Agency	144
■ Deltron Inc. Benn Associates	29	■ Machlett Laboratories Inc. Fuller & Smith & Ross Inc.	9	■ Vernitron Corporation Harold Marshall Advertising Company Inc.	140
■ Dressen-Barnes Corp. Writing and Advertising Incorporated	147	■ Mallory & Company Inc. P.R. The Aitkin Kynett Company	107	■ Vitro Corporation of America Buchen Advertising Inc.	28
■ DuPont de Nemours & Co., Inc. E.I. Batten, Barton, Durstine & Osborn Inc.	56, 100	■ McGraw-Hill Book Company	110		
■ Dymec, A division of Hewlett-Packard Company Lennen & Newell Incorporated	41	■ Melpar Inc. Arthur J. Lamb Inc.	118		
■ Electrical Industries George Homer Martin Associates	111	■ Metals for Electronics Inc. Sub. of Chas Pfizer Newmark, Posner and Mitchell Inc.	139		
■ Electronic Modules Corporation Ray Thompson & Associates	124	■ Motorola Semiconductor Products Inc. Lane and Bird Advertising Inc.	50, 51, 148		
■ Elgeet Optical Hutchins Advertising Company Inc.	141	■ National Semiconductor Corporation Michel Cather Inc.	32		
■ Emcee Electronics Inc. R.E. Lovekin Corp.	136	■ New Hermes Engraving Machine Corporation Doner-Harrison Inc. Advertising	140		
■ Fairchild Dumont Laboratories The Roger and Wilbur Company Inc.	14, 96, 97	■ North American Electronics Div. of International Resistance Co. Arndt, Preston, Chapin, Lamb & Keen Inc.	112		
■ Fluke Mfg. Co. Inc. John Bonfield Associates Inc.	44, 45	■ North Atlantic Industries, Inc. Murray Heyert Associates	8		
■ Flying Tiger Lines Cole Fischer Rogow Inc.	52	■ North Carolina Dept. of Conservation & Development Bennett Advertising Inc.	43		
■ General Aniline & Film Corporation Hazard Advertising Company Inc.	123	■ North Hills Electronics Inc. N.S. Advertising	138		
■ General Radio Company K.E. Morang Company	2nd Cover				
■ For more information on complete product line see advertisement in the latest Electronics Buyers' Guide					

Classified advertising

F. J. Eberle, Business Mgr.	
■ Employment Opportunities	149
■ Equipment (Used or Surplus New) For Sale	149

Classified advertisers index

Atomic Personnel Inc.	149
■ Barry Electronics	150
Edroy Products Co., Inc.	150
Electronicraft Inc.	150
Electronic Communications, Inc.	149
■ Fair Radio Sales	150
Hallicrafters	149
Machlett Laboratories Inc.	149
Marty's Mart	150
Metals & Controls Inc., Texas Instruments Inc.	149
■ Radio Research Instrument Co.	150
■ Resistors Unlimited Co.	150
■ Universal Relay Corp.	150

Executive, editorial, circulation and advertising offices: McGraw-Hill Building, 330 West 42nd Street, New York, N.Y. 10036. Telephone Area Code 212-971-3333. Teletype TWX N.Y. 212-640-4646. Cable: McGrawhill, N.Y. Officers of the Publications Division: Shelton Fisher, President; Vice Presidents: Joseph H. Allen, Operations; Robert F. Boger; Administration: John R. Callahan, Editorial; Ervin E. DeGraff, Circulation; Donald C. McGraw, Jr., Advertising Sales; Angelo R. Venezian, Marketing. Officers of the Corporation: Donald C. McGraw, President; Hugh J. Kelly, Harry L. Waddell, L. Keith Goodrich, Executive Vice Presidents; John L. McGraw, Treasurer; John J. Cooke, Vice President and Secretary. Title R registered U.S. Patent Office; © copyright 1965 by McGraw-Hill, Inc. All rights reserved, including the right to reproduce the contents of this publication, in whole or in part.

Articles, manufacturers and advertising are all cataloged in the 1964 Electronics Index

Tom Egan
Electronics Reprint Dept. 1-25-65
330 West 42nd St., New York, N. Y. 10036

Enclosed is my check for \$1.00.
Please send me a copy of the 1964 Electronics Index.

NAME _____

COMPANY _____

ADDRESS _____

Use this coupon to order your copy

Now, readers of Electronics can get an Index to the magazine that will help them find out not only technical articles by subject – but also references to any electronics company, company advertisements, and news and feature material.

This new, easy to use Index will be available in January for \$1.00. It will be published in addition to the regular abbreviated index in the December 28th issue of the magazine.

The Index – attractively bound, 8½ by 11 inches in size – will have three sections:

ARTICLES: This section contains a complex index of technical articles, news, features, and the key new products. They're grouped in more than 250 categories and cross-indexed for easy reference.

MANUFACTURERS: This corporate reference gives the page and issue for each mention of an electronics company in the editorial pages of the magazine. It will also reference government and military organizations.

ADVERTISERS: Every advertiser in the 1964 issues of Electronics will be listed in this section alphabetically with the issue dates and page numbers of their ads.

This Index is a valuable, year-round reference tool for your home, office or company library. Use the coupon above to order your copy today. Enclose check or money order – no stamps please. Your copy will be mailed to you as soon as the Index is off the press.

Electronics

A McGraw-Hill Market-Directed Publication
330 West 42nd Street, New York, N. Y. 10036



Advertising sales staff

Gordon Jones [212] 971-2210
Advertising sales manager

Atlanta, Ga. 30309: Gus H. Krimmier,
Michael H. Miller, 1375 Peachtree St. N.E.,
[404] TR 5-0523

Boston, Mass. 02116: William S. Hodgkinson
McGraw-Hill Building, Copley Square,
[617] CO 2-1160

Chicago, Ill. 60611: Robert M. Denmead,
Daniel E. Shea, Jr., 645 North Michigan
Avenue, [312] MO 4-5800

Cleveland, Ohio 44113: Paul T. Fegley, 55
Public Square, [216] SU 1-7000

Dallas, Texas 75201: Richard P. Poole, The
Vaughn Building, 1712 Commerce Street,
[214] RI 7-9721

Denver, Colo. 80202: John W. Patten, David
M. Watson, Tower Bldg., 1700 Broadway,
[303] AL 5-2981

Houston, Texas 77025: Kenneth George,
Prudential Bldg., Halcombe Blvd.,
[713] RI 8-1280

Los Angeles, Calif. 90017: Ashley P.
Hartman, John G. Zisch, 1125 W. 6th St.,
[213] HU 2-5450

New York, N.Y. 10036:
Donald R. Furth [212] 971-3615
Frank LeBeau [212] 971-3615
George F. Werner [212] 971-3615
500 Fifth Avenue

Philadelphia, Pa. 19103: William J. Boyle,
Warren H. Gardner, 6 Penn Center Plaza,
[215] LO 8-6161

San Francisco, Calif. 94111:
James T. Hauptli, 255 California Street,
[415] DO 2-4600

London W1: Edward E. Schirmer, 34 Dover
Street, Hyde Park 1451

Frankfurt/Main: Gerd Hinske, 85
Westendstrasse Phone: 77 26 65 and
77 30 59

Geneva: Michael R. Zeynel,
2 Place du Port 244275

Paris VIII: Denis Jacob, 17 Avenue
Matignon ALMA-0452

Tokyo: Nobuyuki Sato
Shiba, Minato-ku (502) 0656

Osaka: Kazutaka, Miura, 163, Umegae-cho,
Kilta-ku [362] 8771

Nagoya: International Media Representatives,
Yamagishi Bldg., 13, 2-Chome,
Oike-cho Naka-ku

Hugh J. Quinn: [212] 971-2335
Manager Electronics Buyers' Guide

David M. Tempest: [212] 971-3139
Promotion manager

Milton Drake: [212] 971-3485
Market research manager

Richard J. Tomlinson: [212] 971-3191
Business manager

Theodore R. Geipel: [212] 971-2044
Production manager

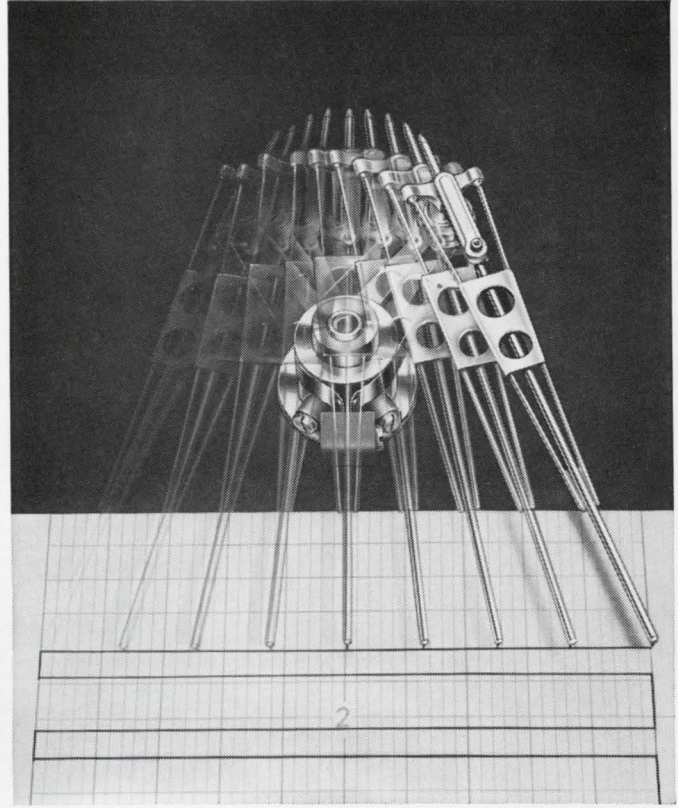
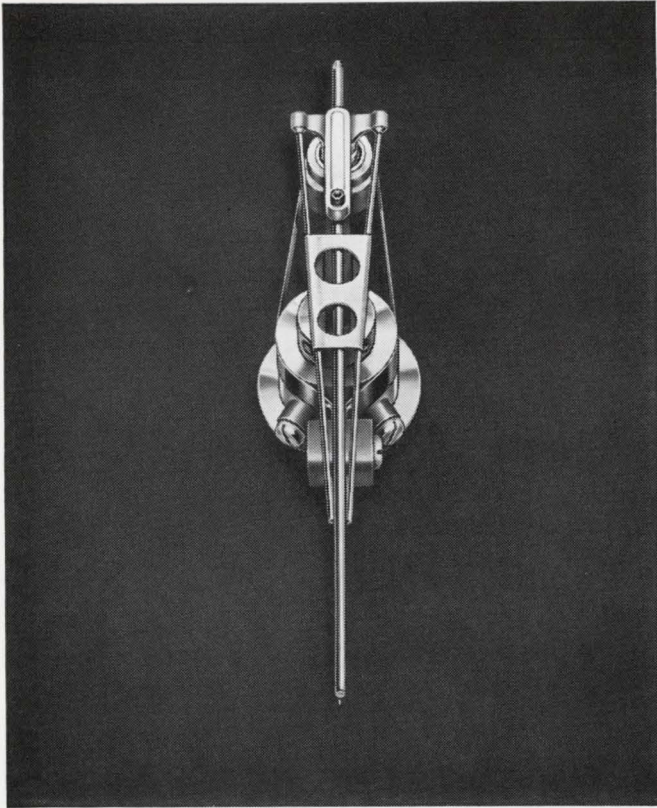

This is a **brush**
Magnetic Pen Recorder,
Rotary-to-Linear
Mechanism.

It goes in circles
to draw a
straight line to
0.1% ACCURACY!

(modern oscillography will never be the same)

This unique pen-linkage is one of several innovations that change some notions about direct writing recorders. It's one of the reasons why no other recorder can approach the new portable Mark 280. Nowhere else can you find such perfect rectilinear traces—so uniform and crisp that you cannot misjudge what you see. Recording channels are *80 millimeters* wide . . . not the usual 40. Yet speed of response is not sacrificed . . . as high as 200 cps at useable amplitude and better than 30 cps full scale. In effect, resolution is *doubled*. And, it's all done with a system accuracy of $\frac{1}{2}\%$! There's more. The pen position is constantly "policed" by a Brush super-sensor that provides instant self-correction with no mechanical gadgets involved. Add a pressurized ink system that completely eliminates spatter or smear . . . and you'll understand why modern oscillography will never be the same. It's all in a package only $10\frac{1}{2}''$ x $18\frac{3}{8}''$ x $11\frac{1}{2}''$. Your letterhead request will bring you the complete story.

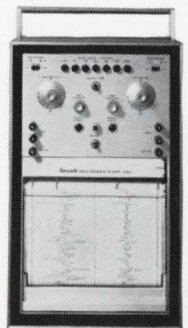

brush INSTRUMENTS
DIVISION OF CLEVITE 37TH AND PERKINS, CLEVELAND 14, OHIO

Circle 901 on reader service card

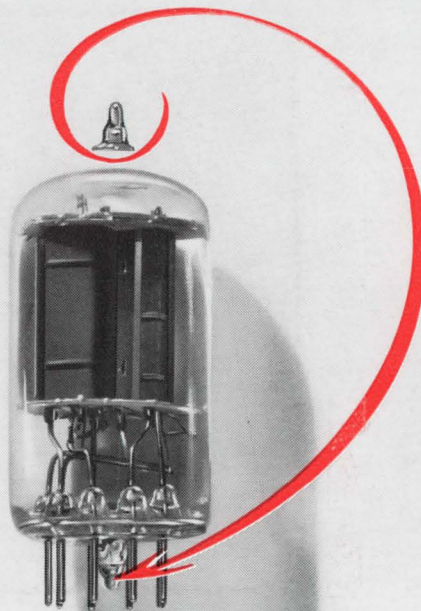

New low-silhouette NOVAR

Bottom-exhaust NOVARS permit more compact TV designs

You can now take full advantage of the outstanding performance and proven reliability of RCA's NOVAR tubes *while making your color and black-and-white TV receivers more compact.*

New bottom-exhaust NOVARS fit all existing NOVAR sockets and are unilaterally interchangeable with their prototypes. They add lower overall height to the many advantages that have made the NOVAR line first choice among design engineers, for their high-dissipation sockets:

- High dissipation capability—short, large-diameter internal leads provide high thermal conductivity for very effective heat dissipation.
- RCA Dark Heater (in heater-cathode types)—gives cooler heater operation, longer tube life and more stable performance.
- RCA Bonded Cathode—delivers long life, top performance and high reliability in types operating under high-voltage, high-temperature conditions.

The NOVAR line now includes 34 types of tubes, most of which have been changed

to bottom-exhaust construction. In this broad line of highly reliable receiving tubes, you are sure to find one or more that will benefit your new equipment designs—both mechanically and electrically.

For application information and technical data on specific NOVAR types, call your nearest RCA District Office. Or, for a copy of "NOVAR Tubes" booklet, write RCA Commercial Engineering, Harrison, New Jersey 07029.



RCA NOVAR tube characteristics are detailed in Technical Booklet ICE-311.

RCA ELECTRONIC COMPONENTS AND DEVICES

RCA DISTRICT OFFICES—EAST, 32 Green St., Newark, N.J., 07102, (201) 485-3900
 MID-ATLANTIC, 605 Marlton Pike, Haddonfield, N.J. 08034, (609) 428-4802 • MID-CENTRAL, 2511 East 46th St., Building Q2, Atkinson Square, Indianapolis, Ind. 46205, (317) 546-4001 • CENTRAL, 446 East Howard Avenue, Des Plaines, Illinois 60018, (312) 827-0033 • WEST, 6363 Sunset Blvd., Hollywood, Calif. 90028, (213) 461-9171



The Most Trusted Name in Electronics