

# Electronics®

Tunnel diode inverters: page 56

High-temperature safeguard for transistors: page 66

Transmitting high power by microwave: page 86

September 21, 1964

75 cents

A McGraw-Hill Publication

Below: the scr invades the industrial scene, page 78

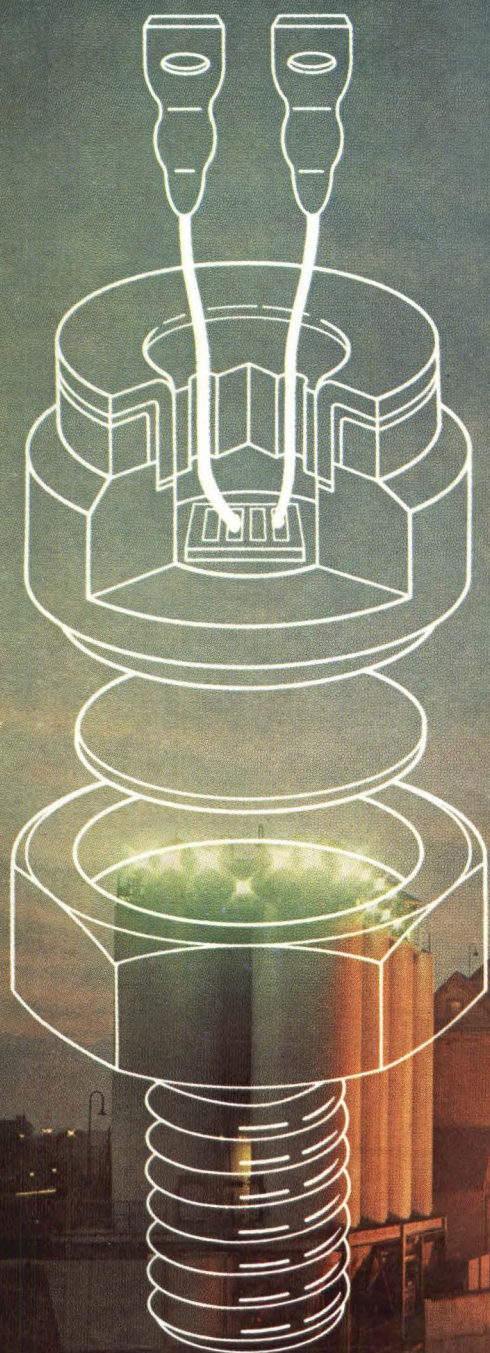

R D SKINNER  
1020 GOVINGTON RD  
LOS ALTOS CALIF  
C 3  
SUPV DEV

**"SPECIAL"  
CUSTOM BUILT**



# POWER TRANSFORMERS & INDUCTORS

## TO YOUR SPECIFICATIONS

Exceptional quality and reliability is provided in all UTC designs. Over 30 years of engineering knowledge and experience backed by complete environmental testing and life testing facilities assure the highest standard in the industry. Full analysis and evaluation of materials are conducted in UTC's Material and Chemical Laboratories. Rigid quality control measures coordinated with exhaustive statistical findings and latest production procedures results in the industry's highest degree of reliability. Range covered in Power Transformers is from milliwatts to 100 KVA. Some typical applications include: Current Limiting, Filament, Isolation, Plate, Transistor Inverter, Transistor Supply.

**MILITARY AND COMMERCIAL TYPES FOR  
EVERY PHASE OF THE ELECTRONICS ART**

**POWER TRANSFORMERS • AUDIO TRANSFORMERS • INDUCTORS • PULSE TRANSFORMERS • ELECTRIC WAVE FILTERS • LUMPED CONSTANT DELAY LINES • HIGH Q COILS • MAGNETIC AMPLIFIERS • SATURABLE REACTORS • REFERENCE UNITS**

<p>Low capacity current limiting filament transformer. Primary 118 V. 60 cycles to 6.3 V. at 3 A., 8 A. at short circuit. 25 MMFD capacity. 30 KV hipot and 200:1 capacity divider; 5 x 3 3/4 x 4 1/2", 9 lbs.</p>	<p>MIL-T-27B ultraminiature Scott connected power transformer, 5/16 Dia. x 13/32" H., 1/10 Oz. Primary 28 V. 400 — with taps @ 50% &amp; 86.6%. Two units provide 28 V two phase from three phase source.</p>	<p>Molded Power Transformer 3 Phase. Input 200V, 380-420 cps. Electrostatic Shield, 8 output windings, 26 terminals. MIL-T-27B, Grade 2 Class S. Max. Alt. 50K Ft. Size 6 x 2 1/2 x 5", 8 lbs.</p>
<p>Commercial type molded power transformer. Primary 115/230 V., 50/420 cycles to 680 VCT-.015 A., 6.3 VCT-1.2 A., 6.3 V.-6A. Size: 2 1/2 x 3 x 2 7/8", weight: 1.6 lbs.</p>	<p>Three phase high voltage power transformer. Primary jumper hardware for easy conversion from delta to wye inputs. Made to MIL-T-27B specifications. Primary: 440 V 60 cycles delta or wye 3 phase input. Secondary: 2100 V line to line or 1215 V line to line @ 242 ma.</p>	<p>High current filament transformer. Primary 140/156 V., 47/63 cycles to 1.8 V.-1070 A. Current limiting through separate primary reactor, MIL-T-27B; 10 x 10 x 11 1/2", 150 lbs.</p>

Write for catalog of over  
1,200 UTC HIGH RELIABILITY  
STOCK ITEMS  
IMMEDIATELY AVAILABLE  
from your local distributor.



## UNITED TRANSFORMER CORP.

150 VARICK STREET, NEW YORK 13, N. Y.

PACIFIC MFG. DIVISION: 3630 EASTHAM DRIVE, CULVER CITY, CALIF.  
EXPORT DIVISION: 13 EAST 40th STREET, NEW YORK 16, N. Y. CABLE: "ARLAB"

# *Moseley introduces AUTOGRIP\**

**A REVOLUTIONARY  
PAPER HOLD-DOWN  
TECHNIQUE FOR X-Y  
RECORDERS**

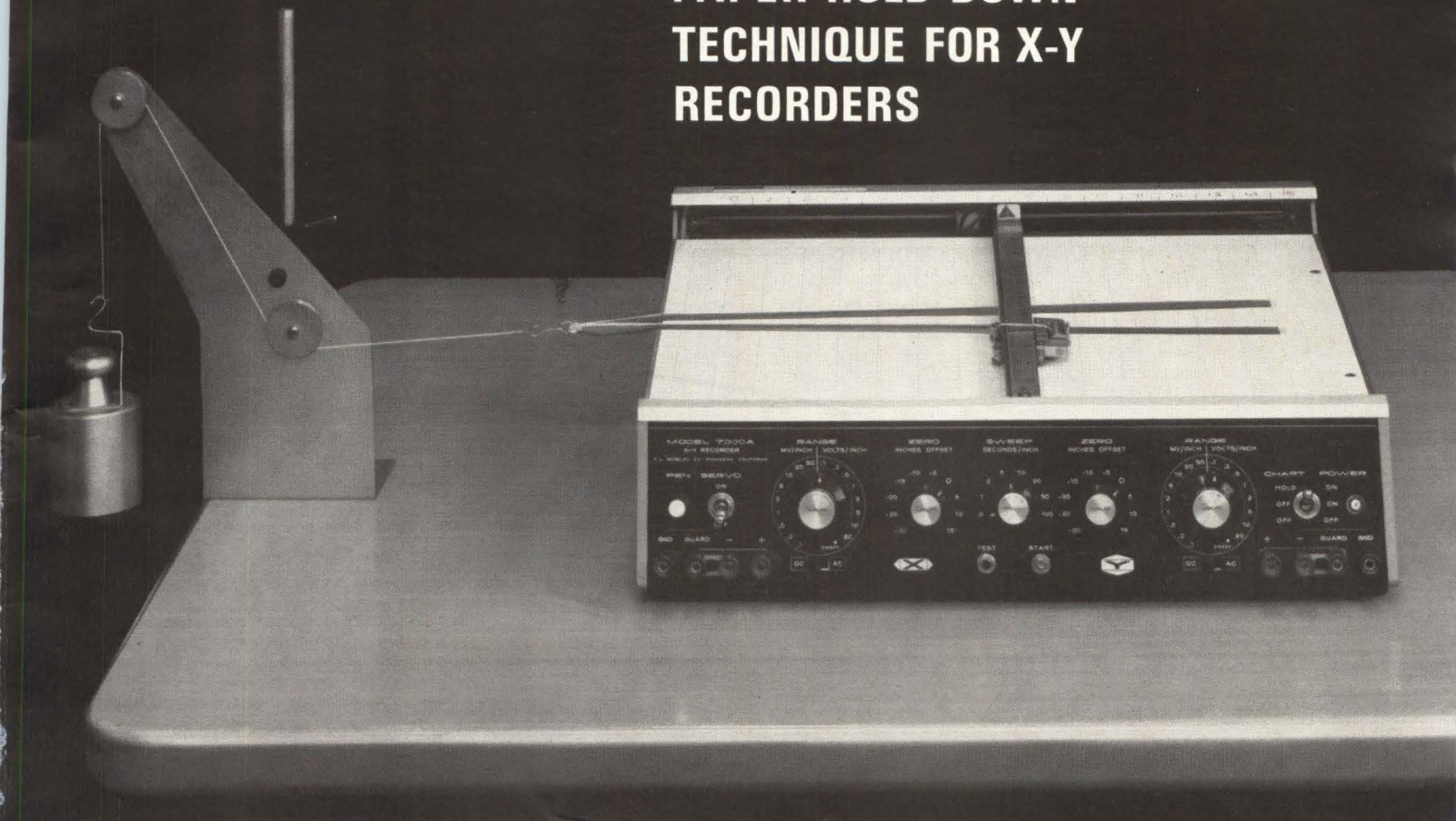

Test shows Moseley AUTOGRIP\* in action. Paper is pulled by a 4 lb. weight without tearing, slipping or wrinkling.

AUTOGRIP\* is a significant breakthrough in chart paper hold-down systems. Eliminated are all moving or mechanical parts, no clips, no fans, no pumps, no motors. Uses an electrical principle with specially constructed platen. Quiet with full gripping efficiency even with paper smaller than platen.

Standard on new Moseley 7000A and 7030A. Retrofit kits may be ordered for the following Moseley models for \$125, or may be specially ordered on new: 135, 135A, 135M, 135R, 135AM, 135MR, 135AMR, 136A, 136AR, 2D, 2DR, 2D-2, 2DR-2, 2D-2A, 2DR-2A, 2D-2M, 2DR-2M, 2D-2AM, 2DR-2AM, 2D-3, 2DR-3, 2D-3M, 2DR-3M, 2FRA. Call your Moseley/Hewlett-Packard field engineer or write: F. L. MOSELEY CO., 433 N. Fair Oaks Avenue, Pasadena, California 91102.

\*Trade Mark Pat. pend.

**MOSELEY**   
an affiliate of Hewlett-Packard

CIRCLE 1 ON READER SERVICE CARD

# ticklish signals?

## PUT THEM ON PAPER WITH EASE WITH THIS NEW SOLID STATE OSCILLOGRAPH

Now you can precisely measure and record a greater variety of AC and DC variables — over wider dynamic ranges and with more signal-conditioning capabilities at your command — with this new Sanborn 7700 Series 6- and 8-channel oscillograph. A choice of highly developed plug-in preamplifiers (eight in 7" x 19" of panel space) gives you recording capabilities such as: 1  $\mu\text{V}/\text{div.}$  to 250 volts full scale in a single preamp, which also has multi-range, calibrated zero suppression built in . . . phase-sensitive demodulation of in-phase or 180° out-of-phase floating signals, 60 cps to 40 KC, with calibrated or uncalibrated adjustable phase shifting . . . carrier signal recording from 10  $\mu\text{V}/\text{div.}$  and with calibrated zero suppression and cal. factor.

The all-solid-state circuits in this new system also mean cooler operation with less power than tube circuits . . . easy servicing of modular circuits on accessible plug-in cards . . . simpler, smaller power supplies with integral AC excitation . . . and generally improved drift, gain stability, noise and linearity characteristics. Combine these advantages with the proven and widely-used Sanborn *heated stylus-Permapaper*® recording method: true rectangular coordinate writing with *higher* resolution at slow chart speeds, *no* spills or smears, *greater* environmental immunity, *no* priming or constant attention needed. Call your HP field engineering office for complete specs — or write Sanborn Company, Industrial Division, Waltham, Mass. 02154

**SANBORN**   
A SUBSIDIARY OF HEWLETT-PACKARD

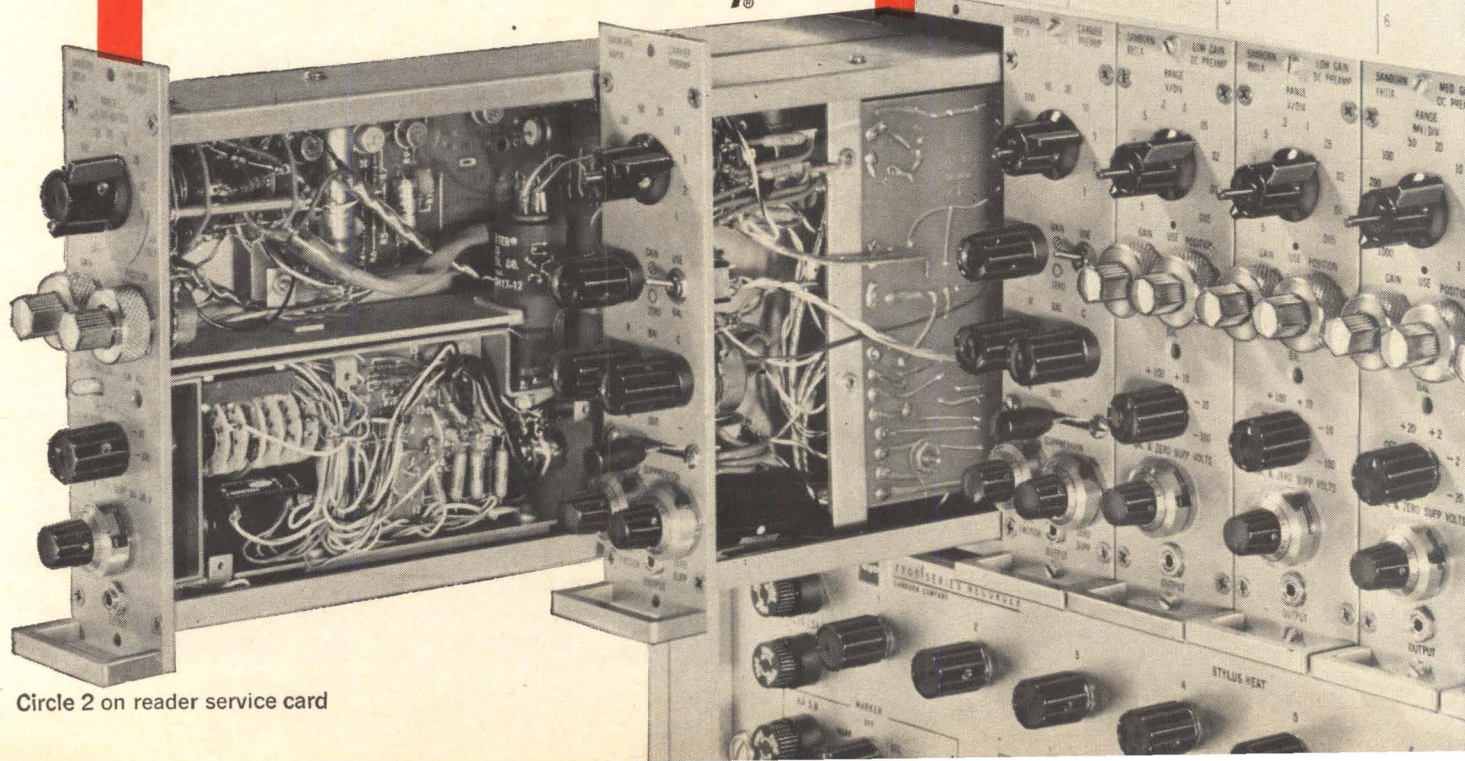
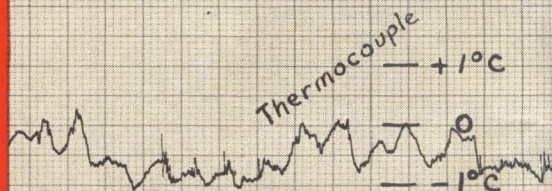
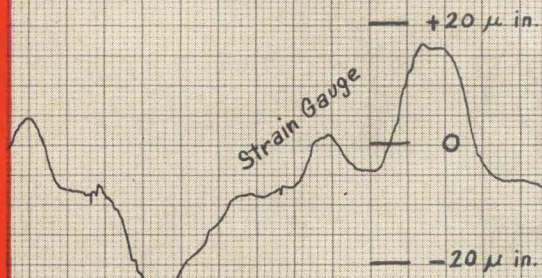
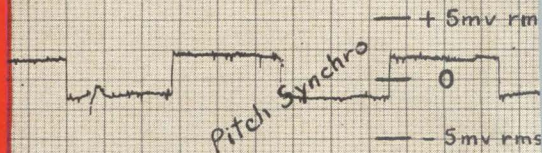

Circle 2 on reader service card

# Electronics

Page 4	Readers Comment
8	People
10	Meetings
15	Editorial
17	Electronics Newsletter
47	Washington Newsletter
109	New Products
133	New Literature
134	New Books
137	Technical Abstracts

## In this issue

### Electronics review

Page 31	Music with a bounce	33	Sun-pumped laser
31	Rescue radio	34	Circuits by the yard
32	Jungle sounds	34	Cloud analyzer
32	Passivating transistors	36	Plasma anodization
33	Space-fuel gauge	36	In a spin
33	Bomb detectors	38	One-gun picture tube

### Probing the news

Page 97	Soft Talk from the Pentagon
100	Europe: new battleground for U.S. computer firms
105	Multichip circuits get off the ground

### Technical articles

#### I. Design

<b>Solid state</b>	<b>56</b>	<b>Inverting d-c to a-c with tunnel-diode circuits</b> High-current tunnel diodes invert 0.1 to 0.65 volts with efficiencies to 65% Fred M. Carlson, Radio Corp. of America
<b>Circuit design</b>	<b>66</b>	<b>More for your money from solid state</b> One way to cut costs is to consider heat-transfer problems early in a design Edward Trunk, Staver Co.
<b>Components</b>	<b>69</b>	<b>Forced-air cooling for high-power equipment</b> Guidelines to help choose the right fan when forced-air cooling is required Leonhard Katz, Astro Dynamics, Inc.
<b>Circuit design</b>	<b>72</b>	<b>Protection against thermal overload</b> Even if you use heat sinks, you should protect critical circuits with an automatic cutoff Henry Epstein and Charles Flanagan, Texas Instruments, Inc..
<b>Circuit design</b>	<b>74</b>	<b>Designer's casebook</b> Diamond circuit measures phase shift; tunnel-diode multivibrator recovers quickly; circuit always applies correct voltage
<b>II. Application</b>		
<b>Industrial electronics</b>	<b>78</b>	<b>The widening world of the scr (cover)</b> Silicon controlled rectifiers find new uses controlling golf carts and steel mills John C. Hey, General Electric Co.
<b>Advanced technology</b>	<b>86</b>	<b>A comeback for wireless power?</b> An old idea and new technology may stimulate the microwave business George V. Novotny, advanced technology editor

# Electronics

**Editor:** Lewis H. Young

**Senior editors**

**Technical:** Samuel Weber  
**News:** Kemp Anderson, Jr.

**Senior associate editors:** John F. Mason, George Sideris

**Department editors**

**Advanced technology:** George V. Novotny  
**Avionics:** W.J. Evezia  
**Circuit design:** Michael Elia  
**Communications:** Alexander A. McKenzie  
**Components:** Michael F. Tomaino  
**Computers:** Stephen B. Gray  
**Industrial electronics:** Louis S. Gomolak  
**Instrumentation:** George J. Flynn  
**Manufacturing:** George Sideris  
**Military electronics:** John F. Mason  
**New products:** William P. O'Brien  
**Solid state:** Jerome Eimbinder, G.G. Tirellis  
**Space electronics:** Joel A. Strasser  
**Staff writers:** Leon H. Dulberger, Peggy Jackson

**Regional editors**

**Boston:** Thomas Maguire, editor; Susan Turner  
**Chicago:** Cletus M. Wiley, editor; Leslie Krimston  
**Los Angeles:** Harold C. Hood, editor  
**San Francisco:** Laurence D. Shergalis, editor; Mary Jo Jadin  
**London:** Derek Barlow, editor

**Copy editors**

Howard Rausch, Sally Powell

**Illustration**

**Assistant art director:** John C. Wright, Jr.  
**Editorial production:** Ann Mella, Sandra A. Le Mond

**Editorial secretaries:** Claire Benell, Mary D'Angelo, Lynn Emery, Kay Fontana, Carolyn Michnowicz, Lorraine Rossi, Lorraine Werner

**McGraw-Hill news service**

**Director:** John Wilhelm; **Atlanta:** Fran Ridgeway; **Chicago:** Bruce Cross; **Cleveland:** Arthur Zimmerman; **Dallas:** Marvin Reid; **Detroit:** Donald MacDonald; **Los Angeles:** Michael Murphy, Ron Lovell; **San Francisco:** Margaret Ralston, Ed. Addeo; **Seattle:** Ray Bloomberg; **Washington:** George Bryant Jr., Glen Bayless, Charles Gardner

**McGraw-Hill world news service**

**Bonn:** Richard Mikton; **Brussels:** Arthur Erikson; **London:** John Shinn; **Mexico City:** Wesley Perry; **Milan:** Bruce Bendow; **Moscow:** Donald Winston; **Paris:** Dan Smith; **Rio de Janeiro:** Leslie Warren; **Tokyo:** Marvin Petal, Charles Cohen

**Circulation manager:** Hugh Quinn

**Reprints:** T.M. Egan

**Publisher:** C.C. Randolph

**Electronics:** September 21, 1964, Vol. 37, No. 25

Printed at 99 North Broadway, Albany, N.Y.  
Second class postage paid at Albany, N.Y.

Subscriptions are solicited only from those actively engaged in the field of the publication. Position and company connection must be indicated on orders. Subscription prices: United States and Possessions and Canada, \$6.00 one year, \$9.00 two years, \$12.00 three years. All other countries \$20.00 one year. Single copies, United States and Possessions and Canada 75¢. Single copies all other countries \$1.50.

Published every other Monday by McGraw-Hill Inc. 330 West 42nd Street, New York, N.Y. 10036. Founder: James H. McGraw, 1860-1948.

**Subscribers:** The Publisher, upon written request to our New York office from any subscriber, agrees to refund that part of the subscription price applying to copies not yet mailed. Please send change of address notices, subscription orders or complaints to Fulfillment Manager, Electronics, at the address below. Change of address notices should provide old as well as new address, including postal zone number if any. If possible, attach address label from recent issue. Allow one month for change to become effective.

**Postmaster:** Please send Form 3579 to Fulfillment Manager, Electronics, P.O. Box 430, Hightstown New Jersey 08520

## Readers Comment

### Thinking machines

The views you express in "Machines that think" [July 13, p. 90] disregard the general view ably expressed in Michael A. Arbib's book "Brains, Machines and Mathematics." Computers and automation have a future that, both from a materialistic and spiritual point of view, is limited only by the number of available communication channels.

If the term "cybernetics" is used to describe the theory of making computers that perform in relation to the working of the brain, as a shadow is related to a person, then cybernetics will prove useful. But statements like the one you ascribe to [W. Ross] Ashby that "we know definitely that a computer can do anything a human brain can do—or more" are misleading and utterly remote from reality.

Forty years ago there might have been justification for this sort of talk; but today, when our knowledge of physics is being atomized and is becoming more and more incomprehensible; when we know that even animals (migrating birds, shells, etc.) are working with detectors beyond our comprehension; when we know from experiments carried out at London University that an extra-sensory capability exists that has all but demolished the law of causality; today we must accept the fact that even the best heuristic programing is not going to help beyond a certain improvement of our calculating machines.

It is time that our cyberneticians accept what all leading physicists have recognized for years: that there is an unbridgeable gulf between models and reality in spite of the fact that models can, for special applications, and with the help of our brain, develop reality.

F. Steghart

Gerrards Cross, Bucks  
England

▪ Ashby means that the computer can perform any one particular function of the human brain, providing we can specify that function;

**Now from Sprague!**

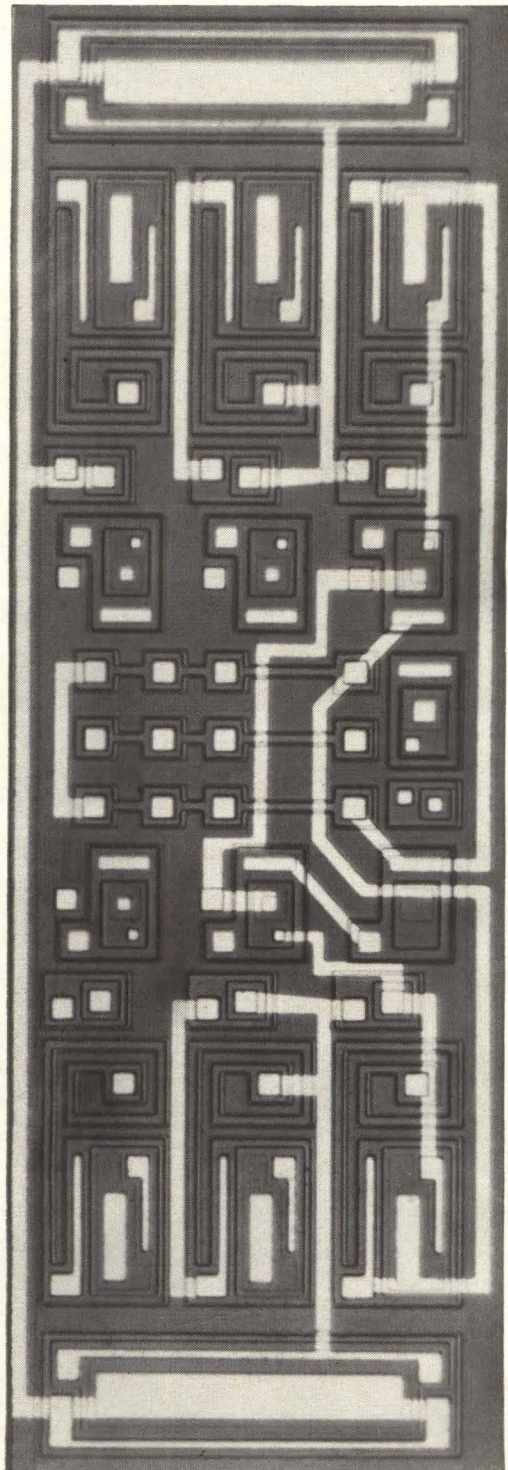

# UNICIRCUIT<sup>®</sup>

## INTEGRATED CIRCUITS

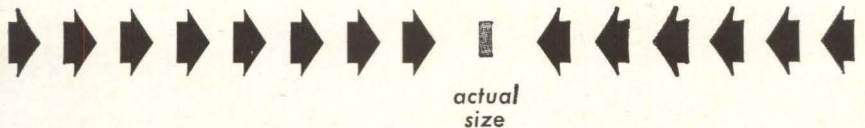

This is a master-matrix UNICIRCUIT, interconnected to meet the requirements of a military systems manufacturer for an RS flip-flop. The photograph at the left, enlarged 38 diameters (1444 times area), speaks for itself as to the technical capability of the Sprague Electric Company to produce complex silicon monolithic integrated circuits.

If you would like to discuss your integrated circuit needs with an old-line established electronic components manufacturer who has a proven reputation for reliability, please write or telephone Mr. Albert B. Dall, Marketing Manager, Semiconductor Division, Sprague Electric Company, Concord, New Hampshire.

area code 603 Tel. 224-1961

### SPRAGUE COMPONENTS

INTEGRATED CIRCUITS  
THIN-FILM MICROCIRCUITS  
CAPACITORS  
TRANSISTORS  
RESISTORS

PULSE TRANSFORMERS  
INTERFERENCE FILTERS  
PULSE-FORMING NETWORKS  
TOROIDAL INDUCTORS  
ELECTRIC WAVE FILTERS

CERAMIC-BASE PRINTED NETWORKS  
PACKAGED COMPONENT ASSEMBLIES  
BOBBIN and TAPE WOUND MAGNETIC CORES  
SILICON RECTIFIER GATE CONTROLS  
FUNCTIONAL DIGITAL CIRCUITS



'Sprague' and '®' are registered trademarks of the Sprague Electric Co.

# Battery

150 Volts/inch<sup>3</sup>

20 Yrs. Shelf Life

1. How would I keep a capacitor charged for up to 20 years?
2. Is it *really* possible to pack 150 volts/cu. in. into a battery?
3. Where can I get a *solid* electrolyte battery whose mass and center of gravity will not change with time or use?
4. Can I find a battery which will endure short circuits (for hours) and recover to its original open circuit voltage within seconds?
5. Is it possible to obtain high voltage batteries in almost any configuration?
6. Where can I find a battery which will behave like this . . .

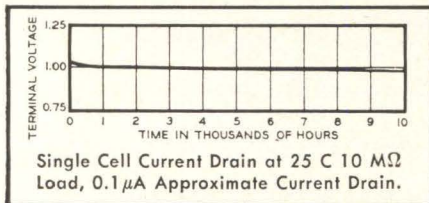

. . . and which has a total available charge of 1500 microampere-hours or 5 coulombs per cell?

The answers to these questions are:

1. Using Sprague Solid Electrolyte Batteries.
2. Yes indeed!
3. Sprague Electric.
4. Yes.
5. Yes.
6. Sprague Electric. For complete technical data, write for Engineering Bulletin 11,101 to Technical Literature Service, Sprague Electric Co., 35 Marshall Street, North Adams, Massachusetts 01248

45B-4150

**SPRAGUE**  
THE MARK OF RELIABILITY

'Sprague' and '®' are registered trademarks of the Sprague Electric Co.

not that we can remove a human being's brain and replace it with a computer. Ashby's work concerns finding the mathematical limits for possible machines, which of course is very different from knowing how to build them.

## Superpower tubes

Some of the information by one of us (L. F. Eastman) in "Superpower tubes: their capabilities and limitations" [July 13, p. 48] may be misleading due to lack of completeness.

First, curves D and E on normalized cathode current (versus beam voltage) are actually  $J_c R/K$  for the solid beam and  $J_c R\delta/K$  for the hollow beam, where  $J_c$  is the cathode current density,  $K$  is the gun perveance,  $R$  is the cathode-to-beam area ratio and  $\delta$  is the hollow beam thickness-to-radius ratio. It should be noted, as stated in the article, that all  $R$  ratios are not possible at all beam voltages. Hollow-beam  $R$  ratios are at present small; that is, less than 20.

Next, even though curve C gives the potential depression between the anode cylinder and the electron beam (a parameter important for estimating the necessary control of the outer beam diameter), it does

not indicate the total potential depression to the beam center (inner edge of the hollow beam). This total potential depression is less for a hollow beam and thus allows much higher gun perveance in a hollow beam than in a solid beam for the same total potential depression. A curve of representative total potential depression versus perveance for solid and hollow beams (below) helps to explain in this idea.

(Miss) R. Biss

Cornell Aeronautical Laboratory  
Buffalo, N.Y.

L.F. Eastman

Cornell University  
Ithaca, N.Y.

## Magneto-resistance

Concerning my article "Magneto-resistance: better than Hall-effect multipliers" [Apr. 6, p. 66], may I ask you to print an additional remark that part of this work was developed during the author's sojourn in Switzerland, with the Institut für höhere Elektrotechnik, Federal Technical Institute, Zurich, and Landis & Gyr AG, Zug.

S.F. Sun

Institut für Höchsthfrequenztechnik  
Stuttgart, Germany

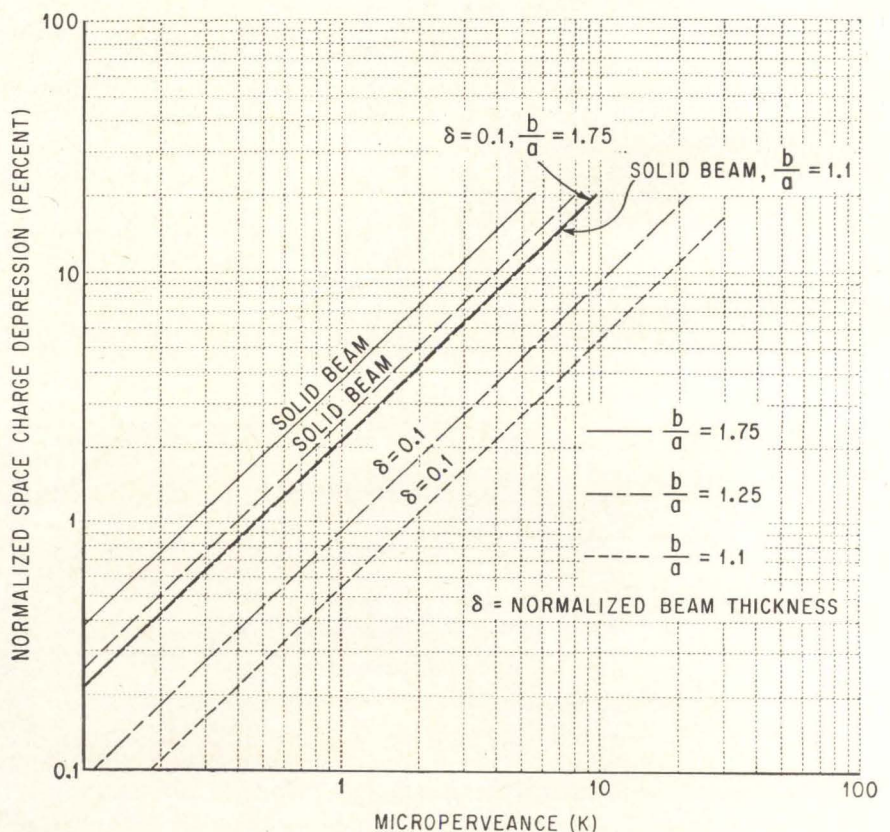



High frequency

will burn out  
this rectifier

but not this  
Unitrode

Now Unitrode eliminates excessive reverse power dissipated in the diode during turn-off. This means you can reduce ripple and the size of transformers and filters by increasing operating frequency.

At 100 KC, the rectification efficiency of the Unitrode® fast-recovery rectifier is only 1% less than at 60 cps. Reverse recovery time is typically 75 nanoseconds . . . and continuous average rectified current ratings are 2 amps even with PIV's of 600 volts!

Unitrode makes this possible by a novel silicon diffusion process that nearly eliminates the reverse current spike during turn-off — and considerably shortens turn-off time. Further, the new fast-switching series has the unique one-piece Unitrode construction that survives long term overloads without damage and is immune to aging effects.

With a hard glass sleeve fused to all exposed silicon surface, the resulting void-free junction cannot be contaminated. And they're no bigger than . . .

. . . this 

Individually inspected, 100% tested, Unitrode fast-recovery rectifiers have to cost more than ordinary rectifiers. But if performance is more important to you than pennies, compare all the remarkable devices based on the Unitrode principle: 3-amp silicon diodes, 3-watt zeners, high-voltage stacks and bridge assemblies. They're stocked by Unitrode representatives nation-wide.

For information, product demonstration and samples, contact UNITRODE CORPORATION, 580 Pleasant Street, Watertown, Massachusetts 02172. Tel: (617) 926-0404, TWX: (617) 924-5857.

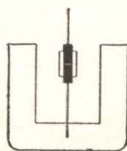

**UNITRODE**

**CONSIDERING VAPOR COOLING?  
SELECT ONE OF MACHLETT'S  
4 BASIC SYSTEMS...**

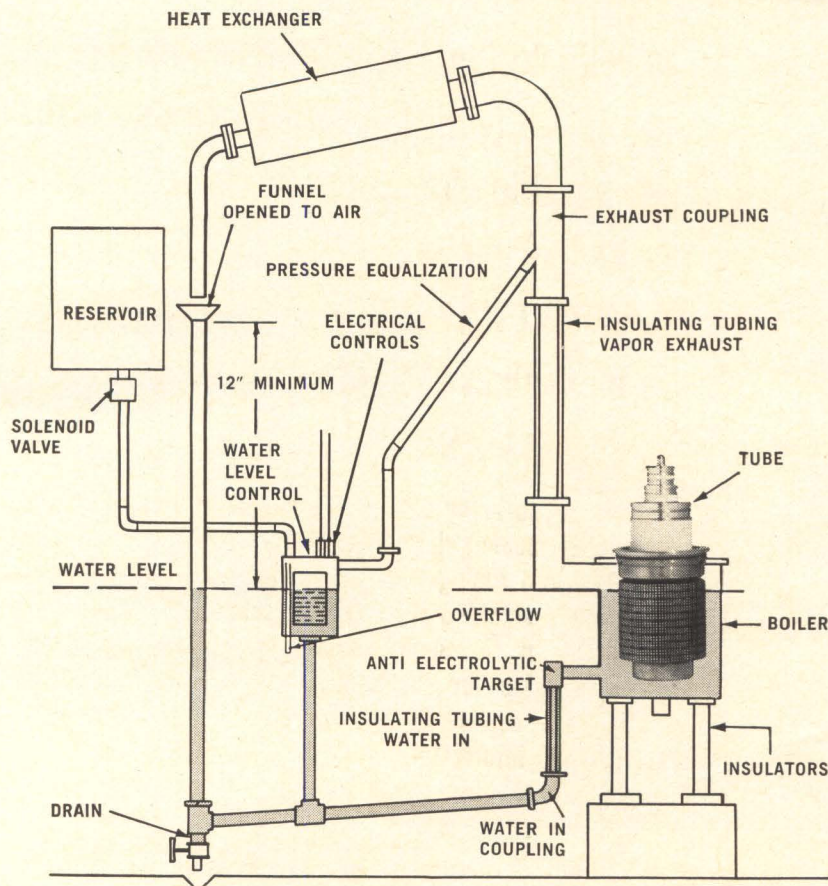

**From 50kW to 500kW, Machlett offers four basic Vapor Cooling Systems for cooling high power electron tubes:**

SYSTEM	TYPICAL APPLICATION
Vapor-Up (shown above)	General Broadcast (HF)
Vapor-Down	General & SSB Communications (HF)
Boiler Condenser	Industrial
Integrated	Special Service. Particularly suited to VHF.

System advantages include: 200-300% greater anode dissipation as compared to forced-air cooling; 10-20% greater anode dissipation over conventional water cooling; extremely large overload protection for anode; stable, quiet cooling; low water consumption; low operating costs.

Each of the above four systems is highly adaptable to a wide range of applications. Consider the advantages of each system—outlined in "Vapor Cooling," obtained by writing to The Machlett Laboratories, Inc., Springdale, Conn., an affiliate of Raytheon Company.



## People

**Russel A. Schlegel**, 50 years old, is leading the Rockwell Manufacturing Co. into the new and hotly competitive market of medium-sized systems for process control. One of Rockwell's major rivals will be the Honeywell Corp., Schlegel's employer for 19 years.



Rockwell hired Schlegel about seven years ago to head its newly acquired Republic Flow Meters Co. About a year ago, he was named a vice president in charge of the new Measurement and Control division that had absorbed Republic.

The division will make its big splash next month when it introduces 14 products for process control. Schlegel conceived most of them.

What does he do when he isn't planning new products? "I try to sell them," Schlegel answers. He holds an amateur pilot license, but the 100,000 miles he logged last year between plants in California, Georgia and Chicago were in commercial aircraft. A self-styled "frustrated architect," Schlegel had a hand in remodeling Rockwell's 50-year-old building in Chicago.

The Raytheon Co. has named **Joseph A. Ricca** general manager of the commercial computer business it bought

from the Packard-Bell Electronics Corp. Ricca, 42 years old, directed memory-system business operations at the Aeronautics division of the Philco Corp. His professional background is in engineering and marketing. He's also an excellent chef. Ricca has developed several microprogramming techniques. Raytheon expects to use his skills to expand its line of microprogrammed computers.



A switch by any other name



is not ...

- as reliable (potential 50,000 hr. life)
- as rugged (vibration 15 G's, shock 100 G's)
- as versatile (for counting-decoding)
- as fast (2 mc's)
- as small (1 1/4" x 3")
- as inexpensive (\$24)
- as **BEAM-X®** Switch

That's why so many electronics engineers use this unique 10-position beam-switching tube for counting, distributing, decoding and timing with or without NIXIE® Tube Readout. Available in shielded or unshielded models, or in functional modular form, the Beam-X Switch is an ideal high vacuum decimal device for commercial and military instruments, systems and control equipment. For complete technical and applications information, write for Brochure #405.

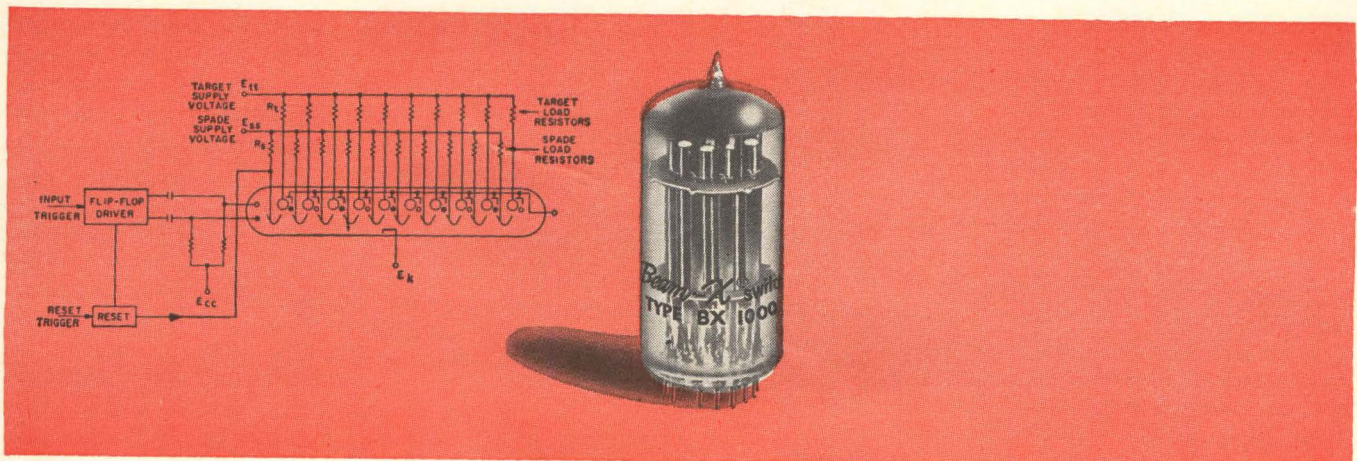

ANOTHER ELECTRONIC CONTRIBUTION BY  
**Burroughs Corporation**  
ELECTRONIC COMPONENTS DIVISION  
PLAINFIELD, NEW JERSEY

NIXIE and BEAM-X are registered trademarks of Burroughs Corporation.

## New from Sprague!

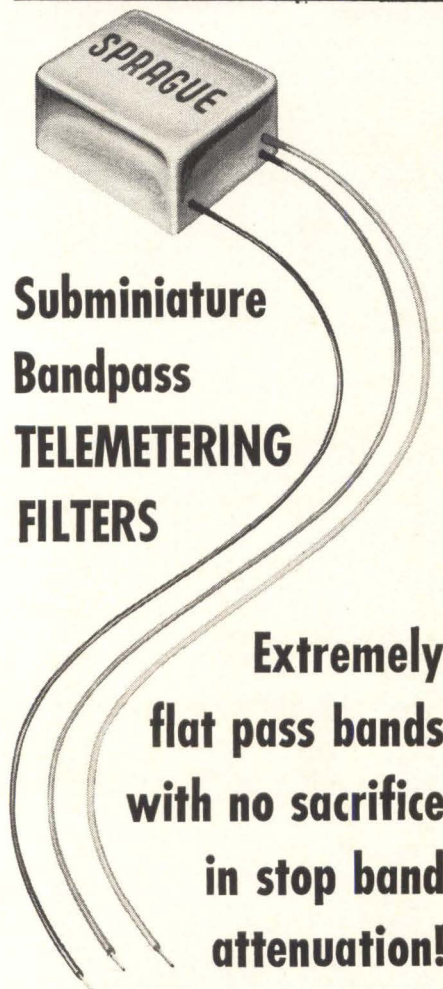

### Subminiature Bandpass TELEMETERING FILTERS

**Extremely  
flat pass bands  
with no sacrifice  
in stop band  
attenuation!**

Designed for standard IRIG channels, Sprague Telemetering Filters are sealed in metal cases with special potting compound for protection from humidity and other atmospheric conditions.

#### Check these key characteristics!

- Insertion loss: < 2 db
- Input and output impedance: 10 K $\Omega$
- Maximum power: 10 dbm
- Operating temp.: -20 C to +105 C
- Bandwidth data: (a) 14.5 kc and below
  - < 1 db @  $\pm 7.5\%$   $F_0$
  - $\geq 30$  db @ .5 and 2  $F_0$
- (b) 22 kc and above
  - < .8 db @  $\pm 16.2\%$   $F_0$
  - $\geq 40$  db @ .5 and 2  $F_0$

Application engineering assistance is available to you from strategically located Sprague Filter Development Centers in North Adams, Mass.; Vandalia, Ohio; and Los Angeles, Calif. For complete information, write to Filter Division, Sprague Electric Co., 35 Marshall St., North Adams, Mass.



45F-177-03

## Meetings

**AIAA Military Aircraft Systems and Technology Meeting, (Secret)**, AIAA, USAF, BuWeps; NASA; Langley Research Center, Va., **Sept. 21-23.**

**AE-4 Electromagnetic Compatibility Conference**, SAE; McDonnell Aircraft Corp., St. Louis, Mo., **Sept. 22-23.**

**Profession Technical Group on Antennas and Propagation International Symposium**, PTGAP/IEEE; International Hotel, John F. Kennedy International Airport, New York, **Sept. 22-24.**

**Broadcasting Annual Symposium**, PTGB/IEEE; Willard Hotel, Washington, **Sept. 24-26.**

**Annual Communications Conference**, Cedar Rapids Section of IEEE; Hotel Roosevelt, Cedar Rapids, Iowa, **Sept. 25-26.**

**Canadian IEEE Communications Symposium**, Canadian Region IEEE; Queen Elizabeth Hotel, Montreal, **Sept. 25-26.**

**National Power Conference**, IEEE, Inc., ASME; Mayo Hotel, Tulsa, Okla., **Sept. 27-Oct. 1**

**Society of Motion Picture and Television Engineers Technical Conference**, SMPTE, Inc.; Commodore Hotel, New York, **Sept. 27-Oct. 2.**

**Allerton Conference on Circuit and System Theory**, University of Illinois, CTG/IEEE; Allerton House, Conference Center of the University of Illinois, Monticello, Ill., **Sept. 28-30.**

**Tube Techniques National Conference**, Advisory Group on Electron Devices; Western Union Telegraph Co. Auditorium, New York, **Sept. 28-30.**

**Society for Applied Spectroscopy National Meeting**, SAS; Sheraton-Cleveland Hotel, Cleveland, **Sept. 28-Oct. 2.**

**Physics of Failure in Electronics Annual Symposium**, Rome Air Development Center, IIT Research Institute; IIT Research Institute, Chicago, **Sept. 29-Oct. 1.**

**Society for Information Display National Symposium, SID**; Shoreham Hotel, Washington, **Oct. 1-2.**

**Current Trends in Optical Physics Semiannual Symposium**, American Physical Society; State University of New York College at Cortland, Cortland, N.Y., **Oct. 2-3.**

**American Documentation Institute Annual Meeting, ADI**; Sheraton Hotel, Philadelphia, **Oct. 4-8.**

**Air Traffic Control Association National Meeting**, ATCA; Chalfonte-Haddon Hall, Atlantic City, N.J., **Oct. 5-7.**

**National Communications Symposium**, PTGCT/IEEE; Utica, N.Y., **Oct. 5-7.**

**Industrial and Commercial Power Systems Annual Conference**, ICPSC/IEEE, Philadelphia Section IEEE; Marriott Motor Hotel, Philadelphia, **Oct. 6-8.**

**Electronic Information Handling Conference**, University of Pittsburgh, Goodyear Aerospace Corp., and Western Michigan University; Webster Hall Hotel, Pittsburgh, **Oct. 7-9.**

**Fall URSI Meeting**, PTG/IEEE; University of Illinois, Urbana, Ill., **Oct. 11-14.**

**Electrochemical Society Meeting**, Electrochemical Society; Sheraton-Park Hotel and Motor Inn, Washington, **Oct. 11-15.**

**Energy Conversion and Storage Conference**, Oklahoma State University, Stillwater, Okla., **Oct. 12-13.**

**ISA Instrument-Automation Annual Conference and Exhibit**, ISA, Park-Sheraton and New Yorker Hotels and Coliseum, New York, **Oct. 12-15.**

**The Road to Commercial Electronics: A Conference on Converting Military Capabilities to Civilian Markets**, Electronics Magazine, IIT Research Institute; Grover M. Hermann Hall, Chicago, **Dec. 1-2.**

## Call for papers

**Joint Automatic Control Conference**, ASME, IEEE, ISA, AIAA, AICE; Rensselaer Polytechnic Institute, Troy, N.Y., **June 22-25. Nov. 15** is deadline for submitting papers to J.L. Shearer, Mechanical Engineering Dept., Pennsylvania State University, University Park, Pa. Topics include control theory, applications, components and control reliability.

**Microwave Theory and Techniques Symposium**, G-MTT/IEEE; Jack Tar Harrison Hotel, Clearwater, Fla., **May 5-7. Nov. 15** is deadline for submitting 10 copies of a summary (not to exceed four pages) to John E. Pippin, Chairman, Technical Program Committee, 1965 G-MTT Symposium, Sperry Microwave Electronics Co., P. O. Box 1828, Clearwater, Fla.

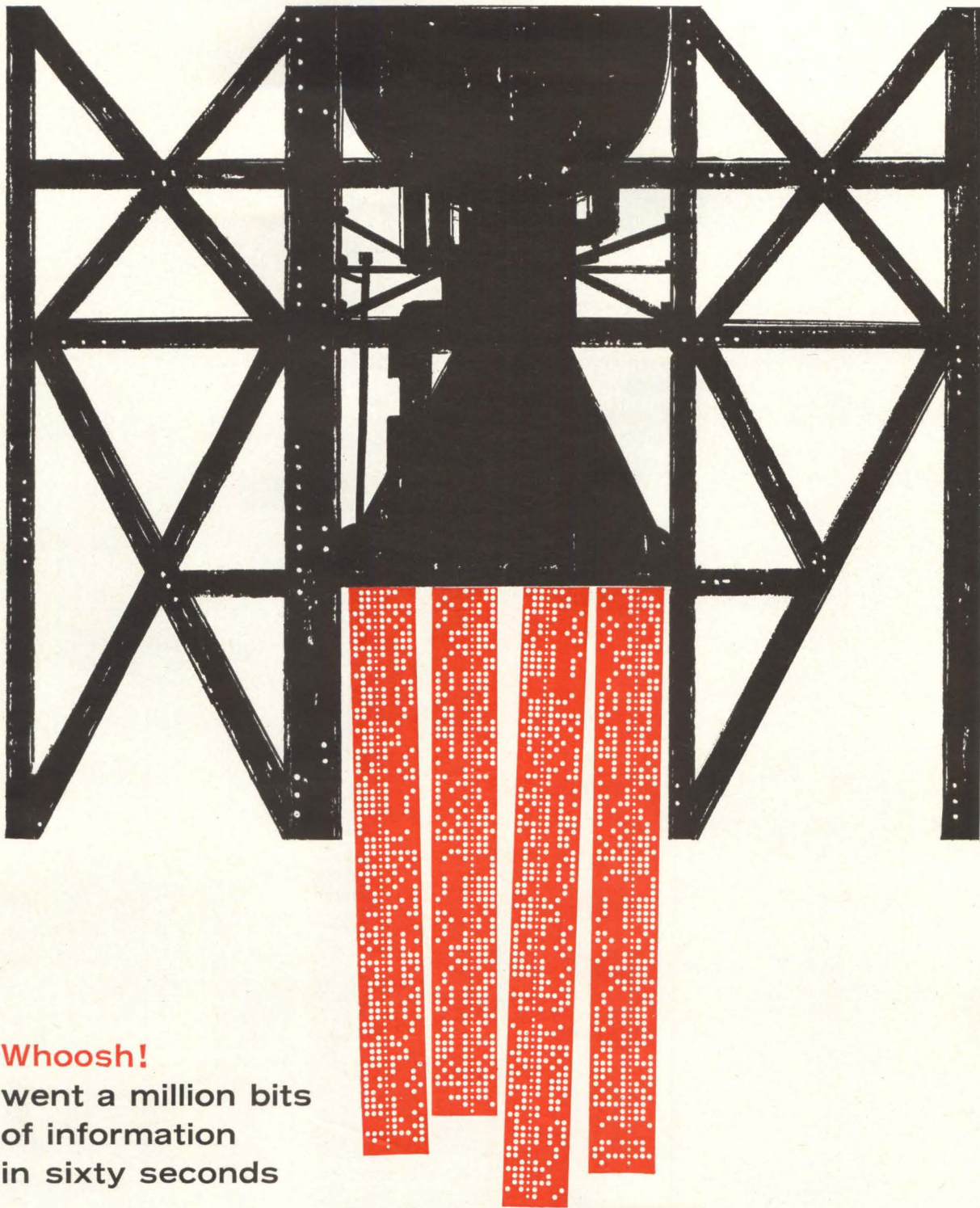

**Whoosh!**  
went a million bits  
of information  
in sixty seconds

... of a typical rocket engine firing test. And this high-speed digital data system gets them all—*accurately*. The system samples 15,000 channels per second, conditions, amplifies and digitizes analog information from any one of three rocket engine firing bays and records the result on an IBM 729-IV digital tape recorder in computer-compatible format for entry into an “off-line” computer. It has an input capability of 20 high-level and 80 low-level channels. Additional output equipment includes an FM tape recorder, analog oscillo-

graphic recorder, digital printer and visual data displays.

Perhaps you don't have a rocket engine test stand from which you wish to acquire data, but you do have other problems in the data acquisition and processing, telemetry, or range timing instrumentation fields where Astrodata's vast experience in dynamic information handling and hybrid computer techniques can help you. Write for your free copy of our 20-page brochure “Astrodata's Systems Experience.”



**ASTRODATA**

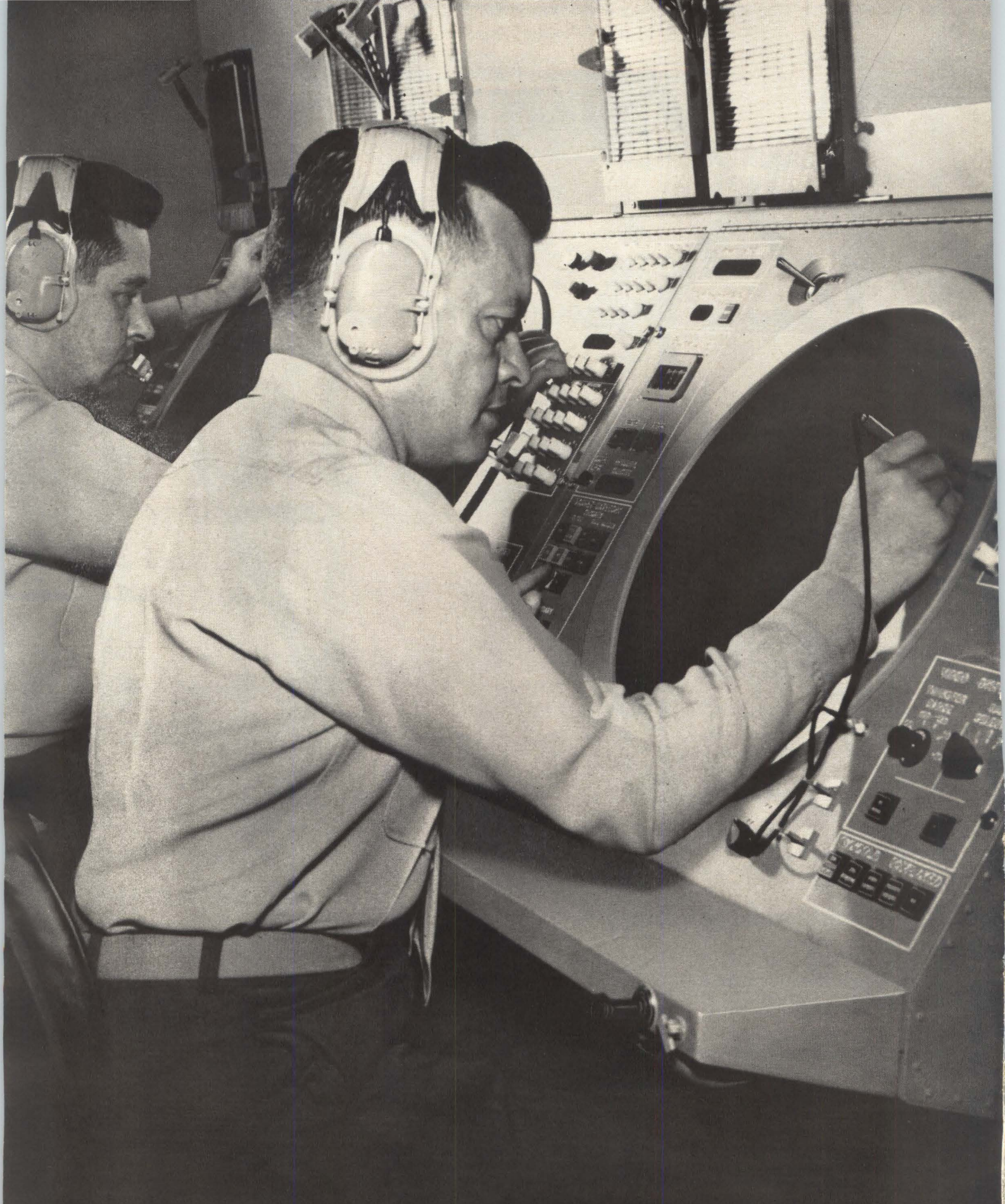

The scanner-classifier console of the MTDS system. Microelectronic shift register cards using TI integrated circuits improved the reliability of the tracking computer used in the system.

# How Litton achieved “cost effectiveness” with TI integrated circuits\*

Each Marine Corps Tactical Data System is more reliable because 9100 SOLID CIRCUIT® semiconductor networks are used in vital shift registers of the system's tracking computer. Here is how engineers of the Data Systems Division of Litton Industries saved time and reduced costs on this improvement.

Litton engineers wanted to use Texas Instruments integrated circuits in a tracking computer in the Marine Corps Tactical Data System (AN/TYQ-2). They had already achieved a reliability improvement in the AN/ASA-27 (ATDS) computer indicator used in the Grumman E2A Aircraft by replacing discrete-component shift registers with microelectronic units made by TI. The question at hand was “how to gain the benefits of integrated circuits quickly and at the lowest possible cost.”

Litton's investigation revealed that modules already developed and proved in the ATDS System could be used without modification. These modules are assembled on printed circuit boards to form shift registers that are directly interchangeable — on a card-for-card basis — with the original discrete-component circuits.

Many benefits were realized. Litton costs for the modification were low. Delays in production were avoided. Evaluation procedures were simplified. Existing production facilities were used without modification. Production economies realized as a result of multiple system procurement were passed on to the end system users.

To summarize, the effectiveness of the Litton MTDS was achieved without delaying the project or adding to development costs appreciably . . . thanks to the versatility of Series 51 semiconductor networks and “Master Slice” variations supplied by TI.

Ask your local TI sales engineer or distributor for more information on the several linear and digital lines of SOLID CIRCUIT semiconductor networks and on the economies of using Master Slice variations. A telephone call will bring the information you need.

\*Patented by TI

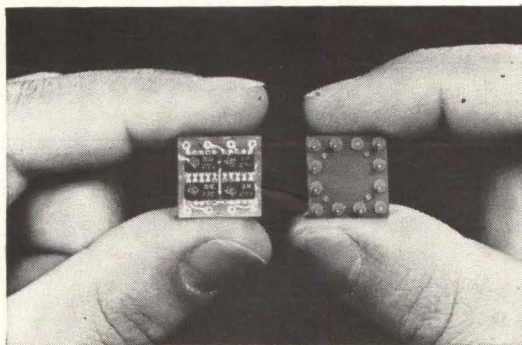

Here is the basic module supplied Litton by TI. Four semiconductor networks are assembled on a miniature circuit board with pin spacings adapted to Litton production requirements.

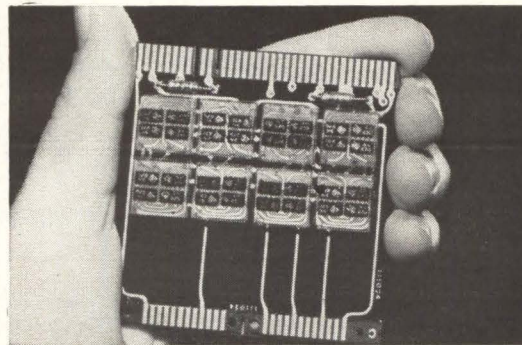

Several basic modules are then assembled to form a shift register card as shown. These cards are interchangeable with the discrete-component cards they replace.



**TEXAS INSTRUMENTS**  
**INCORPORATED**  
SEMICONDUCTOR-COMPONENTS DIVISION  
P. O. BOX 5012 • DALLAS 22, TEXAS

TOTAL SEMICONDUCTOR CAPABILITY FROM SEMICONDUCTOR PLANTS IN  
BEDFORD, ENGLAND • NICE, FRANCE • DALLAS, TEXAS

20745

Circle 13 on reader service card



(SERIES 500)

## Available Worldwide:

# Semiconductor testing costs reduced by 75%

**Test transistors, diodes and integrated circuits automatically with Fairchild precision instruments. High volume capacity and simplicity of operation save time and expense.**

Now semiconductor manufacturers and users throughout the world can take advantage of these features in the complete Fairchild family of proven equipment. As an example of the advanced capabilities offered, the Series 500 Transistor Tester (pictured) tests over 1000 devices-per-hour or will measure and record up to 8000 test results-per-hour. This is compared to a maximum rate of 200-300 devices-per-hour possible with conventional test equipment. And a worker with no technical training can learn to operate the Series 500 in two hours or less. First developed to meet Fairchild's implant requirements, Fairchild instruments have been purchased by over 20 U.S. semiconductor producers and dozens of other electronics firms.

**Accuracy and repeatability.** The family includes nine instruments—ranging from the Model 50 Transistor Beta Tester to the Series 4000M Integrated Circuit Multiparameter Tester with Magnetic Disc Programming. Each is built to insure unparalleled accuracy—resolution as fine as  $\pm 1$  millivolt and  $\pm 1$  picoamp. Fairchild also employs advanced digital and low current pulse testing techniques to insure repeatability: when tests are repeated, conditions are identical and users can be confident that changes in results reflect changes in the device itself and not the equipment.

**Low maintenance requirements.** Highly reliable silicon Planar transistors and diodes are used exclusively in all Fairchild instruments. In addition, most models also feature self-protective circuitry, such as automatic short prevention. Users average less than 5% down-time. For prompt help with any maintenance problem, sales offices are staffed with thoroughly trained engineers and technicians.

**Relatively low capital investment.** Prices for these instruments are far below the research and development expenditure any company would incur attempting to build its own equipment with similar capabilities. Because of the modular design approach used, each instrument is readily expandable to avoid obsolescence. This feature also allows Fairchild a great deal of flexibility in assembling custom testing systems.

**30-Day Delivery.** Your firm can start profiting from the economies of volume semiconductor testing with Fairchild equipment almost immediately. For complete information, write the nearest Fairchild sales office on your letterhead. Or, a technical representative will be happy to discuss your company's specific testing requirements.

**FAIRCHILD**  
SEMICONDUCTOR  
(INSTRUMENTATION)

UNITED STATES: All Principal Cities

ENGLAND: Avelley Electric, Ltd., South Ockendon—Essex; Tel: South Ockendon 3444; Telex: 24120 Avel Ockendon

GERMANY: Präzisionstechnik, Vertriebs—GMBH Cologne; Tel: SA.-NR. 23 49 61; Cable: Präzision Köln

844 CHARLESTON RD., PALO ALTO, CALIFORNIA, 962-2451 ■ TWX: 415-492-9414 ■ FAIRCHILD SEMICONDUCTOR, A DIVISION OF FAIRCHILD CAMERA AND INSTRUMENT CORP.

FRANCE: Radiophon, Paris; Tel: Kueber 32-50 (4 lignes); Telex: 25849 Rdifon—Paris

SWEDEN: Lagercrantz, Stockholm; Tel: 83 07 90; Telex: 10363 Fivessvee

JAPAN: F. Kanematsu & Co., Ltd., Tokyo; Tel: 281-6811; Telex: TK 2333, 2334



**Editorial**

# Rx for a 'can't-do' headache

Not everybody agrees that suppliers of military electronics should diversify into commercial markets. More and more often you hear that companies just can't make the transition, they don't have the know-how.

Early this month we received a thoughtful letter from a reader who spelled out this view clearly. In part, he wrote: "In view of the sustained levels of military spending, your continued pleas for diversification seem to this reader rather like over-reacting. The basic inflexibility of some companies looks like the major stumbling block because such companies are product- and technique-oriented instead of problem- and solution-oriented. They do not seem able to envisage ways in which their engineering and product capabilities can meet the shift even from strategic systems into tactical weapons."

This argument is partly true; however, it doesn't negate the basic need for companies to diversify if they are to share in the coming boom in electronics. We believe that a management that is willing to diversify can acquire the essential knowledge.

One giant step in the learning process can take place Dec. 1 and 2 at the conference on "The Commercial Road to Electronics" cosponsored by Electronics magazine and the Illinois Institute of Technology Research Institute.

On this program, industrial leaders who have succeeded in commercial electronics will describe how they did it, spelling out the necessary changes in philosophy and pointing out some pitfalls. Dr. L. T. Rader, vice president of the General Electric Co.'s Industrial Electronics division, will keynote the conference, discussing "The management view of commercial operations."

Here is the program:

## Session I. Product Planning

1. Comparing commercial and military product planning
2. What is a good product idea?
3. Panel: How we do product planning in:  
Consumer electronics      Medical electronics  
Industrial electronics

## Session II. Engineering

1. Engineering organization and philosophy for commercial products
2. Cost consciousness in design
3. Profile of the engineer needed for commercial work

## Session III. Manufacturing

1. Slanting production to commercial markets
2. The engineering aspects of commercial manufacturing

## Session IV. Marketing

1. The basis for commercial marketing
2. Marketing opportunities
3. Marketing panel  
Consumer electronics      The retailer's view  
Industrial electronics      The distributor's view  
Medical electronics

Most students of electronics markets agree that a boom is coming, but that it will be in the industrial and consumer fields. Industry is about to see a flood of new electronic controls. Microelectronic instruments are only a hairbreadth away. And integrated circuits in entertainment products and household appliances are already in the breadboard phase.

Companies outside the electronics industry see this. That's why chemical companies, builders of mechanical products and manufacturers of electrical products are diversifying into electronics.

We believe the die is cast. Many companies that fail to diversify will simply fail altogether in the next decade.

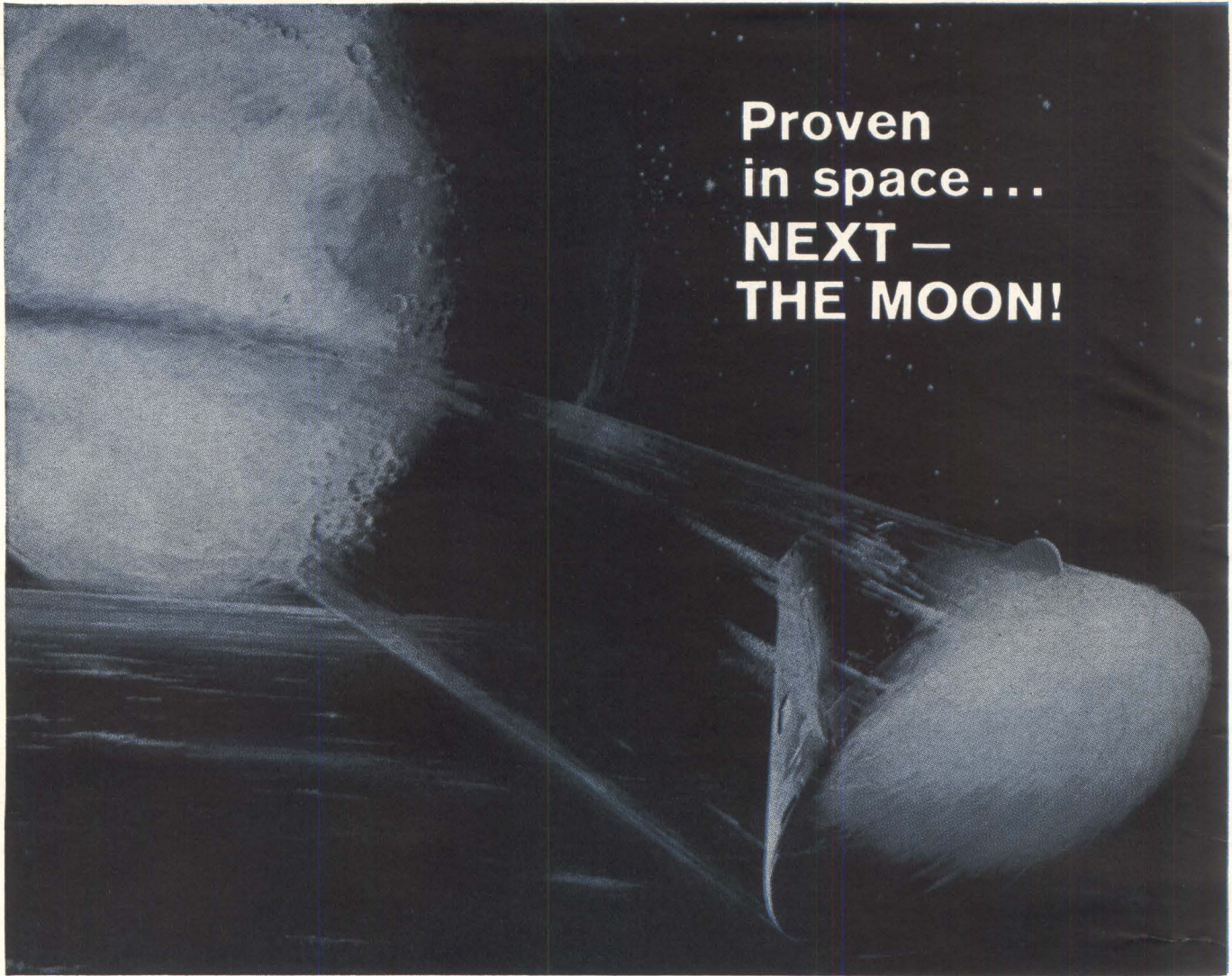

Proven  
in space...  
**NEXT —  
THE MOON!**

**\*These  
are the  
MINUTEMAN  
sizes of  
FH Series  
Resistors...  
and  
APOLLO  
designs  
are now  
utilizing ALL  
SIX models.**

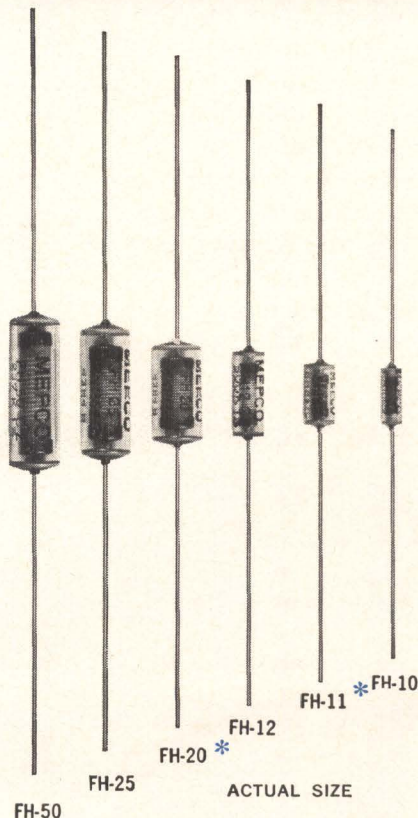

Now, MEPCO FH Series Hermetically Sealed Glass Enclosed Metal Film Resistors are part of the lunar project! The FH Series features a true hermetically sealed enclosure that protects the highly stable resistance element against the most adverse environmental and use conditions. FH Series Resistors conform to High Reliability Specifications MIL-R-55182. They are constructed to MIL sizes RNR55, RNR57, RNR60, RNR63, RNR65 and RNR70 and meet Characteristics C and E of the specification. Available in ratings from  $\frac{1}{10}$  watt to  $\frac{1}{2}$  watt. Advanced manufacturing methods, rigid in-process quality control and individual unit testing techniques insure uniform quality, long life and stable performance. Write or call today for complete information and technical data.

**MEPCO, INC.**  
35 Abbett Avenue  
Morristown, New Jersey  
Phone: (201) 539-2000  
TWX 201-538-6709



---

# Electronics Newsletter

---

September 21, 1964

## Wants circuits to have a ball

Scientific Data Systems, Inc., which recently announced the largest order of integrated circuits to date for industrial use, isn't happy with the packaging. Scientific Data is using both flatpacks and TO-5 can types in its 92 process computer system but finds the circuits, especially the flatpacks are "hard to handle, hard to test and hard to insert on printed circuit boards." The leads, 14 of them, are too close together and bend too easily.

The company suggests the flatpack be embedded in a plastic ball with self-supporting leads. "With this type of package, we could really reduce manufacturing, handling and testing costs," says a company official.

## Fashion note for astronauts

One of the world's most unusual workshops has just been completed at Wright-Patterson Air Force Base, Ohio. It is a space-maintenance facility in which astronauts will practice spaceship repairs while wearing electronically controlled space suits. First in-orbit use of the suits will be in 1966, as part of the Gemini flight program.

An astronaut will be strapped into a mechanism that floats on films of air, nearly duplicating weightlessness. It can spin him like a top if he makes any unbalanced movement. To avoid this, he'll use torqueless tools. Other equipment to be tested includes electron-beam and ultrasonic welders being developed for space use.

The astronaut will also wear a maneuvering unit smaller than the one he'll use in space. The backpack contains a gyro-controlled automatic stabilization system that prevents tumbling by firing tiny gas jets. At his waist, he wears a control unit that lets him turn on the jets to move in any direction. The backpacks, made by Ling-Temco-Vought, Inc., have been tested for more than a year in cargo planes. But the planes must fly in ballistic trajectories which provide weightless conditions for only 20 seconds at a time. Operational units of the spacesuits will include a telemetry system to transmit biomedical and performance data, and two-way radio.

A companion simulator, for tests of a radio-controlled version of the backpack, is also in use at the base. With it and a closed-circuit television system, the astronauts will practice repairs with a remote-controlled system. The astronauts will remain in the spacecraft while remotely-controlled tools get to work on the outside.

## Lasers tackle microcircuit job

The growing market for microcircuit-interconnection equipment is the target of a very low power laser being developed at the Speedway, Ind., laboratories of the Linde Co., a division of the Union Carbide Corp.

The welder will be able to make welds as small as a fraction of a mil in diameter. Beam outputs will range from 1 joule down to a few hundredths of a joule (1,000 joules equal one British thermal unit). The welder will compete with precision electrical welders and may even compete with the thermocompression bonders that are a staple tool for attaching hairlike lead wires to microcircuits. For example, an optical mask might be used to divide the beam so six or eight welds could be made simultaneously.

Linde says a beam output somewhere between 0.02 and 0.5 joule will

---

# Electronics Newsletter

---

be needed for delicate microcircuit work. When leads were welded to thin-film circuits at 0.5 joules—the lowest output with the present lab model—the welds looked like doughnuts—a bare spot on the substrate surrounded by a ring-shaped weld. The new welder will be ready in January and cost about \$10,000.

## Color-tv tests for Netherlands

Selected viewers in a 60-square-mile area near Eindhoven, the Netherlands, will get a look at the United States color-television system on Oct. 14. They'll submit technical reports on the transmission to Philips Gloeilampfabriken, N.V.

Philips has already experimented with the United States system and, because it is the most advanced, favors it over the French and German systems. But the method European color television will adopt still depends on the long-awaited decision of the International Radio Consultative Committee [Electronics, March 6, p. 17].

## Lightning strikes space program

There will be no manned Gemini flight this year. Bad weather has forced postponement of the first launch until early next year. Lightning struck the Gemini launch pad at Cape Kennedy and the resultant damage necessitated repairs in the pad's electrical wiring. Valuable checkout time was lost when the Gemini launch vehicle had to be taken off the pad because of threats from hurricanes Cleo and Dora.

## Klystron amplifier loses weight

A klystron amplifier weighing only 32-ounces paves the way for lighter weight, more compact and more efficient space communication systems. The new klystron developed by Litton Industries Electron Tube division is electrostatically focused. Earlier versions, introduced two years ago, weighed five pounds. [Electronics, Dec. 28, 1962, p. 26.]

The all-metal ceramic microwave tube has a nominal power output of 20 watts, continuous wave, at 2287.5 megacycles, but can be varied from 5 to 50 watts by varying the beam voltage. At the 20-watt power level, the beam voltage is 1,650 volts, the nominal efficiency is 30% (without a depressed collector), the gain is 20 decibels, the bandwidth is 5.5 megacycles, and the noise figure is 28 decibels.

Values do not vary substantially over the entire power range. Since the focusing is electrostatic instead of magnetic, there are no external magnetic fields and only one power supply voltage in addition to the cathode heater supply is needed.

## Lasers to measure Explorer's range

The search for laser applications continues. Now, for the first time, lasers will be used by the National Aeronautics and Space Administration to determine the range of a satellite.

After the Ionosphere Beacon Explorer is launched—during the next two weeks—an air-cooled ruby laser situated near NASA's Wallops Station, Va., will direct a beam of light, with one joule of power at one pulse per second, toward glass reflectors on the satellite as it passes. When the laser beam strikes the reflectors, it will be returned to the source, permitting precise measurements to be taken of the satellite's position in space. A water-cooled laser at Goddard Space Flight Center will perform identical experiments.

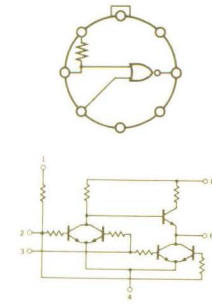
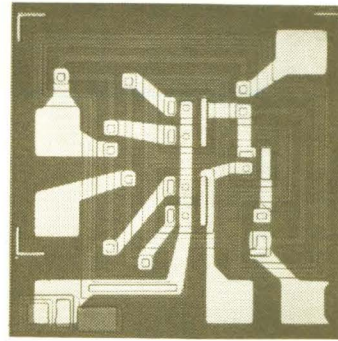
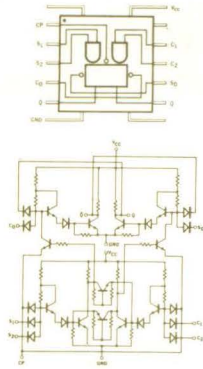
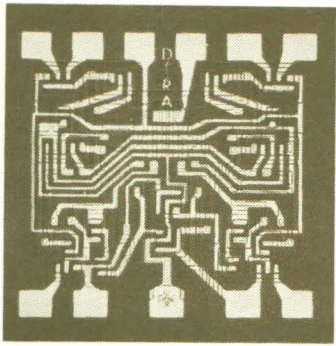

1. \_\_\_\_\_

2. \_\_\_\_\_

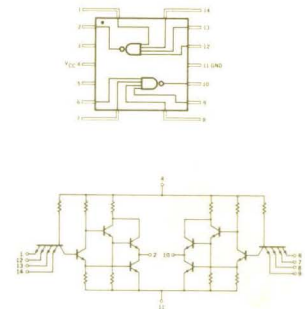
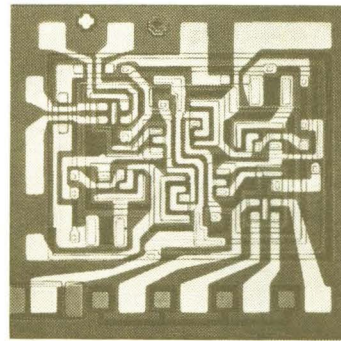
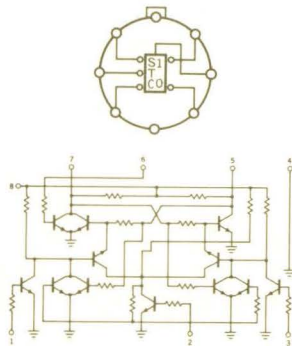
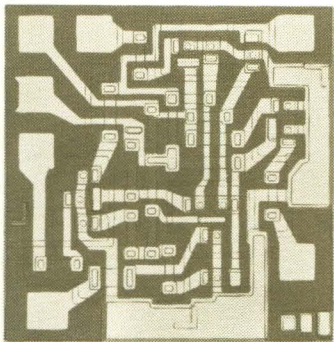

3. \_\_\_\_\_

4. \_\_\_\_\_

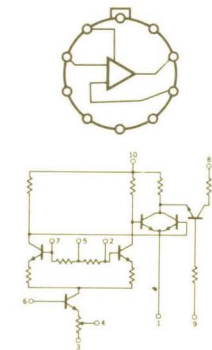
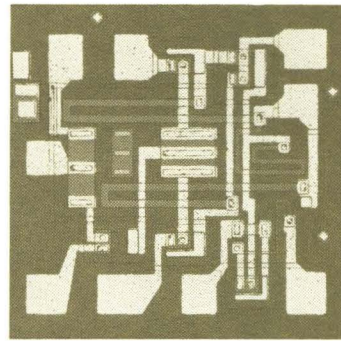
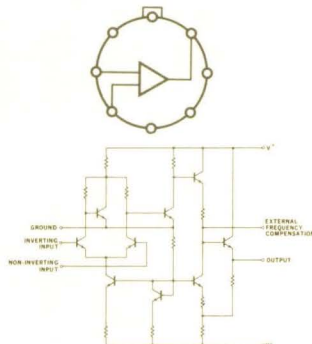
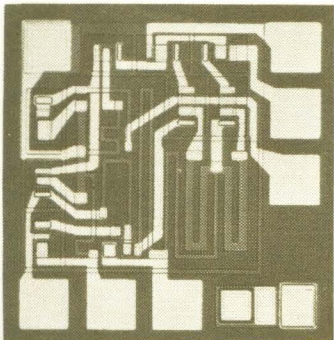

5. \_\_\_\_\_

6. \_\_\_\_\_

# Can you identify these integrated circuit types?

Match the correct letter below with number above:

- (a) J-K flip-flop, a complete general purpose storage unit by Fairchild
- (b) Dual gate using transistor-transistor logic by Fairchild
- (c) Diode-transistor logic clock-gated flip-flop by Fairchild
- (d) Low power inverting driver circuit by Fairchild
- (e) Sense amplifier custom-manufactured by Fairchild
- (f) Operational amplifier by Fairchild

Find the answers inside—  
along with more information on the industry's widest integrated circuit line...

# Total Capability—Fairchild Microcircuits

## 1(c)

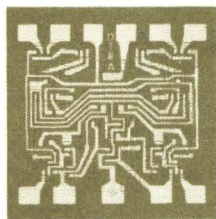

### Diode-Transistor Micrologic (DT $\mu$ L)

#### DT $\mu$ L Flip-Flop 931

Clock Gated flip-flop  
 Propagation Delay (Typ):  
 50 nsec  
 Power Diss (Typ) 25°C: 20mW  
 Fan Out: 9

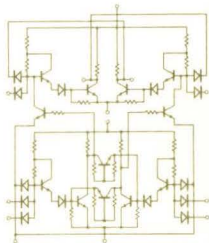

#### DT $\mu$ L Dual Gate 930

Dual 4-Input Gate  
 Propagation Delay (Typ):  
 25 nsec  
 Power Diss (Typ) 25°C: 5mW  
 Fan Out: 7

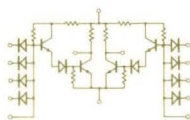

#### DT $\mu$ L Buffer 932

Dual 4-Input  
 Propagation Delay (Typ):  
 25 nsec  
 Power Diss (Typ) 25°C: 15mW  
 Fan Out: 20

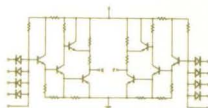

#### DT $\mu$ L Input Extender 933

Dual input 4 high speed diode anode array to be used when increased fan-in is required

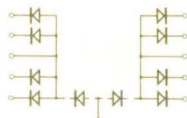

#### DT $\mu$ L Quad Gate 946

Quad 2-input gate. Noise immunity 1 volt @ 25°C  
 Propagation Delay (Typ):  
 25 nsec  
 Power Diss (Typ) 25°C: 5mW  
 Fan Out: 8  
 Available September, 1964

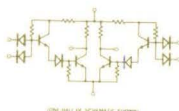

## 2(d)

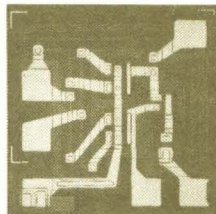

### Milliwatt Micrologic (MW $\mu$ L)

#### Gated Buffer 909

A low impedance inverting driver circuit. Used typically as a line driver, in multi-vibrators, or for pulse differentiation  
 Propagation Delay (Typ):  
 80 nsec  
 Power Diss (Typ) 25°C: 10mW  
 Fan Out: 30

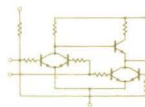

#### Modulo 2 Adder 908

Generates the Mod. 2 addition or exclusive OR function  
 Propagation Delay (Typ):  
 90 nsec  
 Power Diss (Typ) 25°C: 10mW  
 Fan Out: 4

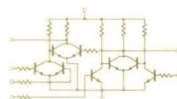

#### Dual Gate 910

Used as a pair of NOR gates R-S flip-flop, pair of inverters, or double inverter  
 Propagation Delay (Typ):  
 45 nsec  
 Power Diss (Typ) 25°C: 4mW  
 Fan Out: 4

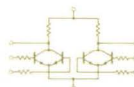

#### 4-Input Gate 911

Used as an OR gate by applying true inputs  
 Propagation Delay (Typ):  
 80 nsec  
 Power Diss (Typ) 25°C: 4mW  
 Fan Out: 4

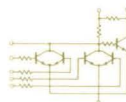

#### Half-Adder 912

A multipurpose combination of three basic RTL circuits for a complete half-adder or an exclusive OR gate  
 Propagation Delay (Typ):  
 90 nsec  
 Power Diss (Typ) 25°C: 8mW  
 Fan Out: 4

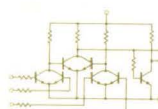

#### Type D Flip-Flop 913

This element is a gate flip-flop for use as a binary in registers and counters

Propagation Delay (Typ):  
 100 nsec  
 Power Diss (Typ) 25°C: 15mW  
 Fan Out: 3

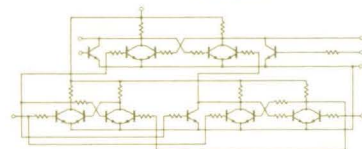

#### Gate Expander 921

A Dual 2-input gate without node resistors, to be used when increased fan-in is required  
 Propagation Delay (Typ):  
 40 nsec

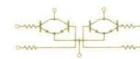

## 3(a)

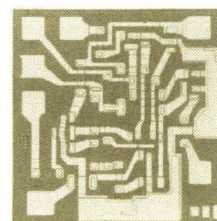

### High Speed Micrologic ( $\mu$ L)

#### J-K Flip-Flop 916

A complete, general purpose, storage element suitable for use in shift registers, counters, or any type of control function  
 Propagation Delay (Typ):  
 10 mc  
 Power Diss (Typ) 25°C: 52mW  
 Fan Out: 3

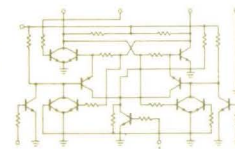

#### Buffer 900

A low impedance inverting driver circuit  
 Propagation Delay (Typ):  
 16 nsec  
 Power Diss (Typ) 25°C: 30mW  
 Fan Out: 25

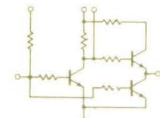

#### Counter Adapter 901

Provides gated, non-inverted complementary outputs from a single-valued input  
 Propagation Delay (Typ):  
 24 nsec  
 Power Diss (Typ) 25°C: 55mW  
 Fan Out: 5

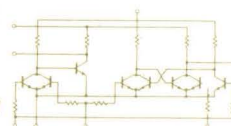

# Off-the-shelf silicon Planar digital and analog circuits plus a complete custom capability. Devices for full military temperature range: $-55^{\circ}\text{C}$ . to $+125^{\circ}\text{C}$ .

## Flip-Flop 902

A bistable flip-flop storage unit

Propagation Delay (Typ): 14 nsec  
Power Diss (Typ) 25°C: 22mW  
Fan Out: 4

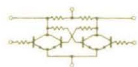

## Three-Input Gate 903

A three-input NAND/NOR circuit

Propagation Delay (Typ): 12 nsec  
Power Diss (Typ) 25°C: 12mW  
Fan Out: 5



## Half-Adder 904

A two-level AND/OR gate suited for use as a complete half-adder, an exclusive OR gate or any similar logic function

Propagation Delay (Typ): 16 nsec  
Power Diss (Typ) 25°C: 34mW  
Fan Out: 5

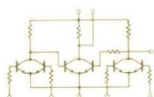

## Half-Shift Register 905

A gated input storage element with inverter

Propagation Delay (Typ): 18 nsec  
Power Diss (Typ) 25°C: 53mW  
Fan Out: 4

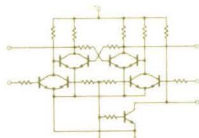

## Half-Shift Register 906

A gated input storage element without inverter (reduces power dissipation)

Propagation Delay (Typ): 22 nsec  
Power Diss (Typ) 25°C: 36mW  
Fan Out: 4

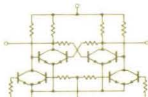

## Four-Input Gate 907

A four-input NAND/NOR circuit

Propagation Delay (Typ): 12 nsec  
Power Diss (Typ) 25°C: 12mW  
Fan Out: 5

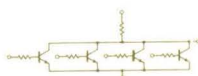

## Dual Two-Input Gate 914

Dual NAND/NOR gates capable of forming a flip-flop, non-inverting gate, or gate plus inverter

Propagation Delay (Typ): 12 nsec  
Power Diss (Typ) 25°C: 24mW  
Fan Out: 5

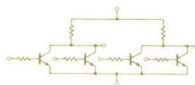

## Dual Three-Input Gate 915

A dual combination of three-input circuits, one of three similar basic NAND/NOR gates

Propagation Delay (Typ): 12 nsec  
Power Diss (Typ) 25°C: 24mW  
Fan Out: 5

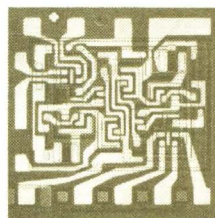
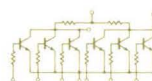

## 4(b) Transistor-Transistor Micrologic (TT $\mu$ L)

### TT $\mu$ L Dual 4-Input Gate 103

Micrologic Dual 4-Input Gate

Propagation Delay (Typ): 25 nsec  
Power Diss (Typ) 25°C: 22mW  
Fan Out: 15

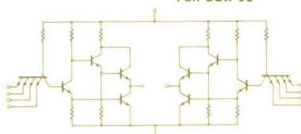

### TT $\mu$ L 8-Input Gate 104

Micrologic 8-Input Gate

Propagation Delay (Typ): 30 nsec  
Power Diss (Typ) 25°C: 22mW  
Fan Out: 15

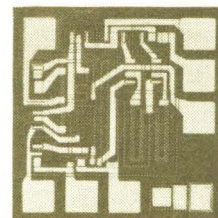
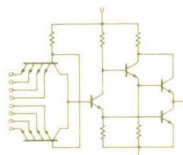

## 5(f) Analog

### μA702

Operational Amplifier

Gain (Typ): 64 db  
Bandwidth (Typ): 1.1 MC  
Input Resistance Ohms (Typ): 5 K  
Output Resistance Ohms (Typ): 300  
Power Diss (Typ) 25°C: 100mW

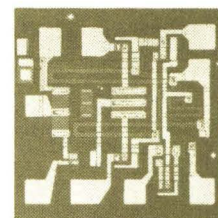
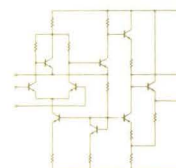

## 6(e) Custom

### μC113

Sense Amplifier

Gain (Typ): 200  
Bandwidth (Typ): 2 MC  
Input Resistance Ohms (Typ): 3 K  
Power Diss (Typ) 25°C: 40mW

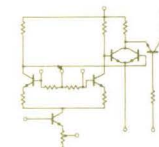

This is just one example of countless digital and linear microcircuits Fairchild can manufacture *to your specifications*. You design and breadboard it, we integrate it. Write for Fairchild's Custom Microcircuit Design Handbook.

For more answers to your integrated circuit requirements, see the next page.

# Total Capability... Low Price Microcircuits

COMPATIBLE SILICON PLANAR EPITAXIAL DIGITAL ELEMENTS GUARANTEED OVER 15°C TO 55°C TEMPERATURE RANGE

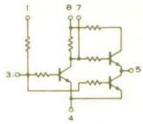

**F $\mu$ L 90029  
BUFFER**

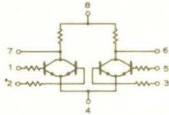

**F $\mu$ L 91029  
DUAL  
2-INPUT GATE**

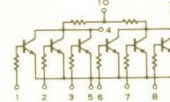

**F $\mu$ L 91529  
DUAL  
3-INPUT GATE**

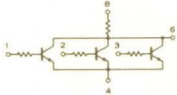

**F $\mu$ L 90329  
3-INPUT GATE**

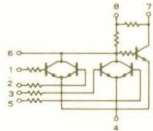

**F $\mu$ L 91129  
4-INPUT GATE**

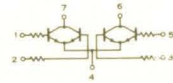

**F $\mu$ L 92129  
EXPANDER**

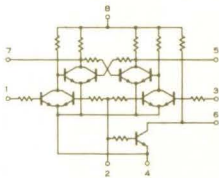

**F $\mu$ L 90529  
HALF SHIFT  
REGISTER**

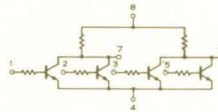

**F $\mu$ L 91429  
DUAL  
2-INPUT GATE**

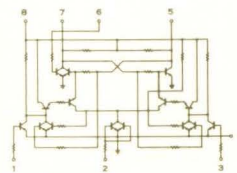

**F $\mu$ L 92329  
J-K FLIP-FLOP**

These integrated circuits are specially priced for non-military applications such as commercial computers, industrial control equipment, instrumentation and test equipment. Functional equivalents of Fairchild's Micrologic and Milliwatt Micrologic elements, they are guaranteed from 15°C. to 55°C. They are available in volume quantities, packaged in low silhouette TO-5 type headers with eight or ten leads.

**Proven quality.** The Fairchild commercial microcircuit line has grown from the industry's oldest and largest integrated circuit capability. Since 1960, Fairchild has produced more than 1,000,000 Micrologic units, primarily for space and defense. Commercial units are manufactured by the same Planar Epitaxial techniques and benefit equally from Fairchild's long experience and rigid production control.

## PRICE LIST

	1-24	25-99	MIX 100	NON MIX 100
F $\mu$ L 92329 J-K FLIP-FLOP	9.50	7.60	6.65	6.35
F $\mu$ L 90529 HALF SHIFT REGISTER	6.50	5.30	4.55	4.35
F $\mu$ L 90029 BUFFER	3.75	3.00	2.65	2.55
F $\mu$ L 90329 3-INPUT GATE	3.75	3.00	2.65	2.55
F $\mu$ L 91529 DUAL 3-INPUT GATE	4.75	3.80	3.35	3.20
F $\mu$ L 91129 4-INPUT GATE	4.00	3.20	2.80	2.65
F $\mu$ L 91029 DUAL 2-INPUT GATE	4.00	3.20	2.80	2.65
F $\mu$ L 92129 EXPANDER	4.00	3.20	2.80	2.65
F $\mu$ L 91429 DUAL 2-INPUT GATE	4.00	3.20	2.80	2.65

# FAIRCHILD

## SEMICONDUCTOR

### FRANCHISED DISTRIBUTORS

AVNET Toronto, Canada, 789-2621 • BOHMAN Orlando, Fla., 425-8611 • CRAMER ELECTRONICS Newton, Mass., WO 9-7700; Hamden, Conn., 288-7771 • CRESCENT ELECTRONIC SALES Orlando, Fla., 423-8586 • DART SALES Clarence, N.Y., 874-1212; Syracuse, N.Y., GL 4-9257 • DENNY-HAMILTON San Diego, Cal., 279-2421 • EASTERN SEMICONDUCTOR Syracuse, N.Y., 454-9247 • E. C. ELECTRONIC SALES Minneapolis, Minn., 888-0102 HAMILTON Phoenix, Ariz., 272-2601; Culver City, Cal., 870-0236; Palo Alto, Cal., 321-7541; Seattle, Wash., 282-3836 • HYER Englewood, Colo., 761-0754; Albuquerque, N. Mex., 268-6744; Salt Lake City, Utah, 322-5849 MARSHALL Scottsdale, Ariz., 946-4276; San Marino, Cal., MU 1-3292; San Diego, Cal., BR 8-6350; Redwood City, Cal., EM 6-8214 • NORVELL Dallas, Tex., FL 7-6451; Houston, Tex., MO 5-0558 • POWELL Beltsville, Md., 474-1030; Philadelphia, Pa., 724-1900 • SCHLEY Watertown, Mass., WA 6-0235 • SCHWEBER Westbury, L.I., N.Y., ED 4-7474 • SEMICONDUCTOR SPECIALISTS Chicago, Ill., 622-8860; Minneapolis, Minn., UN 6-3435; Dearborn, Mich., LU 4-5901 • SHERIDAN Cincinnati, Ohio, 761-5432; Cleveland, Ohio, 884-2001; Dayton, Ohio, 277-8911 • SOLID STATE Chicago, Ill., 889-8033 • STANDARD Buffalo, N.Y., TT 3-5000 SUMMIT DISTRIBUTORS Buffalo, N.Y., 884-3450 • TAYLOR Baldwin, L.I., N.Y., BA 3-8000 • TEC-SEL Huntsville, Ala., 534-7304 • VALLEY Winter Park, Fla., 647-1216; Baltimore, Md., NO 8-4900; Cherry Hill, N.J., NO 2-9337.

### FACTORY SALES OFFICES

HUNTSVILLE, ALA. 536-4428, 4429 • SCOTTSDALE, ARIZ. 946-6583 • PALO ALTO, CAL. 321-8780 • SHERMAN OAKS, CAL. TR 2-1380; ST 8-8701 • ENGLEWOOD, COLO. 761-1735 • ORLANDO, FLA. CH 1-2596 OAK PARK, ILL. VI 8-5985 • COLLEGE PARK, MD. 779-6868 • BEDFORD, MASS. 275-8450 • MINNEAPOLIS, MINN. UN 6-3301 • ENDWELL, N.Y. 754-2600 • JERICHO, L.I., N.Y. ED 4-8500 • POWHKEEPSIE, N.Y. 454-7320 • SYRACUSE, N.Y. GR 2-3391 • DAYTON, OHIO 228-1111 • JENKINTOWN, PENN. TU 6-6623 • SEATTLE, WASH. AT 2-5344 • CANADA OFFICE: TORONTO, ONTARIO 782-9230.





*"Yes, sir, straight ahead...  
it's the third new  
plant on the right."*

**In 1963 alone, 192 new plants and  
478 expansions paced North Carolina's industrial growth.  
What's here for you?**

Growth, like Good Government, is a habit in North Carolina. Companies thrive here because the business climate is right. They find people who work hard. A string of 20 Industrial Education Centers that turn out willing workers trained to employer specifications—at no expense to industry. All the advantages of being close to the nation's

population centers without sharing their problems. These are some of the reasons North Carolina has led the Southeast in industrial growth in the past decade. There's more you should investigate. Write

Governor Terry Sanford, State Capitol, Raleigh, for an industrial information package . . . free (and confidential) of course.

**GO NORTH  
CAROLINA**

WHERE GOOD GOVERNMENT IS A HABIT

10  
9  
8  
7  
6  
5  
4  
3  
2

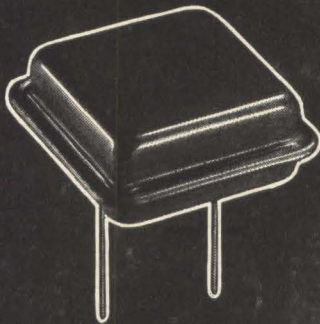

**1**st on the Moon!

**REEVES-HOFFMAN COLD-WELDED CRYSTAL UNITS**



A leak rate reliability more than 100,000 times better than the requirement of MIL-Spec 3098 is provided by Reeves-Hoffman cold-welded crystal holders. The miniaturized crystal-controlled dual filter shown above contains two crystals in cold-welded holders.

When NASA's Ranger VII blasted off, cold-welded crystal units supplied by Reeves-Hoffman went with it. These units, which are now spread across the moonscape, functioned perfectly in Ranger VII's central controller and sequencer. They were selected by engineers at the Jet Propulsion Laboratory because they provided the needed reliability in the smallest possible package. It is because of this reliability and miniaturization that cold-welded units are not only on the moon, but also in use in submarine cables and in many other applications where main-

tenance is impossible or extremely difficult.

Reeves-Hoffman's new cold-welding process eliminates solder, and attendant flux and heat, removes undesirable damping and corrosion, solves problems of thermal isolation. The results: substantial increases in the reliability and stability of crystal units, oscillators and filters; further opportunity for miniaturization; faster delivery; lower cost.

For space, undersea or "down-to-earth" applications, get complete information on Reeves-Hoffman cold-welded units.

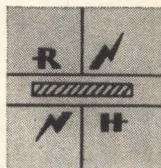

**REEVES-HOFFMAN**  
DIVISION OF **DCA**

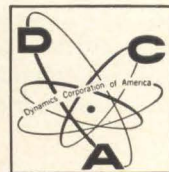

400 WEST NORTH STREET, CARLISLE, PENNSYLVANIA

### TIME BASE CORRECTION

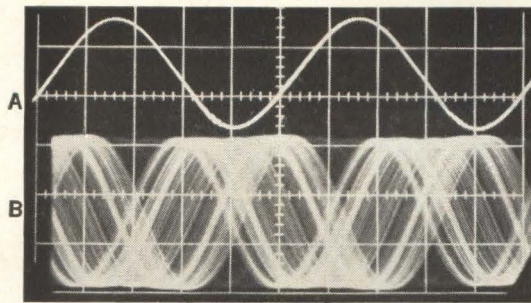

### CONVENTIONAL

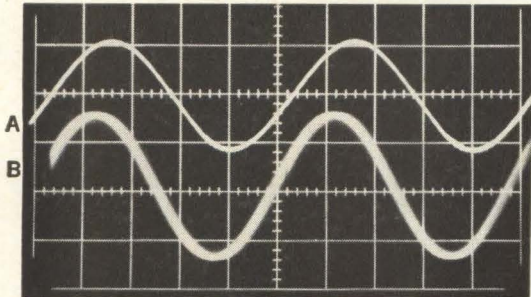

### TICOR II

TRACE A: 100-kc oscillator reference signal  
TRACE B: 100-kc line driver output, track 13  
One-inch tape, speed 60 ips. Sweep rate: 2.0  $\mu$ sec/cm.  
Photo exposure: 1/25 sec.



## EXCLUSIVE STORY ON MINCOM'S NEW 1.5-mc TICOR II

**On playback, lock in** your tape reference track to TICOR II's reference oscillator signal—the traces above demonstrate a time-base correlation between events holding well within  $\pm 0.5 \mu$  sec, continuously anywhere on the tape. This unique and exclusive Mincom 1.5-mc recorder/reproducer immediately updates any existing data reduction center. It opens new doors to data analysis in radar recording, single sideband, serial PCM and other systems dependent on precise time-base stability. Flutter components below 200 cps are essentially removed. Rapidly convertible from 1/2-inch to 1-inch tape, all solid state, one equipment rack, RFI-shielded. Write for specifications.

**Mincom Division** **3M**  
COMPANY

300 South Lewis Road, Camarillo, California • 320 Shaw Road, South San Francisco, California • 529 Pennsylvania Building, 425 13th Street, N.W., Washington, D.C. • 135 West 50th Street, New York, New York • Post Office Box 272, Fairborn, Ohio • 1230 Orange Avenue, Winter Park, Florida • 2121 Santa Anna Avenue, Dallas, Texas • Eltron Engineering Sales, Inc., 246 Walnut Street, Newtonville, Massachusetts



## Some people call our inspectors fuss-budgets *(but Speer customers think they're great)*

The man up there in the picture is a member of Speer Carbon's Quality Control and Inspection team. He's checking a resistor lead for solderability—one of many tests that are S.O.P. for Speer fixed carbon resistors.

He's also one big reason why Speer customers are *happy* customers. They know they can rely on Speer electronic components for uniformity and performance—time and time again.

Actually, all of our inspectors are fuss-budgets. They just won't take anything for granted and we're glad. That's why Speer has one quality-assurance employee for every eight employees in production and one quality-assurance engineer for every seventy-five employees in production. And that holds for every manufacturing step ...from raw materials to the finished product.

Mil specs? Speer participates in industry committees that cooperate with military departments in writing them. What's more, our tests don't stop there. This year, 141,912,000 unit life test hours are scheduled for Speer resistors and 40,000,000 for Jeffers coils.

But just to keep the record straight, our inspectors don't deserve all the credit for Speer quality. The folks up and down the line, in all departments, have the same kind of pride in Jeffers' and Speer's performance that our quality-assurance employees have. And we suspect that Speer's multi-million dollar research and development program has something to do with it, too.

**SPEER** Carbon Co.



Dept. 489, St. Marys, Pennsylvania 15857  
 Speer Carbon Co. is a Division of Air Reduction Company, Inc.

BUT WHAT DOES  
MILO HAVE  
THAT I DON'T?

PARTS, BABY —  
LOTS A NAME BRAND  
ELECTRONIC PARTS!

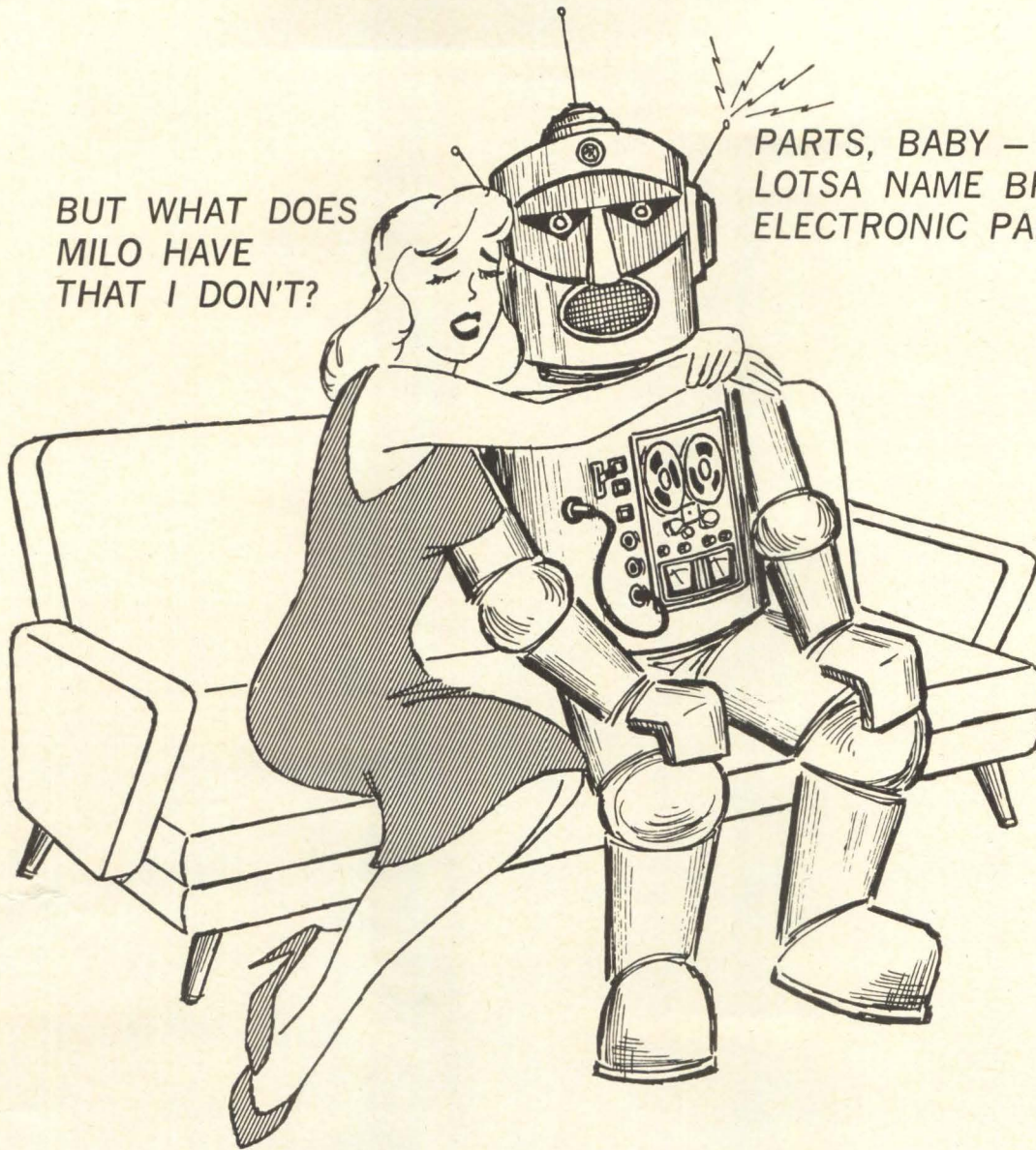

**MILO'S "EX" APPEAL** is what counts most with those who specify and purchase industrial electronic components: Extremely extensive off-the-shelf stock — we're extravagantly stacked with thousands of different products, over a hundred top name brands; Express delivery of exactly what you order; Expert technical assistance; Exacting followup and expediting of exigent orders; Exemplary experience acquired over twenty years of exclusively industrial distribution. So whenever your desires are explicitly electronic, exploit Milo's dependability — because we really care about your needs, and take extra care to meet them.



**MILO ELECTRONICS CORP.**

530 CANAL STREET, NEW YORK, N.Y. 10013 • TEL 212-BE 3-2980 • TWX 212-571-0195  
BRANCH WAREHOUSES AND SALES OFFICES IN PRINCIPAL INDUSTRIAL AREAS

7<sup>3</sup>/<sub>4</sub>

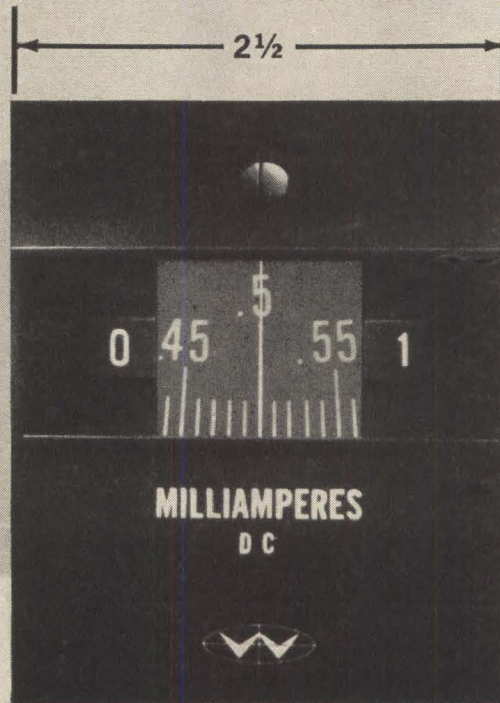
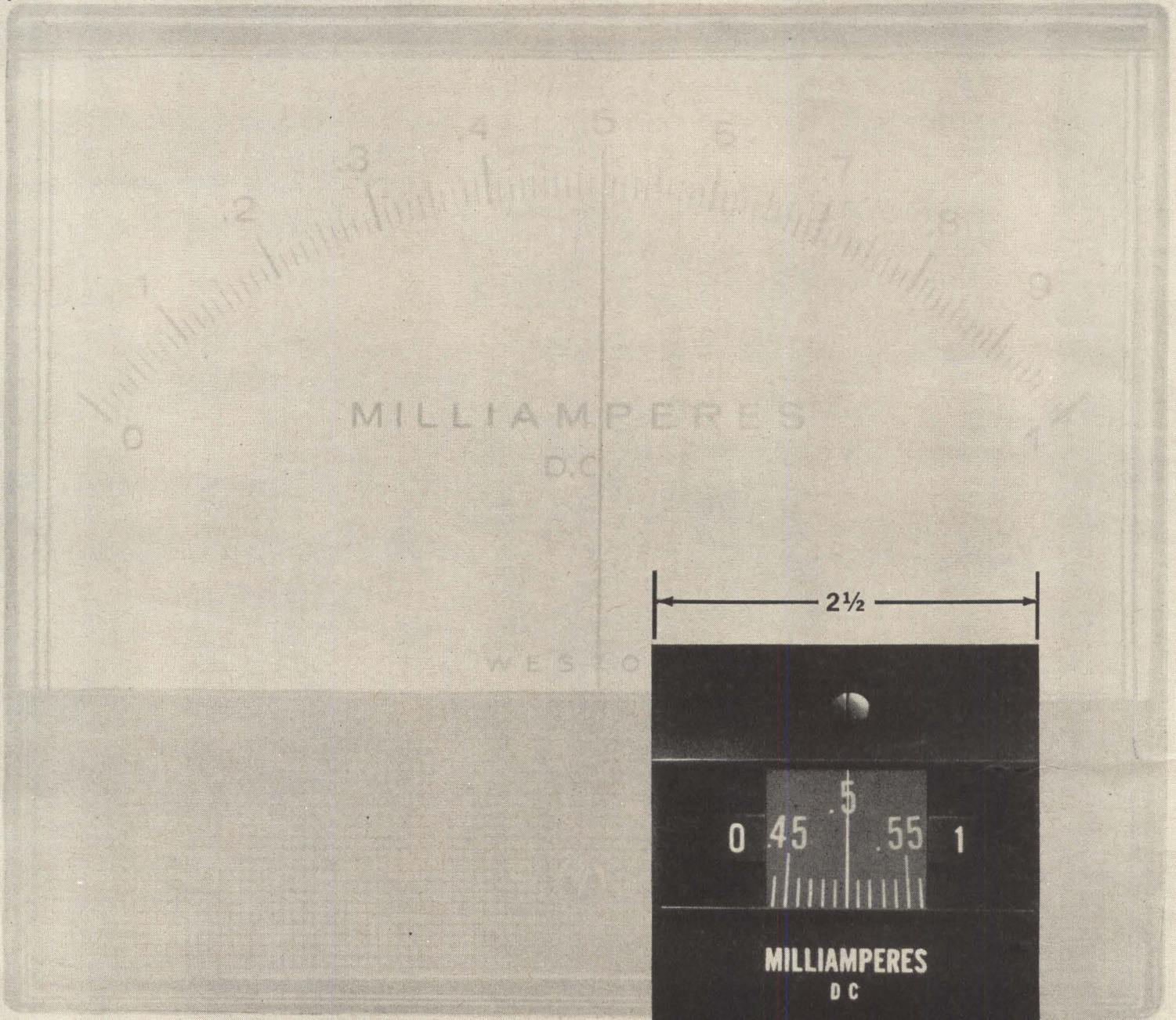

## Revolutionary new panel meter

- Puts 8 inches of scale into this little 2<sup>1</sup>/<sub>2</sub> inch front
- Retains all the advantages of an 8-inch meter
- Eliminates parallax
- Self-illuminated scale
- Requires only 8 sq. in. panel space
- Self-shielded mechanism

Another outstanding product from the leader in measurement and display

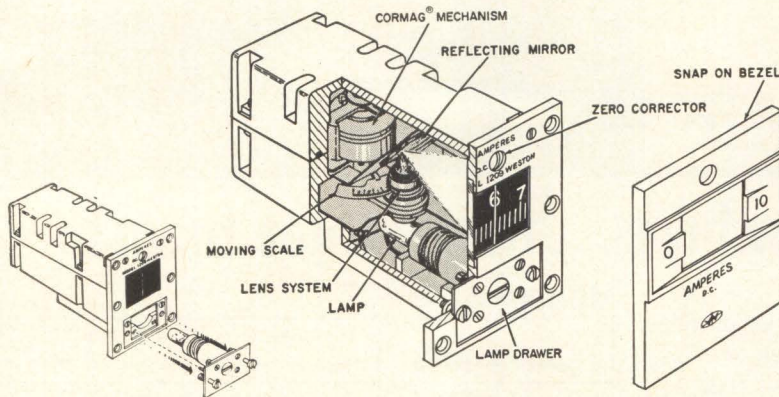

Weston announces the most advanced panel meter line ever designed. PMS (Projected Moving Scale) panel instruments allow an unusual degree of miniaturization . . . and establish a new standard of performance at the same time. For example, the PMS provides characteristics of 9" x 7" pointer type instrument in the space normally required by a 2.5" meter . . . 8 sq. in. instead of 63!

#### unique design

A simple optical system projects a moving scale onto the viewing window. All parallax is completely eliminated since the hairline is on the same plane as the projected image. A CORMAG® meter mechanism, heart of the instrument, is the same type mechanism which has proved its reliability in

thousands of quality instruments produced by Weston over the years. An added feature is the fact that the mechanism axis is vertical, thus eliminating pivot roll.

#### modern styling

Weston's PMS instruments are extremely compact, requiring less than 2.5" x 3.2" of panel space. Rectangular shape permits installation of units side by side for in-line presentations. The instruments may be front-panel mounted or recessed, and are supplied with snap-on bezels which allow the replacement of the bulb from the front of the panel.

#### wide application

The new Weston PMS instrument allows the designer full freedom of

miniaturization without loss of accuracy. Because parallax is eliminated, these meters may be monitored at oblique angles with the human eye or TV cameras without fear of reading errors occurring.

#### custom features

Optional designs can be supplied on request. These include special scales, provision for colored readout and special bezels. This permits design flexibility in the styling of electronic equipment requiring meter readouts.

#### technical information

Complete data is available on Weston Model 1209 Projected Moving Scale instruments. Write for a brochure on the revolutionary new line of PMS panel instruments.

# Weston Model 1209 PMS

QUALITY BY DESIGN



**WESTON INSTRUMENTS, INC.**

614 Frelinghuysen Avenue, Newark, New Jersey, 07114

# NEW! TRYGON Modular DC Supplies

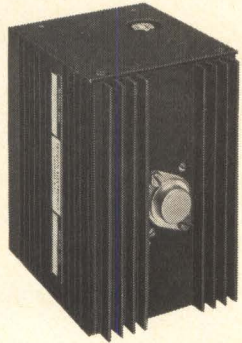

**SERIES 1, 2 & 4**  
(71°C ambient)



**SERIES 8**  
(50°C ambient)

## Plug them in anywhere... then forget them!

Whether you need Trygon modules for your own use or to incorporate into systems you are producing, you can rely on Trygon dependability. You merely select the proper Trygon module, mount it—horizontally or vertically—and forget it!

Here's why: High-efficiency circuits result in less internal heat build-up and longer life. Series 1, 2 and 4 feature all silicon semiconductors, designed to operate in ambients up to 71°C WITHOUT ANY DERATING! All series have generous built-in heat sinks—no additional heat sinking or forced air cooling is required. Current-limited short circuit protection automatically resets when the fault is removed—so again, you don't have to worry about where you place a Trygon module in a system.

Remote sensing and programming provisions are also built-in. And premium components plus derated circuits yield MTBF figures in excess of 30,000 hours. All components are readily accessible. For additional flexibility, input/output connections are available with either terminal strips, solder lugs or octal sockets.

Overvoltage protection is available on all units as an optional extra. Series 1 is provided with Fixed Overvoltage Protection (FOV) while all other modules (Series 2, 4 and 8) are available with Trygon's standard Automatic Overvoltage Protection (OV).

See the chart for standard models, then contact your Trygon rep. Or, write for complete catalog to Dept. E-24.

### ELECTRICAL SPECIFICATIONS

Model	Reg. Load	Reg. Line	Ripple mv RMS	Recovery Time	Ambient Oper. Temp.
Series 1, 2 & 4	0.02%	0.01%	Less than 0.5	Less than 50μ sec	-20°C to +71°C
Series 8	0.01%	0.01%			-20°C to +50°C

Complete line of module rack adapters available for assembly of complex power supply systems to meet your specific needs.

### MODELS

Series	Model	OUTPUT		PRICE†	Overvoltage Protection
		Volts	Amps		
1*	PS20-400	0-20	0-0.4	\$140	For Fixed Overvoltage Protection (FOV) add \$75 per unit.
	PS32-250	0-32	0-0.25	140	
	PS50-150	0-50	0-0.15	155	
	PS3-1.5F	2.5-3.5	0-1.5	130	
	PS6-1F	4-8	0-1	120	
	PS12-900F	10-14	0-0.9	115	
	PS15-800F	13-17	0-0.8	120	
	PS18-800F	16-20	0-0.8	120	
	PS24-700F	22-26	0-0.7	120	
	PS28-600F	26-30	0-0.6	120	
2	PS48-400F	46-50	0-0.4	130	Note A
	PS10-2	0-10	0-2	160	
	PS20-1.5	0-20	0-1.5	160	
	PS32-1.25	0-32	0-1.25	165	
4	PS50-750	0-50	0-0.75	180	Note B
	PS10-4	0-10	0-4	195	
	PS20-3	0-20	0-3	195	
	PS32-2.5	0-32	0-2.5	200	
8	PS50-1.5	0-50	0-1.5	215	Note C
	PHR20-5	0-20	0-5	250	
	PHR20-10	0-20	0-10	325	
	PHR40-2.5	0-40	0-2.5	250	
	PHR40-5	0-40	0-5	295	
	PHR60-2.5	0-60	0-2.5	325	
PHR60-5	0-60	0-5	395		

\*Lower current models also available, at lower prices

†Write for discount prices on larger quantities

A. For Automatic Overvoltage Protection (OV) add \$90 per unit.

B. For Automatic Overvoltage Protection (OV) add \$95 per unit.

C. For Automatic Overvoltage Protection (OV) add \$95 per unit, except for Model PHR60-5, \$125.

# TRYGON

## ELECTRONICS INC.

111 Pleasant Avenue

(516) FReeport 8-2800

Roosevelt, L.I., N.Y.

TWX (516) 868-7508





---

## Consumer electronics

---

### Music with a bounce

Stereophonic music is a delight to the ear but often an offense to the eye. The large speakers that have to be separated physically to produce the enveloping effect of stereo are connected by wires to the record player. This frequently results in a hazardous, unsightly tangle of wiring in the living room or den.

Now the CBS Laboratories, a division of the Columbia Broadcasting System, have developed a single-unit phonograph that produces high-quality stereo sound without large speakers or outside cables. The Columbia Stereo 360 creates stereo sound by playing the sound out both sides of the phonograph and then reflecting it off the walls of the room.

To produce high quality sound, CBS has turned the record-playing compartment into an acoustic chamber, and coupled it to the bass speakers. Since volume of a speaker is an important factor in tone quality, CBS adds the volume of the chamber to that of its six-inch bass speakers. It even put a false bottom on the instrument to increase the volume further and improve tone quality still more.

This novel approach is the brain-storm mainly of Peter Goldmark, director of CBS Laboratories. It was Goldmark who developed the long-playing record in 1948.

The new phonograph is only 22 inches wide, about 30 inches long, and 6 inches high. Six speakers, three on each side, are squeezed into its functional shape. Two are bass, two are medium and two are high-frequency speakers.

**Bouncing sound.** While listening to music at concerts and studying its path to the audience, Goldmark discovered that nearly three-quarters of the sound was produced by reverberations coming

from every direction. He thought he might be able to build a stereo set based on the same principle.

Placement of the phonograph can affect, to some extent, the fidelity of the sound reproduction. CBS recommends it be positioned diagonally in the corner of a room so that sound from each side of the instrument bounces off a wall and back into the room.

**Transistorized amplifier.** To fit the electronics into the flat front edge of the unit so they would not intrude into the acoustical record-player chamber, Goldmark built two solid-state amplifiers that draw little power, only 15 watts apiece. Each amplifier is designed as a push-pull transistorized circuit so neither needs transformers. This reduces the total number of components and the cost. CBS claims that the elimination of the transformers also improves the amplifiers' fidelity since these components can cause distortion.

**High quality, low price.** Though Goldmark is most proud of the fine quality sound his compact stereo produces, he is almost as proud of its cost. The new unit will retail for about \$250, far below the cost of most stereo units capable of the same high fidelity.

---

## Communications

---

### Rescue radio

To an airman downed at sea, the next best thing to a rescue vessel would be a radio beacon sending out a distress signal, loud and clear. It would be reassuring if he had some way of knowing that the equipment worked. If the set also allowed two-way talk with rescue parties, so much the better. And if a distress signal could be sent, even though the flier were unconscious, his chances for survival would be increased tremendously.



Peter Goldmark and his compact stereo

Advances in microelectronics are making all this possible. At the Naval Air Test Center, Patuxent River, Md., first models of a new pocket-sized two-way radio and beacon are being evaluated. Developed for the Navy by Sylvania Electronic Systems, a unit of the General Telephone & Electronics Corp., the AN/PRC-63 is designed around thin-film hybrid microcircuits. It is believed to be the first operational uhf transceiver using microelectronics.

The set weighs about 16 ounces and includes a self-contained helical antenna. There is no need for whip wires in airmen's flying suits or for protruding antennas. The aluminum helix is topped by a plastic radome. The 14-cubic-inch package also includes a rechargeable nickel cadmium battery. A silver cadmium cell under development for future models is about half the size of the nickel cadmium battery.

**Vest-pocket size.** Carried in a flier's life vest, the PRC-63 will operate automatically in the beacon mode. When a flier's chute opens, a

switch activates the beacon. Even if the airman loses consciousness during ejection from a fast-moving jet the signal is sent. A distinctive chirp is emitted at the survival-call frequency of 243 megacycles. The chirp is initiated with square-wave amplitude modulation at 1,000 cycles per second. It is then dropped in frequency to 300 cps by frequency modulating the wave.

The beacon uses a side-tone monitor technique. Operating as a detector of output power, it "steals" only about one milliwatt, and provides the pilot with comforting proof that the unit is operating even before he succeeds in communicating with search parties.

In the beacon mode, the AN/PRC-63 puts out 250 milliwatts peak. On voice transmission, the carrier output drops to about 60 milliwatts. The battery can operate the beacon for at least 24 hours.

The microelectronic circuitry occupies only two cubic inches. It is designed to operate in temperatures from  $-60^{\circ}\text{C}$  to  $60^{\circ}\text{C}$ . A metal case and the plastic radome allow the beacon-transceiver set to function even after exposure to the pressure under 50 feet of salt water or at an altitude of 40,000 feet.

**Receiver and transmitter.** The receiver is a superheterodyne unit including a radio-frequency preamplifier and a crystal-controlled local oscillator. Automatic gain control is designed into the receiver circuitry. Sensitivity of the receiver is about five microvolts, and band width about two megacycles.

The transmitter is crystal-controlled, and the overtone oscillator at 121.5 Mc drives the final stage at 243 Mc. Transmitter design includes provision for beacon modulation and also an audio amplifier for voice modulation.

## Military electronics

### Jungle sounds

Do jungle creatures — animals, birds, insects—have specific vocal reactions to the presence of men? If they do, and if the differences

can be identified, researchers will have a valuable tool for the development of equipment to detect the presence of enemy guerrillas.

In a research program conducted by the Army, Cornell University and the General Electric Co., men from GE's Advanced Technology Laboratory are recording natural jungle sounds on stereo microphones sensitive enough to pick up sounds inaudible to man. The sounds are recorded at the base station laboratory on a seven-channel tape recorder. Visual monitoring is accomplished with a four-channel oscilloscope, in addition to a regular headset listening device. After the natural sounds have been recorded, U.S. Army troops move into the jungle and the animal and bird reactions are recorded.

**Warning alarm.** In yet another program, Texas Instruments, Inc., has developed a device that it says can detect and warn of movements within an area of about six square miles. The SID-150—or seismic intrusion detector—monitors waves in the sub-audio range of 15 to 30 cycles per second, converts them to audible sounds through an am-fm modulator, and sounds a warning alarm to an operator.

The main console weighs eight pounds and operates on six flashlight batteries. It comes equipped with four seismometers, each weighing 13.5 ounces.

The company says that even the sounds of a man creeping through underbrush a mile away will be



People detector is tested in the field.

picked up by the device. It may not help much—the operator must decide whether the sounds are made by friend or foe.

## Solid state

### Passivating transistors

Passivation—the growth of an oxide layer on the surface of a semiconductor—provides electrical stability by isolating the transistor surface from electrical and chemical conditions in the environment. Without passivation, normal mesa etching leaves the base-collector and emitter-base junctions exposed. This results in high reverse-leakage currents, low breakdown voltages, low betas at low currents and low power dissipation rating. Now, Hitachi, Ltd., a Japanese electronics firm, has developed a way to passivate silicon mesa transistors.

Most transistor makers use the planar technique, which eliminates the mesa etching process. But while avoiding electronic problems, they have run into patent problems with the Fairchild Camera & Instrument Corp. whose Semiconductor division claims the basic patent on the planar process. They have also had to make large investments in new facilities to mass-produce planars.

Hitachi avoids both pitfalls by using a passivated silicon mesa transistor which it claims is competitive with planar transistors in both cost and performance. Electrical characteristics include long life, collector breakdown voltages in excess of 200 volts, and gain maintained to low values of collector current. Heat dissipation ratings are 35 milliwatts for a TO-1 cold-seal can, 750 milliwatts for a TO-5 ring-weld can with no heat sink and 2 watts for a TO-5 can with a heat sink.

The new product line is aimed at the entertainment industry. A complete line of hermetically sealed transistors produced with the passivation process would have applications ranging from low-level d-c amplifiers through moderate power vhf amplifiers. Hitachi says its her-

metically sealed transistors are more reliable than resin mold planar units now in use.

## Avionics

### Space-fuel gauge

A radioisotope gauge coupled to a microcircuit computer will be used aboard the Apollo spacecraft to give spacemen some vital information. It tells how much fuel they have.

Absence of gravity in space permits fuel to slosh around in the tanks; therefore conventional measuring techniques, based upon the fuel level, are unsatisfactory. Instead, 200 cobalt-60 sources are embedded in one side of a glass fiber blanket that surrounds the fuel tank. Scintillation detectors on the other side of the blanket measure the radiation rate, which increases as the fuel is used and the chamber empties.

The detectors convert the gamma rays from the cobalt into light pulses, and direct them to the base of a phototube which, in turn, sends out a series of electrical impulses that are routed to a small computer. The computer, designed by the Giannini Controls Corp. which developed the gauging system, includes about 2,000 diode-transistor-logic microcircuits manufactured by the Signetics Corp. Outputs from buffer amplifiers on the propellant tanks are fed to the computer.

Fuel levels are displayed digitally on Nixie tubes, after conversion from binary to decimal form. They are also telemetered to the ground.

**A snap.** The system is easy to install. It snaps into place on the propellant tanks, reducing the interface required between the tanks and the gauging system and eliminating the necessity of placing probes or other sensors directly into the fuel.

Giannini is developing the gauge under a contract with the Space and Information Systems Division of North American Aviation, Inc.

## Advanced technology

### Bomb detectors

An average of six lives a year have been lost since 1933 as a result of bomb explosions on American civilian aircraft. Now the Federal Aviation Agency is testing two electronic methods of finding bombs before they can do any damage.

One method involves detecting tiny amounts of vapor that are given off by all types of explosives. The other uses a nuclear coincidence indicator to respond to nuclear tracers, such as cobalt 60, that would be placed in bombs' percussion caps.

**Encouragement.** Vapor detection is the subject of a \$39,000 project at the IIT Research Institute in Chicago. The one-year study, scheduled for completion in December, aims at establishing some basic facts that may lead to a fool-proof bomb-finder. Results so far are "encouraging," according to Andrew Dravnieks, science adviser.

Dravnieks, a physical chemist by training, says feasibility studies are being made on a detection system "based on physico-chemical processes and electronic detection and information processing."

A report on the percussion-cap studies is due in about a month, according to William C. Richardson of the FAA's program-development services. The present phase of the studies deals with radioactive isotopes that are put into the caps.

Even if the isotope technique works technically, it will face formidable economic and logistic problems. All makers of percussion caps in this country and abroad would have to agree to insert the radioactive tracer material. Another problem is the possible danger to the manufacturers' employees from exposure to radiation.

### Sun-pumped laser

Electro-Optical Systems, Inc., in Pasadena, Calif., has developed a sun-pumped laser that can be

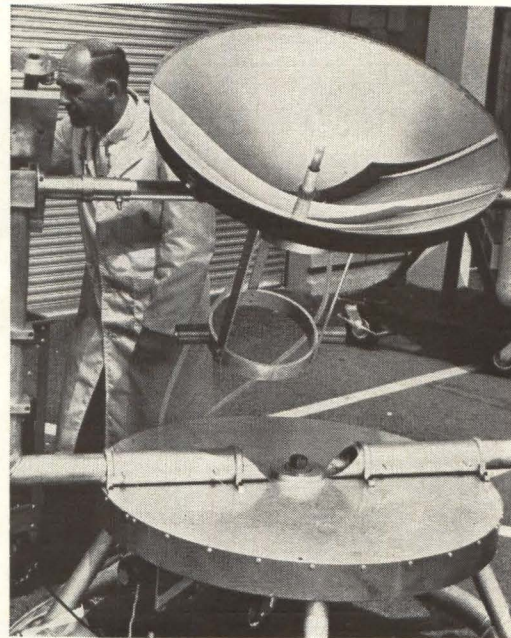

Parabolic mirror concentrates sun to pump laser.

carried aboard a satellite and modulated to provide an optical communications system. The work was done under an Air Force contract.

The sun-pumped laser weighs less than electrically pumped lasers that need power supplies, capacitor banks and flash tubes; and it eliminates the dangers inherent in present-day chemically pumped lasers, several of which have exploded during pumping.

The key to the sun-pumped device is a new laser crystal, an yttrium aluminum garnet crystal rod, which has a very low threshold and doesn't have to be cooled down to cryogenic temperatures, as did previous sun-pumped lasers. The special garnet is doped with neodymium to emit at 1.06 microns, and is surrounded by a water-filled cooling glass flask that serves as a liquid lens.

The sun's energy is concentrated by a paraboloidal mirror 30 inches in diameter. So far, this mirror has pumped up a continuous-wave laser to produce 25 milliwatts at 300° K in ground-level sunlight. The company says that in space, without atmospheric effects, a mirror of half that area could operate a continuous-wave laser at over one watt.

**Manufacturing**

**Circuits by the yard**

**Take two facts:** Silicon crystals can be grown in thin, narrow strips several yards long, called dendritic webs, and electron beams can expose the photo-resist needed to make integrated circuits on silicon crystal. Put these together with computer control and the automated production of one-of-a-kind microcircuits becomes an attractive possibility.

The web could serve as its own conveyor belt, going from the crystal-pulling furnace into a series of masking, etching, diffusion and deposition machines that would fabricate one circuit after another on the web. At the end, single circuits, or series of circuits connected as a subsystem, could be snapped off and packaged.

Such a production system is now only a far-off goal for researchers at the Westinghouse Electric Corp.'s labs near Pittsburgh. In 1959, when Westinghouse first proposed such a system, it wouldn't work with conventional photo-resist masking methods. But now Westinghouse believes it has nailed down that problem by exposing the photo-resist with electronically controlled electron beams. Operating transistors, including field-effect devices, have been made using the beam technique. In present experiments, as many as 12 integrated circuits are made on short pieces of web.

**Electron-beam masking.** The work on masking is part of a much larger, long-term project at Westinghouse. The company is concerned with the use of electron beams to make and test semiconductor devices automatically. The program, partly sponsored by the Air Force, has been under way for several years. The primary research tool is a scanning electron microscope [Electronics, July 28, 1961, p. 39].

The microscope's electron beam can be focused to a spot size of 0.1 micron and used to cross-link the polymers in thin layers of

photo-resist. Thus, in a few seconds, complex patterns only a few microns square can be developed in the resist. The electron beam is synchronized with a flying-spot scanner that scans a large pattern on film. The electron beam goes on and off as the scanning beam sees opaque or transparent areas on the film.

This technique avoids the tiny, precision, mechanical masks generally used to optically develop photo-resist for etching and diffusing. Mechanical masks cost little per circuit when circuits are mass-produced, but can raise the cost of one-of-a-kind circuits to hundreds or thousands of dollars.

Even the inexpensive patterns used by the electron beam system may be eliminated. Westinghouse is completing a new microscope that is digitally controlled. With it, computer-prepared programs on punched cards could be used to control the electron beam.

**The web.** Dendritic webs aren't new. Westinghouse, for example, announced transistors made on webs in 1959 and the Philco Corp. was feeding germanium webs to its automated transistor production lines by 1960 [Electronics, Sept. 11, 1959, p. 98, and Nov. 11, 1960, p. 128].

Unlike the conventional rod-shaped crystals, webs don't have to be sliced, lapped and etched. They come out of the furnace with a mirror-like finish. A recent Westinghouse-Air Force report on the use of webs for solar cells and transistors estimates the cost of usable diced crystal as one-fifth that of conventionally prepared dice and says they're just as good.

But the shape of the web frustrates attempts to use them for integrated circuits. It is more efficient to use a large slice of crystal rod if hundreds of circuits are to be made at a time using optical masks. Also, a web is shaped like an I-beam. A web 0.3 inch wide may have dendrites, or side rails, 0.06 inch high. A mechanical mask can't sit directly on the web. Even if the rails are trimmed off, the web isn't perfectly flat. Both conditions distort the pattern developed in the

resist when a mask is used. This becomes a serious problem when tiny, precise patterns are needed. It's no problem for the electron beam; it can be aimed directly onto the web.

**Instrumentation**

**Cloud analyzer**

Airports, which analyze clouds electronically to get weather forecasts, now have three technical advances for their radar equipment: a new magnetron, a receiver of added capability, and new facsimile recording equipment. They are designed to improve cloud pictures considerably.

Precise data on cloud size, density and altitude are necessary for flight-weather information. The new, integrated measuring system was developed for the Air Force by the Data and Controls division of Lear Siegler, Inc. Now the Federal Aviation Agency has ordered three systems for its own studies.

The integrated system gathers, processes, transmits and displays weather data. It starts with an AN/TPQ-11 radar making basic measurements. The radar signals are conditioned, processed and displayed, both on a cathode-ray tube and on a hard-copy facsimile recorder.

**Inside the cathode.** Probably the most radical change is in the design of the magnetron tube that generates the radar beam. The

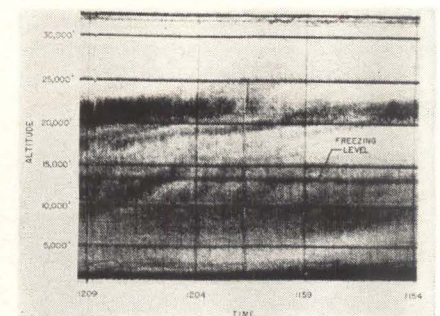

A cloud profile facsimile recording made by the AN/TPQ-11. The moisture freezing level (dark line) is shown at 13,000 feet. Variations in cloud density are indicated by the white and black shading.

**Only  
Lambda  
offers**

**1/4 rack  
power supplies  
with multiple current ratings**

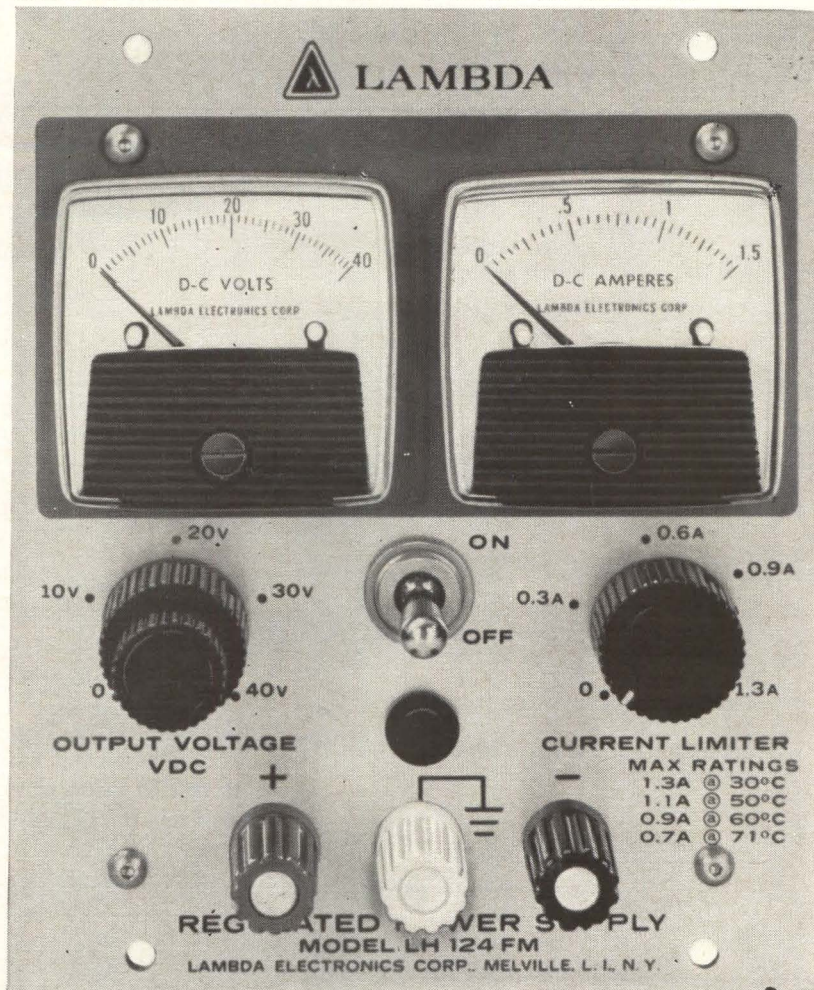

PATENTS PENDING



- Now LH Series is available in 0-10 VDC as well as 20, 40, 60 VDC 1/4 and 1/2 rack models.
- Multi-Current-Rated™ up to 71°C.
- Modular-Subrack design for bench, chassis and rack use.

- Regulation—.015% or 1 MV (line or load)
- Ripple—250 microvolts rms, 1MV P-P
- AC Input — 105-135 VAC, 45-480 CPS.
- Size: LH 118, 121, 124, 127 — 5 3/16" x 4 3/16" x 15 1/16"  
LH 119, 122, 125, 128 — 5 3/16" x 8 3/8" x 15 1/16"

Model	Voltage Range	CURRENT RANGE AT AMBIENT OF: (1)				Price (2)
		30°C	50°C	60°C	71°C	
LH 118	0-10VDC	0-4.0A	0-3.5A	0-2.9A	0-2.3A	\$175.00
LH 119	0-10VDC	0-9.0A	0-8.0A	0-6.9A	0-5.8A	\$289.00
LH 121	0-20VDC	0-2.4A	0-2.2A	0-1.8A	0-1.5A	\$159.00
LH 122	0-20VDC	0-5.7A	0-4.7A	0-4.0A	0-3.3A	\$260.00
LH 124	0-40-VDC	0-1.3A	0-1.1A	0-0.9A	0-0.7A	\$154.00
LH 125	0-40-VDC	0-3.0A	0-2.7A	0-2.3A	0-1.9A	\$269.00
LH 127	0-60VDC	0-0.9A	0-0.7A	0-0.6A	0-0.5A	\$184.00
LH 128	0-60VDC	0-2.4A	0-2.1A	0-1.8A	0-1.5A	\$315.00

(1) Current rating applies over entire voltage range. DC OUTPUT Voltage regulated for line and load.

(2) Prices are for non-metered models. For metered models and front panel controls, add suffix (FM) to model number and add \$25.00 to the price. For non-metered chassis mounting models, add suffix (S) to model number and subtract \$5.00 from the non-metered price.

SEND FOR LAMBDA CATALOG



**LAMBDA ELECTRONICS CORP.**

515 BROAD HOLLOW ROAD • MELVILLE, L. I., NEW YORK • 516 MYRTLE 4-4200

SALES OFFICES AND REPRESENTATIVES CONVENIENTLY LOCATED IN MAJOR CITIES

LA155

Circle 35 on reader service card

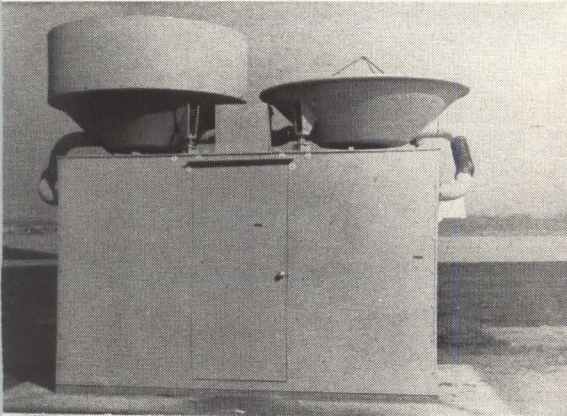

A side-lobe suppressor element has been added to the transmit antenna of the new AN/TPQ-11 weather radar installation at Hanscom Field, Mass. Both the transmit antenna (left) and the receive antenna (right), have improved de-icing and drying facilities.

cathode now surrounds the anode, instead of the opposite way.

This inverted approach increases the life of the tube. With a larger cathode area, cathode flaking—a major contributor to tube failure—is negligible because the larger area reduces the peak current density in the cathode. Two other tube diseases—loss of emission and cathode poisoning from arcing and high current density—are also cured by the new design.

Magnetrons operating in the Ka-band—where the weather radars function—are particularly sensitive to these ills because the working elements of the tube have to be so small. Tubes with the new design have operated more than 3,000 hours without failure.

The new tube, an inverted coaxial type, can generate 100 kilowatts of peak power at Ka-band propagated through the top of the tube by a circular waveguide. The r-f energy is coupled into the tube's cavity by slots through the anode.

**No place to hide** Adding a range normalization system to the receiver produces a target signal of the same amplitude whether the target is 1,000 or 30,000 feet from the antenna. Normalization is available in two stages: 500 to 15,000 feet and 500 to 30,000 feet. This permits forecasters to measure cloud density.

The receiver also offers a choice of linear or logarithmic output plotted against linear input. With logarithmic output, a forecaster can examine signal returns of large dynamic range.

In either case, the receivers have excellent characteristics: in logarithmic phase, within  $\pm 1$  db of the theoretical curve from 5 to 65 db above the noise level; in linear mode, within  $\pm 1$  db of the theoretical from noise level to 15 db above noise level.

**Seeing the clouds.** A forecaster can see a cloud formation immediately on a cathode-ray tube, or he can wait for a permanent record from a facsimile recorder. The new recorder operates in two modes instead of one: normal where the recorder dot is proportional to the intensity of the signal, and quantized where the recorder dot is a quantitative representation of it.

In the quantized mode, however, target density levels are recorded in only four densities: 0 to 10, 10 to 20, 20 to 30 and over 30 db above noise level. Three different shades of gray represent the first three. The fourth gray shade is white or iso-echo. Clouds are outlined by variations in the four gray shades.

## Microelectronics

### Plasma anodization

A simpler and more efficient way to manufacture better thin-film microcircuits is claimed by the General Instrument Corp.'s Applied Research Laboratory.

The two scientists who developed the method, George J. Tibol and William M. Kaufman, use plasma anodization instead of wet anodization to make passive thin-film circuits. The technique permits fabrication of the circuits in a single pass through a bell-jar system. With the wet-anodization method, the microcircuit must be removed from the vacuum system so it can be immersed in an anodizing bath. Carrying out this process, between two vapor deposition steps, increases the danger of

contamination.

**Method.** Plasma anodization consists of using a low-pressure gas plasma of oxygen ions as the electrolyte to anodize evaporated aluminum films on a glass substrate. The plasma of charged particles is formed by a continuous electrical discharge in the bell jar at about 50-microns pressure. A d-c potential applied between an aluminum film and a cathode causes a current to flow and the surface of the aluminum film to be oxidized. Electrodes of aluminum are applied by vapor deposition without opening the bell-jar system to the air.

Higher capacitance per unit area can be obtained with multi-layer capacitors; these are made by alternating the deposition and anodization steps. Thus far, nearly 100% of the capacitors made this way have been free of pinholes.

**Electrical characteristics.** The aluminum-oxide film has a capacitance of 0.2 microfarads per square inch after anodizing at a 50-volt potential. The temperature coefficient of the capacitance is +340 parts per million per degree centigrade between 55°C and +150°C. The capacitance decreases 2% from one kilocycle to one megacycle while dissipation factor is 1% at one megacycle.

## Space electronics

### In a spin

On Sept. 8, when 19 of the 20 experiments aboard the Orbiting Geophysical Observatory were, at long last, working, the National Aeronautics and Space Administration called the satellite a success.

There had been a lot of breath-holding until then. Two of the six booms that should have extended fully, once the satellite went into orbit, failed to unfold.

One boom, 22 feet long, carried a magnetometer experiment at its end. The other, four feet long, was equipped with an ultrahigh-frequency omnidirectional antenna and carried a spherical ion and

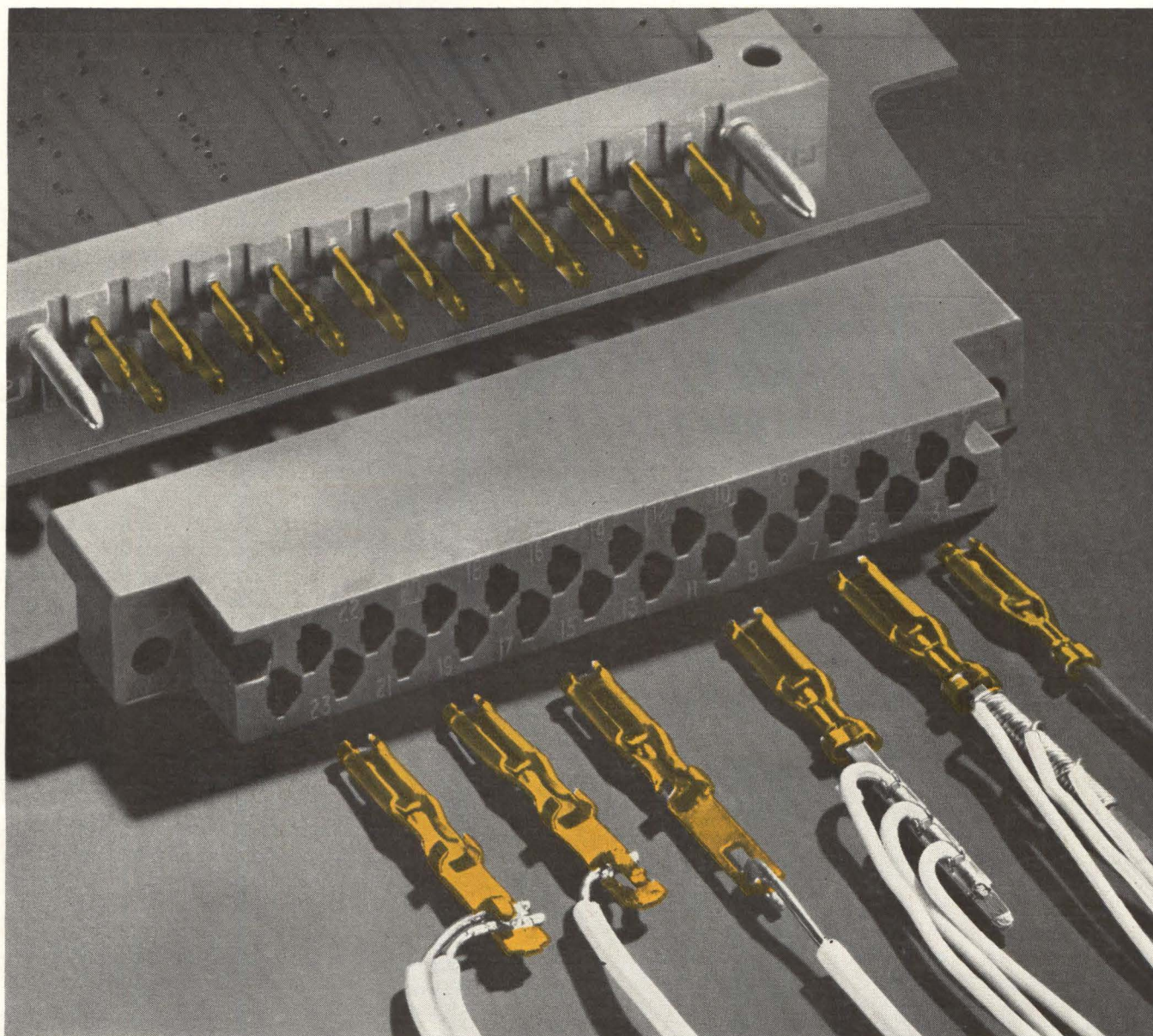

## Do it your way

Crimp, solder, weld, wrap . . . *name your method!*

If you have to live with solid wire, you can spot weld or make wrap-type terminations. If the application calls for stranded wire, soldering or crimping may be more your speed. Better yet, make TERMI-POINT\* clip applications using either *solid or stranded wire*. This new technique lets you cut, strip and terminate the conductor—all in one convenient operation—to make gas-tight, easily serviced post connections.

Here is real back end versatility in a printed circuit connector that's way out front in performance. Select any one of *five terminating methods*. Any way you wire it, our two-piece blade-type connector gives you all these precision engineered features:

- staked down half, clinched to the board, minimizes warpage
- gold over nickel plated contacts prevent oxide creep

- low porosity of contact plating assured by AMP's exclusive X-ray measurement
- three areas of contact provide maximum redundancy
- staggered cavity arrangement offers high density potential
- Available in 17, 23, 29, 35, 41 and 47 positions —for 1/16 in. and 3/32 in. boards

Write today for complete details on this two-piece connector to fit your particular termination requirements.

\*Trademark of AMP INCORPORATED



A-MP\* products and engineering assistance are available through subsidiary companies in: Australia • Canada • England • France • Holland • Italy • Japan • Mexico • West Germany

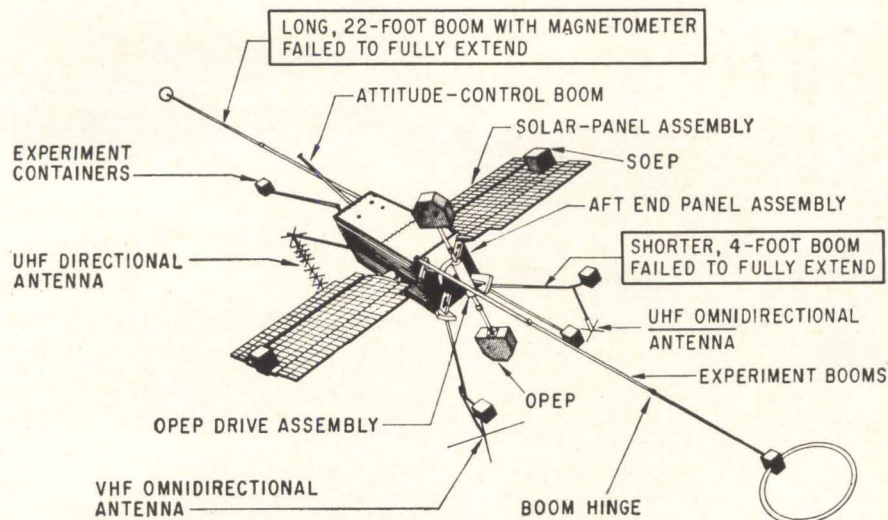

**OGO ran into trouble** when a partially extended four-foot boom obstructed the view of an infrared horizon sensor that controls attitude orientation. Another boom, 22 feet long, also failed to extend fully.

electron trap experiment. The four-foot boom is blocking the satellite's infrared horizon scanners. This prevents the satellite from locking onto the earth, so OGO is now spinning at the rate of five revolutions per minute. Nonetheless, NASA hopes to get the remaining experiment—a radio propagation experiment—working.

The cause of the failure of the two booms to extend fully is still undetermined. Nor is it known whether the spacecraft will produce full experimental data as programmed. The quality of the data already received ranges from "outstanding to marginal."

## Electronics abroad

### One-gun picture tube

Early next year the Sony Corp. will market a color television set built around a new, 19-inch, one-gun picture tube. The initial price, in Japan, will be about \$565. Later, Sony plans to sell the sets in the United States.

The picture tube is a Chromatron, a type of tube that has vertical color stripes and a deflection grid instead of the color dots and shadow mask of the conventional, three-gun color tube.

This is the second Japanese set using a Chromatron-type tube. Last spring, the Yaou Electric Co. introduced a transistorized color set with an eight-inch tube and a line-sequential system. The Sony set uses the dot-sequential system of U. S. color sets.

**Tube advantages.** Sony says the pictures seen on its set are at least twice as bright as those on conventional tubes. This, it explains, is because the wire deflection grid passes 80% of the electron beam energy to the phosphor color stripes. With the conventional tube, the shadow mask passes only 15% of each of the three beams.

Alternate vertical wires in the grid are connected to form a deflection system. Depending on the voltages between the two sets of wires, electrons passing through the grid are deflected so they hit only red, green or blue phosphor stripes to form the picture.

Research is under way at Sony for a three-gun Chromatron that is expected to be three times as bright as the one-gun tube.

Convergence problems are also eliminated by the use of one gun instead of three. The shadow-mask tubes require vertical and horizontal alignment to obtain color purity, while only horizontal alignment is needed in the Chromatron tube. This makes assembly of the Chrom-

atron tube easier. And because the color stripes are vertical, variations in the earth's magnetic field—which shift vertical positions of the beam—do not affect color purity when sets are moved from one location to another.

The stripe pattern is red-green-red-blue, repeated 400 times across the width of the faceplate. The fundamental three-color element is on one-half of a green stripe, a whole red stripe and one-half of a blue stripe, providing 800 picture elements per line for black-and-white operation. In the actual set, however, the bandwidth of the video amplifier limits resolution to about 300 lines horizontally and the beam spot size limits vertical resolution to about 400 lines.

There are twice as many red stripes as blue or green because the efficiency of the red phosphor is lower.

**Solving the problems.** One of the tougher problems was the interference radiation that is emitted when the grid is driven by a high-power signal at a frequency of 3.58 megacycles. This was overcome by inserting a coil in the tube. The coil tunes out the effects of capacitance between the grids. Capacitance between the grids and coil forms a high-Q tuned circuit. Only losses in the circuit, typically five watts, need be supplied from an external circuit.

Side-by-side operation of two sets, tuned to different stations, proved that Sony's technique worked. One set did not interfere with the other. Had the sets been radiating appreciable amounts of power there would have been interference.

The tuned-circuit method also avoids another problem that can be caused by a high-power signal—heating and thermal expansion that would cause the grid to become loose and make the tube microphonic.

The Sony set uses a new re-encoding circuit to control electron-gun current, but it does the same job as earlier circuits developed in the U. S. The set has 27 other tubes in its circuits and is 20 inches deep.



*feature for feature*

you'll find the

**NEW**

# CLAROSTAT RV6

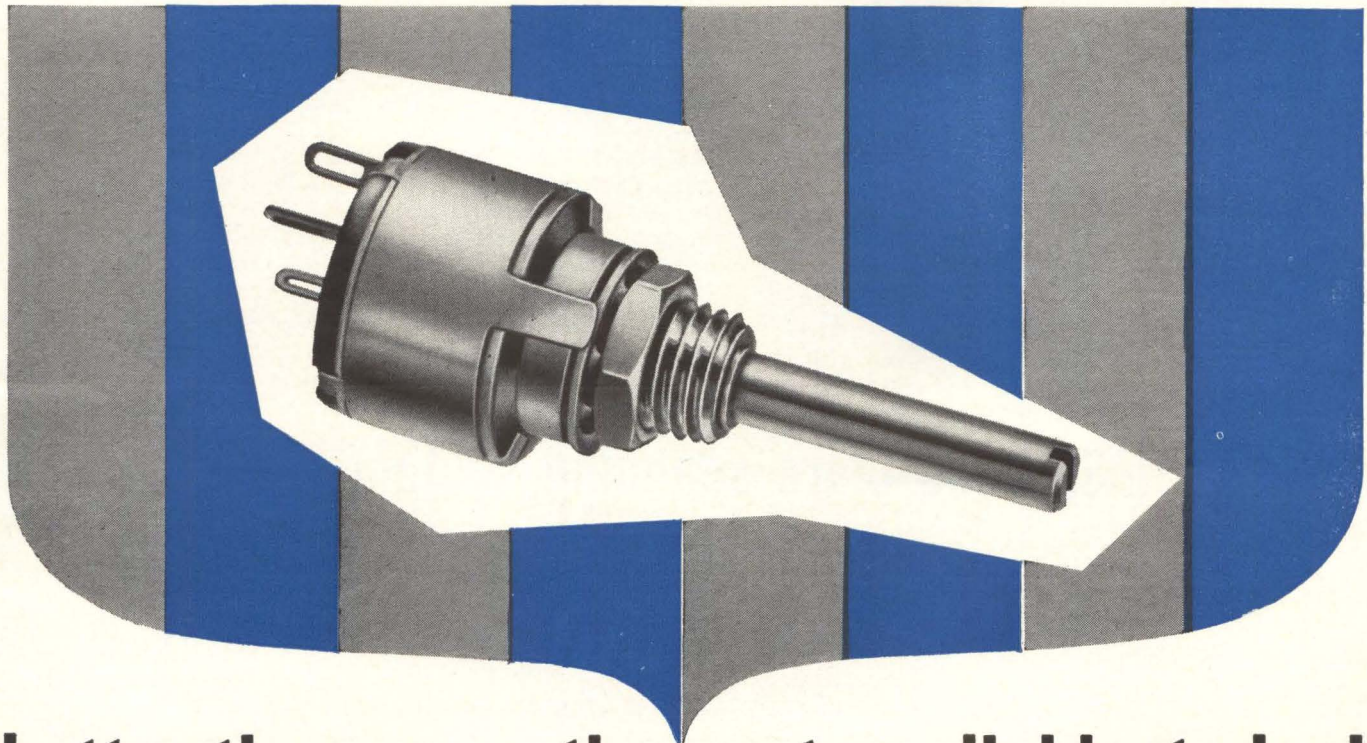

**better than any other pot available today!**

■ *improved design* ■ *upgraded performance*

**SPECIFICATIONS:** True compatibility, carbon-to-carbon and metal-to-metal moving contacts, giving you longer life, greater stability, and a lower noise level. High tensile, stress-relieved beryllium-copper contact spring. Strong metal stops eliminate non-metallic material failures. Power rating: 0.5 watt @ 70°C. Derated to 0 power @ 125°C. 350 VDC across end terminals. Resistance range 100 ohms to 1 megohm, linear. Mechanical and electrical rotation 295° ( $\pm 3^\circ$ ). Voltage

breakdown 750 VAC between terminals and ground for 1 minute. Torque: standard bushing 0.5 to 6 oz. in. Locking type, 20 oz. in. minimum with jam nut tightened to 8 lb. in.

Feature-for-feature the new Clarostat RV6 is designed to work better and last longer. And most important . . . they're in stock at your local Clarostat Military Products Distributor for IMMEDIATE DELIVERY. Call him today for your RV6 requirements at factory prices.

# CLAROSTAT

CLAROSTAT MFG. CO., INC. DOVER, NEW HAMPSHIRE

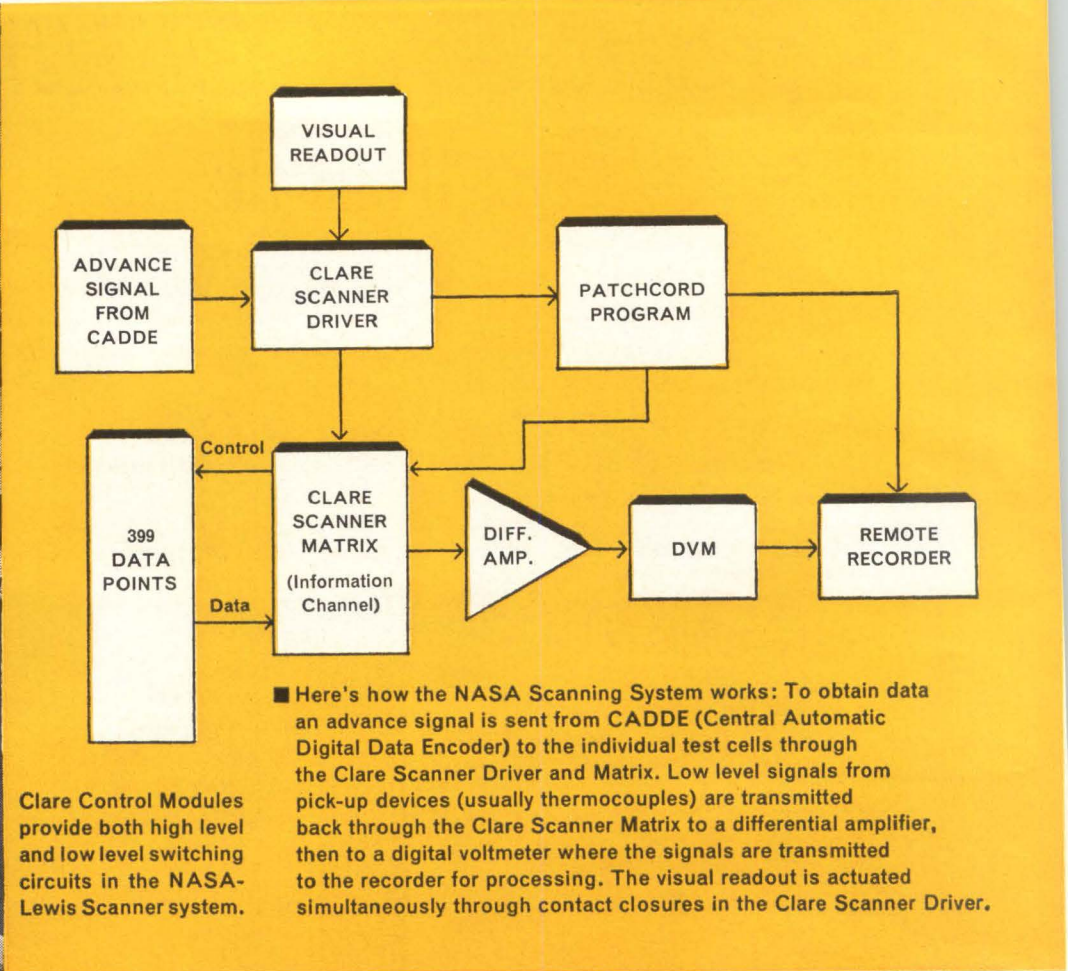

Clare Control Modules provide both high level and low level switching circuits in the NASA-Lewis Scanner system.

## NASA uses Clare scanning system to double speed, eliminate maintenance, assure reliability and reduce system cost

*NASA-Lewis Research Center applies inherent advantages of Clareed® Control to improve data-gathering techniques in space vehicle engine and fuel research*

**Design Problem:** NASA required a system which would scan several hundred data-gathering devices, and provide:

- ...Speed to scan 40 points per second, with inherent capability to function at greater speed as required.
- ...High reliability with freedom from maintenance
- ...Compatibility with existing systems which used relays and solid-state devices
- ...Low cost

NASA evaluations indicated that spring-driven switches (which were previously used) and cross-bar switching were too slow and presented mechanical maintenance problems; solid state devices, with the necessary peripheral circuitry, were too expensive for this size system.

NASA engineers asked Clare to propose a solution to the design problem.

**Clareed Solution:** The NASA system, shown above, represents a typical Clare Scanner function. How does this system utilizing flux logic meet the requirements of speed, reliability, freedom from maintenance, compatibility, and low cost?

Clare designed Scanner Systems separate the matrix from the driver to increase versatility and permit a wider selection of functions in either unit. The driver, with Clare mercury-wetted contact modules providing the control logic, consists of decade counters with selectable set and reset inputs in each decade.

The matrix has a scanning speed capability of 100 cross points per second. This easily meets both present and future switching requirements. The present system sequentially scans 400 points at a speed of 40 points per second and effects five

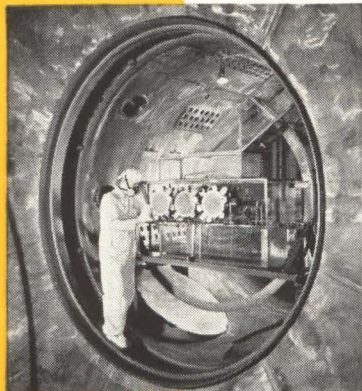

Space vehicle engines are tested in individual cells similar to the one shown here.

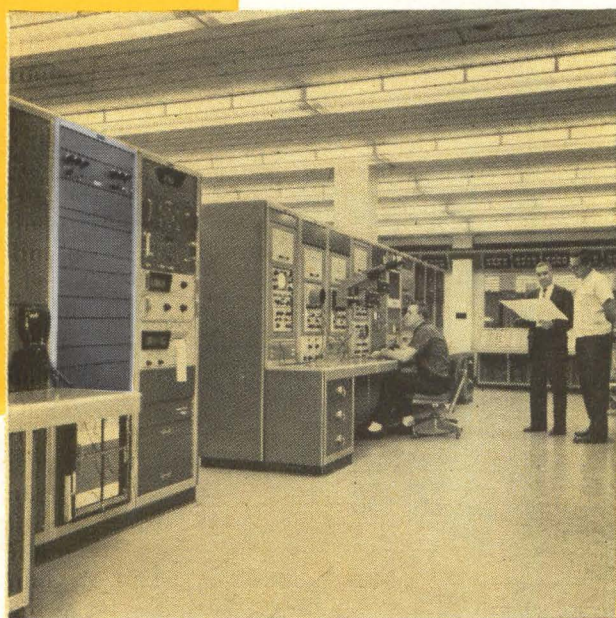

Central Control Room at NASA-Lewis Research Center monitors activities of each test cell. Clare Scanner System shown at left is one of seven specified by NASA.

contact closures at each cross-point. Clared Control Modules provide the high level switching; Clare Type F (Crystal Can) Relays handle low level circuits.

Clare design provides more versatile, flexible programming than is feasible with crossbar or semiconductor switching; and the system can be readily adapted, or expanded, as NASA system requirements change.

In addition, Clare Scanners provide manual access to any one of the 400 points, contact closures at each point to actuate control and program relays or a visual readout, and the capability to select and scan a number of prime interest points.

Simplified Clared Control circuitry reduces overall costs, and (with the inherent reliability of sealed-contacts) assures greater over-all system reliability. The positive off-on characteristics of,

isolated contacts assure accurate test data results. Also, the system is virtually immune to inadvertent operation caused by transient noises and voltage fluctuations.

Clared Control circuitry is compatible with previously used data handling procedures. The advance signal pulse generated by CADDE and the previously used stop-start control pulses are applied without re-design of the existing system.

Clared Systems can be designed to meet the requirements of practically any instrumentation sampling, data logging or control system function requiring multiplexing. Evaluate Clared Control capabilities; you'll see why Clare designed systems can provide reliable, maintenance-free control systems with practical switching speeds...and at low cost.

## CLAREED CONTROL DESIGN CONSIDERATIONS

If you work with control systems, take a look at these Clared advantages. You'll find the plus features you need for your system:

- multiple input and output capabilities, making possible logic at both input and output.
- switching capabilities from low level up to 15va, ac or dc.
- complete isolation between input and output. The output is the contact closure.
- data handling speeds up to 250 bits per second.
- modular printed circuit board construction compatible with modern electronic assembly techniques ... meets the requirement of almost any application or environment.

Standard Clared Control Modules offer versatile, reliable, simplified means of performing these functions:

**In counting:** Three basic flip-flops which can be used in ring counters, bi-directional counters and shift registers for binary, binary-coded decimal, decimal, and radix<sup>(N)</sup> counters.

**In selection:** A variety of selection systems, using a single-mode matrix, a single-mode memory matrix, or a two-mode matrix (Mode 1: all crosspoints normally open; Mode 2: all crosspoints normally closed).

**In logic:** AND, inclusive OR, NOR, NAND, exclusive OR, exclusive NOR as well as more complex logic in a single module.

Want to know more about the versatile Clared approach to modern control techniques? Write for Manual 400, (Clared Control Modules), and Bulletin 1001 (Clare Scanners). We'll answer promptly. C. P. CLARE & CO., Group 9N4, 3101 Pratt Boulevard, Chicago, Illinois 60645.



Another first from **DAGE**

## A PERFECT, WEATHERPROOF CONNECTION in 30 SECONDS

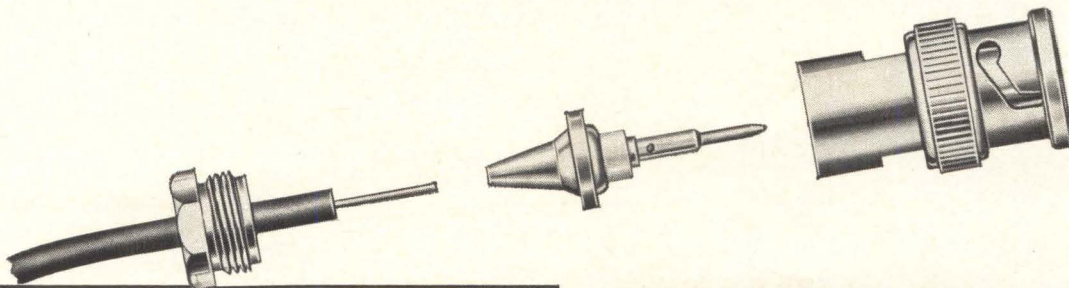

### ASSEMBLY IS THIS SIMPLE:

1. Take one clean square cut through cable insulation, braid and dielectric, exposing  $\frac{1}{4}$ " of conductor. Slip nut onto cable.

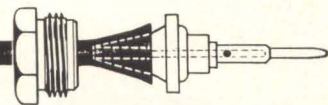

2. Insert conductor into tapered, self-clamping sleeve and contact sub-assembly; force edge of sleeve between dielectric and braid until insulation rides well onto taper. Solder conductor to contact at solder hole. See detail.

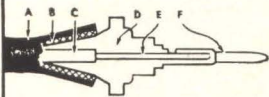

A = Insulation      D = Self-Clamping Sleeve  
 B = Braid            E = Conductor  
 C = Dielectric      F = Contact

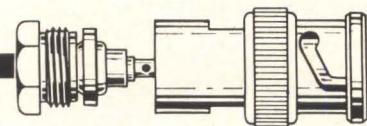

3. Fit contact sub-assembly into connector body; screw nut into body, binding insulation and braid tightly against tapered sleeve . . . thus forming a strong, weatherproof connection.

All illustrations enlarged for clarity

# DAGE SQUARE CUT<sup>®</sup> RF CONNECTORS

(Only 3 Parts . . . No Special Tools Required)

Again DAGE solves a major problem for equipment builders! New DAGE Square-Cut RF Connectors reduce *assembly time* by as much as 50%-75% . . . produce weathertight seals with a pull test of 50 lb.!

No need to comb, flair or taper the braid . . . just one clean *square cut* prepares the cable, then all you do is push, solder and tighten. As simple as that!

Now available for popular cable sizes in choice of silver, gold or NT-34 (Non-Tarnish) finishes.

Call your DAGE representative or write direct to the factory for specifications and prices. Also custom made to *your specs*.

Call or write for literature and prices on the complete line of

**DAGE COAXIAL CABLE CONNECTORS**  
**and PRECISION HERMETIC SEALS**

Engineering service and custom designs for special problems

# DAGE

**ELECTRIC COMPANY, INC.**  
 Hurricane Road • Franklin, Indiana  
 TEL. 317/736-6736

• **FIRST in Ideas** • **FIRST in Quality** • **FIRST in Service**



**If you ship from  
5 to 50 pounds anywhere in the U. S.  
you're missing a bet**

**...unless you check Air Express.**

There are many reasons why. For example, you can actually ship a 20 pound package from New York to Chicago by Air Express for less than motor carrier (\$6.20 vs. \$6.82)...and at a sizable saving in time.

Among air cargo services, Air Express is often cheapest *and* quickest too.

Another point. Air Express rates are figured door-to-door. You only

have one call, one waybill.

And there's more. Air Express can deliver by sunset tomorrow to any one of 21,000 U.S. cities. Pickup is made within 2 hours of your call. Your packages get top priority on every scheduled airline after air mail.

On the ground, 10,500 delivery trucks speed deliveries between you, the airports and your customers. Com-

pare this with any other service.

Air Express is a joint venture of all 39 scheduled airlines and R E A Express. No wonder it gives you the best service in the air and on the ground.

Next time you ship from 5 to 50 pounds, try Air Express. Simply call your R E A Express agent.

**Air Express outdelivers them all... anywhere in the U.S.A.**

**Air Express**

Division of R E A Express



# ALL THESE MEASUREMENTS MADE EASY BY A SINGLE SCOPE—hp 140A!

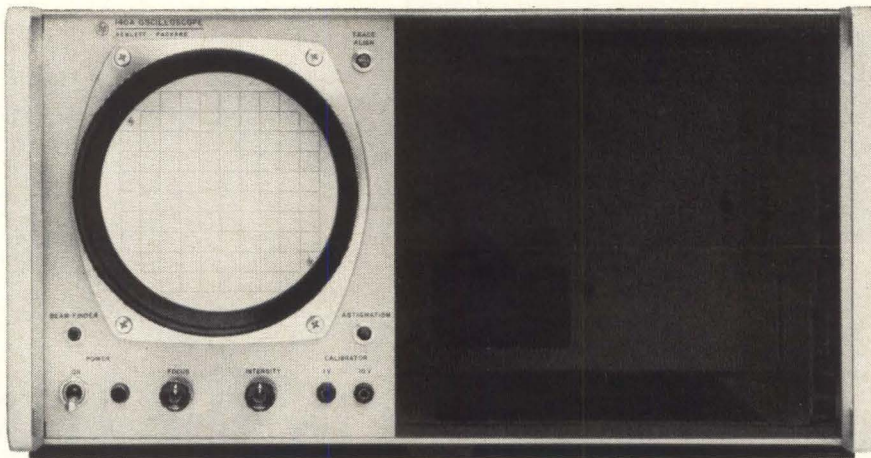

Measure to 20 mc. Measure to  $10 \mu\text{v}/\text{cm}$ . Standard time base or sweep delay. Time domain reflectometry for measuring cable, connector, strip line and other broadband devices. And do it all with one scope—the Hewlett-Packard 140A!

New concepts in oscilloscope design give you a low-cost versatility you've never experienced... a unique plug-in arrangement that lets you buy what you need now, then add to your capability as your need expands. No longer need you buy 3 scopes, match your particular measuring needs against limited specifications. What you need today can be more tomorrow from today's most versatile... and promising scope!

The 140A offers a unique dual plug-in design which permits use of two separate plug-ins, such as one for vertical presentation and one for sweep... or a

single double-size plug-in for special-purpose applications. Plug-ins drive the crt directly, so there's no intermediate circuitry to become obsolete. Two vertical plug-ins may be used simultaneously for x-y measurements. With two dual-trace plug-ins, you can even display two x-y plots simultaneously.

What's more, the 140A gives you unmatched low-cost performance, in addition to its versatility. It does more for you than many of the bulkier and more expensive scopes available today.

Your initial buy on the 140A, the main frame, gives you a bright  $10 \times 10 \text{ cm}$ , non-parallax, internal-graticule crt offering big-picture viewing that makes even pulse applications simple and clear. Wide bandwidth, too, plus plenty of reserve in the solid-state heavy duty power supplies. Even a fan is included to assure low operating temperatures when the 140A is rack mounted.

As for plug-ins, Time Domain Reflectometry (TDR) alone is worth the main frame investment. With TDR, a double-size plug-in for your inexpensive 140A main frame lets you examine and locate discontinuities in connectors, measure  $Z_0$  of cables, examine strip lines, tune broadband antennas and make a host of other measurements—all in a fraction of the time required by the familiar swr techniques. Save countless hours of engineering and production time on all types of broadband devices with a versatile basic scope and a TDR plug-in.

A look at the available plug-ins for the 140A (\$575) indicates what you can measure today. More tomorrow. Why not investigate? Just call your Hewlett-Packard field engineer for a demonstration or for complete data. Or write Hewlett-Packard, Palo Alto, California 94304, Tel. (415) 326-7000; Europe: 54 Route des Acacias, Geneva; Canada: 8270 Mayrand St., Montreal.

Eight plug-ins  
available now:

**1400A**  $100 \mu\text{v}$  Differential Amplifier — Sensitivities to  $100 \mu\text{v}/\text{cm}$  at 400 kc bandwidth for low-level measurements, \$210.

**1401A** 1 mv Dual Channel Amplifier — Sensitivities to  $1 \text{ mv}/\text{cm}$  at 450 kc bandwidth, \$325.

**1402A** 20 mc Dual Channel Amplifier—Sensitivities to  $5 \text{ mv}/\text{cm}$  for pulse and cw work, built-in delay line for viewing rise of fast pulses,, \$550.

**1403A**  $10 \mu\text{v}$  AC Differential Amplifier — Sensitivities to  $10 \mu\text{v}/\text{cm}$  at 400 kc bandwidth; adjustable bandwidth minimizes noise on low-level signals, \$350.

**1405A** 5 mc Dual Channel Amplifier — Sensitivities to  $5 \text{ mv}/\text{cm}$  for TV and other general-purpose work in the 5 mc regions, \$325.

**1415A** Time Domain Reflectometer—Analyze broadband devices; examine and identify discontinuities as close as 1 in. apart, \$1050.

**1420A** Time Base — Sweeps from 5 sec/cm to 50 nsec/cm, triggers beyond 20 mc, \$325.

**1421A** Time Base and Delay Generator — Sweeps from 1 sec/cm to 20 nsec/cm, delays to 10 sec, triggers beyond 20 mc, \$625.

*Data subject to change without notice.  
Prices f.o.b. factory.*

*An extra measure of quality*

**HEWLETT  
PACKARD** 

9612

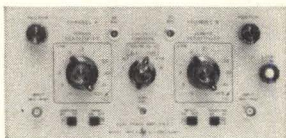

1402A 20 MC Dual Channel Plug-in

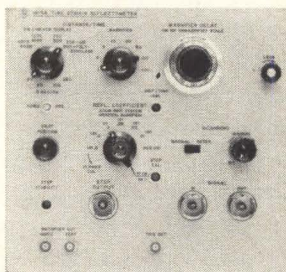

1415A Time Domain Reflectometer

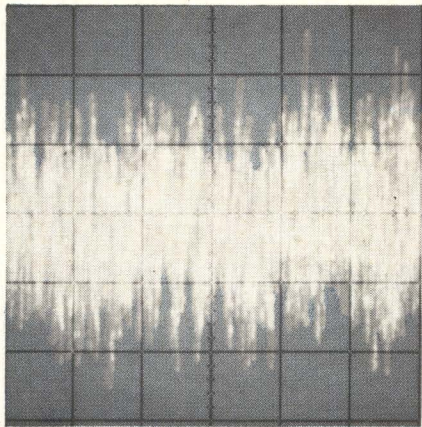

**noise**

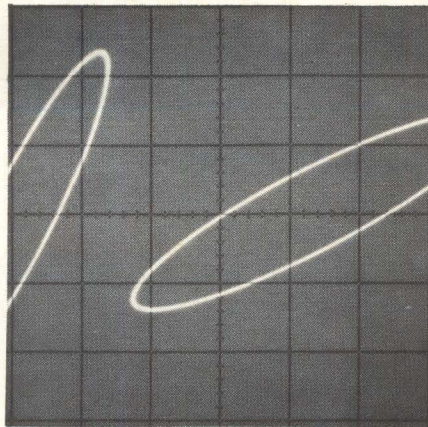

**phase**

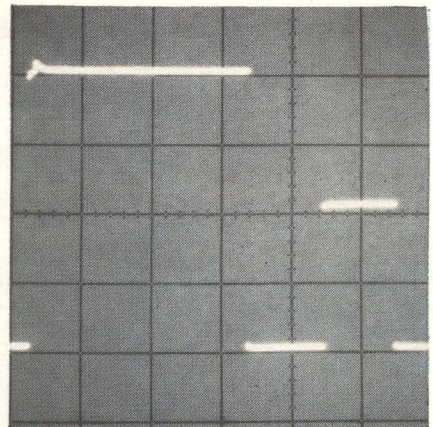

**pulse codes**

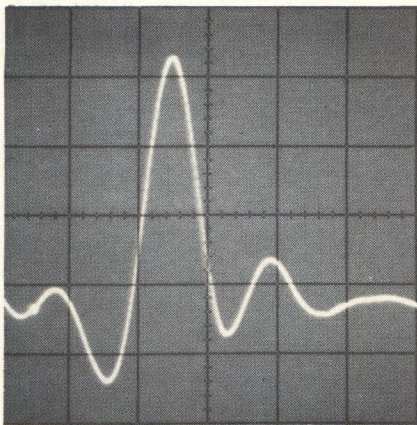

**connector mismatch**

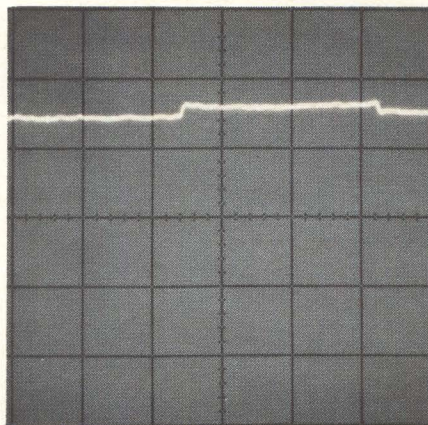

**cable impedance**

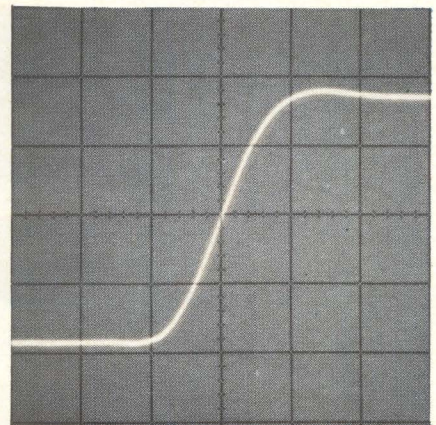

**rise time**

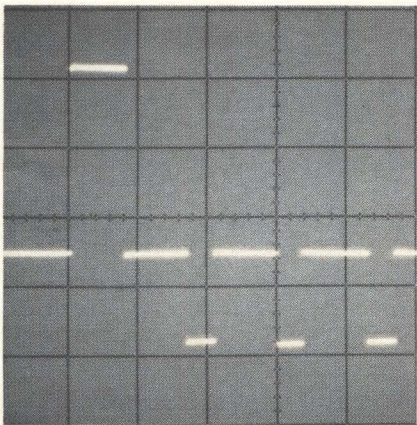

**computer logic**

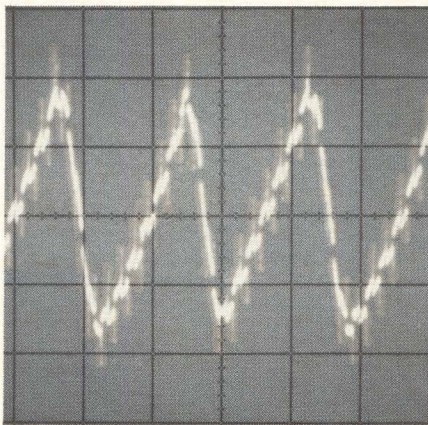

**power supply ripple**

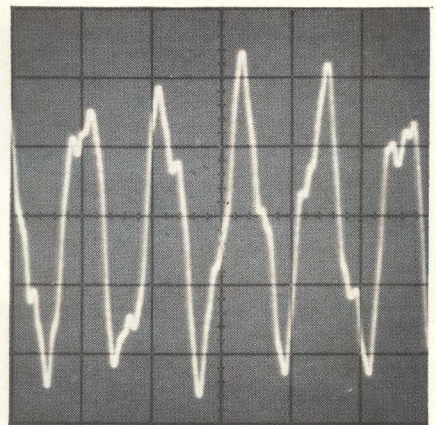

**vibration**

**your trace?**

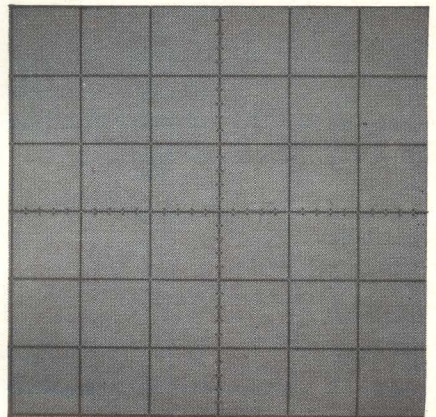

# INTERNATIONAL RECTIFIER ZENER CALCULATOR

Pinpoint Your Zener Diode Needs in Seconds

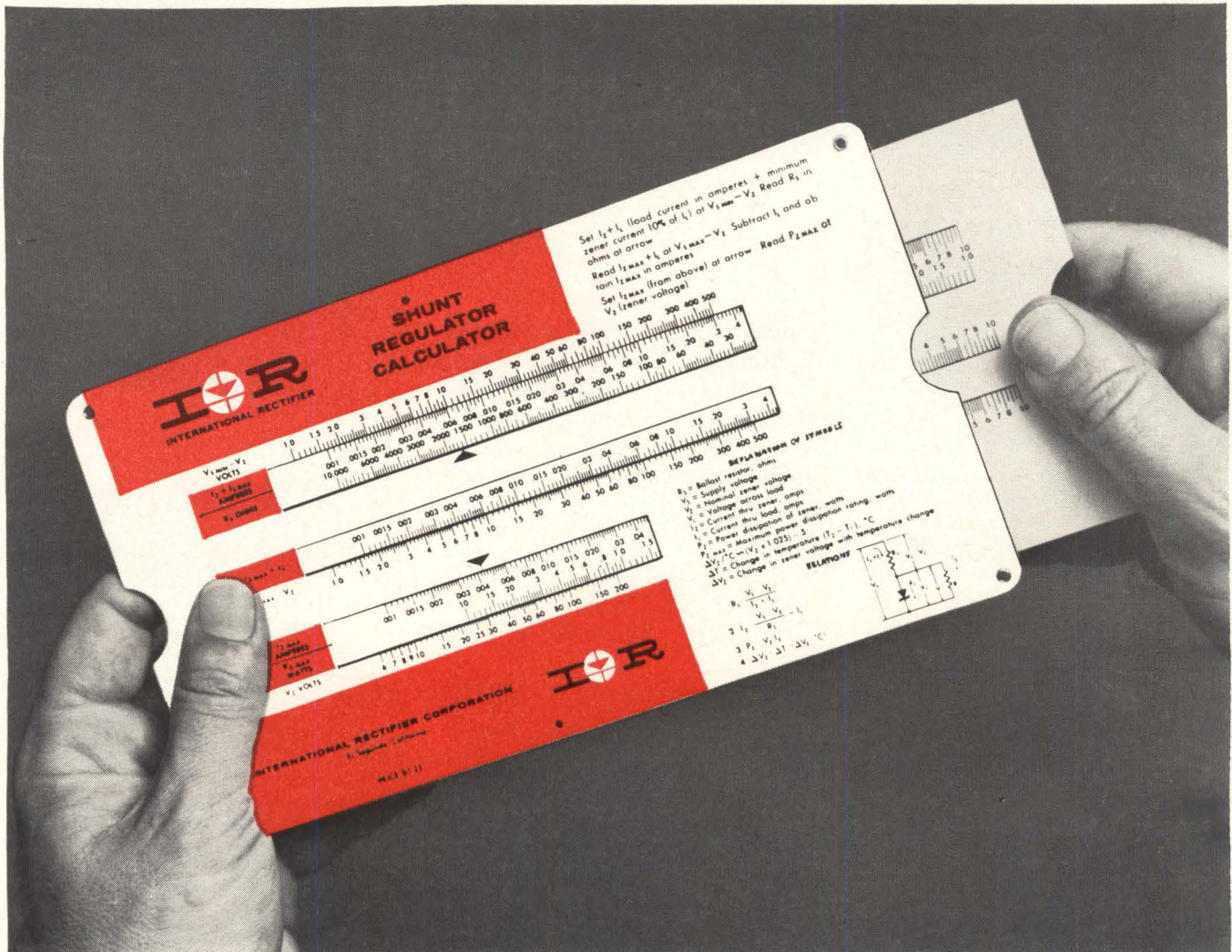

With just two quick slip-stick calculations, this new compact International Rectifier Zener Calculator gives you Zener diode specifications in terms of easy reference JEDEC numbers and case styles. You may obtain this circuit design aid without charge upon written request on your company letterhead to International Rectifier Corporation, 233 Kansas Street, El Segundo, California.

When you specify International Rectifier Zeners you have this unique assurance of performance... a demonstrated in-use reliability index of 99.988%. To meet a wide range of requirements, International Rectifier offers a selection of over 640 types. International Rectifier's sales offices and distribution network throughout the United States provide immediate customer service.



# INTERNATIONAL RECTIFIER

INTERNATIONAL RECTIFIER CORP., EL SEGUNDO, CALIF., PHONE OR 8-6281 • CABLE RECTUSA • REGIONAL OFFICES IN NEW YORK CITY, CH 4-0748 • FORT LEE, N.J., WI 7-3311 • SYRACUSE, N.Y. HE 7-8495 • CAMBRIDGE, MASS., UN 4-6520 • ARDMORE, PA., MI 9-3667, GR 3-3932 • SILVER SPRING, MD., JU 9-3305 • MIAMI, FLA., 445-5201 • CHICAGO, ILL., OR 6-4090 • CLEVELAND, OHIO, 734-4100 • DAYTON, OHIO, 223-7691 • HUNTINGTON WOODS, MICH., LI 8-1144 • ST. LOUIS, MO., TE 8-6333 • MINNEAPOLIS, MINN., 920-1200 • DALLAS, TEX., LA 1-0110 • LOS ANGELES, CALIF., OR 8-6281 • IN CANADA: TORONTO, ONT., PL 9-7581 • MONTREAL, QUE., 861-0562



---

# Washington Newsletter

---

September 21, 1964

## Inventory time for research labs

The first job of the special panel of President Johnson's Science Advisory Committee will be to take inventory. Government officials frankly concede that they have lost track of the extent and even the location of some of the research the government has tackled.

Under Emanuel R. Piore, of the International Business Machines Corp., the committee has been asked to examine the role of government in-house research. There is a suspicion that once begun, government research is self-perpetuating. Research and development firms have become increasingly hostile to the extent of the government's inroads into electronics, radiation, and the whole spectrum of defense, space and nuclear programs.

Government laboratories are created at a far faster rate than they expire. Additions on the way are the \$50-million Electronics Research Laboratory authorized for Boston, and the \$30-million Environmental Health Center to be built near Baltimore. Right now nearly 20% of the Federal research and development budget goes into the government's own research operations.

## McNamara delays briefing sessions

The election campaign has upset Defense Secretary McNamara's plan to brief industry on the long-range defense spending outlook. Briefings scheduled for this month and next in New York, Chicago, Dallas and Los Angeles have been postponed.

McNamara feared that Republican candidate Barry Goldwater would be able to use the sessions as campaign ammunition. Goldwater is saying that McNamara's policies are undermining the strategic power of the United States. If the Administration is returned to office, the briefings will be held in February.

## Bid-riggers face stiffer fines

The Justice Department is using a case involving three temperature-control makers—Honeywell, Inc., the Johnson Service Co., and the Powers Regulator Co.—to test a new way to level higher fines on companies convicted of fixing prices.

Fines in price-fixing cases are moderate compared with the amount of business usually involved in a big conspiracy case. The government collects considerably less than the treble-damages allowed private customers who suffer losses through price fixing.

The strategy of the Department of Justice is to skip the antitrust laws entirely when suing to collect for government losses. Instead, it will bring civil fraud charges that provide for double damages, in addition to a \$2,000 fine for each count. The theory is that anyone who rigs bids on a government contract is defrauding the government in addition to violating the antitrust laws.

Last year, the three temperature-control makers declined to contest the bid-rigging charges and were fined \$105,000. Then last September, the government filed a fraud complaint on the same charges. Everything in the case, including the complaint, has since been sealed. The Justice Department's investigation of hundreds of construction jobs involving

---

# Washington Newsletter

---

control equipment is continuing. It will probably be another year before it gets out into the open.

## Fair-traders revise plans

Backers of Federal fair-trade legislation, aimed at halting sharp discounting of such items as radios and television sets, are revising their strategy. Their chief supporter in Congress, Sen. Hubert H. Humphrey, as vice-presidential nominee, can no longer be counted on for help. **The Johnson Administration is strongly opposed to the fair-trade proposal. Its supporters know they would only embarrass Humphrey by expecting his assistance now.** If the Johnson-Humphrey ticket is elected in November, fair-trade advocates may give up the drive for Federal legislation. They'll concentrate instead on individual state legislatures, with the hope of getting beefed-up bills there.

## Air Force Ass'n chides both parties

The Air Force Association, which has bluntly criticized the Democratic administration's military policies in the past, is taking a nonpartisan stance this year. A policy statement adopted at its annual convention last week **criticizes both Democrats and Republicans for insufficient awareness of the importance of three national security needs:** more national support for research and technological growth, a higher degree of "scientific literacy" on the part of the public, and making the military service as attractive financially and otherwise as civilian employment.

## Study hits plans for R & D dispersal

The Stanford Research Institute disputes some widely-held notions about the structure and dynamics of the defense research and development industry. **The Institute's tentative conclusion, in a study made for the Defense Dept., will be tested in a larger sampling of the industry.**

A view often expressed in Congress is that the Pentagon should use its contract-award power to force a dispersal of the R&D industry from its concentration in southern California, San Francisco, New York City-Northern New Jersey, Boston and Washington. The Stanford group says that economic and social forces accounting for this concentration are so powerful that the forced-dispersal efforts made so far have been largely ineffectual. **To persist in such efforts would be costly and require a lowering of standards of quality and efficiency as the basis for contract awards, according to the report.**

The study also knocks the assumption that a large, nearby university offering graduate courses and extensive research programs would, in itself, attract defense research and development plants. The researchers do say that such plants aid development of local universities by supporting advanced studies, providing part-time faculty members and students.

The report finds that although the turnover rate of the R&D work force is considerably higher than that for all industry, the movement of workers is largely from one military R&D company to another.

## Defense companies keep tax credit

Pentagon financial watchdogs have turned down the Comptroller-General's proposal to take investment tax credits away from defense contractors. They will continue to receive the same credit—up to seven percent of the cost of productive equipment—as nondefense companies. Defense feared taking the credit away would blunt contractors' incentive.

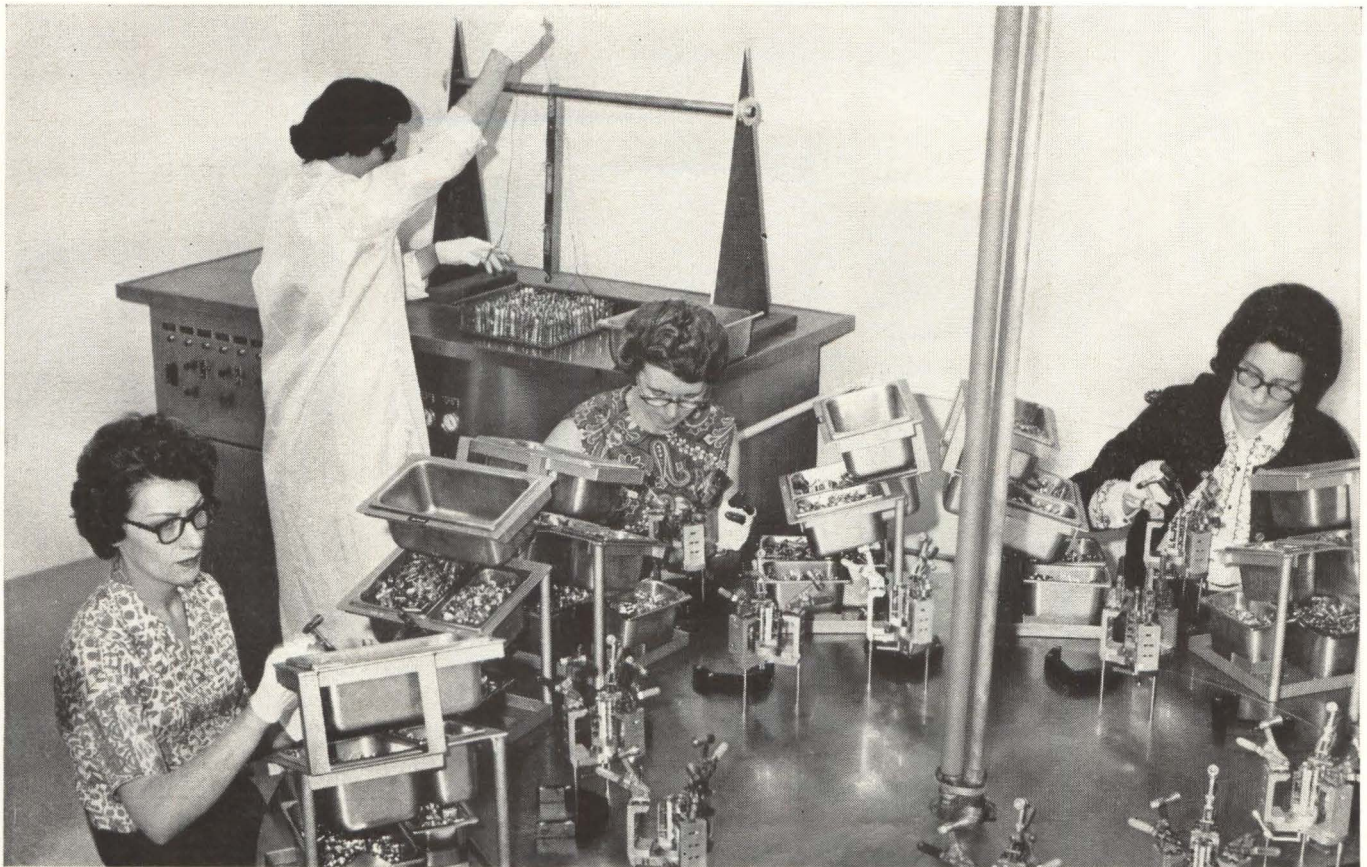

Because FREON solvents are nonflammable, virtually nontoxic and free from irritating odors, Rauland Corp. can safely locate its cleaning equipment directly at the end of its assembly line for maximum efficiency.

## Rauland uses FREON® TF to “super-clean” color-TV picture-tube subassemblies

Cleaning of color-TV tube gun subassemblies is a critical operation because of the extremely high voltages to which they will be subjected. Any particulate matter not removed

could cause arcing and a blown tube . . . any leftover lubricants would seriously affect the rise time and service life of the tube. For this critical cleaning operation, the Rauland Corporation, Chicago—a division of Zenith Radio Corporation—uses FREON TF solvent.

Now, cleaning of the subassemblies is a quick, simple, low-cost operation . . . thanks to a cleaning system engineered and installed by a FREON solvent sales agent. This cleaning system uses FREON TF. The combined action of extremely low surface tension and high density enables FREON TF to penetrate minute crevices and effectively release and float away soils . . . even particulate matter. This results in complete, residue-free cleaning.

If you would like to investigate the many ways you can use FREON solvents in your cleaning operations, mail the coupon at the right.



This combination cleaning system was engineered specifically for the Rauland Corporation by G. S. Blakeslee Co., Chicago, Illinois. It is just another example of the complete cleaning system engineering you can expect from your representative for Du Pont FREON®.

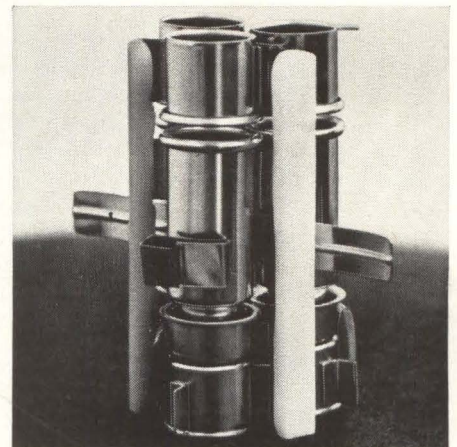

After being cleaned in quick-drying FREON TF, the residue-free subassembly is ready immediately for final processing.

**FREON®**  
SOLVENTS



Better Things for Better Living . . . through Chemistry

Du Pont Co., “Freon” Products Division  
N-2430 E-2, Wilmington, Delaware 19898

Please send information on FREON solvents.  
I am interested in cleaning \_\_\_\_\_

Name \_\_\_\_\_ Title \_\_\_\_\_

Company \_\_\_\_\_

Address \_\_\_\_\_

City \_\_\_\_\_ State \_\_\_\_\_ Zip \_\_\_\_\_

# UNIQUE...

*first low level solid-state unit  
joins industry's most versatile  
line of telegraph relays*

Radiation's new solid-state low level to high level neutral relay is the first of its kind. The unit, Model 9338, is designed for such applications as conversion of low level computer outputs to higher telegraph levels, and for computer/computer switching.

This advanced relay features modular construction and unlimited service life without maintenance. Because it operates at an input level of  $\pm 6$  v at 50 to 100  $\mu$ a, conducted and radiated RFI are greatly reduced.

**Radiation Telegraph Relays** are supplied with octal bases in three standard models (at right). They can replace all electromechanical units except in rare applications. These versatile units are completely solid state, and are powered by input loop current alone.

**Special Plug-In Adapters** are available in all popular types (examples at right), and permit you to update your present system easily and quickly. Radiation can also supply special adapters, units wired for direct replacement, or devices on plug-in printed circuit cards.

All **Radiation Solid-State Relays** operate at speeds up to 2400 bits/second with less than 3% distortion. Input is essentially resistive. They do not induce transients in the line as do electromechanical units. And a unique Radiation circuit protects inputs against abnormal line conditions such as spikes and overvoltages.

In addition, Radiation Relays are extremely resistant to environmental extremes. They require no adjustment, and will operate for an indefinite period of time without attention.

**Radiation engineers** will be glad to assist if you have a unique application or would like help in evaluating system requirements. Write for information, or describe your needs. Products Division, Dept. EL-09, Radiation Incorporated, Melbourne, Florida.

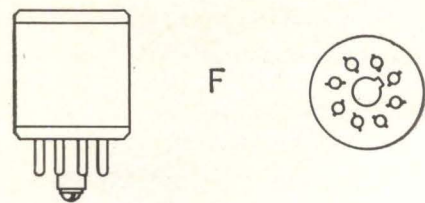
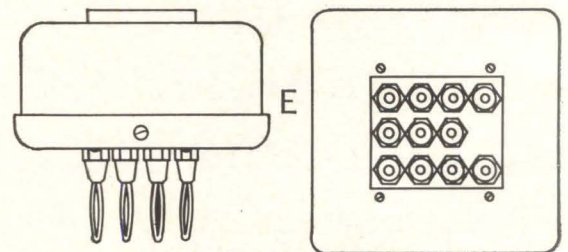
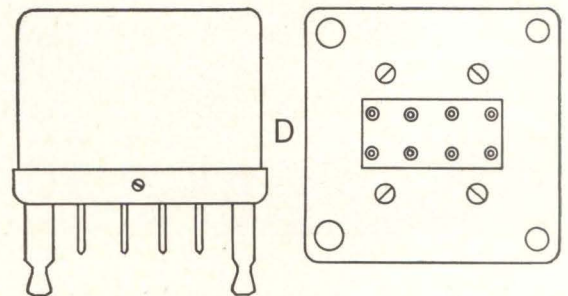
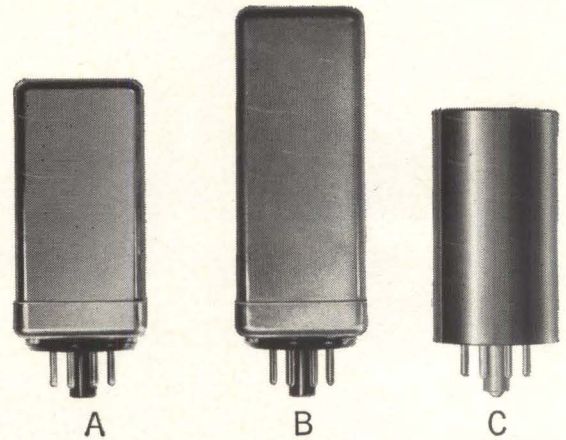

## RADIATION SOLID-STATE RELAYS

Type	Model	Body Size	Figure
Neutral	9214	1.46 x 2.86	A
Neutral	9220	1.46 x 2.86	A
Polar	9212	1.46 x 3.66	B
Univ.	9218	1.38 x 2.63	C
Low Level	9338	1.38 x 2.63	C

Note: Other configurations are available, including plug-in circuit cards.

### Standard Plug-In Adapters

Octal-to-Western Electric 255-A	D
Octal-to-Western Union 202-A	E
Octal-to-Octal	F

Note: Other adapters are available, or units can be wired for direct replacement.



**Western Electric  
carbon resistors  
now protected  
by Kynar®**



Latest refinement in carbon film resistors made by Western Electric is a sleeve of Kynar,\* Pennsalt vinylidene fluoride resin. Western Electric produces 30 million resistors of this type yearly for ANI (Automatic Number Identification) equipment.

Western Electric engineers selected Kynar for two principal reasons—strength and stability. Kynar won't melt, drip or burn, under the most severe overloads. Its superior stability assures freedom from degradation due to aging

or environmental conditions. Kynar is completely compatible with high-speed production. Extruded tubing feeds readily through forming equipment, cuts cleanly, heat-forms easily, takes marking inks.

Kynar offers a unique combination of electrical strength, mechanical toughness and stability. If you have a problem where you need extra performance, write or call us for data. Plastics Dept., PENNSALT CHEMICALS CORPORATION, 3 Penn Center, Philadelphia 2, Pa.

***Kynar...a fluoroplastic that's tough!***

\*Kynar is a Registered Trademark of Pennsalt Chemicals Corp.



# WHAT MAKES AN INSTRUMENTATION CABLE FAIL?

**It can pass inspection perfectly one minute and fail miserably the next. Simply manufacturing it to spec isn't good enough. Insurance against failure must be built into the cable at every step from diagram to installation.**

Where can it go wrong? At almost any point not adequately safeguarded. Here are four of the most common trouble spots:

- (1) Incompatible Plasticizers
- (2) Filler Material
- (3) Component lay-factors
- (4) Shielding

**INCOMPATIBLE PLASTICIZERS** A unique form of chemical warfare within cable materials has fouled more than one missile program. Plasticizer materials have to be added to compounds to obtain the required flexibility. These additives are seldom compatible with each other. Incompatible plasticizers used in systems in contact with each other without control may attack each other with disastrous effects. (As a prime example, additives in low temperature neoprene jackets are not always compatible with the insulating materials.)

Manufacturers can control plasticizer migration problems by selecting proper materials and by using suitable barriers between components. Many specifications make the use of barrier material optional and a manufacturer whose only concern is price will leave it out.

Rome-Alcoa, as a result of its wide experience with materials, always uses barriers where migration could be a problem.

**FILLER MATERIALS** When spurious signals arrive at your display, recording or control panel, the fault could be in the improper selection of filler material. Compatibility between insulations and filler materials is of prime importance.

In the case of some plastics or rubbers, the material's "memory" can cause it to shrink disproportionately, creating undue stresses internally in the cable. This can cause kinking of the insulated conductors; electrical failures follow.

Only experience can tell a cable manufacturer how to compensate for "memory" and how to control compatibility in filler materials. Experience in areas such as this has given Rome-Alcoa its remarkable record of instrumentation cable reliability.

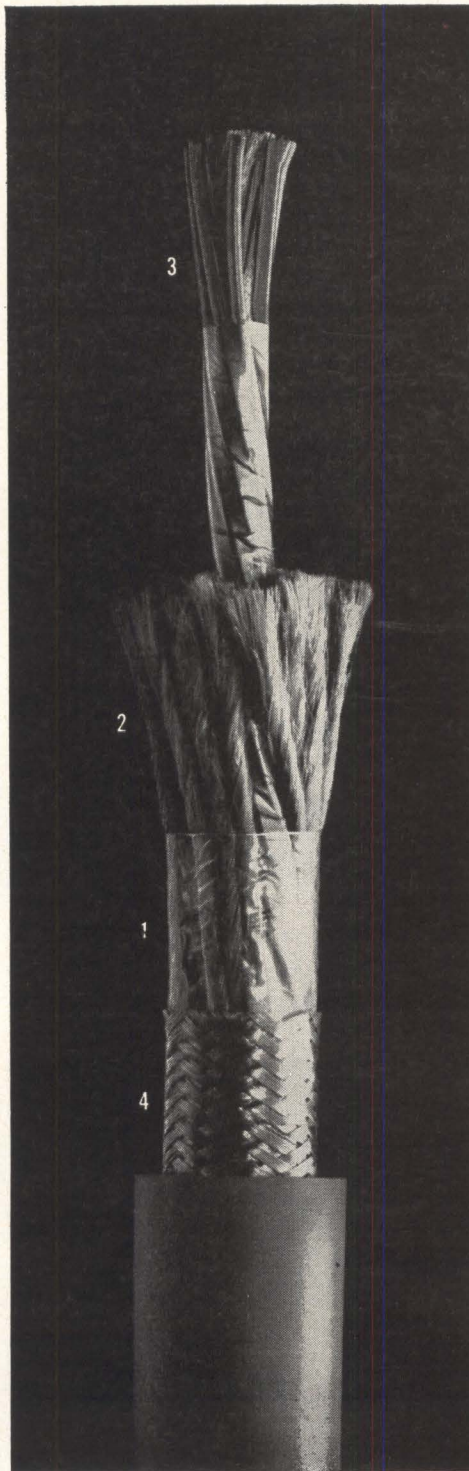

**COMPONENT LAY-FACTORS** Conductor kinking can also be a result of mistake in the twisting of component conductors. Inconsistent tensions and improper sequence of lay-up can create uneven tensions in the assembled conductors.

In such cases, individual conductor may actually push through their insulations, causing electrical failures.

Obviously, these mistakes should be avoided during cabling. At this stage in cable construction careful, experienced workmanship can provide safeguard against possible trouble later on. Such careful craftsmanship sometimes costs a little more, but it can make the difference between success and failure.

**SHIELDING** Constructed of many ends of fine strands, shielding braids are prone to having broken and loose ends. These can break through insulations and short out component conductors. Improperly treated, they are the most common cause of shielding failures.

It's cheaper to let such loose ends remain in the braid—but it can also be disastrous. Experience on thousands of such shieldings has taught Rome-Alcoa the exact tensions which must be maintained, as well as methods of protecting and treating loose ends.

**HOW TO AVOID FAILURES** No manufacturer can promise you 100% reliability at every development stage. But it's only logical that the one way to be sure of maximum reliability is to have your cable planned and manufactured by a company with depth of experience and a record of reliability in the field.

Rome-Alcoa is, frankly, one of the few companies that qualify. We've been designing and constructing these cables since their first conception—long enough to know what can cause a cable failure, and how to avoid it. If you're planning to design or install instrumentation cable soon, call us.

As a starter, send for our 24-page booklet titled "Instrumentation Cables, Cable Assemblies and Hook-up Wires." In it, we describe instrumentation cable constructions, production, military specifications and our qualifications.

For your copy, write Rome Cable Division of Alcoa, Dept. 27-94, Rome, N.Y.



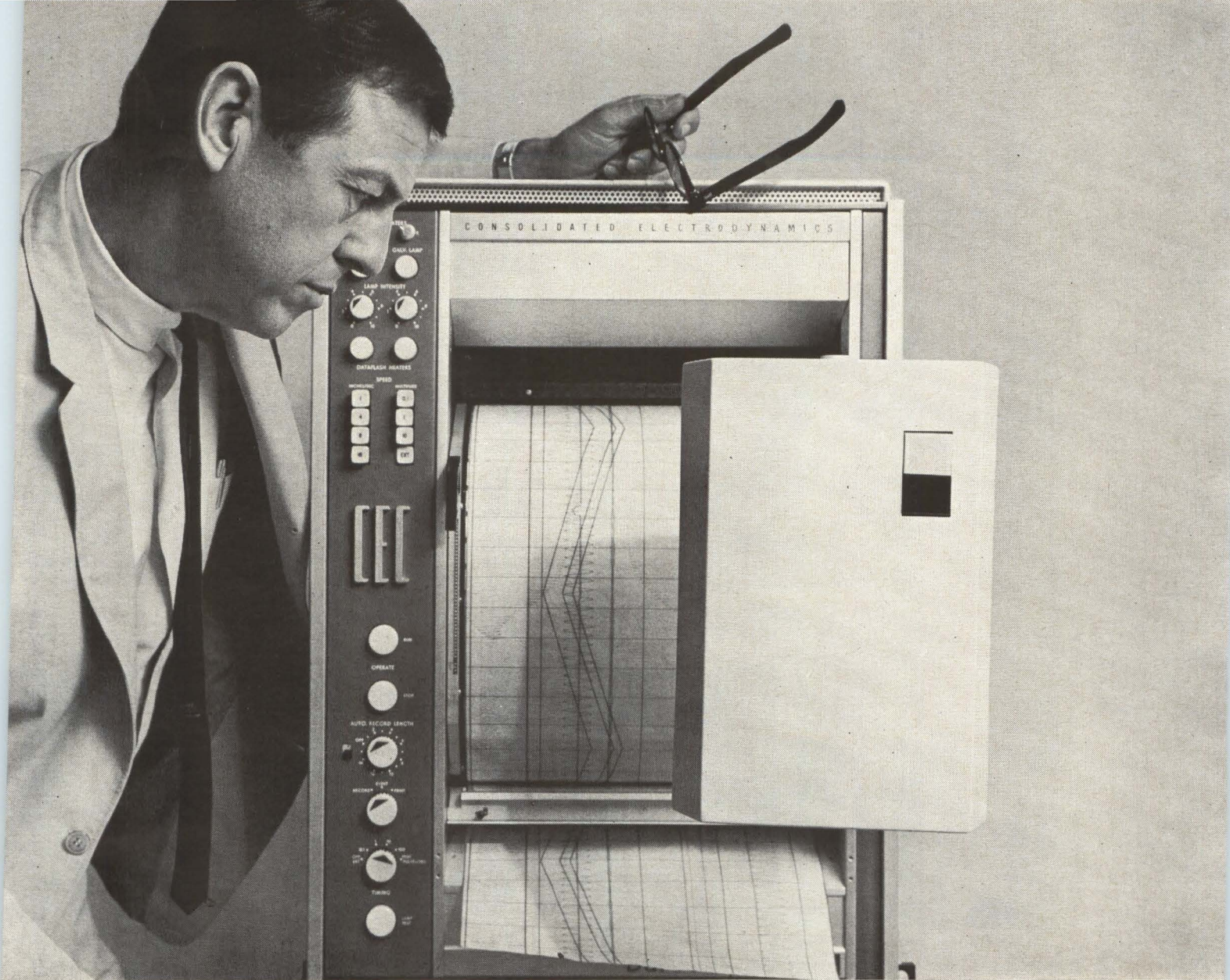

## The oscillograph that defies improvement

### CEC's advanced 5-133

Some day, no doubt, CEC will build an instrument to surpass the 5-133 DataGraph® Recording Oscillograph. But until new advances are made in the state-of-the-art, the 5-133 will remain the standard by which all other oscillographs are judged.

For CEC's 5-133 provides versatility, performance, and convenience; advantages unmatched by any other. This direct-writing instrument produces 36 or 52 channels of data on 12-inch-wide light-sensitive paper—may be rack-mounted or bench-mounted—surpasses the most demanding technological requirements. It is also available fully RFI certified, including its Remote Control Unit, in accordance with MIL I6181D.

#### Important Advantages:

**STATIC MAGNETIC REGULATED LAMP POWER SUPPLY**—provides proper power to lamp regardless of input voltage variations, allows start/restart times of less than one second.

**SLOT-EXIT CAPABILITY**—up to 160-inches-per-second.

**ADJUSTABLE GRID LINE INTENSITY**—continuously variable vernier control.

**TIMING LINE GENERATOR**—electronically flashes timing lines at intervals of 10, 1, 1/10, 1/100 and 1/1000 second. Every 10th line accented.

**RECORD/EVENT NUMBERING**—selected by front panel switch.

**AUTOMATIC RECORD LENGTH CONTROL**—continuously variable from 0 to 15 feet, multiplier extends range to 0 to 150 feet.

**TWELVE RECORDING SPEEDS**—pushbutton selectable speeds of .1, .4, .8, 1, 1.6, 4, 8, 10, 16, 40, 80, and 160 inches-per-second.

**TRACE IDENTIFICATION**—optical trace interruption and trace numbering.

**VIBRATION ISOLATION**—four isolator mounts on recorder and four on the drive motor/transmission assembly.

**GALVO LIGHT INTENSITY CONTROLS**—manual and automatic controls provide optimum trace quality for each galvanometer block.

**FILTERED AIR COOLING**—cools and pressurizes the optical module for maximum cleanliness.

**MODULE CONSTRUCTION**—all major modules removable as single assemblies.

For complete information on this 5-133, call your CEC sales and service office or write for Bulletin CEC 5133-X22

# CEC

Data Recorders Division

**CONSOLIDATED ELECTRODYNAMICS**

A SUBSIDIARY OF BELL & HOWELL/PASADENA, CALIF. 91109  
INTERNATIONAL SUBSIDIARIES: WOKING, SURREY, ENGLAND  
AND FRANKFURT/MAIN, GERMANY

Circle 53 on reader service card



# Silicone Rubber Adhesive/Sealant solves 1000 production problems ...permanently



New General Electric silicone rubber adhesive sealants are ready-to-use, permanent and waterproof. Available in a variety of colors (white, black, red, aluminum and translucent), RTV sealants set up in minutes and cure in air to form a tough, flexible bond. They won't shrink, crack, harden or peel, even at temperatures from  $-75^{\circ}\text{F}$  to  $+500^{\circ}\text{F}$ . Like all silicones, RTV's resist moisture, weathering and ozone.

In either the non-sagging form or the free flowing form, RTV makes an excellent caulk, gasket, encapsulant, electrical insulator, sealer, laminate and general stick-um. Here are eight ways this unique do-it-yourself rubber solves production problems or reduces manufacturing time. Look around in your plant. You'll think of many more.



1. RTV-108 provides instant, "see-through" insulation as well as vibration resistance and environmental protection. RTV needs no pre-mixing; is applied directly from the tube.

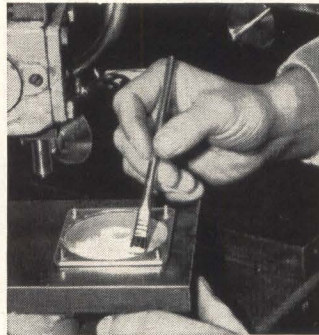

2. RTV seals filament condenser plates in dielectric heaters. Reasons: RTV resists high temperature, insulates electrically, locks out conductive contamination.



3. RTV seals AN connectors, terminals and wire harness joints and other flexible parts. It will absorb shock and vibration, eliminating the fatigue failure of connections.

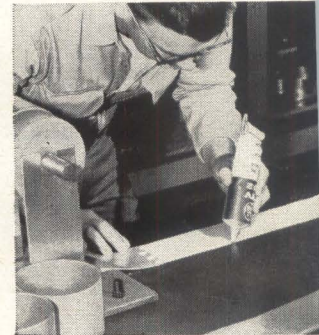

4. RTV bonds sheeting into desired configuration in low volume production of cylindrical air ducts for dielectric heaters. Results: production costs cut more than 300%.



5. RTV laminates layers of mica sheeting and plates in production of plate condensers. Results: improved operational reliability, assembly time cut from 24 hours to 20 minutes.

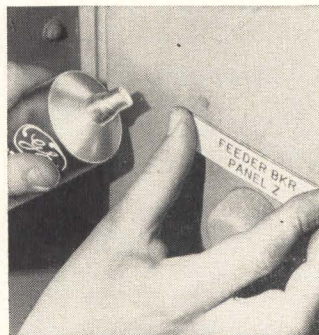

6. RTV eliminates need for screws and drilling when used to affix name plates and decorative emblems on any surface. Results: no unsightly rust drainage; plates stay put indefinitely, but can be cut loose when desired.



7. RTV seals out moisture and dust, making cases, cabinets and chassis completely and quickly weatherproof. An excellent material for vibration dampening in electronic equipment.

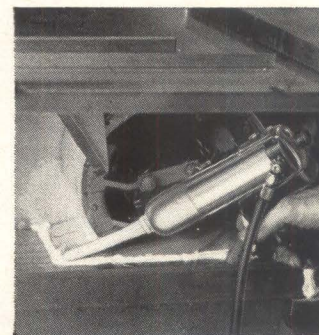

8. RTV bonds vent units and ducts in new Hotpoint range, seals areas of metal-to-metal contact to prevent escape of cooking vapors. RTV is damping medium for vent motor, reducing sound and vibration.

Will a dab of RTV in the right place shorten your production time? Find out. RTV comes in 3 oz. and 12 oz. tubes and in polyethylene cartridges for use with automatic pressure guns. For more information on these new silicone rubber adhesive-sealants, write to: Sect. N9124, Silicone Products Department, General Electric Company, Waterford, New York.

GENERAL  ELECTRIC



# Technical articles

## Highlights

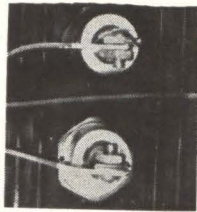

### Inverting d-c to a-c with tunnel diodes: page 56

After having been a disappointment, the tunnel diode is finally coming into its own. Improved manufacturing techniques have reduced a lot of objections to its use. The tunnel diode appears promising in inverters: it is simple, reliable and efficient.

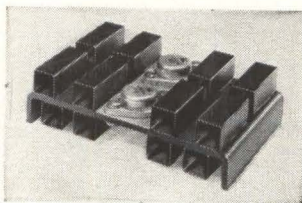

### More for your money in solid-state equipment: page 66

Inadequate cooling drastically affects design parameters, so thermal design should be considered early in the game. You may have to use forced-air cooling instead of just plain heat sinks.

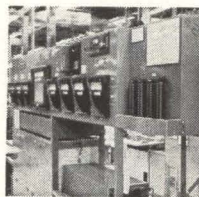

### Widening world of the scr: page 78

The silicon controlled rectifier is popping up in applications from golfcarts to steel mills. It is replacing silicon diodes because it can do more.

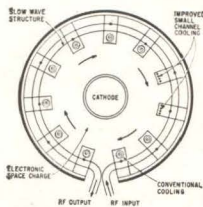

### A comeback for wireless power? page 86

Nikola Tesla first experimented with electromagnetic radiation as a source of power in 1889—and failed. Many others have followed Tesla to failure since. But now microwave technology has progressed to the point where power transmission by radiation is technically feasible.

**Coming  
October 5**

- Inside industrial computers
- Balanced bipolar circuits for shift registers
- A new kind of electronic ignition for autos
- Microwave equipment for televising the Olympics

# Tunnel-diode circuits invert direct to alternating current

High-current tunnel diodes are simple, reliable and efficient; they invert 0.1 to 0.65 volts with efficiencies as high as 65%

By Fred M. Carlson

Radio Corp. of America, Applications Dept., Somerville, N.Y.

**New energy sources**, such as thermionic and thermoelectric generators, seawater batteries, fuel cells and solar cells, have created the need for an efficient means of d-c to a-c inversion at low-input voltages and high-input currents. Inverter circuits using high-current tunnel diodes satisfy this need; they operate with 0.1 to 0.65-volt d-c input and peak efficiencies as high as 65%. Power outputs of 100 watts are feasible.

When the tunnel diode first appeared in the literature about six years ago, it was expected to revolutionize the electronics industry. It offered the circuit designer a means of achieving oscillation, amplification, conversion, switching and even a combination of these properties all in one simple device. In addition, the device promised high-speed, high-frequency operation, low power consumption, resistance to nuclear radiation and temperature, small size and light weight. But disillusionment set in with the appearance of design and manufacturing problems. Now, many of these problems have been solved and the circuit designer is taking a second look. He is beginning to realize that the tunnel diode has some very useful properties that lend themselves to particular applications. Such an application is inversion of low

d-c voltages put out by exotic power sources now being developed in many areas of our defense effort.

Although transistorized inverters have proved useful for the inversion of the output of d-c power sources, their conversion efficiency is severely reduced when the d-c source voltage is appreciably less than 1 volt—typical of the new energy sources. Under such conditions, tunnel-diode circuits have demonstrated greater efficiency as inverters. Additionally, the extreme simplicity of tunnel-diode circuits can offer greater reliability than possible with transistorized circuits. An evaluation of the design criteria and performance characteristics of several tunnel-diode inverter circuits indicates their applications.

Simple circuit arrangements for using high-current tunnel diodes as d-c to a-c inverters may be described as the single-diode circuit, the parallel circuit, and the push-pull circuit.

## Single-diode circuit

The single-diode inverter circuit shown at the right is basically a tunnel-diode relaxation oscillator. For tunnel diodes operating as relaxation oscillators, the switching path on the static characteristic is shown on page 60. If the diode is d-c biased in its negative resistance region, the sequence of operation is as follows: if the action is assumed to start at point C, the diode switches very rapidly, in the order of nanoseconds, to point D. From D, the diode drops rapidly to E, and decays at a slightly slower rate to F. Upon reaching F, the diode very rapidly switches to A. From A, it rises rapidly to B, and then rises at a slightly slower rate to C, at which point the cycle is repeated. The output waveform is trapezoidal, or partly square.

## The author

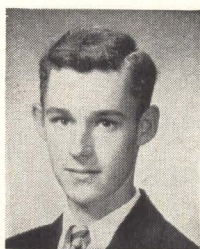

Fred Carlson has been an applications engineer with the Radio Corp. of America since 1959. He has worked on switching applications for tunnel diodes. Currently he's investigating communications applications for the insulated-gate field-effect transistor.

## Tunnel-diode inverter theory

In inverter applications, the tunnel diode is made to switch between its high-voltage ( $\cong V_p$ ) state and its low-voltage ( $\cong V_v$ ) state.<sup>1</sup> This switching effectively chops the d-c voltage, and the resultant diode output can be applied to a transformer to step up its voltage.

If a tunnel diode is d-c biased, as shown on page 60, and if it oscillates (switches) between its peak point and valley point with equal periods, a condition known as threshold operation prevails. For this condition, the d-c power input to the diode  $P_{in}$ , the a-c power output of the diode  $P_{out}$ , and the efficiency of conversion  $P_{out}/P_{in}$  are determined as follows:

$$P_{in} = \left[ V_p + \frac{V_v - V_p}{2} \right] \left[ I_v + \frac{I_p - I_v}{2} \right] \quad (1)$$

$$= (1/4) (V_v + V_p) (I_p + I_v)$$

$$P_{out} = \left[ \frac{V_v - V_p}{2} \right] \left[ \frac{I_p - I_v}{2} \right] = (1/4) (V_v - V_p) (I_p - I_v) \quad (2)$$

$$\frac{P_{out}}{P_{in}} = \frac{\left( \frac{V_v}{V_p} - 1 \right) \left( \frac{I_p}{I_v} - 1 \right)}{\left( \frac{V_v}{V_p} + 1 \right) \left( \frac{I_p}{I_v} + 1 \right)} \quad (3)$$

where  $V_p$  is the tunnel-diode peak voltage (in volts),  $V_v$  is the valley voltage (in volts),  $I_p$  is the tunnel diode peak

current (in amperes), and  $I_v$  is the valley current.

Diode efficiency versus peak-to-valley voltage ratios for several values of the peak-to-valley current ratios (shown on page 60) indicates two conditions that are essential for the achievement of high conversion efficiencies in tunnel-diode inverters:  $I_p/I_v \gg 1$  and  $V_v/V_p \gg 1$ .

Present tunnel-diode inverters require that the following three conditions be satisfied if the tunnel diode is to switch alternately between its high-and low-voltage states:

1. The total d-c circuit resistance, including the diode series resistance, the power-supply resistance, and the wiring resistance, must be less than the negative resistance of the diode at its operating point; thus,

$$R_T < |-R| \quad (4)$$

2. The total circuit series inductance must be greater than the product of the total d-c circuit resistance, the negative resistance, and the junction capacitance; hence,

$$L_T > (R_T C) |-R| \quad (5)$$

3. The source voltage must lie between  $V_p$  and  $V_v$ ; thus the diode must be biased in its negative-resistance region.

The third criterion presents no problem other than that of selecting the proper d-c source for the tunnel diodes. The second one is also easily met, primarily because  $|-R|$  is so small. The first criterion is more difficult, however, because the diode series resistance  $R_s$  is  $\leq (1/2)(|-R_{min}|)$ . Therefore, to insure that the total d-c circuit resistance will not exceed  $|-R|$ , the circuit should be designed so that the sum of its resistances will not be greater than the diode series resistance.

The theoretical operating frequency for a symmetrically oscillating (equal positive and negative periods) loaded, single-diode inverter is given by the following equation:<sup>2</sup>

$$f = \frac{1}{4L} \left( \frac{V_v - V_p}{I_p - I_v} \right) \quad (6)$$

where  $L$  is the inductance of the primary of the transformer.

More detailed theoretical analyses of the single-diode circuit are given by Hanrahan,<sup>2</sup> Storm and Shattuck,<sup>3</sup> and Wang.<sup>4</sup>

### Parallel circuit

The parallel inverter circuit at the right is basically two single-diode circuits in parallel, both using the same transformer core and secondary. The primary is wound in opposite directions on each side of the center tap. The unique feature of this current is that the diodes become locked; they oscillate at the same frequency rather than independently. Thus, all the flux in the core is additive, and the diode outputs are summed.

The advantage of the parallel circuit over the single-diode circuit is that higher output power can be obtained without the use of higher peak-current diodes. It operates in the same manner as the single-diode inverter circuit.

### Push-pull circuit

The push-pull inverter circuit differs from the parallel circuit only in the direction in which the two halves of the primary are wound. For the push-pull circuit, the two halves of the center-tapped primary are wound in the same direction. The

transformer core material should be a square-hysteresis-loop type, although the push-pull mode of operation has been observed when standard core materials were used. This circuit may operate in either of two modes; the particular mode selected is determined by the transformer used and the value of the load resistor.

In the first mode of operation, if a large transformer is used, and the core is not driven to saturation the operation of the push-pull circuit is similar to that of the single-diode circuit except that the inverter is drawing a constant, rather than a pulsating current from the d-c source. Frequency stability is poor as the bias voltage changes.

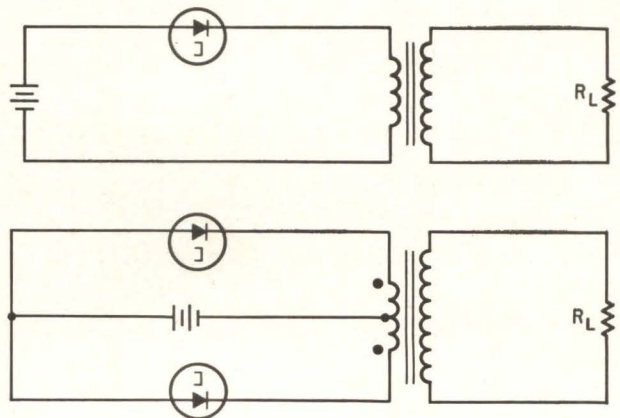

Single-diode inverter circuit is simple and reliable and is recommended for use with d-c power sources that supply a varying voltage. Parallel inverter is useful when the output power required is greater than that obtainable from one diode. The push-pull inverter (not shown) differs from the parallel circuit only in the directions in which the primary is wound.

In the second mode of operation if a small transformer, with square-hysteresis-loop core material is used, then a unique mode of operation results when the core is driven to saturation every half-cycle. This mode differs from the non-saturating mode in that the output waveform is much more square, and the operating frequency is lower and more stable with changes in input voltage or load.

Both the nonsaturating and the saturating circuits have two possible forms of diode oscillation. The two diodes may either oscillate in phase (symmetrical mode), or 180° out of phase (asymmetric mode). When the diodes oscillate in phase, the resultant fluxes they produce in the transformer windings buck each other, and the output power is reduced to practically zero. In the asymmetric mode, the magnetic fluxes produced in the primary are additive, and the output power is high. The factors determining whether the diodes operate in or out of phase are: 1) the value of the load resistance,  $R_L$ , and 2) the coupling between the two primary halves of the transformer. It has been shown that the in-phase mode will predominate whenever the load resistor is reduced below a certain critical value given by:

$$R_L = 2n^2 \left[ \frac{(V_v + R_T I_p) - (V_p + R_T I_v)}{I_p - I_v} \right] \quad (7)$$

where  $n$  is the turns ratio and  $R_T$  is the winding resistance of the transformer primary, both measured from the center tap to one end.<sup>5,6</sup>

This property, unique to the push-pull circuit, provides excellent short-circuit protection. Whenever the load develops a short circuit (or overload), the inverter reverts to the in-phase mode, and its output power drops to zero. If the circuit is designed properly, it will return to the asymmetric mode as soon as the overload is removed.

### Saturated-core inverter

The operation of the saturating core inverter in the asymmetrical mode is as follows: assume that

one diode has just switched to its high state. This switching induces a voltage across the primary in such a direction as to force the second diode to switch from its high state to its low state. The induced voltage across the primary windings then has a polarity that maintains the first diode in its high state and the second diode in its low state. This induced voltage remains until the flux in the core cannot change anymore (the transformer becomes saturated). At this point, the induced voltages collapse, causing the diodes to switch to their opposite states. They remain in this state until the transformer again saturates. The cycle is then repeated. Unlike transistorized d-c to a-c inverters, there is no sudden, large increase in current through the diodes when the core saturates. The equation for the operating frequency of the saturating-core inverter is:<sup>2</sup>

$$f = \frac{1}{4} \left( \frac{E}{NAB_s} \right) 10^8 = \frac{1}{8} \left( \frac{\Delta V}{NAB_s} \right) 10^8 \quad (8)$$

where  $f$  is the operating frequency in cps,  $N$  is the number of turns on half of the primary,  $A$  is the area of the core in square centimeters,  $B_s$  is the saturating flux density in gaussses, and  $\Delta V$  is the voltage swing of the tunnel diode (generally  $\Delta V \approx V_v - V_p$ ).

For the non-saturating mode, the operating frequency is given by<sup>2</sup>

$$f = \frac{1}{8L} \left( \frac{\Delta V}{\Delta I} \right) \quad (9)$$

where  $L$  is the inductance of the primary.

This mode of operation is similar to that of the single-diode inverter. This similarity is illustrated by a comparison of the frequency equations (equations 6 and 9) for single-diode and the non-saturating push-pull inverters.

The equations used to predict the performance of both single-ended and push-pull tunnel-diode inverters are summarized below.

### Theoretical equations are used to predict the performance of both single-ended and push-pull tunnel-diode inverters.

Parameter	Symbol	Single-ended inverter	Push-pull inverter
		Equation	Equation
Power input (watts)	$P_{IN}$	$1/4 (I_p + I_v) (V_v + V_p)$	$1/2 (I_p + I_v) (V_v + V_p)$
Power output (watts)	$P_{OUT}$	$1/4 (I_p - I_v) (V_v - V_p)$	$1/2 (I_p - I_v) (V_v - V_p)$
Diode efficiency (%)	$\eta_o$	$\left[ \frac{(I_p - I_v) (V_v - V_p)}{(I_p + I_v) (V_v + V_p)} \right] 100$	$\left[ \frac{(I_p - I_v) (V_v - V_p)}{(I_p + I_v) (V_v + V_p)} \right] 100$
Frequency (cps)	$f_o$	$\left( \frac{1}{4L} \right) \frac{(V_v - V_p)}{(I_p - I_v)}$	$\left( \frac{1}{8} \frac{\Delta V}{NAB_s} \right) 10^8$
Critical load (ohms)	$R_c$	.....	$2N^2 \left[ \frac{(V_v + R_T I_v) (V_p + R_T I_p)}{(I_p - I_v)} \right]$

$L$  = primary-circuit inductance (henries)  
 $N$  = transformer turns ratio (CT to end)  
 $B_s$  = saturated flux density (gaussses)

$R_T$  = circuit resistance (ohms)  
 $A$  = core area (sq. cm.)

## Advantages and disadvantages of various types of tunnel-diode inverter circuits are compared.

Type of Inverter	Advantages	Disadvantages
Single-diode circuit	Simplicity and reliability. No critical load resistance. Wide load and voltage operating range. No starting or hysteresis problems. Maximum output power occurs at point of maximum efficiency. Only slight variation in output power over a relatively large bias-voltage range. Higher operating frequency.	Lower conversion efficiency. Poor frequency stability. Pulsating current drawn from d-c source. Output waveform requires more filtering if rectified.
Parallel circuit	Same as the single-diode circuit; in addition, it will twice the amount of output power than that obtainable from the single-diode circuit.	Same as the single-diode circuit.
Non-saturating push-pull circuit	Allows higher frequency operation than the saturated push-pull circuit.	Poor frequency stability. Larger and heavier core required.
Saturating push-pull circuit	Highest conversion efficiency Greater frequency stability. A relatively steady current is drawn from the d-c source; thus, provides highest efficiency from standpoint of available power from the d-c source. Output waveforms are approximately square, which eases filtering requirements.	Smaller load and source-voltage operating range. Lower frequency operation. Operation affected by starting problems and hysteresis effects under certain conditions. Wide variation in output power with changes in source voltage. Maximum power output does not occur at maximum-efficiency bias point. Load resistance has a critical value (may be advantageous in some applications).

### Comparison of circuits

Of the tunnel-diode inverter circuits discussed, the single-diode circuit is the simplest and most reliable. This type of inverter is recommended for applications in which the output waveform and frequency are not critical and for use with d-c power sources that supply a varying voltage. For example, single-diode inverters can be advantageously employed in flasher beacons at sea that are powered by seawater batteries (batteries with magnesium and nickel electrodes that using seawater as the electrolyte; the loaded output voltage of such batteries is approximately 0.2 to 0.3 volt).

The parallel inverter, except for being more complex, has all the advantages of the single-diode circuit. This inverter is useful when the output power required is greater than that obtainable from one diode.

There are few, if any, applications for which the nonsaturating push-pull circuit would be recommended. The use of the saturating push-pull inverter, however, is desirable whenever maximum conversion efficiency is needed or when the inverter output is to be rectified to provide a relatively ripple-free d-c voltage. For example, this type of circuit would be preferred for supplying the power to a radio transmitter.

The advantages and disadvantages of each type of inverter circuit are listed above.

### Design procedure

Tunnel-diode inverters are much simpler to design than are transistorized inverters, primarily because no base-current feedback or starting circuits are needed. The initial steps are to establish what the primary d-c source will be and to determine its output voltage, the expected variations in that

voltage, and its series resistance. These factors automatically limit, to some extent, the type of diode and circuit configuration that can be used. For example, if the source voltage is in the range of 0.1 to 0.2 volt, only germanium tunnel diodes operated in a single-ended or parallel circuit would be satisfactory. If the source voltage is in the range of 0.40 to 0.6 volt, only gallium-arsenide diodes should be used. Two germanium diodes operated in series could provide the higher-voltage operation, but the circuit arrangement would be much more complicated; therefore, the use of the higher-voltage gallium-arsenide diodes is desirable. If the source voltage is greater than 0.7 volt, transistorized inverters are preferred. The experimental data that is presented graphically will aid in determining the proper operating voltage for the various circuits and diodes. The comparison of various types of tunnel-diode inverter circuits above may be used to help select the optimum type of circuit configuration for a given application.

After the type of circuit to be used is determined, the tunnel diode must be selected. The peak-current ( $I_p$ ) requirement of the diode is dependent on the required output power. For the single-diode stage the required peak current is, approximately,

$$I_p = 23 P_{\text{out (max)}} \quad (\text{for germanium diodes}) \quad (10)$$

for a push-pull circuit, the peak current per diode is one-half that obtained by equation 10. If gallium-arsenide diodes are used, multiply equation 10 by 0.5. Equation 10 is derived from equation 2 by substituting typical values for  $V_p$  (peak voltage),  $V_v$  (valley voltage), and  $I_v$  (valley current). Once the approximate peak current is calculated, the commercially available tunnel diode that most nearly provides this value can be determined. From the

data sheet for the selected tunnel diode, the worst-case values of  $V_v$ ,  $V_p$ , and  $I_p$  may be substituted in equation 2 to determine if the tunnel diode will be adequate. Also, if the d-c source voltage is expected to vary, allowance will have to be made for the resultant changes in the output power.

Once the  $I_p$  of the tunnel diode is known, the diode negative resistance may be approximated by the empirical relation:

$$|-R_{min}| \approx 0.12/I_p \quad (11)$$

where  $R$  is in ohms and  $I_p$  in amperes. A check should now be made to see if the series resistance of the power supply is small enough to permit oscillations by using equation 4.

The final steps are to use equation 6 or 8 to determine the transformer requirements needed for a given frequency of operation and to establish the primary-to-secondary turns ratio based on the desired output voltage. If a push-pull circuit is used, equation 7 should be used to check whether the turns ratio,  $n$ , or the load resistance  $R_L$ , are too high or too low, respectively. When using equation 7, the term  $R_T I_v$  may usually be neglected, while the  $R_T I_p$  term is generally less than 0.1. Thus  $R_T < -R \approx 0.12/I_p$  and  $R_T I_p < (0.12/I_p) (I_p) = 0.12$ . The preceding design techniques will now be applied to the construction of a single-ended and a push-pull inverter.

### Design example

A d-c source having an output of  $0.25 \text{ v} \pm 10\%$  and a source resistance of one milliohm was available. Two inverters using available 10-ampere germanium tunnel diodes were to be built to evaluate the single-diode circuit and the push-pull circuit. An output voltage greater than 20 volts was desired. The frequency for the single-diode inverter was not specified because it changed readily with bias variations. A frequency of 15 cps was required for the push-pull inverter circuit. Maximum power output was desired from both circuits.

Since the parameters of the diodes to be used were already known from previous experiments, the output power expected from the single-diode circuit was computed, using equation 2 rather than equation 10, as follows:

$$P_{out(max)} = 1/4 (.345 - .104) (8.9 - 0.8) = 0.49 \text{ watt}$$

From the curves at the right, the efficiency was found to be 44%. For the push-pull circuit,  $P_{out}$  was computed to be approximately 1.0 watt; the efficiency was found to be 41.5%.

The negative resistance of 10-ampere diodes is typically 12 milliohms. Since the supply had an internal resistance of 1 milliohm, equation 4 was easily satisfied.

For the push-pull circuit, a frequency of 15 cps was desired. From equation 8,  $15 = \Delta V (10^8)/8 NAB_s = 0.25 (10^8)/8NAB_s$ ,  $NAB_s = 2.1 \times 10^5$ . Special materials with nearly square hysteresis loops should be used for the transformer core. These materials saturate easily and produce

squarer output waveforms. Either 79 Square Mu or Permalloy 80 would be a suitable choice. However, for this case, only Carpenter 49 material was available. This material has a  $B_s$  of approximately 14,000 gauss. Core area was selected to be 0.5 square inch. For these values, the transformer turns ratio ( $N$ ) is determined as follows:  $N(0.5) (2.54^2) (14,000) = 2.1 \times 10^5$ , or,  $N = 5$  turns. Operating frequencies may be increased: 1), by using more materials that have a lower  $B_s$ ; 2), by using gallium-arsenide diodes (which have a  $\Delta V$ , equal to twice that of germanium diodes); and 3), by reducing core area. Frequencies greater than 400 cps are easily obtained.

To insure an output voltage greater than 20 volts rms, a turns ratio of 100 to 1 was used for the single-diode circuit. This value should provide a peak voltage of approximately 40 volts. For the single-diode circuit, a good first approximation of the rms voltage is 0.7 of the peak if the waveform is perfectly square. Because of the irregular nature of the output waveform, the exact rms voltage is hard to calculate, and is best determined experimentally. For the push-pull inverter, a turns ratio of 60 to 1 (secondary to half primary) was used. The critical load for the push-pull inverter was calculated to be:

$$R_L = 2 (60)^2 \left[ \frac{0.33 - (0.1 + 0.02)}{8.8} \right] = 172 \text{ ohms}$$

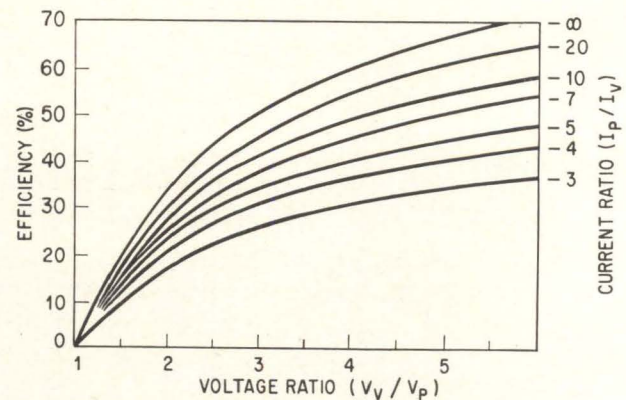
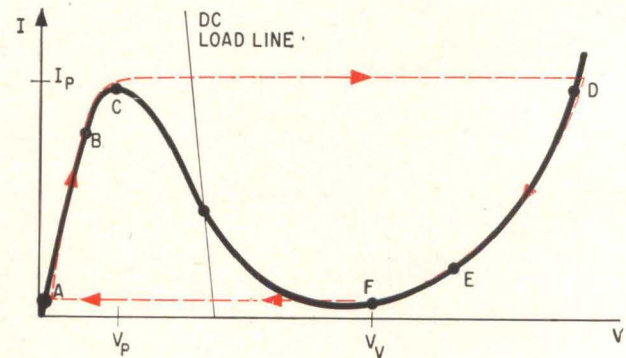

**Tunnel-diode** relaxation oscillator switches between its high-voltage state,  $V_v$ , and its low-voltage state  $V_p$ . Switching path is in color. Diode efficiency varies with peak-to-valley voltage ratio for a given peak-to-valley current ratio.

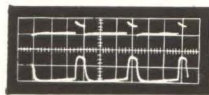

BIAS = 150 mV  
HORIZ = 200 μSEC/DIV

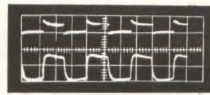

BIAS = 236 mV  
HORIZ = 200 μSEC/DIV

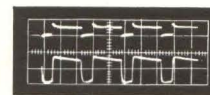

BIAS = 300 mV  
HORIZ = 500 μSEC/DIV

VERTICAL SENSITIVITY UPPER TRACE = 0.5 V/DIV LOWER TRACE = 20.0 V/DIV.

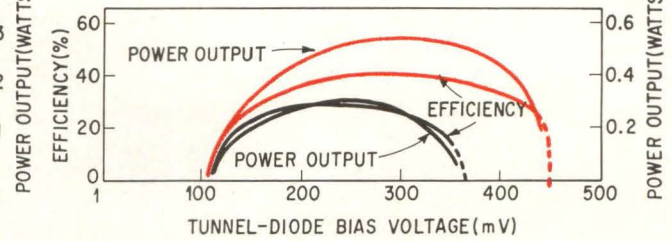
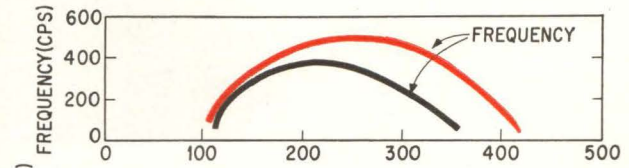
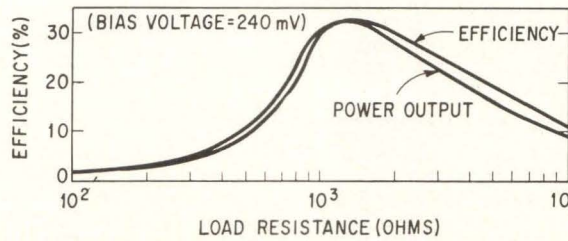
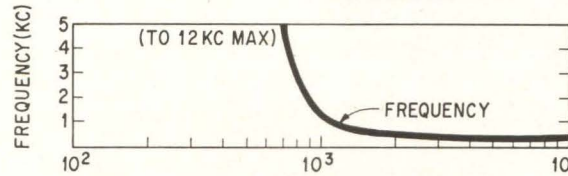

**Single-ended inverter** using a germanium tunnel-diode has input and output waveforms (top). Variations in efficiency, frequency and power output are a function of the load resistance for a fixed bias voltage (left). The variation of the same parameters when the bias voltage is changed and the load held constant is at the right. Characteristics improve when operated at  $-196^{\circ}\text{C}$  (color) with load resistance held constant.

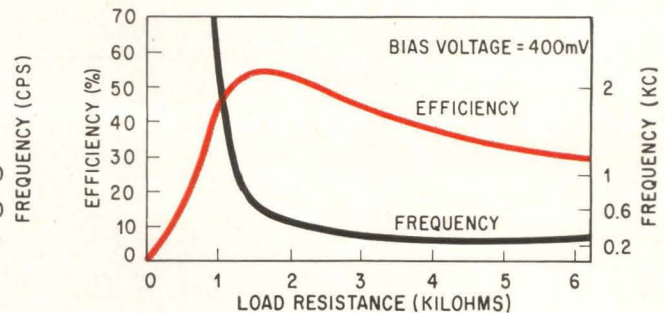
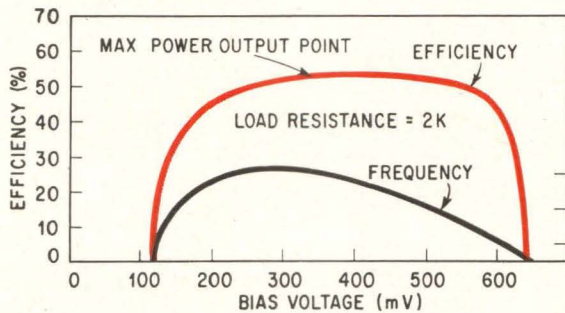

**Single-diode inverter** circuit uses a 6-ampere GaAs diode to get an approximately flat power output over a wide range of bias voltage. Curves show efficiency as a function of bias and load.

### Experimental circuits and techniques

The power source used in most of the experiments described in this section was a transistorized, regulated, 15-ampere d-c power supply with an internal impedance of one milliohm.

The input power to the diodes was computed from direct-current and voltage measurements. The transformer secondary was connected to a precision decade-resistance box to provide a resistive load; the output voltage across the load was measured with a true rms-reading voltmeter, and the a-c output power was computed from

$$P_{\text{out}} = V_o^2/R_L \quad (12)$$

The  $I^2R$  power losses in the primary windings and connecting leads were not included in measurements of  $P_{\text{in}}$  because the use of sufficiently large connecting leads and transformer windings make such losses negligible.

### Single-diode inverters

A single-diode inverter circuit was constructed using a transformer with a turns ratio of approxi-

mately 100 to 1. The primary was wound from AWG No. 14 wire. Both germanium and gallium-arsenide high-current diodes were operated in this circuit. The electrical parameters of the diodes used in these tests are listed below.

The results of the tests are presented graphically above. The variations in efficiency, frequency, and power output are shown as a function of the load resistance for a fixed bias voltage. The variation of the same parameters when the bias voltage is changed and the load is held constant shows that peak efficiency is obtained for a bias voltage that is

### Electrical characteristics of germanium (Ge) and gallium-arsenide (GaAs) high-current diodes in inverter circuits.

Type	$I_o$ (amp)	$V_p$ (mv)	$I_v$ (amp)	$V_v$ (mv)	$\eta_o$ (%)
Ge	8.9	104	0.84	345	44.5
Ge*	10.5	102	0.40	455	58.7
GaAs	6.6	110	0.30	660	65

The asterisk denotes a diode at  $-196^{\circ}\text{C}$  case temperature.

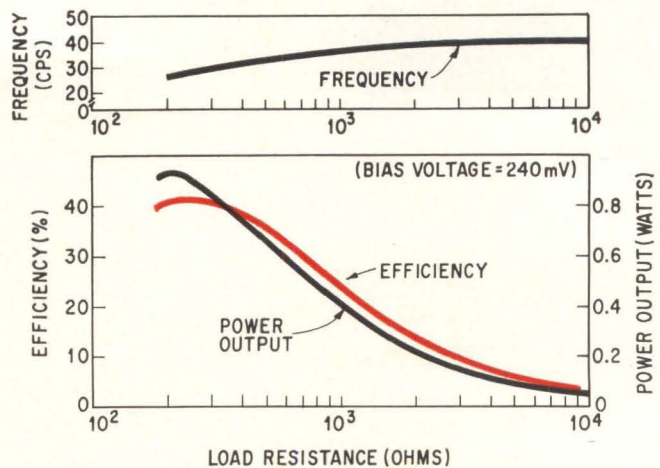
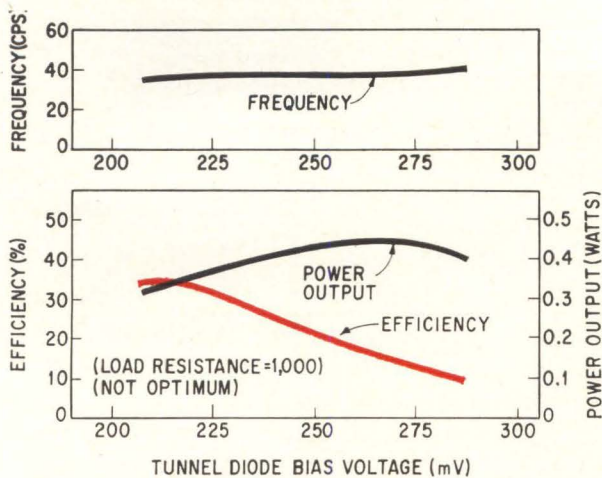

Germanium diodes used in the push-pull inverter circuits have variations in efficiency, frequency and power output with load resistance at a fixed bias level (left) and variations in the same parameters with bias voltage at a fixed load resistance (right). Short-circuit protection is ensured by symmetric mode (zero power output).

### Characteristics of the germanium diodes used in the push-pull inverter circuits.

$I_p$ (amp)	$I_v$ (amp)	$V_p$ (mv)	$V_v$ (mv)	$\eta_o$ (%)
9.2	0.97	108	333	41.5
9.8	1.00	107	330	41.5

### Characteristics of the gallium-arsenide diodes used in push-pull inverter circuits.

$I_p$ (amp)	$I_v$ (amp)	$V_p$ (mv)	$V_v$ (mv)	$\eta_o$ (%)
5.8	0.275	105	640	65
6.6	0.300	110	660	65

approximately midway between the peak- and valley-voltage points. At this value, the diode oscillates with equal positive and negative durations. The variation in efficiency with load resistance is caused by the impedance mismatch that is created when the load resistance is other than the optimum circuit output impedance. The efficiency curve could be flattened to some extent by adjusting the bias level each time the load resistance is changed.

The frequency of the single-diode circuit changes by an order of magnitude over the operating bias range. This large change is attributed to the following factors:

1. The negative-resistance region of the diode is non-linear; thus, as the bias is changed, the negative resistance presented to the circuit varies.
2. As the bias is changed from the optimum point, the diode dwells at either the peak or the valley point for more extended periods; as a result, the frequency drops.

Variations in efficiency, frequency, and power output as a function of bias voltage, at a constant load are shown on page 61 when the inverter is operated at  $-196^\circ\text{C}$ . Results to be noted are the significant increase in efficiency, the shift in the bias voltage for which maximum efficiency is obtained, and the increased operating bias range. These effects are caused by a large reduction in  $I_v$ , which increases  $I_p/I_v$  from 10 to 26 and an increase in  $V_v$  which increases  $V_v/V_p$  from 3.5 to 4.5. These changes increase the theoretical diode-conversion efficiency from 44.5% to 58.7% with a corresponding increase in power output. These results clearly show the desirability of using tunnel

diodes with high current and voltage ratios.

A gallium-arsenide diode was also tested in the single-ended inverter. The performance curves (shown on page 61) exhibit the same general shape as those of the single-ended circuit with germanium diodes. The most significant difference is the wider operating bias range obtainable with gallium-arsenide diodes. Also there is little variation in power output over a wide range of bias voltage.

A comparison between the measured efficiency and calculated efficiency for the single-diode inverter shows a large discrepancy. Even when allowances are made for transformer losses, the measured efficiency is still significantly lower than that calculated. The reason is that the diode remains for an appreciable percentage of each cycle at a voltage greater than  $V_v$ , increasing the diode power dissipation. Thus, the diode is not operating in the mode assumed in the derivation of the efficiency equation (equation 3).

The solution of the Van der Pol equation<sup>4</sup> gives an efficiency of 87.5% of that obtained by use of equation 3. This method, with allowances for transformer losses, gives good agreement between theoretical and experimental values.

The parallel inverter essentially consists of two single-diode inverters in parallel. The general shapes of the curves for efficiency as a function of bias and load are the same as those for the single-diode circuit; hence, no operating characteristic curves for the parallel inverter need be presented.

### Push-Pull Saturating Inverters

The advantages and disadvantages of saturated



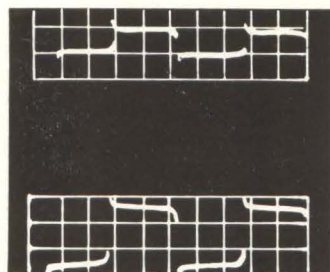
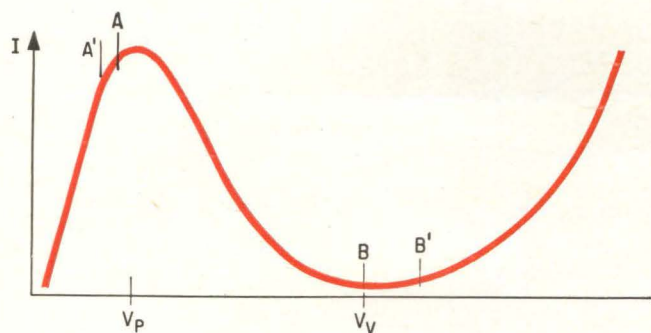

VERTICAL : 0.5V / DIV  
HORIZONTAL : 5MS / DIV

VERTICAL : 20.0V / DIV  
HORIZONTAL : 5MS / DIV

Theoretical (A,B) and actual diode operating points (A',B') of a push-pull saturated core inverter explain discrepancies between measured and calculated results. Input and output waveforms for the push-pull inverter circuit that uses two 10-ampere germanium tunnel diodes.

and nonsaturating push-pull inverter operation are summarized on page 59. Based on preliminary data, it was decided that the saturated push-pull mode of operation would be more advantageous than the nonsaturated mode; hence, all data presented here refers to the saturated mode.

The main disadvantages of the nonsaturated mode are the larger weight of transformer iron required, and the wide variation of frequency with changes in load and bias. Its main advantage is that it is capable of operation at higher frequencies, as indicated by equation 9, provided the current levels are not too high.

A number of different push-pull, saturating inverters were constructed to determine the optimum transformer size and number of primary turns required for maximum efficiency and optimum frequency. All transformers were constructed using L-laminations of Carpenter "49" material. This material is not an optimum square-

loop core material. For best performance, true square-loop tape-wound cores would be more desirable.

The operating characteristics of the germanium diodes used in the push-pull circuits are shown on page 62.

The theoretical efficiency ( $\eta_0$ ) of such diodes is rather low, but it is possible to make germanium tunnel diodes with more than 50% efficiency. Variations in efficiency, frequency, and power output with load resistance at a fixed bias level and variations in these same parameters with bias voltage at a fixed load resistance are shown on page 62.

The measured peak efficiency of the push-pull circuit approaches the calculated efficiency, which would seem to indicate a transformer efficiency of nearly 100%. A possible explanation for the closeness in the values of measured and theoretical efficiency is indicated by the fact that the diodes do not switch between points A and B, as is assumed in the calculation of the theoretical efficiency, but rather at points A' and B' (see left) where the effective value of  $V_v/V_p$  is greater than that at A and B. Thus, the theoretical efficiency is increased. This increase in  $\eta_0$  partially compensates for the circuit losses, and the result is an experimental efficiency that is approximately equal to the theoretical efficiency computed initially.

The graph of efficiency versus load stops abruptly at 190 ohms. This resistance was the experimentally determined value of the critical load resistance,  $R_L$ . If the load resistance is reduced below the critical value, the mode of operation changes from asymmetric to symmetric, reducing the output power to zero. This feature of the push-pull circuit provides excellent short-circuit protection and means that practically no condition can occur on the secondary side of the transformer that can damage the tunnel diodes or the d-c source on the primary side.

The calculated and measured values of frequency differ by a factor of approximately 2. This discrepancy is the result of two factors: a core stacking factor is not included along with core area in equation 8 and the actual voltage swing,  $\Delta V$ , is larger than  $V_v - V_p$ . A more exact expression for the voltage swing that the diode actually undergoes would result in a more accurate frequency calculation.

#### Performance parameters of a 100-ampere GaAs tunnel-diode push-pull inverter operated from a thermionic generator.

Input current (amperes)	Input voltage (volts)	Load resistance (Ohms)	Output voltage volts (RMS)	frequency (CPS)	Power output (watts)	efficiency (%)
45	0.45	200	45	36	10.1	47.9
52	0.425	150	40	36	10.6	48.0
60	0.41	100	37	36	13.6	55.2
65	0.42	100	38	33	14.4	52.8
72	0.42	75	37	33	18.2	60.3
85	0.45	65	37	33	21.0	55.0

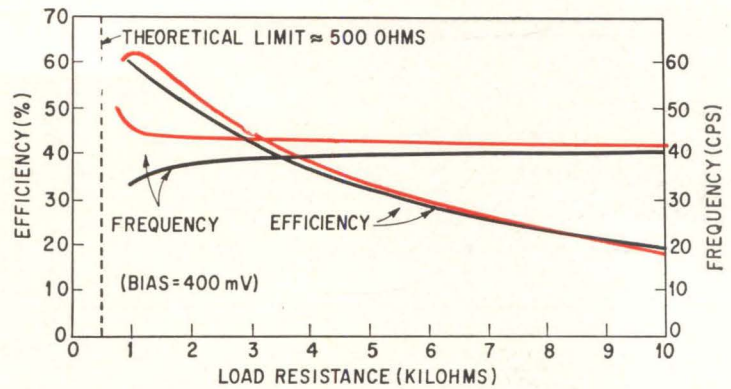
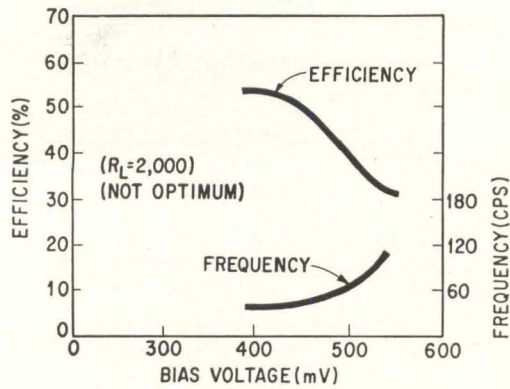

**GaAs 6-ampere diodes as push-pull inverters** have efficiencies greater than 60% (right). Data at left was taken with the inverter at other than optimum load conditions thus causing reduced efficiencies. The use of capacitors greatly improves starting characteristics of some inverters and reduces efficiencies only 3% (color).

The push-pull inverter, unlike the single-diode circuit, was found to operate over only half of its negative-resistance region. If the source voltage becomes too low, the inverter reverts to the symmetric (zero-output-power) mode. The minimum permissible source voltage is approximately half the valley voltage of the diode. A high circuit resistance on the primary side reduces the operating voltage range; hence, it is good design practice to keep the primary circuit and transformer winding resistance as low as feasible.

The parameters of the gallium-arsenide diodes used in the push-pull inverters are given on page 62.

There are two major reasons why gallium-arsenide tunnel diodes may be preferred over germanium units in push-pull inverters: First, because the voltage swing for GaAs is twice that in germanium diodes, the operating frequency of the inverter circuit will be doubled, as indicated by equation 8. Second, higher conversion efficiencies can be realized with GaAs diodes because of their higher current and voltage ratios. In addition, GaAs tunnel diodes have a higher operating voltage range. The d-c source voltage normally will be the determining factor as to which type of diode will be used.

Efficiency and frequency versus bias voltage and load resistance, respectively, for a push-pull inverter using GaAs tunnel diodes are shown above below. Efficiencies greater than 60% have been achieved.

Some inverters when operating at their critical load resistance may exhibit a form of hysteresis when an overload is applied. That is, if an overload is placed on the inverter output (causing the diodes to operate symmetrically and reducing their output to zero) and then removed, the power output remains at zero. To reestablish the out-of-phase (power-producing) mode, the load resistance must be increased to well above the critical value. Furthermore, it is possible that the circuit, when turned on, may start in the symmetric mode rather than the asymmetric mode. A large-value capacitor connected across each diode reduces the

hysteresis effect and greatly improves the starting characteristics. A comparison of the operating characteristics of an inverter with and without a capacitor across each diode shows a loss in conversion efficiency of about 3%. Apparently the capacitors suppress the characteristic higher-frequency mode of in-phase inverter operation and thus allows the inverter to operate in the low frequency asymmetric mode.

It is apparent from the results and graphs presented that both the single-diode and push-pull circuit have some unique features. These features are summarized in the table on p. 59. Additional

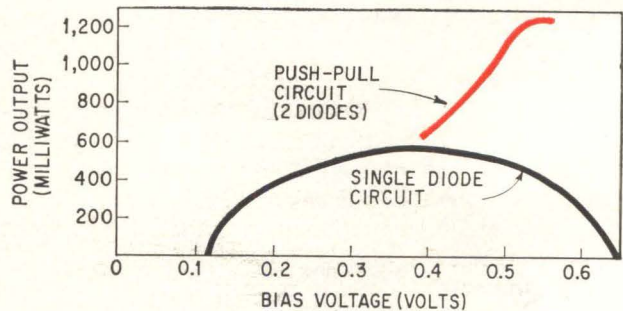

**Power output versus bias voltage** at a fixed load is compared for the two main types of inverters. Six-ampere GaAs diodes are used.

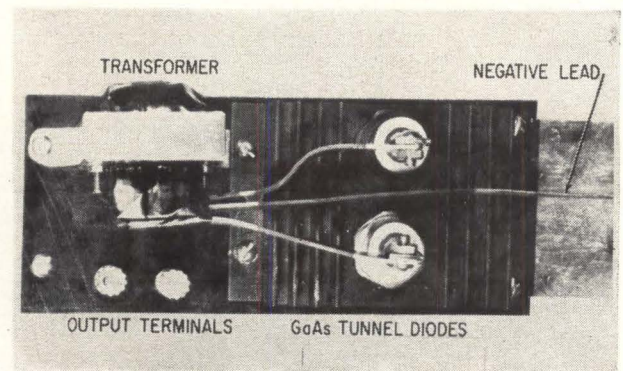

**Ten-Watt, 400 cps inverter** uses two 60-ampere GaAs tunnel diodes. Output voltage is greater than 130 volts rms.

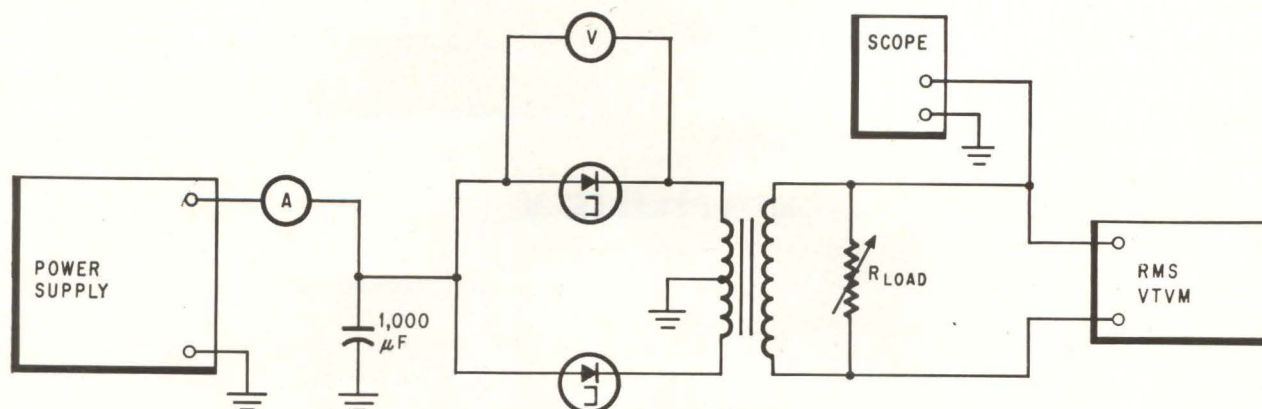

**Test circuit** was used to evaluate all the tunnel-diode inverter circuits. A large capacitor across reduces circuit transients caused by the inverter. An RMS voltmeter at the output determines the true power output regardless of waveshape. The variable resistor, a precision decade resistance box, provides a load resistance known to 1%.

comparison data between these two forms of tunnel diode inverters (see p. 64) is presented in a graph of output power versus bias voltage.

### Thermionic Thermoelectric Sources

Experiments which thermionic and thermoelectric power sources were mated with tunnel-diode inverters were conducted. Successful d-c and a-c inversion was obtained in both cases. Practical use of tunnel-diode inverters with seawater batteries has also been demonstrated.<sup>7</sup>

A thermoelectric generator was connected to a low-current tunnel-diode inverter. Because of the relatively low output current and voltage of this generator, two 5-ampere germanium tunnel diodes were used in a push-pull circuit. (GaAs diodes could have been used in a single-diode inverter circuit). After connecting the inverter to the d-c source, a square-wave output was obtained at a frequency of 10 cps. The frequency could have been increased at least 50 times if a smaller transformer core and fewer primary turns had been used.

A large thermionic converter was connected to a saturating push-pull inverter containing two 100-ampere gallium arsenide tunnel diodes. GaAs diodes were used because the operating voltage of the thermionic converter was approximately 0.5 volt. The transformer used four turns of copper sheet, center-tapped, for its primary, and 210 turns of No. 24 wire for its secondary. With the power source connected to the inverter a square-wave output similar to that shown on page 63 was obtained. The results obtained are summarized in a table on page 63. The theoretical maximum diode efficiency was approximately 61%. Cumulative measurement errors probably were less than  $\pm 5\%$ .

The inverter was operated for approximately one hour at several power levels with good overload recovery. Each diode was bolted to a black, aluminum, heat sink.

Two 200-ampere GaAs tunnel diodes were also inserted in this inverter. Oscillation was obtained, but because the circuit was not designed to oper-

ate at such high currents, it ceased after about one minute. This was attributed to excessive circuit series resistance, the heating effects of the high primary current, and power source voltage drift.

A 10-watt, 400-cps inverter circuit that uses two 60-ampere gallium-arsenide tunnel diodes is shown at left. The output voltage of this unit is greater than 130 volts rms. The physical size of this inverter circuit could be considerably reduced by use of different transformer core material such as tape-wound cores. The heavy connecting leads are necessary to cut down the  $I^2R$  heating losses.

The test circuit shown above was used to test all the inverter circuits described in this article. An RMS voltmeter at the output determines the true power output regardless of the waveshape. The oscilloscope is used to observe the waveform and output frequency.

### Acknowledgment

The author gratefully acknowledges the assistance of P.D. Gardner and A.E. Roswell, who were responsible for the design and development of the high-current tunnel diodes; A.J. Herd, E.M. Strouse, and P.M. Britt, who fabricated the diodes; H. Krautter, who was responsible for the packaging of the devices and R. Glicksman, who initiated the project.

The work described in this paper was performed, in part, under the sponsorship of the Aeropropulsion Laboratory, Aeronautical Systems Division, Air Force Systems Command, USAF, under contract No. AF33(657)-8964.

This article was presented in greatly abbreviated form at the 1963 Power Sources Conference. An article similar to this, but with much more emphasis on tunnel-diode device design and less emphasis on circuit performance, has been published in the Proceedings of the 1963 Power Sources Conference.

### References

1. J.M. Marzolf, "Tunnel Diode Static Inverter," USNRL Report No. 5706, Oct. 1961.
2. D.J. Hanrahan, "Analysis of Tunnel Diode Converter Performance," USNRL Report No. 5722 U.S., Dec., 1961. (Also, IRE Trans. on Electron Devices, July, 1962.)
3. H.F. Storm and D.P. Shattuck, "Tunnel Diode D.C. Power Converter," Trans. AIEE, (Communications and Electronics No. 55), July, 1961.
4. S. Wang, "Converter Efficiency and Power Output of a Tunnel Diode Relaxation Oscillator," Proc. IRE, Vol. 49, July, 1961.
5. A.C. Scott, "Design and Oscillator Applications of High Current Tunnel Diodes," Proc. IRE, p. 1851, Aug., 1962.
6. A.C. Scott, "Symmetrical D.C. Converter Using Six Ampere Tunnel Diodes," Proc. IRE, p. 1851, Aug., 1962.
7. J.M. Marzolf, "Sea Water Battery Plus Tunnel Diode Converter as a Power Source," USNRL Report 5961, May 22, 1963.

# More for your money

Circuit designers can cut costs by early consideration of heat-transfer problems

By Edward Trunk

The Staver Co., Bay Shore, N.Y.

**At an early point** in the design of solid-state circuitry, a method must be chosen for removing the heat generated by the semiconductor devices. This may be done by providing for adequate heat removal in the basic structural design of the equipment or by incorporating dissipation devices into the design. The equipment designer must decide which road to follow.

If his decision is to use dissipators, the next question is: Which is the best dissipator to use from both an economical and a technical standpoint?

Whether the engineer chooses dissipator-assisted cooling or natural cooling, a choice should be made as early as possible. If the decision is to use dissipators, their selection should also be one of the first steps in the design. Otherwise, unnecessary

problems are introduced.

### A typical dilemma

For example, let's consider the fictional case of the Whoops Electronic Equipment Co. Whoops' circuit designers came up with a new equipment item containing new circuits. Then they built a breadboard model. It performed brilliantly. Because it was a commercial item intended for a highly competitive market, germanium transistors were used in the circuits. The maximum junction temperature rating for the transistors was 90°C, but to insure thermal stability (prevent thermal runaway) the circuit was designed to hold the maximum operating junction temperature to 70°C. It was anticipated that the ambient temperature would

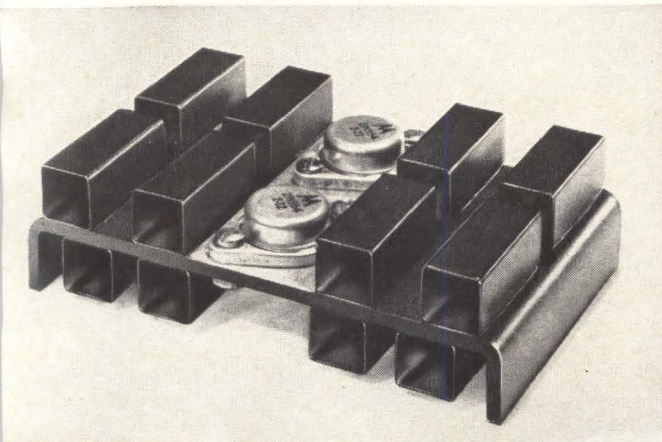

The laminated heat sink eliminates the standoff insulator usually used to prevent electrical conduction between a transistor and a heat sink. The two sections of the heat sink are electrically separated by the hard anodized coating on the top plate.

### Effect of temperature upon thermal conductivity of metals and alloys\*

[Main body of table is  $k$  in Btu/(hr)(sq ft)(deg F per ft)]

Temperature	32	212	392	572	752	932	1112	Melt-
Deg. F.								ing
Deg. C.	0	100	200	300	400	500	600	point
								(Deg. F.)
<b>Aluminum</b>	117	119	124	133	144	155		1220
<b>Brass (70-copper, 30-zinc)</b>	56	60	63	66	67			1724
<b>Cast Iron</b>	32	30	28	26	25			2192
<b>Copper</b>	224	218	215	212	210	207	204	1976
<b>Graphite (longitudinal)</b>	97	87	76	66	58	53	48	None
<b>Lead</b>	20	19	18	18				621
<b>Nickel</b>	36	34	33	32				2642
<b>Silver</b>	242	238						1760
<b>Steel, mild</b>		26	26	25	23	22	21	2507
<b>Tin</b>	36	34	33					450
<b>Wrought iron, Swedish</b>		32	30	28	26	23		2741
<b>Zinc</b>	65	64	62	59	54			786

\*William H. McAdams, Heat Transmission, McGraw-Hill, N.Y., 1954 and International Critical Tables, McGraw-Hill, N.Y., 1929.

not rise above 45°C. Even so, this meant a temperature difference of only 25°C between the junction temperature and the ambient temperature.

When the circuit designers were through, the packaging engineers took over. By the time they finished, some of the transistors had been placed at the interior of the set where they would be subjected to a local environmental temperature considerably higher than 45°C. Moreover, the physical arrangement of the circuit components was more confining and the air flow more hampered than in either the breadboard model or the prototype which followed it.

Next, overheating and premature failure of the transistors was discovered during the testing of the first production models. Transistor dissipators were purchased in a hurry and squeezed into place. They were the last step in the design. The result was that dissipators were not used to their best advantage. Fortunately, they provided enough cooling to permit the marketing of the equipment.

It's conceivable that if the use of dissipators had been planned early in the design, heat dissipators costing considerably less could have been used. The competent designer has learned that the dissipator is a fundamental design component just like the capacitor, resistor, or transformer.

#### Chassis as heat sink

One economical solution of a heat dissipation problem is to use the chassis or an outer surface of the cabinet as a heat sink. Frequently this approach works—especially if the chassis or surface material is aluminum, if the thermal conditions are not severe, and if the surface chosen is not subject to appreciable heating by other components. On

the other hand, if the material is a thin-gauge steel and has numerous mounting holes filled by other components, its use as a transistor heat sink could be disastrous. Copper, aluminum, and magnesium surfaces may be acceptable as heat sinks, depending on the application. Brass and steel surfaces are usually poor choices for use in this manner.

It is essential to construct a full-size model of the cabinet or chassis proposed for use as a heat sink, and to duplicate the actual conditions which will exist for the production model. Suppose the

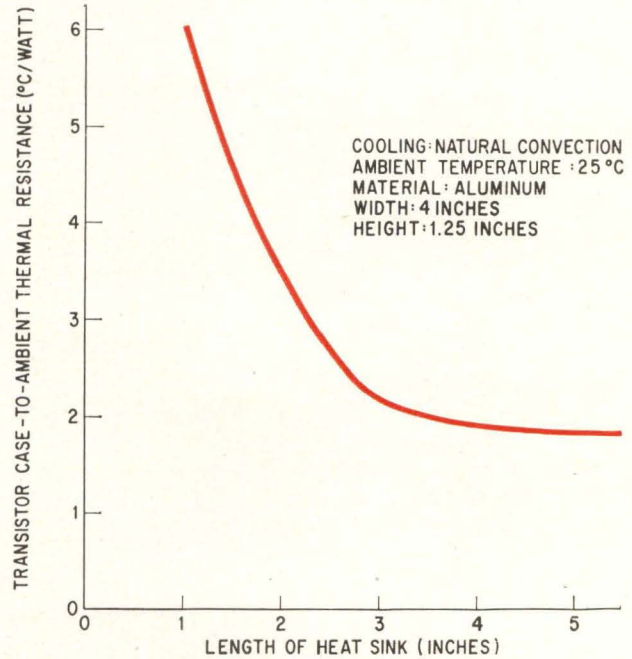

Variation of thermal resistance with heat sink size

#### Thermal conductivities of metals\*

[ $k = \text{Btu}/(\text{hr})(\text{sq ft})(\text{deg F per ft})$ ]

Substance	Deg. F.	$k$	Substance	Deg. F.	$k$	
<b>Metals:</b>			<b>Metals:</b>			
Antimony	32	10.6	Mercury	32	4.8	
Antimony	212	9.7	Nickel alloy (60Ni, 12Cr, 26Fe)	68	7.8	
Bismuth	64	4.7	Platinum	64	40.2	
Bismuth	212	3.9	Platinum	212	41.9	
Cadmium	64	53.7	Tantalum	64	32	
Cadmium	212	52.2	<b>Alloys:</b>			
Gold	64	169.0	Admiralty metal	86	65	
Gold	212	170.0	Bronze, commercial		109	
Iron, pure	64	39.0	Constantan (60Cu, 40Ni)	64	13.1	
Iron, pure	212	36.6	Constantan (60Cu, 40Ni)	212	15.5	
Iron, wrought	64	34.9	Nickel silver	32	16.9	
Iron, wrought	212	34.6	Nickel silver	212	21.5	
Iron, cast	129	27.6	Manganin {	84Cu	64	12.8
Iron, cast	216	26.8		4Ni	212	15.2
Steel (1 per cent C)	64	26.2		12Mn		
Steel (1 per cent C)	212	25.9	Platinoid	64	14.5	
Magnesium	32-212	92.0				

\*L. S. Marks, Mechanical Engineers' Handbook, McGraw-Hill, N.Y., 1951.

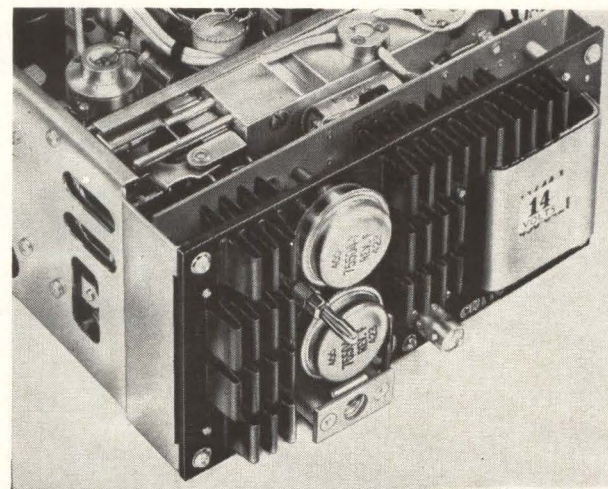

Advance planning allowed integration of the heat sink into this equipment design. The equipment is a distance-measuring unit, model UDI-3, manufactured by the National Aeronautics and Space Administration, Fort Washington, Pa.

test results show that the chassis or cabinet is not adequate to the cooling job. Before specifying dissipators, consider a different chassis material. The heat dissipation problem might be solved by replacing the aluminum material under consideration with a more-conductive or heavier-gauge type. Another solution might be to coat the bare aluminum surface with black paint. This could increase the dissipating ability of the aluminum by about 15%.

#### Allow air flow

If an internal surface is used as the heat sink, ample openings in the cabinet in addition to internal air flow passageways may be the answer. In the example of the Whoops Electronic Equipment Co. such an approach might have eliminated the need for dissipators entirely. It is even possible, although not often done, to add fins to the cooling surface to provide greater heat convection. If a cabinet surface is to be used as a heat sink, the vertical exterior surfaces are best.

If the use of a chassis or cabinet surface is not adequate, the designer will have to employ individual heat sinks. With printed circuits employed in plastic or thin-gauge steel cabinets, he has to use dissipators. His next step is to calculate the thermal resistance figure required for the heat dissipator.<sup>1</sup> The curve on p. 67 shows how the value of thermal resistance changes with changes in the size of the heat sink. For lengths beyond three inches, further increases in length still have some effect on thermal resistance but add considerably to the dissipator cost.

Usually, the lower the thermal resistance of a dissipator, the higher its price and the greater its size. Specifying a lower thermal resistance than needed is costly in terms of both space and dollars.

#### Include safety factor

Therefore, the designer shouldn't go overboard when designing-in safety factors. If he uses 250% when 25% will suffice, he's not gaining much in additional reliability or lifetime, but he's losing a lot in terms of space, weight, and cost. He's well past the optimum point, where his dollar is buying the most it can get in cooling capability.

To determine the optimum dissipator to use, a useful tool is the price-thermal resistance figure of merit. This indicates how many watts can be dissipated per dollar spent for a given temperature

#### The author

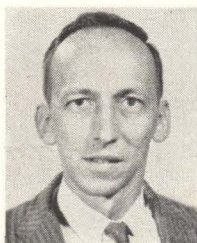

Edmund G. Trunk, a professional engineer, is acting as consultant to the Staver Co. He holds a master's degree in electrical engineering from the Polytechnic Institute of Brooklyn. His fields of specialization are servomechanism systems and solid-state circuitry. A sailing enthusiast, Trunk has been experimenting with the conversion of wind into electrical energy—perhaps to power his boat.

Dissipator	(a) Price (cents)	(b) Thermal resistance (°C/watt)	[1/(a) (b)] Thermal figure of merit [watts/(dollarsx°C)]
No. 1	.38	5.5	.48
No. 2	.40	6.4	.39
No. 3	.90	5.0	.22
No. 4	.95	3.5	.30

rise. The table shows how this thermal figure of merit is obtained.

#### Making a comparison

From the table, dissipator No. 1 appears to be a much better value than No. 3 although its thermal resistance is slightly higher. The correct use of the thermal figure of merit requires that the user test each dissipator under identical conditions. The manufacturer's data sheet values will probably not be acceptable for direct comparison of dissipators since thermal resistance values vary considerably according to the testing conditions. For example, a heat sink with a thermal resistance of 1.9°C/watt (when measured for a 57°C temperature rise and 30 watts dissipation) can provide a thermal resistance of 2.4°C/watt if the dissipation is reduced to 10 watts (the corresponding temperature rise from 25°C with this dissipation is 24°C). This illustrates that the relationship between temperature rise and power dissipation is not linear. Typically, the temperature increases by the 0.83 power of the increased dissipation.

#### Avoid insulator

There are also other ways in which the cost of providing for adequate heat transfer can be kept down. When possible, the use of an electrical insulator between the transistor and the heat dissipator should be avoided. Insulators add 0.5° to 1.0°C per watt to the total thermal resistance which may require the use of a larger dissipator. One way to eliminate the insulator is to isolate the heat sink from the chassis ground. This practice is advantageous from a thermal standpoint but it may present a safety hazard. Another way to eliminate the insulator is to use a two-layer or laminated dissipator which has a hard anodized coating on one layer to prevent electrical conduction [Electronics, June 15, 1964, p. 84]. Such a dissipator is shown on page 66.

Early consideration and selection of the method and devices to carry off the heat from solid-state circuitry is important. A last-minute discovery that dissipators are needed can mean high costs. The discovery can be particularly expensive if fabrication is so far along that only a custom-made shape can fit the available space. Remember that early integration of large dissipators into the design sometimes allows their use as structural supports.

#### Reference

1. A.D. Abel, Power Transistor Cooling, Solid State Journal, Oct., 1961, p.24-25.

# Cooling high-power equipment by forced-air convection

Selection of the right fan for the system is critical.

Here are some guidelines for the equipment designer

By Leonhard Katz

President, Astro Dynamics, Inc., Burlington, Mass.

**Forced-air cooling** is one solution to the growing problem of cooling high-density equipment. The need to cool electronic equipment containing an ever-increasing number of transistors, semiconductor diodes or silicon controlled rectifiers is forcing engineers to turn from free-convection cooling to other methods. In some cases, liquid cooling is effective but not always practical because of the requirement for bulky pumps and heat exchangers. For very compact high-power equipment, natural convection is especially impractical because it requires large heat sinks.

## Design goals

Forced-air convection is usually the method chosen. To do the job properly, however, a compact heat-sink assembly using forced convection must meet the following design criteria:

1. The individual dissipator (or heat sink) package should be modular, so that several can be stacked together to form a modular package.
2. The dissipator should provide a mounting surface for the transistors that permits external wiring and easy testing of circuits.
3. The heat sinks, when mounted in place, should be electrically insulated from each other.

## The author



Leonhard Katz, has been a consultant for many years in the fields of heat transfer, mass transfer, television, telemetering, and radar. His company manufactures electromechanical devices, heat sinks and heat exchangers. He is a consultant to the President's Science Advisory Committee and is teaching a graduate course in heat transfer at Northeastern University.

However, if the use of an electrical insulator between the transistor and the heat sink can be avoided, heat flow will be improved.

4. The dissipator must be designed to provide minimum temperature difference between the transistor and the air which surrounds it.

5. The heat-sink assembly and the fan should be of integral design so that maximum output from the fan can be effective.

The forced-convection system should also be designed around commercially available components. Avoiding the use of custom-made products not only allows savings in time and cost but also permits design on the basis of known performance.

## First Step

The first consideration in the selection of components for a forced-convection system is the right fan. Electronic circuits involving power transistors or semiconductor rectifiers typically require 5 to 20 transistors. The power dissipation for each transistor usually does not exceed 20 watts. The assembly, for a typical 15-transistor system may thus be required to dissipate about 300 watts. For this particular system, the fan must provide enough air movement so that the air temperature, when 300 watts are dissipated, will not rise excessively. Ideally, to restrict significant shortening of the transistor lifetime, the air temperature should not be permitted to rise more than 10°F to 20°F.

The first law of thermodynamics defines the rate at which heat is carried off by forced air convection as:

$$Q = W C_p \Delta T \text{ or } W = Q/C_p \Delta T \quad (1)$$

where  $Q$  = heat dissipation rate in BTU/hr

$W$  = weight flow of air in lb/hr

$C_p$  = specific heat of air in BTU/(lb)(°F)

$\Delta T$  = temperature rise of the air in °F

Front view of a modular heat-sink assembly capable of mounting 12 power transistors.

Rear view of a modular heat sink assembly. The fan is a fundamental structural component of the package.

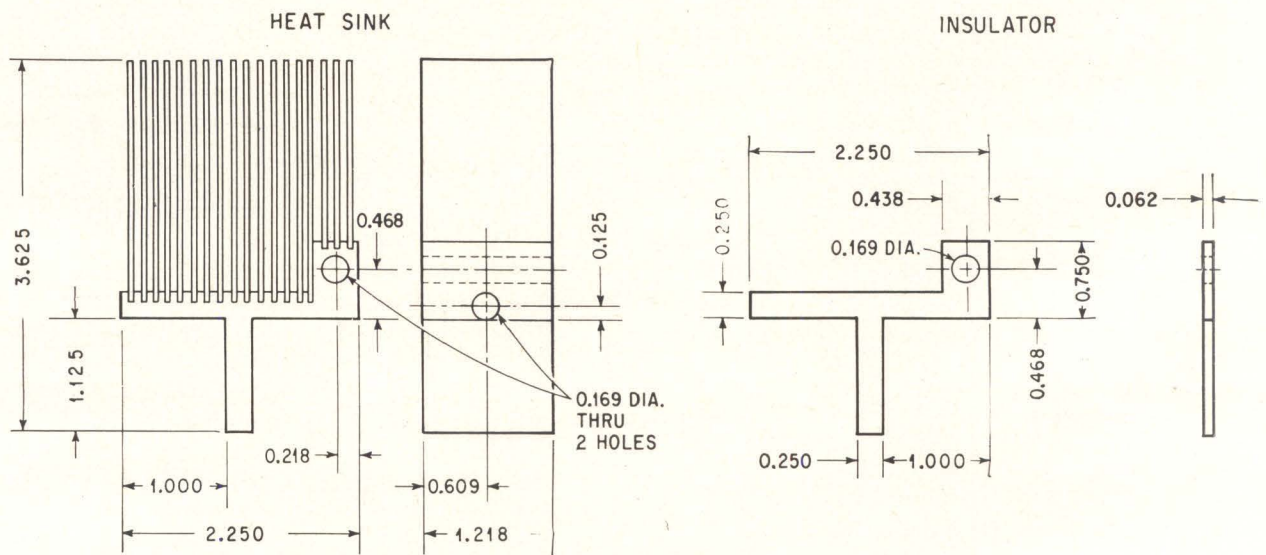
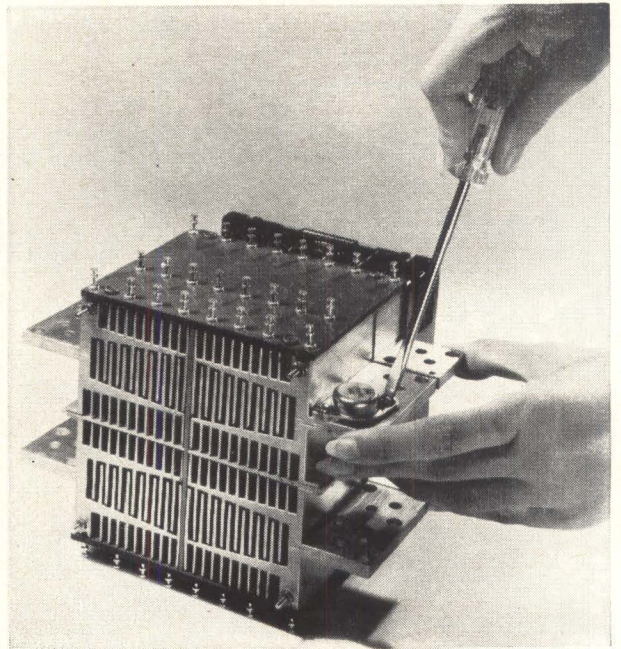
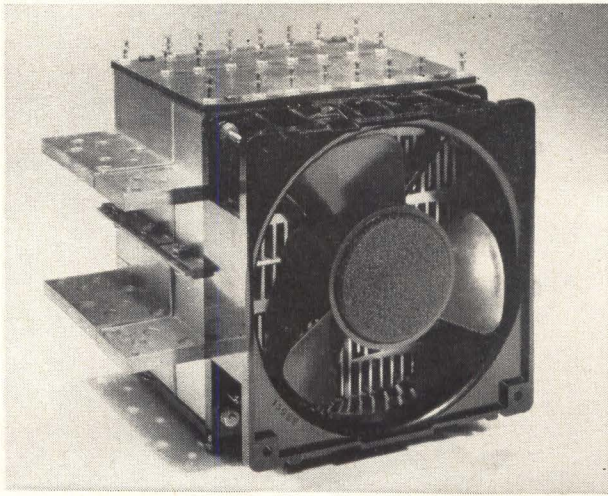

The basic heat sink used as a building block

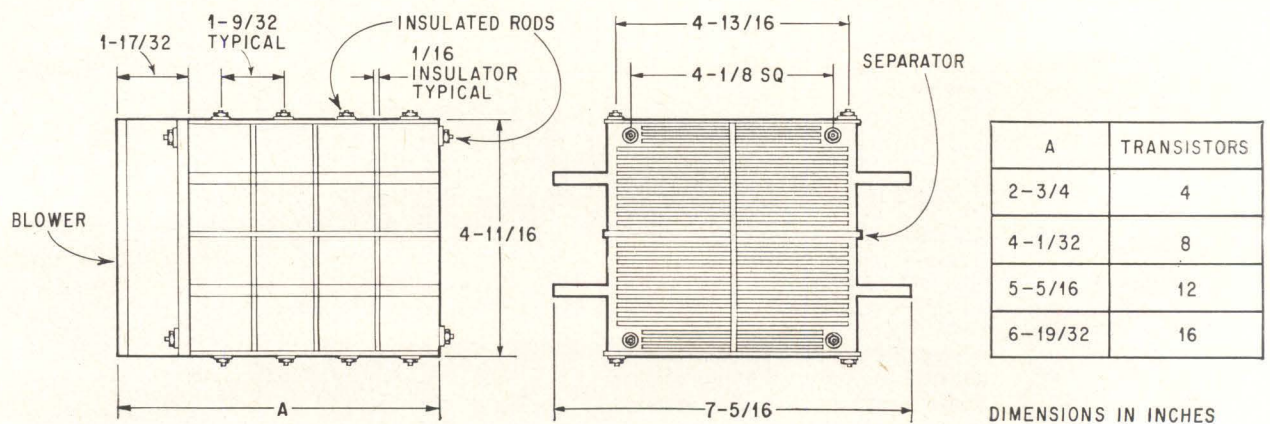

A forced convection system with 16 heat sinks

DIMENSIONS IN INCHES



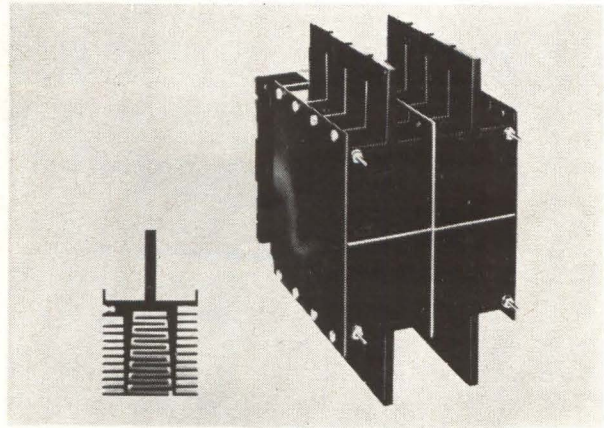
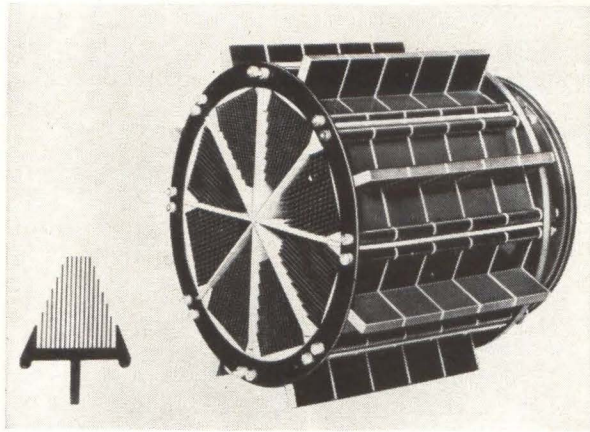

Circular assembly for mounting 40 power transistors, left; rectangular assembly for 16 power transistors, right

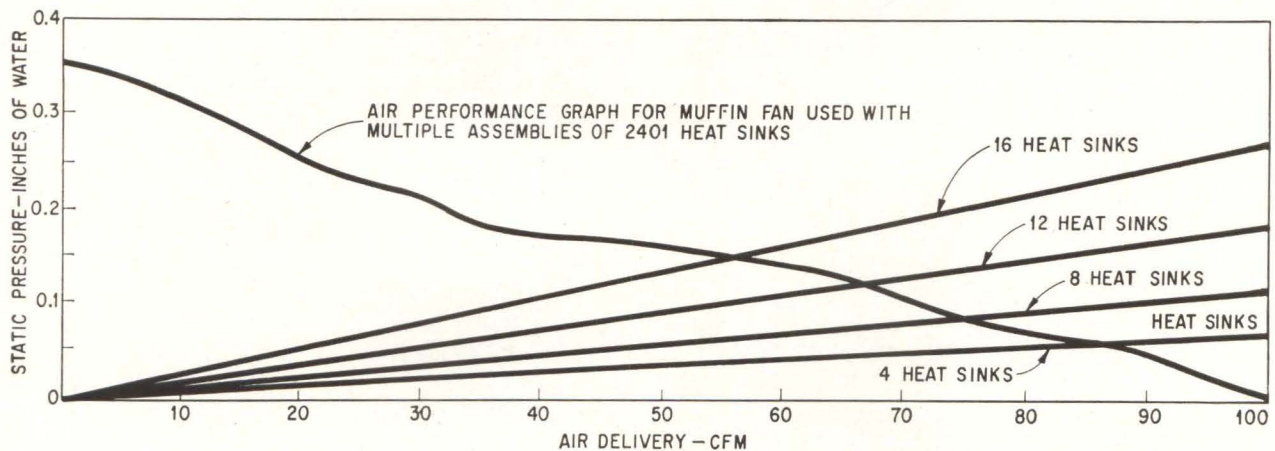

#### Performance of fan

Since 1 watt = 3.41 BTU/hr and 1 cubic foot per minute (CFM) = 4.2 lb/hr, the required air flow may now be determined for the typical system.

$$Q = 300 \text{ watts} = 300 (3.41) \text{ BTU/hr} \\ = 1023 \text{ BTU/hr}$$

$$C_p = 0.24 \text{ for air at } 100^\circ\text{F}$$

$$\text{If } \Delta T = 10^\circ\text{F}$$

From equation 1:

$$W = 1023 / 0.24 (10) = 426 \text{ lb/hr} \\ = 426 / 4.2 \text{ CFM} = 100 \text{ CFM}$$

For  $\Delta T = 20^\circ\text{F}$ , eq. 1 yields  $W = 213 \text{ lb/hr} = 50 \text{ CFM}$ . Therefore, a fan capable of providing between 50 to 100 CFM is required.

Another requirement influencing fan selection is that the power needed to drive the fan should not exceed 10% of the power to be dissipated. For this example, the fan power should not exceed 30 watts. Several compact fans which can deliver 100 CFM of air are commercially available. A typical fan, made by the Rotron Manufacturing Co., Woodstock, N. Y., is approximately five inches square and consumes approximately 13 watts. The four corner-mounting holes of the fan can be used as the mounting holes for the whole assembly. The pressure drop obtainable from the fan is about 0.15-inch water pressure at 50 cubic feet per minute which is approximately equal to the pressure drop

for the equipment.

Pressure drop is an indication of the ability of air to flow through the equipment being cooled. The larger the pressure drop, the higher the resistance presented by the equipment to the flow of air. For a fan to be effective, its pressure-drop rating should be equal to or greater than the pressure drop measured for the equipment.

This fan allows the mounting of four heat sinks in a layer, each heat sink occupying one quadrant. Up to four layers of heat sinks can be stacked, thereby providing accommodations for 4, 8, 12, or 16 transistors. Since the application being discussed employs 15 transistors, four layers are required.

#### Second step

Theoretically, the next step is the design of the individual heat sink—determination of the size, shape and number of fins, their thickness, spacing and length, together with the design of the fin base and the shelf for transistor mounting. Actually, the equipment designer will rarely conduct this part of the design. Each heat-sink manufacturer has one or more basic dissipators specifically designed for use in forced-convection cooling systems. The use of a standard dissipator assures the equipment designer that losses in the form of temperature

drops in the system have been previously studied and minimized. Those temperature drops which must be minimized are:

$\Delta T_1$  = drop between air and fins

$\Delta T_2$  = drop along the fin, due to conduction

$\Delta T_3$  = drop in the fin base, due to conduction

$\Delta T_4$  = drop in the shelf

$\Delta T_5$  = interface loss between transistor and shelf

Drop  $\Delta T_1$  is determined by the magnitude of the heat-transfer coefficient  $h$  [Electronics, Sept. 7, p. 101] between the air and the fins, while  $\Delta T_2$ ,  $\Delta T_3$ ,  $\Delta T_4$ , are determined by the heat-transfer properties of the conduction material. The interface loss  $\Delta T_5$  is a function of the surface area of the transistor base.

### Building block

A recommended dissipator configuration which satisfies most forced-convection requirements is shown on p. 70. The complete assembly shown uses

this dissipator as a building block with the fan previously described.

Typical values (in °F/watt) of temperature drops obtained using this arrangement are:

$\Delta T_1 = 0.5$   $\Delta T_4 = 0.2$

$\Delta T_2 = 0.3$   $\Delta T_5 = 0.2$

$\Delta T_3 = 0.2$

The total temperature drop associated with the heat-sink assembly alone is  $\Delta T_1 + \Delta T_2 + \Delta T_3 + \Delta T_4$  or 1.2 °F/watt, equivalent to 0.67 °C/watt. ( $\Delta T_5$  is determined by the mounting surface of the transistor used.)

The air flow that can be expected is obtained from the curves shown on p. 71. If only one layer (four heat sinks) is used in the assembly, air flow at 87 CFM can be expected (75 CFM for 8 heat sinks, 67 CFM for 12 heat sinks). Since 15 heat sinks are required in the example discussed, the air flow is about 55 CFM. This is within the desired 50 to 100 CFM range.

## Circuit Design

# Insurance against transistor failure

Automatic cutoff protects semiconductor devices from damage or destruction by heat

By Henry Epstein and Charles Flanagan

Texas Instruments, Inc., Attleboro, Mass.

**Extensive studies** of the failure of electrical-magnet wire insulation as a function of conductor temperature have shown that for every 10°C change in temperature the projected insulation life halves (for a temperature increase) or doubles (for a temperature decrease). A similar pattern appears to apply for semiconductor devices.

R. H. Norris and J. E. Drennan have reported a range of 8° to 15°C for the halving (or doubling) of lifetime depending on the type of semiconductor device and the application.

The failure-rate pattern shown indicates the effect of operation at an increased temperature on a semiconductor device.

The effect of the operating temperature on the failure rate of semiconductor devices is further illustrated by the curve shown on p. 73. This curve reveals that a typical silicon device operated at a junction temperature of 160°C will have a lifetime of about 500 hours. However, the same device operated at a 100°C temperature can provide more than 10,000 hours of service.

There are a number of ways to prevent heat from damaging or destroying the transistors in solid-state equipment. These include adding an

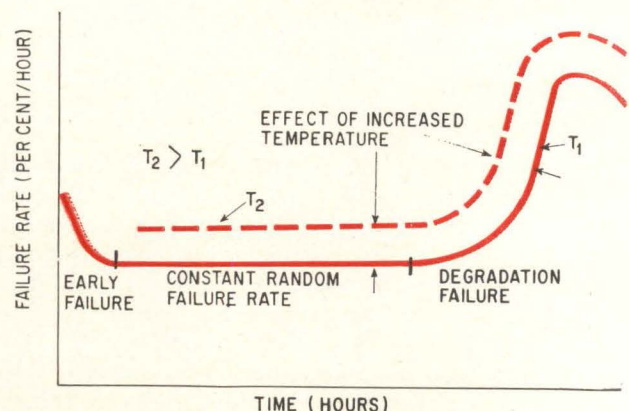

Typical failure pattern for semiconductor devices.

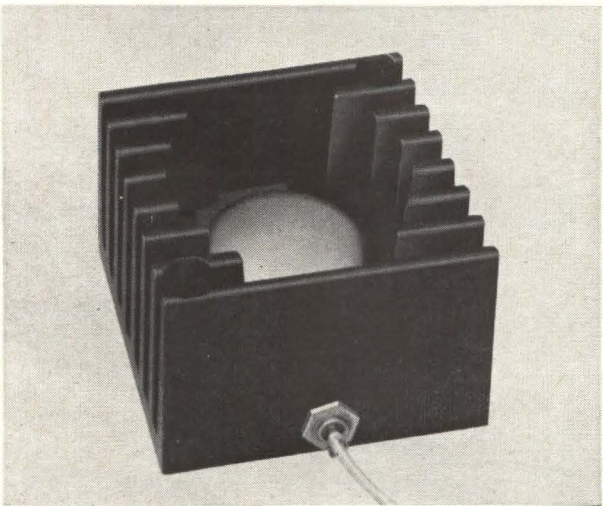
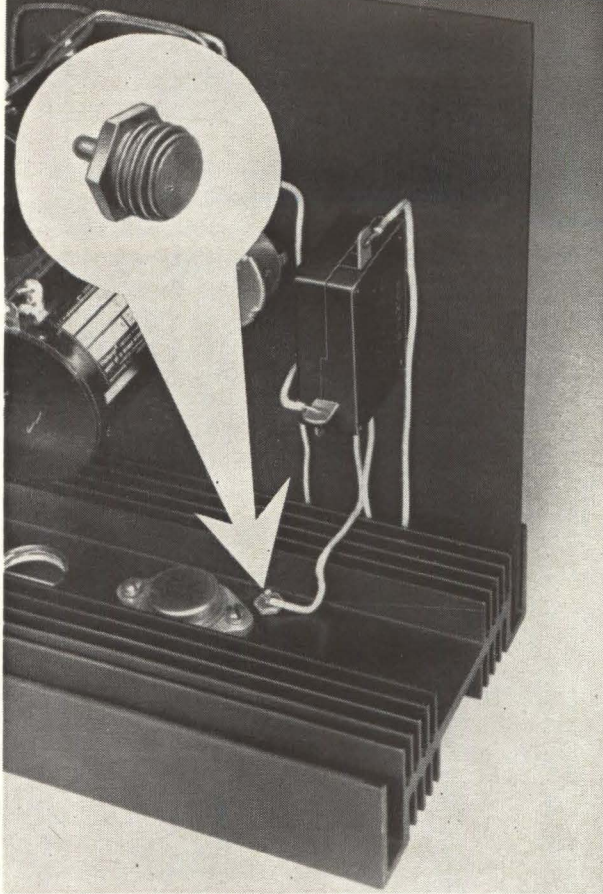

**Thermostat** mounted on heat sink shuts off circuit or sounds alarm when temperature exceeds safe level.

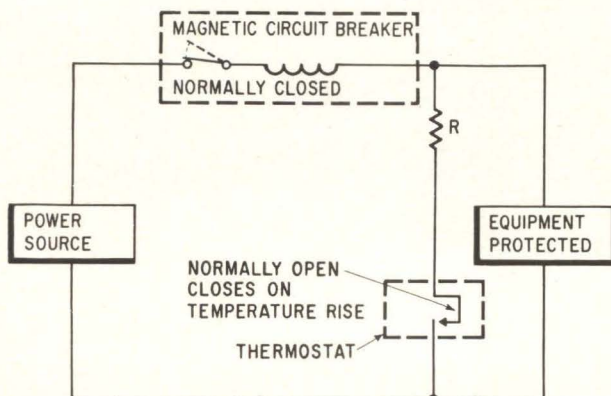

**Protection circuit** for guarding solid-state equipment against temperature and current overloads

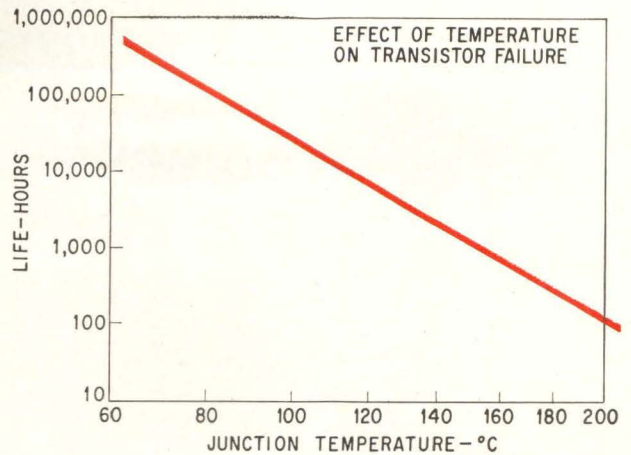

**Transistor lifetime** as a function of junction temperature

alarm circuit to indicate the overheating of the transistor, provision for automatically bypassing or attenuating of harmful power transients, protection by effective cooling systems, and system interruption before excessively high temperatures are reached. A combination of two or more of these methods promises added protection.

For example, an ideal two-level protective system would work as follows: The first level would energize an alarm system and permit corrective action when the approach to failure is slow. The second level would de-energize the equipment being protected or initiate corrective action if the rate of approach to failure is rapid.

### Thermal monitors

A transistor which is expected to operate under conditions that may cause it to overheat, will probably be used with a heat sink. The heat sink, therefore, may be used in conjunction with a thermostat to protect the transistor. For example, a small thermostat can be mounted directly on the heat sink near the transistor. When the heat-sink temperature exceeds a safe value, the thermal monitor can be set to open or close an electrical circuit. At the critical temperature it can activate an alarm, shut down the system, or both.

Two typical mounting arrangements for thermal monitors are shown at left. In both cases, the temperature protective device used is a Texas Instruments model 3BT3.

Thermal monitoring may also be used in conjunction with a circuit breaker to provide a protection scheme for all conditions of current and ambient temperature. The thermal monitor is designed to close at a certain temperature. In typical use, it is connected across the line on the load side of a magnetic circuit breaker coil as shown. Closing of the circuit by the thermal monitor causes an overload which trips the magnetic circuit breaker. The system cannot be re-energized until the thermal monitor and the equipment being protected have cooled to a safe operating temperature.

# Designer's casebook

Designer's casebook is a regular feature in Electronics. Readers are invited to submit novel circuit ideas, packaging schemes, or other unusual solutions to design problems. Descriptions should be short. We'll pay \$50 for each item published.

## Diamond circuit measures phase shift

By Harry R. Deveraux

University of Wyoming, Laramie, Wyo.

A circuit utilizing the diamond switch<sup>1</sup> can measure phase shift with accuracies of 1% at frequencies up to 2,000 cycles per second. This circuit can be useful for high-speed analog instrumentation and computers.

The diamond switch is a follower circuit. For a sine wave input, the output will be a sine wave

of the same magnitude and phase. Transistors  $Q_1$  and  $Q_2$  are control transistors that turn the switch on and off. The switch in the on condition ( $Q_1$  and  $Q_2$  off) has an input impedance of approximately 450 kilohms. For a transistor  $\beta$  of 75, the output impedance is about 10 ohms; the voltage gain is approximately unity, and the current gain is approximately 4,000. The bandpass is from 0 to 9 mc.

Turning on  $Q_1$  and  $Q_2$  causes the output of the switch to go to zero. When the inputs to the bases of  $Q_1$  and  $Q_2$  are positive and negative, respectively, the bases of  $Q_5$  and  $Q_6$  see a low impedance path to ground through the saturated transistors,  $Q_1$  and  $Q_2$ . This causes  $Q_5$  and  $Q_6$  to be cut off, resulting in zero output. The input to the control transistors is supplied through a comparator and a Schmitt trigger. The waveshapes show the results when the input to the Schmitt trigger is in phase

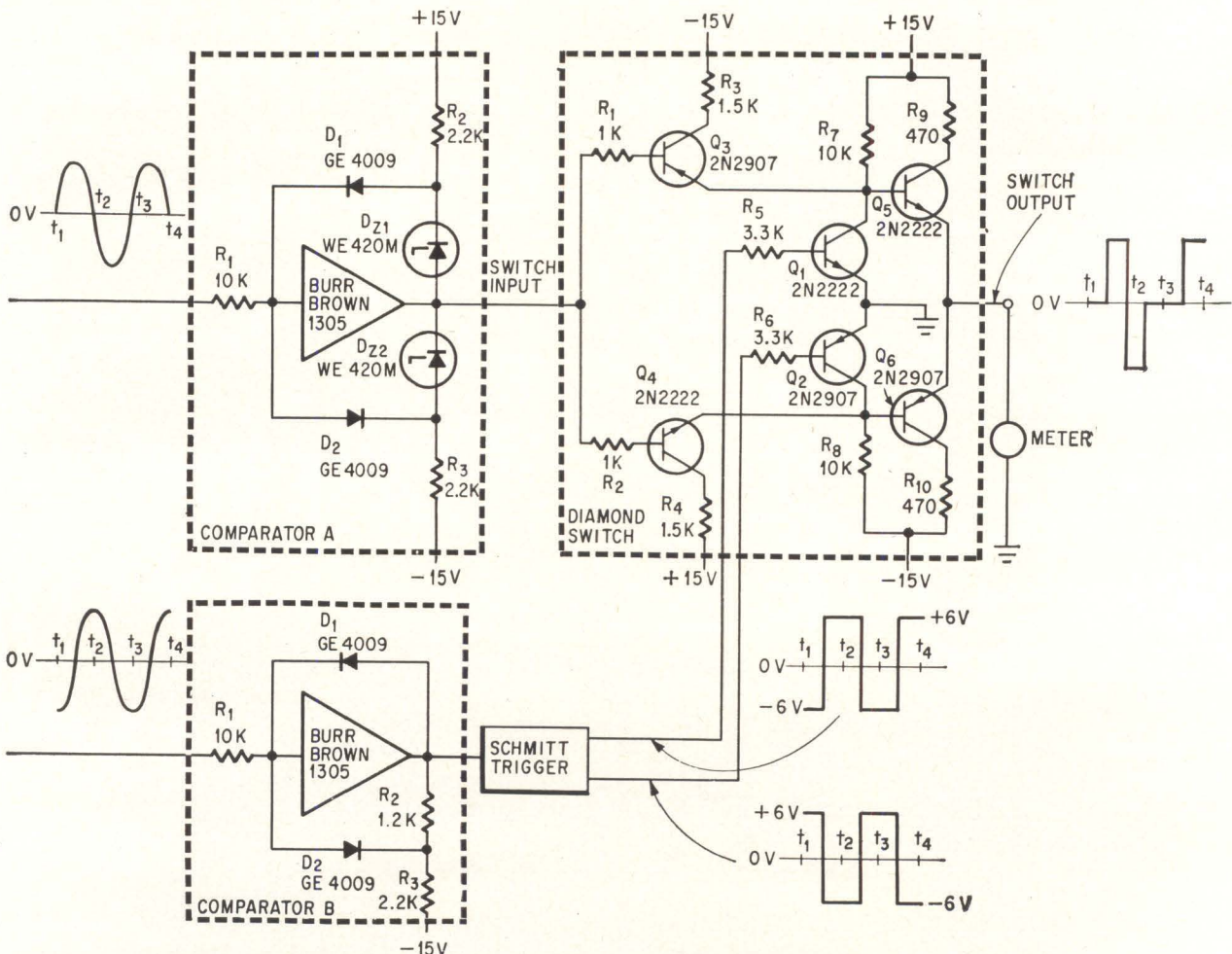

The diamond switch used to measure phase shift. Output waveshape is for 90° phase shift.

with the input to the switch, and when the input to the Schmitt trigger is phase-shifted  $90^\circ$  with respect to the switch input. The shape of the output of the switch is a measure of the phase difference between the input to the Schmitt trigger and the input to the switch.

A d-c zero-center ammeter, placed across the output of the switch, will read the average value of the output wave. For the two outputs shown (bottom waveshapes), the meter indicates a negative value for zero phase shift and zero for  $90^\circ$  phase shift. When the input to the Schmitt causes the control transistors to be on, the output of the switch is zero; and while the control transistors  $Q_1$  and  $Q_2$  are off, the output equals the input. Therefore, the ammeter will read some minimum value for zero phase shift, zero for  $90^\circ$  shift, and some maximum value for  $180^\circ$  shift. The output of the switch is a linear function of the phase shift. The meter can be calibrated accordingly.

To use a normal, linear scale meter, the sine wave input to the diamond switch should be converted to a square wave. This conversion is accomplished by comparator A in the circuit diagram on page 74. Comparators A and B make the switch output amplitude independent of the input signal amplitude.

In the circuit tested, the accuracy and sensitivity of the system were limited by the meter used to indicate the phase shift. The meter had a zero center scale reading with  $+10\mu\text{a}$  and  $-10\mu\text{a}$  full scale deflections, where  $-10\mu\text{a} = 0^\circ$ ,  $0 = 90^\circ$ , and

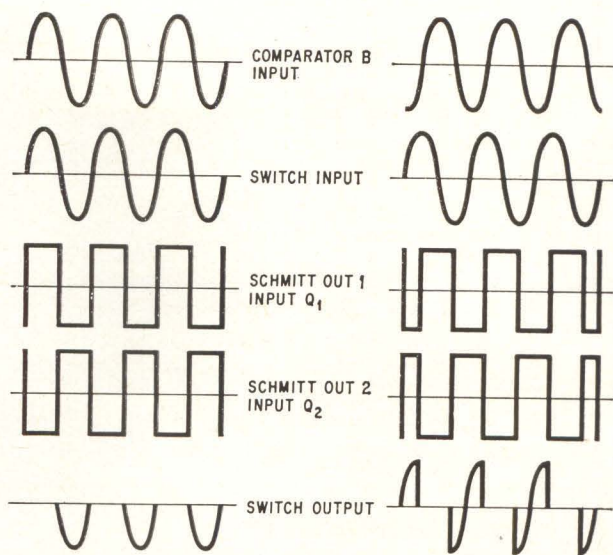

The waveshapes for  $0^\circ$  phase shift (left) and  $90^\circ$  phase shift (right) between the input to the Schmitt trigger and the diamond switch

$+10\mu\text{a} = 180^\circ$  phase shift. Resolution was limited by the smallest division on the meter which was  $0.25\mu\text{a}$ , equivalent to  $2.15^\circ$  phase shift.

#### Reference:

I. R.H. Baker, M.I.T. Lincoln Lab, Lexington, Mass., "The Diamond Circuit," 1963 International Solid-State Circuits Conference, Feb. 1963.

## Tunnel diode multi recovers quickly

By Paul Heffner

Goddard Space Flight Center,  
National Aeronautic and Space Administration,  
Greenbelt, Md.

This monostable multivibrator employing a tunnel diode has the following advantages over monostable circuits with two active devices: 1) a greater duty cycle (0.90); 2) a faster output rise time as transition from the quasi-stable to the stable state takes place, and 3) the ability to vary the time delay continuously by a proportion greater than 100-to-1. The rise time at termination of the delay period is independent of the delay time or the value of capacitance chosen to determine the delay. Instead, the rise time is a function of the tunneling process in the tunnel diode and the switching time of a common-emitter transistor switch. The time delay may be varied continuously over a large range because the transistor bias current remains essentially constant, regardless of the value of resistance used to establish the delay time.

The tunnel diode across the base and emitter of a transistor switch acts as a current-controlled threshold detector. The supply of current to the tunnel diode depends upon the potential impressed across timing capacitor,  $C_2$ . Before an input to the circuit is received, the capacitor is uncharged, the tunnel diode is held at a high voltage by a fixed bias current, and the transistor switch is on and kept on by the tunnel diode and a base bias current. When an input is applied to the circuit, the tunnel diode is switched to its low-voltage state, turning off the transistor. While the transistor is off, the timing capacitor  $C_2$  is allowed to charge until the potential across the capacitor delivers enough current to the tunnel diode to switch the diode back into its high-voltage state, turning the transistor on, thus terminating the monostable period of the multivibrator.

In the steady-state condition, the tunnel diode is in the high-voltage region of its characteristic, and  $Q_1$  is saturated. The value of  $R_2$  is so chosen that it is small enough to supply the current necessary to maintain both the tunnel diode and  $Q_1$  in this condition. But, when the tunnel diode is switched to the low-voltage region, the value of  $R_2$  must be large enough to prevent the peak current that switches the tunnel diode back to the high-voltage state. The collector of  $Q_1$  will be at ground

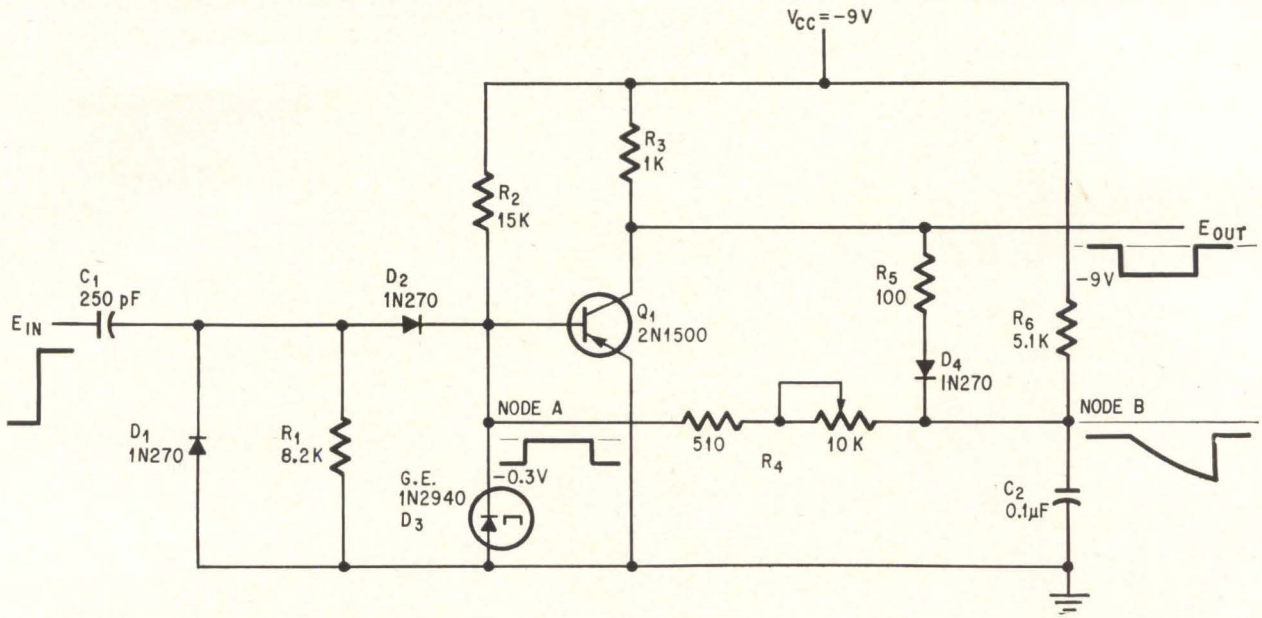

**Tunnel diode monostable multivibrator**

potential since  $Q_1$  is saturated. The voltage across the capacitor at node B will be the sum of the saturation voltage drop across  $Q_1$ , the drop across  $R_5$  and the forward-voltage drop across  $D_4$ . Resistor  $R_6$  provides the current path necessary to maintain this initial voltage at node B.

The application of a positive step voltage at the input to the circuit provides a positive differentiated pulse to the tunnel diode which switches it to the low-voltage state, turning  $Q_1$  off. The duration of the quasi-stable state of the monostable multivibrator is governed by  $R_2$ ,  $R_4$ ,  $R_6$ , and  $C_2$ . With  $D_4$  back biased and presenting a high impedance to node B, capacitor  $C_2$  begins to charge. Two super-

imposed currents, one from  $V_{cc}$  through  $R_2$  and one from the voltage at node B through  $R_4$  (fixed resistor of 510 ohms in series with the variable 10,000 ohm resistor) contribute to the switching of tunnel diode  $D_3$ . The current through  $R_2$  is insufficient to supply the necessary switching current to  $D_3$ . The current through  $R_4$  increases proportionally with the voltage across capacitor  $C_2$  until the sum of the two currents reaches the peak current value for  $D_3$ . The tunneling process is initiated and the diode switches to the high-voltage state. Since the voltage across  $D_3$  is impressed across the base-to-emitter junction of  $Q_1$ , the transistor switches to its saturated state, terminating the quasi-stable state of the multivibrator. Capacitor  $C_2$  then discharges through the low impedance of the now forward-biased diode  $D_4$ , the current limiting resistor  $R_5$ , and saturated  $Q_1$ , quickly establishing the steady-state condition necessary before a new quasi-stable period can be initiated. This provides the high duty cycle ability of the multivibrator.

The tunnel diode characteristic curve and the manner in which the two currents are superimposed is shown at left. The current  $I_1$  is governed by  $R_4$  and the voltage across the capacitor at node B. The current  $I_2$  is contributed through resistor  $R_2$  and is nearly constant, regardless of the state of  $D_3$ . The algebraic sum of the two load lines is shown by the dotted line. In this illustration, the peak current has been reached so that the tunnel diode would switch through the negative resistance region into the high-voltage region. The quasi-stable period may be controlled by  $R_4$  and  $C_2$ .

To determine the delay time as a function of circuit parameters consider the Thevenin equivalent circuit seen by the tunnel diode,  $D_3$ . During the quasi-stable state, transistor  $Q_1$  will be off and the tunnel diode will be in the low-voltage state.

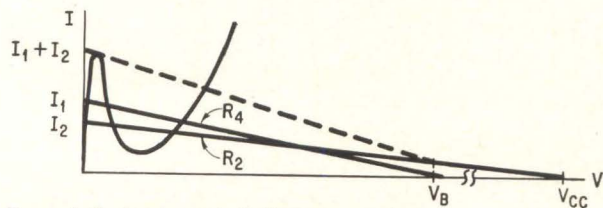

**Tunnel diode characteristic curve and superposition of contributing currents**

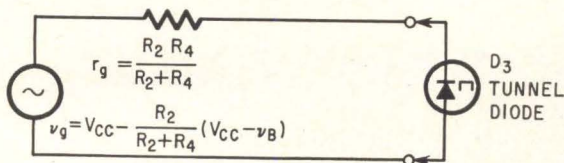

**Equivalent circuit seen by tunnel diode**

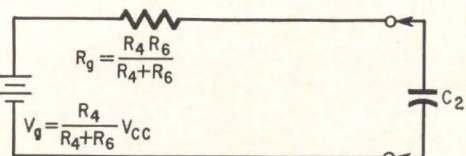

**Equivalent circuit seen by  $C_2$**

The high impedance seen looking into the base of transistor  $Q_1$  and the high impedance seen looking into back-biased diode  $D_4$  is neglected. The instantaneous voltage at node B is denoted by  $v_B$ .

Because  $r_g \gg R_{D3}$ , the current delivered to the tunnel diode during the quasi-stable period can be expressed as:

$$i_{D3} = \frac{V_g}{R_g} = \frac{V_{cc}(R_2 + R_4) - R_2(V_{cc} - v_B)}{R_2 R_4} \quad (1)$$

The tunnel diode will switch into its high-voltage region when the input current to  $D_3$  reaches the peak current value,  $I_p$ , of the diode. Expressing the voltage at node B when transition takes place, as  $V_B$ , and expressing it in terms of  $I_p$  gives

$$V_B = R_4 I_p - \left( \frac{R_4}{R_2} \right) V_{cc} \quad (2)$$

The equivalent source driving the capacitor during the quasi-stable period at node B is shown on

page 76. The circuit neglects the impedance of the tunnel diode since  $R_{D3} \ll R_g$ . An initial voltage,  $V_i$ , is impressed across  $C_2$  before the delay period begins and can be expressed as:

$$V_i = V_{SAT} + \frac{R_5}{R_5 + R_6} V_{cc} + V_{D4} \quad (3)$$

where  $V_{SAT}$  = saturation-voltage drop across  $Q_1$   
 $V_{D4}$  = forward-voltage drop across  $D_4$ .

During the quasi-stable period  $v_B$  is:

$$v_B = V_i + (V_g - V_i)(1 - e^{-t/R_g C_2}) \quad (4)$$

When  $v_B = V_B$ ,  $t = \Delta T$ , and the delay period ends. Equating relations 2 and 4 and expressing the result as a function of the quasi-stable period, the delay time  $\Delta T$ , in terms of the circuit parameters:

$$\Delta T = R_g C_2 \ln \frac{V_g - V_i}{V_g + \frac{R_4}{R_6} V_{cc} - R_4 I_p} \quad (5)$$

## Circuit always applies correct operating voltage

By Lando K. Moyer

Bedminster, Pa.

The simple, inexpensive circuit below can be used to prevent the accidental application of the wrong voltage to equipment, when both a 230-volt and 115-volt power line are available. The output of a bridge rectifier feeds a zener diode-resistor bridge having a relay across it. When 230 volts are applied to the input, the voltage developed across the zener diodes and resistors back-biases

diode  $D_5$ , preventing the relay from being energized. This connects the input voltage to the 230-volt terminal of transformer  $T_1$ . When 115 volts are applied at the input terminals, the voltage developed across the zener diodes and resistors will cause the diode,  $D_5$ , to conduct. The relay becomes energized, connecting the input voltage to the 115-volt terminal of the transformer.

The values of  $R_2$  and  $R_3$  and the relay sensitivity determine the actual voltage which energizes the relay. The transformer is selected on the basis of the voltage and power required to operate the equipment. If any components short or open (except  $D_6$  and  $D_7$ ), the input remains connected to the 230-volt terminal.

Developed in association with American Electronic Laboratories, Inc., Colmar, Pa.

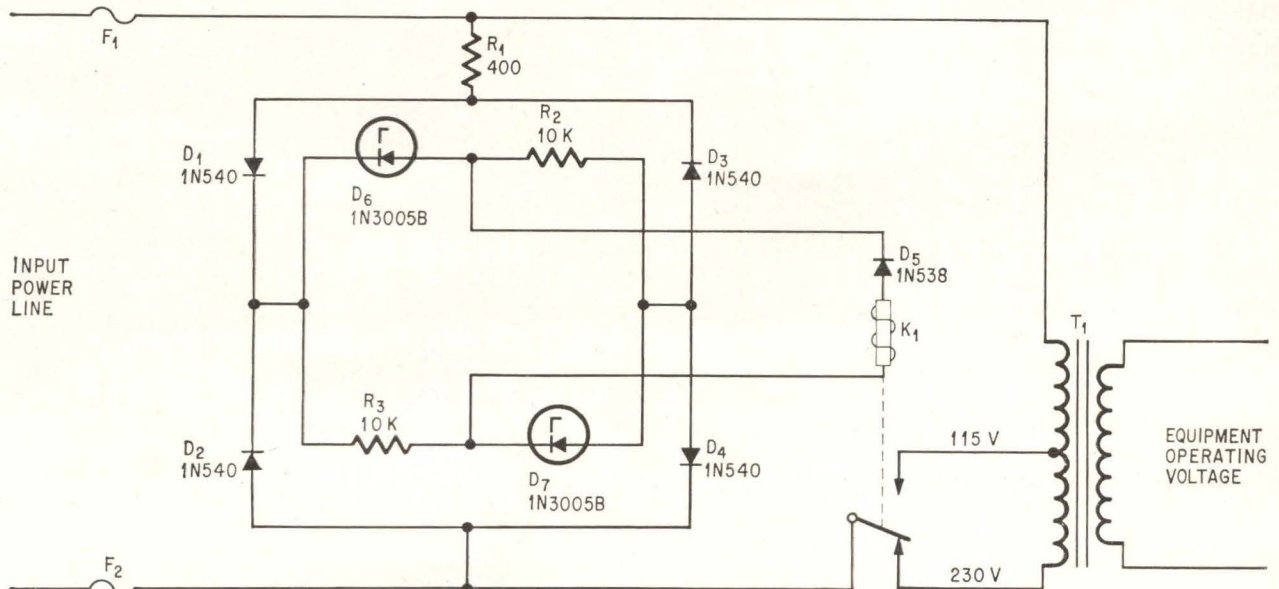

Relay senses supply voltage and connects input line to proper transformer terminal.

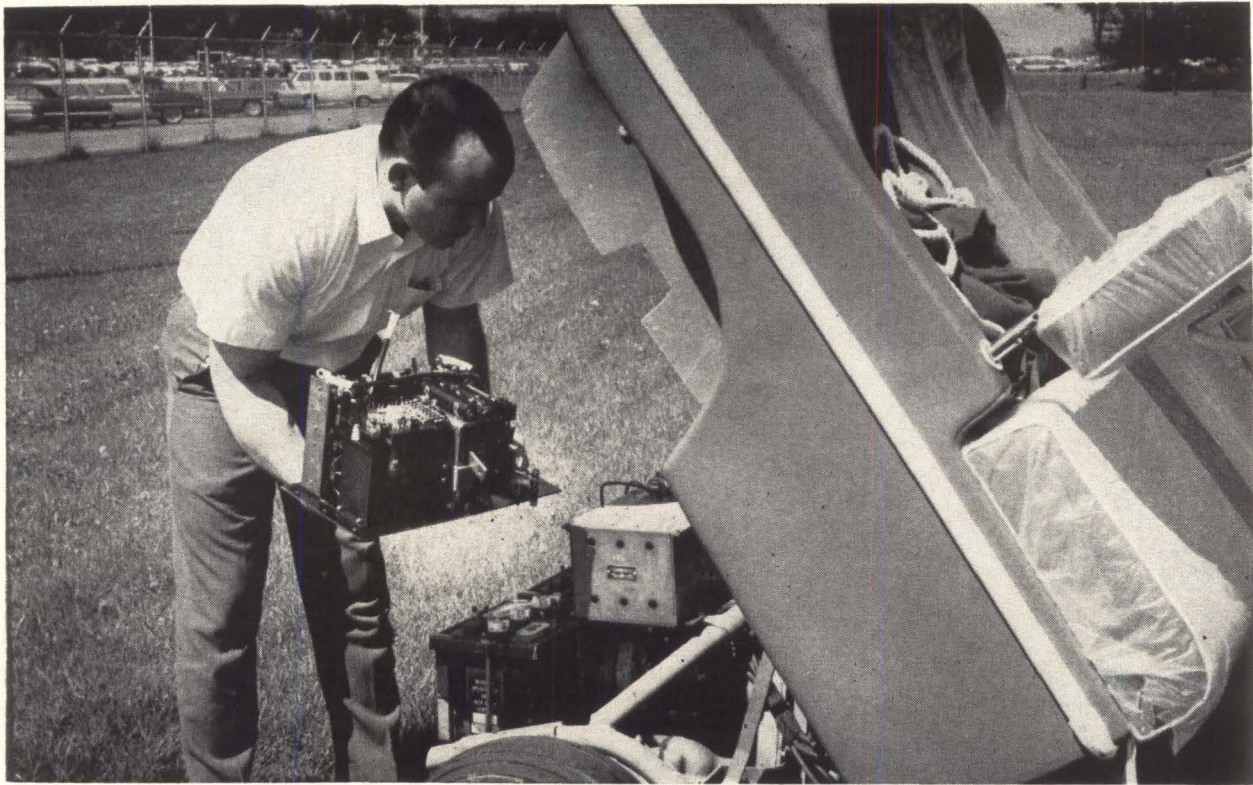

Industrial electronics

## The widening world of the scr

Silicon controlled rectifiers are finding many new uses, from powering golf carts to controlling steel mills

By John C. Hey

General Electric Co., Rectifier Components Dept.

**At an iron mine** in the Mesabi range in Minnesota, a huge shovel gulps tons of earth at a time. On a manicured golf course in Georgia, a golf cart quietly follows a straight-line route to the spot where a ball landed after its arced flight from the tee.

In both machines, the power—10,000 watts for the shovel and 1,200 watts for the cart—is controlled by a device about the size of a sparkplug. The device is a silicon controlled rectifier, and it's finding its way into new fields almost daily—in

industry, transportation and building services.

Like silicon diodes, their immediate predecessors, scr's regularly handle thousands of watts of power in the 400-ampere range. They're available with blocking voltages of above a kilovolt.

### Steel and paper

In Porter County, Ind., the Bethlehem Steel Co. is building a computer-controlled mill to produce 80-inch-wide strips of steel for automobiles and



railroad cars. The drive machinery for all the steel-handling equipment will be powered by compact, scr controllers with a capacity said to exceed 63 million watts.

The papermaking industry also has been invaded. In Snodland, England, C. Townsend Hooke, Ltd., is using an scr system to control a machine that rolls out 1,000 feet of paper, 144 inches wide, every minute (Electronics, June 29, p. 42).

For both industries—as well as in cement plants, lighting installations and other uses—the scr power-control elements include voltage regulators, static inverter-frequency changers and adjustable-speed drives for a-c and d-c machines.

### On the golf course

An scr application in a battery-vehicle controller is the golf cart. This vehicle uses a controller similar to a fork-lift truck's—designed to operate for 100 holes between battery chargings—more than double the normal 36-hole expectancy.

The speed of a d-c series motor can be varied efficiently by chopping the d-c voltage delivered to it at either a constant pulse width and variable frequency (frequency modulation) or at constant frequency and variable pulse width. To chop the d-c suitably, a fast-acting switch is needed, one that is able to handle sizable amounts of power. The scr is an excellent choice.

In the power circuit of a controller for a battery-powered vehicle (right), when the main scr is triggered, voltage is applied to the load and to the transformer. The voltage at the transformer secondary charges the commutation capacitor. The pump-up diode holds the capacitor charge until the auxiliary, or commutating, scr is triggered. When the auxiliary scr is triggered, the capacitor voltage is placed directly across the main scr. This reverse bias turns it off. The load current transfers to the auxiliary scr and the capacitor is provided with a discharge path.

When the capacitor is charged to a peak (opposite to that shown), the current attempts to reverse, cutting off the auxiliary scr. Voltage is now removed from the load, and the "off" period continues until the main scr is triggered again.

Although the main scr must be capable of handling full-rated motor current (called stalled armature current), the auxiliary scr and pump-up diode can have much lower current capacity because they conduct current pulses for only a relatively small fraction of a cycle.

### A light approach

Mechanical moving components are susceptible to wear and tear. Replacing them with a solid-state device increases their lifetime and eliminates contact bounce. The schematic in the middle of page 80 is one such approach, using a light-activated scr (Lascr).

The Lascr is identical to an scr, except that there are two ways of triggering it (Electronics, May 4, p.

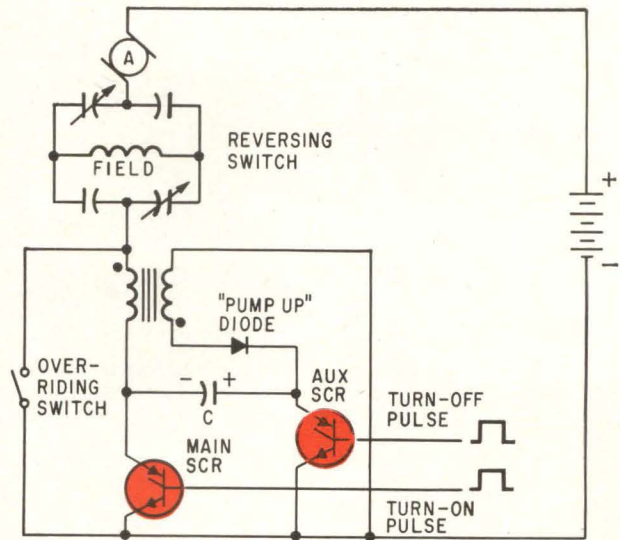

The name's the same, whether the scr controller is used in the golf cart at the beginning of this article, or in the fork-lift truck above. Below is a speed-controller circuit with main scr turn-off controlled by the auxiliary scr (both in color).

53). Current can be delivered to the gate terminal, or a light beam can be flashed on a light-sensitive part of the semiconductor pellet.

When light is the actuator, the power-handling and actuation circuits are electrically isolated in much the same way as if a mechanical relay were used. With this approach, switching is usually faster and triggering is usually more sensitive.

When an activating signal is applied to terminals 1 and 2, the lamp—operating at a reduced voltage—provides enough light to trigger the Lascr.



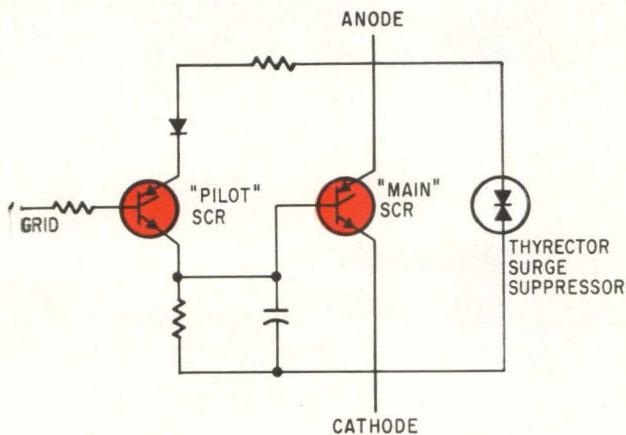

In welding control the gaseous thyristor (above) is out, replaced by a solid-state thyristor. The heart of the replacement is two scr's (color), shown below in a typical circuit configuration. The Thyrector limits transient voltage to that of the scr's.

single-pellet device that is in effect an inverse, parallel combination of silicon controlled rectifiers. It can conduct and block in both directions, and can be triggered into conducting in either direction with a positive or negative gate current signal. The Triac is commutated with inverse voltage in a manner similar to that used with inverse parallel scr's.

Where you find a Triac, you'll often find a Diac (for diode a-c switch) nearby. This triggering device couples a discharge pulse from a capacitor to the Triac gate. The Diac is a two-lead a-c switch that breaks over, or conducts, at about 35 volts and then switches to some lower voltage. The Diac, like the Triac, is symmetrical—that is, it switches in both directions.

The sensing element is  $R_4$ ; deadband and gain are determined by  $R_1$  and  $R_5$  respectively.

This drive can just as easily be controlled automatically by transducers instead of manually operated potentiometers and variable resistors. Photoresistors, thermistors, even strain-sensing elements can be substituted

### The solid thyristor

Gaseous thyristors, in a given application, can be replaced by a semi-conductor assembly designed for direct plug-in substitution. This substitute is not universally applicable. Each application must be considered separately.

A solid-state thyristor offers the following advantages over gaseous types:

- Reliability and long life because there is no inherent "wear-out" mechanism. This means less down-time and lower inventories of spare parts.
- Absence of filament and heater means a saving in power; less heat is dissipated in the package; the operation is instantaneous, with no warmup needed.
- Rugged construction.
- Higher efficiency with less heat dissipated because of lower operating voltage.

A typical solid-state thyristor's circuitry is at the left. The heart of the thyristor is a power-switching scr. To achieve a gate sensitivity comparable to gas-filled thyristors a pilot scr—a highly sensitive, low-current type—is used in this circuit. When a signal is applied to the pilot scr gate (analogous to the grid of a gas thyristor), it switches into conduction, providing gate current to the main scr. When the main scr switches into its conduction state, the voltage on the pilot scr is removed, turning it off.

The grid resistor provides a stabilizing gate bias for the pilot scr when the grid has a negative potential. When the line is positive, the pilot scr draws a maximum current of about 200 microamperes, triggering the pilot scr into conduction.

The over-all current handled by the main scr is determined by the pilot scr, a feature that allows this solid-state thyristor to be used in controlling highly inductive loads.

The diode in the anode lead of the pilot scr prevents a transistor type of reaction in the pilot scr when a positive grid voltage coincides with a negative anode voltage.

A thyrector surge-suppressor limits transient voltages to the voltage ratings of the pilot and main silicon controlled rectifiers used.

The photo above on the left shows a maintenance man comparing the solid-state thyristor, which

### The author



John Hey is an application engineer at the General Electric Co. in Auburn, N.Y., specializing in inverter circuits and high-voltage applications of scr's. He holds a master's degree from the University of Pennsylvania and a Sharpshooter's rating on the rifle range.

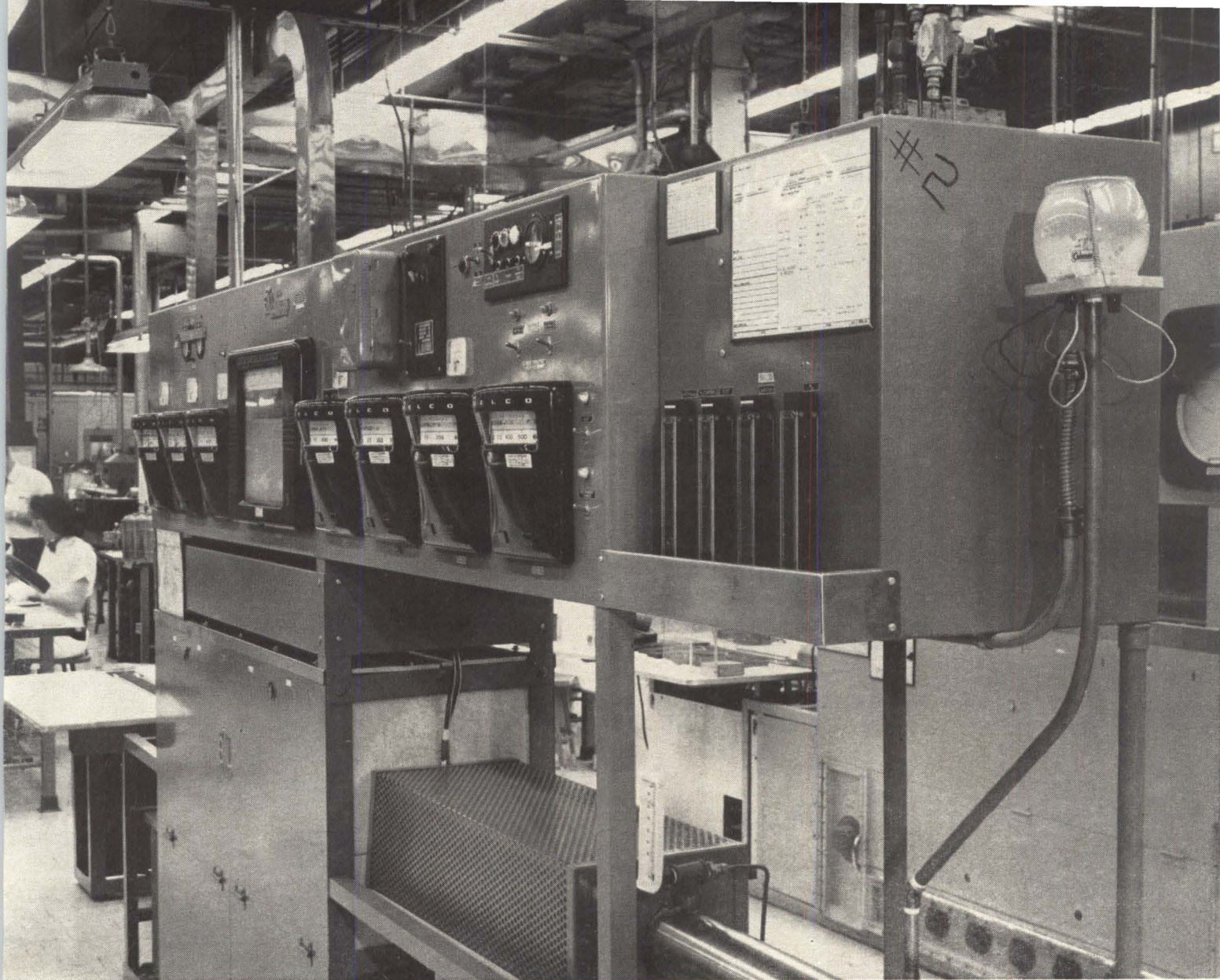

---

## Evolution of an idea

In September, 1956, the Proceedings of the Institute of Radio Engineers published a paper entitled "PNPN transistor switches." The reaction of the electronics industry was decidedly below the furor level.

That article, by four engineers at the Bell Telephone Laboratories, led—via labs of the General Electric Co.—to the silicon controlled rectifier. Last year, scr sales nationally totaled about \$20 million.

The IRE article described work on small devices such as signal transistors. But at General Electric, the article stirred visions of cheap, reliable control of power for industrial uses.

R. A. York, manager of engineering at GE's rectifier plant in Clyde, N. Y., set out to find out whether Bell's "transistor switches" might be used to control large amounts of electric power. His research staff consisted of young men, all under 40 years of age, but all veterans in the infant semiconductor business.

One of these bright young engineers, Gordon Hall, came up in 1957 with the three-lead silicon controlled rectifier. The Bell article had described a device with only two leads, a cathode and an anode, and suggested

three leads. Hall's third lead proved that the Bell idea was practical for power-handling.

The switching device had been achieved. But there still remained the problem of finding a practical way to use it. This task was given to another GE project engineer, F. W. Gutzwiller, then 30 years old.

Gutzwiller's first move was to the local hardware store. He bought a six-volt windshield fan used in automobiles. Recently he recalled the breadboard demonstration that followed. He said, "With the fan and the scr I whomped together a phase control to vary the speed of this fan by the use of the 'scr'."

After Hall and Gutzwiller demonstrated that their new device could control motor speeds, it was clear that a solid-state equivalent of the thyatron tube had been built, and that the device had vast potential in industrial control.

GE was lavish with development funds. More engineers were employed to develop products and find new applications.

The growing acceptance of the scr in industry indicates that all the efforts were worthwhile.

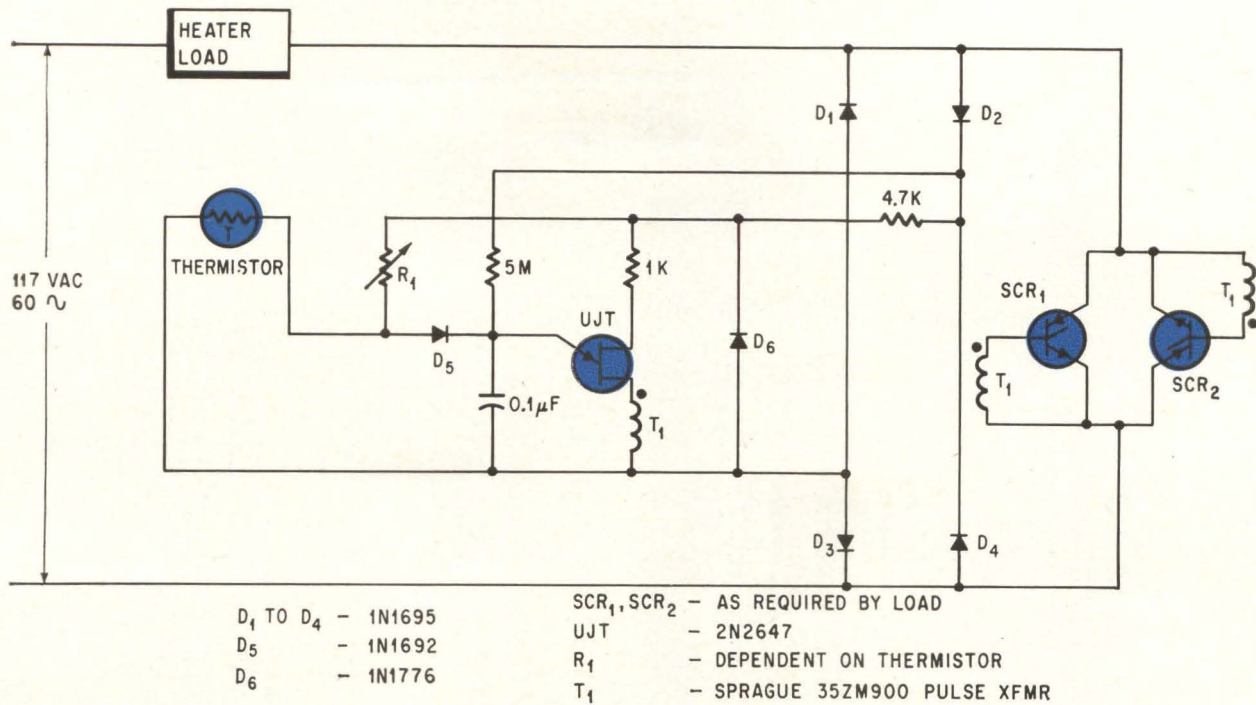

**Temperature control** is one of the largest potential fields for scr's. The seven-zone tunnel oven (right) for making semiconductors is one example. In the circuit above, the thermistor (color) senses load temperature. As the temperature rises, thermistor resistance falls, causing the unijunction transistor (color) to trigger, firing the scr's (color) that deliver the required power to the load. At the right is a typical scr temperature-controller assembly with the cover removed.

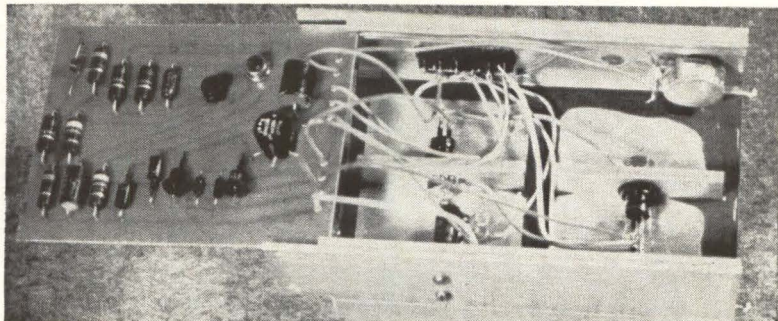

he's holding, with the gaseous version that is to be replaced.

### Temperature controllers

Scr's are even used to promulgate their own species. The General Electric Co.'s rectifier components department in Auburn, N. Y., uses a tunnel oven for making semiconductors including scr's. The oven's seven different temperature zones are under precise scr control.

The temperature controller is a closed-loop system. A sensor measures temperature of the heater load and controls the powder-delivering scr's.

Temperature control is an area where scr's are especially applicable. In the schematic above, the thermistor has a negative temperature coefficient; as the temperature goes up the resistance goes down, and visa versa. As the load temperature increases, thermistor resistance decreases, causing the uninjunction transistor to be triggered later in the line voltage cycle, controlling the scr's that deliver load power. As the load cools the opposite occurs.

In this design, a milliwatt thermistor controls either medium- or high-current scr's that deliver thousands of watts of power. The photos above show a 1,000-watt temperature controller ready to be installed on page 82 is a tunnel oven used in the manufacturing of semiconductors.

### Speed controllers for a-c motors

One of the most maintenance-free motors in industrial use is the three-phase squirrel-cage induction motor. It have no brushes or slip rings. On the other hand, it is somewhat difficult to control the speed of an a-c motor, particularly if wide range and smooth variability are required.

Other than pole-changing methods that provide only a few discrete operating speeds, there are two primary methods of varying the speed of an a-c motor. Both use a motor-driving voltage. Either a constant volt-second variable frequency or a variable voltage constant-frequency drive can be used.

The cost of the variable-frequency approach is somewhat higher than that of the variable-voltage approach.



constant-frequency approach.

Due to the complex nature of a motor load, the problem of speed control can only be attached from the system standpoint—controller plus motor load. Each approach has some advantages and disadvantages.

#### Variable frequency—complex, but . . .

The constant-frequency approach is simpler than the variable-frequency. It is seldom more than a sophisticated three-phase controller with tachometer feedback for improved torque at low speed. The variable-frequency approach requires, in addition to a frequency changer (rectifier and inverter), some way to vary voltage with frequency to keep the volt-seconds delivered to the motor constant. But once this is done, the controller has some desirable features:

- Relatively high efficiency at low speed.
- Independence of power-line frequency, except in the rectifier filter.
- Ability to operate from a d-c voltage source.
- Ability to operate at speeds above 3,600 revolutions per minute.
- Capability of multiple operation in synchronism.

#### Constant frequency—simple, but . . .

The variable-voltage, constant-frequency approach is simple, but slip losses can be high at slow speeds. Also, this approach requires large machines with more cooling than the variable-frequency method.

The variable-voltage, constant-frequency approach is shown on page 85. Triggering is achieved magnetically, using saturating reactors (transform-

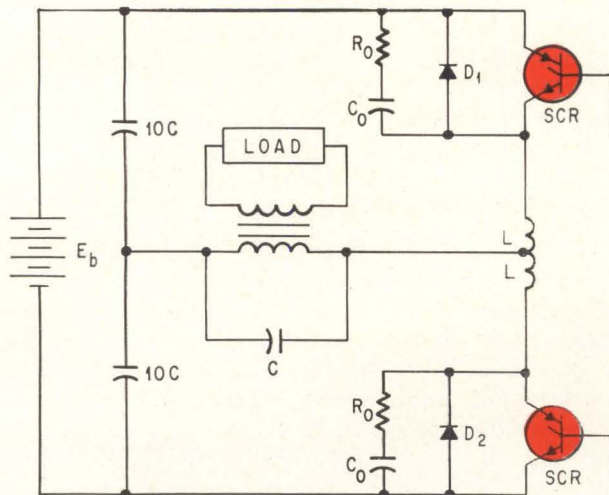

Bringing more light to the subject, a prototype high-frequency (10kc) inverter is for use in a fluorescent lighting system. This new device uses high-speed scr's to deliver 15,000 watts to the fluorescent lamp tepee. Turn-off time of the scr's (both in color), determined by the resonant frequency of C and L, is about 10 to 12 microseconds.

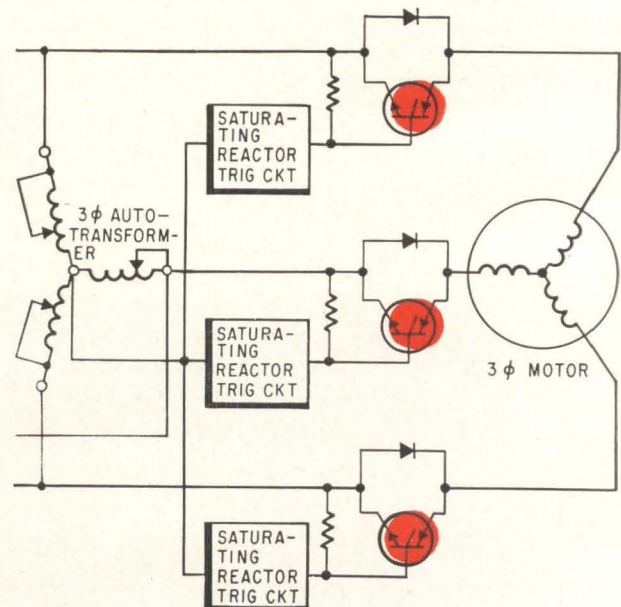

ers). The trigger circuits must be designed so that the scr's are always fired at 120-degree phase intervals to insure a balanced voltage to the load. If this is not done, the load sees a d-c voltage component, which tends to brake the motor because of eddy-current effect. In other words, the reset-voltage amplitudes delivered to each of the three saturating reactors must be identical. On the right is an industrial speed control of the variable-voltage type, using saturating reactor triggering.

Another approach eliminates the saturating reactors in the trigger circuit, at right, p. 84. Here a pilot scr is used to trigger the load-carrying scr. After the pilot scr is triggered, it maintains trigger current for the remainder of the half-cycle, a condition that is required when the load is inductive, as in the case of an a-c motor.

### High-frequency fluorescent lighting

Because of new, higher-speed scr's with improved dynamic characteristics, scr inverters can operate in the 10- to 20-kilocycle region. These can now be used to power large blocks of fluorescent lamps at high frequency in office buildings or drafting rooms, wherever large numbers of fluorescent lamps are used. Operation in this frequency range results in a big increase in lamp and ballast efficiency. At the same time, ballast size is considerably reduced and lamp life is greatly extended. One such prototype system (photo, p. 84) is a 10-Kc inverter that delivers 1.5 kilowatts to a bank of fluorescent tubes.

The power circuit of the inverter (bottom left, p. 84) provides sine-wave output voltage with good regulation. With the exception of scr turn-off time, dynamic stresses on the scr's are not severe. Turn-

off time is determined by the resonant frequency of C and L. These in turn are determined to some degree by the desired operating frequency. These high-speed scr's can be turned off in approximately 10 to 12 microseconds within the 10- to 20-Kc region.

The circuit on the left, page 84, operates as follows: When scr<sub>1</sub> is triggered, current flows to the load from the d-c source through inductor L. When capacitor C has been charged to its peak voltage, current rings back through D<sub>1</sub> reverse-biasing the scr and turning it off. As the capacitor voltage reaches zero, scr<sub>2</sub> is triggered and the capacitor charges to a peak voltage of opposite polarity, again ringing back through D<sub>2</sub> and turning off scr<sub>2</sub>. The cycle then repeats. Resistor R<sub>0</sub> and capacitor C<sub>0</sub> limit the rate-of-rise of forward voltage across the scr's to the amount they can tolerate without misfiring.

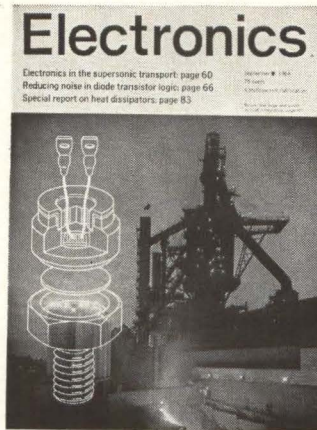

### The cover

A silicon controlled rectifier has been superimposed on photographer Arthur d'Arazien's dramatic photograph of a steel mill to symbolize the ever-increasing use of scr's metallurgical controls.

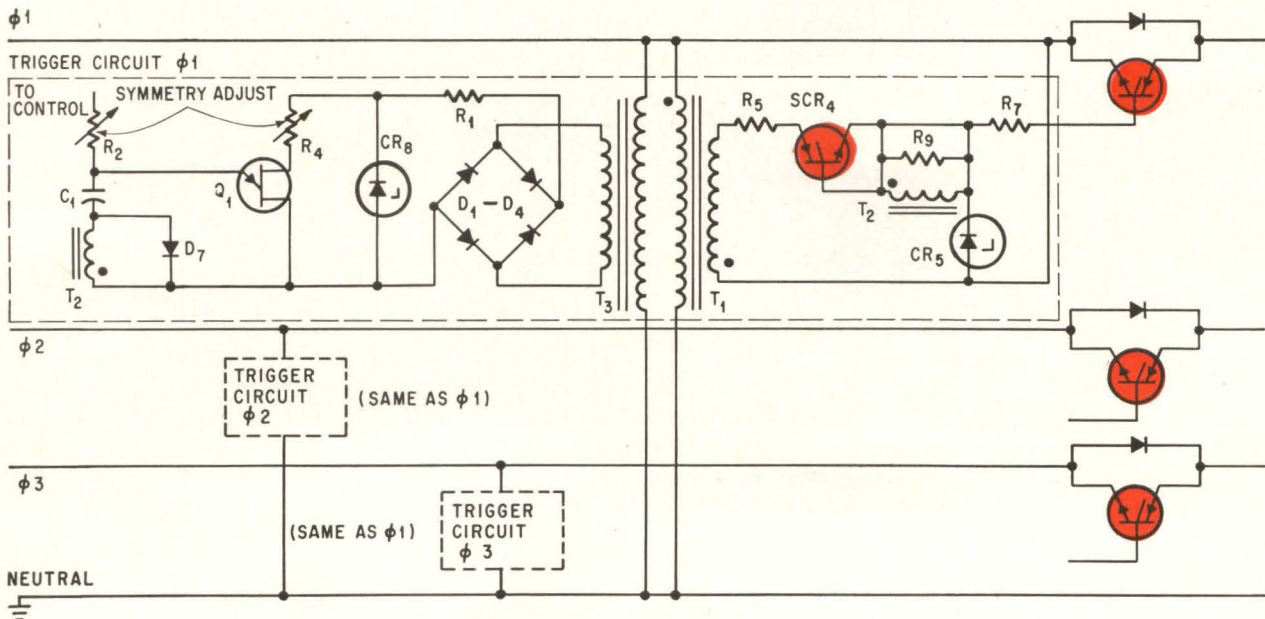

Circuit for speed-controller section for three-phase a-c motor. The approach above uses saturating reactors (transformers) for triggering the scr's (color). At the left is another approach that eliminates the saturating reactors, replacing them with a pilot scr (color) to trigger the load-carrying scr (color).

# A comeback for wireless power?

An old idea and a new technology give promise of a new and prosperous life for the microwave industry

By George V. Novotny

Advanced Technology Editor

**Transmitting power** without wires, cooking steaks from the inside out, powering a helicopter from the ground, and controlling tornadoes are novel applications that might not have occurred to a microwave engineer in 1940. Today, some of these are already in commercial hardware form, others will be here soon, and still more may be generations away—but all share a common basic technology.

Microwave power engineering—sometimes called electronic power, or superpower—is a new technology concerned with the generation, transmission and application of energy rather than the transmission of information, as in radar or communications microwave.

The idea of using electromagnetic radiation as power rather than as an information carrier is not new—Nikola Tesla experimented with it, unsuccessfully, at Colorado Springs in 1889—but only recently, with knowledge gained from the design of very high power radar systems, have engineers viewed this idea as a practical possibility.

A number of radically new developments will be needed, but already the work in microwave power has led to some startling advances in the whole microwave field. The designers' change of attitude from communications to power has been responsible. These days there is a good deal of discussion and speculation,<sup>1</sup> a moderate amount of research, and a modest resurgence of government interest and funding. In fact, as some observers see it, microwave power may mean a new and prosperous life for the microwave industry.

### Three classes of applications

Three principal areas of interest are gradually emerging for microwave power. The first of these—the most intriguing and most immediate—is the transmission of small and moderate amounts of power, in the form of a free beam focused through the atmosphere or space, to hovering vehicles such

as helicopters, blimps or satellites. The Air Force has recently called for bids on a feasibility contract showing that a hovering helicopter model, entirely powered from the ground by microwave beam, can be built; similar studies involving satellites have been undertaken by the National Aeronautics and Space Administration. W. C. Brown, head of the Superpower section of Raytheon's Spencer Laboratory in Burlington, Mass., says such a hovering vehicle is well within the present state of the art.

A second group of applications involves the transmission of large amounts of microwave power through waveguide. While this application seems remote it is nonetheless a challenge. In theory, the waveguide scheme could have great power-carrying capacity, and numerous advantages over overhead high-voltage transmission lines; among them, efficiency, safety, and invulnerability.

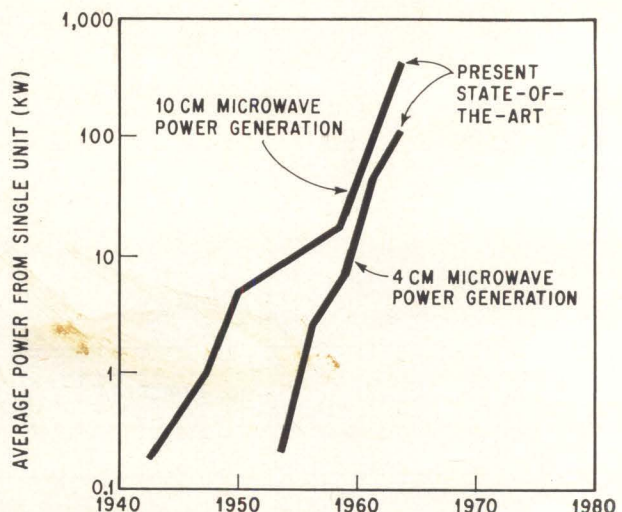

Progress in microwave power generation levels in a single unit, plotted for the two main frequencies of interest for microwave power applications.



The third group of applications uses microwave power directly, without intermediate rectification to d-c current. These involve various applications of microwave heating, such as cooking and food processing<sup>2</sup> [Electronics, Sept. 7, p. 111], food sterilization, and industrial melting of substances such as sulphur and tars. Some more unusual and distant nonheating applications are the destruction of swarming insects, control of tornadoes, and electronic countermeasures—all involving huge amounts of radiated microwave power.

### Common hardware

No matter what the final application, microwave power engineering involves a limited number of necessary components. For the time being, such components are being developed as an extension of existing microwave hardware, but with emphasis on high power output and efficiency in continuous-wave operation. These include power generators, antennas, rectifiers and waveguide techniques.

### Microwave power generators

There are several principal contenders for the function of producing large quantities of microwave power. They range from the traditional klystron tube to the somewhat revolutionary electromagnetic amplifying lens. Present power levels are in the hundreds-of-kilowatts range, and the rate at which power levels have been increasing is shown on page 86 for the frequencies of interest in power applications.

### High-power klystrons

Development of the klystron tube toward higher power levels has recently led to the generation of over 200 kilowatts, continuous-wave, by a single tube at X-band frequencies, with 60% efficiency. The Eitel-McCullough, Inc. X 3030 tube has more than twice the power capability of other existing X-band devices. It uses an extended-interaction principle, which involves the lengthening of the resonant cavities to a length of several electron ballistic wavelengths.<sup>3</sup>

Other Eimac work in this area has been focused on a two-cavity extended-interaction klystron, the X 3028, which yielded 65% conversion efficiency in continuous-wave S-band operation (2,890 Mc) at kilowatt power levels.<sup>4</sup>

### Superpower Amplitron

The largest microwave power generator developed to date is Raytheon's superpower Amplitron.<sup>5</sup> This tube uses a nonthermionic cold (water-cooled) platinum cathode, and has achieved continuous-wave operation at 400 kilowatts and 3,000 megacycles with 70% efficiency. As shown above right, the Amplitron has a continuous cathode, surrounded by a slow-wave structure and a magnetic field whose direction is normal to the plane of the figure.

The slow-wave structure carries the r-f wave and acts as a collecting surface for the electrons, which

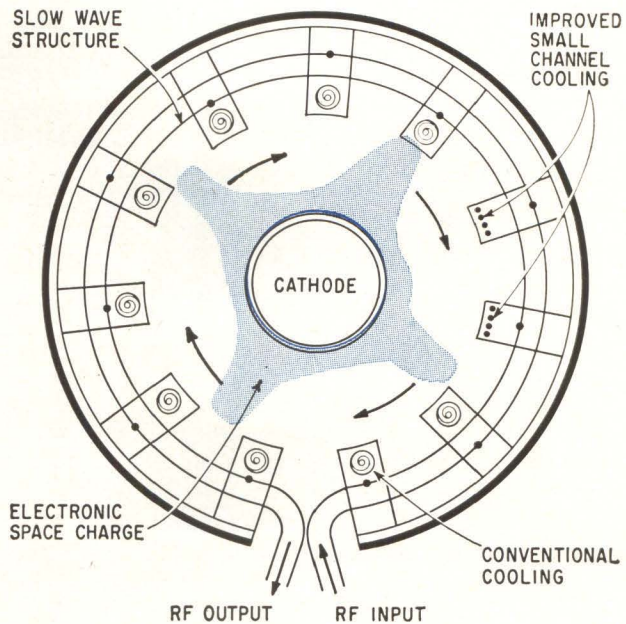

Schematic of the Amplitron interaction region shows space-charge spokes rotating about center cathode.

are emitted from the cathode and subsequently impinge on the anode. A d-c potential is placed between the cathode and anode. As the potential is raised, electrons emitted from the cathode rotate in concentric orbits, ultimately reaching the anode. During the transit, the electrons become synchronous with the phase velocity of the r-f wave on the network. Interaction occurs, causing the electrons to coalesce into spokes of space charge, which then induce currents in the slow-wave structure. The phasing is such that reinforcement occurs in the direction of the output, while cancellation occurs toward the input.

The entire interaction mechanism is controlled by the r-f power introduced at the input terminals of the Amplitron, so that the output frequency is identical to the driving frequency.

While the Amplitron is suitable for immediate applications, such as the microwave-beam powering of hovering vehicles, its power level is not likely to be substantially increased. One reason is the window problem—the necessity for building large dielectric windows in the tube structure that can pass the microwave power without substantial loss or heat dissipation and yet act as hermetic seals for the interior vacuum. A second reason is that the relatively small size of the electron interaction area presents an upper limit to the amount of power that can be handled in the interaction region.

### Electromagnetic amplifying lens

A possible candidate for the generation of power levels two or three orders of magnitude above the Amplitron's 400 kilowatts is the electromagnetic amplifying lens.<sup>6, 7</sup> This concept, shown in the diagram on page 88, uses a large number of waveguides symmetrically arranged with respect to the

free space wave excitation, and thus excited with equal amplitude and phase; however, in the transition region between the input face and the electronic interaction region, adjacent waveguides are dimensioned to have different phase velocities. Thus, the energy from adjacent waveguides arrives at the input to the interaction region  $180^\circ$  out of phase.

In the interaction region, a slow-wave transverse interaction takes place between the electron stream and the r-f wave, producing a net gain. As shown in the figure below, the use of half-width waveguides establishes electric fields in the interaction region at the edges of the waveguides that face the cathode. A rotating space charge interacts with these electric fields. The half-width waveguides form resonant cavities just as vanes do in a conventional magnetron.

Although high-power tests have not been run on the electromagnetic amplifying lens, prototype measurements and calculations indicate that power levels of the order of several megawatts can be expected, with conversion efficiencies near 70%.

### Microwave power rectifiers

The development of devices that rectify microwave power efficiently into direct-current power has lagged considerably behind generator development, perhaps because high-power rectifiers are not intrinsic to traditional microwave work.

Although there are a number of experimental and potential devices, the highest power level achieved so far with any efficiency is of the order of one kilowatt—several hundred times below generator output power levels. However, for hovering-vehicle applications, where over-all system efficiency tends to be low, a one-kilowatt rectifier may be all that is needed by the time the several hundred kilowatts

of radiated power have undergone losses and attenuation in the transmission chain. Substantial rectifier developments will, however, be necessary to make high-power and utility applications practical.

### Silicon point-contact diode

Initial development work by Prof. R. H. George and E. M. Sabbagh of Purdue University, Lafayette, Indiana, has shown that simple silicon point-contact diodes are suitable for microwave rectification. These diodes, operated in bridge configurations, have achieved efficiencies up to about 70% in the 2,440 megacycle band.

However, semiconductor point-contact diodes are intrinsically small and low-power, capable of handling no more than 50 milliwatts each, and only 10 to 20 milliwatts per diode for maximum efficiency.<sup>8</sup> They have been combined in large arrays, consisting of as many as 680, and their size and weight give them a favorable watts/pound figure.

Point-contact diodes have found a very promising use in the Rectenna, a nondirectional rectifying microwave antenna, which is described later.

### Close-spaced vacuum diode

The largest presently available microwave rectifier component is the close-spaced thermionic diode, shown schematically below. It is a diode vacuum tube in which the cathode-anode spacing (cylindrical configuration) is of the order of 0.010 to 0.005 inches. This device was first developed by W. H. Hayt of Purdue University, and further developed and built by W. C. Brown of Raytheon. Operating at plate voltages of the order of 1,000 volts, the tube makes use of the kinetic energy of the skin-effect loss electrons in the microwave sig-

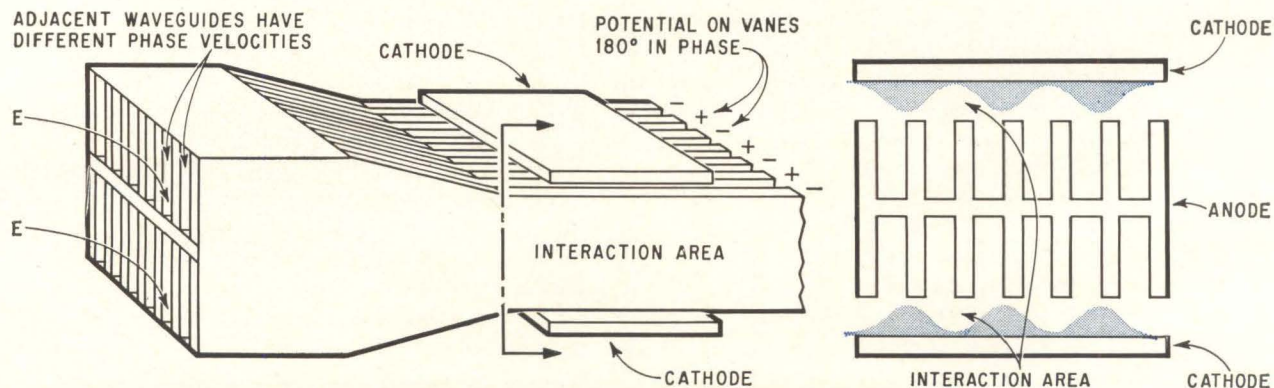

Waveguides process free space wave for slow-wave electronic interaction in the electromagnetic amplifying lens, (left) before wave enters interaction area, (right).

Close-spaced thermionic diode by the Raytheon Co. Power-handling capacity can be increased somewhat by extending anode-cathode rectifying area.

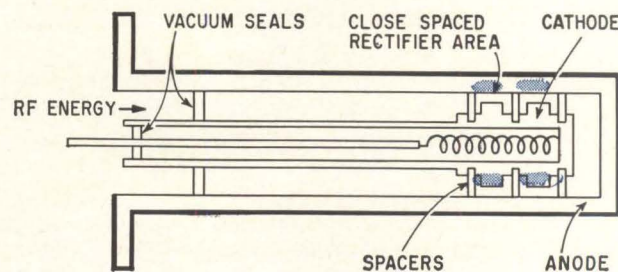

nal to heat the thermionic cathode. It has developed power levels up to 900 watts, continuous-wave, at 55% efficiency, and has an operating Q factor of about 15.

A low-impedance device, this type of diode can be used to operate a light load such as a motor, and has been so used in W. C. Brown's demonstrations of microwave-beam power transmission.<sup>9</sup>

### Other microwave rectifiers

Other rectifier schemes that have been studied in a preliminary way include the reverse operation of microwave tubes such as the magnetron. The most promising of these is the injected-beam crossed-field device, called the planotron or the Microfier, and developed by Raytheon. It has achieved 160 watts with an efficiency of 42%.

Preliminary work on klystrons operated as rectifiers has been done by W. H. Hayt at Purdue University and by S. P. Yu Electron Tube division of Litton Industries, Inc. According to Yu's computer simulation of the electrostatically focused klystron, the efficiency of these devices is expected to be about 54%, with a power/weight ratio of 150 watts/lb. The klystron scheme is illustrated in the diagram below.

### Multipactor diode

Another potential candidate is the multipactor diode rectifier (for multiple electron impact). In a multipactor discharge, a thin electron cloud, supplied by secondary emission from the diode's two electrodes, is driven back and forth across a gap, in synchronism with an r-f field applied across the gap. The maximum electron density is determined by the secondary emission coefficients, which must be carefully designed.

The full-wave multipactor rectifier, shown on p. 90, uses a reentrant microwave cavity with the electric fields concentrated at the center of the cavity where the secondary emitting electrodes are located. These electrons are perforated to allow some of the electrons to escape through the holes to electron collectors that constitute the negative d-c terminal. The walls of the cavity that supply the electrons form the positive d-c terminal.

Studies of the multipactor have been performed by P. P. Keenan of the Scientific Research Laboratory at Lockheed-California in Burbank. Calculated efficiencies range up to 59%, and 80% to 90% in polyphase operation.<sup>10</sup>

Studies have also been performed on the magnetron used as a rectifier, by W. H. Hayt of Purdue. The device delivered 25 watts at 22% efficiency. Another device is Raytheon's cyclotron rectifier, similar in operation to the classical research cyclotron machine (magnetic field causes input electrons to circulate, an electric field extracts a net unidirectional drift), developing 6 watts at 12% efficiency. These and the other crossed-field devices share the disadvantage of having to carry a heavy external magnet, which adversely affects their watts/pound ratio.

### Microwave power antennas

Microwave power can be radiated by beam with fairly conventional antennas, but the beam must be narrowly collimated to minimize loss by stray radiation. Horns, parabolic dishes and large, flat, multi-plate antennas are all practical, depending on application. Their heavy weight, need for precise positioning and shaping is a disadvantage in schemes that involve power transmission between spaceships, for example, but are acceptable for

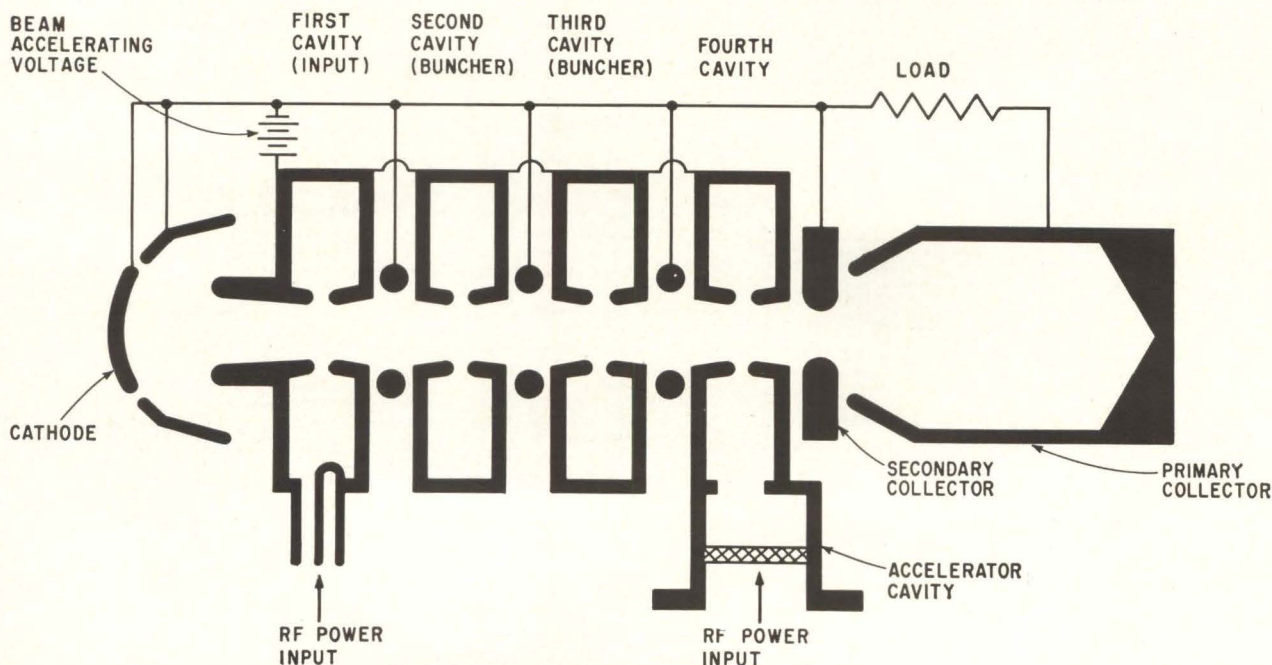

Electrostatically focused klystron rectifier has the advantage that no external magnet is needed as in the magnetically focused case. Tube is by Litton Industries, Inc.

transmission from the ground.

Free beam attenuation in the earth's atmosphere is negligible for wavelengths up to about 1.2 cm (K-band), providing the weather is good; in heavy rain even 3-cm wavelengths (X-band) are heavily attenuated, while 10-cm wavelengths (S-band) are not affected by the weather.

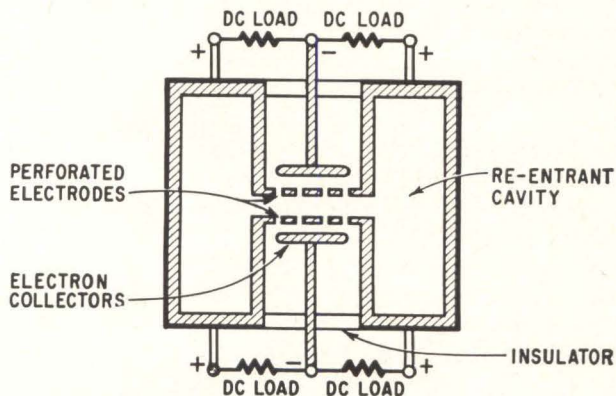

Rectifier cavity of the full-wave multipactor. Secondary electron emission is used to produce electron beam.

For the receiving antenna, the horn was until recently the best choice, and was used in the Raytheon experiments. However, in space applications a directional antenna of several hundred feet diameter would have been necessary; this was a major drawback until the invention of the Rectenna.

### The Rectenna

This new concept, developed by R. H. George of Purdue,<sup>8</sup> together with W. C. Brown of Raytheon, combines the semiconductor point-contact diodes with an antenna, to obtain an almost nondirectional antenna that receives microwave power and delivers direct current to the output terminals.

The Rectenna is made up of a large number of small dipoles, each of which has its own small diode rectifier network. The networks are connected to d-c busses, which are combined in series-parallel.

Such an antenna could be made to any desired size and shape, and fabricated as a thin flexible sheet of plastic, to be unfurled from a satellite. Because it is not highly directional, there is no need for a rigid structure or accurate orientation; it also eliminates the need for any subsequent rectifier.

Tests conducted at Raytheon on a prototype Rectenna showed a conversion efficiency of 63.5% at 2,440 megacycles.

### Waveguide power transmission

Although still far from realization, transmission of large amounts of power by buried, uninsulated waveguide is a distinct possibility. In theory, such waveguide could be extremely efficient.

According to a study by E. C. Okress of American Standard Research Laboratories,<sup>11</sup> an oversized circular waveguide 1.008 meters in diameter, transmitting power at 10 Gc in a high-order circular electric mode, notably the  $TE_{01}$  mode, can transmit

2,000 megawatts continuously. The capacity is equivalent to 18 parallel overhead lines, operating on three-phase, 132-Kv power. The negligible skin depth at this frequency,  $6.6 \times 10^{-5}$  cm, would call for only a thin copper coating inside the pipe.

Unfortunately, waveguide transmission must be maintained in a high-order mode while eliminating all other possible modes by continuous mode filtering. No work has been done yet in this field except at communication power levels.<sup>12</sup>

Only in recent years has emphasis been placed on studying microwave power in terms of systems rather than components. W. C. Brown of Raytheon was the first to demonstrate a system that remotely powered an electric motor; right now, Prof. D. Dunn at Stanford Electronic Laboratory is starting a project for evaluating microwave power systems.

### Other microwave applications

Microwave ovens and food processors have been on the market for some years, but are only now becoming commercial possibilities. Among some other proposed uses is microwave melting in industry—the melting of underground deposits for the mining and transportation of sulphur and tar (presently, sulphur is shipped in freighters in the highly dangerous liquid form; with suitable microwave equipment it could be shipped in solid form and melted out for unloading.) Another is the use of huge amounts of microwave power to control insect swarming. This would be accomplished with frequencies whose wavelengths are of the order of the average insect's length. Still another application would check the progress of tornadoes—this application is based on a recent theory that tornadoes are a plasma phenomenon, having large electron-plasma bodies inside their funnels, about 100 feet thick and 50 feet in diameter, 900 feet above the ground. Beaming an intense microwave generator at this plasma concentration might be enough to disrupt the tornado entirely.

### References

1. IEEE Special Symposium on Electronic Power, May 6, 1964, Clearwater, Fla.
2. R.P. Allaire, J.G. Sample, "Super Power Microwaves for Advanced Food Systems," U.S. Air Force Contract No. AF30(602)-2205, available from Raytheon.
3. W.R. Luebke, "A Super Power CW X-Band Klystron," internal report, Eitel-McCullough, Inc., San Carlos, Calif.
4. D.H. Priest, W.J. Leidigh, "A Two-Cavity Extended-Interaction Klystron Yielding 65% Efficiency," 1963 IEEE PG Electron Devices meeting, Washington, D.C.
5. J.F. Skowron, W.C. Brown, G.H. MacMaster: "The Super Power CW Amplifron," Microwave Journal, to be published.
6. W.C. Brown, G.E. Dombrowski, "Analysis of a New Crossed-Field Amplifier, the 'EAL,' or Electromagnetic Amplifying Lens," IRE Transactions of PG Electron Devices, ED-9, 2, March 1962, p 221.
7. W.C. Brown, "The Electromagnetic Amplifying Lens: Progress and Potentialities," Spencer Laboratory Engineering Report PT-435.
8. R.H. George, "Solid State Microwave Rectifiers," IEEE Symposium on Electronic Power, Clearwater, Fla., May 6, 1964.
9. W.C. Brown, "Laboratory Experiments in Microwave Power Transmission and Rectification," IEEE Symp. on Electronic Power, Clearwater, Fla., May 6, 1964.
10. P.P. Keenan, "Power Beaming and High Level Microwave Rectification," Wescon 1964 paper, Aug. 24-28, 1964.
11. E.S. Okress "Concerning Electronic Power as an Emerging Technology," IEEE Symposium, Clearwater, Fla., May 6, 1964.
12. A.P. King, G.D. Mandeville, Bell Telephone System Technical Journal, 40, p. 1,323, Sept. 1961.

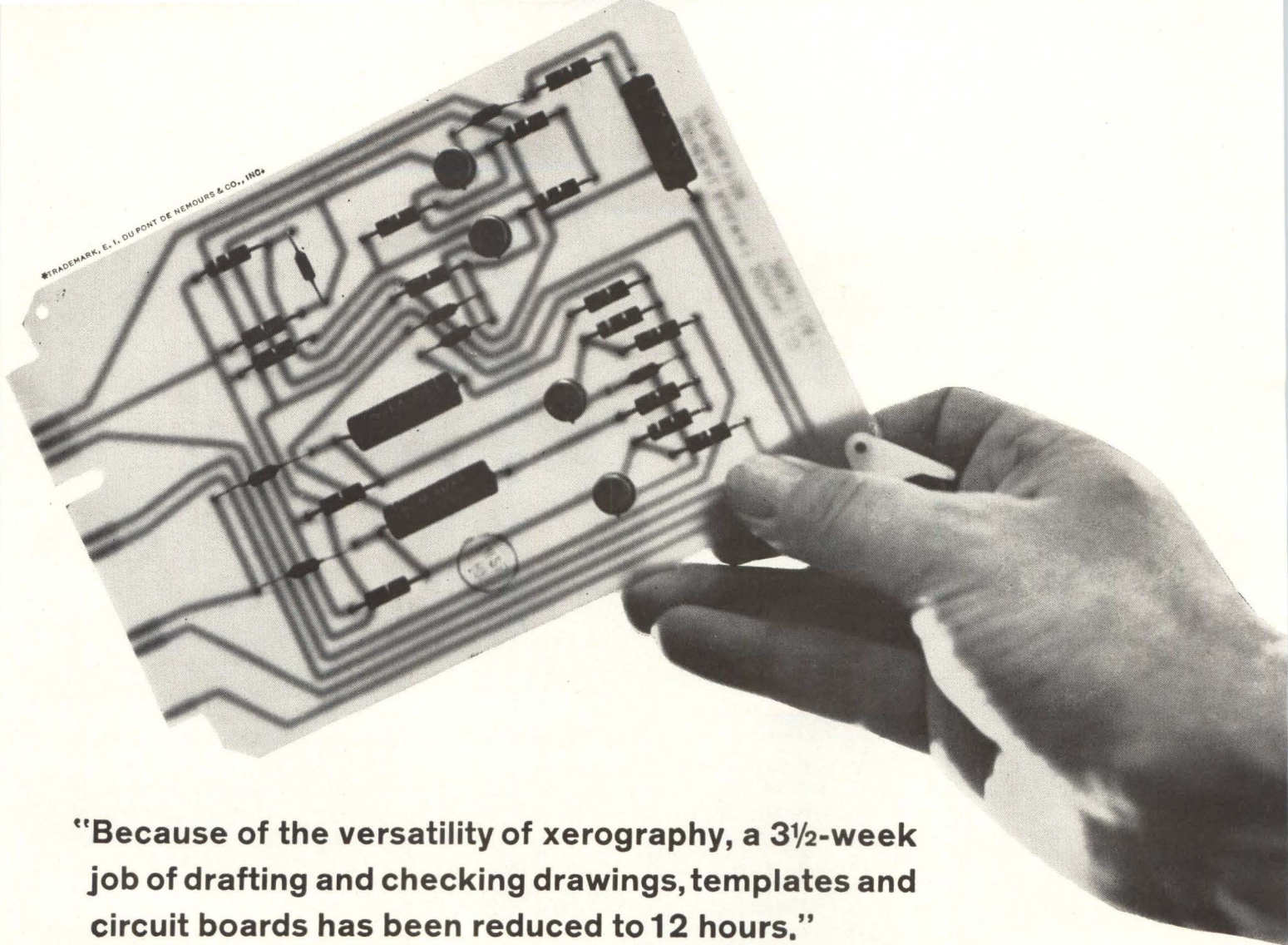

**"Because of the versatility of xerography, a 3½-week job of drafting and checking drawings, templates and circuit boards has been reduced to 12 hours."**

*W. F. "Pete" Harman, Chief Draftsman,  
General Railway Signal Company*

They used to make three separate drawings for each new printed circuit board. Each of the drawings was checked against the others. Then a template was made. This was checked against the circuit board detail drawing and the circuit art work. Then the circuit board was made and checked again.

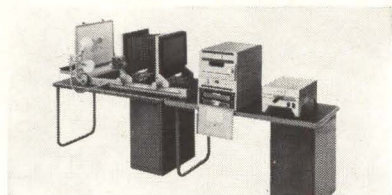

Now they make just one drawing. That's all. Once it's checked, they produce everything else, even the printed circuit boards, from this single drawing. Xerox Standard Equipment does it. Simple. Fast.

And guaranteed accurate.

The drawing is made twice-size on a dimensionally stable Mylar\* sheet. Circuit lines are drawn in ink or by placing strips of black tape on the layout. Holes and terminal points are inked in.

Then the Xerox Standard Equipment is used to copy the drawing, reduced to the exact size required, onto the copper surface of a circuit board. Because Xerox Standard Equipment makes perfect copies, no more drawing or checking of dimensions is needed. All they have to do is put the board in the etching bath.

Total time: 12 hours.

Xerox Standard Equipment is the most versatile way to copy on just about anything that will hold still. Wiring diagrams on circuit boards. Photographs on offset masters. Draw-

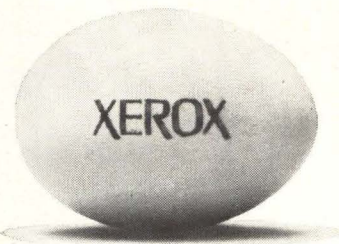

ings on acetate for projection. Even an image on an egg.

Find out how many ways xerography can save you time and money. We'll lend you the equipment for 30 days. No charge. Supplies, too.

Call your Xerox representative, Xerox Corporation, Rochester, N.Y. 14603. Offices in U.S. cities.

CANADA: XEROX OF CANADA LIMITED, TORONTO, OVERSEAS: RANK XEROX LTD., LONDON; FUJI-XEROX CO., LTD., TOKYO, BOTH JOINTLY OWNED WITH RANK ORGANISATION, LTD.

*Xerox Standard Equipment  
the most versatile way to copy.*

See General Eisenhower, Senators Humphrey & Ervin on ABC-TV and XEROX convention and election night coverage.

Circle 91 on reader service card

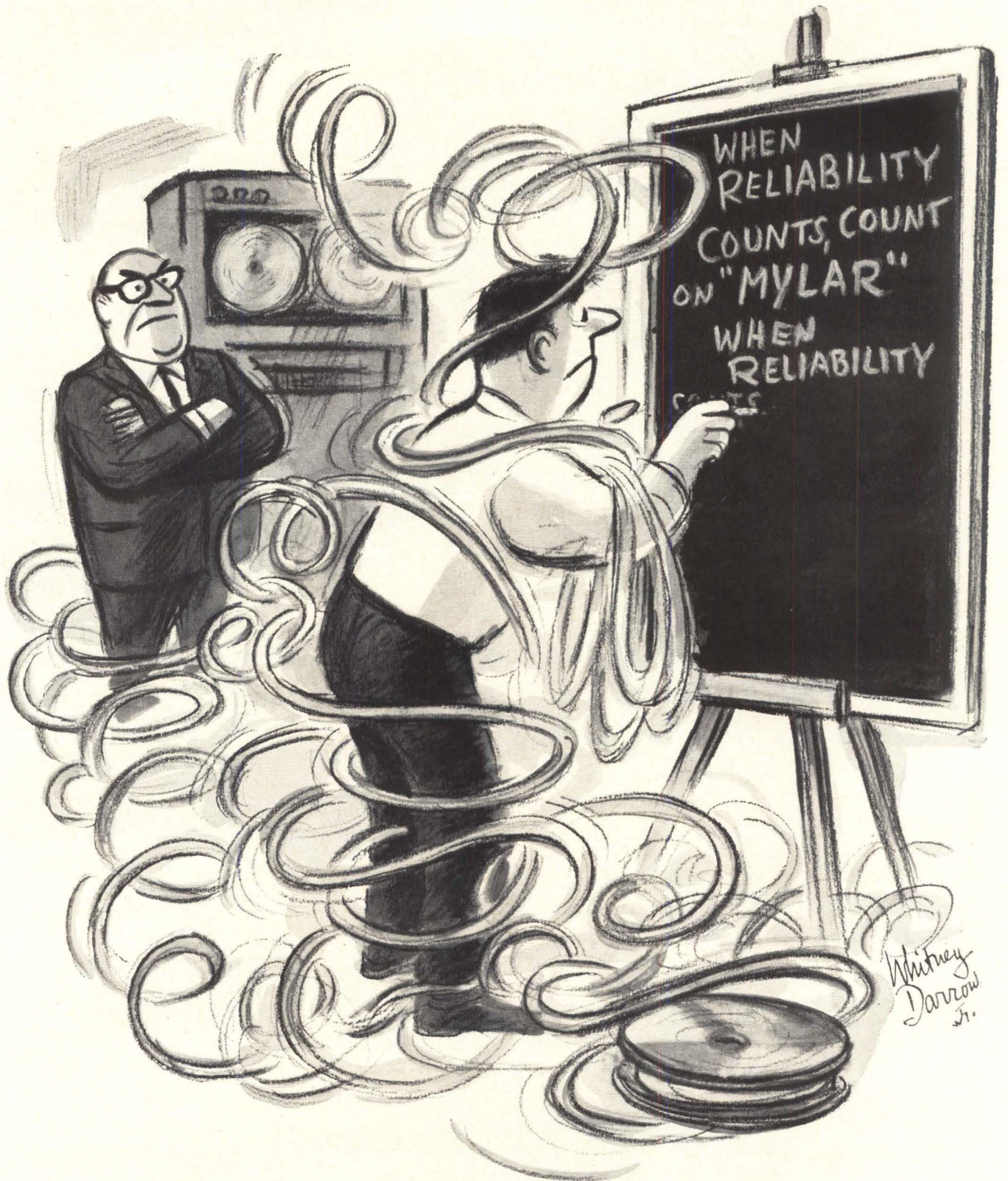

It would be difficult to conceive of anyone but the rawest novice not knowing the advantages of tapes of "Mylar"\*. After all, for ten years "Mylar" has been far and away the first choice for EDP work. Good reasons, too. "Mylar" is strong (a tensile strength

of 20,000 psi), stable (unaffected by temperature or humidity changes) and durable (can't dry out or become brittle with age.) There's no need to write it 50 times . . . just once: When reliability counts, count on "Mylar!" \*Du Pont's registered trademark for its polyester film.

**DU PONT**  
REG. U.S. PAT. OFF.  
 Better Things for Better Living  
 . . . through Chemistry

only **DU PONT** makes  
**MYLAR**<sup>®</sup>  
 POLYESTER FILM

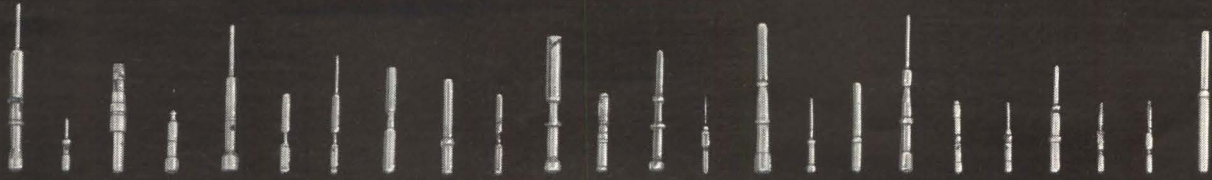

Every contact here (and most others\*)...



Fits here!

\*20 Contact and Smaller

## New miniature cycle-controlled crimping tool!

6 $\frac{3}{4}$ " from end to end. 10 ounces, total weight. Open handle span, 4". These are the facts behind this unique new Buchanan<sup>®</sup> miniature cycle-controlled crimping tool . . . that crimps miniature removable pin and socket contacts in a multitude of sizes and designs.

Now crimp in confined areas. Now crimp with much less fatigue. (Low hand pressure makes it ideal for female operators.) Now get all the operating advantages of the Buchanan MS-3191-A crimping tool — in half the size!

And what features: one tool and inexpensive

positioners can crimp almost any contact . . . #20 or smaller, in wire sizes #20 through #30. There are no operator adjustments. By selecting the proper positioner, you program the tool to provide the correct crimp depth, crimp location and point of ratchet release . . . under-crimping or over-crimping are virtually impossible. The four-indent crimp provides the most uniform displacement of wire and contact material over a wide range of contact and wire sizes.

Get all the facts on this exciting new miniature cycle-controlled crimping tool by Buchanan.

Write today for complete crimping library and the new catalog

**BUCHANAN**  
ELECTRICAL PRODUCTS CORPORATION

216-420 Route #22

HILLSIDE, NEW JERSEY

a subsidiary of Elastic Stop Nut Corporation of America

A COMPLETE LINE OF NON-OPERATOR, ADJUSTABLE AUTOMATED AND POWER ACTUATED CRIMPING TOOLS FOR HIGH VOLUME APPLICATIONS ARE ALSO AVAILABLE.

## THE EI VIEWPOINT

by Dr. Walter East  
President, Electro Instruments, Inc.

So far, in this series, I have talked nothing except industrial jobs our instruments have contributed to in the past, or are contributing to now.

In this I am going to do a bit of speculating on how our measurement instruments could benefit present non-users

I recently read an interesting history, covering everything from the first gasoline engines to today's highly com-

plex jets. Reading it set me wondering why engine manufacturers wouldn't benefit from devices which could precisely measure contents of engine exhaust gases. Ultimately it might contribute to the reduction of smog.



Dr. East

a direct clue to engine performance. Measurements of exhaust residues, for example, can reveal much about the quality of the fuel mixture used, or the degree of total burning achieved. If, therefore, certain quantities present in exhaust gases can be precisely measured, engine manufacturers are in possession of valuable information about proper fuel mixtures, injection pressures, and overall engine efficiency.

Methods of making such measurements, both with jet engines and the automobile engine, are the subjects of the two stories contained herein.

### Exhaust A "Record"

With few exceptions, exhaust gases are containers of elements which provide

# Classic Jobs of Measurement Performed by Electro Instruments

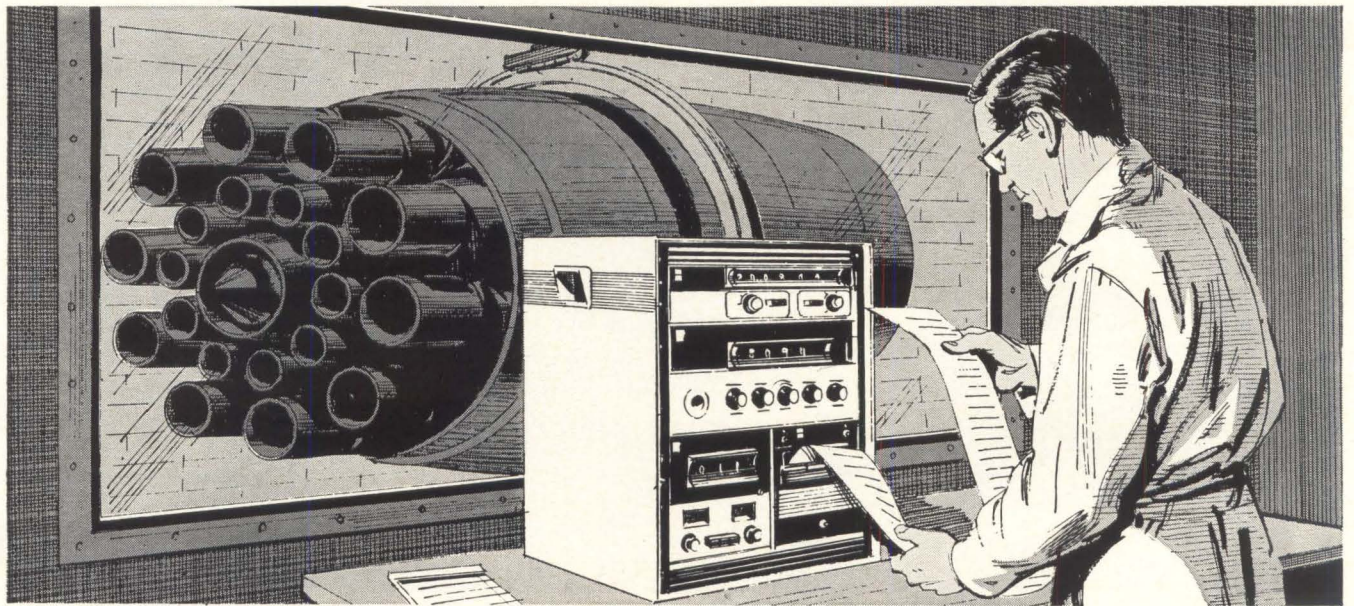

Typical set-up for running tests on jet engine's exhaust gases

### Analyzing Exhaust Gases of the Jet Engine

Fast, accurate and reliable measuring of a variety of elements is the principal problem involved in analyzing the performance of a new jet engine.

The performance of a conventional piston type engine can be extrapolated for various conditions of outside air temperature and density from data taken under standard sea level conditions. This is quite difficult with a jet.

### More Data Required

The compression of the manifold air before combustion results in a non-linear function making extrapolation for other conditions difficult. Much more data is required before performance characteristics under non-standard conditions can be established.

Of critical importance is the compo-

sition of the exhaust gases. From these, measures of percent of combustion and engine efficiency may be determined. These must be taken from a remote position while the engine is operating. Instrumentation is the key.

By offering a wide selection of amplifiers and other measuring instruments, Electro Instruments can provide systems that will operate reliably under

the most adverse of test conditions, and provide a record of results for immediate evaluation or for further processing in a computer.

Tests involving strain gauges, or tests involving vibration and torque indications, can also be made with Electro Instruments equipment—swiftly and accurately.

Write today for full information.

### Oscilloscope Displays Car Engine Tests Immediately

A battery-operated oscilloscope offers a reliable means of quickly checking the performance of automobile engines. Through the use of suitable sensing devices, such features as torque, timing, pressure and temperature may be monitored while the vehicle is actually traveling. Measurements will be given instantaneous visual display—often more desirable than printed records which must await further evaluation.

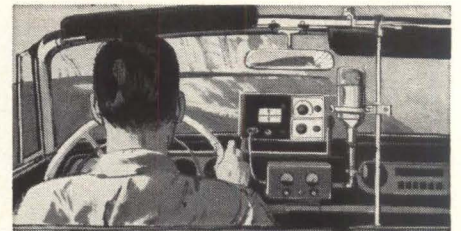

**Electro Instruments, Inc.**  
8611 Balboa Avenue, San Diego, California 92112

ELECTRO INTERNATIONAL, INC., ANNAPOLIS, MARYLAND • TRANSFORMER ENGINEERS, SAN GABRIEL, CALIFORNIA



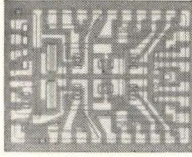

BREADBOARD CIRCUIT (12x)

**Why waste  
six weeks while  
somebody designs  
and builds the  
experimental micro-  
circuit you need  
this week?**

**Norden can do it  
in 48 hours.**

Now you can get fully integrated microcircuits in just 48 hours. That's because Norden has developed a series of single-crystal "Master Dice" breadboard circuits that contain all elements required by a wide variety of advanced microcircuits. All that is lacking are connections between circuit elements.

Simply tell Norden what connections you want. Then, within hours, you'll have a low-cost fully integrated .065" x .085" microcircuit for immediate trial. And you can have quantity production just one week after tests show the circuit is adaptable to your new design.

This new microcircuitry concept is based on a design originally developed for the Apollo program. Each breadboard contains 15 resistors and 7 NPN transistors. Circuits already produced by this new Norden technique include 2-strobe sense amplifiers, differential current amplifiers, Schmitt trigger and a binary switching element.

Complete information on this rapid, new, low-cost approach to microcircuits is available. For details, contact Dept. E, Norden Division of United Aircraft Corporation, Norwalk, Connecticut, or telephone 203:838-4471.

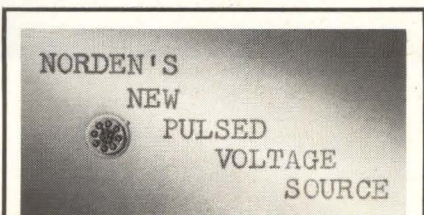

Norden's new pulsed voltage source is capable of unprecedented switching speed and power. It can complement existing circuitry or can be incorporated as new circuitry in computer designs.

The unit will accept a low level logic pulse signal, typically from the collector of a NOR gate or buffer, and provide at its output a 2 volt pulse, into a 50 ohm resistive load, shunted with 62 pfd of capacitance.

Rise time, fall time, storage time and propagation delay time are less than 15 nanoseconds each. Write for full details and data sheets.

**Norden** DIVISION OF UNITED AIRCRAFT CORP.  
NORWALK, CONNECTICUT

U  
A

## How do you take a picture of something you can't see?

Transient oscilloscope traces in the sub-nanosecond range move too fast for the human eye. How can you study them?

Use Polaroid 10,000-speed Land film. It's fast enough to make clear, high-contrast pictures of the most fleeting traces. And the results are fast, too.

Your pictures are fully developed in 10 seconds. If you are studying sequential traces, you can click off a full roll (8 exposures) in 20 seconds. Simply let the film stay in the camera back for 2 seconds, then pull the tab,

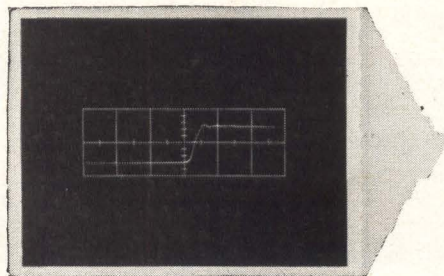

repeating the process for each exposure. Strip away the negative and you've got eight finished pictures.

The catalog name for this film is Polaroid PolaScope Type 410. It's panchromatic, responds best to blue phosphors such as P-11. The film's extreme sensitivity lets you use small camera apertures and low beam intensities too, so your trace pictures are really sharp.

Try Type 410 Land film the next time you need oscilloscope pictures. And see.

POLAROID®

Circle 96 on reader service card

### Polaroid 10,000-speed Land film.

# Probing the News

---

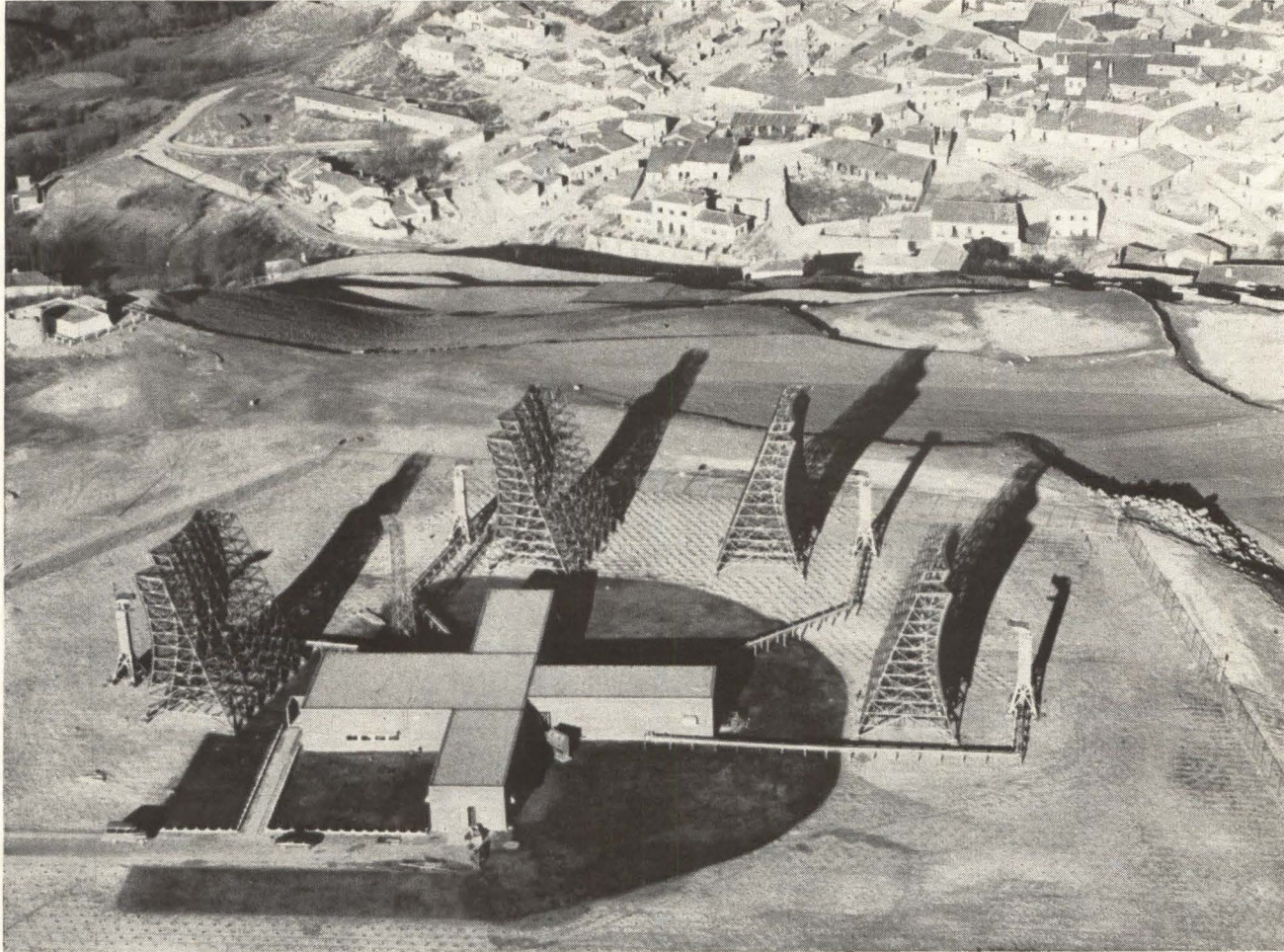

This troposcatter antenna array in Spain provides multichannel voice service for Air Force operations in Europe. Extra bandwidth is available for digital capabilities.

## Military electronics

# Soft Talk from the Pentagon

This project, part of the switch to digital communications, will permit classified data to be beamed anywhere on earth

By Tom Maguire

Regional Editor

**Five major** defense communications systems are being built or rebuilt as digital networks. The shift from analog, ordered two years ago by the Defense Department, is now in the various stages of equipment

design and procurement.

One network involves the worldwide collection of weather data. The other four are also primarily air-ground systems, concerned with the secure transmission of

messages—many of them highly classified and in code—over thousands of miles.

Digital communications offer at least three big advantages over analog: They are faster, more ac-

curate and less vulnerable to interception.

## I. Soft Talk.

When a high-ranking government official is airborne thousands of miles from Washington, his usefulness is severely limited. All his communications with the ground must be unclassified.

This handicap may be remedied in a little over a year. That's when Project 484L, commonly called Soft Talk, is expected to be in operation. Soft Talk will permit any government official, flying over any part of the world, to discuss classified information safely with Washington. He will simply dial the Defense Department, or any other agency, and talk.

Part of the Soft Talk program is the installation, starting next September, of kilowatt multiplex transmitters operating at ultrahigh frequencies. Their range will be 150 miles for four channels in full duplex operation. Ultimately, a network of uhf ground stations will be built around the world for receiving these transmissions.

Digital communication is relatively easy to garble by introducing interpositions or inversions at the transmitter and by rearranging the digital stream at the receiver. Such immediate encoding and decoding, for both data and voice, are feasible only with digital systems.

At present the Air Force is using high-frequency radio systems on jet aircraft of its Special Air Missions fleet at Andrews Air Force Base near Washington. These are being upgraded by the addition of transceivers and automatic tuning devices for high-ranking officials.

**Ground system.** A system is also being designed to link Washington with key military centers. This network, designated Project 493L, but commonly known as Vocom (for voice communication), will be compatible with Soft Talk aboard the jets. It will be part of the National Military Command System now being developed (Electronics, March 22, 1963, p. 28).

Switching will be accomplished with computers—another advantage of using digital data. Digits are the language of the computers that process the information; therefore there's no delay for translation

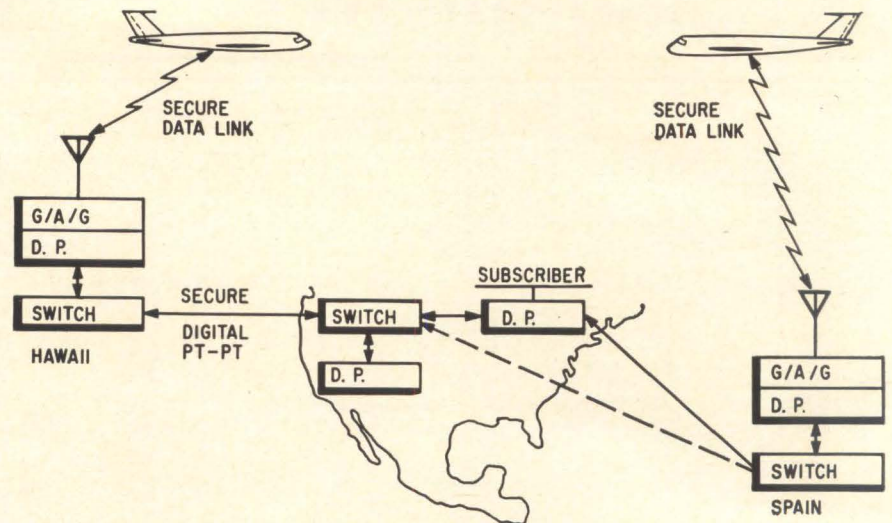

**Idealized digital system** knits air and ground communications stations together with data processors and switching centers.

when digital data is used.

The Radio Corp. of America, the prime contractor for Vocom, is building prototype hardware while continuing research and development on the program. Equipment made by the Philco Corp. is being installed in one plane of the Special Air Missions fleet, using modulator-demodulator devices produced by the Collins Radio Co.

**Binary typing.** Like VOCOM, little is said about 483L, the project to provide a secure air-ground system for teletypewriter transmission of binary data. The network may involve simply a coded radioteletypewriter, but details on the type of data and the users are classified.

## II. Weather reports in 3-D

Flying at 30,000 feet are several obsolete B-47 bombers carrying ultramodern devices for making continuous weather observations. The devices comprise the AN/AMQ-19 meteorological apparatus, measuring temperature, pressure and relative humidity along the flight path.

The weather communications system is the farthest along of any of the new digital systems. It provides the Air Force Weather Service with information about upper-air atmospheric conditions around the world. It is expected to be particularly useful in determining the characteristics of air masses over large bodies of water and near hostile land areas where ground observations are not available.

Because weather is caused by the

interaction of three-dimensional air masses, the new system uses a novel three-dimensional approach for better vertical soundings. Radiosondes—miniature weather stations equipped with tiny radio transmitters—are dropped every half-hour from the B-47s. The vertical and horizontal information is then digitized and stored temporarily on magnetic tape. As soon as the plane comes close enough to a ground station, the stored data is released in a multiplexed digital stream, as a high-frequency single-sideband radio signal.

**On the ground.** At the ground station, a data analysis central (AN/GMH-4) decodes, error-checks and translates the observations before feeding them at 640 or 1,040 words a minute through a buffer storage unit onto the slower-speed (60 to 100 wpm) teletypewriter line (diagram). The masses of data are finally combined with others in computers to aid forecasters in making short- and long-term weather predictions.

The weather apparatus is being installed by the Friez Instrument division of the Bendix Corp. under contract with the Air Force's Electronic Systems division and Aeronautical Systems division. The Air Force Communications Service provides ground stations and existing equipment needed to pass data to the Air Force Weather Service. The Aeronautical Systems division is responsible for modifying B-47s, and the Electronic Systems divi-

sion takes care of new ground-station equipment.

The nine stations set up to receive data from the flying weather observers are at Andrews Air Force Base, Washington; McClellan Air Force Base, Calif.; Hickam Field, Honolulu; Anderson Field, Guam; Elmendorf Air Force Base, Alaska; Fuchu Air Station near Tokyo; Lajes Air Base in the Azores; the Croughton base in England; and Wheelus Air Base, Libya. Full-scale system tests began late in August from McClellan, with a plane gathering data from 1,100 miles out over the Pacific Ocean. A message of 6,000 characters, equivalent to 1,000 words, can now be sent in 80 seconds. When keyed out at 20 words a minute it takes 50 minutes. The huge distances involved in worldwide communications point up another advantage of digital methods: greater accuracy

repeated as many times as desired.

### III. The brain center

Technical proposals for a multi-million-dollar improvement are now being evaluated at the Air Force's Electronic Systems division (ESD) at Hanscom Field, Mass. Most major communications contractors have submitted bids.

Present thinking is in the direction of augmenting existing uhf with more sophisticated equipment employing single-sideband modulation. The technique is complex but well known, and should provide satisfactory transmission at much narrower bandwidth than at present. From another viewpoint, many more communications channels can be fitted into the band now occupied by simpler equipment.

The project officer at ESD, Lt. Col. W. E. Bird, says the equipment will be the most advanced

Communications Agency (Electronics, Apr. 19, 1963, p. 22). His office is the focal point for the switch to digital communications.

The military, Roberts explains, needs digital techniques for reliability, flexibility, speed and security. Aircraft engaged in surveillance and tactical support, for example, make stringent demands on data-transmission speeds. Such a system must handle data at 600 to 38,000 bits a second from computer to computer, and at 75 to 600 bits a second between computers and access-and-display devices. The move to digital will have its greatest impact on Air Force operations in the 1970s, Roberts predicts.

**Triservice systems.** At ESD, Roberts is deputy for communications systems management. He receives engineering advice from ITT Communication Systems, Inc., a subsidiary of the International Telephone

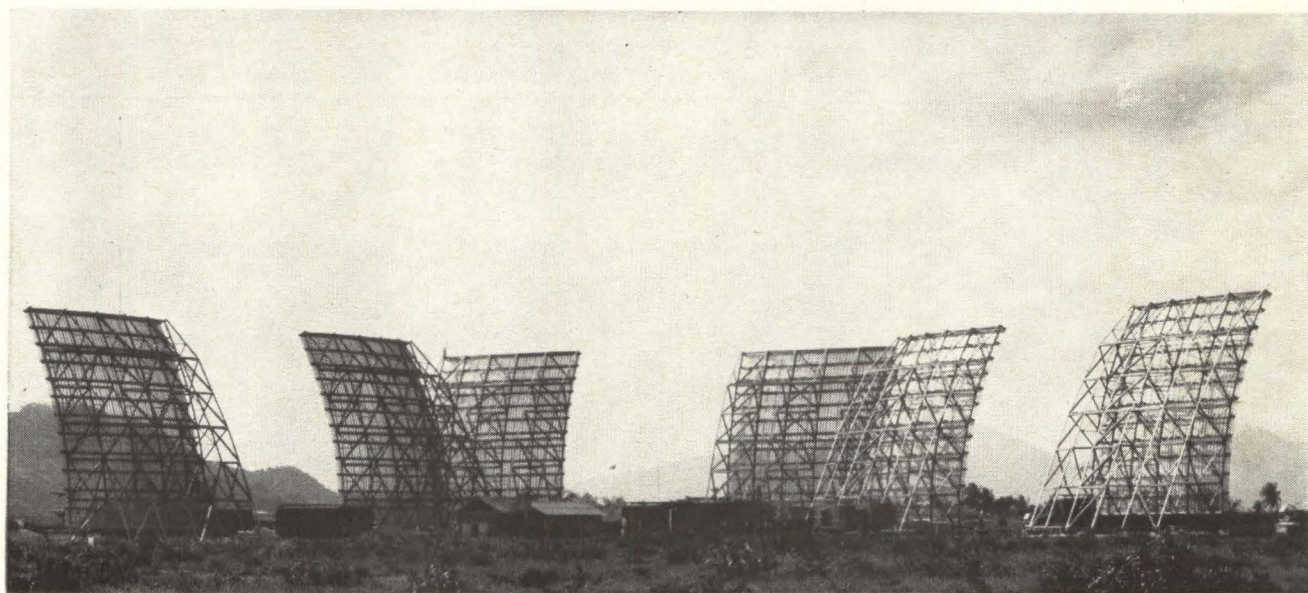

At Nha Trang, South Vietnam, antennas face north, south and west. Tropo system has voice channels only, but will probably be modified to provide digital capability.

over longer ranges. Analog methods, such as simple voice telephony, require frequent amplification to keep the signal above the level of ever-present noise. But residual noise is amplified along with the signal. Finally, signal and noise become hopelessly mixed.

Digital methods are like on-off Morse Code signaling—either an impulse is there or it isn't. Even when a code pulse is nearly buried in noise, it can be regenerated by a repeater and started off again, strong and noise-free. This can be

off-the-shelf gear available. The only research involved will be toward selecting the right equipment. To do this, studies are planned on atmospheric disturbances, maximum transmission distances for a given power, receiver sensitivity and antenna gain requirements. In his office at Hanscom Field, Col. Donald W. Roberts presides over the \$100-million-a-year business of planning, developing and acquiring a worldwide complex of communications systems to fill the needs of the Air Force and the Defense

and Telegraph Corp. The Mitre Corp., a nonprofit firm near Boston, also provides technical support in specific areas.

More than half of the tasks within Roberts' organization are assigned by the Defense Communications Agency in the evolution of the Defense Communications System. This system is a tri-service, complex, automatically switched that basically comprises two different worldwide networks. One is for voice (Autovon), the other an automatic digital network (Autodin).

# Europe: newest battleground for U.S. computer companies

GE and RCA, girding to battle IBM for the European market, form alliances with Italian, French and German companies

By Peggy Jackson

Staff Writer

**Enticed by Europe's prosperity** and her mushrooming computer market, two major United States companies established beachheads there this summer and seem to be girding to challenge the dominance of a third American concern, the International Business Machines Corp., on the continent.

In July the General Electric Co. invested \$43 million in the French Compagnie des Machines Bull, acquiring 51% interest in its computer sales company and 49% of its manufacturing and research units.

At the end of August, GE branched out into Italy with the acquisition of the data-processing operations of Ing. C. Olivetti & Co.

This month the Radio Corp. of America confirmed that it is planning a joint computer venture in Europe with Siemens & Halske A. G. of West Germany.

## I. The view from IBM

If these incursions evoked any concern at IBM, it wasn't evident to the world outside the company's World Trade Corp. offices in Manhattan. Most observers agreed that IBM, whose share of the European computer market has been estimated at from 50% to 90%, has little cause to worry.

A representative of one American company that is not involved in European mergers said, "It's going to be a long time before anybody gets IBM sales down." GE's move in France, he added, should not affect IBM's sales there to "any significant extent."

But Europe seems to have computer-market prospects outside of IBM's present grasp. One interna-

tional marketing man estimated that the European computer market is less than 60% developed—not counting replacements and trading-up.

Any serious impact on IBM would be at least a couple of years away. The industry figures that it takes about five years to build a computer business abroad. "If you can go in with a local sales force and local manufacturing facilities," said a spokesman for one company's international division, "you

can cut two to three years off that time."

## II. From Britain's standpoint

If RCA's negotiations with Siemens & Halske take the course expected, the result would leave Britain the only country in Europe with a major computer industry independent of U. S. capital. But Britain's three top computer makers—International Computers and Tabulators, Ltd., Electric-Leo Computers, Ltd., and Elliott-Automation,



Chief negotiators in setting up Olivetti-General Electric were Olivetti's Bruno Visentini, GE's Louis T. Rader and Olivetti's Aurelio Peccei.

Ltd.—would probably be hard-pressed in competition with the three American giants on the continent.

Elliott, a maker of automation equipment, electronic equipment, and office and vending machines, has 38 wholly owned subsidiaries abroad. It earned \$4.24 million in 1962, the last year for which figures are available.

International Computer's international agreements include one with RCA for the exchange of patents, technical information and such. The British company's profit in 1963 slipped to \$3.36 million from \$3.64 million the year before.

### III. GE's fine hand in Italy

Although Italy's "economic miracle" has begun to fade, her computer market is expected to double in the next four years. That's too little time for a foreign company to start from a stationary position; GE needs a local organization if it is to bid for a share of that market.

Olivetti provided it with Italian manufacturing and research facilities, a line of three basic computers (the Elea 9003, 6001 and 4001) with peripheral equipment, and—perhaps most important—a sales and servicing organization operating from 18 branch offices throughout Italy.

Under the agreement, GE will own 60% and Olivetti 40% of a new subsidiary, Olivetti-General Electric, with headquarters in Milan. GE will pour an unspecified amount of cash into the new venture, which will specialize in data-processing operations. Until GE names a permanent manager of the new company, Ottorino Beltrami, former director of Olivetti's electronics divisions, is acting manager of Olivetti-General Electric.

The GE-Olivetti marriage was brought to its final stages by Aurelio Peccei, Bruno Visentini and Roberto Olivetti of Olivetti's Executive Committee and by Louis T. Rader, vice president and general manager of GE's Industrial Electronics division. The Olivetti transaction was probably Rader's biggest accomplishment since returning to GE in July from the Sperry Rand Corp., where he had been president of the Univac division since 1962.

**Battle lines.** Until the GE-Olivetti

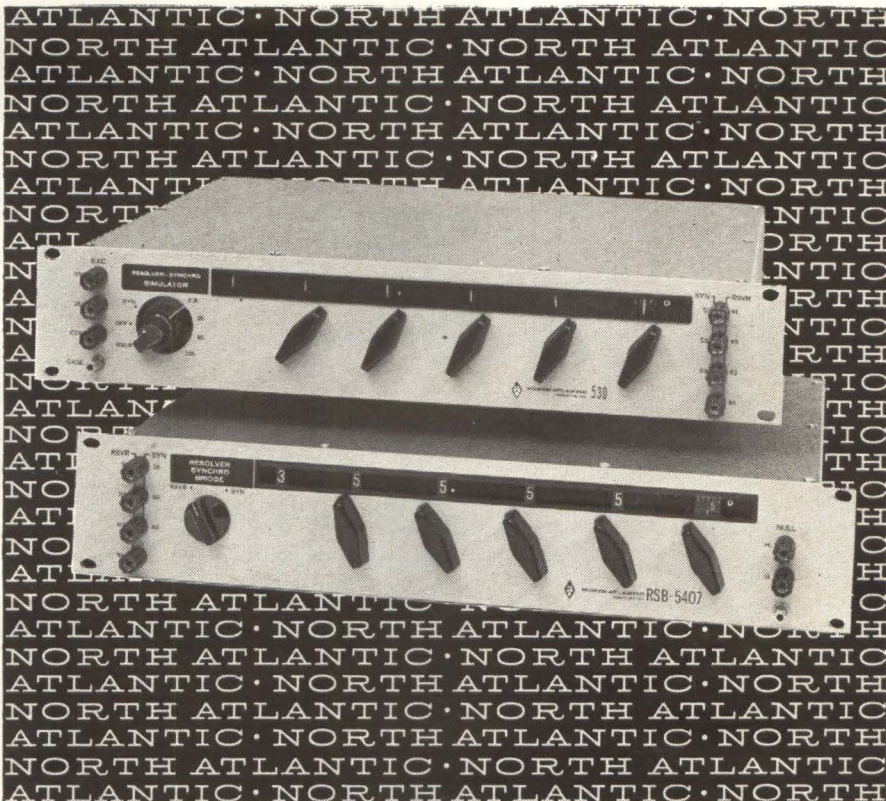

## you are looking at the state-of-the-art in resolver/synchro testing

These two instruments provide the widest measurement capability available today for resolver/synchro testing. Each is a dual-mode unit, measuring **both** resolvers and synchros. Series 530 Simulators are ideal transmitters, and Series 540 Bridges are ideal receivers.

In addition to their dual-mode capability in 3½" of panel space, both series provide in-line decimal readout continuously switched through 360°, 2 second accuracy at any angle, and input/output isolation.

#### SERIES 530 SIMULATORS FEATURE

- Resolution 0.001°, 1°, or 5°
- Dual 26/115 volt excitation
- Switch selected line-line voltages 11.8, 26, 90, and 115 volts
- Low matched output impedance

#### SERIES 540 BRIDGES FEATURE

- Resolution 0.0001°, 1°, or 5°
- 500K input impedance
- Constant null-voltage gradient at all line-line voltages
- Unaffected by null detector loading

Prices range from \$1480.00 to \$2680.00

The flexibility of these instruments meets every need for rapid and accurate testing in the engineering laboratory, in production, and in ground support equipment. Used with a Phase Angle Voltmeter, they provide a complete facility for component or system test.

Programmable models with decade or binary input are also available. Your North Atlantic representative will be glad to arrange a demonstration. Call or write him today.



**NORTH ATLANTIC industries, inc.**  
TERMINAL DRIVE, PLAINVIEW, L. I., NEW YORK • Overbrook 1-8600

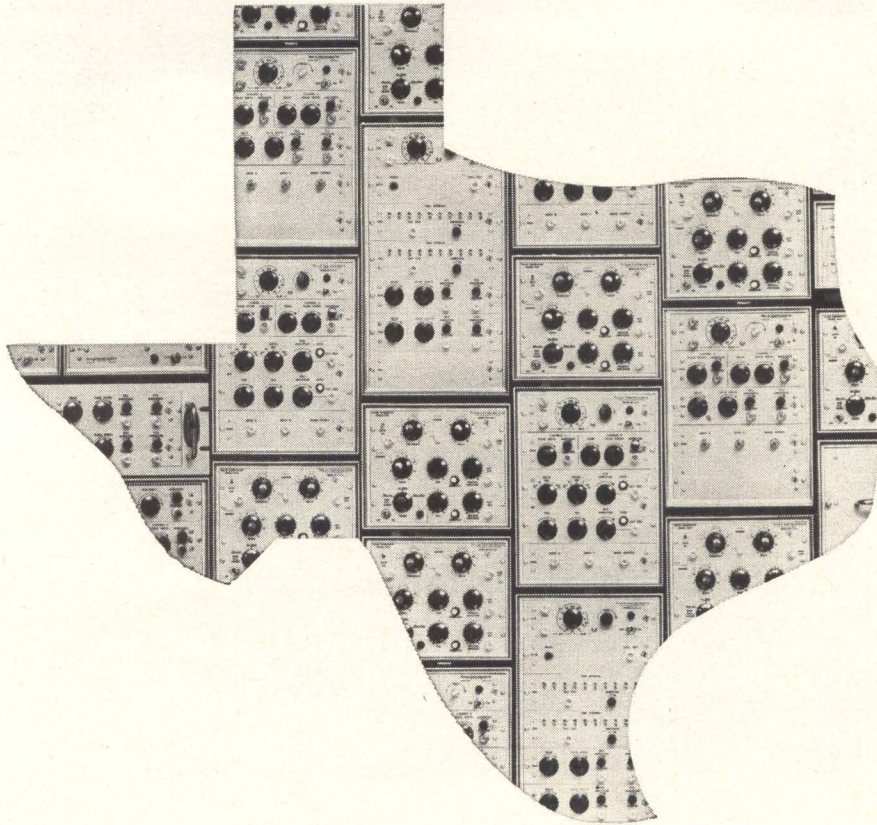

## Texas Instruments Makes 247 Pulse Generators

(one must meet your requirement)

- Repetition Rates to 100 MC
- Rise and Fall Times from .3 nanosecond
- Pulse Shaping and Programming
- Solid-State Construction
- Easy to Use, Easy to Expand
- Prices from \$950

TI's complete line of flexible, high performance signal generating equipment offers units to satisfy any test or design application. Fixed, fast or variable rise and fall times; standard special or mixed waveforms; variable amplitude, width and delay . . . all with characteristic, stable, clean waveforms. Available as portable or rack-mounting instruments, TI Pulse Generators are lightweight, compact and extremely easy to use. Write for information, wire for demonstration, call collect to order.

INDUSTRIAL  
PRODUCTS  
GROUP



**TEXAS INSTRUMENTS**  
INCORPORATED  
P. O. BOX 66027 HOUSTON, TEXAS 77006  
7 RUE VERNONNEX GENEVA, SWITZERLAND

transaction, Italy's computer market seemed destined to fall to IBM by default. Of 688 computers installed in Italy by the end of 1963, IBM had supplied 465. Olivetti ranked second with 104 and the Sperry Rand Corp. third with 78.

GE is expected to tighten the Olivetti product line. An early step probably will be the abandonment of the 9003, Olivetti's oldest (five years) and largest model. It is comparable to the IBM 7070. GE may also drop the medium-size 6001, which was designed primarily for scientific work, then modified for commercial use. But another medium-size model, the 4001, will extend the range of GE's computer line on the lower end of the price scale. The 4001, a relatively low-cost data processor, was introduced last year.

Some of Olivetti's peripheral equipment—such as a high-speed printer, magnetic character readers and data-transmission gear—will also strengthen GE's marketing position. One big advantage is that the equipment is adapted to European standards.

**Mounting debt.** Olivetti could not hope to compete with the giant American computer companies. For one thing, its technology was weak; compared with the third generation of U.S. computers, Olivetti's limited line was only slightly advanced from its first computer, introduced in 1959. Another drawback was the company's failure to develop an adequate backup of computer programs.

Olivetti's plunge into the computer business in 1959 was engineered by Adriano Olivetti, the son of Camillo Olivetti, the company's founder.

When Adriano bought control of the faltering Underwood Corp. in 1959 and tried to bolster the American company, Olivetti's long-term debt began to climb. From \$21.3 million in March, 1958, it soared to \$66.6 million in December, 1963.

**New stockholders.** Last spring the Olivetti family sold almost half of its stock in the company. The buyers brought in Bruno Visentini, former vice president of the government holding company IRI and a long-time adviser to the Olivetti family; Aurelio Peccei, formerly a top executive of Fiat, S. p. A., the automobile manufacturer; Silvio



Borri of Istituto Mobiliare Italiano, the government-controlled credit institute; and Roberto Olivetti. This four-man executive committee pushed through the deal with General Electric.

Olivetti is staying in the electronics business. A group of its engineers is working on, among other things, a small desk-size computer. The company also plans to continue producing electronic accounting and billing machines, an automatic collector of production data, and numerical-control equipment for machine tools.

In fact, it is reported that Olivetti recently concluded an agreement with Britain's Electrical and Musical Industries, Ltd., for sales and service of the machine-tool control equipment throughout much of Europe.

The company's sales last year totaled \$422.7 million. Of this, computers accounted for only about 5%.

#### IV. West German venture

With assets exceeding \$1.2 billion, Siemens & Halske is one of Europe's largest and most respected industrial concerns. Its marketing operations are strong throughout the noncommunist world, and its research is considered one of the most advanced. Its sales last year totaled \$1.46 billion, putting the company in ninth place among all companies outside the United States.

Observers believe that a joint effort by RCA and Siemens & Halske could result in Europe's biggest computer company.

The German company now offers three computers. The best seller is the 2002, a medium-size computer introduced in 1960 that is roughly comparable with the RCA 501 that went into production in 1960. It is used in science and industry. About 40 have been delivered so far.

The 3003, which falls somewhere between RCA's 301 and 501, is also capable of processing both scientific and industrial data. Only three or four have been delivered. Deliveries are also just beginning on the 303, an industrial process-control computer.

RCA has declined to tell any details of its transactions with Siemens & Halske other than that discussions of the proposed agreement with the German concern "are

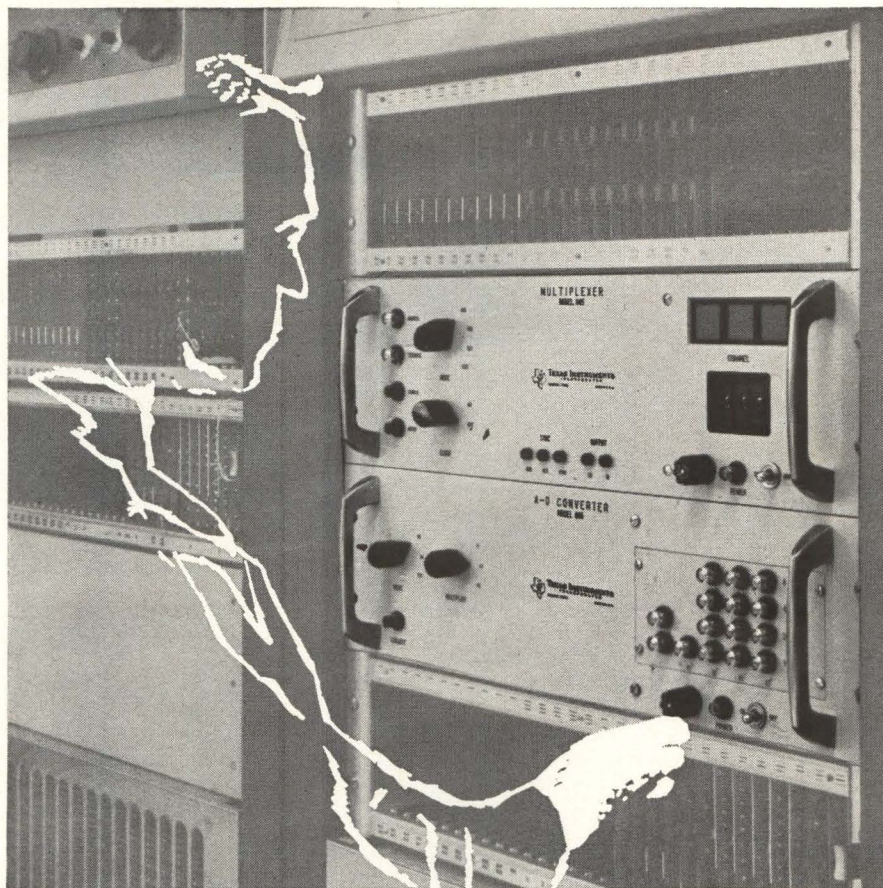

## Accurate Data Sampling and Conversion at 50 KC plus

**Model 846 A-D Converters**, in straight binary or BCD code, include an integral sample and hold circuit with 100 nanosecond aperture and automatic zero stabilization. Accuracy at 50 kc is 0.025% full scale . . . *sample and hold included!* Offered in a wide choice of input specifications, logic levels and output codes, plus D-A conversion option.

**Model 844/845 Multiplexers** feature 0.01% linearity with low dynamic crossfeed, fast settling time and variable sample duration. Choose from addressable, sequential, direct channel select, or combined addressable/sequential—all accommodate input levels to  $\pm 10$  volts. Basic capacities of 10 and 16 channels can be expanded tenfold with plug-in PC cards.

Ask a TI Application Engineer for further information on digital data handling equipment for your specific needs; one model must meet your requirements!

INDUSTRIAL  
PRODUCTS  
GROUP



**TEXAS INSTRUMENTS**

INCORPORATED

P. O. BOX 66027 HOUSTON, TEXAS 77006  
7 RUE VERNONNEX GENEVA, SWITZERLAND

692



Olivetti Electronics division employees will work for Olivetti-General Electric.

still in the early stages.”

#### V. American computers in Paris

When all pending transactions are completed, RCA's German venture could find itself competing with RCA computers in Europe. Machines Bull, the French company with the GE money, manufactures the RCA 301 among other computers.

RCA's interest in pushing its older 501 computer in Europe is clear. A company official disclosed recently that the computer had paid for all of its development costs; any sales abroad would be “gravy.”

At about the time of GE's deal with Machines Bull, RCA announced that it was modifying its business arrangement with the

French concern. RCA hastened to add, however, that Machines Bull would retain patent licenses to manufacture the RCA 301 and other computers, and that RCA would continue to supply “technical aid and know-how on the RCA 301 and its future enhancements.” But the technical-aid provision is being modified, RCA said, although the company wouldn't give details.

# new epoxy coated PAKTRON<sup>®</sup>



550 series

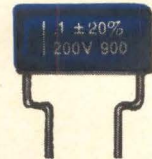

800 series

# Multichip circuits get off the ground

They'll be used exclusively in a microelectronic system for an advanced Orbiting Geophysical Observatory

By Jerome Eimbinder

Solid State Editor

As space contracts go, the one recently awarded the General Instrument Corp. is far from spectacular—the National Aeronautics and Space Administration is buying only one microelectronic data processor for about \$100,000. That's chicken feed in these days of multi-million dollar contracts for space

systems. Yet, officials of the company are jubilant. Jack Herre, the vice president who handles government relations for General Instrument rates the contract among the most important in the company's history. And he may be right.

**Flying start.** For some time now, General Instrument has been

championing a multichip approach to integrated circuitry. With its award, NASA has approved the first use of multichip construction methods in a satellite system. The completely microelectronic data processing system, using multichip circuitry exclusively, will go aloft in an advanced Orbiting Geophysical Observatory (OGO) research satellite. Thus, it will be the first time that multichip circuits have been used in space vehicles.

"We'll have an opportunity," says Herre, "to demonstrate, in space, the capabilities of a microelectronic system composed entirely of multichip circuits."

Last week, the first phase of the program was completed with the construction of a feasibility model of the system.

**Monolithic or multichip?** There has been spirited, if inconclusive, debate in microelectronics circles on monolithic versus multichip construction. In a monolithic circuit, the active and passive components share the same substrate in what is essentially a two-

## hi-blu™ capacitor

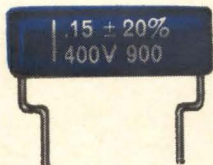

1180 series

New high performing Mylar\* film/foil epoxy coated capacitor for quality instrument, computer, and military applications where price is a factor. Capacitance values to 0.5mfd.

The new PAKTRON® hi-blu™ Capacitor is epoxy coated for superior moisture resistance and durability. High volumetric efficiency in a thin uniform package. Outstanding insulation resistance. Wide range of lead lengths and spacings as standard.

Write for detailed information. Request test samples on your letterhead.

**Working voltages** ..... 100, 200, 400, 600V DC

**Tolerance** ..... ±1%, ±5%, ±10%, ±20%

**Dissipation factor** .....  $4 \times 10^{-3}$  max. @25°C, at 1KC

**Temperature Stability** ..4% max. deviation from 25°C value in range of 0°C to 85°C, at 1KC.

Made under one or more of the following U.S. Patents: 3,040,415/3,134,059/2,950,070/3,117,364

\*Du Pont T.M.

**i t PAKTRON**  
**w** DIVISION ILLINOIS TOOL WORKS INC.  
1321 LESLIE AVENUE • ALEXANDRIA, VIRGINIA

dimensional unit. By a series of manufacturing steps, the monolithic circuit is produced on a single substrate.

By contrast, multichip construction involves making a number of identical components on the same wafer, dicing them apart into microelements and then combining them, with other separately made components, to form circuits.

General Instrument says the multichip approach runs rings around the monolithic technique when a relatively small number of microcircuits are needed quickly. The system being built for the space agency will use about 150 microcircuits. The company will deliver it in five months to the Goddard Space Flight Center, Greenbelt, Md.

**The satellites.** NASA plans to orbit a total of six of the geophysical observatory satellites. The first OGO was launched from Cape Kennedy on Sept. 4. It was boosted into an oval orbit, ranging from 177 to 93,313 miles above the earth, by an Atlas Agena rocket. The launch was excellent but the satellite developed trouble when two booms failed to deploy. This meant the satellite couldn't travel without spinning. None of the 20 experiments carried by OGO were turned on until Sept. 7. Then, despite the spin, 14 were turned on and successfully transmitted data.

The over-all aim of the OGO program, said George Ludwig, project scientist for NASA, is "to find out as much as we can about the environment near earth and to obtain a better idea of earth-sun relations." Such knowledge, Ludwig explained, is vital to Project Apollo because manned flights to

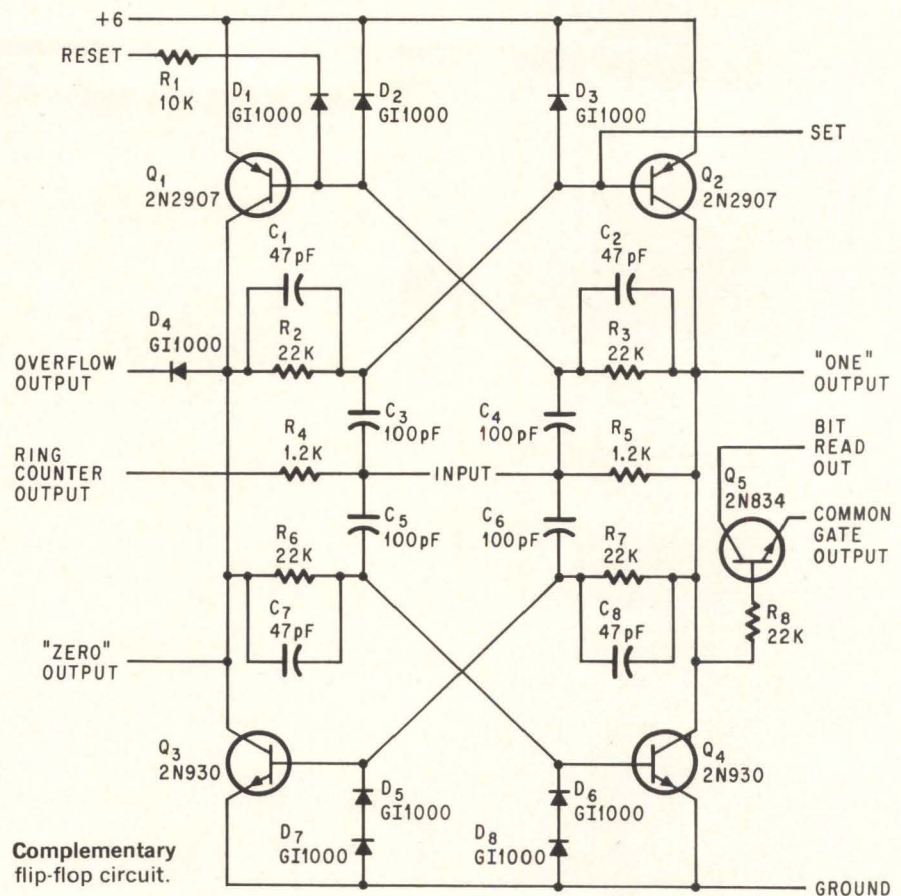

the moon now face the hazard of potentially dangerous solar flares. OGO will be collecting information about these bursts of gas and flame for the astronauts.

**The reasons.** Officials of General Instrument refer to the contract as a victory. One spokesman emphasized that General Instrument did win out over a number of advocates of the monolithic technique.

When asked why, he advanced several reasons: the high tooling-up cost for monolithic circuitry, the length of time required for that tooling up, and the fact that in a

monolithic circuit the common substrate material has to be a compromise. What may be the ideal substrate material for a particular transistor may not be the best material for a particular capacitor. This problem does not exist in multichip-circuit construction which allows the use of the most suitable substrate for each of the individual components.

The power consumption of the microelectronic data processing system is extraordinarily low. It needs between 277 and 370 milliwatts to operate. This is about half

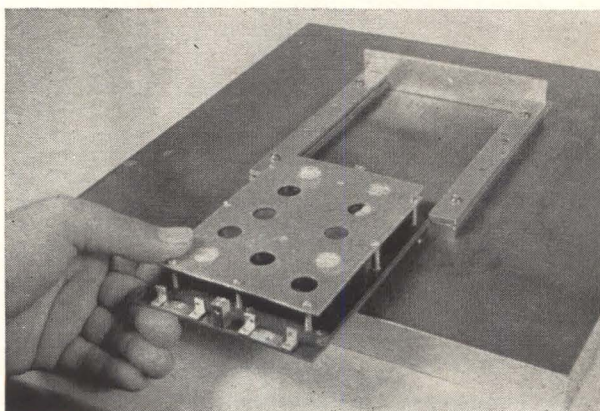

An actual-size mechanical sample, simulating the completed system, being placed into a vibration test fixture.

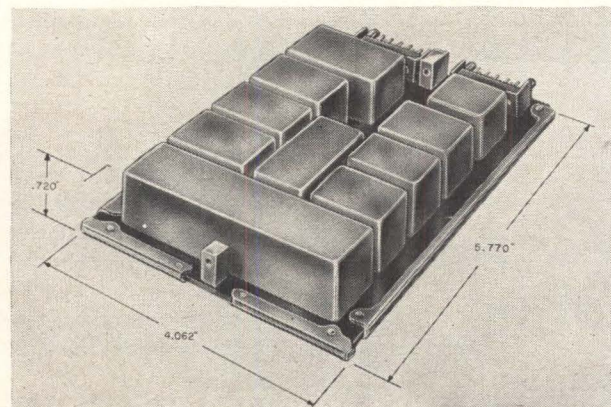

The system consists of ten modules mounted on a plug-in circuit card.

the power consumed by an ordinary flashlight. The entire data processing unit will occupy about eight cubic inches and will weigh approximately 200 grams.

**Building block.** A complementary flip-flop microcircuit is the key building block. According to General Instrument, it duplicates the performance of a conventional circuit 140 times its size.

The system will be housed in a total of 10 modules. Seven will contain binary-counter register subsystems; each subsystem will use nine of the complementary flip-flop circuits. The other three modules will consist of a quasi-binary floating-point register subsystem, containing 24 flip-flop circuits, a read-out register subsystem with 10 flip-flop circuits, and a control subsystem.

**What it does.** The processor will collect information on conditions in space from the satellite's 20 sensing devices and feed it, on command, into the central data system. It will be able to handle information from as many as eight of the sensing devices at a time. Data can be accumulated at the rate of one million bits per second, stored on tape, or fed out immediately at a rate of up to 64,000 bits at a time. This output could be speeded up, but the system is limited by the speed of the external equipment to which the information is fed.

**In charge.** A three-man team, headed by Sol Schwartz, senior project engineer, is directing the system-building program at General Instrument's design and engineering products group facilities in Hicksville, L. I. Schwartz's colleagues are Marc Swirlock, assistant project engineer, and Emery Vezer, mechanical project engineer. Harry Zacharia is consultant.

The recently completed feasibility model (a breadboard model using conventional circuits) closely simulates the actual microelectronic system. It occupies 4,800 cubic inches and weighs 75 pounds.

Only one other microelectronic system has ever been used in space. This is the microelectronic optical computer for attitude determination installed in NASA's Interplanetary Monitoring Probe, launched late last year. The optical computer uses monolithic circuits made by Texas Instruments, Inc.

## HOW TO BUY POWER SUPPLIES AND SAVE MONEY

Over the years, Acme Electric has designed and supplied DC regulated power supplies in substantial quantities to some of the largest electronic equipment builders.

A number of these **Custom Designed** units have specifications and performance features that make them uniquely suited for **standard** industrial and laboratory use.

If you have an application in which one of these custom designed power supplies would be acceptable, the probability is that you can save money and at the same time obtain greater value represented by improved performance parameters.

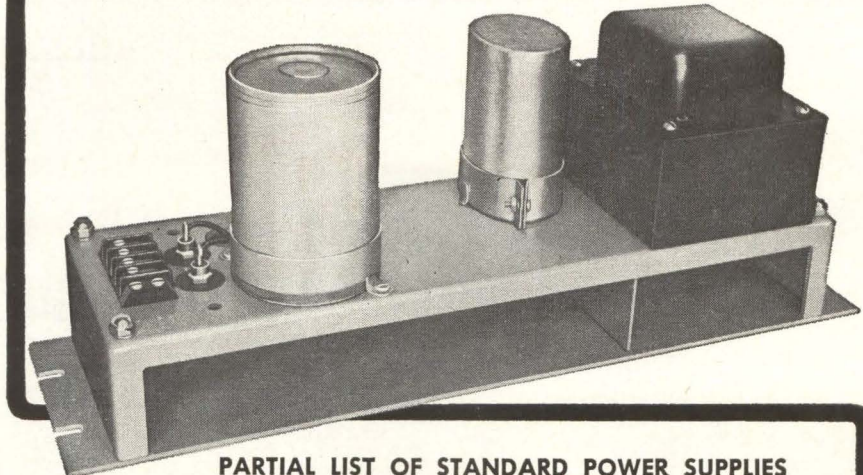

### PARTIAL LIST OF STANDARD POWER SUPPLIES

INPUT: 110-130 Volt, 50/60 cycles

LINE REGULATION:  $\pm 1\%$  for  $\pm 13\%$  line voltage change

LOAD REGULATION:  $\pm 2\%$  for load change between 50% and 100%

TYPE	DC VOLTS	DC AMPS	PANEL SIZE
PS-41922	24	2	19 x 3½ x 7
PS-41423	24	6	19 x 5¼ x 9¾
PS-47173	24	25	19 x 7 x 9¾
PS-41424	48	4	19 x 5¼ x 9¾
PS-47519	48	10	19 x 7 x 9¾
PS-41425	125	2	19 x 5¼ x 9¾
PS-41428	250	1	19 x 5¼ x 7¾

RIPPLE: 1% RMS MAXIMUM

For full details covering component features, operating performance and price, write for Bulletin 175.

# Acme Electric

Engineers and Builders of...

319 WATER STREET, CUBA, NEW YORK

Canadian Representative: Polygon Services, Ltd.  
50 Northline Rd., Toronto 16, Ont.

SAA-3767-3075

REGULATED POWER SUPPLIES  
STATIC POWER RECTIFIERS  
VOLTAGE STABILIZERS  
VOLTAGE REGULATORS

... the package  
designed for  
**POWER**

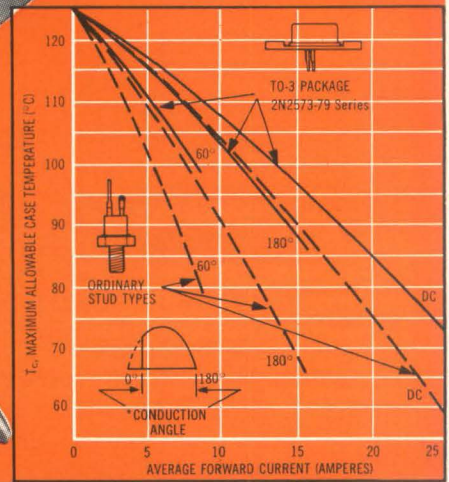
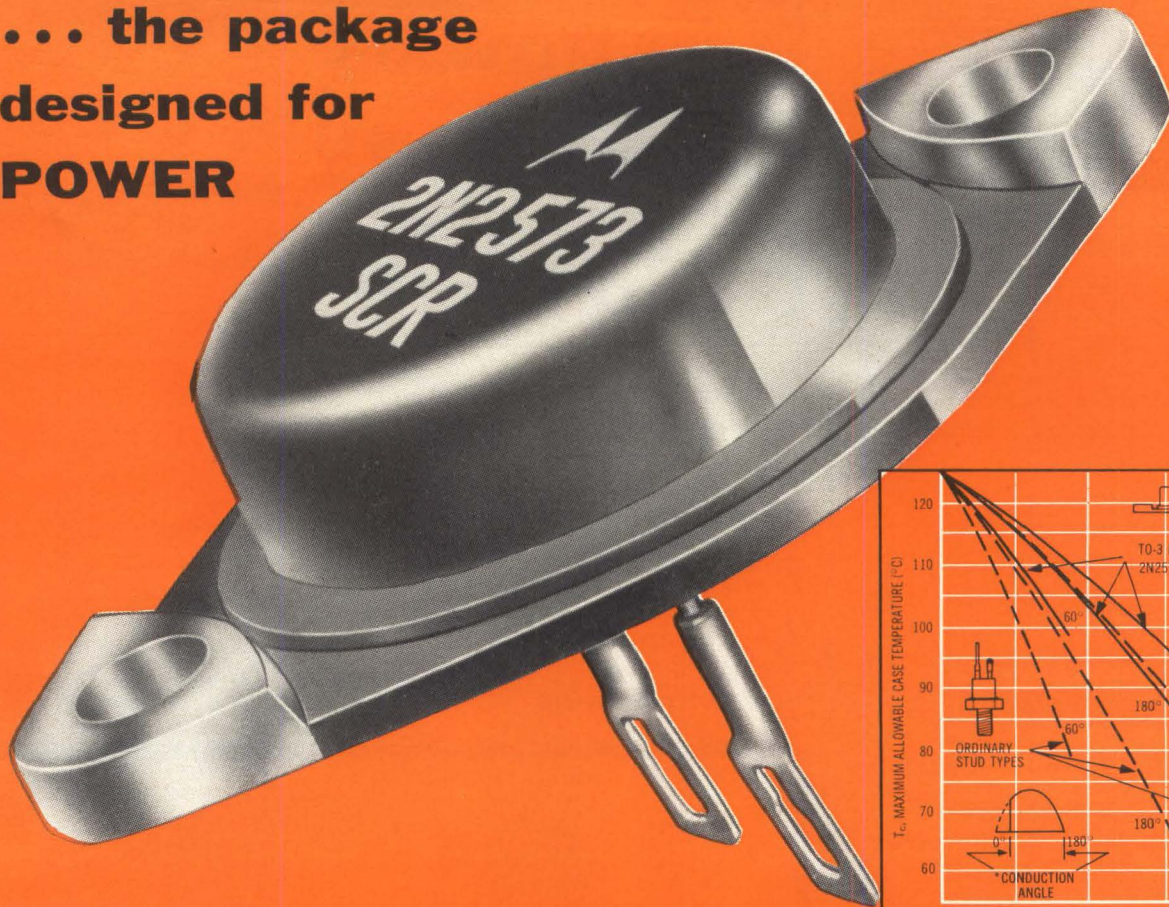

## MOTOROLA'S NEW 25-AMP SILICON CONTROLLED RECTIFIER GIVES YOU FULL POWER AT HIGHER TEMPERATURES

These new Motorola 25-amp silicon controlled rectifiers (types 2N2573-79), electrically equivalent to the 2N681-9 series stud-type SCR's, utilize the natural power operation advantages of the TO-3 package design to give improved performance over stud-mounted devices in areas such as:

- Higher DC current output — 25 amps @ 71°C
- Higher surge current — 260 amps at rated load @ 125°C
- Lower thermal resistance — 1.5°C/W
- Freedom from failures due to excessive stud torquing
- Lower vertical dimension — only .41"

With the low forward voltage drop (only .7 volts @ 16 amps full cycle average, 180° conduction angle,  $T_J = 125^\circ\text{C}$ ) plus the low thermal resistance of the TO-3 package, you can operate at higher current levels for any given case temperature ... or in applications with lower current requirements, you can reduce the heat sink area required for your equipment.

Find out for yourself how the TO-3 package provides you with highest performance silicon controlled rectifiers at lowest cost for *your* equipment applications!

### LOOK AT THESE PERFORMANCE ADVANTAGES

This chart gives key parameter comparisons for Motorola TO-3 package 2N2573-79 type and stud-type 2N681-89 silicon controlled rectifiers.\*

	(2N685)	2N2576	
$P_{\text{LOSSES}}$ (Av. forward power loss @ max. junction temp. @ $I_{\text{AVG}}$ above)	(24)	21	Watts
$T_C$ (Max. allow. case temp. @ $I_{\text{AVG}}$ max. for 180° conduction angle)	(65)	85	°C
$I_{\text{SURGE}}$ (Peak 1/2-cycle 60 cps surge current @ max. junction temp.)	(150)	260	Amps
$I^2t$ (Max. subcycle surge rating as function of RMS current/time @ max. junct. temp.)	(75)	275	A <sup>2</sup> sec

\*Data obtained from published specifications

If you would like additional information on Motorola's 2N2573-79 series 25-amp silicon controlled rectifiers, contact your nearest Motorola District Office or Distributor or write Technical Information Center, Motorola Semiconductor Products Inc., Box 955, Phoenix 1, Arizona.



**MOTOROLA**  
Semiconductor Products Inc.  
A SUBSIDIARY OF MOTOROLA INC. D13-014  
BOX 955 • PHOENIX 1, ARIZONA

A GROWING LIST OF MOTOROLA SILICON CONTROLLED RECTIFIERS ■ High Efficiency Diamond Package types 2N2573-79 & MCR649 ■ 11/16" Stud-mounted types 2N681-89 ■ 7/16" Stud-mounted types MCR846 ■ Low Cost Industrial Press-Fit Package types MCR808 ■ ALSO — Gate Controlled Switch — Diamond package types MGCS821 series — with pulse turn-on, turn-off gate control.

# Custom-integrated circuits by design kit

New approach circumvents manufacturer's premium, thus reducing customer costs

A designer's kit has been announced for the layout of custom-integrated circuits. It permits the design engineer to arrange and define his own schematic in a form compatible with the microcircuit state-of-the-art. Until now, this type of circuit has been designed primarily by the semiconductor manufacturer, and at a premium cost. The kit approach returns the circuit—design function to the customer without price penalties. This is possible through the use of the integrated-circuit technique of diffused active devices, with thin-film passive devices deposited directly upon the silicon dioxide that covers the diffused portion.

This technique, known as the Mosaic monolithic circuit, is said to offer many engineering advantages over the more common all-diffused technique. These include wider resistance range, tighter tolerance and matching on resistors, low parasitic capacitance, improved temperature stability and greater circuit density.

**What you get.** A customer is offered the option of several active devices in the kit—amplifier and switching transistors or diodes. These basic specifications represent active device geometries that are already tooled and manufactured as "master slices." It should be noted that these device parameters can be adjusted further by such techniques as varying diffusion depths and doping levels; these do not require any additional masking costs.

After active devices are selected, the next step is to choose passive component values within the listed range of capability allowed by size and industry know-how. Thus a circuit can be developed that is ready to be converted directly into microelectronic technology.

Upon completion of his sche-

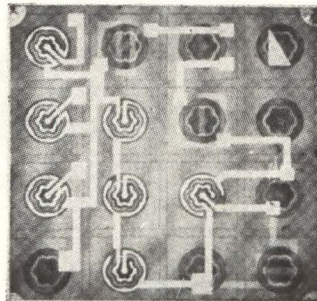

ACTUAL CIRCUIT

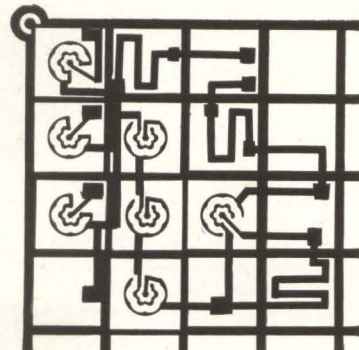

ACTUAL LAYOUT

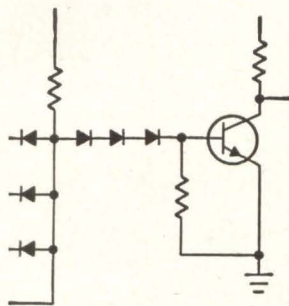

ACTUAL SCHEMATIC

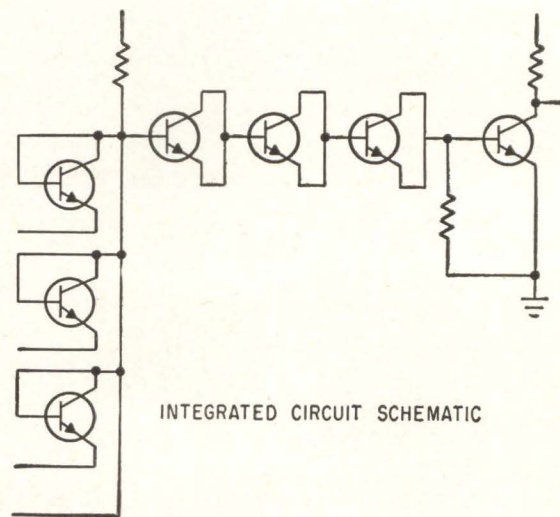

INTEGRATED CIRCUIT SCHEMATIC

matic, the designer is in a position to do an actual layout of a custom-integrated circuit chip. He is provided with a scaled-up address format and separate component and contact pattern representations that can be placed upon the format as desired. Instructions are provided describing cross-over techniques, spacing of components and contact runs, and mechanical size required to achieve desired values of resistance and capacitance.

Upon completion of the custom layout, the customer is invited to forward the circuit to the company for development of a firm engineer-

ing proposal and quotation. At such time, the input and output functions will be confirmed, the customer's package preference verified; unusual environments evaluated, and availability and cost figures stated.

Some examples of costs are: custom buffer amplifier, \$55 each for 100 pieces; custom DTL single NAND circuit, \$22 each for small quantities; and diode ring modulator, \$11 each in quantities of 1,000 pieces.

Bendix Semiconductor Division, Bendix Corp., Holmdel, N.J.  
Circle 301 reader service card

# what difference does that make?

Quite a bit. The probe you see (a) is the new business end of our PEL 626 RF Millivoltmeter.

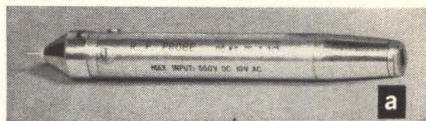

This new probe permits us to offer improved specifications (b). Read them carefully.

PEL 626 SPECIFICATION IMPROVEMENTS		
Parameter	Standard	Improved
Frequency Accuracy	3% from 50 KC to 100 MC	5% 10 to 20 KC
	5% to 300 MC	3% to 100 MC
	20% to 2000 MC	5% to 300 MC
		10% to 1000 MC
VSWR	Less than 1.2 to 1200 MC, less than 1.3 to 2000 MC	Less than 1.2 to 2000 MC

If you followed our advice, you may wonder why we bothered to improve our specs. The PEL 626 (c) already had the greatest sensitivity and widest range of any instrument of its kind. We bothered because we insist that our instruments provide maximum performance, even if it means competing with ourselves.

Find these facts hard to believe? Don't. They're all verified in black and white in our new brochure. Send for your copy today.

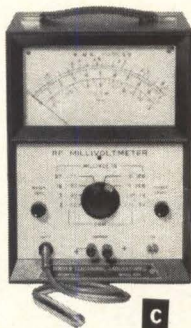

Every PEL 626 is accompanied by an individually charted record of both frequency response and VSWR. No other RF Millivoltmeter is sold with a record of its own performance.

**PORTER**  
ELECTRONIC LABORATORIES

BOONTON, NEW JERSEY

*Instruments that advance the art*

## New Components and Hardware

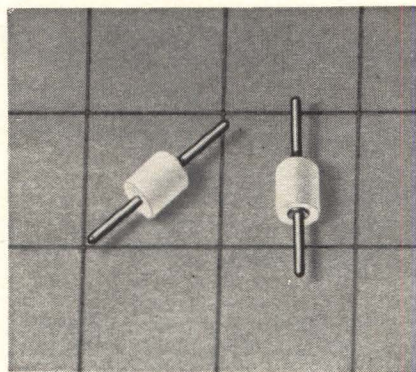

### Feed-through terminal in microminiature size

A microminiature feed-through terminal serves as probe and guide for mating chassis to chassis. The FT-MM-100 is bonded in place with an epoxy compound after insertion. The lug is brass with a solder plating and is approximately 0.328 in. long by 0.020 in. in diameter. It extends 0.117 in. beyond the bushing at each end. The bushing is 0.075 in. in diameter by 0.093 in. deep. The terminals are made with bushings of 100% virgin-pure Teflon machined to precision specifications. Any of the 10 EIA colors may be ordered for color coding of the circuits. Seaelectro Corp., 225 Hoyt St., Mamaroneck, N.Y. [311]

### Pellet film resistors with fluted design

Pellet film resistors featuring a fluted design are available in diameters of 0.100 in. and thicknesses of either 0.030 in. or 0.063 in. They are said to be ideal for application

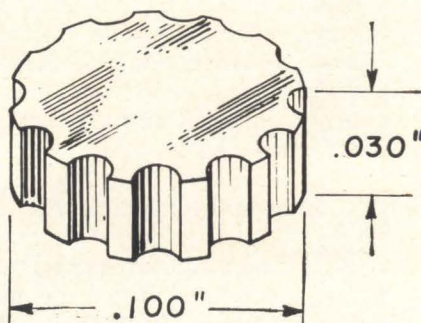

in high-frequency equipment in the uhf region. Test results indicate that these pellets have a low standing-wave ratio when used as r-f terminations and fast rise time when used in pulse applications. Actual swr measurements made with a 50-ohm pellet indicate a swr of less than 1.1 at 1,200 Mc. P. R. Mallory & Co. Inc., 3029 E. Washington St., Indianapolis, Ind. [312]

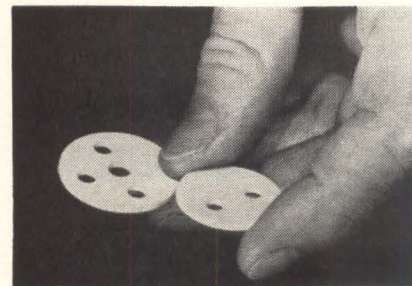

### Mounting wafers of boron nitride

Transistor mounting wafers of boron nitride, a material that is an electrical insulator and a heat conductor, have been announced. Designed primarily for power-handling transistors ranging up to 100 w, the wafers provide 90% of the performance of premium materials at about half the cost. While electrically insulating the collector from the chassis under the transistor, the  $\frac{1}{16}$ -in.-thick wafers remove the heat generated in the transistor and conduct it into the chassis, which serves as a heat sink. No conductive greases are required, as dry boron nitride has a thermal resistance of less than 0.1°C per w. Union Carbide Corp., 270 Park Ave., New York 10017. [313]

### Ceramic capacitors offer high Q

Fixed ceramic capacitors have been developed in a configuration only  $\frac{7}{8}$  in. square and  $\pm \frac{1}{16}$  in. thick. Series YUO1 are available in capacitances from 0.5 to 62 pf, for a working voltage of 300 v d-c. A choice of tolerances is available for



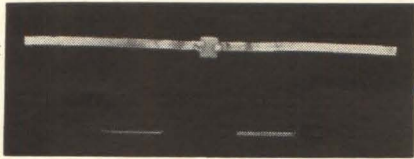

each size, from  $\pm 0.25$  to  $\pm 0.50$  pf at the low C end of the line to from  $\pm 1$  to  $\pm 10\%$  at the high end. All units have a guaranteed minimum Q of 3,000. Ceramic dielectric layers, fused into a monolithic structure and encapsulated in solid glass, insure complete protection against moisture and other environmental factors. Stability is maintained through extremes of voltage, frequency, temperature and other stresses. Standard leads are silver ribbon, axial, a minimum of  $\frac{7}{8}$  in. long,  $0.050 \pm 0.003$  in. wide and  $0.008 \pm 0.002$  in. thick. Other types and configuration leads can be furnished on special order.

JFD Electronics Corp., 1462 62nd St., Brooklyn, N.Y. 11219. [314]



### Power tetrodes survive severe treatment

Two new power tetrodes of metal-ceramic construction are offered. When cooled by forced air, the 4CX125C and F have a maximum plate dissipation of 125 w. The tubes have a high endurance for extreme environmental conditions of temperature, shock and vibration. Operating at frequencies up to 500 Mc, they can be used in Class C f-m telephony and telegraphy, Class C plate-modulated telephony, and Class AB1, audio or single-sideband amplification. Standing  $2\frac{1}{2}$  in. high, the tubes have diameters of approximately

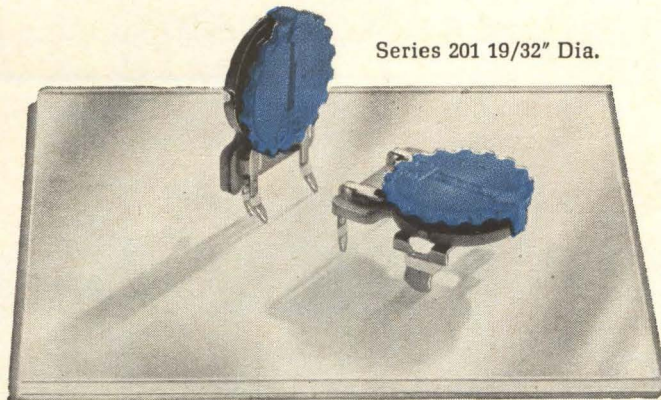

Series 201 19/32" Dia.



### NEW MINIATURE LOW COST CARBON TRIMMER RESISTOR

is especially designed for P.C. applications. Instantly, firmly snaps into position with self-supporting bracket. Two versions for parallel or perpendicular mounting. Attached knob has arrow indicator for easy adjustment and convenient screw-driver slots on front and rear.

Uses the same highly reliable composition resistance element as the broad line of CTS commercial and industrial carbon controls. An unusually wide resistance range of 250 ohms through 2.5 megohms (linear taper), and power rating of 1/8 watt at 55°C derated to no load at 85°C (linear taper), make the 201 series particularly adaptable for instruments, communication equipment, electronic machine controls, micro-wave transmission, medical electronic equipment, electro-data processing equipment applications.

Priced under a dime in quantities of 3,000. Write for Data Sheet 1201.



Founded 1896

**CTS CORPORATION**  
Elkhart, Indiana

# Rich Mans Motor

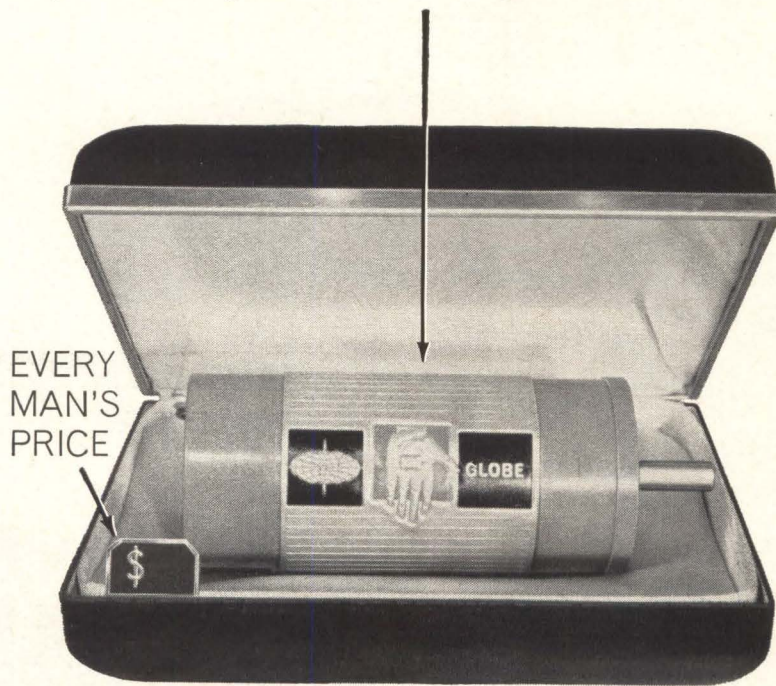

## HYSTERESIS SYNCHRONOUS MOTORS EXACT SPEED

Until recently designers had to settle for a low-torque clock motor—or spend a lot of money for a bigger hysteresis synchronous motor—to get constant speed. Globe has changed all this. Our new family of small commercial motors **started out** hysteresis synchronous. Result: motors that hold 1,800 or 3,600 rpm sync speed through thick and thin. If you overload them they stop, but they don't burn out. Sync motors are the original GO—NO GO machines. To make each motor more useful Globe offers integral gearboxes with **many** standard ratios.

These motors cost less because we have taken precision military performance, combined it with manufacturing engineering, and relaxed environmental specs. Of course there are induction versions of these motors if you want higher torque. Request Bulletin SM-1.



**TYPE CMC.** 1 $\frac{3}{4}$ " dia. x 2 $\frac{3}{32}$ " long. To 0.75 oz. in. max. sync. torque @ 1,800 or 3,600 rpm.



**TYPE CFC.** 1 $\frac{1}{2}$ " dia. x 2 $\frac{7}{8}$ " long. 2.0 oz. in. max. sync. torque.



**TYPE UC.** 2 $\frac{5}{16}$ " dia. x 1.870" long (min.), 3.370" long (max.) 6 oz. in. max. sync. torque.



**TYPE WC.** 3 $\frac{1}{4}$ " dia. x 1 $\frac{1}{4}$ " long. 1 and 2-speed. 3.5 oz. in. max. sync. torque.



**TYPE CLC** fan cooled. 3 $\frac{3}{8}$ " dia. x 3 $\frac{3}{4}$ " long. 10 oz. in. max. sync. torque.

Globe Industries, Inc., 1784 Stanley Avenue,  
Dayton, Ohio 45404, U.S.A. Tel.: 513 222-3741.



GLOBE

## New Components

1 $\frac{1}{4}$  in. including the radial cooling fins designed for either liquid or forced-air cooling. The base is a special breechblock type with radial contact tabs. In single quantities, the 4CX125C and F are priced at \$43 and \$86.50, respectively.

Raytheon Co., Industrial Components Division, 55 Chapel St., Newton, Mass. 02158. [315]

## Metal-film resistor saves board space

A molded, precision metal-film resistor, type PE- $\frac{1}{4}$ , for printed-board applications, is designed to conserve board area and surpasses MIL-R-10509E characteristic E and C levels. Power rating is  $\frac{1}{4}$  w at 100°C and  $\frac{1}{8}$  w at 125°C. Voltage rating is 250 v and the resistance ranges from 10 ohms to 0.5 megohm. Dimensions are 0.140 by 0.200 by 0.468 in., and the two leads projecting from one end are 0.025-in.-diameter tinned copper, or gold-plated Dumet, a low-expansion alloy, in either case  $\frac{3}{4}$  in. long, the leads can be trimmed to suit the application. Standard tolerance is  $\pm 1\%$ , but tolerances from  $\pm 0.1\%$  to  $\pm 5\%$  are available. The unit features low noise and temperature coefficients of  $\pm 25$  ppm per °C,  $\pm 50$  ppm per °C, and  $\pm 100$  ppm per °C. Prices range from \$2 to 45 cents depending on tolerance, temperature coefficient, and quantity.

American Components, Inc., 8th Ave. & Harry St., Conshohocken, Pa. [316]

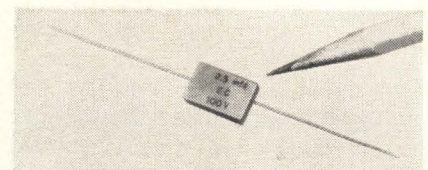

## Ceramic capacitor rated 100 wvdc

A new subminiature ceramic capacitor offers a 0.1 to 2.5  $\mu$ f capacitance with a  $\pm 20\%$  tolerance and maximum capacitance change of

$\pm 15\%$  over a temperature range of  $-55^{\circ}\text{C}$  to  $\pm 125^{\circ}\text{C}$ . The voltage rating is 100 vdc with no derating to  $125^{\circ}\text{C}$ . The dissipation factor is less than  $2\frac{1}{2}\%$  at  $25^{\circ}\text{C}$ . The envelope is dipped in epoxy for maximum environmental protection. Nytronics, Inc., 550 Springfield Ave., Berkeley Heights, N.J. [317]

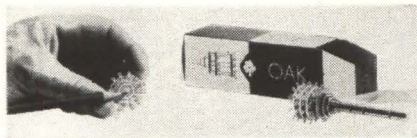

### Distributor switches in subminiature sizes

Rotary distributor switches have been developed in subminiature sizes. The line of "A" switches offers eight different types and features silicone glass stators and rotors of Kel-F material. Frames for the switches are 1 in. high,  $\frac{1}{16}$  in. wide by  $1\frac{3}{16}$  in. over clips. They are equipped with  $\frac{1}{4}$ -in.-diameter shafts,  $2\frac{3}{8}$  in. long, with break-off points at  $\frac{3}{4}$  in.,  $1\frac{1}{8}$  in. and  $1\frac{7}{8}$  in. from the mounting surface. The switches meet 200-hr. military salt-spray requirements. They are rated 1 amp at 28 v d-c and 0.5 amp at 115 v a-c. Silver-plated brass contacts are double wiping, shorting or nonshorting types.

Oak Mfg. Co., a division of Oak Electro/Netics Corp., Crystal Lake, Ill. [318]

### Tiny toggle switch operates up to $85^{\circ}\text{C}$

This single-pole change-over toggle switch has a working temperature range of  $0^{\circ}$  to  $85^{\circ}\text{C}$ . Primary applications are in portable test sets, instrumentation, radar display equipment and as a computer test facility. Two models are available. The TS70, with fine silver contacts, is rated at 1 amp resistive at 50 v d-c or 0.25 amp at 125 v a-c. Initial contact resistance is 10 milliohms. Type TS71 has heavily gold plated



another major **AEL** technical  
**BREAKTHROUGH!**

**AEL** will increase sensitivity of your present crystal video system by

**5 to 7 db**

with just a simple retrofit

American Electronic Laboratories announces the revolutionary, new Integrated Video Detector Package that includes the new ultra-high performance AEL-12 Diode (see block diagram) and a miniaturized low noise video amplifier specifically designed to provide maximum sensitivity concurrent with maximum video bandwidth. This tiny integrated package enables you to increase the sensitivity of your present crystal video system by 5 to 7 db.

The retrofit is simple. You just remove your present detector mount and video pre-amplifier, and replace them with the new AEL Integrated Video Detector Package. This is accomplished by merely extending the cables used with the original components. The only other modification required is provision of the very low power requirement for the transistorized amplifier.

Broadband integrated mounts are offered in the microwave region — contact AEL for your specific requirements.

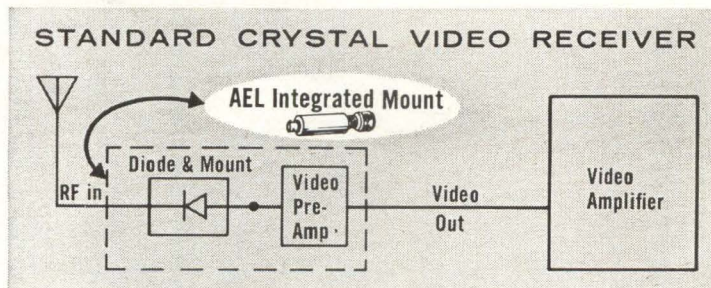

Also available is the triple combination of a miniature bandpass filter and detector-preamplifier in an integrated package, which eliminates the conventional bulky components used in present crystal video systems.

Write or call for complete information on AEL's new Integrated Video Detector Package.

Visit AEL at the  
MILICON Show  
Booth 119



**American Electronic Laboratories, Inc.**  
P. O. BOX 552, LANSDALE, PA. 19446 • (215) 822-2929 • Suburban Philadelphia

# COMINCO

HIGH PURITY METALS  
AVAILABLE FORMS

*clip and save*

Product	ALUMINUM	ANTIMONY	ARSENIC	BISMUTH	CADMIUM	GOLD	INDIUM	LEAD	SILVER	TIN	ZINC
BARS	✓	✓	✓	✓	✓	✓	✓	✓	✓	✓	✓
SHEETS	✓				✓	✓	✓	✓	✓	✓	✓
WIRE	✓				✓		✓	✓		✓	✓
POWDER		✓	✓	✓	✓	✓	✓	✓	✓	✓	✓
SHOT		✓		✓	✓	✓	✓	✓	✓	✓	✓
ROD	✓			✓	✓		✓	✓	✓	✓	✓
RIBBON							✓	✓			
PRE-FORMS	✓				✓	✓	✓	✓	✓	✓	✓
SALTS					✓		✓				

## COMINCO PRODUCTS, INC.

electronic materials division

818 West Riverside Avenue, Spokane, Washington 99201  
Phone Area Code 509 RI 7-6111 • TWX 509 328-1464

3602

Circle 201 on reader service card

## NEW EPOXY-ENCAPSULATED 30,000 V 5 MA Power Supplies

- Good Regulation
- Replaceable Selenium Rectifiers
- Surge Limiting
- Corona Free
- Replaceable Diodes
- Component Type Construction
- Reversible—Ground or Floating
- No Protruding HV Bushings
- Low Ripple
- Compact
- Low Cost
- Light Weight
- Rugged
- Trouble Free
- Insensitive to Environment
- Conservatively Rated

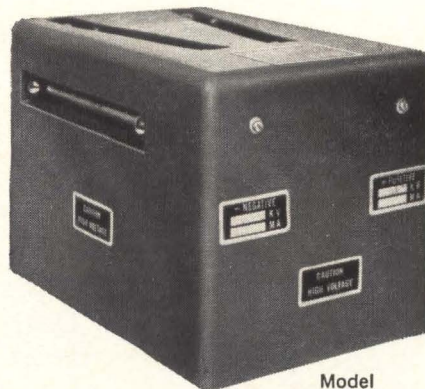

Model  
PSF 30-5

WRITE FOR COMPLETE DETAILS



**ELECTRONICS DIVISION**

**RESEARCH-COTTRELL, INC.**, BOUND BROOK, NEW JERSEY  
CHOICE REPRESENTATIVE TERRITORIES AVAILABLE

RC-278E

## New Components

contacts, rated at 100 ma at 1 v d-c, contact resistance 6 milliohms. They are otherwise identical—0.25 in. diameter and 0.5 in. body length, and intended for panel mounting.

Miniature Electronic Components, Ltd.,  
St. Johns, Woking, Surrey, England.  
[319]

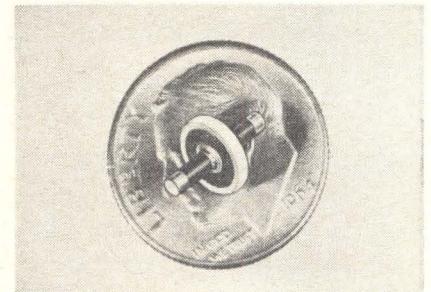

## Co-ax T-pad assembly offered in microminiature

A microminiature coaxial T-pad is being offered with an over-all length of 0.425 in. and attenuation values of 3, 6, 10, 15 and 20 db. Units are assembled and shipped from stocks of standard rod and disk resistors fabricated with metal-resistive films deposited on precision substrates of high-alumina ceramic. The resistance tolerances are  $\pm 1\%$  and the units operate over a temperature range of  $-55^{\circ}\text{C}$  to  $200^{\circ}\text{C}$  with a range of 0 to 100% relative humidity.

Nytronics, Inc., 550 Springfield Ave.,  
Berkeley Heights, N.J. [320]

## Transolvers combine servo-system functions

A series of transolvers—combinations of transformers and resolvers—range from size 5 ( $\frac{1}{2}$ -in. diam-

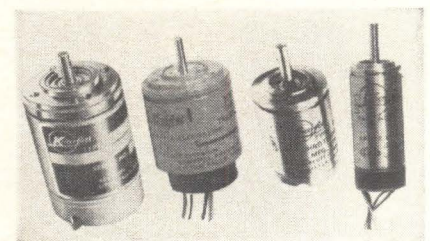

eter) to size 11 (1.062-in. diameter). They are used in phase conversion, vector resolution, servo system monitoring, angle summing and other applications in systems that transmit, convert, use or indicate information in electrical form. The transolver can provide sine and cosine outputs simultaneously, contrasted to the single sine function produced by a conventional synchro control transformer. The transolver consists of a three-phase, Y-connected winding and two single-phase windings, either of which may be the fixed or rotating element. By using transolvers judiciously to replace other sets of individual components, systems may be greatly simplified and significant savings in volume and weight can be made.

Kearfott Division, General Precision Equipment Corp., 1150 McBride Ave., Little Falls, N.J. 07424. [321]

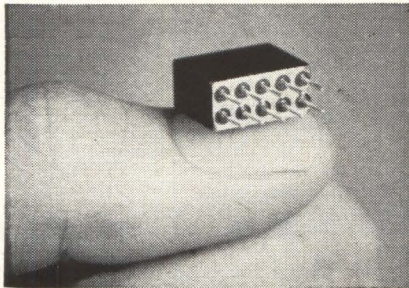

## Latching relay is 1/6 crystal-can size

A one-sixth crystal-can-size dpdt relay has been developed with contacts rated at 1 amp resistive at 28 v d-c. Operated from a short-duration, low-power pulse, the contacts remain in either position without consuming power. Type LJ, a hermetically sealed latching relay, operates in a  $-65^{\circ}$  to  $+125^{\circ}\text{C}$  temperature range and is unaffected by extreme aerospace conditions such as high altitude and severe shock and vibration. The relay measures only 0.2 by 0.4 by 0.5 in. It is available with coils for operation at 6, 12, 24 and 48 v d-c. A variety of case and header styles are offered to satisfy all mounting requirements. Type LJ meets or exceeds applicable section of MIL-R-5757D.

Branson Corp., 41 South Jefferson Rd., Whippany, N.J. [322]

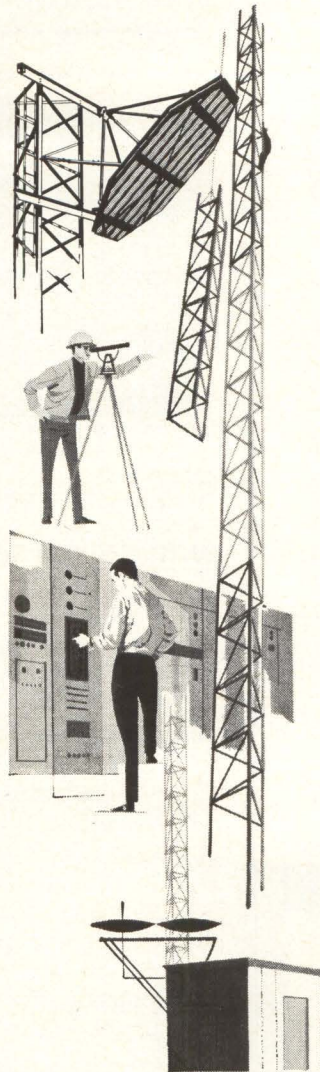

TOWER COMMUNICATIONS IS ON THE MOVE . . . in every phase of the company's operations . . . in staff, services and products. Our new "TC" mark signals a new outlook, new forward thinking. We've established an extensive program to expand upon the design, engineering and installation of complex systems.

With a greatly augmented staff of designers, engineers, technicians and constructors, Tower is geared to handle world-wide communications and microwave system installation and structural fabrication and erection of all magnitudes . . . on this continent and in foreign fields. "TC" is the hallmark of new world-wide dependability.

*You can look for project reports by Tower regularly in the contents of this magazine.*



**TOWER COMMUNICATIONS CO.**

SIoux CITY · DALLAS · TORONTO

505 SIXTH STREET / SIOUX CITY, IOWA  
TWX 910-967-2503 / Phone 492-3631 Area Code 712

**Make .01% measurements  
1 microsecond after  
100,000 to 1 over-range  
... with ULTRA-NULL™**

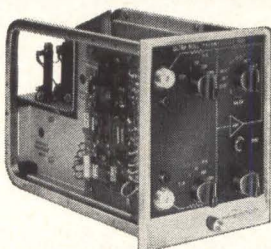
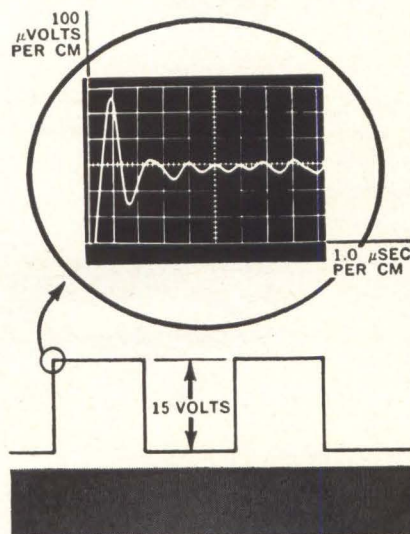

Adage ULTRA-NULL is a remarkable new oscilloscope plug-in preamplifier featuring, in unique combination, 10 microvolts/cm sensitivity, high speed of response, and overload immunity. In addition to near-zero measurement capability, a small slice of any waveform may be observed by nulling against a reference input.

**Typical applications:**

- Recovery characteristics of semiconductor diodes and transistors to nanoamp levels.
- Recovery characteristics of precision wire-wound resistors.
- Transient response characteristics of amplifiers to .001% of full scale.
- Frequency response of amplifiers and/or networks to .01%.
- Measurement of AC peak voltage to .01%.

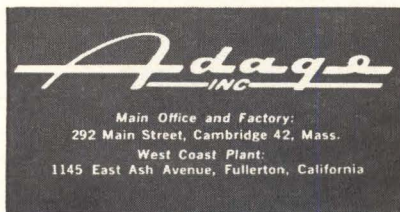

Adage, Inc. welcomes employment inquiries from professional engineers.

**New Instruments**



**Solid-state servo repeater  
with digital readout**

Solid-state servo repeater, model PPR, indicates the position of remotely located synchros and resolvers with an accuracy of six minutes of arc. Readout angle, in 3/4-in. character height, is displayed on an illuminated, in-line module which consumes only 1 in. by 4 in. of panel space. Decimal or BCD (1, 2, 4, 8) code at a 24-v d-c level is simultaneously available from the servo. Useful in performing gyro system measurements, the unit indicates gyro pitch, roll, and yaw angles. It displays the angular positions of any system containing synchros or resolvers. Range of the instrument is 360° continuous; slewing time, 8 sec; price \$1500. Theta Instrument Corp., Saddle Brook, N.J. 07663. [351]



**Counter features  
front plug-in design**

A new counter has been introduced with a versatile front plug-in design. Model 1014 measures frequencies directly to 100 Mc by means of prescaling (non-indicating) decade. The front plug-in feature provides for simple interchange of functional plug-ins that tailor the basic model 1014 to a

broad range of specific frequency measuring and timing applications. Associated plug-ins available include universal, dual-measurement, preset, time interval, and frequency extenders covering the full range to 15 Gc. Standard oscillator stability is 3 parts in 10<sup>7</sup> per week. Model 1014 can also be provided with an optional high-stability oscillator that has an aging rate of 1 part in 10<sup>9</sup> per day. Other options include display storage, remote programming, and BCD output. Unit is priced at \$2,250. Systron-Donner Corp., 888 Galindo St., Concord, Calif. [352]

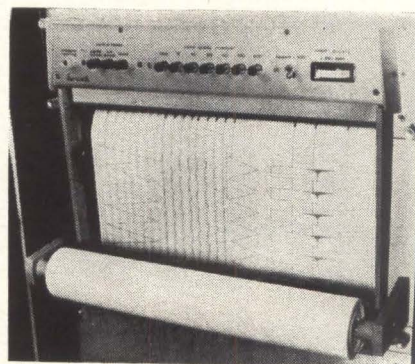

**Recording systems  
in modular design**

A series of direct-writing recording systems permits a variety of different writing modules to be grouped into a single recorder in any combination desired. Modular grouping in the series 1707, Mark 200 system, allows a variety of data to be recorded simultaneously. Each type of recording is said to be presented in the most readable form possible—extreme resolution for precision measurements, closely spaced presentation for several channels of dynamic or trending information, and well-organized “yes-no” information from relays, actuators, time codes and digital functions. Three independent writing modules, available for insertion into the combination unit, produce data correlated to the same time base. They include a dual-channel 40-mm analog module, a single-channel 80-mm analog module and an 8-channel Multi-

marker event-recorder module. Each writing module occupies one-fourth of the space available in the series 1707. Any recorder can be made up of four individual modules. All four modules may be alike, or two or three can be selected in any combination. All writing modules share a common writing-fluid supply system. Cost of the series 1707 system is about \$900 per channel.

Brush Instruments division of Clevite Corp., 37th and Perkins, Cleveland 44114. [353]

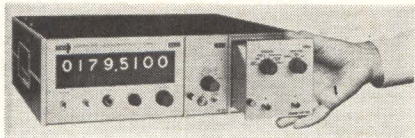

## Phase meter plug-in for use with counters

A new phase angle meter plug-in is designed for the Digi-Twin line of electronic counters. The 838-A plug-in provides an accurate means of measuring phase angle and digitally displaying the results directly in degrees. The device has a frequency of 10 cps to 100 kc. It will measure phase angle from 1° to 360°, with automatic decimal point indication. Sensitivity is 0.5 v rms to 4 v rms maximum, without attenuator. The phase meter plug-in is one of 10 modules which can be inserted in the 800 series solid-state counters—said to be the only twin plug-in counters currently on the market. It can be used directly with a frequency range module or to provide all the functions of a frequency-period module. Price of the 838-A is \$750.

Computer Measurements Co., 12970 Bradley Ave., San Fernando, Calif. [354]

## Gaussmeters use cryogenic sleeve

A new vacuum-insulated sleeve for Rawson-Lush rotating-coil gaussmeters makes possible accurate measurements of magnetic fields at liquid helium temperatures. The sleeve is designed for the types 829S, 729S, 820S and 720S gaussmeters (all 50-in. probe lengths). It consists of three concentric

# New at the ISA

**INSTRUMENT-AUTOMATION EXHIBIT,  
COLISEUM, NEW YORK, OCTOBER 12-15**

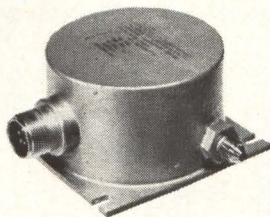

**MASS FLOW SENSOR AND LEAK DETECTOR.** New TMF124 Thermal Mass Flow Sensor, built to withstand the rigorous environments of airborne and space vehicles, gives highly accurate readings of true mass flow of gaseous oxygen and hydrogen, hot gases of combustion, and RP-1 (liquid) for flow ranges from 0 to 15,000 cc/min. High sensitivity makes it an excellent leak detector.

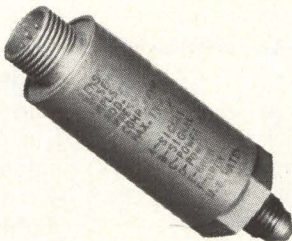

**PRESSURE SENSOR, Model 810C,** covers full scale ranges of 300 to 10,000 psia at cryogenic or high altitude atmospheric temperatures. Excellent temperature compensation.

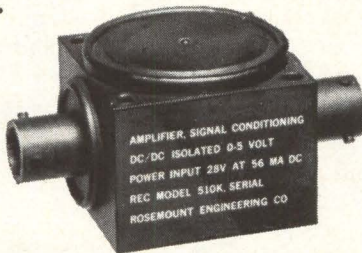

**SIGNAL CONDITIONING AMPLIFIER.** This light weight (under 4 ounces) unit was designed for use with dc resistance sensor bridges in space flight applications, including telemetry. Standardized 0 to 5 vdc isolated output. Highly stable from -65° F to +212° F. Hermetically sealed.

**VISIT US IN BOOTH 2504.** See all this equipment at the ISA show. Bring your specific questions, because there will be engineering personnel in the booth qualified to discuss all your temperature and pressure measurement problems. If you are not planning to attend the show, please feel free to call or write us in Minneapolis.



**ROSEMOUNT  
ENGINEERING  
COMPANY**

4900 West 78th Street • Minneapolis 24, Minn.

**SPECIALISTS IN TEMPERATURE & PRESSURE MEASUREMENT**



**TEMPERATURE SENSORS NOW IN STOCK.** For the first time you can now buy aerospace or laboratory quality platinum resistance temperature sensors from stock. An assortment of highest accuracy sensors is now carried in inventory, not sold on a slow delivery, custom basis. Ask us what's available for immediate delivery.

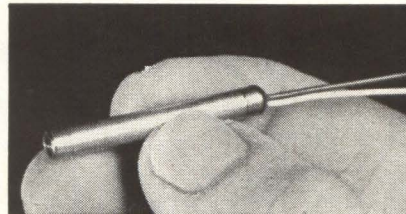

**INDUSTRIAL SENSORS** also are available for delivery from stock. More economical than our military quality sensors, but still considerably more accurate than most other industrial quality sensors. Wide range of models.

**MAGNETICALLY SHIELD YOUR COMPONENT IN SECONDS**  
 Versatile Netic and Co-Netic Foils cut to any size or outline with ordinary scissors—wrap easily

High attenuation to weight ratio possibilities; can dramatically enhance component performance. The shields stop degradation from unpredictable magnetic fields. When grounded, they also shield electrostatically. Co-Netic and Netic shielding foils are not significantly affected by dropping, vibration or shock, and do not require periodic annealing. Foils are available in thicknesses from .002" in rolls 4", 15", and 19-3/8" wide. Extensively used in experimental evaluation and production line operations for military, commercial and industrial applications.

**MAGNETIC SHIELD DIVISION**  
 Perfection Mica Company  
 1322 N. ELSTON AVENUE, CHICAGO 22, ILLINOIS  
 ORIGINATORS OF PERMANENTLY EFFECTIVE NETIC CO-NETIC MAGNETIC SHIELDING

Circle 202 on reader service card

## YOKE SPECIFYING PROBLEM?

**ASK AN EXPERT...**

**A SYNTRONIC DEFLECTION YOKE SPECIALIST**



Since we make more types of yokes than anyone else, it's natural enough for our team of experts to know more about yoke design, application engineering, and quality control.

Specifying can be a challenging problem, and with this in mind, we put our experience at your disposal. Don't hesitate to call or write us when you're puzzled as to the right deflection yoke for your display.

*syntronic*

**INSTRUMENTS, INC.**  
 100 Industrial Road, Addison, Illinois  
 Phone: Area 312, 543-6444

## New Instruments

tubes: a) a thin-walled outer tube having an o-d of 7/8 in., the main length of which is nonmagnetic stainless steel for minimum heat transfer, but there is an 8-in. length of copper at the tip so it will be truly non-magnetic near the rotating coil; b) an inside tube of 0.450 in. i-d copper, to contain the probe; c) a third tube of aluminum between the other two, to act as a heat radiation shield. A vacuum valve and connection are provided for evacuating the space between the tubes. Only a moderate vacuum is required for operation in liquid helium, since the remaining gas between the tubes will soon freeze out, leaving an almost perfect vacuum. This will keep the gaussmeter tip from further cooling for an indefinite period. Price of the sleeve is \$450. Prices for complete cryogenic gaussmeters, with limit of measurement to 100 kg, range from \$975 for type 720S (transverse fields, 1% accuracy) to \$1,725 for type 829S (axial and transverse fields, 0.1% accuracy).

Rawson Electrical Instrument Co., 110 Potter St., Cambridge 42, Mass. [355]

## Electrometer features high input impedance

Model 610B electrometer offers 79 ranges for d-c measurements; 11 voltage ranges from 1 mv full scale to 100 v; 28 current ranges from 10<sup>-14</sup> amp full scale to 0.3 amp; 25 resistance ranges from 100





ohms full scale to  $10^{14}$  ohms; 15 coulomb ranges from  $10^{-12}$  coulomb full scale to  $10^{-5}$  coulomb. The instrument uses solid-state components except for two electrometer tubes and one other vacuum tube. This results in high stability, sensitivity and accuracy. Applications include directly measuring potentials of vacuum-tube plates and grids, pH electrodes, piezoelectric crystals, capacitors, electrochemical cells and gate potentials of field effect transistors. Price is \$565.

Keithley Instruments, Inc., 12415 Euclid Ave., Cleveland, O. [356]



## Test sets measure transistor noise

Three new noise test sets offer an economical, convenient means for making rapid measurements of electrical noise in transistors as an aid to elimination of failure-prone devices prior to installation as well as to achieve optimum signal-to-noise ratio. They are intended for those applications where the full multipoint spectrum analysis of noise is not required, for example in production testing, quality control and incoming inspection functions. Models 510, 511, and 512 have collector-current ranges of 0.1 to 10 ma, 3 to 300  $\mu$ a, and 10  $\mu$ a to 1 ma, respectively. Noise voltage and current spectral densities are measured in the models 510 and 511 at 1 kc. In the model 512, broad-band noise figure measurements are made over a frequency range from 10 cps to 15.7 kc. All of these instruments are readily adaptable to high-speed go/no-go test procedures, and may be easily integrated into existing component testing programs. Prices are: model 510, \$1095; 511, \$1145; 512, \$1145. Quan-Tech Laboratories, 43 S. Jefferson Road, Whippany, N.J. [357]



## A TRIGGERED, CALIBRATED, WIDEBAND OSCILLOSCOPE FOR \$235

Don't settle for an uncalibrated repetitive time base oscilloscope when the budget is tight. All the features of the professional instrument are in the S51A (see the abridged specs below) one of a full range of quality oscilloscopes from Data Instruments.

Call or write today for a demonstration by your local representative or for full specifications!

Vertical Amplifier	DC—3 mc at 100 mv/cm
Input Attenuator	9 compensated steps, 100 mv/cm-50V/cm accuracy $\pm 5\%$
Time Base	6 calibrated speeds 1 $\mu$ s/cm-100 ms/cm $\pm 5\%$
Triggering	Automatic to 1 mc plus trigger control
DC Coupled Unblanking	5" flat faced CRT operated at 3 KV
Phosphor	P31 standard, P7 available
Dimensions	7" x 15½" x 8"
Weight	16 lbs.
Price	\$235.00

*data instruments*

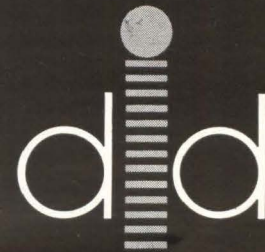

7300 CRESCENT BOULEVARD PENNSAUKEN, NEW JERSEY 609-662-3031

A Division Of

INDUSTRIAL ELECTRONIC HARDWARE CORP.

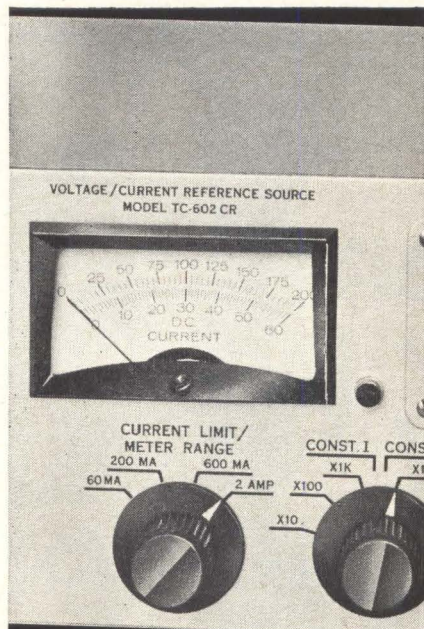

## VOLTAGE / CURRENT REFERENCE SOURCE

0 TO 60v @ 2A

0 TO 2A @ 60v

STABILITY: .001%

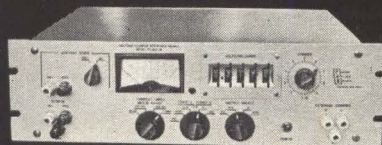

Model TC-602CR

- output selection: 2 voltage ranges; 3 current ranges
- extremely low ripple and noise
- resolution: 1  $\mu$ v voltage; 10 m $\mu$ a current
- complete short circuit protection
- completely solid state
- price \$1750.00
- complete line of solid state voltage and current references available — all with 0.001% stability

Write for Bulletin No. 112 to:

**P** **PRINCETON**  
**A** **APPLIED RESEARCH CORP.**  
**R** Dept. D  
Box 565, Princeton, New Jersey

## New Semiconductors

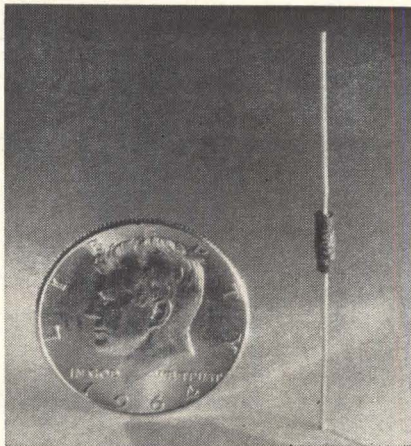

### Silicon rectifiers in rugged package

Miniature plastic silicon rectifiers have been introduced that meet humidity requirements of MIL Standard 202A, Method 16. Series B silicon rectifiers are said to possess electrical ratings equal to or better than larger epoxy package types. Voltages to 1200 piv, currents to 1.5 amps and high-performance avalanche types are offered. Axial lead, tubular-insulated construction and small size facilitate circuit-board and point-to-point wiring needs in industrial and commercial power supplies. The ruggedness of the package permits reliable operation even with severe humidity and other environmental conditions. Weight is 0.4 gram, body length  $\frac{3}{8}$  in. and diameter 0.115 in.

Edal Industries, Inc., 4 Short Beach Rd., East Haven, Conn. [331]

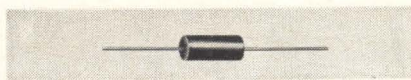

### Silicon varactor diodes for shifting frequencies

New silicon abrupt-junction varactor diodes provide the circuit designer with a wide choice of characteristics, including:  $Q_s$  to 200, low frequencies through microwave frequencies, capacitances from 6.5 to 500 pf, working voltages from

15 to 200 v, power ratings from 0.5 to 2.0 w, and low inductance. The epitaxial varactor diodes are expected to find wide application in communications for shifting frequency and in electronic tuning, harmonic generation and parametric amplification. The products are intended for both commercial and military applications.

Solitron Devices, Inc., 500 Livingston St., Norwood, N.J. [332]

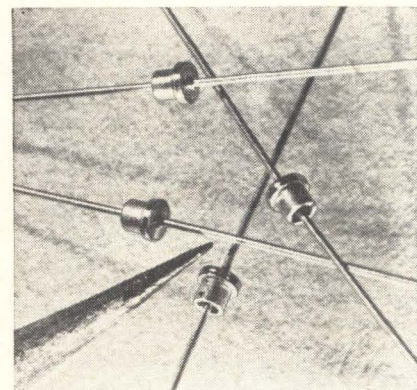

### Silicon tunnel diodes feature high stability

These silicon tunnel diodes consist of JEDEC types 1N4393 through 1N4399, with peak current ratings from 0.10 to 10 ma as well as other types with peak current ratings up to 100 ma. The devices offer extreme stability over a wide temperature range, and feature closely controlled electrical and mechanical tolerances. They are supplied in standard JEDEC TO-17 cases, and have gold-plated weldable leads for maximum installation flexibility. According to the manufacturer, environmental specifications easily meet the requirements of MIL-S-19500 or MIL-STD-750. The tunnel diodes are specifically designed for applications in low-level, high-speed switching circuits where operating temperatures may vary from  $-65^{\circ}\text{C}$  to  $+150^{\circ}\text{C}$ . They are also said to perform well in vhf-uhf oscillators, level detectors, event counters, and time delay circuits.

Heliotek, a division of Textron Electronics, Inc., 12500 Gladstone Ave., Sylmar, Calif. [333]

## Silicon transistors in two power types

Silicon power transistors, both JEDEC series 2N3470 and 2N3429, are designed for amplifier, regulator and switching applications. They provide design advantages to circuits having inductive loads. The 2N3470 series has a rated collector current of 10 amps and is available with collector-emitter voltages through 200 v. The device has a peak power of 2 kw and can produce gains of 1,000 at 2 amps. The 2N3429 series has a rated collector current of 7.5 amps and collector-emitter voltages through 250 v. Its peak power is 1.8 kw. Both transistors are free from secondary breakdown within the complete range of maximum current, maximum voltage ratings. The devices are 100% power tested; thus derating for actual operating conditions is not required. They are guaranteed for the life of the original equipment in which installed.

Westinghouse Electric Corp., Semiconductor Division, Youngwood, Pa. [334]

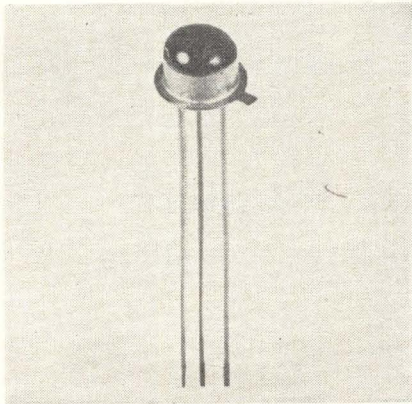

## Low-noise transistor designed for uhf tv

This high-frequency, low-noise transistor is an improved npn silicon type, packaged in a modified TO-18 outline. It is designed primarily for uhf television and commercial uhf amplifier applications. Power gain measures 15 db at 200 Mc. Noise factor is 4 db at 60 Mc. Oscillator power is 5 mw at 930 Mc. Maximum power dissipation is 0.5 w at 25° C.

Kmc Semiconductor Corp., Parker Road, R.D. 2, Long Valley, N.J. [335]



# LAPP STAND-OFF INSULATORS

*...in all these standard sizes  
to save you time  
and money*

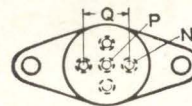
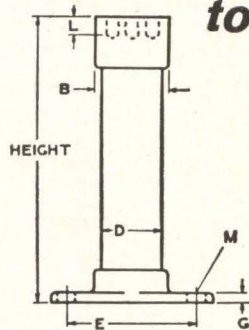

Other tapped hole sizes or arrangements available on special order.

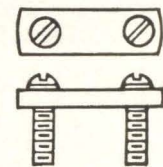

ORDER  
KEEPER  
SEPARATELY

### STAND-OFF INSULATOR DIMENSIONS IN INCHES

(STOCK HEIGHTS LISTED BELOW)

Cat-log No.	Material	Cantilever Strength inch-pound	Height in inches	Dimensions in inches								
				B	D	E	G	L	M	N	P	Q
14761 24229	Porcelain Steatite	375 450	4-6-8	1 $\frac{3}{8}$	1	2 $\frac{1}{4}$	$\frac{3}{16}$	$\frac{3}{32}$	$\frac{3}{32}$	$\frac{1}{4}$ -20	$\frac{1}{4}$ -20	$\frac{3}{16}$
14760 24114	Porcelain Steatite	600 700	4-6-8-10	1 $\frac{3}{8}$	1 $\frac{1}{4}$	2 $\frac{5}{8}$	$\frac{7}{32}$	$\frac{3}{8}$	$\frac{3}{32}$	$\frac{1}{4}$ -20	$\frac{1}{4}$ -20	1 $\frac{3}{16}$
22408 41775	Porcelain Steatite	1200 1400	6-8-10-12	1 $\frac{7}{8}$	1 $\frac{1}{2}$	2 $\frac{7}{8}$	$\frac{1}{4}$	$\frac{7}{16}$	$\frac{3}{32}$	$\frac{1}{4}$ -20	$\frac{1}{4}$ -20	1 $\frac{3}{8}$
13981 24110	Porcelain Steatite	1800 2100	6-8-10-12	2 $\frac{1}{4}$	1 $\frac{3}{4}$	3 $\frac{3}{4}$	$\frac{1}{4}$	$\frac{9}{16}$	$\frac{1}{32}$	$\frac{5}{16}$ -18	$\frac{3}{16}$ -16	1 $\frac{1}{4}$
42588	Porcelain	4000	6-8-10-12	3 $\frac{1}{8}$	2 $\frac{1}{2}$	5	$\frac{3}{8}$	$\frac{1}{2}$	$\frac{1}{32}$	$\frac{5}{16}$ -18	$\frac{3}{16}$ -16	2

# Lapp

Insulators shown are standard. Similar insulators available with caps or bases on both ends.  
WRITE for Bulletin 301-R.  
Lapp Insulator Co., Inc.,  
222 Sumner Street, LeRoy, N.Y.



Judge us  
by the  
Companies  
We  
Serve

## HOWCOR LAMINATIONS Are Standard Components of many of the World's Best Known Products

In the products of internationally famed manufacturers every component must contribute to product performance.

The number of world-known manufacturers who use HOWCOR Laminations (partial list on request) is your best reason for getting the latest facts on HOWCOR facilities, standards, engineering services and prices.

Write for Bulletin 100 and catalogs on HOWCOR Motor Laminations . . . Nickel Alloy Transformer Laminations . . . Silicon Steel Transformer Laminations.

**HOWCOR**  
LAMINATIONS  
A Division of Howard Industries, Inc.  
3912 McLean Ave., Chicago, Illinois 60647

## New Subassemblies and Systems

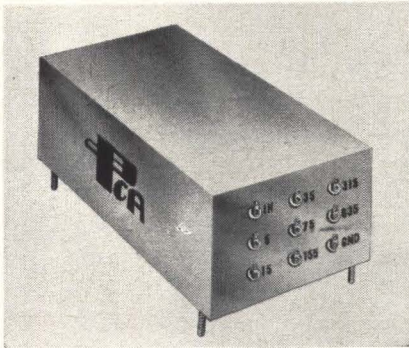

### Telemetry delay line covers f-m band

A subcarrier delay line featuring a delay bandwidth product of over 50 and a delay time of 635  $\mu$ sec, is designed to cover the entire f-m telemetry band from 400 cps to 80 kc with only 3 db of attenuation. Taps are provided at 5, 15, 35, 75, 155 and 315  $\mu$ sec to a tolerance of  $\pm 1.5\%$ . Impedance is 1,000 ohms. Measuring 15 in. in length, 6 in. high, and 9 in. wide, the unit is mounted by means of four  $\frac{1}{4}$ -in. studs projecting from the bottom of a hermetically sealed can. Price is under \$2,000 each.

PCA Electronics, Inc., 16799 Schoenborn St., Sepulveda, Calif. [371]

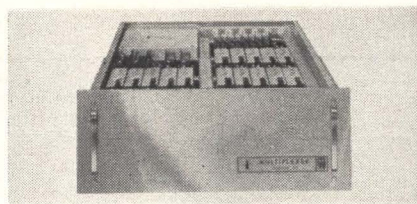

### Analog subsystem in miniature package

A miniature analog subsystem has been developed for low-level data acquisition. The new 625 Min  $M_x$  incorporates an amplifier, filter and multiplex switch on a single card and costs less than \$450 per channel. Features of the system include the following: a precision, low-level differential amplifier with six selectable gain positions, and with an accuracy, linearity and stability of  $\pm 0.01\%$ ; an active filter which re-

jects the amplifier, wideband noise, and low-level signal source frequencies that may cause errors resulting from distortion; and a multiplex switch that can be operated at d-c to 50 kc (randomly). Thirty-two channels can be packaged in a box measuring 7 in. by 19 in. by 22 in.

Redcor Corp., 7760 Deering Ave., Canoga Park, Calif. 91304. [372]

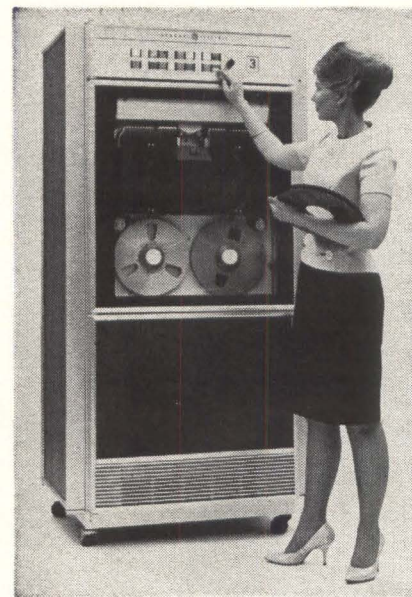

### Tape subsystems for large computers

A line of six computer magnetic tape units has been introduced. All are available in seven and nine-channel models and will operate with the recently announced Compatibles-400 and the new large-scale Compatibles-600 computers. Employing vacuum-grip drives and photocell protective devices, the new tape units are designed to virtually eliminate the inconvenience and expense of broken, scratched and stretched magnetic tape. Nothing but the read-write head touches the oxide side of the tape. Two basic tape-handling mechanisms are used in the six models: a single-capstan, low-inertia drive for tape transfer rates from 7,500 to 80,000 characters per sec; and a multiple-capstan, constant-speed drive (shown above) for the high-

performance range up to 160,000 characters per sec. Prices range from \$100,000 for a minimum rational magnetic tape subsystem, through \$80,000 for a large multi-channel subsystem with monthly rentals from \$2,000 to \$20,000. Deliveries take eight months. General Electric Co., Deer Valley Park, Phoenix, Ariz. [373]

## Pulse generator for diode lasers

New pulse source has been designed especially for use with gallium arsenide diode laser systems. Model DLP-2 has a rated peak output of 300 amps, with a nominal pulse width of 10 nsec and a rise time of 1 nsec. The unit can be internally or externally triggered, or operated in a single-shot manner. With internal triggering, the pulse repetition rate can be continuously varied from 10 to 200 pulses per sec. With external timing, it can be varied continuously from zero to 200 pps. A special feature of the DLP-2 is the fact that it permits room temperature operation of the diode laser. Price of a single unit is \$695.

Maser Optics, Inc., 89 Brighton Ave., Boston 34, Mass. [374]

## Multifunction-register universal flip-flops

The UF universal flip-flop series of digital logic cards are designed for use in multifunction registers such as add-subtract counters, preset counters, digital programmers, time clocks and digital servo controls. They can count in any number base, up and down, and can shift either left or right. Six models are

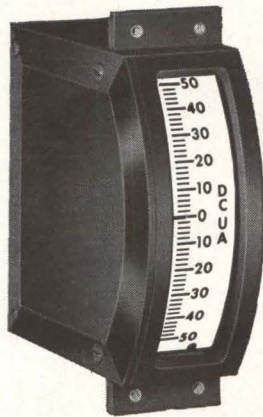
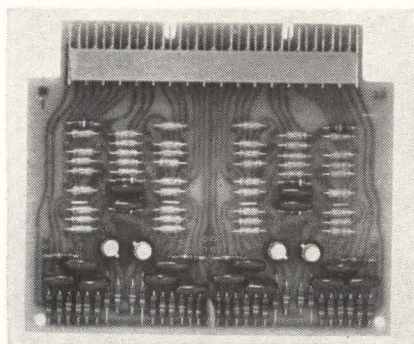

Model 1147 Scale length 2.7"

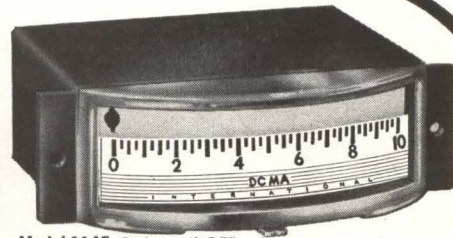

Model 1145 Scale length 2.7"  
PAT. NO. 2,871,451

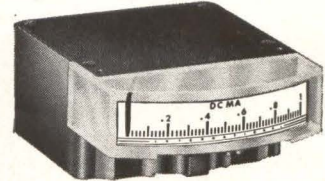

Model 1135 Scale length 2.1"  
PAT. NO. 2,871,450



Model 1120 Scale length 1.2"



Model 2120  
Scale length 1.3"

## who makes the broadest line of EDGEWISE METERS?

We do.

International pioneered the concept of Edge-wise Panel Meters in 1947 and today offers you more models of top-quality, realistically priced Edgewise Meters than any other company.

Engineers know us as the one best source for standards and specials in a wide variety of ranges and with all these high-performance features:

- Bi-level scale that minimizes parallax.
- External, easily accessible zero adjust.
- Meet applicable portions of ASA Specification C39.1.

- Specially designed clear plastic front for maximum illumination of scale — reduces shadow and glare.
  - Zero at left, center or right, according to your needs.
  - May be used as null indicator.
  - Internal illumination on some models.
  - Some models meet applicable portions of MIL-M-10304B.
  - Conveniently located modification and service centers.
- FOR ENGINEERING DATA SHEETS . . . and for your special requirements on Edgewise Meters, Panel Meters and Electronic Control Products . . . phone, wire or write our sales department.



**international instruments inc.**

88 Marsh Hill Road, Orange, Connecticut, Cable: "INTERINST"

Member of NEMA  
Electrical Indicating Instrument Section

## TRANSISTORIZED DISTORTION ANALYSER

MODEL 2331 \$795

- Frequency Range 20cps to 20 kc
- Switchable bandwidths 20kc and 100 kc
- Seven distortion ranges 0.1% to 100% F.S.D. (reads to -72 dbm)
- L. F. cut can eliminate hum components



# MARCONI INSTRUMENTS

DIVISION OF ENGLISH ELECTRIC CORPORATION  
111 CEDAR LANE, ENGLEWOOD, NEW JERSEY

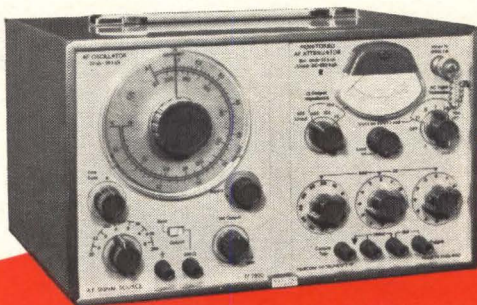

## LOW DISTORTION SIGNAL SOURCE

MODEL 2000 \$745

- OSCILLATOR 2100 \$420
- AF Signals 20 cps to 20 kc
  - Distortion < 0.05% 63 cps to 6.3 kc  
< 0.1% 20 cps to 20 kc
  - Output 15 dbm in 600Ω (8.5 V open)
- ATTENUATOR 2160 \$325
- 111 db in 0.1 db steps monitored
  - 75Ω, 150Ω and 600Ω balanced,  
600Ω unbalanced.

MAIN PLANT: ST. ALBANS, ENGLAND

124 CIRCLE 124 ON READER SERVICE CARD

## NEW MAGNETIC LATCHING RELAY plugs into your Printed Board!

NO Springs, NO Wiring,  
NO Sockets, NO Soldering,  
NO Mechanical Linkage



# Printact<sup>®</sup>

Series LS/LD, Latching  
Series G, Standard

PLATED CONDUCTORS ON YOUR PC BOARD  
ARE THE FIXED CONTACTS OF THIS NEW RELAY

Save SPACE, MONEY and MANHOURS with these new small, lightweight, highly reliable Standard and Latching PRINTACT Relays.

Available with Bifurcated Palladium or Gold Alloy contacts for more than 10 million cycle 2 or 3 pole switching. Handles up to 3 amp. res. loads. Coils for 6, 12, 24 and 48 vdc at 500 mw. Operating temperature -30°C to +95°C. Operate time 7 ms. The little gem is an 0.8 oz. 7/8" cube. Quality features include: double-break contacts; balanced armature, enclosed housing, plug-in application; encapsulated coil; self-wiping contacts and inherent snap-action—and the cost is lower than you think!

Write today, on your letterhead, for data and prices.

## Executone inc.

PRINTACT RELAY DIVISION

47-37 Austell Place, Long Island City, N. Y. 11101

CIRCLE 203 ON READER SERVICE CARD

## VITREOUS-SILICA

(PURE FUSED QUARTZ) is

# VITREOSIL<sup>®</sup>

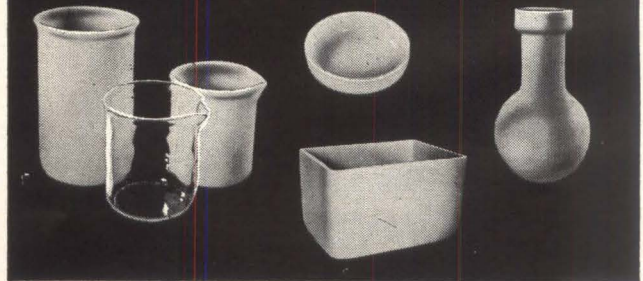

Once a laboratory curiosity pure fused quartz now plays leading roles in American industry. It handles hot liquids or gases up to 1100°C, is virtually corrosive free, is unaffected by thermal shock and has exceptional optical and electrical qualities. Write for our 32 page catalog today for more details on "VITREOSIL".

24



THERMAL AMERICAN FUSED QUARTZ CO.

RT. 202 & CHANGE BRIDGE RD. MONTVILLE, NEW JERSEY

CIRCLE 204 ON READER SERVICE CARD

Electronics | September 21, 1964

## New Subassemblies

available: UF-1, with frequency range d-c to 300 kc; UF-2, to 2 Mc; UF-1A, to 5 Mc. For asynchronous systems, models UF-3, UF-4 and UF-3A correspond in frequency to the three synchronous models UF-1, UF-2, and UF-1A. Each card contains two independent flip-flops. Each flip-flop has three set gates ORed together and three reset gates ORed together. By wiring at the connector, any three of the four functions—count up, count down, shift left, shift right—may be performed. Two set gates and two reset gates are internally "steered" by diodes from the collectors, and trailing-edge clock-triggering is used. Thus no "race" condition can occur and reliable operation is assured.

Computer Logic Corp., 11800 W. Olympic Blvd., Los Angeles 90064. [375]

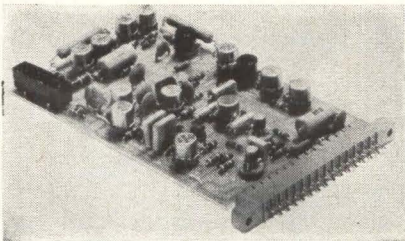

## Operational amplifier is chopper-stabilized

A series of inexpensive, general purpose amplifiers has been announced. Employing solid-state chopper stabilization, the 140 series units are designed for use in automatic production checkout systems where heavy capacitive loading is anticipated. All versions have  $\pm 20$  v output range and gain of  $10^6$ . Drift is within  $5 \mu\text{V}/^\circ\text{C}$  with input current of only  $10^{-11}$  amp/ $^\circ\text{C}$ . Full output to above 125 kc and a slewing rate of 12 v per  $\mu\text{sec}$  makes the amplifiers useful in high speed digital-to-analog conversion. Maximum load current is 100 ma, and all units are short-circuit proof. Chopper drive is internal, and the amplifiers require only  $\pm 24$  v d-c for operation. Price is \$125. Zeltex Inc., 2350 Willow Pass, Concord, Calif. [376]

# New Compact Trio from CEI



## 2 VHF RECEIVERS AND A SIGNAL MONITOR IN 5 1/4" OF RACK SPACE

Advanced circuitry and solid state construction make the new 400 series receivers and 4300 series signal monitors really compact. Either 1, 2 or 3 separate units, in any combination, can be installed in a single 19" mount just 5 1/4" high.

These compact VHF receivers include the Type 405 for AM and Type 406 for Pulse modulation. Each is available in 9 standard models to cover the frequencies from 60 to 155 mc. A front panel switch on each instrument selects 1 of 4 preset channels within its

frequency range. The companion Type 4300 signal monitor was designed especially for use with these receivers. If this transistorized trio requires little space, it requires even less power . . . only 2.5 watts for each receiver and 6.5 watts for the signal monitor.

For complete information about these and other CEI products, please write:



### COMMUNICATION ELECTRONICS INCORPORATED

6006 Executive Boulevard, Rockville, Maryland 20852, Phone (301) 933-2800

Circle 205 on reader service card

# TR MICRO TV TUNER

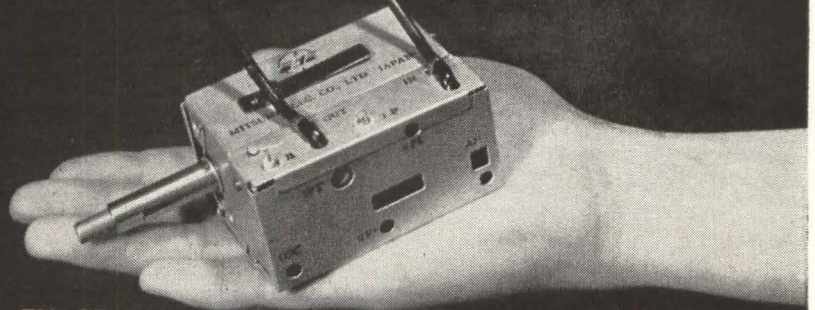

MODEL TU-15U

This MICRO TV TUNER, using 3 transistors, provides you with excellent performance while keeping high quality stability, thanks to our latest technical advancement. Spurious radiation meets the requirements of FCC and is guaranteed for performance of more than 40,000 operations. We also offer you many other lines of components for your use. Please write us asking for catalogs available on the following products:

#### Main Products

Polyvaricon, IF Transformers, Oscillator Coils, Antenna Coils, Variable Resistors, FM Tuners, TV Tuners, Micro-motors, Sockets.



## MITSUMI ELECTRIC CO., LTD.

Head Office Komae, Kitatama, Tokyo, Japan.  
New York Office 11 Broadway, New York 4, N.Y., U.S.A.

NOW AVAILABLE FROM TI



## EPITAXIAL GALLIUM ARSENIDE

### R&D or Production Requirements

- Highly uniform N-type epitaxial layers in any thickness from one micron to 15 mils
- Carrier concentrations from  $5 \times 10^{15}$  to  $5 \times 10^{18}$  per cc
- Wide choice of TI gallium arsenide substrates, including semi-insulating material, in (1-1-1) or (1-0-0) orientations
- Slices 0.5-inch to 0.8-inch nominal diameter and 20 mils thick
- P-type epitaxial layers also available

### DELIVERY: TWO WEEKS

For your single crystal requirements TI also supplies gallium arsenide, indium arsenide and indium antimonide. Immediate shipment.

FOR INFORMATION WRITE:

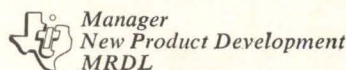

TEXAS INSTRUMENTS  
INCORPORATED

MATERIALS & CONTROLS DIVISION  
P. O. Box 5009 Dallas 22, Texas

## New Microwave



### Octave bandwidth directional couplers

Series CSD octave bandwidth directional couplers are available in coupling values of 6, 10, 15 or 20 db. They offer 15 db minimum of directivity over frequency bands of 250 to 1,000 Mc, 750 to 3,000 Mc, or 1,000 to 4,000 Mc. Units are light, small and of rugged encapsulated design with reliable performance over a broad frequency band. Price is \$120.

LEL, Inc., 75 Akron St., Copiague, N.Y. [391]

### Parametric amplifier designed for L-band

A commercial, nondegenerate type parametric amplifier is announced with a noise figure of 0.9 db without diode cooling. Fixed-tuned to 1,667 Mc for observation of oxygen-hydrogen-line radiation from distant galaxies, the model L-5 increases detection range more than three-fold over techniques now in use, according to the manufacturer. The amplifier is also suited, through modification, for use wherever a low-noise amplifier will aid performance as in telemetry, satellite communication, or radar. Heart of the model L-5 paramp is a silicon varactor diode with very high cut-off frequency. The diode's figure of merit is said to be considerably greater than that of varactors commonly employed in L-band parametric amplifiers. To utilize effectively the low-noise amplification properties of the diode, a pump frequency of approximately 24 Gc is required, resulting in a pump-to-

signal frequency of 14:1. Tuned filters are incorporated in the microwave structure to isolate the signal, pump and idler circuits from each other. The L-5 displays a 30 Mc 3 db instantaneous bandwidth at 20 db gain with a single-tuned signal input circuit.

Microwave Physics Corp., 420 Kirby St., Garland, Texas. [392]



### Power source for microwave tubes

A hard tube pulse modulator has been developed that is suitable for pulsing triodes, tetrodes and magnetrons. Model MH20 has continuously variable pulse voltage up to 4.5 kv at 5 amps and filament voltage variable to 7 v at 4 amps. Pulse width is continuously variable from 0.25 to 6  $\mu$ sec and rate from 200 to 4,000 pps. Internal and external synchronization are provided as well as metering, viewing, overload and safety features.

Applied Microwave Laboratory, Inc., 106 Albion St., Wakefield, Mass. [393]

### Coax terminations cover d-c to 12.4 Gc

Miniature coaxial fixed terminations—models 4370 M/4370F—cover a broad sweep of d-c to 12.4 Gc and

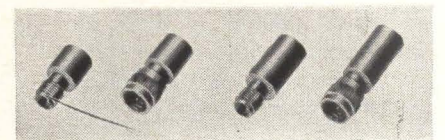



feature NPM connectors that can be mated with 0.141 in. coax line connectors. Critically controlled close tolerances afford improved vswr over a wide range of frequencies: d-c to 8 Gc, 1.10 max; 8 to 12.4 Gc, 1.15 max; and 10 to 12.4 Gc, 1.20 max. The terminations are approximately  $\frac{1}{8}$  in., lightweight, with  $\frac{1}{2}$ -w power rating. Price is \$30.

Narda Microwave Corp., Plainview, L.I., [394]

## Tunnel-diode receiver for X-band applications

An all-solid-state, tunnel-diode receiver has been developed for microwave applications in X-band. It consists of a tunnel-diode amplifier, a mixer-preamplifier and a main i-f amplifier. The main i-f amplifier exhibits approximately 90 db of gain and has a peak holding type of automatic-gain-control network. The charging time constant is 0.05 millisecond and the discharging time constant is 150 millisecond. The center frequency is 9.7 Gc  $\pm$  50 Mc with an i-f of 30 Mc. Noise figure is 5.5 db; gain, 125 db; i-f bandwidth, 1 Mc; output impedance, 50 ohms; age, 40 db; local oscillator power, 2 mw; and maximum power drain, 3 w. The receiver weighs less than 2 lb and has a cubic volume of only 20 in. It is suited for space or aircraft applications where size, weight and reliability are at a premium.

International Microwave Corp., subsidiary of Microwave Associates, Inc., Burlington, Mass. [395]

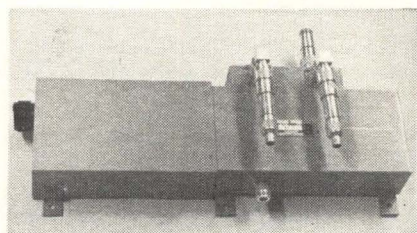

## Preselector-mixers span 250 Mc to 10 Gc

Tunable preselector-mixers cover the range 250 Mc to 10 Gc in six units and exhibit a relatively constant bandwidth for a fixed noise

These SEC Polystyrene Capacitors have an accuracy in the order of 0.1% or better and longtime stability in the order of 0.03%. Natvar Styroflex film is used as the dielectric.

SOUTHERN ELECTRONICS CORPORATION, Burbank, California, manufactures precision capacitors for applications where difficult specifications have to be met, such as computer integrators, test equipment, secondary standards and certain weapons programs.

Because polystyrene comes closest to meeting specifications for a perfect dielectric, various polystyrene films were tested. Natvar Styroflex film was selected because of its uniformly excellent pliability, freedom from faults, high shock resistance and excellent dielectric characteristics.

Natvar Styroflex film is available in standard thicknesses from .00025" to .006" in widths from  $\frac{1}{2}$ " to approximately 10" or in special put-ups to meet manufacturing requirements.

**NATVAR CORPORATION**  
 FORMERLY THE NATIONAL VARNISHED PRODUCTS CORPORATION  
 201 RANDOLPH AVENUE • WOODBRIDGE, NEW JERSEY  
 Telephone: Area Code 201-FUIton 8-8800 • TWX: 201-381-8056 • Cable Address: NATVAR: RAHWAY, N. J.



**PRODUCTS:** Varnished cambric • Varnished canvas and duck • Varnished silk and special rayon • Varnished papers—rope and kraft • Varnished, silicone varnished and silicone rubber coated fiberglass • Slot cell combinations, Aboglas®, Isoplex® • Teraglas® Acryliglas® • Isoteraglas® • Epoxy coated glass • Isoglas® • Isolastane® sheet, tape, tubing and sleeving • Vinyl coated and silicone rubber coated fiberglass tubing and sleeving • Extruded vinyl tubing and tape • Styroflex® flexible polystyrene tape  
 We will be very happy to supply information on any of our products on request.

Circle 127 on reader service card

**WANT TO  
 DO BUSINESS  
 WITH THE  
 GOVERNMENT ????????**

Then check the Military and Government Procurement Guide in the orange section of your **ELECTRONICS BUYERS' GUIDE**.



**Find  
the  
product...  
Fast!**

It's quick and easy to locate any of the thousands of electronic and allied products in your **Electronics Buyers' Guide**. All are listed clearly and unmistakably, cross-indexed with end use terms, synonyms and newly devised terms. And, all advertisers in the **EBG** are carefully cross-referenced to their catalog-advertisement. Top this off with 6,000 trade names indexed alphabetically and you have the most complete, accurate and authentic product listings in the industry!

**Electronics Buyers' Guide**  
A McGraw-Hill Publication  
330 West 42nd Street,  
New York, N.Y. 10036

## New Microwave

figure over the tuning range. They are ready for plug-in to a receiver for rejection of image frequencies and to provide a minimum noise figure for optimum receiver performance. The preselector is normally a two-section filter that is tuned by means of a single control shaft for remote tuning or easy manual adjustment. Additional sections can be provided to improve selectivity. The mixers are stripline devices that incorporate balanced hybrids with matched crystals to achieve the best noise figure and match between the filter and mixer. They can be furnished in single or double-ended types with crystal current monitoring. Noise figure is 8 db at 2 Gc and up to 12 db maximum at 10 Gc. Maximum vswr is 1.5. Price is approximately \$1,600.

Frequency Engineering Laboratories, Farmingdale, N.J. [396]

## Signal sources are solid-state

Two signal sources offer new standards of frequency and power stability for testing, aligning and measuring communications and radar systems. The c-w model DG502 and pulse model DG503 are both solid-state sources with an output frequency drift less than  $\pm 0.0015\%$  over the entire working temperature range of  $-7^\circ\text{C}$  to  $70^\circ\text{C}$ . Crystal control and high efficiency harmonic generation are the key to this frequency and power stability. Unlike klystron signal sources, output power of these solid-state models does not drop or change transmission modes with age. Also, frequency does not drift

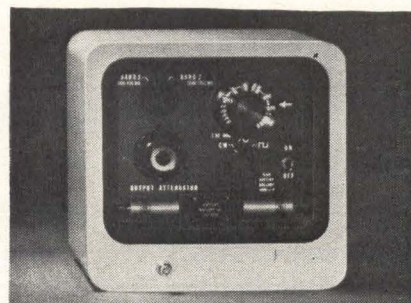

widely with small power supply voltage variations. Bulky high-voltage power supplies are not required. Units operate with maximum output power capabilities from 0.1 to 10 mw. Dual band models offer up to 12 fixed frequencies within the two bands—400 to 450 Mc and 1,200 to 1,320 Mc. All models measure 12 in. by 12 in. by 8 in., and weigh 25 lb. Sanders Associates, Inc., 95 Canal St., Nashua, N.H. [397]

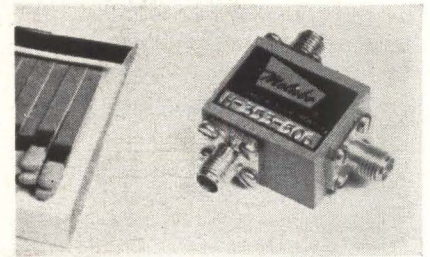

## Small and light ferrite circulator

A three-port ferrite circulator is available for use in the 4.4 to 5.0-Gc range. Especially useful for space and airborne applications, the model H-353-506 circulator has a minimum isolation of 20 db, maximum insertion loss of 0.3 db, and maximum vswr of 1.2. Designed in a T configuration, the circulator is only  $\frac{3}{8}$ -in. long,  $\frac{7}{8}$ -in. wide, and  $\frac{5}{8}$ -in. high, excluding the length of its OSM connectors. It weighs 1 oz. The unit also is available with one port terminated for service as an isolator.

Melabs, 3300 Hillview Ave., Stanford Industrial Park, Palo Alto, Calif. [398]

## Balanced mixers save weight and space

Subminiature balanced mixers are designed to replace previous types weighing over 20 times as much and having over three times the volume. Series CM504 single-ended mixers are available in both S band and C band with a 20% bandwidth. They have typical noise figure of 8 db and a conversion loss of 7 db.



The Tri-Plate mixers are of interest to microwave design engineers where weight and space saving are of vital concern in receivers, and antenna front-end applications. The new mixer weighs less than 1/2 oz and is 1 1/2 in. in diameter with a body thickness of approximately 1/8 in. Total thickness is less than 1/2 in. including miniature coax connectors. Semiconductor components are shielded by the ground plane and the leads are clamped between the inner surfaces of the dual center conductors to provide a stable clamped contact on the lead wire right up to the component body for optimum control of inductance. The crystal, chokes, resistors and capacitors are all of the most advanced microminiature type according to the manufacturer. Unit price is \$390. In production quantities the unit price is approximately \$150.

Sanders Associates, Inc., 95 Canal St., Nashua, N.H. [399]

## Traveling-wave tube for uhf-tv transmitters

A high-efficiency traveling-wave tube is offered as a video driver amplifier and as an audio output amplifier in uhf-tv transmitters. The VA-651 twt delivers a c-w output of at least 275 w over the frequency range of 450 to 900 Mc, with a minimum efficiency of 21% and a mid-band efficiency of approximately 33%. The tube and integral focusing electromagnet are cooled by forced air, thus simplifying the design of the transmitter. Only a single forced-air supply is required, with the air entering the focus magnet at the cathode end of the tube, discharging through the finned collector. Uhf color tv transmitter phase and amplitude linearity requirements are met by the VA-651. Varian Associates, 611 Hansen Way, Palo Alto, Calif. [400]

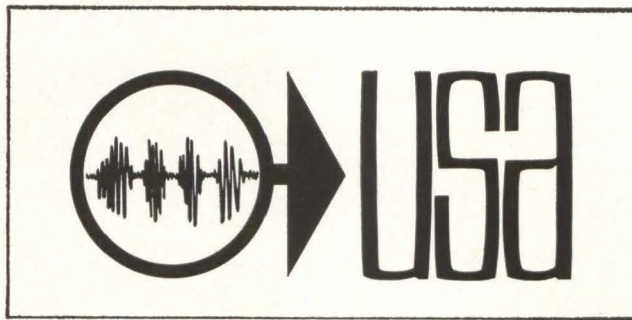

See Us At  
The United States Exhibition  
Stockholm Technical Fair  
Area 540  
October 2-9, 1964  
Stockholm, Sweden  
A Trade Expansion Activity  
United States Department Of Commerce

## DC POWER SUPPLIES



CONTINUOUS VOLTAGE COVERAGE — 4.7 to 60 vdc

Input: 105-125 vdc, 50-400 cps  
Regulation: From  $\pm 0.05\%$   
Ripple: From .002% or 1 mv, rms  
Temp. Coeff.: From  $\pm 0.01\%/^{\circ}\text{C}$   
Voltage Adjustment:  $\pm 5\%$   
Max. Temp. of Base:  $65^{\circ}\text{C}$

- WIDE VARIETY OF CURRENT RATINGS
- ELECTRONIC SHORT CIRCUIT PROTECTION
- FULLY REPAIRABLE
- 7 STANDARD SIZES (OVER 450 MODELS)
- PRICE RANGE **\$45-\$225**



INSTRUMENTS: EEM ('63-64 Pg. 902)  
EBG (1964 Pg. 462)

POWER SUPPLIES: EEM ('64-65 Pg. 341)  
EBG (1963 Pg. 301)

VOLTAGE STANDARDS: EEM ('64-65 Pg. 929)



**DYNAGE, inc.**

390 CAPITOL AVE., HARTFORD, CONN.

Circle 207 on reader service card

## Reed Relays

3 mA. to 50 Amp.

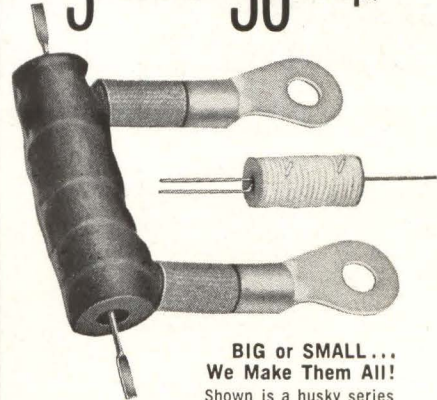

**BIG or SMALL ...  
We Make Them All!**

Shown is a husky series type 50 Ampere reed switch coil with a Form A switch (Form C available too). Also a tiny Form C relay to handle 250mA for 10 x 10<sup>6</sup> cycles with only 3mA input. Standard or special coils are available with or without reed switches. Special coils with 2 and 3 windings to provide various percent  $\emptyset$  (mmf).

Write for catalog and prices of our standard line of magnetic reed relays. For special requirements, give complete details for quotation.

**Coto-Coil**

**COMPANY INC.**

65 Pavilion Ave.  
Providence, R.I. 02905  
Phone: (401) 941-3355

Circle 129 on reader service card

129

Precision drawn  
and cut glass  
tubing and rod

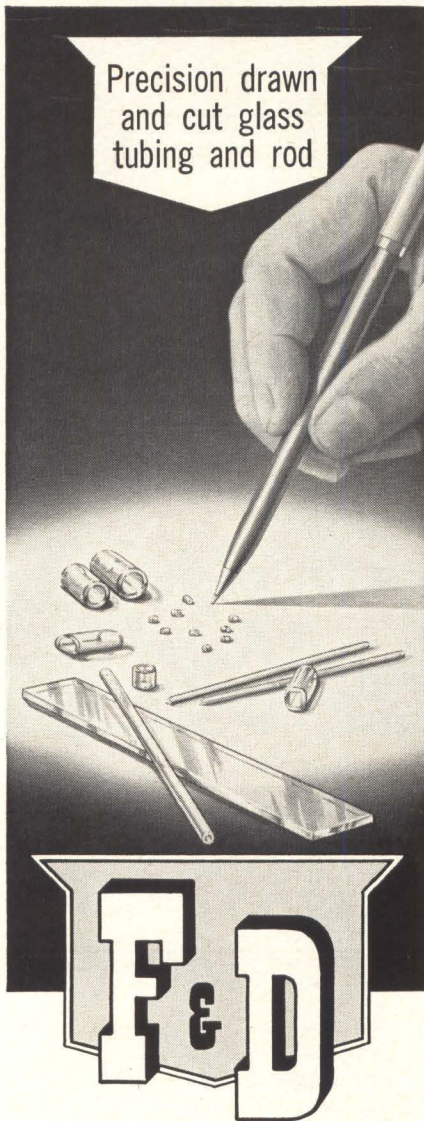

## GLASS TUBING & ROD redrawn and cut to your specifications

Over 44 years experience in redrawing glass enables us to supply you with redrawn glass tubing and glass rod to your specifications. We can redraw tubing finer than a human hair or as large as .225" and be consistent about it. Perhaps you would like your tubing diamond saw cut to lengths of .020" upwards to tolerances of  $\pm .001$ " or supplied in regular mill lengths.

We maintain adequate stocks of redraw blanks from many glass formulas, some of which are EN-1, KG-12, R-6 or N-51A. We can deliver what you need in a hurry. We can produce experimental lots or large quantities both at competitive prices. You will find, as many others have, that our quality is tops and our service fast and dependable. We welcome your inquiries.

**FRIEDRICH & DIMMOCK, INC.**  
MILLVILLE, NEW JERSEY

Serving industry for nearly half a century

## New Materials

### Polyurethane resin for component potting

A new polyurethane resin, No. 8788, is said to have unusually low initial viscosity for potting electronic components. Pot life for a half-pound mass is at least 60 minutes at room temperature. The compound is recommended for dip-coating of p-c boards and welded modules to provide maximum protection where a minimum number of coats is desirable. In the cured state, this resin has high electrical and physical properties, plus excellent solvent and abrasion resistance. Its high mechanical resilience protects against extremes in vibrational shock. Properly cured, the compound withstands temperatures up to 250°F without deterioration or loss in electrical properties. At 77°F, the formulation has a Shore A hardness of 80, a tensile strength of 3,000 psi, and elongation of 600% minimum. Mold release time is 2 hours at 180°F, and cure time to Shore A hardness is 6 hours. When degassed, the compound forms void-free castings. Application is by pouring at room temperature, or by dipping or brushing.

The Epoxylite Corp., 1428 N. Tyler Ave., S. El Monte, Calif. [411]

### Magnet material offers high energy product

A new permanent magnet material, Hyflux Alnico IX, achieves an energy product of up to 9.5 million and a coercive force of at least 1,400 oersted. The previous energy

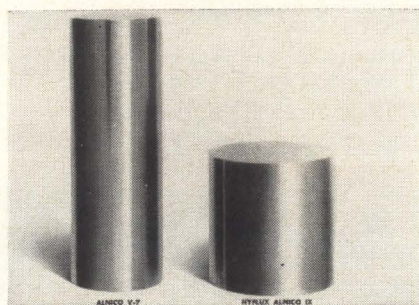

leader, Alnico V-7, has a typical value of 7.5 million, according to the manufacturer. Alnico IX is a premium magnet material developed for critical applications requiring a minimum of size and weight, a maximum level of energy and extreme resistance to demagnetization. Typical applications include straight field focus devices, ppm twt stacks, high performance holding, repulsion and torque transmitting devices, specialized motors, generators and alternators. Residual induction (typical) of Alnico IX is 10,500 gauss; peak magnetizing force, 3,000 oersted; and permeance coefficient, 7.0 to 7.5. Indiana General Corp., Valparaiso, Ind. [412]

### Potting compounds cure at room temperature

Two new potting compounds for electronic components and assemblies feature a color indicator that guards against errors in mixing the two components. They cure at room temperature, and combine favorable electrical properties with extremely low shrinkage. The transparent Microcast 200 has a shrinkage factor of less than 0.1%, a continuous service temperature of -70°C to +150°C, and a pouring viscosity of 2000 centipoise. Microcast 203, with shrinkage of less than 0.05%, is a more rigid, mineral-filled compound featuring high heat conductivity and continuous service temperature of -55°C to +180°C. Both of the new materials are packaged in a pair of tubes or cans from which equal amounts, either in weight or volume, are extracted prior to application. Proper mixing produces a green color, indicating that the compound is ready for application. The compounds will harden at room temperature within several hours, or heat may be applied to further speed the curing process. Microcast 200, in a 4-oz trial kit, is available for \$4.90. The comparable kit price for Microcast 203 is \$5.40.

Electro-Science Laboratories, Inc., 1133 Arch St., Philadelphia. [413]

## New Production Equipment

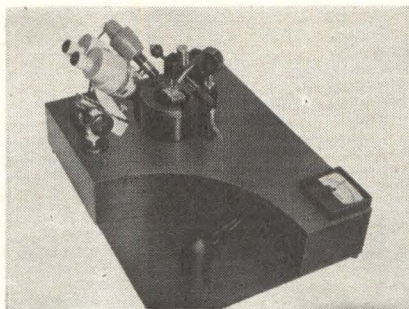

### Fine-wire bonder for microcircuits

A new thermocompression fine-wire bonder for microcircuits is announced. A grip/snap action that eliminates hand-tweezing of wire pigtailed, and one-knob control of both the X-Y position and rotation of the workpiece are two features that permit high production rates. Aluminum or gold wire can be bonded. Model MT measures 20 in. by 24 in. and, including optics, is priced at \$2,450.

Axion Corp., New Fairfield, Conn. [421]

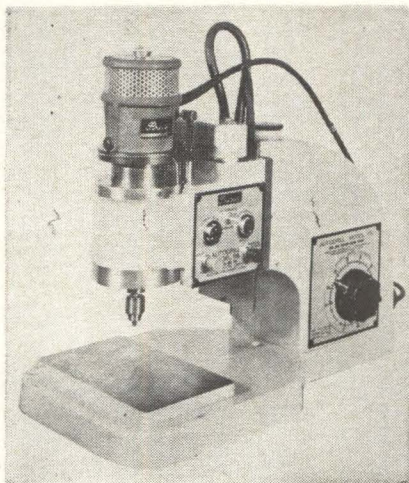

### Compact drill with variable speeds

The Autodrill has spindle speeds varying from 10,000 to 45,000 rpm and built-in variable speed control. According to the manufacturer, the ½ hp electric-powered unit is designed for short-run circuit board drilling, for drilling in plastic or

non-ferrous metals, and for accurate burr-free drilling in ferrous metals. Model 65 is compact, simple to operate and easy to maintain. It features adjustable controlled in-feed from 0 to 120 inches per minute; adjustable rapid traverse, and built-in Vapor Lub cooling unit.

Precise Products Corp., Blue River Road, Racine, Wisc. [422]



### Portable marking kit for metal surfaces

A portable kit is announced for electro/chemical etching metal parts with permanent inspection codes, parts numbers, trade names and marks. The kit may be used anywhere that 110 v, 60 cycle a-c power is available. The Lectroetch process produces a sharply defined mark on any metal surface by controlled electrolysis. The kit includes a low-voltage power unit; also electrolyte fluid, a liquid cleaner, and stencil stock which can be processed with the desired mark by the user. Appliances include choice of several hand pads for use with a ground plate. A bench fixture also is furnished. A mark is produced in several seconds, with the optional choice of clear or dark contrasting marks. The completely self-contained kit meets the need for a tool crib-type of service that allows equipment to be released on requisition. For production marking service, it requires a bench area of only 25 in. deep by 18 in. wide by 15 in. high.

Lectroetch Co., 14925 Elderwood Ave., East Cleveland 12, O. [423]

# LASER GASES

## MIXED TO ANY SPECIFICATION XENON • NEON HELIUM • ARGON OXYGEN

- Scientifically blended and tested mixtures for critical needs.
- Guaranteed ultra-high purity.
- Fast nationwide delivery in bulbs or cylinders.
- Quality based on more than 50 years of rare gas know-how.
- Complete technical service.

### SEND FOR NEW 24-PAGE ONE-SOURCE RARE GAS BOOKLET

First comprehensive price and specification list for most gases and mixtures.

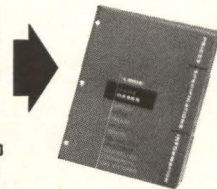

CLIP COUPON ATTACH TO BUSINESS LETTERHEAD

Union Carbide Corporation  
Linde Division, Dept. E-93  
270 Park Avenue, N. Y., N. Y. 10017

Please send a copy of your booklet listing prices, specifications, and information on LINDE Atmospheric Gases.

Have a representative contact me.



"Linde" and "Union Carbide" are registered trade marks of Union Carbide Corporation.



## New storage tube brings "TV contrast" to radar display

Depth has come to radar display—via a new line of Westinghouse display storage tubes that combine extremely high contrast with the ability to reproduce as many as seven half tones (shades of gray).

This patented new design ends the need for switching the phosphor high voltage to obtain a dark background. It thus reduces weight, volume and demand on the power-pulse source from a 10,000-volt pulse to 85 volts.

During simultaneous write-read operation, distracting background light is entirely eliminated without deterioration of other parameters.

First in this new family is the 5"-diameter WX-4951. Other sizes, such as 3", 4" and 7", can be supplied with writing speeds up to 1,000,000 inches per second, brightness to 2,500 foot Lamberts, and storage times to fit your needs. For complete data, write Westinghouse Electronic Tube Division, Elmira, New York, or Westinghouse International Corporation, 200 Park Avenue, New York, N. Y. ET-4102

You can be sure if it's Westinghouse



Induction Heating's Most  
Trusted and Creative  
Craftsmen Since 1926

## High Frequency INDUCTION HEATING UNITS

for

- BRAZING
- MELTING
- SOLDERING
- ZONE REFINING
- HEAT TREATING
- CRYSTAL GROWING
- BOMBARDING
- PLASMA TORCH

### ELECTRONIC TUBE GENERATORS

*Kilocycle Frequency Units*

*Megacycle Frequency Units*

*Dual Frequency Units*

- SPARK GAP CONVERTERS
- ACCESSORY EQUIPMENT

FREE APPLICATION ENGINEERING SERVICE—Our engineers will process your work samples and submit recommendations.

WRITE FOR NEW LEPEL CATALOG  
**Lepel** HIGH FREQUENCY LABORATORIES, INC.

55th St. & 37th Ave., Woodside 77, N.Y.C.

Chicago Office for Sales & Service: 6246 W. NORTH AVE.

Circle 208 on reader service card

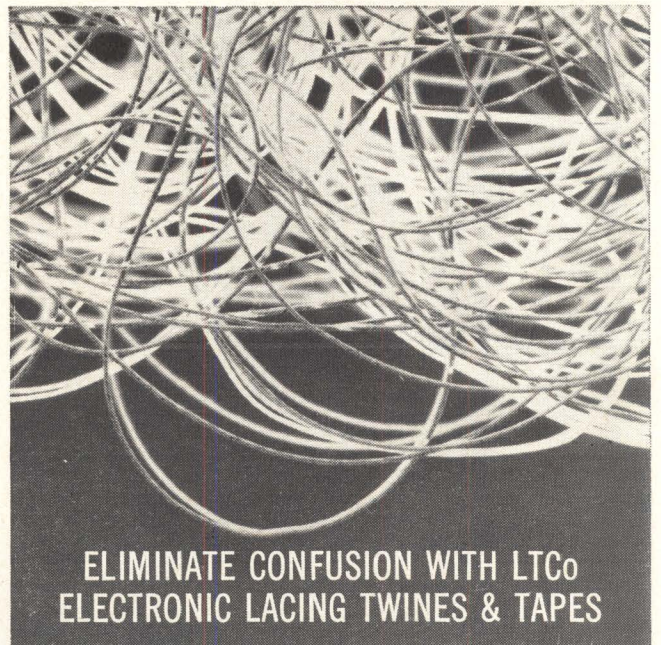

## ELIMINATE CONFUSION WITH LTCO ELECTRONIC LACING TWINES & TAPES

LTCO cords and tapes simplify circuits. Choose from a variety of natural and synthetic fibers: nylon, teflon, linen, cotton and polyester. Free brochure describes put-ups, constructions and finishes. Write:



**THE LINEN THREAD CO.**

*Blue Mountain, Alabama*

A DIVISION OF INDIAN HEAD MILLS, INC.

Circle 209 on reader service card

Electronics | September 21, 1964

## New Literature

**Piezoelectric quartz crystals.** Lenkurt Electric Co. San Carlos, Calif. Vol. 13, No. 7 of the Demodulator contains an illustrated article on the properties and uses of piezoelectric quartz crystals. Circle 451 on reader service card

**Pressure transducer.** Crescent-East Electronics Corp., 363 W. Glenside Ave., Glenside, Pa. Catalog CE-52 gives technical data on a transducer designed to perform precise gage, absolute or differential measurements in the low—pressure ranges. [452]

**Zener and reference diodes.** Motorola Semiconductor Products, Inc., P.O. Box 955, Phoenix, Ariz. 85001, is offering a 19-page cross reference and interchangeability guide for zener and reference diodes. [453]

**Data sorter.** Astrodata, Inc., 240 East Palais Rd., Anaheim, Calif., has available a 6-page brochure describing the model 1500 data sorter. [454]

**Industrial coil catalog.** J. W. Miller Co., 5917 S. Main St., Los Angeles. Catalog 64A describes r-f and i-f coils, chokes, filters and transformers. [455]

**Circuit breakers.** Wood Electric Corp., 244 Broad St., Lynn, Mass., has issued a 20-page catalog describing the latest models in thermal and magnetic circuit breakers. [456]

**Casting resins.** Emerson & Cuming, Inc., Canton, Mass. An updated quick-reference chart for notebook or wall mounting describes the line of Stycast encapsulating and potting resins. [457]

**Delay lines.** Andersen Laboratories, 501 New Park Ave., West Hartford, Conn. Electrically variable delay lines are described and illustrated in a two-page bulletin [458]

**Microminiature amplifiers.** Advanced Products, Loral Electronic Systems, a division of the Loral Electronics Corp., 825 Bronx River Ave., Bronx, N.Y. Amplifiers in microminiature i-f, .i-f video, video or standard packages are described in a 4-page catalog. [459]

**Solid-state amplifiers.** Melcor Electronics Corp., 1750 New Highway, Farmingdale, L.I. A two-page data sheet describes a line of solid-state, differential operational amplifiers. [460]

**Sweep oscillators.** PRD Electronics, Inc., 202 Tillary St., Brooklyn, N.Y. 11201, offers a two-page data sheet describing its 720 series of sweep oscillators. [461]

**Laser systems.** Lear Siegler, Inc., Laser Systems Center, 2320 Washtenaw, Ann Arbor, Mich. A brochure covers a line of advanced laser systems that can be furnished for either burst-type or Q-switched operation. [462]

**Miniature power transformers.** Torwico Electronics, Inc., Lakewood, N.J., has available a 36-page catalog on custom-built Tynymax 400-cycle miniature power transformers. [463]

**RFI gasket material.** Technical Wire Products, Inc., 129 Dermody St., Cranford, N.J. Data sheet RF-204 describes Teckfelt, an easily cut material for gasketing complex joints against radio-frequency interference. [464]

**Pulse generators.** Tempo Instrument Inc., East Bethpage Road, Plainview, L.I. A technical data sheet describes low-frequency, high-power, variable-time pulse generators for industrial applications. [465]

**Microwave filters.** Loral Electronic Systems, a division of Loral Electronics Corp., 825 Bronx River Ave., Bronx, N.Y. 10472, has published a 4-page catalog on a line of YIG electronically tunable microwave filters. [466]

**Tin oxide resistors.** Corning Electronics, Raleigh, N.C. A 6-page folder describes nearly every glass tin oxide film resistor made by the company for general-purpose, precision, power and high-reliability applications. [467]

**Glass regulators.** The National Transistor Division of ITT Corp., 500 Broadway, Lawrence, Mass. Data sheet B-123 lists characteristics and specifications for approximately 100 EIA-registered glass silicon voltage regulators. [468]

**Precision attenuators.** Microwave Development Laboratories, Inc., 87 Crescent Rd., Needham Heights, Mass. Preliminary bulletin AP-1 describes in detail a series of fixed precision attenuators covering EIA waveguide sizes WR51 to WR112. [469]

**Fiber optics displacement detector.** Mechanical Technology, Inc., Latham, N.Y. 12110. An 8-page brochure describes the fiber optics technique used in the Fotonic Sensor for observing vibration and displacement at frequencies to 100 kc. [470]

**Harness tying method.** Thomas & Betts Co., 36 Butler St., Elizabeth 1, N.J. High-speed tying, clamping and identification of wire bundles and harnesses through the use of Ty-Rap ties, straps and accessories is the subject of technical bulletin T-75. [471]

**Microwave spectrum analyzer.** Lavoie Laboratories, Inc., Morganville, N.J. has issued an illustrated catalog sheet on the LA-22 solid-state microwave spectrum analyzer. [472]

**Magnetoresistance multipliers.** American Aerospace Controls, Inc., 123 Millbar Blvd., Farmingdale, L.I. A 7-page application note analyzes the drive requirements of new magnetoresistance analog multipliers. [473]

## SIDE-LOOKING RADAR SYSTEMS ANALYSTS

New programs at HUGHES are generating opportunities for Systems Analysts experienced in high-resolution data gathering, data transfer and data processing systems. Openings exist for Systems Engineers, Mathematicians and Physicists qualified in synthetic array radars, optical, and other data collection systems (IR, Electro-Optical, SIGINT and others). Assignments include:

**Senior Systems Scientist** with 20 years' electronic systems experience—at least 10 years relevant to side-looking radar systems. Applicants will be considered for important program management responsibilities. M. S. or Ph. D. degree required.

**Senior Systems Analysts** with 10 years' electronic systems experience—at least 5 years relevant to high-resolution systems pre-design and evaluation. Applicants will be considered for assignments in concept formulation; single and multi-sensor applications; data transmission, processing and interpretation; systems integration and performance evaluation. M. S. or Ph. D. required.

**Systems Analysts** with 5 years' experience in: detection of signals in noise, optimum filter theory, non-linear signal processing, information theory, MTI and doppler systems analysis. B. S. or M. S. required.

Please airmail your resume to:

**MR. ROBERT A. MARTIN**  
Head of Employment  
Hughes Aerospace Divisions  
11940 W. Jefferson Blvd.  
Culver City 38, California

Creating a new world with electronics

**HUGHES**

HUGHES AIRCRAFT COMPANY  
AEROSPACE DIVISIONS

U. S. CITIZENSHIP REQUIRED  
An equal opportunity employer.

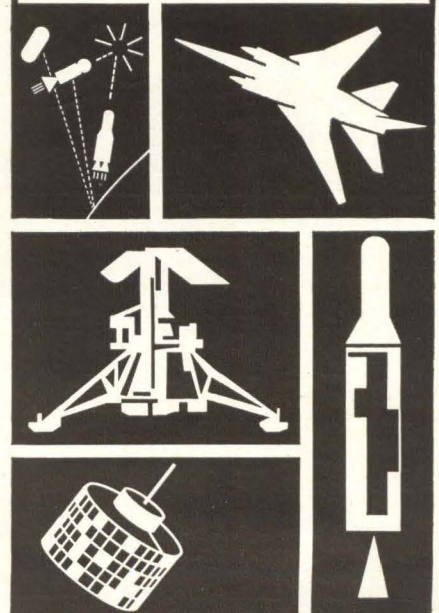

## SENIOR OPENINGS FOR SPACE SYSTEMS COMMUNICATIONS

The positions will involve the development of the state-of-the-art in communications systems for future spacecraft.

A thorough understanding of the fundamentals of communications systems and a detailed familiarity with the capabilities of communications systems components are required. In addition, systems engineering and hardware experience would be helpful. Specific experience in such areas as command & control systems, telemetry systems, secure systems, high processing gain systems, high data rate systems and satellite relay systems, would be most pertinent.

Since the positions are so directly concerned with the development of the state-of-the-art, an open-minded and imaginative approach is of critical importance. A personality which would assure acceptance in contract proposals is a consideration.

Requirements include: M.S. or Ph.D. degree from an accredited university, U. S. citizenship and several years of experience.

For additional details about these exceptionally challenging opportunities, please airmail your resume to:

**MR. ROBERT A. MARTIN**  
Head of Employment  
HUGHES Aerospace Divisions  
11940 W. Jefferson Blvd.  
Culver City 39, Calif.

**HUGHES**

HUGHES AIRCRAFT COMPANY  
AEROSPACE DIVISIONS  
An equal opportunity employer



## New Books

### Electronics, basic & industrial

Standard Electronics Questions and Answers. Steve Elonka and Julian L. Bernstein, McGraw-Hill, Inc., New York, 1964  
2 vols., 452 pp., \$15.95 set

For the intelligent layman, the technician or technologist whose primary field is other than electronics, this two-volume set is an excellent introduction to the subject and a useful reference. The text is written in a question-and-answer fashion, so that each answer, of one or more paragraphs, defines and describes one specific topic, unit, circuit or component.

The questions and answers are well illustrated, where necessary, with formulas, examples and diagrams. They are organized by subject matter under chapter headings in conventional introductory-text style: direct current, alternating current, tubes, amplifiers etc. The question-and-answer method, coupled with a detailed index, makes it very easy to quickly find any subject.

While the first volume deals with basic electronics, covering the essentials of electricity, basic components and most common circuits, the second volume is on industrial applications. Its chapter headings include oscillators, special circuits, transducers and sensors, control systems, closed-circuit and color tv, industrial processes and devices, and test equipment. Under these headings, some very up-to-date topics such as magnetic core memories, other computer components, and digital circuits are qualitatively described.

A certain amount of confusion is caused by the title, which implies that the questions and answers included are in some way standardized or accepted in the industry. This is not the case; the format of the set has been adapted from similar series published in the plant operation, refrigeration and heating fields, where standard examinations for technicians do exist. Similar standardization in the electronics industry has yet to come.

George V. Novotny  
Advanced Technology Editor

### Space electronics

Inertial Guidance Sensors. J.M. Slater  
Reinhold Publishing Corp.,  
New York, 1964, 221 pp., \$11.

J. M. Slater has written a general primer on inertial guidance sensors. He has chosen to emphasize the fundamental technology of conventional gyroscopes and conventional accelerometers; in these areas, he has written an illuminating basic work.

It is stated that the book is aimed at meeting the needs not only of those who "invent and design sensing instruments, but also of those who incorporate them into systems". This reviewer takes issue with the statement, for though the book clearly serves a useful purpose in introducing the nonspecialist to the subject, it has limited value to those who have been exposed to these well documented fields.

The organization of the book is sound; it is well illustrated with easily understandable and meaningful diagrams.

However, as the reader proceeds into the more modern and more esoteric areas, the treatment grows rather sketchy. Coverage of the various three-axes-of-freedom devices in Chapter IV consists of 30 pages; Chapter V on vibrating-mass gyros has 10 pages, and Chapter VII on particle gyros only seven and a half pages. There is simply not enough detail given on these instruments to deal with them with any degree of perception. What is most regrettable, however, is that a well-selected and even annotated bibliography is missing; a total of only 80 bibliographical items are scattered through the volume. A large and unified bibliography would fulfill one of the most important functions of any introductory work: to guide, point, and to lead the reader to a higher level of understanding.

The subject of inertial guidance sensors is complex and difficult. Nonetheless this treatment is concise, and, for the uninitiated, valuable.

J.T. LaVan  
Martin Co.  
Baltimore, Md.



*Special Introductory Offer*

To new members of the  
**ELECTRONICS and CONTROL ENGINEERS' Book Club**

# ANY ONE

**FOR ONLY**

**\$1.00**

YOURS WITH A CHARTER MEMBERSHIP  
AND SENT WITH YOUR FIRST SELECTION

VALUES FROM \$7.00 TO \$23.50

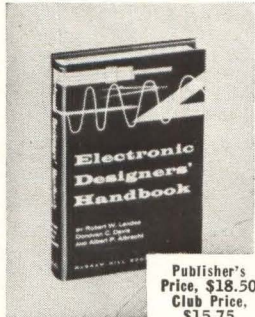

Publisher's Price, \$18.50  
Club Price, \$15.75

**Electronic Designers' Handbook**, Edited by R. W. Landee, D. C. Davis, and A. P. Albrecht. Presents detailed, practical design data.

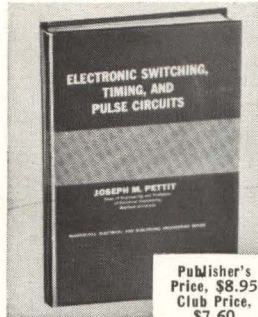

Publisher's Price, \$8.95  
Club Price, \$7.60

**Electronic Switching, Timing, and Pulse Circuits** by J. M. Pettit. Provides a practical understanding of complex circuits.

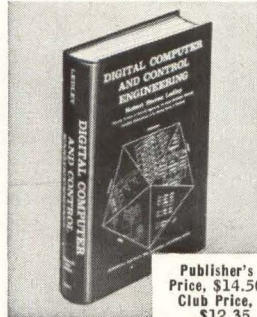

Publisher's Price, \$14.50  
Club Price, \$12.35

**Digital Computer and Control Engineering** by R. S. Ledley. Full coverage from basic design to, advanced programming techniques.

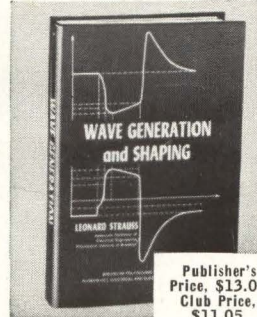

Publisher's Price, \$13.00  
Club Price, \$11.05

**Wave Generation and Shaping** by L. Strauss. Essential features and techniques of practical wave-generating and -shaping circuits.

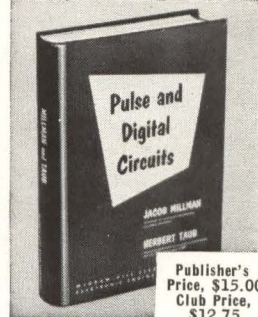

Publisher's Price, \$15.00  
Club Price, \$12.75

**Pulse and Digital Circuits**, by J. Millman and H. Taub. Fully explains pulse and digital circuit operation for electronic systems design.

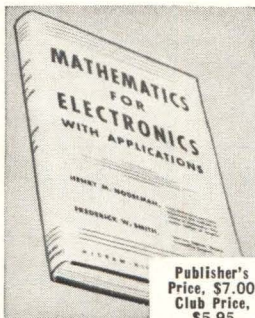

Publisher's Price, \$7.00  
Club Price, \$5.95

**Mathematics for Electronics with Applications** by H. M. Nodelman and F. W. Smith, Jr. Methods for solving practical problems.

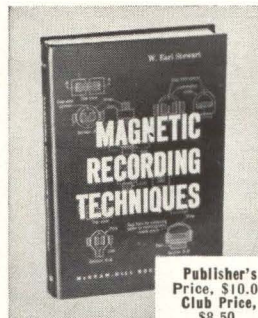

Publisher's Price, \$10.00  
Club Price, \$8.50

**Magnetic Recording Techniques** by W. E. Stewart. Full description of magnetic recording methods and devices.

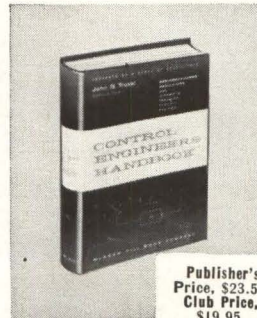

Publisher's Price, \$23.50  
Club Price, \$19.95

**Control Engineers' Handbook** by J. C. Truxal. A wealth of practical help on automatic feedback control systems.

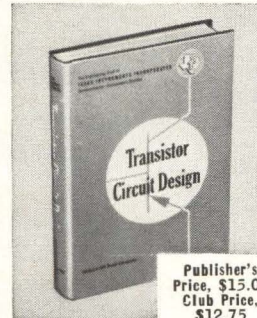

Publisher's Price, \$15.00  
Club Price, \$12.75

**Transistor Circuit Design**, prepared by the Engineering Staff of Texas Instruments Inc. Reduces theory to actual practice.

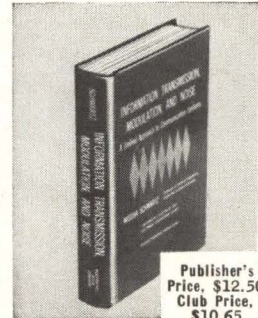

Publisher's Price, \$12.50  
Club Price, \$10.65

**Information Transmission, Modulation, and Noise** by M. Schwartz. A unified approach to communication systems.

**How many of the books shown here do you wish you had immediately at hand?**

Select one for **JUST A DOLLAR!** Choose from *Electronic Designers' Handbook*, *Magnetic Recording Techniques*, *Wave Generation and Shaping*, and seven other valuable books . . . your introduction to membership in *The Electronic and Control Engineers' Book Club*.

If you're missing out on important technical literature—if today's high cost of reading curbs the growth of your library—here's the solution to your problem. *The Electronic and Control Engineers' Book Club* was organized for you, to provide an economical technical reading program that cannot fail to be of value to you.

All books are chosen by qualified editors and consultants. Their thoroughgoing understanding of the standards and values of the literature in your field guarantees the authoritativeness of the selections.

**How the club operates.** Periodically, as issued, you receive free of charge *The Electronic and Control Engineers' Book Bulletin*. This gives complete advance notice of the next main selection, as well as a number of alternate selections. If you want the main selection you do nothing; the book will be mailed to you. If you want an alternate selection . . . or if you want no book at all for that particular period . . . notify the Club by returning the convenient card enclosed with each *Bulletin*.

We ask you to agree only to the purchase of three books in a year. Certainly out of the

large number of books in your field offered in any twelve months there will be at least three you would buy anyway. By joining the Club you save yourself the bother of searching and shopping, and save in cost about 15 per cent from publishers' prices.

Send no money now. Just check any two books you want—one for only \$1.00 and one as your first Club selection—in the coupon below. Take advantage of this offer *now*, and get two books for less than the regular price of one.

**THIS COUPON IS WORTH UP TO \$22.50.**

The Electronic and Control Engineers' Book Club Dept. L-9-21  
330 West 42nd Street, New York, N. Y. 10036

Please enroll me as a member of the Electronic and Control Engineers' Book Club. I am to receive the two books I have indicated at the right. You will bill me for my first selection at the special club price and \$1 for my new membership book, plus local tax, and a few additional cents for delivery costs. (The Club assumes this charge on prepaid orders.) Forthcoming selections will be described to me in advance and I may decline any book. I need take only 3 selections or alternates in 12 months of membership. (This offer good in U.S. only.)

PLEASE PRINT

Name .....

Address .....

City..... State..... Zip Code.....

Company .....

**NO RISK GUARANTEE** If not completely satisfied, you may return your first shipment within 10 days and your membership will be canceled.

Check 2 Books: We will send the higher priced book for only \$1.00, and the other as your Club Selection:

- Electronic Designers' Handbook, \$15.75
- Electronic Switching, Timing, and Pulse Circuits, \$7.60
- Digital Computer and Control Engineering, \$12.35
- Wave Generation and Shaping, \$11.05
- Pulse and Digital Circuits, \$12.75
- Mathematics for Electronics with Applications, \$5.95
- Magnetic Recording Techniques, \$8.50
- Control Engineers' Handbook, \$19.95
- Transistor Circuit Design, \$12.75
- Information Transmission, Modulation, and Noise, \$10.65

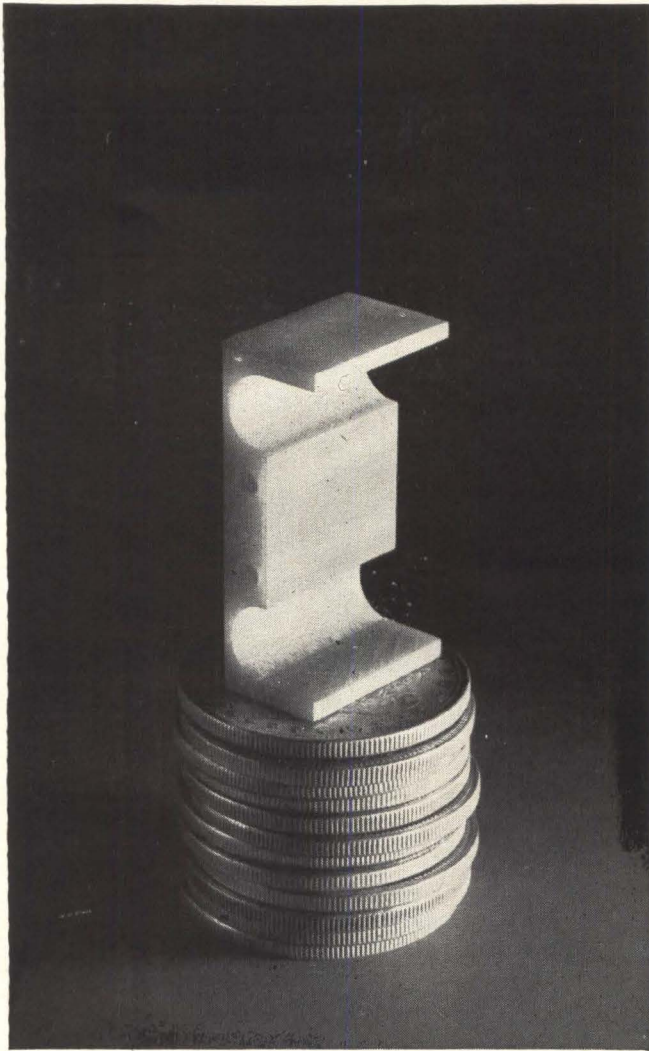

## Quality doesn't cost; it pays

Everything has two prices; the price you pay to buy it and the price you pay to live with it. You may have to pay a little more for quality at first because there are no bargains in good materials and good workmanship. This is as true of laminated plastics as it is of diamonds.

Take a look at Synthane laminates. Your eye will tell you at a glance that Synthane fillers are of spotless quality. To them we add only the best resins, processed under closest laboratory control. Synthane fabrication speaks for itself—parts skillfully machined and beautifully finished, each in its own way a gem. They look quality. They are quality. The kind of quality for which you do not have to pay twice in poor performance of *your* product, *your* customer's dissatisfaction, lowering of *your* reputation, product returns and complaints. Send for a copy of our new booklet—"Laminated Plastics Parts . . . Make or Buy?" Synthane Corporation, 36 River Rd., Oaks, Pa.

You furnish the print... we'll furnish the part

# SYNTHANE

CORPORATION  OAKS, PENNA.  
Synthane-Pacific, 518 Garfield Avenue, Glendale 4, California

## A HEATH-BUILT ELECTRONICS LAB FOR RESEARCH & EDUCATION

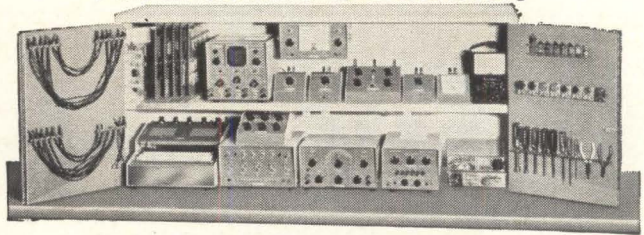

(Available As A Coordinated System Or As Individual Units)

### Complete Lab Station \$1100 (less optional cabinet)

Educators and researchers will find this lab station the most modern and complete group of its type in the industry today! Designed by Heath in close association with Dr. H. V. Malmstadt of the University of Illinois and Dr. C. G. Enke of Princeton University, the EU Series provides researchers in both the physical and life sciences a solid foundation in the principles, design and use of electronic instrumentation plus the highly accurate equipment necessary for their work. The system includes factory assembled & calibrated test equipment, special purpose lab instruments, special experimental groups featuring "solderless" spring-clip connectors and the authoritative Malmstadt-Enke text "Electronics for Scientists." Send for Free brochure today for complete details!

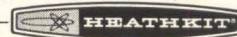

HEATH COMPANY, Dept. 67-9-1  
Benton Harbor, Mich. 49023

- Please send free 8-page EU-100 Brochure.
- Please send free 100-page Heathkit Catalog.

Name \_\_\_\_\_

Address \_\_\_\_\_

City \_\_\_\_\_

State \_\_\_\_\_

Zip \_\_\_\_\_

EK-160

Circle 210 on reader service card

## Don't let the price tag fool you!

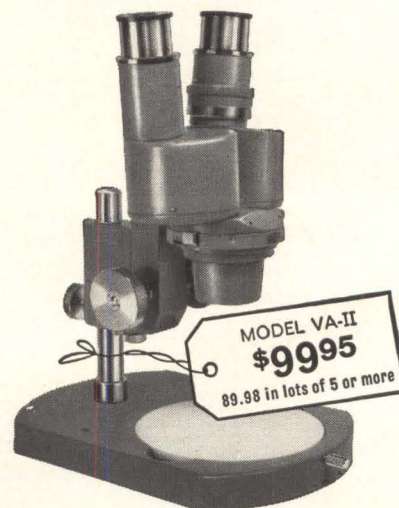

### This is a genuine, full-quality Elgeet-Olympus STEREO microscope

Distortion-free optics, brilliant imagery. Ideal for quality control, inspection and assembly of miniature parts and circuits. Magnification: 8X to 40X. A complete range of coated achromatic optics is available. For details, write Elgeet Optical Co., Inc., 303 Child Street, Rochester, New York 14611.

## Technical Abstracts

### Weldable motherboards

New developments in weldable electronic circuit boards. Richard B. Washer, General Electric Co., Utica, N.Y.

The printed-wiring board's popularity has not diminished in the swing to microcircuits. It is still a basic interconnection medium, although the use of microelectronics requires new joining techniques and materials. Instead of the familiar dip soldering, welding joins component leads to conductors on the boards. Also, to pack more circuits onto a given board area, the familiar single-sided boards have given way to double-sided boards and multilayer boards.

One of the newer welding methods is parallel-gap or surface circuit welding, which makes the welds on the top side of the leads. Two electrode tips touch the lead surface, and some of the current passing between the tips is shunted through the conductor, fusing it to the lead.

This technique permits closely spaced, easily inspected welds, but it doesn't work well on copper conductors. To improve weldability, conductors are terminated in tabs of high-resistivity metal or special clad conductors. One such material is a sandwich composed of nickel for the weldable surface, iron to insulate the board from welding heat, and aluminum to provide a good bond to the epoxy board.

A preferred type of board is the laminated multilayer board, with weldable conductors in the exposed layer and copper in the internal layers. Besides providing greater freedom of interconnection design than do single- or double-sided boards, multilayer boards avoid the tight production tolerances that are required to get close spacing on regular boards.

An experimental alternative to plated-through holes for interlayer connections is the step-weld. Holes of progressively different lengths are punched in each layer, forming steps. A weldable ribbon then runs down the steps, interconnecting the conductors on each layer. After welding, the layers are laminated with resin. Resin overflow encap-

ulates the interlayer connections. Copper, however, cannot be used for the internal layer conductors.

Presented at the National Electronic Packaging and Production Conference, New York, June 9-11.

### FETs for a-m radios

Designing FETs and MOSTs into a-m radios. Larry Blasser and Earl Cummins, Semiconductor division of Fairchild Camera and Instrument Corp., Mountain View, Calif.

The relative simplicity of the field-effect transistor (FET) and the metal-oxide transistor (MOST), their high input impedance and electrical characteristics that are similar to vacuum tubes, suggest the use of these devices in the radio-frequency stage of a-m radios. FETs and MOSTs are smaller than vacuum tubes and have lower power requirements. In addition, they reduce automatic-gain-control power requirements and obtain better cross-modulation performance than is possible with r-f stages using bipolar-junction transistors.

The Fairchild 2N3277 FET has a p-type channel between the source and drain. With the gate at source potential and an increasing negative voltage applied to the drain, the voltage gradient in the conductive p-channel creates a depletion region that reduces the cross-sectional area of the channel until a pinch-off condition is reached. Then the drain current becomes relatively independent of further increases in source-drain voltage, giving the FET its pentodelike characteristics. A drain voltage of -10 volts and a gate bias of zero volts puts the FET in the pinch-off or pentode region with the following characteristics: input gate capacitance of 2 pf, output drain capacitance of 0.5 pf, drain resistance of 1 meg, drain-to-gate feedback capacitance of 1.2 pf, and transconductance of 150 micromhos.

Performance data of an experimental a-m automobile radio that uses p-channel FETs in the radio-frequency stage and npn silicon planar bipolar transistors in the converter and intermediate-frequency stages is better than in the typical transistor radio. With ex-

### 60 cps Precision SERVO REPEATER

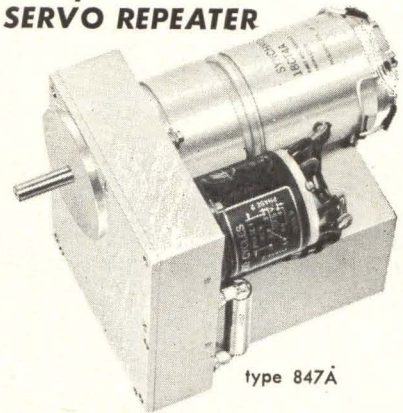

- Follows 60 cps, 3-wire synchro data
- Power required, 117V, 60 cps
- Solid state, modular package
- 400 cps models available

#### WRITE FOR CATALOG

Catalog lists off-the-shelf availability of servo amplifiers, packaged servo systems, and servo testers

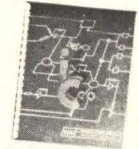

### INDUSTRIAL CONTROL COMPANY

CENTRAL AVENUE AT PINELAWN  
FARMINGDALE, L. I., N. Y. • MYRTLE 4-3002

Circle 212 on reader service card

## How To Get Things Done Better And Faster

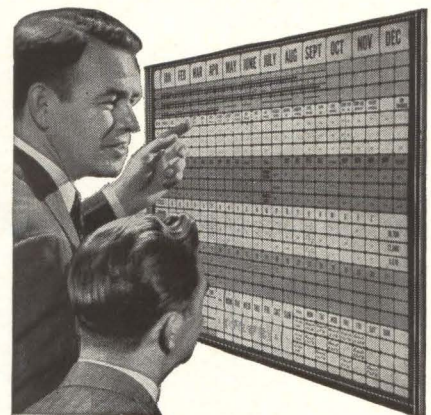

### BOARDMASTER VISUAL CONTROL

- ☆ Gives Graphic Picture—Saves Time, Saves Money, Prevents Errors
- ☆ Simple to operate—Type or Write on Cards, Snap in Grooves
- ☆ Ideal for Production, Traffic, Inventory Scheduling, Sales, Etc.
- ☆ Made of Metal. Compact and Attractive. Over 750,000 in Use.

Full price \$4950 with cards

**FREE** 24-PAGE BOOKLET NO. C-30  
Without Obligation

Write for Your Copy Today

**GRAPHIC SYSTEMS**  
YANCEYVILLE, NORTH CAROLINA

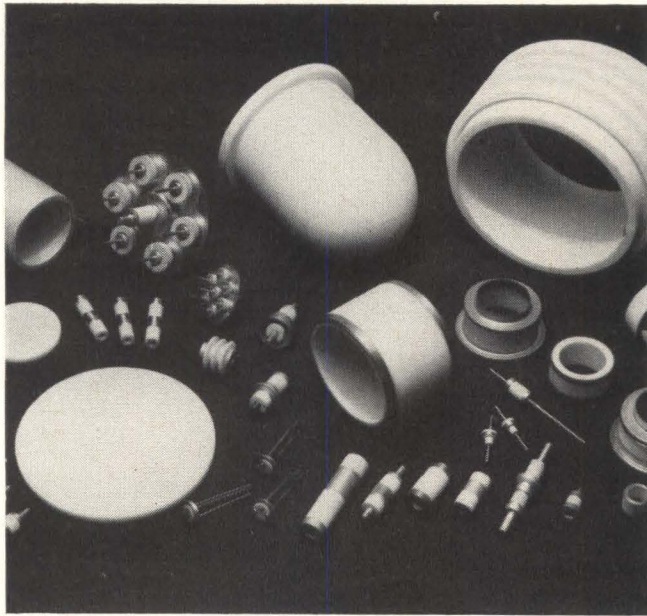

## C.G.E.C.

Pure sintered oxides

### Vacuum-tight ceramic-metal assemblies

In the field of pure sintered oxides produced by C.G.E.C. two ceramics are specially adapted to electronic applications :

**Alucer 97 and Berycer**

#### ALUCER 97

97 % pure alumina sintered at high temperature, specially well adapted to refractory metallizing for ceramic-metal seals.

#### BERYGER

pure beryllia (BeO content higher than 99,9 %) sintered at high temperature. Berycer provides a very good thermal conductivity and a great electrical resistivity.

Both oxides are vacuum-tight, non porous (therefore immediatly degassed), very refractory. They have a high mechanical strength, a good resistance to thermal shocks, low losses under high frequency, good dielectric properties. They can be machined to accurate dimensions and offer an excellent surface finish.

C.G.E.C. can produce components in Alucer 97 or Berycer, according to your specifications.

**COMPAGNIE GENERALE  
D'ELECTRO CERAMIQUE**

P.O. Box 113 TARBES (H.P.) FRANCE  
TEL: 93-32-91 TARBES

*Around the world ...*

## KYORITSU Measuring Instruments

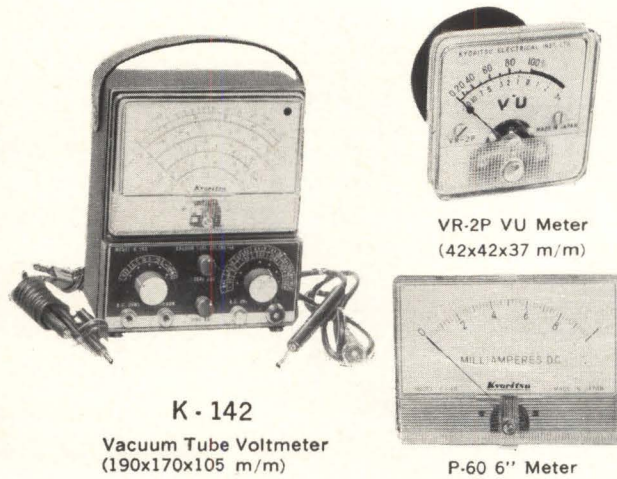

K - 142

Vacuum Tube Voltmeter  
(190x170x105 m/m)

VR-2P VU Meter  
(42x42x37 m/m)

P-60 6" Meter



# Kyoritsu

ELECTRICAL INSTRUMENTS WORKS, LTD.

120, Nakane-cho, Meguro-ku, Tokyo, Japan

Cable address: KYORITSUKEIKI TOKYO

Telex: TK 2849

Direct Inquiry Welcomed

Circle 213 on reader service card



**See Us At**

**The United States Exhibition**

**Stockholm Technical Fair**

**Area 540**

**October 2-9, 1964**

**Stockholm, Sweden**

**A Trade Expansion Activity**

**United States Department Of Commerce**

pected improvements in device characteristics, such as lower feedback capacitance and higher transconductance, it is likely that FETs and MOSTs will be mass-produced for use in car radios and other consumer products, particularly since they are easily incorporated into integrated circuits that are becoming inexpensive enough to be attractive in entertainment applications.

Presented at the Chicago Spring Conference of the IEEE Group on Broadcast and Television Receivers, June 15-16.

**New solid-state device**

The surface controlled avalanche transistor. William Shockley and W.W. Hooper, Clevite Corp., Semiconductor Division, Palo Alto, Calif.

A new transistor structure has been designed which may make it possible to build transistors capable of amplification at frequencies in the 10-Gc range.

In one form, the new device consists of a silicon (n<sup>+</sup>)p junction covered with a thin insulating layer of SiO<sub>2</sub>. The three electrodes are the source (an n<sup>+</sup> region), the drain (a p region), and the gate (a metal layer over the oxide and covering the intersection of the junction with the surface).

In the surface-controlled avalanche transistor, amplification results from controlling the avalanche breakdown of a p-n junction. A voltage is applied to an external electrode so that an electric field penetrates the semiconductor surface and extends into the space-charge layer. This field is modified by another field produced by the reverse bias across the p-n junction.

By varying these two fields, the voltage at which avalanche breakdown occurs across the junction may be controlled. In turn, the avalanche breakdown current and, therefore, the power delivered to a load in series with the junction is also controlled.

By using experimental units having low breakdown regions near the surface, it is possible to change the breakdown voltage by a factor of two. Current and power gains greater than 1,000 may be obtained at low frequencies.

Presented at the 1964 Western Electronic Show and Convention (Wescon), IEEE, August 25-28, Los Angeles.

**Reprints Available from Electronics**

**Special Reprint Offer:** For your reference file—a complete set of Special Reports reprinted from the pages of Electronics in the past year. A total of 155 pages of valuable and informative articles combined in an attractive folder. The reports are individually bound. The special discount price for the reports is \$2.50 which includes both handling and shipping costs. Order now using the coupon at the bottom of this page. The following reprints are included in this offer:

**Oceanography**—A survey of the growing electronics technology associated with underseas exploration. 15 pages.

**Magnetics**—An Electronics special report on what's new in today's magnetic technology. 24 pages.

**Digital Instrumentation**—A look at some new techniques in instrumentation. 16 pages.

**Modern Electronic Packaging**—How to locate, connect and afford protection for electronic devices and components. 16 pages.

**Electronic Markets New Directions 1963-64-67**—Surveys present markets and forecasts future electronics marketing opportunities. Includes marketing statistics and projections. 20 pages.

**Today's Semiconductors**—Survey of the newest semiconductor devices available to circuit designers. Tells how and where to use them to the greatest advantage. 24 pages.

**Materials for Space Age Electronics**—A comprehensive survey of a materials technology that is now shaping the course of the Electronics industry. 16 pages.

**Radio Frequency Interference—Causes, effects and cures.** How RFI has grown in the electronics industry making what was once a nuisance to a few an industry wide problem. 24 pages.

Remember to refer to this special offer when you order. Price is \$2.50 for the complete set or you may order them individually at 50¢ per copy.

Send your order to:

**Electronics Reprint Dept.** 330 West 42nd Street  
New York, N.Y. 10036

**Reprint order form**

To help expedite mailing of your reprints please send cash, check or money order with your order.

For reprints of the latest special report:

**Transistor Heat Dissipators, Part I & II**

Send me ..... reprints of key no. R-59 & R-60 at 75¢ each.

For reprints of previous feature articles or special reports fill in below:

Send me ..... reprints of key no(s) ..... at ..... ¢ each.

For prices and listing see the reader service card

**For complete set of special reports (See special offer above)**

Send me ..... complete set(s) of special reports offered for \$2.50 per set.

Name .....

Number & Street .....

City, State .....

Zip Code .....

# The Future is Here

As the Western Center of Motorola's Military Electronics Division advances into the further miniaturization of electronic components and systems, exciting and rewarding career opportunities are created — in inverse ratio to the diminishing size of operational sub-assemblies for military equipments and aerospace hardware.

*To engineers and scientists of demonstrated capability Motorola currently offers these specific opportunities.*

Antennas & Propagation	Integrated Circuitry
Solid State R.F.	Reliability Analysis
Microwave Techniques	Parts Reliability
Missile & Space	Reliability Program
Instrumentation	Coordination
Operational Support Equipment	CW Transponders
	Radar & Radar Transponders
	Guidance & Navigation
	Command & Control
	Space Communications
	Signal Processing
	ECM, CCM & Surveillance
	Tracking & Telemetry

SIZE-WEIGHT

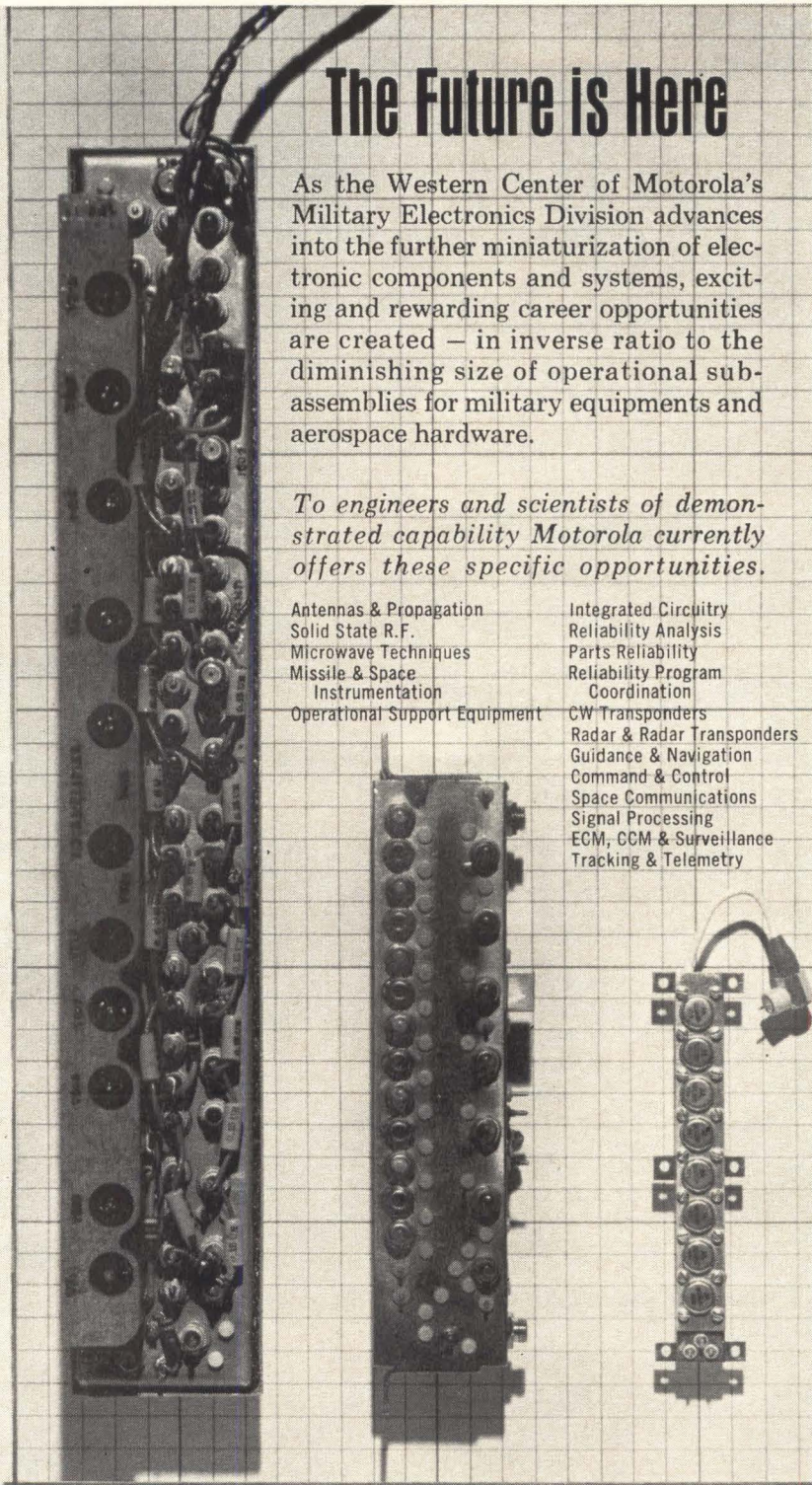

1956

1960

1964

TIME-YEARS

Contact Phil Nienstedt, Manager of Recruitment, Department 659

**MOTOROLA**



**in PHOENIX**

Military Electronics Division • Western Center • P.O. Box 1417, Scottsdale, Arizona  
MOTOROLA ALSO OFFERS OPPORTUNITIES AT CHICAGO, ILLINOIS — AN EQUAL OPPORTUNITY EMPLOYER

## ENGINEERS

Accelerated programs and increased scope of company interests have created new engineering opportunities at The Prestolite Company. This presents an opportunity to get into a responsible engineering position in a long established organization.

Immediate openings exist for junior and senior engineers in the following fields:

1. Physics (advanced degree in solid state or molecular physics preferred).
2. Motor and Magnetic component design.
3. Semiconductor circuit design.
4. Servo system design.
5. Technical report writing.

Applicants must be college graduates with some experience in one or more of the above fields.

Good working conditions and excellent fringe benefits. An Equal Opportunity Employer.

Please forward resume stating education, experience, and salary range to

Personnel Office,

**THE PRESTOLITE COMPANY**

Toledo, Ohio 43601

## HONEYCOMB STRUCTURES MANUFACTURER

SEEKS REPRESENTATION IN FOLLOWING AREAS: North Central, South Central, New England and South Atlantic States.

**ALBANO COMPANY, INC.**

553 West 54th Street

New York City

ADDRESS BOX NO. REPLIES TO: Box No.  
Classified Adv. Div. of this publication.  
Send to office nearest you.  
NEW YORK 10036: P. O. Box 12  
CHICAGO 60611: 645 N. Michigan Ave.  
SAN FRANCISCO 94111: 255 California St.

## POSITION VACANT

**Chief Engineer—Broadcast and CCTV.** Truly a one-time opportunity for the managing design engineer to take over the Engineering Division of an already successful corporation still growing by leaps. The man that will dare in design but pride in thoroughness will find his life's career waiting for him. Must have video design experience with cameras and associated equipment. Mid-Atlantic coast location. B.S.E.E. required plus management training. Age 35-45. Send resume and photo to P-4968, Electronics.

## PROFESSIONAL SERVICES

**GIBBS & HILL, Inc.**

Consulting Engineers

Systems Engineering

Operations Research • Development  
Field Studies • Design • Procurement  
Power • Transportation • Communications  
Water Supply • Waste Treatment

393 Seventh Avenue

New York 1, N. Y.

WHEN TIME

IS SHORT . . . .

put the solution of your problems up to a specialized Consultant. His broad experience may save you months of costly experimentation.

# SCOPE

## OF OPPORTUNITIES WITH GENERAL ELECTRIC ON THE APOLLO PROGRAM

Specific openings are now available on the Apollo Program with General Electric. All are high in technical content... completely concerned with systems analysis and creative design of various systems for ACCEPTANCE CHECKOUT EQUIPMENT—SPACECRAFT (ACE-S/C). These are senior positions requiring men who are recognized in their field. There are some openings for men with lesser amounts of experience, but a capability must exist... as the opportunity does... to become an authority within a short period.

If you are interested in moving into advanced space fields through assignment now on APOLLO with General Electric, you are invited to inquire about current opportunities:

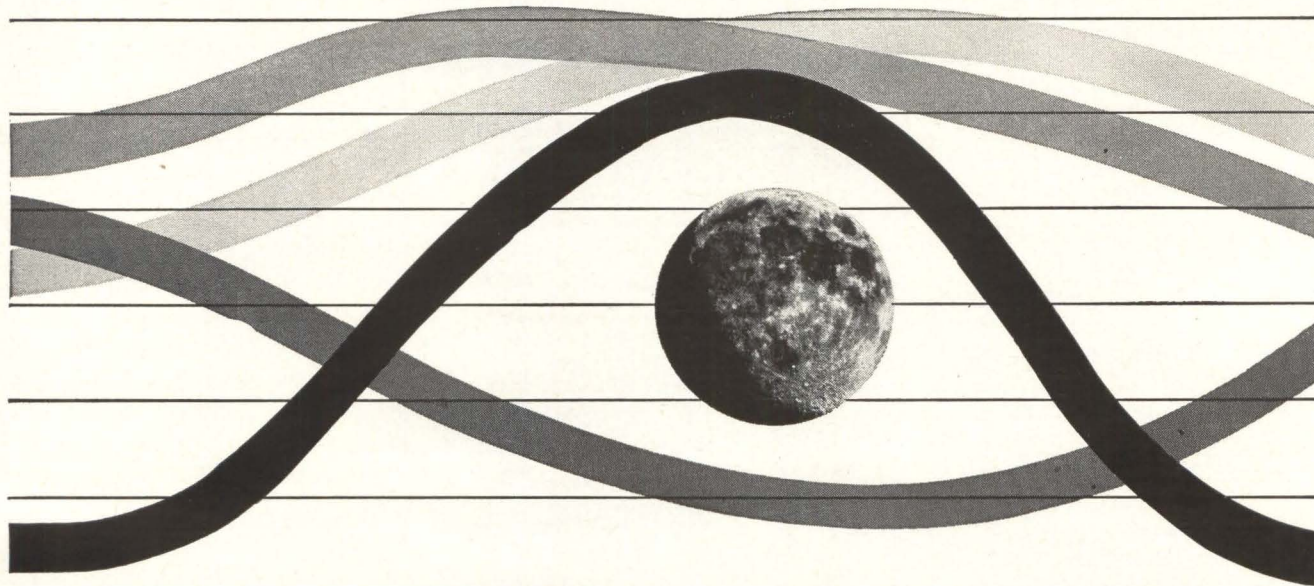

**DIGITAL APPLICATIONS ENGINEER**—Experienced with digital computer utilization for laboratory simulation and launch pad preparation of missile systems checkout required. Operational and testing experience in factory and field a very useful supplement.

**COMPUTER SYSTEMS ENGINEER**—Experience in the design and analysis of computer peripheral equipment systems. Must be able to recognize and specify requirements for electrical interface equipment, language, and associated problem areas.

**DESIGN ENGINEER**—Experience in one or more of the following areas: digital systems/data handling, GSE, servo-design and pad electrical systems.

**LOGIC DESIGN ENGINEER**—Experience in analysis, synthesis and design of digital logic for application to computer directed automatic checkout systems.

**RELIABILITY ENGINEER**—Reliability experience including failure mode, availability, utilization, and malfunction analysis on airborne telemetry and digital equipment.

**PACKAGING DESIGN ENGINEER**—Experienced in packaging electrical/electronic parts, components and subsystems required by automated checkout systems (ESE) for launch vehicles.

**COMPUTER PROGRAMMER**—Experience (with computer programming in a large digital facility) designing computer programs for checkout models and assisting in formulation of analytical models.

**SR. FLIGHT and ORBITAL MECHANICS ENGINEER**—Background in definition and evaluation of performance parameters relating to spacecraft design, such as earth and planetary launch/descent, optimum transfer orbits, etc., and in analysis of performance profile, computer programs, trajectory spectra, midcourse corrections, etc.

**DECOMMUTATION ENGINEER**—4 years' experience in analyzing malfunctions occurring during test on telemetry magnetic recorders, pulse coded decommutator and data distribution systems. Familiarity with solving and processing complex and diverse problems through the data reduction cycle with respect to the general data handling and mathematical techniques employed.

**SR. MECHANICAL ENGINEER (Ordnance and Safety)**—10 to 12 years' experience in evaluating mechanical ordnance support systems and airframe mechanisms.

**SYSTEMS ANALYSIS ENGINEER**—Experience in the analysis of measurement and telemetry systems, both airborne and ground, with particular emphasis on accuracy, validity and techniques for spacecraft sensors and transducers.

**TELEMETRY DESIGN ENGINEER—AIRBORNE**—Related experience in design of airborne telemetry systems—PCM and general airborne system design required.

**CHECKOUT ENGINEER**—3 years' experience at launch site preferably with R&D vehicles, including a familiarity with digital systems. Additional experience should be in one or more of the following areas: RF systems, switchgear, patching systems design, or ground electric systems.

**SR. PROGRAMMER ANALYST**—Experienced in use of digital computers with information or automatic checkout systems. Background in planning, development and implementation of complex programming and real time systems for depth analysis, engineering support and translation of requirements to computer-oriented specifications.

**ANALOG DISPLAY ENGINEER**—Experience in design and development of specifications for analog and alphanumeric display equipment.

DEGREE REQUIRED / ACTIVITIES ARE WIDE RANGING, PROVIDING BROAD INDIVIDUAL OPPORTUNITIES

Please write in strict confidence, including salary requirements, to: Mr. P. W. Christos, Apollo Support Dept., Room 1107-M, General Electric Co., P. O. Box 2500, Daytona Beach, Florida.

**GENERAL  ELECTRIC**

An Equal Opportunity Employer

## AUTOTRACK ANTENNA MOUNT

360 degree azimuth, 210 degree elevation sweep with better than 1 mil. accuracy. Missile velocity acceleration and slewing rates. Amplidyne and servo control. Will handle up to 20 ft. dish. Supplied complete with control chassis. In stock—immediate delivery. Used world over by NASA, USAF. TYPE MP-61 B. SCR-584. NIKE AJAX mounts also in stock.

## SCR 584 AUTOMATIC TRACKING RADARS

Our 584s in like new condition, ready to go, and in stock for immediate delivery. Ideal for telemetry research and development, missile tracking, satellite tracking, balloon tracking. Used on Atlantic Missile Range, Pacific Missile Range, N.A.S.A. Wallops Island, A.B.M.A. Write us. Fully Desc. MIT Rad. Lab. Series, Vol. 1, pps. 207-210, 228, 284-286. Compl. inst. Bk. avail. \$25.00 each.

## PULSE MODULATORS

### MIT MODEL 9 PULSER

#### 1 MEGAWATT—HARD TUBE

Output 25 kv 40 amp. Duty cycle .002. Pulse lengths .25 to 2 microsec. Also .5 to 5 microsec, and .1 to .5 microsec. Uses 6C21. Input 115v 60 cycle AC. Mfr. GE. Complete with driver and high voltage power supply. Ref: MIT Rad. Lab. Series, Vol. 5, pps. 152-160.

#### 500KW THYRATRON PULSER

Output 22kv at 28 amp. Rep. rates: 2.25 microsec. 300 pps, 1.75 msec 550 pps, .4 msec 2500 pps. Uses 5C22 hydrogen thyatron. Complete with driver and high voltage power supply. Input 115v 60 cy AC.

#### 2 MEGAWATT PULSER

Output 30 kv at 70 amp. Duty cycle .001. Rep rates: 1 microsec 600 pps, 1 or 2 msec 300 pps. Uses 5948 hydrogen thyatron. Input 120/208 VAC 60 cycle. Mfr. GE. Complete with high voltage power supply.

#### 15KW PULSER—DRIVER

Biased multivibrator type pulse gen. using 3E29. Output 3kv at 5 amp. Pulse lgths .5 to 5 microsec, easily adj. to .1 to .5 msec. Input 115v 60 cy AC. \$375. Ref: MIT Rad. Lab. Series, Vol. 5, pps. 157-160.

### MIT MODEL 3 PULSER

Output: 144 kw (12 kv at 12 amp.) Duty ratio: .001 max. Pulse duration: .5, 1 and 2 microsec. Input: 115 v 400 to 2000 cps and 24 vdc. \$325 ea. Full desc. Vol. 5, MIT Rad. Lab. series, pg. 140.

#### 250KW HARD TUBE PULSER

Output 16 kv 16 amp. duty cycle .002. Pulses can be coded. Uses 5D21, 715C or 4PR60A. Input 115 v 60 cycle ac. \$1200 ea.

#### 5949 THYRATRON AGING RACK

Compl. Chatham Electronics Console incl. 15 kw power supply & PFN's. \$1800.

## H.V. POWER SUPPLIES

1) 12 kv .75 amps nominal \$1400 ea. 2) 22 kv 100 ma nominal \$2200 ea. Std. 60 cycle inputs.

## MICROWAVE SYSTEMS

### E-4 FIRE CONTROL SYSTEM

Hughes Aircraft X Band. Complete. In stock.

### C-BAND RADAR

250 KW output. C-band, PPI indicator, 5C22 thyatron modulator. Antenna hi gain parabolic section. Input 115 volts 60 cycle AC, complete \$2750.00.

### 300 TO 2400MC RF PKG.

300 to 2400 MC CW. Tuneable. Transmitter 10 to 30 Watts. Output. As new \$475.

### 500KW "L" BAND RADAR

500 kw 1220-1359 mcs. 160 nautical mile search range P.P.I. and A Scopes. MTTI thyatron mod. 5J26 magnetron. Complete system.

### 10 CM. WEATHER RADAR SYSTEM

Raytheon, 275 KW output S Band. Rotating yoke P.P.I. Weather Band. 4, 20 and 80 mile range. 360 degree azimuth scan. Price \$975 complete.

### 10KW 3 CM. X BAND RADAR

Complete RF head including transmitter, receiver, modulator. Uses 2I42 magnetron. Fully described in MIT Rad. Lab. Series Vol. I, pps. 616-625 and Vol. II, pps. 171-185. \$375. Complete System \$750.

### 50KW 3 CM RADAR

Airborne radar. 50 kw output using 725A magnetron. Model 3 pulser. 30-in. parabola stabilized antenna. PPI scope. Complete system. \$1200 each. New.

### 100KW 3CM. RADAR

Complete 100 kw output airborne system with AMTI, 5C22 thyr. mod. 4J52 magnetron, PPI. 360 deg az sweep, 60 deg. elev. sweep, gyro stabilizer, hi-gain revr. Complete with all plugs and cables.

### M-33 AUTO-TRACK RADAR SYSTEM

X band with plotting board, automatic range tracking, etc. Complete with 1 megawatt acq. radar.

### 400 CYCLE SOURCE

Output: 115v 400 cycle 1 ph 21.7 amps cont. duty input: 208v 60 cycle 3 ph. req. 30v dc static exc. New. \$325 ea.

### 3KW RCA PHONE & TELEG XMTR

2-30 MC. 10 Autotone channels plus MO. Input 220 vac. 50/60 cycles.

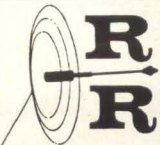

**Radio-Research Instrument Co.**

550 5th Ave. New York 36, N.Y.  
Tel. JUdson 6-4691

CIRCLE 955 ON READER SERVICE CARD

# SEARCHLIGHT SECTION

Classified Advertising

BUSINESS OPPORTUNITIES

EQUIPMENT - USED or RESALE

### DISPLAYED

The advertising is \$27.25 per inch for all advertising other than on a contract basis. AN ADVERTISING INCH is measured 7/8" vert. on a column, 3 cols.—30 inches—to a page. EQUIPMENT WANTED or FOR SALE ADVERTISEMENTS acceptable only in Displayed Style.

Send NEW ADVERTISEMENTS or Inquiries to Classified Adv. Div. of Electronics, P. O. Box 12, N. Y. N. Y. 10036

### RATES

\$2.70 a line, minimum 3 lines. To figure ad- vance payment count 5 average words as a line. BOX NUMBERS count as one line additional. DISCOUNT of 10% if full payment is made in advance for four consecutive insertions.

### UNDISPLAYED

## ARROW

### FREIGHT FORWARDERS

Sub. of LIFSCHULTZ TRANSPORT, Inc.

## FASTEST COAST TO COAST

5th & 6th DAY EAST COAST TO CAL., ARIZ., NEV., ORE. and WASH.

7th DAY TO EAST COAST from CAL., ARIZ., NEV., ORE. and WASH.

Specialists in Shipment of Electronics Products  
Call for information

NEW YORK — PHILADELPHIA  
BALTIMORE — BOSTON — NEW JERSEY  
HOLYOKE — NEW HAVEN — PROVIDENCE  
LOS ANGELES — SAN FRANCISCO — SEATTLE

CIRCLE 950 ON READER SERVICE CARD

## FREE Catalog OF THE WORLD'S FINEST ELECTRONIC GOV'T SURPLUS BARGAINS



HUNDREDS OF TOP QUALITY ITEMS — Receivers, Transmitters, Microphones, Inverters, Power Supplies, Meters, Phones, Antennas, Indicators, Filters, Transformers, Amplifiers, Headsets, Converters, Control Boxes, Dynamotors, Test Equipment, Motors, Blowers, Cable, Keys, Chokes, Handsets, Switches, etc., etc. Send for Free Catalog—Dept. E-4.

**FAIR RADIO SALES**  
2133 ELIDA RD. • Box 1105 • LIMA, OHIO

CIRCLE 951 ON READER SERVICE CARD

OVER 2,000,000

## RELAYS IN STOCK!

Send for Catalog 55  
**Universal RELAY CORP.**  
42 WHITE ST., N.Y. 13, N.Y. • WAlker 5-6900

CIRCLE 952 ON READER SERVICE CARD

## ENGINEERS TECHNICAL MANAGEMENT SCIENTISTS

Computer usage means greater job efficiency, higher pay, more rapid advancement, prestige positions. Learn computer fundamentals and FORTRAN (the universal language of engineering and science). Professional home study course by qualified experts. Student problems executed on commercial IBM computer. Very reasonable fee. Nonprofit corporation. Free details. Computer Department, ESRI Corporation, Box 13281, Phoenix 2, Arizona.

CIRCLE 953 ON READER SERVICE CARD

## INDUSTRIAL—RECEIVING SPECIAL PURPOSE TUBES

BEST QUALITY—LOWEST PRICES  
Semiconductors—All Types

FREE CATALOG—write

ROBERT G. ALLEN CO.

P.O. Box 1882 Dept. E-1, Beverly Hills, Calif. 90213  
Phone (213) 657-1583

CIRCLE 954 ON READER SERVICE CARD

## Antique

### TELEPHONES

As is complete, decorative purpose \$17.50. Working order, inter-comm. \$19.50 Ext. on dial \$24.50, talking circuit only. Write for complete list. All shipments FOB, Simpson, Pa.

TELEPHONE ENGINEERING CO.  
Dept. E-9214, Simpson, Pa.

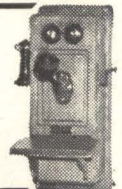

CIRCLE 956 ON READER SERVICE CARD

## EMPLOYMENT OPPORTUNITIES:

for all employment advertising including Positions Vacant or Wanted and Selling Opportunities Offered or Wanted.

## SEARCHLIGHT SECTION:

A national medium for Surplus New or Used Equipment and other Business Opportunities.

## PROFESSIONAL SERVICES:

A dignified method for Specialized consultant skills and services.

## BENEFIT YOURSELF BY ADVERTISING IN THESE SECTIONS

For Rates and Information Write:

## Electronics

Classified Advertising Div.,

P.O. Box 12, New York, 10036



# SEARCHLIGHT EQUIPMENT LOCATING SERVICE

## No Cost or Obligation

This service is designed to help you, the reader of SEARCHLIGHT SECTION, to locate used or rebuilt equipment not currently advertised.

**HOW TO USE:** Check the ads in this SEARCHLIGHT SECTION to see if what you want is advertised. If not, print clearly the specifications of the equipment and/or components wanted on the coupon below, or on your own letterhead.

**THIS IS A SERVICE TO OUR READERS. THIS PUBLICATION DOES NOT BUY, SELL OR STOCK EQUIPMENT OR MATERIALS OF ANY TYPE.** Your requirements will be brought promptly to the attention of the used equipment dealers advertising in this section. You will receive replies directly from them.

Obviously, the list of such advertisers is limited by comparison with the over 63,000 subscribers to ELECTRONICS, all directly engaged in the electronics industry. A small "EQUIPMENT WANTED" advertisement in the SEARCHLIGHT SECTION will bring your needs to the attention of ALL who read ELECTRONICS. The cost is low.

### SEARCHLIGHT EQUIPMENT LOCATING SERVICE

CLASSIFIED ADVERTISING

c/o Electronics

P. O. Box 12, N. Y., N. Y. 10036

Please help us to locate the following used equipment:

.....

.....

NAME .....

TITLE .....

COMPANY .....

STREET .....

CITY .....ZONE .....

STATE .....9/21/64

# INDUSTRIAL ELECTRON TUBES

0A2.....	.75	4CX300A.....	35.00	12AU7WA.....	1.35	807W.....	2.50	5777.....	100.00
0A2WA.....	1.50	4D32.....	12.50	12AX7W.....	1.15	809.....	5.00	5778.....	100.00
0A3.....	.85	4E27.....	10.00	12AY7.....	1.10	810.....	18.85	5787.....	1.25
0B2.....	.65	4J50.....	80.00	12SA7GT.....	1.00	811.....	2.25	5800.....	6.00
0B2WA.....	1.25	4J52.....	50.00	12SK7Y.....	1.00	811A.....	4.50	5803.....	4.00
0B3.....	.90	4J63.....	100.00	12SY7.....	1.00	812A.....	4.50	5814WA.....	1.25
0C3.....	.60	4PR60A.....	50.00	X-13.....	225.00	813.....	14.75	5825.....	12.50
0D3.....	.50	4X150A.....	11.75	C16J.....	30.00	814.....	4.00	5829WA.....	1.35
0D3.....	10.00	4X250B.....	22.50	HK-24.....	4.00	815.....	4.00	5836.....	35.00
1AD4.....	2.00	5ABP1.....	20.00	25T.....	8.50	816.....	2.50	5837.....	35.00
1AE4.....	1.25	5BP1A.....	15.00	26A7GT.....	3.00	826.....	12.50	5840.....	1.50
1B24A.....	10.00	5C22.....	17.50	26Z5W.....	1.25	828.....	17.50	5841.....	3.50
1B35A.....	2.50	5CP1.....	5.00	28D7W.....	3.50	829B.....	10.00	5845.....	3.50
1B63A.....	10.00	5CP1A.....	10.00	35T.....	10.00	832A.....	7.50	5854.....	.50
1D21/SN4.....	6.00	5J26.....	50.00	83.....	1.25	833A.....	38.75	5876A.....	13.00
1K1.....	5.50	5LP1.....	12.50	KU-99.....	16.50	837.....	3.50	5879.....	1.25
1P21.....	32.50	5R4GY.....	1.35	1010.....	1.00	838.....	5.00	5886.....	4.00
1P28.....	16.50	5R4WGB.....	5.00	101F.....	2.25	842.....	7.50	5894.....	16.75
1Z2.....	3.50	5R4WGY.....	2.50	101L.....	2.25	845.....	15.00	5899.....	1.50
2-01C.....	12.50	5RP1A.....	30.00	FG-105.....	25.00	849.....	50.00	5906.....	3.00
2APIA.....	8.50	5Y3WGT.....	1.35	242C.....	15.00	851.....	75.00	5915.....	.95
2AS15A.....	6.00	6AC7W.....	.75	249B.....	10.00	866A.....	2.00	5927.....	15.00
2BP1.....	10.00	6AG7Y.....	1.25	249C.....	8.85	872A.....	5.00	5931.....	2.50
2C39A.....	10.00	6AH6WA.....	3.00	250R.....	15.00	884.....	1.35	5948/1754.....	50.00
2C40.....	10.00	6AJ5.....	1.00	250TH.....	28.50	902A.....	5.00	5949/1907.....	75.00
2C43.....	10.00	6AK5W.....	1.00	251A.....	35.00	913.....	15.00	5963.....	.90
2C51.....	1.00	6AK5WB.....	2.50	259A.....	2.50	920.....	2.00	5964.....	.75
2C53.....	7.50	6AL5W.....	.60	V-262.....	200.00	923.....	1.75	5965.....	.60
2D21.....	.75	6AM6.....	1.55	262B.....	3.50	927.....	2.00	5993.....	4.00
2D21W.....	1.00	6AN5.....	1.50	FP-265.....	15.00	931A.....	5.00	6012.....	4.00
2E24.....	3.50	6AQ5W.....	1.00	271A.....	12.50	959.....	1.00	6080.....	2.65
2E26.....	3.00	6AR6.....	.75	274A.....	2.50	R-1130B.....	12.00	6080WA.....	4.00
2J42.....	60.00	6AS6W.....	1.25	275A.....	5.00	1603.....	3.75	6080WB.....	10.00
2J51.....	50.00	6AS7G.....	2.00	276A.....	7.50	1613/6F6.....	1.25	6082.....	3.35
2J55.....	70.00	6AU6WA.....	1.00	279A.....	175.00	1614/6L6.....	2.00	6115A.....	50.00
2K22.....	25.00	6AW6W.....	1.25	287A.....	2.50	1619.....	.50	6130/3C45.....	6.50
2K25.....	12.50	6B4G.....	4.50	300B.....	4.50	1620/6J7.....	3.50	6146.....	2.75
2K26.....	25.00	6BA6W.....	.85	304TH.....	35.00	1624.....	1.00	6146A.....	3.75
2K28.....	20.00	6BE6W.....	1.25	304TL.....	35.00	1625.....	.75	6146B/8298A.....	4.25
2K29.....	25.00	6BF7W.....	1.75	310B.....	5.00	1655/65C7.....	.85	6146W/7212.....	4.75
2K33A.....	200.00	6BH6W.....	2.75	311A.....	5.00	2050.....	1.35	6159.....	3.75
2K41.....	20.00	6BL6.....	20.00	328A.....	5.00	ZB-3200.....	200.00	6161.....	50.00
2K44.....	85.00	6BM6A.....	25.00	348A.....	3.50	5545.....	20.00	6197/6CL6.....	1.25
2P21.....	25.00	6C4WA.....	.85	349A.....	3.50	5550/415.....	35.00	6216.....	2.25
2X2A.....	1.35	6C21.....	35.00	350B.....	3.50	5557/FG-17.....	4.50	6236.....	95.00
3B4.....	1.50	6D4.....	1.00	352A.....	10.00	5559/FG-57.....	7.50	6252.....	16.50
3B24 (WE).....	1.00	6DJ8.....	1.85	355A.....	7.50	5560/FG-95.....	16.50	6293.....	4.50
3B24W.....	3.50	6F4.....	3.50	371B.....	2.50	5586.....	150.00	6299.....	37.50
3B25.....	3.00	6GJ.....	7.50	403B.....	3.00	5639A.....	2.50	6316.....	50.00
3B28.....	3.00	6J4.....	2.00	404A.....	5.00	5642.....	2.00	6336.....	6.50
3C22.....	30.00	6J4WA.....	2.50	407A.....	3.75	5647.....	3.00	6336A.....	9.75
3C23.....	4.00	6J6W.....	.85	408A.....	2.25	5651.....	.85	6360.....	4.00
3C24.....	4.00	6L6.....	7.50	416B.....	17.50	5654/6AK5W/ 6096.....	1.50	6386.....	6.00
3C45.....	6.00	6L4.....	2.50	417A.....	6.00	6096.....	1.50	6390.....	80.00
3CX100A5.....	12.50	6L6GAY.....	1.15	420A.....	3.00	5667/889RA.....	150.00	6442.....	17.50
3D21WA.....	10.00	6L6WGB.....	2.00	GL-434A.....	25.00	5670.....	1.00	6528.....	9.00
3D22.....	7.50	6Q5G.....	3.50	450TH.....	47.50	5672.....	1.10	6550.....	3.50
3DP1A.....	5.00	6SA7WGT.....	2.00	450TL.....	50.00	5675.....	4.50	6678/6UBA.....	1.35
3E29.....	10.00	6SA7Y.....	1.50	VA-508.....	350.00	5678.....	1.50	6700.....	30.00
3GP1.....	3.50	6SJ7WGT.....	1.35	QK-531.....	45.00	5686.....	1.75	6807.....	20.00
3CJ/A.....	10.00	6SJ7Y.....	.85	QK-532.....	45.00	5687.....	1.00	6829.....	3.00
3J21.....	125.00	6SK7Y.....	.85	QK-549.....	45.00	5687WA.....	2.50	6879.....	8.35
3KP1.....	9.75	6SL7WGT.....	1.25	575A.....	15.00	5691.....	4.50	6883.....	3.00
3RP1.....	8.50	6SN7W.....	.65	673.....	15.00	5692.....	3.00	6893.....	3.25
3WP1.....	15.00	6SN7WGT.....	1.15	677.....	45.00	5693.....	3.00	6939.....	7.50
4-65A.....	10.00	6SU7GT.....	1.00	BL-696.....	30.00	5696.....	1.00	7077.....	18.85
4-125A.....	25.00	6V6GT.....	1.00	715B.....	4.00	5702WA.....	2.50	7167.....	1.30
4-250A.....	27.50	6X4W.....	.70	715C.....	25.00	5703WA.....	2.50	7586.....	2.50
4-400A.....	38.00	6X5WGT.....	.85	719A.....	15.00	5704.....	1.50	7895.....	2.50
4-1000A.....	75.00	6Y6.....	.75	721B.....	5.00	5718A.....	.75	8002R.....	25.00
4B31.....	15.00	7C24.....	150.00	725A.....	25.00	5719.....	.65	8008.....	6.00
4C35.....	17.50	7MP7.....	25.00	BL-800.....	25.00	5721.....	70.00	8013A.....	5.00
4C35A.....	22.50	10KP7.....	25.00	803.....	6.50	5751.....	1.15	8121.....	17.50
4CX250B.....	25.00	10WP7.....	25.00	804.....	10.00	5762/7C24.....	150.00	9003.....	2.00
4CX250K.....	50.00	12AT7WA.....	1.15	805.....	10.00	5763.....	1.50	9005.....	3.50

ALL TUBES ARE UNUSED, INDIVIDUALLY CARTONED, FULLY GUARANTEED

## western engineers

TELEX or TWX:  
916-881-3061  
Telephone:  
916-685-9582

ELK GROVE, CALIFORNIA  
SUPPLIERS OF ELECTRON TUBES SINCE 1932

Prices FOB  
Min order \$10

CIRCLE 957 ON READER SERVICE CARD

# Mr. Used Equipment Dealer:

When you advertise in the Searchlight Section . . .  
You have hired your most persuasive salesman:

He's efficient . . . He thrives on long hours . . . His territory is the entire nation . . . and overseas . . . He doesn't see buyers of used and new surplus equipment: They see him—regularly. They depend on him. He is Searchlight—The section of this publication where wise dealers advertise and list their stocks for sale.

## SEARCHLIGHT SECTION

Classified Advertising Div.  
Post Office Box 12, New York, New York 10036

# Electronics advertisers

September 21, 1964



■ AMP Inc.	37	■ Mitsumi Electric Co., Ltd.	125
Garceau, Hargrave & McCullough Inc.		Dentsu Advertising Ltd.	
■ Acme Electric Corp.	107	■ Moseley, F.L.	1
Scheel Adv. Agency		L.C. Cole Company Inc.	
Adage Inc.	116	■ Motorola Semiconductor Product Inc.	108
Fuller & Smith & Ross Inc.		Lane & Bird Adv. Inc.	
Air Express Div. of REA Express	43	Natvar Corporation	127
Ketchum, Macleod & Grove Inc.		Sanger-Funnel Inc.	
American Electronic Laboratories Inc.	113	■ North Atlantic Industries, Inc.	101
Benn Associates		Murray Heyert Associates	
Astrodate Inc.	11	■ North Carolina Dept. of Conservation & Development	23
Bonfield Associates, Inc.		Bennett Advertising Inc.	
Buchanan Electrical Products Corp.	93	Paktron Div. Illinois Tool Works Inc.	104, 105
Keyes, Martin & Company		Raymond E. Finn & Associates	
Burroughs Corp. Electronics Components Div.	9	■ Pennsalt Chemicals	51
Conti Adv. Agency, Inc.		Aitkin-Kynett Co., The	
CTS Corporation	111	■ Perfection Mica Co., Magnetic Shield Div.	118
Burton Browne Adv.		Burton Browne Advertising	
■ Clare & Company, C.P.	40, 41	■ Polaroid Corporation	96
Reincke, Meyer & Finn Adv.		Doyle, Dane, Bernbach Inc.	
■ Clarostat Mfg. Co.	39	■ Porter Electronic Laboratories	110
Lescarboura Advertising Inc.		Conti Adv. Agency, Inc.	
■ Cohu Electronics, Kin Tel Div.	3rd Cover	■ Princeton Applied Research Corp.	120
Erwin Wasey, Ruthrauff & Ryan		Mort Barish Associates	
■ Cominco Products Inc.	114	■ Radiation Inc.	50
McKim Adv. Limited		G.M. Basford Company	
■ Communication Electronics Inc.	125	■ Radio Corporation of America	4th Cover
Compagnie Generale D'Electro Ceramique	138	Al Paul Lefton Co.	
Termon Technique		■ Reeves Hoffman, Div. of Dynamics Corp. of America	24
■ Consolidated Electrodynamics Corp.	53	Adams Associates, Inc.	
Hixson & Jorgensen, Inc.		■ Research-Cottrell Inc.	114
■ Coto Coil	129	Michel Cather, Inc.	
The Williams Company		■ Rome Cable, Div. of Alcoa	52
■ Dage Electric Co., Inc.	42	The Rumrill Co. Inc.	
La Grange & Garrison Inc.		■ Rosemount Engineering Co.	117
■ Data Instruments, Div. of Industrial Electronic Hardware Corp.	119	Midland Associates, Inc.	
A. D. Adams Advertising Inc.		■ Sanborn Co., a Sub. of Hewlett-Packard Co.	2
■ DuPont de Nemours & Co. Inc., E.I.	49, 92	Culver Adv., Inc.	
Batten Barton Durstine & Osborn		■ Speer Carbon Company	26
■ Dynage, Incorporated	129	Hazard Advertising Co. Inc.	
The F.W. Prelle Co.		■ Sprague Electric Co.	5, 6, 10
■ Electro Instruments Inc.	94	The Harry P. Bridge Co.	
Teawell Inc. Adv.		■ Synthane Corp.	136
■ Elgett Optical Co., Inc.	136	Arndt, Preston, Chapin, Lamb & Keen Inc.	
Hutchins Adv. Co., Inc.		■ Syntronic Instruments, Inc.	118
■ Executone Inc.	124	Burton Browne Adv.	
J.A. Richards		Texas Instruments Incorporated	
Fairchild Semiconductor	14, 19, 22	Industrial Products Group	102, 103
Johnson & Lewis Inc.		Robinson-Gerrard, Inc.	
■ Friedrich & Dimmock, Inc.	130	Texas Instruments Incorporated	
Wyble Advertising		Metals & Controls, Inc.	126
■ General Electric Co., Silicone Products Dept.	54	Horton, Church & Goff, Inc.	
Ross Roy Inc.		Texas Instruments Incorporated	
■ Globe Industries Inc.	112	Semiconductor-Components Division	12, 13
Odiorne Industrial Adv. Inc.		Don L. Baxter	
■ Graphic Systems Inc.	137	■ Thermal American Fused Quartz Co. Inc.	124
Caswell Adv. Agency		Kniep Associates	
■ Heath Company	136	■ Tower Communications Co.	115
Advance Advertising Service Inc.		McCarty Co.-Rice, Inc.	
■ Hewlett Packard Co.	44, 45	■ Trygon Electronics Inc.	30
L.C. Cole Company, Inc.		Carpenter, Matthews & Stewart, Inc.	
■ Howcor Lamination Division of Howard Industries Inc.	122	United Aircraft Corp., Norden Div.	95
Bachrodot, Newell, O'Kane and Gano		Cunningham & Walsh Inc.	
■ Hughes Aircraft Company	133, 134	■ United Transformer Corp.	2nd Cover
Foot, Cone & Belding		Bradley, Rosen & Kaus Adv., Inc.	
Industrial Control Co.	137	■ Unirode Corporation	7
Connolly Associates, Inc.		Chirurg & Cairns Inc.	
International Instruments, Inc.	123	Westinghouse Electric Corp.	132
Thomas R. Sundheim Inc.		I T S M	
■ International Rectifier Corp.	46	■ Weston Instruments & Electronics, a div. of Daystrom Inc.	28, 29
Communication Associates		G.M. Basford Co.	
■ Kyoritsu Electrical Instrument Works, Ltd.	138	Xerox Corporation	91
Nichiden Adv. Ltd.		Papert, Koenig, Lois Inc.	
■ Lambda Electronics Corp.	35	Classified advertising	
Michel Cather, Inc.		F. J. Eberle, Business Mgr.	
■ Lapp Insulator Co., Inc.	121	Professional services	140
Wolf Associates, Inc.		Employment opportunities	140-141
■ Lepel High Frequency Laboratories Inc.	132	Equipment	
Apex Graphic Company		(Used or Surplus New)	
■ Linde Division of Union Carbide Corp.	131	For sale	141-142
J.M. Mathes Incorporated		Classified advertisers index	
■ Linen Thread Co.	132	Albano Co. Inc.	140
Robert Luckie Adv.		Allen Co. Robert G.	142
■ Machlett Laboratories Inc., The	8	Arrow Freight Forwarders	142
Fuller & Smith & Ross Inc.		ESRI Corp.	142
■ Marconi Instruments	124	■ Fair Radio Sales	142
Armand Richards Adv. Agency		General Electric, Appollo Support Dept.	142
■ McGraw-Hill Book Co. Inc.	135	Motorola Military Electronic Division	140
Mepeco, Inc.	16	Prestolite	140
Ray Ellis Adv., Inc.		■ Radio Research Instrument Co.	142
■ Milo Electronics Corp.	27	Telephone Engineering Co.	142
Industrial Marketing Associates		■ Universal Relay Corp.	142
Div. of J.M. Schrier, Inc.		■ Western Engineers	143
■ Minnesota Mining & Mfg. Co., Mincom Division	25		
Reach, McClinton & Co., Inc.			

## Advertising sales staff

**Gordon Jones:** [212] 971-2210  
Advertising sales manager

**Atlanta, Ga. 30309:** Gus H. Krimsier, Michael H. Miller, 1375 Peachtree St. N.E., [404] TR 5-0523

**Boston, Mass. 02116:** William S. Hodgkinson, McGraw-Hill Building, Copley Square, [617] CO 2-1160

**Chicago, Ill. 60611:** Robert M. Denmead, Daniel E. Shea, Jr., 645 North Michigan Avenue, [312] MO 4-5800

**Cleveland, Ohio 44113:** Paul T. Fegley, 55 Public Square, [216] SU 1-7000

**Dallas, Texas 75201:** Dick Poole, The Vaughn Building, 1712 Commerce Street, [214] RI 7-9721

**Denver, Colo. 80202:** John W. Patten, David M. Watson, Tower Bldg., 1700 Broadway, [303] AL 5-2981

**Houston, Texas 77025:** Kenneth George, Prudential Bldg., Halcombe Blvd., [713] RI 8-1280

**Los Angeles, Calif. 90017:** Ashley P. Hartman, John G. Zisch, 1125 W. 6th St., [213] HU 2-5450

**New York, N.Y. 10036:** Donald R. Furth [212] 971-3616  
Frank LeBeau [212] 971-3615  
George F. Werner [212] 971-3617  
500 Fifth Avenue

**Philadelphia, Pa. 19103:** William J. Boyle, Warren H. Gardner, 6 Penn Center Plaza, [215] LO 8-6161

**San Francisco, Calif. 94111:** James T. Hauptli, 255 California Street, [415] DO 2-4600

**London W1:** Edward E. Schirmer, 34 Dover Street, Hyde Park 1451

**Frankfurt/Main:** Matthee Herfurth, 85 Westendstrasse Phone: 77 26 65 and 77 30 59

**Geneva:** Michael R. Zeynel, 2 Place du Port 244275

**Paris VIII:** Denis Jacob, 17 Avenue Matignon ALMA-0452

**Tokyo:** Nobuyuki Sato  
Shiba, Minato-ku (502) 0656

**Osaka:** Kazutaka Miura, 163, Umegae-cho, Kita-ku [362] 8771

**Nagoya:** International Media Representatives, Yamagishi Bldg., 13-2-Chome, Oike-cho Naka-ku

**R.S. Quint:** [212] 971-2335  
General manager  
Electronics Buyers' Guide

**David M. Tempest:** [212] 971-3139  
Promotion manager

**Milton Drake:** [212] 971-3485  
Market research manager

**Richard J. Tomlinson:** [212] 971-3191  
Business manager

**Theodore R. Geipel:** [212] 971-2044  
Production manager

■ For more information on complete product line see advertisement in the latest Electronics Buyers' Guide

## Why settle for too little or pay for too much in a digital voltmeter?

...now you can get  
exactly what you need at a  
sensible price from KIN TEL

These eight KIN TEL instruments, plus off-the-shelf accessories, meet every known requirement for digital voltmeters. This means you no longer have to over- or under-buy. You just select the one instrument that delivers the exact degree and combination of speed, accuracy, stability, adaptability, range, and reliability your particular applications call for.

**Militarized Digital Voltmeter (Model 412).** Rugged, programmable, differential input. Auto ranging, displays polarity. Measures AC and  $\pm$ DC potentials between 0.001 and 999.9 volts. Accuracy is 0.01% (of reading)  $\pm 1$  digit for DC, 0.1% of full scale for AC. Designed to MIL-E-4158A. Ideal for use in automatic systems. Price, in quantities of five or more: \$10,000.

**DC Digital Voltmeter (Model 864A).** New! High speed, solid state, programmable, modular construction. Measures 0.000 to  $\pm 999.9$  volts to an accuracy of 0.02% of full scale  $+0.01\%$  of reading ( $23^{\circ}\text{C} \pm 1^{\circ}$ ) or 0.05% of full scale ( $10^{\circ}\text{C}$  to  $40^{\circ}\text{C}$ ) within approximately 0.02 second — within 0.005 second when programmed to any single range scale. Bidirectionally follows inputs changing as fast as 10 volts per second on the low range, 100 volts per second on the 100-volt range, or 1000 volts per second on the high range. Has electrical outputs for BCD, BCD excess-3, or 10-line parallel signals which are accessories. Price: From \$3180.

**AC/DC Digital Voltmeter/Ratiometer (Model 551).** New! First to bring you 5-readings-per-second speed with mercury-wetted relays. Full 5-digit, measures DC from 0.0000 to  $\pm 999.99$  volts to an absolute accuracy within 0.005% of full scale  $+0.005\%$  of reading, AC from 30 to 10 kc between 0.0000 and 999.99 volts to an accuracy within 0.05% of full scale  $+0.05\%$  of reading. Ratio accuracy is 0.005% of full scale  $+0.001\%$  of reading. Adaptable without modification to fit a variety of data-logging systems. Ideal for laboratory use. Accessories include projection readout, BCD mercury-relay output, 10-line mercury-relay output, and AC converter. Price (without optional visual readout) for the basic 5-digit instrument with buffer register and auto/manual/command range: \$4150.

**DC Digital Voltmeter and Ratiometer (Model 507D).** Measures voltages between  $\pm 100$  microvolts and  $\pm 1000$  volts, ratios between  $\pm 0.0001:1$  and  $\pm 999.9:1$  with 0.01% (of reading)  $\pm 1$  digit accuracy. Accessories permit AC/DC and AC/AC ratio measurements. Stepping switches guaranteed for 2 years. Price: \$3835.

**DC Digital Voltmeter (Model 501B).** Four-digit, fifth-digit over-ranging. Measures DC between  $\pm 100$  microvolts and  $\pm 1000$  volts, with 0.01% (of reading)  $\pm 1$  digit accuracy. Automatic or programmable range; auto polarity. Combines the useful accuracy of a 5-digit voltmeter with the price advantage of a 4-digit voltmeter. Stepping switches guaranteed for 2 years. Price: \$2995.

**DC Digital Voltmeter (Model 501BZ).** Similar to Model 501B (see above). Circuit is automatically and continually calibrated against a Zener diode reference source instead of against an unsaturated mercury-cadmium standard cell. For submarine and other special environment applications. Price: \$3160.

**AC/DC Digital Voltmeter (Model 502B).** Gives you AC accuracy within 0.1% of reading; over-ranging on both AC and DC; automatic ranging and remote (programmable) control. Measures DC between  $\pm 100$  microvolts and  $\pm 1000$  volts, AC from 30 cps to 10 kc between 1 millivolt and 1000 volts. Five-digit readout. Stepping switches guaranteed for 2 years. Price: \$4245.

**AC/DC Digital Voltmeter (Model 502BZ).** Similar to the Model 502B (see above). Circuit is automatically and continually calibrated against a Zener diode reference source instead of against an unsaturated mercury-cadmium standard cell. Price: \$4410.

*Write for detailed literature or a demonstration of any of these exceptional instruments. Representatives in all major cities. All prices FOB, San Diego, Calif. (Additional export charge.)*

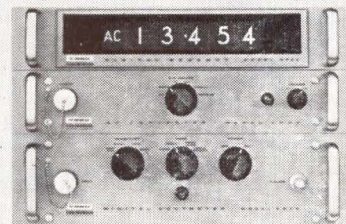
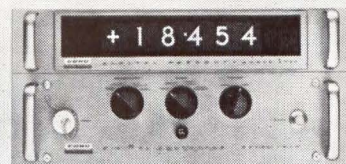
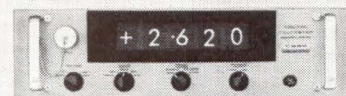
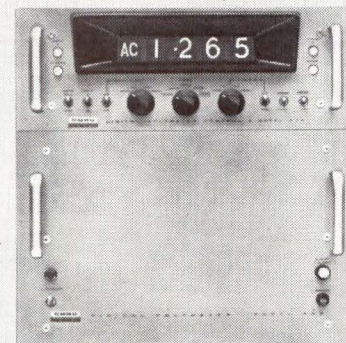

Box 623  
San Diego, California 92112  
Phone (714) 277-6700

**COHU**  
ELECTRONICS, INC  
KIN TEL DIVISION

Circle 901 on reader service card



## RCA-C22001

### A NEW SHORT, HIGH-RESOLUTION SCAN-CONVERSION TUBE

The compact Developmental Type RCA-C22001 is specifically designed for high reliability in airborne systems requiring unusually high resolution. An original RCA concept already demonstrated successfully, the C22001 offers numerous benefits. Check them for yourself.

**Resolution**—Over 400 range markers per display radius at 50% response.

**Size**—16 inches long (even shorter variants are available for applications requiring less resolution; e.g., the Developmental Type C74413 is 13.5 inches long).

**Storage Time**—Adjustable over a wide range to provide signal persistence on the final display of from a fraction of a second to over a minute.

**Environment**—Land, sea, or airborne.

This short scan-converter has application with high resolution Cathode-Ray Tubes in systems requiring alternate display of television and raw radar information. It can be used to store externally-generated symbols for subsequent flicker-free read-out. It provides excellent processing of raw radar with controllable, variable persistence for CRT display with externally-generated digital or symbol information.

Your RCA Representative has complete price and delivery information on the C22001 and other RCA conversion tubes. See him today. For technical data, write: Manager, Conversion Devices, RCA, Lancaster, Pa.

RCA ELECTRONIC COMPONENTS AND DEVICES, HARRISON, N. J.



The Most Trusted Name in Electronics

▪ The maximum collector current ( $I_C$ ) is selected on the basis of the power dissipation and speed compromise desired.

▪ The input diodes must be reverse biased by a minimum voltage  $V_R$  when all inputs are high; therefore, the following conditions must be satisfied:

$$V_{CC} - \frac{V_{LL} \frac{R_F}{R_L} + nI_R R_F + V_{BE}}{1 + \frac{R_F}{R_L}} \geq V_R \quad (1)$$

▪ When all inputs are high, the transistor should be on and saturated, or

$$\frac{V_{LL} - V_{BE}}{R_L + R_F} - \frac{V_{BB} + V_{BE}}{R_B} \geq \frac{I_C}{h_{FE}} \quad (2)$$

▪ When any one of the inputs is low, the transistor must be in a cutoff mode and its base-emitter junction must be reverse-biased by a minimum voltage  $V_B$  (off), or

$$\frac{V_{BB} - I_{BEV} R_B - (V_{CE} + V_F) \frac{R_B}{R_F}}{1 + \frac{R_B}{R_F}} \geq V_{B(\text{off})} \quad (3)$$

▪ When the transistor is on, the maximum collector current is given by

$$I_C = \frac{V_{CC} - V_{CE}}{R_C} + m \left[ \frac{V_{LL} - (V_{CE} + V_F)}{R_L} + (n-1)I_R - \frac{V_{BB} - I_{BEV} R_B + (V_{CE} + V_F)}{R_B + R_F} \right]$$

Therefore, the maximum fanout  $m$  is determined as follows:

$$m = \frac{I_C - \frac{V_{CC} - V_{CE}}{R_C}}{\frac{V_{LL} - (V_{CE} + V_F)}{R_L} + (n-1)I_R - \frac{V_{BB} - I_{BEV} R_B + (V_{CE} + V_F)}{R_B + R_F}} \quad (4)$$

The value of the collector resistance  $R_C$  in equation 4 is selected as a compromise between fanout and speed, because the fall time of the voltage at the collector is almost directly proportional to the collector resistance,  $R_C$ .

The dynamic design of the diode-transistor logic circuit involves the determination of the values for  $C_F$  and  $L_C$ . The capacitance of  $C_F$  is determined by the amount of charge stored in the base region of the transistor, for which it must compensate.<sup>2</sup> The inductance  $L_C$  may be obtained by finding the value necessary for a critically damped output for maximum fanout.<sup>3</sup> The following design equations are used:

$$C_F \geq \frac{Q_s}{V_{CF}} \quad (5)$$

## Symbolism of "worst case" equations

All the values in the design equations on this page are either maximums (bold face) or minimums (light face).

**A** denotes maximum value of quantity **A** where **A** is the nominal or typical value.

## Definition of symbols

$h_{FE}$	— Transistor common emitter dc current gain
$V_{CE}$	— Transistor collector to emitter saturation voltage
$V_{BE}$	— Transistor base to emitter saturation voltage
$I_{BEV}$	— Transistor base cutoff current
$I_C$	— Transistor collector current
$I_B$	— Transistor base current
$V_{B(\text{off})}$	— Transistor base to emitter cutoff voltage
$V_F$	— Diode forward voltage drop
$I_R$	— Diode reverse leakage current
$V_R$	— Diode reverse bias voltage
$V_{CC}$	— Collector supply voltage of DTL circuit
$V_{BB}$	— Base supply voltage of DTL circuit
$V_{LL}$	— Load or diode gate supply voltage of DTL circuit
$R_C$	— Collector resistor of DTL circuit
$R_B$	— Base holdoff resistor of DTL circuit
$R_F$	— Base forward resistor of DTL circuit
$R_L$	— Load or diode gate resistor of DTL circuit
$C_F$	— Speed up capacitor of DTL circuit
$L_C$	— Collector inductance of DTL circuit
$n$	— Circuit fan-in of DTL circuit
$m$	— Circuit fan-out of DTL circuit
$C_e$	— Emitter capacitance of transistor
$C_c$	— Collector capacitance of transistor
$C_s$	— Stray capacitance at base of transistor
$Q_s$	— Total stored charge of transistor
$C_o$	— Output capacitance of a fanout including strays
$C_i$	— Input capacitance at base of transistor
$V_{CF}$	— Voltage across capacitor $C_F$
$V_{n(-)}$	— Negative noise voltage at input of DTL circuit required to cause a change in output
$V_{n(+)}$	— Positive noise voltage at input of DTL circuit required to cause a change in output
$\%NI(-)$	— Percent noise immunity of DTL circuit to negative noise voltage
$\%NI(+)$	— Percent noise immunity of DTL circuit to positive noise voltage
$\%NI$	— Percent noise immunity of DTL circuit to any noise voltage, positive or negative
$t_d$	— Delay time of DTL circuit output
$t_r$	— Rise time of DTL circuit output
$t_s$	— Storage time of DTL circuit output
$t_f$	— Fall time of DTL circuit output
$t_{p(+)}$	— Propagation delay time of positive edge of signal through a pair of DTL circuits
$t_{p(-)}$	— Propagation delay time of negative edge of signal through a pair of DTL circuits

$$L_C \geq \left( \frac{R_C}{2} \right)^2 m C_o \quad (6)$$

where  $Q_s$  is the total stored charge of the transistor,  $V_{CF}$  is the minimum voltage across  $C_F$  consistent with the conditions which establish  $Q_s$ ,

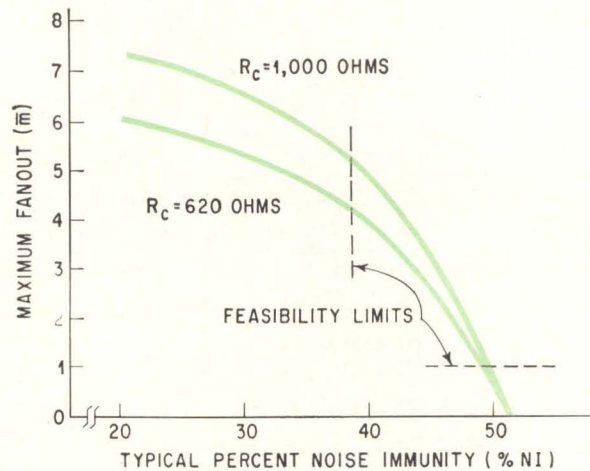
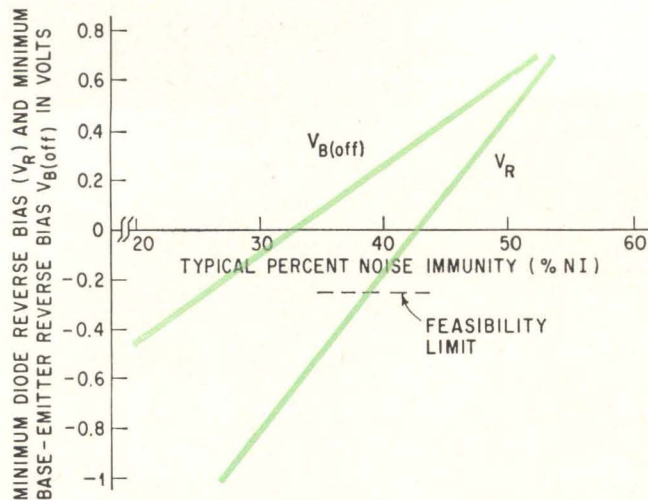

**Design example** of a diode-transistor logic circuit results in the calculation of the minimum reverse bias for the diode and for the base-emitter (left) and the maximum fanout (right) as a function of noise immunity.

and  $C_o$  is the maximum capacitance of a fanout, including strays.

### Optimum immunity to noise

Before noise immunity can be set at the optimum value in a switching circuit, the designer must determine what noise-voltage amplitude at the input is required to cause a change in the output. This amplitude is a function of the transient response of the switching circuit, and of the pulse width or duration of the noise voltage.

It is assumed that the noise voltage is of sufficient duration so that effects of the circuit transient response can be neglected, or, in other words that the noise-voltage duration is no less than the longest turn-on or turn-off time of the switching circuit.

If all inputs are high in the circuit on page 66, any negative noise pulse at any input would tend to turn the transistor off from its on condition; however, a positive noise pulse would have no effect. The amplitude of negative noise that can change an output voltage is determined by the reverse bias  $V_R$  on the input diodes, the amount of forward bias  $V_F$  necessary on an input diode to cause appreciable conduction, and the stored charge  $Q_s$  of the "on" transistor. Thus, for the on condition, the negative noise-voltage amplitude required to cause a change in the output is given by

$$V_n(-) = V_R + V_F + \frac{Q_s}{C_F} \quad (7)$$

When any of the inputs is low, the transistor is off; consequently, only a positive noise pulse at a low input would have any effect on the transistor output. The positive pulse would tend to turn the transistor on. The amplitude of the positive noise voltage required to turn the transistor on is determined by the amount of reverse bias  $V_{B(off)}$  on the base-emitter junction of the transistor, the forward bias  $V_{BE}$  required on the base-emitter junction for

appreciable conduction of base current and the amount of charge stored on the input capacitance at the base ( $C_e + C_c + C_s$ ) through the voltage  $V_{B(off)} + V_{BE}$ . Therefore, for the off condition, the positive noise-voltage amplitude required is given by

$$V_n(+) = V_{B(off)} + V_{BE} + [V_{B(off)} + V_{BE}] \left( \frac{C_e + C_o + C_s}{C_F} \right)$$

or

$$V_n(+) = [V_{B(off)} + V_{BE}] \left( 1 + \frac{C_i}{C_F} \right) \quad (8)$$

It is now possible to define a "percent noise immunity" as the ratio of the noise voltages given in equation 7 and 8 to the normal voltage swing of a true input. A normal input swing would be  $V_{CC} - V_{CE} \cong V_{CC}$ .

Hence, the percent noise immunity may be defined as

$$\%NI(-) = \frac{V_R + V_F + \frac{Q_s}{C_F}}{V_{CC}} \times 100 \quad (9)$$

and

$$\%NI(+) = \frac{[V_{B(off)} + V_{BE}] \left( 1 + \frac{C_i}{C_F} \right)}{V_{CC}} \times 100 \quad (10)$$

It is desirable to have equal noise immunity for both on and off conditions, because the percent noise immunity of a switching circuit is no better than the lowest figure, whether it be negative or positive. Therefore, an essential step in optimizing the design for noise immunity is to make  $\%NI(-) = \%NI(+)$ . Circuits can be designed for a given  $\%NI$  with the help of equations 1 and 3. The value of  $V_R$  selected for equation 1 determines  $\%NI(-)$  because the other factors of equation 9 are constants for a given design. Likewise, the

**Limit values**

**Typical values (25°C)**

$h_{FE}(0^\circ C) = 20$	$I_R(0^\circ C) = .05 \mu amp$	$V_{CE} = .25 V$
$I_{BEV}(125^\circ C) = 10 \mu amp$	$I_R(125^\circ C) = 10 \mu amp$	$V_{BE} = .9 V$
$V_{BE}(0^\circ C) = 1.05 V$	$V_F(125^\circ C) = .7 V$	$V_F = .65 V$
$V_{BE}(125^\circ C) = .8 V$	$V_F(0^\circ C) = .6 V$	$Q_s = 15 pC$
$V_{CE}(125^\circ C) = .45 V$	$n = 15$	$C_i = 5 pF$
$V_{CE}(0^\circ C) = .4 V$		

Tolerance on all resistors and supply voltages =  $\pm 5\%$

value of  $V_{B(off)}$  in equation 3 determines the %NI (+) of equation 10.

Thus, the design can be made not only to obtain %NI (-) = %NI (+), but also to obtain a specific value of %NI.

However, a compromise must be made between %NI and circuit fanout (m). For optimum design, a plot of fanout versus %NI is required. A plot of  $V_R$  and  $V_{B(off)}$  versus %NI is also necessary to determine over which range of %NI these parameters have practical values.

**Design example**

In the following diode-transistor logic circuit, a sample calculation of m,  $V_R$  and  $V_{B(off)}$  is made for a given %NI.

First, a specific transistor and diode are selected. Supply voltages and the current level of the circuit of page 66 are also chosen. After these factors are established, all other constants of the design equations can be found for the given temperature range over which the circuit must operate.

For example, the following design is assumed:

Transistor — 2N2475

Diode — 1N914

Temperature  $0^\circ$  to  $125^\circ C$

Max. Collector Current  $I_C = 22$  milliamperes

Supply Voltages —  $V_{CC} = 5$  volts

$V_{BB} = V_{LL} = 15$  volts

Speed — as fast as possible

The other circuit constants are as shown in the table above.

A value for  $C_F$  is needed because it appears in equations 9 and 10. At this point, a reasonable value for  $C_F$  will be assumed. After the design is completed, this value must be checked to see if it meets the necessary requirements. The sample calculation for one value of %NI is carried out as follows:

Let %NI(-) = %NI(+) = 40%  
and  $C_F = 20$  picofarads (11)

Then equation 9 becomes

$$\frac{V_R + .65 + \frac{15pC}{20pf}}{5} \times 100 = 40 \quad (12)$$

or  $V_R = +0.6$  volt

From equation 10:

$$\frac{[V_{B(off)} + .9 \left(1 + \frac{5pf}{20pf}\right)]}{5} \times 100 = 40 \quad (13)$$

or  $V_{B(off)} = +0.7$  volt

Therefore, equations 1 and 3 on a typical basis at room temperature ( $25^\circ C$ ) become

$$V_R = .6 = 5 - \frac{15 \frac{R_F}{R_L} + .9}{1 + \frac{R_F}{R_L}} V_{B(off)}$$

$$= .7 = \frac{15 - (.25 + .65) \frac{R_B}{R_F}}{1 + \frac{R_B}{R_F}}$$

or

$$\frac{R_F}{R_L} = .330 \quad \text{and} \quad \frac{R_B}{R_F} = 8.95 \quad (14)$$

Also

$$\frac{R_B}{R_L} = \left(\frac{R_F}{R_L}\right) \left(\frac{R_B}{R_F}\right) = 2.95 \quad (15)$$

When solved for  $R_B$  in the worst case at  $0^\circ C$ , equation 2 becomes

$$R_B \geq \frac{17.68(R_F + R_L)}{12.57 - 1.10(R_F + R_L)} \quad (16)$$

but

$$R_F + R_L = \left(\frac{R_F}{R_B} + \frac{R_L}{R_B}\right) R_B$$

$$= \left(\frac{1}{8.95} + \frac{1}{2.95}\right) R_B \quad (17)$$

Substitution of this result in equation 16 and

**The author**



Donald Gipp is a computer-device applications engineer at the Radio Corp. of America, Electronic Components and Devices division in Somerville, N.J. He is a 1959 graduate of the Milwaukee School of Engineering and is doing graduate work at the Stevens Institute of Technology.

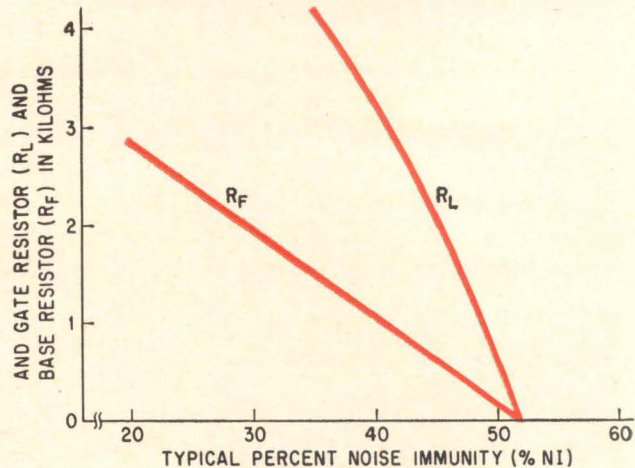
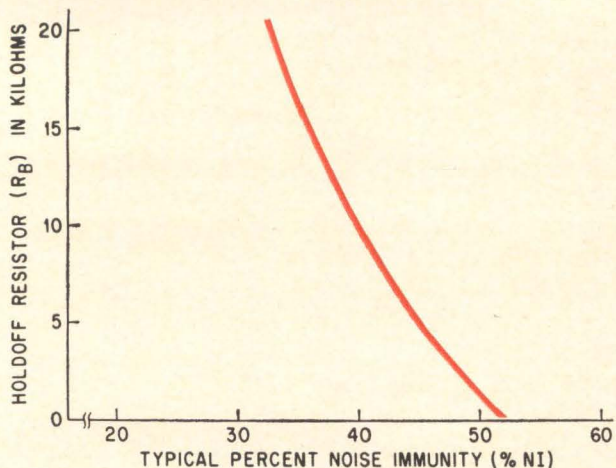

**Holdoff**—gate and base resistor versus percent noise immunity—permits the selection of exact resistor values for any particular fanout and noise immunity.

solving for  $R_B$  yields

$R_B = 9.27$  kilohms. Equations 14 and 15 yield

$$R_F = \frac{9.27}{8.95} = 1.037 \text{ kilohms}$$

$$R_L = \frac{9.27}{2.95} = 3.14 \text{ kilohms} \quad (18)$$

Because the worst case for  $V_R$  and  $V_{B(off)}$  occurs at  $125^\circ\text{C}$ , equations 1 and 3 for worst-case become

$$V_R = 4.75 - \frac{17.4 \frac{R_F}{R_L} + .1575R_F + 0.8}{1 + 1.105 \frac{R_F}{R_L}}$$

or  $V_R = -0.16$  volt

$$V_{B(off)} = \frac{14.25 - .0105R_B - 1.272 \frac{R_B}{R_F}}{1 + 1.105 \frac{R_B}{R_F}} \quad (19)$$

or  $V_{B(off)} = +0.254$  volt

The maximum fanout worst-case conditions occur at  $0^\circ\text{C}$ . Hence, equation 4 becomes

$$m = \frac{22 - \frac{5.1}{R_C}}{\frac{15.53}{R_L} - \frac{14.52 - .01R_B}{R_B + R_F}} \quad (20)$$

For  $R_C = 620$  ohms  $m = 3.88$       For  $R_C = 1000$  ohms  $m = 4.76$

A plot of  $V_R$  and  $V_{B(off)}$  as a function of %NI for repeated calculations of the above analysis is shown on page 68. At  $125^\circ\text{C}$ , the maximum forward bias on the input diodes that can be tolerated without allowing appreciable conduction is 0.25 volt. This is indicated by the dashed line, which shows that a design with %NI less than 38.7% is not feasible.

The maximum fanout  $m$  as a function of %NI is shown on page 68. There are two feasibility limits, one at 38.7% (because of the limit on  $V_R$ ), the other  $m = 1$  (because beyond this point the circuit would have a logical gain of less than one).

Resistor values  $R_B$ ,  $R_F$ , and  $R_L$  may also be plotted against % NI, as shown above. These plots permit the selection of exact resistor values for any particular fanout and noise-immunity compromise that may be chosen for the final design.

The final design was selected to obtain a fanout of four. From the graph on page 68  $R_C$  may be 1,000 ohms to provide noise immunity of about 43%, or 620 ohms, for noise immunity of 39.5%. When  $R_C$  is 620 ohms, however, fall times are possible about 40% faster than those obtained with a value of 1,000 ohms. Therefore, the best compromise is 620 ohms which, from the design curves, gives the following values:

$$\begin{aligned} m &= 4R_C = 620 \text{ ohms} \\ \%NI &= 39.5 \\ R_B &= 9.8 \text{ kilohms} \cong 10 \text{ kilohms} \\ R_F &= 1.09 \text{ kilohms} \cong 1.1 \text{ kilohms} \\ R_L &= 3.25 \text{ kilohms} \cong 3.3 \text{ kilohms} \end{aligned} \quad (21)$$

The approximate values are the nearest standard values of 5% resistors. These approximate values for  $R_B$ ,  $R_F$  and  $R_L$  should then be substituted back into equations 1 through 4 to verify that all design requirements are satisfied for these values.

To complete the design, it is necessary to check the value of  $C_F$  and also to determine the inductance  $L_C$ . For the first step, it is noted that maximum stored charge  $Q_s$  occurs for the condition of maximum base current  $I_B$  and minimum collector current  $I_C$  at the highest operating temperature. The minimum collector current occurs when the fanout is only one. Calculation of these values gives

$$I_B = 1.9 \text{ ma} \quad I_C = 9.2 \text{ ma at } 125^\circ\text{C} \quad (22)$$

For the above conditions on the 2N2475 transistor the maximum stored charge becomes

$$Q_s = 40 \text{ picocoulombs at } 125^\circ\text{C} \quad (23)$$



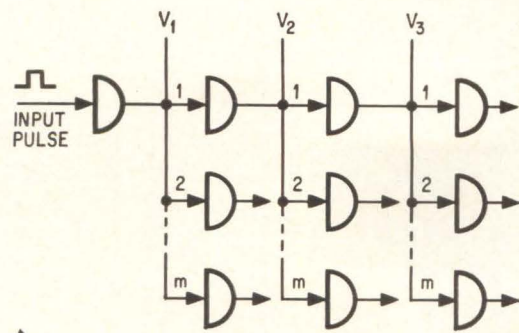

A

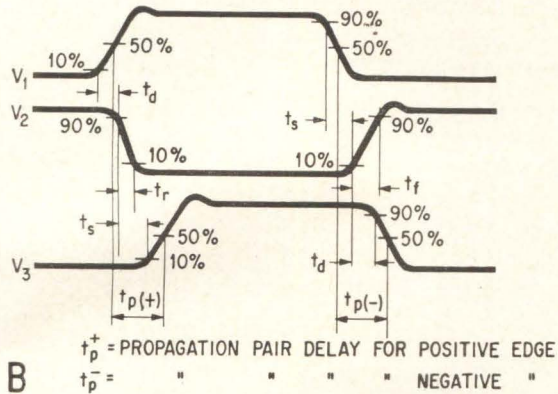

B

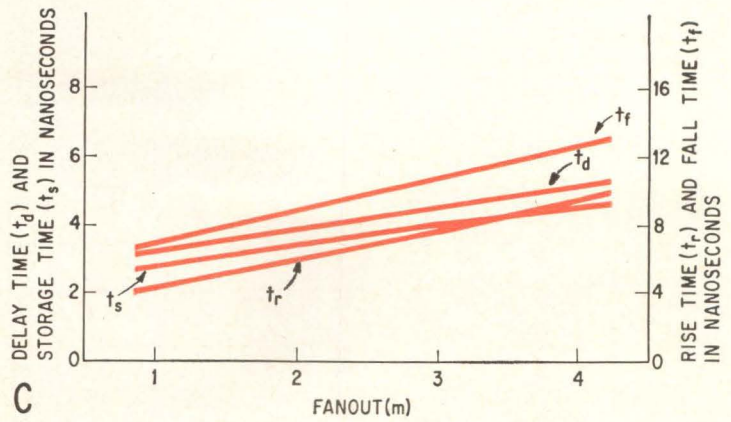

C

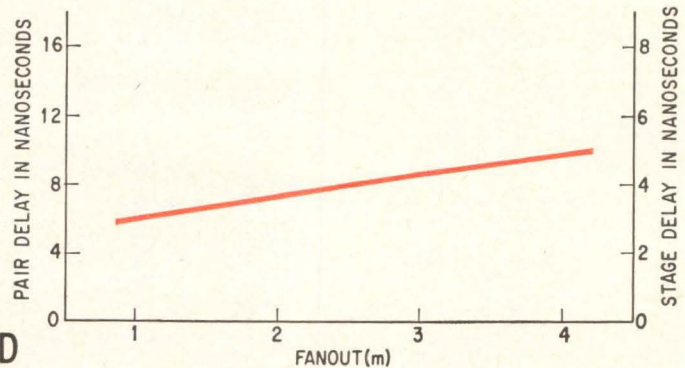

D

Test circuit determines transient responses (A). Delay, rise and storage fall times and propagation delay per pair of stages were measured in (B). The circuit's transient response is given as a function of fanout (C). The stage delay is actually one-half of a pair delay (D).

From equation 5

$$C_F \geq \frac{40pC}{2.35V} \geq 17.0 \text{ picofarads} \quad (24)$$

Hence the selected value,  $C_F = 20$  picofarads, is satisfactory. If  $C_o$  is assumed to be five picofarads, the value of  $L_C$  is obtained from equation 6 as follows:

$$L_C = \left( \frac{1.05 \times 620}{2} \right)^2 (4)(5 \times 10^{-12})$$

$$= 2.1 \text{ microhenries}$$

Therefore,  $L_C$  is selected as 2.4 microhenries.

### Test results

The first test of the diode-transistor logic circuit was the determination of its transient response. The test setup, shape of waveforms and measured transient response times are shown above. Typical delay, rise, storage and fall times, as well as the propagation delay per pair of stages, were measured. The transient response of the circuit is presented as a function of fanout. A stage delay is actually one-half of a pair delay and, in terms of the switching speeds, may be expressed as

$$\text{Propagation delay per stage} = \frac{t_d + t_s}{2}$$

The inductance  $L_C$  in the collector circuits reduced fall times and increased switching speeds and stage delays. When the circuit transient response was checked without any inductance, fall times were about twice as long. Other switching speeds and stage delays were also poorer under these conditions. For a fanout of one, the value of 2.4 microhenries produced about 15% overshoot. For a fanout of four, there was essentially no overshoot.

The test setup for measuring noise immunity is illustrated above. The pulse generator used for simulation of the noise pulse had rise and fall times on one nanosecond. Noise immunity was obtained by measuring the input pulse amplitude required for a one-volt change at the output of the circuit. This measurement was made for pulse widths of 2 to 20 nanoseconds. Both %NI (+) and %NI (-) were obtained for fanouts of one and four.

The curves show that the noise immunity is lowest when the fanout is minimum. This is because the transient response of the circuit is fastest when the fanout is smallest.

The dependence of noise immunity on the noise-voltage duration (p. 72) level off for noise durations greater than 10 nanoseconds. This decrease is due to the fact that the noise duration is now longer

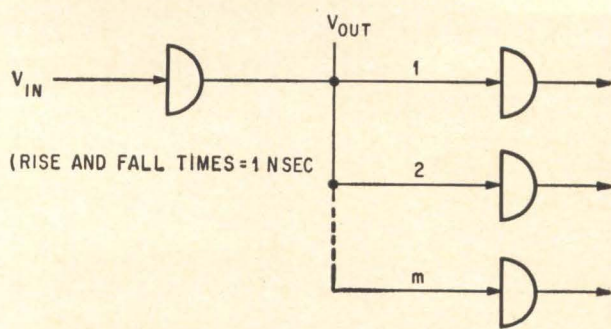

A

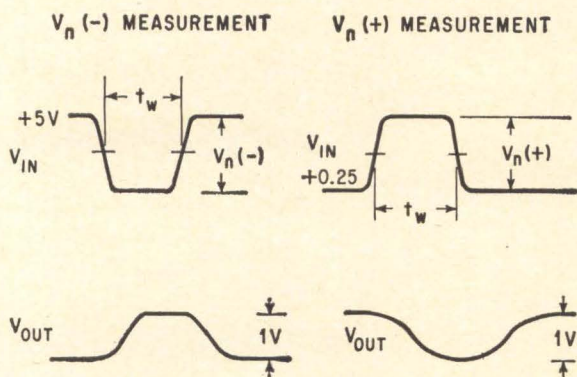

B

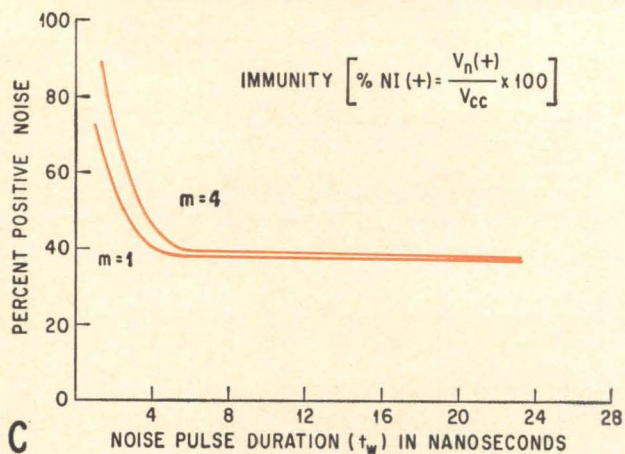

C

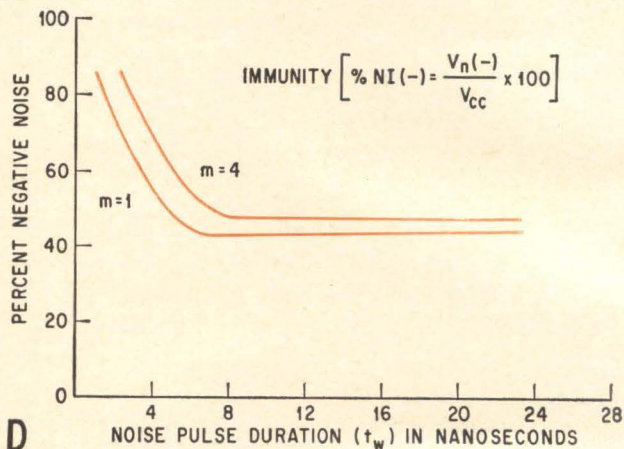

D

Test setup for measuring noise immunity (A) uses a pulse generator to simulate a noise pulse having rise and fall times of one nanosecond. Pulse widths were varied from 2 to 20 nanoseconds (B). The dependence of noise immunity, positive (C) and negative (D) on the noise-voltage duration, levels off for noise durations greater than 10 nanoseconds.

than the transient response of the circuit, and so a further increase in noise-voltage duration has very little effect on the output.

Before the actual noise immunity is compared with that calculated, it is necessary to point out that the calculations were based on the assumption that the noise duration was at least as long as the transient response of the diode-transistor logic circuit. Therefore, the comparison should be made for a noise duration of about 15 nanoseconds.

At 15 nanoseconds, the lowest noise immunities measured are

$$\begin{aligned} \%NI_{(on)} &= 44\% \\ \%NI_{(off)} &= 37\% \end{aligned}$$

These results are contrasted to the calculated values

$$\begin{aligned} \%NI_{(on)} &\approx 40\% \\ \%NI_{(off)} &\approx 40\% \end{aligned}$$

The circuit's noise immunity varies with the operating temperature. This relation is due to the temperature dependence of  $V_R$ ,  $V_F$ ,  $Q_s$ ,  $V_{B(off)}$  and  $V_{BE}$  which actually determines the noise immunity as given in equations 9 and 10.

Calculations show that, for typical variations of

the temperature-dependent parameters, the  $\%NI (+)$  should change no more than 1% per 50 degrees centigrade, and the  $\%NI (-)$  should vary less than 1% per 10 degrees centigrade. The larger change of  $\%NI (-)$  is caused by the significant effects of temperature on  $Q_s$ ;  $\%NI (+)$  variation is caused by temperature changes of  $V_F$ ,  $V_{BE}$  and  $V_{CE}$ . Therefore, it is evident that  $\%NI (+)$  decreases whereas  $\%NI (-)$  increases with rising temperature.

The relatively high noise immunity was made possible by the use of silicon transistors and diodes. This noisy immunity represents an important advantage of silicon devices over germanium types in diode-transistor logic circuits.

## References

1. H.J. Gray, "Digital Computer Engineering Principles," Prentice Hall, 1963, Chapter 10.
2. J.S. Fleischman, "Total Stored Charge in Junction Transistors," Application Note SMA 11, RCA Electronic Components and Devices, Somerville, N.J., 1962.
3. J. Millman and H. Taub, "Pulse and Digital Circuits," McGraw-Hill, 1956, Chapter 3.
4. A.I. Pressman, "Design of Transistorized Circuits for Digital Computers," Ryder, 1959.



**Tape-programmed electron-beam machine.** Operator peering through binoculars is monitoring the operation. A wired-program machine is used to produce the two micro-modules shown. One module is a binary divider with 20 integrated circuits. The other is a sense amplifier with chip semiconductor devices and deposited thin-film resistors.

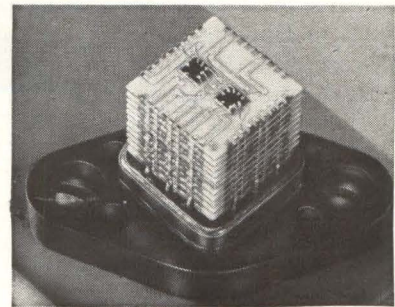
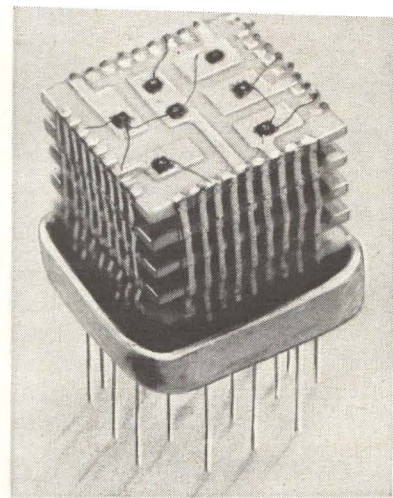

## Manufacturing

# Production-line packaging of solid-state circuits

Programmed electron-beam welders assemble new microcircuit module with up to 10 times as many components as before

By D.J. Garibotti and Lee R. Ullery Jr.

Hamilton Standard Division of United Aircraft Corp.

**Automated production** began last month on a new type of micro-module that can contain up to 10 times as many components as earlier models.

The production line includes an electron-beam welding machine that performs final assembly and hermetic sealing of the modules. The program is financed jointly by the Hamilton Standard division of the United Aircraft Corp. and by the Army Electronics Command. Hamilton Standard provides machines and tooling at its plant in Broad Brook, Conn.; the Army sponsors design equipment and testing.

The units, called microcircuit modules, are an

outgrowth of the Army Electronics Command's six-year program<sup>1, 2</sup> to develop three-dimensional packaging. Most of the original micro-module program ended last March.

The new program aims at taking advantage of the compactness achieved by integrated circuits while retaining enough design flexibility to accommodate practically any kind of microcomponent.

The modules being produced are 10-stage binary dividers comprising 20 integrated-circuit chips that are interconnected and hermetically sealed in a 0.1-cubic-inch metal can.

The pilot program calls for the production, in

an eight-hour work shift, of a mix of 100 of these and engineering and test modules without the integrated circuits. The manufacturing equipment can turn out 200 modules in one work shift.

During preliminary work over the past three years, prototypes of a variety of assemblies were made, including linear and digital systems. These have used discrete semiconductor devices, thin-film passive components fabricated by electron-beam techniques, integrated circuits, and hybrid approaches to microminiaturization.

### The microcircuit module

The dimensional standardization of the original micro-module—a cube about 0.4 inches on a side—is retained in the new microcircuit module. But for interconnection, the old module depends on riser wires soldered into 12 notches around the periphery of each wafer. The new module has an upnotched wafer that accommodates 36 welded connections. The number of components that can be placed in the module is increased at least an order of magnitude, particularly if the wafers carry integrated circuits. This provides a significant increase in design flexibility.

Because the higher packing density is not achieved at the expense of standardization of form factors, computer techniques can be used to design circuits and determine the arrangement of parts in the module. Most production steps, tools and test equipment are standardized, allowing a new module to be designed and put into production in about two weeks.

Even on the pilot line, manual operations are confined to loading the production fixtures and attaching semiconductor-device chips to the wafers. Welding is fully automated. The electron-beam welding machine, loaded and programed, can make 76,000 welds in four hours.

Production costs, therefore, promise to be low. Small-lot circuit production is expected to compete in cost with packaged, mass-produced integrated circuits. Hamilton Standard plans to manufacture modules for sale.

The target assembly cost for the pilot plant is \$4 for a 10-wafer module, plus the cost of the semiconductor devices. Costs of passive components should also be low for military equipment. Thin-film capacitors with values in the 1,000-picofarad range are deposited on ceramic wafers. Thin-film area resistances with a total value of 500,000 ohms can be deposited and fabricated, at tolerances of 1%, into ten 50,000-ohm resistors.

When electron-beam welding is used, the circuits are sealed in a vacuum. Individual packages for the components would be superfluous. This saves the cost of having components prepackaged, and allows shorter lead lengths for better high-frequency performance.

Other production and performance advantages are built into the microcircuit module. No fluxes or encapsulants are necessary; contaminants are minimized, and stresses associated with potting are avoided. The inorganic materials used make the structure compatible with 200°C operation, while the ruggedness of a welded structure accommodates other environmental extremes. Continuous thermal paths link the wafers with the outside world through the stack stabilizers and conductor matrix. The can is also an interference shield.

### Producing a binary divider

Because a 10-stage binary divider contains 20 uncased integrated-circuit chips, it provides a rigorous test of the compatibility of the microcircuit module concept and solid-state technology. The circuit is also an ideal choice for comparison with equivalent circuits assembled by other techniques, because this circuit is widely used in equipment for such functions as timing events, generating binary numbers and counting pulses.

The production sequence followed for the elements of the dividers is illustrated in the flow diagram at the left and described in the following paragraphs.

### Making the wafers

After they are cleaned, the wafer blanks are loaded on edge in "cross-arm" jigs that fit, like seats, into a "ferris wheel" fixtures. As the wheel rotates, each jig also rotates around its own axis. Loaded between each blank is a spacer mask that defines the areas on which edge terminations are to be deposited. Combs, resembling the conductor matrices, mask the edges of the blanks. The wheel holds 13 jigs carrying a total of about 1,400 blanks.

The wheel fits into the 21-inch chamber of a vacuum-deposition system. As the wheel revolves, all the wafers are exposed to an equal flux of the materials vaporized in the chamber. A 100-angstrom-thick layer of chromium is first deposited to

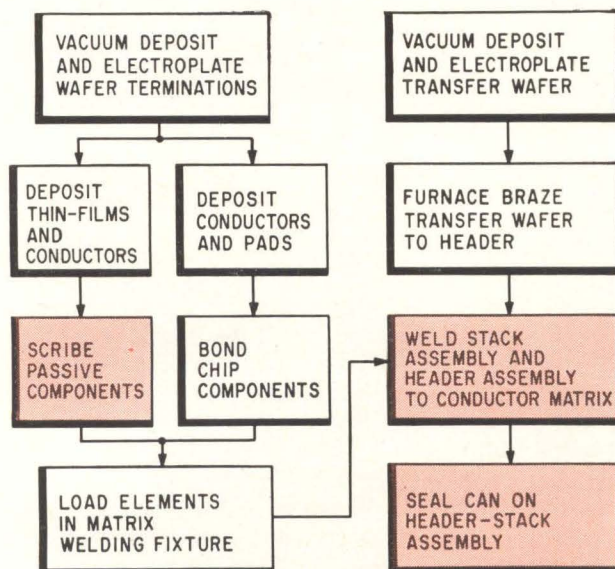

Production flow for the micro-module. Electron-beam processes are in color.

provide a tenacious bond to the substrate; then 1,000 angstroms of gold are deposited.

The jigs are then reloaded with the flat surfaces of the wafers exposed. The edge terminations are masked, and aluminum is deposited over the surface.

The aluminum serves as a current carrier during a subsequent electroplating operation. It is anodized to prevent plating except on the edge terminations. Relatively thick (0.001 to 0.002 inch) nickel is plated onto the terminations so that the copper conductors can be welded to them. The aluminum is etched off with sodium hydroxide.

The gold-on-chromium conductors and pads needed for bonding the semiconductor chips are then deposited.

A copper plating used to be employed. This produced reliable welds in most cases. However, when the wafers were heated during chip-bonding, a thin film of oxide was formed. The oxide tended to degrade the weld even when bonding was done under a curtain of forming gas.

Nickel is not oxidized after 10 minutes at 450°C, a time and temperature adequate for bonding. Copper can be used if it is overplated with nickel, gold or both, but nickel plate obviates the extra steps and satisfies electrical design requirements.

An alternative to depositing conductors through a mask is making an area deposit of chromium and gold, then etching the pattern. A promising method of reducing the cost entailed in masking or etching is to use a programmed electron-beam to remove unwanted portions of an area-deposited film. The techniques are similar to scribing (p. 78). Wafers can be made and stored in quantity and patterned as needed, simply by punching a control tape.

### Bonding the chips

The integrated-circuit chips are bonded to the pads by the gold-silicon eutectic method. The wafers are heated to 400 to 425°C on a hot post, then the chip is transferred to the pad with a vacuum probe and vibrated to promote wetting.

Next, commercial thermocompression-bonding machines (made by the Kulicke & Soffa Manufacturing Co.) bond gold lead wires to the terminations on the chip and the conductors on the wafer. Wafer temperature is 300°C and wire diameter is two mils. A nail-head bond is used at the chip, and a wedge bond at the conductor.

Similar techniques bond the chip components. For example, a sense amplifier has been made, using six chip transistors and a diode on one wafer and 18 thin-film resistors on three other wafers.

It was found during process development that a relatively thick layer of gold must be deposited over the chromium for satisfactory bonds of the chips and the leads. Thin fold films are porous, and diffusion between a thin gold film and chromium apparently lowers the gold's oxidation resistance. The difficulty can be overcome by using gold solder preforms for bonding. But it is simpler, in practice, to increase the gold thickness.

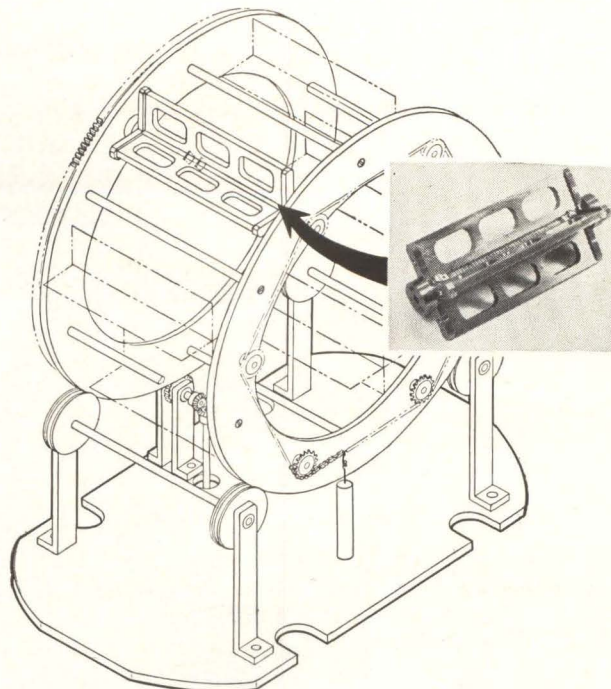

Ferris-wheel fixture deposits edge terminations on wafers. Photo shows loaded cross-arm.

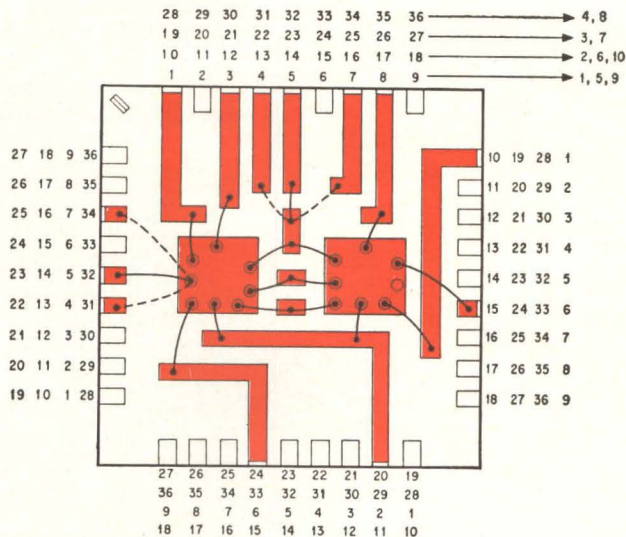

Layout for wafers with two integrated circuits bonded to deposited gold (color). While wafers are stacked, they are rotated 90° as indicated by termination numbers.

Semiconductor chips can also be welded to the wafer by an electron beam. This has been done successfully, but is not yet qualified by the military as a production method.

### Layout of chip connections

The illustration (above) of a morphological layout for interconnecting Micrologic circuit chips, Fairchild type 905, also shows how the chips are connected on the wafers used in the binary divider. All the chips are wired identically, except for B+, ground, input and output. As it is placed in the stack, each wafer is rotated 90° with respect to the preceding wafer.

After it is deposited on the transfer wafer, the conductor pattern is brazed to the header. Headers

are purchased from vendors.

The brazing technique is the same as furnace-alloying of junction transistors. The header and wafer are positioned in a stainless-steel boat that holds 11 assemblies. Eight alloy spheres, 80% gold and 20% tin, are positioned over the eight interior pinholes. The pins are brazed to the wafer in nitrogen at a temperature of 325° to 340°C. No flux is needed.

Hydrogen atmosphere was used initially, but this reduced the oxide on the Kovar in the glass-to-metal seals, lowering the yield to around 80%. Present yield is 95% to 97%.

### Enter the electron beam

All the elements of the module are now ready for electron-beam welding. A brief review of beam welding and a description of the beam controls is therefore in order at this point.

Although electron-beam welding is 10 years old, most applications have been concerned with exotic materials or relatively large workpieces. The Hamilton Standard welder used in the module program can weld pieces three inches thick. But beam-welding is particularly attractive for microelectronics fabrication. This program, in fact, marks the transition of beam-welding from laboratory and prototype work to the mass production of electronic circuit assemblies.

Because the beams are controlled electronically, the operation can be automated easily with resolution, speed and precision that are inherently greater than in mechanical equipment. Beam diameters of 0.001 inch are maintained regularly, and diameters in the micron range are feasible.

Beam-power densities of  $10^6$  to  $10^{10}$  watts per square centimeter and accelerating voltages to 150 kilovolts are produced. With proper operat-

### Microcircuit module packaging system

Each module is an assembly of up to 10 wafers interconnected by a copper conductor matrix and mounted on a 20-pin header. Over-all dimensions of the module are 0.390 by 0.390 inch square and 0.4 to 0.8 inch high. The system includes the following elements.

**Microwafer**—the basic building block, 0.310 inch square. It is 0.010 inch thick if made of beryllia or alumina, and 0.020 inch thick if made of glass. On each edge are nine edge terminations on 0.025-inch centers. Terminations are vacuum-deposited gold on top of chromium, with a heavy nickel overlay for welding.

**Microelement wafer**—a microwafer carrying one or more components or a simple network. The network can consist, for example, of several thin-film resistors deposited directly on the wafer.

**Microcircuit wafer**—a microwafer carrying one or more circuit functions, such as a flip-flop or gate. Integrated-circuit chips may be bonded to deposited conductors.

**Microwafer stack**—an assembly of up to 10 wafers interconnected by a conductor matrix welded to appropriate wafer-edge terminations. The matrix consists of nine ribbons, each 0.010 inch wide, photoetched from 0.002-inch copper foil.

**Stack stabilizer**—a comb-like part made of a beryllium-

ing parameters, this energy is converted from kinetic to thermal within a closely controlled amount of material. The electrons slow down almost instantly when they strike a solid.

Beams are formed by boiling electrons off a heated filament cathode. The beam, controlled by a grid that is slightly negative with respect to the cathode, is accelerated by a grounded anode and focused by coils that form a magnetic lens. It is deflected to the target point by deflection coils for the X and Y axes.

Each of these components provides a parameter that the control system can modulate. The beam

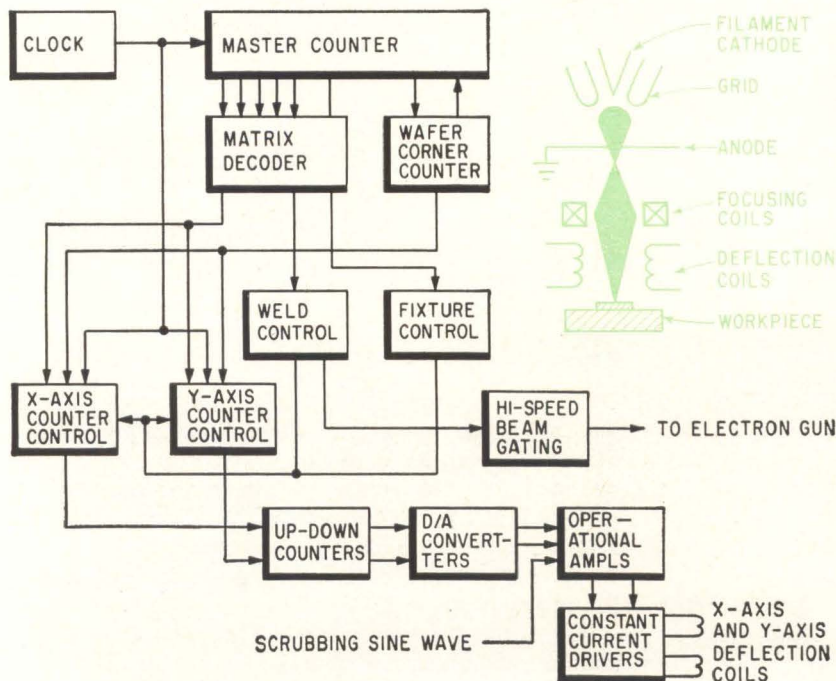

**Repetitive welding**, to connect the conductor matrix to the wafer terminations, is controlled by programmer. Beam (insert) is deflected to hit weld points and is gated on and off by setting instructions into console.

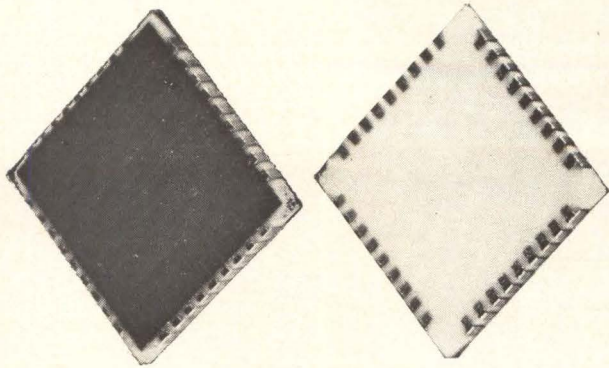

**Resistive microelement and a microwafer.** Sketches are an assembled stack, a transfer wafer and the edge termination. Welded and brazed connections are in color.

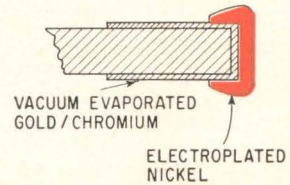
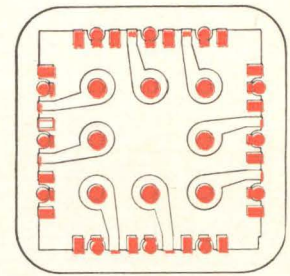
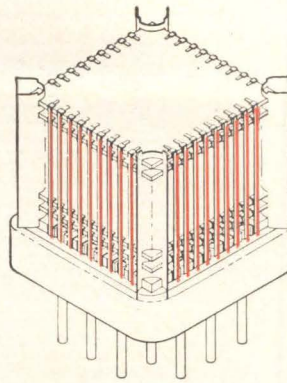

copper alloy. It aligns the wafers in the stack, provides a constrained fit between stack and can, and a thermal path between the wafers and the can.

**Transfer wafer**—translates the 0.025-inch grid pattern of the matrix to the 0.075 grid pattern of the 20-pin header. The wafer accepts 12 pins in edge notches and

eight pins in holes that are connected to edge terminations by vacuum-deposited conductors.

**Transfer wafer-header subassembly**—serves as the plug-in base for the module. The transfer wafer is brazed to the header. The stack is welded to the header. Then the can is welded to the header to complete the package.

can be scanned, pulsed, moved from point to point, gated on or off, oscillated and varied in intensity depending on the nature of the work. The beam can be used for welding, cutting, scribing, heating, or analyzing materials by x-ray techniques.

Typical parameters for the matrix welding are: accelerating voltage, 90 kilovolts; beam current, 0.36 milliamperes; weld time, 6 milliseconds; scrubbing deflection, 1.1-kilocycle sine wave.

Scrubbing is a technique for oscillating the beam, to make the weld spot larger than 0.001 inch and thereby improve the strength of the weld.

### Automating the welding machine

Welding a matrix, such as that used in the modules, is a repetitive operation. Therefore, an elaborate control system is not required to automate the welder. A "wired" or semifixed programmer was developed during the past year as part of the pilot production effort.

The control used with the stack-welding system can be set to weld at any combination of the 90 weld points available in a conductor matrix. Also, by changing magnification—that is, by changing the distance from the deflection coils (diagram above) to the workpiece—matrices ranging in size from 0.75 to 0.1 inch square can be scanned by the beam.

In the microcircuit modules, the weld points are on a 0.025-inch grid. The control is basically a multiphase clock set to control the beam so it moves, stops, scrubs and is gated on and off. This can be done at increments of 0.001 inch. So in the present application the clock creates one of these events at every 25th pulse, at the grid points set into the console.

The subsystems in the control direct the clock signals to the proper beam—control or transfer-

mechanism control. They also keep track of beam and fixture actions so the beam will move from one weld point to the next in the proper sequence.

Another control, which is programmed by punched paper tape, was developed during earlier work sponsored in part by the Air Force. This control provides greater flexibility for prototype or small-lot production. The machine can thus be used for all the various electron-beam processing applications mentioned earlier.

This control permits the beam to scan any point over an area of one inch square. For precision, however, the scan is restricted to about 0.2 inch square. The programmer also feeds directions to an X-Y

### The authors



D.J. Garibotti, a senior scientist at Hamilton Standard, directs a group studying ways to use electron beams to process semiconductor crystals as well the microcircuit module applications. He received a doctorate in physical metallurgy at Case Institute of Technology in 1955.



Lee R. Ullery Jr. has helped to develop dozens of optoelectronic devices and pieces of equipment, as well as ways to make and use them. His seven patents include rights on infrared detectors and electroluminescent-photoconductor image memory devices. At Hamilton Standard he directs advanced development in the electronics department.

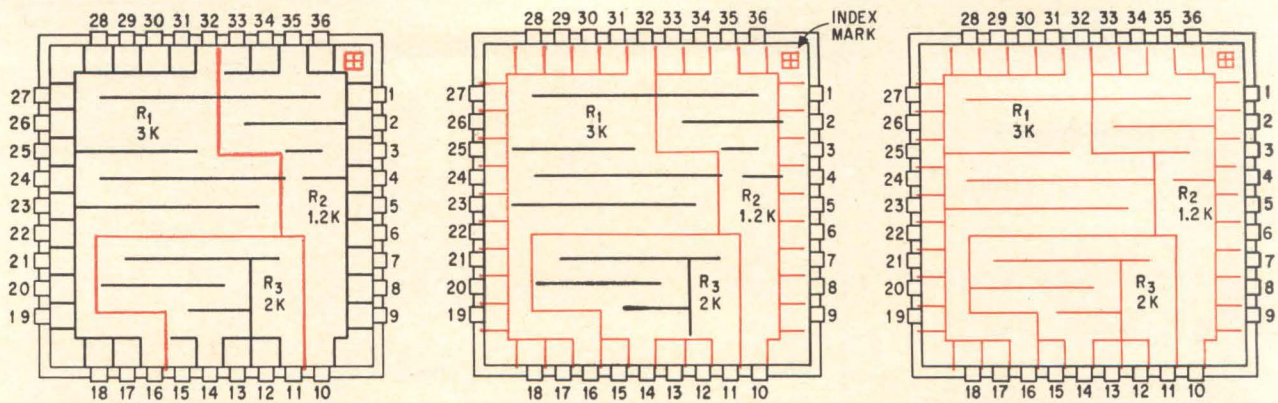

Steps in scribing thin-film microelement resistors are shown cumulatively in color. Areas for three resistors are separated at left.  $R_1$  will run between terminations 16 and 32,  $R_2$  between 10 and 35, and  $R_3$  between 11 and 14. Next, unused terminations are isolated (center). Finally, meander paths are scribed to bring resistors to within 1% of desired value.

positioning table (a General Electric Co. Mark Century) in the vacuum chamber. When the table is loaded with wafer dispensers and other transfer mechanisms, also under program control, a variety of work can be done without breaking the vacuum. This work might be resistor scribing, random welding over a large circuit-board.

Beam actions are almost instantaneous. The limiting speed is imposed by the control system. The system takes about 25 milliseconds to execute each instruction on the tape. Positional accuracy of the beam and worktable is 0.001 inch.

### Welding the matrix

Before the matrix welds are made, the stack of 10 wafers for the binary divider must be positioned so the beam can "see" the matrix.

This is done by loading the microcircuit wafers into a cartridge-type jig. The stack stabilizers act as spacers in the jig. When the wafers are positioned, the copper matrices are clamped in place by means of tabs at their ends. Special tools for handling prevent contamination from contact with the hands. The tools grip the wafer corners.

The jigs are loaded into a transfer mechanism, which fits into the electron-beam machine's vacuum chamber and is controlled by the programmer so that it presents all four sides of the stack to the beam in succession, moving a new stack into posi-

tion when the preceding stack is welded.

A hold-down device holds the matrix ribbons firmly against the wafer edge terminations while each row of welds is made.

After all the stacks are welded, the fixtures are unloaded and the excess ribbon is trimmed off.

The transfer wafer-header assembly is welded to the stack assembly using the same fixtures. One end plate of the cartridge is replaced by a jig that accepts the plug-in base. The beam is programmed to weld the ribbons to the terminations on the transfer wafer.

Environmental and electrical tests have demonstrated that such electron-beam welding is exceptionally reliable.<sup>3</sup> Pull strengths are well above 200 grams and weld resistances is about 1.5 milliohms. Environmental extremes do not significantly degrade these values.

### Sealing the package

The can and header are hermetically sealed by a program that causes the beam to follow the can-header interface.

The stack assemblies and cleaned cans are loaded, 200 at a time, into a transfer mechanism that fits the assemblies into nickel cans and presents the interface to the beam.

The fixture is loaded in a dry box containing nitrogen with a dew point of  $-100^{\circ}\text{C}.$ , it is then baked out at least two hours in a vacuum at  $250^{\circ}\text{C}.$

It takes less than one-half minute to seal each package; welding time is 1.6 seconds. Sealing is verified by a helium leak tester made by the Vacuum Electronics Corp. Leak rates are lower than  $10^{-8}$  standard cubic centimeters per second.

Electron beams can seal metal enclosures at 300 inches a minute. The method is already competitive in cost with other weld-sealing methods and is cheaper for relay-can sealing.<sup>4</sup> At least five relay manufacturers are now using beam welders.

Also, unlike the braze-type seals often used for microcircuit packaging, electron-beam welding does not heat other parts of the package. Brazes, which seal some flatpacks, melt at only a few degrees

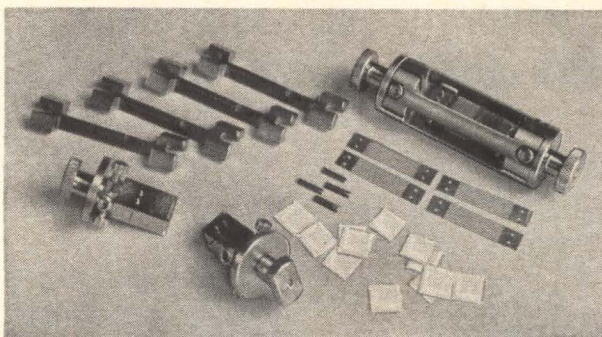

Cartridge Fixture used to load stack assembly. Cartridge parts are at left, stack parts at right below and assembled fixture.



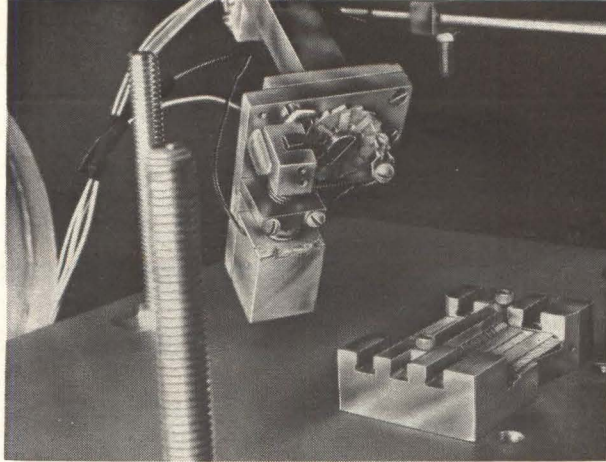

**Multilayer ceramic circuit-board** represents another marriage of electron-beam and thin-film techniques. Designed for 300°C service, it was developed under an Air Force contract. The metallized substrates (top right) are scribed to define interconnections between layers. Layers are stacked with mica insulation between them. Molten silver solder is sucked into the feed-through holes by vacuum casting. The leads of the flatpacks (right) inserted in the grooves are welded using the fluorescent paint technique. The welding fixture is shown above with the photodiode sensor over it. The layers can also carry deposited and scribed thin-film components.

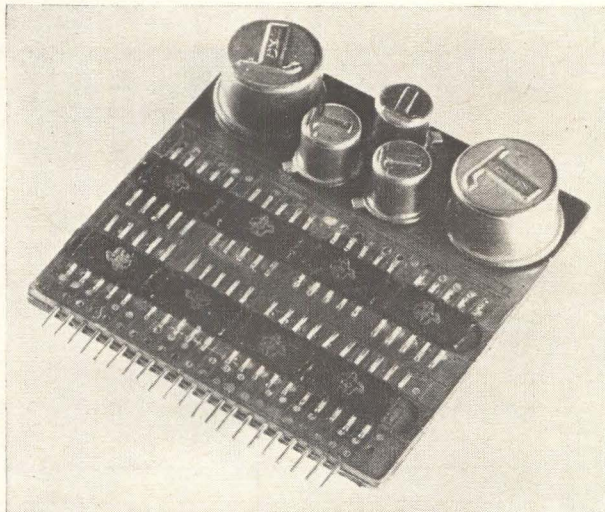
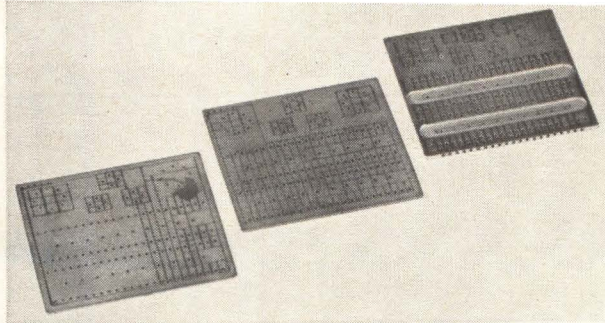

lower than the chip-bonding materials, presenting a difficult process-control problem.

#### Thin-film passive components

Microelement wafers are now made with the tape-programmed machine. After edge terminations are deposited on the wafers, an area film of resistive material such as chromium or capacitive material such as silicon monoxide with aluminum electrodes is deposited, plus a protective coating.

For making a resistor—capacitor techniques are similar—the electron beam is set to scribe a pattern of lines on the wafer surface. Scribing is a subtractive process in which the beam vaporized a path through the material.

First, the unused edge terminations are isolated by scribing around them. Then the film is divided into the desired number of resistive areas. Finally, a meander path is scribed in each area to bring the resistor to within 1% of the desired value by increasing the effective length of the resistive film. As the beam scribes the meander (illustration above), resistance is monitored by a bridge circuit and beam power is cut off when the desired value is reached.

It takes about a second to position the wafer on the worktable, and 50 miliseconds to scribe each line—a total of about three or four seconds per wafer, depending on the number of resistors.

Besides maintaining 1% tolerances, this method greatly simplifies vacuum deposition. Masks and tight control of the deposition process are unnecessary. Nor must changes, which normally occur in film value after deposition, be accounted for.

The beam technique allows a tolerance of 10% on sheet resistance. The wafers can be stored and well stabilized before scribing.

Punching a control tape is much simpler than preparing masks or changing a photoetching setup.

#### Welding random patterns

The tape-programmed machine also comes in handy for selective welding and for welding over a large area such as a circuit board, because table and beam motions can be combined.

The welds can either be programmed to a grid pattern or made randomly.

When exact positions of the weld points are unknown, a difficult technique can be used. The desired weld points, or reference points, are covered with a spot of fluorescent paint. The table and beam deflection are programmed to scan the workpiece with a "soft" beam whose intensity is too low for welding or cutting. The paint spots fluoresce when the beam hits them. The fluorescence is detected by a photodiode whose output is used as a signal to increase beam energy to welding intensity. The spot is scrubbed to make the weld.

#### Acknowledgment

Significant contributions to the developments described in this article were made by Weldon Lane of the Army Electronics Command during the development of the microcircuit module; Eugene H. Miller of the Manufacturing Technology division, Air Force Materials Laboratory, in the development of the tape-programmed methods; and Paul G. Anderson of Hamilton Standard, who was responsible for the design of program controls.

#### References

1. M.M. Perugini and N. Lindgren, "Microminiaturization." *Electronics*, Nov. 25, 1960, p. 87.
2. R.A. Gerhold and D.S. Elders, "Micro-Modules—circa 1963." *Proceedings of the 1963 Electronic Components Conference, IEEE*.
3. D.J. Garibotti and W.V. Lane, "Microminiature electron beam welded connections." *Welding Research Journal Supplement*, September, 1963.
4. W.C. Theiler, "Electron beam welding solves relay sealing problems." *Electronics*, June 28, 1963, p. 90.

# Designer's casebook

Designer's casebook is a regular feature in Electronics. Readers are invited to submit novel circuit ideas, packaging schemes, or other unusual solutions to design problems. Descriptions should be short. We'll pay \$50 for each item published.

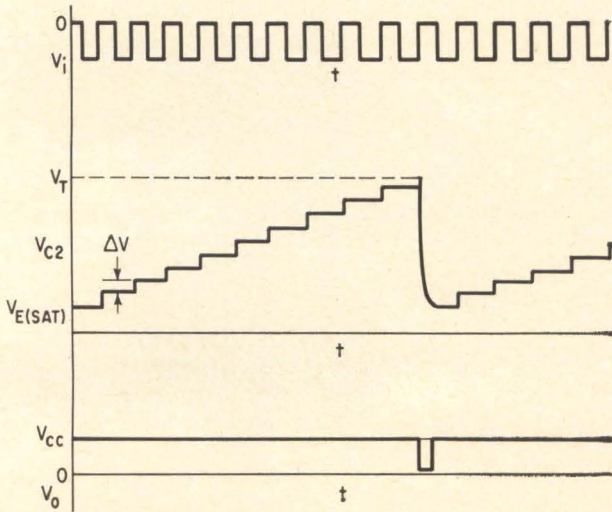

Voltage waveforms

## Staircase generator triggers a unijunction transistor

By Joseph J. Panico

General Instrument Corp., Westwood, Mass.

**This versatile circuit** can be used as a pulse counter, delay circuit or linear staircase generator. It uses a unijunction transistor  $Q_2$  and two conventional n-p-n transistors,  $Q_1$  and  $Q_3$ . Transistor  $Q_3$  provides inversion for the unijunction transistor's output signal so that the proper phase relationship is maintained between the circuit's input and output.

Without a trigger voltage, the bias voltage at the emitter of  $Q_2$  is too low to activate the unijunction transistor. The trigger voltage  $V_T$  which is required for  $Q_2$  to conduct, is given by

$$V_T = V_{CC} \eta' + V_{DE} \quad (1)$$

where  $V_{CC}$  is supply voltage (10 volts),  $\eta'$  is modified intrinsic standoff ratio for  $Q_2$ , and  $V_{DE}$  is forward voltage drop across the  $Q_1$  emitter-to-base junction.

The intrinsic standoff ratio  $\eta$  of a unijunction transistor is a parameter that is determined by the characteristics of the bar from which the device is made. Basically, it represents the voltage-dividing action that occurs within the device. The modi-

fied intrinsic standoff ratio for  $Q_2$  in the circuit shown takes into account the presence of  $R_2$  and  $(R_3 + R_4)$ . However, since the resistance of the unijunction is much greater than  $R_2$  and  $(R_3 + R_4)$ ,  $\eta' \approx \eta$ .

A variable resistance is used for  $R_3$  to allow compensation for the variation in intrinsic standoff ratio from one transistor to another. This adjustment permits sufficient signal strength across  $R_5$  when the unijunction transistor  $Q_2$  conducts, so that  $Q_3$  is triggered.

### Staircase generator stage

When a negative input pulse  $V_i$  is applied,  $D_1$  conducts and  $C_1$  charges through  $D_1$  and  $Q_1$ ;  $Q_1$  conducts throughout the entire input cycle. When the pulse is removed,  $D_1$  turns off and  $D_2$  conducts. A transfer of charge from  $C_1$  to  $C_2$  through  $D_2$  occurs. The increment  $\Delta V$  that is added to the voltage across  $C_2$  for each charge transfer is given by

$$\Delta V = C_1 (V_i - 2V_D) / (C_1 + C_2) \quad (2)$$

where  $V_i$  = input pulse (-10 volts)

$V_D$  = voltage drop across  $D_2$  or  $D_1$

The above relation is derived as follows: The voltage that is transferred from  $C_1$  to  $C_2$  during each positive portion of the input waveform is a function of the difference in voltage across the capacitors and the ratio of the capacitance values of the capacitors. Let  $V_{C2}$  be the voltage across  $C_2$  at any time. After the negative input pulse, the voltage across  $C_1$  is  $V_i + V_{C2}$  (neglecting the voltage drops across the diodes), since  $Q_1$  is, in effect, a unity-gain amplifier. Therefore the voltage trans-

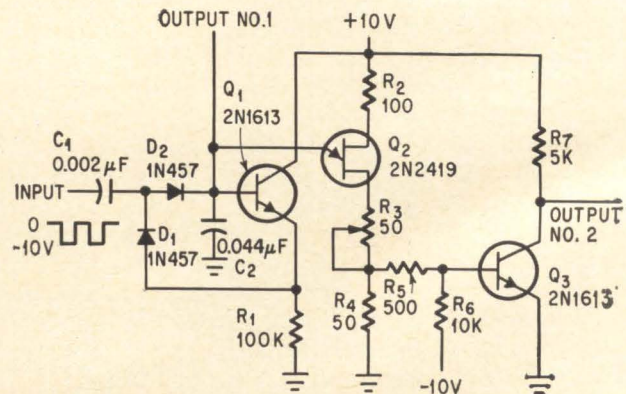

Continuous train of input pulses provides a voltage across  $C_2$  that increases incrementally until  $Q_2$  conducts.

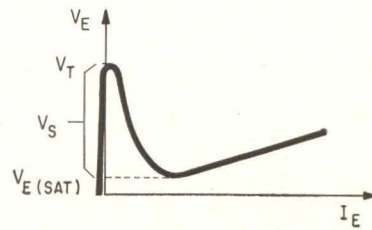
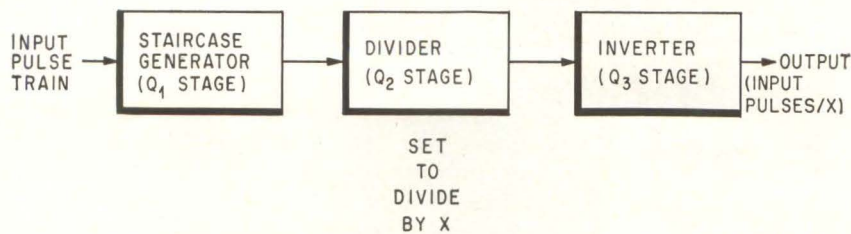

Circuit divides the number of input pulses by a preselected divisor (left). Voltage-current characteristic for unijunction transistor (right).

ferred,  $\Delta V$ , is approximately

$$\Delta V = (V_i + V_{C2} - V_{C2}) [C_1 / (C_1 + C_2)]$$

or

$$\Delta V = V_i [C_1 / (C_1 + C_2)] \quad (3)$$

The charging of  $C_2$  is continued until the voltage across  $C_2$  is sufficient to turn on  $Q_2$ . Then  $C_2$  discharges until the voltage across it can no longer sustain conduction and  $Q_2$  turns off. At this point the voltage at the emitter of  $Q_2$  is  $V_{E(SAT)}$ . Therefore the maximum voltage swing  $V_S$  at the emitter is the difference between  $V_{E(SAT)}$  and the trigger voltage  $V_T$  applied to  $Q_2$  or:

$$V_S = V_T - V_{E(SAT)} \quad (4)$$

From (1) and (4) and considering  $\eta' = \eta$ :

$$V_S = V_{CC} \eta + V_{DE} - V_{E(SAT)} \quad (5)$$

### Pulse counting

The number of pulses that can be applied to the input before a pulse is generated by  $Q_2$  depends on several factors. One is  $V_S$ , which may be obtained from equation 5. Another factor is the value of  $\Delta V$ , which can be determined from

$$\Delta V = V_S / x \quad (6)$$

where  $x$  is the number of input steps required to obtain one output pulse.

Assuming that the input pulse voltage level is known, the capacitance ratio of  $C_2$  and  $C_1$  can be found by equating equations 3 and 6 for  $\Delta V$ . The resulting expression is

$$C_2 / C_1 = [x(V_i - 2V_{DE})] - [V_T - V_{E(SAT)}] / [V_T - V_{E(SAT)}] \quad (7)$$

The choice of the proper capacitor for  $C_2$  is more critical than for  $C_1$ . The value chosen for  $C_2$  determines the amount of charge that leaks off during the input cycle and also affects the recovery time of  $Q_2$ . Capacitor  $C_2$  must be made large enough to maintain its voltage over the input cycle, yet small enough to avoid counting errors because of incomplete recovery when recycling occurs. Capacitor  $C_1$  should be large enough so that its charge is not limited by the rise time of the charging current.

In a typical application of the circuit, a staircase voltage was needed for the horizontal sweep of an alphanumeric display system. The required voltage rise per step,  $\Delta V$ , was 0.4 volts ( $\pm 10\%$ ). The input

signal was a 20-kilocycle (period of 50 microseconds), 10-volt square wave.

Resistor  $R_2$  was chosen as 100 ohms—a sufficient value for temperature compensation. Therefore, the sum of  $R_3$  and  $R_4$  should also be 100 ohms. A 50-ohm variable resistor was selected for  $R_3$  to adjust for the standoff ratio variation between transistors, and a 50-ohm fixed resistor was used for  $R_4$ . A 10-volt supply was used and a 2N2419A was considered for  $Q_2$ . The value of  $V_{E(SAT)}$  and  $V_{BE}$  for a 2N2419A are typically 3 volts and 0.7 volts respectively. The circuit was designed so that 10 steps would trigger  $Q_2$ . The remaining circuit specifications are determined as follows:

from (6):  $V_S = x \Delta V = 10(.4) = 4$  volts  
 from (4):  $V_T = V_{E(SAT)} + V_S = 3 + 4 = 7$  volts  
 from (1):  $\eta = (V_T - V_{DE}) / V_{CC} = (7 - 0.7) / 10 = .63$

The 2N2419A was satisfactory for the values calculated above.

### The staircase generator

A 2N1613 was selected for  $Q_1$  because of its high current gain and low collect leakage current specification. A 100,000-ohm resistor was used for  $R_1$  to provide high input resistance. The input impedance  $R_{in}$  for  $Q_1$  is:

$$R_{IN} = h_{FE} R_1 = 30 (100K) = 3 \text{ megohms} \quad (8)$$

The relation between  $C_1$  and  $C_2$  is determined from 7:

$$C_2 / C_1 = [10 (10 - 1.2) - (7 - 3)] / (7 - 3) = 21$$

Next, the recovery time constant  $\tau_1$ , which must be less than 0.1 times the period of the input pulses, is calculated.

$$\tau_1 \leq 0.1 T = 0.1 (50) = 5 \text{ microseconds} \quad (9)$$

Then  $C_2$  is obtained as follows:

$$C_2 = \tau_1 / [R_{E\mu} + (R_3 + R_4)] = 5 \times 10^{-6} (100 + 100) = 0.025 \text{ microfarads} \quad (10)$$

where  $R_{E\mu} = Q_2$  emitter-to-base dynamic resistance

The charge leak-off time constant  $\tau_2$  is determined from:

$$\tau_2 = C_2 R_{IN} = (0.044 \times 10^{-6}) (3 \times 10^{-6}) = 0.075 \text{ second} \quad (11)$$

The total time  $T_0$  for one cycle for the  $Q_2$  stage is:

$$T_0 = x T_1 = 10 (50 \times 10^{-6}) = 0.5 \text{ millisecond} \quad (12)$$

The ratio  $\tau_2 / T_0$  is  $0.075 / 0.5 \times 10^{-3}$  or 150. Since this ratio is very large, little charge will leak off

## Designer's casebook

during the cycle to trigger  $Q_2$ .

Now that  $C_2$  has been determined,  $C_1$  can be found.

$$C_1 = C_2/21 = 0.025 \times 10^{-6}/21 \\ = 0.0012 \text{ microfarads.}$$

The circuit was constructed using the components determined above and performed reliably from  $0^\circ$  to  $65^\circ\text{C}$ .

## Constant-current source controls sweep rate

By James J. Collins

Kollsman Instrument Corp., Syosset, N.Y.

A constant-current generator stage is used in this circuit to obtain linear sweeps ranging from a few microseconds to one second in duration. The constant-current source portion of the circuit, contained within the dashed-line box, consists of  $Q_2$ ,  $R_3$ ,  $R_4$ , and  $R_5$ .

Transistor  $Q_2$ , in the constant-current source stage, and transistors  $Q_3$  and  $Q_4$ , which are connected in a Darlington amplifier configuration, conduct at all times during the operation of the circuit.

At first, an input voltage  $-E_i$  is applied to the base of the emitter-follower  $Q_1$ . This voltage maintains  $Q_1$  in conduction, and places nearly  $-E_i$  volts at the upper plate of capacitor  $C$  through a path consisting of  $R_2$  and  $D_1$ .

When the input signal rises to ground,  $Q_1$  is cut off; diode  $D_1$  becomes back biased and also stops conducting.

Now the only current being supplied to the capacitor is the small positive current from the constant-current source. The voltage across  $C$  increases linearly from approximately  $-E_i$  volts and approaches  $+V_{cc}$ , the voltage at the collector of  $Q_2$ . This process continues until the input pulse is removed—before or when the voltage at the upper plate of  $C$  reaches ground potential.

With the return of the input signal to  $-E_i$  volts,  $Q_1$  and  $D_1$  conduct, and the upper plate of the capacitor also goes to  $-E_i$  volts.

The voltage across a capacitor is defined by:

$$V_C = 1/C \int i dt$$

With a constant current flowing, this becomes:

$$V_C = (i)(t)/C$$

In a typical application, with an input pulse voltage ( $-E_i$ ) of  $-12$  volts, the constant-current source was set at two milliamperes. The total sweep time desired was 100 microseconds, and a full 12-volt sweep was also desired. Therefore:

$$C = (2 \times 10^{-3})(10^{-4})/12 \\ = 0.016 \text{ microfarad}$$

The retrace time  $T_R$  (time for the voltage to revert to nearly  $-E_i$ ) is given by:

$$T_R = 3 RC$$

where

$$R = (Z_S/\beta_1) + Z_{D1} + R_2$$

$\beta_1$  = Beta of  $Q_1$

$Z_S$  = Source impedance

$Z_{D1}$  = Forward impedance of  $D_1$

For the example specified above, the retrace time was about four microseconds.

The Darlington connection of  $Q_3$  and  $Q_4$  presents a high input impedance to the sweep circuit and acts as a buffer to the load. For sweep times greater than one second, with good linearity,  $Q_3$  should be replaced with a transistor having high current gain with low base current.

Resistor  $R_2$  was added to the circuit to limit the peak current handled by  $Q_1$  during the discharge of  $C$ . Resistor  $R_2$  is 100 ohms.

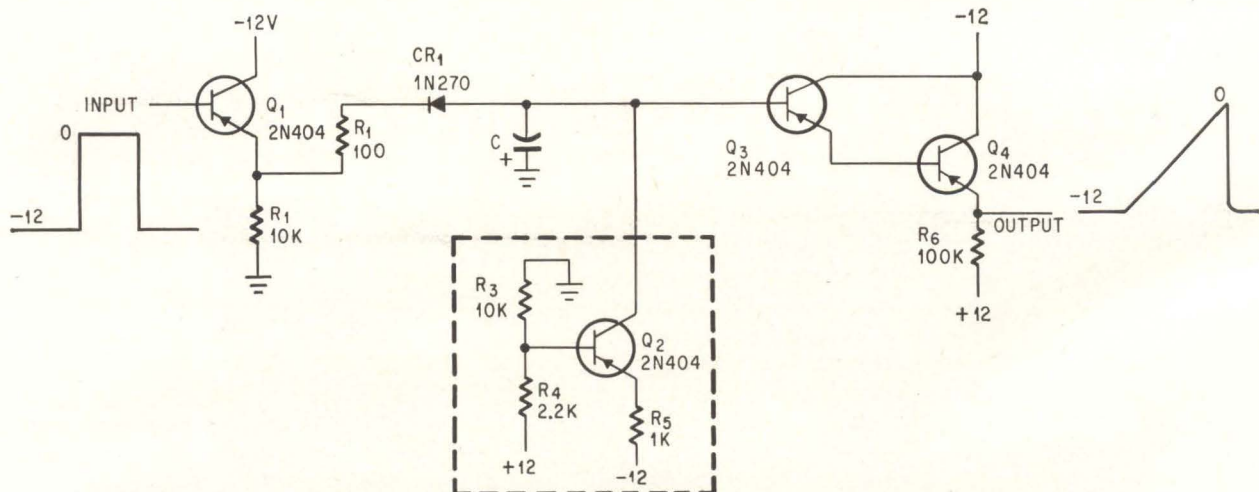

The constant-current generator stage (shown in dashed box) supplies a 2-milliamper current to the capacitor.

Reprints available  see reader service card

© copyright 1964 Electronics® A McGraw-Hill Publication

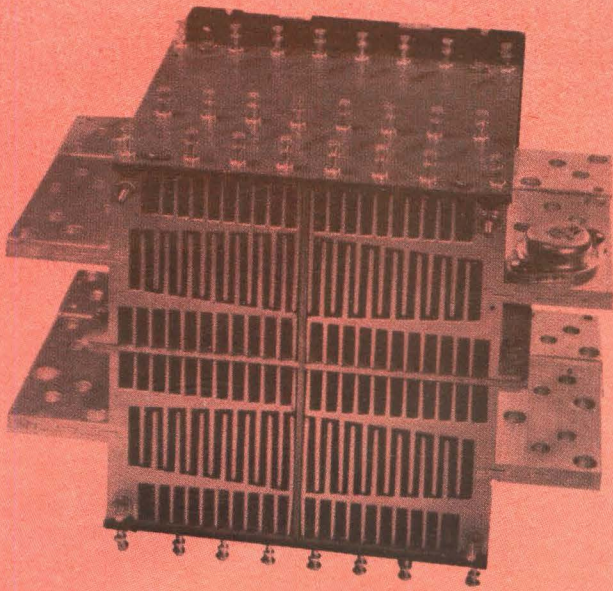

Fan-cooled modular heat sink, above  
Long-pin dissipator, right  
Water-cooled cold plate, below

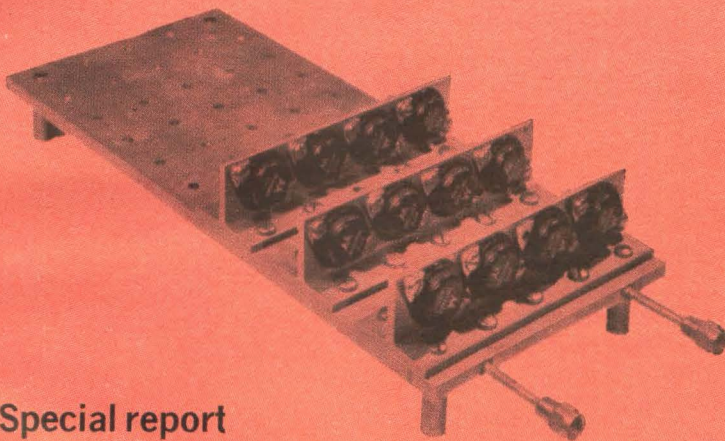
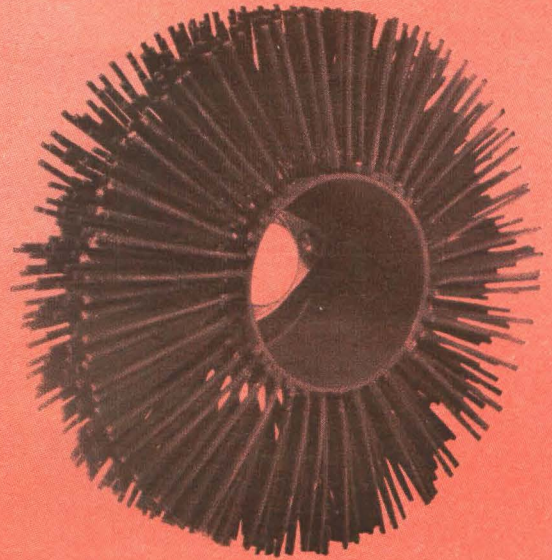

Special report

## Transistor heat dissipators

Heat dissipators, also known as heat sinks, are devices which carry off heat from transistors, silicon controlled rectifiers, other products made of semiconductor material and, in some cases, nonsemiconductor devices.

The sensitivity of semiconductor devices to temperature created the need for dissipators. Various studies indicate that a reduction in operating temperature of from 8° to 15°C doubles the lifetime of a semiconductor device.

The ability of a high-power dissipator to lower the case temperature of a power transistor demonstrates its usefulness. At a 2.5-watt power level, without a dissipator, the case temperature for a typical germanium power transistor rises to 80°C (close to the maximum allowable temperature for this device). With a high-power dissipator, but without the added cooling help of a fan, the case temperature can be maintained at 35°C. This represents an approximate increase in lifetime by a factor of three to five for the transistor. Without a dissipator the same transistor cannot be safely operated above three watts. With a dissipator and forced-air cooling, the transistor can be safely operated to 50 watts.

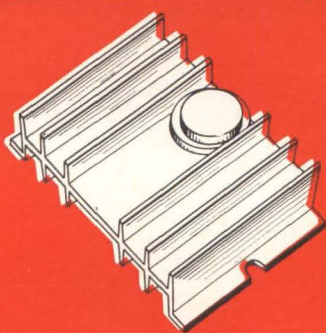

AAVID

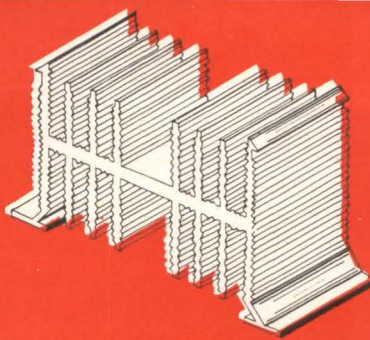

ACCEL

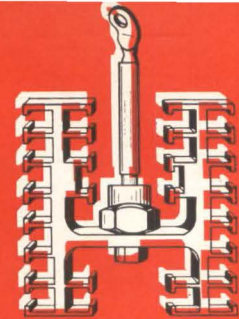

ASTRO

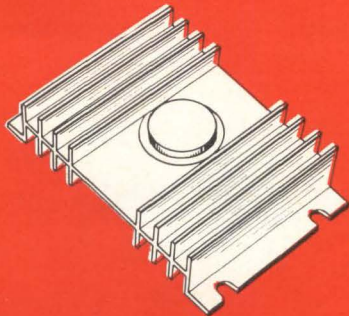

COOL-FIN

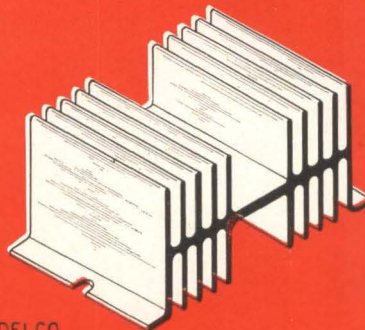

DELCO

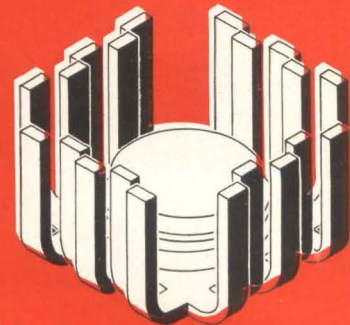

IERC

Some of the heat-sink types currently available. The average manufacturer's line of power-transistor dissipators

## Profile: the heat-sink industry

The battle for business is hotly fought in a new industry devoted to taking the heat off transistors and other semiconductor devices

By Jerome Eimbinder

Solid State Editor

**Heat-sink manufacturers** are nostalgic about the early days of their industry. Those "good old days" only go back seven years but, according to the officials of many companies, they were a harmonious, happy time when industry relations were cordial and cooperative. In that golden era no company tried to steal another's customers or design ideas.

The marketing approach was educational. Salesmen concentrated on acquainting companies, not then using heat sinks, of the advantages of designing them into equipment. Dissipators were often custom-tailored to the buyer's requirements. One manufacturer says, regretfully, "In the beginning all we had to do was convince customers to use heat sinks. Later on, we had to sell them on ours rather than a competitor's."

By last fall the dissipator manufacturers were getting rather cool to each other. More companies had entered the field. Many of the new outfits, it is

charged, just imitated the market-accepted shapes of the dissipators already being sold. Suspicion ran high and the original manufacturers started to re-examine each other's lines, as well, for possible infringement of ideas and pending patents.

### Philosophy changes

Then too—two changes in basic philosophy were having an effect on the industry. The first was the change from direct selling either by the company's sales force or by manufacturers' representatives to a less direct approach—the widespread use of stocking distributors. The use of the distributors produced the second change. Manufacturers switched the emphasis from custom-made products to standard available-off-the-shelf dissipators.

Though the switch to standard commercial product lines and distributor sales networks is credited with ushering in large-scale operations for the dis-

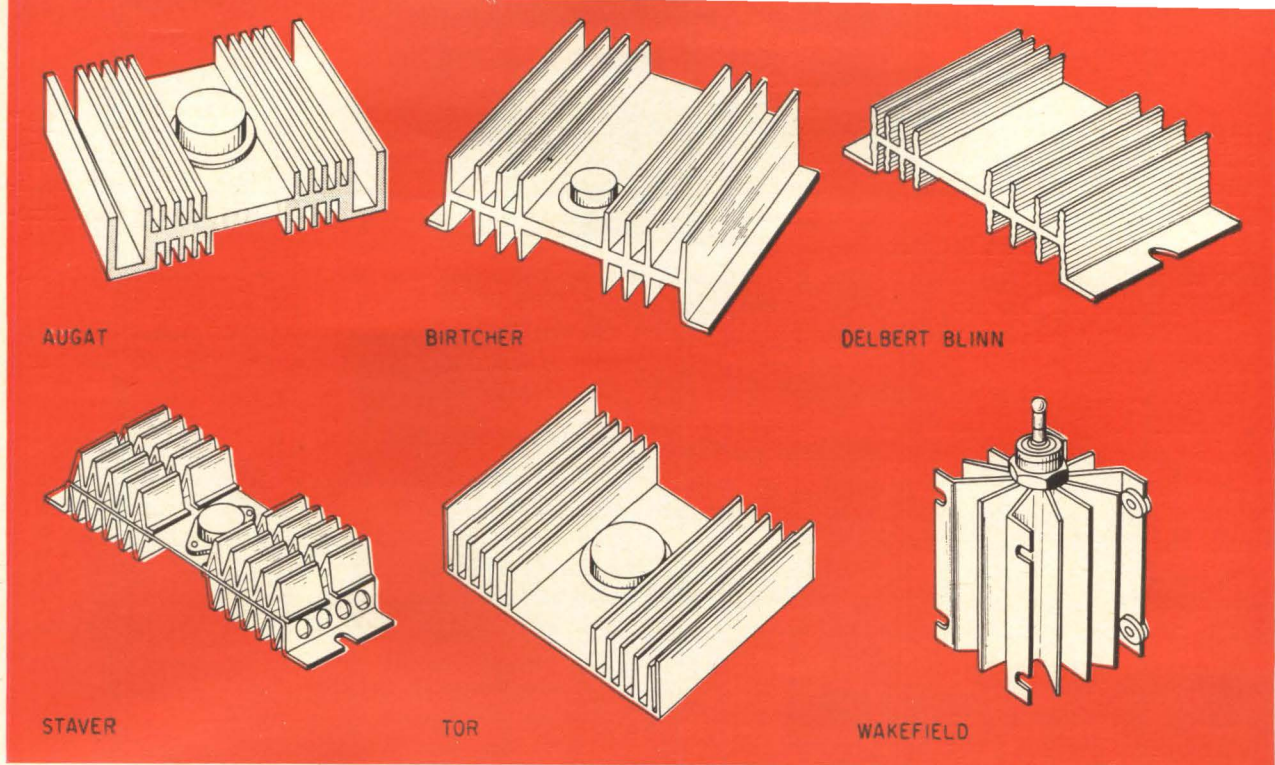

contains from five to fifteen different basic shapes—each is usually available in several different sizes.

sipator manufacturers, it also introduced a new problem. Obviously, the distributors were not anxious to carry the almost infinite variety of products previously made available by the manufacturers.

Prior to 1962, when a customer selected a power-transistor dissipator he specified material (usually aluminum) and finish, length (usually anywhere from 1.5 to 6.0 inches), hole pattern, number of hole patterns (occasionally two or more transistors are mounted on a single dissipator), diameters and locations of holes for mounting hardware, and other custom touches. The new marketing setup was not geared to the continuance of this practice. Standardization was essential.

### Standardization

Deciding on a standard material and finish was hardly a problem. The majority of requirements were satisfied by black anodized aluminum—already the standard in the industry. Those applications which demanded copper's higher thermal conductivity per unit volume would continue to receive factory custom service.

But after deciding on black anodized aluminum, the road to further standardization became rougher. About eight power-transistor hole patterns (see chart of hole patterns on pp. 90 and 91) were already in popular use and more were emerging. In addition, seven different stud sizes were being used for silicon controlled and other semiconductor rectifiers. Thus, if a distributor planned to stock a particular dissipator shape in four lengths, he needed 60 different variations of the basic shape for complete coverage.

One method hopefully introduced to ease the staggering inventory problem was the use of uni-

versal hole patterns. These combine two or more of the basic hole patterns in one. Although they do not affect the thermal resistance of the dissipator significantly, there has been reluctance on the part of many engineers to use them because the non-universal hole patterns are also available. As a result, instead of reducing the inventory problem—in providing an extra style—universal hole patterns actually add to the number of inventory types.

The efforts to standardize still have a long way to go. For example, the Birtcher Corp. has more than 10,000 different dissipator types available, including tube coolers. The combined tube and transistor dissipator line of the International Electronic Research Corp. numbers more than 5,000. The situation is similar for other manufacturers.

### Product copying

Today the dissipator industry is involved in an

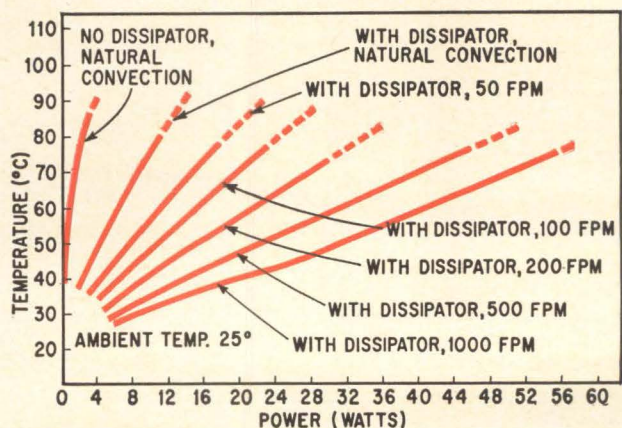

Typical lowering of the operating temperature by the use of a dissipator and forced-air cooling

area completely removed from distributors and standard product lines. The once-friendly relationships are giving way to law suits. Companies are fighting product-copying in the courts. Each of three dissipator manufacturers in the immediate Boston area—Astro Dynamics Inc., Pin Fin Inc., and Wakefield Engineering Inc.—for example, have initiated suits against competitors for copying their cooling devices.

You wouldn't expect someone to copy a concept as unusual as that of the Pin Fin Co. It has been pioneering a construction concept radically different from its competitors. Its dissipators rely on an array of needle-like projections which look like porcupine quills to carry off heat (page 99).

John Jacoby, president, says, "When a small machine shop copies one of your heat sink styles for a customer, you may never find out about it." According to Tom Coe of Wakefield: "Copying often results when a customer brings a competitor's type to another manufacturer and asks for a better price." William Venema, president of Vemaline Products Co., Inc., agrees. He notes: "We know of a few cases where our products were copied by competitors at the specific requests of the customers. We've learned to live with this." He concedes, "We've been accused of copying, too." John McAdam, engineering vice president of the International Electronic Research Corp. adds, "They (competitors) pick off the cream of our design, winding up doing very little original work."

Many of the manufacturers feel that the copying is being initiated by the customers. The practice doesn't hurt the customers who justify their action by arguing that it is a step towards standardization. It's also a way of obtaining lower prices.

In one case, a manufacturer okayed copying. Lenhold Katz, president of Astro Dynamics explains: "We recently received a large order with an extremely short delivery date. To protect the customer, we recommended that he also use a second source. We directed him to a competitor with

facilities for producing a shape similar to ours."

Katz is not always this generous, however. His company is launching suits against three competitors for alleged unauthorized purloining of Astro-developed dissipator designs.

The copying has not been limited to the dissipators. Thomas Coe, president of Wakefield, claims, "A West Coast competitor of ours took one of our catalogs, pasted his name over ours, and then reprinted it."

### Customer education

The educational service provided by the dissipator manufacturers is still considerable. Most of the dissipator manufacturers offer to evaluate a customer's needs and recommend the required dissipator size, shape and finish. Occasionally, they are also asked to compare various approaches (such as free vs. forced convection), or to assist in the integration of the dissipator into the design as a structural support.

Because many of the engineers involved in the specifying of dissipators have little previous experience with the heat-transfer devices, the manufacturers are sometimes asked why they don't make magnesium heat sinks. Magnesium does have excellent thermal conductivity, but is expensive and it does not stand up well under salt spray. It is not being used, at present, in standard product lines.

Part of the educational program conducted by the manufacturers is directed toward switching customers from a custom-designed product to a standard product. Katz told us, "Too many engineers make the selection of a heat sink the last step in the design. This often means that only a custom-made shape can fit into the remaining available space. A standard dissipator will often work just as well or better." Everett Nance, vice president of the Cool-Fin Electronics Corp. adds, "If they would only put them (dissipators) at the beginning of the design, they would save money." McAdam of IERC believes, "If systems were designed to include heat

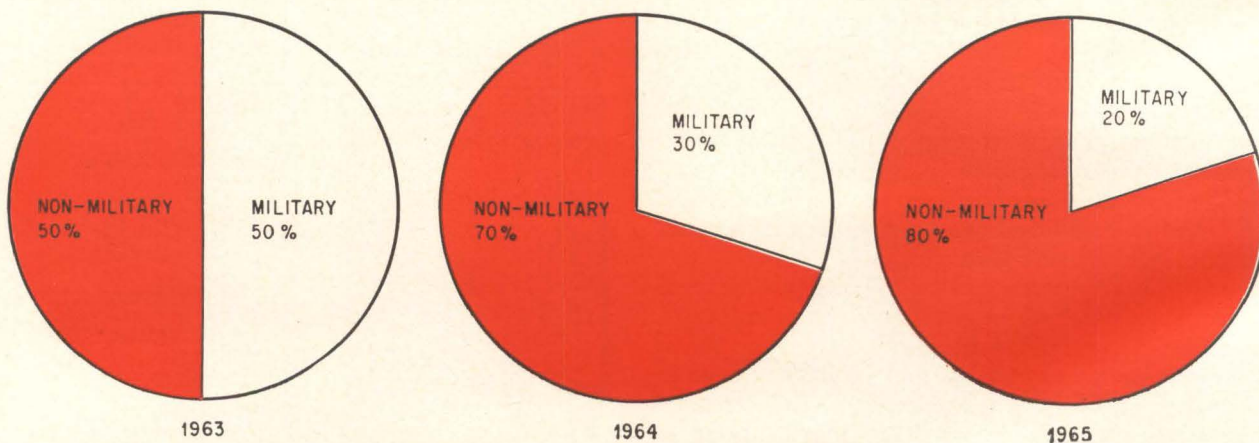

The changing market for transistor heat dissipators.





"Our engineering department is developing a new model."

sinks from the start, we wouldn't have the problem we have now—components that won't fit and thousands of part numbers when we only need hundreds."

#### Business outlook in the East

The recent cut in government spending hasn't

bothered the Eastern dissipator manufacturers much. All are experiencing substantial increases in volume. Nearly all of the new business is nonmilitary. Much of it is for computer power supplies, motor speed controls in mills, metal purification and plating systems, and communication system power supplies. Sales for airborne and ground sup-

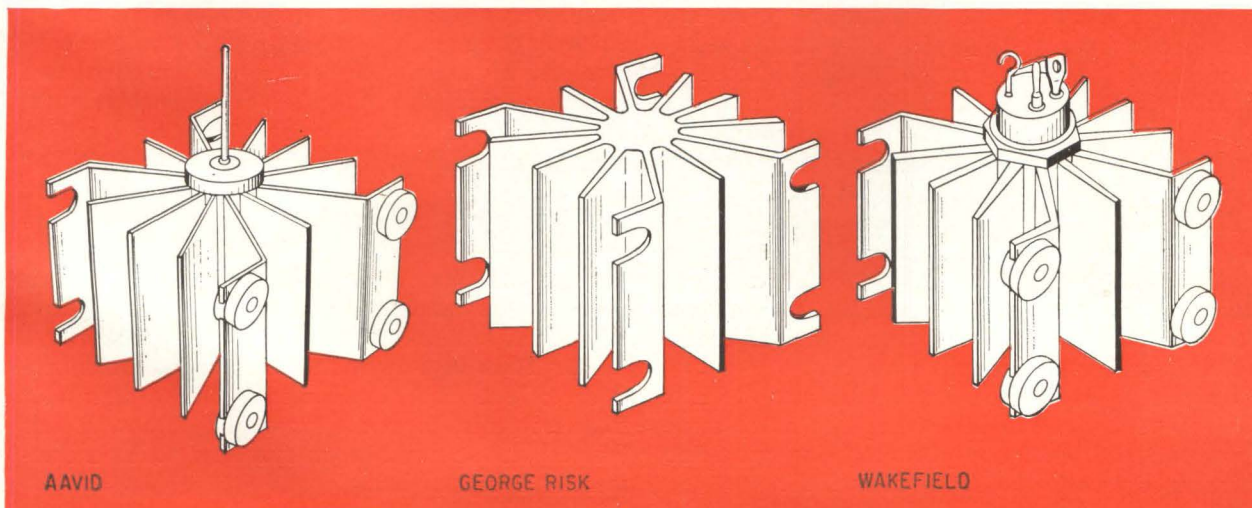

The availability of similar heat-sink configurations from different manufacturers is welcomed by buyers as a trend towards standardization.

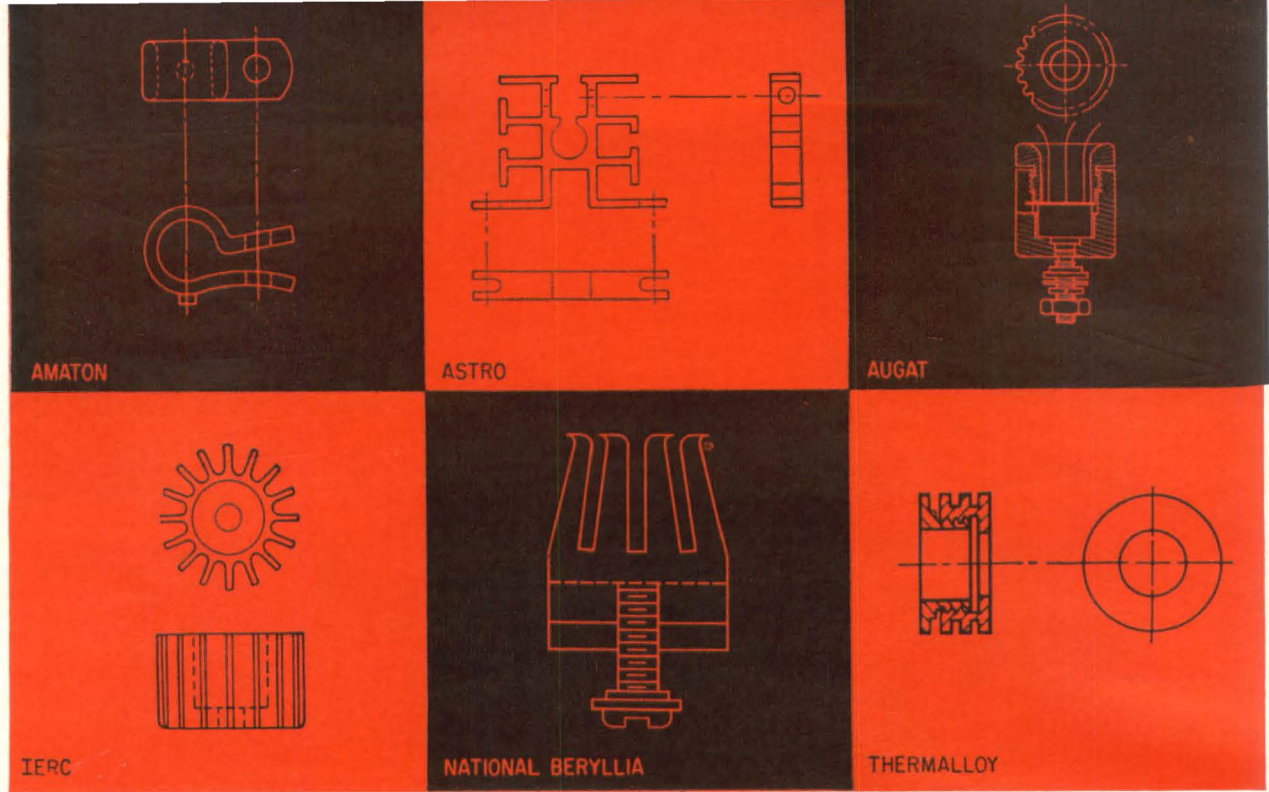

A representative sample of low-power transistor dissipators and retainers

port equipment are reported off.

Sales for Astro Dynamics, Inc. the first half of 1964 were 90% over its sales for the same period in 1963. Bob Keezer, sales manager, expects 1964 sales will be double the sales made in 1963. Three shifts are working around the clock to produce Astro's new forced-convection dissipators. Honeywell Inc. is one of the principal buyers. Astro is particularly pleased with its increasing sales volume in the hobbyist and experimenter field.

Sales for Augat, Inc. the first half of 1964 were more than 25% over its sales for the first half of 1963. The company reports that its military business is holding steady with the gains being made in its commercial product sales.

Pin Fin Inc. is only one year old. During the second quarter of 1964, it tripled the total sales it achieved for the first quarter. Fourteen of its sixteen product lines are intended for use with semiconductor devices; two are for use with special-purpose tubes. Rumors that Pin Fin is affiliated with Augat have been denied by both companies. Pin Fin did discuss the marketing of its products by Augat but the negotiations fell through.

The Staver Co.'s line of dissipators comprises only a small percentage of its total business. Its main products are tube shields and transformer cans. Staver's dissipator sales are climbing steadily, and it expects that its brand-new laminated dissipator will further brighten the sales outlook.

Vemaline's dissipator sales volume for the first half of 1964 is up about 15% compared to the same period for 1963. Vemaline plans to bring out a line of liquid-cooled heat sinks in early 1965.

Wakefield, whose only products are dissipators, reports that it made more money during the first quarter of 1964 than during all of 1963. Wakefield

had eight product lines at the start of 1963 and ten at the start of 1964, but will have increased to fifteen by January, 1965. Three-quarters of Wakefield's production is for nonmilitary end use. Its new line of kingsize heat sinks is receiving considerable attention—the buyers already include General Electric and Westinghouse.

#### In the West

Here the picture is not as bright as in the East. The West Coast dissipator makers depend considerably on military business. IERC is the exception. Because of its national sales setup it reaches the same markets as the Eastern manufacturers.

Again with the exception of IERC, the West Coast dissipator manufacturers report that business is disappointing. Nance of Cool-Fin says: "Heat sink sales are picking up but there is no big crashing demand. A year ago, people said that they were the big thing. We got into the business then but this prediction hasn't been borne out." According to Jay Cook, U.S. Heat Sink Co. president, "In general, the situation is not too good. He adds, "The run-of-the-mill heat sink is, for the most part, the rule now. This makes the business a highly competitive one."

IERC's dissipator business was up about 10% during the past year. McAdam is encouraged. "As a whole, our business looks good," he reports.

The TOR Manufacturing Co., originally a producer of extruded aluminum for use by dissipator manufacturers, is not discouraged either. It has jumped on the bandwagon and now offers a commercial dissipator line.

#### Elsewhere

The Modine Manufacturing Co. of Racine, Wis.

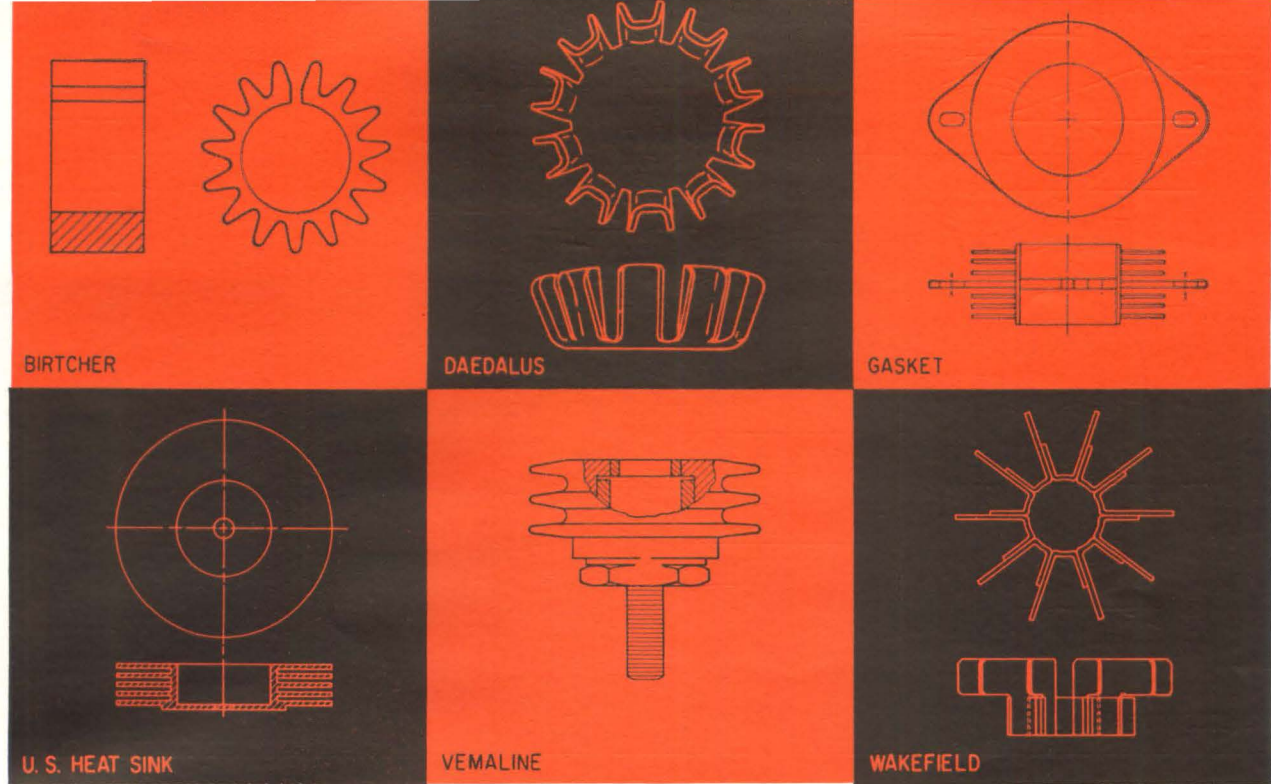

is betting on its line of forced-convection dissipators. This company knows it has to overcome the reluctance of many engineers to use this approach. But it is convinced that ducted forced-convection cooling with heat sinks is the ultimate answer to heat removal problems.

Modine has found that many engineers hesitate to use forced-air cooling systems because of the required fan and associated duct work. Other reasons for this attitude, James A. Mosier, Modine engineer, points out, are "lack of education in heat removal at the design engineer level and approaching the use of heat sinks on a piece part basis rather than total package cost."

George Risk Industries, Inc. in Columbus, Neb. is another newcomer having entered the field in late 1962. The company is marketing four basic product lines—one of which is a forced-convection line. Sales for the first half of 1964 are reported double the first-half sales for 1963.

The Thermalloy Co. of Dallas hasn't decided to market a forced-convection unit as yet but is producing a wide line of free-convection types.

#### Financial picture

Based on projected sales for the second six months of the year, 1964 factory sales of dissipators for semiconductor devices (excluding sockets, associated hardware, and tube heat dissipators), will top \$10 million.

First-half-of-1964 reports for the dissipator industry indicate over-all earnings up about 50% over the first half of 1963, despite the military cut-backs. This figure compares favorably with the 41% net gain in earnings compiled by the New York Times survey of major companies in electronics and associated industries (except defense).

The stability of aluminum prices is comforting to the dissipator manufacturers. The current price of aluminum from the producers to the mills, although up slightly from last year, is still 7.7% below the 1961 price.

#### Future prospects

Most manufacturers look for the industry's gross sales to rise slowly but steadily. Few expect to get rich fast even with minor breakthroughs in dissipator technology. Price competition, already being felt, is expected to get stiffer. Some of the shakier manufacturers may be forced out of the market.

Copying of devices is expected to become even more common. Some feel that the law suits, both those launched and those contemplated, will be ineffectual and thus will serve only to open the door to more copying.

The dissipator market has been clearly established. No longer can a design engineer afford to regard the heat sink as a novelty. David Appleton of Augat, Inc. sums it up: "As long as semiconductor devices generate heat, and as long as the use of semiconductors continues to grow, the heat-sink market will continue to grow."

## How to order a heat sink

Once the equipment designer has determined the thermal resistance required for a free-convection dissipator, he is ready to make a choice. But even after he selects a dissipator from his file of manu-

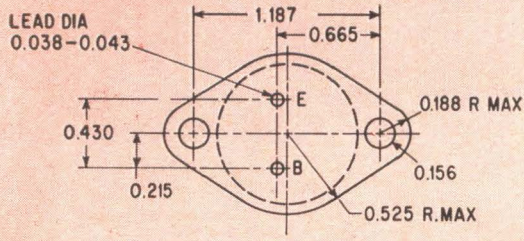

2N301 (TO-3)

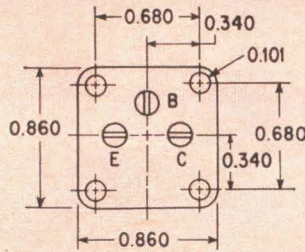

2N389 (TO-53)

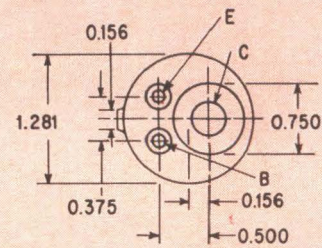

2N1016

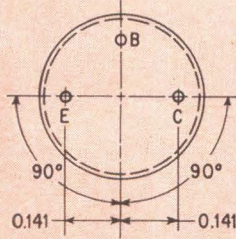

2N2035 (TO-8)

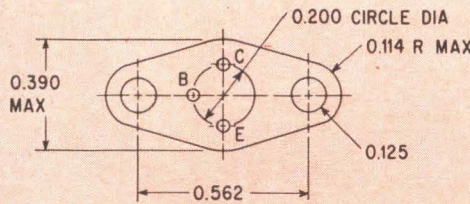

2N2036 (TO-37)

The variety of base patterns for transistors has been a problem for the dissipator manufacturers. Some of the many patterns currently in use are shown at left and at right.

facturers' catalogs his specifying job is not over. In fact, it's only beginning.

The procedure for specifying a dissipator consists of eight basic steps.

1. Select the basic structure from the manufacturers' catalog
2. Specify material—such as aluminum or copper
3. Specify finish—such as black anodized or hard-coat
4. Specify transistor hole pattern or transistor

to be accommodated—such as TO-36 or 2N1511

5. Specify number of hole patterns—typically one but occasionally two to four

6. Specify dimensions—lengths from 1.5 to 6 inches are usually available, with a limited choice in width and height dimensions

7. Specify location of transistor hole pattern and locations of holes for mounting hardware—unless otherwise instructed, the dissipator manufacturer will place the transistor hole pattern at the center

## Directory of dissipator manufacturers

### Free convection dissipators

Free convection dissipators		Forced convection dissipators	Dissipator manufacturers	Addresses
Low power	High power			
■	■		Aavid Engineering, Inc.	28 Arch St., Laconia, N.H.
■	■		Accel Electronic Products	P.O. Box 467, Monterey Park, Calif.
■			Amatom Electronic Hardware Co.	432 Main Street, New Rochelle, N.Y.
■	■	■	Astro Dynamics, Inc.	Second Avenue, Northwest Industrial Park, Burlington, Mass.
■			Atlee Corp.	2 Lowell Avenue, Winchester, Mass.
■	■		Augat, Inc.	33 Perry Ave., Attleboro, Mass., 02703
■	■		The Birtcher Corp.	745 S. Monterey Pass Rd., Monterey Park, Calif.
■	■		The Delbert Blinn Co.	P. O. Box 757, Pomona, Calif.
■	■		Compagnie D' Electricite	54 Rue de la Boetie, Paris, France
■	■		COPRIM	130 Avenue de Ledru-Rollin, Paris 11, France
■	■		COSEM	12 Rue de la Republique, Puteaux, Seine, France
■	■		Cool-Fin Electronics Division of Elco Corp.	1717 N. Potrero Ave., South El Monte, Calif.
■	■		Daedalus Company	129½ Rosecrans Ave., Manhattan Beach, Calif.
	■		Delco Radio Division	700 E. Firmin, Kokomo, Indiana, 46901
		■	Gasket Manufacturing Co.	319 West 17th St., Los Angeles, Calif.
■			Horex Electronics, Inc.	2114 Pico Blvd., Santa Monica, Calif.

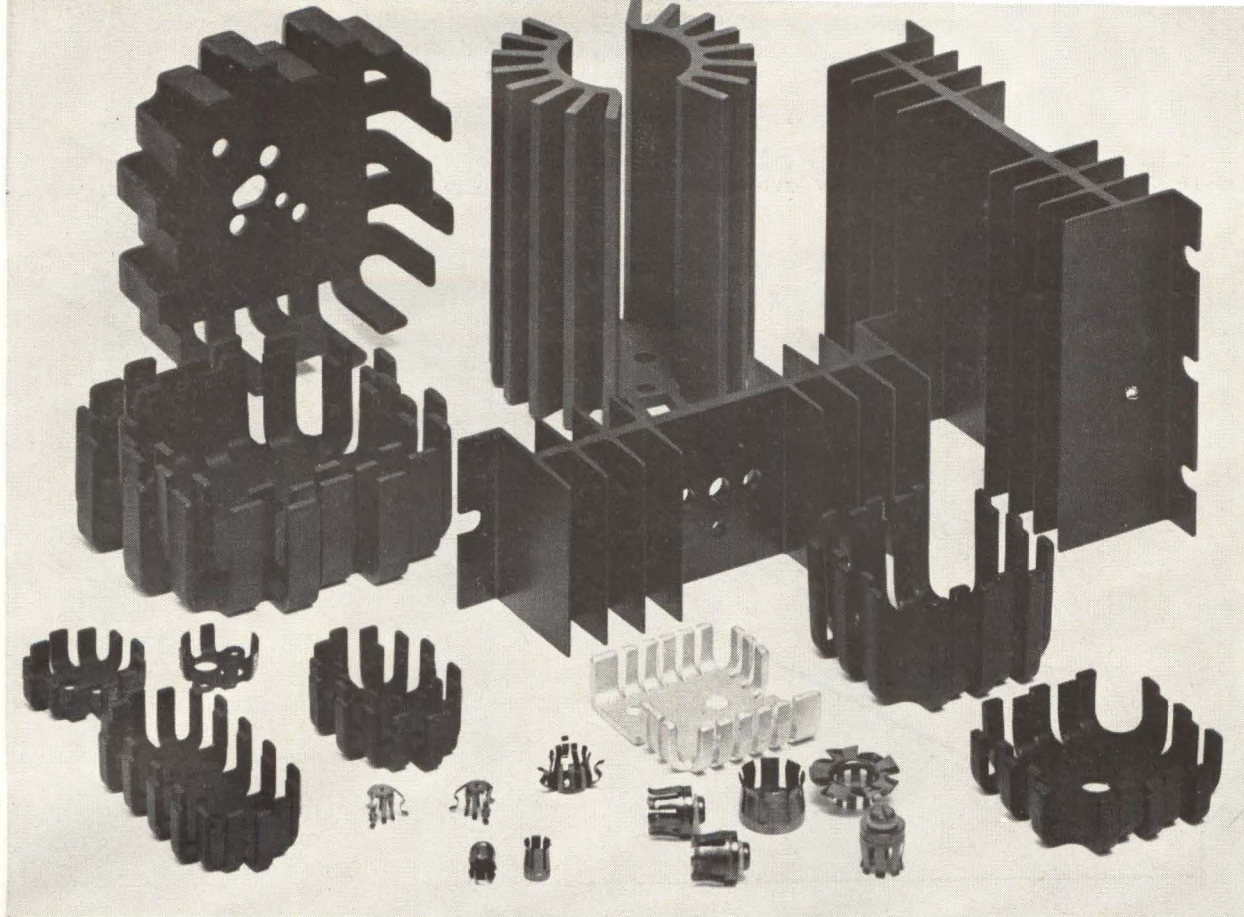

Typical heat-dissipator shapes: Retainers, medium-duty staggered-finger dissipators and a fan-top radiator are shown in foreground. Heavy-duty dissipators, including staggered-finger (left), appear in the background.

Thermal capacitance<sup>4</sup> is omitted in this discussion but included in the illustration to point out the many time-constants associated with heat power-flow. The total thermal resistance,  $\theta_r$ , is the sum of the individual thermal resistances through which heat power flows from its origin to the device's ambient environment.

### Thermal resistance

Typical thermal resistances for a power transistor dissipating 20 watts and mounted on a medium-size dissipator in natural air (no forced air movement) at 25°C are determined as follows:

1. Transistor junction temperature . . . 95°C
2. Transistor case temperature . . . 79.5°C
3. Dissipator temperature . . . 75°C
4. Ambient temperature . . . 25°C

The thermal resistance between two points is the difference in temperature of the two points divided by the power dissipated between the points. Thus,

$$\begin{aligned} \theta_j - c &= (95 - 79.5)/20 = .77 \text{ } ^\circ\text{C/W} \\ \theta_c - s &= (79.5 - 75)/20 = .23 \text{ } ^\circ\text{C/W} \\ \theta_s - a &= (75 - 25)/20 = 2.5 \text{ } ^\circ\text{C/W} \\ \theta_j - a &= \theta_j - c + \theta_c - s + \theta_s - a \\ &= 3.5 \text{ } ^\circ\text{C/W} \end{aligned}$$

Thermal resistance values vary considerably depending upon the measuring conditions. Thermal resistance will vary depending on the power being dissipated and on the ambient air-flow conditions even though the same transistor and dissipator are being used.

For example, the junction-to-ambient thermal re-

sistance found above will be reduced from 3.5° to 1.5°C per watt if 500 feet-per-minute of air is blown on the dissipator and the power is increased to 90 watts.

### Thermal runaway

An increase in junction temperature changes transistor parameters in such a way that collector current flow is increased. With high operating junction temperatures, the circuit designer must guard against the possibility of a continuously increasing collector current—accompanied by rising dissipation—leading to transistor ruin. To avoid this chain-reaction condition, known as thermal runaway,<sup>5,6</sup> the rate at which heat released at the junction increases must not exceed the rate at which power can be dissipated as the temperature rises.

The requirement for thermal stability<sup>7</sup> is:

$$dP_j/d \Delta T_{j-a} > (dP_j/di_c) (di_c/dt_j)$$

where  $dP_j$  = change in junction power dissipated  
 $d\Delta T_{j-a}$  = change in difference between junction and ambient temperatures  
 $di_c$  = change in collector current  
 $dt_j$  = change in junction temperature

J. A. Walston<sup>8</sup> describes thermal runaway as the repetition of three physical processes—first, a change in collector current causes a change in the power released at the junction; next, the change in junction power causes a change in junction temperature; and finally, the change in junction temperature causes a change in collector current. “Each

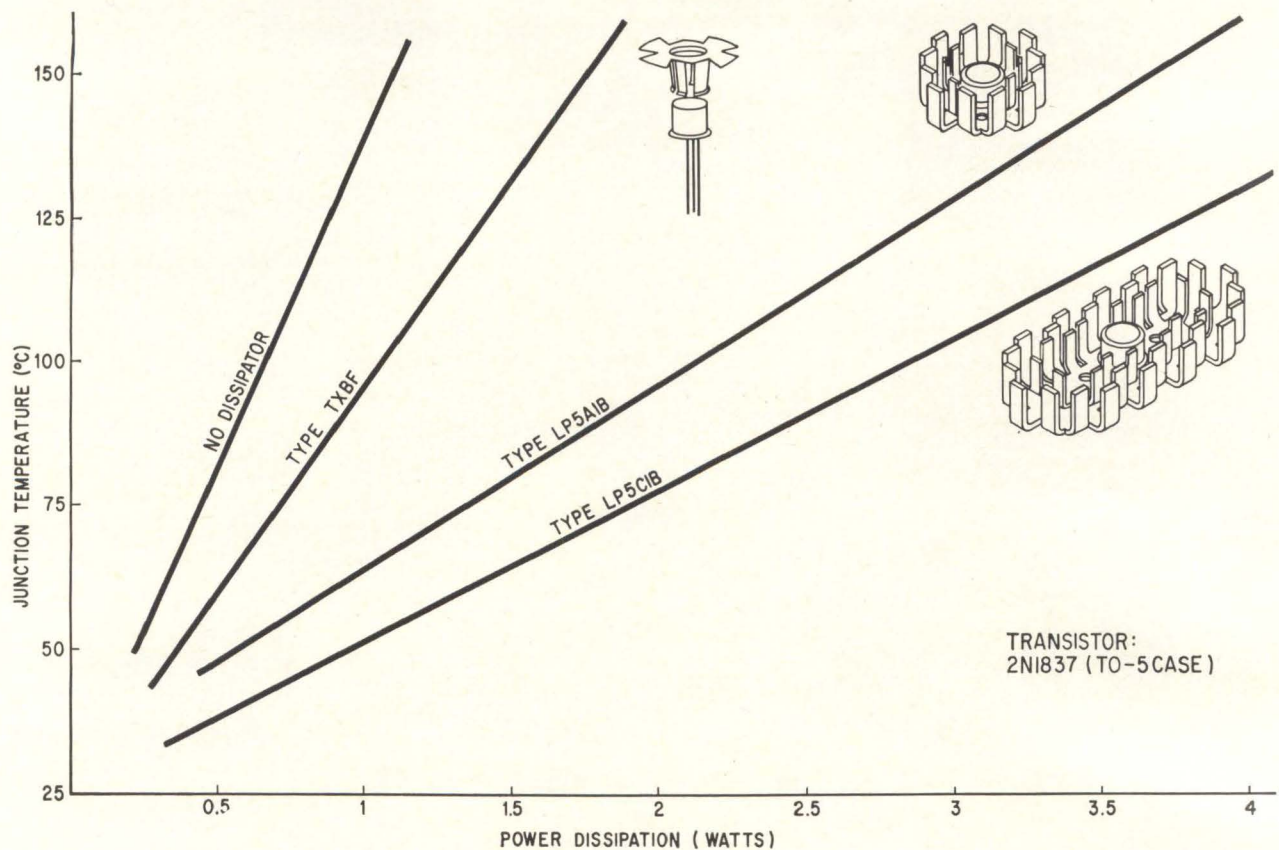

process," Walston says, "may be considered as a black box defined by an input, an output, and a transfer function [as shown on p. 95]. If the loop gain around this network is unity or greater than unity at any frequency, that is, if:

$$(\Delta i_{C1} / \Delta t_{j1}) (\Delta t_{j2} / \Delta P_{j2}) (\Delta P_{j3} / \Delta i_{C3}) \geq 1$$

then thermal runaway is possible."

The quantities in the preceding equation are defined as follows:

- $i_{C1}$  = initial collector current change
- $\Delta t_{j1}$  = initial junction temperature change
- $P_{j2}$  = change in heat power released at junction
- $t_{j2}$  = change in junction temperature caused by  $\Delta P_{j2}$
- $i_{C3}$  = change in collector current caused by junction temperature change
- $P_{j3}$  = change in heat power released at junction caused by change in  $i_{C3}$

The possibility of thermal runaway is increased

#### The author



John C. McAdam directs design, development and testing and supervises the research program at the International Electronic Research Corp. He is a technical advisor on international specifications for the Electronic Industries Association and the International Electrotechnical Commission and was one of the delegates to the recent IEC meeting in France.

when the transistor is subject to thermal feedback from another heat source in the system—as when two transistors connected in a Darlington amplifier configuration are mounted on the same heat sink.

Thermal stability, by the way, is usually of concern to the circuit designer only when the transistor is conducting normally and is not in saturation or cut off.

#### Excursions of characteristics

As if transistor destruction by excessive heat were not problem enough to harass the designer, there is the allowable range of characteristics in the semiconductor devices themselves to consider. By nature they have a normal excursion range for characteristic values which is sometimes tight—but more often considerably loose. For example, one manufacturer's specification sheet for the 2N697 lists characteristic spreads at 25°C which represent differences in the maximum value from the minimum value from 30% to 990%.

If the semiconductor junction were always operated at 25°C, circuitry could be designed very simply to compensate for these spreads. But unfortunately, semiconductor device junction temperatures quickly rise above 25°C during operation. Therefore the actual excursions of characteristics are greater than indicated by the specification sheet. Furthermore, many variables affect circuit operation, depending on environmental conditions, complicating the determination of actual minimum-maximum ranges for parameters.

In addition to affecting d-c pulse current gain, cutoff current, and saturation voltage, temperature

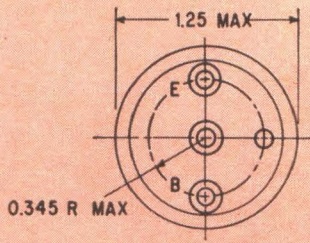

2N1511 (TO-36)

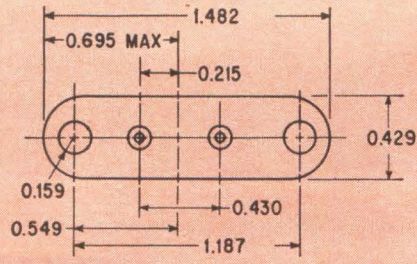

2N1755

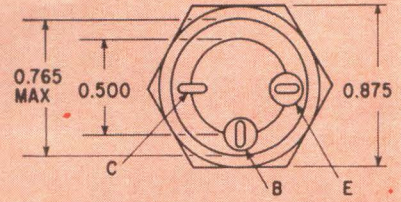

2N1936

The two most commonly used base patterns are the TO-3 (top left, p 90) and the TO-36 (top left above). Some heat-sink manufacturers offer a universal hole pattern which accommodates both.

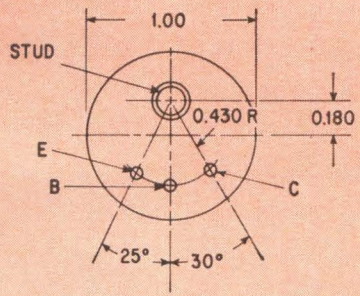

V15/30 P (BRITISH)

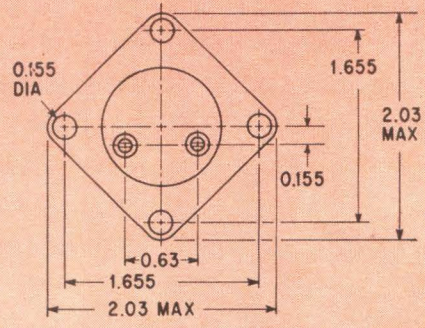

2SB 125 (JAPANESE)

of the heat sink

8. Specify associated hardware to be supplied with heat sink—brackets, washers, nuts, etc.

Once the procedure has been completed, the designer's next job is to find the commercially available heat sink which is closest to his requirements—unless he is willing to pay a premium for a custom-made dissipator.

The designer may wind up revising several of his requirements in order to take advantage of the

availability of an inexpensive standard dissipator. He will probably find it wise to alter his equipment package design to accommodate standard heat sinks.

The variety of heat sinks available gives the designer a considerable amount of choice and the modifications he must make in his plans are often minor. Most manufacturers offer each of their basic aluminum heat sinks with a number of different modifications directly from stock.

Free convection dissipators

Low power      High power

Forced convection dissipators

Dissipator manufacturers

Addresses

Low power	High power	Forced convection dissipators	Dissipator manufacturers	Addresses
■	■	■	International Electronic Research Corp. (IERC)	135 West Magnolia Blvd., P. O. Box 271, Burbank, Calif., 91502
	■		Mideast Aluminum Corp.	Route 130, Dayton, N.J.
	■	■	Modine Manufacturing Co.	1500 DeKoven Ave., Racine, Wis.
■	■		National Beryllia Corp.	First and Haskell Aves., Haskell, N.J.
■	■	■	Pin Fin Inc.	751 Main Street, Waltham, Mass.
	■		Precision Extrusions, Inc.	731 E. Green Ave., Bensenville, Illinois
■	■		Relco Products	2456 West Second Ave., Denver, Colo.
■	■	■	George Risk Industries, Inc.	672 15th Avenue, Columbus, Neb.
■	■		The Staver Co.	41-51 N. Saxon Ave., Bay Shore, N.Y.
■	■		Thermalloy Co.	P. O. Box 26036 414 Exposition, Dallas 26, Tex.
■	■		Tor Manufacturing Co.	1533 E. Walnut St., Pasadena, Calif.
■	■		U.S. Heat Sink	637 S. Isis Ave., Inglewood 1, Calif.
■	■		Vemaline Products Co.	Franklin Lakes, N.J.
■	■		A.R. Vetter	Box 128 Lemont, Pa.
■	■	■	Wakefield Engineering, Inc.	139 Foundry St., Wakefield, Mass.

Compiled by Electronics and McGraw-Hill World News (Ron Lovell, Los Angeles; Dan Smith, Paris).

# Beating the heat in semiconductor devices

How dissipators reduce operating temperatures, improve circuit performance and save money

By John C. McAdam

Vice President, Engineering  
International Electronic Research Corp., Burbank, Calif.

**It's simple and inexpensive** to reduce the operating temperature of a semiconductor device. A 30-cent heat sink can lower the junction temperature of a 2N1837 transistor, operating at one watt, from 130°C to 90°C. And with a 42-cent sink, the junction temperature at one watt goes down to 45°C. But why bother?

The answer is that semiconductor operating temperatures represent both a problem and a challenge. They are a problem because they impose an operating limit on transistors. They are a challenge because with deliberate control of temperature the engineer can design new circuitry, improve or simplify existing circuits and often save money.

All transistors have maximum allowable operating temperatures—commonly from 85° to 100°C for germanium devices and from 150° to 200°C for silicon transistors. Transistor data sheets usually specify the absolute maximum junction temperature allowable. Exceeding this limit can permanently damage or destroy a transistor. A typical example is the 2N441, a germanium type; without a dissipator it can be operated up to 3 watts, which heats the junction temperature to 90°C—at or be-

yond the limit at which this type will be damaged. To run this transistor at a higher power level, such as 10 watts, would require a highly efficient heat dissipator which would hold the junction temperature at or below 85°C.

## Thermal-flow diagram

One convenient and commonly used way of expressing the basic flow of heat through a solid is to use an analogy between heat power and electrical power.<sup>1, 2, 3</sup>

In electricity, moving an electrical charge (coulombs) from one point to another requires a difference in electrostatic pressure (voltage). Impeding this flow is electrical resistance measured in ohms (volts per ampere). In the same manner, to move heat energy (joules) from one point to another, a difference in heat pressure, or temperature, must exist. The impedance to this flow is called thermal resistance measured in thermal ohms, or degrees centigrade per watt.

The analogy is illustrated by the simplified thermal-flow diagram. The transistor is dissipating constant power into an air-cooled heat sink.

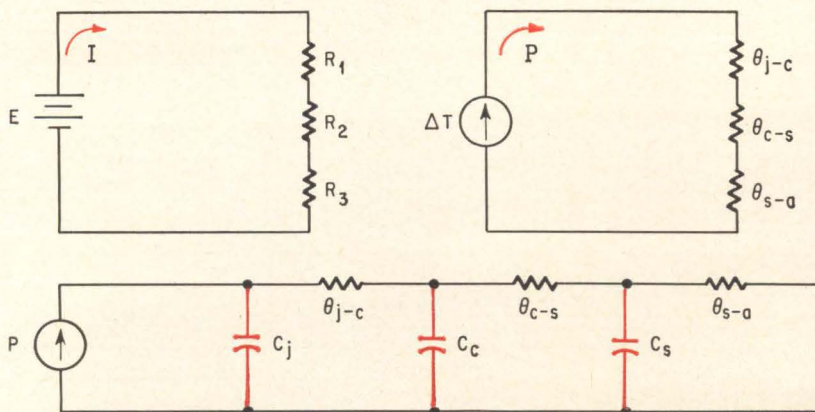

THEMAL RESISTANCE ( $\theta$ ) SUBSCRIPTS:  
j-c = JUNCTION-TO-CASE  
c-s = CASE-TO-HEAT SINK  
s-a = HEAT SINK-TO FREE AIR

THEMAL CAPACITANCE (C) SUBSCRIPTS:  
j = JUNCTION  
c = CASE  
s = HEAT SINK

Current-flow diagram, top left. Thermal-flow diagram, top right.  
Thermal-flow diagram including thermal capacitance, bottom.



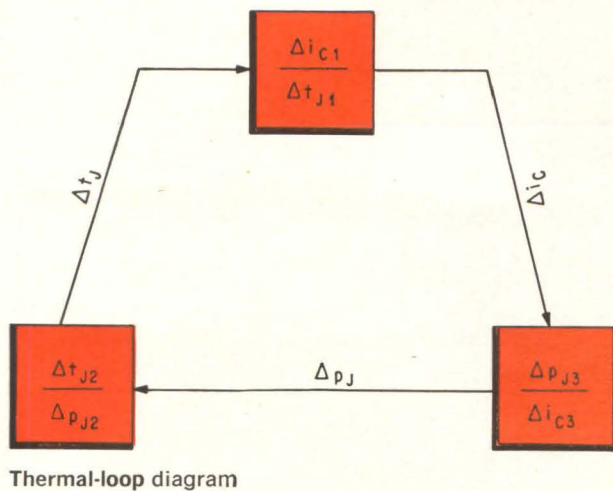

Thermal-loop diagram

◀ The relationship between dissipation and junction temperature for a low-power silicon transistor using various dissipators

Typical variation of characteristics with temperature for a silicon transistor. ▶

also has a profound influence on switching speeds, small signal characteristics ( $h$  parameters), and other parameters as shown at right. As the junction temperature increases from 25°C to 150°C, the collector cutoff current  $I_{CBO}$  increases by several orders of magnitude while  $h_{FE}$ , rise time, and fall time approximately double from 25°C to 150°C.

### Dissipator advantages

The ability of dissipators to retard the increase in junction temperature with an increase in dissipation is shown on page 94 for a TO5-packaged transistor. It is evident that heat-dissipating devices can reduce high-power high-temperature problems. As shown, a silicon device operated at a 1-watt power level with an ambient temperature of 25°C and without a dissipator exhibits a junction temperature of 140°C. By applying a small slip-on fan-top radiating dissipator, the junction temperature is reduced to 95°C. Remounting the transistor in a heavier-duty dissipator further decreases the junction temperature to 65°C.

By holding down the junction temperature  $I_{CBO}$  is decreased substantially. The use of the small, inexpensive dissipator reduces the increase in  $h_{FE}$  from 50% to 30% above its 25°C value. Use of a larger dissipator further limits  $h_{FE}$  to only a 16% increase above its 25°C value.

It can be seen, too, that use of the dissipators decreases the rise and fall times by 20% to 40%. In fact, with a typical silicon transistor, by limiting the junction temperature to 50°C or lower, rise and fall times are decreased an order of magnitude from their values at the maximum junction temperature.

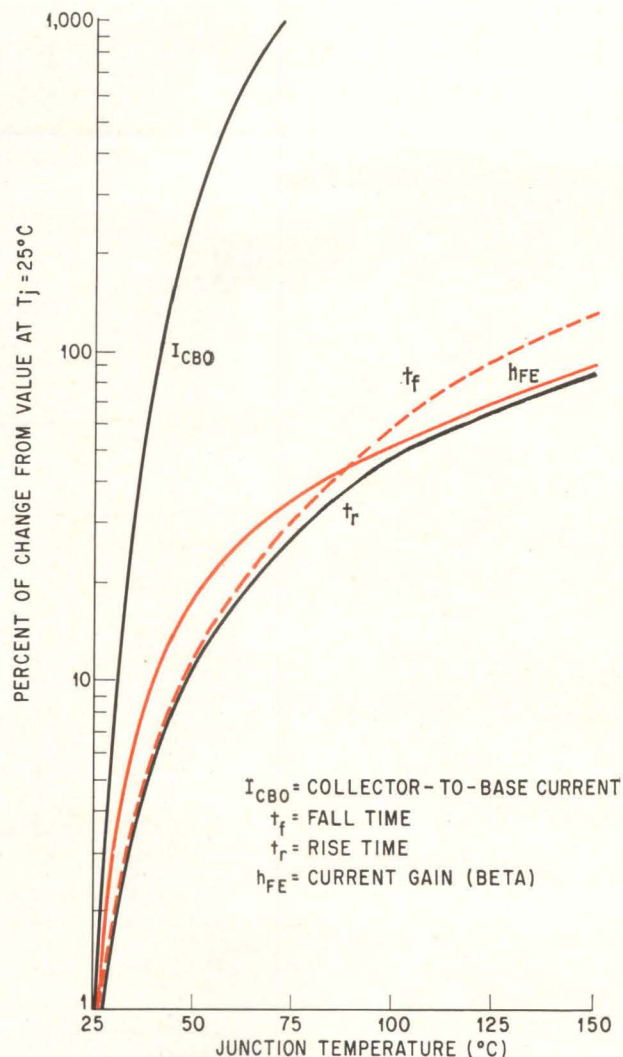

Other improvements with lowered temperatures include:

- Higher small signal gain and higher d-c beta.
- Decreased leakage current. This reduces the loading effects of a circuit. For example, the fan-out capability of computer circuitry is improved by reducing the load on the driver.
- Longer transistor life and greater circuit reliability.

Greater economy in circuit construction may be achieved by using high-beta transistors with dissipators in place of low-beta transistors without dissipators. In one high-current application, three low-beta emitter follower stages were used to provide sufficient current for driving purposes. When high-beta transistors were utilized in the same application, one emitter-follower stage was eliminated. The three transistors, each with a beta of 20, provided a total current gain of 8,000 whereas the two transistors, with betas of 90, provided the same gain.

In another application, each transistor of a pair was operated at 2.5 watts because it was discovered that a single unit at five watts became too hot. The same circuit could have used a single transistor at five watts with a dissipator—saving transistor costs, assembly costs, and probably mak-

## Parameter test circuits

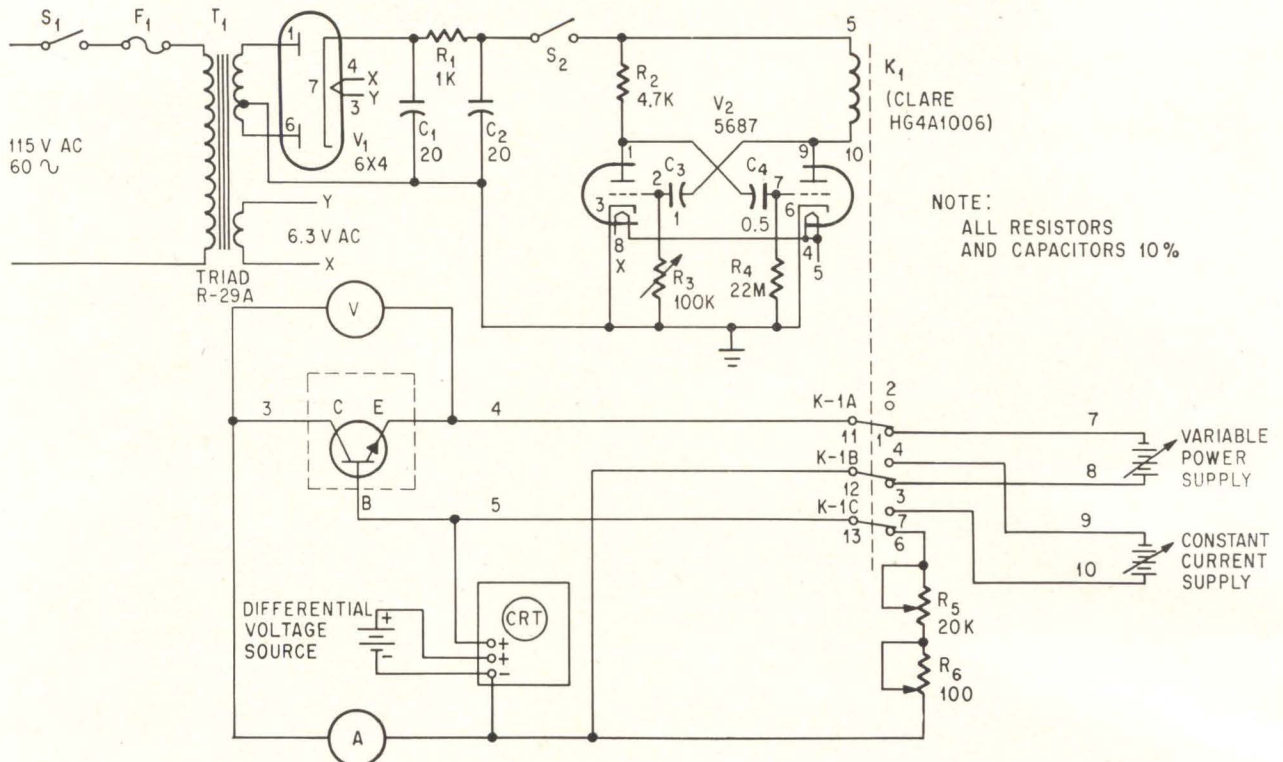

Test circuit for measuring transistor junction temperature as a function of forward voltage drop

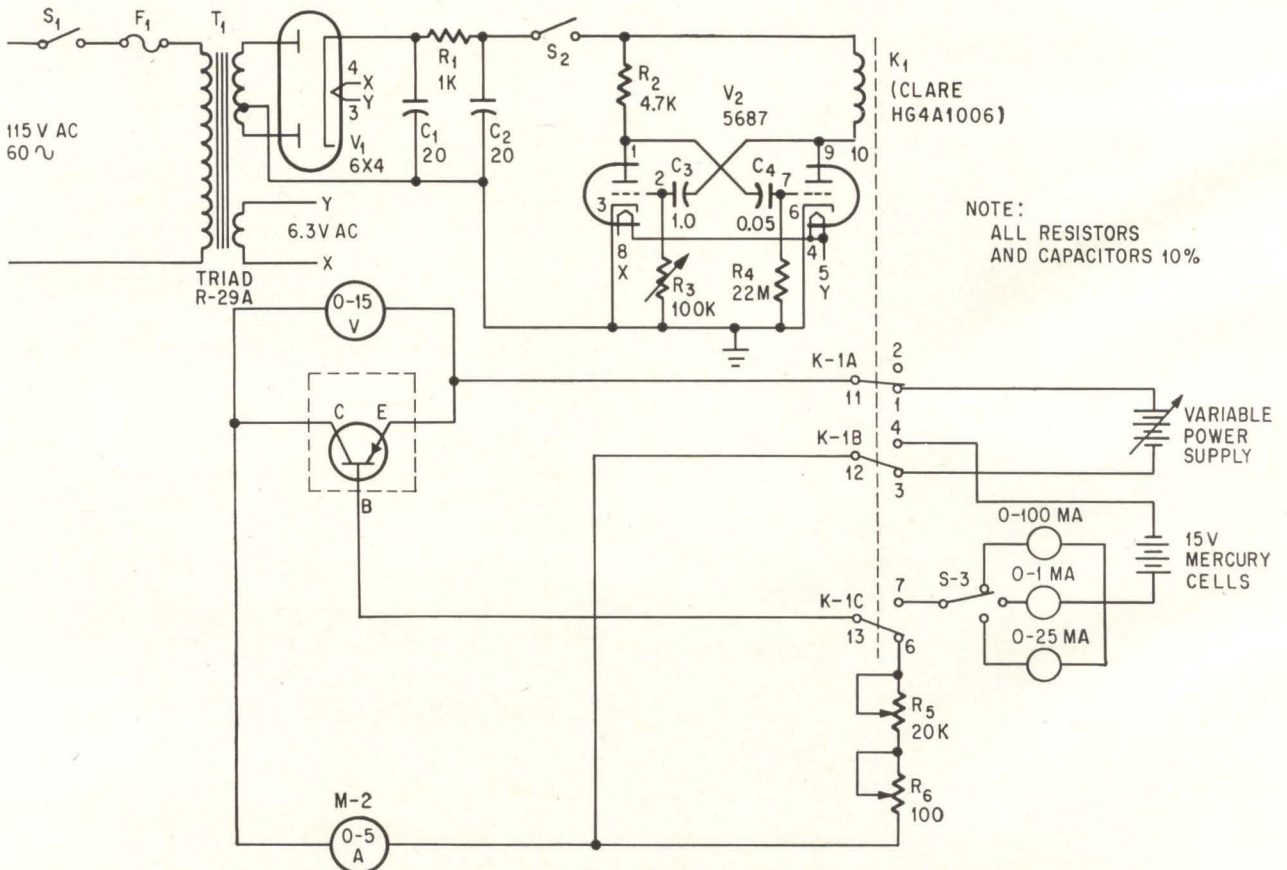

Test circuit for measuring transistor junction temperature as a function of collector cutoff current ( $I_{cbo}$ )

ing the over-all performance of the circuit more reliable and predictable.

### Measuring junction temperature

An awareness of the thermal aspects of circuit design is half the battle. The other half consists of knowing how to measure and control the temperatures involved.

Junction temperature values at a given power level can be obtained from several sources such as mathematical approximation, tables and curves already compiled for similar applications, and laboratory testing. The curves shown on page 94 for a typical semiconductor device were obtained in the laboratory. For many designs, the use of such curves is sufficient. Another method for obtaining design criteria is described below:

First,  $T_j$  is determined by measuring the electrical parameters of the transistors that are functions of  $T_j$ . The parameter used for silicon transistors is the forward voltage drop from collector to base, with the emitter open ( $V_{CBO}$ ). For germanium transistors, the collector junction leakage current ( $I_{CBO}$ ) is the parameter employed to measure  $T_j$ . The circuits used to measure these parameters are shown on page 96.

To determine the relationship of  $V_{CBO}$  or  $I_{CBO}$  to  $T_j$  for a group of transistors, the units are placed in a temperature-controlled chamber. Starting at 25°C, the temperature of the chamber is raised in 5°C steps to the maximum allowable junction temperature of the transistors. There is a 30-minute time interval at each step to insure that the transistor junction temperature is the same as its case temperature. Switch  $S_2$  (in either circuit) is then closed, causing  $K_1$  to energize briefly at set intervals, thereby permitting the  $I_{CBO}$  or  $V_{CBO}$ , whichever the case may be, to be measured. The measurement of  $V_{CBO}$  takes 27 milliseconds and is repeated every two seconds. For  $I_{CBO}$ , the measuring time is 150 milliseconds, also repeated every two seconds. Curves of  $I_{CBO}$  vs.  $T_j$  or  $V_{CBO}$  vs.  $T_j$  may be constructed from the data obtained.

### Measuring heat dissipation

Next it is necessary to determine how much of the device's heat will be drawn away, or dissipated, by the surface (circuit board, metal chassis or heat sink) to which it will be attached.

The heat-transfer meter, shown above was specifically designed to determine thermal resistance. The heat sink under test is initially at room temperature. A front-panel control on the heat-transfer meter sets the desired transistor case temperature. The actual temperature at the heat sink is sensed by the probe and compared to the preset temperature. Any heat imbalance results in an error signal being fed to a high-gain amplifier which provides power to the heating unit in the meter. The operation is similar to the feedback which takes place in a servomechanism. The probe, which is simulating a transistor, continues to be heated and quickly reaches the preset temperature. A wattmeter on the

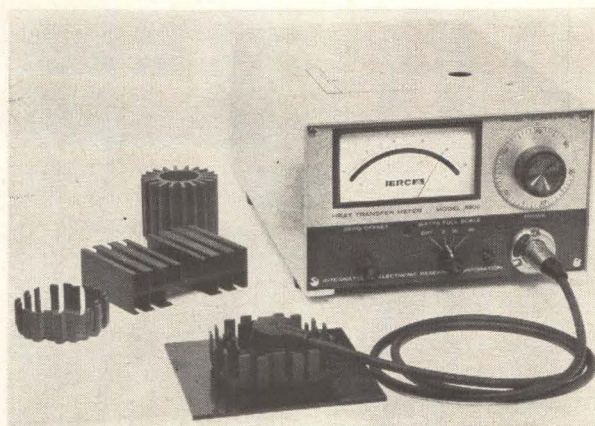

Heat-transfer meter and probe for determining thermal resistance

face of the unit indicates the amount of power used to maintain the preset temperature. The power supplied by the heating unit is then reduced to a steady state value necessary to replace the thermal energy flowing into the heat sink and maintain the probe contact point at the preset temperature. The higher the wattmeter reading, the better the heat conduction capability of the heat sink.

Thus the heat-transfer characteristics of a surface may be measured under specified mounting conditions by attaching the probe, setting the probe temperature-dial for the desired temperature and, after allowing the system to reach a stable condition, reading the dissipated power on the meter. Comparison of various heat dissipating devices, methods of mounting and conditions of air flow may be quickly investigated in this manner.

Also, the temperature contours of a chassis may be plotted, using the heat-transfer meter in conjunction with a thermocouple-pyrometer. The probe is mounted in several places on the chassis, one place at a time, and the meter is set for the expected case temperature of the devices to be mounted at each given spot. The data obtained can be used to calculate the resulting over-all temperature rise of the complete equipment.

To measure the thermal resistance of a heat sink, the probe is applied to the heat sink, and the system stabilized at the case temperature for which the thermal resistance value is desired. From the recorded dissipated power and the temperature rise above ambient temperature, the thermal resistance  $\theta_{C-A}$  is found from:

$$\theta_{C-A} = (T_C - T_A) / P \text{ } ^\circ\text{C/Watt}$$

where  $T_C$  = case temperature ( $^\circ\text{C}$ )

$T_A$  = ambient temperature ( $^\circ\text{C}$ )

$P$  = power reading on meter (watts)

This procedure assumes that the probe dissipation simulates the additional dissipation of a transistor case.

In addition to investigating the thermal resistance of transistors, the meter can also be used to measure the thermal resistance of materials. A constant temperature source is used. The face of the probe is shielded from stray air currents, and the

meter is set at zero with the zero offset control. The probe is then placed in contact with one surface of the sample to be tested. The other surface is maintained at a constant temperature on a heat sink. The thermal resistance of the material will be

$$\theta = T_P - T_S / P \text{ } ^\circ\text{C/Watt}$$

where  $T_P$  = preset probe temperature ( $^\circ\text{C}$ )  
 $T_S$  = controlled heat sink temperature ( $^\circ\text{C}$ )  
 $P$  = power reading on meter (watts)

### How to lower temperatures

With today's high-power semiconductor devices, knowing how heat dissipators do their job is of great concern to the circuit designer. Once the requirements for the dissipator have been determined, a variety of shapes is usually available, regardless of the power level needed.

Considering only such mechanical factors as surface area and mass when selecting a transistor heat dissipator can be misleading. It may work in the design of a heat exchanger for a power plant which occupies an acre of land; however, when considering dissipating heat from a one-inch device in a crowded electronic system, the efficiency of the dissipating device, as related to its size and weight, is critical. The dissipator should be designed for optimum effective area rather than for available square inches of area. For example, a dissipator designed with the staggered-finger arrangement shown below can dissipate as much power as

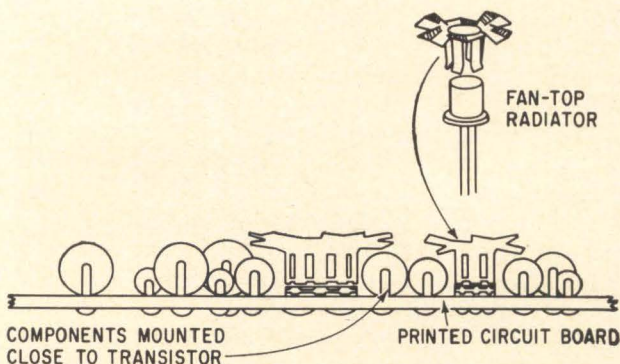

Fan-top radiator fans reach above components and enter forced-air path.

Linking of dissipators may be used to equalize the temperatures of two transistors (lower left and lower center) or to provide greater dissipating ability (lower right and above).

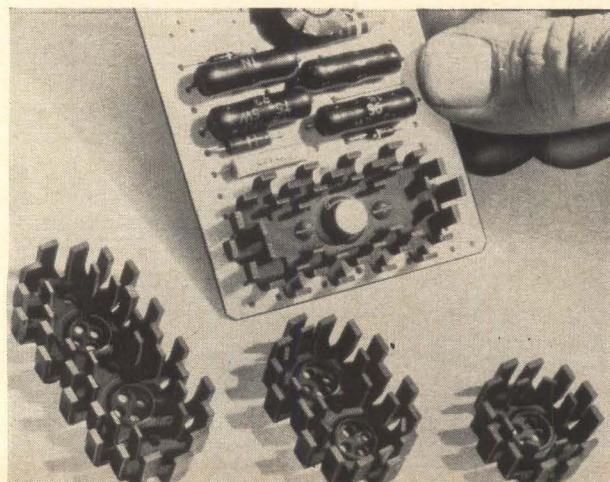

another type of dissipator, although it is only one-third of the weight and two-thirds of the volume of the second dissipator.

Dissipator construction should be compatible with equipment construction. For example, in equipment using closely spaced printed cards with air forced between them, the dissipator is attached to a transistor that is surrounded by components. For efficient cooling, a portion of the dissipator should extend into the forced air current. This is accomplished as shown below.

In some applications it is necessary to isolate the transistor electrically and reduce its capacitive coupling with the heat sink. This can be accomplished by brazing beryllium oxide material to the bottom of the dissipator. This material is an excellent electrical insulator but has thermal conductivity comparable to that of aluminum.

In many applications it is advisable to use a heat sink compound. The thermal resistance of a typical power transistor mounted to a heat-dissipating device is approximately  $0.25^\circ$  to  $0.5^\circ\text{C}$  per watt. Application of a good silicone compound will cut this value in half—or to about  $0.1$  to  $0.2^\circ\text{C}$  per watt. This happens because the compound has a much lower thermal resistance than the dead air in the small cavities of the interface joint. The compound fills in the cavities and allows more heat transfer across the total surface area of the joint. The use of such compounds has reduced many heat dissipation problems.

Circuit applications such as differential amplifiers, push-pull amplifiers, flip-flops and multistage configurations often require characteristic similarity in the semiconductor devices being used. One answer is to purchase matched pairs selected for mated parameters. Temperature control also plays a part here since differences in operating temperatures may cause an imbalance in temperature and affect the sensitive parameters and therefore cause deviation from ideal circuit operation. Thermal linking of two or more semiconductor devices and heat sinks equalizes junction temperatures and maintains matched or similar characteristics.

The thermal requirements of a circuit should be determined and the appropriate dissipators chosen early in the design. Any circuit design is incomplete if it is concerned solely with the electrical requirements of an application.

### References

1. H.R. Persh, Some Considerations for Mounting and Cooling the Power Transistor, Application Note, Silicon Transistor Corp., Aug. 1963, pp. 1-2.
2. Peter Lefferts, When to Specify Thermoelectric Temperature Stabilization, Application Note, Carter-Princeton Div., Carter Products, Inc., 1963, pp. 4-5.
3. Thermal Design for Cooling Rectifiers, Application Note, Transtron Electronic Corp., Wakefield, Mass., May, 1963, p. 1.
4. Texas Instruments, Inc. staff, Transistor Circuit Design, McGraw-Hill, Inc., pp. 55-58.
5. Paul, Penfield, Jr., Protecting Power Transistors from Thermal Runaway, Electronic Industries, Feb., 1958.
6. C.R. Turner, Determining Permissible Dissipation for Silicon Power Transistors, Electronic Design, Aug. 16, 1961, pp. 44-49.
7. Op. Cit., Texas Instruments, Inc., staff, pp. 110-123.
8. J.A. Walston, Thermal Considerations in Transistor Circuit Design, Application Note, Texas Instruments, Inc.

# Long-pin approach to dissipator design

One of many possible methods of removing heat from semiconductor devices is examined

By John H. Jacoby

President, Pin Fin, Inc., Waltham, Mass.

**Of the many** designs for dissipators that will remove heat effectively from semiconductor devices, the standard finned heat sink is the most popular because of its proven cooling capability and low fabrication cost. But pin-fin construction is another approach with some advantages. It is already being used in computer power supplies, microwave transmission equipment, thermoelectric systems, and other applications.

In such a device, an array of pin projections (or pin fins) transfer the heat from the semiconductor device to the surrounding fluid (usually air). A typical pin dissipator is shown at the right. Heat removal by such devices was reported by W. M. Kays and A. L. London<sup>1</sup> several years ago. Although they reported favorably on this type of construction, the technique did not appear practical from an economical standpoint. As a result, little effort was made in this direction until recently.

## Thermal conductivity of air

Free-air convection is the method most commonly used to carry off heat from a heat sink even though air is inherently a poor heat-transfer agent. Therefore, for adequate heat dissipation in compact electronic equipment, care must be taken in dealing with the thermodynamic problems involved.

The power-handling capability of an air-cooled heat sink is a function of many variables including the exposed (or effective) surface area, finish, air-flow rate, temperature levels of heat sink and air,

## The author

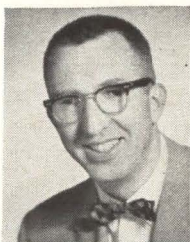

John H. Jacoby, 41-year old president of Pin Fin, Inc., spent 10 years designing liquid and vapor process equipment in New England and on the Texas Gulf Coast. Another eight years was devoted to managerial posts. During his spare time, he experimented with long-pin dissipators and in June, 1963, he formed Pin Fin, Inc.

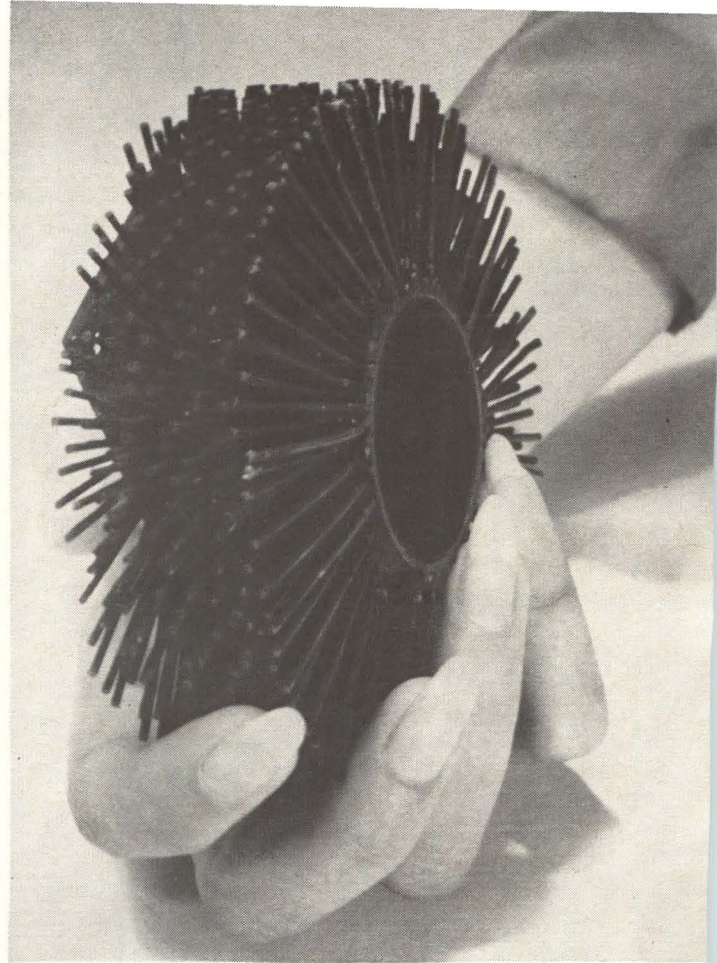

Typical long-pin dissipator

and thermal conduction paths within the heat sink. The most influential factor of all the variables is the geometry of the surface area. If the design is poor here, overdesign of the other variables is not likely to compensate.

The long-pin approach allows a large area to be exposed while maintaining short conduction paths to the core of the heat sink. In addition, the rate of fluid activity at the metal surface is desirably high.

Since air has low heat conductivity the flow of a significant quantity of heat from a heat sink into free air must be accomplished by moving the surrounding air mass. Whether the cooling system uses natural- or forced-air convection, its effectiveness depends on the rate at which the heated air at the heat-sink surface is displaced by cooler air.

## Boundary-layer considerations

The phenomena of increasing the heat-transfer rate, or dissipation capacity, from a surface without changing the fluid stream properties or temperature levels is achieved by increasing the "h" factor, or film coefficient. The film coefficient of a fluid in contact with a solid surface can be considered as an indication of the insulation effect of the thin layers of fluid clinging to the surface. The films, or so-called boundary layers of fluid, in contact with a surface tend to be stagnant, trapped by microscopic surface irregularities. They form an insulating blanket between the solid and the main fluid stream. Further from the solid surface, the fluid

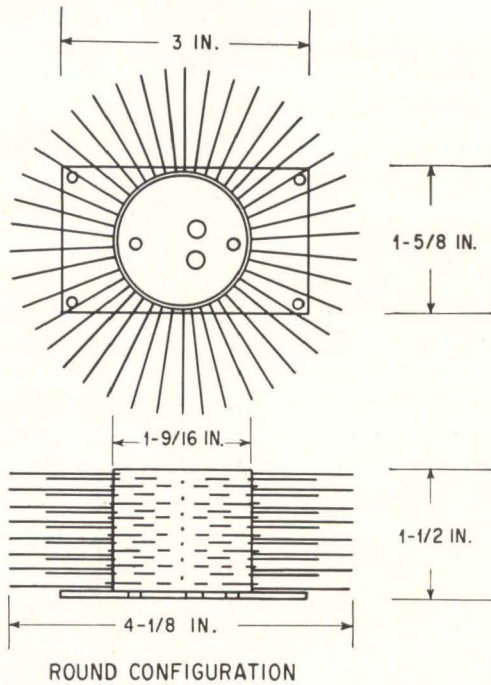

ROUND CONFIGURATION

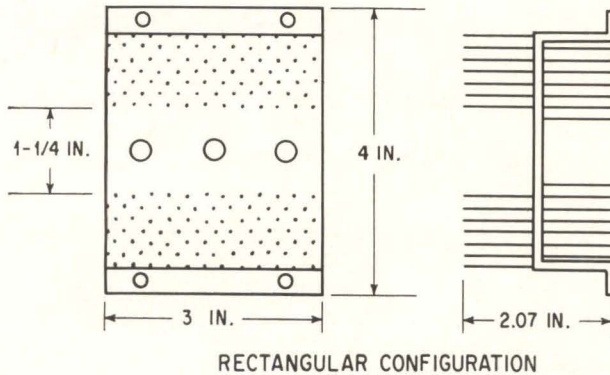

RECTANGULAR CONFIGURATION

FLAT CONFIGURATION

Typical dissipator shapes

**Case-to-ambient thermal resistances**

Thermal Resistance (°C/Watt)	Configuration		
	Rectangular	Round	Flat
<b>Natural convection:</b>			
no enclosure . . . . .	1.2	1.1	6.1
flush enclosure . . . . .	0.6	0.6	2.8
<b>Forced air:</b>			
at 10 to 30 CFM . . . . .	0.5 to 0.3	.....	.....
at 5 to 20 CFM . . . . .	.....	0.4 to 0.16	.....
at 3 to 15 CFM . . . . .	.....	.....	1.7 to 0.8

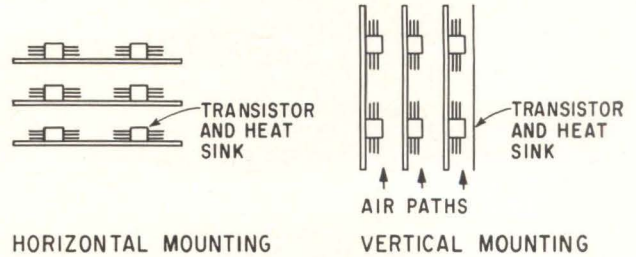

HORIZONTAL MOUNTING

VERTICAL MOUNTING

**Printed circuit-board layouts.** Arrangement at left has boards placed in horizontal position. This prevents heat sinks from developing effective natural convection drafts. Layout at right, with boards vertical, increases heat-sink dissipation in proportion to height of chimney formed by boards. The layout at right can provide up to three times the dissipation of the layout at left.

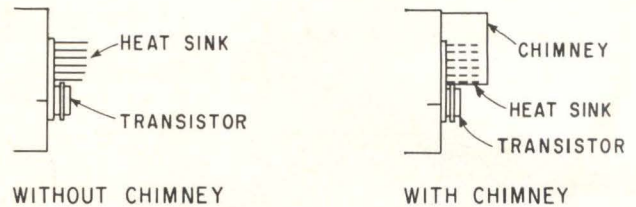

WITHOUT CHIMNEY

WITH CHIMNEY

**Isolated heat-sink arrangements.** The heat-sink arrangement at left will dissipate essentially the same power when placed in either a vertical or a horizontal position in a location with ample surrounding air space. Installation of an open-ended chimney, shown at right, can double the dissipation rate of the heat sink. With the heat sink on a horizontal chassis, the chimney must be raised slightly to allow air access under the bottom edge.

molecules can slide over each other with relative ease, and the film layers become more active. The insulation effect of these boundary layer films, or the film coefficient, is the major barrier to heat flow in air heat-transfer systems.

**Breaking up the layers**

The value of the film coefficient in a given application is related to the viscosity, heat capacity, thermal conductivity, temperature, and stream velocity of the fluid. These properties are usually fixed or limited by the application requirements, and the only remaining method of improving the film coefficient value is to break up the film layers mechanically. This can be done by arranging the surface configuration so that the kinetic energy of the moving fluid molecules continually breaks up or reduces the film layers. The ideal surface produces this required fluid activity with a minimum loss of energy from the stream. To attain high film coefficient values with a flat-plane heat transfer surface requires high velocity impingement of the fluid on the surface. Consequently, high energy, or pressure-drop losses occur when a large surface area is compacted into a small space. Arrays of long pins have low energy loss because of their ability to maintain high fluid turbulence.

**Heat-sink chimney**

The natural convection conditions under which heat sinks are evaluated can be misleading. What

is considered natural convection in one case may be equivalent to a low-velocity forced-flow condition in the next, by virtue of the induced drafts created by component arrangement and vent locations. It is often feasible to gain considerable performance improvement in natural convection applications by arranging components in vertical columns with top and bottom cabinet venting, or by installing a chimney above the heat sink. Surfaces without blind areas or that do not block air motion in any direction are the most desirable.

One other basic characteristic of heat-sink construction that contributes to its effectiveness is low

metallic mass in proportion to the surface area—assuming good convection occurs from all exposed areas. The long-pin array structure provides extremely high surface area-to-mass ratios.

Continued investigation of fabrication techniques for long-pin cooling devices is expected to uncover new methods which will lower production costs. The adaptability of long-pin surfaces to direct bonding to component cases also has distinct space-saving advantages. Semiconductor devices with pins directly bonded to the cases could provide space savings in the order of 50% to 75% over combinations of transistors with conventional heat sinks.

## Liquid cooling

Polaris and Apollo use it to take the heat off transistors. Now industry is taking another look

By John H. Sununu

Astro Dynamics, Inc., Burlington, Mass.

**Almost always,** a designer starts investigating heat-dissipator shapes with one assumption clearly made. He'll use free-air or forced-air convection cooling. Almost never does a designer even consider liquid cooling.

Yet, liquid cooling of semiconductor devices is neither new nor unknown. It has been effectively employed for several years in many areas, including the Polaris program. Its chief drawback is that it is expensive. Because of its cost, liquid cooling has been used mainly in the high-budget systems of military and aerospace equipment.

If the performance of a liquid-cooled system is, in fact, far superior to that of an air-cooled system of similar size or larger then the weighing of economic factors becomes extremely complicated. One must consider such factors as greater cooling density, longer lifetime of semiconductor devices, and even operating costs, before accurately defining the relative costs of the two approaches.

First, let's see if a liquid-cooled system really is a marked improvement over an air-cooled system. A comparison of the heat transfer coefficients for liquid and air cooling shows heat transfer can be increased 133 times by using water instead of air.

To start this comparison, the heat transfer coefficient  $h$  is defined by:

$$h = q/A\Delta T \quad (1)$$

where  $q$  = rate of heat transfer area in sq. ft.

$A$  = effective heat transfer area in sq. ft.

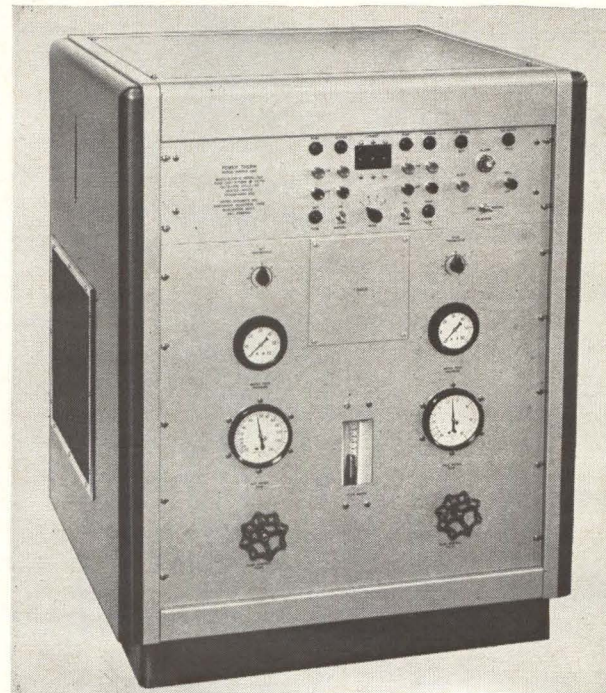

Transient-temperature generator delivers hot and cold fluids in repetitive cycles to the cold plate

$\Delta T$  = Temperature difference between heat transfer surface and coolant in °F  
The approximate expression for the heat transfer

## Other approaches to liquid cooling

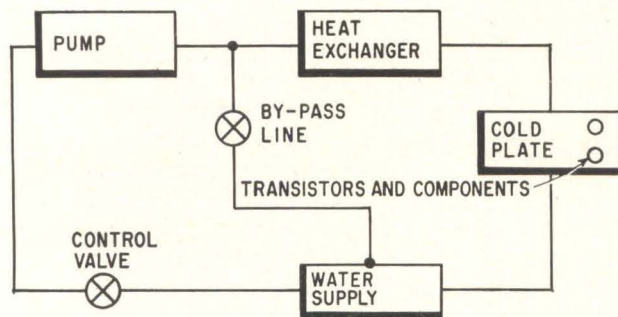

Typical flow diagram for cold plate system

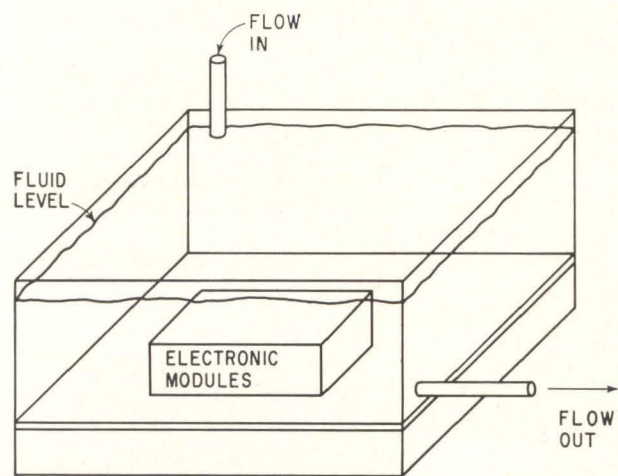

A simple approach to liquid cooling. Direct cooling is accomplished by the flow of the liquid.

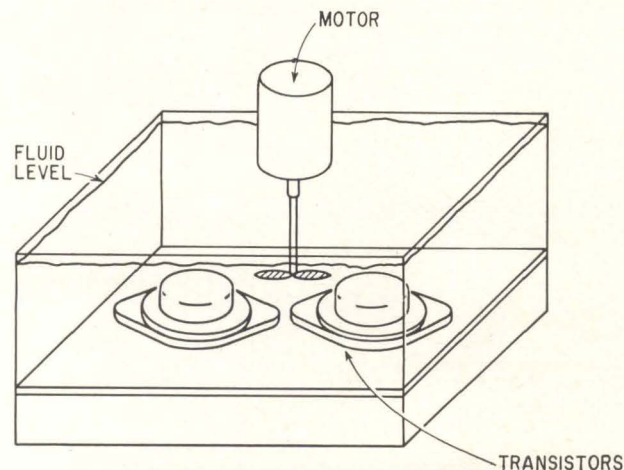

Direct liquid cooling by agitation. With this method, the liquid remains in the tank.

coefficient for forced convection in ducts, is:

$$h = 1.86 (K/D) [(N_R) (N_P) (D/L)]^{1/3}$$

where  $N_R$  = Reynolds Number =  $DV\rho/\mu$  (2)  
(the ratio of the inertia forces to the viscous forces)

$N_P$  = Prandtl Number =  $C_p\mu/K$   
(the ratio of momentum rate to thermal-diffusion rate due to molecular motion)

$D$  = Duct diameter (ft.)

$L$  = Duct length (ft.)

$\rho$  = coolant density (lbs/cu.ft.)

$C_p$  = Specific heat of air in BTU/(lbs) (°F.)

$\mu$  = coolant viscosity (lbs/hr.ft.)

$V$  = coolant velocity (ft./hr.)

$K$  = thermal conductivity of fluid [(BTU/hr.)] (sq.ft.) (°F./ft.)

For a given duct of constant diameter and length, a ratio may be written for the heat transfer coefficients of a liquid and air passing through the duct. Assuming equal velocity for both liquid and air we obtain:

$$\frac{h_{liq.}}{h_{air}} = \frac{K_{liq.}}{K_{air}} \left[ \frac{(\rho_{liq.})(\mu_{air})(N_{Rliq.})}{(\rho_{air})(\mu_{liq.})(N_{Rair})} \right]^{1/3} \quad (3)$$

Using water as the liquid to be compared with air, the constants involved are:

For water:

$$K = 0.35 \text{ [BTU/(hr.)] (sq.ft.) (°F./ft.)}$$

$$\rho = 62 \text{ lbs/cu.ft.}$$

$$\mu = 2 \text{ lbs/hr.ft.}$$

$$N_R = 8$$

For air:

$$K = 0.016 \text{ [BTU/(hr.)] (sq.ft.) (°F./ft.)}$$

$$\rho = 0.07 \text{ lbs/cu.ft.}$$

$$\mu = 0.045 \text{ lbs/hr.ft.}$$

$$N_R = 0.7$$

Substituting these values in equation 3, we obtain:

$$h_{water}/h_{air} = 133$$

This indicates that heat transfer from a fluid to a duct wall can be increased 133 times if the fluid is water instead of air and if both travel at the same velocity. The above calculation is based on the characteristics of water. However other fluids are also used in liquid-cooling systems. These include water-glycol mixtures for operation at temperatures below the freezing point of water, and fluorocarbon liquids for operation in environments subject to temperatures which range from above the boiling point to below the freezing point of water. For these liquids, the parameters are slightly different, but the results are generally the same or better.

### Aluminum cold plate

Efforts are being made to design liquid-cooled dissipation devices which will provide high-density cooling at a price attractive to industrial equipment producers. One possibility is the aluminum cold plate—a thin device containing 1/4-inch internal tubing through which a coolant flows.

The cold plate method of transistor cooling has been accepted for use in space vehicles. In the Apollo spacecraft, for example, virtually all of the critical components, including the inertial measure-



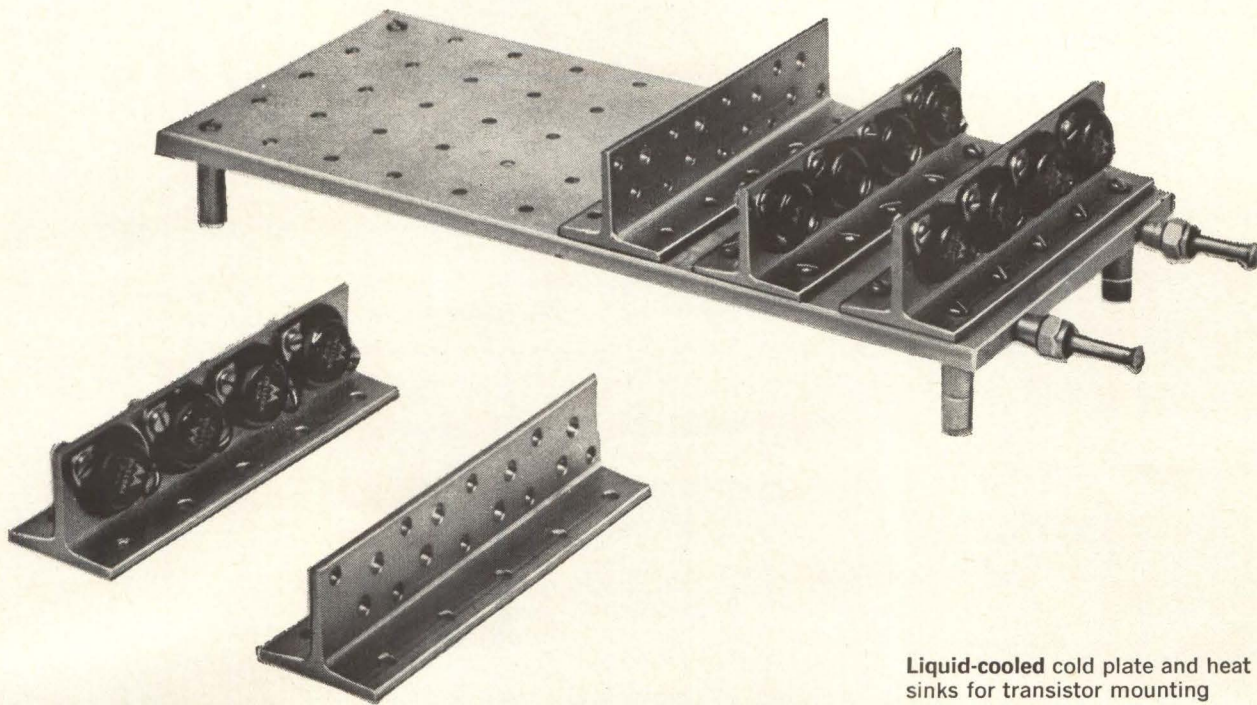

Liquid-cooled cold plate and heat sinks for transistor mounting

ment unit and the navigation computer, will depend on cold plates to protect the systems from overheating.

The cold plate handles coolants at pressures greater than 500 psi and, because of its efficient performance, permits the mounting of transistors on both top and bottom surfaces of the plate. Typical heat loads handled by the cold plates may approach two kilowatts per square foot of plate cross section.

The surface of a cold plate may be used in conjunction with a temperature-controlled water supply when it is desired to expose components to a precise thermal environment. In addition, the cold plate may be used with a transient-temperature generator, shown on page 101, for observing the effects of various temperatures and thermal transients on electronic components. The transient-temperature generator contains a temperature-controlled water supply and may be programed to generate square waves of temperature. For example, the cold plate can be cycled repetitively between  $-40^{\circ}\text{F}$  and  $+240^{\circ}\text{F}$  with cycles as short as three seconds.

The cold plate and other liquid-cooling methods offer highly efficient cooling for high-density systems. With standard commercial units becoming available in an area that previously was strictly a custom-basis business, the liquid-cooled dissipator has a promising future.

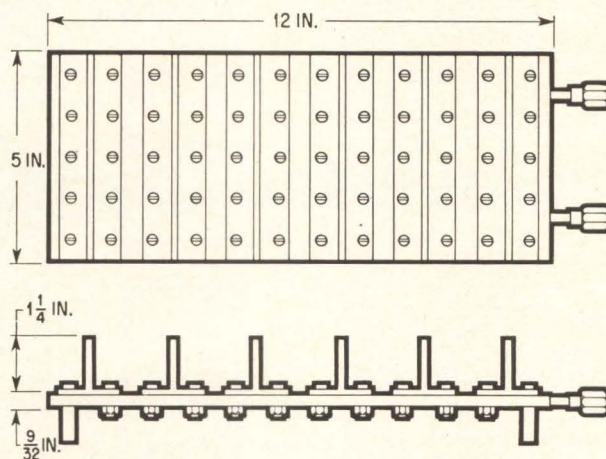

Outline of typical cold plate

The author



John H. Sununu has been designing dissipators, heat exchange systems and electronic equipment packages for the past four years at Astro Dynamics. His duties include assisting customers in using and designing Astro products into electronic systems. He received his bachelor's and master's degrees from the Massachusetts Institute of Technology.

Bibliography

1. F. Kreith, Heat Transfer, International Textbook Co., Aug., 1960.
2. L. Katz, Heat Transfer Designs for Electronic Equipment, Applications Note, Astro Dynamics Inc., 1962.

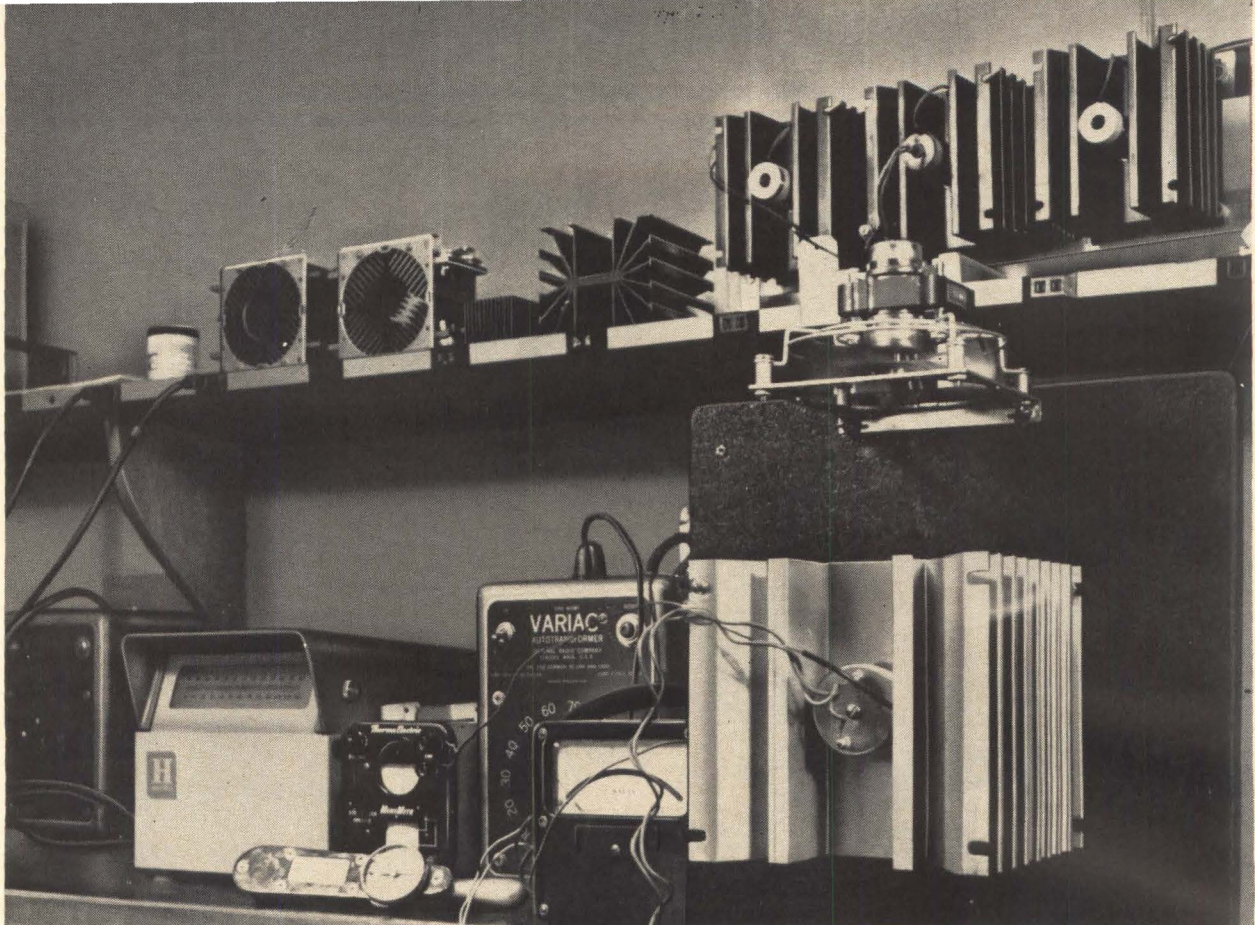

Actual test setup. The heat sink is placed in a vertical position with the fan mounted directly above.

## Torque and thermal resistance

Testing determines optimum torque setting;  
use of compound doubles conductivity

By Wayne E. Goldman

Wakefield Engineering, Inc., Wakefield, Mass.

**Both torque and** conductive greases between mating surfaces have an effect on thermal resistance. This effect must be examined in cooling stud-mounted semiconductor devices to determine the optimum conditions for operation.

The extent to which torque affects the value of the case-to-sink thermal resistance can be determined by a test setup such as the one shown above. The thermocouples measure the temperature at the hottest part of the load and at a point on the hottest part of the heat sink directly below the load. The thermal resistance ( $\theta$  c-s) is then

obtained from:  $\theta$  c-s =  $\Delta T/P$  °C/watt where  $\Delta T$  = temperature difference between case and heat sink in °C and  $P$  = power dissipated in watts.

### Thermal compound

Because of the irregularities in the surfaces of the heat sink and the base of the semiconductor device, air pockets occur when the two surfaces are mated. A thermal joint compound is generally used to eliminate these thermal insulators. The resulting reduction in thermal resistance may also be demonstrated by the torque test setup.



Close-up of the test load.

◀ The heavy-duty NC1541-6 heat sink contrasted with a model 201 lightweight cooler. Both dissipators are also shown on the cover. The NC1541-6 was used in the first test run.

In the experiments described, type 120 compound manufactured by Wakefield Engineering, Inc., was used to fill the air gaps. This compound is a blended mixture of silicone fluids and purified metallic oxides and has a thermal conductivity which is 20 times greater than that of still air.

Other thermal conductive greases intended for the same use include type 340 made by the Dow Corning Corp., Midland, Mich.; types G640 and G641 made by the General Electric Co's Silicone Products department, Waterford, N. Y., and Thermate, produced by the International Electronic Research Corp., Burbank, Calif.

### Torque studies

The test setup was tried for a large heat sink with a fan, moving 100 cubic feet per minute, mounted above the heat sink. The case simulated by the test load was a package with a  $\frac{3}{4}$ -inch stud and a hexagon base measuring  $1\frac{3}{4}$  inches in width. The test was first conducted without compound between the heat sink and load mating surfaces. It was then repeated with a thin coating of the type 120 compound applied between the mating surfaces. The results are shown on p. 106. Two conclusions can be made from the results obtained. The first is that an optimum torque exists at which the thermal resistance is at its lowest value. The second is that the use of a thermal conductive grease also reduces the case-

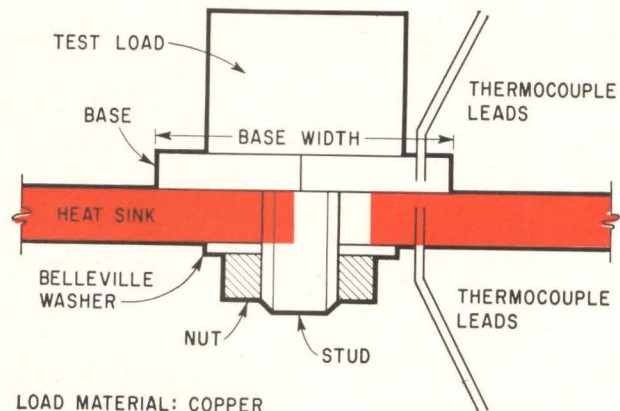

LOAD MATERIAL: COPPER

Test setup for measuring thermal resistance at various torque settings

### The author



Wayne E. Goldman's main assignment at Wakefield is to help customers design dissipators into electronic equipment as a structural support. This is not a new area for Goldman; before joining Wakefield he designed commercial and residential buildings.

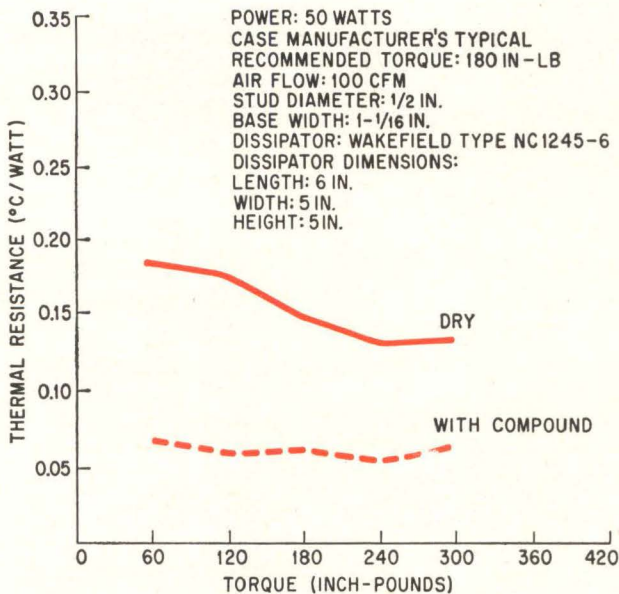
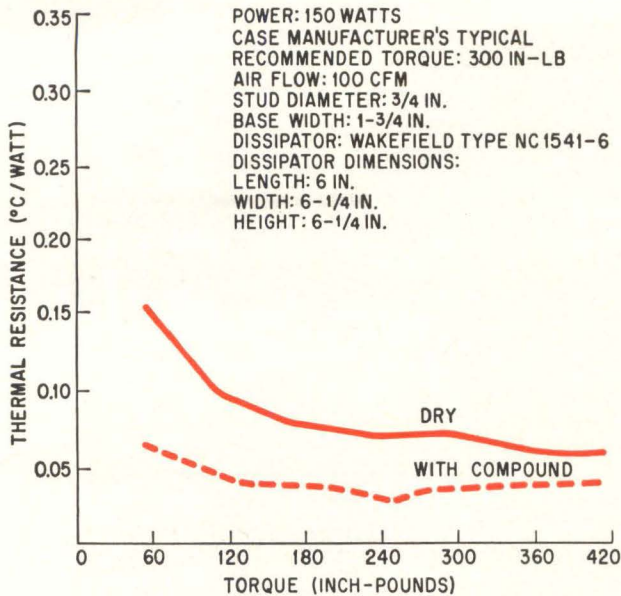

Initial test results

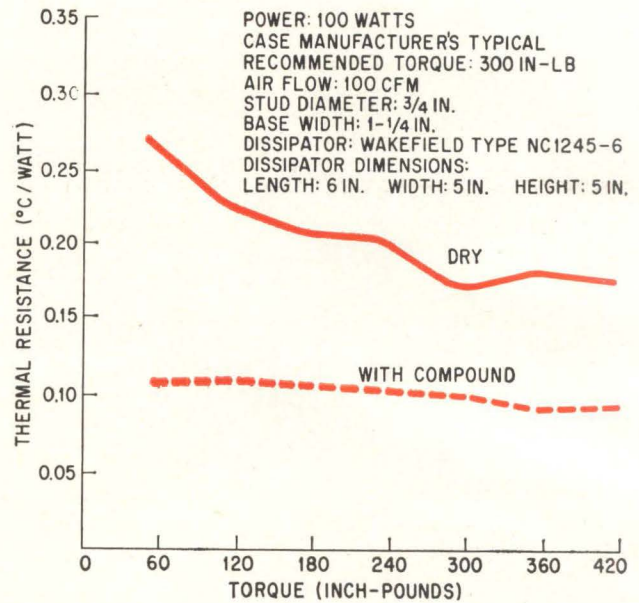

Second test results

Third test results

to-heat sink thermal resistance.

To substantiate the results obtained in the first test, two additional tests were conducted using different test loads, and power levels. As shown by the curves given above, the additional tests verify the conclusions made from the initial test.

Another conclusion from the test results is that minimum thermal resistance may not be achieved at the maximum torque setting recommended by the manufacturer unless a thermal conductive grease is used. The use of the compound in the tests reduced the thermal resistance substantially at all torque settings. At the torque setting recommended by the manufacturer, the decrease in thermal resistance was approximately 50%.

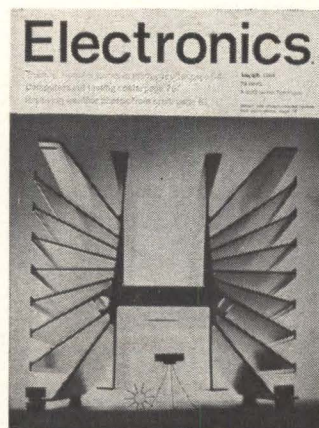

The cover

Tibor Hirsch, photographer, conveys the feeling of heat in this color study. The big unit is a heavy-duty fin sink, roughly 6 in. by 6 in. by 6 in. The small one is a clip-on device for cooling TO-5 cans. Both are made by the Wakefield Engineering Corp.

Years of research create a New Battery!

# The new Eveready® Nickel-Cadmium Rechargeable Battery

**Protected against overcharge!**  
**Protected against deep discharge!**

From Union Carbide's Technical Center at Cleveland, Ohio, comes an important advance in the rechargeable battery field — a new improved battery of superior performance and reliability. This is Union Carbide's latest contribution to the growth of the cordless product business.

The NEW "Eveready" nickel-cadmium sealed rechargeable battery is now being manufactured in the new plant at Union Carbide Corporation's Edgewater Works, Cleveland, Ohio.

It is available in a variety of sizes designed to accommodate new cordless products of all kinds. This new improved battery provides you with a new freedom in product design.

In addition to its two-way protection against overcharge and deep discharge, it gives long life, has level voltage curve at high discharge rates. And, of prime importance, this outstanding new battery provides a uniformity never before achieved.

Union Carbide is proud of this new "Eveready" Battery, and we think you'll find its versatility and performance challenging. You can be sure you're building top power efficiency right into the products you will be creating for the age of cordless power.

**2,000 TO 1**

A typical "Eveready" nickel-cadmium battery for cordless appliances can deliver 2,000 times the power required by a portable radio. So, letting  represent 1/20 watt (the wattage needed to power a transistor radio) it's easy to see the powerful difference the "Eveready" nickel-cadmium battery makes.

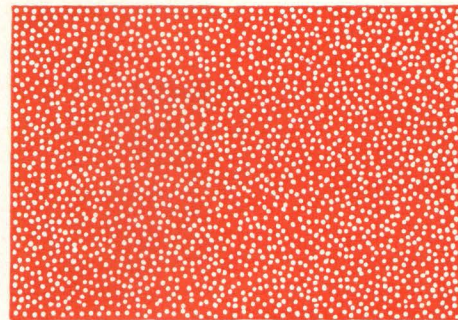

**100 WATTS**

Complete "Eveready" B/M/C POWER PACKAGE available (Battery/Motor/Charger)! Only Union Carbide offers this three-way package with all the power parts you need for your new products:

- "Eveready" nickel-cadmium rechargeable battery
- High quality electric motor (efficiency of 75%-80%)
- Correct battery charger

For personalized technical service for your cordless design problems, call or write: Battery Engineering Dept., Union Carbide Corporation, Consumer Products Division, New York, N. Y., 10017.



**Look to the Leader in Cordless Power—  
"Eveready" Batteries with "Power to Spare"**

"Eveready" is a registered trade mark of Union Carbide Corporation



# Garrett heard you're looking for a closed cycle cryogenic cooling system that will last the life of an aircraft without an overhaul. How soon do you want delivery?

Garrett-AiResearch has the system you're looking for. It's our version of the Joule-Thomson approach to closed cycle cryogenic cooling.

This is the system that will let you forget major maintenance for the life of the average aircraft. Actual test data show that its compressor unit will operate unattended for 2500 hours.

The only attention the system normally needs is replacement of an adsorber coil after 500 hours. And that's no problem because the coil is fitted with quick disconnects.

There are two major reasons for our high system reliability. First, our design concept uses few moving parts, so there are few things to go wrong. Second, we have 20 years of experience in building compressors, motors, fans, heat exchangers and valves. That's your assurance that the remaining moving parts will keep moving.

The AiResearch closed cycle system is well suited to cooling

infrared detectors. It's flexible. You can install the 14-pound compressor module wherever it's convenient. Put the 1-pound

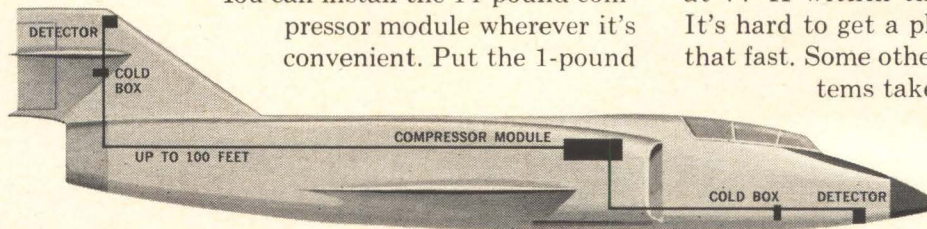

cold box as much as 100 feet away. The AiResearch cold box module solves the usual interface problem between a gimballed detector cell and the Joule-Thomson system. High pressure gaseous nitrogen, produced by the

develops five watts of refrigeration at 77°K within three minutes. It's hard to get a plane in the air that fast. Some other kinds of systems take as long as 13 minutes to get going. You probably have some important

questions. We'll be happy to answer them. We can also send you detailed information on this and other AiResearch cryogenic cooling systems.

You'll find the unique capability to solve your particular cryogenic cooling problem at Garrett's AiResearch Manufacturing

Division, Los Angeles, because...

## Garrett is experience



AiResearch Manufacturing Division  
Los Angeles • Phoenix

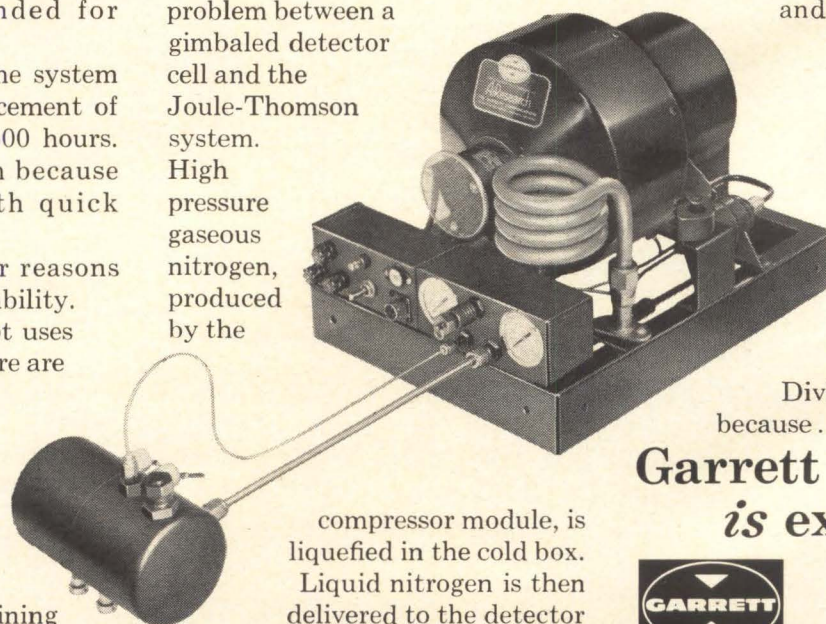

compressor module, is liquefied in the cold box. Liquid nitrogen is then delivered to the detector through an uninsulated flexible line. What about actual performance? A typical AiResearch system

## PRODUCTION TEST REPORT

	62	560	2,200	33 K	470 K	4.37 M
Lot No.	F-1235	F-1185	F-1184	F-1292	F-1340	F-1419
Size - Watts	1/2	1/2	1/2	1/2	1/2	1/2
Solder Change %	0.2	0.6	0.6	0.6	0.2	0.5
Voltage Coefficient	N.A	N.A	.0033	.0071	.0164	.0166
Moisture Resistance %	3.7	3.3	5.5	6.8	8.3	
Temperature Characteristics						
-55° C%	+1.9	+2.9	+3.0	+3.1	+4.3	+7.1
-15° C%	+0.6	+0.9	+0.9	+0.8	+0.9	+2.2
+65° C%	+0.4	+0.3	+0.7	+1.1	+1.0	+0.4
+105° C%	+1.3	+1.3	+2.2	+3.1	+3.3	+1.9
Load Life @ 70°						
75 Hrs. %	* 0.0	-0.8	-1.0	-1.4	-0.9	-0.6
150 Hrs. %	0.0	-0.8	-1.0	-1.8	-1.1	-0.7
250 Hrs. %	-0.1	-0.8	-1.2	-2.0	-1.2	-0.7
500 Hrs. %	-0.1	-1.7	-1.7	-2.4	-1.4	-1.2
750 Hrs. %	-0.2	-1.5	-1.9	-2.7	-1.5	-0.8
1,000 Hrs. %	-0.2	-1.5	-2.1	-3.0	-1.5	-0.7

\*62 ohm value tested @ 25° - 30°c

# STACKPOLE 100% TESTING CUTS YOUR INSPECTION COSTS

Never a failure... catastrophic, or otherwise with Stackpole fixed composition resistors. Solderability, load life, and humidity-temperature characteristics checks insure constant control of quality. The result is uniformity, plus reliability. 100% Stackpole testing insures that each resistor is right. You eliminate expensive, unnecessary incoming inspection. Best of all, there's no extra charge for this money-saving Stackpole service. Ask your Stackpole representative about it; or write: Electronic Components Division, Stackpole Carbon Company, Kane, Pa. Phone: 814-837-7000. TWX: 814-826-4808.



**STACKPOLE**  
ELECTRONIC COMPONENTS DIVISION

# wire and cable division

The logo for International Telephone and Telegraph Corporation (ITT), consisting of the letters 'ITT' in a bold, stylized, blocky font.

## NEW NAME

**for the combined resources of Surprenant and Royal.**

Effective August 1st, Royal Electric Corporation of Pawtucket, R. I., and Surprenant Manufacturing Co. of Clinton, Mass., subsidiaries of International Telephone and Telegraph Corporation, were combined into a single organization known as the WIRE AND CABLE DIVISION, ITT.

The consolidation makes available to Royal and Surprenant customers, and to the industry in general, the broadest line of wire and cable products and the greatest and most diversified reservoir of wire and cable engineering skill from a single manufacturer.

Royal products include rubber, neoprene and thermoplastic-jacketed fixture wires, machine tool wires, appliance wires, portable cords, welding cables, control cables, cord sets, power supply cords, fuses, wiring devices and many other products for military, industrial, O.E.M. and domestic applications.

Surprenant has achieved an unsurpassed reputation in the electronics, submarine, aircraft and aerospace fields for its line of Teflon\*, vinyl, silicone, nylon and irradiated polyolefin-insulated hook-up wires, coaxial cables, custom-engineered electronic cables, special cable assemblies, water-blocked cables, instrumentation cables, MIL-spec cables and heat-shrinkable tubing.

This merger of two industry leaders offers many advantages to ITT customers. Among them: increased engineering and manufacturing capabilities, improved product availability and increased service efficiency.

Investigate the newest, biggest and most progressive name in the industry . . . Wire and Cable Division, International Telephone and Telegraph Corporation, Pawtucket, Rhode Island.

\*DuPont Company's registered trademark for its fluorocarbon resins.

wire and cable division

The logo for International Telephone and Telegraph Corporation (ITT), consisting of the letters 'ITT' in a bold, stylized, blocky font.



# Probing the News

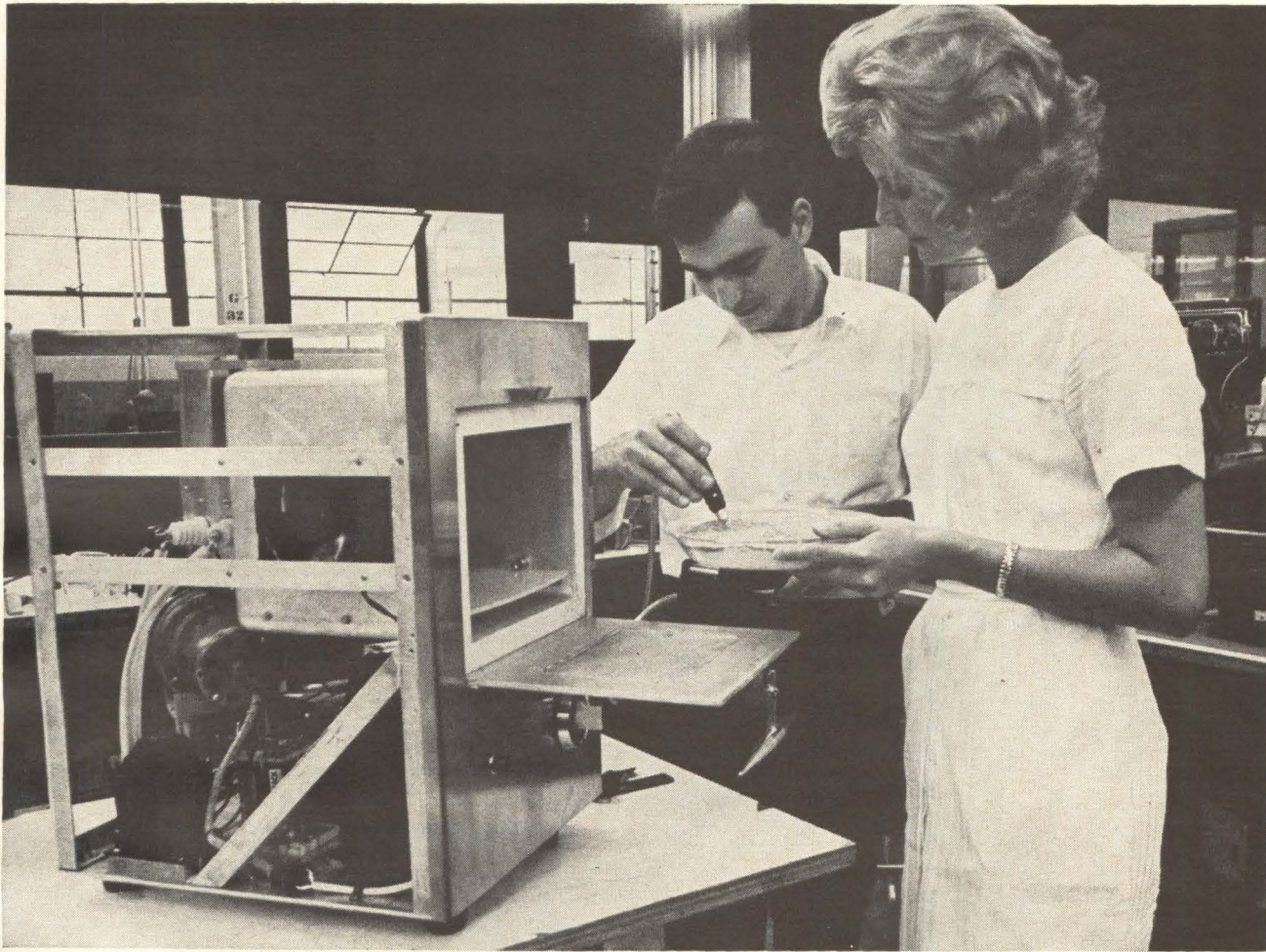

Prototype of microwave oven for home use built by Amperex in developing its new magnetron and associated circuitry. A technician makes a pyrometer temperature test of a cake baked in the oven.

## Consumer electronics

# Microwave at the kitchen door

Electronic ovens have a bridgehead in commercial food-dispensing; now they're preparing to invade the home

By Leon H. Dulberger

Staff writer

**What's cooking** in microwave ovens? Plenty.

In terms of technology, the big advance is a low-cost magnetron, developed by the Amperex Elec-

tronic Corp., that is expected to allow home oven prices to be cut to \$400 from the present low of \$800.

In terms of home oven sales,

1964 volume has been forecast at 1,500 units at a total cost of \$400,000. This is expected to climb to 20,000 units and \$9 million next year, 45,000 units and \$17 million

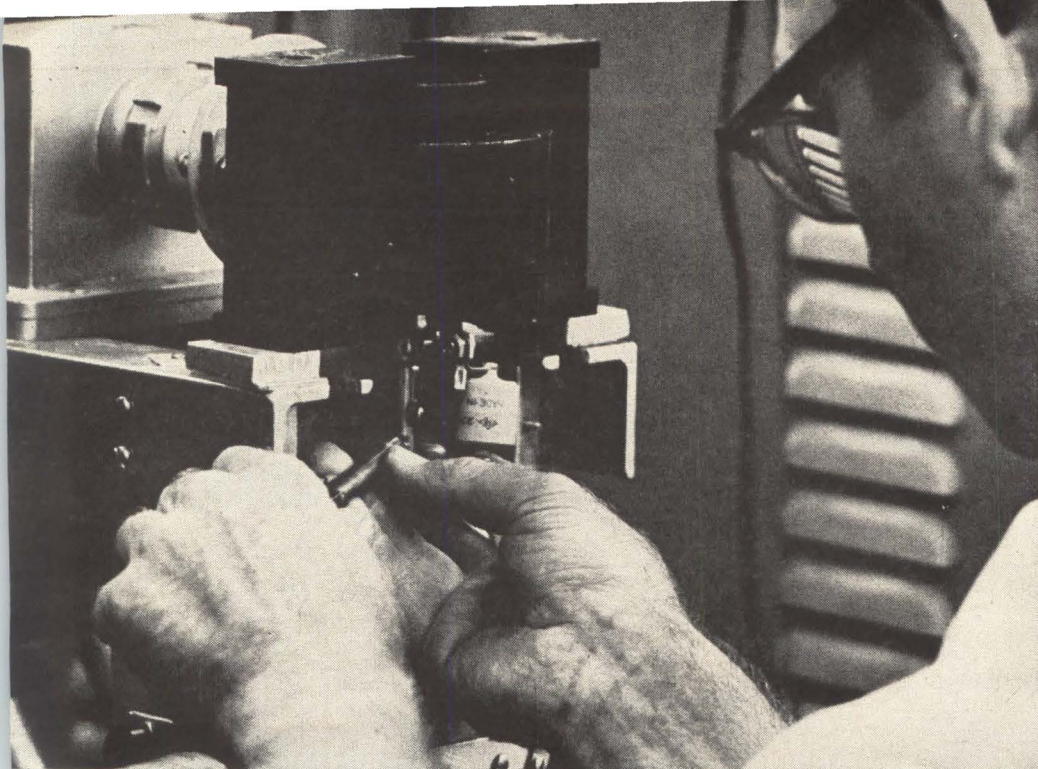

Engineer works on low-cost magnetron developed by Amperex. Rated at 1,200 watts, it uses permanent magnets instead of conventional electromagnets. A ceramic output window is employed.

in 1966, and 100,000 units and \$35 million in 1967. By 1970, the industry expects to be selling a million microwave ovens a year.

In terms of food, it's packaged, pre-cooked items ranging from family meals to dinners for big groups of company employees, hospital patients and the like.

### I. Success breeds success.

As with any new industry, sales and technology will advance hand-in-hand if either is to advance at all. Improvements such as the magnetron should reduce prices from the cafeteria level to the kitchen range. And as more of the lower-priced ovens are sold, food processors are likely to expand the present meager variety of frozen pre-cooked foods; this in turn should encourage more families to add microwave ovens to their lists of "must" appliances.

Edward King, Amperex's assistant manager of industrial products, predicts: "Food-product manufacturers such as Swift (& Co.), General Foods (Corp.) and Campbell Soup (Co.) will be turning out products for highly effective use in microwave ovens to a greater extent than they do now. In time, electronic ovens will take their place in lower-middle-class homes

along with air conditioners, clothes dryers and dish washers."

**\$300 barrier.** Market men predict that a mass market will appear when the price of a microwave oven falls to \$300, below the price of a cheap color television set. The new Amperex tube, together with associated components and circuits, is expected to spur a big part of that price cut.

Amperex has used several engineering developments in designing its new magnetron. Chief among these is the use of permanent magnets instead of electromagnets to supply a magnetic field for the tube. A high-temperature magnet, Ticanol CG, is used, made of an alloy that retains magnetic strength at high temperature.

A compact tube design is achieved by running the tube at 200° instead of 100° C. This permits air-cooling to be used instead of water. The magnetron, which is 55% efficient with the power supply used with it, is rated at 1,200 watts with an end-of-life rating of 1,000 watts. A fast-heating filamentary cathode eliminates the need for time-delay circuitry to control the application of anode high voltage. The filament, of thoriated tungsten, heats in about three seconds. Life tests, made with the

magnetron coupled to an oven and over a range of cycling conditions, indicate that tubes should give more than three years of service.

Other techniques that bring the magnetron's price down include: use of a ceramic microwave output window in place of special glass; self-jigging assembly techniques in tube construction, such as mating an insulator with a conductor using a dual-cone mating; multiple use of common parts, such as input and output connector mounts made from the same basic molding.

**Breaking the waves.** Microwave ovens normally employ a mechanical technique to break up standing waves present within the oven cavity. This eliminates hot spots to achieve uniform heating in the cooking cavity; another technique incorporates a rotating turntable that supports the food.

Amperex has developed a broadband coupling technique for delivering magnetron energy to the cooking cavity, which does not require moving parts or active elements. The company explains that this coupling method eliminates hot spots.

Amperex will provide engineering assistance in oven design to buyers of its tube. The company has worked out a computer technique that permits optimizing the cooking cavity in oven design for maximum uniformity of standing wave pattern without laborious cut-and-try methods. If the oven maker supplies rough cavity dimensions, the computer method determines which wall of the cavity to vary in dimension to achieve this optimum pattern. For example, if a 10-by-12-by-16-inch cavity is desired, information is obtained to determine which dimension to vary in one-eighth inch increments over a two-inch range while holding the other two dimensions constant.

Amperex has also developed a cold-oven check method for production runs of microwave ovens without operating them with live magnetrons. A dummy antenna is used to simulate a magnetron and feed system that is usually coupled to the cavity. A commercial microwave test-set, which includes a slotted line and signal generator, provides the necessary instrumentation. This permits oven manufac-

turers who may not be familiar with microwave techniques to optimize ovens using a production test fixture.

## II. Future called bright.

Amperex predicts that many companies will enter the home microwave oven market, and that its magnetron and kit of components will permit concerns to become competitive quickly.

The industry's big need, according to many marketing men, is a compact, economy model for the kitchen. B. C. Palmer, marketing manager of the Thermowave Corp., says: "The industry has been building trailer-trucks; now, to satisfy the housewife, compact-car ovens are needed to achieve the price goals that will allow a volume market." He adds that food processors "must develop foods the housewife wants to buy."

**Combination ovens.** Bruce Cameron, advertising manager, says Tappan will introduce a combination oven and promote it "above and beyond the regular advertising budget." Tappan's combination oven will include a conventional oven, conventional surface units and a full-size microwave oven. It will sell for \$900 to \$1,000."

The General Electric Co. is testing a combination unit. It, with a price-tag of about \$800, is being test-marketed in the Detroit and Los Angeles areas.

**End to burn-out.** This year, manufacturers will build into home microwave ovens a means of preventing magnetron burn-out when the oven is accidentally operated while empty. Under these conditions, standing-wave feedback of energy tends to overload the magnetron. Standing-wave traps or other techniques will be used.

The problem of door-arc-ing in home ovens will also be eliminated on an industry-wide basis. One method is to use choke door-seals, a form of wave trap. Another involves a dielectric seal to insulate the door from the oven cavity to prevent leakage and arcing. A capacitance is thus formed that permits microwave cavity parameters to be maintained.

**Tappan's plans.** Tappan, which dominates the consumer market, expects to sell 3,000 units this year,

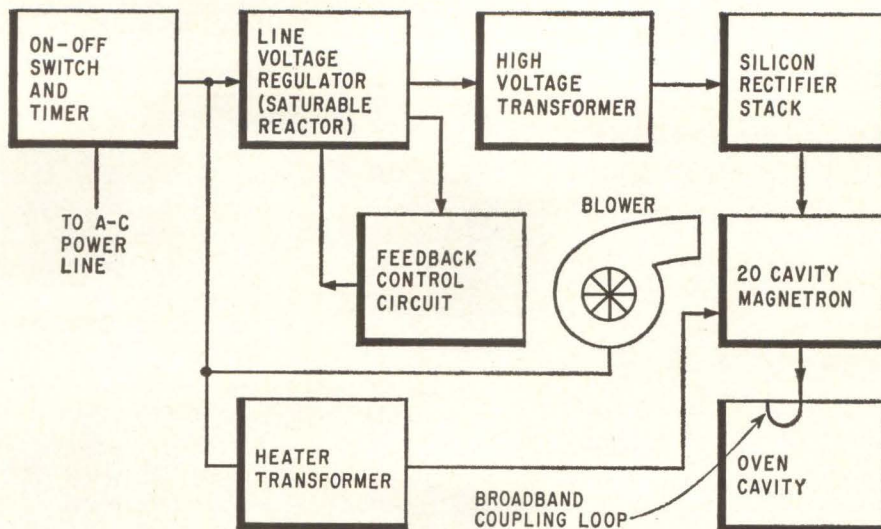

Control and power supply circuitry for Amperex's low-cost microwave oven magnetron. A negative 5,600 volts is applied to the magnetron filamentary cathode. Broad-band coupling from the magnetron to the oven cavity reduces standing waves.

both for homes and business. Its newest entry in the domestic market, will use a full-wave, power supply and deliver 1,000 watts to the microwave cooking cavity.

The home microwave oven operates at 2,450 Mc and uses water cooling of the magnetron. Unlike other microwave oven-makers, Tappan uses a full-wave power supply that is regulated over the range of 200 to 250 volts input a-c and permits achieving 80% magnetron efficiency. Tappan is able to use several commercial magnetrons in its ovens; for the bulk of its ranges it purchases tubes from Litton Industries, Inc., and also from Amperex.

Tappan provides two heat settings, with "low" delivering 650 watts to the cavity and "high" delivering 1,000 watts to the cavity. Low is used for high-protein foods such as eggs and dairy products.

**More users seen.** The Raytheon Co., the pioneer in microwave ovens, expects the biggest sales growth to occur in the commercial market — restaurants and vending machines — through 1967. After that, according to Carl Bixby, manager of marketing for the company's Radarange operation, "consumer sales of microwave ovens should pass commercial sales."

Raytheon has supplied ovens to customers ranging from restaurants along the Indiana Toll Road

to the nuclear-powered merchant ship Savannah. Its Radarange vending-system oven uses preset selector buttons to control heating periods.

**In the air.** Marketing men talk hopefully of putting microwave ovens in commercial aircraft so that airlines can abandon the routine of bringing hot lunches aboard before takeoff.

**On the rails.** Microwave ovens have already been tested on railroads. When the New York Central Railroad first installed them, the car carrying the ovens was called Meal-A-Mat and was equipped with a Radarange able to turn out hot sandwiches in 10 seconds and main courses in minutes. The Radarange is installed in a car that has automatic dispensers of food products; the cooker requires only one attendant, who serves drinks and makes change.

The New York Central says: "the oven worked very well for the purpose for which it was intended, gives little trouble, and requires very little repair."

The railroad is concerned temporarily about the power requirements for the oven which, it says, "places a heavy load on the car-borne diesel generator."

**Litton.** Litton Industries banked on its experience as a major producer of high power microwave tubes when it entered the micro-

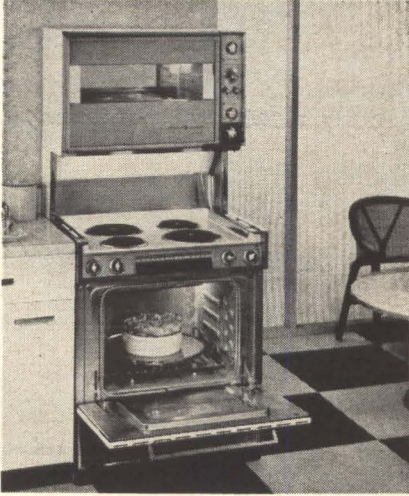

**General Electric** combination home range is being test-marketed in Los Angeles and Detroit. A conventional oven on the top, range units at center and a microwave oven with a browning unit in the lower portion provide a complete kitchen instrument. The concern uses a magnetron operating at 915 Mc developed for microwave oven use.

wave-oven field. Litton now produces various microwave ovens for commercial use and plans to introduce one soon for the home market. The company is said to have spent \$1.5 million so far in developing its microwave ovens.

Litton offers various models for commercial service, but other companies—such as Tappan—build the oven using the Litton tube. When Litton enters the home-oven market, a major promotional campaign is expected. Litton also has a new commercial oven, using a magnetron protection system that turns off the power if the oven is operated unloaded.

**Rudd-Melikian.** For years Rudd-Melikian, Inc., in Warminster, Pa., has dominated the food-vending machine business. Four years ago it added microwave ovens to its product line, starting with purchased ovens. Now Rudd-Melikian manufactures its own equipment.

The Rudd-Melikian unit uses a water-cooled magnetron operating at 2,450 megacycles. This summer, the company says, its microwave ovens "became one of the highest-volume products, doubling its sales over the previous year." Their oven sells for \$995.

The Rudd-Melikian oven, which is used for reconstituting food in vending machines, employs a timing dial with eight basic time settings. The timer is continuously variable and permits infinite settings between eight calibrated

points. This allows the user to suit individual preferences for food temperature.

### III. Trends in design.

GE's new consumer unit uses a special GE magnetron and operates at 915 megacycles. A 30-inch double-oven design is used. The top portion is a conventional oven unit; conventional surface units are provided at the mid-portion, and a high-speed microwave oven is included in the lower half of the instrument, along with a browning unit to crust foods. The two ovens can be used separately or simultaneously; and in the microwave oven, cooking and browning may be done at the same time. A turn-

table in the microwave oven rotates food to assure uniform cooking.

GE says a six-pound roast can be cooked by microwaves in 30 minutes, compared with the three hours required with a conventional unit. The company says it spent almost \$3 million dollars over 18 years to develop the combination range.

**Commercial units.** The microwave ovens built by GE for the commercial market are nearly all air-cooled. The latest designs use a low anode voltage on the magnetron, about 600 volts, to increase reliability by reducing voltage stresses in both the power supply and magnetron. Most commercial microwave ovens use about 6,000 volts on the anode.

## Military electronics

# Electronics in the Mekong Delta

Feedback from U.S. troops in South Vietnam provides valuable data for electronics designers

By John F. Mason

Senior Associate Editor

**One hundred combat troops** in South Vietnam recently got lost, could not contact the other units by radio, and wandered around all day long, in a jungle of bamboo, palms and marshes. One man was critically wounded, all of them were demoralized, and a valuable day was wasted. They were lucky not to have fallen into the hands of the Vietcong.

The reason these men couldn't communicate with the other units was that the radio equipment being used in South Vietnam can't penetrate the lush vegetation and 100-foot-high trees for more than a mile. Sometimes it won't even do that. Further complicating the communications picture in Southeast Asia are the severe thunderstorms that plague the area, and the radical way in which the ionosphere and troposphere fluctuate.

The United States forces in South

Vietnam, however, are learning to combat some of these problems. "We're learning more about the art of communications by being over there than we ever could in the United States," says Col. Robert W. Garrett, chief of the Special Warfare Office in the Pentagon. Garrett, a paratrooper and a Ranger, has had extensive duty in Vietnam, Panama and the Pacific.

### I. Clearing the obstacles

One solution to the propagation problem is to get the antenna above as many obstructions as possible. Discovering new ways to do this tests the ingenuity of the men in South Vietnam as well as engineers in the United States.

On occasion, the Army's Special Forces have improved transmission by tying the antenna to a rock and hurling it as high as they could into the branches of a tree. This is

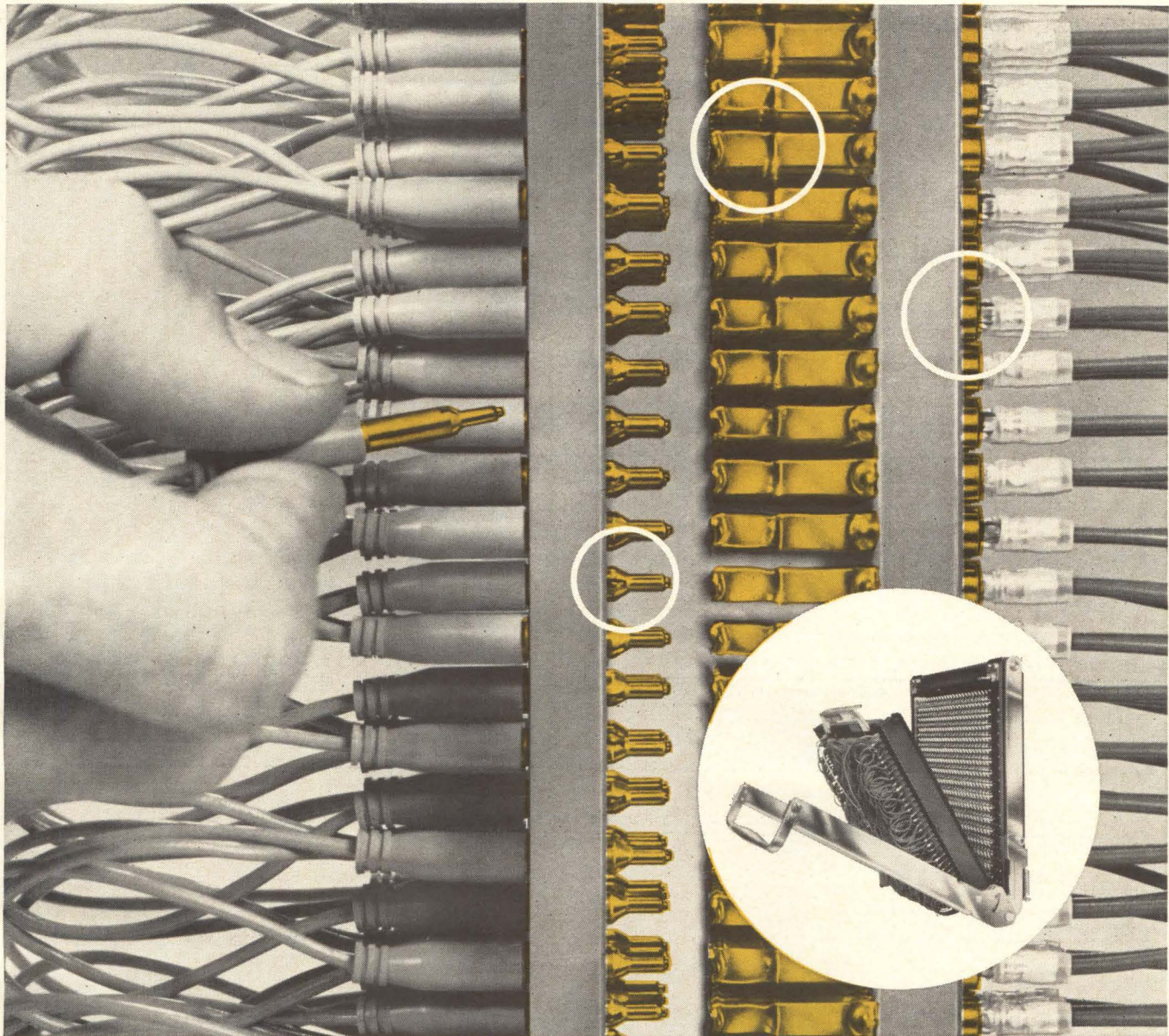

## Zero in on quality

There's not even the hint of a "miss" in this A-MP\* Patchcord Programming System!

Patchcord Programming Systems are comprised of a series of metallic contact junctions. The electrical performance of these systems is determined by the sum of the mechanical properties of these junctions.

Check ours out . . . feature by feature . . . and one fact is outstanding: it's quality-built at *every point* for overall *reliable* performance.

Ours is a modern, compact, lightweight system designed with fewer moving mechanical parts and is quality-controlled to maintain precision tolerances, resulting in increased reliability.

All contacts are gold-over-nickel plated. This, coupled with our patented double-wiping action that pre-cleans contact springs and patchcord pins, assures positive, reliable connections everytime.

Twin-Detent Patchcords, in manual or semi-permanent types, incorporate a specially designed, wholly contained spring-member that

locks the cord to board and prevents program failure by accidental dislodgement. Patchcords can be easily hand-removed to facilitate program changes.

As for rear board wiring, precision crimped LANCELOK\* contacts provide maximum electrical performance and positive retention in the board through a unique locking lance design.

These are just highlights. All of them add up to the quality you look for to assure reliable performance. Get all the details you need by writing today for complete information.

\*Trademark of AMP INCORPORATED



A-MP\* products and engineering assistance are available through subsidiary companies in: Australia • Canada • England • France • Holland • Italy • Japan • Mexico • West Germany

easier than climbing the tree, but sometimes it's hard on the arm.

The Army has been experimenting with an antenna sent 500 feet up on a balloon developed by the Aerospace division of the Goodyear Tire and Rubber Co. Next week, the Army will send five antenna-equipped balloons to South Vietnam for testing. A folded dipole antenna hangs about 20 feet below the balloon and is attached to the tether. A 300-ohm twin-lead television wire is used as the transmission line.

The Air Force, which has its Special Warfare Forces (air commandos) in Vietnam too, has several projects designed to lick the foliage and line-of-sight problems.

The Rome Air Development Center, which handles research and development for the air commandos, is undertaking the development of a group of engineering models of 50-foot, inflatable uhf antennas. (Rome already has worked on inflatable antennas for low-frequency transmission).

For the uhf effort, Rome has

bought two 35-foot inflatable antennas that weigh 4 pounds each. This off-the-shelf equipment will be tested by the air commandos in Panama. The objective will be to develop antennas that will extend 100 feet up.

**Relays.** Another way to get above the trees as well as over the horizon is to use a radio relay in an elevated place. One relay the Air Force is testing is the Jungle Buoy, a two-radio unit that receives on one frequency and transmits on another. Built with a counterrotating blade, the relay can be dropped by an aircraft into the high branches of a tree. The device, conceived and developed by Litton Industries, Inc., is now being tested at the Special Air Warfare Center at Hurlburt Field, Fla.

Another relay station developed by Litton, called Sir, can be mounted in a pod and hung from the wing of a plane like the AN/RRQ-5 made by the Radio Corp. of America. Sir can be hung in a tree, placed on a ridge or in any elevated spot that appears to be safe. Sir differs from Jungle Buoy in that

it receives, records on tape, and replays on interrogation. A prototype of Sir went to the Air Force in May for testing.

The Air Force would like a relay to have another attachment: a low-drain sensor, or electronic switch that, with very little power, could wait for a signal to tell it when to turn on the main power for relaying the message.

The Bendix Corp. has developed a repeater relay that receives and retransmits on the same frequency.

## II. Guiding planes

One item the Army, Air Force and Marines want in South Vietnam is a homing beacon for guiding an aircraft to a drop zone where paratroops or cargo are to be delivered [Electronics, June 1, p. 83].

The best one available is the old Rebecca-Eureka beacon used during World War II—a 200-megacycle system that uses lobe-switched antennas to determine azimuth. Because of its poor accuracy, however, the Army Special Forces won't use it. They rely instead on ordinary aircraft naviga-

# new epoxy coated PAKTRON<sup>®</sup>



550 series

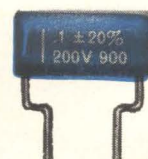

800 series

tion to get them close to the drop zone; then railroad flares guide them to the precise spot. The obvious disadvantage of a flare is that it is visible to foes as well as friends.

**Too many lights.** Flares also present problems for the pilot. Farmers in Southeast Asia burn rice husks that smolder and flare up in little bursts of light from dusk until dawn. These lights confuse a pilot looking for the drop zone flare.

Another disadvantage of flares is that they burn for only four minutes. In that time the pilot has to get over the drop area and get the troopers lined up and out of the plane.

Missing the drop zone in Vietnam is a serious matter. If a paratrooper lands in a tree he may have to hang there until dawn. Cutting himself loose in the jungle in the dark is even more risky than remaining in the tree.

**Beacons tested.** The Army, Air Force and Marines are testing candidates for a good homing beacon. By June the three services hope to write up performance requirements



Manpack transceiver, the AN/PRC-10, is used by South Vietnamese troops and U.S. advisers.

they all want in a beacon, and to ask industry for bids. The beacon selected will be used not only by the Army Special Forces but by conventional ground forces of all three services.

The beacon sought will weigh less than 35 pounds, transmit on specific frequencies and emit an identification code that can be changed for each mission. It must also be compatible with existing

## hi-blu™ capacitor

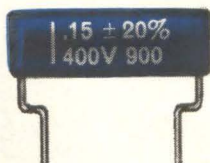

1180 series

New high performing Mylar\* film/foil epoxy coated capacitor for quality instrument, computer, and military applications where price is a factor. Capacitance values to 0.5mfd.

The new PAKTRON® hi-blu™ Capacitor is epoxy coated for superior moisture resistance and durability. High volumetric efficiency in a thin uniform package. Outstanding insulation resistance. Wide range of lead lengths and spacings as standard.

Write for detailed information. Request test samples on your letterhead.

**Working voltages** .....100, 200, 400, 600V DC

**Tolerance**.....±1%, ±5%, ±10%, ±20%

**Dissipation factor** .....4 X 10<sup>-3</sup> max. @25°C, at 1KC

**Temperature Stability** ..4% max. deviation from 25°C value in range of 0°C to 85°C, at 1KC.

Made under one or more of the following U.S. Patents: 3,040,415/3,134,059/2,950,070/3,117,364

\*Du Pont TM.

**i t PAKTRON**  
**DIVISION ILLINOIS TOOL WORKS INC.**  
 1321 LESLIE AVENUE • ALEXANDRIA, VIRGINIA

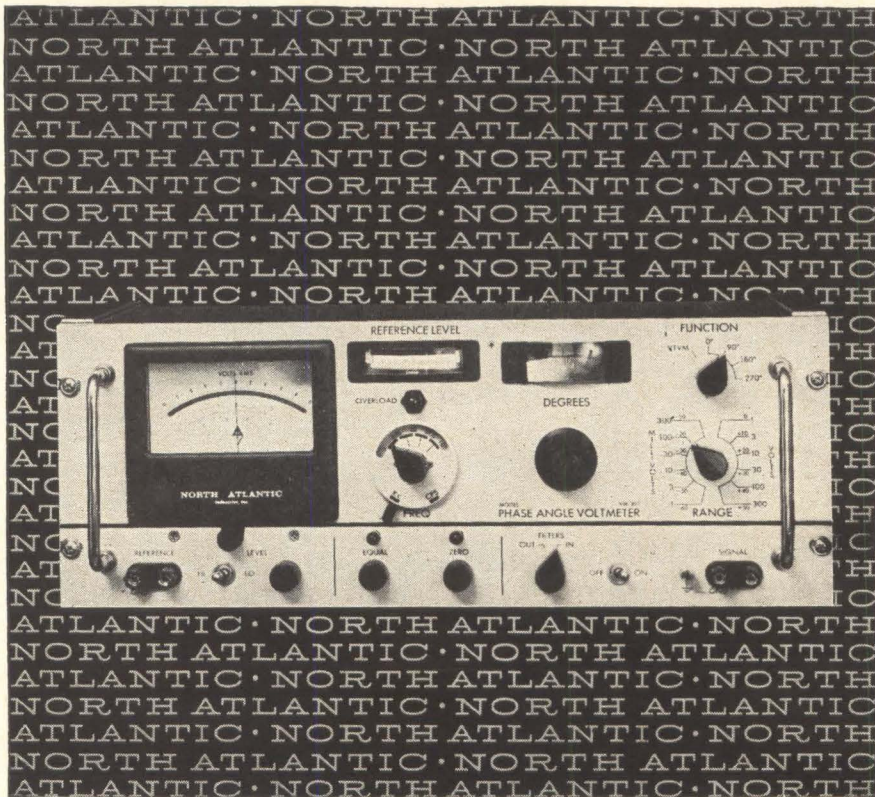

## how to measure in-phase, quadrature and angle while sweeping frequency to 100 kc

North Atlantic's latest addition to the PAV line of Phase Angle Voltmeters\* enables you to make measurements while frequency is varying over half-decades without recalibration. The VM-301 **Broadband Phase Angle Voltmeter\*** provides complete coverage from 10 cps to 100 kc, and incorporates plug-in filters to reduce the effects of harmonics in the range of 50 cps to 10 kc with only 16 sets of filters. Vibration analysis and servo analysis are only two of the many applications for this unit. Abridged specifications are listed below:

Voltage Range.....	1 mv to 300 volts full scale
Voltage Accuracy.....	2% full scale
Phase Dial Range.....	0° to 90° with 0.1° resolution (plus 4 quadrants)
Phase Accuracy.....	0.25°
Input Impedance.....	10 megohms, 30μpf for all ranges (signal and reference inputs)
Reference Level Range.....	0.15 to 130 volts
Harmonic Rejection.....	50 db
Nulling Sensitivity.....	less than 2 microvolts
Size.....	19" x 7" x 10" deep
Price.....	\$1990.00 plus \$160.00 per set of filters

North Atlantic's sales representative in your area can tell you all about this unit as well as other Phase Angle Voltmeters\* for both production test and ground support applications. Send for our data sheet today.



**NORTH ATLANTIC** industries, inc.  
 TERMINAL DRIVE, PLAINVIEW, L. I., NEW YORK • Overbrook 1-8600

\*Trademark

equipment in military planes, and bring the plane in to a specific spot with an error no greater than 600 feet.

The Army's candidate is being developed by Matrix Systems, Inc., under the direction of the Army's Limited-Warfare Laboratory at the Aberdeen Proving Ground, Md. The Matrix beacon operates at low frequency, weighs 19 pounds including a 35-foot pole antenna, and has voice capability. It works on only one frequency. The Army will get six prototypes for more extensive testing.

The Marines are also testing a low-frequency beacon. It is equipped with a synthesizer, a frequency-generating device that provides the operator with a variety of discreet frequencies. Built by Tridea, Inc., of Pasadena, Calif., the beacon is designated AN/TRN-19. The latest version is still too heavy, but Tridea is redesigning the antenna and hopes soon to get the total weight down below 35 pounds.

The Air Force is interested in several beacons. Litton Industries has developed the AN/TRN-20, a low-frequency transmitter in the 260- to 520-kilocycle band. The Wilcox Electric Co. built and delivered to the Tactical Air Command an X-band beacon, the AN/PPN-16, that is now being tested on maneuvers in the United States.

A precision beacon that would guide a plane to the center of the drop zone with an accuracy of 100 feet is being developed for the Air Force by the G. C. Dewey Co. of New York. Operating on two modes, high-frequency (30 Mc) and low-frequency (500 Kc), the whole system would weigh about 10 pounds.

At the Farnborough Air Show in Britain, this month, Rank-Bush Murphy, Ltd., will show for the first time a new beacon for the Rebecca-Eureka. The company says the beacon has a 20-mile range for a plane flying at 500 feet. Called Eureka MR 343, the beacon operates with standard Rebecca airborne equipment. It is transistorized, has 100-watt power and operates at 200 Mc. The device weighs 24 pounds and measures 4½ by 11½ by 11½ inches.

**Bundle beepers.** The absence of good homing beacons is not only





Inflatable package can become a 50-foot antenna, thereby getting over some of the foliage that blocks transmission in South Vietnam.

a danger for paratroopers, but may cause cargo to fall outside the drop zone. Ground troops then must spend valuable time—often risking their lives—looking for it. The Army Special Forces would like to put a radio beeper on the bundle to lead the troops right to the spot. Since thousands of bundles are dropped, the beacon would have to be cheap. It has not yet been decided whether to make it a throw-away beacon or a more expensive device that would be recovered and used again. The Army wouldn't want them to be too expensive because the enemy might get to some of them first.

A small survival beacon, attached to parachute harnesses, works well for Navy pilots. Transmitting from the flat ocean to an aircraft above, however, is not as difficult as from the jungle where foliage and ground clutter distort the transmission and reduce the range.

The Army has no solution yet, but hopes industry will soon come up with something.

### III. New radio frequencies

Although the Army has in production a standard, transistorized manpack radio for patrols—the AN/PRC-25—and a new vehicular radio for headquarters—the AN/VRC-12—the troops in South Vietnam are not getting them. The reason is that the new radios operate

**NOW AVAILABLE!**

# HECON COUNTERS

The complete range of Hecon electro-mechanical and mechanical counters sets new standards in counter performance, reliability and economy! Figure on Hecon for your counter needs.

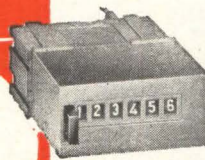

**FO 43**  
(CONTINUOUS)



**FA 043**  
(PREDETERMINING)

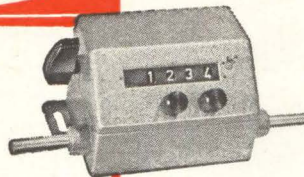

**UE 093**  
(PREDETERMINING)

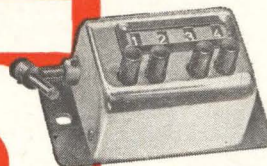

**HE 040**  
(PREDETERMINING)

## HECON Electromechanical Counters

Hecon Series F043 six digit counters provide high-speed AC or DC operations (to 50 counts per second), low power consumption (1.5 watt min.) and remote electrical or manual reset and locking provision. Predetermining model (FA043) features a separate 6 digit indicator, directly above the numerical readout, for hand-setting predetermined cut-off point.

Compact modular design and interchangeable connecting boxes permit "building block" panel arrangement. Also special front plates for individual mounting. Hecon quality components and superior workmanship are your assurance of reliability.

## HECON High-Speed Revolution Counters

Versatile, direct-acting, 5 digit predetermined revolution counters subtract to zero at speeds up to 12,000 RPM, providing a warning signal at any preset point in the counting cycle. On reaching zero, the unit is automatically released or stopped mechanically or electrically and can be reset manually.

Also available with pre-signal.

## HECON Ratchet Counters

Compact, sturdy, four digit counter permits predetermination of a specific number of repeat operations through simple push-button selection on each of the four digits. Choice of electrical or mechanical stop and choice of drive — either side, either direction.

Get all the data on economical Hecon Counters Today! Write for Catalog and Prices.

**HENGSTLER NUMERICS, INC.**

312 Bergen Boulevard, Palisades Park, N. J. 07650

## END GREASE-PENCIL GUESSWORK IN PRODUCTION MEASUREMENTS



### NEW JERROLD 890 SWEEP GENERATOR and TC-3 COAXIAL SWITCHER

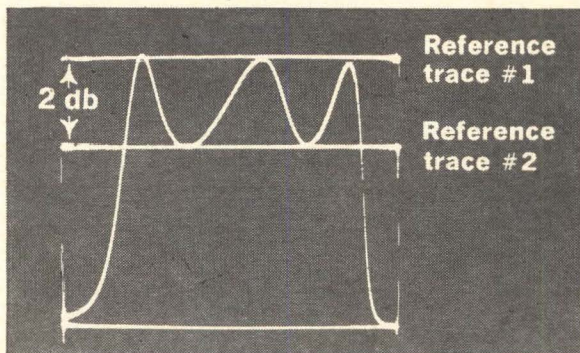

Typical network rf loss displayed with upper and lower limits by Jerrold 890 Sweep Generator and TC-3 Coaxial Three-Way Switcher.

This new medium-priced team lets you throw away your grease pencil—and all your troubles with drift and inaccuracy. It provides precise, drift-free electronically-produced upper and lower limits.

The Model 890 Sweep Generator has a frequency range from 500 kc to 1,200 mc, and offers sweep widths from 100 kc to 200 mc. Extremely stable output.

The solid-state TC-3 Coaxial Switcher (frequency range 0 to 1,200 mc) features three-position operation, enabling the insertion through variable attenuators of two reference traces in addition to the test trace.

Write for free brochure explaining details of this and other applications of comparative sweep techniques. Ask for demonstration.



Model 890 Wide-Band Sweep Generator. Price \$845



Model TC-3 Solid-State Three-Position Coaxial Switcher. Price \$295.

**JERROLD**  
ELECTRONICS

Industrial Products Division, Philadelphia, Pa. 19132  
SWEEP GENERATORS • PRECISION ATTENUATORS • AMPLIFIERS • COMPARATORS



Long-range transceiver, the AN/PRC-64 Limited-War Laboratory. Developed by unit has a range, under ideal conditions. The Army has not yet approved it.

on frequencies different from the old ones, and therefore would not be compatible with the network of existing gear. Introduction of the new units would require an across-the-board change in equipment throughout South Vietnam. That's why South Vietnam is keeping the older gear and the new sets will go to Europe.

The equipment being used in South Vietnam includes the PRC-10 manpack, vhf/f-m with a rated range of 3 to 5 miles, and the jeep-mounted VRC-10 with a range of 35 miles.

The frequency was changed on the new equipment for two reasons: to provide a broader frequency spectrum to get more channels, and to avoid interference that was being picked up by the old equipment that used frequencies below 30 Mc.

For longer distances. Longer-



was tested in Hawaii by the Army's General Motors' Delco division, the of 200 miles for voice, 500 for c-w.

range equipment is being developed, however. The Army Special Forces have been testing a radio set that promises to take care of many needs of long-range patrols. Designated the AN/PRC-64, the unit is transistorized and weighs only seven pounds. Tested in the United States under ideal conditions, the PRC-64 provided a voice range of 200 miles, and c-w up to 500. In Vietnam, the Army hopes to transmit voice 50 miles and c-w 100 miles.

The PRC-64 evolved from a set built for an unrelated project by the Delco Radio division of the General Motors Corp. Although the Army Special Forces like the equipment, Army headquarters has not yet approved the formal requirement for it that was submitted by the overseas command.

Another long-range radio under development is the AN/PRC-62, a

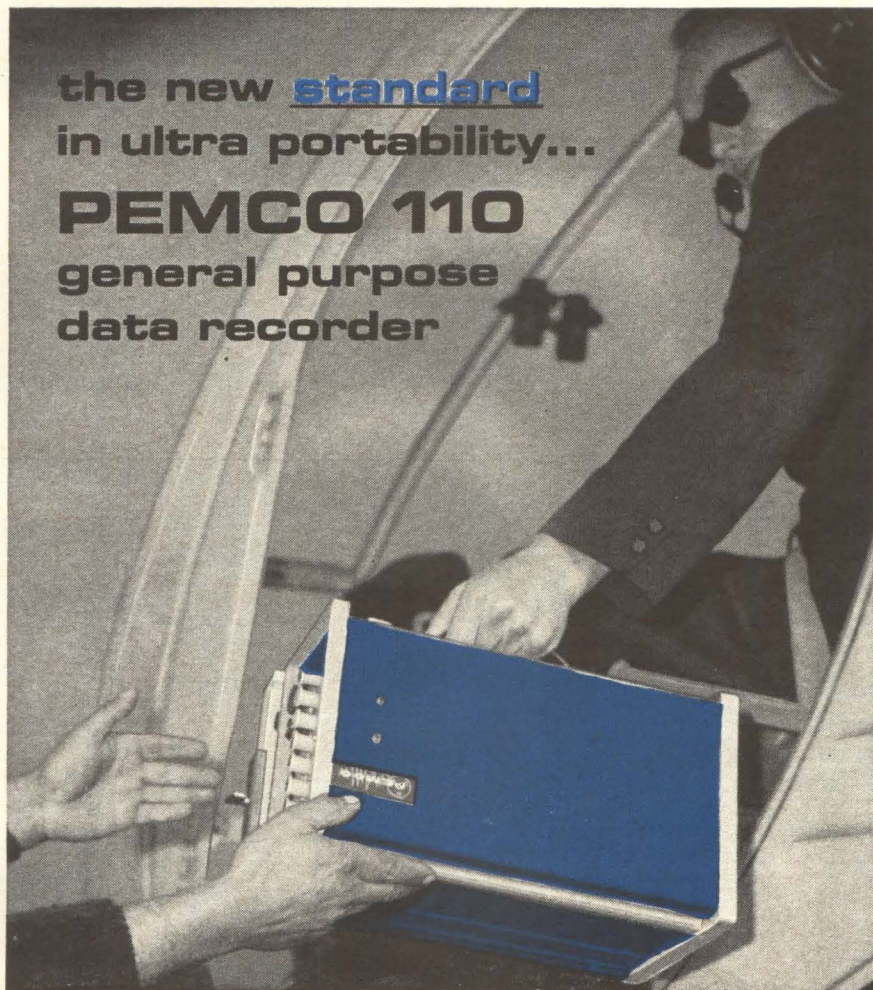

the new standard  
in ultra portability...

## PEMCO 110 general purpose data recorder

**17 lbs-35 watts-dc to 100 kc  
fm and direct-ac or dc power**

The Pemco Model 110 general purpose data recorder sets a new standard in ultra-portability for high-performance instrumentation recorders. Less than 1/5 the size, weight and power consumption of most conventional portable recorders, the Model 110 boasts a signal to noise ratio of 40 db FM and 35 db Direct, long term speed stability of better than  $\pm 0.5\%$  from a 22-34 VDC input, and FM center carrier drift of only 0.1% over a full reel of tape.

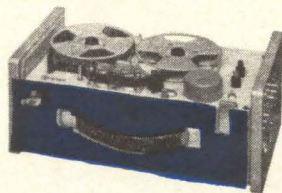

Shown above with the Model 14 rechargeable Power Pack, the Model 110 offers standard 2-speed drive over a range of 1 7/8 to 30 ips, with 3-speed ac and 4-speed dc available. With optional converter, the model 110 easily operates from 12v dc, in addition to the standard 28v dc or 117v ac. 1/4", 1/2" or 1" tape widths accommodate 2, 7 or 14 standard IRIG channels respectively. Interchangeable plug-in FM and direct record/reproduce electronics.

Entirely compatible with double bandwidth and IRIG standards, the PEMCO Model 110 offers lab precision for extreme and remote environments. Ask your PEMCO representative or write us direct. We'll be pleased to send complete technical and operating data.



**PACIFIC  
ELECTRO  
MAGNETICS**

942 Commercial Street  
Palo Alto, California • (415) 321-1177

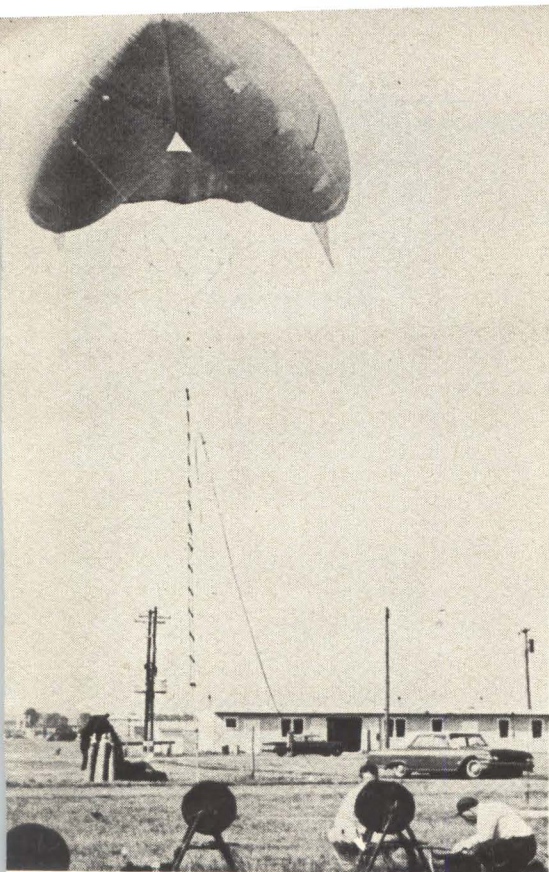

**Balloon, designed by the Goodyear Tire and Rubber Co., will be used to lift antennas above the dense foliage of the South Vietnam jungles.**

single-sideband, high-frequency (2 to 30 Mc) unit weighing 30 pounds. Its range should be measured in the thousands of miles. The PRC-62 is being developed by RCA and is expected to be ready for service testing in December.

A new unit being tested in South Vietnam is the HC-162, a high-frequency (2 to 12 Mc) single-sideband radio built by the Hughes Aircraft Co. The transistorized unit weighs 25 pounds and uses a log-wire antenna.

Meanwhile, the Army Special Forces in Vietnam are using the AN/GRC-109, an a-m, c-w unit that operates in the high-frequency band (3 to 22 Mc). It has a 15-watt power output and weighs 40 to 55 pounds, depending on the power supply used. The GRC-109 has been used to communicate between Okinawa and Thailand.

Still in the advanced study stage is the AN/PRC-70, a microminiaturized transceiver designed to provide coverage between 2 and 76 Mc. Transmission can be single-sideband a-m, f-m or c-w. The unit must weigh no more than 30 pounds. Putting all this into a 30-

pound package would strain the state of the art. A contractor will be chosen soon to study the feasibility of developing the equipment.

**Ground-to-air.** The Air Force has bought 40 TR-500A Forward-Air-Control Packs made by Sylvania Electronic Products, Inc. (Electronics, Aug. 24, p. 17). This four-radio unit weighs 51 pounds. Whether the Air Force will buy more of these sets or ask for proposals for a lighter one of 20 to 25 pounds has not been decided. RCA has proposed specifications for a unit weighing 30 pounds.

The Air Force is already developing two very light radio sets for use by air controllers: the PRC-66, a uhf set, and the PRC-65 for vhf. The breadboard model of the PRC-66 will be ready this month for inspection by the Air Force. It will operate on all channels in the 225- to 400-Mc band and weigh 6.75 pounds. The unit is being built under a three-year contract with the Collins Radio Co.'s Canadian subsidiary. The first 18 months' work will be carried out in Cedar Rapids, Iowa, and the remainder in Canada.

The PRC-65 will weigh 5.5 pounds and operate on 1,120 channels in the 100- to 156-Mc range. It will combine advanced digital techniques with thin-film radio-frequency circuits. The heart of its frequency selection is a one-cubic-inch digitally controlled synthesizer that includes a voltage-controlled oscillator 0.1 cubic inch in volume using 1.5-octave thin film. Simmonds Precision Products, Inc., is developing the set for the Air Force.

**Power sources.** The General Electric Co. recently finished a six-month study for the Rome Air Development Center on advanced power sources of 100 watts or less. The Air Force would like to replace batteries with a light, long-life power source for radios for combat-control teams.

GE studied thermionic and thermoelectric converters, fuel cells and ferroelectric and thermo-photovoltaic devices. Results of the study, made at GE's facility in West Lynn, Mass., may pass from the Air Force to the Army at Fort Monmouth, N. J., where work on power sources has also been going on.

# If you don't see this...



*Somebody's beat you to an informative 8-page bulletin on Military Type Relays*

## but DON'T GIVE UP--WE'LL SEND YOU ANOTHER

*Just circle Reader Service Number below*



Circle 122 on reader service card  
Circle 123 on reader service card →

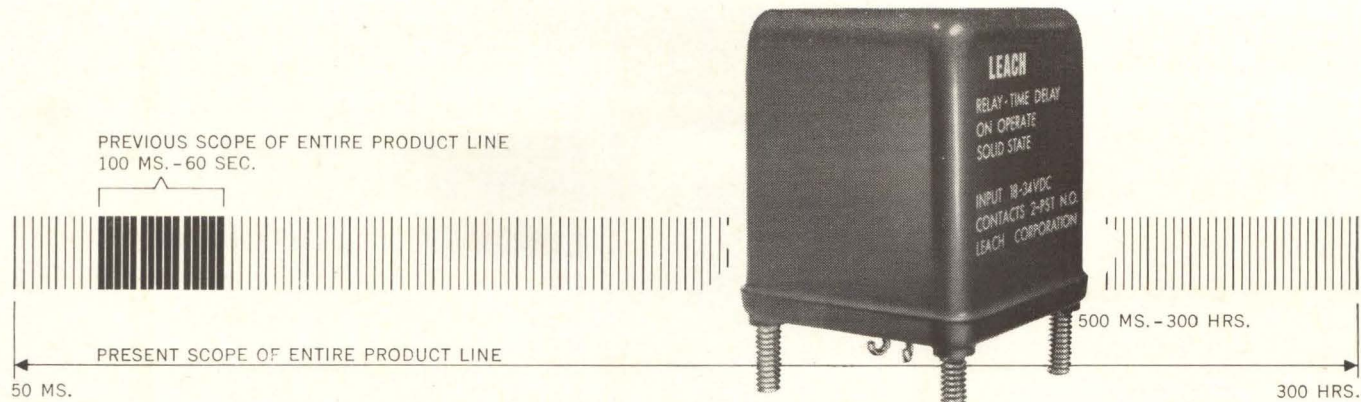

## extended range smaller sizes

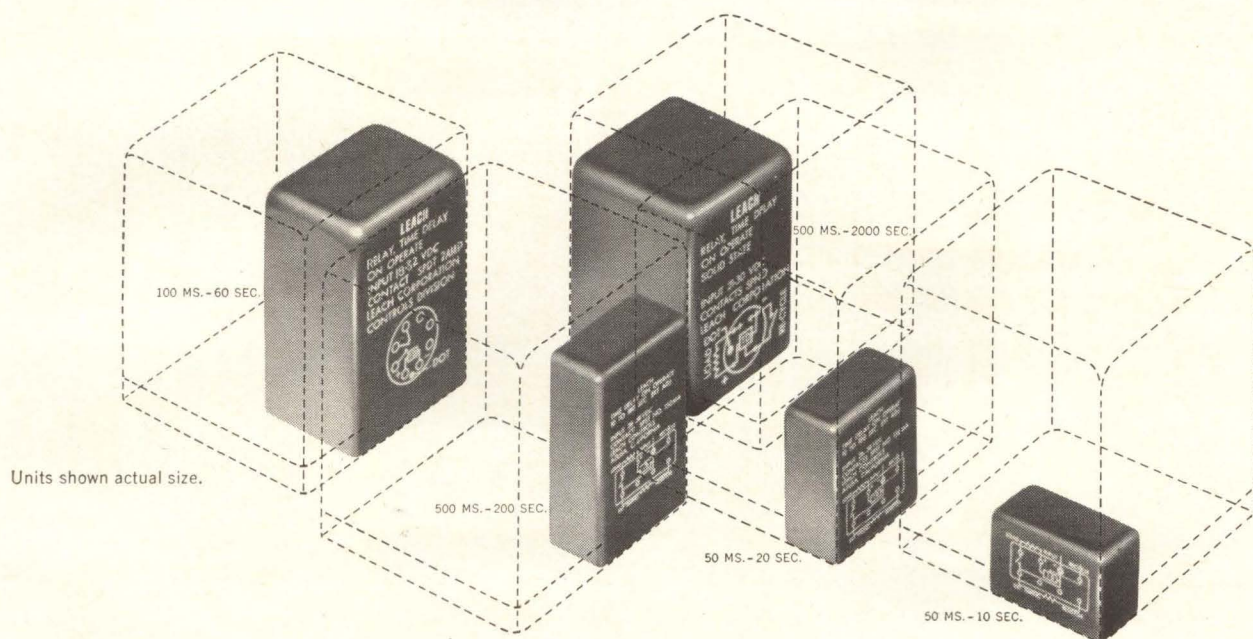

## — now offered in Leach standard electronic time delay relays

Recent Leach developments in miniature magnetic cores, new applications in time base generators, and the complete redesign of Leach-patented unijunction circuits now make possible many additional maximum-performance features in standard time delays.

**NON-DESTRUCT MEMORY** is an example. In the event of interruption of input power, the non-destruct memory will maintain the timing count in the unit. Upon reapplication of power, the unit will continue timing as though no interruption had occurred. (Available in four of nine standard models.)

**HIGH ACCURACY OVER A BROAD TEMPERATURE RANGE:**  $\pm 3\%$  from  $-20^{\circ}\text{C}$  to  $+71^{\circ}\text{C}$ ,  $\pm 5\%$  from  $-55^{\circ}\text{C}$  to  $+85^{\circ}\text{C}$ ,  $\pm 10\%$  from  $-55^{\circ}\text{C}$  to  $+125^{\circ}\text{C}$ .

**INHERENT RELIABILITY** guaranteed by design simplicity and solid state silicon components. All units can be built to meet Minuteman reliability specs.

**MANY OTHER FEATURES**, including minimum power drain, fast automatic recycle and voltage regulation. Units are available with solid state or relay output, fixed or adjustable timing, and with delay on operate or release.

**CHOICE OF 6 CONFIGURATIONS:** Standard MS, Double Crystal Can (2), Crystal Can (2), and Half-size Crystal Can, with a wide variety of mounting and terminal configurations.

**CUSTOM DESIGNS WITH SPECIAL CAPABILITIES** can be produced to meet your most stringent requirements. Extended timers with up to 3 years delay. Accuracy to  $\pm 0.02\%$ . Multiple output programmed events.

**FOR PROMPT DELIVERY** of standard units, or regarding custom orders, see your Leach representative, or write, wire or phone:

# LEACH

**CORPORATION**  
**CONTROLS DIVISION**  
717 North Coney Avenue, Azusa,  
California • Phone: (213) 334-8211  
Export: LEACH INTERNATIONAL S.A.

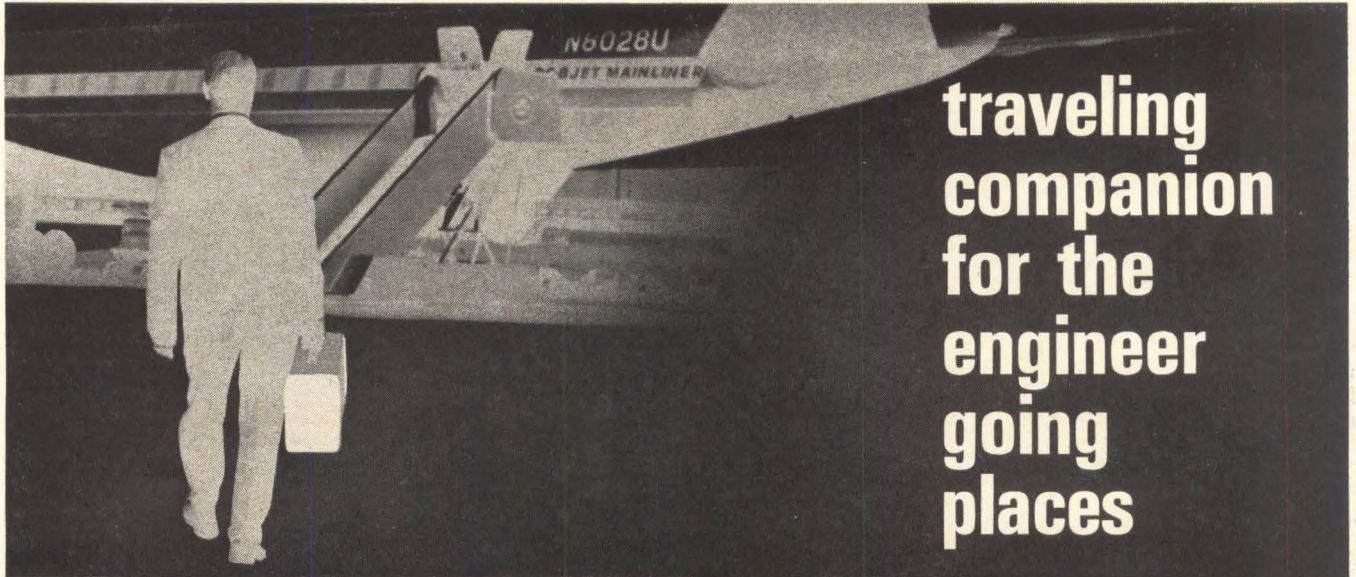

**traveling  
companion  
for the  
engineer  
going  
places**

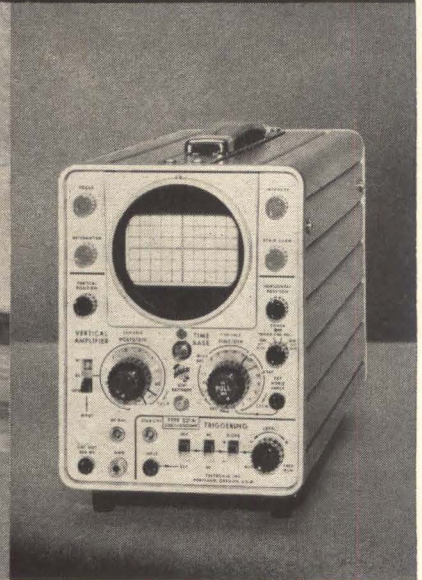

## The New Improved Type 321A



Here's an ideal oscilloscope for the traveling engineer—Tektronix Type 321A.

The Type 321A is small and light—weighs only 18 pounds. It operates from almost any convenient power source—typically from 4 to 4½ hours on self-contained rechargeable batteries (recharging them through its own recharging circuit), from any dc source of 11.5 to 35 volts—or from any source of 105 to 125 volts, at frequencies from 50 to 800 cps.

It's rugged—designed to resist shock, vibration, and other conditions likely to be encountered traveling or operating in remote locations.

It's easy to maintain—with all components readily accessible, and no selected transistors or tubes.

It's dependable—practically solid-state throughout and built to exact Tektronix standards to operate efficiently over a wide range of temperature and altitude conditions.

Passband is dc to 6 Mc, with writing speed and triggering capability necessary for bright, steady traces over the entire passband.

Precise linearity and accurate calibration assure exact time and amplitude measurements and make the Type 321A suitable for applications involving the most modern complex electronic circuitry.

Type 321A Oscilloscope . . . . .	\$900
(without batteries)	
Rechargeable battery set . . . . .	70
Protective Carrying Case . . . . .	30
(as illustrated)	

U. S. Sales Prices f.o.b. Beaverton, Oregon

Send for complete specifications—ask your Tektronix Field Engineer for a demonstration of the Type 321A's ability to meet your particular requirements.

## Tektronix, Inc.

P. O. BOX 500 • BEAVERTON, OREGON 97005  
Phone: (Area Code 503) Mitchell 4-0161  
Telex: 036-691 • TWX 503-291-6805

Cable: TEKTRONIX  
OVERSEAS DISTRIBUTORS IN 25 COUNTRIES  
TEKTRONIX FIELD OFFICES in principal cities in United States. Consult Telephone Directory.  
Tektronix Australia Pty., Ltd., Melbourne, Sydney.  
Tektronix Canada Ltd., Montreal, Toronto.  
Tektronix International A.G., Zug, Switzerland.  
Tektronix Ltd., Guernsey, C. I.  
Tektronix U. K. Ltd., Harpenden, Herts.

## LABOR SAVING DEVICE



MINCOM's TICOR II

### **MINCOM'S NEW AUTOMATIC GAIN CONTROL / LIMITER**



**Takes a big load off the back** of the operator, eliminates manual adjustments by automatically maintaining input signals at a predetermined level. Attack time: 3 milliseconds. Recovery time: 10 milliseconds. **Seven channels in 1¾ inches of rack space.** Designed as an optional accessory to Mincom's wideband systems, the new AGC/Limiter also is useful as a line amplifier, a constant output amplitude linear mixer, or wherever you need precise automatic gain control. Suitable for FM or analog data analysis, for data reduction systems where information must be distributed to many points at a constant level, or for situations where different signals must be selected from random sources. Write today for specifications.

**Mincom Division** **3M**  
COMPANY

300 S. Lewis Rd., Camarillo, Calif. • 2049 S. Barrington Ave., Los Angeles, Calif. • 320 Shaw Rd., So. San Francisco, Calif. • P. O. Box 3384, Santa Barbara, Calif. • 529 Penn. Bldg., 425 13th St., N.W., Washington, D. C. • 135 W. 50th St., New York, N. Y. • 1230 Orange Ave., Winter Park, Fla. • 2121 Santa Anna Ave., Dallas, Tex. • 3322 Cork Ave., El Paso, Tex. • Eltron Engineering Sales, Inc., 246 Walnut St., Newtonville, Mass. • Eltron 2345 Whitney Ave., Hamden, Conn.

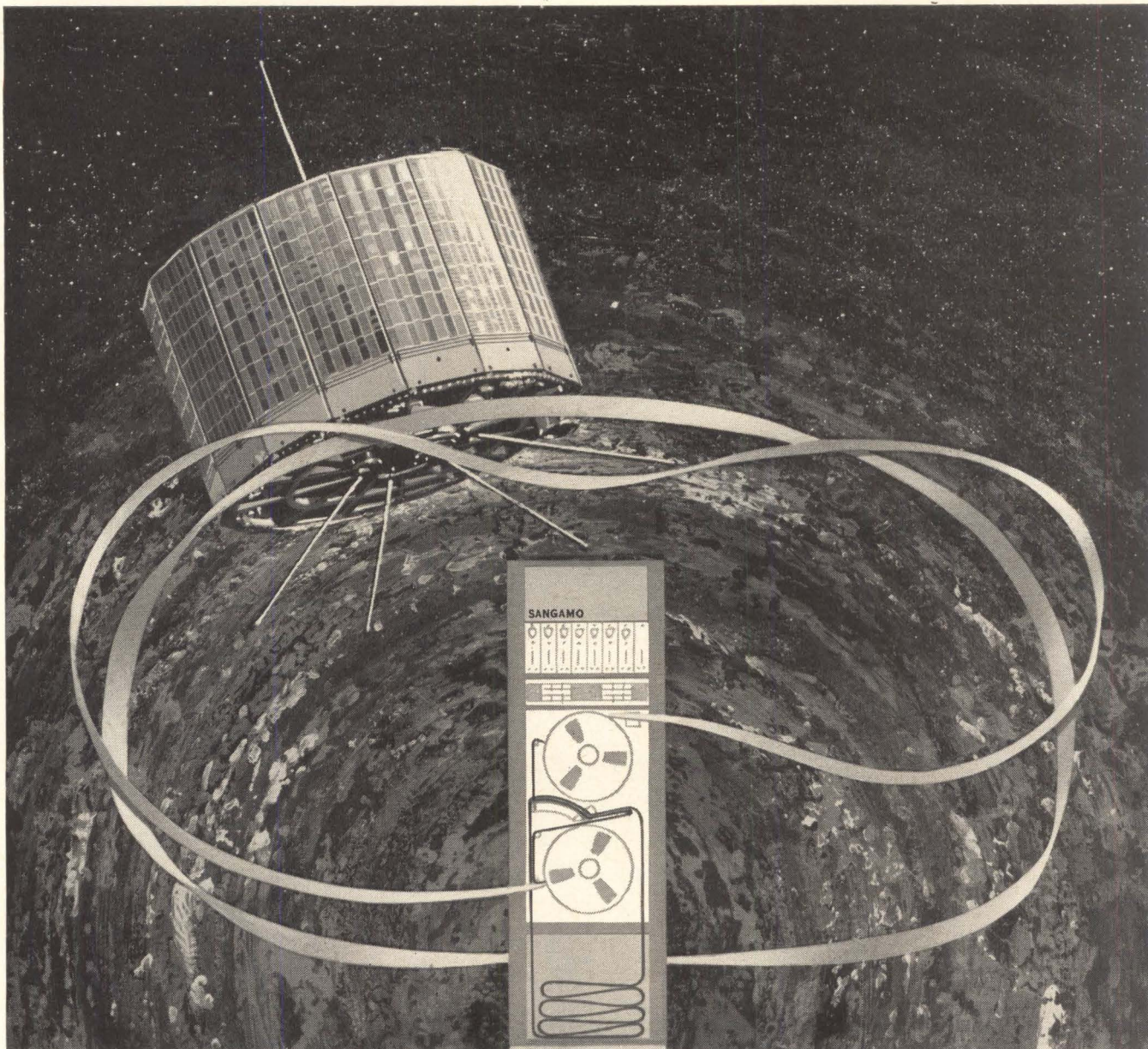

Another Sangamo first in Magnetic Tape Flexibility

## NOW THE SANGAMO 4700 HANDLES BOTH 1" AND 1/2" TAPE SIMULTANEOUSLY

**Record or Reproduce either width without mechanical or electrical changes.**

*Make continuous loop dubs from original tapes on one recorder. Operating at your choice of 8 electrically-selected tape speeds, Sangamo 4700 now has an optional feature which allows you to handle two different tape widths at the same time. One width operates in reel-to-reel mode . . . the other width operates as a continuous loop.*

Flexibility is unparalleled. Without time-consuming mechanical or electrical changes—without even changing heads or guides—the 4700 will handle 1/2" or 1" tape, either on reels or in a loop.

The Sangamo 4700 is unique in analog tape instrumentation. Its light mass capstan drive and unmatched servo speed control provide unsurpassed data accuracy in FM (DC to 20 KC) and Direct (300 to 300,000 cps) ranges.

Be sure to investigate the 4700 for general recording applications and the 480 time delay magnetic tape recorder/reproducer for auto- and cross-correlation applications.

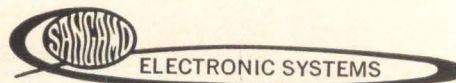

ELECTRONIC SYSTEMS

ES64-1

**SANGAMO ELECTRIC COMPANY**  
SPRINGFIELD, ILLINOIS



# Microcircuit uses matched input transistors

Advanced multichip technology produces high-performance differential amplifier

A microelectronic differential amplifier has been developed with a d-c stability typically  $5 \mu\text{v}$  per  $1^\circ\text{C}$ , and a common-mode rejection ratio typically 100 db. Designed for use in critical operational amplifier and transducer amplifier applications, the PC-201 microcircuit is said to achieve its unusual performance through an extremely close matching of two 2N930-type input transistors and the use of both npn and pnp high performance transistors in a unique circuit configuration.

A multichip microcircuit, the PC-201 employs 7 silicon transistors, 6 multiple resistors and 1 capacitor. All the dice are mounted on a ceramic substrate, measuring approximately 0.570 by 0.325 in. and the entire package is epoxy encapsulated. The complete device measures only 0.625 by 0.375 in. and is less than 100 mils thick. According to the manufacturer, advanced multichip technology permits construction of the high performance PC-201 without compromise on gain,

input impedance or temperature stability. Similar close matching of input transistors is not possible with conventional monolithic microcircuits, it was noted.

**Construction.** Since the d-c stability of the differential amplifier depends largely on the matching characteristics of the input transistor pair, careful procedures are employed during production to insure the closest possible match, the company reports. The transistor dice are first selected from the same silicon wafer. Because transistors of this type change characteristics in manufacture, each silicon die is first premounted on a small gold-plated ceramic substrate, measuring approximately 60 mils by 60 mils, bonded to the substrate, wire-bonded for electrical connection and then heat-soaked for several hundred hours to insure complete stabilization. Tests are then performed to insure matching without additional contact to the active device. After final inspection

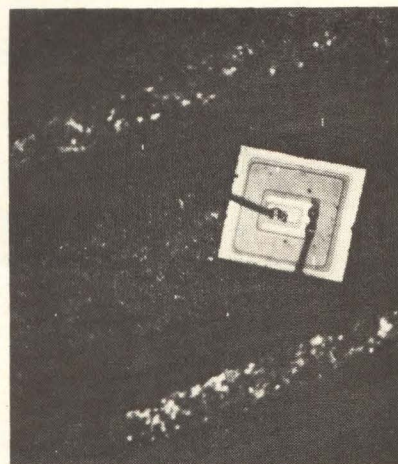

Microphotograph shows one of the input transistors, premounted, with connections from base and emitter.

procedures, the units are incorporated into the differential amplifier microcircuit.

The new microcircuit has a single-ended open loop gain typically 73 db, and a differential input of 200 kilohms. The two input transistors have an initial base-to-emitter voltage match typically 1 mv—compared with the industry standard of 10 mv. The  $V_{BE}$  match with temperature is typically  $5 \mu\text{v}$  per  $1^\circ\text{C}$  from  $-55^\circ\text{C}$  to  $+125^\circ\text{C}$ —compared with the industry standard of  $25 \mu\text{v}$  per  $1^\circ\text{C}$ .

The amplifier has an operating range of  $-55^\circ\text{C}$  to  $+125^\circ\text{C}$  and a storage temperature range of  $-65$  to  $+200^\circ\text{C}$ . Maximum electrical ratings include: power supply voltage,  $+V_{CC}$ , 25 v; negative supply voltage,  $-V_{EE}$ , 25 v; reference supply voltage, 25 v; input voltage, 8 v.

Prices for the new microcircuit are as follows: quantities of 1,000 and up—\$90 each; 500 to 999—\$100; 100 to 499—\$120; 1 to 99—\$150.

Semiconductor Products Group, General Instrument Corp., 600 West John St., Hicksville, N.Y.

Circle 301 reader service card

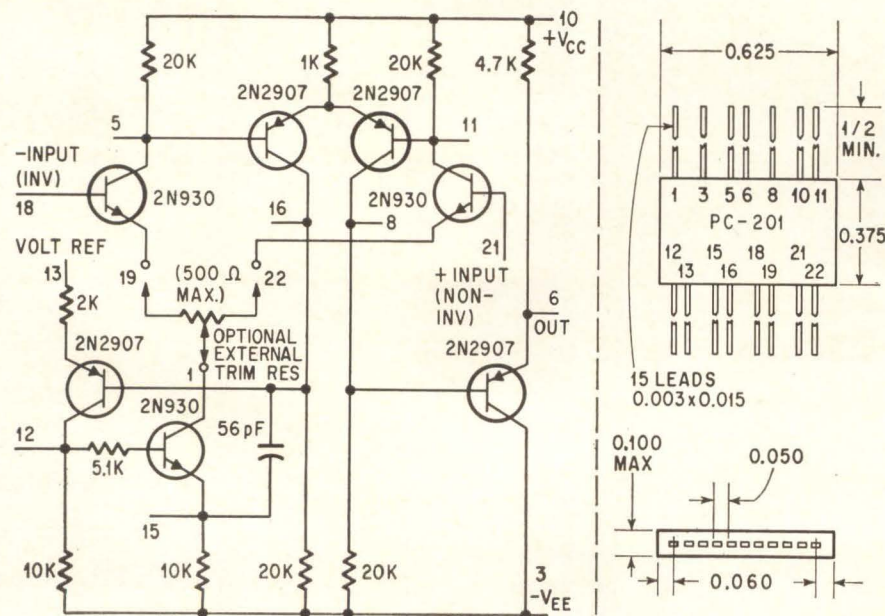

Circuit and outline diagrams of PC-201 microelectronic differential amplifier.

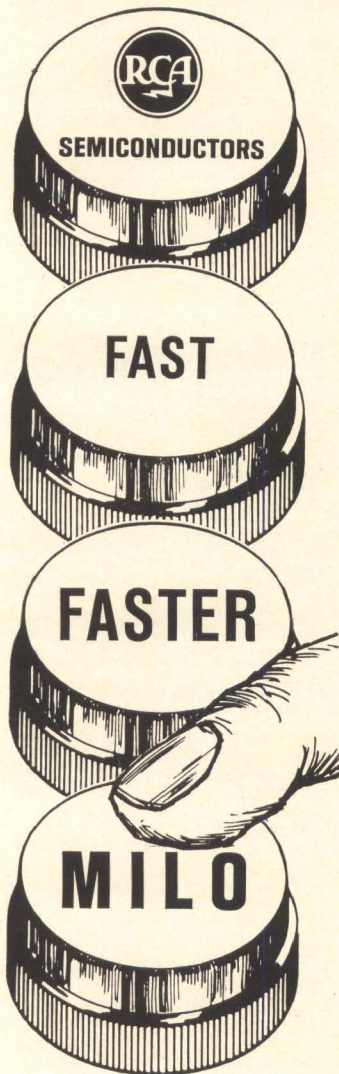

When the pressure is on for RCA semiconductors, don't panic—push the Milo button. One call will bring you everything you need—fast—from our complete off-the-shelf line of RCA semiconductor products. Silicon and germanium transistors, switching transistors, germanium diodes, tunnel diodes, rectifiers and SCR's—they're all here, including the new 2N3440, 3441 and 3442 high voltage, low cost, 200°C silicon transistors.

For the best in semiconductor service, you don't need pull—just push the Milo button and specify RCA. Our men, materiel, and methods will move fast—because we really care about your needs, and take extra care to meet them.



BRANCH WAREHOUSES AND SALES OFFICES  
IN PRINCIPAL INDUSTRIAL AREAS

## New Components and Hardware

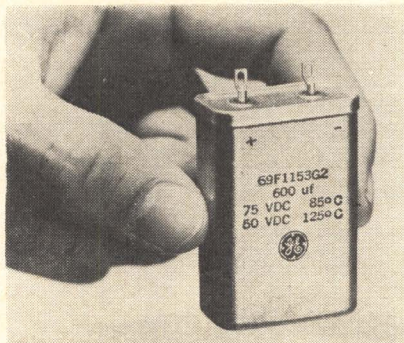

### Tantalum capacitor with 3,500 microfarads

A new 125°C tantalum electrolytic capacitor is claimed to have the industry's highest microfarad rating for such a unit. It offers bulk capacitance by providing as high as 3,500  $\mu$ f and features a hermetic seal which gives long life by virtually eliminating electrolyte leakage. The capacitors are well suited for military and aerospace filtering applications. Providing up to 150 v with polar construction, the units are available in five case sizes and operate over a temperature range of -55°C to +125°C. The new jelled acid electrolyte line meets the requirements of MIL-C-3965/21, CL55.

General Electric Co., 392 S. Stratford Rd., Winston-Salem, N.C. [311]

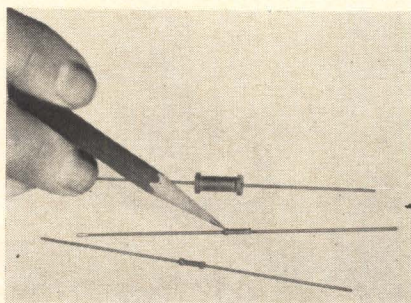

### Tiny coil forms come in variety of shapes

A series of miniature CeraMag coil forms and matching sleeves are said to permit large inductance in small space. The forms are used in fixed-inductance applications where it is advantageous to wind the coil

directly onto the core and attach the coil ends to wire leads. Advanced grinding techniques permit many shapes. CeraMag coil forms can be furnished with one or two flanges, or with none. They are available as small as 0.200 in. long, 0.064 in. in diameter with 0.069-in.-diameter flanges. There are 16 material grades to cover frequency ranges from 10 kc to 200 Mc. These materials have initial permeabilities ranging from 10 to 2,500. The coil forms are being manufactured with leads of Dumet, gold-plated, standard and other types, and in dumbbell form, without leads.

Electronic Components Division, Stackpole Carbon Co., St. Marys, Pa. [312]



### Microminiature tuning fork resonators

Four new series of miniature and microminiature precision tuning fork resonators are designed to generate audio frequencies between 400 cps and 18,000 cps. Available accuracies range from  $\pm 0.05\%$  to  $\pm 0.005\%$  over military temperature ranges without the use of ovens. Smallest size is 0.16 cu in. in volume and weight is 0.4 oz. Accuracies of  $\pm 0.001\%$  are also available in solid-state oscillator packages. Philamon Laboratories Inc., 90 Hopper St., Westbury, N.Y. [313]

### Packaged blowers are rfi-shielded

A series of packaged cooling equipment has shielding in the airstream to overcome and suppress

# New from Sorensen...40 volts at 10 amps in a constant current power supply for \$325.00

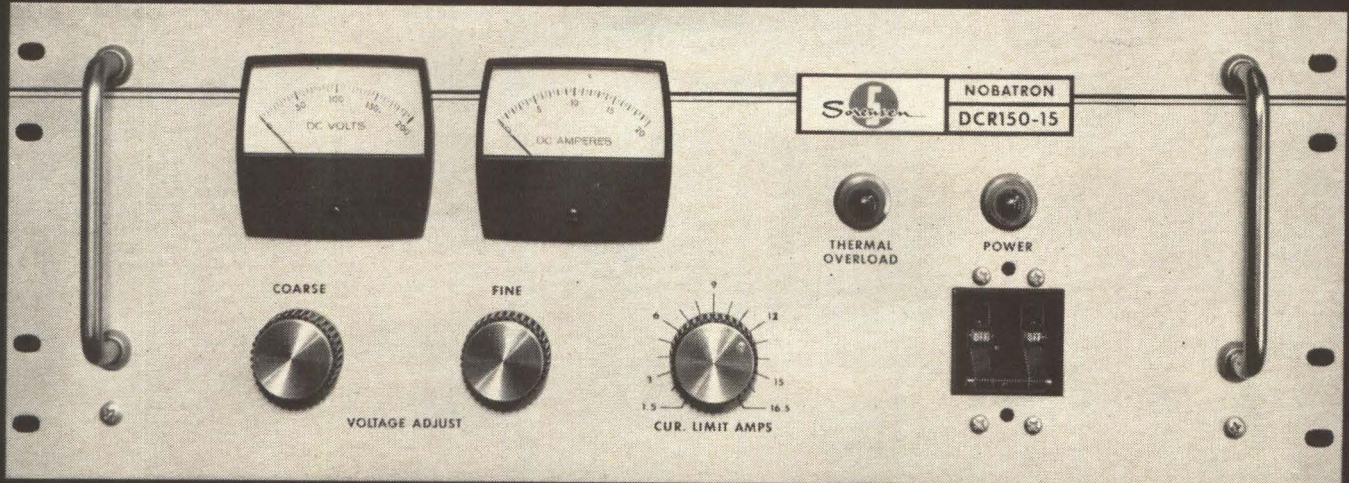

## Now...19 DCR supplies from 0-400 to 0-2400 watts

1. 19 SILICON CONTROLLED RECTIFIER SUPPLIES AVAILABLE... Delivery in 30 days or less.
2. LOW PRICES... Starting at \$325 (Voltmeter and Ammeter included with no increase in price)
3. COMPACT PACKAGING... 7" or 5 1/2" Rack Height
4. HIGH EFFICIENCY
5. CONSTANT VOLTAGE REGULATION... with continuously adjustable current limiting.
6. CONSTANT CURRENT REGULATION... with continuously adjustable voltage limiting.
7. AUTOMATIC CROSSOVER... full automatic transition from constant voltage to constant current operation, or from constant current to constant voltage operation, at any operating point.
8. REMOTE PROGRAMMING... Voltage and Current
9. REMOTE SENSING... At distances up to 200 feet
10. SERIES OR PARALLEL OPERATION
11. VOLTAGE REGULATION... (as low as  $\pm 0.1\%$  or 15 mv) Line and Load combined
12. CURRENT REGULATION... As low as  $\pm 15$  ma
13. LOW RIPPLE... 0.5% + 50 mv (RMS)
14. UNITIZED CONTROL CIRCUITRY... for easy maintenance
15. COARSE AND FINE CONTROLS... for Voltage Output

For complete data on the DCR series and other Sorensen products, send for the new, 140-page "Controlled Power Catalog and Handbook." Write to: Sorensen, Richards Avenue, South Norwalk, Connecticut. Or use Reader Service Card Number 200.

### DCR ELECTRICAL AND MECHANICAL SPECIFICATIONS:

MODEL NUMBER	VOLTAGE RANGE (VDC)	VOLTAGE REG. (LINE & LOAD COMBINED)	OUTPUT CURRENT (AMPS.)	CONSTANT CURRENT RANGE (AMPS.)		CURRENT REG.	RMS RIPPLE	TRANSIENT RESPONSE	PACKAGE SIZE (INCHES)			WEIGHT (LBS.)	PRICE
									WIDTH	HEIGHT	DEPTH		
DCR 300-1.25	0-300	$\pm 1\%$ or 60mv	0-1.25	0.125 to	1.37	$\pm 15$ ma	0.5% + 50mv	30msec	19	5 1/4	15	52	\$325
DCR 150-2.5	0-150	$\pm 1\%$ or 30mv	0-2.5	0.25 to	2.75	$\pm 15$ ma	0.5% + 50mv	30msec	19	5 1/4	15	52	325
DCR 80-5	0-80	$\pm 1\%$ or 30mv	0-5	0.5 to	5.5	$\pm 15$ ma	0.5% + 50mv	30msec	19	5 1/4	15	56	325
DCR 40-10	0-40	$\pm 1\%$ or 15mv	0-10	1 to	11.0	$\pm 20$ ma	0.5% + 50mv	30msec	19	5 1/4	15	55	325
DCR 300-2.5	0-300	$\pm 1\%$ or 60mv	0-2.5	0.25 to	2.75	$\pm 15$ ma	0.5% + 50mv	30msec	19	5 1/4	18	77	525
DCR 150-5	0-150	$\pm 1\%$ or 30mv	0-5	0.5 to	5.5	$\pm 15$ ma	0.5% + 50mv	30msec	19	5 1/4	18	77	525
DCR 80-10	0-80	$\pm 1\%$ or 20mv	0-10	1.0 to	11.0	$\pm 20$ ma	0.5% + 50mv	30msec	19	5 1/4	18	77	525
DCR 60-13	0-60	$\pm 1\%$ or 15mv	0-13	1.3 to	14.3	$\pm 20$ ma	0.5% + 50mv	30msec	19	5 1/4	18	77	525
DCR 40-20	0-40	$\pm 1\%$ or 15mv	0-20	2.0 to	22.0	$\pm 25$ ma	0.5% + 50mv	30msec	19	5 1/4	18	77	525
DCR 300-5	0-300	$\pm 1\%$ or 60mv	0-5	0.5 to	5.5	$\pm 15$ ma	0.5% + 50mv	30msec	19	7	18	95	710
DCR 150-10	0-150	$\pm 1\%$ or 30mv	0-10	1.0 to	11.0	$\pm 20$ ma	0.5% + 50mv	30msec	19	7	18	95	710
DCR 80-18	0-80	$\pm 1\%$ or 20mv	0-18	1.8 to	19.8	$\pm 25$ ma	0.5% + 50mv	30msec	19	7	18	98	710
DCR 60-25	0-60	$\pm 1\%$ or 15mv	0-25	2.5 to	27.5	$\pm 25$ ma	0.5% + 50mv	30msec	19	7	18	100	710
DCR 40-35	0-40	$\pm 1\%$ or 15mv	0-35	3.5 to	38.5	$\pm 35$ ma	0.5% + 50mv	30msec	19	7	18	102	710
DCR 300-8	0-300	$\pm 1\%$ or 60mv	0-8	0.8 to	8.8	$\pm 20$ ma	0.5% + 50mv	30msec	19	7	18	115	825
DCR 150-15	0-150	$\pm 1\%$ or 30mv	0-15	1.5 to	16.5	$\pm 25$ ma	0.5% + 50mv	30msec	19	7	18	115	825
DCR 80-30	0-80	$\pm 1\%$ or 20mv	0-30	3.0 to	33.0	$\pm 30$ ma	0.5% + 50mv	30msec	19	7	18	120	875
DCR 60-40	0-60	$\pm 1\%$ or 15mv	0-40	4.0 to	44.0	$\pm 40$ ma	0.5% + 50mv	30msec	19	7	20	130	900
DCR 40-60	0-40	$\pm 1\%$ or 15mv	0-60	6.0 to	66.0	$\pm 60$ ma	0.5% + 50mv	30msec	19	7	20	131	925



A UNIT OF RAYTHEON COMPANY

CIRCLE 200 ON READER SERVICE CARD

**A NEW RECORDER  
priced right  
and packaged  
any way  
you need it!**

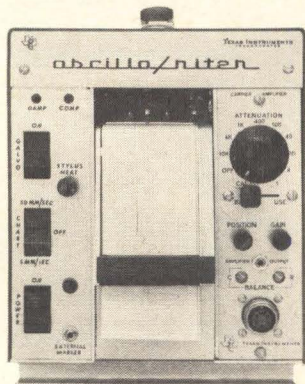

**CARRY IT!**

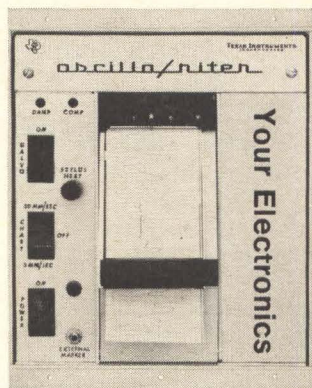

**MOUNT IT!**

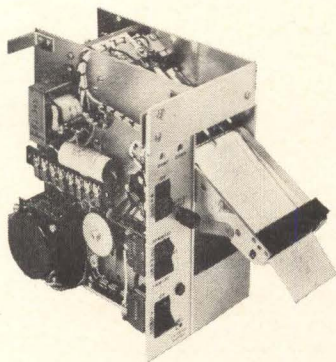

**PACKAGE IT!**

Complete flexibility in recorder and package makes the *oscillo/riter*\* an easy choice for OEM's needing a direct-writing oscillographic recording capability. It is available as either a portable or flush-mounting instrument with or without input amplifier . . . or simply as an assembly of galvanometer, writing system and chart drive for incorporation in other equipment.

This single-channel *oscillo/riter* recorder features a trouble-free, heated stylus writing system. It uses either roll or Z-fold chart paper, producing sharp, clean rectilinear traces. Standard chart speeds of 5 mm/sec and 50 mm/sec (or other 1:10 ratio speeds) are selectable by means of a front-panel push-button switch. Interchangeable amplifiers satisfy almost any input function requirement.

*oscillo/riter* recorders also are available in a dual-channel model offering eight chart speeds and either heat or ink writing. The portable case is readily adaptable to rack mounting.

\* A trademark of Texas Instruments

## New Components

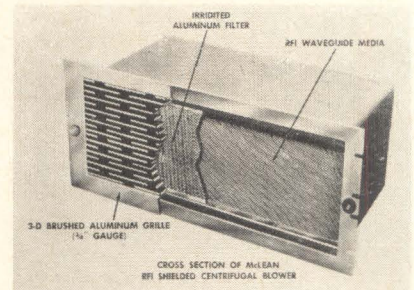

radio frequency interference. Units maintain a 100-db attenuation through the range of 15 kc to 10 Gc when installed to specification. Airflow ratings are from 150 cfm to 1,000 cfm. All models are without r-f noise generation or transmission. The Computer Age rfi-shielded line is certified by government agencies and all models conform to a variety of applicable Mil-Specs. They are quickly and easily installed. Filters can be serviced without tools.

McLean Engineering Laboratories, P.O. Box 228, Princeton, N.J. [314]

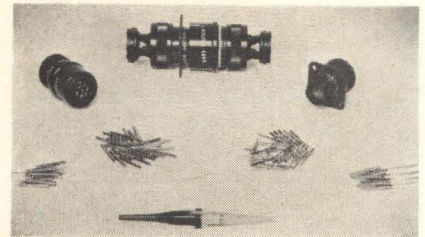

## Connectors feature push-pull coupling

Advanced push-pull coupling is incorporated in the DBA70 line of high-reliability connectors. The push-pull has a ball-lock coupling mechanism that features five keyways to guarantee against mismatching. Operation is always in the direction of plug travel—push for positive lock and seal, pull for instant disengagement. No lock wiring or twisting is required. Mating can be checked visually or by probe. The connectors feature Big Brutus contacts, interchangeable accessory hardware, rear entry insertion-removal and a wide range of shell sizes and layouts. The line is available in square-flange

INDUSTRIAL  
PRODUCTS  
GROUP



**TEXAS INSTRUMENTS**

**INCORPORATED**

P. O. BOX 66027 HOUSTON, TEXAS 77006  
7 RUE VERNONEX GENEVA, SWITZERLAND

676



## Now... a really new s-c tester featuring digital programming and low cost

TI's Model 658 Transistor/Diode Test System has many new features to make production/inspection testing easier, faster, more economical. An out-of-the-way digital programming section uses digit-switch and rotary selectors for choosing test conditions. Both d-c and pulse tests can be performed with each module. Up to 48 plug-in modules may be mounted vertically or in slide-out drawers. Tests may be programmed in any sequence. Test duration is independently adjustable from 50 milliseconds to 5 seconds.

The 658 features digital control of test circuitry; close proximity of clamps and limiters to device under test; Kelvin connections eliminating IR drop errors; front panel lights displaying go/no-go results; memory storage permitting sorting and classification into 16 categories with an accessory sorter; swing-out card racks and plug-in assemblies for simplified maintenance and long-term reliability. Bias and reference supplies are digitally programmable with repeatability better than 1/2%. Readout accuracy is 1/2%.

Write for information.

INDUSTRIAL  
PRODUCTS  
GROUP



**TEXAS INSTRUMENTS**

**INCORPORATED**

P. O. BOX 66027 HOUSTON, TEXAS 77006  
7 RUE VERNONNEX GENEVA, SWITZERLAND

# VIDEOSCAN THE CRT RECORDER THAT SETS NEW RECORDS IN HIGH FREQUENCY DATA ANALYSIS

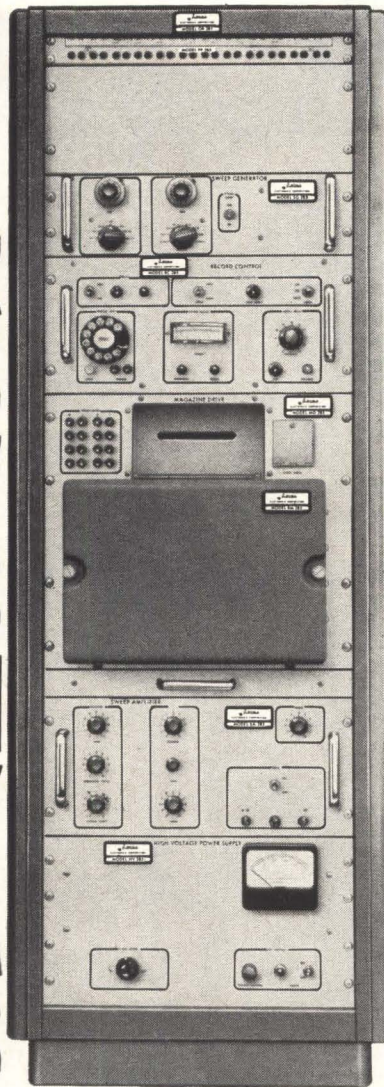

This precision, high-speed Interstate VIDEOSCAN combines images from a high-resolution cathode ray tube with galvanometer traces onto single, moving 12-inch film or paper... providing a detailed, permanent recording for data analysis that up to now was impossible.

- Records at spot-image-speeds as high as 200,000 inches-per-second
- Resolution of 500 line pairs on 10 inches of recording media
- Cathode Ray Tube record is linear, flat to 20 kc in the swept axis, and intensity modulated via a 4-mc video amplifier, making it useful to 30-ips paper speed with a spot size of less than 4 mils
- Allows visual monitoring of the tube face while recording
- Provides record identification
- Designed with auxiliary modules—sweep generator, sweep amplifier, recording magazine and video patch panel—for wide range of applications

Interstate's VIDEOSCAN provides an extremely accurate method of signal analysis, pulse rate or pulse shape analysis, high frequency vibration analysis, telemetry signal analysis, high frequency phenomena display, radar visual recording, coordinated time base display and facsimile and video recording.

Read the full story of VIDEOSCAN in a new Interstate brochure. Write or check reader service card for your copy.

 **Interstate ELECTRONICS CORPORATION**  
707 EAST VERMONT AVENUE, ANAHEIM, CALIFORNIA  
Telephone 714-772-2222, TWX 714-776-0280  
A Subsidiary of Interstate Engineering Corporation Worldwide Representatives

## New Components

mounted receptacles and push-pull plugs.  
Deutsch Electronic Component Division,  
Municipal Airport, Banning, Calif. [315]

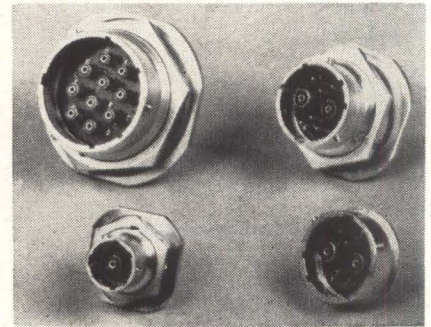

## Coaxial connectors with hermetic seal

Sealed connectors for coax and shielded circuitry provide closed entry and positive spring retention in a one-piece contact member. The connectors meet or exceed MIL-C-26482 and MIL-C-26500 helium leakage requirements and mate with Hyfen Bantam coax or proprietary configurations. Insulation is of hard-compression blue glass, making contact identification extremely legible. The connectors are available with outer conductors either fully insulated or grounded to connector shell. The various designs accept any shielded wire using No. 20 Awg center conductor, covering standard and miniature coax applications. They may be obtained in solder, box, or jam-nut mounting, with a choice of solder pot, solder eye or special wiring terminations, and in a variety of plated finishes. The units are also available as a feed-through coax and as a composite, with both power and coax contacts in a single connector.

Burndy Corp., Norwalk, Conn. [316]

## Metal-film resistor saves board space

A miniaturized, molded, precision resistor of metal-film, type PE-1/4, is designed to conserve printed-

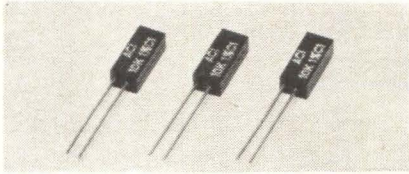

board area, and in performance surpasses MIL-R-10509E characteristic E and C levels. Power rating is  $\frac{1}{4}$  w at  $100^{\circ}\text{C}$ , and  $\frac{1}{8}$  w at  $125^{\circ}\text{C}$ . Voltage rating is 250 v while resistance range coverage is 10 ohms to 0.5 megohm. Dimensions are 0.140 by 0.200 by 0.468 in. high. Leads are  $\frac{3}{4}$  in. long, and can be trimmed to suit the application. Standard tolerance is  $\pm 1\%$ . The unit features low noise and temperature coefficients of  $\pm 25$  ppm/ $^{\circ}\text{C}$ ,  $\pm 50$  ppm/ $^{\circ}\text{C}$ , and  $\pm 100$  ppm/ $^{\circ}\text{C}$ . Prices range from \$2 to 45 cents depending on tolerance, temperature coefficient, and quantity. American Components, Inc., 8th Ave. & Harry St., Conshohocken, Pa. [317]

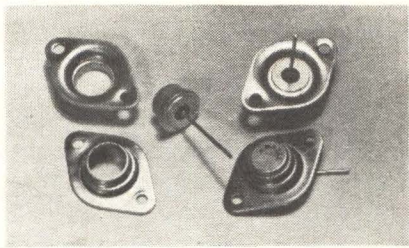

## Flange adapter offered for press-fit rectifier

Latest addition to a line of transistor heat-sinks is Part 700, a TO-3, flange adapter for 0.500-in. press-fit rectifiers. The metal chassis and printed-circuit structures found in the electronics industry are not inherently compatible with the principle of the press-fit rectifier. The new flange adapter enables the customer to convert the rectifier into the traditional TO-3 outline with which the industry has extensive experience. The rectifier can be inserted easily into the adapter, using a drill press as an arbor and a  $\frac{9}{16}$ -in. socket as a bucking fixture. A multistrand wire can be inserted during the process. This provides a swaged second electrode that is more reliable than the conventional solder-lug techniques commonly used with TO-3 and other semiconductor config-

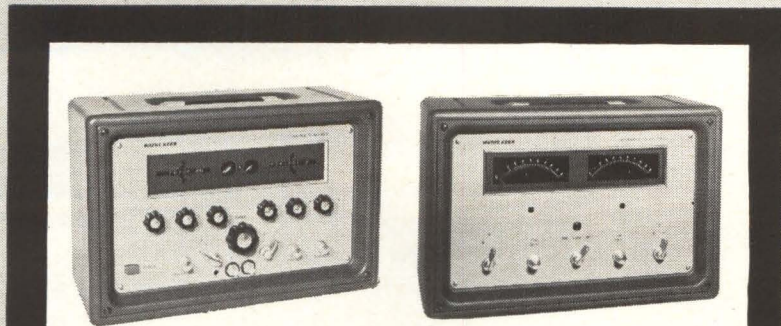

THE VERNIER IS

**ORNAMENTAL**

(...we may have Gone Too Far)

Are we being fair to the Man in the Lab? Will he feel Left Out? Unwanted? Will his Life be Empty without the Vernier? With AUTOBALANCE<sup>®</sup>, you see, the vernier on our B221A Universal Bridge becomes a useless ornament.

The principle is simple.\* Any bridge unbalance is fed to an operational amplifier, which furnishes a proportional "re-balance" voltage. Two phase-sensitive detectors give readings of the in-phase and quadrature components of the rebalance signal, (directly, on meters). Add these to the decade settings and you have the resistive and reactive answers—without touching the vernier... electronic, automatic, and terribly modern.

Think of batch-lot-checking to four digits, without touching a knob (once the decades are set at the start). Think of automatically recording component drift! The question is, is the Game worth the Candle?

Help us! Tell us you care more for efficiency than for tradition! Buy the AA221 and write us admiring and forgiving letters. (If you're not all that impulsive, at least ask for the literature.\*\*)

One last word—if you ever feel sickeningly "over-automated" with the AA221, you can always pull out the adapter cable and "go native" with the raw B221A.

### B221AQ SPECIFICATIONS

Capacitance: 0.0002  $\mu\text{F}$  to 100,000  $\mu\text{F}$       Frequency Range: 1000 or 1592 cps Internal;  
Resistance: 25 $\mu\text{ohms}$  to 50,000 megohms      20 cps to 20KC External  
Inductance: 5 $\mu\text{H}$  to 10<sup>8</sup>H      Accuracy:  $\pm 0.1\%$

<sup>®</sup> AUTOBALANCE is a registered trademark of Wayne-Kerr

\* And patented

\*\* While you're at it, go all the way, and ask about the B541, a  $\pm 0.25\%$  Capacitance Bridge with built-in AUTOBALANCE!



**WAYNE KERR**  
CORPORATION

14-22 FRINK ST., MONTCLAIR, N. J. [201] 746-2438

**INNOVATIONS in INSTRUMENTATION**

**Complete DVM versatility now available from Hughes.** Programmable from test systems and with output capability for data recorders, Hughes new Model 5000A integrating DVM offers increased reliability, exceptional precision, outstanding dependability and speed.

*Features include:* Five-digit accuracy ■ All-electronic design ■ All solid state components ■ Rugged, dependable Accessory Power Supply ■ Easy-to-use, plug-in accessories: AC-DC Converter, Ohms Converter.

**Easily worth \$1,000 more than its price!**

Find out for yourself what a buy the new Hughes Model 5000A DVM really is. Wire, write or call today for full information: Hughes Instruments, 2020 Oceanside Boulevard, Oceanside, California 92057. For export information, write: Hughes International, Culver City, California 90232.



**HUGHES**

HUGHES AIRCRAFT COMPANY  
HUGHES INSTRUMENTS  
OCEANSIDE, CALIFORNIA

## New Components

urations. The rectifier can be replaced without damaging the flange adapter.

Daedalus Co., 129 $\frac{1}{2}$  Rosecrans Ave.,  
Manhattan Beach, Cal. 90266. [318]

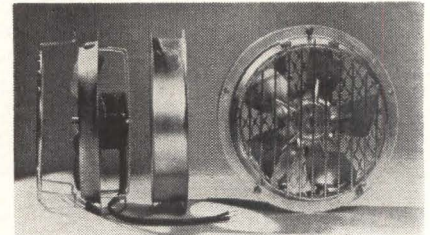

## Ultra-thin fans benefit designers

Four new models in a two-part series of ultra-thin fans offer design latitude to those concerned with electronic cabinet cooling. Both blower and suction models are just 3 $\frac{3}{8}$  in. deep overall. Blower models are designed to insure broad distribution of cooling air to all corners of the cabinet. This is achieved by inclusion of a substantial radial component, rather than straightforward chimney flow. This family line comprises a whole range of sizes, from 165 cfm to 800 cfm. Flexible thin fan suction models, for direct mounting to the side panel or rear door of typical electronic cabinets, will also drop into the base, thus clearing side walls and most or all of panel space. Intrusion into cabinet need be only from 2 $\frac{7}{8}$  in. to 4 $\frac{3}{8}$  in. to obtain air deliveries ranging from 165 to 800 cfm.

Kooltronic Fan Co., P.O. Box 504,  
Princeton, N.J. [319]

## Metal film resistor meets MIL-R-10509E

A  $\frac{1}{20}$ -w miniature resistor, designated FE5, dissipates 0.05 w to 125°C and derates linearly to 175°C. It meets all MIL-R-10509E requirements. The FE5 features cap and lead construction for greater mechanical strength and assurance of positive electrical contact under most stringent environmental extremes. Noise levels are



less than 0.2  $\mu\text{V}$  per v. The resistor is available in resistance ranges from 50 ohms to 100 ohms, tolerance of  $\pm 1\%$ , and temperature coefficients of  $0 \pm 50$  ppm. It is transfer encapsulated with a high-density epoxy material which is said to provide better environmental protection than the commonly used molding or conformal coating materials. The FE5 measures only 0.150 in. maximum length by 0.054 in. maximum diameter. Its standard No. 26 Awg gold-plated nickel lead can be welded and soldered.

Mepco, Inc., Morristown, N.J. [320]

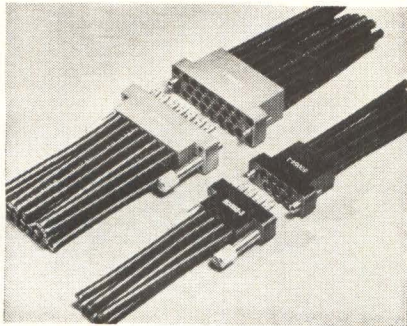

### Coaxial connectors have snap-in contacts

Availability of 20-position, 14-position and 7-position coaxial cable connectors has been announced. They are miniature pin-and-socket connectors with snap-in contacts, designed for high-density, multiple-coaxial connections. Both connectors feature one-step termination of inner conductor, outer braid and cable support. Both accommodate cable sizes from RG55B/U to RG188/U. The snap-in contacts utilize a special type of retention spring that assures firm seating in the connector block and acts as a shield over crimping ports. AMP, Inc., Harrisburg, Pa. [321]

### Ceramic-to-metal header for power transistors

A ceramic-to-metal seal header in the TO-8 JEDEC configuration, available for packaging power transistors, consists of 0.030-in.-diameter nickel iron leads, silver-brazed into a pure copper base. The leads must withstand bending over a

**NOW! TRANSMIT LIGHT  
IN FLEXIBLE CURVES...**

**NEW Bausch & Lomb  
LIGHT WIRES**

**Your first low-cost source for production-run incoherent fiber optics!** Out of the "high-priced, laboratory stage" . . . and into your hands to be designed and engineered into your products and systems as a practical economical tool. That's the big news from Bausch & Lomb, leaders in fiber optics research.\*

Thin glass fibers, each about 15 microns in diameter, are made to transmit light by a process of total internal reflection. Each fiber is clad in a coating of lower refractive index than itself . . . bundles of these high optical quality fibers are clustered together into flexible "wires" . . . the ends are bonded, ground and polished . . . and you have Bausch & Lomb LIGHT WIRES! They can be specified by known parameters . . . and ordered by diameter and length . . . to fit your design problem.

LIGHT WIRES transmit light and light impulses efficiently around flexible curves and into inaccessible areas. As flexible as electrical wires, they can be bent and twisted around corners, harnessed together by butt-contact splicing and fed through conduits, to move light signals or illumination from one point to another. Applications in illuminating, signaling, monitoring, and actuating are virtually unlimited . . . where higher efficiency, reliability, space reduction, potential fire and explosion, lower cost, and inaccessibility are design problems.

Write for complete information Catalog D-2045, Bausch & Lomb Incorporated, 61409 Bausch Street, Rochester 2, New York.

*Light Wires is a registered trademark*

\*Another Bausch & Lomb first in fiber optics . . . "The FLEXISCOPE" . . . a great new tool for production and quality control, which transmits images from inaccessible areas. Catalog D-2042 available on request.

**BAUSCH & LOMB** 

In Canada, write Bausch & Lomb Optical Co., Ltd., Dept. 614, Scientific Instrument Division, 16 Grosvenor St., Toronto 5, Canada

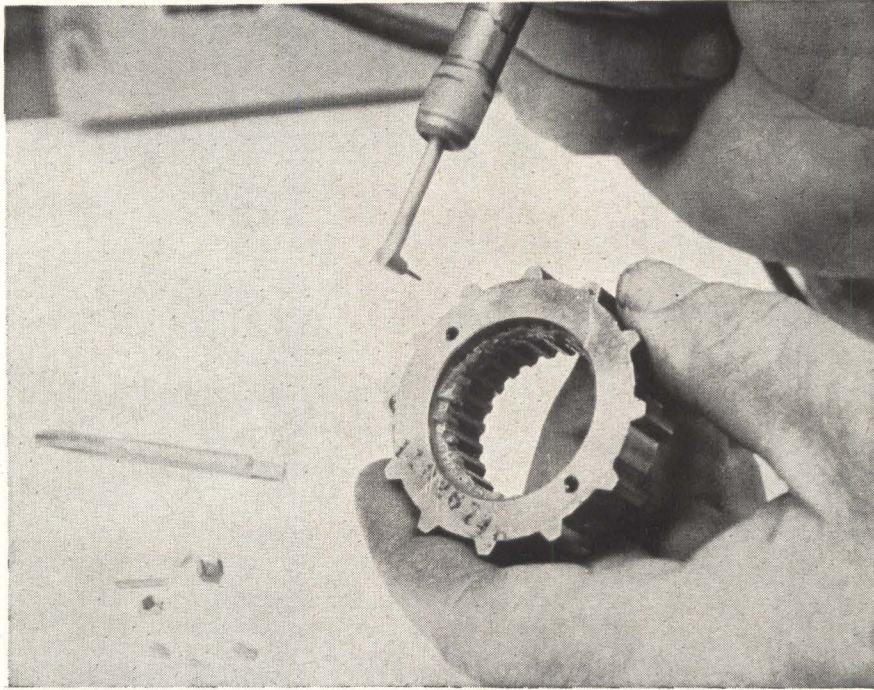

## Airbrasive® blasting of broken tool bits saves Martin Co. \$10,000 a year

Martin Co. used the Airbrasive to put a stop to an annual loss of \$10,000 in rejects. At least 90% of these precision parts that had broken taps or drill bits embedded in them had to be scrapped.

The Airbrasive — a unique tool of a thousand uses in shop or laboratory — directs a fine stream of abrasive particles on the broken tap. The tap quickly breaks into small, easily removed pieces without damaging the original part.

*Result: a saving of at least \$10,000 a year.*

**Here is a remarkable instrument.** Use it to shape, cut, abrade, drill, clean, wirestrip almost any hard, brittle material . . . ceramics, germanium, silicon, ferrites, glass, tungsten, alloy steels . . . wherever cool, shockless, precision work is required.

**Cost is low, too . . .** for under \$1000 you can set up your own Airbrasive unit in your plant or laboratory.

*Let us make a free trial for you send samples for test or telephone collect for a demonstration.*

SEND FOR  
BULLETIN 6407A



**S. S. WHITE INDUSTRIAL DIVISION**  
Dept. EU, 10 East 40th St., N.Y. 16, N.Y. • Telephone MU 3-3015 collect

for superfine cutting • deburring • cleaning

hard brittle materials

**S.S. White INDUSTRIAL AIRBRASIVE**

## New Components



30° arc to meet specifications. A nickel-coated molybdenum disk is mounted on the face of the header to match the thermal expansion of silicon that is also mounted on the header. The entire header can be gold-plated, if desired, to meet thermal cycling as high as 500°C. Advac Products, Inc., 174 Richmond Hill Ave., Stamford, Conn. [322]

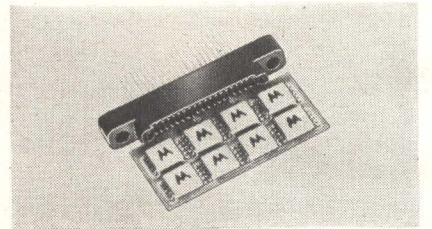

## P-c connector in varied sizes

A new connector has been announced for printed card and tape cable applications. Designated series 600, these receptacle-type units are made in a variety of single and dual readouts with sizes from 6 to 210 contacts capable of accommodating board thicknesses of  $\frac{1}{32}$  in.,  $\frac{1}{16}$  in.,  $\frac{3}{32}$  in. or  $\frac{1}{8}$  in. Illustrated is a 40-terminal micro-miniature unit with 0.050 center-to-center spacing assembled with a micromodule integrated circuit on a  $\frac{3}{32}$  in. p-c board. This connector is also available with 128 terminations. Connectors meet or exceed applicable MIL-C-21097 specifications. Wiring styles include eyelet lug for soldering, solderless-wrap termination for wire-wrapping technique, taper tab solderless wiring and contacts for dip soldering. Molding material is usually glass-reinforced diallyl phthalate type GDI-30 per MIL-M-19833 specifications although other materials are used and available on order.

Continental Connector Corp., 34-63 56th St., Woodside 77, N.Y. [323]

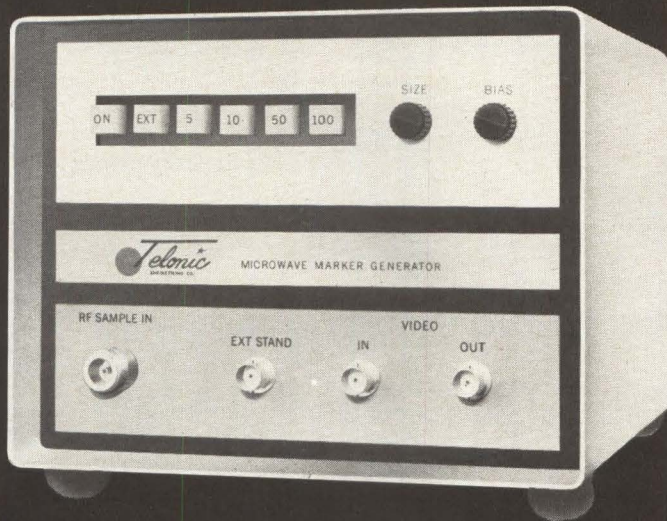
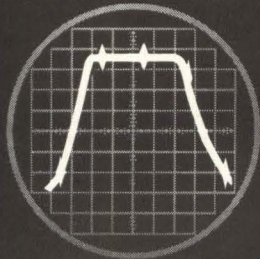
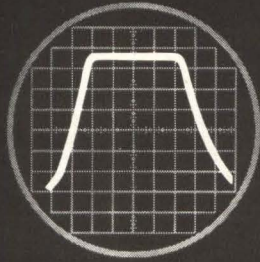

## TMS MICROWAVE MARKER GENERATOR 1 Gc to 10 Gc

The new Telonic TMS Marker Generator lets you know precisely where you're operating, frequency-wise, from 1 to 10 Gc. It provides continuous indication of frequency by producing Birdy-type markers on the oscilloscope every 5, 10, 50, or 100 Mc. Designed to be used with a sweep generator, the new TMS system obsoletes every other type of frequency meter in accuracy, price, and convenience.

Marker intervals are selected by convenient push-button for speed and precision. If intervals other than the four standard are desired, an RF connection and selector button allows use of an external oscillator for any frequency from 2 Mc to 200 Mc.

Accuracy of the new TMS is .001%, or 100 times better than that of a frequency meter. Its accuracy approaches that of a frequency counter but at a fraction of the price.

Contact your local Telonic representative for a demonstration or write direct for complete details and specifications.

### GENERAL SPECIFICATIONS

FREQUENCY RANGE.....	1 Gc to 10 Gc
MARKER INTERVAL.....	5, 10, 50, 100 Mc
ACCURACY.....	.001%
CONNECTIONS.....	Sample in, external oscillator, video in, and video out
POWER REQUIREMENTS.....	115V, 60 cycle
DIMENSIONS.....	6" high x 8" wide x 10" deep



**ENGINEERING  
CO.**

Division of Telonic Industries, Inc.  
480 Mermaid Street • Laguna Beach, California  
Phone 714-494-7581 • TWX 714-673-1120

*Representatives in all principle cities.*

# KAY

## ELECTRIC COMPANY

Maple Avenue, Pine Brook, Morris County, New Jersey

RF Frequency: 10 to 120 mc, accurate to  $\pm 1\%$ .

RF Output: 0.5 volts rms into 50 ohms.

Carrier-Off Level: 85 db to 30 mc, 80 db to 70 mc, 70 db to 120 mc.

Carrier rise & decay: less than 10 ns.

Pulse Width: 100 ns to 100 micro sec.

Pulse rep. rate: 50 to 5000 pps.

Price: \$875.

NEW!

# KAY

Kada-Pulser

## 5070-A

### 10 to 120 mc Pulsed Signal Generator

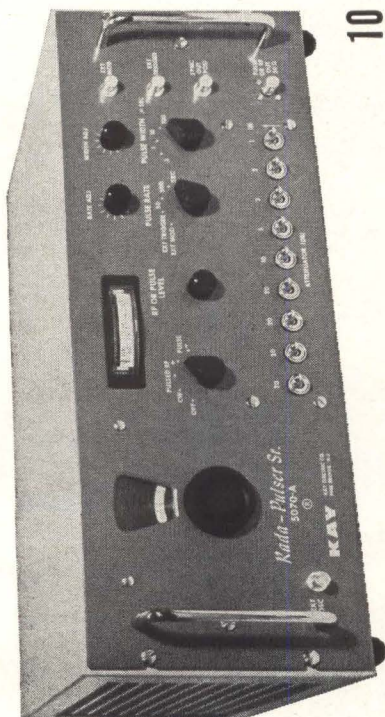

## New Instruments



### Pulse generator with fast rise time

An all-solid state pulse generator has been introduced. Model 139 features fast, variable, ultralinear 6 nsec to 100  $\mu$ sec rise time. Repetition rate is continuously variable from 1 kc to 20 Mc. Base line offset is  $\pm 2$  v, adjustable, either polarity. Delay, width and amplitude are fully controllable. Price is \$1,275.

E-H Research Laboratories, Inc., Oakland, Calif. [351]



### F-m detector offers d-c to 400 kc response

This wide-band, tunable, direct carrier f-m discriminator can demodulate, with very low distortion and wide frequency response, f-m signals. Model FMD-1 can be used for accurate measurements of frequency response, pilot phasing, distortion, and stereo separation in f-m broadcast transmitters as well as for measurements in phase and f-m telemetry transmitters. Specifications include: carrier center frequency, 85 to 115 Mc; frequency response; d-c to 400 kc;

distortion, less than 0.1%; sensitivity, 0.05 v/1 v per 75 kc deviation; input impedance, 50 ohms; vswr, less than 1.2:1; maximum input level,  $\frac{1}{2}$  w; output impedance, 10,000 ohms; size exclusive of knob and connectors, 4 in. wide by  $2\frac{1}{2}$  in. deep by 3 in. high; price, \$89.50. Belar Electronics Laboratory, 1204 Childs Ave., Drexel Hill, Pa. [352]

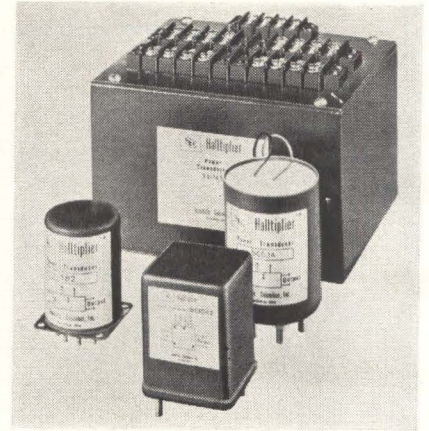

### Power transducers cover from 1 w to 5 kw

A line of power transducers, based on the Hall effect, cover full-scale ranges from 1 w to 5 kw. The Hall effect can measure power because it is a true electrical multiplier. Providing a d-c voltage proportional to true power, these rugged, solid-state transducers are designed to meet specifications for most power-control systems, metering and recording applications. Single or three-phase models, covering frequencies up to 10 kc, are available in a variety of enclosures and terminations.

Scientific Columbus, Inc., 1035 W. Third Ave., Columbus, Ohio. [353]

### Flame photometer with digital readout

A digital-readout instrument is announced for measurement of sodium and potassium in serum, urine or other biological samples. Model 143 flame photometer provides simple calibration, quick analysis, no serial

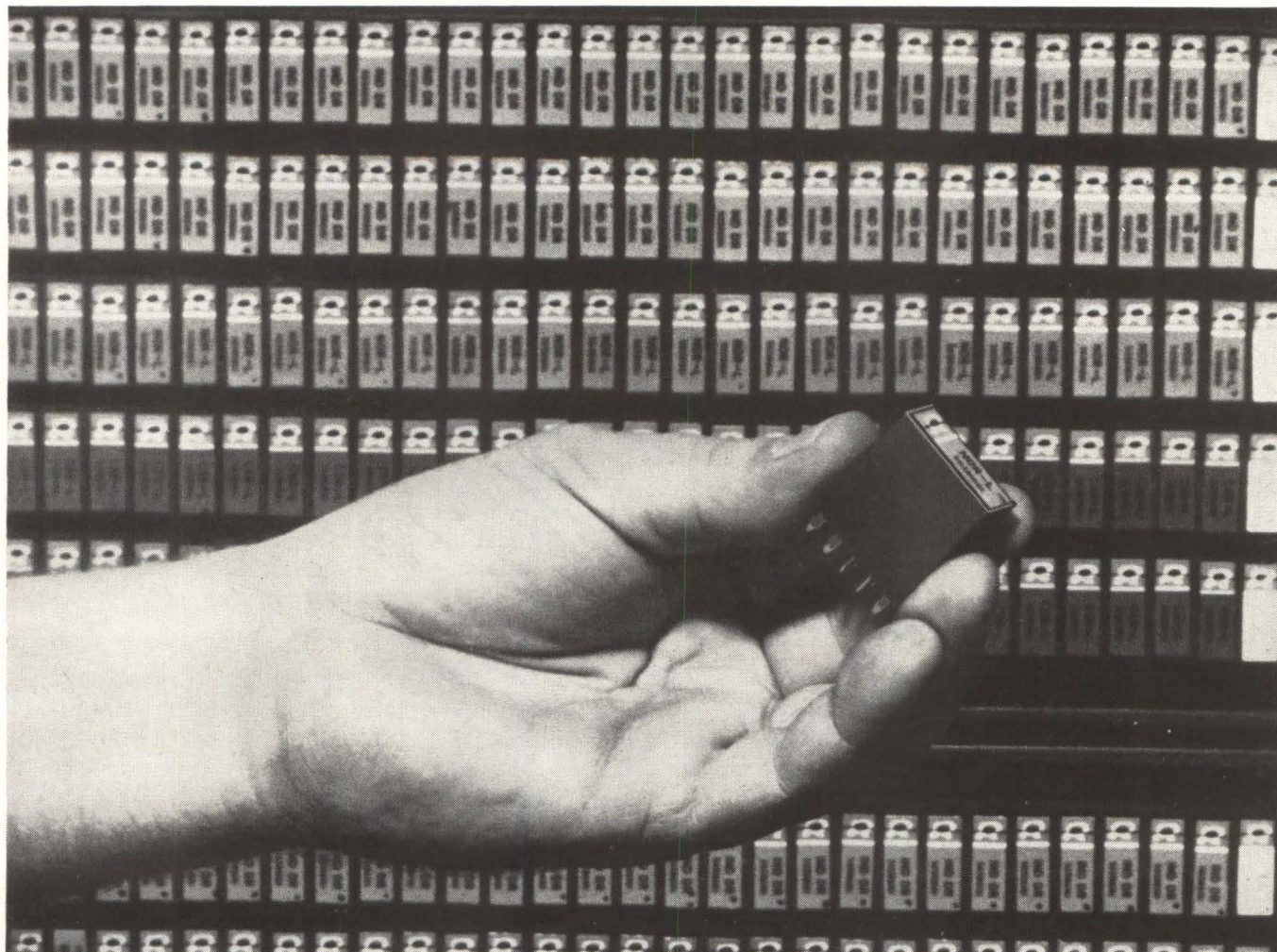

## Simplify Digital Design

*Radiation Logic Modules are packaged for flexibility, reliability, high-density mounting*

There's no need for design compromise when you specify Radiation Logic Modules. They can be used in any configuration, type or number compatible with your digital system requirements. They can be mounted in vertical or horizontal drawers, in standard 19" racks, or on breadboards... fixed or removable.

Radiation Logic Modules are supplied from stock in standard as well as special-purpose types. Two sets of fully compatible resistor-transistor logic circuitry are available. They cover bit rates up to 200 kc, and rates to 1 Mc. More than a dozen types include: 4-input NOR-Counter Shift Register-Power Inverter-Emitter Follower-Complementary Driver-Differential-Filter (Decoupler).

**RELIABILITY** Superior engineering and rigid component selection assure highest reliability: based on extensive tests, MTBF for low-speed NOR Modules exceeds 2,940,000 hours! The units are also packaged for rugged use. Construction consists of welded circuitry

molded in epoxy and mounted with high-density module connectors on cast aluminum frames. The resulting positive-contact units measure only 0.4" x 1" x 1.1" with a 0.25" pin protrusion.

**ECONOMY** Each module represents a fraction of the entire digital system. Each is designed for easy interrogation. Change or replacement is as simple as plugging in another unit. Thus, expensive downtime is reduced, costly benchwork completely eliminated.

**APPLICATIONS ASSISTANCE** Radiation offers the services of its engineering staff in the application of digital logic modules, or in helping solve your unique data problems. Write or phone for technical data sheets. Radiation Incorporated, Products Division, Department EL-09, Melbourne, Florida. Telephone: (305) 723-1511.



**RADIATION**  
INCORPORATED

### PRICE LIST—DIGITAL MODULES

Low initial cost is another attractive feature of Radiation Digital Logic Modules. Contact Radiation for unit prices on greater quantities than indicated below:

Part Number	Description	Unit Price
503815G1	NOR—Medium Speed	\$ 10.38
503816G1	NOR—Low Speed	6.40
503818G1	Power Inverter—Low Speed	5.95
503818G2	Power Inverter—Medium Speed	10.69
503819G1	CSR—Low Speed	8.82
503819G2	CSR—Medium Speed	11.66
503819G3	CSR—Medium Speed	37.65
503820G1	MSMV "B" Side	7.74
503821G1	Diff (MSMV "A" Side)	9.68
503834G1	Filter (Decoupler)	7.55
503860G1	Compl. Driver—Low Speed	12.55
505694G1	Diode Gate	11.40
505703G1	D/A Converter	14.20
505704G1	Indicator Driver	14.15
506030G1	CSR-M1	21.20
507318G1	Emitter Follower—Low Speed	7.29
507318G2	Emitter Follower—Medium Speed	12.11
508334G1-G8	Octal Patch	4.20
508335G1-G2	Jumper Patch	4.84
508367G1	5 Volt Reference	196.20
508517G1	Module, Special Component	13.62
509050G1	Indicator Driver (Negative Coincident Input)	15.15

Specifications and prices subject to change without notice due to technological advances. Delivery, discount schedules and additional pricing information available upon request.

# How to get an office of your own

*(Without waiting for the boss to retire)*

**1. Specialize.** Pick yourself a rare, exotic area of interest that other, less discerning, people have neglected. Like relays. Learn all about them. (We explain how below.) Then, as "the bright young man who knows all about relays," you will have a steady stream of co-workers seeking your advice. Point out to management that you should have a quiet spot to dispense this advice. Like an office, for instance.

**2. Know more than your boss.** He's probably an old hand with relays, but you can beat him at his own game. You see, he probably gets his information from a book called *Relay Engineering*. Struthers-Dunn wrote that book in 1944, and has rewritten it twice. Get yourself a copy of the new third edition. (Ten bucks. No C. O. D.) Depending on how old the boss's edition is, you will either be one-up or two-up on him. This is referencemanship at its best. One-up referencemen get offices. Two-up referencemen get secretaries.

**3. Choose your friends wisely.** Next to the president's daughter, your best friend should be a Struthers-Dunn sales engineer. He will make you an expert on supply sources and expediting. He has 5,384 different types of Struthers-Dunn industrial, military, and reed relays on tap. (Nobody else makes that many kinds of relays.) He, or one of his distributor friends, can get you precisely the one you need, when you need it. Like right now, for instance.

A copy of *Relay Engineering*, its 654 fact-crammed pages enclosed in a blue-leather cover, gold stamped with your name, will give just the right touch to your new office. You can get it fastest by writing directly to us at Pitman, N. J. 08071. No matter how much you enjoy the book, the ten bucks is still tax-deductible.

## STRUTHERS-DUNN, Inc.

*Relay problems? Ask the people who wrote the book.*



SALES ENGINEERING OFFICES IN: Atlanta • Boston • Buffalo • Charlotte • Cincinnati • Cleveland  
Clifton, N. J. • Dallas • Dayton • Encino • Englewood • Houston • Kansas City • Las Vegas • Memphis  
New York • Orlando • Phoenix • Pittsburgh • St. Louis • Salt Lake City • San Antonio • San Diego  
San Mateo • Seattle • Southfield, Mich. • Wichita • Wilmette. Canadian Licensee: Renfrew Electric  
Co., Ltd., Toronto. Export Department: 1505 Race St., Philadelphia 2, Pennsylvania, U.S.A.

## New Instruments

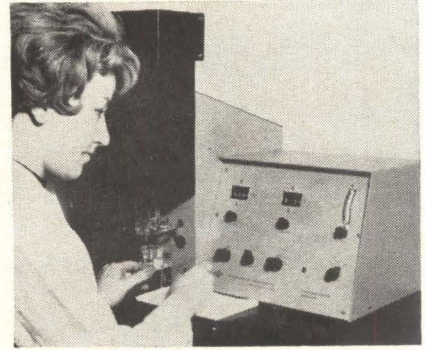

dilutions or computations and optimum reproducibility from a sample as small as one microliter. With only one dilution necessary, calibration becomes a simple procedure accomplished in about 30 seconds with no reiterative steps or serial dilutions. Once calibrated, the instrument permits samples to be read at the rate of one every five seconds. Since the final answers are presented automatically as large legible numbers, computation errors are eliminated. Model 143 provides such a high degree of reproducibility that typical coefficients of variation for both sodium and potassium are no greater than 0.3%.

Instrumentation Laboratory Inc., 9 Galen St., Watertown Square, Boston, 72. [354]



## Low noise, distortion in decade amplifiers

A series of all-transistor decade amplifiers, with frequency responses from below 5 cps to 1 Mc, have voltage gains of 1, 10 or 100. High-gain silicon transistors in the input stages insure temperature-stable, low-level operating points, and provide extremely low-noise performance. Equivalent input noise is less than 2.5  $\mu$ v, and har-

monic distortion is under 1%. The high-input and low-output impedances offer a convenient way to isolate critical circuits from undesirable loads. Applications include examination of low-level signals direct from the playback heads of tape recorders and standardization of termination impedance between sections of complex filter networks. Signals above ground reference can be amplified because the series 851 units operate on their own internal battery supplies. In addition, battery operation insures freedom from power-supply hum.

Arvee Engineering Co., 11263 Washington Blvd., Culver City, Calif. [355]

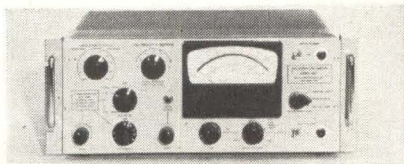

## D-c microphotometer with fast rise time

A new d-c microphotometer has been developed for making picolumen light measurements with exceptionally short rise time and high stability. A variety of detachable probes [not shown] are offered for visible, infrared and ultraviolet, all of which use multiplier phototubes as transducers. Model 380 is suitable for laboratory uses and as an automatic inspection device for shape or color on production lines. Rise time is 0.5 millisecond in most ranges and 1 millisecond in the 1-millimicroampere range. Seven switchable low-pass filters are used to permit reducing the speed if fast rise is not desired. The d-c amplifier drifts less than 2% in 4 days. It is calibrated permanently in microamperes within 1.5%, and has 9 ranges from  $10^{-5}$  amp to  $10^{-9}$  amp. Equipment is included for zero suppression up to 100 times full scale. A 6-in. meter and a 3-ma recorder jack are the outputs. The integral h-v power supply is adjustable from -500 v to -1,800 v, and regulated within  $\pm 0.1\%$ . Price is \$945 plus the cost of the probe selected.

Grace Electronics, Inc., 4380 Warner Road, Cleveland, 44105. [356]

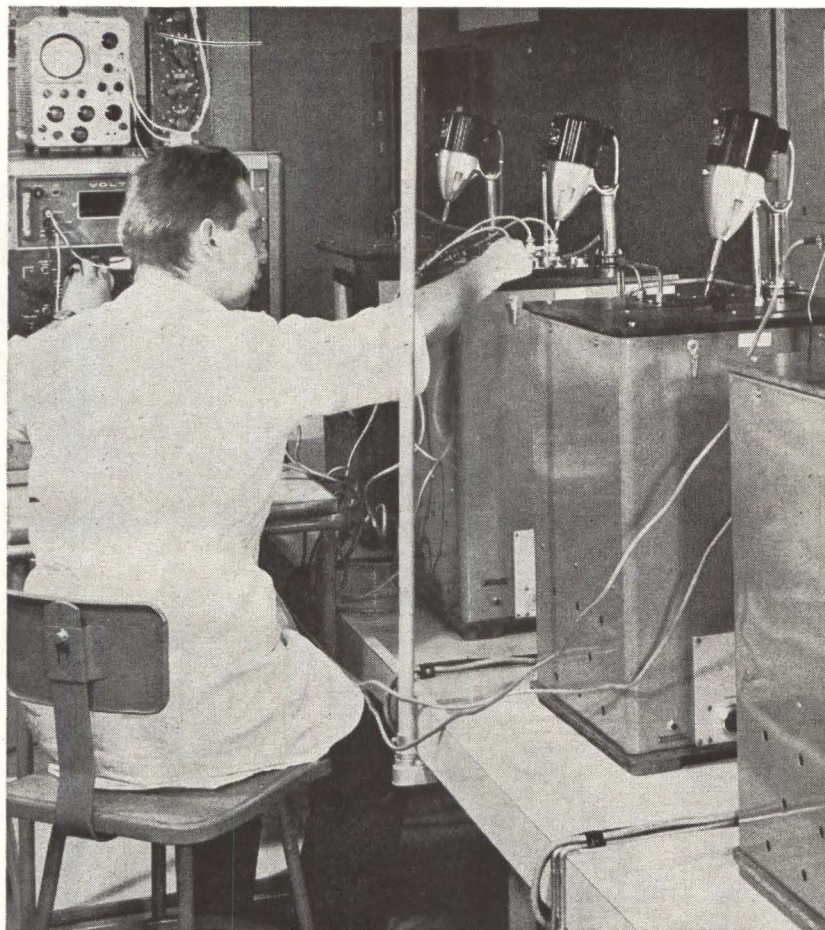

## How to calibrate a sensitive Temperature Transducer

Do what the gentleman at Micro-Systems, Inc.\* (in the picture) is doing. Lower it gently into the warm, luxuriously isothermal interior of a Hallikainen Constant Temperature Bath.

Why Hallikainen? Because Micro-Systems' customers insist on having their transducers calibrated to within  $0.1^\circ\text{F}$  accuracy. Hallikainen Baths of the type shown above better this stringent spec ten times over. That's why Micro-Systems have taken delivery on 15 Hallikainen Baths over the past three years.

Whether you're calibrating thermometers, filled system temperature instruments, or Piezo-Resistive Temperature Transducers, one of the 27 different Constant Temperature Baths you'll find on tap at Hallikainen will answer your needs. They offer control ranges that begin at  $-100^\circ\text{F}$  and end at  $1300^\circ\text{F}$ , proportional and proportional with reset temperature control modes, and exclusive Jet-Stir Impeller agitation that banishes temperature gradients from your bath.

Why not dip your problems into the world of Hallikainen Constant Temperature Baths? We've prepared a packet of warm literature to help you get a feel for the subject.

\*Division of Electro-Optical Systems, 170 N. Daisy Ave., Pasadena, California

# HALLIKAINEN

*Instruments*

Dept. E

1341 Seventh St./Berkeley, California 94710

# THERMALLOY HEAT SINKS & ACCESSORIES

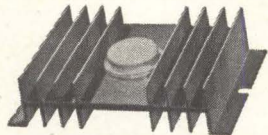

POWER HEAT SINKS

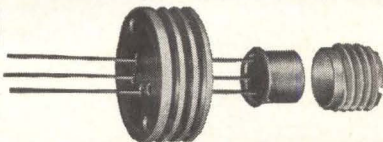

CONVECTION COOLED HEAT SINKS

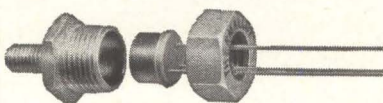

CONDUCTION COOLED HEAT SINKS



MULTIPLE HEAT SINKS

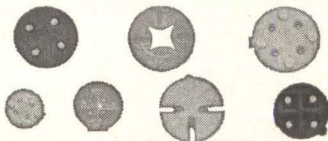

TRANSISTOR MOUNTING PADS

For your high power transistors, select from Thermalloy's complete line, with thermal resistances from 2.2° c/w to less than 0.8° c/w.

For your low-power transistors, choose from Thermalloy's popular conduction or convection cooled types which contact the transistor weld flange for maximum thermal efficiency... these designs are proved superior in tests by leading semiconductor manufacturers\*. Tapped hole or stud mountings for positive retention. For TO-5, TO-8 and TO-18 case types.

For your dual transistor heat sink requirements, maintain equal case temperatures in critical circuits such as choppers and differential amplifiers with Thermalloy duosinks. 2-, 4-, 6-, 8- and 10-transistor heat sinks are available.

For your mounting pad needs, check Thermalloy's low prices for TO-5, TO-18, TO-18-to-TO-5 converters and multi-lead integrated circuit pads. Your choice of 3 materials, DAP, Nylon, or Polypropylene.

Many other off-the-shelf and custom-designed Thermalloy products available. Devices illustrated above are only a few of the extensive Thermalloy line.

Contact Thermalloy Now For:

- FREE EVALUATION SAMPLES
- FREE CATALOGS



\*Write for reprints.

**Thermalloy  
Company**

P. O. Box 26036  
414 Exposition/Dallas 26,  
Texas /TA 7-3333  
Area Code 214

## New Semiconductors

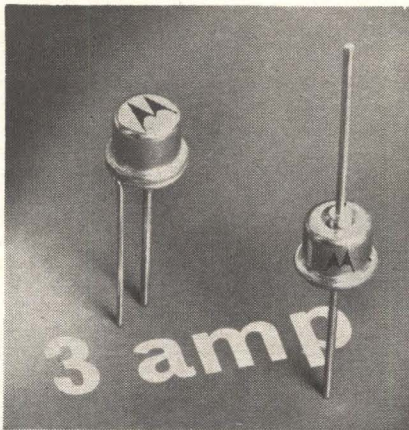

### Lead-mount rectifiers rated at 3 amperes

A new series of rectifiers is available in lead-mount packages. Rated at 3 amps forward current with 300-amp surge handling capacity, the MR1030 series are priced 50% to 70% lower than conventional rectifiers in the same current range, according to the manufacturer. These devices are especially suited for circuit board use in 1 to 3-amp applications that previously required the larger stud-mount package. The series includes seven devices in either axial-lead or single-ended packages with peak repetitive reverse-voltage ratings from 50 to 600 v. Reverse polarity units are available. Temperature operating range is -65°C to +175°C. The unusual current handling characteristics are said to be achieved through an increased semiconductor junction area combined with a slight increase in lead diameter for optimized heat dissipation.

Motorola Semiconductor Products Inc.,  
P.O. Box 955, Phoenix, Ariz. [331]

### Silicon transistors for uhf-tv tuners

A line of high-gain, silicon planar transistors is designed for use as local oscillators in uhf-tv tuners. A typical device is the SE3002, with 8 mw power output at 930 Mc. At 200 Mc this device has the follow-

ing specifications: a power gain of 12 db minimum with a collector current of 6 ma and collector-to-base voltage of 12 v. At a frequency of 60 Mc, the SE3002 has a typical noise figure of 4 db with 1 ma of collector current, collector-to-emitter voltage of 6 v, and a source resistance of 400 ohms. Leakage current is guaranteed less than 0.5  $\mu$ a at 15 v collector-to-base.

Fairchild Semiconductor, a division of Fairchild Camera & Instrument Corp., 545 Whisman Road, Mountain View, Calif. [332]

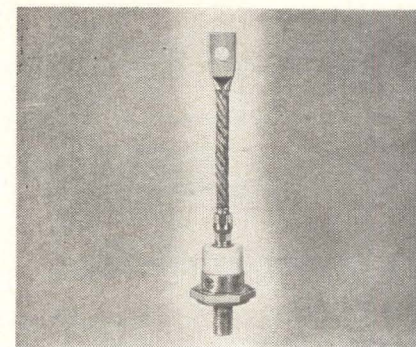

### Rectifier diodes withstand severe use

Medium-power silicon rectifier diodes (type 402 JEDEC series 1N1183A) are designed for heavy industrial service involving cyclic loading and widely varying operating conditions. Principal applications are in d-c power supplies, inverters, welding controls, converters, motor controls, and frequency changers. The diodes are rated 40 amps with low reverse-leakage current, but can be used at currents up to 70 amps with proper cooling. Maximum one-cycle surge current under load is 1,000 amps peak; maximum reverse-voltage ratings are up to 1,000 v peak. Units have a junction operating temperature range from -65° to +200°C. These rectifier diodes have hermetic seals and fused, double-diffused, hard-solder construction to insure dependability under fluctuating load currents and tough duty cycles that can cause soft-soldered junctions to fail. They have all-welded cases to withstand thermal





**CHARGE-TO-FREQUENCY OR VOLTAGE-TO-FREQUENCY:  
WITH THE FLICK OF A SWITCH, THIS NEW CONVERTER  
DOES EITHER. FREQUENCY PLUG-INS AVAILABLE FOR ALL  
IRIG, CONSTANT BANDWIDTH, & FM TAPE FREQUENCIES.**

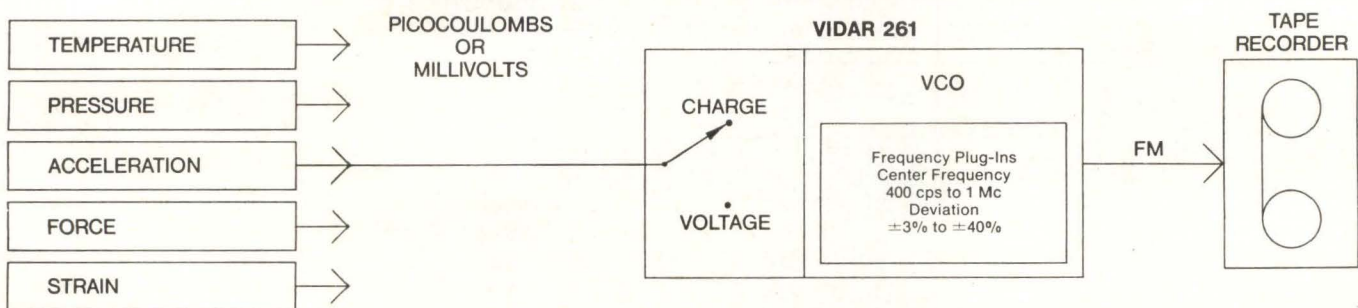

FUNCTIONAL DIAGRAM OF THE CHARGE-TO-FREQUENCY CONCEPT

if you work with piezo-electric and other transducers with high output impedances, you are probably well aware of the problems associated with gathering data from these sources. Almost any amount of capacitance introduces RC roll-off. With the Vidar 261 operating in the charge mode, the voltage drop across the input circuit and the line capacity are kept at zero. Because no charge is stored, RC attenuation of high frequency data is prevented.

In the voltage mode, the Vidar 261 works directly from low-output transducers such as strain gage bridges, thermocouples, and biomedical sensors. True floating input with guard shielding assures immunity to ac or dc common-mode voltages in spite of source unbalances. High input impedance eliminates source loading errors.

The Vidar 261, with its wide range of possible center carriers and deviations, is ideally suited for both FM multiplex systems and straight FM recording. Because of its high sensitivity, no preamplifiers are needed. Fast response and quick overload recovery also allow the Vidar 261 to be used in commutated systems.

#### Brief Specifications

(Charge mode) Full scale sensitivities: 50 to 50,000 pico coulombs. Frequency response: 10 cps to 20 kc.

(Voltage mode) Full scale sensitivity: 5 millivolts to 5 volts. Input impedance: 1000 megohms per volt.

(Common to both modes) Common mode rejection: > 170 db at dc, 130 db at 60 cps. Non-Linearity: < 0.015%. Drift: < 0.1% per week. Overload recovery time: Within 1% after 1 millisecond following 1,000% overload. Size: 7" high x 2 3/4" wide with up to six individual units in a standard Vidar rack housing. Price \$1,100.

For more information drop us a line or circle the number below. We're located at 77 Ortega Avenue, Mountain View, California. Phone: 415-961-1000.

16

# VIDAR

# EXPERIENCE

Space Craft is a supplier of packaged electronics, welded circuitry, specialized components and custom fabrication for more than 24 of our nation's major spacecraft and space vehicle programs. This experience can pay off for your company. When you buy from our new Components Division you get aerospace quality and reliability, on-time delivery and—best of all—competitive industrial pricing.  Now there's no excuse for buying less than the best.  Your communication will bring us running.



Components Division  
**Space Craft, Inc.**  
 8620 S. MEMORIAL PARKWAY, HUNTSVILLE, ALABAMA

CIRCLE 202 ON READER SERVICE CARD

## IMMEDIATE DELIVERY!

### ALITE<sup>®</sup> STANDARD HIGH ALUMINA BUSHINGS

**OVER 100 TYPES AND SIZES!**

Save time . . . cut costs . . . simplify design problems with Alite standard high alumina high voltage terminals, feed-throughs, cable end seals and high amperage bushings — all stocked for "off-the-shelf" delivery.

Vacuum-tight, rugged and heat-shock resistant, Alite Bushings maintain their dielectric properties at elevated temperatures. Virtually any assembly procedure, such as welding, brazing or soldering, may be used.

Send today for free catalog showing types and sizes.



57-J

ALITE

DIVISION

**U. S. STONWARE**

BOX 119

ORRVILLE, OHIO

## New Semiconductors

stresses, eliminating leakage or moisture penetration. The new diodes are available from stock as individual units or in various assembled configurations. Prices start at \$1.71 each in quantities of 100 or more.

Westinghouse Semiconductor Division, Youngwood, Pa. [333]

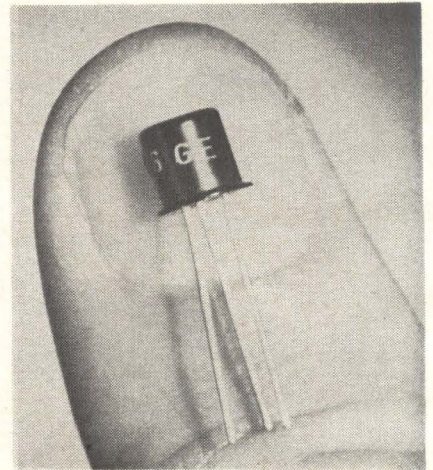

## Miniature scr's offer long life

A family of low-current, TO-18-packaged, miniature silicon controlled rectifiers offers proved reliability and long life. The space-saving devices are light in weight and permit improved packing density of active components and simplified circuitry through use of pnpn structure. Applications are primarily military and industrial, including timing circuits, squib switches, ring counters, threshold detectors, relay drivers and shift registers. Peak forward current is 0.5 amp rms. Peak forward voltage ranges up to 200 v. Maximum junction temperature is 150°C. The new scr's feature a low holding current of 3 ma for the 2N877-881 and 5 ma for the 2N885-889. Gate sensitivity is 200  $\mu$ a max for the former series and 20  $\mu$ a for the latter series. Prices in lots from 100 to 999 range from \$6.70 to \$20 for the 2N877-81 and from \$7.50 to \$24 for the 2N885-89.

General Electric Co., Rectifier Components Department, Auburn, N.Y. [334]

*Looks good, doesn't it?*

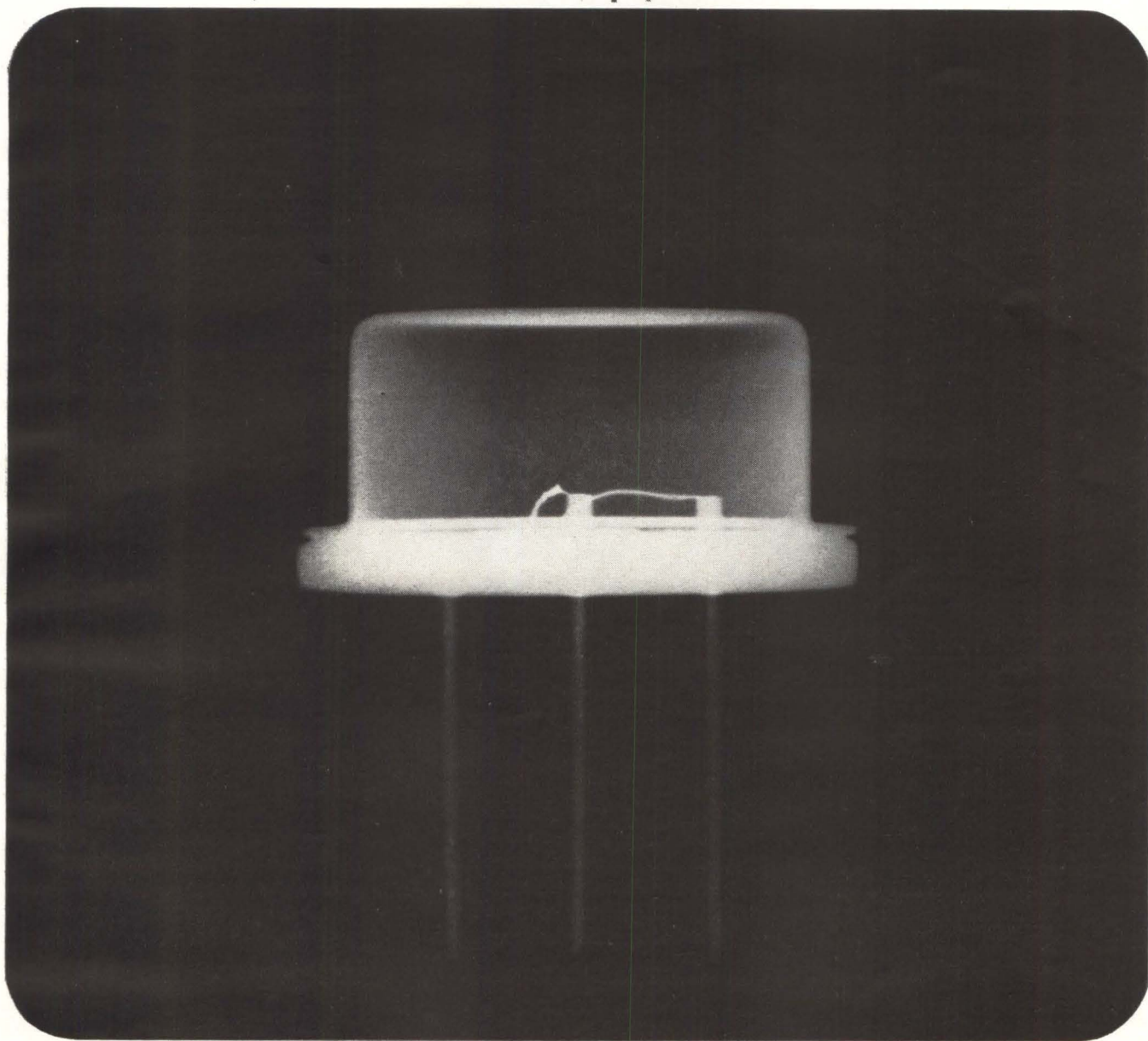
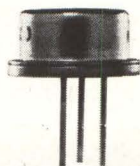

*...but, look at it this way to be sure!*

Appearances *can* be deceiving. Often a tiny defect can escape most methods of detection. That's why so many companies depend on Ansco Industrial X-ray films to make the final check on their components.

No method of non-destructive inspection shows up tiny imperfections, (especially in tiny components), more clearly or quickly than a radiograph on Ansco Superay<sup>®</sup> 'H-D' X-ray film.

This Class I film is especially designed for high definition radiography. It has an ultra-fine grain and very high contrast and provides the ultimate in image quality. Although used

primarily with low voltage techniques, Superay 'H-D' maintains its high definition characteristics and image quality throughout the full KvP range.

Ask your Ansco X-ray Products Representative how Ansco Industrial X-ray films and chemicals can be of significant value in your inspection procedures. He's always at your service.



X-RAY PRODUCTS OF  
GENERAL ANILINE & FILM CORPORATION  
140 WEST 51ST STREET NEW YORK 10020

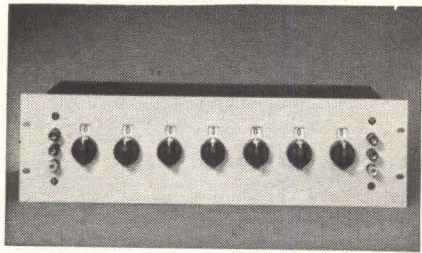

# Kelvin and Varley would be exultant!

**(Their circuit is being used in this ESI Voltage Divider to give you 1 ppm accuracy.)**

The Kelvin-Varley Circuit was invented while the two men were collaborating on the Project Mercury of their day—the laying of the Atlantic Cable.

It is now used to achieve state-of-the-art accuracy in the decade voltage divider above (our model RV-722). This instrument has a terminal linearity of 1 ppm.

At low settings you will be able to do even better than 1 ppm. If, for example, the first three dials are set at zero, the output voltage will be accurate to a fraction of one division of the seventh dial. Each step of that dial is *one part per ten million*.

With each instrument, you get a calibration certificate giving check-out readings accurate to 0.2 ppm. All at a price worthy of Lord Kelvin's Scottish heritage: \$900. ESI, 13900 NW Science Park Drive, Portland, Oregon (97229).

#### Model RV 722 DEKAVIDER Decade Voltage Divider

**Circuit:** Kelvin Varley Resistive Divider

**Resolution:** 10,000,000 divisions—0.1 ppm steps

**Input Resistance:** 100 Kilohms  $\pm 0.005\%$

**Temperature Coefficient:**  $\pm 0.5$  ppm/ $^{\circ}$ C

**Power Coefficient:**  $\pm 1$  ppm/watt maximum

**Maximum Input Power:** Five watts

**Maximum Input Voltage:** 700 volts rms, 1000 volts peak

Input terminals for individual decades are provided for calibration of each decade. Paralleled switch contacts of silver alloy provide improved accuracy at all settings.

**esi** Electro Scientific Industries

## New Subassemblies and Systems

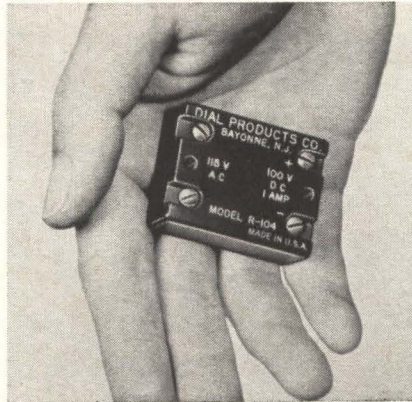

### Miniature power supply is hermetically sealed

This power supply, measuring  $\frac{1}{2}$  in. by  $1\frac{3}{8}$  in. by  $1\frac{3}{4}$  in., has built-in reverse-voltage transient protection and line-surge protection. Input voltage for model R-104 is 115 v; output voltage, 100 v; output current, 1000 ma; peak inverse voltage, 1200 v; surge current, one cycle, 45 amps max; operating temperature,  $-65^{\circ}$ C to  $125^{\circ}$ C. Components of this supply are hermetically sealed against moisture and severe environmental conditions, and the unit is designed to provide reliable service in military and commercial applications. Model R-104 is a reliable source of direct current for clutches, brakes, solenoids, machine tools and motors.

Dial Products Co., 21 Cottage Place, Bayonne, N.J. 07002. [371]

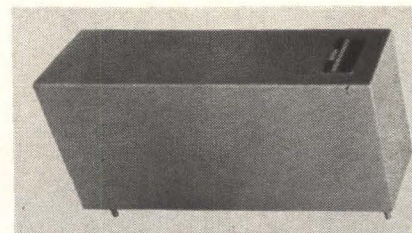

### Crystal filter designed for carrier systems

Designed for use in carrier communication systems, model A-24 crystal filter has a high rejection over a narrow bandwidth around

60 kc. Bandwidth at 3-db rejection is 60 cps maximum, 16 cps minimum at 80 db and 6 cps minimum at 100 db. Passband is 12 kc to 59.970 kc and 60.030 kc to 1,010 kc. Peak-to-peak ripple is 3 db maximum. Insertion loss, measured at peak passband response, is 4 db maximum. Both source and load impedance, unbalanced, are 75 ohms. Operating temperature range is from  $40^{\circ}$  to  $100^{\circ}$ F. Case size measures  $10\frac{3}{8}$  by  $3\frac{3}{8}$  by  $4\frac{3}{8}$  in. high.

Systems, Inc., 2400 Diversified Way, Orlando, Fla. [372]

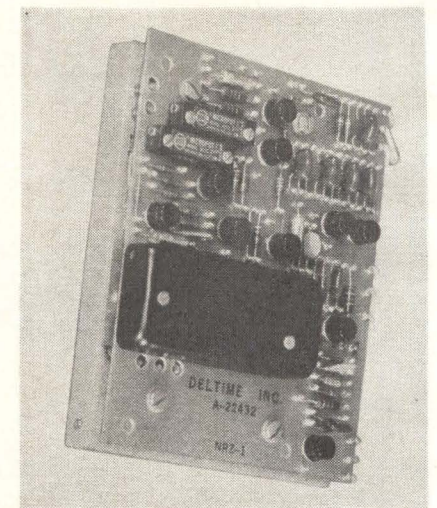

### Digital circuit module for delay line use

A unity gain non-return-to-zero digital circuit module is available for magnetostrictive delay line application. The nrz-1 circuit module provides storage of up to 10,000 bits of binary information in nrz form, at a 2 Mc/bit rate when combined with a 5,000- $\mu$ sec delay line and an external logic controlled recirculating loop. Complementary nrz input logic is required. Input and output nrz logic levels are 0 and  $-9$  v. Input rise and fall time requirements are 0.070  $\mu$ sec and 0.150  $\mu$ sec respectively. Output rise time is 0.075  $\mu$ sec and fall time is 0.050  $\mu$ sec. Complementary nrz output logic is identical to input logic but delayed by delay time of delay line. The nrz-1 is de-

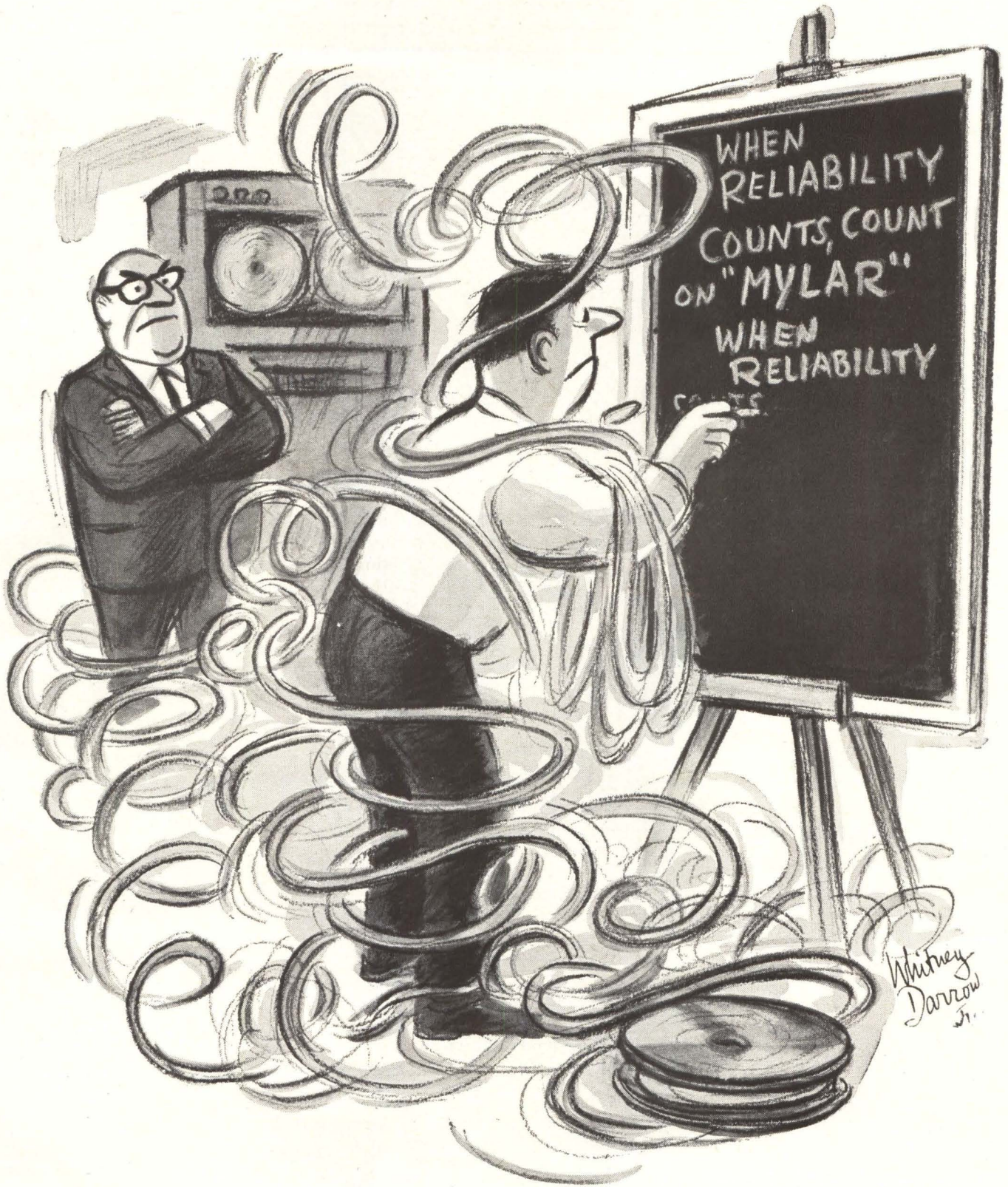

It would be difficult to conceive of anyone but the rawest novice not knowing the advantages of tapes of "Mylar"\*. After all, for ten years "Mylar" has been far and away the first choice for EDP work. Good reasons, too. "Mylar" is strong (a tensile strength

of 20,000 psi), stable (unaffected by temperature or humidity changes) and durable (can't dry out or become brittle with age.) There's no need to write it 50 times . . . just once: When reliability counts, count on "Mylar". \*Du Pont's registered trademark for its polyester film.

**DU PONT**  
REG. U.S. PAT. OFF.  
 Better Things for Better Living  
 . . . through Chemistry

only **DU PONT** makes  
**MYLAR**<sup>®</sup>  
 POLYESTER FILM

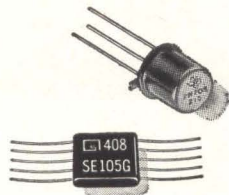

Need to say a lot  
in a little space?

(or make markings  
more **durable**...or  
more **economical**...  
or at **higher rates**?)

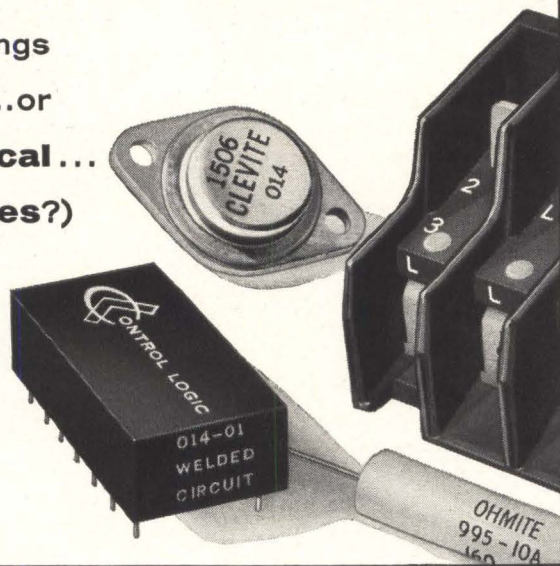

## We can show you how

We can show you how to identify products so they will resist extreme amounts of handling, abrasion, many solvents and other atmospheric conditions . . . or how to sequentially number and identify components with savings of more than \$50 per 1000 . . . or how to print trademark, type number, value and date code on 90 units a minute . . . or how to produce an imprint that remains readable after 1000 hours at 200°C. . . or get 10 digits and 2 letters in a micro-circuit area of 0.090" — or 21 characters on a TO-5 case with interchangeable type number and date code . . . or save 75 cents of every dollar you now spend on buying, applying, inventorying and discarding obsolete preprinted labels.

The answers are in proven Markem machines, type and specialty inks, which daily produce better product or package identification by reducing costs, smoothing production control and increasing customer acceptance. And while Markem machines, type and inks are helping to produce better products through more complete and lasting identification, they frequently pay for themselves in the savings they make possible. Tell us what *you* make, what it must say, and for how long: we'll give you a specific recommendation and cost estimate right away. Write Electrical Division, Markem Machine Co., 305 Congress St., Keene, New Hampshire 03431.

# MARKEM

## New Subassemblies

signed for operation from 0°C to +55°C and measures only 5 $\frac{5}{16}$  in. by 4 $\frac{3}{8}$  in. by  $\frac{7}{8}$  in. over-all. Deltime Inc., 608 Fayette Ave., Mamaroneck, N.Y. [373]

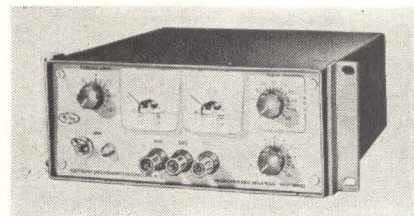

## Power supplies offer programmable operation

The new series PRO power supplies feature constant voltage with current control for automatic E/I crossover. Other features include programmable remote-sensing, series and parallel operation, front and rear terminals, calibrated controls and main and vernier controls. Voltage ranges are 0 to 20, 0 to 40, 0 to 60 and 0 to 100 with current ranges up to 0 to 4 amps, depending upon model. Regulation is 0.04%. The units measure only 3 $\frac{1}{2}$  in. high by 9 $\frac{1}{2}$  in. wide by 12 in. deep. Removable mounting brackets provide for either half-rack or table mounting. Price of a unit, complete with meters, is \$250; less without meters. Electronic Measurements Co., Inc., Eatontown, N.J. [374]

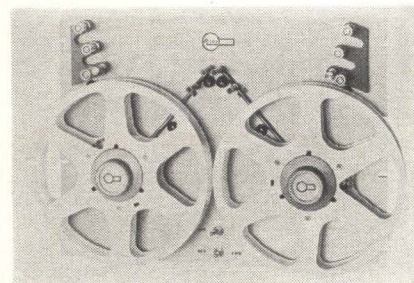

## Punched-tape spooler with 10 $\frac{1}{2}$ -in. reels

A tape spooler with 10 $\frac{1}{2}$ -in. diameter reels is being introduced. Model RS-502-10 $\frac{1}{2}$  is offered with

reel overhang on a 14-in. high panel and without reel overhang on a 21-in.-high panel. New features that extend the application and operation range include high-speed, bi-directional rewind at 20 in. per sec, self-adjusting electric brakes, no-tape and broken-tape sensing, and electronic noise suppression. The spooler is priced at \$1,495 with reel overhang, and at \$1,550 without reel overhang.

Rheem Electronics, 5250 W. El Segundo Blvd., Hawthorne, Calif. 90251. [375]

### Flip-flop module operates at 100 kc

A new cordwood flip-flop circuit module can operate over a wide range of voltages outside of the design center. The all-purpose device, known as CM-12, operates at 100 kc, and may be used as a general-purpose divider flip-flop. Operating temperature range of the unit is  $-15^{\circ}\text{C}$  to  $+65^{\circ}\text{C}$ , and the storage temperature range is  $-35^{\circ}\text{C}$  to  $+100^{\circ}\text{C}$ . Dimensions are 1.25 in. by 1 in. by 0.600 in. Price is \$4.97 per unit in quantities of 1,000. Electra Mfg. Co., Independence, Kansas 67301. [376]

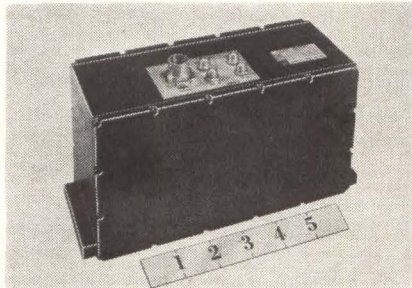

### Inertia compensated recorder-reproducer

A new inertia compensated, magnetic tape recorder-reproducer is announced. Model 005 is immune to the forces of acceleration (100 g), vibration and shock, because the tape transport operates in an inert fluid which matches the density of the tape. Data is recorded on a continuous loop of tape and played back after a preset time delay. Typical applications include recording of data during communications blackout for reproduction when

## WHEN YOU NEED A PROTOTYPE MOTOR OR BLOWER

### RIGHT NOW

### CALL GLOBE

### DIAL 513-222-3741

### WE WILL SHIP YOUR

### ORDER WITHIN 24 HOURS

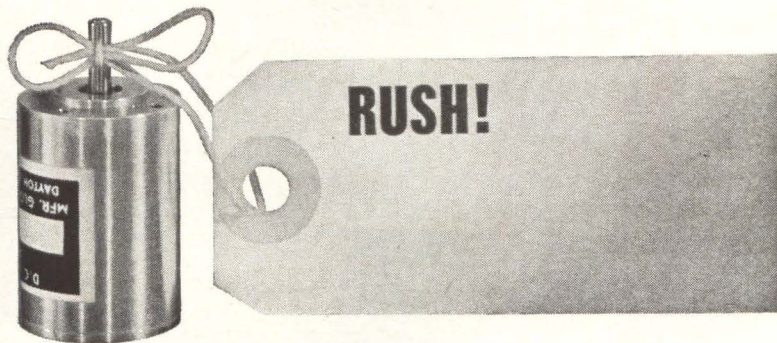

#### Sample 24-hour stock (subject to change)

A.C. MOTORS		HYSTERESIS SYNCHRONOUS						
type	P/N	dia.	length	torque	rpm	volts	cycles	phase
SC	53A106-2	1 1/16"	1 1/16"	.12 oz. in.	12,000	115	400	1
MC	18A107	1 1/4"	2 1/4"	.7 oz. in.	1,800	115	60	1
MC	18A108	1 1/4"	2 1/4"	.7 oz. in.	3,600	115	60	1
FC	75A119-2	1 1/16"	2 1/4"	1.0 oz. in.	1,200	115	60	1
FC	75A120-2	1 1/16"	2 1/4"	1.0 oz. in.	1,800	115	60	1
FC	75A121-2	1 1/16"	2 1/4"	1.0 oz. in.	3,600	115	60	1

D.C. MOTORS		dia.	length	torque	rpm	volts	amps
SS	41A100-13	7/8"	1 3/8"	.20 oz. in.	17,000-20,000	27	.18 to .25
MM	3A1002-10	1 1/4"	2 1/2"	.5 oz. in.	9,000	24	.30
LL	3A1003-1	1 1/4"	2 3/8"	1.0 oz. in.	11,000	24	.65
GRP	166A100	2 1/4"	3 3/4"	.75 lb. in.	8,000	27	4.0

GEARMOTORS		PLANETARY							
type	P/N	dia.	length	torque	rpm	volts	cycles	phase	amps
MM	5A555-1	1 1/4"	3 1/4"	250 oz. in.	11.5	24 v.d.c.	—	—	.6
MC	33A603-600	1 1/4"	3 3/2"	170 oz. in.	6	115 v.a.c.	60	1	—
FC	83A115-27.94	1 1/16"	3.190"	20 oz. in.	64.4	115 v.a.c.	60	1	—

BLOWERS		dia.	cfm @	"H <sub>2</sub> O	volts	cycles	phase	amps	watts
VAX-1-AC	19A1173	1 1/8"	10	.6"	26 v.a.c.	400	1	.32	7.7
VAX-1-DC	19A1040	1 1/8"	8.5	.5"	26 v.d.c.	—	—	.25	6.5
VAX-3-FC	19A911	3"	60	1.0"	200 v.a.c.	400	3	—	65
VAX-3-GN	19A908	3"	68	1.5"	115 (a.c. or d.c.)	60	—	—	55
AC-AXIAL	19A533	2 5/8" sq.	20	0"	115 v.a.c.	60	1	—	13

If we can't meet your requirements precisely we can probably tide you over until we manufacture the exact units you need.



Globe Industries, Inc., 1784 Stanley Avenue  
Dayton, Ohio 45404, U.S.A., Area 513 222-3741

# LITTLE CHOPPER



# BIG PERFORMER

Where component space is limited—Bristol's Subminiature Chopper offers:

- 0.1 cu. in. size
- complete shielding
- radiation resistance
- airborne environmental ratings
- lowest noise level

Write for detailed spec sheet. **The Bristol Company**, Aircraft Division, 152 Bristol Road, Waterbury, Conn. 06720.

A subsidiary of American Chain & Cable Company, Inc. 4.7

**BRISTOL** . . . engineers for precision, builds for reliability

## New Subassemblies

communications are restored. Tape speeds are available at 30, 15,  $7\frac{1}{2}$ ,  $3\frac{3}{4}$  and  $1\frac{7}{8}$  ips. Frequency response is flat from 300 cps to 100 kc at 30 ips. Pcm data may be recorded at 1,200 bits per inch. Wow and flutter are 1% rms maximum. Delay time is 1 to 80 sec at 30 ips. Input power is 28 v d-c at 0.7 amp maximum. Weight is less than  $7\frac{3}{4}$  lb. A solid state switch will allow the model 005 to be commanded to change its record, playback, erase cycle to repeated playback until a new comand to return to the normal cycle is received.

College Hill Industries, Inc., Warwick Industrial Drive, Warwick, R.I. [377]

## Helium refrigerator cools paramps

A miniature helium refrigerator has been developed to operate in conjunction with the ground-terminal signal receivers for communications satellites. Its function is to cool parametric amplifiers to approximately  $-390^{\circ}\text{F}$ , thereby reducing thermal noise within the receiver system and permitting useful reception and amplification of signals which would otherwise be lost. Designed and developed for ruggedness and reliability, the model 502 represents one of a family of units operating between  $-455^{\circ}\text{F}$  and  $-320^{\circ}\text{F}$  which can, among other cryogenic applications, improve the

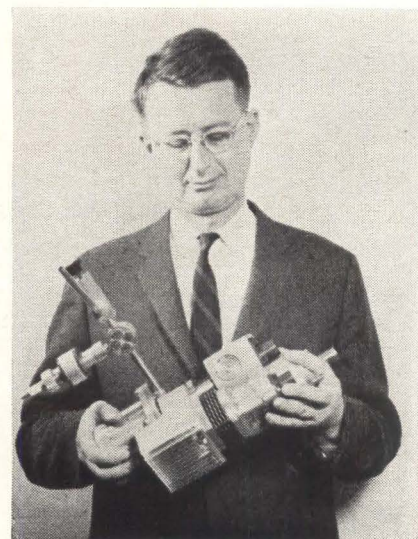



signal reception of distant-star-finding radio telescopes as well as communication satellites.

Cryonetics Corp., Burlington, Mass. [378]

## Indicator device for toggle switches

Designated as 13LT1, a new indicator device for toggle switches is intended for use in aircraft and spacecraft consoles, commercial equipment, and requirement calling for positive toggle-switch control and vivid status indication. It can be used with a wide array of 2- and 3-position toggles. Legends can be applied easily. It fits 15/32-in. diameter bushings, can be assembled without tools, and needs no power for color display. The toggle-indicator device provides a clearly visible color legend display that signals the toggle-switch control status. As the toggle lever is pushed to an extreme position, it triggers a flag that indicates actuation has taken place. Throwing the toggle lever to the other extreme position will trigger another flag, at the same time releasing the previously actuated flag. Colored with fluorescent hues, these flags are visible several yards from the panel. This enables the operator to observe the panel from a distance and to recognize the control status of individual stations or a row of stations, even though he may not be able to determine the exact position of the toggle levers. Micro Switch, Freeport, Ill. [379]

## Indicator light uses transistors

The Transindicator, a neon indicator light using transistors, offers the operational advantages of a single, hermetically sealed package containing all the necessary circuit components for positive and negative turn-on and turn-off. It is available in various mechanical configurations. These include clip-mounted types for printed-circuit boards, front and rear panel-mount adapter types, and complete standard or special printed-circuit board assemblies. The compact

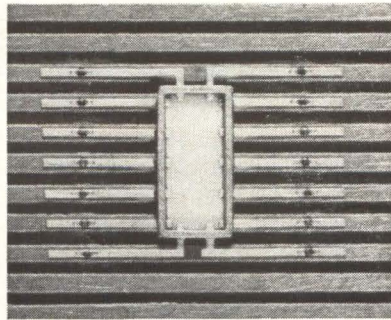

## FLAT PACKS...

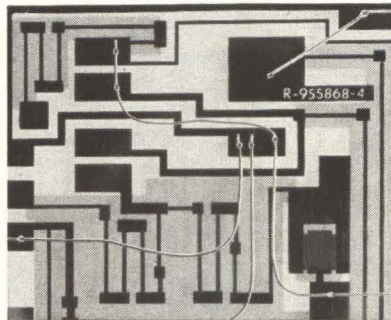

## THIN FILMS...



## THE NEW MICROWELDER MARK II WELDS BOTH!

Literally two welders for the price of one—the advanced Microwelder Mark II offers unprecedented microelectronic welding versatility. The Mark II welds large external flat pack leads to printed circuit boards, and fine wires onto thin films. It can perform such "exotic" tasks as welding .009" steel balls to the rim of a cone, or .001" thick foil to a .00003" film on mylar... as well as the more conventional welds. • **A few of its features:** automatic high speed weld cycle • single tip with .002" working end • dead weight system for uniform force from 10-1600 grams • ultra precise AC weld energy • all solid state power supply with plug-in boards. • **Price:** \$5250—F.O.B. Azusa, California. • **Write** for further information and/or a personal demonstration of the versatile Mark II by our electronic representative in your area: Commercial Products, Dept. E, P. O. Box H, Azusa, California



COMMERCIAL PRODUCTS, Azusa, California

LATEST FROM **Solitron**  
**VOLTAGE  
 VARIABLE  
 CAPACITORS**

THESE  
 VARACTOR  
 DIODES  
 FEATURE

**HIGH Q**

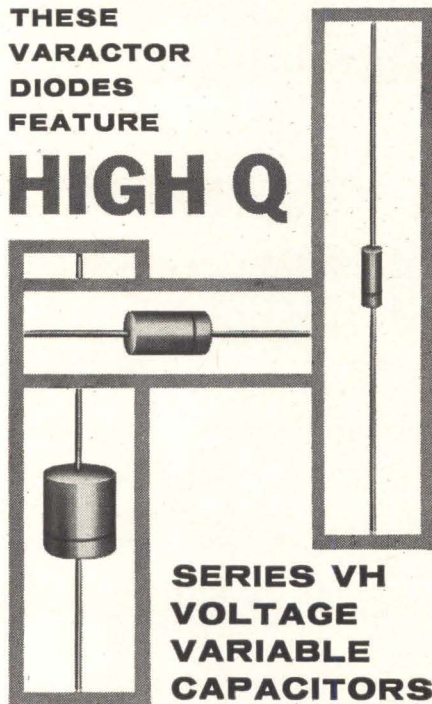

**SERIES VH  
 VOLTAGE  
 VARIABLE  
 CAPACITORS**

**DIODE CHARACTERISTICS:**

- Operating Range—Through VHF
- Voltage—25 to 200 volts
- Capacitance—(Standard) From 6.5 to 500 pf in single junction units
- Diode Q—As high as 200
- Size and Power Ratings:  
 0.5 watt—DO-14  
 1.0 watt—.200" dia. x .350" long  
 2.0 watt—.400" dia. x .350" long

Complete Specifications, Graphs & Application Data Contained In 8-Page Catalog Available On Request.

**CUSTOM DESIGN**

Solitron engineers will be happy to design special packages and modules to your individual requirements.

**Solitron**  
 DEVICES, INC.

256 Oak Tree Road • Tappan, N.Y. 10983  
 914-359-5050 • IN N.J. — 201-768-3770

Leader in Solid-State High Voltage Rectifiers, Temperature Compensated Zeners, and Random/White Noise Components.

**New Subassemblies**

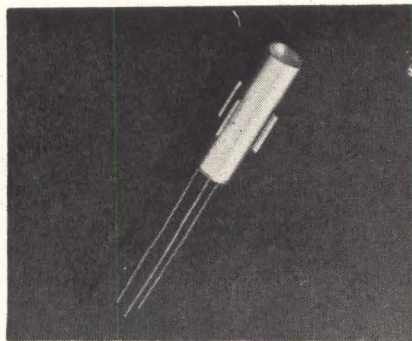

Transindicator can be mounted on  $\frac{3}{8}$ -in. centers with maximum height above circuit card of 0.390 in. which is compatible with conventional p-c board spacing. Transitron Electronic Corp., 168 Albion St., Wakefield, Mass. [380]

**Crystal filters meet  
 DCA specifications**

A set of four crystal filters is designed to meet the Defense Communications Agency specification 175-2A for a 175-kc ssb multiplex communications system. The filters provide a combination of extremely high selectivity, low ripple, and a relatively high 70-db ultimate attenuation. Channel B<sub>2</sub> filter has a center frequency of 1745.405 kc; upper 1.0-db frequency, 1746.745 kc minimum; lower 1.0-db frequency, 1744.065 kc maximum; upper 60-db frequency, 1746.970 kc

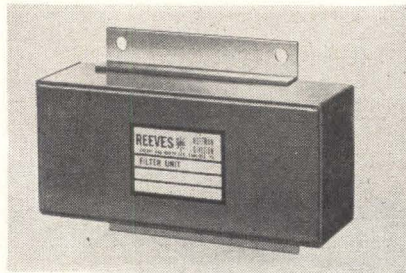

maximum; lower 60-db frequency, 1743.680 kc minimum. Channel B<sub>1</sub> filter's center frequency is 1748.355 kc; upper 1.0-db frequency, 1749.745 kc minimum; lower 1.0-db frequency, 1746.965 kc maximum; lower 60-db frequency, 1746.740 kc minimum; attenuation at 1750.000 kc, 55 db minimum. Channel A<sub>1</sub>

**Manufacturing  
 Quality Resistors  
 under Rigid  
 Reliability  
 Control**

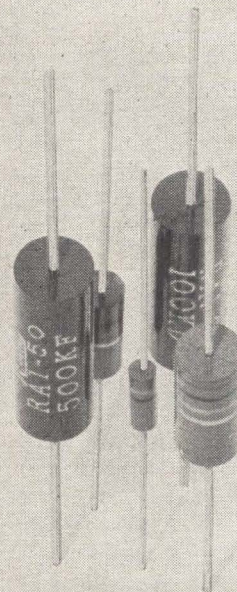

**Rohm**

METAL FILM RESISTOR  
 CARBON

**TOYO  
 ELECTRONICS  
 INDUSTRY  
 CORPORATION**

P. O. BOX 103 CENTRAL  
 KYOTO, JAPAN

filter's center frequency is 1751.645 kc; upper 1.0-db frequency, 1753.035 kc minimum; lower 1.0-db frequency, 1750.255 kc maximum; upper 60-db frequency, 1753.260 kc maximum; attenuation at 1750.000 kc, 55 db minimum. Channel A<sub>2</sub> filter has a center frequency of 1754.595 kc; upper 1.0-db frequency, 1755.935 kc minimum; lower 1.0-db frequency, 1753.255 kc maximum; upper 60-db frequency, 1756.320 kc maximum; lower 60-db frequency, 1753.030 kc minimum. Ripple is held to  $\pm 0.5$  db max on all four filters. Attenuation skirts project to 70 db. This attenuation level is maintained for  $\pm 60$  kc from the center frequencies of the individual filters. Insertion loss is 6 db max with reference to average passband response. Each filter is in a hermetically sealed case 2 in. wide, 4½ in. long and 1¾ in. high, excluding coax connectors. Reeves-Hoffman Division of Dynamics Corp. of America, Cherry & North Sts., Carlisle, Pa. [381]

## Digital modules for ground systems

A new digital building-block design approach to ground systems incorporates integrated circuits. The manufacturer says the new system design offers increased reliability, high-speed performance, greater noise immunity, and dependable operation over wide environmental extremes, and a significant reduction in system cost and space requirements. Each module of the system measures 1.4 by 0.8 by 1.4 in. and weighs less than one ounce. The modules each contain two or more integrated circuits to perform logic and such complex functions as sequential counting, decade counting, shifting, storing, adding, subtracting, comparing and code converting. The modules also can accommodate cordwood and other special circuit techniques using discrete components, where required. The modules plug into standard 17 by 18-in. panels which are rack-mounted in a cabinet, like pages in a book. Each page can be either hand-wired or automatically wired into the system configuration desired and will accommodate up to 190 logic modules. Use of silicon

# MASSA SOUND PRESSURE MICROPHONES



## EXTEND the DYNAMIC RANGE of SOUND LEVEL MEASUREMENTS

THE MASSA MICROPHONES, MODEL M-141 SERIES, WERE DESIGNED TO EXTEND THE DYNAMIC RANGE OF COMMERCIALY AVAILABLE SOUND LEVEL METERS BY 50 DB!

A few of the important features of the M-141 series are:

- Linear Dynamic Ranges to sound pressures in excess of 200 db (re: 0.0002 microbars).
- No External Power Supply required.
- ADP (Ammonium Dihydrogen Phosphate) for uniform reliability, stability, and accuracy.
- Frequency Ranges from 20 cps to 30,000 cps.
- Omni-Directional Pattern for sure pickup of sound in difficult areas.
- Near Infinite Acoustic Impedance or no loading of the sound field.

For more accurate Sound Pressure Measurements, complete systems are available from Massa featuring: microphones with frequency ranges from 20 cps to 100,000 cps; a precision 60 db calibrated amplifier; preamplifiers; and a portable battery operated power supply.

**MASSA**  
A DIVISION OF  
**COHU**  
ELECTRONICS, INC.

Write for:  
"Guide Posts  
for Selecting  
Sound Pressure  
Microphones."



280 LINCOLN STREET • HINGHAM, MASS. 02043

# NEW 1/2 INCH TWO WATT PHOTOCELLS



**AVAILABLE  
NOW!**

Additional data plus new 16 page photo-cell manual for design engineers free on request.

Clairex now offers a new "5M" Series of photoconductive cells with two watts power dissipation in a rugged, hermetically sealed metal case only .490" in diameter. Available in all standard Clairex CdS and CdSe photosensitive materials offering numerous combinations of response time, sensitivity and spectral response. Suitable for direct relay operation and many other applications.

## CLAIREX

"The LIGHT Touch in Automation and Control"

8 West 30 Street, New York, N. Y. 10001, 212 MU 4-0940

Circle 204 on reader service card

## New Subassemblies

planar integrated circuits make possible systems with operating frequencies from d-c to 5 Mc over a temperature range of 0°C to 75°C, using only 5 volts d-c. A single rack of logic modules will replace up to six racks which now use standard printed-circuit card techniques, the firm says. The new modular line can be used to design ground support equipment for space communications, data acquisition, data processing, and both military and commercial system checkouts.

Philco Corp., Western Development Laboratories, 3825 Fabian Way, Palo Alto, Calif. [382]

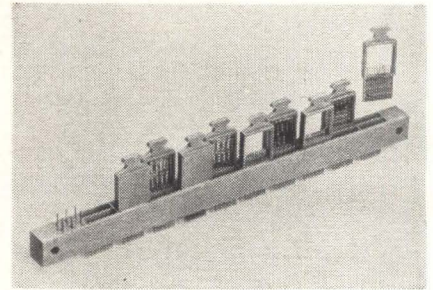

## Diode matrix assembly in modular design

This diode matrix assembly is designed for p-c boards, memory frames, and other electrical/electronic applications. A 0.050-in., modular-design connector that accepts diode matrix circuits, axial lead components, flat circuits and substrate-type circuits, the assembly consists of plugs or cells that are plugged into a compartmentalized strip. The strip can be mounted to p-c boards and memory frames, or soldered to wires by means of tines protruding from its bottom. Each module cell that is inserted in the strip contains twenty 0.050-in. cell contacts. Components are assembled in the cell prior to insertion in the strip, and cell modules can be extracted and inserted from the strip by hand to accommodate circuit changes, repairs and maintenance. Strip lengths can be increased or decreased as required.

AMP Inc., Harrisburg, Pa. [383]

## MITSUBISHI "Laddertron" (Klystron)

### Specifications

Model	LV - 3510	LV - 5010
Anode Voltage	1.7 - 2.1 kV	2.0 - 2.3 kV
Cathode Current	100 - 120 mA	100 - 120 mA
Weknet Voltage	-150 ~ -250V	-150 ~ -300V
Output Power	10 W	6 W
Frequency Range	33.5 - 35.5 GC	49 - 51 GC
Electronic Tuning Range	50 MC	50 MC
Cooling	0.5 - 1 l/min.	0.5 - 1 l/min.
Weight	abt. 12 kg	abt. 12 kg

LV-5010

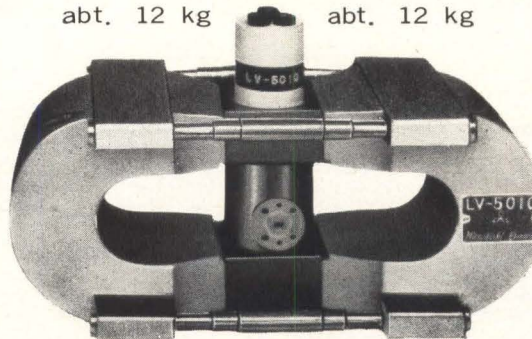

For detailed information, write:  
Electronics Division

**MITSUBISHI ELECTRIC CORPORATION**

Head Office: Mitsubishi Denki Bldg., Marunouchi, Tokyo. Cable Address: MELCO TOKYO



Opportunities for

## Design & Development Engineers in Electronic Signal Processing

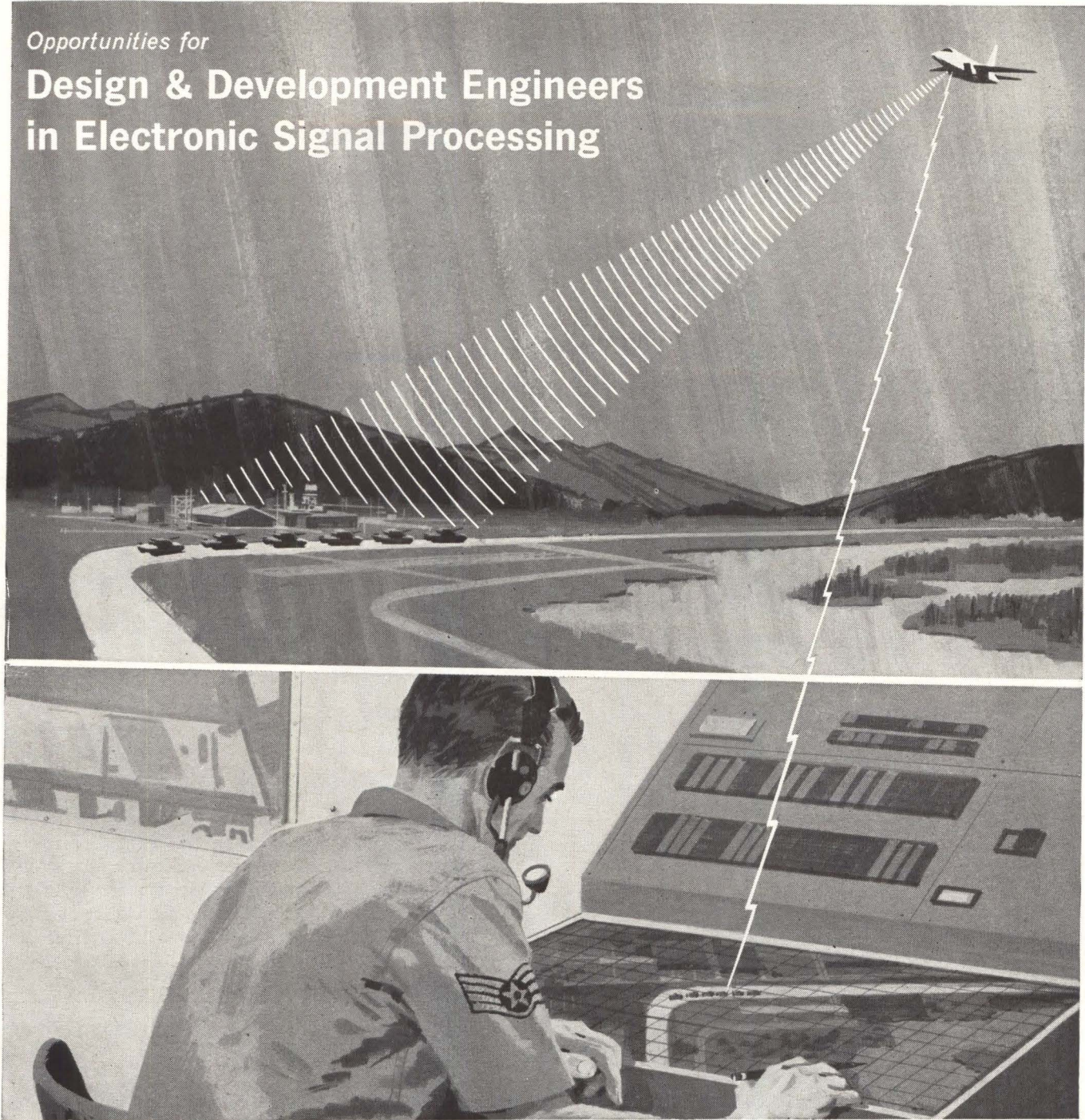

Design and development activities in the field of Electronic Signal Processing are rapidly expanding today at HUGHES Aerospace Divisions.

Development of systems utilizing advanced correlation and matched filter techniques for *High-Resolution Radar, Acoustic Detection & Classification* and *Pulse Doppler Radar* is being accelerated.

Specialists in Signal Processing, Circuit Design, Mechanical Design, Packaging Design, Performance Analysis and Project Engineering will be interested in the outstanding assignments now available.

Graduate engineers with experience in wide-band video amplifiers; high-resolution cathode ray tube circuits and applications (including ultra-linear sweep, gamma correction and dynamic focus); high-voltage power supplies; low-jitter timing circuitry; high-speed analog sampling circuitry; precision film transports; ultra-high speed film development; scan conversion systems; synthetic array radar systems; imagery recording, or similar fields—are invited to submit resumes.

For immediate consideration  
please write:

**Mr. Robert A. Martin**  
Head of Employment  
HUGHES Aerospace Divisions  
11940 W. Jefferson Blvd.  
Culver City 37, Calif.

*Creating a new world with electronics*

**HUGHES**

HUGHES AIRCRAFT COMPANY  
AEROSPACE DIVISIONS

An equal opportunity employer

U. S. CITIZENSHIP REQUIRED

for  
military  
applications

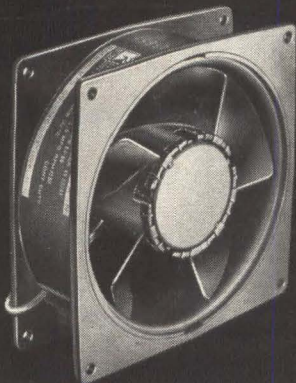

## SPARTAN FAN<sup>TM</sup>

Power-packed performer designed to meet all the critical requirements of military ground applications. Five bladed propeller offers excellent pressure-to-volume characteristics. Interchangeable with "Muffin Fan" and "Sentinel Fan" mounting dimensions.

- 100 CFM AT FREE DELIVERY
- THIN—ONLY 1½" AXIAL DEPTH
- INTEGRAL UNIT—READY TO MOUNT
- MEETS MILITARY SPECIFICATIONS
- 115 VAC, 50-60 CPS, 1Ø
- AIRFLOW REVERSIBLE
- STAINLESS-STEEL BALL BEARINGS
- AVAILABLE IN SQUARE AND ROUND VERSIONS

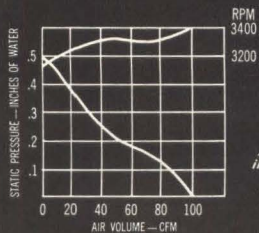

integrated  
with integrity

Write today for complete information.



**ROTRON**  
MFG. CO., INC.  
WOODSTOCK, NEW YORK  
ORiole 9-2401

West Coast: Rotron/Pacific, Glendale, Calif.  
Canada: The Hoover Co., Ltd., Hamilton, Ont.

## New Microwave

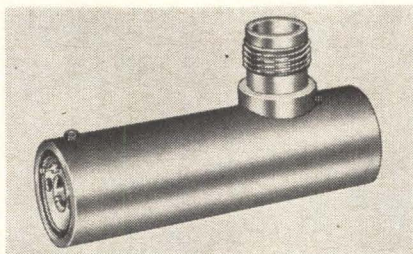

### C-band c-w oscillator delivers high power

A C-band c-w oscillator has been developed with a power output of 100 mw minimum and 200 mw center range. Especially designed as a parametric amplifier pump, it can also be used as a local oscillator or a harmonic generator driver to produce X-band and K-band local oscillator sources. Manual tuning range of the type 9186-1019 is 5.4 to 5.9 Gc. Power input requirements are 175 v at 30 ma. Physical dimensions are 5/8 in. diameter by 2 5/8 in. long, excluding projections; weight, 1 3/4 oz. Trak Microwave Corp., Tampa, Fla. [391]

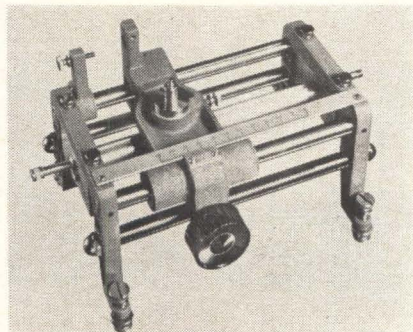

### Co-ax slotted line covers a range of 2 to 18Gc

Covering the frequency range of 2 to 18 Gc, the model 20010 coaxial slotted line provides a means for accurate measurement of vswr and phase on miniature microwave components and 0.141-in. coaxial line. The slotted section is a miniature air-dielectric line with integral connectors, one plug and one jack, mounted permanently on the

carriages. Probe travel is 10 cm. The probe is a special untuned device using a high-sensitivity diode having a flat frequency response. Price is \$960. Omni Spectra, Inc., 8844 Puritan Ave., Detroit, 48238. [392]

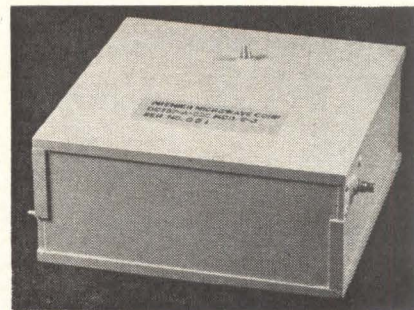

### Variable attenuators for 350 to 380 Mc

Nanosecond speed, voltage-variable attenuators are designed for use as microwave amplitude modulators. The devices are basically phase and temperature stable. Frequency range is 350 to 380 Mc; insertion loss, 1.2 db max; attenuation, 70 db min.; vswr, 1.2 max; switching speed, 20 nsec; bias voltage, 0 to 20 v; bias current, 0 to 2.10 ma; size, 5 in. by 5 in. by 2 1/4 in. Units are priced at \$1,250. Premier Microwave Corp., 33 New Broad St., Port Chester, N.Y. [393]

### Ferrite isolators reduce system size

Ferrite isolators have been designed to plug in stripline sub-systems simply, without the need for coaxial connectors. This feature allows more complete system continuity and offers significant reduction in size and weight for missile and space uses. A typical example

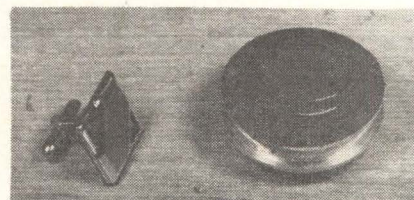

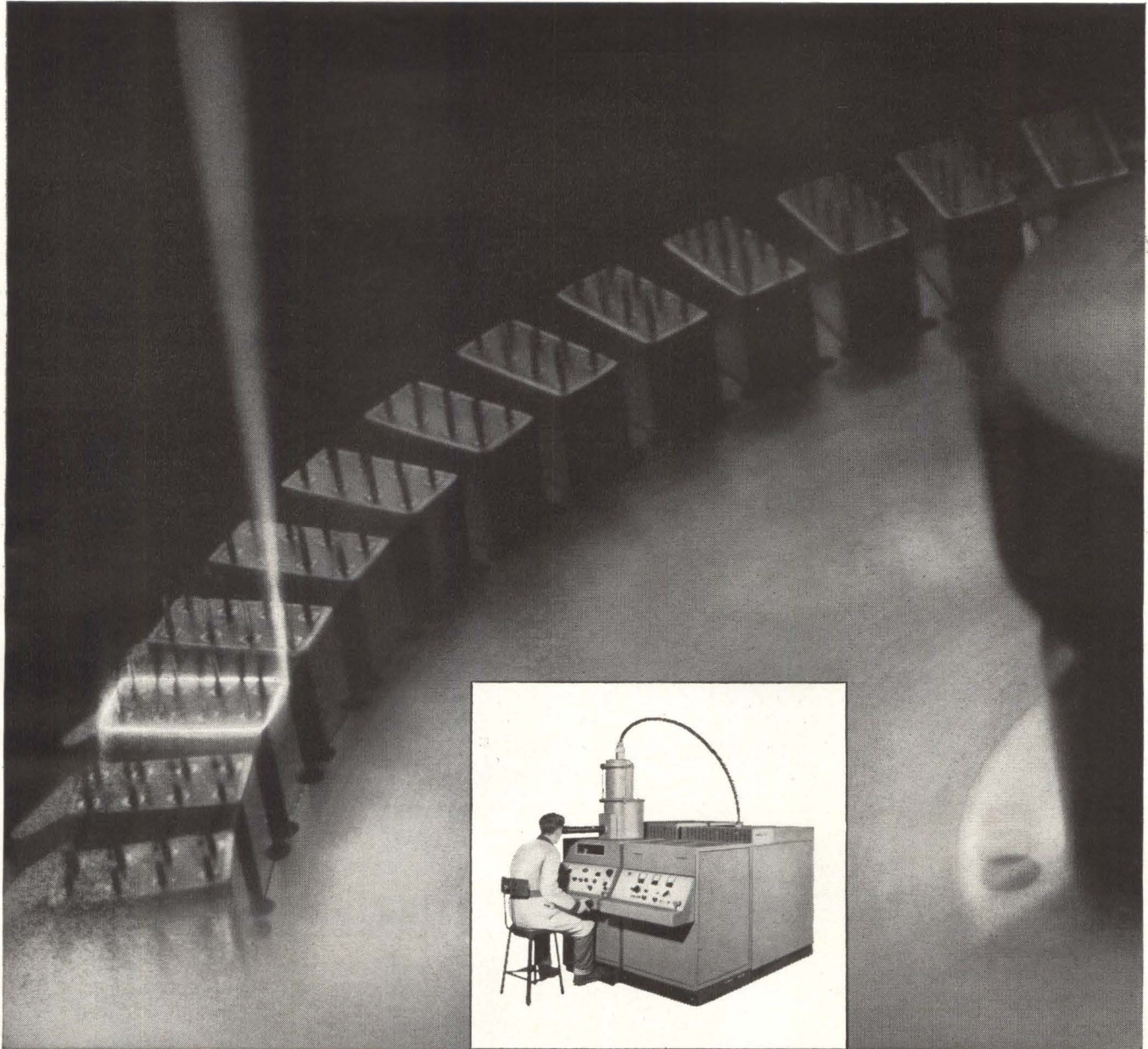

## Why three leading relay manufacturers use the Hamilton Standard Electron Beam Welder to seal subminiature relays

The Hamilton Standard Electron Beam Welder can be programmed precisely enough to seal a crystal case type relay in a few seconds, with production rates up to 250 units an hour. It allows engineers to design for lowest weight and highest reliability, because the high energy density of the beam concentrates all the heat in a remark-

ably small area. Contamination is eliminated because electron beam welding takes place in a vacuum. Physical and electrical properties remain unchanged because electron beam welding involves very low heat input.

Filtors, Inc., General Electric (Waynesboro), and the Leach Relay Division have all found the Hamilton

Standard Electron Beam machine an important tool in crystal case relay manufacture. Other companies have discovered its value in many different problems of microelectronic production. To find out how it can help **you**, send for bulletin. Write: Manager, Electron Beam Systems, Hamilton Standard, Windsor Locks, Connecticut.

**Hamilton Standard** DIVISION OF UNITED AIRCRAFT CORPORATION • WINDSOR LOCKS, CONNECTICUT



# SPECIFY HANDSETS

by  
**Stromberg-Carlson**



... for mobile radio, dictating systems, carrier, microwave and other applications.

Illustrated are **lightweight** models No. 33 and No. 35. Both incorporate push-to-talk switches and high-gain receivers and transmitters. These Stromberg-Carlson handsets meet a great variety of needs in a broad range of industrial applications.

No. 33 lightweight handset is furnished with a rocker bar switch.

No. 35 comes with a button switch, or with both the button and rocker bar switches.

Get technical data on these and other handsets from our Industrial Sales Department.

**STROMBERG-CARLSON**  
A DIVISION OF **GENERAL DYNAMICS**  
114 CARLSON ROAD • ROCHESTER 3, N. Y.

## New Microwave

of this device is the model ICS-344 isolator which covers the 2.7 to 3.3 Gc range with the following specifications: isolation, 20 db minimum; insertion loss, 0.5 db maximum; vswr, 1.2 maximum; termination,  $\frac{1}{2}$  w integral.

Western Microwave Laboratories, 1045 DiGiulio Ave., Santa Clara, Calif. [394]

## Triode oscillator is ferrite-tuned

Model ET-504 is a 260% sweep-width ceramic triode oscillator that can be electronically tuned from 500 Mc to 1,300 Mc. The tuning principle is the change in resonant characteristics of a ferrite-loaded cavity. This occurs when the ambient magnetic field is changed. The ET-504 is said to be superior to voltage-tuned magnetrons and backward-wave oscillators in size, stability, fine structure of its output spectrum and flatness of its power characteristic. In addition, it costs less in large quantities, requires only 150 v of plate potential, is rugged and meets demanding military environments. Specifications include: filament voltage, 6.3 to 7.3 v; filament current, 0.400 amp; cathode voltage, -150 v; cathode current, 60 ma max; power output (500 to 1,000 Mc), 75 mw typical; size,  $3\frac{5}{8}$  by 2 by  $2\frac{1}{4}$  in.; weight, 2.2 lb.

Trak Electronics Co., 59 Danbury Rd, Wilton, Conn. [395]

## Frequency marker covers 1 to 10 Gc

A highly accurate, solid-state frequency-marker generator can operate over a range of from 1 to 10 Gc. It is designed generally for use with a sweep oscillator or generator and an oscilloscope or X-Y recorder. It provides a precise frequency pip, every 5, 10, 50, or 100 Mc, enabling the operator to chart signal response with a degree of accuracy said to be heretofore attainable only with high-priced frequency counters. The new device

# TOWER

Specialists in Electrical and Electronic Components

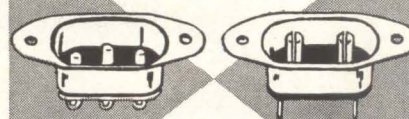

H-1061  
H-1061-IG\*

D-1061

Tower produces a varied and extensive line of 2- and 3-prong all-purpose recessed male receptacles for hundreds of applications including business machines, electronic instruments and any conceivable appliance or apparatus where a detachable cord set is required. Variations of our standard receptacles are available on request.



U-1061

U-1061-IG\*

Write for detailed brochure.

\*Internally Grounded

**TOWER MANUFACTURING CORP.**  
158 Pine St. Dept. E. Providence, R.I. 02903  
PHONE GAspee 1-2061

Circle 205 on reader service card

Leading manufacturer in Japan

New  
**Ceramics**  
for the electronic industry  
& BETTER PERFORMANCE

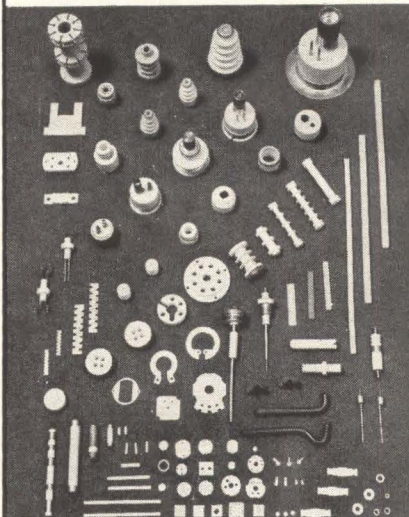

Widest choice of advanced ceramics.  
**Forsterite, Alumina, Steatite, Zircon, Mullite, Cordierite, Magnesia, Titania, Beryllia, Multiform Glass, etc.**

**KYOTO CERAMIC CO., LTD.**

11, Haramachi, Nishinokyo, Nakagyo-ku, Kyoto, Japan.

Circle 206 on reader service card

Electronics | September 7, 1964





functions by sampling the unknown r-f from the sweep source and mixing this sample with harmonics produced from its own internal crystal oscillators. The mixer output is channeled to a low-noise video amplifier and then combined with the vertical input to the oscilloscope. Accuracy of the new instrument is specified 0.001%, a factor of 100 times better than most frequency meters, according to the manufacturer.

Telonic Engineering Co., 480 Mermaid St., Laguna Beach, Calif. [396]

## Coaxial isolators occupy minimum space

Two new broadband coaxial isolators are magnetically shielded and have 3/4-inch outside diameters. Model L19N is 10 inches long, weighs less than 11.5 oz. and provides a minimum of 15 db isolation, a maximum insertion loss of 1.0 db, and a maximum vswr of 1.20 over the frequency range of 1.0 to 2.0 Gc. Model S21N is 7.7 inches long, weighs less than 9.0 oz. and, over the frequency range of 2.0 to 4.0 Gc, provides a minimum of 15-db isolation, a maximum insertion loss of 1.0 db and a maximum vswr of 1.25.

E & M Laboratories, 7419 Greenbush Ave., North Hollywood, Calif. [397]

## Symmetrical circulator for low-power uses

An X-band, four-port symmetrical circulator, model CL5595, is designed for low-power applications. It operates over a 250-Mc bandwidth in the frequency range 8.95 Gc to 9.45 Gc. Typical isolation and cross-coupling are greater than 20 db. Insertion loss is less than 0.4 db, and the input vswr is better



## how much should high reliability transformers cost?

The extra costs of Raytheon high reliability transformers can be and often are surprisingly small. Of course, should you require complete, quantitative, ultra-high reliability, then the program must be priced accordingly.

As a supplier of magnetic components for Minuteman and Apollo, Raytheon is eminently qualified to meet your most exacting specifications for high reliability transformers. If your budget or time requirements do not allow for a complete high reliability program, we can tailor a program that meets your reliability needs within your monetary and scheduling limitations. We can also assist you in establishing your own reliability specifications.



Full facts on Raytheon's High Reliability Program for its wide range of transformers are contained in a new eight-page brochure. Write or call for your free copy, Raytheon Company Magnetics Operation, Foundry Avenue, Waltham, Massachusetts 02154. Telephone 899-8400



# new

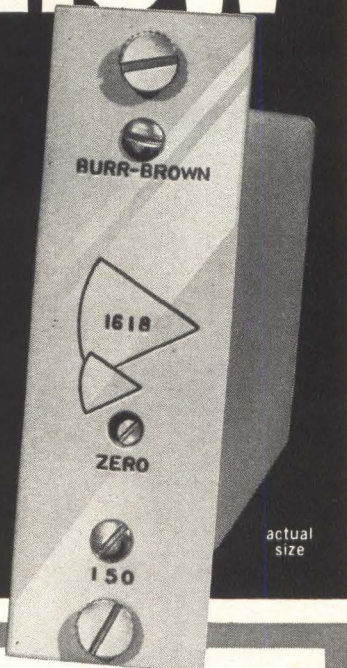

## BURR-BROWN chopper stabilized OPERATIONAL AMPLIFIER

### PROVIDES

- High Voltage Gain 160 db @ DC
- Low Voltage Drift  $\pm 1 \mu\text{V}/^\circ\text{C}$
- Low Current Drift  $\pm 0.01 \text{ na}/^\circ\text{C}$
- Low Current Input Offset  $\pm 0.1 \text{ na}$

Burr-Brown's new 1618 solid-state DC operational amplifier is ideal for integrator, comparator and amplifier applications requiring extreme stability. Rated output is  $\pm 10 \text{ V}$  @ 20 ma and frequency response is 0 db @ 1 Mcps. Zero can be adjusted internally. Priced at \$235 in unit quantity. FOR COMPLETE TECHNICAL INFORMATION write, wire or phone, today.

### OPERATIONAL AMPLIFIER HANDBOOK

96-pages of valuable theory and circuits. A note on your letterhead will get you a free copy

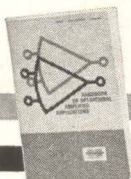

# BURR-BROWN

RESEARCH CORPORATION  
Box 6444 TUCSON, ARIZONA  
Telephone: 602-623-0328 • TWX: 602-792-2681

## New Microwave

than 1.13. Weight is 13 oz. and physical dimensions are approximately  $2\frac{1}{2}$  by  $2\frac{1}{2}$  by  $1\frac{5}{8}$  in. Mullard Overseas, Ltd., Torrington Pl., London W.C. 1, England. [398]

## Coaxial bolometers for high frequencies

A group of high-frequency coaxial bolometers and thermistors, completely interchangeable with standard 1N26 and 1N53 crystals, has been announced. Held to the closest tolerances for precise attenuation and vswr measurements and for all pulse-modulation applications, these units fit all commercial barretter mounts and compatible waveguide detectors. The necessary square-law detection characteristic is provided by a microscopically thin, thoroughly cleaned Wollaston wire element

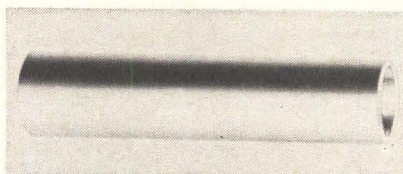

axially located and soldered in place. Response error is less than 1% for power levels of 0.2 mw. Carefully finished coin-silver casings and dielectric bead supports hold loss down over the entire 12.4 to 90.0 Gc range. Filmohm Corp., 48 W. 25th St., New York, 10010. [399]

## Traveling-wave tubes have low distortion

Two new traveling-wave tubes feature low a-m/p-m conversion. The N1055 covers 5.8 to 7.2 Gc with a working power output of 10 w. The a-m/p-m conversion is typically  $1.5^\circ$  per db with a noise figure of 26 db. The N1056 covers 3.6 to 4.2 Gc with a working power output of 10 w. The a-m/p-m conversion is typically  $1^\circ$  per db with a noise figure of 25 db. These tubes comply

# PRIMO

## MICROPHONES

A complete line of  
microphone cartridges  
and units for  
the OE market

- Types : \*Uni-Directional  
\*Velocity \*Crystal \*Magnetic  
\*Dynamic \*Condenser \*etc.



For catalog write to :

**PRIMO CO., LTD.**  
2043 MURE, MITAKASHI,  
TOKYO, JAPAN

CIRCLE 207 ON READER SERVICE CARD

### Reprint order form

Send to: Electronics Reprint Dept.  
330 West 42nd Street  
New York, N. Y. 10036

For listing of reprints available see the reader service card.

To help expedite mailing of your reprints please send cash, check or money order with your order.

For reprints of the latest special report:

### Transistor Heat Dissipators, Part I

Send me . . . . . reprints of key no R-59 at 50¢ each.

For reprints of previous special reports fill in below:

Send me . . . . . reprints of key

no. (s) . . . . . at . . . . . ¢ each.

For prices see the reader service card.

Name . . . . .

Number & Street . . . . .

City, State . . . . .

Zip code . . . . .

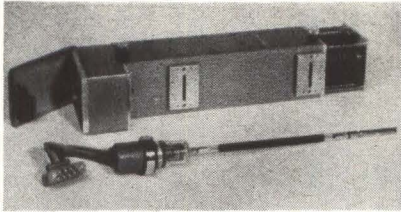

with the requirements of designers of multichannel microwave links, where their low a-m/p-m conversion and noise figure will enable cross-talk and distortion to be kept to a minimum. Both tubes are focused in ppm mounts.  
Calvert Electronics, Inc., 220 E. 23rd St., New York, 10010. [400]

### Power dividers cover 1 to 12 Gc

A series of stripline power dividers covers the 1- to 12-Gc spectrum in four small, lightweight units. They feature phase balance between outputs of  $\pm 3^\circ$  max, and output power balance of  $\pm 0.3$  db max. Type 06-33-03880 covers the 1 to 2-Gc band, has dimensions of 3 in. by 3 in. by 1.25 in. and weighs only 10 oz. The other units, which are even smaller and lighter, are 06-33-03890 (2-4 Gc); 06-33-03900 (4-8 Gc); and 06-33-03910 (8-12 Gc).

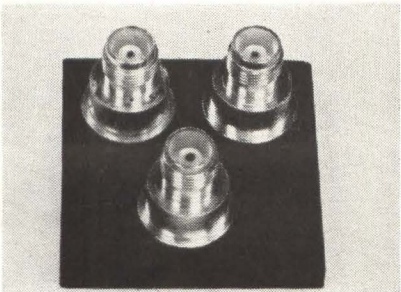

Standard TNC or other connectors can be provided in the configuration shown, or in line. The power dividers are priced at \$90 each in small quantities.  
Electronic Specialty Co., 5121 San Fernando Road, Los Angeles, Calif. [401]

### Fixed-tuned r-f probe spans 400 Mc to 18 Gc

This fixed-tuned r-f probe, model 228, covers frequencies from 400 Mc to 18 Gc and features a replace-

Typical display of MPC panoramic receiver displaying signals over a decade bandwidth. The first three signals are the fundamental (greatly attenuated), and the second and third harmonics from a backward wave oscillator tuned to 1.1 Gc. The next two signals are from klystron oscillators tuned to 4 and 5.2 Gc.

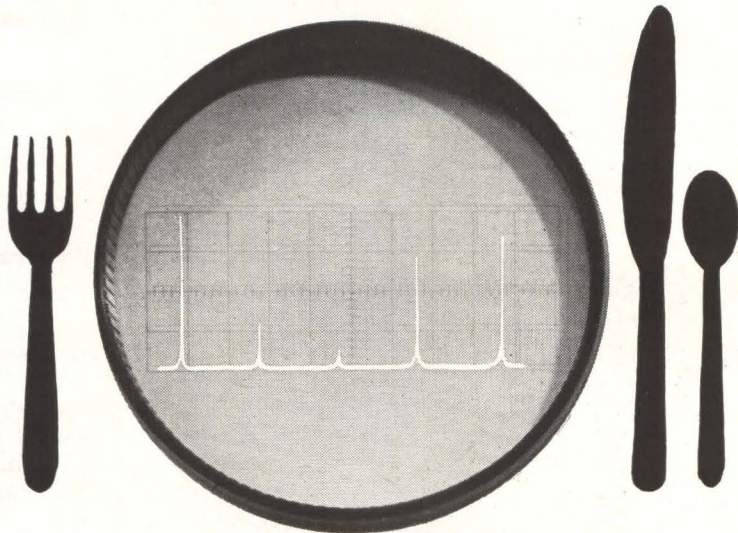

## FEAST YOUR EYES ON THIS PANORAMIC VIEW

Instantaneous Signal Display in the 0.5 to 5.0 Gc, or the 2.0 to 12.0 Gc Bands

Through Microwave Physics Corporation's plug-in module, Hewlett-Packard and Tektronix oscilloscopes may be converted into wide-band panoramic receivers, useful for measuring spurious content in pulsed or CW signals from harmonic generators, solid-state signal sources, BWO's, and other signal sources. Also useful as RFI survey receivers and transmitter field strength and check-out receivers. These new modules utilize an electronically tunable YIG filter and sensitive video detector, thereby eliminating all mixing products, images and harmonically related spurious responses common to spectrum analyzers.

In addition to use with the Hewlett-Packard or Tektronix scopes, the modules may be used with any scope when supplied as a self-contained unit with integral power supply. Specify scope name and series when ordering. Model MPR-U (0.5-5.0 Gc) — Model MPR-X (2.0-12.0 Gc).

Price, either model..... \$1,795.00

Price, self-contained unit..... 2,045.00

Delivery, 60 to 90 Days

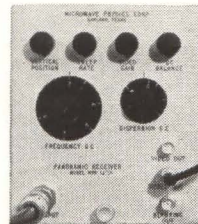

# MICROWAVE PHYSICS CORPORATION

420 KIRBY STREET, BR 6-7189, GARLAND, TEXAS — A SUBSIDIARY OF MELPAR, INC.

EQUAL EMPLOYMENT OPPORTUNITIES: ENGINEERS AND PHYSICISTS WITH RELEVANT EXPERIENCE INTERESTED IN POSITIONS WITH GROWTH POTENTIAL CONTACT PERSONNEL DEPARTMENT.



NEW FROM GENERAL ELECTRIC

# Engineered reproducibility in G-E's new line of TANTALUM SHEET and FOIL

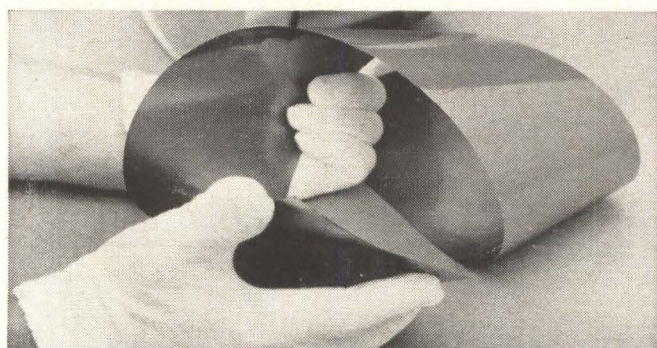

## GUARANTEES: the same ductility, the same flatness, the same finish, the same uniform fine grain, EVERY TIME YOU ORDER

Precisely controlled processing of G-E tantalum from ingot consolidation through rolling and heat treatment insures sheet and foil of unvarying physical and mechanical properties. (Spinning and deep drawing without cracks, tears, or excessive "orange peel" is especially facilitated with G-E tantalum's uniformly fine grain.)

IMPROVED weldability and better high temperature-vacuum performance result from controlled purity. This means you get:

- Interstitials less than 200 ppm by specification (less than 130 ppm is typical).
- Metallic impurities (20 elements) typically less than than 400 ppm total.
- Freedom from surface contamination.

G-E TANTALUM sheet and foil now available from stock.

Thickness—from .001" to .500"

Width—foil up to 12", sheet up to 24"

Write today for full information on G-E tantalum sheet and foil to General Electric Co., Lamp Metals & Components Dept., 21800 Tungsten Road, Cleveland, Ohio 44117.

*Progress Is Our Most Important Product*

**GENERAL  ELECTRIC**

## PRINT DATA / COUNT / TIME

**M O D U P R I N T**

As data printer or printing counter (or both) these completely new and highly flexible tape printers can be supplied in an almost countless variety of combinations to meet the special needs of your application at prices that — FINALLY — make printing possible. They can be delivered complete and ready to operate with all controls built-in, requiring only your input commands.

- ★ Three sizes: 9, 14 or 20 digits
- ★ Counting rate: 80 per sec. max.
- ★ Printing rate: 3 lines per sec.
- ★ Prints: numbers, letters, time, symbols
- ★ Prices: **Lower than you think possible**

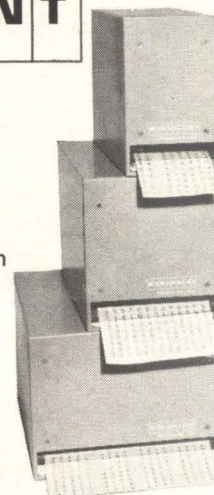

For further information write for Bulletin 602

MADE IN U.S.A. BY  
**PRESIN COMPANY, INC.**  
Box 3245, Bridgeport 5, Connecticut  
Phone: 203-333-9491

Circle 208 on reader service card

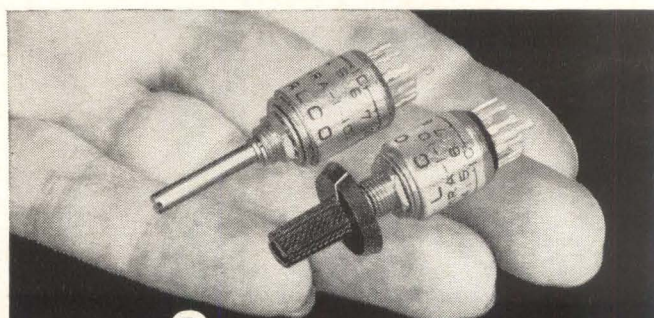

## 2 BRAND NEW MINIATURE ROTARY SWITCHES

### LESS KNOB

Shaft:  $\frac{1}{8}$ " diameter  
 $\frac{1}{16}$ " length  
For use with standard miniature knobs.

### WITH KNOB

Shaft:  $\frac{5}{32}$ " diameter  
 $\frac{1}{4}$ " length  
Equipped with knurled black phenol knob.

500 MA. @ 125 VAC.

First ultra-miniature, multiple-stop switch available. Long life cycle. Only  $\frac{1}{2}$ " diameter.  $36^\circ$  spacing. Fully enclosed. Ideal for aircraft, computers, electronic equipment. **\$3.85**

USABLE - 2-10 pos. - 2-5 pos. - 2-3 pos. - 2 pos.



**ALCOSWITCH**

SEND FOR FREE CATALOG

Lawrence, Mass. Dept. I-50

## New Microwave

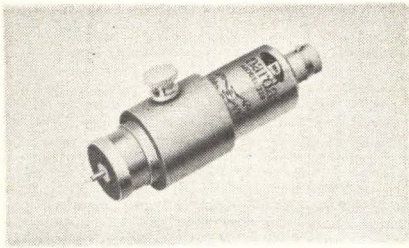

able crystal detector plus an optional bolometer. The probe is designed to operate with a standard 3/4-in.-diameter slotted-line carriage. Its depth is adjustable to approximately 1/4 in. and the setting can then be locked. Accurate scale readouts are permanently marked on the probe body to facilitate resetting. The fine wire probe tip is covered with a plastic shield to reduce the possibility of tip bends. The crystal detector element can be replaced by removing a BNC connector and then sliding out the crystal unit. Price of the model 228 with crystal model 822 is \$55. The model N607 bolometer costs \$20. Narda Microwave Corp., Plainview, N.Y. [402]

## Variable couplers use direct-reading dial

Eliminating the need for a large assortment of fixed value couplers, these Vari-Couplers facilitate system prototype and laboratory testing. Utilizing a direct-reading dial calibrated in db, selection of coupling from 5 to 50 db (model 501)

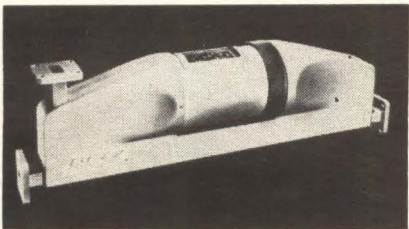

or 10 to 60 db (model 601) can be obtained quickly and accurately without removing the unit from waveguide lines. Unit price is \$275. Belz Industries, a division of El-Tronics, Inc., 140 Terminal Drive, Plainview, N.Y. [403]

# Newest Ballantine R-A-P VTVM! Measures Wide Range of Voltages, Frequencies, and Waveforms

**Three instruments in one:  
Measures True-RMS,  
Average, or Peak Voltage**

**Same Accuracy and  
Resolution over entire  
Five-Inch Log Scales**

**Accuracy of 2% of  
Indication is far better  
over the lower half of  
the scale than for a  
linear scale instrument  
rated at 1% F.S.D.**

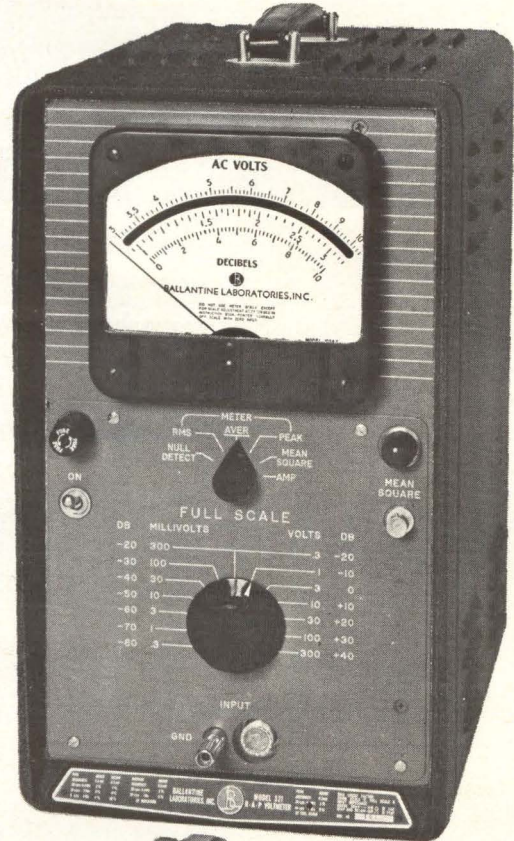

Model 321 Price: \$560

Ballantine's Model 321 is an electronic voltmeter designed for accurate measurements of the true-rms, average, or peak values of a wide range of voltages and waveforms. It is *not* limited to measurement of pure sine waves to obtain the specified accuracy, but will measure sine, distorted sine, complex, pulse, or random signals whose frequency components lie within the designated frequency range.

The instrument's five-inch voltage scales make it possible for you to specify uniform resolution and accuracy in % of indication over the entire scale length. This feature is not possible with a linear scale meter.

### PARTIAL SPECIFICATIONS

<b>VOLTAGE RANGE</b>		<b>FREQUENCY RANGE</b>	
RMS .....	100 $\mu$ V — 330 V	RMS .....	5 cps — 4 Mc
Average & Peak .....	300 $\mu$ V — 330 V	3 db bandwidth .....	2 cps — 7 Mc
As null detector .....	to 10 $\mu$ V		
<b>WAVEFORMS</b>		<b>ACCURACY, ABOVE 300 <math>\mu</math>V, MID-BAND</b>	
Sine, distorted sine, complex, pulse, random		RMS & Average .....	2% of indication
		Peak .....	3% f.s.
<b>Power Requirements:</b> 115/230 V, 50 — 420 cps, 90 W		<b>Amplifier:</b> 90 db	
		<b>Mean Square Output (dc):</b> 1 V	

Available in portable or rack versions

Write for brochure giving many more details



Since 1932 —  
**BALLANTINE LABORATORIES INC.**  
Boonton, New Jersey

CHECK WITH BALLANTINE FIRST FOR LABORATORY VACUUM TUBE VOLTMETERS, REGARDLESS OF YOUR REQUIREMENTS FOR AMPLITUDE, FREQUENCY, OR WAVEFORM. WE HAVE A LARGE LINE, WITH ADDITIONS EACH YEAR. ALSO AC/DC LINEAR CONVERTERS, CALIBRATORS, WIDE BAND AMPLIFIERS, DIRECT-READING CAPACITANCE METERS, AND A LINE OF LABORATORY VOLTAGE STANDARDS 0 TO 1,000 MC.

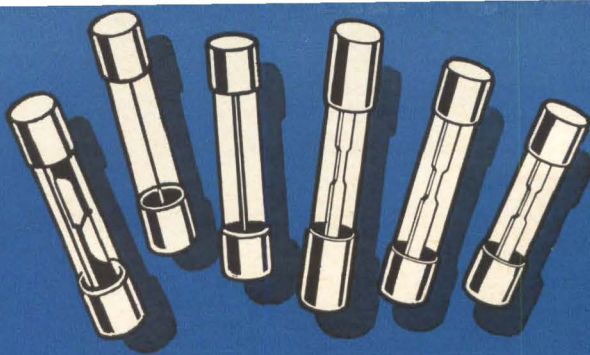

## **BUSS** *quick-acting Fuses*

"Fast Acting" fuses for protection of sensitive instruments or delicate apparatus;—or normal acting fuses for protection where circuit is not subject to starting currents or surges.

# **BUSS**

Write for BUSS  
Bulletin SFB

**BUSSMANN MFG. DIVISON**, McGraw-Edison Co., St. Louis, Mo. 63107

Circle 173 on reader service card

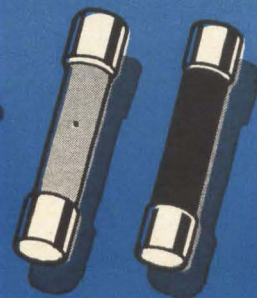

**BUSS MBO**  
1/4 x 1-1/4  
inch

**BUSS ABC**  
1/4 x 1-1/4  
inch

## **BUSS** *high interrupting capacity* **Fuses**

For the protection of circuits capable of delivering currents as high as 25,000 amps. at 125 volts or 10,000 amps. at 250 volts.

# **BUSS**

Write for BUSS  
Bulletin SFB

**BUSSMANN MFG. DIVISON**, McGraw-Edison Co., St. Louis, Mo. 63107

Circle 173 on reader service card

## **BUSS: 1914-1964, Fifty years of Pioneering**



### **Find the manufacturer... Fast!**

It's just a matter of seconds to get the valuable information you need about electronic manufacturers and suppliers in the Electronics Buyers' Guide. The EBG has over 200 pages listing the names, addresses, phone numbers and key individuals of manufacturers of electronics equipment, related components and materials. All this plus vital company statistics. At a glance you know important facts about the company, exactly what each company makes, and where to find the manufacturers' representatives in your area. No wonder the EBG is the industry's standard catalog-directory!

#### **Electronics Buyers' Guide**

A McGraw-Hill Publication

330 West 42nd Street, New York, N. Y. 10036

## New Production Equipment

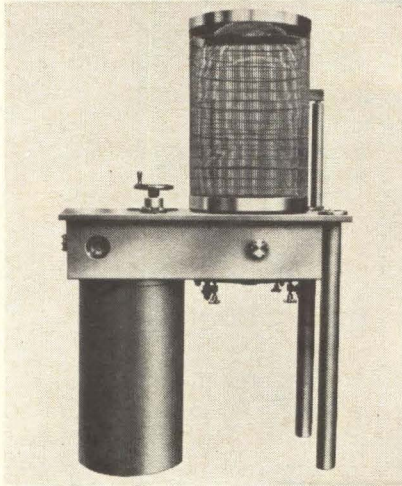

### Vacuum system offers rapid cycle

A versatile, rapid-cycling VacIon pumped system for coating or evaporation in research, engineering,

and production has been introduced. The VI-3 pumps to  $10^{-6}$  torr in 30 minutes, and the fastest of the optional versions reaches this pressure in 10 minutes. Base pressure is below  $10^{-7}$  torr. The system meets the need for low-cost, clean vacuum, providing an alternative for those who, up to now, have had to consider diffusion-pumped systems for economic reasons. The heart of the functional design is the high-vacuum pumping system. A fully-enclosed 380 liter-per-sec VacIon pump is said to provide the highest possible pumping speeds in the higher pressure region for faster cycling. Direct attachment of the pump to the baseplate chamber and the special valve minimizes conductance losses. Also included in the system is a high-speed titanium sublimation pump. An optional cryopump adds even more speed for condensable gases. Flex-

ibility and a variety of feedthrough arrangements are provided by the rectangular baseplate chamber. Horizontal and vertical feedthrough ports include four on the sides and five directly below the bell jar. More can be added for special requirements.

Varian Associates, Vacuum Products Division, 611 Hansen Way, Palo Alto, Calif. [421]

### Hand tool tightens cable ties and straps

A new pistol-type hand tool automatically tightens self-holding Ty-Rap cable ties and straps to the desired tension and in one simple motion cuts off the excess, flush with the tie. Tension of the Ty-Rap is easily adjustable on the tool. The tool, WT-199, accommodates three sizes of Ty-Raps which cover a wire bundle range from 0 to 4-in. diameter.

The Thomas & Betts Co., Elizabeth, N.J. [422]

## New Developments in Electrical Protection

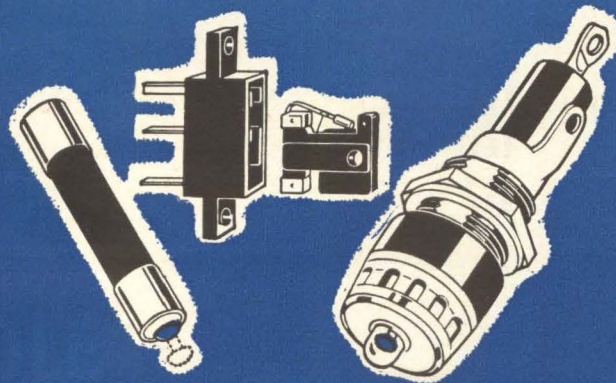

### INDICATING FUSES AND FUSEHOLDERS HAVE MANY USES

Unusual fuseholders and fuses perform complex functions in addition to providing safeguards for circuitry and components.

They can provide quick, positive identification of faulted circuits... by visual signal, by activating an alarm, or both.

# BUSS

Write for BUSS  
Bulletin SFB

BUSSMANN MFG. DIVISION, McGraw-Edison Co., St. Louis, Mo. 63107



### Save Assembly Time with Quick-Connect Terminals on BUSS Fuseholders

Eliminates soldering. Permits use of pre-assembled harness. Reduces assembly time.

# BUSS

Write for BUSS  
Bulletin SFB

BUSSMANN MFG. DIVISION, McGraw-Edison Co., St. Louis, Mo. 63107

# PAMOTOR

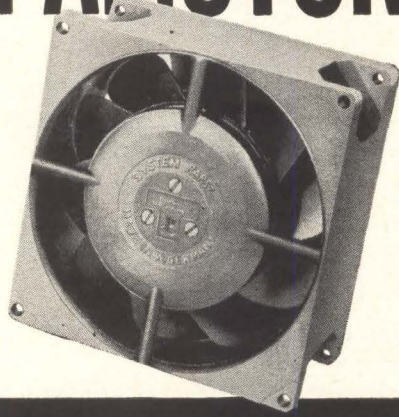

## A VERSATILE NEW LINE OF MINIATURE AXIAL FANS

with features that surpass  
other cooling devices in  
**CONSTRUCTION,  
PERFORMANCE,  
RELIABILITY!**

Superior inside-outside rotating motor design yields higher torque capabilities • Flywheel effect produces constant, quiet fan speed • Available in both induction (capacitor-type squirrel cage) and shaded-pole types • Large surface sinter-metal sleeve bearings designed for permanent lubrication • Housings are of die-cast, warp-free metal construction, unlike plastic housings of many conventional fans • Ruggedly-built, yet extremely light in weight—18 oz. to 26 oz., depending upon model no. • Wide range of performance characteristics to meet specific requirements.

model no.	volts	freq. (cy.)	air flow (cfm)	overall size (inches)	
				w.	h. d.
1000A	115	60	125	4½ x 4½	x 2
1000B	115	50	100	4½ x 4½	x 2
1100	115	400	100	4½ x 4½	x 2
1200	115	60	60	4½ x 4½	x 2
1300A	220	60	125	4½ x 4½	x 2
1300B	220	50	110	4½ x 4½	x 2
2000A	115	60	134	4½ x 4½	x 2
2000B	115	50	116	4½ x 4½	x 2
2000C	220	50	116	4½ x 4½	x 2
2500A*	115	60	100	4½ x 4½	x 2
2500B*	220	60	90	4½ x 4½	x 2
2500C*	220	50	80	4½ x 4½	x 2
3000A	115	60	60	3½ x 3½	x 2
3000B	115	50	54	3½ x 3½	x 2
3000C	220	50	54	3½ x 3½	x 2
5000A	115	60	115	5 dia. x 2½	deep
5000B	220	50	100	5 dia. x 2½	deep

\*Series 2500 is shaded-pole type. All others are induction type, equipped with appropriate capacitor.

For complete specifications and name of nearest stocking distributor, write to:

**PAMOTOR, INC.**  
312 SEVENTH STREET • SAN FRANCISCO, CALIF.

## New Materials

### Room-temperature casting systems

A new series of room-temperature polyurethane casting systems is designed to improve the protection of electronic components and circuits. Using Polycin-U liquid isocyanate-terminated prepolymers and Polycin curing polyols (hardeners), the systems are suitable for potting, filling, embedding and encapsulating electronic parts. They offer low water absorption and shrinkage; good electrical properties; excellent abrasion, thermal shock and impact resistance; good heat and electrical stability and usefulness over a wide temperature range. The two-component, 100%-solids systems are said to have dielectric properties equal to or better than epoxy and styrene polyester casting compounds. They are readily used in transformers, power supplies, packaged modules, amplifiers, and computer circuiting, as well as for thin-film protective coatings on circuit boards and components.

The Baker Castor Oil Co., Bayonne, N.J. [411]

### High-permeability magnetic alloy

Hipernik, a soft magnetic alloy of 50% nickel and 50% iron, exhibits an initial permeability of 10,000 to 15,000 and a maximum permeability of 100,000 to 200,000 with low hysteresis loss throughout the range of operating flux densities. The alloy's magnetic and mechanical properties make it ideal for applications in electronic transformers and inductors where high permeability and low core loss are required to meet performance and size specifications. Specific applications include electronic power transformers, isolation and impedance-matching transformers, servo devices, a-c and torque motors, solenoid cores of sensitive relays, and magnetic shielding. The material is available from stock in cold-rolled strip form in thicknesses from 0.006 to 0.110 in. and in

widths from ¼ to 15 in. In the cold-rolled form, it is readily punched for laminations or can be slit into tape.

Westinghouse Materials Mfg. Division, Blairsville, Pa. [412]

### Combination laminates for p-c boards

A line of combination laminated materials for printed-circuit boards is said to allow use of parallel gap welding techniques to fasten components to the boards. The materials combine a glass-fabric epoxy laminate with a cladding of nickel alloy, such as Kovar or Nichrome. Since leads on micromodules are made from the same alloy, parallel gap welding can be used to fasten components to the circuits. The combination material is being offered in a variety of thicknesses of base laminates and cladding. Sheets can be clad on one or both sides.

Synthane Corp., Oakes, Pa. [413]

### Photo resist for semiconductors

Formulated to meet the requirements of semiconductor and micro-electronic manufacturing, the AZ-1350 photo resist features resolution, edge acuity, multiple exposure capability, clean developing, and clean removal. The necessity for applying extremely thin coatings is eliminated because of superior resolution. Even with coatings as thick as 0.000070 in., which is 3 to 20 times thicker than conventional applications on semiconductor wafers, the AZ-1350 will reproduce lines and spacings smaller than ½ micron. AZ-1350 coatings have excellent adhesion to substrates. Edge acuity of the highest degree is said to be possible because the developer solution does not soften the unexposed image. Removal of the coatings is quick and complete by simple immersion in the aqueous AZ remover solution. Shipley Co., Walnut Park, Wellesley 81, Mass. [414]



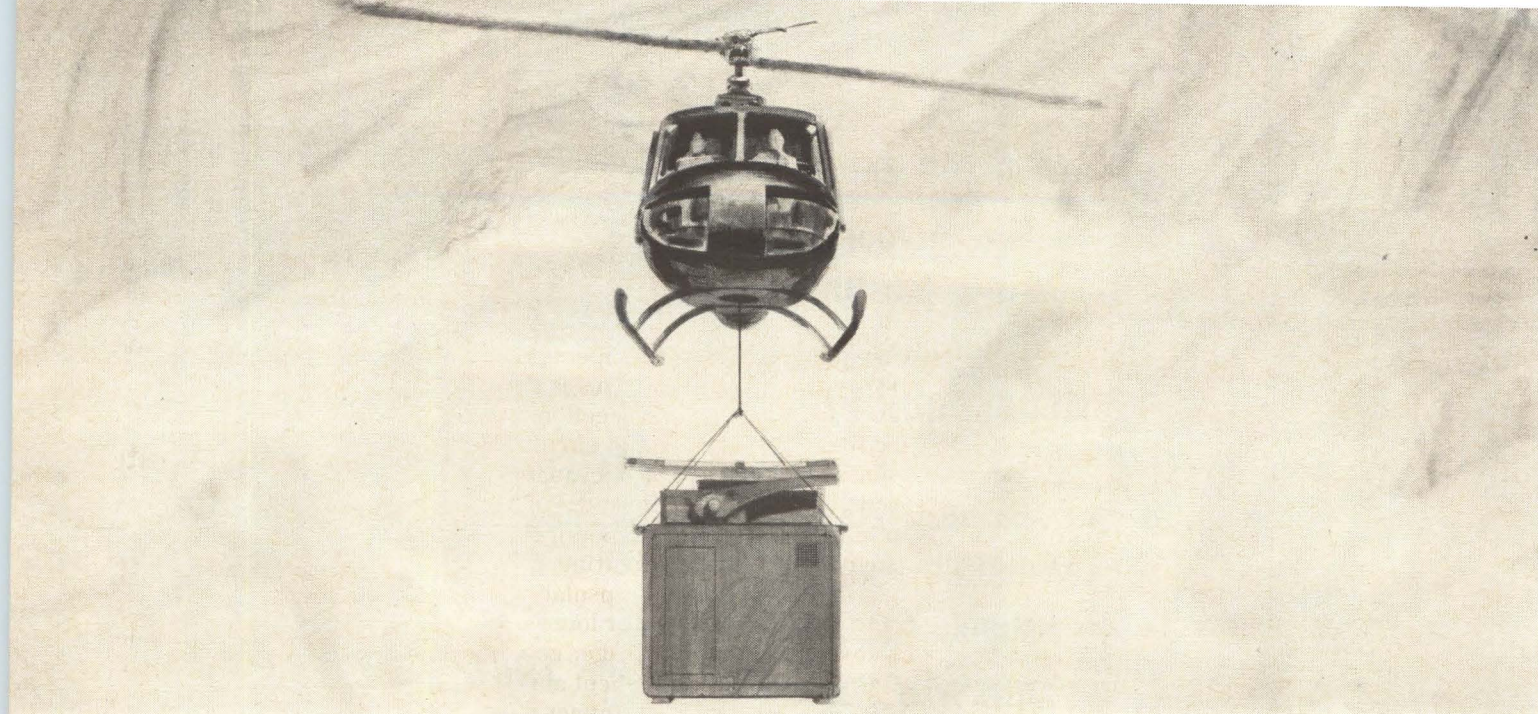

**Weight is the only thing missing...**

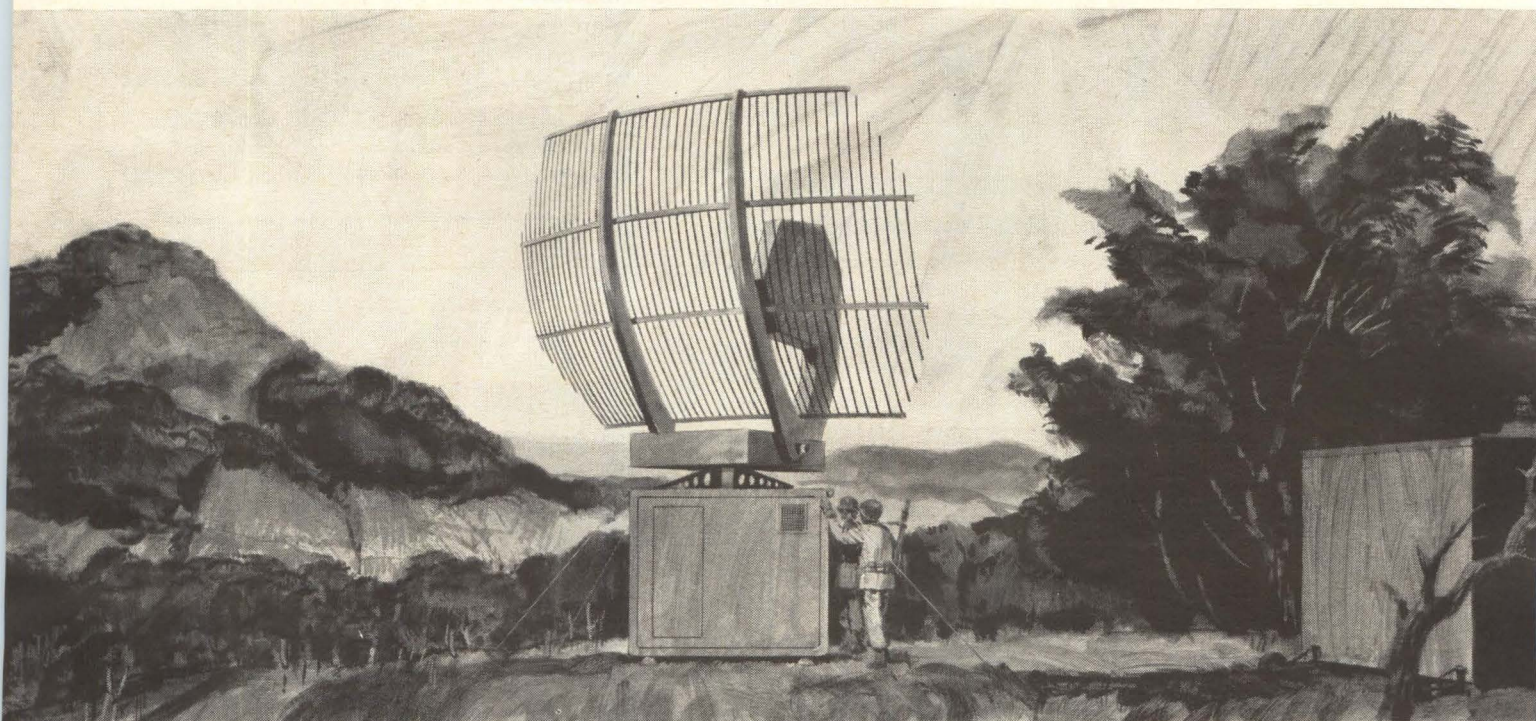

**from this new Westinghouse tactical radar system**

Westinghouse has designed a tactical radar system so light it rides into combat in a single helicopter load, so simple it sets up in 30 minutes or less. Yet this lightweight unit has all of the sensing, coverage, range, height accuracy and performance of present systems weighing many times more.

Design of this new breed of radar draws

on Westinghouse experience in developing the first successful, fully transportable, long range tactical radar and the first successful 3-D tactical radar.

Pioneering in micro-miniaturization (thin film and molecular circuitry), Westinghouse radar experts have applied these advanced techniques to today's proven

systems, as well as to future designs.

The result: a dramatic improvement, not only in size and weight reduction, but in overall performance and reliability.

For further information on what's really new in tactical radar and communications, write Westinghouse Electric Corporation, Box 868, Pittsburgh, Pennsylvania 15222.

J 02364

**You can be sure if it's Westinghouse**





When you are face to face with a **timing problem** that demands **dependability**

**SYNCHRON** motors usually supply the **answer**



SEE US AT  
BOOTH 1215  
ISA SHOW

### QUICK FACTS ON SYNCHRON MOTORS

- Self-Starting** — Hysteresis motor with positive direction of rotation. Either clockwise or counterclockwise rotation.
- Power** — 8, 20 or 30 in.-oz. torque (at 1 RPM).
- Speeds** — From 1 RP week to 600 RPM (60 cycles).
- Output Drives** — More than 300 available.
- Bearings** — Special bronze bearing plates with oil retainer for gear train; babbit bearings for polished rotor shaft. Bronze output bearing.
- Standard Voltages** — 24v, 110v, 220v. Others available.
- Standard Cycles** — 60 cy., 50 cy., 25 cy.
- Flexible Installation** — Operates equally well mounted in any position.
- Easy to Mount** — Available with standard pear shape, 2-hole mounting. (Also round, with 4-hole or 2-hole mounting.)
- Durable Construction** — May be stalled continuously (at speeds of 1 RPM and faster) without electrical or mechanical damage.
- Silicone Lifetime Lubrication** — Gear train sealed for protection from dust and elements.
- Underwriters' Laboratories, Inc. and CSA listed.

Write for data on SYNCHRON Timing Motors, Instrument Motors, D-C Motors, Clock Movements.

HANSEN ENGINEERS WILL WORK WITH YOUR ENGINEERS ON SPECIAL PROBLEMS AND, FOR YOUR PURCHASING DEPT., DELIVERY DATES YOU CAN RELY ON!



HANSEN REPRESENTATIVES:  
**CAREY & ASSOCIATES**, Houston, Texas  
**R. S. HOPKINS COMPANY**, Sherman Oaks, Calif.  
**EICHORN & MELCHIOR, INC.**, San Carlos, Calif.  
**THE FROMM COMPANY**, Chicago, Ill.  
**H. C. JOHNSON AGENCY, INC.**, Rochester, N.Y.  
**WINSLOW ELECTRIC COMPANY**, Essex, Connecticut  
**EXPORT DEPARTMENT**, 64-14 Woodside Ave., Woodside, N.Y.

Handled exclusively in Canada by Sperry Gyroscope Ltd., Ottawa, Canada

exclusively  
for  
industry

free

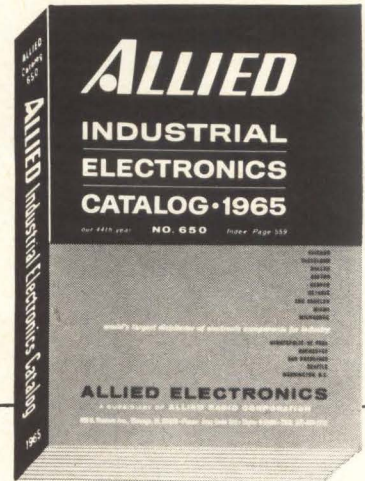

ask for  
your **1965 ALLIED**  
**INDUSTRIAL CATALOG NO. 650**

**576 PAGES • COMPLETE INDUSTRIAL ELECTRONICS CATALOG FOR THE SPECIAL USE OF PURCHASING AGENTS AND ENGINEERS**

- World's Largest Stocks of Electronic Components
- Same Day Shipment • Factory OEM Prices

for **FREE** copy, check reader service card or write direct

**ALLIED ELECTRONICS**

subsidiary of **ALLIED RADIO CORPORATION**

100 N. Western Ave., Dept. 80-J, Chicago, Illinois 60680

Circle 210 on reader service card

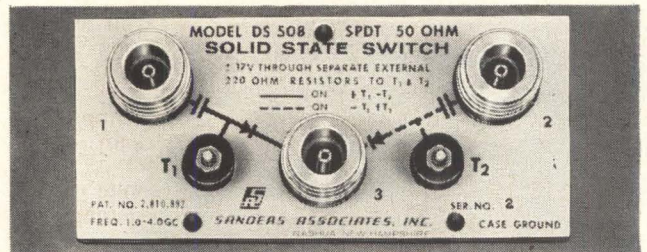

## New SPDT solid state switch

- fast rise time (less than 50 nanosec)
- broadband (1.0 to 4.0 GC)
- compact (3 3/4" x 1 11/16" x 9/32")

SPDT Model DS508 — latest in broad Sanders line of switches — utilizes advanced TRI-PLATE® strip transmission line techniques. New switch is ideal for such applications as multiplexing, RF signal suppression, broadband pulse modulation. Isolation 30 db min.; insertion loss 2.5 db max., 1.5 db typical; VSWR 2.0:1 max. Average quantity price only \$285 — delivery 30 days.

**CREATING NEW DIRECTIONS IN ELECTRONICS**  
**SANDERS TRI-PLATE® STRIP TRANSMISSION LINE**

Sanders Associates, Inc.  
Electronic Products Department  
Canal Street, Nashua, N. H.

- Rush me Switch Model DS508 data sheet.
- Have applications engineer call.

Name ..... Title .....

Company ..... Dept. ....

Street .....

City ..... State ..... Code .....

©Reg. T.M. Extensive patent coverage, Sanders Associates, Inc.

Circle 211 on reader service card  
Electronics | September 7, 1964

## New Literature

**Clean rooms.** Angelica Uniform Co., 700 Rosedale Ave., St. Louis, Mo. 63112. A new glossary, covering 74 definitions, deals with the terminology of environmentally controlled areas, the equipment used in clean rooms, and gives special emphasis to the fabrics and uniforms for personnel. Circle 451 on reader service card

**D-c power modules.** Electronic Research Associates, Inc., 67 Factory Place, Cedar Grove, N.J., offers a technical bulletin describing a line of d-c power modules for military and other rugged applications. [452]

**Coaxial connectors.** Microdot Inc., 220 Pasadena Ave., S. Pasadena, Calif. High-quality miniature coaxial connectors in all-crimp form are described in a two-page bulletin. [453]

**Magnetic amplifiers.** Airpax Electronics Inc., Fort Lauderdale, Fla. Bulletin 8E-1 describes PRS3, PRS4, and PRS5 d-c magnetic amplifiers used in control circuits and systems, instrumentation and measurement. [454]

**Measuring instruments.** Waveforms, Inc., 333 Sixth Ave., New York City, 10014. Characteristics of the company's oscillators, voltmeters, and transmission measuring sets are summarized on a single sheet. [455]

**Motor tach generators.** Avionic Division/John Oster Mfg. Co., One Main St., Racine, Wis. A designer's hand book describes a wide range of available motor tach generators and some of the many possible variations and gearheads. [456]

**High-reliability semiconductors.** Motorola Semiconductor Products, Inc., 5005 E. McDowell Rd., Phoenix, 8, Ariz., offers a brochure discussing the details of its Meg-A-Life II Assurance Program for high-reliability semiconductor devices. [457]

**Weldable contacts.** ITT Cannon Electric Inc., 3208 Humboldt St., Los Angeles, has available a brochure describing Weldcon weldable contacts. [458]

**Transistor curve tracer.** Aero Geo Astro Corp., 13624 Magnolia Ave., Corona, Calif., announces a specification sheet on the TVT-1 transistor curve tracer which is built as a plug-in unit for use with Tektronix and Hickok oscilloscopes. [459]

**Filter-crystal test set.** Systems Inc., 2400 Diversified Way, Orlando, Fla. A six-page technical bulletin describes a filter-crystal test set designed to measure parameters of high Q devices over a range of 750 kc to 50 Mc. [460]

**Housings and accessories.** Premier Metal Products Co., Inc., 337 Manida St., Bronx, N.Y. 10474, has issued a 64-page catalog No. 640 dealing with metal housings and accessories for the electronics industry. [461]

**Silicon modules.** Packard Bell Computer, 2700 South Fairview St., Santa Ana, Calif. Catalog SP-147B on silicon digital modules is now available. [462]

**Synthesizers.** Rhode & Schwarz, 111 Lexington Ave., Passaic, N. J. A 4-page catalog sheet provides complete technical data, block diagrams, applications, and operational theory for types 262 and 263 synthesizers. [463]

**Digital voltmeters.** Electronic Associates, Inc., West Long Branch, N.J. An 8-page illustrated brochure covers the series 6000/6001 all-solid-state digital voltmeters which operate at speeds of one conversion per millisecond. [464]

**Steerable tracking antenna.** Electronic Specialty Co., 4561 Colorado Blvd., Los Angeles, Calif., 90039. A 4-page, illustrated brochure describing a high-velocity, steerable telemetry antenna system for missile tracking is announced. [465]

**Microwave system noise performance.** Lenkurt Electric, San Carlos, Calif. Volume 13, No. 6 of the Demodulator contains the second part of a two-part article entitled "Noise Performance in Industrial Microwave Systems." [466]

**Gold bonding wires.** Sigmund Cohn Corp., 121 So. Columbus Ave., Mount Vernon, N. Y., has available a bulletin dealing primarily with the use of gold bonding wires in the manufacture of transistors and diodes. [467]

**Accelerometers.** Gulton Industries, 212 Durham Ave., Metuchen, N. J. Fact sheet ASI-101 covers a new line of Glennite subminiature, high-frequency accelerometers. [468]

**Resistor test network kit.** Corning Glass Works, Electronic Products Division, Raleigh, N. C. A kit of microcircuits designed for evaluation testing is described in bulletin CE-11.01. [469]

**Heat dissipators.** International Electronic Research Corp., 135 West Magnolia Blvd., Burbank, Calif., offers a test report on new low-priced, "staggered finger" heat dissipators for high-power semiconductors. [470]

**Precision film resistors.** EMC Technology, Inc., 1133 Arch St., Philadelphia, Pa., 19107. A 16-page booklet describes newly developed precision film resistors that exhibit bulk properties. [471]

**Controlled power products.** Sorensen, a unit of Raytheon Co., Richards Ave., South Norwalk, Conn., offers a 140-page controlled power catalog and handbook. [472]

**Silicon diodes.** Computer Diode Corp., 250 Garibaldi Ave., Lodi, N.J., has published a catalog on a complete line of silicon semiconductor diodes. [473]  
Continued on page 179

# NO MORE POWER FAILURES!

Not even a flicker of  
the lights as an  
**ELECTRO-PAC "A"**  
Standby Power Supply  
maintains  
uninterrupted power  
to the load

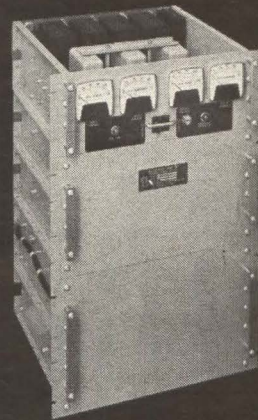

The ELECTRO-PAC "A" is more than an emergency inverter which changes a reserve power battery source to ac... it is a full-time voltage regulator, maintaining the ac line within  $\pm 5\%$  of 120 volts.

For emergency power when a few cycles interruption can be tolerated, the economical ELECTRO-PAC "B" is available... to "invert" dc to sinusoidal ac... for use with dc generators... to provide an ac source while "floating" on a battery.

ELECTRO-PAC "A" or "B" units are available for outputs of 0.5 to 5 KVA and for use with inputs of 22-28 v., 42-56 v., and 100-140 v., dc. Efficiencies up to 80%.

Write for application bulletins on standard "A" and "B" units. Complete standby power systems also available.

**ELECTRO-SEAL  
CORPORATION**

946-C North Avenue  
Des Plaines, Illinois



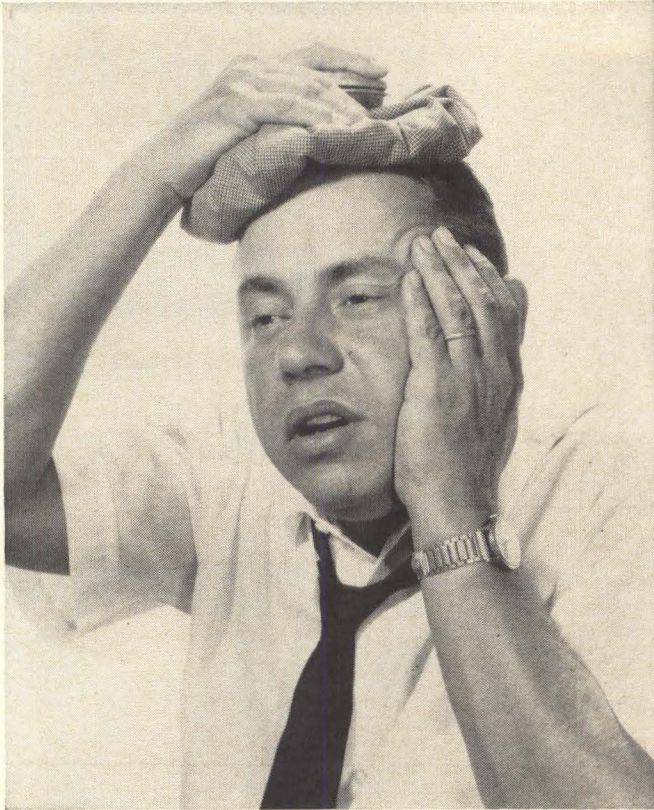

*Got A Mixer Hangover?*

**LEL's New Broadband Mixers are better for your system...**

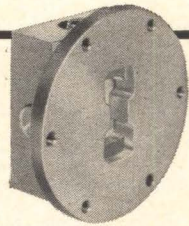

Isolation too low? Mixers too big? Bandwidths too narrow? New LEL Mixers are the perfect prescription to set your system right. LEL's multiple-octave coax and full waveguide range models cover the spectrum from 250 Mc to 18 Gc. High performance, low noise units like the LEL 12 - 18 Gc mixer come in pill-sized packages, measuring a mere 2 cu. inches. Isolation in many models is in the order of 20 - 30 db.

Chances are you're already using other LEL top quality products, so you know what to expect in terms of reliability, economy and rugged construction. Send today for full information on LEL's new mixer line.



*New...*

**LEL Catalog '64**

**FREE...send for it today!**

**LEL INC.** AKRON ST., COPIAGUE, L. I., NEW YORK 11726  
(516) AMityville 4-2200 • (516) PYramid 9-8200 • TWX Code 516-691-5085

# HEAT SINK

DELTA  
DIVISION

## LITERATURE

- Semiconductor Cooling — Theory and Practice
  - Featherweight Semiconductor Coolers
  - Radial Rectifier Coolers
  - Natural Convection Heat Sinks
  - Circuit Board Coolers
  - Forced Convection Heat Sinks
  - Forced Cooling Packaged Assemblies
  - Flat Plate Forced Cooling Assemblies
  - Thermal Joint Compound
  - Dielectric Coating

WRITE DIRECT FOR SPECIFIC LITERATURE ABOVE. On general inquiries thru this magazine, you will receive our short-form-catalog, prices and the names of our representative and your Electronic Distributor.

## WAKEFIELD ENGINEERING, INC.

139 FOUNDRY ST. / WAKEFIELD, MASS. (617) 245-5900 • TWX 617-245-9213

Circle 212 on reader service card

another  
**ROSEN PUBLIC AUCTION**

**COMPLETE TV TUBE MANUFACTURING AND REMANUFACTURING PLANT**

**VALUABLE REAL ESTATE LOCATED IN MIDDLE OF SOUTHWESTERN UNITED STATES TRADE AREA**

TO BE SOLD AT

## PUBLIC AUCTION

Pursuant to authorization of Small Business Administration we will offer these assets—  
—on the premises at—

**C. R. T. CORPORATION**  
MANSFIELD, TEXAS (18 Mi. South of Ft. Worth)

**Tues., Sept. 22, 1964, 10:00 A. M. (CST)**

OFFERED: Entirety, Units and Single Lots

**PERSONAL PROPERTY:** Complete processing equipment for remanufacture of used TV picture tubes and manufacturing of new TV picture tubes. Air compressors. Office furniture and equipment. Maintenance and shop equipment. Dock, shipping and receiving equipment.

**REAL ESTATE:** Approximately 11.9 acres of land with 558' fronting on major highway. Approximately 38,300 sq.-ft. modern industrial building includes manufacturing and warehouse areas and air conditioned office space.

FOR DETAILED INFORMATION AND FREE BROCHURE—CONTACT AUCTIONEER.



**Reprint order form**

Send me ..... complete set(s) of special reports listed below at \$2.50 per set.

Name .....

Number of street .....

City, State .....

Zip code .....

## SPECIAL OFFER

### Reprints of Special Reports from Electronics

Now, for your reference file a complete set of special reports reprinted from the pages of Electronics in the past year. 155 pages of valuable and informative articles. Each report surveys the field it covers, reporting and discussing, the latest techniques and developments. Each report is individually bound and they will be sent to you together in an attractive folder. The discount price for the complete set, which includes both handling and shipping cost is \$2.50. The following reports are included in this special offer:

Oceanography, 15 pages.

Magnetics, 24 pages.

Digital Instrumentation, 16 pages.

Modern Electronic Packaging, 16 pages.

Electronic Markets New Directions, 1963-64-67, 24 pages.

Today's Semiconductors, 24 pages.

Materials for Space Age Electronics, 16 pages.

Radio Frequency Interference, 24 pages.

Remember when you order refer to this special offer or  
[Use coupon at top of this page]

Send your order to:  
**Electronics Reprint Dept.**  
McGraw-Hill Inc.  
330 W. 42nd Street  
New York, N. Y. 10036

**Epoxy tubing.** Resdel Corp., P. O. Box 217, Rio Grande, N. J. A four-page bulletin describes the company's epoxy tubing for potting, encapsulation, insulation, and other uses. [475]

**YIG filters.** Microwave Physics Corp., 420 Kirby St., Garland, Texas 75040, has released a bulletin on its full line of octave bandwidth, electronically tuned YIG filters. [476]

**Semiconductors.** General Electric Co., Syracuse, N.Y. Applications and characteristic ratings for a line of more than 1,400 semiconductors are given in a new 40-page catalog. [477]

**Telemetry ground system.** Beckman Instruments, Inc., Systems Division, 2400 Harbor Blvd., Fullerton, Calif., has issued an 8-page brochure on the model 4400 pam/pdm telemetry ground system. [478]

**Power amplifier.** Leach Corp., 1123 Wilshire Blvd., Los Angeles 17, Calif. Bulletin TA-10664 contains technical data on the model TA-1000 solid-state, 10-watt r-f power amplifier. [479]

**Accelerometer-amplifiers.** Gulton Industries, Inc., 212 Durham Ave., Metuchen, N.J. A new series of subminiature, composite accelerometer-amplifiers are described in bulletin ASI-107. [480]

**Rotating components.** Avionic Division, John Oster Mfg. Co., One Main St., Racine, Wis. A designer's handbook describes a wide range of available synchros and some of the many possible unit variations. [481]

**Resistor catalog.** Dale Electronics, Inc., P.O. Box 488, Columbus, Neb. Catalog A is a 32-page book listing complete specifications for a full line of wire-wound and film resistors. [482]

**Ferrite memory cores.** RCA Electronic Components and Devices, 64 "A" St., Needham Heights 94, Mass. A quick-reference guide summarizes pertinent data for the company's most widely used ferrite memory cores. [483]

**Silicon transistors.** Westinghouse Semiconductor Division, Youngwood, Pa. High quality npn silicon power transistors at germanium transistor prices are described in bulletin B-7960. [484]

**Circuit board materials.** Panelyte Industrial Division of Thiokol Chemical Corp., N. Enterprise Ave., Trenton, N. J., 08604, has published a brochure on epoxy-glass, copper-clad, multi-layer circuit board materials. [485]

**Power signal sources.** Sierra Electronic Division of Philco, 3885 Bohannon Drive, Menlo Park, Calif. A bulletin describes two all-solid-state signal sources that offer a choice of 190-600 Mc and 470-1,000 Mc coverages in power outputs beginning at 50 mw. [486]



## WHERE QUALITY COMES FIRST

### MYLAR FILM CAPACITOR

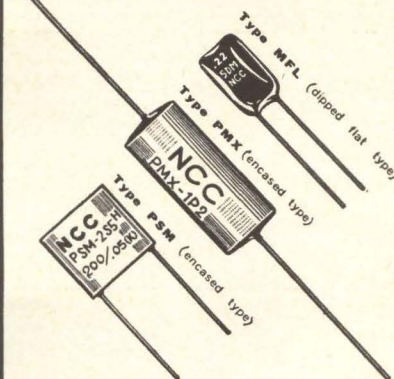

### POLYSTYREN FILM CAPACITOR

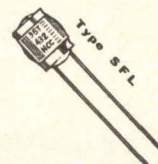

### SOLID TANTALUM CAPACITOR

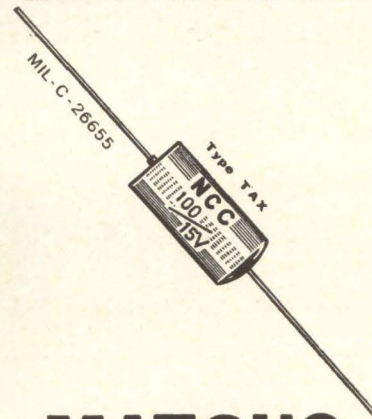

# MATSUO ELECTRIC CO., LTD.

**HEAD OFFICE :**  
3-5, 3-CHOME, SENNARI-CHO, TOYONAKA-SHI, OSAKA, JAPAN.

**TOKYO OFFICE :**  
25-2-CHOME, KANDA AWAJI-CHO, CHIYODA-KU, TOKYO, JAPAN.

**Cable Address "NCC MATSUO" OSAKA**



**Hoffman**  
NOW OFFERS  
**RFI SHIELDED**  
**ELECTRICAL ENCLOSURES\***

In compatibility packaging of electromagnetic energy, Hoffman has devised shielding that controls wanted energy while preventing escape of troublesome rogue signals. The details will interest you. Write us. Standard boxes or special boxes, with or without conduit hubs. Oil and dust-tight.  
\*Attenuation of 60-75db at 1.8-35mc

*Write for Information*



NEMA 12 Cabinets



JIC Terminal Boxes



Console Cabinets



Pushbutton Boxes

**Hoffman ENGINEERING CORPORATION**  
"has the experience"  
Dept. E-223, Anoka, Minn.

Circle 214 on reader service card

*Draw us a picture*

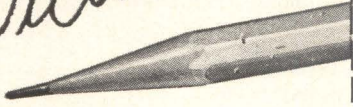
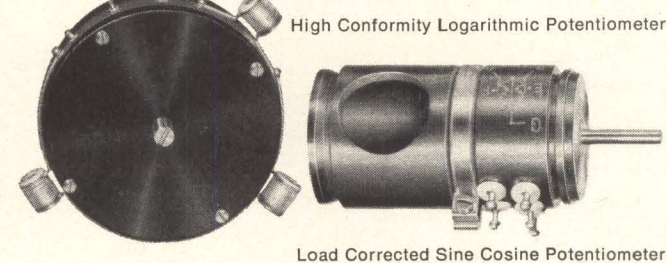
**Before the need arises . . . draw us a picture of the problem.** To produce custom potentiometers that conform most closely to the desired function, GAMEWELL has the facilities to arrive at the optimum combination of variable pitch-shunted windings, wire-size and mandrel shape.

For unrivaled skill and experience, look to GAMEWELL. Whatever the specification . . . we'll meet it. The Gamewell Company, 1609 Chestnut St., Newton, Massachusetts 02164, a Division of E. W. Bliss Company.

**GAMEWELL®**  
ELECTRONICS DIVISION

Circle 215 on reader service card

**THERMO-VANES®**

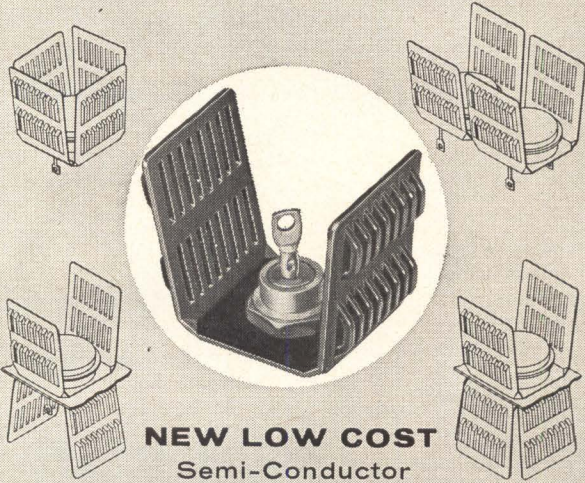

**NEW LOW COST**  
Semi-Conductor  
**HEAT DISSIPATORS**

*pat. applied for*

Thermo-Vanes dissipate semi-conductor heat by conduction, convection and radiation. They are designed for use with all low to medium power transistors in the TO-3, TO-36 (and other) configurations. Their unique modular construction permits multiple use to match the total heat dissipation to the power of the semi-conductor used.

Send for prototype samples and free Dissipator Selection Chart.

**Staver** THE **Staver** COMPANY, INC.  
47-55 N. Saxon Ave. • Bay Shore, L. I., N.Y.

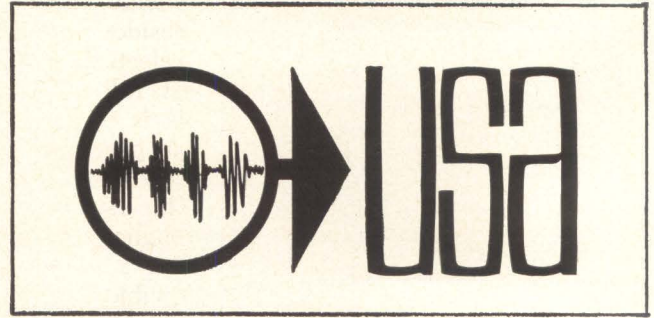

**See Us At**  
**The United States Exhibition**  
**Stockholm Technical Fair**  
**Area 540**  
**October 2-9, 1964**  
**Stockholm, Sweden**  
**A Trade Expansion Activity**  
**United States Department Of Commerce**

## New Books

### Useful tables

Elphyma Tables. Compiled by Erik Ingelstam and Stig Sjöberg. John Wiley & Sons, Inc., New York, 1964, 100 pp., \$3.50

Translated and imported from Sweden, this small volume packs an amazing amount of useful reference information, including logarithms, roots and powers, mathematical formulas, basic information from mechanics, physics, optics, radio and electricity and circuit nomograms.

The information is ingeniously arranged and appears to be much easier to locate quickly than in other reference books. One of the chief merits of the book is its compactness, in contrast to the bulky reference volumes usually found on engineers' shelves.

The information contained is entirely up-to-date; for instance, the omega-minus hyperon particle, discovered in February, 1964, is included in the table of subatomic particles. The authors were obviously conscious of the various systems of measurement in use throughout the world, so that English cgs, mks and metric figures are found with almost equal ease.

George V. Novotny  
Advanced Technology Editor

### Space electronics

Ion Propulsion for Space Flight. Ernst Stuhlinger. McGraw-Hill, Inc., New York, 1964 373 pp., \$17.50.

Dr. Stuhlinger's book meets the reader's expectations of a work by one of the foremost authorities in the new field of electric propulsion. Its coverage of the subject is thorough without being excessively wordy; with historical background, proceeds through the analytics of operation and concludes with future applications.

The text strikes a balance between mathematical development and descriptive material. Certainly it fills a need in the available literature. For the engineer involved in this field, it will serve as a ready reference; for the person entering this field, the book provides the breadth necessary for an under-

standing of ion propulsion and its applications; and for one having a passing interest, selective readings give a basic appreciation of the subject.

Of particular interest to engineers in general should be the sections discussing the systems aspects of ion propulsions and describing exemplary space missions for ion engine systems. In the systems discussion, Stuhlinger does indeed point up the areas needing further development; in the description of space missions he presents a clear picture of the future roles of this new technology.

It is a credit to the author's objectivity that he makes no attempt to promote or advocate the actual use of ion propulsion space flights, which would involve vast effort and expenditure. One statement, in the closing chapters, stands out: "No attempt has been made here to offer reasons for the desirability of space missions. It is assumed that flight into space is desirable, and that it should be undertaken as soon as the necessary technology is available."

Besides ion propulsion, the type of electric propulsion described most fully is photon propulsion. This is unusual, because plasma-type propulsion has been more widely publicized.

The use of numerical examples throughout the text is valuable in giving a practical appreciation of the subject. The presentation on the flight mechanics of ion-propulsion spacecraft covers the engineering formulations of the more important cases with a sufficient amount of analytical treatment. Solutions are given to a wide variety of pertinent problems that concern the propulsion specialist.

The author's style is extremely readable. However, the reader must be prepared to participate in order to follow the analytical developments presented. Each section contains a rather complete bibliography; however, many of the referenced papers are not readily available in the open literature.

Lawrence E. Golden  
and T. Todd Reboul  
Radio Corp. of America

Here's how Atlee

spells **RELIABILITY**

## BERYLLIUM COPPER COMPONENT HOLDERS

**NOW AT NEW  
LOW PRICES**

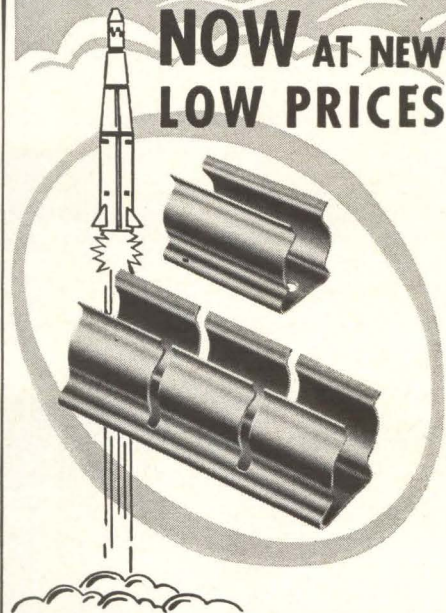

To even the most critical component mounting problems, Atlee's 100-300\* series Component Holders bring the added assurance of **functional superiority**. When checked against holders made of conventional materials **Beryllium Copper Component Holders** are . . . **always superior . . . superior all ways.**

- ✓ Tensile Strength
- ✓ Electrical Conductivity
- ✓ Thermal Conductivity
- ✓ Corrosion Resistance
- ✓ Wear Resistance

Atlee component holders and clips are ideal for mounting capacitors, resistors, relays, wires, cables, tubing and related components against shock and vibration; accommodating component diameters from .175" to 3.00". Atlee's **contour design** automatically increases holding power as environmental stress increases.

**Finishes Available:** Cadmium Dichromate, Silver Dalcoat, Silver, Nickel, Black Matte, Hot Tin Dip, Electro Tin, Dalcoat B (a dielectric), and Natural.

For further information, contact our Engineering Department or request our Application Data Sheet.

\*Beryllium Copper

**atlee corporation**



2 LOWELL AVE. WINCHESTER, MASS

## Technical Abstracts

### Adaptive memories

A magnetic variable-gain components for large adaptive networks.\*  
J.B. Angell and R.C. Woodbury,  
Solid State Electronics Laboratory,  
Stanford University, Stanford, Calif.

Large-capacity, trainable systems require large numbers of adaptive (variable-gain-with-memory) elements. The total cost of such elements is exorbitant unless an economical, integrated-device technique can be used. In addition, the cost of switching circuitry is high if the adaptive elements must be switched individually for the training and readout cycles. This paper describes a new device that holds promise of easing these difficulties.

One method of alleviating the problem of individual component switching, previously devised by H. S. Crafts, depends on a switching-field threshold in the device. Crafts found this characteristic exhibited by his two-core magnetic adaptive component, which was developed several years ago. The square-loop cores are driven with a sinusoidal current that results in a second-harmonic output proportional to the remanent state.

Adaption or change of the remanent state will not occur unless the sinusoidal driving field is present in addition to an appropriately chosen d-c field. This adaption constitutes the threshold characteristic, and it enabled Mr. Crafts to devise a coincident selection scheme that would eliminate much of the switching circuitry.

Certain ferromagnetic-tape cores, sinusoidally driven in the longitudinal direction, possess a second harmonic in the flux response by virtue of certain nonlinear properties of residual domains. A more direct way of producing a second harmonic proportional to remanence is to apply the a-c field at right angles to the magnetization and sense directions. One method of accomplishing this is to pass alternating current along the magnetic material itself. This technique is employed by the device described.

The experimental structure consists of a two-tape sandwich that

has been sectioned into separate components with spot-welded seams and squares at equal intervals along the running direction of the tape. Only one conductor passes through each section, and it serves to carry both the sense and adaption signals. This same conductor passes through all other tapes if an array is used. As stated above, the a-c drive signal flows along the tape itself. It is believed that this structure can be integrated in such a way as to bring about a large reduction in cost per component.

### Photoelectric array

A microelectronic reading aid for the blind.\* J.G. Linvill,  
Solid State Electronics Laboratory,  
Stanford University, Stanford, Calif.

A blind person can, with his fingertips, "read" a dynamically embossed version of printed material viewed by a photoelectric device coupled to an electromechanical device.

The photoelectric part includes a rectangular array of photoconductors on which the image of a part of a page is focused. The electromechanical part consists of an array of piezoelectric reeds having a one-to-one correspondence to the photoconductors.

The reeds corresponding to the dark cells vibrate in flexure; those corresponding to the lighted cells do not. The tips of vibrating reeds are sensed by the reader's finger. Thus he obtains a dynamically embossed version of the printed material.

A primitive version of the device was constructed, using a 7/8-by-1 1/8-inch array of photoconductors connected to an array of piezoelectric reeds. This version provided an embossed form of characters presented to it.

Subsequently, a more precise piezoelectric-reed array of 96 elements was made and connected to a computer that Dr. James Bliss and his colleagues at the Stanford Research Institute (SRI) can use to simulate the printed material and photoelectric sensing part of the

reader. A blind subject has read the embossed output of Roman capital letters at more than 25 words a minute.

### Gambling Adaline

Bootstrap learning.\* B. Widrow,  
Solid State Electronics Laboratory,  
Stanford University, Stanford, Calif.

Adaptive logic elements (Adalines) are usually trained to respond to pattern inputs by supplying both input patterns and the associated desired binary response (decisions). This procedure involves learning with a teacher.

Often the desired responses to specific input patterns are not supplied, but the quality of performance based on a series or combination of decisions is known. If response quality is better than average, adaption can be effected by assuming that actual responses are the true desired responses. On the other hand, if performance quality is low, the active process will take the desired responses to be opposite to the actual responses. This is learning with a critic. Deriving the desired responses from the actual responses will be called "bootstrap adaption."

These principles have been applied to the game of blackjack, or 21. A single Adaline can learn to play with close to optimal strategy after several hundred games, without being told how to play or what the object of play is. When the Adaline player wins, it is adapted assuming that the decisions made were optimal. When the Adaline loses, the responses are assumed to have been the worst possible. The pattern and responses from the previous game are stored for adaption purposes pending the outcome of the game.

Bootstrap adaption requires the critic or performance evaluator to have much less knowledge than that required of the teacher during the more conventional training processes. Adaptation is not always effected in the correct direction.

Bootstrap adaption may be applicable to a variety of situations.

\*Presented at the Stanford Electronics Laboratories annual Contractor's Meeting, August 18, 19, Stanford, Calif.



# Find the manufacturer... Fast!

It's just a matter of seconds to get the valuable information you need about electronic manufacturers and suppliers in the Electronics Buyers' Guide. The EBG has over 200 pages listing the names, addresses, phone numbers and key individuals of manufacturers of electronics equipment, related components and materials. All this plus vital company statistics. At a glance you know important facts about the company, exactly what each company makes, and where to find the manufacturers' representatives in your area. No wonder the EBG is the industry's standard catalog-directory!

## **Electronics Buyers' Guide**

A McGraw-Hill Publication

330 West 42nd Street, New York, N. Y. 10036

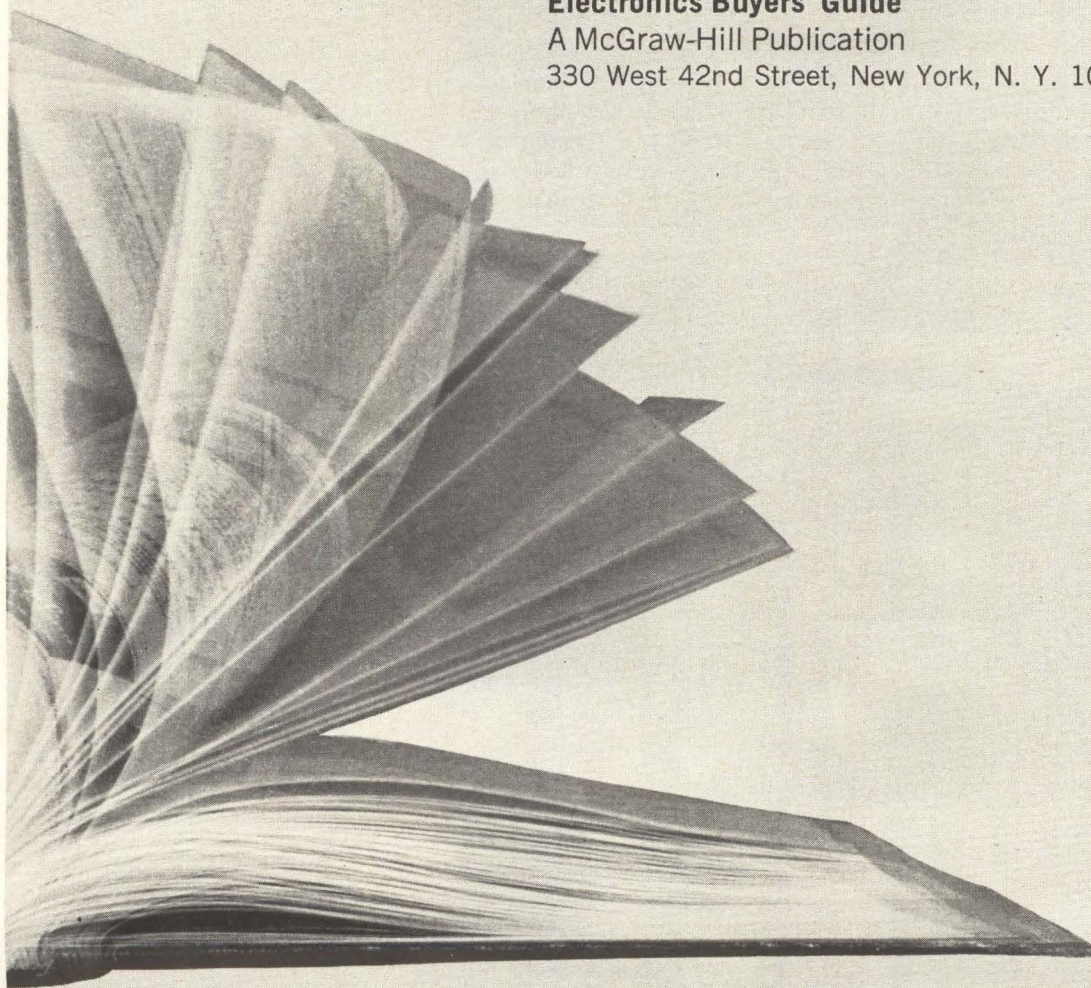

# SEARCHLIGHT SECTION

(Classified Advertising)

BUSINESS OPPORTUNITIES

EQUIPMENT-USED or RESALE

STEPPING SWITCHES  
SENSITROLS  
STRUTHERS  
DUNN  
ROTARY RACHET  
ALLIED  
LEDEX  
CLARE  
LEACH  
MINIA  
SIGMA  
NORTH  
ELECTRIC  
DORMEYER  
TELEPHONE TYPE  
KURMAN  
STEVENS  
ARNOLD  
CONTACT  
MERCURY  
SOLENOIDS  
ADVANCE  
ALLEN  
POTTER  
BRUMFIELD

SIGMA HERMETICALLY SEALED  
WARD LEONARD  
AUTOMATIC  
ELECTRIC  
LEACH  
CLARE  
EVENS  
NOLD  
ANCE  
ALLIED  
CRAFT  
LEDEX  
KEYING  
PHILLIPS  
CONTROLS  
AMPERITE  
WESTERN  
ELECTRIC  
CUTLER  
HAMMER  
GENERAL  
ELECTRIC  
GUARDIAN  
CONTACTORS  
PRICE  
ELECTRIC  
WESTON  
MINIATURE AIRCRAFT

**LARGEST STOCK OF RELAYS IN THE WORLD**

PRODUCTION QUANTITIES  
MOST MAKES IN STOCK

Send for Latest Catalog

**Universal RELAY CORP.**

42 WHITE ST. NEW YORK 13, N. Y. Walker 5-6900  
CIRCLE 950 ON READER SERVICE CARD

**V-I-S\* SERVICE**

FASTEST TO BOTH COASTS



FOR YOUR VERY IMPORTANT SHIPMENTS

2nd DAY between Chicago—Milwaukee and Eastern Terminals  
4th DAY between Chicago—Milwaukee and West Coast.

**LIFSCHULTZ FAST FREIGHT**

NEW YORK — CHICAGO — PHILADELPHIA — BOSTON  
HOLYOKE — BALTIMORE — BLOOMFIELD, N. J.  
NEW HAVEN — PROVIDENCE — MILWAUKEE  
LOS ANGELES — SAN FRANCISCO

CIRCLE 951 ON READER SERVICE CARD

**free catalog**  
POTTING APPLICATORS  
MANUAL AND DISPOSABLE

6cc 12cc 30cc  
FOR POTTING, ENCAPSULATING, AND SEALING OF MINIATURE COMPONENTS

PHILIP FISHMAN COMPANY  
7 CAMERON ST., WELLESLEY 81, MASSACHUSETTS

CIRCLE 952 ON READER SERVICE CARD

**FOR SALE**  
**(2) USED COMPUTERS**

- (1) UNIVAC SOLID STATE, SS-80. Used 1 year. Excellent.
- (1) BURROUGHS—220, new 1961. Complete installation. Excellent.

Do YOU have a computer for sale?

Murray Grainger  
CAPITAL EQUIPMENT  
40 WALNUT ST., NEWARK 2, NEW JERSEY  
(201) 622-5222

CIRCLE 953 ON READER SERVICE CARD

TUBES & COMPONENT  
**FREE...CATALOG**  
**BARRY ELECTRONICS**

512 BROADWAY 212-Walker 5-7000  
NEW YORK 12, N.Y. TWX-571-0484

CIRCLE 954 ON READER SERVICE CARD

**SMALL AD but BIG STOCK**

of choice test equipment and surplus electronics  
Higher Quality—Lower Costs  
Get our advice on your problem

ENGINEERING ASSOCIATES  
434 Patterson Road — Dayton 19, Ohio

CIRCLE 955 ON READER SERVICE CARD

RADAR AUTO-TRACK & TELEMETRY ANTENNA PEDESTALS  
3 & 10 CM. SCR 584 AUTOTRACK RADARS. M-33 RADAR  
TPS-1D SEARCH. APS-45 TPS-10D HT. FINDERS. WX RADARS.  
FPN-32GCA. APS-10 APS-15B APS-27 (AMT) SEARCH. ■ ■ ■  
APN-102 DOPPLER. DOZENS MORE. CARCINOTRONS. PFN'S.  
.25-.5-1-2-3-6 MEGAWATT PULSE MODULATORS. CAVITIES.  
PULSE TRANSFORMERS. IF STRIPS. WAVEGUIDE. BENDS  
200 MC. 1 KMC. 3 KMC. 6 KMC. 9 KMC. 24 KMC. RF PKGS.

**RADIO RESEARCH INSTRUMENT CO.**  
550 5TH AVE., NEW YORK 36, N. Y. JU 6-4691

CIRCLE 956 ON READER SERVICE CARD

**OPTICAL BENCHES**  
\$13. to \$13,000. New Catalog

**THE Ealing CORP.**

2250 Massachusetts Avenue, Cambridge, Mass., 02140

CIRCLE 957 ON READER SERVICE CARD

**ELECTRON TUBES**

KLYSTRONS • ATR & TR • MAGNETRONS  
SUBMINIATURES • C.R.T. • T.W.T. • 5000-  
6000 SERIES

• SEND FOR NEW CATALOG A2 •  
A & A ELECTRONICS CORP.  
1063 PERRY ANNEX  
WHITTIER, CALIF.  
AN 92865 OR 696-7544

CIRCLE 958 ON READER SERVICE CARD

WRITE FOR NEW **KEYSTONE free catalog**

**BATTERY HOLDERS, TERMINALS, TERMINAL BOARDS & HARDWARE**

KEYSTONE ELECTRONICS CORP.  
49 BLEECKER ST., NEW YORK 12, N. Y.

CIRCLE 959 ON READER SERVICE CARD

**Somebody—Somewhere**

needs your idle equipment! Reach that buyer quickly and economically thru the

**"SEARCHLIGHT SECTION"**

The meeting place of Used Equipment Buyers and Sellers



The Advertisements in this section include all employment opportunities—executive, management, technical, selling, office, skilled, manual, etc. Look in the forward section of the magazine for additional Employment Opportunities advertising.

Positions Vacant Civil Service Opportunities  
Positions Wanted Selling Opportunities Wanted  
Part Time Work Selling Opportunities Offered  
Employment Agencies  
Employment Services  
Labor Bureaus

**- RATES -**

**DISPLAYED:** The advertising rate is \$52.00 per inch for all advertising appearing on other than a contract basis. Contract rates quoted on request. An advertising inch is measured 7/8" vertically on a column—3 columns—30 inches to a page.

**Subject to Agency Commission.**  
**UNDISPLAYED:** \$2.70 per line, minimum 3 lines. To figure advance payment count 5 average words as a line.

Box numbers—count as 1 line.  
Discount of 10% if full payment is made in advance for 4 consecutive insertions.  
Not subject to Agency Commission.



**E. E.'s**  
for FEE-PAID Positions  
**WRITE US FIRST!**

Use our confidential application for professional, individualized service... a complete national technical employment agency.  
**ATOMIC PERSONNEL, INC.**  
Suite 1207L, 1518 Walnut St., Phila. 2, Pa.

ADDRESS BOX NO. REPLIES TO: Box No. Classified Adv. Div. of this publication. Send to office nearest you.

NEW YORK 10036: P. O. Box 12  
CHICAGO 60611: 645 N. Michigan Ave.  
SAN FRANCISCO 94111: 255 California St.

**POSITIONS VACANT**

**Chief Engineer—Broadcast and CCTV.** Truly a one-time opportunity for the managing design engineer to take over the Engineering Division of an already successful corporation still growing by leaps. The man that will dare in design but pride in thoroughness will find his life's career waiting for him. Must have video design experience with cameras and associated equipment. Mid-Atlantic coast location. B.S.E.E. required plus management training. Age 35-45. Send resume and photo to P-4968, Electronics.

**Electronic and Electro/Mechanical Technicians, designers, checkers, draftsmen and detailers—Work for leading firm of licensed professional Engineers.** Write to United Engineers, 150 Causeway Street, Boston 14, Mass.

"Put Yourself in the Other Fellow's Place"

**TO EMPLOYERS**

**TO EMPLOYEES**

Letters written offering Employment or applying for same are written with the hope of satisfying a current need. An answer, regardless of whether it is favorable or not, is usually expected.

**MR. EMPLOYER,** won't you remove the mystery about the status of an employee's application by acknowledging all applicants and not just the promising candidates.

**MR. EMPLOYEE** you, too, can help by acknowledging applications and job offers. This would encourage more companies to answer position wanted ads in this section. We make this suggestion in a spirit of helpful cooperation between employers and employees.

This section will be the more useful to all as a result of this consideration.

Classified Advertising Division

**McGRAW-HILL, Inc.**

330 West 42nd St., New York, N. Y. 10036

# Electronics advertisers

September 7, 1964



■ AMP Inc. 115	Hansen Mfg. Co. Inc. 176	■ Primo Co., Ltd. 168
Garceau, Hargrave & McCullough Inc. 159	Keller-Crescent Co. 55	General Adv. Agency
Aerojet General D'Arcy Adv. Co. 41	Heinemann Electric Co. Thomas R. Sundheim Inc. 119	■ Radiation Inc. 147
Airpax Electronics, Inc. Welch, Mirabile & Co., Inc. 170	Hengstler Numerics Josephson, Cuffari & Company L.C. Cole Company Inc. 2, 49, 50	G.M. Basford Company 4th cover
Alco Electronic Products, Inc. Marketronics Adv. 44	■ Hewlett Packard Co. Hitachi Ltd. 51	Radio Corporation of America Al Paul Lefton Co.
Allen Organ Company N.W. Ayer & Son Inc. 176	Dentsu Advertising Ltd. Hoffman Engineering Corporation The Erle Savage Company 180	■ Raytheon Company Fuller & Smith & Ross Inc. 167
Allied Radio Corp. George Brodsky Adv. Inc. 21	Honeywell Precision Meter Division Batten, Barton, Durstine & Osborn Inc. 32	Rosen Associates, Inc., Ralph Don May Advertising
Amplex Corp. Cunningham & Walsh Inc. 153	■ Hughes Aircraft Company Foote, Cone & Belding 142, 163	■ Rotron Mfg. Co. Lescarboursa Advertising Inc. 164
Ansco, A Div. of General Aniline & Film Corp. Hazard Advertising Company Inc. 181	■ ITT—Wire and Cable Division West, Weir & Bartel, Inc. 110	Sanders Associates Chirung & Cairns, Inc. 176
Atlee Corporation Gunnar Myrbeck & Company 171	International Electronic Industries Buti-Roberts Advertising 56	Sangamo Electric Company Winuius-Brandon Company 134
■ Ballantine Laboratories Lang-Lawrence Adv. Inc. 143	Interstate Electronics Jones, Maher, Roberts Adv. 140	■ Sinner Company, Metrics Div. Solitron Devices, Inc. 28, 29, 33 160
Bausch & Lomb, Inc. Wolff Associates, Inc. 45	■ JFD Electronics Corporation Michel Cather Inc. 39	■ Sornsen Fuller & Smith & Ross Inc. 137
■ Bourns Inc. Allen, Dorsey & Hatfield Inc. 158	■ Jennings Radio Mfg. Corp. L.H. Waldron 186	Space Craft Inc. Preiss and Brown Adv. Inc. 152
Bristol Co., The Chirurg & Cairns, Inc. 16	Jerrold Corp. Irving Gould Adv. Inc. 120	Sprague Electric Co. The Harry P. Bridge Co. 5, 6
■ Brush Instruments, Div. of Clevite Carr Liggett Adv., Inc. 3rd cover, 22	Kay Electric Company Josephson, Cuffari & Co. 146	Stackpole Carbon Co. Meek and Thomas, Inc. 109
Burr-Brown Research Corp. N.A. Winter Adv. 168	Keithley Instruments Inc. Bayless-Kerr Company 24	Staver Co., The Lewis Advertising Agency 180
■ Bussmann Mfg. Co., Div. of McGraw Edison Co. 172, 173	Kyoto Ceramics Co. Ltd. International Ad Service, Inc. 166	Stromberg-Carlson Div. of General Dynamics The Rumrill Company Inc. 166
■ Chatham Electronics, Div. of Tung-Sol Electric Inc. E.M. Freystadt Associates Inc. 46	■ Lambda Electronics Corp. Michel Cather, Inc. 25	Struthers-Dunn, Inc. The Harry P. Bridge Co. 148
■ Clairex Corp. S. Paul Sims Co. 162	■ Leach Corp. Hixson & Jorgensen, Inc. 178	Tektronix Inc. Hugh Dwight Adv. Inc. 132
Clare & Company, C.P. Reincke, Meyer & Finn Adv. 122, 123-130	LEL, Incorporated Snow & Dewep Advertising 12, 13	Telonic Engineering Co. Jansen Associates 145
■ Clifton Precision Products Div. of Litton Industries Ivey Adv. Inc. 43	Lina-Temco-Vought Wyatt, Allen & Ryan Inc. 8	Texas Instruments Incorporated Industrial Products Group Robinson-Gerrard, Inc. 138, 139
Consolidated Electrodynamics Corp. Hixson & Jorgensen, Inc. 9	■ Machlett Laboratories Inc., The Fuller & Smith & Ross Inc. 11	Thermalloy Company Sam Bloom Advertising Agency 150
Defense Electronics Inc. Compton Jones Associates 10	■ Mallory & Co. Inc. P.R. The Aitkin-Kynett Co. 156	Tower Manufacturing Corp. Goldsmith Tregar Co. 166
Di-Acro Corp. Charles E. Brown Adv. 57, 155	Markem Machine Culver Adv. Inc. 179	■ Toyo Electronics Ind., Corp. Dentsu Advertising 160
■ DuPont de Nemours & Co. Inc., E.I. Batten, Barton, Durstine & Osborn Inc. 1	Massa Division of Cohu Electronics Inc. L.K. Frank Co. Inc. 52	Union Carbide Corporation William Esty Co. 107
■ Dymec Div. of Hewlett Packard Co. L.C. Cole Company Inc. 19-30	Matsuo Electric Co., Ltd. Asahi Advertising Agency & Co. 169	U.S. Stoneware Ralph Gross Adv. Inc. 152
EIME—Electronic Instrument Manufacturers Exhibit Electro Scientific Industries Inc. Nadler and Larimer Inc. 177	■ Micro Switch Div. of Honeywell Batten, Barton, Durstine & Osborn Inc. 136	Vidar Corp. Bonfield Associates, Inc. 151
Electro-Seal Corporation Merchandising Advertisers, Inc. 31	Microwave Physics Corp. L.T. Merrill Marketing 136	Wakefield Engineering Inc. Sales Promotion Services 178
■ FXR—Division of Amphenol Borg Marsteller Inc. 54	Milo Electronics Corp. Industrial Marketing Associates Div. of J.M. Schrier, Inc. 133	Wayne Kerr Corp. Marsteller, Inc. 141
Fairchild Dumont Laboratories The Roger and Wilbur Co. Inc. 7	Minnesota Mining & Mfg. Co. Mincom Division Reach, McClinton & Co., Inc. 162	Westinghouse Electric Corp. Ketchum, MacLeod & Grove Inc. 175
Flying Tiger Line Hixson & Jorgensen, Inc. 58	■ Mitsubishi Electric Corp. Sun Gain Shia, Ltd. 34	White, S.S. W.L. Towne Co. Inc. 144
Formica Corp. Perry-Brown Inc. 26	Multicore Sales Corp. Div. of British Industries Corp. Irving Greene Advertising 118	Classified advertising F.J. Eberle, Business Mgr. [212]-971-2557 184
Gamewell Company, The Chirurg & Cairns, Inc. 108	Non-Linear Systems, Inc. Barnes Chase Advertising 53	Employment Opportunities Equipment (Used or Surplus New) For Sale 184
Garrett Corp. AiResearch Mfg. Div. J. Walter Thompson Co. 170	North Atlantic Industries, Inc. Murray Heyert Associates 53	Classified advertisers index A & A Electronics Corp. 184
■ General Electric Company Lamp Metals & Components Batten, Barton, Durstine & Osborn Inc. 14	■ Ohmite Mfg. Co. The Fensholt Adv. Agency 116, 117	Atomic Personnel Inc. 184
■ General Electric Tube Department Doe-Anderson Advertising, Inc. 23	Pacific Electro Magnetics Co. Inc. Sturges and Associates 174	Barry Electronics 184
General Radio Co. K.E. Morang Co. 2nd cover, 23	Paktron, Div. Illinois Tool Works Inc. Raymond E. Finn & Associates Inc. 174	Capital Equipment 184
■ Globe Industries Inc. Odiorme Industrial Adv. Inc. 149	Pamotor, Inc. Harry P. Bridge Co. 27	Ealing Corporation, The Engineering Associates 184
Hallikainen Instruments Hal Lawrence Incorporated 165	■ Philbrick Researches, Inc. George A. Stanley R. Tippett and Associates 170	Fishman Co., Philip 184
Hamilton Standard, Div. of United Aircraft Corporation Cunningham & Walsh Inc. 170	Presin Company, Inc. Ted Sommers, Inc., Advertising 184	Keystone Electronics Corp. Lifschultz Fast Freight 184
		Radio Research Instrument Co. 184
		Universal Relay Corp. 184

■ For more information on complete product line see advertisement in the latest Electronics Buyers' Guide

Executive, editorial, circulation and advertising offices: McGraw-Hill Building, 330 West 42nd Street, New York, N.Y., 10036. Telephone Area Code 212-971-3333. Teletype TWX N.Y. 212-640-4646. Cable: McGrawhill, N.Y. Officers of the Publications Division: Shelton Fisher, President; Vice Presidents: Joseph H. Allen, Operations; Robert F. Boger, Administration; John R. Callahan, Editorial; Ervin E. DeGraf, Circulation; Donald C. McGraw, Jr., Advertising Sales; Angelo R. Venezian, Marketing. Officers of the Corporation: Donald C. McGraw, President; Hugh J. Kelly, Harry L. Waddell, L. Keith Goodrich, Executive Vice Presidents; John L. McGraw, Treasurer; John J. Cooke, Vice President and Secretary. Title R registered U.S. Patent Office; © copyright 1964 by McGraw-Hill, Inc. All rights reserved, including the right to reproduce the contents of this publication, in whole or in part.

# LIGHTWEIGHT CHAMPION OF THE T-R RELAYS

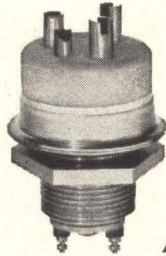

Actual Size

**TYPE RJ1A**  
**2KV PK (16 MC)**  
**7 AMPS RMS (16 MC)**  
**1<sup>3</sup>/<sub>16</sub>" LONG**  
**ONE OZ.**

Ounce for ounce the RJ1A controls more power than any other relay in the world. It will handle 2 KW average power into a 50 ohm load at VSWR 1:1 at 2 to 32 megacycles. And since it was designed for high volume production it offers the utmost economy.

The high strength vacuum dielectric guarantees a tremendous internal overvoltage safety factor — more than double the rated peak test voltage. Resistance is low (.010 ohms) and remains low and stable for the life of the relay.

The RJ1A is ideally suited for such applications as airborne, mobile, or marine communications systems for switching between antennas, antenna couplers or transmitters, or between transmitters and receivers. In sonar equipment they are being used as long life relays to switch 25 amp, 100 milliseconds pulses to transducers.

For higher power applications Jennings offers a complete line of vacuum transfer relays not much larger than the RJ1A. These relays are available in peak test voltages up to 38 KV Peak and continuous current ratings up to 75 amps RMS.

*Write for more detailed information on the RJ1A and Jennings complete line of vacuum transfer relays.*

**RELIABILITY MEANS VACUUM | VACUUM MEANS**

**Jennings**

JENNINGS RADIO MFG. CORP., 970 McLAUGHLIN AVE., SAN JOSE 8, CALIF., PHONE CYpress 2-4025



## Advertising sales staff

**Gordon Jones:** [212] 971-2210  
Advertising sales manager

**Atlanta, Ga. 30309:** Gus H. Krimsier,  
Michael H. Miller, 1375 Peachtree St. N.E.,  
[404] TR 5-0523

**Boston, Mass. 02116:** William S. Hodgkinson,  
McGraw-Hill Building, Copley Square,  
[617] CO 2-1160

**Chicago, Ill. 60611:** Robert M. Denmead,  
Daniel E. Shea, Jr., 645 North Michigan  
Avenue, [312] MO 4-5800

**Cleveland, Ohio 44113:** Paul T. Fegley, 55  
Public Square, [216] SU 1-7000

**Dallas, Texas 75201:** Dick Poole, The  
Vaughn Building, 1712 Commerce Street,  
[214] RI 7-9721

**Denver, Colo. 80202:** John W. Patten, David  
M. Watson, Tower Bldg., 1700 Broadway,  
[303] AL 5-2981

**Houston, Texas 77025:** Kenneth George,  
Prudential Bldg., Halcombe Blvd.,  
[713] RI 8-1280

**Los Angeles, Calif. 90017:** Ashley P.  
Hartman, John G. Zisch, 1125 W. 6th St.,  
[213] HU 2-5450

**New York, N.Y. 10036:**  
Donald R. Furth [212] 971-3616  
Frank LeBeau [212] 971-3615  
George F. Werner [212] 971-3617  
500 Fifth Avenue

**Philadelphia, Pa. 19103:** William J. Boyle,  
Warren H. Gardner, 6 Penn Center Plaza,  
[215] LO 8-6161

**San Francisco, Calif. 94111:**  
James T. Hauptli, 255 California Street,  
[415] DO 2-4600

**London W1:** Edward E. Schirmer, 34 Dover  
Street, Hyde Park 1451

**Frankfurt/Main:** Matthee Herfurth, 85  
Westendstrasse Phone: 77 26 65 and  
77 30 59

**Geneva:** Michael R. Zeynel,  
2 Place du Port 244275

**Paris VIII:** Denis Jacob, 17 Avenue  
Matignon ALMA-0452

**Tokyo:** Shigeo Chiba, 1, Kotohiracho,  
Shiba, Minato-ku (502) 0656

**Osaka:** Kazutaka Miura, 163, Umegae-cho,  
Kilta-ku [362] 8771

**Nagoya:** International Media Representa-  
tives, Yamagishi Bldg., 13.2-Chome,  
Oike-cho Naga-ku

**R.S. Quint:** [212] 971-2335  
General manager  
Electronics Buyers' Guide

**David M. Tempest:** [212] 971-3139  
Promotion manager

**Milton Drake:** [212] 971-3485  
Market research manager

**Richard J. Tomlinson:** [212] 971-3191  
Business manager

**Theodore R. Geipel:** [212] 971-2044  
Production manager

Signal on  
conventional channel width  
40mm

Identical signal  
on Mark 280 channel width  
80mm

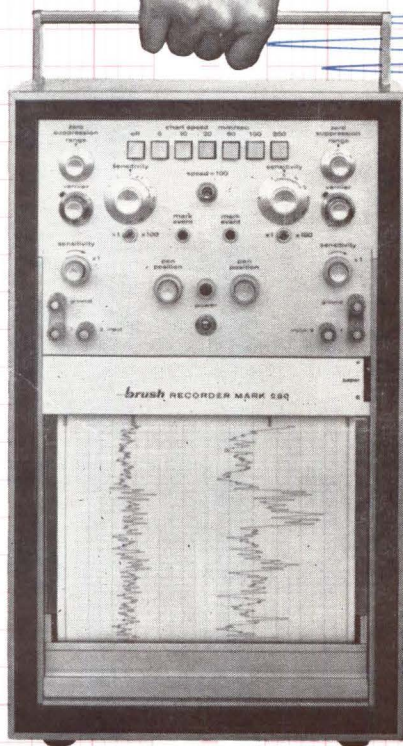

**New!**  
**Brush Mark 280**  
**suppresses**  
**up to**  
**400 times**  
**full scale**

...and it has a dynamic response up to 200 cps, at usable amplitude. Forced fluid writing also presents traces at better than 30 cps. full scale. *With true zero suppression you can look at 1 division out of 20,000.* Dual channels each have 50 divisions in an 80 mm width, with trace width constant at one-tenth of a chart division. In effect, resolution is doubled! And, it's all done with a system accuracy of 1/2%. Matched solid-state amplifiers provide a sensitivity of 0.5 millivolts/div. Couple all of this with perfect rectilinear traces . . . so uniform and crisp that you cannot misjudge what you see . . . and you'll understand why no other recorder can match the total capability of the

**brush** INSTRUMENTS

DIVISION OF CLEVITE 37TH AND PERKINS, CLEVELAND 14, OHIO

Circle 901 on reader service card



## How "Computerized Testing"

# helps assure the reliability of RCA Receiving Tubes

This engineer is studying final test results of another production run of RCA Receiving Tubes. Nothing surprising here . . . except for one thing: the production run had been completed only hours before!

A few years ago, a thorough quality evaluation of a day's production run of a certain tube type took days, even weeks. But now, at RCA, it's done automatically, with computers, the same day.

Computers in conjunction with the Special Tube Analyzing Recorder (STAR) accumulate and store test data on every receiving tube type we make.

Sample tubes from the production lot are individually analyzed on STAR. As many as 60 tests may be made quickly and automatically on each tube depending on the type. Test

results are recorded simultaneously on a test sheet and on punched cards. The computers compare the results with predetermined standards, make "accept" or "reject" decisions and then add the results to the historical record of the tube type.

Thus, in a mere half-hour of running time each night, a full day's receiving-tube output can be evaluated before it is released for shipment. Equally important, the test data for any day's production of a particular tube type together with the historical record for that tube type are on the desks of the production, qual-

ity-control and design engineers the following morning. With these data, the engineers can evaluate performance, analyze trends and quickly initiate any corrective measures necessary to assure the consistent quality of RCA Receiving Tubes.

"Computerized testing" is one more reason why you should specify RCA Receiving Tubes for all your requirements. For technical information on specific types, call your nearest RCA District Office or write Commercial Engineering, Section I19DE-1, RCA Electronic Components and Devices, Harrison, N. J.

**RCA Electronic Components and Devices, Harrison, N. J.**



**The Most Trusted Name in Electronics**