

Electronics®

Designing micropower amplifiers: page 73

A military answer to interference: page 79

Redundant circuitry for safer aircraft: page 85

May 18, 1964

75 cents

A McGraw-Hill Publication

Below: New hybrid analog-digital computer, page 57

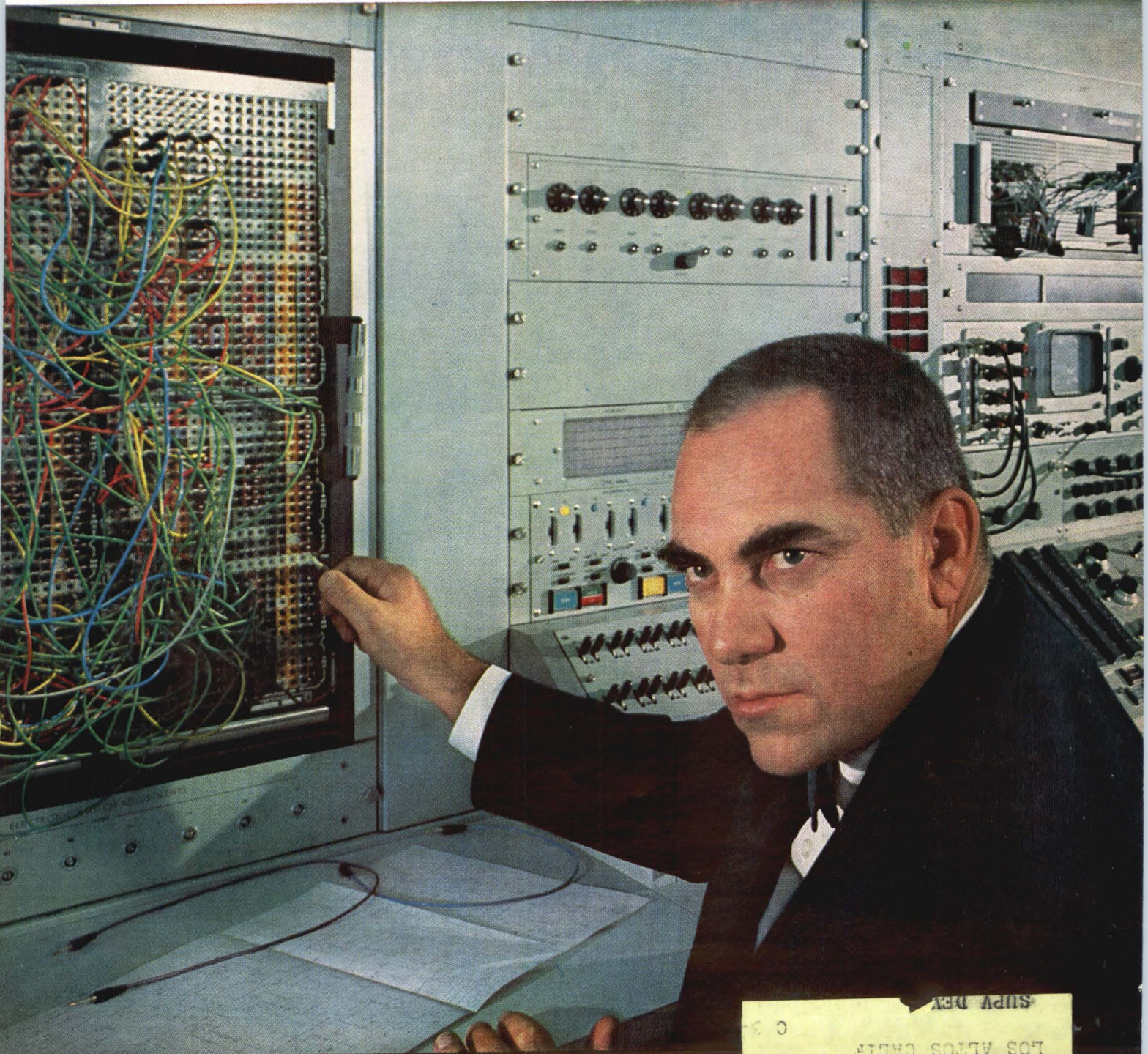

Special
report

Digital instrumentation

SUPV DEV
LOS ALAMOS CALIF
1020 GOVINGTON RD
R D SKINNER

DC-to-400 kc Counter

With High Performance at Low Cost

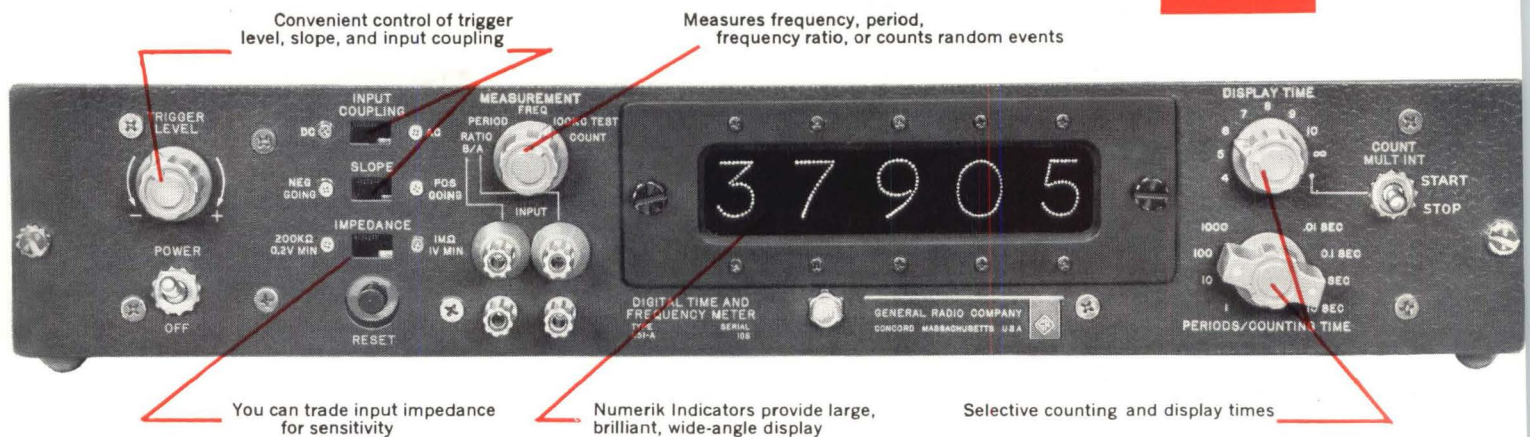

Convenient control of trigger level, slope, and input coupling

Measures frequency, period, frequency ratio, or counts random events

You can trade input impedance for sensitivity

Numerik Indicators provide large, brilliant, wide-angle display

Selective counting and display times

The Type 1151-A Digital Time and Frequency Meter contains all the features most people want in a low-frequency counter: ability to make multiple measurements (frequency, period, frequency ratio, or the counting of events), in-line readout, flexible input circuits, good program, high sensitivity, excellent stability . . . all at a relatively low cost.

This counter's input circuits are, we believe, the best you will find on the market — almost without regard to cost. To achieve optimum performance and maximum flexibility, four input controls have been included: (1) AC or DC coupling, (2) zero-crossing slope for triggering, (3) triggering level, and (4) optional input sensitivity/impedance of 0.2 volt/200k Ω or 1 volt/1M Ω .

Equivalent input noise is less than 5 millivolts peak-to-peak, a factor which contributes significantly to the accuracy of low-frequency measurements.

The Type 1151-A has an all new and highly efficient program that eliminates the annoying "zero-resting" time interval found in most low-cost counters. In this new program, all but 0.01 second of the total cycle time is occupied by the measurement and display intervals. The measurement program is completely synchronous with the quartz-crystal oscillator; both the gate and display-time intervals being derived by division of the 100-kc quartz frequency using aperiodic (flip-flop) dividers.

Frequency Measurement:

Range — DC to 400 kc.
Sensitivity — 0.2 volt, peak-to-peak, at 200 kilohms or 1 volt, peak-to-peak, at 1 megohm (1 microampere), switch-selected.
Counting Interval — 10 milliseconds to 10 seconds, extendible by multiplier switch.
Accuracy — ± 1 count \pm crystal-oscillator stability.

Period Measurement:

Range — DC to 20 kc.
Number of Periods — 1, 10, 100, or 1000.
Sensitivity — 0.2 volt at 200 kilohms or 1 volt, peak-to-peak, at 1 megohm (1 microampere), switch-selected.
Accuracy — ± 1 count \pm time base accuracy \pm noise errors.
Input Noise — 5 millivolts equivalent open-circuit input noise at 1 megohm, less at 200 kilohms.

Counted Frequency — 100 kc.

Ratio Measurement:
Range — B/A, 10 B/A, 100 B/A, or 1000 B/A.
Frequency Range — A input, dc to 20 kc; B input, dc to 400 kc.

B Input — 1 volt peak-to-peak, 100 kilohms.
Display: 5-digit, in-line Numerik register, incandescent-lamp operated.
Display Time: 0.16, 0.32, 0.64, 1.28, 2.56, 5.12, or 10.24 seconds, switch-selected.

Input Impedance: 1 megohm shunted by 40 pf or 200 kilohms shunted by 100 pf, switch-selected.

Input Trigger Level: Adequate to permit triggering on zero-crossings of signals twice minimum amplitude and on brief pulses of either polarity.

Input Trigger Slope: AC or dc coupled, positive- or negative-going.

Crystal-Oscillator Stability:

Short-Term — Better than $\frac{1}{2}$ part per million.
Cycling — Less than counter resolution.
Temperature Effects — Less than $2\frac{1}{2}$ parts per million for rise of 0 to 50°C ambient.
Warmup — Within 1 part per million after 15 minutes.

Aging — Less than 1 part per million per week after four weeks, decreasing thereafter.

Crystal Frequency Accuracy: The frequency is within 10 parts per million when shipped. Frequency adjustment is provided.

Accessories Available: Type 1136-A Digital-to-Analog Converter and Type 1137-A Data Printer operate from output of Type 1151-AP model.

Price: Type 1151-A . . . \$1195 in USA
 Type 1151-AP (with output for printer or D/A converter) . . . \$1250 in USA

Make Your Own Evaluation . . . Ask for a Demonstration

Also available is the Type 1150-B Digital Frequency Meter. It incorporates practically all the design innovations found in the Type 1151-A, but its operating modes are limited to measuring frequency over a 10 cps to 400-kc range and to counting events. Priced at \$995 for the "B" model; \$1050 for the "BP" model.

Please write for complete information

IN CANADA: Toronto 247-2171, Montreal (Mt. Royal) 737-3673
 IN EUROPE: Zurich, Switzerland — London, England

GENERAL RADIO COMPANY

WEST CONCORD, MASSACHUSETTS

NEW YORK, N. Y., 964-2722 (Ridgefield, N. J.) 943-3140 CHICAGO (Oak Park) 848-9400 PHILADELPHIA, 424-7419 (Abington) 887-8486 WASHINGTON, D. C. (Rockville, Md.) 946-1600 SYRACUSE 454-9323 DALLAS FL 7-4031 SAN FRANCISCO (Los Altos) 948-8233 LOS ANGELES 469-6201 ORLANDO, FLA. 425-4671 CLEVELAND 886-0150

Circle 900 on reader service card

SIX DIGITS!

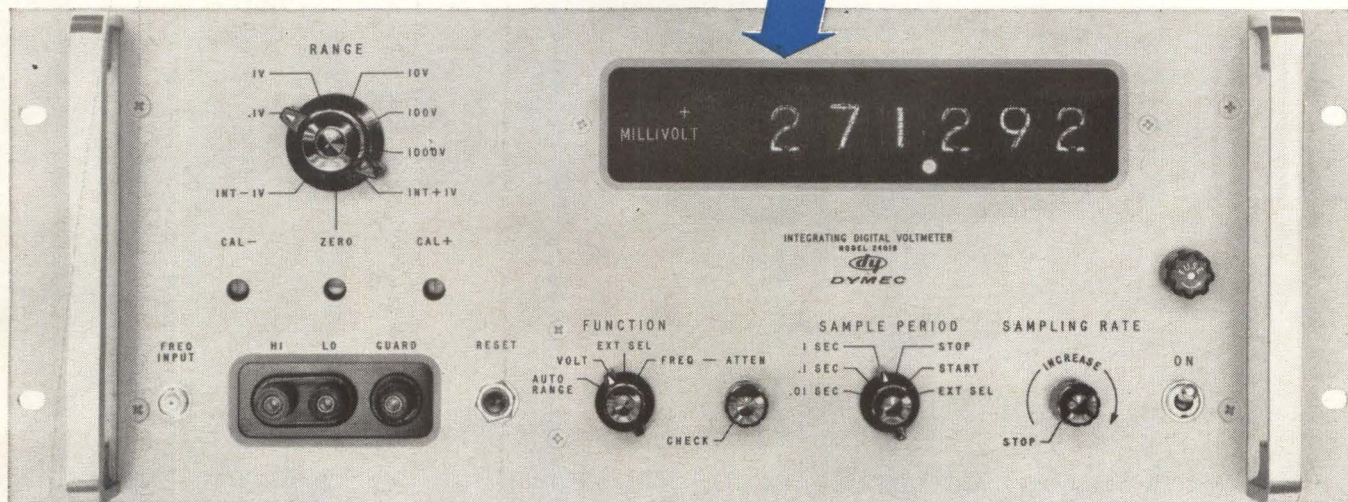

to display full 300% overranging of the Dymec Integrating Digital Voltmeter

A new sixth digit is available on the world's first and finest integrating digital voltmeter, the DY-2401B... and here's what it gives you:

New convenience in taking advantage of the voltmeter's 300% overranging capability on the 100 millivolt, 1, 10 and 100 volt ranges. For example, you don't have to measure 3 volts on the 10 volt range, thereby losing a full decade of resolution. Measure it on the 1 volt range, taking advantage of the overranging feature. The sixth digit tells you the most significant figure.

Additionally, an optional autoranging feature is available with the 2401B, for your maximum measuring convenience and speed (only 34 milliseconds maximum range-change time).

The DY-2401B offers a broader measuring capability than any other digital voltmeter available. Guarded input and integrating operation permit measuring low level signals... even in the presence of high common mode

and superimposed noise. Flip a switch and the voltmeter becomes a 300 kc frequency counter. All functions are programmable by contact closures to ground; BCD output is standard.

Accessory instruments include the DY-2411A Guarded Data Amplifier, which adds a 10 mv full scale range (again, with 300% overranging). The DY-2410B AC/Ohms Converter provides floated and guarded, broadband ac voltage and resistance measurements.

Ask your Dymec/Hewlett-Packard field engineer for a demonstration of the 2401B, now available with these new options: automatic ranging with or without the sixth digit, or the sixth digit with standard manual ranging.

DY-2401B	\$3950
DY-2410B	\$2250
DY-2411A	\$1150

Data subject to change without notice. Prices f.o.b. factory.

DYMEC

A DIVISION OF HEWLETT-PACKARD COMPANY

DEPT. E-5, 395 PAGE MILL ROAD, PALO ALTO, CALIFORNIA • PHONE (415) 326-1755 TWX 415-492-9363



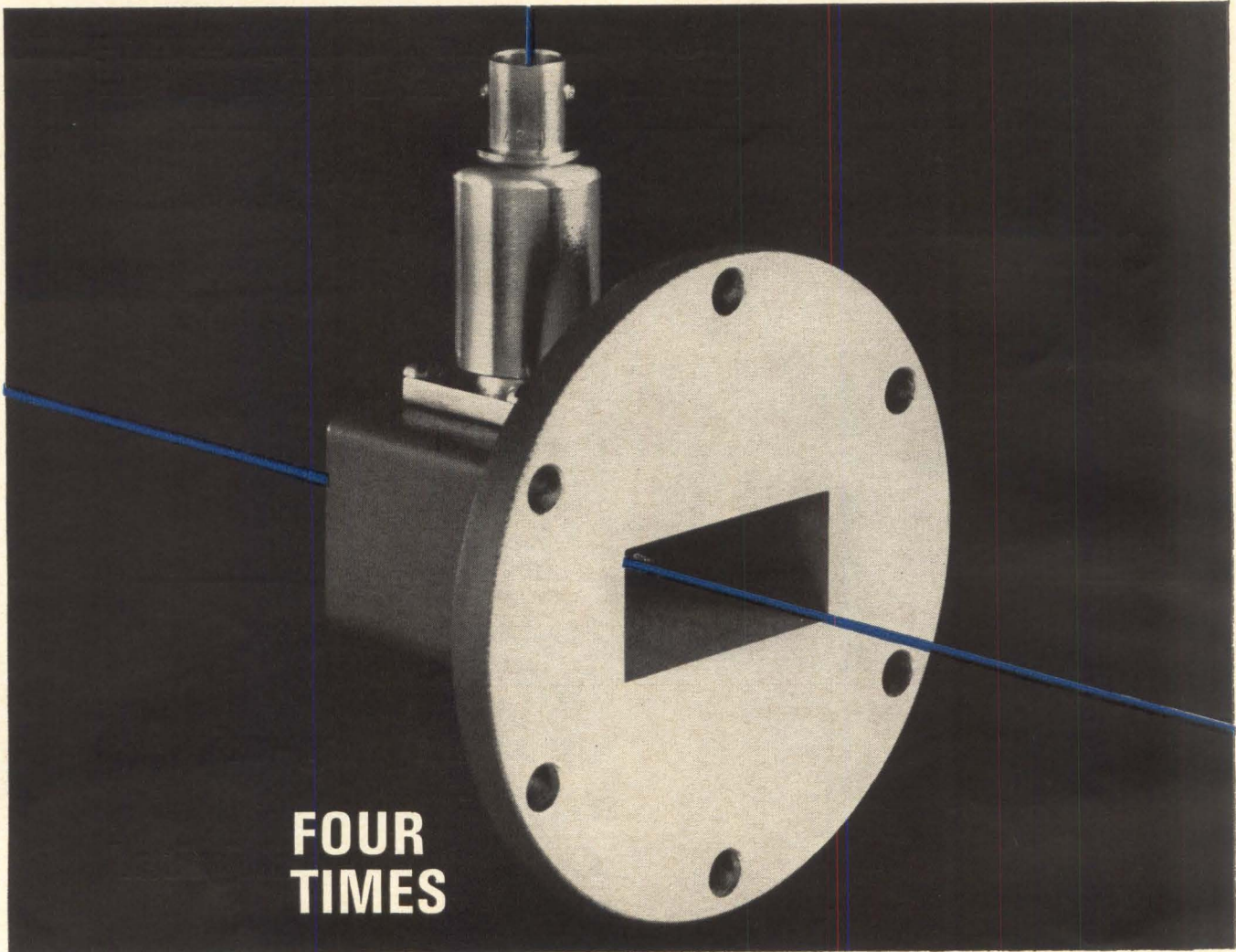

**FOUR
TIMES**

FLATTER

New hp 424A Microwave Crystal Detectors simplify monitoring, leveling, 2.6 to 18 gc Unprecedented frequency response of 7 new waveguide crystal detectors introduces new simplicity and accuracy in power leveling. Response is so flat that any two are a matched pair. Low swr; ideal for reflectometer applications. High output permits easy scope presentation. These instruments advance the state of the art

by using a new diode designed specifically for video detection. The diode, sealed in a capsule, is easily replaced without tools or soldering.

Ask your Hewlett-Packard field engineer about these detectors . . . at least four times flatter than any previously available. Or write: Hewlett-Packard, Palo Alto, California 94304, Telephone (415) 326-7000; Europe: 54 Route des Acacias, Geneva; Canada: 8270 Mayrand Street, Montreal.

ALL MODELS

Sensitivity (into 75 K ohms): high level, 0.35 mw produces 100 mv out; low level, 0.4 mv dc/ μ w cw
Output impedance: 15 K max., shunted by approx. 10 pf
Max. input: 100 mw
Output polarity: negative
Output connector: BNC female
Option .02: square law load furnished (\pm 0.5 db up to 50 mv out) \$20
 Data subject to change without notice.
 Prices f.o.b. factory.

Model	Frequency (gc)	Freq. Resp. (db)	Max. SWR	Price
S424A	2.6-3.95	\pm 0.2	1.35	\$175
G424A	3.95-5.85	\pm 0.2	1.35	165
J424A	5.3-8.2	\pm 0.2	1.35	165
H424A	7.05-10.0	\pm 0.2	1.35	155
X424A	8.2-12.4	\pm 0.3	1.35	135
M424A	10.0-15.0	\pm 0.5	1.5	250
P424A	12.4-18.0	\pm 0.5	1.5	175

**HEWLETT
PACKARD** 

*An extra measure
of quality*

9198

Electronics

Electronics review

Page 27	Storm signals	30	Ranger's last chance
27	Exit analog	32	Guidance that thinks
27	Cutting the price	32	Polaris sonar
28	Pay as you see	34	Radiation-resistant
29	Gas-fired laser	34	Search for problems
29	Solid achievement		

Probing the news

105	Cause for alarm: the drop in jobs
107	The employment situation at a glance
112	Dumbbell concept aids space design

Technical articles

I. Design

Page 4	Readers comment
8	People
10	Meetings ahead
15	Editorial
17	Electronics newsletter
43	Washington newsletter
119	New products
154	New literature
157	New books
159	Technical abstracts

Special Report

57	Digital instrumentation (cover) George Flynn, instrumentation editor
58	The case for digital systems A comparison of factors that influence the decision to go digital or analog
60	Obtaining digital data Here are the fundamental operations a digital circuit has to perform
64	Processing digital data The hybrid computer competes with special-purpose and general-purpose machines
69	Using digital data Eight applications that show the advantages of digital techniques

Microelectronics

73	How to design micropower amplifiers: Part I Technique minimizes power drain while maximizing power gain J.D. Meindl, R. Gilson, O. Pitzalis, and W. Kiss, Army Electronics Research and Development Laboratories
----	--

Military electronics

79	The quest for compatibility One solution to interfering transmitters and receivers John M. Carroll, managing editor
----	--

Computers

85	Majority voting protects aircraft and pilot Redundant circuitry in an aircraft control system makes flying safer Harold Moreines, Robert Worthington and Frank Thomas, Bendix Corp.
----	--

Circuit design

92	Designer's casebook Complementary amplifier boosts input impedance; single transistor shifts phase; reed switches for breadboarding
----	---

Communications

94	Sweeping carrier signals through interference Varying the rate of change of frequency modulates a chirp-type radar W.H. Chiles and H.G. Lafuse, Bendix Corp.
----	---

In this issue

Electronics

Editor: Lewis H. Young

Managing editor: John M. Carroll

Senior editors

Technical: Samuel Weber
News: George Sideris

Senior associate editors: Michael F. Wolff, John F. Mason

Department editors

Advanced technology: George V. Novotny
Circuit design: Jerome Eimbinder
Communications: Alexander A. McKenzie
Components: Michael F. Tomaino
Computers: Stephen B. Gray
Consumer electronics: V.S. Acunto
Industrial electronics: Louis S. Gomolak
Instrumentation: George J. Flynn
Manufacturing: C.R. Whetstone
Military electronics: John F. Mason
New products: William P. O'Brien
Solid state: Michael F. Wolff, G.G. Tirellis
Space electronics: Joel A. Strasser
Staff writers: Leon H. Dulberger, Peggy Jackson

Regional editors

Boston: Thomas Maguire, editor; Alice M. Moyer
Chicago: Cletus M. Wiley, editor; Virginia T. Bastian
Los Angeles: Harold C. Hood, editor; Linda Hamner
San Francisco: Laurence D. Shergalis, editor; Mary Jo Jadin
London: Derek Barlow, editor

Copy editors

Howard Rausch, Sally Powell

Illustration

Art director: Howard R. Berry
Assistant art director: John C. Wright, Jr.
Editorial production: Ann Mella, Sandra A. LeMond

Editorial secretaries: Claire Benell, Lynn Emery, Kay Fontana, Lorraine Rossi, Barbara Schubert, Lorraine Werner

McGraw-Hill news service

Director: John Wilhelm; **Atlanta:** Fran Ridgeway; **Chicago:** Bruce Cross;
Cleveland: Arthur Zimmerman; **Dallas:** Marvin Reid;
Detroit: Donald MacDonald; **Los Angeles:** Kemp Anderson, Michael Murphy,
Ron Lovell; **San Francisco:** Margaret Ralston, Ed. Addeo;
Seattle: Ray Bloomberg; **Washington:** George Bryant Jr., Glen Bayless,
Charles Gardner

McGraw-Hill world news service

Bonn: Richard Mikton; **Brussels:** Arthur Erikson; **London:** John Shinn;
Mexico City: Wesley Perry; **Milan:** Bruce Bendow;
Moscow: Donald Winston; **Paris:** Dan Smith;
Rio de Janeiro: Leslie Warren; **Tokyo:** Richard Halloran, Charles Cohen

Circulation manager: Hugh Quinn

Reprints: T.M. Egan

Publisher: C.C. Randolph

Electronics: May 18, 1964, Vol. 37, No. 16

Printed in Albany, N.Y. Second class postage paid at Albany, N.Y.

Subscriptions are solicited only from those actively engaged in the field of the publication. Position and company connection must be indicated on orders. Subscription prices: United States and Possessions and Canada, \$6.00 one year, \$9.00 two years, \$12.00 three years. All other countries \$20.00 one year. Single copies, United States and Possessions and Canada 75¢. Single copies all other countries \$1.50.

Published every other Monday by McGraw-Hill Inc. 330 West 42nd Street, New York, N.Y. 10036. Founder: James H. McGraw, 1860-1948.

Subscribers: The Publisher, upon written request to our New York office from any subscriber, agrees to refund that part of the subscription price applying to copies not yet mailed. Please send change of address notices, subscription orders or complaints to Fulfillment Manager, Electronics, at the address below. Change of address notices should provide old as well as new address, including postal zone number if any. If possible, attach address label from recent issue. Allow one month for change to become effective.

Postmaster: Please send Form 3579 to Fulfillment Manager, Electronics, P.O. Box 430, Hightstown, New Jersey 08520

Readers Comment

The big conventions

A month ago your editorial staff ran a provocative article [March 13, p. 39] on one of our favorite controversial subjects—the big convention. . . .

Let's look at this problem as if it were a system engineering task for a big important client. Believe me, our client is very important—it's us! . . .

The easy way to run our show will be to just continue what others have been doing. We will need a larger committee, of course, and more meeting rooms, because as the trade show expands, we expand the size of the convention: 1,000 exhibits last year and 200 twenty-minute papers; 1,200 exhibits this year, therefore 240 twenty-minute papers.

Experience has taught us that this doesn't work. First of all, let's discard that senseless time standard—20 minutes for the paper, and 20 minutes for discussion. We know very well that in some cases editing the material down to 20 minutes leaves it threadbare, and better left out. In other cases, a 10-minute bombshell might cause the whole convention to come alive.

Let's be sure we know what the man in going to say. It is really naive to assume from an abstract received in the mail that the verbal presentation from the platform will be worth listening to.

Let's keep in mind that this is a person-to-person confrontation. We will not waste the time of visitors by having someone read aloud to them. Presumably all attendees learned to read at the age of six. There has to be some reason for a man to face an audience. We will be hard as granite to the pressures of the public relations offices of some of our bigger companies. Don't discount this one. I have seen the pressure applied and papers accepted as a result.

We will know where the really significant work is being done and see to it that it comes to the convention if at all possible.

I don't think we will be able to come even close to satisfying our

All from Sprague!

Make the right move... specify Sprague SOLID TANTALUM CAPACITORS!

 <p>TYPE 150D Metal-Encased Hermetically-Sealed TANTALEX® CAPACITORS (polarized)</p>	 <p>TYPE 151D Metal-Encased Hermetically-Sealed TANTALEX® CAPACITORS (non-polarized)</p>	 <p>STYLE CS12 Metal-Encased TANTALEX® CAPACITORS to MIL-C-26655A (uninsulated case)</p>	 <p>STYLE CS13 Metal-Encased TANTALEX® CAPACITORS to MIL-C-26655A (insulated case)</p>	 <p>TYPE 155D Metal-Encased Hermetically-Sealed TANTALEX® CAPACITORS (for high vibration)</p>
 <p>TYPE 172D Metal-Encased Hermetically-Sealed TANTALEX® CAPACITORS (for 'cordwood' modules)</p>	 <p>TYPE 250D Metal-Encased Hermetically-Sealed HYREL® ST CAPACITORS (for Minuteman Program)</p>	 <p>TYPE 350D Metal-Encased Hermetically-Sealed HYREL® ST CAPACITORS (polarized)</p>	 <p>TYPE 351D Metal-Encased Hermetically-Sealed HYREL® ST CAPACITORS (non-polarized)</p>	 <p>STYLE CSR12 Metal-Encased TANTALEX® CAPACITORS to MIL-C-39003 (uninsulated case)</p>
 <p>STYLE CSR13 Metal-Encased TANTALEX® CAPACITORS to MIL-C-39003 (insulated case)</p>	 <p>TYPE 180D Metal-Encased Hermetically-Sealed TANTALEX® Feed-Thru CAPACITORS</p>	 <p>TYPE 164D Metal-Tube Axial-Lead RED-TOP* TANTALEX® CAPACITORS (polarized)</p>	 <p>TYPE 166D Metal-Tube Axial-Lead RED-TOP* TANTALEX® CAPACITORS (non-polarized)</p>	 <p>TYPE 167D Metal-Tube Single-ended RED-TOP* TANTALEX® CAPACITORS (polarized)</p>
 <p>TYPE 168D Metal-Tube Single-ended RED-TOP* TANTALEX® CAPACITORS (non-polarized)</p>	 <p>TYPE 165D Film-Jacketed TANTALEX® CAPACITORS (for 'cordwood' modules)</p>	 <p>TYPE 154D Molded-Case Bullet-nose® TANTALEX® CAPACITORS</p>	 <p>TYPE 190D Molded-Case Rectangular-Shaped TANTALEX® CAPACITORS (for printed boards)</p>	 <p>TYPE 160D Film-Jacketed Axial-Lead TANTALEX® CAPACITORS (Hearing Aid Type)</p>
 <p>TYPE 161D Film-Jacketed Single-ended TANTALEX® CAPACITORS (Hearing Aid Type)</p>				

*Trademark

Number 1 in Solid Tantalum Capacitors Across the Board!

Pioneer in the development of tantalum capacitors, Sprague has the largest and most complete research and production facilities in the capacitor industry. That's why Sprague, with its unmatched experience, is

your *dependable* source of supply!

For additional information, write Technical Literature Service, Sprague Electric Company, 35 Marshall St., North Adams, Mass., indicating the types in which you are interested.

SPRAGUE COMPONENTS

CAPACITORS
TRANSISTORS
RESISTORS
MICROCIRCUITS
INTERFERENCE FILTERS

PULSE TRANSFORMERS
PIEZOELECTRIC CERAMICS
PULSE-FORMING NETWORKS
TOROIDAL INDUCTORS
ELECTRIC WAVE FILTERS

CERAMIC-BASE PRINTED NETWORKS
PACKAGED COMPONENT ASSEMBLIES
BOBBIN and TAPE WOUND MAGNETIC CORES
SILICON RECTIFIER GATE CONTROLS
FUNCTIONAL DIGITAL CIRCUITS

SPRAGUE®
THE MARK OF RELIABILITY

*Sprague and ® are registered trademarks of the Sprague Electric Co.

New Bridge Design For Safe, Accurate, Easy Measurement of 'Lytic Capacitors

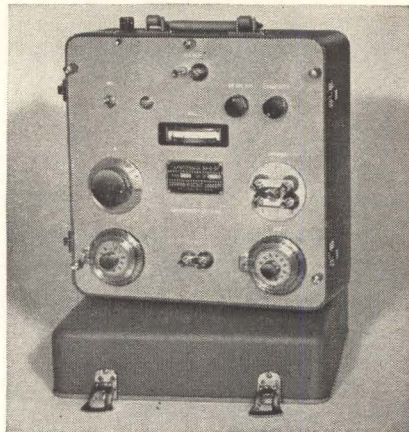

The Sprague Model 1W2A Capacitance Bridge introduces new, improved technical refinements as well as restyling for added attractiveness and ease of operation. Built by capacitor engineers for capacitor users, it incorporates the best features of bridges used for many years in Sprague laboratories and production facilities.

Precision Measurements over Entire Range from 0 to 120,000 μ F

The internal generator of the 1W2A Bridge is a line-driven frequency converter, and detection is obtained from an internal tuned transistor amplifier-null detector, whose sensitivity increases as the balance point is approached. It has provision for 2-terminal, 3-terminal, and 4-terminal capacitance measurements, which are essential for accurate measurement... $\pm 1\%$ of reading + 10 μ F... of medium, low, and high capacitance values, respectively.

No Damage to Capacitors

The model 1W2A Capacitance Bridge will not cause degradation or failure in electrolytic or low-voltage ceramic capacitors during test, as is the case in many conventional bridges and test circuits. The 120 cycle A-C voltage, applied to capacitors under test from a built-in source, never exceeds 0.5 volt! It is usually unnecessary to apply d-c polarizing voltage to electrolytic capacitors because of this safe, low voltage.

Complete Specifications Available

For complete technical data on this precision instrument, write for Engineering Bulletin 90,010A to Technical Literature Service, Sprague Electric Company, 35 Marshall Street, North Adams, Massachusetts.

4SSP-128-63

client as long as we continue to assign the responsibility to short-term volunteers—largely as an honor. The big convention is big business. The annual budget for one of these will approach a million dollars (maybe more for the New York shows).

I think the key to better big conventions is a paid technical program manager, supported by a competent staff. First of all, it eliminates the problem of part-time effort and short tenure. The manager would spend all his time monitoring the technology, cultivating the acquaintance of the real leaders, and planning for not only this year's convention, but next year's and perhaps the one after that. Second, and so important, it provides a penalty for a bad job. When a volunteer committee is a bad one, nothing much is lost. It will soon be forgotten, and next year there will be new victims. When a paid manager does a bad job—need I elaborate? . . .

There would, of course, be a volunteer committee to support the paid staff. But here also I would make a change. All committee appointments could be for three years, and staggered so there would always be overlap and continuity. There is no other way of implementing long-range plans. One-year tenure gives a man just barely enough time to copy what the last man did.

The two largest conventions can afford the cost, and I don't think they will solve the problem any other way. Let's stop putting patches on the patches and get a fresh start.

Richard G. Leitner
System Development Corp.
Santa Monica, Calif.

Sound synthesis

I was fascinated by your cover picture of April 20 [Permanent optical memories for compact systems, p. 64]. It recalled some very extensive work we did back in 1944-46 on sound synthesis. See: Photoelectric Tone Generator [Electronics, Sept., 1946, p. 93] a widely quoted article that reappeared in many places such as the International Rectifier Handbook on photocells and sun batteries.

Our method of making up the

master disk used a special camera, but the glass plate remained stationary and we moved the pattern on a flat black background several feet away, using a multiple-exposure technique of one exposure for each pattern. We found that we could reproduce disks of almost unbelievable accuracy with simple equipment using this method, and photographic reduction.

As I recall, our master pattern was about 10 feet in diameter and was covered with dead-black paint. We made up one cut-out, from white paper, of the complex waveform to be reproduced and simply moved it around in front of the dead-black background with a simple indexing head having the required number of predetermined steps. Our indexing head was quite large, as I recall, and it was easy to get almost any ratio we wanted. We also tried a system whereby we left the pattern stationary on a black background and moved the plate in a special camera, but it was nowhere nearly as accurate as the other method.

I suppose this just goes to show that there is nothing new under the sun, although at the time we were interested primarily in music, with no thought of data storage applications.

As I recall, our primary difficulties were with the glass disks and all the headaches we had with mounting, machining and breakage. The present state of the art has overcome many of the problems that were serious at that time.

I would like to congratulate you on the recent change in Electronics. Weekly was just too much. I found it impossible to even read the publication, not to mention the storage and filing problems involved. I have nearly all the issues since 1934, almost a complete 30-year file, and your weekly splurge almost ran me out of office space.

Lyman E. Greenlee
Anderson, Ind.

■ The eight-inch tone wheel described in reader Greenlee's 1946 article was a sheet of positive photographic film, on which were the fundamental and nine harmonics. Only the upper half of each sinewave cycle was required, as the lower half of the pattern closely resembles the other half.

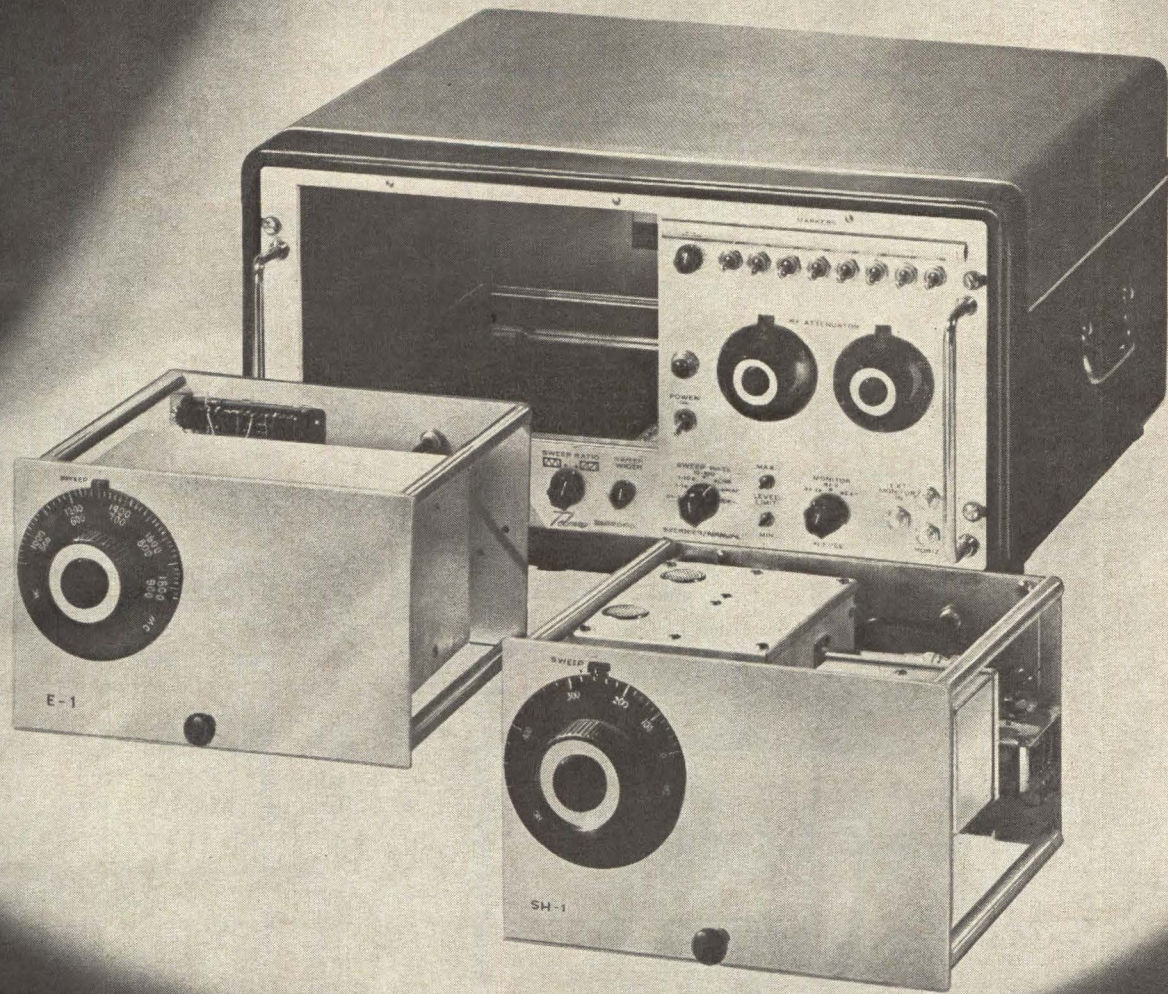

640,000,000 cycles-free!

The engineer who has determined the profitability of using sweep generator techniques now has another 22 pleasant discoveries awaiting him. That's the precise number of oscillator heads that conveniently plug into Telonic's SM-2000 Sweep Generator.

The trio shown above, for example, consists of an SM-2000 with just two of these heads, an SH-1 and an E-1. Together they cover a frequency range of 500 Kc to 1840 mc, over 600 mc further than any comparable instrument and at several hundred dollars less cost. Add to this the flexibility of being able to utilize any of 20 other oscillators and you have an instrument that obsoletes anything available for precise frequency generation and response testing.

General Specifications

Display linearity.....Better than 1.2:1
 Source VSWR.....Below 1.3:1
 Vernier attenuation.....0 to 10 db
 Horizontal sweep.....Approx. 15 volts
 Zero base line.....Oscillator off during return sweep
 Frequency markers.....Birdy-By-Pass

Sweep rate.....Line frequency, 50-60 cps

Frequency range*

SH-1 oscillator head (variable marker optional).....500 Kc to 460 mc
 E-1 oscillator head (variable marker optional).....460 mc to 1840 mc

Prices

SM-2000695.00
 SH-1400.00
 E-1750.00

*There are 22 different plug-in heads available for the SM-2000 covering audio to 3000 mc in various frequency ranges and sweep widths. Prices range from 300.00 to 995.00. Complete catalog on request.



INDUSTRIES, INC.

60 NORTH FIRST AVENUE
 BEECH GROVE, INDIANA
 PHONE STATE 7-7241 AREA CODE 317

TWX 317-635 4748

Representatives in

Baltimore, Boston, Chicago, Cleveland, Dallas, Dayton, Denver, Huntsville,
 Indianapolis, Los Angeles, New York City, Orlando, Philadelphia, San Francisco,
 Seattle, St. Louis, Syracuse and principal cities throughout the world.

❖ SWEEP GENERATORS

❖ RF ATTENUATORS

❖ CW OSCILLATORS

❖ COAXIAL SWITCHES

**NEW MINIATURE PLANAR TRIODES...
FREQUENCY STABLE...HIGH CATHODE CURRENT**

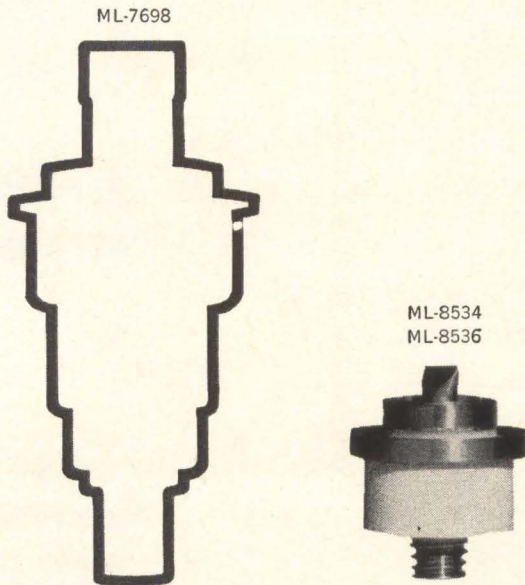

Same ratings...1/3 size

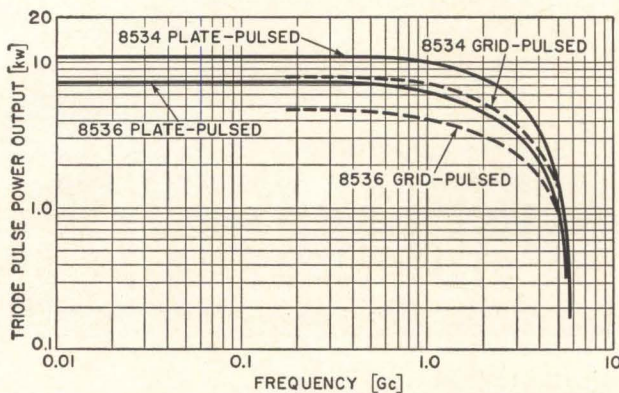

As UHF plate or grid pulsed amplifier

The same fast frequency stable performance—100 times faster than normal—is obtained with both the miniature ML-8534 and ML-8536 planar triodes. Both tubes employ the Phormat (matrix) cathode. Both allow use of variable duty cycle operation without noticeable frequency shift. But the ML-8534 and ML-8536 miniature planars are only 1/3 the size of the ML-7698 and permit significant reductions in cavity and equipment size. Ratings: ML-8534, plate pulsed, 3500v, 5.0a; grid pulsed, 2500v, 5.0a. ML-8536, plate pulsed, 3500v, 3.0a; grid pulsed, 2500v, 3.0a. For complete data on miniature planar triodes, write: The Machlett Laboratories, Inc., Springdale, Connecticut. An affiliate of Raytheon Company.



People

Ramon H. Aires will head the new department of defense microelectronics at the Defense Electronics Products division of the Radio Corp. of America. The department consists of engineers who are skilled in integrated circuits and who will



conduct training programs for other RCA engineers. Creation of the department is apparently an effort by RCA to increase its integrated circuit capability by training engineers who had been working previously with discrete components. The group will develop skills in microcircuit technology that can be used by several RCA divisions. Aires worked previously as a staff engineer for RCA's defense research and development programs. He was also electrical design manager of the RCA group that built the first Tiros weather satellite.

Capt. John K. Leyden has been nominated by President Johnson to a three-year term as Chief of Naval Research. The appointment of Leyden, who had been deputy chief of naval materiel for management and organization, is seen by some as a move



to more closely coordinate the Navy's research and production activities. Leyden is one of the youngest men to head naval research. Most of his predecessors held the job just prior to retirement. He has served on the armed forces special weapons project at the Sandia Base in Albuquerque, N.M. He will assume his post on July 1, at which time he will be promoted to rear admiral. One of his hobbies is antique automobiles, including three vintage Rolls Royces that he keeps at his farm in Lahaska, Pa.



SILICON POWER INDUSTRIAL TRANSISTORS

2N3233 2N3234 2N3235 2N3236 2N3237
2N3238 2N3239 2N3240

Silicon Transistor Corporation, the leading manufacturer of silicon power products, is now producing an entirely new series of low-cost, industrial power transistors. Our basic product philosophy of manufacturing high quality devices will not deviate, despite the low prices on these new power transistors.

This series is in the all-copper TO-3 header with a maximum junction temperature of 200°C. The D.C. power capabilities range from 117 to 200 watts, with peak switched power ratings for approximately 20 times the D.C. ratings. Maximum collector current capability ranges from 7.5 to 20 amps with BV_{CEO} ratings ranging from 60 to 160 volts. Saturation resistance values range from types having 0.1 ohms @ $I_c = 10A$ to others having 0.8 ohms @ $I_c = 3A$.

This series is now available from stock and from your local Silicon Transistor Corporation distributor. For complete specifications and information on reducing your silicon power transistor costs for industrial applications, contact:

SILICON TRANSISTOR CORPORATION

CARLE PLACE, L.I., NEW YORK 516-Pioneer 2-4100

DISTRICT OFFICES: LONG BEACH 2, CALIF., 217 ELM AVE. (213) 437-2788. TWX 213-549-1972.

DAYTON 19, OHIO, 49 PARK AVE. (513) 298-9913. TWX 513-944-0372. HUNTSVILLE, ALA., POST OFFICE BOX 1467. (205) 881-4793

NOW...

**THE FAMOUS
JERROLD
900-B
SWEEP SIGNAL
GENERATOR**



**OFFERS CENTER
FREQUENCIES FROM
500 kc to 2,000 mc
without plug-ins**

The versatile Jerrold Model 900-B Sweep Signal Generator now extends its useful frequency range all the way up to 2,000 mc, with sweep widths ranging from 10 kc to 800 mc. A diode frequency doubler, priced at only \$150, increases the usefulness of the 900-B without the need for plug-ins.

Frequency Doubler Specifications

Input Frequency ... 500-1000 mc
Output Frequency ... 1000-2000 mc
Conversion loss at
1 volt RMS less than 12 db
Output component, other
than harmonic
of input 20 db or more below
Maximum Input 1 volt RMS
Connectors 50 ohm, BNC

The diode frequency doubler can also be used with the economical Jerrold 900-A Sweep Generator.

Model 900-B \$1,980
Model 900-A \$1,260
Frequency Doubler \$ 150

Write for complete technical data,
Jerrold Electronics Corporation, 15th
& Lehigh Ave., Philadelphia 32, Pa.



A subsidiary of THE JERROLD CORPORATION

Meetings

Tenth Annual Radar Symposium, Army, Navy, Air Force, University of Michigan Inst. of Science and Technology; Fort Monmouth, N.J., **May 26-28.**

Analysis Instrumentation Symposium, ISA; Sheraton Palace Hotel, San Francisco, Cal., **June 1-3.**

Reliability Training Course, ARINC Research Corp.; Statler Hilton Hotel, Washington, D.C., **June 1-5.**

Electromagnetic Windows Symposium, The Antenna Lab., Dept. of Electrical Engineering, Ohio State Univ. in conjunction with US Air Force; Ohio State Univ., Columbus, Ohio, **June 2-3.**

Telemetry National Conference, AIAA; Biltmore Hotel, Los Angeles, Cal., **June 2-4.**

Conference on Precision Electromagnetic Measurements, NBS, Radio Stds. Lab., IEEE PTG-IM, Inter. Scientific Radio Union, US Commission on Radio Measurements and Standards; NBS Boulder Laboratories, Boulder, Colo., **June 23-25.**

Computers and Data Processing Annual Symposium, University of Denver's Research Institute; Elkhorn Lodge, Estes Park, Colo., **June 24-25.**

Joint Automatic Control Conference, ASME, AICE, ISA, IEEE, AIAA; Stanford University, Stanford, Cal., **June 24-26.**

Conference of Vacuum Metallurgy, Vacuum Metallurgy Div., American Vacuum Society; Barbazon Plaza Hotel, New York City, **June 29-30.**

Rochester Conference on Data Acquisition and Processing in Medicine and Biology, U. of Rochester; U of R Whipple Auditorium, Rochester, N.Y., **July 13-15.**

Special Technical Conference on Nuclear Radiation Effects, IEEE PTG-NS, Radiation Effects Committee; University of Washington, Seattle, Wash., **July 20-24.**

Special Program on Language Data Processing, Harvard, Div. of Engineering and Applied Physics; Harvard Summer School, Cambridge, Mass., **Aug. 10-21.**

UAIDE Annual Meetings, Users of Information Display Equipment; International Hotel, Sepulveda and Century Blvds, Los Angeles, Cal., **Aug. 12-14.**

Symposium on Ultra Low Frequency Electromagnetic Fields, NBS Central

Radio Propagation Lab. and National Center of Atmospheric Research; Boulder Laboratories, Boulder, Colo., **Aug. 17-20.**

WESCON 1964, 6 Region IEEE and Western Electronic Manufacturers Asso.; Los Angeles Sports Arena and Hollywood Park, Los Angeles, Cal., **Aug. 25-28.**

International Conference on Microwaves Circuit Theory and Information Theory, Inst. Electrical Comm. Engrs of Japan, Science Council of Japan and International Scientific Radio Union; Alaska Prince Hotel, Tokyo, **Sept. 7-11.**

International Convention on Military Electronics (MIL-E-CON 8), IEEE; Shorham Hotel, Wash. D.C., **Sept. 14-16.**

Ceramic-To-Metal Session, American Ceramic Society; Philadelphia, **Sept. 17.**

AIAA Military Aircraft Systems and Technology Meeting (Secret), AIAA, USAF, and BuWeaps; NASA-Langley Research Center, Va., **Sept. 21-23.**

Third Canadian IEEE Communications Symposium, Canadian Region IEEE; Queen Elizabeth Hotel, Montreal, **Sept. 25-26.**

Call for papers

Ceramic-To-Metal Session, American Ceramic Society; Philadelphia, Pa., September 17. June 1 is deadline for submitting abstracts to Leonard Reed, manager, Device Research Laboratory, Eitel-McCullough, Inc., 301 Industrial Way, San Carlos, Calif.

Annual East Coast Conference on Aerospace and Navigational Electronics, IEEE; Emerson Hotel, Baltimore, Maryland, October 21-23. June 8 is deadline for submitting two copies of a 30 word abstract and 300 word summary, along with a brief professional record of the author to Melvin Hastings, Mail No. 1281 A, Baltimore Space and Defense Center, Westinghouse Electric Corp., P. O. Box 1693, Baltimore, Maryland 21203. Papers are invited relating to space vehicles, missiles or aircraft in areas of design for space, airborne electronics, space vehicle guidance and control, and space system support.

More than 50% of all taut band meters in use today are Weston

There is no better proof of reliability than acceptance! From the largest production capability available today, you can choose any size, function, accuracy, mounting and style.

World's standard for measurement and display

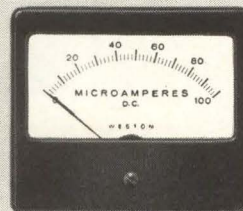
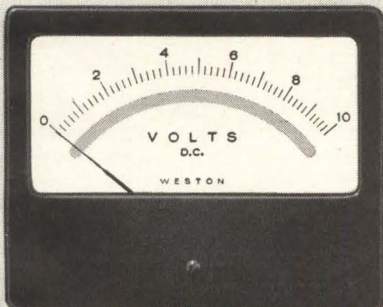
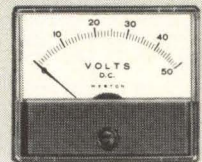
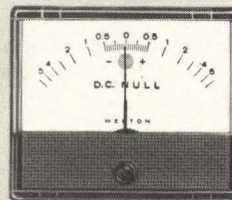
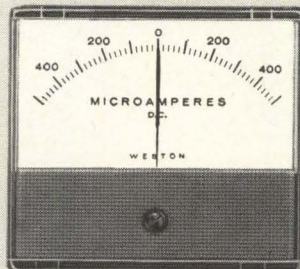
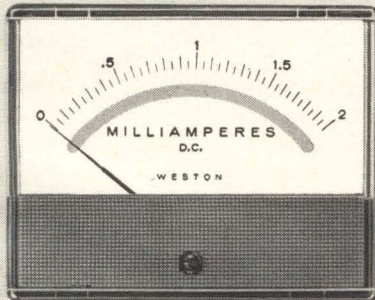
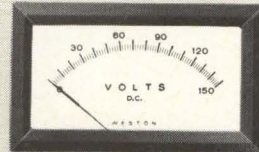
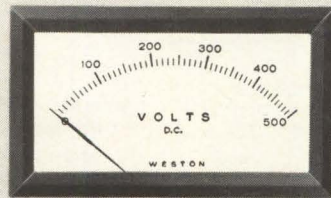
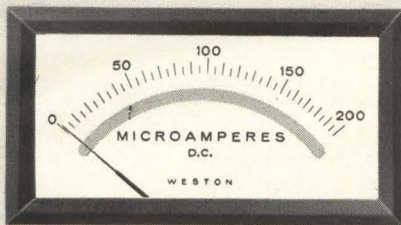

world's standard in measurement and display

 **WESTON**
INSTRUMENTS & ELECTRONICS

614 Frelinghuysen Ave.,
Newark 14, New Jersey
Division of
Daystrom, Incorporated

Circle 11 on reader service card

New products from TI to help you

Smaller, more efficient equipment possible with new microwave transistors

Now you can fill your microwave applications needs with either silicon or germanium transistors from TI! Amplification and oscillation at frequencies as high as three gigacycles can be accomplished with these two new series.

The TIX 3023 series are germanium epitaxial diffused-base microwave transistors capable of delivering 10 mw at 3 gc, or amplifying 1 gc with a typical noise figure of 4.5 db.

The TIX 3015 series silicon planar microwave transistors can give you 50 mw at 2 gc, with a 1 gc noise figure as low as 6 db. Maximum frequency of oscillation (f_{MAX}) is as high as 4 gc.

A three-gigacycle oscillator cavity using the TIX 3023 is shown in figure 1. The new "μ line" and "TI-axial" packages, designed by TI for microwave transistor applications, are shown in the inset.

Circle 209 on the reader service card for information.

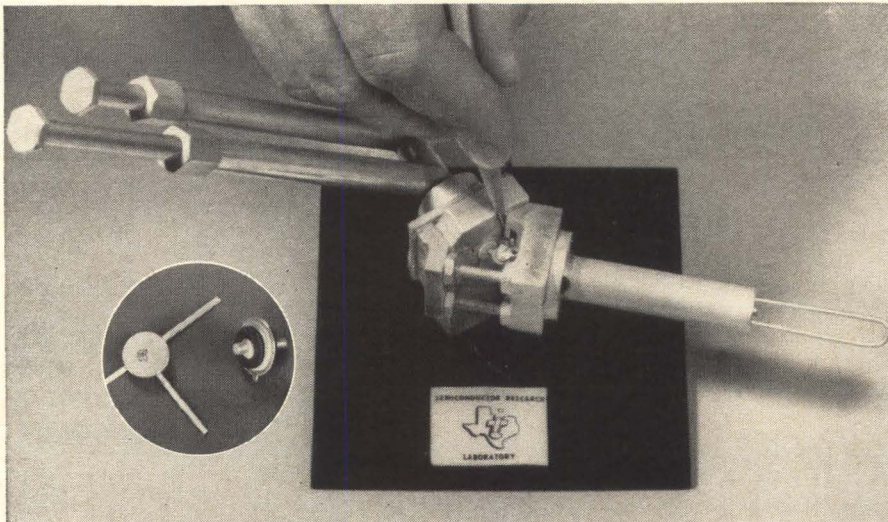

FIGURE 1. 3 Gc oscillator using TIX 3023 transistor. Inset shows two package designs for TI microwave transistors

New 25-amp, 10 μsec turn-off silicon controlled rectifiers reduce power losses

You can increase efficiency and reduce the size of your power supplies with TI's new ultra-fast TI3037-42 SCR's. A maximum turn-off time of 10 μsec at 25 amps combined with an unmatched dV/dt rating of 200v/μsec (See figure 2) marks a new industry high in switching speed for high-current SCR's.

This high speed reduces power losses and permits use of smaller transformers.

The new series spans a voltage range from 50 to 500 volts and offers anode surge-current capability of 200 amps.

Circle 210 on the reader service card for data sheet.

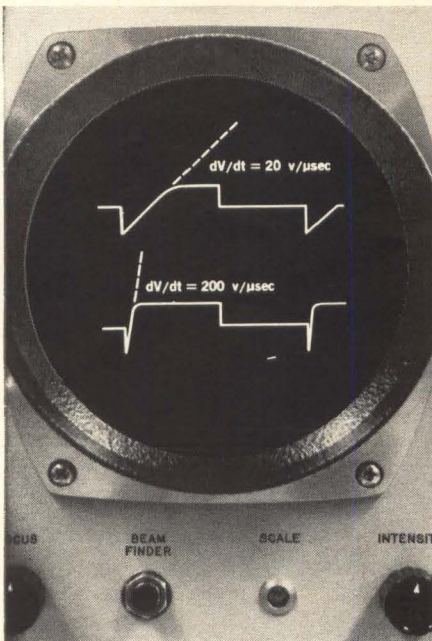

FIGURE 2. dV/dt comparison between TI 2N3037-42 and conventional SCR's

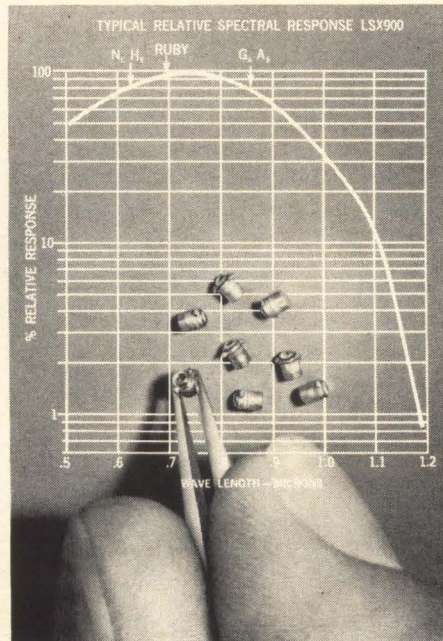

FIGURE 3. Sensitivity curve and packages for LSX 900 light sensor

Detect light modulation up to 2 Gc with new LSX 900

Designed for the detection of laser emission modulated at frequencies up to 2 gc, the LSX 900 is a silicon planar epitaxial light sensor. Its maximum sensitivity is in the frequencies of the most commonly used types of lasers (see figure 3). An additional advantage is the use of the 1/16 inch by 1/10 inch light sensor package originally designed by TI for the LSX 600, specially suited for microwave use.

Also newly available as a part of TI's extensive line of light sensing semiconductors is the LSX 515. Combining the functions of a light sensor and an SCR in the TI miniature package, the LSX 515 is a silicon planar PNP device, only 1/10 by 1/16 inch.

The units shown in figure 3 are the

TI cannot assume any responsibility for any circuit shown or represent that they are free from patent infringement.

*Trademark, Texas Instruments Incorporated

improve performance and reduce costs

package in which both the LSX 515 and the LSX 900 are available. Additional information can be obtained by circling 211 on the reader service card.

New economy transistors offer highest power per dollar

TI3027-31 germanium alloy power transistors give you industry's highest power-to-cost ratio in a JEDEC TO-3 package.

Characteristics: 90 watts at 55°C case temperature, 7 amp collector current, 45-120 volts BV_{CBO} , minimum h_{FE} of 40 at 3 amps. Figure 4 shows a 70-watt audio amplifier output stage using these advanced new TI devices. Other consumer and industrial applications include electronic organs, d-c converters, series regulators for power supplies, light flashers, and tape recorder bias oscillators.

Circle 212 on the reader service card for data sheets and circuit information.

Low noise, major size reduction possible with new TI molecular multiplex switch/choppers

Optical coupling of a gallium-arsenide infrared light source with a silicon photo-transistor provides extremely low noise, complete isolation and a size reduction of at least ten-to-one over conventional solid-state choppers and multiplexers. These new TI opto-electronic multiplex switch/choppers, the PEX 3002 and PEX 3003, are experimental Functional Electronic Blocks.

The function of the new molecular devices is similar to that of double-emitter chopper transistors, but no transformers or large capacitors are needed. Sampling rates from dc to 30 kc are possible. The optical coupling provides ac and dc isolation between driver and switch. A typical noise figure of 3 μ v, rms, is generated with a 400-cps sampling rate, less than 1% of that generated by conventional solid-state multiplexers.

Additional information may be obtained by circling 213 on the reader service card.

Now — carbon-film resistors at composition prices

Now you can get the superior stability, temperature, noise, and frequency characteristics of carbon-film resistors... at a cost competitive with comparable 5% carbon-composition units. (Compare for yourself in figure 6 at right.)

With these new resistors you can upgrade present equipment without redesign or cost penalty. You also may be able to reduce system cost of next-generation digital equipment.

Ratings: 1/4 w, 1/2 w, 1w, 2w; 10 ohms to 2 megohms. Circle 214 on the reader service card for data sheets and prices.

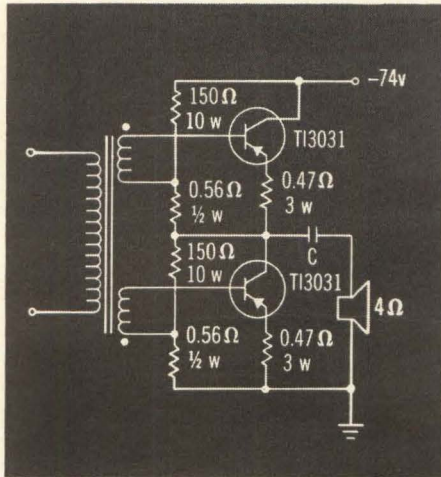

FIGURE 4. 70-watt audio amplifier output stage using TI 2N3031 transistors

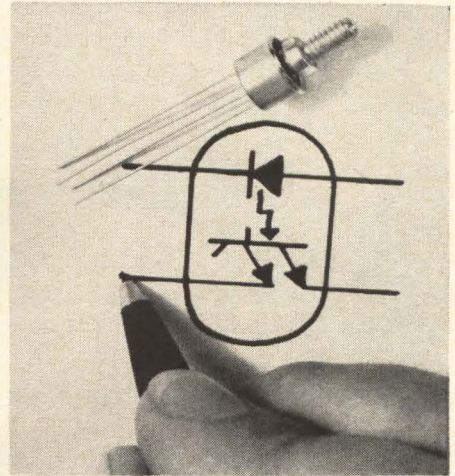

FIGURE 5. PEX 3002 multiplex switch/chopper and graphical symbol

Get all this performance at competitive cost ‡

TEST	MIL-R-11D* LIMITS	TYPICAL PERFORMANCE OF TI GP RESISTORS
Temperature Coefficient ($T_A = 25^\circ\text{C}$ to 105°C)	± 625 to ± 1250 ppm max	-200 to -500 ppm
Temperature Coefficient ($T_A = -55^\circ\text{C}$ to $+25^\circ\text{C}$)	± 815 to ± 1875 ppm max	-200 to -500 ppm
Voltage Coefficient	0.02%/volt max	0.01%/volt
Insulation Resistance	10^4 M Ω min	10^6 M Ω
Low Temperature Operation	$\pm 3.0\%$ max	-0.5%
Temperature Cycling	$\pm 4.0\%$ max	-0.5%
Moisture Resistance	$\pm 10.0\%$ max	+4.0%
Short Time Overload	$\pm 2.5\%$ max	-0.5%
Load Life	$\pm 8.0\%$ max	$\pm 2.0\%$

‡Unless otherwise noted, data are per cent change in initial resistance.

*Mil Spec for Carbon Composition Resistors

FIGURE 6. Compare these carbon film advantages with composition units of similar price



TEXAS INSTRUMENTS

INCORPORATED
13500 N. CENTRAL EXPRESSWAY
P. O. BOX 5012 • DALLAS 22, TEXAS

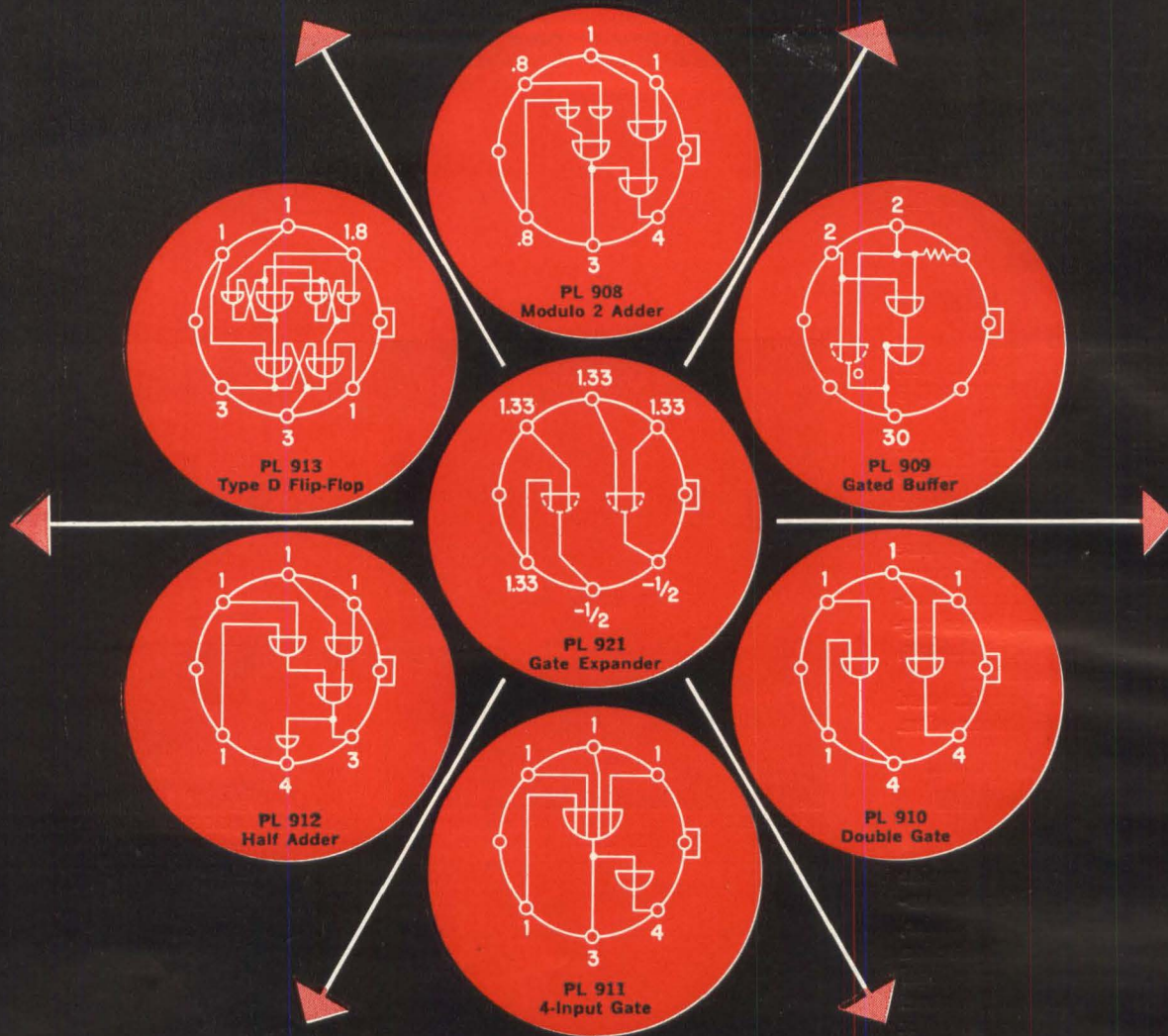

PHILCO ANNOUNCES MILLIWATT MICROLOGIC CIRCUITS

Now, a second Micrologic family—seven integrated logic circuits for use where power dissipation is limited. These new silicon circuits have power dissipations as much as 80% less than standard Philco Micrologic elements, yet retain speeds in the range of 40 nsec per stage. All elements are compatible on a worst-case basis over the military equipment environment range from -55° to $+125^{\circ}\text{C}$. All 11 Philco Micrologic and 7 Milliwatt Micrologic Circuits are manufactured by the Planar Epitaxial Process, under a cross-licensing agreement with Fairchild Camera and Instrument Corporation.

Each is identical to and interchangeable with the equivalent Fairchild circuit.

When you consider Microelectronic circuitry, be sure of two-source interchangeability, compatibility and off-the-shelf availability . . . specify Philco Micrologic and Milliwatt Micrologic — the industry's only bona fide two-source circuit families. Delivery in quantity is now available.

For complete specifications on these new Philco Milliwatt Micrologic circuits or on other items in the Philco Microelectronics line, write Department E51864.



MICROELECTRONICS OPERATION

PHILCO[®]

A SUBSIDIARY OF *Ford Motor Company*

LANSDALE DIVISION, LANSDALE, PA.
In Canada: Don Mills Road, Don Mills, Ontario, Canada

High life: the bill comes due

Suddenly the electronics boom has ended for a lot of people. Companies are finding their sales and profits shrinking. And many engineers are finding themselves unemployed with only a two-week warning.

Some people are saying the electronics industry is sick. If it is truly sick, it can't complain that it caught a virus from somebody else. Electronics companies have lived high, wide and handsome during the past ten years and, like an undisciplined playboy, they have grown flabby and susceptible to infection. You can sum it up simply: Too much military activity has led to inefficient operation, complex and expensive engineering and stultified marketing.

The sharpest symptom of the illness is the worsening employment situation (p. 105). The market for electronics engineers has deteriorated sharply since the IEEE show in March, and those who have strayed from broad engineering into narrowly specialized fields or into contract administration find the going hardest.

You have to sympathize with the engineer who wants to work but can't find a job worthy of his education. But for 10 years electronics engineers, like many of their employers, have enjoyed a seller's market. Some jumped from job to job, reaching for higher salaries without any concern for building a future with a company or for acquiring well-rounded technical competence and experience. Many fooled themselves into believing they were executives because they shuffled reams of military-required red tape. Others contented themselves with very specialized technical work, pacified by the size of the paycheck. Now they are paying the piper.

You can build a convincing case for blaming military contractors for this professional idiocy. They nurtured the boom, wining and dining potential employees. Some companies set up what can only be described as production-line engineering departments, in which every engineer was slotted into a pigeonhole to do one specific task—such as acceleration testing of one kind of component. When the big project was phased out, the specialized engineers went out with it.

For many years there was always another project. Now there isn't, and the squeeze is on.

Still, every man charts his own destiny. What's happening today ought to be noted carefully by every engineer. It proves that sometimes the best-looking job is not always the best one in the long run.

For many engineers, the fatal mistake has already been made. Our survey on (p. 105) shows it is particularly difficult for an engineer with 10 years' experience, accustomed to earning \$12,000 to \$15,000 a year, to relocate. For him the only answer is to beat the bushes and hope.

In the next issue we'll examine some steps we think the managements of electronics companies should take to improve the health of their companies and the opportunities of their employees.

KEPCO

**ADDS
EXTRA
VALUE**

**VIX
REGULATED
POWER
SUPPLIES**

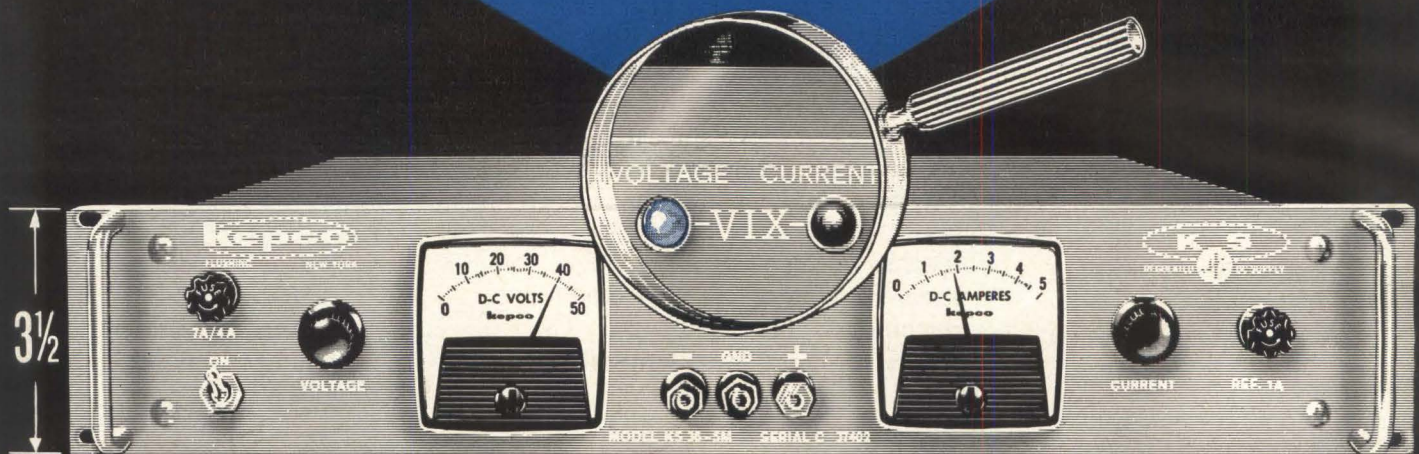

Model KS 36-5M

NEW VIX^{*} INDICATORS AT NO EXTRA COST!

Kepeco voltage/current regulated power supplies in the KS series now come equipped with voltage/current mode indicators called "VIX". Time saving and added utility are provided by these indicators which show at a glance whether the power supply is in its voltage regulating mode or its current regulating mode. This indication is especially useful in the Kepeco KS Models since they have extremely sharp cross-over characteristics.

*VOLTAGE/CURRENT CROSSOVER SIGNAL

Send for complete data on
Kepeco KS Models
featuring NEW "VIX" Indicators

Circle 16 on reader service card



KEPCO 3 1/2" K S MODELS
REGULATED DC SUPPLY

0.01% REGULATION and STABILITY

DC OUTPUT RANGE		MODEL	PRICE
VOLTS	AMPS		
0-8	0-15	KS 8-15M	\$595.00
0-18	0-10	KS 18-10M	550.00
0-36	0-5	KS 36-5M	495.00
0-60	0-2	KS 60-2M	495.00

kepeco inc.

131-38 SANFORD AVE. • FLUSHING, N.Y. 11352
Phone (212) IN 1-7000 • TWX # 212-539-6623
Cable Address: KEPCOPOWER NEWYORK

Other features include:

- High Power in Compact Design
3 1/2" H x 19" W x 14" D
- SCR Preregulation
- 10-turn-pot Resolution
- Flexible Programming
- Dual Kepeco "Bridge Circuitry"
with Automatic Cross-over
- Remote VIX Signal
- Key Circuitry brought to rear
Terminal Board
- Six Operating Modes with External
Connections
- Series/Parallel Versatility

† Patents issued and pending.

See our complete
Catalog in



Electronics Newsletter

May 18, 1964

Transistors make tv color debut

A nine-inch color television set, the first made with transistor circuits and an improved Lawrence picture tube, was introduced in Japan on May 6 by the Yaou Electric Co. The set, designed to meet U. S. requirements, has room for a uh tuner. Sales will begin in Japan this fall. Initial price is \$375, but the company hopes to cut that to \$275 when mass production begins next spring.

The picture tube, which has one gun instead of the conventional three guns, is supplied by the Kobe Kogyo Corp. It differs from the regular Lawrence tube mainly in location of a unipotential focus grid close to the color switching grid, between that grid and the gun. Kobe Kogyo says the focus grid permits low-cost optical fabrication of the color screen and improves the tube's color purity. The set uses a line sequential system rather than the dot sequential system of U. S. tv sets. This simplified set circuitry. For example, the conventional convergence circuits are not needed.

Anybody want a used computer?

The used-computer market is reportedly nosediving as a result of the wholesale ordering of new computer models, especially the International Business Machines Corp.'s system/360. The Standard Oil Co. (N. J.) is said to have just ordered 21 system/360 computers to replace 27 older computers.

Integrated circuit: Is price war on?

Has a price war broken out in integrated circuits? Some observers said "yes" when the semiconductor division of the Fairchild Camera & Instrument Corp. slashed prices—from \$25 to \$5 apiece for some integrated circuit types.

Robert Noyce, a Fairchild vice president, said: "I think there are too many people in the business. The time has come to put up or shut up." A competitor, the Clevite Semiconductor Corp. of Palo Alto, Calif., declared, "The war is on."

The Fairchild action caused consternation at one company that had been planning a cut of its own. The Semiconductor division of Motorola, Inc., said, "It would appear that Fairchild has beaten us by about one month." The Motorola spokesman expected no price war, but he predicted the price of integrated circuits would approach that of circuits made with discrete components.

But spokesmen for Texas Instruments Incorporated, and the semiconductor division of the Hughes Aircraft Corp. laid the price cuts to dumping on the market of Fairchild units that can't meet government specifications.

The price war theory is strengthened by an apparent trend of computer makers to build their own microcircuits. The International Business Machines Corp. is making hybrid circuits for its System/360. The semiconductor division of the Sperry Rand Corp. has been licensed by Fairchild to manufacture integrated circuits. Other computer manufacturers with in-house capabilities for making integrated circuits include the Radio Corp. of America, Westinghouse Electric Corp. and the General Electric Co.

The low-priced "industrial" units according to Fairchild, have the same

Electronics Newsletter

characteristics as their military counterparts, except for the range of operating temperature. The industrial units are for service at 15 to 55 c.

Automaker goes for thin films

The first high-volume application of thin-film circuits may be in the auto industry. The Delco Radio division of the General Motors Corp. is now operating a pilot production line and may convert to full-scale production within a year. **The initial use of thin films is expected to be in voltage regulators.** But Delco's investment is aimed at the probable car radio of the future—a microminiaturized am-fm model with stereophonic sound and multiplex channels.

Army slows down RADA program

An Army project that could revolutionize military communications and result in more than \$100 million dollars in procurement—is being slowed down. Under the random-access discrete address program, many radio users would share one wide band instead of each user getting a narrow band for himself. One sharing technique under development is to allot to each user a time-frequency slot [Electronics, Apr. 5 1963, p. 18].

The Army requested only \$1 million for RADA in fiscal 1965, a decrease from \$4 million spent in 1964.

Recently released congressional hearings on Army appropriations disclose that RADA has apparently run into multipath and interference problems. "When you start transmitting to someone 20 miles away and there is someone 50 feet away," an Army official said, "there are all sorts of signal reflections and extraneous signals." He said the problem would not be solved quickly.

The Army is studying proposals on RADA that were turned in to the Army Electronics Command on May 11 by three competing firms: the Martin Co., Radio Corp. of America and Motorola, Inc.

Air Force, which is scheduled to begin investigating RADA in fiscal 1965 is reportedly eyeing an alternate technique called spread spectrum. One such system, Phantom, is used in a classified project. **Some proponents say it overcame RADA's problems four years ago.**

Phantom was developed by the General Electric Co. [Electronics, Aug. 5 1960 p. 30]. **Many different signal waveforms can be transmitted in a wide band.** Power is spread thinly over the band so narrowband radios can operate within the wide band without interference.

Multipath problems were licked by time-diversity—as one or more paths fade, the system uses the remaining ones.

The tables are turned

Technograph Printed Electronics, Inc., has been suing about 70 companies, claiming infringement of basic patents for etched circuits [Electronics, June 7, 1963 p. 24]. Its suit against Admiral Corp. was dismissed Apr. 30 by a U.S. District Court in Chicago. **Now Technograph will pay Admiral royalties on 14 patents for etched circuits.**

3 cities may get phone tv in June

The Bell System hopes to put its Picturephone into public service next month in three cities. The equipment transmits television over regular phone lines [Electronics May 4 1964 p. 29].

Precise overcurrent protection

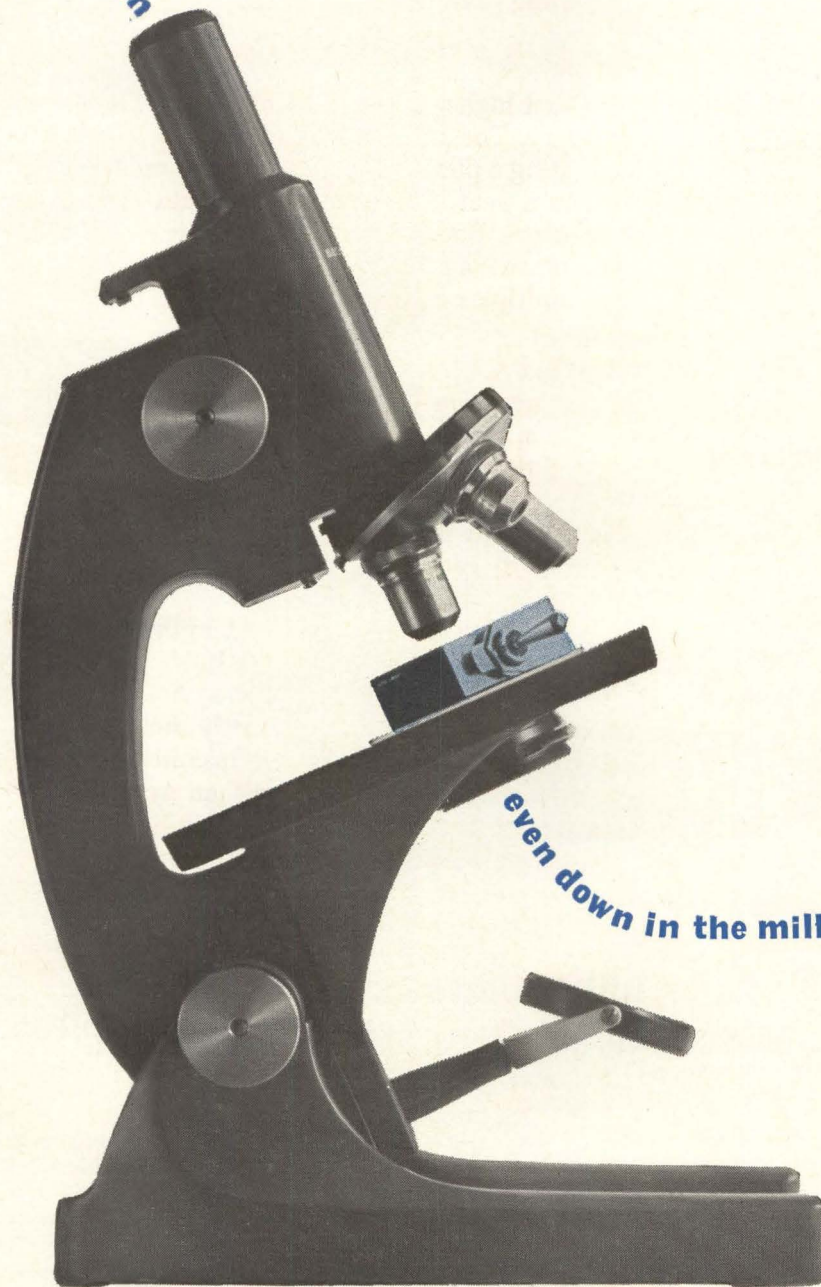

even down in the milliamp range

In case you didn't know it, there *are* circuit breakers for milliamper-level equipment protection. We make them. And if you're at all familiar with Heinemann breakers, you know that means you get a lot more than just overcurrent protection.

For one thing you can have any current rating you need, not just a few "standards." Specify it down to 0.010 amps, even to three figures.

And you can count on that rating to stay unaffected by ambient temperature. Our breakers are hydraulic-magnetic—no thermal actuation elements. They trip precisely as specified and hold rated current anywhere within their overall operating temperature range.

You also get your choice of a number of inverse time delays, or non-time-delay (instantaneous-trip) action if you need it. Choose from a variety of special circuit arrangements, too (shunt-trip and relay-trip, among others, in addition to the standard series-trip).

We make a number of OEM breaker models, with one, two, three, or more poles. All can be had with low current ratings. And all have the obvious extra advantage that they can serve as on-off switches. Heinemann breakers have no confusing reset, just a simple two-position handle.

More information? Ask for our Engineering Guide, Bulletin 202. It will give you complete data on our entire line.

HEINEMANN ELECTRIC COMPANY  **2600 BRUNSWICK PIKE, TRENTON, N.J. 08602**

SA 2892



• Full 100 mc Wide Video Sweep

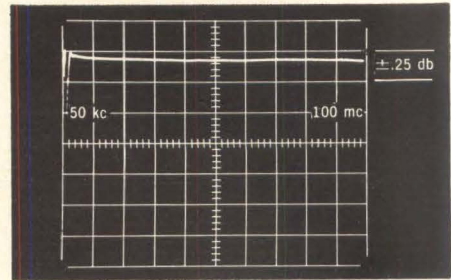

• Programmable, Voltage Controlled Oscillator

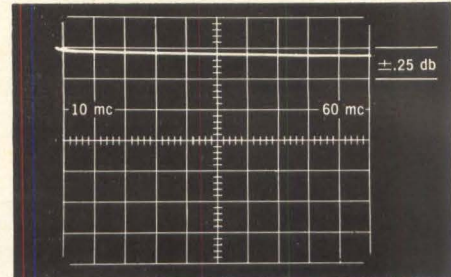

• Extremely Stable Narrow Sweeps

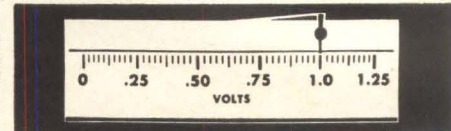

• High, Flat Output: 1.0 v rms, ± 0.25 db

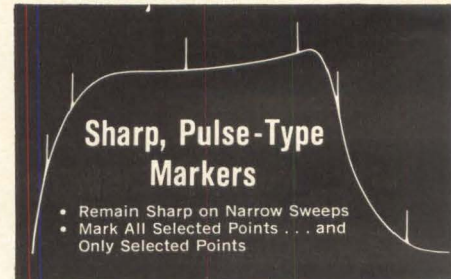

New Wide 50 kc to 100 mc Sweeping Oscillator and Marker Generator: **KAY** *Marka-Sweep* **154-A**

A complete, all-solid-state sweeping oscillator and marker generator system, the 154-A covers the spectrum from 50 kc to 100 mc in a single sweep — and provides a continuously variable sweep display throughout its full range.

Performance characteristics include line-lock, cw, manual and variable sweep rates for versatile modes of operation.

A complete selection of plug-in marker heads offers up to eight optional, individually switched crystal plug-in markers per head. Marked points stay sharp, clear, and precise even on the 154-A's narrow, extremely stable sweeps.

A variable birdie marker provision is included as standard equipment on the same display. To complement these, accurate, harmonic type markers are also available. All plug-in marker heads may be changed or added as required.

The 154-A also has provision for external modulation from dc up to more than 15 kc. A built-in detector and switched attenuator are supplied as standard features. Sweeps high-to-low or low-to-high.

SPECIFICATIONS

- Frequency Range:** 50 kc — 100 mc.
- Sweep Width:** Continuously variable from 50 kc to 100 mc.
- Operating Modes:** Line-locked, variable from 5 to 60 cps, manual, and CW.
- RF Out:** 1 volt rms into 50 ohms (70 ohms on request), metered.
- Flatness:** ± 0.25 db over widest sweep.
- Attenuator:** Individually switched 20, 20, 20, 10, 6 and 3 db steps, plus 3 db variable.
- Sweep Output:** Triangular wave synchronized with sweeping oscillator; approx. 10 v p-p.
- Markers:** Up to 8 crystal controlled pulse or birdie type markers located between 1 and 100 mc. Pos. pulses approx. 7 v peak. Variable birdie marker developed from external oscillator.
- Power Supply:** Approx. 20 watts input 117 v (±10%) 50-60 cps regulated.
- Weight:** 28 lbs.
- Price: \$795.00**
 - Marker plug-in: \$75.00
 - Pulse marker: \$17.00
 - Osc. marker: \$30.00

KAY ELECTRIC COMPANY
PINE BROOK, MORRIS COUNTY, N.J.

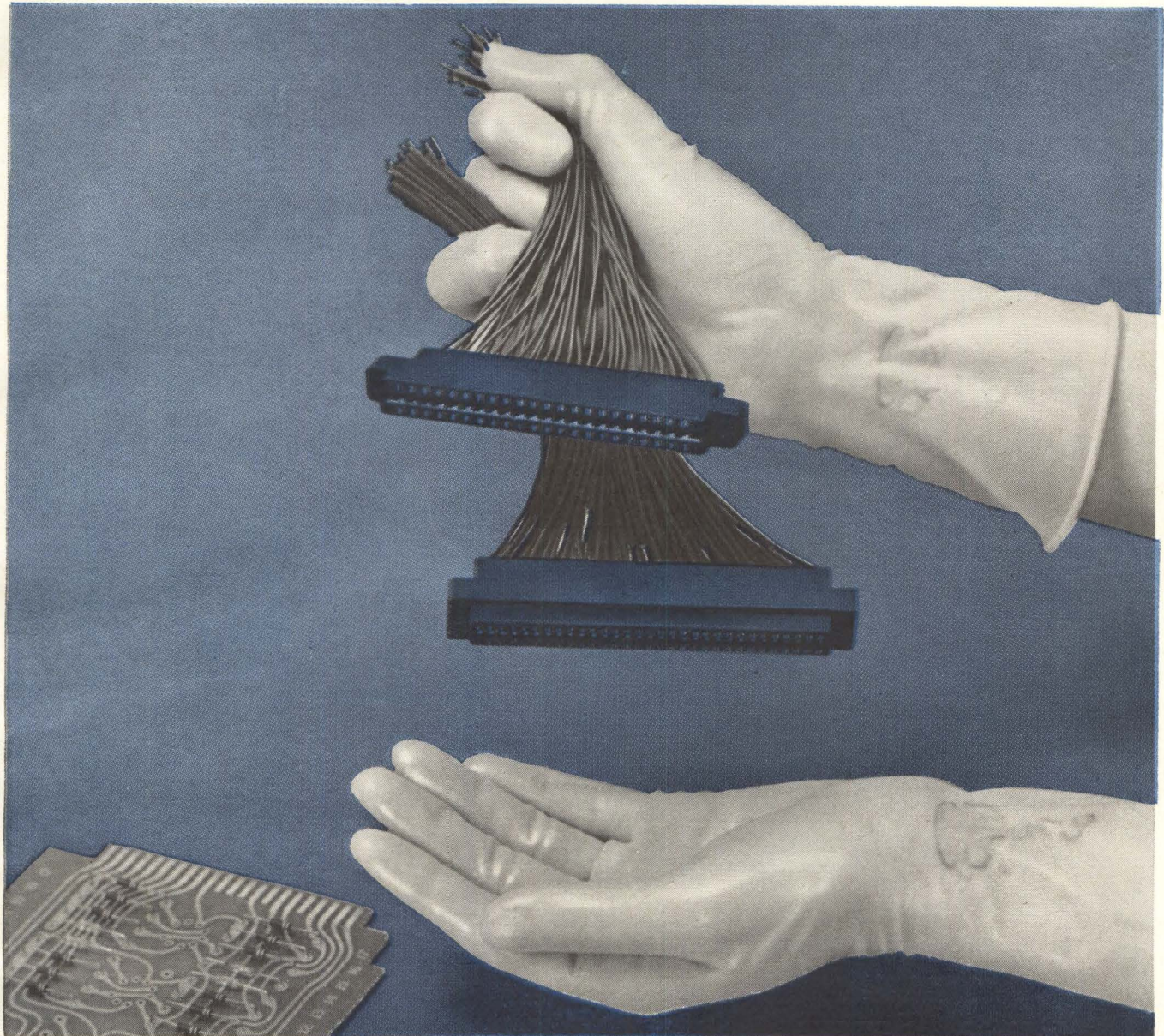

Twins or quads delivered to order

If you're planning an addition to your printed circuit connector family, AMP delivers new maximums in range and versatility at the lowest installed cost.

The new twin- and quad-position AMP-TAB★ Connectors are just what the doctor ordered. A choice of three contact spacings— .100, .125 and .156 inches. With all these connectors you make changes, replacements or repairs in a twinkling . . . without removing the board.

The dual housing accepts two tab terminals per position into a single contact. This commons the top and bottom paths of the board. The quad type accepts four tab terminals per position. Two common to the top of the printed circuit board, two common to the bottom. Board paths are not commoned.

Lowest installed costs are assured because:

- Tab terminals are: (1) crimped on wire with high speed application tooling; (2) quickly hand inserted into the rear of the connector; (3) held firmly in place by a mechanical locking device; (4) easily removed from rear of connector without removal of the board.
- sleeving is eliminated—egg-crate design completely insulates terminals
- alpha-numeric contrasting color cavity identification assists in circuit wiring

- one hand crimping tool is used for entire wire range (#18-#26 AWG).

In addition other features include . . .

- standard AMP gold over nickel plating on phosphor bronze
- diallyl phthalate block material—conforms to MIL-M-14F, Type SDG-F
- available in 10, 15, 18, 22, 30, 31, 41 and 43 positions for wire range #18 through #26 AWG
- dimensions and performance conform to MIL-C-21097.

There's still more to tell, so send today for the whole information package.

★Trademark of AMP INCORPORATED



A-MP* products and engineering assistance are available through subsidiary companies in: Australia • Canada • England • France • Holland • Italy • Japan • Mexico • West Germany

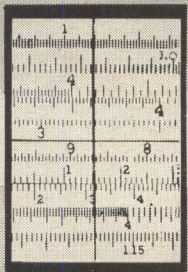

MALLORY

P. R. MALLORY & CO. INC., INDIANAPOLIS 6, INDIANA

New electrolytic capacitors with snap-in mounting

The new Mallory Type CVM electrolytics are the easiest yet to install. All you do is push in the special* spring-action mounting bracket. No twisting, no bending of tabs, no bother. They snap into place in vertical mounting position . . . fit a standard E.I.A. punch-out for 1" diameter FP capacitors.

The CVM series is ideal for record players, radios and other entertainment equipment. Cardboard

container has improved design for better retention of electrolyte and longer life. UL approved leads are plastic insulated, color coded.

Temperature rating is -20°C to $+65^{\circ}\text{C}$. Values range from 3 to 150 VDC, 5 to 5000 mfd. Singles, duals and triples are available in a wide range of standard ratings.

*Patent pending

CIRCLE 240 ON READER SERVICE CARD

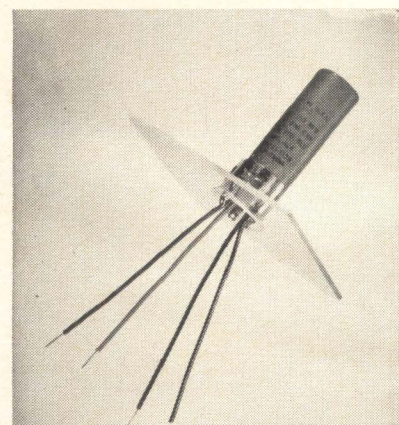

Film resistors show high stability on 10,000-hour load life test

Resistance change was less than 1% when Mallory MOL metal oxide film resistors were subjected to a 10,000-hour load life test. A group of random production samples were cycled at full load, 1½ hours on, ½ hour off. At the end of this extended endurance test,

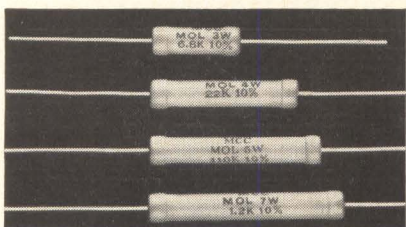

the MOL resistors proved again that they afford premium stability — at prices so economical that they're within the budget reach of any commercial, entertainment or industrial equipment.

And that's not all. The MOL series has excellent resistance to humidity . . . show stability averaging better than 1% after 1000 hours at 95% humidity at full load. Their tough silicone coating is flame resistant even at 315% overload. Temperature coefficient is only 250 PPM/ $^{\circ}\text{C}$. available in 2, 3, 4, 5 and 7 watt ratings.

CIRCLE 241 ON READER SERVICE CARD

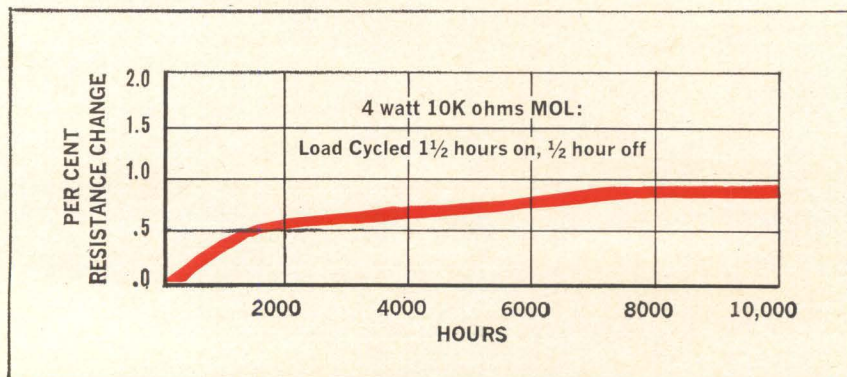

High-reliability miniature metallized Mylar* capacitors

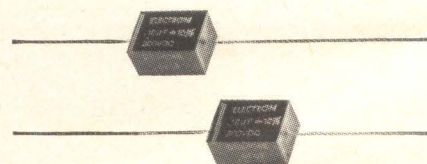

A line of miniature metallized Mylar capacitors with exceptional reliability is now available through Franchised Mallory Distributors. These capacitors, made by Electron Products, combine the high insulation resistance and dielectric strength of metallized Mylar with the compactness of rectangular epoxy packaging. Self-healing properties of the dielectric prevent random shorts in the event of flash breakthroughs from voltage surges. Meet most military humidity specifications. Either axial or radial leads. Ratings: 100, 200, 400 and 600 WVDC; up to 10 mfd. at 100 WVDC. 100-volt types use thin film (0.00015") Mylar, are especially useful in high density packaging.

*Registered trademark E. I. du Pont de Nemours

CIRCLE 242 ON READER SERVICE CARD

DESIGNER'S FILE

Two different kinds of Mallory Mercury Battery systems



Mallory Mercury Batteries are available in two standard variations of the basic chemical system: with a pure mercuric oxide depolarizer and with a small percentage of manganese dioxide in the depolarizer. This option in the chemical system provides different combinations of properties.

Mallory batteries with pure mercuric oxide depolarizer all have an "R" suffix... as, for example, RM401R. Their no-load voltage per cell is highly accurate and stable... guaranteed to be 1.350 ± 0.007 volts. Their shelf life is exceptionally long. We have had cells on test for up to 12 years. They give excellent service life at low to moderate drains. And because of their precise voltage, they are preferred for reference applications, such as instrument and telemetering circuits.

Mallory Mercury Batteries *without* the "R" suffix have a small amount of manganese dioxide in the depolarizer. They produce slightly higher no-load voltage... 1.4 volts. But their voltage tolerance of ± 0.05 volts per cell is somewhat wider, so they are not recommended where extreme precision is essential. This chemical mix provides reliable performance in transistor circuitry, especially hearing aids and radios. The "non-R" batteries are slightly more economical in cents per milliampere-hour.

We can supply, on special order, other variations of the mercury system and of eight other Mallory energy systems. Our engineers can help you select and apply the Mallory battery that matches your requirements.

CIRCLE 243 ON READER SERVICE CARD

New Miniature Wet Slug Tantalum Capacitor

The new Mallory Type MTP wet slug tantalum capacitor gives designers considerably higher microfarad-volts ratings per unit volume than conventional wet slug, solid or foil MIL types.

The MTP is an industrial version of an extremely high reliability capacitor which we developed originally for military use. It is available in ratings from 4 mfd, 50 WVDC to 450 mfd, 6 WVDC. It operates at ambients from -55°C to $+85^{\circ}\text{C}$ without derating. Smallest case size is only 0.115" in diameter by 0.312" long. Three other case sizes are supplied, largest of which is 0.225" in diameter by 0.764" long.

The MTP shows excellent resistance to vibration, shock, temperature cycling, immersion and humidity. Life tests, quality control history and temperature stability tests indicate that the MTP has performance and reliability compatible with the most stringent specifications.

CIRCLE 244 ON READER SERVICE CARD

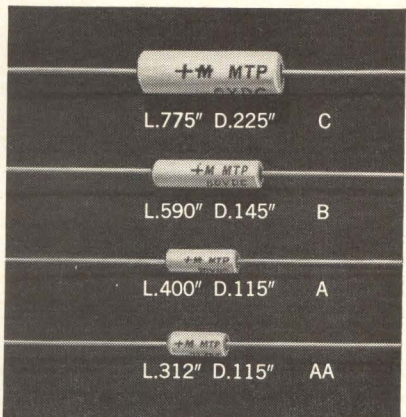
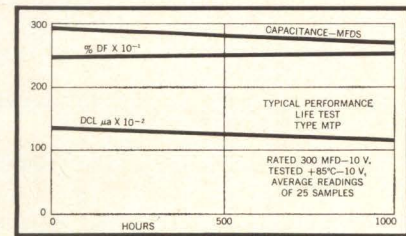
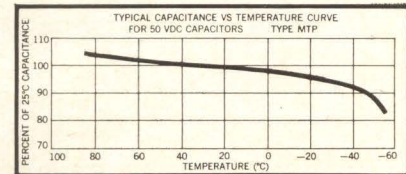

Matched volume controls for stereo systems

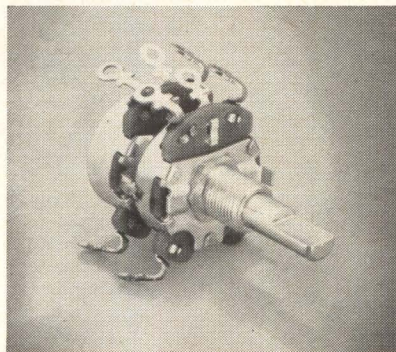

Single-knob control of dual amplifiers is made accurate and practical by Mallory matched volume controls. Resistance-versus-rotation

characteristics of two controls on the same shaft are so closely matched that both amplifiers will "track" in precise balance over the entire volume control range.

Single-shaft dual controls for stereo applications can be supplied with both controls in fixed matched position on the shaft, or with a clutch design to permit biasing of control settings to compensate for differences in amplifier gain. A broad range of resistance values, tapers, taps and mounting arrangements can be supplied.

CIRCLE 245 ON READER SERVICE CARD

New low prices on Digital Modules

Here's an opportunity to stretch your systems development and construction dollars without compromising on quality or performance. ■ Price reductions averaging \$29.00 have just been announced for a third of the items in Digital's line of computer circuit modules and module accessories. The lower prices, which reflect manufacturing economies and the use of silicon semiconductors, represent reductions of as much as \$237.00 on 130 individual units in the industry's most complete line of quality-built, high-reliability packaged circuits. ■ The new prices affect all three speed lines — 500 kilocycles and 5 and 10 megacycles. The systems designer can show substantial savings whether he is working with the patchcord-logic Laboratory Module line or with plug-in System Modules — or a combination of both. ■ For a copy of the new Digital Module Price List, contact your nearest Digital Sales Office.

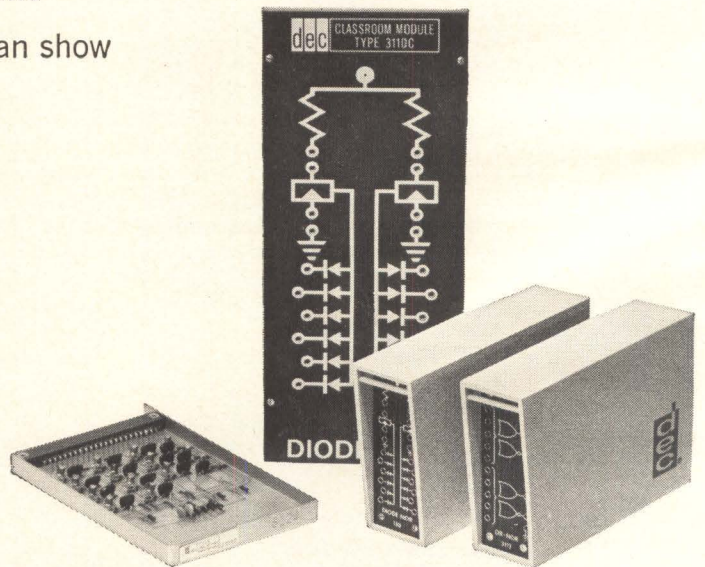

digital

**EQUIPMENT
CORPORATION**

MAYNARD, MASSACHUSETTS

Los Angeles • Palo Alto • Pittsburgh
Washington, D.C. • Parsippany, N.J.
Chicago • Ottawa • Munich, Germany
Reading, England • Sydney, Australia

ASTRODATA

ADVANCED TIME CODE GENERATORS FOR YOUR TIMING SYSTEMS APPLICATIONS

Astrodata's advanced time code generators give you state-of-the-art design for a wide range of timing requirements.

You can select the basic generator most suited to your system. When desired, standard circuit cards can be installed for special

requirements or for updating your present system.

All presently used codes can be furnished, or special codes can be devised to provide the timing most compatible with your instrumentation data.

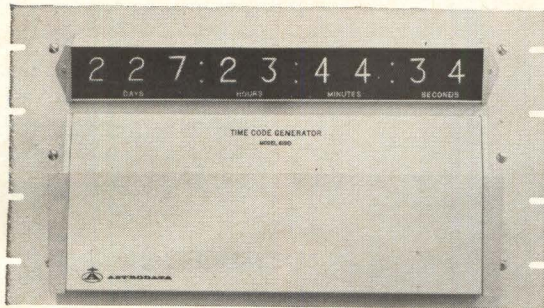

Model 6190 provides up to 10 dc shift and carrier modulated codes simultaneously...drift rate less than 5 parts in 10^9 per day...more than 30 options available...code matrix cards easily replaced to meet changing requirements.

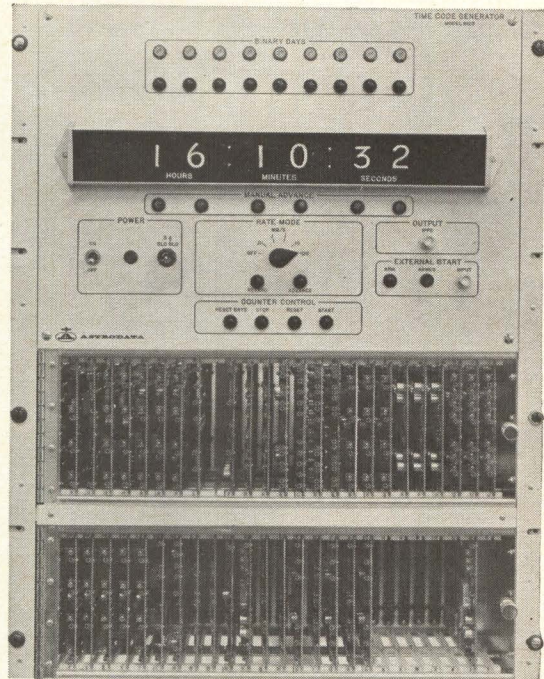
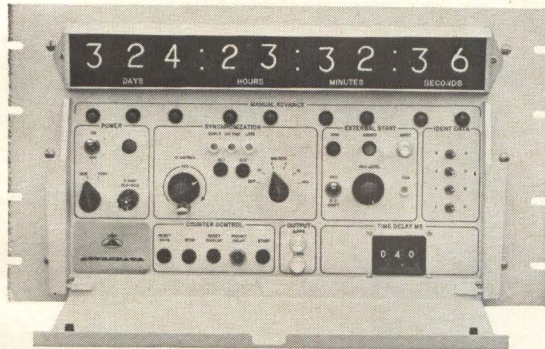

Model 6120 provides all required serial time codes simultaneously... pulse rates... decimal display... stability to 5 parts in 10^9 per day... front access to circuit cards.



Model 6140 provides up to 3 specified code formats simultaneously... drift rate less than 1 part in 10^8 per day... standard pulse rates... decimal display.

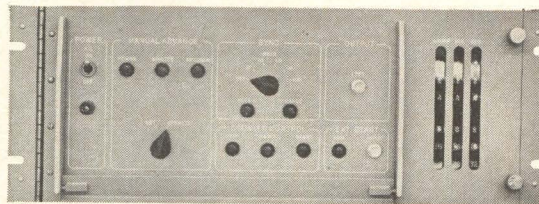

Model 6100 provides up to 3 specified code formats simultaneously... drift rate less than 1 part in 10^8 per day... standard pulse rates... binary-coded display.

Write for your copy of the 20-page brochure "Capabilities and Experience of Astrodata in Timing Instrumentation and Systems."



ASTRODATA INC.

240 East Palais Road • Anaheim, California
Phone (714) 772-1000 • TWX 714-776-3760

ES Product of the month: 400 CPS FREQUENCY CONVERTER

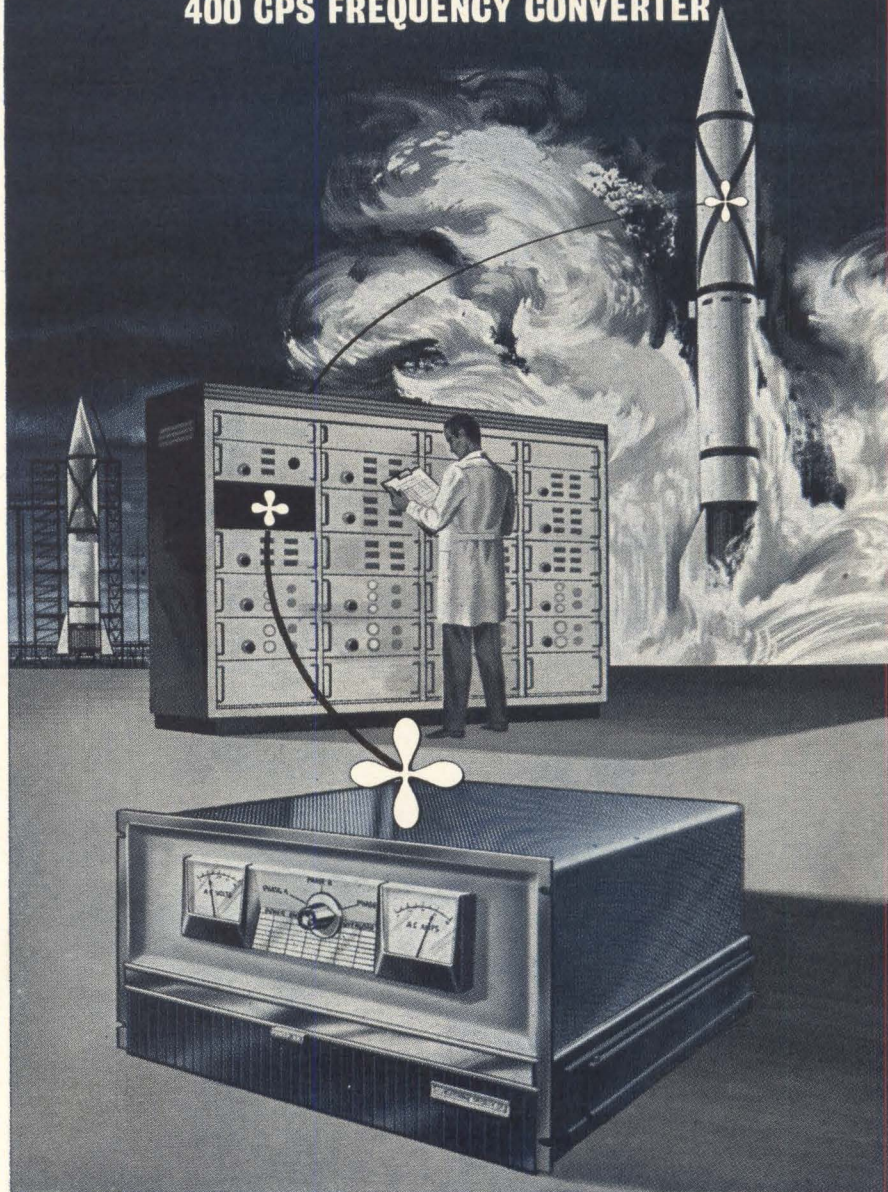

Electronic Specialty's extensive engineering experience in the power conversion field has led to a major development in the state-of-the-art. A unique, small, lightweight, solid state, 60 to 400 cps frequency converter is now entering production. The 80 pound unit, in portable laboratory or standard 19 inch rack configuration, was designed for testing military aircraft and missile electrical systems. A low acoustical noise factor makes it ideally suited for military Mobile Training Units. The new unit offers substantial reductions in cost, weight, size, and maintenance.

This reliable frequency converter has the following outstanding specifications. Size: 19" w x 10½" h x 21" d. Weight: 80 lbs. **INPUT:** Voltage, 115/200 VAC $\pm 10\%$, 3 phase wye or delta; Frequency, 50 cps or 60 cps. **OUTPUT:** Voltage, 115/200 VAC, 3 phase, 4 wire; Frequency 400 cps $\pm 1\%$; Voltage regulation, ± 2 VAC, L-N; Phase displacement angle, $120^\circ \pm 5^\circ$; Load, 0-3 KVA (0-1 KVA per phase); Load P.F., .85 lead to .75 lag; Temperature, 0°F to $+125^\circ\text{F}$ operating. The unit is uncritical to load balance and has a total harmonic distortion of 5% maximum.

FOR COMPLETE INFORMATION WRITE TO WILLIAM MARCY, DIRECTOR OF MARKETING, ADDRESS BELOW.

ES is a diversified, dynamic, multi-divisional organization serving defense and industry over a broad range of vital areas with advanced systems, sub-systems, and state-of-the-art components. Major contributions are currently being made in the following:

ELECTRONIC AND ELECTROMECHANICAL CONTROLS:

gyroscopes, relays, static switching devices, sensors, flashers, regulators, converters, rotary and linear actuators, motors, generators, weapon and camera controls, electromechanical assemblies for aerospace applications.

COMMUNICATIONS:

antennas, flexible and rigid waveguides, coaxial switches, diplexers, power dividers, filters, radio telescopes, solar furnaces, matching networks, antenna drive motors and controls.

POWER:

precise power systems, dynamotors, computer power sources, motor - generators, actuators, starter generators, power conversion systems, transmission towers for public utilities.

SPACE CONDITIONING:

electronically programmed environmental controls and systems for industrial, commercial, and military applications.

SYSTEMS:

Systems Laboratories conduct research, development and study programs in reconnaissance, electronic countermeasures, interferometer phased array systems, and total energy packages; integrating divisional components, sub-systems, and specialized technical skills.

For information concerning the corporate systems capability, product line, or research and development programs, write to the Director of Marketing, address below.



ELECTRONIC SPECIALTY CO.

5121 SAN FERNANDO ROAD, LOS ANGELES, CALIFORNIA 90039

Electronics Review

Volume 37
Number 16

Instrumentation

Storm signals

A new device that warns of storms by detecting atmospheric electricity has been developed by the Applied Science division of Litton Industries. Called SPARSA, the detector can scan a radius of 200 miles to detect electromagnetic disturbance (sferics) that could wrench the wings off a jet plane. Or it can predict lightning that could cause property damage. A system incorporating four of the new instruments is to be delivered to the Air Force for installation at Cape Kennedy.

It will work like this. Four ferrite core antennas, with circular radiators, scan a 1½-degree of arc beam. The antennas are aimed by manually rotating the octagonally-shaped pedestal on which the array is mounted, through 360 degrees, at the monitoring station.

The antenna array detects lightning or sub-lightning discharges up to 200 miles away. It angle-encodes

their position, processes them through 500-kc filters, and counts the frequency of the discharges. Ambient sferic count may run as low as no pulses a minute. A count of 100 impulses a minute or higher indicates a storm is building up in the area under study.

Early storm warnings. Hailstorms have been detected a half hour ahead, rain 15 to 20 minutes.

An increase in sferic frequency count directly measures the growing intensity of the storm. Counts as high as 200,000 discharges a minute were logged during preliminary field tests at Norman, Oklahoma.

The sferics detector has corrected radar-given false alarms by finding no storm disturbances inside otherwise threatening-looking clouds. The present processing system accumulates disturbance counts and forwards these as intensity patterns to a radar scope for superimposition on a radar display. But Litton says the system could operate by itself.

Next development will be to miniaturize the 250 to 300 pounds of equipment to airborne radar's weight and volume.

Industrial electronics

Exit analog

When the Monsanto Chemical Co. opens a plant next year in Chocolate Bayou, Tex., it will include the most extensive use to date of direct digital control [Electronics, Mar. 23, 1964, p. 49]. Analog equipment will not be used, according to the company.

For its production process, which includes 80 controlled variable loops, Monsanto will employ the new Prodac 50 computer made by the Westinghouse Electric Corp. The total installed cost of the control equipment has been esti-

mated at \$80,000 to \$150,000.

Monsanto says it will be about two years before the system's success can be evaluated.

The plant will make biodegradable detergents—soaps that decompose readily in water—as an answer to those foamy streams that made news last year.

Price is right. F. G. Willard, advisory engineer for Westinghouse's computer system department, said the Prodac 50 would make direct digital control of 50 closed economically feasible right now at a cost of \$1,000 per loop, plus the cost of input transducers and final control valves. Total cost for one complete controlled loop is said to be about \$4,000.

Willard added that the computer's reliability—the most common stumbling block in direct digital control—attains the process industry's specification of 99.95% because it uses all-silicon transistors and special hermetic packaging.

Breaking even. How big must a direct digital control system be in order to be economical? The break-even point has been pegged at 50 loops if one computer is used, and 120 loops if two computers are used in parallel to assure reliability. A chemical plant or petroleum refinery with 100 controlled variables, or loops, is considered average size.

Another. Esso Research and Engineering Co. will install a direct digital control in a new refinery. A Foxboro Co. M/97400 modular system will be used. Foxboro is rumored to have at least four more orders, one of them from the Dupont Co.

Cutting the price

When Westinghouse Electric Corp. engineers sat down to design the Prodac 50, the company's new \$50,000 computer-controller system,



John Barkley and John Miller of Litton Industries inspect their handiwork.

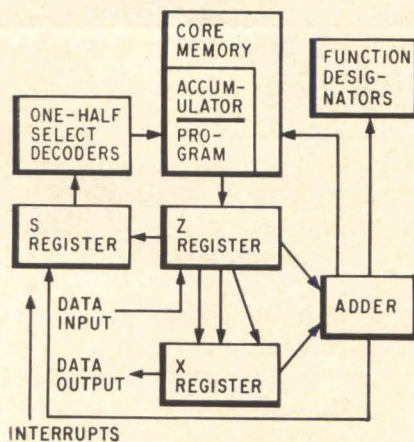

Westinghouse's Prodac 50 time shares components with this logic arrangement. Registers and memories do double duty for computation, logic decision making and control.

the chief requirement was clear: keep the cost way down. The method, they agreed, was equally clear: cut down the number of components.

Reducing the number of components, however, threatened to reduce the capability of the machine until a speed compromise was introduced. Since none of the jobs the new controller will do requires very fast computation, components are time-shared so they do more than one task. The duplication cuts the speed of arithmetic operation of the machine and the number of components required. Mostly there is a reduction of the number of flip-flops needed, enough to make it the least expensive general-purpose computer system available for control.

Time sharing. The block diagram above shows the unusual time-sharing organization of the machine. For example, the add operation takes four complete memory cycles as information and addresses are moved from memory storage to registers to the accumulator, which is located in the memory to save still more flip-flops.

Because most of the controller's operation involves logic decisions, the restricted mathematical capability is not a serious limitation.

Once the organization was determined and circuitry selected—diode-coupled NAND with an aver-

age switching speed of 50 nanoseconds—the big problem was packaging.

One bit, one card. Westinghouse rejected microelectronics for the time being because of high cost and a lack of field test data. Instead, it chose silicon planar discrete active elements mounted on big—six inch by ten inch—plastic printed circuit cards that solve interconnection problems easily and make the machine easier to maintain by electronic technicians in an industrial plant.

Because everything in the machine—all registers, and the adder—operate on a 14-bit word, Westinghouse designed one card to hold all the components for a single bit. For example, the first digit in all the registers and the adder are on the same card; the second digit is on a second card, and so forth.

In all, Westinghouse designed 13 different circuit cards; there are 37 cards in the entire computer, including the 4,096-word core memory and 64 external interrupts.

64 channels. The finished machine—a 14-bit additive computer with binary structure, operating in parallel—has 64 channels, with a theoretical capability of scanning 50,000 input and output points. Power required is less than 500 watts.

It comes complete with a limited software package composed of arithmetic routines, executive routines and a few application routines such as tables of steam temperatures and pressures, analog scan, contact scan, monitoring, and limit checking.

Production is scheduled at the rate of a few machines a week.

Consumer electronics

Pay as you see

Starting July 1, three color television channels and one f-m channel for music and information will be piped by telephone company lines to subscribers in Los Angeles and San Francisco. Subscription

Television, Inc., (STV), headed by Sylvester Weaver, former president of the National Broadcasting Corp., will use equipment designed and built by the Data and Controls division of Lear Siegler, Inc.

High speed billing. Unlike broadcast tv, the California system is not subject to FCC control because it is a closed-circuit, wired system. The use of wire transmission of programs is not new to pay tv, but until now billing has posed an economic problem.

A new automated billing technique has simplified the system and enabled STV to use the facilities of the Pacific Telephone & Telegraph Co. A specially designed general purpose computer, programed for high speed operation, scans up to 712,320 subscribers within a six-minute billing period and supplies information to an IBM billing machine.

The device that scans the subscriber's set to find out which programs are being watched is the interrogator/responder unit. It sends a 34-megacycle interrogation signal to the subscriber's program selector through a modulator located at the telephone company facility. A coded audio response, corresponding to the channel in use, is fed back to the computer, converted to binary code in the receiver, and stored in a random-access memory. A format generator converts the information in the memory storage unit to the format of an IBM 1410 billing machine. The converted data is then recorded on magnetic tape for use with the billing machine. A control console in the interrogator/responder group includes a typewriter or paper tape punch for commands and readout.

The console can control all functions and is self-checking, self-monitoring and diagnostic, so that the computer can locate a fault in the system and determine how to correct it.

Changing channels. A program selector at the subscriber's location converts his tv set to pay tv. It weighs 9 lb. contains 20 transistors and consumes 2 watts of power. The selector is fed 4 channels from the telephone drop, a coaxial cable

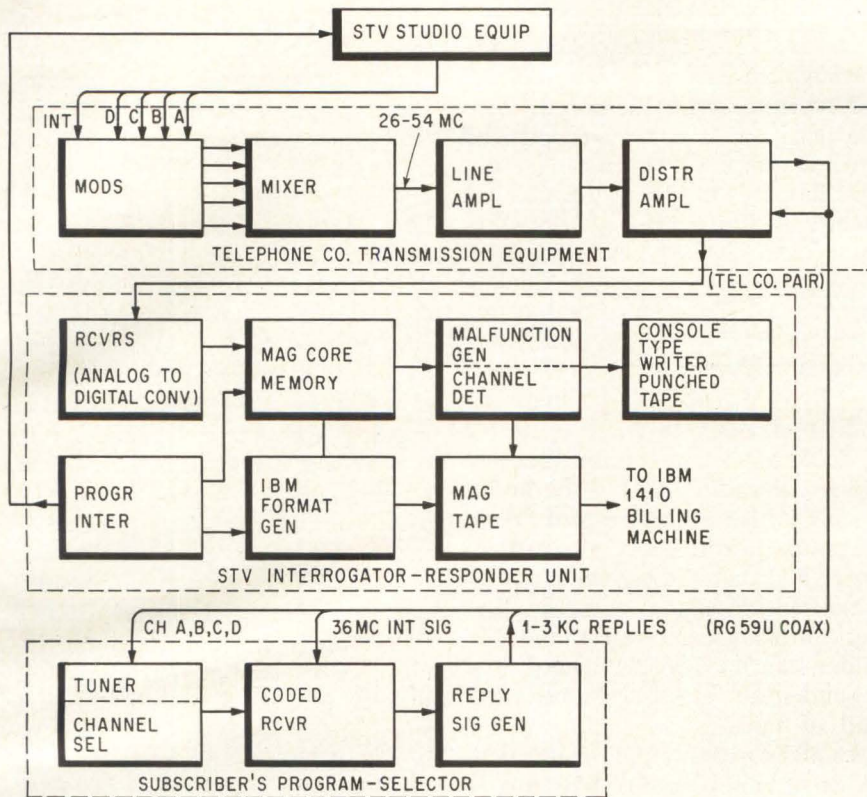

Interrogator/responder unit keeps track of tv viewing time.

installed between the telephone central and the subscriber. The channels have standard 6-Mc bandwidth for tv and 4.5-Mc for f-m.

Carrier frequencies are between 26 and 54 Mc. The f-m channel must be 4.5 Mc wide because audio i-f of an intercarrier tv set is 4.5 Mc. Thus the 54-Mc carrier must be modulated by a 4.5-Mc subcarrier which is, in turn, modulated by the audio signal. A Standard Kollsman Industries Inc. transistorized tuner converts the selected channel to channel 6 for reception on the subscriber's set. In addition to the four program channels, a 34-Mc signal from the interrogator/responder unit is applied to the program selector. Inside the program selector, a coded receiver containing gate and flip-flop circuits triggers a Hartley oscillator in the reply signal generator which is mechanically connected to the channel selector. This coded audio output, corresponding to the channel in use, is fed back to the interrogator/responder unit for storage in the computer memory.

Free sample. There is no rental

charge for the program selector but a \$5 charge is made for installation of a coaxial cable connecting the outside telephone drop to the program selector. Monthly bills for the programs are sent to the subscribers and vary from 5¢ to \$1.50 per program unit. Since an interrogation is made every six minutes, and two responses are required for a billing unit, a viewer may sample a program for six minutes without charge.

The California method differs from the system being tested in Hartford, Conn., in which a scrambled program is broadcast and only viewers with proper coin-operated unscramblers can see it.

Advanced technology

Chemically pumped lasers

A significant step toward achievement of a light, powerful laser with high repetition frequency and possible portability has been made by researchers from the Pyro labora-

tory of the Army's Picatinny Arsenal and Temple University. They have developed a chemical pumping source which might work with ruby lasers and eliminate the need for the bulky electronic power supplies now used as triggers. This would solve one of the major problems in the use of lasers for military applications.

With the new technique, a gas system of gaseous fuel and oxidant operating at atmospheric pressure and ignited by an electric spark, a brightness temperature of 6,400°K has been attained. The previous high was 5,000°K with zirconium fuel.

Nondestructive explosion. The major research goal is the development of chemical explosives (pyrotechnics) that will produce a flash sufficiently intense to trigger the laser crystal at the desired frequency without destroying the laser in the explosion.

The new high energy pump is designed to pump a ruby crystal laser. Ruby has not yet been pumped chemically, although researchers have chemically pumped the less powerful glass lasers. The main obstacle, which may be overcome by the new development, is developing a sufficiently high color temperature, to match the energy level of the ruby crystal.

Microwaves

Solid achievement

Successful development of an all-solid-state V-band oscillator and mixer for a receiver application may give millimeter-wave technology the boost it needs to overcome competition from the laser, according to X. A. De Angelis, project engineer at Sylvania's Electronic Systems subsidiary at Williamsville, N. Y.

A few years ago, the millimeter-wave spectrum was the research darling of the microwave laboratory. Interest in developing components for millimeter waves was high because, potentially, one could obtain high gain from tiny

antennas and produce high effective radiated power with extremely small, lightweight equipment. All this was very attractive to airborne radar and communication system designers.

Enter the laser. Two things combined to slow down millimeter wave technology in recent years: the advent of the laser, and the unreliability of millimeter-wave oscillators. The potential simplicity of optical systems threatened to bypass the millimeter wavelength portion of the spectrum. Available millimeter wave generators such as klystrons are relatively bulky, have low lifetime, require high-voltage power supplies (with attendant heavy transformers) and exhibit frequency instability that requires complex circuit compensation.

The new solid-state development by the subsidiary of Sylvania Electric Products, Inc. may stimulate new interest in millimeter wave equipment. Design of the circuit begins with a crystal-controlled transistor oscillator operating at a frequency of 44.596 Mc in a temperature-controlled oven. This is followed by a transistor multiplier-amplifier with an output of 14 watts at 133.789 Mc. An eight-stage varactor harmonic generator chain, utilizing commercially available varactor diodes throughout, raises the frequency to 68.5 Gc. Final stage of the chain is a quadrupler that uses a gallium arsenide varactor. Output of about 0.1 milliwatt of power at 68.5 Gc drives a balanced mixer consisting of a folded hybrid tee and two wafer diodes in waveguide mounts. Result of mating the oscillator and mixer is a receiver front end with a noise figure better than 20 db.

Diode will help. De Angelis emphasizes the low voltage (30 v) and moderate current (about 1½ amps) requirements of the oscillator. He feels that solid-state oscillators operating from 100 Gc on down, competitive with klystrons, can be made available in the near future. He concedes that the oscillator doesn't operate very efficiently at present, but feels sure that with the help of improved diodes such

as the new diffused-junction gallium arsenide types rapidly becoming available, power output can be increased to the point where the oscillator can be used also as a low-power transmitter. This would pave the way for an all solid-state transceiver.

Medical electronics

Bacteria-free food

At a hospital in London, a combined infrared and microwave oven is helping to protect weak patients from harmful food bacteria. This new microwave application is still in the research stage but results are encouraging.

The sterilized food is being supplied to an eight-bed germ-free unit in Fulham hospital specially set up for patients who have been cured of womb cancer. The cancer treatment, used at Fulham since 1958, employs two drugs, methotrexate and mercaptopurine. It has already cured tumors. Womb cancer occurs particularly after childbirth and is fatal in 90% of the cases.

Space electronics

Ranger's deadline

Ranger 7, successor to a half-dozen ill-starred lunar probe vehicles, is caught in a squeeze between the demands of time and technology.

It is scheduled for launch toward the moon late in June. The moon will also be in the right position late in July.

"Ranger 7 can play musical chairs for a couple of months" with other devices scheduled for orbit, says Homer E. Newell, associate administrator of the National Aeronautics and Space Administration. "But if Ranger 7 doesn't go up in June or July, then it's next year." The reason is a tight schedule for the launch facilities at Cape Kennedy.

For Apollo's sake. Early this month, Newell said that the lunar surface information expected from Ranger 7 is important for Apollo, the project to land men on the moon by 1970. Early data is needed, he said, to fix the design of the landing gears for the lunar excursion module. Data from Ranger 7 will also help in plans for Surveyor flights, scheduled to begin in the first half of 1965. Unlike Ranger, which is to televise the moon as the vehicle goes in for a crash landing, Surveyor must land safely on the moon and send back data on the lunar surface.

Newell insists the Ranger 7 flight will not be cancelled, even if it has to be postponed for a year. Another high NASA official, Robert C. Seamans Jr., the associate administrator, doubts that Ranger 7 will be scrapped, but he doesn't rule out the possibility. "After all," he said at a conference in Boston, "we had to scrap the Block V Rangers." Successive designs of spacecraft are designated by "block" number. Rangers 6 through 9, all identical, are in Block III.

In a letter to the chairmen of the Senate and House Space Committees, NASA administrator James E. Webb pointed out that Block IV and Block V flights had been called off, so that "the results of the entire Ranger program are dependent upon the Block III spacecraft."

Other pressures. The squeeze on Ranger 7 is intensified by a crash program for design corrections, a congressional scrutiny, and a feeling among NASA people that "this is our last chance to salvage the Ranger program."

Besides design changes, more rigorous testing procedures are being imposed on Ranger 7 to avert accidents like the unscheduled turn-on of television and telemetry equipment that spoiled the Ranger 6 shot on Feb. 2 [Electronics, Feb. 7, 1964, p. 17].

Adding to the Ranger 7 "squeeze" is the pressure on the Jet Propulsion Laboratory and its management of the Ranger program. Newell characterized the Ranger failure as "a severe morale blow

You'd expect the price of this new SCR to be considerably higher than it actually is

1 The fact is, it costs only \$1.60 (100 up).

2 Which means it's the most economical 200-volt SCR available today for applications up to 8 amperes. Same thing is true of the 25, 50, 100, 300, and 400 volt versions.

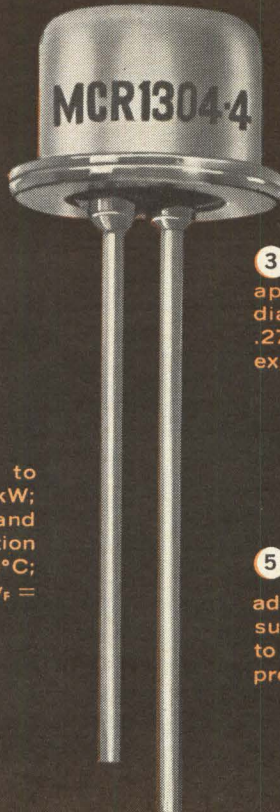

3 It's also the smallest unit available for applications at this current level. Case diameter is only .345"; case height: only .278" (compare with heavier, bulkier, more expensive alternates).

4 Performance-wise, it has this to offer: ability to switch up to 3.2 kW; it can control a full 8 amp d-c output and is designed for operation over a junction temperature range of -40 to +100°C; extremely low power loss (typical $v_f = 1.05V @ 8A \text{ peak} @ T_j = 25^\circ C$).

5 Most important, this is a reliable device — in fact, the same know-how and advanced fabrication techniques we use in supplying tens of millions of power devices to various industries have been utilized to produce it.

THE POINT IS . . .

If the size and cost of presently available SCR's has prohibited their use in your equipment, you'll find Motorola's MCR1304 Series eliminates these obstacles. It's ideal for power and motor speed control devices in all types of commercial and industrial equipment, including portable electric tools, washers and other appliances as well as in light dimming and temperature control units.



ACTUAL SIZE

From the standpoint of low-cost, small size, really good performance and quality, the MCR1304 Series is your best SCR value today . . . bar none! Evaluation quantities are available now from your local Motorola semiconductor distributor at OEM factory prices.

Electrical Characteristics ($T_j = 25^\circ C$ unless otherwise specified)	Symbol	Min.	Typ.	Max.	Units
RMS Forward Current	I_f			8	Amps
Peak Forward Surge Current (One cycle, 60 cps, $T_j = -40^\circ C$ to $100^\circ C$)	I_{surge}			80	Amps
Forward Voltage Drop ($I_f = 5 \text{ amps DC}$)	V_f		1.0	1.25	Volts
Gate Trigger Current (anode voltage = 6 volts)	I_{GT}		7	20	mA
Gate Trigger Voltage (anode voltage = 6 volts)	V_{GT}	0.2 ($T_j = 100^\circ C$)	0.8	1.5	Volts
Holding Current	I_H		3	25	mA
Turn off time ($I_f = 5 \text{ amps}$, $I_a = 5 \text{ amps}$) $T_j = 25^\circ C$ $T_j = 100^\circ C$	t_{off}		12 16		μsec



MOTOROLA Semiconductor Products Inc.

BOX 955 • PHOENIX, ARIZONA 85001 • A SUBSIDIARY OF MOTOROLA INC.

88E5

to JPL and to us.”

One of the strengths of the lab, Newell said in Boston, is the fact that it grew in an academic atmosphere, at the California Institute of Technology. But its rapid expansion into a \$270 million a year, industry-type engineering organization has generated difficult management problems, he added.

NASA has suggested and Newell said the lab has agreed to what he calls a more “projectized” organization at the lab, where grouping according to engineering discipline is the general practice. Newell said many industrial firms favor a “mix” of the project team plus technological grouping. The people working on Surveyor at the lab are not the same as in the Ranger group, he noted.

Guidance that thinks

A missile guidance system that reacts to unexpected situations is being developed by the Bell Aerosystems Co., a division of Textron, Inc.

Guidance systems in today's missiles use preprogramed inputs and therefore can only correct anticipated difficulties. Bell's system would make corrections in missile trajectories, acting on position and velocity data to correct deviations from the programed trajectory. If either position or velocity were incorrect, a variable-gain device at the control system's output would correct the signal and return it to the system's input.

The theory behind this system is applicable not only to space control systems but to autopilots, pattern recognition and business machines. It is described as a self-organizing system for adaptive control of missiles.

A self-organizing system has no basic transfer function and can cope with unexpected inputs and outputs [Electronics, Feb. 16, 1962, p. 40, March 16, 1962, p. 60, and June 8, 1962, p. 20]. An adaptive control system adjusts to its operating environment and has a basic transfer function built into it, but may have unexpected out-

puts for variations in input.

The mathematical analysis and computer simulation for the self-organizing system have been done. Hardware development is expected to take a year. It will take up to five years to develop an in-flight system.

Bell hasn't yet found an acceptable variable-gain device. It has rejected two—a magnetic device and Stanford University's memistor, a variable-plating device [Electronics, Sept. 15, 1961, p. 20, and June 8, 1962, p. 20].

Military electronics

Polaris sonar system

Presentation of a Polaris flag to the General Instrument Corp. by the Navy partially took the wraps off a complex sonar system of unique design, developed and produced by the company for the Polaris program. The flag signifies membership on the Polaris team. It was presented jointly to the corporation's Radio Receptor division in Hicksville, N.Y. and Harris ASW Anti-Submarine Warfare division in Westwood, Mass.

Details of the sonar system (called officially an array sonar sounding set) are classified but this much is known: The project has been under way for 26 months under cost-plus-fixed-fee contracts totaling \$9 million. The system was proposed to the Navy by General Instrument and purchased under directed procurement. It is said to have been based on previous work for the United States Coast and Geodetic Survey. A good guess is that the system is designed for precision mapping of the ocean bottom at great depths. It might even form the basis of a terrain following sonar or navigational system for nuclear submarines.

Already at sea. Four units will be bought for the Polaris program and none will be operated in a submarine although the equipment could easily be modified for such use. The first unit is already under

evaluation aboard the U. S. S. Compass Island (EAG-153) and has produced usable data at sea. The first operational unit will be installed soon.

The equipment is described as an active array sonar incorporating digital display and magnetic storage. Although it is said to represent the first practical application of new but previously known sonar techniques, the receiver decision circuits mark an advance in the state of the art. All data processing circuits are solid state; tubes are used in indicator circuits.

The front end of the equipment consists of six equipment racks and the conformal sonar arrays. Three racks house the transmitter, two the receiver and check-out circuits and one the power supply. The transmitter frequency can be varied for best penetration of sea water according to information fed back from the digital output circuitry. There may also be inputs from salinity, ocean temperature and pressure sensors; the transmitter may utilize pulse doppler techniques.

The data processing equipment consists of seven racks. Three house display equipment, five are a Thomson-Ramo-Wooldridge computer with two tape units, and two are plotters; an X-Y plotter and a McKiernan-Terry precision depth recorder. An IBM electric typewriter can provide a manual data input. The computer has a 15-bit register.

Sonar domes, manufactured by the H. I. Thompson Fiberglass Co., are located on the ship's bottom one-third of the way aft.

Periodic pings. The display console includes analog and digital monitors and a dual-beam oscilloscope, probably for test purposes. The analog display shows a sector of ocean 35° left and right of the ship's center line. Range marks can indicate either slant range or depth—range to 5,000 fathoms (30,000 feet) and depth to 1,000 fathoms. Received data can be sampled every 5, 15 or 25 pings (pulses from the transmitter.) Transmitter frequency is adjust-

New Ink Rectilinear Recorder for analog computer or telemetry write-out

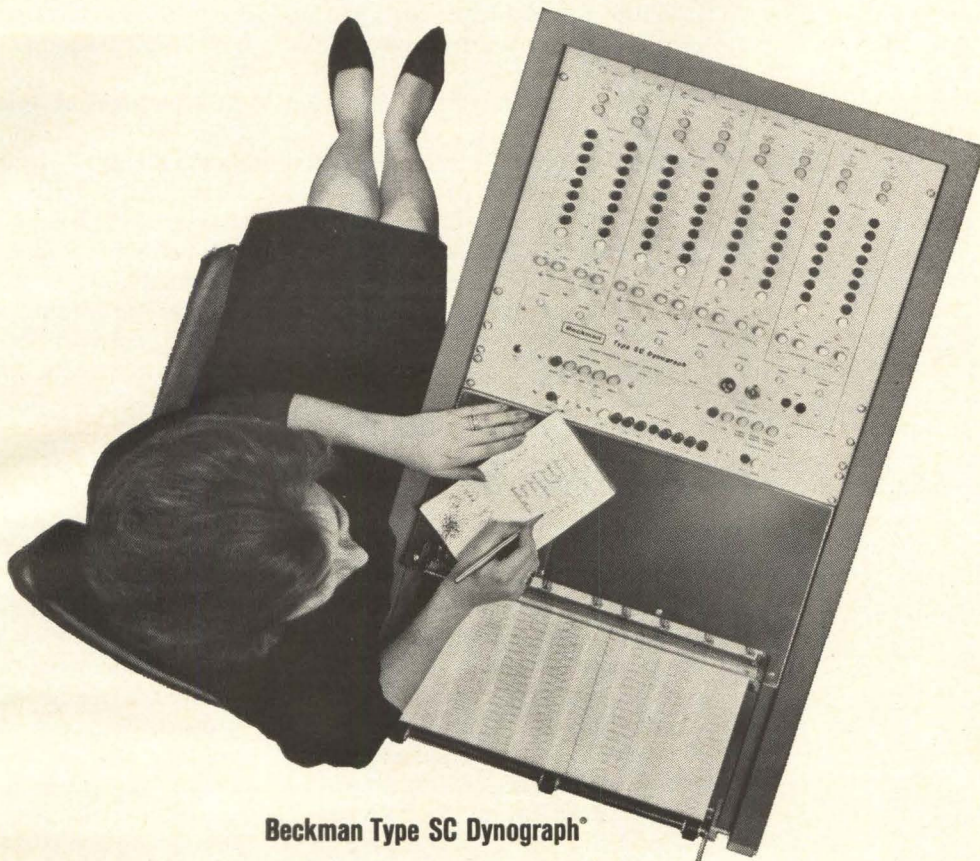

Beckman Type SC Dynograph®

All the desirability of the Dynograph ink-rectilinear recorder, in a design for complete compatibility with analog computers

Famous Locked-In Accuracy at the tracing! Servo system constantly compares pen tip and input signal for maximum accuracy and linearity.

Reliable Solid-State Circuitry eliminates drift, component aging. No warm-up time; low total power consumption (230 w. max., for 8 channels).

- Channels: 8 analog plus event marker (standard)
- Width: 40 mm (50 divisions) /channel
- Sensitivity Range: 2.5–250 volts full scale
- Input Impedance: 1 megohm, single-ended or differential
- Linearity: $\pm 0.25\%$
- Frequency Response: DC-150 cps
- Zero Suppression: 3 times full scale
- Computer Controls: "Operate," "Hold," "Reset"
- Polarity Reversal: for each channel
- Local-remote Controls: "Chart Speed," "Event Marker"
- Centralized Push Button Controls: "Sensitivity," "Paper Speed," "Calibrate," "Polarity," "Local-Remote"
- Pressurized inking system
- Paper Capacity: 1,000 ft. high gloss maximum contrast
- Paper Take-up: Reel standard, optional take-up assembly available
- Paper Drive: Zero weave, 8 or 16 speeds
- Calibration: Operate, zero, calibrate, attenuator
- Overload Indicator: each channel
- Timing Marker: one/sec or remote; second marker optional

Write, or see your local Offner Representative, for Bulletin O64-1039 on the Type SC Dynograph®

Beckman®

INSTRUMENTS, INC.

OFFNER DIVISION

SCHILLER PARK, ILLINOIS • 60176

INTERNATIONAL SUBSIDIARIES: GENEVA, SWITZERLAND; MUNICH, GERMANY; GLENROTHES, SCOTLAND; PARIS, FRANCE; TOKYO, JAPAN; CAPE TOWN, SOUTH AFRICA

able from about 12 kc upward and it can ping either periodically or only when wave motion places the ship on a desired position.

Inputs from the ship's stabilizers are pitch, roll and skew of 15° or more. Other inputs include ship's speed, and position taken from the Ship's Inertial Navigation System. One indicator control permits selecting contour intervals of 5, 10 or 24 fathoms.

Last fall [Electronics, Nov. 22, 1963, p. 14] Raytheon Co. demonstrated a sonar navigation system in Narragansett Bay. It used four-headed sonar transducers to bounce signals off the bottom in four directions. However, the Raytheon system operates at relatively high sonar frequencies and consequently is best adapted for work near shore. The General Instrument system is a low-frequency system, better adapted to penetrating great depths of sea water.

Components

Radiation-resistant

The first potentially practical microwave, super high-frequency transistor, with 10 times the radiation resistance of present transistors has been developed by the Sprague Electric Co. according to F. Lincoln Vogel, associate director of research.

The device extends the useful transistor frequency range upward by a factor of 10, says Vogel, and this high frequency will be of significance in commercial applications.

However it is the radiation-resistance of the new transistor that will be of considerable interest to the military.

The transistor is a hot-electron amplifier. An extremely thin metal layer controls the current flow from one semiconductor to another.

No effect. The single-crystal structure is said to be superior to earlier majority-carrier devices. Significant damage to the crystal structure of the metal-based transistor can be tolerated since the

thin base region presents a very small cross section for radiation particles to damage.

The device was inserted in the core of a nuclear reactor and exposed to fast neutrons for a period of eight hours, with no observable effects.

Single crystal. Sprague's big contribution is a single-crystal growth process. A polycrystal metal is deposited, then converted to a single crystal. The layers are grown by a chemical vapor-deposition process. There is no contamination at the interfaces of the device.

Two layers of single-crystal silicon are separated by a layer of metal only 100 angstroms thick. The key center layer is reportedly 25 times thinner than the thinnest possible layer used in present transistors.

More amplification. Numerous reports on this type of device have appeared in recent years. However, up to now amplifiers utilizing this construction have shown very poor characteristics. The Sprague device is said to have moderate gains with amplification factor (beta) of 10. Power gains of 50 have been measured.

Sprague is now optimizing the device. Samples and data sheets will be available in July. Development work on the metal-base transistor was performed at Stanford Research Institute [for technical details, see Electronics, May 13, 1964, p.42].

Electronics abroad

A search for problems

What problems can lasers solve? More than 300 people discussed that question for two days at Britain's National Physical Laboratory last month. They agreed that the first practical uses for lasers would be in range-finding, surgery and meteorology. These were likely to be followed by neuristor-type computers incorporating fiber optics.

Communications aspects—long considered lasers' primary applica-

tion—received scant encouragement from A. Gardner Fox, supervisor of the coherent-wave physics department at Bell Telephone Laboratories. Laser modulation, demodulation and transmission still pose big problems, according to Fox.

Generation of microwaves. Another laser application—still in the research stage—is the photoelectric generation of millimetric waves by mixing the radiation from two laser beams. Now under study at the University of Sheffield in Britain, the system requires total photoelectric currents in the order of amperes to produce milliwatt power output in the millimeter waveband.

Present experiments are seeking ways to obtain these high photoelectric currents. The next goal will be the correlation of the two laser beams.

Other researchers at Oxford University are studying the generation of dense electron emissions by illuminating metal surfaces with a focused ruby laser. This technique could be used in millimetric wave tubes that require very dense, narrow electron beams. In the experiments, tungsten surfaces are placed in a vacuum system that is evacuated by an ion pump.

Freezing. Another possibility—this one advanced by the Philips Gloeilampenfabriken electronics complex in the Netherlands—is using the laser in refrigeration. By operating the laser just below the current density at which laser action occurs, the device absorbs heat from its surroundings.

Measuring atmosphere. At the radio research station in Slough, England, researchers will collect data on molecular densities and detect layers of dust particles in the atmosphere by measuring light scattered from a vertical laser beam. The system uses a ruby laser giving off high energy, narrow beamwidth and bandwidth pulses. The laser will be mounted on a searchlight barrel. As scattered light is received, a searchlight mirror will direct it from the beam onto a photomultiplier tube's cathode.

LOWEST PRICED EVER!

SILICON CONTROLLED RECTIFIERS & TRANSWITCHES

Transitron's cost-saving **planar** techniques now make these 4 families of highly reliable, circuit-simplifying, 4-layer devices practical for every application.

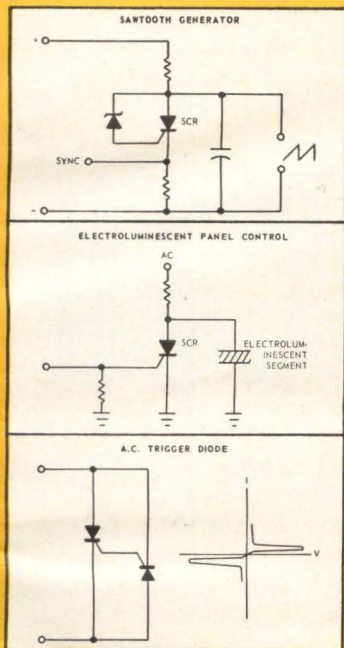

POPULAR PLANAR SILICON CONTROLLED RECTIFIERS



Type	Minimum Forward Breakdown Voltage @ +125°C (Volts)	Maximum DC Forward Current @ +80°C Ambient (Amps)	Maximum Gate Current to Fire @ +25°C (mA)
TCR35C	30*	1.0	3.0
TCR65C	60*	1.0	3.0
TCR105C	100*	1.0	3.0
TCR205C	200*	1.0	3.0

*Negative gate bias 0.5 Volts



Type	Minimum Forward Breakdown Voltage and Minimum Peak Reverse Voltage (Volts)	Maximum Average Forward Current @ +75°C Ambient (mA)	Maximum Gate Current to Fire @ +25°C (μA)
TSW30C	30	200	400
TSW60C	60	200	400
TSW100C	100	200	400
TSW200C	200	200	400

Typical circuits made simpler and more reliable with SCR's or Transwitches.

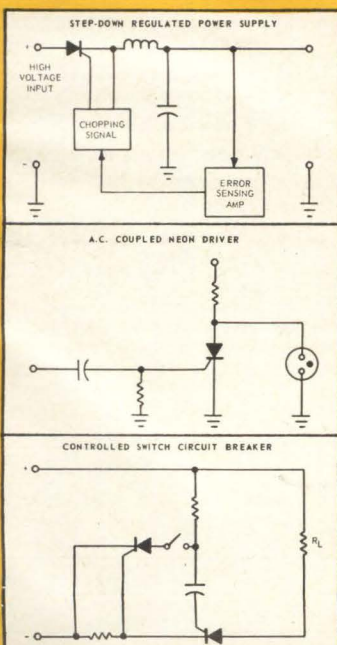

POPULAR PLANAR TURN-OFF TRANSWITCHES

Type	Minimum Forward Breakdown Voltage And Minimum Peak Reverse Voltage	Maximum Forward Current (mA)	Maximum Gate Turn-off Current (AT I _F of 25% Maximum Rating) (mA)
TSW31	30	200	10*
TSW61	60	200	10*
TSW101	100	200	10*
TSW201	200	200	10*



Type	Minimum Forward Breakdown Voltage And Minimum Peak Reverse Voltage	Maximum Forward Current (mA)	Maximum Gate Turn-off Current (AT I _F of 25% Maximum Rating) (mA)
TSW30	30	1000	50*
TSW60	60	1000	50*
TSW100	100	1000	50*
TSW200	200	1000	50*

*Minimum turn-off beta of 5

Now Transitron brings you silicon controlled rectifiers and turn-off Transwitches that you can design into your circuitry no matter how tight the budget. They let you use fewer components, reduce size and weight and, thanks to Transitron's extensive development of planar techniques, they give you greater product reliability and uniformity. All at the lowest prices ever. Choose from 16 types, all in either TO-5 or TO-18 packaging. Equivalent JEDEC registered types are also available. Both the SCR and Transwitch families offer up to 200 volts. Transwitches have minimum turn-off betas of 5. All are on your Transitron Distributor's shelf now. All are immediately available in volume.

Send for our complete file of application notes, specification sheets and prices. Write Transitron, Wakefield, Mass.

For specific design assistance, write Chief Applications Engineer.

Transitron 
 electronic corporation
 wakefield, melrose, boston, mass.

SALES OFFICES IN PRINCIPAL CITIES THROUGHOUT THE U.S.A. AND EUROPE • CABLE ADDRESS: TRELCO

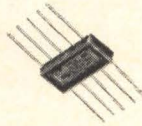

A little look at electronics in

Atlanta

High productivity. For every dollar of wages paid, an Atlanta manufacturer of electronic measuring instruments can expect \$3.76 in value added by manufacture. In Chicago he would gain only \$2.90; in New York-New Jersey, \$2.64 (U. S. Census figures). Atlanta's large labor pool also permits a high degree of selective hiring.

Trained engineers and technicians. In 1964 Atlanta's 19 colleges and universities will grant over 1300 Bachelor of Science degrees — more than 200 in electrical engineering and physics. Nearly 300 technicians graduate here yearly.

Proximity to aerospace and atomic energy installations. Atlanta is at the center of some 26 military, NASA, AEC, and airframe manufacturing installations, including Thiokol Solid Rocket Booster Plant, Marshall Space Flight Center, Cape Kennedy.

Transportation. Close liaison between manufacturer and customer and rapid freight service are guaranteed by Atlanta's transportation facilities. Seven airlines offer non-stop service from Atlanta to more than 50 cities; 75 truck lines provide scheduled service to every major market in the nation; 7 railroads operate into and out of the city over 13 main lines.

Independent research capabilities. Georgia Tech's Engineering Experiment Station, Emory University, the University of Georgia, plus a number of private companies offer a wide range of research capabilities on a contractual basis to business and industry.

Ask for an analysis of your company's probable success in Atlanta as prepared by Georgia Tech's Industrial Development Division. Check coupon; mail with your company letterhead. All inquiries confidential.

Please send me the following reports and other information as checked below:

- Calculators and Computers—A Manufacturing Opportunity in Atlanta
- Electronic Testing and Measuring Instruments—A Manufacturing Opportunity in Atlanta
- Electronics—A Manufacturing Opportunity in Georgia
- I would like information on the following aspect(s) of Atlanta's economic and general make-up (list) _____
- I want to know my company's prospects for success in Atlanta as analyzed by Georgia Tech's Industrial Development Division. We would be interested primarily in a new plant warehouse sales office other _____



"Forward Atlanta"
Paul Miller, Development Manager
Atlanta Chamber of Commerce
1328 Commerce Building
Atlanta, Ga. 30303 Phone: 521-0845

Name _____ Title _____
Company _____
Product _____
Street _____
City _____
State _____ Zip Code _____

CONFIDENTIAL

NEW LAMBDA MODULAR-SUBRACK

All Silicon, 0-20 and 0-40 VDC, Power Supplies Offer Highest Performance AT LOWEST PRICES

RACK MOUNTED—
¼ and ½ rack models
can be mounted
in unique Lambda
rack adapters

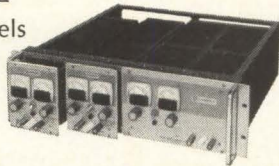

CHASSIS MOUNTED—
Flush chassis
mounting as
component
supply



BENCH USE—
Compact, minimum
bench width, with
protective feet

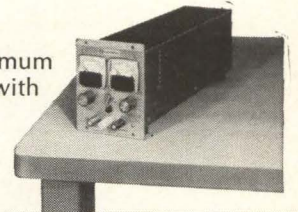

TEMPERATURE COEFFICIENT .015%/°C

LH SERIES
¼ AND ½ RACK MODELS
TO SERVE ALL YOUR NEEDS

REMOTELY
PROGRAMMABLE AND
CONTINUOUSLY VARIABLE

PERFORMANCE-
GUARANTEED FOR 5 YEARS

MEETS RFJ SPECIFICATIONS-
MIL-I-26600, Class 3

WIDE VOLTAGE
AND FREQUENCY RANGE—
105-135 VAC, 45-480 cps

CONVECTION-COOLED—
no blowers, no external heat sinks

SERIES/PARALLEL OPERATION
and ± output to a common reference

REGULATION—Line or Load—
.015% or 1 MV whichever is greater



PATENTS PENDING



RACK ADAPTERS

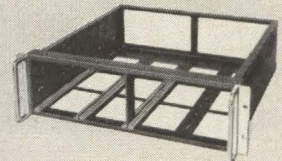

Model RA-1—for ruggedized mounting and use with chassis slides. Features front panel insertion
Price \$60.00

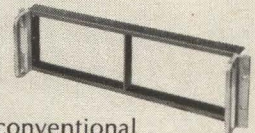

Model RA-2—for conventional rack mounting. Price \$25.00

COMPLETELY PROTECTED

- Short Circuit Proof—Continuously Adjustable Automatic Current Limiting
- Thermal Overload Protection against excessive ambient temperatures
- No voltage spikes due to "turn on, turn off" or power failure.

RIPPLE—less than 250 microvolts rms and 1 millivolt P-P

CONDENSED TENTATIVE DATA

DC OUTPUT—VOLTAGE REGULATED FOR LINE AND LOAD

PRICES
(EFFECTIVE MAY 1, 1964)

MODEL	VOLTAGE RANGE	CURRENT RANGE AT AMBIENT OF: (1)				SIZE			CHASSIS MOUNTING (2)	NON-METERED	METERED (3)
		30°C	50°C	60°C	71°C	H	W	D			
LH 121	0-20V	0-2.4A	0-2.2A	0-1.8A	0-1.5A	5 1/16"	4 3/16"	15 1/16"	\$154	\$159	\$184
LH 122	0-20V	0-5.7A	0-4.7A	0-4.0A	0-3.3A	5 1/16"	8 3/8"	15 1/16"	\$255	\$260	\$285
LH 124	0-40V	0-1.3A	0-1.1A	0-0.9A	0-0.7A	5 1/16"	4 3/16"	15 1/16"	\$149	\$154	\$179
LH 125	0-40V	0-3.0A	0-2.7A	0-2.3A	0-1.9A	5 1/16"	8 3/8"	15 1/16"	\$264	\$269	\$294

(1) Current rating applies over entire voltage range

(2) Non-metered models with flush panel (add suffix S to model number)
LH 121-S and 124-S: 4-5/16" x 3-13/16" x 15-5/16"
LH 122-S and 125-S: 4-5/16" x 8" x 15-7/16"

(3) Metered models with front panel controls (add suffix FM to model number)

SEND FOR COMPLETE LAMBDA CATALOG.



LAMBDA ELECTRONICS CORP.

515 BROAD HOLLOW ROAD • MELVILLE, L. I., NEW YORK • 516 MYRTLE 4-4200

SALES OFFICES AND REPRESENTATIVES CONVENIENTLY LOCATED IN MAJOR CITIES

Circle 37 on reader service card

MATHEMATICIANS, SCIENTISTS & INSTRUMENTATION ENGINEERS / MATHEMATICIANS, SCIENTISTS & INSTRUMENTATION ENGINEERS / MATHEMATICIANS, SCIENTISTS & INSTRUMENTATION ENGINEERS / MATHEMATICIANS, SCIENTISTS & INSTRUMENTATION ENGINEERS / MATHEMATICIANS, SCIENTISTS & INSTRUMENTATION ENGINEERS / MATHEMATICIANS, SCIENTISTS & INSTRUMENTATION ENGINEERS / MATHEMATICIANS, SCIENTISTS & INSTRUMENTATION ENGINEERS / MATHEMATICIANS, SCIENTISTS & INSTRUMENTATION ENGINEERS / MATHEMATICIANS, SCIENTISTS & INSTRUMENTATION ENGINEERS / MATHEMATICIANS, SCIENTISTS & INSTRUMENTATION ENGINEERS

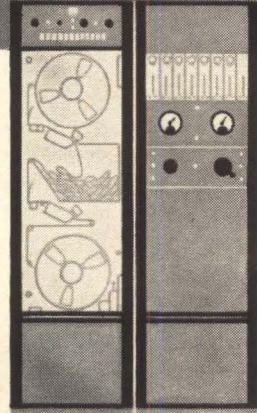
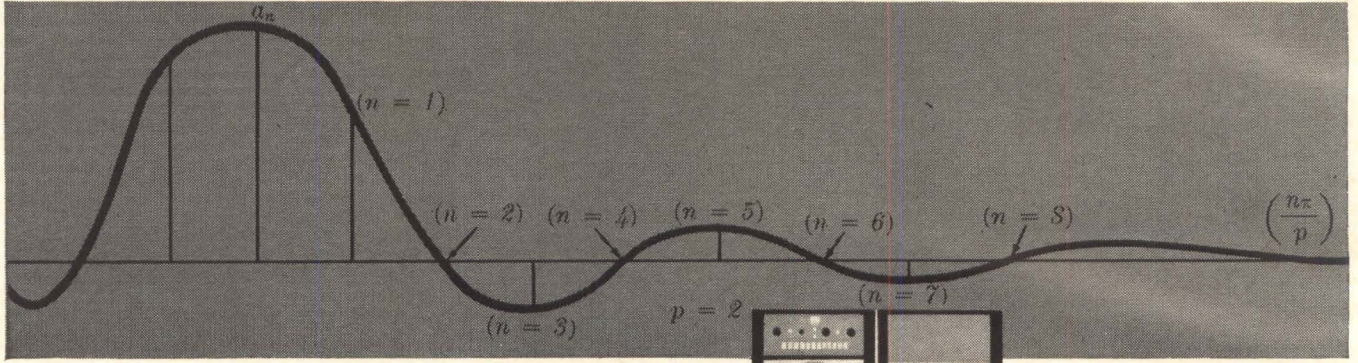
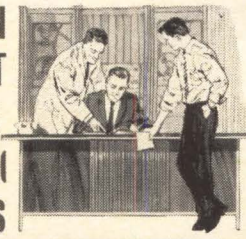

ONLY THE SANGAMO 480 PROVIDES A DELTA TAU
For Auto & Cross-Correlation • Simulates • Buffers Time • Matches Data to Computer Speed

Manipulating time with acquired analog data, the new SANGAMO 480 simplifies many measuring and simulating tasks. It actually plays tricks with time . . . warping, shifting or stretching time to meet given requirements. Applying magnetic tape techniques, it functions as a bridge between incoming analog data and the finished plot or graph.

Auto or Cross-Correlation. Operating with fixed or variable time delays, accuracies of ± 25 microseconds can be maintained. Delays can be achieved from zero to as much as 30 minutes while obtaining a complete correlation result. As an example, wind profiles from a wind tunnel can be correlated to determine whether or not a gyro's capability-limit is sufficient to function successfully in a jet-plane as it moves through certain wind conditions.

Time Delay Range	Time Delay Precision	Bandwidth	
		DC Coupled	AC Coupled
0 to 30 sec.	$\pm 25 \mu\text{sec.}$	20 kcps	250 kcps
0 to 120 sec.	$\pm 100 \mu\text{sec.}$	5 kcps	60 kcps
0 to 30 min.	$\pm 1000 \mu\text{sec.}$	300 cps	7500 cps

Simulation. Artificial aspects may be created electronically with the Sangamo 480, thus saving valuable equipment that would otherwise be destroyed or damaged in actual test. The outcome of many tests or ex-

periments can be predicted with precision. Simulation of Doppler modulation may be obtained by programming the variation in time delay between an input signal and its delay output.

Analog Computer Room Programming. The Sangamo 480 speeds or slows analog data . . . changes the rate at which computing work can be accomplished. Incoming data can be fed to computers in rapid bursts or at a new fixed rate at higher or lower speed. A speed-match is possible to obtain maximum utilization of computing equipment.

Tell us about your problem. The Sangamo 480 may be the answer! Write, wire or phone—address inquiries to: Application Engineering Manager, Electronic Systems Division.

SANGAMO ELECTRIC COMPANY
P. O. Box 359, Springfield, Illinois 62705
Phone: 217-544-6411

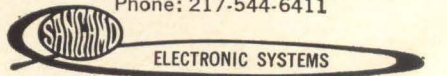

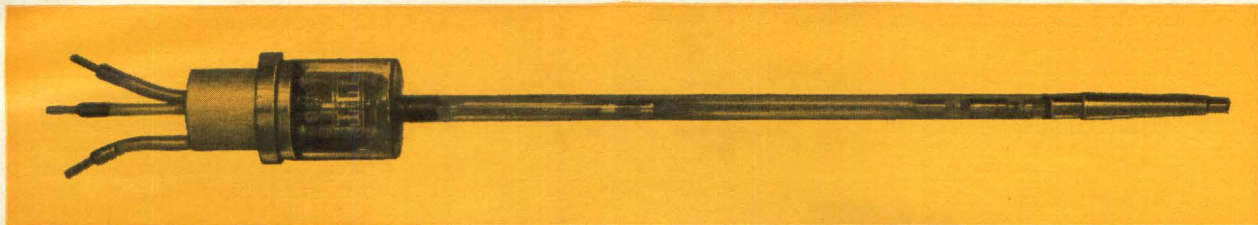
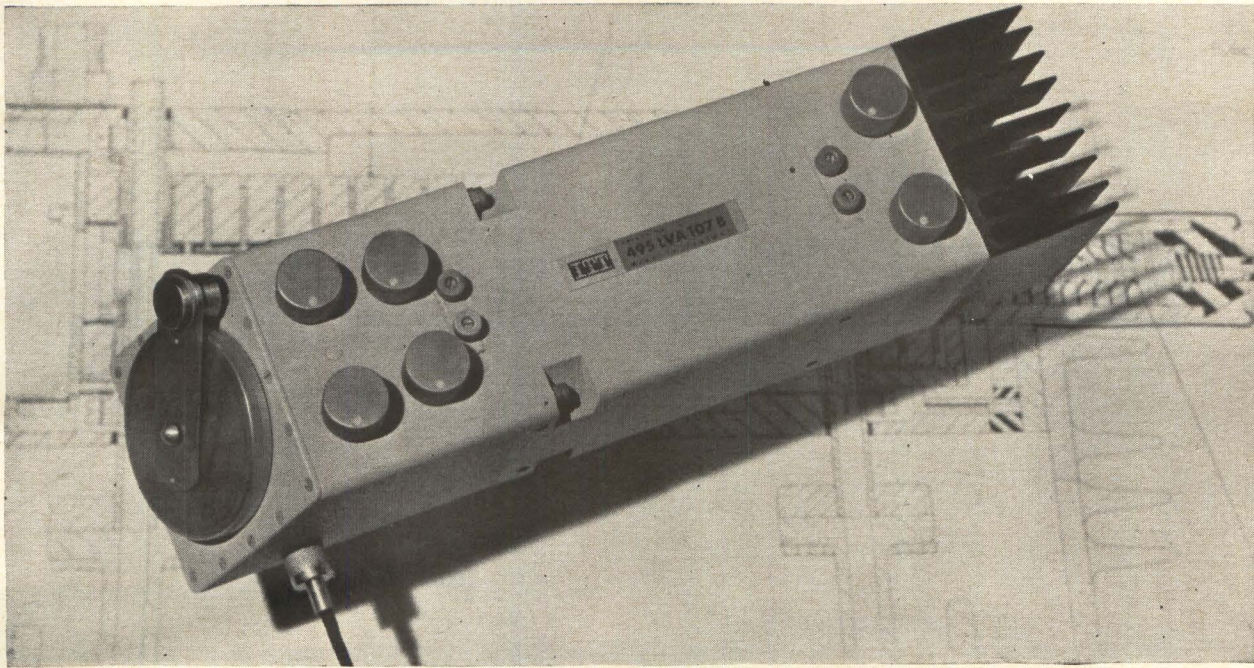

More Microwave Tubes

More Microwave Tubes from STC — leaders in the design and production of microwave components and systems. STC microwave tube development and production programs have resulted in improved gain, higher synchronous saturated output, lower noise factor and lower phase modulation distortion. These features are combined with a high degree of reliability and simplicity of operation.

S-BAND

For the Communication frequencies of this band (3.6 to 4.2 Gc/s) there are two STC travelling wave tubes: Type W7/3G performance has been proved in national and international microwave systems in fourteen countries.

Type W7/4G is a higher gain version of the W7/3G. It is provided with a periodic permanent magnet mount which incorporates simple mechanical adjustments for obtaining the very best performance from any tube of this type.

ABRIDGED DATA

Tube Type	Mount Type	RF Connexion (W.G. Flange)	Frequency Range (Gc/s)	Sync. Sat. Output (W)	Gain (db)	Noise Factor (db)
W7/3G	495-LVA-104	12A*	3.6 to 4.2	8 to 10	28	27
W7/4G	495-LVA-101A	12A*	3.6 to 5.0	8 to 12	38 to 42	27

* Transition pieces to WR229 available

C-BAND

Travelling wave tube type W5/1G has an established reputation in microwave link repeaters operating at about 5.0W output level in the 6.0 Gc/s band. A modified tube type W4/1G can be used in the same periodic permanent magnet mount as the W5/1G to cover the upper frequencies of this band (7.0 to 7.8 Gc/s). Type W5/2G has been especially designed for 1 800 channel link systems and is intended for operation with a 10 to 15W output.

ABRIDGED DATA

Tube Type	Mount Type	RF Connexion (W.G. Flange)	Frequency Range (Gc/s)	Sync. Sat. Output (W)	Gain (db)	Noise Factor (db)
W4/1G	As for W5/1G	As for W5/1G	7.0 to 7.8	8 to 11	37 to 40	26
W5/1G	495-LVA-105B 495-LVA-105C 495-LVA-105D	UG344/U	5.85 to 7.2	8 to 11	35 to 39	26
		CMR137				
		UG344/U				
W5/2G	495-LVA-107B	UG344/U	5.85 to 7.2	16	39 to 72	27
W4/2G	WM108	UG51/U	7.0 to 8.5	8 to 11	36	26

For full information, write, 'phone or Telex for Data Sheets to STC Valve Division, Brixham Road, Paignton, Devon, England. U.S.A. enquiries for price and delivery to ITT Electron Tube Division, Box 104, Clifton, New Jersey.



high-grade electronic components by

STC

COMPONENTS GROUP

WHAT MAKES "INSTRUMENTATION CABLE" DIFFERENT?

It is no more like power or control cable than a Ferrari is like the old family sedan. Not knowing this can cause you a lot of grief: project delays, costly replacements, malfunctions.

THE THIN BLACK LINE On your schematics, instrumentation cable is a black line from launching pad to blockhouse or from one part of a computer to another. In the broadest sense, it connects data or signal sources with display or recording or control devices. Its function is to carry those signals unflinchingly and with the required reliability. In this day and age, it's no easy job.

WHAT CAN GO WRONG The improperly designed cable can simply fail. This has happened and at important sites. An untried saturant, lacquer or compound ingredient used in the cable may destroy the electrical integrity of this primary insulation. This sort of deterioration need not be sudden; only experts know which impregnants will migrate in a week or a month or more.

Or a relative lack of art in manufacture may create problems for the future. Under certain circumstances in use, variations in insulation thickness, conductor placement, or conductor unbalance in the cable lay-up may cause spurious or ambiguous signals to arrive at the display, recording or control panel. Your sharp, precise pulses become displaced in time, are a little too fuzzy, or are joined by other unwanted signals from another line.

DESIGN IS HALF THE STORY Configuration of conductors within the cable is important, for physical as well as for electrical reasons. For example, positioning of coaxial components within the cable is critical in order to assure maintenance of minimum standards of concentricity between the inner and outer conductors when the cables may be subjected to bending operations during installation work.

Selection of insulating, filler and

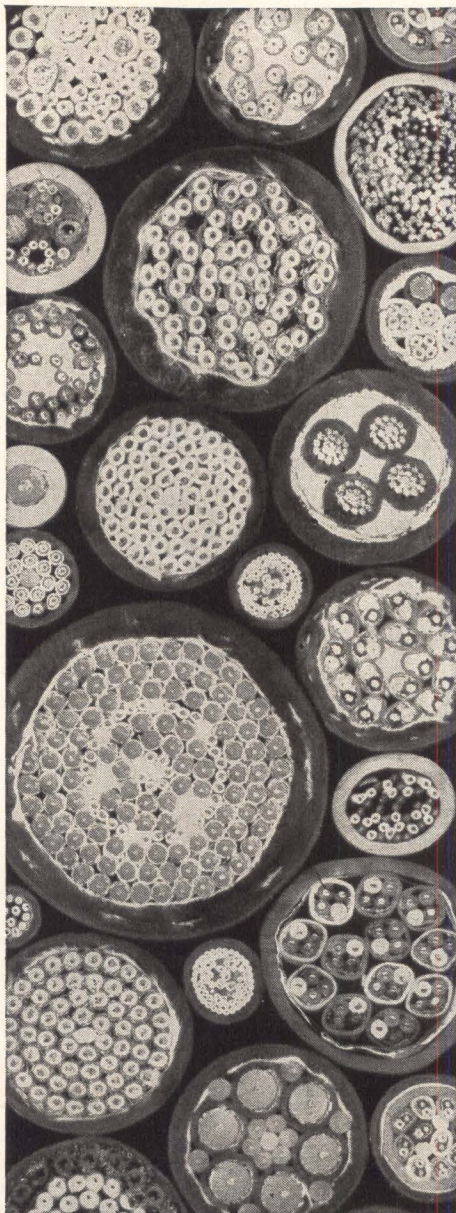

jacketing materials requires expert knowledge and judgment. Some materials, as mentioned above, tend to migrate. Others harden or soften with cold or heat. Some change their electrical characteristics in time. These are not fundamentally new problems in cable design, *but in instrumentation cable the standards are far more severe than ever before.*

MANUFACTURE IS THE OTHER HALF Even a properly designed cable may well become unacceptable sooner or later if it is not manufactured to new standards of precision. This requires stranding machines that reduce circular eccentricity to remarkably low figures and help assure insulation uniformity, insulating machines of considerable precision, and highly precise cabling equipment. It also requires, as is so often the case in precision manufacture, an indefinable skill on the part of machine operators.

ASK THE EXPERTS To protect the functioning of your system, there's only one way to make sure the thin black lines on your schematics become cables with the requisite dependability: have them designed by experts, in consultation with you, and constructed by experts.

Rome-Alcoa is, frankly, one of the very few companies that qualify. We've been designing and constructing these cables since their first conception. If you're going to need instrumentation cable soon, call us, the sooner the better.

We now have a 24-page booklet titled "Instrumentation Cables, Cable Assemblies and Hook-up Wires." In it, we describe instrumentation cable constructions, production, military specifications and our qualifications. For your copy, write Rome Cable Division of Alcoa, Dept. 27-54 Rome, N. Y.



ALCOA
ROME CABLE
DIVISION

THE
REMARKABLE

SQUAREMAKER

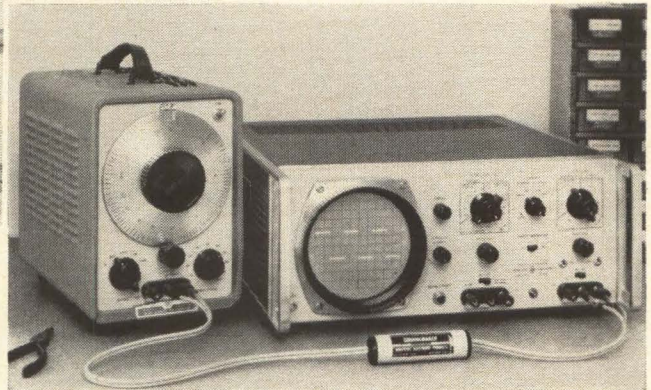
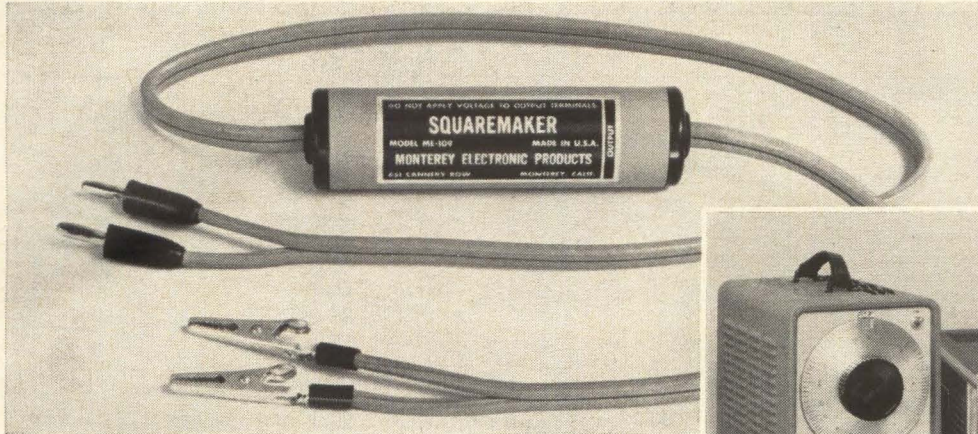
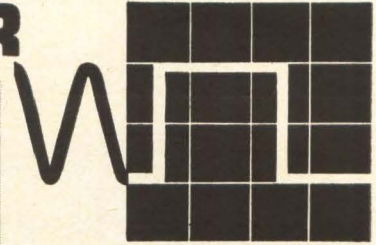

- Fast Rise Time—50 nanoseconds
- High Output Voltage—35v
- Wide Frequency Range—1cps-1Mcs

The SQUAREMAKER* Model ME-109 is a precision electronic instrument for converting an audio or video oscillator into a high-quality squarewave generator. The SQUAREMAKER consists of a set of test leads with a solid state series converter which develops a fast rise time squarewave from a sinewave input. While providing rise and fall times in the nanosecond range, the unique circuitry of the SQUAREMAKER has the additional advantage over conventional diode clipping of providing a high output voltage.

The transistors in the SQUAREMAKER derive their collector supply voltage directly from the input sinewave. This permits the amplitude of the SQUAREMAKER's output to be adjusted by the amplitude control of the oscillator. *No batteries or power connections are required.*

The extreme low cost, convenience and high performance suggest that the SQUAREMAKER belongs in the basic equipment of every workbench. Just use the SQUAREMAKER as a special set of test leads.

FREE OSCILLOSCOPES?

Not quite. We expect the SQUAREMAKER to serve for about 90% of a \$300 squarewave generator's applications. Thus you save about \$250 per SQUAREMAKER. You would need at least six SQUAREMAKERS to modify the equipment budget enough for a *bonus* 50 Mcs scope!

APPLICATIONS

When used with a sinewave oscillator, the SQUAREMAKER serves the functions of more complex and more expensive conventional squarewave generators. It permits squarewave testing of amplifiers for determining frequency characteristics and transient response. The SQUAREMAKER serves as a signal source when experimenting with pulse circuits such as differentiators, integrators, clippers, clampers, sweep circuits, computer logic circuits, and industrial control circuits.

The SQUAREMAKER is an ideal trigger source for operating and testing binaries, one-shots, Schmitt triggers, counters, timers, etc.

TYPICAL SPECIFICATIONS

Rise Time (2000 ohm load)	50 nanoseconds
Fall Time (2000 ohm load)	85 nanoseconds
Open Circuit Output Voltage	—35 volts
Maximum rms input	25 volts
Over-All Frequency Range	1 cps to 1 Mcs
Frequency of 5% tilt	15 cps
Frequency of 5% rounding	500 kcs
Output Impedance	2000 ohms
Overshoot	1%
Symmetry Variation	±5%
Jitter (viewing one cycle)	None observable
NET PRICE (f.o.b. Monterey)	\$19.95

Write or Wire—Shipment from Stock
90 Day Unconditional Guarantee

*Patent Pending

MONTEREY ELECTRONIC PRODUCTS

651 Cannery Row Monterey, California

DIGITAL TIMERS • ELECTRONIC COUNTERS • CIRCUIT MODULES • INSTRUMENTS • INDUSTRIAL ELECTRONIC CONTROLS

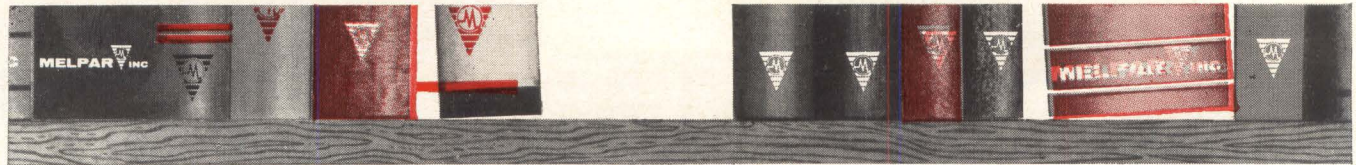

SIMULATION AND TRAINING

INTRODUCTION

Like all MELPAR contributions to the aerospace library, the volume on Simulation and Training is *bound in success*. MELPAR's exceptional research and developmental skills have added many chapters to the technology of training.

Each chapter represents an accomplishment in which MELPAR's creative technical capability resulted in a successful advanced simulation and training system.

And MELPAR's off-the-shelf technical experience is backed by a production capability that is establishing a near-perfect record in on-time delivery of quality products.

MELPAR's growth and success in Simulation and Training continue to create new employment opportunities for scientists and engineers with backgrounds in programming, computer systems design, and display techniques. If you feel that you are the person who can contribute to the MELPAR story of achievement, write to: Manager, Professional Placement.



GAM-83 Missile Systems Trainer

SIMULATION AND TRAINING

CHAPTERS

- I. F-86D Aircraft Flight Simulators
- II. A4D Series Aircraft Operational Flight Trainers
- III. F-100 Series Aircraft Flight Simulators
- IV. RF-101 Aircraft Flight Simulators
- V. F-101B Weapon System Simulators
- VI. HSS-2 Helicopter Weapons System Trainers
- VII. CH-46A Helicopter Operational Flight Trainers
- VIII. GAM-83 Missile System Trainers
- IX. Space Simulation Equipment
- X. Radar and Sonar Trainers

MELPAR INC

A SUBSIDIARY OF WESTINGHOUSE AIR BRAKE CO.

3000 Arlington Boulevard, Falls Church, Va.

IN HISTORIC FAIRFAX COUNTY,
ONLY 10 MILES FROM WASHINGTON, D. C.

an equal opportunity employer

Second in a Series

Washington Newsletter

May 18, 1964

Renegotiation Act may include FAA

Despite opposition by the electronics and aerospace industries, **Congress is certain to extend the life of the Renegotiation Act** two more years to June 30, 1966. The House has passed the extension of the machinery for recovering excess profits from government contracts, and expanded it to cover radars, computers and other electronic aids for air traffic control that are bought by the Federal Aviation Agency. The Senate is expected to concur.

At present the act covers buying by the Pentagon, National Aeronautics and Space Administration, Atomic Energy Commission, General Services Administration and the Maritime Administration.

Industry failed to convince the House that sharper procurement techniques and the absence of wartime pressure in contracting made renegotiation obsolete. **A Republican effort to exempt many more small businesses also failed.** It would have raised the limit for exemption from the present \$1 million in annual renegotiable business to \$3 million in 1965 and \$5 million in 1966.

Cutback effects will be studied

The government is financing a year-long study to determine what **problems and opportunities the electronics industry will face** as the result of reduced defense demands. The Arms Control and Disarmament Agency has awarded a \$107,000 contract to the Battelle Memorial Institute, Columbus, Ohio, to make the study and to recommend ways of minimizing adjustment problems.

Beyond ZIP code with optical scans

The Post Office's program to automate letter-sorting is jumping beyond optical scanners to read the five-digit ZIP code [Electronics, July 12, 1963, p. 26].

Simultaneous development of address readers is being pushed. Equipment that can read the printed names of all 50 states and two major cities will be tested this year in Detroit. By about 1966, the Post Office hopes it will have machines reading 50 states and 50 cities.

The Farrington Electronics Co. and the Philco Corp. designed the equipment. Now they are refining methods of reading combinations of **characters and numbers, for more advanced readers.** Government officials are particularly impressed by Farrington's stream-following technique of number identification. It promises a direct method of integrating number and word recognition.

Satellite Corp.'s \$200 million plan

Besides disclosing how it plans to raise and spend \$200 million in working capital through stock sales, **the Communications Satellite Corp. has outlined operational plans** in the preliminary prospectus it filed with the Securities and Exchange Commission.

The corporation wants to own the domestic ground station. This move may be contested by some of the communications common carriers. The law approving the corporation gives the Federal Communications Commission some discretion in deciding station ownership.

If a system of medium-altitude satellites is selected, **stations will be located in the Northeast, Northwest and Southwest, with a terminal**

Washington Newsletter

station in Hawaii. If a synchronous-altitude station is adopted, there will be stations in the East and West as well as the Hawaiian terminal. **By 1966, a command and control station will be built in the continental U. S.**

The corporation plans to spend \$14 million to \$20 million for experimental operational satellites, \$55 million to \$65 million to develop satellites before the decision on a satellite type is made by late 1965. It also wants to spend \$75 million to \$90 million to build the system, \$9 million to \$10 million for the command and control station, \$17 million to \$20 million for ground stations, and \$20 million to \$25 million for other costs. If the military decides to lease channels in the commercial system, the cost will be higher.

The corporation will sell 10 million shares of stock at \$20 a share. Half is reserved for communications common carriers and half will be offered to the public starting about June 2.

Disaster-proof alarm is sought

The government is still backing and filling on a home warning system for civil defense. Conelrad (control of electromagnetic radiation) is phased out, replaced by emergency warnings and instructions broadcast on all stations. But the Office of Civil Defense and the Federal Communications Commission are still aiming for a disaster-proof setup.

Conelrad was a system for preventing an enemy from using radio signals from any particular a-m station as a guide for planes or missiles. The system involved shifting all a-m stations to either 640 kc or 1240 kc and having them broadcast in a group in random order for short intervals on only these frequencies.

One plan, NEAR (National Emergency Alarm Repeater), is down for the count. At one point it was to have been built in 1962. But it was swamped with troubles—chiefly an escalating cost estimate—and no more funds have been requested. Even though NEAR is about dead, the civil defense agency is proceeding with a major test in Michigan. Twelve signal converters are to be installed on eight electric power systems in the state. These central stations will be capable of feeding warnings to devices attached to power outlets in about 50,000 homes.

Now, thinking turns back to a radio warning system, somewhat a combination of Conelrad and NEAR. Signals fed through standard a-m radio would activate in the radio a shrieking device that would never be turned off. The Civil Defense Office is asking \$1.1 million for next year for field tests and engineering studies.

Further easing of trade with East?

A further relaxation of U.S. restrictions on trading with Communist countries [Electronics, Apr. 20, 1964, pp. 105-113] is apparent. An upswing is particularly likely for Rumania. **The Rumanians are openly resisting economic domination by Moscow, and the U. S. wants to encourage them.** They also have cash from oil sales, and have settled American expropriation claims.

Several U.S. firms have already been authorized by the Commerce Department to bid on parts of a 5.5-million-ton steel complex being built at Galati, Rumania. The bids would include technical data for an oxygen steelmaking process.

Meanwhile, the Chamber of Commerce, working counter to the position of the Republican leadership in Congress, is pressing for liberalization of U.S. restrictions on Red-bloc trade.

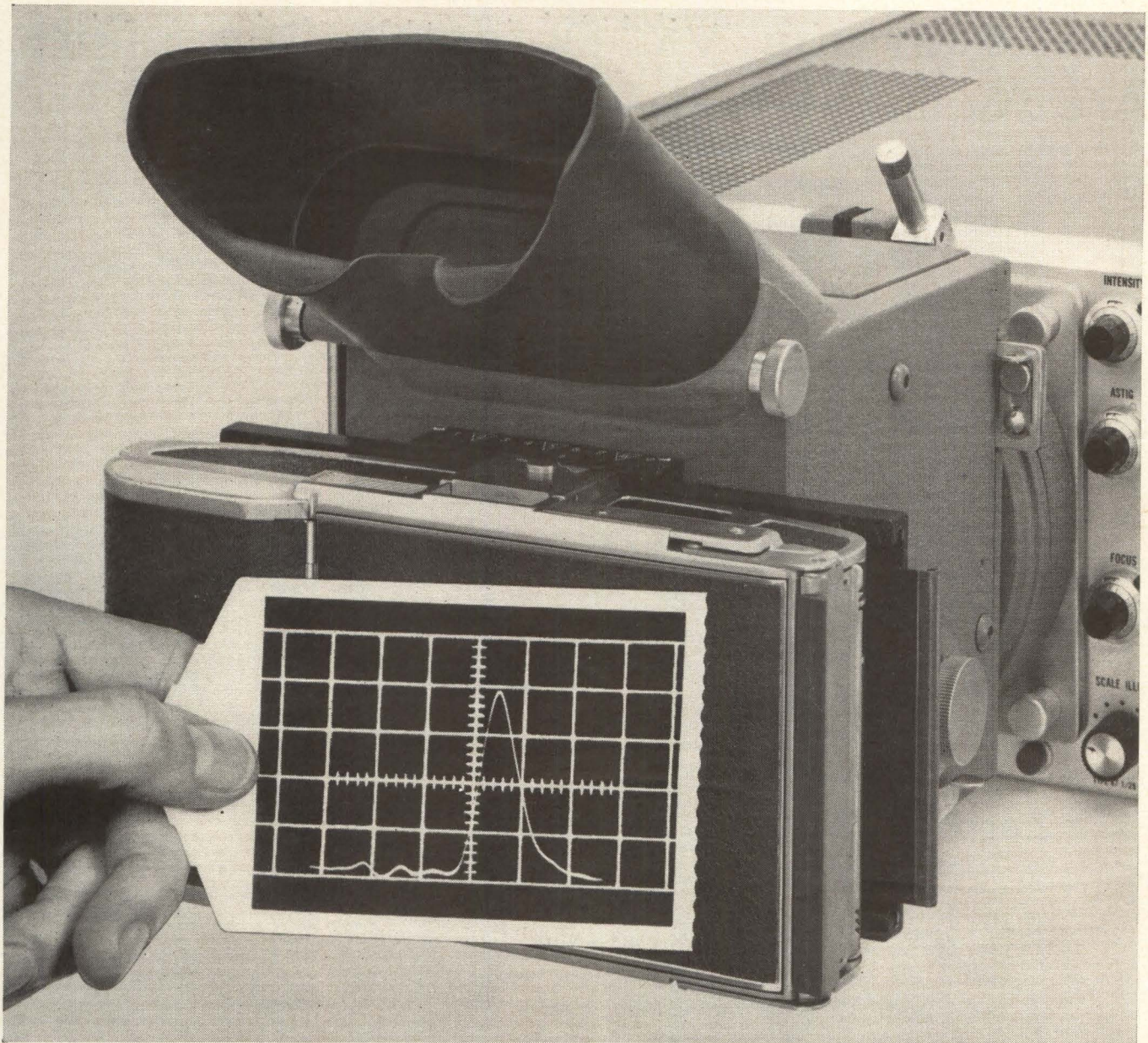

HOW TO FILM AN ULTRA-FAST LASER PULSE

Fairchild Scope Camera and Polaroid Land® 10,000 Film capture pulse with 9 nsec rise time on 4 cm scan

This photo shows the duration and shape of a single shot, 20 megawatt ruby laser pulse. It was made by a Fairchild Oscilloscope Camera mounted on the new type 757 Fairchild ultra-high writing rate scope. The Camera was fitted with a Polaroid Back using Polaroid Land 10,000 speed film. With the scope armed for single sweep, the camera set at f/1.9, and the shutter on bulb, the laser was fired. The film had not been pre-fogged in any way, but as you can see, it was unnecessary: the 9 nsec pulse rise time was recorded on 4 cm scan with the clarity and contrast usually seen only in multiple exposures. The versatility of Fairchild Oscilloscope Cameras matches their high performance. That's one reason more of them are in use today than any other kind. Such features as precision control of object-to-image ratios and a data chamber for recording written data on the print are examples of this versatility. For details on models and prices, write Fairchild Scientific Instruments, Dept. 104, 750 Bloomfield Ave., Clifton, N. J.

©Reg. TM of Polaroid Corp.

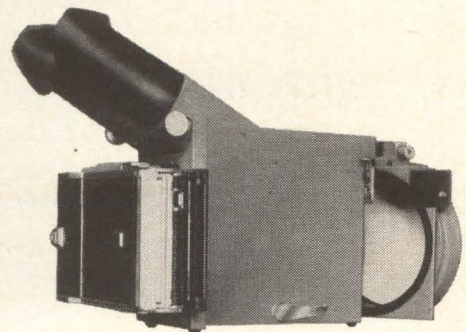

Swing-away feature of Type 453A Camera adds to convenience. All models available with new Polaroid Film Pack Backs.

FAIRCHILD

DU MONT LABORATORIES
SCIENTIFIC INSTRUMENTS DEPARTMENT

Now! Famous "VY" Porcelain Capacitors
Are Available With A

ZERO

temperature coefficient
(as well as standard +105PPM/°C).

VY "0"

- * Conforms with MIL-C-11272
- * 10 to 1000 pf
- * -55°C to 125°C operation
- * 300 and 500 vdc

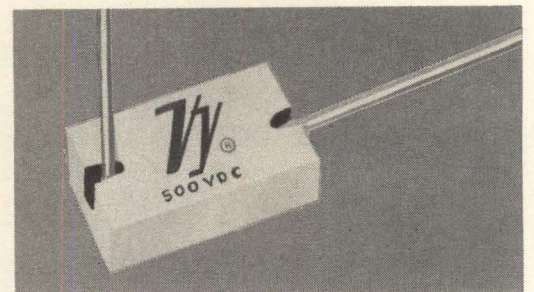

Zero TC Solid State Capacitor

Here's a capacitor designed to pull its own weight in tuned circuits, rf, and high frequency applications. This new "VY" Capacitor has a temperature coefficient of 0 ± 25 ppm/°C. Axial-radial lead configuration saves board space . . . gives greater flexibility to circuit wiring.

Available with choice of Dumet, Nickel A, or Solder Coated leads.

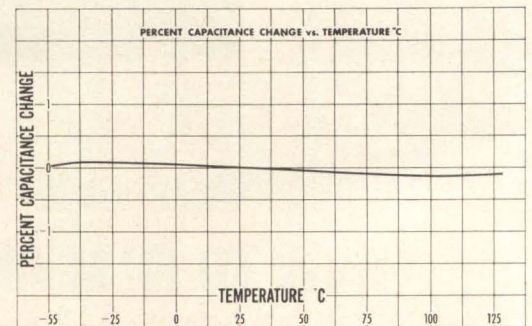

OFFERS THESE OUTSTANDING CHARACTERISTICS INHERENT IN ALL "VY" CAPACITORS

- **DISSIPATION FACTOR:** Less than .001 at 1.0 KC and 25°C; less than .003 at 1.0 KC and 125°C
- **INSULATION RESISTANCE:** 100,000 megohms minimum at 25°C; 10,000 megohms at 125°C
- **Q:** Greater than 1000 at 1.0 MC and 25°C
- **CAPACITANCE DRIFT:** .05% or .05 pf whichever is greater
- **DIELECTRIC STRENGTH:** 400% of rated voltage at 25°C for 10 seconds

Available in standard lead material from local distributors after May 15, 1964

©Vitramon, Inc. 1964

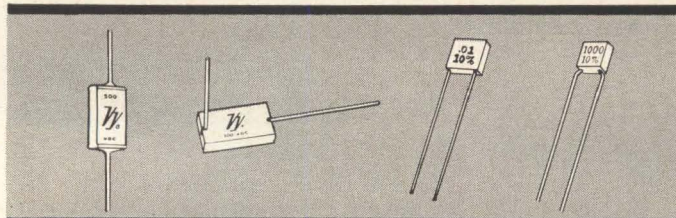

Vitramon
INCORPORATED

BOX 544 • BRIDGEPORT 1,
CONNECTICUT, U.S.A.

In United Kingdom contact:
Vitramon Laboratories
Limited
45 Holloway Lane
Harmondsworth, Middlesex
England

COMPLETELY
GNU



MINCOM'S NEW TIDAX 1.5-mc RECORDER/REPRODUCER

The new TIDAX is a head-on approach to your problems in telemetry and general instrumentation. This high-performance Recorder/Reproducer provides a full fourteen 1.5-mc tracks in one rack — with fully automatic equalization at all speeds. Wideband FM (DC to 500 kc) is available without modification. Signal-to-noise ratio (RMS/RMS) is 25 db at all speeds. TIDAX telemetry capabilities include simultaneous post- and pre-detection recording in PCM, PCM/FM, PAM/FM, PACM and FM-type carrier systems. Mincom's exclusive DC Top Plate is rugged, simple and reliable — full dynamic braking, instant push-button speed control, tape change from 1/2" to 1" in less than ten minutes. Write today for details and complete specifications.

Mincom Division **3M**
COMPANY

300 South Lewis Road, Camarillo, California • 320 Shaw Road, South San Francisco, California • 529 Pennsylvania Building, 425 13th Street, N.W., Washington, D.C. • 135 West 50th Street, New York, New York • Post Office Box 272, Fairborn, Ohio • 1230 Orange Avenue, Winter Park, Florida • 2121 Santa Anna Avenue, Dallas, Texas • Eltron Engineering Sales, Inc., 246 Walnut Street, Newtonville, Massachusetts

LOGIC...

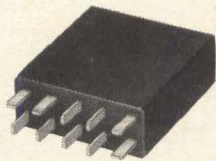

*New line of digital modules
offers flexibility, economy
and high packaging density*

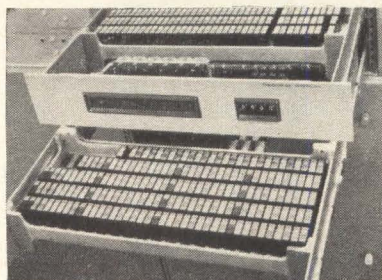

horizontal drawer mounting

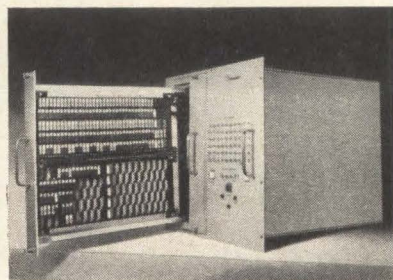

vertical drawer mounting

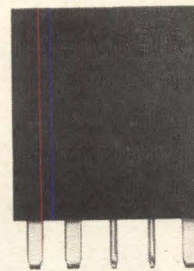

actual size

tests, MTBF for Radiation's low-speed NOR Module is in excess of 2,940,000 hours!

Radiation Incorporated now provides the most versatile and reliable line of logic modules available today. Superior electrical design and unusual stability have been proved through use in a wide range of digital applications. Calculated mean time before failure indicates a significant breakthrough in high reliability design. For example: based on extensive

FLEXIBILITY...

Two sets of fully compatible resistor-transistor logic circuitry are available. One operates at bit rates up to 200 kc, the other at rates up to 1 Mc. More than a dozen standard modules are available from stock. Types include: 4-input NOR; Counter Shift Register; Power Inverter; Emitter Follower; Complementary Driver; Differential; and Filter (Decoupler).

ECONOMY...

Radiation Logic Modules provide unusual economy of use. Each module represents a fraction of the entire digital system, and is designed for easy interrogation. Replacement or circuit changes is achieved by simply plugging in another unit. Downtime is greatly reduced, and bench work is completely eliminated!

PACKAGING DENSITY...

Construction consists of welded circuitry molded in epoxy, and mounted with high-density module connectors on cast aluminum frames. The resulting positive-contact module measures only 0.4x1x1.1 inches, with a 1/4-inch pin protrusion. This configuration permits packaging densities of 113 to 137 modules per inch of panel space in standard racks. In addition, the units may be mounted in any manner—vertical or horizontal drawer, removable or fixed.

Write or phone for technical information on these unique logic modules. Radiation offers the services of its experienced engineering staff in the application of logic modules. We will also be glad to help solve your unique data problems. Radiation Incorporated, Products Division, Dept. EL-05, Melbourne, Florida. Telephone: (305) 723-1511.

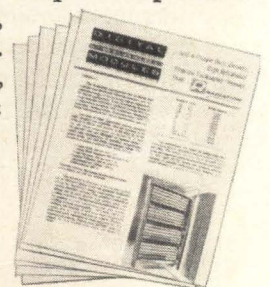

RADIATION
INCORPORATED

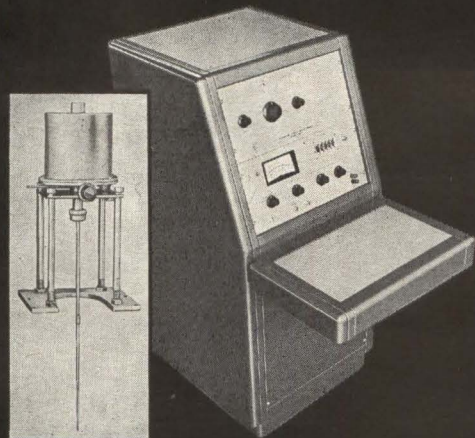

Magnetic Susceptibility Measurements
Vibrating Sample Magnetometer with high sensitivity and wide dynamic range for measuring magnetic moments of solids, gases and liquids. \$12,500. Write for Bulletin No. 110

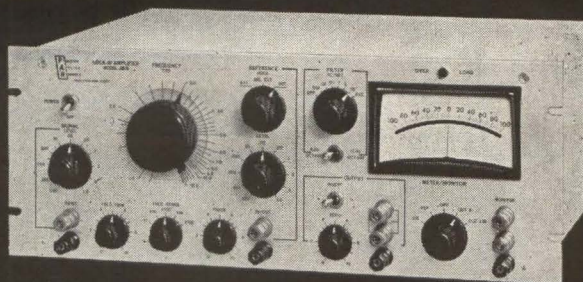

Low-Level Signal Recovery Instruments

Lock-in amplifiers (phase-sensitive detectors) continuously tunable 1.5 cps to 150 kc for the recovery of signal intensity information from noise. \$990 to \$1350. Write for Bulletin No. 111

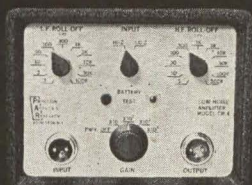

Low Noise, High Gain Amplifier
Extremely low-noise pre-amplifiers to greatly extend operating range of lock-in detectors and for general small signal applications. \$575 to \$680. Write for Bulletin No. 114

Precision Instruments for Research

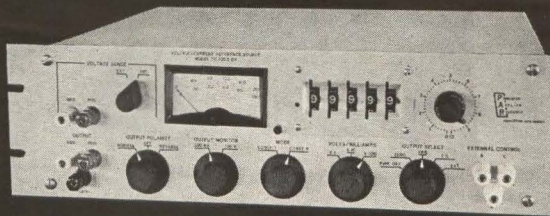

Voltage/Current Reference Sources

Completely solid state, voltage/current reference supplies with 0.001% stability, 0.01% absolute accuracy and up to 7 decades resolution. \$1185 to \$2200. Write for Bulletin No. 112

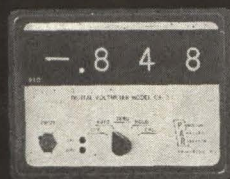

Digital Voltmeters

World's smallest transistorized digital panel meter with truly floating and guarded differential input circuit and other outstanding operating characteristics. \$995 to \$1070. Write for Bulletin No. 107

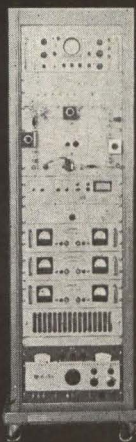

Plasma Diagnostics

Microwave Interferometers of the "zebra stripe" display type at discrete frequencies up to 140KMC (2mm) for measuring electron densities in plasmas. \$16,000 to \$48,500. Write for Bulletin No. 104

Openings exist for permanent positions in our R&D Department. Write to the attention of the personnel director.



PRINCETON APPLIED RESEARCH CORP., Box 565, Princeton, N. J., Tel: 799-1222 (609)

*looks
good,
doesn't
it?*

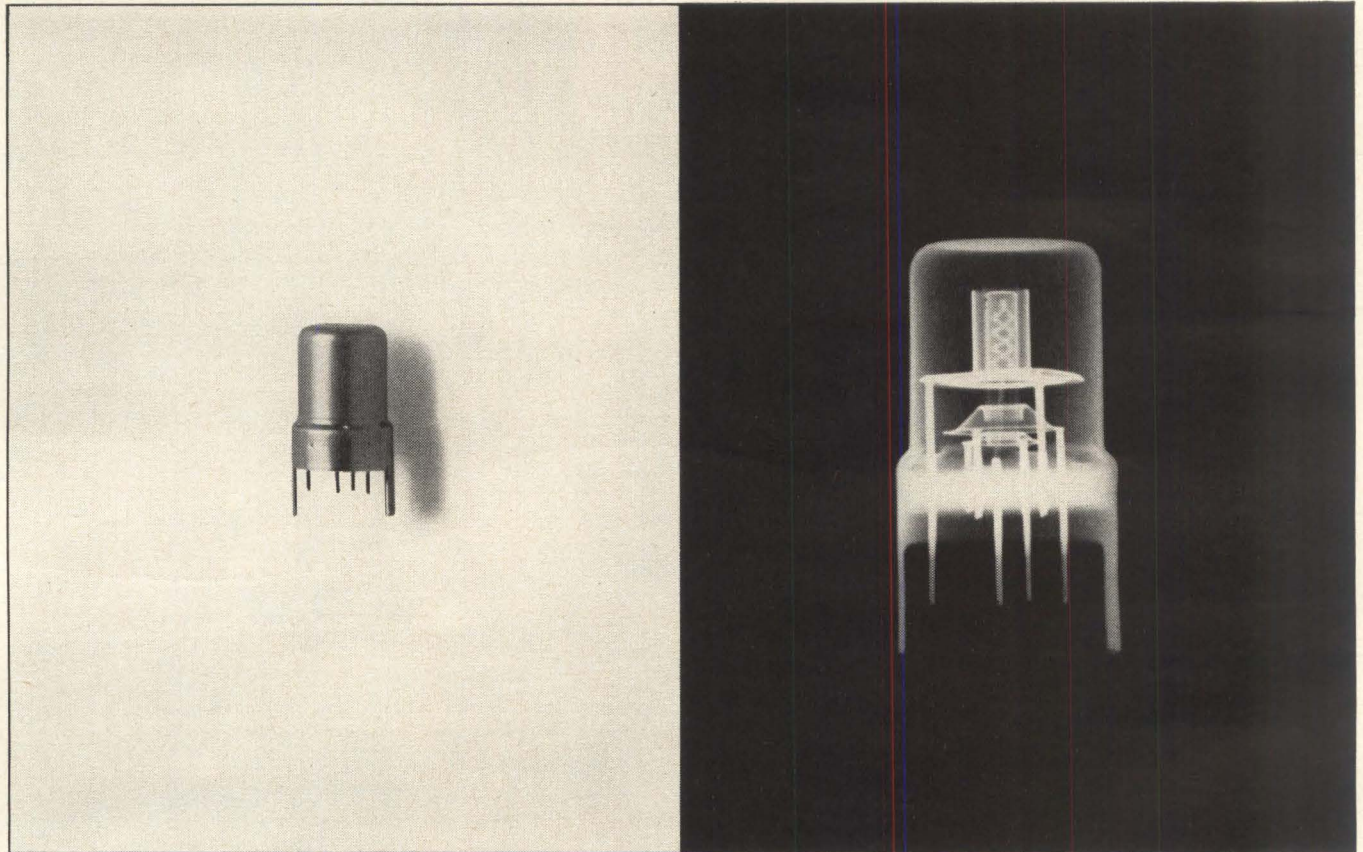

*...and you're sure it is when you
look at it the "AnSCO Way"!*

Often a tiny defect can escape most methods of detection. That's why so many companies depend on AnSCO Industrial X-ray films to make the final check on their components.

No method of non-destructive inspection shows up tiny imperfections (especially in tiny components) more clearly or quickly than a radiograph on AnSCO Superay® "H-D" X-ray film.

This Class I film is especially designed for high definition radiography. Its ultrafine grain and high contrast provide the ultimate in image quality. Although used primarily with low voltage tech-

niques, Superay "H-D" maintains its high definition characteristics and image quality throughout the full KvP range.

Make your final checks on components the "AnSCO Way"... it's the sure way. Ask your AnSCO X-ray Products Representative for full details about AnSCO Industrial X-ray films and chemicals. He's always at your service.

gef **AnSCO**
X-RAY PRODUCTS
GENERAL ANILINE & FILM CORPORATION
BINGHAMTON, NEW YORK

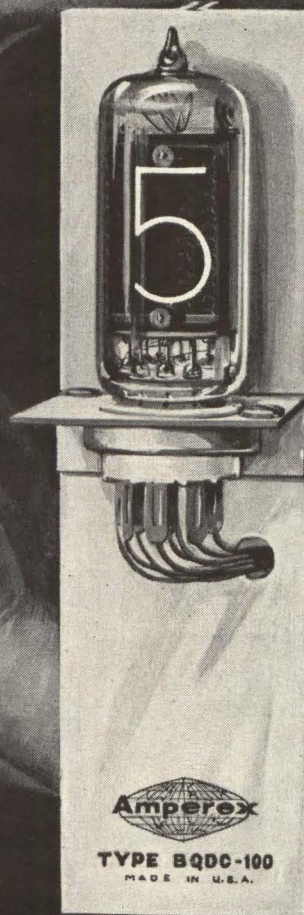

newest
idea in
decades

Decade Counter Modules Utilizing Biquinary Counting

with built-in, automatic, error-detection capabilities

with fewer components in simpler circuits, and hence:

with the reasonable price you have been looking for

with ruggedized construction

with high reliability

New BQDC-100 (illustrated with faceplate removed) is available in production quantities in two versions: as a complete 100 kc or 1 Mc biquinary decade counter card, including counter, driver and Amperex *Bi-Qui* numerical indicator tube; as a biquinary driver card including *Bi-Qui* numerical indicator tube and a conversion matrix to match your special requirements.

For detailed information, write: Amperex Electronic Corporation, Components Division, Hicksville, Long Island, New York.

In Canada: Philips Electron Devices, Ltd., 116 Vanderhoff Ave., Toronto 17, Ont.

Amperex®

Circle 51 on reader service card

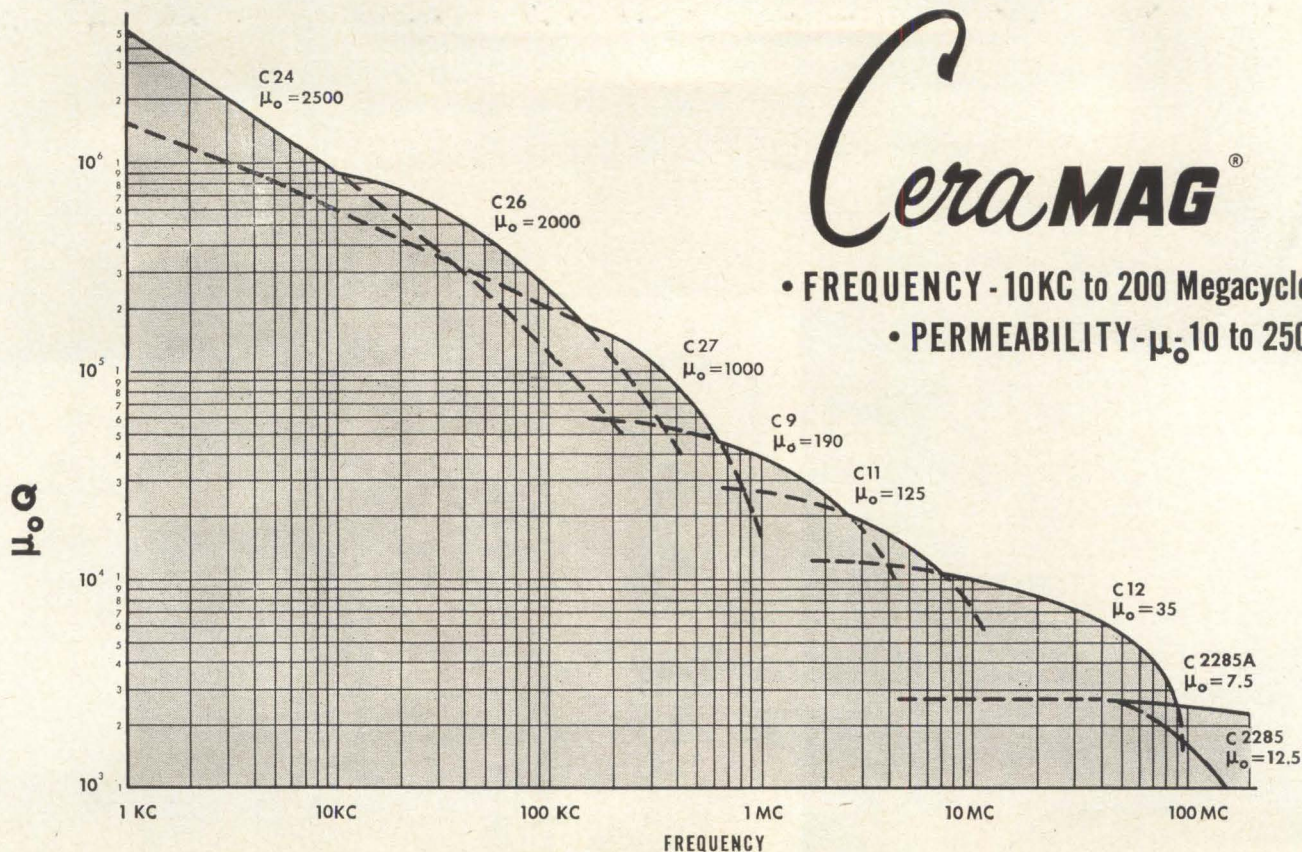

CeraMAG[®]

- FREQUENCY - 10KC to 200 Megacycles
- PERMEABILITY - μ_0 10 to 2500

Continuous research and development by Stackpole in the use of its ferromagnetic material CeraMAG, presents you with the opportunity to consider new applications for this unusual product. CeraMAG offers the unique advantages of complete moldability; one-tenth the cost of steel alloys for low frequency applications; for high frequency it provides better permeability and high Q than powdered irons.

MANY GRADES OF CeraMAG are immediately available from Stackpole. Some offer the high permeability desired in toroids; others provide the high Q at high frequency best suited for transformer and filtering applications. Power grades are available for transformer cores and yokes.

NEW APPLICATIONS FOR CeraMAG keep Stackpole in the forefront in development of new grades and applications for ferrites in miniaturized circuits; electronic, ignition systems; fluores-

cent light ballasts; pulse transformers; miniaturized transducers; and in telecommunications applications.

HUNDREDS OF CeraMAG PARTS are already tooled as toroids, cup cores, insert cores, thread cores, miniature coil forms, sleeves, transformer cores, deflection yokes and rectangular solids.

WRITE FOR CeraMAG Bulletin 50A. It provides complete technical information and a list of tooled parts.

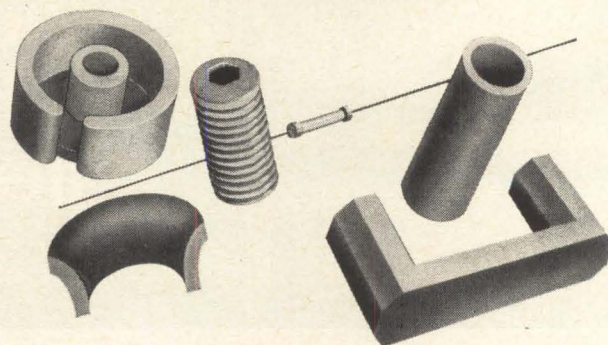

Electronic Components Division, Stackpole Carbon Company, St. Marys, Pa. Phone: 814-834-1521. TWX 814-826-4808



STACKPOLE
Electronic Components Division

Want to print and plot
simultaneously...
at high speeds?



Like a low cost, high speed
Read/Write converter to link
Data Phones and Computer?

*Here are two new
Potter developments
you'll want to know about*



NEW

FROM POTTER

a high-speed
Graphical Printer that
prints and plots
simultaneously
yet costs less than half
what people thought
they had to pay

A printer that puts out line copy at 2000 characters per second is no news. Many computers are equipped with this now. But a high-speed printer that gives a graphical representation of the printed data in addition to alpha/numerics (and in multiple copies) — *that is new!* Brand new from Potter.

Write today for full details on Potter's new 3501 Graphical Printer.

SPECIFICATIONS:

Alpha-Numeric Printing Speed: 1000 Lines/minute.

Plotting Speed: 2000 sq. in./min.

Paper Width: 4-3/16 in. to 17-25/32 in.

Multiple Copy: Up to 6 part interleaved, multilith masters or card stock.

Slewing Speed: 75 inches/second.

APPLICATIONS:

Financial and management reporting

Real time trend indication

Scientific data presentation

Graphs with . . .

axis labeled

point coordinates indicated

tabular data shown

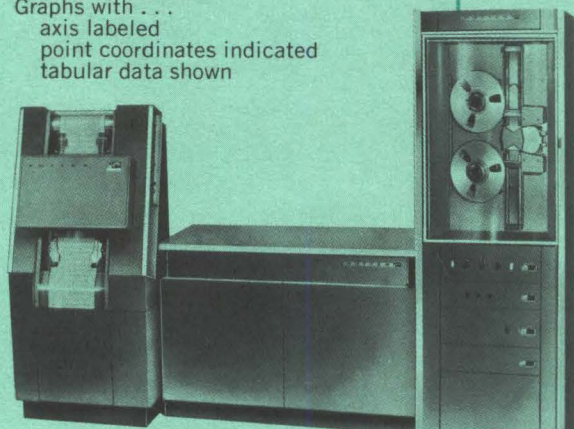

For article entitled "High Speed Plotting and Printing" circle 293 on Reader Service Card.



POTTER INSTRUMENT CO., INC.
Sunnyside Boulevard • Plainview, New York

THE LEADER IN EDP EQUIPMENT

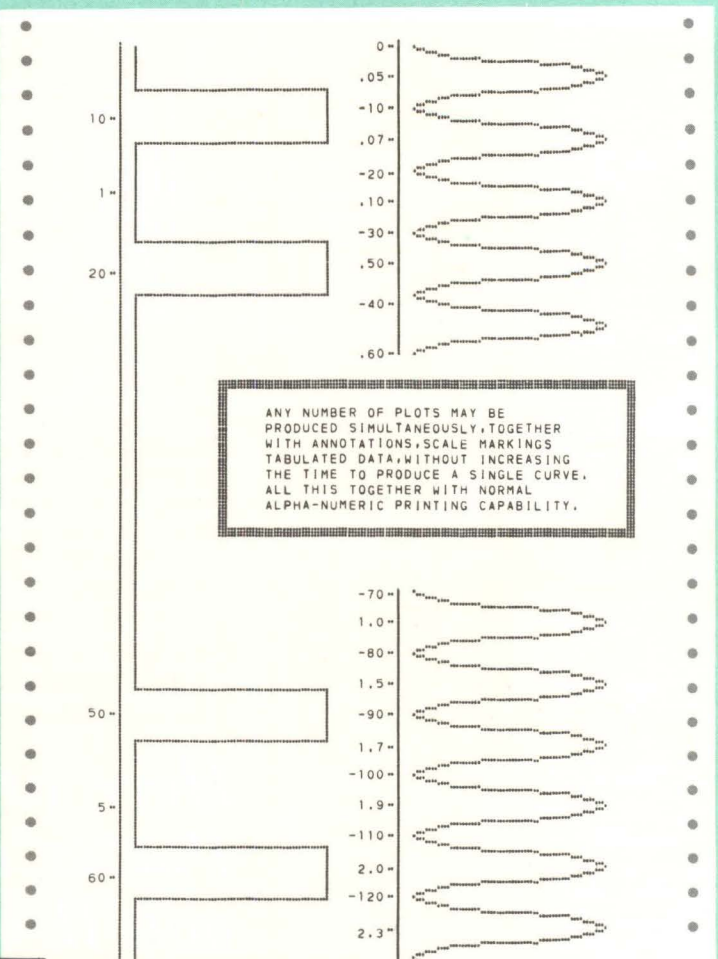

NEW

FROM POTTER

low-cost magnetic tape stepper that provides a high-speed *read/write* link between Data-Phone and Computer...without buffering

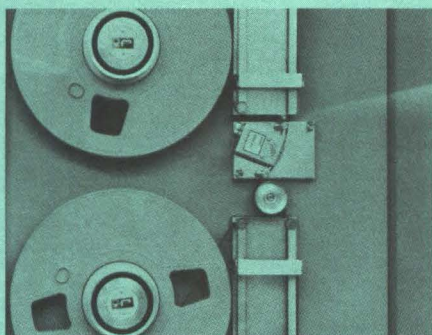
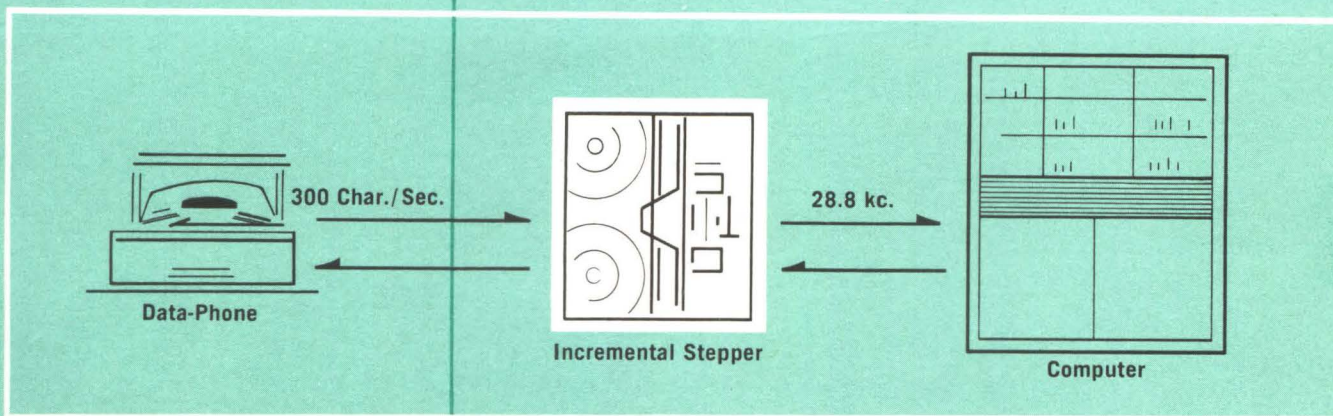

APPLICATIONS:

High speed data communications
■ Random data logging ■ Computer I/O ■ Numerical machine control.

Devices that record digital data on tape, a character at a time are nothing new. But to have one transport (IBM compatible) capable of both reading and writing 1 character at a time— asynchronously — and also block at a time — synchronously — that is new! New from Potter.

Write today for full details on Potter's new model 1501 Incremental Transport.

SPECIFICATIONS FOR THE POTTER 1501 INCREMENTAL TAPE TRANSPORT

Stepping (asynchronous) mode

Speed: to 300 characters/sec., one character at a time ■
Operation: Read and write ■ Bidirectional with 36 ips slew ■
High speed interrecord gap generation ■ Packing density 200 bpi scatter $\pm 10\%$ (max. at 300 cps)

Continuous (synchronous) mode

Speed: 36 ips ■ Operation: Read and write ■ Rewind: 4 min.

For article entitled "Applications for Magnetic Steppers" circle 294 on Reader Service Card.



POTTER INSTRUMENT CO., INC.
Sunnyside Boulevard • Plainview, New York

THE LEADER IN EDP EQUIPMENT

NEW

FROM POTTER

a complete family of magnetic tape transport systems ranging from asynchronous to 60 kc

They look alike, operate alike, are designed alike . . . with most parts interchangeable.

Here's a whole new "family" of vacuum column transports, each designed to serve a specific data spread range. From asynchronous to 75 ips, 200 to 800 bpi . . . but common in operating, parts, service and maintenance procedures. The benefits of standardization—yet a wide choice of performance and price.

Write Potter today to find what the family concept can mean to you.

For complete technical data circle 295 on Reader Service Card.

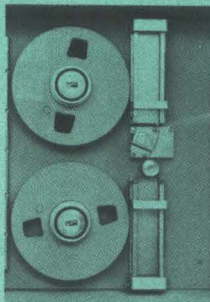

1501
Incremental Transport
IBM compatible, 200 bpi
Read, write or read/write capability to 300 cps
asynchronous—7.2 kc
synchronous



MT-24
1-36 ips
IBM compatible
200 commands per sec.
packing densities to 800 bpi
data transfer to 28.8 kc

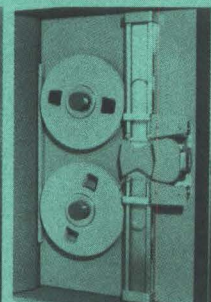

MT-36
1-50 ips
IBM compatible
200 commands per sec.
packing densities to 800 bpi
data transfer to 40 kc

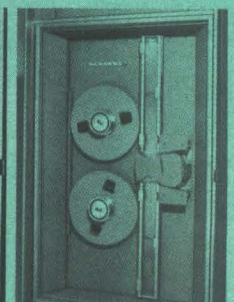

MT-75
1-75 ips
IBM compatible
200 commands per sec.
packing densities to 800 bpi
data transfer to 60 kc



POTTER INSTRUMENT CO., INC.
Sunnyside Boulevard • Plainview, New York

THE LEADER IN EDP EQUIPMENT

Special report

Digital instrumentation

By George J. Flynn, Instrumentation Editor .

Digital techniques are being used when data increases rapidly or when accuracy needs are critical. But they have some limitations: the circuitry is complex and can be expensive

In this special report:

The case for digital instrumentation

Obtaining digital data

Processing digital data

Using digital data

Reprints available



see reader service card

The case for digital systems

They're fast, accurate, and compatible. But they're not always the most practical way to tackle a problem

Clamped tightly in a gantry near Huntsville, Ala., a 10-ton engine undergoes periodic tests of its ability to propel a Saturn rocket to the moon and beyond.

The F-1, made by the Rocketdyne division of North American Aviation, Inc., is the largest kerosene-fueled engine being developed in the free world. It burns three tons of kerosene and liquid oxygen every second, generating extreme temperatures, pressures, thrusts and flows.

All of these forces must be measured, handled and stored, in periods ranging from a few seconds up to 2½ minutes. This involves coping with 15,625 input channels per second.

This job, and others of almost comparable complexity in business and industry, could not be done without digital instruments.

Digital vs. analog

Digital instruments use the same kinds of logic circuits that comprise a digital computer. This similarity results in a valuable byproduct—compatibility. Data from a digital instrument can be processed in a digital office computer if their codes are compatible.

The biggest difference between digital and analog signals is decisiveness. Digital data is always decisive—although it may, of course, be decisively wrong. The least significant bit must be either a one or a zero, and not something in between. The logic circuits force a yes-or-no answer.

Digital data has several advantages over analog information. It can be amplified infinitely without any loss of information, can be stored easily and transferred errorlessly from one store to another.

Although analog data can be stored on chart recorders, in photographs, on magnetic tape and even on phonograph records, some information is always lost in transfer.

Digital data can be degraded by transients in a data processor, or when it is transmitted over long distances, but pulses can be restored by regenerative repeaters. Accuracy can often be recovered by parity checking and redundancy.

Because digital data can be stored and moved around readily, it is particularly suitable for data processing. The processes used for digital multi-

plication and division, for example, require moving the same bit in and out of stores and buffers many times. Amplification is added as a matter of course as the bit travels through flip-flops, shift registers and other circuits.

Drift problems vanish

Digital data is also stable and not subject to drift. Drift of d-c amplifiers in analog systems is so severe a problem that chopper-stabilized amplifiers have been specially developed so that a-c coupling can be used and straight d-c amplification avoided. In a digital system, however, if the reference zero is defined as a certain configuration of zeros in specific magnetic cores—for example, 0000—the zero does not change as a result of minor shifts in temperature, voltage levels and other factors. This stability of setting also accrues to system set points and to the parameter limits at which alarms or safety devices are set off.

Some users of digital equipment have found that recalibration problems are practically eliminated. Of course a code wheel on a shaft-angle encoder can get out of alignment, but this is relatively infrequent.

Analog limitations, include system noise, calibration errors, potentiometer linearity, meter parallax, jitter, amplifier drift and gain changes, line losses, transducer hysteresis and linearity.

The digital signal's accuracy is affected only by errors introduced before the signal is encoded. The other degrading factors are eliminated.

Some drawbacks

Digital techniques aren't always the best, nor the cheapest, way to solve an instrumentation problem. Digital circuits tend to be considerably more complex than analog and therefore more expensive.

Mathematical operations such as integration, differentiation and multiplication require elaborate circuits for mechanization with digit data, whereas analog integration and differentiation can be accomplished satisfactorily for many purposes (particularly control) with simple RC circuits and operational amplifiers.

Also, analog operations can be performed instan-

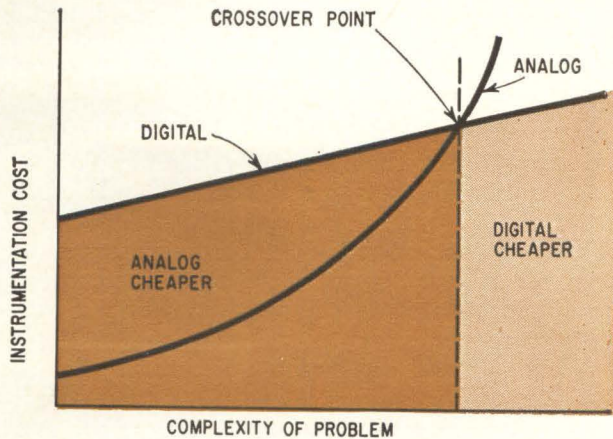
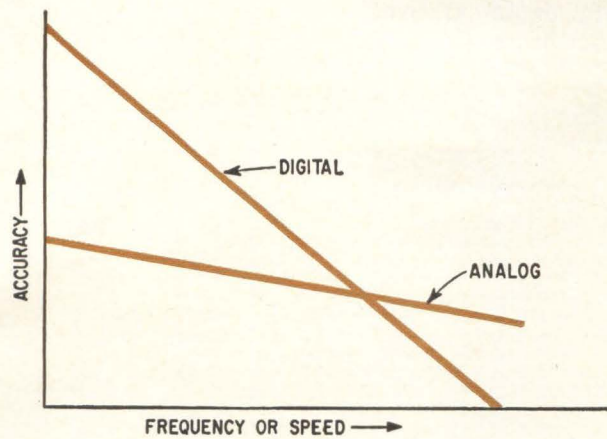

Digital systems tend to lose accuracy faster than analog systems as operating speed increases (left). Analog systems are generally cheaper (right) than digital for simple problems but cost more to expand.



Digital power supply gives 0.005% per day and 0.02% per year stability at voltages between 0000 and 2111 volts d-c. The device may be used as a multiplier photo tube supply, an ionization-chamber supply, a klystron supply, or a backward wave oscillator supply, according to the manufacturer, the Calibration Standards Corp., Alhambra, Calif.

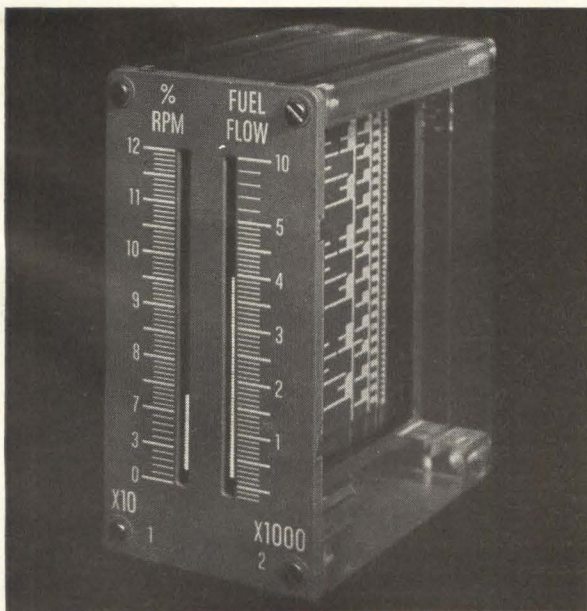

Electroluminescent bar graph by Sylvania produces 25 lines to the inch with 25- to 30-foot lamberts brightness. The unit shown is intended for aircraft or space-craft instrumentation.

taneously, whereas digital operations require some finite time and may even have to be performed off line. But digital methods allow computations to be carried out to any desired number of places.

Savings in equipment cost may be outweighed by other expenses. For example, an oil refinery with several hundred control loops may replace most of its chart recorders with a few printers and a signal multiplexer. But if the maintenance of the multiplexer requires the refinery to be shut down for only a few hours, the lost productivity could cost many times the purchase price of the multiplexer.

One engineer has also cited a psychological factor in considering a change in instrumentation. "The digital people don't understand analog and the analog people don't understand digital," he says. "So sometimes you get better results by putting full authority in one group and eliminating the interface. Ideally, however, most systems today should use both techniques."

Comparison method

One way to compare analog and digital systems is in accuracy vs. speed. Although the curves (shown above) are drawn to illustrate the use of simulation for solving scientific problems, they also apply to instrumentation. Entry points for such a curve cannot be established precisely except for a specific problem. Digital logic circuits operating at 50 megacycles are commercially available, however, and electronic counters reach 500 Mc and higher.

Market potentials provide another contrast. Digital sales are measured in billions of dollars annually; analog sales total about \$100 million.

Cost comparisons

Digital instrumentation begins to pay off when the complexity of the problem being solved reaches a critical level. The break-even diagram (above)

shows the nature of the costs of analog and digital instrumentation.

Digital instrumentation has a relatively high initial cost, particularly in problems requiring sophisticated data-processing. Even when only voltage measurements are being made, a digital voltmeter may cost 1,000 times more than a simple panel meter.

Measurement or data-collecting becomes more complex as greater accuracy or more frequent measurements are required or as data flows in from more sources.

All of this adds to the cost of instrumentation. But the additional costs tend to increase more slowly for digital than for analog instrumentation.

It is impossible to define "complexity of the problem" used in the drawing (page 59) but a satisfactory entry on the curve can be made from the dollar scale.

One computer manufacturer estimates the intersection point at \$175,000, but another puts it at \$35,000 to \$40,000. However, the two estimates may be for different kinds of instrumentation. Instrumentation for simple process control and data collection during a rocket engine test is quite different from controlling an entire plant.

The general shape of the cost-comparison curves is significant. Both curves are dropping and the digital curve is sagging faster than the analog curve. Yet it is unlikely that digital techniques will

Why digital systems

1. Errors can be held to 0.01%.
2. Data can be transmitted more easily.
3. Error detecting schemes more powerful.
4. Data processing is easier.
5. Information storage is easier.
6. Sample and hold techniques easier.
7. Less susceptible to noise.
8. Drift free operation.
9. Fewer zero and screwdriver adjustments.
10. Only low power is needed for remote equipment.
11. Memory allows easy multiplexing.
12. Designs can be checked and verified more easily; design problems show up more clearly so it is easier to troubleshoot.
13. Arithmetic operations easier.
14. Can handle non-linear problems more easily.
15. Stored program type processors can handle a greater variety of problems than analog.
16. Easier to control by computer.
17. Readout easier but display techniques are more expensive.

Why analog systems

1. System accuracy to 0.1%.
2. Operations basically instantaneous.
3. Has the necessary bandwidth to solve multivariable problems.
4. Calculus operations easier.
5. Works best with linear devices.
6. Quick-look interrogation easier.
7. Easier to produce mathematical model of a system.
8. Usually easier to understand since problem fragmentation is less.
9. System complexity usually less.

ever be cheaper than analog for all problems. There's no substitute for simplicity in some applications.

Obtaining digital data

Measurable digital data seldom emerges naturally from a process. It has to be converted electronically.

Here are some ways this is done

Very little process data is digital to begin with. Most of it involves measurable changes in magnitude rather than specific yes-or-no factors.

About the only truly digital transducers in use today measure nuclear events. These devices produce an electrical pulse for each particle entering the transducer. The pulse can be counted and expressed as digital "words" for computer processing.

The best-known transducer of this type is the geiger counter.

A variation of this technique is a three-dimensional array of magnetic cores whose states of magnetization are changed by passage of nuclear par-

ticles. A device of this type is used to monitor nuclear events and automatically select the one event in several million that matches a previously predicted path. The predicted path is stored in the data processor and comparison with an actual track is made automatically.

There have also been thoughts about making a pressure transducer by counting the number of molecules striking a given area in a given period of time. But no serious effort to make such a device is known.

Turbine flowmeter

The quantum transducer is one step removed

from the completely digital transducer. An example is the turbine flowmeter. The meter rotates through the force of the fluid acting on the meter's curved vanes. Rotation speed is proportional to flow. The meter's rotation speed is an analog of fluid flow, and speed is affected by the fluid's temperature, viscosity, turbulence, bearing wear, breakaway torque at low flow rates, and other factors.

Each metal vane of the meter generates a pulse as it moves past a pickup coil. In this way the pulse train generated by the meter is a quantized signal that is directly proportional to speed, and the conversion is without error.

In a well-engineered turbine meter, the conversion from fluid flow to rotational speed is off only 0.5% to 0.1%. The devices have won wide accept-

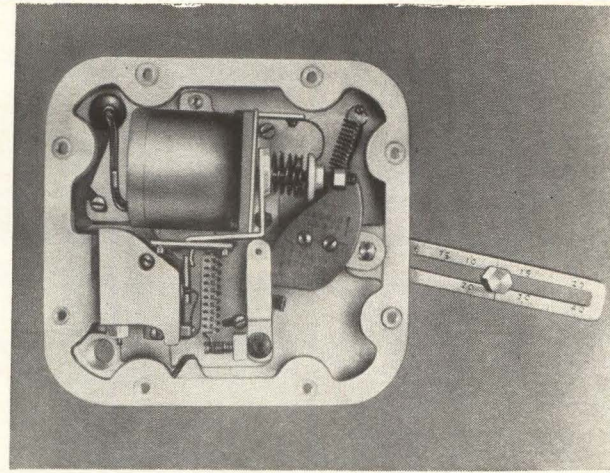

Digital valve positioner uses an air supply and feedback cam to position a control valve in response to a pulse input from a digital computer. Device feeds or bleeds air pressure until feedback spring force equals motor-spring force.

A primer of digital circuits

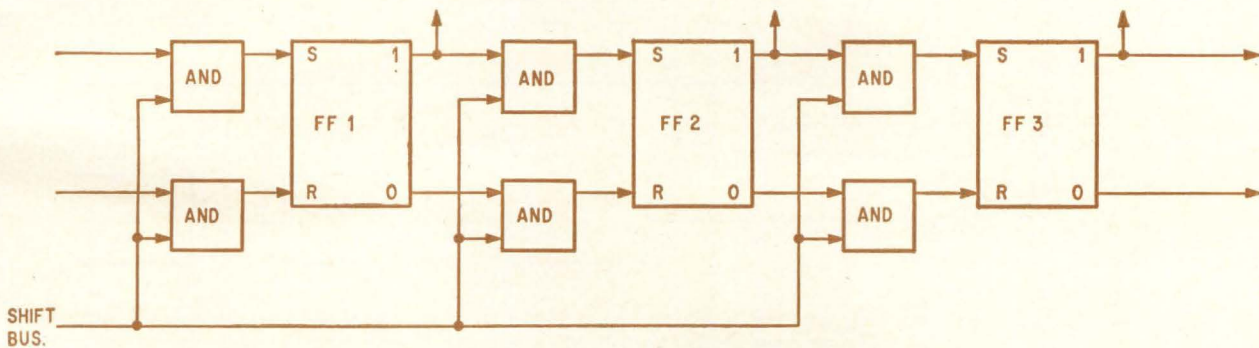

A flip-flop, also called a bistable multivibrator or a toggle, has two stable states. It remains in either state until made to change to the other. If a **one** input to the set input sets FF₁ in the shift register above as shown, further **ones** applied to the set input then cause no change. But a **one** applied to the reset input causes that output to become a **one** and the set output to become a zero. Now a **one** pulse at the set input can flip it again. A flip-flop can store one binary digit, or bit.

The shift register shown will, upon application of a pulse on the shift bus, move the binary information in the flip-flops one place to the right. For example, if there is a **one** at the one output of FF₁, it and the shift pulse turn on the following and gate and thus generate a pulse at the set input of FF₂; FF₂ will be changed to the set condition if it is on reset; it will not change if it is on set. Similarly, if FF₂ is on reset, the shift pulse will gate a signal into the reset input of FF₂. Data is inserted serially in this shift register; that is, the pulses are fed through in order, one at a time. This particular shift register is a parallel-to-serial converter; it can be read out in parallel by simultaneously reading all the set or all the reset outputs of the flip-flops. In a shift register for parallel-to-serial conversion, the data digits are presented simultaneously, in parallel, to the set inputs of the flip-flops, and shift pulses move the data out of the register in serial form.

In brush-type digital encoder, fixed brushes ride in contact with a code wheel that is alternately conductive and nonconductive. For the condition shown, the supply

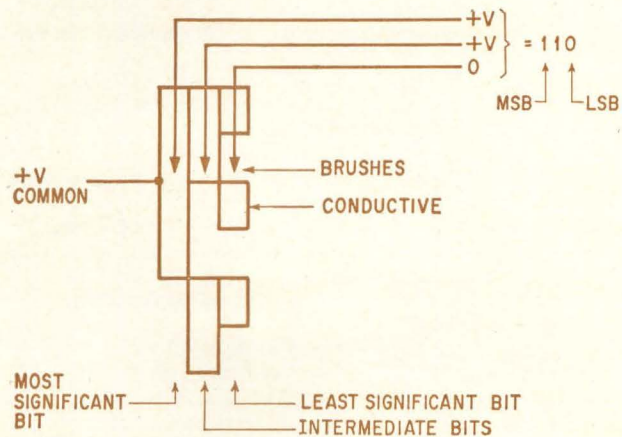

voltage appears on two output lines but not on the other. The resulting digital signal corresponds to a position of the driven code wheel with respect to the brushes. This type of encoder—also called a whole-value encoder—has one wire for each bit, plus a common wire.

Brush-type encoders are relatively inexpensive, but have the disadvantages of moving contact devices. Magnetic or ferrit disk encoders, operating similarly to the playback mode in magnetic tape recording, allow high-speed operation but tend to degrade resolution. Optical encoders using code wheels that are alternately transparent and opaque, together with a photoelectric pickup, allow high resolution. Purely

ance in industry.

Pulse-generating revolution counters use the same principle.

Converting to digital

Analog information is converted to digital in the turbine flowmeter and in many other transducers. The conversion mechanism can take many forms. Code wheel converters [see panel above] of many types have been developed to convert shaft rota-

tion to digital, and linear code converters are used for displacement. The trend in military usage is toward pure binary coding, while industrial users often favor binary-coded decimals. Since four binary bits are required to represent the 10 levels from 0 through 9, and since any arrangement of the four bits can be used to represent any of the 10 levels, a total of about 7.6×10^7 codes are possible in binary-coded decimals.¹

The best code for a given system depends on

A primer of digital circuits (continued)

mechanical encoders using cams to close switches are also being used.

High-reliability precision encoders are available with

resolutions of one part in 2^{10} or 2^{20} . They are used to read out angles for high-precision radar antennas and for telescopes.

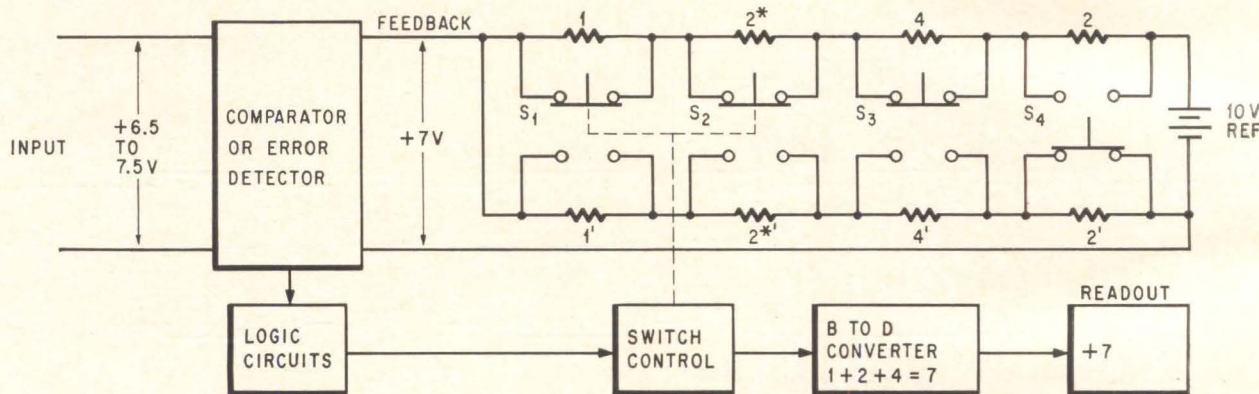

Converting analog voltage to digital involves the addition of discrete amounts of voltage until the total equals the input. The steps are stored, or remembered, and the stored information represents the digital equivalent of the input.

The sketch² shows one way of generating the digital equivalent by switching resistors. If all the resistors in the top row are short-circuited, the feedback voltage is 10; if all those in the bottom row are shorted, the feedback is zero. In the sketch, the feedback is 7 v, which is as close as a one-level converter can match an input that is between 6.5 v and 7.5v. After the converter has settled on the closest match for a given decade, it switches to the next decade and again determines the best output, and so on until the reading is complete.

Some digital voltmeters work through the decades from the most significant digit to the least, and some work in the opposite direction. Tradeoffs include the complexity of the logic circuits, the desirability of minimizing switching when electro-mechanical elements are used, speed and economics.

Another widely used voltage conversion technique is to compare an internally generated ramp voltage with the analog input. As the ramp starts, it gates on an electronic counter that is fed by a precision oscillator. When ramp and input voltages are equal, the counter is gated off and the accumulated count is a measure of the input.

In the charge-counting type converter, the feedback signal is a staircase voltage. An electronic counter counts the number of steps required to equal the input.

In the charge transfer digitizing circuit, the analog voltage is equalled by switching discrete amounts of charge. The number of charges required is a measure of the voltage.

Servo type converters use a precision potentiometer

which is driven until the feedback voltage equals the input. The motor that drives the potentiometer also drives a revolution counter to provide a digital readout.

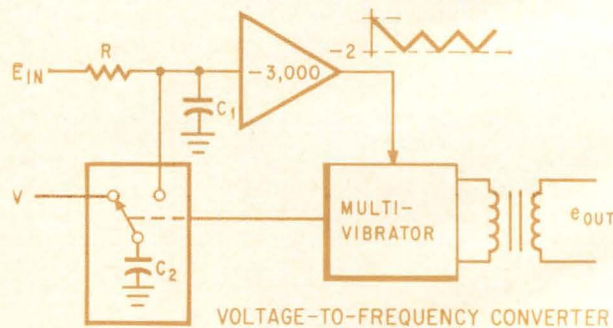

Another important type of conversion from analog to digital is in the voltage-controlled oscillator, where the output frequency varies in accordance with a d-c input signal. The output frequency is equivalent to a pulse train, or a quantized signal, and can be converted to a digital word by counting the pulses in a calibrated interval.

A voltage-to-frequency converter is shown above. In this version, when E_{in} is in zero, the output of the amplifier is zero and the multivibrator is biased off. When E_{in} is not zero, the multivibrator fires when amplifier output reaches 2 volts; it then acts to remove the charge built up on C_1 by neutralizing it with an opposite polarity charge from C_2 , which in turn decreases amplifier output. The result is a series of pulses, with a repetition rate proportional to E_{in} . The circuit is used by the Vidar Corp.

the logic system used for mathematical operations, on error-checking and correcting schemes, and on other factors.

Regardless of what code is used, the encoding process generates either a coded word or an incremental bit of information, as in the turbine meter. The incremental technique provides greater accuracy because the total of bits generated can be counted over any desired period with great accuracy. This type of encoding is used in long-

range navigation equipment to provide readout for aircraft position to within less than one mile accumulated error in thousands of miles.

Honeywell Inc. has developed a valve that is positioned by electrical pulses. The pulses drive a stepper motor that positions a pneumatic set-point device, and valve-operating power is obtained from air pressure. The Conoflow Corp. has a valve that is driven directly by a stepping motor; operating power is obtained by amplifying the control pulses.

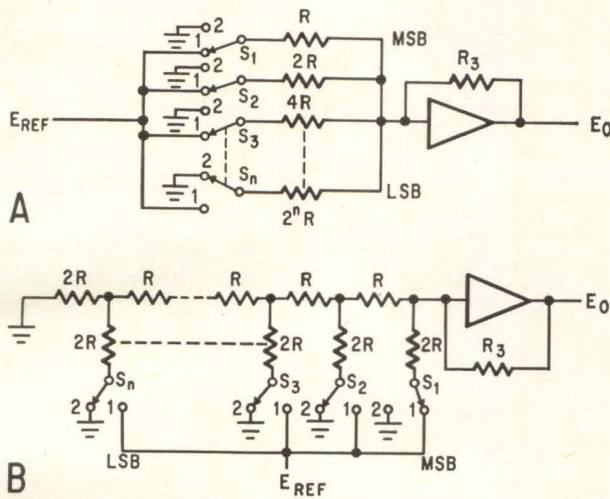

Conversion to analog can be performed by integrating the pulses in a capacitor or by driving a stepping motor which, in turn, drives a potentiometer or a pneumatic set-point device. When the signal is a digital word, the weighted bits can drive relays to build up the voltage step by step.

In the sketch, a precise d-c voltage is applied to a weighted or ladder network of precision resistors. Switches, correlated with the bits in the code, are closed or opened to put the required resistors in the circuit. The resulting voltage at the end of the chain is the analog of the input and is typically fed to an operational amplifier. Error for a 10-bit converter can be held to half of the least significant bit. Switching can be electronic.

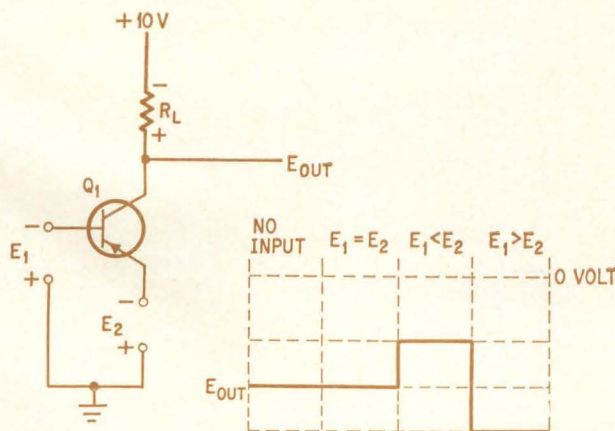

The analog comparator provides an output proportional to the differences between two input signals. In its simplest form it is a transistor or triode with one input connected to the base and the other connected to the emitter or, in a triode, the grid and cathode. A negative signal on the base

acts as a positive signal on the emitter, and vice versa. Therefore, as long as both signals change by the same amount in the same direction—positive or negative—there is no change in the output. If the signals differ, however, there will be a corresponding (amplified) change in the output.

To obtain a zero-referenced output, a two-transistor (or tube) circuit is used. The transistors are connected push-pull and the output is taken across the collectors.

Further amplification is then usually added to bring the output of the comparator up to the level required to drive the basic logic circuits.

The amount of amplification required depends on the level of the least significant bit the comparator must identify. Adjustments to decrease sensitivity are often provided to allow readout stability or to suppress changes in the least-significant bit when these are too erratic or meaningless. Hysteresis is often provided so that the output does not oscillate when the input is half-way between two least-significant bits.

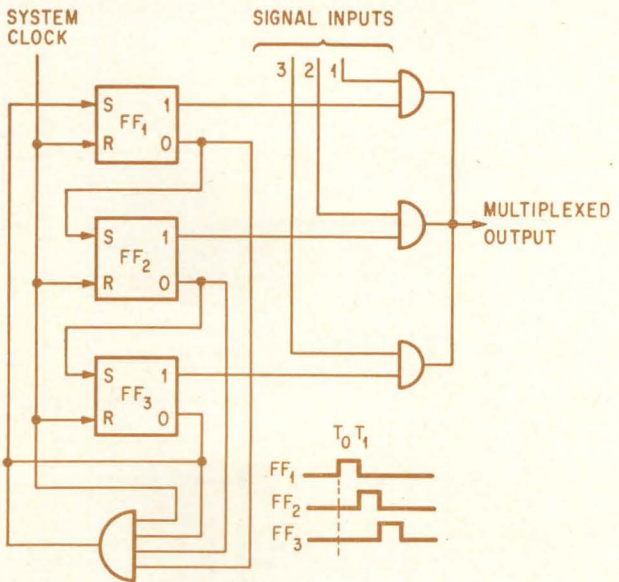

Multiplexing in digital instrumentation usually means time-sharing. One channel of the system is examined for a few microseconds and the signal is passed to the next operation. Then the next channel checked.

The interrogation or sampling device, or multiplexer, can be a manually operated selector switch in simple problems. Stepping switches are relatively low-cost but highly effective devices for channel sampling. They have proved their worth in many systems. High-speed electronic multiplexers perform the same function as stepping switches, and can be programmed easily. The sketch shows a simple multiplex circuit using a shift register and and gates. When both inputs to a given gate are on, the gate is open and the output goes to the level of the input signal, which can be analog or digital.

Processing digital data

Easy processing and storage of data, high accuracy, and cost reductions of plant operations make digital systems increasingly attractive

Digital data can be easily stored and processed. Once data is in digital form it can be compared with other data, relationships can be derived and the results used to make decisions. Cost savings, as well as technical advantages, may sometimes justify the use of a digital system, as in the digital mass spectrometer—used to analyze chemicals—which pays for itself in three years by savings on photographic film alone, and in six months by overall cost reductions.

A special-purpose computer is usually required for data processing in instrumentation systems but

there are some applications which can use small general-purpose computers. No universal data processor has yet emerged because specific problems in instrumentation are still very individual. But there are a number of highly adaptable units on the market which can serve as building blocks in system design (see photos).

Over-all view

The large diagram below does not represent any known real system; it is an over-all view of digital instrumentation.

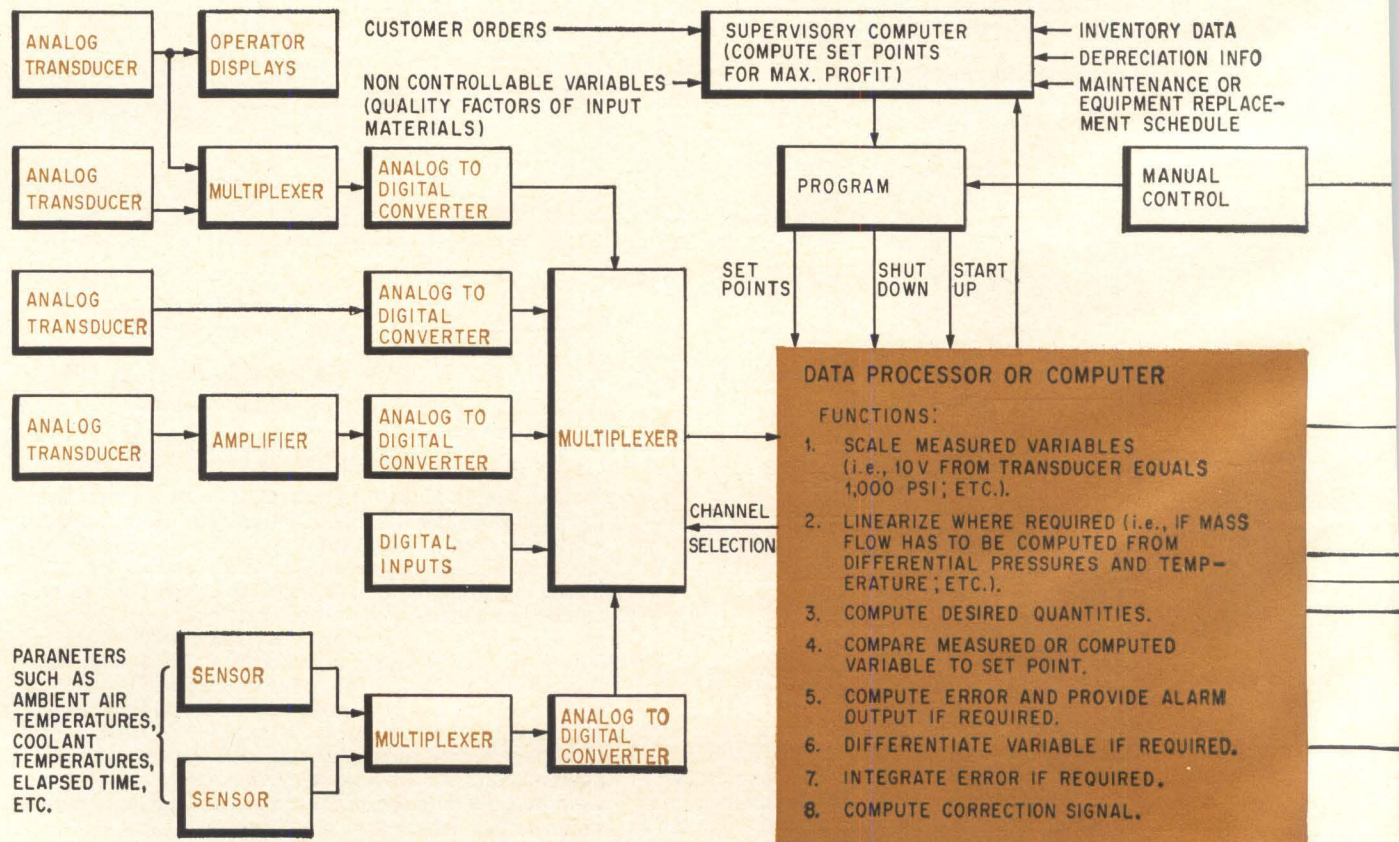

Systems approaching it in complexity—one will be used at Cape Kennedy—are now at least in the planning stage. All parts of the diagramed system are in use in various combinations. The supervisory computer function is being used by the International Business Machines Corp. and others in electric-power generating plants. For wind-tunnel tests of a rocket model, on the other hand, where control requirements may be handled separately, data may simply be collected on magnetic tape and analyzed later in a separate step.

Some of the sophisticated types of data processing shown on the drawing are not required in many industrial processes, where the flows, temperatures and pressures, etc., are fairly stable and the system responds slowly to set-point changes. Sampling in these cases need not be performed more than once a second or once in several minutes. Last spring the Chemical and Petroleum Industries division of the Instrument Society of America set design goals of one sample per second for flows, one per five seconds for level and pressure, and one per 20 seconds for temperature.

Once the data enters the processor, it can be treated with considerable sophistication. The major limitations are the speed of the data processor and the validity of the mathematical models that are assumed to represent the process. Day-to-day operations combined with tuning and trimming set points can sometimes be used to refine the models although some processes, such as papermaking, are still too little understood to be satisfactorily

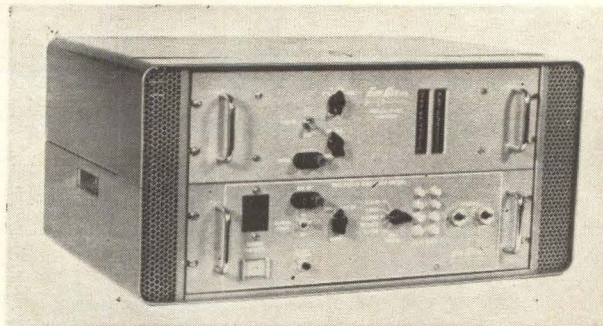

Multichannel data acquisition and recording system by Ess-Gee, Inc. of White Plains, N.Y. offers five modes of operation—continuous scan, single scan, automatic single channel, manual single channel, and manual scan with rapid mode selection. The device will scan six channels per second with single digit channel identification, or ten channels per second with two digit data.

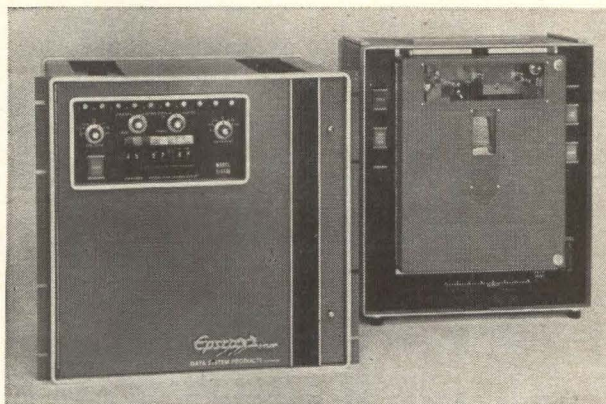

Portable data processor by Epsco Inc., Cambridge, Mass., has been used to field-test automotive components. Up to 100 sensors measure shock, vibration, acceleration and other variables while the car is in motion. Signals are digitized to 1 part in 1,000 at 20,000 samples per second.

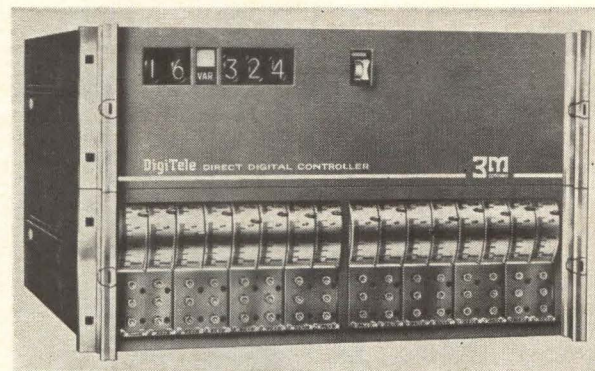
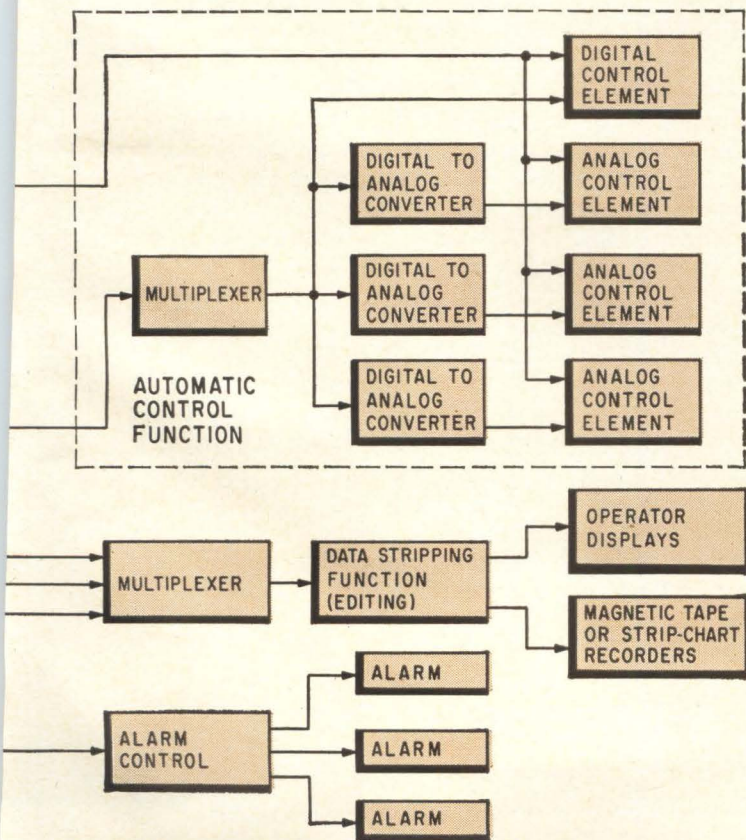

Direct digital multiloop controller will control pressure, temperature, flow and similar variables, relieving computers of competitive control calculations according to 3M Company, the manufacturer.

Comprehensive view of digital instrumentation. Because of the great flexibility of most of the equipment, the mechanization can differ greatly from that shown. Also, some of the multiplex equipment and the data-editing function might actually be contained within the data processor.

controlled. But this is at most a temporary situation. Even processes involving taste and smell, where suitable sensors or transducers are not available, can be subjected to some degree of quality control.³

The number of channels and the sampling speeds of data processors are so flexible that real-time control of missiles and similar high-speed systems is

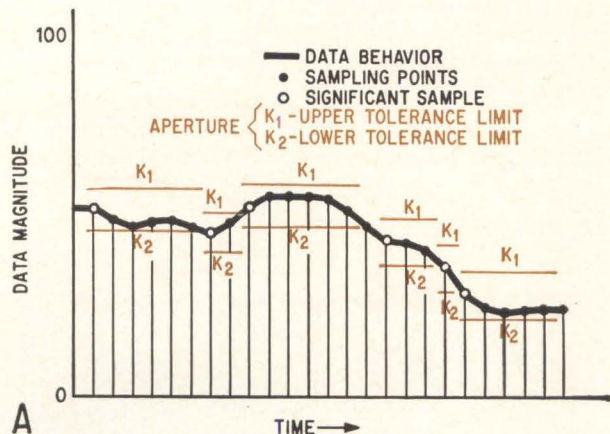

A

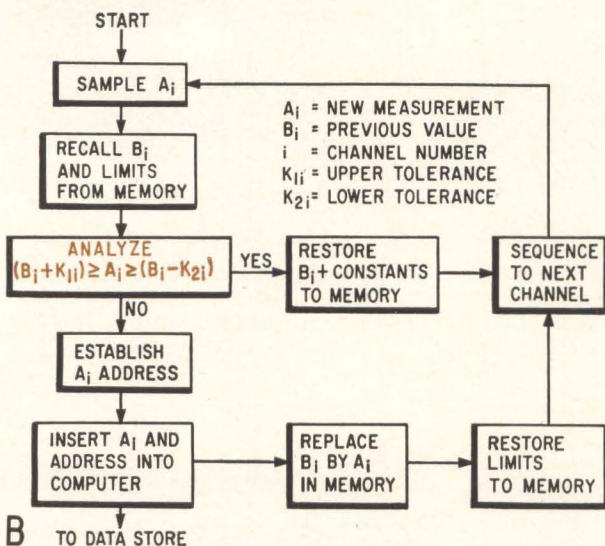

B

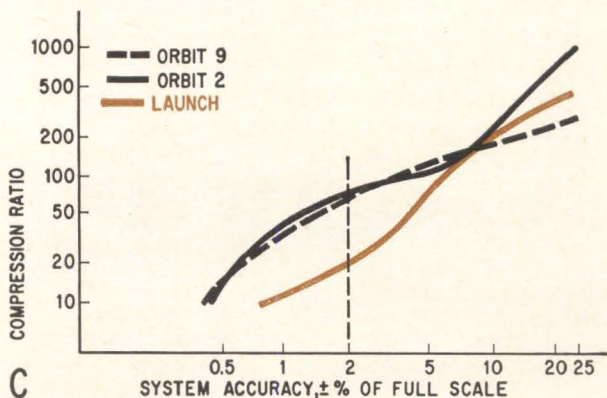

C

Data compression using floating aperture, is accomplished (A) by recording data only when the variable exceeds preset limits K_1 and K_2 . Mechanization (B) is straightforward. Compression ratios obtainable for a given accuracy are indicated in (C) for an Agena missile.

possible. Sampling rates can be as high as 100,000 per second, with a major limitation being the settling time of the signal being sampled—that is, how long it takes the sampling circuit to stabilize to the correct value. There is no theoretical limit on the number of input or output channels, since these can be paralleled endlessly but a practical limit is set by how often a given channel must be sampled. Programing, of course, allows channels to be sampled in any order, and allows important channels to be sampled at more than the average frequency.

Assume that one channel of the instrumentation system is measuring the pressure in a boiler. The transducer may be a bourdon tube with an output shaft rotation of 100° for 1,000 psi internal pressure. The output shaft can drive a digital code wheel directly and thus transmit a digital signal back through the data channel or the shaft may be used to drive a precision potentiometer and thereby produce an analog voltage. After the signal is passed through the multiplexer, as indicated in the generalized drawing, the analog-to-digital conversion can then be performed.

Data scaling

The digital data enters the processor where it can be manipulated. First the data may be scaled or translated. The data word coming from the A/D converter represents a digital version either of the voltage generated by the transducer or of its shaft angle. This information must be scaled so that a digital signal is produced that is proportional to the pressure in the boiler. In the process of scaling, the pressure signal can also be linearized; thus if 50% of full scale pressure in the boiler produces only 40% shaft rotation, the signal for 40% rotation can be used to call up a digital word representing 50% pressure—in this example, 500 psi. Offset or suppressed zero information can similarly be supplied; temperature measurements, for example, are typically made as a departure from an ambient temperature but mathematical treatment may require absolute temperatures.

In the boiler instrumentation system a digital word representing boiler or line pressure can be used with other words to calculate the mass flow of a gas through a pipe. Computed mass flow can measure raw material being used in production. Mass flow can be compared with input costs and used to measure plant efficiency, for inventory control purposes, warehousing, etc.

IBM's 1710 system, as programed for electrical power generating stations⁴, can analyze plant operation closely enough to detect such effects as soot build-up on boiler heating pipes and can alert plant operators to schedule a cleaning.

The supervising computer shown in the sketch may be used in some cases to increase profits through improved plant efficiency but it is still difficult to work out the mathematical model for a profit equation.

IBM says "Each term . . . is fairly complex be-

cause the profit equation must be expressed in terms of variables that define the condition of the process rather than in variables that are dependent on other variables for their values."

Data editing or compression

Digital data follows Parkinson's Law: It expands to fill all the storage media available. Often the quantity of data makes analysis difficult and tedious. One Lockheed telemetry system, for example, will generate more than 100,000 words per second, made up of 1.6 million bits per second. Small computers or data processors cannot even handle information at this rate. If the data is recorded on tape and then processed at a slower rate, the advantages of real-time processing are lost and the processing delay may slow up an important project. Compression on-line, as the data is generated, is therefore desirable.

Much data, fortunately, need not be recorded. The trick is to identify the valuable data and record it only. Useless data—which generally means redundant data—is simply ignored or discarded. For example, if the exhaust temperature of a rocket under test goes to its design value and remains there during the period of interest, almost all data about exhaust temperature will be redundant, particularly if this parameter is not the one of interest during the test. Readings may still be recorded at intervals to check out system functioning but the amount of compression possible is apparent.

Parameters are monitored because they are capable of changing. Even when the changes are small they create a range or band of normal readings. This normal range can be called the aperture or window for the parameter in question. Thus one technique in data compression is to define an aperture and record only data that is outside the normal range.

Floating apertures

L. J. Lauler of the Lockheed Aircraft Corp. has described a method for data compression⁵ using a variable or floating aperture, as illustrated on p. 66. The aperture is defined by data limits K_1 and K_2 ; data is sampled at the system rate but is recorded only when a parameter reaches or exceeds a limit. The excursion of the parameter to a limit results in an automatic change in limits, and thus the aperture floats around the actual value of the parameter being measured. Mechanization logic is shown in the block diagram. The effectiveness of floating aperture compression has been calculated by feeding recorded data from an actual Agena satellite vehicle flight into a computer programed to simulate floating aperture compression.

As indicated by the curves, data-compression ratios from 20-to-1 to 70-to-1 are possible for errors of $\pm 2\%$.

Since data rates can be high when parameters are changing rapidly, temporary data storage may be needed. In a sophisticated system, the aperture

limits can be increased arbitrarily to prevent an overflow of data.

More complex methods of data compression are possible using more sophisticated prediction methods similar to the prediction of the expected range of the parameter implied in the floating aperture technique. If a temperature does not exceed a specified rate of change, for example, readout may not be required. In other cases, a change in one parameter may not be significant unless another parameter also changes, and thus the one can be used to inhibit the recording of the other.

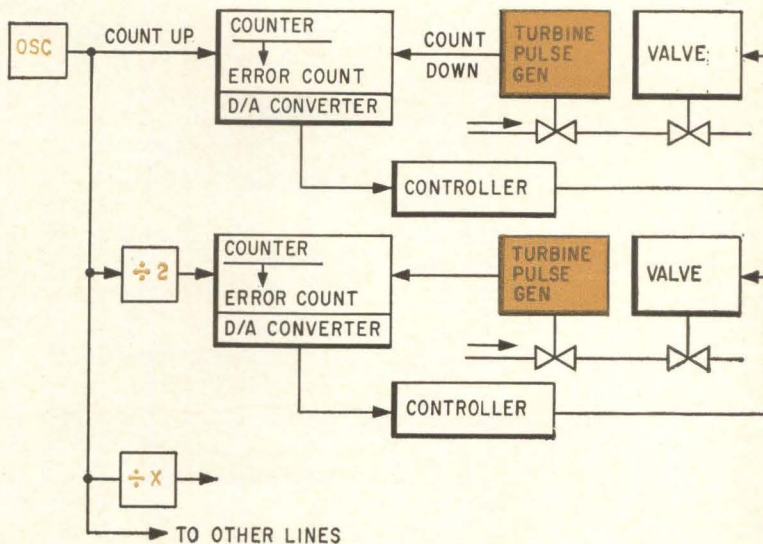

Digital blending system uses incremental encoding of turbine meters plus up-down counters to bring flow variables under control to integrate errors to ± 1 pulse over any desired time interval.

Direct digital control

When the big hurricane hit Texas City in the late 50's, several oil refinery installations took a severe beating. Electric and electronic controls suffered less damage than pneumatic control.

The experience demonstrated another reason for electronic control, which (with the data-processing required) often translates to direct digital control.

One variant of direct digital control is already in wide use for blending operations. Blending, in most applications, involves mixing a number of different liquids to obtain a product with a given specification, as in mixing gasoline ingredients to obtain high, medium and low grades of gasolines. More of the volatile components are added in winter, for example, and all the major oil companies vary their formulas, although in many cases the same refinery will produce gas for a number of major companies.

The blending of gasoline is controlled not only to meet specifications but to prevent what is known as "quality giveaway." The oil companies don't want to put as much of the expensive volatile com-

ponent into cheap gas as they put into expensive gas. However, if they don't use enough the result may be unusable. Digital blending has solved this problem for the oil companies.

The basic method in digital blending is shown on page 67. Pulses from a master oscillator are fed to a number of electronic counters; pulses from turbine pulse generators are also fed to the counter. When pulses from the oscillator arrive at the same rate as the pulses from the turbine meter, the error is zero. When the pulses differ, the error signal generated is used to position a control valve. Thus the volume of fluid flowing through the controlled line is proportional to the number of pulses from the oscillator; further, the error integrates to zero since the turbine meter must furnish the counter with exactly the same number of pulses as the oscillator.

Total process volume is controlled by oscillator frequency, changing with it in direct proportion. Ratios between the various ingredients in the blend are determined by the divider circuits as shown on the sketch and by scale factors on the turbine meters.

Advantages

Digital blending systems have demonstrated that they can blend mixtures as accurately as the specifications can be written. Several other characteristics are of interest. Mixing can be continuous, instead of being done in batches, with the result that more product can be put through for a given plant and less storage is required. In addition, ingredients can be added to a partially-mixed blend even in a pipe line or other optimum point, since another turbine meter can act as an oscillator to measure one flow while a turbine meter for the ingredient being added can match it, using appropriate scale factors. An important application of this technique is demonstrated when a volatile component is added to gasoline as the gasoline is pumped from a storage tank or pipe line to a truck or tank car. Addition of the volatile component at the last moment cuts down loss by evaporation.

Accuracy

Accuracy in a digital instrumentation system can often be an order of magnitude better than in an analog system, with 0.01% error often claimed for digital and 0.1% error for analog. A system's accuracy specification however, cannot be limited usually to a statement of allowable error for a given measurement. When many measurements are made, accuracy is best expressed statistically and is a function of the distribution of the data, the deviation or spread of the data, and the confidence interval.

The distribution of the data refers to the average value on which a large number of readings converge. The average of measured values and the true average value of the population will differ.

The deviation is a measure of how far individual readings will probably differ from the average

value. If a significant number of readings is far from the average, the deviation or scatter of data is large. If repeatability is high and all readings are close to the average, the deviation or scatter is small.

The confidence interval refers to the probability that a given reading will be within the normal scatter of the system. If the confidence interval is 99%, then the expectation is that only 1 reading in 100 will be either higher or lower than the expected scatter range.

The three system-accuracy factors mentioned apply only when the measuring system has a Gaussian distribution (errors in measurement are random.) If the system is not Gaussian, more measurements than expected will be outside the scatter region and as a result the confidence interval widens. Most instrumentation systems are Gaussian, however.

Some general conclusions about system accuracy can be stated.

- A high-accuracy system must have high precision, or high repeatability, or small scatter.
- A system can have a large offset error and still have high repeatability. High repeatability is a necessary but not a sufficient condition for high accuracy. If the large offset or systematic error is stable, high accuracy can be obtained by biasing out the error or by calibration. Statistical techniques in reducing the data can also be used to compensate for systematic error.

- Systems with low repeatability or precision cannot produce accurate data nor can accurate data be obtained by processing methods or reducing the amount of data.

One important way to obtain accuracy is to reduce scatter by making measurements as precisely as possible. If a voltage measurement is desired that is accurate to three places, a three-digit A/D converter will have uncertainty in the third digit while a four-digit converter will have uncertainty in the fourth digit; thus with a four-digit converter the three desired digits of a given measurement will be highly repeatable and precise.

Hybrid computer

As digital techniques have been applied to more and more problems, both their strengths and weaknesses have been recognized and defined. It has been possible to isolate a whole group of problems whose optimum solution requires a combination of both digital and analog techniques and the hybrid computer has been developed. The cover of this issue shows one of the newest of the hybrids, the combination Beckman Scientific Data Systems integrated computer system.

The digital function provides high resolution, storage, arithmetic and control capabilities; the analog function provides operating speed, ease in modeling and ease of parameter variation; signal flows are indicated in the drawing. Analog circuits can compute an answer quickly but at relatively

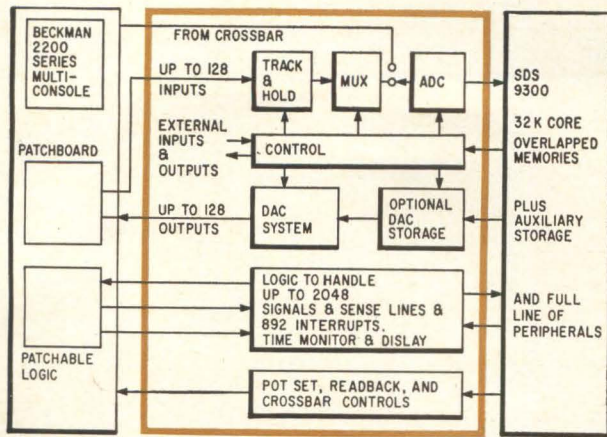

In the Beckman/Scientific Data Systems hybrid computer two low-cost general-purpose computers are linked by powerful interface equipment.

low accuracy; the analog solution thereby establishes limits on the parameters of interest and these are fed to the digital circuits, which solve the problem over and over again, varying each parameter within set limits until a highly accurate answer is obtained. Over-all computing time can thus be reduced by 98% or more, since the analog solution may put the digital circuits within 2%

or better of the final solution. If, however, the problems converge rapidly and programing is powerful, a preliminary analog solution may not be worth while.

The following types of problems are said to be ideally suited to the hybrid computer.

- Simulation studies of systems having characteristics of interest at high and low-frequencies.
 - Very high speed prediction and optimization studies of systems characterized by differential equations.
 - Systems requiring on-line, real-time statistical analysis, data filtering, smoothing, editing, etc.
 - Systems using Monte-Carlo or random-walk procedures.
 - Systems with transport delays.
 - Simulation studies of sampled data systems where both continuous and sampled data are required.
 - Studies of systems involving functions of two or more variables.
 - Systems described by very large simultaneous sets of ordinary differential equations.
- Many of the above problems are strictly computer type problems requiring intermittent or off-line operation. Others are right at the forefront of instrumentation today.

Using digital data

Blending systems, a signal-averaging memory, mass spectrometer, simulators, a frequency synthesizer, chemical digitizer, phase-angle meters and Q-meters are among the many applications possible.

Despite the numerous applications already in existence, those who work in the field of digital techniques say that digital technology is just beginning. Everyone, they point out, will be affected ultimately and it's hard to argue the point when applications such as direct digital telephone dialing or the new system installed by the Internal Revenue Service are cited as examples.

There is a demand for an extension of digital techniques from many sources.

Those using digital blending to control fluids want to extend the technique to control bulk products and mass flows. Manufacturers of digital volt-

meters are trying to reduce costs in order to attract a large untapped market. Process engineers believe direct digital control will provide more optimum solutions. And some companies, not working directly with digital techniques, are finding that more and more of their customers are requesting them.

Many engineers believe that the amount of research and development effort in digital techniques is almost negligible and that the only important research work going on is in the field of Perceptrons (self-organizing systems), in character recognition machines, and in the design and optimization of the basic logic circuits. An indication

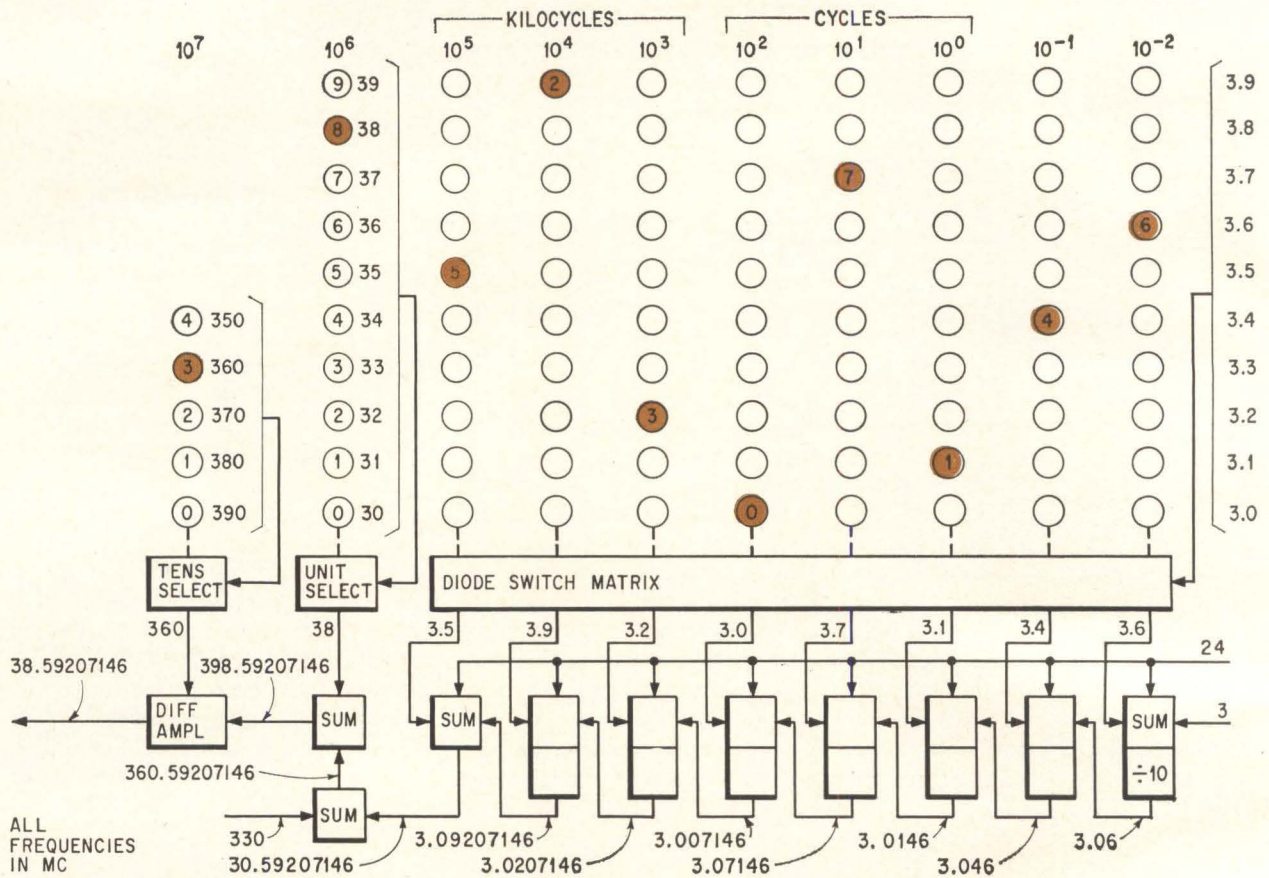

Typical of the flexibility of digital techniques is the digitally controlled frequency synthesizer. Additions and subtractions are performed on quantized signals (frequencies), however, instead of on digital words. Circuit operation is explained in the text.

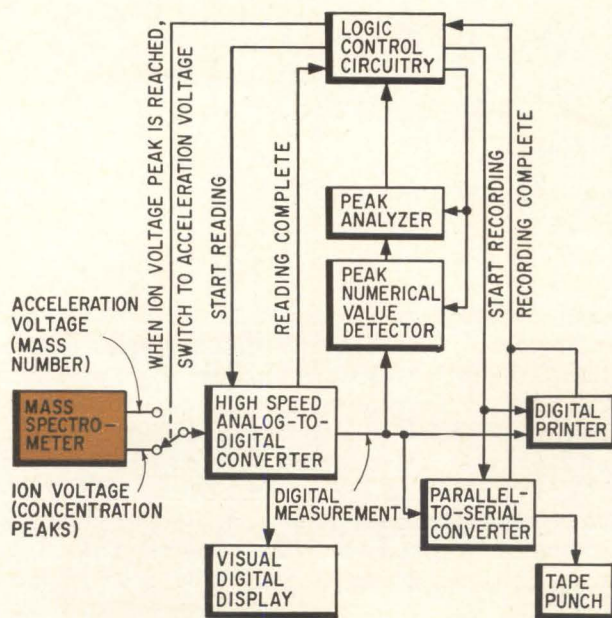

Simplified functional diagram of mass spectrometer digitizer

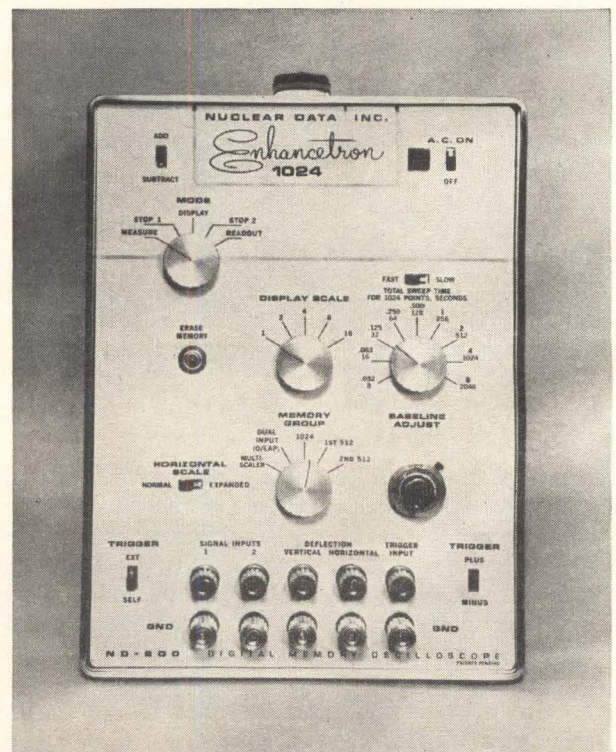

Signal averaging core memory acts to pull signals out of noise by allowing noise on repeating waves to cancel. Output signal can drive oscilloscope or recorder

of the relative lack of effort is the fact that few basic papers appear to have been written in the research area, although a large number of applications have been described in the technical press.

Besides the large systems and control areas already mentioned, digital techniques have been applied to a large number of other problems. A few of these will be discussed briefly to illustrate the range of problems susceptible to digital solutions.

Signal-averaging memory

A magnetic core memory of 1024 words is used by Nuclear Data Inc. in its Enhancetron 1024 digital memory oscilloscope. Low-level analog waveforms are fed into the instrument and are digitized at 1024 points. The digital words are then stored in the memory. As the wave-form repeats, it is digitized again and the new values at the 1024 points are averaged with the stored values to produce an enhanced signal. Enhancement occurs because any noise signal on a given part of the wave is swamped by the averaging process. The equipment operates at low sweep rates and is intended for studies of brain waves, nuclear magnetic resonance, radar astronomy, oceanography, and other scientific areas.

The equipment develops output signals that can be used to drive an oscilloscope or pen recorder.

Mass spectrometer

Mass spectrometers, performing chemical analyses are operated by some control laboratories on a nonstop basis. Analysis is performed by measuring the ratio of the mass of an ionized particle to its charge by subjecting it to magnetic and electrostatic fields. Output signals consist of the acceleration voltage, which is proportional to mass number, and detector output, which is proportional to ion current and varies as the acceleration voltage is swept through its range. These two signals are digitized and processed as shown in the sketch.

Results of the digitizing⁶ include a cost reduction per sample of 57%, an increase of 66% in spectrometer capacity, and an increase in the precision of the analysis.

Simulators

Analog computer circuits in trainers—or simulators—are giving way to digital computers. Where previously each function was computed by a special-purpose analog element the functions are now gathered into a central digital computer where they are analyzed and proper response functions generated.

Many digital simulators have been constructed around specially-designed digital computers which pushed costs rather high but a Polaris sub simulator used a commercially-available Packard Bell computer and standard interface equipment.

Frequency synthesizer

The Hewlett-Packard frequency synthesizer uses

a precision 1-Mc signal from which are developed the other signals used to synthesize the output. Push buttons are used to select the basic frequencies that are applied to the summing and dividing circuits. If the output frequency is to be 38.59207146 Mc for example, a 3.6 Mc signal is applied to the 10^{-2} summing amplifiers (see sketch). The 3.6 Mc is combined with 24 Mc and 3.0 Mc to obtain 30.6 Mc which is then divided by ten. (That is: $3.6 + 24 = 27.6$ and $27.6 + 3.0 = 30.6$.)

The resultant 3.06 Mc is summed with 24 Mc and 3.4 Mc in the 10^{-1} summing amplifiers. The resultant 30.46 Mc signal is divided by 10 and the 3.046 Mc resultant is applied to the succeeding summing amplifiers, and so forth until a 30.5920714 Mc signal is taken from the 10^5 summing amplifier, and—without division—summed with a 330 Mc and applied to the 10^6 summing amplifier. A 38 Mc signal—selected by the 10^6 push button—is added on in the 10^6 summing amplifier and the resultant 398.5920714 Mc signal is applied to the 10^7 difference amplifier. The difference between the input signal and a 360 Mc signal selected by the 10^7 pushbutton—the selected 38.5920714 Mc signal—is taken in the difference amplifier and supplied as output.

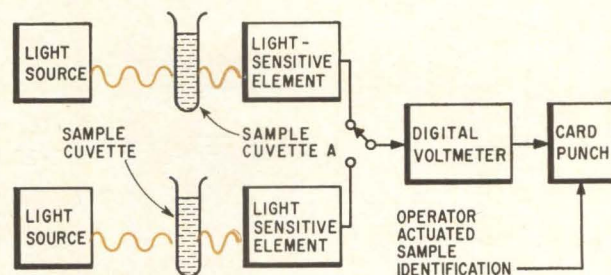

System measures and records of the clarity of a bacterial culture automatically.

Chemical digitizer

A digital voltmeter can provide an all-in-one system for measurements of analog signals and conversion from analog to digital. Charles Pfizer & Co. Inc. used a digital voltmeter as a major link in its system to measure and record the clarity of a bacterial culture solution.

A beam of light passing through the culture is measured with a photosensitive device and the output supplied to a digital voltmeter (see diagram). The voltmeter provides a digital display and also operates contacts to control a card punch. The card is punched to identify the sample and the reading from the voltmeter. Later, the card is used in an IBM 650 computer system that evaluates the samples and provides reports. Numerous other equally ingenious applications of digital voltmeters have been made.

Digital phase-angle meters

A digital voltmeter is used to measure phase angle digitally as shown by the accompanying

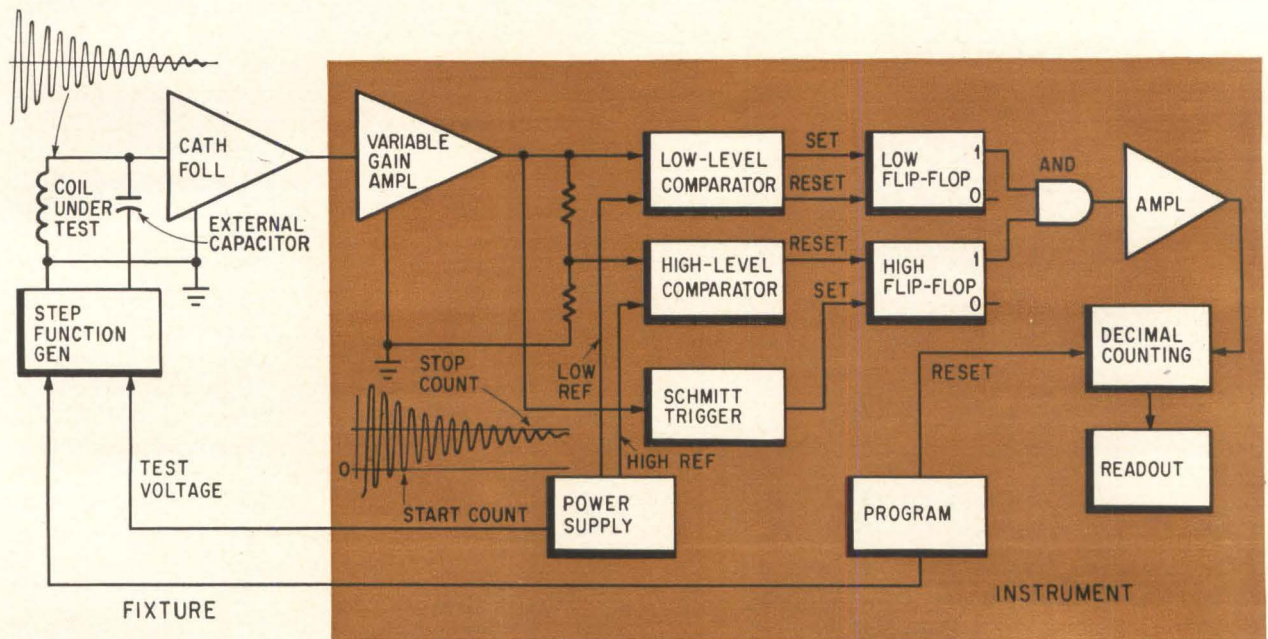

Digital Q-meter measures Q of coil by counting cycles in decay envelope.

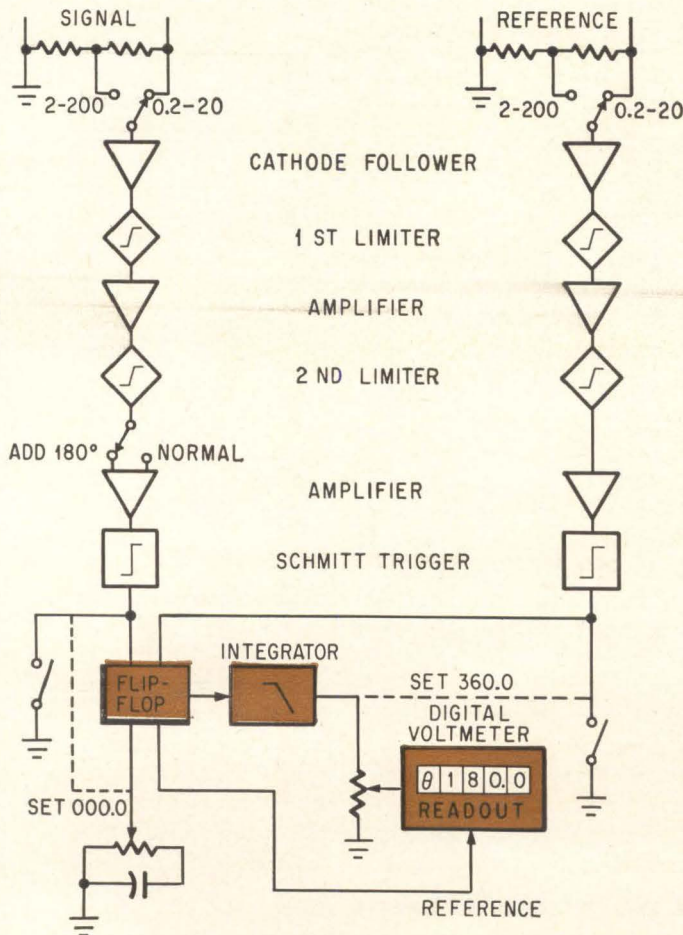

Digital phase-angle meter averages output of flip-flop, then converts it to digital readout.

sketch. The zero crossing of the reference signal is used to turn the flip-flop on. The zero crossing of the measured signal turns it off. The time the flip-flop is on is thus proportional to phase angle. The average signal from the flip-flop is smoothed and converted in the voltmeter, giving direct phase-angle readout. This technique is used by the Acton Labs, Inc. in its 330 line of meters, which have a range from 30 cps to 40 Kc.

Digital Q-meter

When the drive from a tuned circuit is removed, the oscillations decay exponentially. In the digital Q-meter above the external capacitor is first charged, then suddenly connected to the coil under test. The circuit produces oscillations until the energy is dissipated by circuit resistance, and the number of oscillations is proportional to the Q of the circuit. Since most of the losses are in the coil, the Q of the coil can be determined by counting the oscillations. To improve accuracy, the J-Omega Co. circuit shown counts the oscillations between two specified levels. Error is said to be 2% for 2 μ h to 1 h from 10 kc to 1 Mc.

References

1. Yaohan Chu, "Digital Computer Design Fundamentals," McGraw-Hill Book Co., 1962, p. 53.
2. Non-Linear Systems Staff, "Digital Voltmeters" (book), 1962.
3. L. S. Gomolak, "Take Two Tons of Flour," Electronics, Apr. 20, 1964, p. 82.
4. General Information Manual, IBM 1710 Control System for Steam-Electric Generating Units.
5. L. J. Lauer, "A System-Oriented PCM Ground Station Incorporating Data Compression, Lockheed Missiles and Space Co. technical paper.
6. E. M. Thomson, "A Solid State Digitizer for Mass Spectrometers," Analytical Chemistry, December 1963, p. 2155.

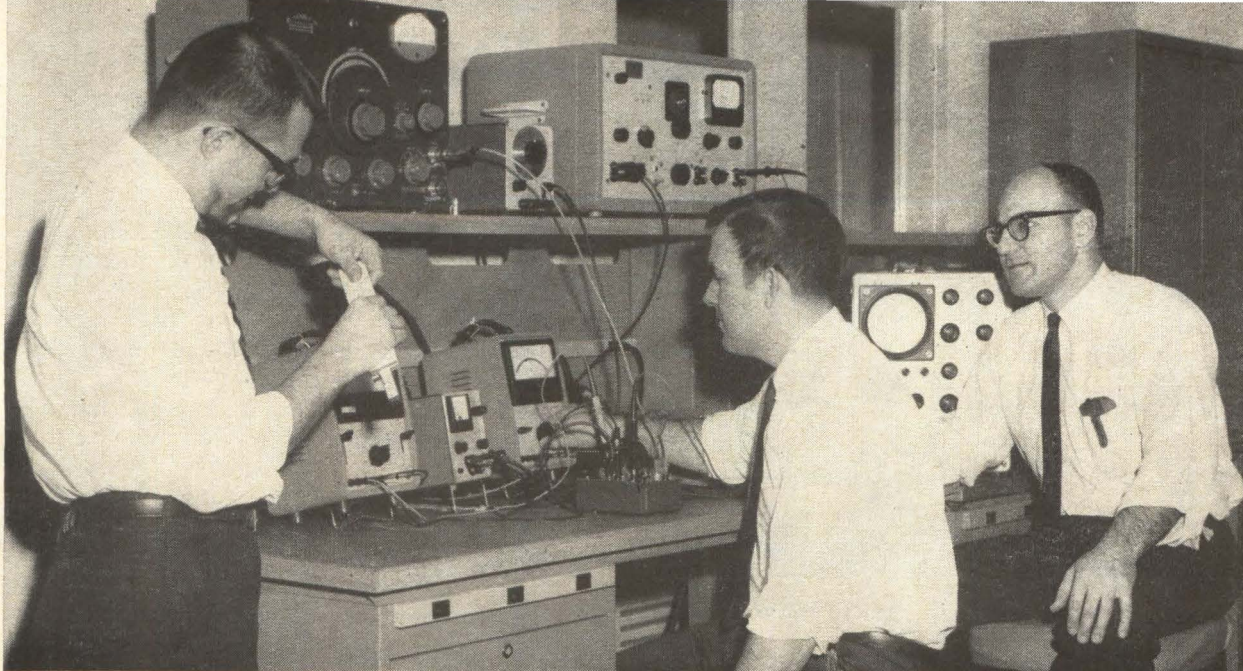

Engineers test common-emitter amplifier at the Army Electronics Research and Development Laboratory.

Microelectronics

How to design micropower transistor amplifiers: part I

Technique provides specified output power capability over a wide temperature range, minimizes amplifier power drain and maximizes power gain

By J. D. Meindl, R. Gilson, O. Pitzalis and W. Kiss

U.S. Army Electronics Research and Development Laboratories, Fort Monmouth, N.J.

One of the chief problems in space electronics and portable military communications equipment, where size, weight and power drain are crucial, is designing circuits that consume little power. For this reason, increasing emphasis is being placed on micropower electronics—the design of circuits that consume microwatts rather than milliwatts.

Recent advances in semiconductor device technology have produced silicon planar transistors which exhibit junction reverse currents less than one nanoampere and common-emitter current gains

greater than 50 for collector currents of 1 to 10 microamperes. Because of their ultralow-level operational capabilities, such micropower transistors offer attractive possibilities for alleviating the problem of excessive power drain in space electronics and portable military communications equipment.

This article is the first of two which give a design technique for micropower amplifiers, including the characteristics of commercially available micropower transistors, an optimum design theory for linear broadband micropower transistor amplifiers

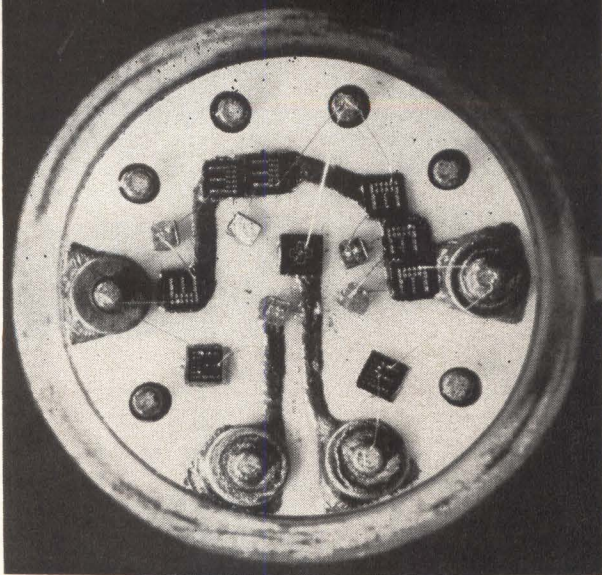

Multichip common-emitter amplifier

and a cascode micropower amplifier configuration. A salient feature of this design technique is that for the first time it provides a single approach to both the d-c and large-signal a-c design of micropower amplifiers. Subject to the initial constraints on the design, the technique provides a specified amplifier output power capability over a wide temperature range, minimizes amplifier power drain and maximizes amplifier power gain. This performance is assured for the worst possible combination of transistor, resistor and supply voltage tolerance margins. Specifically, the technique permits designing micropower amplifiers that can provide an 0.18-volt peak a-c load voltage over the temperature range -50° to $+100^{\circ}$ C for a power drain of only 25 microwatts and a power gain of 25 db.

If the peak load voltage capability is reduced to 0.15 v, this amplifier can accept 10% worst-case tolerance margins on all circuit resistors. Depending on transistor barrier capacitances and stray circuit capacitances, amplifier bandwidth may vary from about 10 kc to 25 kc with five times and larger increases possible with the cascode circuit to be described in the second article.

Fabrication

The amplifiers described here were fabricated by using an approach to microelectronics known as the multi-chip technique. This involves using separate silicon chips for the active and passive components to cut parasitic capacitances to less than would be found in a comparable monolithic (single-chip) integrated circuit at present.

The silicon chips are bonded to metal islands on a ceramic substrate as shown in the photo. The active-component chips are simply planar transistors in a silicon substrate. The separate passive-component chips use diffused resistors or thin-film resistors deposited on top of a silicon substrate passivated with silicon dioxide.

This feature allows using resistors that have values of 300,000 ohms or more and provides another reason for the multi-chip approach because such

values are presently not feasible in monolithic integrated circuits.

Design theory

The initial consideration in designing micropower amplifiers is the characterization of the micropower transistor. Briefly, micropower transistors differ from ordinary silicon transistors in that they have:

- 1). Junction reverse currents less than one nanoampere at room temperature.
- 2). Forward current transfer ratios (h_{fe} and h_{FE}) greater than 50 for collector currents of 1 to 10 microamperes.
- 3). Greater sensitivity of the d-c forward current transfer ratio h_{FE} and four terminal parameters h_{11e} and h_{21e} to changes in quiescent collector current and temperature.
- 4). A relatively limited gain-bandwidth product f_T .

Micropower transistor characteristics

Six typical micropower transistors are characterized in the table below. The devices include three npn planar transistors (devices A, B and C), an npn planar epitaxial transistor (device D), an npn mesa transistor (device E), and a pnp planar transistor (device F). Each transistor is supplied by a different manufacturer. The tabulated d-c characteristics indicate that the temperature variation of transistor current gain h_{FE} at a 10 microampere collector current may often be greater than the corresponding variation at milliampere collector current levels. For example, device D exhibits a 5.5 times increase in h_{FE} from 23 to 128 for $-50 \leq T \leq 100^{\circ}$ C. In addition, it is evident that at temperatures above 100° C, collector junction reverse current I_{CBO} can become significantly large compared with base current, if not collector current, for collector currents in the 1 to 10 microampere range. Again considering device D, the I_{CBO} of 0.33 microampere at 100° C, which increases to about 2.5 microampere at 125° C, illustrates this point.

The variations with collector current of the small

D-C characteristics						
Device	$I_C = 10 \mu\text{a}$ $I_B = 1.0 \mu\text{a}$		$I_C = 10 \mu\text{a}$ $V_{CE} = 3.0 \text{ v}$		$V_{CB} =$	I_{CBO} (na)
	V_{CES} (v)	V_{BES} (v)	h_{FE}	h_{FE}	h_{FE}	
	T ($^{\circ}$ C) = 25		-50	25	100	100
A (2N929)	0.10	0.55	23	66	106	1.0
B (unregistered)	0.09	0.52	14	54	125	3.8
C (2N2510)	0.13	0.53	62	91	156	9.0
D (2N2784A)	0.16	0.60	23	71	128	33.0
E (2N2251)	0.05	0.49	20	50	96	14.0
F (2N2604)	0.13	0.52	58	115	192	30.0

These properties are described in more detail in the panel (p 74) which also presents characterization data for six typical diffused silicon micropower transistors.

In designing a micropower amplifier, several problems arise that are far less severe or even non-existent at normal milliwatt power levels in silicon transistor linear circuits. In d-c operation, transistor bias point stabilization becomes more difficult due to three factors: 1) at 1 to 10 microampere collector currents, collector junction reverse current I_{CBO} can become significant at temperatures above 100°C ; 2) the temperature variation of common emitter current gain h_{FE} is somewhat larger than that at collector currents of 1 to 10 milliamperes; a five-to-one variation for $-50^\circ\text{C} \leq T \leq 100^\circ\text{C}$ is not unusual; 3) temperature variation of base-emitter diode conductance g_{BE} makes the d-c operating

point unstable. This effect becomes more difficult to counteract at the low battery voltages which usually accompany microwatt power levels, because V_{BE} is a greater percentage of the battery voltage.

In a-c operation, a major problem stems from the fact that quiescent collector currents in the micro-ampere range severely restrict the dynamic range of an amplifier and effectively contribute to a large signal mode of operation. Careful attention must be paid to the effects of temperature as well as transistor saturation and cut-off on the dynamic range of a design. The influence of both transistor and passive component tolerances assumes a greater importance in micropower amplifiers. Finally, poor high-frequency response of currently available silicon transistors at microwatt power levels seriously limits the bandwidth of micropower amplifiers. The design technique described has been found useful in pro-

signal, low frequency, common emitter parameters, $h_{11e}=h_{ie}$ and $h_{21e}=h_{fe}$, indicate the changes that occur in the values of transistor a-c input impedance and current gain as quiescent collector current is reduced. For example, h_{ie} increases markedly from 4,000 to 217,000 ohms while h_{fe} decreases moderately from 140 to 78 as I_C varies from a 1 ma to 10 microampere collector quiescent current as indicated. Typical low frequency values for the reverse voltage transfer ratio $h_{12e}=h_{re}$ and the output admittance $h_{22e}=h_{oe}$ for micropower transistors are indicated at the bottom of the table; h_{12e} and h_{22e} can generally be neglected in micropower circuits.

The three-decibel cutoff frequencies f_{3db} and current gain-bandwidth products f_T shown in the table illustrate the strong dependence of transistor frequency response on quiescent collector current. In the case of device D the current gain-bandwidth product decreases from 600 to 7 Mc as I_C is reduced from 1 ma to 10 microampere. By means of the conventional hybrid pi small signal equivalent circuit for a transistor, it can be shown¹ that the gain-bandwidth product of a micropower transistor is approximately directly proportional to collector current

I_C . The governing relationship is

$$f_T = h_{fe} f_{3db} = \frac{1}{2\pi} \frac{h_{fe}}{h_{ie} (C_{b'e} + C_C + C_s)}$$

$$= \frac{1}{2\pi} \frac{q}{kT} \frac{I_C}{(C_{T_e} + C_C + C_s)}$$

where the total base-to-emitter capacitance $C_{b'e}=C_D+C_{T_e}$ is essentially equal to the emitter junction capacitance C_{T_e} , C_C is the collector junction capacitance, C_s is stray base-to-ground package capacitance, q is the electronic charge, k is Boltzmann's constant, and T is absolute temperature. Normal base diffusion capacitance C_D is virtually negligible at the low operating current levels of interest for micropower transistors. High frequency response must be achieved by reducing junction areas in order to minimize the barrier capacitances C_{T_e} and C_C . The table indicates device D exhibits both the minimum barrier capacitances and the maximum gain-bandwidth product. For micropower applications, it is generally the best performing device of those listed.

A-C characteristics

$I_C = 10 \mu\text{a}$ $V_{CE} = 3.0 \text{ v}$		$I_C = 100 \mu\text{a}$ $V_{CE} = 3.0 \text{ v}$		$I_C = 1.0 \text{ ma}$ $V_{CE} = 3.0 \text{ v}$		$I_C = 10 \mu\text{a}$ $V_{CE} = 3.0 \text{ v}$		$I_C = 10 \mu\text{a}$ $V_{CE} = 3.0 \text{ v}$		$I_C = 10 \mu\text{a}$ $V_{CE} = 3.0 \text{ v}$		$I_C = 100 \mu\text{a}$ $V_{CE} = 3.0 \text{ v}$		$I_C = 1.0 \text{ ma}$ $V_{CE} = 3.0 \text{ v}$		$C_{T_e}, V_{BE} = +0.3 \text{ v}$ $C_C, V_{CB} = -3.0 \text{ v}$ $C_D, I_C = 1.0 \text{ ma}$		
25		25		25		-50		100		25		25		25		25		
h_{11e} (K Ω)	h_{21e}	h_{11e} (K Ω)	h_{21e}	h_{11e} (K Ω)	h_{21e}	h_{11e} (K Ω)	h_{21e}	h_{11e} (K Ω)	h_{21e}	f_{3db} (KC)	f_T (MC)	f_{3db} (KC)	f_T (MC)	f_{3db} (KC)	f_T (MC)	C_{T_e} pf	C_C pf	C_D pf
184	71	26	95	3.2	120	73	37	350	107	24	1.7	150	14	935	112	16.7	6.2	27
200	76	38	141	6.4	230	46	22	460	146	42	3.2	184	26	532	123	9.0	2.4	35
335	125	65	248	10.6	390	172	91	600	188	30	3.7	118	29	286	112	5.0	3.0	43
217	78	30	110	4.0	140	66	33	435	134	90	7.0	595	65	4290	600	2.1	1.3	5
187	68	37	130	5.8	210	61	30	400	121	44	3.0	200	26	675	142	8.8	2.8	29
330	124	43	159	4.6	172	138	71	545	173	16	2.0	90	14	470	81	16.4	4.6	51

Typical characteristics	T ($^\circ\text{C}$) =	$I_C = 10 \mu\text{a}, V_{CE} = 3.0 \text{ v}$			$I_C = 1.0 \text{ ma}, V_{CE} = 3.0 \text{ v}$
		-50	25	100	25
$h_{12e} =$		2.3×10^{-4}	5×10^{-4}	1×10^{-3}	3.2×10^{-4}
$h_{22e} (\text{ohms})^{-1} =$		0.013×10^{-6}	0.02×10^{-6}	0.032×10^{-6}	16×10^{-6}

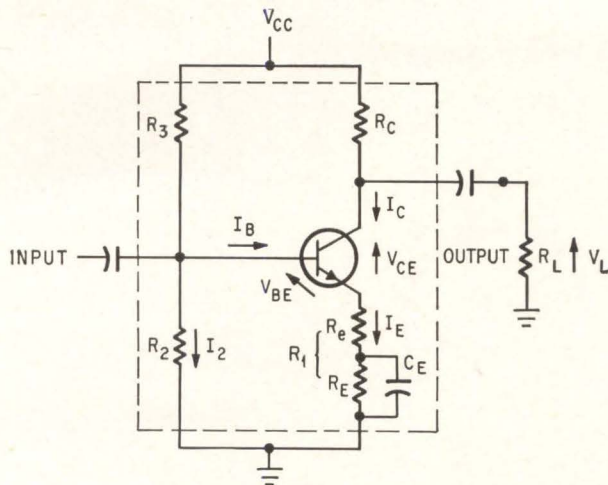

Common-emitter micropower amplifier schematic indicating circuit d-c currents and voltages, and peak a-c load voltage V_L .

viding amplifier designs to minimize these difficulties.

The initial constraints assumed in the design of the common-emitter broadband micropower amplifier shown schematically above are: (a) the amplifier supply voltage V_{CC} and operating temperature range $T_y \leq T \leq T_x$ are fixed; (b) the amplifier load impedance R_L , the peak a-c output voltage V_L , and the bandwidth f_{3db} are specified; (c) the d-c power consumption of the amplifier should be as small as possible.

Design procedure

Subject to the assumed initial constraints, the objectives of the design technique summarized below are to determine optimum values for the minimum and maximum temperature transistor quiescent collector current and voltage (I_{cy} , V_{cey}) and (I_{cx} , V_{cex}), as well as for the circuit resistances R_C , R_1 , R_2 and R_3 . [Note that throughout this article

The authors

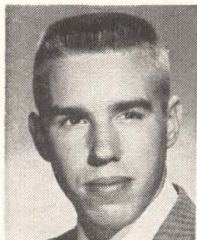

James D. Meindl received a Ph.D. degree in electrical engineering from the Carnegie Institute of Technology in 1958. Prior to this he held positions at C.I.T. as a research assistant and at Westinghouse Research Laboratories and North American Aviation as a development engineer. He joined the Central Research Laboratories of the Westinghouse Electric Corp. in 1958

where he was engaged in advanced solid state circuit development. In 1959 he was called to active duty as a first lieutenant with the U.S. Army Electronics Research and Development Laboratories, Fort Monmouth, N.J., where he became engaged in microcircuit research. Following the completion of his military duty in 1961, Dr. Meindl remained with the Army laboratory where he is presently chief of the semiconductor and microelectronics branch. He is responsible for the development and application of a wide range of semiconductor devices and integrated circuits.

the subscripts x and y refer to maximum and minimum temperatures, respectively.]

(a) From the schematic, write the d-c load line (DCLL) equation for the amplifier at the nominal operating temperature T_n . This equation is

$$V_{CC} = I_{Cn} R_C + V_{CEn} + V_{R1n} \quad (1)$$

where

$$V_{R1n} = I_{En} R_1 \simeq I_{Cn} R_1$$

is the emitter d-c feedback voltage.

(b) Also, from the schematic write the a-c load line (ACLL) equation for the amplifier at T_n in terms of the quiescent collector current and voltage. This equation is

$$I_{Cn} = -(1/R_C + 1/R_L) V_{CEn} - V_{Ren} \quad (2)$$

where

$$V_{Ren} = (I_{En} - I_o) R_e \simeq (I_{Cn} - I_o) R_e$$

is the emitter a-c feedback voltage. (I_o is the amount of offset from the transistor cut-off region.)

(c) In order to provide the specified peak a-c output voltage V_L at T_n for minimum d-c power consumption, the d-c operating point Q_n must bisect the ACLL in order for the output signal voltage swing to be a maximum. From the load line diagram the locus of ACLL midpoints can be shown to be

$$I_{Cn} - I_o = (1/R_C + 1/R_L) (V_{CEn} - V_o) - V_{Ren} \quad (3)$$

with V_o the transistor saturation region offset and I_o the cut-off region offset.

(d) Since the quiescent collector voltage required to accommodate a peak output voltage V_L is

$$V_{CEn} = V_L + V_{Ren} + V_o \quad (4)$$

simultaneous solution of equations (1), (3) and (4) yields the nominal collector current and the maximum allowable value of the collector resistance:

$$I_{Cn} = \frac{V_{CC} - V_L - V_{R1n} - V_{Ren} - V_o}{V_{CC} - 2V_L - V_{R1n} - V_{Ren} - V_o} \left(\frac{V_L}{R_L} + I_o \right) \quad (5)$$

$$R_C = \frac{V_{CC} - 2V_L - V_{R1n} - V_{Ren} - V_o}{\frac{V_L}{R_L} + I_o} \quad (6)$$

Given V_{R1n} , equations (5) and (6) define the smallest I_{Cn} and the largest R_C , respectively, that satisfy the initial design constraints on V_{CC} , R_L and V_L . This is advantageous since a small value of I_C decreases



Russell A. Gilson joined the Electronics Research and Development Laboratories of the U.S. Army at Fort Monmouth in 1960. He has been engaged in microcircuit design techniques and is presently pursuing a master's degree at New York University. He obtained his bachelor's degree in engineering from the University of Wisconsin.

power dissipation P_D and a large value of R_C increases amplifier gain. The proper selection of V_{Rin} in equations (5) and (6) obviously constitutes a key point in the design.

A practical procedure for obtaining the d-c emitter feedback voltage V_{Rin} is to complete designs for several arbitrarily selected values of V_{Rin} and compare their over-all performance. The a-c emitter feedback voltage V_{Ren} and the saturation region offset V_o and cut-off region offset I_o should be judiciously selected (as zero in some cases) to satisfy the design constraints of particular applications. For instance, a major consideration in choosing I_o and V_o might be the acceptable limit of distortion for a particular design.

(e) From the load line diagram, it is evident that because the quiescent point bisects the AC LL at T_n , operating point drift will limit the output voltage swing to values less than the specified V_L when T does not equal T_n . A key feature of the present design theory lies in regulating the d-c operating point drift such that the amplifier can handle the desired a-c output voltage swings at the operating temperature limits ($K_y V_L$ at the minimum temperature T_y and $K_x V_L$ at the maximum temperature T_x with $0 < (K_y, K_x) < 1$). Furthermore, it is particularly important to insure that the already minimal dynamic range of a micropower amplifier is preserved in the face of worst case tolerances for both the transistor, the resistors and the supply voltage. From the diagram, it is apparent that the critical function of a worst case design technique for linear broadband micropower amplifiers is to insure that I_{Cy} will not be less than

$$I_{Cy}(\min) = K_y V_L (1/R_{C(\max)} + 1/R_L) + I_o \quad (7)$$

in order to provide an output voltage swing $K_y V_L$ at T_y and that V_{CEx} will not be less than

$$V_{CEx}(\min) = K_x (V_L + V_{Ren}) + V_o \quad (8)$$

in order to provide an output voltage swing $K_x V_L$ at T_x .

(f) Employing worst case tolerances, the d-c output loop equation at T_y

$$V_{CEy} = V_{CC}(\min) - I_{Cy}(\min) (R_{1(\max)} + R_C(\max)) \quad (9)$$

together with $I_{Cy}(\min)$ gives the operating point at T_y . The output loop d-c equation at T_x

$$I_{Cx} = (V_{CC}(\min) - V_{CEx}(\min)) / (R_{1(\min)} + R_C(\max)) \quad (10)$$

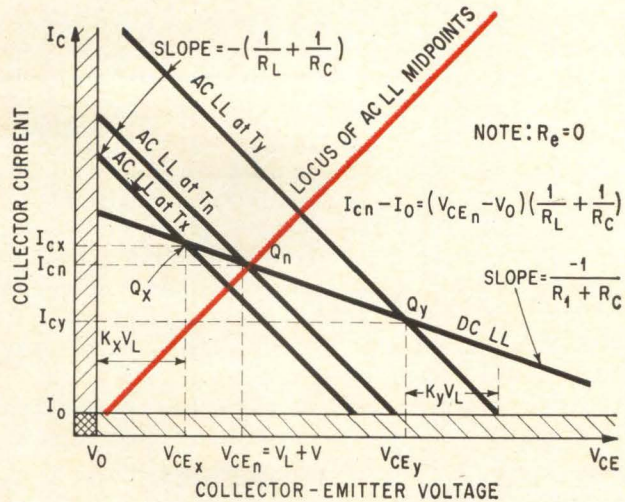

Load line diagram for common-emitter micropower amplifier.

gives the value of I_{Cx} which accompanies $V_{CEx}(\min)$ at T_x . It is evident here that the selection of the factors K_y and K_x or the dynamic range constants of the amplifier effectively determines its d-c operating point stability or the temperature stability of the dynamic range. For the typical design constraints on the amplifiers described here $0.50 \leq K_y, K_x \leq 0.80$ is a useful range of values for K .

(g) The establishment of the transistor collector quiescent points at T_y and T_x in equations (8), (9) and (10) effectively defines the corresponding transistor base drive conditions. From the schematic (p 76) a solution of the four simultaneous worst case equations¹

$$V_{CC}(\min) = (I_{By}(\max) + I_{2y}) R_{3(\max)} + I_{2y} R_2(\min) \quad (11)$$

and

$$0 = V_{BEy}(\max) + I_{Ey} R_{1(\max)} - I_{2y} R_2(\min) \quad (12)$$

at T_y and

$$V_{CC}(\min) = (I_{Bx}(\min) + I_{2x}) R_{3(\min)} + I_{2x} R_2(\max) \quad (13)$$

and

$$0 = V_{BEx}(\min) + I_{Ex} R_{1(\min)} - I_{2x} R_2(\max) \quad (14)$$

at T_x yields the maximum allowable values for R_2 and R_3 , considering both worst case temperature and manufacturing tolerances for all circuit ele-



Octavius Pitzalis, Jr. specializes in microcircuit design techniques. He received his bachelor's degree from the University of Missouri in 1959 and is presently engaged in graduate study for a master's degree at New York University.



William F. Kiss is presently engaged in ultrahigh-frequency and very high frequency high-power transistor characterization for the semiconductor and microelectronics branch which he joined in 1959. Initial assignments were in characterization of switching transistors and uhf small-signal transistor evaluation. He received his electrical engineering degree

from Drexel Institute of Technology and is presently doing graduate work at New York University.

ments, which will insure the specified output voltage swing at a minimum power consumption.

By its nature, this design technique yields a common emitter amplifier design which must comply with all initial constraints except the specified bandwidth. For the proper choice of V_{Rin} , the technique yields the maximum allowable values of R_C , R_2 and R_3 and thus minimizes the power dissipation in and the signal drain through these resistors. The design therefore exhibits the maximum power gain per unit of power consumption consistent with the specified supply voltage, operating temperature range, load impedance, dynamic range and element tolerances. Additional bandwidth can be achieved as required in the common emitter configuration by increasing the collector quiescent current.

In many cases a preferable alternative, which is far less costly in terms of power consumption although it requires more components, is to employ a cascode-circuit configuration. The salient features of the cascode stage and a comparison of its performance with that of the common emitter stage will be given in the second article of this series.

Reference

1. "Static and Dynamic Performance of Micropower Transistor Linear Amplifiers," R.A. Gilson, O. Pitzalis, W. Kiss, and J.D. Meindl; U.S. Army Electronics Research and Development Laboratories Tech Rep 2386 Fort Monmouth, N.J. Sept. 1963. (This material was presented in the Micropower Electronics lecture series of the AGARD of NATO in Paris, France; Malvern, England; Stuttgart, Germany; and Rome Italy, in June, 1963. It will be available soon in a book published by Pergamon Press and edited by E. Keonjian.)

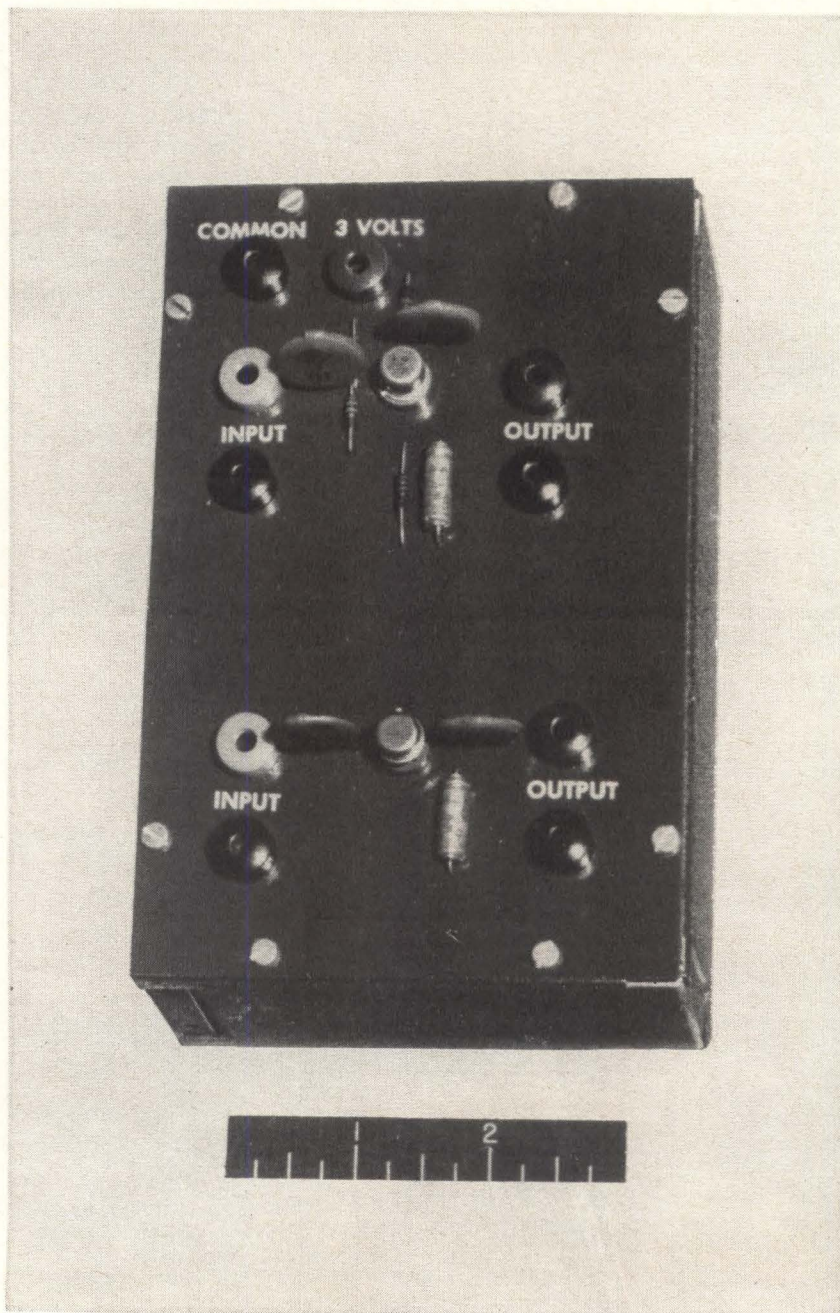

Conventional-component version of common-emitter micropower transistor amplifier at top of chassis and multi-chip version at bottom.

Air Force AN/FPS-35 search radar is replacing older radars to enhance the capability of the SAGE system. But these newcomers are potential interference problems in some areas.

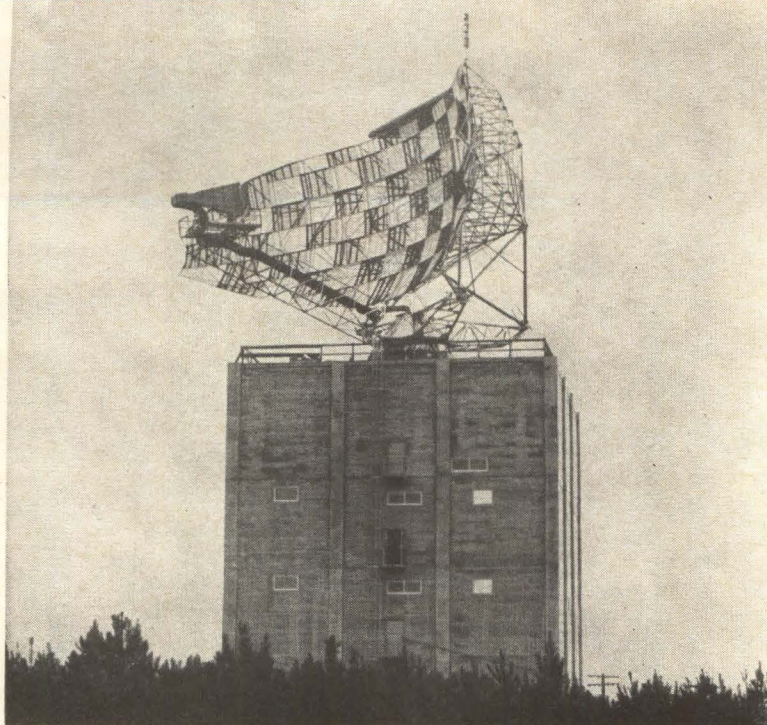

Military electronics

The quest for compatibility

Thousands of mutually interfering transmitters and receivers make military operations an electronic Babel, but our armed services may have found one solution

By John M. Carroll

Managing Editor

Jutting out on a pier across the broad Severn River from the United States Naval Academy at Annapolis is an unimposing structure best described architecturally as "warehouse modern."

It is, nevertheless, the nerve center of a tri-service effort to eliminate radio frequency interference in research and development stages and to provide technical coordination for military frequency allocations.

The Electromagnetic Compatibility Analysis Center is run by the Air Force with representation from the Army, Navy and Marines. A contractor, Illinois Institute of Technology Research Institute, handles data processing and computer programming.

Basically the center has the mission of assembling a data base of spectrum signatures (or transmission characteristics), deployment and operation of all electromagnetic equipment anywhere in the world, carrying out an engineering analysis program, and supplying the services with technical advice both in research and development of elec-

tronic equipment and in allocating radio frequencies to military organizations.

The interference mess

This help is badly needed too.

Launch of a super-rocket at Cape Kennedy was delayed more than an hour when the radar of a ship offshore interfered with a critical tracking radar on the missile range. The Navy had to spend a million dollars reworking radar altimeters erroneously designed to operate in the wrong frequency band. A taxicab driver in Texas detonated a missile at Cape Kennedy. The job of locating intrasystem interference that caused the altimeter of an RB-47 jet bomber to malfunction cost \$180,000. And new AN/FPS-24 radars installed near Pittsburgh and Almaden, Calif. have local residents up in arms over interference to radio, tv and hi-fi.

And there is more trouble to come as the existing AN/FPS-20 search radar and AN/FPS-60 heightfinders of the North American Air Defense Com-

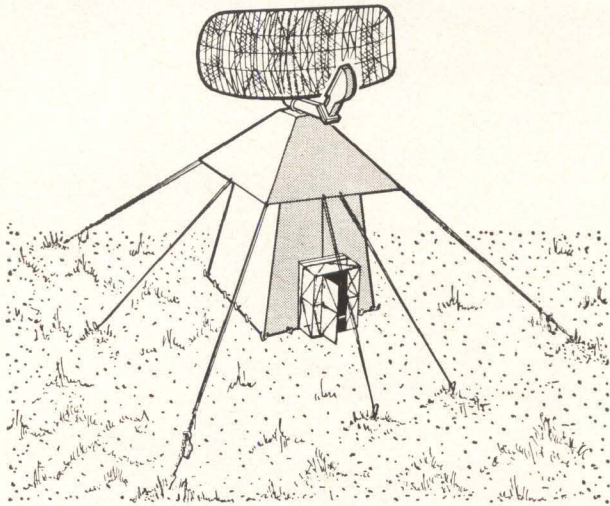

Marine Corps AN/TPS-1 battlefield surveillance radar has already figured in four-service study of electromagnetic compatibility. Other participants were Navy AN/SPS-6, Army AN/FPS-36 and Air Force AN/FPS-7

mand are replaced by new and more powerful frequency-diversity units such as the AN/FPS-24, 35, 27 and 7 search radars and the AN/FPS-26 height finder. Powerful new radar for the Space Detection and Tracking System (Spadats) will give even more trouble.

Problems to be solved

The Center receives its frequency-allocation problems from JF-12, a working group of the Joint Frequency Panel of the Joint Chiefs of Staff. It receives its design problems from the office of the deputy secretary of defense for research and engineering. Its method consists of defining the problem, translating it into terms used by the center, computing, performing engineering analysis and retranslating the problem into terms used by the poser. The tools the center uses are broad-gage data files on equipment environment, operating characteristics and terrain and an impressive library of mathematical models and computer pro-

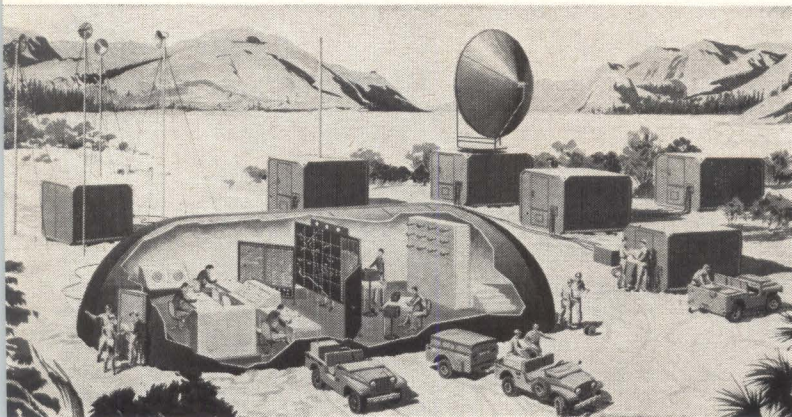

Marine Corps Tactical Air Control Center is representative of transportable equipment that can radically change the electromagnetic environment of an area when it is moved in.

grams. Problems are solved on the equipment component level (interference within a specific receiver or transmitter) the intrasystem level (such as aboard a particular missile or aircraft), the inter-system level (between ships and aircraft, for example) or on the total electronic environment level.

The center has worked on a problem of interference between uhf radar and airborne tactical data links in the Montgomery Air Defense Sector. It has studied interference problems of AN/TPS-1D and AN/SPS-6C radars at the equipment level in the Naval Aeronautical Navigation Experimental Project at Patuxent River, Md.

It has studied one-to-one interference (one transmitter interfering with one receiver) assuming both smooth-earth and terrain reflection propagation at Rome Air Development Center between TPS-1D and AN/FPS-65 radars. At Ft. Huachuca it studied five-to-one interference among three T-33 radars in terrain and back-scatter propagation modes.

In San Diego the problem of a mutually interfering Marine Corps TPS-1D radar, Navy SPS-6C radar, Army Nike FPS-36 radar and an Air Force-FAA FPS-7 radar at Mt. Laguna was studied. Propagation studies are underway at Eglin Air Force Base in connection with the Spadats project.

Other pending problems have to do with Satellite Communications (Satcom), the Marine Tactical Data System, Ship Comparative Analysis Project and Signal Density Contour Analysis.

Help from a robot

The center uses a Univac 1107 computer. It is a binary machine having thin-film, magnetic-core, magnetic-drum and tape storage. The core storage holds 32,000 words each having 36 binary bits (equivalent to 10 digits or 6 letters). There are two thin-film memories and two drums—1.5 million words of random-access storage. There are 12 tape handlers feeding two input channels, also a 700-line-per-minute printer.

Environmental Data File

The main data file at the center is called the Environmental Data File. For each installation the file contains identification of the military unit operating it and its site, location and description of the site; equipment identification, antenna characteristics and modes and times of operation.

Electronic Equipment Environment Survey

The basic input to the Environmental Data File is the Electronic Equipment Environment Survey booklet designed to be completed by military users on authority of the Military Communications and Electronics Board. Not only the military forces but also the Federal Aviation Agency, Space Agency, Weather Bureau, Coast Guard and Corps of Engineers have agreed to complete the booklet.

Information on about 30,000 fixed military installations in the U.S. operating above 100 Mc is already in the file. It is planned to add information on installations run by U.S. forces in Europe

by January 1965. The center is now processing FAA data on fixed installations and will finish by July. Weather Bureau data is already in the file.

Additional data

In addition to the completed booklets, the center has abstracted some 50,000 records from Federal Communications Commission files. These installations are all above 100 Mc. The number of items to be filed in reduced by treating generic items of equipment, such as police speed radar, as a single entry. The center is also collecting data from the Interdepartment Radio Advisory Committee.

It is planned to collect data on mobile equipment from the FAA and from the U. S. Maritime Commission. This information will be largely equipment oriented and will include statistical data to determine vehicle occupancy factors (what planes and ships are likely to be where when). The purpose is to gather background deployment data to acquire a capability for predicting trouble when operational situations are being planned—like when our forces moved into Lebanon some years ago.

Later on, data on foreign installations will be added. Data on friendly installations will come from the European Radio Frequency Agency, International Telecommunications Union, Strategic Air Command, U. S. Army Signal Intelligence Agency, the North American Air Defense Command, Defense Communications Agency and Foreign Technology Division. These agencies will also contribute data on unfriendly installations as will these additional agencies: U. S. European Command, Air Force Security Service, National Security Agency, Central Intelligence Agency, Naval Security Group, Office of Naval Intelligence, Defense Intelligence Agency, and Army Security Agency.

Processing environmental data

When a Survey booklet is received at the center, the clerical staff manually verifies and codes the information in it. Then up to 750 booklets at a time are microfilmed and processed on a Film Optical Sensing Device for Input to Computers at the Census Bureau. The output of the sensing device is on magnetic tape.

The tape is checked on the Census Bureau's Univac 1105 computer. Back at the center, the tape is verified by computer for logical consistency. It is planned later to check also against a computer-based file of electronic equipment nominal characteristics. The data is filed on the Univac 1107 by a geographically-derived accession number. Two verification copies of the computer printout and the completed Survey booklet are returned to the respondent who sends back a corrected computer printout to correct the computer file.

Spectrum Signature Data Base

The second most important file is the Spectrum Signature Data Base. It consists of two parts. Some 1800 sets of nominal equipment characteristics are stored on the computer. There will be 3500 by

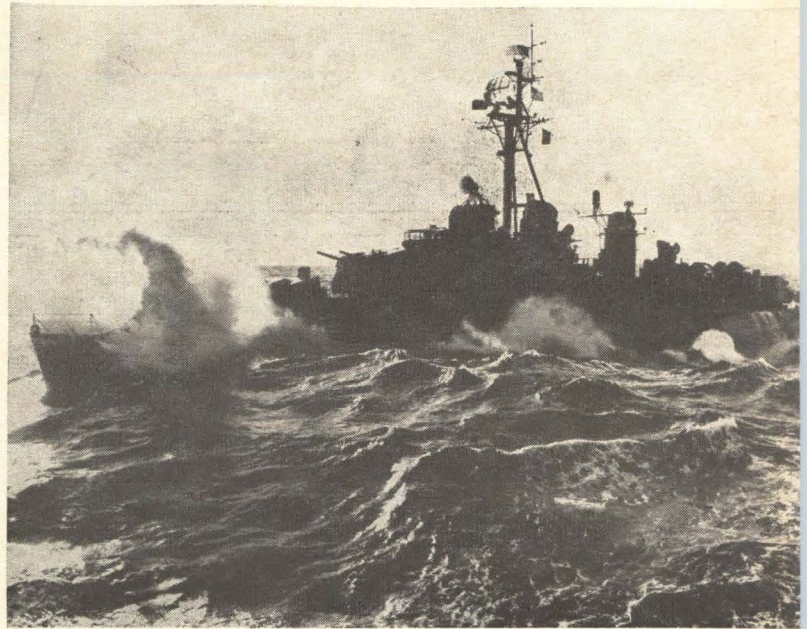

Navy AN/ SPS-6C surface search radar seen at yard-arm height on main mast of the destroyer Ingraham has already been a participant in compatibility analysis studies.

November. These characteristics are obtained by abstracting information from technical manuals and using eight separate data-reporting sheets for each equipment type.

There is also a spectrum signature library that is operated manually. It consists of about 150 reports assembled in the military data collection program established by Military Standard 449A. Contractors such as the University of Michigan, Ohio State, Jansky and Bailey, Bendix, Pan American and Frederick Research have participated in this work.

Generalized performance curves

The objective of gathering these spectrum signatures is to develop generalized curves showing parameter value envelopes with their two-sigma statistical confidence levels. These curves will be used for environment modeling. Examples of such curves are curves of the emission spectrums and spurious emissions of transmitters; the selectivity and spurious responses of receivers; and a plot of the probability of exceeding a level of gain versus gain for antennas.

The parameters in the spectrum signature file are obtained by collecting and averaging data on samples of equipment nomenclature types—that equipment bearing the same AN number.

Transmitter parameters of interest include fundamental peak pulse power (or average power for continuous wave transmitters), spurious emissions, emission spectrum or the energy distribution around the center frequency, modulation, intermodulation, modulation bandwidth and carrier frequency stability.

Receiver parameters include: sensitivity, selec-

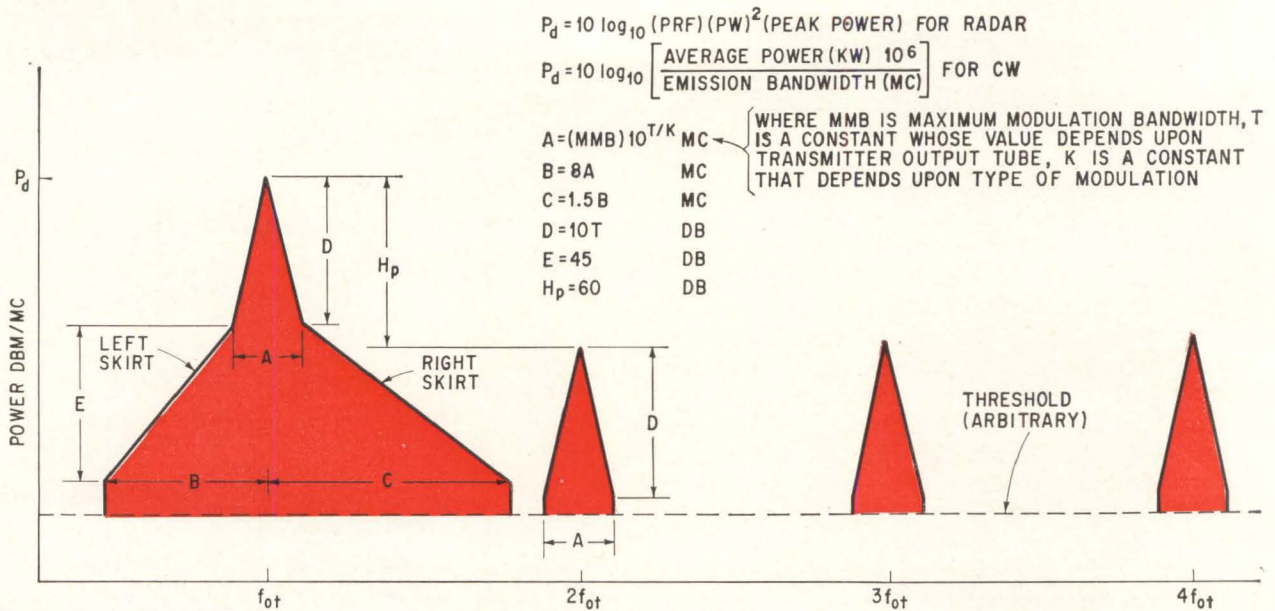

Stylized transmitter emission spectrum used in interference prediction.

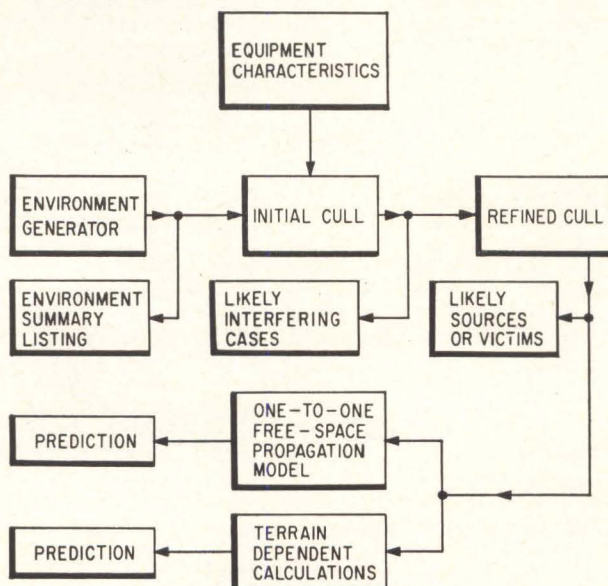

How coarse and fine culls and coarse and fine predictions reduce calculation time in a compatibility analysis problem.

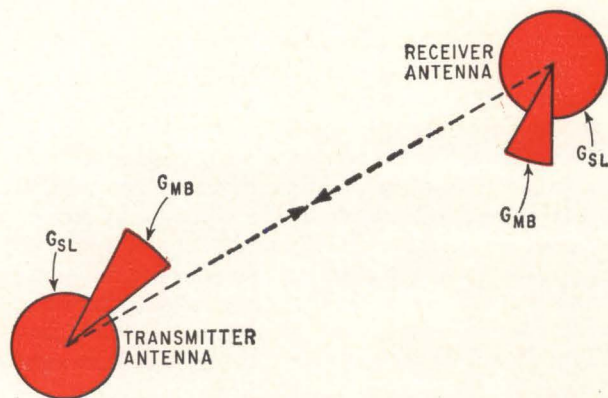

Simplified model of antenna gain-vs-angle characteristic used for coarse predictions. Worst-case angles are used to develop gain-vs-frequency characteristic.

tivity, spurious responses (usually found by the formula $f_{sp} = (pf_{co} + f_{if})/q$ where p and q are integers), over-all susceptibility, intermodulation, adjacent signal interference, pulse desensitization, c-w desensitization, dynamic range and oscillator radiation. Antenna information will consist of gain and pattern characteristics. Detailed definitions and measuring techniques relating to these parameters are given in MIL STD 449A.

Terrain Data Base

The last file is the Terrain Data Base. This file will be used to develop path profiles between selected points on the earth's surface. The file will store terrain elevation data in 121 by 121 matrices each matrix giving elevation data for a block of the earth's surface one degree of latitude wide by one degree of longitude deep. Elevation readings are taken in 1/2-nautical-mile increments. About 920 of these matrices would be needed to cover all the U. S.

So far only two areas are covered: one around Los Angeles, the other around San Diego. But the center is working with the Army Map Service to use digital data developed in the preparation of new three-dimensional relief maps to expand the Terrain Data file.

Mathematical models

The mathematical model of an interference situation represents in mathematical terms the significant characteristics of the culprit transmitter or transmitters, the victim receiver or receivers and the intervening propagation path or paths. These models are useful in determining signal density in a location, degradation of equipment performance, distance and frequency separation criteria and, eventually, a frequency-assignment plan.

Actually there are several models of varying degrees of complexity and refinement used to study

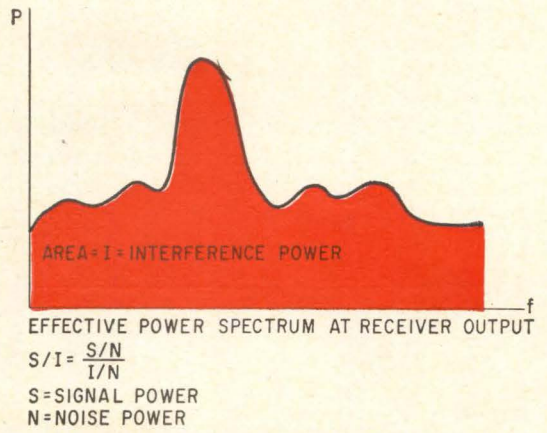
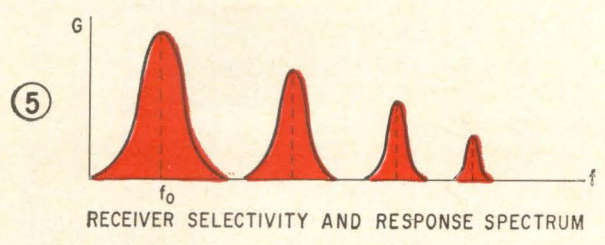
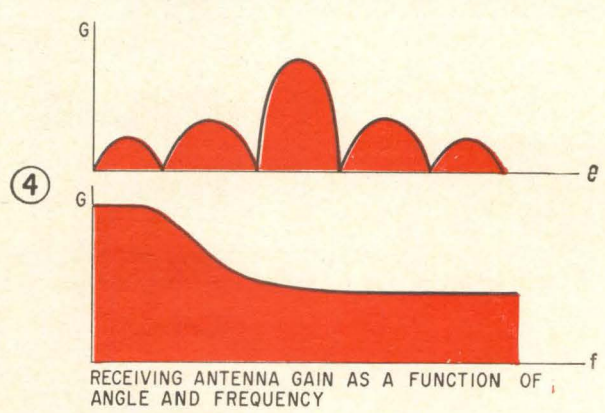
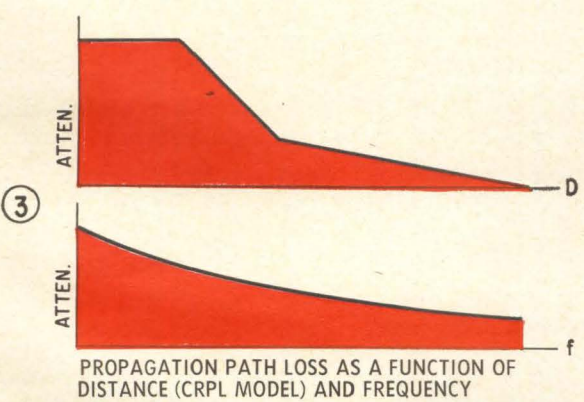
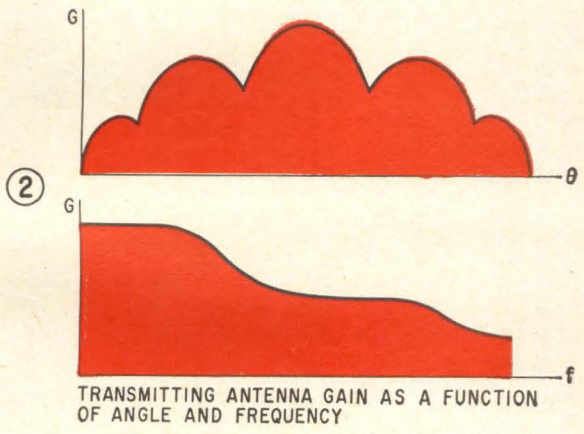
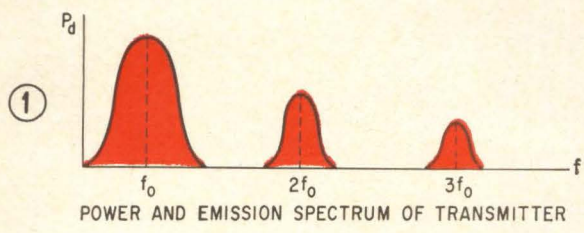
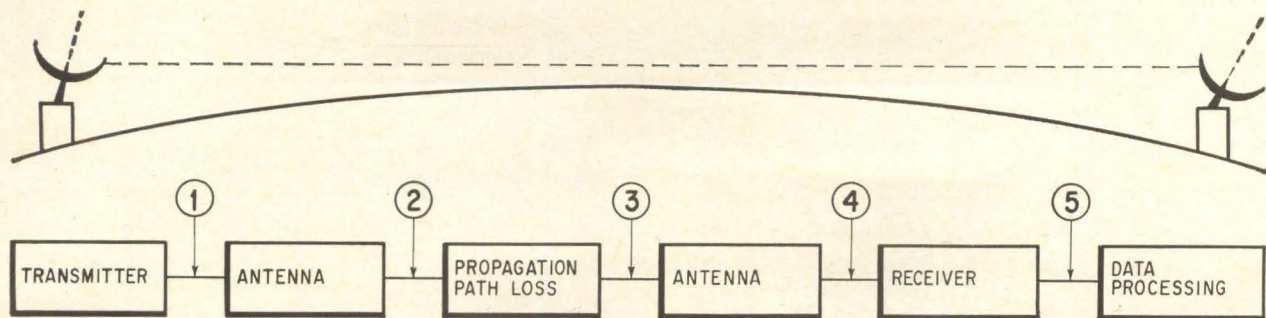

How method of superposition of spectral characteristics is used to develop a measure of overall signal-to-interference.

interference problems or potential problems. In a typical problem there might be 10,000 transmitter-receiver combinations at the beginning and an initial cull might eliminate 9,700 combinations with a computer running time of, say, 1/25 second per combination. A refined cull can then cut this to 10 or 20 combinations. A coarse prediction on a one-to-one basis using, say, a free-space propagation model (the simplest type), can reduce the field even further. Refined predictions using terrain-

dependent calculations of the propagation path zero in on the real trouble spots. The final predictions may require a minute of computer time per combination or may even be performed manually.

Sample problem

A simple one-to-one interference problem (one transmitter, one receiver) is shown in the diagram. This problem is really oversimplified and serves only to illustrate one approach. The first input is

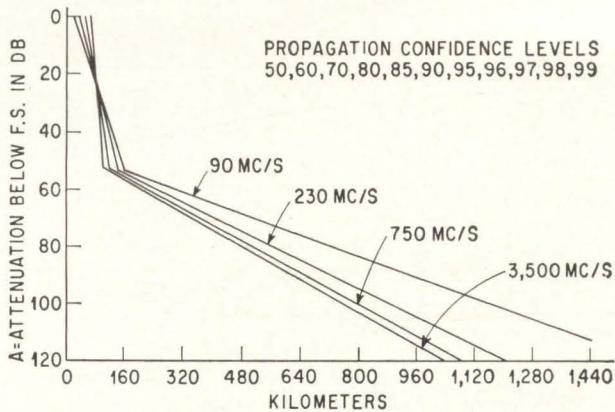

Empirically derived curves used to represent propagation path losses. These are CCIR curves. The more generally used CRPL curves have a flat top at short ranges.

the transmitter power and emission spectrum. Actually, a stylized spectrum based upon data derived from analysis of the spectral signature file data is employed.

Next, the gain of the transmitting antenna expressed as a function first of pointing angle and then of frequency is brought into the model. Antenna gain as a function of frequency is considered at the antenna pointing angle most unfavorable from the standpoint of mutual interference.

Several models are available for bringing the propagation loss into the model. The simplest one is, of course, the free-space model. It is sometimes used for making coarse predictions. The model most often used, however, is one derived empirically by the Central Radio Propagation Laboratory of the National Bureau of Standards (CRPL). It plots attenuation versus antenna separation at various operating frequencies. The CRPL model is similar to one made by the CCIR (International Radio Consultative Committee of the International Telecommunications Union), and illustrated in a drawing. The propagation-loss characteristics of

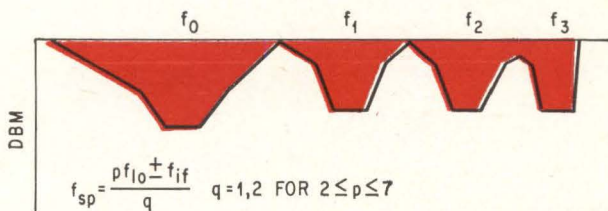

Receiver frequency response illustrates selectivity and spurious response spectrum.

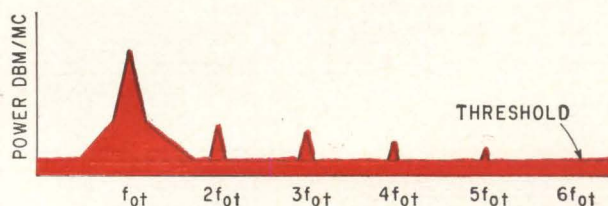

Combined emission spectrum at receiver input terminals.

the model can be presented on a gain-frequency basis to be compatible with the rest of the model. Other propagation modes that have been programmed for computer computation are the smooth or 4/3-earth model and the rough-earth-beyond-line-of-sight model. Propagation mode such as rough-earth-within-line-of-sight, ionospheric scatter and skywave propagation can be computed manually. A model that takes in the effects of propagation via ducts or channels in the troposphere is being developed for manual implementation.

Now the receiving antenna gain is brought in at the most unfavorable pointing angle from the standpoint of mutual interference. It is represented as a function of frequency. Then receiver response is incorporated in the model using the stylized receiver response spectrum illustrated. The receiver's data-processing capability would also be considered if it were found to be frequency dependent and to make a significant contribution to the interference problem.

Finally the five or six spectrums are convolved to develop an effective interference spectrum. The area under this curve is equal to I, the interference power. Then, taking into account the thermal noise input to the receiver, an interference-to-noise ratio is found which is divided into the signal-to-noise ratio desired at the receiver to get the signal-to-interference ratio. And this is the criterion sought in the analysis.

Some analyses proceed beyond a basic model and arrive at a so-called equipment model. Such a model includes mathematical representations of specific equipment features such as moving target indication, automatic gains control, sensitivity time control, side-lobe blanking and so forth.

And the future

It is essential that the interference and confusion in the employment of electronic equipment yield to improved design and better frequency planning because without adequate communications no undertaking has ever been able to succeed. For example, this happened many milleniums ago.

And they said, Go to, let us build us a city, and a tower, whose top may reach unto heaven; . . .
And the Lord said, Behold, the people is one, and they have all one language; and this they begin to do: and now nothing will be restrained from them, which they have imagined to do.
Go to, let us go down, and there confound their language, that they may not understand one another's speech.
Therefore is the name of it called Babel; because the Lord did there confound the language of all the earth. . . .
Genesis 11:4-9

If man in the twentieth century is to reach to the planets and beyond, he must do away with the Babel that confounds his essential electronic equipment. At the Electronic Compatibility Analysis Center the first hesitant steps are being taken in that direction.

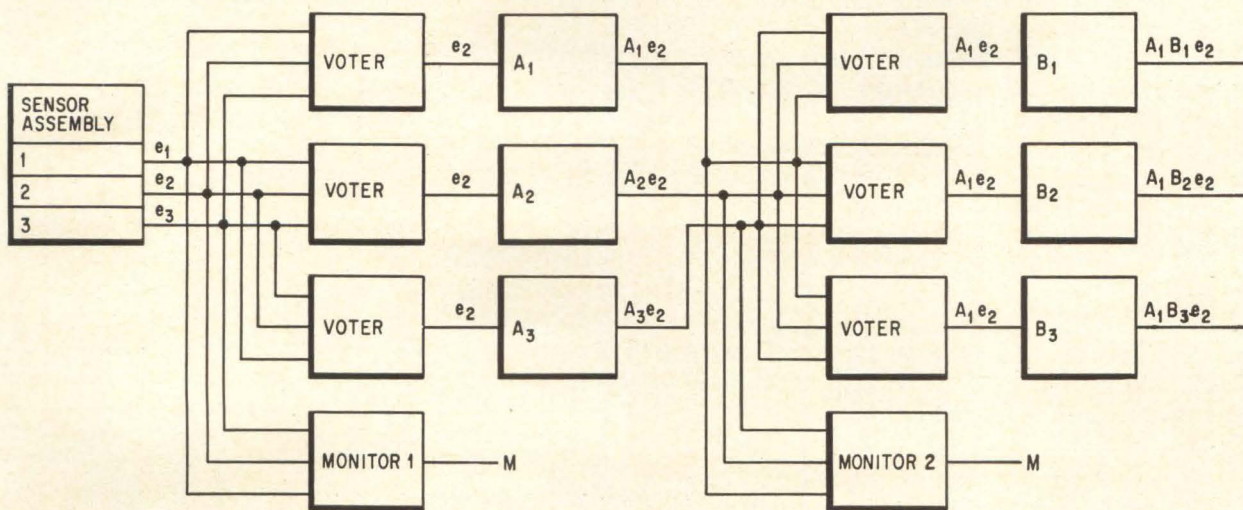

Basic triple-redundant configuration, with on-line voters and off-line monitors

Computers

Majority voting protects aircraft and pilot

Redundant circuitry provides effective safeguards and high-reliability operation during critical flight conditions, by selecting intermediate-amplitude signal from three inputs

By H. Moreines, R. Worthington and F. Thomas

Flight Control Laboratory, Eclipse-Pioneer division
Bendix Corp., Teterboro, N.J.

High-performance aircraft need both ultra-reliable automatic flight-control systems and fail-operative systems (which continue to operate after a single failure). Redundancy techniques, using identical circuits in parallel to increase reliability, are fulfilling this need.

The fail-operative requirement is an overriding

consideration in designing critical subsystems. Such a subsystem is stability augmentation where stability is increased by the automatic operation of control surfaces to compensate for minor disturbances, whether the pilot is in active command of the aircraft or not.

Equipment must facilitate failure detection, dis-

play and fault isolation, while maintaining simplicity of circuit design to minimize power dissipation, weight, volume and cost.

The application of redundancy techniques to the system described here provides the required fail-operative performance. The system uses a volt-monitor concept. In digital circuits, the equivalent is majority logic, which provides an output when a majority of the inputs are present; here the signals are analog and vary continuously. The voter is on-line, and continuously selects and transmits a signal having an intermediate amplitude among three input signals; that is, it ignores hardovers (full command signals), null failures (signal going to zero, opposite of hardover), degraded signals and the like. This is done with a simple and reliable electronic circuit with no active contact switching of signals (solid-state switching, no moving parts) or interruption of the signal transmission path. At the same time, the monitoring function is on an off-line basis and provides the necessary logic to determine malfunctions, in a manner that in no way interferes with or interrupts the channel signal path. In fact, the monitor's malfunction threshold may be adjusted to any level of signal degradation as determined by system performance requirements. This assures that, for minor changes in component characteristics, nuisance disconnects or warnings (due not to failures, but to tolerance buildups) will not occur even though the signal is being rejected by the voter circuit. However, should this degradation worsen either on a long-term or short-term basis, the monitor circuit will indicate a malfunction when the degradation exceeds specification levels.

Power supplies

The three control axes (roll, pitch and yaw) of a typical system would have to be completely separated or isolated to prevent failures in one axis from affecting any of the other control axes; this requires separate electrical power in each axis.

Features of the system

1. Fail-operative for single failures.
2. Initial single failure indicated to the pilot.
3. Multiple dissimilar failures have no effect on system operation except to maintain a single-failure indication.
4. Two similar failures displayed to the pilot by a second-failure indicator.
5. The power supplies to be used for redundant series elements are separate and independent of single-element failures.
6. A power supply failure gives the same indication as other single-element failures.
7. Monitor failures result in fail-safe operation; that is, either to indicate the monitor failure or to continue to monitor and detect a subsequent system failure. The monitoring equipment is off-line, allowing continued system operation in the event of a monitor failure.

Also, to keep a single failure from inactivating two channels at one time, within each axis (roll, pitch or yaw) the power supplies are triplicated to maintain independence of the three channels of the axis.

Page 85 shows a series-parallel arrangement of triple-redundant elements (three of each), with on-line voters and off-line monitors, in which true signals are reconstituted in the voters; although a voter may have two good signals and one bad one at its input, the output is one of the good signals. By reconstituting the true signals in the voters, the build-up of tolerances in the three channels is minimized, allowing more precise monitoring thresholds to be maintained, so that the system can be set to discriminate between small differences that do not signify a failure, and larger differences that do. Note in the figure that only one of three input signals is transmitted by the first set of voters (e_2). This signal is operated on by functional block A and transmitted as A_1e_2 , A_2e_2 , and A_3e_2 to the next set of on-line voters. The output of this set of voters has again one common value (A_1e_2) which is transmitted to the next functional block and so forth through the channel. To minimize switching transients, the voter is designed to be a series element

The authors



Harold Moreines is assistant chief engineer at the flight control laboratory of the Bendix Corp. He directs the development of advanced electronic computing and control systems and the product design of major electronic systems and components for aircraft, missiles and space vehicles. He holds six patents, with other applications pending, in connection with his

assignments at Bendix. He is a member of Tau Beta Pi, the Institute of Electrical and Electronics Engineers, and American Aeronautical Society. He is a graduate of the Newark College of Engineering, with a master's degree from Stevens Institute of Technology in 1951.



Robert Worthington has been active since 1956 in the design of electronic circuits and components necessary to perform the functions of analog and digital computers as applied to guidance and control systems. He also is responsible at the Eclipse-Pioneer division of the Bendix Corp. for evaluating electronic components under adverse conditions, such as high

and low temperature exposure and for designing studies to prove reliability under "worst-case" conditions. Before coming to Eclipse-Pioneer, he was engaged in the design of special receiving tubes and the application of these tubes and semi-conductor devices. He received his engineering education at Iowa State University and was awarded a bachelor's degree. He is a senior engineer.

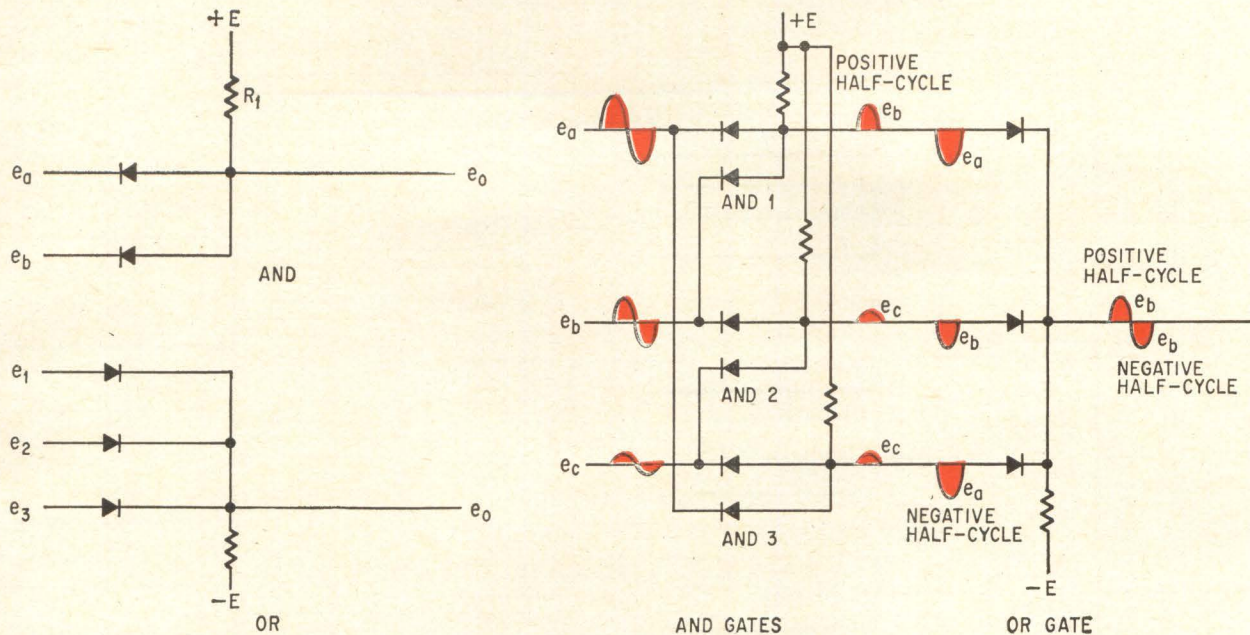

Amplitude selective gates, AND and OR, as used in voter circuit at right

in the signal path, or on-line. The monitors, however, are off-line to minimize the possibility of a monitor failure causing a malfunction of the control channel. Off-line monitor 1 detects a failed or non-conforming sensor unit, and off-line monitor 2 detects a failure in the voters or functional block A.

The electronic circuits for the triple redundant system are a voter circuit, an off-line monitor and a logic-light driver circuit, plus the existing circuits for the required functions of data processing and amplification.

Voter

The use of majority logic redundancy in digital computing and control systems is well known. Where binary (two-level) data is used in tripli-

cated system, a two-out-of-three logic permits the selection of true signals in the event of a single failure. That is, there will be an output if a majority of the inputs (for example, two out of three inputs) are present. In an AND gate, on the other hand, all the inputs must be present for an output to exist.

When the signal levels are continuously variable (that is, analog in nature) the method of selection of a true signal out of three signals may not be immediately obvious. Previously, comparison methods have been used where signals have been compared in pairs with respect to amplitude. Significant deviations permitted the detection of a false signal and subsequent switching of that signal to an off condition. This approach, however, had the disadvantages of transmitting initial hardover effects before the monitor could disconnect and of requiring active switching elements.

An alternate approach to redundant system monitoring of continuously varying signals is the use of passive amplitude-selective gates, which are voter circuits without active elements such as transistors, and which select the intermediate amplitude from the various inputs. An inherent property of digital logic gates is their capability for amplitude selection. This characteristic can be applied to a set of continuously varying signals in a triple redundant system (three of each circuit) in which signal failures are effectively rejected. The configuration used consists of a combination of diode AND and OR gates arranged to select the intermediate amplitude from among three input signals. In total, this configuration is referred to as an intermediate-amplitude selective gate, or voter.

The gates are shown in the figure above. The AND gate consists of two diodes and a current-limiting resistor. Its amplitude selective property



Frank Thomas has been a member of the Eclipse-Pioneer engineering staff since 1960. He received his bachelor's degree in electrical engineering from Fairleigh Dickinson University in 1963. He is primarily concerned with the design of analog, digital and hybrid circuits as applied to guidance and control systems. He has several patents pending

in relation to his assignments at the Eclipse-Pioneer division of the Bendix Corp. He is a project engineer in the flight-control laboratory.

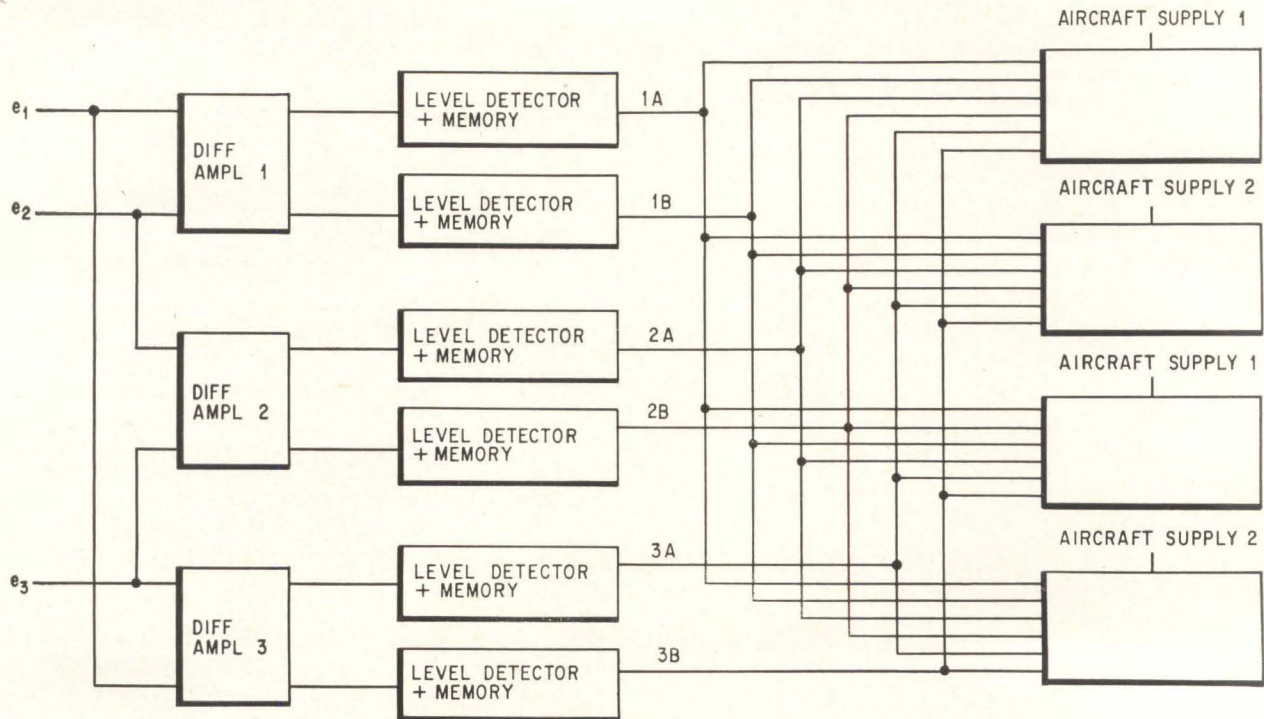

Monitor logic and light-driver circuit compares three signals, two by two

is such that, if two signals e_a and e_b are applied, output e_o will be equal to the more negative of the two inputs. The OR gate consists of three input diodes and a current limiting resistor. Its amplitude selective property is such that if three signals e_1 , e_2 , and e_3 are applied, output e_o will be equal to the most positive of the three inputs. These properties hold true on an instantaneous basis and, therefore, may be applied to any synchronous time-variant data. In most flight-control computers, these signals are usually 400-cps suppressed-carrier modulated voltages. However, the technique may be applied as well to modulated d-c, amplitude-modulated or width-modulated pulses, binary-modulated carrier or, more conventionally, to binary level digital data.

The circuit (p. 87) shows three inputs applied to the voter. The inputs are sinusoidal with ampli-

tude differences such as $e_a > e_b > e_c$. Circuit operation is best understood when considering the signal selection properties of the AND and OR gates on a half-cycle basis. During the positive half-cycle each AND gate output is clamped to the least positive input signal. Therefore, for the situation shown in the figure, AND gate 1 has e_b as its output, while AND gates 2 and 3 have signal e_c as outputs. These three half-cycle outputs are inputs to the OR gate which selects the most positive input signal. The output for the positive half-cycle is therefore e_b . During the negative half-cycle, AND gates 1 and 3 have e_a as an output while the output at gate 2 is signal e_b . When these outputs are applied to the OR gate, signal e_b is selected as the output for the negative half-cycle. Therefore, e_b , the intermediate value input signal, is transmitted through the voter during the entire cycle.

Why redundancy?

Flight-control systems using redundancy (repetition of circuits to increase reliability) have increased with the advent of supersonic flight, terrain-following tactical missions and all-weather automatic landing.

Most high-performance aircraft need stability augmentation (circuits that add to stability by damping the effects of gusts, fuel shifts, and even the failure of some controls), so that the aircraft can be handled satisfactorily throughout the widely varying aerodynamic conditions caused by requirements of low landing speed, high-altitude and high-speed cruising.

The sudden failure of an augmentation circuit during flight could seriously endanger pilot and aircraft. Therefore, fail-operative stability augmentation systems

are being specified for some current and future aircraft.

Fail-operative is not the same as fail-safe. Fail-operative means that the augmentation system can continue to operate after one failure. The fail-safe feature tells the pilot that the first failure has occurred. In the event of a second failure, the pilot is aware that the augmentation circuits will be disconnected to prevent a hardover, and he has enough advance warning to take over full manual control of the aircraft, or he may elect to avoid some critical flight condition. The system is fail-safe in that the aircraft is not endangered after the second failure, either because of a hardover or lack of pilot warning.

Conventional redundant configurations have used primary and standby channels, with switchover to the standby channel when a primary failure is detected. Disadvantages in this approach are: 1. fail-to-pulse

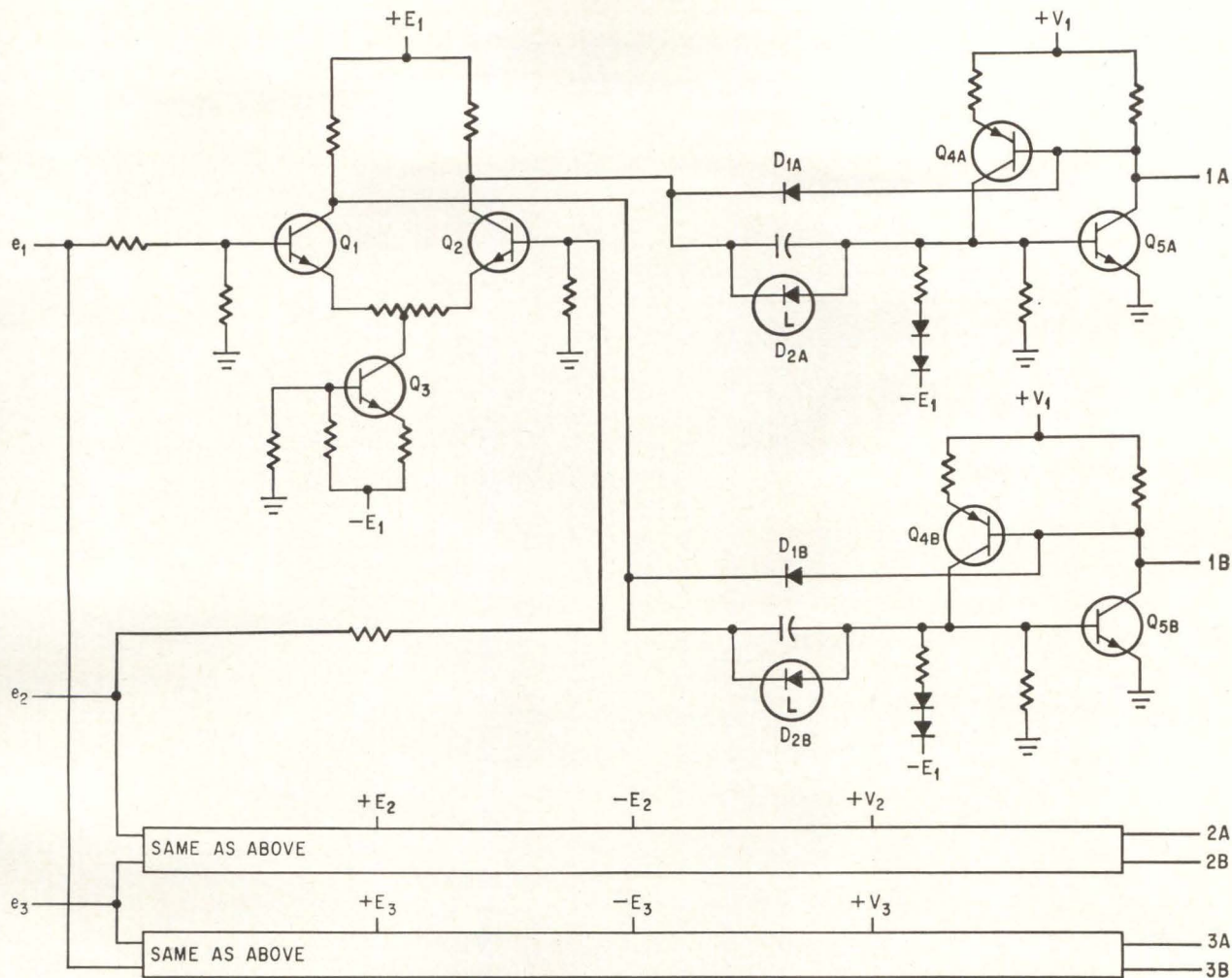

Off-line monitor has three identical channels, each with a differential amplifier and a dual Schmitt trigger.

A limitation of the voter is the threshold level and its variation among the diodes. This limitation is overcome by scaling the system signals and by matched diodes in the voter circuit.

When the voting function is required, triplicated voters are used (see the figure on p. 85). Each voter is excited from a separate power source thus maintaining channel isolation. A failure of a power supply will disable only one of the triplicated voters.

operation, since the aircraft may be subjected to a hardover pulse (from maximum movement of a control) before switchover is effected and 2. loss of an entire channel for any single failure.

The concept presented here provides majority voting (an output is present if a majority of the inputs is present) to eliminate hardovers after a first failure, even on a transient basis, and effectively bypasses a failed portion of the channel to permit multiple dissimilar failures without loss of system function. As there is no warning physical disturbance to the aircraft in the event of failures, an off-line monitor is added to display the system status and to alert the pilot to the first failure.

This concept has been applied in a current military jet transport and it appears to be applicable to the supersonic transport flight-control problem as well.

Since the voter consists of passive elements (resistors and diodes), it is a highly reliable circuit. Propagation of erroneous signals due to a voter component failure is minimized by judiciously placing several voting levels in cascade within the system. Component redundancy applied to the last voter in the system satisfies the fail-operative requirement of the voter function.

Monitor logic and light-driver

The monitor logic and light-driver circuit, as illustrated on p. 88, compares three signals by applying them in pairs (e_1 and e_2 , e_2 and e_3 , e_3 and e_1) to difference amplifiers, the outputs of which go to level detectors, which generate outputs whenever the difference between any two input signals exceeds a predetermined threshold level. As an example, assume that signal e_1 fails (null, hardover, out of phase). Difference amplifiers 1 and 3 will generate signals that will fire their respective dual Schmitt triggers. The binary outputs of Schmitt triggers 1A, 1B, 3A, and 3B will change state. The binary outputs from the Schmitt triggers are ORed into the single-failure light driver circuit, assuring a light for any single failure. Without a failure memory provision, a second failure could occur

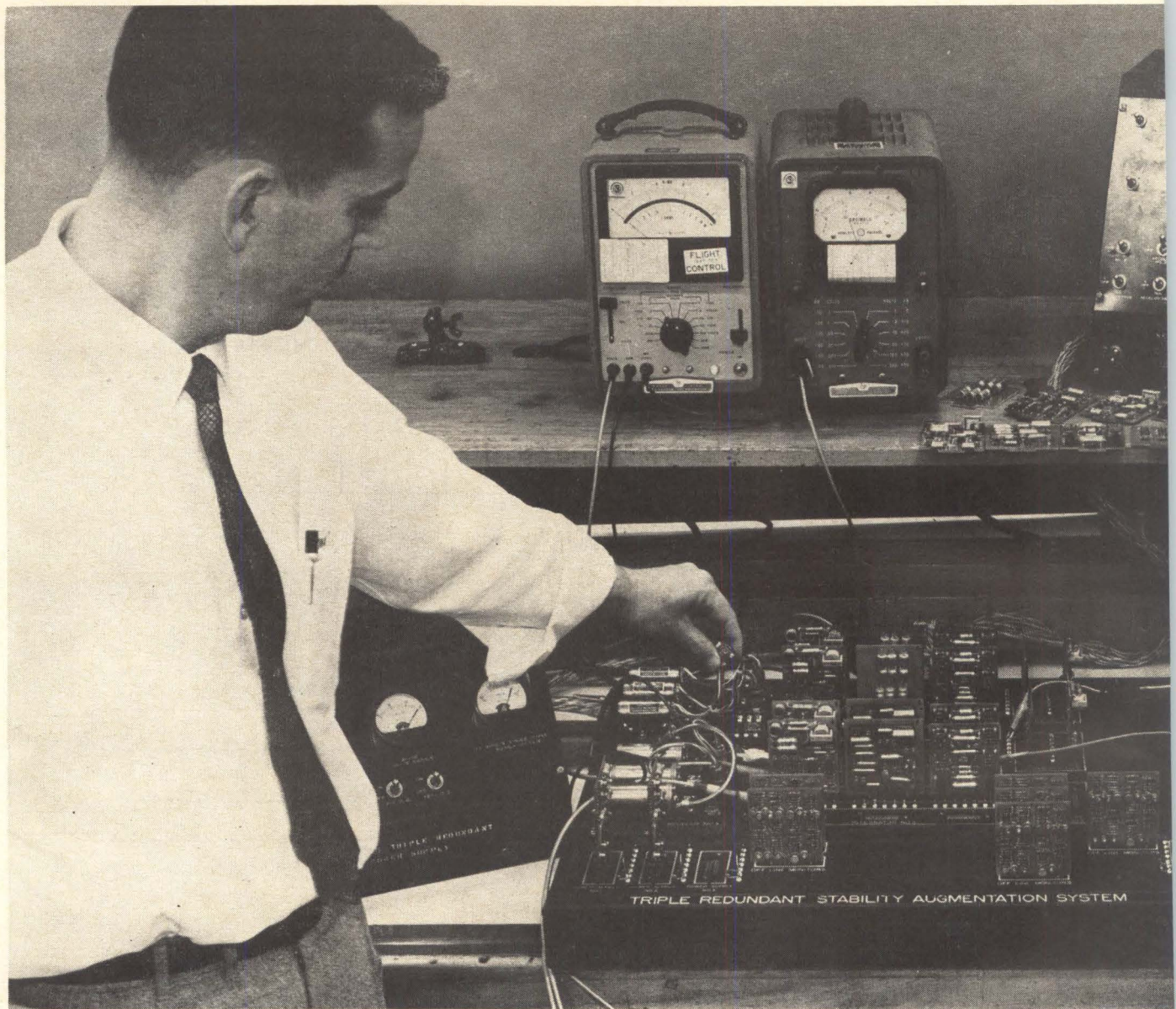

which is identical to the first failure (that is, signal e_1 and e_2 fail to null). The difference amplifiers would interpret this as a single failure (that is, e_3 would not compare with e_1 and e_2) and the single-failure state would be indicated. To assure an indication of this second failure, memory of the first failure is required, which is done by designing the Schmitt trigger so that the first failure occurrence causes it to latch into the new binary state. The outputs from the Schmitt triggers (1A, 1B, 2A, 2B, 3A, and 3B) will, therefore, all be in the same state upon the receipt of the second failure. This information is then ANDed into the second-failure light-driver circuit.

Off-line monitor

The off-line monitor (p. 89) consists of three identical channels. Each channel contains a differential amplifier and a dual Schmitt trigger. The monitor is completely fail-safe, that is, a failure of any component in any failure mode will result in

the circuit indicating an alarm or continuing to function with increased sensitivity. The Schmitt triggers are of the latching type, providing the monitor with memory.

The fail-safe feature of the off-line monitor is due to the symmetry of the differential amplifier and the two triggering inputs of the series type Schmitt trigger. The symmetry and balance of the differential amplifier provide a double-ended output. Failure of any component in the differential amplifier will either increase the sensitivity or cause the d-c quiescent level at the collectors to change. A failure causing a decrease in a collector d-c voltage will forward bias D_1 thus firing the Schmitt via Q_4 . A failure causing an increase in a collector d-c voltage will cause D_2 , a zener diode, to break down thus firing the Schmitt via Q_5 .

The monitor is also equipped to detect power supply failures. Each channel of the monitor is excited from a separate power supply. A failure in a single power supply will result in a single-failure

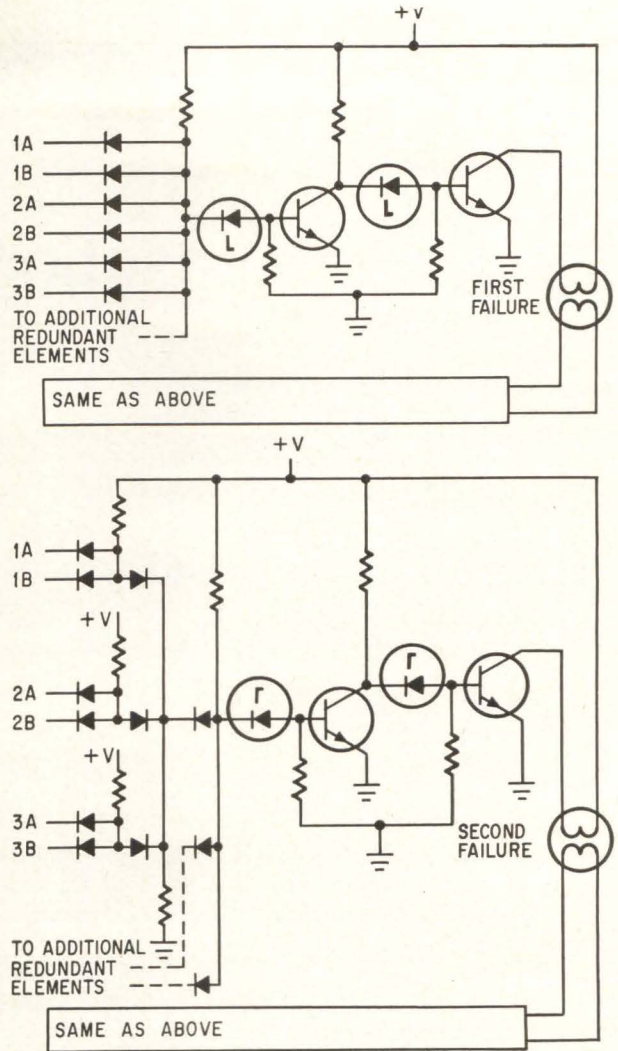
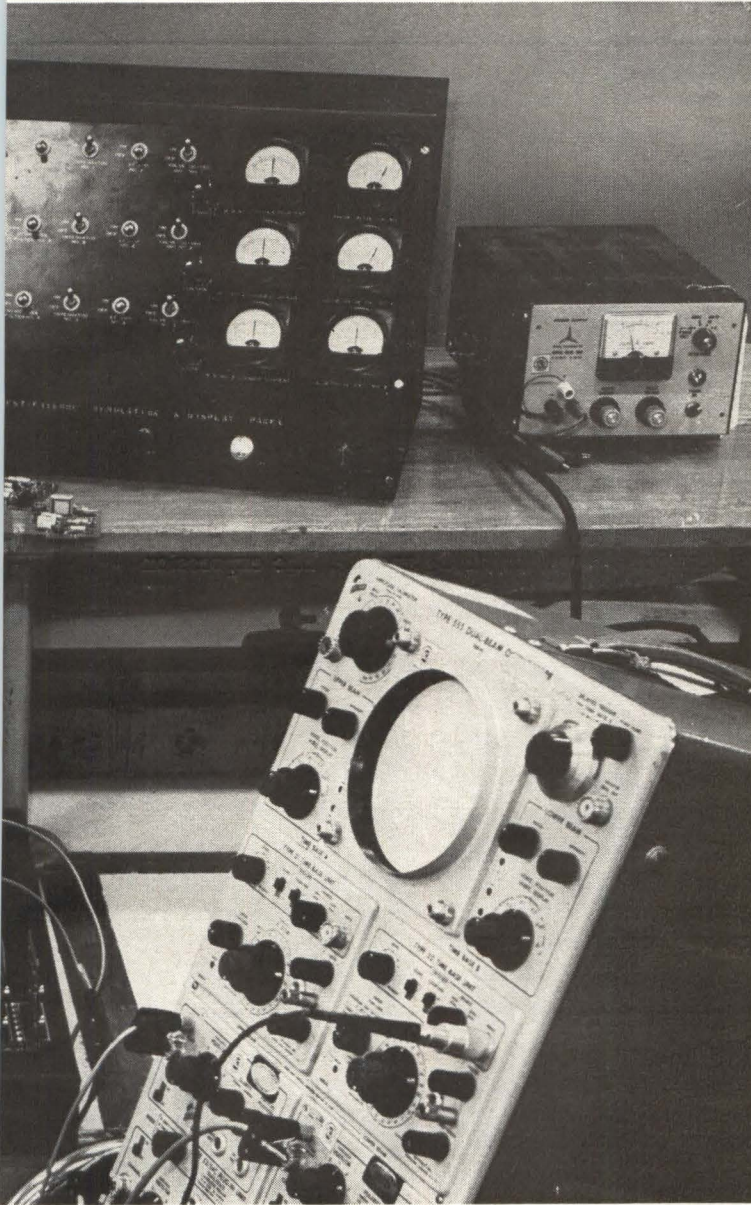

Logic and driver circuits, which use double-filament lamps

Frank Thomas tests breadboard of triple-redundant stability system.

indication. A second power supply failure will generate the second failure indication. Therefore, power supply failures are detected in the same manner as an element failure.

Logic and driver circuit

The logic and driver circuits for controlling the first and second lights are shown above, right. The first failure light goes on when a single failure occurs. Assuming X, Y, and Z to be monitor outputs from three off-line monitors, and defining a failure as the negation of X, and then the first failure light function is $F(\text{first failure}) = \overline{X_{1A}} + \overline{X_{1B}} + \overline{X_{2A}} + \overline{X_{2B}} + \overline{X_{3A}} + \overline{X_{3B}} + \overline{Y_{1A}} + \overline{Y_{1B}} + \overline{Y_{2A}} + \overline{Y_{2B}} + \overline{Y_{3A}} + \overline{Y_{3B}} + \overline{Z_{1A}} + \overline{Z_{1B}} + \overline{Z_{2A}} + \overline{Z_{2B}} + \overline{Z_{3A}} + \overline{Z_{3B}}$. A second failure indication occurs when two signals of a triple redundant element have failed. In this case all three outputs of the monitor will be negated. The logic expression for the second failure light in a three-element triple-

redundant system is $f(\text{second failure}) = \overline{(X_{1A} + X_{1B}) (X_{2A} + X_{2B}) (X_{3A} + X_{3B}) + (Y_{1A} + Y_{1B}) (Y_{2A} + Y_{2B}) (Y_{3A} + Y_{3B}) + (Z_{1A} + Z_{1B}) (Z_{2A} + Z_{2B}) (Z_{3A} + Z_{3B})}$.

To provide fail-safe indications, the logic, driver circuits, and lamps are dual-redundant (two of each), and excited directly from the aircraft's primary power supply.

A breadboard system for detailed laboratory study has been fabricated and is shown in the photo. A flight-control system using these techniques has been delivered and is presently undergoing flight test and evaluation.

Additional efforts have been directed toward the use of integrated circuits for fabrication of a triple-redundant system. To date, the functions of voting, monitoring, amplification, data processing by operational amplifiers, signal modulation and demodulation, and the logic and light drivers have been achieved using integrated circuit techniques.

Designer's casebook

Designer's casebook is a regular feature in Electronics. Readers are invited to submit novel circuit ideas, packaging schemes, or other unusual solutions to design problems. Descriptions should be short. We'll pay \$50 for each item published.

Single transistor provides low-cost phase shifter

By James J. Collins

Kollsman Instrument Corp., Elmhurst, N. Y.

This circuit eliminates the need for a costly center-tapped transformer in applications requiring a specific phase-shift from 0 to 180°. The transformer is replaced by a transistor type 2N404, a germanium pnp unit that sells for about 50 cents in small quantities. The circuit generates a controlled constant-amplitude phase-shift for input signals up to one volt rms with frequencies to 3 Mc.

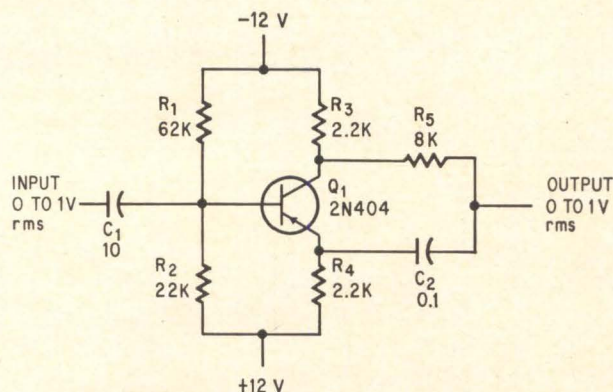

Fifty-cent transistor permits phase shifting from 0 to 180° up to 3 Mc.

The collector-to-emitter voltage gain is considered as unity. Since the transistor input and output signals are 180° out of phase, this is equivalent to the outputs available at either side of a center-tapped transformer with 1-to-1 turns ratio. The frequency of operation and the desired phase shift

determine the values of C_2 and R_5 . The expression for the phase shift ϕ is:

$$\phi = 2 \times \tan^{-1} \frac{R_5}{X_{C_2}}$$

where $X_{C_2} = \frac{1}{2\pi f C_2}$, and

f = frequency of input signal (cps)

The phase shift obtained with the circuit shown was 90° for a 200-cps input signal. The accompanying chart indicates the changes in phase that may be achieved by varying the value of R_5 .

Input signal frequency (cps)	C_2 (uf)	R_5 (ohms)	Phase shift ϕ (degrees)
200	0.1	3,300	45
200	0.1	8,000	90
200	0.1	1,600	135
200	0.1	9,150	170

Complementary amplifier offers high input impedance

By Leonard J. Ernst

Design Engineer, General Magnetics, Inc., Bloomfield, N.J.

A pair of high-gain, complementary, silicon planar transistors was employed to provide exceptionally high input impedance (220,000 ohms), wide ambient operating stability (-55 to +100°C), and low output impedance (61 ohms) in an amplifier.

The voltage gain (6.25) is determined by the ratio $(R_1 + R_{EQ})/R_{EQ}$. The undistorted output swing is 7 volts rms. The stabilized gain over the wide

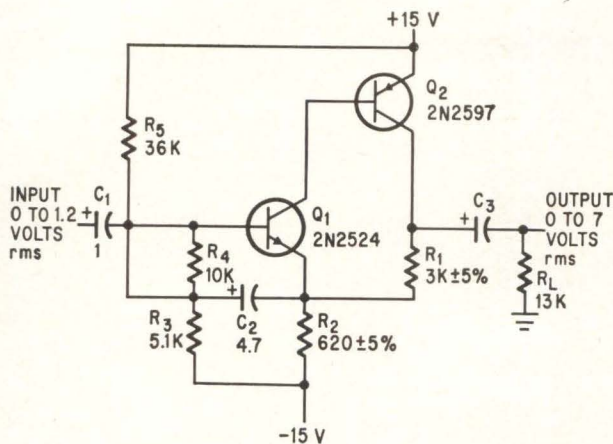

Complementary amplifier provides 220,000-ohm input impedance and wide operating temperature stability.

temperature range results from the large amount of negative feedback which also lowers the output impedance. Resistor R_2 contributes negative d-c

feedback and determines the collector current of Q_2 . When the collector current of Q_2 increases, the voltage across R_2 also increases, lowering the base-to-emitter voltage of Q_1 . This, in turn, reduces the collector current of Q_1 and subsequently that of Q_2 . Because of the bootstrapping effect of C_2 and the large equivalent current gain of the circuit, the input impedance is high. The input impedance may be calculated from:

$$Z_{in} = (\beta_1 + \beta_1 \times \beta_2 \times K) R_{EQ}, \text{ where}$$

$$\beta_1 = 2N2524 \text{ beta}$$

$$\beta_2 = 2N2597 \text{ beta}$$

$$K = \frac{R_L [1 - (1/A_V)]}{R_1 + R_L [1 - (1/A_V)]}$$

$$A_V = \text{Closed loop gain}$$

$$R_L = \text{Load resistance (13,000 ohms)}$$

$$R_{EQ} = \text{Parallel combination of } R_2, R_3 \text{ and } R_5$$

Both the npn 2N2524 and the pnp 2N2597 are manufactured by the Sperry Semiconductor Division, Norwalk, Conn.

Reed switches for breadboarding

By M. Berwyn Knight

Radio Corporation of America, Harrison, N.J.

The reed switch is most often used in telephone switching, industrial switching, and counting. But it is also a flexible tool in breadboarding and testing.

For example a reed switch was incorporated into a television circuit stage to check the effect of adding a series grid resistance (see figure above). In this circuit, the switch was operated by a strong bar magnet from a distance of two and a half inches, so there were no hand capacitance effects nor danger of electric shock, two possibilities when components are bridged by hand.

For miniature reeds, a magnetomotive force of about 50 ampere-turns is sufficient to make the reeds snap together. The contacts are generally capable of switching one-eighth ampere or withstanding 300 volts or more.

The advantages of the reed switch include low resistance (less than 0.2 ohm) in the closed-switch position and minimum capacitance effects. The direct capacitance between open contacts of an unshielded switch is less than 0.2 picofarad and it is under 0.1 picofarad when the actuating coil is used as a shield.

Closure time is less than one millisecond (includ-

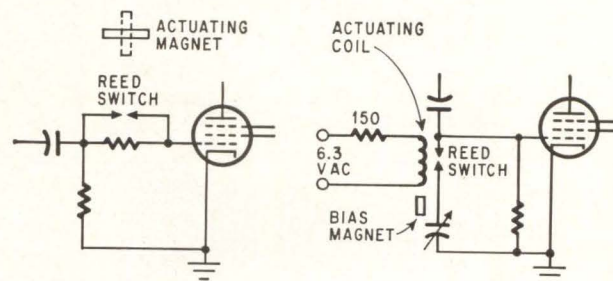

Using the reed switch to determine the influence of a series grid resistor

Use of the reed switch to see a transient caused by added capacitance

ing contact bounce) and drop-out time is less than 0.1 millisecond. High-speed operation is not always practical, however, because the reeds continue to vibrate after opening.

In another television application, (see figure above) a single transient in the horizontal synchronization caused by the addition of a small capacitance from grid to ground was difficult to observe. The reed switch was used repetitively at field frequency and the picture disturbance observed continuously while circuit adjustments were made. The switch was operated from the 60-cps heater voltage by use of a 1000-turn coil with a series resistor to limit the coil current. A permanent magnet supplied a steady bias to the magnetic field so that the switch would operate at a 60-cps rate. If the bias was removed, the switch would close on both polarities of the magnetic field and operate at twice the frequency of the a-c current.

Sweeping carrier signals through interference

Chirp-radar type output is modulated by varying the rate of change, or slope, of the signal frequency

By William H. Chiles and Harry G. Lafuse

Bendix Corp., Mishawaka, Ind.

The frequency slope modulation (FSM) system was developed to provide radio-frequency communication that is not susceptible, as are conventional amplitude- or frequency-modulation systems, to interference from undesired signals occupying the same portion of the frequency spectrum.

The FSM system uses a swept-frequency carrier signal rather than a fixed-frequency signal, so the r-f energy is distributed evenly over the width of the band. The effect of modulation is to change the bandwidth of the system but not the uniform distribution of energy. The desired information can be recovered using any part of the system bandwidth.

This means that any interfering signal occupying a fraction of the new FSM system bandwidth can be filtered out without losing the desired information. Available signal power is decreased by the function of the bandwidth decreased. For narrow-band interference, degradation of the FSM system depends upon interfering bandwidth rather than the power of the interference.

Conventional a-m and f-m systems both use fixed-frequency carrier signals with the information contained in a relatively small bandwidth centered

at the carrier frequency. Undesired signals in this band degrade or disrupt an operating system.

Modulation

The FSM communication system¹ uses a chirp radar type of signal as the unmodulated carrier. This signal is a constant-amplitude sinusoid having a frequency that varies linearly with time. Information is added to the signal by varying the rate-of-change, or slope, of the signal frequency. The experimental system uses a periodically swept-frequency signal shown at the left. Selection of the chirp-type signal as a carrier stems from the desire for a wide-band communication system that can operate in the presence of narrow-band systems with relatively little interference between systems, even though they are not separated in frequency. It has been shown that the amplitude spectrum of the chirp signal² is essentially flat over the band being swept, and is the same as the spectrum of band-limited white noise. To the first order, the r-f signal may be represented as an increase in noise in the band of operation of a narrow-band system.

The FSM transmitter is basically a voltage-controlled oscillator of frequency $f(t)$ whose derivative, $df(t)/dt$ is proportional to the straight-line approximation of the modulation signal during each sweep interval. The receiver must produce an output that is proportional to the time rate-of-change of the frequency of the r-f signal. In theory, this can be done with an ideal discriminator followed by a differentiating circuit.

Details of the experimental system are clarified in the block diagram. Periodic sweeping of the r-f signal at a 33.3-kc rate allows the voice-frequency modulation to be assumed approximately constant during each sweep interval. The unmodulated carrier is swept over the range $\Delta f_0 = 50$ Mc. Modula-

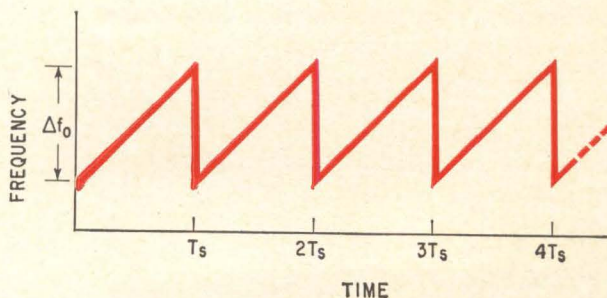

Periodically swept-frequency signal is the basis of the FSM system.

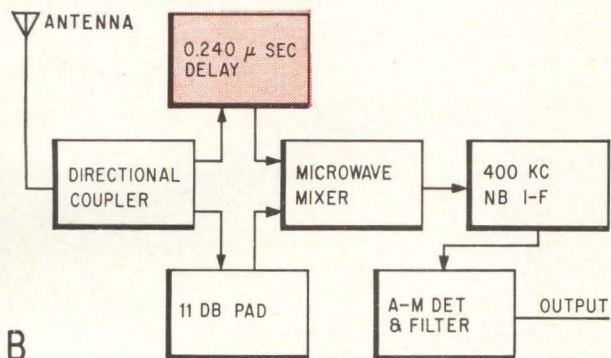
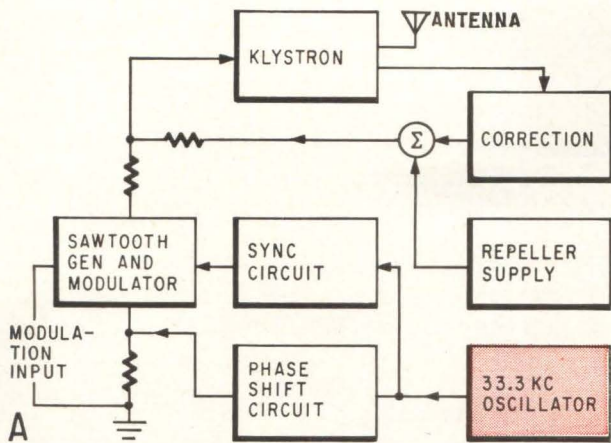

Block diagram of the experimental system shows the simplicity of the transmitter (A) and the receiver that utilizes out-of-phase signals (B). Sweeping r-f at 33.3-kc rate provides constant voice modulation. Delay unit produces a mixer output proportional to frequency slope.

tion increases the frequency range by 10 Mc at most. The periodicity of the signal is utilized in the receiver to recover the information without need for a discriminator having r-f signal bandwidth.

Transmitter

A C-band klystron is used as a voltage-controlled oscillator to generate the swept-frequency r-f signal. For the bandwidth desired, the repeller voltage and output frequency are not linearly related. The klystron voltage curve (A above) shows linear voltage versus time, and that at (B) shows the frequency of a typical klystron for this repeller voltage. The dashed lines of these figures show the desired linear frequency behavior and the voltage waveform that would produce it for this klystron. A control voltage of the desired waveform is ap-

The authors



William H. Chiles received a Bachelor of Arts degree in psychology from Kent State University in 1949 and a Bachelor of Science degree in electronics from Indiana Technical College in 1959. During the last four years he has been involved in the design and development of solid-state circuits for power supplies, amplifiers and afc and apc circuits.



Harry G. Lafuse received a Bachelor of Science degree in electrical engineering from Purdue in 1957. His Master of Science degree was awarded by the University of Illinois in 1958 and his doctorate in 1962. Presently he is a consultant with the Mishawaka division. He is a member of the faculty at the University of Notre Dame, teaching electromagnetic field theory.

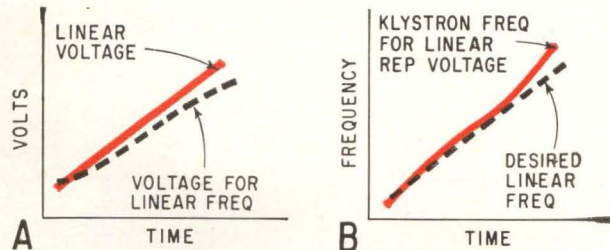

Klystron repeller voltage vs time for linear voltage (color) and voltage required for linear frequency (A) and typical frequency (color) for linear repeller voltage and desired linear frequency (B)

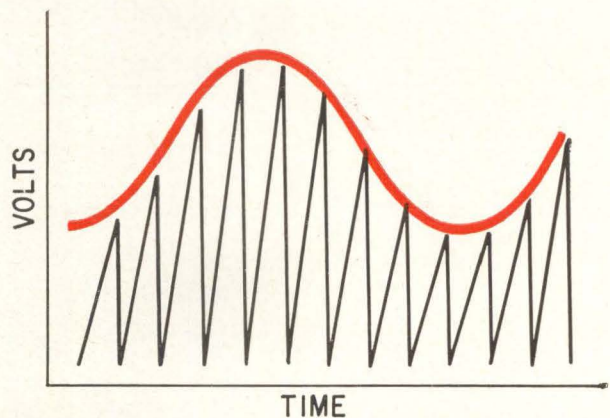

Desired signal frequency for sinusoidal modulation of the carrier signal

proximated in the system by adding a sinusoidal voltage and an error voltage derived from the klystron output to a linear sawtooth voltage.

The main requirements for the sawtooth voltage generator are that the slope of the voltage must be proportional to the modulating signal during each period, the period must be constant, and the flyback time must be small. The desired waveform for a sinusoidal modulating signal is shown at the right.

The circuit for generating the modulated sawtooth voltage is shown on p 96. The ramp of the sawtooth is produced by using the linear portion of the voltage change across a capacitor (C_2) being charged through a resistor (R_6 plus the output resistance of the modulator). The capacitor is discharged through Q_2 , a transistor operated in the avalanche mode. Resistor R_7 limits the peak current through the transistor reducing the turn-off time

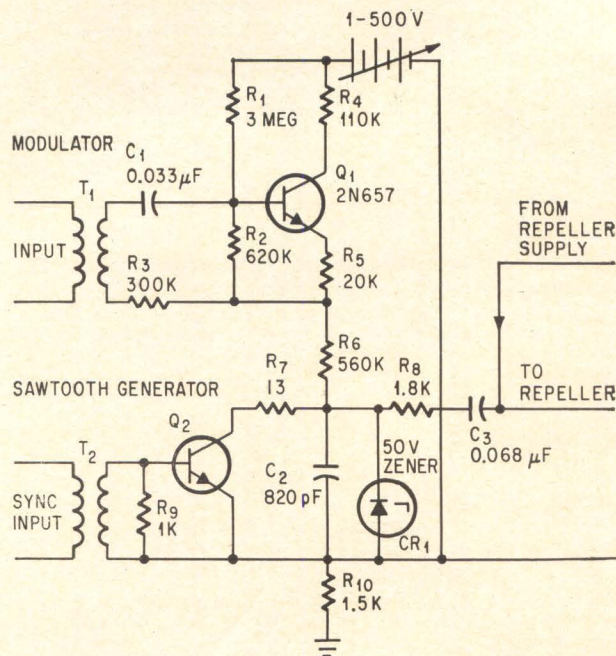

Sawtooth voltage generator that produces the desired constant-frequency, variable-slope signal.

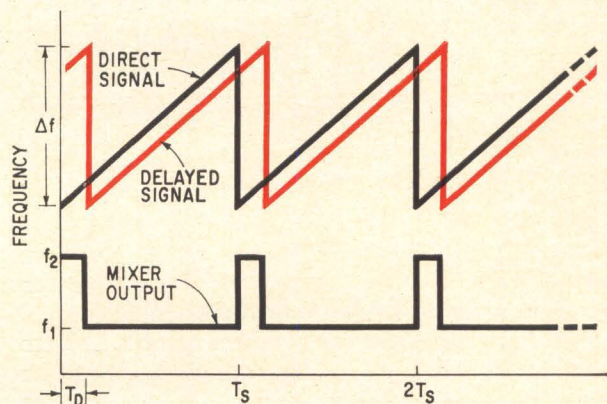

Frequency versus time for mixer input signals (delayed signal in color) and output signal at the difference frequency.

of the transistor. Circuit elements C_2 , R_7 , the saturation resistance of the transistor, and the turn-off delay of the transistor determine the total flyback time of the sawtooth. When the pulse width of the trigger pulse becomes longer than the time as it was previously determined, the flyback time is approximately equal to the width of the trigger pulse. The measured flyback time during operation was approximately 90 nanoseconds. Resistor R_8 is an isolation resistor and C_3 is a direct-current block and a coupling capacitor. The function of CR_1 is to prevent the collector-to-emitter voltage of Q_2 from exceeding the breakdown voltage and burning out the transistor. Transformer T_2 couples the trigger pulse to the transistor. It is loaded by R_9 in the off condition of the transistor to reduce ringing.

Modulation of the sawtooth is accomplished by varying the resistance in the charging path of C_2 . This varies the time constant of the ramp and,

therefore, the slope of the ramp. Resistors R_1 , R_2 , R_4 , and R_5 determine the quiescent point of Q_1 and, thus, the static resistance of Q_1 . Resistor R_3 isolates the sawtooth from T_1 , the coupling transformer. Capacitor C_1 serves both for coupling and as a d-c block for ease of biasing Q_1 . The total resistance in the charging path of capacitor C_2 is approximately the sum of R_6 , R_5 , R_4 and the resistance of the transistor. The resistances in the bias network are large enough not to change the total resistance appreciably.

Receiver

The experimental receiver utilizes the phenomenon that if a linearly swept r-f signal is mixed with the same signal delayed in time, the mixer output is a constant frequency directly proportional to the frequency slope of the r-f signal. The illustration (left) delineates the frequencies of the r-f signal, the delayed signal and the difference-frequency signal that is the mixer output. The instantaneous frequency of the mixer output has one of two values:

$$f_1 = \frac{\Delta f T_d}{T_s} \text{ or } f_2 = \frac{\Delta f}{T_s} (T_s - T_D)$$

Disregarding the portion during which the mixer output is at the frequency f_2 , the mixer output has a line spectrum composed of the harmonics of the sweep frequency (33.3 kc) with an envelope of the form $\sin x/x$ centered at the frequency f_1 . A change in the frequency slope $\Delta f/T_s$, changes the center frequency f_1 of the envelope. This results in a change in the amplitudes of the harmonic components of the video signal. The mixer output is fed to a narrow-band amplifier centered at 400 kc, the 12th harmonic of the sweep frequency. As the frequency slope varies at an audio rate, the 12th harmonic is amplitude-modulated. This signal is fed through an audio amplifier to an audio detector to recover the information. An m-derived low-pass filter with a cutoff at 8 kc filters detector output.

The experimental system was tested using a coaxial link between transmitter and receiver to avoid interfering with other work in the area. The voltage gain through the system varied less than 0.5 db over the range from 60 cycles to 5 kilocycles. Using 100-cycle and 500-cycle signals with a four-to-one ratio, the total intermodulation distortion was 18 percent. Total harmonic distortion was less than 7 percent from 65 to 5,000 cycles, and average total harmonic distortion over this range was 5.3 percent. These figures substantiated the belief that the FSM system could provide satisfactory audio communications. Preliminary tests using interfering signals have substantiated the theory that the system is insensitive to narrow-band interference.

References

1. H.G. Lafuse. A Wideband Communication System Using Frequency Slope Modulation, Proc NEC, Vol 19, 1963.
2. Klauder, J.R., Price, A.C., Darlington, S., and Albersheim, W.J., The Theory and Design of Chirp Radars, BSTJ, Vol 39, p 745, 1960.

These are the smallest packages around that give you decimal readout direct from low level BCD or decimal input. They're Burroughs semiconductor driver/decoder packs combined with standard NIXIE® Indicator tubes. These packages aren't just small. They're highly reliable, and so easy to use that every engineer with a display requirement should take a look.

The new decoder socket packs (BIP-8200 Series) operate NIXIE tubes from low voltage binary coded decimal information, and are available for a wide range of input logic levels.

The transistor driver (BIP-8500 Series) is physically identical but operates as a straight NIXIE Tube driver from low voltage decimal inputs.



Get complete details on these new compact, easy-to-use packages. Write today for Bulletin #1038 & #1039.

ANOTHER ELECTRONIC CONTRIBUTION BY
Burroughs Corporation
ELECTRONIC COMPONENTS DIVISION
PLAINFIELD, NEW JERSEY



NIXIE is a registered trademark of Burroughs Corporation.

high-speed

**Tektronix Oscilloscope
with general-purpose
convenience**

Type 585A / 82 unit features

■ **Dual-Trace Operation** with 4 operating modes and independent controls for each channel—for individual attenuation, positioning, inversion, and ac or dc coupling as desired.

■ **Passband** typically DC-TO-85 MC (3-db down) at 100 mv/cm (12-db down at 150 Mc), and typically DC-TO-80 MC (3-db down) at 10 mv/cm.

■ **Calibrated Sensitivity** in 9 steps from 100 mv/cm to 50 v/cm, and in *10X Amplifier Mode*, from 10 mv/cm to 5 v/cm, variable between steps.

■ **Internal and External Triggering** to 150 Mc.

■ **Sweep Range** from 10 nsec/cm to 2 sec/cm.

■ **Single-Sweep Photography** at 10 nsec/cm.

■ **Calibrated Sweep Delay** from 2 microseconds to 10 seconds.

■ **Bright, High-Resolution Display** with small spot size.

■ **Conventional Passive Probes** for convenience.

plus

■ **Compatibility with 17 Letter-Series Plug-Ins** to permit differential, multi-trace, sampling, other laboratory applications—when used with Type 81 adapter.

Type 585A Oscilloscope \$1725
Type RM585A Oscilloscope . . . \$1825
Type 581A Oscilloscope \$1425

No sweep-delay capabilities, but other features similar to Type 585A.

Type 82 Dual-Trace Unit \$ 650
Type 86 Single-Trace Unit \$ 350
Type 81 Plug-In Adapter \$ 135

Allows insertion of 17 Tektronix letter-series plug-ins. Band-width (up to 30 Mc) and Sensitivity depend upon plug-in used.

U.S. Sales Prices, f.o.b. Beaverton, Oregon

For a demonstration, call your Tektronix Field Engineer.

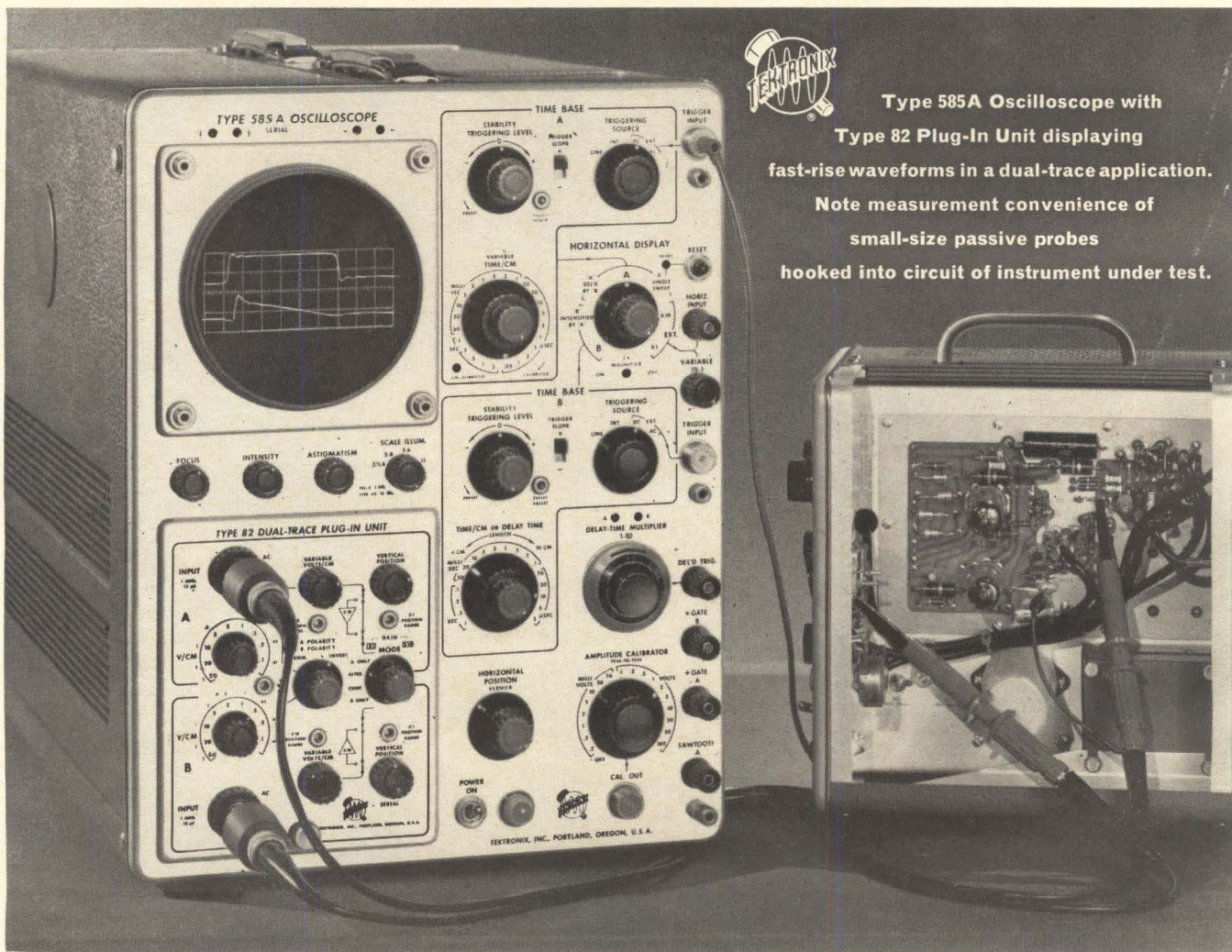

**Type 585A Oscilloscope with
Type 82 Plug-In Unit displaying
fast-rise waveforms in a dual-trace application.
Note measurement convenience of
small-size passive probes
hooked into circuit of instrument under test.**

Tektronix, Inc. / P.O. BOX 500 • BEAVERTON, OREGON 97005 • Phone: (Area Code 503) Mitchell 4-0161 • Telex: 036-691
TWX: 503-291-6805 • Cable: TEKTRONIX • OVERSEAS DISTRIBUTORS IN 25 COUNTRIES
TEKTRONIX FIELD OFFICES in principal cities in United States. Consult Telephone Directory
Tektronix Australia Pty., Ltd., Melbourne; Sydney • Tektronix Canada Ltd., Montreal; Toronto
Tektronix International A.G., Zug, Switzerland • Tektronix Ltd., Guernsey, C. I. • Tektronix U. K. Ltd., Harpenden, Herts

Type TLS Wet Slug Tantalum Capacitor

MIL-C-3965 Styles CL64 and CL65

Mallory Type TLS wet slug tantalum capacitors meet requirements of MIL-C-3965C for Styles CL64 and CL65. They offer mfd-volt ratings per unit volume higher than most comparable tantalum units, wide operating temperature range, low DC leakage current, and high stability versus both temperature and life. Low DCL makes the TLS suitable for RC timing networks and instrument circuits. For example: 100 mfd, 25 volt TLS capacitor has maximum DCL of 2.5 microamperes at 125°C; other values have comparably low leakage.

The TLS withstands MIL requirements for vibration, shock, temperature cycling, immersion and moisture. Its small size makes it ideal for use in high-density circuit packaging subjected to severe physical environments. Cases are silver; three sizes are available.

The TLS capacitor is available in ratings from 1.7 mfd, 125 WVDC to 650 mfd, 6 WVDC. Operating

ambients range from -55°C to +125°C. For complete details, write or call Mallory Capacitor

Company, Indianapolis, Indiana 46206—a division of P.R. Mallory & Co. Inc.

TYPICAL PERFORMANCE CURVES TYPE TLS CAPACITORS

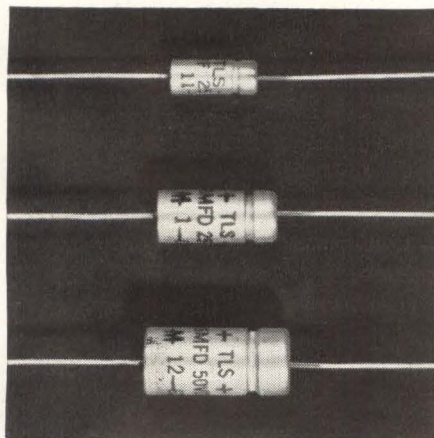
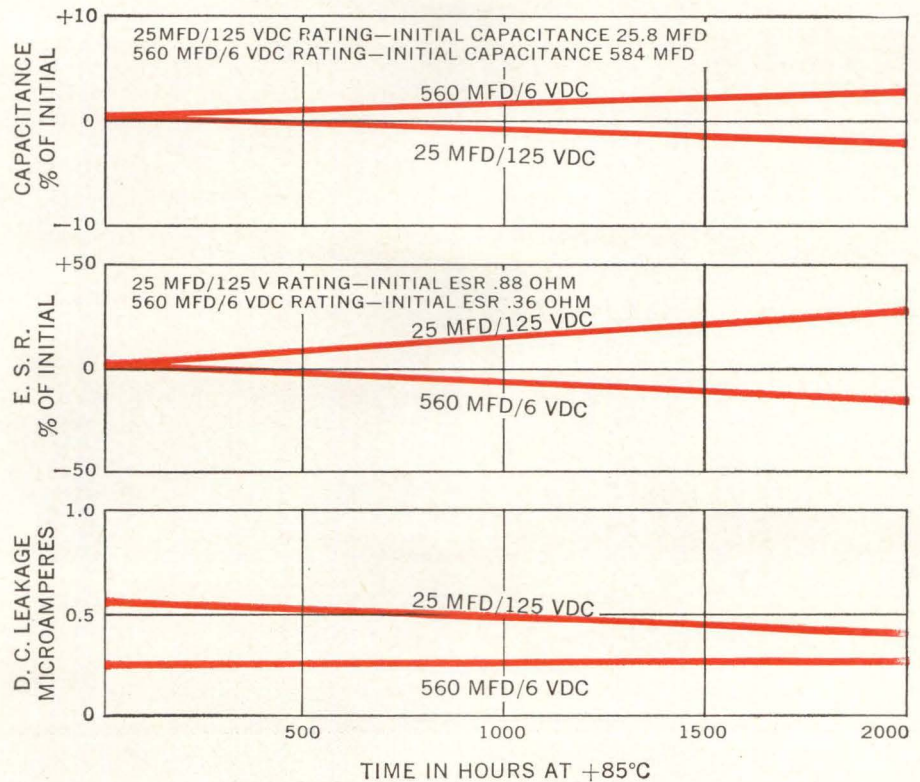

ACTUAL SIZE

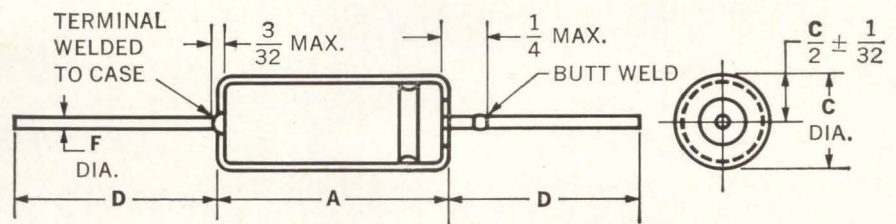

Case Size	UNINSULATED			INSULATED			F +.005 -.001
	A $+\frac{1}{32}$ $-\frac{1}{64}$	C $\pm \frac{1}{64}$	D $\pm \frac{1}{4}$	A $\pm \frac{1}{32}$	C Max.	D $\pm \frac{1}{4}$	
A	$\frac{29}{64}$	$\frac{3}{16}$	$1\frac{1}{2}$	$\frac{31}{64}$	$\frac{7}{32}$	$1\frac{1}{2}$.025
B	$\frac{41}{64}$	$\frac{9}{32}$	$2\frac{1}{4}$	$\frac{43}{64}$	$\frac{5}{16}$	$2\frac{1}{4}$.025
C	$\frac{49}{64}$	$\frac{3}{8}$	$2\frac{1}{4}$	$\frac{51}{64}$	$\frac{13}{32}$	$2\frac{1}{4}$.025

WET SLUG, FOIL AND SOLID TANTALUM CAPACITORS



MITSUBISHI MICROWAVE ANTENNAS FOR TELECOMMUNICATIONS

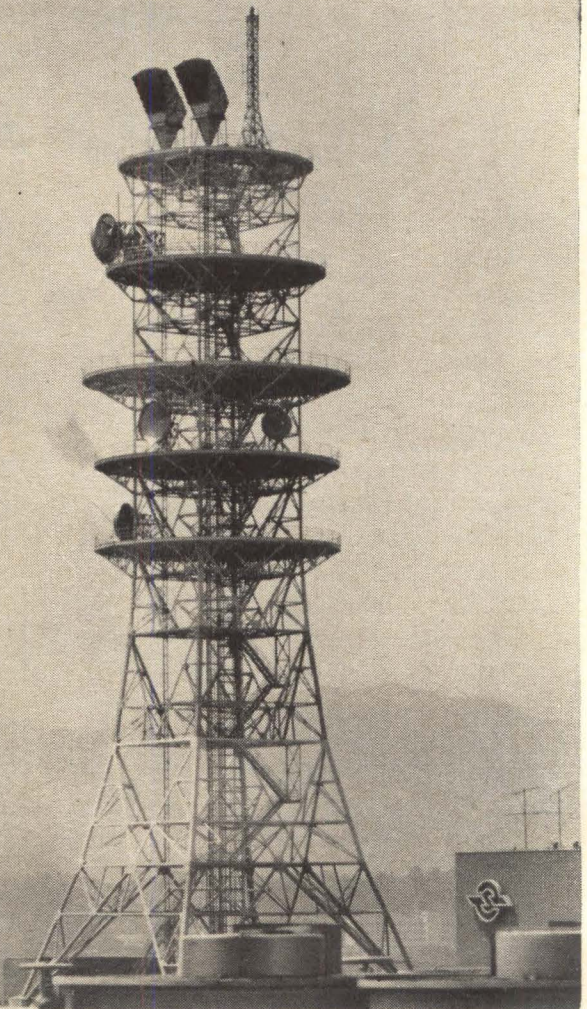

Japan today has the second largest microwave network in the world. Mitsubishi Electric, with the longest microwave antenna experience in Japan, has supplied 90% of the antennas used in the trunk lines of this extensive network. Mitsubishi antenna systems include parabolic, scatter, horn reflector and radar types, as well as a complete line of waveguide components and accessories. Frequencies from 900 Mc. to 24 KMc. are covered. The IU-62, shown above and specified at the right, is typical of the outstanding performance of Mitsubishi microwave antennas. Full technical information on any of these types of antennas is available at your request.

IU-62 Horn Reflector Antenna

Frequency Range : 3,000-12,000 MC
 Aperture : 9m²
 Max. width : 4,050mm
 Max. depth : 2,560mm
 Max. height : 7,418mm
 Gain at 3,900MC : V 41.5 db
 H 41.2 db
 Gain at 6,100MC : V 44.9 db
 H 45.0 db
 VSWR : 1.01
 Front/Back : 67-70 db
 (over 60 degrees)
 Discrimination of : V 57 db
 cross polarization : H 78 db (at 3,900MC)
 V 45 db
 H 37.5 db (at 6,100MC)
 Guaranteed wind velocity : 140 miles/hr



MITSUBISHI ELECTRIC CORPORATION

Head Office: Mitsubishi Denki Bldg., Marunouchi, Tokyo. Cable Address: MELCO TOKYO

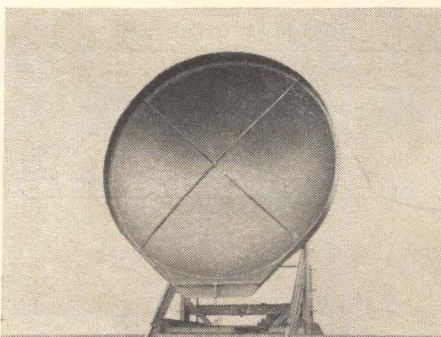

■ IU-61 parabola antenna

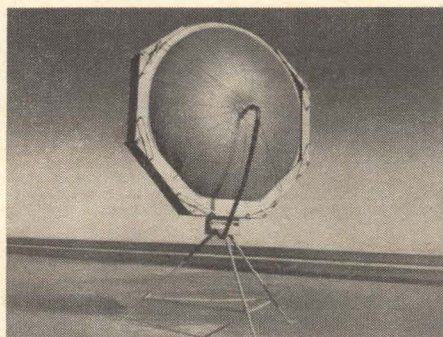

■ Air inflated parabola antenna

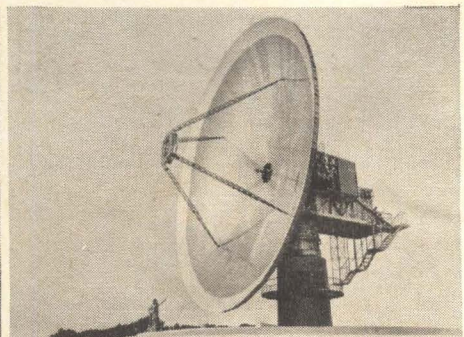

■ 20 meter diameter antenna for satellite communication

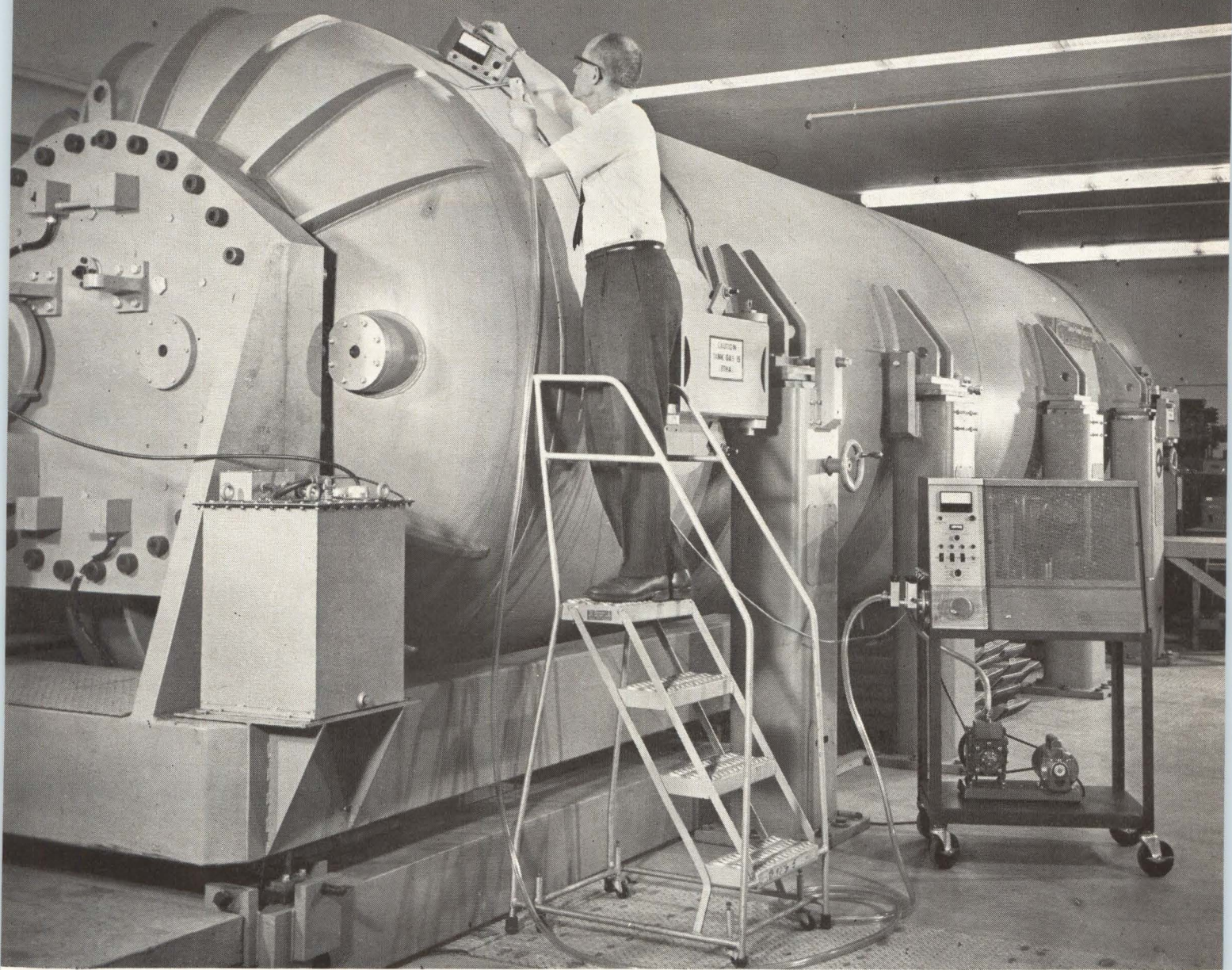

You can leave CEC's newest leak detector behind

Thanks to remote control

There are some places you just can't take a leak detector. That's when you need a Remote Control Unit—standard equipment for CEC's new 24-120B Leak Detector. This handy remote unit contains all the controls needed by the operator including an indicator meter, a dynamic range switch (with 9 steps of attenuation from X-1 to X-10,000), a filament indicator lamp, zero control and an optional audio alarm. If there's a remote possibility of leaks . . . you can find them with CEC's new 24-120B.

Most versatile of all helium/mass spectrometer leak detectors, the compact 24-120B may be hand carried to places other instruments can't go. Or it may be mounted on a mobile workstand and equipped with a quick-disconnect inlet and bell jar base plate. Or it may be installed on top of an Automatic Test

Port and Roughing Station for total application flexibility. Or it even may be hooked up to a Test Port Station with large tabletop worksurface for check-out of mass-produced components. Whatever your application, a 24-120B can be supplied to fit it.

Exclusive features for which CEC's 24-120 series leak detectors are preferred include:

- High-conductance 2-inch manifold constructed entirely of stainless steel.
- A high-conductance roughing valve that permits use of 15 cfm pumps for the fastest pumpdown available.
- A vacuum-operated automatic protection valve that closes instantly if a pressure surge results from failure of a part being tested.

- Detection & location of leaks as small as 5×10^{-11} atm cc/sec/div of helium.

For the full story on CEC's latest leak detector, contact your nearby CEC Sales and Service office, or write for CEC Bulletin 24120-X13.



Analytical & Control Division **CEC**
CONSOLIDATED ELECTRODYNAMICS
 A SUBSIDIARY OF BELL & HOWELL/PASADENA, CALIF. 91109
 INTERNATIONAL SUBSIDIARIES: WOKING, SURREY, ENGLAND
 AND FRANKFURT/MAIN, GERMANY

Circle 101 on reader service card

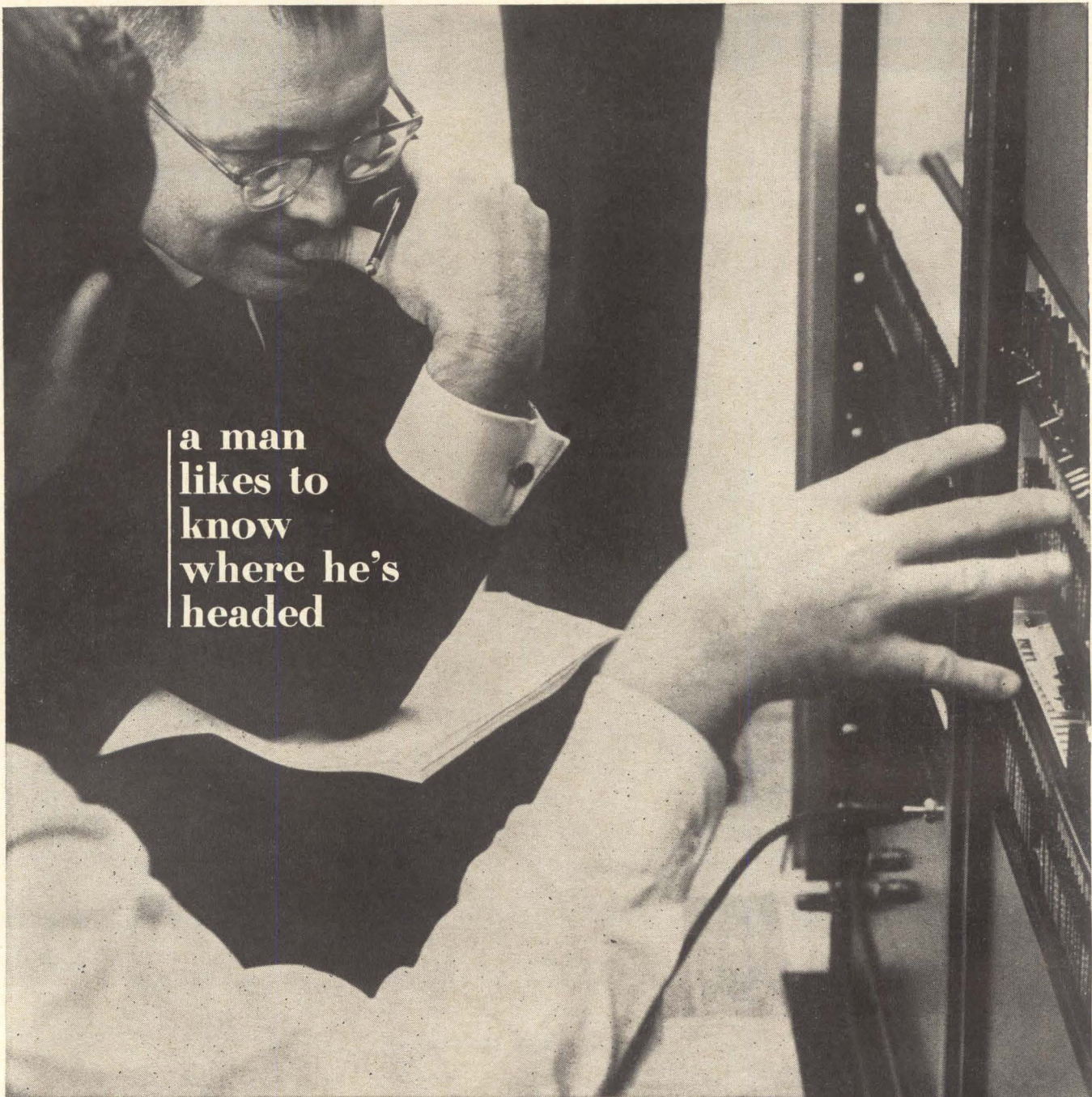

a man
likes to
know
where he's
headed

You are the best judge of your own talents, your ability, your job interests. Collins offers you an opportunity to grow in the areas of engineering which best match your capabilities and which will give you the most satisfaction and sense of accomplishment.

It isn't always easy to find opportunities like this. Perhaps you've felt restlessness from not being able to make full use of your talents. Maybe you've found yourself going off in a direction which held no particular interest for you. Or which didn't challenge your ability. Or spark your imagination. Or

get you excited over the potential and possibilities.

Whatever your engineering interest might be, we'd like to talk with you. We make this broad statement because the scope of our work is broad. The challenges presented in such diverse fields as Space Communication, Data Processing, Avionics, Microwave, Antenna Systems and HF, VHF and UHF Communication to mention a few, offer you creative opportunities in every area of engineering activity.

If you'd like to get your career back on course, or if you'd like to be assured

of heading in the direction you've already chosen, Collins offers you an opportunity to do so. Write in confidence to our manager of professional employment, Dept. 102.

COLLINS RADIO COMPANY
Cedar Rapids, Iowa • Dallas, Texas
Newport Beach, California



An equal opportunity employer

WHEN EVERY GRAM COUNTS—

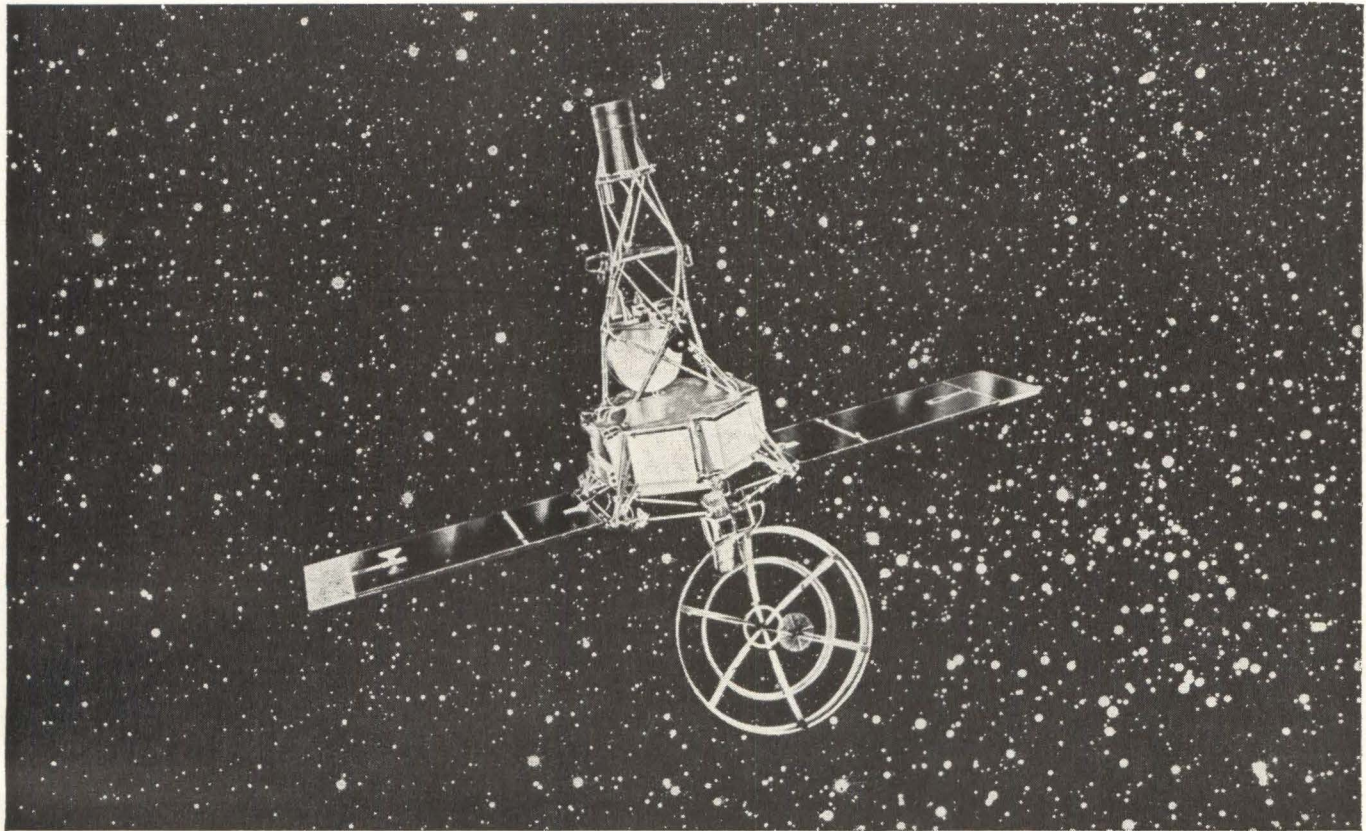

CANNON

OFFERS NEW HERMETIC SEALS OVER 40% LIGHTER

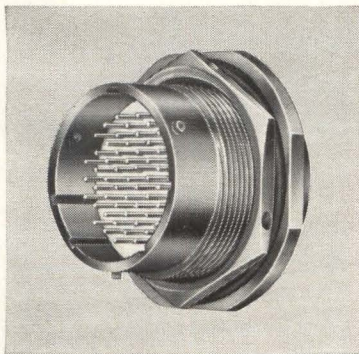

Cannon's new, lightweight hermetic connectors are the answer when weight and reliability are major factors for any aerospace program. Featuring aluminum alloy shells and one-piece compression glass inserts, these miniature circular connectors average 40% less weight than their steel shell counterparts. Proof-tested successfully to a thermal shock of -320°F to $+500^{\circ}\text{F}$ while retaining hermeticity (leak rate of less than 1×10^{-8} cc/sec.), the aluminum shell KPTH line meets all requirements of MIL-C-26482. Whatever your space application, you can depend on the utmost in weight savings when you specify hermetic seals from CANNON[®], the world's largest and most experienced manufacturer of electrical connectors. For information write to:



CANNON ELECTRIC INC.

3208 Humboldt Street, Los Angeles 31, California

A SUBSIDIARY OF INTERNATIONAL TELEPHONE AND TELEGRAPH CORPORATION

® "CANNON" IS A TRADEMARK REGISTERED IN U.S. PATENT OFFICE AND IN OTHER COUNTRIES BY ITT CANNON ELECTRIC INC. © 1964 ITT CANNON ELECTRIC INC.



**Why buy
4 materials
when one
will
do... at
no
premium!**



industrial plastics

FORMICA CORPORATION

Department I-422, Cincinnati, Ohio 45232

subsidiary of

CYANAMID

At last! A single grade which meets the property requirements of NEMA G-10, G-11, FR-4, and FR-5! It's Formica's new FR-45 . . .

New Formica FR-45 also meets requirements of MIL-P-18177 Types GEE & GEB and MIL-P-13949C Types GE, GB, GF, & GH.

New Formica FR-45 gives you the NEMA G-11 feature of high strength retention at elevated temperatures plus the excellent machining characteristics of G-10.

New Formica FR-45 easily passes through processing environments encountered in printed circuit operations with no harmful effects.

New Formica FR-45 meets the flammability requirements of NEMA LP 1-7.07E, both horizontal and vertical.

With new Formica FR-45 you have a single grade, a single inventory . . . yet, you pay no more for versatile Formica FR-45 than you would for any top-quality single-purpose grade!

Evaluation samples and detailed data available upon request.

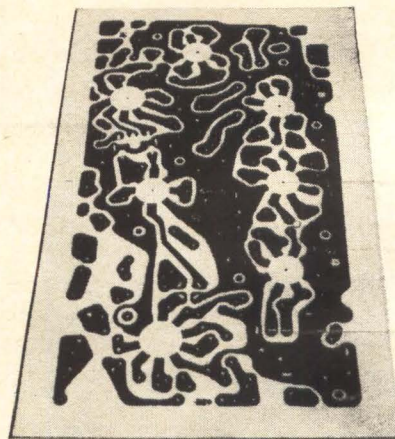

Also write for catalogs on:

- Electrical/electronic grades
- Copper clad laminates
- Mechanical grades
- Engraving stock

See The Formica World's Fair House at New York for the newest and best in carefree contemporary living.

Probing the News

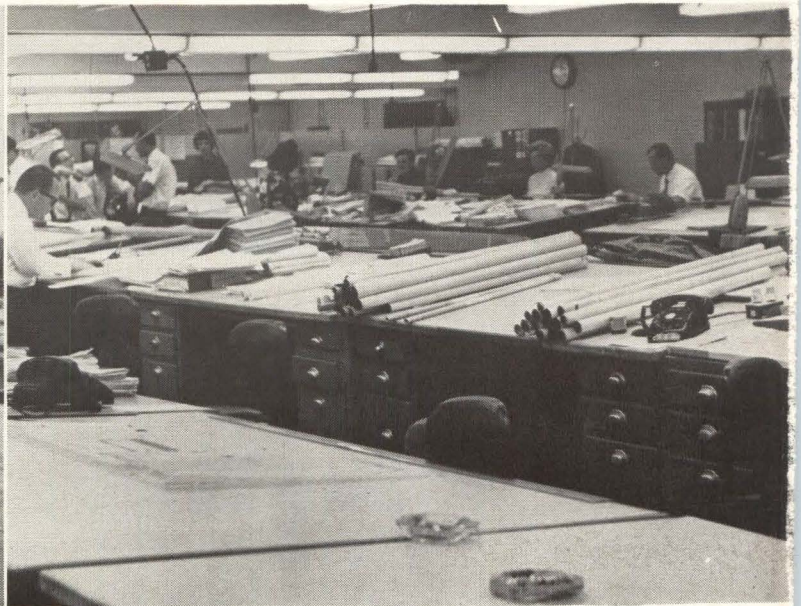

Employment office at the Van Nuys, Calif. plant of Lockheed Missiles and Space Co. is almost deserted. It used to be one of the busiest places at the plant. At right is the Lockheed aerospace ground-equipment engineering department. By June 26, all employees will be gone from the ground-equipment engineering department at right.

Manpower

Cause for alarm: slump in jobs in electronics

Nationwide survey shows a decline in opportunities for engineers. Although jobs are fewer and requirements tougher, certain specialists are still in demand

The president of a Boston electronics company reports, "Never since World War II have so many engineers been available."

An employment-agency official on Long Island says, "If it weren't for Grumman (Aircraft Corp.), you could just cut Long Island off and let it float into the Atlantic."

A Chicago agency that specializes in jobs for engineers advises applicants to relocate and be prepared to drop out of the five-figure salary range.

In Orange County, Calif., 88 electronics engineers collect unemployment

insurance, in contrast to 19 just nine months earlier.

These are typical findings in a coast-to-coast employment survey by Electronics magazine. With the help of McGraw-Hill news bureau, Electronics queried more than 100 companies, employment agencies and individual engineers in all parts of the country.

Stress on specialties

There's still demand for engineers who are topnotch specialists in microcircuits and other expanding fields.

"We don't care if a candidate has a Ph.D. in electronics," says the personnel manager for the Hickok Electrical Instrument Co. in Cleveland. "If he doesn't have thorough oscilloscope experience, we don't want him."

A maker of components in New England says he can use 15 or more solid-state engineers right now, plus a manager of microcircuit production. Today the company can afford to be selective.

An official of the Bendix Corp. in Detroit declares, "We don't want a man with specific experience with radios, we want one who has worked with certain parts of a radio."

Along the West Coast's hard-hit aerospace belt, Varian Associates in Palo Alto, Calif., seeks experienced instrument designers. And the semiconductor division of the Fairchild Camera & Instrument Corp. in Mountain View, Calif., has only six openings, all for specialists in developing semiconductor devices.

Arms and the man. Of 155,000 electronics engineers in the United States, only 106 are in the defense industry. Continued on page 106

Kind of position wanted: **ELEC. ENG**

Single Married: **Single**

Least Salary Considered: **11.3K**

Permanent Address and Phone: **SAMI AS ABOVE**

Language: **SA**

Prof. License: **None**

Citizenship: **USA**

Age: **35**

Education: **BROOKLYN POLY BEE 1957**

Travel: **SA**

Release: **SA**

Foreign Employment? **NO**

Locations Considered: **1st WILMINGTON DE**

Have you car for daily use? **YES**

Today's Pay: **4310K**

Name of person with whom you live: **WIFE**

How did you hear of our Service? **TIMES**

What newspaper do you read our ads in? **TIMES**

IMPORTANT - PLEASE LIST BUSINESS EXPERIENCE BELOW EVEN THOUGH YOU HAVE A RESUME.

Starting Date	Leaving Date	Firm Name and Address	Type of business	Name & Title of person who engaged you	Position held and duties	Reason for leaving	Salary Received
4/54	3/64	5 Terry Sq	Mfg.	P. Suler	Eng.	Reduct. in pay	12.3K
2/57	4/54	3 W 10th St	Mfg.	D. Pleckin	Des. Eng.	Better Offer	8.2K
4/56	2/57	Long Island City	Mfg.	?	Eng.	Better Offer	6.8K

IMPORTANT - PLEASE LIST BUSINESS EXPERIENCE BELOW EVEN THOUGH YOU HAVE A RESUME.

Starting Date	Leaving Date	Firm Name and Address	Type of business	Name & Title of person who engaged you	Position held and duties	Reason for leaving	Salary Received
SEPT. 1953	MARCH 1961	HABELTINE CORP. LITTLE NECK, N.Y.	ELECTRONICS	J. F. HARRIGAN	PROJECT ADMINISTRATOR - SECTION HEAD	ASSIGNMENT IN DRASITIL ECONOMY MOVE	13,500
JAN. 1953	AUG. 1953	FEDERAL AVIATION AGENCY N.Y. N.Y. + WASHINGTON, DC	NAV AID		ELECT. ENG. - PROCUREMENT, ACCEPTANCE, INSTALLATION	BETTER POSITION	4940

IMPORTANT - PLEASE LIST BUSINESS EXPERIENCE BELOW EVEN THOUGH YOU HAVE A RESUME.

Starting Date	Leaving Date	Firm Name and Address	Type of business	Name & Title of person who engaged you	Position held and duties	Reason for leaving	Salary Received
6-1953	3-1964	FOOD INSTRUMENT CO 31-10 THOMPSON AVE	ELECTRONICS	McCaffrey	SENIOR EMPLOYMENT	2.4K OFF	13K

IMPORTANT - PLEASE LIST BUSINESS EXPERIENCE BELOW EVEN THOUGH YOU HAVE A RESUME.

Starting Date	Leaving Date	Firm Name and Address	Type of business	Name & Title of person who engaged you	Position held and duties	Reason for leaving	Salary Received
11/62	2/64	BENDIX CORP. ETIENNA, TETERBORO, N.J.	MANUFACTURING	MR. H. ANTONAZZI	CHIEF ENG.	LAYOFF	857/MO.
9/62	11/62	FEDERAL ELECTRIC CORP. INDUSTRIAL PARK, PHARMACY, N.J.	MICROPHONE	MR. DYER	DEPT. CHIEF	WANTED TO WORK OUTTA EL PORT TO GO BACK TO SCHOOL	6257/MO.
9/59	2/62	40 MULBERRY ST. NEWARK, N.J.	MANUFACT.	E. G. KING	ASSOC. ENG. W/TELETYPE		4857/MO.

IMPORTANT - PLEASE LIST BUSINESS EXPERIENCE BELOW EVEN THOUGH YOU HAVE A RESUME.

Starting Date	Leaving Date	Firm Name and Address	Type of business	Name & Title of person who engaged you	Position held and duties	Reason for leaving	Salary Received
6/58	3/64	SPERRY GYROSCOPE CO. GREAT NECK, L.I., N.Y.	RADAR		ASSOCIATE ENGINEER - RELIABILITY DESIGN	LAY OFF	7815/MO.
6/52	6/58	EDO CORPORATION COLLEGE POINT, L.I., N.Y.	SONAR		ENGINEER (DEVELOPMENT) ASSC. DESIGN ENGINEER STUDENT TRAINEE	NO WORK WIDEN SCOPE SUMMER JOB	1056 MO. 640 MO. 50 WK
6/51	9/51	MATERIAL LAB, BROOKLYN NAVY YARD, BKLYN, N.Y.	ELECTRONICS EVALUATION				

IMPORTANT - PLEASE LIST BUSINESS EXPERIENCE BELOW EVEN THOUGH YOU HAVE A RESUME.

Starting Date	Leaving Date	Firm Name and Address	Type of business	Name & Title of person who engaged you	Position held and duties	Reason for leaving	Salary Received
4-56	2-64	FOOD INSTRUMENT CO. Long Island City, N.Y.	MFG.	A. ESSER	DEPT. HEAD		6000
6/51	6/51	YALE UNIV. RESEARCH DIV. N.Y.U.	RESEARCH	A. SPILHAUS	DIRECTOR OF ASSOC. IN INSTRUMENT DESIGN		

IMPORTANT - PLEASE LIST BUSINESS EXPERIENCE BELOW EVEN THOUGH YOU HAVE A RESUME.

Starting Date	Leaving Date	Firm Name and Address	Type of business	Name & Title of person who engaged you	Position held and duties	Reason for leaving	Salary Received
5/62	PRESENT	EGS GEE INC. 1101 44th Ave. Bayside, N.Y.	ELECTRONICS	BURT WALKER	DIA SYS ENGR		41800

IMPORTANT - PLEASE LIST BUSINESS EXPERIENCE BELOW EVEN THOUGH YOU HAVE A RESUME.

Starting Date	Leaving Date	Firm Name and Address	Type of business	Name & Title of person who engaged you	Position held and duties	Reason for leaving	Salary Received
1942	MAR. 1964	HABELTINE ELECTRONICS DIV. INDUSTRIAL CORP. LITTLE NECK, N.Y.	MILITARY ELECTRONICS	W. RAC DONALD	ASSIST CHIEF PROJECT ADMINISTRATOR AND ADMINISTRATIVE MANAGER INT'L PROJECTS		16,500.7K

IMPORTANT - PLEASE LIST BUSINESS EXPERIENCE BELOW EVEN THOUGH YOU HAVE A RESUME.

Starting Date	Leaving Date	Firm Name and Address	Type of business	Name & Title of person who engaged you	Position held and duties	Reason for leaving	Salary Received
3/56	3/64	FEDERAL LABS 500 WASH. AV. NUTLEY N.J.	DEFENSE MFG	E. ALTON J. ASSOC. LAB. DIR.	DEV. ENGR. SYSTEMS/PROPOSALS CONSULTANT COMMUNICATIONS/WELDRG	LAY OFF	12000
1-62	4-64	MGT CO. 2 PENN CTR PHILA. PA.	College	W. BRAMLEY	PRIN ENGR.		16,700
5-58	12-61	RCA HARRISON N.J.	MANUFACTURING	E. G. SPITZER	Eng Proj Supv. (Reconnaissance) Project Eng. (Spar sets)	accept position	16,700
4-49	4/64	RCA LANCASTER PA	"	E. W. RITTER	CHIEF ENGR. TUBE DESIGN ENGR.		16,700
1-33	47	RCA HARRISON N.J.	"	E. W. RITTER	CHIEF ENGR. TUBE DESIGN ENGR.		16,700

States, about 75% were working on government-supported projects a couple of years ago. As military orders decline, laid-off engineers are having trouble finding new jobs in their narrow specializations. Sometimes they qualify in other areas of electronics, but their salaries are way out of line with their relatively meager experience in these specialties. One estimate is that five percent of design specialists are out of work.

At Cape Kennedy, the antennas are out for engineers with about three years' experience. But the National Aeronautics and Space Administration says it has all the management types it needs. There is relatively little research and development now; techniques for firing the birds are well known, and NASA is looking for youngsters who will work for under \$8,500 a year.

Other companies are wary of engineers with military backgrounds. The Chrysler Corp., which is advertising for engineers with three to five years' experience in certain specialties, looks askance on victims of defense cutbacks who are willing to take salary cuts at Chrysler. "We don't want a guy who is looking for a way station and then takes off when the rains come again," a Chrysler official explains.

Selling insurance. The cold employment statistics don't tell the whole story. They don't include, for example, the aerospace engineer who, after two months of unsuccessful job-hunting in electronics, joined an insurance company's sales training program. Nor do they take into account the electronics engineer who now designs mechanized toys. Both men live in California.

Stress on quality

Few executives agree with the Lockheed Aircraft Corp. official near New York who sees the present dilemma as "an excuse for companies to clean house—they're

A few of the work-wanted cards on file in one New York City employment agency. Most are from men laid off in the last few months by leading military electronics companies on Long Island

Continued on page 108

Employment picture at a glance

BOSTON—Downturn in hiring of electronics engineers, especially of military oriented engineers. Department of Defense procurement in Massachusetts down \$200 million fiscal 1963, compared to fiscal 1962. Some say there's an actual surplus of engineers. But computer companies in Boston area doing quite well; they are advertising for engineers.

NEW YORK—The unemployed electronics engineer is in trouble, with no one particular salary or experience classification affected more than another. Some exceptions: IBM is hiring men with backgrounds in military computers. Grumman wants men with radio-frequency interference backgrounds, can't find them. Many high paid men—\$16,000 a year, out of work because their specialty is unneeded.

LOS ANGELES—Severely hit with layoffs by many electronics firms. Lockheed moving its aerospace ground-equipment group out of the area. Electronic Engineering Co. and Collins Radio have reduced staffs. Salary cuts seem a must for five figure men looking for new jobs.

SAN FRANCISCO—Electronics firms are not doing much hiring because of government spending cuts. Large scale layoffs recently in the area. Lockheed dropping 200 people a week, many of them engineers; will total four thousand this year. Varian Associates cut back heavily. Solid experience and exact specialization needed to find job in the area.

GREATER SEATTLE—Highly specialized opportunities only in this area. Heavy layoffs at Boeing Co. force many engineers to leave the area in search of employment.

DALLAS-FORT WORTH—Hiring is good in the Southwest, if the man fits the specialty. Ling-Tempco-Vought wants engineers for airborne communications and r-f engineering. Bell Helicopter, Texas Instruments and General Dynamics are also hiring.

SOUTHEASTERN STATES—Employment opportunities here are good, mostly in non-defense industry—such as steel, textiles, chemicals. Defense and space agency contracts in this area were few in the past. Thus the unemployment

problems besetting electronics engineers in other parts of the country are less accentuated in the Southeast.

HUNTSVILLE, ALA.—Openings in NASA for electronics men are few, with applicants carefully screened.

CAPE KENNEDY—Not a very encouraging picture. Men with specialized experience or good general backgrounds wanted to some extent, but salaries are relatively low for the positions offered. But a big upturn in demand for electronics engineers is expected in the future. Right now, NASA is very selective.

CHICAGO—Electronics engineers may have to take salary cuts to find work in Chicago, if their experience is not in line with needs. However, military electronics specialists are not wanted. But industrial and consumer electronics firms are not firing—and are hiring some. Demand is for men with directly applicable experience. Needed are applications engineers, men for sales, and field service. Midwest process control industries offer opportunities.

CLEVELAND—Engineers are sitting tight, holding on to the jobs they have without much chance to advance by changing positions. To obtain new jobs, experience must tailor-fit the work. Most industrial firms find their needs stable, are not hiring.

DENVER—Martin Co. is letting engineers go, particularly the below-average man.

DETROIT—Only the low-level, limited-ability engineer is in trouble in this area. Chrysler is hiring, but is not too eager to hire military-experienced electronics engineers even if they are willing to take a pay cut. They'll consider related experience, however, when their hard-to-fit, new specialties can't be met. Ford Motor Co. is hiring but looks for men with a flair for innovation—and wants substantial proof of this. Bendix is laying off because of a lack of government work, however.

SALT LAKE CITY—Sperry is laying off because of a cutback on the Sergeant missile. New jobs are not available in the immediate area.



Sitting pretty are these top avionics engineers at Ling-Temco-Vought, Inc., in Dallas. The company won a contract to produce the Navy's new A-7A attack bomber, and is now hiring engineers. Shown D.C. Thomas, electronics project engineer, E.F. Cvetko, deputy program director, and H.J. Luke, electronics engineering specialist.

cutting out the dead wood." Yet it's abundantly clear that accent has shifted from quantity to quality.

A man in charge of hiring engineers with advanced degrees at the Radio Corp. of America says that at least one kind of applicant is still "very much in demand." He describes him as "the kind of man who is going to invent something 10 years from now." As for the engineers with only a bachelor's degree, he adds, "The good ones will still find jobs, but instead of getting six offers, as they did a few years ago, they'll only get three."

In Seattle, where cutbacks at the Boeing Co. have forced 2,500 engineers to leave the area, an official of the Washington State Employment Service complains: "We have 75 openings in electronics from a certain area, but each one is specialized. We may not be able to fill a single one of them from those who are registered with us."

Back to school. In Boston, the IEEE reports increased participation among area engineers. This indicates that more people are worried about their jobs and concerned about keeping up with advances in the field.

A group of employees have asked the Boeing Co. for four hours a week to review the latest technology as preparation for job-hunting.

Members of the Class of '64 are getting fewer job offers than in the past, but there's little worry about being jobless. One straw floating against the tide is Northwestern University, near Chicago, which reports heavier-than-ever recruiting. A total of 699 electronics firms conducted 21,000 interviews in the current school year.

Where to look

Young men in electronics are no longer going—or even looking—west. A Boston engineer observes: "There was a time when, if things got tough in the East, you could always move to the West Coast. All you needed there was a warm body and a degree. Now things are rough there too."

Narrow specializations in the military fields, as well as high salaries, often force engineers to follow the government contracts to the West Coast, Houston and Cape Kennedy, with more hopes than prospects. On the other hand, the International Business Machines Corp. and some other concerns are hiring engineers who have worked with military computers.

Many engineers are taking a fresh look at the Southeast—a region often looked on with disdain. Now the area from Alabama to the tip of Florida has one of the few stable employment situations in America. A new factor in defense employment, this region has firms that are looking hard for good electronics engineers. And to be out of work is no handicap, observers say, if the applicant has kept up with developments in the electronics field.

No romance. The Midwest, which never wooed engineers with the same ardor as did the Pacific Coast, has a relatively stable "mix" of military and civilian industries. Jobs aren't abundant, and pay isn't the best, but unemployment isn't nearly as serious as in New England or the West Coast.

In Cleveland, the engineer who may be slightly disgruntled with his present job is also thankful that he has one. He's not likely to be shopping for another. As in other parts of the country, observers report a premium on professional development and on

above-average individual ability.

The brightest picture in the Midwest seems to be in Detroit, where one leading supplier of electronics personnel—the Detroit Engineering Agency—reports that it had no jobless engineers on its rolls at the end of April. The Ford Motor Co. continues to assemble a staff for its research laboratories. The country's second-largest automaker says it's looking for young holders of doctorates or "proven senior individuals."

The strongest demand in the Midwest seems to be for applications engineers, with a trend toward sales also noticeable.

Bottoming out

The job situation figures to get somewhat worse before it improves. The attrition in some companies is not as apparent as in others, because they can shift their engineers around as the orders change. But new engineers aren't being hired.

Lockheed's Missiles and Space Co., which is moving its aerospace ground equipment group from Van Nuys to Sunnyvale, Calif., is reported to be dropping 200 people a week from the Sunnyvale facility, many of them engineers. About 100 jobs a week are said to be lost through attrition and 100 other employees are laid off. Lockheed expects to cut its employment by 4,000 this year.

One Lockheed official, asked about the future for electronics engineers at the Van Nuys plant, answered, "How do you spell 'kaput'?"

The slump seems to have hit bottom in Florida. The outlook is expected to rise considerably over the next couple of years, especially for the average engineer. But the veterans will still have rough going, because salary increases are likely to slow down sharply, if not cease altogether.

Too much glamor? A California engineer would like to see the electronics field deglamorized. "Young people are encouraged to go into engineering," he notes. "Somebody should start as far back as high-school counseling and say, 'Okay, the field is great, but don't go into

Continued on page 110

with Integrated Circuits was the problem ~~is~~ testing

here are the BIG problem solvers

TI Integrated Circuit Testers make up to 36 d-c tests using kelvin connections on devices having as many as 14 active leads. Programming is a simple operation easily accomplished in **your** plant by **you** without costly delays or down time. Power supply regulation is .05%, long-term drift is less than 1 millivolt, accommodating all logic types.

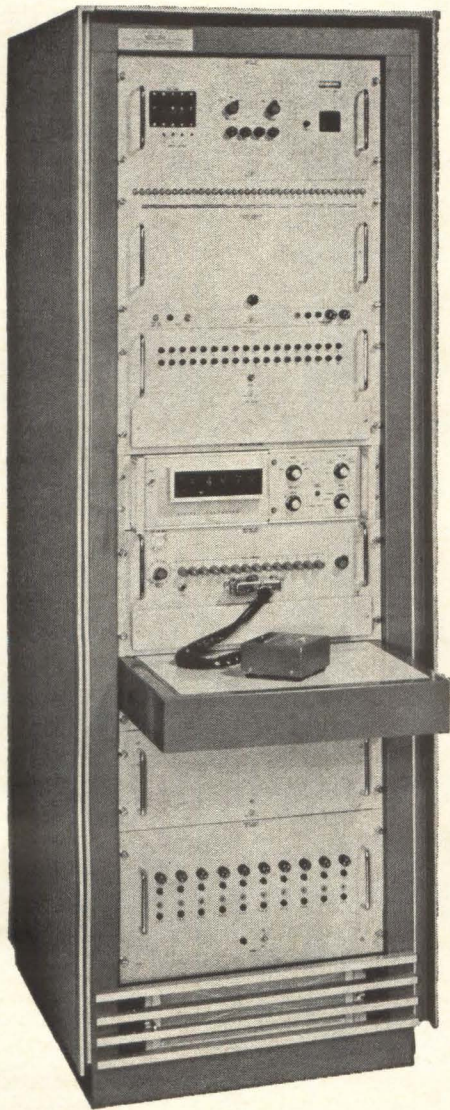

MODEL 662

Digital readout for quality control and incoming inspection testing. Optional digital comparator provides accurate, repeatable trip points. Can be quickly programmed for both high *and* low limits on each of the 36 tests. Recording output for a tape punch, typewriter, card punch or digital printer. Both automatic and manual handling equipment can be furnished for a variety of devices.

MODEL 659A

A fast go/no-go instrument designed for high-volume production and incoming testing. Short test times permit a complete 36-test sequence in less than 2 seconds. Four programmable power supplies provided.

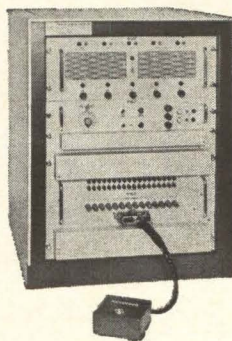

MODEL 659B

Similar to the 659A with space and connections for digital voltmeter. Includes two fixed power supplies and eight programmable power supplies.

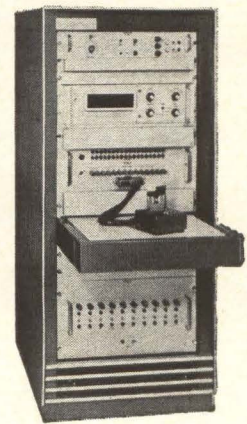

INDUSTRIAL
PRODUCTS
GROUP



TEXAS INSTRUMENTS
INCORPORATED
P. O. BOX 66027 HOUSTON 6, TEXAS

69

**Immediate
delivery!**

ELMENCO

CAPACITORS

IN QUANTITIES UP TO
500 Per Item

CONTACT THESE AUTHORIZED

ELMENCO INDUSTRIAL DISTRIBUTORS

ALABAMA, Birmingham: MG Electronics, Huntsville: Electronic Wholesalers, Inc.

ARIZONA, Phoenix: Kierulff Electronics, Inc., Midland Specialty Co.

CALIFORNIA, Glendale: R. V. Weatherford Co., Inglewood: Newark Electronics Co. Inc., Los Angeles: Federated Purchaser, Inc., Hollywood Radio & Electronics Inc., Kierulff Electronics, Inc., Mountain View: Kierulff Electronics, Inc., Oakland: Brill Electronics, Palo Alto: R. V. Weatherford Co., Zack Electronics, Riverside: Electronic Supply of Riverside, San Diego: Shanks & Wright, San Jose: Peninsula Electronic Supply Inc.

COLORADO, Denver: Newark-Denver Electronic Supply Co.

DISTRICT OF COLUMBIA, Capitol Radio Wholesalers, Inc., Electronic Wholesalers Inc., Silberman Industrial Sales Corp.

FLORIDA, Melbourne: Electronic Wholesalers, Inc., Miami: Electronic Wholesalers Inc., Orlando: Hammond Electronics, Inc.

ILLINOIS, Chicago: Allied Electronics Corp., Newark Electronics Corp.

MARYLAND, Baltimore: D & H Distributing Co., Inc., Kann-Ellert Electronics Inc., Wholesale Radio Parts Co., Inc.

MASSACHUSETTS, Cambridge: Electrical Supply Corp., Newton: Cramer Electronics, Inc.

MINNESOTA, St. Louis Park: Admiral Distributors, Inc.

NEW JERSEY, Camden: General Radio Supply Co., Springfield: Federated Purchaser, Inc.

NEW MEXICO, Alamogordo: Kierulff Electronics, Inc., Albuquerque: Electronic Parts Co. Inc.

NEW YORK, Binghamton: Stack Industrial Electronics Inc., Farmingdale: Arrow Electronics Inc., New York City: Newark-Electronics Center, Inc., Harvey Radio Co., Inc., Lafayette Radio Electronics Corp., Milo Electronics Corp., Terminal-Hudson Electronics Co., Inc., New Hyde Park: Boro Electronics, Inc.

NORTH CAROLINA, Winston-Salem: Electronic Wholesalers Inc.

OHIO, Dayton: Electronic Material Supply Co.

PENNSYLVANIA, Harrisburg: D & H Distributing Co., Inc., Philadelphia: Almo Industrial Electronics, Phila. Electronics Inc., Radio Electric Service Co. of Penna., Inc., Reading: George D. Barbey Co., Inc., York: Wholesale Radio Parts Co., Inc.

TENNESSEE, Nashville: Electra Distributing Co. Inc.

TEXAS, Dallas: All State Electronics Inc., Wholesale Electronic Supply, El Paso: Midland Specialty Co., Houston: Busacker Electronic Equipment Co., Inc.

WASHINGTON, Seattle: C & G Electronics Co.

CANADA, Montreal, Quebec: Atlas Wholesale Radio, Inc., Toronto, Ontario: Electro Sonic Supply Co. Ltd., Vancouver, British Columbia: Canadian Electronics, Ltd.

ARCO

electronics inc.

Community Drive, Great Neck, New York

NEW YORK • DALLAS • LOS ANGELES
Exclusive Supplier of ELMENCO Capacitors to
Distributors and Jobbers in U.S.A. and Canada

it thinking there is real security and plenty of dough.' By the time these kids get out into the field, it will be pretty grim."

A placement official at the University of Southern California says some companies are trying to get by with fewer engineers than in the past, and hiring more trained technicians. "This points to a change in thinking in the educating of engineers," she says.

Bright spots

A few bright spots are shining through the gloom. But most of them apply only to highly skilled specialists.

Grumman Aircraft, a subcontractor on the new TFX military plane, complains that it can't find enough people with backgrounds in radio-frequency interference.

In Massachusetts, where defense orders have fallen \$200 million below last year, the General Radio Co. says it has not slowed down its hiring of sales and development engineers. A company official, at his office near Boston, says: "The door is always open to good engineers. When business is down, that is not the time to trim back your sales effort or development effort."

Help wanted. "I need people," says a hiring official of Ling-Temco-Vought, Inc., a big diversified company in Dallas. "We are looking for people highly experienced in such areas as r-f engineering and airborne communications equipment." The man with the best future in electronics, according to the Ling-Temco spokesman, is the engineer who has been in small programs for a few years, has "stayed around the design board" and has "had to think total systems."

Computer concerns in the Boston area continue to advertise for engineers, a situation prevalent among computer firms in most of the country. The increasing stress on microcircuits is also producing an added demand for engineers, especially those with a good background in semiconductors.

In the Southwest, the three biggest employers of aerospace engineers are all looking for qualified people. They are General Dynamics Corp. in Fort Worth, Tex., Texas Instruments, Inc., in Dallas, and the Bell Helicopter Co., a division

of the Bell Aerospace Corp., in Fort Worth. Their need of engineers added to the opportunities at Ling-Temco-Vought is making Texas a Mecca for qualified electronics and aerospace engineers.

The dollar sign

Even in Southern California, unemployment hits hardest at certain types of specialized jobs. James Lewis, of the Los Angeles Chamber of Commerce, says: "It is not the engineer in the \$10,000 to \$12,000 bracket who is having trouble finding a job. It's the man who worked as a project engineer, but without a managerial title, in a large company like Hughes (Aircraft Co.) or Systems Development Corp., drawing a salary in the \$20,000 to \$25,000 bracket." When he leaves the company, he is often forced into accepting a position at a salary of \$10,000 to \$15,000."

At the Massachusetts Institute of Technology, company recruiters have been interviewing engineering students as faithfully as ever. Salary offers are up 3% to 5% from last year. But the Class of '64 has only about half as many offers as its predecessor.

Young and old

No consistent trend is discernible as to which age groups are most vulnerable to firing. One company in the New York area reports that youth is most expendable, in favor of experience. A concern just a few miles away prefers young, lower-paid engineers and is whittling away at some of its higher-priced veterans.

Experienced military engineers in the Denver area are finding that they can't command their usual salaries from any of the civilian concerns.

A young engineer in California reports: "They let guys go who had been here 15 years or so. They laid off senior engineers above me because they were either stagnant or their abilities weren't needed."

The situation is described bluntly by James Kallgren, employment manager at Varian Associates. It doesn't matter whether a man has 10 years with the firm or only one, he says. "If he's no longer useful to Varian, he goes, and it's up to the engineers to keep themselves useful."

SELECTED FOR THE MINUTEMAN PROJECT

More than 6 million El-Menco Dipped Mica Capacitors have been used in the Minuteman ground support and control equipment.

After 64,000,000 ACTUAL TEST unit-hours at 85°C with 225% of the rated DC voltage applied, no failures of any type occurred.

The accumulated 64×10^6 test unit-hours without any failures can be used to calculate many different failure rates depending upon the confidence level desired. However, we shall explore the meaning of the results at a 90% confidence level.

Assuming no acceleration factor for either temperature or voltage, we have verified a failure rate of less than 0.004% per 1000 hours. (Actually, there is a temperature effect and it has been found that, with the DC voltage stress remaining constant, the life decreases approximately 50% for every 10°C rise in temperature. There is also a voltage effect such that, with the temperature stress remaining constant, the life is inversely proportional to the 8th power of the applied DC voltage.)

Assuming no temperature acceleration factor and assuming the voltage acceleration exponent is such as to yield an acceleration factor as low as 100, we have nevertheless verified a failure rate of less than 0.00004% per 1000 hours.

Assuming no temperature acceleration factor and assuming the voltage acceleration factor is on the order of 250 (test results are available to confirm this) we have accumulated sufficient unit-hours to verify a failure rate of less than 0.000015% per 1000 hours!

All above failure rates are calculated at a 90% confidence level!

Write for a complete reliability study on your company letterhead.

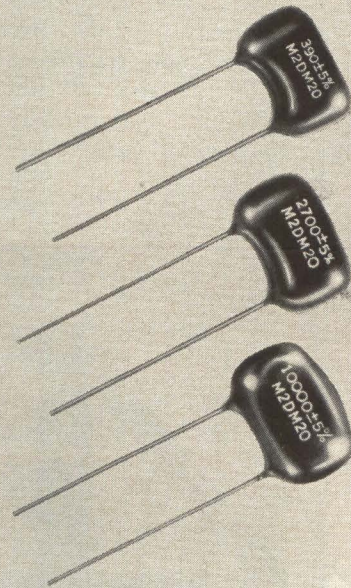

**DIPPED MICA
CAPACITORS
TYPE M2DM**

THE ELECTRO MOTIVE MFG. CO., INC.

WILLIMANTIC, CONNECTICUT

*Dipped Mica • Molded Mica • Silvered Mica Films • Mica Trimmers & Padders
Mylar-Paper Dipped • Paper Dipped • Mylar Dipped • Tubular Paper*

MANUFACTURERS OF
El-Menco
Capacitors

ARCO ELECTRONICS, INC., Community Drive,
Great Neck, L. I., New York
*Exclusive Supplier to Jobbers and Distributors
in the U. S. and Canada*

West Coast Manufacturers Contact:
COLLINS & HYDE CO., 1020 Corporation Way
Palo Alto, California
5380 Whittier Boulevard, Los Angeles, California

Dumbbell concept aids space electronics design

When spacecraft are stabilized by gravity, electronics systems can be smaller, simpler, more reliable

By Joel A. Strasser

Space Electronics Editor

Space mechanics will be causing big changes in space electronics soon. By proving that gravity alone will keep one end of a satellite always pointing at earth, physicists have demonstrated that space electronics can be made simpler, use less power and be more reliable.

NASA is budgeting about \$5 million in fiscal 1965 for "early gravity gradient experimental spacecraft,"

in support of Defense Department programs. At least five gravity-gradient devices have flown in the last year aboard secret Navy satellites, at relatively low altitudes of around 500 miles. At last report, two of the systems worked.

NASA plans to orbit three gravity-gradient stabilized satellites, beginning in 1966. One will orbit at an altitude of 6,500 miles. Two will

orbit at 22,240 miles—the synchronous altitude at which satellites move at the same speed as earth and appear to hover motionless.

Just one year ago, NASA didn't think it was practical to stabilize synchronous satellites by gravity-gradient techniques.

Eugene Fubini, the Defense Department's director of defense research and engineering, has suggested that the military adopt a communications satellite system of 30 to 40 satellites with gravity stabilization. This system, which would cost about \$180 million, is an alternative to the proposed leasing of channels from the Communications Satellite Corp. for \$30 million a year.

The satellite corporation itself doesn't want to sponsor the first experimental satellites. It is waiting to see what NASA comes up with.

Other uses. Communications satellites aren't the only probable use. The gravity-gradient technique is also being developed for use on navigation, reconnaissance, weather, data-gathering, and geo-

only **4** basic materials... **1** ...mylar*..

...a new capacitor construction concept to give high performance and low cost. Filmatic® by Paktron

detic and other types of scientific satellites.

Companies and labs working on the technique include the Applied Physics Laboratory of Johns Hopkins University, Lockheed Missiles and Space Co., General Electric Co., Goodyear Aerospace Co., Philco Corp., NASA's Ames Research Center, Space Technology Laboratories, Inc., Naval Research Laboratory, Massachusetts Institute of Technology and Bell Telephone Laboratories.

What is it? Gravity is always there, so stabilization would not require power. It is potentially foolproof.

The basic idea is simple: put a dumbbell into orbit and the bar connecting the two weights will always point to earth. One end becomes "heavier" than the other because of the gravity gradient—gravity decreases with the distance from earth. The same thing will happen with any satellite that has properly distributed moments of inertia.

What good is it? Because gravity

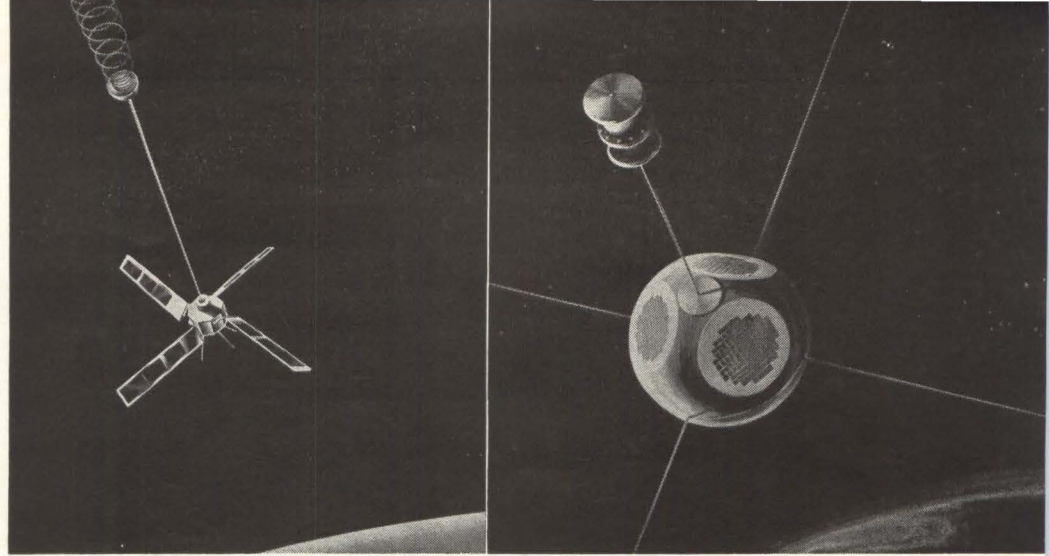

First successful gravity-gradient satellites. Applied Physics Laboratory system (left) and General Electric system (right) both used dumbbell design.

can be made to keep a satellite continually pointing to earth, attitude control systems will not be needed. This would eliminate electronic referencing systems like horizon scanners, gas jets and their controls, and the links to ground that are sometimes used to operate attitude and stabilization controls.

Difficulties with such equipment caused the loss of one satellite, Syncom I, last year, and contributed to a setback in the weather satellite program.

Thus, gravity stabilization would pull some electronics out of the satellite and ground stations. But more important are the potential

...foil...

...leads...

...impregnant

This unique combination provides a rugged self-case, high lead strength, excellent moisture resistance, improved life, high volumetric efficiency . . . all at a considerable savings in cost.

Available in three case sizes.

Range:	.001 mfd. through .5 mfd.
Voltage:	50-100-200-400-600 WVDC
Tolerance:	± 10% & ± 20%

*DuPont

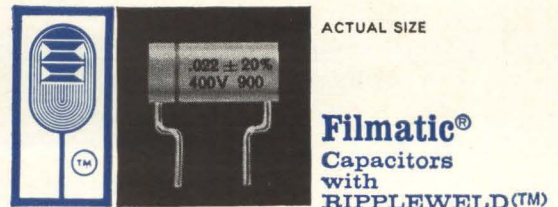

PAKTRON
DIVISION ILLINOIS TOOL WORKS INC.
1321 LESLIE AVENUE • ALEXANDRIA, VIRGINIA

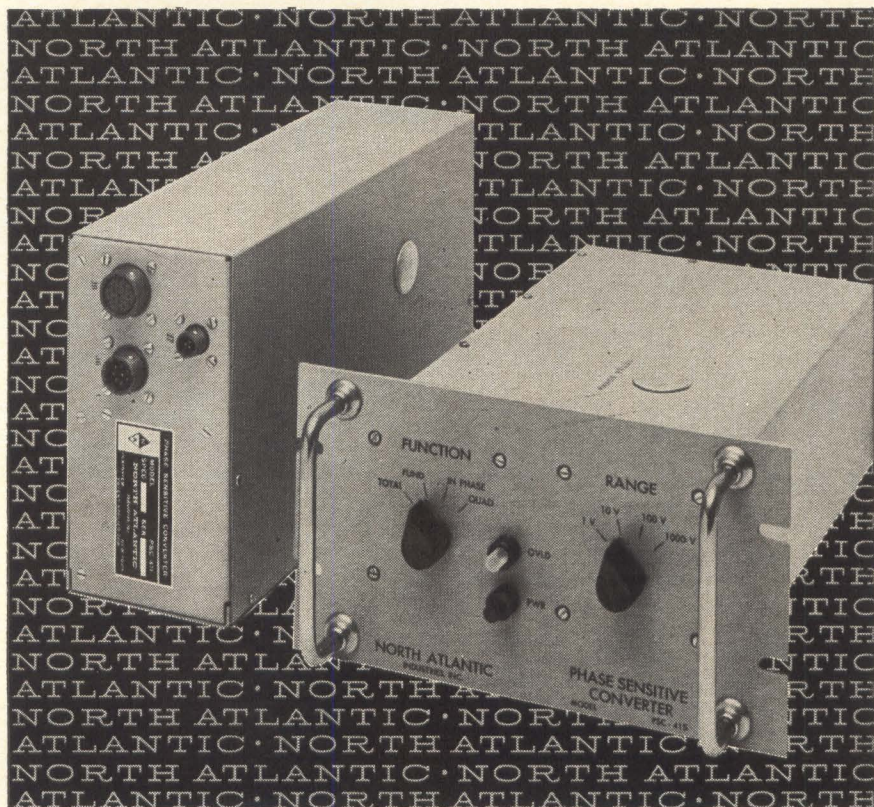

Stabilizing boom is withdrawn from canister at Applied Physics Laboratory by Frederick Mobley, left, and Robert Fischell. Boom is made of metal tape that forms a strong rod when extended.

how to measure in-phase and quadrature with 0.1% accuracy—in milliseconds

Previously unobtainable accuracy and millisecond response are only two of the reasons why NAI's Phase Sensitive AC-to-DC Converters meet the most critical requirements in computer, recording, automatic test and digital display systems.

Unlike conventional converters, these all solid state modules measure **not only total signal—but quadrature, in-phase and fundamental components as well.** DC output is proportional to selected input component, yet unaffected by harmonics. A wide range of manual and relay-actuated models permits selection and programming of function, range and frequency to suit test or system requirements.

Specifications of relay-programmed models PSC-410 and -411, and manually switched models PSC-415 and -416 are given in the table.

Voltage Range	PSC-410, PSC-415 PSC-411, PSC-416	1 volt to 300 volts f.s., 4 ranges 10 millivolts to 300 volts f.s., 6 ranges
Functions		Total, Fundamental, In-Phase Quadrature
Frequency Range	Total mode & response*	60 cps to 10kc 0.5 sec. 350 cps to 10kc 0.1 sec. Single frequency from 60 cps to 2kc.
	Phase Sensitive	
Input Impedance		1 megohm
Output		-10 to +10 vdc into 10k load
Linearity		0.1% f.s. (10 mv dc)

*dependent upon output filter

The North Atlantic man in your area can quickly show you how the PSC models simplify automatic AC measurements. Call today for his name and request Bulletins.



NORTH ATLANTIC industries, inc.
TERMINAL DRIVE, PLAINVIEW, L. I., NEW YORK • OVerbrook 1-8600

advantages:

- Communications transmitters on the satellite can be smaller and less powerful, yet provide greater gain than a transmitter whose antenna is spinning or tumbling with the spacecraft. Radiated power is beamed constantly at earth, so less is wasted.

Philco Corp. says the gain would be 8 or 9 db more, compared to that in a spin-stabilized satellite orbiting at 5,000 to 6,000 miles. A high-gain parabolic antenna, mounted at the base of the satellite, could emit a narrow beam, provided the satellite didn't wobble more than a few degrees.

At synchronous altitudes, gains should be about 26 db better than in unstabilized satellites and 10 db better than in spin-stabilized satellites, according to Robert E. Fischell, a project supervisor at Johns Hopkins University's Applied Physics Laboratory.

- Ground equipment can be smaller, for similar reasons. At present, ground antennas for satellite communications range in size up to 85 feet in diameter. APL figures that gravity gradient will permit a 9-foot dish, or a yagi array, to give the same signal clarity as a 30-foot dish. A 30-footer is now about the smallest ground antenna used with synchronous satellites.

This should boost development and use of fixed and transportable ground stations, and help promote communications satellites.



LAPP HEAVY-DUTY ENTRANCE INSULATORS

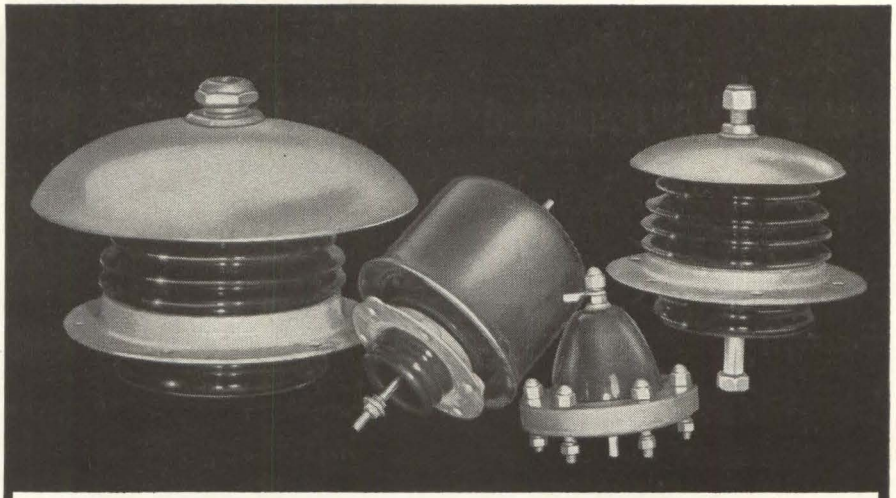

▪ Power supplies could be smaller in the spacecraft. Or, the same size of power supply could feed a larger number of communications channels. Redundancy could be provided for added reliability. Or, the power saved in communications gear could be allotted to other kinds of equipment to make satellites more versatile.

Instead of conventional solar cell and battery power sources, very high power nuclear sources could be used. The reactor, with minimum or no shielding would be one end of the dumbbell and the electronics equipment the other end of the dumbbell.

▪ Weather and reconnaissance satellites could eye the earth without blinking—or without special equipment to offset tumbling or spinning.

▪ Passive satellites — satellites that relay communications signals by reflecting a radio beam—could have more efficient design. Instead of being spherical, as are the present Echo balloons, they could be shaped like dishes or beans pointing at earth. Work on these designs has already begun [Electronics, Sept. 6, 1963, p. 24].

Building a satellite in the shape of an antenna would also make it easier to power a satellite from the ground with r-f energy.

Satellite program. NASA recently initiated a flight program called the Advanced Technological Satellite. Five of these satellites, to be built by the Hughes Aircraft Co., will be launched beginning in 1966.

The first will be stabilized at an altitude of 6,500 feet by a gravity-gradient system developed at

...in all these standard sizes to save you time and money

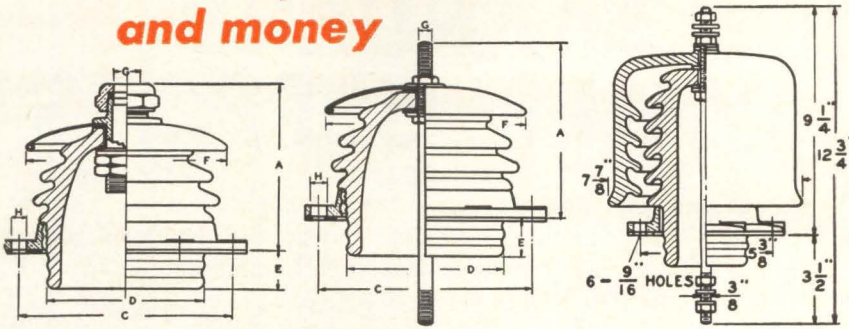

TYPE A
Permits use of continuous pipe conductor through the insulator.

TYPE B
Stud secured to porcelain bowl.

TYPE C—NO. 11896
Similar to Type B, but with porcelain hood added.

DIMENSIONS IN INCHES—FLASHOVER AND RADIO RATINGS

Catalog Number	Type	A	C	D*	E	F	G	H	DRY FO 60° kv eff.	Radio Rating kv eff.
10030	A	12 $\frac{3}{4}$	14 $\frac{5}{8}$	12 $\frac{1}{2}$	1	16	2	Max.**	$\frac{5}{16}$	80 16
9553	A	10 $\frac{1}{2}$	12	9 $\frac{3}{4}$	2 $\frac{1}{2}$	16	1 $\frac{1}{2}$	Max.**	$\frac{5}{16}$	70 12
9554	A	7 $\frac{1}{16}$	9	7 $\frac{1}{2}$	2	9 $\frac{1}{4}$	1 $\frac{1}{2}$	Max.**	$\frac{5}{16}$	55 8
22913	A	6 $\frac{1}{8}$	7 $\frac{1}{4}$	6 $\frac{1}{2}$	1 $\frac{1}{2}$	7 $\frac{1}{4}$	1	Max.**	$\frac{5}{16}$	45 9 $\frac{1}{2}$
7321	B	12 $\frac{1}{2}$	14 $\frac{5}{8}$	12 $\frac{1}{2}$	1 $\frac{1}{2}$	13 $\frac{3}{8}$	$\frac{3}{4}$	$\frac{1}{16}$	$\frac{5}{16}$	80 16
5363	B	10 $\frac{5}{8}$	12	9 $\frac{3}{4}$	2 $\frac{1}{2}$	16	$\frac{3}{4}$	$\frac{5}{16}$	$\frac{5}{16}$	70 12
8141	B	6 $\frac{1}{2}$	7 $\frac{3}{4}$	6 $\frac{1}{2}$	1 $\frac{1}{2}$	7 $\frac{1}{4}$	$\frac{1}{2}$	$\frac{5}{16}$	$\frac{5}{16}$	45 9 $\frac{1}{2}$
22611	B	8 $\frac{3}{4}$	5 $\frac{5}{8}$	4 $\frac{1}{4}$	1 $\frac{1}{2}$	8 $\frac{1}{2}$	$\frac{3}{8}$	$\frac{5}{16}$	$\frac{5}{16}$	55 9 $\frac{1}{2}$
10300	B	6 $\frac{1}{2}$	5 $\frac{5}{8}$	4 $\frac{1}{4}$	1 $\frac{1}{2}$	5 $\frac{1}{4}$	$\frac{3}{8}$	$\frac{5}{16}$	$\frac{5}{16}$	45 8

*D is mounting hole diameter.
**Always specify outside diameter of conductor.

Lapp

WRITE for Bulletin 301-R.
Lapp Insulator Co., Inc.,
218 Sumner Street, LeRoy, N. Y.

NOW YOU
CAN GET . . .

**CUSTOMIZED
FEATURES**

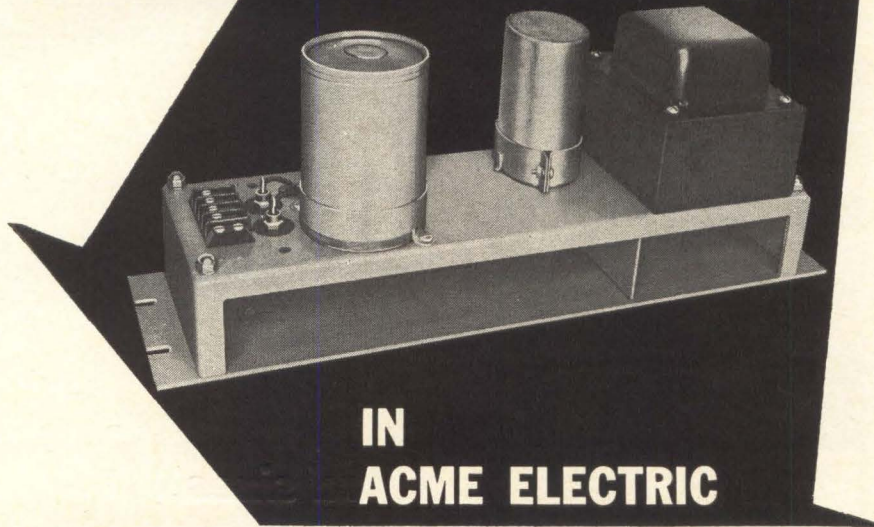

**IN
ACME ELECTRIC**

STANDARD POWER SUPPLIES

Why be satisfied with the performance limitations of ordinary power supplies when Acme Electric makes a **standard regulated power supply** with operating features usually obtainable only in specially designed units? This line of Acme Electric power supplies originated as custom designed models, then were simplified and standardized.

RELIABILITY EVALUATION PROVED BY DESIGN SIMPLICITY

- Continuous duty, constant voltage transformer
- resonant capacitor with adequate bleeder to discharge after turn-off,
- computer grade, electrolytic filter,
- silicon rectifiers,
- practical positioning of terminal board provides input and output connections in one place,
- heavy gauge, relay rack panel with components spaced for maximum free air circulation,
- negligible thermal drift
- losses and instability of tubes eliminated,
- zero to full load recovery time, 0.1 second,
- practically instantaneous recovery under input voltage fluctuation,
- current limiting protection,
- ripple voltage RMS less than 1%,
- efficiency 80% or better,
- standard rack models in ratings from 50 watts to 2400 watts, 24 to 250 volts dc.
- Write for catalog 174.

Acme  Electric

Engineers and Builders of...

315 WATER STREET, CUBA, NEW YORK

In Canada: Acme Electric Corp. Ltd.
50 Northline Rd., Toronto, Ont.

SAA 3722-3038
REGULATED POWER SUPPLIES
STATIC POWER RECTIFIERS
VOLTAGE STABILIZERS
VOLTAGE REGULATORS

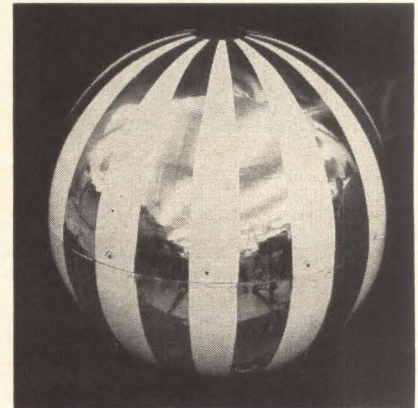

Which came first, the girdle or the stripes? Magnetic viscous sphere dampers have been developed independently by General Electric Co. (top) and Lockheed Missiles and Space Co. (bottom).

Ames Research Center.

Two synchronous satellites will be test flown about 1968.

The program, which will also provide an orbiting test bed for other new satellite designs, is costing \$18.5 million this fiscal year and \$31 million for fiscal 1965.

Systems flown. The first launch of a gravity-gradient system on November 15, 1962, was unsuccessful. This was an Applied Physics Laboratory device using Navy satellites. APL tried again on June 15, 1963, and it worked.

The device was a 100-foot-long boom with the spacecraft at one end and a weight mounted on a spring at the other. The weight bobbed up and down to damp oscillation of the spacecraft, which then pointed to earth with an accuracy of 2°. Two later launches failed; the satellites tumbled. A fifth try is being made.

Last January, a General Electric device was also successfully launched on a Navy satellite. Its pointing accuracy, however, may be less than the 2° achieved by the APL device.

Synchronous satellites. Doubts that gravity-gradient stabilization is practical at altitudes of 22,240 miles (where gravity is weak) are subsiding.

Some think that booms 1,000 feet long would be required. But Applied Physics Laboratory is studying a configuration of two satellites separated by a 200-foot-long boom.

"The only problem is setting the right moments of inertia," according to Fischell.

Computer simulations have indicated that a variety of other designs are feasible.

NASA's present plans are to use the Ames configuration in the Advanced Technological satellites. This configuration is a three-axis system. Two long bars intersect in the spacecraft at an angle of 60°.

Local vertical—the imaginary line that points to the earth's center—passes through the angle between the two long bars.

Problems to solve. So far, only two-axis systems have been flown. Systems to stabilize in all three primary axes—pitch, roll and yaw—are needed. Pointing errors must be pared down to 1°. Stabilization rods must be made bendproof, a taxing metallurgical and mechanical problem. The most controversial subject is how to damp oscillations.

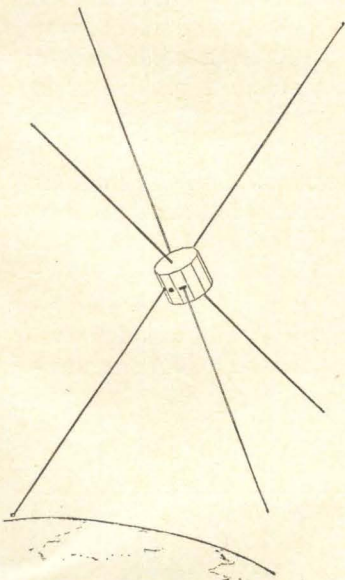

Ames design uses crossed rods with local vertical passing through acute angle created by rods. General Electric has worked on this design with Ames Research Center.

NEW—go anywhere, do anything DC METROLOGY PACKAGE

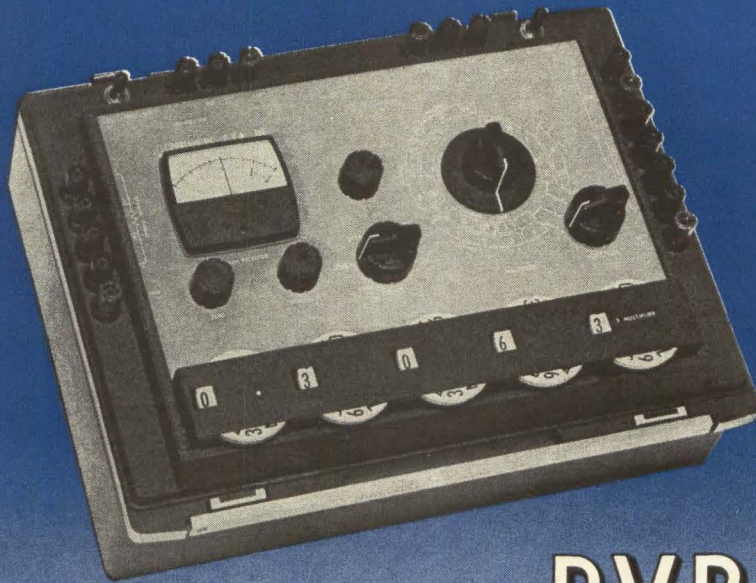

Portametric PVB*

IT'S A FIVE-DIAL POTENTIOMETER... A FOUR-TERMINAL KELVIN BRIDGE... A FIVE-DIAL VOLTAGE DIVIDER... A DIRECT-READING COMPARISON BRIDGE... A PICO AMMETER... A DIRECT-READING RATIOMETER... AN ELECTRONIC NULL DETECTOR

Combines the functions of seven instruments (estimated cost if bought separately, \$4000.00). Accuracy $\pm 0.02\%$ for essentially all functions. Battery-operated, portable. For detailed information, request Catalog Sheet C-54.

Price: **\$750⁰⁰**

* Potentiometric Voltmeter Bridge

Function	Ranges	Full Scale	Minimum Step
Voltmeter	5	0.051110 to 511.10 volts	1 microvolt
Ammeter	8	0.51110 μ a to 5.1110 amperes	10 picoamperes
Resistance Bridge (4 terminal, guarded)	10	0.51110 ohms to 511.10 megohms	10 microhms
Comparison Bridge (4 terminal, guarded)	To 5.1110 times reference standard	1.0000	0.01%
Ratiometer (Direct reading)	3	0 to 1.00000 0 to 0.051110 0 to 0.0051110	1 part in 10 ⁻⁵ 1 part in 10 ⁻⁶ 1 part in 10 ⁻⁷
Null Detector	Sensitivity—5 microvolts; Input impedance—approximately 1 megohm; AC rejection 60 cps and up; 80 db, Guarded, battery operated.		
Accuracy	$\pm 0.02\%$ of reading or 1 switch step on virtually all ranges and functions.		
Portable	Rugged portable case, battery operation, 2000 hour battery life.		

AT YOUR SERVICE—toll-free telephone network direct to the factory. Check your local directory—call us direct at no cost to you. If we are not listed in your local exchange, call collect 646-4141, Area Code 503.



Electro Scientific Industries, Inc.

13900 N.W. Science Park Drive • Portland, Oregon 97229

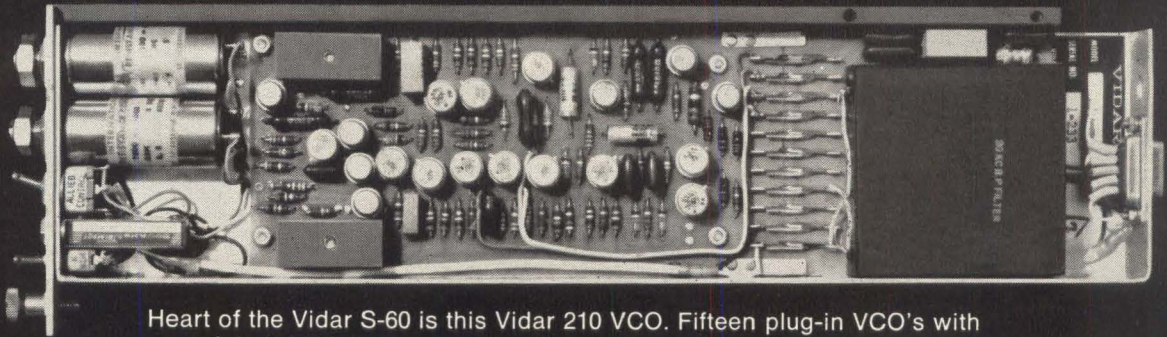

Heart of the Vidar S-60 is this Vidar 210 VCO. Fifteen plug-in VCO's with associated multiplexers, power supply, reference oscillator and housing use just 3 1/2" of standard 19" rack space.

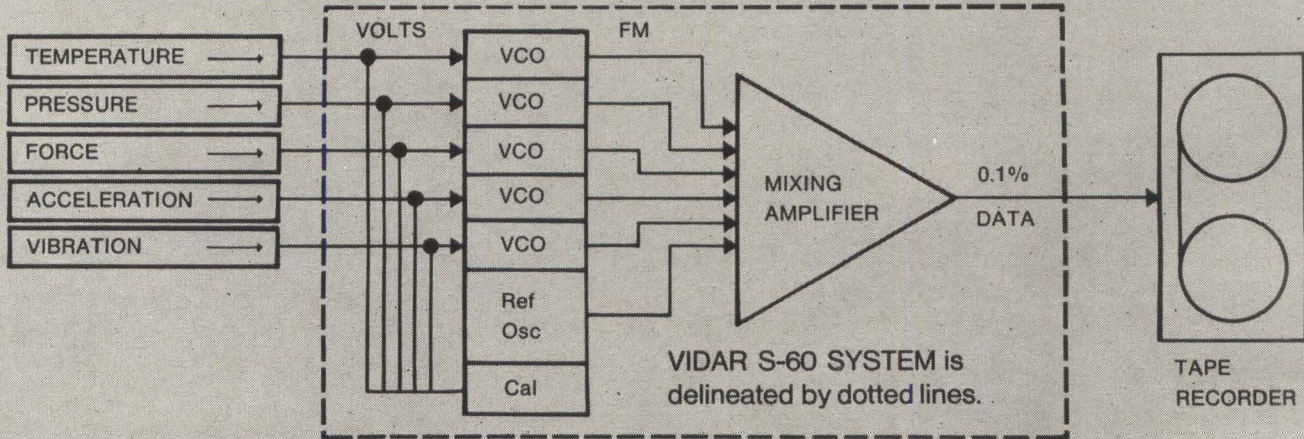

HOW TO MULTIPLEX 5 CHANNELS OF FM ANALOG DATA ON 1 TAPE TRACK WITH A SYSTEM ACCURACY OF 0.1%

Multi-channel data to be recorded in analog form has presented the instrumentation engineer with a dilemma. To achieve high accuracy, he could record one data channel per tape track. But this approach is costly because of the number of tape recorders required. The alternative of frequency multiplexing several data channels on one tape track meant a sacrifice in accuracy due to inadequate VCO performance.

The new Vidar S-60 answers the problem. This high performance data system provides 0.1% stability, 0.1% linearity, and solid state reliability for telemetry or FM magnetic tape storage of static and time varying data via multiplex techniques. For the first time, you can use competitively priced VCO's to achieve 0.1% overall system accuracy!

In operation, precision voltage-controlled oscillators provide frequency-modulated sub-carrier signals at standard IRIG center frequencies. A highly refined

relaxation oscillator effects the voltage-to-frequency conversion.

In addition to high stability and linearity, the Vidar S-60 offers exceptional flexibility. The center frequency can be located anywhere within an IRIG channel. Deviation sensitivity is continuously adjustable to provide up to 30% output deviation with any selected input voltage span from 5 to 40 volts.

A plug-in sub-assembly determines the IRIG band for each VCO and includes a front panel presentation of the channel number. Front panel switches provide zero and 2.5 volt calibration from an internal reference. Output level of each VCO is adjustable from the front panel. We would be pleased to send you complete technical specifications. Please call your nearest Vidar engineering representative or write directly to Vidar Corporation, 77 Ortega Avenue, Mountain View, California. Phone: (415) 961-1000.

8

VIDAR

Scanning locates microelectronic flaws

Primary electron beam scans specimen surface in a raster, similar to that used in tv, with image appearing on crt screen

A nondestructive testing apparatus for use in microelectronics is said to provide, for the first time, a reliable means of checking circuitry and accurately determining faults, with capabilities far beyond that of ordinary test equipment. The Micro-Scan system is designed to examine in microscopic detail the physical topography of various specimens by presenting on a cathode-ray tube secondary electron emission from the specimen. It differs from an electron microscope in that the primary electron beam scans the sample surface in a raster, similar to that used in television, with the image appearing on the screen of a crt, where it can be photographed using standard techniques. The Micro-Scan is a valuable tool because the specimen is not destroyed by the electron beam, nor are any special sample preparation steps necessary.

Even when a semiconductor surface is covered with a layer of silicon oxide, junction topography is clearly visible. The microscope can locate the most minute particles of dust or dirt, improperly diffused junctions, surface scratches, or poor registration.

Micro-Scan is expected to have wide application in many separate fields of science and technology, especially where the required magnification is greater than that obtainable from optical systems, where nondestructive inspection is mandatory, or where great depth of focus is required.

Operation. The block diagram illustrates the principle of operation. Briefly described, the Micro-Scan "sees" with a beam of electrons (variable from 5 to 50 kv), accelerated by an applied voltage, and focused with magnetic lenses onto the sample. Magnetic deflection coils guide the beam across the surface of the sample in a scanning sequence. When the primary electrons strike the surface they cause the material to emit low-energy secondary electrons in quantities determined by the nature of the material and the angle of incidence. A portion of these secondary electrons is collected by a scintillator, whose light output is detected by a photomultiplier. The signal from the photomultiplier is converted to a voltage, amplified, and used to control the brilliance of a display crt whose electron

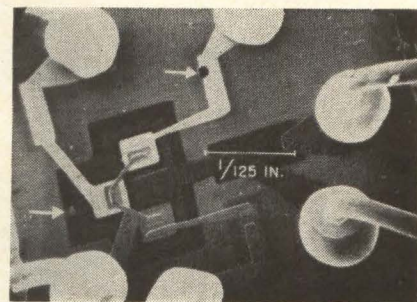

Scanning electron micrograph of an experimental direct-coupled transistor logic NOR gate. Micrograph illustrates voltage contrast between areas at different potentials. Arrows indicate flaws.

beam is moved in synchronism with the primary beam on the specimen. The display crt thus presents an image, in terms of secondary electron emission, of the surface topography of the specimen. The image will appear as if the sample were observed from the direction of the electron gun, and were illuminated from the direction of the scintillator.

The microscope contains an electron gun and magnetic lenses which can focus the beam to as small as 0.1 micron diameter at the focal point where the semiconductor specimen is placed. By means of electromagnetic scanning coils, the beam can be directed to scan any portion of the specimen. Magnifications are continuously variable from 40 to 1,500 times.

Four units comprise the new system—power supply module, mechanical vacuum pumps, specimen chamber/electron optical column, and the high vacuum/electronics module. Over-all dimensions of the main console are 9 ft wide, 3½ ft deep, and 5½ ft high. This console contains the high vacuum pumping station with its gages and controls, the scan generator, the magnetic lens controls, the various amplifiers, and the display cathode-ray tubes.

Westinghouse Electric Corp., P.O. Box 868, Pittsburgh, Pa. 15230.
Circle 301 reader service card

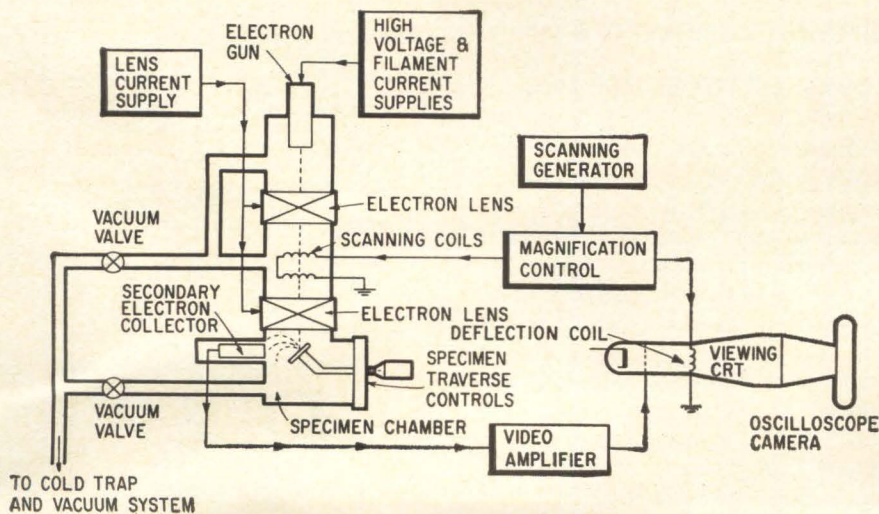

New Components and Hardware

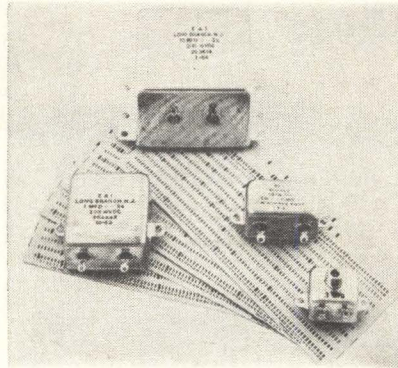

Polystyrene capacitors hold close tolerance

Rectangular, precision capacitors of polystyrene are built in miniature. A 5- μ f unit measures only 2 by 2 by 1 in., while a 1- μ f unit is just 1 by 1 $\frac{1}{8}$ by $\frac{5}{8}$ in. They are designed to operate in a temperature range of -55° C to $+95^{\circ}$ C. Units maintain tolerances as close as 0.05%, and the dissipation factor is also less than 0.05%. Long-term stability is less than 0.01% deviation a year, and temperature coefficient is -100 ppm per degree C. Standard voltage is 25 vwdc with a capacitance range of 0.47 μ f to 30 μ f.

Electronic Associates, Inc., Long Branch, N.J. [311]

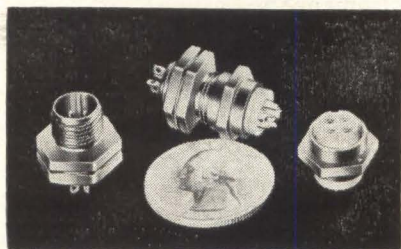

Tiny connectors have ratings to 2,000 volts a-c

Compact series 2400 includes multiple-pin connectors that have high-voltage test ratings up to 2,000 volts, d-c, yet a mated pair weighs less than $\frac{1}{4}$ oz. and is under 1 in. long. Design features include a knurled or hex-shaped coupling nut, integral with plug and cross-

drilled for safety wire; closed-entry socket contacts mounted in a Teflon body; contact pins fused in a compression-sealed glass header that provides a positive barrier and distributed strength to withstand pressures from 3,000 psi to 10,000 psi and temperatures to 482° F. The line meets or exceeds MIL-G-45204 (plating) and MIL-C-5015 (environment).

Nu-Line Industries, Inc., 1015 S. Sixth St., Minneapolis, Minn. 55415 [312]

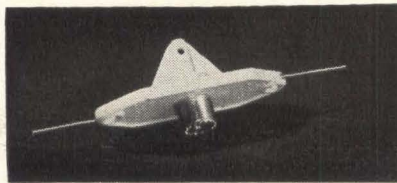

Connector couples antenna to coax feeder

A rugged GB1 connects a coaxial feedline to antenna elements. The molded plastic and metal fitting features holes at both ends for element tie-points and has molded-in copper leads for electrical connection to the SO239 coax connector. A reinforced high center rib provides support for the entire antenna system. The connector fits standard PL259 attached to the feedline.

Budwig Mfg. Co., P.O. Box 97, Ramona, Calif. [313]

Circular connectors designed for space use

Miniature circular connectors, developed for space and high-performance applications, are designed to meet National Aerospace Standards Committee Specifications NAS1599 and NAS1600. The KV has a threaded coupling and is interchangeable as a unit and mates with existing MIL-C-26500 types. The PV has a bayonet coupling and is interchangeable as a unit and mates with MIL-C-26482 types. Both have Little Caesar rear release system which enables con-

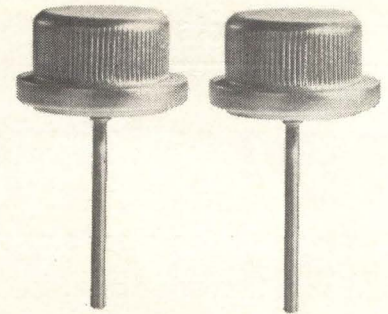

AVAILABLE AT THESE DISTRIBUTORS

EAST

- Binghamton, N. Y.**—Federal Electronics
P. O. Box 208/PI 8-8211
- Philadelphia 23, Penn.**
Almo Industrial Electronics, Inc.
412 North 6th Street/WA 2-5918
- Pittsburgh 6, Penn.**—Radio Parts Company, Inc.
6401 Penn Avenue/EM 1-4600
- Newton 58, Mass.**—Greene-Shaw Company
341 Watertown Street/WO 9-8900
- New York 36, N. Y.**—Harvey Radio Company, Inc.
103 West 43rd Street/JU 2-1500
- Baltimore 1, Md.**—Radio Electric Service Company
5 North Howard Street/LE 9-3835

SOUTH

- Birmingham 6, Ala.**—Forbes Distributing Company, Inc.
2610 Third Avenue, South/AL 1-4104
- West Palm Beach, Fla.**—Goddard, Inc.
1309 North Dixie/TE 3-5701
- Richmond 20, Va.**—Meridian Electronics, Inc.
1001 West Broad Street/353-6648

MIDWEST

- Detroit 3, Mich.**—Glendale Electronic Supply Company
12530 Hamilton Avenue/TU 3-1500
- Minneapolis 16, Minn.**—Admiral Distributors, Inc.
5305 Cedar Lake Road, St. Louis Park/LI 5-8811
- Indianapolis 25, Ind.**—Graham Electronics Supply, Inc.
122 South Senate Avenue/ME 4-8486
- Cleveland 1, Ohio**—W. M. Pattison Supply Company
Industrial Electronics Division
777 Rockwell Avenue/621-7320
- Chicago 30, Ill.**—Merquip Electronics, Inc.
4939 North Elston Avenue/AV 2-5400
- Cincinnati 10, Ohio**—United Radio, Inc.
1308 Vine Street/CH 1-6530
- Kansas City 11, Mo.**—Walters Radio Supply, Inc.
3635 Main Street/VA 1-8058
- St. Louis 44, Mo.**—Electric Components for Industry Co., Inc.
2605 Henley Road/MI 7-5505

WEST

- Dallas 1, Texas**—Adieta Company
1907 McKinney Ave./RI 1-3151
- Houston 1, Texas**—Harrison Equipment Company, Inc.
1422 San Jacinto Street/GA 4-9131
- San Diego 1, Cal.**—Radio Parts Company
Division of E.C.I., 2060 India Street/232-8951
- Los Angeles 15, Cal.**—Radio Products Sales, Inc.
1501 South Hill Street/RI 8-1271
- Los Angeles, Cal. 90022**—Kierulff Electronics
2585 Commerce Way/OV 5-5511
- Mountain View, Cal.**—Kierulff Electronics
2484 Middlefield Road/968-6292
- Denver, Colo.**—L. B. Walker Radio Company
300 Bryant Street/WE 5-2401
- Seattle 1, Wash.**—C & G Electronics Company
2221 3rd Avenue/Main 4-4355
- Phoenix, Ariz.**—Midland Specialty Co., Inc.
1930 North 22nd Ave./258-4531
- Albuquerque, N.M.**—Midland Specialty Co., Inc.
1712 Loma Blvd., N.E./247-2486
- Tucson, Ariz.**—Midland Specialty Co., Inc.
951 South Park Ave./MA 4-2315

Ask for a complete catalog



Division of General Motors, Kokomo, Indiana

Circle 120 on reader service card

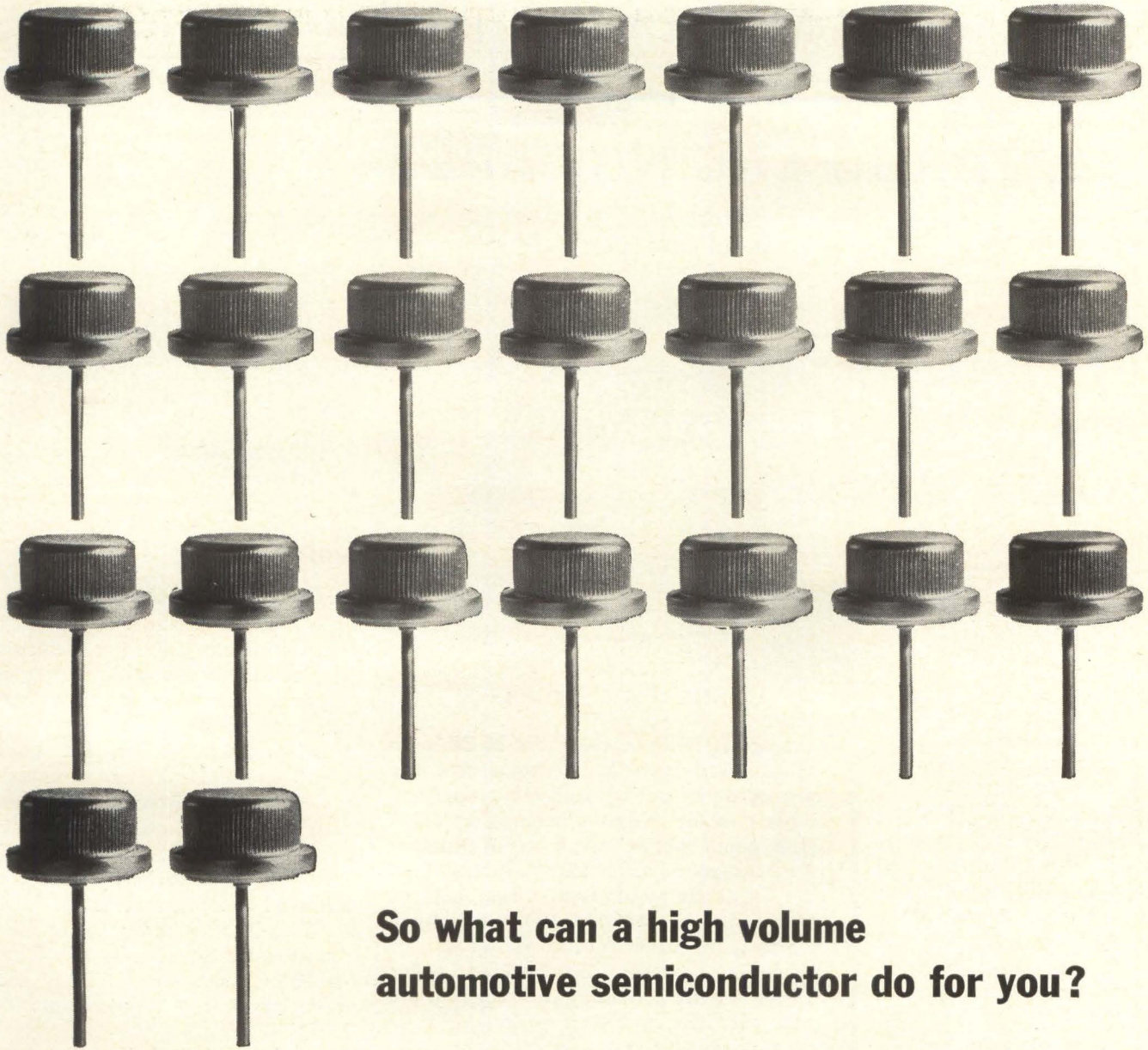

So what can a high volume automotive semiconductor do for you?

Save you money, for one thing.

Consider Delco Radio's press fit and stud base rectifiers. They're designed and built for rugged automotive applications, where devices don't stick around long unless they're especially reliable—(successful operation for several billion device hours insure this)—and they don't get used at all unless their price is low.

The 18-ampere 1N3491-93 press fit series in 50, 100 and 200 P.R.V. ratings will withstand current surges to 300 amperes. Hermetic sealing and extensive thermal cycling assure stability of operation from -65°C to $+175^{\circ}\text{C}$ —for as low as two cents an amp.

For stud mounting, the same basic rectifier is available in the 15-ampere 1N3208-10 series with stud

package. They will maintain full-rated peak reverse voltages of 50, 100 or 200 volts to $+175^{\circ}\text{C}$ which extends through the forward current derating range of 150°C to 175°C .

Or maybe you'd be interested in other rectifiers being readied for high volume applications such as: the new 750 ma, 50 or 100 volt silicone encapsulated DRS 100 series, the DRS 150 series of 1.5 ampere "top hats," or the heavy-duty 800 to 1200-volt, 250-ampere DRS-250 series.

For the full story on delivery, price and reliability advantages these high volume devices can offer you, contact any Delco Radio sales office. They'll supply you with data, prices and applications assistance.

*Union, New Jersey
324 Chestnut St.
MURdock 7-3770
AREA CODE 201

Detroit, Michigan
57 Harper Ave.
TRinity 3-6560
AREA CODE 313

Palo Alto, California
201 Town & Country
Village
DAvenport 6-0365
AREA CODE 415

*Santa Monica, Cal.
726 Santa Monica
Blvd.
UPton 0-8807
AREA CODE 213

Syracuse, N.Y.
1054 James St.
GRanite 2-2668
AREA CODE 315

*Chicago, Illinois
5151 N. Harlem Ave.
775-5411
AREA CODE 312

DELCO RADIO 
DIVISION OF GENERAL MOTORS, KOKOMO, INDIANA

*Office includes field lab and resident engineer for applications assistance. General Sales Office: 700 E. Firmin, Kokomo, Ind., Gladstone 2-8211—Ext. 500 • Area Code 317

HOW MUCH MORE WILL THE COST BE IF YOU SPECIFY GUDEBROD LACING TAPE?

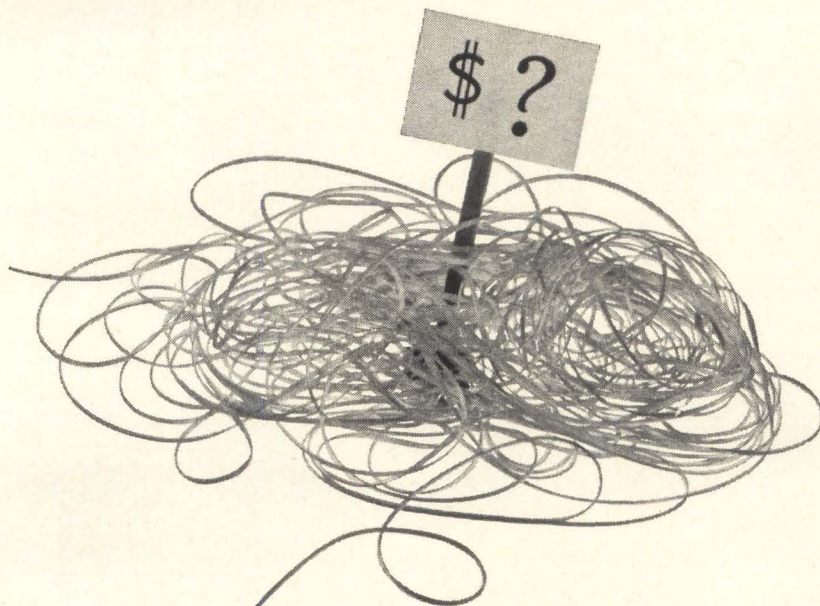

GUDEBROD FLAT BRAIDED LACING TAPES FOR EVERY NEED

Strict manufacturing control guarantees the quality of Gudebrod Tapes. There are many different types meeting wide range of needs, including:

GUDELACE®-non-slip—Nylon with microcrystalline wax finish—complies with MIL-T-713A.

GUDELACE-H®. Nylon with special coating of fungistatic synthetic rubber.

STUR-D-LACE-FLH®. Dacron* fibers impregnated with fungistatic, burn proof finish. Tem. -100°F. to 350°F.

TEMP-LACE PRE-SHRUNK® Teflon*—virtually unaffected by temperatures from -100°F to 425°F.

GUDE-Q®-Extreme Temperature—excellent tying qualities. Essentially stable in excess of 1500°F.

The Gudebrod Cable-Lacer speeds and eases the Harness tying operation. Inquire about it.

Lacing tape might represent as little as 1/100,000th part of the total cost for producing a standard electronic unit. The labor cost for tying the harness with this tape could be as much as 500 times greater than the material cost. Where then, can the economy of saving a few cents on wire lacing be profitable? Of much more worth is the confident knowledge that in specifying Gudebrod Flat Braided Lacing Tapes you are providing the very best for your wire harness lacing work.

Specifically made for wire harness lacing, Gudebrod Lacing Tapes meet many particular requirements for fungus resistance, temperature fluctuations, chemical content, as well as meeting or exceeding MIL-T-713A specifications.

In addition Gudebrod Lacing Tapes are soft and flat. Stress is distributed over the full width without cut-through or harshness to injure insulation or fingers. Knots stay tied. The good handle of Gudebrod Tapes pleases harness room workers—assures production improvement.

For samples, for further information, for the Technical Data Book, get in touch with your local Gudebrod representative, or write to the Electronics Division.

*Du Pont registered trademarks



GUDEBROD BROS. SILK CO., INC.

FOUNDED IN 1870

Electronics Division

12 SOUTH 12TH STREET, PHILADELPHIA, PENNSYLVANIA 19107

New Components

tacts to be inserted and released and removed from the rear of the connector with the aid of a single expendable plastic tool.

Cannon Electric Co., 3208 Humboldt St., Los Angeles 31, Calif.[314]

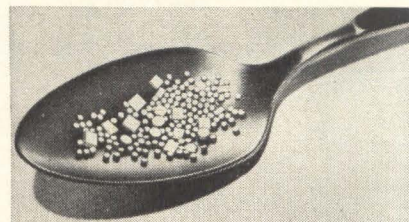

Capacitor elements for microelectronics

Microminiature capacitor elements of ceramic are available for direct soldering and welding in micro-electronic applications. Uses include hybrid circuits, flat pack assemblies and miniature can headers. Capacitor elements are available from 47 pf to 0.1 μ f, 50 wvdc. A 0.01 μ f element measures 0.025 in. thick by 0.125 in. by 0.125 in., and a 0.1 μ f element measures 0.055 in. thick by 0.20 in. by 0.20 in. Elements operate from -55° C to +150° C with high stability and meet applicable requirements of MIL-C-11015C.

Scionics Corp., 8900 Winnetka Ave., Northridge, Calif. [315]

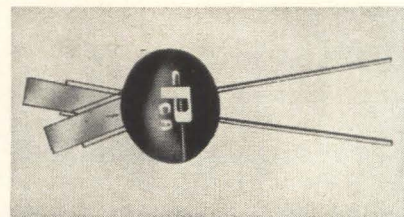

Pulse transformer modulates lasers

A miniaturized pulse-transformer designed for pulse-modulating an experimental laser features a very low load impedance. The unit is capable of coupling a 0.1-microsecond pulse of 5 volts amplitude from a transistor driving circuit to

a load of 0.1 ohm. Sample price for Part No. EP-2498 modulation transformer is \$35.

PCA Electronics, Inc., 16799 Schoenborn St., Sepulveda, Calif. [316]

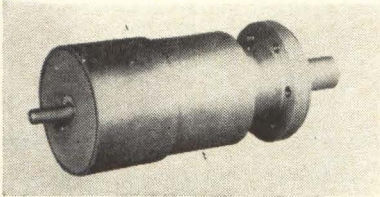

Harmonic drive positions servos

Size 18 harmonic drive has been developed for positioning servos, automation actuators, and machine tool drives. It weighs only 15 oz but is capable of high positioning accuracy and resolution at the 2,000 in.-oz operating torque level. Drive can withstand momentary overloads up to 12,000 in.-oz, can be used as speed reducer or speed increaser, and offers low backlash and high torsional rigidity.

Harmonic Drive Division, United Shoe Machinery Corp., Beverly, Mass. [317]



Solid-state switches for low-level use

A complete transformer and semiconductor switch unit is found in the type AC series. The switch is ideal for high-speed, low-level multiplexers that require high common mode rejection and voltage and low offsets. They feature close times of 500 μ sec and capacities of only 0.06 pf. Offsets are less than 50 μ v from -25° to $+100^{\circ}$ C, and contact voltage ratings are ± 18 v. Frequency range is 1 to 100 kc, and the units can be used as choppers in this range. Both single and dif-

ECONOMICAL

AVAILABLE

ACCURATE

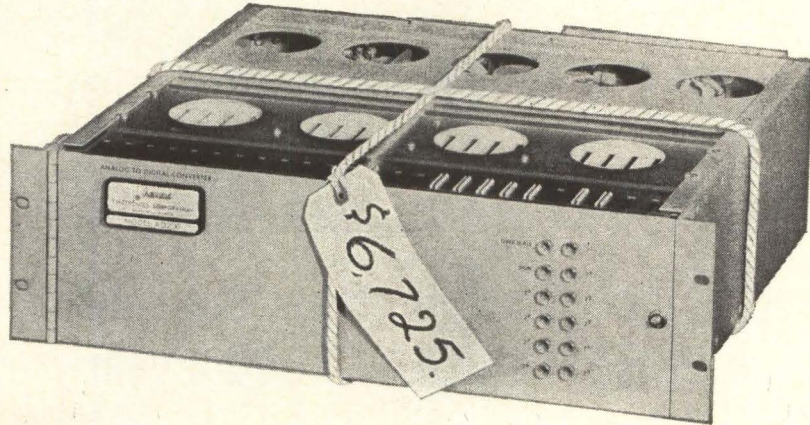

PRICED RIGHT-- OFF-THE-SHELF-- FASTEST, HIGH-ACCURACY A-D CONVERTER

**770,000 bits per second...
.05% accuracy**

This fastest, high accuracy Analog-to-Digital Converter provides 770,000 bits per second and accuracy to .05%. Yet Interstate's Model AD-200 costs less than many slower, less accurate converters. And it's available off-the-shelf.

Model AD-200 is a high-speed, highly accurate 11-binary-bit converter featuring optional sample-and-hold circuitry and internal clock. Accuracy is increased by minimum drift of less than 1 bit in 30 days. System oriented impedance is 10 megohms with an input of ± 10 V.

Its performance features and low price make the AD-200 your best converter buy.

A complete series of MX-300 Multiplexers, with from 16 to 96 analog inputs, is available to interface with Model AD-200 for full system integration. These high-speed multiplexers provide accuracy to .01%... sampling range up to 75 kc... and sequential or random scan.

For full details on this fast, high-accuracy A-to-D Converter and Multiplexer series, write direct or use reader service card.

 **Interstate** ELECTRONICS CORPORATION
707 EAST VERMONT AVENUE, ANAHEIM, CALIFORNIA
Telephone 714-772-2222, TWX 714-776-0280

A Subsidiary of Interstate Engineering Corporation Worldwide Representatives

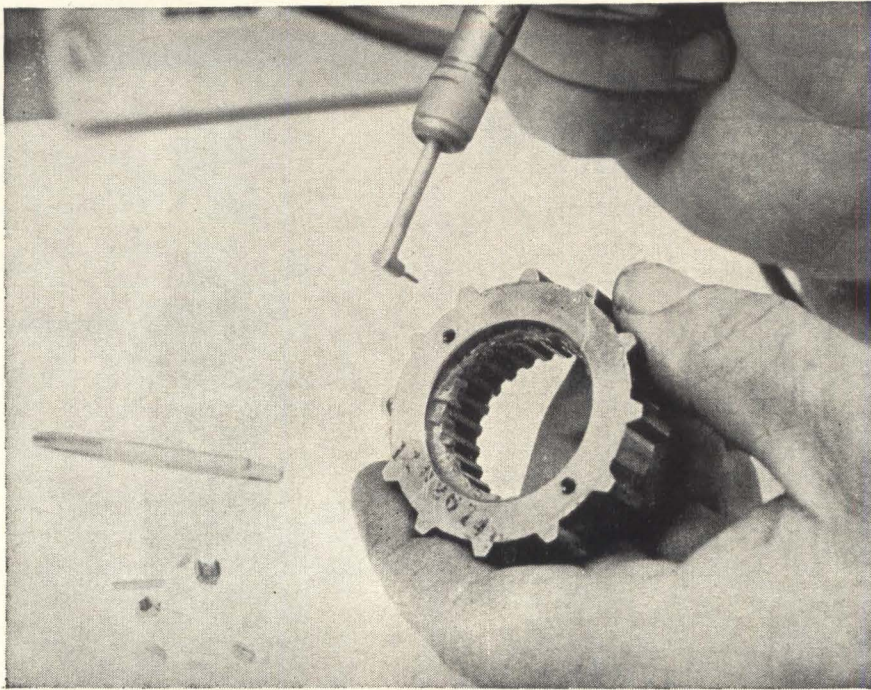

Airbrasive® blasting of broken tool bits saves Martin Co. \$10,000 a year

Martin Co. used the Airbrasive to put a stop to an annual loss of \$10,000 in rejects. At least 90% of these precision parts that had broken taps or drill bits embedded in them had to be scrapped.

The Airbrasive — a unique tool of a thousand uses in shop or laboratory — directs a fine stream of abrasive particles on the broken tap. The tap quickly breaks into small, easily removed pieces without damaging the original part.

Result: a saving of at least \$10,000 a year.

Here is a remarkable instrument. Use it to shape, cut, abrade, drill, clean, wirestrip almost any hard, brittle material . . . ceramics, germanium, silicon, ferrites, glass, tungsten, alloy steels . . . wherever cool, shockless, precision work is required.

Cost is low, too . . . for under \$1000 you can set up your own Airbrasive unit in your plant or laboratory.

*Let us make a free trial for you
send samples for test or telephone
collect for a demonstration.*

SEND FOR
BULLETIN 6006
. . . complete information



S. S. WHITE INDUSTRIAL DIVISION
Dept. EU, 10 East 40th St., N.Y. 16, N.Y. • Telephone MU 3-3015 collect

for superfine cutting • deburring • cleaning

hard brittle materials

S.S. White INDUSTRIAL AIRBRASIVE®

New Components

ferential channels are available. Over-all size is 1.31 in. diameter by 0.719 in. high. Prices start at \$49.50. Rho Associates, Inc., 917 Terminal Way, San Carlos, Calif. [318]



Long-life chopper exhibits low noise

A maximum noise level of only 35 μ v rms and a maximum offset level of only 50 μ v rms are features of the type 7040 chopper. Unit can be driven by sine or square wave and may be switched over a d-c to 5-kc chopping rate. Life is 10,000 hours minimum. Price is less than \$85 in quantity.

Airpax Electronics Inc., Cambridge, Md. [319]

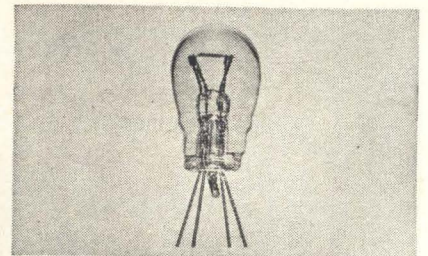

Barretters protect power transistors

Three new barretters provide protection of power transistors from damaging current surges or overloads. They are made with tung-

sten filaments chosen for their positive temperature coefficient of resistivity. Placed in series with a transistor emitter, the barretters act like variable resistors, offsetting any increase in transistor collector current by a corresponding increase in the resistance of their filaments. Types CE101, -2 and -3 operate between 6.2 and 6.5 v at currents ranging from 1.85 to 4.25 amps; resistance (cold) of the filaments is 0.20 ohm, 0.12 ohm and 0.26 ohm respectively. Each barretter combines two tungsten filaments in a single glass envelope the size of an ordinary automotive lamp. Color-coded leads already processed for soldering are brought out through the bottom of the envelope permitting each barretter to be wired directly into transistor circuits.

Tung-Sol Electric Inc., One Summer Ave., Newark 4, N.J. [320]

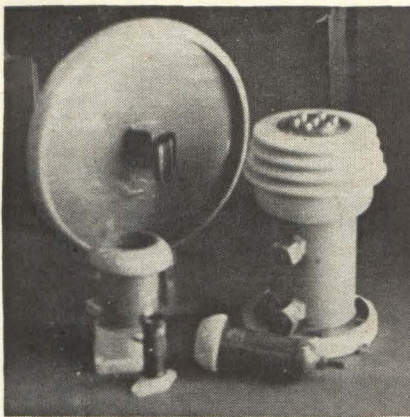

Transmitter capacitors use ceramic dielectric

Designed for use in r-f generators of all types, for communications or industrial applications, these transmitter capacitors feature high rated voltage, low self-inductance, and small dimensions. Space requirements are less than those of heavy oil-dielectric units. Flash-over at high modulation peaks under unfavorable climatic conditions, or when industrial generators work with unloaded tanks is eliminated. The capacitors employ ceramic dielectrics, whose loss tangent is low at radio frequencies. Included are watercooled capacitors for l-f high-energy industrial generators, up to 140 amperes r-f at 10,000 v, to give a rated reactive power of 1.5 Mw. Also available are grid-coupling,

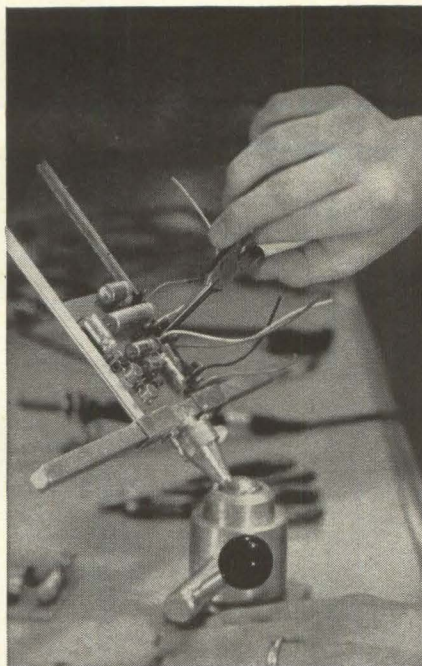

Require stable DC amplification?

Stable, drift-free DC amplification for instrumentation applications is yours with Esterline Angus self-balancing amplifiers . . . ideal for thermocouples, strain gages, meter and recorder preamplifiers, null detectors, voltage to current and current to voltage converters and DC shunt amplification.

These patented solid state self-balancing amplifiers use potentiometric feedback with magnetic amplifier circuitry to obtain high linearity and null and drift stability.

You can choose high or very low input resistance with negligible power drain from the signal source.

Esterline Angus can also meet your needs for conventional magnetic amplifiers and transducers.

Write for self-balancing amplifier and transducer catalogs.

ESTERLINE ANGUS INSTRUMENT COMPANY, INC., Box 596E, Indianapolis, Indiana 46206

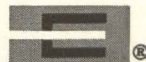

ESTERLINE ANGUS

Excellence in instrumentation for over 60 years

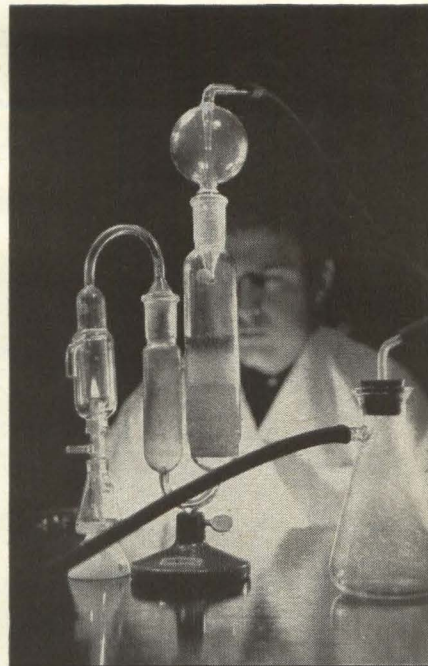

Need 1/8 second response?

Only the Esterline Angus Speed-servo has it. Eight times faster than most, the Speedservo records 4 cycle per second signals without significant attenuation, and handles virtually all signals, even those of one millivolt level.

Its unique shuttle servo motor has no drive cords to break or gears to wear. One-piece construction of drive coil, pen assembly and sliding contact provides low inertia and accompanying high response speed.

The Speedservo's feedback potentiometer has virtually unlimited life.

The Speedservo is available in the illustrated portable, sloped writing surface model or in a flush model with 8" x 8" case front.

Write for Series "S" catalog.

1/4" MECHATRIM®

metal film trimmer potentiometer

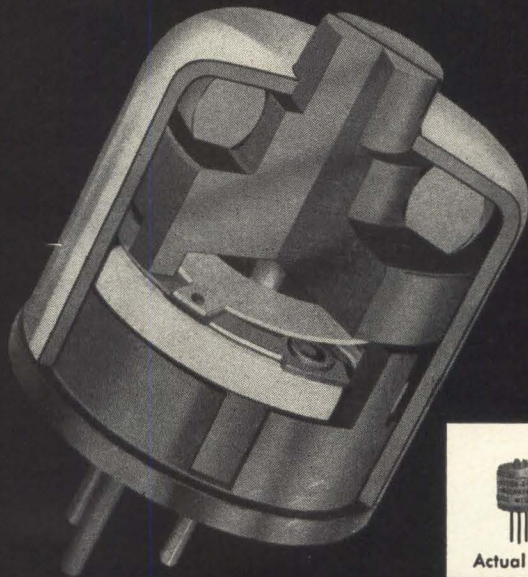

Outperforms All Wirewounds!

SETTING STABILITY TESTS

Type of Test Per MIL-R-22097B Characteristic C	No. of Units	% Setting Stability Change			
		Mil-Spec Tolerance	HT250-2 Min.	MECHATRIM Avg.	Max.
Thermal Shock Method 107A MIL-STD-202 Condition B, 5 cycles of 1/2 hour at -55°C and 1/2 hour at +125°C.	6	1.0	0.01	0.10	0.19
Moisture Resistance Method 106A MIL-STD-202, 20 cycles at 95% relative humidity, 2 hours at +25°C and 4 hours at +65°C with Full excitation.	6	not required	0.02	0.15	0.25
Shock, Medium Impact Method 205B MIL-STD-202 Condition C, 3 shocks, approximately 50 g's each, applied in each direction of three mutually perpendicular axes.	6	1.0	0.00	0.03	0.06
Vibration, High Frequency Method 204A MIL-STD-202 Condition D, vibration over the frequency range of 10 to 2000 cps at 20 g's, 12 cycles in each of three axes.	2	1.0	0.00	0.02	0.03
Life Method 108 MIL-STD-202 Condition D, 1000 hours at +85°C, rated excitation cycled 1 1/2 hours on, then 1/2 hour off.	11	1.0	0.01	0.09	0.13
High-Temperature Operation 250 hours at +150°C, no excitation.	16	2.0	0.01	0.10	0.27

(Copies of Test Report available upon request)

SM/I SERVOMECHANISMS/INC.

MECHATROL DIVISION

New York — Home Office 1200 Prospect Ave., Westbury, L. I., N. Y. 516 ED 3-6000
California — Branch Office 200 North Aviation Blvd., El Segundo, Calif. 213 OS 5-7111

New Components

plate-coupling and plate capacitors. United Mineral & Chemical Corp., 16 Hudson St., New York 13, N.Y. [321]

Chopper transformers in miniature size

Hermetically-sealed chopper input transformers are designed to transfer efficiently 30- to 500-cps transducer or thermal couple signals to instrument amplifiers at signal levels ranging from 0.5 μ v to 0.5 v. Features include 90-db magnetic shielding, low microphonics and accurate center taps. Units meet requirements of MIL-T-27B, Grade 4, Class R, Life X. Size is 1 3/8 in. high by 1 3/8 in. diameter.

Microtran Co., Inc., 145 E. Mineola Ave., Valley Stream, N.Y. [322]

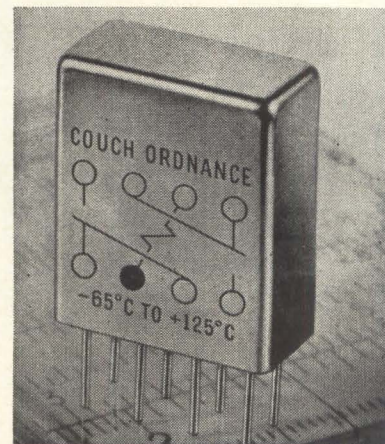

Relay designed for p-c applications

Now in production is a relay with a case size of 0.5 in. by 0.4 in. by 0.2 in. for use in high density electronic systems. The terminals for the two form C contact sets use standard 0.1-in. grid spacing for convenience in p-c applications. Contacts are rated for 0.5 amp at 30 v d-c. Coil sensitivity at pull-in is 150 mw which allows a coil resistance of 1,000 ohms for a nominal coil voltage of 26.5 v d-c. Vibration resistance is 20 g and shock rating is 75 g.

Couch Ordnance, Inc., 3 Arlington St., North Quincy 71, Mass. [323]

New Instruments



Integrating voltmeter gives 33 readings a sec

An integrating digital voltmeter with a 4-digit readout and a minimum input range of 20 mv is being marketed for \$1,500. In the 20-mv range, input impedance is 50 megohms and resolution is 10 μ v. The all-solid-state model 1420 has a completely isolated input and a common mode rejection of more than 120 db at 5,000 ohms unbalance. It gives 33 readings a second and can be used as a counter-timer. In the 200-mv range, input impedance is 500 megohms and resolution is 100 μ v; in the 2-v range, input impedance is 5,000 megohms and resolution is 1 mv; in the 20 v, 200 v and 1,000 v ranges there is an input impedance of 10 megohms, with resolutions of 10 mv, 100 mv and 1 v, respectively. Accuracy on all six ranges is 0.05% of full scale.

Weston Instruments and Electronics division, Daystrom, Inc., 614 Frelinghuysen Ave., Newark 14, N.J. [351]



Temperature controller has variable bandwidth

Control of temperature between -200° and $+1,200^{\circ}$ C in liquids,

gases and solids is provided by the model CTC-1 proportional temperature controller. A highly sensitive phase-comparison system furnishes a short-term temperature stability in a well-designed bath of $\pm 0.002^{\circ}$ C and a long-term stability of $\pm 0.005^{\circ}$ C. The unit's bandwidth can be quickly varied by the operator between 0.1° and 1.0° C to insure precise operation without either oscillation or unsatisfactory stabilization response. A temperature-sensitive platinum probe senses increments of temperature change in the medium under control, causing a silicon-controlled rectifier to provide up to 1.5 kw to the heater load as required for satisfactory temperature control.

Melabs, 3300 Hillview Ave., Stanford Industrial Park, Palo Alto, Calif. [352]

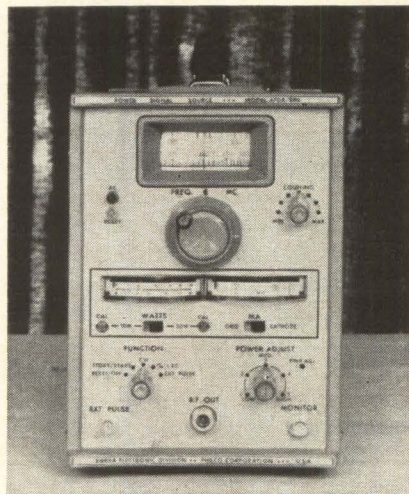

Power signal sources for equipment testing

Models 470A-500 and 470A-1000 power signal sources generate strong, stable signals in the vhf-uhf frequency region. They are designed for use in testing and calibrating r-f filters, r-f detectors, receivers, antennas and other equipment, and as the signal source in rfi testing applications. The 470A-500 reaches from 190 to 600 Mc; and the 470A-1000 operates from 470 to 1,000 Mc. Both have direct-reading power ranges of 0-10 and 0-80 w over the entire signal output band. The instruments incorporate

SIX-CHANNEL TIME CODE PROGRAMMING SYSTEM 2"x3"x3.5"

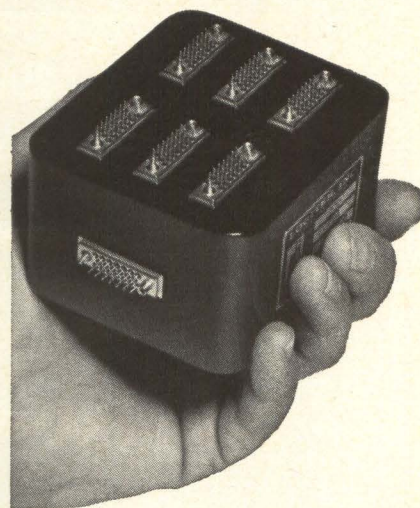

ADJUSTABLE PROGRAMMER PLUS TIME CODE GENERATOR IN A SINGLE 21 CUBIC INCH PACKAGE

Designed specifically for programming missile and satellite functions, Model A744 Programmer is a six-channel, solid state systems, fully qualified for aerospace applications. Control outputs can be programmed for any intervals from 0 to 2047 seconds, can fire pyrotechnics or operate latching relays directly. Integral time-code generator, is completely compatible with IRIG requirements, provides 11-bit serial pulse trains, with marker pulses every second, for telemetry and data correlation. Time programs can be field adjusted in minutes. Other features:

- Timing Accuracy: 0.05%
- Resolution, Time Code: 43 Milliseconds
- Resolution, Programming: 1 Second
- Output: 12 A. per channel
- Temperature Range: -55° to $+125^{\circ}$ C.
- Power: 28v dc nominal at 85 ma. max.
- Code Formats: straight binary, BCD, IRIG

Other timing ranges and formats available on order. Also 2-unit systems and add-on decoders for increased programming capability.

For complete data, call or write

LOGITEK, INC.

42 Central Drive, Farmingdale, N.Y. • (516) MY 4-3080

MODEL PG-2/repetition rate 1cps to 16mc/single or double pulse/positive or negative pulse/one-shot pushbutton/adjustable reference, delay, width/variable rise and fall time/adjustable trigger sensitivity, threshold, slope/dc coupled output/\$985

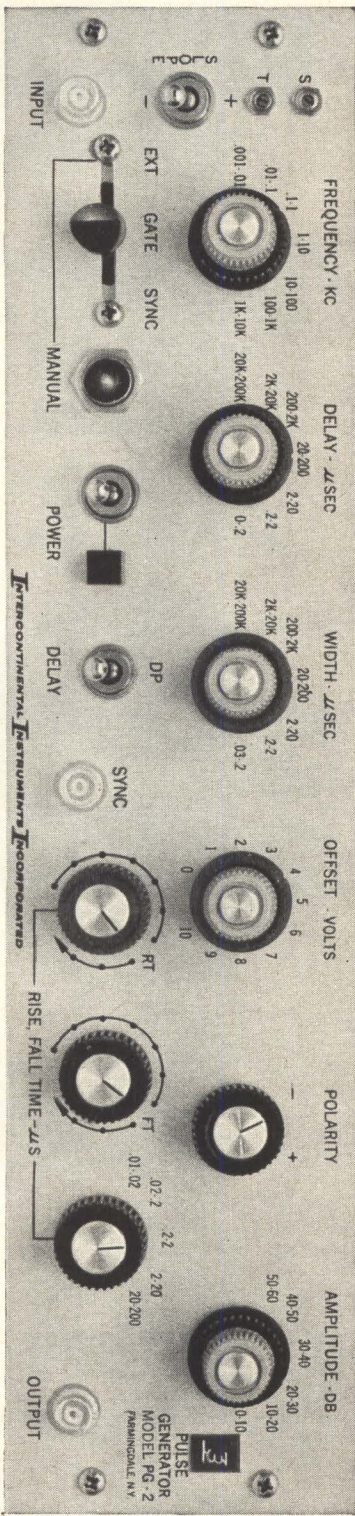

Lab and production line pulse generator 3½" high. Rack-mountable? Sure! And the specs are great!



Send for Bulletin 101.
INTERCONTINENTAL INSTRUMENTS INC.
 123 Gazza Blvd., Farmingdale, N.Y.
 Phone: (516) MYrtle 4-6060

New Instruments

selective use of either c-w, square-wave, or pulse-modulated outputs, with 100% modulation being supplied either from an internal square-wave generator or from an external source. Both units feature all-solid-state power supplies and automatic protection against no-load or underload conditions by an over-current relay in the grid circuit. Price is \$2,250.

Sierra Electronic division of Philco Corp., 3885 Bohannon Dr., Menlo Park, Calif. [353]



Bidirectional counter with wide-angle display

This solid-state, electronic counter is capable of accepting add-subtract information from two different sources, from the same source on separate lines, or from quadrature signals. Model CF-400R is available with 4, 5, or 6 wide-angle Nixie displays plus polarity sign. It is designed for applications such as position indicating, flow-blending, or speed synchronization in the fields of data measurement, industrial process control, and ground support equipment. It is priced from \$850. Anadex Instruments Inc., 7833 Haskell Ave., Van Nuys, Calif. [354]



Indicator/control for liquid helium level

Three new liquid helium level indication/control systems provide control accuracies of ± 0.060 inch

Manufacturing Quality Resistors under Rigid Reliability Control

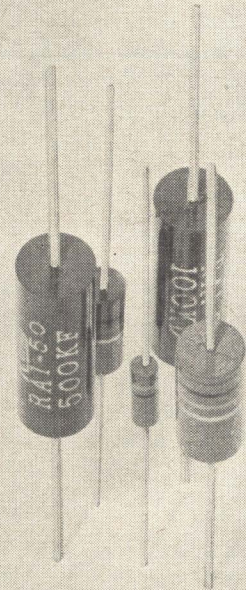

Rohm

METAL FILM RESISTOR
 CARBON

TOYO ELECTRONICS INDUSTRY CORPORATION

P. O. BOX 103 CENTRAL
 KYOTO, JAPAN

and introduce no electrical output into the dewar. A sensor, incorporated into a suitable probe configuration, provides the key to reliable indication and control of liquid helium levels. Models 500C, 500V and 500VMT provide fixed single and dual point control, and sense the liquid interface even when gas and liquid are at the same temperature. Since the probe introduces no electrical output and is completely passive, it can be utilized in critical areas such as nuclear environments, superconductivity studies and maser operation. Prices vary from \$375 to \$970. Cryogenics, Inc., 5821 Seminary Road, Baileys Crossroads, Va. [355]

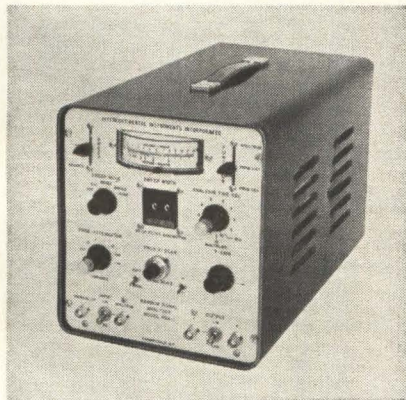

Dual mode unit analyzes noisy signals

The random signal analyzer illustrated is designed for analysis of noisy signals in the fields of vibration, sonar, radar and similar applications. The dual-mode, solid-state RSA-1 may be used to measure power spectral density in the frequency domain or probability density and probability distribution in the time domain. Amplitudes can be measured as integrated linear voltage or voltage squared, with amplitude and frequency outputs available as linear or log voltages suitable for display on oscilloscopes or X-Y recorders. Integration time is variable from 0.1 to 100 sec. The RSA-1 will accommodate input signals from 0 to 10 v and provides a linear dynamic range of 60 db and a squared range of 30 db. Amplitude, frequency and probability outputs are 0 to 10 v. In the probability density mode, averaging time is variable

NEW! HIGH SENSITIVITY

GENERAL PURPOSE 247A

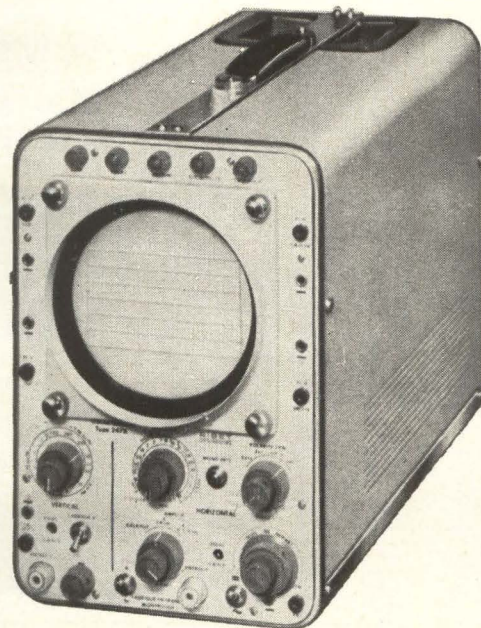

The type 247-A oscilloscope fully qualifies as a universal instrument because its performances and the size (13 cm (5") dia.) of its C.R. Tube authorize accurate measurements and tests in all fields of low-frequency instrumentation. Also, because of its simplicity of operation, the 247-A is ideally suited for practical laboratory work of an educational nature.

TECHNICAL SPECIFICATIONS

Vertical amplifier

1 channel; Frequency range: DC to 1 Mc/s (-3 dB)
Sensitivity: 50 mV/cm

AC: 10 c/s sine wave or 50 c/s square-wave to 100 Kc/s (-3 dB)
Sensitivity: 5 mV/cm

Calibrated attenuator: step-adjustable from 5 mV to 20 V/cm in 12 positions
Sequence: 1 - 2 - 5 - 10 etc...

Attenuator vernier ratio 1/3
Constant input impedance: 1 M Ω 47 pF

Sweep

Free-running - triggered - single sweep
Duration: 1 s/cm to 0.5 μ s/cm in 20 calibrated positions
Vernier: 1: 3 ratio -
x 5 magnification expanding sweep durations from 3 s/cm to 0.1 μ s/cm

Sync

5 positions: single-sweep, HF, LF, TV-line, TV-frame
Polarity: + or - internal or external
selection of triggering level

Horizontal Amplifier

Frequency range: 0 to 500 Kc/s (-3 dB)

Oscilloscopes

204 A - High speed and fast rise oscilloscope
241 A - 242 A - 243 A, Multi-function osc. with plug-in preamplifiers.
255 B - Portable oscilloscope
245 A - High performance portable oscilloscope
246 A - High sensitivity low-frequency oscilloscope
248 A - Maintenance oscilloscope.

Sweep frequency Generators

411 A - Laboratory sweep frequency generator
410 B - TV - FM sweep frequency generator
476 A - Radio sweep frequency generator

Signal Generators

405 A - Low frequency RC signal gen. (30 c/s-300 Kc/s)

Sensitivity: 1 V/cm or 10 V/cm (switch-selected)
Vernier: 0 to 1
Constant input impedance: 1 M Ω and 47 pF

Cathode-ray Tube

5 ADP 2 or equivalent type
Screen: 13 cm (5") dia.
deflection factors:
X: 30 V/cm (approx.)
Y: 20 V/cm (approx.)

Direct drive of H and V plates
Acceleration voltage: 3 Kv

MECHANICAL FEATURES

Light-alloy chassis, readily-detachable panel for easy access to circuits.

1) Tube complement

9/ECF80 - 2 NM2L or equivalent types

2) Power supply

105 - 115 - 127 - 220 - 240 V - 50 or 60 c/s

3) Dimensions

Width: 20,5 cm - (8")
Depth: 38,5 cm - (15")
Height: 31 cm - (12")
Weight: 14 kg - (30 lbs)

OTHER INSTRUMENTS

428 A - HF constant amplitude signal generator (100 Kc/s-30Mc/s)
458 - Pulse generator (5 c/s - 50 Kc/s).

TV pattern generators

465 C - Portable electronic pattern generator
464 A - Test - pattern generator

Regulated power supplies

117 A - Transistorised regulated power supply
114 A - Regulated power supply

Cameras

1000 A - oscilloscope camera with Polaroid
1001 B - oscilloscope recorder

INTER-PLANS

RIBET-DESJARDINS

MEASURE & CONTROL DEPARTMENT, 13-17, rue Périer MONTRouGE/PARIS TEL: ALESIA 24-40
CANADIAN BRANCH: RIBET-DESJARDINS (CANADA) Room 114, 5757 Decelles Avenue - MONTREAL.

NEW 40 MC PULSE GENERATORS

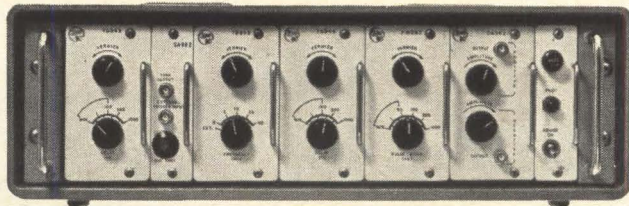

Feature Modular Expandability, Rise / Fall to 5 ns

The new SERVOPULSE® 9000 Series offers general-purpose pulse generators conveniently modularized to provide special capabilities. Among their outstanding features are very high clock rates, rise times to 5 ns and expandability which defies obsolescence. They deliver clean, sharp waveforms, and permit multi-pulse functions. Several Modules are available for each function of time delay, pulse width, frequency, and amplification. The units are packaged for either rack-mount or benchwork, with integral power supply. A wide spectrum of special functions is possible at prices you would expect for standard generators. Detailed information on request.

	MODEL 9350	MODEL 9450	MODEL 9455	MODEL 9550
Frequency Range	.2 cps—5 kc	100 cps—2 mc	100 cps—10 mc	2 mc—40 mc
Delay	.1 ms—1 sec.	0—1 millisecc.	0—1 microsec.	0—1 microsec.
Pulse Width	.1 ms—1 sec.	.1 μ s—1 ms.	25 ns—1 μ s	25 ns—1 μ s*
Simultaneous Pos & Neg Outputs	10V open circuit 7V into 93 ohms	10V open circuit 7V into 93 ohms	10V open circuit 7V into 93 ohms	10V open circuit 7V into 93 ohms
Rise & Fall Time	Under 5 nanosecc.	Under 5 nanosecc.	Under 5 nanosecc.	Under 5 nanosecc.
Max Duty Cycle At Full Amplitude	70%	70%—40% at 2 mc	90%	90%—60% at 40 mc
One Shot/Sync & External Trigger	Yes	Yes	Yes	Yes
Price	\$660.00	\$835.00	\$975.00	\$1,390.00

FLAT TOP FOR ALL INSTRUMENTS LESS THAN $\pm 2\%$ AT MAX. PULSE WIDTH.

* 15 ns at 40 mc



SERVO CORPORATION OF AMERICA SERVOPULSE® PRODUCTS
111 New South Road • Hicksville, L. I., New York • Wells 8-9700

Circle 205 on reader service card

Pt / PtRh

Thermocouple Wire

600°C - 1500°C

Thermocouples made of Reference Grade Platinum/Platinum-Rhodium match the EMF values given in National Bureau of Standards Circular No. 561 within $\pm 0.1\%$ above 600°C.

Write for Bulletin on Thermocouple Wires

SIGMUND COHN Corp.
121 So. Columbus Ave., Mount Vernon, N.Y.



SIGMUND COHN CORP. OF CALIFORNIA, Burbank, Cal. / SIGMUND COHN-PYROFUZE, INC., Dallas, Texas

New Instruments

from 0.1 to 10 sec. Sensitivity is adjustable from 0.001 to 100 v by decade switch and vernier. Unit is priced at \$3,000.

Intercontinental Instruments Inc., 123 Gazza Blvd., Farmingdale, N.Y. [356]

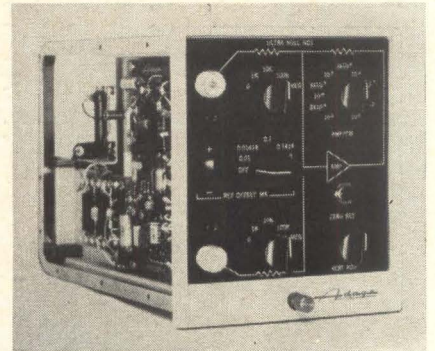

Scope preamplifier offers rapid recovery

The Ultra-Null oscilloscope plug-in preamplifier eliminates the difficulty previously encountered in measuring weak signals occurring within a few microseconds after high-amplitude transient signals. Recovery characteristics of other amplifiers have inhibited their low-level use for long periods after an overload signal. The Ultra-Null recovers in 1 μ sec. It can accurately measure and display a signal whose amplitude has changed 100,000-fold in a few microseconds. At the same time, the sensitivity is 10 microvolts per centimeter. Typical applications are: recovery characteristics of semiconductor diodes and transistors to nanoamp levels; recovery characteristics of precision wire-wound resistors; transient response characteristics of amplifiers to 0.001% of full scale; and frequency response of amplifiers and/or networks to 0.01%.
Adage, Inc., 292 Main St., Cambridge 42, Mass. [357]

Multichannel analyzer processes pulses fast

A 256-channel thin-film memory analyzer, model 34-26, is said to

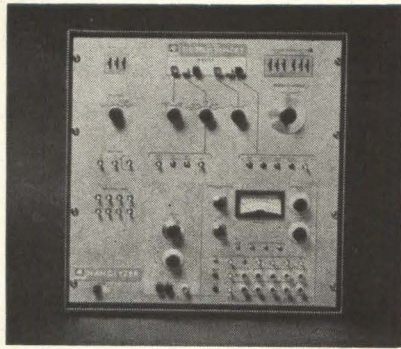

operate about 50 times faster than conventional multichannel analyzers. The memory and 100-Mc analog-to-digital converter permit experiments that were previously impractical. Ten to 50 times the number of pulses can be analyzed in any given period, permitting great saving in the accelerator's operating time. Analysis of extremely short half-lives and short burst activity is practical because many more pulses are processed by the analyzer. A double-delay-line amplifier and analog-to-digital converter are separate plug-in modules.

Radiation Instrument Development Laboratory, 4501 W. North Ave., Melrose Park, Ill. [358]

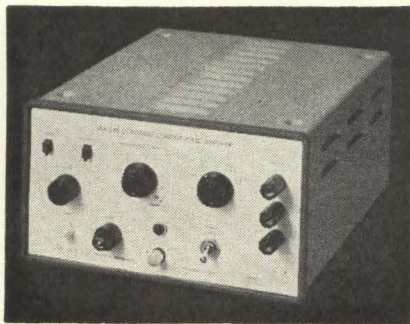

Pulse amplifier has variable output

An isolated and floating source of rectangular current pulses of duration determined by an external control signal, is provided by the LRA 046 constant current pulse amplifier. Amplifier current output may be varied from 0.1 ma to 50 ma in steps of 1, 2, 5 sequence, with variable control provided between steps, and as low as 20 μ a. An output function switch allows choice of positive or negative-going floating or grounded output pulse generation. Typical applications in-

GERTSCH STANDARDS RECEIVERS



VLF

PCR-1 Phase Comparison Receiver

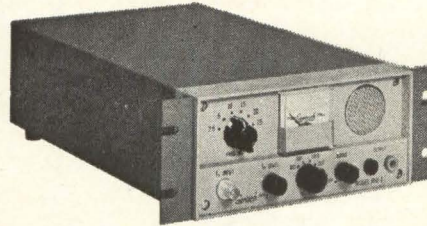

WWV

RHF-1 High-Frequency Standards Receiver

— provide rapid calibration checks on frequency and time standards ... frequency comparisons against carrier-stabilized frequency transmissions — with high accuracy

VLF Phase Comparison Receiver—an all solid-state receiver incorporating a built-in servo-driven, strip-chart recorder. Instrument features front-panel frequency selection, permitting rapid switching of up to 4 plug-in frequencies within the range of 10 to 100 kc. Frequencies are easily changed or added as they are needed. PCR-1 is for use with local frequency standards accurate to 1 part in 10^6 or better. Unit utilizes the propagation stability of low-frequency waves, allowing comparisons to an accuracy of 5 parts in 10^{10} to be made in one hour. Send for Bulletin PCR-1.

WWV High-Frequency Standards Receiver. Instrument is an all-transistorized superheterodyne unit designed for receiving WWV and other high-frequency standard transmissions. Ideal in precision time measurements, reception of standard audio frequencies, pulse code modulation, and radio propagation notices transmitted at these frequencies. Local frequency standards comparisons accurate to 1 part in 10^7 . Operates from either a 115/230-volt power line, or a 12-volt battery. Send for Bulletin RHF-1.

Gertsch

GERTSCH PRODUCTS, INC.

3211 S. La Cienega Blvd., Los Angeles 16, Calif. • Upton 0-2761 • Vermont 9-2201



Power Inverter

60 CYCLE SINE OR SQUARE WAVE FROM 6-48 VDC INPUT

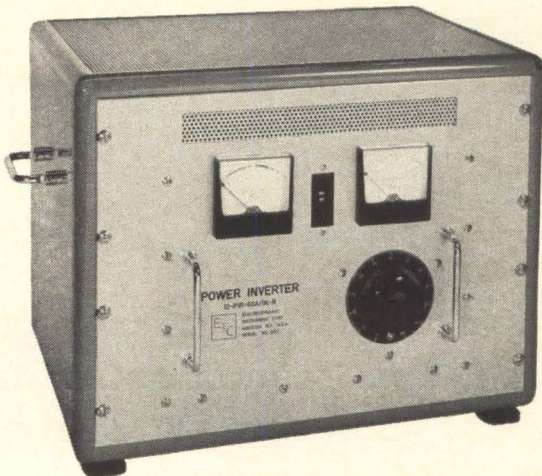

APPLICATIONS:

- Emergency line voltage supply
- AC power source in ground-support
- Pipe line control
- Ship board power source
- Microwave
- Mobile television-radio installations

The 1 KW series Power Inverter supplies a single phase, 60-cycle sine or square-wave output of 115 volts from a DC input in the 6 to 48 volt range. In the 2 KW series, a single driver stage operates two power amplifiers with separate, independently controlled 1 KW outputs. Each unit is equipped with adjustable output for 0 to 130 volts control.

KW/PI series Inverters are available in regulated or unregulated models with free-running oscillator, fork or crystal-controlled frequency source. KW/PI units will mount in standard 19-inch racks or in custom-built cabinets.

GEO SPACE CORPORATION



5803 GLENMONT DRIVE
HOUSTON, TEXAS 77036
TELEPHONE: AREA CODE 713-MO 6-1611
CABLE ADDRESS: GEOSPA

Around the world ...

KYORITSU Measuring Instruments

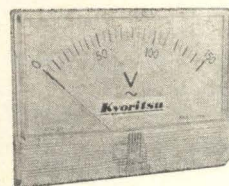
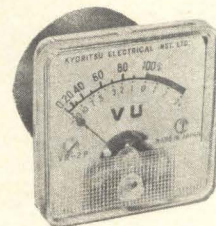
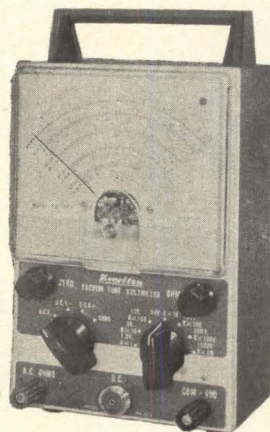

Kyoritsu

ELECTRICAL INSTRUMENTS WORKS, LTD.

120, Nakane-cho, Meguro-ku, Tokyo, Japan

Cable address: KYORITSUKEIKI TOKYO

Telex: TK 2849

Circle 206 on reader service card

NEW

Packed with more important data than ever before... the 1964-65 issue of **Electronics Buyers' Guide**. Four great major sections: Product Listings; Product Advertising; Index of Electronics Manufacturers; Government, Other Agencies and Technical Services.

USED

Week in, week out, EBG is the industry's standard catalog-directory... a necessary working tool for the men who buy and the men who sell components, equipment, systems, materials and services.

Electronics Buyers' Guide

A McGraw-Hill Publication
330 West 42nd Street,
New York, N.Y. 10036

New Instruments

clude: a pulse amplifier for high-current stimulation from a floating source, constant-current pulse generation, and an isolated current pulse that may have as its reference a d-c voltage reference level offset from ground. The LRA 046 will also function as an isolated constant current supply with a compliance of ± 200 v when operated continuously. Isolation of the output pulse is greater than 1,000 megohms at d-c. Price is \$235.

Argonaut Associates Inc., P.O. Box K, Beaverton, Ore. [359]

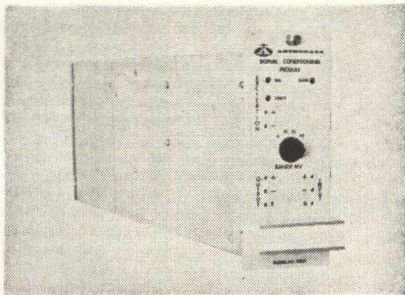

Signal conditioner features versatility

A universal d-c signal conditioner with self-contained excitation power supply and amplifier has been introduced. Model 2003 uses field-effect transistors in place of mechanical choppers in stabilizing circuits to yield maximum reliability. Plug-in circuit cards provide matching to any d-c transducer; bridge completion and balancing; thermocouple biasing; potentiometer signal or voltage attenuation; and complete manual or automatic calibration. Output levels of ± 5 v at 40 ma or ± 40 mv can be selected. From signal sources such as thermistor bridges, strain gages (1, 2, or 4 arm), resistance probes, thermocouple, and potentiometers, model 2003 provides complete conditioning facilities, including transducer excitation, bridge balancing and completion, thermocouple biasing, calibration, differential amplification, attenuation and filtering. Astrodata Inc., 240 E. Palais Road, Anaheim, Calif. [360]

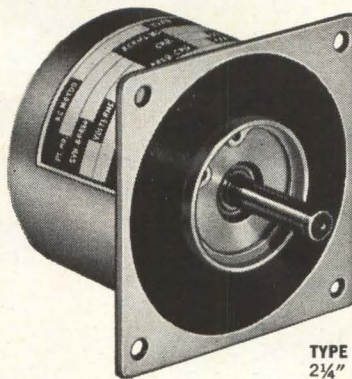

TYPE UC MOTOR
2¼" dia. x 3½" max. length

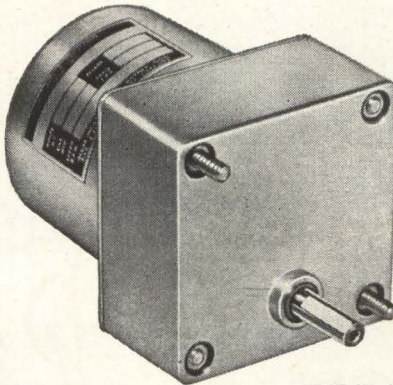

TYPE UC GEARMOTOR

NEW 2¼" A.C. GEARMOTORS HIGH TORQUE, MANY SPEEDS

Get torques from 1.2 oz. in. to 10 lb. in. from Globe's new Type UC commercially priced a.c. motor family. Induction capacitor motor is available in three stack lengths rated at 1, 3 or 6 oz. in. torque at 3,000 rpm. Standard windings available for 115 or 230 v.a.c., 1 or 3-phase, 2, 4 or 6 poles, 60 cps. Epoxy encapsulated stator seals out dirt and moisture. Motors have ball bearings, stainless steel bearing seats and shafts. Type UC is available with choice of 13 life-lubed spur gearheads with ratios from 6:1 to 1800:1, continuous output torques from .4 to 10 lb. in., speeds from 3,000 down to .8 rpm. Each gear cluster has separate mounting shaft for maximum support. Hysteresis synchronous versions can be stalled without damage. Mounting is interchangeable with traditional type 2½" motors. Request Bulletin UC.

Globe Industries, Inc., 1784 Stanley Avenue,
Dayton, Ohio 45404. Area 513 222-3741.



GLOBE

DUAL MOTOR MOUNT

shows versatility...

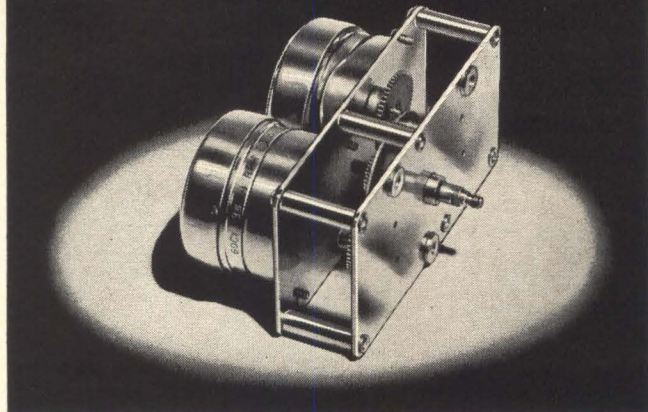

TWO SYNCHRON® MOTORS BY HANSEN provide flexible output speed from one shaft

Two SYNCHRON motors on a dual mount provide a good mix of accurate speeds from the same shaft in right or left rotation, or both; this or a similar mounting might solve a timing problem you have. There can be three precise speeds: the speed of one motor by itself, the speed of the second motor by itself, and the combined speeds of both. Perhaps you need only two speeds — fast and slow — but both must be accurate. This particular unit meets that specification; as an example, it can be applied for fast, accurate readout to a chart drive.

ALL SYNCHRON MOTORS will perform reliably for years. Two burnished Babbitt bearings on the polished rotor shaft of SYNCHRON motors are permanently lubricated with Hansen's own silicon formula. Gear train plates are of bearing bronze and gears are subject to 100 per cent inspection.

Hansen's hardened steel rotor ring has patented separations to delineate residual magnetic fields — providing additional torque — and the rotor moves between paired shaded inner and outer fields.

SYNCHRON motors and gear trains are available in 179 speeds at 8, 20, or 30 inch ounce torques rated at 1 RPM; a full range of voltages at 25, 50, or 60 cycles. Inquire today for full information.

MAXIMUM SPACE REQUIREMENTS
Round Mount — 2" diameter, 1 3/8" deep
Pear Shape — 2" wide, 2 1/2" high, 1 21/32" deep

OUTPUT DRIVES
Pinion drives, flatted, threaded, cross-drilled, knurled, or slotted shafts; adapters, or crank assemblies. OR HANSEN WILL INTEGRATE PINIONS, GEARS, OR SPECIAL DRIVE ASSEMBLIES OF YOUR OWN MANUFACTURE.

Information on D.C. motors available on request.



Sweet's Product
Design File

**HANSEN
MANUFACTURING
COMPANY, INC.**
PRINCETON, INDIANA

Handled exclusively in Canada by Sperry Gyroscope Ottawa Ltd., Ottawa, Canada

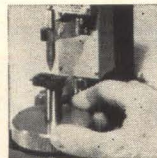

NEW!

AC Power Supply

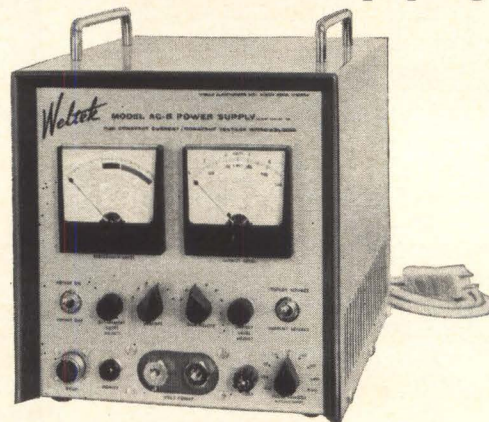

for

Miniature Welding

A true AC welder so finely controlled that it will solve almost any microminiature welding problem! Has upslope and downslope controls, 10 to 800 ms pulse length, resistance sensor, both constant V. and constant I. source. Send for details on Model AC-5.

Weltek Precision Welders
by WELLS ELECTRONICS, INC.
1701 S. Main Street, South Bend, Indiana, U.S.A.

Circle 207 on reader service card

VITREOUS-SILICA

(PURE FUSED QUARTZ) is

VITREOSIL®

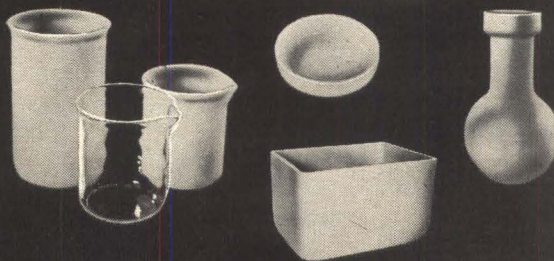

Once a laboratory curiosity pure fused quartz now plays leading roles in American industry. It handles hot liquids or gases up to 1100°C, is virtually corrosive free, is unaffected by thermal shock and has exceptional optical and electrical qualities. Write for our 32 page catalog today for more details on "VITREOSIL".

24



THERMAL AMERICAN FUSED QUARTZ CO.
RT. 202 & CHANGE BRIDGE RD. MONTVILLE, NEW JERSEY

New Semiconductors

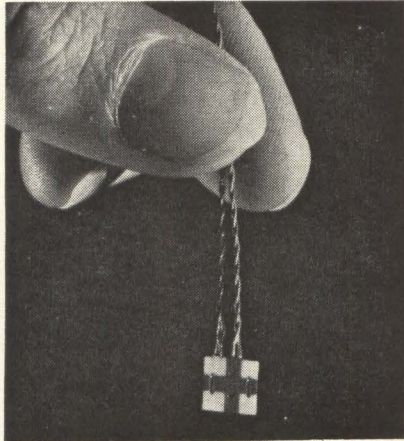

Hall generator uses alumina substrate

A new low-cost Hall-effect voltage generator accepts two inputs: a current and a magnetic flux field. The output voltage is proportional to the vector cross product of the two inputs. Model 331 features higher sensitivity and reliability than its predecessors, but is half the size and less than half the price. It measures only 0.240 in. by 0.240 in. by 0.020 in. and has a thin film of indium arsenide vacuum-deposited on a non-magnetic alumina substrate. This substrate displays thermal conductivity 15 times better than glass, and provides increased dynamic range with minimum disturbance in the flux field. The indium arsenide film gives optimum performance over a wide temperature range. Available output sensitivities range from 0.2 to 1.2 v/ampere-kilogauss. Connecting leads are 32 gage copper wire spot-welded to the metallized substrate for extra ruggedness and reliability. Prices begin at \$9.75.

Helipot Division of Beckman Instruments, Inc., 2500 Harbor Blvd., Fullerton, Calif. [331]

Rectifiers feature controlled avalanche

Three new series of controlled-avalanche silicon rectifiers include the 1-amp type FA in 400, 600, and 800-v piv ratings, and the 6-amp

HA3 and 12-amp ST2A, both offering 100 to 600 piv. Units are made of silicon with low resistivity, and low radial gradient with controlled lattice dislocation. Extremely high transient over-voltages can be withstood, since the units are capable of dissipating the same power in the reverse as in the forward direction. Dielectric breakdown is eliminated. Only thermal conditions must be met as units cycle in and out of avalanche region to the limit of heat-dissipation capacity. Sarkes Tarzian, Inc., 415 North College, Bloomington, Ind. [332]

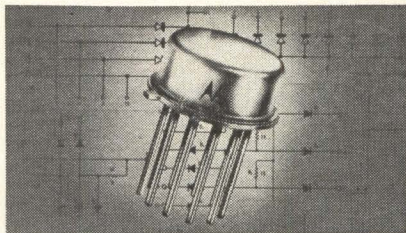

Integrated circuits meet military specs

Eight integrated circuits meet MIL-M-23700/1 (Navy) through MIL-M-23700/8 (Navy), the first MIL specs issued for integrated circuits. Types USN ME1 through USN ME8 are designed for use in high-speed diode transistor logic systems and can be used for various gating functions. The USN ME1-4 are diode AND gates with different input configurations; the USN ME5 is a dual inverter; and the USN ME6-8 are memory-drive diodes. All circuits are packaged in the low-profile, 10-pin TO-5 package. Gates with propagation delay as low as 5 nsec can be fabricated using the USN ME1 through 5 configurations. Surface-passivated diodes used in this series are similar to 1N914-type high-speed devices. The USN ME6-8 diode arrays are 40-v devices with a rated 1.2 v maximum forward voltage drop at 300 ma. The diode elements are basically similar to the 1N697 diode, but have a faster maximum recovery time of 90 versus 150 nsec. Motorola Semiconductor Products, Inc., Phoenix, Ariz. [333]

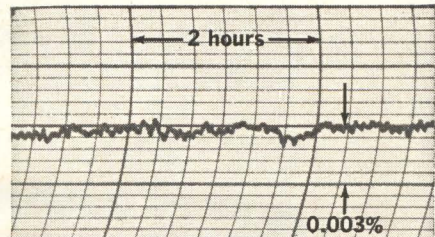

0.0025% stability

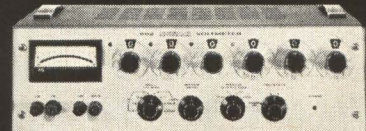

0.01% accuracy



NEW DC DIFFERENTIAL VOLTMETER

The Keithley Model 662 is a self-contained, guarded potentiometer system. Measuring dc voltages from 100 millivolts to 500 volts within 0.01%, it provides stability approaching that of a primary standard. Used with a recorder, the 662 can detect source instabilities down to 25 ppm over weeks of continuous measurements.

- infinite input resistance at null
- zener diode reference eliminates need for manual restandardization
- 100 microvolt f.s. null range
- 0.0025% repeatability
- 6-dial readout
- price \$995

also available

Model 660 (0.02% limit of error) \$650

send for new 662 Engineering Note



KEITHLEY INSTRUMENTS

12415 Euclid Avenue • Cleveland 6, Ohio

New Subassemblies and Systems

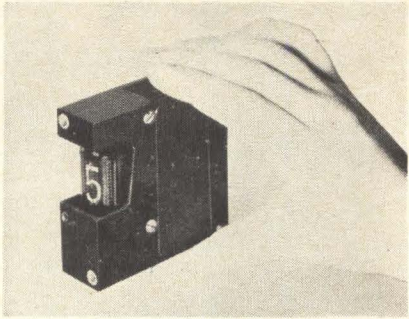

Latching display for readout storage

A new latching display module fills the need for a low-cost memory readout storage display in applications involving decoding, storing and reading of relatively high-speed, binary-coded numerical data. On command of a pulse—which can be initiated manually or under control of an automatic sequencing device—the all-silicon

module B100-21 will display the numerical digit represented at that time to its input. Thus, digital data received in serial/parallel form can be "latched" onto at any desired time and presented for convenient visual observation. A major feature of the unit is that it can be made to accept any standard or special binary code at its input, including: 8-4-2-1, 4-2-2-1, and 2-4-2-1. Another feature is the provision of a low-level blanking control. Operating temperature range is -20° to $+85^{\circ}\text{C}$. Price is \$49.50. Janus Control Corp., Hunt St., Newton, Mass. [371]

Electrooptical pen speeds data processing

A new electrooptical pen permits "closing the loop" in man-machine communications systems by controlling the generation of digital pulses

to read, edit, and transmit information from plan-position-indicator and character-generating crt's. The triggered pulse coincides with the leading edge of the crt writing pulse. Design features of the Photo-pen that make it feasible as a display-processing link are the very high speed of response, extreme sensitivity, and precise selectivity of display data on the crt face. Linking to the computer is

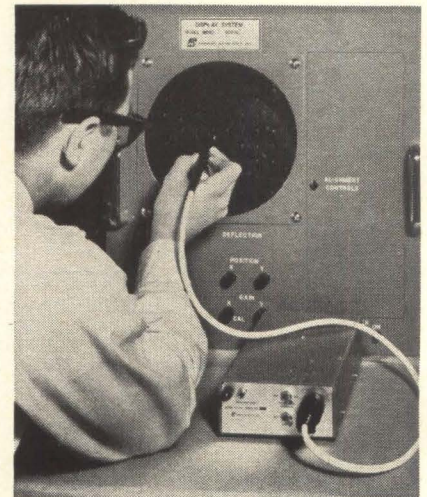

NEW!

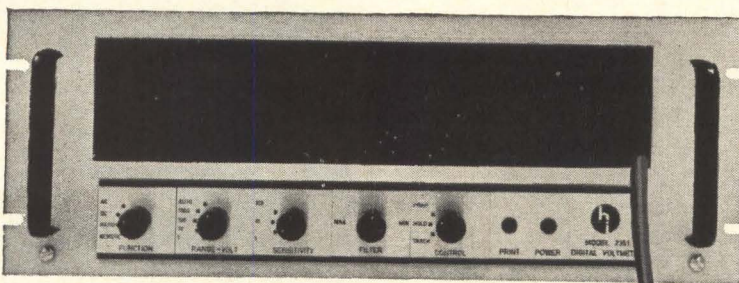

in digitals

The working removable readout of the model 2351 DVM is just one of its many operating features and conveniences, which are listed on the opposite page. These complement the following solid specifications:

- 10 μV sensitivity
- .005% DC accuracy
- completely floating
- common mode rejection is 120 db at DC, 100 db at 60 cycles
- all reed switching
- 0° - 50°C operating temperature range with no change in accuracy $\pm 15^{\circ}\text{C}$ about 25°C operating ambient temperature



houston instrument corporation

4950 Terminal Avenue / Bellaire, Texas 77401 / MOhawk 7-7403
Cable: HOINCO / TWX 713-571-2063

(Advertisement)

Multi-Channel Analyzer Recorder Readout

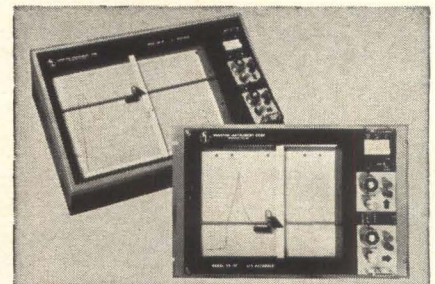

Through a unique design approach to null detection, these new X-Y recorders are fast, accurate, sensitivity-adjustment-free point plotters for use with pulse-height analyzers and averaging computers. Models HR-95TN ($8\frac{1}{2}'' \times 11''$) and HR-97TN ($11'' \times 17''$) feature better than 0.01% sensitivity, 7 point/sec. maximum point plotting speed, 0.25% overall accuracy and 0.1% repeatability. Price FOB Houston: HR-95TN \$1525, HR-97TN \$1625. Availability: 30 days ARO. Houston Instrument Corp., 4950 Terminal Ave., Bellaire, Texas 77401.

CIRCLE 201 ON READER SERVICE CARD

THE FRONT DISPLAY PANEL SNAPS OUT

accomplished by gating with proper voltage and impedance values. The output of the Photo-pen is conducted by the center bundle of coax fibers, and is not affected by any of the following conditions: increased signal intensity, changes in ambient lighting, or reflections from the tube face. Response of the beam permits it to detect displays with sweep times from 1 μ sec/cm and sweep frequencies up to 15 kc. Pulsed beam detects pulsed displays with pulse widths from 0.2 μ sec to 1.0 millisecc and repetition rates to 15,000 cps. Output voltage is + 4 v, 10 μ sec duration, especially suited for digital system use. Price is \$1,500.

Sanders Associates, Inc., 95 Canal St., Nashua, N.H. [372]

Vhf multipliers handle input power to 30 w

Two solid-state vhf frequency multipliers, the P8404 and P8405, are well suited for use in wide-range tunable oscillators. They are also

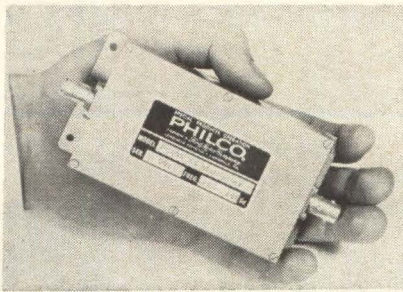

ideal for application in broadband frequency generators and synthesizers operating in the microwave region. Designed to handle input powers up to 30 w, the multipliers exhibit conversion efficiencies greater than 42%, with less than 0.4 db variation over a 15% bandwidth. Both multipliers are frequency triplers, the P8404 converting inputs between 40.0 and 46.6 Mc to outputs between 120 and 140 Mc, and the P8405 converting inputs between 120 and 140 Mc to outputs between 360 and 420 Mc. Spurious outputs from both multipliers are maintained at least 25 db below signal level.

Philco Corp., Lansdale, Pa. [373]

Tiny delay line is continuously variable

Subminiature continuously variable delay lines are announced. Delay time from 0 to 60 nsec, at impedances of 300 to 600 ohms, is avail-

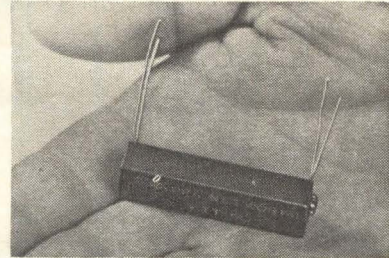

able. Rise time obtained is approximately 5 to 15 nsec and dielectric strength is 300 v. Resolution of better than 0.5 nsec is obtained and attenuation is less than 0.5 db. Mounting is provided for p-c boards or units can be stacked. The shafts use "O" ring seals and leads are Dumet, which are solderable and weldable. Contacts are of precious metals. Operating tempera-

(Advertisement)

New Millivoltmeter Offers Wide Frequency Range



Model VM-77B is a versatile, general purpose instrument for laboratory and production work. It has 12 ranges between 0.001 volts and 300 volts AC full scale and a frequency range of 10 cps to 4.5 megacycles. Input impedance is 10 megohms 20 pf. Amplifier output maximum is 1 volt RMS. Price FOB Houston: \$195. Availability: 2 weeks ARO. Houston Instrument Corp., 4950 Terminal Ave., Bellaire, Texas 77401.

CIRCLE 202 ON READER SERVICE CARD

FOR REMOTE READOUT . . . UP TO SIX FEET.

fully operable
**REMOVABLE
READOUT**



Supplementing the unparalleled specifications listed on the facing page, model 2351 DVM offers the following operating features and conveniences:

- internal calibrating voltage
- six digit resolution with front panel analog meter
- AC/DC/ratio measurements in one instrument
- printout, remote programming and AC converter can be incorporated into basic DC/ratio instrument in the field



houston instrument corporation

4950 Terminal Avenue / Bellaire, Texas 77401 / MOhawk 7-7403
Cable: HOINCO / TWX 713-571-2063

PRODUCT NEWS from EPL

NEW... hi-voltage regulated DC Power Supply under \$400.

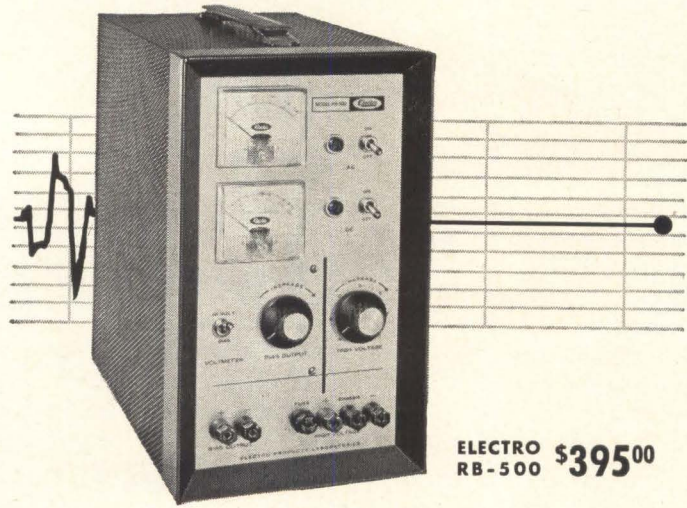

ELECTRO RB-500 \$395.00

Compare Value

Brand	Volts	Current	Regulation (Combined line & load)	Price
K	0-325	0-200 MA	0.02%	\$495.00
S	0-500	0-200 MA	2.0%	400.00
Electro RB-500	0-500	0-250 MA	0.03%	395.00

Compare Features

High Voltage Output: 0-500 VDC. 0-250 MA
Precise Regulation: 0.03% or .015V, whichever is greater, for combined line (105-125V) and load (no-load to full-load) variations.
Ripple: 5MV, RMS maximum.
Bias Output: 0-150 VDC.
Filament Outputs: Two separate 6.3V at 5A outputs for 6.3V at 10A or 12.6V at 5A.
Primary and Secondary Protection.
2% D' Arsonval Meters: Dual scale . . . 0-500V/0-150V. 0-250 MA
Separate AC, DC Switches.
Continuous Output Voltage Adjustment: Regulation maintained well below 3V output setting.
 Wherever precisely regulated DC power is a must, the EPL RB-500 fills the bill economically. Engineered and built for heavy-duty production testing; electronic circuitry development and design in industry, laboratories and schools.

Write for Literature & Name of Your Electro Distributor!



ELECTRO PRODUCTS LABORATORIES
 6125-F Howard, Chicago (Niles), Ill.
 60648 Phone: 312/775-5220
 Canada: Atlas Radio Corp., Toronto

3200

Since 1936—Pioneers in DC Power Supplies

HOW TO USE CATALOG 700



FOR ALL IT'S WORTH!

TAKE ADVANTAGE OF UNIQUE INDEXING (PAGE 172-6)

Find any part in seconds, anywhere in your comprehensive design catalog of more than 15,000 *guaranteed* CAMBION® electronic components. Exhaustive master index locates products by part number, function code, volume weights. Helpful cross-reference list identifies simplified new part numbers. Countless other aids for locating and selecting specific components. Contact your authorized CAMBION Distributor or write for particular samples, problem solving or additional free copies of Catalog 700. Cambridge Thermionic Corporation, 205 Concord Ave., Cambridge, Massachusetts 02138.



Standardize on CAMBION...The Guaranteed Electronic Components
 Circle 215 on reader service card

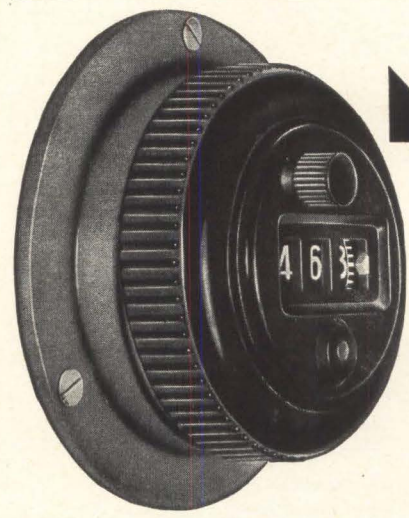

With or without locking device



Counting knob Zivy Z 1003

for mounting on precision multiturn-potentiometers, controls of precision instruments, for machine tools, etc. read to 1/500 of a turn estimate 1/1000th
 Z 1003 A = On-Panel Mounting
 Z 1003 E = Flush Mounting, with flange

Write to:
V. G. Herman
 49 West 96th Street
 New York 25, N. Y.
 Phone:
 Riverside 9-3369

New Subassemblies

tures range from -55° to $+125^{\circ}$ C. Kappa Networks, Inc., 165 Roosevelt Ave., Carteret, N.J. [374]

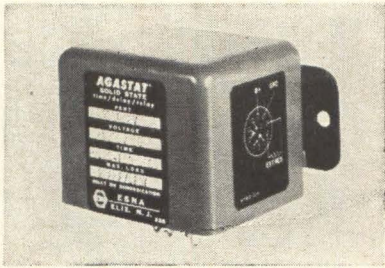

Timing circuit delays relay dropout

Series 2733 represents a practical delay-on-dropout solid-state time-delay relay. The R-C timing circuit provides delays up to 100 sec upon removal of power. No stand-by power is required during the timing cycle. Unit is available in two timing ranges—0.020 to 10 sec and 0.20 to 100 sec, for operation from 18 to 32 v d-c, -55° C to $+71^{\circ}$ C ambients. It offers dpdt relay output, with capacities of 2, 5 or 10 amperes (to MIL-R-5757D) at 32 v d-c, resistive. Repeat accuracy is ± 3 percent at fixed conditions, ± 10 percent over voltage and temperature extremes. Price is \$214. Elastic Stop Nut Corp. of America, Elizabeth 3, N.J. [375]

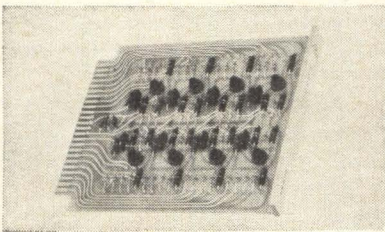

Logic modules have high fan-out

Availability of a 2-Mc series of digital logic modules is announced. The modules have high fan-out capability and high noise rejection, use saturated circuits and clamped loads. Both NAND and inverter logic are offered. Modules are manufactured of military-grade glass base epoxy,

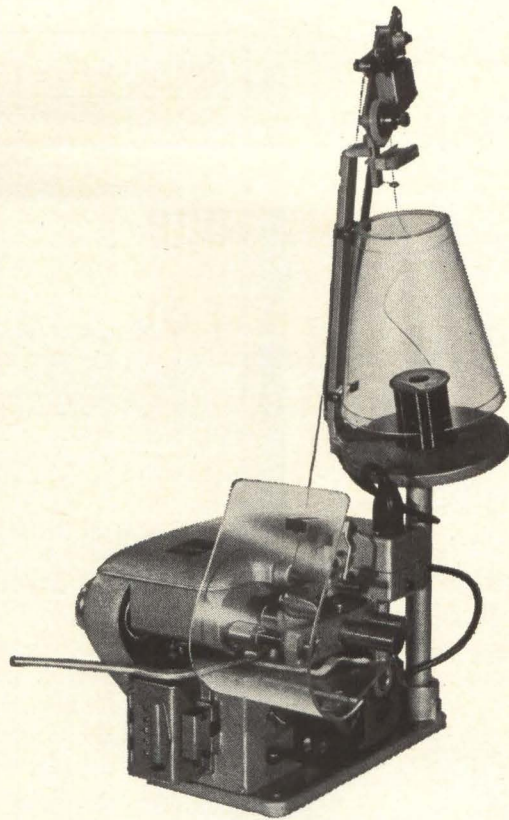

Leesona[®] Bachi Bobbin Winder No. 115

Compact—Leesona No. 115 is a single head winder suitable for bench mounting.

Flexible—winds all types of coils up to 3" diameter and 3" long.

Fast—runs up to 12,500 R.P.M., and as high as 15,000 R.P.M. when coil construction and wire size permit.

Accurate—stops automatically within ± 2 turns of predetermined counter setting.

Easy to operate—when coil is completed, one lever retracts tailstock, opens guard, resets counter, returns wire-guide to starting position. One operator can tend more than one machine.

For detailed information describing LEESONA NO. 115 and other coil winders write Leesona Corporation, Warwick, R.I.



23B.4.6

NO MORE POWER FAILURES!

Not even a flicker of
the lights as an
ELECTRO-PAC "A"
Standby Power Supply
maintains
uninterrupted power
to the load

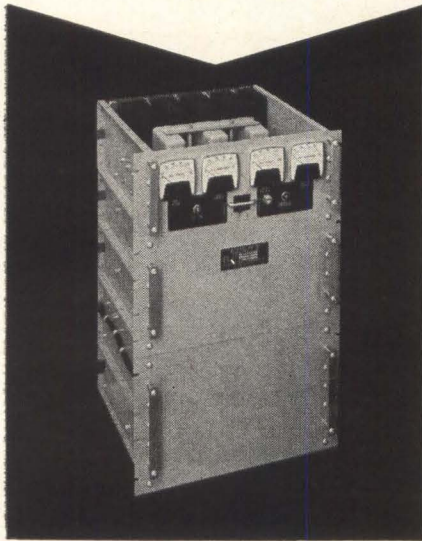

The ELECTRO-PAC "A" is more than an emergency inverter which changes a reserve power battery source to ac... it is a full-time voltage regulator, maintaining the ac line within $\pm 5\%$ of 120 volts.

For emergency power when a few cycles interruption can be tolerated, the economical ELECTRO-PAC "B" is available... to "invert" dc to sinusoidal ac... for use with dc generators... to provide an ac source while "floating" on a battery.

ELECTRO-PAC "A" or "B" units are available for outputs of 0.5 to 5 KVA and for use with inputs of 22-28 v., 42-56 v., and 100-140 v., dc. Efficiencies up to 80%.

Write for application bulletins on standard "A" and "B" units. Complete standby power systems also available.

**ELECTRO-SEAL
CORPORATION**

946-C North Avenue
Des Plaines, Illinois



New Subassemblies

have rhodium-plated contacts, and use computer-grade components. Control Equipment Corp., 19 Kearney Road, Needham Hts., Mass. [376]



Phase-tracking receiver for 10 to 60 kilocycles

All-channel vlf phase-tracking receiver tunes continuously from 10 through 60 kc and locks on any one of the 501 channels on multiples of 100 cps in this band. Model 1312 includes a receiver, synthesizer and phase-tracking servo in a compact modular package, occupying only $5\frac{1}{4}$ in. of standard 19-in. rack space. Features include an ultra-stable synthesizer whose frequency may be quickly set and is continuously monitored in a digital display, broad- and narrow-band signal outputs (at 2 kc), an auxiliary broadband-detected output for 60 kc (WWVB) modulation, both amplitude and accumulated phase-shift output data. Sensitivity is 0.05 μ V and rejection of spurious responses is better than 60 db.

RMS Engineering, Inc., 486 14th St., N.W., Atlanta 30318. [377]

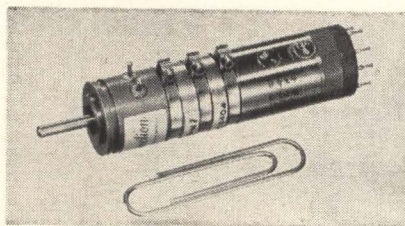

Module controls aircraft altitude

Servo mounting module MCO8-2 combines, in line, a magnetic clutch, synchro transmitter and a spring return in a package less than $2\frac{3}{4}$ in. long and weighing 4.5 oz. In a typical altitude-control application, the module's clutch is acti-

SPECIFY Stromberg-Carlson TELEPHONE-TYPE RELAYS

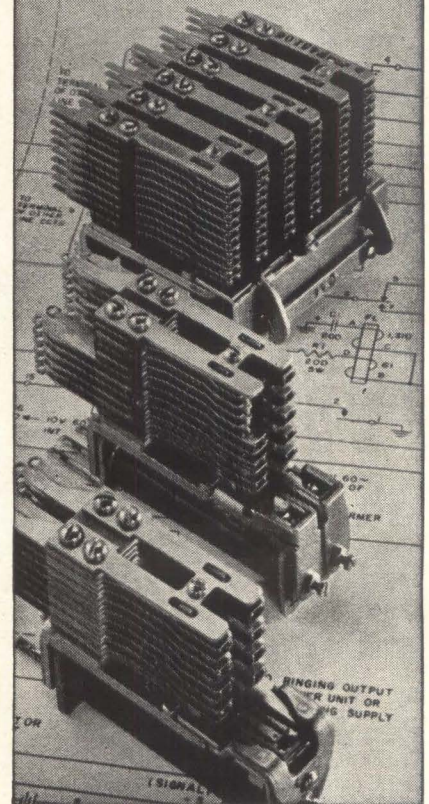

The sound design and long, reliable life of these Stromberg-Carlson relays have been proved by many years of successful use in the exacting field of telecommunication:

Type A: general-purpose relay. Up to 20 Form "A" spring combinations.

Type B: multi-contact relay. Up to 60 Form "A" spring combinations.

Type BB: multi-contact relay. Up to 100 Form "A" springs.

Type C: two relays on one frame; mounts in same space as one Type A.

Type E: general-purpose relay; universal mounting; interchangeable with relays of other manufacturers.

All standard spring combinations are available in these telephone-quality relays. For complete technical data and details on special features, write to Industrial Sales Department.

STROMBERG-CARLSON
A DIVISION OF GENERAL DYNAMICS
114 CARLSON ROAD • ROCHESTER 3, N. Y.

vated when a desired altitude has been attained. This sets the electrical zero of the synchro transmitter at the referenced altitude. If the altitude changes, the transmitter turns, providing an error signal that is used to correct the craft's altitude. To resume manual altitude control, the pilot disengages the clutch, and the synchro is automatically spring-returned to zero position.

Technology Instrument Corp. of California, 850 Lawrence Dr., Newbury Park, Calif. [378]

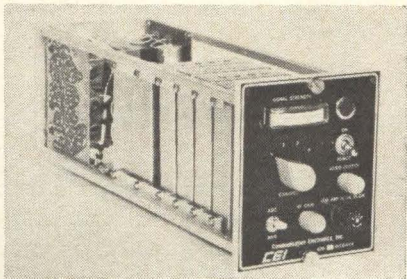

**Pulse receiver
is crystal-controlled**

Type 406 four-channel, crystal-controlled, wide-band pulse receiver, for surveillance work and telemetry applications, covers the 60 to 155-Mc frequency range. It uses transistors to achieve low power consumption and low heat dissipation. The i-f bandwidth is 2 Mc. Total dimensions are 5 in. high by 4.5 in. wide by 14 in. long, allowing as many as three receivers to be mounted in the same 19-in. standard rack. Price is \$995.

Communication Electronics, Inc., 4908 Hampden Lane, Bethesda 14, Md. [379]

**Q-spoiler device
boosts laser outputs**

A new Kerr Cell laser Q-spoiling device makes it possible for presently existing ruby lasers to deliver

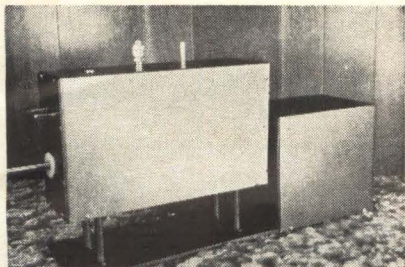

engineering report no. 132

**what you
should know
before
you specify
(HIGH TEMPERATURE)
ceramic
to-metal
seals**



CI's Engineering Report No. 132 poses all the questions that should be asked before you specify your high temperature Ceramic-to-metal seal requirements. Write for your free copy of this report . . . today.



CERAMICS INTERNATIONAL CORP.
MAHWAH, NEW JERSEY

COMINCO
HIGH PURITY METALS
AVAILABLE FORMS

clip and save

Product	ALUMINUM	ANTIMONY	ARSENIC	BISMUTH	CADMIUM	GOLD	INDIUM	LEAD	SILVER	TIN	ZINC
BARS	✓	✓	✓	✓	✓	✓	✓	✓	✓	✓	✓
SHEETS	✓				✓	✓	✓	✓	✓	✓	✓
WIRE	✓				✓		✓	✓		✓	✓
POWDER		✓	✓	✓	✓	✓	✓	✓	✓	✓	✓
SHOT		✓		✓	✓	✓	✓	✓	✓	✓	✓
ROD	✓			✓	✓		✓	✓	✓	✓	✓
RIBBON							✓	✓			
PRE-FORMS	✓				✓	✓	✓	✓	✓	✓	✓
SALTS					✓		✓				

COMINCO PRODUCTS, INC.

electronic materials division

933 West Third Avenue, Spokane 4, Washington

Phone Area Code 509 RI 7-7103 • TWX 509 328-1207

3402

Circle 217 on reader service card

HAVE YOU CONSIDERED
USING PHOTOCELLS?



WE'VE JUST MADE IT
EASY FOR YOU ...

Free On Request —
Designers' Kit Information
plus New 1964 Edition
16 page Designers' Manual

New! — from Clairex — a selection of photoconductive cells, varying in sensitivity, spectral response, speed and size to suit most applications, and including the CL505, CL603A, CL704L, CL707 and CL902 — in convenient kit form complete with technical data — only \$10.00.

CLAIREX

"The LIGHT Touch in Automation and Control"

8 West 30 Street, New York, N. Y. 10001, 212 MU 4-0940

142 Circle 142 on reader service card

New Subassemblies

giant power pulses in excess of 200 million w. Model 560 is designed around the electro-optical characteristics of nitrobenzene under an applied field, in conjunction with two Glanprisms. Pulse widths of 10 nsec and less have been consistently achieved with this device in both laboratory and field tests. Price is \$4,000.

Maser Optics, Inc., 89 Brighton Ave., Boston, Mass. 02134. [380]

Laser modulator spans d-c to 4.5 Mc

Developed as part of a space communications program, the AM-4 laser optical modulator is now being fabricated as a new product. The c-w unit can transmit television images using a beam of light generated by a laser. It occupies less than 11 cu. in., weighs one pound, yet is simple in design and very reliable. Bandwidth is from d-c to 4.5 Mc at 40% modulation and less than 2 w of input power is required. Primary applications are communications, display, recording and optical radar. Price is about \$4,000.

North American Aviation, Inc., 12214 Lakewood Blvd., Downey, Calif. [381]

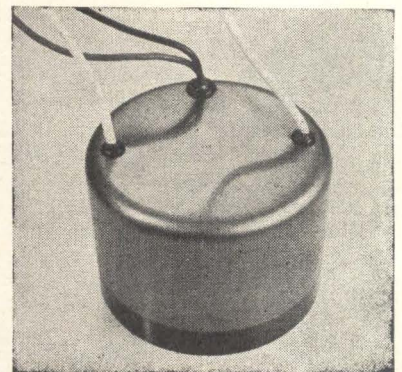

Energy pump supply furnishes 300 joules

All-solid-state energy pump power supply model 285 furnishes 300 joules at voltages up to 20 kv d-c to capacitor banks in energy pumps used for pulsed lasers. Output is current limited and fully floating.

Electronics | May 18, 1964

Supply is 6 in. in diameter and 4½ in. high, and is ruggedized for use in adverse environments. Operating temperature range is -55° C to +100° C; vibration, 20 g to 20 kc, shock or acceleration, 100 g. It operates to vacuum and in 100-percent humidity or salt-spray environments. Price is approximately \$345, depending on specified voltage.

Grafix Inc., Box 3296, Albuquerque, N.M. 87110. [382]

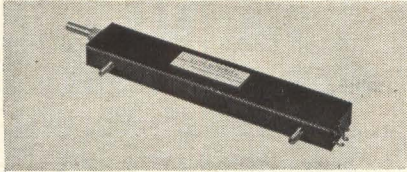

Variable delay lines with fast rise times

Continuously variable delay lines with delay times from 0 to 1,500 nsec at impedances of 100 to 1,000 ohms are being offered. The temperature coefficient of delay is 50 ppm/deg C, and resolutions of 1/1000 of total delay or 1 nsec (whichever is greater) are available. All units use "O" ring shaft seals and the operating temperature is - 55 to + 125°.

Kappa Networks, Inc., 165 Roosevelt Ave., Carteret, N.J. 07008. [383]

Smallest transceiver offers a-m and f-m

Compact 1-kw transmitter/receiver combination is claimed to be the smallest uhf radio system ever designed to operate in both the a-m and f-m mode without an adapter. It occupies only 2.30 cu ft of space. Total volume of the transmitter is 1.91 cu ft; receiver, 0.39 cu ft. With a frequency range of 225 to 400 Mc, the a-m/f-m transmitter is designed to handle either single or multi-channel transmissions, voice

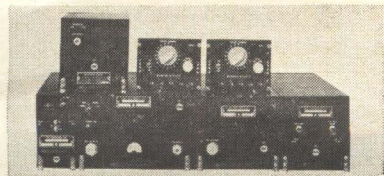

-260° C. to +500° C. Industrial temperature sensors

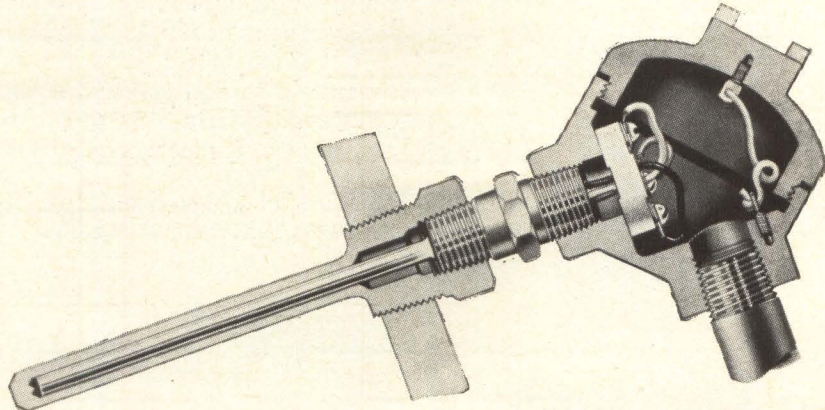

REC's 104 series platinum resistance temperature sensors

Models for direct immersion, thermowell, or surface applications. Designed for high pressure and a wide temperature range, this new line of rugged, platinum resistance temperature sensors is competitively priced. Check these features of the Model 104 series:

- Wide range: -260° C. to +500° C.
- Stability: repeats within 0.05° C. at 0° C. when used over above range.
- Fast Response: Models available with time constant less than one second.
- Interchangeability: within 0.1% of master resistance curve at 0° C (or within 0.250° C.)
- Versatility: Mount in thermowells, directly into pipes or pressure vessels, or on surfaces.
- High Pressure Rating: 3000 psi on all models.

The REC Model 104 element is made of highly pure platinum wire mounted strain-free in a ceramic rod, and hermetically sealed into a stainless steel sheath. Sensors are available with diameters as small as .084". Many options in mountings, lead wires, and connectors.

A complete line

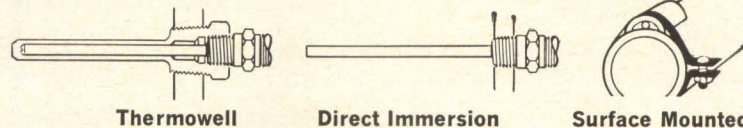

For further details on how the new REC Model 104 sensors will fit your application, write for Bulletin 8622 on Industrial Applications of platinum resistance temperature sensors. This 32-page bulletin gives a variety of fundamental engineering data on platinum thermometry and provides detailed performance specifications.



**ROSEMOUNT
ENGINEERING
COMPANY**

4900 West 78th Street • Minneapolis 24, Minn.

SPECIALISTS IN TEMPERATURE & PRESSURE MEASUREMENT

Master Eraser



CEC's high performance Automatic Tape Degausser

The CEC TD-2903 Automatic Tape Degausser has set a new standard of efficiency for the erasure of all types of magnetic tape.

Here are some of the TD-2903's significant advantages:

- Degausses magnetic tapes a nominal 90 db below saturation level in only 120 seconds.
- Accepts all reel sizes; tape widths from 1/4" to 2", including video tape.
- Anyone can operate it. Just press a button, and the tape is automatically erased.
- Weighs only 90 lbs. (15" x 12" x 23") so will fit a bench top, RETMA rack or cabinet.
- Virtually maintenance-free due to superior components and simplicity of design.

Add up the reasons for selecting CEC's TD-2903, and you can understand why it is becoming so popular with both the electronics and broadcasting industries.

For further information, call or write for Bulletin CEC 2903-X11.

CEC
Data Recorders Division
CONSOLIDATED ELECTRODYNAMICS
A SUBSIDIARY OF BELL & HOWELL/PASADENA, CALIF. 91109
INTERNATIONAL SUBSIDIARIES: WOKING, SURREY, ENGLAND
AND FRANKFURT/MAIN, GERMANY

New Subassemblies

or high speed data. Combination can be used duplex in transmitter-receiver pairs or simplex as a transceiver. Transmitter includes four separate modules, giving it a flexibility particularly appropriate for aircraft use. It meets requirements of MIL-E-5400.

Electronic Communications, Inc., Box 12248, St. Petersburg 33, Fla. [384]



Digital translator aids systems integrator

This all-purpose unit, model 160, compensates for logic differences between incompatible digital systems. It increases or decreases logic levels, shifts voltage references and performs logic inversions as required for correct interfacing. Different combinations of internal modules permit a variety of operations—from 10-bit translation, inversion and power amplification to 30-bit operation at one function (translation, inversion or power amplification). Five models cover a wide range of digital data processing requirements. Basic model 160, rated at 10 ma per channel, performs conversions at bit rates from d-c to 10 Mc and at a maximum data level of ± 12 v. Optional high-current drivers for relay or lamp-driven applications control more than 1 w per channel at bit rates from d-c to 100 kc and a maximum data level of 30 v. Translators with integral logic inverters also are available.

Missouri Research Laboratories, Inc., 2109 Locust St., St. Louis, Mo. [385]

Operational amplifier with differential input

An all-solid-state differential d-c amplifier is designed primarily for application as an operational amplifier. The differential input capability and the extremely high open-loop gain allow versatile

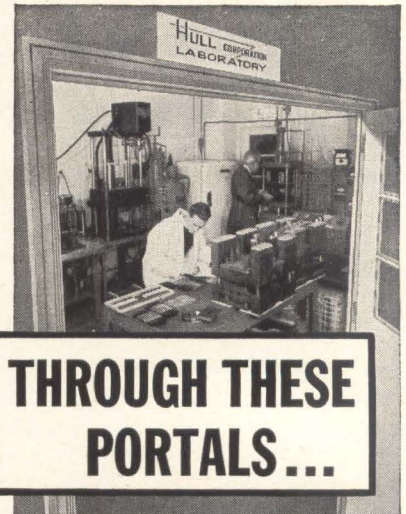

THROUGH THESE PORTALS...

...pass the most skeptical electronics engineers in the world!

Here's why they come to Hull Corporation's Laboratory.

They want to see how Hull equipment can encapsulate their components—in quantity—at guaranteed production rates.

They need to know how the Hull "package" plan combines engineering, compound selection, design of molds and fixtures—and the working setup.

They query us about encapsulation by transfer molding, about vacuum potting. About our proportioning, mixing and dispensing machines for short pot-life resin systems.

They demand proof that Hull can recommend an ideal process for insulating components against shock, vibration, corrosive atmospheres, high ambient temperatures.

Like to know "What's in it for me?"

You're invited!

HULL H-12
CORPORATION
4320 Davisville Road
Hatboro, Pennsylvania 19040

Export Division:
1505 Race St., Philadelphia, Pa. 19102

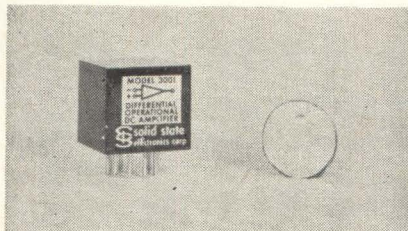

utilization of external networks and closed-loop negative feedback to achieve exceptional stability, high linearity and precise predictable transfer functions. Model 3001 typically has an open-loop gain greater than 50,000, a non-inverted input impedance of 1 megohm, a gain-bandwidth product of 2 Mc and an output capability up to ± 10 v at ± 2 ma. These characteristics are extremely useful for closed-loop feedback designs. Under typical operating conditions, the equivalent input drift is less than 100 μ v. Solid State Electronics Corp., 15321 Rayen St., Sepulveda, Calif. [386]

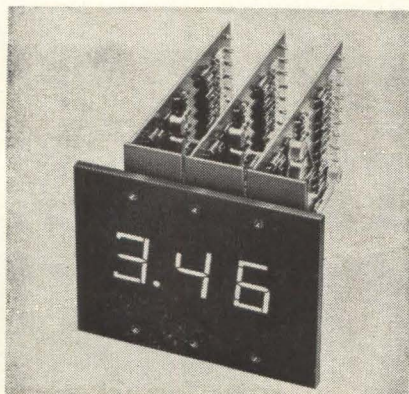

Digital display with decoder-driver

The NSD series digital-display- and decoder-drivers now operate directly from full-wave rectified line voltage with no filtering or regulation required. Silicon decoder-drivers that operate from positive logic levels have been added to the series. These units feature diode-coupled inputs with 4-ma current requirements, and accept any of several BCD codes. They can be mounted integrally with the display or remotely located. The silicon decoder-drivers and display sell for \$45 per decade complete, in quantities of 25 or more.

MB Associates, P.O. Box 4994, Philadelphia 19. [387]

TESTING 500 MILES UP!



Whether you're testing materials or components for space exploration, NRC now offers an off-the-shelf simulation chamber, model 2004, at surprisingly low cost. The new 30 cubic foot test facility will produce pressures in the 10^{-11} torr range (500 miles up) within a period of 24 hours, including system bakeout.

Simple, functional design. Full opening, self-supporting hinged

door. Double pumped door seal eliminates need for refrigerated gaskets. Free standing control console. Pumping system is completely housed beneath the chamber. Even 750° F chamber bakeout with removable heating mantle. Mass spectrometer tests have indicated no trace of hydrocarbons in evacuated chamber. For details, send for the space simulation system data sheet SS-1.



NRC EQUIPMENT CORPORATION

A subsidiary of NATIONAL RESEARCH CORPORATION

A Norton Company Affiliate



160 CHARLEMONT STREET • NEWTON, MASSACHUSETTS 02161

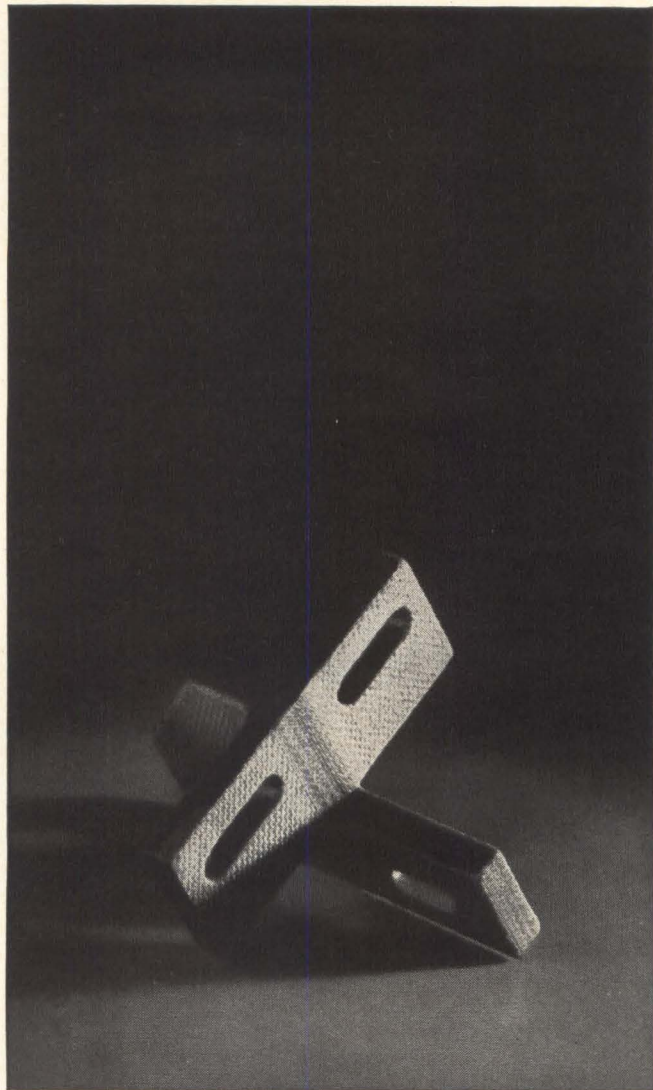

We also make sheets, rods, and tubes

Synthane responsibility for laminated plastic parts starts with the manufacture of the material itself—in over 60 grades and in sheets, rods, and tubes. This means you can be sure of getting the grade you ordered—laboratory controlled and tested. You can be sure of meeting government specifications. When necessary to meet your special requirements, properties of the material can be modified.

If we find that the part should be molded-laminated or molded-macerated, rather than machined, we'll say so. If we find a slight change in design will increase strength or save money, we'll tell you.

Synthane's only business is laminated plastics. Our especially-equipped fabricating shop is probably the largest in the U.S. Send for "Laminated Plastics Parts ... Make or Buy?" Synthane Corporation, 36 River Rd., Oaks, Pa.

You furnish the print... we'll furnish the part

SYNTHANE

CORPORATION **S** OAKS, PENNA.

Synthane-Pacific, 518 Garfield Ave., Glendale 4, California

When you need a better way to
MEASURE or CONTROL Temperature

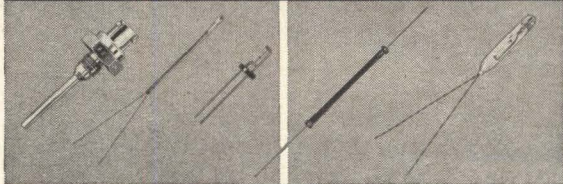

...Check F.E.I. Precision Thermistors

- Direct readout
- Exceptional accuracy
- Fast response
- High output level
- Excellent resolution
- High stability
- Small, rugged, versatile
- Interchangeable units available

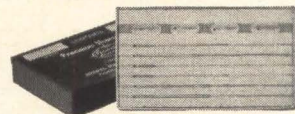

Try them in your lab

F.E.I. experimental kits include an assortment of thermistor types with complete operating characteristics, application data, etc.

G700	4 thermistors	\$4.95
G701	10 thermistors	\$9.95
G200	12 thermistors	\$19.95

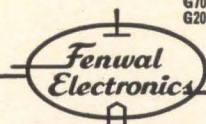

FENWAL ELECTRONICS, INC.
Dept. C, 63 Fountain St., Framingham, Mass.

Circle 219 on reader service card

For any kind of MICROWAVE COMPONENT

try

RADAR DESIGN CORP.

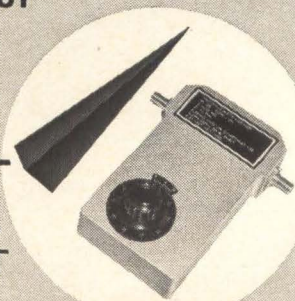

From broad-band waveguide terminating inserts, to continuously adjustable attenuators 0-10Gc/s, RDC maintains a perpetual inventory of more than 200 standard components **ready for delivery**. Modifications to your specifications promptly produced.

Special systems applications? An important segment of RDC is the Special Products Department regularly engaged in advanced design and development of microwave components for specific systems applications. Check our RFQ response capability.

ABSORBERS
ATTENUATORS
COUPLERS
DETECTORS
FILTERS
POWER DIVIDERS
SLOTTED LINES
TERMINATIONS
TUNERS
WAVEMETERS

Write for complete catalog #3A of standard microwave components. Information on custom "State of the Art" capabilities available on request.



107 PICKARD DR., SYRACUSE, N. Y.

New Microwave

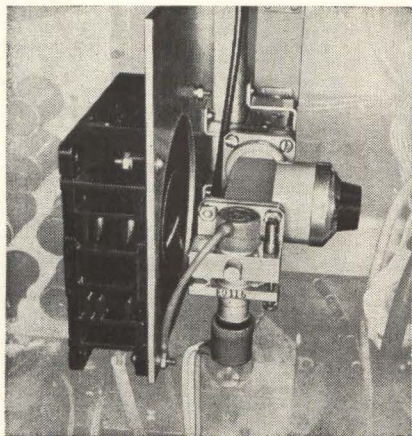

Parametric amplifier for L-band radar

A tunable parametric amplifier, designed for retrofit into existing L-band radar systems, can be installed within an existing equipment cabinet, whereas the power supply control unit may be located at any convenient remote point. The amplifier is tunable over the range of 1,250 to 1,350 Mc and has a noise figure of 1.5 db when followed by a second stage of 10 db or less. It can be tuned over a range of about 20 Mc by varying the varactor bias voltage only. For frequency changes in excess of 20 Mc, adjustment of the pump frequency is required also. Weight of the amplifier is 5 lb. Control panel and power supply weigh 27 lb.

Airborne Instruments Laboratory, a division of Cutler-Hammer, Inc., Deer Park, Long Island, N.Y. [391]

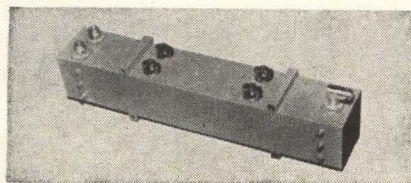

Tunable filters feature low vswr

These devices are said to be the industry's first tunable interdigital filters. They employ a new method of coupling resonators to obtain

outstanding performance characteristics and open the door to many applications not possible before. Interdigital structures combine low in-band vswr and insertion loss with high skirt rejection and power-handling capability. At the same time, they are lighter, smaller, and more reliable than conventional devices. Another important advantage is the ease with which they can be fed from a common junction. Typical L-band performance is as follows: tuning range, 25% minimum; center frequency separation, 2% minimum; bandwidth (3 db), 13 Mc; insertion loss, 0.75 db max; rejection, 70 db minimum at $f_0 \pm 45$ Mc; power, 2 kw c-w minimum; in-band vswr, 1.10:1 max. Single-bandpass or multiplexing types are available in narrow- or broad-band designs for highly selective filtering in retrofit or in advanced microwave and communications equipment. An important example of the many applications possible is in over-the-horizon tropospheric frequency-diversity systems.

Premier Microwave Corp., 33 New Broad St., Port Chester, N.Y. [392]



Lightweight supply powers klystrons

All voltages required for operating millimeter klystrons are provided by the model 940 power supply that is contained in a compact cabinet weighing 49 lb. and measuring 20 by 19 by 8 in. Voltage outputs are: for resonator, 300 to 3,600 v d-c, 120 w output; reflector, 0 to -650 v d-c; focus, 0 to -300 v d-c; filament, 1.0 to 6.3 v d-c; and reflector modulation, 1,000 \pm 200 cps, 0-100 v p-p square wave. High beam voltage is continuously adjustable with one control.

TRG, Inc., 400 Border St., East Boston 28, Mass. [393]



Crown

— first choice
of those who
demand the best!

NEW

**Solid
State
RECORDERS**

**INCOMPARABLE
PERFORMANCE**

Quarter-Track Record/Play Data

ips	db	cps	s/n
7-1/2	± 2	50 — 28,000	54db
3-3/4	± 2	30 — 18,000	52db
1-7/8	± 3	30 — 13,000	46db

The most complete recording instruments ever designed for stereo use. Audio circuitry, $\pm 1/4$ db from 10-100,000 cps; extended range, 5-500,000 cps. Plug-in circuit modules are printed on epoxy and gold plated. Engineered to space craft reliability.

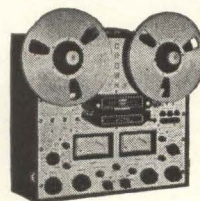

THE HALLMARK
OF CROWN —
SUPERLATIVE
CRAFTSMANSHIP
THROUGHOUT!

**INDIVIDUAL PERFORMANCE
RECORD SUPPLIED
WITH EACH CROWN**

WRITE DEPT. EL-05



**Crown
INTERNATIONAL**
1718 Mishawaka Rd. • Elkhart, Ind.

You expect it first from API

1% tracking is now standard for API taut-bands —at no extra cost!

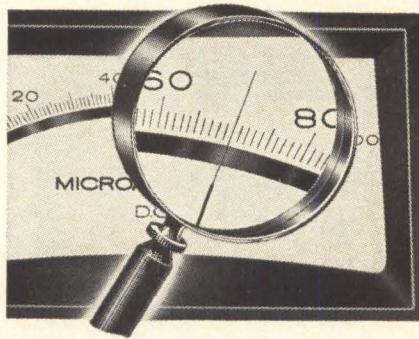

You get an inherently better meter—and it costs us less to make it. Hence it'll cost you less too.

That's the net result of exciting design and production improvements in taut-band panel meters now being offered by Assembly Products. Effective April 1,

**When you order
an API taut-band meter,
you automatically get
±1% tracking**

The only exceptions will be extremely sensitive and extremely small meters. Please ask about these.

1% tracking gives you better measurement

1. You can measure very precisely the fractions of a full-scale signal.
2. Therefore, as long as you know (and can control) the current that makes the meter read full-scale, you will read very accurate absolute values anywhere on the scale.

Ask for Bulletin 38



Assembly Products, Inc.
CHESTERLAND, OHIO • AREA CODE 216 HA 3-3131

New Production Equipment

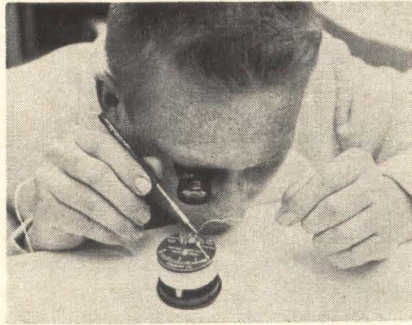

Soldering instruments for microcircuits

Two new featherweight soldering tools provide a degree of operator control not usually associated with a hand-held iron. Model 5A weighs only 8 grams, including tip, and has an overall length of less than 5½ in. The low-voltage heating element is located entirely within the tip, insuring high efficiency and extremely fast heat recovery. It operates on 6 v and consumes 5 w. Free air tip temperature is maintained at approximately 600°F. The 1¹/₁₆-in. diameter tip may be removed easily for cleaning or replacement. Model 5-S is a special design featuring a short shaft to increase finger control. It is useful in soldering operations carried out under a microscope or when using an eyepiece. The tools are priced at less than \$5 each in production quantities.

Oryx Co., 13804 Ventura Blvd., Sherman Oaks, Calif. [421]

Reliable welder forms substrate assemblies

Tweezer-Weld model TW-2-M provides a constant resistance that is said to permit reliability unattain-

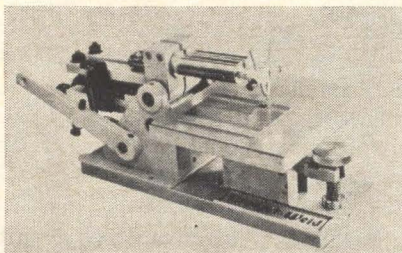

able with single-point welders or unmodified gap welders. It also features the constant pressure and controlled set-down principle designed to meet stringent specifications for difficult module and substrate assembly welding. Closely positioned, individually pressurized holders and calibrated matched cantilever springs assure consistent reliability in welding substrate assemblies. Due to the inaccessibility of some parts, such welding is a difficult and delicate operation. Fixed and elevating platforms are available, and set-up accuracy is assured by means of a combination gap and height gage.

Federal Tool Engineering Co., 1386 Pompton Ave., Cedar Grove, N.J. [422]

Testing package gives true 50-cycle wave form

To establish standard values for 50-cycle frequency testing, a new packaged power source has been

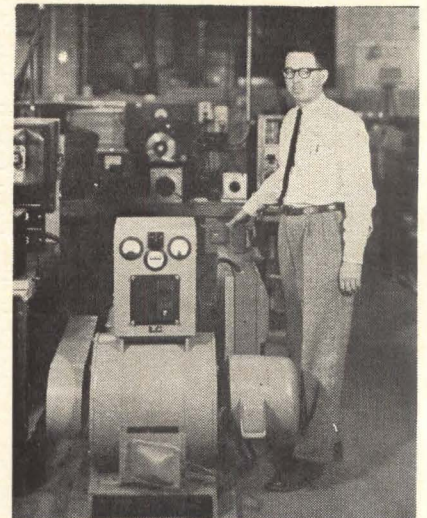

designed. The unit consists of a 15 kva, 240/120-v, 50-cycle synchronous generator. The single-phase generator has a 1.0 power factor. The generator is mounted on a common base and belt driven by a 3-phase, reluctance-type synchronous motor of 25 hp and 60 cycles. All units are drip-proof. A control panel mounted on the generator frame includes an a-c line

MICO

PRECISION DRILL PRESSES

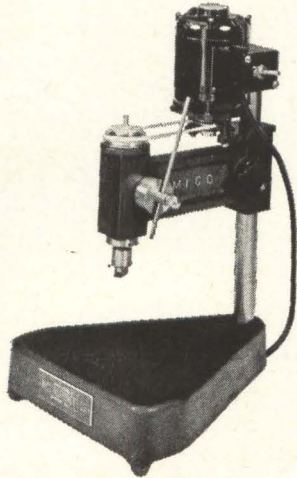

FEATURES

1. Durable, accurate, sensitive, variable speed;
2. Four models—with various size bases and throat dimensions from 6 1/2" to 12 1/2";
3. Ball bearing spindle assemblies with built-in dust protectors. Spindles with taper-oiless bearings available.
4. Drill head can swing radially and is adjusted vertically.

Send for illustrated catalogs

MICO INSTRUMENT CO.

77 Trowbridge St.

Cambridge 38, Mass.

Circle 221 on reader service card

Magnetic Reed

Relays — Coils

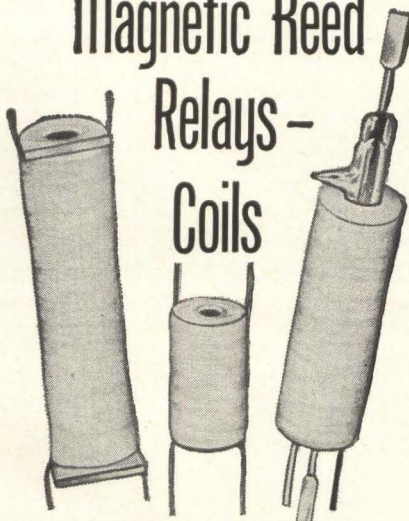

Basic and special REED RELAYS and/or COILS for high reliability and sophisticated switching.

Operating Inputs: low as 1mA. and 15mW.

Standard Coil Voltages: 6, 12, 24, 32, 48V in stock for immediate delivery.

Special Voltage or Resistance, multiple windings for flip flop, memory and crosspoint selection applications — to customer specifications.

New Type SP Coils: for high voltage vacuum-type reeds, 1 1/4" lg.

Standard Coil Termination: 3" flexible leads. Also available with solid copper leads, printed circuit pins and rigid lugs — silver plated or tinned.

Relay Contacts in Form A, B, C and latching.

Coto-Coil

Write for Prices

COMPANY, INC.
65 Pavilion Ave.
Providence, R. I. 02905

Circle 222 on reader service card

voltmeter, a-c line ammeter, ammeter transfer switch, frequency meter, voltage regulator and exciter field rheostat. Manufacturers testing their 50-cycle components can now determine performance on frequencies common in foreign countries.

Columbia Electric Mfg. Co., 4519 Hamilton Ave., Cleveland 44114. [423]

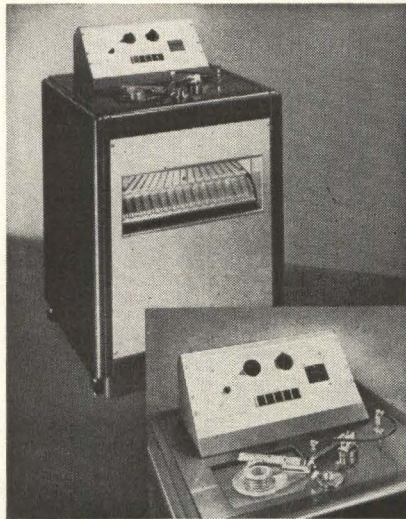

Dice classifier is fast operating

A fully automatic tester, the DS-10, can handle, test and sort dice as small as 0.030 in. round or square at the rate of 1 per sec or 28,000 per shift. During the test part of the cycle, electrical contact is made to both sides of the die and a series of electrical tests are applied. After test, the die is deposited in one of 16 bins, a new die is picked up by the vacuum chuck, and moved into the test position. Actual transport time is 0.6 sec, leaving 0.4 sec for test time. Most silicon or germanium diode dice and many transistor dice may be tested with the DS-10 with minor modifications of the equipment.

Transistor Automation Corp., 101 Erie St., Cambridge 39, Mass. [424]

Ultrasonic step-rinse for tiny components

A 3-stage rinsing system is designed for fine cleaning and rinsing of microelectronic components where de-ionized water is a suit-

Precision drawn and cut glass tubing and rod

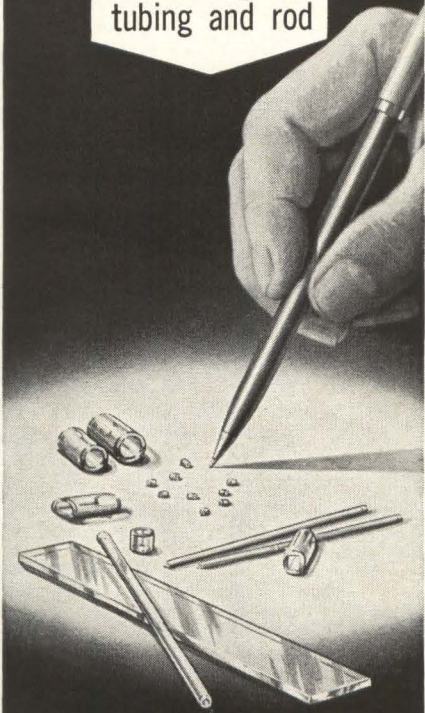

GLASS TUBING & ROD redrawn and cut to your specifications

Over 44 years experience in redrawing glass enables us to supply you with redrawn glass tubing and glass rod to your specifications. We can redraw tubing finer than a human hair or as large as .225" and be consistent about it. Perhaps you would like your tubing diamond saw cut to lengths of .020" upwards to tolerances of $\pm .001$ " or supplied in regular mill lengths.

We maintain adequate stocks of redraw blanks from many glass formulas, some of which are EN-1, KG-12, R-6 or N-51A. We can deliver what you need in a hurry. We can produce experimental lots or large quantities both at competitive prices. You will find, as many others have, that our quality is tops and our service fast and dependable. We welcome your inquiries.

FRIEDRICH & DIMMOCK, INC.

MILLVILLE, NEW JERSEY
PHONE 825-0305 AREA CODE 609 • CABLE: FRIMOCK

Serving industry for nearly half a century

Circle 149 on reader service card

149

LOW COST PROPORTIONAL CONTROL OVEN



JKO-44 Proportional Oven:
A compact, plug-in oven designed for use with both crystals and components requiring precise temperature control. Advanced circuit design, excellent performance at modest cost. Utilizes a thermistor sensing unit followed by a high gain DC amplifier. Ideal where switching action of a thermostat cannot be tolerated and where high stability is a must. For specification and performance data, write today.



THE
JAMES
KNIGHTS
COMPANY
SANDWICH, ILLINOIS

Circle 223 on reader service card

New Production Equipment

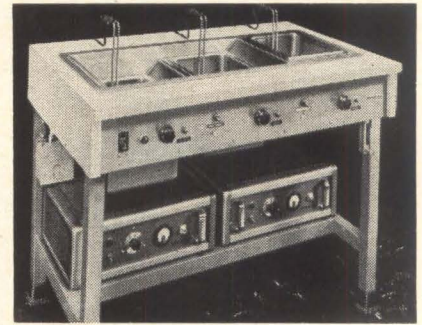

able cleaning agent. An overflow weir system is employed, water-flow input to the upper tank being regulated by a flow meter. Output of the upper tank (at right) flows into the center tank whose own overflow runs into the bottom of the third and lowest tank. Tank fluid is heated by contour immersion heaters whose elements are shaped to fit around the edge of the tank bottom. Both ultrasonic generators are solid-state devices whose output frequency may be set for automatic control at either 25 kc or 45 kc, thus providing a choice of operating frequency for all tanks. At each operating frequency, an automatic frequency sweep is employed (23-27 kc and 43-47 kc) to insure uniform distribution of energy in the transducer tank. Power output level is continuously variable (and accurately resettable) from zero to 300 w average (600 w peak). Variable transformers are employed for this purpose and no de-tuning is involved.

Interlab, Inc., Box No. 38, Harmon-on-Hudson, N.Y. 10520. [425]

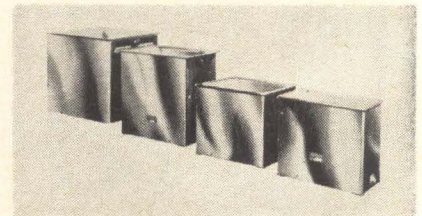

Ultrasonic cleaners in modular units

A series of ultrasonic cleaning machines in modular units is being marketed. The units are equipped with tanks of heavy-gauge, stainless

Proven Principle



Repackaged for printed Circuit Boards



LOW NOISE LEVEL
TWIN CONTACT RELIABILITY
LONG LIFE

AC Drive Models
DC Drive Models
SPDT or DPDT
MBB or BBM

**STEVENS
INCORPORATED
ARNOLD**

QUALITY SINCE 1943
7 ELKINS ST., SOUTH BOSTON 27, MASS.

S/A-33-S 1/4



Request Catalog No. 515



**FREE-FLEX*
CIRCUITRY
BREAKTHROUGH**

SOME PEOPLE THINK THIS IS A PARABOLIC ANTENNA!

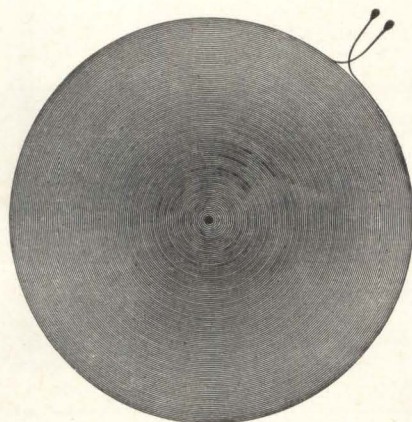

Visualize this "way out" idea. 5 mil wide copper lines laid in a mere 2 1/8" diameter circle with 5 mil wide spacing! It's just one small example of how Garlock FREE-FLEX* Circuitry is allowing engineers everywhere new design freedom, new reliability, new economy! FREE-FLEX* is setting new standards in point-to-point wiring, basic circuitry, inter-chassis circuitry and countless other applications.

By the way, that isn't a parabolic antenna, but if you have had difficulty reducing fresh, new "way out" ideas to realistic applications, why not let Garlock lend a helping hand?

FREE-FLEX* ENGINEERING HANDBOOK

This new handbook gives complete technical and practical data on Garlock FREE-FLEX* Circuitry. Your free copy is waiting, just write to:

*Garlock Trademark

GARLOCK
ELECTRONIC PRODUCTS
CAMDEN, NEW JERSEY 18101

Circle 224 on reader service card

steel for resistance to solvents and cleaning liquids. The tanks are built in a step-up series of sizes that make it possible to specify capacity and load level in accordance with user requirements. Power supplies are also offered in a series corresponding in size and output to the various tank sizes and arrangements. All components are part of the standard line offered in a wide choice of sizes—1/2 gallon up and from 80 w to multi-kw range—permitting flexibility for adaptation to a great variety of cleaning requirements.

General Instrument Corp., Ultrasonics Division, Woodbury, Conn. [426]

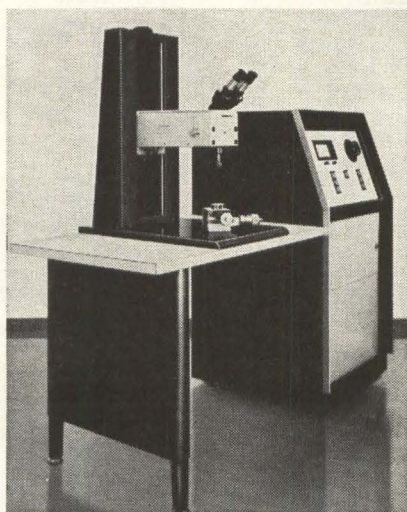

A laser welder for microcircuits

Model 500 utilizes a pulsed-ruby laser to achieve a powerful burst of highly concentrated energy. It will find application in the manufacture of microcircuits and other semiconductor devices. Beam energy in the new laser is adjustable from 0.1 to 2.0 joules per pulse. Repetition rate is 12 pulses per minute at 1 joule or 9 pulses per minute at 2 joules, and pulse duration is 0.5 to 1.5 millise. The laser welder is intended for use by non-technical personnel to accomplish precision miniature welds in production applications. Either manual or automatic firing control can be selected, and the weld spot size is adjustable from 0.005 in. to 0.020 in.

Hughes Electronic Products division, 500 Superior Ave., Newport Beach, Calif. [427]

Raster **PPI**

GCA Display **Elevation Scope**

Character Display

**Composite Display:
Horizon-Altitude-Airport**

Off Centered Sector Scan **Precision Linear Sweeps**

Loran

O Scope **DF Scope**

A YOKE FOR ANY SCAN to your Specifications

COMPLETE LINE of deflection yokes for every military and special purpose—in production quantities or custom designed to your exact requirement.

For engineering assistance with your display problems, call on your nearest

SYNTRONIC YOKE SPECIALIST today:

Boston-New Eng.:	762-3164
Metropolitan N.Y.:	695-3727
Upstate N.Y.:	315, 652-7911
Phila. Area:	789-2320
Wash.-Balt. Area:	277-1023
Florida Area:	813, 527-5861
Los Angeles:	283-1201

syntronic
INSTRUMENTS, INC.

100 Industrial Road, Addison, Illinois
Phone: Kingswood 3-6444

Circle 151 on reader service card

151

THE MOST RELIABLE MODULES ARE POTTED IN *TIMONIUM*

2 McPS

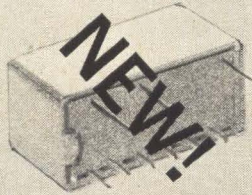

SILICON

DIGITAL LOGIC MODULES

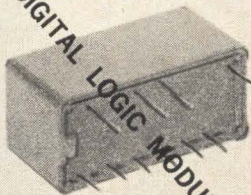

EMC MODULES ARE UNCONDITIONALLY GUARANTEED

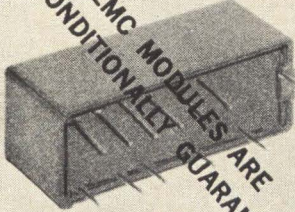

250 KcPS & 2 McPS



GERMANIUM

D.O.D. LOW SPEED DIGITAL MODULES

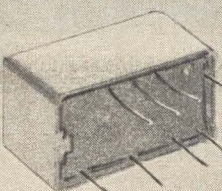

FLYBALL FAMILY

SPECIAL MODULES TO SUIT YOUR REQUIREMENTS

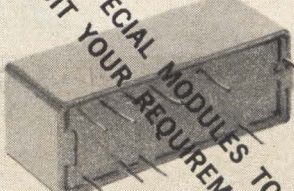

SPECIAL CIRCUIT AND PACKAGE DESIGN FROM INCEPTION TO A PRODUCTION UNIT IN THE SHORTEST TIME AND AT THE LOWEST COST

**ELECTRONIC
MODULES
CORPORATION** **EMC**

1949 GREENSPRING DRIVE • TIMONIUM, MD. 21093
301 - CLearbrook 2-2900 • TWX - 301-252-0723

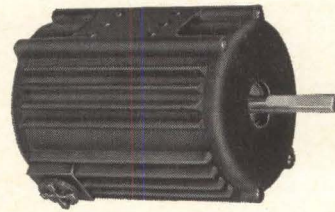

NEW

HIGH TORQUE 2½" MOTOR

For high torque from a compact 60 cycle motor you can't beat Globe's family of Type YC precision induction motors. They are available in three standard stack lengths (longest is illustrated), and provide a wide range of speed-torque options to 12 oz. in. of torque at 3,000 rpm. Standard windings are for 115 and 230 v.a.c., 60 or 50 cycles, single or three-phase. These MIL spec-quality motors have finned aluminum housings, stainless steel bearing seats, life-lubed ball bearings; heaviest weighs only 26 ounces. Mounting is by tapped holes in front face or by tapped holes in top and bottom mounting pads. Many variations are possible to suit your application exactly. Request Bulletin YC-1.

Globe Industries, Inc., 1784 Stanley Avenue, Dayton 4, Ohio.

GLOBE motor type	length	nom. cont. dy. HP at 3000 rpm
YCS	1½"	¼ ₁₀₀
YC	2½"	½ ₆₀
YCL	3½"	½ ₂₅

Circle 225 on reader service card

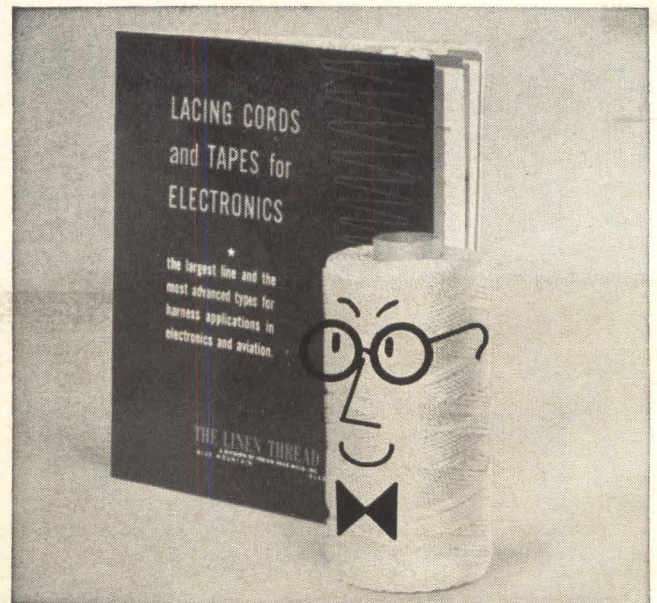

It's the 'Who's Who' in Electronic Threads

The most complete catalog in the industry... LTC's illustrated brochure covering electronic lacing cords and tapes. LTC's line includes nylon, linen, teflon, cotton and dacron... a variety of constructions, put-ups and special finishes.

For catalog, write:



THE LINEN THREAD CO.

Blue Mountain, Alabama
A DIVISION OF INDIAN HEAD MILLS, INC.

New Materials

Dry-film lubricant has long-wear life

A solid dry-film lubricative coating, called Henderlube, is a blend of thermosetting resins and lubricative pigments such as molybdenum disulphite, graphite and metallic salts. It is designed to provide adequate lubrication under a variety of conditions. It meets MIL-8-8937 requirements for film adhesion, thermal stability, fluid resistance, load-carrying capacity and corrosion resistance. Its maker says wear-life is better than twice that of any similar dry lubricant and more than three times as long as is required by the specification. Henderlube's industrial applications include aircraft and missile installations and assemblies, precision instrumentation, digital computers and electronic components. H.A. Henderson Co., 5039 W. Jefferson Blvd., Los Angeles 16. [411]

Irradiated polyolefin is heat-shrinkable

A complete line of irradiated polyolefin heat-shrinkable tubing is being introduced under the trade-name Heatrax. Sizes range from 24 through 2, and from $\frac{5}{16}$ in through 2 in. The material has a 2:1 recovery ratio with minimum elongation shrinkage, according to the manufacturer. It meets or exceeds MIL-P-12050.

Illumitronic Engineering Corp., 680 E. Taylor, Sunnyvale, Calif. [412]

Coating protects modules and p-c boards

A welded module and printed-circuit board coating has been designed for equipment intended to meet the humidity and salt-spray requirements of MIL-E-5272. In its cured state, No. 9653 coating has an insulation resistance of 6.2×10^{12} ohms initially, on test cards, rising to 4.6×10^{11} ohms after 50 hours of salt spray. Breakdown voltage ranges from 6,300 v rms in

the dry state to 2,000 v rms at 90% relative humidity. In vibration resistance, the compound passes 30 g input when used with No. 8751 filleting compound. Application of Epoxylite No. 9653 is by dip or spray. Price is \$3.20 per lb. in gallon units.

The Epoxylite Corp., 1428 N. Tyler Ave., South El Monte, Calif. [413]

Thin-film resist used in microelectronics

A photo resist has been formulated to permit ultrathin application of resist material and provide sub-pinpoint resolution in photo etching for microelectronics. It permits use of films of resist thinner than 0.0003 in. and resolving separations of $\frac{1}{2}$ micron and less. The thin film resist is chemically inert—after photo-polymerization and heat treatment—to hydrofluoric acid and other etching agents used in microelectronics. It protects the image while the acid etches away the unprotected excess metal. Price is \$18.25 a quart.

Eastman Kodak Co., Rochester, N.Y. 14650. [414]

Dielectric material for microwave use

Ray-K dielectric material for waveguide loading, waveguide and microwave optics components, and antennas is available in panels $9\frac{1}{2}$ in. and $4\frac{1}{2}$ in. square and either $\frac{1}{2}$ in. or 1 in. thick. It combines extremely low loss tangent (less than 0.0007 at 10,000 Mc) with extremely close dielectric constant tolerance (guaranteed to be within $\pm 2\%$ but more commonly within $\pm 1\%$) over a wide range of values. Standard values of dielectric constant are 3, 4, 5, 6, 8, 10, 12, 14, 16 and 20. Ray-K can be machined readily with tungsten carbide tools, and bonded with epoxy or similar adhesives.

Raytheon Co., 130 Second Ave., Waltham, Mass. 02154. [415]

WANG DIGITAL SYSTEMS ENGINEERING

UNIVERSAL PRESET COUNTER MODEL 2019

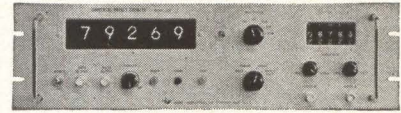

SPECIFICATIONS:

- A. Sensitivity:** 100 mv to 10 volts RMS Channels A & B.
- B. Inputs & Controls:**
- (1) Two Channels, A & B, by BNC Connector on front panel.
 - (2) Sensitivity & Test Controls on front panel for Channels A & B.
 - (3) **Time Base Multiplier Control:** 5 position switch in units of seconds, for 1, x 10, x 100, x 1000, and x 10,000.
 - (4) **Function Switch:** 4 positions for:
 - (a) Rate (for frequency, rate and ratio N X A/B. 2 cps to 300KC on input A for rate. For ratio, 2 cps to 300KC on input A; input B, 2 cps to 100KC on x 1 and to 300KC on x 10, 100, 1K, and 10K.
 - (b) **For Time Interval & Period Measurements:** 2 cps to 100KC on input A; to 300KC on x 10, 100, 1K, & 10K.
 - (c) **Count (for manual count control)** Input A 2 cps to 300KC.
 - (d) **Preset Gate (for batch and preset counting)** 2 cps to 100KC on Input A; to 300KC on x 10, 100, 1K, & 10K.
 - (5) **Reset, Start & Stop:** By front panel push buttons and rear panel connectors.
 - (6) **Display Control:** Continuously adjustable from .2 to 5 seconds and infinite position.
 - (7) **Preset:** 5 decades of in-line Digital Switches on the front panel for control of Input A.
 - (8) **Gate Output for Time Base & Pulse Output** when reaching end of preset count available on rear BNC connectors.

Consult factory for details on modifications available.

REVERSIBLE COUNTER AND OPTICAL ENCODERS

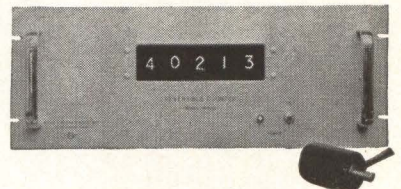

Standard Features:

- 3-6 Decades plus Sign
- Transistorized
- NIXIE readouts
- DC to 200kc frequency
- Compact— $5\frac{1}{4}$ "H x 19"W x 15"D
- Function to:
 - a. add and/or subtract counts directly
 - b. add and/or subtract counts on "gate" command
 - c. inhibit, with no count

Many other modifications available. Consult factory for details.

NON-CONTACT ENCODERS

- Available with Incremental, Direction Sensing Outputs, and Non-ambiguous, Absolute Outputs.
- Resolution covers from 1 to 1000 parts per turn and up to 10,000 turns.
- Size: 2" to 4"D & 1.5" to 6"L

Wang Laboratories, Inc.

NORTH STREET • TEWKSBURY, MASS.
617-851-7311

DYNAMICS TEST EQUIPMENT

—measures voltage, current, and resistance
—eliminates ac power lines from low-level measurements



Price \$785.00 ea.

Model 4132 dc micromultimeter—a fully floating, all-transistorized volt-ohm-microammeter. Operation from a nickel-cadmium battery insures complete isolation from the power line. Up to 12 hours continuous battery operation. Battery recharges when unit is operated on power line. Instrument features exceptionally high input impedance on all dc voltage ranges.

Typical applications: Measuring differences in dc potential between points in electronic circuits; use as an electronic null indicator, or as an isolated current meter. Numerous uses in measuring resistance.

VOLTAGE

full-scale range: ± 100 microvolts to ± 1000 volts
accuracy: $\pm 1.0\%$ of full scale, all ranges

CURRENT

full-scale range: ± 0.1 microampere to ± 1.0 ampere
accuracy: $\pm 1.0\%$ of full scale, all ranges

RESISTANCE

full-scale range: 10 ohms to 100 megohms
accuracy: $\pm 0.1\%$ of full scale from 10 ohms to 1.0 megohm ($\pm 1.0\%$ of full scale for other readings.)

Dynamics manufactures a wide variety of microvoltmeters, microvolt-ammeters, micromultimeters, and general test equipment. Write for literature on Model 4132, or the entire line.

DYNAMICS INSTRUMENTATION COMPANY
583 Monterey Pass Rd., Monterey Park, Calif.—Phone: CUMberland 3-7773

Circle 227 on reader service card



Get the "SMILE OF SATISFACTION"

...that comes with a job well done for you by

DAGE

Dage Hermetically Sealed

MULTI-PIN CONNECTORS and HEADERS

meet or exceed all applicable MIL specs. Shell sizes and finishes for most needs; custom engineering and finishes available. WRITE FOR NEW CATALOG T-503

• FIRST in Ideas • FIRST in Quality • First in Service

DAGE ELECTRIC COMPANY, INC.
FRANKLIN, INDIANA • PHONE 317/736-6136

New Literature

Digital instrumentation Systron-Donner Corp., 888 Galindo St., Concord, Calif. A six-page illustrated brochure is a specification guide to a line of digital instrumentation including counters, front plug-ins and systems modules. Circle 451 reader service card

Coaxial cables Alpha Wire Corp., 180 Varick St., New York, N. Y. 10014. A 16-page catalog describes construction and characteristics of 58 Mil-Spec coaxial cables made with polyethylene and Teflon insulation. [452]

Vaneaxial fan Rotron Mfg. Co., Inc., Woodstock, N.Y. Bulletin F-3201 covers the half-size AX-2 fan which delivers 30 cfm and is designed to meet MIL specs for application in ground support equipment and airborne installations. [453]

Microcircuitry General Instrument Corp., 600 W. John St., Hicksville, L.I., N.Y. A brochure describes the Multichip technique, which combines the major advantages of conventional monolithic integrated microcircuits with the major advantages of conventional circuit boards. [454]

Glass trimmer capacitors Roanwell Corp., 180 Varick St., New York, N.Y. 10014. A catalog data sheet gives specifications on what are claimed to be the smallest glass trimmer capacitors available in the 1.0 to 10.0-pf range. [455]

Potentiometric pressure transducers Tectron Electronic Corp., 91 Rome St., Farmingdale, N. Y., has available a booklet providing recommended terminology and definitions pertaining to potentiometer-type pressure transducers. [456]

Instruments Houston Instrument Corp., 4950 Terminal Ave., Bellaire, Tex. 77401, offers a packet describing an a-c millivoltmeter, three audio signal generators, and an electro-optical very low frequency function generator. [457]

Field-effect choppers Siliconix Inc., 1140 W. Evelyn Ave., Sunnyvale, Calif., offers an application note discussing field-effect transistors for low-level d-c modulation where typical offset voltages in the 0.6 to 6- μ V range are expected. [458]

Digital printers Franklin Electronics Inc., Bridgeport, Pa. 19405. A 24-page engineering guide covers the application of digital printers. [459]

Rotating components Rotating Components, Inc., 1560 Fifth Ave., Bay Shore, N. Y., has available its 1964 catalog featuring a full line of small a-c motors and rotating devices made to military and high quality commercial specifications. [460]

There's nothing so simple or satisfactory as recording with

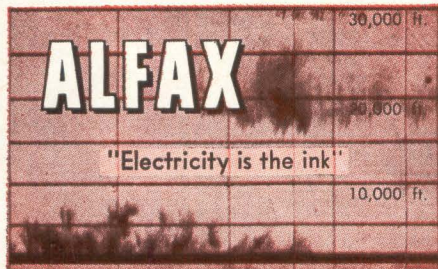

High-altitude weather data from radar ceilometer is recorded instantly and vividly on ALFAX electro-sensitive paper. 20-minute chart segment shows returns to 30,000 feet.

Progressive innovators are obtaining **vital information never before possible and often unsuspected** in such fields as . . .

LONG RANGE RADAR DETECTION

As opposed to scope cameras, operator sees returns instantly, evaluates more rapidly, gets permanent record with increased sensitivity.

RADAR SAMPLING

Tone shades keyed to signal intensity provide vivid "picture" of radar return even when bulk of data is gated out.

SONAR ACTIVE AND PASSIVE

Unparalleled identification and location of returns even in poor signal to noise ratio through integrating capability of Alfax paper.

OCEANOGRAPHY

High resolution capability, dynamic tone shade response with Alden recording techniques adding synchronizing ease provide "optimization" of underwater sound systems.

FREQUENCY ANALYSIS, SAMPLING AND REAL TIME

Intensity modulation and frequency vs. real time provide continuous vital information with permanence and past history to achieve previously unattainable evaluation.

SEISMIC STUDIES

Dynamic response at high writing speeds yields discrete geological data at resolution never before possible.

HIGH SPEED FACSIMILE

Why? Because of

ALFAX EXCLUSIVES

- broad, dynamic response of 22 distinct tone shades
- remarkable expansion at low level signal, where slight variation may provide critical information
- records in the sepia area of the color spectrum where the eye best interprets shade differentials in diminishing or poor light
- writing speed capabilities from inches per hour up to 1400 inches/second
- captures 1 microsecond pulse or less
- dynamic range as great as 30 db
- integration capability for signal capture in signal to noise ratio conditions worse than 1 to 4
- resolution capabilities of 1 millisecond = 1 inch of sweep
- accuracy capabilities of few thousandths of an inch
- sensitivity to match most advanced sensing devices

By merely passing a low current through Alfax everything from the faintest trace signal of microsecond duration to slow but saturated signal can be seen instantly, simultaneously.



ALFAX

PAPER AND
ENGINEERING
COMPANY, INC.

Alden Research Center, Westboro, Mass.
Dept. A-1

Ultrasonic brochure Macrosonics Corp., 1001 Roosevelt Ave., Carteret, N. J. High-power ultrasonic concepts and equipment are taken up in a 16-page booklet. Manufacturer's facilities for R&D work are discussed. [461]

Backward-wave oscillators Stewart Engineering Co., Santa Cruz, Calif. 95062. Technical specifications for backward-wave oscillators are contained in a quick-reference catalog. [462]

Phase calculation nomograph General Radio Co., West Concord, Mass. A phase calculation nomograph, covering the frequency range from 200 to 10,000 Mc, is available. [463]

Epoxy resins The Epoxylite Corp., 1428 N. Tyler Ave., S. El Monte, Calif., has released an expanded listing of its epoxy resins designed for electrical manufacturing applications. [464]

Lasers Maser Optics, Inc., 89 Brighton Ave., Boston 34, Mass. A 20-page catalog gives complete operating data on a line of solid state and gas lasers, laser systems and accessories. [465]

Isolation parameters Elcor, a division of Halliburton Co., 1225 W. Broad St., Falls Church, Va. 22046, has issued a brochure describing all seven isolation parameters for its 1-kva isolation transformer. [466]

Military/space power supplies Elasco Inc., 5 Prescott St., Roxbury 19, Mass. High reliability power supplies for military and space applications are presented in brochure 763M/A. [467]

Lumped constant delay line Hi-G Inc., Rt. 75 and Spring St., Windsor Locks, Conn. Catalog EM-1 covers a comprehensive line of electromagnetic delay lines for computer, communication, aircraft, missile and telemetry system applications. [468]

Microwave components E&M Laboratories, 7419 Greenbush Ave., N. Hollywood, Calif., offers a 20-page catalog of microwave components and ferrite devices. [469]

Optical meter-relay Assembly Products, Inc., Chesterland, O. Circuits for achieving different types of control action with a contactless optical meter-relay are described and illustrated in bulletin 35-B. [470]

Directional filters Melabs, 3300 Hillview Ave., Stanford Industrial Park, Palo Alto, Calif. Four-port, symmetrical directional filters with very good electrical characteristics, particularly useful for separating or combining signals of different frequencies, are described in a technical bulletin. [471]

Nickel-cadmium batteries Gulton Industries, 212 Durham Ave., Metuchen, N. J. Bulletin VO114c details a series of hermetically - sealed, nickel - cadmium space batteries. [472]

Instant Graphic



Helix recording of ultrasonic inspection of rocket case-to-liner bond. Dynamic tone shades accurately portray bonding effectiveness — middle tones show porous areas; light spots are bubbles.

Simple, reliable Alden "flying spot" helix recording techniques—combine with ALFAX electro-sensitive paper to produce visible, informative "pictures" of sonar, radar, infrared and other instrumentation outputs. Pulse length, relative signal strength and timing are continuously integrated on a single real-time recording. Data from sampling arrays, time-base signals, scan or sweep sources are synchronized with the Alden "flying spot" helix to present—as scale model "visual images"—observed phenomena, with new and essential meaning instantly revealed.

Why? Because of

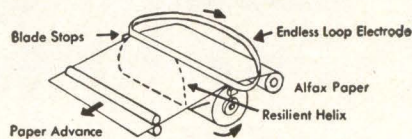

Resilient helix provides low inertia, constant electrode pressure over a wide range of recording speeds. Endless loop electrode deposits ions on the Alfax Paper when a signal appears on the helix. The electrode "blade" moves continuously to provide a freshening of its surface, for thousands of feet of continuous recording. Precision blade stops maintain precise, straight-line electrode relationship to the resilient helix, while protecting paper sensitivity by acting as paper chamber seal-off.

Alden "flying spot" recorders are available . . .

- for any recording speed from 8 rpm to 3,600 rpm
- with any helix configuration — linear 360° sweep — nonlinear — reciprocating — multi-helix
- in any record size — 2", 5", 8", 11", 19" . . . to five foot widths
- plus plug-in modular construction — interchangeability with a high degree of flexibility and adaptability

It's simple to get started.

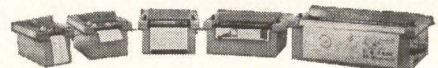

Alden "flying spot" Component Recorders, detachable drives, plug-in electronics, accessories are available to incorporate the Alden instant graphic recording techniques into your instrumentation.

ALDEN

ELECTRONIC & IMPULSE

RECORDING EQUIPMENT CO., INC.

Westboro, Mass.

SINGLE CRYSTALS NOW IN STOCK!

Copper Gold • Cobalt Iron
Bismuth Antimony

Platinum • Iridium • Rhodium
Palladium • Chromium

Thorium Oxide
Tungsten Nitride

CRYSTALS of
Cadmium and Zinc
Sulphide • Telluride • Selenide

YOUR COMPLETE
SOURCE FOR

- Gas Laser Systems
- Laser Materials
- Laser Diodes

MKIA Gas Laser System
Complete **\$995**

MKIC Gas Laser System
Complete **\$895**

WRITE FOR CATALOG OF

SINGLE CRYSTAL CHIPS
Random Orientation Suitable
For Many Physical Studies

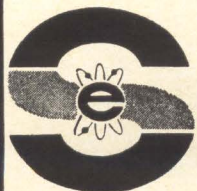

semi-elements, inc.

Saxonburg Boulevard, Saxonburg, Pa.
Phone: 412-362-1548

MRC MATERIALS BULLETIN #2

Magnetic Alloys of Ultra-High Purity

If purity is of concern in your magnetic alloy application, why settle for just vacuum-melted alloys. MRC now offers ultra-high purity alloys of iron-nickel-molybdenum, and iron-cobalt-vanadium prepared by dual refinement—zone melting plus ultra high vacuum purification. The highest purity base metals attainable are further purified and blended to precise composition in high-vacuum electron-beam float-zone refiners. By working with small charges under carefully controlled conditions highest quality is assured.

These alloys are available in rod, wire, and foil forms. Special compositions can be custom processed on request.

Please write for technical bulletins.



**MRC
MANUFACTURING
CORPORATION**

1007 Glenshaw Road, Orangeburg, New York
a subsidiary of
MATERIALS RESEARCH CORPORATION

Circle 229 on reader service card

NEW SERIES E MOTORS Cool, Dependable . . . Low Cost TIMING MOTORS by **HURST**

150 Inch Ounces at 1 RPM
3600 RPM thru 2/3 RPM

NEW E SERIES, open frame, shaded pole, extremely cool running, synchronous timing motor, 150 inch-ounce torque rating at 1 RPM — superior materials including bronze bearings, brass gears, hardened steel pinions and wheel shafts, stainless steel output shaft. Recommended when a dependable, low cost timing motor is required.

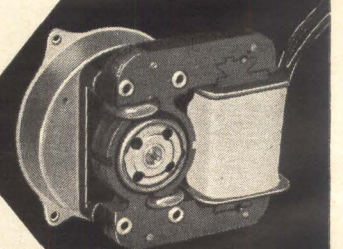

**SERIES E
OPEN
FRAME**

Write for complete literature today.
Standard speeds stocked by your local distributor

hurst MANUFACTURING
CORPORATION
PRINCETON, INDIANA • Phone FU 5-2564

New Books

Pulse Generation

Pulse Circuits: Switching and Shaping. Daniel S. Babb. Prentice-Hall Inc., Englewood Cliffs, N.J., 1964, 379 p, \$15.35

Primarily an advanced undergraduate-level textbook, this is also a collection, by function, of the circuits that perform the large variety of operations on pulses encountered today. In the author's words these are: "limiting, clipping, clamping, peaking, delaying, comparing, sweeping, differentiating, integrating, summing, gating, timing, triggering, rectifying, shaping, storing, blocking, synchronizing, counting, pulsing and pulse stretching."

Since the circuits are arranged by function, as well as in the order of increasing complexity, the volume will be a useful reference for the designer's bookshelf.

Each class of circuit is described in some detail, both qualitatively and by the necessary equations. A generous supply of problems lets the reader try out the recommended design procedures.

In complexity the circuits range from the simple diode clippers to logic circuits and transistor monostable, astable and bistable operating modes. A section on silicon-controlled rectifiers and one on magnetic amplifiers keeps the book up to date.

Circuit Analysis

The Analysis of Linear Systems. Wayne H. Chen, McGraw-Hill Book Co. Inc., New York, 1964, 577 p, \$16

This is the first of two books by Professor Chen designed to give a unified analysis-synthesis approach with a consistent viewpoint and a uniform terminology. The book is written on an advanced-undergraduate to graduate level; with its companion volume (Linear Network Design and Synthesis) it will form an authoritative textbook and reference set for the practicing design engineer.

After an introduction to the basic problems of network analysis and synthesis, loop and nodal analysis and the generalized con-

cepts of frequency, impedance and admittance, the author goes at some length into network characterization: network parameters and interconnections, and network topology, equivalence and duality.

Fourier series and Fourier transforms analysis is treated next in a section on the frequency analysis of excitation and response of a circuit. The following section deals with Laplace transformation methods and pole location. The next techniques treated are the unit-step function and indicial function, and other superposition integrals.

Three chapters deal with signal-flow analysis and diagrams as aids to circuit analysis, particularly analysis of transistor amplifiers of one or more stages and with different feedback arrangements.

The last group of chapters describes stability problems in closed loops, establishing the Nyquist stability criterion and giving examples of simple closed-loop control systems, their transfer functions and input-output relations. In the last chapter, Dr. Chen describes the available methods of compensating closed-loop systems to improve their stability and accuracy.

The volume contains a great wealth of technical information and is written with striking thoroughness. While it provides the reader with the necessary theory, it is never too far from practical application.

The book is easy to find one's way in, due to effective indexing and a very detailed table of contents. Technical information, formulas and diagrams are presented in tabular form where possible, again making it easy to find any one particular instance or to form a clear idea of a subject. For textbook use, practical illustrations and problems are included in each chapter. Also, the author's detailed introduction provides specific suggestions as to which sections should be studied depending on the reader's direct interest or intended depth of coverage, and classifies the principal network problems and the available methods of solution.

Profiles in Packaging

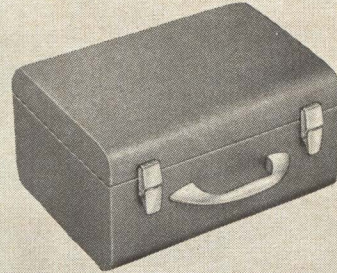

BUD TRANSICASE

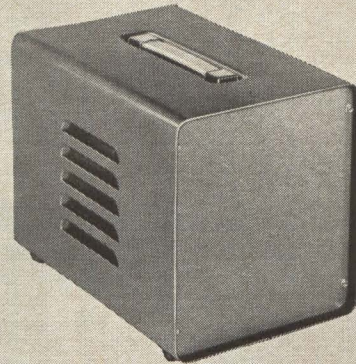

BUD PORTACAB

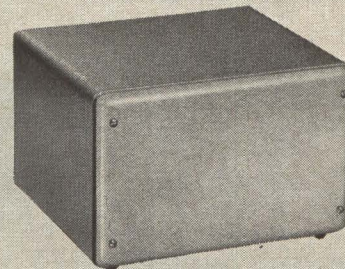

BUD CONTOUR CABINET

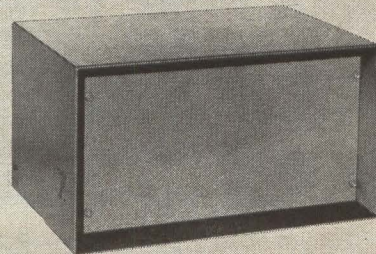

BUD SHADOW CABINET

See these products at your local Bud distributor or write for literature.



BUD RADIO, INC.
Willoughby, Ohio 44094



ULTRA-MINIATURE DELAY LINES

no bigger than a dime...



FOR IMMEDIATE DELIVERY . . .

ultra-miniature modular delay lines measuring only $\frac{5}{8}$ " x $\frac{5}{8}$ " x .450" high. Suitable for printed circuit mounting . . . may be combined to give taps wherever desired. Completely encapsulated, temperature coefficient 50 PPM per degree centergrade.

Stocked Delay Lines Available from 20 Nanoseconds to 15 Microseconds. Complete catalog on request.

Type	Imp. Ohms	Time Delays	Time-Delay to Rise Time Ratio
"N"	100	20, 30, 40, 50, 60, 70, 80 ns 90, 100 ns	3½ to 1
"A"	500 1000	0.1, 0.2, 0.3, 0.4, 0.5 us 0.5, 0.6, 0.7, 0.8, 0.9, 1.0 us	3½ to 1 3½ to 1

ALLEN AVIONICS, INC.

DELAY LINES • FILTERS • NETWORKS

255 EAST SECOND STREET • MINEOLA, NEW YORK 11502
Phone: 516 Pioneer 7-5450

Circle 248 on reader service card

Component Manufacturers!

The active and growing German Electronics Market offers you new and wide sales opportunities!

Show your Component Lines — Capacitors, Coils and Transformers, Relays, Switches, Printed Circuits, Fuses, Connectors, Semi-conductors, Tubes, Power Supplies, Modules and Sub-assemblies, Test Instruments and allied products at



ELECTRONICA

INTERNATIONAL TECHNICAL EXHIBIT

Munich, Germany
October 21-28, 1964

Your audience will be design engineers and representatives of the Electronic, Electrical, Aviation, Space Navigation, Railway, Chemical, Power, Postal, Military and other government agencies and industries.

Send for details NOW!

Write, wire or telephone
Gerald G. Kallman Associates
9 Journal Sq., Jersey City 6, N. J.
telephone 201-OL 3-3304

Circle 231 on reader service card

SERVO NEWS

HIGH PERFORMANCE
VERNITRON SERVOMOTORS ⁹
now available from inventory in 7 frame sizes...
150 models
200

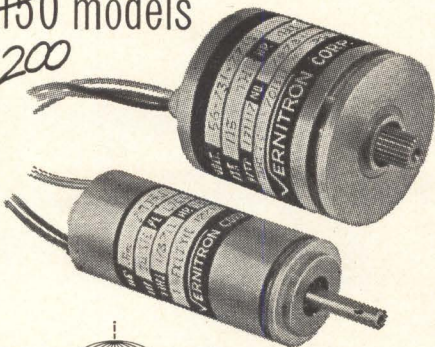

At the Vernitron Servomotor plant, military specifications are the starting point in performance. "Meet or exceed" is the word of the day—every day—for every size and model motor.

Modifications of housing, shaft, windings, torque and speed are regularly accommodated to handle special requirements. No matter what your specific Servomotor needs may be—at Vernitron they are treated with the utmost regard, from design to finished hardware.

Write, wire, phone now for complete price, delivery and specification data; ask for the new Vernitron Catalog.



THE QUALITY NAME
IN PRECISION
SERVO COMPONENTS

FARMINGDALE DIVISION: 65 Gazza Blvd., Farmingdale, N.Y. (516) MY4-5002
TWX: 516-248-9525
TORRANCE DIVISION 1765 S. Crenshaw Blvd., Torrance, Calif., (213) FAirfax 8-2504
TWX: 213-328-1802

158 Circle 158 on reader service card

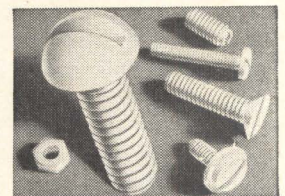

Widest Selection of MOLDED NYLON SCREWS

- High quality—close tolerances—clean accurate threads
- Sizes from miniature No. 0 to ¼"
- Lengths from ¼" to 1-1/16"
- Standard commercial heads, Slotted or Phillips
- Set screws with plain and standard points
- Hex nuts from No. 4 to 5/16"
- Screws also available in Delrin

When you need nylon screws you want GRC! Send for: stock list . . . HUNDREDS of sizes . . . samples and specification sheet.

GRC stock plastic parts are available in many sizes and types . . . are precise, uniformly high in quality and economical because they are mass produced by exclusive automatic, single cavity techniques. These advantages apply to "specials" and parts to your specs . . . in Nylon, Delrin and other engineering thermoplastics. Send prints for quotation and details on GRC's special methods for molding (and die casting, too). NO SIZE TOO SMALL!

Write, wire, phone TODAY for samples, prices, literature.



GRIES REPRODUCER CORP.

World's foremost producer of Small Die Castings and Plastic Moldings

151 Beechwood Ave. • New Rochelle, New York
(914) New Rochelle 3-8600

Circle 249 on reader service card

Technical Abstracts

Improved tv camera tube

The Plumbicon: a camera tube with a photoconductive PbO layer. E.F. de Haan and A.G. v. Doorn, Philips Research Laboratories, Eindhoven, The Netherlands.

The Plumbicon is a small lightweight television camera tube that utilizes the photoconductive properties of lead monoxide instead of the tin sulfide or tin selenide materials of conventional vidicons.

The tube's special properties are derived from its construction. First, a transparent, conductive layer is deposited on the tube face. Over this layer, which is used as a signal electrode, a microcrystalline layer of PbO is applied by evaporation. Thus the photoconductor element of a Plumbicon consists of three layers. The layer in the middle is almost pure lead oxide, an intrinsic semiconductor. On the gun side, the lead oxide is transformed by appropriate doping into a p-type semiconductor. On the electrode side, tin oxide is transformed into an n-type. In effect, the photoconductive layer behaves as if it were a reverse-biased p-i-n diode. This results in high sensitivity, and low dark current, producing good black-level uniformity.

The tube operates as follows: each picture element represents a capacitor with one plate connected to the positive potential of the signal electrode, and the other floating. Illumination of the photoconductive layer causes the discharge of the capacitor elements through the layer, resulting in a pattern of positive elemental potentials on the gun side of the layer surface, corresponding to the image being viewed. When scanned by an electron beam, the surface potential is reduced by electrons deposited from the beam to that of the cathode of the electron gun. The charging currents of the capacitances represented by each of the picture elements form the video signal. Complete storage of the image will be achieved if the discharging time constant of the target capacitance is greater than the period of frame scanning.

Experiments have shown the Plumbicon to have long life, to be

free of objectionable persistence, and to produce excellent contrast. It is especially suitable for color tv pickup. Three Plumbicon cameras that have been built have exhibited excellent stability and good color rendition. With a lighting level of 100-150 ft-candles, fully saturated color pictures were obtained at a lens setting of $f/2.8$, with a signal-to-noise ratio in the luminance channel of better than 40 db.

Presented at the 42nd annual meeting of the National Association of Broadcasters, April 5-8, Chicago, Ill.

Magnetic sensor

Variable junction magnetic effect. Hujiro Yamamoto, Autonetics division, North American Aviation, Inc., Anaheim, Calif.

A properly biased silicon pnp or npn junction controls an externally applied current to produce a voltage signal proportional to the applied magnetic field. Using state-of-the-art transistor technology and semiconductor fabrication techniques, the junction can be made very thin, thus providing a sharp resolution of magnetic information reading. Some suggested applications for this device are: signal multiplier, wattmeter modulator, rotary portion transducer, magnetic tapes or drum reader, gaussmeter, electromagnetic radiation detector and gyrator.

The small device is essentially a transducer, effecting the conversion of magnetic-to-electric information. Conversion is accomplished in an extremely small region. The device is temperature-sensitive, the small size of the specimens contribute to this difficulty and temperature stabilization presents a problem. Also because of the nature of the configuration, the device has a limited frequency response. The capacitance of the junction limits the efficiency at the high frequency range. This limit probably confines operation of the device to the low megacycle region. While higher frequency response is possible in Hall-effect devices, the output impedance obtainable with the variable junction

PAMOTOR

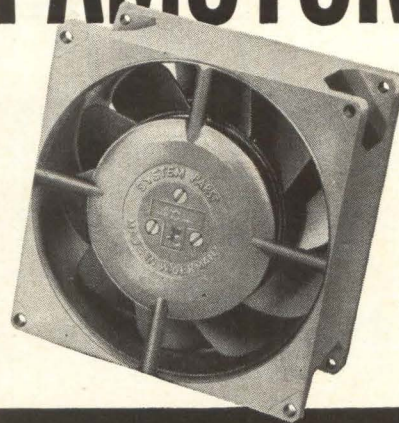

A VERSATILE NEW LINE OF MINIATURE AXIAL FANS

with features that surpass
other cooling devices in
**CONSTRUCTION,
PERFORMANCE,
RELIABILITY!**

Superior inside-outside rotating motor design yields higher torque capabilities • Flywheel effect produces constant, quiet fan speed • Available in both induction (capacitor-type squirrel cage) and shaded-pole types • Large surface sinter-metal sleeve bearings designed for permanent lubrication • Housings are of die-cast, warp-free metal construction, unlike plastic housings of many conventional fans • Ruggedly-built, yet extremely light in weight—18 oz. to 26 oz., depending upon model no. • Wide range of performance characteristics to meet specific requirements.

model no.	volts	freq. (cy.)	air flow (cfm)	overall size (inches)		
				w.	h.	d.
1000A	115	60	125	4½ x 4½	x 2	
1000B	115	50	100	4½ x 4½	x 2	
1100	115	400	100	4½ x 4½	x 2	
1200	115	60	60	4½ x 4½	x 2	
1300A	220	60	125	4½ x 4½	x 2	
1300B	220	50	110	4½ x 4½	x 2	
2000A	115	60	134	4½ x 4½	x 2	
2000B	115	50	116	4½ x 4½	x 2	
2000C	220	50	116	4½ x 4½	x 2	
2500A*	115	60	100	4½ x 4½	x 2	
2500B*	220	60	90	4½ x 4½	x 2	
2500C*	220	50	80	4½ x 4½	x 2	
3000A	115	60	60	3½ x 3½	x 2	
3000B	115	50	54	3½ x 3½	x 2	
3000C	220	50	54	3½ x 3½	x 2	
5000A	115	60	115	5 dia. x 2½	deep	
5000B	220	50	100	5 dia. x 2½	deep	

*Series 2500 is shaded-pole type. All others are induction type, equipped with appropriate capacitor.

For complete specifications and name of nearest stocking distributor, write to:

PAMOTOR, INC.
312 SEVENTH STREET • SAN FRANCISCO, CALIF.

NON-STOP COOLING



McLEAN PACKAGED BLOWERS

GO STEADY FOR
**THOUSANDS
OF HOURS**

THAT'S TOTAL RELIABILITY!

**RFI SHIELDED
MIL-SPEC
COMMERCIAL**

McLean's new "Computer Age" line of blowers offers striking good looks that won't wear off, won't wear out and won't need replacement. That's the ultimate in packaged cooling.



SEND TODAY
FOR
1964 CATALOG

**McLEAN ENGINEERING
LABORATORIES**
P.O. Box 228, Princeton, New Jersey
Phone 609-799-0100 • TWX 609-799-0245
The Originator and Leader in Packaged Cooling

160 Circle 160 on reader service card

sensor is higher than in Hall-effect devices (normally 20-200 ohms). The magnetic sensitivity appears comparable to Hall-effect devices if built with similar dimensions and of the same material.

Future work will involve an optimization for sensitivity by choosing a more suitable material, revising associated circuit element values and designing the sensing junctions as part of an integrated amplifying current chip.

Presented at the IEEE Region 3 annual meeting and technical conference, May 4-6, 1964, Clearwater, Fla.

Parametron

The magnetic thin-film parametron as a computer element.* Sidney N. Einhorn and Wilmer S. Powell. Burroughs Corp. Defense and Space Group, Paoli Research Laboratory, Paoli, Pa.

The parametron configuration studied uses a rectangular planar magnetic thin film in a center-tapped inductor as the reactive element, and a fixed capacitor. Inputs are applied through resistors, and outputs taken from either side of the tank circuit. The inductance of the tank circuit is varied by applying current to the pump winding, which is orthogonal to the tank winding.

The tank circuit is tuned to frequency f , and a magnetic field is applied in the easy direction, by the pump winding, at frequency $2f$. A d-c bias field is also applied in the easy direction, by the pump winding. An instantaneous increase occurs in the pump field when the flux linkage is at an absolute maximum. This increase in field results in a reduction of tank-circuit inductance, which adds energy to the tank circuit twice per cycle.

A feasibility model using 69 parametrons was constructed for testing packaging, signal-coupling and pump distribution concepts, with a pump frequency of 50 megacycles and 0.925-Mc clock rate.

The reliable operation achieved with the feasibility model demonstrates the practicality of interconnecting large numbers of parametrons in a logic network. No serious problem appears to result from the majority-logic properties of the parametron, or from the three-beat excitation scheme.

NEW From WILTRON I. F. PHASEMETER

Make fast, accurate phase and amplitude readings with 0.1° resolution for full 360° coverage. Voltage Output proportional to phase and to level with app. 1 ms response time.

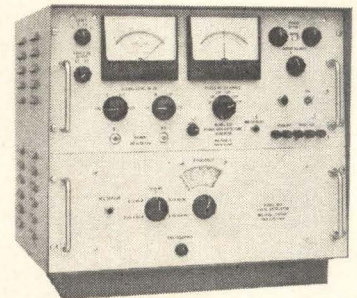

Absolute phase accuracy of 1° plus 1% of reading. Continuous frequency coverage of 2.5 Mc to 400 Mc with two interchangeable local oscillators. $100 \mu\text{v}$ sensitivity. For demonstration in your plant write to:



Circle 232 on reader service card

How To Get Things Done Better And Faster

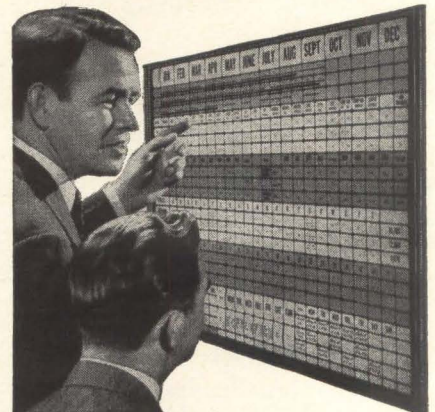

BOARDMASTER VISUAL CONTROL

- ☆ Gives Graphic Picture—Saves Time, Saves Money, Prevents Errors
- ☆ Simple to operate—Type or Write on Cards, Snap in Grooves
- ☆ Ideal for Production, Traffic, Inventory Scheduling, Sales, Etc.
- ☆ Made of Metal. Compact and Attractive. Over 750,000 in Use

Full price **\$49.50** with cards

FREE 24-PAGE BOOKLET NO. C-10
Without Obligation

Write for Your Copy Today
GRAPHIC SYSTEMS
YANCEYVILLE, NORTH CAROLINA

Circle 234 on reader service card

Nor does conversion to and from pulse representation of binary data represent obstacles.

Significant problems were met. The gated-bias scheme introduced a problem of "phase preference," in which oscillations tend to build up, not in response to the majority input phase, but in a phase determined by the timing of the bias waveform with respect to the r-f pump. Another difficulty was the sensitivity to position of the tank inductor in the pump strip, the pump and bias field having been applied to the parametron inductors in each group by a shortened strip line.

Distributed-network processor

A distributed-network processor.* James A. Ogle and Jerome M. Kurtzberg. Burroughs Corp., Defense and Space Group, Paoli Research Laboratory, Paoli, Pa.

This machine uses optical and photographic components in a moving mechanical structure to control the flow of signals in a simulated network. A connectivity pattern is specified by photographic aperture plates that can be stored and reused at will. The transfer function of network nodes is executed by a single set of simple electronic circuits, consecutively connected to the specified weighted input and output points. Ground rules were chosen for weight changes, which are photographically integrated.

The network may be effectively cross-coupled and layered, or it may be specified as having a more restricted structure. Some 10^4 connections to 10^3 nodes, for each of 16 layers, can be handled by the processor with an operate cycle time of about one second per layer. Inputs are introduced by a flying-spot channel.

The processor uses a display-storage cathode-ray tube for temporary storage of an array of spots of varying intensity, some of which are controlled by system input, some by element output. Preprocessed photographic plates, opaque except for small apertures, move cyclically with respect to images of the stored field, and select consecutively a prescribed but unconstrained series of these storage-field points. The photoelectric

WRAP-AROUND MAGNETIC SHIELDS

APPLIED IN SECONDS

**Cut to any size or outline
with ordinary scissors**



Co-Netic and Netic foils are ideal for initial laboratory or experimental evaluation . . . also for production applications and automated operations. Dramatically enhance component performance by stopping degradation from unpredictable magnetic fields. When grounded, foils also shield electrostatically. They are not significantly affected by dropping, vibration or shock, and do not require periodic annealing. Available in thicknesses from .002" in rolls 4", 15", and 19-3/8" wide. High attenuation to weight ratio possibilities. Every satellite and virtually all guidance devices increase reliability with Netic and Co-Netic alloys, saving valuable space, weight, time, and money.



MAGNETIC SHIELD DIVISION

Perfection Mica Company

1322 N. ELSTON AVENUE, CHICAGO 22, ILLINOIS

ORIGINATORS OF PERMANENTLY EFFECTIVE NETIC CO-NETIC MAGNETIC SHIELDING

Circle 233 on reader service card

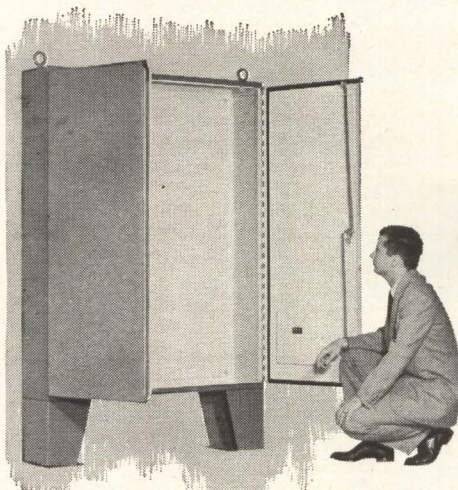

**Floor-mounted or wall-mounted
in any size you want**

Rigid and strong, these NEMA 12 enclosures provide the type of oil and dust-tight protection required for today's costly and sensitive controls. Superior design, tougher materials and quality construction are combined to provide an attractive box with solid protection.

**Cancel out
dust and oil
problems . . .**

GO HOFFMAN NEMA 12!

In some two-door models a unique overlapping door design eliminates the centerpost—simplifies installation and servicing. All seams are carefully welded; gasketed doors close true. A removable subpanel is mounted on collar studs. 144 sizes and styles—user-engineered for on-the-job convenience. Standard finish is white enamel interior with gray prime exterior over phosphatized surfaces. Available in aluminum and stainless steel too. Listed by Underwriters. Looking for an odd size? Custom fabrication is another Hoffman specialty.

Hoffman

"... has the experience"
Hoffman Engineering Corporation
Dept. E 251, Anoka, Minnesota

ELECTRICAL ENCLOSURES

CRITICAL ELECTRONIC FOIL REQUIREMENTS ?



CALL THE MAN FROM REPUBLIC

He has had extensive experience in the development and production of consistently superior aluminum foils . . . adhering to the most rigid specifications through continual in-process laboratory tests such as: testing of surface residues (organic and inorganic) rolling oils, tensile, foil "power factor" and static etchability. Combined with standard in-process mill checks the result is continuous quality control.

Republic's complete aluminum foil line includes:

- LIGHT GAGE FOIL for paper and film wound capacitors of all types.
- ETCHED ANODE & CATHODE FOIL
- PLAIN FOIL FOR ETCHING
- PLAIN FOIL for electrolytic capacitors, coil winding, and other uses.

LET US SEND YOU . . .

literature describing Republic's foil line along with the name of the man technically qualified to assist you with your foil problems.



QUALITY
in foil for

LEADERSHIP
electronics

REPUBLIC FOIL INC.

GENERAL OFFICES & ROLLING MILL DIVISION
Danbury, Connecticut

ELECTROCHEMICAL DIV. — Salisbury, North Carolina
CONSOLIDATED BAG & FOIL DIV. — Somerville, Mass.
BRANCH SALES OFFICES —

5306 West Lawrence Ave., Chicago 30, Illinois

WEST COAST — Electrical Specialty Co.,
158 Eleventh St., San Francisco 3, Cal.

signals, along with signals from variable-density weight tracks in a synchronous section of the mechanism, are processed by whatever transfer-function circuitry the experimenter chooses to implement. During one machine cycle, this circuitry performs consecutively the role of each of the elements in a conventional network structure.

Presented at the National Aerospace Electronics Conference, May 11-13, 1964
Dayton, Ohio.

New doppler/inertial combo

Helipath, the next generation in self-contained navigation.
J.C. Forrest. General Precision, Inc.,
Pleasantville, N.Y.

Doppler radar and inertial components have been combined to provide a self-contained navigation system for helicopters and low-to-medium-performance fixed-wing aircraft. The system will sell for far less than existing navigation systems. It is now under test and will be available in the near future.

The system is said to have an accuracy of 0.3 percent of distance traveled. It weighs 44 pounds and has a meantime between failures in excess of 600 hours. Components consist of a General Precision Laboratories' Helipath doppler radar, a heading reference using a gyro compass and a pictorial display.

The radar weighs 35 pounds, occupies a volume of less than 0.9 cubic feet and has an accuracy of velocity measurement better than 0.1 percent over land or water. Speed ranges are from -50 (opening) to +300 knots and altitude from 0 to 10,000 feet.

Considerable care was taken to adapt the circuit functions required to available off-the-shelf linear microcircuits. A majority of the circuits have been reduced to practice in microcircuit form.

The heading reference will weigh only five pounds and will be capable of utilizing the gyro compass to find true north while the aircraft is on the ground.

In addition to its utility for navigation, the availability of highly accurate true-heading information can be used for artillery spotting and for transfer of a north reference from one base line to another.

Presented at the American Helicopter Society meeting, May 15, 1964, Washington.

Instrument Line Magnetic Tape Heads by NORTON

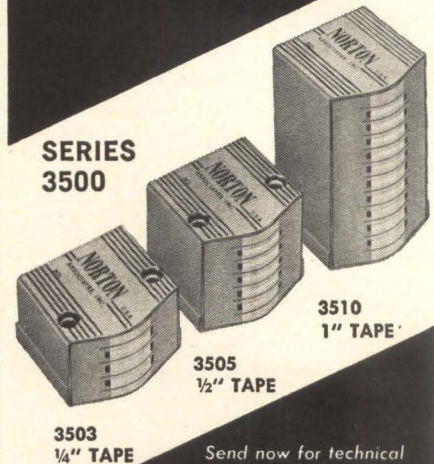

SERIES
3500

3503
1/4" TAPE

3505
1/2" TAPE

3510
1" TAPE

Send now for technical literature with specifications on the complete Norton line of magnetic heads.

NORTON

ASSOCIATES, INC.

240 Old Country Road, Hicksville, N. Y.

Circle 235 on reader service card

SILICON SOLID STATE FREQMETER FREQUENCY-TO-DC CONVERTER

-55 C. TO +85 C.

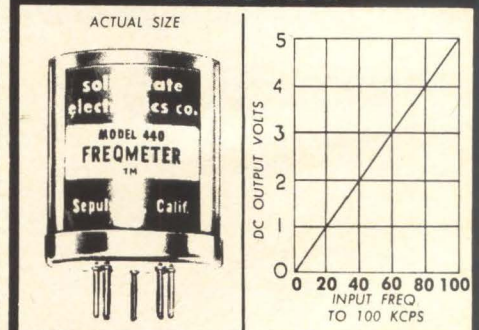

MICROMINIATURE
LIGHTWEIGHT

LINEAR
LOW POWER

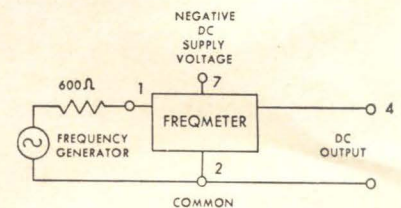

WRITE OR PHONE FOR BULLETINS

SOLID STATE ELECTRONICS CORP.
15321 RAYEN STREET
SEPULVEDA, CALIFORNIA
EMpire 4-2271 • 5Tate 5-4473



Data compressor

Superconductive nanosecond data compressor*. Richard J. Allen. Martin Company, Baltimore

The superconductive nanosecond data compressor provides a means of recirculation compression and storage that will operate in the range from 100 megacycles up to at least the low gigacycle frequencies. The device becomes more effective at increased frequencies as storage capacity increases. Alteration to data expansion or readout is elementary. Since the delay line has a wide dynamic range and very low dispersion, it can also accommodate analog signals for either time compression or expansion, with suitable normalizing amplifiers and recirculation synchronization.

Here is an approach to the problem of providing input data for high-speed computers at speeds compatible with the high-speed logic circuit capability. The compressor also provides low-capacity, high-speed storage such as for scratch-pad needs and a means of readout to low-speed equipment. The approach is basically that of sampling, and using a processing recirculating storage to accumulate an effectively "time-compressed" high-speed input. The recirculating loop by itself provides a scratch-pad storage, and when used with sampling and pulse-stretching circuitry, can be used to expand the stored data for slow-speed readout.

The use of electromagnetic delay lines, such as coaxial cables, is of little value at low frequencies due to the low storage time per unit length. The electromagnetic delay (coaxial cryogenic lines) acquires practical significance at higher frequencies due to its increase in storage capacity per unit length, and to the frequency limitations on other methods of dynamic storage.

The use of the electromagnetic delay line for data compression in the device is felt to be significant through the capability it affords, which is that of extending this technique to high-speed logic applications.

Presented at the National Aerospace Electronics Conference, May 11-13, 1964 Dayton, Ohio

MARYLAND fact 3 MARYLAND

The fastest growing major science-industry complex in the nation is the Maryland-D. C. area — the best possible testimony to its unique combination of economic, educational, cultural and recreational advantages.

Get ALL the FACTS - NOW!



Ask For New, Revised
1964 Edition of
"MARYLAND
BASIC PLANT
LOCATION DATA"
Write, Wire
or Phone Collect

MARYLAND
DEPARTMENT OF
ECONOMIC DEVELOPMENT
Division EM
State Office Bldg. Annapolis, Md.

Circle 238 on reader service card

NEW FLUKE 64A
CATALOG DIGEST
DESCRIBES OVER 40
MODELS OF PRECISION
TEST AND MEASURE-
MENT INSTRUMENTS

REMEMBER, FLUKE
BUILDS GOOD EQUIPMENT,
CONSERVATIVELY RATED
SEND FOR YOUR
FREE COPY

For CATALOG DIGEST: Write
JOHN FLUKE MFG. CO., INC.,
Box 7428, Seattle, Wash. 98133

FLUKE

Circle 237 on reader service card

DIGITEC

LOW COST

DC-DVM

.1% accuracy



base price \$310.00 portable model "200" shown

36 models

- New Styling
- Improved Mechanical & Circuit Details
- Higher Ambient Operating Temperature
- Increased Life & Reliability
- Single & Multi-Range Models from 0.0000 to 1000. V-DC
- Auto-Polarity—Optional

AC-DC CONVERTER

portable model "900" shown



.3% Accuracy

base price \$285.00

DigiTec & Converter offered in Panel and Flange Models

UNITED SYSTEMS CORPORATION
918 Woodley Road, Dayton 3, Ohio (513) 254-3567

Stocking Representatives Throughout the United States and Canada

QUALIFICATION FORM FOR POSITIONS AVAILABLE

ATTENTION: ENGINEERS, SCIENTISTS, PHYSICISTS

This Qualification Form is designed to help you advance in the electronics industry. It is unique and compact. Designed with the assistance of professional personnel management, it isolates specific experience in electronics and deals only in essential background information.

The advertisers listed here are seeking professional experience. Fill in the Qualification Form below.

STRICTLY CONFIDENTIAL

Your Qualification form will be handled as "Strictly Confidential" by Electronics. Our processing system is such that your form will be forwarded within 24 hours to the proper executives in the companies you select. You will be contacted at your home by the interested companies.

WHAT TO DO

1. Review the positions in the advertisements.
2. Select those for which you qualify.
3. Notice the key numbers.
4. Circle the corresponding key number below the Qualification Form.
5. Fill out the form completely. *Please print clearly.*
6. Mail to: Classified Advertising Div., Electronics, Box 12, New York, N. Y. 10036.

COMPANY	SEE PAGE	KEY #
AEROSPACE PLACEMENT CORP. Phila., Pa.	164	1
ATOMIC PERSONNEL INC. Phila., Pa.	164	2
COLLINS RADIO CO. Cedar Rapids, Iowa	102	3
GUIDED MISSILES RANGE DIV. PAN AMERICAN WORLD AIRWAYS, INC. Patrick Air Force Base, Fla.	165	4
METALS & CONTROL, INC. A CORPORATE DIV. OF TEXAS INSTRUMENTS, INC. Attleboro, Mass.	164	5
MOTOROLA, INC. Scottsdale, Arizona	142*	6
U. S. ARMY ENGINEER GEODESY, INTELLIGENCE AND MAPPING, RESEARCH AND DEVELOPMENT AGENCY Fort Belvoir, Pa.	165	7

* These advertisements appeared in the May 4th issue.

(cut here)

(cut here)

Electronics WEEKLY QUALIFICATION FORM FOR POSITIONS AVAILABLE

(Please type or print clearly. Necessary for reproduction.)

Personal Background

NAME

HOME ADDRESS

CITYZONE.....STATE.....

HOME TELEPHONE

Education

PROFESSIONAL DEGREE(S)

MAJOR(S)

UNIVERSITY

DATE(S)

FIELDS OF EXPERIENCE (Please Check)

51864

- | | | |
|--|--|---------------------------------------|
| <input type="checkbox"/> Aerospace | <input type="checkbox"/> Fire Control | <input type="checkbox"/> Radar |
| <input type="checkbox"/> Antennas | <input type="checkbox"/> Human Factors | <input type="checkbox"/> Radio—TV |
| <input type="checkbox"/> ASW | <input type="checkbox"/> Infrared | <input type="checkbox"/> Simulators |
| <input type="checkbox"/> Circuits | <input type="checkbox"/> Instrumentation | <input type="checkbox"/> Solid State |
| <input type="checkbox"/> Communications | <input type="checkbox"/> Medicine | <input type="checkbox"/> Telemetry |
| <input type="checkbox"/> Components | <input type="checkbox"/> Microwave | <input type="checkbox"/> Transformers |
| <input type="checkbox"/> Computers | <input type="checkbox"/> Navigation | <input type="checkbox"/> Other |
| <input type="checkbox"/> ECM | <input type="checkbox"/> Operations Research | <input type="checkbox"/> |
| <input type="checkbox"/> Electron Tubes | <input type="checkbox"/> Optics | <input type="checkbox"/> |
| <input type="checkbox"/> Engineering Writing | <input type="checkbox"/> Packaging | <input type="checkbox"/> |

CATEGORY OF SPECIALIZATION

Please indicate number of months experience on proper lines.

	Technical Experience (Months)	Supervisory Experience (Months)
RESEARCH (pure, fundamental, basic)
RESEARCH (Applied)
SYSTEMS (New Concepts)
DEVELOPMENT (Model)
DESIGN (Product)
MANUFACTURING (Product)
FIELD (Service)
SALES (Proposals & Products)

CIRCLE KEY NUMBERS OF ABOVE COMPANIES' POSITIONS THAT INTEREST YOU

1 2 3 4 5 6 7 8 9 10 11 12 13 14 15

ELECTRONIC ENGINEERS

Instruments in Massachusetts
New opportunities at Texas

Metals & Controls Inc., nationally known manufacturer of precision electromechanical controls, now has challenging openings for two electronic design engineers. These men will develop new solid state controls for applications in the appliance, electric motor, electronic and aerospace industries. Both positions offer project-type responsibility ranging from customer applications work to manufacturing problems.

Applicants should have a BS or MS in electrical engineering and 2-4 years experience, preferably in the design of low frequency or power-type circuits. Salary commensurate with experience. Outstanding TI benefits.

To apply, send confidential letter or resume to Mr. T. M. Fowler, Director of Salaried Employment. All inquiries will receive immediate attention.



METALS & CONTROLS INC.
34 FOREST STREET • ATTEBORO, MASS.
A CORPORATE DIVISION OF
TEXAS INSTRUMENTS
INCORPORATED

An equal opportunity employer



E. E.'s for FEE-PAID Positions WRITE US FIRST!

Use our confidential application for professional, individualized service . . . a complete national technical employment agency.

ATOMIC PERSONNEL, INC.
Suite 1207L, 1518 Walnut St., Phila. 2, Pa.

New York • Los Angeles • St. Louis • Minneapolis • Atlanta

EE-MATH

CONFIDENTIAL
SELECTIVE
FEE-PAID
ALL DEGREES
SEND RESUME TO:



AEROSPACE
PLACEMENT CORPORATION
P.O. Box 2125 Philadelphia, Pa. 19103

ASTRONOMERS, MATHEMATICIANS, ELECTRONIC ENGINEERS, AND PHYSICISTS

Immediate openings with the U. S. Army Engineer Geodesy, Intelligence and Mapping, Research and Development Agency (GIMRADA), at Fort Belvoir, Virginia. Opportunities for research projects which include optics, photogrammetry, automatic data devices, space sciences and related fields. Salaries range from \$5,650 to \$13,615 p/a. Applicants must meet Civil Service requirements. Contact Mr. Payne, Telephone 781—8500, extension —24267, or submit resumes to Civilian Personnel Office, Fort Belvoir, Virginia.

An Equal Opportunity Employer



IT TAKES GUTS....

and technical savvy . . . and the ability to be boss . . . to be a Ship Operations Manager with Pan Am's Guided Missiles Range Division.

With a launch in progress, be it missile, manned space craft, satellite or space probe, he repeatedly makes important, split-second decisions with the chips down. A multi-million dollar mission may depend on his know-how.

These are the men who manage the instrumentation complex on each tracking ship along the 10,000 mile length of the Atlantic Missile Range. They take full responsibility for directing the real-time monitoring of vehicle performance in flight . . . using pulse and CW radar, telemetry, optics, infrared, timing, command/control, data encoding and transmission equipment of the latest design. They perform in-flight trajectory measurements, utilizing digital computers and inertial navigation systems. Among major programs to be supported in the future are GEMINI, MOL/ GEMINI B, and APOLLO.

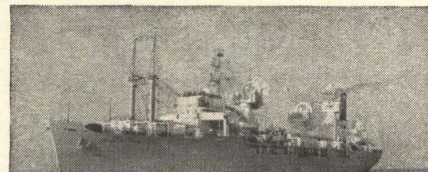

If you have a strong technical background in these many areas of electronics . . . if you have engineering management ability and can make the right decision under pressure . . . if you want broad exposure to the whole world of range technology, a springboard to even more important positions at the Cape, write in confidence to Manager, Professional Employment, Dept. 28E-3.



GUIDED MISSILES RANGE DIVISION

PAN AMERICAN WORLD AIRWAYS, INC.
P. O. BOX 4465, PATRICK AIR FORCE BASE, FLORIDA

An Equal Opportunity Employer

PINPOINT YOUR EMPLOYMENT ADVERTISING . . .

It's a fact that electronics engineers *pay* to read Electronics magazine every other week. What's more, *virtually all subscribers* work in the electronics field . . . All the more reason why your employment advertising belongs in Electronics—the publication where *maximum* interested engineer readership pinpoints your message at *minimum* cost to you.

For Rates and Information Write:

Electronics

A McGraw-Hill Publication
Classified Advertising
Division
P.O. Box 12, New York
10036

SEARCHLIGHT SECTION

(Classified Advertising)

BUSINESS OPPORTUNITIES

EQUIPMENT - USED or RESALE

STEPPING SWITCHES SENSITORS STRUTHERS DUNN ROTARY RACHET ALLIED LEDEX CLARE LEACH MINIA SIGMA NORTH ELECTRIC DORMEYER TELEPHONE TYPE KURMAN STEVENS ARNOLD CONTACT MERCURY SOLENOIDS ADVANCE ALLEN BRADLEY POTTER BRUMFIELD

SIGMA HERMETICALLY KURMAN SEALED WARD LEONARD M. AUTOMATIC ELECTRIC LEACH CLARE EVENS NOLD ANCE ALLIED CRAFT LEDEX KEYING PHILLIPS CONTROLS AMPERITE WESTERN ELECTRIC CUTLER HAMMER GENERAL ELECTRIC GUARDIAN CONTACTORS PRICE ELECTRIC WESTON MINIATURE AIRCRAFT

LARGEST STOCK OF RELAYS IN THE WORLD

PRODUCTION QUANTITIES MOST MAKES IN STOCK

Send for Latest Catalog

Universal RELAY CORP.

42 WHITE ST. NEW YORK 13, N. Y. WALKER 5-6900

CIRCLE 950 ON READER SERVICE CARD

NEW DISC CAPACITORS

OVER 3 1/2 MILLION IN STOCK
ALL SIZES—BELOW FACTORY PRICES

Call or Write for Quotes

SAMUEL GLICK & SONS
313 Broadway, Dept. C New York 7, N. Y.
Phone: 212 WO 4-5162

CIRCLE 951 ON READER SERVICE CARD

ARROW

FREIGHT FORWARDERS

Sub. of LIFSCHULTZ TRANSPORT, Inc.

FASTEST COAST TO COAST

5th & 6th DAY EAST COAST TO CAL., ARIZ., NEV., ORE. and WASH.

7th DAY TO EAST COAST from CAL., ARIZ., NEV., ORE. and WASH.

Specialists in Shipment of Electronics Products
Call for information

NEW YORK — PHILADELPHIA
BALTIMORE — BOSTON — NEW JERSEY
HOLYOKE — NEW HAVEN — PROVIDENCE
LOS ANGELES — SAN FRANCISCO — SEATTLE

CIRCLE 952 ON READER SERVICE CARD

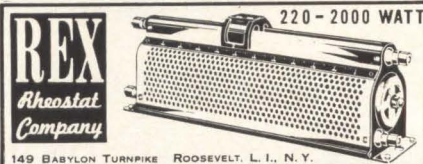

149 BABYLON TURNPIKE ROOSEVELT, L. I., N. Y.
CIRCLE 953 ON READER SERVICE CARD

POTTING APPLICATORS
MANUAL AND DISPOSABLE
6cc 12cc 30cc
FOR POTTING, ENCAPSULATING, AND SEALING OF MINIATURE COMPONENTS
PHILIP FISHMAN CO.
7 CAMERON ST., WELLESLEY 81, MASS.

CIRCLE 954 ON READER SERVICE CARD

Antique

TELEPHONES

As is complete, decorative purpose \$17.50. Working order, inter-comm. \$19.50 Ext. on dial \$24.50, talking circuit only. Write for complete list. All shipments FOB, Simpson, Pa.

TELEPHONE ENGINEERING CO.
Dept. 51864, Simpson, Pa.

CIRCLE 955 ON READER SERVICE CARD

TUBES & COMPONENT
FREE...CATALOG
BARRY ELECTRONICS

512 BROADWAY 212-WALKER 5-7000
NEW YORK 12, N. Y. TWX-571-0484

CIRCLE 956 ON READER SERVICE CARD

• TOP BRAND ELECTRON TUBES •
WE BUY AND SELL
★ EXCESS INVENTORIES
★ TERMINATION CONTRACTS
TERRIFIC SAVINGS!
Send for FREE Buyers' Guide
METROPOLITAN SUPPLY CORP.
443 PARK AVE SOUTH • NEW YORK 16, N. Y.
212-MU 6-2834 • TWX 212-867-5888

CIRCLE 957 ON READER SERVICE CARD

RADAR AUTO-TRACK & TELEMETRY ANTENNA PEDESTALS 3 & 10 CM. SCR 584 AUTOTRACK RADARS. M-33 RADAR TPS-1D SEARCH. APS-45 TPS-10D HT. FINDERS. WX RADARS. FPN-32GCA. APS-10 APS-15B APS-27 (AMIT) SEARCH. ■ ■ ■ APN-102 DOPPLER. DOZENS MORE. CARCINOTRONS. PFN'S. 25-5-1-2-3-6 MEGAWATT PULSE MODULATORS. CAVITIES. PULSE TRANSFORMERS. IF STRIPS. WAVEGUIDE. BENDS 200 MC. 1 KMC. 3 KMC. 6 KMC. 9 KMC. 24 KMC. RF PKGS.

RADIO RESEARCH INSTRUMENT CO.
550 5TH AVE., NEW YORK 36, N. Y. JU 6-4691

CIRCLE 958 ON READER SERVICE CARD

INDUSTRIAL—RECEIVING SPECIAL PURPOSE TUBES

BEST QUALITY—LOWEST PRICES

Semiconductors—All Types

FREE CATALOG—write

ROBERT G. ALLEN CO.

P.O. Box 1882 Dept. E-1, Beverly Hills, Calif. 90213
Phone (213) 657-1583

CIRCLE 959 ON READER SERVICE CARD

TEST EQUIPMENT

Germ. Transistor Asby. Eq. Lab. Xtal Grow. Auto. GE and SIL Diode and Trans. Test Eq.

FS-4122, Electronics
255 California St., San Francisco, Calif. 94111

CIRCLE 960 ON READER SERVICE CARD

WRITE FOR NEW **KEYSTONE**
free catalog

BATTERY HOLDERS, TERMINALS, TERMINAL BOARDS & HARDWARE

KEYSTONE ELECTRONICS CORP.
49 BLEECKER ST., NEW YORK 12, N. Y.

CIRCLE 961 ON READER SERVICE CARD

Your Used, Surplus and Rebuilt Equipment Advertising here in the SEARCHLIGHT SECTION will impress key buyers . . .

Buyers regularly turn to these pages for their used equipment needs . . . You can reach these buyers quickly and economically with your advertising in this "meeting place" of used electronics equipment buyers and sellers.

For more information, please contact:

Electronics

Classified Advertising Div.,

P.O. Box 12, New York, N. Y. 10036

Area Code 212, 971-2557

Electronics advertisers

May 18, 1964

■ AMP Inc.	21
Garceau, Hargrave & McCullough Inc.	
■ Acme Electric Corp.	116
Scheel Adv. Agency	
■ Alden Electronics & Impulse Recording Co.	155
Larcom Randall Advertising Inc.	
Alifax Paper Company	155
Larcom Randall Advertising Inc.	
Allen Avionics Inc.	158
Gilbert S. Nearman Co. Inc.	
■ Amperex Electronics Corp.	51
Sam Groden Incorporated	
Anasco, A Div. of	50
General Aniline & Film Corp.	
Lennen & Newell Inc.	
■ Arco Electronics Inc.	110
Milchar Adv. Inc.	
Assembly Products	148
George Z. Griswold Adv.	
Astrodata Inc.	25
Bonnfield Associates Inc.	
Atlanta Chamber of Commerce	36
Tucker Wayne & Company	
Beckman Instruments Inc., Offner Division	33
Erwin Wasey, Ruthrauff & Ryan Inc.	
Brush Instruments, Div. of Clevite	3rd Cover
Carr Liggett Adv., Inc.	
Bud Radio Inc.	157
Allied Advertising Agency Inc.	
Burroughs Corp.	
Electronics Components Div.	97
Conti Adv. Agency, Inc.	
Cambridge Thermionic Corp.	138
Chirurg & Cairns Inc.	
Ceramics International Corp.	141
Conti Adv. Agency, Inc.	
■ Clairex Corp.	142
S. Paul Sims Co.	
■ Cohn, Siamound	130
William G. Seidenbaum & Co.	
Collins Radio Company	102
Tracy Locke Co. Inc.	
■ Cominco Products Inc.	142
McKim Adv. Limited	
Consolidated Electrodynamics Corp.	101, 144
Hixson & Jorgensen Inc.	
Coto Coil	149
The Williams Company	
Crown International Communications Inc.	147
■ Dage Electric Co., Inc.	154
La Grange & Garrison Inc.	
Delco Radio	120, 121
Campbell-Ewald Company	
Digital Equipment Corp.	24
Loudon Adv., Inc.	
■ Dymec Div. of Hewlett Packard Co.	1
L.C. Cole Company Inc.	
Dynamics Instrumentation Co.	154
Balsam Advertising, Inc.	
■ Electro Motive Mfg. Co. Inc., The Cory Snow Inc.	111
Electro Products Laboratories Inc.	138
C.M. Gotsch, Advertising	
Electro Scientific Industries Inc.	117
Ken Webber Adv.	
Electro-Seal Corporation	140
Merchandising Advertisers, Inc.	
Electronica Components Exhibition	158
Gerald G. Kallman Associates	
Electronic Modules Corp.	152
Ray Thompson & Associates Inc.	
Electronic Specialty Co.	26
Grant Adv. Inc.	
Esterline Anaus Instrument Co. Inc.	125
Caldwell, Larkin & Sidener-Van Riper Inc.	
Fairchild Dumont Laboratories	45
The Roder and Wilbur Co. Inc.	
■ Fenwal Electronics	146
Larcom Randall Adv. Inc.	
Fluke Mfg. Co., Inc., John Pollock & Loth, Inc.	163
Formica Corp.	104
Perry-Brown Inc.	
■ Friedrich & Dimmock Inc.	149
Wyble Advertising	
■ Garlock Electronic Products Inc.	151
Atlantic Industrial Adv.	
General Radio Co.	2nd Cover
K.E. Morang Co.	
Geo Space Corporation	132
Gertsch Products Inc.	131
Balsam Advertising Inc.	
■ Globe Industries Inc.	133, 152
Odiome Industrial Adv. Inc.	
Graphic Systems Inc.	160
Caswell Adv. Agency	

Gries Reproducer Corp.	158
Harold Marshall Adv. Co.	
Gudebrod Bros. Silk Co. Inc.	122
Lee Ramsdell & Co. Inc.	
Hansen Mfg. Co. Inc.	134
Keller-Crescent Co.	
Heinemann Electric Co.	19
Thomas R. Sundheim Inc.	
■ Hewlett Packard Co.	2
L.C. Cole Company Inc.	
Hoffman Engineering Corporation	161
The Erle Savage Company	
Houston Instrument Corp.	136, 137
Cooley & Pate Inc.	
Hull Corporation	144
The Michener Company Adv.	
Hurst Mfg. Co.	156
Taylor, Crook Associates	
Intercontinental Instruments Inc.	128
Dunwoodie Associates Inc.	
Interstate Electronics	123
Jones, Maher, Roberts Adv.	
■ ITT Cannon Electric Inc.	103
West, Weir & Bartel Inc.	
Jerrold Corp.	10
Irving Gould Adv. Inc.	
Kay Electric Company	20
Josephson, Cuffari & Co.	
■ Keithley Instruments Inc.	135
Bayless-Kerr Company	
■ Kepco, Inc.	16
Weiss Advertising	
■ Knights Co. James	150
Kenneth B. Butler & Associates	
■ Kyoritsu Electrical Instrument Works, Ltd.	132
Nichiden Adv. Ltd.	
■ Lambda Electronics Corp.	37
Michel Cather, Inc.	
■ Lapp Insulator Co., Inc.	115
Wolff Associates, Inc.	
Leesona Corp.	139
Chirurg & Cairns, Inc.	
■ Linen Thread Co.	152
Robert Luckie Adv.	
Logitek, Inc.	127
Dunwoodie Associates Inc.	
MRC Manufacturing Corporation	156
Pritchard Wood Incorporated	
Machlett Laboratories Inc., The Fuller & Smith & Ross Inc.	8
Mallory & Co. Inc. P. R.	22, 23, 99
The Aitkin-Kynett Co.	
Maryland Dept. of Economic Development	163
Rosenbush Adv. Agency Inc.	
Matsuo Electric Co., Ltd.	168
Asahi Advertising Agency & Co.	
■ McLean Engineering Laboratories	160
Healy Adv. Agency	
Mechatrol Div. of Servomechanisms Inc.	126
Lewis, Hunt & Harland Associates	
Melpar Inc.	42
Lewis, Dobrow and Lamb	
Mico Instrument Company	149
Minnesota Mining & Mfg. Co. Mincom Division	47
Reach, McClinton & Co., Inc.	
Mitsubishi Electric Corp.	100
Hakuhodo Inc.	
Mitsumi Electric Co., Ltd.	168
Dentsu Advertising Ltd.	
Monterey Electronic Products	41
Michelson Advertising	
Motorola Semiconductor Products Inc.	31
Lane and Bird Advertising Inc.	
■ NRC Equipment Co.	145
S. Gunnar Myrbeck & Co. Inc.	
■ North Atlantic Industries Inc.	114
Dunwoodie Associates Inc.	
■ Norton Associates, Inc.	162
J.J. Coppo Company Inc.	
Paktron, Div. Illinois Tool Works Inc.	112, 113
Raymond E. Finn & Associates	
Pamotor, Inc.	159
Harry P. Bridge Co.	
■ Perfection Mica Company, Magnetic Shield Div.	161
Burton Browne Advertising	
■ Philco, A Sub. of Ford Motor Co.	14
Maxwell Associates, Inc.	
Potter Instrument Co. Inc.	53, 54, 55, 56
Larcom Randall Adv. Inc.	
Princeton Applied Research Corp.	49
Mort Barish Associates	
Radar Design Corp.	146
Barlow/Johnson Inc.	
Radiation Inc.	48
G.M. Barford Company	

Radio Corporation of America	4th Cover
Al Paul Lefton Co.	
■ Republic Foil Inc.	162
John S. Kemble Advertising	
■ Ribet Desjardins	129
Inter-plans	
Rome Cable, Div. of Alcoa	40
The Rumrill Co. Inc.	
■ Rosemount Engineering Co.	143
Midland Associates Inc.	
■ Sangamo Electric Company	38
Winius-Brandon Company	
■ Semi-Elements, Inc.	156
Axelband & Brown Associates	
Servo Corp. of America	130
Mabuchi, Kameny & Smith Inc.	
Silicon Transistor Corp.	9
A.D. Adams Adv. Inc.	
Solid State Electronics Corp.	162
Modernart Company	
Sprague Electric Co.	5, 6
The Harry P. Bridge Co.	
Stackpole Carbon Co.	52
Meek and Thomas, Inc.	
Standard Telephones and Cables	39
Brockie Haslam & Co.	
■ Stevens-Arnold, Inc.	150
Meissner & Company Inc.	
Stromberg-Carlson Div. of General Dynamics	140
The Rumrill Company Inc.	
■ Synthane Corp.	146
Arndt, Preston, Chapin, Lamb & Keen Inc.	
■ Syntronic Instruments, Inc.	151
Burton Browne Adv.	
■ Tektronix Inc.	98
Hugh Dwight Adv. Inc.	
■ Telonic Industries Inc.	7
Jansen Associates	
Texas Instruments Incorporated	
Industrial Products Group	109
Robinson-Gerrard, Inc.	
Texas Instruments Incorporated Semiconductor Division	12, 13
Don L. Baxter	
Thermal American Fused Quartz Co. Inc.	134
Knep Associates	
■ Toyo Electronics Ind. Corp.	128
Dentsu Advertising	
Transitron Electronic Corp.	35
The Bresnick Co. Inc.	
United Systems Corporation	163
Advertising and Merchandising Inc.	
Vernitron Corporation	158
Harold Marshall Adv. Co. Inc.	
Vidar Corp.	118
Bonfield Associates Inc.	
■ Vitramon, Inc.	46
Ted Sommers, Inc.	
Wang Laboratories Inc.	153
Robert Hartwell Gabine Adv.	
Wells Electronics Inc.	134
Weco Adv.	
■ Weston Instruments & Electronics	11
G.M. Basford Co.	
White, S.S.	124
W.L. Towne Co. Inc.	
Wiltron Company	160
Stadler/Cowman Advertising	
Zivy & Co., N.	138
Gerhard Rechsteiner	

Classified advertising	
F.J. Eberle, [212] 971-2557	
Business Manager	
Employment Opportunities	164-165
Equipment	
(Used or Surplus New)	
For Sale	166
Classified advertisers index	
Aerospace Placement Corp.	164
Allen, Robert S.	166
Arrow Freight Forwarders	166
Atomic Personnel Inc.	164
■ Barry Electronics	166
Fishman, Inc., Philip	166
Glick & Sons, Samuel	166
Keystone Electronics Corp.	166
Metals & Controls, Inc.	164
Metropolitan Supply Corp.	166
Pan American World Airways Inc.	165
R & D Procurement Office	165
■ Radio Research Instrument Co.	166
Rheostat Co., Rex	166
Telephone Engineering Co.	166
■ Universal Relay Corp.	166

■ For more information on complete product line see advertisement in the latest Electronics Buyers' Guide

Executive, editorial, circulation and advertising offices: McGraw-Hill Building, 330 West 42nd Street, New York, N.Y., 10036. Telephone Area Code 212-971-3333. Teletype TWX N.Y. 212-640-4646. Cable McGrawhill, N.Y. Officers of the Publications Division: Shelton Fisher, President; Vice Presidents: Joseph H. Allen, Operations; John R. Callahan, Editorial; Ervin E. DeGraff, Circulation; Donald C. McGraw, Jr., Advertising Sales; Angelo R. Venezian, Marketing. Officers of the Corporation: Donald C. McGraw, President; Hugh J. Kelly, Harry L. Waddell, L. Keith Goodrich, Executive Vice Presidents; John L. McGraw, Treasurer; John J. Cooke, Vice President and Secretary. Title R registered U.S. Patent Office; © copyright 1964 by McGraw-Hill, Inc. All rights reserved, including the right to reproduce the contents of this publication, in whole or in part.

TR MICRO TV TUNER

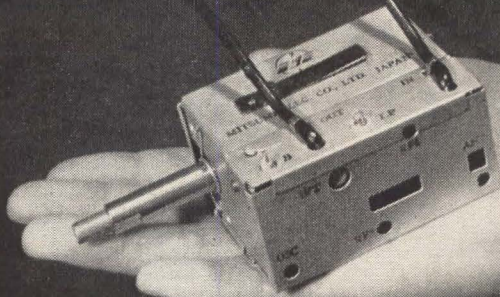

MODEL TU-15U

This MICRO TV TUNER, using 3 transistors, provides you with excellent performance while keeping high quality stability, thanks to our latest technical advancement. Spurious radiation meets the requirements of FCC and is guaranteed for performance of more than 40,000 operations. We also offer you many other lines of components for your use. Please write us asking for catalogs available on the following products:

Main Products

Polyvaricon, IF Transformers, Oscillator Coils, Antenna Coils, Variable Resistors, FM Tuners, TV Tuners, Micro-motors, Sockets.



MITSUMI ELECTRIC CO., LTD.

Head Office Komae, Kitatama, Tokyo, Japan.
New York Office 11 Broadway, New York 4, N.Y., U.S.A.

Circle 239 on reader service card

WHERE **QUALITY**
COMES FIRST

NCC
RELIABLE CAPACITORS

MYLAR FILM CAPACITOR



Type MFL (dipped flat type)

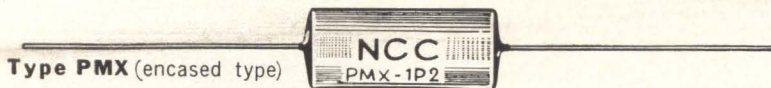

Type PMX (encased type)

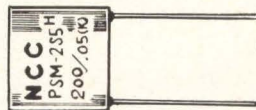

Type PSM (encased type)

POLYSTYREN FILM CAPACITOR



Type SFL

SOLID TANTALUM CAPACITOR



MIL-C-26655

Type TAX

MATSUO ELECTRIC CO., LTD.

HEAD OFFICE : 3-5, 3-CHOME, SENNARI-CHO, TOYONAKA-SHI, OSAKA, JAPAN.

TOKYO OFFICE : 25, 2-CHOME, KANDA AWAJI-CHO, CHIYODA-KU, TOKYO.

Cable Address "NCC MATSUO" OSAKA



Electronics

May 18, 1964

Advertising sales staff

James T. Hauptli: [212] 971-2210
Advertising sales manager

Atlanta, Ga. 30309: Gus H. Krimsier,
Michael H. Miller, 1375 Peachtree St. N.E.,
[404] TR 5-0523

Boston, Mass. 02116: William S. Hodgkinson,
McGraw-Hill Building, Copley Square,
[617] CO 2-1160

Chicago, Ill. 60611: Robert M. Denmead,
Daniel E. Shea, Jr., 645 North Michigan
Avenue, [312] MO 4-5800

Cleveland, Ohio 44113: Paul T. Fegley, 55
Public Square, [216] SU 1-7000

Dallas, Texas 75201: Frank Le Beau, The
Vaughn Building, 1712 Commerce Street,
[214] RI 7-9721

Denver, Colo. 80202: John W. Patten, David
M. Watson, Tower Bldg., 1700 Broadway,
[303] AL 5-2981

Houston, Texas 77025: Kenneth George,
Prudential Bldg., Halcombe Blvd.,
[713] RI 8-1280

Los Angeles, Calif. 90017: Ashley P.
Hartman, John G. Zisch, 1125 W. 6th St.,
[213] HU 2-5450

New York, N.Y. 10036:
Donald R. Furth [212] 971-3616
Donald H. Miller [212] 971-3615
George F. Werner [212] 971-3617
500 Fifth Avenue

Philadelphia, Pa. 19103: William J. Boyle,
Warren H. Gardner, 6 Penn Center Plaza,
[215] LO 8-6161

San Francisco, Calif. 94111: Richard C.
Aicorn, 255 California Street,
[415] DO 2-4600

London W1: Edwin S. Murphy Jr., 34 Dover
Street

Frankfurt/Main: Matthee Herfurth, 85
Westendstrasse Phone: 77 26 65 and
77 30 59

Geneva: Michael R. Zeynel,
2 Place du Port 244275

Paris VIII: Denis Jacob, 17 Avenue
Maignon ALMA-0452

Tokyo: Shigeo Chiba, 1, Kotohiracho,
Shiba, Minato-ku (502) 0656

Osaka: Kazutaka Miura, 163, Umegae-cho,
Kita-ku [362] 8771

Nagoya: International Media
Representatives, Yamagishi Bldg.,
13,2-Chome, Oike-cho Naga-ku

R.S. Quint: [212] 971-2335
General manager
Electronics Buyers' Guide

David M. Tempest: [212] 971-3139
Promotion manager

Henry M. Shaw: [212] 971-3485
Market research manager

Richard J. Tomlinson: [212] 971-3191
Business manager

Theodore R. Geipel: [212] 971-2044
Production manager

Signal on
conventional channel
width

40mm

Identical signal
on Mark 280 channel width

80mm

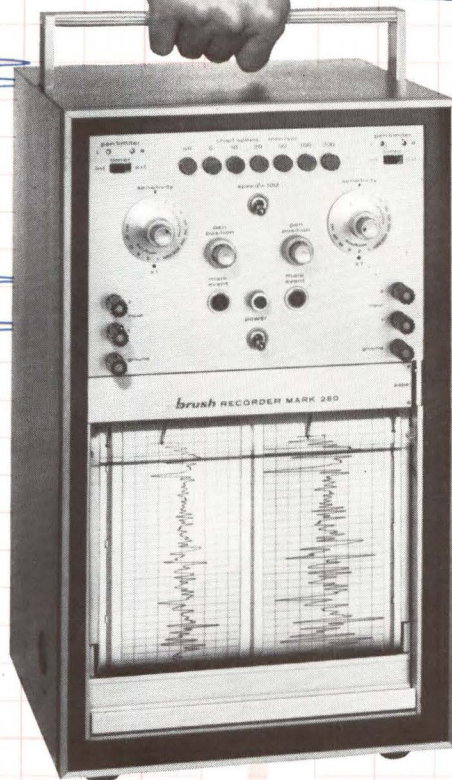

New! Brush records 35 cps full scale on 80mm

The new portable Mark 280 doubles resolution of traces without sacrificing frequency response! And . . . you get instantaneous rectilinear ink records of unparalleled accuracy and clarity. Forced fluid writing presents traces, at frequencies to 35 cps full scale, on low cost chart paper. Dual channels each have 50 divisions in an 80 mm width, with trace width constant at one-tenth of a chart division. So now, you can easily detect minute signal variations and take *full* advantage of a $\frac{1}{2}\%$ system accuracy. Matched solid-state amplifiers provide a sensitivity of 0.5 millivolts/div. Operating controls include attenuator, pen-position, variable gain and 12 push-button chart speeds. No other recorder can match the total capability of the Mark 280. Write for details.

brush INSTRUMENTS
DIVISION OF CLEVITE 37TH AND PERKINS, CLEVELAND 14, OHIO

Circle 901 on reader service card

CLEVELAND, OHIO

DIVISION OF CLEVITE CORPORATION

BRUSH INSTRUMENTS

NOW YOU CAN ELIMINATE TEMPERATURE CONTROLS FROM FERRITE MEMORIES ... EVEN FROM 2 μ SEC HIGH-SPEED SYSTEMS

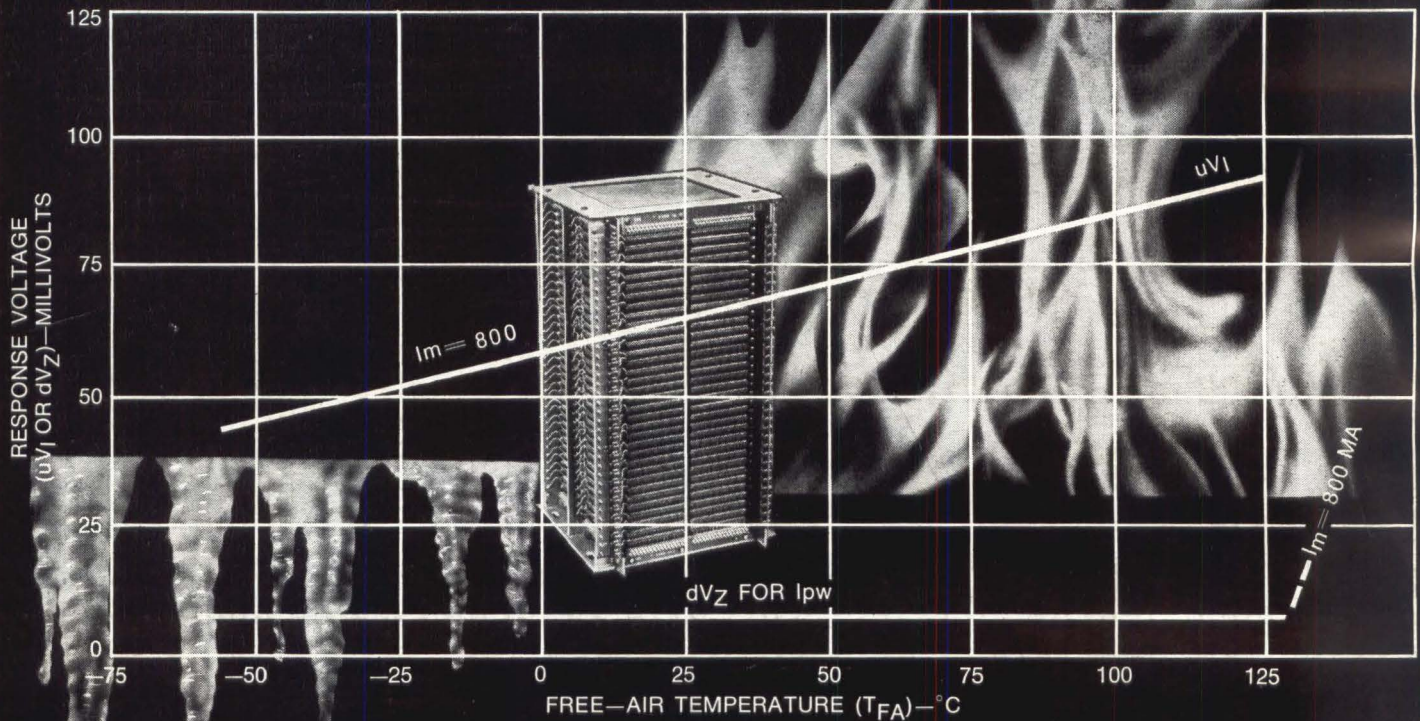

At -55°C ... or +125°C

New RCA Wide-Temperature-Range Memory Cores Switch in 1/2 Microsecond

RCA high-speed, wide-temperature-range ferrite memory planes and stacks operate without temperature controls or current compensation over any 100 centigrade degree range between the limits of -55°C and +125°C.

Memory planes and stacks using RCA 0146M5 ferrite cores provide high-speed operation over the full temperature range with less than 480 ma partial-write current. At full driving current of 800 ma, these temperature-stable cores have a switching time of approximately 0.5 μ sec, making them particularly suitable for memory systems with 2 μ sec operating cycles.

RCA wide-temperature-range cores are also available for low-drive operation at slower speeds.

The full line of RCA cores, planes and stacks offers a wide variety of types for coincident-current, word-address, and switching applications at speeds to 250 nsec. Complete RCA memory systems range in size from 256 words x 8 bits to 16,384 words x 20 bits and offer speeds to 250 nsec.

Whatever your memory requirements, call your RCA Representative for a coordinated application service for RCA memory components and devices, ranging from cores and transistors to complete memory systems. For technical data, write: RCA Electronic Components and Devices, Memory Products Operation, Section C-N-5-2, 64 "A" Street, Needham Heights 94, Mass.



The Most Trusted Name in Electronics

Circle 902 on reader service card