

Electronics®

Diodes to replace mechanical tuners: page 49

A survey of laser detectors: page 54

Fast, compact rotary-tuned magnetrons: page 76

April 6, 1964

75 cents

A McGraw-Hill Publication

Below: planar techniques
for germanium, page 62

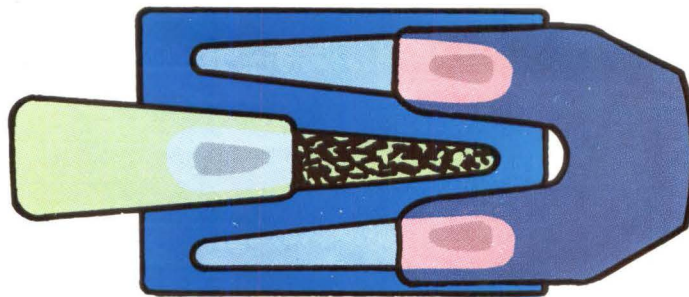

R D SKINNER
1020 GOVINGTON RD
LOS ALTOS CALIF
C 3-
L
SUPV DEV



DI-T200™ SERIES

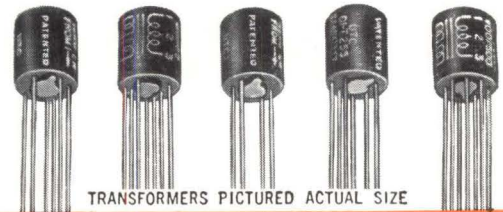

ULTRAMINIATURE TRANSISTOR TRANSFORMERS & INDUCTORS

TYPICAL DI-T200 PERFORMANCE

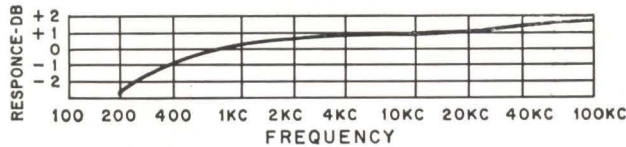
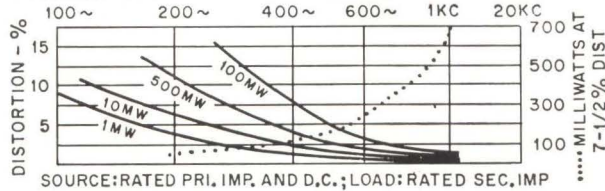

- ➔ DUMET LEADS
(gold plated, weldable and solderable)
- ➔ STRAIGHT PIN TERMINALS
(printed circuit application)
- ➔ HIGHEST PERFORMANCE
for size in the industry
- ➔ METAL ENCASED
(Grade 4, Ruggedized)

Type No.	Pri. Imp.	DCma† in Pri.	Sec. Imp.	Pri. Res.	Mw Level	Application
DI-T225	80 CT 100 CT	12 10	32 split 40 split	10	500	Interstage
DI-T230	300 CT	7	600 CT	20	500	Output or line to line
DI-T235	400 CT 500 CT	8 6	40 split 50 Split	50	500	Interstage
DI-T240	400 CT 500 CT	8 6	400 split 500 split	50	500	Interstage or output (Ratio 2:1:1)
DI-T245	500 CT 600 CT	3 3	50 CT 60 CT	65	500	Output or matching
DI-T250	500 CT	5.5	600 CT	35	500	Output or line to line or mixing
DI-T255	1,000 CT 1,200 CT	3 3	50 CT 60 CT	110	500	Output or matching
DI-T260	1,500 CT	3	600 CT	90	500	Output to line
DI-T265	2,000 CT 2,500 CT	3 3	8,000 split 10,000 split	180	100	Isol. or interstage (Ratio 1:1:1)
DI-T270	10,000 CT 12,000 CT	1 1	500 CT 600 CT	870	100	Output or driver
DI-T273	10,000 CT 12,500 CT	1 1	1,200 CT 1,500 CT	870	100	Output or driver
DI-T276	10,000 CT 12,000 CT	1 1	2,000 CT 2,400 CT	870	100	Interstage or driver
DI-T278	10,000 CT 12,500 CT	1 1	2,000 split 2,500 split	620	100	Interstage or driver
DI-T283	10,000 CT 12,000 CT	1 1	10,000 CT 12,000 CT	970	100	Isol. or interstage (Ratio 1:1)
DI-T288	20,000 CT 30,000 CT	.5 .5	800 CT 1,200 CT	870	50	Interstage or driver
DI-T204	Split Inductor	§ .1 Hys @ 4 maDC, .08 Hys @ 10 maDC, DCR 25Ω §§ .025 Hys @ 8 maDC, .02 Hys @ 20 maDC, DCR 6Ω				
DI-T208	Split Inductor	§ .9 Hys @ 2 maDC, .5 Hys @ 6 maDC, DCR 105Ω §§ .2 Hys @ 4 maDC, .1 Hys @ 12 maDC, DCR 26Ω				
DI-T212	Split Inductor	§ 2.5 Hys @ 2 maDC, .9 Hys @ 4 maDC, DCR 630Ω §§ .6 Hys @ 4 maDC, .2 Hys @ 8 maDC, DCR 157Ω				
DI-T216	Split Inductor	§ 4.5 Hys @ 2 maDC, 1.2 Hys @ 4 maDC, DCR 2300Ω §§ 1.1 Hys @ 4 maDC, .3 Hys @ 8 maDC, DCR 575Ω				

†DCma shown is for single ended usage (under 5% distortion—100mw—1 KC) ... for push pull, DCma can be any balanced value taken by 5W transistors (under 5% distortion—500mw—1 KC) DI-T200 units have been designed for transistor application only ... not for vacuum tube service. U.S. Pat. No. 2,949,591 other pending.
Where windings are listed as split, ¼ of the listed impedance is available by paralleling the winding.
§Series connected; §§Parallel connected.

ALL STOCK UNITS MIL TYPE TF4RX
Class "S" Available on Special Order

High Power Rating up to 100 times greater.
Excellent Response twice as good at low end.
Low Distortion reduced 80%.
High Efficiency up to 30% better . . . compare DCR.
Moisture Proof hermetically sealed to MIL-T-27B.
Ultraminiature Size 5/16 Dia. x ¾" H, 1/15 Oz.

The unique structural design of the DI-T200 series transformers and inductors provides the excellent electrical characteristics, high reliability and wide application possibilities inherent in the UTC DO-T family of miniaturized units. The DI-T200 series units employ the same high quality design found in UTC's DO-T, DI-T, and PIP lines. This unique transformer structural concept affords unprecedented power handling capabilities coupled with extremely small size. Further, the high degree of reliability has been dynamically proven in the field. These characteristics are basic in the structure, which is ruggedized, hermetically sealed, employing a completely rigid bobbin, eliminating stress and wire movement. The turns are circular in shape rather than square, eliminating turn corner stress, and effecting uniform wire lay. The coil wire and external lead are rigidly anchored terminal board fashion, employing no tapes and brought out through strain relief. The curves illustrated indicate the superior performance of these units compared to similar size units now on the market.

The leads are uninsulated 1" long, .017 Dumet wire, spaced on a .1" radius circle to conform to terminal spacing techniques of the "TO-5" case semiconductors and micrologic elements.

**IMMEDIATE DELIVERY
FROM STOCK**

Write for catalog of over
**1,200 UTC HIGH RELIABILITY
STOCK ITEMS**
IMMEDIATELY AVAILABLE
from your local distributor



UNITED TRANSFORMER CORP.

150 VARICK STREET, NEW YORK 13, N. Y.

PACIFIC MFG. DIVISION: 3630 EASTHAM DRIVE, CULVER CITY, CALIF.
EXPORT DIVISION: 13 EAST 40th STREET, NEW YORK 16, N. Y. CABLE: "ARLAB"

5 Billion Programmable Frequencies from the NEW hp Frequency Synthesizer

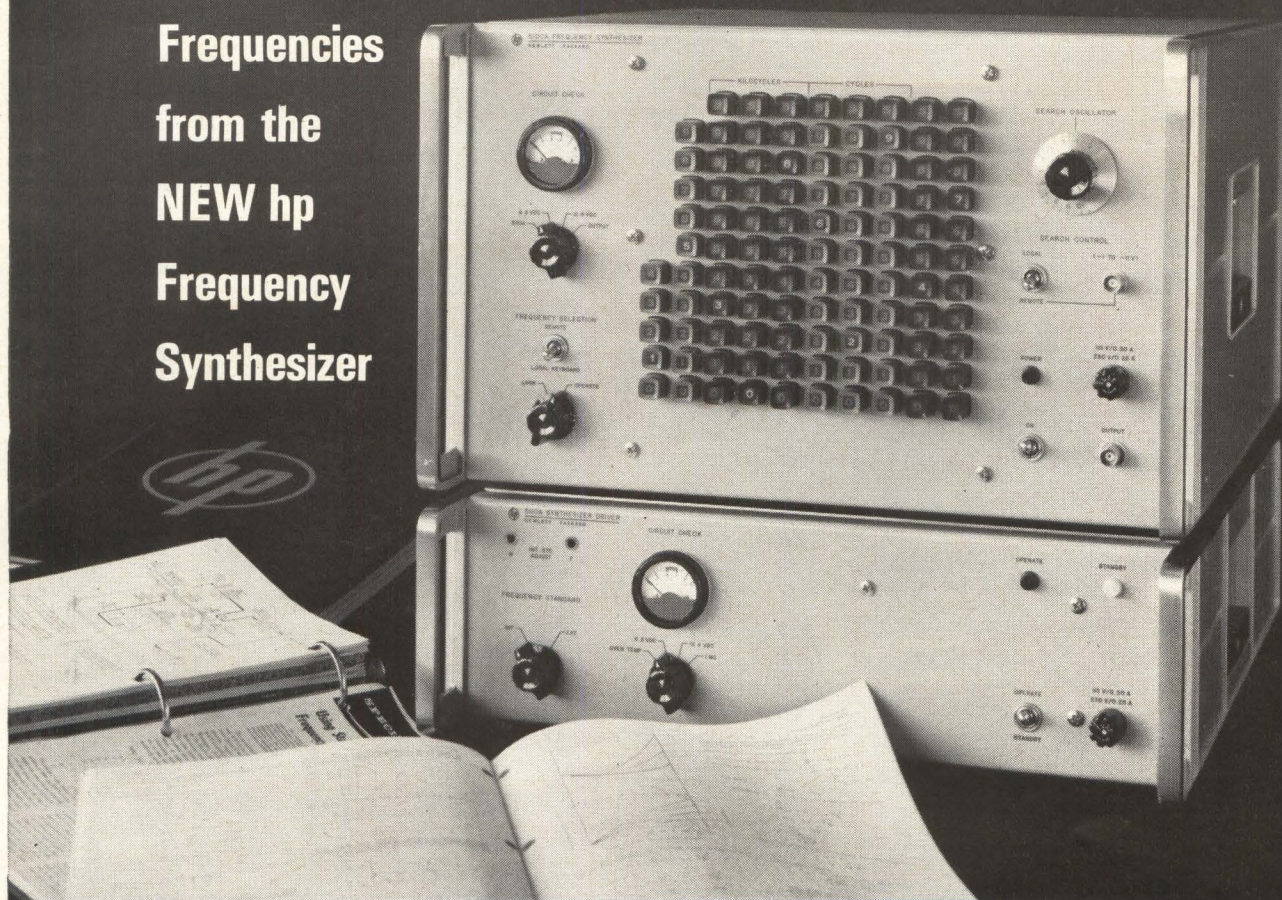

Discrete signals, dc to 50 mc
 Frequency increments from 0.01 cps to 10 mc
 Remote programming — 1 msec switching speed
 High stability and spectral purity — spurious signals 90 db down

The new hp 5100A/5110A Frequency Synthesizer offers pushbutton convenience for fast, accurate selection of frequencies from 0.01 cps to 50 mc in steps as fine as 0.01 cps. Remote programming of frequencies may be accomplished in less than 1 millisecond. The system consists of the 5100A Frequency Synthesizer and the 5110A Synthesizer Driver. All output frequencies are derived from a single 1 mc quartz crystal oscillator which has a long-term stability of ± 3 parts in 10^9 per day—or from your own frequency standard. Spurious signals, including power line components, are at least 90 db down. Check the specifications, then call your nearest Hewlett-Packard field engineer for further information. Or write Hewlett-Packard Company, Palo Alto, California 94304, Tel. (415) 326-7000; Europe: 54 Route des Acacias, Geneva; Canada: 8270 Mayrand St., Montreal.

SPECIFICATIONS

Output frequency:	0.01 cps to 50 mc
Digital frequency selection:	From 0.01 cps per step to 10 mc per step; selection is by front panel pushbutton or by remote contact closure
Spurious signals and harmonic distortion:	All non-harmonically related signals including power line components are more than 90 db below the selected frequency; harmonics are more than 30 db below the fundamental
Signal-to-phase-noise ratio:	More than 60 db down in a 3 kc band centered on the signal
Frequency stability and accuracy:	With internal standard, less than ± 3 parts in 10^9 per day; with external standard, same as external standard
Output voltage:	1 v rms ± 1 db from 100 kc to 50 mc; 1 v rms $+2$ db -4 db from 50 cps to 100 kc, into 50-ohm resistive load
Output impedance:	50 ohms nominal
Search oscillator:	Allows continuously variable frequency selection with an incremental range of 0.1 cps up to 1 mc, depending on the digit position being searched; dial accuracy is $\pm 3\%$ of full scale; linearity with external voltage control is within $\pm 5\%$ (-1 to -11 v)
External standard input:	1 or 5 mc, 0.2 v rms minimum, 5 v maximum across 500 ohms; purity of output signal will be determined partially by purity of external standard
Price:	5100A/5110A, \$15,250

Data subject to change without notice. Prices f. o. b. factory.

**HEWLETT
PACKARD**  *An extra measure of quality*

8946

ticklish signals?

PUT THEM ON PAPER WITH EASE WITH THIS NEW SOLID STATE OSCILLOGRAPH

Now you can precisely measure and record a greater variety of AC and DC variables — over wider dynamic ranges and with more signal-conditioning capabilities at your command — with this new Sanborn 7700 Series 6- and 8-channel oscillograph. A choice of highly developed plug-in preamplifiers (eight in 7" x 19" of panel space) gives you recording capabilities such as: 1 $\mu\text{V}/\text{div.}$ to 250 volts full scale in a single preamp, which also has multi-range, calibrated zero suppression built in . . . phase-sensitive demodulation of in-phase or 180° out-of-phase floating signals, 60 cps to 40 KC, with calibrated or uncalibrated adjustable phase shifting . . . carrier signal recording from 10 $\mu\text{V}/\text{div.}$ and with calibrated zero suppression and cal. factor.

The all-solid-state circuits in this new system also mean cooler operation with less power than tube circuits . . . easy servicing of modular circuits on accessible plug-in cards . . . simpler, smaller power supplies with integral AC excitation . . . and generally improved drift, gain stability, noise and linearity characteristics. Combine these advantages with the proven and widely-used Sanborn heated stylus-Permapaper® recording method: true rectangular coordinate writing with higher resolution at slow chart speeds, no spills or smears, greater environmental immunity, no priming or constant attention needed. Call your HP field engineering office for complete specs — or write Sanborn Company, Industrial Division, Waltham, Mass. 02154

SANBORN 
A SUBSIDIARY OF HEWLETT-PACKARD

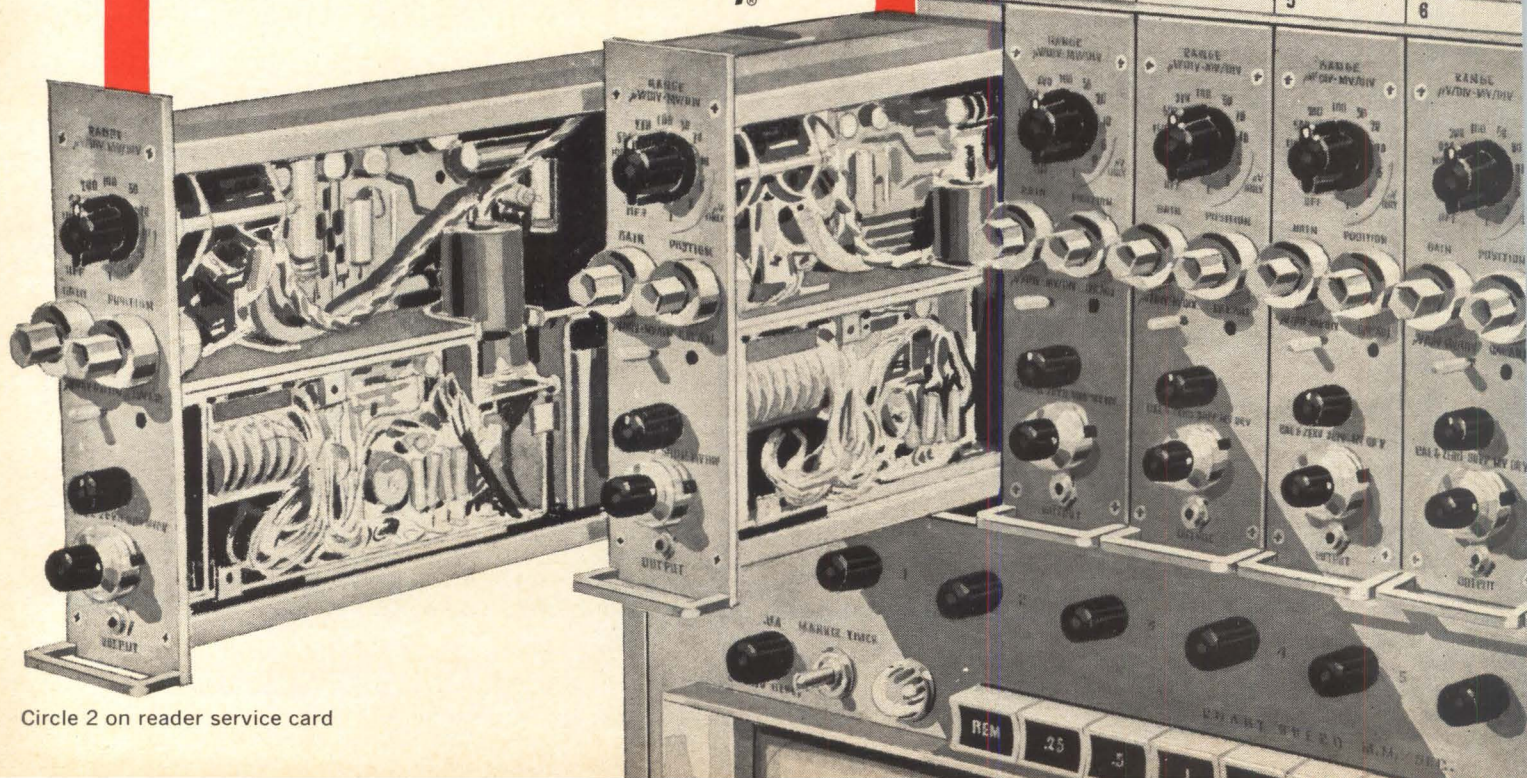

Electronics

Page 4	Readers comment
8	People
10	Meetings ahead
15	Editorial
17	Electronics newsletter
43	Washington newsletter
115	New products
141	New literature
142	New books
144	Technical abstracts

In this issue

Components

Advanced technology

Solid state

Solid state

Design analysis

Circuit design

Microwaves

Space electronics

Medical electronics

Page 27	On ice patrol	30	Olympics on tv?
27	In the newspapers	30	Satellite sale
28	Jam in the tube	32	Ranger 7
29	Killing the parasitics	32	Belt tightening
30	Tinier junctions	34	Warming up
		34	Brain sonar

Electronics review

Probing the news

99	World's fair: programed for fun
106	Natural undersea laboratory tests weapons

Technical articles

I. Design

Boost for electronic tuning: part I

Voltage-variable capacitance diodes open the door to new circuit-tuning applications.
L.A. Weldon and R.L. Kopski, Philco Corp.

Evaluating light demodulators

A survey that compares optical detection methods in laser communication or radar systems
B.J. McMurty and D.E. Caddes, Sylvania Electric Products, Inc.

An expansion for germanium technology

General-purpose transistors can now be built with a planar structure, extending germanium's use (Cover) K.B. Landress, Texas Instruments Inc.

Magnetoresistance: better than Hall-effect multipliers

A new circuit makes the magnetoresistive multiplier practical in many applications.
S.F. Sun, Institut fur Hochstfrequenztechnik

Simplified r-c ladder network design

Designing networks to exact specifications without complicated synthesis methods
Charles F. White, U.S. Naval Research Laboratory

Designer's casebook

A one-transistor operational amplifier; a monostable multivibrator with constant pulse width; accurate voltage regulation regardless of temperature

II. Applications

New magnetron shifts frequency fast

Rotary tuning gives radar systems non repetitive frequency patterns for countermeasure security.
Robert E. Edwards, Raytheon Co.

Tracking missiles with television

Two vidicon cameras automatically track high-speed aircraft and missiles.
John R. Kruse, Barnes Engineering Co.

Electronic weapon against cancer

Redesigning the laboratory linear accelerator into a clinical tool for hospitals
N.A. Austin, Varian Associates

Electronics

Editor: Lewis H. Young

Managing editor: John M. Carroll

Senior editors

Technical: Samuel Weber

News: George Sideris

Senior associate editors: Michael F. Wolff, John F. Mason

Department editors

Advanced technology: George V. Novotny

Communications: Alexander A. McKenzie

Components: Michael F. Tomaino

Computers: Stephen B. Gray

Consumer electronics: V. S. Acunto

Industrial electronics: Louis S. Gomolak

Instrumentation: George J. Flynn

Manufacturing: C.R. Whetstone

Military electronics: John F. Mason

New products: William P. O'Brien

Solid state: Michael F. Wolff, G.G. Tirellis

Space electronics: Joel A. Strasser

Staff writers: Leon H. Dulberger, Peggy Jackson

Regional editors

Boston: Thomas Maguire, editor; Alice M. Moyer

Chicago: Cletus M. Wiley, editor; Virginia T. Bastian

Los Angeles: Harold C. Hood, editor; Linda Hamner

San Francisco: Laurence D. Shergalis, editor; Mary Jo Jadin

Copy editors

Howard Rausch, Sally Powell

Illustration

Art director: Howard R. Berry

Assistant art director: John C. Wright, Jr.

Editorial production: Ann Mella, Sandra A. LeMond

Editorial secretaries: Claire Benell, Lynn Emery, Kay Fontana, Sharon Parks, Lorraine Rossi, Barbara Schubert, Lorraine Werner

McGraw-Hill news service

Director: John Wilhelm; **Atlanta:** Fran Ridgeway; **Chicago:** Bruce Cross; **Cleveland:** Arthur Zimmerman; **Dallas:** Marvin Reid;

Detroit: Donald MacDonald; **Los Angeles:** Kemp Anderson, Michael Murphy, Ron Lovell; **San Francisco:** Margaret Ralston, Ed. Addeo;

Seattle: Ray Bloomberg; **Washington:** George Bryant Jr., Glen Bayless, Charles Gardner

McGraw-Hill world news service

Bonn: Michael Mikton; **Brussels:** Arthur Erikson; **London:** Derek Barlow;

Mexico City: Wesley Perry; **Milan:** Bruce Bendow;

Moscow: Donald Winston; **Paris:** Dan Smith;

Rio de Janeiro: Leslie Warren; **Tokyo:** Richard Halloran, Charles Cohen

Circulation manager: Hugh Quinn

Reprints: T.M. Egan

Publisher: C.C. Randolph

Electronics: April 6, 1964, Vol. 37, No. 13

Printed in Albany, N.Y. Second class postage paid at Albany, N.Y.

Subscriptions are solicited only from those actively engaged in the field of the publication. Position and company connection must be indicated on orders. Subscription prices: United States and Possessions and Canada, \$6.00 one year, \$9.00 two years, \$12.00 three years. All other countries \$20.00 one year. Single copies, United States and Possessions and Canada 75¢. Single copies all other countries \$1.50.

Published every other Monday by McGraw-Hill Inc. 330 West 42nd Street, New York, N.Y. 10036. Founder: James H. McGraw, 1860-1948.

Subscribers: The Publisher, upon written request to our New York office from any subscriber, agrees to refund that part of the subscription price applying to copies not yet mailed. Please send change of address notices, subscription orders or complaints to Fulfillment Manager, Electronics, at the address below. Change of address notices should provide old as well as new address, including postal zone number if any. If possible, attach address label from recent issue. Allow one month for change to become effective.

Postmaster: Please send Form 3579 to Fulfillment Manager, Electronics, P.O. Box 430, Hightstown, New Jersey 08520

Readers Comment

Threat to freedom

The unusual tone of emotion and fear expressed in your Editorial of 28 February [p. 5] documents the considerable degree to which the most accepted and respectable areas of our society have habitually ignored our heritage of civilian control of the military. The continued acceptance of the values expressed can lead only to the ultimate erosion and withering of the freedom and representative democracy we consider to be the essence of our community.

It is indeed remarkable that extent to which Secretary McNamara has returned our practice to constitutional compliance. The refractory nature of the obstacles in his path was not even hinted at in your editorial. More than 150 reserve armed service officers occupy seats in Congress, beholden to Pentagon generals and admirals for promotions and special duty pay. The conflict of interest, obvious on its face, is in flagrant and profligate violation of Article 1, Section 6, paragraph 2, clause 2, of the United States Constitution. In addition, a special Pentagon lobby is detailed to tail every member of Congress.

Unification of the Defense Department is now twenty years overdue. Contemporary military operations are not a fragmented decathlon conveniently segregated into rival land, air and sea engagements. Your quaint concept of public choice of weapon systems flies in the face of anguished cries that the digitalized Secretary ignores the advice of generals.

The fine machiavellian art of Pentagon-controlled leaks of classified information is used to pressure Congress and the Cabinet via a partially informed public opinion and a jingoistic press. To return administration to the Executive and dispassionate deliberation to the Congress, it is essential to control public relations and press releases of the Defense Department. It is also necessary to circumvent Congressional attempts to expand inefficient production programs for political reasons when defense de-

New from Sprague!

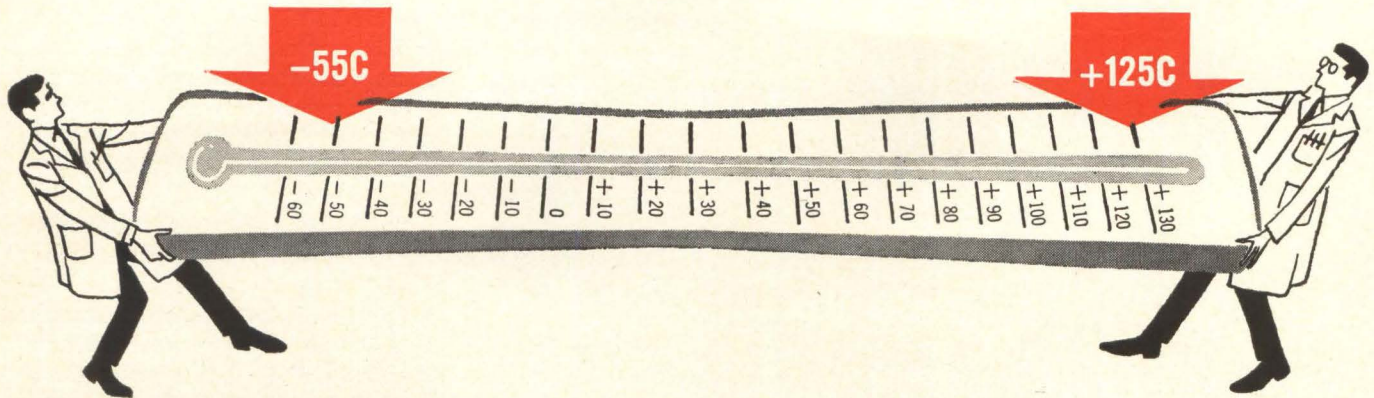

E-X-T-E-N-D-E-D T-E-M-P-E-R-A-T-U-R-E R-A-N-G-E

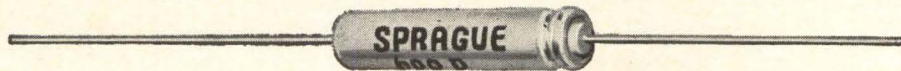

TYPE 600D **EXTRA-LYTIC*** ALUMINUM ELECTROLYTIC CAPACITORS

VOLTAGE RATINGS TO 150 VDC, unlike other so-called "wide temperature range" aluminum electrolytics with compromise voltage ratings only to 60 volts.

CAPACITANCE STABILITY over entire temperature range. Even at -55°C , capacitance drop is very small.

OPERATING AND SHELF LIFE comparable to or better than that of foil tantalum capacitors.

LESS EXPENSIVE than foil tantalum capacitors, yet in many cases meet the electrical requirements of MIL-C-3965 for tantalum capacitors.

SMALLER AND LIGHTER than tantalum capacitors in equivalent capacitance values and voltage ratings.



For complete technical data, write for Engineering Bulletin 3420 to Technical Literature Service, Sprague Electric Company, 35 Marshall Street, North Adams, Massachusetts.

*TRADEMARK

SPRAGUE COMPONENTS

CAPACITORS
TRANSISTORS
RESISTORS
MICROCIRCUITS
INTERFERENCE FILTERS

PULSE TRANSFORMERS
PIEZOELECTRIC CERAMICS
PULSE-FORMING NETWORKS
TOROIDAL INDUCTORS
ELECTRIC WAVE FILTERS

CERAMIC-BASE PRINTED NETWORKS
PACKAGED COMPONENT ASSEMBLIES
BOBBIN and TAPE WOUND MAGNETIC CORES
SILICON RECTIFIER GATE CONTROLS
FUNCTIONAL DIGITAL CIRCUITS



'Sprague' and '®' are registered trademarks of the Sprague Electric Co.

48C-155-63

Only from Sprague!

DOUBLE FEATURE!

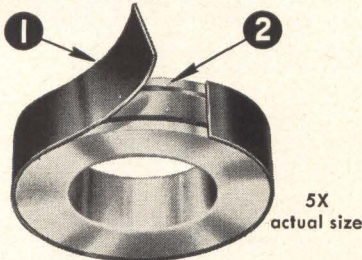

Dynacor® Bobbin Cores have 2 built-in reasons for long operating life without degradation...

1 TOUGH ARMAG® JACKET. Withstands ambient temperatures to 180 C and is compatible with poured potting compounds, permitting Dynacor Cores to be used with normal encapsulation techniques.

2 JET-SMOOTH BOBBIN. Finely-polished stainless steel, completely eliminating sharp protrusions, square corners, or other abrasive action on copper wire windings. Improved manufacturing process results in a bobbin with a more uniform radius than that of an ordinary machined bobbin.

Dynacor Bobbin Cores are also available with ceramic bobbins where needed.

A large stock of popular sizes and flux values insures prompt delivery.

Special cores to customer specifications are quickly and accurately processed.

For complete technical data, write for Engineering Bulletins on Dynacor Bobbin Cores to Technical Literature Service, Sprague Electric Company, 35 Marshall St., North Adams, Mass.



® Sprague and ® are registered trademarks of the Sprague Electric Co.
ISSP-170-63

depends on a rational integrated approach. The Secretary's procurement policies should have nothing to do with Senatorial hobby horses and fantastic Erector sets.

Perhaps we may consider return to civilian control of the military complete only when, for example, the Federal Communications Commission can control the Gargantuan emissions of military weapon systems [Radar adds beeps to home sets, p. 17] so that "some die-hard audiophiles" won't find themselves "even moving to locations shielded from the radar beam by natural obstacles" after "the modifications don't always work." If "the American citizen should be told a little more about what's in store for him," the answer is in the Pittsburgh item: "FCC's Buffalo, N. Y., office . . . says it isn't taking any specific action."

Russ Linton

San Diego, Calif.

War gamesmanship

Secretary McNamara and his whiz kids seem like military operations research a la Stephen Potter:

War gamesmanship—how to be one up on the armed services without actually knowing what the shooting is all about.

(Name Withheld)

Tantalizing mirage

If I read you correctly, your editorial of Feb. 28 takes Robert McNamara to task for taking charge of the Department of Defense rather than simply stamping his approval on the recommendations of the Pentagon. Both logic and long tradition place responsibility for our military affairs in the hands of a civilian Secretary of Defense. The military, and the industry which supplies its weapons and technology, see the world in the context of its present, military situation. This is as it should be—this is their job. Congressmen are under intense pressure to obtain defense contracts for the industries in their areas. These contracts bring increased employment and prosperity, and incidentally, help to re-elect Congressmen.

The military, industry, and Congress all take the position that no price is too high to pay for our

military security. Congress can pass a military budget constituting half of the entire Federal budget after an afternoon of desultory debate, but spend three weeks debating the foreign-aid program which constitutes only 4% of the budget. It may be true that no price is too high for our security, but this is not to say that there is no point at which more money ceases to buy more security.

The vision of security based on an enormous industrial-military complex is, in the long view, only a tantalizing mirage. It may make the probability of nuclear annihilation very small, but even an infinitesimal probability, when summed over an unlimited period of time, becomes a certainty. Ultimately, our only security lies in a disarmed world. If this is the direction which Secretary McNamara is leading, he should be encouraged and supported, not condemned. Our economy needs to learn how to get along without the largess of a \$50 billion budget.

Eldon Eller

Duarte, Calif.

Cooling

The section on Cooling in your article, *Modern Electronics Packaging* [Feb. 7], includes a most unfortunate paragraph on page 43.

The last half of the paragraph is an all-too-good example of the statement in the first half, "Failure to obtain the amount of heat transfer desired may result from a misunderstanding of the mechanism of cooling or how to implement the basic mode." This is true; the remainder of the paragraph illustrates a thorough misunderstanding of two basic modes, radiation and conduction.

The surface finish on a tube shield has nothing to do with the conduction of heat to, through, or from it. Surface finish affects the radiation heat flow: bright metal finishes greatly reduce radiation, and a flat black finish minimizes it (this effect is not just theoretical—it is very practical and often demonstrated). On the other hand, the mounting method controls the conduction heat flow from (or to) the shield.

Leonard J. Lyons

Los Angeles, Calif.

EARTH PEOPLE...

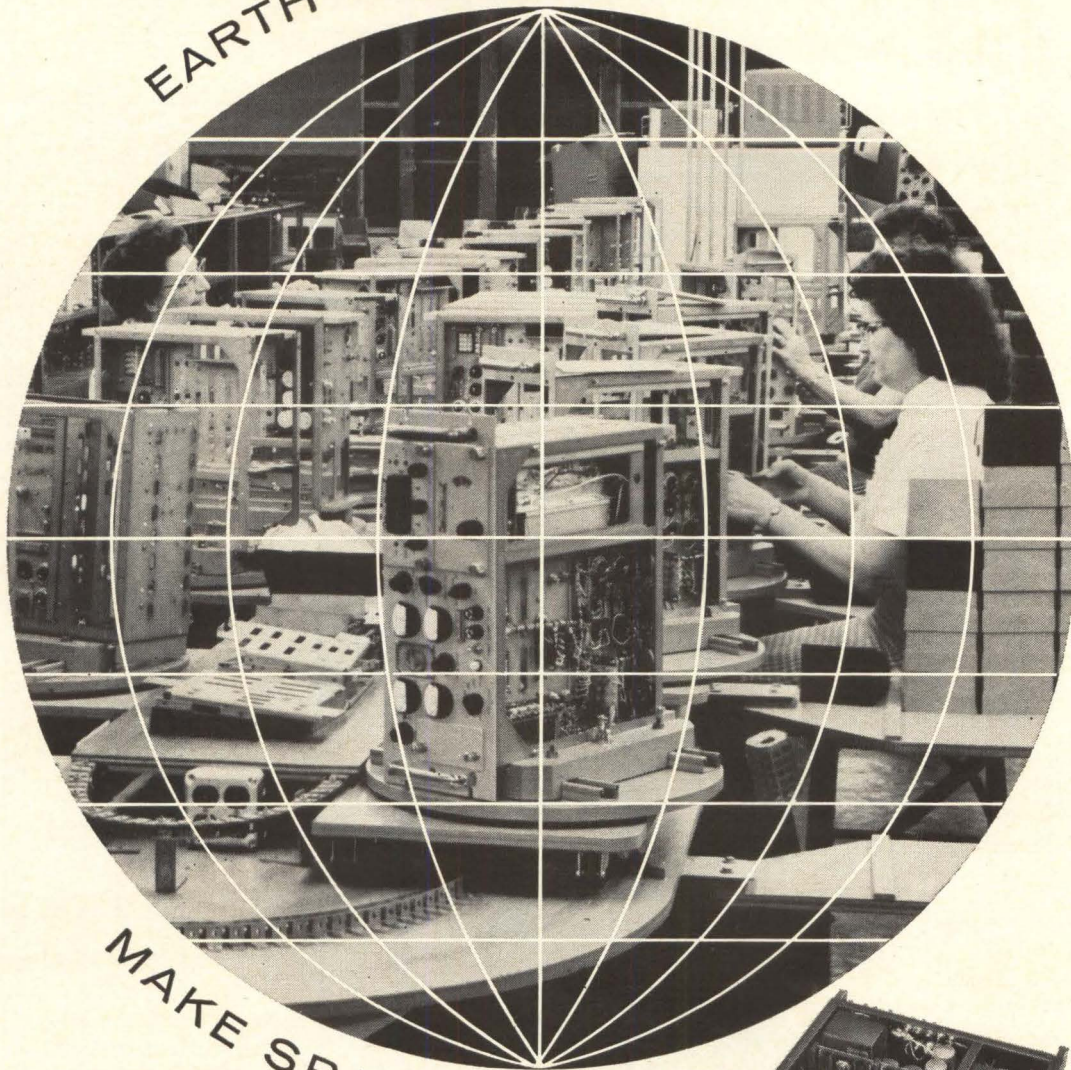

MAKE SPACE MAGIC!

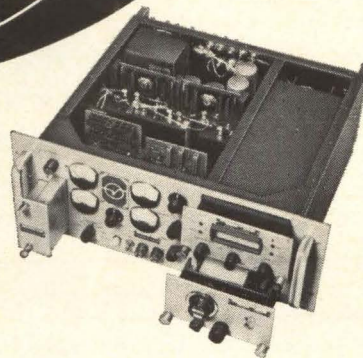

WORLD'S MOST ADVANCED VHF/UHF RECEIVER IS IN ITS THIRD PRODUCTION RUN

Theoretical science and practical application are often years apart in space technology. In part, it's why space exploration is so expensive. So when a truly magic black box goes into its third production run as off-the-shelf hardware, all of us benefit.

After 50 years of constant inspection of the problems of signal reception, Vitro Electronics developed the 1037A solid state/nuvistorized telemetry receiver

that makes it possible to track to below the horizon. It is completely modular so that any new tracking job can be done with a simple change. Vitro engineering capabilities thus have solved one of the major ground support responsibilities of space flight... and at off-the-shelf prices. For complete information on the Nems-Clarke product line, contact K. B. Boothe, Vitro Electronics, 919 Jesup-Blair Dr., Silver Spring, Md.

VITRO CORPORATION OF AMERICA • 261 MADISON AVENUE • NEW YORK, N. Y. 10016

Vitro

**CONSIDERING VAPOR COOLING?
SELECT ONE OF MACHLETT'S
4 BASIC SYSTEMS...**

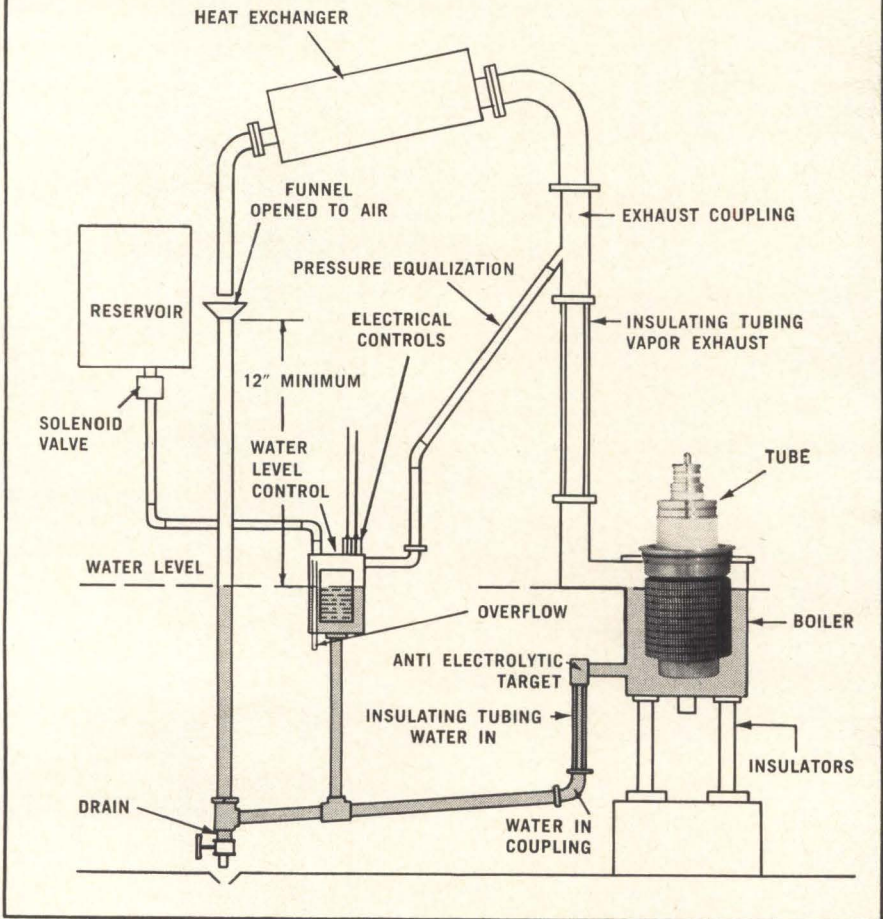

From 50kW to 500kW, Machlett offers four basic Vapor Cooling Systems for cooling high power electron tubes:

SYSTEM	TYPICAL APPLICATION
Vapor-Up (shown above)	General Broadcast (HF)
Vapor-Down	General & SSB Communications (HF)
Boiler Condenser	Industrial
Integrated	Special Service. Particularly suited to VHF.

System advantages include: 200-300% greater anode dissipation as compared to forced-air cooling; 10-20% greater anode dissipation over conventional water cooling; extremely large overload protection for anode; stable, quiet cooling; low water consumption; low operating costs.

Each of the above four systems is highly adaptable to a wide range of applications. Consider the advantages of each system—outlined in "Vapor Cooling," obtained by writing to The Machlett Laboratories, Inc., Springdale, Conn., an affiliate of Raytheon Company.



People

Frederick S. Sherwin, a leader in the second generation of value engineers, is the new director of value engineering services at Raytheon Co. and a nominee for president of the Society of American Value Engineers. Sherwin's interest in the field goes back to the early 1950's when he attended the first workshop seminar in Value Engineering conducted by Lawrence D. Miles, who created this new engineering discipline almost single-handedly. (Miles will retire from General Electric Co. May 1). Now Sherwin, along with several other Miles disciples, is preaching the gospel of value-engineering with a near-missionary zeal, hoping to combat the cost-unconsciousness that reigned in the cost-plus-fixed-fee contract era. Sherwin is not talking about saving small marginal costs. "If you can't value-engineer a product and save more than 20 percent, forget it." He says that average cost reduction effected by value engineering teams is 65 percent.

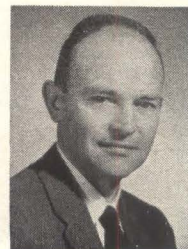

D. J. Jones, new executive vice president of the Centralab Electronics Division of Globe-Union, Inc., Milwaukee, Wis. insists that the market for Centralab's packaged circuits will not be undercut by integrated circuits. Meanwhile, he is quietly building up the staff and technology that Centralab needs to enter the microcircuit market. The company produces a million packaged circuits each week and sells them for a fraction of a cent, says Jones, whereas the two biggest integrated semiconductor producers turn out 5,000 units a week. Nevertheless, Jones is recruiting 80 scientists and engineers to develop integrated circuits for Centralab.



Why is
Roanwell's
"Little One"
like a
vitamin
capsule?



Because this new piston trimmer capacitor packs a load of virtues into the smallest possible space. Just some of them, for example:

- * Highest capacity in this length of any glass trimmer—
Capacitance Range: 1.0 to 10.0 pf
Length behind panel: 9/32"
Diameter: 1/4"
- * Great on electrical specs—
Q approx.: 1000 at 1 MC; 250 at 1000 MC
Working voltage: 500 VDC
Temp. Coeff.: 0 ± 50 ppm/ $^{\circ}$ C
- * Right prescription for many applications—
SG 11054—Panel mount, gold-plated parts
SG 11054/AG—Panel mount, silver-plated parts

SG 11114—Printed ckt. mount, gold-plated parts
SG 11114/AG—Printed ckt. mount, silver-plated parts

- * Unique advantages of Roanwell piston trimmers—
Solid metal electrode bands permit soldering and resoldering of leads to bands. Less breakage in production.

Sample quantities available from stock. Send for data sheet on the "Little One," Roanwell SG 11054, SG 11054/AG, SG 11114, and SG 11114/AG.



ROANWELL CORPORATION
ELCOM DEPARTMENT
Roanwell Building
180 Varick Street New York, N.Y. 10014
(212) YUkon 9-1090 • TWX: (212) 640-4791



Package Deal

Do you ship regularly to many customers in or around distant cities? Flying Tigers now has a new plan that combines the low cost of surface parcel post with the speed and convenience of airfreight.

All you do is consolidate your surface parcel post shipments for a single general area of the country into one shipment. You address and pre-meter each package at the applicable zone rate within the destination area. Flying Tigers then flies the consolidated shipment at special bulk

rates to a major post office in the destination area. Parcels are distributed by surface parcel post to your customers.

This Flying Tigers' service can keep you competitive in markets where you have neither a warehouse nor inventory. It can even save you money over straight surface parcel post, and will help you reach new markets.

Have your Flying Tigers man explain all the details of this package deal. We think you'll buy it.

first in airfreight with airfreight first

FLYING TIGER LINE



ETERNMA ETER



The Industry's Broadest Line of Cermet Potentiometers and Trimmers

BORN RELIABLE AT 650°C • NO CHANCE FOR CATASTROPHIC FAILURE
 • BEST HIGH TEMPERATURE CHARACTERISTICS • RESOLUTION
 APPROACHING INFINITY • EXCELLENT STABILITY • LOW NOISE • WIDE
 RESISTANCE RANGE • LOW INDUCTANCE



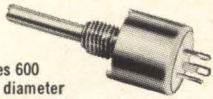
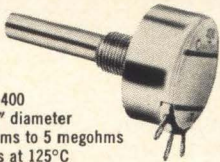
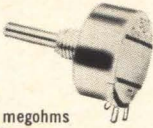

ALL CTS CERMET POTENTIOMETERS AND TRIMMERS FAR EXCEED MIL-R-94B
 TEMPERATURE AND STABILITY SPECIFICATIONS AND MEET APPLICABLE SPECIFICATIONS
 OF NEW MIL-R-22097, AND MIL-R-23285 (NAVY).

CTS is an old hand at precision mass production of military, industrial, and commercial type variable resistors. (Over one billion produced since 1922.) This extensive experience, plus many years of cermet development, enables us to produce in volume the industry's broadest line of cermet potentiometers and trimmers. You may specify any of these controls in volume quantities and be assured of high quality and prompt delivery.

CERMET POTENTIOMETERS

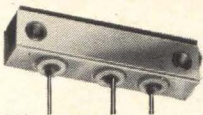
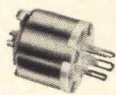
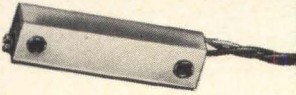
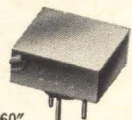
 <p>Series 600 1/2" diameter 100 ohms to 5 megohms 1/2 watt at 125°C Max. operating temp. 175°C VOLUME PRODUCTION SINCE 1959</p>	 <p>Series 400 1-3/64" diameter 100 ohms to 5 megohms 2 watts at 125°C Max. operating temp. 175°C VOLUME PRODUCTION SINCE 1961</p>	 <p>Series 500 3/4" diameter 100 ohms to 5 megohms 1 watt at 125°C Max. operating temp. 175°C VOLUME PRODUCTION SINCE 1961</p>	 <p>Series 660 3/8" diameter 100 ohms to 500K ohms 1/4 watt at 125°C Max. operating temp. 175°C VOLUME PRODUCTION SINCE 1963</p>
---	---	--	---

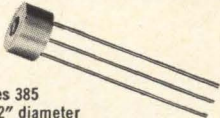
CERMET TRIMMERS

 <p>Series 180PC 1-1/4" x 19/64" x 21/64" 100 ohms to 1 megohm 1 watt at 125°C Max. operating temp. 200°C VOLUME PRODUCTION SINCE 1961</p>	 <p>Series 600PC 1/2" diameter 100 ohms to 5 megohms 1/2 watt at 125°C Max. operating temp. 175°C VOLUME PRODUCTION SINCE 1962</p>	 <p>Series 180WL 1-1/4" x 19/64" x 5/16" 100 ohms to 1 megohm 1 watt at 125°C Max. operating temp. 200°C VOLUME PRODUCTION SINCE 1960</p>	 <p>Series 170 1/2" x 1/2" x .260" 100 ohms to 1 megohm 3/4 watt at 85°C Max. operating temp. 150°C VOLUME PRODUCTION SINCE 1961</p>
 <p>Series 171 1/2" x 1/2" x .225" 100 ohms to 1 megohm 3/4 watt at 85°C Max. operating temp. 150°C VOLUME PRODUCTION SINCE 1961</p>	 <p>Series 385 11/32" diameter 100 ohms to 500K ohms 1/8 or 1/4 watt at 125°C Max. operating temp. 175°C VOLUME PRODUCTION SINCE 1962</p>	 <p>Series 172 1/2" x 1/2" x .190" 100 ohms to 1 megohm 3/4 watt at 85°C Max. operating temp. 150°C VOLUME PRODUCTION SINCE 1962</p>	 <p>Series 660PC 3/8" diameter 100 ohms to 500K ohms 1/4 watt at 125°C Max. operating temp. 175°C VOLUME PRODUCTION SINCE 1963</p>

**DATA SHEETS ARE AVAILABLE GIVING COMPLETE ELECTRICAL
 AND MECHANICAL SPECS ON ALL CERMET PRODUCTS.**

Circle 12 on reader service card

NAL ?

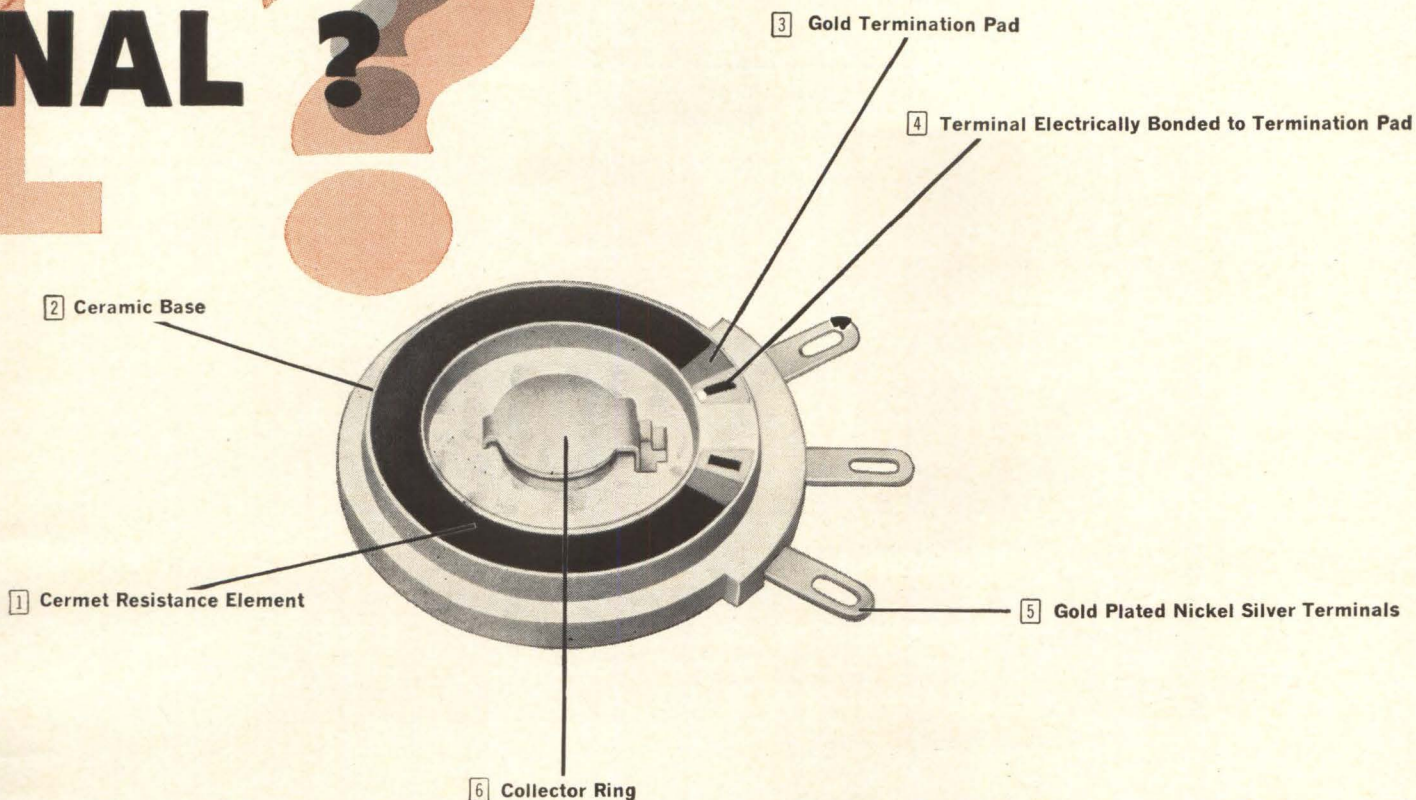

In five years of volume production

our Cermet Element (fired at more than 650°C) has more than withstood application challenges requiring:

- extreme stability and reliability under severe environmental conditions
- temperature extremes
- high loads
- resolution approaching infinity
- radiation exposure

Here, point by point, is why:

- 1 **Cermet Resistance Element** is fired to ceramic base.
- 2 **Ceramic Base** serves as built-in heat sink.
- 3 **Gold Termination Pad** diffuses with cermet resistor, becomes part of substrate after firing.
- 4 **Terminals Electrically Bonded** to fired on termination pad with high temperature conductor.
- 5 **Gold Plated Nickel Silver Terminals** rigidly anchored to ceramic substrate.
- 6 **Collector Ring** for contactor is integrally connected to center terminal to avoid series connections.

Elements can't separate from substrate during varying environmental conditions. Thermally bonded cermet resistors are a virtually indestructible combination of a matrix of inorganic material and precious metal alloys after firing.



Founded 1896

CTS CORPORATION
Elkhart, Indiana

Sales Offices and Representatives conveniently located throughout the world.

Principal Products

Variable Resistors
Selector Switches
Loudspeakers
Trimming Potentiometers
Microminiature Components
& Circuit Packages

Subsidiaries

CTS of Asheville, Inc., Skyland, N. C.
CTS of Berne, Inc., Berne, Indiana
CTS of Paducah, Inc., Paducah, Kentucky
Chicago Telephone of California, Inc.,
South Pasadena, Calif.
CTS of Canada, Ltd., Streetsville, Ontario

NEW 2N3277

P-CHANNEL FET!

LOW LEAKAGE

LOW CAPACITANCE

SILICON PLANAR FIELD EFFECT TRANSISTOR

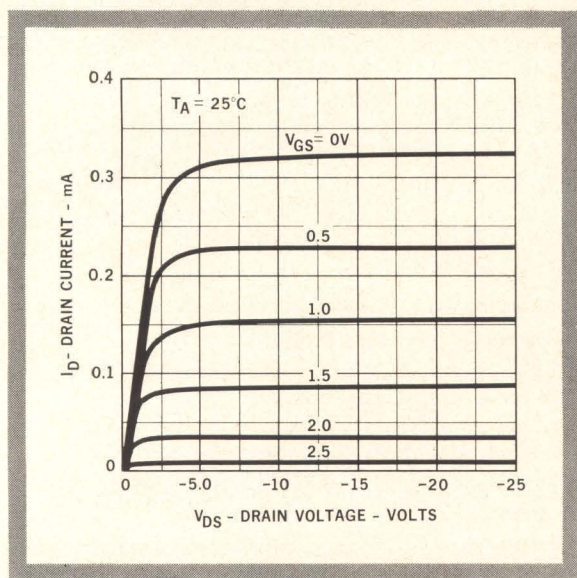

- High Input Impedance: 50 Meg Ohms @ 1 Kc
- Low Leakage: 0.4 nanoamps max, V_{DG} 10V
- Low Noise: 0.7 db max, R_s = 10 Meg Ohms @ 1 Kc
- Transconductance: 100 μmhos min @ 1 Kc
- High Drain Resistance: .5 Meg Ohm min, V_{Ds} = 10V
- Gate Pinch-off: 5 Volts max @ I_D = 1 nanoamp

The 2N3277 silicon Planar P-channel field effect transistor is specially designed for low level, low noise applications. Its simplified design gives it extra high reliability in such circuits as amplifiers for high impedance transducers and multiplier circuits. Compound amplifiers have been developed as Special Products using this type FET in combination with Fairchild standard low level amplifier transistors. Write for complete specifications.

AVAILABLE DIRECTLY FROM DISTRIBUTOR STOCKS

FAIRCHILD
SEMICONDUCTOR

Keep the door open

"I'm a victim of specialization," a 33-year old engineer complained during the IEEE meeting last month. "For almost five years I've been working on circuit design for intercontinental ballistic missiles. Suddenly our military projects are phasing out and nobody wants an engineer with my specialty."

His plight is a sad one. He's caught in a trap of his own making. He's failed to keep his technical education up-to-date and well-rounded.

Another engineer who had just been phased out of a government project found himself a job in a consumer electronics company. He told us that his broad engineering abilities more than offset his lack of long experience in this new field. "I still can solve this company's problems faster than a young new engineer" he said, "and faster than one who's concentrated solely on a very narrow area of consumer electronics."

A personnel man—a veteran recruiter—confirmed this view. He told us, "We always can find a place for a man with real engineering talent."

All this serves to point up that too many engineers forget what they heard when they were freshmen in college: Engineering is solving problems. It takes knowledge from many disciplines—physics, chemistry, mathematics, circuit theory, information theory, and even mechanics, artfully combined.

A good electronics engineer does more than just design circuits. He has to plan instrumentation and devise tests to evaluate it. Often he has to program how the circuits are to be built. He usually has a packaging problem, sometimes a heat-transfer dilemma and even a stress overload to resolve. He can't work his way out of these problems by cookbook rote. Cookbooks are based on past accomplishments. The successful engineer is the man who can go beyond the cookbooks, contributing on his own initiative from a broad fund of knowledge.

The hazard to careers is likely to be more, not less, perilous in the months ahead. Just last month, Congress heard a report (from the Seminar on Industrial Conversion at Columbia University) that pinpointed the problem. Said the study, "Militarily oriented skills are often not readily applicable to civilian work." The group also reported that 67,000 technical, clerical and production workers had been laid off recently by 19 major defense contractors. Many of them were engineers.

A lot of companies, particularly, in the aerospace business, insist that their engineers specialize. In fact, most companies cannot afford the luxury of only broad-gage engineers.

The answer, it seems to us, is simple and obvious. Specialize by all means, but keep the door open to learning in other parts of the technical world. Attend local technical meetings, read technical articles, and even take additional formal courses in areas outside your specialty.

To help you keep your engineering education up-to-date, Electronics has started publishing broader technical articles and more of them. And we've stepped up our coverage in industrial electronics for two reasons. First, it appears there will be many new engineering job opportunities here. And secondly, many militarily oriented companies are anxious to diversify into industrial or consumer business. One West Coast components company, currently enjoying record sales, told us frankly it had lost a big share of its military business in the past six months and would have been in trouble if engineers had not been able to modify one of its products for use in uhf-tv tuners, required on all television sets after April 30.

But in the final analysis, only YOU can safeguard your career.

KEPCO

REGULATED **WR** DC SUPPLIES



POWER SUPPLIES WITH EXPERIENCE

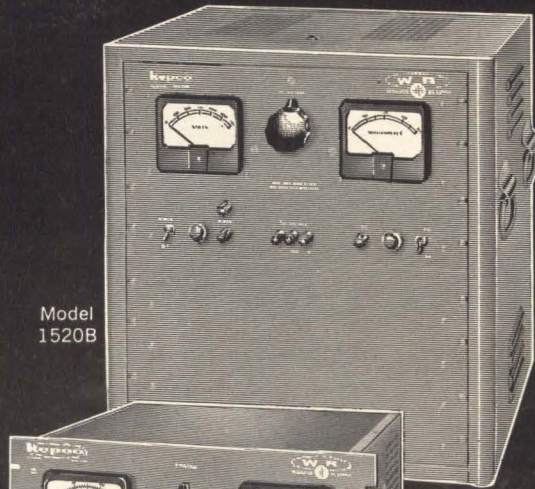

Model 1520B



Model 605



Model 430D

The WR Group includes eleven time-proven models from Kepeco's current production of 230 standard models. Kepeco's representatives in your area can supply you with complete technical information, application ideas, and delivery.

APPLICATIONS:

- ELECTROPHORESIS ■ RADAR
- ELECTROCHEMICAL PROCESSES
- MICROWAVES ■ PHOTOMULTIPLIERS
- COMMUNICATIONS-TELEVISION
- TELEPHONE SYSTEMS
- ELECTRO-MECHANICAL DEVICES

GENERAL SPECIFICATIONS:

- **Input:** 105-125 VAC 50-65 cps single phase
- **Operating Temperature:** -20°C to +55°C
- **Temperature Coefficient:** <0.01% per °C
- **Recovery Time:** 50 microseconds
- **Isolation:** 400 volts (except HB 2050)
- **Meters:** Voltmeter and Ammeter
- Convection Cooling
- For Relay Rack or Bench Use
- Multiple output and high voltages
- Plate, Grid and Heater Voltages
- Continuously Variable, Zero to full output

See our Complete Catalog in



MODEL	DC OUTPUT RANGE		REGULATION				RIPPLE RMS MV	AUX. OUTPUT 6.3VAC Unregulated	PRICE
	VOLTS	MA.	LOAD 0-MAX %		LINE %				
2400 B - #1	0-150	0-5	*	*	*	*	1	\$540.00	
	#2 0-400	0-150	0.025	0.1	0.1	0.4	3		
	#3 0-400	0-150	0.025	0.1	0.1	0.4	3		
400 B	0-400	0-150	0.025	0.1	0.1	0.4	3	10 AMP 270.00	
	0-150	0-5	*	*	*	*	1		
430 D - #1	0-450	0-300	0.025	0.1	0.1	0.4	3	10 AMP 675.00	
	#2 0-450	0-300	0.025	0.1	0.1	0.4	3		
800 B - #1	0-600	0-200	0.02	0.1	0.1	0.4	3	10 AMP 575.00	
	#2 0-600	0-200	0.02	0.1	0.1	0.4	3		
605	0-600	0-500	0.02	0.1	0.1	0.4	3	20 AMP 425.00	
	0-150	0-5	*	*	*	*	1		
615B	0-600	0-300	0.02	0.1	0.1	0.4	3	10 AMP 355.00	
	0-150	0-5	*	*	*	*	1		
1250 B	0-1000	0-500	0.01	0.1	0.05	0.4	3	650.00	
1220 C	0-1200	0-50	0.01	0.1	0.05	0.4	3	10 AMP 465.00	
1520 B	0-1500	0-200	0.01	0.1	0.05	0.4	3	695.00	
HB 2050	0-2000	0-500	0.005	0.1	0.02	0.4	3	1565.00	
HB 2500	0-2500	0-50	0.005	0.1	0.02	0.4	5	975.00	

*0-150V bias - Regulation: 0.01% Line / 2% Load at 150V



For complete specifications on more than 230 standard model Power Supplies, send for NEW Catalog B-631.

Electronics Newsletter

April 6, 1964

Japan opens door to foreign plants

On April 1, Japan became a full member of the General Agreement on Tariffs and Trades, a world trade organization that grants its members certain tariff concessions. To remain in the organization Japan will have to alter its ban on foreign-owned facilities.

Very soon, the Japanese government will announce that United States and European manufacturers may build and own plants in Japan.

First in line is Texas Instruments Inc. Other manufacturers are rooting for that company's application, already filed, to be approved. Japanese officials have already offered Texas Instruments a chance to own 50% of an operation. Previously they had insisted on no more than 25% foreign ownership—the American company insists on 100% ownership.

U.S. component and semiconductor makers are anxious to compete in the lush Japanese consumer and industrial markets. Such a move could hurt the slowly growing electronics industry recently established in Hong Kong, even though Hong Kong labor rates are down to 86 cents a day.

Minuteman first in specs, too

The Air Force's first set of specifications for integrated circuits are based on the circuits in the guidance and control system for the improved Minuteman missile.

The move sounds like a boost for companies selling such circuits to the Autonetics division of North American Aviation, Inc. It was Autonetics that designed the circuits and drafted the specifications for the Air Force [Electronics, March 23, 1964, p. 26]. But Autonetics says it isn't necessarily so.

The company points out that other concerns will have a chance to comment on the specs and ask for changes. Also, it predicts that **nailing down the specs will result in a longer list of qualified manufacturers.** This is what happened with the specs for high-reliability parts for the original Minuteman, the company notes.

The Air Force adds that it is standardizing a spec system rather than specific circuits. The new specs, numbered Mil-M-38104/901 through 924, come under the Air Force's standard reliability spec Mil-M-38100.

The specs are supervised by the Air Force Ballistic Systems division at Norden Air Force Base, California. In July, qualifying action will be shifted to the Air Force's Air Development Center at Rome, N.Y.

In another stride for microcircuitry, Autonetics is testing two airborne radars built with 20 standard microcircuits. One radar, the 100-pound R45, is a multimode set. The other, the 30-pound R47, is a terrain-avoidance type for low-flying missiles and planes.

Bell Telephone switching lab

The research-hungry Chicago area will, in two or three years, get a big new laboratory with 1,200 people, 400 of them scientists and engineers. Bell Telephone Laboratories, the home of the transistor, will build an electronic switching research and development lab in Naperville, just west of Chicago. About two thirds of the staff will be transferees from Bell's present switching lab in Holmdel, N. J. The new lab, officials explained, will be near the Western Electric Company's Hawthorne Works in Cicero, which is slated to become the Bell System's number

Electronics Newsletter

one manufacturing facility for electronic switching equipment. The Bell System plans to convert all its central telephone offices from electro-mechanical to electronic switching. **The target date for completion of this enormous task is the year 2,000.** The Bell System has been installing electronic telephone exchanges on a test basis since 1960. The first commercial electronic central office will go into operation in Succasunna, N. J., early in 1965.

Motorola refrains from Navy bidding

The Navy has been collecting bids for a new combination system—comprising communications, telemetry, tracking and command—for three range instrumentation ships and the Apollo spacecraft program. Bidders include the Lockheed Aircraft Corp., Martin-Marietta Corp. and Radio Corp. of America. **But the Motorola Corp., which was thought to have the inside track, isn't bidding.** The reason seems to be Motorola's confidence that it will get the contract for the unified S-band system, even as a subcontractor. The company believes it has the only one available—it is already making such a system for NASA ground stations. The unified S-band system will be the only custom-designed item in the contract. Most of the other equipment will be off-the-shelf.

Another bit of Motorola intelligence—picked from the grapevine of last month's IEEE show—was that corporate headquarters would be moved from Chicago to Arizona. Not so, company spokesmen insist. "We just couldn't afford to decentralize to that extent," they explain. The inspiration for the rumor, one official suggested, could have been someone's wishful overreaction to a long, hard winter.

Space needles found not guilty

Project West Ford, the controversial orbital scatter communications belt, has received a clean bill of scientific health from the Space Science Board of the National Academy of Sciences. The belt, consisting of 400 million tiny copper-wire dipoles in a 2,000-mile-high polar orbit, was created last year to serve as a reflector for radio signals in long-distance communications experiments. The project drew protests from optical and radio astronomers, who said the needles would interfere with their observations. But now Prof. H. H. Hess, of Princeton University, who headed the science academy's study group, says West Ford did not hinder other scientific observations. **This supports earlier reports by backers of the West Ford project, who have complained that political constraints—resulting from scientists' protest—were hampering the project** [Electronics, Nov. 8, 1963, p. 26].

Rolling playroom in Ford's future

The Ford Motor Co. has come out with a prototype for a car that's half rumpus room. **A communications console controls a television set, three a-m/f-m radios and a recorder that feeds music, movies or business correspondence into the system.** A power-operated glass screen protects the driver from noises from the rear "lounge," where one of the radios is likely to be turned to a children's program. There's also a thermo-electric oven-refrigerator for snacks, and an unexplained "kiddie-quiet ion dispenser," based perhaps on the theory that negative ions in the air are soothing to frazzled nerves.

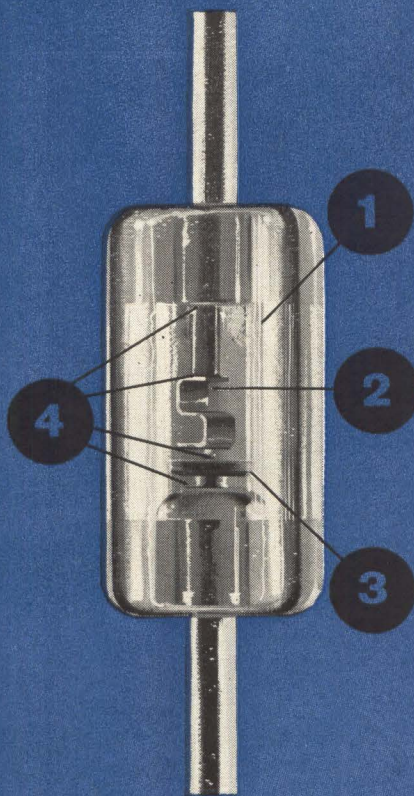

Ordinary diode
trouble spots



Unitrode
trouble spots

That's
reliability!

(1) Void in conventional diode becomes contaminated by trapped impurities, degrading diode characteristics. Unitrode® diodes have no void — the silicon dice is high-temperature bonded *directly* between the terminal pins, and hard glass is fused to all exposed silicon. Electrical performance is fixed, permanently. And because they're simpler, Unitrodes are smaller . . . in fact, this small: 

(2) Whisker can be burned out by surges, and contacts broken by vibration. Unitrodes have no whisker — their broad contact surfaces withstand continuous 10-watt power overloads, thermal shock and cycling from -195°C to $+300^{\circ}\text{C}$.

(3) Exposed silicon dice can easily be tipped, cracked or contaminated in assembly. The Unitrode dice — sandwiched between terminal pins and sealed in hard glass — is practically invulnerable.

(4) Delicate construction increases chances of faulty assembly — loose solder balls, double whiskers, flaking gold, defective glass seal, distorted elements. One-piece Unitrodes are so simplified, trouble-free and rugged that characteristic readings do not change through all MIL-S-19500 environmental testing . . . and performance will not deteriorate throughout a long service life.

This kind of reliability has to cost a little more — but it's essential for electronic packages that require all the performance possible in the smallest space. Allow our representative a few minutes to demonstrate the entire Unitrode line of diffused 3-ampere silicon diodes, fast switching rectifiers, 3-watt zeners, high voltage stacks and bridge assemblies, and ask him for the Unitrode Reliability Manual. Just write or call . . . UNITRODE TRANSISTOR PRODUCTS, INC., 214 Calvary Street, Waltham, Massachusetts 02154. Tel: (617) 899-8988, TWX: (617) 894-9876.

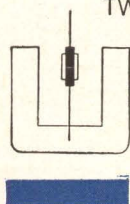

UNITRODE

THE COMPONENTS THAT HAVE MADE THE ALLEN ORGAN FAMOUS.
USED BY AMERICA'S LEADING ELECTRONICS MANUFACTURERS.



ALLEN COMPONENTS

of Uniformly High Grade at Attractive Prices for Wide
Electronic Application, Always in Stock, Write for Catalog

The uncompromising quality of Allen components has developed a steady demand for them from prominent electronic users—commercial, scientific and government.

Allen makes the finest electronic organ. The finest organ is made of the finest components. This is every buyer's assurance of dependable quality down to the minutest manufacturing detail.

Because these components are produced in such quantity and variety, and are generally in stock, they represent an advantageous source of supply for other component users, at moderate prices.

Write for our catalog, indicating which of the components may be of interest to you.

Allen Frequency Source Type C

A moderately priced compact audio oscillator designed for applications that do not have most stringent requirements for stability in respect to temperature and frequency drift.

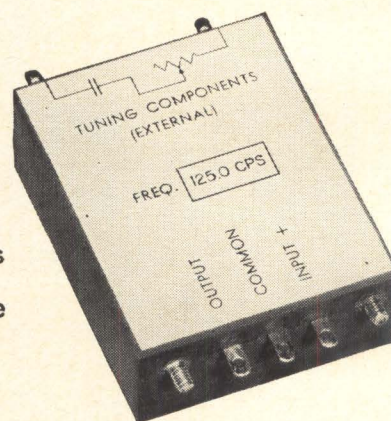

Allen Toroids

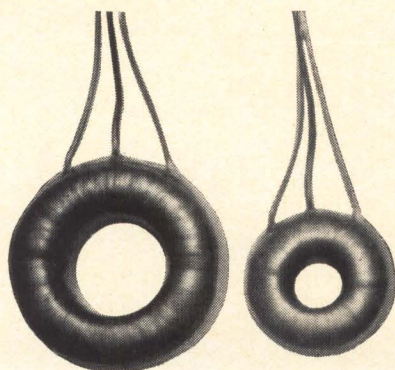

Over 150 sizes available from stock include Permalloy, Ferrite and Powdered iron types. Inductant and Q measured at 1 volt 1000 c.p.s. Inductance tolerance $\pm 2\%$.

Allen 20-watt and 50-watt Transistorized Amplifiers

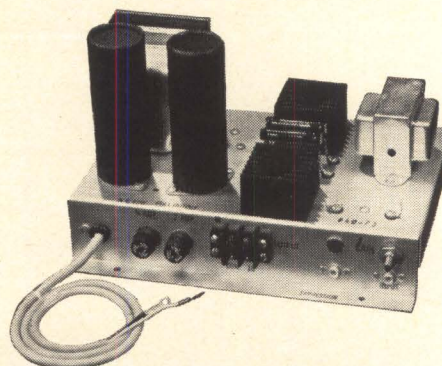

Utilize latest developments in solid-state technology. They demonstrate characteristics normally associated with such circuitry (compact design, low heat dissipation). Operate over wide ambient temperature range.

©A.O.Co.

Allen Organ Company, Macungie, Pa. Phone 065-9801

Allen

COMPONENTS
DIVISION

NOW YOU SEE IT...

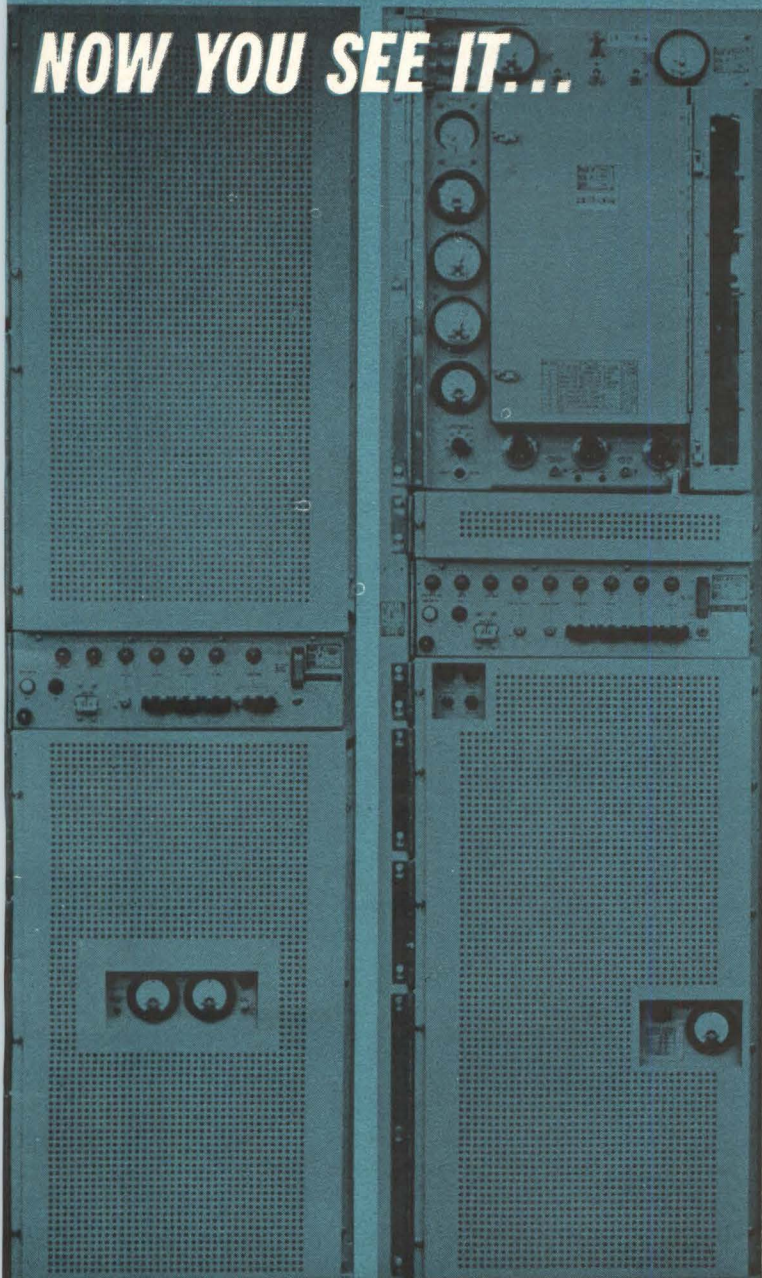

**NOW YOU SEE IT AGAIN
REDUCED TO
SOLID-STATE
BY REL**

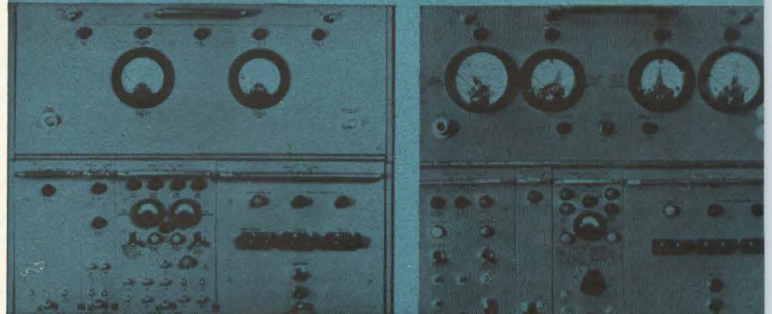

New 2600 Series by REL represents completely solid-state tropo scatter radio equipment.

Advanced solid-state design by REL—pioneering leader in tropo scatter communications—provides a rugged and reliable system that meets tactical communications requirements for both tropo and line-of-sight applications.

Meeting and exceeding performance standards of REL's famed AN/FRC-39-A(V) radio system, the 2600 Series truly represents the latest development of solid-state, modular-constructed tropo scatter radio hardware.

Reduced to one-fifth the size, weight, and power drain of conventional tube equipment, the new 2600 Series proves out for tactical use as well as for transportable and fixed-plant installations in wide-ranging commercial and military applications.

For the future, as in the past, this same REL engineering and performance leadership stands ready to help solve your military or commercial telecommunications problems.

For additional information on 2600 Series, write for Brochure SE-1.



24-channel, dual-diversity, 1 kw tactical tropo terminal in S-144 shelter—total weight only 1500 lbs.



RADIO ENGINEERING LABORATORIES

A division of Dynamics Corporation of America
Long Island City 1, New York

CIRCLE 21 ON READER SERVICE CARD

FACTS...

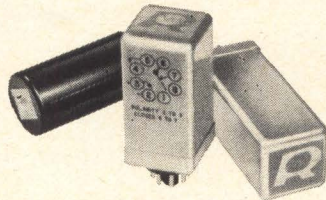

*about today's most
advanced solid state
telegraph relays*



RADIATION
INCORPORATED

Are all solid-state relays alike?

No. Some are transistorized versions of mechanical units, while others are partially solid-state. Radiation Telegraph Relays are all solid-state. There are no moving parts.

Why invest in solid-state relays?

Because they eliminate routine maintenance, require no adjustments, and cut costly downtime and service calls.

How long will they operate under normal conditions?

Indefinitely.

APPLICATIONS . . .

Which mechanical relays can solid-state units replace?

All known types . . . except those rare applications where no solid-state device can be used.

How many kinds would I have to stock?

Only three: Radiation supplies polar, neutral and universal types.

Can I simply plug in your relays and expect them to work?

Yes. But because there are so many different wiring options, an adapter plug may be required to match your particular system.

How do you power Radiation Relays?

You don't. A unique circuit (patent applied for) allows the unit to operate on input current . . . the signal itself supplies the power.

TECHNICAL . . .

What are the features of Radiation Relays?

Non-polarized output contacts, high MTBF . . . 73,000 hours of actual field test without failure, high speed . . . up to 2400 bits/second, low distortion . . . less than 1% at 1000 bauds, and low leakage . . . less than 5 μ a at 130 volts. The units provide long operating life with extremely high reliability, and are designed with special protective circuitry.

What type of protective circuitry?

Thanks to a unique Radiation design, the units are highly resistant to spikes and overvoltages. Not only do they provide a cleaner telegraph signal, but they are also protected against destruction caused by abnormal line conditions.

Suppose a Radiation Relay is badly overloaded . . . how do I check it out?

We can supply our Model 7110 Solid-State Relay Tester. Incidentally, it comes with an adapter for use with electromechanical units, too.

What if the unit's actually damaged by abnormal conditions . . . do I have to throw it away?

Absolutely not! Due to modular construction Radiation Telegraph Relays are repairable.

QUALITY ASSURANCE . . .

Are your relays guaranteed?

They certainly are. Radiation warrants Neutral Model 9214 and Polar Model 9212 against all defects of performance for a year after shipment . . . providing they're used under normal conditions.

How can I prove the superiority of Radiation Solid-State Telegraph Relays?

Simply phone or write Product Sales Manager at Radiation Incorporated, Products Division, Dept. EL-04, Melbourne, Florida. We will supply technical information, and, if you wish, have a Field Engineer provide a relay to test on the line of your choice.

Why not call today? Prove to yourself that Radiation Relays assure higher circuit efficiency, lower cost operation and dependable service!

Machine-wired backplanes for "Burroughs" Computers now use hook-up wire insulated with "Kynar,"* Pennsalt vinylidene fluoride resin. Why "Kynar"? No cold flow or cut-through when wire is pulled tight around sharp corners. "Kynar" is tough ... withstands tension of machine application to backplane. Has U.L. approval for "Burroughs" B-5000 computer operation.



Each "Burroughs" backplane is checked visually, tested electronically. Machine wrapping with Gardner-Denver "Wire-Wrap"† drastically reduces incidence of error; concentrates 100,000 circuits in same space that formerly allowed only 10,000 circuits.

†"Wire-Wrap" is a Registered trademark of Gardner-Denver Company.

For more data on "Kynar"...sources of hook-up wire insulated with "Kynar," write Plastics Department, Pennsalt Chemicals Corporation, Three Penn Center, Philadelphia, Pa. 19102.

"Burroughs" is a Registered trademark of Burroughs Corporation.

Kynar... a fluoroplastic that's tough!

*"Kynar" is a Registered trademark of Pennsalt Chemicals Corporation.



Fairchild Controls' Industrial Potentiometers Can Save You 20%

FAIRCON

FAIRCHILD'S NEW LINE GUARANTEES HIGHEST QUALITY AND CUTS THE HIGH COST OF POTENTIOMETERS

Faced with the problem of high cost for high performance? The FAIRCON line offers a new high level of precision for industry—bridging the gap between low quality commercial grades and ultra

sophisticated MIL spec potentiometers.

Top Performance Plus Substantial Savings Too

Check the FAIRCON LIN-Chart below. The white band in the chart indi-

cates the standard high linearity available in the FAIRCON F200 two-inch, single-turn potentiometer. If your requirements fall within this broad range, you can save UP TO 20% over the complete MIL spec unit you may now be using. Similar savings (and precision) are available throughout the entire FAIRCON line of single-turn and multi-turn potentiometers.

You save money with Fairchild GUARANTEED quality and performance—and with quality potentiometers especially engineered and manufactured for large volume industrial applications. Whatever your control problems... computing... instrumentation... process control... communications... involving potentiometers, send us your requirements, blueprints and specifications for prompt appraisal and quotations. FAIRCON for quality... at a price commensurate with overall system cost.

LIN-CHART FOR FAIRCON F200 POTENTIOMETER

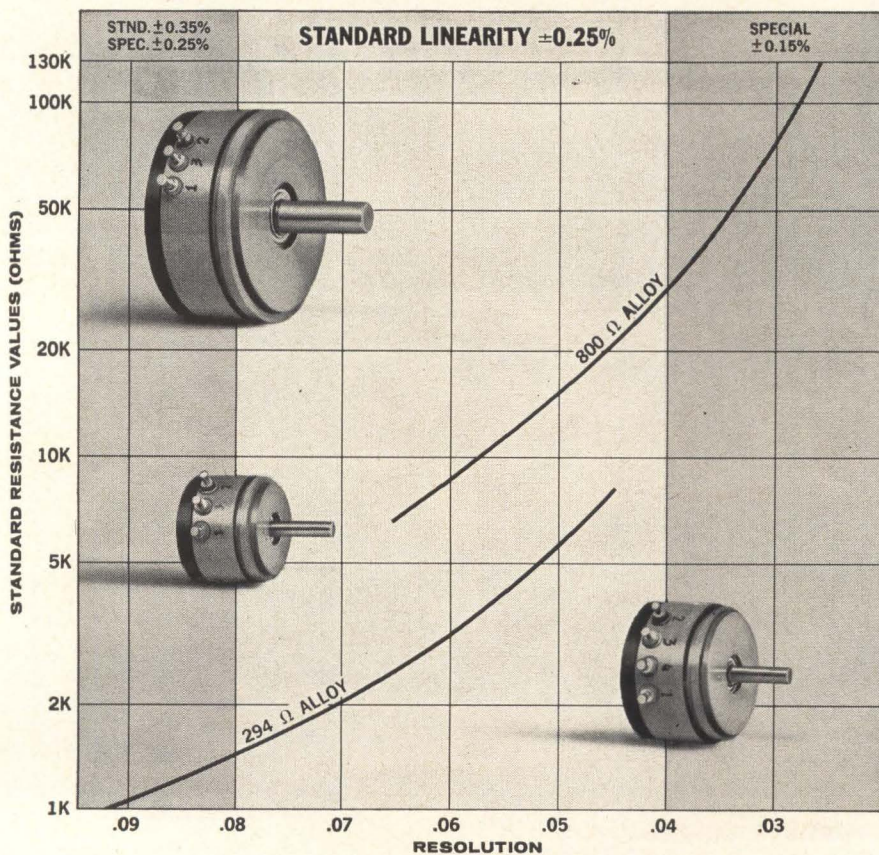

Chart and specifications for complete FAIRCON line available on request.)

Similar Savings on Trimmers

You can save with volume requirements for industrial trimmers too. Check Fairchild Controls' prices on new FAIRCON trimmers.

FAIRCHILD
CONTROLS

A DIVISION OF FAIRCHILD CAMERA AND INSTRUMENT CORPORATION
225 PARK AVENUE, HICKSVILLE, L.I., NEW YORK
TELEPHONE: (516) WE 8-5600. TWX: 516 433-9146
CABLE: FAIRCON-HICKSVILLE, NEW YORK, U.S.A.

New Miniature Wet Slug Tantalum Capacitor Offers Higher Ratings Per Unit Volume

The new Mallory type MTP wet slug tantalum capacitor offers higher capacitance-voltage product than conventional wet, solid or foil MIL types. The MTP is an industrial version of an extremely high reliability capacitor developed by Mallory. It is available in ratings from 4 mfd., 50 WVDC to 450 mfd., 6 WVDC. It operates at ambients from -55°C to $+85^{\circ}\text{C}$ without derating, and comes in 4 case sizes, from 0.115" diameter by 0.312" long, to 0.225" diameter by 0.775" long (all dimensions maximum).

The MTP has good ability in withstanding vibration, shock, temperature cycling, immersion and moisture resistance. Life tests, quality control history and temperature stability tests indicate that the MTP has performance and reliability

STANDARD RATINGS

MFDS CAPACITANCE	RATED VOLTS	MAX. DCL (@ 25°C.	MAX. DF (@ 25°C.	CASE SIZE
4	50	2.5 μa	10%	AA
6.8	50	3 μa	20%	A
30	50	8 μa	20%	B
78	50	10 μa	20%	C
6	30	2.5 μa	12%	AA
10	30	3 μa	15%	A
45	30	8 μa	25%	B
120	30	10 μa	30%	C
60	20	7 μa	25%	B
80	15	6 μa	30%	B
200	15	8 μa	30%	C
120	10	5 μa	35%	B
300	10	7 μa	35%	C
180	6	5 μa	37%	B
450	6	6 μa	50%	C

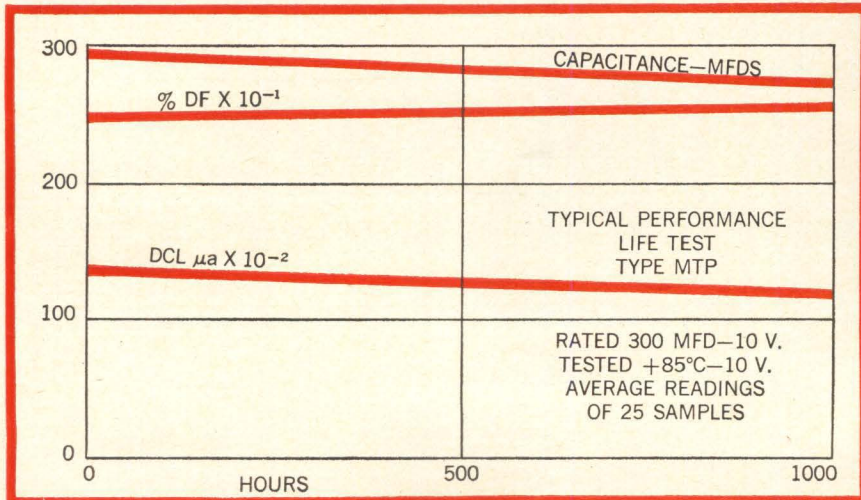
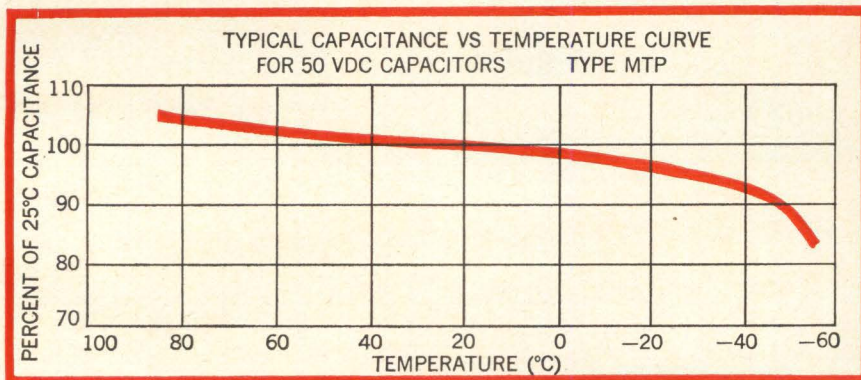

compatible with the most stringent specifications.

Size and reliability of this unit make it ideal for use in microminiature applications where discrete components are used in conjunction with thin film circuits. For complete data and prices, write or call Mallory Capacitor Company, Indianapolis 6, Indiana—a division of P. R. Mallory & Co. Inc.

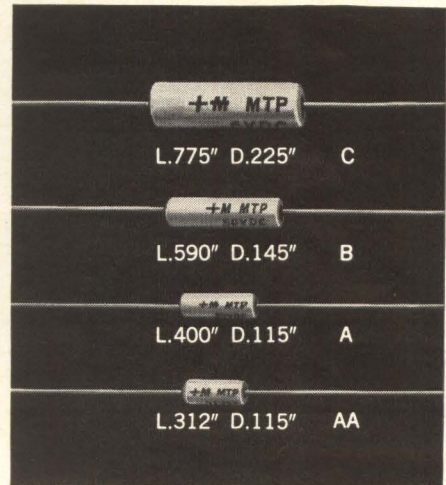

All dimensions shown are maximum.



WET SLUG, FOIL AND SOLID TANTALUM CAPACITORS

PRECISION MACHINING WITH LEVIN HIGH-PRECISION LATHES:

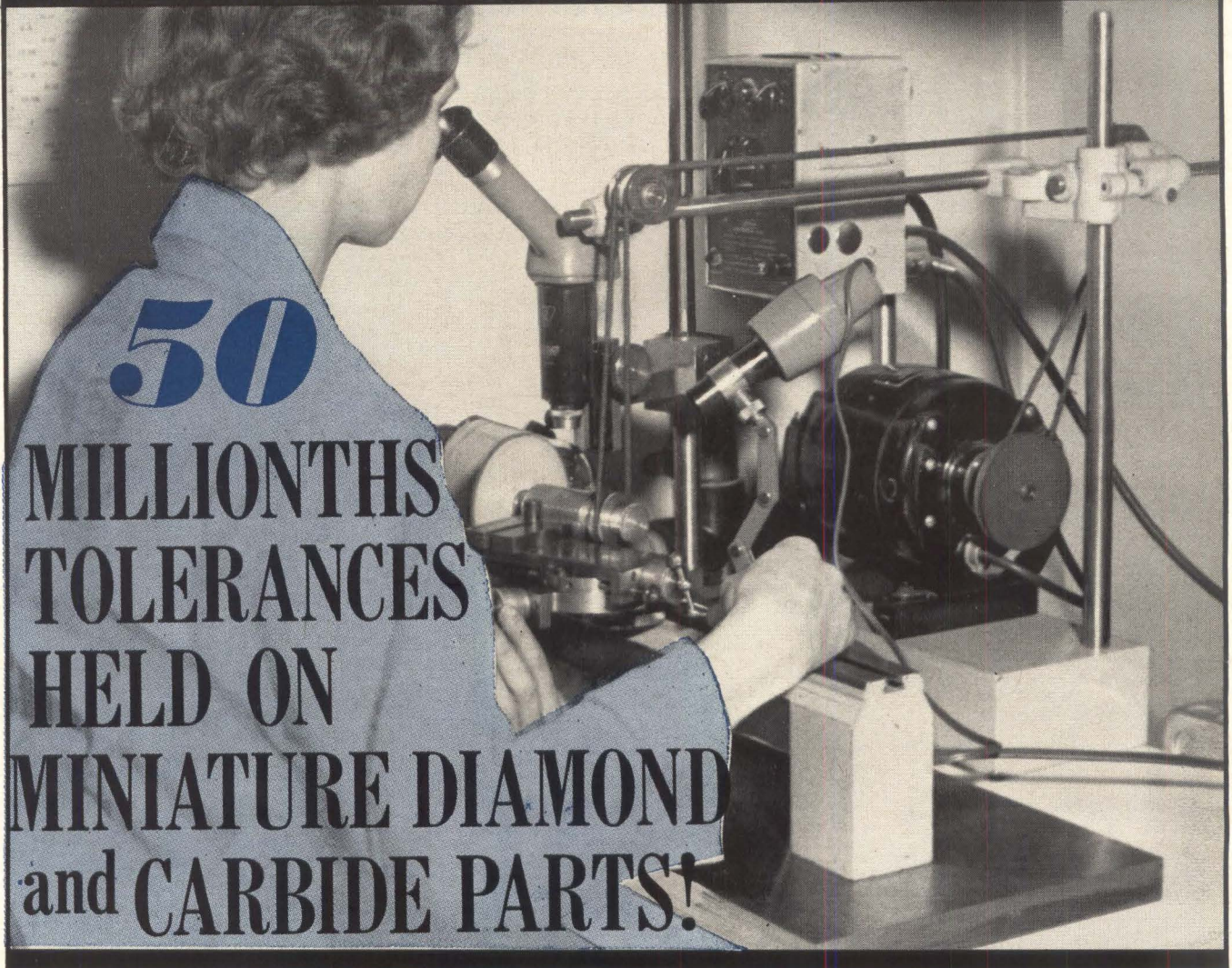

50
MILLIONTHS
TOLERANCES
HELD ON
MINIATURE DIAMOND
and CARBIDE PARTS!

Levin high-precision lathe with grinding attachment used in grinding tungsten carbide parts for a heated carbide capillary tube. Capillary tube is used to bond semiconductor leads.

At Tempress Research Co., Sunnyvale, California, many Levin high-precision lathes are used to produce miniature tools used in the manufacture of such intricate devices as semiconductors and other subminiature space-age products. These lathes, equipped with Levin precision collets and standard attachments, are used for general precision machining operations, to perform threading and tapping down to 0.0000-160, and to lap surface finishes down to 1/2 microinch in such materials as diamond and carbide. And some operations involve tolerances of 0.00005 inch.

Practically all of Levin's extensive line of standard tools and attachments are used at Tempress. Some of them have even been modified to facilitate either small-lot machining or production machining of all types of any material.

If you do precision work of this type, Levin lathes may be just what you need to realize substantial savings or to increase profits by increasing production. It's certainly worth checking into. We'd like to hear from you.

LEVIN[®]

LOUIS LEVIN & SON, INC. / 3573 Hayden Avenue / Culver City, California / Telephone: UP 0-9555 (area code 213)
Exclusive Dealers / Russell-Holbrook & Henderson, Inc., New York and Los Angeles / Industrial Tool & Supply Company, San Jose / Marshall Tool & Supply Corporation, Los Angeles / Royal-Tschantre, Baltimore / Morton L. Friedman Co., Chicago / Plus Dealers in all important Industrial Centers

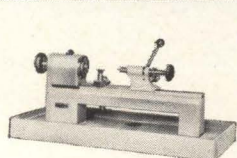

INSTRUMENT LATHE

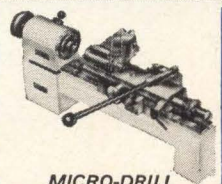

MICRO-DRILL

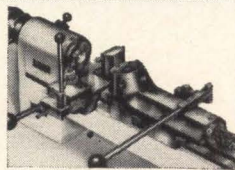

TURRET LATHE

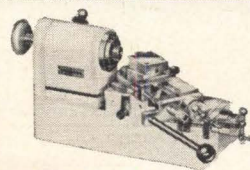

RADIUS TURNING



PRECISION COLLETS

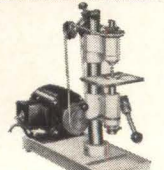

PRECISION DRILL

Computers

On ice patrol

When the Coast Guard cutter Evergreen left Boston last month to patrol the North Atlantic shipping lanes a one-bay computer, made by the Digital Equipment Corp., was aboard.

Since 1946 the Evergreen has been doing much of the Coast Guard's oceanography, charting currents and ice drifts. The computer's primary job will be the determination of drift and the melting rate of ice, but it will also help to plot currents to determine the location of fishing grounds, which are often found where a cold current merges with a warm current.

After 50 years. The veteran oceanographic ship is part of the International Ice Patrol, which was established half a century ago, soon after the Titanic went down after colliding with an iceberg. The maritime nations of the world, shaken by the tragedy in which more than 1,500 lives were lost, set up a conference for safety at sea. The conference established the ice patrol over North Atlantic shipping lanes. Responsibility for the patrol was ultimately delegated to the United States Coast Guard.

The main job of the patrol is to find and track icebergs that float down into the Atlantic Ocean ship routes. Aerial reconnaissance and radar, besides visual sighting from ships, are the prime sources of information. To do a real job of alerting ships, the ice patrol must also operate as an oceanographer. The Coast Guard, which has very few oceanographers, would like to find out whether its computer can be operated by a trained enlisted man. If the experiment works, 30 weather and ice-patrol ships may be computer-equipped. The computer helps detect instrument errors, so that new observations may



Iceberg: here today, where tomorrow?

be taken at once. Previously, several months of work might turn out to be useless upon returning to port.

Samples. At regular intervals a thermometer is lowered over the side, along with a Nansen bottle, which opens at a predetermined depth to capture a sample of water and then clamps shut. After both are brought up, the temperature reading is entered into the computer on a teleprinter keyboard. The water sample is titrated to determine salinity—based on the over-all mineral content—which is also entered into the computer.

Data on latitude and longitude, number and time of cast, wave and wind factors, dry and wet bulb readings, and fog or clear factors go into the computer. All the data is printed out on the teleprinter, along with the rate of change of volume of the sample. The computer performs various interpolations and integrations in reducing the data.

The computer will help with current detection and prediction. The current flow is important, as the Labrador Current brings icebergs and ice packs down into the shipping lanes with wide variations of time and place. Fog and bergs are

found where the Labrador Current meets the Gulf Stream. This is near the southwest tail of the Grand Banks, reaching into the North Atlantic sea lanes.

The bergs are too large to destroy, so the ice patrol reports their location. By charting the currents, the computer will help predict the future location of bergs. This is believed to be a long-range goal; the patrol will not try to predict iceberg drift from this year's studies alone.

In the newspapers

Harris-Intertype Corp. is traveling a new road to an old destination—typesetting by computer—but may find some old roadblocks already in place. The computer giants, International Business Machines Corp. and Radio Corp. of America are already in the market with their general-purpose computers adapted to this specialized application. Harris-Intertype hopes that its intimate knowledge of the printing industry, and its special-purpose machines, will appeal to an estimated potential market of several thousand.

Harris-Intertype is offering three models of its computer. All per-

form the same two functions with varying degrees of automation: line justification (making both right- and left-hand margins even) and hyphenation. The most complex model, the Series 300, works like the RCA and IBM computers. It hyphenates by means of both logical rules of English and a stored dictionary of exceptions. Harris-Intertype would not disclose the price of its computers but claimed they will sell for about 30 to 50% less than the comparable RCA and IBM models. RCA's 6-month-old Newscom 30, a specialized justifying and hyphenating computer, rents for \$1,985 a month including reader and perforator; IBM's lowest priced system rents for \$1,850 a month, without extras.

Working computers. Both RCA and IBM have machines in operation. Harris-Intertype has delivered its prototype model to a newspaper in Kingsport, Tenn. RCA has its 301 computer installed at the Los Angeles Times, the Washington Post and at the Perry Publications in Florida, where one computer, in West Palm Beach, sets up the type for nine newspapers throughout Florida. RCA's Newscom 30 is currently being installed at the Baltimore Sun. IBM 1620 computers are setting type at the South Bend (Ind.) Tribune, the Daily Oklahoman (Oklahoma City), the Miami Herald and the Washington Star. IBM has sold a computer to the New York Daily News. But that one isn't doing much of anything. The reason? The unions.

Union opposition. So far, computers have been sold to several newspapers employing union typographers. But both major computer manufacturers agree that the unions, particularly in New York City, are the major stumbling block in industry acceptance of computer typesetting. Said an RCA spokesman: "You'd have computers in every one of the New York papers right now if it weren't for the labor unions." IBM, speaking circumspectly, says that the unions are "a major consideration" in selling computers.

Bertram A. Powers, president of the New York Typographical

Union, declares that "this is the time to fight." What he is fighting for is an agreement that New York newspaper publishers who install computers will not cut back existing personnel, but will rely on normal attrition over a period of time to reduce their staffs. He also wants the publishers to turn over to the union a percentage of any cost savings resulting from use of the computers. The cost savings could result either from job attrition or from increased productivity.

As for the specific percentage, Powers says he'd be willing to let arbitrators decide, but insists that the unions are entitled to some financial benefit from the computer installations.

Perhaps this is where Harris-Intertype's new machine will provide the most competition. Its lowest priced model, the Series 100, types out the words that must be hyphenated but needs an operator to decide how. This might be the most acceptable first step for automation-shy unionized plants.

Industrial electronics

Jam in the tube

The Port of New York Authority, one of the world's busiest agencies, is responsible for the safe and rapid movement of millions of vehicles each year between New York and New Jersey. The bistate agency, always faced with the nightmare of traffic jams, is hoping to solve

some of its problems electronically.

The Port Authority believes it can stave off complete stoppage of transportation by continually building new facilities—airports, bridges and tunnels—but new tunnels are expensive (the last tube of the three-tube Lincoln Tunnel cost \$95 million) so the agency's engineers are now planning to modernize the old ones in much the same manner that communications engineers dream up sophisticated schemes to make cables carry more messages.

The system will use photoelectric vehicle detectors, a computer programmed for optimum speeds, a closed-circuit television system that will enable police to view any part of the roadway and special underground two-way radio communication. A nonelectronic monorail car will whisk tunnel police past stalled traffic at 30 miles an hour.

Pilot installation is scheduled for the 8,000-foot Lincoln Tunnel south tube early in 1965. If the system proves out, it will be installed in the remaining two tubes of the Lincoln Tunnel and both tubes of the older Holland Tunnel.

Need ideas. Television is the best tool available for determining the specific place and nature of a tie-up, but Port Authority engineers willingly admit they don't know exactly how they should use it. They invited bids, late in January, but are holding the due time open until the first of May to get as many ideas as possible from the electronics industry. The Authority ex-

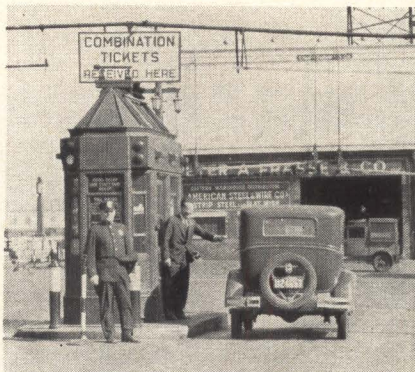

Then and now. Toll booth at Holland Tunnel was topped in the 1930's by an electronic device that gauged height of trucks. Today, cop in the Lincoln Tunnel whisks past stalled traffic.

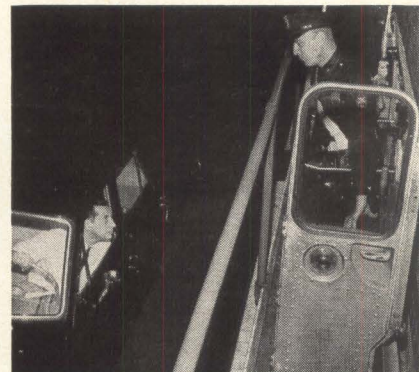

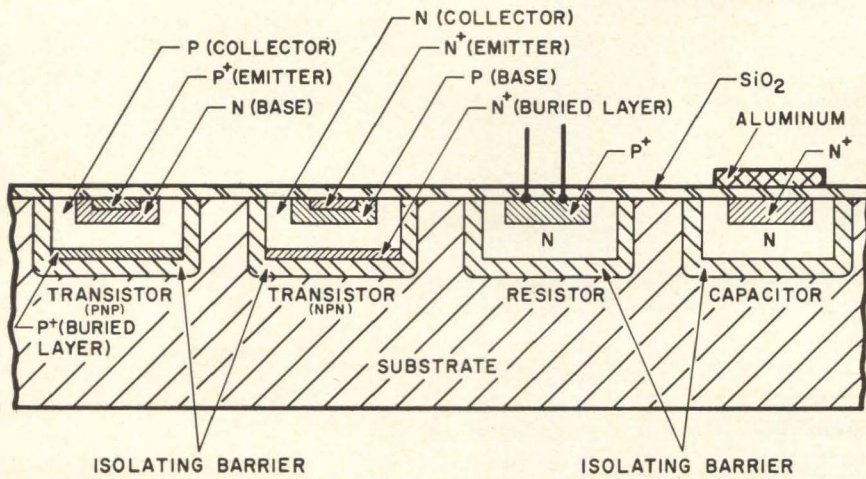

Epic process simplifies fabricating npn and pnp transistors within same semiconductor substrate, top, and improves speed and power dissipation as shown at right. "Floating collector" technique is illustrated right.

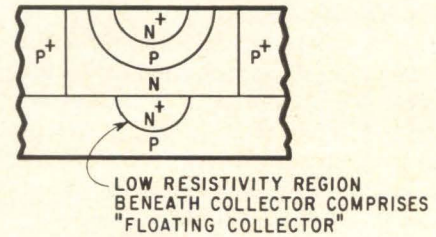
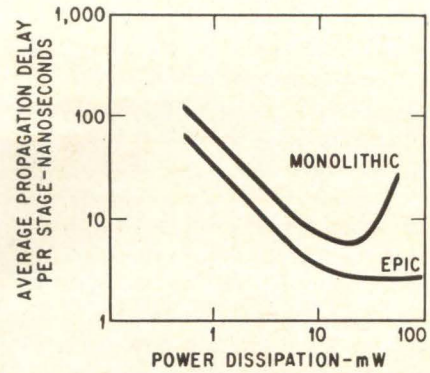

pects to need at least eight fixed cameras, and three control centers.

Surveillance equipment has already come a long way in development by the Port Authority engineering staff. One economical and reliable vehicle detector comprises 72 photocells with a special optical system beneath the tunnel roadway. The photocells will pick up light from existing illumination. When a car passes, light will be cut off and the corresponding impulse will be fed into a computer. Photocell traps comprising pairs at 13-foot intervals are to be installed at 480-foot intervals in each lane of the two-lane tube. The computer will quickly sense a slowing of the advancing pattern from trap to trap.

The computer memory will be continuously adjusted to the traffic situation. Tests show that tunnel traffic flow reaches a maximum when the traffic stream is moving at speeds of 20 to 25 miles an hour, with average spacing of about 55 feet between vehicles. When traffic is heavy, an alarm will be sounded after about 30 seconds if a vehicle fails to pass a detector. In light traffic, alarms will not be set off for intervals as long as three minutes.

Another kind of alarm will be sounded whenever a vehicle is detected taking an unduly long time to pass through a 13-foot trap section between successive photocells.

Microelectronics

Killing the parasitics

One of the problems with semiconductor integrated circuits has been to provide d-c isolation between the different components in the silicon chip. The common technique has been to separate these components with back-biased diodes. While the technique works, the parasitic capacitance associated with these diodes has been a limiting factor on circuit speed.

It now looks as if more and more companies are overcoming this problem. A few months ago Signetics announced that it was able to completely eliminate the need for back-biased diodes by isolating the components with an un-named dielectric of extremely low capacitance per unit area and breakdown voltage of 1,000 volts.

Similar process. An apparently similar process was announced by Motorola at the IEEE Show. It says its process for producing an epitaxial passivated isolated integrated circuit allows construction of monolithic integrated circuits where most major parasitics are eliminated without adding any cost to manufacturing.

The technique is indicated by the diagram. The circuits' elements are

isolated from each other, and from the substrate, by an insulator that is said to provide both electrical insulation and protection against peripheral impurity penetration. As an example of the results, Motorola said that one isolation island on a three-input gate that normally had collector-to-substrate capacitance of 33 pfarads, gave only one pfarad with the "epic" process.

Motorola feels that the results are as good as the best hybrid circuits it has built and that this broadens the applications for monolithic circuits in both digital and linear circuits. "Epic" circuits are only in pilot production, but Motorola expects them to be commercially available in five or six months. Signetics Corp., too, feels it is several months from production, believes the process might boost the present line of 10-Mc gates it has delivered to the Army to near 20 Mc. But some skeptics are waiting to learn prices before calling it a breakthrough.

While neither Motorola nor Signetics has disclosed the isolating material being used, conceivably it could be SiO₂, silicon dioxide, SiO, silicon monoxide, ruby, or possibly some sort of glazed ceramic substrate. (Sylvania Electric Corp. has grown experimental thin-film silicon transistors on glazed ceramics.)

The techniques described are not

necessarily the only ways to do this job. Westinghouse Electric Co. gets its propagation delays down to five nsec by using a "floating collector" technique. This eliminates the junction between the n^+ collector and the p^+ isolation walls as shown in the sketch. This requires an additional diffusion step, however.

Raytheon Semiconductor is working on hybrid direct coupled transistor logic circuits for high-speed applications. It points out that all the transistors can be put in the same substrate without isolation since DCTL is common collector logic. The silicon is then passivated with a layer of SiO_2 and resistors are deposited on top. This has allowed getting 15-nsec propagation delays in the laboratory.

Texas Instruments Inc. is studying several different techniques for reducing collector-to-substrate capacitance, but points out there is still not an overpowering demand for 50 Mc logic and that its Series 51 meets 80% of circuit requirements. A spokesman adds the intriguing notion that there are times when collector-to-substrate capacitance might be desired; for instance, in transmitting energy within the chip by some sort of transmission-line structure.

Components

Tinier junctions

With a new twist on an old concept—stacking little ones to make big ones—Motorola Semiconductor Products Inc. is entering the high-current silicon rectifier business.

A universal type of rectifier cell is a building block. Several of these cells are connected, in parallel, in a single can. Equal current distribution is achieved by matching each cell's forward voltage to within 20 millivolts at 100 amperes. Rectifiers with current ratings of 1,000 amperes or higher, and with surge capacities up to six times as large as other devices, can be built up, Motorola says.

Using small junctions to get the current capacity of a single large

junction avoids several reliability problems, the company adds. The smaller the junction area, the less chance for imperfections. Also, large single junctions really consist of many small junctions intimately connected in parallel. Since the voltage drop across the junctions is unequal, some areas will take more than their share of current. They can heat up, suffer thermal fatigue and deterioration, and fail during surges, destroying the rectifier.

Space electronics

Olympics on tv?

Americans' chances of watching the Olympic Games from Tokyo via live television this fall have run into technical and legal snags.

Two Japanese tv stations will be equipped to transmit Olympic coverage to a communications satellite. But each existing satellite seems to be unsuitable.

Relay I will be in an ideal orbit to send the signals across the Pacific, but the satellite is living on borrowed time. It should have conked out long ago.

Relay II and Telstar II will be in unsuitable orbits.

Syncom II and Syncom III-C (to be launched soon) are incapable of handling commercial-quality television, according to NASA. Besides, the United States agency says it has no receiving antenna on the U. S. West Coast and the Japanese have no Syncom-frequency (7,360 megacycles) transmitter.

Japanese proposals. An engineer from the Japan Broadcasting Corp. says the technical problems can be licked. He points out that one of the transponders on Syncom III will have a 10-megacycle bandwidth, more than enough to carry television signals. But NASA says Syncom's signal-to-noise ratio is too low for commercial-quality television.

The Japanese also say they could use the narrow-band system of Syncom II by compressing their television signals from 4.5 megacycles to 1.5 megacycles. They are

also prepared to change their transmitter frequencies to those appropriate for Syncom.

As for receiving antennas, NASA has at least three 85-foot dishes on the West Coast. But the agency refuses to consider modifications, even if the Japanese were to supply the ground equipment.

The legal problem stems from the exclusive television rights that Japan granted to the National Broadcasting Corp. If the coverage were to be sent via a NASA satellite, such as the Relay or Syncom, the telecasts would have to be available to all U. S. networks.

A spokesman for the Japanese company says he understands that NBC would not hog the programs but would share them with other American broadcasters.

Still another possibility is being advanced by the Communications Satellite Corp. It is discussing with NASA the possibility of "borrowing" Syncom for the Olympics, and making the coverage available to NBC.

Satellite sale

The Communications Satellite Corp. plans to order an Early Bird synchronous satellite from the Hughes Aircraft Co.

The proposed contract sounds complicated. It would include various incentive bonuses for such variables as satellite lifetime, use, durability, functioning capacity, available circuits, commercial usability, delivery and reliability. Hughes would receive between \$7.8 million and \$11.1 million.

Military interested. The satellite company's plans have aroused the military's attention. The Pentagon is trying to get the right to use the commercial satellites.

Eugene G. Fubini, assistant secretary of defense, told Congress that the commercial system provides greater capacity and bandwidth than the military's, at one-third the cost. The only way the Defense Department could get comparable capacity (a 600% increase) would be with gravity-gradient stabilization, which would allow the use of a nine-foot dish



NOW, PHILCO OFFERS VOLTACAP * UNIFORMITY

Four Voltage-Variable Capacitance Diodes
with a specified one percent maximum tracking error



Philco's expanded line of Epitaxial Silicon Planar Voltacap diodes offers circuit designers high reliability (meets all requirements of Mil-S-19500 C) and uniformity with a specified 1% maximum tracking error for all types.† ■ Designed and specified for single or multiple electronic tuning applications, Voltacap diodes offer high Q, high usable change ratio, low noise and low leakage at high temperatures. All types now available in new plastic packages for optimum mounting density. ■ For detailed information on Philco Voltacap diodes, write Department E-4364.

PHILCO VOLTACAP RATINGS AND CHARACTERISTICS

Parameter	V4090	V4091	V4092	V4093
†Capacitance C_v (@ -8V, 1 mc)	47pf ± 20%	150pf ± 20%	250pf ± 20%	500pf ± 20%
Max. Reverse Leakage Current I_R (@ $V_R = -100V$ 85°C ambient)	2.5 μa	5 μa	8 μa	15 μa
Min. Q (@ $V_R = 8V$)	90 f = 50 mc	180 f = 25 mc	160 f = 25 mc	200 f = 10 mc
Min. Capacitance Change Ratio ($V_R = -4V$ to $-100V$)	4:1	4:1	4.1:1	4.1:1
Max. Reverse Bias Voltage V_R	115V			
Max. Temperature Coefficient T = -55°C to +85°C; $V_R = 8$	0.03%/°C			
†Max. Tracking Error $V_R = -4V$ to $-100V$	1%			

†Tighter Tolerances on tracking error & capacitance or matched units available on request.

SPECIAL PRODUCTS OPERATION

PHILCO

A SUBSIDIARY OF *Ford Motor Company*

LANSDALE DIVISION, LANSDALE, PA.

IN CANADA: Don Mills Road, Don Mills, Ontario



Trademark of Philco Corporation for
Epitaxial Planar Voltage-Variable
Capacitance Diode



antenna instead of a 30-foot dish.

If the Pentagon became a customer, the satellite company would probably have to choose the medium-altitude, random-orbiting system that is favored by the military for the later full-scale satellite system. That would give an advantage to bidders proposing medium-altitude systems — American Telephone and Telegraph Corp. and the Radio Corp. of America, Space Technology Laboratories and the Philco Corp. Until recently, satellite company officials were believed to be leaning toward the synchronous high-altitude system being proposed by Hughes.

Joseph V. Charyk, president of the satellite concern, says that a combined civilian-military system would cost one-third less than the cost of two separate systems, and that even if the military used half of the system's capacity, a sharing arrangement would still permit transmission of as many messages as a completely civilian network.

Ranger 7

"Let's face it, the heat's on," said one NASA source describing the agency's determination that Ranger 7 will not meet the fate of Ranger 6 whose television cameras failed before it got to the moon. The government is concerned by the repeated failure of Ranger space probes to accomplish their missions.

The heat is on at the Radio Corp. of America. Engineers there have disassembled the tv subsystem for Ranger 7 at its Hightstown, N. J. space center and are rewiring a lot of black boxes. The heat is also on at the Jet Propulsion Laboratories of the California Institute of Technology, whose contract with the space agency is being renegotiated long before the current one expires in December. And it's probably even hotter at NASA.

Top brass at RCA has decreed that no advance information be released on the next Ranger spacecraft. The company will make public statements after the next flight—and then only if it's successful. One source estimates that

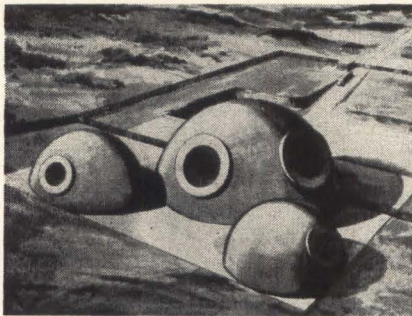

Nike-X radar, left, uses many more components than earlier Nike-Zeus.

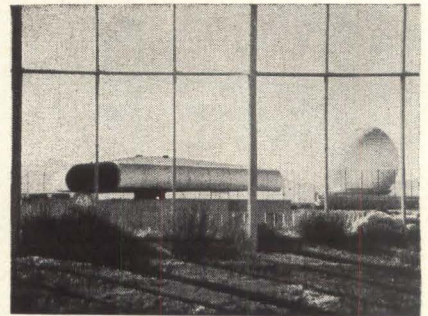

the spacecraft couldn't be put back together to fly before the end of May.

No connection. NASA insists that its negotiations with the lab "started long before the failure." The new contract, already initialled and supposed to go into effect in June, would give the space agency more direct management responsibility. Here's how:

- The agency will make the decision on who directs work on the Ranger, Surveyor and Mariner spacecraft. At present, the lab shares in the decision.

- There will be a periodic formal review of the lab's management and technical performance.

- A new formula will be set up for determining fees, based on NASA's judgment of Jet Propulsion Laboratories' performance.

Microwave

Belt-tightening time

It won't be long before there is a wholesale shakeout of small microwave firms, people in the business say. Sales have been uncomfortably low for over a year. In desperation, small components producers are often cutting prices to below cost to keep their plants open, hoping for a pickup in military business or a decent merger offer.

The reason is a familiar one: over-capacity caused by a sagging defense market. Microwave design and production capacity mushroomed in the 1950's and early 1960's. A series of big military programs—aircraft radar, air-defense radar networks, radar-guided anti-

aircraft missiles, communications—built sales up to about \$1½ billion in 1961. But as government money switched into strategic missiles, microwave business eased up and then began to slide.

Over optimism. As defense needs expanded, recalls Edward Ginzton, president of Varian Associates, "we were asked to participate in larger and larger programs, with ever greater commitments for space and facilities." Defense agencies expressed a "sense of urgency" for expansion into 1963 and 1964, and companies planned accordingly.

Varian's main business is microwave tubes. Its sales of these climbed from \$10 million in 1954 to \$50 million in 1962. The total market rose from \$50 million in 1954 to \$150 million in 1962. Military agencies indicated they would need \$200 million in tubes this year, but actual procurement has slumped to about \$120 million because the Defense Department cut inventories and phased out or cancelled microwave-heavy projects like the Typhon missile.

During the decade of growth, about 25 companies entered the microwave tube business. "With the sudden shrinking of markets in recent months," Ginzton says, "competition has become extreme."

Another industry leader feeling the pinch is Microwave Associates, Inc. Even though it has a strong position in a growing field, solid-state microwave devices, its sales have declined from \$12.8 million in 1962 to \$10.5 million in 1963, and its profits from \$1½ million to \$200,000. Dana W. Atchley, Jr., president, is bullish, though.

Array jackpot. Atchley thinks the

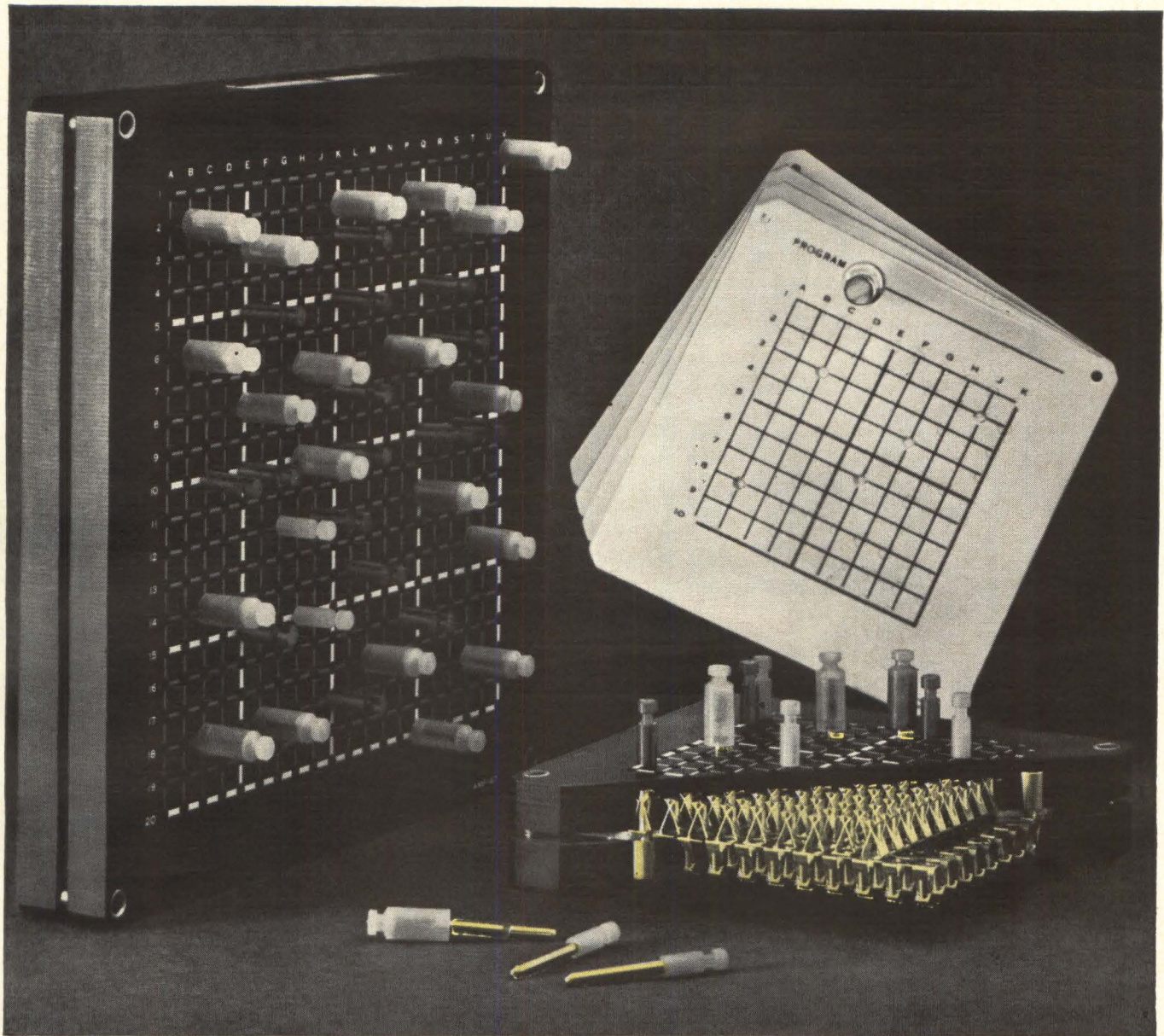

What's a good matrix pinboard really like?

That's a natural question, if you go sifting through claims. But why wade through the echoes of claims? If your reputation rests on the choice of a quality pinboard, the best way to judge is through engineering features.

What has gone into the making of the pinboard? The answer to this question tells you what level of pinboard performance you can expect. Take a moment and check these features against those of any other pinboard on the market. Our pinboard offers:

- precision made and fitted solid phenolic blocks
- precision formed busses plated with hard alloy gold over nickel
- special "funnel" designed contacts of X-Y coordinates assure positive entry of pins
- shorting, diode and other component carrying pins that won't bend, buckle or malfunction, regardless of number of insertions and extractions
- interchangeable templates, pre-programmed by pencil punch-out, permit storing of hundreds of intricate switching combinations

- .250" x .250" grid design which accepts .095" diameter pins

Somewhere in your design, right at the heart of it, there's a need for pinboard programming. Possible applications range from vending machines on through digital computers and include such functions as digital memory, sequencing and input-output switching. Why short-change your plans with anything less than the best pinboard.

The best proof is the real board on your desk. But before that happens you can write and get all the sound engineering facts on what makes it the best. Isn't that a good way to approach a decision? Try it. Write today.

★Trademark of AMP INCORPORATED



A-MP* products and engineering assistance are available through subsidiary companies in: Australia • Canada • England • France • Holland • Italy • Japan • Mexico • West Germany

next jackpot for microwave could be phased array radar. Just three arrays like the Multifunction Array Radar (MAR) being developed for the Nike-X antimissile system could use as many components as the entire microwave industry produced in 1960. If the big arrays go into production, components sales alone might hit \$300 million in three or four years.

Another Nike-X supplier jokes that it might be worthwhile to build plants right at the system sites, just as dam builders build cement plants at the construction scene. MAR requires literally thousands of components. How many isn't being revealed, but here's a clue: the Air Force's phased-array prototype for space surveillance [Electronics, Feb. 14, 1964, p. 28] has some 25,000 components.

There are some other bright hopes for microwave, too. The buildup in tactical warfare forces will mean more money for transportable and hand-held radars, mobile communications and air control systems. The hiatus in large-scale aircraft equipment buying will probably be ended by the new VAL light attack plane and the TFX (F-111) tactical fighter programs [Electronics, Feb. 21, 1964, p. 10 and Dec. 14, 1962, p. 18] and by plans to equip existing planes with new equipment like terrain-following radar [Feb. 21, 1964, p. 10]. Another prospect is a wholesale switch of new telemetry systems to microwave because of signal traffic jams at uhf and vhf.

Warming up

To offset the sagging military market for microwave components, Raytheon Co. is trying to sell the big industrial processing industries on superpower microwave tubes for materials heating.

The concept under development at the company's Spencer Labs, in Burlington, Mass., is built around the Amplitron, a crossed-field power generator that can put out 425 kilowatts at S band (around 3,000 Mc) with an efficiency of 72%. This is immense, compared

to the output of small dielectric heaters conventionally used in industry for such applications as sealing plastics.

Roy Allaire, manager of R&D marketing, figures canneries, oil refineries, lumber curers, plastics manufacturers and other materials processors should be interested. Radio frequency energy, he says, is quicker and more efficient than conventional heating—the heat is created almost instantaneously in the material being processed.

Because an Amplitron heating system would cost about a half-million dollars, Raytheon will sell potential customers a far smaller one, a one to two kw system with a magnetron tube. Customers can experiment with it in a pilot plant.

Medical electronics

Brain sonar

Seeing a potential market of \$30 million in 10 years for ultrasonic medical equipment, Sperry Products Division of Automation Industries, Inc., has introduced an echo-encephalograph and an echocardiograph. One can detect tumors and other brain disorders; the other observes the action of heart valves as they move in the patient.

Both work almost the same as the industrial types of ultrasonic Reflectoscopes that Sperry has

been selling for 20 years (power, displays and video processing are the main differences). The Reflectoscopes sound out materials for flaws, much like sonar detects fish in water or layers in the ocean bottom.

Sperry doesn't claim a pioneer position in medical ultrasonics, although in 1944 Navy doctors were experimentally using a Reflectoscope to find gallstones (Floyd A. Firestone, of the University of Michigan, patented the first machine in 1940). Sperry licensees in Europe and Japan have been making echo-encephalographs for years and they are regularly used in foreign clinics. One licensee, Branson Instruments Inc., got into the U. S. market well before Sperry. Some foreign companies are also making ultrasonic scanners that produce picture-like displays of internal organs. Sperry plans to make them, too.

Sperry figures the more the merrier, because most U. S. doctors are unfamiliar with the echo-encephalograph equipment. The market today is maybe \$1 million or less. Only about 20 machines are in regular hospital use, which leaves about 9,980 hospitals still to be sold at \$4,000 to \$5,000 a sale.

The echo-encephalograph is used mainly to determine if a membrane separating two brain lobes has shifted from its "midline" position. Pulse echo soundings are made from both sides of the skull. If the distances from both sides don't match, the midline has shifted, probably because of pressure from a tumor. The technique has been batting 0.920 in tumor detection. It takes only five minutes, is painless and less hazardous than some of the more conventional tests for brain tumor. Doctors double-check suspected cases with x-ray or other tests.

The ultrasonic pulses are transmitted at a frequency of 1 to 5 megacycles. Transmitter output is in milliwatts, but the actual energy in each pulse is negligible. It isn't enough to heat the brain or cause discomfort, says V. E. Van Valkenburg, Sperry's product manager.

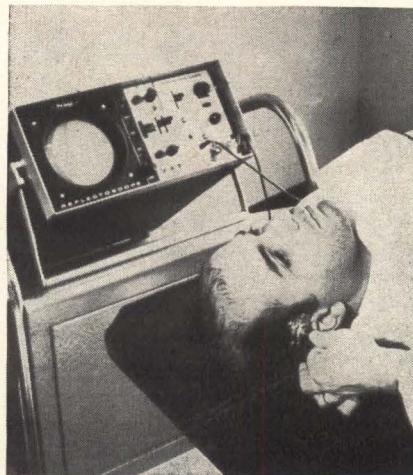

Examination. A bit of jell couples transducer, lower right, to skull.

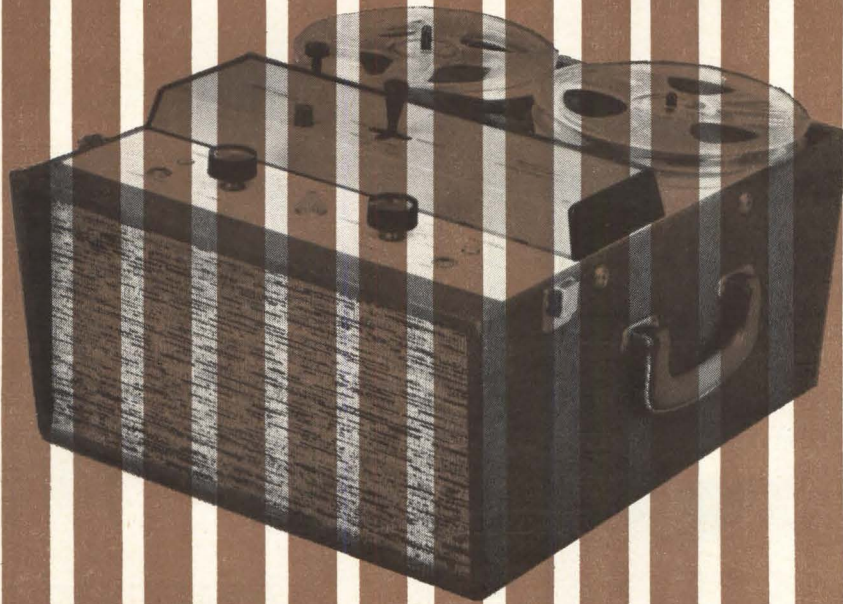

Quality in Magnetic Recording depends on the Specialized Uses of Magnetic Iron Oxides . . .

Recording devices are as good as their reception media. Tapes, film sound tracks, computer memory drums, carbon transfers and even the code numbers on the bottom of your checks depend on the proper use of magnetic iron oxides of consistently high quality.

This indispensable requirement for continuous, uninterrupted recording is provided by C. K. Williams & Co. Here, magnetic iron oxides are created with a wide range of controlled magnetic properties. Both the black ferrosferric and brown gamma ferric oxides are described in a Data Sheet listing magnetic properties of six grades.

Write to C. K. Williams & Co. to find "solutions" to your specific recording problems. Our research laboratories are available to help you. Write today.

WILLIAMS
COLORS & PIGMENTS

DIVISION, CHAS. PFIZER & CO., INC.
Dept. 30, 235 East 42nd Street, New York 17, New York

Announcing . . .

THE NEW HUGHES MICROGLASS DIODE

The Hughes Semiconductor Division is proud to introduce the MICROGLASS diode—the direct result of Hughes' effort to develop a more reliable, lower cost silicon diode.

THE GLASS AMBIENT JUNCTION STRUCTURE

To improve on present reliability, Hughes engineers searched for a new junction passivation process—one that completely protects the structure from all contaminants. The oxide passivation technique most commonly used to date is subject to minute pin holes which can cause device failure or degradation. The glass-to-metal bond has proven to be universally successful in providing hermetically sealed device packages. It was therefore apparent that a seal between glass and the silicon body containing the junction might well lead to the ultimate solution of the passivation problem. This approach has been under investigation at Hughes for over ten years. The new glass ambient junction structure represents the culmination of these efforts in a practical device.

THE MICROGLASS PACKAGE

In addition to its inherent hermetic properties, the glass ambient junction structure is in turn encapsulated in a glass-to-metal sealed envelope—the MICROGLASS package. The utilization of two glass seals in a single device results in a double hermetically sealed diode with a heretofore unattainable reliability potential.

NEW ECONOMICAL PRODUCTION METHODS

The MICROGLASS diode utilizes a new method of diode manufacture. Deviating from conventional high-cost rotating equipment, the MICROGLASS diode is produced by a linear tape-fed assembly line. This simplified process plus automated testing reduces labor costs.

PLUS FEATURES

The MICROGLASS diode features whiskerless construction. The glass ambient process provides a large area silver contact which is metallurgically bonded to the silicon die through a window in the

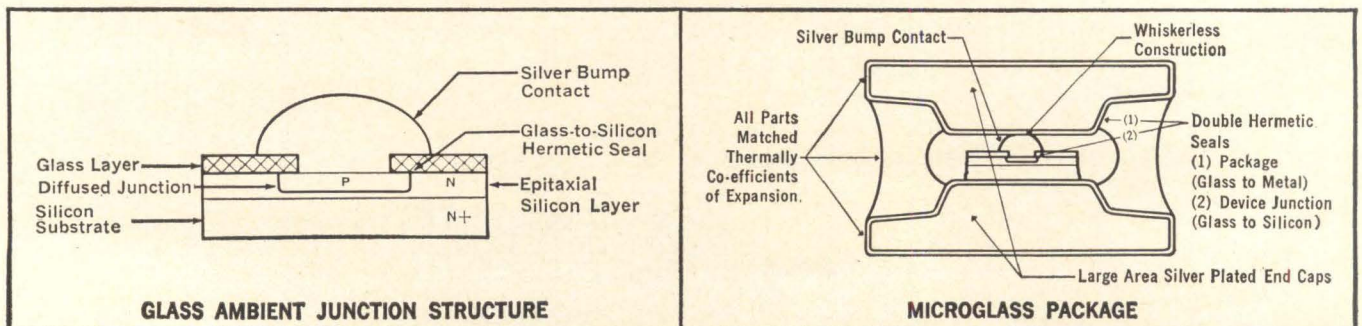

glass layer. This gives greater shock and vibration resistance than is possible with sphere-type or mechanical pressure contacts.

The diode's large area metal end caps provide higher inherent heat dissipation ratings than comparable sized packages with small diameter leads. The heart of the diode is an epitaxial silicon junction with its well-established advantages of high forward currents, low capacitance and fast recovery.

CONFIGURATION FLEXIBILITY

The MICROGLASS diode is available not only in "pellet" form, but also with ribbon or round leads for direct replacement of "industry standard" diodes. A modification of the cylindrical pellet is the "rivet" version with positive polarity identification for fast, low-cost insertion in circuit cards. Special multi-diode MICROGLASS modules for extreme packaging densities are dimensionally compatible with today's integrated circuits. (See diagrams below.) The silicon glass ambient die is also offered in the conventional DO-7 subminiature glass

package. The MICROGLASS diode is the first in a series of new devices from Hughes using glass ambient junction structures.

Hughes Types	EIA EQUIVALENTS
9001	1N662A, 1N663, 1N663A, 1N837A, 1N844, 1N914B
9002	1N662, 1N818, 1N914, 1N914A, 1N916A,B, 1N3257
9003	1N3207, 1N4308, 1N4316, 1N4310, 1N3669
9004	1N3063, 1N3604, 1N3069, 1N3598, 1N930, 1N915
9005	1N3062, 1N3064, 1N3065, 1N3066, 1N3536, 1N659A
9006	1N4309, 1N4311, 1N4315, 1N4317
9007	1N3600, 1N840, 1N3873, 1N4322, 1N4150, 1N3954
9008	1N3605, 1N3606, 1N3956, 1N3596, 1N948, 1N929
9009	1N251, 1N252, 1N626, 1N810, 1N815, 1N903A, 1N4147
9010	1N625, 1N811, 1N904A, 1N906A, 1N3067, 1N3068

For further information and a six-page technical brochure describing the HUGHES MICROGLASS DIODE write: Marketing Department, Hughes Semiconductor Division, Newport Beach 2, California. Or, contact your nearest Hughes representative.

HUGHES
HUGHES AIRCRAFT COMPANY
SEMICONDUCTOR DIVISION
NEWPORT BEACH, CALIFORNIA

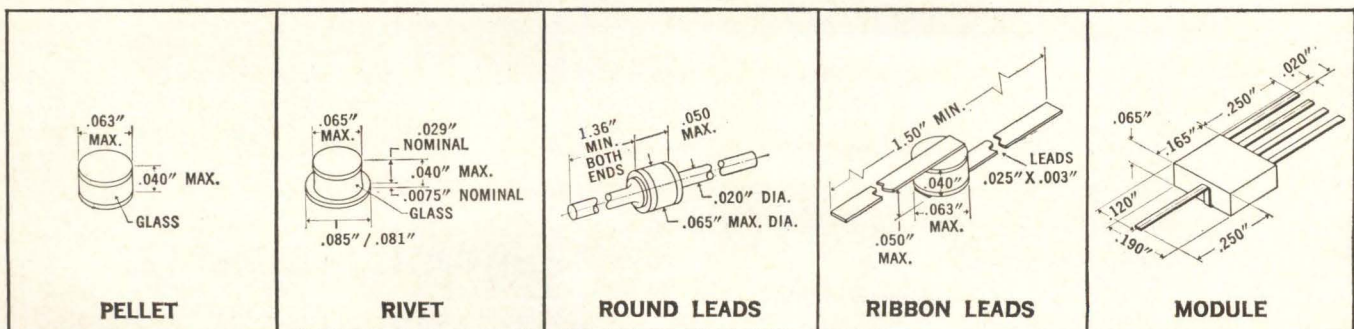

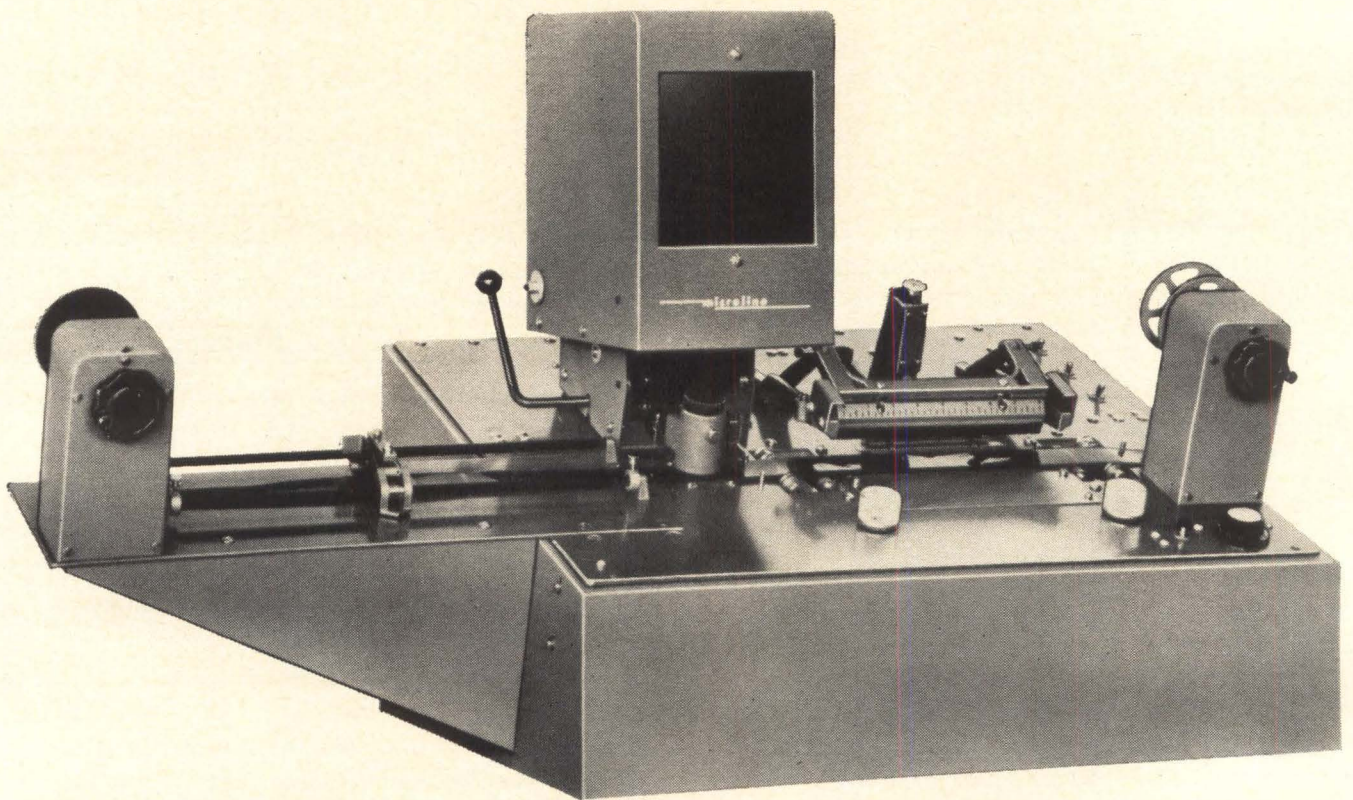

NEW MICROLINE ACTIFILM® PRINTER PUTS UP TO 100 IMAGES ON MICROFICHE . . . WITHOUT CUTTING

Now you can unitize **any** microfilm image from **any** location and from **any** roll on a selective basis . . . without cutting or damaging your originals.

The new Actifilm Printer creates a microfiche from rolls, strips, or aperture cards; copies as many as 100 16mm images onto a single 5" x 8" sheet of microfilm. A 6" x 6" viewer makes it easy.

Start enjoying the time and space-saving advantages and economy microfiche offers your organiza-

tion. Call your GAF Ozalid Representative for full details about the new Actifilm Printer and Actifilm sheet film. Or write: General Aniline & Film Corp., Dept. DQ-9, Binghamton, New York.

gaf **MICROLINE**
MICRO IMAGE PRODUCTS
GENERAL ANILINE & FILM CORPORATION
BINGHAMTON, NEW YORK

Report from
**BELL
LABORATORIES**

$$F_s > F_{LV} + F_{SL}$$

Spontaneous spreading of a liquid on a solid occurs when surface tension of the solid (F_s) is greater than the sum of the surface tension of the liquid in contact with its vapor (F_{LV}) and the interfacial tension between the solid and liquid (F_{SL}).

A NEW WAY OF LOOKING AT ADHESION

It is well known that any two clean solids will form a strong joint if their contacting surfaces are ideally flat and smooth. But real surfaces are rough and do not provide the proper interfacial contact necessary for forming a strong joint.

If, however, one of the materials is a liquid that *spreads* spontaneously over the second material, interfacial contact occurs extensively and rapidly. Thus the key to making strong joints is to have one material

in the form of a liquid which "wets" the second material.

By the proper application of this simple theory of adhesion, research chemists at Bell Laboratories have made strong adhesive joints between what had previously seemed to be "unbondable" materials—for example, epoxy and solid untreated polyethylene. The procedure is first to cure the epoxy to its solid form, and then to bring it into contact with molten polyethylene. The molten polyethylene

spreads on the epoxy and when solidified forms a strong joint.

While a complete understanding of the bonding process must await further research, detailed consideration of the spreadability concept seems to be invaluable in dictating which one of a pair of materials must be put into the liquid state to form the joint. **BELL TELEPHONE LABORATORIES**, World Center of Communications Research and Develop-



HOW TO MAKE A "COMPACT" INSTRUMENTATION CABLE

To any engineer who has ever tried to design a 1¼" instrumentation cable into a 1" space, Rome-Alcoa dedicates this new, "compact" component insulation.

The material that makes this new insulation possible is colored Heat Sealable Mylar* polyester film.

We wrap two spiral layers directly over the shielding braid of the individual component...thus replacing thicker, extruded insulations of polyethylene or polyvinyl chloride.

Besides the obvious advantages of significantly smaller cable diameters and lighter weight, this new material offers the additional advantages of high dielectric strength, moisture resistance and excellent mechanical protection. Because of the reduced build-up of a cable component, longer, continuous, unspliced lengths of finished cable may be possible.

HOW IT'S MADE Each of the Mylar layers is coated on one side with polyethylene. The first layer is spiral-wound over the shielding braid with the polyethylene side facing outward. The second layer is spiral-wound over the first with the polyethylene side facing inward.

The component is then heated to a temperature high enough to fuse the adjacent coatings into one homogeneous polyethylene layer. This bonds both Mylar layers into one tough, flexible, waterproof lamination to give mechanical protection inside and out.

INSULATION QUALITIES The Mylar insulation is at least as reliable as extruded plastics, with these added benefits—it reduces the chances of "pinholes"—it is lighter—it gives the finished cable a smaller diameter—it is more flexible than extruded insulations and is therefore easier to work with.

Mylar-wound insulation has electrical properties superior to nylon and approximately equal to PVC and polyethylene. It has greater resistance to electrical breakdown than any of the extruded plastics. For example, typical

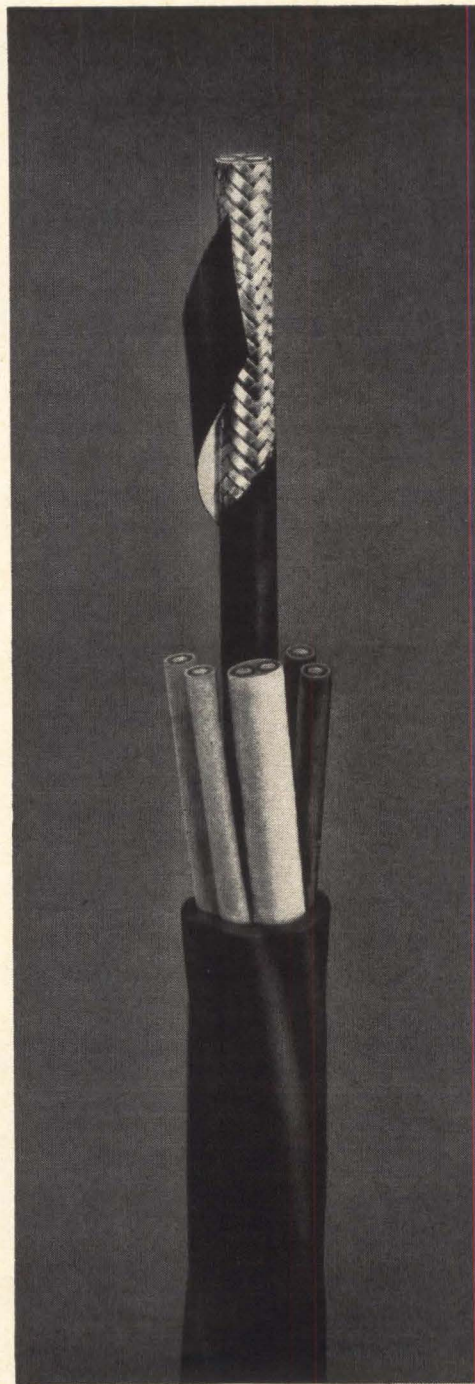

tests have shown dielectric strength breakdown voltages of 4000 volts/mil as compared to 800 volts/mil for polyethylene.

One of the most significant characteristics of Heat Sealable Mylar polyester film is its excellent resistance to cut-through and abrasion. Mylar has been shown to resist cut-through better than PVC extrusions having three to four times the Mylar thickness.

WHERE TO APPLY IT To the user of instrumentation cable, this new Rome-Alcoa product means a wider range of component insulating materials available for selecting the precise cable construction you need.

In some cases—notably where either small diameter, lighter weight or longer lengths of unspliced cable are vital—we recommend Mylar-wound shield isolation. In others, we may recommend other standard materials.

ASK THE EXPERTS The increasing complexity of instrumentation cable and the choice of insulation materials available to you make it more necessary than ever to go to an authority on instrumentation cable. You can help protect the functioning of your system by having instrumentation cable designed and constructed by experts.

Rome-Alcoa is, frankly, one of the few companies that qualify. We've been designing and constructing these cables since their conception. If you're going to need instrumentation cable soon, call us. As a starter, send for our 24-page booklet entitled, "Instrumentation Cables, Cable Assemblies and Hook-up Wires." In it, we describe instrumentation cable constructions, cable production, military specifications, and our qualifications. For your copy, write **Rome Cable Division of Alcoa, Dept. 27-44 Rome, N. Y.**



*DU PONT REGISTERED TRADEMARK

R-Series
2-sizes: 3-1/2", 4-1/2"

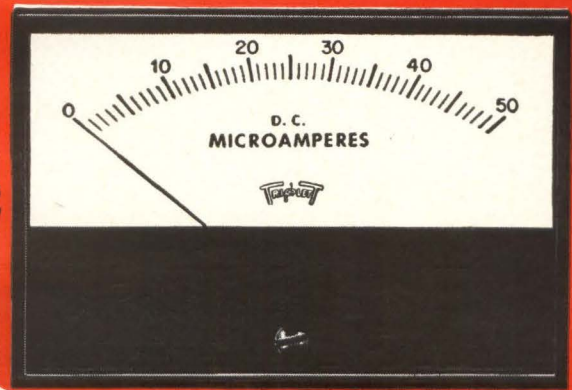

TRIPLET

"CLEAN SWEEP" PANEL INSTRUMENTS

A fresh approach to ultra-modern instrument design provides a "clean sweep" of the pointer over the full scale.

- 1** You get instant readability easier and at greater distances—plus more attractive designs to integrate into your equipment.
- 2** Self-shielded, accurate, reliable D.C. instruments have the exclusive Triplet BAR-RING movements.
- 3** Whatever your panel instrument requirement, look to Triplet for the right size and style, the right capability at the right price.

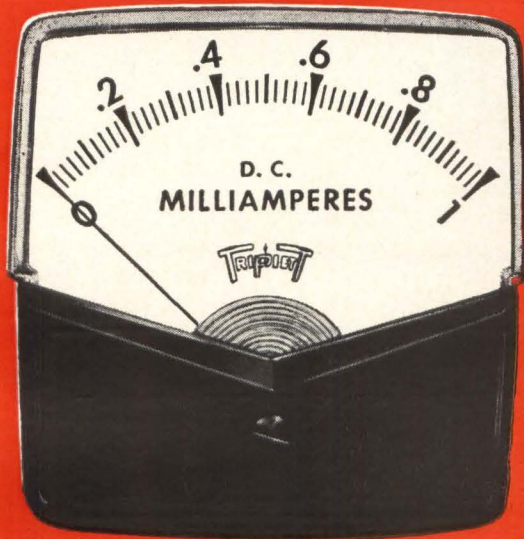

M-Series
4-sizes: 2-1/2", 3-1/2", 4-1/2", 8"



New 3/4" Meter
Model .75S

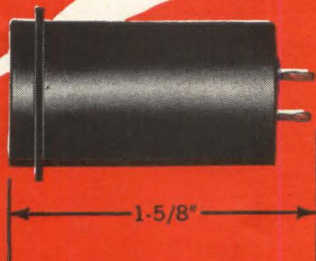

SHIELDED BAR-RING MOVEMENTS

ALNICO MAGNET IS MOUNTED INSIDE SOFT IRON RING; FULLY SELF-SHIELDED

Not affected by magnetic panels or substantially by stray magnetic fields for D.C.

More Torque
Lower Terminal Resistance
Faster Response
Exceedingly Rugged and Accurate

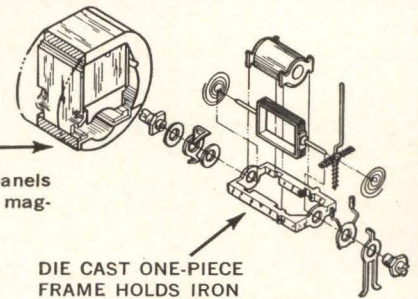

DIE CAST ONE-PIECE FRAME HOLDS IRON CORE IN EXACT ALIGNMENT

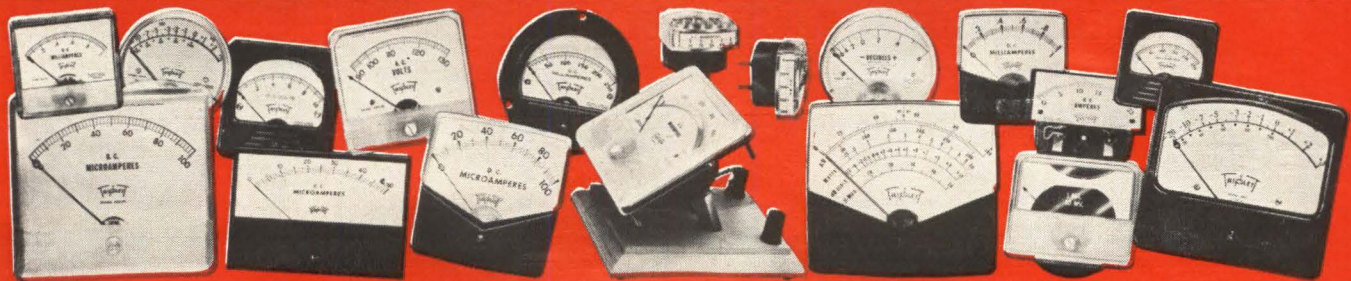

TRIPLET ELECTRICAL INSTRUMENT COMPANY, BLUFFTON, OHIO
Circle 41 on reader service card

IF THE RECENT FUROR OVER SEMICONDUCTOR RELIABILITY HAS SHAKEN YOU UP...

Read This Documented Record of International Rectifier Zener Diode

99.988% DEMONSTRATED INDUSTRIAL RELIABILITY!

For seven years, International Rectifier has been a major supplier of Zener Diodes. As such, in-plant reliability programs of the highest order have been the keystones to production programming. The results of these exacting programs can best be demonstrated by this fact: Of the hundreds of thousands of alloyed and diffused junction top-hat and flangeless zener diodes produced during the last two years, the documented rate of return of devices having catastrophically failed during field performance totalled 0.01197 of one percent! This is *demonstrated reliability* of 99.98803% . . . not a promise of reliability based on statistical calculations, manipulated acceleration factors or assumptions made from sample tests under laboratory conditions. This is *practical reliability* proved in every conceivable equipment type . . . under every condition of field use and application. You can put your confidence in this kind of reliability and the programs that have produced it. Our customers have . . . for seven years.

FOR AN "EXTRA-MARGIN" OF PERFORMANCE...

WITH DEMONSTRATED RELIABILITY... BUY IR ZENERS!

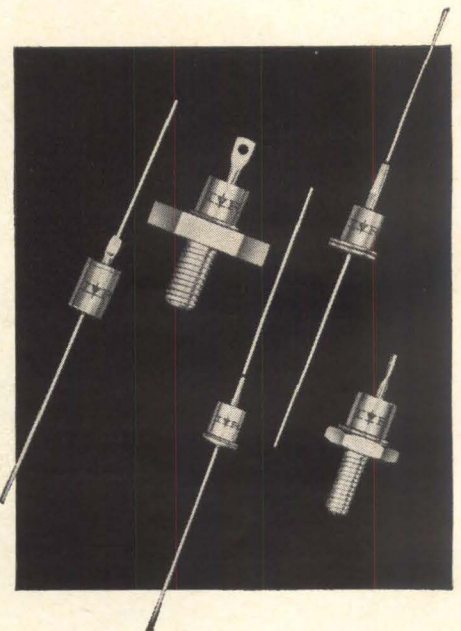

INTERNATIONAL RECTIFIER

INTERNATIONAL RECTIFIER CORPORATION: EL SEGUNDO, CALIFORNIA • PHONE OREGON 8-8281 • CABLE RECTUSA • REGIONAL OFFICES IN NEW YORK CITY, CHICKERING 4-0749 • FORT LEE, NEW JERSEY, WINDSOR 7-3311 • SYRACUSE, NEW YORK, HEMPSTEAD 7-8495 • CAMBRIDGE, MASSACHUSETTS, UNIVERSITY 4-6520 • ARDMORE, PENNSYLVANIA, MIDWAY 9-1428 • SILVER SPRING, MARYLAND, JUNIPER 9-3305 • CHICAGO, ILLINOIS, ORCHARD 6-4090 • HUNTINGTON WOODS, MICHIGAN, LINCOLN 8-1144 ST. LOUIS, MISSOURI, TEMPLE 8-6333 • MINNEAPOLIS, MINNESOTA, 920-1200 • DALLAS, TEXAS, 3511 HALL ST., LA 1-0110 • LOS ANGELES, CALIFORNIA, OREGON 8-6281 • IN CANADA: TORONTO, ONT., PLYMOUTH 9-7581 • MONTREAL, QUE., VICTORIA 9-3571

Contact the International Rectifier Regional Office nearest you for the Authorized Distributor in your area.

Washington Newsletter

April 6, 1964

Pentagon eases patents policy

Last October, the White House ordered government agencies to do something about eliminating agency-to-agency differences in patents policy. Now the Defense Department's Armed Services Procurement Agency is the first to implement the order. **The Pentagon will be sending out new patent regulations to industry by the end of the month.**

The National Aeronautics and Space Administration, the Atomic Energy Commission and other invention-stimulating agencies are also working up proposals. But the agencies plan to disturb their existing policies as little as possible.

President Kennedy wanted contractors with established commercial positions to retain patent titles stemming from those positions. He favored **government ownership of the patent if the government has a prime interest** in an area or has been the major investor in previous technology. NASA had previously held most titles in the "public interest," while Defense left most in the hands of contractors. Both have been softening their positions somewhat over the last few years.

The guidelines also **reduce from five to three years the time a contractor with exclusive license of a government patent can exploit its development.** After that time, he can be compelled to release the license to a contractor interested in reducing an invention to practice. Defense will implement this on a request-by-request basis.

Defense will take title to more inventions coming out of privately operated government facilities and contract-managers' operations; it also expects to **establish a board to determine granting of title where a contractor claims previous commercial position.** At the same time, it will give new companies or new divisions of existing concerns five years to establish a commercial position, before making final decisions on disposition of patent rights.

Defense officials expect "few important effects" on industry, though it may end up taking over more patents from universities and non-profit corporations doing coordinating or similar work.

All roads do not lead to Rome

The New York and Massachusetts congressional delegations are battling over which state should have the Air Force's Electronics System Division. The division is now located at Hanscom Field, Bedford, Mass. But the New Yorkers would like to have it moved to Rome, N.Y., to fill a gap caused by the closing down of the Rome Air Materiel Area. While the Air Force is considering New York's request, **there is little likelihood the division will be moved.** Both locations handle development of Air Force ground equipment. Bedford specializes in command and control systems, while the Rome Air Development Center works on a wide range of equipment, including radar and communications.

Teaching plan gets new life

A scaled-down program to upgrade science and technology in Midwestern and Southern universities is underway, spearheaded by the National Science Foundation. NASA and the Pentagon are lending support. Gripses from congressmen that East and West Coast universities get the lion's share of federal research and development support give the new "centers of excellence" program political appeal, even though it was

Washington Newsletter

set back last year in congressional economizing. In last year's slashes of the foundation's funds, the centers of excellence plan, and a program called EMP (so named because it is designed to encourage graduate students in engineering, mathematics and physical sciences) went down the drain. Now, they are both being started on a shoestring. The centers of excellence idea is being started at a \$3-million to \$6-million level, though it was originally planned to begin at about \$25 million. By the end of next year the foundation hopes to make grants to a dozen universities.

A guiding principle behind this reduced effort will be to build new centers for future use, and to avoid undermining universities that are first-rate now. Atomic Energy Commission chairman Glenn T. Seaborg wants to avoid turning "our best scientists into migratory workers". At the same time, NASA feels it will need more topflight university support as the space program develops than is now available.

Incentive fees aren't answer

Secretary of Defense Robert S. McNamara's enthusiasm for incentive-type contracting is getting a dash of cold water from the Air Force. Initial experience with incentive contracting, on large advanced development contracts, is not encouraging. This appraisal comes from Alexander H. Flax, Air Force research and development chief.

He says the Air Force has already seen overruns approaching 50% on cost-plus incentive fee contracts, although incentives were supposed to hold costs to below target figures. The contractor is given a higher profit if his costs fall below a target figure and is penalized if costs exceed the target.

The Air Force has had some trouble with incentive agreements on development contracts. The contractor may eschew profits on the development phase, to make something to be sold in quantity later.

Flax feels that contractors may increase costs of developmental units to justify higher production prices later. Then, when production costs are "cut," the contractor can claim incentive profits.

Russell for more anti-sub research

The Pentagon is being urged to put greater emphasis on antisubmarine warfare in its research and development efforts. Chairman Richard B. Russell of the Senate Armed Services Committee has told Defense officials he considers submarine detection and destruction, along with the anti-ballistic-missile missile, to be the "two most important opportunities before us" and the two developments with the greatest potential for preventing war. Other Senators joined Russell.

Although over-all R&D funds are going down in fiscal 1965, the amount spent on antisubmarine warfare will increase, according to defense officials. The amount is classified, however.

draws draws bidders

Nine firms have submitted technical proposals for COIN, the counter-insurgency aircraft the Navy will build for the Defense Department [Electronics, March 6, 1964, p. 19]. The Navy hopes to select a manufacturer before Aug. 1. \$6 million is included in the fiscal 1965 budget for initial development and production of four prototypes. One of the bidders, the Martin Co., is trying for a military aircraft contract for the first time since 1957.

How Barden gained a 50% increase in cleaning capacity for precision bearings!



PROBLEM: Precision cleaning of assembled ball bearings for instruments used to be a time-consuming operation for the Barden Corporation, Danbury, Connecticut. Bearings up to 1" diameter went through a spray-cleaning machine at a relatively low production rate. Larger bearings were individually spray-cleaned.

SOLUTION: A new cleaning system based on an ultrasonic bath of FREON fluorocarbon solvent coupled with spray cleaning. FREON is a *selective* solvent in that it effectively removes dirt, yet has no effect on critical steel, bronze, plastic and fiber components of these bearings. Ultrasonic action combined with the extremely low surface tension of FREON digs contaminants out of the tiniest crevices. Result: Barden now cleans completely assembled bearings *in batches of hundreds*. Over-all cleaning capacity is up 50%!

And Barden reports that FREON solvents give them *better cleaning quality*. Particle count is 15% lower than before, which is a significant drop because the count was very low to start with.

Barden also points out that FREON dries quickly and leaves no residue, and that its very low toxicity and nonflammability let them operate without expensive ventilating equipment. They've found the new system economical to use, because FREON can be recovered in simple equipment—for reuse over and over again.

We'll be glad to show you how FREON solvents can improve your own cleaning operation. First, *send the coupon or Reader Service Card* for our new booklet on cleaning!

FREON®
solvents



BETTER THINGS FOR BETTER LIVING... THROUGH CHEMISTRY

MAIL COUPON FOR NEW BOOKLET ON CLEANING

E. I. du Pont de Nemours & Co. (Inc.)
FREON Products Division
N-2420-E-4R, Wilmington 98, Delaware

Name _____ Title _____

Company _____

Address _____

Please send new booklet on FREON solvents for precision cleaning.

I am interested in cleaning _____

I would like to talk to a cleaning specialist.

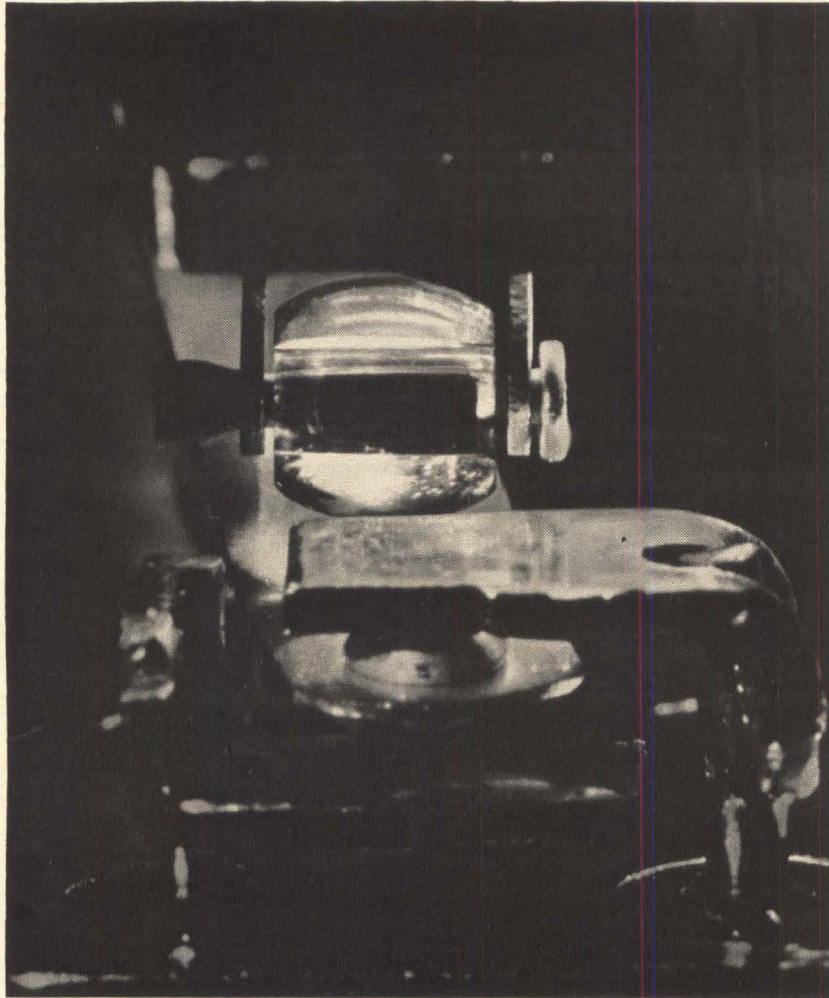

Only Sigma relays have sapphire rollers Result: Unequaled performance

Sapphire rollers to actuate relay contact springs are exclusive with Sigma Series 32 and 33 relays. For you, this means better relay performance. Here's why:

Greater Sensitivity—These hard sapphire rollers can be shaped and polished with such precision that friction virtually disappears. Result: Fast, positive reaction, even to a 50 mw signal.

Extra Ruggedness—Sapphire rollers can withstand 30 g's vibration to 5,000 cycles and shock of 100 g's. Typ-

ical result: Sigma 32's and 33's went to Venus with Mariner II and performed flawlessly.

Superior Vibration Immunity—Sigma sapphire rollers always bear on relay contact springs at a point near the contacts. Result: The spring's resonant frequency is increased to a point well beyond the rated frequency range.

High Stability and Durability—Virtually no wear and friction by-products with sapphire rollers. Result: Assured long, trouble-free performance.

Better Isolation—Sapphire has a high dielectric strength. Result: Assured isolation between motor and switch.

If superior relay performance is important to you, send for Sigma Design Bulletins on Series 32 and 33. Write to Box No 34.

Or call your Sigma Applications Engineer. He will help you select the best switching control for your particular need—from more than 100,000 different standard Sigma relays—both latching and non-latching, electromagnetic and solid state.

SIGMA DIVISION  SIGMA INSTRUMENTS INC

Assured Reliability With Advanced Design/Braintree 85, Mass.

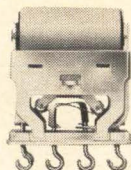

How do Relays Operate?

You might be surprised at what goes on in a sensitive relay between input and output. If you are interested in a complete description of the step-by-step operating sequence, we'd like to send you our new booklet on the subject. Write to Box 34A.

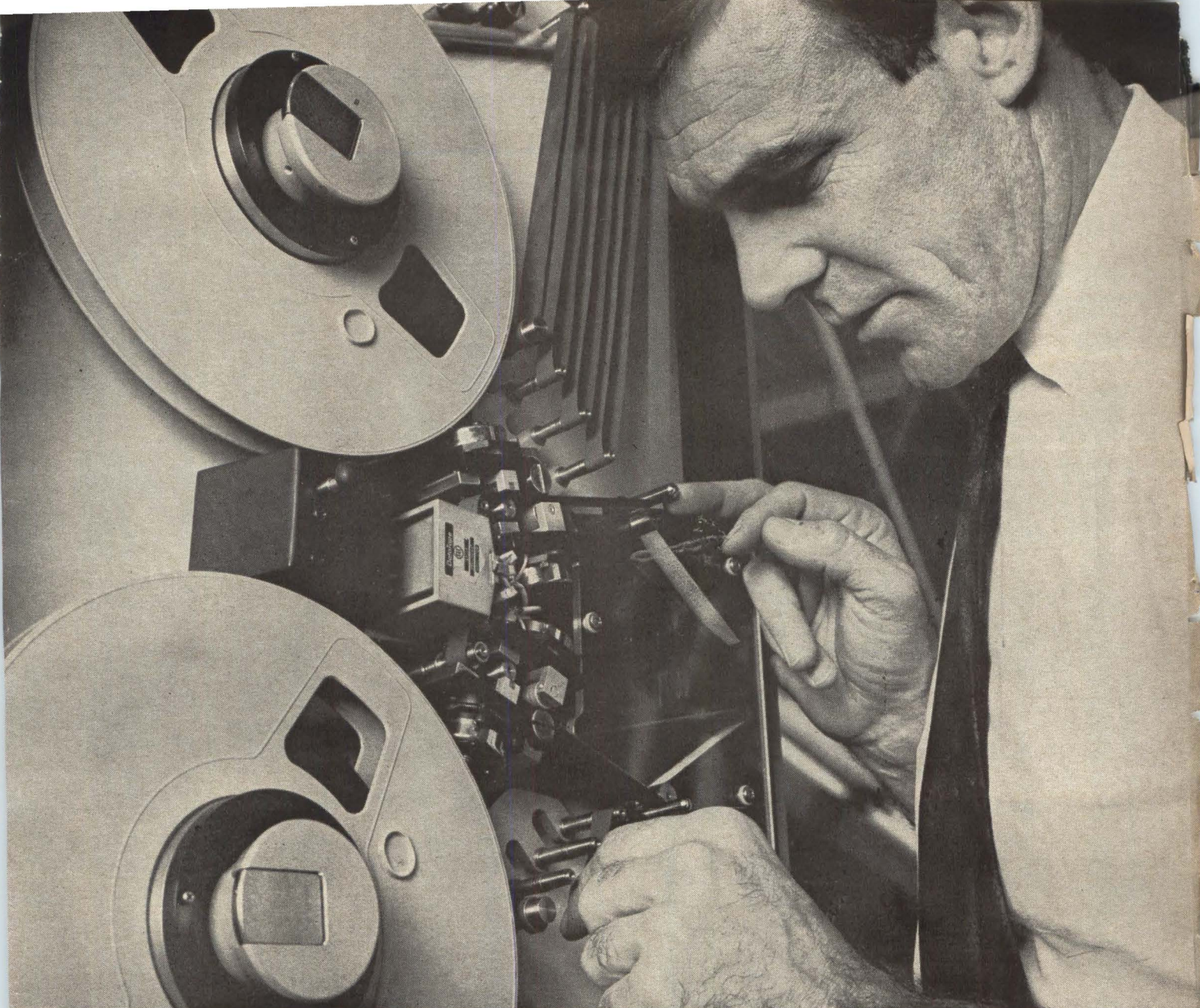

Sophisticated – yet so simple

That's CEC's DR-2700 Digital Recorder/Reproducer

It took 31 months of intensive research and development to perfect this instrument. But it was worth it. The DR-2700 has set completely new standards of reliability and efficiency for digital recorders. Yet it's so simple to maintain, it virtually never requires off-the-line servicing.

The DR-2700 is a consistent choice for both commercial and military use. These basic advantages will explain why:

- Solid state electronics throughout.
- No programming restrictions at speeds to 150 ips.
- Interlocked command circuits to prevent response to contradictory commands.
- Start/stop time less than 3.0 milliseconds.
- 7 through 16-channel capability in a 72-inch-high cabinet.
- IBM 729 IV compatible.
- ½" or 1" tape configuration.
- All-metal-front-surface magnetic head stacks.
- Vacuum-buffered tape storage for gentler tape handling.
- Densities up to 555.5 bits per inch.
- Full line of optional accessories.

Are we delighted with the DR-2700? You bet we are.

More important, our customers are, too. For full information about the DR-2700, call or write for Bulletin CEC 2700-X12.



CEC

Data Recorders Division

CONSOLIDATED ELECTRODYNAMICS

A SUBSIDIARY OF BELL & HOWELL/PASADENA, CALIF. 91109
INTERNATIONAL SUBSIDIARIES: WOKING, SURREY, ENGLAND
AND FRANKFURT/MAIN, GERMANY

Circle 47 on reader service card

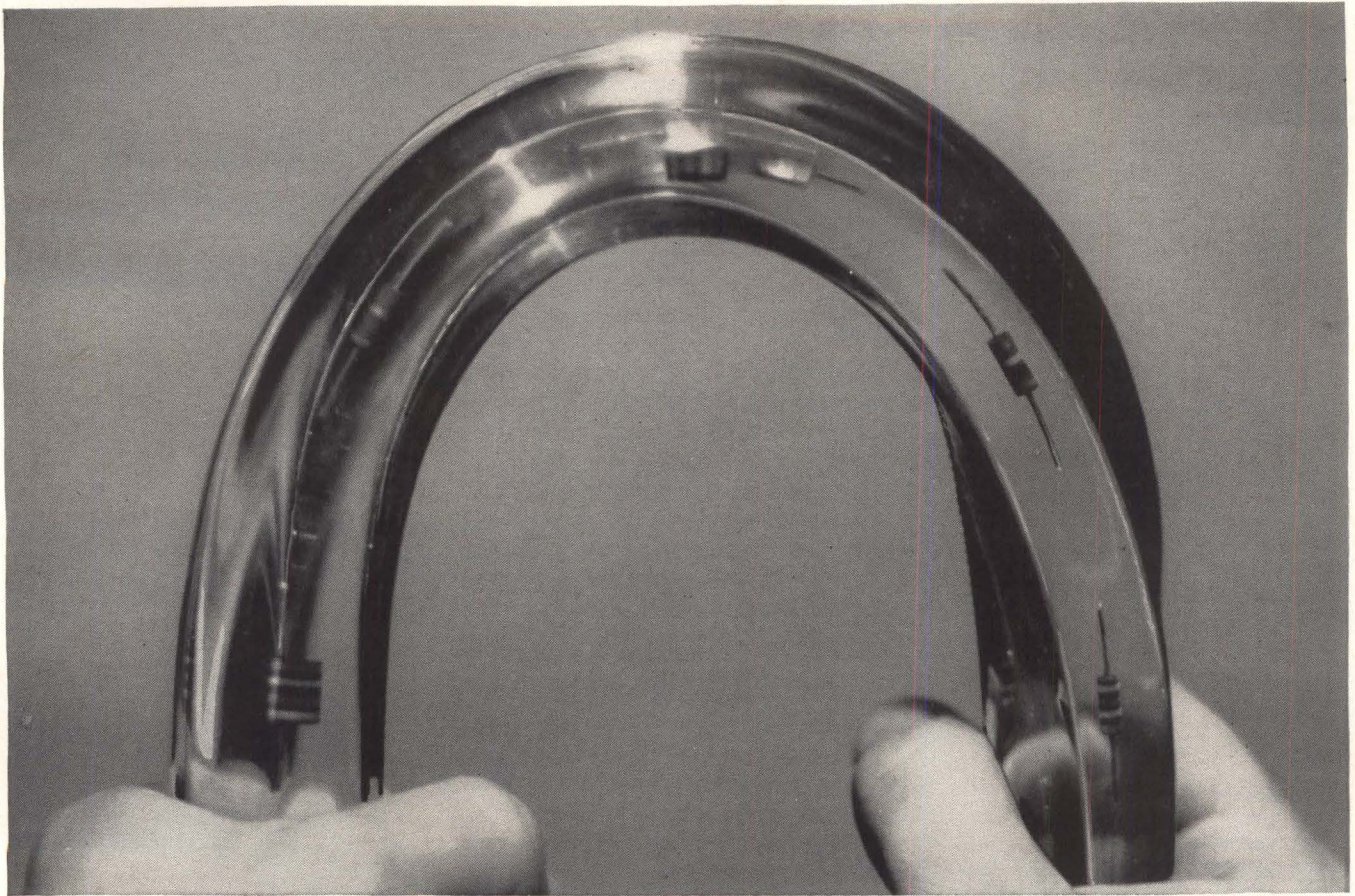

Tough new silicone speeds potting rates

Higher strength RTV-615 cures to a clear resilient compound in 15 minutes at 150°C

RTV-615 is a new addition to General Electric's family of rubber-like potting and encapsulating compounds. It offers the interesting combination of greater strength (1000 psi), toughness, low viscosity (very pourable) and excellent transparency.

RTV-615 lends itself to production line potting since it can be cured tack free in 15 minutes at 150°C, in one hour at 100°C, in 4 hours at 65°C or

24 hours at room temperature. Pot life at room temperature is 4 hours. Mixing procedure has been simplified over previous materials.

RTV-615 is designed to protect assemblies against thermal shock, vibration, moisture, ozone, corona, dust and chemicals from -65°C to 200°C. Its complete transparency permits easy component identification and repair.

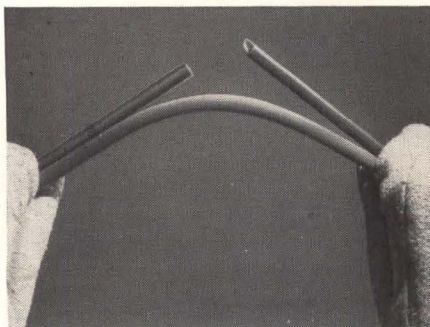

NEW! RTV's that protect to -150°F. RTV-511 and RTV-560 stay resilient at temperatures that cause other types of potting materials to crack. They also have a higher degree of flame resistance than other RTV's. Excellent for aerospace use, both new RTV's retain full ozone, corona and weathering resistance.

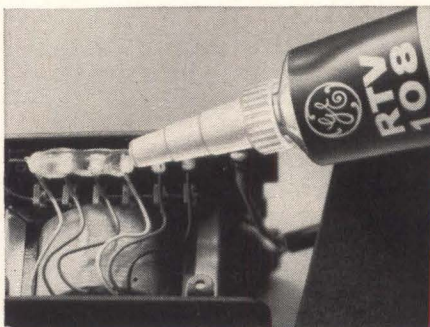

NEW! RTV-108 translucent adhesive sealant. Combining easy tube dispensing with powerful adhesion, RTV-108 is a translucent seal and insulator for terminals, joints and other electrical and mechanical sealing jobs. There is no mixing. RTV-108 air cures to a flexible, resilient silicone rubber.

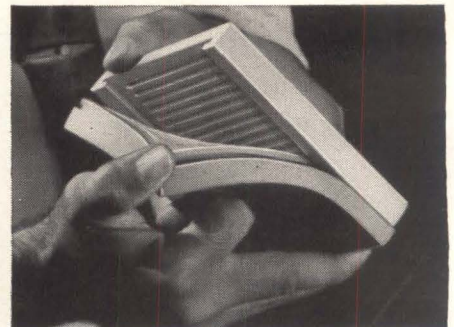

NEW! RTV-30 combines low viscosity with high strength. RTV-30 is a new compound with low viscosity for filling small and complicated configurations. Yet it also possesses excellent physical strength, making it a superior flexible mold material for prototypes and short-run production.

If you would like a free sample of one of these new General Electric RTV silicones for evaluation, write on your letterhead, describing your application. For additional information, check reader service card. Section N4107, Silicone Products Dept., General Electric Company, Waterford, New York.

GENERAL  **ELECTRIC**

Boost for electronic tuning: part 1

Voltage-variable capacitance diodes work better and are tougher than ever. They open the door to many circuit possibilities

By L.A. Weldon and R.L. Kopski

Philco Corp., Lansdale, Pa.

Recent improvements in voltage-variable capacitance diodes are encouraging design engineers to take a fresh look at electronic tuning.

These silicon diodes permit major tuning changes to be made in milliseconds, and their power requirements are measured only in milliwatts. They can tune two or more circuits electronically to the same frequency, hold the circuits in phase, and can be used for frequency power multiplication with good efficiency at relatively high power levels.

A high-quality diode of this type may have a capacitance as high as 1,000 picofarads at eight volts (see table below).

Many circuit possibilities are also suggested by the diodes' small size and freedom from capacitance change caused by shock and vibration.

Used for many years

The voltage-variable capacitor is nothing new. It

has been used for many years in automatic frequency control and in frequency modulation.

Basically it is a reverse-biased diode whose capacitance can be changed by varying the reverse-bias voltage. But the older types of this diode were unsuitable for high-grade communications equipment. They resulted in poor control of capacitance, and were limited by high leakage current, high intrinsic series resistance and limited range of tuning.

In recent months, diodes made by silicon epitaxial technology have overcome many of the disadvantages that had been encountered with diodes made with alloy or mesa techniques. Planar construction techniques [Electronics, Aug. 17, 1962, p. 46] now keep leakage low. The intrinsic series resistance of the device is held to a minimum, a characteristic that is inherent in planar technology. The silicon planar process permits large capacitance values to be attained easily by enlarging the

Key parameters of voltage-variable capacitors*

	Conditions	47 pf	150 pf	250 pf	500 pf
115-Volt Types					
Breakdown voltage, V_B	$I_R = 500\mu a$	115V min.	115V min.	115V min.	115V min.
Reverse current, I_R	$V_R = -100V,$ $T_A = 85^\circ C$	2.5 μa max.	5.0 μa max.	8.0 μa max.	15.0 μa max.
Capacitance (pf)	$V_R = -8V$	37.6 min. 56.4 max.	120 min. 180 max.	200 min. 300 max.	400 min. 600 max.
Capacitance ratio	$V_R = -4V$ to $-100V$	4.0:1 min.	4.0:1 min.	4.0:1 min.	4.1:1 min.
Quality factor, Q	$V_R = -8V$ $f_o = 10Mc$	450 min.	450 min.	400 min.	200 min.
165-Volt Types					
Breakdown voltage, V_B	$I_R = 500\mu a$	165V min.	165V min.	165V min.	165V min.
Reverse current, I_R	$V_R = -150V,$ $T_A = 85^\circ C$	4.0 μa max.	8 μa max.	15 μa max.	30 μa max.
Capacitance (pf)	$V_R = -8V$	42.3 min. 51.7 max.	135 min. 165 max.	225 min. 275 max.	450 min. 550 max.
Capacitance ratio	$V = -4V$ to $-150V$	4.7:1 min.	4.7:1 min.	4.7:1 min.	5.1:1 min.
Quality Factor, Q	$V_R = -8V,$ $f_o = 10Mc$	500 min.	450 min.	400 min.	200 min.

* Philco types only. 1,000-pf devices will be available in July. Voltage-variable capacitors are also available from several other manufacturers. These devices cover a wide range of capacitance values, Q , breakdown voltages and leakage currents. 47-pf units are also available from such manufacturers as Crystalonics, TRW Electronics/PSI, and Texas Instruments.

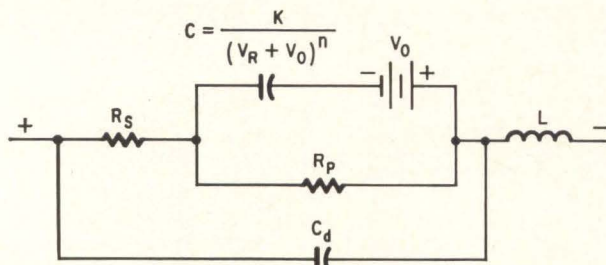
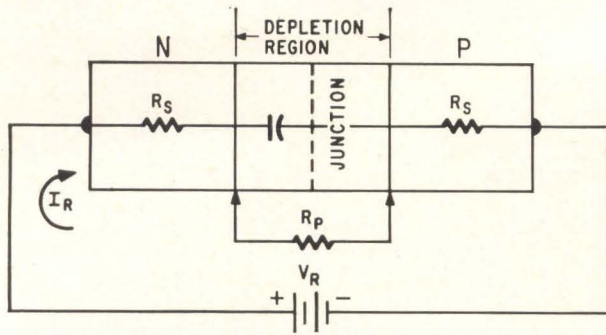

Voltage-variable capacitor equivalent circuit.

junction area.

These advances have increased the demand for silicon diodes for military equipment and high-quality commercial gear where electronic tuning is gaining popularity. Electronic tuning is already widely used in commercial test equipment and in communication systems for commercial aviation. Further applications are expected in the quality market for remotely tuned f-m receivers.

New look at costs

Right now, electronic tuning is usually more expensive than the mechanical tuner. But circuit designers are taking a fresh look at final cost comparisons, especially for high-quality equipment such as in communications, radar, navigation, telemetering, instrumentation and equipment for generating radio-frequency power.

Planar diodes are now available for systems where several circuits must be tuned simultaneously. The new diodes have a large usable ratio of capacitance-change to voltage-change, low radio-frequency resistance, and extremely well-controlled capacitance characteristics. Voltage-variable diodes with very high capacitance are now used for low frequencies.

Many advantages

Voltage-variable capacitors have several advantages over mechanically tuned capacitors. The voltage-variable version is small, and its use eliminates the need for mechanical linkage. Its electrical characteristics are more stable than those of mechanical capacitors because it has no moving parts to vibrate, become loose or wear out. The tuning plates of a mechanical capacitor have contacts that gradually wear out when the plates are moved.

To operate remotely, the voltage-variable capac-

itor needs only a very low bias source, whereas the mechanical capacitor needs a servo or some other motor drive. This means additional size, weight and circuit complexity, and hence more money. The voltage-variable capacitor also tunes more rapidly, has more stable temperature characteristics and permits greater uniformity in production. These diodes are produced uniformly and during operation their temperature characteristics are predictable and can be easily compensated.

Two kinds of uses

Applications for voltage-variable capacitors can be divided roughly into two categories, depending on whether the alternating r-f signal voltage modulates or causes a significant change in the diode capacitance.

With small signals, it is important that the capacitance be unaffected significantly by the r-f voltage. The capacitor must perform as a linear circuit element. Typical small-signal applications are receiver tuning, tunable filters (resistance-capacitance and inductance-capacitance single and multiple section), low-power oscillator frequency control, capacitance bridges, frequency modulation and automatic frequency control.

In large-signal applications, the diode acts as a nonlinear element. Examples of large signal applications are frequency multipliers, frequency dividers, parametric amplifiers and various wave-shaping circuits.

The largest range of applications for voltage-variable capacitance is probably in the small-signal area. The frequencies at which these capacitors will find greatest applications are roughly related to the nominal capacitance value, see table below.

It is possible to obtain a high-capacitance unit by paralleling a number of low-capacitance diodes. This is more expensive in initial cost and in assembly costs, is less reliable because of the interconnections involved, and in most cases requires more volume and mounting area in the equipment. A single high-capacitance diode saves cost and space, and is more reliable.

Voltage-variable capacitors are not applicable in any circuit where distortion cannot be tolerated and where, at the same time, signal voltages are large.

Equivalent circuit

The voltage-variable capacitor can be represented electrically by the equivalent circuit shown above. The equivalent capacitor is the junction

Frequencies at which vvc's operate*

Type	Nominal C @ 8V	Range of Application
V4090 V2853.....	47 pf	3 Mc to 60 Mc
V4091 V2854.....	150 pf	1 Mc to 20 Mc
V4092 V2855.....	250 pf	600 kc to 12 Mc
V4093 V2856.....	500 pf	300 kc to 6 Mc

* Philco types. The V4090 series are plastic encapsulated types which are gradually replacing the metal types.

capacitance and varies with the bias voltage. Theoretically, junction capacitance is independent of frequency up to several thousand megacycles per second.

Equivalent resistor R_s is the series resistance. This is the resistance of the bulk semiconductor material external to the depletion region and the resistance of leads and contacts to the diode. These are lumped into one resistance in the equivalent circuit; R_s also varies with reverse bias voltage.

Series resistance, converted to the four-volt value, versus bias voltage is shown below. Equivalent resistor R_p is the shunt-leakage resistance across the depletion region. This leakage resistance gives rise to a reverse bias leakage current I_R . The diffusion potential V_o is included because its effects must be carefully considered in temperature stabilization. Equivalent capacitance C_d is the case capacitance and can be neglected except in critical applications or for very small capacitance diodes. Finally, inductance L is the parasitic lead inductance and depends upon the lead lengths used. Lead inductance can be calculated assuming a straight wire of circular cross section.

The method generally used to specify the efficiency of capacitors is to quote the quality factor or figure of merit, Q . Curve below plots Q vs frequency for a typical variable voltage capacitor. This curve is useful for determining the four-volt Q at any operating frequency for this particular diode.

Most diodes are measured at four volts.

The circuit designer is primarily interested in how diode Q varies with frequency in a tuned circuit. Since Q is an inverse function of both capacitance and frequency, the specified value of Q can be increased by making the measurements at low frequency and capacitance. When comparing Q specifications, the bias voltage (capacitance) and frequency at which the measurements are made should be the same.

Leakage current should be measured under the worst case conditions—at maximum operating voltages and temperature. A room-temperature measurement of leakage current is not in itself sufficient to guarantee satisfactory high-temperature operation.

Changes with temperature

There are two effects in the variable-capacitance diode that will cause a change in junction capacitance with temperature. A change in the contact potential V_o and a change in the dielectric constant ϵ of the semiconductor material makes up part of constant K in the equation given for the junction capacitance (see p. 52). K is a function of the diode material and the junction area. It is the value of diode capacitance achieved where the total junction bias ($V_R + V_o$) equals one volt. Changes in both dielectric constant and junction capacitance are in a direction to increase over-all capacitance with increasing temperature.

The change in V_o with temperature is nearly linear over the operating temperature range of the

voltage-variable capacitance and decreases approximately 2.3 mv per degree centigrade increase in temperature. At low values of V_R , where the change is significant compared with the total junction bias ($V_R + V_o$), a significant change in C with temperature will result. As V_R is increased, changes in capacitance due to changes in V_o becomes less predominant.

The change in ϵ with temperature causes a proportionate change in capacitance that is constant over the entire reverse-voltage range.

The temperature coefficient of capacitance is generally converted to room-temperature capacitance at some stated value to bias voltage, usually four or eight volts, and is specified in parts per million change in capacitance per degree Centigrade temperature change. Curve on p 52 plots the temperature coefficient of a capacitance vs reverse-bias voltage for a typical voltage-variable capacitor.

In tuning the temperature coefficient of frequency caused by variation in capacitance will be equal to one-half the temperature coefficient of capacitance. This is a handy relationship for design evaluation using a voltage-variable capacitance.

Temperature compensation

A silicon diode, forward biased from a constant

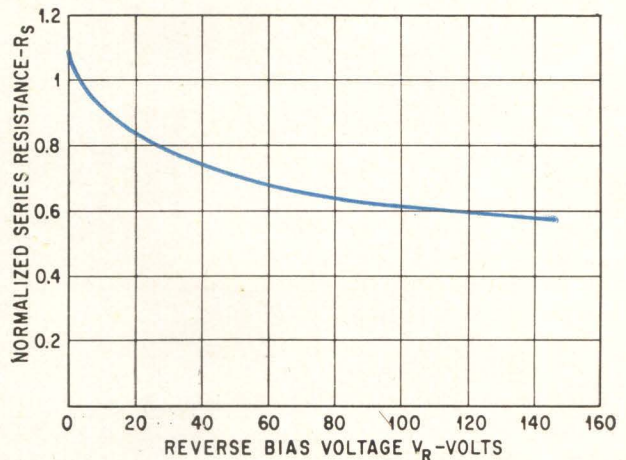

Series resistance vs reverse bias voltage normalized to 4-volt value.

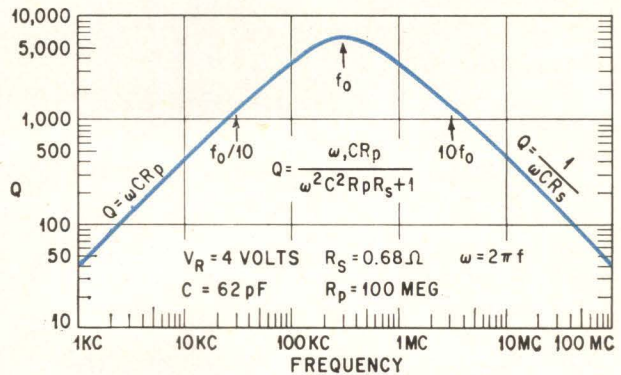
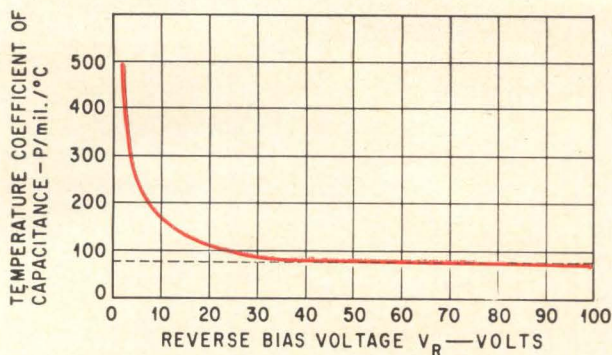

Figure of merit, Q , plotted against frequency.



Temperature coefficient of capacitance vs reverse bias voltage.

source, has a voltage-versus-temperature characteristic that can be used to provide a correction voltage for V_o . A method for accomplishing V_o compensation by using a forward-biased diode is shown p 53 top. The next circuit shows how to generate a correction-voltage function. Thermistor R_T should have a negative temperature coefficient and should have a resistance change such that the required voltage change is obtained across the control potentiometer. For accurate temperature compensation, the methods shown in the first two circuits on p 53 should be combined.

Tracking

There are many applications where the resonant frequency of two or more resonant circuits within the same frequency must be tuned to maintain a constant frequency difference. The capacitance characteristics must follow each other while tuning. This is called tracking. For instance, in a superheterodyne receiver there are three circuits that must be tuned: the r-f amplifier, mixer and local oscillator. The tuning arrangement of these three circuits must track each other in such a way as to maintain the correct i-f frequency. Conventionally, this has been done by tuning mechanical capacitors manually or by tuning motors. The voltage-variable capacitance diode eliminates the need for mechanical linkage, and such a system can be tuned much faster and more accurately than with a mechanical tuner. In multiple tuning, voltage-variable capacitance allows improved circuit layout and substantial savings in cost and size.



Robert L. Kopski received his B.S.E.E. in 1963 from Lehigh University. He joined the Philco Corp. in 1961. He worked in the transistor application department on switching and communication circuit design, transistor evaluation and the evaluation of voltage-variable capacitor tracking error. He is currently working in the circuit engineering department of

the company's special products operation, and is responsible for the design of microwave solid-state switch drivers.

Multiple tuning categories for voltage-variable capacitance diode eliminates the need for mechanical linkage, and such a system can be tuned much faster and more accurately than with a mechanical tuner. In multiple tuning, voltage-variable capacitance allows improved circuit layout and substantial savings in cost and size.

Multiple tuning categories for voltage-variable capacitance are of two types: those requiring the frequencies of tuned circuits to track over a given range, and those requiring the capacitance of the diodes to track over a given range.

Capacitance characteristics

The capacitance of the voltage-variable capacitance follows the relationship

$$C = \frac{K}{(V_R + V_o)^n} \quad (1)$$

where C is junction capacitance, V_R is reverse bias control voltage, K is constant, V_o is diffusion potential, n is slope factor. Slope factor describes the curve of capacitance vs applied voltage.

Tracking error between multiple-tuned circuits is caused by variations in the constants K , V_o and n from diode to diode. Of the three, K exhibits the greatest variation. A good estimate of this variation can be made from the specified diode capacitance if it is assumed that variations in n and V_o are small compared with K . This is a valid assumption for any diode suitable for multiple tuning.

Capacitance is generally specified at some low value of bias voltage, as a nominal value with a tolerance of plus or minus a percentage of this value.

Frequency tracking

Substituting equation (1) into the resonance equation

$$f = \frac{1}{2\pi\sqrt{LC}} \quad (2)$$

gives

$$f = \frac{(V_R + V_o)^{n/2}}{2\pi\sqrt{LK}} \quad (3)$$

for the resonant frequency of a tuned circuit con-



Lawrence A. Weldon joined the Philco Corp. in 1960 as an applications engineer. He is currently applications supervisor for communications circuits and is responsible for evaluation of semiconductor devices intended for communications applications. He is a 1959 graduate of Drexel Institute of Technology in Philadelphia.

trolled by a voltage variable capacitance diode.

Since f is a function of the LK product, L can be adjusted to compensate for differences in K to eliminate K as a source of tracking error.

In equations 1 and 3, V_o appears as a voltage aiding the reverse bias voltage. Voltage V_o is nominally 0.75 volt at room temperature. Its differences from diode to diode will have the greatest effect on tracking at the low end of the bias voltage (frequency) range. These differences can be approximately compensated by a compromise adjustment of L.

Differences in slope factor n from diode to diode have their greatest effect on tracking at high bias values. These differences can be approximately compensated by small trimmer capacitors in shunt with the diodes.

Conventional two-point tracking is the adjustment of shunt capacitance together with the adjustment of L. Tuning coincides exactly at two points, one at the low end of the curve, the other at the high end of the curve. Here the two tuned circuits are tracked by L and shunt C adjustments. The midrange values of L_1 and L_2 should be calculated from the nominal capacitance at the low end of the frequency and bias voltage range. The adjustment range of L should be somewhat larger than the diode's capacitance tolerance to allow for compensating V_o . The adjustment range of the trimmer capacitors C_1 and C_2 is about $\pm 2\%$ of diode nominal capacitance at the high-frequency tracking point and should have additional range to compensate possible differences in circuit stray capacitance (see circuit right).

Experiments with voltage-variable capacitor diodes have shown that minimum tracking error is obtained by making adjustments at bias voltage values 1.5 times the low-voltage end point and 0.6 times the high-voltage end point. Error in frequency tracking is typically less than 0.25% over a 2-to-1 frequency range, with a few diode pairs being above 0.5%.

Three-point tracking

By introducing a small adjustable voltage source in series opposition to the bias control voltage, the variation in V_o can be exactly compensated. To provide this compensation, the series opposing voltage should have an adjustment range of about ± 0.25 volt. Adjustment of this series voltage together with adjustments of L and shunt C provide three-point tracking and will reduce tracking error by more than an order of magnitude over that obtained by the two-point method. The series voltage is adjusted near the low-voltage end point, the inductance near the middle of the voltage range, and the shunt capacitor near the high-voltage end point.

The series-opposing voltage may be supplied from a separate voltage source in the system, or obtained from the bias supply shown. The potentiometer for adjusting tracking voltage allows the bias voltage of VVC_1 to be offset by a small amount with respect to the bias applied to VVC_2 .

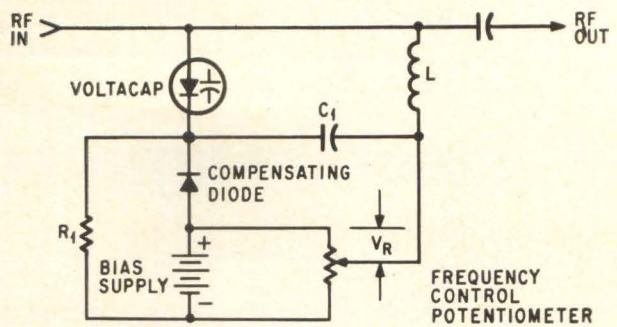

Compensating for diffusion potential v_o with a forward bias.

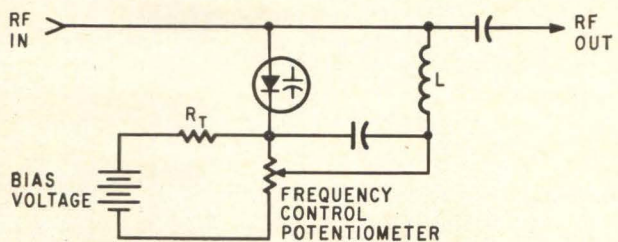

Compensating dielectric constant change with temperature.

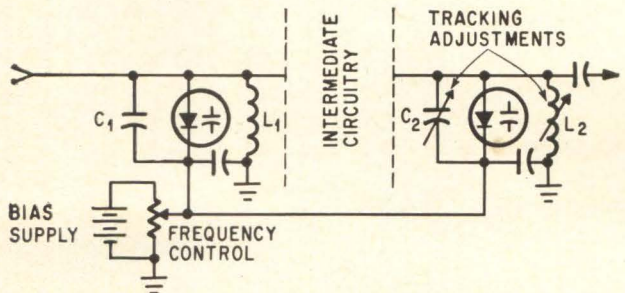

Conventional two-point tracking uses L and C adjustment.

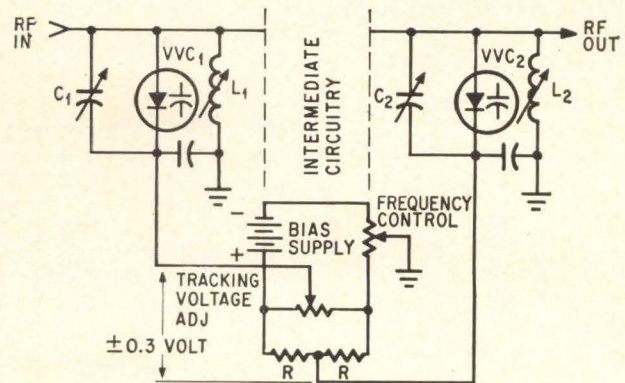

Three-point frequency tracking method uses a series offset voltage.

In the next issue, part 2 will describe capacitance tracking, tracking specification, measurement of tracking error, and testing the diodes. A circuit will be given for measurement of tracking error.

Evaluating light demodulators

A method is proposed for comparing various designs of a key element in laser communications or radar systems

By D.E. Caddes and B.J. McMurtry

Electronic Defense Laboratories, Sylvania Electronic Systems, Mountain View, California

The light detector is a key element in an optical communications or radar system. It determines the entire system's bandwidth, sensitivity and flexibility.

Yet there are no generally accepted criteria for evaluating the detector.

Since detectors are appearing in a widening array of designs, the time may come for users to consider a meaningful system for comparing them.

Three major criteria

It is possible to formulate objective criteria for evaluating these devices. The power and noise performance of a photodetector can be described in terms of three major factors:

1. Quantum efficiency of the photo process, expressed in current-carriers per photon input.
2. Current multiplication factor—the amount by which the amplitudes of the a-c and d-c components of photocurrent are increased.
3. Equivalent load resistance—a fictitious quantity comprising all the effects that participate in converting the a-c component of current into useful output power.

Other important considerations are modulation

bandwidth and frequency response, both of which affect the information-carrying capacity of the beam.

Illumination-handling capacity is also of interest, because devices that cannot survive moderate light levels are restricted to the detection of very weak signals. Such devices cannot, for example, be used in heterodyne receivers.

A-m and f-m systems

As in radio, an optical communications system transmits information by modulating the amplitude, phase or frequency of a carrier and transmitting the modulated carrier to a receiver, where the signal represented by the modulation is recovered by a detection process.

Most photoconductors respond to amplitude modulation (a-m). An a-m photodetector can be used in a frequency-modulation (f-m) receiver if the detector is preceded by elements that convert f-m to a-m. Such conversion can be accomplished by discriminators and ratio detectors. Since such converters have been demonstrated at optical-carrier frequencies¹⁻³, a discussion of a-m detectors will be applicable to f-m receivers.

A second f-m demodulation scheme, currently under investigation, involves converting f-m into "spatial modulation" by passing the beam through a prism or similar dispersing element, that physically deflects the beam in accordance with the modulating signal. This spatial modulation is then detected with a device that responds to the movement of the light beam.⁴⁻⁵

General a-m photodetector

The operation of any a-m photodetector can be divided into two processes, see bottom of page 55.

1. Conversion of light into photocurrent whose a-c component represents the detected modulation, and any subsequent current multiplication.

2. Conversion of the a-c component of photocurrent into output power.

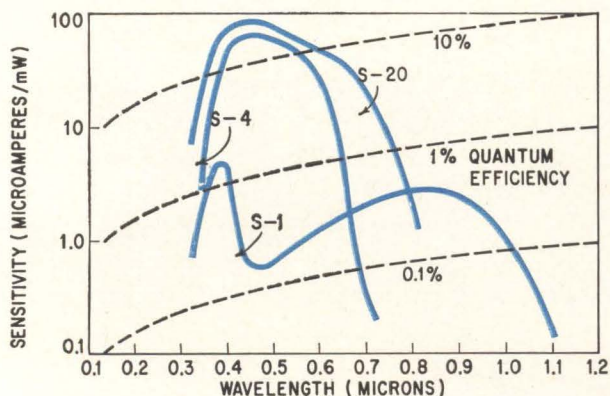

Typical spectral response curves for S-1, S-4 and S-20 photoelectric cathodes

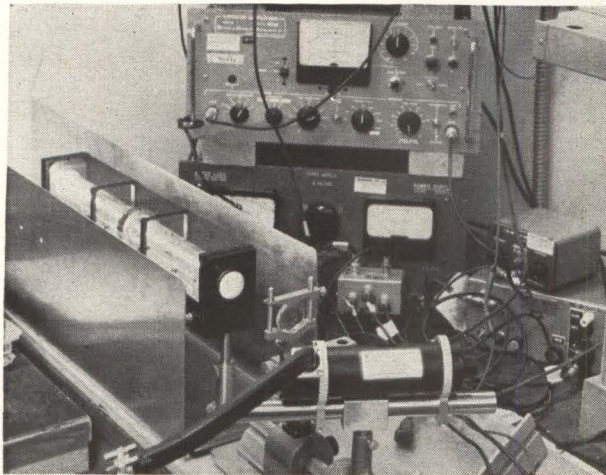

Test setup of an 11-to-20-gigacycle traveling-wave phototube and helium-neon gas laser.

In the first process, the input light produces a photocurrent of average amplitude

$$I_o = P_{\text{light}} \eta e/h \nu \quad (1)$$

where P_{light} is the average input light power, η is the quantum efficiency of the photo-process (current-carriers out per photon in), e is the electron charge, h is Planck's constant, and ν is the optical carrier frequency. It is convenient to relate the peak a-c component of current, i , to the d-c current, I_o , by the definition $i = mI_o$; m will be referred to as the "modulation index," and is twice the conventional a-m modulation index. Current multiplication simply increases the amplitudes of both the a-c and d-c components by the multiplication factor m .

This current-generating process is a perfect "square-law" process in which the output current is directly proportional to the input power and hence to the square of the input amplitude. Therefore, two optical signals of different frequencies can be heterodyned by the square law photoelectric process. The peak a-c current at the difference, or "beat" frequency, is then $2(I_1 I_2)^{1/2}$, where I_1 and I_2 are the average currents due to the individual light signals.

This property of the photoelectric effect is exploited in optical heterodyne receivers, where a light source performs a role similar to that of the local oscillator in a radio-frequency heterodyne. Heterodyne reception is ideal for optical radar systems where the return signal, possibly doppler-shifted by reflection from a moving target, is mixed with a portion of the transmitter signal. The photo-mixing effect has also been used to study simultaneously oscillating laser modes.⁷⁻⁹

The second step shown in the figure is the conversion of the a-c component of current, which carries the a-m signal being transmitted, into useful output power. All the factors that participate in this process may be lumped into a fictitious "equivalent load resistance," R_{eq} , defined by

$$P_{\text{out}} = \frac{1}{2}(MmI_o)^2 R_{\text{eq}} \quad (2)$$

Then, depending on the particular detector being

considered, R_{eq} may include the influence of such factors as carrier lifetimes, the frequency of modulation, and the voltage applied.

Sensitivity

The weak-signal detection capability of an optical communications receiver depends largely on the performance of its photodetector. It is of interest, therefore, how the signal-to-noise ratios of photodetectors depend on parameters η , M , and R_{eq} .

The noise sources usually include:

1. Thermal noise, kT per unit bandwidth, from the internal resistance of the device, where h is Boltzmann's constant and T the temperature in degrees Kelvin.

2. Shot noise, $2emI_T R_{\text{eq}}$ per unit bandwidth. Shot noise arises from the fact that the current is comprised of moving discrete charge carriers and is not a flowing continuum of charge. Average current I_T includes current from all sources, including background light and thermally generated current. In bulk photoconductors, where the carrier lifetimes are shorter than the transit time required for carriers to cross between electrodes, generation-recombination noise rather than shot noise must be considered.

3. Velocity fluctuation noise, due to the statistical distribution of carrier velocities about the average. This is usually negligible compared with shot noise, because the fluctuations are usually very small.

4. Low-frequency noise—"flicker" effect or "1/f" noise. Since this article is primarily concerned with broadband, and hence high-frequency applications, this will be ignored, although it would be important with audio-frequency modulation rates.

Thus, the signal-to-noise ratio for direct a-m detection is

$$S/N = \frac{1}{2}(MmI_o)^2 R_{\text{eq}} (kTB + 2emI_T R_{\text{eq}}B)^{-1} \quad (3),$$

keeping in mind that the shot-noise term should be replaced by a generation-recombination noise term for bulk photoconductors for photoconductive insulators. In the high-frequency limit, the generation-recombination term is $8e\beta I_o B R_{\text{eq}}$, where β represents the average number of times an electron is trapped, which may be of the order of 10^3 .³²

Thermal noise

In general, thermal noise dominates shot noise at very weak light levels, and determines the minimum detectable signal. However, at high light levels, shot noise (or generation-recombination

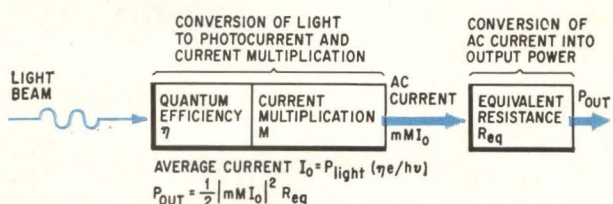

Photodetector for a-m optical signals.

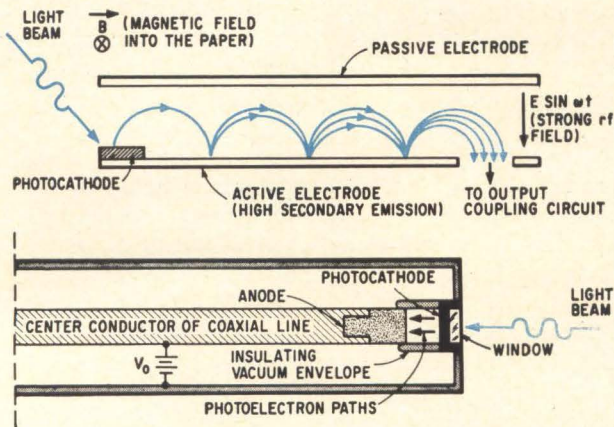

Dynamic crossed-field electron multiplier detector, top; simple planar photoelectric diode, bottom.

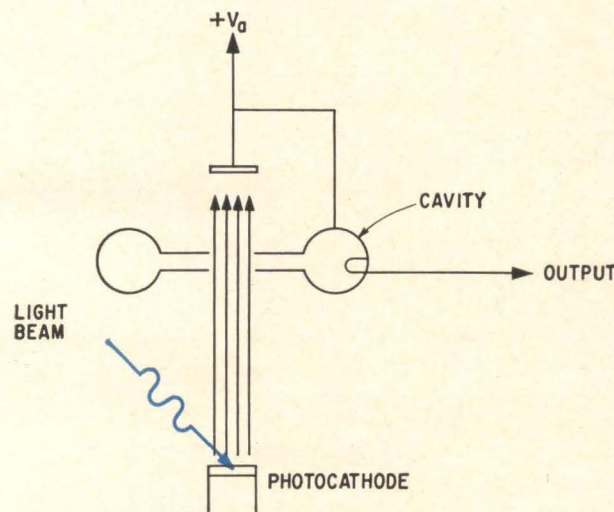

Cavity-type photoelectric diode, or photoklystron.

noise) fixes the signal-to-noise ratio. "High light levels" are high enough to make $2eMI_T R_{eq} \gg kT$ (or $8\beta eI_0 R_{eq} \gg kT$ for the photoconductor).

For thermal-noise-limited operation, the appropriate sensitivity figure of merit is $\eta^2 M^2 R_{eq}$. That is, for any two thermal-noise-limited photo-detectors, the one with the larger $\eta^2 M^2 R_{eq}$ will have the better signal-to-noise ratio. The high-level, shot-noise-limited, S/N-dependent figure of merit is just ηM , if the current consists only of the carrier induced I_0 . For high-frequency generation-recombination noise, the high-level figure of merit is η/β .

While the first figure, $\eta^2 M^2 R_{eq}$, is the important quantity for detection of weak a-m signals, a different situation prevails in the case of detecting weak signals by optical heterodyning. Here the signal-to-noise ratio is

$$S/N = 2M^2 I_1 I_2 R_{eq} (kTB + 2eMI_T R_{eq} B)^{-1} \quad (4)$$

If one of these currents, say I_1 , is due to a strong enough local oscillator, this ratio can be shot-noise limited even though the light carrying the signal is weak. The appropriate sensitivity figure of merit for this case, where $I_T \cong I_1$, is just ηM . However, it will be recalled that dependence on R_{eq} is implicit,

since the requirement for shot-noise-limited operation is $2eMI_T R_{eq} \gg kT$. At room temperature, this demands $MI_T R_{eq} \gg 10^{-2}$, a condition that can be difficult to meet if MR_{eq} is not large.

Let's see how this proposed comparison system is applied to some of the major types of detectors.

Electrostatic photomultiplier tubes

Electrostatic photomultiplier tubes are unchallenged for direct detection of weak a-m signals with modulation frequencies below a few hundred megacycles with carriers in the visible region of the spectrum. Like other photoemissive devices, these tubes can be made with fairly high quantum efficiencies at visible and near-infrared wavelengths, as shown at bottom left of page 54. More important, the electron multiplication process can give current amplification of 10^5 to 10^7 . Assuming R_{eq} of about 10^3 ohms at low frequencies, $M \cong 10^6$, and $\eta \cong 10^{-1}$, this gives a sensitivity figure of merit $\eta^2 M^2 R_{eq} \cong 10^{13}$. This is very high compared with other detectors, showing the great utility of photomultiplication in weak-signal, low-frequency detection.

Unfortunately, the R_{eq} of conventional electrostatic photomultipliers is so poor at higher frequencies, because of transit-time effects, that the current-multiplication advantage is negated. For multi-gigacycle bandwidths, other kinds of detectors must be chosen.

A familiar problem resulting from current multiplication is that high levels result in tube currents large enough to destroy the final multiplier-dynode stages. This limits the operation to weak optical signals or to attenuated strong signals. In optical heterodyning, this restriction, may limit the optimum noise performance, because it was required that the local oscillator-induced shot noise be the dominant noise source,

$$2eMI_1 B R_{eq} \gg kTB + 2eM(I_B + I_D) B R_{eq}$$

where I_1 , I_B , and I_D are the average photocurrents due to the local oscillator, background light and thermionic (D for "dark") emission, respectively.

Since the thermal noise term is generally the smallest of the noise terms, the problem boils down to making $I_1 \gg I_B + I_D$. However, this condition may mean a dangerously high total current. With laser systems, the background light may often be reduced with narrow-band optical filters; reducing the thermionic, or "dark," current requires refrigeration, which is not always feasible.

Crossed-field photomultipliers

A photomultiplier tube that has been proven capable of demodulation in the gigacycle range is the dynamic crossed-field electron multiplier.^{10, 11} In this novel device, shown schematically at the upper left, current multiplication of about 10^5 by secondary emission is accomplished by the combined effects of a strong r-f electric field and a perpendicular d-c magnetic field to cause the trajectory shown in the figure.

Only those electrons are accelerated that are

emitted in the proper phase of the accelerating electric field, and these follow the trajectory. The current is initially "sampled," with further phase-focusing at each multiplication step. This process minimizes transit time spread, making possible the detection of microwave modulation if the r-f driving field is a microwave signal. This multiplier has, in fact, been used at three gigacycles (Gc).

The combination of the quantum efficiencies with current multiplication and an R_{eq} in the hundreds of ohms makes this device potentially valuable for sensitive detection. In experimental models, however, problems have been caused by amplification of noise from the magnetron source of the strong r-f field required. Elimination of this "external" noise should result in noise performance comparable with that of electrostatic multipliers.⁸

The predicted bandwidth is half the driving signal frequency, so gigacycle bandwidths should be possible. The requirement of a driving signal is one of the less attractive features of this multiplier, since it adds to cost and complexity. To the authors' knowledge, this multiplier is not commercially available, although it is being developed.

Vacuum photodiodes

The simplest photoelectric tube is the planar photodiode, which consists of just a photocathode and an anode. This device, mounted as part of the center conductor of a coaxial line, or in a waveguide, has detected signals at as high as X-band.^{12, 13}

These experiments consisted of observing the difference-frequency signal generated by the photo-mixing of simultaneously oscillating modes of a high-power pulsed-ruby laser. However, these diodes are not "sensitive" detectors. Their quantum efficiencies are as shown on page 54; they have no current multiplication, and at high frequencies their equivalent resistance is small because of transit-time reduction.

Even when the transit time of electrons is reduced by operating at three times the rated diode voltage, R_{eq} is only about six ohms at X-band and 0.5 ohm at X-band. Hence, $M^2\eta^2R_{eq}$ is only 6×10^{-2} and 5×10^{-3} , respectively, even when operating at wavelengths for which η can be 10%.

Although these diodes can handle visible continuous-wave (c-w) light powers in the tens-of-milliwatts range, they are not as useful for heterodyning as might be desired. To reach shot-noise-limited operation at room temperature requires $I_1 \cong 10$ ma if R_{eq} is one ohm. This would mean a light power input of about 200 milliwatts in the visible part of the spectrum, which is both higher than is available from c-w lasers and dangerous to the small photocathode. At practical levels of a c-w optical local oscillator, the diode's operation would be limited by its thermal noise level, where its low R_{eq} is a serious liability.

Photoklystron

Another relatively simple high-frequency detector is the photoklystron, or cavity-type photodiode,

shown at center left of page 56.^{6, 14} The a-c current modulation induces a signal in the coupling cavity, tuned to the modulation frequency.

As in the other photoelectric devices, the figure on page 54 gives the quantum efficiency possibilities for the photoklystron. The R_{eq} of high-Q (and hence narrow-band) cavities can be over 100 ohms, even at high microwave frequencies; the transit-time limitation that plagues the planar photodiode is overcome because the beam is preaccelerated and passed through a narrow coupling gap. This device could, in principle, be built at any frequency at which klystrons are built—to over 100 Gc—although the tube would have to be quite small for these frequencies. The photoklystron has $M^2\eta^2R_{eq}$ of up to unity at high microwave frequencies, and is therefore markedly superior to the simple planar photodiode as a sensitive photodetector.

The major disadvantage of this device is its narrow bandwidth. The band can be broadened only at the expense of reducing R_{eq} , in which case it is no better a detector than the simple photodiode. Even over a narrow bandwidth, as shown below, the photoklystron is inferior to the traveling-wave phototube and solid-state photodiode.

Distributed-emission photodiode

The distributed-emission photodiode^{15, 18} is a family of schemes proposed for broadband detection at millimeter modulation wavelengths. In this detector, a "running wave" of photocurrent is generated, which has the same wave velocity as the transmission line, so the current wave can couple power into the transmission line.

These devices are among the most promising for millimeter waves, since they permit using practical component dimensions even at 100 Gc. The coaxial line version has already been used over the frequency range 1.65 to 34.65 Gc to detect photomixing "beats" between modes of a ruby laser.¹⁹ Quantum efficiencies are like those of other photoelectric tubes, and R_{eq} of 10 ohms or so is predicted at 100 Gc. Other detectors are better at lower microwave frequencies, but distributed-emission phototubes show promise at millimeter wavelengths.

Traveling-wave phototubes

The traveling-wave phototube^{8, 20, 21} offers broad demodulation bandwidths and high R_{eq} , and is the best broadband photodetector for visible light. Octave instantaneous bandwidths are easily feasible at microwave frequencies, with R_{eq} typically in the range of 10^5 to 10^6 ohms.

In this phototube, shown schematically at the center of the top figure on page 59, the a-m light causes the emission of a current-modulated photoelectron beam passed near a broadband microwave circuit, such as a helix. Power at the modulation frequency is efficiently coupled to the circuit if the electron beam velocity is roughly equal to that of the electromagnetic wave on the circuit. As with traveling-wave tube amplifiers, these conditions may be instantaneously realized over an octave

bandwidth also with travelling-wave phototubes.

The efficient beam-to-circuit power transfer results in R_{eq} of 10^4 to 10^7 ohms. This is not the output impedance, but a fictitious load resistor; the output is typically delivered to a 50-ohm line, or to a waveguide, with low voltage standing-wave ratio. The quantum efficiency of the photocathode is given in the same figure as the other efficiencies. Assuming $\eta = 0.1$ and $R_{eq} = 10^6$ ohms, $M^2\eta^2R_{eq} = 10^4$, the sensitivity is far better than that of the other high-frequency photoemissive detectors, the photodiode and the photoklystron. However, photocathodes with useful infrared sensitivities are not yet available, so the traveling-wave phototube is limited to use with optical carriers below a micron.

A traveling-wave phototube was developed by Sylvania Electric Products, Inc., for the Air Force Cambridge Research Laboratories.²² This tube has an S-1 cathode and an instantaneous detection bandwidth of 9 Gc, from 11 to 20 Gc, with R_{eq} in the 10^5 range.

Traveling-wave phototubes were used in the first continuous microwave modulation and demodulation experiments²³ and in the first heterodyne demodulation of microwave f-m and a-m light.²⁴

Multiplier TWP's

As noted earlier, current multiplication is an important way of increasing the sensitivity of photodetectors. A proposed method of combining current multiplication with the high R_{eq} and broad bandwidth of TWP's is shown at the bottom of the top figure on page 59. Transmission secondary emission multiplication (CTSEM)²⁵ films are the current-gain multiplier elements. With about five kilovolts of applied voltage per stage, gains of about four per stage are possible.²⁶ Thus, even a single stage could improve $\eta^2M^2R_{eq}$, and hence the sensitivity, by a factor of 16.

Unfortunately, the present TSEM films cannot handle much more than one μ amp of incident current per square centimeter,²⁶ which severely limits the safe light-input power. For example, if a cathode has $\eta = 0.1$ at 6,000A in an S-band TWP, the total light input cannot safely exceed about 0.5 microwatt, and in higher-frequency tubes with smaller cathodes even less light can be handled.

The authors



Burton J. McMurtry, a 29-year-old native of Houston, is head of the optics department at the Electronic Defense Laboratories of Sylvania Electronic Systems, a division of Sylvania Electric Products, Inc. He is a 1957 graduate of Rice University with master's and doctor's degrees in electrical engineering from Stanford. At Sylvania he has worked on the design and

development of klystrons, traveling-wave tubes and microwave optical devices. In 1961, working with Prof. A.E. Siegman of Stanford, McMurtry obtained the first conclusive results from optical-heterodyne experiments involving microwave-difference frequencies.

Thus, even if traveling-wave phototubes of the TSEM type were commercially available, their use would be restricted to the direct detection of very weak amplitude-modulated carriers.

It should be pointed out here that a current density restriction necessarily implies a signal-to-noise ratio limitation, as seen from equation 3. If shot noise is the dominant noise, and if $I_o \cong I_T$, S/N is proportional to MI_o , then at lower I_o , where thermal noise is dominant, S/N is proportional to $(MI_o)^2$. The quantity MI_o is the product of the current density and the cross-sectional area of the electron beam, after the multiplication process.

To illustrate the limitation imposed on S/N by the beam current-density, equation 3 has been plotted for dimensions representing traveling-wave phototubes in-production for the L, S, C and X-band. In this figure, page 59, the M is included in I_o . R_{eq} was arbitrarily set at 10^6 , 100% amplitude modulation was assumed. The one-gigacycle bandwidth was chosen for convenience as representing an instantaneous microwave bandwidth of which all four tubes are capable; for other bandwidths, it is enough to multiply the S/N of this graph by the ratio of one gigacycle to the new bandwidth.

The important points are the dependence of S/N on current density, and the fact that this limitation becomes more serious with tubes for higher frequency. For example, even if the maximum safe current density is as high as $4 \mu\text{a}/\text{cm}^2$, the S/N at X-band is only 4; for an S/N of 30 db, the bandwidth would have to be reduced to 4 Mc.

In heterodyning, the situation is at best the same as the case described. That is, "100% modulation" is achieved when $I_1 = I_2$ in equation 4, and the graph applies. Other combinations of I_1 and I_2 give smaller signal-to-noise ratios. The change of slope of the curves represents the transition from thermal to shot-noise-limited operation and shows that shot-noise-limited operation often requires average currents of dangerously high amplitude.

Bulk photoconductors

Bulk photoconductors constitute a class of relatively simple, broadband photodetectors. Their advantages are high quantum efficiency and high capability for handling light power. Disadvantages



Donald E. Caddes has been employed since 1959 at the Microwave Device division of Sylvania Electric Products, Inc., at Mountain View, Calif. He has worked on the development of travelling-wave microwave phototube theory, and recently designed and developed a traveling-wave phototube capable of detecting microwave modulation of light over

a nine-gigacycle bandwidth. Caddes was graduate from Rice University in 1959 with a B.S. in electrical engineering. He received his master's from Stanford in 1962 and is working on his doctorate there.

are high generation-recombination noise and a low R_{eq} , which varies approximately as the inverse square of the modulation frequency at microwave frequencies.²⁷⁻³²

The figure shows the device and its equivalent circuit. If the frequency of input light is higher than that corresponding to the energy gap between the valence and conduction bands of the photoconductive semiconductor material, the light is absorbed, creating electron-hole pairs. Since practically every incident photon creates a pair of charge carriers, η is nearly unity for wavelengths between the "band-gap" wavelength, which can be well into the infrared, and that at which the material begins to be highly reflective—typically in the visible range. Some useful spectral ranges, estimated at room-temperature are: indium antimonide, 0.4 to 5.7 microns; indium arsenide, 0.4 to 3.4 microns; germanium, 0.6 to 1.5 microns; silicon, 0.5 to 1.0 microns; lead selenide, 0.4 to 3.5 microns; and cadmium selenide, 0.4 to 0.7 microns. Only cadmium selenide and indium antimonide have received much attention as high-frequency detectors.

The equivalent resistance is, unfortunately, low at microwave frequencies, due chiefly to the effects of carrier lifetimes, trapping effects and transit time. The amplitudes of the a-c and d-c currents are significantly reduced by trapping lifetime effects.³² At microwave frequencies, R_{eq} is given approximately by $(4G_p\omega^2T_t^2)^{-1}$, where T_t is the transit time, ω is the radian frequency and G_p is the conductance. G_p does not depend largely on the illumination level, at least for cadmium selenide.³²

For a recent cadmium selenide detector³² that has $T_t \cong 10^{-7}$ sec, $G_p \cong 5 \times 10^{-5} \Omega^{-1}$, and $\eta = \frac{2}{3}$, R_{eq} is about 10^{-3} ohm at 3Gc, so $M^2\eta^2R_{eq}$ is less than 10^{-3} . Hence, this type of bulk photoconductor is not a sensitive detector. However, better results may be possible with indium antimonide,³⁰ also useful far into the infrared region (about six microns).

If operation limited only by generation-recombination noise can be approached in heterodyning, sensitivity depends on η/β . But since β is of the order of 10^3 , the bulk photoconductor is not particularly sensitive.

The outstanding property of the bulk photoconductor is its power-handling capability. Tens of kilowatts from pulsed-ruby lasers have caused no damage to CdSe samples. For very high power levels such as these, the bulk photoconductors seem to have the greatest potential.

Semiconductor photodiodes

Another important type of solid-state photodetector is the semiconductor diode.³¹⁻³⁶ The figure above represents the PIN configuration. When a large back-bias is applied, photo-generated carriers will be swept out of the I-region, with the resulting current containing a-c components corresponding to the a-m of the incident light beam.

The active region is where the high-bias field exists, between or nearly between N and P areas.

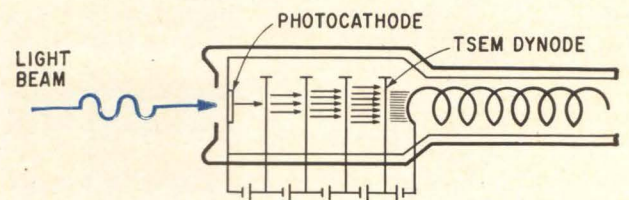
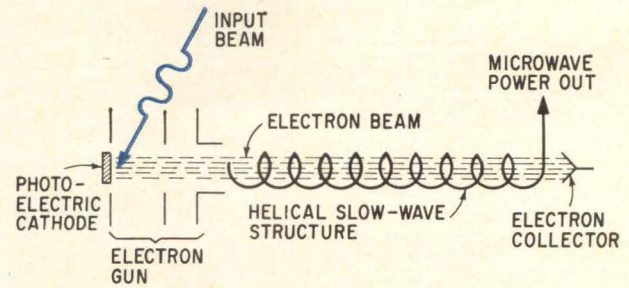
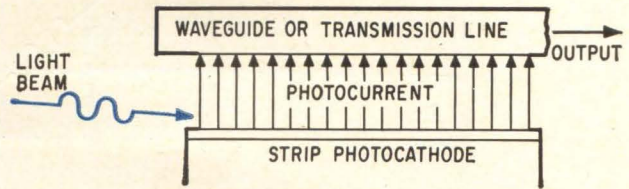

Distributed-emission photodiode, top; traveling-wave phototube, center; a traveling-wave phototube using transmission-type electron multiplication, bottom.

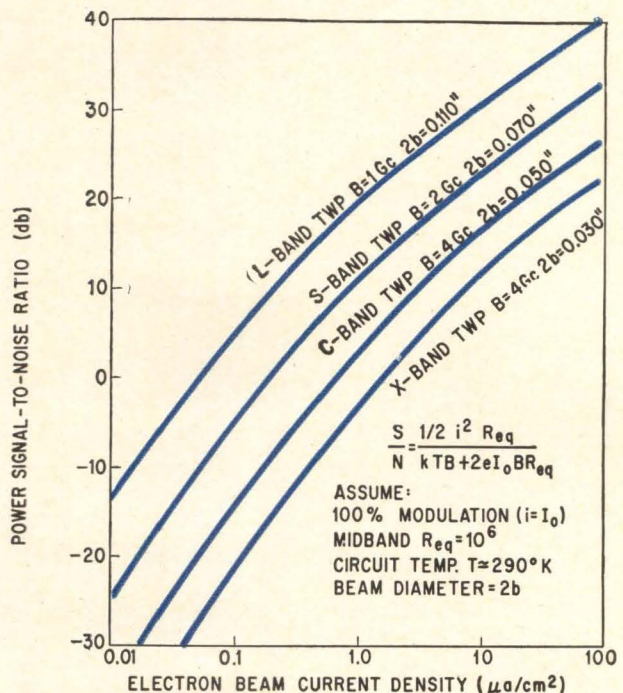

Plot of signal-to-noise ratio (equation 3, page 55) shows dependence of traveling-wave phototube signal-to-noise ratio on electron-beam current density.

Since the I-region is only of the order of a micron in thickness, it is not practical to focus light onto it in cross-section. Instead, the region next to the P-I junction is illuminated in the figure as shown. If a single spot of P-material is used, the sensitive area

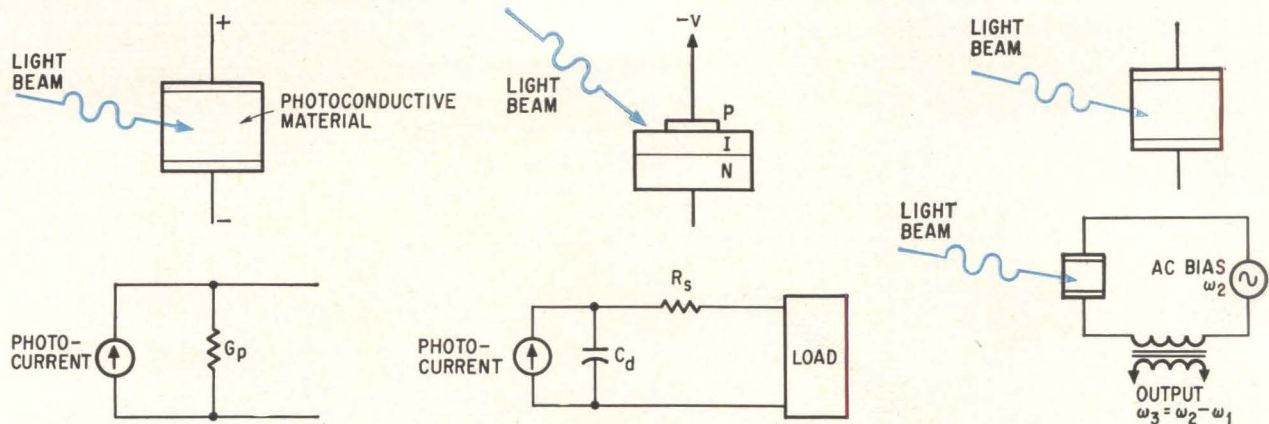

Bulk photoconductor and its microwave equivalent circuit, left; a fast PIN photodiode, and its microwave equivalent circuit, center; and a bulk photoconductor used as a combined photodetector-mixer, right.

is an annoyingly small target, demanding extremely precise positioning.

A more convenient arrangement, which also improves high-frequency response, is to use a grid of P-material. Thus, although η is essentially unity for light that reaches the I-region, the shadowing effect reduces the effective maximum η to about 0.4, somewhat poorer than that of the bulk photoconductor.

However, R_{eq} is much higher than it is for the bulk photoconductor, being given by $(4R_s\omega^2C_d^2)^{-1}$. Large back-bias across the narrow I-region results in only a little signal degradation due to transit-time effects. In fact, R_{eq} can be as high as 100 ohms at 3 Gc if the bias is high enough so the transit time is negligible.

However, the narrow I-region also has the disadvantage of producing the shunt capacitance shown. (For good diodes, it is about 2 pf, and the series resistance about two ohms). This capacitance

causes the $1/f^2$ frequency dependence of R_{eq} , so the diode with $R_{eq} \cong$ ohms at 3 Gc would have $R_{eq} \cong$ 10 ohms at 10 Gc, neglecting the transit-time effects that also begin to be important in the 10-Gc range. In addition, the 100-ohm R_{eq} is realistic only if the diode is conjugate-matched, resulting in a relatively narrow bandwidth. Broader bandwidths are possible only at the expense of reducing R_{eq} .

For narrow-band detection, the photodiode then has $\eta^2R_{eq} \cong$ 10 at 3 Gc, and about one at 10 Gc, both much higher than the bulk photoconductor. The traveling-wave phototube has much higher η^2R_{eq} at wavelengths below 0.7 micron but, as shown, this phototube is not useful beyond one micron.

As noted, some semiconductors can respond well into the infrared. At one micron, with an S-1 cathode, the traveling-wave phototube with $R_{eq} = 10^6$ ohms has $\eta^2R_{eq} \cong$ 1, so the "cross-over wavelength"

References

- 1 S.E. Harris, "Conversion of FM Light to AM Light Using Birefringent Crystals," *Applied Physics Letters*, Vol. 2, p 47, Feb. 1962.
- 2 S.E. Harris and C.F. Buhrer, "An Optical Ratio-Detector," Paper presented at 1963 Conference on Electron Device Research, June 26, 1963.
- 3 E.O. Ammann et al, "Research on Techniques for Light Modulation Detection," Interim Engineering Report No. 6 on Contract AF 33(657)-8995, Sylvania Electric Products, Mountain View, California, Dec. 1963.
- 4 S.E. Harris and A.E. Siegman, "A Proposed FM Phototube for Demodulating Microwave-Frequency-Modulated Light Signals," *IRE Trans on Electron Devices*, ED-9, p 322, July 1962.
- 5 E.O. Ammann et al, "Research on Techniques for Light Modulation Detection," Interim Engineering Report No. 5 on Contract AF 33(675)-8995, Sylvania Electric Products, Mountain View, California, Sept. 1963.
- 6 A.T. Forrester, R.A. Gudmundsen, and P.O. Johnson, "Photoelectric Mixing of Incoherent Light," *Phys Rev*, 99, p 1,691, Sept. 15, 1955.
- 7 A. Javan, W.R. Bennett, Jr., and D.R. Herriott, "Population Inversion and Continuous Optical Maser Oscillation in a Gas Discharge," *Phys Rev Lett*, 6, p 106, Feb. 1, 1961.
- 8 B.J. McMurtry and A.E. Siegman, "Photomixing Experiments with Ruby Optical Maser and a Traveling-Wave Microwave Phototube," *Appl Opt*, 1, p 51, Jan. 1962.
- 9 B.J. McMurtry, "Investigation of Ruby Optical Maser Characteristics Using Microwave Phototubes," *Appl Opt*, 2, p 767, Aug. 1963.
- 10 O.L. Gaddy and D.F. Holshouser, "High-Gain Dynamic Microwave Photomultiplier," *Proc IRE*, 50, p 207, Feb. 1962.
- 11 O.L. Gaddy and D.F. Holshouser, "A Microwave Frequency Dynamic Crossed-Field Photomultiplier," *Proc. IEEE*, 51, p 153, Jan. 1963.
- 12 P.A. Lindsay, S.F. Paik, K.D. Gilbert, and S.A. Rooney, "Optical Mixing in Phototubes," *Proc IRE*, 50, p 2,380, Nov. 1962.
- 13 K.D. Gilbert, H.C. McClees, P.A. Lindsay, and S.F. Paik, "Photomixing Experiments at X-Band," *Proc IEEE*, 51, p 1,148, Aug. 1963.
- 14 M.D. Petroff, H.A. Spetzker and E.K. Bjornerud, "X-Band Microwave Phototube for Demodulation of Laser Beams," *Proc IEEE*, 51, p 614, April, 1963.
- 15 A.L. Cullen and P.N. Robson, "A New Principle in the Design of a Millimetric Photoelectric Laser Mixer," Third International Symposium on Quantum Electronics, Feb. 1963.
- 16 A.L. Cullen and J.A. Jones, "Proposals for Millimetric Photomixing Using Surface Waves," *Proc Sym Optical Masers*, April 1963, p 585, Polytechnic Press, N.Y., 1963.
- 17 A.E. Siegman, B.J. McMurtry, and S.E. Harris, "Microwave Demodulation of Light," Third International Symposium on Quantum Electronics, Feb. 1963.
- 18 B.J. McMurtry et al, "Investigation of New concepts in Optical Mixing," Final Report on Contract AF 19(628)-2472, Sylvania Electric Products Inc., Mountain View, California; 10 Oct. 1963.
- 19 N.C. Wittwer, "Detection of Higher Order Ruby Optical Maser Modes," *Appl Phys Lett*,

between the two types of devices as narrow-band detectors is about one micron at 10 Gc and probably about 0.8 micron at 3 Gc. Of course, the traveling-wave phototube has many times the instantaneous bandwidth capability of the photodiode.

In narrow-band optical heterodyning, where only the quantum efficiency is important, the photodiode is superior to the traveling-wave phototube. With an R_{eq} of 100 ohms, shot-noise-limited operation at room temperature demands a total current in the 100-microamp range, which is not unreasonably high.

Photo-parametric detectors

In addition to the direct a-m detection and heterodyne schemes, the detection stage may be combined with parametric amplification to raise the apparent R_{eq} .³⁷⁻³⁹ The last two figures show ways of accomplishing this with a diode used simultaneously as a photo- and a varactor-diode, and with a bulk photoconductor. Detailed experimental and analytical information on these schemes is still scarce. In addition, development directed toward producing a diode that is at once a good photodiode and a good varactor should improve the performance of that arrangement.

Conclusions

For direct detection of amplitude-modulated light, the photodetector sensitivity may be characterized by $M^2\eta^2R_{eq}$. The high current gain of photomultiplier tubes therefore makes them the most sensitive detectors of low-frequency modulation, for optical carriers in the visible range where good photoemission quantum efficiencies are possible.

Unfortunately, available photomultipliers cannot detect microwave-frequency a-m. The most sensi-

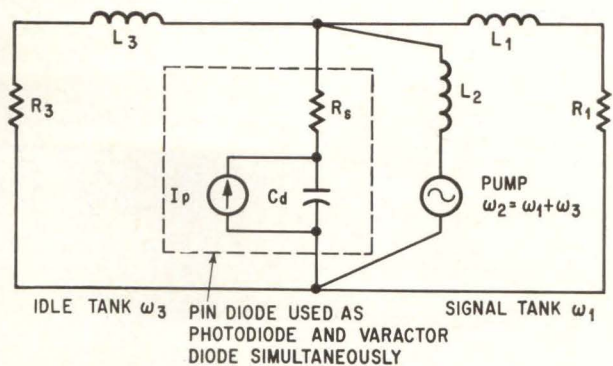

Photodiode parametric amplifier. A photodiode can be used simultaneously as the detector and as the varactor diode in a parametric amplifier which amplifies the detected signals.

tive broadband detector for the visible spectrum is the traveling-wave phototube, which has R_{eq} in the megohm range over octave bandwidths at microwave frequencies. For detection in the infrared regions, the semi-conductor photodiode is the most sensitive a-m detector, but junction capacitance makes a trade-off necessary between bandwidth and R_{eq} . Bulk photoconductors have better inherent bandwidth capability, but very low R_{eq} .

In optical heterodyne detection, sensitivity is determined solely by current multiplication and quantum efficiency, $M\eta$ (η/β for photoconductors), so long as $M(I_1 + I_2)R_{eq}$ is large enough so that shot noise dominates thermal noise. This is a difficult condition to meet with present c-w laser local oscillators, unless R_{eq} exceeds 100 ohms. Thus, for c-w microwave-frequency systems, the same two photodetectors, the traveling-wave phototube and the semiconductor photodiode, are of great practical importance.

2, p 194, May 1963.

20 B.J. McMurtry, "Microwave Phototube Design Considerations," IEEE Trans Electron Devices, ED-10, p 219, July 1963.

21 a) D.E. Caddes, B.J. McMurtry, and A.E. Jacques, "The Traveling-Wave Phototube: Theoretical Analysis," and

b) R. Targ, D.E. Caddes, and B.J. McMurtry, "The Traveling-Wave Phototube: Experimental Analysis," (both to be published in IEEE transactions on Electron Devices, April 1964).

22 D.E. Caddes, "Design and Development of a Photomixing Device," Final Report on Contract AF 19(628)-1671, Sylvania Electric Products Inc., Mountain View, Calif.; 9 Aug. 1963.

23 S.E. Harris, B.J. McMurtry, and A.E. Siegman, "Modulation and Direct Demodulation of Coherent and Incoherent Light at a Microwave Frequency," Appl Phys Lett, 1, p 37, Oct. 1962.

24 R. Targ, "Optical Heterodyne Detection of Microwave-Modulated Light," Proc IEEE (to be published).

25 E.J. Sternglass, Rev Sci Instr, 26, p 1,202, 1955.

26 D.J. Blattner, J. Ruedy, and F. Sterzer, Third Quarterly Progress Report, Contract No. DA36-039-SC-90846 for USAERDL, Ft. Monmouth, N.J., March 1963.

27 M. DiDomenico, Jr., R.H. Pantell, O. Svelto, and J.N. Weaver, "Optical Frequency Mixing in Bulk Semiconductors," Appl Phys Lett, 1, p 77, Dec. 1962.

28 A.W. Smith "Photoconductive Mixing in Bulk Semiconductors," Bull Am Phys Soc, 8, p 381, April 1963.

29 G. Lucovsky, R.F. Schwarz, and R.B.

Emmons, "Photoelectric Mixing of Coherent Light in Bulk Photoconductors," Proc IEEE, 51, p 613, April 1963.

30 E.N. Fuls, "Optical Frequency Mixing in Photoconductive InSb," Appl Phys Lett, 4, p 7, Jan. 1964.

31 M. DiDomenico, Jr., and O. Svelto, "Coherent Photodetections: A Comparison Between Photodiodes and Photoconductors," to be published.

32 M. DiDomenico, Jr., and L.K. Anderson, "Signal-to-Noise Performance of CdSe Bulk Photoconductive Detectors," to be published.

33 R.P. Riesz, "High-Speed Semiconductor Photodiodes," Rev Sci Instr, 33, p 994, Sept. 1962.

34 H. Inaba and A.E. Siegman, "Microwave Photomixing of Optical Maser Outputs with a PIN-Junction Photodiode," Proc IRE (Correspondence), 50, p 1,823, Aug. 1962.

35 G. Lucovsky, M.E. Lasser, and R.B. Emmons, "Coherent Light Detection Utilizing Solid-State Photodiodes," Electrochem Soc, Electronics Div Abstracts, II, p 284, May 1962.

36 C.K.N. Patel and W.M. Sharpless, "Optical Heterodyning Using Point Contact Germanium Diodes," Proc IEEE, 52, p 107, Jan. 1964.

37 S. Saito, K. Kurokawa, Y. Fujii, T. Kimura, and Y. Uno, "Detection and Amplification of the Microwave Signal in Laser Light by a Parametric Diode," Proc IRE, 50, p 2,369, Nov. 1962.

38 P.D. Coleman, R. Eden, and J. Weaver, "Mixing and Detection of Laser Light in a Bulk Photoconductor," to be published.

39 M. DiDomenico, Jr., "Direct Demodulation and Frequency Conversion of Microwave Modulated Light in a CdSe Bulk Photoconductor," Jour Appl Phys, (in press).

New technology sparks an expansion for germanium

General-purpose germanium transistors can now be built with a planar structure, possibly extending applications to phased array radar, tv tuners and computer switching circuits.

By K.B. Landress

Senior project engineer, Semiconductor-Components Division,
Texas Instruments Incorporated, Dallas, Texas.

Although the first commercial semiconductor devices were made of germanium 15 years ago, silicon devices have outstripped them in the high quality device area, even though germanium has better high-frequency electrical characteristics. The reason is simple: Silicon transistors are easier to build to the tighter dimensions required for devices that operate at high frequency. In fact, commercially it has been impossible to build germanium transistors with good high-frequency characteristics beyond 5 gigacycles.

That's why the heterogeneous oxide technology developed at Texas Instruments Inc. looms so significantly. With it, the circuit designer can have general-purpose germanium transistors with excellent high-frequency characteristics at costs that compare favorably with present germanium mesa structures. The company can build germanium transistors to almost any dimensional tolerances. This development may mean an expansion for germanium as a semiconductor material even in such applications as L-band phased array radar, television tuners and computer switching circuits.

The single most significant feature of the germanium planar transistor—in itself a major development—is its structure. Now for the first time it is possible to manufacture the very small device structures required for outstanding performance in the 1 gigacycle to 5 gigacycle range.

In the past, the design engineer has been severely limited in the size of the active areas of the transistor because of the exponentially increasing difficulties of assembling smaller and smaller structures. This limitation has been overcome by the use of expanded contacts, which are described later.

The outstanding electrical performance in the 1 Gc to 5 Gc frequency range will be provided primarily through increased values of the maximum frequency of oscillation, much lower values of extrinsic base resistance, lower noise figure, significantly lower values of capacitance between the three terminals of the device, and improved gain-bandwidth product. In addition, higher production rates than with mesa transistors are achievable because the lead attachment problem has been lessened.

Planar technology

Development of the planar technology for silicon gave a boost to the use of silicon transistors because the planar process provides inherent surface passivation and also allows using photographic masking in the manufacturing process. Latter is particularly important for high-frequency transistors because photographic masks give higher resolution than metal masks and therefore allow making small, closely controlled junction areas. This small size and close spacing between collector and emitter results in lower junction capacitance and smaller base resistance than in mesa transistors with resulting higher frequency operation and lower noise figures.

The present standard technology for germanium, has been limited to the mesa type of device shown in the illustration. A key reason for the interest in germanium is that it has higher hole and electron mobilities than silicon, and is therefore inherently capable of operating at higher frequency. Germanium also lends itself to automation more readily than does silicon.

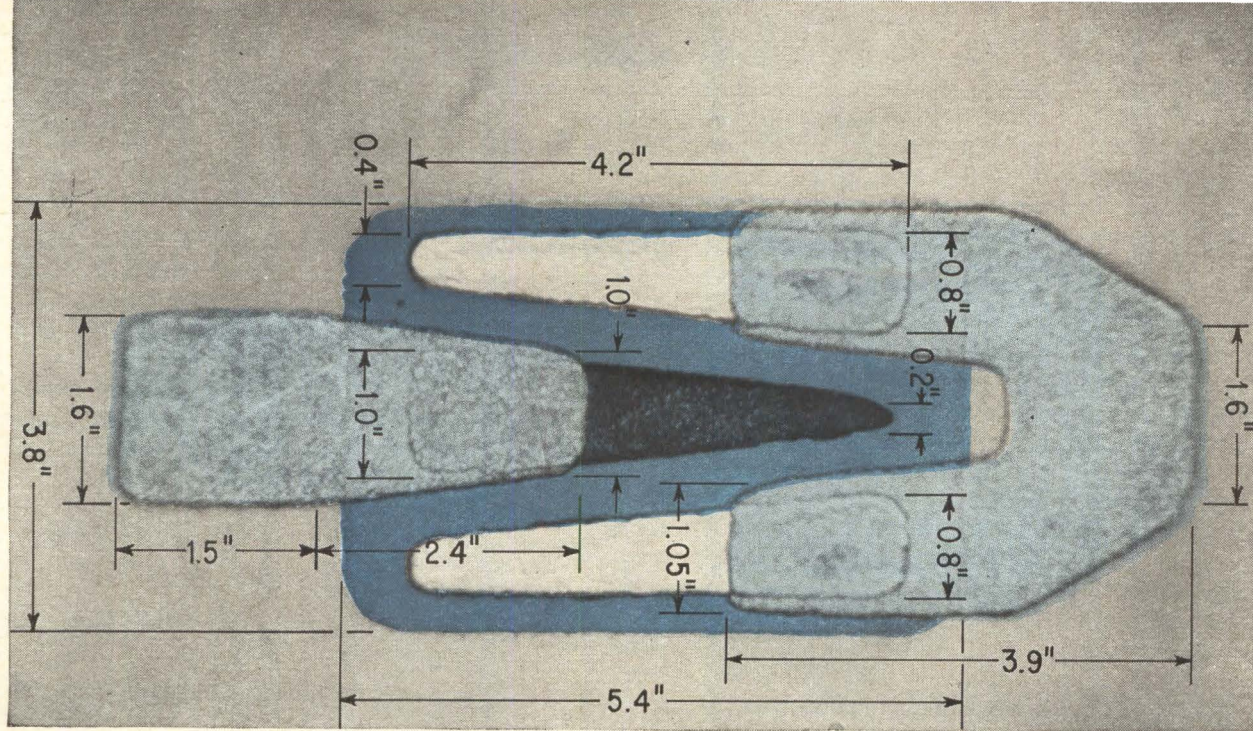

Planar germanium transistor has alloyed p-type emitter stripe and two alloyed base stripes.

Thus, a germanium planar transistor should be useful wherever high frequency (1 to 10 Gc) transistors are desired at operating temperatures below 100°C. This would include consumer electronics and computer switching, for example.

Fabrication of silicon planar transistors involves growing a passivating layer of silicon monoxide thermally on the surface of the silicon substrate and then etching through this oxide layer. This technique cannot be used with germanium because germanium monoxide has a high vapor pressure and would simply evaporate. However, a technology has been developed that combines the inherent high-frequency capabilities of the germanium mesa structure with the high mechanical resolution techniques used in manufacturing silicon planar transistors. This technology shows promise of providing devices with excellent high-frequency characteristics in the 5 to 10 Gc range, and also devices with low noise figures in the 1 Gc to 3 Gc range.

Successful mating of the two technologies meant solving several basic problems. One was to discover a material suitable for diffusion masking and insulating the contacts. This was accomplished by a technique in which an amorphous film of silicon dioxide is deposited at high temperatures on ger-

manium. This method, which requires careful control of impurities and of film deposition to avoid pinholes, can be used to produce a planar collector-base junction with extremely sharp breakdown characteristics at the knee of the reverse voltage-current curve. Typical reverse characteristics are shown in the oscilloscope trace.

Glass masks

In the production of the typical germanium mesa transistor, the geometric patterns of the alloyed emitter and the base contact are produced by vacuum evaporation of the desired materials through metal masks. The definition of the resulting patterns is naturally limited by the definition of the metal mask patterns. In addition, the minimum linear-device dimension that can be obtained is controlled by that obtainable in metal mask fabrication. The present state of the art in metal mask fabrication limits the minimum linear dimension to approximately 0.0005 inch with a definition permitting adjacent metal areas to be separated by 0.0005 inch. These values can only be obtained if the geometric pattern is limited to a relatively simple shape. By way of contrast, the glass photographic masks employed in production of silicon planar structures

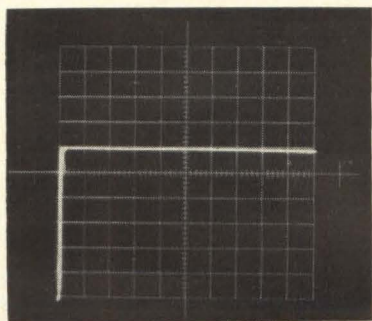

Reverse collector-base characteristics. Vertical scale is 5 v/div. horizontal is 10 microamp/div.

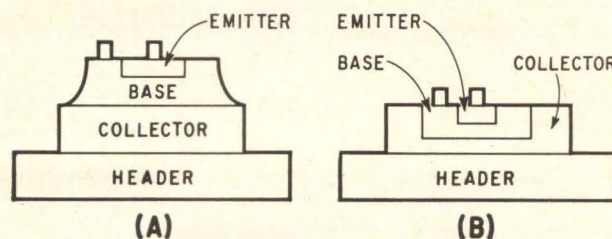

Basic structure of mesa transistor (A) and planar transistor (B).

are limited to a minimum linear dimension of approximately 0.0001 inch with a definition adequate to permit separation of distinct areas by 0.0001 inch.

Early in the development program, it was recognized that for the germanium planar transistor to reach full potential, the use of metal evaporation masks would have to be discontinued. Consequently, a technology based on glass photographic masks was developed to provide formation of the geometric metalized device areas. The decision to continue the alloyed emitter structure of the germanium mesa devices, rather than pursue the diffused emitter structure of the silicon planar devices was made because of the theoretical advantages of the alloyed emitter structure. As a result of the development activities, well-defined metalized areas with a minimum linear dimension of 0.0003 inch are being produced routinely. The processing steps that were finally developed are outlined below.

1) Slice preparation

The basic substrate material (see diagram p 65) is obtained from a gallium-doped, germanium, single-crystal of 0.002 ohm-centimeter resistivity, oriented in the 110 plane. The sliced crystal is chemically polished to provide a smooth surface. A vapor deposited epitaxial layer of 1 ohm-centimeter resistivity is grown on the lapped and polished substrate. The thickness of the slice is approximately 5 mils.

The completed epitaxial material is placed in a specially designed SiO_2 reactor where a 2,000 angstrom SiO_2 film is deposited onto the epitaxial layer by the pyrolytic decomposition of tetraethoxysilane. Through the use of photolithographic techniques, windows are etched out of the SiO_2 film in preparation for the base diffusion.

2) Base diffusion

The slice is then placed into a diffusion chamber at elevated temperatures and arsenic is allowed to diffuse for a specified length of time into the epitaxial layer through base windows etched out of the SiO_2 film in step 1. Arsenic is vaporized at an elevated temperature and is transported across the slice using a constant flow of gas consisting of a mixture of hydrogen and nitrogen.

The author



K.B. Landress is a senior project engineer in the Semiconductor Research and Development Laboratories, responsible for design of planar germanium very-high-frequency amplifier transistors and management of the germanium passivation development project. He was a member of the International Operations Department from 1958 to 1961. Before coming

to TI, Landress was employed as an engineer by the firm of A. Earl Cullum, Jr., Consulting Radio Engineers.

3) Emitter stripe deposition

A continuous film of Kodak metal etch resist (KMER) is placed on the entire surface of the base-diffused side of the slice. With the use of a glass photomask, the emitter stripe design is etched into the thin film of KMER. A continuous film of emitter material is then vacuum deposited on top of the KMER film. A second KMER film in the outline of the emitter, on registry with the original emitter windows, is placed onto this film of emitter material. After etching away the exposed emitter material, the "top-hat" KMER film is removed, leaving a well defined, desired emitter pattern. The emitter stripe is alloyed at elevated temperatures.

4) Base stripe deposition

The ohmic-base contact is fabricated by the same techniques employed for fabricating the emitter. Highly conductive materials such as gold and silver are used in conjunction with the appropriate impurity to provide ohmic contact to the base. The base stripes are then alloyed at elevated temperatures to insure ohmic contact to the base.

5) Fabrication of expanded contacts

A continuous film of SiO_2 approximately 3,000 angstroms thick is deposited onto the slice (this is the second pyrolytic deposition). KMER techniques are employed to cut a window through the SiO_2 film to the emitter and base alloyed stripes.

A relatively thick, continuous film of aluminum is vacuum-deposited on top of the SiO_2 film. KMER patterns in the outline of the desired expanded contact area are placed on the thin film. After the etching of exposed aluminum film and removal of the KMER "top-hat", the expanded contact appears well defined and of the desired shape. These expanded contacts provide large metalized areas for attaching the lead wires, the size of the lead wires no longer being limited by the minimum dimension of the emitter stripe.

The remaining device assembly steps are consistent with those normally used in fabricating germanium mesa devices except that no etching or wet processing is employed.

Design

The capability of fabricating very small active regions in a device with relatively complex geometric shapes permits the design engineer to exploit more fully the capabilities of the basic germanium semiconductor material. The most obvious approaches in improving the electrical device characteristics by geometry are the reduction in emitter area and the use of the interdigitated geometry. The theoretical advantages of even the simple interdigitated geometric pattern of one emitter stripe and two base stripes in comparison to the usual mesa pattern of one emitter stripe and one base stripe has long been understood.

The difficulties associated with providing lead attachment to three rather than two distinct areas,

however, have relegated this structure to small quantity, high cost, experimental laboratory devices. The use of expanded contacts to parallel the individual areas while providing a large region for lead attachment should result in the use of the interdigitated structure in future production device designs.

Prototype unit

A prototype pnp germanium planar epitaxial transistor was designed to demonstrate the capabilities of this type of structure and to evaluate further its production aspects. The designed active areas of the germanium planar device were selected to approximate those of the small germanium mesa device in high volume production. A photograph of the geometric structure is shown on p 63. As seen, the geometric design is an interdigitated structure of comparatively complex active device areas paralleled by means of expanded contacts.

This prototype germanium planar epitaxial transistor was announced by Texas Instruments Inc. at the IEEE meeting in New York last month. The transistor is designated as the TI X-3032 and characterized as a general purpose 1 Gc amplifier/oscillator. The typical high-frequency device parameters obtained in the laboratory are in the table.

The TI X-3032 was not specifically designed to meet the requirements of any particular application. To repeat, the purpose of design was to demonstrate the capabilities and applicability of the basic structure to the 100 Mc to 10 Gc frequency range. It is quite possible, however, that the specific design will find general acceptance in several areas of application. It is considered a general-purpose transistor that can be used in the same circuits as the germanium mesa transistor.

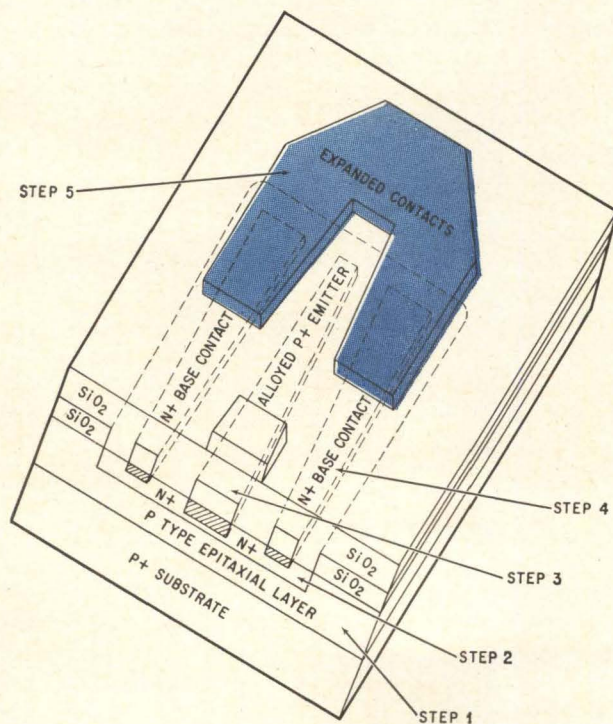

Structure of pnp germanium planar transistor.

Transistor characteristics

f_T	—	750 Mc
f_{max}	—	3,000 Mc
r_b'	—	15 ohms
$r_b' C_c$	—	3.0 psec
CTc	—	3.0 pF
Noise fig.	—	2.5 db @ 200 Mc

Sufficient time has not elapsed to permit any extensive high temperature storage or operating life test data to be accumulated. Early indications are, however, that the reliability is consistent with that expected from silicon dioxide surface passivated structures. The mechanical reliability and the moisture resistance of the planar structure have been proven superior to the mesa structure as had been anticipated. No concrete statement of the device failure rate can be made until sufficient data on all reliability tests is available, however.

The mechanical structure of the device should be greatly enhanced because the expanded contacts permit using large diameter wires for leads. Moisture resistance data shows that the planar structure is exceptionally superior to the ordinary mesa structure where no surface protection is used, such as the silicon dioxide on the planar structure.

Reverse leakage currents are comparable to those found in germanium mesa transistors. Well constructed and carefully assembled mesa devices have reverse leakage currents equal to the theoretical minimum obtainable for a given device area and material resistivity.

The typical mesa structure, however carefully constructed, normally exhibits a certain degree of rounding at the breakdown voltage knee. It has been established that this rounding is caused by surface effects of the unprotected mesa structure. The planar structure, because of its surface passivation from the silicon dioxide film, exhibits extremely sharp breakdown characteristics at the knee (see oscillogram). The breakdown voltages of the planar structure equal or exceed those obtained by the mesa structure for equal values of starting resistivity and the same primary diffusion.

Front cover

Art director Howard Berry has symbolized the germanium planar transistor inserting a representation of the structure into a giant TO-18 can. His representation shows the alloyed p-type emitter stripe and two alloyed-base stripes. The violet area is for the expanded contacts.

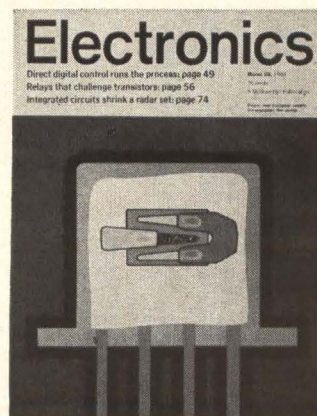

Magnetoresistance: better than Hall-effect multipliers

A new circuit makes this multiplier practical in many applications. It is more efficient than Hall-effect devices currently used in amplifiers and oscillators

By S.F. Sun

Institut für Hochfrequenztechnik, Stuttgart, Germany

Physicists have known for years that the magnetoresistive effect in semiconductors (the resistance of a material changes in a magnetic field) was theoretically more efficient for high (3000) gauss fields than the Hall effect where a semiconductor carrying a current generates a voltage at right angles to the current. The magnetoresistive effect could be especially useful in devices like a multiplier (two input voltages are multiplied to produce the output) but has been impractical because the magnetoresistive element always needed an extra-biasing magnetic field to improve its non-linear characteristics. This extra field posed additional problems. If the field was weak, it did not make the element sensitive enough or linear enough for large signal applications. To make a strong field, an engineer had to design a complex and impractical circuit.

The author



S. F. Sun joined the Institute of High-Frequency Technology, Technical University of Stuttgart, Germany in 1961 as a Research Fellow sponsored by the German research foundation, Deutsche Forschungsgemeinschaft. Since 1954, he has been engaged in the application of solid-state devices at the Swiss Federal Institute of Technology and in industry. He

is currently engaged in research on the microwave application of semiconductors. Dr. Sun received his B.Sc. degree in electrical engineering from the University of Chekiang, Hangchow, China, in 1946; the M.Sc. degree in engineering from the University of London, England, in 1953, and the Dr.Sc. degree in technology from the Swiss Federal Institute, in 1955.

The extra-biasing field is no longer needed, however, if a specially designed push-pull magnetoresistive circuit (page 67) is used. This new circuit basically is a three-dimensional multiplier that can replace any Hall-effect device. It is more sensitive and more efficient than the widely used device. In addition, the magnetoresistive multiplier is easier to adjust than a Hall-effect device and can operate at room temperature.

Particularly in Europe, Hall voltage generators have been put to work in industry because they are simple, economical and reliable. The new magnetoresistive multiplier may well replace Hall devices in such applications as amplifiers, mixers, modulators and d-c transformers.

Theory

The increase in semiconductor resistance influenced by a weak magnetic field may be considered as following the square law, in relation to flux density. In terms of flux density B , the resistance R may be expressed as:

$$R = R_0 + mB^2$$

where R_0 is the initial resistance at zero magnetic field and m in the equation is a proportionality constant.

A magnetoresistive unit consists of a semiconductor placed in the air gap of a magnetic core which has two excitation windings. If two semiconductors with identical properties are used, and are arranged in a bridge circuit (similar to a push-pull amplifier) the external resistance (R_{ex}) is much larger than that of the semiconductors. With one unit subjected to the influence of the sum of two variable magnetic fields, ($B_1 + B_2$), and the other

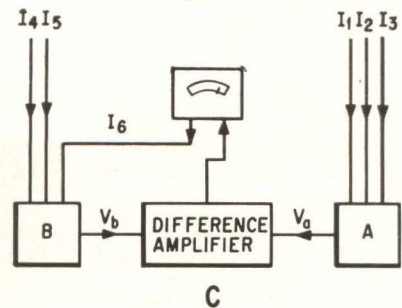
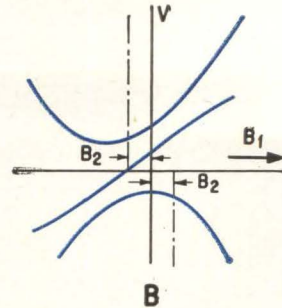
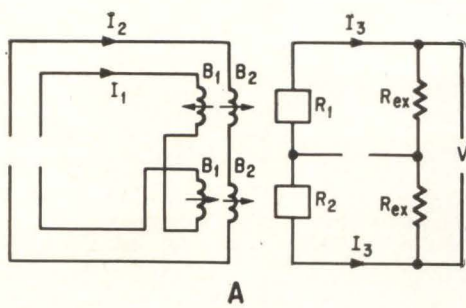

3-D multiplier with input currents representing three parameters and output voltage giving their product (A). Dynamic characteristic curves of bridge (B). Practical circuits relationship (C) of output voltages A and B and amplifier current I_6 can be used to carry out a large number of mathematical operations.

subjected to their difference ($B_1 - B_2$), the resistance of the specimens R_1 and R_2 becomes:

$$R_1 = R_0 + m (B_1 + B_2)^2$$

and

$$R_2 = R_0 + m (B_1 - B_2)^2$$

respectively. Under conditions that the magnetic cores are well below saturation and the core reluctance is negligibly small in comparison with that in the air gap, inductions B_1 and B_2 may be considered as proportional to the excitation currents I_1 and I_2 .

By passing a current of equal magnitude (I_3) through each unit, the voltage difference, V , between the terminals of R_1 and R_2 will be

$$V = I_3 (R_1 - R_2) = 4m B_1 B_2 I_3$$

or

$$V = K I_1 I_2 I_3$$

where K is a constant which includes the factor $4m$ and also takes care of the proportionality between the inducted and the exciting currents. The result is a three-dimensional electronic multiplier whose input currents represent three parameters and whose output voltage gives their product.

The 3-D multiplier may be reduced to a two-dimensional multiplier by keeping one of the parameters B_1 , B_2 or I_3 constant. This parameter will then be used to adjust the sensitivity of the device or to improve the linearity of the composite characteristics. Some examples of practical circuits follow.

Analog computing element

Since the output voltage of the multiplier is proportional to the product of three currents, the output voltages of two multipliers, A and B, can be written as

$$V_A = K_A I_1 I_2 I_3, \quad V_B = K_B I_4 I_5 I_6$$

respectively. If the outputs of multipliers A and B are connected to a difference amplifier, and V_A and V_B will be compared and, as a result, the amplifier will supply to unit B an output current corresponding to I . This current will become stable when V_A is equal to V_B ; it gives the equations:

$$I_6 = (K_A/K_B) (I_1 I_2 I_3 / I_4 I_5).$$

Computing with a magnetoresistive multiplier

$$I_6 = K x = (K_A/K_B) (I_1 I_2 I_3 / I_4 I_5)$$

X	Conditions	Constants	X	Conditions	Constants
I_1	—	I_2, I_3, I_4, I_5	$I_1 I_2 / I_4^2$	$I_4 = I_5$	I_3
$I_1 I_2$	—	I_3, I_4, I_5	$I_1 I_2 I_3 / I_4^2$	$I_4 = I_5$	—
$I_1 I_2 I_3$	—	I_4, I_5	I_1^2 / I_4^2	$I_4 = I_5, I_1 = I_2$	I_3
I_1^2	$I_1 = I_2$	I_3, I_4, I_5	I_1^3 / I_4^2	$I_4 = I_5, I_1 = I_2 = I_3$	—
$I_1^2 I_2$	$I_1 = I_2$	I_4, I_5	$I_1^2 I_2 / I_4^2$	$I_4 = I_5, I_1 = I_3$	—
I_1^3	$I_1 = I_2 = I_3$	I_4, I_5	$\sqrt{I_1}$	$I_5 = I_6$	I_2, I_3, I_4
$1/I_5$	—	I_1, I_2, I_3, I_4	$\sqrt{I_1 I_2}$	$I_5 = I_6$	I_3, I_4
$I_1 I_2 / I_5$	—	I_3, I_4	$\sqrt{I_1 I_2 I_3}$	$I_5 = I_6$	I_4
$I_1 I_2 I_3 / I_5$	—	I_4	$\sqrt{I_1^3}$	$I_5 = I_6, I_1 = I_2 = I_3$	I_4
I_1^2 / I_5	$I_1 = I_2$	I_3, I_4	$\sqrt{I_1^2 I_2}$	$I_5 = I_6, I_1 = I_3$	I_4
I_1^3 / I_5	$I_1 = I_2 = I_3$	I_4	$\sqrt[3]{I_1}$	$I_4 = I_5 = I_6$	I_2, I_3
$I_1^2 I_2 / I_5$	$I_1 = I_3$	I_4	$\sqrt[3]{I_1 I_2}$	$I_4 = I_5 = I_6$	I_3
$1/I_4 I_5$	—	I_1, I_2, I_3	$\sqrt[3]{I_1 I_2 I_3}$	$I_4 = I_5 = I_6$	—
$I_1 / I_4 I_5$	—	I_2, I_3	$\sqrt[3]{I_1^2}$	$I_4 = I_5 = I_6, I_1 = I_2$	I_3
$I_1 I_2 / I_4 I_5$	—	I_3	$\sqrt[3]{I_1^2 I_2}$	$I_4 = I_5 = I_6, I_1 = I_3$	—
$I_1 I_2 I_3 / I_4 I_5$	—	I_4	$1/\sqrt{I_4}$	$I_5 = I_6$	I_1, I_2, I_3
$I_1^2 / I_4 I_5$	$I_1 = I_2$	I_3	$\sqrt{I_1 / I_4}$	$I_5 = I_6$	I_2, I_3
$I_1^3 / I_4 I_5$	$I_1 = I_2 = I_3$	—	$\sqrt{I_1 I_2 / I_4}$	$I_5 = I_6$	I_3
$I_1^2 I_2 / I_4 I_5$	$I_1 = I_3$	—	$\sqrt{I_1 I_2 I_3 / I_4}$	$I_5 = I_6$	—
$1/I_4^2$	$I_4 = I_5$	I_1, I_2, I_3	$I_1 / \sqrt{I_4}$	$I_5 = I_6, I_1 = I_2$	I_3
I_1 / I_4^2	$I_4 = I_5$	I_2, I_3	$I_1 \sqrt{I_3 / I_4}$	$I_5 = I_6, I_1 = I_2$	—
$1/I_5$	—	I_2, I_3, I_4	$\sqrt{I_1^3 / I_4}$	$I_5 = I_6, I_1 = I_2 = I_3$	—

This relationship can be used to carry out a large number of mathematical operations (see table).

Polyphase wattmeter

In electrical power system, the multiplier is modified by a permanent magnet inserted in the core of the magnetoresistive unit. This allows one of the variable magnetic fields to be kept constant. The voltage difference, V , will be reduced to

$$V = (4mB_1) B_2 I_3 = K I_2 I_3$$

If the excitation current I_2 of the variable field is made proportional to the instantaneous phase current, i , of an electrical power network, while the current I_3 through the semiconductor is proportional to the instantaneous phase voltage, so that

$$I_2 = k_i i = k_i I_m \sin(\omega t + \theta)$$

and

$$I_3 = k_e e = k_e E_m \sin \omega t$$

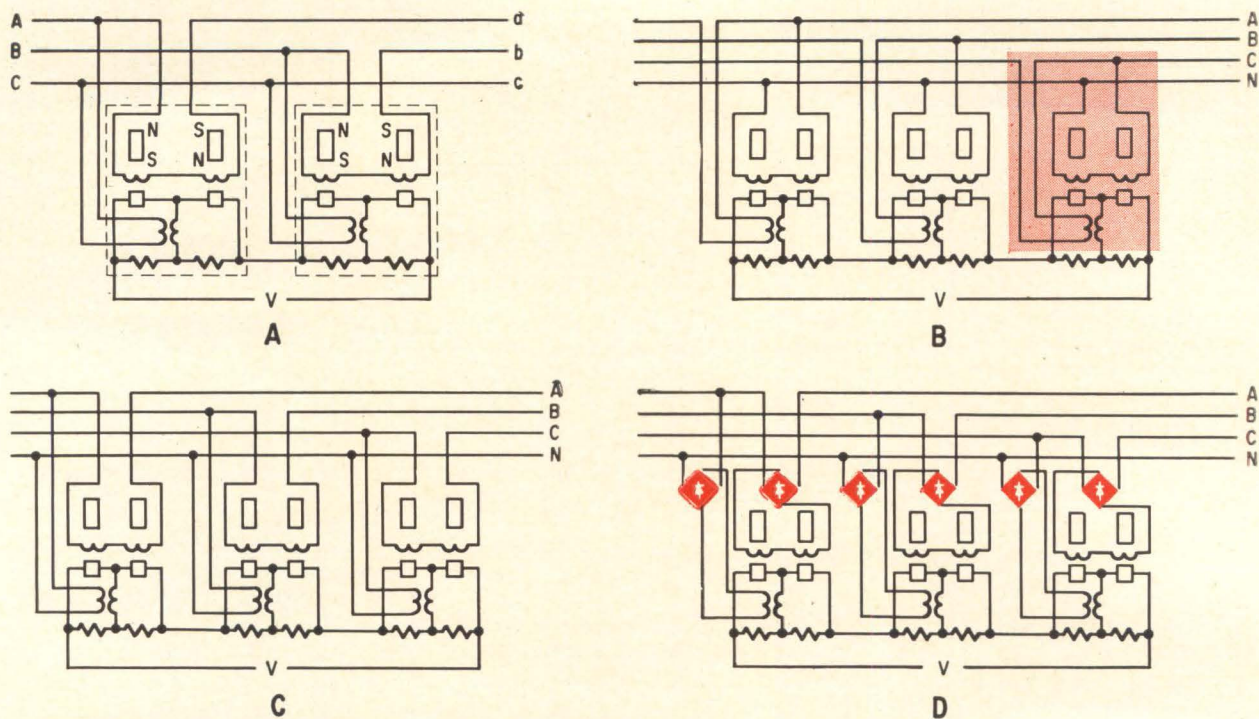

Polyphase wattmeters, (A) and (C), are modified, (B) and (D), to measure reactive power or apparent power

the output voltage of the multiplier will become

$$\begin{aligned}
 V &= K I_2 I_3 \\
 &= -\frac{1}{2} K k_i k_e I_m E_m \cos(2\omega t + \theta) \\
 &\quad + \frac{1}{2} K k_i k_e I_m E_m \cos \theta
 \end{aligned}$$

which consists of an alternating-current and a

direct-current component, the latter being in proportion to the power of the network. It is possible to construct a polyphase wattmeter with a single indication to show the total power consumed in a multiphase system. Take a three-phase network as example; the circuit arrangements are shown with those parts enclosed by the dotted lines as units of a single-phase wattmeter. Since the current in the semiconductor is drawn from the source through a voltage transformer, the output ter-

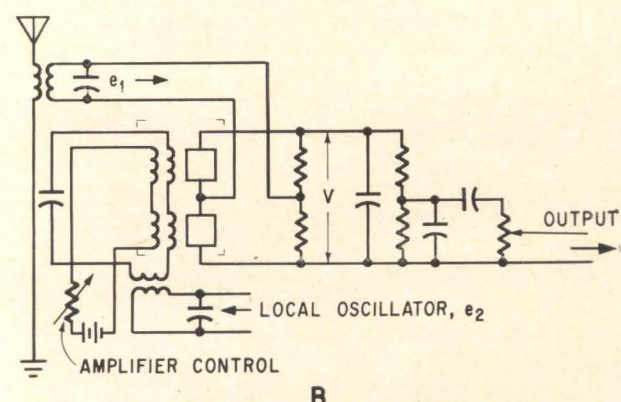
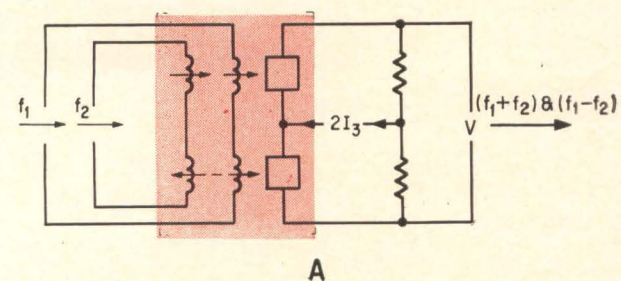

Magnetostrictive elements replace nonlinear elements in mixer circuits (A) and modulator circuits (B) because they can operate in the multiplication model

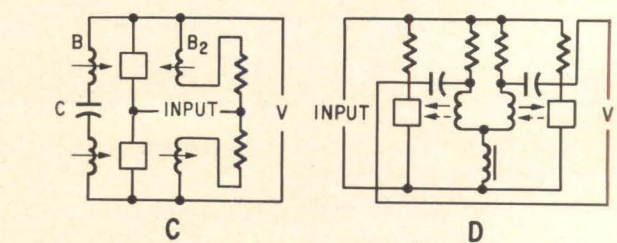
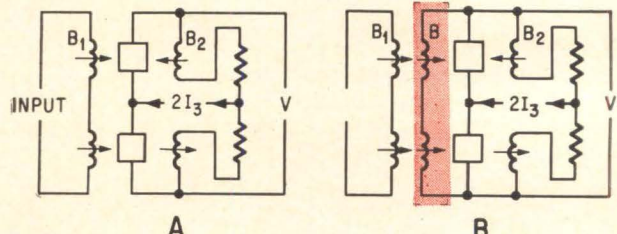

Amplifier in (A) is modified with feedback winding in (B) for a d-c amplifier. If the feedback is equal to or larger than unity and a capacitor is connected between the feedback windings, the oscillator shown in (C) is produced. Two capacitors in tank circuit give oscillator (D)

minals of the units can be joined in series so that the output voltage will be added together and the sum can be indicated by a d-c voltmeter. Modifying the circuit produces polyphase power meters able to measure reactive power or apparent power.

Amplifiers and oscillators

There are many ways to construct amplifiers and oscillators. One of them is to make two of the parameters of the three-dimensional multiplier mutually dependent, for example $B_2 = k I_3$ so that the voltage difference may be rewritten as

$$V = 4mkB_1 I_3^2 = KB_1 I_3^2$$

where the k 's are a proportional constant. An amplifier circuit has the field winding of B_2 in series with the semiconductor and the input is applied to the field winding of B_1 which may have many turns. The amplitude of the output voltage will be controlled by current I_3 and is proportional to its square.

An amplifier is shown with a feedback winding that may produce an induction B , additive (or subtractive) to B_1 . If the mmf (magnetomotive force) required by the magnetic path in the core is negligible, the value of B will be dependent on the air-gap length g , the permeability in the gap μ_a , the resistance of the feedback winding r and the number of turns of the feedback winding N . The voltage difference becomes

$$V = KI_3^2 (B_1 + VN\mu_a/2gr)$$

or

$$V = KI_3^2 B_1 / (1 - KN\mu_a I_3^2 / 2gr)$$

and the output voltage V is increased by the factor of

$$\alpha = 1 / (1 - KN\mu_a I_3^2 / 2gr).$$

This kind of amplifier with feedback arrangement is suitable only for d-c signals.

In the last voltage difference equation, if the feedback term

$$\beta = KN\mu_a I_3^2 / 2gr$$

is made equal to or larger than unity, the circuit becomes unstable and an oscillator can be obtained by simply connecting a capacitor between the two feedback windings and omitting the field winding of B_1 . Frequency f will be determined by

$$f = 1/2\pi \sqrt{LC}$$

with L the total inductance of the windings and C the capacitance. Another example for an oscillator circuit is given in (D) where two capacitors complete the tank circuit.

Mixer, modulator and demodulator

Since all these devices are based upon a process by which the output frequency differs from the input signal, yet is controlled by it, the nonlinear elements, used to achieve this purpose, can be replaced by magnetostrictive elements capable of

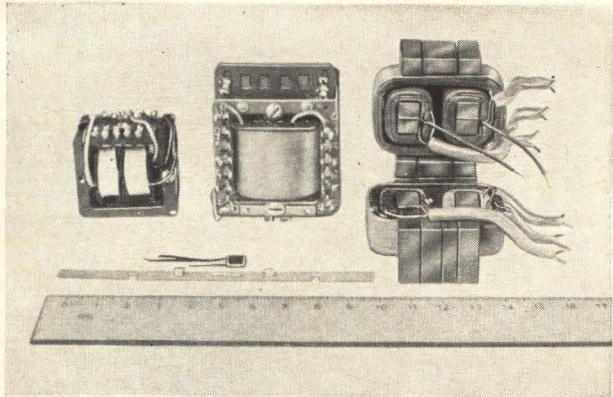

Magnetostrictive elements and three experimental multipliers using them. Two types of magnetostrictive semiconductor elements are shown, one imbedded between two square ferrite plates and the other deposited up on a substrate the size of filament wire.

multiplication operation. Circuit (A) illustrates a three-dimensional multiplier as a mixer. Signals of different frequencies f_1 and f_2 are fed to any two inputs of the three parameters, while the last one supplied with d-c can be used as a means of regulating the amplitude of the output voltage consisting of the components of $(f_1 + f_2)$ and $(f_1 - f_2)$. Eventually the last parameter can also be used as the input of a third signal of frequency f_3 to mix three frequencies.

The principles of modulator and demodulator are similar and explained by an example of a demodulator. The semiconductor bridge circuit (B) receives a modulated signal from input terminals while one of the magnetic fields is tuned to the carrier frequency by means of a resonant circuit and a local oscillator. The third multiplier parameter is the amplitude control element. If the input modulated signal is

$$e = E_1 (1 + M \cos \omega_M t) \cos \omega_c t$$

and the local oscillator supplies to the field winding of a signal of

$$e_2 = E_2 \cos \omega_c t$$

the output voltage of the three dimensional multiplier is

$$\begin{aligned} V &= e_1 e_2 = E_1 E_2 (1 + M \cos \omega_M t) \cos^2 \omega_c t \\ &= \frac{1}{2} E_1 E_2 [1 + M \cos \omega_M t + \cos (2\omega_c + \omega_M) t \\ &\quad + \cos (2\omega_c - \omega_M) t] \end{aligned}$$

The modulating term ($M \cos \omega_M t$) can be filtered out by conventional techniques.

D-C current transformers

This device is suggested for measurement of very heavy direct current. Using the magnetic field of an U-shaped permanent-magnet as the constant bias field the magnetostrictive elements are placed on the pole faces and the whole unit is situated between the d-c bus-bars. With the bridge circuit drawing current from a d-c or a-c supply, the heavy d-c through the bus-bars will excite a magnetic field on the specimens and be measured with a d-c or a-c voltmeter.

If the d-c voltage of the bus-bar supplies current to the bridge, the voltage at the output will be proportional to the power through the bus-bar. However, by means of a quotient-measuring instru-

ment having one pair of its terminals connected to the output of the multiplier, and the other pair connected across the bus-bar voltages the current

in the bus-bar will be indicated by the deflection of the instrument ψ , which is

$$\psi = K V_{dc} I_{dc} / V_{ac} = K I_{dc}$$

This arrangement has the advantage that no extra supply for the bridge circuit is required. Also, the correct value of the direct current is always shown by the instrument without being affected by d-c voltage fluctuations.

Experimental result

The perfection of a three-dimensional multiplier depends mainly on its linearity and sensitivity. With InSB (Indium antimonide) of proper doping as the active element, it is possible to make magnetoresistive specimens with resistance equal to 100 ohms at zero flux density, and about seven times that amount at a flux density of 10 kilogauss. The specimen is reproducible and almost temperature independent within the range of ordinary working temperatures. Characteristic curves of two such magnetoresistive specimens are shown to have identical form when the magnetic field is less than four kilogauss. The three-dimensional multiplier constructed with these elements will have a family of curves which are very linear when B_1 and B_2 are less than four kilogauss but do not go exactly through the origin. This discrepancy can, however, be eliminated by introducing a potentiometer of low resistance between the magnetoresistive elements. If the external resistances R_{ex} are connected together through a potentiometer, and the field circuit of the individual magnetoresistive unit is provided with tunable choke coils, the linearity and symmetry of the characteristic curves can be adjusted. Further adjustment is possible by varying the length of air gap in the magnetic core.

Using a control current $I_3 = 10$ ma and at $B_1 = B_2 = 2$ kilogauss, the experimental multiplier has an output voltage of 1.2 volts. Since the magnetic fields are low, the magnetic circuit can be constructed with small ferrite cores of very narrow air gap, and the indium antimonide which is in the form of a thin film may be deposited directly on the pole face. The multiplier unit can thus be made compact, shockproof and rugged.

Other advantages include lifetime of all parts in the multiplier is practically unlimited; the multiplier is also suitable for high frequency operation up to the megacycle range; and, the output of the multiplier can be used in regulation or telemetering applications.

The efficiency of the magnetoresistive device is always better than that of a Hall effect device when the magnetic field is sufficiently large. To obtain higher efficiency, the magnetic core should be composed of a material other than a ferrite, so that larger flux densities can be applied to the specimen without approaching core saturation.

The author thanks Prof. H. Welker and H. Weiss, Siemens-Schuckertwerke, Erlangen, Germany, for supplying the semi-conducting materials used in construction of the above units.

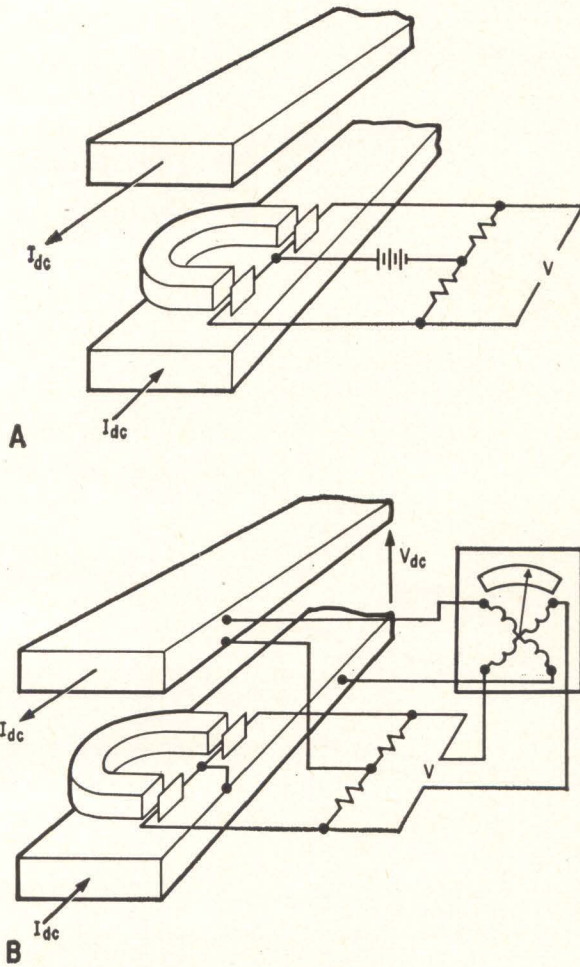

Heavy d-c measurements are possible with circuit in (A) where heavy d-c flowing through bus-bars is measured with d-c or a-c voltmeters. Arrangement in (B) requires no extra supply for the bridge circuit and provides an accurate measurement unaffected by d-c voltage fluctuations.

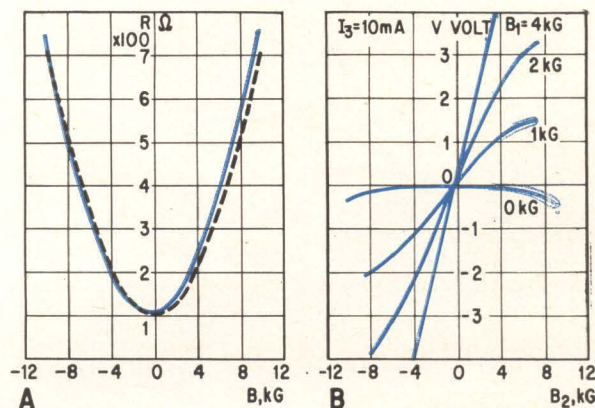

Indium antimonide used in two active elements gives identical curves when the magnetic field under four-kilogauss (A). A 3-D multiplier using these elements gives the family of curves in (B). The curves are linear when variable magnetic fields are less than four-kilogauss.

Design analysis

Simplified r-c ladder network design

With this straightforward technique, non-specialist engineers can design networks to exact specifications without resorting to complicated synthesis methods.

By Charles F. White

U. S. Naval Research Laboratory, Washington, D.C.

Network design by synthesis methods requires complicated techniques with which most engineers, except for a relatively few network design specialists, are not familiar. It begins with knowledge of the desired transfer function (mathematical description of the frequency behavior of network output voltage as a function of the input voltage) from which the appropriate circuit configuration and component values are evolved. If, as a preliminary step, a suitable network configuration can be decided upon, and its response to the desired input voltage analyzed for the purpose of refining the network design, the need for a generalized synthesis is avoided. The component values can be derived by use of the more familiar node or mesh analysis techniques.

The method to be presented is illustrated using a transfer function that is always realizable with a resistance-capacitance network. Such a function may be prescribed by a signal processing requirement or a servosystem equalizer specification. For the latter, the desired transfer function may have been decided upon on the basis of graphical studies using log-magnitude log-frequency (Bode) plots. Or, in the design of highly-complicated multiple-loop systems, an analytical expression for the equal-

izer voltage-transfer function may result from a detailed system study.

Example

The figure illustrates an example of the transfer function specified by an analytic expression in terms of the complex-frequency variables ($s = \sigma + j\omega$; at steady state, $\sigma = 0$, $s = j\omega$) and by a log magnitude log-frequency asymptotic-segment representation. In the notation used, radian frequency is the re-

$$\frac{E_{OUT}}{E_{IN}} = K \frac{(\tau_1 S + 1)(\tau_4 S + 1)}{(\tau_2 S + 1)(\tau_3 S + 1)} = K \frac{(\tau_1 S + 1)}{(\tau_3 S + 1)} \cdot \frac{(\tau_4 S + 1)}{(\tau_2 S + 1)}$$

$S = \sigma + j\omega$; AT STEADY STATE, $\sigma = 0$, $S = j\omega$

NOTE: $\omega_1 = 1/\tau_1$, ETC. $\omega_1 < \omega_2 < \omega_3 < \omega_4$

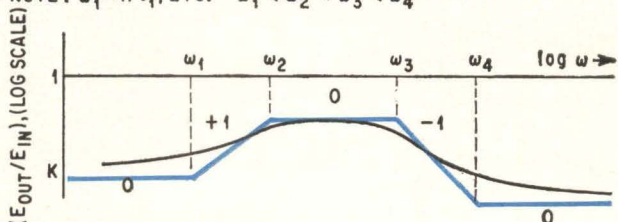

Typical graphical representation of a prescribed transfer function.

reciprocal of time constant, e.g., $\omega_1 = 1/\tau_1$.

With this information, an exact realization of the desired network is possible. First, the overall requirement is divided into separate functions to be realized as a cascaded combination. Second, on the basis of knowledge of the characteristics of frequency-dependent voltage-dividers a selection of networks is made. In the present example, two suitable networks are chosen from the chart of familiar L-section networks shown at right.

Recapitulating, to realize a network with a prescribed transfer function, subdivide the overall transfer function into combinations of elementary forms for which simple network prototypes are known. Next, determine the transfer function of the network formed by cascading prototypes. This is the familiar analysis problem.

Using coefficients

Since the network under discussion is an R-C-only type, a useful simplification may be introduced. As shown in (A), the magnitude of each of the elements of the network is indicated by a literal coefficient.

The a indicates a magnitude of a ohms, the b indicates a magnitude of b farads. If desired, units of megohms and microfarads may be used. This method simplifies calculations as there is no need to use capacitive reactances. It enables the analysis to proceed as though only a resistive network were involved. Only the literal coefficients need be manipulated.

For the network of (A), the voltage transfer function, derived by straightforward network analysis is

$$\frac{E_{out}}{E_{in}} = \frac{d}{a+d} \frac{(absCR+1)(fgsCR+1)}{\left[\frac{abdg(e+f)}{a+d} s^2 C^2 R^2 \right] + \left[\frac{ad(b+g)}{a+d} + (e+f)g \right] sCR + 1} \quad (1)$$

A comparison of Eq. 1 with the prescribed transfer



Charles F. White is a consultant in the equipment research branch, Radar Division, at the Naval Research Laboratory. He is chiefly concerned with weapons systems planning, design and development, specializing in servosystems and networks. He received engineering degrees at the University of California and is currently enrolled at the National War College studying

the military and political aspects of national security. His professional associations include Sigma Xi, Scientific Research Society of America, IEEE, and the American Association for the Advancement of Science. Mr. White is a registered professional engineer in the District of Columbia.

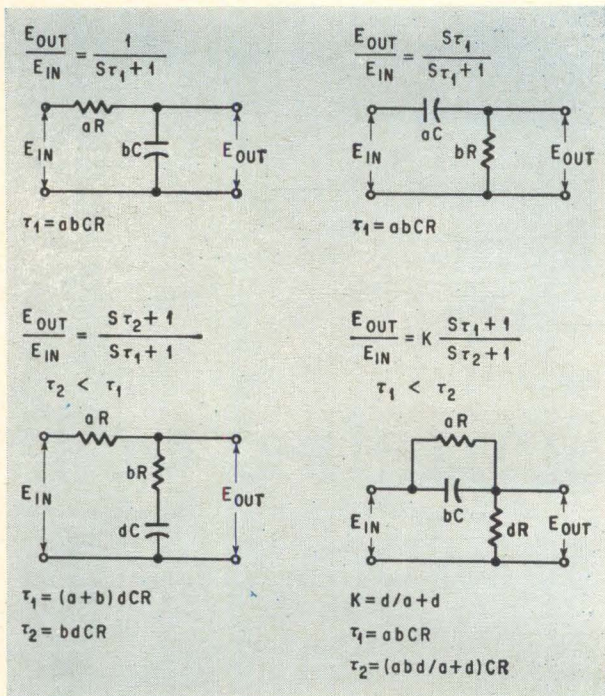

Simple L-section network prototypes and their transfer functions.

function

$$\frac{E_{out}}{E_{in}} = k \frac{(\tau_1 s + 1)(\tau_4 s + 1)}{\tau_2 \tau_3 s^2 + (\tau_2 + \tau_3) s + 1} \quad (2)$$

shows that Eq. 1 is of the desired form, confirming that the network realization is progressing in the desired direction.

Solving network equations

At this point, by direct comparison of Eq. 1 and 2, the coefficients can be equated, producing five equations. Setting $CR = 1$ to avoid complexity,

$$k = \frac{d}{a+d} \quad (3)$$

$$\tau_1 = ab \quad (4)$$

$$\tau_4 = fg \quad (5)$$

$$\tau_2 \tau_3 = \frac{abd(e+f)g}{a+d} \quad (6)$$

$$\tau_2 + \tau_3 = \frac{ad(b+g)}{a+d} + (e+f)g \quad (7)$$

To meet the performance constraints imposed by the specified $\tau_1, \tau_2, \tau_3, \tau_4$ and k , at least five adjustable quantities—the parameters specifying the size of the network elements—must be available. In this case, there is one more element than the minimum number required so one parameter must be selected. For this example the capacitance specified by the parameter g is arbitrarily chosen.

The final step in the network realization is the simultaneous solution of Eq. 3 through 7 in terms

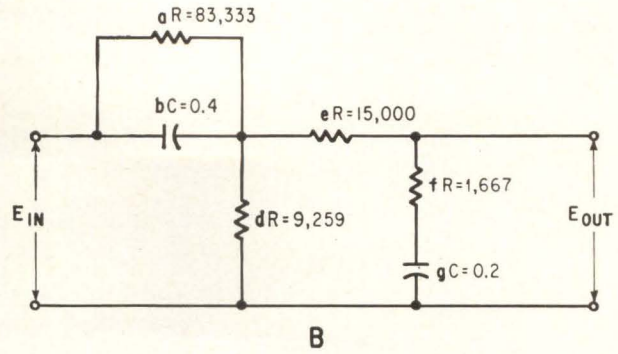
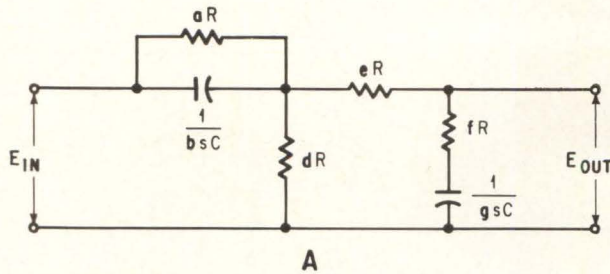

$$\frac{E_{OUT}}{E_{IN}} = \frac{(\tau_2 S + 1)(\tau_4 S + 1)}{\tau_1 \tau_3 S^2 + (\tau_1 + \tau_3)S + 1} = \frac{\tau_2 S + 1}{\tau_1 S + 1} \cdot \frac{\tau_4 S + 1}{\tau_3 S + 1}$$

NOTE: $\omega_1 = 1/\tau_1$, ETC. $\omega_1 < \omega_2$, $\omega_3 < \omega_4$

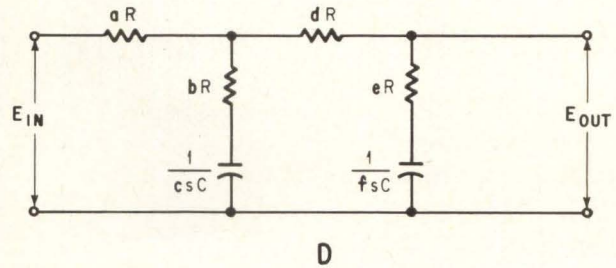
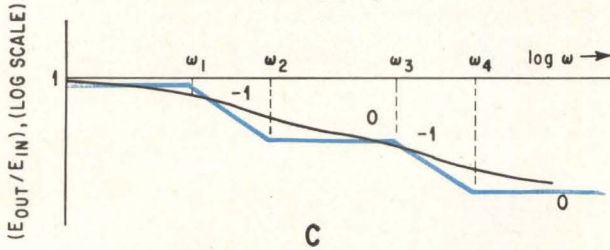

Cascaded combination of two L-sections (A) forms a network which is a physical realization of the transfer function described on p 71, when the element values are properly chosen. With the values shown in (B), the network solved a telemetry problem. A change in the order of pole-zero combination (C) results in the network (D).

of the parameter g and the five prescribed performance constraints. The desired network equations are

$$aR = [\tau_2 + \tau_3 - (\tau_2 \tau_3 / \tau_1 k) - \tau_1 k] / kgC \quad (8)$$

$$bC = \tau_1 kgC / [\tau_2 + \tau_3 - (\tau_2 \tau_3 / \tau_1 k) - \tau_1 k] \quad (9)$$

$$dR = [\tau_2 + \tau_3 - (\tau_2 \tau_3 / \tau_1 k) - \tau_1 k] / (1 - k) gC \quad (10)$$

$$eR = [(\tau_2 \tau_3 / \tau_1 k) - \tau_4] / gC \quad (11)$$

$$fR = \tau_4 / gC \quad (12)$$

Note that a direct solution for the roots of the quadratic in Eq. 1 was not required. This convenience will be especially appreciated by the designer in the realization of functions of a higher degree, where cubic, quartic, and higher-order terms invariably appear.

Frequency scaling

The steady state performance characteristic of the network of (A) may be regarded as centered at the geometric mean frequency $\omega_c = \sqrt{\omega_2 \omega_3}$. A specification based upon $\omega_c = 1$ radian per second permits easy translation by "frequency scaling" to any desired center frequency. In a recent telemetry research problem, the same network performance was desired at each telemetry subcarrier frequency. With a center frequency of 1 radian per second, the normalized specifications called for $k = 1$, $\tau_1 = 10$, $\tau_2 = 2$, $\tau_3 = 0.5$, and $\tau_4 = 0.1$. Using the values $R = 1$, $C = 1$, and $g = 2$ in Eq. 8 through 12, the following parameter values resulted: $a = 2.5$, $b = 4.0$, $d = 0.2778$, $e = 0.45$, and $f = 0.05$. For one of the center frequencies, $\omega = 300$ radians per second, the 300:1 frequency-scaling ratio was

introduced by dividing all resistance parameters by 30 and all capacitance parameters by 10 (equivalent to an original choice of $R = 1/30$ and $C = 1/10$). The network element values to produce the desired $k = 0.1$, $\omega_1 = 30$, $\omega_2 = 150$, $\omega_3 = 600$, and $\omega_4 = 3000$ are shown in (B).

If instead of the zero-pole-pole-zero sequence of the transfer function of (A) the requirement was for a pole-zero-pole-zero combination as shown in (C), then a suitable network is represented by the circuit (D). (Poles and zeros are the values of s at which the transfer function goes to infinity or zero, respectively.) By applying the same procedure the reader may confirm the design equations derived for this example:

The arbitrarily chosen parameters will be c and f . The value of d can be found from the relation:

$$d^2 cf^2 = d cf [(\tau_1 - \tau_4) + (\tau_3 - \tau_4)] + c (\tau_1 - \tau_4). \quad (13)$$

Further,

$$(\tau_3 - \tau_4) - f (\tau_1 - \tau_2) (\tau_2 - \tau_3) = 0 \quad (14)$$

$$a = \frac{\tau_1 \tau_2 - \tau_2 \tau_4 - f \tau_2 d}{f \tau_2 + c \tau_4 + cfd} \quad (15)$$

$$b = \tau_2 / c \quad (16)$$

$$c = \tau_4 / f \quad (17)$$

Although the examples used in this article were confined to the R-C network for the sake of simplicity, the method applies equally well to networks containing inductive components.

- One-transistor operational amplifier
- Monostable multivibrator with constant pulse width
- Accurate voltage regulation regardless of temperature

Designer's casebook is planned as a regular feature in Electronics. Readers are invited to submit novel circuit ideas, packaging schemes, or other unusual solutions to design problems. Space is limited, so keep them short. We'll pay \$30 for each item used

Operational amplifier suppresses third harmonic

By Mel Schmidt

Giannini Controls Corp. Duarte, California

This simple, active network for 400-cps servosystems uses only one transistor, gives an accurate 90° phase shift at the carrier frequency. It keeps third harmonics 20 db down. The circuit uses standard 2% inductors and 5% capacitors.

The single-stage transistor amplifier provides adequate gain. The open-loop gain varies between 34 db (50 times) using a 2N332 with a beta (h_{fe}) of 9, to 43.5 db (150 times) using a 2N338 with a beta of 90. A 2N333 is chosen as a compromise.

The stabilization factor is less than two for this circuit. If only one source of supply voltage is available instead of the two sources shown, a voltage divider can be used at the base. In this case the emitter resistor is connected to ground. Feedback from the collector to the base should not be used for stabilization, as it will decrease the open-loop gain of the circuit and the Q of the network.

If L-C₁ is made series resonant at 1,200 cps, the output voltage will tend to zero at this frequency, giving third-harmonic suppression.

Below 1,200 cps, the impedance of L-C₁ is capacitive, above 1,200 cps it is inductive; thus the circuit contains an equivalent capacitance at 400 cps, giving the required 90° phase shift.

Above 1,200 cps, the output voltage will rise with frequency, and all harmonics above the third

will be amplified. To avoid this, capacitor C₂ is placed across the inductor, and the resulting Foster-type network can be analyzed readily. Having set the first zero to occur at 1,200 cps, the second pole can be chosen anywhere above 1,200 cps; if this pole is set to occur below 1,600 cps, the fourth and all higher harmonics can be attenuated.

The last circuit parameter to choose is the value of the reactance at any frequency. It is convenient to adjust the capacitive reactance at 400 cps to equal R, and thus achieve unity gain.

One-shot multi produces constant pulse width

By Roger T. Stevens

Sanders Associates, Inc., Nashua, New Hampshire

This monostable multivibration is capable of maintaining pulse width constant to better than ±0.5% from -65 to +110° C.

A new circuit was conceived in which the number of temperature variables and the effect of their variation would be decreased. Using a differential amplifier for Q₂ tends to stabilize the base voltage for turn-on of Q₂ near ground, since changes in the base-to-emitter voltage of each half of the amplifier tend to be the same.

In the conventional monostable multivibrator (without Q₃ and Q₄, and with a single transistor at Q₂), when Q₁ turns on and lowers the voltage at the left side of timing capacitor C₁ by nearly the amount of the supply voltage, the right side of the capacitor instantaneously drops the same amount, but then almost immediately rises as it dumps current into the low input impedance of Q₂, while shutting it off.

The amount of current determines to just what voltage the right side of the timing capacitor will rise before orderly charging begins, and this amount varies widely with temperature. The differential amplifier, which has high input impedance at all times, completely eliminates this variation.

By using constant-current-charging transistor Q₃, the charging voltage is made to appear much larger than the actual supply voltage. This reduces the effects of small voltage variations in the transistors.

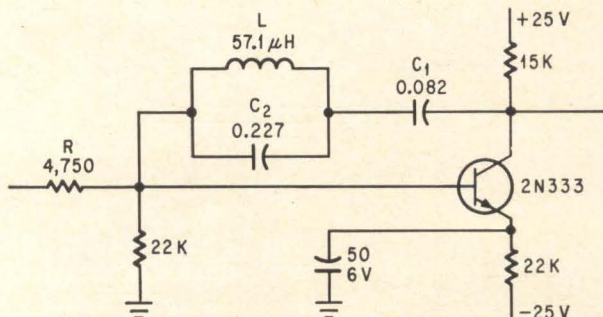

One-transistor operational amplifier is resonant at 1,200 cps and antiresonant at 1,400 cps.

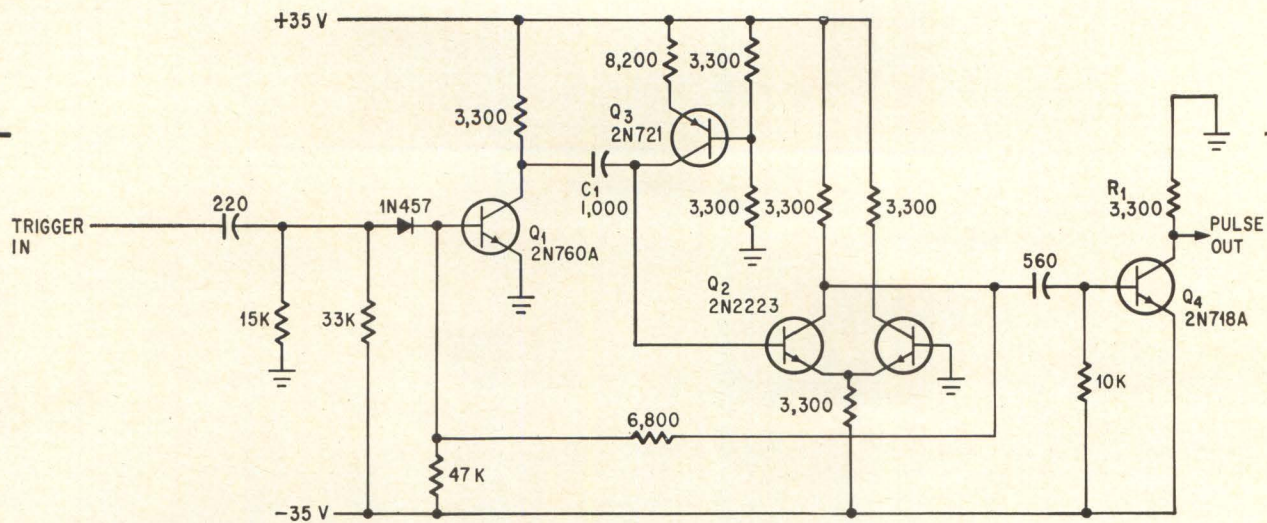

One-shot multivibrator maintains pulse width within ± 0.5 percent despite wide temperature variation.

Switching transistor Q_4 provides a pulse with a base line always at ground (neglecting the negligible 10-na drop of the $Q_4 I_{co}$ through R_1) and with

an amplitude of almost $+35$ volts; Q_4 also isolates the regenerative portion of the circuit from the output.

A high performance voltage regulator

By A. Dargis

Johns Hopkins University, Applied Physics Laboratory, Silver Spring, Md.

Among the features of this regulator circuit are the elimination of temperature compensation, the fact that only 1.5 ma are consumed by the regulator, starter and zener circuits, and that no starting resistor changes are required for different loads.

Transistors Q_1 and Q_2 form the starting circuit. When the input voltage is switched on, Q_2 supplies base current to Q_4 until the regulated bus to which the collector of Q_4 is connected reaches 7 v . Then D_1 starts conducting and Q_1 is turned on. The collector current of Q_1 raises the voltage across R_3 until the Q_2 emitter-base junction is reverse biased, stopping collector current flow to Q_4 . D_2 ensures this cutoff. At this point, the voltage comparison circuit supplies the proper base current to Q_4 .

The differential amplifier stage is a 2N2642 matched transistor pair, functioning as a voltage comparator with an FCT 1021 zener diode as a reference. R_9 adjusts the zener current and R_7 facilitates measuring. R_{11} equalizes the two V_{BE} voltages of Q_5 . Q_6 converts voltage to current.

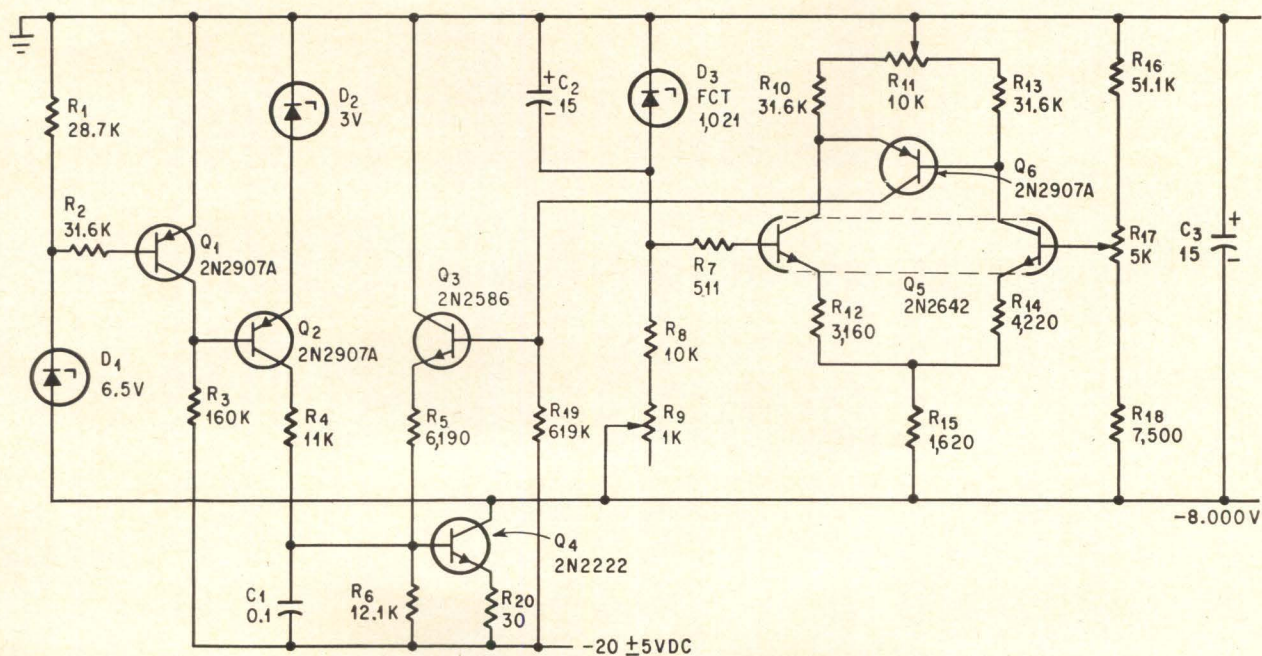

During tests this regulator's output remained within ± 0.1 percent under wide range of parameter variations.



Tuned magnetron being examined by S. Ameen (right) is tuned by motor held by J. Butler (left) while the author looks on. All are section heads at Raytheon's Spencer Laboratory.

Microwaves

New magnetron shifts frequency fast

Random frequency agility by rotary tuning gives radar systems nonrepetitive frequency patterns that deny electronic countermeasure information to enemy

By Robert E. Edwards

Spencer Laboratory, Raytheon Co., Burlington, Mass.



Radar applications often require rapid and continual shifting of frequency (called "frequency agility") to avoid jamming by the enemy, to reduce mutual interference with friendly sources, enhance echoes from targets or provide necessary patterns of ecm (electronic countermeasures) or eccm (electronic counter-countermeasures) radiation. In a typical case, with a rotary-tuned magnetron, no pattern of repetition occurs within 20 minutes.

The rotary-tuned magnetron, just developed, is several orders of magnitude better than existing devices for producing this ability to shift frequency rapidly. The tube resembles conventional magnetrons used as high-power radar oscillators but it has a slotted disk added above the cylindrical cavities of its anode block. The disk is attached to a shaft that is magnetically coupled to a driver motor outside the tube. When the disk is spun, the moving slots alternately vary both the inductance and capacitance of the anode. This produces a relatively wide frequency sweep.

Previous methods

Until now, there were two principal means of

shifting frequency: (1) the reciprocally finger magnetron using a servo-tuned hydraulic actuator (2) cascaded broadband r-f amplifiers.

The hydraulic servo-tuned magnetron will still be useful where a single high-power oscillator tube is to be swept in frequency at rates no higher than 100 cps. With the new tube, the speed of frequency shifting is 10 to 50 times as fast. The chains of broad band r-f tube amplifiers that generate various frequencies at low power level for amplification before delivery to the antenna are required by more sophisticated ecm developments. But such chains often become prohibitively expensive and also introduce a multiplicity of circuits that tend to reduce over-all reliability.

The rotary-tuned magnetron is a major step toward faster tuning with simpler, less costly equipment. Radar systems employing this device exhibit the typical performance advantages of frequency agility, eliminating mutual interference to friendly radar and enhancing echoes from targets. Yet these performance advantages are achieved with equipment that can be made small enough that it can be readily transported even by air. Furthermore, the tube and associated circuits are simple enough to permit existing radar systems to be modified in the field.

Interpulse bandwidth

The new tuners can be used in high-power pulsed magnetrons, so that multimegawatt radars with a single fast-tuning r-f transmitter tube are feasible. Tuning speed is so rapid that the tube can be tuned over eight percent of its center frequency in the period between radar pulses.

The inherently high efficiency of the magnetron type of oscillator is retained. Yet the complexities of the drive devices of earlier tuners or of frequency switching equipment are avoided. Instead, the tube uses a simple, variable-speed rotary-drive motor. Life and reliability are further increased because the forces encountered in the continuously rotating tuner are lower than those encountered in the high-speed reciprocating devices formerly used. There is no short-lived flexible bellows required in the tuner assembly.

Construction

The new tube looks like a conventional tunable magnetron. It has a ceramic high-voltage bushing, a ceramic output assembly and permanent magnets. The rotary tuner is located at one end of the tube in the normal geometry (shown). A relatively small fractional-horsepower motor rotates the tuner.

A small control box provides power and speed control for the motor. This control achieves frequency agility of the r-f output. The motor is outside the tube and torque is applied through a commercially available magnetic coupling. A major portion of the coupling is located outside the tube and is removable, so it is unnecessary to provide a complete magnetic coupling unit with each tube.

The basic concept of the rotary tuner is that the

frequency of oscillation of a magnetron may be changed by continuous rotation of a slotted disk suspended above the resonant cavities of the tube. In the conventional reciprocating magnetron tuner, the magnetron's oscillating frequency is changed by an axial motion of pins or tuning fingers in and out of the resonant cavities as shown.

In a slow, manually tuned magnetron the tuning plunger and fingers are moved up and down with a tuning screw and gear arrangement. However, hydraulic servos have recently been used to increase the cycling speed. The motion is transferred through the vacuum wall by the use of a thin flexible metal bellows that forms part of the vacuum envelope of the tube.

The rotary tuner at the right consists of a slotted disk rotating above the anode cavities. As the alternating slots and metallic segments of tuning disk pass over the successive anode cavities, the composite inductance and capacitance of the anode resonant circuit is varied, causing changes in the frequency of oscillation. The combined LC tuning effect, in which inductive tuning occurs for one portion of the cycle of rotation and capacitance tuning occurs over the remaining part of the cycle, results in a wider tuning range than would be possible with either separate L or C tuning alone.

Tuning speed

One complete cycle back and forth across the available tuning range occurs each time the disk is rotated past a cavity. Thus, for a ten-cavity magnetron, ten complete cycles each way across the range are obtained for each complete rotation of the tuner. As a result, the effective tuning speed of rotary-tuned magnetrons is high.

The tuner is suspended from bearings inside the tube, and is rotated by the magnetic coupling shown. The tuner disk is shown as supported from the outer edge in the sketch or from the inner edge in the photograph. The choice is dictated primarily by considerations of end cavity resonances, tuning range and mode separation.

The three tubes shown represent L-band, S-band and Ku-band versions of the design. From the cross sectional view it is seen that rotary tuners can often be installed in magnetrons without need for other internal design revisions. The anode, cathode r-f output and magnet designs may remain generally the same as in the basic prototype tubes.

The bearings supporting the tuner are capable of speeds up to several thousand rpm in a vacuum and must be unaffected by the 500° C bakeout temperatures used in processing the tubes.

Several different designs of bearings were considered. Among them were specially treated ball bearings, impregnated graphite, and glazed ceramics. The ball bearings used in the L-band magnetron have been extensively tested at speeds up to 10,000 rpm and have operated continuously at 3,000 rpm for many thousands of hours. The bearings are not a limiting factor in any of the rotary tuners tested.

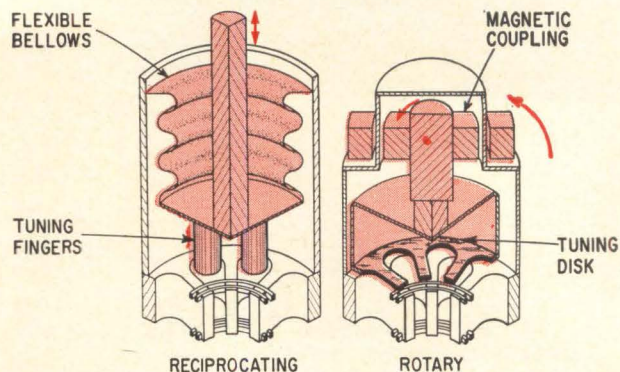

Rotary tuner (right) compared with reciprocating type (left) shows tuning disk that does not come into physical contact with magnetron slots as so the tuning fingers of the bellows-driven reciprocating tuner.

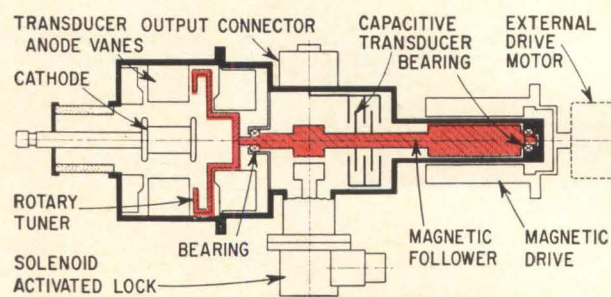

Solenoid lock shown at center of cross-section drawing holds tube at fixed frequency. Capacitive transducer indicates the approximate frequency to the receiver local oscillator.

A solenoid-activated lock or brake can be used to hold the frequency fixed. This brake avoids any possibility of motion or wandering of the tuner angular position, although the magnetic drive coupling is sufficiently rigid to prevent tuner angular motion under average conditions of shock or vibration.

Feedback indicator

There must be some indication of the approximate frequency of the magnetron so the receiver local oscillator can be preset to the correct corresponding frequency. One method utilizes a capacitive feedback transducer with a meshing set of capacitive plates in which the capacitance variation as a function of angular rotation is adjusted to resemble the frequency tuning curve of the magnetron. One set of capacitive plates is attached to the tuning shaft while the other set remains stationary.

These capacitive plates are divided into the same number of segments as the number of anode cavities in the magnetron, thus producing one capacitive cycle for each frequency tuning cycle. This capacitance variation is fed to the receiver local oscillator as an indication of tuner position and output frequency at any instant.

The tracking of the feedback transducer with the tuning curve of the L-band magnetron is shown. For this ten-vane tube, one half of a tuner cycle

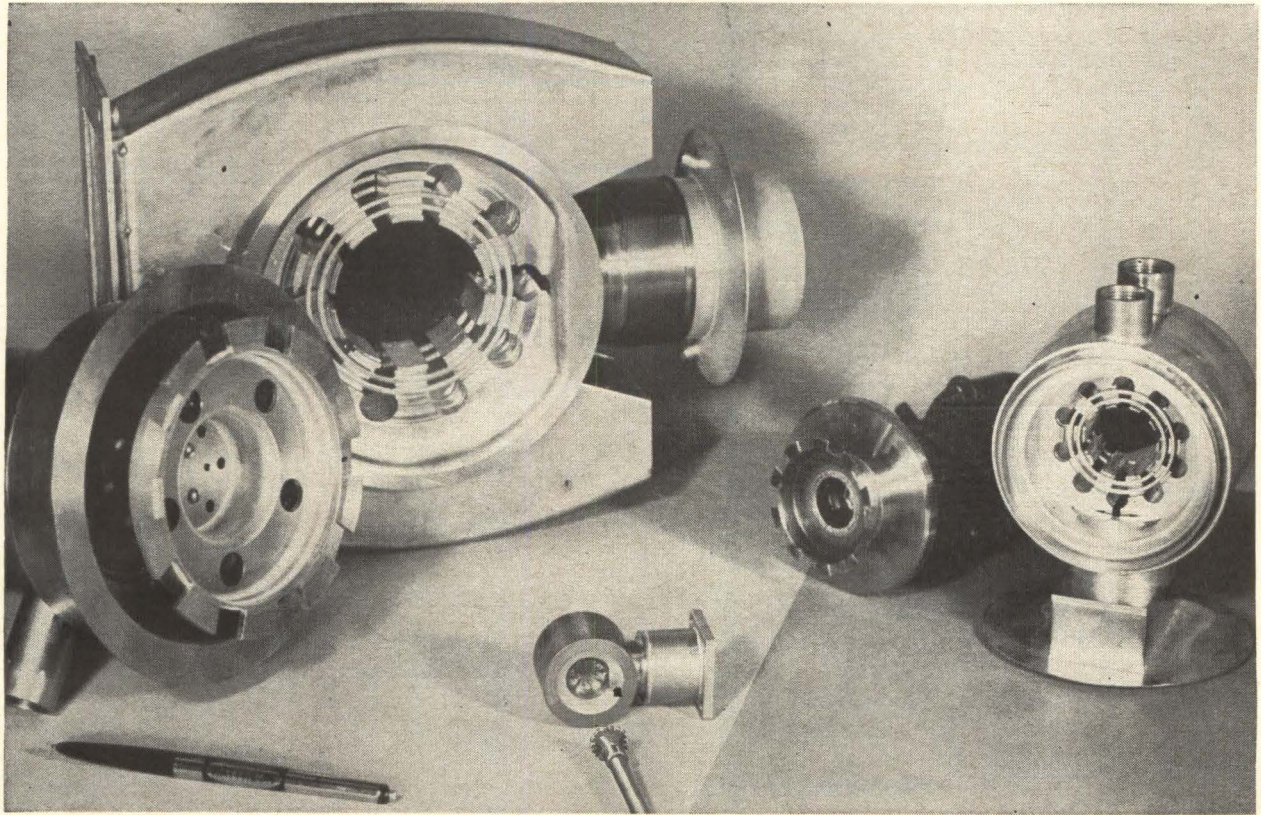

Tuning is accomplished by rotating the toothed wheels relative to the anode structures. Subassemblies shown are for the L,S and Ku bands.

(across the frequency range in one direction) occurs in 18° of shaft rotation, corresponding to movement past one half of an anode cavity.

While the total frequency excursion of the L-band tube is presently rated as 100 Mc (1,250 to 1,350 Mc), bandwidths up to 200 Mc have been achieved in special cold test models—working at very low power. Bandwidth is influenced by many factors, such as shape of slots in the tuning disk, various characteristics of the anode design and tuner-to-anode spacing. For instance, the 100-Mc range of the L-band tube can be increased to 130

Mc by decreasing the spacing from 0.050 to 0.030 inch.

The main limitations thus far encountered with rotary tuners are similar to those of the conventional reciprocating-finger type of magnetron tuners. Care must be exercised in the tuner-to-anode spacings and in the thermal design of the tuner. Excessively close spacings could introduce r-f arcing at high power levels.

Thermal expansion and heat distribution in the tuner components must be optimized by selection of appropriate materials. As with the finger-type tuners, the problems of arcing and heat dissipation factors become more critical at the higher operating frequencies, where tube dimensions scale down so that spacings and areas are relatively small. However, solutions to these problems have been worked out even for a Ku-band tube.

Special shaping of the tuning curve can be accomplished by modifying the shape of the tuner plate and the anode cavities to provide waveforms that are somewhat trapezoidal or triangular in shape. Manipulation of the tuning curve may make these magnetrons useful in pulse compression and frequency-scan radars.

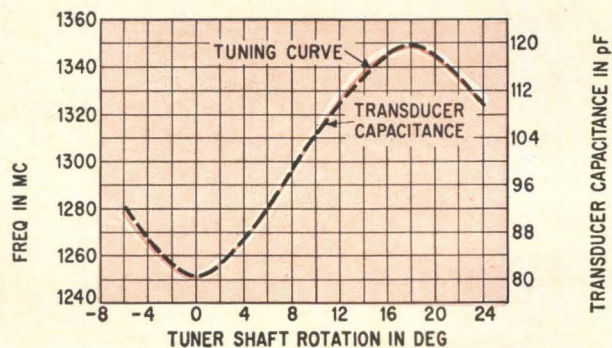

Transducer capacitance and tuning curves for a ten-vane L-band magnetron show close correspondence.

Pulse vs speed

Frequency changes in a radar using a rotary tuned magnetron are obtained by changing either

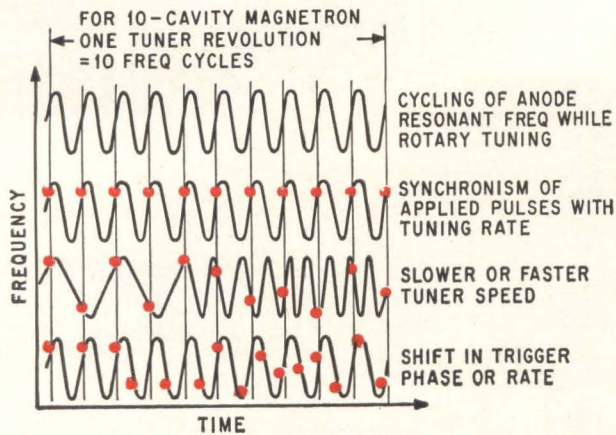

Frequency agility with rotary tuners shows the varied effects of changing both tuner speeds and shifting trigger phase contrasted with holding synchronism.

speed or pulsing rate. As the tuner is rotated, the magnetron's resonant frequency is continually cycled back and forth across the full available tuning range, as shown. If the pulses applied by the radar transmitter are synchronized with the tuner rotation rate, constant output frequency is obtained on each pulse.

Rotation speeds faster or slower than the synchronous value will result in various output frequencies on successive pulses. The radar pulse repetition rate can remain constant if desired. With higher rotational speeds, more than one frequency cycle can be made to occur in the interpulse interval. By proper selection of the tuner speed or by continuously varying it with a coded signal or a random noise source, random output frequencies can be obtained. This condition may be required to prevent enemy analysis of jamming. In one typical case where a rotary tuner was evaluated in a radar system under conditions of constant pulse rate and noise-controlled variable tuner speed, it was found that no pattern of repetition occurred over a period of 20 minutes—the duration of the detailed signature analysis.

Frequency agility can also be obtained by varying the trigger phase or pulse repetition rate of the radar while maintaining constant tuner rotational speed, a technique made practical by the high tuning speed. The cycling rate of the tuner is constant, but the modulator pulses are applied at various time intervals along the tuning curve.

This method also offers a high degree of random frequency agility, although changes in duty cycle or shortening of the interpulse interval (affecting range) must be handled in a manner that does not deteriorate system performance. It is often more desirable to obtain agility by changing speed, especially when existing radars are modified with rotary tuners. The modulator trigger circuits need not then be disturbed. The necessary system changes involve only installation of a rotary-tuned tube in place of the previous magnetron, addition of the

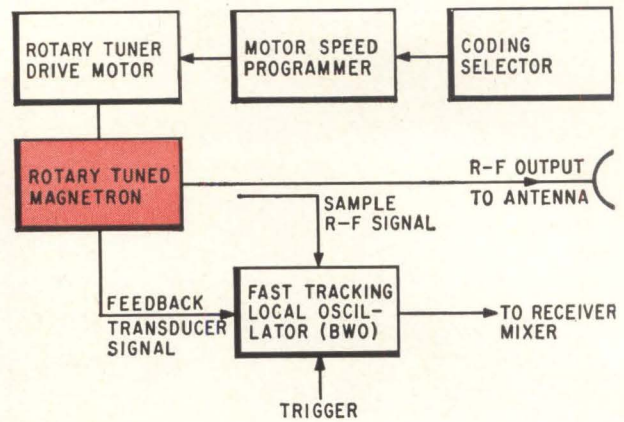

System of rotary tuning that might be applied as a modification kit for an existing radar.

drive motor and its speed controller and revision of the local oscillator circuit. Such changes can be performed in the field.

Interpulse sweep

A full excursion across the frequency range of the tube—and even back again—can easily be achieved between pulses while using moderate tuner rotation speeds. Tuning rates up to 2,000-Mc per second can be achieved at X band on Ku band by this technique. This speed is ten times faster than is presently attained with X-band hydraulically tuned magnetrons. The L-band tube tunes 50 times faster than its hydraulically tuned counterpart. The difference results largely from the use of continuous rotation rather than reciprocating motion. Also, several tuner cycles occur for each revolution of the tuner around the anode.

Hydraulic tuners still are sometimes preferable to rotary tuners. For example, a hydraulic tuner is better when a stable fixed frequency is desired for several pulses, shifting to a new stable frequency for the next group of pulses.

The elements required for a rotary tuning system modification are illustrated. The main building blocks are the tube, its tuner drive motor, a speed control and the tracking circuits. Initial feedback information from the capacitive transducer of the magnetron is used for preliminary lock-on of the local oscillator and the r-f output signal from each pulse is sampled for final lock-on, the oscillator being held at this frequency until just before the next pulse is applied.

Standard O-type backward wave oscillators have been used for tracking the rotary-tuned magnetrons.

Applicational advantages

High speed frequency agility offers ecm for both old and new radar systems, thus adding a capability that can extend the useful life of many existing radars simply and inexpensively.

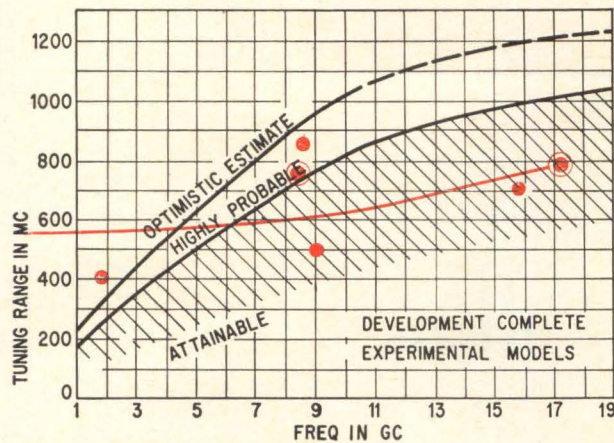

Projected tuning ranges based upon a completed rotary tuning development and three experimental models shows probable tuning range of better than 1 Gc at 19 Gc.

Another advantage is production of enhanced target echoes. With a fixed frequency radar or a slowly tuned system, the many components of the r-f echo from the target can return in an unfavorable phase relationship resulting, under certain circumstances, in weak target indication. With frequency agility, a so-called scintillation effect occurs, in which some pulses at favorable frequencies result in strengthened echoes and the over-all average of the echo return is increased. To ensure high detection probabilities, it is best to see that there are both good and poor phase relationships for each scan and that the varying frequency ensures a good average. For a detection probability of 85 percent, performance equivalent to an increase of 6 db in transmitter power has been calculated and confirmed by tests with frequency agility at L-band. High detection probability is thus achieved at longer ranges than with single-frequency radar.

With increasing numbers of radars and other electronics equipment in the field today, mutual interference between these systems has become commonplace. Nearby radars often interfere with each other, requiring shifting of operating frequency. Tests conducted with adjacent radars in which the frequency of one system could be varied at a high speed have shown that mutual r-f interference is greatly reduced. Seldom does an output pulse from the frequency agile radar fall at exactly the proper frequency to be detected by the adjacent radar. When it occurs, it is only as a single pulse rather than a succession of pulses that produce a strong false-target indication on the display tube.

System reliability is increased by the fact that only one r-f transmitter tube is now needed instead of a chain of high-power devices. Reliability is enhanced in as much as only a single modulator is needed and because the tuner drive and control circuits are simple with actuation accomplished by only a variable speed motor and magnetic coupling. The new elements cost less, are smaller and weigh less than comparable devices. With the continuous

tuner rotation, acceleration strains are minimized and there is no flexible vacuum seal or bellows to limit the life of the tuner.

In addition, the common system problem of false-target indication from second-time-around echoes (distant targets whose echoes return during the next successive receiving interval) is completely eliminated. The receiver local oscillator frequency remains constant for only a single interpulse interval, and any late echoes from previous pulses at other frequencies are rejected.

Present capability

Construction of rotary-tuned magnetrons was begun with ultrahigh frequency (400 Mc) devices. The first tube was operated at a power level of about 1 megawatt across a 15-megacycle tuning range. Tubes have since been operated at several other frequency bands, as indicated. The curve shows the tuning ranges known to be attainable, and also illustrates the maximum tuning range to which these designs may be extended by further development.

The completed L-band tubes that have undergone extensive systems testing are presently capable of about 100 megacycles tuning range (although up to 200 Mc has been observed in special cold test models). The S-band tubes can tune 200 Mc at a power level of several megawatts, and the Ku-band tubes provide 60 kw over a 500-Mc range at present. The tests at uhf, S-band, and X-band have been primarily in the nature of feasibility studies. In each case operable tubes have been built to demonstrate that rotary tuners would be effective and practical in these frequency bands.

The author



Robert Edwards is an engineering section head in the magnetron laboratory of the Raytheon Microwave and Power Tube Division. He has been responsible for the development of numerous high-power pulsed magnetrons, stabilized magnetrons, rapidly tunable tubes using hydraulic servos, initial rotary tuner development, research for

high-temperature magnetron applications and basic studies on rfi reduction. He has also performed product engineering on infrared detectors, and some of the early development work on Amplitron and Stabilotron devices.

After graduation from Union College with the degree of B.S. in E.E. he was employed at Western Electric on the development of military communications equipment. During two years in the U. S. Naval Reserve, he studied radar, sonar and electronic countermeasures at M.I.T. and Harvard University. He served as an electronics specialist officer at the Naval Research Laboratory and as assistant electronics officer with the Columbia River Group. While working at Raytheon, Edwards has done graduate work at Northeastern University, Boston. He is registered professional engineer in Massachusetts, a senior member of the IEEE, and a member of the IEEE Professional Groups on Electron Devices and Military Electronics.

Automatic tv tracker keeps eye on missiles

Two vidicon cameras automatically track high-speed aircraft, missiles in the launching phase of flight and targets re-entering the earth's atmosphere. Their accuracy is superior to that of radar.

By John R. Kruse

Head, Electronic Engineering Section

Defense and Space Div., Barnes Engineering Co., Stamford, Conn.

Recently increased interest in television trackers for guided missiles is attributed, primarily, to the fact that they have demonstrated higher accuracy than radar and that they have certain advantages over devices using infrared techniques. Tv trackers with a 1° field of view (a cone subtending a 1° solid angle) can track a missile to within $1/600^\circ$. Such trackers are now being built to lock onto the target itself, and to track several targets at once.

Practical limitations on antenna size (a function of wavelength) set a limit on radar accuracy, and at higher frequencies radar is hampered by atmospheric noise. In comparison with infrared techniques, television, while not an all-weather device, has the advantage of being as accurate as infrared without requiring the aircraft beacon or missile tail plume that infrared has to sense.

The author



Jack Kruse supervises the development of electronic systems, subsystems and components used in equipment developed for defense and space applications at the Barnes Engineering Co. These include radiometers, spectrometers, electrooptical trackers, and spacecraft instrumentation used for satellite attitude control, space navigation, and meteorological reconnaissance. Born in Leesburg, Fla., he received a B.S.E.E. from the University of Michigan in 1950.

A television tracker has been seen to track point sources as small as the image of the planet Jupiter. The system's resolution is 600 tv lines and the frame rate is 30 frames per second. A pair of vidicon cameras mounted on a compact servo-driven pedestal as well as a remote control station equipped with multiple displays and an operator's joystick comprise the system. The operator begins tracking by using the joystick to position the pedestal and bring the target within the system's acquisition field. He then surrenders manual control of the pedestal.

Once the camera pedestal is positioned to bring the target to the center of the wide field of view, the target image appears on the console within the narrow field tracking display. An electronic gate is maintained at the center of the narrow field until it encloses the target of interest. Operation is then changed to automatic and held as long as a target is present.

Operating the tracker

Two vidicon cameras—one for acquisition, the other for tracking—are mounted on the precision elevation-over-azimuth pedestal. The acquisition camera gives the operator a 15° field of view, while the tracking camera uses longer focal length optics for a much narrower (1.8°) field.

The operator's control console includes two 17-inch tv monitors that display both acquisition and tracking pictures side by side. A recently developed

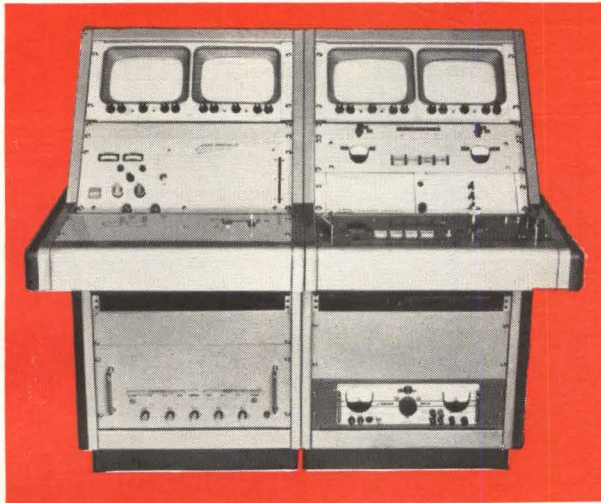

Remote station has multiple displays and an operator's joystick.

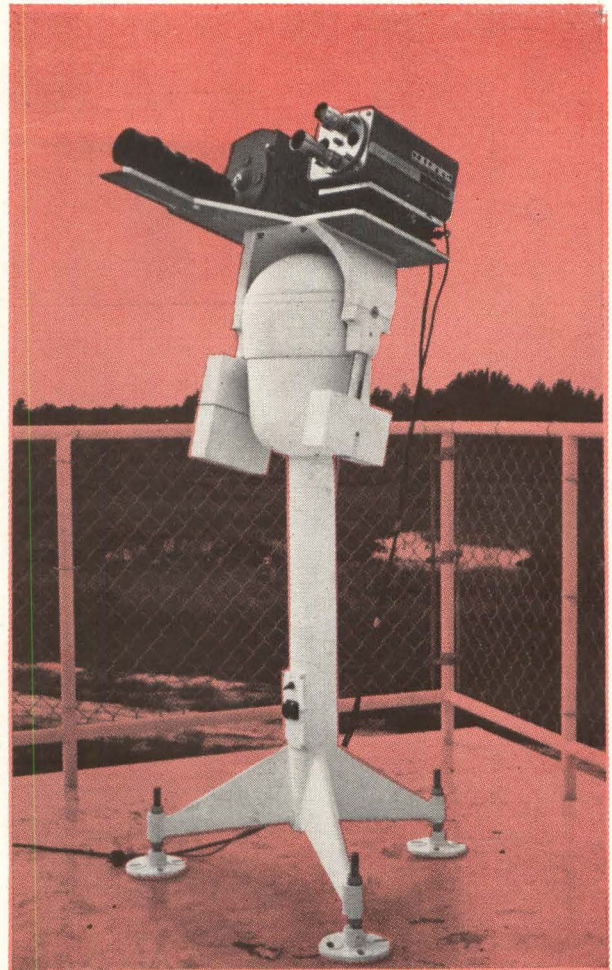

Two television cameras stand atop a servo-driven pedestal.

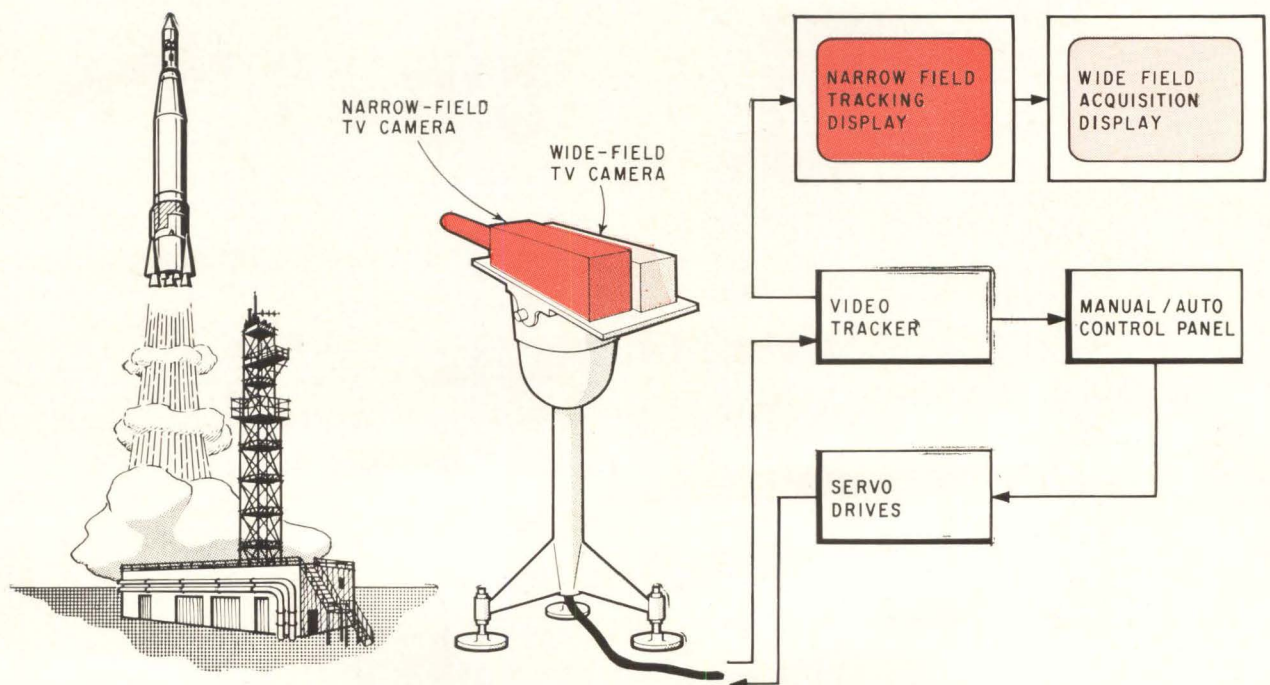

Wide-field camera acquires target while the tracking camera uses longer focal length optics for a narrower (1.8°) field.

video tracker extracts elevation and azimuth error voltages from the narrow-field tv camera video output signals, and supplies them to a control unit.

The tracker, which consists primarily of two circuits (one for vertical, one for horizontal) each having a target discriminator, gate generator and phase discriminator, automatically trains a gate of controllable size to cover the target image of interest. The resultant position of the gate is then read out with respect to the center of the field of view and provides the error signals for the pedestal servoamplifiers. Except for the vidicon camera tubes, the entire system is of solid-state design. Video tracking waveforms and target-referenced waveforms are called out by letter in the block diagram of the video tracking unit.

Each gate generator produces a rectangular gate whose position on the tv display is controlled by a d-c voltage and whose size is manually adjusted

without any effect on the center position of the rectangle. The target discriminator selects the desired target from the restricted field of view of the gate. Each phase discriminator compares the position of the center of the gate in the same coordinate, to produce a d-c error voltage.

Error voltage polarity determines the direction in which the gate must move to make its center coincide with the target center. By closing the internal servoloop, this error voltage becomes a measurement of displacement from the center of the field of view or boresight axis, and is used to drive the external servosystem for automatic tracking.

Circuit design features

Gate generators for both elevation and azimuth coordinates operate identically but their component values differ because of different scanning rates. Gate-generator waveforms are called out by letter

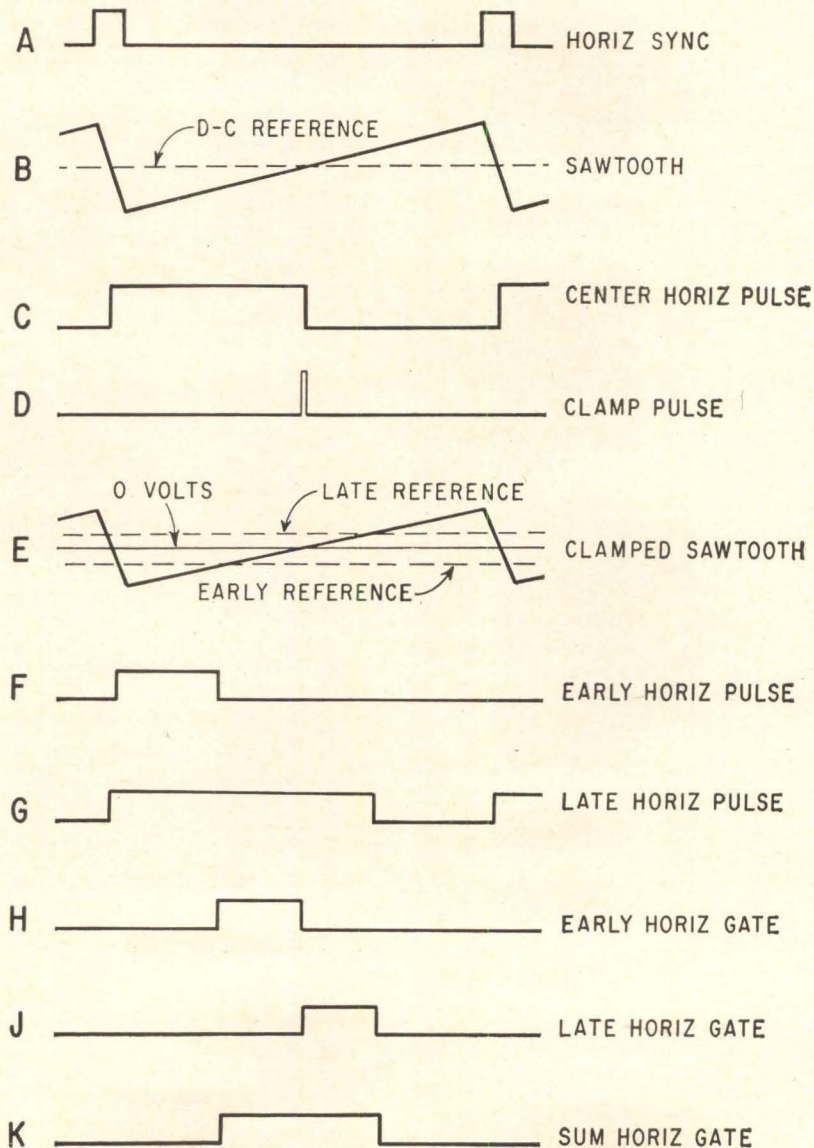

Gate generator waveforms. Letter callouts refer to the gate generator schematic.

on the schematic diagram for the horizontal (azimuth) gate generator.

After separation from the incoming composite video signal, the horizontal synchronizing pulses trigger a unijunction linear sawtooth oscillator Q_1 and Q_2 . The sawtooth waveform is summed with an external d-c source (the servo error voltage) at pin A to provide an input voltage to a tunnel-diode level-detector circuit consisting of D_1 and Q_3 .

A negative step function, identified as the center horizontal pulse, is produced at the collector of Q_3 whenever the combination of the sawtooth, the external d-c, and an internal d-c boresight adjustment permits the tunnel-diode current to exceed its peak point. The retrace slope of the sawtooth waveform resets the tunnel-diode circuit at the end of each line.

To close in on the target with azimuth and elevation information, early and late horizontal and vertical pulses are formed to generate early and late horizontal and vertical gates from which a sum-gate is ultimately formed. The early and late horizontal gates will yield azimuth error, and early and late vertical gates the elevation error. Here's how it's all done.

The center horizontal pulse is differentiated and amplified to trigger Q_4 which operates on the sawtooth waveform controlled in amplitude by gate-size potentiometer R_3 . Q_4 is a fast responding switch that is held open until signaled to close, and operates with either a positive or negative supply. It is called a keyed-clamp bilateral transistor.

The clamped sawtooth now changes its d-c reference to ground as a function of center horizontal pulse position. After the clamped sawtooth signal is transformed from 1 megohm to less than 100 ohms in impedance by a Darlington emitter follower stage it is impressed on two sets of parallel tunnel-diode level detectors, D_2 and Q_5 ; and D_3 and Q_6 —one each for the early and late horizontal pulses. On the early horizontal detector, d-c offset is introduced to the base input of Q_5 by R_1 so that the output step function at the collector of Q_5 occurs just prior to the center horizontal pulse. This becomes the early horizontal pulse. Potentiometer R_2 is adjusted so that the late horizontal pulse is produced at the collector of Q_6 , just following the center horizontal pulse.

The spacing between center and early horizontal pulses is unaffected by a change in position of the center horizontal pulse. Similarly, an altered slope of the clamped sawtooth waveform—resulting from a change in gate size control R_3 —will produce an equal change in the spacing between early and center horizontal pulses, and between center and late horizontal pulses, without influencing center horizontal pulse position.

The three output pulses are combined in two flip-flops to produce early and late horizontal gates. Early and late vertical gates are formed in the same way in the vertical gate generator. Combining the horizontal and vertical gates by appropriate logic generates the complete sum-gate.

The horizontal and vertical phase discriminators combine the standard amplitude target pulse derived from the target discriminator with the early and late gates. A dual-input integrator compares the width of the target pulse falling in the early horizontal gate. When the two are equal, output voltage is zero, indicating coincidence of gate center and target center. Voltage information is stored in a capacitor to prevent line by line tracking as opposed to target centroid tracking for the duration of one field. It is then read out via d-c amplifiers as tracking error voltages to the external servo-system for the pedestal and to the gate position generator.

System performance

This tv tracker is designed for background-referenced tracking primarily but is also capable of target-referenced and edge tracking. Performance of a system of this type depends upon the type of target discrimination used.

The background-referenced system samples the available background adjacent to the target and defines target as any deviation from background brightness level within the sum-gate. Although the video tracking waveforms show a white target only, a given target may appear with either positive or negative contrast and, in fact, both conditions can exist within the same target. This approach works extremely well with reasonably constant background levels and with targets of any size.

The target-referenced system is particularly attractive because discrete targets may be tracked

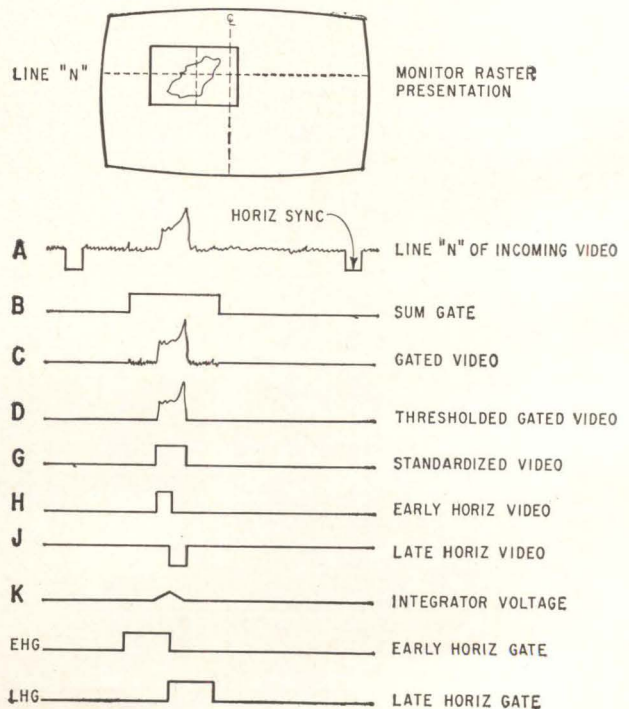

Target reference waveforms. Letter callouts refer to video tracker block diagram.

against a random background. Target brightness level is actively sampled, and areas within the sum-gate that deviate from target brightness level are defined as non-target. Consequently, a target pulse is derived when the video information coming in from the camera has a brightness level different from its immediate surroundings. Otherwise, the target offers zero contrast and is invisible. Target reference waveforms are shown.

Several modes of edge tracking (locking onto the edges of targets) are available through simple differentiation of the video signal. They are useful in some specialized applications such as point source tracking, but don't accurately track target centers.

Performance of the demonstrated system was limited by the pedestal characteristics to a dynamic tracking accuracy of about 20 sec of arc. The system can track at velocities up to 36°/sec and accelerations up to 60°/sec².

Because the ability to detect a target is contrast-limited, demonstration equipment required approximately a 10% contrast (referenced to the dynamic range of the vidicon camera tube) to produce reliable tracking. Similar tests in the laboratory with improved circuitry have produced reliable tracking with signal-to-noise ratios of less than unity. This is equivalent to tracking a target that could not be seen on the tv display.

Tracking multiple-targets within the same field of view has been demonstrated. For specialized applications, automatic acquisition and assignment of a separate sum-gate for each target has been accomplished. Basically, this is done automatically by detecting the target anywhere in the field of view, sensing its position within the field of view and driving the desired gate to that point. Variations on the basic track-while-scan system are limited only by engineering imagination and ingenuity.

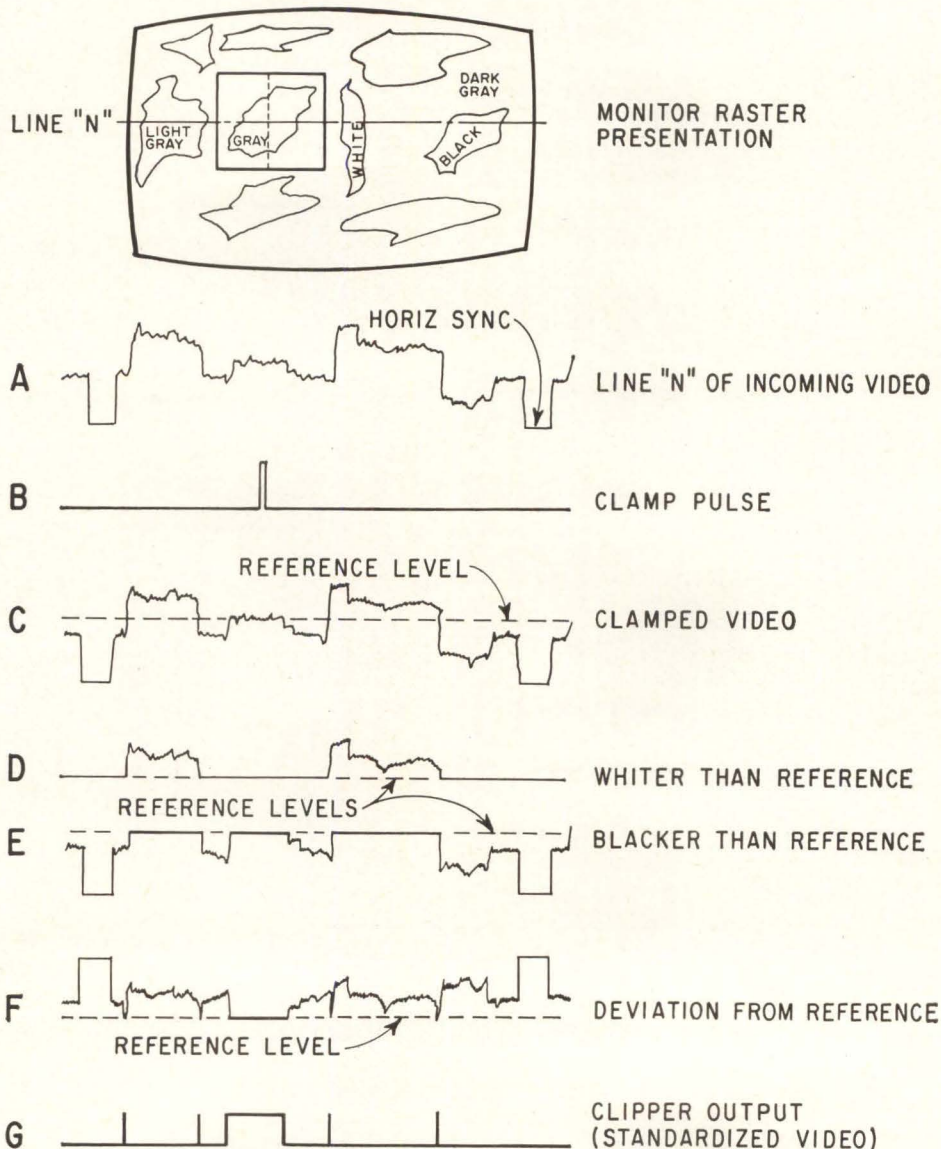

Video tracking waveforms show white target, but a given target may appear with either positive or negative contrast and can include both conditions within the same target. Letter callouts refer to black diagram of video tracking unit.

Electronic weapon against cancer

Converting a laboratory instrument into a clinical tool involves electron optics, high-power pulse modulator techniques and a host of other specialties

By N.A. Austin

Manager, Engineering Radiation division, Varian Associates, Palo Alto, Calif.

The **electron linear accelerator** has branched out of the physics laboratory into the hospital. It has become a powerful weapon in the war on cancer.

The transition required solving many engineering problems. Radiation scatter to healthy tissues must be held to a minimum; the patient must be kept reasonably comfortable; and the accelerator must be packaged compactly to simplify its operation in the cancer therapy room.

Design techniques include electron optics, accelerator waveguide design, high-power pulse-modulator design, d-c motor controls and low-level current measurement for X-ray dosimetry, and digital counting.

The clinical linear accelerator—Clinac—produces ionizing radiation in the form of high energy X-rays or direct electron beams to kill cancer cells in deep-seated tumors. Eight of these machines

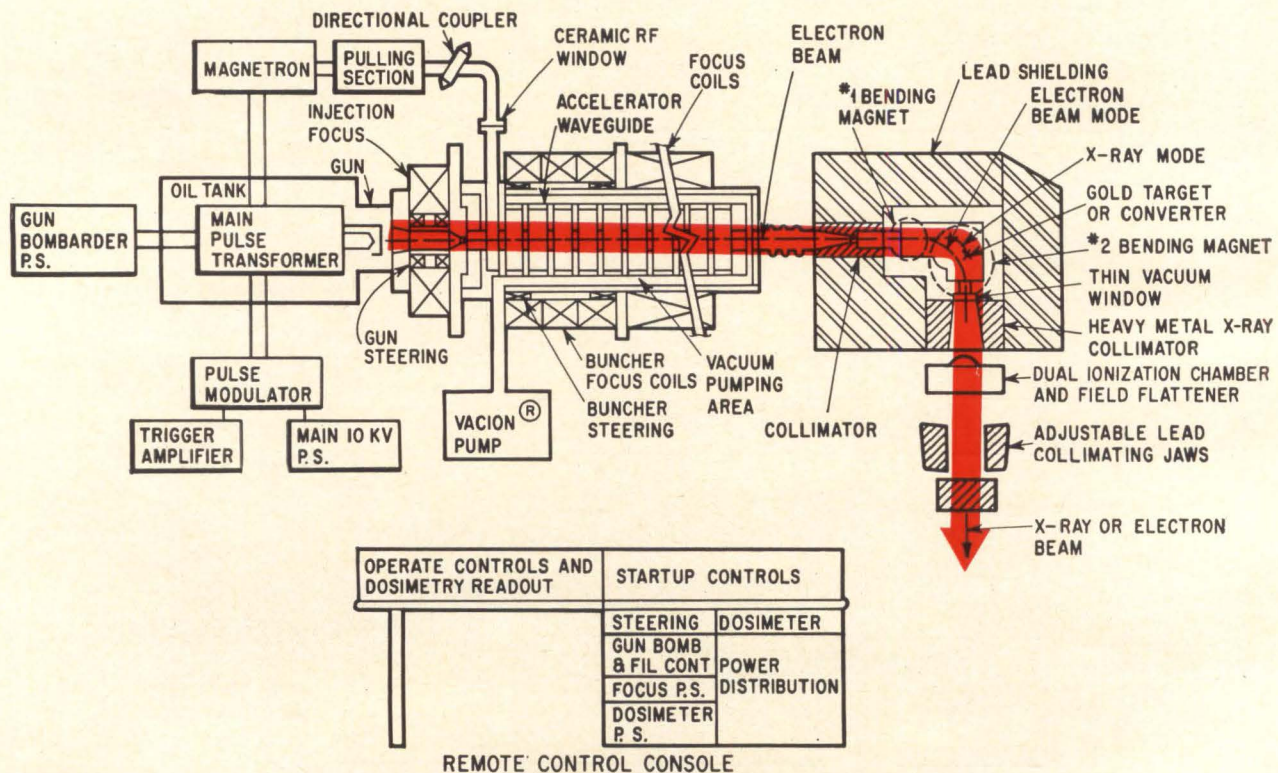

X-ray system operates by applying negative pulse to electron gun and magnetron cathode. Electron beam, arrow, is injected into traveling-wave r-f structure, accelerated to six-million electron-volts and bent 90 degrees in the magnet to hit a gold target or X-ray converter

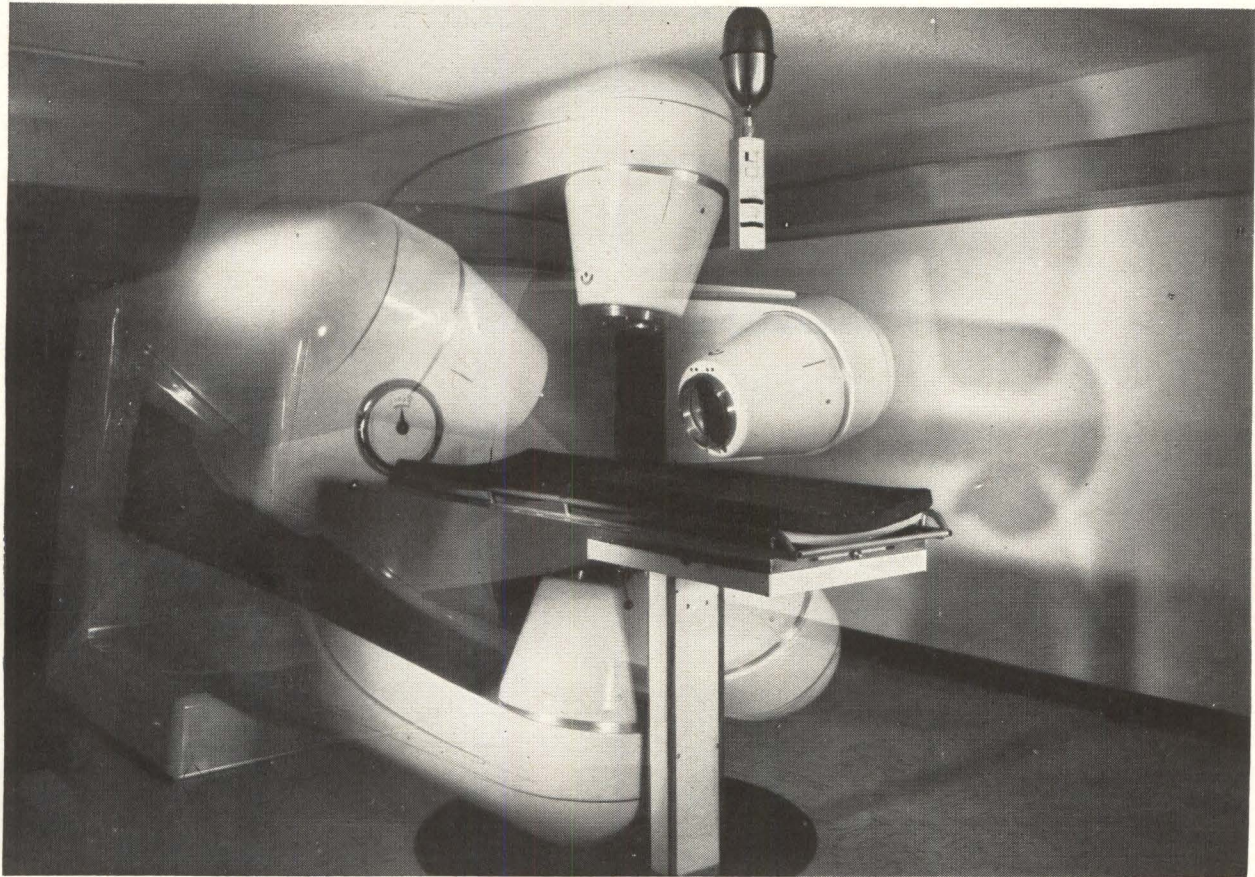

Deepseated cancer tumor receives radiation dose as the machine rotates around the patient. Accelerator rotation gives minimum dose to healthy surface tissue.

have been installed: three in Los Angeles, others at Stanford and Yale Universities, the Mayo Clinic in Rochester, Minn., the Sydney Hospital in Australia and the Nippon Cancer Center in Japan. All are similar to the Clinac at the Stanford Medical Center at Palo Alto, Calif. (photo above).

Accelerator

Predecessors to the Clinac did not bend the electron beam 90° to hit the X-ray converter or target. They located the target in-line with the electron gun and the four- to six-foot-long accelerator guide. Consequently, the shielded room required high ceilings, and rotation about the patient was limited to a maximum of 240°. These previous machines also used vacuum tubes rather than solid-state circuitry and required separate equipment rooms for the power supplies and heat exchange equipment.

In the Clinac, the main power supplies, modulator, microwave, vacuum and water-cooling distribution systems are all housed in the rotating gantry with the electron gun, the accelerator guide and the X-ray head. The heat exchange and accelerator rotation drive system are in the fixed stand behind the gantry. Both gantry and patient can be rotated in a complete circle.

The isocenter of the system is the intersection of the X-ray beam's central axis and the rotation axes of the accelerator gantry and patient support assembly. With the tumor located at isocenter, either

multi-port or rotation techniques can be used to produce the maximum dose at the tumor, with minimum dose to surrounding healthy surface tissue.

The radiation-therapy instrument discussed here produces six million volt-electrons. The X-ray beam produced by these electrons delivers ionizing radiation to a tumor below the skin surface with a minimum dose on the surface. With Clinac, the absorbed radiation dose at the skin surface is only 10% of the dose at the tumor. Most lower energy radiation sources such as radioactive cobalt-60 and 250-kilovolt X-ray machines produce higher percentage doses at the skin surface.

For electron-beam therapy, the beam can be extracted through a thin window in the vacuum chamber. Electron-beam therapy at six million electron volts is most effective for skin cancers, because the maximum dosage is absorbed at the skin surface.

System operation

The system operates by applying negative pulse voltages through a single-pulse transformer (see diagram at left) to an electron gun and magnetron cathode. The electron beam from the gun is injected into a traveling-wave r-f structure, where it is accelerated up to six million electron-volts. The beam is then bent 90 degrees in a magnet and aimed at a gold target or X-ray converter. This design delivers a high dosage to the area being treated with

three-millimeter limit on the beam diameter. The beam also must be fed into the bending magnet in the correct injection position. Magnetic steering, solenoidal coils and a collimator provide the required beam controls.

Trigger amplifier

The trigger generator and pulse amplifier for the modulator are shown below. When the charge on the 0.5 μf capacitor reaches six volts, the unijunction transistor conducts, producing a positive pulse.

Trigger amplifier uses four-layer diodes and a unijunction transistor, colored, to produce a peak pulse power gain of 10^4 , eliminating troublesome small thyratrons

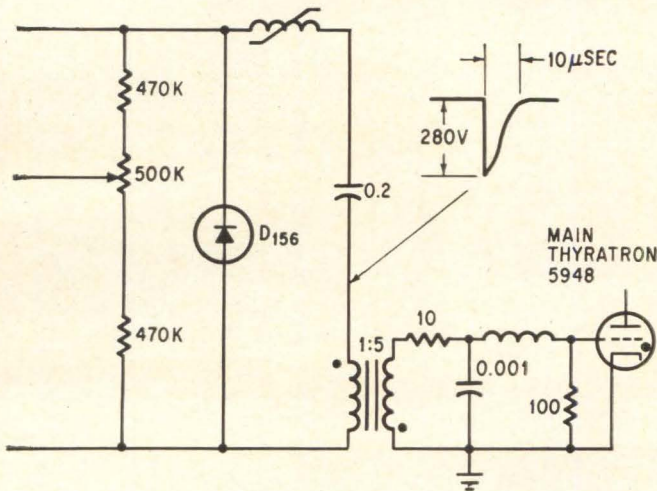

MODULATOR and power supply protective circuitry, color block, combined with component pretesting do away with diode failures

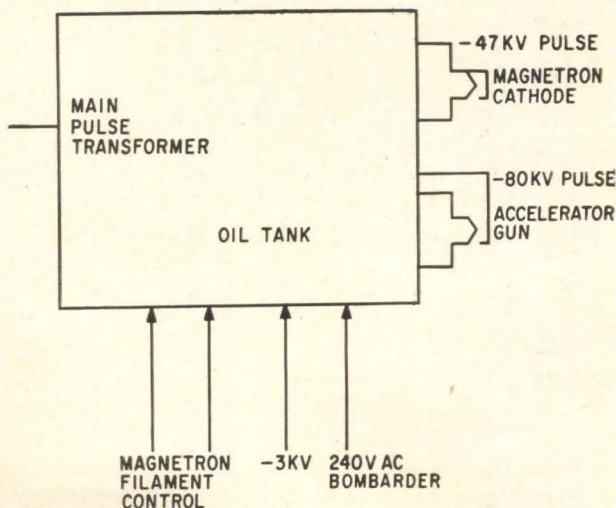

Charge time, and therefore pulse repetition rate, is controlled with the 50,000 ohm logarithmic potentiometer.

The positive pulse on the base of the four-layer diode causes breakdown and discharges the 0.022 μf capacitor, producing a 17-volt pulse. This pulse triggers two 200 volt, 75-ampere, four-layer diodes in series, producing a 280 volt pulse that triggers the main thyatron. The four-layer diodes produce a peak pulse power gain of 10^4 , doing away with any need for troublesome small thyratrons.

Power supply and modulator

The main power supply and modulator are shown at the bottom of the page. Silicon diodes are used for rectifiers, as hold-off diodes and for the shunt-diode protective circuit.

Thyrites—devices with nonlinear voltage-resistance characteristics—provide transient protection across the complete rectifier system. Individual diode r-c compensation provides both uniform reverse-voltage division and transient protection across the individual rectifiers.

These protection features, combined with component pretesting, eliminate diode failures. The plate transformer has 10% impedance, to limit short-circuit current to six amperes. A variable autotransformer on the primary of the supply is unnecessary because voltage is adjusted and regulated by an electronic deQing system described later on this page.

The capacitors in the pulse-forming network are charged from the main power supply through the resonant charging choke. The capacitors and the choke of the L-C resonant circuit charge the capacitors to almost twice the power supply voltage. The hold-off diodes prevent discharge of the capacitors.

DeQing system

Regulation of pulse voltages is achieved by triggering the deQing thyatron across the resonant charging choke at the desired preset capacitor charge voltage. Charge current is diverted from the pulse-forming network to the thyatron and a damping resistor.

A transistorized Schmitt trigger senses the level of the resonant charge voltage from a resistance divider. The Schmitt trigger output is amplified through a two-stage, four-layer diode pulse amplifier identical with the trigger amplifier described above, and connected through a 10 kv isolation pulse transformer to the thyatron grid. Manual adjustment of the Schmitt trigger bias provides control of the charge voltage. Automatic bias control, with a two-second time constant, provides a gradual run-up of magnetron pulse voltage, each time the magnetron is energized.

The minimum voltage adjustment level is approximately 12 kv because there must be a positive voltage on the deQing thyatron plate for it to conduct. The positive voltage is present during the last half of the charging cycle when the current through



Cross-hairs accurately aim center of X-ray beam within lighted rectangle confining beam to treatment area

the inductance is decreasing.

The magnetron cathode pulse is 47 kv at 90 amperes for two microseconds, through a five-to-one step-up bifilar pulse transformer from the pulse-forming network. One secondary winding has additional turns to provide up to an 80 kv pulse to the electron gun. A gun voltage of 80 kv was chosen to obtain efficient capture of the electron beam by the r-f wave. The gun cathode is made of thoriated tungsten. It is heated from the rear to emission temperature by three-kv electron bombardment from a tungsten filament. A-C power is connected to the filament through a binfilar choke, which is a high impedance load to the 80-kv pulse voltage. Coupling capacitors hold the cathode to filament voltage constant at three-kv during the pulse. A transistor differential amplifier and a magnetic amplifier regulate a-c filament voltage to maintain constant bombarder current. The gun is space-charge limited in operation.

Magnetron frequency must be held constant

The author



Norman A Austin received a B.S.E.E. with honors from Oregon State College in 1949 and his Masters from Stanford University in 1950. Before joining Varian Associates in 1957, Mr. Austin concentrated on instrumentation and systems design for refineries

and chemical plants at the Standard Oil Co. of California.

within 50 kc to produce stable X-ray intensity. Since the magnetron is not pulsed during patient setup, it must warm-up during the first part of each two-to-four minute exposure. The warm-up frequency change is 300 kc. A similar magnitude frequency change can also occur when the machine is rotated around the patient, because of movement of the magnetron cathode.

Frequency changes are kept within 50 kc with an automatic frequency-control system, which includes an r-f reference cavity and crystal detector. An error-amplifier signal is proportional to the difference between a reference voltage and the crystal detector voltage. The cavity frequency is set so that the accelerator operating frequency is at the three db point on one side of the cavity Q curve. Consequently, error polarity indicates direction of frequency error. The error-amplifier output is then amplified to drive a split-phase servomotor and a tuning probe located in the rectangular waveguide.

X-ray dosimetry

The X-ray dosimetry system has a dual ionization chamber in the X-ray field. Direct current from each plate in the chamber is proportional to the X-ray intensity. The current from one plate is the input to a conventional d-c amplifier that is chopper-stabilized. The analog computer-type amplifier has resistance feedback. The amplifier output operates an X-ray rate meter.

The current from the second plate is the input to a second amplifier with capacitance feedback, which integrates the X-ray dose. When the output ramp voltage from the amplifier reaches 80 volts, a Schmitt trigger initiates a reed-relay that momentarily shorts the amplifier back to zero and initiates a count to the plug-in stepping switches and digital readout. The trigger is adjusted so that one count occurs for each rad of X-ray dose. The three-digit readout is usually preset to the desired exposure; then the system counts back to zero and switches the machine off. X-ray beam symmetry is confirmed with a pair of matched cadmium-sulfide cells mounted in the X-ray head. They are connected in a bridge circuit with a zero center meter at the console.

A ton of lead

Auxiliary controls include an intercommunication system and a d-c motor speed control for accelerator rotation. The control is of the silicon-controlled rectifier type.

Vacuum is maintained at 10^{-8} millimeters of mercury with a VacIon[®] electronic vacuum pump. A transistor temperature controller maintains cooling water temperature constant to ± 0.2 degrees centigrade. The system isocenter is maintained within a one-millimeter radius.

A ton of lead is molded around the X-ray converter to reduce any leakage X-ray intensity, outside the defined field, below 0.1% of central axis intensity.

... and asks a lot of questions

Infrared goes in, orange comes out

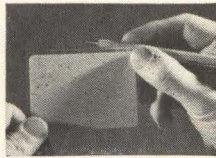

No, it's not raw film. Roomlight or daylight does it no harm. In fact, it is intended to be left lying around exposed to fluorescent-lamp light. That's how you charge it up. That's *all* there is to charging it up. Then you take it to the laser room. Don't rush. The energy won't leak away that fast. If the 5 o'clock bell rings and it's Friday, forget about it until Monday. But do *not* forget to protect your eyes with 7 mm of Pittsburgh No. 2043 glass (or the equivalent thereof) before firing the laser at it.

The whole point of this picture is that this is a far-field pattern not of a visible-light laser but of an infrared one.* Thus we demonstrate what should be the big market for sheets of a product for which purchasing directories will have to establish a new category, a product we choose to call KODAK IR Phosphor, an interesting bit of business from our chemists of the inorganic persuasion.

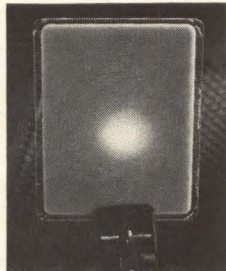

Except for a technicality, one could say that it converts infrared to orange, replacing more sophisticated-looking receptors that less vividly show the location and approximate distribution of the output from an infrared laser. The technicality is that infrared (0.7 μ to 1.3 μ) merely stimulates the phosphor to release as orange light (peaking at 640m μ) the energy it has soaked up while lying around in white light.

The pattern can be photographed from the phosphor on any panchromatic or color film but preferably one that comes in a yellow box.

It is very easy to acquire 2" x 3" sheets of KODAK IR Phosphor. All you do is multiply the number you can use around the place by \$25 and dispatch a purchase order valid for the product of these two numbers to Eastman Kodak Company, Apparatus and Optical Division, Rochester, N. Y. 14650.

Price subject to change without notice.

* Reason for the goggles: an unlucky reflected jolt of infrared can damage an eye with little immediate awareness. Putting your eye behind the sheet is even less lucky.

Glass all the way

Two giants of the electronics industry, who may or may not choose to step forward and identify themselves, are the customers for a little known product designated merely as "KODAK Special Plate Type 033-01." Despite the present brevity of the roster of users, we are at liberty to describe the product with the aim of lengthening the list.

One almost feels embarrassed in this day and age and in this magazine to be advertising simple sheets of very flat glass that bear on one side a thin, orange-colored coating sensitive to nothing more subtle than mechanical scribing with a sharp tool. The tool removes the coating. That's it.

Since a) the product is not particularly cheap per square foot, b) it can be purchased at present in quantities no less than 300 square feet, and c) the two giants didn't attain their present prosperity by throwing their money around like mad things, there must be *something* afoot.

What our ear to the ground picks up is a cry from the leading edge of the microelectronics art that sounds like "Glass all the way!" Meaning, very probably, all the way from the original layout through every successive mask along the way, through any and all changes of scale. The Type 033-01 Special seems to be taking its place at the start of the route, for that original layout. So long as geometrical fidelity remains important in the business, this is not illogical.

The thermal expansion coefficient of glass is low—lower than that of the famous steel gage-blocks that epitomize Absolute Truth in any precision machine shop, certainly lower than that of the most dimensionally stable plastics. Its humidity coefficient is a flat zero.

Glass can't be gouged by the scribing tool. Scribed corners of the pattern are less likely to tear for this reason. They stay sharp, furthermore, because of the nature of the coating and its adhesion, a little specialty of our house. The ease with which the tool pushes through as it rides the glass keeps the line width uniform and its edges clean. We would suspect this leads to a capability for more closely spaced detail than on plastic-based scribing material. The orange coating looks opaque to the photographic material that will receive the pattern but not to an eye over a light

table. The absence of gouges to diffuse light during the photographic printing kills the intersection flare spots that may well be plaguing circuit-builders who have not yet learned of this material.

When your inquiry about sizes and prices of KODAK Special Plate Type 033-01 is answered by Special Sensitized Products Division, Eastman Kodak Company, Rochester, N. Y. 14650, you will be given our recommendations for tool shape to use with them.

2 colors to wiggle in?

We have made some 2-color oscillograph paper on a thin, quick-drying stock of high dimensional stability.

Should we make some more? Would you buy any of it?

Do you ever have trouble separating superimposed traces?

Would you be willing to modify your conventional oscillographs by insertion of KODAK WRATTEN Light Filters between lamps and galvanometer mirrors? Are you by chance an oscillograph manufacturer instead of a user?

Are you a little more interested than when color oscillograph paper had to be thick and far more expensive than black-and-white paper?

Do science and engineering benefit from this kind of small improvement in the tools of the trade?

Is there an oscillograph-processing machine down the hall? If not, why not? If there is, would anybody mind if you slipped a different set of chemicals into the four tanks once in a while when you felt the need of color?

Do you believe those tales about organizations that seek out the brightest young engineers that money can lure and then put them to work with assorted crayons marking each of 50 separate channels of data on a 400-foot length of oscillogram? Do you believe in the dignity of labor?

Is it enough to say that one seldom has occasion to demand higher trace-writing speed than this new 2-color paper can handle? And that it can be processed at 4 to 6 feet per minute?

Do we pant too hard?

How can we help you unless you ask a few questions of your own from Photorecording Methods Division, Eastman Kodak Company, Rochester, N. Y. (Phone 716-562-6000, Ext. 3257)?

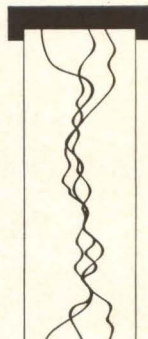

This is another advertisement where Eastman Kodak Company probes at random for mutual interests and occasionally a little revenue from those whose work has something to do with science

Microwave Associates at Ka-BAND

a
complete
capability

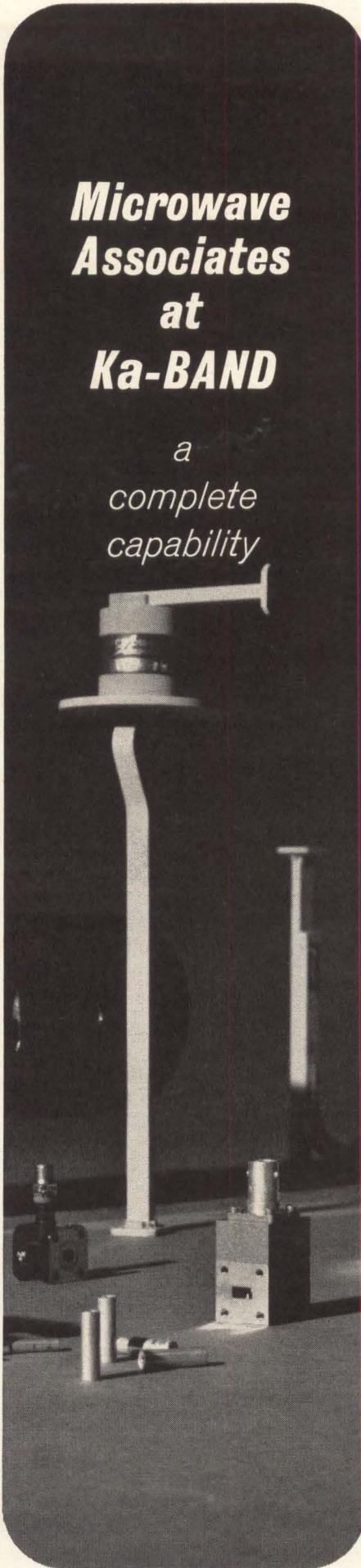
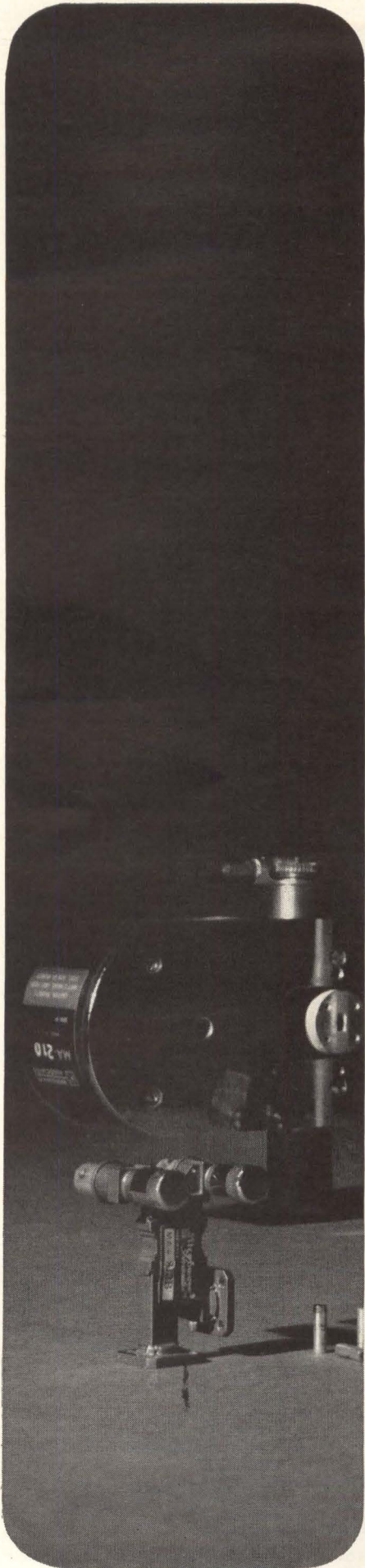

Semiconductors

Microwave Silicon Mixer
and Video Detector diodes.
Varactor Diodes.

Waveguide Components

Attenuators. Loads. Waveguide
Switches. Pressure Windows.
Waveguide Accessories. Power
Dividers — many types.
Detector Mounts. Antenna
Components. Circular Waveguide
Components. Waveguide Castings.
Standard Mixers. Microwave
Shutters.

Tubes and Duplexers

TR Tubes for all power and
environmental conditions.
CW and pulsed
Beacon Magnetrons.
Ferrite Duplexers.

Solid State

Semiconductor
SPST Waveguide Switches.
Ferrite Duplexers.
Low Power narrow band
Power Sources. Broadband
frequency amplifier/multiplier
Harmonic Generators.
High & Low Power
Ferrite Isolators,
Circulators & Circulator Switches.

Instruments & Assemblies

Waveguide Assemblies and
Subsystems fully proven in our
own high power test facilities.
Microwave Test Equipment.
Research & Development.

Products available at VHF, UHF,
L, S, C, X, Ku and Ke Bands.

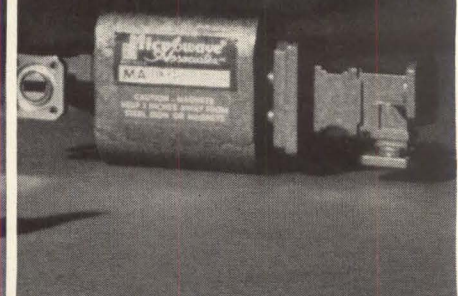

**MICROWAVE
ASSOCIATES, INC.**

BURLINGTON, MASS. • WESTERN UNION FAX
TWX: 617-272-1492 • TEL: 617-272-3000

Overseas Sales: Microwave Associates International, Inc.
Burlington, Massachusetts

United Kingdom Sales: Microwave Associates, Ltd.
Cradock Road, Luton, Beds, England

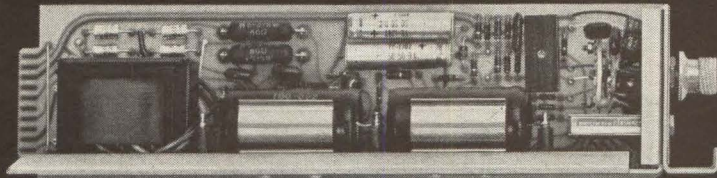

Amplifier Modules

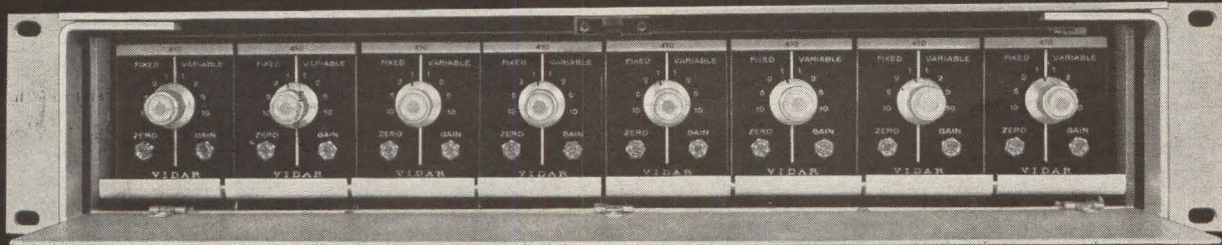

Rack-mounting housing with amplifiers in place

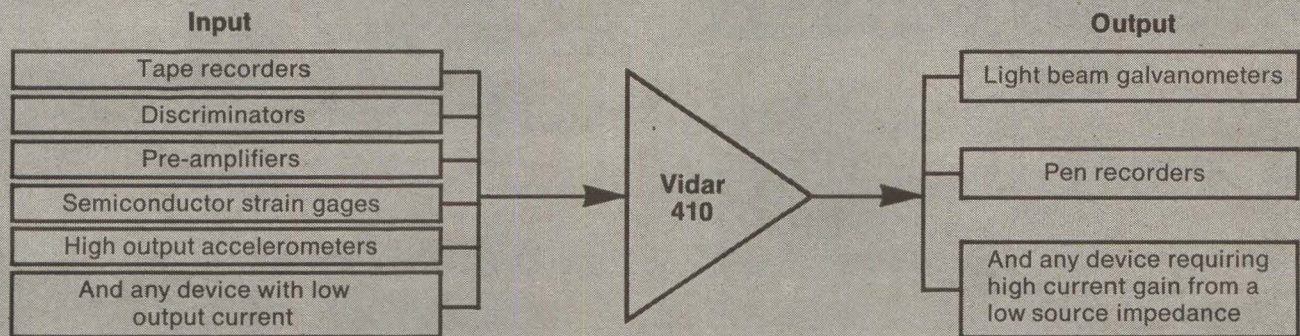

Typical applications for the Vidar 410 Galvanometer Amplifier

OUTPUT, ± 10 v, ± 100 ma . . .
LINEARITY, 0.2% . . . DRIFT, 0.3 mv/°C
 Good reasons to select the Vidar 410 Galvanometer
 Amplifier to drive your high frequency oscillograph

The Vidar 410 Galvanometer Amplifier is a high level current amplifier designed to link high frequency mirror galvanometers and high impedance sources such as instrumentation tape recorders, force motors, or audio oscillators. The Vidar 410 can also be used as a line driver, driving lines as long as 10,000 feet.

All solid-state, the Vidar 410 will drive low impedance loads requiring currents up to 100 ma. Input impedance is greater than 1 megohm, output impedance, less than 1 ohm. The amplifier can be ordered with series and shunt resistors to provide correct damping and current limiting for a particular galvanometer or other load.

Unusual gain-setting flexibility is achieved through the eight position attenuator. Four of the positions provide gains in calibrated steps of 1, 2, 5, and 10. The other four positions let the gain be set to any value between 1 and 20 by an interpolating multi-turn vernier. Frequency response is flat within $\pm 2\%$ from DC to 10 kc. The instrument is self-protected from input overloads,

so that a signal of 20 volts will not cause damage. Recovery time from an input overload is 10 microseconds.

Each channel in the compact Vidar 410 contains its own integral power supply. Up to eight units fit in 3½ inches of rack space.

Price of the Vidar 410 without output resistors is \$290. Two output resistors to customer specifications add \$5. The Vidar 905 Module Housing which will carry eight individual units costs \$290.

For complete information, please call your Vidar engineering sales representative (listed in EEM) or write us at 77 Ortega Avenue, Mountain View, California.

13

VIDAR

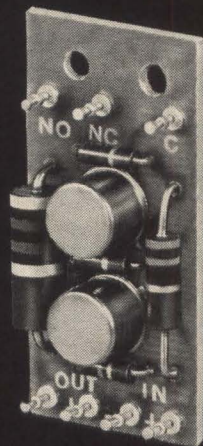

ACTUAL SIZE

SIMPLE WAY to buff the rough out of switching



Here's the simple, inexpensive way to eliminate switch contact interference in fast-responding electronic circuits—in electronic test equipment, digital equipment, numeric machine tool controls, etc. It not only saves costly custom circuit development time, it saves space and is easy to wire-in.

This "buffer" device is an electronic circuit which can be mounted on a standard mechanical switch. Triggered by the switch, it provides the quick, interference-free contact required by systems involving high-speed electronic circuits that operate in less than a millisecond. This simple device can also be used independently as a flip-flop. Four circuits are available: positive output for resistive loads of 100 to 500 ohms; 500 ohms or greater; and negative output for those loads.

Send for Data Sheet 177 or see the Yellow Pages for the nearest MICRO SWITCH Branch Office.

These "circuit-buffers" are available as separate packages, or assembled to any of a variety of manual or cam operated switches. Shown are two types of pushbutton assemblies.



PUSHBUTTON
ACTUATOR



ILLUMINATED
ACTUATOR



MICRO SWITCH

FREEPORT, ILLINOIS

A DIVISION OF HONEYWELL

IN CANADA: HONEYWELL CONTROLS LIMITED, TORONTO 17, ONTARIO

Now Meet All Your Mil Spec Power Module Requirements From This Catalog...

Get Rapid Delivery, Low Cost, Mil Certification!

ERA now makes available a *complete inventory* of full mil-spec, ultra compact DC power modules for the most rugged military requirements.

Surprisingly low prices even in prototype lots are made possible by the elimination of special engineering charges. In addition delivery is made on a "stock order" basis rather than "special design" schedules, providing unprecedented savings in time. And remember, ERA "MIL SPEC" doesn't mean just "MIL type" or "designed to meet," etc., but rather designs with *full* MIL components, certified as meeting applicable military specifications. The new units are available in repairable MIL SPEC Silicon 75°C or Germanium 55°C types as well as exclusive transparent-encapsulated Low Cost Silicon models for type-approval applications. The line includes a total of 175 basic catalog models plus hundreds of stock variations within each category.

Write for this catalog *today* and include ERA all-Mil modules in your *present* designs.

Meets Mil-E-4158, Mil-E-5400, Mil-E-16400, Mil-E-5272, Mil-T-21200 component and environmental requirements. Independent testing laboratory certification available for representative units.



ELECTRONIC RESEARCH ASSOCIATES, INC.

Dept. E-4, 67 Factory Place • Cedar Grove, N. J. 07009 • (201) CEnter 9-3000

SUBSIDIARIES: ERA Electric Co. • Advanced Acoustics Co. • ERA Pacific, Inc. • ERA Dynamics Corp.

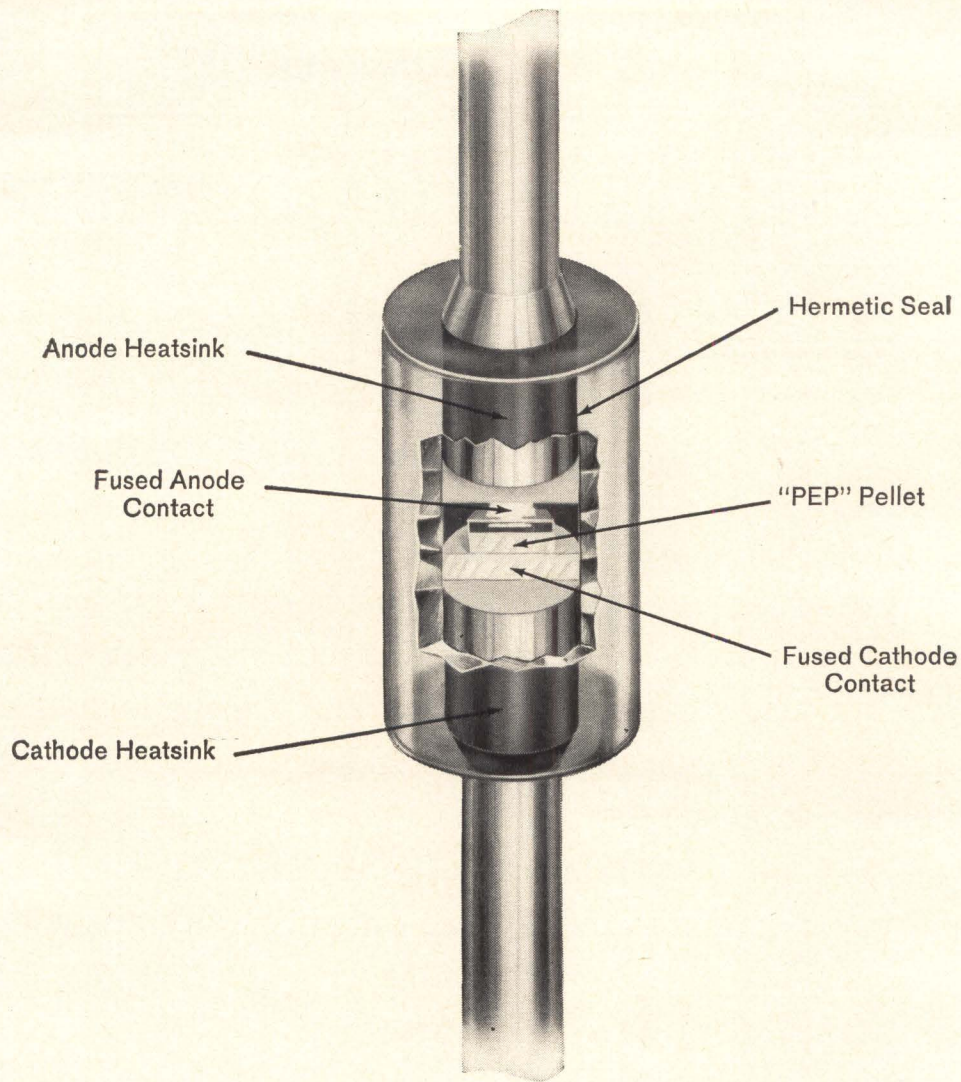

smaller than most...as rugged as they come...and inherently more reliable!

The new General Electric **Double Heatsink Diode** features a simplified design that eliminates the "S" strap, offers fused anode and cathode contacts, and provides increased power dissipation in less unit volume. Process stabilization at 300°C assures outstanding parameter stability. This combination of design and process control, coupled with the advantages of the DHD Planar Epitaxial Passivated pellet, offers outstanding electrical performance and device reliability.

To learn more about the performance and economic advantages the **Double Heatsink Diode** can offer your designs, see your Semiconductor Products District Sales Manager, or write Semiconductor Products Department, Section 16D160, General Electric Company, Electronics Park, Syracuse, New York. In Canada: Canadian General Electric, 189 Dufferin Street, Toronto, Ontario. Export: International General Electric, 159 Madison Avenue, New York 16, New York.

Comparison of General Electric "PEP" Diode Pellets

	1N4151-54	1N4148-49	SD-300	1N4150	SD-400	SD-800	
Breakdown Voltage BV @ 5 μ a	35-75	100	40		40	40	volts
Leakage Current I_R @ 30 volts, 25°C	50	50	0.1 @ 10V	50	50	50	nano-amps (max)
Capacitance C @ 0 volts	2-4	2-4	3	2.5	6	30	pico-farads
C @ -10 volts						15	pico-farads
Recovery Time t_r ($I_R = I_F = 10$ ma, recovery to 1 ma)	4	5	100	4	10	20	nano-seconds
Conductance typical I_F @ $V_F = 1$ volt, 25°C	100	150	100	250	400	800	ma

Available through your G-E semiconductor distributor



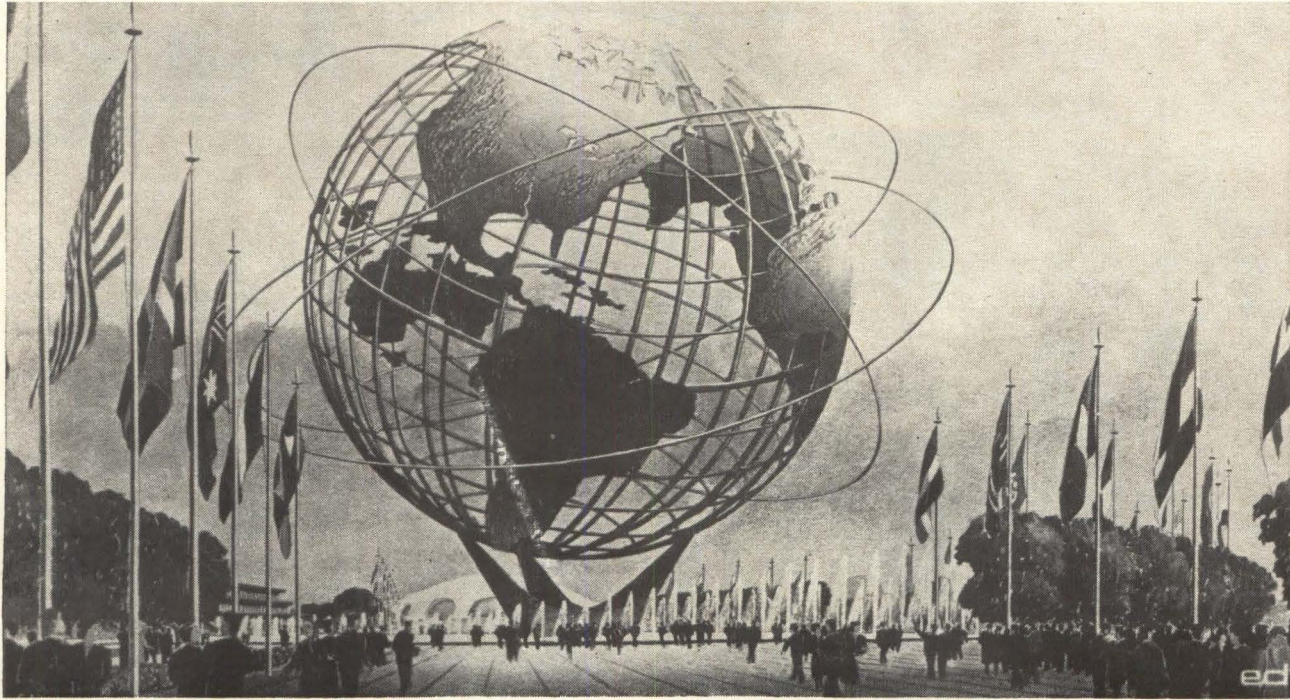

Twelve stories high, the stainless-steel Unisphere at the center, of the fairground will remain after the fair.

Industrial electronics

Fair programed for fun

Electronics puts words in Lincoln's mouth,
designs buildings and choreographs dancing waters
at the New York World's Fair opening April 22

By George V. Novotny

Advanced Technology Editor

In the 25 years since President Roosevelt opened the last New York World's Fair, life has become increasingly dependent on electronics. So has the art of producing a world's fair.

Without electronics the fair would have been possible, but much less an expression of our time. Even before shovels began to dig into the ground at Flushing Meadow, the fair's official symbol and focal point, the United States Steel Co.'s Unisphere, was being designed by a computer. Without the help of the IBM 704, a U. S.

Steel engineer says, the project "would have taken us something like 10 years."

About 670 simultaneous equations had to be solved to design this 120-foot sphere. Its 940,000 pounds of stainless steel form a structure that is mathematically indeterminate to over 1,000 degrees. The solution was done in matrix form in several trials.

Another computer-planned exhibit is the General Electric Co. building. A GE 225 computer with critical-path-method programing helped to plan the construction of

the complex pavilion.

A 90-foot white egg also was hatched with the help of a computer. Floating over a forest of red steel trees at the International Business Machines pavilion, the egg—IBM prefers to call it an ovoid—contains a multiscreen theater dedicated to explaining computers and their operations. The audience will be whisked up into the egg by a moving bleacher-like structure called a People-Wall.

Inside the egg and in the steel forest below, little theaters and corridors will contain more exhibits



Resembling a huge Easter egg, the IBM ovoid contains a 500-seat theater. The structure carries the letters IBM almost 1,000 times.



Color tv studio in the RCA building will enable visitors to watch a shown in production from galleries and on monitors.

about data processing.

Computers in show biz

In addition to their role behind the scenes, computers will be performers at the fair. In IBM's red forest, visitors will be able to write down any date in the last century, and an IBM 1460 will read the date through a pattern-recognition device and print out the major event of that day. Another IBM machine will translate Russian into English. Animated exhibits will explain other facets of data processing.

Elsewhere at the fair, a variety of electronic brains stand ready to serve in both familiar and strange ways. A Univac 490 at the Federal pavilion will give forth, on demand, bibliographies on a variety of subjects, and essays in four languages as part of the Library U.S.A. exhibit. An electronic coiffure consultant at the Clairol pavilion will advise girls on how to deceive everybody except their hairdressers.

An NCR 315 computer at the National Cash Register pavilion will show its versatility by answering questions about both recipes and science. In the Parker Pen building, an IBM 1440 will act as a match-maker to find pen-pals anywhere in the world. It will match data about prospective correspondents on a wide variety of interests and languages, including Swahili and Esperanto.

An animated celebrity

In an obvious attempt to replace people with something more durable, several exhibits are featuring animated figures that talk, sing, dance and make faces. About 460 Audio-Animatronic figures for four pavilions were produced by Walt Disney's Imagineers.

One Disney figure, Grandma, is already something of a celebrity. She has been passed off as a real person on a first-class transcontinental flight and checked in and out of the Presidential Suite at the Americana Hotel in New York, both without major incident. Starting April 22 she'll work at the GE exhibit, joining other animated figures in telling the story of progress through electricity.

An animated Abraham Lincoln in the Illinois pavilion will resemble the 16th president down to the



Uncle Ben, principal in a cast of mixed-up characters in the Electric Power and Light exhibit, will present a show on the uses of electricity and new power sources. A totally uninhibited laboratory is one of his settings.

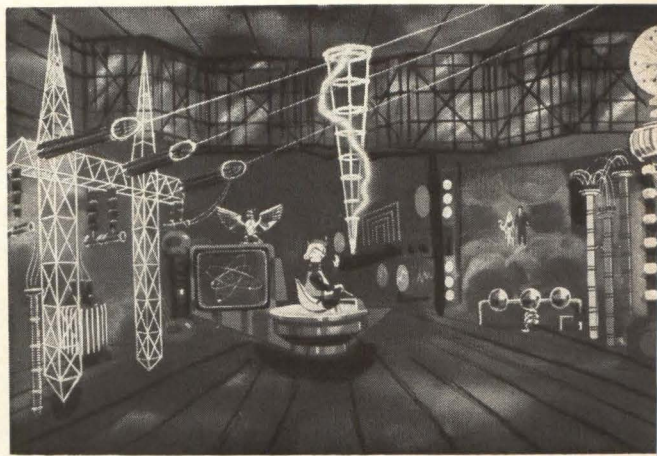

Five-thousand-year capsule: Westinghouse will sink this stainless-steel capsule, filled with evidences of the state of our civilization, for retrieval in the year 6965. Detailed directions are being deposited in remote monasteries.

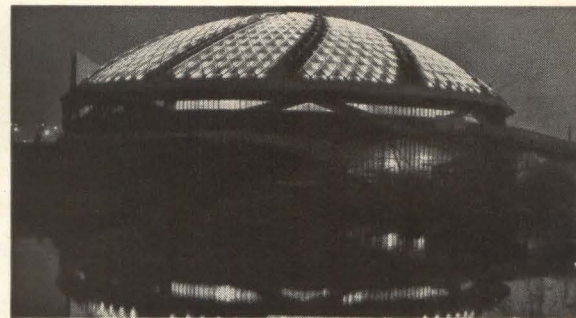

GE Progressland pavilion's 200-foot dome, lit at night by multicolored lights that make it appear to turn, contains a planetarium-like show and a controlled nuclear-fusion experiment.

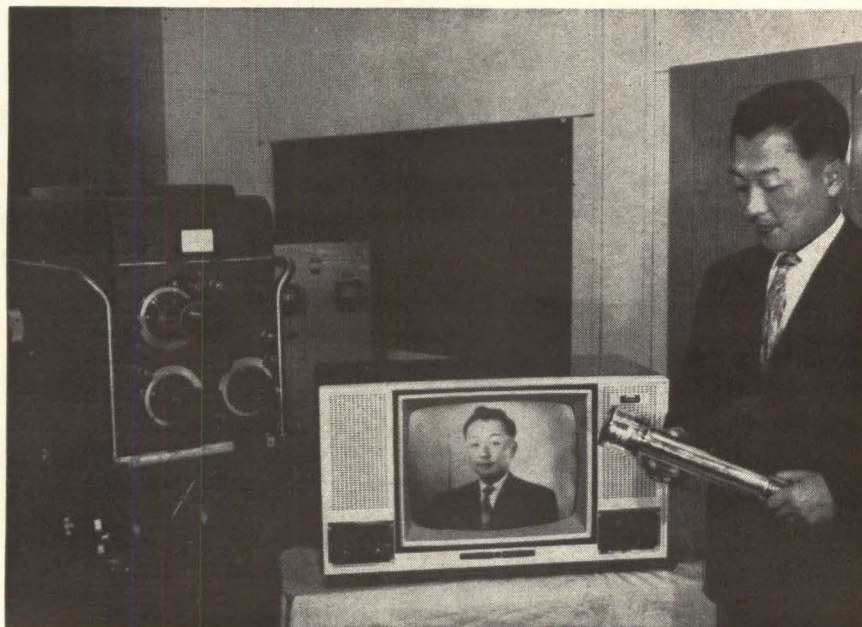

Japanese storage-tube camera: One of many industrial and consumer items to be shown in Japan's exhibit, a Toshiba storage tube, held by an engineer, can remember an image and deliver it to a tv monitor minutes later. It was made by the Tokyo Shibaura Electric Co.



Briefing from the master: electronically programed animated figure, a narrator in GE Progressland story of electricity, gets final instructions from Walt Disney.

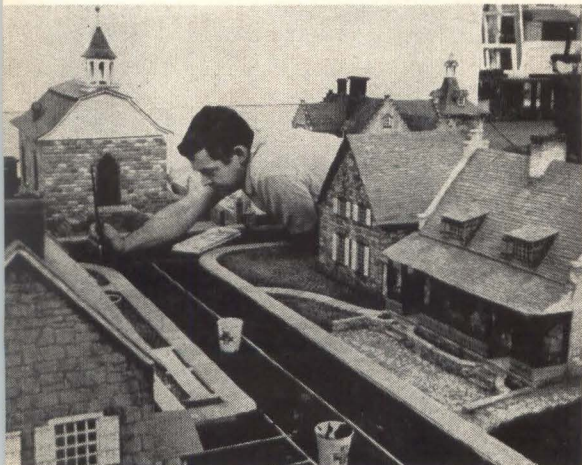

A giant in the streets of Colonial America, a Disney technician puts finishing touches on animated display scene for the Ford pavilion.

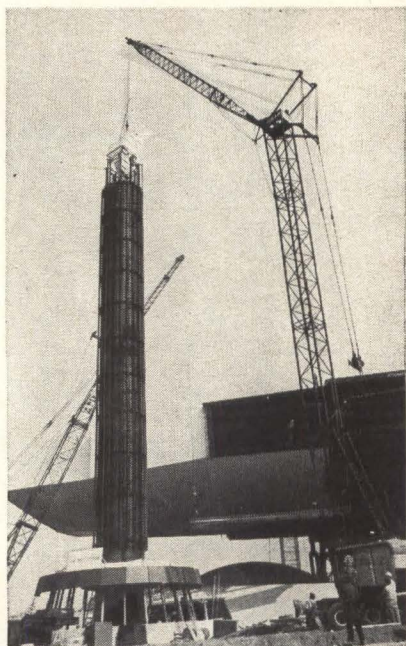

Television link between the fair and Manhattan, a single-horn antenna is being erected on a 130-foot tower next to the floating wing of the Bell System pavilion.

smallest detail and mannerism. Lincoln will be programed for 47 complex body motions and 17 facial expressions. He will clear his throat, twitch one eyebrow at a time, and deliver patriotic speeches with lavish choral accompaniment and lighting effects.

Though the figure will be operated by hydraulic, pneumatic and mechanical means, his actions will be programed on a 32-channel magnetic tape one inch wide, carrying speech and music tracks as well as sonic and ultrasonic pulses that control up to 438 separate actions. Besides determining Lincoln's actions, the tape will control stage and theater lighting, sound effects and the stage curtain.

Cavemen and monsters

In the Ford Motor Co. pavilion, Disney animations will depict cavemen and a family of fighting prehistoric monsters. The Pepsi-Cola show will include a salute to Unicef—the United Nations International Children's Emergency Fund—by Disney figures of singing and dancing children from several countries.

A show on advanced power sources will be given at the Electric Power and Light exhibit by an animated light bulb that resembles Benjamin Franklin. He will be host at an uninhibited show about fuel cells, thermoelectricity, thermionics and magnetohydrodynamics. Incidentally, this pavilion should be easy to find at night because its 12-billion-candlepower tower of light may be visible as far off as Washington.

The Power and Light exhibit also will feature a research scientist's nightmare—a Rube Goldbergian laboratory that somehow manages to demonstrate, amid smoke and flashes, some solid truths about electricity.

In a farm scene at the same pavilion, an electronically controlled cow will sing out, in a rich bovine contralto, her satisfaction at being milked by a snugly electric milker rather than by Farmer Brown's cold clammy hands. And a duet of pigs, the Happy Hams, assert that "electric thingamajigs make for premium pigs."

An animated figure of Sherlock Holmes in caricature will be one of the animations at the IBM pavilion.

To the amazement of Dr. Watson, Holmes will use digital logic to solve "The Case of the Elusive Train, or The Plurality of the Singular Green Moustache," in which a switchman's green mustache provides the key clue to finding a stolen Glasgow Express.

Rides and more rides

In contrast to the activities of the hundreds of animated figures, real people will have to put forth a minimum of energy at the fair. At many of the larger pavilions, visitors will ride through the exhibits in a variety of ways.

The Bell System will provide moving contour chairs equipped with binaural sound systems. Ford's visitors will ride in new convertibles through animated worlds representing the remote past and the distant future. At the General Motors Futurama, visitors will travel to the moon in groups of bucket seats, and ride past displays depicting an Arctic weather station, an electronically controlled desert farm, an undersea resort and a jungle city. Each group of seats will have an optical-film recording sound unit, triggered along the route for synchronization.

Other rides include a monorail train, a Swiss skyride gondola over the fairground, and a mammoth ferris wheel that looks like a U. S. Royal tire.

Color tv

The World's Fair alone will contain some 300 television sets, almost twice as many as existed in the whole country when the 1939 New York World's Fair opened. This network of color TV monitors throughout the fair will serve, among other things, to reunite lost children with their parents.

Color television programs will originate in the Radio Corp. of America building, which features a complete color TV studio built so that visitors can watch all phases of show production from walk-around galleries. RCA is planning audience participation shows, news telecasts, see-yourself-on-color TV demonstrations and listening rooms for stereo and hi-fi music.

Telecasts originating at the fair will be relayed to Manhattan from the Bell System pavilion by a horn

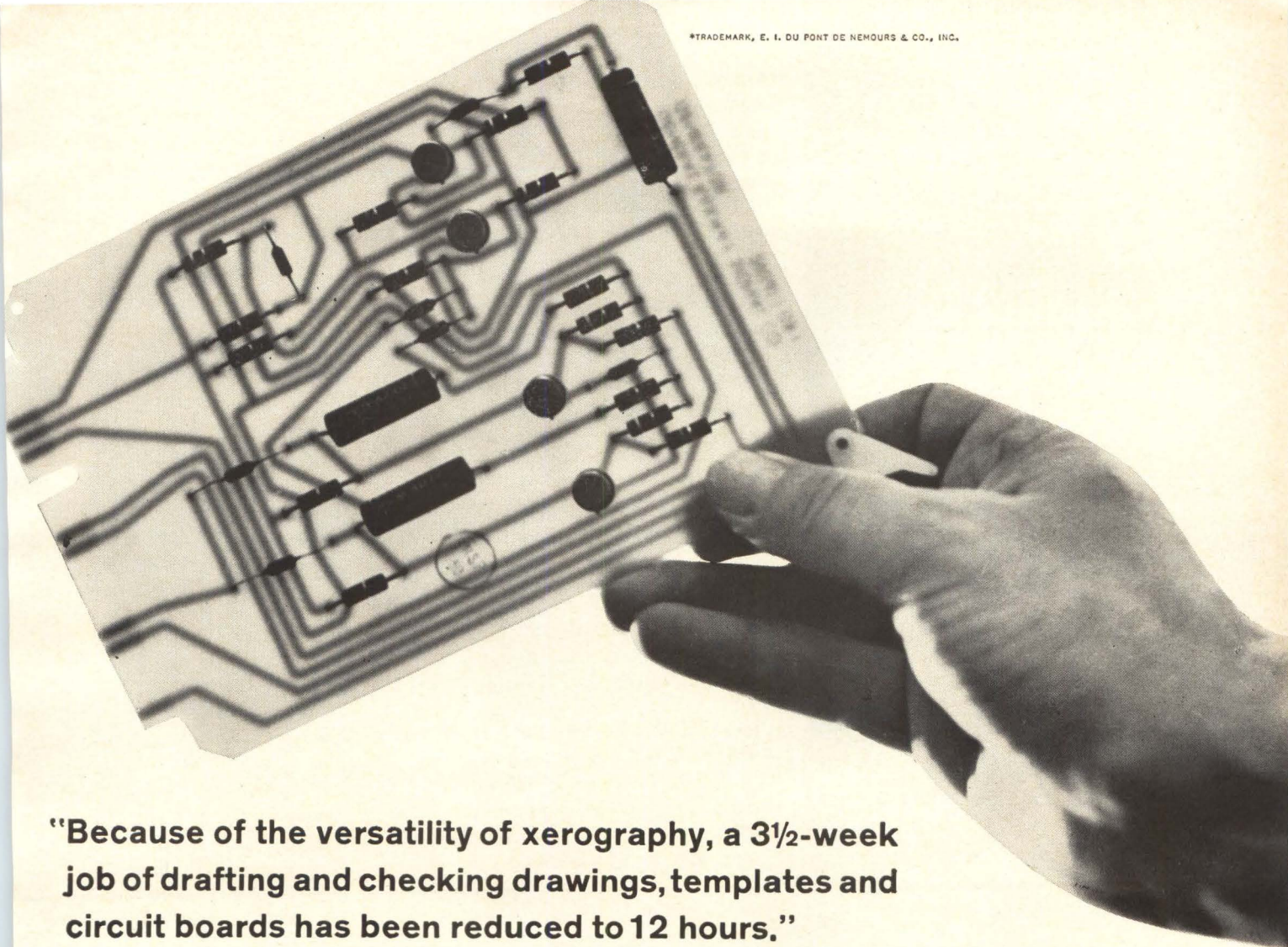

"Because of the versatility of xerography, a 3½-week job of drafting and checking drawings, templates and circuit boards has been reduced to 12 hours."

*W. F. "Pete" Harman, Chief Draftsman,
General Railway Signal Company*

They used to make three separate drawings for each new printed circuit board. Each of the drawings was checked against the others. Then a template was made. This was checked against the circuit board detail drawing and the circuit art work. Then the circuit board was made and checked again.

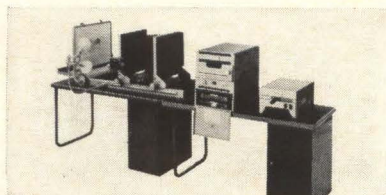

Now they make just one drawing. That's all. Once it's checked, they produce everything else, even the printed circuit boards, from this single drawing. Xerox Standard Equipment does it. Simple. Fast.

And guaranteed accurate.

The drawing is made twice-size on a dimensionally stable Mylar* sheet. Circuit lines are drawn in ink or by placing strips of black tape on the layout. Holes and terminal points are inked in.

Then the Xerox Standard Equipment is used to copy the drawing, reduced to the exact size required, onto the copper surface of a circuit board. Because Xerox Standard Equipment makes perfect copies, no more drawing or checking of dimensions is needed. All they have to do is put the board in the etching bath.

Total time: 12 hours.

Xerox Standard Equipment is the most versatile way to copy on just about anything that will hold still. Wiring diagrams on circuit boards. Photographs on offset masters. Draw-

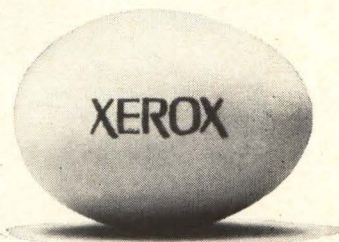

ings on acetate for projection. Even an image on an egg.

Find out how many ways xerography can save you time and money. We'll lend you the equipment for 30 days. No charge. Supplies, too.

Just call your Xerox representative.

Xerox Corporation, Rochester 3, N. Y. Offices in principal U. S. cities. In Canada, Xerox of Canada Ltd. Overseas: Rank Xerox Ltd., London; Fuji-Xerox Co., Ltd., Tokyo.

Xerox Standard Equipment—the most versatile way to copy.

Circle 103 on reader service card



Nation's first public demonstration of nuclear fusion being triggered at the GE pavilion

antenna atop a 130-foot tower. The control room at its base will be clearly visible.

The rest of the Bell System pavilion will tell the story of communications. Exhibits will explain the operation of the eye, ear and throat, crystals and solid-state components. A torsional-wave machine will be shown, and another exhibit will make speech visible. The public will be invited to try out the new Picturephone television-telephone, which Bell is getting ready to market. A visitor will also be able to engage an electronic adversary in a game of wits at tic-tac-toe.

Radio hams will head for the Coca-Cola pavilion, where a fully equipped amateur station with three operating positions will be available for licensed operators and for kibitzers. Station K2US, built by the Hallicrafters Corp., is sponsored by the American Radio Relay League.

Coca Cola also has the world's largest electric carillon on a 120-foot tower. Turned up to full volume of 3,600 watts of acoustic

power, its rock-and-roll or symphonies would be easily heard in Times Square, 15 miles away.

Science unlimited

The basic science exhibits range from "Atomsville, U.S.A.," a children-sized nuclear-science exhibit by the Atomic Energy Commission in the Hall of Science, to a controlled nuclear-fusion experiment performed in the white dome of the GE pavilion.

At GE, with space-age sound effects, gongs, flashing lights and a science-fiction countdown, every six minutes a theta-pinch plasma device will release about 51 million neutrons produced by the fusion of deuterium nuclei at energies equivalent to 100 million degree Fahrenheit.

Guy Suits, head of GE's research laboratories, says that visitors "will be told that, hopefully, fusion will become a practical power source during the lifetime of the youngest child in the audience"—which could mean a decade or a century.

GE's other exhibits will include

only **4** basic materials... **1** ...mylar*

...a new capacitor construction concept to give high performance and low cost. Filmatic® by Paktron

a simulated electric storm on the sun's surface and will have exhibits of lasers, space technology and cryogenics.

An electrified model of the human brain in the Upjohn Co. display at the Hall of Science will use 30,000 small flashing lights to show how information is handled in thought processes.

Odds and ends

A model collection of modern diagnostic and patient-monitoring equipment, much of it electronic, will be found at the Atomedic Hospital [Electronics, Dec. 27, 1963, p 41]. This is a complete small hospital serving the fairground; it can be visited by appointment only. Its purpose is to show how medical-care costs can be reduced by using automation and remote control.

Almost every spot at the fair will be in sight of one of 11 electronic communications arches, put up by the General Foods Co. These will provide continuous news coverage and summaries of fair events in

large bright-letter displays. Electronics also will direct the Fountain of the Planets, the largest of eight fountains that punctuate the fairground.

The fountain is made up of hundreds of movable jets whose waters change color, height and shape. It will put on shows with background music, topped every evening by \$1,000 worth of fireworks.

To quote the fair's president, Robert Moses:

How to enjoy the fair

The fair is going to get pretty crowded. About 80 million admissions are expected during the two seasons of operation, and nobody would be surprised if half a million people turned up on a sunny summer Sunday. So plan to beat the rush; go on rainy mid-week mornings.

The fair will be big. Its 646 acres are divided into five major areas: industrial, international, federal and state, transportation, and the lake amusement area. There are about 150 exhibits.

It would take two full weeks of 12-hour days to breeze through them all, not counting transportation and waiting time. Read the literature first, decide what you want to see, plan your itinerary. Specialize.

You can come to the fair in a variety of interesting ways. If you drive, there will be parking for 20,000 cars. There are also other ways to get there:

- Subway, 15 cents from anywhere in New

"This time the barkers and shills will not disappoint you. What do you want? Vast forces dormant in nuggets of imprisoned sunlight? Machines that fly, think, transport, fashion and do man's work? Spices, perfumes, ivory, apes and peacocks? Dead Sea scrolls? Images divine and graven? Painted lilies and refined gold? The products of philosophy which is the guide of life, and knowledge, which is power? We shall have them all."

York City.

- Long Island Railroad, 50 cents and 12 minutes from Pennsylvania Station.

- Boat from Pier 81, or a hydrofoil boat from lower Manhattan.

- Helicopter from lower Manhattan or the major airports. Fare is about \$8, the trip takes 5 to 10 minutes, and there is a magnificent view and landing on the fair's own heliport-restaurant.

More than 75 restaurants will serve anything from a hamburger to a three-hour luau. You can leave your children in a supervised playground at one of several pavilions.

Although the admission fee is \$2 for adults and \$1 for children aged 2 to 12, books of tickets and group tours can save you money.

And if your busman's holiday of electronic exhibits proves too much, you may want to go to the Simmons Beautyrest pavilion where, for a dollar, you can get a half hour's relaxation on a comfortable mattress.

2
...foil...

3
...leads...

4
...impregnant

This unique combination provides a rugged self-case, high lead strength, excellent moisture resistance, improved life, high volumetric efficiency . . . all at a considerable savings in cost.

Available in three case sizes.

Range:	.001 mfd. through .5 mfd.
Voltage:	50-100-200-400-600 WVDC
Tolerance:	± 10% & ± 20%

*DuPont

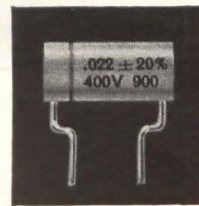

ACTUAL SIZE

Filmatic®
Capacitors
with
RIPPLEWELD™



PAKTRON

DIVISION ILLINOIS TOOL WORKS INC.
1321 LESLIE AVENUE • ALEXANDRIA, VIRGINIA

New power supply for millimeter klystrons

universal capabilities in less than 50 lbs.

The TRG Model 940 Klystron Power Supply provides all voltages required for operating klystron oscillators with each voltage continuously variable over a wide range to permit use with a large variety of tubes.

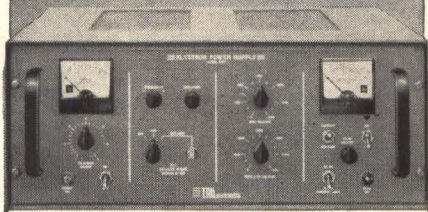

Model 940 Universal Klystron Power Supply

A unique new design — not just scaled down brute force power — incorporates advanced circuits and fully transistorized plug-in modules in an easily portable cabinet measuring 20" x 18" x 8". All necessary controls and indicators are on the front panel. Power requirements are 105 to 125 volts, 50 to 60 cps maximum. Power output 120 watts maximum. Total weight of the unit is 49 lbs.

Voltage Supply for	Range ΔV	Remarks
Resonator	300 to 3600 VDC	Continuously Adjustable
Reflector	0 to -650 VDC	"
Focus	0 to -300 VDC	"
Filaments	1.0 to 6.3 VDC	"
Reflector Modulation	1000 ± 200 CPS	Square Wave

TRG is the only specialist in the design and manufacture of a complete line of standard millimeter components (26-220 Gc) available from stock. For more complete information, contact your TRG engineering representative or write TRG INCORPORATED, 400 Border Street, East Boston, Massachusetts

MILLIMETER MICROWAVE COMPONENTS

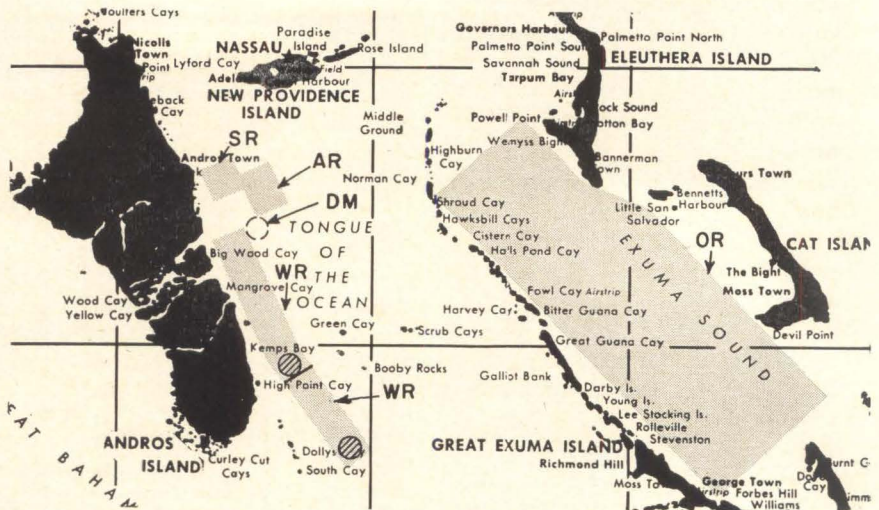

The Navy's Atlantic Undersea Test and Evaluation Center will consist of a weapons range (WR), acoustic range (AR) sonar range (SR), and an operations range (OR). Deepsea mooring (DM) is between SR and AR. Cost of project will be more than \$100 million.

Military electronics

Natural undersea laboratory tests Navy's new weapons

Extended sonar range spurs search for new techniques and weaponry

By John F. Mason

Senior Associate Editor

The Navy has quietly moved into a new era of undersea weaponry. It is now preparing to instrument a natural chamber—unique in all the world—in which to conduct tests. The facility, known as the Atlantic Undersea Test and Evaluation Center (Autec) is off Andros Island, in the British-owned Bahamas, an hour by air from Florida.

Successful use of a new technique [Electronics, March 23, 1964, p. 25] has doubled the range of existing sonar and promises, in time, to double it again. Right now the Navy has learned to send a sonar signal approximately 30 nautical miles, using the peculiar properties of the convergence zone—a sound channel deep in the sea. The one-bounce sonar, the AN/SQS-26 built by General Electric Co. and Edo Corp. is now operational.

The surface of the water off Andros Island is a nearly ideal reflector when smooth, and will send the signal off on a second convergence zone trip. Theoretically, there is no end to the number of the 30-mile convergence zone bounces sonar can make. Practically, however, the Navy is happy with one bounce, believes two to be possible, and will speculate on three when the time comes.

A kill weapon to take advantage of this 30-mile sensor is Subroc, the torpedo that takes to the air for most of the trip, then dives like a depth charge on the target. When a two-bounce sonar is built, Navy will undoubtedly want a follow-on weapon for that.

Tongue of the ocean. Locating a place to test Navy's new weapons took time and diplomacy. Nego-

tations dragged on for more than two years before the Navy was permitted to use a portion of the island for living quarters for 275 men, a small area for a data processing and communication center, reefs where microwave towers would be built, and the ocean east of the island. But all is in order now, and Navy is eager to get started. Architects and engineers Reynolds, Smith and Hills are under contract to build the main center. Autec will be operational by the summer of 1966.

A natural. Andros is a natural for Autec because of the deep, protected chamber of water that lies so close to a body of land. Only one or two miles off the eastern edge of the island, the shallow floor of the sea drops suddenly to 6,000 feet. The deep sea, called Tongue of the Ocean, because of its long, narrow shape, extends from north to south for more than 60 miles, bounded by Andros Island on the west and a string of treacherous coral reefs on the east. The reefs, lying anywhere from 18 inches to seven feet below the shark-infested sparkling blue-green water block out noise from the open sea, as well as discourage intruders who would introduce unprogrammed noise in the ranges.

The Autec complex will consist of four different ranges: for weapons, sonar, and acoustics in the Tongue of the Ocean, and an operations range (to be built last) in nearby Exuma Sound.

Besides the operational and living quarters near Andros Town on the island, seven tracking stations will be built on Andros and adjacent islands, and two on towers on the reefs. A Decca navigational system—one master and three slave stations—will establish ship's position during tests.

The variety of skills needed to design and build the Autec complex will bring together most of Navy's bureaus and laboratories. The Bureau of Ships will coordinate the work, relying for help on the Office of Naval Research, Bureau of Yards and Docks, Navy's Oceanographic Office, Bureau of Weapons, Navy Underwater Ordnance Station, David Taylor Model Basin, Navy Underwater Sound Laboratory, and others.

The weapons range. The largest

IEA

INSTRUMENTS ELECTRONICS AUTOMATION

INTERNATIONAL

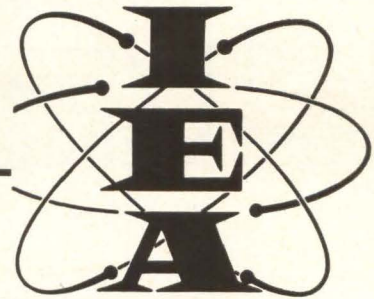

EXHIBITION

OLYMPIA LONDON ENGLAND 25-30 MAY 1964

The fifth International I E A Exhibition opens on Monday 25th May, occupying all the halls of Olympia. Nearly 700 British and foreign manufacturers of electronic equipment, scientific instruments and industrial controls are showing their newest products and developments in the 1964 I E A—the largest exhibition of its kind in the world.

Plan your visit to London and the IEA NOW!

1964

For your Official Invitation Card and further details contact



INDUSTRIAL EXHIBITIONS LTD 9 ARGYLL STREET LONDON W 1 ENGLAND

thin-film circuits □ vacuum pumping devices □ integrated circuits □ multi-track recording heads □ high speed gallium arsenide diode □ 1000Mc/s varactor diode □ subminiature zener diodes □ high voltage thyristors □ low saturation voltage planar transistors television monitor tubes □ infra-red image converter □ U/V photocell for gas flame control □ tunnel diodes □ 12kW UHF power klystron □ specialized microwave components □ low-cost vidicon camera tube

Mullard highlights at the IEA



The above are just a few of the important developments in tubes, semiconductor devices and passive components that Mullard will be exhibiting at the 1964 Instruments, Electronics and Automation Exhibition.

Join us on Stand G37 and discuss these and other developments with our engineers.

In any case be sure to call for your copies of our latest Quick Reference Catalogues, giving abridged data on over 1,200 electronic devices.

Instruments Electronics and Automation Exhibition, Olympia, London, May 25th—30th.

Meet Mullard on stand G37

EM 118

Mullard

Mullard Limited, Mullard House
Torrington Place, London, W.C.1 Tel: LANgham 6633

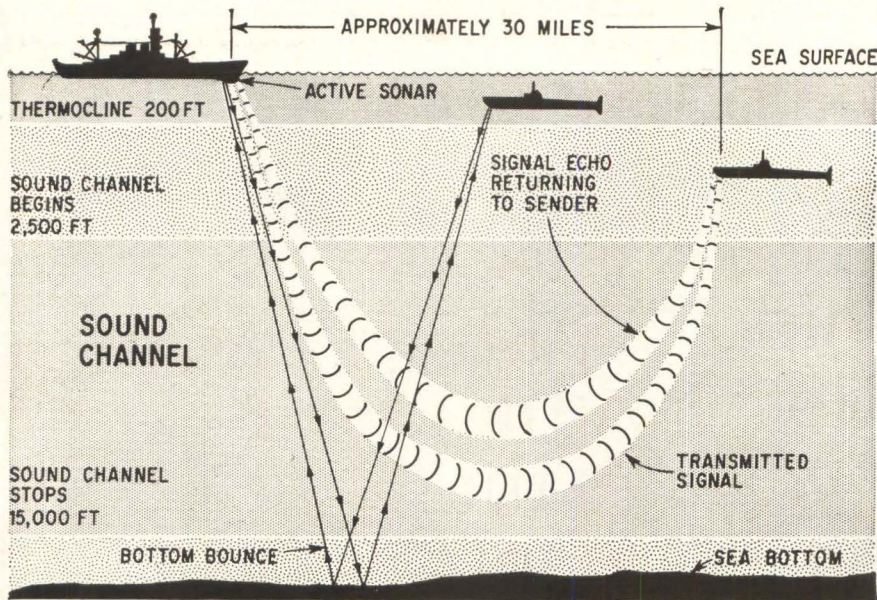

Convergence zone phenomenon extends sonar range to approximately 30 miles. Signals from sound channel are deflected in much the same way over-the-horizon radar takes advantage of the ionosphere.

of the three Tongue of the Ocean ranges will be the weapons range. It will consist of two 30-mile legs that almost make a straight line 60 miles long—perfect for one- and two-bounce convergence tests. The entire stretch, both in the air and below the surface, will be instrumented for tracking weapons such as torpedoes, missile/torpedoes (Asroc), torpedo/missile/depth-charge—weapons (Subroc), and future refinements of these.

The prime contractor, the Federal Laboratories Division of International Telephone & Telegraph Corp. was named last month to review the planned program and then to begin design, development, fabrication, test, and installation.

Tracking equipment for airborne weapons is fairly extensive, but will be mainly government surplus gear, such as modified Nike-Ajax radars using cooperative beacons and infrared sensors for acquiring the targets.

New gear will be the telemetry receiving system for data from weapons and the range instrumentation. It will be capable of simultaneous reception and demodulation of up to eight separate telemetry links, for operation from two antennas. The complete 90-channel demultiplex system will be required to demultiplex in accordance with IRIG (Inter-Range Instrumentation Group) standards,

including 18, 30, 45, 60, and 90-channel capability on pulse amplitude or pulse duration modulation.

Deep water tracking. Underwater tracking will be one of the most difficult tasks performed at Autec, because of the depth of the range. Accurate tracking in water a mile deep had never been done before, but the Navy Underwater Ordnance Station has learned how to do it at Autec with experimental instrumentation installed.

The tracking system is a grid network of hydrophones on the sea bottom, using long base lines. It is a deep water version of the system the Navy is using in Narragansett Bay, R.I. The Philco Corp. tested the deep water system and is now developing a signal processing system for tracking multiple targets.

Acoustics range. Ability to detect the presence of enemy ships and determine their positions is essential but the Navy also will determine just how noisy its own subs and surface ships are and how noise can be eliminated.

Special emphasis will be placed on signal processing, and on means of obtaining prompt and accurate classification of the target as submarine or non-submarine. New acoustic techniques are also being explored.

Lockheed Electronics Co. has already built and installed a noise-

THE SMALLEST HIGH PRESSURE AXIAL BLOWER IN THE WORLD

The new Thimble blower—believed to be unequalled in performance for a blower of this size—has been specially designed for easy mounting on a densely packed chassis, and can direct up to 4.5 cubic feet (127.43 litres) of air per minute on to a selected component. It conforms to all current military specifications.

With an overall length of only 1.85" (47 mm.), a diameter of 1.13" (28.7 mm.) and weighing 2.5 ounces (70.87 gm.), the Thimble has an output of 2.5 c.f.m. (70.79 litres/min.) at 1.0" (25.4 mm.) s.w.g. or 4.5 c.f.m. (127.43 litres/min.) at 0.5" (12.7 mm.) s.w.g. on a power input of 10W. It operates on a power supply of 115V or 200V, 3 ph, 400 c/s.

See the Thimble—and other blowers from the Plannair range of over 1,000 designs—on Stand N.418, First Floor, National Hall, International Instruments, Electronics and Automation Exhibition, London: 25th–30th May, 1964.

Plan with Plannair—specialists in aero-thermal control.

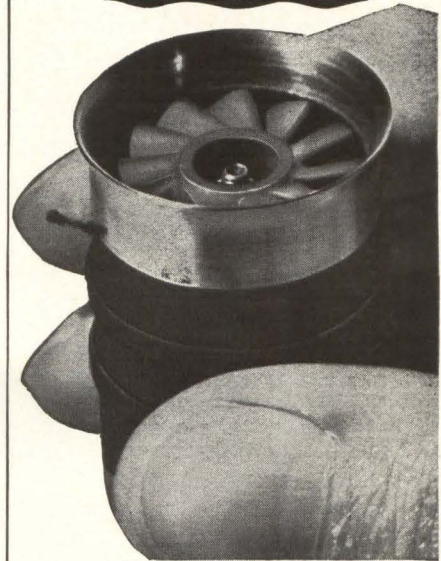

If you cannot get to the I.E.A. Exhibition, fill in the coupon for full details of the Thimble Blower and send to:

Plannair Limited, Leatherhead, Surrey, England.

NAME _____

POSITION _____

COMPANY _____

ADDRESS _____



VHF TETRODE

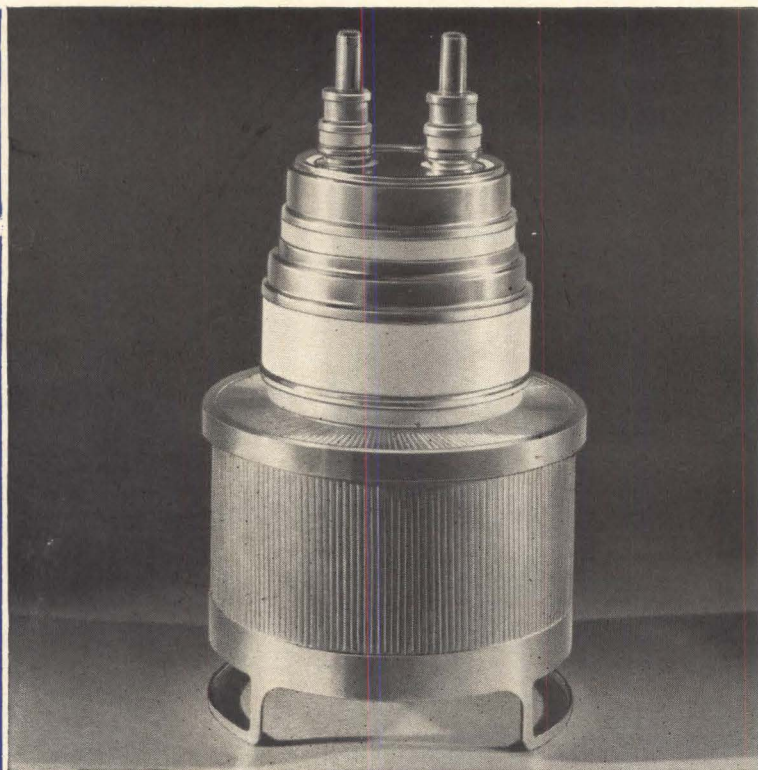

AN RF POWER AMPLIFIER which is a direct replacement for the American 7007 is the new forced-air-cooled tetrode from STC. Primarily intended for power amplifier use, especially in Class B television service, the STC 7007 has a ceramic/metal envelope to ensure robustness and low electrical loss. Anode dissipation is 12kW and the maximum supply ratings apply at frequencies up to 200 Mc/s. Abridged data are given below.

**RF POWER AMPLIFIER
CLASS B TELEVISION SERVICE**

MAXIMUM RATINGS

DC anode voltage	7 500 V
DC screen grid voltage	2 000 V
DC anode current	4.0 A
Anode input	24 kW
Screen grid input	400 W
Anode dissipation	12 kW
Control grid dissipation	300 W

**TYPICAL OPERATION IN GRID DRIVE
AND CATHODE DRIVE CIRCUITS**

Synchronizing Level approx. power output	12 kW
Pedestal Level approx. power output	6.8 kW

Synchronizing and pedestal level data above are based on standard American negative modulation technique.

For full information, write, 'phone or Telex for Data Sheets to STC Valve Division, Brixham Road, Paignton, Devon, England. U.S.A. enquiries for price and delivery to ITT Electron Tube Division, Box 104, Clifton, New Jersey.

**LINEAR RF POWER AMPLIFIER IN
CLASS AB SSB SUPPRESSED CARRIER SERVICE**

Maximum signal anode power output (single tone modulation) 11 kW

**ANODE MODULATED RF POWER AMPLIFIER
IN CLASS C TELEPHONY**

Approx. power output (grid driven) 6.0 kW

RF POWER AMPLIFIER—CLASS C

Approx. power output (grid driven) 12 kW
Approx. power output (cathode driven) 6.0 kW



high-grade electronic components by

STC
COMPONENTS GROUP

64/11MS

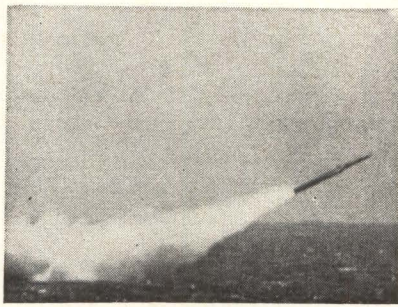

Subroc—a torpedo, missile, and depth charge, in that order—has a range of 30 miles and takes advantage of convergence zone detection range.

measurement system in Autec. It consists of hydrophones, underwater communications and tracking, sonar, beacons and reflectors. Everything works fine except for the hydrophones. Use of polyurethane to seal sensitive portions from water was not successful. The polyurethane would not bond to metal. The components are now being reinstalled, this time using butyl rubber to make them water tight, and should be ready by this June.

The undersea tracking part of the acoustic system was developed by International Business Machines Corp. Data for it are processed by a light weight, high speed IBM computer now on board a small ship. This equipment will be permanently installed on shore when the main buildings are finished. Navy will have specifications for the shore-based data processing center ready this month. It will include a complete acoustic measurement and analysis system, one output of which will be a digital signal compatible with the large digital general-purpose computer of the IBM 7090 class. Data from the acoustics and sonar ranges will be transmitted to the center by wire, and from the weapons range by microwave and telemetry.

Sonar range. Lockheed has finished a feasibility study for building an instrumentation barge and a towed array of hydrophones and acoustic projectors for the range where sonars will be calibrated. Navy will also study an alternative approach which depends on fixed facilities. A comparison of the two will dictate which system Navy will buy. A supplier will be chosen late this year.

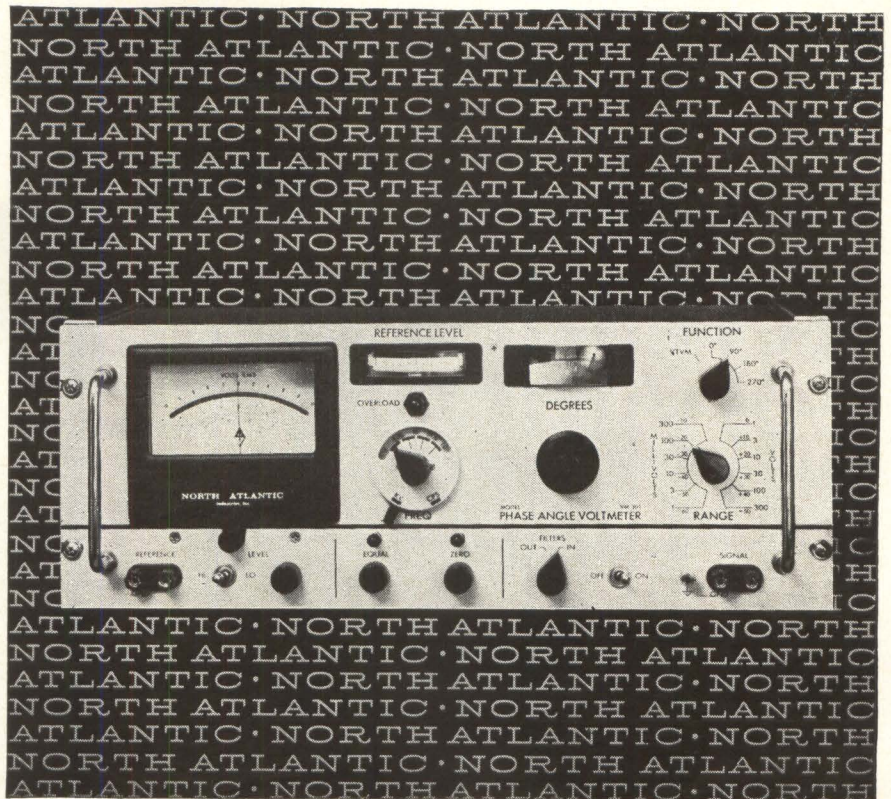

how to measure in-phase, quadrature and angle while sweeping frequency to 100 kc

North Atlantic's latest addition to the PAV line of Phase Angle Voltmeters* enables you to make measurements while frequency is varying over half-decades without recalibration. The VM-301 **Broadband Phase Angle Voltmeter*** provides complete coverage from 10 cps to 100 kc, and incorporates plug-in filters to reduce the effects of harmonics in the range of 50 cps to 10 kc with only 16 sets of filters. Vibration analysis and servo analysis are only two of the many applications for this unit. Abridged specifications are listed below:

Voltage Range.....	1 mv to 300 volts full scale
Voltage Accuracy.....	2% full scale
Phase Dial Range.....	0° to 90° with 0.1° resolution (plus 4 quadrants)
Phase Accuracy.....	0.25°
Input Impedance.....	10 megohms, 30μf for all ranges (signal and reference inputs)
Reference Level Range.....	0.15 to 130 volts
Harmonic Rejection.....	50 db
Nulling Sensitivity.....	less than 2 microvolts
Size.....	19" x 7" x 10" deep
Price.....	\$1990.00 plus \$160.00 per set of filters

North Atlantic's sales representative in your area can tell you all about this unit as well as other Phase Angle Voltmeters* for both production test and ground support applications. Send for our data sheet today.



NORTH ATLANTIC industries, inc.
TERMINAL DRIVE, PLAINVIEW, L. I., NEW YORK • Overbrook 1-8600

*Trademark

Secretary of the Treasury Douglas Dillon discusses prospects for 1964 with the chairman of the United States Industrial Payroll Savings Committee—Frank R. Milliken, President of Kennecott Copper Corporation.

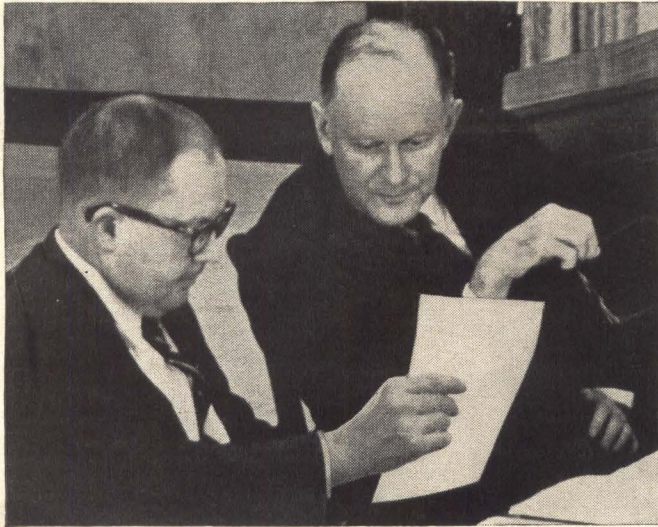

The leaders of America's business community invite you to join in a major fiscal undertaking

"The volunteer efforts of such distinguished business leaders as yourselves on behalf of the Payroll Savings Plan are a notable instance of the active and productive concern of American business generally for the fiscal soundness and economic well-being of this nation."

With these words the Secretary of the Treasury greeted leaders of 27 basic industries and opened the 1964 planning of the U. S. Industrial Payroll Savings Committee, a group formed of key businessmen and industrialists who assist the Treasury Department in its debt management program by promoting U. S. Savings Bonds.

The Committee's prospects for 1964 are bright. Thousands of companies will be urged to promote the Payroll Savings Plan enthusiastically within their organizations. *Your support is needed.* Will you join your fellow businessmen to help millions of American employees help themselves by saving regularly? Your own organization—with your backing—can make a splendid showing!

For full information, contact the chairman of your field of activity —today.

THE 1964 INDUSTRIAL PAYROLL SAVINGS COMMITTEE OF THE TREASURY DEPARTMENT

Honorary Chairman:
Honorable Douglas Dillon
Secretary of the Treasury

Chairman:
Frank R. Milliken, Pres.
Kennecott Copper Corporation
(Copper)

Members:
Crowdus Baker, Pres.
and
James T. Griffin, Vice Pres.
Sears, Roebuck and Company
(Retail Merchandising)

Walter Bouldin, Pres.
Alabama Power Company
(Public Utilities)

Maurice R. Chambers, Pres.
International Shoe Company
(Shoe Manufacturing)

Harold W. Comfort, Pres.
The Borden Company
(Food Manufacturing)

John D. deButts, Pres.
Illinois Bell Telephone Company
(Telecommunications)

John D. Ehrgott, Chm. of the Bd.
The Great Atlantic & Pacific
Tea Company, Inc.
(Retail Food)

Dr. Elmer W. Engstrom, Pres.
Radio Corporation of America
(Electronics)

Ray R. Eppert, Pres.
Burroughs Corporation
(Office Equipment)

Raymond C. Firestone, Pres.
Firestone Tire & Rubber Company
(Rubber)

Alexander H. Galloway, Pres.
R. J. Reynolds Tobacco Company
(Tobacco)

Harold S. Geneen, Pres.
International Telephone &
Telegraph Corporation
(At Large)

John F. Gordon, Pres.
General Motors Corporation
(Automotive)

Crawford H. Greenewalt, Chm. of the Bd.
E. I. du Pont de Nemours & Co., Inc.
(Chemicals)

John L. Gushman, Pres.
Anchor Hocking Glass Corporation
(Glass)

Reed O. Hunt, Pres.
Crown Zellerbach Corporation
(Paper)

Thomas V. Jones, Pres. and Chm.
Northrop Corporation
(Aerospace-Aircraft)

Clarence A. Kelley, Pres.
Dixie Ohio Express, Inc.
(Trucking)

Lawrence Litchfield, Jr., Chm. of the Bd.
Aluminum Company of America
(Aluminum)

Joseph A. Martino, Chm. and Pres.
National Lead Company
(Lead)

Charles F. Myers, Jr., Pres.
Burlington Industries, Inc.
(Textiles)

William J. Quinn, Chm. and Pres.
Chicago, Milwaukee, St. Paul and
Pacific Railroad Company
(Railroads)

M. J. Rathbone, Chm. of the Bd.
Standard Oil Company (New Jersey)
(Petroleum)

H. I. Romnes, Vice-Chm. of the Bd.
American Telephone and
Telegraph Company
(Electrical Equipment)

W. Cordes Snyder, Jr., Chm. of the Bd.
Blaw-Knox Company
(Machinery Manufacturing)

C. E. Woolman, Pres.
Delta Air Lines Inc.
(Air Transportation)

Leslie B. Worthington, Pres.
United States Steel Corporation
(Steel)

Charles J. Zimmerman, Pres.
Connecticut Mutual Life
Insurance Company
(Insurance)



in your plant...promote the **PAYROLL SAVINGS PLAN** for U.S. SAVINGS BONDS



AUTOMATIC DISPLAY SWITCHING

with the new Tektronix Type 547 Oscilloscope and 1A1 Unit

DC-TO-50 MC
DUAL-TRACE
50 MV/CM
DC-TO-28 MC, 5 MV/CM

Type 547 also uses 17 "letter-series" plug-in units



With Automatic Display Switching, the Type 547 provides two independent oscilloscope systems in one cabinet, time-sharing a single-beam crt.

You can control either or both traces with either time-base generator. You can operate one time-base unit as a delay generator—hold off the start of any sweep generated by the other for a precise interval from one-tenth microsecond to 50 seconds—and observe both the original display and the delayed display.

Used with the normal sweep, this mode allows an alternate presentation of the same signal at different sweep rates—Channel 1 can be locked to Time Base A and Channel 2 can be locked to Time Base B. In many applications, this provides the equivalent of a dual-beam oscilloscope.

Used with the delayed sweep, as illustrated, this mode allows an alternate presentation of a waveform brightened over a selected portion, and the selected portion expanded to fill the full display area.

With its facility for displaying both time bases alternately or separately, the Type 547 provides high adaptability in displaying waveform phenomena—even under difficult environments of temperature, shock, altitude, and vibration.

Some of the Type 547/1A1 Unit Features

No-Parallax Crt—which assures measurement accuracy over the full 6 cm by 10 cm display area. (Crt has controllable graticule illumination.)

2 Independent Triggering Systems—which simplify set-up procedures, provide stable displays over the full passband and to beyond 50 Mc, and include bright-line automatic modes for convenience.

2 Independent Sweep Systems—which provide 24 calibrated time-base rates from 5 sec/cm to 0.1 μ sec/cm and three magnified positions of 2X, 5X, and 10X, with the 10X magnifier increasing the maximum sweep rate to 10 nsec/cm.

Calibrated Sweep-Delay—which extends continuously from 0.1 microsecond to 50 seconds, provides jitter-free operation for delayed-sweep presentations.

Single-Sweep Operation—which enables one-shot displays for photography of either normal or delayed sweeps.

Horizontal Display Modes—See Horizontal Display Switch, illustrated.

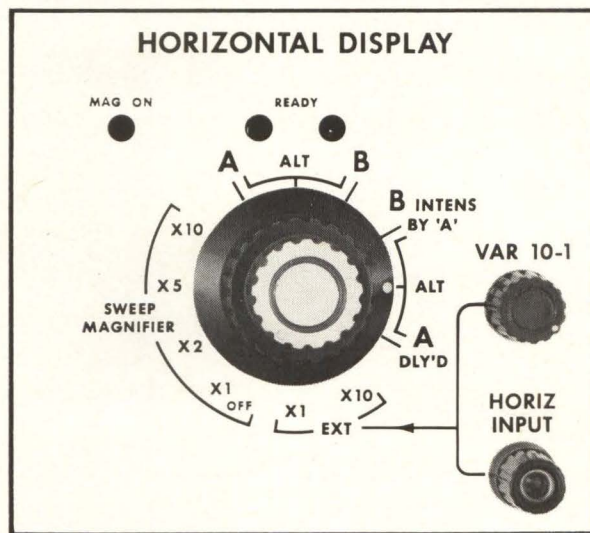
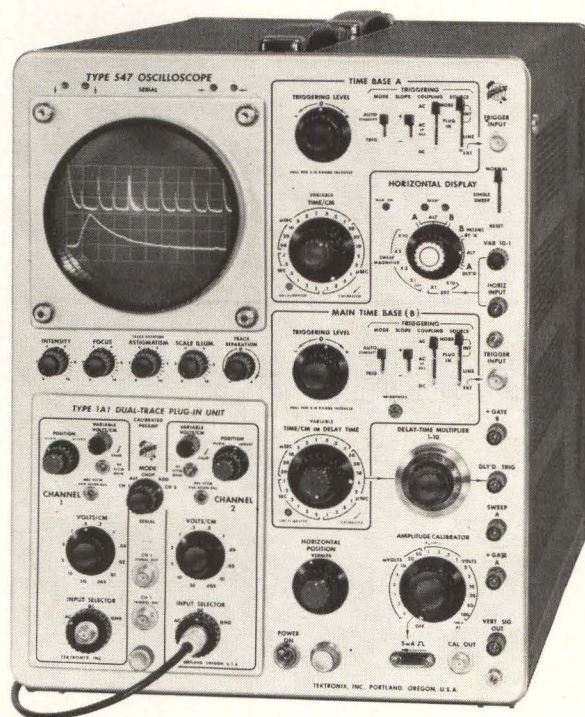

Type 547 Oscilloscope (without plug-in unit) . . . \$1875
 Type 1A1 Dual-Trace Unit . . . \$ 600
 Rack-Mount Model—Type RM547 available . . . \$1975

U. S. Sales Prices f.o.b. Beaverton, Oregon

**For a demonstration,
 call your Tektronix Field Engineer.**

Tektronix, Inc.

P.O. BOX 500 • BEAVERTON, OREGON 97005 • Phone: (Area Code 503) Mitchell 4-0161 • Telex: 036-691
 TWX: 503-291-6805 • Cable: TEKTRONIX • OVERSEAS DISTRIBUTORS IN 25 COUNTRIES
 TEKTRONIX FIELD OFFICES in principal cities in United States. Consult Telephone Directory

Tektronix Australia Pty., Ltd., Melbourne; Sydney • Tektronix Canada Ltd., Montreal; Toronto

Tektronix International A.G., Zug, Switzerland • Tektronix Ltd., Guernsey, C. I. • Tektronix U. K. Ltd., Harpenden, Herts

only WELCH **DUO-SEAL**
vacuum pumps
offer you all **6**
of these benefits!

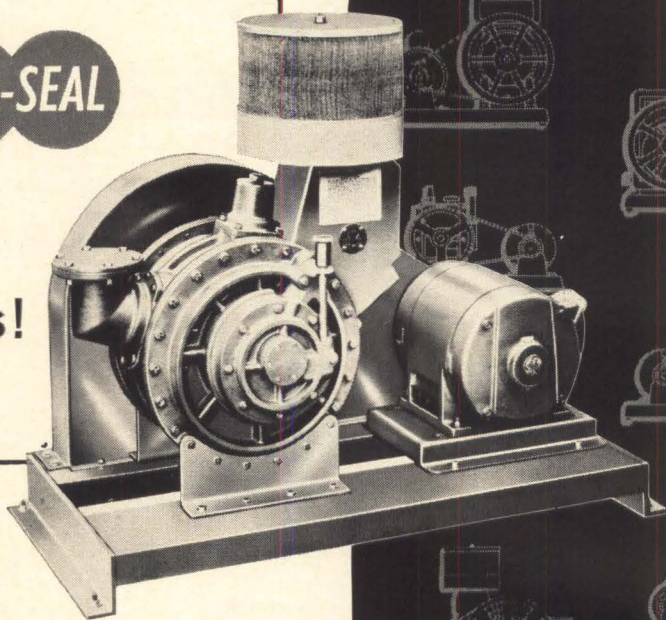

**30 YEARS OF VACUUM
PUMP DESIGN AND
MANUFACTURING
KNOW-HOW**

The Welch "Duo-Seal" vacuum pump was developed to fill the need for a highly efficient, quiet, reliable pump for producing high vacuum. Thirty years of research and development of the internal vane design has given Welch the engineering and manufacturing know-how to produce the present Welch line of "Duo-Seal" pumps . . . the best mechanical, oil sealed vacuum pumps ever available.



**IMMEDIATE
DELIVERY FROM
STOCK FROM FOUR
KEY INDUSTRIAL AREAS**

Four completely stocked locations are maintained by Welch, offering immediate delivery on all "Duo-Seal" pumps. These locations are New York City, Chicago (Skokie); Illinois, and San Carlos and Los Angeles (North Hollywood), Calif.



**FOUR STRATEGICALLY
LOCATED REPAIR
FACILITIES AND FULLY
STOCKED REPLACEMENT
PUMP POOLS**

All four Welch locations (above) are fully staffed with factory trained "Duo-Seal" service experts to properly repair your pumps with a minimum of lost time to you. Further, each of the four locations include a Welch "Duo-Seal" Replacement Pump Pool to virtually eliminate all of your pump downtime. In the event of pump trouble, phone the nearest Welch location and you will be immediately shipped a completely tested, perfectly operating replacement pump of the same catalog number as your faulty pump. Upon receipt, your pump can then be returned in the replacement pump's shipping container.



**ALL WELCH VACUUM
PUMP SALES PERSONNEL
ARE HIGHLY TRAINED
VACUUM SPECIALISTS**

The Welch vacuum sales personnel consist only of highly qualified vacuum experts whose business is vacuum, nothing else. Feel free to call on them at any time.



**NEW, FULL REPAIR
OR REPLACEMENT
GUARANTEED**

All Welch "Duo-Seal" vacuum pumps carry a new, no-charge repair or replacement guarantee for one full year from date of purchase. Simplicity of design, highest quality materials and superior craftsmanship in manufacture go into every "Duo-Seal" pump. Before delivery, every pump is completely run-in and tested at the factory until its performance exceeds its vacuum guarantee. The confidence that these superior vacuum pumps will give trouble-free performance is reflected in the new Welch, no-charge repair or replacement guarantee.



**REDUCED
INSTALLATION TIME**

The extremely quiet, vibration-free, air-cooled operation of all Welch "Duo-Seal" pumps eliminates permanent installation . . . no water cooling connections to make . . . no need to bolt down the base. Merely place pump on any firm, flat surface and plug into proper electrical outlet and switch on the pump motor. It will "stay-put".



Send for **FREE**, new
condensed catalog and
replacement 'Pump-Pool'
bulletin.

Catalog contains photos,
descriptions, specifications
and typical performance
curves of all "Duo-Seal"
vacuum pumps.

Welch "Duo-Seal" Vacuum Pumps are manufactured in a wide variety of capacities and ultimate vacuum characteristics. They range in capacity from 21 to 1400 liters/minute and ultimates from 2×10^{-2} to 5×10^{-5} mm Hg (torr).



THE WELCH SCIENTIFIC COMPANY

FOREMOST MANUFACTURER OF SCIENTIFIC EQUIPMENT
1515 Sedgwick Street, Dept. 906, Chicago, Illinois 60610

Radiometric receiver spans 50 Mc to 1.5 Gc

Signals many times lower than noise level can be measured. Unit is also useful in uhf component testing

Using low-loss switching at the input and synchronous detection in the output of model LR-101 radiometric receiver allows signals which are many times lower than the receiver noise level to be measured and recorded. Block diagram illustrates the new receiver which utilizes a crystal mixer, superheterodyne configuration and has a frequency range of 50 Mc to 1.500 Mc. According to the manufacturer, no other commercially available radiometric receiver covers the range and has the operating features of the LR-101. The intermediate frequency is 30 Mc with a band pass of 8 Mc.

In addition to the radiometric mode of operation, the LR-101 may be operated as a conventional superheterodyne receiver for monitoring signal levels which are well

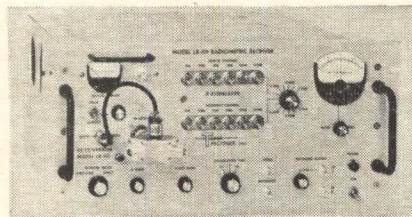

above the noise level. Individual calibrated front panel attenuators in the signal and reference channels allow a direct determination of the relative signal strength at the two input terminals of the radiometric receiver. Integration time constants of 0.1, 1 and 10 seconds are available at a front panel selector switch. The integrated d-c output is presented on a zero center front panel meter and at high and low impedance front panel jacks for use with external recorders.

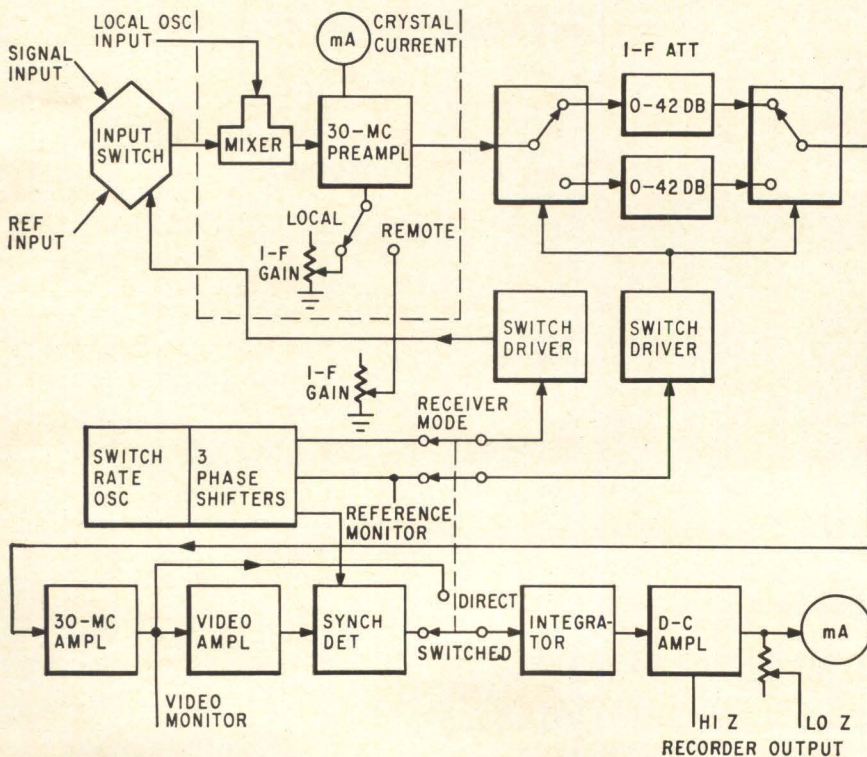

Testing the performance of uhf components may be facilitated by comparing the test unit with some standard or reference unit. In this case the LR-101 is used as a sensitive differential detector.

Sensitivity of the radiometric receiver is such that input signals of $0.1 \mu\text{V}$ give an output signal-to-noise ratio which is greater than 2:1. Unit is packaged in an $8\frac{3}{4}$ in. by 19 in. rack panel mount and operates on 115-v, 60-cycle. Delivery is 60 days. Price is \$3,900.

Triconix, Inc., Hickory Drive, Waltham, Mass. 02154.

Circle 301 reader service card

Current limiters protect semiconductors

Solid-state current limiters have been developed that are said to be 3 or 4 times faster acting than other protective devices available. The limiters offer positive and predictable protection for semiconductor devices, featuring limit time of less than 0.001 sec and a temperature coefficient of resistance of ± 0.25 percent/deg C.

Model S-100 current limiters use a one-piece ceramic element. Designed to fit standard fuse holders, the units are manufactured by a new technique which eliminates arcing and conductive gases.

Clearing time (or the time it takes to open a circuit) is less than 0.001 sec at 316 percent of rated value. Resistance before clearing at 32 v is 0.023 ohm to 15.8 ohms. At 115 v, it is 0.046 ohm to 31.6 ohms. Resistance after clearing is 10,000 megohms. The limiters, which measure $\frac{1}{4}$ in. by 1 in., are rated $\frac{1}{2}$ ampere to 5 amperes. Quantity price is 85 cents per unit. Microelectron, Inc., subsidiary of Electra Mfg. Co., Independence, Kansas. [302]

ASK FOR FREE SAMPLE!

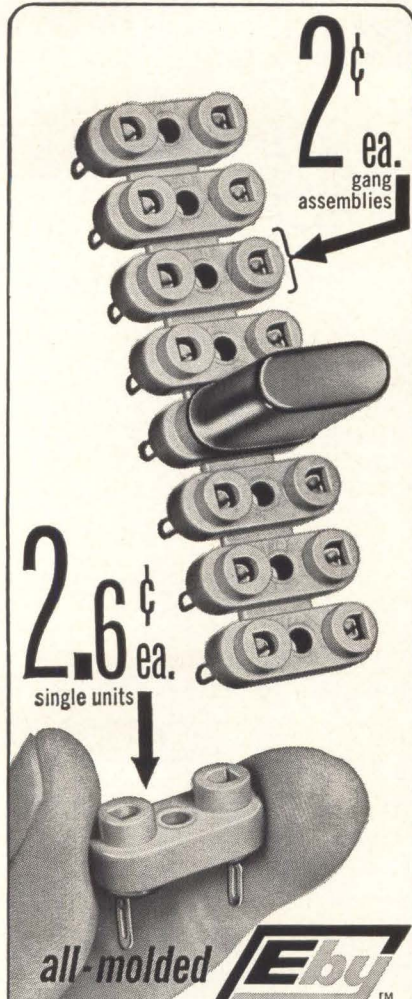

all-molded **Eby**™

CRYSTAL SOCKETS

cost **45%** less than identical ceramic versions

EBY's all-molded phenolic crystal sockets do everything that identical ceramic versions do... yet they cost about half as much... and they eliminate the breakage problem present with ceramic sockets. These molded sockets accept all standard HC-6/U crystals, and have many commercial and military applications. Ideal for severe shock and vibration conditions, they are available in single units, or in integral (snap-apart) gang assemblies of 4, 6 and 8 units. Contacts are available in brass, phosphor bronze, and beryllium copper. Prices above are based on 5,000 quantity. Single mica-filled sockets with silver plated, phosphor bronze contacts meet TS0205P01.

■ For your FREE SAMPLE and technical bulletin, circle reader card or write to EBY



HUGH H. EBY CO.

4701 Germantown Ave., Philadelphia, Pa. 19144
(215) 324-7000 a division of REDM Corp.

New Components and Hardware

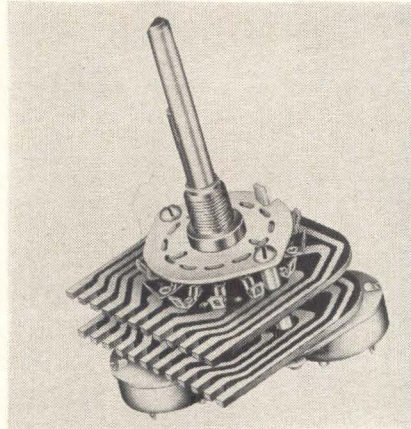

Rotary switches have mounting flexibility

Type PB printed-circuit rotary switches are versatile controls readily interchangeable with existing p-c switches. Their use in equipment eliminates hand wiring (hence wiring errors) and reduces assembly time. The switch accommodates up to 22 type K insulated clips per section, 12 on one side, 10 on the other—all with 30-deg spacing; each also is adaptable to meet 45 and 60-deg functions. Type of contacts supplied can be varied to suit low power circuit requirements. Silver-alloy contacts are available for higher currents. Oak Mfg. Co., Crystal Lake, Ill. [311]

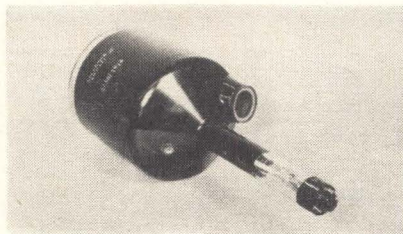

Rear window crt for radar navigation

Development of a compact 7-in. rear window cathode-ray tube particularly suitable for aerial reconnaissance and radar navigation has been announced. The SC-3821 permits photographic reproduction of images that appear on the screen of the tube. Reproduction does not

interfere with normal front viewing. By using the optically designed rear window, still photographs or movie film in black and white or color can be made.

Furthermore, images or maps can be projected through the rear window and will then appear on the face screen of the tube. Data being received by the tube, such as positions of aircraft, can then be assessed in a real-time relationship with the map.

Crt's using the rear window concept have proven particularly useful in aircraft. They are applicable also to telemetry, altitude, distance, pressure measuring, or other areas that require the display and photographic recording of electronic voltage data simultaneously. The new tube has a single electron gun and utilizes a 7-in. round glass envelope whose phosphor screen possesses slow-decay characteristics. The optically flat rear window is sealed to the funnel of the tube. Sylvania Electric Products, Inc., Seneca Falls, N. Y. [312]

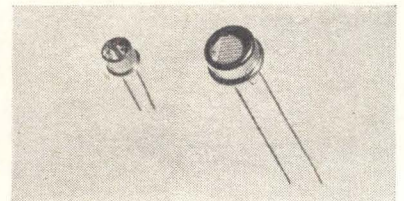

Photoconductive cells aid chopper design

Three new cadmium selenide high-speed photoconductive cells are said to make possible the design of low-cost photoelectric choppers operating at rates of up to 1,000 cps. Additional features of such choppers include the absence of moving parts or electromagnetic shielding, the ability to modulate submillivolt signals, and a wide impedance range. Rise and fall response times of each cell is less than 0.4 msec and 3.0 msec respectively. Depending on the type selected, the light and dark resistances range from 2.3 kilohms to 500 megohms respectively. Voltage ratings are available



“Mylar” makes a smaller capacitor than paper

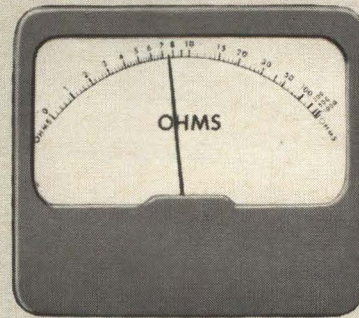
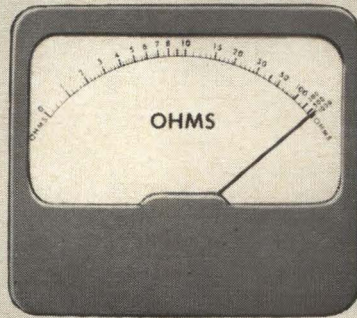

“Mylar” absorbs less moisture than paper

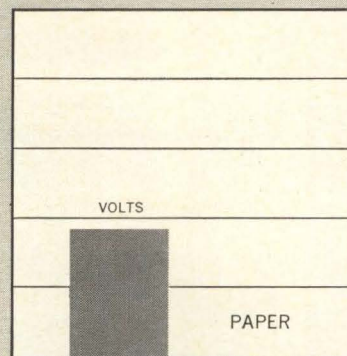
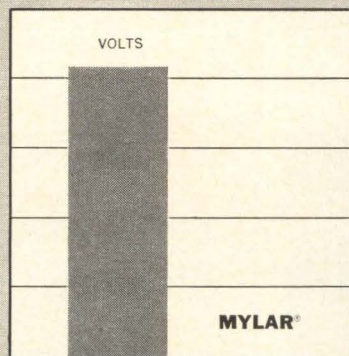

“Mylar” operates at higher voltage stress than paper[†]

and capacitors of “Mylar”^{*} cost about the same as paper

Within the range of .001 to 1. MFD under 600 volts, you get the added dielectric strength, reduced leakage and greater stability of “Mylar” at equivalent cost to paper on a set-complement basis. Specify “Mylar”.

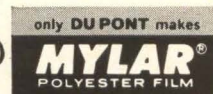

BETTER THINGS FOR BETTER LIVING . . . THROUGH CHEMISTRY

[†]At higher voltage stress “Mylar” operates with equal or better reliability than paper. ^{*}Du Pont registered trademark.

Go ahead,
promise
long tube
life

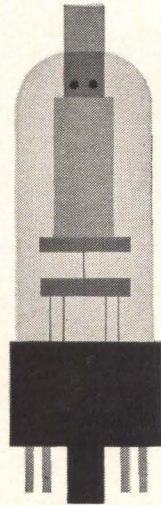

Superior
cathodes
will back
you up

Once your electron tubes are plugged into a circuit, your reputation will depend on the performance of the cathodes you use. Do you want tubes with long life, high shock resistance, uniformity, high-temperature tolerance, and various other desirable characteristics? Choose your cathodes from the broad Superior line. Write us for a copy of Catalog 51. Superior Tube Co., 2500 Germantown Ave., Norristown, Pa., 19404.

Widest choice of cathode alloys

Includes regular commercial materials, plus the versatile Cathaloy® series, developed by Superior. Each heat tested by Superior before approval for production.

Cathaloy A-31. For extreme stress applications. 4% tungsten. Approximately twice as strong as tungstenfree alloys.

Cathaloy A-32. Contains 2% tungsten. Excellent emission, rapid activation, very low sublimation and interface impedance.

Cathaloy A-33. All-purpose cathode alloy. Combines high emission with freedom from sublimation and interface impedance.

Cathaloy P-50. Long-life passive alloy for high-reliability power output tubes requiring low grid emission.

Cathaloy P-51. 100% stronger than P-50 at high temperatures. For use in tubes subject to shock and vibration.

Nickel 220, Nickel 225, Nickel 230 and Nickel 233 ("330 Nickel"). Contain silicon and magnesium. Rapid activation.

Driver-Harris 399, 599 and 799. Silicon activated. Rapid activation, plus high-level d-c emission.

Widest choice of cathode forms

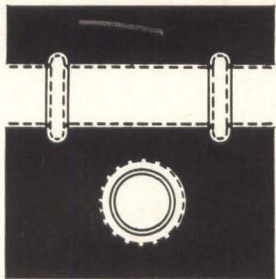

Seamless WELDRAWN.® No seam. Can be made to close tolerances.

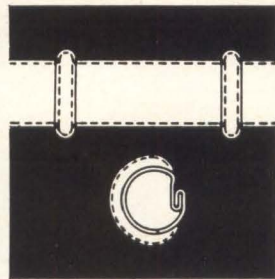

Lockseam.* Available with serrations, vertical rib or integral tab.

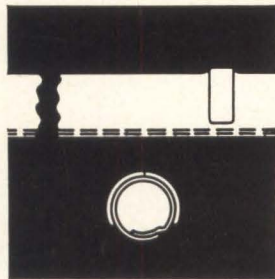

Lapseam. Gives tighter fit in mica. Available in rounds and shapes.

*Manufactured under U.S. patents



Disc cathodes. One of four basic types. Separate cap alloy. Close control of E-dimension. Shadow groove. Flared shank.

Superior Tube 

The big name in small tubing
NORRISTOWN, PA.

West Coast: Pacific Tube Company, Los Angeles, California

Johnson & Hoffman Mfg. Corp., Carle Place, N.Y.—an affiliated company making precision metal stampings and deep-drawn parts

New Components

from 60 to 250 v while power dissipation is 50 mw or 125 mw. Clairex Corp., 8 W. 30th St., New York, N.Y. [313]

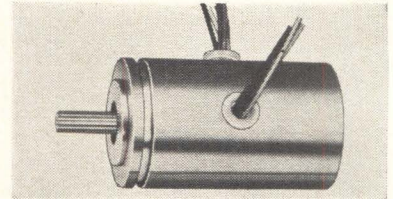

Motor-tach operates over -55 to +125 C

A new short-length series of size 8 motor-tachometers measures less than 1¼ in. in length to the register face. The 400-cycle motor-tachs are equipped with a 26-v fixed phase winding and a 33- or 26-v (series) split phase control winding for the motor portion. The tachometer input winding is for 26 v, and output is 0.275 v min/1,000 rpm. Operating ambient temperature range is -55 to +125 C. No load speed, with tachometer excitation, is 6,000 rpm, and input power requirement to the motor is 3.2 w at stall for both fixed and control phases.

Bowmar Instrument Corp., 2000 Bluffton Road, Fort Wayne, Ind. [314]

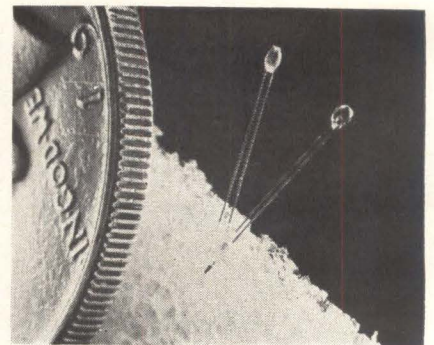

Single crystal thermistor cut from silicon carbide

Tiny single crystal silicon carbide thermistors, highly stable and reproducible, are available in commercial quantities. The P-type semiconductor bodies have been utilized to produce a thermal trans-

ducer which, in effect, cross-fertilizes some of the most desirable characteristics of thermistors on the one hand, and resistance thermometers on the other. Temperature coefficient of the devices at -100 C is 2.5 percent/deg C, decreasing to 1 percent/deg C at 300 C . Resistance ratio is 1,000/1 nominal. Resistance rating of the device at 25 C is 2,600 ohms ± 2 percent. The negative coefficient of the device is high enough to minimize signal amplification requirements, but moderate enough to cover a wide range of ambient temperatures. The single crystal, boron-doped silicon carbide disk is 0.050 in. diameter by 0.010 in. thick. Standard encapsulant is resin or ceramic bead, max dimension 0.065 in. diameter. Ceramic bead is required for operation below 100 C or above 200 C . Price of device is \$20.

The Carborundum Co., P. O. Box 337, Niagara Falls, N. Y. [315]

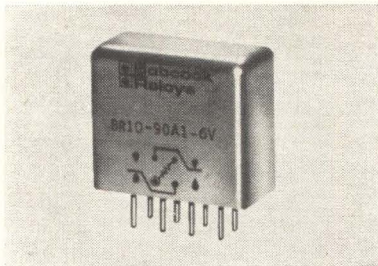

Dpdt relays switch dry circuit to 1 amp

Series of microminiature dpdt relays that will switch dry circuit to 1-amp loads provide the same sensitivity as other dpdt relays many times their size. Measuring only 0.400 by 0.230 by 0.500, the BR-10 relays are designed for low profile, p-c mounting. They meet the requirements of MIL-R-5757D, and will withstand severe environmental conditions normally encountered in airborne applications. Vycor getters have been incorporated in the design to assure maximum reliability. The getters absorb outgassed organic contaminants after production degassing. The BR-10 series can be supplied with either solder or welded header seal. Self-wiping, gold-plated contacts of AgMgNi alloy

NEW! BALLANTINE SENSITIVE TRUE-RMS RF MILLIVOLTMETER

Measures $300\ \mu\text{V}$ to $3\ \text{V}$
from $0.1\ \text{Mc}$ to $1,000\ \text{Mc}$

Measures True-RMS regardless of Waveform and Voltage

High, Uniform Accuracy and Resolution over entire 5-inch scale



Model 340
Price \$760
(with all accessories*)

Ballantine's new Model 340 is an extremely sensitive RF millivoltmeter designed for accurate True-RMS measurements with high resolution. Its 5-inch voltage scale spreads out the readings logarithmically so that you can make measurements to the same high resolution and accuracy at the bottom as at full scale. This advantage means that you can not only measure voltages accurately, regardless of waveform, but also calibrate the 340 using a signal source that may be far from sinusoidal. The new 340 is now available in both portable and rack versions.

SPECIFICATIONS

Voltage Range.....	$300\ \mu\text{V}$ to $3\ \text{V}$	Crest Factor.....	100 to 3 depending on voltage range
Frequency Range.....	$0.1\ \text{Mc}$ to $>1,000\ \text{Mc}$; calibrated to $700\ \text{Mc}$	Scales.....	Two logarithmic voltage scales, 0.95 to 3.3 and 3.0 to 10.6. One decibel scale, 0 to 10
Indication.....	True-RMS on all ranges, all voltages	Mean Square DC Output...	$0.1\ \text{V}$ to $1.0\ \text{V}$ dc. Internal resistance 20 kilohms. (For connection to recorder.)
Accuracy....% of Reading	$0.1\ \text{Mc}$ — $100\ \text{Mc}$, 4%; $100\ \text{Mc}$ — $700\ \text{Mc}$, 10%; above $700\ \text{Mc}$ as sensitive indicator		

*Accessories include a probe tip for in-circuit measurements, an adapter for connection to N or BNC, a T adapter for connection to a 50 ohm line, and a 40 db attenuator

Write for brochure giving many more details

— Since 1932 —



BALLANTINE LABORATORIES INC.

Boonton, New Jersey

CHECK WITH BALLANTINE FIRST FOR LABORATORY VACUUM TUBE VOLTMETERS, REGARDLESS OF YOUR REQUIREMENTS FOR AMPLITUDE, FREQUENCY, OR WAVEFORM. WE HAVE A LARGE LINE, WITH ADDITIONS EACH YEAR. ALSO AC/DC LINEAR CONVERTERS, CALIBRATORS, WIDE BAND AMPLIFIERS, DIRECT-READING CAPACITANCE METERS, AND A LINE OF LABORATORY VOLTAGE STANDARDS 0 TO $1,000\ \text{MC}$.



we've got your number

... in binary coded decimal format at 50,000 conversions per second, including sample and hold. Texas Instruments new Model 846 A-D Converter features 100 megohm input impedance, voltage ranges from 1 to 10 volts (manual or external selection) and 100 nanosecond aperture time.

Available options include three digits (± 999) or four digits ($\pm 1,999$), differential input, decimal or BCD display and digital to analog conversion capability. The 846 is another high-speed, high-accuracy instrument in TI's line of digital data handling equipment.

Model 844 and 845 high-speed Multiplexers are ideal companion instruments for use with TI A-D Converters.

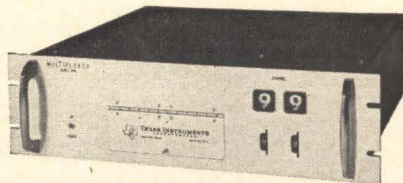

Addressable, sequential and addressable/sequential models are available, sampling at 50,000 channels per second. Features up to 160 channels, variable frame length, accuracy $\pm 0.02\%$ full scale with input levels to ± 10 volts.

Write for complete information.

INDUSTRIAL
PRODUCTS
GROUP



TEXAS INSTRUMENTS
INCORPORATED
P. O. BOX 66027 HOUSTON, TEXAS 77006

New Components

with specially designed configurations assure miss-free performance under load and minimize low-level contact resistance. Unitized construction throughout adds to the overall reliability.

Babcock Relays, a div. of Babcock Electronics Corp., 3501 Harbor Blvd., Costa Mesa, Calif. [316]

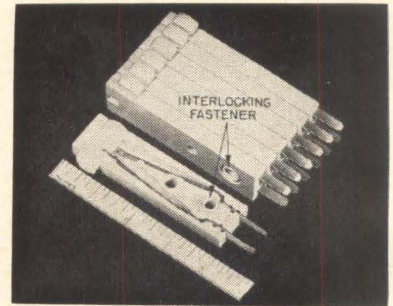

Non-snap switch features long life

Type 40 series non snap-action switch is designed to be operated 100 million cycles minimum at 350 ma, 170 v a-c or 10 ma, 30 v d-c. Blade design provides high contact pressure and no measurable contact bounce. Only 0.190 in. thick, the switch case has a built-in fastener to interlock with other type 40 switches to facilitate gang mounting side by side. Operational to 190 F ambient, the switch has quick disconnect terminals, and is available in either normally open or normally closed momentary contact.

Licon Division, Illinois Tool Works Inc., 6615 West Irving Park Road, Chicago, Ill. 60634 [317]



Power transformers are metal encased

Series of 400-cycle power transformers, the DO-T400, are metal-encased, hermetically-sealed units manufactured and guaranteed to MIL-T-27B, MIL type TF4RXO-3YY. Especially designed for tran-

sistor or filament use they are suited to ground or airborne applications. The flexible leads employ solder melting insulations which are color coded. They are both solderable and weldable. Parameters include: primaries, 28 v 380-1,000 cps; secondaries, 6.3 v to 28 v, 20 ma to 60 ma. Isolation transformers are electrostatically shielded. Size is $\frac{5}{16}$ -in. diameter by $\frac{1}{2}$ -in. height. Weight is 1/10 oz. Lead length is $1\frac{1}{2}$ in.

United Transformer Corp., 150 Varick St., New York 13, N.Y. [318]

Metal film resistors meet MIL-R-55182

Hermetically-sealed glass-enclosed metal film resistors, the model FH line, are available in four sizes and designed for high reliability service in conformance with MIL-R-55182. They feature hard glass enclosures permitting visual inspection of resistive core elements and terminations. The sealed, helium-filled enclosure prevents atmospheric contamination and facilitates core heat dissipation. The enclosure also makes possible mass spectrometer testing of finished resistors.

Mepco, Inc., Morristown, N.J. [319]

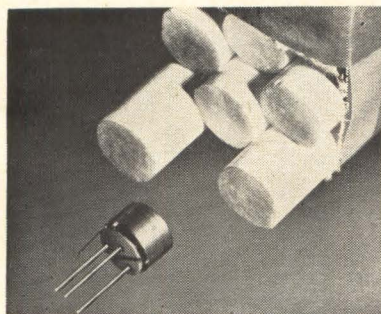

Trimming pot is rated $\frac{1}{2}$ w at 85 C

Subminiature model 61 Helitrim trimming potentiometer is a single-turn unit with bottom pins spaced on a 0.10-in. grid. It has a ceramic/metal resistance element with essentially infinite resolution and standard resistances from 10 ohms to 1 megohm. The resistance element also offers freedom from sudden failure. Power rating is $\frac{1}{2}$ w at 85 C, derating to 0 at 175 C. Com-

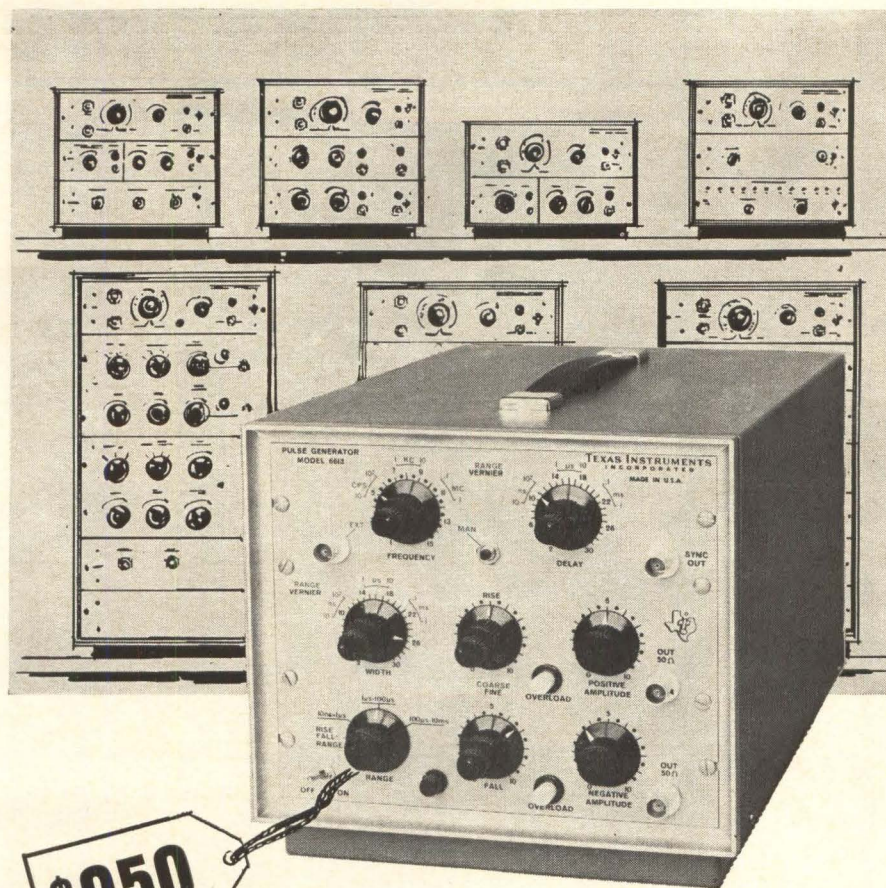

\$950

a new one off the shelf... quality, high-spec pulse generator

The Model 6613 General Purpose Pulse Generator fills the need for a low-cost, high-quality test instrument with exceptional performance specifications. It is a general purpose instrument ideal for most pulse applications such as testing integrated circuits, digital circuit design, system design and checkout, testing of diodes and transistors.

The 6613 provides coincident positive and negative pulses determined by an internal clock generator or external source, with rep rate variable in 6 steps. Pulse width and delay are also variable in 6 steps. Amplitude is variable from near zero to 10 volts, with overload protection provided. Solid-state circuitry is utilized throughout. The compact unit measures $8\frac{1}{2}$ in. high, $8\frac{1}{2}$ in. wide, 12 in. deep and weighs only 10 lb.

SPECIFICATIONS

Clock Pulse Repetition Frequency

15 cps to 150 cps	15 to 150 kc
150 to 1500 cps	150 kc to 1.5 mc
1500 cps to 15 kc	1.5 mc to 15 mc

Delay

30 to 300 nanosecs	30 to 300 microsecs
300 nanosecs to 3 microsecs	300 microsecs to 3 milliseecs
3 to 30 microsecs	3 to 30 milliseecs

Width

30 to 300 nanosecs	30 to 300 microsecs
300 nanosecs to 3 microsecs	300 microsecs to 3 milliseecs
3 to 30 microsecs	3 to 30 milliseecs

Pulse Amplitude—10 v into 50 ohms

Rise and Fall Times—variable; less than 10 nanosecs to 1 microsec, 1 microsec to 100 microsecs, 100 microsecs to 10 milliseecs, minimum rise time typically 8 nanosecs

INDUSTRIAL
PRODUCTS
GROUP



TEXAS INSTRUMENTS
INCORPORATED
P. O. BOX 66027 HOUSTON, TEXAS 77006

663

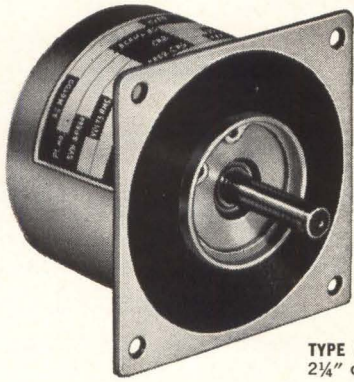

TYPE UC MOTOR
2¼" dia. x 3½" max. length

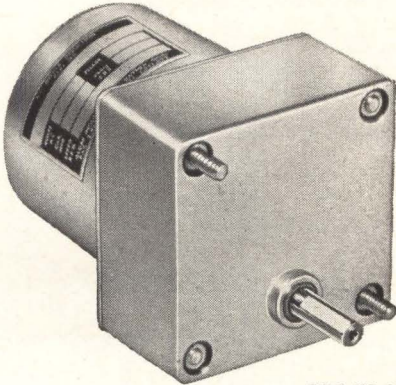

TYPE UC GEARMOTOR

NEW 2¼" A.C. GEARMOTORS HIGH TORQUE, MANY SPEEDS

Get torques from 1.2 oz. in. to 10 lb. in. from Globe's new Type UC commercially priced a.c. motor family. Induction capacitor motor is available in three stack lengths rated at 1, 3 or 6 oz. in. torque at 3,000 rpm. Standard windings available for 115 or 230 v.a.c., 1 or 3-phase, 2, 4 or 6 poles, 60 cps. Epoxy encapsulated stator seals out dirt and moisture. Motors have ball bearings, stainless steel bearing seats and shafts. Type UC is available with choice of 13 life-lubed spur gearheads with ratios from 6:1 to 1800:1, continuous output torques from .4 to 10 lb. in., speeds from 3,000 down to .8 rpm. Each gear cluster has separate mounting shaft for maximum support. Hysteresis synchronous versions can be stalled without damage. Mounting is interchangeable with traditional type 2½" motors. Request Bulletin UC.

Globe Industries, Inc., 1784 Stanley Avenue,
Dayton, Ohio 45404. Area 513 222-3741.



GLOBE

New Components

pact unit weighs only about ½ gram, measures $\frac{3}{16}$ in. high and occupies less than 0.01 cu in. of mounting space. It is enclosed in a stainless steel housing which is sealed to meet immersion tests of MIL-R-22097B.

Helipot Division of Beckman Instruments, Inc., 2500 Harbor Blvd., Fullerton, Calif. [320]

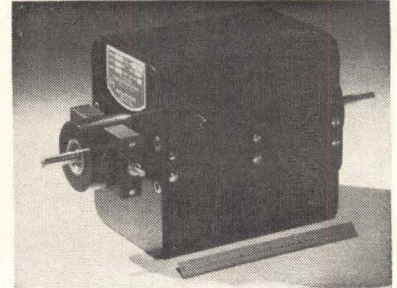

Servo motor offers fast response

Designed for use in high-speed positioning and incrementing applications the Incredyne servo motor has an undamped mechanical time constant of 1.8 millisecc. Rated speed is 3300 rpm at 40 v d-c. Maximum pulse torque capability is 500 in.-oz. Continuous duty running torque is 150 in.-oz. and continuous-duty stall torque is 84 in.-oz. Dimensions are $3\frac{7}{8}$ in. by $5\frac{9}{16}$ in. by $8\frac{3}{16}$ in.

Photocircuits Corp., Glen Cove, N.Y. [321]

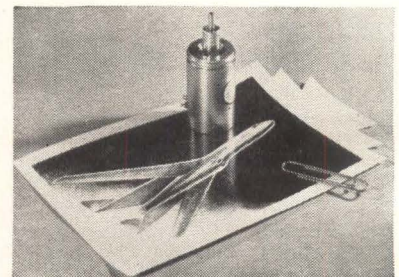

Coax clutch controls slip precisely

Designed for precise control use, size 11 coaxial magnetic dry particle clutch can be operated in either direction with chatter-free,

exactly-controllable slip. Rated torque is 28 oz-in. at a recommended maximum 3,500 rpm. Inertia is very low. Nominal response time is 6.45 millisecc; this can be reduced to 1.05 millisecc by use of a constant current driving source of 1,000 ohms impedance. Input power is 3.46 w at 24-28 v d-c.

Vibrac Corp., Alpha Industrial Park, Route 129, Chelmsford, Mass. [322]

Clutches and brakes have high torque

Precision miniature electric clutches and brakes feature the use of a metallic composition friction face that increases torque capacity without sacrificing other performance specs. External clamp bands are eliminated, further reducing the diameter of these high-torque-for-size packages. Ten torque ratings and five sizes are available in each of 9 different models. Sizes are 6, 8, 11, 13 and 18. Models are clutch, duplex clutch, clutch neutral clutch, clutch failsafe, brake, brake failsafe, clutch brake, clutch neutral brake and clutch brake failsafe. Torque range from 2.25 to 260 oz in.

Warner Electric Brake & Clutch Co., Beloit, Wisc. [323]

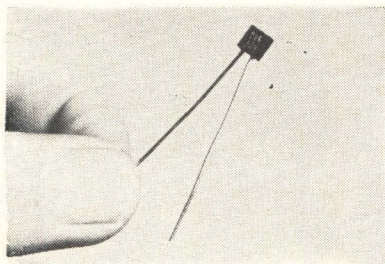

Ceramic capacitors exceed MIL-C-11015C

Line of miniature square capacitors offer capacitance of 0.01 μ f in CK05 case size. The CK-15 series is rated at 50 v d-c over a temperature range from 1,200 to 10,000 pf in tolerances of ± 10 percent and ± 20 percent. Measuring 0.195 in. square and packaged in a molded plastic case, the series are available with radial leads in tinned copper or weldable gold plated dumet. Gulton Industries, 212 Durham Ave., Metuchen, N.J. [324]

MAGNETICALLY SHIELD YOUR COMPONENT IN SECONDS

Versatile Netic and Co-Netic Foils cut to any size or outline with ordinary scissors—wrap easily

High attenuation to weight ratio possibilities; can dramatically enhance component performance. The shields stop degradation from unpredictable magnetic fields. When grounded, they also shield electrostatically. Co-Netic and Netic shielding foils are not significantly affected by dropping, vibration or shock, and do not require periodic annealing. Foils are available in thicknesses from .002" in rolls 4", 15", and 19-3/8" wide. Extensively used in experimental evaluation and production line operations for military, commercial and industrial applications

MAGNETIC SHIELD DIVISION

Perfection Mica Company
1322 N. ELSTON AVENUE, CHICAGO 22, ILLINOIS
ORIGINATORS OF PERMANENTLY EFFECTIVE NETIC CO-NETIC MAGNETIC SHIELDING

Circle 203 on reader service card

DIALCO®

SINGLE PLANE NUMERIC READOUT*

FOR 12 TO 160 VOLT SUPPLY

Exceptionally bright, crisp, easy to read digits are produced by an exclusive DIALCO light cell system. Numerals lie in a single plane—can be seen at extremely wide angles.

The availability of plus-minus module, optional colon, or floating decimal point offer flexibility in readout presentation.

A choice of long-life incandescent lamps for operation on low voltages, or seasoned and selected neon lamps for use at 100 to 160 volts, is available. DIALCO readouts are adaptable to all power supply voltages.

Transistorized translators can be provided on application.

FOR COMPLETE DATA, REQUEST CATALOG L-171A. *PATENT APPLIED FOR

DIALCO®

FOREMOST MANUFACTURER OF PILOT LIGHTS

DIALIGHT CORPORATION

60 STEWART AVENUE, BROOKLYN, N.Y. 11237 212 HYACINTH 7-7600

New! BUSS SPACE SAVER PANEL MOUNTED FUSEHOLDER

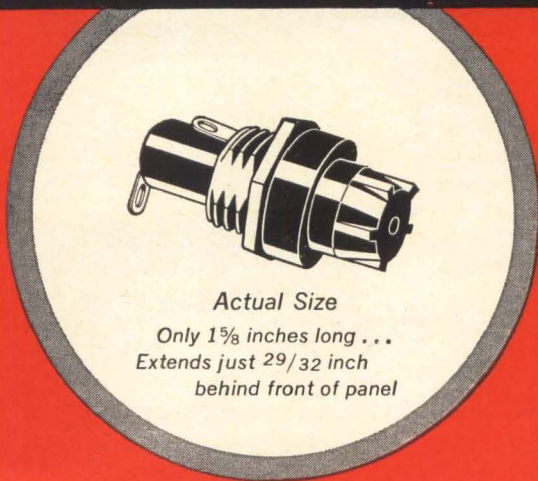

Actual Size
Only 1 5/8 inches long . . .
Extends just 29/32 inch
behind front of panel

- Fuseholder takes 1/4 x 1 1/4 inch fuses. Converts to 9/32 x 1 1/4 inch fuses simply by changing screw type knob. Holder is rated at 30 ampere for any voltage up to 250.

- Also available in military type which meets all requirements of MIL-F-19207A.

BUSS

Write for BUSS
Bulletin SFH-10

BUSSMANN MFG. DIVISION, McGraw-Edison Co., St. Louis 7, Mo.

Save Assembly Time with Quick-Connect Terminals on BUSS Fuseholders

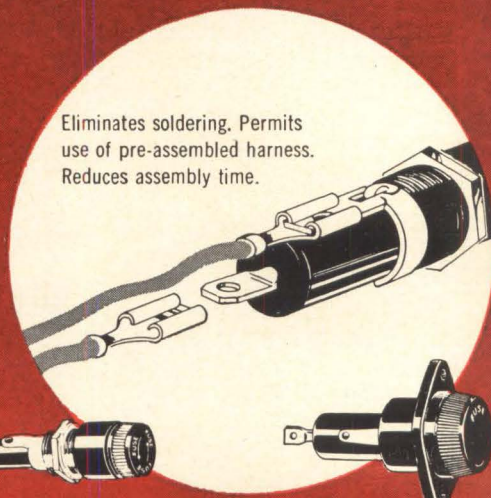

Eliminates soldering. Permits
use of pre-assembled harness.
Reduces assembly time.

For 1/4 x 1 1/4 inch fuses
Series HJ, HK, and HLD

For 1 1/2 x 1 1/2 inch fuses
Series HPC

BUSS

Write for BUSS
Bulletin SF8

BUSSMANN MFG. DIVISION, McGraw-Edison Co., St. Louis 7, Mo.

BUSS: 1914-1964, Fifty years of Pioneering..

Circle 125 on reader service card

Circle 125 on reader service card

MICO

(KING SIZE ENGRAVER)

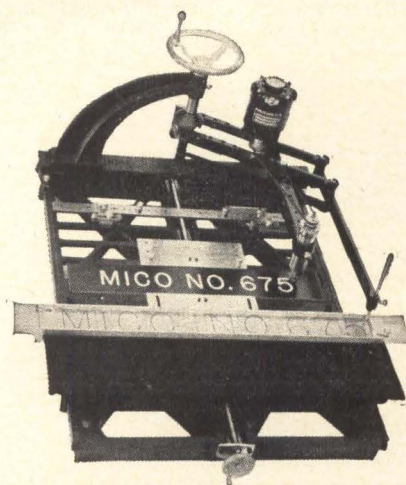

FEATURES

1. Seven reduction ratios available. From 1.5:1 to 8:1.
2. Spindle has integral micrometer depth control of 1/2".
3. Twenty-four inch line of two-inch characters can be engraved in a single set-up.
4. Uses 1/2" diameter shank cutters. Adaptor available for 1/8" diameter shanks.
5. Standard Mico master type available—1/4" to 3" high.
6. Copy carriers available in four widths and two lengths, can be spaced separately.
7. Constant-depth attachment supplied; for uniform depth of engraving over large areas.

Send for illustrated Catalog

MICO INSTRUMENT CO.

77 Trowbridge St. Cambridge 38, Mass.

Circle 124 on reader service card

TR MICRO TV TUNER

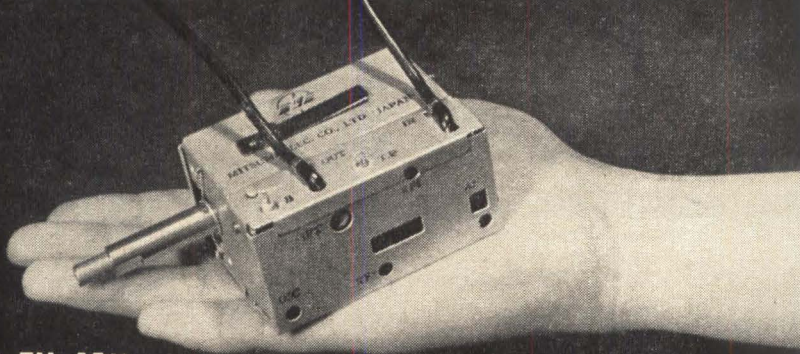

MODEL TU-15U

This MICRO TV TUNER, using 3 transistors, provides you with excellent performance while keeping high quality stability, thanks to our latest technical advancement. Spurious radiation meets the requirements of FCC and is guaranteed for performance of more than 40,000 operations. We also offer you many other lines of components for your use. Please write us asking for catalogs available on the following products:

Main Products

Polyvaricon, IF Transformers, Oscillator Coils, Antenna Coils, Variable Resistors, FM Tuners, TV Tuners, Micro-motors, Sockets.



MITSUMI ELECTRIC CO., LTD.

Head Office Komae, Kitatama, Tokyo, Japan.
New York Office 11 Broadway, New York 4, N.Y., U.S.A.

Circle 213 on reader service card

New Semiconductors

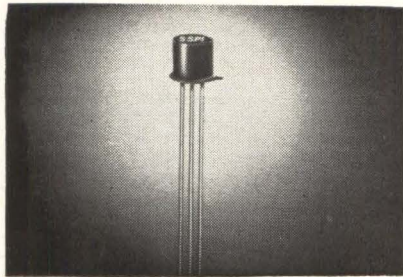

Controlled switches are fast operating

Typical turn-on time of 0.12 μsec (to 1 amp), and recovery with 0.7 μsec are featured in the fast-switching 2N3027-2N3032 series. Units are silicon, planar, pnpn controlled switches, featuring intrinsic parameter stability, with complete passivation of all junctions. The devices, in TO-18 size, handle 5 to 500 ma (d-c), with blocking voltages to 100

v. Saturation voltage is 1.5 v at 1 amp, with blocking currents of 100 nanoamp, and triggering levels below 20 μa . The switches have many applications including use in ring counters, high current pulse generation, gating, as well as timing and time delay circuits.

Solid State Products, Inc., 1 Pingree St., Salem, Mass. [331]

Hall generators available in wide voltage range

A line of general-purpose Hall generators is available. These semiconductor devices linearly multiply current and an orthogonal negative field to produce an output voltage. They can be used as gauss meters, ammeters, watt-meters, function generators, choppers and position indicators. Units come in voltage

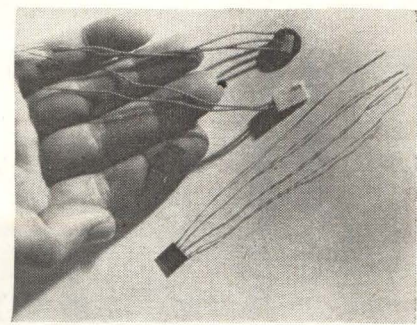

classifications from 210 to 420 mv in a ten-kilogauss field. Linearity is held to 1% with moderate temperature coefficients. The units are epoxy encapsulated and have dimensions of 0.375 by 0.375 by 0.023 inch. One 225-mv unit is an 0.55 by 0.05-inch thick disk. For precise measurements of magnetic fields, there is a ceramic encased unit with linearity of 0.2% and moderate output. For position indicators and contactless switches, there are three thin-film devices with Hall-voltage outputs of 1.7, 1.5 and 1.1 v. Westinghouse Semiconductor Division, Youngwood, Pa. [332]

...New Developments in Electrical Protection

BLOCKS for BUSS FUSES

All Types Available for Every Application . . .

Single pole, multiple pole, small base, full base, molded base, bakelite base, porcelain base for fuse from $\frac{1}{4} \times \frac{5}{8}$ inches up to $\frac{1}{2} \times 2$ inches. Also signal fuse blocks and special blocks of all types.

Send us your requirements—we have the block you need or can engineer it for you.

BUSS Write for BUSS Bulletin SFB.

BUSSMANN MFG. DIVISION, McGraw-Edison Co., St. Louis 7, Mo.

Circle 125 on reader service card

If you should have a special problem in electrical protection . . .

. . . we welcome your request either to quote or to help in selecting the type of fuse or fuse mounting best suited to your particular conditions.

Submit description or sketch, showing type of fuse to be used, number of circuits, type of terminal, etc. If your protection problem is still in the engineering state, tell us current, voltage, load characteristics, etc. Be sure to get the latest information BEFORE final design is crystallized.

At any time our staff of fuse engineers is at your service to help solve your problems in electrical protection and save you engineering time.

BUSS Just call or write:

BUSSMANN MFG. DIVISION, McGraw-Edison Co., St. Louis 7, Mo.

Circle 125 on reader service card

PLUS
 1,000,000 inches_A per second writing speed, bright trace and long-life display tube in this precision oscilloscope and storage instrument.



HUGHES MEMO-SCOPE® OSCILLOSCOPE

The Hughes MEMO-SCOPE oscilloscope is two fine instruments in one . . . a precision high frequency oscilloscope and a storage unit that can store fleeting phenomena for an indefinite period of time.

And you don't have to baby it. Use it as a standard scope day after day. Its Hughes MEMOTRON® storage tube provides superior light output, fast writing speed and contrast ratio even after long, continuous use.

When you need a storage instrument, it's right there for use. And uses for the MEMO-SCOPE oscilloscope are rapidly widening. Its unique qualities provide exciting new test capabilities that no other instrument can attain.

Consider this rugged, versatile, two-in-one instrument for your test needs. For full information, write or call HUGHES INSTRUMENTS, 2020 Ocean-side Boulevard, Oceanside, California. For export information write Hughes International, Culver City, California.

HUGHES
 HUGHES AIRCRAFT COMPANY
 HUGHES INSTRUMENTS
 OCEANSIDE, CALIF.

**INSTANTLY REVERSIBLE
 3600 RPM thru 2/3 RPM**

**HURST
 HEAVY-DUTY
 SYNCHRONOUS
 MOTOR**



NO OVERHEATING DURING CONTINUOUS OPERATION

120 Inch Ounces at 1 RPM

Instantly reversible (with SPDT switching), this 120 inch-ounce heavy duty motor maintains complete timing accuracy in both clockwise and counter-clockwise directions. Completely enclosed case measures only 2½" in diameter by 1¼" in length. Will not overheat during CONTINUOUS operation.

Series D motors can be supplied sealed to withstand salt spray and other moisture conditions.

Write for complete literature today.

Standard speeds stocked by your local distributor



hurst MANUFACTURING CORPORATION

PRINCETON, INDIANA • Phone FU5-2564

Circle 204 on reader service card

To order reprints

Fill in, cut out coupon below
 insert in envelope and mail to:

Electronics Reprint Department

330 W. 42nd Street, New York, N. Y. 10036

Reprint order form

[To help expedite mailing of your reprints please send cash, check or money order with your order.]

For listing of reprints available see the Reader Service Card.

For reprints of the latest special report:
Modern Electronic Packaging

Send me reprints of Key no. R-48 at 50¢ each

For reprints of previous special reports or feature articles fill in below:

Send me reprints of Key No.(s) @ ¢ each
 (For prices, see Reader Service Card.)

*For orders of bulk reprints of other editorial articles in this issue or past issues:

Send me reprints of page no.[s] of issue date

of article entitled

*Minimum bulk order 100 copies. You will be advised of costs by return mail.

Name

Number of street

City, State, Zip code

New Instruments

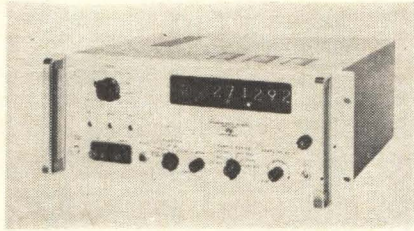

Digital voltmeter eliminates noise effects

An integrating digital voltmeter, the DY-2401B, eliminates the effects of noise on the measured signal. It provides greater than 140-db effective common-mode rejection at all noise frequencies including d-c. This means that 100 v of common mode on the measured signal will not cause a significant change in measurement. Unit combines floated and guarded measuring circuitry with an active integrating technique which provides the average reading of the input over a crystal-controlled sample period. Five d-c measuring ranges include a 0.1 and 1-v range. Optional automatic range selection is available, providing 34 ms maximum range-change time. Frequency measurements up to 300 kc can be made with the standard model.

Dymec, a div. of Hewlett-Packard Co., 395 Page Mill Road, Palo Alto, Calif. [351]

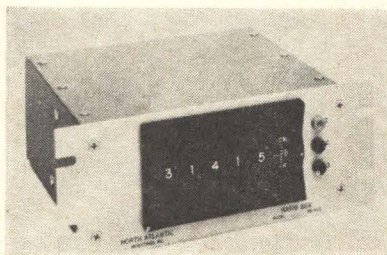

Ratio dividers read out six decades

Series of miniature half rack inductive ratio dividers with thumb-wheel numerical switches has been introduced. Models RB-525 and 526 feature in-line readout of six decades, permitting ratio measurement from 0 to 1.111110. The last decade

of the RB-525 is a precision potentiometer which permits a resolution of 1/10 part per million. The RB-525 has a voltage-to-frequency ratio of 0.35 and operates at a frequency range of 50 cps to 3 kc. Its 400-cycle input impedance is greater than 30,000 ohms and it has a maximum output resistance of 4.0 ohms. The RB-526 operates from 400 cps to 10 kc with a maximum input impedance at 10 kc of more than 30,000 ohms. Voltage-to-frequency ratio is 0.1 and output resistance is 2.0 ohms. Applications include precision calibration of resolvers, Inductosyns and other a-c transducers, measurement of transformation ratio, zeroing of potentiometers, and matching of precision resistors and capacitors.

North Atlantic Industries, Inc., Terminal Drive, Plainview, N.Y. [352]

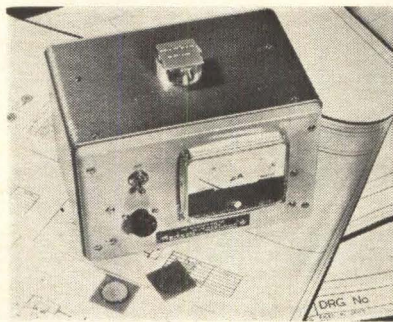

Resistivity tester needs no contact

Type 74711 resistivity test set does not require electrical contact with the material under test. It operates on the principle of measuring the damping effect of the sample on a lightly-loaded tuned circuit. The coil of the tuned circuit projects slightly from the top of the instrument and the sample is placed in proximity to it. Unit is particularly useful for the rapid production-line testing of thin slices of semiconductor material used in the manufacture of transistors. The tuned-circuit damping method employed is much quicker than the conventional four-point probe method of resistivity checking. Also, the thickness of thin sheets of semiconductor material of known resistivity can be

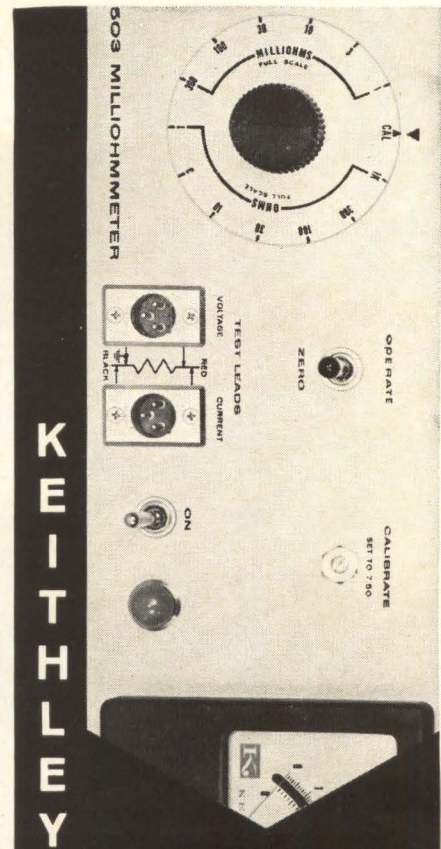

MILLIOHMETER

The Model 503 provides fast, accurate direct-readings from 10 micro-ohms to 1000 ohms. The measurement technique involves a four terminal ammeter-voltmeter method. By using an ac test current maximum power dissipation through the sample is 10 microwatts. Thus, the 503 is useful in dry-circuit testing of contact resistance and safe measurement of fuses and squibs.

- **Range:** 0.001 to 1000 ohms fs on linear scales with 13 overlapping ranges
- **Accuracy:** 1% of fs on all ranges
- **Output:** 100 millivolts
- **Line Operated**
- **Max. Sample Dissipation:** 10 microwatts
- **Price:** \$675

also available

MODEL 502 Milliohmeter:
Battery operated . . . \$390

Send for catalog giving full details



**KEITHLEY
INSTRUMENTS**

12415 Euclid Avenue • Cleveland 6, Ohio

DURANT

Your answer to
ACCURATE, HIGH SPEED
COUNTING by
REMOTE CONTROL

ELECTRIC COUNTERS

There's a standard Durant Electric Counter to fit practically any OEM application . . . enabling you to build modern electric counting into your PRODUCT, MACHINE or METHOD.

Durant's "HIGH VISIBILITY", with clean-cut legible figures set high up and close to the window, show the exact figure at a glance. Many Durant fully enclosed Electrics have been performing accurately and dependably under varying conditions for years and years — giving the reliability so necessary in a counting operation.

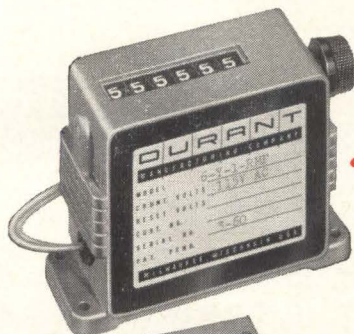

"Y" Electric Series
 (Model 6-Y-1-MF)
 1000 CPM

"CS" Electric Series
 (larger size —
 larger figures)



"YE" Electric Series
 Push Button Reset
 (Model 5-YE-8947-Q)
 1500 CPM

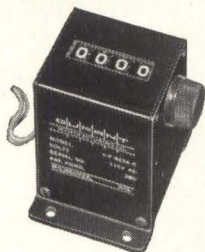

"Y" Electric Series
 4 figure
 (Model 4-Y-9434-B)
 600 CPM

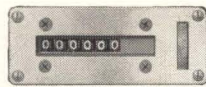

Ideal for PANEL MOUNT
 (placed and mounted from front)
 on machine or at control center

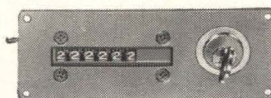

Tumbler Lock Key Reset
 for "tamper control"

"Y" Electric — Small, compact; AC counters equipped with integral rectifier for high speed and long life. Records accurately at high, low, or intermediate speeds.

"CS" Electric — Same external design and features as "Y" Series, but with larger case size and larger figures . . . for more rugged, heavy duty applications.

"YE" Electric — With electric instant reset or finger-flick instant reset.

ACTUATORS and CONTACTORS
 Durant offers photo-electric, lever, roller arm, star wheel, or limit switch units for use with Electric Counters.

Send for Catalog

DURANT MANUFACTURING CO.
 dependable since 1879

612 N. Cass St. 12 Thurbers Ave.
 Milwaukee 1, Wis. Providence 5, R. I.

DURANT®

COUNTING INSTRUMENTS

Accurately Count Everything . . . EVERYWHERE



"YE" SERIES
 HERMETICALLY
 SEALED FOR
 MILITARY



MODEL 3-3-5-Y
 ELECTRIC
 COUNTERS
 ONE FRAME



MODEL 6-Y
 ELECTRIC
 PREDETERMINING
 COUNTER



PUSH BUTTON
 RESET ELECTRIC
 FOR MILITARY
 APPLICATION

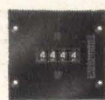

4 FIGURE
 "Y" ELECTRIC
 PANEL
 MOUNT



"SP-MF"
 ELECTRIC
 PREDETERMINED
 COUNTER

REPRESENTATIVES IN ALL PRINCIPAL CITIES

New Instruments

measured, and changes in resistivity around discontinuities in large-area samples can be detected. Resistivity measurement range is from 10^{-2} to 10^{-5} ohm cm. Standard Telephones and Cables Ltd., London, England. [353]

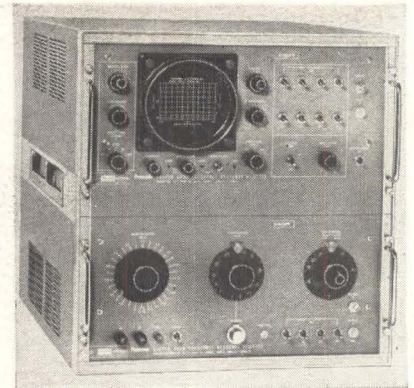

Plotter traces filter response

An ultrastable frequency response plotter (Model SGR-3), especially designed for crystal filter network testing from 10 kc up to 15 Mc is well suited for accurate and repeatable response tracings of modern, steep-skirted narrow-band filters. It includes in a compact single unit a sweep generator and selective receiver-indicator. Readout is on a high persistence 5-in. crt that is calibrated linearly in frequency for sweep widths up to 100 kc and has 40-db and 3-db range. The Singer Co., Metrics Division, Bridgeport, Conn. [354]

Megohm bridge offers high accuracy

New megohm bridge, type 1644-A, measures resistances from 1,000 ohms to 1,000 teraohms (10^3 to 10^{15} ohms), with 1-percent accuracy up to 10^{13} ohms. Seven test voltages are provided, from 10 to 1,000 v in 1-2-5 steps. A ΔR dial with a ± 5 -percent range permits matching of resistors to within 0.1 percent and accurate measurements of voltage coefficients. Unit is priced at \$625. General Radio Co., West Concord, Mass. [355]

New Subassemblies and Systems

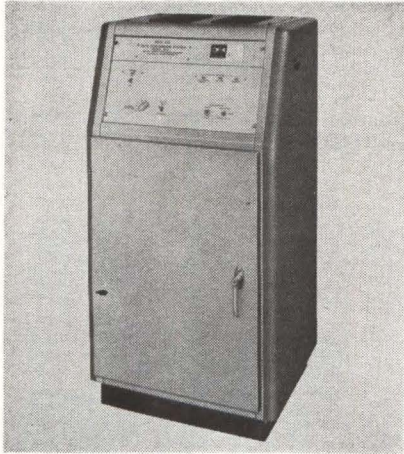

A-d conversion system samples to 20,000/sec

The ADIC-III is intended for on-line use with a wide range of input sampling rates—from 0 to 20,000 samples per sec. The system accepts electrical input data in analog form then converts and transmits this data in digital form directly to a general-purpose computer via interconnecting cables. Input channels are selectable from 1 to 8. Analog input voltage is 1-5-10 v rms. Input impedance (analog) is 10,000 ohms. Output is 10-bit binary data compatible with digital computer inputs. System inaccuracy is 0.2 percent full-scale defined as the rms of all errors over the operating range.

Airborne Instruments Laboratory, Deer Park, L.I., N.Y. [371]

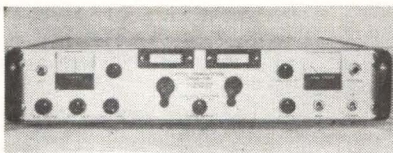

Vhf receiver can be battery-operated

A solid-state modular surveillance receiver is designed for reception of a-m, f-m, and c-w signals in the 30 to 300-Mc range. The ACL type SR-201 covers the range in two bands, with separate antenna in-

puts provided for each band. All active elements in the receiver are solid-state devices. The equipment requires approximately 15 w of power. Optional operation from a battery supply permits field use. The receiver front end employs two-section preselectors in the r-f input to provide maximum reduction of cross modulation products. Except for the front ends, all circuits use plug-in printed-circuit boards as modules.

Aero Geo Astro Corp., Edsall and Lincolnia Roads, Alexandria, Va. 22314. [372]

D-c amplifiers for torque motor drives

All-transistor 500 and 800-w d-c amplifiers for torque motor drives, control excitation and similar applications are announced. Internal feedback from the output to the input reduces deadband and stabilizes amplifier gain should parameters change; and provisions are made for external feedback in servo applications.

Inland Motor Corp., subsidiary of Kollmorgen, Radford, Va. [373]

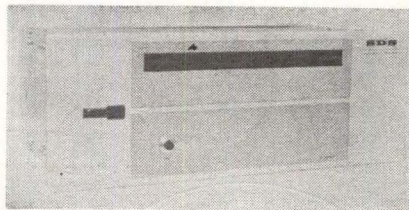

Low-cost converters work at quick pace

A series of four low-cost all-silicon analog-to-digital converters have conversion rates up to 30,000 bits per sec, with accuracies up to ± 0.01 percent. Operating temperature range is from ± 1 v to ± 10 v. Two binary models have an output format of 10-bits plus sign or 13-bits plus sign; two BCD models have 3 or 4 decimal digits plus sign. Transformer coupling for control and output signals minimizes

Lepel

is proud to introduce

THE NEW INDUCTO-PLASMA UNIT



a controlled high temperature heat source for

- CRYSTAL GROWING
- SPHEROIDIZING
- VAPOR COATING
- HEATING FLUIDS
- LABORATORY RESEARCH

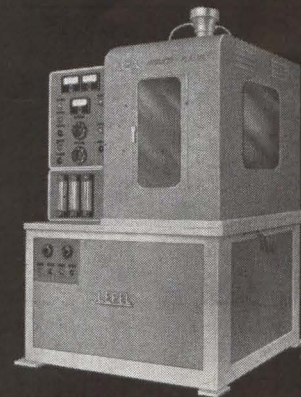

The new Lepel Inducto-Plasma unit is the result of extensive research and more than two years of experimental work with plasmas. Energized by a Lepel megacycle generator, this versatile unit provides a controlled high temperature plasma source which permits the use of oxidizing, neutral or reducing gas-mixtures. It is designed to accommodate accessories for crystal growing, spheroidizing, vapor coating, heat transfer studies in fluids, or other areas of research interest.

The Lepel Inducto-Plasma unit is also available without the sub-cabinet or the remote controls for the generator.

WRITE FOR BULLETIN F-101

Lepel HIGH FREQUENCY LABORATORIES, INC.

55th ST. & 37th AVE., WOODSIDE 77, N. Y. C.
CHICAGO OFFICE: 6246 WEST NORTH AVENUE

COMINCO

HIGH PURITY METALS
AVAILABLE FORMS

clip and save

Product	ALUMINUM	ANTIMONY	ARSENIC	BISMUTH	CADMIUM	GOLD	INDIUM	LEAD	SILVER	TIN	ZINC
BARS	✓	✓	✓	✓	✓	✓	✓	✓	✓	✓	✓
SHEETS	✓					✓	✓	✓	✓	✓	✓
WIRE	✓					✓	✓	✓		✓	✓
POWDER		✓	✓	✓	✓	✓	✓	✓	✓	✓	✓
SHOT		✓		✓	✓	✓	✓	✓	✓	✓	✓
ROD	✓			✓	✓		✓	✓	✓	✓	✓
RIBBON							✓	✓			
PRE-FORMS	✓					✓	✓	✓	✓	✓	✓
SALTS					✓		✓				

COMINCO PRODUCTS, INC.

electronic materials division

933 West Third Avenue, Spokane 4, Washington
Phone Area Code 509 RI 7-7103 • TWX 509 328-1207

3602

Circle 205 on reader service card

CONTINUOUS VARIABLE FILTERS

Center frequency continuously adjustable over 6 to 1 range.

High Input Impedance. Over 40 db attenuation for harmonics and noise. Matched pair available.

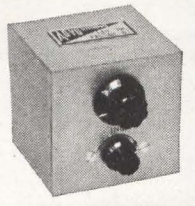

TYPE A103

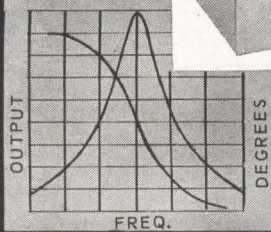

Attenuation Characteristics: 3 db points at 6%, 10 db points at 10%, 20 db points at 30% off center frequency.

Phase Characteristics: Phase shift is zero at center frequency, 45° at 3 db points, 75° at 10 db points.

GROUP 1 - 1.5 to 1 Range: Center at 50, 60, 80 cps up to 12 kc.

GROUP 2 - 2 to 1 Range: Center at 50, 90, 150 cps up to 40 kc.

GROUP 3 - 3 to 1 Range: Center at 50, 60, 200 cps up to 30 kc.

GROUP 4 - 6 to 1 Range: Center at 50, 100, 200 cps up to 12 kc.

AD-YU ELECTRONICS INC.

249 TERHUNE AVE., PASSAIC, N. J.

Primo MICROPHONES

A complete line of
microphone cartridges
and units for
the OE market

Types :

- *Uni-Directional
- *Magnetic
- *Velocity
- *Crystal
- *Dynamic
- *Condenser
- *etc.

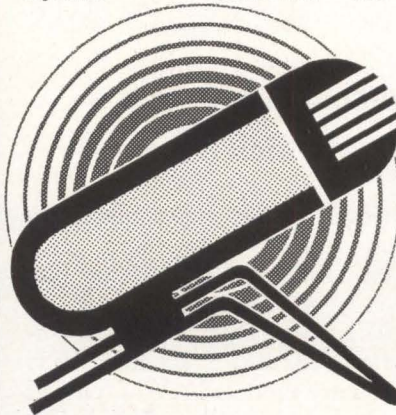

For catalog write to :

PRIMO CO., LTD.

2043 MURE, MITAKASHI,
TOKYO, JAPAN

Circle 214 on reader service card

New Subassemblies

grounding problems. Price for model AD20-14, 13 binary bits plus sign, 13,300 conversions per sec, is \$3,700.

Scientific Data Systems, 1649 Seventeenth St., Santa Monica, Calif. [374]

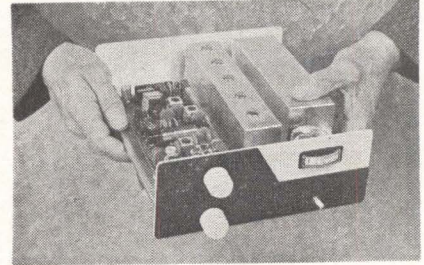

Ssb transceiver provides 75-w output

Linear LST-1 single-sideband transceiver provides 75-w output with low battery consumption of 4 w on receive and an average of only 60 w under ssb voice modulation. The design also permits total enclosure with no ventilation—(hermetic sealing if required) making the transceiver particularly unaffected by extremes of ambient operating conditions. Operating from 2 to 15 Mc single-channel simplex, selectable sideband, or compatible a-m with inserted carrier, the LST-1 is ideally suited to replacement applications in operations below 10 Mc where single-sideband operation becomes mandatory in 1970 by FCC regulation.

Linear Systems Inc., 605 University Ave., Los Gatos 2, Calif. [375]

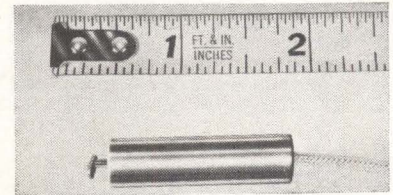

Dissipative filters absorb rfi

Low-loss true absorber type rfi filters have been developed. Specific applications of the LossyLine

filters include power transmission lines, pre-programmed and/or random impulse actuated systems, control systems, and communication systems involving a wide spectrum of frequencies. Design assures high reliability for ground, airborne or space requirements. Filter's dissipative element embodies a temperature resisting (175 C) molded part, optimized as a magnetic lossy core, molded around the conductor and case shielded. Result is a true magnetic trap that absorbs rather than rejects or reflects unwanted energy. No oil is required to cool since the inductive heating loss in the pass-band is extremely low, and the magnetic trap and case are sufficient as a heat sink for dissipated r-f energy. LossyLine can attenuate 100 db minimum, or beyond the range of standard instrumentation, from 100 kc up to 45 Gc and attenuation does not fall off with current.

McMillan International Corp., Ipswich, Mass. [376]

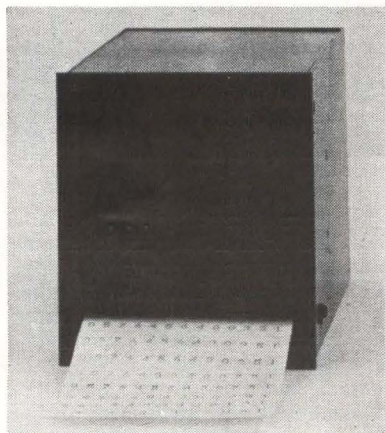

Tape printers use modular elements

New group of tape or card printers designed for serial counting or parallel input is announced. Every working element in the Moduprints is modular, and so can be shifted about or interchanged at will. Also, each digit may be separately energized to position or cascaded in any desired configuration. Available are 10- or 12-position wheels marked with any numbers or characters desired. Moduprints offer forward or backward counting, will serve to accumulate quantity, time or date. An electrical reset is built in and



THERE IS A JENNINGS VACUUM CAPACITOR FOR EVERY HIGH POWER RF APPLICATION

Jennings has been designing and building vacuum capacitors for 21 years. In this time we have designed vacuum capacitors for hundreds of standard and special applications. These designs are now production items—over 450 types. We can deliver from stock a vacuum capacitor to solve practically every specialized application.

But if a new design is necessary consider these resources ready to work for you at Jennings. • 21 years experience designing and building vacuum capacitors.

• Exclusive processing techniques that assure superior performance. • Qualified, experienced engineering staff. • The only complete rf laboratory in existence for proper testing of vacuum capacitors in high power rf circuits through 100 kw that duplicate actual operating conditions.

Jennings offers a complete line of vacuum capacitors for operating in the high frequency range at voltages up to 120 kv and capacities up to 5000 pf. We will be happy to send detailed catalog literature at your request.



UXCF 500

Capacity Range . . . 20-500 pf
Voltage Rating . . . 20 kv pk
RF Current Rating . 45 amps rms
Length 9 $\frac{7}{8}$ inches
Width 4 $\frac{3}{4}$ inches



MMHC 1000

Capacity 1000 pf
Voltage Rating . . . 45 kv pk
Current Rating . . 150 amps rms
Length 13 inches
Width 9 $\frac{1}{4}$ inches



CVHA 650

Capacity Range . . 30-650 pf
Voltage Rating . . . 55 kv pk
Current Rating . . 150 amps rms
Length 11 $\frac{1}{2}$ inches
Width 7 inches

RELIABILITY MEANS VACUUM | VACUUM MEANS

Jennings

JENNINGS RADIO MFG. CORP., 970 McLAUGHLIN AVE., SAN JOSE 8, CALIF., PHONE CyPress 2-4025

OUR
NEWEST
RESONANT
REED
IS SMALLER
THAN A
DOMINO ...

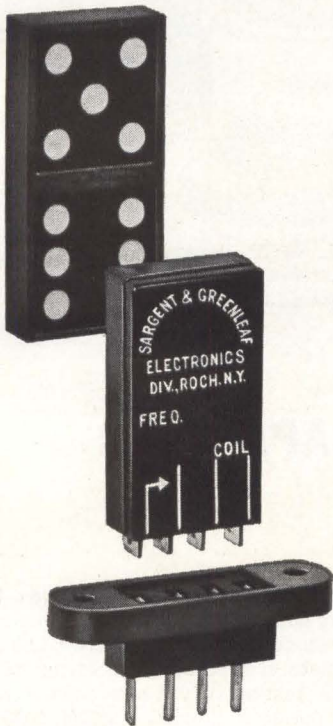

mini-reed

from S & G Electronics!

Miniaturized Reed Relay (M-510) or Reed Oscillator Control (M-610) —either way, the most compact units available today.

These tiny relays (1.375" x .750" x .375") are ideal for portable applications like pocket paging. They shrink system size and cost in applications like continuous tone squelch, data transmission, remote control, telemetry, selective signalling.

A special socket is available upon request for applications where other mounting is not supplied.

Good things very often come in small packages. Write us for more small print details.

 **ELECTRONICS**
SARGENT & GREENLEAF, Inc.
Rochester, New York 14621
(formerly Security Devices Laboratory)

New Subassemblies

operates in 150 millisecc. Counting rate is either 40 or 80 per sec. Company says Moduprints offer a 50-percent cost saving over anything comparable on the market. These tape printers are available in 3 standard sizes: 3¼ in., 4¾ in. or 6¾ in. in width; 5½ in. high and 9 in. deep — for 9, 14 or 20 digit spaces maximum capacity, respectively.

Presin Co., Inc., Bridgeport, Connecticut [377]

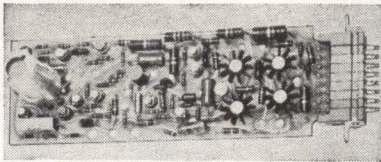

D-c amplifiers for computer systems

Solid-state d-c operational amplifiers for computer systems and instruments are announced. Model 2051 delivers ±30 ma with a ±50 v output swing, with a 1-megohm input impedance 6 db per octave rolloff and 2 Mc gain-bandwidth product. It may be used with any passive feedback element. The 20-kc full output capability makes the 2051 an ideal swinging reference in hybrid computing systems. Price is \$225 in 1-24 quantities.

Computer Dynamics, Inc., 46 Evans St., Torrington, Conn. [378]

Magnetic tapes reduce headwear

Two new Micro-plate magnetic recording tapes reportedly have a surface so smooth that the oxide-coated side can scarcely be visually distinguished from the base side. Micro-plate tapes reduce headwear, have intimate tape-to-head contact, are much more wear-resistant and are said to have the lowest incidence of head or tape fouling. Computer tape type 225 is a heavy-duty, high-resolution tape, 100 percent pretested and certified at 800 bpi, and instrumentation

**How to
pick a
plant site
without
leaving home!**



Call your secretary . . . quick! Dictate a letter to Niagara Mohawk asking for your free copy of "The World's Richest Market." In return, you'll get 44 pages of facts and figures about the Northeast proving that Upstate N. Y. deserves careful consideration for plant location. □ This book pinpoints trends and potentials for manufacturers of consumer and industrial products . . . gives detailed projections to 1975 of the 204 counties within a 250-mile radius of Niagara Mohawk territory by population, income, percentage of income over \$4,000 and over \$7,000. With over 25% of the nation's population, 28% of its income and 32% of America's industry, this area is truly the World's Richest Market. □ For your free copy, write on your company letterhead to: Richard F. Torrey, Director of Area Development, Dept. E-4, Niagara Mohawk Power Corp., 300 Erie Blvd. West, Syracuse, N. Y. 13202.

NIAGARA MOHAWK
INVESTOR OWNED • TAXPAYING

type HRMB is a heavy-duty, high-resolution tape for analog recording.

Reeves Soundcraft, Division of Reeves Industries Inc., Great Pasture Road, Danbury, Conn. [379]

System tests integrated circuits

An integrated-circuit test system, model 2500, is announced. It is intended for either data logging or go, no-go testing of the parameters of integrated circuits and micromodules. System is capable of high accuracy ($\pm 1/2$ percent of reading) and high speed (200 Mc/test). It is digitally programmed by punched tape and can perform an unlimited number of tests on a single device. Five digitally programmed precision power supplies are used to apply bias stimuli. Either constant voltage or current can be programmed to any random combination of leads on the test specimen. Tests available include voltage (1 mv to 100 v), current (1 na to 100 ma), gain and logic functions.

Optimized Devices, Inc., Pleasantville, N.Y. [380]



Programmable dvm has 100- μ v sensitivity

Ten new 5-digit series 9100 digital voltmeters are well suited for data systems use. Fully automatic and programmable, they are in the ± 0.01 -percent accuracy class and feature 100- μ v measurement sensitivity. Yet, no damage or accuracy degradation occurs with 1,000 v continuously applied on any range or polarity. Ranges are $\pm 9.9999/99.999/999.99$ v d-c and ± 99.999 percent d-c voltage ratio. By means of accessory converters, the instruments also measure a-c voltage and ohms. Minimum speed is 1 reading per sec. Input resistance is 10 megohms for volts and 1,000 megohms for voltage ratio. Prices range from \$3,490 to \$5,990.

Non-Linear Systems, Inc., P.O. Box 728, DelMar, Calif. [381]

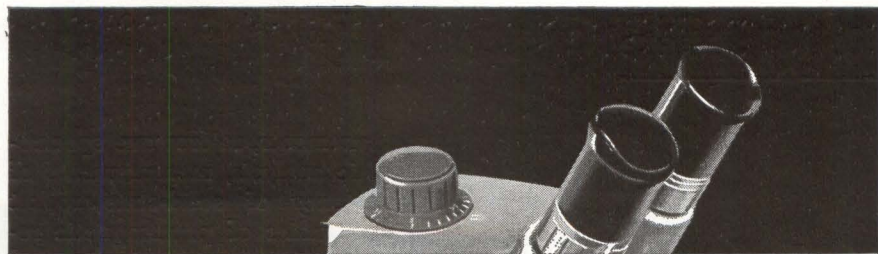

WHAT'S YOUR PROBLEM IN 3-D MICROVISION?



A BAUSCH & LOMB
STEREOZOOM[®]
CAN SOLVE IT...

IN YOUR PRODUCT...

The Kulicke and Soffa Automatic Wafer Bonder automatically feeds, bonds and severs transistors and microcircuit components as fine as 0.0005" ... has a built-in StereoZoom Microscope to locate the right bonding position ... fast.

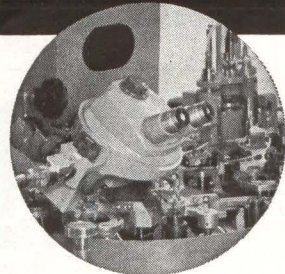

ON YOUR PRODUCTION LINE...

The Semiconductor Division of HUGHES AIRCRAFT uses StereoZoom Microscopes in fabricating tiny transistors and diodes ... so small they're barely visible on a fingertip.

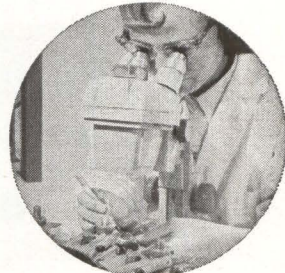

FOR YOUR QUALITY CONTROL...

Although each undersea telephone cable repeater amplifier contains more than 5,000 separate precision parts ... Bell System's Western Electric Company rates them for a minimum of 20 maintenance-free years. To make sure of alignment, bond and freedom from flaws or foreign particles, they are inspected with StereoZoom Microscopes.

If your product requires microvision with big, bright, 3-dimensional views to make sure a job is done right ... Bausch & Lomb has 24 StereoZoom models to choose from. They're all precision designed, sturdily built for years of rugged use. Bodies and stands can be conveniently interchanged for every problem in 3-D microvision. To find the best answer for you, write Bausch & Lomb Incorporated, 65604 Bausch Street, Rochester, New York 61404.

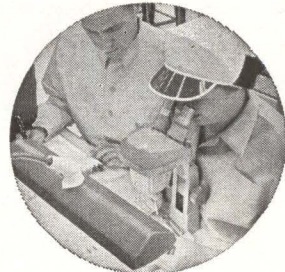

BAUSCH & LOMB 

In Canada, write Bausch & Lomb Optical Co., Ltd., Dept. 614, Scientific Instrument Division, 16 Grosvenor St., Toronto 5, Ont.

New Microwave

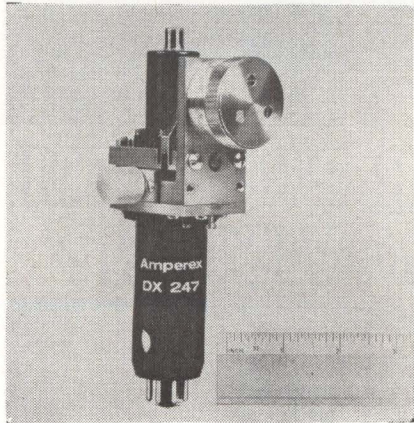

Reflex klystron operates at 2 mm

Model DX247 klystron operates at 2 mm, is mechanically tunable from 140 to 150 Gc, ± 3 Gc, and features a high power output of 20 mw over the band. It is expected to facilitate research in such areas as dielectric

measurements, microwave spectrographic analysis, measurements of consistency of solid-state rocket fuels, studies of paramagnetic resonance, space communication and line-of-sight secret communication. Tube can be warranted for a minimum of 250 hr.

Tuning is by means of a large micrometer knob with scale divisions; one turn covers the full frequency band. Resonator voltage is 2,500 v.

Ampere Electronic Corp., Hicksville, N.Y. 11802 [391]

Actuator designed for magnetron tuning

Model E/HA-106 hydraulic servo-actuator for the tuning of magnetron tubes is designed to hold any position within its stroke to very close

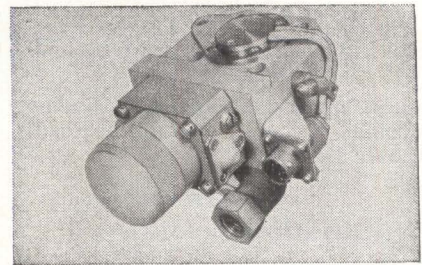

tolerances—or it can adjust the tuning of magnetrons over a wide range of cycling frequencies and stroke. Stroke ranges to 0.250 in. peak-to-peak; cycling rate is from 0 to 60 cps. Unit is designed for 60 Mc at maximum stroke and frequency. A specially developed seal assures negligible leakage during life of actuator—total leakage during service life is held to 3 cc max. Other design features include a coaxial transducer within the piston—no external arms or linkages to produce backlash. A latching device centers piston and locks it when pressure is reduced or shut off.

Eastern Industries, a div. of Laboratory for Electronics, Inc., 100 Skiff St., Hamden 14, Conn. [392]

(Advertisement)

NEW!

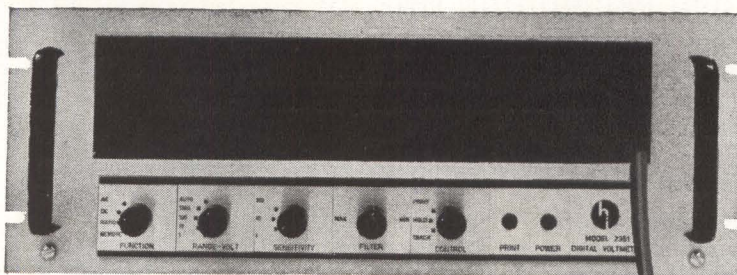

in digitals

The working removable readout of the model 2351 DVM is just one of its many operating features and conveniences, which are listed on the opposite page. These complement the following solid specifications:

- 10 μ v sensitivity
- .005% DC accuracy
- completely floating
- common mode rejection is 120 db at DC, 100 db at 60 cycles
- all reed switching
- 0°-50° C operating temperature range with no change in accuracy $\pm 15^\circ$ C about 25° C operating ambient temperature



houston instrument corporation

4950 Terminal Avenue / Bellaire, Texas 77401 / MOhawk 7-7403
Cable: HOINCO / TWX 713-571-2063

Multi-Channel Analyzer Recorder Readout

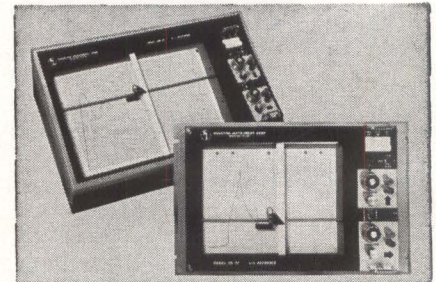

Through a unique design approach to null detection, these new X-Y recorders are fast, accurate, sensitivity-adjustment-free point plotters for use with pulse-height analyzers and averaging computers. Models HR-95TN (8½" x 11") and HR-97TN (11" x 17") feature better than 0.01% sensitivity, 7 point/sec. maximum point plotting speed, 0.25% overall accuracy and 0.1% repeatability. Price FOB Houston: HR-95TN \$1525, HR-97TN \$1625. Availability: 30 days ARO. Houston Instrument Corp., 4950 Terminal Ave., Bellaire, Texas 77401.

CIRCLE 201 ON READER SERVICE CARD

THE FRONT DISPLAY PANEL SNAPS OUT

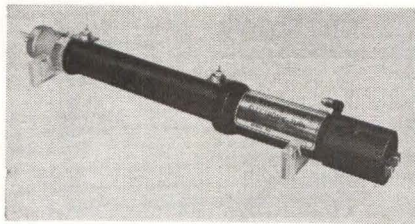

Traveling-wave tube for radar systems

A traveling-wave tube designed for the power-output stage in modern radar systems has an electrical bandwidth of ± 300 Mc and can be centered anywhere within the C band. Tube provides excellent performance where stringent control of gain, power and phase characteristics are required. The ring bar structure of the WX-5383 permits high efficiency with light weight (8 lb) and small size (22 in. in length). The tube has a 40-db saturation gain with a peak power of 10 kw. It is capable of functioning at 0.01 duty cycle. The focusing structure is shielded from the effects of external fields and is tem-

perature compensated.
Westinghouse Electronic Tube Division,
Elmira, N.Y. [393]



Hybrid junction provides high isolation

Model H-5 hybrid junction has a frequency range from 0.5 to 35 Mc. The exceptionally high isolation (48 db at 0.5 Mc, greater than 30 db at 35 Mc) makes it particularly useful when two isolated loads must be fed from a single source or when two isolated sources must serve a common load. Insertion loss is less than 0.5 db, and output unbalance less than 0.2 db. Impedance is 50 ohms at all ports. Size is $2\frac{1}{2}$ by $1\frac{5}{8}$ by $1\frac{1}{2}$ in. Price is \$145.

Anzac Electronics, Inc., Moody's Lane,
Norwalk, Conn. [394]

Directional coupler for space applications

Miniature 3-db directional coupler measures 3 in. by 3 in. by $\frac{1}{8}$ in. and weighs less than 2 oz. Operating at 136.5 Mc ± 10 percent, the unit can withstand temperatures from -30 C to 100 C. V_{swr} is 1.2:1 maximum; isolation, 30 db. Model 02-9G directional coupler was designed for airborne and space applications. Price is \$145 up to 10 units.

Advanced Development Laboratories,
Inc., 24 Simon St., Nashua, N.H. [395]

Coaxial switch for missile uses

Designed for missile and space craft applications, model VC13SC coaxial transfer switch is ruggedly constructed to withstand extreme environments. Optional features available on special order include hermetic sealing and remote posi-

(Advertisement)

New Millivoltmeter Offers Wide Frequency Range

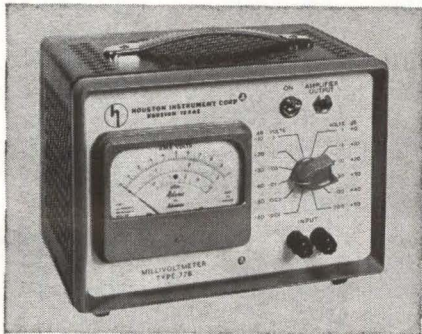

Model VM-77B is a versatile, general purpose instrument for laboratory and production work. It has 12 ranges between 0.001 volts and 300 volts AC full scale and a frequency range of 10 cps to 4.5 megacycles. Input impedance is 10 megohms 20 pf. Amplifier output maximum is 1 volt RMS. Price FOB Houston: \$195. Availability: 2 weeks ARO. Houston Instrument Corp., 4950 Terminal Ave., Bellaire, Texas 77401.

CIRCLE 202 ON READER SERVICE CARD

FOR REMOTE READOUT . . . UP TO SIX FEET.

fully operable
**REMOVABLE
READOUT**



Supplementing the unparalleled specifications listed on the facing page, model 2351 DVM offers the following operating features and conveniences:

- internal calibrating voltage
- six digit resolution with front panel analog meter
- AC/DC/ratio measurements in one instrument
- printout, remote programming and AC converter can be incorporated into basic DC/ratio instrument in the field



houston instrument corporation

4950 Terminal Avenue / Bellaire, Texas 77401 / MOhawk 7-7403
Cable: HOINCO / TWX 713-571-2063

YOKE SPECIFYING PROBLEM?

**ASK AN
EXPERT...**

A SYNTRONIC DEFLECTION YOKE SPECIALIST

Since we make more types of yokes than anyone else, it's natural enough for our team of experts to know more about yoke design, application engineering, and quality control.

Specifying can be a challenging problem, and with this in mind, we put our experience at your disposal. Don't hesitate to call or write us when you're puzzled as to the right deflection yoke for your display.



syntronic

INSTRUMENTS, INC.
100 Industrial Road, Addison, Illinois
Phone: Area 312, 543-6444

Circle 206 on reader service card

COSMICAR INDUSTRIAL TV LENSES



90% of all Japanese ITV cameras use COSMICAR lenses.

12.5mm f/1.4
12.5mm f/1.9
25. mm f/1.4
25. mm f/1.9
50. mm f/1.4
50. mm f/1.9
75. mm f/1.4
75. mm f/1.9
150. mm f/4.5
All available in
C-mount



For further details, write today:

ICHIZUKA OPTICAL CO., LTD.

2-568, SHIMOOCHIAI, SHINJUKU-KU, TOKYO CABLE ADDRESS: "MOVIEKINO TOKYO"

New Microwave

tion indicator circuits. Specifications include: frequency, 0 to 6.0 Gc; crosstalk, 40 db minimum between channels; insertion loss, 0.3 db max; vswr, 1.25 max; weight, 10 oz max; shock, 50 g minimum in 3 axes; drive requirements, 8 w nominal; temperature, -55 C to +100 C.

E&M Laboratories, 15145 Califa St., Van Nuys, Calif. [396]

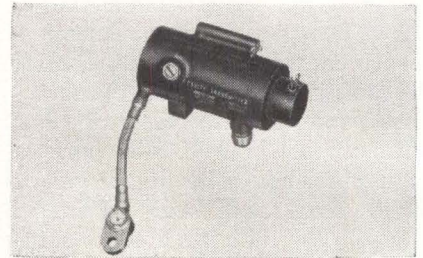

Transmitter cavity for rugged radar use

A hermetically-sealed rugged radar transmitter cavity, using a type 6442 planar triode, delivers 1 kw peak from 4,290 to 4,310 Mc, and has an operating life of 500 hr. Type 34-34-00390 has a frequency stability of ± 5 Mc over a temperature range of -54 C to +125 C, pulse widths of 40 to 100 nsec, and a rise time of 35 nsec. Duty factor is 0.001 maximum. Unit will withstand a shock of 40 g, 11 millisecond. Price is \$325 in production quantities.

Electronic Specialty Co., 5121 San Fernando Road, Los Angeles, Calif. 90039. [397]

Circulator covers 500 to 1,000 Mc octave

Type CU-51 was developed to meet the bandwidth requirements imposed by broadband microwave communications and countermeasures receivers in the 500 to 1,000 Mc octave. Specifications are: isolation, 17 db minimum; insertion loss, 0.8 db maximum; and vswr, 1.3:1 maximum. The new octave circulator has type N connectors in

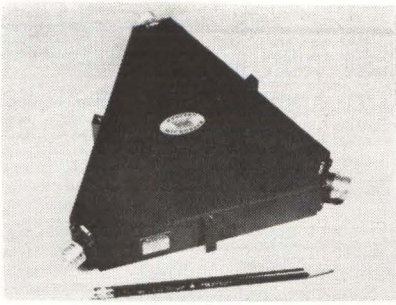

Y configuration and is 8½ in. in diameter and 1¼ in. thick. Western Microwave Laboratories, Inc., 1045 DiGiulio Ave., Santa Clara, Calif. [398]

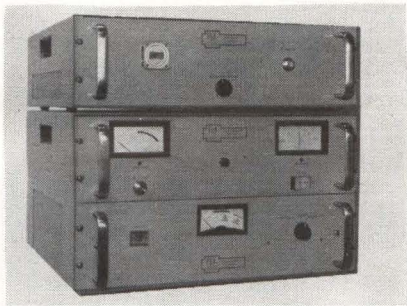

Oscillators incorporate stability monitor

Ultrastable fixed-frequency oscillators in the 2.0 to 12.4-Gc range exhibit a short term stability of better than 1 part in 10⁸ and a long term stability of 1 part in 10⁶ under normal lab conditions. Power output is a function of the klystron used in the system. The series has application in doppler tracking systems as the local oscillator or source of the transmitted signal; in narrow bandwidth communication systems to conserve the spectrum by precisely controlling the carrier and modulation signals; and as a lab source to aid in the development and calibration of microwave components and equipment. A stability indicator circuit monitors the output impedance of the control circuit. When the impedance drops due to closed loop operation, a lamp is energized indicating stable operation. A balance meter indicates the error voltage from the phase detector to facilitate adjustment of the oscillator. Price is \$4,000 to \$5,000.

Frequency Engineering Laboratories, Farmingdale, N.J. 07727. [399]

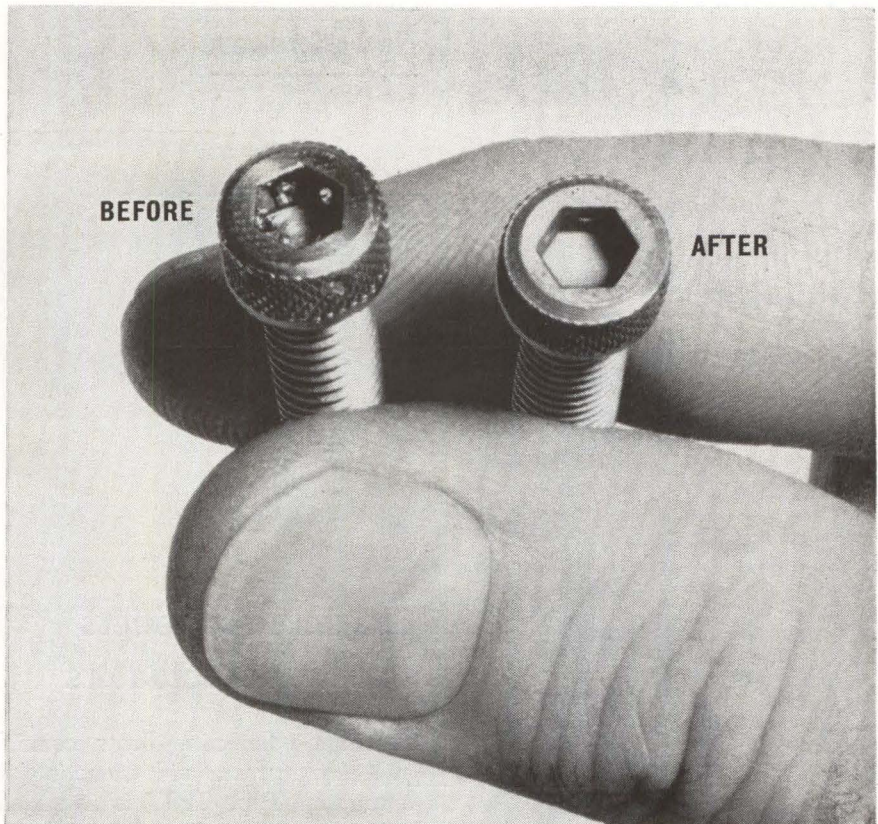

Airbrasive® deburrs tiny 3/32 x 0.060" screws... reject rates drop from 20% to zero

Tiny screws like these were a real problem to Bristol Company, Division of American Chain and Cable, Inc. Embedded in the microscopic sockets of the screws were stubborn burrs. Removing them with hand picks was a time consuming, fatiguing process. Rejects ran as high as 20% and more. Since these tiny screws are widely used in electronic instruments, computers, and missiles, quality is a must.

The high-speed, gas-propelled stream of abrasive jetted by the Airbrasive Unit was the answer. Particles in the 10 to 50 micron range, traveling at the speed of sound, deburr up to 200 of these small screws in as little as six minutes. Best of all, the reject rate is zero and quality is doubly assured, even when inspected under 30 power magnification.

Cost is low for an Airbrasive Unit . . . under \$1000. Why not look into one now?

Let us make a free trial for you send samples for test or telephone collect for a demonstration.

SEND FOR BULLETIN 6006 . . . complete information

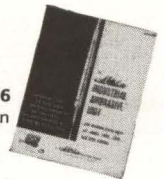

S. S. WHITE INDUSTRIAL DIVISION
DEPT. EU, 10 East 40th St., N. Y. 16, N. Y. Telephone MU 3-3015 collect

for superfine cutting • deburring • cleaning

hard brittle materials

S.S. White INDUSTRIAL AIRBRASIVE®



livability

(an industrial location advantage)

There's fun-filled living for you and your employees when you locate your plant in WESTern PENNSylvania. Ski on nearby slopes . . . fish for wary trout and bass . . . hunt big and small game . . . water-ski . . . listen to music by a top symphony orchestra . . . go to art festivals, opera and straw hat theaters . . . or visit reminders of a romantic past. Beautiful large-acreage sites, suitable for industry, are available on many rivers and streams. There's room to spread out . . . room to live and grow in WESTern PENNSylvania.

WEST PENN POWER

an operating unit of ALLEGHENY POWER SYSTEM



INDUSTRIAL SHELL BUILDINGS available at \$2.95 to \$3.25 a sq. ft. completed to your specs in 60-90 days.

Area Development Department Phone: 412-TE 7-3000
WEST PENN POWER
Greensburg, Pa. 15602

Yes, I'd like more information about WESTern PENNSylvania:

- 4-Season Livability Favorable Tax Climate
 Financing Plans Pre-production Training
 Industrial Properties ADA4-12 E

Name _____

Title _____

Company _____

Address _____

City _____ State _____

Zip _____

Code _____ Phone _____

New Microwave

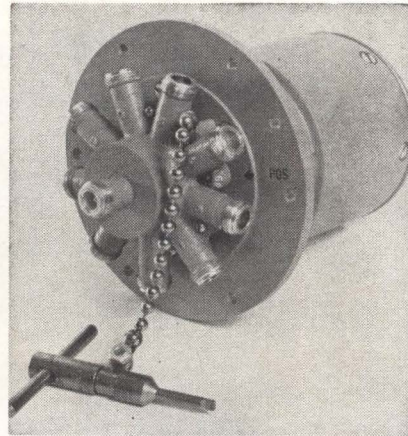

Coaxial switch offers selection of actuators

A single-pole, nine-throw coaxial switch features a wide selection of actuators. Type IP9T is intended for applications involving a large number of switching positions. Control can be either remote or manual. The remote version can be furnished with manual over-ride. Remote actuators are available for all standard power supplies. The switch operates up to 11 Gc providing isolation of 50 db minimum at 3.0 Gc, vswr 1.3 max at 3.0 Gc, and insertion loss of 0.2 db max at 3.0 Gc. Unit is fitted with type N r-f connectors. Prices begin at \$100 each according to actuator specified.

TRW Microwave Division, 20945 Plummer St., Chatsworth, Calif. [400]

Triodes and tetrodes designed for uhf

Compagnie Francaise Thomson Houston of Paris announces a complete range of uhf triodes and tetrodes. Company has developed and tested a ceramic tetrode capable of 25 kw of output power, which, it claims, could edge out the klystron in uhf tv transmission. The new range of tetrodes and triodes includes types offering from 0.5 to 25.0 kw output over the uhf band up to 1,000 Mc. These tubes can be used individually or in parallel depending on power output. Thomson Electric Co., Inc., 50 Rockefeller Plaza, New York 20, N.Y. [401]

SENIOR MANAGEMENT POSITION FOR SPACE SYSTEMS COMMUNICATIONS

This position will involve the direction of a group concerned with developing the state-of-the-art in communications systems for future spacecraft.

A thorough understanding of the fundamentals of communications systems and a detailed familiarity with the capabilities of communications systems components are required. In addition, systems engineering and hardware experience would be helpful. Specific experience in such areas as command & control systems, telemetry systems, secure systems, high processing gain systems, high data rate systems and satellite relay systems, would be most pertinent.

Since the position is so directly concerned with the development of the state-of-the-art, an open minded and imaginative approach is of critical importance. A personality which would assure acceptance in contract proposals is a consideration.

Requirements include: M.S. or Ph.D. degree from an accredited university, U.S. citizenship and 12 years' experience.

For additional details about this exceptionally challenging opportunity, please airmail your resume to:

MR. ROBERT A. MARTIN
Head of Employment
HUGHES Aerospace Divisions
11940 W. Jefferson Blvd.
Culver City 42, Calif.

Creating a new world with electronics

HUGHES

HUGHES AIRCRAFT COMPANY
AEROSPACE DIVISIONS

An equal opportunity employer

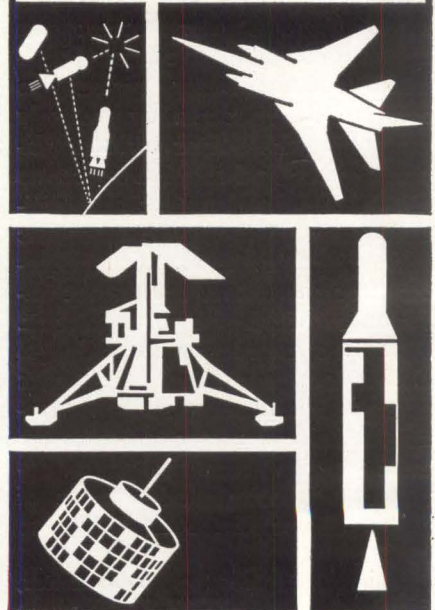

New Materials

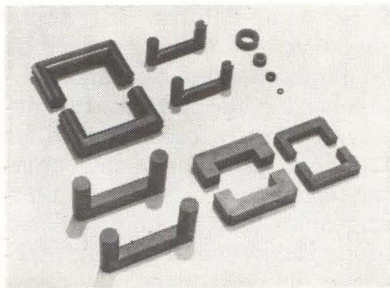

Ferrite boosts coil voltages

New ferrite material has electrical characteristics which make it particularly effective for high power, low loss applications, such as color tv flyback transformers, adjustable and fixed inductors and transformers. Called Ferramic 0-5, it has an initial permeability of approximately 2400 minimum, with a saturation value of 4700 gauss and a loss factor of approximately 1.0×10^{-5} at 100 kc. Because of these values, the material permits designers to increase operating voltages of inductors and transformers without changing core configuration or to decrease input voltage while maintaining previous coil inductance. Indiana General Corp., Kearsbey, N.J. [411]

Rectifier reliability increased by new alloy

Reliability of high power silicon rectifiers can be increased substantially by use of Amzirc copper alloy for mounting studs. The stud material also helps sidestep both the derating and vibration problems facing rectifier users. Amzirc is a high-conductivity, oxygen-free copper-zirconium alloy with a tensile strength of 50,000 psi at 750°F. It has high strength at temperatures up to 500°C. Most of its strength and hardness is developed with cold working; aging greatly increases its electrical and thermal conductivity, ductility and resistance to softening.

American Metal Climax, Inc., 1270 Ave. of the Americas, New York 20, N.Y. [412]

UNITRON

INCORPORATED

**PRECISION 115V 400 CPS SINE WAVE
FROM A 28V DC SOURCE**

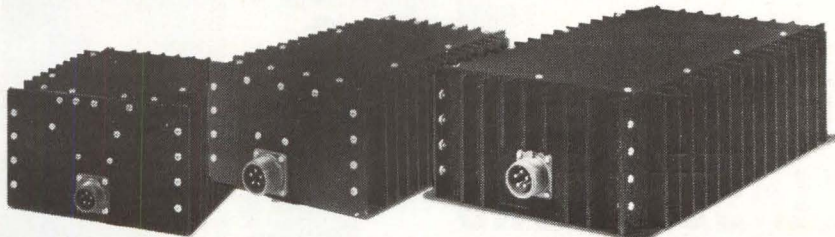

4S1125-1P
125VA

4S1250-1P
250VA

4S1500-1P
500VA

These high performance static inverters surpass the extreme conditions of applicable military and FAA specifications for airborne equipment and are available at economical prices from stock. In addition they feature • guaranteed reliability • protection of output from no load to short circuit under any and all conditions • the input is protected against reverse polarity, high transients and high input voltage • low distortion • voltage regulated • high efficiency • stable frequency • light weight.

Write For Information On These And Other Static Inverters

1624 N. FIRST ST.
BOX 1331

GARLAND, TEXAS
AC 214 BR 6-8591

OTHER UNITRON PRODUCTS
ON PAGES 141 & 143

Circle 207 on reader service card

HAVE YOU CONSIDERED USING PHOTOCELLS?

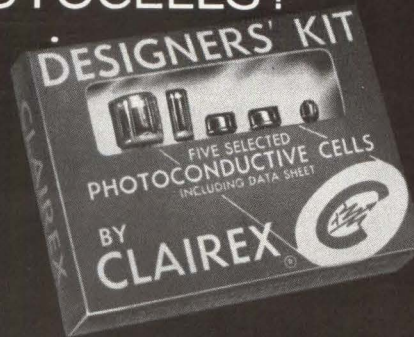

WE'VE JUST MADE IT EASY FOR YOU . . .

New! — from Clairex — a selection of photoconductive cells, varying in sensitivity, spectral response, speed and size to suit most applications, and including the CL505, CL603A, CL704L, CL707 and CL902 — in convenient kit form complete with technical data — only \$10.00.

Free On Request —
Designers' Kit Information
plus New 1964 Edition
16 page Designers' Manual

CLAIREX

"The LIGHT Touch in Automation and Control"

8 West 30 Street, New York, N. Y. 10001, 212 MU 4-0940



**GARLOCK
REPORTS**

NEW! MIL-T INSULATORS

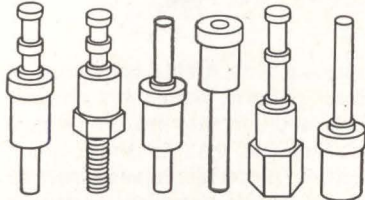

A brand-new line of insulators to MIL-T-55155 are now available for high frequency, voltage and temperature applications. A wide assortment of types includes compression and metal body mounts . . . single and multiple turrets. Save specification fussing . . . ask for Garlock MIL-T Insulators. Write for catalog EP170.

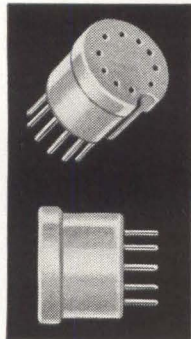

MICRO-MODULE SOCKETS

New CHEMELEC sockets are specifically designed for use with Fairchild and Signetics micro-modules (molex-type semiconductor networks used in computer and other critical circuits). These top quality products are manufactured in TFE and nickel-plated, gold-flashed Beryllium Copper. For complete technical data write for specification sheet EP171.

COPPER CLAD TFE

Now available in standard stock sizes of 18" x 36" (special sizes to 12" x 150"), Garlock Copper Clad TFE is an outstanding material with uniform dielectric constant and dissipation factor with excellent resistance to delamination. Available in a wide range of TFE thicknesses to .500; copper weights to 6 oz.

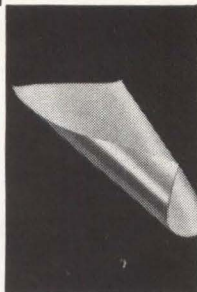

GARLOCK PRODUCTS ARE AVAILABLE FOR IMMEDIATE DELIVERY FROM YOUR LOCAL ELECTRONICS DISTRIBUTOR. FOR FURTHER INFORMATION WRITE:

GARLOCK ELECTRONIC PRODUCTS
GARLOCK
INC.
CAMDEN, NEW JERSEY 08101

New Production Equipment



Automatic system tins printed circuits

Now available is ACTA (Automatic Centrifugal Tinning Apparatus). It dips the p-c board into an oil-film-covered molten solder bath, spins the board in the solder for an intensive washing effect, slings off the excess solder and shakes clear the component holes and eyelets. Photo shows the operator placing the board in position. Processing capacity is 180 to 200 boards per hour, 10-in. max diameter (corner to corner). Price is \$8,650. Electrovert Ltd., 3285 Cavendish Blvd., Montreal 28, Quebec, Canada. [421]



Soldering pencil has low-voltage feature

Low-voltage tip temperature controlled soldering pencil, model W-TCP, is designed to insure reliability and quality control. The small (7½ in. long) and light weight (1¼ oz) tool features a choice of differ-

ent tip temperatures, is packed with 60 w of energy and can be used for both miniature and general soldering applications. Its low-voltage (24 v) feature provides component protection and operator safety. A choice of interchangeable tips premium plated for long life by a new plating process is available.

Weller Electric Corp., 601 Stone's Crossing Road, Easton, Pa. [422]



Percussive welder joins wire to terminal

A percussive welder, which automatically drives a wire against a terminal as it welds them together, is designed for use in electronic assembly where high reliability, low electrical resistance, and high density wiring criteria must be met. It can join dissimilar metals—for example, it can weld 26, 28 or 30 Awg tinned copper wire to phosphor bronze electro-tin plated strip stock. The PW-200 consists of two units: a lightweight pistol-grip welding gun and a combination power supply and carrying case. In performing the weld, the trigger is pulled to advance a wire held in a gripper, toward the terminal. A stored charge, released as the wire nears the terminal, melts the metals to be joined, and the wire is driven under controlled impact into the terminal to form the weld. International Business Machines Corp., 1000 Westchester Ave., White Plains, N.Y. 10604. [423]

New Literature

Chopper life Airpax Electronics Inc., Cambridge, Md. "Will A Chopper Live Forever?" is the title of the fourth of the technical series on chopper parameters and applications. [451]

Silicon logic modules Electronic Modules Corp., 1949 Greenspring Drive, Timonium, Md., offers a brochure on a complete silicon logic module family which performs with a very high degree of reliability over extreme temperature ranges. [452]

Time delays Standard Instrument Corp., 657 Broadway, New York 12, N.Y. Technical brochure describes the function of seven different types of time delays, including momentary, pulsed, delayed make and delayed break. [453]

Differential amplifier Rochar Electronique, 51, Rue Racine, Montrouge (Seine), France, has prepared a brochure giving specifications for the W63 differential amplifier, for low d-c voltage. [454]

Timing terminal unit & modules Astrodata, Inc., 240 E. Palais Road, Anaheim, Calif. Technical bulletins describing model 6620 modular timing terminal unit and associated modules are available. [455]

Coaxial terminators Omni Spectra, Inc., 8844 Puritan Ave., Detroit, Mich. 48238, Single-sheet bulletin describes model 20030P and 20030J precision coaxial terminations for d-c to 18.0 Gc and d-c to 12.4 Gc, respectively. [456]

Temperature test chambers The Scionics Corp., 8900 Winnetka Ave., Northridge, Calif. Two new data sheets describe models BTC-720 and BTC-730 precision temperature test chambers. [457]

Lighted pushbutton switches Micro Switch, Freeport, Ill. Data sheet 218 is devoted to the remote control series 2 lighted pushbutton switch with the new Mag-Pull design. [458]

Pressure transducers Columbia Research Laboratories, Inc., MacDade Blvd. & Bullens Lane, Woodlyn, Pa. Data sheet T-149 describes a new series of pressure transducers whose output voltages are ultrasensitive to applied pressures from 10 to 300 psi. [459]

Communications products Raytheon Co., 213 E. Grand Ave., South San Francisco, Calif. An 8-page communications brochure describes a line of Ray-Tel citizens band two-way radios and accessories. [460]

Oscilloscopes DuMont Laboratories, divisions of Fairchild Camera and Instrument Corp., Clifton, N.J. A 6-page folder illustrates and describes the 765 H series solid-state, high-frequency oscilloscopes with associated plug-in units. [461]

High-reliability capacitors EMI Electronics, Ltd., Hayes, Middlesex, England. High-reliability capacitors available up to 5,000 v d-c are discussed in a 12-page bulletin. [462]

UNITRON

INCORPORATED

1000VA OF PRECISION 115V 400 CPS
SINE WAVE FROM ANY 60 CPS OUTLET



MODEL PS62-64

This unit offers freedom, versatility, and flexibility never before experienced in a 400 cycle power source. Rack mounted for powering complete ground systems or in the cabinet for laboratory, quality control, offsite presentations, and production. This unit features • precision and adjustable frequency • low distortion • voltage regulated • adjustable voltage • light weight for portability • complete metering • economically priced • overload and short circuit protected.

Write For Information On These And Other Frequency Converters

1624 N. FIRST ST.
BOX 1331

GARLAND, TEXAS
AC 214 BR 6-8591

OTHER UNITRON PRODUCTS
ON PAGES 139 & 143

Circle 208 on reader service card

TYPE HFM-8

MULTICOUPLER



The HFM-8 series multicouplers provide optimum coupling between a single antenna and as many as eight receivers in the 2-30 mc range. Compact in size (only 3.5 inches high), the HFM-8 provides a nominal gain of 8 db, a low noise figure of 10 db max. Quick change connectors are provided on the front panel of the type HFM-8 and on the rear apron of the HFM-8-1; BNC connectors on the front panel of the HFM-8-2 and on the rear apron of the HFM-8-3.

Frequency Range 2-30mc, flat \pm 2 db
Input Impedance 75 ohms

Gain 8 db nominal
Power 115/230v,
50/60/400 cps, 32 watts

Communication Electronics Incorporated

4908 HAMPDEN LANE, BETHESDA 14, MARYLAND

Trace the template, push the button.

Watch the rhythm build. Faster than a hole a second.

This is a brand new turret punch press. Electronically linked to a floating stylus. Just trace the template, touch the button—punch your holes, count your money.

It clocked 69-plus holes per minute over a nine-hour stretch. The situation? Regular production of an electronic chassis.

You could amortize this unit over 100 days at less than $\frac{1}{4}c$ per hole. 69 holes per minute, six hours a day. Our Di-Acro Stylus Operated Turret Punch Press No. 18 is just \$5,950. Beautiful!

The feather-touch stylus floats on recirculating ball bearings. It holds punching accuracy within .005" of the template. Both upper and lower turrets rotate simultaneously . . . that's togetherness! Eighteen punches and dies always perfectly aligned. Manual or color-coded electronic selection. Change setups as fast as you can drop in new templates.

Capacity is 18" x 24" blank. Up to 14 gauge steel. Choose dies up to 2" diameter or equivalent. Round, square, oval and rectangular shapes in 1/64" increments. Many "specials" are standard, too. Custom shapes made to your order.

New as this machine is, your bright-eyed Di-Acro distributor already has full information on it. Call him or write us. Ask for our Punching Catalog while you're at it.

It's brand new, too.

GOLDEN TOUCH

PLACE THE STYLUS, PUNCH

A HOLE □ PLACE THE STYLUS, PUNCH A

HOLE ○ PLACE THE STYLUS, PUNCH A HOLE △ PLACE THE

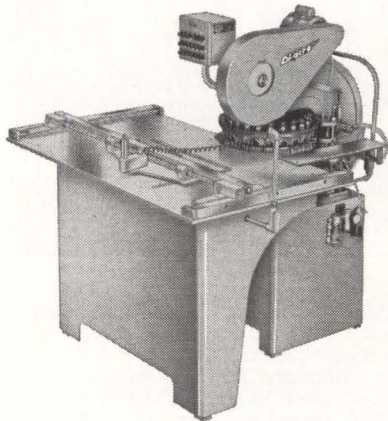

DI-ACRO CORPORATION
434 Eighth Ave., • Lake City, Minn.

Di-Acro manufactures a complete line of benders, rod parters, brakes, press brakes, press brake dies, shears, notchers, rollers, punch presses, layout machines, spring winders and punches and dies. Write for catalog.



New Books

Nondestructive tests

Proceedings of the fourth annual symposium on nondestructive testing of aircraft and missile components, San Antonio, Texas, Feb. 26-28, 1963. Available from Southwest Research Institute, P.O. Box 2296, San Antonio, Texas, 379 p, \$10

The papers and discussions from the fourth San Antonio symposium summarize new developments in thermal and infrared nondestructive testing of metallic and fiber glass filament-wound missile-case structures, novel electronic- and acoustic-emission test systems, and recent evaluations of porosity and crack growth effects on serviceability of steel missile-case weldments. These proceedings are essential reading for those who must keep up to date on new methods of nondestructive testing for critical structures for aerospace, missile, nuclear and other severe-service uses.

The first five papers from the Symposium document the coming of age of thermal and infrared methods of nondestructive testing. For the first time, such methods are shown to be practical by confirming reports from five industrial development organizations.

Several independent investigations have led to a common preferred method of testing in which a scanning test employs heat injection into a small, moving spot at a rate of about 250 watts per square inch. Sensitive infrared detectors scan a small spot of similar size, following along the scan lines after a time interval that provides optimum resolution of detail, to produce C-scan recordings or maps similar to those widely used in immersion ultrasonic testing.

These tests indicate potentials for thermal detection of metallic material properties such as grain size, intergranular corrosion, wall thinning, porosity and laminations, and bonding properties in composite structures including delaminations, voids and lack of bond.

Five papers are concerned with nondestructive testing of fiber glass solid-propellant missile cases. Extensive development and evaluation work is described for radiographic, corona-discharge, moisture-detect-

tion, ultrasonic, optical-transmission, electrified-particle, sonic, microwave, eddy-current and beta-ray backscatter types of tests. Use of strain-sensitive coating tests is also described. Infrared scanning of preheated missile assemblies to detect anomalies in case and bonding is described in detail. Conditions detected include irregular indexing and relaxation of rovings, location of reinforcements, foreign inclusions, delaminations, crazing, surface cracks, insulation thickness, leaks and bonding, glass-to-resin ratios, separation of attachments, resin-rich areas, voids, variations in casing thickness, seepage of moisture through insulator joints and into fine cracks (crazing) in epoxy, surface strain distributions, modulus of elasticity filaments, and others critical to serviceability of missile case assemblies.

Three papers are directed toward problems of defects in welded steel materials and vessels. Shear-wave ultrasonic tests were used to detect discontinuities in thicker-walled structures, and test indications were correlated with woody-structure discontinuities (voids and inclusions sometimes interconnected by fine cracks) and with rates of crack propagation in low-cycle plastic fatigue tests. In the latter tests, rapid propagation of cracks occurred after their initiation was detected by ultrasonic tests.

An unusual paper in the series is devoted to fluorescent-penetrant inspection of Teflon hose, to reveal the many fine cracks and leak areas probably resulting from improper installation or application, in a material with very high sensitivity to crack propagation.

As a whole, the proceedings provide a valuable insight into the most critical nondestructive test problems and the advances toward their solution. Of equal value are concepts, both novel and fundamental, that are revealed in highly-sensitive test methods and in analysis of mechanisms of material failures.

Robert C. McMaster
Professor of welding engineering
Ohio State University
Columbus, Ohio

Cost estimating

Electronics Industry Cost Estimating Data, By Fred C. Hartmeyer, The Ronald Press Co, New York, 304 p, \$12.

The organization of this book and coverage of materials are excellent. They compare favorably with such other books as "Machine Operation Standards" by Derse and "Practical Work Standards" by Poppas and R. Dimberg, to name just two.

The chapter on concept estimating, though brief, deals with a timely subject and its information can be used readily to establish preliminary cost targets for those quick-reaction programs where design and production lead-time cycles are at a minimum.

The technical data and range of coverage are very good. Of particular interest is the inclusion in the data of information pertaining to inspection, packing, finishes and materials procurement. The inclusion in the finish data of gold, silver and other special plating processes is of particular interest and a worthwhile source of information for estimators and cost personnel.

The sections on allowances to be applied to the standard data seem to be adequate for hardware requiring good workmanship and high standards for commercial product lines. However, insufficient consideration may have been given to applications in military-oriented procurements. In such cases the nature of the hardware requires special processing techniques for cutting, stripping, forming and cleaning, and additional allowances for restrictions in wiring and assembly due to package configuration, miniaturization, radio-frequency requirements etc.

The information in the sections on learning curves, manufacturing, engineering, personnel and facility planning, special tooling and materials cost data is of good philosophical value, though somewhat limited as reference material for use by the average estimator.

Finally, the book can serve as an excellent guide and source of reference material for the sophisticated estimator and cost manager.

Vincent D. Lauria
Supervisor of industrial engineering
Airborne Instrument Co,
a division of Cutler-Hammer, Inc.

UNITRON INCORPORATED

400 CPS 3 ϕ TO 60 CPS 1 ϕ AT 3 5KVA
ALL SILICON SOLID STATE FREQUENCY CONVERTER

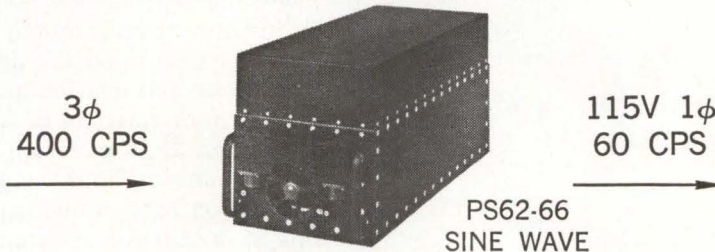

The Model PS-62-66 is an all silicon solid state frequency converter with proven performance in both airborne and air-transportable systems where precision 60 cycle is required from a 400 cycle source. This unit features

- proven reliability
- high performance
- high efficiency
- low distortion
- voltage regulated
- light weight
- 25,000 feet altitude
- MIL-I-26600
- excellent stability
- short circuit protection.

Write For Information On These And Other Frequency Converters

1624 N. FIRST ST.
BOX 1331

GARLAND, TEXAS
AC 214 BR 6-8591

OTHER UNITRON PRODUCTS
ON PAGES 139 & 141

Circle 209 on reader service card

STUCK FOR MAGNETS?



CALL

PERMAG

We stock all sizes, all shapes, all grades, for all uses... all ready for 24-HOUR DELIVERY. Also magnets engineered and fabricated to your needs.

PERMAG PACIFIC CORP. 6176 W. Jefferson Blvd., Los Angeles, Calif. 90016 / Phone: Area Code 213 VErmont 7-4479 / TWX: 213 836-0445

PERMAG CENTRAL CORP. 5301 D Otto Ave., Rosemont, Des Plaines, Illinois 60018 / Phone: Area Code 312 678-1120 / TWX: 312 678-2063

PERMAG CORP. 88-06 Van Wyck Expressway, Jamaica, N. Y. 11418 / Phone: Area Code 212 OlymPIA 7-1818 / TWX: 212 479-3654

Circle 210 on reader service card

HOW TO MEASURE
DC TO $\pm 0.01\%$
AC TO $\pm 0.1\%$
WITH ONE
PORTABLE
INSTRUMENT:

GET A NEW
FLUKE
MODEL 823A
DIFFERENTIAL
VOLTMETER

For CATALOG DIGEST: Write
JOHN FLUKE MFG. CO., INC.,
Box 7428, Seattle, Wash. 98133

FLUKE

Circle 143 on reader service card

143

NEW IDEAS in PROGRAMMED TIMING



SUMMATION TIMING,

a new concept in a solid state timer in which the timing interval may be interrupted and resumed without resetting the timer or affecting its accuracy. It will time total flow up to 5 minutes . . . ignore interruptions up to 15 minutes. Programmed from a single set of external contacts.

MONITOR TIMING,

in which the timer times the interval between events. Resets when the event occurs, operates if the event is omitted or delayed. Can monitor rate of flow of liquid, objects on a conveyor line, etc. Programmed from a single set of external contacts.

STANDARD DELAY-ON-MAKE and DELAY-ON-BREAK —

timers provide time delays from 0.2 seconds to 5 minutes . . . repeat accuracy of $\pm 1\%$. . . operate from 115 vac. Rugged industrial construction. For precision timing applications requiring solid state reliability and extended life.

Above timers described in bulletin 2163-1.

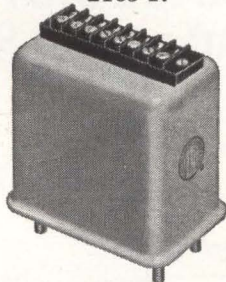

STEPPING SWITCH TIMER,

operates stepping or rotary selector switches in timed steps which may be fixed or variable. Provides simple, low-cost means of building sequencing and scanning systems. Programmed from external potentiometers or resistors. Ask for bulletin 6311.

COMPLETE SEQUENCING and CONTROL SYSTEMS —

designed and built to your specifications. Complete packaging facilities for industrial or military applications. Consultation on your control problems without obligation.

**ELECTRO-SEAL
CORPORATION**

946-C North Avenue
Des Plaines, Illinois



Technical Abstracts

Lasers in a fog

A Laser Fog Disdrometer. Bernard A. Silverman, Air Force Cambridge Research Labs, Bedford, Mass., and Brian J. Thompson and John H. Ward, Technical Operations Research, Burlington, Mass.

An instrument built around a laser has been developed for determining the size and distribution of fog droplets four microns in diameter and larger. It is capable of sampling volumes up to five cubic centimeters on each frame of 35 mm film at a rate of 10 frames per minute. The short pulse length of the laser, as short as one microsecond, enables the measurement to be made in moderately high winds without loss of accuracy. A quasi-continuous film record of the fog droplets is obtained as they pass relatively undisturbed through the collimated beam of light from a Q-switched pulsed ruby laser. Diffraction patterns which are associated with the individual droplets are then observed and recorded.

Although the laser disdrometer was designed specifically for fog measurements on the ground, and is important primarily to meteorologists, it does have a much wider applicability. The dynamic range and accuracy of the method makes it suitable for general laboratory and field measurements of aerosols, sprays, mists and other fine particles. An advanced device is being developed that will use electronic techniques for scanning the samples and sizing the patterns automatically.

(Presented at the 44th annual meeting of the American Meteorological Society, January 29-31, Los Angeles, Calif.)

Communications satellite design

Communications System Design For Orbiting Repeaters,* W.R. Wood and G.A. Myers, Philco Corporation, Western Development Laboratories, Palo Alto, California

A means of readily determining the values of important communication system parameters and their trade-off in the design of communications satellites is provided by this paper. The analysis and design presented specifically considers a system of satellite repeaters having

a multiple access capability; i.e., the ability to simultaneously relay messages from more than one ground station thus providing one or more full duplex channels. The discussion is confined to FM multiplex voice transmission.

The communications link considered consists of four main parts: the up link, the repeater, the down link, and the ground receiver (demodulator). Development of the equations in this manner, for each of these subsystems, permits their adaptation to other satellite system. This separation facilitates tracing the effects of parameter variation such as fading and power output fluctuations on other parts of the system.

A fixed bandwidth, two-channel (parallel) repeater is used in the calculations. Angle modulation permits use of limiting circuits. If desired, a common limiter may be used prior to the traveling wave tube amplifier output stage. The receiver is assumed to use a phase-locked loop demodulator for which threshold conditions are derived. Then the dependence of system capacity, in terms of number of voice channels, on signal quality and received signal-to-noise ratio is developed. These equations are translated to a series of nomographs from which system analysis or design can proceed.

Spacecraft display

A Prototype Electroluminescent Spacecraft Display John Frost, Autonetics, a Division of North American Aviation, Inc.

Life and brightness characteristics of electroluminescent light sources are sufficient to warrant consideration for display uses. In spacecraft displays, size, weight, power consumption and reliability offer advantages over competitive approaches.

However, electrical and photometric characteristics of currently available electroluminescent devices require the use of novel design techniques to optimize performance. The display is a high voltage, high impedance, capacitive device, and cannot be directly

**Manufacturing
Quality Resistors
under Rigid
Reliability
Control**

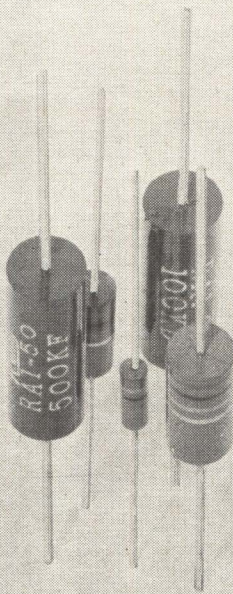

Rohm

METAL FILM RESISTOR
CARBON

**TOYO
ELECTRONICS
INDUSTRY
CORPORATION**

P. O. BOX 103 CENTRAL
KYOTO, JAPAN

controlled by standard semiconductor switching.

The author describes a compact, medium resolution electroluminescent display package, designed to solve a problem in spacecraft visual instrumentation. It operates either from analog transducer inputs or from a central digital computer. The display uses a pair of nonlinear resistive matrices to perform binary to decimal conversions at high voltage levels. Data storage is accomplished by optical feedback of selected bits onto a photoconductive matrix. Analog-to-digital conversion is effected within the display package, utilizing the coincidence of the input voltage with a voltage-time ramp, and interrupting a cyclic counter at the time of coincidence.

Panel resolution is 16 lines per linear inch. The output bits are selectively illuminated in response to X- and Y-axis selections, and present to the observer discrete and sequential data regarding the magnitude of the ordinate selected during each time period. A curve is thus formed with an appearance approximating that of an oscilloscope trace.

(Presented during week of Feb. 24-28 at the third national symposium of the Society for Information Display in San Diego, Calif.)

Voltage conversion made easy

One-step Converter for Ease of Voltage Conversion*
James A. Mcleod,
Light Military Electronics Dept.,
General Electric Co., Utica, N. Y.

Variable pulse width d-c to d-c converters encounter problems caused by input voltage changes and magnetic component drift. The author has developed switching techniques that successfully offset voltage variations produced by these instabilities and has applied them to an inherently stabilized d-c power supply. A 75-watt version of the supply was designed for the Relay satellite.

The variable pulse width signal is rectified to obtain a d-c output voltage stable for input variations from 78 to 32 vdc over a temperature range from -10° to $+50^{\circ}$ C. Conversion efficiency is above 80% for supplies rated from five to 125 watts.

The price paid for the variable pulse converter is an increase in

Precision drawn
and cut glass
tubing and rod

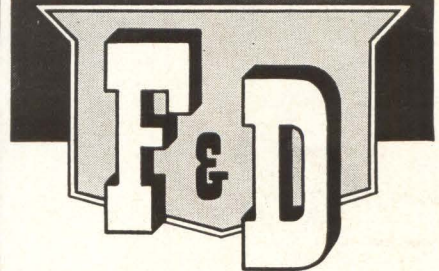
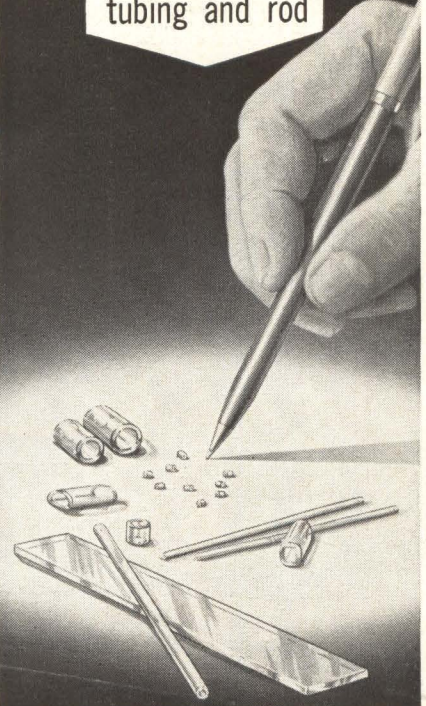

**GLASS TUBING & ROD
redrawn and cut to
your specifications**

Over 44 years experience in redrawing glass enables us to supply you with redrawn glass tubing and glass rod to your specifications. We can redraw tubing finer than a human hair or as large as .225" and be consistent about it. Perhaps you would like your tubing diamond saw cut to lengths of .020" upwards to tolerances of $\pm .001$ " or supplied in regular mill lengths.

We maintain adequate stocks of redraw blanks from many glass formulas, some of which are EN-1, KG-12, R-6 or N-51A. We can deliver what you need in a hurry. We can produce experimental lots or large quantities both at competitive prices. You will find, as many others have, that our quality is tops and our service fast and dependable. We welcome your inquiries.

FRIEDRICH & DIMMOCK, INC.

MILLVILLE, NEW JERSEY
PHONE 825-0305 AREA CODE 609 • CABLE: FRIMOCK

Serving industry for nearly half a century

When the need is critical . . .

ALITE[®] MISSILE NOSE CONES



with

MAXIMUM PERFORMANCE CHARACTERISTICS

As requirements become more demanding, high alumina ceramic—with its ability to withstand temperatures in excess of 3000°F — is being used more frequently for missile nose cones.

Increasingly, missile manufacturers are turning to Alite for their alumina nose cones for two principal reasons:

- Alite's capability for the electromagnetic and mechanical design of a nose cone with maximum transmission efficiency and structural reliability.
- Alite's capability for the production of nose cones which are uniformly accurate—physically and electrically—in production lots. Here, not only close dimensional tolerances but also absolute uniformity of high purity ceramic formulations from batch to batch is essential.

Produced under rigid Quality Control procedures, you can rely on Alite high alumina ceramic nose cones' low loss tangent . . . zero water absorption . . . dimensional and chemical stability . . . and high temperature resistance.

★ ★ ★

Let us review your specific requirements — without obligation: send us prints and other pertinent data. Or, write for free bulletins giving complete information about Alite.

ALITE

DIVISION

U. S. STONEWARE

BOX 119

ORRVILLE, OHIO

62-J

Circle 146 on reader service card

NIMS

NATIONWIDE IMPROVED MAIL SERVICE PROGRAM

For Better Service

Your Post Office

Suggests

That You Mail Early In The Day!

circuit complexity over the typical d-c to d-c converter. A square wave oscillator drives a simple pulse generating stage that turns on switching transistors that gate the input supply voltage to the primary of the converter. A voltage from the secondary of the converter is fed back to a control transformer made from square loop core material. The control transformer integrates the signal from the converter and generates turn off pulses when the integrated output signal is at the design value. When the supply voltage is high the output pulses are relatively narrow, when it is low, the pulses become square. In essence, they follow the signal from the square wave generator.

The "one-step" in the title of the paper refers to the fact that a separate regulating circuit is not required on the rectified output. Two major design problems were discussed in the paper.

1. Switching the converter (also using square loop core material) flux density without undue stress on the power switching transistor.

2. Furnishing sufficient base drive to the power switching transistors without a waste of base drive power.

Comsats and rain

Effects of Rain on Transmission Performance of Satellite Communication System,* D. Gible, Bell Telephone Laboratories, Inc., Murray Hill, New Jersey

Sky noise measurements during rain and snow were made at 5350 Mc at Whippany, N. J., at various antenna elevation angles from 3° to 90° using a low noise receiver and a small horn-reflector antenna. The results are given in the form of distribution curves of sky noise for certain elevation angles for summer months and non-summer months. The values range up to 200° K at 3° elevation.

The water on a radome during rainfall causes an increase in signal attenuation and in apparent sky noise. Theoretical expressions are developed to calculate, first, the thickness of water on the radome during rainfall, second the reflection and absorption of the signal by the combination of radome material and water, and third, the increase in attenuation and sky noise



**WHERE
QUALITY
COMES
FIRST**

MYLAR FILM CAPACITOR

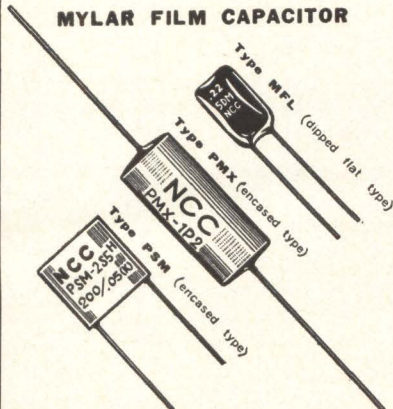

POLYSTYREN FILM CAPACITOR

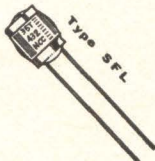

SOLID TANTALUM CAPACITOR

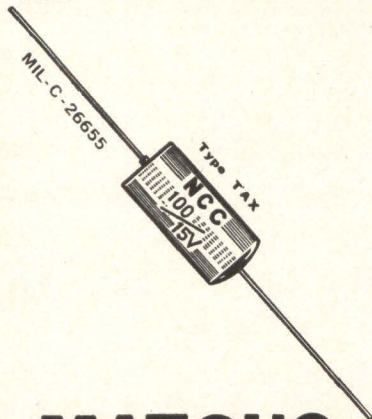

**MATSUO
ELECTRIC
CO., LTD.**

HEAD OFFICE :
3-5, 3-CHOME, SENNARI-CHO, TOYONAKA-SHI,
OSAKA, JAPAN.
TOKYO OFFICE :
25, 2-CHOME, KANDA AWAJI-CHO, CHIYODA-KU,
TOKYO, JAPAN.
Cable Address "NCC MATSUO" OSAKA

Circle 212 on reader service card

Electronics | April 6, 1964

caused thereby. Comparison with experimental results is given. Rain-fall of 0.1 in/hr causes a sky noise increase of about 50°K and an attenuation increase of about 2 db.

These statistical distributions of noise are combined with the distribution of loss variations due to range, antenna pattern and libration for a 6,000-mile orbit satellite system. Gravity gradient attitude control and earth pointing gain antennas on the satellites are assumed and an overall distribution curve of carrier to noise ratio is determined.

Combining spacecraft signals

The Design of Signals for Space Communications and Tracking,* Elie J. Baghdady & Kenneth W. Kruse, ADCOM, Inc., Cambridge, Massachusetts.

The concept of a "unified system" combining communications signals, telemetry, command and related verifications, tracking and guidance, into a single carrier promises substantial equipment economics and power utilization efficiency. A major handicap to the realization of such a system is the precision tracking function. Precision tracking imposes a degree of severity on performance requirements that is well in excess of the requirements of the other functions.

For a variety of reasons, it is convenient to classify signals intended for ranging into harmonic and non-harmonic. A waveform belongs in the harmonic class if it consists of a finite sum of discrete, harmonically related phase-coherent sine waves. An important example of a harmonic ranging signal is one consisting of a number of low-frequency tones (sometimes called side-tones) whose frequencies are chosen so that the highest one meets the desired range-measurement accuracy, and the lower ones provide for adequate ambiguity resolution. Non-harmonic signals include all categories that do not fit into the above description of harmonic signals; of particular interest is the class of pseudorandom waveforms.

Criteria for the comparison of systems based on each type of tracking waveform can be formulated. The most important system comparison criteria are: performance characteristics, including the effects of systematic errors and

**INSTANT
LOADING**



**INSTANT
DEVELOPING with
new Beattie-Coleman Oscillotrons
using the new Polaroid® Land
FILM PACK**

The added convenience of the new Polaroid Land Film Pack is now available with the new Beattie-Coleman Mark II or K-5 Oscillotron, or as a retrofit. Combines these many advantages:

- Fast film-pack loading. No threading.
- Easier removal of film. No door to open. Pulls out smoothly through slot.
- Picture develops in 10 seconds; outside camera. Easier stripping of print.
- Film lies flat in focal plane for maximum accuracy of registration.
- Compact. 1¼ lbs. lighter.
- Variable ratio — 1:0.5 — 1:1.
- 13 multiple exposures on one frame.
- Vertical or horizontal format.
- Non-reversed, direct view of CRT.
- Data recording optional.
- Immediate delivery.

"Polaroid"® by Polaroid Corporation



**OSCILLOTRON®
'SCOPE CAMERAS**

1004 N. Olive St., Anaheim, California
Phone (714) 774-4503

Circle 147 on reader service card

You can solve
all your staking
problems for just
\$163 with the NEW
portable, all electric
ELECTROSTAKE

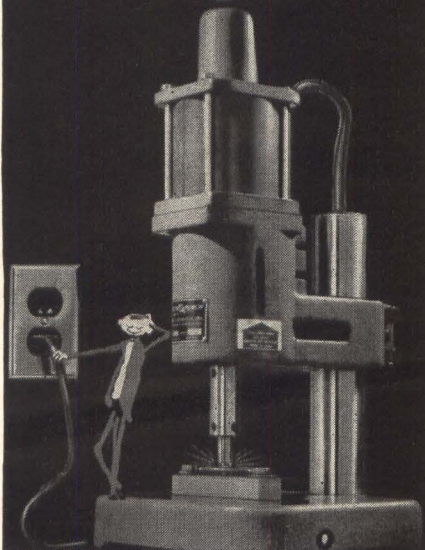

BLACK & WEBSTER
INC.
570 PLEASANT STREET,
WATERTOWN 72, MASS.

Gentlemen:
Please send me information about the Series 4
Black and Webster ElectroStake models F.J.S.,
B.S. & S.M.S. which:

1. stake up to 120 units per minute with controlled impact to 3500 lbs.
2. are easily movable from job to job
3. never need air lines
4. don't require skilled labor
5. set up easier and quicker
6. cut costs, time, labor

NAME _____
COMPANY _____
STREET _____
CITY _____ ZONE _____ STATE _____
DEPT. E _____

random errors, within limitations on bandwidth and signal power; costs, including system complexity and penalties paid in exchange for any unique advantages; operational considerations, such as time requirements on calibration and signal acquisition, and adaptability to automate operation; and adaptability to integration into a single system combining the added functions of communications, telemetry, command, video and recovery.

Space malfunction detector

Optimization of Malfunction Sensing and Decision Systems For Space Vehicles,* E.S. Joline and R.L. Smith, Sperry Gyroscope Company.

Rocket engine analyzer and decision Instrumentation comprises a comprehensive instrumentation system designed to sense abnormalities in rocket propulsion systems and to initiate remedial action. The final objective is to improve the likelihood of accomplishing mission objectives including the safe return of the crew.

The model of the process starts with a set of transducers that measure engine variables. These transducer signals are then processed to produce binary indications of malfunctions, and these malfunction indication signals are combined in logic networks with indications of vehicle state to determine the best remedial action decision. The remedial action is either initiated automatically or, if time allows, displayed to the pilot for his judgment and action.

Since installation and qualification of transducers on an engine involves considerable direct and indirect cost, the system must be designed to utilize the set of transducers that is optimum from the cost-effectiveness point of view.

The optimum set of transducer signals, and the general level of system complexity depend on many factors such as the probability of possible malfunctions, the availability of remedial actions, and the consequences of the malfunctions with and without the remedial actions. In addition, negative factors such as false alarm must be considered if realistic results are to be obtained.

* paper delivered at IEEE Convention, N. Y. Coliseum, March 23-26, 1964

Just Published
**MECHANICAL DESIGN
AND SYSTEMS
HANDBOOK**

Edited by H. A. ROTHBART
Fairleigh Dickinson Univ.

Provides a systematic and scientific basis for machine design and the dynamic analysis of mechanical systems. The latest mathematical methods and data are brought together to help you solve problems in the design, analysis, and synthesis of machines, mechanical elements, electromechanical and mechanical systems, controls, servomechanisms, analog computers, and automation. 1,500 pp., illus., \$39.50. Payable \$9.50 in 10 days, \$10 monthly.



ELECTRONIC CIRCUITS

Just Out—2nd Ed. Develops fundamental concepts and techniques that are basic to physical electronics, solid-state physics, linear amplifiers, pulse circuits, rectifiers, and related topics. Second Edition brings you abreast of advances in transistors. By E. Angelo Jr., Polytech. Instit. of Bklyn. 2nd Ed. 652 pp., 445 illus., \$11.50

CONTROL SYSTEM DESIGN

Just Out—2nd Ed. Uses practical examples to present fundamentals of feedback control system theory and design. A wide range of control system components are covered, and the fundamentals of system equalization are treated. By C. J. Savant, Jr., Hughes Tool Co. 2nd Ed. 448 pp., illus., \$11.50

BASIC TELEVISION

Just Out—3rd Ed. A comprehensive guidebook to TV fundamentals and servicing practices. The TV system, camera tubes and transmission, video and audio signals, picture tubes, power supplies, and each block of circuits in the receiver are explained. Includes many trouble-shooting helps. By B. Grob, RCA Instit, 3rd Ed. 672 pp., 479 illus., \$11.95

10 DAYS' FREE EXAMINATION

**CONVENIENT MAIL SERVICE
DIRECT FROM MCGRAW-HILL**

McGraw-Hill Book Co., Dept. L-4-6
327 W. 41st St., N.Y.C. 10036

Send me book(s) checked below for 10 days' examination on approval. In 10 days I will remit for book(s) I keep plus few cents for delivery costs, and return unwanted book(s) postpaid. (If you remit with coupon, plus local tax, we pay delivery costs—full refund and return privileges.)

- Rothbart—Mech. Design & Sys. Hdbk., \$39.50
Payable \$9.50 in 10 days, \$10 monthly
- Angelo—Electronic Circuits, \$11.50
- Savant—Control Sys. Design, \$11.50
- Grob—Basic Television, \$11.95

Name _____
Address _____
City _____ State _____ Zip Code _____
Company _____
Position _____

For price and terms outside U.S.
write McGraw-Hill Int'l., N. Y. 10036 L-4-6

QUALIFICATION FORM
FOR POSITIONS AVAILABLE

ATTENTION: Engineers, Scientists, Physicists

This Qualification Form is designed to help you advance in the electronics industry. It is unique and compact. Designed with the assistance of professional personnel management, it isolates specific experience in electronics and deals only in essential background information.

The advertisers listed here are seeking professional experience. Fill in the Qualification Form below.

Strictly Confidential

Your Qualification Form will be handled as "Strictly Confidential" by Electronics. Our processing system is such that your form will be forwarded within 24 hours to the proper executives in the companies you select. You will be contacted at your home by the interested companies.

What To Do

1. Review the positions in the advertisements.
2. Select those for which you qualify.
3. Notice the key numbers.
4. Circle the corresponding key number below the Qualification Form.
5. Fill out the form completely. Please print clearly.
6. Mail to: Classified Advertising Div., Electronics, Box 12, New York, N. Y. 10036.

Company	See Page	Key #
AFSC-AFLC JOINT PROFESSIONAL PLACEMENT OFFICE United States Air Force New York, NY	141*	1
ASSEMBLY PRODUCTS INC. Chesterland, Ohio	150	2
ATOMIC PERSONNEL INC. Phila., Penn.	150	3
GUIDED MISSILE RANGE Div. of Pan American World Airways Inc. Patrick AFB, Fla.	150	4
MOTOROLA INC. Scottsdale, Arizona	142*	5
NATIONAL CASH REGISTER CO. Hawthorne, Calif.	149	6
SNELLING & SNELLING Boston, Mass.	153*	7

* These Advertisements appeared in the March 23, issue.

(cut here) (cut here)

Electronics Qualification Form For Positions Available

(Please type or print clearly. Necessary for reproduction.)

Personal Background

Name
 Home Address
 City Zone State
 Home Telephone

Education

Professional Degree(s)
 Major(s)
 University
 Date(s)

Fields of Experience (Please Check)

34664

<input type="checkbox"/> Aerospace	<input type="checkbox"/> Fire Control	<input type="checkbox"/> Radar
<input type="checkbox"/> Antennas	<input type="checkbox"/> Human Factors	<input type="checkbox"/> Radio-TV
<input type="checkbox"/> ASW	<input type="checkbox"/> Infrared	<input type="checkbox"/> Simulators
<input type="checkbox"/> Circuits	<input type="checkbox"/> Instrumentation	<input type="checkbox"/> Solid State
<input type="checkbox"/> Communications	<input type="checkbox"/> Medicine	<input type="checkbox"/> Telemetry
<input type="checkbox"/> Components	<input type="checkbox"/> Microwave	<input type="checkbox"/> Transformers
<input type="checkbox"/> Computers	<input type="checkbox"/> Navigation	<input type="checkbox"/> Other
<input type="checkbox"/> ECM	<input type="checkbox"/> Operations Research
<input type="checkbox"/> Electron Tubes	<input type="checkbox"/> Optics
<input type="checkbox"/> Engineering Writing	<input type="checkbox"/> Packaging

Category of Specialization

Please indicate number of months experience on proper lines.

	Technical Experience (Months)	Supervisory Experience (Months)
Research (pure, fundamental, basic)
Research (Applied)
Systems (New Concepts)
Development (Model)
Design (Product)
Manufacturing (Product)
Field (Service)
Sales (Proposals & Products)

Circle Key Numbers of Above Companies' Positions That Interest You

1 2 3 4 5 6 7 8 9 10 11 12 13 14 15

DIGITAL SYSTEMS
ENGINEERS

Step into worldwide
business automation
with NCR, Los Angeles

At NCR, you can make original contributions in the most advanced areas of digital technology, creating business systems for use in 120 countries. You can step into a life where independent, searching minds find greater nourishment and reward—where there is no compromise between career values and living values.

Why not take that step now?

SYSTEMS ANALYSIS ENGINEERING

Programming and analysis of business and industrial electronic data processing systems with real-time applications involving communications network.

ADVANCED MECHANISMS DESIGN

Position will entail analysis and advanced design of complex mechanisms and applied mechanics problems. Ph.D. preferred with applicable experience. Should be equally skilled in mathematical analysis and laboratory measurements.

ADVANCED
ELECTRONIC MEMORY DESIGN

Job entails design of word-select memories and memory circuits. Requires BSEE, MSEE desired, and at least three years' experience in the above-mentioned field.

RANDOM-ACCESS MEMORY DESIGN

Senior position open in development of high-speed random-access mechanisms and general random-access equipment. Requires BSEE with at least four years' applicable experience.

SYSTEMS/COMMUNICATIONS DESIGN

This senior position will involve analysis and advanced design of on-line, real-time systems. Requires BSEE, MSEE desired, with some applications experience necessary.

INTERVIEWS AT SJC CONFERENCE,
WASHINGTON, D. C., APRIL 21-23

For an appointment, please send a resume, including training, experience and salary history, to Bill Holloway, Personnel Department, or phone collect.



The National Cash Register Company
ELECTRONICS DIVISION
2815 W. El Segundo Blvd., Hawthorne, Calif.
Telephone: Area Code 213-757-5111
an equal-opportunity employer

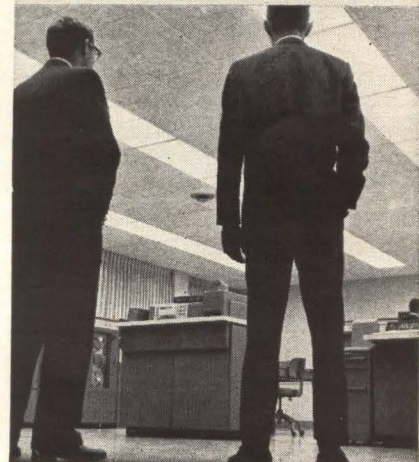

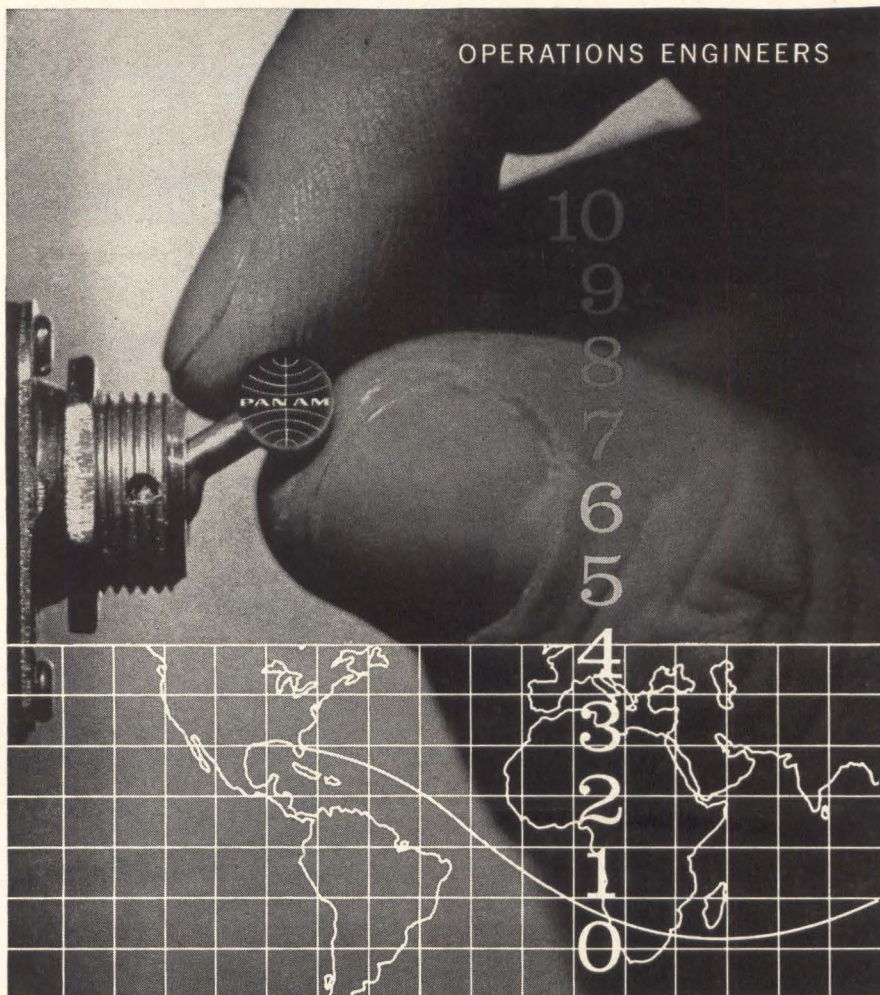

OPERATIONS ENGINEERS

ON THE FIRING LINE

of the Big Birds at the Atlantic Missile Range

All the knowledge and experience of the Operations Engineers with Pan Am's Guided Missiles Range Division at Cape Kennedy come into play in the vital decision which starts at countdown—the decision to launch.

Whether ballistic missile, manned space vehicle, satellite or space probe, these Engineers coordinate all of the range instrumentation systems from countdown through to impact. This responsibility encompasses real-time monitoring of the vehicle's performance in flight... an exacting responsibility shared by Pan Am Operations Engineers at down-range tracking stations and on the fleet of advanced range instrumentation ships.

For engineers who can make significant decisions while under pressure, and who have 3-5 years experience in instrumentation systems employing radar, telemetry, optics, infrared, and supporting data handling equipment, these important positions are open at Pan Am: Superintendents of Range Operations (at Cape Kennedy) / Base Operations Managers (at down-range stations) / Ship Operations Managers (on board tracking vessels).

Address inquiries in confidence: Manager, Professional Employment, Dept. 28D-1.



GUIDED MISSILES RANGE DIVISION

PAN AMERICAN WORLD AIRWAYS, INC.
P. O. BOX 4465, PATRICK AIR FORCE BASE, FLORIDA
An equal opportunity employer

LIVEWIRE ENGINEER

Needed for small, transducer system development and application group in rapidly growing activity within a moderate size growth company. Unusual flexibility required in a position with excellent technical and financial future. Desired man probably is an E. E., experienced with both industrial electronic instrumentation AND cold finishing operations of steel sheet mills. Personality must be suitable for both customer relations and development lab. Travel up to 50% of the time, but usually home (Cleveland area) weekends.

Air mail resume, including home phone number, references, availability and salary requirements, in first communication to R. Petruschke,

ASSEMBLY PRODUCTS, INC.
Chesterland, Ohio



E. E.'s

for FEE-PAID Positions
WRITE US FIRST!

Use our confidential application for professional, individualized service... a complete national technical employment agency.

ATOMIC PERSONNEL, INC.
Suite 1207L, 1518 Walnut St., Phila. 2, Pa.

PROFESSIONAL SERVICES

GIBBS & HILL, Inc.
Consulting Engineers

Systems Engineering
Operations Research • Development
Field Studies • Design • Procurement
Power • Transportation • Communications
Water Supply • Waste Treatment

393 Seventh Avenue New York 1, N. Y.

EMPLOYMENT

for all employment advertising including Positions Vacant or Wanted and Selling Opportunities Offered or Wanted.

SEARCHLIGHT

A national medium for Surplus New or Used Equipment and other Business Opportunities

PROFESSIONAL SERVICES

A dignified method for Specialized skills and services

Benefit yourself

by using these sections

Most useful to the advertiser

Most useful to the reader

For Rates and Information Write:

ELECTRONICS

Class. Adv. Div.,
P. O. Box 12, N. Y., N. Y. 10036

SEARCHLIGHT SECTION

(Classified Advertising)

BUSINESS OPPORTUNITIES

EQUIPMENT - USED or RESALE

SMALL AD but BIG STOCK

of choice test equipment
and surplus electronics

Higher Quality—Lower Costs
Get our advice on your problem

ENGINEERING ASSOCIATES

434 Patterson Road — Dayton 19, Ohio

CIRCLE 957 ON READER SERVICE CARD

TRANSISTORS • DIODES

MINIATURE COMPONENTS
IS OUR BUSINESS. NEW SURPLUS ONLY.
SMALL OR LARGE QUANTITIES AVAILABLE
WRITE FOR FREE CATALOG

TRANSISTORS UNLIMITED COMPANY

462 JERICHO TURNPIKE, MINEOLA, N. Y.
516-PI7-7221

CIRCLE 958 ON READER SERVICE CARD

ELECTRONIC ORGANS

In kit or component form.

The Model 8000A two manual organ kit
with sustain costs only \$350.

PANTRONIC, INC. Dept. E-4
Box 7395, Riverside, Calif.

CIRCLE 959 ON READER SERVICE CARD

(1) Used U.H.F. Impulse Generator

Model 1G-102, Serial #218
Manufacturer—Empire Products Corp.
Late Model—Excellent Condition

Contact

THE EQUITABLE EQUIPMENT CO.
1201 Champlain Street Toledo, Ohio 43601

CIRCLE 960 ON READER SERVICE CARD

SPECIAL SERVICES

A Contact in England—Advisory, installation,
maintenance service. All electronic electro-
mechanical equipment. Stoneman & Turpin
Ltd., 40 Branch Road, Park Street, St.
Albans, England.

An Investment!

Productive advertising is an
INVESTMENT rather than
an EXPENDITURE.

"Searchlight" advertisers in-
variably report prompt and
satisfactory results.

BE CONVINCED — send us
your advertisement TODAY.

Address

Classified Advertising Division

ELECTRONICS

P. O. BOX 12, N. Y., N. Y. 10036

Commercially polished

METAL MIRRORS

Any size—a Fraction of an
inch up to 50 Square Feet

- Available for immediate delivery.
- Also ferrotypes and laminating mirror plates.
- Submit your requirements for samples and prices.

FABRITE METALS CORPORATION

205 East 42nd St. - New York 17 •
(212) MU 3-8855 Cables: Metallfab, N.Y.

CIRCLE 952 ON READER SERVICE CARD

LIFSCHULTZ

FASTEST...

4th DAY
between
Chicago and
West Coast

2nd DAY
between
Chicago—
Milwaukee and
Eastern
Terminals

Specialists in Shipment of Electronics Products

LIFSCHULTZ FAST FREIGHT

NEW YORK — CHICAGO — PHILADELPHIA — BOSTON
HOLYOKE — BALTIMORE — BLOOMFIELD, N. J.
NEW HAVEN — PROVIDENCE — MILWAUKEE
LOS ANGELES — SAN FRANCISCO

CIRCLE 953 ON READER SERVICE CARD

Color DIAL TELEPHONES \$10.95

Factory rebuilt Western Electric
in white, beige, ivory, pink, green,
or blue. If 4 prong plug is re-
quired add \$2.00. Fully guaranteed.
Write for free list. All ship-
ments FOB.

Complete



SURPLUS SAVING CENTER
Waymart Dept. MH-E 464 Penna.

CIRCLE 954 ON READER SERVICE CARD

ELECTRON TUBES

KLYSTRONS • ATR & TR • MAGNETRONS
SUBMINIATURES • C.R.T. • T.W.T. • 5000-
6000 SERIES
• SEND FOR NEW CATALOG A2 •
A & A ELECTRONICS CORP.
1063 PERRY ANNEX
WHITTIER, CALIF.
AN 92865 OR 696-7544

CIRCLE 955 ON READER SERVICE CARD

OPTICAL BENCHES \$13. to \$13,000. New Catalog

THE Ealing CORP.

2250 Massachusetts Avenue, Cambridge, Mass., 02140

CIRCLE 956 ON READER SERVICE CARD

AUTOTRACK ANTENNA MOUNT

TYPE SCR 584, MP 61B

360 degree azimuth, 210 degree elevation sweep
with better than 1 mil. accuracy. Missile velocity
acceleration and slewing rates. Amplidyne and servo
control. Will handle up to 20 ft. dish. Supplied
complete with control chassis. In stock—immediate
delivery. Used world over by NASA, ABMA, USAF.
(NIKE AJAX MOUNTS) in stock

SCR 584 RADARS AUTOMATIC TRACKING

Our 584s in like new condition, ready to go, and in
stock for immediate delivery. Ideal for telemetry
research and development, missile tracking, satellite
tracking, balloon tracking, weather forecasting, anti-
aircraft defense tactical air support. Used on
Atlantic Missile Range, Pacific Missile Range,
N.A.S.A. Wallops Island, A.B.M.A. Desc. MIT Rad.
Lab. Compl. inst. bk. available \$25.00 ea. Series,
Vol. 1, pps. 207-210, 228, 284-286.

PULSE MODULATORS

MIT MODEL 9 PULSER

1 MEGAWATT—HARD TUBE

Output 25 kv 40 amp. Duty cycle, .002. Pulse lengths
.25 to 2 microsec. Also .5 to 5 microsec. and .1 to .5
msec. Uses 6C21. Input 115v 60 cycle AC. Mfr. GE.
Complete with driver and high voltage power supply.
Ref: MIT Rad. Lab. Series Vol. 5 pps. 152-160.

500KW THYRATRON PULSER

Output 22kv at 28 amp. Rep. rates: 2.25 microsec.
300 pps, 1.75 msec 550 pps, .4 msec 2500 pps. Uses
5C22 hydrogen thyatron. Complete with driver and
high voltage power supply. Input 115v 60 cy AC.

2 MEGAWATT PULSER

Output 30 kv at 70 amp. Duty cycle .001. Rep rates:
1 microsec 600 pps, 1 or 2 msec 300 pps. Uses 5948
hydrogen thyatron. Input 120/208 VAC 60 cycle.
Mfr. GE. Complete with high voltage power supply.

15KW PULSER—DRIVER

Biased multivibrator type pulse generator using 3E29.
Output 3kv at 5 amp. Pulse lghs .5 to 5 microsec,
easily adj. to .1 to .5 msec. Input 115v 60 cy AC.
\$475. Ref: MIT Rad. Lab. Series Vol. 5 pps. 157.

MIT MODEL 3 PULSER

Output: 144 kw (12 kv at 12 amp.) Duty ratio: 001
max. Pulse duration: 5.1 and 2 microsec. Input:
115 v 400 to 2000 cps and 24 vdc. \$325 ea. Full
desc. Vol. 5 MIT Rad. Lab. series pg. 140.

MICROWAVE SYSTEMS

NIKE MISSILE GUIDANCE SYSTEM

Complete electronic guidance section of Nike missile
including: control amplifier, steering amplifier, roll
amplifier, R.F. transmitter, Pitch & Yaw accelera-
ometers, beacon, modulator, video amplifier, steering
order demodulator, magnetron #TK6229, gyro unit,
pressure transmitter, roll amount gyro, roll rate gyro,
yaw rate gyro, pitch rate gyro.

300 to 2400MC RF PKG.

300 to 2400MC CW. Tuneable. Transmitter 10 to 30
Watts. Output. As new \$475.

X BAND DOPPLER SYSTEM

AN/APN-102 G.P.L. ANT/RCYR/XMTR PKG. 4
Beam Pulsed Janus Planar Array—New \$1600.

AN/TPS-ID RADAR

500 kw 1220-1359 mcs. 160 nautical mile search range
P.P.I. and A Scopes. MTI. thyatron mod. 5J26
magnetron. Complete system.

10 CM. WEATHER RADAR SYSTEM

Raytheon, 275 KW output S Band. Rotating yoke
P.P.I. Weather Band. 4, 20 and 80 mile range. 360
degree azimuth scan. Supplied brand new complete
with instruction books and installation drawings.
Price \$975 complete.

AN/APS-15B 3 CM RADAR

Airborne radar. 40 kw output using 725A magnetron.
Model 3 pulser. 30-in. parabola stabilized antenna.
PPI scope. Complete system. \$1200 each. New.

10KW 3 CM. X BAND RADAR

Complete RF head including transmitter, receiver,
modulator. Uses 2I42 magnetron. Fully described in
MIT Rad. Lab. Series Vol. I, pps 616-625 and Vol.
II, pps. 171-185 \$375. Complete System. \$750.

AN/APS-27 X BAND RADAR

Complete 100 kw output airborne system with AMTI,
5C22 thyr. mod, 4J52 magnetron, PPI. 360 deg az
sweep, 60 deg. elev. sweep, gyro stabilizer, hi-gain
revr. Complete with all plugs and cables \$2800.

M-33 AUTO-TRACK RADAR SYSTEM

X band with plotting board, automatic range track-
ing, etc. Complete in 2 van complex incl. 1 mega-
watt acquisition radar.

AN/APS-45 HEIGHT FINDER

Airborne system, 40,000 ft. altitude display on PPI
& RH. 9375 mcs. 400kw output using QK-172
magnetron, 5622 thyatron.

L BAND RF PKG.

20 KW peak 990 to 1040 MC. Pulse width .7 to 1.2
microsec. Rep rate 180 to 420 pps. Input 115 vac.
Incl. Receiver \$1200.

200MC RF PKG

175 to 225 mc. Output: 200 to 225 kw. 5 microsec 60
pps. Input: 115v 60 cycle AC. \$750.

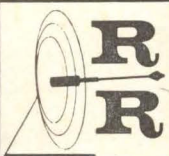

Radio-Research
Instrument Co.

560 5th Ave. New York 36, N.Y.
Tel. JUdon 6-4691

CIRCLE 951 ON READER SERVICE CARD



■ A M P Inc.	33	Mallory & Co. Inc., P.R. The Aitkin-Kynnett Co.	25
Garceau, Hargrave & McCullough Inc.		■ Matsuo Electric Co., Ltd.	147
■ Ad-Yu Electronics, Inc. P & G Advertising Agency	130	Asahi Advertising Agency & Co.	148
Allen Organ Company N.W. Ayer & Son Inc.	20	McGraw-Hill Book Co. Inc. Mico Instrument Company	124
■ Ballantine Labs. Lang-Lawrence Adv. Inc.	119	Microline, A Div. of General Aniline & Film Corp. Lennen & Newell Inc.	38
Bausch & Lomb, Inc. Wolff Associates, Inc.	133	■ Micro Switch Div. of Honeywell Batten, Barton, Durstine & Osborn Inc.	96
Beattie-Coleman, Inc. Taggart & Young, Inc.	147	Microwave Associates Kalb & Schneider Inc.	94
Bell Telephone Laboratories N.W. Ayer & Son Inc.	39	Mitsumi Electric Co., Ltd. Dentsu Advertising Ltd.	124
Black & Webster Inc. Larcom Randall Adv., Inc.	148	■ Mullard Ltd. Roles & Parker Ltd.	108
■ Bussmann Mfg. Co., Div. of McGraw Edison Co.	124, 125	Niagara Mohawk Power Corporation Batten, Barton, Durstine & Osborn Inc.	132
Henderson Advertising Company		■ North Atlantic Industries, Inc. Dunwoode Associates Inc	111
■ CTS Corporation Burton Browne Adv.	12, 13	Paktron, Div. of Illinois Tool Works Inc.	104, 105
■ Clairex Corp. S. Paul Sims Co.	139	Raymond E. Finn & Associates	
■ Cominco Products Inc. McKim Adv. Limited	130	Pennsalt Chemicals The Aitkin-Kynnett Co.	23
Communication Electronics Inc. John E. Waterfield/Admasters Adv., Inc.	141	■ Perfection Mica Co., Magnetic Shield Div. Burton Browne Advertising	123
Consolidated Electrodynamics Corp.	47	Permag Corp. Schneider, Allen, Walsh Inc.	143
Hixson & Jorgensen, Inc.		■ Philco, A Sub., of Ford Motor Co. Maxwell Associates, Inc.	31
Dialight Corp. H.J. Gold Co. Adv.	123	Plannair Ltd. Roles & Parker Ltd.	109
Di-Arco Corp. Charles E. Brown Adv.	142	Primo Co., Ltd. General Adv. Agency	130
DuPont de Nemours & Co. Inc., E.I.45, Batten, Barton, Durstine & Osborn Inc.	117	Radiation Inc. G.M. Basford Company	22
Durant Manufacturing Co. Keck Advertising Agency	128	Radio Corporation of America	4th Cover
Eastman Kodak Company The Rumrill Company Inc.	93	Al Paul Lefton Co.	
Eby Co, Hugh H. Benn Associates	116	Radio Engineering Laboratories, Div of Dynamics Corp. of America Arthur Falconer Associates Corp.	21
Electro-Seal Corporation Merchandising Advertisers, Inc.	144	Roanwell Corporation Zam & Kirshner, Inc.	9
Electronic Research Associates, Inc.	97	Rome Cable, Div. of Alcoa The Rumrill Co. Inc.	40
Josephson, Cuffari & Co.		■ Sanborn Co., Sub. of Hewlett-Packard Culver Adv., Inc.	2
■ Fairchild Controls Corp. Dunwoode Associates Inc.	24	Sargent & Greenleaf, Inc. Wolff Associates, Inc.	132
Fairchild Semiconductor Johnson & Lewis Inc.	14	■ Sigma Instrument, Inc., The McCann-Marschalk Co., Inc.	46
Fluke Mfg. Co., Inc. John Pollock & Loth, Inc.	143	Sprague Electric Co.	5, 6, 10
Flying Tiger Line Hixson & Jorgensen Inc.	11	The Harry P. Bridge Co. Standard Telephone & Cable	110
■ Friedrich & Dommock, Inc. Wyble Advertising	145	Brockie Haslam & Co.	
■ Garlock Electronic Products Inc. Atlantic Industrial Adv.	140	■ Superior Tube Co. Gray & Rogers, Inc.	118
General Electric Co., Semiconductor Products Dept.	98	■ Syntron Instruments, Inc. Burton Browne Adv.	136
Ross Roy Inc.		■ TRG Incorporated Culver Advertising Inc.	106
General Electric Co., Silicone Products Dept.	48	■ Tektronix Inc. Hugh Dwight Adv. Inc.	113
Ross Roy Inc.		Texas Instruments Incorporated Industrial Products Group	120, 121
■ Globe Industries Inc. Odiorne Industrial Adv. Inc.	122	Robinson-Gerrard, Inc.	
■ Hewlett Packard Co. L.C. Cole Company Inc.	1	■ Toy Electronics Ind., Corp. Dentsu Advertising	145
Houston Instrument Corp.	134, 135	Triplett Electrical Instrument Company Burton Browne Advertising	41
Cooley & Pate Inc.		■ United Transformer Corp.	2nd Cover
■ Hughes Aircraft Company 36, 37, 126, 138 Foote, Cone & Belding		Bradley Rosen & Kaus Adv., Inc.	
Hurst Mfg. Co. Taylor, Crook Associates	126	Unitrode Transistor Products Inc.	19
Ichizuka Optical Co., Ltd. Matsushita Inc.	136	Chirurg & Cairns Inc.	
Industrial Exhibitions Ltd. Walkley Hodgson Limited	107	Uniton Inc.	139, 141, 143
International Rectifier Corp. Communication Associates	42	U.S. Stoneware Ralph Gross Adv. Inc.	146
■ Jennings Radio Mfg. Corp. L.H. Waldron	131	Vidar Corp. Bonfield Associates, Inc.	95
■ Keithley Instruments Inc. Bayless-Kerr Company	127	■ Vitro Corp. of America Buchen Adv., Inc.	7
■ Kepco, Inc. Weiss Advertising	16	Welch Scientific Co., The Armstrong Adv. Agcy. Inc.	114
Kin Tel, Div. of Cohu Electronics	3rd Cover	West Penn Power Fuller, Smith & Ross Inc.	138
Erwin Wasey, Ruthrauff & Ryan		White, S.S. W.L. Towne Co. Inc.	137
Lepel High Frequency Laboratories Inc. Apex Graphic Company	129	■ Williams & Co., C.K. Newmark, Posner & Mitchell, Inc.	35
Levin & Son, Inc., Louis M.R. Crossman Co.	26	Xerox Corporation Papert, Koenig, Lois, Inc.	103
Machlett Laboratories Inc., The Fuller, Smith & Ross Inc.	8		

■ For more information on complete product line see advertisement in the latest Electronics Buyers' Guide

Advertising sales staff

James T. Hauptli: [212] 971-2210
Advertising sales manager

- Atlanta, Ga. 30309:** Gus H. Krimsier, Michael H. Miller, 1375 Peachtree St. N.E., [404] TR 5-0523
- Boston, Mass. 02116:** William S. Hodgkinson, McGraw-Hill Building, Copley Square, [617] CO 2-1160
- Chicago, Ill. 60611:** Robert M. Denmead, Daniel E. Shea, Jr., 645 North Michigan Avenue, [312] MO 4-5800
- Cleveland, Ohio 44113:** Paul T. Fegley, 55 Public Square, [216] SU 1-7000
- Dallas, Texas 75201:** Frank Le Beau, The Vaughn Building, 1712 Commerce Street, [214] RI 7-9721
- Denver, Colo. 80202:** John W. Patten, David M. Watson, Tower Bldg., 1700 Broadway, Tower Bldg., 1700 Broadway, [303] AL 5-2981
- Houston, Texas 77025:** Kenneth George, Prudential Bldg., Halcomb Blvd., [713] RI 8-1280
- Los Angeles, Calif. 90017:** Ashley P. Hartman, John G. Zisch, 1125 W. 6th St., [213] HU 2-5450
- New York, N.Y. 10036:** Donald R. Furth [212] 971-3616, Donald H. Miller [212] 971-3615, George F. Werner [212] 971-3617, 500 Fifth Avenue
- Philadelphia, Pa. 19103:** William J. Boyle, Warren H. Gardner, 6 Penn Center Plaza, [215] LO 8-6161
- San Francisco, Calif. 94111:** Richard C. Alcorn, 255 California Street, [415] DO 2-4600
- London WI:** Edwin S. Murphy Jr., 34 Dover Street
- Frankfurt/Main:** Mathee Herfurth, 85 Westendstrasse Phone: 77 26 65 and 77 30 59
- Geneva:** Michael R. Zeynel, 2 Place du Port 244275
- Paris VIII:** Denis Jacob, 17 Avenue Matignon ALMA-0452
- Tokyo:** Shigeo Chiba, 1, Kotohiracho, Shiba, Minato-ku (502) 0656
- Osaka:** Kazutaka Miura, 163, Umegae-cho, Kita-ku [362] 8771
- Nagoya:** International Media Representatives, Yamagishi Bldg., 13,2-Chome, Oike-cho Nagaku
- R.S. Quint:** [212] 971-2335
General manager
Electronics Buyers' Guide
David M. Tempest: [212] 971-3139
Promotion manager
Henry M. Shaw: [212] 971-3485
Market research manager
Richard J. Tomlinson: [212] 971-3191
Business manager
Theodore R. Geipel: [212] 971-2044
Production manager

Classified

- F.J. Eberle: [2557]
Business Manager
- Professional Services** 150
- Employment opportunities** 149-150
- Equipment**
(Used or Surplus New)
For Sale 151

Classified advertisers index

- A & A Electronics Corp 151
- Assembly Products Inc. 150
- Atomic Personnel Inc. 150
- Ealing Corp., The 151
- Engineering Associates 151
- Equitable Equipment Co., The 151
- Fabrite Metals Corp. 151
- Lifschultz 151
- National Cash Register Co., The 149
- Pan American 150
- Pantronic Inc. 151
- Radio Research Instrument Co. 151
- Surplus Saving Center 151
- Transistors Unlimited Co. 151

Executive, editorial, circulation and advertising offices: McGraw-Hill Building, 330 West 42nd Street, New York, N.Y., 10036. Telephone Area Code 212-971-3333. Teletype TWX N.Y. 212-640-4646. Cable McGrawhill, N.Y. Officers of the Publications Division: Shelton Fisher, President; Vice Presidents: Joseph H. Allen, Operations; John R. Callahan, Editorial; Ervin E. DeGraff, Circulation; Donald C. McGraw, Jr., Advertising Sales; Angelo R. Venezian, Marketing. Officers of the Corporation: Donald C. McGraw, President; Hugh J. Kelly, Harry L. Waddell, L. Keith Goodrich, Executive Vice Presidents; John L. McGraw, Treasurer; John J. Cooke, Vice President and Secretary. Title R registered U.S. Patent Office; © copyright 1964 by McGraw-Hill, Inc. All rights reserved, including the right to reproduce the contents of this publication, in whole or in part.

which of these

13

*KIN TEL instruments
does your standards
lab need?*

Used in leading standards labs
throughout the country, they may
supply the exact degree of accuracy,
stability, range, and versatility
your applications demand.

CERTIFIED

■ STANDARDS

- 1. DC Voltage Standard (Model 303B).** So accurate, so stable, you can use it to calibrate any digital voltmeter. Lets you control output from 0 to over ± 1100 volts in steps as small as 1 microvolt. Accurate to within 0.01% of the dial setting; stable to within 0.0025%. Floating guarded circuit. Price: \$2995.
- 2. AC Voltage Standard (Model 601A).** Output is 1 to 501 volts RMS AC, adjustable in 0.1 volt steps and between steps by a multi-turn potentiometer. Voltage accuracy is 0.1%, short term stability is 0.01%. Ideal for calibrating AC measuring instruments, designing servo or gyro equipment, evaluating magnetic properties. Price: \$4500.
- 3. Programmable DC Voltage Standard (Model 313).** You can select voltages—automatically and in any sequence—from 0 to ± 1111.1110 volts, with 0.01% accuracy and in steps as small as 1 microvolt. Parallel entry, 1-2-4-4 binary-coded-decimal signals. Stability: less than 0.005% for 30 days. Price: \$3995. Remote control unit available. Price: \$500.
- 4. DC Voltage Standard and Null Voltmeter (Model 301).** Has an accuracy of 0.02% and stability of 0.01%. Measures and supplies DC from 1 to 501 volts. Price: \$995. Available in 1 to 502 volts (Model 302) with 0.01% accuracy, 0.002% stability. Price: \$1495.

Write for detailed literature or a demonstration of any of these exceptional instruments. Representatives in all major cities. All prices FOB, San Diego, Calif. (Additional export charge.)

■ VOLTMETERS

- 5. AC/DC Digital Voltmeter (Model 502B).** Gives you DC accuracy within 0.01% of reading; over-ranging on both AC and DC; automatic ranging and remote (programmable) control. Measures DC between ± 100 microvolts and ± 1000 volts, AC from 30 cps to 10 kc between 1 millivolt and 1000 volts. Five-digit readout. Price: \$4245. Available as a DC digital voltmeter only (Model 501B). Price: \$2995. Either of above models available with Zener diode reference source.
- 6. DC Digital Voltmeter/Ratiometer (Model 507D).** Measures voltages between ± 100 microvolts and ± 1000 volts, ratios between $\pm 0.0001:1$ and $\pm 999.9:1$ with 0.01% (of reading) ± 1 digit accuracy. \$3835.
- 7. AC/DC Digital Voltmeter/Ratiometer (Model 551).** Measures DC voltages between 0.0000 and ± 999.99 , ratios between $.00000:1$ and $\pm 99.999:1$. Measures AC with optional plug-in AC converter from less than 30 to more than 10,000 cps between 0.0000 and 999.99 volts RMS. Accuracies: DC, 0.005% of full scale +0.005% of reading; AC, 0.05% of full scale +0.05% of reading; ratios, 0.005% of full scale +0.001% of reading. Price (without AC converter and readout): \$4150.
- 8. DC Digital Voltmeter (Model 864A).** High speed, solid-state with basic DC voltage range of 0.000 to ± 9.999 ; plug-in accessories extend DC voltage measurement from .0000 to ± 999.9 . Accuracy: 0.02% of full scale +0.01% of reading ($23^{\circ}\text{C} \pm 1^{\circ}\text{C}$); better than 0.05% of full scale (10° to 40°C). Price: \$3180.

■ LABORATORY INSTRUMENTS

- 9. Micromultimeter (Model 208R).** Combines five precision instruments in one: DC microvoltmeter, microammeter, wide-range ohmmeter, electronic galvanometer, narrow-band DC amplifier. 19 voltage, current and resistance ranges. Price: \$1495.
- 10. Meter Calibrators and Power Supplies.** Provide voltages and currents calibrated in absolute units. Long term stability is $\pm 0.01\%$. Use as accurate reference, as wide-range null voltmeters, as secondary voltage and current standards. Price: \$575 to \$2995.
- 11. Electronic Galvanometer and Amplifier (Model 204A).** A combination DC null detector, linear deflection indicator, microvolt ammeter, and inverting DC amplifier. Accurate measurement of voltages from 1 microvolt to 10 volts or currents from 100 microamperes to 1 milliamperes at a constant input resistance of 10,000 ohms. Price: \$425.
- 12. DC Microvolt Ammeter and Amplifier (Model 203A).** Drift-free stability, high input impedance. Measures voltages from 100 microvolts to 1000 volts, full scale; 19 current ranges cover from 1 millimicroampere to 1 ampere, full scale. 3% accuracy. Price: \$750.
- 13. DC Microvoltmeter and Amplifier (Model 202B).** Provides high sensitivity, drift-free stability, high input impedance. Fourteen voltage ranges cover from 300 microvolts to 1000 volts, full scale. Measures as little as 10 microvolts. Price: \$500.

COHU
ELECTRONICS, INC
KIN TEL DIVISION

5725 Kearny Villa Road
San Diego, California 92112
Phone (714) 277-6700

Unit shown 1½ times actual size

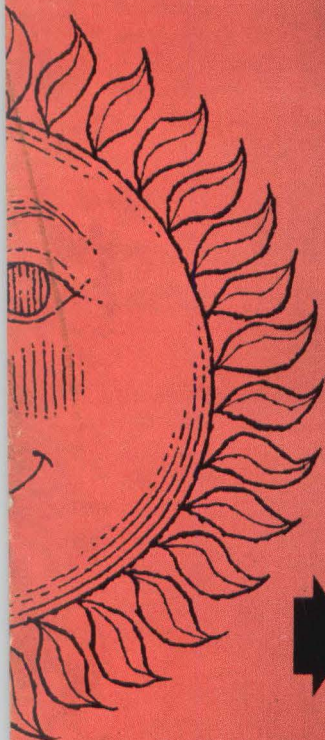

Sensitivity · Reliability · Long Life



Over 3 Million Units Sold

SPECIFY RCA—THE INDUSTRY'S WIDEST LINE OF PHOTOCELLS FOR STREET-LIGHT CONTROLS

Is there an RCA Photoconductive Cell in your street-light control? It could be an RCA-SQ2504—a 1"-diameter cadmium-sulfide unit that represents the latest improvements in photocells. It is characterized by high sensitivity, proved reliability, and long life.

Field experience shows that RCA Photocells in light-operated control, switching, and measurement applications last and last and last! This is why RCA Cells are so often selected by leading manufacturers of street-light controls.

Today, over 3 million RCA Photocells have been sold. More than 70% of these are used in street lighting.

The RCA line of Photocells is designed to provide a wide choice of electrical ratings, cell size, and cell shape. The RCA-SQ2504 (1"), RCA-C70351 (½") developmental type, and RCA-SQ2508 (¼") are good examples. They are compact, with the photosensitive cadmium sulfide sealed in hermetically. You can depend on RCA Photocells to give outstanding performance in diverse environments of humidity and temperature.

So don't take chances with unproven products. Always specify RCA Photocells for proved reliability and performance.

Consult your RCA Representative for your requirements.

Also available from your authorized RCA Industrial Tube Distributor.

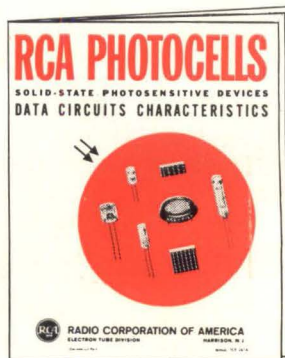

RCA's booklet, ICE-261A, contains technical information on RCA's commercially available line of Photoconductive, Photojunction, and Photovoltaic Cells. For your copy, see your authorized RCA industrial Tube Distributor or write: Commercial Engineering, Section D-19-Q-2, RCA Electronic Components and Devices, Harrison, N. J.



The Most Trusted Name in Electronics