

electronics®

THIN-FILMS GO TO WORK

Scan generator uses
100 thin-film transistors

(photo right)

LINING UP THE SATURN

Electro-optical system
compensates for sway

DESIGNING D/A CONVERTERS

Pros and cons of two
widely used techniques

NONLINEAR "RESISTOR"

Voltage-variable units
use field-effect transistors

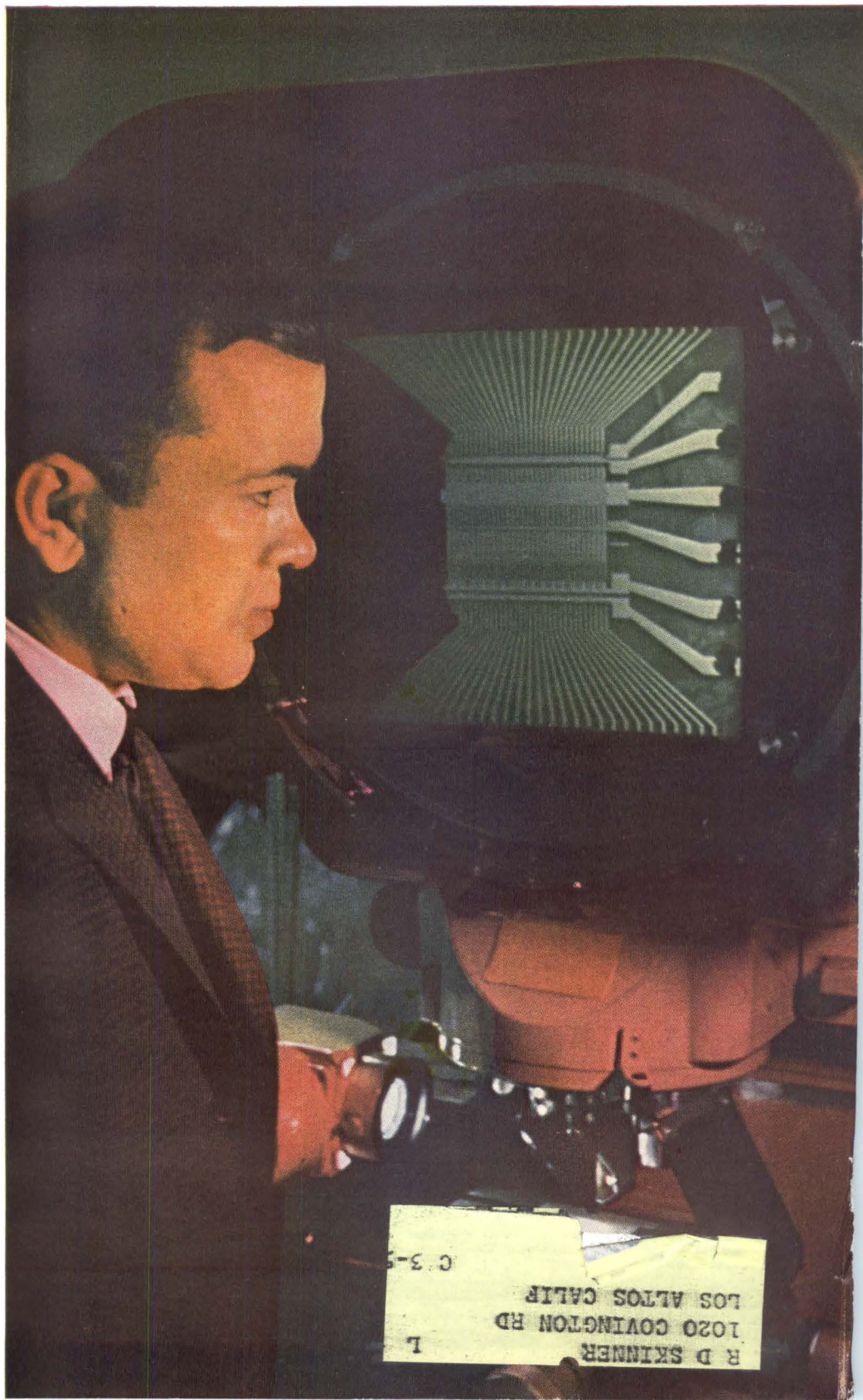

CALIBRATE YOUR OSCILLATOR AGAINST THE U.S. FREQUENCY STANDARD

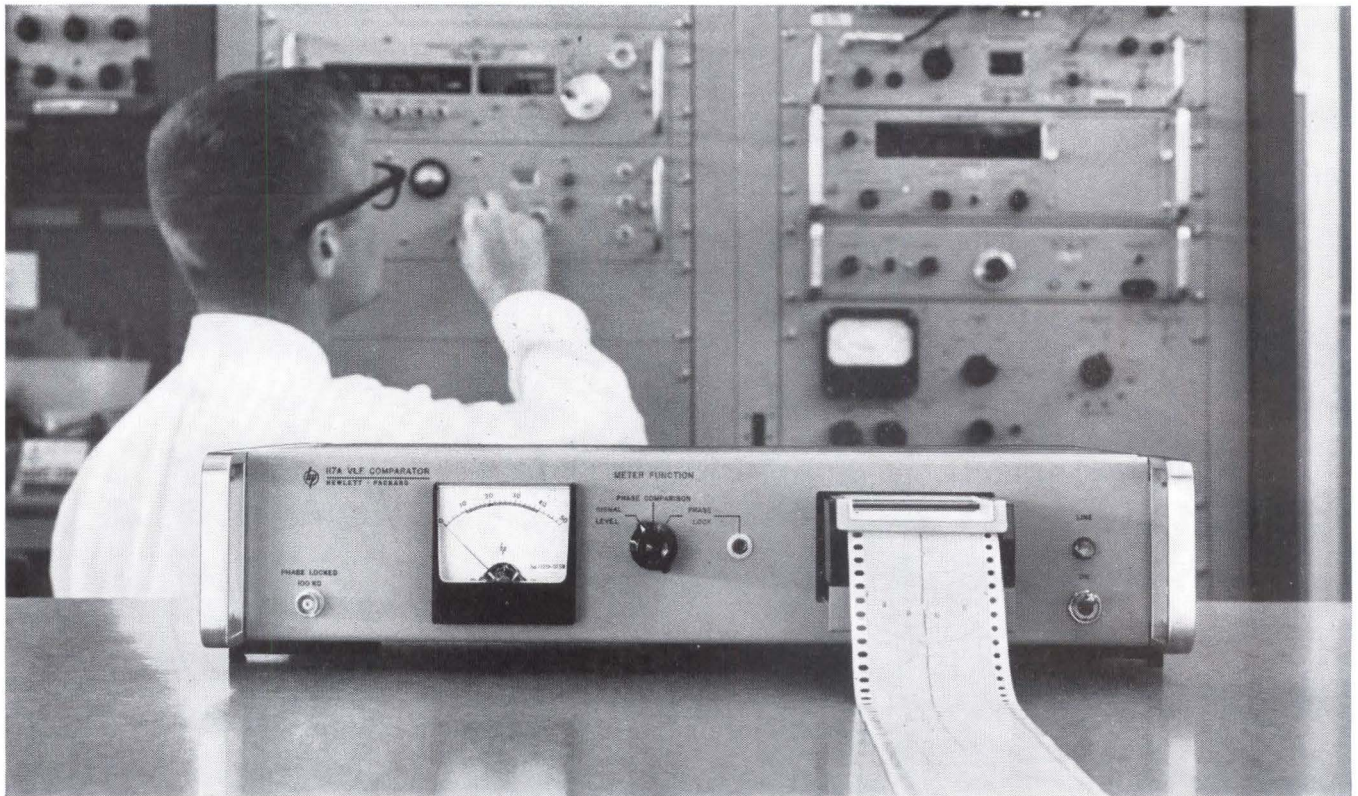

New hp 117A VLF Comparator for only \$1150

Here is an easy, precise and inexpensive way to calibrate your own oscillator against the United States Frequency Standard... whether it's the time base in your electronic counter or your laboratory frequency standard. The new hp 117A VLF Comparator provides all the features needed for frequency standardization. You need no other instruments.

The 117A makes accurate phase comparisons between local oscillators and the 60 kc U. S. Frequency Standard broadcast by the National Bureau of Standards on WWVB.

This instrument makes comparisons with an accuracy approaching 1 part in 10^9 over an 8-hour period. WWVB broadcasts a signal capable of being received at a precision of about 5 parts in 10^{11} during a 24-hour period.

The 117A employs an electronic servo system that permits the utilization of the WWVB signal to phase lock a voltage controlled oscillator. The local standard is then compared to this phase-locked oscillator and a continuous phase difference recording is made on a built-in strip chart recorder. Templates are furnished for direct reading of recorder charts. A front panel meter shows signal level, satisfactory phase lock with WWVB, or phase comparison, depending on switch setting. The 117A provides a 100 kc phase-locked output accurate enough to use as a

local standard during stable propagation conditions. External recorder outputs are included for recording phase comparison and signal level.

Check your oscillator requirements and consider the advantages of a fast VLF U. S. Frequency Standard transfer, then ask your Hewlett-Packard field engineer for all the information.

SPECIFICATIONS

USFS input:	60 kc (WWVB carrier)
Sensitivity:	1 μ v rms into 50 ohms
Local standard input:	100 kc, 1 v rms into 1000 ohms (1 mc option)
100 kc phase-locked output:	20 v rectangular positive pulses into 5000 ohms
Phase stability:	± 1 μ sec, 0-50°C
Chart width:	50 μ sec or 16 $\frac{2}{3}$ μ sec (internal switch)
Chart speed:	1 inch per hour, others available upon request
Size:	3 $\frac{1}{2}$ " high, 11 $\frac{1}{2}$ " wide, 16 $\frac{3}{4}$ " deep, 15 lbs.
Price:	\$1150 including 60 kc antenna

Data subject to change without notice. Price f.o.b. factory.

**HEWLETT
PACKARD
COMPANY**



An extra measure of quality

1501 Page Mill Road, Palo Alto, Calif. 94304, (415) 326-7000. Sales and service in all principal areas. Europe, Hewlett-Packard S.A., 54 Route des Acacias, Geneva, Switzerland; Canada, Hewlett-Packard (Canada) Ltd., 8270 Mayrand St., Montreal, Que.

CIRCLE 900 ON READER SERVICE CARD

J. M. CARROLL, Managing Editor (2293)

SENIOR EDITORS

Samuel Weber (2371)
George W. Sideris (3444)

SENIOR ASSOCIATE EDITORS

Michael F. Wolff (2600)
John F. Mason (2666)

ASSOCIATE EDITORS

Michael F. Tomaino (2071)
William P. O'Brien (2297)
George J. Flynn (2188)
George V. Novotny (3151)
Leon H. Dulberger (3446)
Alexander A. McKenzie (2685)

ASSISTANT EDITORS

Stephen B. Gray (2245)
Barry A. Briskman (2306)
Dan Smith (2467)
Joel A. Strasser (2127)
Vincent S. Acunto (2592)
C. R. Whetstone (3495)
Eric Valentine (2710)
Louis S. Gomolak (2472)
G. G. Tirellis (2187)

REGIONAL EDITORS

Harold C. Hood,
1125 W. 6th St., Los Angeles 90017, Calif.
(213-482-5450)
Laurence D. Shergalis,
John Hancock Bldg., 255 California St.,
San Francisco 94111, Calif. (415-362-4600)
Thomas Maguire
McGraw-Hill Bldg., 607 Boylston St.,
Boston 02116, Mass. (617-262-1160)
Cletus M. Wiley,
Blair Bldg., 645 N. Michigan Ave.,
Chicago 60611, Ill. (312-664-5800)

ART DIRECTOR

Howard R. Berry (2430)

ASSISTANT ART DIRECTOR

John C. Wright, Jr. (3430)

EDITORIAL ASSISTANTS

Lorraine Rossi, Virginia T. Bastian,
Lynn Emery, Ann Mella, Lorraine Werner,
Alice M. Moyer, Sharon Parks,
Claire Benell, Kay Fontana,
Sandra A. Le Mond, Mary Jo Jadin

FOREIGN NEWS BUREAU

DIRECTOR, John Wilhelm, (2532);
Lawrence Mihlon (2997), Alyne Elias
(2998)
LONDON—John Shinn, Derek Barlow,
Nicholas Landon, 34 Dover St., London
W.1, England
BONN—Richard Mikton,
Silke McQueen, Mittelstrasse 39, Bad
Godesberg, Germany
BRUSSELS—Arthur Erikson, 27 Rue Ducarle,
Brussels, Belgium
PARIS—Robert Farrell, 17 Ave. Matignon,
3rd Fl., Paris 8, France
MILAN—Bruce Bendow, Via Manzoni
No. 12, Milan, Italy
MEXICO CITY—Wesley Perry, Jr.,
Lafragua 4-314, Mexico 1 D.F. Mexico
RIO DE JANEIRO—Leslie Warren, Rua
Mexico 3-S/1507 1509, Rio de Janeiro,
Brazil
MOSCOW—Donald Winston,
Kutuzovsky Prospekt 19, Apt. 28-29,
Moscow, USSR
TOKYO—Richard Halloran, Charles Cohen,
John Yamaguchi, Toranomon Sangyo
Bldg., 1 Kotohiracho Shiba, Minato-Ku,
Tokyo, Japan

CIRCULATION MANAGER

Hugh J. Quinn (2310)

C. C. RANDOLPH, Publisher (3996)

electronics

A MCGRAW-HILL PUBLICATION

75 CENTS

SCAN GENERATOR. Projection microscope shows an RCA thin-film circuit containing thirty separate stages. Their outputs are the narrow leads coming out vertically from the circuit. Heavier horizontal leads are power and control connections. *This is one of the first actual uses of cadmium-sulfide thin-film active and passive components.* See p 23 **COVER**

TERRAIN-FOLLOWING RADAR. Because it's getting easier to locate and shoot down high-flying planes, U.S. bombers and other planes are being equipped to hug the ground at high speed. *Terrain-following radar systems guide planes over hills and through valleys. Some systems operate with autopilots* 10

WEATHER BY SATELLITE. Plans for a new type of satellite are being pushed by the Weather Bureau. As it orbits, the satellite would collect data from ships at sea, buoys and remote ground stations. *The network may include high-altitude balloons whose transmitters would be thin films deposited on the balloon surface* 14

THIN-FILM TRANSISTORS GO TO WORK. Scanning generator for visual displays uses more than 100 cadmium-sulfide thin-film transistors deposited over an area of 0.15 square inch. Generator contains 30 stages each consisting of thin-film transistors, diodes, capacitors and resistors. *Two such scan generators could address a completely solid-state display panel.* By M. F. Wolff, Senior Associate Editor 23

LINING UP SATURN. Our mightiest rocket finds it hard to hold still on the launch pad when buffeted by the elements. But a highly accurate, automatic theodolite fixes the true azimuth heading of the guidance and control system immediately prior to launch. *Heart of the system is an autocollimator which generates an error signal due to missile sway, flexing or bending.* By W. S. Zukowsky, Perkin-Elmer Corp. 26

HOW TO DESIGN D/A CONVERTERS. Digital-to-analog converters must operate at high speed in many modern data-processing applications. Conversion accuracy should be independent of amplifier gain. Two widely used decoder circuits are the weighted-resistor network and the ladder network. *The ladder network is shown to be superior in most applications.* By C. R. Pearman and A. E. Popodi, Westinghouse Electric 28

Published weekly, with Electronics Buyers' Guide as part of the subscription, by McGraw-Hill, Inc. Founder: James H. McGraw (1860-1948).

SUBSCRIPTIONS: Available only by paid subscription. Publisher reserves the right to refuse non-qualified subscriptions. Subscriptions to Electronics solicited only from those actively engaged in the field of the publication. Position and company connection must be indicated on subscription orders forwarded to address shown below. Subscription rates for individuals in the field of the publication: U. S. and possessions and Canada \$6 one year, \$9 two years, \$12 three years (single copies 75¢). All other countries \$20 one year (single copies \$1.50).

EXECUTIVE, EDITORIAL, CIRCULATION and ADVERTISING OFFICES: McGraw-Hill Building, 330 West 42nd Street, New York, N. Y., 10036. Telephone Area Code 212-971-3333. Teletype TWX N. Y. 212-640-4646. Cable McGrawhill, N. Y. Printed in Albany, N. Y. Second class postage paid at Albany, N. Y. Title reg. ® in U. S. Patent Office. Copyright © 1964 by McGraw-Hill, Inc. All Rights Reserved. The contents of this publication may not be reproduced either in whole or in part without consent of copyright owner.

OFFICERS OF MCGRAW-HILL PUBLICATIONS: Shelton Fisher, President; Vice Presidents: Joseph H. Allen, Operations; John R. Callahan, Editorial; Ervin E. DeGraff, Circulation; Donald C. McGraw, Jr., Advertising Sales; Angelo R. Venezian, Marketing.

CORPORATION OFFICERS: Donald C. McGraw, President; L. Keith Goodrich, Hugh J. Kelly, Harry L. Waddell, Executive Vice Presidents; John J. Cooke, Vice President and Secretary; John L. McGraw, Treasurer.

UNCONDITIONAL GUARANTEE: The publisher, upon written request, agrees to refund the part of the subscription price applying to the remaining unfiled portion of the subscription if service is unsatisfactory.

SUBSCRIBERS: Please address all correspondence regarding subscriptions, change of address notices, and subscription orders to Fulfillment Manager, Electronics, P. O. Box 430 Hightstown, N. J., 08520. Change of address notices should be sent promptly; provide old as well as new address; include zip code or postal zone number if any. If possible, attach address label from recent issue. Please allow one month for change of address to become effective.

POSTMASTER: Please send Form 3579 to Fulfillment Manager, Electronics, P. O. Box 430, Hightstown, N. J., 08520.

RAMP GENERATOR FOR A DVM. In digital voltmeters multi-step dividers, servoed potentiometers or linear ramps may be used to provide the internally generated comparison voltage. Most ramp generators entail use of complicated circuits. *This one avoids use of an input d-c amplifier in most cases.*
By R. C. Weinberg, Harmon-Kardon, Inc. 33

VOLTAGE CONTROLS A NONLINEAR RESISTANCE. This resistor varies from 1,300 to 33,000 ohms depending upon the magnitude of voltage applied across its terminals. Its characteristic is an S curve. *The "resistor" consists of a field-effect transistor, two diodes and a bias circuit.*
By F. D. Neu, University of California 36

TAPE RECORDERS. NASA is issuing new specifications for the magnetic recording tapes flown in space probes. Operating temperature and dimensional accuracy are being raised. *NASA's in-house developments include a new recording technique and a capacitor-sensing brushless d-c motor* 40

DEPARTMENTS

Crosstalk. Help Wanted—Customer Relations Division 5

Comment. Bastardizing. Airborne Educational TV 6

Electronics Newsletter 17

Meetings Ahead. Canadian Communications Symposium 18

Washington This Week. AEC and NASA May Adopt Pentagon's New Guidelines on How To Cut Costs 20

Research and Development. New Displays for Space Flight 42

Components and Materials. Flat Cable Shrinks Microcircuit Modules 44

Production Techniques. Laser Trims Resistors 46

New Products. Scope Has Automatic Display Switching 48

Literature of the Week 53

People and Plants. Boeing Plans Space Research Center 55

Index to Advertisers 60





Testing Integrated Circuits? reduce test time and cost

With TI's new Integrated Circuit Tester, the 659A, you can make 36 d-c or logic function tests on integral circuit packages in less than 2 seconds. Two-terminal (Kelvin) connections are made to 14 active leads. You can stack two units—operate them in series—for a 72 test sequence. You can program the 659A easily using printed circuit boards for bias conditions, tim-

ing, limits, and sorting logic. Integral circuit packages, no matter their size or shape, mount on device holders which plug into the test socket. To operate, simply press the start button. Four solid-state power supplies provide test bias voltages. Internal logic determines classification to 15 categories for use with a companion sorter. Failures are indicated on front

panel lights. The 659A is compact, yet designed for ease of maintenance. Test points are accessible on the front panel, printed circuit boards are easily removable . . . and the basic unit is priced at \$16,500 f.o.b. plant. Let a TI representative show you the advantages of 659A integrated circuit testing.

Write for complete information.

INDUSTRIAL
PRODUCTS
GROUP



TEXAS INSTRUMENTS
INCORPORATED
P. O. BOX 66027 HOUSTON 6, TEXAS

605

GRC

How to engineer more value into your small parts with GRC tiny die castings & plastic moldings

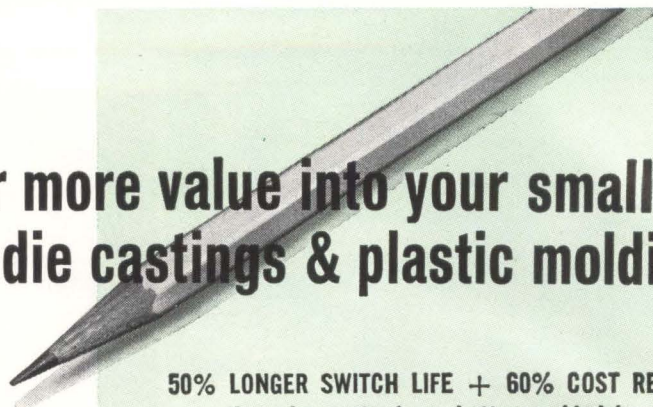

50% LONGER SWITCH LIFE + 60% COST REDUCTION
thru change to 1 pc. button molded by GRC

Two of 8 major improvements; result of redesign of a 2-pc. plastic/metal assembly into a 1-pc. GRC molding. Long-wearing nylon extends service life. Final result: a more profitable, saleable product.

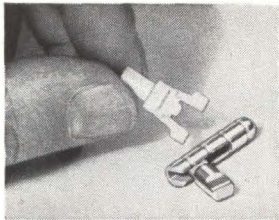

You can achieve startling profit and performance improvement in your product when GRC special methods get together with Value Engineering. Your own products might benefit even more than these typical examples.

It happens every day—GRC special methods and Value Engineering combine to uncover new ways to reduce a product's cost, and—at the same time—improve its performance. How about your products—how many unsuspected ways can you build higher value into them? Find out—today—how GRC engineering skills and experience can benefit you.

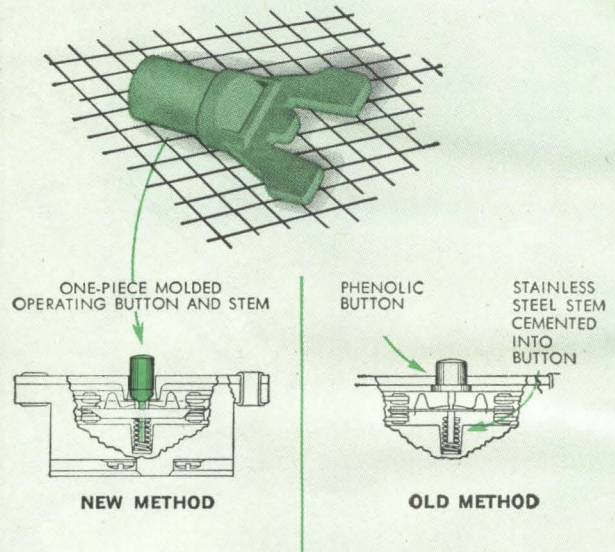

SINGLE INTERCAST MOVEABLE PART DIE CAST BY GRC
replaces 3 assembled parts

HINGED LUGGAGE LATCH. Pre-GRC, unit had 2 separate machined parts plus rivet. Unique GRC INTERCAST process produces one-piece moveable-element die castings which reduced number of parts, assembly steps, rejects and inspection steps.

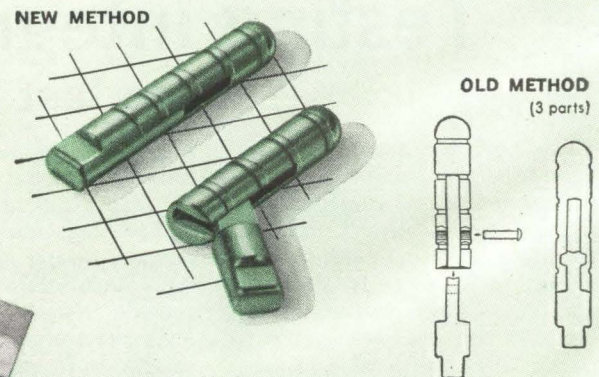

GRC SPECIAL METHODS produce tiny zinc alloy die castings and plastic moldings in engineering thermoplastics by exclusive automatic single cavity techniques. Parts have great design flexibility, are highly uniform and precise. Automatic assembly is facilitated, secondary operations and production steps are reduced.

Maximum sizes: zinc alloy—2" long; ½ oz.
—plastics—1 ¾" long; .05 oz.

No minimum sizes

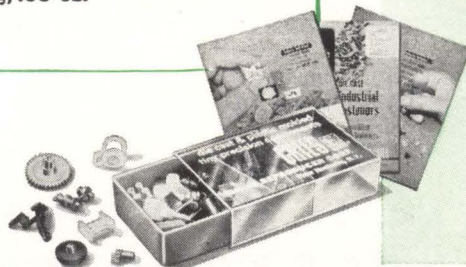

Write today for these helpful guides to achieving higher value in small parts... full information and samples of GRC's complete services.



GRIES REPRODUCER CORP.

world's foremost producer of small die castings & plastic moldings • 151 Beechwood Ave., New Rochelle, N. Y. • (914) NEW Rochelle 3-8600

GRIES

Help Wanted— Customer Relations Department

THE ELECTRONICS INDUSTRY has just lost another job because somebody out there is suspicious.

In an employment ad in a New York newspaper, a paper company announced it was forming a team to design a dynamic process-control system for one of its large mills. It would hire a project supervisor, instrument and electrical engineer, systems control-process engineer and computer programmer.

We answered the ad. "Why, we asked, isn't an electronics company, already staffed to do the job, being hired?" First we got the stock answer: "We know what we want and how to do it." Then came the real reason: "We would rather build our own system than have it done by a controls company which would only turn around and sell an identical system to some other paper company."

This is not an isolated case. Materials processing companies frequently design and install their own control systems. They jealously guard proprietary processes by restricting knowhow to employees they trust, or employees who sign contracts barring disclosure, or more likely, both.

The upshot is that the electronics industry is frequently on the outside looking in. We sell a brace of transducers there, a telemetry system here, and once in a while, a process-control computer. The opportunities to design and install an integrated dynamic control system are restricted.

This situation helps frustrate the development and widespread use of advanced process-control systems. The evolution of better and better process controls,

and especially the evolution of basic systems that can be produced in quantity for families of applications, requires experience. It requires, moreover, a continuity of experience in companies specializing in producing such systems, not an unrelated series of one-of-a-kind installations.

If dynamic, computer-based, process control is to become the flaming success predicted, instead of the unprofitable business it now is, the suspicions of potential customers like the paper company will have to be overcome. It is difficult, if not impossible, to design and install an efficient process-control system if the potential customer refuses to divulge to the designer the process information vital to the operation of the process controller.

A solution to this impasse must be found. Some way must be found to convince materials processing companies that no reputable controls company would divulge proprietary information to a customer's competitor. But the suppliers are going to have to earn this confidence. It might help to start a coordinated customer relations campaign sponsored by the controls industry. Electronics companies should put extra stress on the extent to which a system developed for one application can be applied to another application. Control theory, principles and general-purpose equipment developed by the controls company should be freely transferable. Adaptations, such as the mathematical model unique to the computer control of one customer's process, should remain proprietary.

This should not impose any practical limitation on process control installations. The processes used by two companies to make the same product may appear similar, but generally they are unique in minor detail that can change the process sharply. In fact, even processing plants that are built as duplicates of each other often operate like individual beasts.

At the same time, the process companies have to realize that they can confide in process-control system companies, just as they confide in consultants and so-called constructors. In the petrochemicals industry, where processing techniques are closely guarded, it is common practice for a producer to hire a chemical engineering and construction company to do a turnkey job of building a new plant. If such companies have obtained the confidence of the process industries, why can't controls companies?

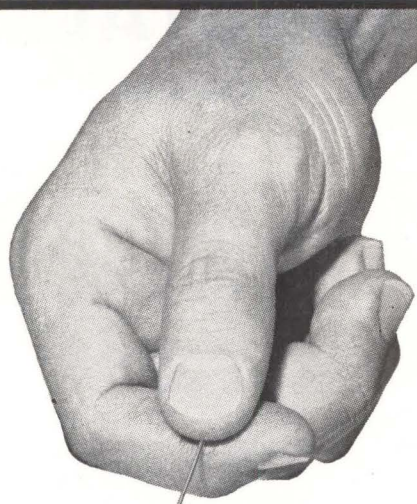

**Improved Type 150D
Solid-Electrolyte
TANTALEX®
CAPACITORS**

PERFORMANCE CHARACTERISTICS NEVER BEFORE POSSIBLE

- Dissipation factor cut by 1/2 for 20 volt and higher ratings!
- Higher permissible a-c ripple currents!
- Lower impedance at high frequency!
- Lower leakage currents!
- Better capacitance stability!
- New ratings to 100 vdc!

For complete technical data on Improved Type 150D Capacitors, write for Engineering Bulletin 3520E to Technical Literature Service, Sprague Electric Co., 35 Marshall Street, North Adams, Massachusetts.

SPRAGUE®
THE MARK OF RELIABILITY

45C-140-63

BASTARDIZING

Your recent letters on the language (correctness, usage, etc.) fail to discuss what I feel to be the truly critical communications breakdown which can occur. I refer specifically to the interchangeable use of words which are not truly or evenly remotely synonymous (e.g., the much abused term "momentarily," which means for a moment and not in a moment).

Taken to extremes, this bastardizing (good word, that) of our language will slowly and almost inevitably impoverish our tongue of the subtle but important differences and shades of meaning it contains. Taken ad absurdum, we shall find ourselves communicating in a series of monosyllabic grunts.

JOHN JOSS

Microwave Electronics Corporation
Palo Alto, California

AIRBORNE EDUCATIONAL TV

In the Nov. 8, 1963, *Washington This Week* column (p 20) were some comments on the FCC and expansion of the air-based principle of direct broadcasting. As a long-time schoolboard member working in this area where the air-based principle has been in operation and perhaps expanding in coverage, and where our schoolboard needs and potential for independent generation and local control of ETV are being usurped or pre-empted by the operation of an air-based system, I would like to pass on to you some comments made in FCC docket 15201 that apply to your item.

Some very undesirable long-term implications of the air-based system are showing up here in this area. Our ETV allocations/assignments are saturated here to the extent that, even before we have hardly started Educational TV (ETV), not a single one of the hundreds of surrounding school districts can have even one channel for local-controlled ETV programming.

Detroit is also saturated to the same extent, even before the air-based system has delivered one-third of the promised channels. The second largest school district in Michigan has been trying unsuccessfully to get one channel for about a year. In these and other areas, the bad inefficiencies of the air-based principle of direct broadcasting are being made even worse and more inefficient of channel/frequency/spectrum space utilization by the use of channel space so that many hundreds of districts cannot have ETV programming for their own independent needs.

The operators of the air-based multi-million dollar system in this area (MPATI—Midwest Program of Air-based TV Instruction) petitioned the FCC: 1, to reallocate the TV-Broadcast spectrum in this six-state area; 2, to regularize the air-based principle; 3, to transfer a large portion of the UHF-TV-BC spectrum to air-based; 4, to change the MPATI two experimental channels to a regular service; 5, to license four more channels to air-based operations; 6, consider expansion of the air-based principle to a country-wide coverage; 7, perhaps usurp part or all of the new FCC docket 14744, 2,500-Mc multi-channel in-school ETV channels for air-based expansion and operations; and 6, change UHF-ETV channel separations from the present six channels to alternate channel separation.

There are some who contend that these docket proposals for rule changes have very undesirable long-time implications for education, communications and electronics in the long pull ahead, because of the very, very poor spectrum utilization and inter-time-zone scheduling inefficiencies.

As ELECTRONICS has often shown interest in communications and education, it seemed that you might be interested in comments on the merging of the two subjects in a very significant way from area to national level.

LLOYD P. MORRIS

Elmwood Park, Illinois

HARNESS TESTER

In your Jan. 24 issue (p 56) you described an inexpensive harness tester that used neon glow lamps as flip-flops to detect and remember intermittent failures.

We feel that this is a fine example of one of the important functions of ELECTRONICS, that of bringing to the engineer's attention helpful devices and processes which he can use to facilitate his work.

There is, however, an error in the copy, apparently typographical, which we feel should be corrected since it might lead to confusion. In describing our T2-32-1 lamp, you indicated that it breaks down between 72 and 70 volts d-c. Actually, the lamp breaks down between 72 and 90 volts d-c.

We, here at Signalite, faithfully read ELECTRONICS and find it one of the highest level publications in this field. Keep up the good work.

EDWARD BAUMAN

Signalite Incorporated
Neptune, New Jersey

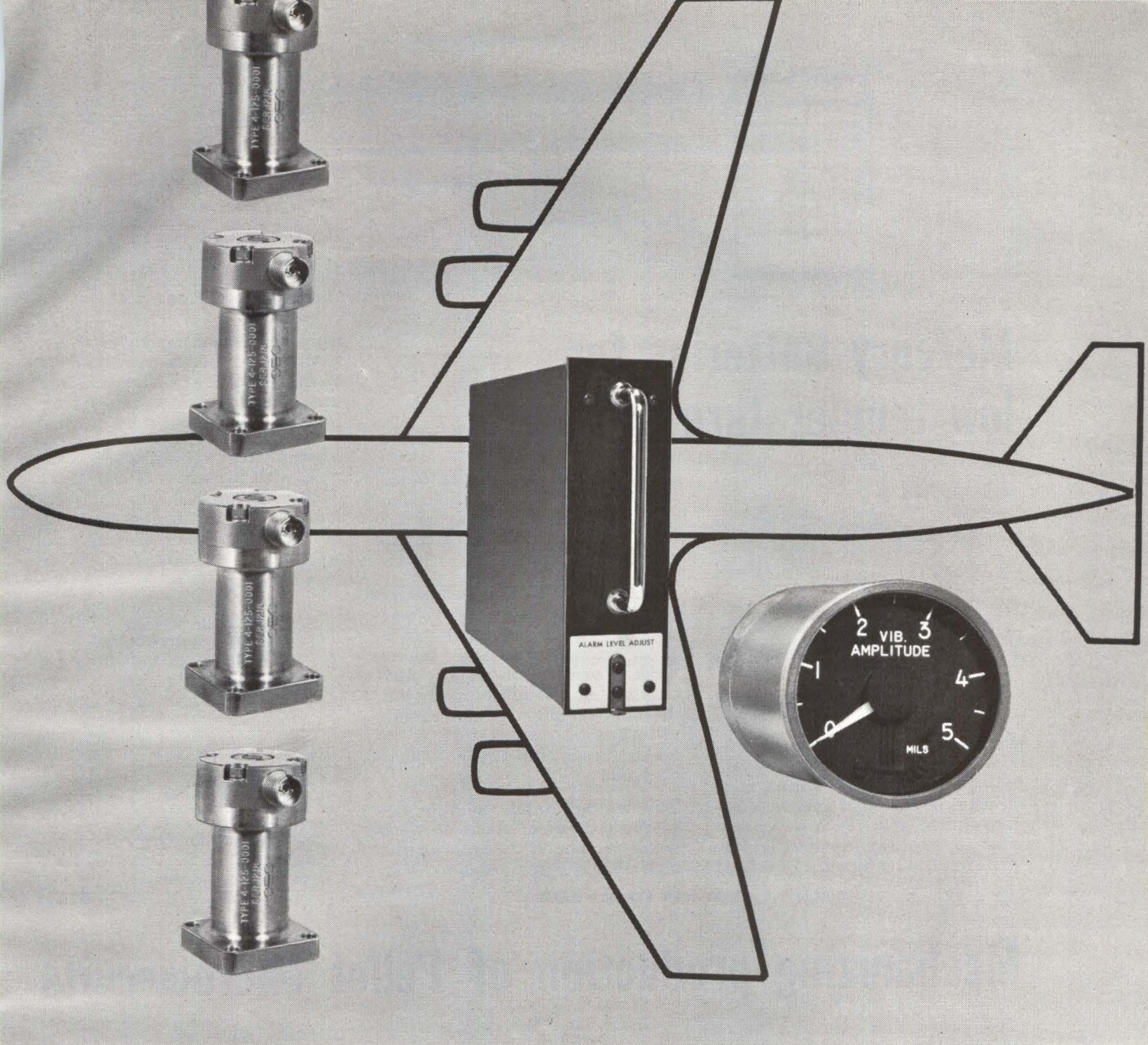

World's most advanced airborne vibration monitoring system

This new CEC vibration monitoring system is the most reliable ever perfected. Reason: the advanced design of the system's basic components. Each channel consists of one to three vibration transducers, an amplifier and indicator.

CEC 4-125 Vibration Transducers have established a new milestone in transducer development. Many 4-125s have already logged more than 3,600 flying hours—and are still functioning perfectly. These transducers will operate continuously at 700°F, are impervious to rough handling and shocks, and are virtually maintenance-free. There are no lubricants to wear out, and special

gold-palladium bearing rings actually reduce friction with wear.

An amplifier to do them justice. This outstanding modular package houses up to four solid-state amplifiers and a single power supply module. The most accessible ever devised, these amplifiers may be quickly removed for service inspection, and are physically and electrically interchangeable.

Plus—the indicator. This is the final, but equally reliable link in the monitor chain. If vibration exceeds predetermined levels on any engine, a warning light alerts the pilot to potential danger. The indicator is compensated to correct

for varying ambient temperatures, and is calibrated to customer specifications. Both lighted and unlighted models are available.

Those are the primary reasons why this Airborne Vibration Monitoring System has obsoleted all others. For complete information, just call or write CEC for Bulletins in Kit #5035-X1.

CEC
Transducer Division

CONSOLIDATED ELECTRODYNAMICS
A SUBSIDIARY OF BELL & HOWELL/PASADENA, CALIF. 91109
INTERNATIONAL SUBSIDIARIES: WOKING, SURREY, ENGLAND
AND FRANKFURT/MAIN, GERMANY

CIRCLE 7 ON READER SERVICE CARD

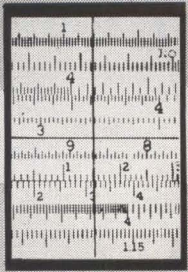

P. R. MALLORY & CO. INC., INDIANAPOLIS 6, INDIANA

Mercury Batteries for low temperature service

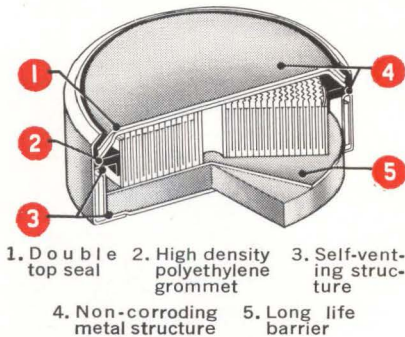

- 1. Double top seal
- 2. High density polyethylene grommet
- 3. Self-venting structure
- 4. Non-corroding metal structure
- 5. Long life barrier

As temperatures drop below 70°F, the energy available from dry cells falls off fairly rapidly. With a modification of the basic mercury battery system, however, we have been able to improve low-temperature performance by a factor of 6 to 12

times, through the use of wound zinc foil anode construction. This design provides much higher surface area and reduces impedance at low temperatures.

Result: at 32°F, this system has 94% of its capacity at 68°F capacity; at +15°F, 46%; at -4°F, 10%. Voltage discharge characteristic, as with all Mallory mercury systems, is substantially flat, dropping off slightly more rapidly as operating temperature is reduced. (See typical discharge curve at right.)

The wound anode system has energy content of about 45 watt-hours per pound. Because of this high level, it is applicable to rescue

transmitters, emergency beacons, navigational buoys . . . and to warning and emergency circuits in unattended locations where temperatures drop in the freezing zone.

Five different cell sizes are available, with capacities of 400, 1200, 2700, 4500 and 13,000 milliampere-hours. Our engineering staff can design power packages to your specific requirements.

RM-1450 R DISCHARGED THRU 25 Ω CONTINUOUS AT TEMPERATURE (F) INDICATED

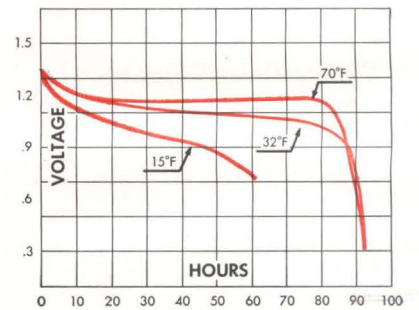

CIRCLE 240 ON READER SERVICE CARD

Mechanizing production of Pellet Microcircuits

The pellet film resistors which Mallory has developed can be assembled into miniaturized networks, by the use of simple accessory hardware which permits mechanized production. All the pellets are of uniform size: 0.10" in diameter by 0.063" thick, with fired-on silver termination. The size of these pellets makes them adaptable to a simple method of interconnection which produces geometry that conforms with widely accepted grid spacing.

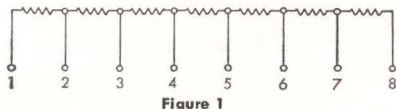

Figure 1

Take, for example, a simple series circuit (Figure 1).

This can be made up of pellets with interleaved "A" and "P" terminations as shown in Figure 2. The

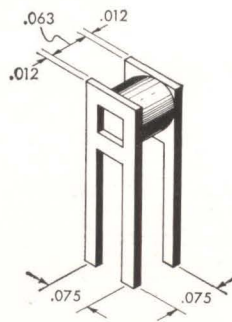

Figure 2

terminals are solder clad, and when stacked with pellets provide 0.075" spacing.

The complete circuit is produced by stacking pellets and solder clad terminal strips in a channel assembly fixture, as in Figure 3. The assembly is then dipped into a hot liquid bath to make the solder con-

nections, after which it can be readily encapsulated.

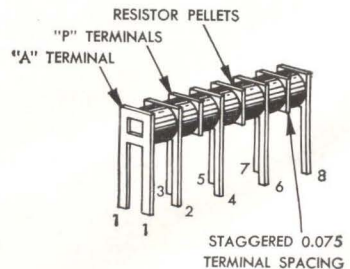

Figure 3

For those who are interested in experimenting with this practical, moderate-cost approach to immediate miniaturization, we can supply not only a comprehensive line of pellet film resistors, but also solder clad termination hardware from which many different circuit configurations can be made.

CIRCLE 241 ON READER SERVICE CARD

DESIGNER'S FILE

Radiation-proof tantalum capacitors

The new XTG line of Mallory wet slug tantalum capacitors is designed to resist the effects of radiation. A group of sample capacitors recently passed a series of radiation exposure tests in the Ground Test Reactor of Lockheed Missiles and Space Company, Sunnyvale, California.

Capacitors were subjected to both gamma ray and neutron bombardment at 75°F. During 6744 minutes of reactor build-up time, the following dosage levels were reached:

Fast neutron bombardment: 6.579×10^{13} neutrons/cm², at energy level greater than 0.1 Mev.

Gamma radiation: 79.56 x 10⁶ gamma rad. (C) from carbon source.

Capacitance, dissipation factor and DC leakage were measured for each capacitor at 120, 400 and 800 cps, both before and at the end of the dosage period. No detrimental changes in electrical characteristics occurred.



The XTG line uses special materials and construction to achieve radiation resistance. Temperature range is -55°C to +85°C. The line includes the same capacitance and voltage ratings as standard MIL-type Mallory wet slug tantalum capacitors, in all MIL terminal configurations.

CIRCLE 242 ON READER SERVICE CARD

High-precision cutting of "difficult" materials

How would you cut the molybdenum wave guide aperture shown here to highly accurate dimensions?

An excellent answer is EDM—

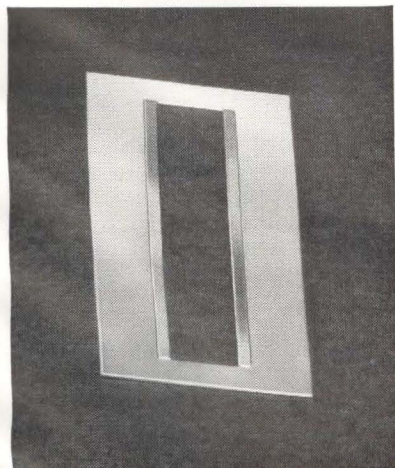

CIRCLE 243 ON READER SERVICE CARD

electrical discharge machining. And where you need to maintain exceptionally close tolerances and accurate reproduction of complex contours, the electrode material to use is Elkonite® 10W3. On the part shown here, for instance, an Elkonite 10W3 electrode made it possible to hold slot width tolerances of 0.0001".

Any time you have a forming job that's difficult enough to warrant electrical discharge machining, it pays to consider Elkonite electrodes. Their ability to machine sharp corners and intricate contours in fine detail . . . their far longer service on the EDM machine . . . their ability to cut to extreme tolerances . . . will speed your production and reduce total machining costs.

Mallory Film Resistors stay stable in high humidity

A recent series of humidity exposure tests demonstrate the ability of Mallory Type MOL metal oxide film resistors to hold stable values of resistance when subjected to extreme moisture.

The tests were run on a group of 33,000-ohm, 3-watt MOL resistors with nominal 10% tolerance. First, the resistors were exposed to 95% relative humidity at 40°C for 100 hours at no load. Result: average change in resistance was +0.37% . . . maximum change was +0.51%.

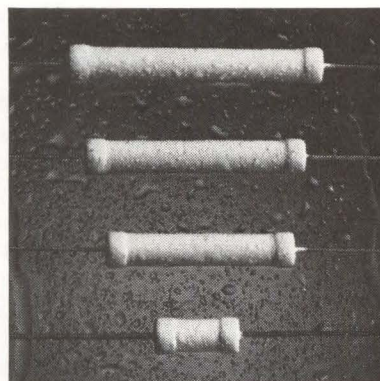

Next, the resistors were held for 1000 hours in this same atmosphere, with full rated wattage applied. Result: average change in resistance was in the band from -0.7% to +0.62%; maximum changes were -1.2% and +1.6%.

Through all this high humidity test Mallory MOL resistors remained at resistance values well within their stated tolerances. On long-term load life tests—10,000 hours—they show equally fine stability, with resistance holding within 1% of initial values.

The MOL series comes in 2, 3, 4, 5 and 7 watt ratings, with resistance values ranging from 30 ohms minimum on the 2 watt to a maximum of 125K ohms for the 7 watt unit. Standard tolerance is 10%; other tolerances can be supplied.

CIRCLE 244 ON READER SERVICE CARD

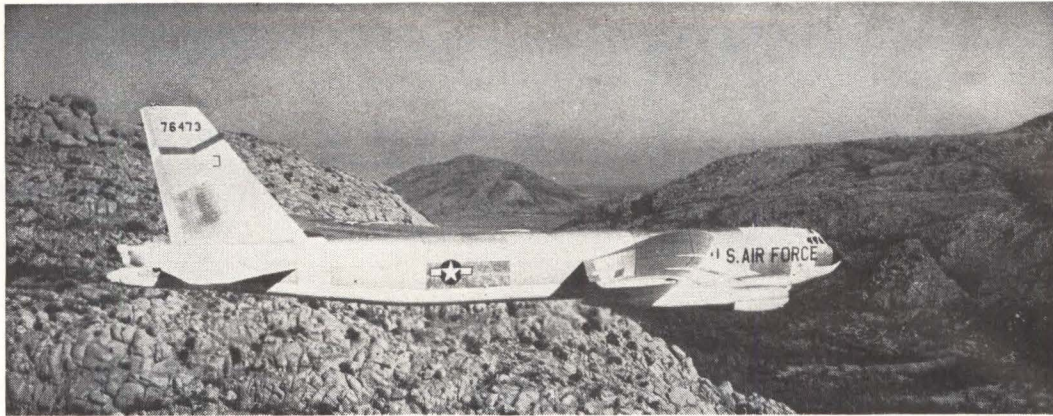

ADVANCED-capability radar displays the terrain in front of the 650-mph B-52H, enables safe hedge-hopping on bomb runs. Planes operate much below 1,000 feet

ATTACK PLANES

Hug Hostile Terrain With New Radar

To evade enemy radar, all three services now want terrain-following radar

By **JOHN F. MASON**
Senior Associate Editor

HAROLD C. HOOD
Regional Editor, Los Angeles

PROOF OF SOVIET ability to knock down high-flying planes (the U-2) forced the U.S. to beef up capability for low-level penetration that would avoid detection by enemy radar. New military planes are being developed to fly ground-hugging missions, and some existing high-altitude aircraft are being retrofitted to drop down to "tree top" level for the last leg of their approach.

Increased emphasis on this low-altitude strategy is creating greater need for precise instrumentation that enables an aircraft or drone to maintain a desired altitude above the ground and avoid obstructions, regardless of visibility.

Terrain-following radar (TFR), to carry out these missions, is being developed for all three military services. Air Force, which more or less led the search for new techniques, has TFR in the B-52H

bomber, and the F-105 fighter. Equipment is being developed for the TFX long-range tactical fighter now being built, and will be developed for any low-altitude penetrator built in the future.

Navy has a number of carrier-based planes capable of low-altitude operations. Those known to have flown with TFR are the A5 Vigilante, the A2F Intruder and the A4D. Navy says the gear is still in R&D.

Army has an active program going for the Mohawk surveillance plane and a healthy interest in the complicated problem of getting TFR for helicopters.

Cornell Aeronautical Laboratory (CAL) has been an important research and development arm of the military on TFR for 10 years.

CAL's Autoflite system was designed, fabricated and flight tested under sponsorship of USAF's Aeronautical Systems Division. Industry has been active in the field for the past four or five years and will be more active in the future.

Equipment—Terrain following refers to vertical change in flight direction—going up or down to maintain a constant altitude above the ground. Terrain avoidance implies ability to turn left or right to avoid obstructions or to take advantage

of the hills that protect a valley. The more sophisticated units provide both. Equipment may be manual, automatic, or both. Other functions sometimes connected with TFR are air-to-air search and ground mapping.

Texas Instruments—Active in the field for several years, TI is known to be working on three important TFR projects: \$5-million subcontract from McDonnell for development work on a low-altitude TFR system for the RF4C—USAF's reconnaissance model of McDonnell's Phantom II fighter; subcontract with General Dynamics for equipment for the F-111 (TFX); and a contract with the Army Electronics Command for an advanced system for Army's Mohawk surveillance aircraft.

Autonetics—North American's Autonetic's division has produced TFR for the F-105F Thunderchiefs, the German Air Force F104G Starfighters, and—with IBM and AC Spark Plug—equipment for the B-52H.

The firm is developing a series of terrain-oriented radars for possible use on a number of future military aircraft. For the VAX program to develop a triservice attack aircraft, a multi-mode radar with automatic terrain-following capability is pro-

posed. Beyond VAX, Autonetics is working on the XR-45, a system that will use thin-film microcircuits and stress reliability. Mean-time-before-failure (mtbf) goal for the entire multimode radar system is from 300 to 500 hours; mtbf for the automatic terrain-following mode will be from 2,000 to 4,000 hours.

Autonetics's emphasis on solid-state components is shifting to micro-miniature techniques. Except for the transmitter and power supply the whole system is microminiaturized. Thin-film is used for the high frequencies. Integrated circuits are as yet of little use anywhere in the system because of the high frequencies used.

NASARR System—The firm has recently demonstrated their modified R-14 NASARR (North American Search and Ranging Radar), described as the first system with simultaneous automatic terrain-following, manual terrain-following and manual terrain-avoidance capabilities. The radar uses a data processor with solid-state electronic circuits.

The automatic terrain-following mode guides the plane at a prescribed altitude while manual terrain avoidance gives the pilot a broad radar view of the terrain ahead, permitting selection of flight-path alternatives. Automatic terrain-following signals are provided by an altimeter in level areas, and by the forward-looking radar over hills or mountains.

The radar has four displays—plan position indication (PPI), three-dimensional terrain, elevation-angle, and manual terrain following.

The PPI and 3-D displays are combined on one tube, giving azimuth and range position in relation to mountains. As a mountain comes into range, it appears on the azimuth-angle scope. With the aid of the manual terrain-following display, the pilot is able to verify automatic terrain following or fly manually over the mountain.

General Dynamics/Electronics—GD/E built the radar portion of the navigation system for Navy's A5 (A3J) Vigilante. The radar is part of the REINS (radar-equipped inertial navigation system) built by Autonetics. The system is used for both low and high-level penetration,

and for launching air-to-ground missiles.

GD/E has checked out a compact TFR unit on a B-25 for more than 150 hours at 400 feet, and on a B-26 for more than 50 hours. The basic system consists of an on-bore-sight radar with a non-scanning antenna 8.3 inches in diameter, and a built-in electronic analog computer. A pilot display and automatic pitch control signals are provided.

The radar is housed in a pod the size of a standard 250-pound bomb, mounted under the wing or in the nose of an aircraft or drone. It weighs 40 pounds, occupies ½ cubic foot.

The K_u-band radar detects small individual objects within a continually moving field a tenth of a mile deep at a selected distance ahead. Terrain information from the antenna is fed to the small analog computer where it is correlated with flight characteristics and altimeter input. Continuous flight instructions are presented to the pilot through a simple meter or to the automatic pilot. No radar scope presentation is required. Instrumentation may be simplified further by combining a climb-and-descend indicator with the attitude indicator.

For safety, an r-f signal is continually fed into the waveguide feed and then through the system. If a failure occurs while the pilot is flying manually, a warning light turns on. Failure during automatic flight results in an automatic climb command to the autopilot.

GD/E's system was developed with company funds. It differs from most other systems in that it uses a fixed beam rather than vertical scanning. It also depends more heavily on input from an altimeter than do other systems. The fixed beam is directed with a fixed depression angle. It is stabilized by servoing it to the angle-of-attack data.

Other Producers—Under an "integrated approach," Hughes is incorporating air-to-air search and ground mapping along with TFR. Hughes has been under contract to improve a prototype system built at the Navy Avionic Facility in Indianapolis (NAFI). The Naval Ordnance Test Facility, China Lake, Calif. is also working on TFR. Other firms include Raytheon, Emerson Electric and Norden.

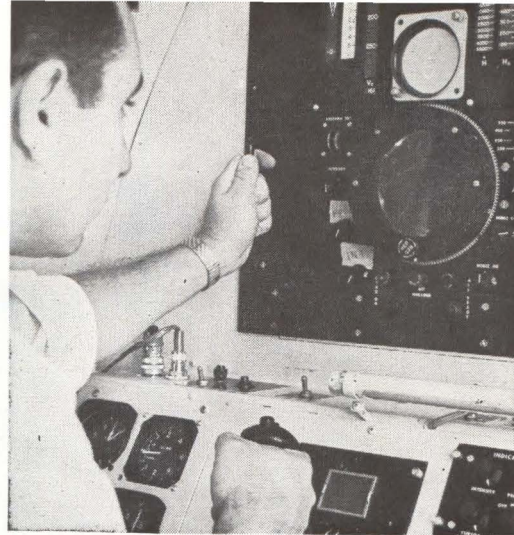

DISPLAYS for automatic TFR, built by Autonetics, consists of (center) plan position indication (PPI) and 3-D terrain to give azimuth, range and elevation information. Upper scope tells position of aircraft (circle) in relation to where automatic terrain following command (dot) says it should be



COMPACT terrain-following radar in pod attached here to Navy's A4C Skyhawk has also been tested by USAF

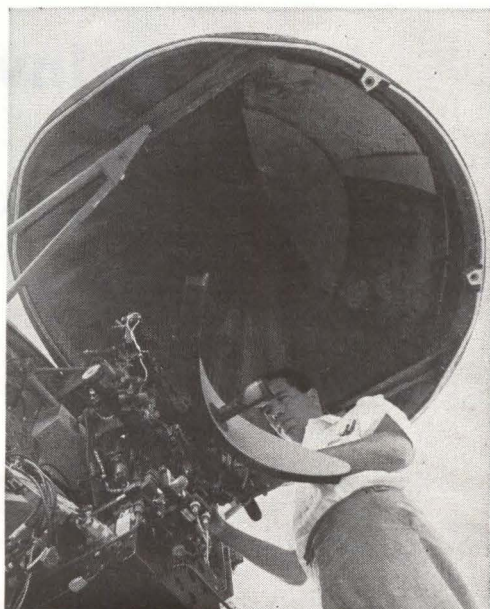

ANTENNA dish permits 90-deg azimuth scan and wide elevation coverage in automatic TFR unit built by Autonetics



Investment Opportunity

The skills he's learning today he will someday put to use for you.

But it is going to take a substantial investment before the strides he takes will be sure and swift and strong. An investment of time, of love, of money and thought.

You have a stake in that investment.

You can protect it by joining with other leading American businessmen to promote the Treasury's Payroll Savings Plan for U. S. Savings Bonds. The Treasury Department's Plan encourages habits of prudence and diligence and responsibility that are

the most valuable currency of a free society and a free economy.

When you bring the Payroll Savings Plan into your plant—*when you encourage your employees to enroll*—you are investing in the skills of tomorrow's workers. In the energy and ability of youth that is our real wealth. You are investing in America's future. In freedom itself.

Don't pass this investment opportunity by. Call your State Savings Bonds Director. Or write today to the Treasury Department, U. S. Savings Bonds Division, Washington, D. C. 20226.



in your plant...promote the PAYROLL SAVINGS PLAN for U.S. SAVINGS BONDS



FACTS...

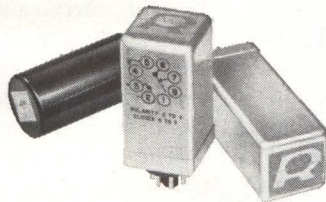

*about today's most
advanced solid state
telegraph relays*



RADIATION
INCORPORATED

Are all solid-state relays alike?

No. Some are transistorized versions of mechanical units, while others are partially solid-state. Radiation Telegraph Relays are all solid-state. There are no moving parts.

Why invest in solid-state relays?

Because they eliminate routine maintenance, require no adjustments, and cut costly downtime and service calls.

How long will they operate under normal conditions?

Indefinitely.

APPLICATIONS . . .

Which mechanical relays can solid-state units replace?

All known types . . . except those rare applications where no solid-state device can be used.

How many kinds would I have to stock?

Only three: Radiation supplies polar, neutral and universal types.

Can I simply plug in your relays and expect them to work?

Yes. But because there are so many different wiring options, an adapter plug may be required to match your particular system.

How do you power Radiation Relays?

You don't. A unique circuit (patent applied for) allows the unit to operate on input current . . . the signal itself supplies the power.

TECHNICAL . . .

What are the features of Radiation Relays?

Non-polarized output contacts, high MTBF . . . 73,000 hours of actual field test without failure, high speed . . . up to 2400 bits/second, low distortion . . . less than 1% at 1000 bauds, and low leakage . . . less than $5 \mu\text{a}$ at 130 volts. The units provide long operating life with extremely high reliability, and are designed with special protective circuitry.

What type of protective circuitry?

Thanks to a unique Radiation design, the units are highly resistant to spikes and overvoltages. Not only do they provide a cleaner telegraph signal, but they are also protected against destruction caused by abnormal line conditions.

Suppose a Radiation Relay is badly overloaded . . . how do I check it out?

We can supply our Model 7110 Solid-State Relay Tester. Incidentally, it comes with an adapter for use with electromechanical units, too.

What if the unit's actually damaged by abnormal conditions . . . do I have to throw it away?

Absolutely not! Due to modular construction Radiation Telegraph Relays are repairable.

QUALITY ASSURANCE . . .

Are your relays guaranteed?

They certainly are. Radiation warrants Neutral Model 9214 and Polar Model 9212 against all defects of performance for a year after shipment . . . providing they're used under normal conditions.

How can I prove the superiority of Radiation Solid-State Telegraph Relays?

Simply phone or write Product Sales Manager at Radiation Incorporated, Products Division, Dept. EL-01, Melbourne, Florida. We will supply technical information, and, if you wish, have a Field Engineer provide a relay to test on the line of your choice.

Why not call today? Prove to yourself that Radiation Relays assure higher circuit efficiency, lower cost operation and dependable service!

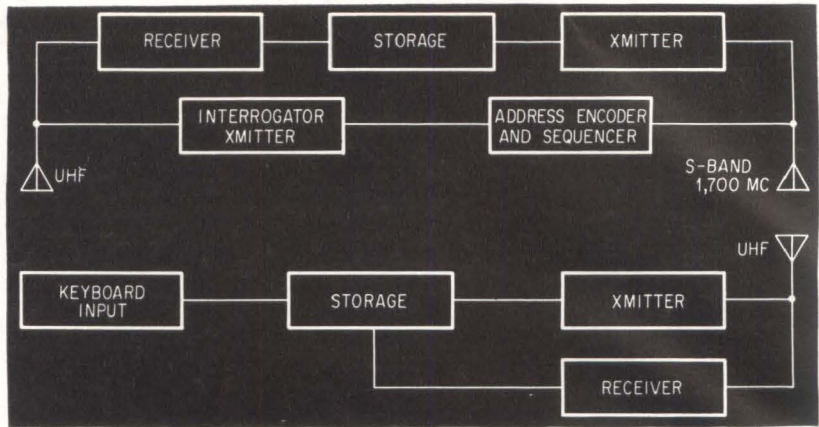

SATELLITE system (top) would receive data stored by shipboard devices (bottom), then transmit accumulated data to ground

THIN-FILM systems deposited on balloons like this one made by G. T. Schjeldahl may report high-altitude wind conditions to satellites

Weathermen Plan Data-Satellite Net

Orbiting data collector would query ships at sea, buoys, ground stations

By **JOEL A. STRASSER**
Assistant Editor

SUITLAND, MD.—One of the Weather Bureau's forecasting problems is that it can observe only one-fifth the earth's atmosphere. It has little coverage over the oceans, although 1,147 merchant ships radio surface observations, and another 312 file reports by mail. Detailed reports come in from 15 merchant ships that carry Bureau meteorological technicians and radiosondes, and from 12 Ocean Station Vessels operated by the U. S. Coast Guard and other nations, equipped with rawinsonde (radio-sonde with wind direction).

To step up both coverage and data-collection speed, the Bureau is actively considering a system called SCOMO, for Satellite Collection of Meteorological Observations. The satellite would gather 34 kinds of information on atmospheric and sea conditions, from the ships, and from buoys and remote ground stations, all equipped with new transmitting devices. Data collected would go to the National Weather Satellite Center (NWSC) at Suitland.

The Bureau is also considering a

new kind of atmospheric tracer balloon to work with SCOMO. Their transmitters would be thin-film circuits deposited on the balloon surface. Spaced 600 nautical miles apart in a free-floating network, the balloons could provide data on winds and other conditions at altitudes of 18,000 to 20,000 feet. This program is called STROBE (Satellite Tracking of Balloons and Emergencies).

SCOMO Network—The ships will need a device to accept and store data, then transmit it to the satellite as it orbits overhead, J. Gordon Vaeth, assistant director (systems) of NWSC, points out.

A five-digit teletypewriter code (synoptic weather code) will be punched into the device with a manual keyboard. The satellite would command the device, by a discrete address code, to transmit stored weather and location data. An emergency code may locate ships in trouble. Frequencies under consideration are 72, 400 and 1,600 Mc.

Hardware contracts will be let if the concept proves out. First contracts would be for 500 or 600 devices to equip ships in the U. S. reporting area. Cost could be traded off against the money the Bureau now pays radio communications companies to handle data from

ships. In the U. S. area alone, the fiscal 1964 bill is \$484,000.

Meanwhile, NASA will design and test-fly a satellite for the Bureau. It will carry a data transmitter-receiver module that could go into any orbital spacecraft. It may also carry a camera system to provide cloud-cover photos.

The diagram indicates basic operation of the satellite and ship equipment. Interrogation and reply is at uhf. When the satellite comes within range of the Command and Data Acquisition (CDA) ground station at Fairbanks, Alaska, the S-band transmitter would send accumulated data to the ground. CDA would relay the data to NWSC over land lines.

Reporting Stations—Besides the ships in the present reporting network, SCOMO would collect data from buoys.

One of these is MAMOS (Marine Automatic Meteorological Observation Stations). It transmits digitized data on winds, air and sea temperature and barometric pressure. Cardion Electronics will test the first MAMOS this month. For service with SCOMO, the buoy will be equipped with storage and address capability. Later versions, without the hull, will be used as automatic stations on land.

The network will also include

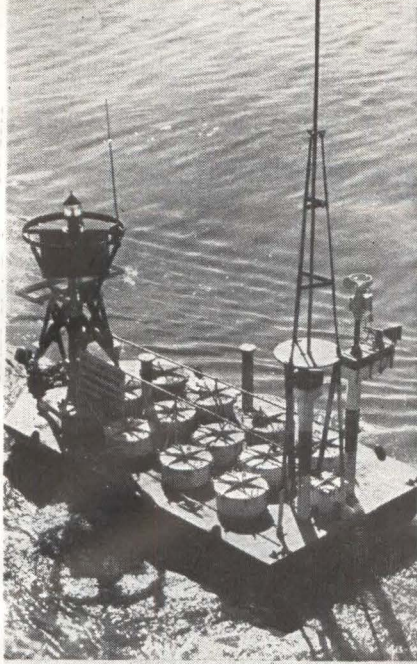

NOMAD BUOY. Martin Co.'s atomic-powered meteorological reporting system has just been installed in the Gulf of Mexico

the Navy's NOMAD (Navy Oceanographic Meteorological Automatic Device). Manned stations on Pacific Islands will also be integrated into the satellite network.

Balloon Circuits—Because aircraft might collide with the super-pressure, 12-foot-diameter STROBE balloon, the Bureau wants to deposit the transmitter, and possibly sensor circuits, as thin-films on the balloon's Mylar surface. Distributing the electronics mass as thin films may allow the balloons to be safely ingested into the air intakes of jet-aircraft engines.

Under consideration, says Jack Puerner, NWSC Systems division electronics engineer, are thin-film solar cells, 10-mw thin-film nickel-cadmium batteries being developed by Harry Diamond Laboratory, passive and active thin-film devices being studied by industry (see, for example, p 23), and thin-film antennas. Batteries and solar cells could spread over a large area, but other component placement is a problem. A happy medium must be found between distributing their mass and keeping them close together to avoid noise.

Radar or Loran-C could be used for balloon location. But, ideally, they would be located by the signals received by SCOMO or relayed to SCOMO by ships or buoys.

NOW YOU
CAN GET . . .

**CUSTOMIZED
FEATURES**

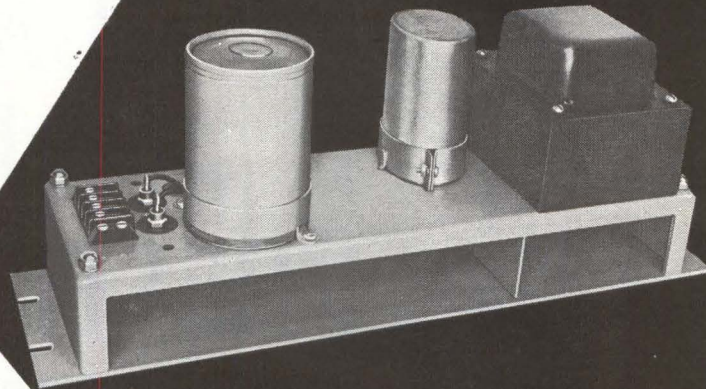

**IN
ACME ELECTRIC**

STANDARD POWER SUPPLIES

Why be satisfied with the performance limitations of ordinary power supplies when Acme Electric makes a **standard regulated power supply** with operating features usually obtainable only in specially designed units? This line of Acme Electric power supplies originated as custom designed models, then were simplified and standardized.

RELIABILITY EVALUATION PROVED BY DESIGN SIMPLICITY

- Continuous duty, constant voltage transformer
- resonant capacitor with adequate bleeder to discharge after turn-off,
- computer grade, electrolytic filter,
- silicon rectifiers,
- practical positioning of terminal board provides input and output connections in one place,
- heavy gauge, relay rack panel with components spaced for maximum free air circulation,
- negligible thermal drift
- losses and instability of tubes eliminated,
- zero to full load recovery time, 0.1 second,
- practically instantaneous recovery under input voltage fluctuation,
- current limiting protection,
- ripple voltage RMS less than 1%,
- efficiency 80% or better,
- standard rack models in ratings from 50 watts to 2400 watts, 24 to 250 volts dc.
- Write for catalog 174.

Acme  Electric

SAA 3722-3038

Engineers and Builders of...

312 WATER STREET, CUBA, NEW YORK

In Canada: Acme Electric Corp. Ltd.
50 Northline Rd., Toronto, Ont.

REGULATED POWER SUPPLIES
STATIC POWER RECTIFIERS
VOLTAGE STABILIZERS
VOLTAGE REGULATORS

cppc — — Your Specialist for

CASCADED AMPLIFIERLESS RESOLVER CHAINS

SIZE 8



SIZE 10
MATCHED
SET



SIZE 11



SIZE 15



PANCAKE



Why not take advantage of the years of pioneering experience which Clifton Precision has gained in cascaded resolvers?

Not only have we designed and developed the widest variety of these resolvers, but we have also become extremely well versed in the attendant systems engineering.

Thus you can have two important advantages by dealing with Clifton: top quality components and wide systems experience.

For further information, contact: Sales Dept. 5050 State Rd., Drexel Hill, Pa. Area 215 MAdison 2-1000 • TWX 215 623-6068 —or our Representatives.

Simple Follow-Up Chains—No Compensation

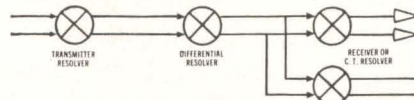

The above chain uses simple production tolerances on the components and represents a four wire data transmission system used in servo work. Variations of the above system can utilize several receivers if necessary by proper impedance matching.

Simple Amplifierless Chains With Matched Sets of Live and Dummy Resolvers

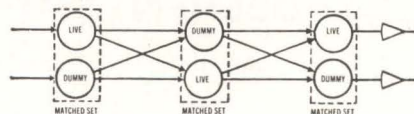

The above concept can be supplied as matched sets of live and dummy resolvers either as independent components or built into a single integral case. Matched sets can be constructed that will be all the same for a system or matched sets for different impedance levels (e. g. matched set #1, set #2, set #3, etc.). No compensation resistor, thermistor or capacitor is used in the above concept.

Intermediate Chains With Interchangeable Components—Some Compensation

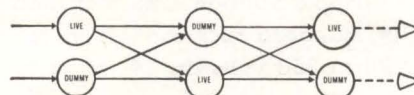

In the system above only one electrical type is utilized for both dummy and live resolver. All live resolvers are interchangeable with any other live resolver and any dummy resolver is interchangeable with any other dummy resolver. Units are compensated for constancy of transformation ratio and phase shift over temperature as well as unit to unit. No capacitors are used in the above system to reduce phase shifts.

Completely Compensated Interchangeable Amplifierless Chains With Thermal Stability

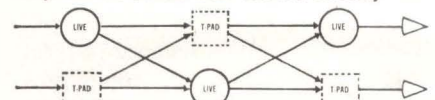

The illustrated system employs the use of completely compensated resolvers. These units are compensated for T.R. and phase shift over temperature with a characteristic impedance concept. T-Pads are shown which are utilized with this system but dummy type transformer units completely compensated will yield better system accuracy and symmetry. The above system is frequency sensitive due to the use of timing capacitors.

Chains For Different Frequencies, Voltages and Environmental Conditions

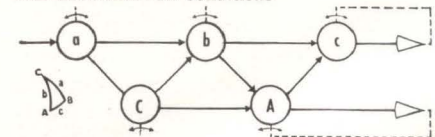

CPPC has developed cascaded chains for different voltages and different frequencies (e.g. 400 ~, 800 ~, 900 ~, 1600 ~, 3200 ~, 5000 ~, 10V., 15V., 26V., 50V., 115V.) employing the use of standard components, pancakes (with and without gymbal bearings), as well as components in aluminum, stainless steel and beryllium. Some chains have been developed which must be calibrated at three different temperature levels.

cppc

CLIFTON PRECISION PRODUCTS

Division of Litton Precision Products, Inc.
Clifton Heights, Pa. • Colorado Springs, Colo.

Navy Will Use Microcircuits in VAL

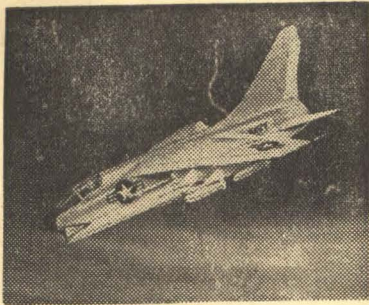

NAVY'S new plane will look like this

WASHINGTON—The Navy's new light attack plane, the VAL, will be equipped eventually with a new microelectronics system that will provide increased low-level navigational capability and improved reliability and maintainability.

The Integrated Light Attack Avionics system (ILAA) is now in the program definition stage. However, since the plane's first flight is scheduled for May, 1965, the VAL initially will carry mostly off-the-shelf electronics equipment. But ILAA systems will, Navy hopes, be ready to go into the plane in the latter half of 1965.

VAL, designated the A7A, will replace the A4E Skyhawk. It will have double the range of the older plane and carry heavier, non-nuclear payloads. Operating at subsonic speeds, VAL will provide close-in troop support for limited-war situations.

Ling-Temco-Vought, of Dallas, won the design competition for VAL, which is an improved version of that company's F8E Crusader fighter. The VAL program is expected to top \$1 billion.

Electronic subsystem specs and dates wanted are not expected to be spelled out for another month or six weeks—not until LTV formally signs the prime contract. Companies that did not work on Crusader are afraid they will not get in on VAL. But those with superior subsystems should be able to break in. VAL's subsystems will be different and will probably include new devices, such as a flight directional system.

Patent Prices Going Up?

WASHINGTON—Bill that would sharply raise Patent Office fees has passed the House and now goes before the Senate. The bill (H.R. 8190) would, for the first time in the U.S., require payments to maintain a patent for the full 17 years. Maintenance fees would be \$50 after five years, \$100 after nine years, and \$150 after 13 years. Filing fee would be raised from \$30 to \$50 and the issuance fee from \$30 to \$75.

Microcircuit Hearing Aid: A First

INTEGRATED CIRCUITS' first application in consumer electronics was claimed last week by Zenith Radio and Texas Instruments. They developed a 6-transistor, 16-resistor amplifier circuit—one-tenth the size of a match head—for a hearing aid to be sold by Zenith. The hearing aid will be unveiled March 23 at the IEEE Convention and will be made available to the public in limited quantities in April. The companies said the single-unit integrated circuit performs as well as conventional printed-circuit hearing-aid assemblies and is more reliable. But the hearing aids will cost more so Zenith doesn't expect to sell many of them initially. Also, the company expects it will be several years before other hearing-aid components catch up with the reduction in size of the integrated circuits.

De Gaulle Blocks Foreign Ownership of Bull Shares

PARIS—French government has vetoed a proposed agreement between General Electric and Machines Bull, France's big, but troubled, computer manufacturer. Bull, which needs fi-

nancial and technical help, wanted to sell 20 percent of its stock to GE.

Government officials, on orders from President de Gaulle, balked at turning over even a minority interest to GE. Bull will be permitted technical agreements with foreigners, but not direct-participation deals. The decision reflects an increasingly nationalistic hue in French policy toward foreign investors.

The government decided to turn Bull over to a new group, including two other French electronics companies, CSF and CGE, and give Bull money and additional government contracts. The moves could mean trouble for IBM. So far, IBM has 75 percent of government business, Bull only 22 percent. It's likely government buyers will favor Bull.

MIT Breaking Up Life-Sciences Computer Team

CAMBRIDGE, MASS — The MIT center for computer technology in the biomedical sciences is being dissolved.

A regional center for a dozen New England academic and medical institutions, the center had pledges of at least seven years of support by the National Institutes of Health (NIH) and NASA. Six months ago, NIH put up \$2.8 million for the first

year's support. Now NIH is phasing out the funding.

Dissolution of the MIT center reportedly developed from a basic policy dispute among its members. Charles H. Townes, provost of MIT, said it became apparent that a permanent organization was not going to work out as envisaged, so the center was never actually formed. He said MIT could not get the proper educational content into the organization to make it an essential part of MIT.

"We had envisaged a regional resources center," said Dr. Townes, "which would be a hybrid organization—with a large research program and yet strong student and faculty participation. It just was not working out that way."

It is expected that by March 1 the ex-Lincoln Laboratory digital computer group that helped organize the center development office will announce relocation of the work. Several universities have expressed interest in the project.

The center was organized around use of the LINC (laboratory instrument computer) as a tool for

research in the life sciences (p 12, April 5, 1963; p 28, July 26, 1963). Fifteen LINC's are now in the hands of biomedical researchers throughout the country, and its evaluation was largely accomplished.

Infrared Test Station Will Check Space Parts

BOEING is buying an infrared test station from Servo Corp. of America. They intend to use it for testing printed-circuit cards and electronic parts. This is, according to Servo, one of the first commercial infrared test stations. Other companies have been investigating the use of infrared to find hot spots and other indications of potential failure (p 62, June 14, 1963). The station will have a temperature sensitivity of ± 0.1 deg C and resolution of 1 sq mm. Response will be in the 10 to 13-micron region and scanning will be automatically controlled by punched paper tape. The equipment is to be delivered to Boeing's Saturn Booster branch, New Orleans, in July.

MEETINGS AHEAD

SOCIETY FOR INFORMATION DISPLAY NATIONAL SYMPOSIUM, SID; El Cortez Hotel, San Diego, Calif., Feb. 26-27.

WELDED ELECTRONIC PACKAGING SYMPOSIUM, WEPA; Miramar Hotel, Santa Monica, Calif., Feb. 26-27.

SCINTILLATION-SEMICONDUCTOR COUNTER SYMPOSIUM, IEEB, AEC, NBS; Hotel Shoreham, Washington, D. C., Feb. 26-28.

DATA PROCESSING CONFERENCE, American Management Association; Statler-Hilton Hotel, New York, N. Y., March 2-4.

ELECTRONIC INDUSTRIES ASSOCIATION SYMPOSIUM, EIA; Statler Hilton Hotel, Washington, D. C., March 9.

EXPLODING CONDUCTOR PHENOMENON CONFERENCE, AFCL; Boston, Mass., March 10-12.

IRON AND STEEL INDUSTRY INSTRUMENTATION CONFERENCE, ISA; Roosevelt Hotel, Pittsburgh, Pa. March 11-12.

COLD CATHODE TUBE INTERNATIONAL SYMPOSIUM, British Institution of Radio Engineers; Cavendish Laboratory, England, March 17-19.

NUMERICAL CONTROL SOCIETY MEETING, NCS; Hotel Commodore, New York, N. Y., March 19-20.

IEEE INTERNATIONAL CONVENTION, IEEB; Coliseum and New York Hilton Hotel, New York, N. Y., March 23-26.

RADIO TECHNICAL COMMISSION FOR MARINE SERVICES MEETING, RTCMS; Boston, Mass., March 31-April 2.

JOINT COMPUTER CONFERENCE, British Computer Society, IRE, IEE; Edinburgh, Scotland, March 31-April 3.

MINING INDUSTRY TECHNICAL CONFERENCE, IEEB; Wilson Lodge, Oglebay Park, Wheeling, W. Va., April 1.

SYMPOSIUM ON ENGINEERING ASPECTS OF MAGNETOHYDRODYNAMICS, IEEB, MIT; Massachusetts Institute of Technology, Cambridge, Mass., April 1-2.

ADVANCE REPORT

CANADIAN COMMUNICATIONS SYMPOSIUM, IEEB (Canadian Region); Queen Elizabeth Hotel, Montreal, Quebec, Sept. 25-26; April 15 is deadline for submitting 350-word summaries and biographical notes, in triplicate, to Dr. F. G. R. Warren, Technical Program, Canadian IEEB Symposium on Communications, P. O. Box 808, Station B, Montreal, Quebec, Canada. Some topics are surface, subsurface, or space communications systems; telemetry and remote control; data handling, coding; adaptive communications; biological or psychological aspects of communications, as well as associated devices, techniques, theories or operating experiences.

TI Moving to Houston? Company Says "No"

DALLAS—Texas Instruments has been negotiating to purchase 200 to 300 acres of land in Houston, and may build a plant there within the next one to three years.

Negotiation reports sparked speculation that the firm may move its headquarters from Dallas to Houston, where NASA's Manned Spacecraft Center is located. Company officials claim no such move is in the works.

J. Erik Jonsson, TI board chairman and Dallas' new mayor, told Dallas newsmen the firm will "undoubtedly" build a plant in Houston sometime in the future, but has no plans to move its headquarters there.

The TI Apparatus division's Industrial Products Group now occupies a 79,000-sq-ft plant on a 3-acre site in Houston. Some sources believe the company may have in mind shifting its entire Apparatus division from Dallas to Houston, if a new plant is built.

Company officials say only that the Houston land acquisition negotiations represent a "normal part of our planning," and they add the company contemplates "no essential transfer of operations between the two cities."

Colored Display Lets Deaf See Symphonies

VIENNA—Deaf people can follow a musical score in light and color once they learn the arbitrarily chosen transformation key. Soviet cyberneticists have reportedly worked out a system to project the pitch, strength and timbre of music on a screen.

The apparatus analyzes the sound signal. Electric signals obtained are translated into different colors of variable brilliance.

The system, described this month in the Czech Technical Digest, was developed at the Cybernetical Laboratory of the Institute for Automation and Telemechanics, a branch of the Soviet Academy of Sciences.

ComSat Wants Satellite in 1965

IN BRIEF

WASHINGTON—Communications Satellite Corporation is seeking FCC permission to use an interim communications satellite in synchronous orbit over the Atlantic next year. The "early bird" satellite would provide interim service until ComSat gets ready to launch a full-scale system by 1966. Hughes, which has built NASA's Syncom satellites, is expected to get the contract.

This fall, ComSat will decide the winner in its design competition for a full-scale satellite system. Within the next few weeks, ComSat is expected to select for six-month detailed studies at least two of the four proposals submitted Feb. 10 (for system specifications, see p 17, Dec. 27, 1963). The system is expected to cost around \$200 million. Stock offerings to cover cost will be made in April or May.

Teams bidding for the contract, and the type of systems they are reportedly proposing are: AT&T and RCA, with GE a potential subcontractor, medium-altitude system with satellites in random orbit; Space Technology Labs, with ITT Federal Labs as principal subcontractor, medium-altitude satellites in phased orbits; Philco's Western Development Labs, medium-altitude, random-orbit satellites; Hughes, high-altitude synchronous system.

Wideband System Speeds Facsimile

SIXTEEN letter-size pages are transmitted each minute over a new Bell System experimental facsimile system, compared to the present one-sixth page a minute. For 100 lines per inch definition, in both cases the bandwidths required are 240 kc and 4 kc respectively.

Speed increases by a factor of 96 for a bandwidth increase of only a factor of 60 because the system takes advantage of the relatively few changes between black and white in average copy. The equipment sends 3.92-microsecond pulses that represent only the changes from black to white. Since they are infrequent, the pulses can be relatively strong and average transmitted power can still be held to a tolerable level.

Diode Laser Amplifier

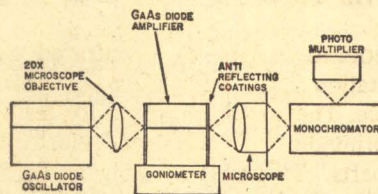

EXPERIMENTAL diode-laser amplifier at IBM's Federal Systems division, Bethesda, Md., is expected to aid in development of laser communications systems (see p 61, Dec. 6, and p 34, Dec. 13, 1963). The device makes it possible to use a multiplier photodiode as a detector, rather than a more sensitive multiplier phototube, and permits signal detection with simple heterodyne equipment. The lab setup amplifies signals more than 1,000 times

Air Force Wants New Planes for Limited War

WASHINGTON—Nearly completed is a new Air Force survey of its aircraft needs up to about 1975. The survey anticipates need for at least five new planes:

- An attack craft with intercontinental range that could deliver a precise, small nuclear blow to military targets so as to minimize civilian casualties and damage and avoid escalation to general atomic war. The plane would fly low to avoid radar detection.

- A transport that could haul paratroops 10,000 to 12,000 miles and return to base without refueling; a vertical take-off and landing (VTOL) attack-reconnaissance plane; a VTOL transport to support troops in the field; and an interceptor to fight bombers flying at three times the speed of sound.

Air Force identifies missile-guidance systems as one of the technologies that must be pushed to make these planes possible.

GENERAL MICROELECTRONICS, of Santa Clara, Calif., has reportedly developed a desk-size computer using integrated circuits. The firm hints it may announce it at the IEEE Show.

PENTAGON is sharply cutting back its space nuclear-power program. Snap-2 and Snap-4 are cancelled. Snap-50 is slowed down. Flight program for Snap-10A, Snap-50 and Snap-8 is eliminated. Pentagon says it doesn't need the power sources.

MICROWAVE OVEN market for magnetrons was jolted last week by Comtek, Inc. The Woburn, Mass., firm said one major appliance firm already plans to use its now 1-kw, c-w magnetron. Price (\$80 in lots of 100) and heater power (18 w) are claimed to be the lowest yet. Tube also has a replaceable cathode.

DESPITE the failure of Ranger 6, NASA has no plans—officially—to make changes in the Ranger, Surveyor, Lunar Orbiter or Apollo program, except postponing Ranger number 7.

ECHO II, the passive communications balloon, is fielding signals well, although NASA still isn't sure whether it has lost shape. The tests with the USSR (p 10, Jan. 17) still hadn't started early this week.

FCC's schedule of filing fees becomes effective March 17. Funds will be held in escrow while court action taken to block imposition of all license fees is resolved.

1.3 MILLION station licenses will be computerized by FCC by the end of fiscal 1965. First electronically processed license goes to KKA-0001, in Caratunk, Maine.

BMEWS (Ballistic Missile Early Warning System) development was officially phased out last week, now that the system is operational. The program cost \$1.2 billion.

IBM reports application of parametric amplification principles to ultrasonic signals. Crystal of MgO transfers energy from an ultrasonic pump wave to an ultrasonic signal wave as both waves travel the length of the crystal.

VECTOR MFG., telemetry equipment producer, has been bought by United Aircraft. Ampex plans to buy Mandrel Industries, a geophysical exploration and equipment company.

NASA and AEC May Adopt Pentagon's New Guidelines on How To Cut Costs

Contractor-efficiency guidelines, just adopted tentatively by the Pentagon, will give Defense Secretary McNamara's cost-cutting drive a sharper edge. The Pentagon will consider the guidelines in awarding competitive contracts, and in setting profit and fee rates on negotiated contracts. NASA and the Atomic Energy Commission are likely to adopt guidelines similar to the Pentagon's.

In brief, the Pentagon guidelines call for cost-reduction programs that have top management sponsorship, are administered by senior officials and cover all functions: engineering, manufacturing, procurement, material management, marketing, services and product support. Specific savings goals and plans for achieving them are called for, but contractors will be allowed to establish their own rules and procedures for documenting, reporting and validating claimed savings internally. A prescribed form has been proposed for contractor use when cost reductions of direct value are reported to the defense department.

The top 100 defense contractors and major defense industry associations have been asked to comment on the proposals by early March. Copies of the proposal are available from Thomas D. Morris, Assistant Secretary of Defense, the Pentagon, Washington 25, D.C.

Bill Would Make Defense Companies "Think Civilian"

Senate Commerce Committee headed by Sen. Warren Magnuson, plans hearings this year on a bill that would require defense contractors to report on what they could do to convert to civilian production if defense orders fall off. Some companies object to the compulsory feature in the bill, proposed by Sen. George McGovern, and the administration is likely to testify that it is unnecessary. McGovern would also set up a federal commission to study problems of gradual conversion to civilian production. President Johnson may have taken some of the steam out of that proposal, however, by establishing a top-level interagency committee, headed by Walter Heller, chairman of the Council of Economic Advisors, to study the impact of defense cut-backs and work out a program to minimize problems (ELECTRONICS, p 20, Jan. 3).

Navy Lets Contract For Big ASW Range

Navy is moving ahead with AUTEK its \$100-million Atlantic undersea electronic test range and evaluation center. It hopes to have AUTEK fully instrumented and in use within two to three years, now that it has given Nat Harrison Associates and Harrison Holding Corp. of Miami an \$11.2-million construction contract. A 6,000-ft-deep canyon in the ocean floor in the Bahamas will be used chiefly to test antisubmarine equipment.

UHF-Tv Interference Can Wait Til Next Year, FCC Decides

FCC hopes makers of uhf tuners can come up with solutions to the problem of oscillator interference within a year. FCC's 500 microvolts per meter radiation limit for tv receivers clashed somewhat with the law requiring all sets being sold in interstate commerce to be equipped with uhf receivers after April 30, 1964. Rather than invoke its rule, the FCC climbed out of the box by agreeing to continue the 1,000- μ v/m radiation limit until April 30, next year. In the meantime, it is calling for research on tuner design and radiation suppression.

The commission's determination to back strongly uhf-tv broadcasting was evident in a decision last week denying a permit for a vhf translator to serve Asheville, N.C. FCC told Spartan Broadcasting Co. that it would look favorably on a uhf translator, or a second uhf station. Asheville already has a uhf station.

PHILCO'S FIRST MICROELECTRONIC LINE!

A COMPLETE FAMILY OF COMPATIBLE, INTEGRATED LOGIC BUILDING BLOCKS NOW AVAILABLE FOR IMMEDIATE OFF-THE-SHELF DELIVERY

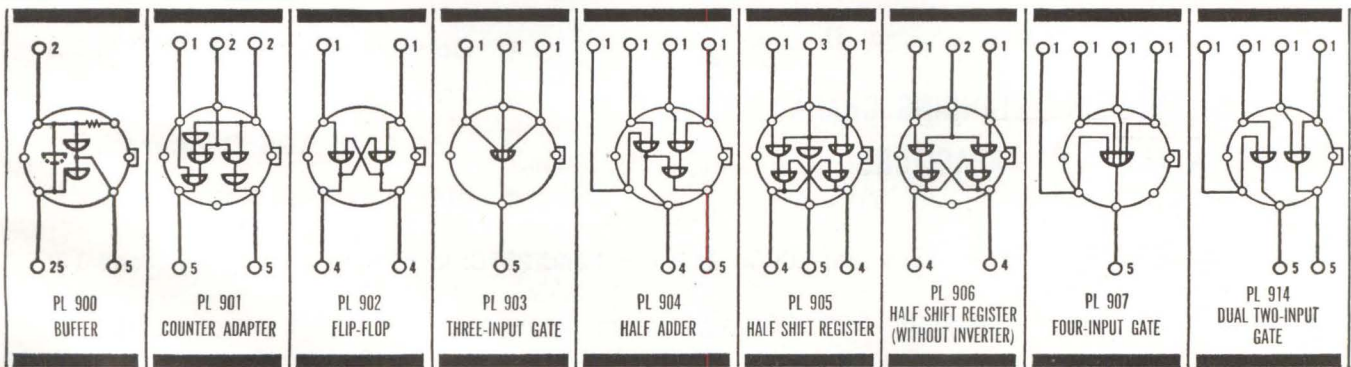
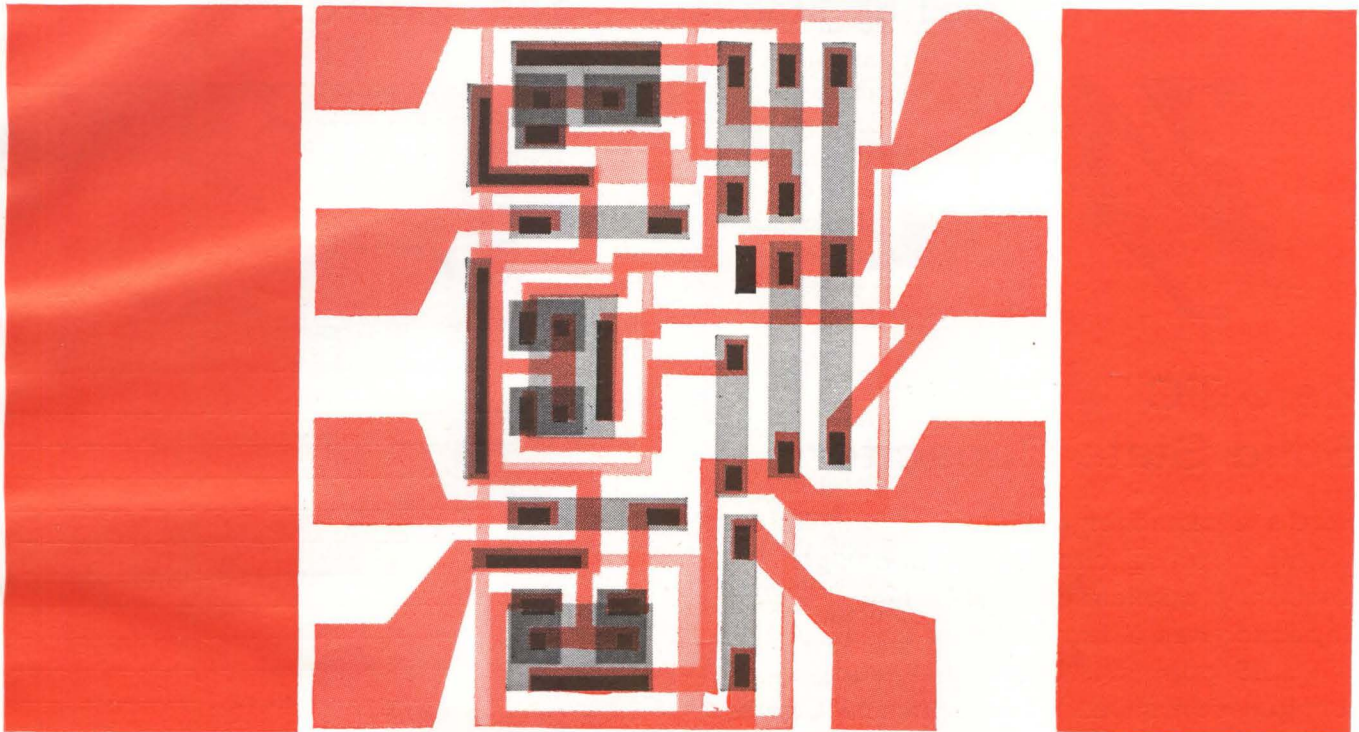

Now, designers can specify Philco Micrologic elements and be sure of immediate availability, Philco quality and dependability. Nine compatible, integrated logic building blocks, manufactured using the Planar Epitaxial Process through a cross-licensing agreement with Fairchild Camera and Instrument Corporation are now available. Eliminate interchangeability problems—buy Philco Micrologic. Available off-the-shelf in TO5. For complete specifications, application data and a list of stocking distributors, write Department E22164.



MICROELECTRONICS OPERATION

PHILCO®

A SUBSIDIARY OF *Ford Motor Company*

LANSDALE DIVISION, LANSDALE, PA.
In Canada: Don Mills Road, Don Mills, Ontario, Canada

Now! Famous "VY" Porcelain Capacitors Are Available With A

ZERO

TEMPERATURE COEFFICIENT

(as well as standard + 105 ppm/°C.)

VY[®] "0"

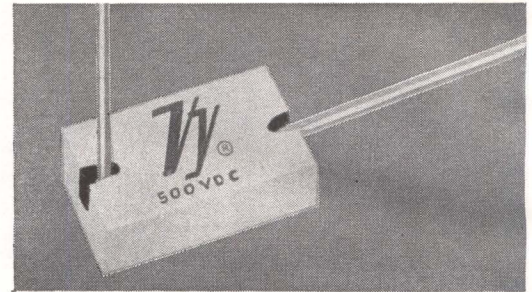

Zero TC Solid State Capacitor

Here's a capacitor designed to pull its own weight in tuned circuits, rf, and high frequency applications. This new "VY" Capacitor has a temperature coefficient of 0 ± 25 ppm/°C. Axial-radial lead configuration saves board space . . . gives greater flexibility to circuit wiring.

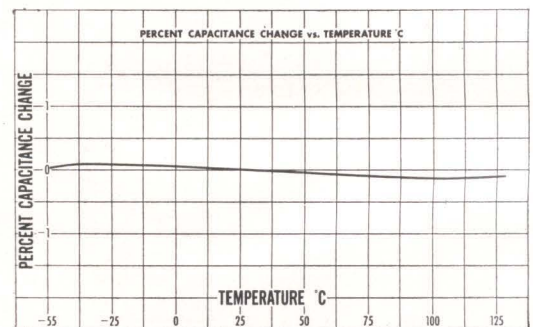

OFFERS ALL THESE OUTSTANDING CHARACTERISTICS INHERENT IN ALL "VY" CAPACITORS

- ★ **DISSIPATION FACTOR:** Less than .0006 at 1.0 KC and 25°C; less than .003 at 1.0 KC and 125°C
- ★ **INSULATION RESISTANCE:** 100,000 megohms minimum at 25°C; 10,000 megohms at 125°C
- ★ **Q:** Greater than 2500 at 1.0 MC and 25°C
- ★ **CAPACITANCE DRIFT:** .05% or .05 pf whichever is greater
- ★ **DIELECTRIC STRENGTH:** 400% of rated voltage at 25°C for 10 seconds

- ★ **Conforms with MIL-C-11272**
- ★ **10 to 1000 pf**
- ★ **-55°C to 125°C operation**
- ★ **300 and 500 vdc**

©Vitramon, Inc. 1964

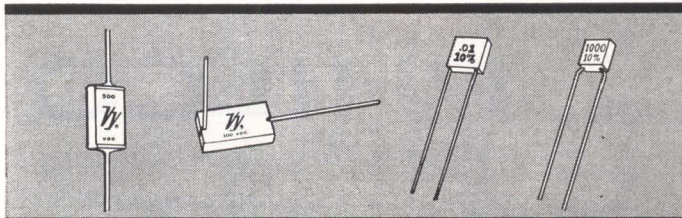

Vitramon
INCORPORATED

BOX 544 • BRIDGEPORT 1,
CONNECTICUT, U.S.A.

In United Kingdom contact:
Vitramon Laboratories
Limited
45 Holloway Lane
Harmondsworth, Middlesex
England

SCAN-GENERATOR
using thin-film transistors
is viewed by engineer
at RCA Laboratories
(See the front cover)



By **MICHAEL F. WOLFF**
Senior Associate Editor

FORWARD STEP IN MICROCIRCUITS:

Thin-Film Transistors Form Scanning Generator

Use of TFT in experimental circuit points toward feasibility
of applying device to all-thin-film integrated circuits

ACHIEVEMENT OF an operating integrated-circuit scan generator using cadmium sulfide thin-film transistors (TFTs) was reported this week by researchers at RCA Laboratories. The development is considered an important step in the evolution of all-thin-film integrated circuits because it demonstrates the feasibility of using the TFT in them.

Announced at the IEEE International Solid State Circuits Conference by P. K. Weimer, H. Borkan,

L. Meray-Horvath and F. V. Shallcross, the scan generator uses more than 100 TFTs deposited over an area of 0.15 square inch. Large-scale deposition of TFTs has hitherto been a stumbling block to their utilization in circuits.

The TFT is a field-effect transistor in which majority carriers are injected from a source electrode into a channel whose conductivity is controlled by the voltage applied to an insulated gate. The device is

generally operated with the gate biased positively with respect to the source. In this mode drain current can be enhanced by several orders of magnitude without drawing appreciable gate current.

Although still in the research stage, the TFT has generally been considered to be further ahead in development than other active thin-film devices such as the experimental hot-electron tunnel triodes. Even so, this is believed to be the

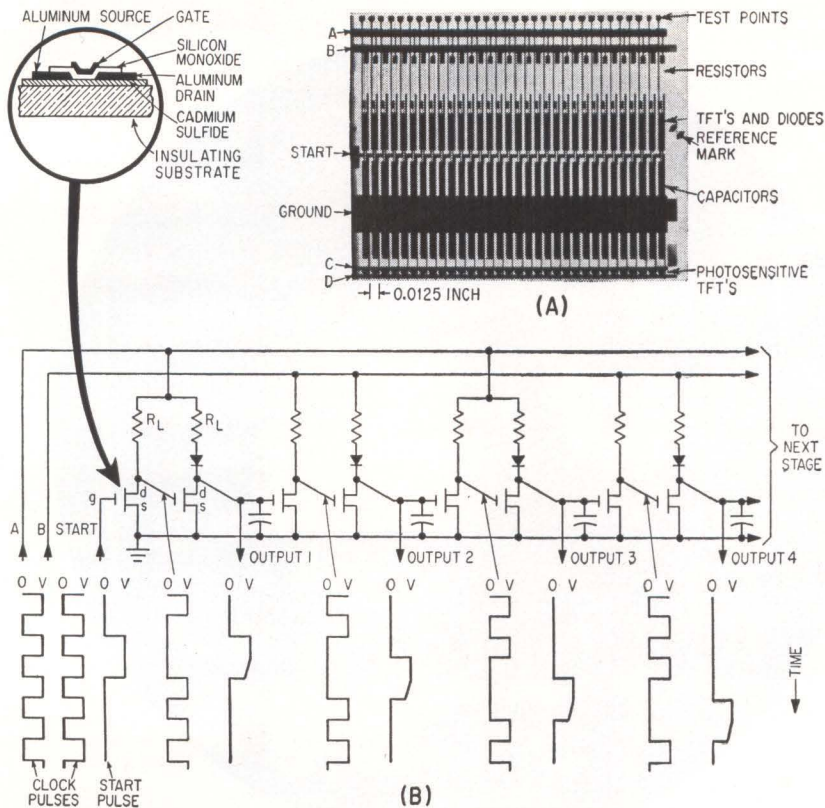

30-STAGE THIN-FILM scan generator (A) employs circuit (B)—Fig. 1

first report of using so many TFTs in an integrated circuit application.

Scan Generator—The scan generator is shown in Fig. 1. Thirty stages have been constructed in integrated form, each stage consisting of 2 TFTs, 2 load resistors, and a diode and capacitor. The diodes are TFTs with the gates connected to the drains, the load resistors are nickel-chromium, and the capacitors consist of aluminum electrodes separated by silicon monoxide. The TFT gates are 1 mil wide, and 3 TFTs are deposited in an area 12 mils wide.

The generator is fabricated in essentially two steps — first polycrystalline cadmium sulfide is deposited on a glass substrate to serve as the semiconductor for the TFTs and the diodes, as well as the photosensitive elements on the image matrix. Next step is precision evaporation of capacitors, resistors and insulators through movable masks.

RCA has demonstrated it can pick up images from single lines; in the single-scan generator 30 consecutive stages have been operated at 100-kc clock rates and output pulses have been found to progress at a uniform rate (see Fig. 2).

Image Sensing Panel—It is anticipated that two such generators could be used as x-y addressing circuits for a completely solid-state image sensing panel—in fact this is the long-range goal of this Air Force sponsored program. The generators would be deposited along the periphery of a photosensitive matrix upon which the image is projected. Voltage pulses from the generator scan the matrix in an operation similar to that of a shift register, and the resulting outputs are intensity modulated signals that could be fed to any reproducing system such

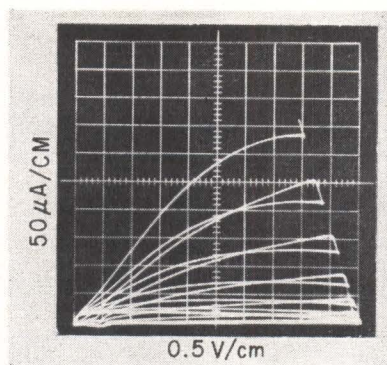

V-I CHARACTERISTIC of TFT made at U. of California, Berkeley. Voltage is applied to gate in 0.2-v steps

as a television picture tube.

Thin-film integrated circuits are considered a natural for such an application since both the photosensitive matrix and the scan generators could be made by evaporation, using cadmium sulfide in both. Work on a complete 30-by-30 element array is in progress.

For regular tv scanning, 4-Mc rates and approximately 500 stages are needed. This would require TFTs with higher g_m 's and capacitors with smaller capacitance values than those used in the present experimental model. This is not considered to be a major problem, however, since the required g_m of about 10,000 micromhos is found in present optimum TFTs. Thus, while RCA feels it is not clear what the place is for the TFT as a single device, it does feel that for a period not less than five years off it could be very important to integrated circuitry in such areas as digital scanning of displays, and content-addressable memories.

Present Research—At the present time much work is required in processing to obtain stability and lifetimes that match those of present commercial transistors. For example, some unencapsulated TFTs deteriorate overnight while others remain stable for a year. RCA is devoting considerable effort to understanding the physical and chemical properties of the TFT that determine the sensitivity of the field effect properties to surface conditions and, hence, affect stability.

Two other aspects of RCA's thin-film program aim at increasing the utility of the TFT. One program, which has just begun, is to develop a process of laying down single-crystal silicon TFTs. This could lead to an improved TFT because of the higher carrier mobility in silicon. It would combine the processing advantages of the all-thin-film device with the improved performance of present metal-oxide-semiconductor transistors. These insulated-gate field-effect devices are constructed by diffusion into silicon and are already being used in a microcircuit ssb transceiver (ELECTRONICS, p 75, Oct. 25, 1963).

A second program is directed at perfecting the hole-conduction equivalent of the cadmium sulfide TFT. This would allow designing

nanowatt logic circuits with complementary pairs of TFTs. Already RCA has succeeded in making a hole-conduction TFT out of tellurium, a naturally *p*-type material. Transistor action has also been shown in organic semiconductors.

Other Work—Several other companies are investigating insulated-gate field-effect TFTs. Melpar is concentrating on cadmium selenide devices because they can be formed entirely in vacuum. These devices have shown very good stability, according to Charles Feldman, manager of the physical electronics laboratory. As of mid-January, two devices had been running continuously for approximately 2,000 hours without any changes in characteristics being observed, Feldman said. One is a kilocycle-range oscillator using one TFT, the other is a single TFT connected to a curve tracer. Both TFTs are unprotected except for the SiO coating. Aluminum rather than gold gates are used because aluminum adheres better to the SiO and is also a more stable film. Melpar plans a concentrated radiation effects study this year and is also looking for materials that can operate at 500 deg C. Work is supported by the Bureau of Naval Weapons.

Emphasis at Hughes Semiconductor division is also on the study of other materials. While the application of CdS films has yielded 2- and 3-terminal devices with good electrical characteristics, in order for the TFT to be a real asset to all-thin-film microelectronics it is important to have thin-film materials with higher mobilities and insulators with lower trap densities and greater temperature stability than SiO, according to Rainer Zuleeg, senior staff physicist. Present r and d at Hughes is aimed at obtaining mobilities greater than 200 cm²/vsec and fabricating better quality insulators by using new techniques.

Research on thin-film transistors is underway at the University of California, Berkeley, as part of an overall study of problems in microelectronic circuits. The Air Force-sponsored work has established the role of Schottky thermionic emission in the breakdown of rectifying contacts made to the CdS films, according to R. S. Muller, who is directing the research. TFTs have been made

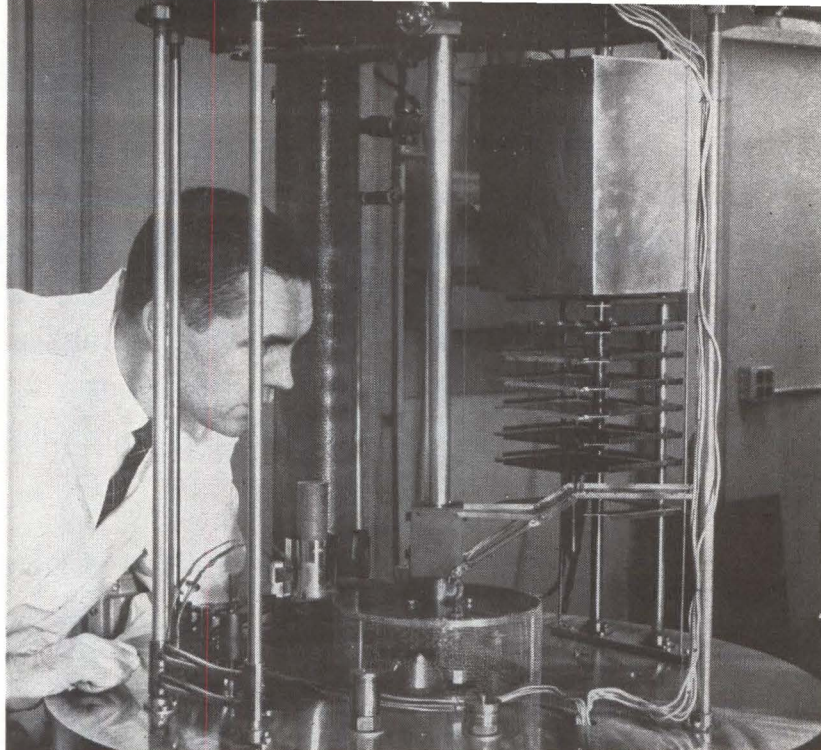

AUTOMATIC DEPOSITION equipment is used to fabricate thin-film circuits at Melpar

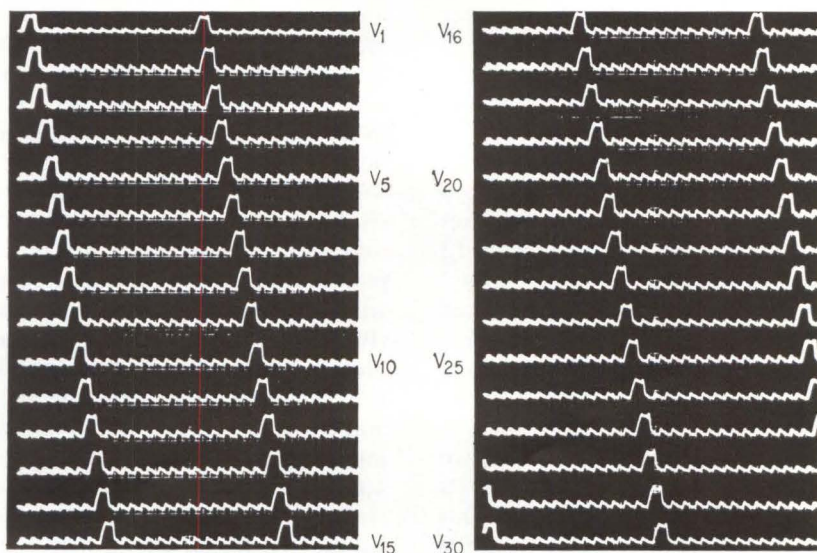

PULSE WAVEFORMS at each scan-generator output. Vertical scale is 3v/div, horizontal is 30 μ sec/div; clock is 100 kc, 3 v peak-to-peak—Fig. 2

with g_m 's up to 2 ma/v and source-drain voltage breakdowns of more than 10v.

Bipolar Transistors—Another approach to thin-film transistors involves growing device-quality semiconductors onto glazed ceramic substrates. It is expected that if one is able to grow an optimum minority carrier transistor in thin-film form it would be faster than the unipolar transistor. However, it might not be as easy to fabricate because more fabrication steps are required.

Sylvania is studying electron-beam vacuum deposition of silicon transistors directly onto glazed ceramic substrates (ELECTRONICS, p 14, November 1, 1963). Feasibility of the technique has been demonstrated by the deposition of simple logic circuits using both *p*- and *n*-type evaporated silicon films.

Individual transistors have been made with alpha cutoffs greater than 50 Mc. Sylvania is investigating an OR gate with 7 resistors, 5 diodes and 1 transistor. Project is headed by Egon Rasmanis.

Aligning Saturn Missile's Guidance

Many environmental factors affect a missile sitting on the launch pad. A Saturn bends, sways, flexes and shrinks. Guidance system alignment is a tough nut to crack. NASA uses an automatic, moveable theodolite

SATURN'S GUIDANCE system is precisely aligned in azimuth by a highly accurate, automatic theodolite. Developed for the NASA-Marshall Space Flight Center, the LR2A equipment fixes the true azimuth heading of the guidance and control system immediately prior to launch, assuring initial accuracy of the flight trajectory. This theodolite can detect angular deviations as small as 1-2 seconds of arc over operating distances from 300 to 1,000 feet. One second of arc corresponds roughly to sensing two points 0.30-inch apart at a distance of 1 mile.

The instrument is also able to operate in the presence of ± 3 inches of dynamic vehicle sway, and ± 12 inches of long-term sway. Long-term missile sway is accommodated by the use of a movable penta mirror capable of translating on a 30-inch ground rail track.

Operation—The penta mirror is two mirrors simulating the optical effects of a fine-sided prism (Fig. 1). This mirror takes the light beam from the autocollimator and deviates it 90-degrees to a prism mounted in the inertial guidance platform in the missile's nose cone. The prism at the guidance platform reflects energy back to the autocollimator, which generates an error signal whenever the prism rotates in azimuth (due to missile sway, flexing or bending) from its nulled position. The amplitude of the error signal is proportional to the amount of prism rotation. Phase of the error signal depends on the direction of rotation. The position of the Saturn vehicle and platform prism can also be remotely viewed at all times through a closed-loop tv system viewing through the autocollimator.

Autocollimator—Heart of the system is an 8-inch aperture, off-axis Maksutov catadioptric (combination of lenses and mirrors) autocollimator of 30-inch focal length, with automatic sensing at its focus. Light from an incandescent lamp is made incident alternately on either side of a slit-sensing prism by a motor-driven chopper. The light is reflected to the objective lens, collimated to the platform prism located in the missile nose and reflected back to the objective lens, which reimages the illuminated slit in its own plane at unity magnification.

If the platform prism is not precisely normal to the autocollimator axis, the returned image will be displaced laterally on the slit and light will be incident on a lead sulfide (PbS) detector, indicating an azimuth error. Linear width of the slit is 0.005-inch, corresponding to an autocollimator proportional measuring range, at any distance up to 1,000 feet, of ± 17 seconds of arc.

The returning alignment error-signal is detected by an active PbS detector arranged in a balanced bridge with a similar, but inactive, PbS detector. The bridge arrangement reduces temperature effects on system sensitivity. The signal is pre-amplified at a control panel, amplified and fed to a synchronous demodulator to provide a d-c output. A phototransistor pickoff at the chopper blade (chopping at a frequency of 226-cps) is used to generate the reference voltage for a ring-demodulator.

D-C Amplifier—The output impedance of the ring-demodulator is approximately 5,000-ohms. To provide a much lower output impedance, because of the required

distance between missile and theodolite, and to overcome base-emitter voltage variation with temperature, a d-c amplifier was constructed, Fig. 2A. The amplifier is in essence a d-c regulator. The emitter follower Q_1 acts as the series pass transistor. The output voltage is compared, in a differential amplifier (Q_2), to a fixed reference voltage. Any variation between output and reference voltage is fed back to reduce the difference. In place of the fixed reference voltage of a varying error voltage is inserted, and as the input signal level from the demodulator fluctuates, the output signal follows it.

The system has an open-loop gain of 48 and an output impedance of 187-ohms. A feedback ratio of 0.67 produces an overall gain of 1.3 and an output impedance of approximately 10-ohms. Since there is sufficient a-c gain, no high-gain d-c amplifier was necessary.

Null Operation—Due to the absence of an error signal at null, it is necessary to distinguish between null and the absence of an error signal (no light returning to the autocollimator). A prism acquired signal is provided by a separate PbS detector which sees a large signal at null. This is done by physically offsetting the detector in the return light beam. The acquisition relay is operated by the combined acquisition and error signal.

In operation, the azimuth error signal appears first. This insures that an acquisition signal is given only when an error signal is presented. As the error signal reduces nearly to null, the acquisition detector signal assumes control, maintaining continuity of acquisition relay indication through the null.

System

By **WALTER S. ZUKOWSKY**
 Electronics Engineer,
 Perkin-Elmer Corp.,
 Norwalk, Conn.

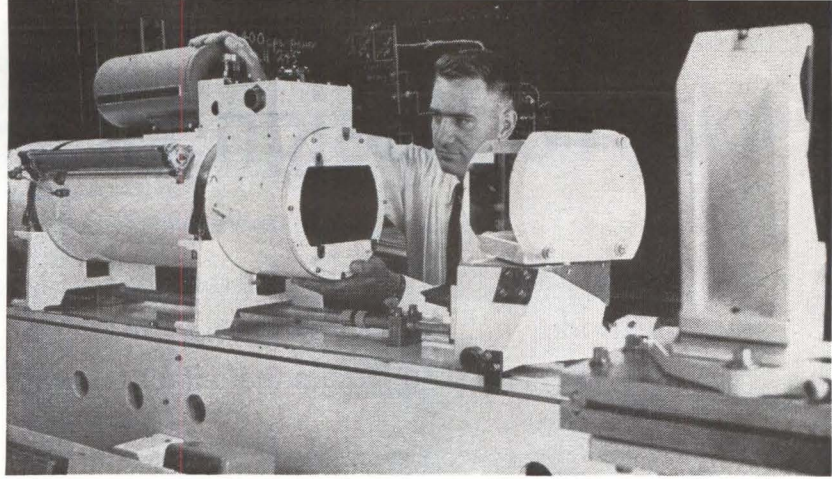

AUTHOR'S HAND rests on vidicon camera atop the autocollimator. In the middle is the penta mirror unit. At far right is the reference-prism unit

Relay Driver—A stable, repeatable acquisition level precludes direct use of a relay, due to hysteresis. The acquisition relay driver, a silicon controlled rectifier (Q_3) with turn-off capability, and a transistor (Q_4), provides a stable triggering point with negligible hysteresis, Fig. 2B. The transistor gives more turn-off gain than is inherent in the SCR.

The combined signals, error and acquisition, are fed to a gain control R_1 which sets acquisition level. Transistor Q_3 is turned-off, except for base leakage current. The collector voltage is 7.8-volts; this level determined by R_2 and R_3 . An increase in input signal from either channel (error or acquisition) causes Q_3 to conduct more heavily. At this time Q_3 goes into a low-voltage condition, permitting Q_4 , the SCR, to conduct. (Because of positive 7.8-volts on the cathode, from the collector of Q_3 , Q_4 has been held in an off condition. Since the positive 3.0-volts on the gate is larger than the positive cathode voltage that prevented Q_4 from conducting, Q_4 now conducts.) A reduction in the input level reverses the process and triggers Q_4 . Relay hysteresis is overcome.

Advanced Version—The LR2A theodolite is a wide-band optical instrument covering from 0.4 to 2.8 microns. An advanced version provides dual-prism sensing. Simultaneous monitoring of two inertial platform prisms, with negligible cross-coupling, from a single theodolite, is done by coating the prisms to respond to different regions of spectrum. One prism responds from 17 to 1.25 microns, the other from 1.35 to 2.6 microns. This provides an advanced, automatic dual-prism theodolite.

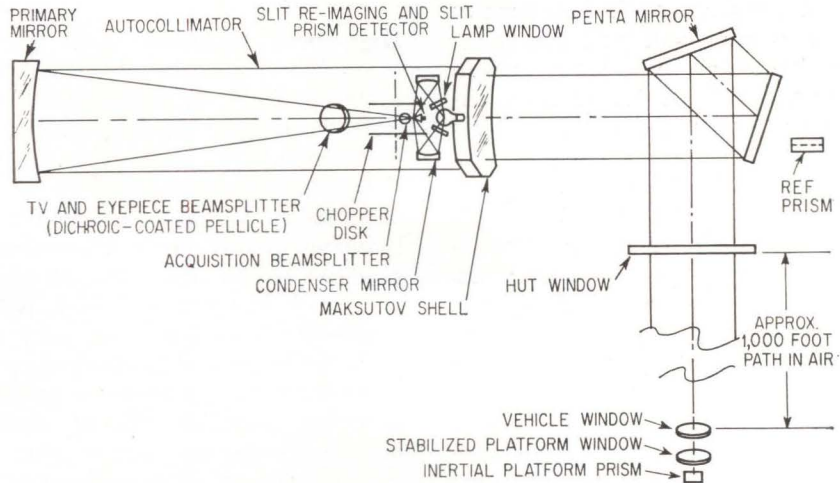

LAUNCH SITE arrangement of the Saturn theodolite and alignment with launch vehicle. Detects deviation of 2-3 seconds of arc at 1,000 feet—Fig. 1

D-C AMPLIFIER, in essence a d-c regulator, gives needed low output impedance (A). Acquisition relay driver circuit eliminates any relay hysteresis. A stable and repeatable acquisition signal level precludes direct use of relays in this circuit (B)—Fig. 2

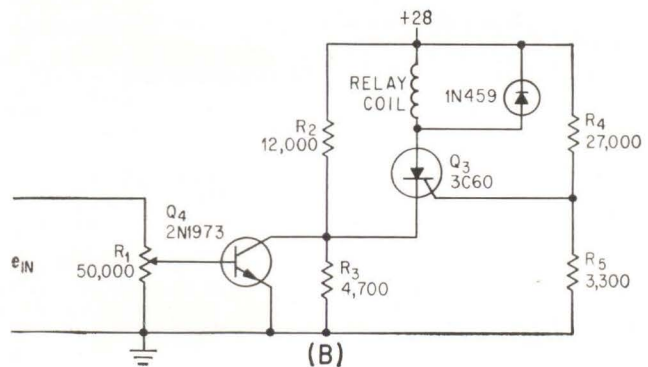
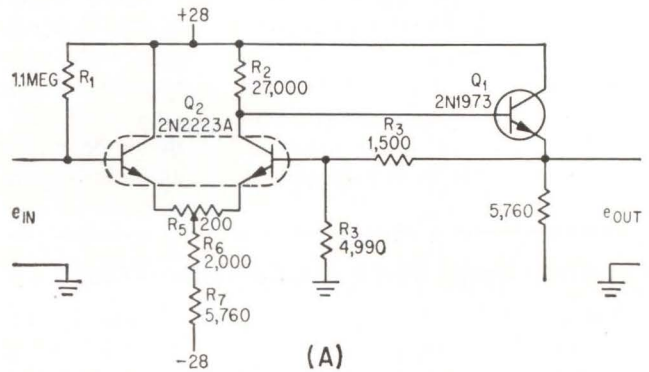

How To Design HIGH-SPEED D-A

Comparison of both weighted-resistor and ladder types of decoder networks, with analysis and design of a 10-bit ladder network decoder, including factors that affect accuracy and speed

FAST and accurate conversion of digital quantities into their analog equivalent plays an important role in data processing systems. In many applications, analog devices, such as servo motors and pen recorders, are controlled by signals derived from a digital source. Another important application is the digitally controlled generation of accurate analog sawtooth deflection voltages for cathode-ray tubes.

Digital-to-analog converters consist essentially of two parts: the actual decoding unit which is usually a high-output-impedance low-current device and a high-gain summing amplifier with a low output impedance (see Fig. 1).

Two basic and mutually exclusive requirements of any digital-to-analog converter are accuracy and speed, although power consumption per bit and packaging also play important roles. Furthermore, it is desirable to make the conversion accuracy independent of amplifier gain, permitting the use of high bandwidth summing amplifiers with relatively low open-loop gains.

This article gives the design en-

gineer a procedure for selecting circuits and components for a digital-to-analog converter that will satisfy his particular requirements.

High-Speed Decoders—Two types of decoding networks are commonly found in fast d-a converters: the weighted-resistor network and the ladder network.

Since d-a conversion requires switching of potentials, several combinations of decoding networks and switches are possible. The decoder with the equivalent of a single-pole double-throw switch (Fig. 1A) is desirable because it always presents a constant input impedance to the summing amplifier, thereby making the decoder accuracy independent of the amplifier gain; but while using (the equivalent of) a single-pole single-throw type, the impedance varies with position of the switches, making the decoder accuracy dependent on the amplifier gain. The single-pole single-throw type of decoder approaches the accuracy of the single-pole double-throw decoder only as the summing amplifier's gain approaches infinity.

Also, the single-pole double-throw type of decoder can be easily designed to work at high speeds. For these reasons, only the single-pole double-throw version will be treated.

A weighted resistor network decoder is shown in Fig. 1A. It consists of n binary related resistors: $R, 2R, 4R$ to $2^n R$; n single-pole double-throw switches S_1 through S_n ; and a high-accuracy regulated reference voltage source E_R . The summing amplifier converts the current inputs from the decoding network into their corresponding voltage equivalent. By virtue of the negative feedback across the amplifier, summing point S is nearly at virtual ground potential, provided the amplifier gain is sufficiently large. If for instance, switch S_n is in position 1, the least significant bit (LSB) current, $i_{LSB} = E_R / 2^n R$, flows toward the summing point. The equivalent circuit for Fig. 1A is shown in Fig. 1B where R_1 represents all resistors connected to E_R and R_2 all resistors connected to ground. The input-to-output relationship is given by

$$\frac{E_o}{E_R} = \frac{R_3}{R_1} \times \frac{1}{1 + \frac{1}{A} \left(1 + \frac{R_3}{R_1} + \frac{R_3}{R_2} \right)}$$

where E_o = amplifier output voltage, E_R = constant reference voltage, R_1 = parallel resistance of all bits on, R_2 = parallel resistance of all bits off, R_3 = feedback resistor, and A = amplifier gain.

Thus the output voltage is a direct function of the switch positions.

The ladder network type of decoder, used with single-pole double-throw switches (Fig. 1C), has the same inherent accuracy as the weighted type. The output voltage is dependent only on the position of the switches and the decoding accuracy is independent of the am-

Specifications: 10-Bit D-A Converter—TABLE

Ladder network resistors: IRC E-9, 1/8 watt 10K and 20K, $\pm 0.059\%$. Temp. coeff. = 0 ± 25 PPM/deg C

Switches transistors Q_1 - Q_{10} : Motorola SM747 (a selected 2N2501 having a saturation voltage of 115 mv ± 5 mv at $I_c = 10$ ma, $I_b = 4$ ma)

Matched clamping diodes D_1 - D_{10} : Fairchild FA2054 (FD100), matched within 10 mv of each other at 5 to 10 ma from -25°C to $+75^\circ\text{C}$.

Reference supply E_R : +20 v d-c. Regulation of 0.02% or better with a 100-ma change.

Auxiliary supply E_S : +50 v d-c, 2% regulation

Transistor switching times

Turn On: 25 nsec

Turn On: 40 nsec

Logic signals: 0 to -8 volts

Maximum ladder output current: 2 ma — 1 LSB = 1.998 ma.

Accuracy: worst case

(1) Maximum binary error due to resistor tolerances: 1/2 LSB

(2) Maximum binary error due to diode mismatch: 1/2 LSB. For any bit, excluding the MSB, the additional mismatch caused by the changing of the decoder never exceed 1/20 LSB and is negligible.

(3) Maximum binary error due to transistor saturation voltage mismatch: 1/4 LSB.

CONVERTERS

By C. R. PEARMAN and A. E. POPODI, Surface Division,
Westinghouse Defense and Space Center, Baltimore, Md.

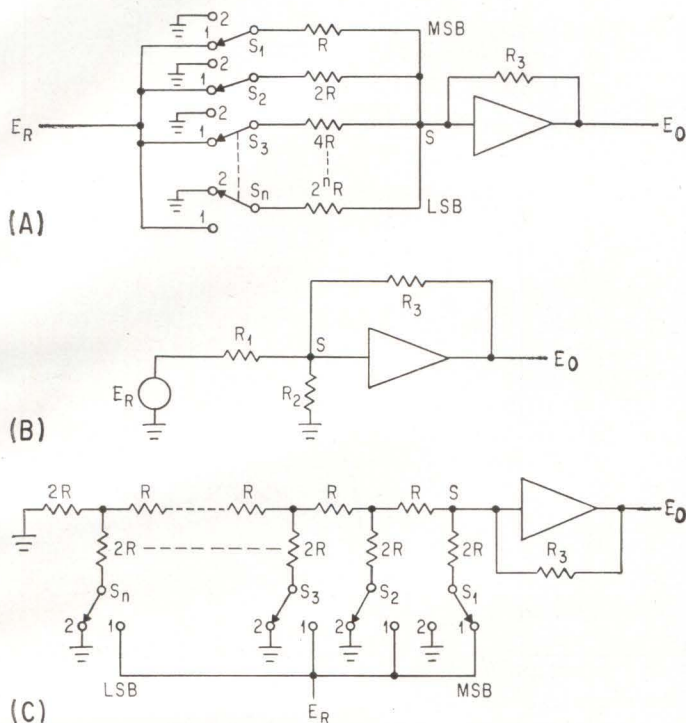

WEIGHTED-RESISTOR decoder (A) and equivalent circuit (B); ladder network decoder (C)—Fig. 1

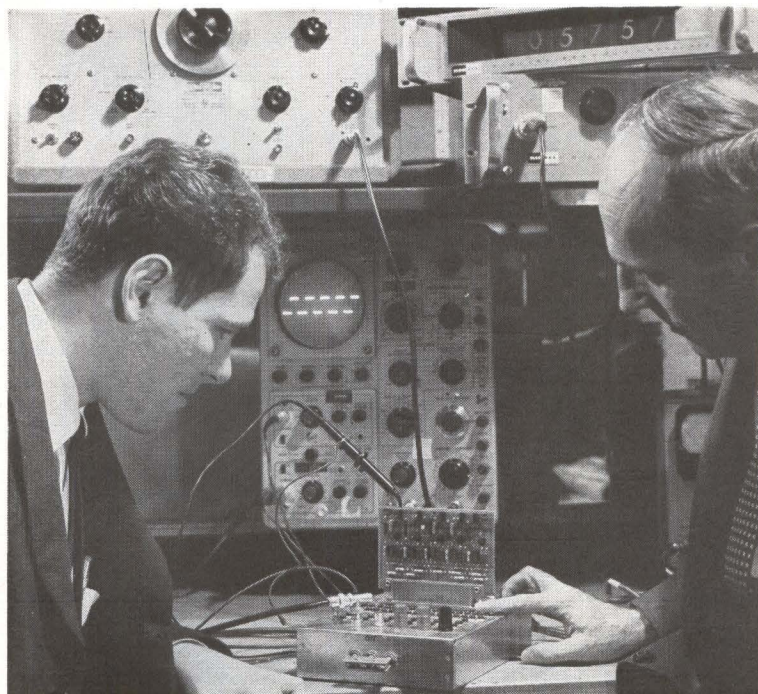

AUTHORS Pearman and Popodi examine 10-bit d-a converter

plifier gain. The current contribution to the summing point from the first ladder bit branch or the most significant bit (MSB) (switch S_1 in position 1), assuming the summing point is a virtual ground, is given by $E_R/2R$ and the current contribution of bit K is $E_R/2^K R$. In practice the summing point is only approximately a virtual ground and the amplifier gain is not infinite. However, the binary relationship does not suffer if this occurs.

Comparison—As stated before, accuracy and conversion speed are the two main criteria of a digital-to-analog converter. From an accuracy point of view, the ladder network is superior for the following reasons: The ladder network has a more uniform current distribution per bit (Fig. 2B), and all switches can be designed for approximately the same currents; for example, in a 10-bit weighted-resistor network, the bit currents vary from $2^{n-1}:1$ or 512:1, while in a 10-bit ladder network the bit currents vary by less than 14:1. The

ladder network's smaller variation in current eases switch design and can improve switching accuracy. An n -bit weighted-resistor network using n binary related precision resistors has a power dissipation ratio of $2^{n-1}:1$; with such a wide range in power dissipation there could be difficulty in maintaining the resistor values in an exact binary relationship especially under varying environmental conditions.

Finally, an n -bit ladder network uses only two values of precision resistors; an n -bit weighted-resistor network, n different values.

The second important criterion of a d-a converter is the decoding speed. If the logic waveforms controlling the decoder are assumed perfect with no delay between switching edges, the ladder network has a drawback due to the unavoidable wiring capacities between each resistor junction point and ground. This causes a delay which increases from the MSB toward the LSB. If however, the ladder is driven by a serial counter, the inherent delay of the counter and the ladder network

tend to cancel each other. As a guideline, the delay per bit of a 5-bit unit with a characteristic impedance of 10,000 ohms assembled on a printed circuit type board has been found to be about 15 nsec. Conversely, the weighted-resistor network, with no appreciable delay from bit to bit, operates better with a parallel counter. In practice, the logic signals are not perfect, and differences in rise and fall times produce commutation spikes that decrease the d-a conversion speed and dynamic accuracy.

For minimum spiking, care must be taken in selecting the proper counter or buffer along with its switching and delay times.

The decoder's absolute accuracy depends only on the absolute accuracy of the resistors and reference potentials; its binary accuracy, only on their relative accuracies. An n -bit decoder has 2^n discrete output states, evenly distributed between the two reference potentials.

Analysis—Figure 2A illustrates the potential distribution along a lad-

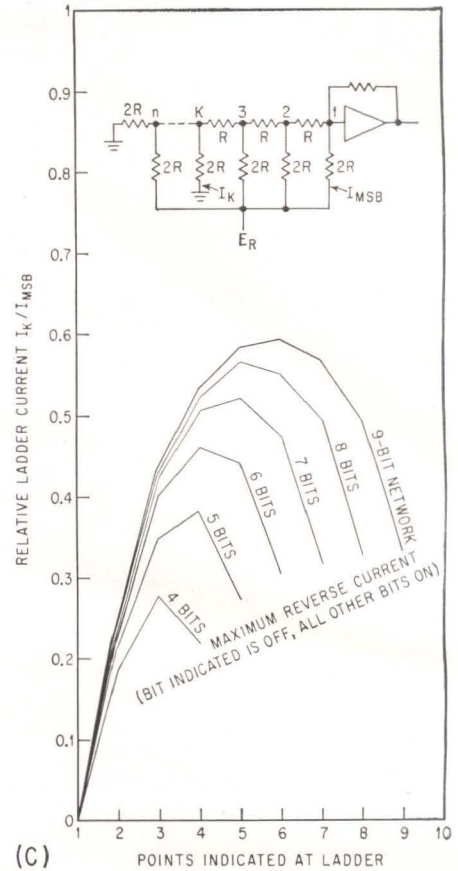
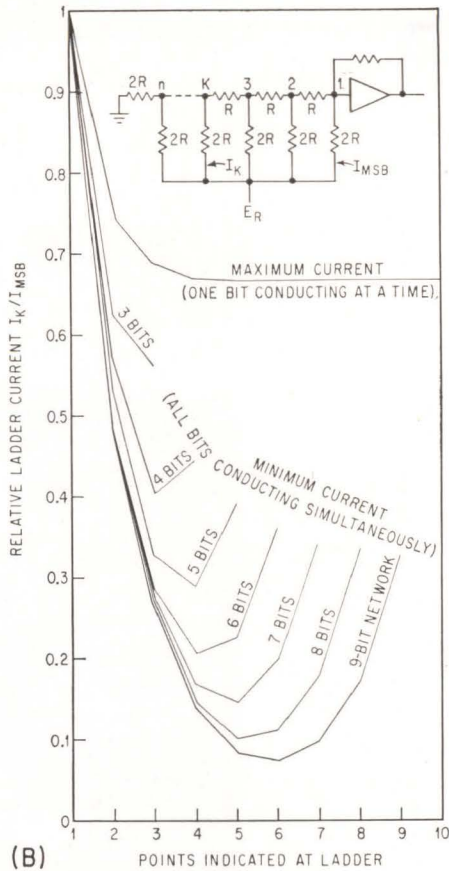
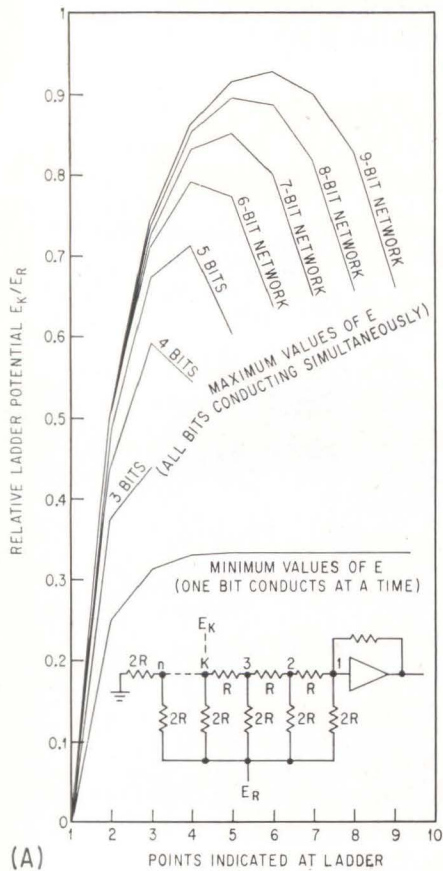

POTENTIAL distribution in ladder network (A); maximum current swing through the ON bit (B); maximum reverse current through the OFF bit (C)—Fig. 2

der network for different ladder lengths as a function of bit location. The top curves indicate the voltages at junction points 1 thru 9 if all bits are simultaneously switched to their upper reference potential assuming a virtual ground at the summing point. The voltage reaches a peak value of about 93 percent of the reference voltage E_R and drops off towards the asymptotic value of $0.666 E_R$ for an infinitely long ladder.

The bottom curve in Fig. 2A shows the voltage at a particular junction if only this bit is switched on and all others are off. Theoretical maximum voltage at the end of an infinite ladder is $0.333 E_R$, this level reached closely after 4 bits.

From Fig. 2A, Fig. 2B can be derived, demonstrating the current variations per bit. The curves are normalized with respect to the MSB current I_{MSB} . The largest current change occurs at bit 6 for a 9-bit ladder. The minimum current of $0.075 I_{MSB}$ flows close to the ladder center at bit 6 and the maximum current is practically constant from bit 4 on. Switch S_6 must be de-

signed for a current range from $0.075 I_{MSB}$ to $0.66 I_{MSB}$.

In Fig. 2B, all currents were flowing from the reference source towards the ladder. But if switch S_K is in the grounded position (bit is off), current can flow from the ladder towards the switch (if other bits are on). This is shown in Fig. 2C, of the back current into a particular "off bit" when all other bits are on, thus denoting the maximum reverse current in any given switch.

Because of these considerations the ladder-type network decoder was chosen over the weighted resistor network. The single-pole double-throw switch is replaced by a transistor. The simplest way to establish the two reference potentials is to use the transistor's own saturation voltage as the lower reference and to clamp the collector by diodes to the upper reference (see Fig. 3A). For binary conversion, the lower reference potential does not have to be zero. Figure 1 shows ground only for simplicity. When using this technique, however, certain critical factors of accuracy and speed must be considered.

Accuracy—The specific factors that concern the accuracy are:

(1) The transistor's saturation voltage ($V_{CE(SAT)}$) tolerances.

For the 10-bit d-a converter, described in this paper, selected transistors having a $V_{CB(SAT)}$ of 115 ± 5 mv at 10 ma collector current and 4-ma base current are used. The slope of the saturation voltage curve (Fig. 4A) is almost flat at 4 ma base current. This particular base current will produce a high yield in the transistor selection process. The $V_{CE(SAT)}$ variation with temperature was found to be 0.1 mv per deg C. This represents an error of about 0.5 LSB (LSB = 2^{-9} MSB) with a 65 deg C temperature change for a 10-bit d-a converter. Errors of this sort will not affect the binary relationship, provided all transistors have the same temperature coefficient, but will make the entire output rise or fall with temperature.

(2) Variation in saturation voltage due to change in collector current, caused by other bits changing states.

Knowing the potential distribu-

tion for the junction points of the ladder networks (Fig. 2A), the maximum changes in collector current for each bit can be computed. Assuming a virtual ground at the input of the summing amplifier, the MSB transistor's collector current will not vary due to other bits changing states. Therefore, no changes occur in the MSB transistor's saturation voltage. Continuing, bits 1 through 3 exhibit less collector current variation than bits 4 through 6. This is an important consequence, as errors generated in the first ladder sections are the most important and should be kept to a minimum. The maximum transistor current variation occurs in bit 6, but the effect of this error at the summing point is 16 times smaller than the error contribution of the second most significant bit. Figure 2B shows that the second MSB is the most critical, followed by the third and so on. With a 20 v reference voltage and 10,000 ohms characteristic ladder impedance, the second MSB current change is about 0.25 ma for a 10-bit unit. However, with 4 ma base current in the saturated mode of the switching transistor, the resulting voltage change can be neglected (less than 1 mv change versus the LSB weight of 20 mv). Therefore, the transistor itself provides a stable lower reference source.

(3) Change in base current due to variations in logic levels.

As the base current must be held at about 4 ma, the turn-on bias level should be well defined.

The above three factors were concerned with the lower reference potential with the transistor turned on. The next item, the upper reference potential, need only be considered when the transistor is off.

A simplified circuit of bit k of a ladder network is shown in Fig. 3A. If the transistor Q_K is cut off, its collector voltage is clamped at the reference potential due to diode D which is forward biased because of the auxiliary supply E_3 and resistor R_1 . The main disadvantage of this circuit is its poor temperature stability. For silicon diodes, as temperature increases, the diode voltage drop decreases approximately 2 mv per deg C, thus decreasing the reference potential. This will only affect the d-a converter's absolute accuracy, the binary re-

lationship remains unchanged provided all diodes vary the same amount.

To overcome this problem, drift compensation with matched diodes can be used (Fig. 3B). Diode D_1 is always forward biased by R_2 and point E_1 drifts towards E_R , the reference supply, if temperature increases. With transistor off, diode D_2 conducts and its forward voltage drop is opposite and equal to that of D_1 . By using matched diodes and by proper selection of R_2 , point E_2 becomes temperature independent. E_3 denotes an auxiliary supply with lower stability requirements than E_R and resistor R_1 provides the saturation current for the transistor in the ON state. During turnoff, R_1 establishes a fast change of the collector voltage towards the upper reference level E_R . Resistor R_1 should therefore

be small for fast switching. Its minimum value is determined by the power dissipation of the transistor and by the permissible power consumption per bit.

(4) Diode current variations.

Having selected E_3 , E_R and R_1 , the current variations in each diode D_2 caused by the changing states of the decoder, can be calculated with the aid of Fig. 2B. Since the matched diodes require equal forward currents for best tracking, resistor R_2 must be chosen accordingly. Since the current in D_2 changes between two limits, R_2 can be selected to provide matching at the average value. This would require different values of R_2 for each bit. However, the differences in R_2 from bit 2 on are small and one common value can be used. Only the MSB diode currents can be exactly matched resulting in a slightly

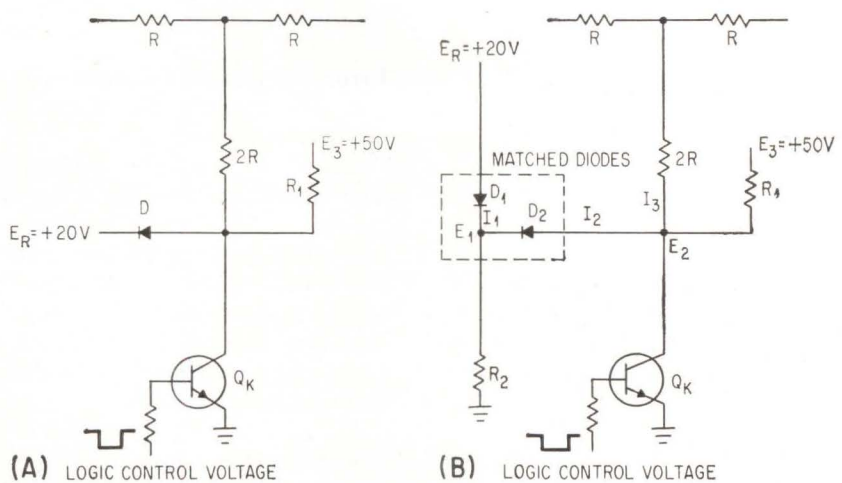

LADDER NETWORK, bit k , with transistor switch (A) and with temperature-compensated switch (B)—Fig. 3

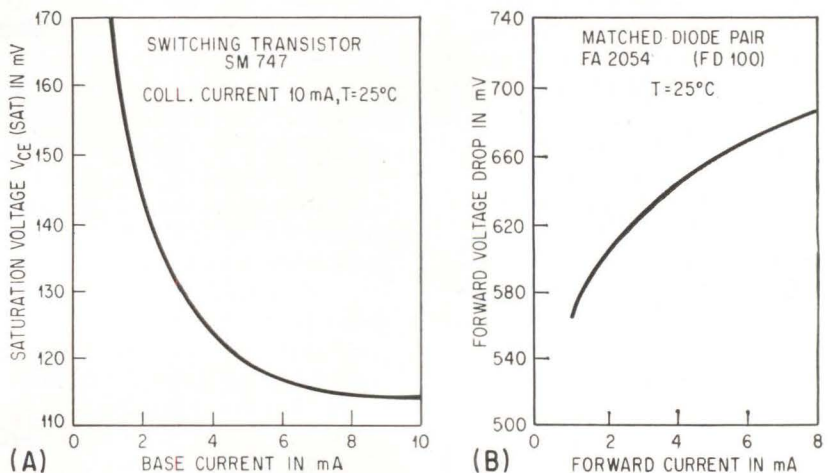

SATURATION voltage versus base current (A); voltage drop versus forward current (B)—Fig. 4

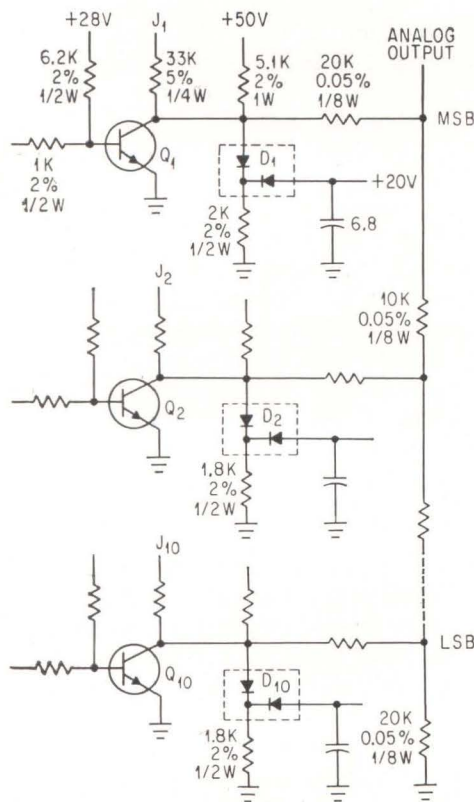

TEN-BIT digital-to-analog converter, accepting negative-pulse digital inputs at 0 to -8 volts—Fig. 5

lower value of R_2 for this bit (see Fig. 5).

Figure 4B shows the typical forward voltage drop of the clamping diode used in this digital-to-analog converter. With forward currents in the 4 to 6-ma region, the voltage drop is approximately linear with current change and the maximum error voltage for each bit can be directly determined. As with the saturation voltage, the error due to diode current mismatch is zero at the MSB, increases to a maximum at bit 6, then asymptotically decreases to a final value from bit 6 to the end of the ladder. As before, the error contribution for any given bit as seen at the summing point must be obtained by proper weighting.

(5) Transistor leakage current variation.

If silicon transistors are used, the temperature dependent leakage current can be neglected for temperatures below 65 deg C. For example, the transistor used in this d-a converter has less than 65 na leakage current at 65 deg C while the minimum diode current I_2 in bit 2 is about 5,500 μ a.

(6) The final factor influencing

d-a converter accuracy are the ladder network resistors themselves.

For high-accuracy d-a converters, these resistors should have a low temperature coefficient and should remain in tolerance from d-c up to the maximum switching rate of the ladder network.

The accuracy requirements of the resistors can be determined by knowing the number of bits that need be converted. For instance, using worst case conditions, the minimum required resistor accuracy for one LSB error in a 10-bit decoder (one part in 1,024) would be about 0.1 percent if no other error sources exist. But because of the errors in reference sources, discussed above, at least 1/20 percent precision resistors or better are required. The maximum binary error can be found simply by knowing the maximum individual errors due to the resistors, the mismatch in the clamp diodes and the transistor saturation voltage.

Error Calculation Example—10-Bit decoder (Fig. 5), worst-case conditions.

Error 1 (resistor tolerance): The maximum possible error due to the 1/20 percent tolerance is equivalent to $\frac{1}{2}$ LSB for a 10-bit d-a converter. It occurs when the MSB resistor has its maximum deviation in one direction and all other bits have maximum deviation in the other direction.

Error 2 (diode mismatch): In this example is a maximum of ± 10 mv mismatch in the clamp diodes. The maximum binary error occurs when the most significant bit is clamped to one extreme level and all other bits are clamped to the other extreme; that is, with all bits on and using a 20-volt reference supply, the most significant bit is clamped to 19.990 volts and all other bits are clamped to 20.010 volts. By knowing that the current contribution of bits 2 through 10 equals the most significant bit current contribution minus one LSB, we see that in this case there is an error that is equivalent to two times the maximum error due to the most significant bit alone. Therefore, the error current would be $(2 \times 10 \text{ mv})/20\text{K} = 1 \mu\text{a}$, which equals $\frac{1}{2}$ LSB for this 10-bit decoder.

Error 3 (transistor tolerance): The maximum error due to toler-

ances in transistor saturation voltage is calculated in the same way as error 2. (Note that errors 2 and 3 cannot occur at the same time). Therefore, add errors 1 and 2, and add errors 1 and 3 to determine the maximum error in the decoder.

Decoding Speed—The factors concerning the decoding speed are:

(1) The rise and fall times of the transistors should be kept as short as possible to minimize commutation spikes.

(2) Due to the high base current, the transistor is hard in saturation and storage time is a problem. Therefore, transistors with low storage times should be used. Speed-up capacitors may be needed to reduce storage time.

(3) The clamp diodes should preferably have low forward resistance with minimum storage and recovery times.

(4) A conflict between speed and accuracy can arise when selecting the values of the ladder resistors.

From a speed point of view they should be low, yielding high decoder bandwidth and consequently high speed. But from an accuracy point of view the ladder resistors should be high, this also reduces power dissipation, improves the decoder's temperature stability and overall packaging density.

(5) The physical layout of the components should minimize stray capacities at all junction points of the ladder network.

(6) The last important factor is the summing amplifier itself. One with high gain and high bandwidth would be most desirable; but, as with selecting the value for the ladder resistors, compromises must be made in speed or accuracy depending on which is most important.

Example—A practical example of a 10-bit d-a converter, designed using the above principles as guidelines, is shown in Fig. 5. The specifications are given in the table.

Transistor switches Q_1 to Q_{10} are controlled by logic signals with zero to -8 v level and a resistor network provides the necessary base current for each transistor. Points J_1 to J_{10} are test jacks. The 33,000-ohm series resistors serve to avoid capacitive loading of the collector circuit due to test-jack capacitance.

AUTHOR studies the characteristics of his solid-state digital voltmeter

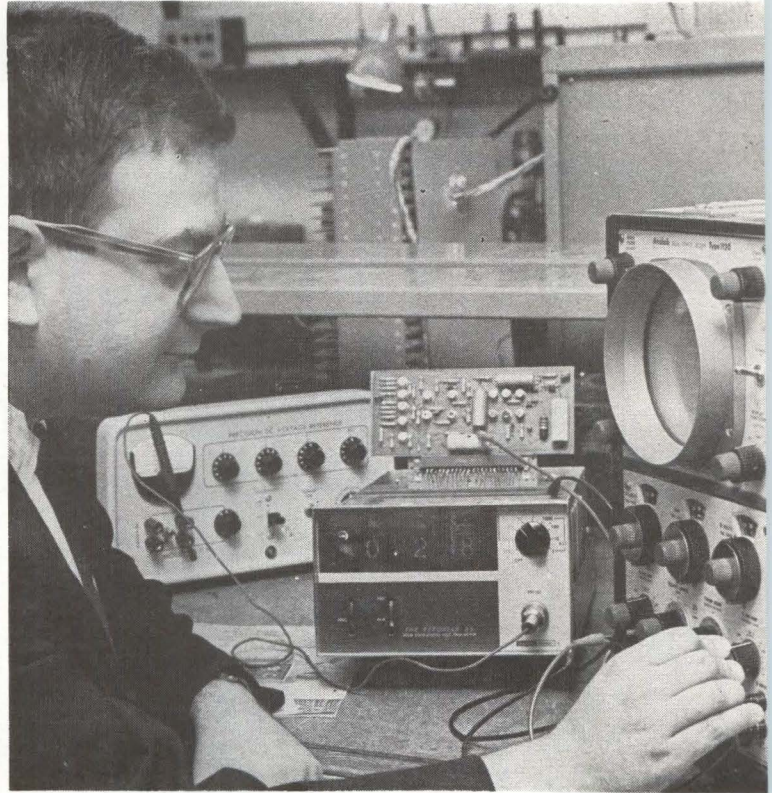

Modified Ramp Generator

Develops High D-C Input Impedance

Classical ramp technique is modified for use in a solid-state voltmeter. The result is reduced cost and simplified operation—no input d-c amplifier is needed in most cases

By **RICHARD C. WEINBERG**
Data Systems Division
Harmon-Kardon, Inc.
Plainview, New York

IN THE DESIGN of a digital voltmeter, if the functions of ramp generator, comparator and flip flop are combined into one circuit designed to have a high d-c input impedance—the result has none of the disadvantages normally associated with digital voltmeters. Mainly, the combination is less expensive and simpler.

Present-day digital voltmeters operate by comparing an internally generated analog voltage with the input voltage. The major difference between the various units is the method of generating the internal comparison voltage. Most units today use a multistep voltage divider operating from a stable standard

fixed voltage and controlled by some form of stepping switch. Although the stepping technique is good for accuracies better than 0.01 percent, the stepping switches, precision resistors, and precise voltage standard comprise the major portion of the cost of a fully solid-state unit using this method.

Lesser used techniques are the ramp type and the servo type. Both of these approaches are suitable for accuracies of 0.1 percent. The servo technique involves a motor driven self-balancing potentiometer seeking to null the input against a divided reference. The motor position is mechanically coupled to rotating wheels with painted numbers (like an automobile odometer) for a digital display.

The ramp technique uses an electronically generated linear sweep voltage which moves through uniform, calibrated increments of volt-

age during each cycle of a precise clock frequency that is usually crystal-controlled. A comparator circuit picks the points in time when the ramp crosses zero volts and crosses the unknown voltage, thereby converting voltage to a time interval which is counted as cycles of the clock.

Classical Approach — The ramp-type voltmeter has the configuration shown in Fig. 1. The input signal is processed by an attenuator and amplifier to a uniform full-scale voltage value. The attenuated input is then compared with a precise linear ramp voltage. At the instant of equality, a pulse is generated, setting the UNKNOWN flip flop. Since the starting point and the initial transient on the ramp are not well known, it is difficult to establish a known voltage point on the ramp. Therefore, the zero comparator is

used to produce a pulse as the ramp goes through zero volts (or some other reference voltage). The time between the comparison pulses of the two comparators is proportional to the absolute value of the difference between the unknown voltage and the zero reference voltage. In

addition, detecting which of the two flip flops was the first to produce a pulse will give the sign of the unknown voltage compared to the zero reference voltage, since the direction of the ramp slope is known.

While this system is known to work well, it has several drawbacks.

First, commonly used differential comparators cannot drive the logic directly but their outputs must go through amplifying and flip flop stages. Second, (and more important) the comparator itself must present a low impedance to the input signal for a substantial fraction of the time, so that input d-c amplification is essential for isolation.

In the combined approach (figure 2) the ramp generator has to be duplicated. Still, the resultant unit is much simpler, and loads the attenuator with gig-ohm effective impedance levels without an input amplifier. Functions within the dotted lines are accomplished by the new comparator section. An input d-c amplifier is used only in those units required to have a more sensitive scale than the basic 10 volt full scale. Fig. 2 shows the block diagram.

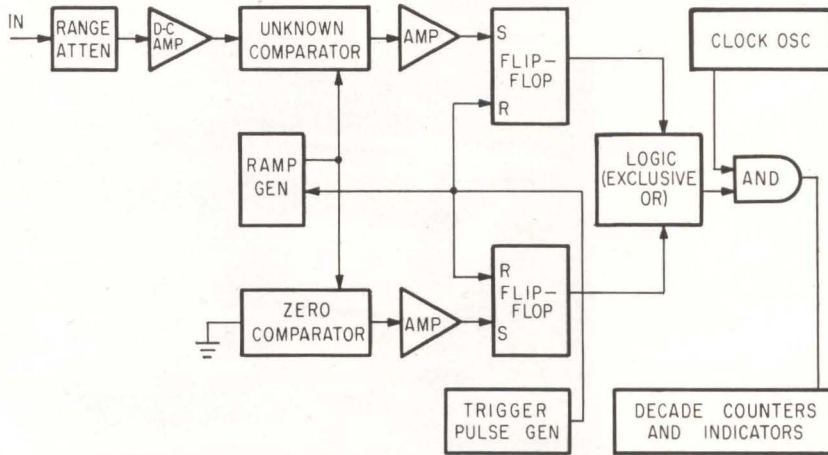

CLASSICAL ramp-type digital voltmeter involves complicated circuits and high cost—Fig. 1

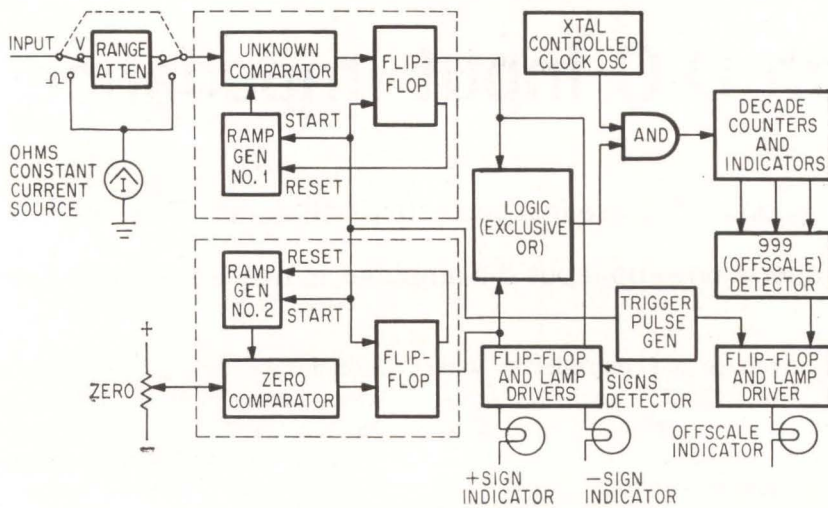

FUNCTIONS of ramp generator, comparator and flip-flop are combined in one circuit (dashed lines) having a high d-c input impedance—Fig. 2

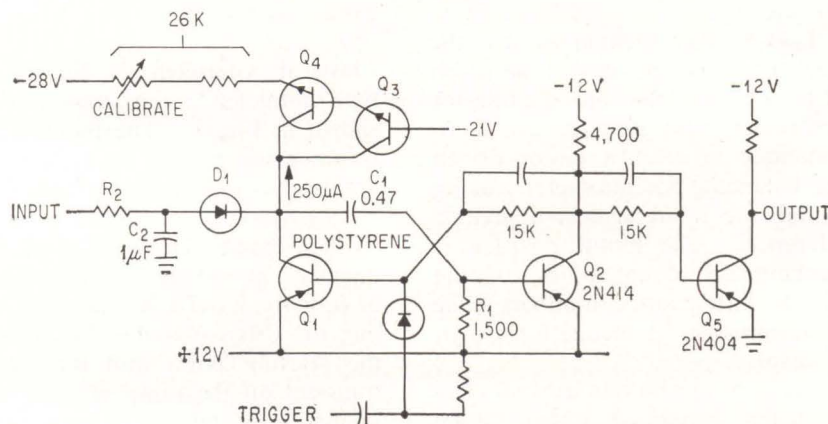

COMPARATOR CIRCUIT uses a silicon alloy chopper (Q_1) to minimize the effects of variation of offset voltage and leakage current—Fig. 3

Circuit Details—The circuit chosen for use in the comparator section is shown in Fig. 3. The two pnp transistors, Q_1 and Q_2 , are arranged as a monostable multivibrator. In the stable state Q_1 is on and Q_2 is off. When a trigger pulse is received the circuit changes to its quasi-stable state. The constant current regulated by Q_3 and Q_4 is diverted to charge C_1 , which charges linearly, producing a ramp of high accuracy. The charging time constant, to a close approximation, is C_1/h_{ob4} (where h_{ob4} is the grounded-base output admittance of Q_4) and can easily be made several thousand times the duration of a comparison cycle. The charging current passing through R_1 produces enough voltage to keep Q_2 turned on. As the ramp voltage passes and begins to exceed the input voltage, some of the charging current is diverted through diode D_1 to charge capacitor C_2 . This reduces the voltage across R_1 , turning off Q_2 , and causing the circuit to return to its stable state. Transistor Q_5 isolates the monostable section from the logic, and restores ground level. The time the circuit is in the quasi-stable state is proportional to the difference between the positive voltage at the emitters of Q_1 and Q_2 and the unknown voltage across C_2 . However, drift of the positive voltage (and that of other circuit variables) is cancelled from the reading of the instrument by the use of another, identical cir-

circuit as the zero-comparator.

The extremely high input impedance of the comparator circuit results from operating D_1 normally cut off. Diode D_1 conducts for only the few microseconds that it takes to reduce the base current of Q_2 sufficiently for regeneration to start. With the total regulated current set at about 250 microamperes, the peak of the current pulse through D_1 is some tens of microamperes, lasting long enough to deliver some 200 picocoulombs into C_2 . The average value of the input pulsed current is in the order of 10^{-9} ampere when sampling at its fastest rate of 200 milliseconds. The leakage current of the diode is of this order of magnitude in the opposite direction and ordinarily dominates the input current.

Note that this high impedance is to d-c only. Impedance for a-c input is essentially equal to R_2 because of the necessity of making C_2 a larger value than C_1 . The value of C_2 also limits the choice of attenuator source resistance at d-c due to time-constant requirements in charging C_2 .

Results—Waveforms produced by the circuit are shown in Fig. 4 and Fig. 6. The ramps start simultaneously but end at different times. When the unknown voltage is positive the input comparator ramp ends before the zero-comparator ramp; when the unknown voltage is negative the input comparator ramp terminates later than the zero comparator ramp. A voltage step equal to the base drop of Q_2 (which is the same as the drop across R_1) precedes the linear portion of the ramp.

The logic is an exclusive OR gating circuit that produces a ground-level signal only when the outputs of the two comparators are in different states. The circuit, which includes transistors Q_6 and Q_7 in Fig. 5, acts as a rectified differential amplifier. A logical ground signal on one input appears also at the output only if the other input is negative enough to saturate the transistor in series with the grounded input. Use of this circuit eliminates the need for complementary inputs required by more conventional types of exclusive logic gates that suffer from the resulting differential delay and pulse leakage. Transistor Q_8

in Fig. 5 gates the clock oscillator (which is continuously running) into the decade counters. Transistor Q_9 generates a blanking gate equal to the duration of the longer comparator ramp. This blanking gate is used to inhibit display and recording of digits and signs during the count-up interval.

A complete measurement, including sign determination, is made fol-

lowing each trigger pulse within 2.5 milliseconds. Measurements may be made at intervals of at least 7 milliseconds to allow circuit recovery. The internal trigger pulse generator is variable from 200 milliseconds to 5 seconds between pulses. The writer acknowledges the aid of L. J. Torn, Vice President, and R. I. Salzer, Chief Engineer.

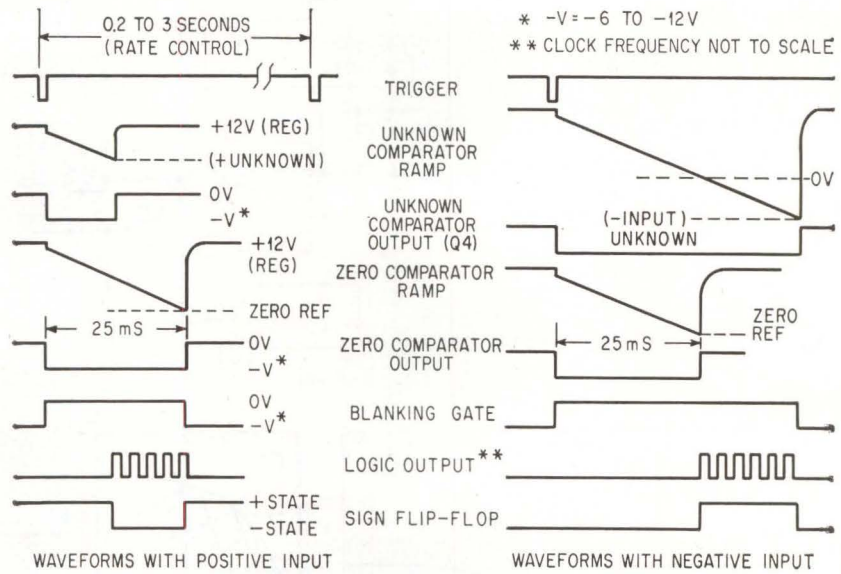

WAVEFORMS are produced by the comparator and logic circuits—Fig. 4

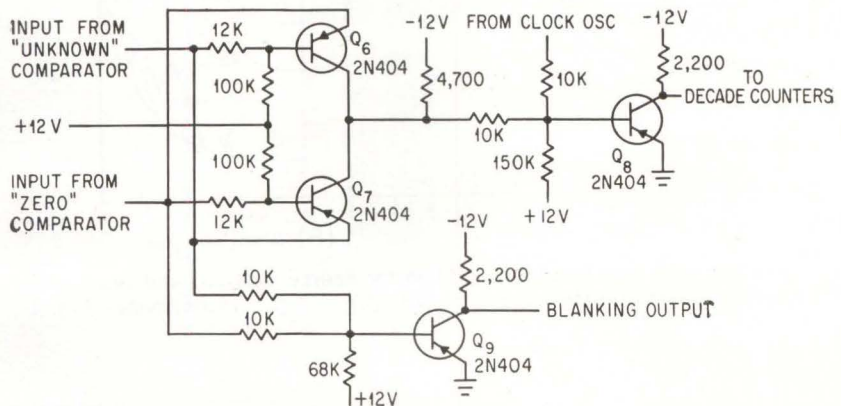

LOGIC is an exclusive OR gating circuit that produces a ground level signal only when the output of the two comparators are in different states—Fig. 5

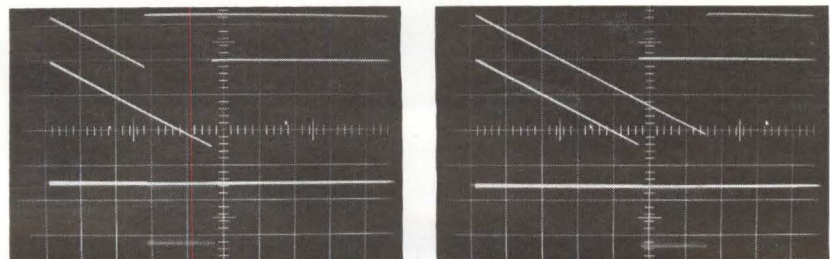

WAVEFORMS result from positive input (left) and negative input (right). The scope traces show: top, the unknown comparator ramp; middle, zero comparator ramp and bottom, the logic output or gated clock pulses. The scales are 5 v per vertical division and 5 ms per horizontal division—Fig. 6

Voltage Controls Solid-State Nonlinear Resistance

Symmetry of device characteristic can be shifted with bias

By **FRANK D. NEU**
Lawrence Radiation Laboratory*
University of California
Berkeley, Calif.

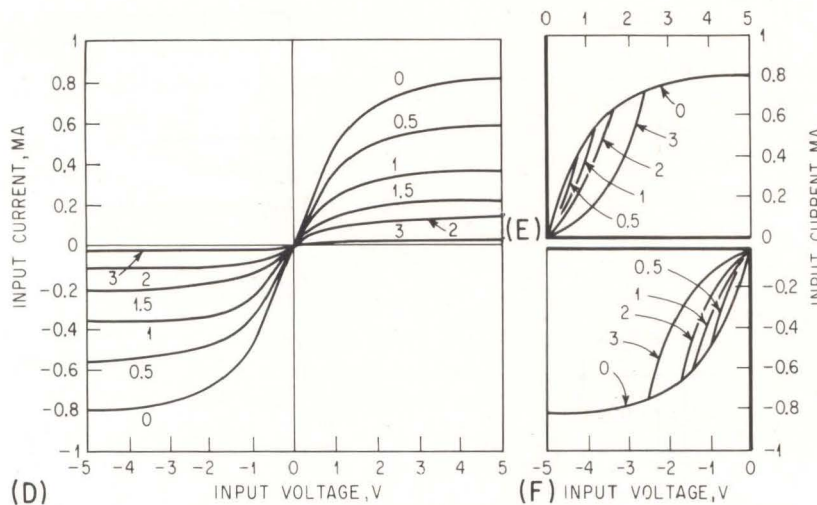
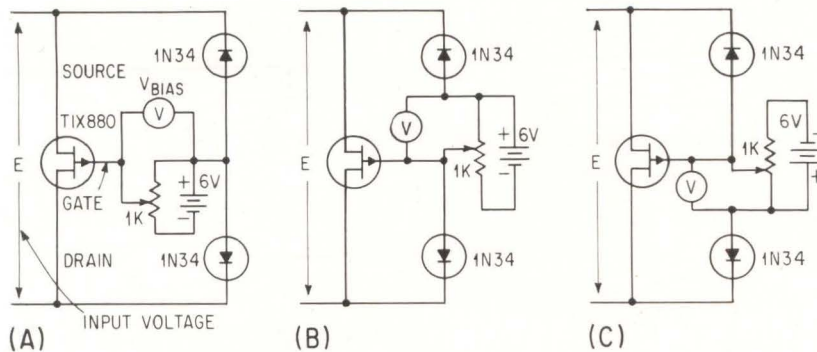

BASIC circuit with gate bias (A) modified for source bias (B) and drain bias (C) produces characteristic curves of (D), (E) and (F), respectively—Fig. 1

A FIELD-EFFECT transistor, two diodes and a biasing arrangement (Fig. 1) can be used as a two-terminal, voltage-controlled nonlinear resistor. Such a combination can be employed in automatic gain control or frequency-multiplication circuits. This network gives symmetrical characteristic curves about the volt-ampere origin. However these curves are modified, their intersection with the O,O point is invariant. A control bias (Fig. 1A) selects the shape of the resistance function (Fig. 1D). The range of resistance variation near the origin in a typical circuit has been measured between 1.33 and 33.3 kilohms.

If biasing is introduced between one of the diodes and the gate (Fig. 1B, C) the volt-ampere characteristics may be translated from the origin (Fig. 1E, F). The device curves

* Work done under the auspices of the U. S. Atomic Energy Commission.

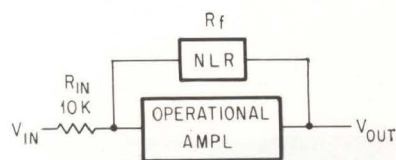

CIRCUIT using the nonlinear resistance for increased voltage gain with increased voltage output—Fig. 2

CURVES show input-out relationship when the nlr is used to increase the voltage gain—Fig. 3

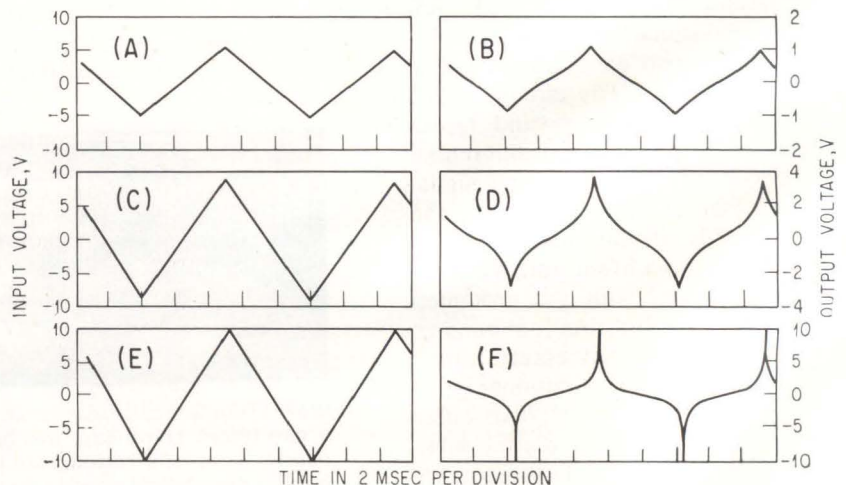

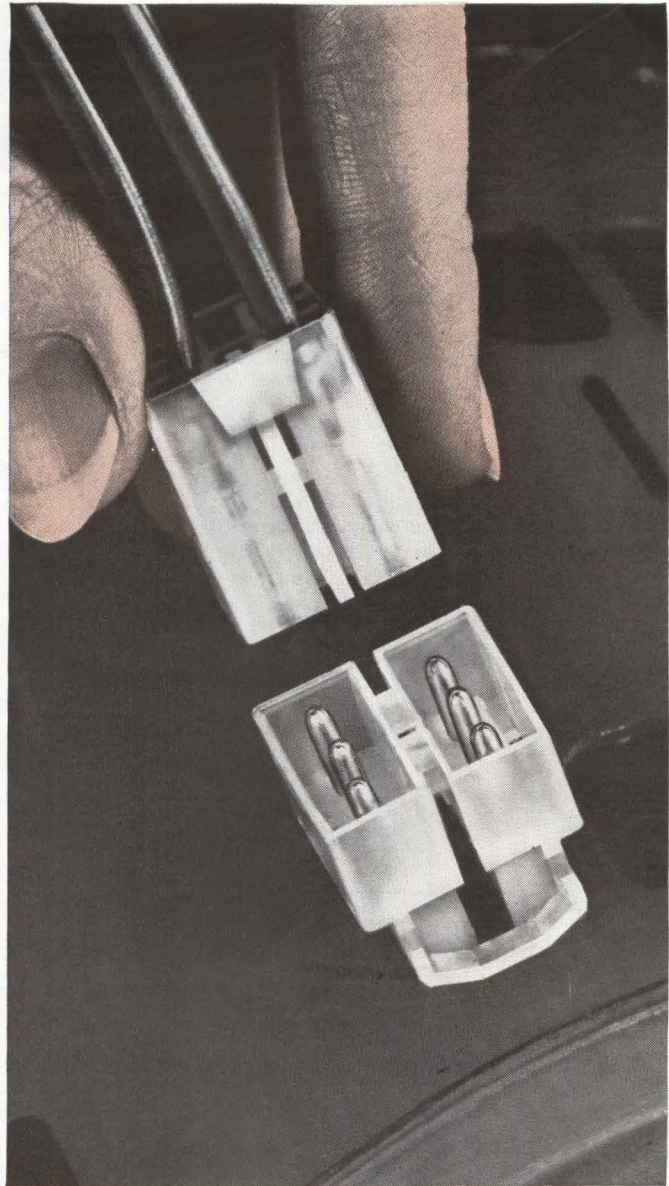
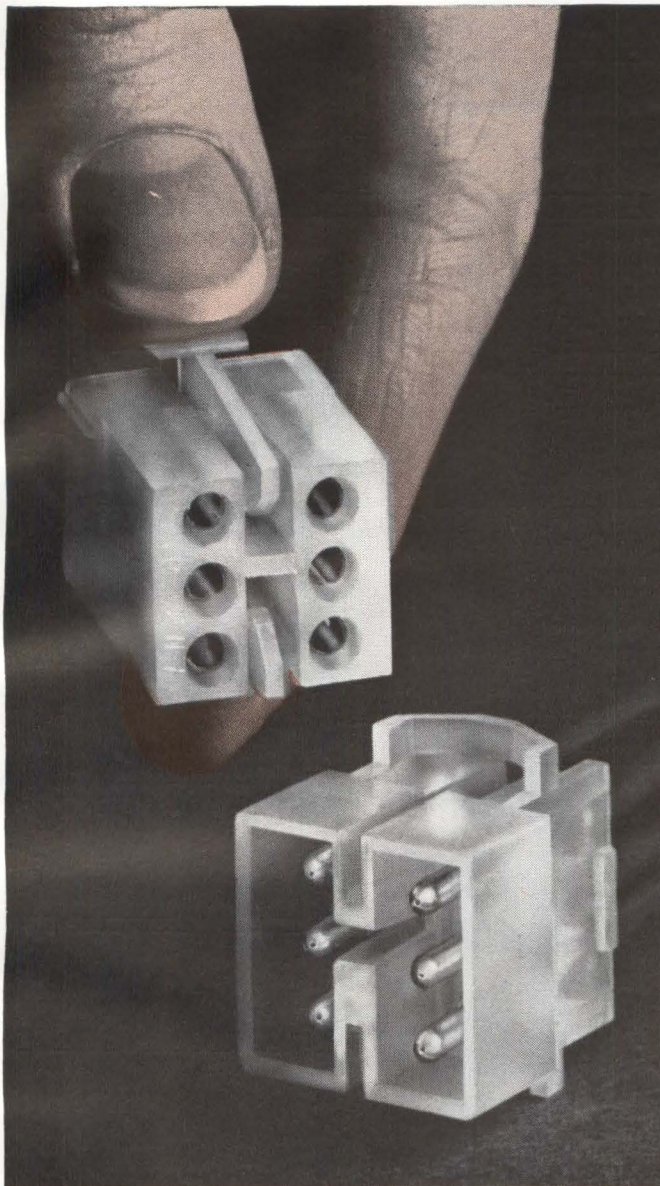

A perfect windup . . . for any motor

Here's what happens to a MATE-N-LOK* Connector when the motor manufacturer's requirements are considered.

Current carrying capacity? This motor mount connector carries up to 25 amps. Number of circuits? Up to 12. Reinsertion of conductor excess into the housing. Easy! No need to push, jam or cram snarled "spaghetti" against motor windings. It projects only a short .10" into the motor cavity. Assembly is quick, clean . . . easy. All done by hand. Hand pressure snaps the connector half into the housing and it snaps to stay! Against flat or curved surfaces040" to .065"—The MATE-N-LOK Connector hangs on securely through an integral rib and wing design that conforms to either surface. And this is all in addition to everything else you find in the MATE-N-LOK Connector line.

You still get:

- clean contact design—no sharp projections to slow up assembly or harm personnel.
- low cost, formed contacts—automatic crimping with matching tooling at rates of up to 4,000 terminations per hour.

- non-oriented hand insertion of snap-in contacts into polarized nylon housing.
- positive locking device to hold connector halves securely together.
- AMP's patented "F" crimp for high resistance to vibration and corrosion.
- off-the-shelf availability of the complete MATE-N-LOK Connector line—6, 9 and 12-way hot-side panel mount and 6, 8, 10 and 12-way cold-side motor mount types . . . all in one type connector to serve every need throughout your equipment.

For complete details write today. Your request for a sample on company letterhead will be answered immediately.



AMP products and engineering assistance are available through subsidiary companies in: Australia • Canada • England • France • Holland • Italy • Japan • Mexico • West Germany
*Trademark of AMP INCORPORATED.

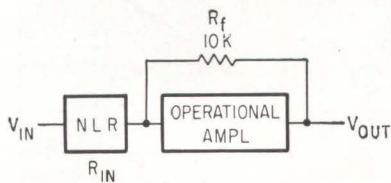

NONLINEAR resistance used to obtain decreased voltage gain with increased input voltage—Fig. 4

OSCILLOSCOPE displays show input-output amplitudes when the nlr is used for decreased gain—Fig. 5

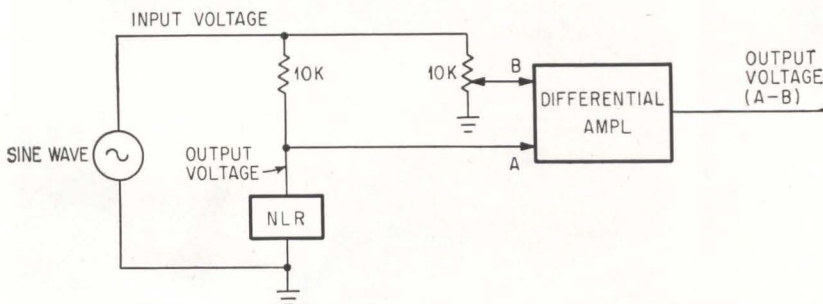
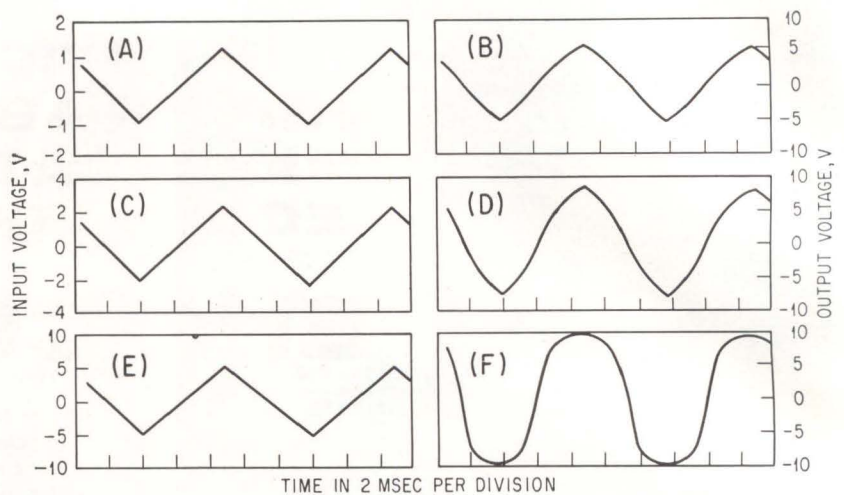

FREQUENCY can be tripled over a range from 1 cps to 100 kc—Fig. 6

WAVEFORMS resulting from connection of the nlr to obtain third harmonic—Fig. 7

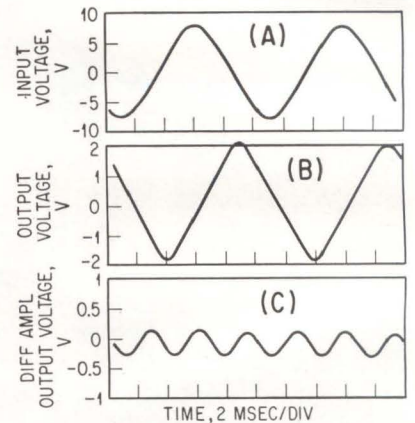

suggest a use as a nonlinear resistor for high-level positive or negative voltage signals where a variable bias voltage can control the shape of the nonlinear resistance curve. The curves of Fig. 1E, F suggest use of a variable bias to control the symmetry of the nonlinear resistor with respect to a positive or negative applied voltage.

The circuit with zero volts bias was used in the feedback loop of an

operational amplifier as shown in Fig. 2. A triangular-wave voltage signal was applied and the output voltage measured. Since the voltage gain is approximately R_f/R_{in} and R_f in this case increases with voltage across it, the amplifier gain increases with input voltage (Fig. 3).

Next, the circuit with zero volts bias was placed in series with the input to an operational amplifier as shown in Fig. 4. As the voltage

across R_{in} increases, the value of R_{in} increases, so that here the voltage gain decreases as the input voltage increases. A triangular-wave voltage was applied to this circuit and the output voltage measured (Fig. 5).

Finally, the nonlinear resistor was used with zero volts bias in the circuit of Fig. 6 to obtain frequency tripling. A sine-wave input to the device through a 10,000-ohm resistor results in a voltage across the nonlinear resistor that has a large third harmonic component. Cancellation of the fundamental frequency by use of a differential amplifier separates the third-harmonic component (Fig. 7). If the sine-wave input amplitude is not changed, the differential amplifier output is triple the fundamental frequency over a range from below 1 cps to above 100 kc.

BETTER THAN A TUBE

The versatility of the electron tube permits it to be employed as a voltage-controlled resistor. But besides other advantages inherent in transistors, the circuit combination described has the advantage of using a field-effect device that is easily biased to produce nonlinear gain or loss

VERSATILE, DEPENDABLE COMMUNICATIONS EQUIPMENT BY AEROCOM

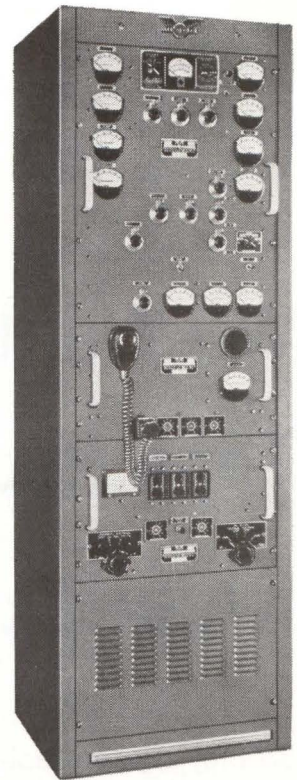
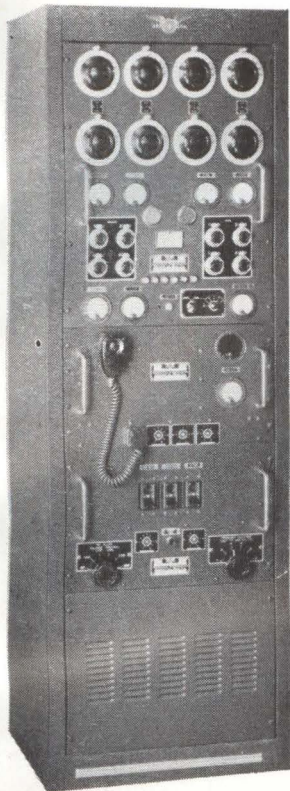

← A versatile stable rugged H.F. transmitter for A-1, A-3, FSK communications. Designed for point-to-point, ground to air, operating on 4 crystal controlled frequencies in band range 2-24 mcs. 1000 watts carrier power. Also available in 100 or 350 watt models. FCC Type accepted.

A VHF transmitter extensively used in extended range and satellite command services. Nominal output of 1000 watts in frequency range of 118-153 mcs. Can be remote controlled. FCC Type accepted. Also available in 200 watt and 50 watt models. →

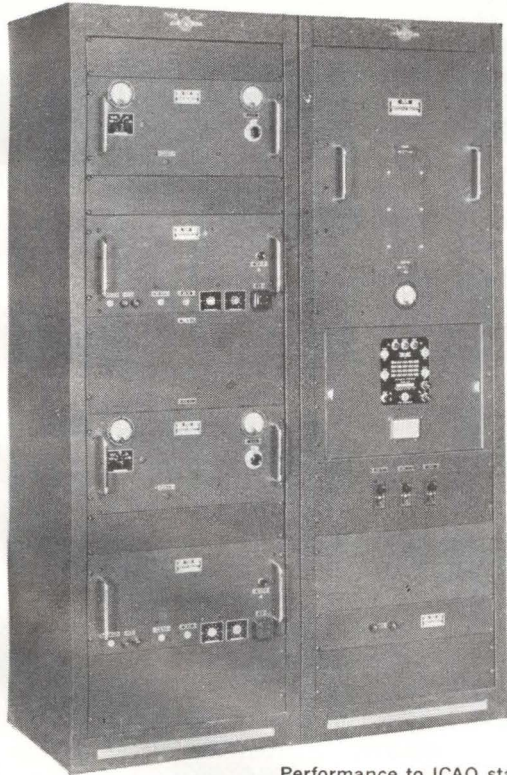

↑ Model 85 — VHF Receiver. Low noise figure, single conversion, crystal controlled and very stable. Receiver covers frequency range 108-154 mcs. Also available, Model 77 for H.F.

Model 10LA—For more communications power AEROCOM 10LA linear amplifier used with your SSB transceiver will provide 1000 watts PEP for continuous service. Housed in cabinet that can be used as stand for exciter. Four non simultaneous channels cover band 2-22 mcs. →

← This dual package type ND Beacon operates in range 200-500 kcs. Intended for unattended service. It consists of 2-100 watt transmitters, 2 keyers, transfer unit and antenna tuner. Available in 50, 400, 1000 and 3000 watt models. FCC Type accepted.

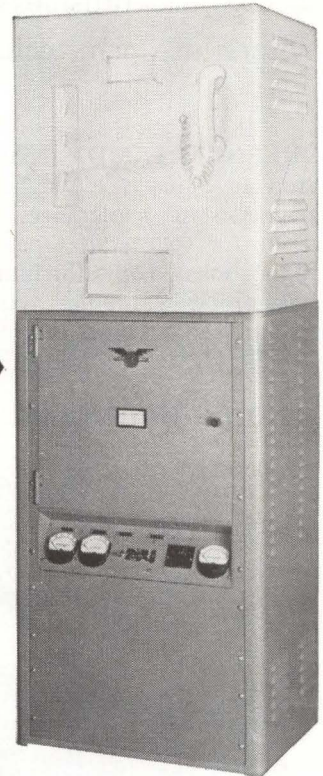

Performance to ICAO standards. All AEROCOM equipment is ruggedly constructed to give long trouble-free service. Additional information on request.

Complete
technical data available
on request

WORLD WIDE



SINCE 1946

FCC Type Accepted
for Aviation Service

3090 S. W. 37th Avenue — Miami 33, Florida

FIRST MODEL of capacitor-sensing brushless d-c motor

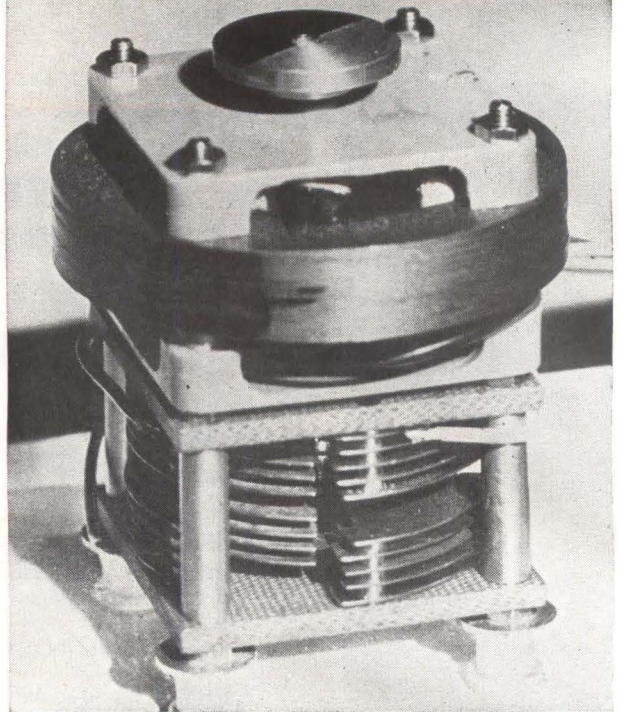

We Want Better Tape Recording, NASA Experts Say

So they tighten tape specs, build brushless motors, use pcm technique

GREENBELT, MD.—NASA is issuing to industry a tougher set of magnetic-tape tolerance requirements for spacecraft tape recorder applications. Tapes for future planetary probes will require oxide binders and backing tapes that are stable

at temperatures up to 145 C. Present tapes, according to NASA sources, have limited reliability above 70 C.

The requirements were set forth at an intercenter tape recorder conference at NASA's Goddard Space Flight Center here, January 29 through 31.

The conference also called for more accurate sizing of tapes. The accuracy of commercial processes of slitting tapes from rolls up to 18 inches wide is marginal and will not

fully meet NASA's future requirements. Spacecraft recording tape tolerance will become ± 0.0005 inch.

Better lubrication and reduction of static electricity are also required. Studies indicate that electrostatic charge may contribute to flutter and other drive-speed errors normally attributed to friction alone.

Improved tapes are needed, the conference made clear, because the industrial tapes now used were not developed specifically for the miniature tape recorders flown aboard spacecraft. The space environment and requirements for compact recorders make present tapes inadequate for future planetary probes, speakers said.

PCM Recording—Among recent NASA advances in recording discussed at the conference is a pulse-code-modulation recording technique. It permits recording with density as high as 10,000 bits per linear inch and reduces dropouts that result from tape wear during long periods of unattended operation.

The integrated waveform out of the playback head is differentiated and combined with the clock playback in a sampling circuit. The output from this triggers a multivibrator which regenerates the pcm data.

Since tape recorder heads cannot be cleaned once the spacecraft has been launched, avoiding signal loss

Radio-Controlled Paraglider Tested

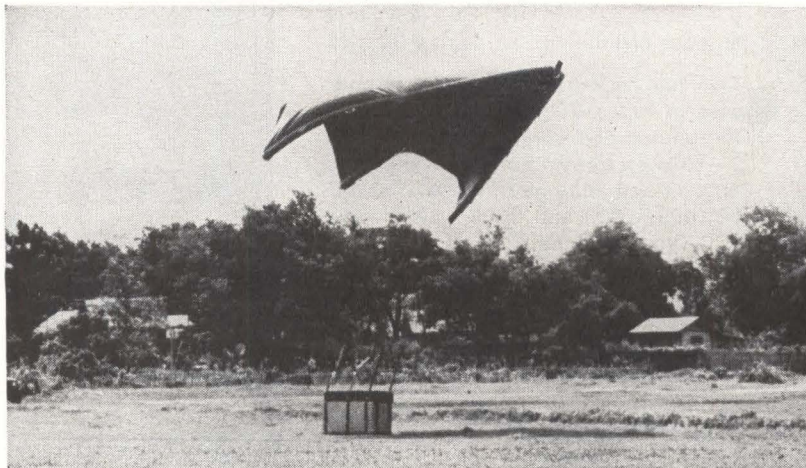

INFLATED-WING GLIDER is maneuvered to landing by radio control during tests in Thailand for U. S. and SEATO forces. The gliders—called Flex Wing by Ryan Aeronautical Co.—are designed to drop supplies in remote areas. They can be radio-guided or will automatically home on target. Meanwhile, Minneapolis-Honeywell has just built a solid-state control system for a projected NASA paraglider that would be controlled by astronauts while landing a manned spacecraft

is extremely important. Oxide rub-off, where the oxide coating of the tape rubs off onto the recording head, is a particular problem in this area.

The pcm technique also conserves spacecraft weight and power because less tape is required and less power is needed to pull the tape. An operational system employing this technique has been developed for the Orbiting Solar Observatory and the Atmospheric Explorer projects.

Brushless D-C Motor—NASA has investigated many types of brushless d-c motors, including devices using photocells, Hall effect and inductance. Brushless designs can improve reliability of recorder drive motors by reducing the number of wearing parts.

A significant advance disclosed at the conference is the development of a capacitor-sensing brushless d-c motor. Switching of power to the d-c windings, needed to drive the motor's rotor, is accomplished by capacitor sensing of the rotor position. The a-c carrier signal is modulated by the capacitor and the output detected. The detector drives a transistor switch which turns the field windings on and off. Capacitance air-gap plates that mesh are used. One set of plates is stationary, while the other is attached to the rotor. In effect, the plates perform the functions of brushes and commutator rings.

Goddard points out that there are no wearing parts in the sensing network and no elements to burn out. Such a motor operates efficiently in the environmental extremes of space. Production cost is comparatively low.

Goddard Space Flight Center has patent applications pending on both the pcm recording technique and the capacitor brushless d-c motor.

The meeting was attended by about 40 spacecraft tape recorder specialists from eight NASA field centers. The conference was the first of its kind and will set a precedent for future meetings. Harold J. Peake, chief of Goddard's Flight R-F Systems Branch, was conference chairman. P. T. Cole, head of the Recording Techniques Section of the branch, originated and organized it.

ARGUMENT(?) ON THERMO- ELECTRICS

Design Engineer: "Thermoelectrics is here to stay. It's by far the best way to temperature-stabilize critical electronic components in the entire range of operating ambients."

Management: "Best—why?"

Design Engineer: "There's no maintenance problem with TE enclosures...less space...less weight...and better system performance."

Management: "Explain 'better performance'."

Design Engineer: "With TE temperature stabilization we gain higher operating efficiency, lower noise levels, greater frequency stability, longer component life."

Management: "But what about reliability?"

Design Engineer: "Thermoelectric enclosures have been and are now functioning without failure in commercial, industrial and military applications."

Management: "Aren't TE units expensive?"

Design Engineer: "Not when you consider the money we can save by simplifying system design. What's more, thermoelectrics can do an efficient stabilizing job in places where it would be impossible, or too costly, to use other equipment."

Management: "Good! How do we get these devices?"

Design Engineer: "Carter-Princeton is the leading manufacturer of TE products especially designed to solve cooling, heating and stabilization problems."

Carter-Princeton is the electronics division of Carter Products, Inc., established in 1880 and one of the world's leading manufacturers.

FREE! "When to Specify Thermoelectric Temperature Stabilization"...

...is the title of a new, authoritative, 12-page, fact-filled study just completed by Carter-Princeton's technical staff. Write for your free copy today: Carter-Princeton, 178-F Alexander Street, Princeton, N. J. 08540, Phone (609) 921-2880.

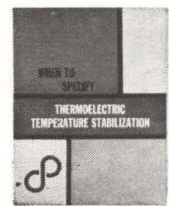

CARTER-PRINCETON



New Displays For Space Flight

Sophisticated approaches will feed pilots more data with less strain

By **RON LOVELL**
McGraw-Hill World News,
Los Angeles, Calif.

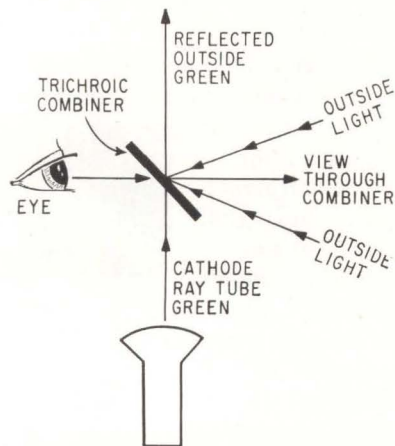

TRICHOIC combiner principle rejects outside green light, reflects cathode-ray-tube green signal into eye's direct view—Fig. 1



HORIZON projector generates an artificial horizon of light around pilot at all times, kept parallel to earth's horizon by vertical gyro commanding pitch and roll drive servos—Fig. 2

ANAHEIM, CALIF.—The most efficient way for man to receive information is through his eyes. A knowledge of human limitations can help to exploit and enhance a pilot's information-receiving ability without fatiguing or sickening him.

To meet the need to eliminate eye fatigue and decrease the burden of pilot duties in high-speed air- and spacecraft, scientists at the Autonetics Division of North American in Anaheim, Calif., are developing new types of display systems.

Most of the new displays for pilots center around an Autonetics-developed specially coated trichroic combiner, mounted in the pilot's normal forward view (Fig. 1). The coating gives the combiner glass a two-way reflection in the green wavelengths, eliminating a narrow band of green light from the outside. The projector transmits a luminous green pattern toward the combiner, where it is reflected to the viewer's eyes. The remaining magenta-hued light (white minus green) is allowed to pass through the combiner. The pilot's eyes sense that the green light is missing and become hypersensitive to this color.

The internally-generated luminous pattern is made up of the same narrow green band that the com-

biner is coated to reject. The eye then sees the displays as a bright green image painted on the earth and clouds ahead. By use of a red filter in the optical system at night, the pilot can view the flight data display without interfering with his eyes' dark adaption; the luminous red patterns are clearly visible.

Head-up unit—The head-up unit consists of an overhead combiner-glass optical system about 28 inches from the viewing eye, and projects information such as instrument panel, radar and landing displays onto the combiner. The pilot can then simultaneously make readings and observe the flight path.

Horizon projector—A display system delivered to NASA's Ames Research Center, Moffet Field, Calif., for use in ultrasonic transport studies, provides a ready horizon reference regardless of pilot position through a ring of light encircling the cockpit (see Fig. 2).

The horizon projector bounces an intense 1/10-in. beam of light off a cone-shaped reflector broadcasting a 270-degree, 3/4-in. band. Pitch and roll drive servos linked to a vertical gyro keep the projector stable with the horizon.

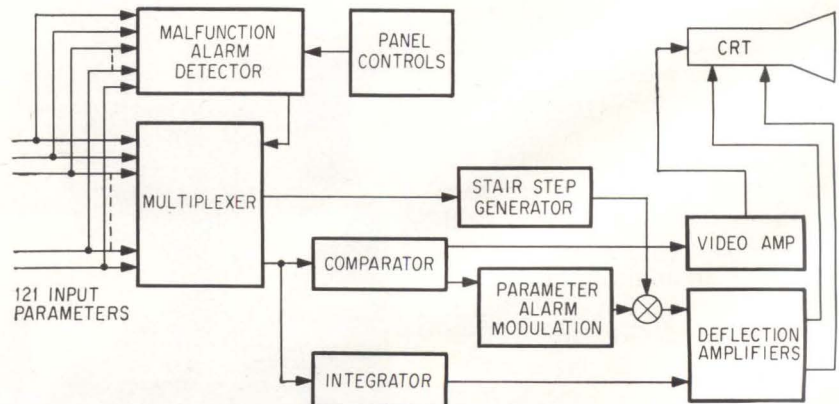

SYSTEM management display block diagram combines 121 input signals into bar-graph form generated on a single crt, and sequentially projected in groups into pilot's line of view—Fig. 3

In the "hops-helps" (for helmet optical system) unit, display is achieved by a device mounted on the visor of the pilot's helmet. Information is displayed on a goggle-like instrument.

Another facet of Autonetics' display research is in the electroluminescence (E-L) control techniques directed to aircraft/spacecraft applications where favorable trade-offs in size, weight, power consumption and reliability exist, and in multi-color E-L panels involving production of multi-color outputs from an essentially monochromatic source.

Recent control-technique work includes the study of direct computer control of a digital display by a combination of an optical technique and a high-resolution solid-state light amplifier.

The multi-color E-L panel development uses a method of color transformation to induce subjective color in the retina. The study has produced five unsaturated but distinct colors from a single phosphor.

Systems management — Systems management displays, consisting of a cathode-ray tube with a magnifying lens, a projector, beam splitter and display panel, monitor and assess information from all spacecraft systems presently using control panel meters. All critical information can be shown in one area of the panel to inform and alert an operator to critical system functions by electronically generated horizontal cursors, grouped by subsystem and resembling a bar graph.

A single integrated display of this type can replace 41 meters, and identify 121 critical spacecraft system parameters. For malfunction indication, the 121 parameters are divided into 13 frames each displaying a given system in bar graph form. In conjunction with high and low limit comparators, OR logic continuously monitors all 121 inputs or that portion of those parameters establishing GO-NO GO limits. When a malfunction is detected, an alarm light is lit under the button corresponding to the malfunction. At the same time, the display is pre-empted to that frame and the malfunction shown by broadening and intensifying the corresponding bar. Block diagram of projection system is in Fig. 3.

MASSA SOUND PRESSURE MICROPHONES



EXTEND the DYNAMIC RANGE of SOUND LEVEL MEASUREMENTS

THE MASSA MICROPHONES, MODEL M-141 SERIES, WERE DESIGNED TO EXTEND THE DYNAMIC RANGE OF COMMERCIALY AVAILABLE SOUND LEVEL METERS BY 50 DB!

A few of the important features of the M-141 series are:

- Linear Dynamic Ranges to sound pressures in excess of 200 db (re: 0.0002 microbars).
- No External Power Supply required.
- ADP (Ammonium Dihydrogen Phosphate) for uniform reliability, stability, and accuracy.
- Frequency Ranges from 20 cps to 30,000 cps.
- Omni-Directional Pattern for sure pickup of sound in difficult areas.
- Near Infinite Acoustic Impedance or no loading of the sound field.

For more accurate Sound Pressure Measurements, complete systems are available from Massa featuring: microphones with frequency ranges from 20 cps to 100,000 cps; a precision 60 db calibrated amplifier; preamplifiers; and a portable battery operated power supply.

MASSA
A DIVISION OF
COHU
ELECTRONICS, INC.

Write for:
"Guide Posts
for Selecting
Sound Pressure
Microphones."



280 LINCOLN STREET • HINGHAM, MASS. 02043

Flat Cable Shrinks Microcircuit Modules

Pins and sockets
eliminated for
interconnections

BUFFALO, N. Y.—Through use of a new thin, flat, high-density micro-miniature cable, it may be possible to hook up 80,000 integrated microcircuits in a volume of one cubic inch, according to Cornell Aeronautical Laboratories, developers of the new cable. This is more than 80 times as many as can be accommodated by more conventional methods, and represents an improvement approaching two orders of magnitude.

The new microcable, a micro-miniature version of flat conductor cable (Electronics, Feb. 16, 1962, p 60; and Feb 23, 1962 p 64), is electroplated on a mylar sheet and then transferred to pressure sensitive, mylar-backed adhesive tape 0.001 inches thick. A low-powered microscope is used to align the integrated circuit wafer with the cable during assembly. Mylar tape encapsulates the circuit.

Connections — The cable can be connected to a small circuit chip—up to 1,000 connections per linear inch. It can be instantly removed and replaced in a module without physical or electrical damage to the cable itself or to neighboring wafers.

A typical commercial integrated circuit wafer measuring 0.05×0.005 inches has a volume of 12.5×10^{-6} inch³. When it is conventionally cemented in a typical protective housing, the volume of the assembly increases at least 100 fold. Cornell Aeronautical Laboratory's method for interconnecting circuits permits the direct connection from any type of integrated circuit wafer to the subsection of a functional module.

Volume-consuming pins and sockets are not employed in this interconnection concept. The weight of

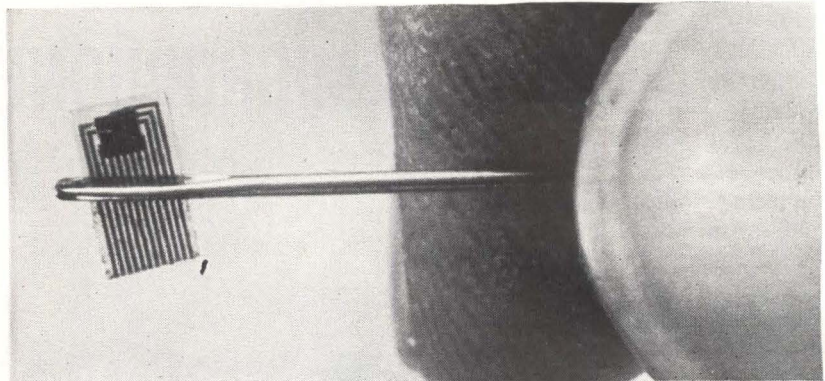

THIN, FLAT cable, electroplated on mylar sheet, fits through needle's eye. Development will greatly reduce the size and weight of microcircuit connections

the protective interconnecting medium approximates the wafer.

If tantalum or titanium is employed as the interconnection medium, a nontoxic liquid metal composition can be used for interface contact. This concept permits noise-free electrical contacts to be made at room temperature and simplifies maintenance. Circuits can be easily removed or changed without affecting others.

Other means for securing interfaces include soldering, spot welding, electron-beam welding or laser-beam welding.

Thomas L. Robinson, originator of the microcable connector concept, believes the development lends itself to automation through implementation of present day technology of phototechniques for developing microcircuits and cables.

The applications of this development of microconnectors may be unlimited, according to Robinson. In the aerospace industry alone, reduction of weight and space made available by fine-line cable connectors is obvious. Plugs, sockets and wiring harnesses occupy more space than the equipment they connect.

Knowledge gained in printing microconnectors is being applied by CAL to making fine line elements for an infra-red image converter.

Ultra-Cold Transistors Yield Usable Gain

THE IDEA came from a customer. A research worker, experimenting with various types of transistors in extreme cold found out that one type worked well under certain conditions. He couldn't get the characteristics he wanted, but reported his findings to the manufacturer, the National Semiconductor Corp. This gave the company the clue they needed. And they came up with a transistor whose forward current transfer ratio, input impedance, breakdown voltage, and other parameters, are all guaranteed down to -200 C.

The cryogenic transistor looks much the same as any other in physical appearance. There is nothing much new about the mechanical construction. What's different about it? NSC spokesmen say its a matter of diffusion. Company won't reveal details, but claim they have been able to develop diffusion techniques in the manufacture of the transistors that give usable gain down to -200 C. Transistor gain normally falls off as temperatures reach down into cold regions. Military transistors can go down to -55 C or -65 C. But electron action slows down below that, and usable gain is not much

good. Diffusion techniques developed by NSC make the difference. And they have come up with a device that gives usable gain at -200 C .

The cryogenic transistor, dubbed CG-1, will operate efficiently from 175 C to -200 C . It is an *npn* silicon device of the signal type.

Who needs a -200 C transistor? Right now their use is not widespread. But they can be important under highly specialized conditions. For instance, infrared sensors that operate in liquid nitrogen can incorporate an amplifier right in the sensing element with no need for temperature compensating devices. The military has a need for passive detection systems, where the signal amplifier can be exposed to the same low temperature as the indium antimonide detection cell.

Mate—Research workers, at several laboratories, say they see the possibility of mating the new transistor with cryotrons and other superconductive logic elements that operate in extreme cold. In industry, the CG-1 could be used in measuring and test equipment.

Complex data processing equipment, for example, operates more efficiently at constant low temperatures. Almost no power is wasted, and circuit design is simplified. Elaborate temperature-compensating devices are no longer needed. Both components and complete circuits can be designed for more efficient operation within a narrower temperature range. The problem of moisture is eliminated, dissipation and loss in conductors and insulators are reduced. Less noise is encountered, and the use of liquid nitrogen to maintain cryogenic conditions slows aging of solid-state components.

Research workers see many as yet unexplored opportunities for the new transistor in circuits functioning at liquid nitrogen temperatures. Liquid nitrogen is effective in reaching cryogenic temperatures. It is comparatively low in cost, chemically inert, has a low dielectric constant and large breakdown voltage. When many similar circuits are to be cooled, as in electronic data processing equipment, the same liquid nitrogen can be used, in turn, to precool containers of liquid helium for use with cryotrons.

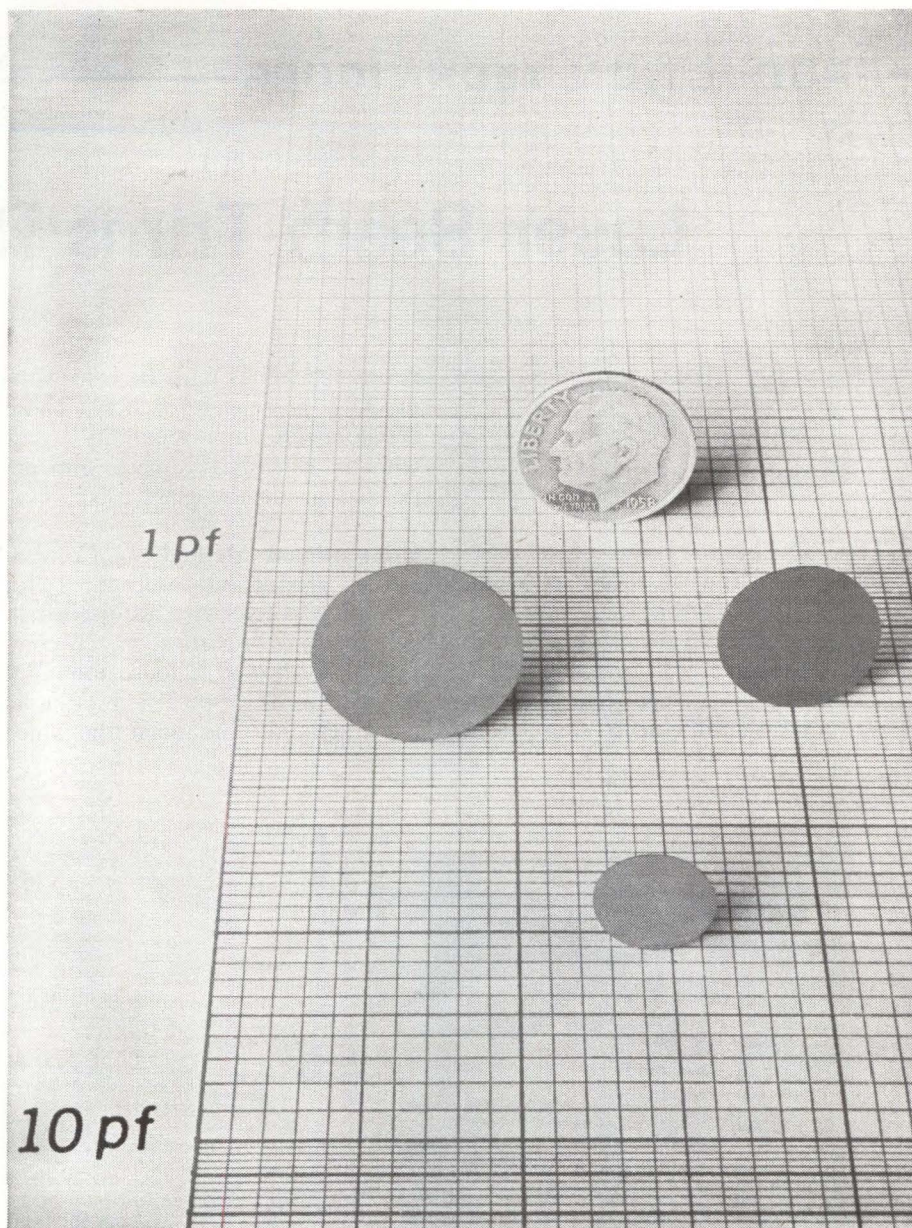

If the capacitance of our silicon optical detectors were any lower, we'd have nothing to talk about.

As matters stand, we have little enough to show at only 2 to 3 picofarads for a 5 mm D detector. Never, before ENL's Type 612, has capacitance so low been combined into a silicon optical detector with all these additional features:

Low Leakage Currents: Less than 1 micro-ampere at 5 volts reverse bias

High D^* (Detectivity): 10^{12} to 10^{13}

Spectral Response: Broad response peaking around 9000 \AA ; down to 70% of peak at 0.5 and 1.03 microns

Series 612 detectors are available now in a wide variety of shapes, dimensions, and mosaic configurations. They match up beautifully with GaAs injection laser and sub-laser diodes (also available from ENL).

For full information about this product and ENL's complete optical systems capabilities, write to the address at right.

Other ENL Optical Detectors

SERIES 9000 SILICON: For extremely precise definition of areal dimensions in simple or multiple detector arrays; for high D^* (detectivity) values to 10^{13} .

TYPE 613 INDIUM ARSENIDE: Function efficiently at room temperature; spectral response near 3.4 microns to match the atmospheric window between 3.4 and 4.2 microns.

TYPE 622 SILICON: For maximum speed, 10-nanosecond time constants.



ELECTRO-NUCLEAR LABORATORIES, INC.

2437 Leghorn Avenue Mountain View, California

Laser Beam Trims Resistors

Trimming after aging
and sealing yields
0.05-percent units

THE INTENSE beam of a laser trims metal film resistors so accurately the Daven Division of General Mills, Livingston, N. J., can sell them as 0.1 percent units. Vaporizing by the high energy beam is a final manufacturing step when

resistance values must be held within 0.05 percent or better. These resistors are high-reliability types with an extra-heavy metal film deposited inside the glass tube.

Conventional Method — Conventional production procedures for trimming to tolerance are used first. A length of resistive metal compound is allowed a loose tolerance by first using a precision lathe to cut a helix into the metal film which

has been deposited on the glass tube's inner surface. Resistance is constantly checked and controlled by a 5-digit bridge.

Daven normally spirals the metal film until the tolerance reaches 0.5 percent and then the resistor is sealed and aged, yielding a tolerance of 0.4 or 0.3 percent. It is then encapsulated.

Laser Method—However, for really tight tolerances, Daven then uses the laser to trim even closer. Where the laser is to be used, the end of the helix cut made by the lathe is located and indexed and the extra metal is vaporized by the laser. An important feature is that all laser work is accomplished after the resistor has been sealed and thoroughly aged. This means that whatever resistance is produced will be maintained.

The laser production steps are as follows:

- Each resistor is inserted into a jig on the laser.
- The laser is fired, vaporizing the metal.
- The resistor is indexed until a tolerance of 0.05 percent or better is shown on the 5-digit bridge.

Extreme accuracy of focusing of the laser beam onto the end-point of the helix is made possible by a 72-power magnifier with cross-hair indices.

After the trimming operation is completed, the resistor is covered by an epoxy outer coating.

Manual or Auto—The intensity of the light provided by the optical system of the laser unit is adjustable. The control panel enables the operator to select either manual or automatic firing and allows simple control of the power output. Infrared heat is removed by water filters. The high-energy output of the laser—equal to 10 million watts per square inch—exceeds the degree of



RESISTOR-TRIMMING laser has control panel operator's left, magnifier in center, and focusing screen on right. Laser head is not visible since it is located beneath the console

vaporization needed for most known types of metal film. The firing rate, nominally one time per second, and power output, nominally 800-joules, are both adjustable. The equipment is made for Daven by Maser Optics Inc., Boston, Mass.

System Positions Photomask To 0.0005-inch Accuracy

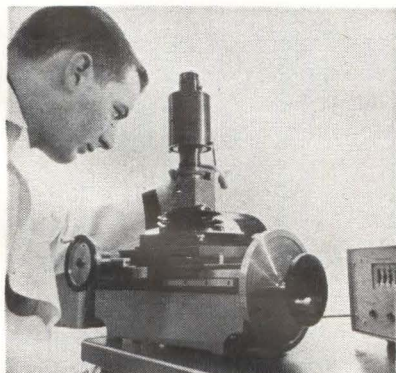

SYSTEM DEVELOPED by David W. Mann Co., Lincoln, Mass. permits in-house production of photomasks within a few hours. The system positions image to an accuracy of 0.00005 inches. Top photo shows photo reduction camera, in the center is the master reticle alignment instrument, and third is the photo repeater that makes the photo mask

700 turns

No. 37 Single Enamel Wire
Insulation on Both Leads Stripped
Finished Coil Taped

800 coils per hour

Leesona No. 116 Automatic
Bachi Bobbin Winder
automatically:

- Closes the tail stock.
- Insulates starting lead with tape.
- Winds coil.
- Stops winding at ± 2 turns.
- Strips insulation from start and finish leads.
- Tapes finished coil.
- Waxes finished coil.
- Indexes wire guide.
- Cuts wire.
- Ejects finished coil.
- Sorts coils of two different specifications.
- Counts number of coils produced.



At 7250 turns, No. 39 single formex wire, 585 coils per hour is a typical production rate reported by prominent manufacturers who use the No. 116. Operator merely loads bobbin on arbor of individual head as table rotates, and clips starting lead. Production can be cycled to operator's loading time by controlling clockwise table rotation from $\frac{1}{4}$ to 2 rpm. Winding speed of each head can be set according to number of turns desired. Write Leesona Corporation, Warwick, Rhode Island.

Or call Leesona at 5700 W. Diversey Ave., Chicago 39, TU 9-5735; 1500 Walnut St., Phila. 2, KI 6-1720, or A. R. Campman & Co., 1762 W. Vernon Ave., Los Angeles, AX 3-6265.



Scope Has Automatic Display Switching

Dual-trace plug-in preamp provides wide passband

DEVELOPMENT of a d-c to 50-Mc oscilloscope featuring automatic display switching, plug-in preamp versatility and wide-range sweep, is announced. Automatic display switching in the type 547 is provided by alternate electronic switching between two identical wide-range time bases—0.1 $\mu\text{sec}/\text{cm}$ to 5 sec/cm . In this mode, the vertical signal from a single-channel plug-in can be alternately displayed on two different time bases. With a dual-trace plug-in unit (such as the new type 1A1) channel 1 can be locked to one time base, and channel 2 locked to the other. For many applications, one has dual-beam performance at a considerable saving of cost over a dual-beam scope.

When the two time bases are used

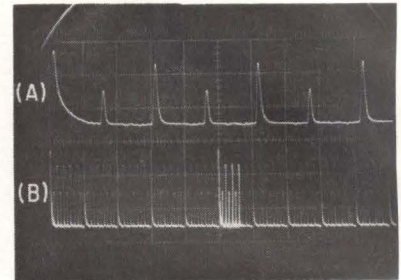

for delayed sweep operation, a continuously-variable and calibrated delay is available from 0.1 μsec to 50 sec. In this mode, each vertical signal—from a single or multi-channel plug-in—can be alternately displayed on time base B intensified by A, and time base A delayed by B, as illustrated in the waveform. A front-panel control allows individual adjustment of trace separation when using automatic display switching.

Triggering is stable over the full passband of the vertical-deflection system, providing triggered presen-

tations to beyond 50 Mc. The triggering circuitry includes automatic mode with bright reference trace, regardless of sweep rate. A type 1A1 dual-trace plug-in preamp provides d-c to 50-Mc passband at 50 mv/cm to 20 v/cm , and d-c to 28-Mc passband at 5 mv/cm . Channel 1 and channel 2 amplifiers can be cascaded to obtain approximately 500 $\mu\text{v}/\text{cm}$ sensitivity at 2 cps to 15-Mc passband. Price of type 547 is \$1,875. The 1A1 preamp sells for \$600. Tektronix, Inc., P.O. Box 500, Beaverton Ore.

CIRCLE 301, READER SERVICE CARD

Multi-Channel Comparator Is Programmable

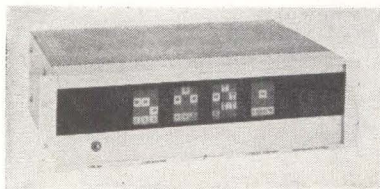

THREE CONDITIONS of up to 12 separate channels or two conditions of up to 24 channels are monitored by the 36A comparator. When used as a multi-level comparator, the instrument can be programmed to sense as many as 25 voltage points with 1-mv resolution. A broad field of application possibilities is provided through choice of input and output configurations, internal or external programming, and a new panel display that permits the user

to select the descriptive terms for channel status and identification that is best suited to each input line being monitored. Plugging in circuit boards expands capacity of the instrument. The unit's uses include process control, sorting operations, alarm systems, automated testing, and the like.

Accuracy of the 36A is ± 0.05 percent of programmed levels. Resolution is 1 mv. Input voltage range is 20 v d-c which can be floated up to ± 250 v. Input current is 1 or 20 μa . Output response is 10 μsec (transistor), 10 millise (relay). All input and output connections are made through a terminal connector at the rear of each board. The power supply is Zener referenced.

Price of the type 36A with 12

comparators is \$995 to \$1,505 depending on options selected. J-Omega Co., 2278 Mora Drive, Mountain View, Calif. (302)

Rugged Fan Delivers 115 CFM Free Air

COMPACT, lightweight, metal-frame fan, the Boxer, in ball-bearing and standard sleeve-bearing versions is announced. It is designed for low-budget cooling, ventilating and area heat transfer in electronic black boxes and other enclosures. Application areas include computers, communications and office equipment, instrumentation, tape re-

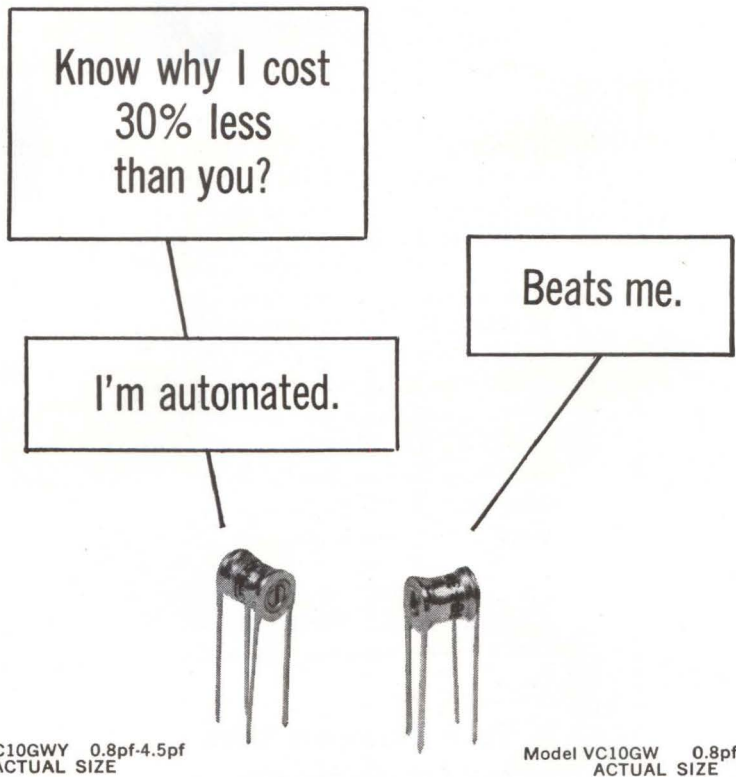

Specify JFD "Y" Hi-life® trimmer capacitors and save 30 per cent—with increased reliability!

Automated production along with new design advances reduce JFD "Y" piston trimmer costs **30** per cent below those of competitive capacitors. "Y" trimmers capacitors also offer the unique HI-LIFE adjust mechanism which guarantees an adjustment life of 500 cycles*—**600** per cent greater than Mil-C-14409B requirements plus . . .

Features: ■ Special process glass dielectric for high stability over a wide range of operating temperatures (—55°C to 125°C) ■ High Q factor—500 measured at 1 MC ■ Ultra linear tuning with no

reversals ■ Fine multi-turn adjustment for increased sensitivity and excellent resolution ■ Space-saving telescopic tuning assembly with little, if any protrusion of adjustment screw for compactness ■ Anti-backlash design maintains its setting despite shock and vibration and gives smooth uniform tuning adjustment.

JFD "Y" trimmers are available in panel mount and printed circuit types—as well as Sealcap, Max-C, split stator, or differential, glass or quartz construction. Special "Y" trimmers can be custom-made to your specs, too. Ask your distributor or write us for Bulletin "Y".

*MIL-C-14409B specifications define a cycle as **four** complete revolutions in the direction of increasing capacitance and **four** complete revolutions in the opposite direction.



Components Division
 JFD ELECTRONICS CORPORATION, 15th Ave. at 62nd St., Brooklyn, N. Y. 11219 • 212 DEwey 1-1000 • TWX: 212-833-7001 • Cable JEFDEE
 JFD NEW YORK NORTHERN Damiano Place, P.O. Box 96, New Hartford, N. Y. 13503 • Phone: 315-732-3507
 JFD NORTHEASTERN, Ruth Drive, P.O. Box 228, Marlboro, Mass. • HUNtley 5-7311
 JFD MID-ATLANTIC, 313 E. Broad St., Palmyra, N. J. • 609-665-0788
 JFD MID-ATLANTIC-MARYLAND, P.O. Box 7676, Baltimore, Md. 21207 • Phone: 301-944-5644
 JFD MIDWESTERN, 6330 Hermione St., Chicago 46, Illinois • 775-5424,5425
 JFD MIDWESTERN-OHIO, P.O. Box 8086 Cincinnati 8, Ohio • 513-421-1166
 JFD WESTERN, 9 Morlan Place, Arcadia, California • 213 HI 6-0312
 JFD CANADA, LTD., 51 McCormack Street, Toronto, Ontario, Canada • ROger 2-7571
 STANDARD TELEPHONE & CABLES LTD., Components Group, Capacitor Sales Dept., Footscray, Sidcup, Kent, England
 LCC STEAFIX, 128 Rue de Paris, Boite Postale 51, Montreuil-sous-Bois, Seine, France
 JFD ISRAEL, LTD., Bldg. 23, Industrial Area B, Azur, Israel
 DUCOR CONDENSER PTY. LTD., Christina Road, Villawood, N.S.W., Australia

Variable Trimmer Piston Capacitors ■ Metalized Inductors ■ LC Tuners ■ Fixed Capacitors ■ Fixed and Variable Distributed and Lumped Constant Delay Lines ■ Pulse Forming Networks

PUNCH

PRINT

DUPLICATE

VERIFY



TAPEWRITER

Now . . . prepare and verify tapes with one unit, at typing speeds. Series 1010 TAPEWRITERS have numeric or full alphanumeric electronic keyboards . . . semiconductor circuits . . . printed characters for instant visual verification, and easy deletion of typing errors. Custom codes and keyboards plus compatibility with remote data systems give complete flexibility. 75% electronic . . . low cost . . . low maintenance.

NAVCOR

NAVIGATION COMPUTER CORPORATION
Valley Forge Industrial Park
NORRISTOWN, PENNSYLVANIA
Booth 3612 IEEE Show

50 CIRCLE 50 ON READER SERVICE CARD

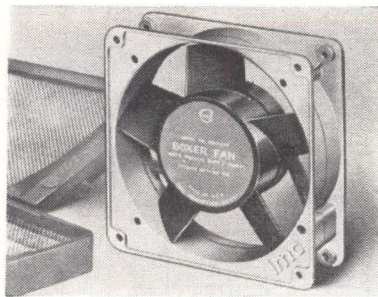

corders and power supplies. Measuring $4\frac{1}{8}$ in. by $4\frac{1}{8}$ in. by $1\frac{1}{2}$ in., and weighing only 1 lb 10 oz, the Boxer is housed in a rugged, shock and vibration-proof frame that also acts as a heat sink and contributes to long life. Boxer-standard has an anticipated life of up to 5 yr at +70 F and 3 yr at +125 F. Boxer-ball bearing has a life expectancy of 25,000 hr at +175 F. The Boxer's aerodynamically-designed impeller delivers 115 cfm free air, 15 percent more than comparable units and up to 100 percent more air at specific back pressures. IMC Magnetics Corp., 570 Main St., Westbury, N. Y. CIRCLE 303, READER SERVICE CARD

Tape Transport Uses Solid-State Electronics

NEW TAPE TRANSPORT, the MT-75, has few moving parts. Tension arms have been replaced by a dual under-and-over vacuum column tape storage system. Ample storage in the vacuum reservoirs provide restriction-free reading and writing. Secondary buffers integrally designed into the vacuum columns permit fast velocity stabilization. Vacuum tape cleaning and vacuum tape drag before the read/write head assure high operating reliability. The MT-75 operates at standard tape speeds of 60 and 75 ips, with



Scope Amplifier Presents 4 Traces

PRESENTING four traces, each channel having 40-Mc bandwidth and 50 mv/cm sensitivity, the model 1754A vertical amplifier permits direct comparison of four simultaneous signals. Designed to make full use of the large 6-cm by 10-cm

a $2\frac{1}{2}$ minute rewind. Data transfer rates are to 60 kc (bcd). Start/stop profiles are smooth and program restrictions free over a command frequency rate up to 200 per sec. Potter Instrument Co., Inc., Sunnyside Blvd., Plainview, N. Y. (304)

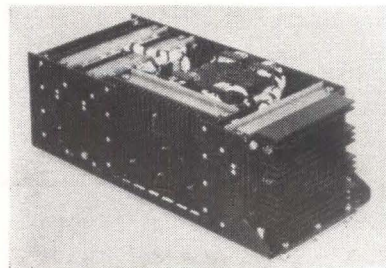

Memory System for Severe Environment

A LOW-COST version of the SEMS-1R, miniaturized, random access, airborne core memory system is announced. Operating over a temperature range of -25 C to $+75$ C, the 4096-word by 32-bit system features a 4.5 μ sec read/write cycle. The memory is available in two modular, welded circuit packages; one with plug-in module interconnections for simplified field maintenance, and the other with welded module interconnections for maximum reliability and package density. Electronic Memories, Inc., 9430 Bellanca Ave., Los Angeles, Calif. (305)

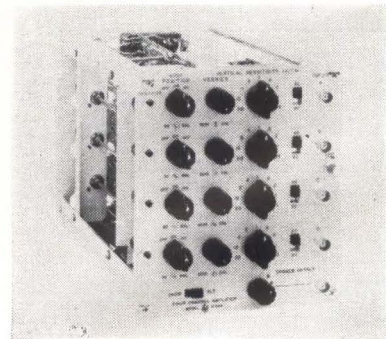

Scope Amplifier Presents 4 Traces

PRESENTING four traces, each channel having 40-Mc bandwidth and 50 mv/cm sensitivity, the model 1754A vertical amplifier permits direct comparison of four simultaneous signals. Designed to make full use of the large 6-cm by 10-cm

February 21, 1964 electronics

viewing area of the model 175A scope, model 1754A is a plug-in unit. Independent position controls on each channel make it possible to separate each trace, or to superimpose any or all over the full height of the screen. A pushbutton for each channel will momentarily display its trace for identification. Price is \$595. Hewlett-Packard Co., 1501 Page Mill Road, Palo Alto, Calif. (306)

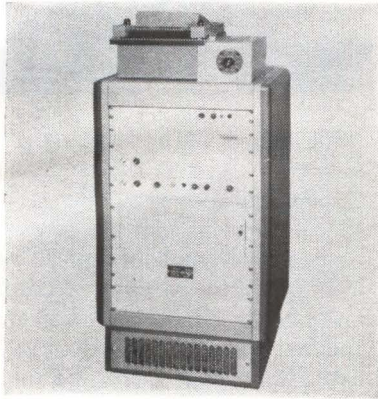

Spectrum Analyzer Contains 100 Filters

MULTIPLE-FILTER spectrum analyzer, model 100-50 MS, simultaneously analyzes any 5-kc frequency band from 100 cps to 25 kc. It uses 100 magnetostrictive filters with constant bandwidths of 50 cps spaced 50 cps apart. Output of each filter is amplified and goes to a separate stylus of a multistylus recorder. Output of the system, giving a plot of frequency vs time and amplitude, is determined by the density of the trace on the paper. Price is about \$24,000. Spectran Electronics Corp., 146 Main St., Maynard, Mass. (307)

Extension Control Improves Core Memory

NEW CONTROL allows the expansion of programmed data processor-4 core memory from 8,192 to 32,768 words. Type 16 includes an extended program counter, an extended memory address register, and a control state called "extend mode". Indirect addressing is used to access locations that are out of the current 8,192-word field. While in the

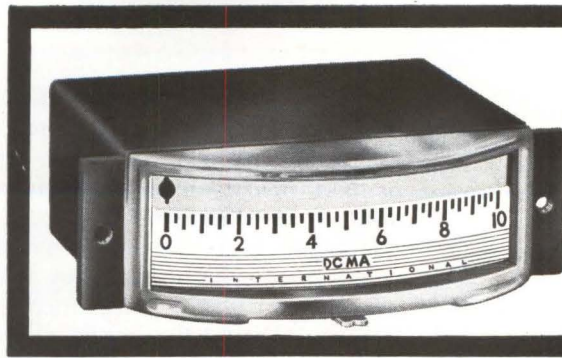

the most
reliable
**EDGEWISE
METERS**
on earth...
or in space!



Rugged, accurate, super-reliable miniature panel meters in a wide variety of ranges and sizes, with horizontal or vertical scales, zero at center, left or right. Also special scales, ranges, sensitivities, resistances, cases and other modifications to your exact requirements. Available as DCUA, DCMA, DCA, DCMV, DCV, ACV, VU, Db.

ACCURACY equal to finest conventional meters.

SAVE SPACE — $\frac{2}{3}$ less panel area than round or square.

SUPERIOR READABILITY — fast, accurate, readout, minimum parallax.

IDEAL FOR STACKING — for speedier, more accurate comparative readings.

CLEAN DESIGN — display only the essential pointer-scale relationship.

INTERNALLY ILLUMINATED (some models).

SPEEDY ACTION ON PROTOTYPES OR SERVICE — conveniently located modification centers in your area.

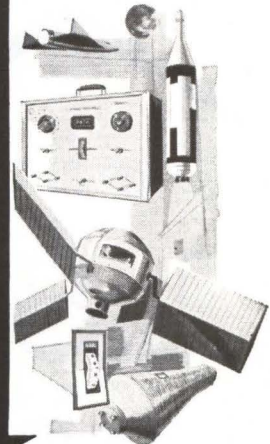

WRITE FOR ENGINEERING DATA SHEETS.

international instruments inc.

88 Marsh Hill Road, Orange, Connecticut, Cable: "INTERINST"

CIRCLE 200 ON READER SERVICE CARD

Origin

Silicon High Voltage Rectifier

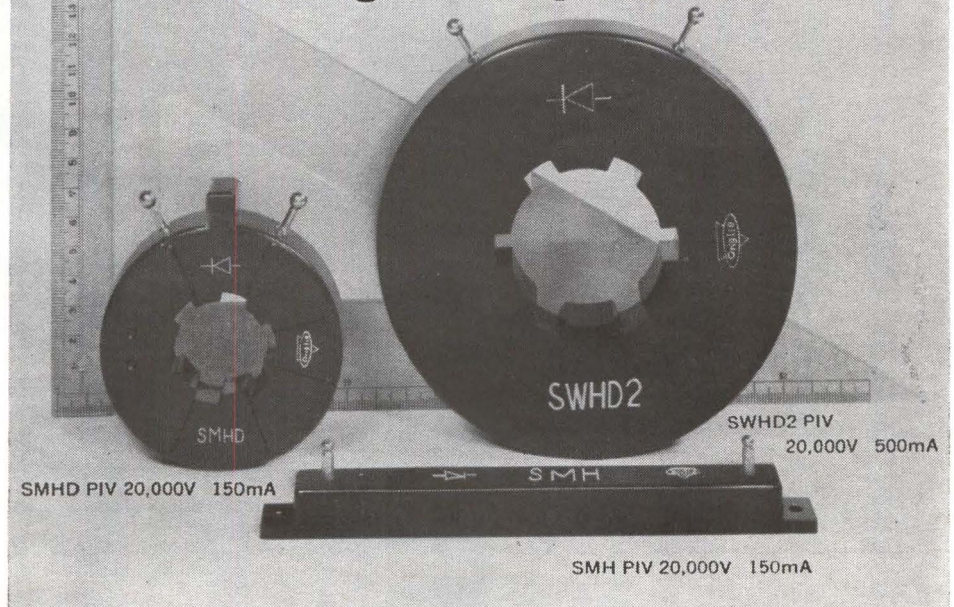

Main Products: Semi-conductors, condenser type spot welder, synthetic enamel and miniature ball bearing.



ORIGIN ELECTRIC COMPANY LTD.

1-195 Takadaminami-cho, Toshima-ku, Tokyo, Japan
Cable Address: "ORIGINELE TOKYO"

CIRCLE 51 ON READER SERVICE CARD 51

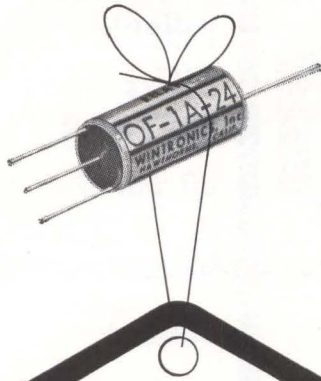

REED RELAYS

1.85
to
99¢

This Form A dry reed relay with coil rating of 6, 12, or 24 volts. Contact resistance : 200 milliohms max.; contact material: gold; internal reed atmosphere: inert gas; temperature range: -65° to 125° C.; order of speed: 1.5 milliseconds; release time: less than 150 microseconds; mounting position : any plane. Open frame series relays now available in price range quoted.

Wintronics now maintains manufacturing facilities and shipping points at Hawthorne, California, and Vermontville, Michigan. Reed relays in all configurations and sizes, and incorporating from one to as many as one hundred reeds, are now available on short delivery schedules to meet your deadlines.

REQUEST BULLETIN 264A



WINTRONICS

DIV. MICHIGAN MAGNETICS, INC.
National Sales Offices: 1132 South
Prairie Avenue, Hawthorne 1, Calif.
Phone: Area Code 213 SPring 2-1916
A subsidiary of VSI Corporation

"extend mode", bits 3-17 in the effective address of an indirectly addressed instruction contain the memory field number and memory address. A feature of the type 16 control is that existing programs can be used, even though they were written for the former memory capacity. Digital Equipment Corp., Maynard, Mass.

CIRCLE 308, READER SERVICE CARD

Silicon Rectifier Has Fast Recovery

SILICON RECTIFIER combines in one unit the characteristics of fast recovery with controlled avalanche. Maximum recovery time for the

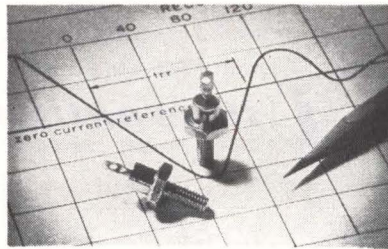

12-amp unit is 100 nsec, with some units available with 35-nsec recovery. Forward voltage drop is 1.2 v at 12 amp, with reverse avalanche rating up to 600 v. Units are available in stud-mounted or micro packages, and all units are rated at 150 C case under operating conditions.

The controlled avalanche features of the device provide protection against high voltage transients which sometimes can cause unexpected failures of rectifiers. The improved rectification at higher frequencies allows for operation at frequencies not now possible, giving design engineers the capability of designing lighter weight, smaller size and more efficient power supplies. Prices for the 200-v, 12-amp unit: 1-99, \$26.75; 100-999, \$17.30. Transitron Electronic Corp., Wakefield, Mass. (309)

Pressure Transducer Gives Rapid Response

ON THE MARKET is the 718 Alphatron pressure transducer (tubular object in foreground), which covers



a wide range of pressure (0.1 to 100 torr) with an accuracy of ± 1.5 percent and less than 1 sec response time. It indicates pressure by a variable frequency pulse output rather than through a continuous signal. The pulse operation eliminates switching requirements for read-out and makes for much more effective telemetry functions. The transducer weighs 13 oz and is $1\frac{1}{2}$ in. diameter by $4\frac{1}{4}$ in. long. Typical applications would be weather rockets and balloons and high altitude aircraft such as the U-2 and X-15. National Research Corp., 70 Memorial Drive, Cambridge 42, Mass. (310)

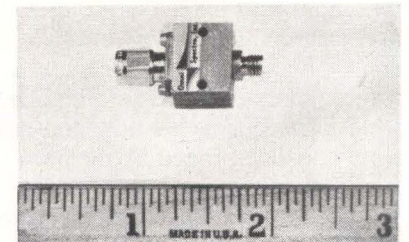

Tunnel Diode Detector Weighs 1/3 Ounce

ULTRA-COMPACT tunnel diode detector mount series 20700 covers frequency range of 2.0 to 18.0 Gc. Sensitivity is in excess of -52 dbm. Vswr is 5.0 max, 2.0 to 18.0 Gc. Suitable for use either as video detector, or mixer detector, the units have an OSM miniature plug r-f input connector and OSSM subminiature jack output connector. Price is \$110 including diode. Omni Spectra, Inc., 8844 Puritan Ave., Detroit, Mich. 48238. (311)

LITERATURE OF THE WEEK

MINIATURE METAL BELLOWS Servometer Corp., 82 Industrial East, Clifton, N.J., offers a catalog on custom-designed, electrodeposited type nickel and nickel-cobalt alloy miniature bellows for aircraft, missile and electronic applications. (360)

UHF COMMUNICATION CAPACITORS Erie Technological Products, Inc., 644 W. 12th St., Erie, Pa. Bulletin describes a line of uhf communication capacitors for screen-grid, by-passing, and coupling of vacuum tubes. (361)

MINIATURE TUBULAR CAPACITORS Gulton Industries, Inc., 212 Durham Ave., Metuchen, N.J. Bulletin H-12 covers the CT-10 series of miniature tubular capacitors with capacitance values to 0.01 μ f. (362)

REAL TIME COMPUTER Honeywell Electronic Data Processing, 60 Walnut St., Wellesley Hills, Mass. 02181. A 16-page brochure describes the real time H-1400 data processing system. (363)

UNIVERSAL BRIDGE Wayne Kerr Corp., 1633 Race St., Philadelphia, Pa., has published a technical bulletin on the universal transformer ratio-arm bridge, type B-221A. (364)

AEROSPACE TRANSDUCER AMPLIFIERS Columbia Research Laboratories, Inc., MacDade Blvd. & Bullens Lane, Woodlyn, Pa. Solid state power amplifiers for handling transducer signals in missiles, rockets, aircraft and satellite studies are described in data sheet T-142. (365)

SERVO AMPLIFIER Electronic Devices Department of Corning Glass Works, Pennel, Pa. Bulletin CE-13.01 contains specifications on a solid-state servo amplifier for industrial and laboratory uses. (366)

CURRENT SENSING AMPLIFIERS Magnetic Controls Co., 6405 Cambridge St., Minneapolis 26, Minn., offers a booklet explaining the use of magnetic amplifiers as current sensors in telemetry and instrumentation applications for the aerospace field. (367)

HYDROGEN THYRATRON Tung-Sol Electric Inc., One Summer Ave., Newark 4, N.J., announces a bulletin on its advanced type 7455 hydrogen thyatron tube, and its application to a broad range of inverse clipping functions in line-type radar modulators. (368)

COAXIAL CABLE Phelps Dodge Electronic Products Corp., 60 Dodge Ave., North Haven, Conn. Bulletin describes Corro-Foam semi-flexible, air dielectric coaxial cable. (369)

LIGHTWEIGHT LASER Maser Optics, Inc., 89 Brighton Ave., Boston 34, Mass. Bulletin provides technical information about the model 600 lightweight, low-cost ruby laser. (370)

RESISTANCE WAFER BONDER Kulicke and Soffa Mfg. Co., 135 Commerce Drive, Fort Washington, Pa. Catalog sheet describes a new machine for bonding dice to transistor headers. (371)

SHAFT POSITION ENCODERS Datex Corp., 1307 South Myrtle Ave., Monrovia, Calif. Bulletin 305 illustrates and describes trigonometric shaft position encoders. (372)

MEMORY DRUMS Houston Fearless Corp., 11801 Olympic Blvd., Los Angeles, Calif. 90064. Brochure describes magnetic memory drums with a full range of capabilities and speeds, in diameters from 3.25 in. to 20.00 in. (373)

D/A CONVERTER Monitor Systems, Inc., Fort Washington Industrial Park, Fort Washington, Pa., offers a bulletin on modular model 116 multichannel digital-to-analog converter for simultaneous high-speed conversions of up to sixteen 10-bit binary numbers. (374)

DIGITAL LOGIC MODULES Applied Development Corp., 1131 Monterey Pass Road, Monterey Park, Calif. Short-form catalog lists more than 80 standard modules in each of three series with specifications and prices. (375)

SOUND PRESSURE MICROPHONE Massa Division of Cohu Electronics, Inc., 280 Lincoln St., Hingham, Mass. Photo, specifications and characteristic curves for model MK-103 sound pressure microphone are included in a catalog sheet. (376)

AIR MAGNET Philip Fishman Co., 7 Cameron St., Wellesley 81, Mass. Bulletin 105 describes the Wellesley air magnet, a complete miniature and subminiature parts handling system that supplants a vacuum pump by using shop air. (377)

MAGNETIC CORE MEMORIES Electronic Engineering Co. of California, Box 58, Santa Ana, Calif. Four-page brochure presents three new memories—a random access, a sequential access, and a sequential interlace (378)

H-V SILICON RECTIFIERS Solitron Devices, Inc., 500 Livingston St., Norwood, N.J. A 16-page Solidpak insulated high-voltage silicon rectifier catalog is available. (379)

DIGITAL MODULES Cambridge Thermionic Corp., 445 Concord Ave., Cambridge, Mass. 02138. Catalog No. 80 contains circuit diagrams and operating characteristics on the line of Cambion 12-pin digital logic modules. (380)

VACUUM ACCESSORIES NRC Equipment Corp., a subsidiary of National Research Corp., 70 Memorial Drive, Cambridge, Mass. 02142, has published a 10-page brochure on vacuum accessories such as seals, switches and feed-throughs. (381)

TRANSDUCERS Arma Division of American Bosch Arma Corp., Garden City, N.Y., offers a bulletin on transducers that utilize ultrasonics for low altitude distance measurement. (382)

DIGITAL READOUT Cal-Glo Co., 111 Euca-lyptus Drive, El Segundo, Calif. A single-sheet catalog describes the new miniature rear-projection type digital readout. (383)

WHAT'S UNIQUE
ABOUT ALL
SEVEN MODELS
OF FLUKE
DIFFERENTIAL
VOLTMETERS

ALL SEVEN
MODELS FEATURE
INFINITE INPUT
RESISTANCE
AT NULL

For CATALOG DIGEST: Write
JOHN FLUKE MFG. CO., INC.,
Box 7428, Seattle, Wash. 98133

FLUKE

CIRCLE 201 ON READER SERVICE CARD

HEATH SERVO PEN
RECORDER...TYPICAL
VALUE IN A NEW
RESEARCH AND TEACH-
ING LAB INSTRUMENTA-
TION SERIES!

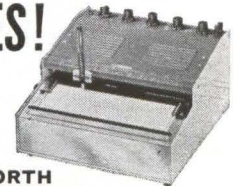

**FEATURES AND
PERFORMANCE WORTH
FIVE TIMES ITS LOW PRICE!**

Unbeatable value! True potentiometric input. Five adjustable ranges: 10, 25, 50, 100 & 250 mv plus plug-in 5-pin connectors for special ranges. Rapid chart advance; pen lift; paper tear-off guide; optional motor speeds; 10" chart; 1 sec. response. Factory assembled & tested. Write for details on entire Malmstadt-Enke Lab series!

Assembled EUW-20A . . . 20 lbs. . . . \$195.00
\$19 mo.

HEATHKIT
by Heathrow

HEATH COMPANY 67-2-1

Benton Harbor, Michigan 49023

Please send free folder on Lab Series Equipment.

Please send Free Heathkit catalog.

Name _____ (please print)

Address _____

City _____ Zone _____ State _____

EK-138

CIRCLE 53 ON READER SERVICE CARD 53

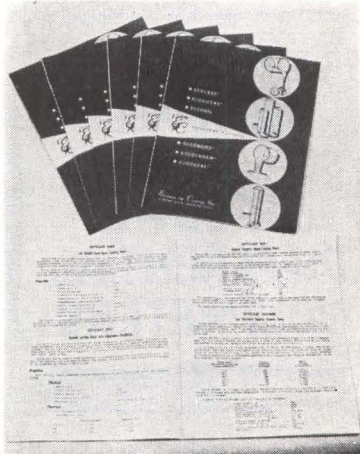

Casting Resins
 Coatings
 Adhesives
 RTV Silicones
 Ceramics
 etc.

FREE BOOKLET

Over 40 materials are described for a wide variety of electrical/electronic applications. Complete ordering information and a list of company sales offices are included.

Write or Circle Reader Service Card



EMERSON & CUMING, INC.

Canton, Mass. / 604 W. 182 St.
 Gardena, Calif.

CIRCLE 202 ON READER SERVICE CARD

The DECI-DUCTOR

*new subminiature molded inductor — 24 Hour Delivery
 up to 1000 uH in 1/10" dia. x 1/4" lg. envelope
 10X the inductance available in the same size*

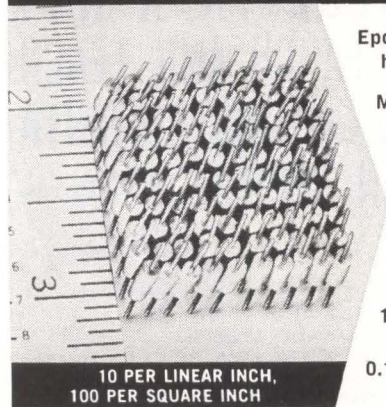

Epoxy molded for highest reliability
 Meets MIL-C-15305B
 Forty nine inductance values in stock
FEATURES
 24 hour delivery
 1/10" dia. x 1/4" lg.
 0.10 uH to 1000 uH

DECI-DUCTOR is the latest addition to Nytronics' DECI Series—a series that consists of inductors, capacitors and resistors in a uniform (1/4 watt resistor and diode size) envelope to facilitate point-to-point assembly in cordwood, printed circuit and other high density module assemblies.

For complete engineering data, write Dept. WL-39, or phone 201-464-9300.

NYTRONICS, INC.

550 Springfield Ave., Berkeley Heights, N. J.

Design Leaders STANDARD components to meet CUSTOM requirements

54 CIRCLE 54 ON READER SERVICE CARD

unidirection-reversible-start-stop
IN 10 MILLISECONDS!

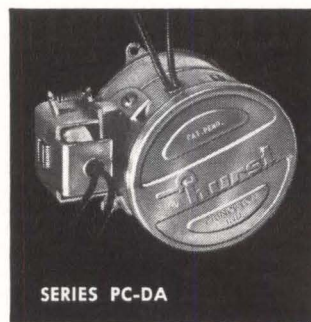

HURST
HEAVY-DUTY
SYNCHRONOUS
MOTORS

POSITIVE CLUTCH
 INSTANTANEOUS BRAKE

Series PC-SM 40 inch ounce
Series PC-DA 120 inch ounce

For extremely fast starts and stops, motor runs continuously with clutch and brake controlled by switching actuator only. This positive clutch will start the output shaft within 10 milliseconds and the brake will stop output shaft within 1/10° at 1 RPM or within 6° at 60 RPM. Other speeds proportional.

Write for Complete Literature Today!



hurst MANUFACTURING CORPORATION

PRINCETON, INDIANA • Phone FU5-2564

CIRCLE 203 ON READER SERVICE CARD

HOW TO USE YOUR ELECTRONICS BUYERS' GUIDE

Page Number References

For your convenience, advertisers in the ELECTRONICS BUYERS' GUIDE have the page numbers of their advertisements listed adjacent to their listings in the Product Listings (yellow paper) section of the book. Refer to these advertisements for full specifications on products. Keep your ELECTRONICS BUYERS' GUIDE at your work area at all times.

ELECTRONICS BUYERS' GUIDE
 A MCGRAW-HILL PUBLICATION

February 21, 1964 electronics

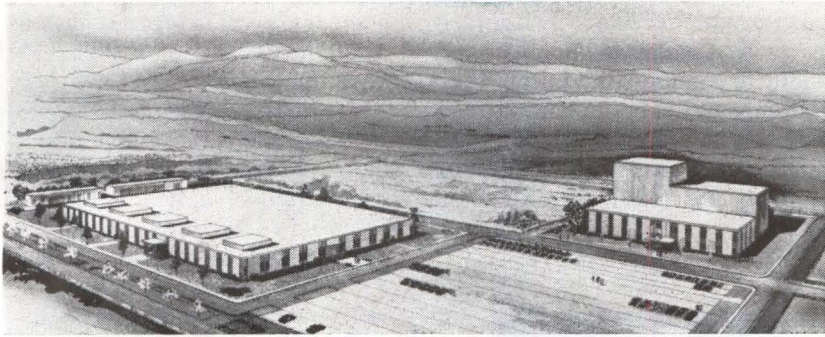

Boeing Plans Space Research Center

ARTIST'S CONCEPT shows buildings which will house four space-oriented laboratories to be constructed by The Boeing Company at Kent, Washington, a few miles south of the company's present Seattle facilities. The new facilities, valued at more than \$15 million, will include a laboratory for the simulation of space flight, one to simulate the environment of space, one for research and development of microelectronics, and a fourth for the testing of new materials and processes.

Boeing's present microelectronics staff of about 110 persons will be transferred to the new 50,000-sq-ft lab in about 18 months, after which employment will build up to a peak of about 300. This will include electronics engineers, chemists, physicists and laboratory technicians.

Separate labs will work in different areas of microelectronics, from the growing of crystals for use in circuits to the study of component packaging and circuit research to make use of new design techniques. Plans call for establishment in the laboratory of a production line under continuous vacuum. The photo room will have three cameras to produce masks, or stencils, for the thin-film and semiconductor processes.

Bendix Consolidates Subsidiary's Activities

EDWARD K. FOSTER, vice president and group executive of the Bendix Corp., Baltimore, Md., has announced the consolidation of all

activities of the company's subsidiary, Microwave Devices, Inc., into a newly completed facility at Farmington, Conn.

The move is part of a long-range accelerated program for the design, development, production and marketing of Bendix microwave com-

ponents and hardware, Foster said. The plant will contain the general management, engineering, sales, and manufacturing functions formerly located in Bristol, Conn., and Rockville, Md.

S. T. Urbank will continue as general manager, maintaining his office at the new facility.



Elms Leaves NASA to Join Raytheon

ELECTION of James C. Elms as vice president and general manager of Raytheon Company's Space and Information Systems division is announced. He has resigned his position as deputy director of NASA's Manned Spacecraft Center at Houston. Before joining NASA he was director of space and electronics for Ford Motor Company's Aeronutronic division.

Elms' appointment will permit D. Brainerd Holmes, senior vice president of Raytheon, to devote full time to his corporate duties. Holmes has been serving for the past four months as acting general manager of the division which currently is engaged in a number of space programs including Apollo.

Texas Instruments Promotes Provost

A. NORMAND PROVOST has been elected an assistant vice president by the board of directors of Texas Instruments Incorporated.

Cecil Dotson, vice president of

IEEE ANNOUNCES MAJOR AWARD WINNERS

The Institute of Electrical and Electronics Engineers will present five major awards at its International Convention, March 23-26, in New York City. Awards and their recipients are:

MEDAL OF HONOR—Harold A. Wheeler of Wheeler Laboratories, Great Neck, N. Y.

EDISON MEDAL—John R. Pierce of Bell Telephone Laboratories, Murray Hill, N. J.

FOUNDERS AWARD—Andrew G. L. McNaughton (retired) of Rockcliffe Park, Ottawa, Canada.

LAMME MEDAL—Loyal V. Bewley of General Electric Co., Schenectady, N. Y.

EDUCATION MEDAL—B. Richard Teare, Jr. of Carnegie Institute of Technology, Pittsburgh, Pa.

SIDE-LOOKING RADAR SYSTEMS ANALYSTS

New programs at HUGHES are generating opportunities for Systems Analysts experienced in high-resolution data gathering, data transfer and data processing systems. Openings exist for Systems Engineers, Mathematicians and Physicists qualified in synthetic array radars, optical, and other data collection systems (IR, Electro-Optical, SIGINT and others). Assignments include:

Senior Systems Scientist with 20 years' electronic systems experience—at least 10 years relevant to side-looking radar systems. Applicants will be considered for important program management responsibilities. M. S. or Ph. D. degree required.

Senior Systems Analysts with 10 years' electronic systems experience—at least 5 years relevant to high-resolution systems pre-design and evaluation. Applicants will be considered for assignments in concept formulation; single and multi-sensor applications; data transmission, processing and interpretation; systems integration and performance evaluation. M. S. or Ph. D. required.

Systems Analysts with 5 years' experience in: detection of signals in noise, optimum filter theory, non-linear signal processing, information theory, MTI and doppler systems analysis. B. S. or M. S. required.

Please airmail your resume to:

MR. ROBERT A. MARTIN
Head of Employment
Hughes Aerospace Divisions
11940 W. Jefferson Blvd.
Culver City 11, California

Creating a new world with electronics

HUGHES

HUGHES AIRCRAFT COMPANY
AEROSPACE DIVISIONS

U. S. CITIZENSHIP REQUIRED
An equal opportunity employer.

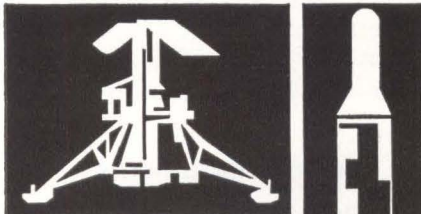
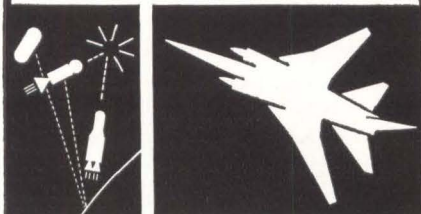

TI's Semiconductor-Components division, said that Provost will continue as manager of the European Semiconductor Group with headquarters in Geneva, Switzerland. Provost is responsible for TI semiconductor manufacture in the Texas Instruments Limited plant in Bedford, England, and in the TI France plant near Nice, France, and semiconductor marketing throughout Europe.

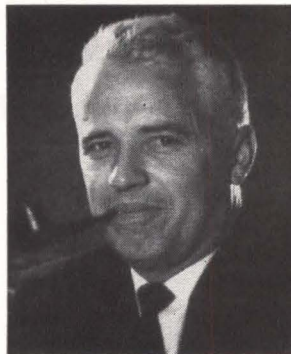

DeMornay-Bonardi Appoints Price

OLIVER RAY PRICE has been named general manager of DeMornay-Bonardi division, Datapulse, Inc. He was previously chief engineer and manager of advanced development for the Microwave division of Thompson Ramo Wooldridge, Canoga Park, Calif.

DeMornay-Bonardi, Pasadena, Calif., manufactures precision, high-frequency microwave components, subsystems, and test equipment.



Tilley Accepts Reeves-Hoffman Post

JOHN H. TILLEY has been appointed director of engineering, Reeves-

Hoffman division of Dynamics Corp. of America, Carlisle, Pa. He will be concerned with the design and development of new products, refinement of existing designs, technical services and customer relations.

Previously, Tilley was employed at Bell Telephone Laboratories in the design and development of feedback amplifier networks, filters and equalizers for broad-base transoceanic submarine cable repeaters.

PEOPLE IN BRIEF

J. V. Holdam, ex-Dresser Industries, elected exec v-p, treasurer and a director of Scantlin Electronics, Inc. **Joseph C. Logue** transfers from IBM's Data Systems div. to the Components div. as mgr., advanced component technology. **Stuart F. Tower**, formerly with Honeywell's EDP div., joins Digital Science Consultants as a senior consultant and v-p. **Harry B. Schultheis**, previously with Benson-Lehner Corp., appointed a senior consulting engineer at Don Lebell Associates. **George R. White** leaves Sperry Gyroscope Co. to become mgr. of the Quantum Physics div. of Electro-Optical Systems, Inc. **Lee W. Topham**, from Parker Aircraft Co. to Wiancko Engineering as asst. to the g-m. **Edwin F. Carey, Jr.**, Col. USAF (Ret), named mgr. of international requirements for GD/Electronics-San Diego. **Edward L. Fensler** promoted to quality assurance mgr. at Computer Measurements Co. **S. M. Treman**, formerly with Curtiss-Wright Corp., now mgr. of engineering for the Defense & Industrial div. of the Otis Elevator Co. **H. T. Hoffman** moves up to mgr. of systems development engineering at Bailey Meter Co. Sperry Rand Corp. raises **Robert B. Roe** to mgr. of its Sperry Phoenix Co. div. Roe succeeds **Percy Halpert** who advances to group mgr. responsible for the Phoenix and Utah divs. **Daniel Wolinsky** elevated to v-p, administration, for Vacuum-Electronics Corp. **John R. Jennings**, most recently with Stanford Research Institute, joins Alto Scientific Co. as director of R&D.

To Order Reprints

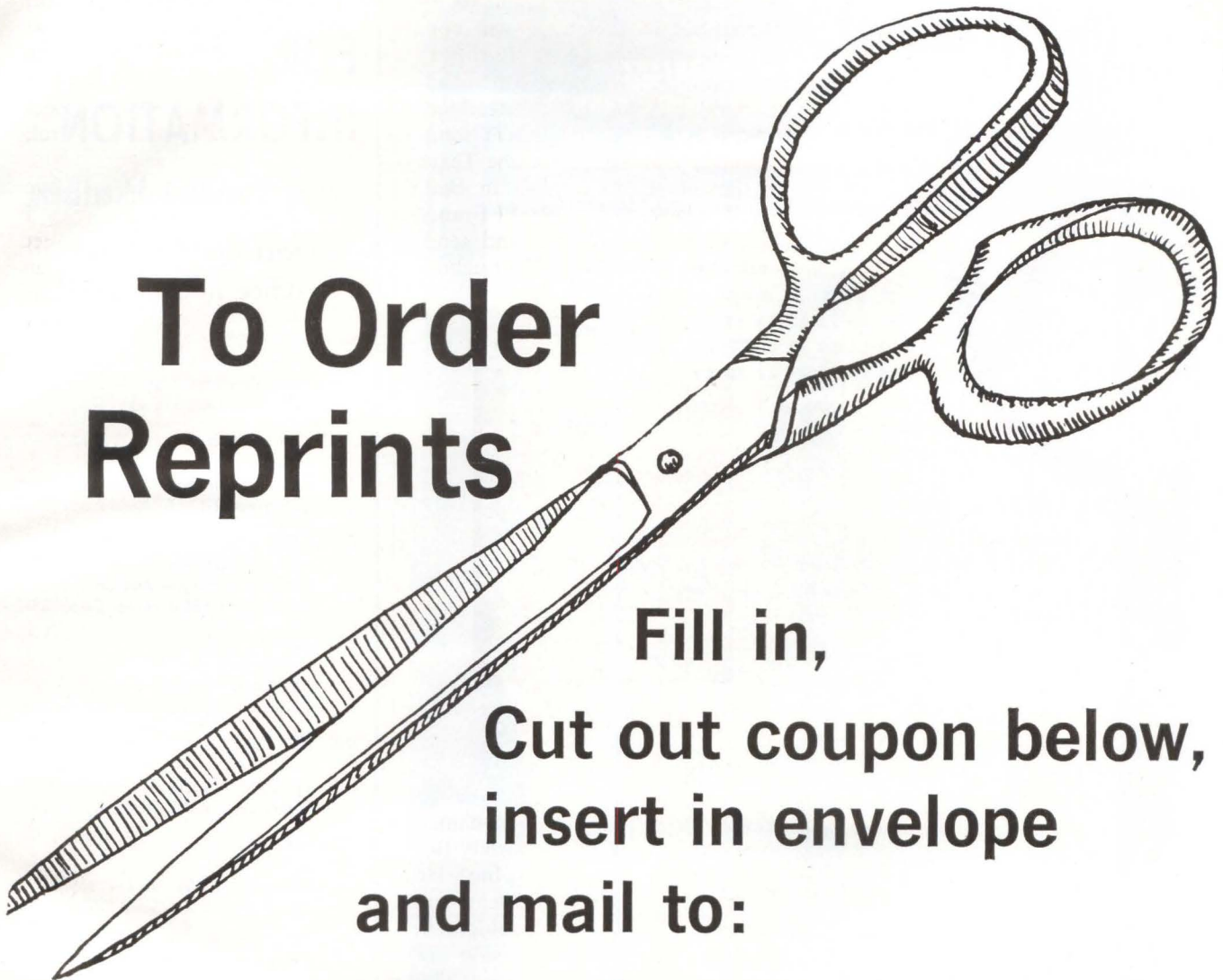

Fill in,
Cut out coupon below,
insert in envelope
and mail to:

electronics Reprint Dept.
330 West 42nd Street,
New York, N. Y.—10036

REPRINT ORDER FORM

For Listing of Reprints Available See Reader Service Card

(To help expedite mailing of your reprints please send cash, check or money order with your order.)

For Reprints of the latest Special Report:

Modern Electronic Packaging

Send me Reprints of Key No. R-48 at 50¢ each.

For Reprints of previous **Special Reports** or **Feature Articles** fill in below:

Send me Reprints of Key No.(s) @ ¢ each. (For prices, see chart above.)

*For orders of Bulk Reprints of other editorial articles in **this issue** or **past issues**:

Send me Reprints of page (no.(s)) of issue
of article entitled

*Minimum bulk order 100 copies. You will be advised of costs by return mail.

Name

Number and Street

City, Zone No., State

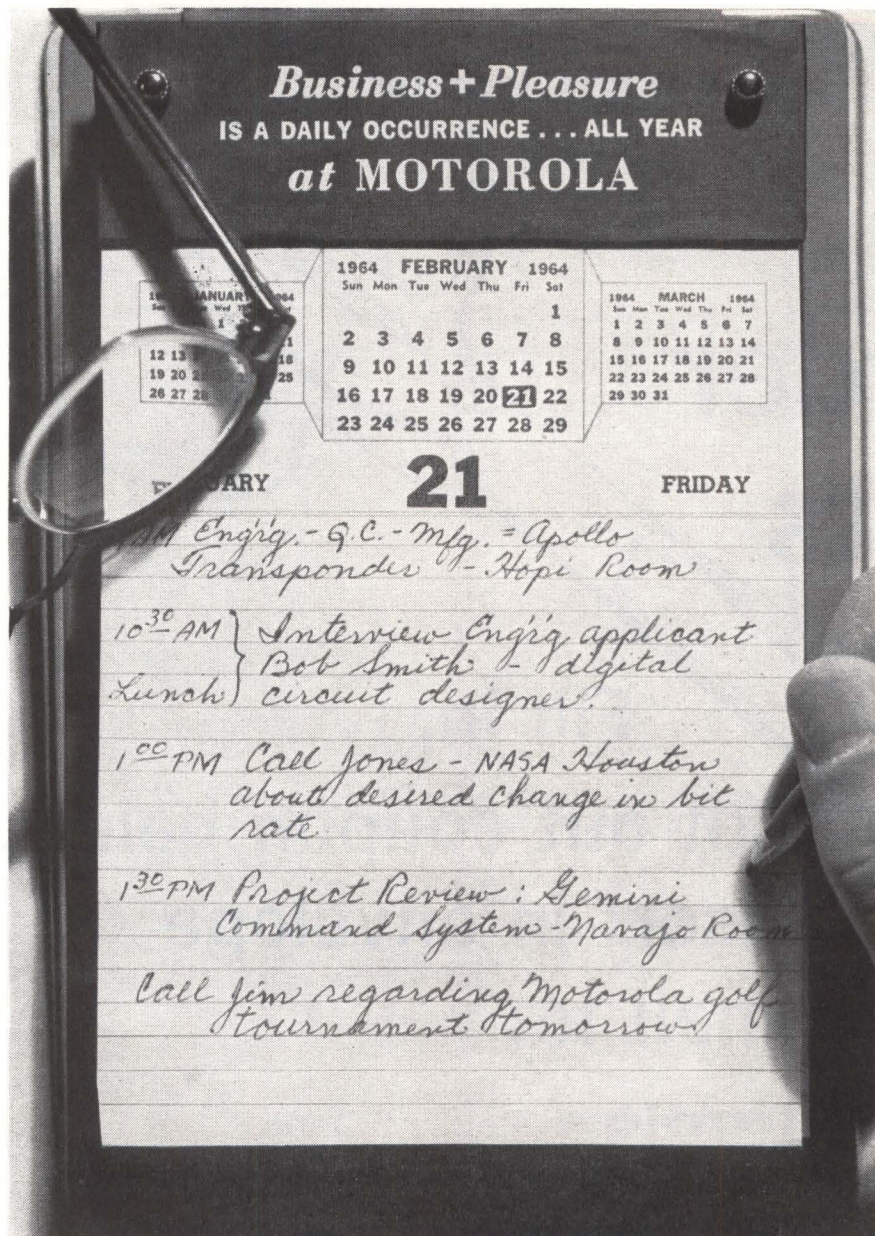

BUSINESS + PLEASURE means a challenge in aerospace electronics and a new world of *year-round* enjoyment for your family. Here you will find intriguing challenges in advanced projects such as Gemini, Apollo and a host of others ranging from inner space to deep space exploration. For a peaceful dry climate, scenic mountains and canyon lakes, balanced by a professional challenge, *check these opportunities.*

Antennas & Propagation
Solid State R. F.
Microwave Techniques
Missile & Space Instrumentation
Operational Support Equipment
Integrated Circuitry

Reliability Analysis
Parts Reliability
Reliability Program Coordination
Data Acquisition, Processing & Display
CW Transponders
Radar and Radar Transponders

Guidance & Navigation
Command & Control
Space Communications
Signal Processing
ECM, CCM & Surveillance
Tracking & Telemetry

Contact Phil Nienstedt, Manager of Recruitment, Department 652

MOTOROLA



in PHOENIX

Military Electronics Division • Western Center • P.O. Box 1417, Scottsdale, Arizona
MOTOROLA ALSO OFFERS OPPORTUNITIES AT CHICAGO, ILLINOIS—AN EQUAL OPPORTUNITY EMPLOYER

FOR INFORMATION

about Classified Advertising

contact the McGraw-Hill
office nearest you

ATLANTA, 30309

M. MILLER
1375 Peachtree St., N.E.
875-0523 (Area Code 404)

BOSTON, 02116

J. WREDE
McGraw-Hill Bldg., Copley Square
COngress 2-1160 (Area Code 617)

CHICAGO, 60611

WM. HIGGENS—G. AMBROZE
645 No. Michigan Avenue
MOhawk 4-5800 (Area Code 313)

CLEVELAND, 44113

R. HARTER
55 Public Square
SUperior 1-7000 (Area Code 216)

DALLAS, 75201

F. LeBEAU
1712 Commerce St., Vaughn Bldg.
Riverside 7-9721 (Area Code 214)

DENVER, 80202

J. PATTEN
1700 Broadway, Tower Bldg.
255-2981 (Area Code 303)

DETROIT, 48226

T. JAMES
856 Penobscot Building
962-1793 (Area Code 313)

HOUSTON, 77025

K. GEORGE
Prudential Bldg., Holcombe Blvd.
Riverside 8-1280 (Area Code 713)

LOS ANGELES, 90017

R. McGINNIS
1125 West Sixth Street
HUnley 2-5450 (Area Code 213)

NEW YORK, 10036

D. HAWKSBY—H. BUCHANAN
500 Fifth Avenue
971-3593 (Area Code 212)

PHILADELPHIA, 19103

WM. SULLIVAN
Six Penn Center Plaza
LOcust 8-4330 (Area Code 215)

PITTSBURGH, 15222

4 Gateway Center
391-1314 (Area Code 412)

ST. LOUIS, 63105

7751 Carondelet Avenue
PArkview 5-7285 (Area Code 314)

SAN FRANCISCO, 94111

J. A. HARTLEY
255 California Street
DOuglas 2-4600 (Area Code 415)

SEARCHLIGHT SECTION

(Classified Advertising)

BUSINESS OPPORTUNITIES
EQUIPMENT - USED or RESALE

DISPLAYED RATE

The advertising rate is \$27.25 per inch for all advertising appearing on other than a contract basis. Contract rates quoted on request. AN ADVERTISING INCH is measured $\frac{1}{8}$ inch vertically on one column, 3 columns—30 inches—to a page. EQUIPMENT WANTED or FOR SALE ADVERTISEMENTS acceptable only in Displayed Style.

UNDISPLAYED RATE

\$2.70 a line, minimum 3 lines. To figure advance payment count 5 average words as a line.

PROPOSALS, \$2.70 a line an insertion.

BOX NUMBERS count as one line additional in undisplayed ads.

DISCOUNT OF 10% if full payment is made in advance for four consecutive insertions of undisplayed ads (not including proposals).

Antique

TELEPHONES

As is complete, decorative purpose \$17.50. Working order, inter-comm. \$19.50 Ext. on dial \$24.50, talking circuit only. Write for complete list. All shipments FOB, Simpson, Pa.

TELEPHONE ENGINEERING CO.
Dept. 22164, Simpson Pa.



CIRCLE 951 ON READER SERVICE CARD

RADAR AUTO-TRACK & TELEMETRY ANTENNA PEDESTALS 3 & 10 CM. SCR 584 AUTOTRACK RADARS. M-33 RADAR TPS-1D SEARCH. APS-45 TPS-10D HT. FINDERS. WX RADARS. FPN-32GCA. APS-10 APS-15B APS-27 (AMTI) SEARCH. ■ ■ ■ APN-102 DOPPLER. DOZENS MORE. CARCINOTRONS. PFN'S. 25-5-1-2-3-6 MEGAWATT PULSE MODULATORS. CAVITIES. PULSE TRANSFORMERS. IF STRIPS. WAVEGUIDE. BENDS 200 MC. 1 KMC. 3 KMC. 6 KMC. 9 KMC. 24 KMC. RF PKGS.

RADIO RESEARCH INSTRUMENT CO.
550 5TH AVE., NEW YORK 36, N. Y. JU 6-4691

CIRCLE 952 ON READER SERVICE CARD

ARROW

FREIGHT FORWARDERS

Sub. of LIFSCHULTZ TRANSPORT, Inc.

FASTEST COAST TO COAST

5th & 6th DAY EAST COAST TO
CAL., ARIZ., NEV., ORE. and WASH.

7th DAY TO EAST COAST
from CAL., ARIZ., NEV., ORE. and WASH.

Specialists in Shipment of
Electronics Products
Call for information

NEW YORK — PHILADELPHIA
BALTIMORE — BOSTON — NEW JERSEY
HOLYOKE — NEW HAVEN — PROVIDENCE
LOS ANGELES — SAN FRANCISCO — SEATTLE

CIRCLE 953 ON READER SERVICE CARD

LOOKING FOR

USED/SURPLUS ELECTRONIC EQUIPMENT/COMPONENTS?

For an up-to-date listing of such equipment see Searchlight Section of February 14th.

RADAR & TELEMETRY ENGINEERS

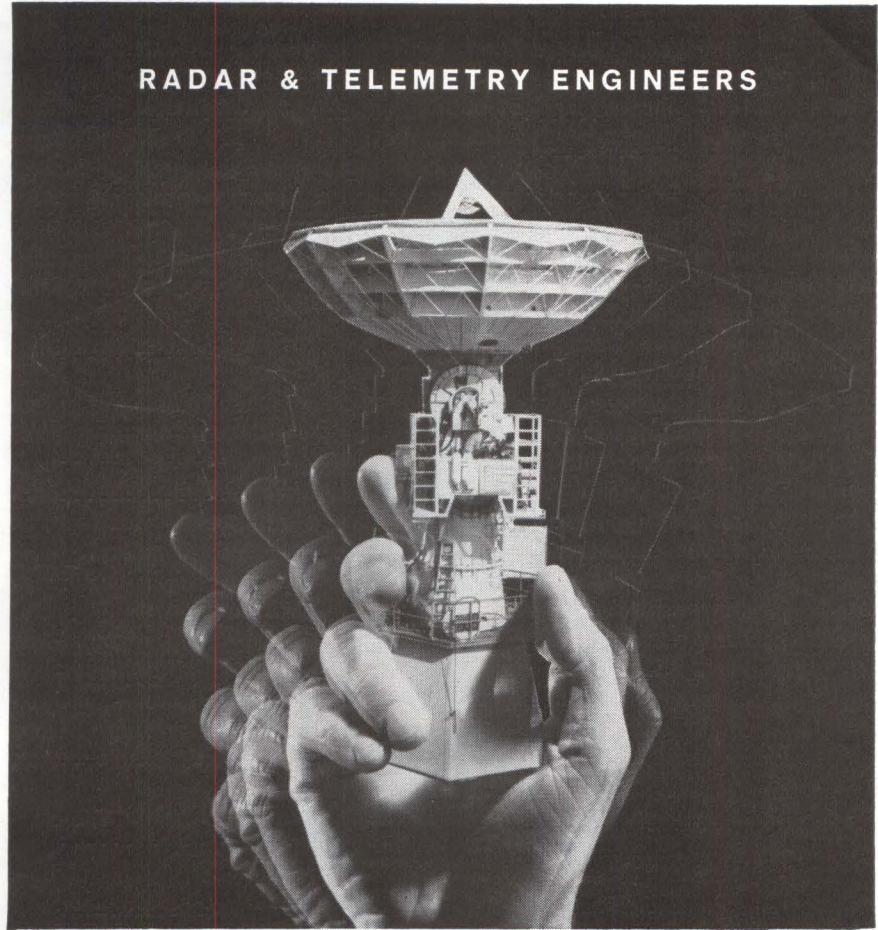

our ears are "UP"

... to track, monitor,
and measure space-
craft and missile per-
formance of every
launch at the Atlantic
Missile Range.

For instrumentation engineers with Pan Am's Guided Missiles Range Division, this means the planning and design of new sensor systems to meet the demanding radar and telemetry requirements of each new mission—Gemini, Apollo, Satellites, Space Probes. These next generation instrumentation systems will provide greater coverage, accuracy, mobility, reliability and automated real-time data delivery.

Examples of diverse approaches being taken to achieve such systems are:

- a new CW doppler range-rate tracking system that measures missile and spacecraft velocity with accuracy of 0.5 fps.
- pulse doppler radars that measure range rate to 0.1 fps.
- large high-gain (85 ft. diam.) wide-band (130-2300 mc) automatic tracking antenna systems
- advanced, universal pulse code modulation (PCM) ground systems (bit rate from 1 to 1 million bits per second).

Engineers interested in joining in this effort are invited to write in confidence to Dr. Charles Carroll, Dept. 28B-3.



GUIDED MISSILES RANGE DIVISION

PAN AMERICAN WORLD AIRWAYS, INC.
P. O. BOX 4465, PATRICK AIR FORCE BASE, FLORIDA
AN EQUAL OPPORTUNITY EMPLOYER

INDEX TO ADVERTISERS

• AMP Incorporated	37	• Kepco, Inc.	4th cover
• Acme Electric Corp.	15	Leesona Corp.	47
Aerocom	39	Levin and Son, Inc., Louis. 3rd cover	
• Carter-Princeton	41	Mallory and Co., Inc., P. R.	8, 9
• Clifton Precision Products Co., Inc.	16	Massa, A Div. of Cohu Electronics, Inc.	43
Consolidated Electrodynamics Corp.	7	• Navigation Computer Corp. (Navcor)	50
Electro-Nuclear Laboratories, Inc.	45	Nytronics Inc.	54
Emerson & Cuming, Inc.	54	• Origin Electric Co., Ltd.	51
Fluke Mfg. Co., Inc., John	53	• Philco, A Sub. of Ford Motor Co.	21
Gries Reproducer Corp.	4	Radiation Inc.	13
Heath Co.	53	Sprague Electric Co.	6
• Hewlett-Packard Company 2nd cover		Texas Instruments Incorporated Industrial Products Group	3
Hughes Aircraft Co., Aerospace Divisions	56	• Vitramon, Inc.	22
Hurst Mfg. Corp.	54	Wintronics Div. Michigan Magnetics, Inc.	52
International Instruments, Inc.	51		
• J F D Electronics Corp.	49		

CLASSIFIED ADVERTISING
F. J. Eberle, Business Mgr. (2557)

EMPLOYMENT OPPORTUNITIES 58-59

EQUIPMENT
(Used or Surplus New)
For Sale 59

CLASSIFIED ADVERTISERS INDEX

Arrow Freight Forwarders	59
Motorola	58
Pan-American—Guided Missiles Range Div.	59
• Radio Research Instrument Co.	59
Telephone Engineering Co.	59

• See advertisement in the July 25, 1963 issue of electronics Buyers' Guide for complete line of products or services.

This Index and our Reader Service Numbers are published as a service. Every precaution is taken to make them accurate, but electronics assumes no responsibilities for errors or omissions.

electronics



Audit Bureau of Circulation



Associated Business Publications

AUDITED PAID CIRCULATION

JAMES T. HAUPTLI (2210)
Advertising Sales Manager
HENRY M. SHAW (3485)
Market Research Manager
DAVID M. TEMPEST (3139)
Promotion Manager

electronics Buyers' Guide

R. S. QUINT (2335)
General Manager

RICHARD J. TOMLINSON (3191)
Business Manager

THEODORE R. GEIPEL (2044)
Production Manager

NEW YORK TELEPHONE: Dial Direct:
971 plus number in parenthesis,
Area Code 212

ADVERTISING REPRESENTATIVES

ATLANTA, GA. 30309
Michael H. Miller, G. Krimsier
1375 Peachtree St. N.E.,
Trinity 5-0523 (area code 404)

BOSTON, MASS. 02116
William S. Hodgkinson
McGraw-Hill Building, Copley Square,
Congress 2-1160 (area code 617)

CHICAGO, ILL. 60611
Harvey W. Wernecke,
Robert M. Denmead
645 North Michigan Avenue,
Mohawk 4-5800 (area code 312)

CLEVELAND, OHIO 44113
Paul T. Fegley
55 Public Square, Superior 1-7000
(area code 216)

DALLAS, TEXAS 75201
Frank Le Beau
The Vaughn Bldg.,
1712 Commerce St.
Riverside 7-9721 (area code 214)

DENVER, COLO. 80202
David M. Watson
Tower Bldg., 1700 Broadway,
Alpine 5-2981 (area code 303)

HOUSTON, TEXAS 77025
Kenneth George
Prudential Bldg., Halcombe Blvd.,
Riverside 8-1280 (area code 713)

LOS ANGELES, CALIF. 90017
Ashley P. Hartman, John G. Zisch,
1125 W. 6th St., Huntley 2-5450
(area code 213)

NEW YORK, N. Y. 10036
Donald H. Miller (212) 971 3615
George F. Werner (212) 971 3617
Donald R. Furth (212) 971 3616
500 Fifth Avenue

PHILADELPHIA, PA. 19103
Warren H. Gardner, William J. Boyle
6 Penn Center Plaza,
LOcust 8-6161 (area code 215)

SAN FRANCISCO, CALIF. 94111
Richard C. Alcorn
255 California Street,
Douglas 2-4600 (area code 415)

LONDON W1:
Edwin S. Murphy Jr.
34 Dover St.

FRANKFURT/Main:
Matthee Herfurth
85 Westendstrasse

GENEVA:
Michael R. Zeynel
2 Place du Port

TOKYO:
Shigeo Chiba,
1, Kotohiracho, Shiba, Minato-ku

LEVIN HIGH PRECISION CABINET MOUNTED INSTRUMENT LATHES

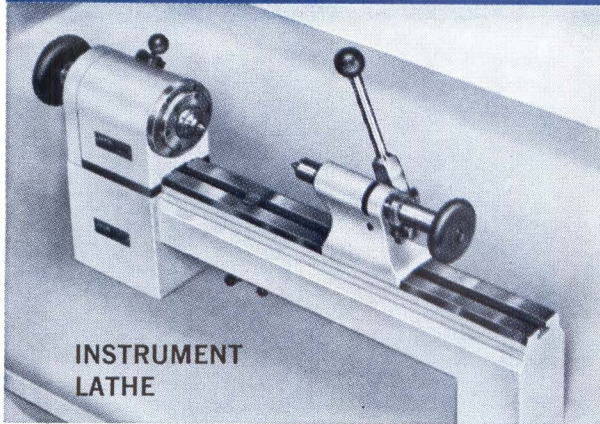

**INSTRUMENT
LATHE**

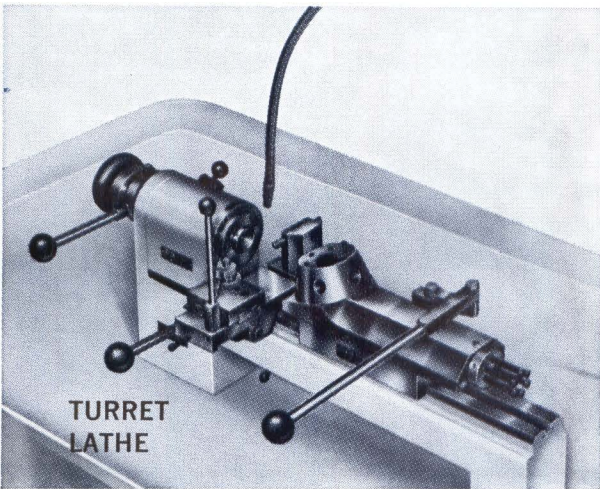

**TURRET
LATHE**



**MICRO-DRILLING
MACHINE**

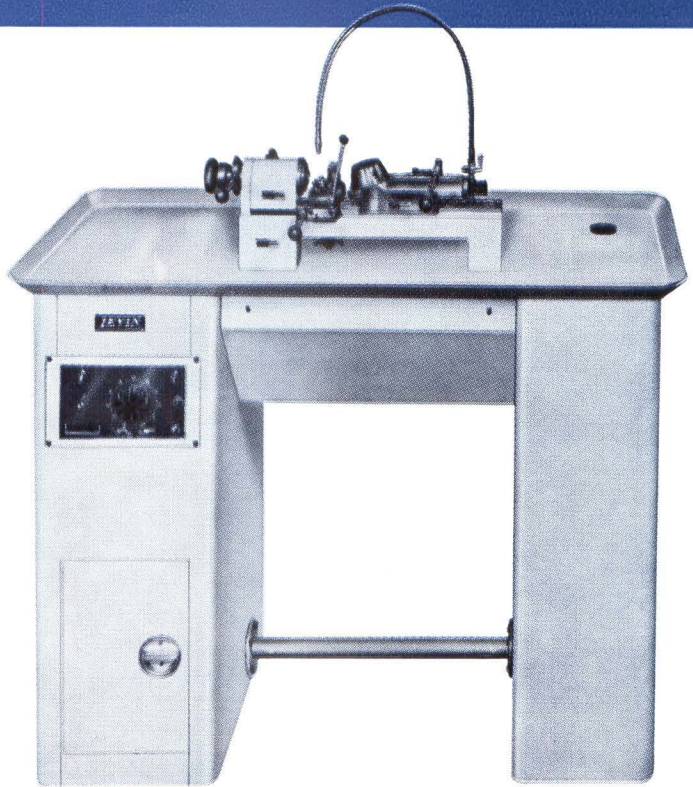

LEVIN now offers a complete line of Instrument Lathes mounted on a welded steel cabinet. These machines have the advantages of greater rigidity, higher spindle speeds, increased operator efficiency due to cabinet design, multi-vee belt drive, and for the first time, operating and alignment tolerances heretofore available only on specially built lathes.

Your *LEVIN* dealer or the factory will be glad to furnish complete details. These machines are on display in dealer showrooms in New York and Los Angeles. Send for complete catalog.

LEVIN[®]

**LOUIS LEVIN & SON, INC., 3573 HAYDEN AVENUE
CULVER CITY, CALIFORNIA**

DEALERS:

RUSSELL-HOLBROOK & HENDERSON, INC.

NEW YORK and LOS ANGELES

INDUSTRIAL TOOL & SUPPLY COMPANY — SAN JOSE

MARSHALL TOOL & SUPPLY CORPORATION — LOS ANGELES

ROYAL-TSCHANTRE — BALTIMORE

CIRCLE 901 ON READER SERVICE CARD

KEPCO

REGULATED **WR** DC SUPPLIES



POWER SUPPLIES WITH EXPERIENCE

Model 1520B



Model 605



Model 430D

The WR Group includes eleven time-proven models from Kepco's current production of 230 standard models. Kepco's representatives in your area can supply you with complete technical information, application ideas, and delivery.

APPLICATIONS:

- ELECTROPHORESIS ■ RADAR
- ELECTROCHEMICAL PROCESSES
- MICROWAVES ■ PHOTOMULTIPLIERS
- COMMUNICATIONS-TELEVISION
- TELEPHONE SYSTEMS
- ELECTRO-MECHANICAL DEVICES

GENERAL SPECIFICATIONS:

- **Input:** 105-125 VAC 50-65 cps single phase
- **Operating Temperature:** -20°C to +55°C
- **Temperature Coefficient:** < 0.01% per °C
- **Recovery Time:** 50 microseconds
- **Isolation:** 400 volts (except HB 2050)
- **Meters:** Voltmeter and Ammeter
- Convection Cooling
- For Relay Rack or Bench Use
- Multiple output and high voltages
- Plate, Grid and Heater Voltages
- Continuously Variable, Zero to full output

See our Complete Catalog in



MODEL	DC OUTPUT RANGE		REGULATION				RIPPLE RMS MV	AUX. OUTPUT 6.3VAC Unregulated	PRICE
	VOLTS	MA.	LOAD O-MAX %	LINE %	LINE % ΔV	LINE % ΔV			
2400 B - #1	0-150	0-5	*	*	*	*	1	\$540.00	
	0-400	0-150	0.025	0.1	0.1	0.4	3		
	0-400	0-150	0.025	0.1	0.1	0.4	3		
400 B	0-400	0-150	0.025	0.1	0.1	0.4	3	270.00	
	0-150	0-5	*	*	*	*	1		
430 D - #1	0-450	0-300	0.025	0.1	0.1	0.4	3	675.00	
	0-450	0-300	0.025	0.1	0.1	0.4	3		
800 B - #1	0-600	0-200	0.02	0.1	0.1	0.4	3	575.00	
	0-600	0-200	0.02	0.1	0.1	0.4	3		
605	0-600	0-500	0.02	0.1	0.1	0.4	3	425.00	
	0-150	0-5	*	*	*	*	1		
615B	0-600	0-300	0.02	0.1	0.1	0.4	3	355.00	
	0-150	0-5	*	*	*	*	1		
1250 B	0-1000	0-500	0.01	0.1	0.05	0.4	3	650.00	
1220 C	0-1200	0-50	0.01	0.1	0.05	0.4	3	10 AMP 465.00	
1520 B	0-1500	0-200	0.01	0.1	0.05	0.4	3	695.00	
HB 2050	0-2000	0-500	0.005	0.1	0.02	0.4	3	1565.00	
HB 2500	0-2500	0-50	0.005	0.1	0.02	0.4	5	975.00	

*0-150V bias - Regulation: 0.01% Line / 2% Load at 150V



For complete specifications on more than 230 standard model Power Supplies, send for NEW Catalog B-631.

131-38 SANFORD AVENUE, FLUSHING, N.Y. 11352 • Phone: (212) IN 1-7000 • TWX #212-539-6623 • Cable: KEPCOPOWER NEWYORK
VISIT US AT IEEE SHOW, BOOTHS 2636-2638
CIRCLE 902 ON READER SERVICE CARD