

# electronics®

## SWITCH DESIGN MADE EASY

Worst-case analysis  
built into plan

## ULTRASONICS: STATE OF THE ART

Sonar systems, parts  
and industrial gear

## NANOSECOND COMPUTER LOGIC

Uses tunnel diodes  
and storage diodes

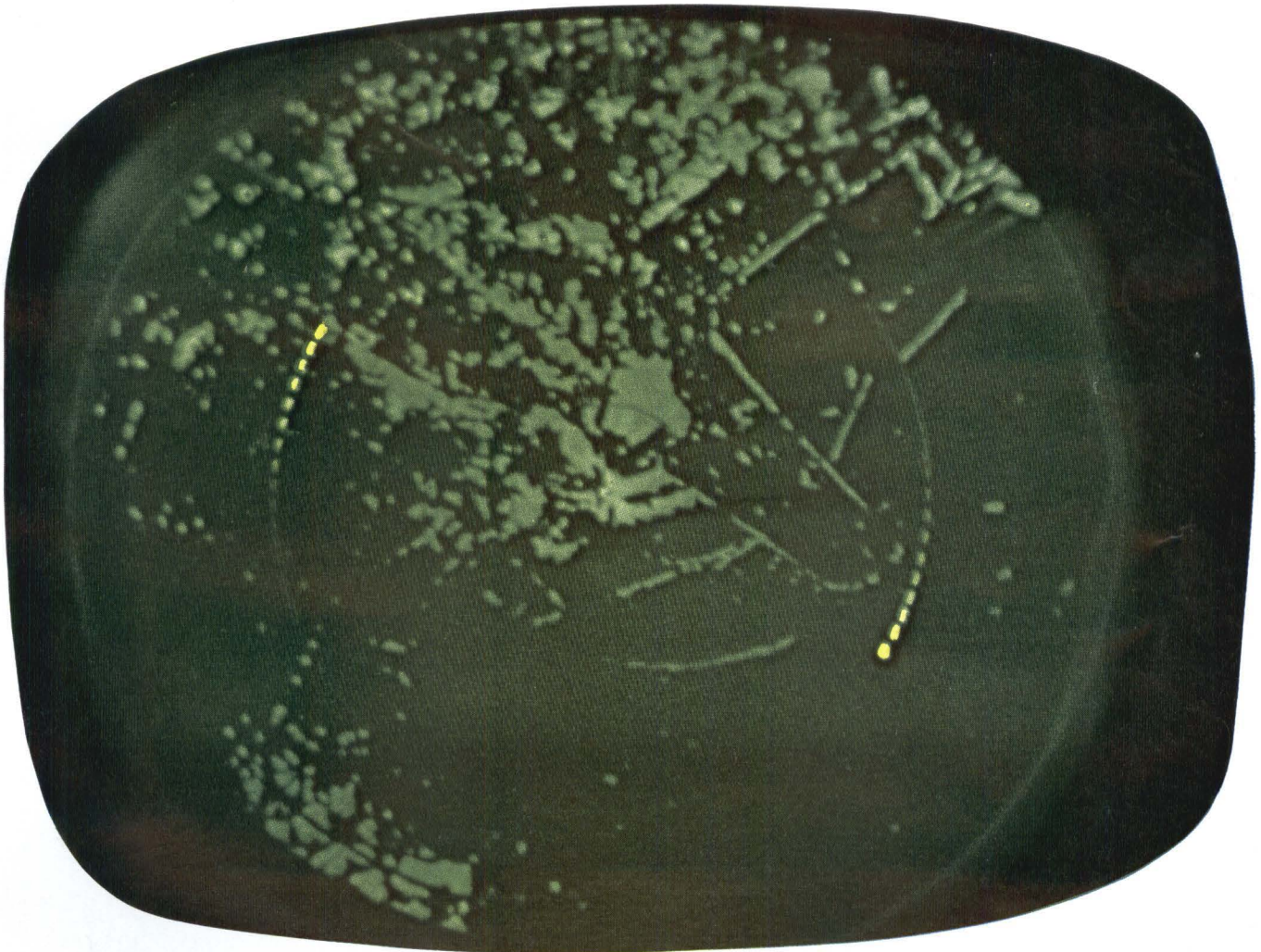

COLOR RADAR. Three-gun shadow-mask tube displays ppi map and moving targets

R D SKINNER  
1  
1020 GOVINGTON RD  
LOS ALTOS CALIF  
C 3-5  
SUPV DEV

*New from Hewlett-Packard*

## An automatic digital voltmeter

**Price:  
only  
\$1295**



**Accuracy:  
0.05%  
of reading,  
BCD output**

All the convenience of digital voltmeter measurement is combined with unprecedented accuracy, speed and low cost in the new hp 3440A Digital Voltmeter. Unique design gives the 3440A inherent flexibility, with plug-in units incorporated to determine function. Plug-ins offer the choice of rapid automatic ranging and remote programming (hp 3442A Automatic Range Selector, \$135) or manual operation (hp 3441A Range Selector, \$40). Wherever you need fast, accurate, dependable measurement—even by non-technical personnel, the hp 3440A is the answer... priced right for quantity use, superior accuracy for the most exacting tasks. The 3440A is ideal for systems use, too. Call your Hewlett-Packard field engineer today. hp 3440A, \$1160 without plug-ins.

### *Here's what the top-value 3440A offers:*

**Automatic measurement with readout to 4 significant figures, 5 readings/sec**

**Total error of less than  $\pm 0.05\%$  of reading  $\pm 1$  digit to 5% above full scale range, 15° to 40°C, including  $\pm 10\%$  line voltage variation**

**Automatic ranging (10 v, 100 v, 1000 v) decimal and polarity indication**

**BCD recorder output in the 1-2-2-4 weighted code**

**Constant 10.2-megohm input impedance**

**Floating input, up to 400 v above chassis ground**

**Display storage for rapid non-blinking readings on easy-to-see rectangular Nixie tubes**

**All solid state basic measuring circuitry, plug-in reed-relay ranging logic**

**Compact size, 5¼" panel height, bench and rack instrument in one**

Data subject to change without notice. Prices f. o. b. factory.



**HEWLETT  
PACKARD  
COMPANY**

1501 Page Mill Rd., Palo Alto, California 94304, (415) 326-7000. Sales and service in all principal areas. Europe, Hewlett-Packard S.A., 54 Route des Acacias, Geneva, Switzerland; Canada, Hewlett-Packard (Canada) Ltd., 8270 Mayrand St., Montreal, Quebec.

CIRCLE 900 ON READER SERVICE CARD

# electronics

W. W. MacDONALD, Editor  
Telephone Area Code 212 (971-2645)

J. M. CARROLL, Managing Editor (2293)

## SENIOR EDITORS

Samuel Weber (2371)  
George W. Sideris (3444)

## SENIOR ASSOCIATE EDITORS

Michael F. Wolff (2600)  
John F. Mason (2666)

## ASSOCIATE EDITORS

Michael F. Tomaino (2071)  
William P. O'Brien (2297)  
George J. Flynn (2188)  
George V. Novotny (3151)  
Leon H. Dulberger (3446)  
Alexander A. McKenzie (2685)

## ASSISTANT EDITORS

Stephen B. Gray (2245)  
Barry A. Briskman (2306)  
Dan Smith (2467)  
Joel A. Strasser (2127)

## REGIONAL EDITORS

Harold C. Hood,  
1125 W. 6th St., Los Angeles 90017, Calif.  
(213-482-5450)  
Laurence D. Shergalis,  
John Hancock Bldg., 255 California St.,  
San Francisco 94111, Calif. (415-362-4600)  
Thomas Maguire  
McGraw-Hill Bldg., 607 Boylston St.,  
Boston 02116, Mass. (617-262-1160)  
Cletus M. Wiley,  
Blair Bldg., 645 N. Michigan Ave.,  
Chicago 60611, Ill. (312-664-5800)

## ART DIRECTOR

Howard R. Berry (2430)

## ASSISTANT ART DIRECTOR

John C. Wright, Jr. (3430)

## EDITORIAL ASSISTANTS

Lorraine Rossi, Virginia T. Bastian,  
Lynn Emery, Ann Mella, Lorraine Werner,  
Alice M. O'Brien, Sharon Parks,  
Claire Benell, Kay Fontana

## FOREIGN NEWS BUREAU

DIRECTOR, John Wilhelm, (2532);  
Lawrence Mihlon (2997), Alyne Elias  
(2998)  
LONDON—John Shinn, Derek Barlow,  
Nicholas Landon, 34 Dover St., London  
W.1, England  
BONN—Bruce Bendow, Richard Mikton,  
Silke McQueen, Mittelstrasse 39, Bad  
Godesberg, Germany  
BRUSSELS—27 Rue Ducarle, Brussels,  
Belgium  
PARIS—Robert Farrell, Arthur Erikson,  
17 Ave. Matignon, 3rd Fl., Paris 8,  
France  
MILAN—Marc A. Messina, Via Manzoni  
No. 12, Milan, Italy  
MEXICO CITY—Wesley Perry, Jr.,  
Lafragua 4-314, Mexico 1 D.F. Mexico  
RIO DE JANEIRO—Leslie Warren, Rua  
Mexico 3-S/1507 1509, Rio de Janeiro,  
Brazil  
MOSCOW—Stewart Ramsey,  
Kutuzovsky Prospekt 19, Apt. 28-29,  
Moscow, USSR  
TOKYO—Richard Halloran, Charles Cohen,  
John Yamaguchi, Toranomom Sangyo  
Bldg., 1 Kotohiracho Shiba, Minato-Ku,  
Tokyo, Japan

## CIRCULATION MANAGER

Hugh J. Quinn (2310)

C. C. RANDOLPH, Publisher (2016)

A MCGRAW-HILL WEEKLY 75 CENTS

**COLOR RADAR.** Here is a novel use for a shadow-mask color cathode-ray tube. Radar display device by Toshiba uses one color to display the plan-position-indicator map and another to show moving targets. The unused gun can display alpha-numeric information. *A storage tube is used to convert the radar ppi sweep into a conventional tv raster. See p 54* COVER

**AIR FORCE DISPLAY.** System developed for command and control use selects data from any one of 1,890 different channels and projects it in six colors. Another new technique is binary storage and display on a dark-trace tube. *Things to come: Air Force standards for display parameters* 10

**DIODE LASER TRANSMITTER.** Laboratory system employs radiation from gallium-arsenide diode to transmit video signal at bandwidth of 12 Mc. *Developers say system can be used for data transmission and that bandwidth can be pushed to gigacycle range* 24

**RAILROAD ELECTRONICS.** Railroads seek new ways of controlling traffic flow to compete with truckers. *One new car-reporting system electrostatically prints out picture of passing train* 26

**ULTRASONICS IN COMMUNICATIONS AND PRODUCTION.** This state-of-the-art report shows how new components, materials and techniques are extending applications of ultrasonic technology in communications, manufacturing and research. Specific subjects covered include sonar, inspection devices, delay lines, transducers, ultrasonic amplifiers, phonon masers and velocity transformers for machining. *The author is a leading authority on ultrasonics.* By W. P. Mason, Bell Telephone Labs 33

**SECONDARY EMISSION MAKES KLYSTRON SELF QUENCHING.** Here is an example of electronic serendipity. A reflex klystron was being used as a superregenerative detector with a 1-Mc quench signal coupled to the repeller. But it was noted that a quench sinusoidal oscillation appeared at the repeller even when the external quench signal was removed. The effect can be attributed to secondary emission. *The new self-modulation technique can replace the external modulator and power supply with a simple tuned circuit.*  
By P. E. Schmid, Aero Geo Astro Corp. 40

**COMBINING TUNNEL AND CHARGE-STORAGE DIODES.** Nanosecond logic circuit requirements have brought forth the TDCT (tunnel-diode charge-transformer) or ETD (enhanced tunnel diode) circuit. It takes advantage of the high current gain of the charge-storage diode and the fast-switching action of the tunnel diode. *Advantages are high-speed operation, excellent fan-in/fan-out capability and improved circuit tolerances.*  
By P. Chow and J. Cubert, Univac div., Sperry Rand 42

Published weekly, with Electronics Buyers' Guide as part of the subscription, by McGraw-Hill Publishing Company, Inc. Founder: James H. McGraw (1860-1948).

Title ® registered U.S. Patent Office; © copyright 1963 by McGraw-Hill Publishing Co., Inc. All rights reserved, including the right to reproduce the contents of this publication, in whole or in part.

Executive, editorial, circulation and advertising offices: McGraw-Hill Building, 330 West 42nd Street, New York, N. Y., 10036. Telephone Area Code 212 971-3333. Teletype TWX N. Y. 212-640-4646. Cable McGrawhill, N. Y. PRINTED IN ALBANY, N. Y.; second class postage paid at Albany, N. Y.

OFFICERS OF THE PUBLICATIONS DIVISION: Shelton Fisher, President; Vice Presidents: Joseph H. Allen, Operations; John R. Callahan, Editorial; Ervin E. DeGraff, Circulation; Donald C. McGraw, Jr., Advertising Sales; Angelo R. Venezian, Marketing.

OFFICERS OF THE CORPORATION: Donald C. McGraw, President; Hugh J. Kelly, Harry L. Waddell, L. Keith Goodrich, Executive Vice Presidents; John L. McGraw, Treasurer; John J. Cooke, Vice President and Secretary.

Subscriptions are solicited only from those actively engaged in the field of the publication. Position and company connection must be indicated on orders. Subscription rates: United States and Possessions and Canada, \$6.00 one year, \$9.00 two years, \$12.00 three years. All other countries \$20.00 one year. Single copies, United States and Possessions and Canada 75¢. Single copies all other countries \$1.50.

THE PUBLISHER, UPON WRITTEN REQUEST TO OUR NEW YORK OFFICE FROM ANY SUBSCRIBER, AGREES TO REFUND THAT PART OF THE SUBSCRIPTION PRICE APPLYING TO COPIES NOT YET MAILED.

Subscribers: Please send change of address notices, subscription orders or complaints to Fulfillment Manager, Electronics, at the address below. Change of address notices should provide old as well as new address, including postal zone number if any. If possible, attach address label from recent issue. Allow one month for change to become effective.

Postmaster: Please send Form 3579 to Fulfillment Manager, Electronics, P. O. Box 430, Hightstown, New Jersey, 08520.



Audited Paid Circulation

**Contents continued**

**MECHANIZING TRANSISTOR SWITCH DESIGN.** Determining resistance values for a simple transistor switch is not complicated but can be time consuming. Here the design equations have been broken down cook-book fashion for convenience. *The result is a worst-case d-c design that accommodates deviations of plus or minus 10 percent in resistance values and supply voltages.*  
By T. E. Osborne, SCM Corp. 47

**COLOR-TV RADAR.** Standard shadow-mask color-tv tube shows moving targets as red trails on a background of green fixed targets. *Future systems might use three colors for cloud and target altitude identification* 54

**VELA HOTEL.** First pair of satellites designed to detect nuclear blasts in outer space are ready for launch. Radiation detectors will watch for violations of the nuclear test ban. *Annual cost of operational system is pegged at \$20 million to \$30 million* 57

**DEPARTMENTS**

**Crosstalk.** What Else Will There Be? 5

**Comment.** Value Engineering 6

**Electronics Newsletter** 17

**Meetings Ahead.** Magnetic Inductance Core Conference 18

**Washington This Week.** Pentagon Will Bear Down Harder on Reliability 20

**Research and Development.** Laser Pulses Track Targets. Fences Remove Radar Clutter 64

**Components and Materials.** How Good Are Beryllia Ceramics? 75

**Production Techniques.** Flip Chips Make Microcircuits Easier to Connect 82

**New Products.** Plug-In Modules Increase DVM Flexibility 93

**Literature of the Week** 106

**People and Plants.** GE Elects Borch President 108

**Index to Advertisers** 116

# New from Sprague!

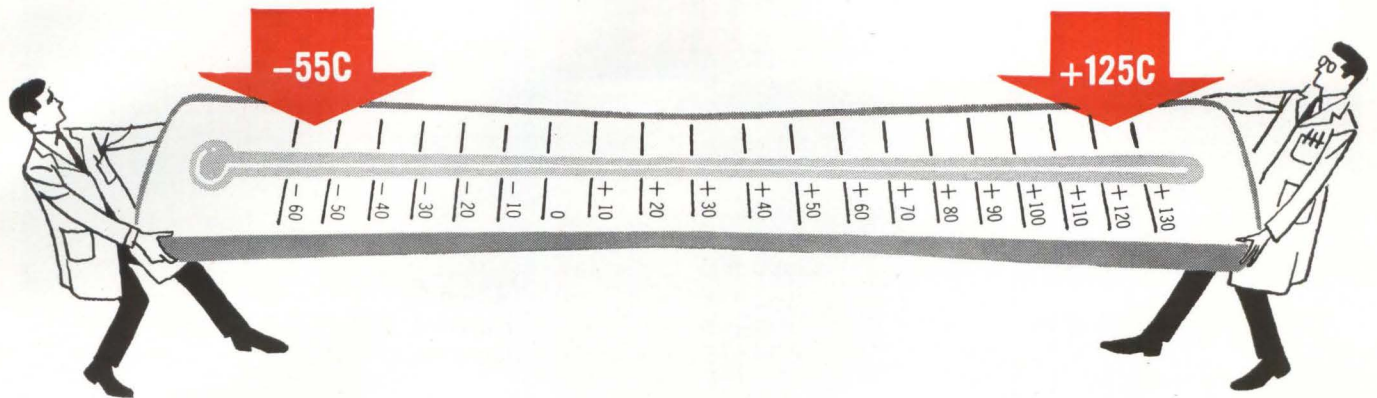

## E-X-T-E-N-D-E-D T-E-M-P-E-R-A-T-U-R-E R-A-N-G-E

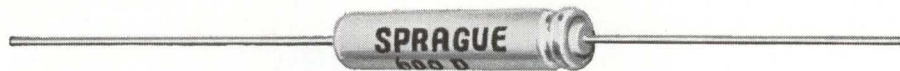

### TYPE 600D **EXTRA-LYTIC\*** ALUMINUM ELECTROLYTIC **CAPACITORS**

**VOLTAGE RATINGS TO 150 VDC**, unlike other so-called "wide temperature range" aluminum electrolytics with compromise voltage ratings only to 60 volts.

**CAPACITANCE STABILITY** over entire temperature range. Even at  $-55\text{ C}$ , capacitance drop is very small.

**OPERATING AND SHELF LIFE** comparable to or better than that of foil tantalum capacitors.

**LESS EXPENSIVE** than foil tantalum capacitors, yet in many cases meet the electrical requirements of MIL-C-3965 for tantalum capacitors.

**SMALLER AND LIGHTER** than tantalum capacitors in equivalent capacitance values and voltage ratings.



For complete technical data, write for Engineering Bulletin 3420 to Technical Literature Service, Sprague Electric Company, 35 Marshall Street, North Adams, Massachusetts.

★TRADEMARK

#### SPRAGUE COMPONENTS

CAPACITORS  
TRANSISTORS  
RESISTORS  
MICROCIRCUITS  
INTERFERENCE FILTERS

PULSE TRANSFORMERS  
PIEZOELECTRIC CERAMICS  
PULSE-FORMING NETWORKS  
TOROIDAL INDUCTORS  
ELECTRIC WAVE FILTERS

CERAMIC-BASE PRINTED NETWORKS  
PACKAGED COMPONENT ASSEMBLIES  
BOBBIN and TAPE WOUND MAGNETIC CORES  
SILICON RECTIFIER GATE CONTROLS  
FUNCTIONAL DIGITAL CIRCUITS



'Sprague' and '®' are registered trademarks of the Sprague Electric Co.

48C-155-63

electronics October 18, 1963

CIRCLE 3 ON READER SERVICE CARD 3

# INJECTION LASERS

NOW AVAILABLE ON  
RAPID DELIVERY SCHEDULES

GaAs Injection Lasers . . . 8400 Å

GaAsP Injection Lasers . . . 6200 Å-8400 Å

Tiny p-n junction diodes emit coherent radiation by direct application of electric current. Standard configurations now available. Consultation and design services on custom configurations offered.



For illustrated brochure, write to:

**ELECTRO-NUCLEAR  
LABORATORIES, INC.**

GaP Injection Sub-Lasers . . . 6400 Å

GaAs Injection Sub-Lasers . . . 9100 Å

GaAsP Injection Sub-Lasers . . . 6600 Å-9100 Å

GaSb Injection Sub-Lasers . . . 16000 Å

Diodes operated beneath the laser threshold emit non-coherent light retaining the general spectral characteristic and fast time-constant of the Injection Laser. Sub-Lasers listed above are available, in standard configurations, on rapid delivery schedules. Other III-V sources available on special order.

2437 LEGHORN STREET, MOUNTAIN VIEW, CALIFORNIA

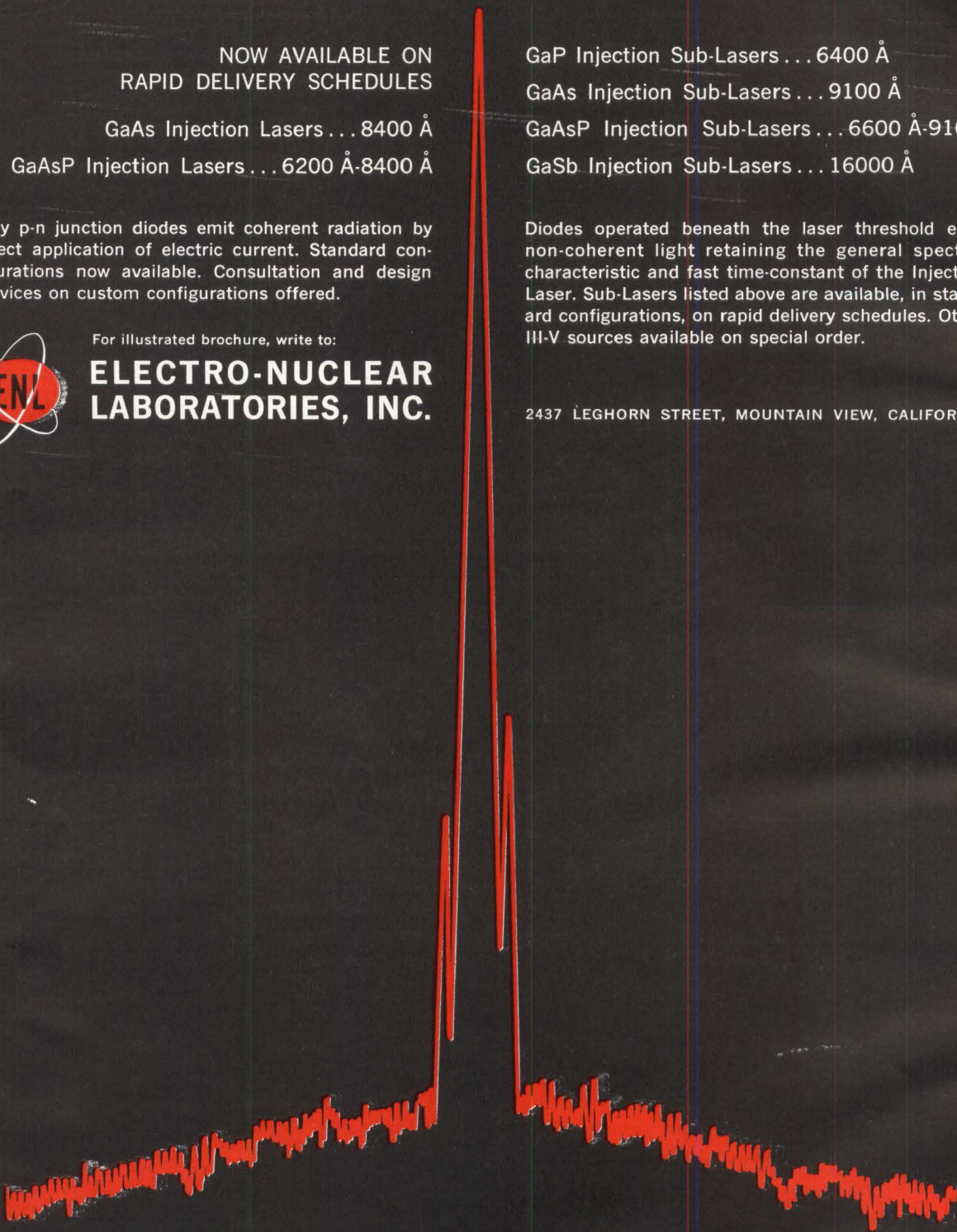

## What Else Will There Be?

**IN THE NEWS** recently have been several applications of electronics that emphasize what should be the main-stream development of this industry. In one case a manufacturer has built a portable electronic computer designed to be used in much the same way that engineers have used slide rules. In England a couple of engineers have made a tv tape recorder intended for home use.

Both examples are in the classic tradition. A market for a particular device is sensed or discovered, equipment is developed to meet the need, and now the product must weather the hazards of the marketplace to see whether users are willing to pay the price to get the benefits offered.

The public does not always agree that the timing, price and features offered are satisfactory. Color tv, for example, was a case of an obvious technical improvement that the public accepted as inevitable but was not willing to pay for when it was first introduced. Now, either through education, set obsolescence, better economic conditions—whatever—the public is beginning to buy color tv in greater volume. All to the good.

Now, how about more attempts to probe the market for some really far-out applications? Certainly there are many jobs that electronics has already shown it can do so far as the technology is concerned. Ultrasonic cleaning, for example, has proved itself in specialized applications in industry but is still used little, if at all, in the home. Why not ultrasonic dishwashers and laundry units and even car washers? It can be argued that price rules out these uses today, and this is probably true. But have the actual technical problems been satisfactorily solved, have the features that that customer really wants been nailed down, has the breakover point between acceptance and nonacceptance been established? Above all, has the inertia of the public to this particular idea been correctly estimated?

This industry is now the fourth largest in the country. In a few decades it may well be first, since the applications of electronics to everyday living offer an almost limitless new dimension. Medical electronics, information retrieval, automobile and traffic control, industrial applications are merely the obvious areas of interest.

There is a color tv set in your future. What else will there be?

### **MATERIALS FOR SPACE-AGE ELECTRONICS.**

Next week, we publish a special report on materials. We believe it is "must" reading for anyone seeking fuller understanding of advances that are contributing to the rapid evolution of electronics today and that will be a dominant factor in the future.



The report, by Associate Editor Tomaino, does not merely review the newest materials. It digs beneath the surface to clarify fundamental approaches that are creating a revolution in technology. Guided by an understanding of what goes on in atoms and molecules, workers in the field of materials are attempting to rearrange the basic building blocks of nature to create new electronic devices.

One concept has been dubbed molecular electronics. An understanding of electrical phenomena derived from an understanding of the behavior of atoms and molecules has tremendous implications for our industry. In the words of Arthur von Hippel, of MIT: "Nature designs everything from atoms; hence we should be able to design any kind of material with foresight if we thoroughly understood the periodic table of elements in all its implications."

**OUR NEWSHAWK** in Japan relays a plea from an importer of American electronic apparatus for better instruction manuals. He says that just shipping equipment itself is not enough, that accompanying printed matter can be the difference between selling and not selling against competitive brands.

Which reminds us that this is also true in Europe, and no doubt elsewhere in the export market.

Not too long ago we personally ran down to our satisfaction reasons why one particular test instrument sold so well in Scandinavia. It is a good product, but then so are several others. Its advertised specifications make sense to engineers, and performance lives up to them. Furthermore, the distributor double-checks the distant factory and tests every single unit, to be sure not only that it works but also that it works the way it is supposed to work when delivered to the customer. And, finally, the instruction manual that goes along with the sale is detailed enough to insure proper use and contains enough additional information to insure proper maintenance.

Make no mistake about this: dead-on-arrival, poorly functioning, inadequately understood and reluctantly serviced equipment cannot be sold in export markets as readily as in the United States which has, somehow, become too resigned to it. So-called "foreigners" just do not think that way.

# FILMISTOR®

METAL FILM RESISTORS  
OFFER 5 TEMP. COEFFICIENTS  
TO MEET ALL CIRCUIT  
REQUIREMENTS

RUGGED END-CAP  
CONSTRUCTION  
FOR LONG TERM  
STABILITY

EXCEPTIONAL  
RESISTANCE TO  
MOISTURE AND  
MECHANICAL DAMAGE

SURPASS MIL-R-10509  
PERFORMANCE  
REQUIREMENTS

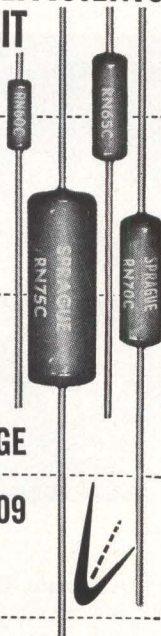

Providing close accuracy, reliability and stability with low controlled temperature coefficients, these molded case metal-film resistors outperform precision wirewound and carbon film resistors. Prime characteristics include minimum inherent noise level, negligible voltage coefficient of resistance and excellent long-time stability under rated load as well as under severe conditions of humidity.

Close tracking of resistance values of 2 or more resistors over a wide temperature range is another key performance characteristic of molded-case Filmistor "C" Resistors. This is especially important where they are used to make highly accurate ratio dividers.

Filmistor "C" Resistors, in  $\frac{1}{8}$ ,  $\frac{1}{4}$ ,  $\frac{1}{2}$  and 1 watt ratings, surpass the stringent performance requirements of MIL-R-10509D, Characteristics C and E.

Write for Engineering Bulletin No. 7025A to: Technical Literature Service, Sprague Electric Co., 35 Marshall Street, North Adams, Mass.

For application engineering assistance, write: Marketing Dept., Resistor Div., Sprague Electric Co., Nashua, N. H.

# SPRAGUE®

THE MARK OF RELIABILITY

73B-R1

## COMMENT

### VALUE ENGINEERING—PRO

Rafter-rattling amens for your Sept. 27 Value Engineering editorial (p 5)!

As an oldtimer in wireless and electronic engineering, I have much too often been shocked and distraught by the Rube Goldbergian complexity of design indulged in by so many modern engineers. Some seem to delight in complexity for its own sake, giving little thought to the old adage: "Anything that *can* go wrong will go wrong sooner or later."

Reliability and lowest possible cost, with the minimum of complexity that will accomplish the job, is the ideal. This, when one finds it, is a joy to behold and respect—this is true engineering.

BENJAMIN F. MIESSNER

Miessner Inventions, Inc.  
Miami Shores, Florida

### VALUE ENGINEERING—CON

I read with amusement your *Crosstalk* section of Sept. 27 (p 5).

I agree that engineering with value is worth the editorial consideration you have given it. I take strong exception, however, to your apparent conception of what an engineer is.

An engineer is *not* "a person who can do for a dollar what any fool can do for five," any more than a physician is a person who can heal in one week that which any fool could heal in five weeks. Both observations are equally absurd. But the medical profession would never be guilty of the latter.

Moreover, your statement "to the applied scientist, the result is what counts," shows an uncommon lack of insight as to what is meant by a professional man.

I should like to refer you to the *Proceedings of the IEEE*, Sept. 1963, page 1175. There the editor, Dr. Ryder, takes the very statement that you have chosen as your keynote and exposes it as a doctrine that can lead to the extinction of our profession.

It is my opinion that our technical journals could spend their time profitably placing the engineer in perspective as a professional man. The alternative, I fear, is the way of the dinosaurs.

BRUCE EISENSTEIN

Bryn Mawr, Pennsylvania

### INDUSTRIAL MORALITY

Mr. A. E. Larson's remarks concerning industrial morality (Comment, p 6, Sept. 20) can not go unanswered. . . . Mr. Larson should ask himself: What is the meaning of money? An engineer works many hours each day. It is presumed that he does his very best professionally on the task that is assigned to him and which he accepts as part of his employment contract. For this service an engineer is paid money by his employer.

An engineer's employer sells at a profit the products that an engineer creates. These products and their sale represent the very best that the engineer's employer has to offer in the way of service to his customers in the presence of real or potential competition. If this were not so, the engineer's employer would eventually disappear from the market even if the employer's sole customer were the United States government. The engineer would then be without employment.

It is from these sales that an engineer's paycheck is derived. It is from profits—the living proof of an engineer's productivity—that stockholders' dividends are paid, new tools are created, and annual pay increases for an engineer are achieved.

An engineer's work and his paycheck are a fair exchange: the very best an engineer can produce in exchange for the very best his employer can produce.

Money is a badge of honor. It is real, living proof of an engineer's ability. He uses it to feed and shelter his family, to educate his children, to pay for everything that he as a free American has the unalienable right to choose.

It was in the United States that it was first possible for man to "make money." The dollar sign is derived from the symbol of the United States and it is only here that it is possible for an engineer to use the symbol of his nation as a symbol of immorality. Money carries no immorality! It is an inanimate object. The immorality is the damning of what money stands for. . . .

"Thou shalt make money" is a clear and rational statement of industrial morality. Implicit in this statement is man's recognition that he should be the sole director of his own life, that creative action is implicit in human life and that no individual has the right to interfere coercively with the life and physical property of any other individual anywhere, at any time.

Without this, an engineer and his family can only contemplate the socialist slavery now encompassing the world.

THOMAS W. SANDERS

Sanders and Sanders  
Reseda, California



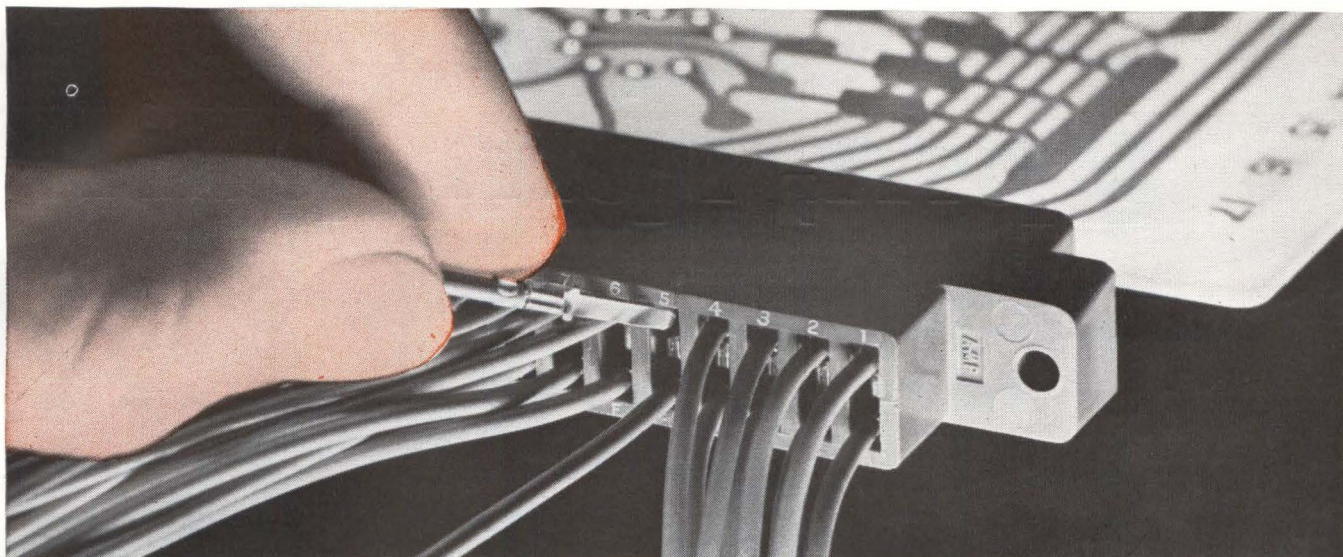

Home . . .

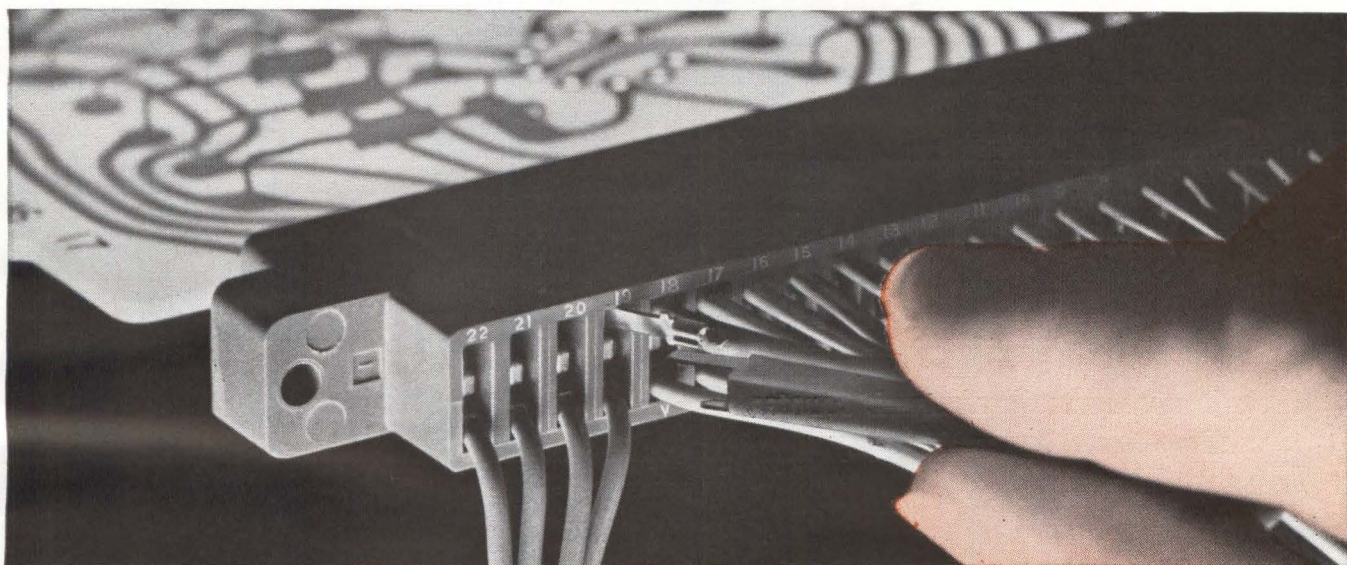

## for quick change artists

Circuit changes, replacements or repairs . . . all these can be done faster with this new AMP-TAB★ Printed Circuit Connector and you need never take the connector off the board!

In this connector, easy hand insertion of tab terminals puts large-surface, formed tabs in touch with pre-inserted contacts. A metal to metal snap-lock device holds the tab securely in place, a simple extraction tool gets them out . . . just that quick! This means contacts last longer and blocks are not subjected to high insertion and extraction forces which may cause block damage.

You get other benefits too! Maximum density through design centers of .100, .125 and .156 inches. Commoning, built-in, for dual read-out and circuit redundancy. And spring values that maintain constant and uniform pressures on circuit paths.

All this is what's different but, you still get other premium AMP-line features. Contacts and tabs of phosphor bronze base material with standard gold over nickel plating. Our reliable "F" crimp for maximum conductivity, near-wire tensile strength and built-in insulation support. And . . . automatic application of leads to tabs

at rates of up to 3,000 per hour for the lowest possible applied cost anywhere.

There's more!

- inter-contact keying plugs
- anti-flashover egg-crating insulates each terminal. Sleeving unnecessary
- dimensions and performance conform to MIL-C-21097
- available in 10, 15, 18, 22, 31, 41 and 43 positions for wire ranges—#18 AWG thru #26 AWG

And, there's still more! Just send today for the complete story on our new AMP-TAB Connector for Printed Circuits.

★Trademark of AMP INCORPORATED



AMP products and engineering assistance are available through subsidiary companies in: Australia • Canada • England • France • Holland • Italy • Japan • Mexico • West Germany

# Direct readout in: gpm, rpm, psi...

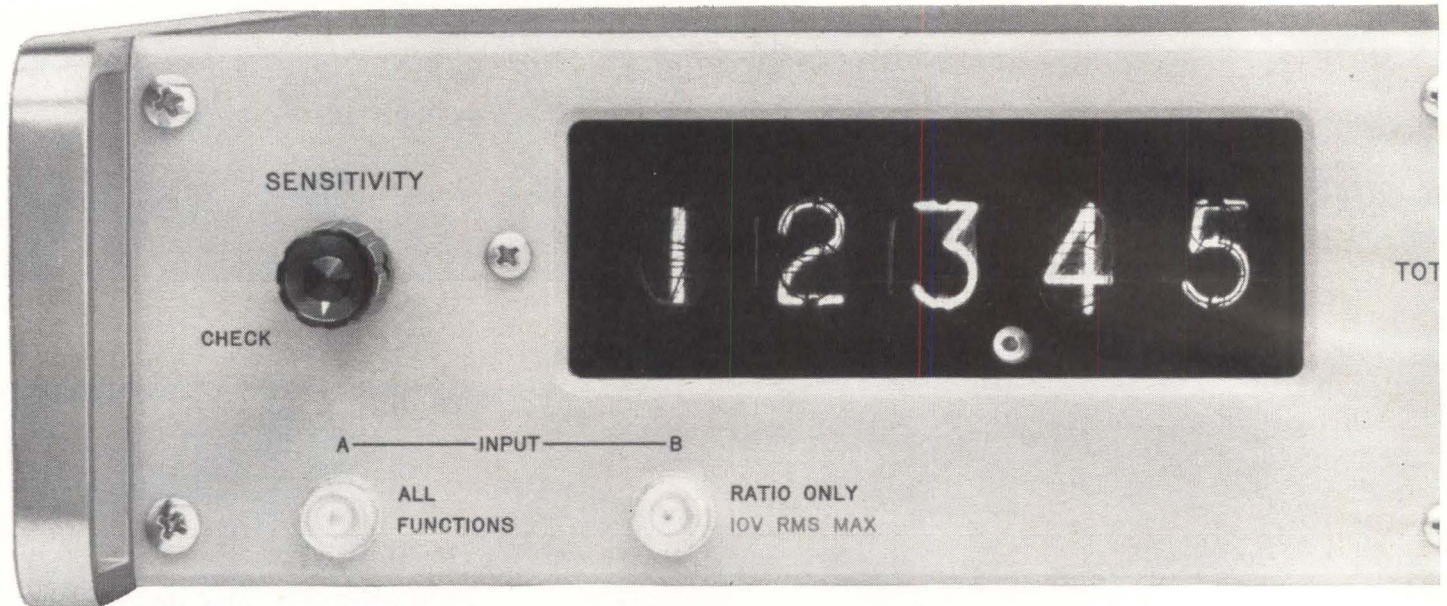

## Measure, normalize, control... with the new

*Today's most versatile electronic counter, in addition to measuring frequency and period and totalizing:*

- measures normalized rate
- measures normalized time (period)
- measures ratio
- measures normalized ratio
- measures time for N events to occur
- counts N events, providing an output pulse at the start and end of the count
- N may be set to any integer from 1 to 100,000

Gallons per minute, pounds per hour, revolutions per second or minute — any event that can be converted to an electrical pulse can be measured in the exact units that are most helpful to your application. The ability to select gate times on the hp 5214L Preset Counter permits normalizing of any measurement.

For example, connecting a tachometer generator to a rotating shaft produces an output which is applied to the counter. Presetting the counter gate permits direct measurement of rps or rpm. Thus, if the tachometer generator produces 100 pulses per revolution, the gate would be set at  $N = 1000$  (0.01 sec) to measure rps or  $N = 600$  (0.6) sec to measure rpm.

Besides making measurements common to most universal counters, the 5214L measures N periods;

measures ratio; measures normalized ratio; measures time for N events to occur; counts N events. This versatility is achieved by using two sets of decades, one of which registers the signal being counted, the other, which may be preset to any integer from 1 to 100,000 by front panel thumb-wheel switches, controls the gate. The number N also may be remotely programmed. Separate output signals are available to operate external equipment whenever the gate opens or closes. Since the 5214L can count N events, it is particularly useful in batching.

The 5214L measures ratio over a wide range of frequencies and with a wide choice of normalizing factors. The reading displayed is  $N \times A/B \times \text{Multiplier}$ . Hence, input B can be used as an external time base input for extending gate time or for normalizing an input signal so that percent change of input signal A may be read directly. The 5214L measures the time in milliseconds for N events to occur—period and multiple period measurements are made easily.

The solid state 5214L incorporates display storage, for continuous display of the most recent measurement and a flicker-free presentation on long life rectangular Nixie tubes. The four-line BCD code output with assigned weights of 1-2-2-4 is convenient for systems use.

Call your Hewlett-Packard representative for assistance in applying the remarkable 5214L Preset Counter to your particular measuring, recording and control problem. He will offer a demonstration at the same time.

# you name it!

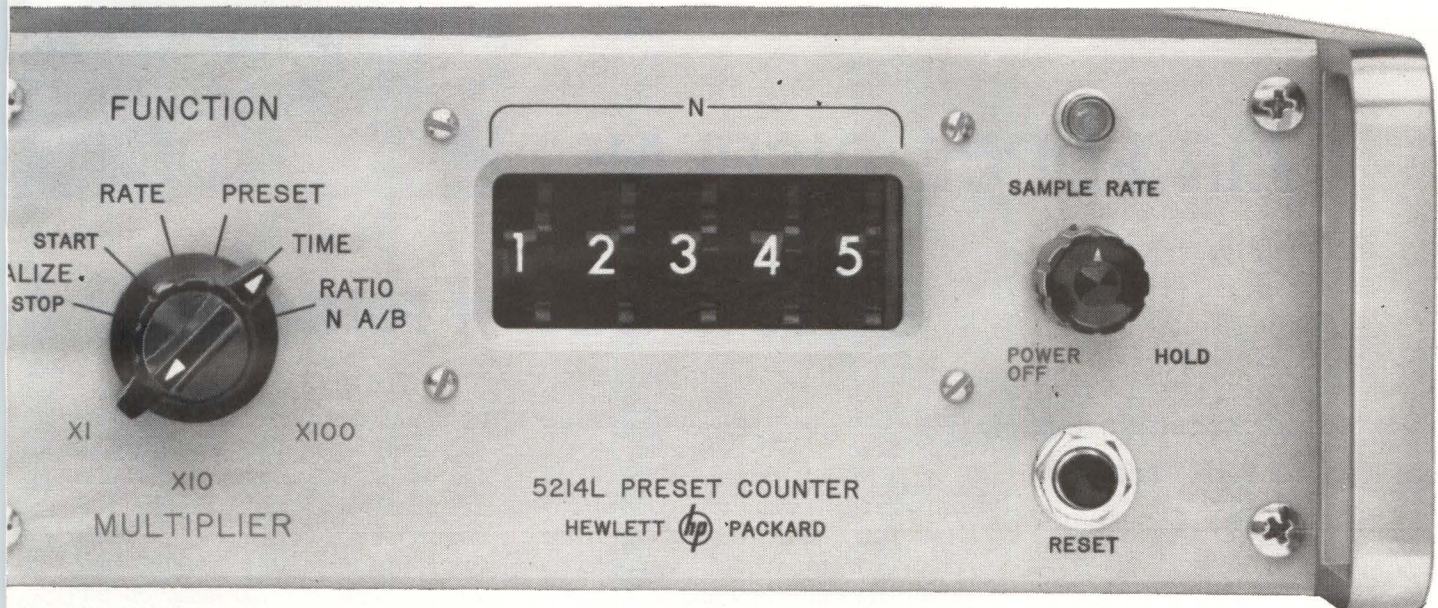

## hp 5214L UNIVERSAL PRESET COUNTER

### SPECIFICATIONS

#### FUNCTIONS

**Totalize (input A):** Range, 2 cps to 300 kc; sensitivity, 0.1 volt rms sine wave; 1 volt negative pulse, 1  $\mu$ sec minimum width; gate time, manual control; input impedance, 1 megohm, 50 pf shunt; capacity, 99,999 counts x Multiplier (1, 10 or 100); check, counts 1 kc, 100 cps or 10 cps

#### Rate (input A):

10  $\mu$ sec to 1 sec, 10  $\mu$ sec steps  
100  $\mu$ sec to 10 sec, 100  $\mu$ sec steps  
1 msec to 100 sec, 1 msec steps

**Preset (input A):** Input frequency range, 2 cps to 100 kc; preset range, 1 to 99,999; outputs, -30 volts to -1.3 volts transition at gate opening and gate closing; check, 100 kc counted, reads N

**Time (input A):** Input frequency range, 2 cps to 100 kc; reads, time for N events in msec; period and multiple period, reads time in msec for N periods; time base, 10  $\mu$ sec, 0.1 msec, or 1 msec; accuracy,  $\pm 1$  count  $\pm$  time base accuracy  $\pm$  trigger error\*; check, 100 kc counted, reads time in msec for N cycles

#### Ratio (input A & B):

Input A: Frequency range, 2 cps to 300 kc  
Input B: Frequency range, 2 cps to 100 kc; sensitivity, 0.1 volt rms sine wave; input impedance, 1 megohm; reads,  $\frac{NA \times \text{Multiplier}}{B}$ ; accuracy,  $\pm$  count; check, reads N x Multiplier (requires an input to B)

#### TIME BASE STABILITY

##### Internal:

Aging rate,  $< \pm 2$  parts in  $10^6$   
 $+15^\circ\text{C}$  to  $+35^\circ\text{C}$ ,  $< \pm 20$  parts in  $10^6$   
 $-20^\circ\text{C}$  to  $\pm 65^\circ\text{C}$ ,  $< \pm 100$  parts in  $10^6$   
Line Voltage  $\pm 10\%$ ,  $< \pm 1$  part in  $10^6$

#### GENERAL

**Maximum Counting Rate:** 300 kc\*\*

**Registration:** 5 long-life rectangular Nixie tubes with display storage

**Sample Rate:** Time following a gate closing, during which gate cannot be reopened, is continuously variable from less than 0.2 sec to greater than 5 sec in rate mode

**Operating Temperature:**  $-20$  to  $+65^\circ\text{C}$

**Dimensions:** 16 $\frac{3}{4}$ " wide, 3-13/16" high, 13 $\frac{1}{4}$ " deep

**Printer Output:** Output, 4-line BCD (1-2-2-4); 1-2-4-8 code on special order; print command, step from -29 volts to -1 volt

**Price:** \$1475

\*Trigger error (sine wave) =  $\frac{0.3\% \text{ of one period}}{\text{number of periods}}$  for 40 db signal-to-noise ratio. Trigger error decreases with increased signal amplitude and slope.

\*\*See detailed specifications under Functions

Data subject to change without notice. Price f.o.b. factory.

8475

**HEWLETT  
PACKARD  
COMPANY**



1501 Page Mill Rd., Palo Alto, Calif., (415) 326-7000. Sales and service representatives in principal areas. Europe, Hewlett-Packard S.A., 54 Route des Acacias, Geneva, Switzerland; Canada, Hewlett-Packard (Canada) Ltd., 8270 Mayrand St., Montreal, Que.

DATA FLOW in multicolor display is from electrical input to projection. Black-and-white film is used as transfer medium. Console (photo) for display is at right, with a request panel on its front. To the left is electronic typewriter section with real-time black-and-white narrative display, internal core storage of three page displays, and input of displayed page to computer



## AIR FORCE DISPLAY

# Selects Data From 1,890

Console for command and control converts data to film within 15 seconds

**NEW YORK**—Members of the Society for Information Display last week got the first good look at the multicolor display and information retrieval console that ITT Fed-

eral Labs has developed for the Air Force's 473-L System.

The 473-L system is the headquarters command and control system that USAF is installing in the Pentagon to acquire and present data from all Air Force commands (ELECTRONICS, p 24, April 21, 1961; p 30, April 20, 1962).

Among other systems described at the Society's second national symposium was a solid-state elec-

troluminescent bar or histogram display unit, reported by H. G. Blank and M. S. Wasserman, of General Telephone & Electronics Labs. Requiring only 1 × 4 inches of panel space for three displays, the unit uses a segmented EL lamp on the edge of a glass substrate as the display. Control circuits are in the form of layer components on the side of the glass substrate.

Another ITT paper described new applications for the dark-trace tube, a cathode-ray tube that writes in dark lines on a white background, with an unusually long persistence phosphor.

**Multicolor Display**—J. D. Edgbert, of ITT, said the Air Force system is designed for use with a high-speed computer, but the console adapts to display a wide range of other digital and analog inputs. Upon request, any one of 1,890 different information channels is displayed within 15 seconds. The data can be on magnetic tape, in disk files, drums, punched tape, under radar or slow-scan tv form. The image is projected in up to six colors plus white on a black background. On request, any display is automatically copied on paper.

The 16-inch-wide console unit includes an automatic electronic and photographic processing system. Dynamic input is received bit serially on a word demand, at a 356-kc clock rate. The 56-bit word defines the character or vector, address in a 1,000 × 1,000 x-y matrix, special

### FIRST DISPLAY STANDARDS?

For the first time, Air Force may establish standards as to exactly what constitutes an acceptable display system, Yale Smith, of Rome Air Development Center, reported at the display symposium.

At RADC, display engineers and psychologists are working together to specify limits for resolution, contrast, color-register and brightness-threshold values; many will have to be established by statistical study of the average observer's response. Difficulty is that some parameters now have different meanings depending on display method used (e.g. crt, projection); there are at least five accepted ways of defining contrast, Smith said

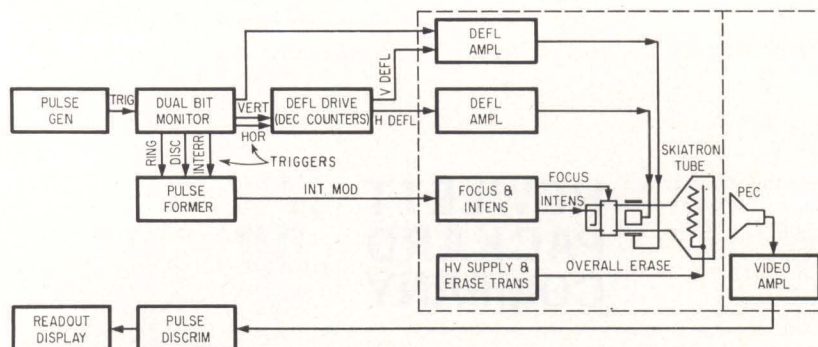

EXPERIMENTAL dark-trace tube storage system uses photoelectric cell facing Skiatron for nondestructive optical readout. Storage is maintained even with power off

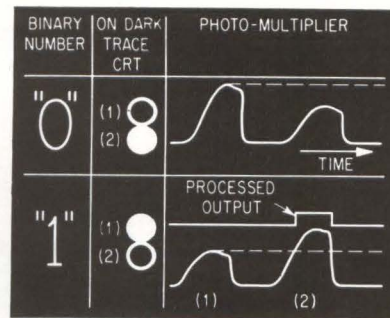
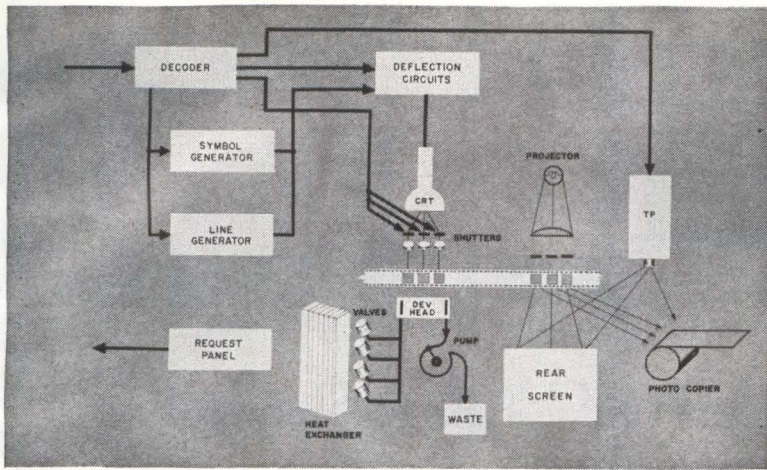

BINARY coding on dark-trace tube is achieved by combinations of dish and ring traces, obviating need for reference. Dishes and rings are produced by different pulse intensities, right

## Channels

By GEORGE V. NOVOTNY,  
Associate Editor

instructions, and the color of symbol. Data is checked for parity and instructions, and converted to visual analog symbology by a high-resolution 5-inch cathode-ray tube. Each individual symbol is thus selected, addressed and then unblanked for 1 millisecond.

Each symbol frame is photographed on 35-mm black-and-white film, making three simultaneous exposures of "white" data, one or two exposures for the other colors, resulting in a combination of one or more frames that are later projected in color by an additive projection system with a primary-color filter for each frame.

The exposed film is automatically developed and rear-projected on the dark screen. The request-to-display cycle is 15 seconds, and the screen blanking period between successive projections is less than 1 second. Static information, such as maps and table grids, is separately projected from a built-in magazine of 300 slides.

A photocopier built into the display console automatically prints, on request, an 8 × 10½-inch paper copy of the display.

Information request, said Edgbert, is by pressing a button on a 30-button request module. Each button is identified by a tag on a coded plastic overlay sheet; the entire overlay sheet is interchangeable and uses mechanical coding for the entire panel. With up to 63 different overlay cards, the panel has a capacity of 1,890 different request words.

**Dark-Trace Storage** — Dark-trace digital storage and display conversion development were described by A. M. Loshin, of ITT's Data and Information Systems division. Loshin detailed several new applications of the dark-trace tube, including a high-density digital storage system.

Different amounts of excitation produce either a disc or a ring on the dark-trace tube phosphor; a binary coding system taking advantage of this fact has been developed. Binary 0 and 1 are denoted by different combinations of rings and discs, obviating need for zero reference and eliminating errors due to fluctuating systems parameters

and aging of record.

Digital data can be stored on the dark-trace tube with a density of up to 60 bits per linear inch, and the information remains there in quasistable centers, without recycling, for days or weeks even when the power is turned off. Nondestructive readout can be done optically.

Another application of the dark-trace tube, said Loshin, is analog-to-digital conversion. The tube can be scanned with a cathode ray through a graph or half-tone transparency. This sets up binary storage of the contours on the tube face. By readout scanning the information is then picked off as digital signals.

## Mercury Wasn't All Bad

**REBUTTAL** to criticism of Mercury program reliability (ELECTRONICS, p 20, Oct. 11) was issued last week by J. S. McDonnell, chairman of McDonnell Aircraft, prime contractor for the space capsules.

He pointed out that six flights were made without a fatality, a feat unmatched in development of any high-performance aircraft. In its report at Houston the week before, McDonnell said, NASA's "principal conclusion" was that the program's success demonstrated the equipment's reliability.

At the Houston meeting, NASA

officials had presented a long list of equipment failures, with most of the electronics failures traced to improper assembly or connections, or to designs later modified. Of 720 system or component discrepancies, 526 were blamed on low-quality workmanship. NASA said mistakes must be corrected to meet the degree of perfection needed for more complicated future programs.

On the plus side, NASA said communications and telemetry system performance was good, enabling backup units to be eliminated from the later flights.

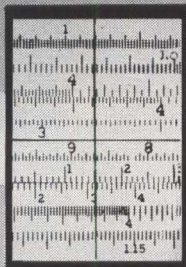

P. R. MALLORY & CO. INC., INDIANAPOLIS 6, INDIANA

## Using Pellet Film Resistors in Hybrid Microcircuits

Mallory pellet film resistors are compatible both with other microcircuit techniques and with conventional components.

With thin films, for example, these tiny discrete resistors can be inserted within the substrate, or added on the substrate in combination with the film element. High resistance values are available within small area.

With integrated circuits, a package of pellet resistors can readily be adapted to permit mounting and interconnection of integrated circuitry within the package for analog and communications circuits.

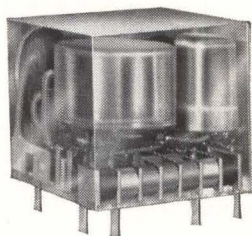

Typical miniaturized circuit using Mallory pellet film resistors with conventional transistors.

With conventional components, such as standard pulse transformers or transistors (see picture above), the pellet elements can be combined with the large components in a module which affords considerable miniaturization at moderate cost.

Mallory pellet resistors are all 0.100" in diameter, and either 0.030" or 0.063" thick. Resistance values are available up to two megohms, tolerances to 1%, powers to 1/4 watt. Their uniform size simplifies automation of handling, testing and assembly. Temperature coefficient is less than 300 PPM/°C for most resistance values, from -65°C to +150°C. Reliability is excellent. These parts plus pellet tantalum capacitors are available from current production.

CIRCLE 240 ON READER SERVICE CARD

## "People-Proof" Voltage Standard

The Mallory Mercury Voltage Reference battery is a new kind of voltage standard. It's electrically and mechanically rugged, and has ample accuracy for measurements in the lab or on the production line. It's the first low impedance, multi-voltage standard of commercial design—ideal for calibrating deflection meters, oscilloscopes, VTVM's, and for bias circuits and telemetering systems.

Non-glass construction resists physical abuse. Operates in any position.

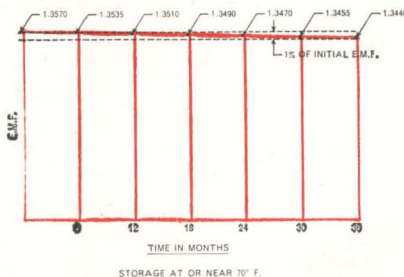

Long-term stability test shows steady output voltage from Mallory Mercury Batteries.



Accuracy is  $\pm \frac{1}{2}$  of 1% of stated voltage. Output stays within rated precision for three years or more. Accuracy is not impaired by momentary heavy overloads, or by sustained load within rated capacity. Impedance is only 1/2 to 1 ohm per cell. Eight output voltages, from 1.35 to 10.8 volts in 1.35 volt steps.

Price: \$39.50, from Mallory electronic parts distributors and from leading laboratory supply houses.

CIRCLE 241 ON READER SERVICE CARD

## Solid Tantalum Capacitors in New 75 and 100 Volt Ratings

Higher voltage ratings have been added to the Mallory line of solid electrolyte tantalum capacitors. Now you can use tantalums with the most stable electrical characteristics for an even broader range of miniaturized circuits. The new capacitance values for these units suit bypass, coupling and filter applications.

These hermetically sealed tantalum capacitors have high capacitance/volume ratio. Two miniature case sizes: 1/8" dia. by 1/4", and .176" by .437". The 75 volt series is available in values from

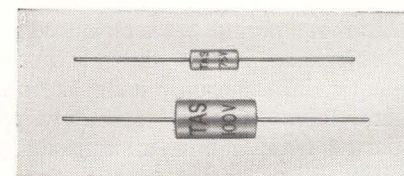

.47 to 3.3 mfd... the 100 volt rating comes in values from .47 to 2.7 mfd. Temperature rating is -80°C to +125°C.

With the addition of these new ratings, Mallory offers coverage of the whole spectrum of solid tantalum capacitor values up to 100 volts, including MIL styles through 50 volts. We have reliability data backed by some 8 million piece-hours of testing which we will be pleased to show you.

CIRCLE 242 ON READER SERVICE CARD

# DESIGNER'S FILE

## 60,000-Hour Test Demonstrates Stability of Mallory Computer Grade Capacitors



The performance characteristics of Mallory CG capacitors indicate that expected life should be ten years or more at 65°C, under rated DC voltage and AC ripple conditions. Tests in our quality control lab for over seven years bear out this prediction. A test group of production computer grade capacitors has been running at 65°C at rated voltage for over 60,000 hours without failure.

Test results are shown on the chart. The RC product is still under specification limit. Capacity has held well within limits, DC

leakage started low and has dropped steadily to an even lower value.

For use in computer power supplies, and anywhere you need a high-capacity, high-reliability filter, you can get the CG series in ratings from 115,000 mfd., 3 volts to 190 mfd., 450 volts.

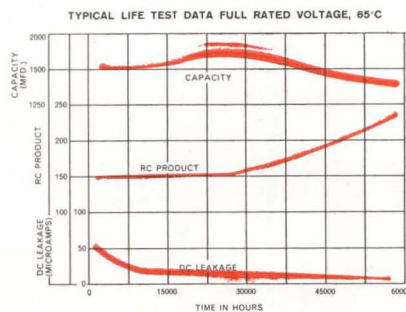

CIRCLE 243 ON READER SERVICE CARD

## Mallory Metal Oxide Film Resistors Maintain Stability to $\pm 1\%$

Because of their high stability at economical price, new Mallory Type MOL metal oxide film resistors offer designers opportunities to reduce component costs in circuits where you'd habitually think of using wire-wound resistors.

A typical stability-life test on the 2-watt model (Type 2 MOL) is shown here. Both after 200 hours of accelerated test at continuous rated load and 85°C ambient, and after 1000 hours at full load at 70°C, resistance change is less than 1%. Similarly, resistance change is less than 1/2 of 1% when the MOL is subjected to 10 times rated load for 5 seconds. The MOL series meets stability requirements of MIL-R-11804D, Characteristic P.

Dielectric strength is greater than 1000 VAC RMS. High frequency

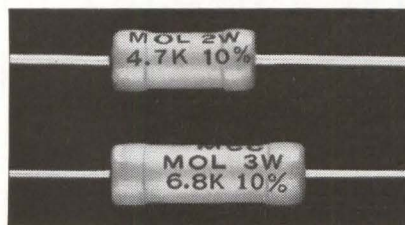

characteristics are excellent. Voltage coefficient is low. Tough silicone coating gives high stability during exposure to humidity. Ratings of 2, 3, 4, 5, 7 watts are available. The MOL series can operate at ambients up to 235°C. Resistance values range from 30 ohms to 125 K ohms. Standard tolerance is 10%; closer tolerances regularly available.

CIRCLE 244 ON READER SERVICE CARD

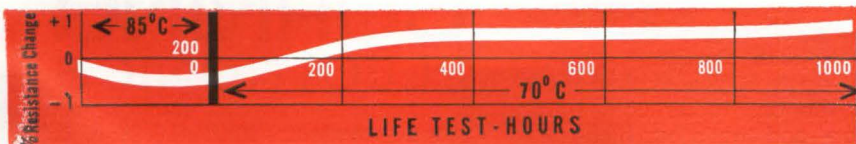

## New Low-Cost Miniature Trimmer Control

A potentiometer, especially designed for uses where resistance adjustments are occasionally needed, is now available from Mallory Controls Company. The new MTC control has the miniature size and low wattage ratings desirable for transistor circuitry.

Case is 0.592" in diameter plus terminals, by 0.185" thick. The MTC is rated at 1/4 watt at 40°C ambient, derated linearly to 0 watts at 100°C. It is supplied in resistance values from 100 ohms to 10 megohms. Standard tolerance is  $\pm 30\%$ ;  $\pm 20\%$  tolerance available on special order.

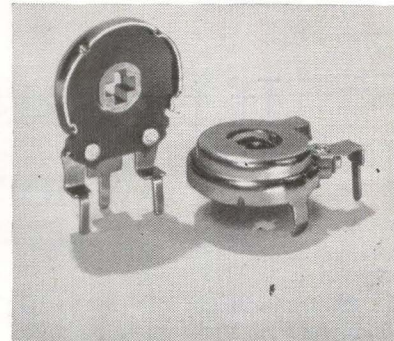

As a straight potentiometer, the MTC has standard rotation of 270°. It can be supplied with fixed end resistance, with 180° rotation. The element can be supplied to 500 volts maximum, within the rated wattage.

The MTC-1 version has terminals arranged for stand-up mounting. The MTC-4 has terminals which permit mounting the control flat.

Prices for the MTC start as low as 9 1/2 cents each in production quantities.

CIRCLE 245 ON READER SERVICE CARD



## If this is such a great capacitor, where's its IBM card?

Feed these characteristics into the computer on top of your shoulders and you'll understand why the CORNING® CYFM Capacitor needs no card.

*Sizes and values*—four case sizes cover pf ranges from 0.5 to 10,000, exceed all requirements of MIL-C-11272B.

*Voltages*—300v and 500v from -55 to +125°C.—no derating.

*TC retrace*—within 5ppm of the curve at any temperature; drift less than 0.1% or 0.1 pf.

*Tolerances*—±5% or ±0.25 pf is standard; also available in ±1%, ±2%, and ±10%.

*I.R.*—tops 500 ohm farads at 125°C., high over entire temperature range.

*Losses*—low over entire range,

D.F. is less than 0.001 at 1 kc and 25°C.

*Life*—less than .5% capacitance change after 2000 hours at 1 mc or 1 kc at 125°C. and 150% of full rated voltage; D.F. at 125°C. is less than 0.007 and I.R. is greater than 10<sup>10</sup> ohms.

*Moisture resistance*—exceeds all requirements of the MIL spec and Mil-Std-202 Method 106 tests.

*Radiation resistance*—no significant change in properties after exposure to 10<sup>18</sup> NVTth.

*Applications*—yours, in coupling, decoupling, filtering, timing, switching, or computer circuits.

*Price*—up to 60% less than you'd pay for the only other comparable capacitor—and that's our high-relia-

bility CYFR.

We make the CYFM the same way we make the CYFR, but the CYFM costs you less because we don't wring every one out—and punch an IBM card—and guarantee a reliability of at least 99.9994%/1000 hours at 60% confidence as we do with the CYFR.

Call your CORNING distributor for complete data sheets on the CYFM or for fast delivery on all case sizes and values. Your circuits won't know there's no IBM card.

# CORNING ELECTRONICS

A DIVISION OF CORNING GLASS WORKS  
3901 ELECTRONICS DR., RALEIGH, N. C.



R-Series  
2-sizes: 3-1/2", 4-1/2"



# TRIPLET

## "CLEAN SWEEP" PANEL INSTRUMENTS

A fresh approach to ultra-modern instrument design provides a "clean sweep" of the pointer over the full scale.

- 1** You get instant readability easier and at greater distances—plus more attractive designs to integrate into your equipment.
- 2** Self-shielded, accurate, reliable D.C. instruments have the exclusive Triplet BAR-RING movements.
- 3** Whatever your panel instrument requirement, look to Triplet for the right size and style, the right capability at the right price.



M-Series  
4-sizes: 2-1/2", 3-1/2", 4-1/2", 8"

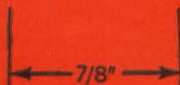

New 3/4" Meter  
Model .75S

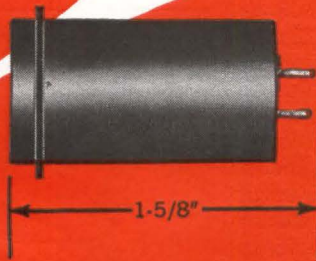

### SHIELDED BAR-RING MOVEMENTS

ALNICO MAGNET IS MOUNTED INSIDE FULLY IRON RING; FULLY SELF-SHIELDED

Not affected by magnetic panels or substantially by stray magnetic fields for D.C.

More Torque  
Lower Terminal Resistance  
Faster Response  
Exceedingly Rugged and Accurate

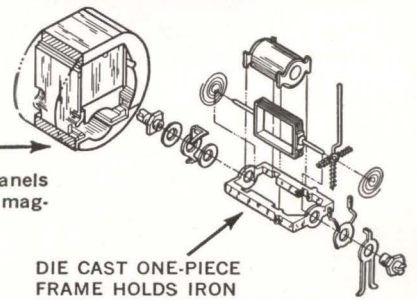

DIE CAST ONE-PIECE FRAME HOLDS IRON CORE IN EXACT ALIGNMENT

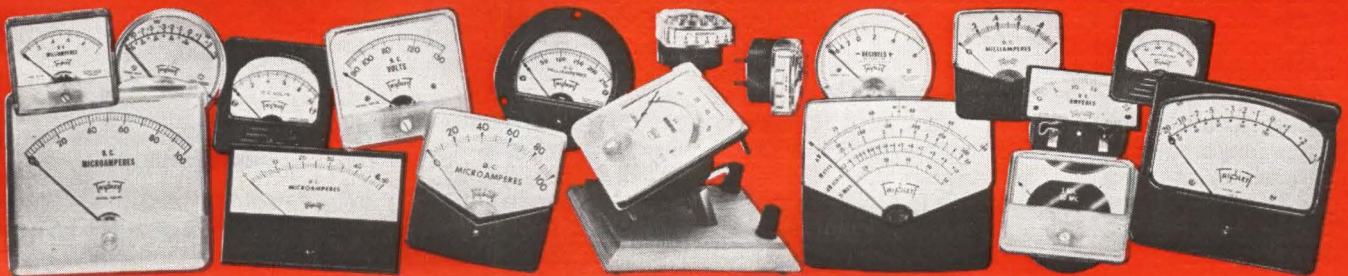

TRIPLET ELECTRICAL INSTRUMENT COMPANY, BLUFFTON, OHIO

CIRCLE 15 ON READER SERVICE CARD

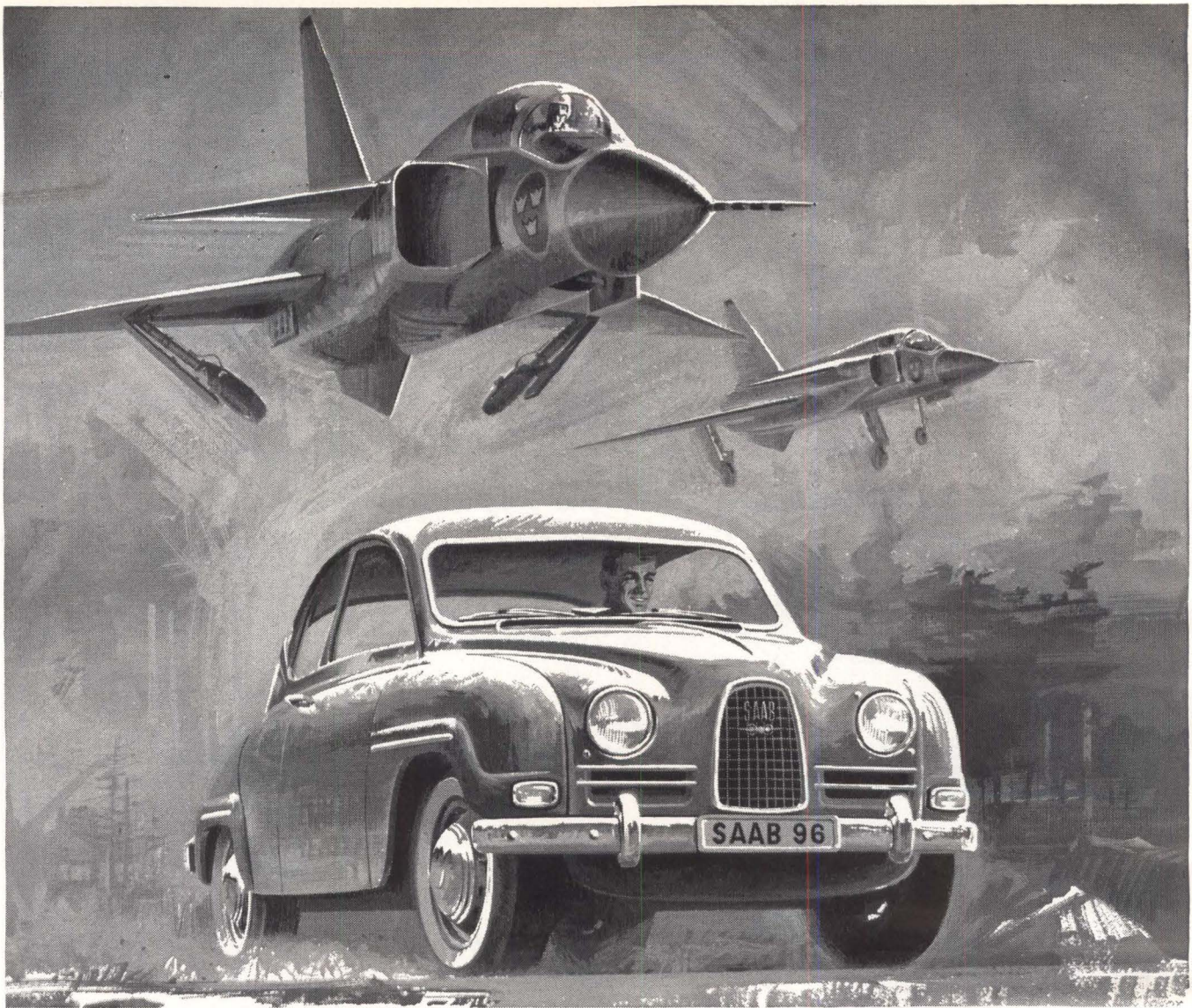

White sidewalls optional at extra cost.

## Some SAABs don't fly. But they have the same solid engineering as the ones that do.

Svenska Aeroplan Aktiebolaget (Swedish Aircraft Company, Ltd.) designs and builds all kinds of SAABs. Some, like the new Viggen Mach 2 fighter shown above, incorporate the world's most advanced aeronautical engineering techniques. Others race all over the roads of Scandinavia (for which they were designed), Europe (where they win rallies), and America (where scientifically enlightened people fall in love with them).

There's nothing strange about that. People who appreciate engineering quality will recognize that SAAB is subject to all the disciplines of aeronautical engineering: extreme, not ordinary reliability . . . abundant safety . . . and thoroughly proved performance. In a car, very refreshing.

Take a 1964 SAAB 96. It has a 3-cylinder, 2-stroke engine\* with only 7 basic moving parts. A modified one hit 103.56 mph at the Bonneville Nationals. Strange. And amazing. A SAAB has front-wheel drive: solid traction and road-holding, plus near-perfect weight distribution. It has an almost uncrushable unitized body with reinforced steel columns front and rear, 18- to 20-gauge body steel, and a new supersafe braking system (dual independent master cylinders with hydraulic lines that diagonally connect front and rear wheels). SAAB also has an aerodynamic shape with no corners or sharp edges; it's almost a wing on wheels. If you're looking for sound engineering in your next car, see your SAAB dealer soon. He sells one of the world's best engineered cars. Only **\$1895 P.O.E.**

\*Engine, transmission and differential warranted for 2 years or 24,000 miles.

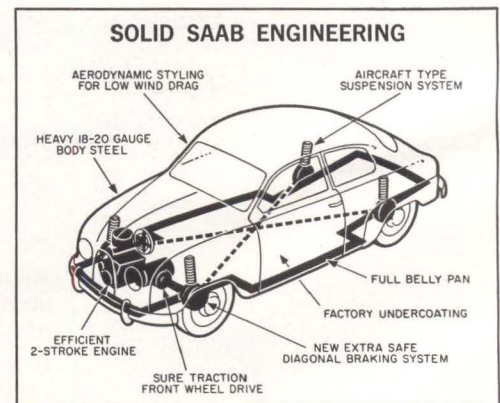

Shopping imports? Write for full descriptive literature on SAAB. SAAB Overseas, Inc., Department 410, 405 Park Ave., New York, N.Y.

**SAAB** STURDY • STYLISH • SWEDISH  
New York • New Haven • Denver • Jacksonville

FOR INFORMATION OTHER THAN LITERATURE, CIRCLE 299 ON READER SERVICE CARD

# Polaris for Britain—1st Step Taken

**MISSILE LAUNCHER**—the first piece of hardware to implement the Polaris agreement between the U. S. and Great Britain—will be built for the Navy by Westinghouse under a \$1,035,000 contract, officials of both countries said this week. The gear, similar to that now aboard U. S. nuclear undersea craft, will be constructed at Sunnyvale, Calif. and delivered by late 1964 to the Royal Navy Polaris School, Scotland. It will be used to fire dummy missile shapes.

Great Britain has four nuclear boats under construction or contracted for, said British officials, and has begun training crews in advance of their commissioning—tentatively scheduled for 1967 or 1968. The agreement to equip them with Polaris came after the U. S. decision to stop work on Skybolt (p 26, Dec. 21, 1962). It stipulates that the U. S. will supply missiles, minus warheads, together with components of the overall Polaris weapons system to British-built and manned boats. These could begin arriving in England by 1965, British officials said, and would be supplied after that on a continuing basis.

## Pan-American Microwave



TWO MORE LINKS of the microwave network that will eventually extend throughout Central and South America are being installed for the Mexican government by Nippon Electric. U. S. has given technical advice for the planning of the network

## A-Carrier Plans Sunk?

WASHINGTON—Confidants of Defense Secretary McNamara say he will reject Navy's request that the next new aircraft carrier be nuclear-powered. Money for a conventional carrier was voted last year, but Navy held up contracts and recommended the switch on the basis that nuclear costs were only 20 percent more than conventional costs.

Navy also recommends that all future surface warships bigger than destroyers be nuclear-powered. DOD is expected to decide this within the next few weeks as Navy's fiscal 1965 budget is prepared. Among the subsidiary questions the decision will resolve is the type of power-plant instrumentation Navy will buy

## Asian Countries Pledge Mutual Help in Electronics

TOKYO—An agreement to swap technical information and promote special technology suited to their own regions was reached by 11 participants in the Asia Electronics Conference here. Japan's Science and Technology Agency was named coordinator until plans for another session are drawn up—probably at a special meeting next year. Conferencees were Australia, Ceylon, China, Hongkong, India, Indonesia, Korea, New Zealand, Pakistan, the Philippines, and Thailand.

## Magnetic Supercooling Aids Search for Superconductors

CHICAGO—Magnetic supercooling to within thousandths of a degree of absolute zero will help University of Chicago's new ultra-low temperature lab search for new superconductors and extend studies of existing superconducting materials. A powerful magnet will permit the lab, due for completion next March, to attain temperatures within 0.001 to 0.0001-K. Since many superconductors work only below 1K,

ultra-low temperatures should permit isolation of basic physical phenomena within crystals from mobility effects of surrounding molecules, the lab says.

## Real-Time System Makes Missile Range Versatile

LOS ANGELES—A real-time data-handling system planned for the Pacific Missile Range is unusual in that it can link as many as 10 computers by digital communication, or split this linkage into smaller groups, providing flexibility for one-shot or multi-shot operations. System design services are being developed by Informatics.

## Laser Welder's 1st Use Seen in Electronics

BOSTON—The immediate use for laser welding is in electronics, according to Prof. C. M. Adams, Jr., of MIT. Speaking at the fall meeting here of the American Welding Society, he said: "Predictions that commercial use is five years away may be true as far as structural, load-carrying welds are concerned,

but connector welding by laser is here, especially in electronics work such as attaching lead wires to films." The laser "wants" to be a one-shot welder, said Adams. Anytime it's a question of a one-point weld, not a seam, the laser is a natural, he said.

One of the laser's attractions for metallurgists, he points out, is its application to high-conductivity metals. "Joining copper lead wires used to be tough, but with the laser high conductivity is an asset instead of a curse."

## \$75-Million Contract Let For Saturn Instrumentation

GUIDANCE instrumentation work for the Saturn IB and Saturn V boosters will be performed by IBM under terms of a five-year contract expected to exceed \$75 million. The contract covers integration and checkout of the instrumentation units, and development of data

## Japanese Government Approves Tv-Price Floor

TOKYO—The Ministry of International Trade and Industry has formally approved an agreement among tv manufacturers fixing minimum prices on sets destined for the U. S. (p 17, Sept. 6). Approval is effective retroactive to Sept. 19. Action is expected Nov. 1 by the Japan Machinery Exporters Association. That agreement, binding on both association members and outsiders, would require that export prices be at least 3 percent higher than manufacturers prices and that sets comply with specifications set down by the FCC in the U. S.

adapters and digital guidance computers. The contract was awarded to IBM Federal Systems Div. by Marshall Space Flight Center.

## Coil-Winding Wire Withstands 1,000 F

LOS ANGELES—Coil-winding wire developed by Permaluster maintains electrical integrity at temperatures as high as 1,000 F, the company reports. Previously, about 600 F was the limit a coil winding could withstand. Permaluster foresees nuclear reactor applications. Composed of a basically aluminum-oxide film, the wire has a melting point of 3,600 F, resists superheated atmospheres and operates under extreme pressure without peeling, chipping or disintegrating, the company said.

## Revolution in Recordings Seen in Standardization

STANDARDIZATION of tape cartridges would make possible a radically different method of marketing recordings, Marvin Camras of IIT Research Institute suggested to the Audio Engineering Society annual meeting in New York this week. A dealer would simply have some unrecorded cartridges and a few recorders connected by telephone lines to a central record library. A customer could bring his own cartridge, select anything in a large catalog, dial a number and pay only for the music he recorded.

## Thermionic Tube Bears Up Under Nuclear Radiation

A VACUUM TUBE that functions reliably under exposure to  $10^{16}$  nvt epithermal neutrons and  $4.5 \times 10^7$  roentgens of gamma radiation has been developed by Sylvania. The firm said its Circuitron, an integrated device with passive and active thermionic components in one envelope, withstands 500-g impact and 2.5-g vibrational accelerations. Operable at 200 C ambient temperature, Circuitrons are undamaged by 160-db noise, said Sylvania. No failure was produced by Mark F. Triga and Linac pulse radiation tests.

## MEETINGS AHEAD

NATIONAL ELECTRICAL MANUFACTURERS ASSOCIATION ANNUAL MEETING, NEMA; Edgewater Beach Hotel, Chicago, Ill., Oct. 21-24.

NATIONAL ELECTRONICS CONFERENCE, IEEE, IIT, Northwestern University, University of Illinois; McCormick Place, Chicago, Ill., Oct. 28-30.

ELECTRON DEVICES MEETING, IEEE; Sheraton Park Hotel, Washington, D. C., Oct. 31-Nov. 1.

17TH NORTHEAST ELECTRONICS RESEARCH-ENGINEERING MEETING, New England Sections IEEE; Commonwealth Armory and Somerset Hotel, Boston, Mass., Nov. 4-6.

RADIO FALL MEETING, IEEE, EIA; Hotel Manger, Rochester, N. Y., Nov. 11-13.

FALL JOINT COMPUTER CONFERENCE, AFIPS, IEEE, ACM; Las Vegas Convention Center, Las Vegas, Nev., Nov. 12-14.

MAGNETISM-MAGNETIC MATERIALS ANNUAL CONFERENCE, AIP, IEEE-PTGMITT; Chalfonte-Haddon Hall, Atlantic City, N. J., Nov. 12-15.

NUMERICAL CONTROL PRESIDENTS' CONFERENCE, NCS; Hotel Plaza, N. Y., N. Y., Nov. 14-15.

TECHNICAL WRITING WORKSHOP, University of California Extension Center; San Francisco, Calif., Nov. 18-19.

ENGINEERING IN MEDICINE AND BIOLOGY ANNUAL CONFERENCE, IEEE, ISA; Lord Baltimore Hotel, Baltimore, Md., Nov. 18-20.

VEHICULAR COMMUNICATIONS NATIONAL CONFERENCE, IEEE-PTGVC; Adolphus Hotel, Dallas, Texas, Dec. 5-6.

FALL URSI MEETING, IEEE Seattle Section, URSI, Boeing Scientific Research Laboratories; University of Washington, Seattle, Wash., Dec. 9-12.

FIRST MICROELECTRONICS CONFERENCE, EIA; Irvine Auditorium, University of Pennsylvania, Philadelphia, Penn., Dec. 10-11.

### ADVANCE REPORT

MAGNETIC INDUCTANCE CORE CONFERENCE, Magnetic Powder Core Association of MPIF; Chicago, Ill., April 28, 1964; Nov. 15 is deadline for submitting titles and 25 to 50-word abstracts to The Program Committee, Magnetic Powder Core Association, 60 East 42nd St., New York 17, N. Y. Topics should deal with applications or measurement techniques of iron powder or ferrite magnetic cores in these fields: delay lines, microwave, radio and tv, filters, computers.

## IN BRIEF

### Loran-C Net Detects A-Blasts

LORAN-C navigation stations now in existence could be used virtually intact as a system to monitor high-altitude nuclear detonations, said Sperry Gyroscope's Walter N. Dean reporting this week on studies the U. S. made during the 1962 atomic test series. The ionosphere's D-layer becomes altered after a 50-mile-or-up blast, he said, and absorbs more of the Loran-C signal. The signal returns to the receiver more quickly and reduced in amplitude. Loran transmitters now covering land-sea areas of the North Atlantic, North Pacific, and Arctic Oceans, plus the Bering and Mediterranean Seas, could be used for this purpose "as is." Dean said there are enough existing receivers that could be modified at low cost within months, and new ones to flesh out the chain could be easily constructed

### Post Office Tests Reading, Sorting Device

POST OFFICE DEPT. is testing electronic equipment built by Philco that optically scans and sorts machine-addressed mail (p 26, July 12). Under its contract Philco will also design and build an intermediate engineering model for testing next year and a prototype automatic, electronic reader for delivery in 1965. The prototype will be designed to read and recognize 500 incoming and outgoing addresses and to direct a letter sorting machine at a rate of 36,000 envelopes per hour.

### Two Firms Introduce New Computer Models

IBM AND HONEYWELL last week introduced new versions of computers that have been on the market for some time. IBM's 1401-G is designed for processing punched-card information only and cannot use magnetic tape drives or disk-file storage as the 1401 systems do. Monthly rental will start at \$1,900, purchase prices at \$125,150.

Honeywell's 1400 model, based on the H-1400 system first shown in February, is designed for real-time business data processing. It has a memory capacity of 32,768 48-bit words. Cycle time is 6.5 microseconds and internal operating speed

is 14,000 three-address additions per second. An average 1400 will rent for \$16,000 a month. Purchase price starts below \$500,000.

### Parametric Amplification At 35 Gc Investigated

LABORATORY for Electronics Inc. will study high-frequency parametric amplification under a \$95,000 Air Force contract. The purpose, the firm said, is to prove feasibility of low-frequency-pumped parametric amplification at 35 Gc. Since a varactor harmonic multiplier can generate the relatively low pumping frequency, the new parametric technique could permit future development of wholly solid-state microwave receivers. It could apply also to low-noise microwave-to-i-f down-conversion.

### Channel Splits Provide Frequencies

WASHINGTON—The number of land-mobile radio channels in the 25 to 42 Mc range will be increased Nov. 24 under an FCC rule change narrowing assignments from 40 to 20 kc between channels. Most stations will remain on present channels, but blocks of frequencies assigned to given services will be affected, since new assignments will have to be dropped into the vacated slots.

**ORGANIZATIONAL** changes designed to strengthen the chain of command between NASA headquarters and its outlying installations will take effect Nov. 1. The Offices of Space Sciences and Applications will be merged, and each center director will be limited to a single contact at NASA headquarters for all center business.

**GENERAL PRECISION** has set up a nationwide network of franchised dealers to market its three low-cost computers, the LGP-21, LGP-30 and RPC-4000.

**AFTER JAN. 1**, FCC will require the payment of fees before action will be taken on radio license applications. The fees range from \$2 to \$100.

**U. S. STRIKE COMMAND** has completed a five-month test of a transportable "Baby Sage" air-weapons-control system (p 28, March 22). It must now decide if the system will be bought in quantity.

**LOGIC TECHNIQUES** to enable character-recognition machines to read garbled or blurred text will be developed by RCA for the Army.

**SPERRY GYROSCOPE** of Canada has \$420,000 USAF contract to develop laser system that will automatically bore holes as small as 0.05 inch with accuracy of 8 micro-inches in space vehicle metals.

**FRIDEN** will merge into Singer. Singer is paying \$178 million in stock.

**NASA** is considering using Apollo spacecraft for long-duration earth-orbit missions. Lunar excursion module would be replaced by lab module. North American Aviation is making the study.

**NASA** has named three firms to compete for a \$4-million job to install, operate, and maintain technical communications at the Merritt Island Launch Area for manned space missions. The three are Bendix, ITT and RCA.

**JOSEPH F. SHEA**, deputy director since March of NASA's Office of Manned Space Flight, is new program manager, Apollo Spacecraft.

**11,000-MILE** undersea phone cable—reportedly the world's longest—will link Britain, Australia, New Zealand, and Canada in December. The \$98-million project was completed Oct. 10.

**HAROLD S. MICKLEY** has been named director of the New Center for Advanced Engineering Study at MIT (p 32, May 3).

## White House Realigning Patent Policy

**Last week**, the White House finished its year-long review of government patent policies and issued a directive designed to bring divergent agency policies closer together without destroying their individuality.

The result enunciates positions toward which the Defense Department and NASA, for example, have been drifting. Defense has been changing its regulations toward limiting its traditional policy of allowing contractors to keep rights to patentable inventions. NASA has been proposing to waive to industry more and more of its patent rights.

The White House now says retention of rights by the contractor should be favored if the contractor has an established commercial position in the field of development or if he can spread the technology faster and wider than government ownership and licensing. Government ownership is favored if the work is in an area where government has a prime interest or has been the major investor in previous technology. To speed application, a licensee is given three years to reduce the invention to practice before he loses exclusive rights. NASA has been seeking to reduce its own limit from five to three years.

## Pentagon and NASA Bear Down On Reliability

**Demands** for more quality, reliability and value in equipment built by industry for the government are being hammered home almost daily.

The Pentagon says "policy is to substantially increase the use of cost, performance and schedule incentives" and has begun to give its buyers intensive training in new contracting methods.

NASA, too, is moving more deeply into incentive contracting (ELECTRONICS, p 20, Oct. 4). Major factor in the drive is Congress' cost consciousness. This year, defense, space and research spending are getting the most critical treatment ever. The House's slash of National Science Foundation's budget (p 17, Oct. 11) halts an upward trend of years. NASA made frantic efforts, but failed to stop the House from cutting \$600 million off its budget. NASA wanted \$5.7 billion, but got \$5.1 billion (in fact, 145 representatives had voted to lop off another \$200 million). NASA does not have high hopes the Senate will restore much of the \$600 million cut.

## New Rules May Reduce Profit To Contractors

**Pentagon's** new weighted guidelines method of profit negotiation (ELECTRONICS, p 12, May 17) "were not intended to raise everybody's profits." This blunt message was given industry at a National Security Industrial Association meeting here by Assistant Secretary G. C. Bannerman. The new methods, now scheduled to be effective next year, will "make it possible for good performance to earn a higher profit." But Bannerman was "not at all sure that the average profit level for industry will rise."

General Bernard A. Schriever told the meeting: "We must get the most out of every dollar." Efforts to achieve savings in time, performance and reliability will continue. "And, gentlemen, I want to stress the word reliability," Schriever said, departing from his prepared text.

## Space Agency Cools Down Mercury Feud

**NASA officials** moved this week to prevent a running feud with industry (see p 11) over the complaints about faulty workmanship in the Mercury space program. They said newspaper reports on their 444-page report on the Mercury program laid undue emphasis on the workmanship issue. But the report cites specifics of faulty workmanship on page after page, and the message from NASA comes through loud and clear: industry performance must be hiked up to space-age requirements, and the supplier that can deliver on costs, dates, and reliability will be getting the work.

## How to put Siliconix UNIFETs\* to work . . .

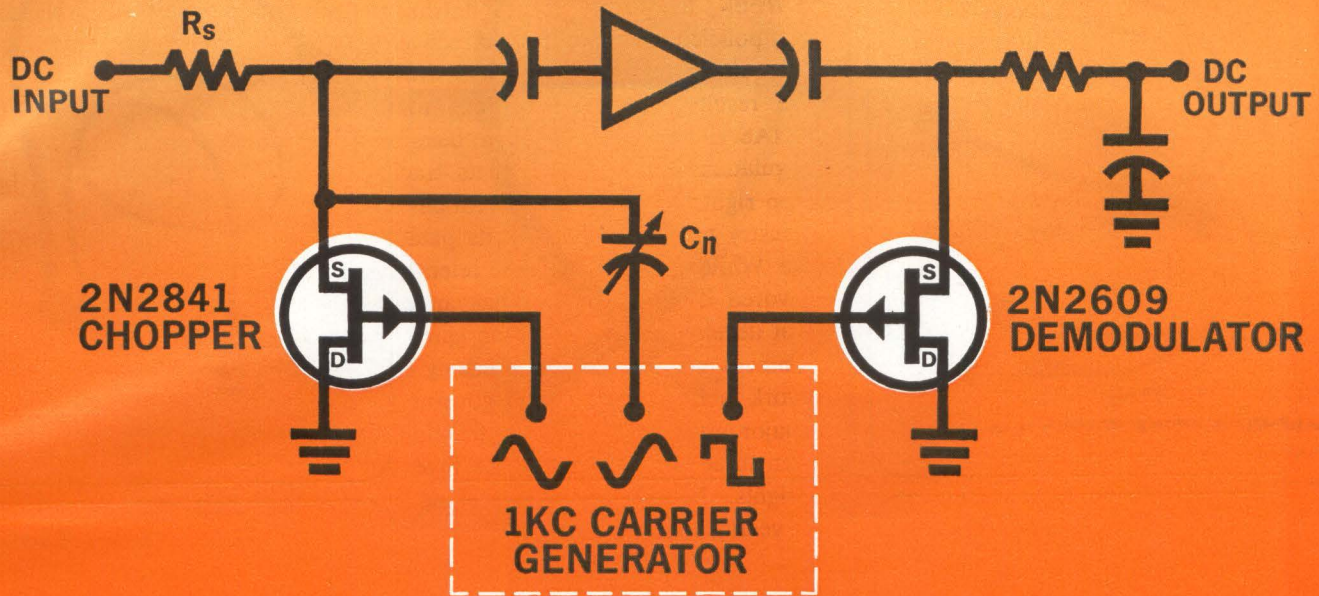

**INPUT DRIFT LESS THAN  $15\mu\text{V}$  for  $T_A - 60^\circ\text{C}$  to  $+65^\circ\text{C}$**

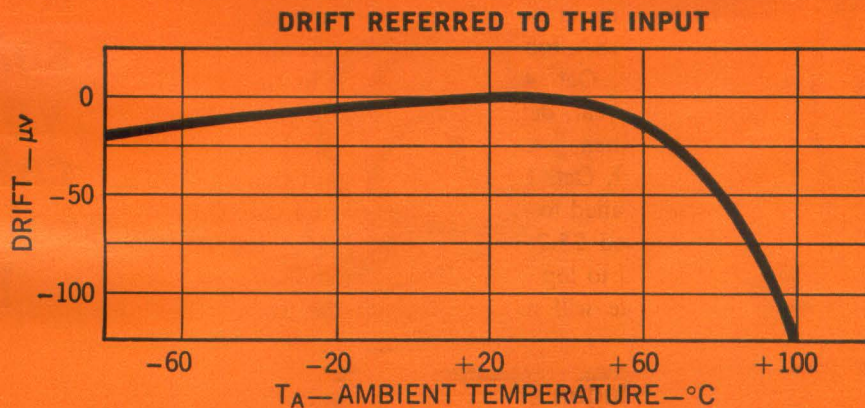

THIS UNIFET-STABILIZED AMPLIFIER PROVIDES VERY LOW DRIFT BECAUSE OF LOW CARRIER FEEDTHROUGH. THE CAPACITIVE COMPONENT OF FEEDTHROUGH IS NEUTRALIZED BY  $C_n$ . THE RESISTIVE COMPONENT IS NOT APPRECIABLE UNTIL HIGHER TEMPERATURES ARE REACHED. WITH UNIFETS YOU DON'T NEED TRANSFORMERS, EITHER. WRITE FOR FILE 103, UNIFET CHOPPER AMPLIFIERS.

\*Unipolar Field-Effect Transistors



**Siliconix incorporated**

1140 West Evelyn Ave. • Sunnyvale 33, California  
Telephone 245-1000 • Area Code 408 • TWX 408-737-9948

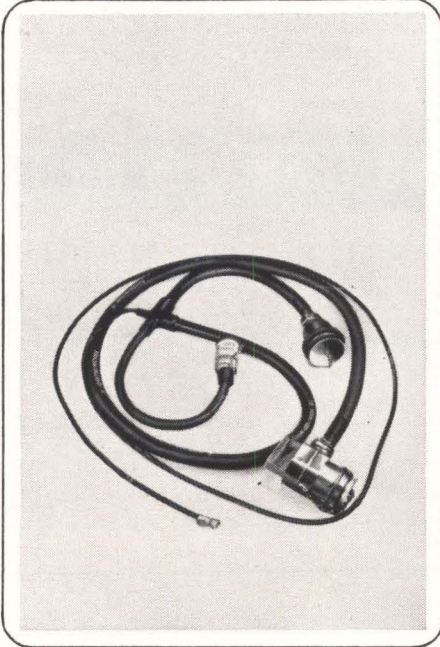
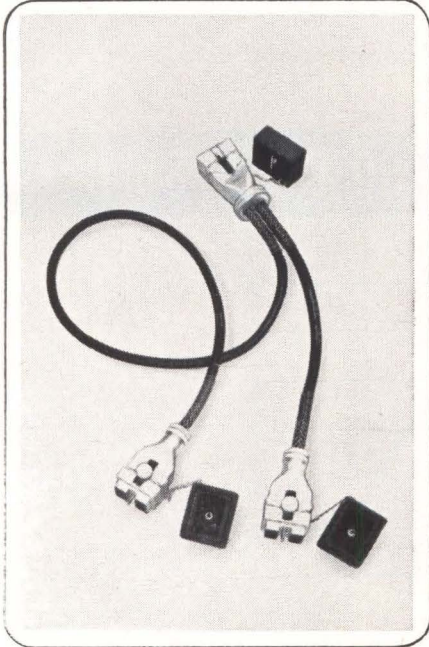
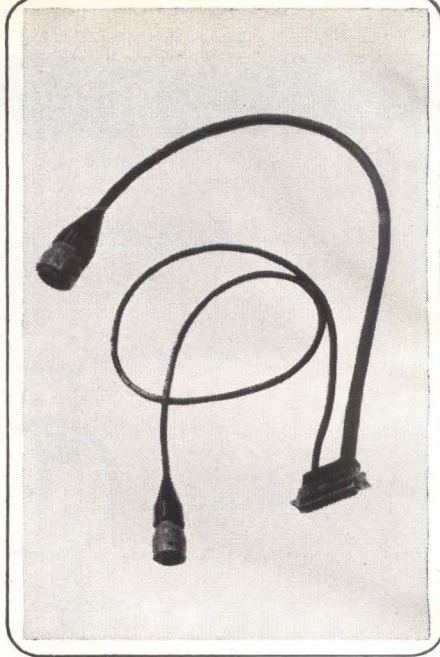
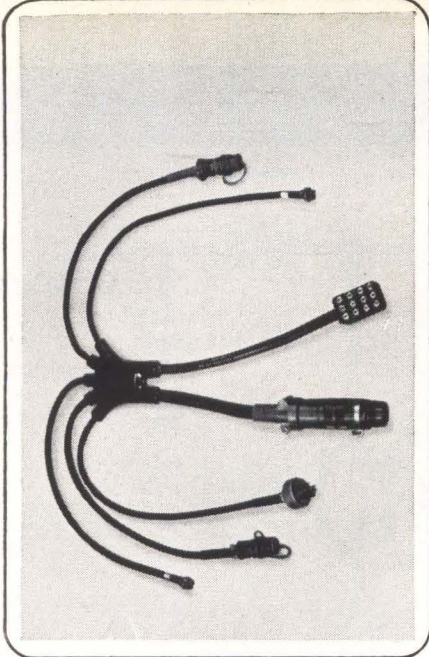

**Now  
let us  
solve  
your  
cable  
problem  
!**

You'll probably never need any of these five cables.

But somebody did. And the same versatility and reliability-control which fit these special cables to special needs are now available to solve your cable problems.

These are products of Rome's Special Products Facility, where unique cable constructions are everyday products.

Cables like these can't afford to fail—there often isn't a second chance. So Rome insures reliability with a quality control program second to none. It tests each cable construction continuously throughout construction and inspection.

The program has been so successful that we recently won the first aerospace reliability contract ever awarded to a cable manufacturer. Its goal is to prevent cable assembly malfunctions in the Minuteman missile.

Other cable constructions from Rome's Special Products Facility have proved themselves reliable on such projects as Hound Dog, Atlas, Mercury, and Sergeant.

Our Special Products Facility brochure explains how you can fit Rome's unique experience, skills and equipment to your specific problems. Just send the coupon.



Special Products Facility  
Rome Cable Division of Alcoa  
2937 South Tanager Avenue  
Los Angeles 22, California

Please send my copy of your brochure describing how I can benefit from Rome's Special Products Facility.

NAME \_\_\_\_\_

COMPANY \_\_\_\_\_

ADDRESS \_\_\_\_\_

CITY \_\_\_\_\_ ZONE \_\_\_\_\_ STATE \_\_\_\_\_



# NEW LOW-COST VERSATILE REGULATED DC POWER SUPPLIES

CONSTANT VOLTAGE/CONSTANT CURRENT WITH AUTOMATIC CROSSOVER



0-18V, 0-10A  
\$435.00  
MODEL 6263A

0-36V, 0-5A  
\$435.00  
MODEL 6266A

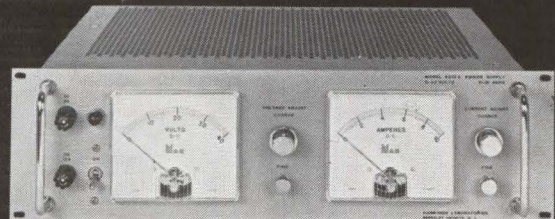

0-36V, 0-10A  
\$525.00  
MODEL 6267A

ECONOMY MODELS CONSTANT VOLTAGE/CURRENT LIMITING

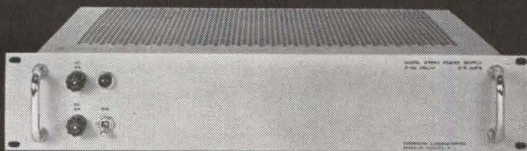

0-18V, 0-10A  
\$359.00  
MODEL 6363A

0-36V, 0-5A  
\$359.00  
MODEL 6366A

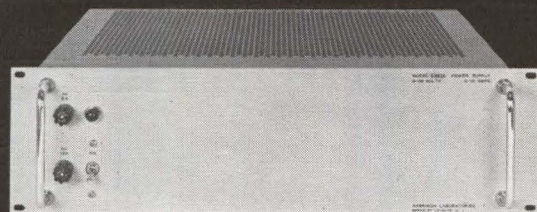

0-36V, 0-10A  
\$450.00  
MODEL 6367A

## COMPACT HIGH PERFORMANCE RACK SUPPLIES FOR BOTH SYSTEMS AND LABORATORY APPLICATIONS

- REGULATION.....0.01 to 0.02%
- RIPPLE.....Less than 1 mv
- RECOVERY TIME.....Less than 50  $\mu$ sec
- SHORT CIRCUIT PROOF

### ADVANCED FEATURES COMMON TO BOTH SERIES

Conservative design for reliability and long life • Silicon differential amplifier control circuitry for improved stability • Continuously variable output voltage and current — no range switching • Remote Programming of output voltage and current can be accomplished using either resistance or control voltage • Remote error sensing • Auto-Series, Auto-Parallel, and Auto-Tracking operation.

### ADDITIONAL FEATURES INCLUDED IN THE 6260 SERIES

Constant Voltage/Constant Current operation with automatic crossover • Coarse and fine controls for both voltage and current • Voltmeter and Ammeter • Optional chopper stabilization and cascaded reference for more stringent applications.

Contact your local sales rep or write directly to factory for complete specifications on any of H-Lab's complete line of regulated power supplies.



Write for new catalog describing the complete H-Lab line.

**HARRISON LABORATORIES**

A DIVISION OF  HEWLETT-PACKARD

45 INDUSTRIAL ROAD • BERKELEY HEIGHTS, NEW JERSEY • 464-1234 • Area Code 201 • TWX—201-464-2117

# GaAs Laser Transmits Wideband Data



System transmits video signal at bandwidth of 12 Mc with  $\frac{1}{4}$ -w input

**PRACTICAL** demonstration of a system that transmits data with a gallium-arsenide laser was reported today by General Electric's Radio-Guidance operation in Syracuse. GE says bandwidth of up to 12 Mc is the broadest to date and that future systems will operate at many times this figure. Spectral response is 9,000 Å.

Originally developed to solve rfi and data-congestion problems at missile test ranges, it can be used to

**PARABOLIC** reflector collects radiation and directs it to receiver

transmit data from missile pads and range-safety tv vans to blockhouse and control center. Guidance or telemetry data can also be sent from ground to booster or spacecraft.

Commercially, information can be transmitted in excess of 10 miles without FCC licensing, according to GE. The company also sees applications in studio transmitter links and remote pickups.

In the laboratory, a high-resolution, 800-line closed-circuit-tv picture with a 35-db signal-to-noise ratio was sent over a 12-ft path with apparently no degradation of the original signal.

The transmitter consists of the laser, parabolic reflector, power supplies and transistor circuits for driving the laser. Receiver optics, photo diode, transistor amplifier and power supplies make up the receiver. The system weighs less than 10 lb.

**Transmitter**—The modulated light source is a GaAs junction laser providing 70- $\mu$ w output at room temperature. While not the maximum, 70- $\mu$ w output gives the minimum 35-db s/n ratio at the receiver output with a maximum anticipated atmospheric background noise.

The diode is modulated by a low-impedance transistor feedback amplifier working from a 6-v battery. It is capable of accepting a 1-v peak-to-peak signal from 30 cps to 12 Mc. Driving power used is 250 ma. The diode's maximum power dissipation is 1 w at room temperature.

The parabolic reflector collects most of the radiation into a 1-degree beam. An improved lens can decrease beamwidth by three.

**Receiver**—At the receiver, an 8-in. lens focuses the collected light energy onto a combination field stop and spectral filter. The energy is incident on the S-1 photocathode of a type 6570 photo-tube. The signal is amplified in a preamplifier that has a nuvistor cascode stage with a 32-db gain. A transistor video amplifier follows the preamp.

**Laser Operation**—The GaAs diode is mounted on a TO-46 copper

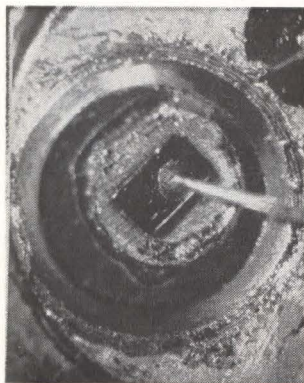

**LASER** is mounted with n-type material facing up. N-type crystal's greater transparency increases transmitter's light output

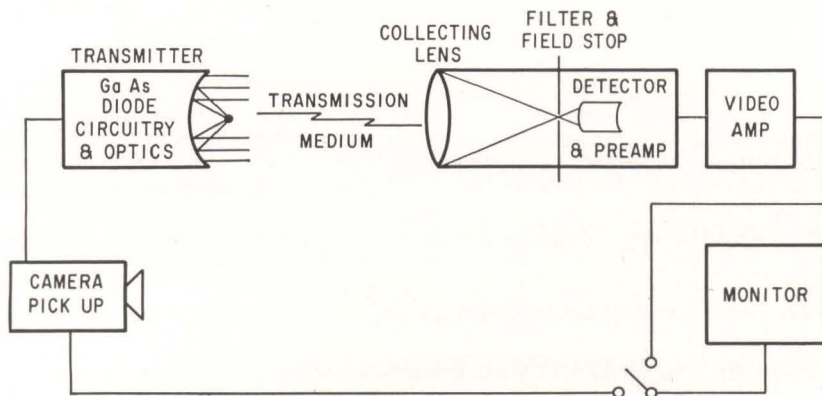
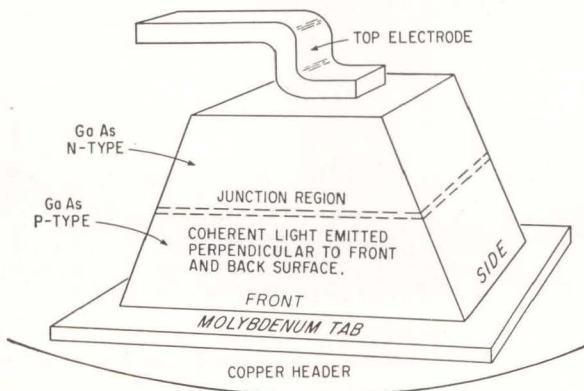

**TV DEMONSTRATION** setup. An 800-line picture was transmitted over a 12-ft path

By **JOEL STRASSER**  
Assistant Editor

header. Because the *n*-type material is more transparent to the radiation, mounting this side of the crystal face up provides added radiation.

Although a *s/n* ratio of 35 db was attained with an input of 250 ma. at room temperature, an increase of 10 db could be attained by operating the diode in the noncoherent mode, cooled to 77 deg K. For coherent operation, the diode must be used at 77 K, and for improved efficiencies, at 20 K.

While the bandwidth is 12 Mc, GE says it can ultimately be raised well into the gigacycle range. Multiplexing signals would get maximum use out of these large bandwidths.

The type 6570 multiplier phototube received the signal with 45  $\mu$ w incident on the photocathode. While the quantum efficiency of this tube is much less than typical semiconductor detectors, its large photoemissive surface offsets this disadvantage and makes it easy to focus the energy.

## Narrow-Band Standards Effective November 1

RADIO TRANSMITTERS at stations in the public safety, industrial and land transportation services at 25 to 50 and 152 to 174 Mc are required to comply fully with the FCC's narrow-band technical standards by Nov. 1. FCC adopted the standards in 1956, but allowed for gradual transition. Under the new rules, maximum frequency deviation must be held within  $\pm 5$  kc and a low-pass filter must be installed between the modulator limiter and the modulated stage of the transmitter, to prevent excessive frequency excursion. The frequency stability of transmitters in the 25 to 50-Mc band will be held to 0.002 percent and those in the range from 152 to 174 Mc will have a tolerance of 0.005 percent.

electronics October 18, 1963

## "A GUY COULD GET KILLED IN HERE"...

... this place is like a roller-skating rink! What's all the traffic? I had to *fight* my way into the instrument room!

*Oh, hello, Rip! Yes, we're doing a rush business here today! Every instrument in the joint's been in and out of here at least twice. Particularly amplifiers — just can't get 'em back here fast enough to meet all the requests!*

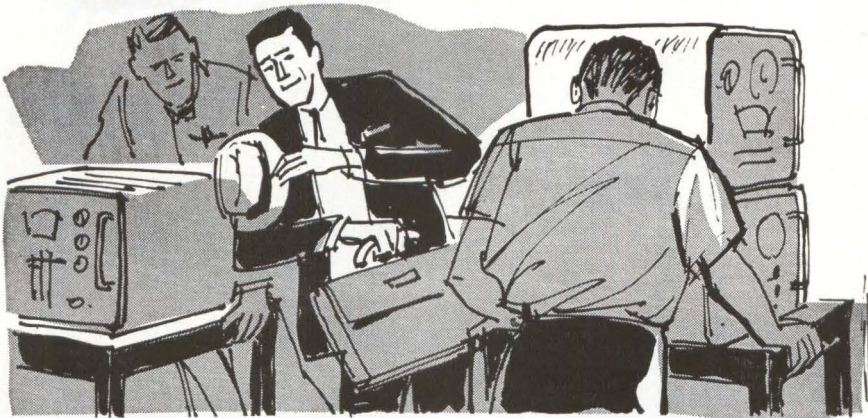

Amplifiers? Any special types really hot right now?

*Dunno. All my data-acquisition types have been out for about a week now. And all my audio amplifiers are down the hall in Dept. 23. Video amplifiers have been on the most-wanted list, too. And here are three requests for RF amplifiers I can't even fill until tomorrow at the earliest!*

What you need are more amplifiers like Krohn-Hite's DCA-10 — a stable ten watts, tenth-percent distortion, wide band!

*We're always using the DCA-10's you sold us — as audio amplifiers, mainly. But how about the other applications I've got to fill?*

But nothing! You're short on data-acquisition types? Look — the DCA-10's direct-coupled, goes all the way down to dc. Only 0.2% distortion at .01 cps. Perfect on data circuitry. And talk about video amplifiers — the DCA-10 is one in disguise! No droop on a step function from a DCA-10, as you'd get from a capacitor-coupled amplifier! And with a megacycle bandwidth, you get a rise time in the order of 0.1 microseconds.

*Yeah, the top end of a megacycle would serve the needs of many of the requests for RF amplifiers.*

Now you're thinking Krohn-Hite! Actually, there's really nothing like it for the money — frequency response flat within a db all the way up, stable dc level, too, and low hum and noise.

*You certainly don't have low hum and noise!*

What do you expect — *I'm a rep!* Just one more thing — when you need 20 watts push-pull — two DCA-10's cascaded, one in the unity gain position, will give it to you. For *more* power, its big brother, the DCA-50 gives 50 watts single-ended or 100 watts push-pull, up to 500kc, with the *same* clean specs of the DCA-10. Now, anything else I can tell you about the DCA-10?

*Yeah — price and delivery on twenty!*



**KROHN-HITE  
CORPORATION**

580 Massachusetts Avenue, Cambridge 39, Mass.  
Area Code 617 491-3211

*Pioneering in Quality Electronic Instruments*

CIRCLE 25 ON READER SERVICE CARD

25

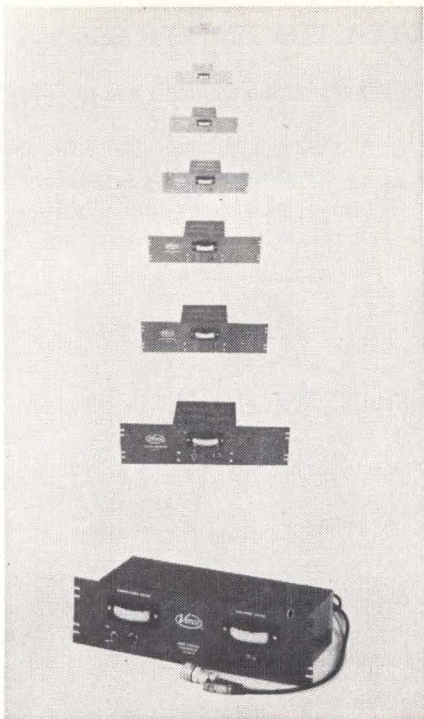

## I command performance . . .

. . . instantly, completely, and sm-o-o-thly. The VEECO TCDG-9 High Vacuum Controller is now ready to be engineered into the command position of your vacuum-processing operations.

This new VEECO versatile dual-range automatic vacuum indicator and controller provides you with continuous vacuum monitoring and indication over a range of 1000 microns to  $5 \times 10^{-6}$  torr, covering the roughing and high vacuum ranges. VEECO's TCDG-9 offers the following advantages:

- Smooth, continuous pressure readings unaffected by control point action. No kick-t h r o u g h as the indicator passes up or down through the control points.
- Integrated, regulated power supply.
- Rack-mounted in 19" x 5 1/4" standard relay rack.
- Available for either 50 or 60-cycle, 115V operation.

The new VEECO TCDG-9 High Vacuum Controller embodies all the high standards of quality, reliability, and accuracy that have given VEECO its valued reputation. It is completely checked in the plant before it is shipped to you. Write for information on this High Vacuum Controller and find out for yourself how your system could follow its command instantly, completely, and sm-o-o-thly.

**VACUUM-  
ELECTRONICS  
CORP.** 

TERMINAL DRIVE,  
PLAINVIEW,  
LONG ISLAND, N. Y.



May we  
send  
you our  
catalog?

NEC Chicago Booth 569-671 • NEREM Booth Q25

MODEL TRAIN demonstrates Videograph system. Electrostatically printed picture of train shows serial number

# RR's Seek Traffic Aids

Railroads want speedup in traffic flow to compete with truckers

**CHICAGO**—In its competition with trucking, the railroad industry will continue to depend on specialized electronic equipment. This was borne out by reports of the American Association of Railroads' Communications & Signal Section at the AAR's exposition here October 9 to 16.

To remain competitive, railroads are convinced they must solve the problem of yard delays by safely speeding up traffic flow. Electronics research is being channeled into three main areas: detection and reporting of cars, physical control of cars, and communications.

**Car Recording**—An A. B. Dick system now in use at a Buffalo, N. Y., yard combines optical scanning with electrostatic printing to produce permanent pictures of a train on a long roll of paper.

The system, called Videograph, makes vertical scans of 1/2-inch strips of the train, at a rate of 1,400 sweeps a second. The train's movement, up to 35 mph, provides the horizontal sweep. The image is printed out remotely by a special crt. Image can also be transmitted by facsimile over a microwave network.

Increased density of railroad yard traffic has led Link to develop a presence detector that operates independently of tracks and car wheels. Unit contains two oscillators, one a reference operating at 89 kc and the other a loop at 94 kc. Their difference frequency, normally 5 kc, is fed into a low-pass filter. The loop oscillator can be tuned by inductance from a wire loop laid out 30

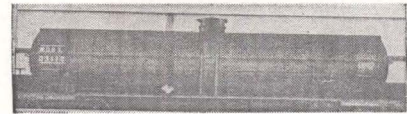
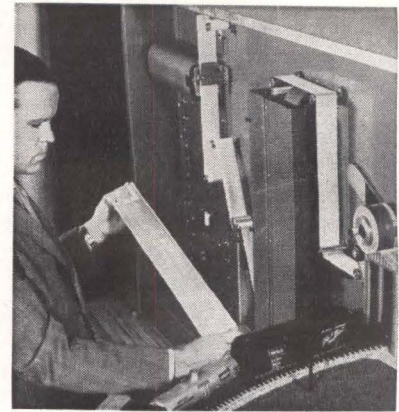

to 100 feet alongside the track. When a train enters the loop it acts as a shorted turn, reducing the inductance, and causing the difference signal to rise in frequency. At the filter cutoff point, 5.25 kc, a relay is released.

Even if the train stops at the loop, its presence will still be detected by the system. Link feels the system will have use in switch protection in classification yards, siding end protection, and other places.

**Train Predictor**—Marquardt Corporation reported there have been more than 100 successful installations of a grade crossing predictor, developed with Stanford Research Institute and Southern Pacific Railroad. It is a solid-state device that activates grade crossing signals a predetermined time before arrival of the train regardless of its speed.

Southern Pacific pushed development because conventional crossing signals operating strictly on train proximity were causing unnecessary auto traffic jams. Cars had to wait too long for slow-moving trains to pass, especially during commuter rush hours.

The Marquardt system uses the train as a short between the tracks and calculates the time of arrival at the crossing as a function of changes in the circuit's reactance as the train approaches. Input is from an l-f oscillator.

Southern Railway is using 72 locomotive data-recording systems demonstrated by Litton's Radcom division. Data on locomotive performance is recorded on metal tape.

*this one latches*

## Only Babcock makes two different half-size crystal can relays

*this one doesn't*

Designed for low profile mounting, Babcock's new half-size crystal can relays are available for latching (BR-17) and non latching (BR-16) application. Both types feature exceptionally high sensitivity and durability. Remarkably efficient coil operation requires only 175 mw pull-in power to switch any load from dry circuit to 2 amps. Predicted failure rate on the BR-16 and BR-17 is less than 0.1% in 10,000 operations with a 90% confidence factor.

These exclusive Babcock high reliability features are the reasons why:

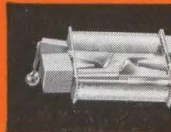

**High-flux armature action.** Balanced armature is located inside coil along path of maximum flux concentration. High density of magnetic force lines in core allows armature movement with minimum field excitation.



**Heat sink / magnetic flux conductor.** Coil cover of high permeability alloy lowers heat generation through improved magnetic circuit efficiency, while functioning in dual capacity as heat conductor-radiator.

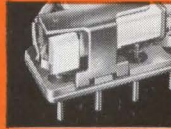

**Activated Vycor getter.** Exclusive to Babcock, this porous glass getter prevents contact contamination by adsorbing outgassed organic substances, following production degassing at 200°C under less than 5 microns vacuum.

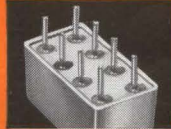

**Welded-header construction.** Automatic sealing process gives stronger header-case bond and prevents solder flux contamination. Leakage rate is less than  $10^{-4}$  c.c. per sec. by mass spectrometer.

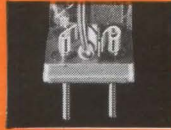

**Self-wiping, gold-plated contacts.** Contacts of AgMgNi alloy with specially-designed configuration assure miss-free performance under load and minimize low level contact resistance.

The BR-16 is available in SPDT and DPDT versions, the BR-17 as DPDT only. Various mounting arrangements and either plug-in or solder hook terminals can be supplied as standard. Send for complete details.

# BABCOCK RELAYS

A DIVISION OF BABCOCK ELECTRONICS CORPORATION  
3501 HARBOR BLVD., COSTA MESA, CALIF. • 546-2711

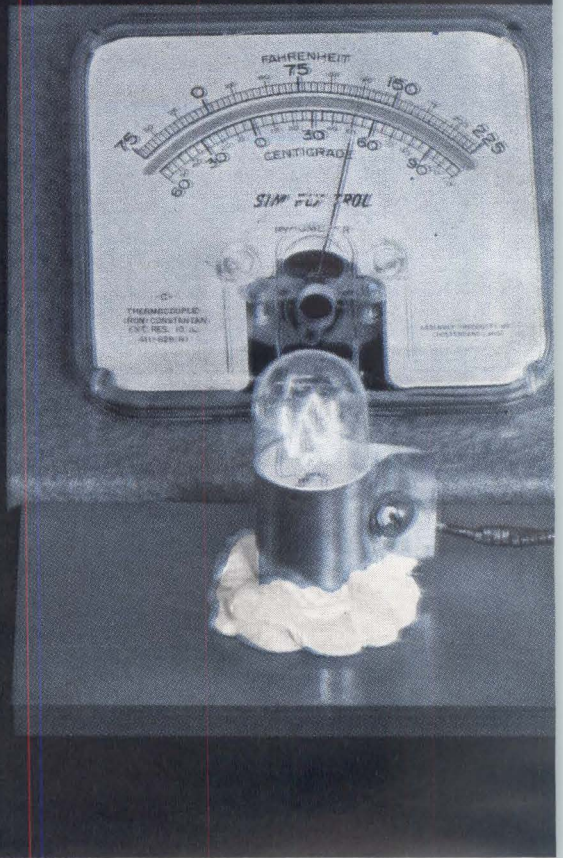
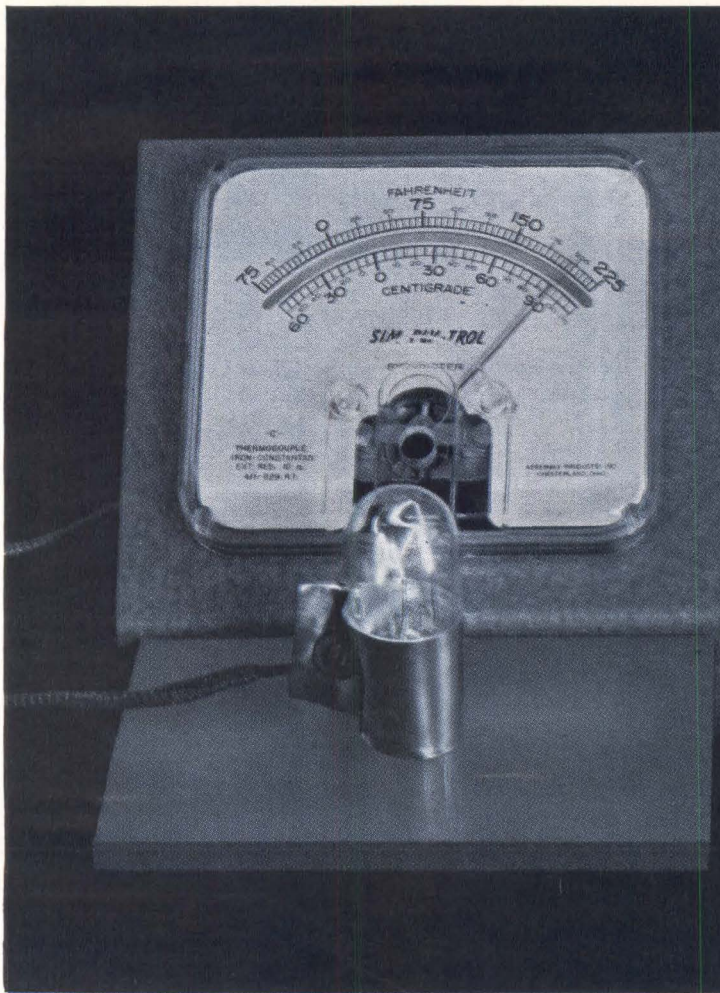

## News Briefs

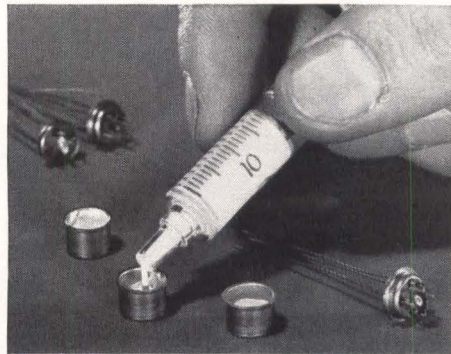

**New compound for transistor potting**  
Dow Corning® 18 semiconductor potting compound keeps junction temperatures at a minimum, cushions against shock, acts as a moisture getter to absorb moisture from within the cap. These advantages — plus high centrifuge stability — assure uniform properties and reliability of transistors, diodes . . . other solid state devices.

CIRCLE 290 ON READER-SERVICE CARD

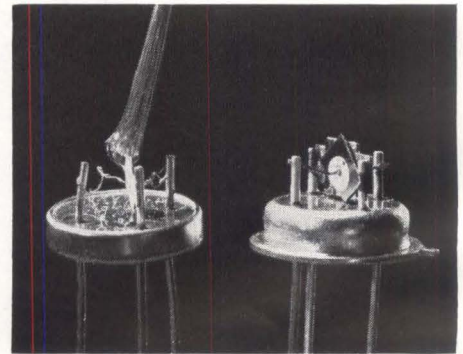

**New resins protect device junctions**  
Exceptionally high purity standards characterize three new Dow Corning transistor junction coating resins. Applied with a dropper or brush, these resins cure to form a tough protective film that seals out contaminants; assures junction integrity. Cure time is adjustable from 30 minutes at 250 C to 16 hours at 150 C.

CIRCLE 291 ON READER-SERVICE CARD

## Speed heat dissipation, extend device life with new compound

Why is one bulb base 75 degrees cooler than its mate? Simply because this new Dow Corning® 340 silicone heat sink compound is carrying heat to the heat sink faster. Having three times the thermal conductivity of other materials, this new compound assures cooler operation, longer life and greater reliability for diodes, transistors, rectifiers and other devices.

Dow Corning 340 silicone heat sink compound fills all air spaces; maintains a positive seal between component and heat sink or chassis; provides a uniform heat transfer path. It will not dry out, harden, gum or melt, even after prolonged exposure to

200 C. Dow Corning 340 is chemically inert, has low loss factor, low power factor, excellent arc resistance.

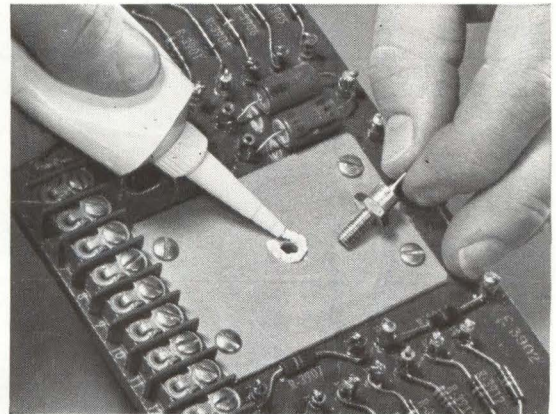

CIRCLE 289 ON READER-SERVICE CARD

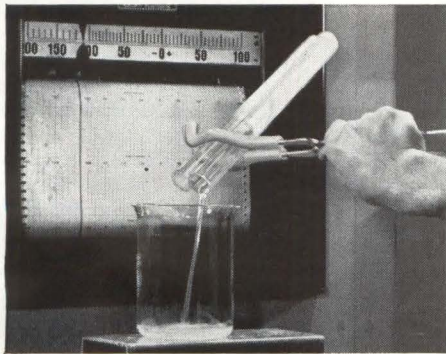

### New fluid non-congealing at -110 F

Higher pumping rates, rapid heat transfer, and smaller, lighter weight pumps are among the design advantages made practical with Dow Corning® 331 fluid coolant. This low viscosity silicone fluid flows freely when other coolants are frozen solid, features high flash point and an operating temperature range from -130 F to 400 F, -90 C to 204 C.

CIRCLE 292 ON READER-SERVICE CARD

We'll be pleased to forward full information on these and other materials that aid reliability and performance. Just write Dept. 3934, Electronic Products Division, Dow Corning, Midland, Michigan.

# Dow Corning

Instant Answers to All Your Industrial X-ray Problems...  
on 1 File-sized Sheet.

**FILM CLASSIFICATIONS**

**DESCRIPTION AND USES**

CLASS	FILM	SPEED	CONTRAST	GRAIN
I	H-D†	Moderate	Very High	Ultra Fine
I	B†	Medium	Very High	Very Fine
II	A†	Fast	High	Fine
III	C†	Very Fast	High	Medium
III	D†	Fast	Moderate	Fine
IV	D‡	Ultra Fast	Medium	Medium

†Used direct with lead foil screens

‡Used with fluorescent screens

**AnscO Superay® 'A' X-ray Film.** This very versatile film is excellent for inspection of all metals...from thin sections at low energy levels to heavy sections and castings with super voltages and radioisotopes. It may be used with X-rays or gamma rays. Its fine grain and high contrast recommend it where recording small defects or fine details is essential. Its high speed permits short exposures over the full range of specimens and sources. May be used with or without lead screens.

**AnscO Superay 'B' X-ray Film.** When very fine radiographic definition is desired, select this film. Its extra-fine grain and very high contrast improve image quality with all types of gamma or X-radiation. It's particularly useful in light alloy radiography, where exacting sensitivity is more important than high speed. It permits accurate identification of discontinuities and inclusions in all metals. Use with or without lead screens.

**AnscO Superay 'C' X-ray Film.** Superay 'C' is the fastest AnscO industrial X-ray film...and is recommended wherever a high relative film speed is of prime consideration. For example, in rapid production line testing or in the detection of gross flaws in heavy specimens with gamma radiation, Superay 'C' reduces exposures to an economical minimum. Generally used with lead-foil screens, it does have a number of non-screen applications.

**AnscO Superay 'D' X-ray Film.** Here is a medium-fine grain film with moderate contrast and very wide exposure latitude. It offers extremely high speed when used with calcium tungstate type screens...but may also be useful in radiographing specimens having a wide range of thickness. And it's ideal for testing heavy metals with low voltage equipment.

**AnscO Superay 'H-D' X-ray Film.** Superay 'H-D' has an ultra-fine grain and very high contrast. It's designed for high definition radiography, provides the ultimate in image quality. Since high definition work often involves minute subjects and very thin materials, low voltage techniques are generally used with Superay 'H-D'. However, the film maintains its high definition characteristics and maximum image quality throughout the full KvP range.

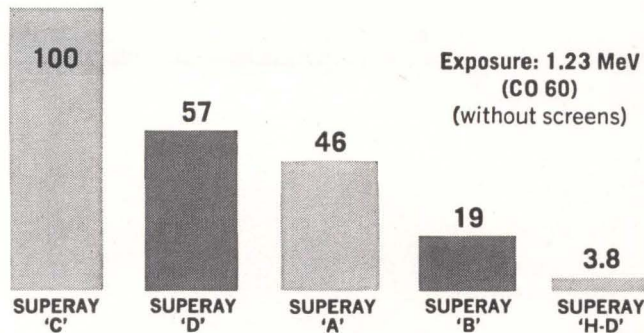
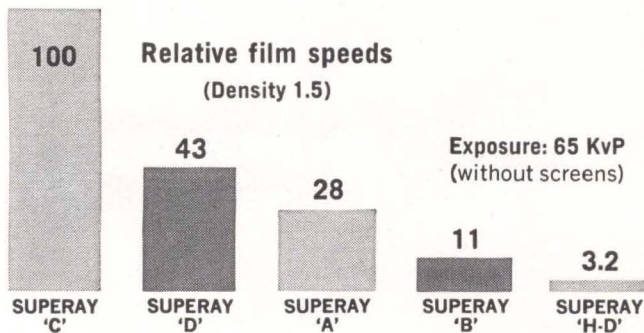

NOTE: Speed determinations made at density 1.5 and all films developed for 6 minutes at 68°F. in AnscO Liquidol Developer.

**ANSCO SUPERAY INDUSTRIAL X-RAY FILM AVAILABILITY**

SHEET FILM SIZES (inches)	STANDARD PACKAGING		SUPERPAK PACKAGING		INDIVIDUAL PACKAGING		'A-B' Sandwich Pak 60 envelopes (120 films)
	75 sheets interleaved	150 sheets non-interleaved	Superpak 300 300 sheets interleaved	Superpak 600 600 sheets non-interleaved	Monopak 100 envelopes (100 films)	TwN-Pak 60 envelopes (120 films)	
3½ x 17	A, B, C, D	A, B, C, D*	A, B*	A, B	B		
4½ x 10	A, B, C, D, H-D	A, B, C*, D*	A, B, C*, D*	A, B	A*, H-D*		Yes
4½ x 17	A, B, C, D, H-D	A, B, C*, D*	A, B*	A, B	A, B, H-D*		Yes
5 x 7	A, B, C, D	A, B, C*, D*	A*, B	A, B	A, B	A*, B*	Yes
7 x 17	A, B, C, D*, H-D	A, B, C*, D*	A, B*	A, B	A, B	A*, B*	Yes
8 x 10	A, B, C, D*, H-D	A, B, C*, D*	A, B	A, B	A, B, H-D*	A*, B*	Yes
10 x 12	A, B, C*, D*, H-D	A, B, C*, D*	A, B*	A, B	A*, B	A*, B*	Yes
11 x 14	A, B, C*, D*, H-D*	A, B, C*, D*	A*, B	A, B	A*, B	A*, B*	Yes*
14 x 17	A, B, C, D*, H-D	A, B, C*, D*	A, B	A, B	A, B, H-D*	A*, B*	Yes
*Special (stocked on demand)							
ROLL SIZES	70 mm x 100'	70 mm x OL☆	52 mm x OL☆	35 mm x 100'	35 mm x OL☆	1½" x 25'	
	A, C	A, B, C, D	A, B	C	B	C	
			☆Odd lengths (101' to 800')				
SPECIAL SIZES AND PACKAGING	1½" x 16" 25 sheets interleaved	8 x 10" 25 Monopaks (25 films) per carton	5 x 7" 25 sheets interleaved	8 x 10" 25 'A-B' Sandwich Paks (50 films) per carton			
	C	B	D	A, B			

**Sold with P. S. ... Personal Service**

Personal Service, prompt service and professional service are the watchwords of your AnscO X-ray Products Representative. To help you solve your technical problems... to help you get the best results with AnscO products he is always at your service. Feel free to call on him any time without obligation.





# reliability and Allen-Bradley hot molded resistors are synonymous

The superiority of Allen-Bradley resistors is based on this company's heavy investment in highly specialized and expensive equipment, developed and built by Allen-Bradley, plus the experience gained over a quarter of a century in manufacturing quality resistors.

A-B hot molded fixed resistors have such consistent uniformity from resistor to resistor—year in, year out—that long term performance can be accurately predicted. At least ten billion field proven resistors—with not one

catastrophic failure—conclusively attest to their reliability. This same hot molding process is used in making A-B variable resistors, which feature a solid, hot molded resistance element that has never been known to “wear out”—in fact, with age, it even improves in quiet operation.

For more complete details on all Allen-Bradley quality electronic components, please write for Publication 6024. Allen-Bradley Co., 110 W. Greenfield Ave., Milwaukee, Wis. 53204. In Canada: Allen-Bradley Canada Ltd., Galt, Ont.

## FIXED RESISTORS

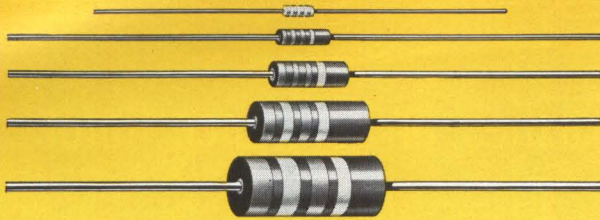

**A-B HOT MOLDED RESISTORS** are conservatively rated. Stable and uniform characteristics. Rated 1/10, 1/4, 1/2, 1, and 2 watts at 70°C. Available in all standard EIA and MIL-11-R resistances and tolerances.

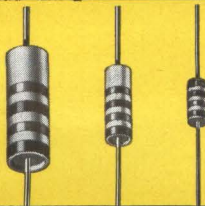

**HERMETICALLY SEALED HOT MOLDED RESISTORS** Environmental protection provided by sealing in ceramic tube. Remain stable. Rated 1/8, 1/3, and 1 watt at 70°C. Tol. = 2% and = 5%. Res. to 22 meg.

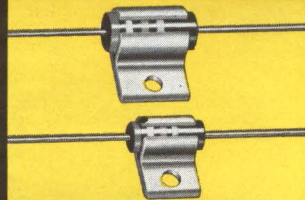

**COPPER CLAD HOT MOLDED RESISTORS** have heavy tinned copper heat sink for increased ratings. Rated 3 and 4 watts at 70°C; 4 and 5 watts at 40°C. Tol. = 5% and = 10%. Res. to 22 meg.

## VARIABLE RESISTORS

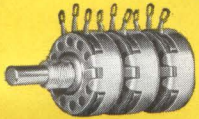

**TYPE J HOT MOLDED POTENTIOMETERS** give smooth, quiet control—long life. On accelerated tests, good for over 100,000 operations with less than 10% resistance change. Can be built to any desired taper. Rated 2.25 watts at 70°C. Values to 5 meg.

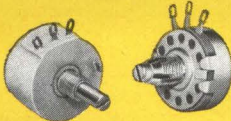

**TYPE K HIGH TEMPERATURE HOT MOLDED POTENTIOMETERS** Same as above but rated 1 watt at 125°C; 2 watts at 100°C; and 3 watts at 70°C.



**TYPE G HOT MOLDED POTENTIOMETERS** are miniature controls—only 1/2" diameter. Smooth control with long life—on accelerated tests will exceed 50,000 operations with less than 10% resistance change. Rated 1/2 watt at 70°C. Values to 5 meg.

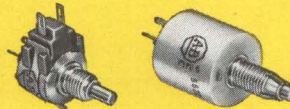

**TYPE L HIGH TEMPERATURE HOT MOLDED POTENTIOMETERS** are same as above but rated 1/2 watt at 100°C—can be used up to 150°C at reduced load.

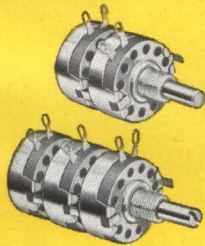

**HOT MOLDED VARIABLE RESISTORS** for use in constant impedance attenuators. Smooth control with nearly infinite resolution. Characteristic impedance can be held to 10% throughout rotation. Excellent high frequency response. Rated up to 5 watts.

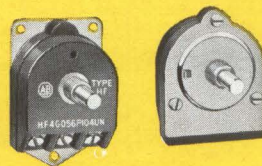

**TYPE H HOT MOLDED POTENTIOMETERS** for industrial and commercial electronic equipment requiring higher voltage and wattage ratings. Stepless control. Life exceeds 100,000 operations on accelerated tests with less than 10% resistance change. Rated 5 watts at 40°C and 3 watts at 70°C, with a maximum of 750 volts.



**TYPE T HOT MOLDED POTENTIOMETERS** have molded plastic covers that serve as actuators, making units unusually flat and compact. Smooth control. Furnished in any desired tapers. Long life—over 50,000 operations on accelerated tests with less than 10% resistance change. Rated 1/2 watt at 70°C. Values to 5 meg.

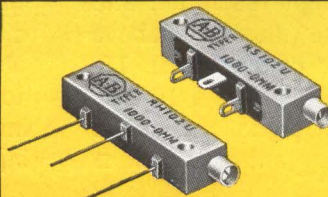

**TYPE R ADJUSTABLE FIXED RESISTORS** remain stable under extremes of shock and vibration. Moving element is self-locking. Smooth, continuous adjustment. Noninductive. Watertight case permits encapsulation. Rated 1/4 watt at 70°C. Values from 100 ohms to 2.5 megs. Tol. = 10% and = 20%.

QUALITY ELECTRONIC COMPONENTS

# ALLEN-BRADLEY



Advances the State-of-the-Art in Angle Measurement

# **DIGISEC™** Optical Encoders Achieve Accuracies of 1 Arc-Second, Peak ...and Better

Natural Codes, Continuous Outputs

Without Code Conversion, Gears, Brushes, or Reference Rotor



UNIT SHOWN: Optical Unit 5" x 2.50"; Translator, 6.5" x 17" x 6" deep; wt. 15 lbs.; Total Power 30 Watts.

Typical DIGISECs\* provide 19-digit resolution and accuracy in a 5-inch diameter case (illustrated above with transistorized translator and display unit), 18-digits in a 3½-inch case, and 20-digits in a 10-inch case. □ Parallel, on-the-fly, direct digital readout in any natural code including binary and decimal. □

Incremental readout for system simplification or precision tachometer applications. □ Analog outputs also available for high precision servos—equivalent to 32,768 pole resolver (19-digit model). □ Low inertia, non-contacting encoder disc, low friction bearings. □ Simple associated circuitry — high reliability.

For more information write or call, Technical Services Manager, Adcon Division, Dept. 57.

\*Trademark — Patents Pending



## **WAYNE-GEORGE CORPORATION**

322 NEEDHAM STREET, NEWTON 64, MASSACHUSETTS (617) 969-7300  
CIRCLE 32 ON READER SERVICE CARD

AUTHOR and T. B. Bateman observe the attenuation at high frequencies in a semiconductor suitable for a delay line

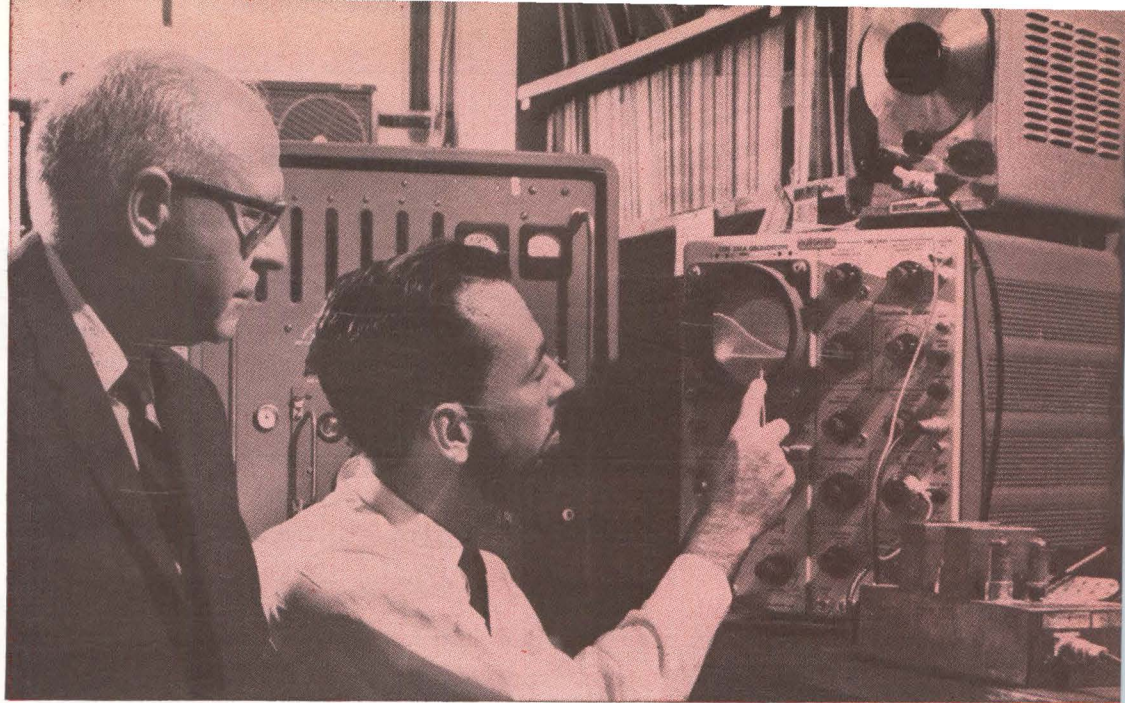

## STATE OF THE ART REPORT

# ULTRASONICS

## IN COMMUNICATIONS AND PRODUCTION

New components, materials, apparatus and techniques extend applications of ultrasonic technology in communications, manufacturing, research and other fields. Subjects covered include sonar, inspection devices, delay lines, filters, transducers, ultrasonic amplifiers, phonon masers and velocity transformers used in machining

By **WARREN P. MASON**, Bell Telephone Laboratories, Inc.,  
Murray Hill, New Jersey

**ULTRASONICS** is a rapidly growing field having many applications in processing and communications. At present some of the processing uses are inspection, calipering, ultrasonic displays for inspection as well as medicine, cleaning, drilling, welding and soldering. The present sales volume in this field amounts to about \$25,000,000 and is likely to grow to \$70,000,000 by 1970. The communication uses are also extensive and may exceed these figures. They consist of underwater signaling and detection, dispersive and nondispersive delay lines used for radio and radar systems, mechanical and electromechanical filters for

communication purposes and the control of stable oscillators and time standards.

New devices that have been proposed and developed to some extent are traveling-wave ultrasonic amplifiers, phonon masers, new types of transducers capable of delivering large power densities and very high frequencies, and velocity transformers capable of delivering four times the energy to a tool point without fatiguing. Prospective uses for these new developments are delay lines capable of storing  $10^6$  bits of information, transducers capable of investigating reactions as short as  $10^{-11}$  second, transducers capable of radiating large power densities at the low frequencies required for underwater sound, and tools capable of producing faster and better grinding, weld-

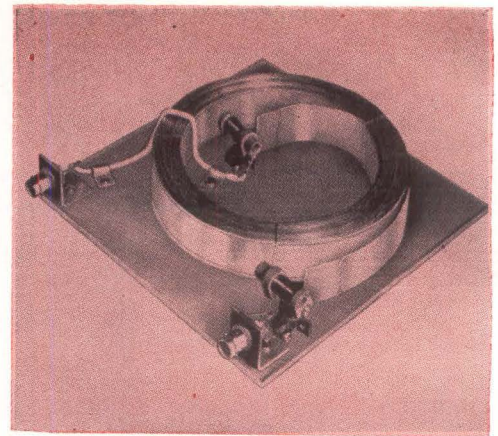
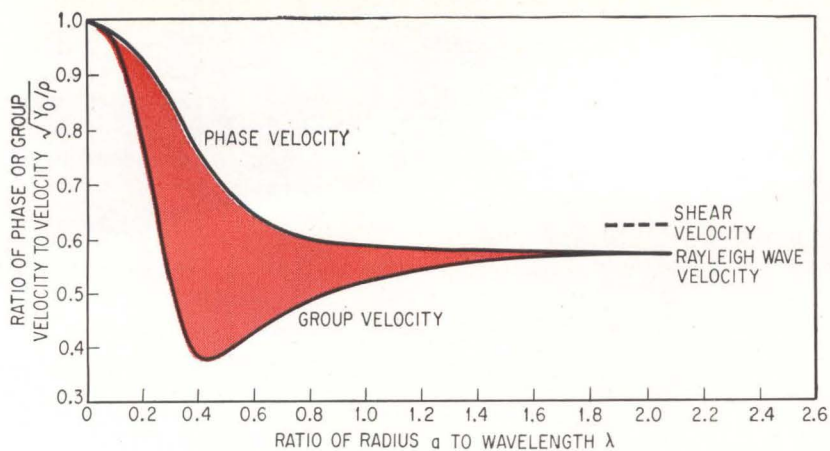

PHASE and group velocity of a circular rod (left); coiled delay line (right)—Fig. 1

ing and cutting operations.

The uses of ultrasonics can be divided into low-power and high-power applications. The dividing line between audible and inaudible sounds has grown artificial, since there are many applications that cover both regions and indeed extend into the infrasound region below the audible range. The tendency has been to refer to the entire field as the sonic region for high-amplitude processing applications and ultrasonic for high-frequency, low-power application. The use of new types of transducers has extended the frequency range above  $10^9$  cycles and this region is now usually called the hypersonic region. For the storage of large amounts of information and for physical investigations of solid-state motions, the tendency is to approach the hypersonic range.

**Underwater Sonar**—The first and still probably the largest use of ultrasonics is the underwater sound or sonar systems to detect submarines and destroy them by acoustic homing torpedoes. The original systems date back to the work of P. Langevin<sup>1</sup> in World War I. Although they were developed too late to be of use at that time, they laid the basis for their use in World War II. Between the two wars this technique was widely used in determining the depth of the ocean, and has been used by commercial fishermen, particularly in Japan, for determining the presence and location of fish.

**Inspection Devices**—Sound pulses in solid materials have been used widely for inspection and for the storage of information in delay lines. Flaws in a sound transmission path cause reflections<sup>2</sup> to the sending transducer. These reflections appear as blips on the receiving oscillograph. By using frequencies from 0.5 to 5 Mc, waves can be transmitted long distances in metal castings and in glass and ceramic. Such methods have been used to inspect adhesive bonds in automobile tires and other products. Transmission-type inspection devices have also been developed in which the presence of a flaw or obstruction shows up as a decrease in the received ultrasonic wave. By scanning a number of receiving crystals with a moving cathode-ray beam, ultrasonic displays are obtained which indicate the presence of all the reflecting objects simultaneously. Such ultrasonic

inspection devices are beginning to be used in medicine, where they have shown heart action.

**Nondispersive Delay**—The storage of sound pulses in imperfection-free solids such as fused silica has many applications in radio and radar systems. The first and still one of the principal uses<sup>3</sup> is the moving target indicator (MTI) radar which accentuates moving targets by minimizing the appearance of reflections due to stationary targets. In this use, one frame containing all the reflections during one pulse period is stored in a delay line having a delay time equal to the period between successive pulses. These pulses are made to balance out the radar reflections coming back from the next pulse, so that fixed targets are minimized with respect to moving targets. The most widely used type of delay line for this purpose is the polygon-type line,<sup>4</sup> made from strain-free fused silica and shaped in a polygon with each surface designed to reflect ultrasonic beams so that a number of reflections are obtained from each face. Shear waves are used in these lines with the direction of particle motion parallel to the reflecting faces, since then only shear waves are reflected.

The limitations inherent in such lines arise from the many modes that can be propagated with slightly different group velocities, the finite bandwidth associated with the transducers and the spreading out of the energy in a direction perpendicular to the wave path. For propagation distances beyond the plane wave Fresnel distance  $l_0$ , given by the equation

$$l_0 = A^2/2\lambda \quad (1)$$

where  $A$  is half the width of the sending transducer and  $\lambda$  the sound wavelength, the pressure decreases in the ratio

## HOW HIGH IS HIGH POWER?

High ultrasonic powers in liquids are values above  $\frac{1}{3}$  watt per sq cm, for which powers the applied stress equals atmospheric pressure. Above this power, cavitation occurs. For solids, low powers might be anything under one watt per sq cm

COMPARISON of a coil-and-capacitor filter and a crystal filter (left); ultrasonic drill with magnetostrictive driver (right)—Fig. 2

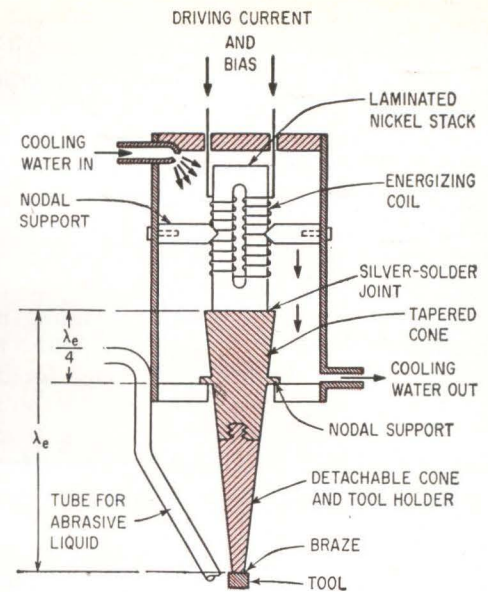
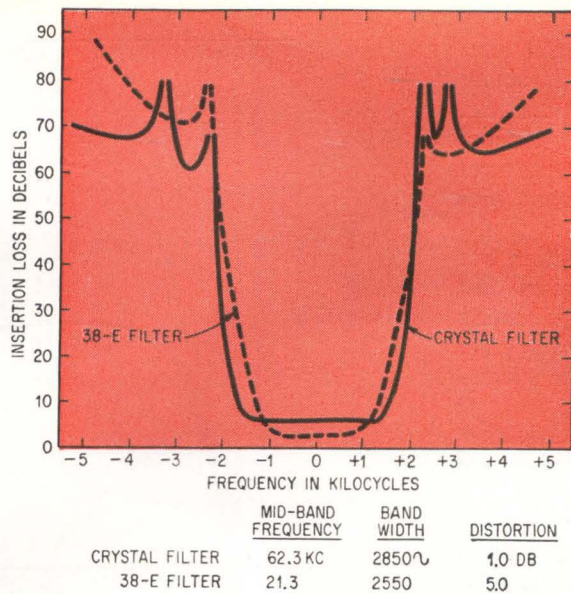

$$\frac{p}{p_0} \doteq \frac{l_0}{l} = \frac{A^2}{2\lambda l} \quad (2)$$

This spreading energy not only produces a loss but it may also cause spurious pulses, which can occur either before or after the desired pulse. This effect becomes smaller with higher frequencies. It is also decreased by aperaturization; that is, by determining the angles of the polygon and the size of the reflecting surface so that a constant-width path is reflected, and by putting absorbing material on those surfaces that are in the direct reflected beam. The best ratio reported for a 2,100- $\mu$ sec line operated at 40 Mc is a 60-db ratio between received and spurious pulses.

The first two limitations result in a finite rise time for the received pulse, which limits the rate of storing information in the delay line. Multiple modes result from a nonpiston-like action of the transducer and can be minimized by careful attachment of the transducer to the delay line and by using backing material for the transducer. The finite width of the transmission band of the transducer is the result of the electromechanical coupling factor of the transducer, which for the best transducer materials limits the ratio of the bandwidth to the mean frequency to a value of 0.6 to 0.8. The rise time of the pulse is given approximately by

$$\tau = \frac{1}{BW} \quad (3)$$

where BW is the bandwidth in cycles. The best rise time obtained with present lines is about 0.06  $\mu$ sec. With lengths of about 2,000  $\mu$ sec., the number of bits stored is limited to about 30,000.

The obvious way to increase this number is to increase the frequency of operation. This is attended with difficulties of producing very thin transducers and by the fact that the attenuation of most solid materials increases about as the square of the frequency. Several techniques are beginning to appear which may overcome these difficulties.

**Dispersive Delay**—The output power of a short pulse

type of radar such as used on MTI radar systems is limited by the high voltage required to produce the large burst of power necessary to obtain reflections from a long distance. If the radiated power can be spread out over the whole cycle, a considerably smaller power density can be used and hence voltage breakdown will not be the limiting factor. The chirp or frequency modulated radar is a recent contribution<sup>5</sup> that answers this question. In this radar a short-amplitude modulated pulse is turned into a long frequency-modulated pulse by dispersive networks. The reflection back, which covers the whole cycle, is turned into a short pulse by a dispersive network having a complementary dispersion to that produced by the sending network. In practice, this is done with a single-type dispersive network by using one sideband of a suppressed carrier for transmission and the other sideband for receiving. After the invention of this system, it was found that the bat and the porpoise had been using the chirp method with the brain and memory performing the function of the dispersive delay line. They perform as well or better than the best radars.

Although any type of dispersive network can be used for this purpose it has been found that the ultrasonic dispersive delay line produces the most satisfactory and most economical solution for this problem. It has been known since the Pochhammer-Chree solution for the propagation of an extensional wave in a cylindrical rod, that the phase velocity of the wave is a function of the ratio of the radius of the rod to the wave length. The corresponding group velocity, as shown by Fig. 1 (left), is a nearly straight-line function of the frequency and satisfies the requirements of the chirp radar. An even better solution is obtained by a thin strip whose ratio of thickness to wavelength takes the place of the ratio of the radius to the wavelength. Such lines can be rolled up and Fig. 1 (right) shows a strip line<sup>6</sup> at 4,200  $\mu$ sec in delay similar in construction to a dispersive delay line. This line is made of a 5052-aluminum metal, which has a low attenuation at low

frequencies and also has a very small grain size.

All polycrystalline metals have a grain structure that scatters the sound wave when the grain size becomes a fraction of the wavelength. This produces an attenuation that initially increases as the fourth power of the average grain size, in agreement with Rayleigh's scattering law. This effect involves a distortion since scattering is not a true attenuation but merely abstracts energy from the main beam and sends it off in all directions, resulting in a trailing hash on the end of the received pulse. Hence grain structure limits the frequency range for both nondispersive and dispersive delay lines.

By using shear waves in a strip line, Meitzler<sup>6</sup> has produced a nondispersive line which can give long delays. It is, however, limited in frequency.

**Filters**—Another large use for ultrasonic vibrations is in providing selective resonators and filters. Due to their small internal friction and high temperature stability, quartz crystals have long been used in obtaining selective filters used to separate out the separate telephone channels of long-distance carrier, radio and submarine cable systems. About 1.5 million crystals are used each year for this purpose. Figure 2 (left) shows the characteristic obtained in one of the channel bank filters as compared with that possible with coil and capacitor filters. The bandwidth obtainable with quartz crystals alone is somewhat limited by the low electromechanical coupling factor and it is necessary to use coils to obtain the desired bandwidth. Synthetic quartz crystals are now grown, which removes any concern about a source of supply.

The ferroelectric ceramics have a higher electro-mechanical coupling factor than does quartz and thus allow the use of ceramics alone to obtain voice bands. The internal dissipation is higher and the frequency stability is not as good. However, for intermediate frequency filters in radio receivers, they are being used in quantity.

Complete electromechanical filters driven by transducers and using the resonances of mechanical parts to obtain the filtering action are also in the picture but have not yet reached the performance characteristics of the other types.

Oscillators are almost universally controlled by

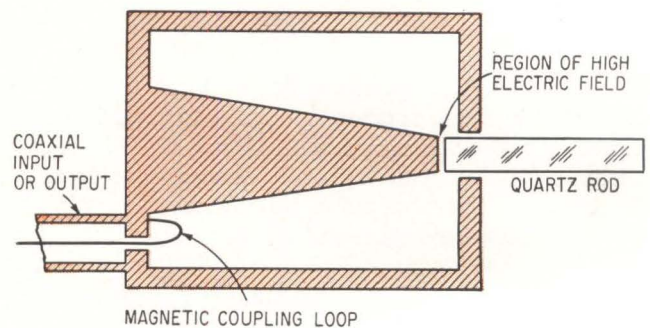
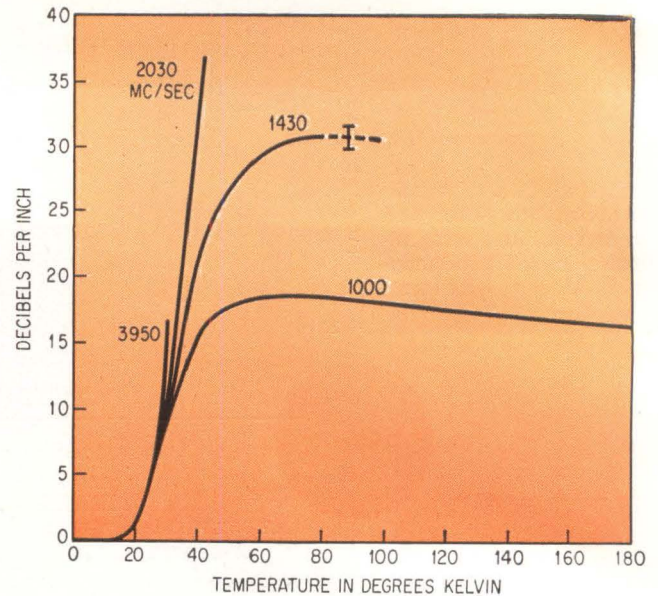

ATTENUATION of shear waves in quartz at hypersonic frequencies (top), in which the Rayleigh wave velocities are about 90 to 95 percent of the shear-wave velocity, shown by the dashed line, depending on the Poisson ratio, which for the curve here is 1/3. High-frequency excitation of quartz (bottom)—Fig. 3

quartz crystals and most of the secondary frequency and time standards of industry, the military and time observatories employ quartz crystals. Although the accuracy obtainable has been eclipsed by that given by atomic frequency standards, quartz crystal oscillators are still the most widely used time and fre-

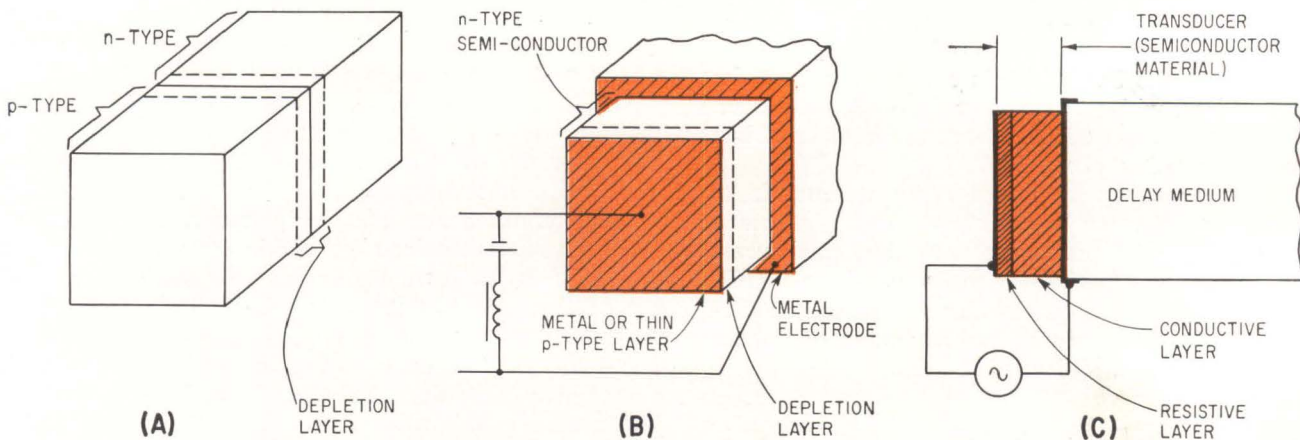

DEPLETION-LAYER transducers in piezoelectric semiconductors (A and B); diffusion-layer transducer (C)—Fig. 4

quency standards and they serve as the balance wheel even for atomic standards.

**High Amplitudes**—In addition to the low-amplitude devices described above, which constitute the bulk of the ultrasonic uses, a number of high-amplitude devices are useful for cleaning and processing uses.

Ultrasonic cleaning uses high-energy sound transmission in liquids, which produces cavitation or actual breaks in the liquids. When these cavities collapse they produce high pressures that can erode metals. These stresses remove layers of contamination from hard objects and are used extensively in cleaning ball bearings, relays, metal castings, watches and many other products.

High-amplitude waves in solids have been used in producing high velocities on the ends of amplitude transformers. Figure 2 (right) shows a Raytheon ultrasonic drill driven by a magnetostrictive transducer attached to a velocity transformer. A tool is attached to the end of the transformer and when an abrasive is supplied, any shape hole can be drilled in hard brittle materials such as tungsten carbide, synthetic sapphires, glass, quartz and even in teeth.

Similar devices with the tool at right angles to the motion have been used to weld thin strips of metal to base layers. The action requires a static force normal to the surface plus a tangential motion, introduced by the vibration, to produce the weld. The action is similar to that for a cold weld which requires a tangential motion to remove oxide layers and to produce a large plastic flow that brings the mating surfaces within atomic distances of each other. Limitations of these devices occur due to limited transducer power outputs and to the limited motion of the tool end of the transformer caused by fatigue of the horn at its point of highest strain.

**Research**—The temperature and frequency dependence of the elastic and anelastic properties of solids, measured by ultrasonic and hypersonic waves, has been used to investigate a large number of solid-state phenomena. The list of processes so investigated is now long and includes such phenomena as thermal relaxation, phonon-phonon scattering, phonon-electron-magnetic field effects, point and line imperfections, magnetic and electrostatic domain motion, phonon-magnon interactions and the interaction of acoustic waves with electron and nuclear spins. The literature is extensive and the reader is referred to several review articles.<sup>7, 8</sup>

One particularly useful result of interest for delay lines, is the low attenuation of sound waves that occurs below 15 deg K in such crystals as quartz.<sup>9</sup> Figure 3 (top) shows the attenuation for shear waves in AC-cut quartz for three different frequencies, plotted as a function of the temperature. Below 15 deg K the attenuation gets very small for frequencies as high as 4 Gc and sound waves can traverse a long path before they are attenuated appreciably.

**Transducers**—Since ultrasonic waves cannot be generated without transducers, the first consideration is given to these devices. During the last few years great strides have been made in producing new

transducer materials. At the end of World War II, the only transducer materials used in quantity were the piezoelectric crystals quartz and ammonium dihydrogen phosphate (ADP) and certain magnetostrictive materials such as nickel laminations. Shortly after the war it was found that ceramics made of barium titanate ( $\text{BaTiO}_3$ ) had ferroelectric properties (that is, could be given a permanent polarization that could be reversed by an applied electric field) and that such ceramics have a high electromechanical coupling factor when polarized. The effective piezoelectric properties were somewhat limited by the low Curie point (120 deg C) at which the spontaneous polarization is lost. More recently two other ceramics, lead titanate-lead zirconate (known by the trade name of PZT) and sodium potassium niobate have been developed which have Curie temperatures above 300 deg C. PZT is largely used in high-power sonar transducers where power levels as high as 10 to 100 watts can be radiated from a square inch of radiating surface. These ceramics make possible high power outputs at the low frequencies of present-day sonar equipment. To obtain a reasonable size transducer, flexure bars or plates are often used<sup>10</sup> and freedom from pressure effects is obtained by using two such plates with a liquid layer of small compliance in between.

The sodium potassium niobates find use in the production of delay lines for very high frequencies. They have coupling coefficients in excess of 50 percent for both longitudinal and shear waves and have the advantage of a low dielectric constant (around 350) which results in a higher electrical impedance for thin plates.

As mentioned previously, it is advantageous to go to high frequencies for delay lines storing a large amount of information. The mechanical properties of the ceramics do not allow thicknesses of less than 0.9 mils, which limits the frequency of fundamental mode transducers to about 100 Mc or less. High harmonics of these frequencies can be used but it turns out that the bandwidth in cycles remains the same, since the electromechanical coupling factor varies inversely proportional to the harmonic number. Recently very high frequencies have been obtained<sup>9</sup> by inserting a quartz rod in a waveguide as shown by Fig. 3 (bottom). It can be shown that this corresponds to an overtone equal to

$$n = 2V/\lambda A \quad (4)$$

where  $\lambda$  is the sound wavelength,  $A$  the cross-sectional area and  $V$  the volume of the quartz rod in which the electric field is concentrated. Even this low coupling is often not the limiting factor since the  $Q$  of the cavity may be high enough to be band limiting. Hence this type of transducer cannot give a wide band at hypersonic frequencies.

Recently several new types of transducers have been devised<sup>11</sup> which seem likely to remove these limitations. Two of these depend on piezoelectric semiconductors such as cadmium sulphide, zinc oxide or gallium arsenide, which have an appreciable electromechanical coupling factor when the electrical conductivity inherent in the doped material is removed by some method. The first method, as shown

in Fig. 4A and 4B, was the use of a *p-n* junction in the material, which is formed by diffusing a *p*-type dopant into an *n*-type base material or conversely. There is a region of high field strength at the *p-n* junction—which occurs when the doping of the two types are equal—called the depletion layer in which all holes and electrons are swept out. Hence if one puts an alternating voltage across this layer, then if the semiconductor is piezoelectric, a stress wave can be generated at the junction. The thickness of such a junction depends on the doping levels and the biasing voltage across the junction. Since most *p-n* junctions are less than  $10^{-4}$  cm thick, depletion-layer transducers are useful in the range above  $10^9$  cycles.

Another technique for semiconductor piezoelectric transducers is the diffusion layer transducer shown by Fig. 4c in which copper, for example, is diffused into cadmium sulphide. Copper acts as a deep trap for electrons and immobilizes any carriers in the region into which it is diffused. This layer can be made thicker than the depletion layer transducer and it has been used down to 50 Mc. One side of the transducer is formed by an evaporated metal layer while the other connection is made through the doping present in the semiconductor. This introduces a series resistance in the transducer which contributes to the insertion loss of the transducer. For example, a cadmium sulphide crystal one inch long with transducers diffused in each end has been constructed<sup>12</sup> which produces a midband loss of 40 db at a mean frequency of 130 Mc with a bandwidth to mean frequency ratio of unity.

The third type of transducer uses the generation of rotary shear waves<sup>13</sup> at the surface of a yttrium iron garnet (YIG) crystal by the simultaneous action of a static magnetic field and an alternating magnetic field. This has produced passbands of 500 Mc at a mean frequency of 750 Mc, with a moderate transducer loss.<sup>14</sup>

**TW Amplifiers**—Since transducers are becoming available with wide bandwidths, the possibility exists of storing large amounts of information in delay lines. The principal problem is the large attenuation resulting at the high frequencies. For single crystals the loss can be reduced by going to very low temperatures, as shown by Fig. 3 (top) for quartz. This process does not work for such materials as fused silica, since their loss is larger at low temperatures than at room temperature. However, two new devices have been conceived which may remove this limitation. One of these devices is the traveling wave acoustic amplifier<sup>15</sup> and the other is the phonon maser.<sup>16</sup>

The traveling-wave ultrasonic amplifier uses a semiconducting piezoelectric crystal. The drift velocity of the electrons is controlled by an applied electric field and when the drift velocity is greater than the velocity of the acoustic wave, energy can be transferred from the electron beam to the acoustic wave and amplification results. Theoretically, the higher the frequency, the greater the amplification

possible per unit length. Difficulties arise from heating due to the current flow, and in the doping of the semiconductors. Nevertheless, amplification has been achieved at frequencies as high as 500 Mc over a wide band of frequencies. The crystals of greatest interest for this application are cadmium sulphide and zinc oxide. Cadmium sulphide is rather readily grown and recently zinc oxide<sup>17</sup> has been grown hydrothermally.

The other types of acoustic amplifier works on the maser principle. In this device, ionized chromium or iron impurities are introduced into a crystal such as magnesium oxide. When the crystal is put into a magnetic field, there are three energy levels present. Ordinarily the population of the lowest level is higher than the other two, in accordance with Boltzmann's principle. If, however, microwave energy of the proper frequency to agree with the energy difference between the lowest and highest states is sent into the crystal, the population of the top level can be made nearly as large as that in the lowest level and larger than that in the intermediate level. If now an acoustic wave, whose frequency corresponds to the energy difference between the intermediate and top energy levels is sent into the crystal, more states will be dislodged from the top level and will fall into the intermediate level than traverse the reverse path and hence a net amount of energy will be returned to the acoustic wave causing an amplification. Phonon amplification has been achieved at 9 Gc by this device. Figure 5A shows a schematic structure and the energy states for such a phonon amplifier.

**Synthetic Crystals**—When synthetic quartz is grown very slowly with small amounts of impurities in the growing solutions, the properties appear to be identical with those associated with natural quartz. However, when quartz is grown rapidly (about an inch in 20 days) enough structural imperfections are introduced so that the internal friction and the temperature stability are seriously impaired. Since it is economically desirable to obtain fast growth, considerable effort has been expended in alleviating these difficulties. Recently it has been found<sup>18</sup> that the introduction of a controlled amount of lithium impurity acts to pin the structural defects present in rapidly grown quartz. While the action is not completely understood, it is possible to grow crystal quartz at a rapid rate, which is substantially the equal of natural quartz.

Similarly, the cause of aging of piezoelectric ceramics has been shown to be associated with the motion of 90-degree domain walls that continue to move as an exponential function of the time. The time constant is so long that it takes several years for the properties to stabilize. Recently it has been shown<sup>19</sup> that the introduction of certain impurities act to pin the domain walls and the aging has been reduced by a factor of 10. Such ceramics are now universally used for intermediate frequency filters.

**Velocity Transformers**—The cutting and welding rates of ultrasonic tools are limited by the amount of



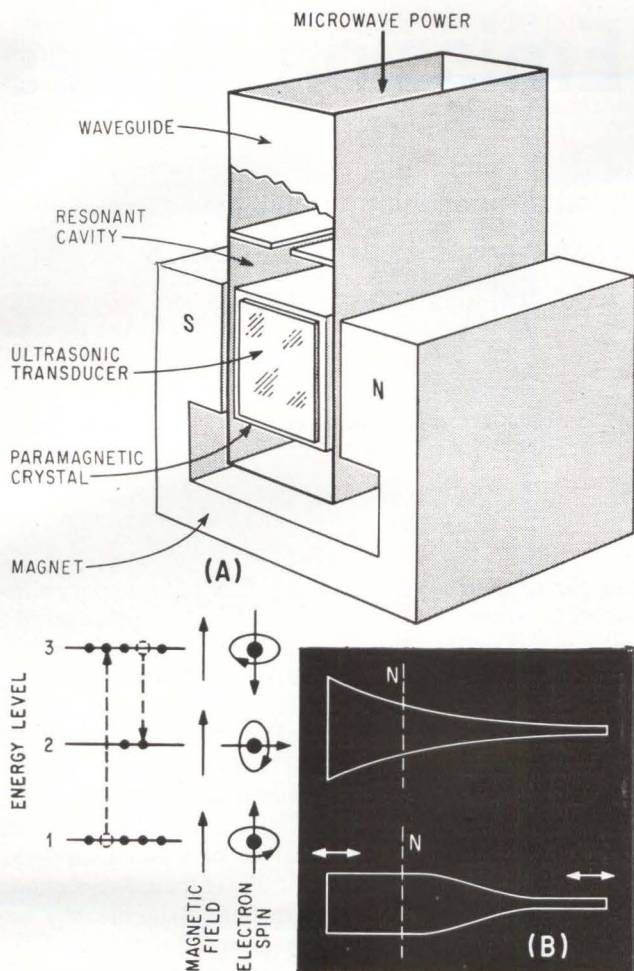

STRUCTURE and energy states of a phonon maser (A); gaussian and exponential-shaped velocity transformer (B) —Fig. 5

power that can be delivered to these tools. The power is controlled by the velocity given to the tool tip and this in turn is limited by the fatigue strain at the point of maximum strain required to give this velocity to the tool point. It can be shown that the maximum velocity of the tool point is given by

$$v = \phi S_F c \quad (5)$$

where  $S_F$  is the strain above which metal fatigue occurs,  $c$  is the velocity of extensional waves in the velocity transformer and  $\phi$  is a factor that depends only on the geometry of the transformer. For a straight rod,  $\phi$  has a value of 1, while for an expo-

ponentially shaped transformer  $\phi$  has a value of 2.5. For the best aluminum alloys  $S_F$  has a value of  $2 \times 10^{-3}$  while  $c$  is  $6.4 \times 10^5$  cm/sec. Hence  $v$  is about  $3 \times 10^3$  cms/sec for an exponential horn. Certain titanium alloys may have a product of  $S_F c = 3.2 \times 10^3$  cm/sec and hence give a velocity of  $8 \times 10^3$  cm/sec.

Studies have recently been made of the geometrical factor  $\phi$  and Eisner<sup>20</sup> has shown that for a gaussian shaped transformer the value of  $\phi$  can be increased to 5. With this shape, about twice the velocity or 4 times the power can be delivered to the tool bit. Figure 5B shows the relative shapes of an exponential and a gaussian transformer for a magnification of 10 to 1.

**New Devices**—Most of the limitations of delay lines decrease as the frequency increases. For example, the spreading losses vary inversely as the wavelength and disappear for distances less than the Fresnel length  $l_o$  of Eq. 1. For a shearing propagating medium having a velocity of  $3 \times 10^5$  cm/sec and a transducer having a radius  $A = 1$  cm, then for a mean frequency of  $10^9$  cycles,  $l_o$  becomes 1,666 cm, corresponding to a delay of 5,500  $\mu$ sec. A bandwidth of  $10^9$  cycles, which can be realized with some of the diffused semiconductor transducers, will produce a rise time about  $10^{-9}$  seconds resulting in a storage of  $10^6$  bits of information for a line length of 300 cms. However, at room temperature the attenuation associated with such a delay will be about 1,800 db for quartz, for example.

One way of reducing this loss is to reduce the temperature to the liquid helium range, where the loss of quartz becomes less than 0.03 db per cm, resulting in an attenuation of 9 db. With a piezoelectric semiconductor as both a transducer and amplifier, and coupling this to a crystal delay line, it is possible to overcome the loss inherent in the transducer and in the line and obtain a usable result. An alternative method is to construct the entire delay line of the same crystal and introduce amplifying sections to compensate for the losses. At the present time, crystal quartz can be grown in any lengths after the seed supply is built up. This cannot be done for any of the present piezoelectric semiconductors, but this appears to be more of a development problem than a fundamental limitation.

It should be emphasized that none of these devices have been reduced to practice but the trends seem to be in these directions.

## REFERENCES

- (1) F. V. Hunt, "Electroacoustics," Chapter I Harvard University Press.
- (2) F. Firestone, *J Acous Soc Am*, **17**, 200, 1946; U. S. Patent 2,280,226.
- (3) A. G. Emslie and R. L. McConnel, "Radar Systems Engineering," Vol. I, Chapter 16, McGraw-Hill Book Co., 1947.
- (4) D. L. Arenberg, *J Acous Soc Am*, **20**, 1, 1948.
- (5) J. R. Klauder, et al, *BSTJ*, **39**, 745, 1960.
- (6) A. H. Meitzler, *IRE Trans on UE*, UE-7, 35, 1960.
- (7) W. P. Mason, "Physical Acoustics," D. Van Nostrand Co., 1958.
- (8) R. Truett and C. Elbaum, "Encyclopedia of Physics," XI-2, Springer Verlag, 1962.
- (9) H. Bömmel and K. Dransfeld, *Phys Rev*, **117**, 1245, 1960.
- (10) R. S. Woollett, paper 11.1, *IEEE Int. Convention*, Mar. 26, 1963.

- (11) D. L. White, *IRE Trans on Ultrasonic Eng*, UE-9, 21, 1962.
- (12) N. F. Foster, *J.A.P.*, **34**, 990, 1963.
- (13) E. G. Spencer, R. T. Denton and R. P. Chambers, *Phys Rev* **125**, 1950, 1962.
- (14) F. G. Eggers and W. Strauss, *J.A.P.*, **34**, 1180, 1963.
- (15) A. R. Hutson, J. H. McFee and D. L. White, *Phys Rev Letters*, **7**, 237, 1961.
- (16) E. B. Tucker, *Phys Rev Letters*, **6**, 547, 1961.
- (17) R. A. Laudise, E. D. Kolband, A. J. Caparoso, *Bell Labs Record*, **41**, 105, 1963.
- (18) J. C. King, A. A. Ballman and R. A. Laudise, *Phys and Chem of Solids*, **23**, 1019, 1962.
- (19) H. Jaffe, *Proc Inst Elec Engs (British)* **109**, part B, Supplement 22, p 351, 1962.
- (20) E. Eisner, "The Design of Resonant Vibrators," Chapter XIV, Physical Acoustics I, Academic Press, 1963.

# Secondary Emission Makes

Klystron oscillator eliminates external quenching circuit by relying on negative resistance characteristic to produce quench oscillations. Principle works with several klystron types

By PAUL E. SCHMID, Staff Engineer, Aero Geo Astro Corp., Alexandria, Va.

**REFLEX KLYSTRONS** have proven to be a rugged and reliable low-power source of microwave energy. Modulation of such klystrons is generally achieved by a-c coupling a square-wave signal to the klystron repeller. A d-c quiescent level of  $-50$  to  $-500$  volts with respect to cathode usually exists at the repeller, and since there is no repeller current in this mode of operation, the modulator need drive only into the interelectrode capacitance,  $C_i$ , shown in Fig. 1. This new self-modulation technique replaces the modulator and its power supply with a simple parallel-tuned L-C circuit. In both the conventional type of modulation and the method described here, a d-c resonator (accelerator) voltage of  $+200$  to  $+500$  volts with respect to cathode is required.

The primary disadvantage of the self-pulsed circuit is the lack of manufacturer's data on secondary emission characteristics of reflex klystrons. For example, while the measured repeller characteristics of seven, randomly-selected 6BL6 (2-4Gc) reflex klystrons are consistent, there is no assurance that all type 6BL6 tubes will be similar in this respect. Nevertheless, experiments have shown that a number of klystron types such as the 6BL6, 6BM6 (2-4 Gc) and X-13 (10 Gc) can be reliably self-pulsed.

**Receiver Experiments**—During a series of experiments where a Varian X-13A 10-Gc integral cavity reflex klystron was used as a super-regenerative detector, the 1-Mc quench

signal was coupled into the repeller circuit by a tuned air-core transformer secondary. It was noted that at times a quench sinusoidal oscillation appeared at the repeller even after the 1-Mc quench signal was removed. Furthermore, during such operation, the repeller voltage was at an average value different from that required for normal klystron operation. This condition was possible because of the unregulated repeller voltage supply, suggesting that the repeller was actually conducting during a fraction of the period of the low-frequency oscillation.

**Self Pulsing**—The behavior of the X-13 with a positive voltage at the repeller suggested a voltage-current characteristic modified by repeller secondary emission. This phenomena is well known and occurs, for example, in a tetrode when the plate voltage is less than that of the screen. Here the electron current to the plate is accompanied by a

simultaneous flow of secondary electrons away from the plate to the screen grid<sup>1</sup>.

Figure 2A indicates the measured d-c repeller voltage-current characteristic of a 6BL6 external cavity klystron. The repeller current reaches an initial maximum of 6.8 ma at 10 volts and then decreases to a minimum of 1.0 ma at  $+32$  volts. If the repeller-to-cathode voltage is increased significantly beyond the region of negative slope, the tube is in danger of being destroyed. This characteristic was observed with several other types of reflex klystrons including the X-13. The decrease in repeller current with a positive increase in repeller voltage is attributed to secondary emission.

The possibility of sustaining low-frequency oscillations across a parallel resonant circuit such as that shown in Fig. 1 is clear if quiescent operation is in a region of decreasing repeller current with increasing repeller voltage. The result is equivalent to placing a negative resistance across the parallel tuned circuit—oscillation will occur whenever the klystron's negative resistance is equal to, or greater than, the parallel resistance associated with circuit losses (and Q) of the tuned circuit.

The foregoing establishes a low-frequency oscillation similar to that possible with the tetrode dynatron oscillator circuit.<sup>2</sup> This still does not explain the microwave output which, as was mentioned earlier, depends on the presence of a negative potential at the repeller relative

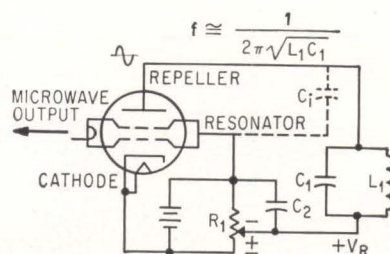

SIMPLIFIED version of superregenerative klystron circuit was found to provide its own quench action—Fig. 1

# Klystron Tubes Self Quenching

## WHO NEEDS MODULATORS

Here's a useful accident. Author Paul Schmid discovered that his superregenerative klystron oscillator continued to produce quench signals and neatly modulated output even when the quench source was removed. He pursued the idea and discovered its source lay in the klystron's secondary emission characteristics. He thinks a tube manufacturer might exploit the possibilities more fully

to the cathode. Figure 2B indicates how the conditions for microwave output are met. In this case, the repeller modes for a 6BL6 klystron operating with an external coaxial TEM cavity tuned to 2 Gc are shown. The resonator voltage is +450 volts. The low-frequency sinusoidal oscillation was observed at the repeller. Thus, during a portion of the sinusoidal oscillation the repeller is negative, leading to microwave output during this excursion.

The results indicate that the principles observed are not due to the peculiarities of any one type of reflex klystron or cavity configuration. The rate of modulation is determined primarily by the LC combination indicated in Fig. 3. The upper frequency limit depends on the interelectrode capacitance between repeller and resonator. Modulating rates from a few hundred cycles per second to as high as 10 Mc have been achieved. The closer the principal repeller mode of operation is to zero repeller voltage, Fig. 2B, the lower the amplitude required by the low-frequency modulation for microwave pulsing. A reflex klystron might therefore be specially constructed to optimize this ability of self-pulsing<sup>3</sup>.

**Future Applications**—This discussion has been qualitative. It is felt, however, that a more rigorous analysis could lead to a new type of ultra simple throw-away type of self-modulated klystron suitable for use with expendable radiosondes, beacons and similar devices where

light weight and low cost are imperative. Over the past few years, a number of secondary emission tubes for use at lower frequencies have been developed by firms such as Philips of Holland. These same secondary-emission techniques might be directly applicable in develop-

ing an optimum self-pulsed klystron.

## REFERENCES

- (1) T. B. Brown, "Electronics" John Wiley & Sons Inc., New York, p 137, 1954.
- (2) L. B. Arquimbau, "Vacuum Tube Circuits" John Wiley & Sons Inc., New York, p 303, 1948.
- (3) L. B. Arquimbau, "Vacuum Tube Circuits" John Wiley & Sons Inc., New York, p 650, 1948.

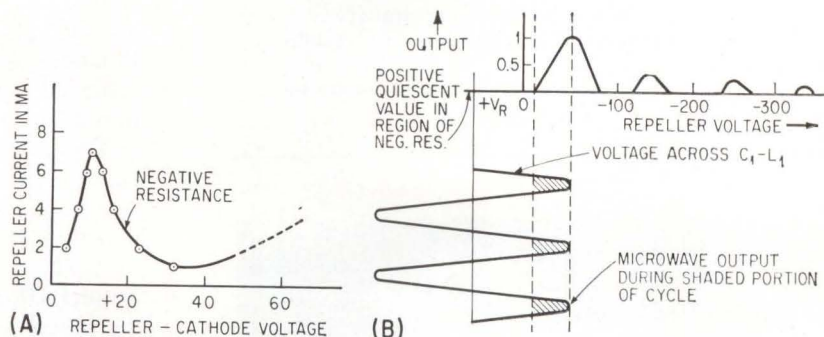

KLYSTRON exhibits negative resistance characteristic (A), conditions under which microwave power is delivered during self-quenching (B)—Fig. 2

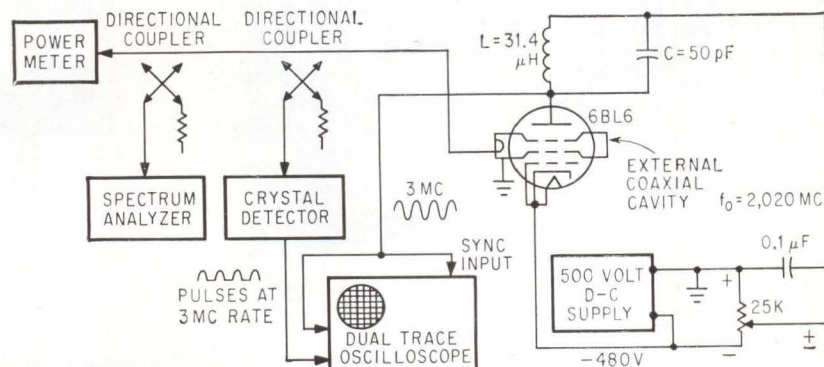

TEST setup finds best conditions for self-quench operation—Fig. 3

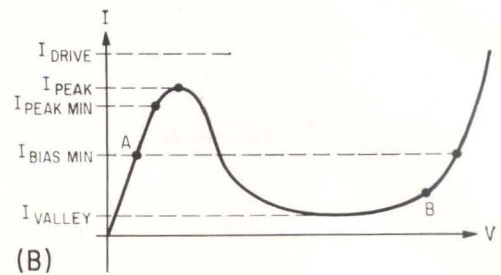
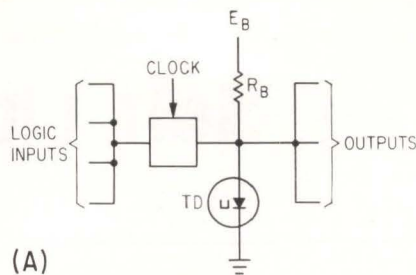

TUNNEL DIODE in (A) is heart of typical tunnel-diode NOR logic circuit. The tunnel charge-storage diode amplifier; current pulses through charge-storage diode are

# A Key to Nanosecond Switching

## COMBINING TUNNEL AND CHARGE-STORAGE DIODES

By P. CHOW and J. CUBERT,  
Univac Div. of Sperry Rand, Blue Bell, Pa.

### ANOTHER HYBRID

By combining the tunnel diode and the charge-storage diode in a logic circuit, a designer can transcend the individual limitations of these devices. The resulting hybrid can operate up to and above 100 Mc, has excellent fan-in and fan-out capabilities and can be built relatively simply and inexpensively

**RESEARCH** in high-speed switching has produced two promising devices: the tunnel diode and the charge-storage diode. Either device, used by itself in a logic circuit, has inherent disadvantages when applied to large digital arrays. Tunnel-diode circuits require tight tolerances and the diode amplifier (using charge-storage diodes) produces output pulses that are too narrow to drive succeeding diode amplifiers. Practical tolerances and high-speed operation are achieved by a cascaded combination of these two devices into an enhanced tunnel diode (etd) circuit.

This article reviews the problems encountered with circuits using only the tunnel diode or the charge-storage diode and describes a functional etd circuit that uses both devices advantageously.

**Tunnel Diodes**—The tunnel diode is unquestionably the fastest bistable switching device presently available and numerous applications have been found for it in specialized pulse circuits. However, its use in logic circuits for large digital systems has been severely restricted by the following characteristics:

- poor isolation between cascaded circuits;
- restricted voltage swings; and
- very tight tolerances required on the tunnel diode, associated coupling elements and power supplies to achieve satisfactory current gain.

Previous efforts to overcome these shortcomings have resulted in poor fan-in/fan-out characteristics or extremely tight tolerances. Attempts to combine tunnel diodes with transistors into hybrid nanosecond circuits have demonstrated an incompatibility in the switching characteristics of these two devices.

**Diode Amplifiers**—The diode amplifier uses a charge-storage diode which relies on the properties of a *p-n* junction operated in the reverse-recovery mode. Charge stored in such a diode at low current during

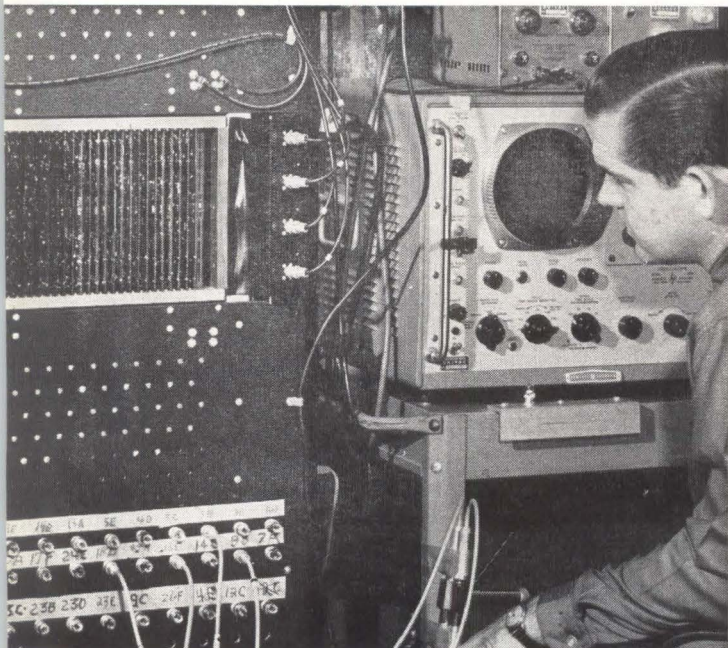

ARITHMETIC tester shown consists of enhanced tunnel diode NOR circuits

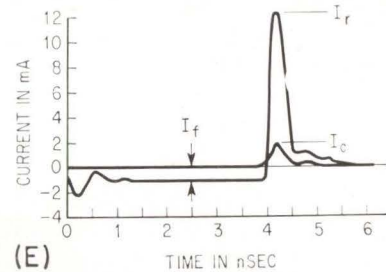
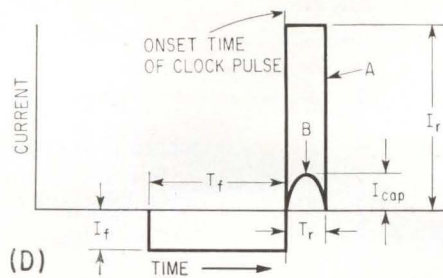
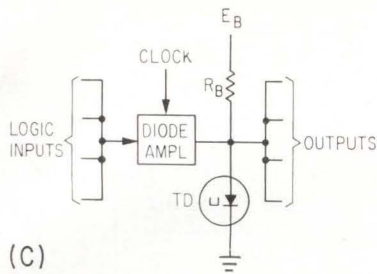

diode is in low-voltage state at point A in (B) and in high voltage state at point B. Enhanced tunnel diode circuit (C) contains shown in (D) and (E)—Fig. 1

Shows how to take advantage of the good features of a tunnel diode and a charge-storage diode by meshing them into a logic circuit that functions at nanosecond speeds. This hybrid circuit works over a wide tolerance of operating parameters and provides high fan-in and fan-out

a period of forward conduction is recovered by applying a fast-rise reverse pulse to the junction. Although a large reverse-current-to-forward-current ratio can thus be obtained, the duration of the output pulse is limited by the total charge stored in the diode and for high current gain the output pulses must be short in relation to the input pulses. A typical output for an input of 10 nsec or less would be about 1 nsec. Therefore, diode-amplifier outputs are generally not adequate for driving succeeding diode amplifiers or transistors, but they are efficient for switching tunnel diodes.

Conversely, the output voltage swing of a tunnel diode is inadequate for driving transistor switches, using reasonable tolerances, but it is sufficient for driving charge-storage diodes. Thus, by taking advantage of the high current gain of the charge-storage diode and the fast-switching bistable action of the tunnel diode, a logic block can be constructed that transcends the individual limitations of each device and provides high-speed operation, excellent fan-in/fan-out capabilities, and improved circuit tolerances.

**TD Versus ETD**—To illustrate the advantages of the enhanced tunnel-diode (etd) circuit over a typical tunnel-diode (td) circuit without diode amplifiers, the operation of the two circuit types will be compared. The derivation of gain figures for a typical tunnel diode circuit (Fig. 1A) is considered first.

Bias current is supplied by  $E_B/R_B$ . Since it makes no difference with respect to tolerances for operation whether the clock current and the logic input currents add or subtract, the case is considered in which the logic input subtracts from the clock. With no input present, the clock signal switches the tunnel diode from point A, Fig. 1B, to the high-voltage state (point B); if an input is present, the tunnel diode remains in the low voltage state.

These optimistic assumptions are made: coupling between tunnel diode stages is 100-percent efficient; there is no feedback current to nonactivated inputs; clock tolerances are neglected; and the tunnel-diode output swing is compatible with the coupling devices.

The total output current ( $I_{out}$ ) available in the worst case occurs when the bias current is at its minimum value. It is expressed as

$$I_{out} = I_{bias-min} - I_v = I_{pk} \left[ \frac{(1-p)(1-b)}{1+b} - X \right] \quad (1)$$

where  $I_v$  or  $I_{valley}$  is approximately equal to the current flowing through the tunnel diode when it operates at point B,  $\pm p$  is the peak (pk) current tolerance,  $\pm b$  is the bias current tolerance, and  $X$  is the valley-to-peak current ratio.

For  $m$  outputs, each of the driven tunnel-diode stages has available a worst-case input current

$$I_{in-min} = \frac{I_{out}}{m} = \left[ \frac{(1-p)(1-b)}{1+b} - X \right] \frac{I_{pk}}{m} \quad (2)$$

The input current, which subtracts from the clock signal, must be sufficient to prevent the tunnel-diode stage from switching. When the tunnel diode switches in the absence of an input pulse, the required drive must be the sum of the maximum peak and overdrive currents to ensure proper switching speed. Thus

$$I_{drive} = I_{pk} (1+p) (1+Q) \quad (3)$$

where  $Q$  is the percent of overdrive required. This drive is supplied by the bias and clock ( $I_{clock}$ ) currents. The required  $I_{clock}$  is obtained from

$$I_{drive} = I_{bias-min} + I_{clock}$$

where

$$I_{bias-min} = \frac{I_p (1-p) (1-b)}{(1+b)} \quad (4)$$

To prevent the tunnel diode from switching, the

input current ( $I_{in}$  must counteract the clock current. Thus,  $I_{in}$  must equal the difference between Eq. 3 and Eq. 4; hence

$$I_{in} = I_{pk} \left[ (1+p)(1+Q) - \frac{(1-p)(1-b)}{1+b} \right] \quad (5)$$

If  $p = 0.02$  (peak current tolerance),  $b = 0.05$  (bias current tolerance),  $Q = 0.1$  (overdrive) and  $X = 0.1$ , then the logic gain  $m$  is

$$I_{out}/I_{in} = 3.34$$

Thus a fan-out of 3 is possible for the idealized case. No consideration has been given to other factors that would further reduce the fan-out.

In the etd circuit (Fig. 1C), the logic inputs allow a charging current ( $I_f$ ) to flow to the diode amplifier during the input period ( $T_f$ ) (Fig. 1D). A clock pulse then reverse-biases the charge-storage diode, producing output current pulse  $A$  (Fig. 1D). The amplitude of the pulse when all the injected charge ( $Q_f$ ) is recovered is

$$I_r = \frac{Q_f}{T_r} = \frac{I_f T_f}{T_r} \quad (6)$$

When the logic inputs prevent charge  $Q_f$  from being injected into the storage diode, only a small capacitive feedthrough pulse ( $I_{cap}$ , curve  $B$ ) appears at the diode amplifier output when the clock pulse is applied.

The following characteristics are required for a diode amplifier application:

(1) The minority-carrier lifetime of the base region ( $T$ ) must be much greater than the forward injection period to obtain efficient charge storage (maximum  $T$  is limited by storage-diode forward recovery).

(2) High current gain requires the recovery of injected charge during the rise time of the clock. This can be accomplished only if injected carriers are concentrated at the junction, where they can be recovered under the control of the external circuit rather than be controlled by the diffusion laws in the base region.

These diode amplifier requirements are met by: a small junction area for low capacitance; a built-in retarding field to assure carrier concentration at the junction; and control of the diode peripheral area to make maximum stored charge available to the external circuit.

Figure 1E illustrates typical charge-storage diode operation at an injection period and current level used in etd logic circuits. Note that the duration of the high-current output pulse ( $I_r$ ) is sufficient to provide constant-current drive for available tunnel diodes.

The gain of an etd circuit can be determined in a manner similar to the gain derivation for the td circuit shown in Fig. 1A. The available output current is derived by Eq. 1, but the capacitive feedthrough current of the charge-storage diode must be taken into account. Therefore

$$I_{out} = \left[ \frac{(1-p)(1-b)}{(1+b)} - (X+W) \right] I_{pk} \quad (7)$$

where  $W = I_{cap}/I_{pk}$ , the ratio of the diode-amplifier capacitive feedthrough current to peak current.

The required input current (see Eq. 5) is reduced by the diode amplifier gain. Thus

$$I_{in} = \frac{I_{pk}}{G} \left[ (1+p)(1+Q) - \frac{(1-p)(1-b)}{1+b} + W \right] \quad (8)$$

where  $G$  is the diode amplifier gain.

For tolerances of  $p = 0.1$ ,  $b = 0.1$ ,  $Q = 0.2$  and  $X = 0.1$ , and for  $G = 10$  and  $W = 0.1$ ,

$$m = \frac{I_{out}}{I_{in}} = 7.84$$

The Table summarizes comparisons between etd and typical tunnel-diode circuits. Note that the increased gain of the etd circuit increases the fan-in/fan-out and circuit tolerances.

The delay per etd circuit is related to:

- charge requirements of the tunnel diode;
- diode-amplifier charge-storage efficiency;
- rise time of the clock pulse;
- capacitance of the uncharged diode amplifier.

The total delay per stage = logic wiring delay + charge-storage time + tunnel-diode switching time.

Presently available tunnel diodes can switch in less than 50 picoseconds, with 20-percent overdrive, when biased within the tolerance calculations shown above. For a diode amplifier gain of ten and a 60-percent charge-storage efficiency, an input forward conduction period of approximately 830 picoseconds is sufficient. Present clocking techniques based on snap-action diodes and local pulse generation allow such gain to be realized. Assuming the availability of low capacitance switching and charge-storage diodes, 1-nsec logic delays can be achieved.

**Circuit Description**—The etd circuit shown in Fig. 2A performs the NOR logic function. The component characteristics of this circuit will be discussed before its overall operation is analyzed.

Diode  $D_1$ , a high-speed rectifier diode, isolates the tunnel-diode output from the input circuit. Diode  $D_1$  causes the tunnel diode to exhibit the unilateral properties of a transistor without losing speed. The reference-voltage source  $+V_T$ , with a source impedance  $R_T$ , biases diode  $D_1$  just below the knee of its forward volt-ampere characteristic to minimize its forward recovery time. Voltage source  $V_1$  also biases charge-storage diode  $D_s$  to a level that enables proper gating to be performed. Inductance  $L_1$  is a high impedance for the fractional-nanosecond clock-pulse current at node  $A$  of the circuit, but it has little effect on the turn-on time of  $D_s$ .

Diode  $D_2$ , a high-speed silicon rectifier, isolates node  $C$  from the clock line except when the positive clock pulse is applied. Since node  $C$  operates at

**TD and ETD Comparisons—TABLE**

Parameter	TD Circuit	ETD Circuit
Pk Current Tol. ....	± 2%	± 10%
Bias Current Tol. ....	± 5%	± 10%
Overdrive. ....	10%	10%
Pk-to-Valley Ratio. ....	10/1	10/1
Logic Gain. ....	3	7

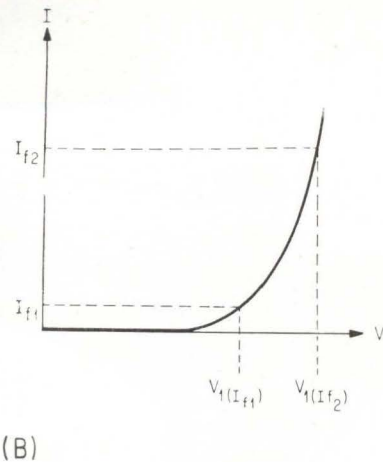
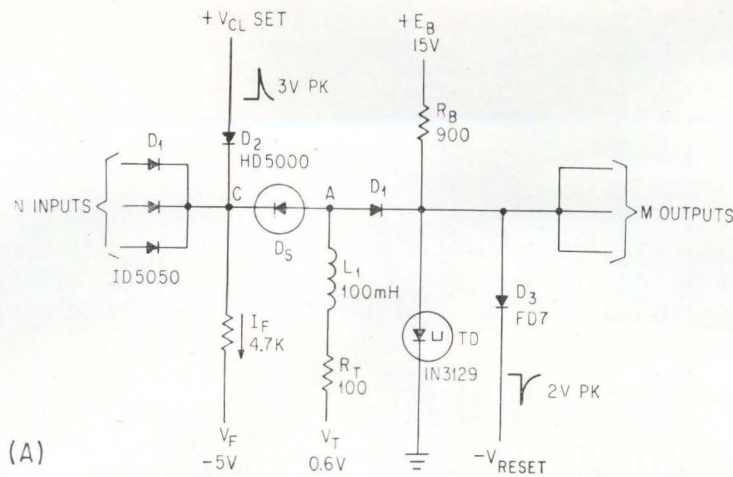

ENHANCED tunnel-diode NOR circuit (A) produces output only if none of the inputs are present; then charge-storage diode  $D_s$  is forward biased in state denoted by  $V_{1(I_{f1})}$  in (B); when clock pulse comes, it sweeps the stored charge of minority carriers across the junction in the reverse direction, producing a current pulse that is large enough to trigger the tunnel diode to its high-voltage state—Fig. 2

approximately ground potential, diode  $D_2$  completely isolates the circuit from negative noise and up to 600 millivolts (22 percent of normal clock voltage) of positive noise. Diode  $D_3$  performs a similar function for the negative reset pulse.

Diode  $D_s$  is a charge-storage diode that passes a large reverse current when switched rapidly from a period of forward conduction to a reverse-bias condition, but passes little or no current if not conducting.

A logical function is performed when a high voltage is applied to one of the etd-circuit inputs from, for instance, a tunnel diode in a preceding stage, or, conversely, when a low voltage is supplied to all inputs. One high input prevents the charge-storage diode from conducting, and all low inputs allow it to conduct.

If the charge-storage diode ( $D_s$ ) is conducting (all inputs low), the clock pulse reverse biases  $D_s$ . A large reverse current is developed which switches the tunnel diode ( $TD$ ) to the high voltage state. A high output thus occurs for all low inputs.

If diode  $D_s$  is not conducting (any input high), the clock pulse causes only a small capacitive current (see Fig. 1E) to flow. The tunnel diode is not affected and remains in its low voltage state. Thus, a low output occurs if any input is high.

**Design Criteria**—Since node  $A$  (Fig. 2A) is a constant-voltage source for all but the fractional-nanosecond clock pulse, and  $I_f$  is a constant-current source, proper specification of the volt-ampere characteristics (Fig. 2B) of diode  $D_s$ . When the voltage across the input diodes,  $D_1$ , allows the input voltages to control conduction in  $D_s$ . When the voltage across the input diode is less than or equal to  $V_{1(I_{f1})}$  the maximum input current is limited to a small forward current ( $I_{f1}$ ) of about  $100\mu\text{a}$ . When the voltage across the input diode is greater than or equal to  $V_{1(I_{f2})}$ , conduction is at least  $I_{f2}$ .

Voltage requirements will now be written for a nor function.

To ensure conduction of  $I_{f2}$  in the charge-storage diode when all inputs are low

$$V_{TDL} - V_{1(I_{f1})} \leq V_T - V_{s(I_{f2})} - I_{f2} R_T \quad (9)$$

where  $V_s$  = charge-storage-diode voltage,  $V_1$  = input-diode voltage,  $V_{TDL}$  = tunnel-diode voltage low and  $V_{TDH}$  = tunnel-diode voltage high.

To ensure little or no conduction in the charge-storage diode if any input is high,

$$V_{TDH} - V_{1(I_{f2})} \geq V_T - V_{s(I_{f1})} - I_{f1} R_T \quad (10)$$

Using the limiting case and subtracting Eq. 9 from Eq. 10 gives the following voltage requirement

$$V_{TDH} - V_{TDL} = [V_{1(I_{f2})} - V_{1(I_{f1})}] + [V_{s(I_{f2})} - V_{s(I_{f1})}] + [I_{f2} R_T - I_{f1} R_T] \quad (11)$$

A typical  $V_{TDH} - V_{TDL} = 400$  mv; thus if

$$V_{1(I_{f2})} - V_{1(I_{f1})} \text{ and } V_{s(I_{f2})} - V_{s(I_{f1})} = 150 \text{ mv}$$

for each type of diode, then  $(I_{f2} - I_{f1}) R_T = 100$  mv. If  $I_{f1} = 0.1$  ma and  $I_{f2} = 1.5$  ma, then  $R_T = 50$  ohms satisfies the condition.

Once the voltage requirements are satisfied, the current requirements can be determined independently.

**Applications**—Worst-case calculations and experimental results have shown that the nor circuit just described can operate with the following typical tolerances and specification figures:

- clock voltage  $\pm 20$  percent; constant current  $\pm 5$  percent; peak current  $\pm 5$  percent; peak voltage  $\pm 30$  percent; high-stage voltage  $> 400$  mv; fan-in/fan-out = 10 units.

These figures indicate that a large digital system based on etd circuits is practicable. Logical elements have been built with a fan-in of 5 and a fan-out of 5, thus yielding an excess fan-out current gain of 5 units to supply the necessary drive for cable terminations and system tolerances—factors which are unavoidable in computer circuitry above 100 Mc.

The authors acknowledge the help of V. Rauzino in preparing this article for publication.

# NEW TSI 500 MC MODULAR ELECTRONIC COUNTERS

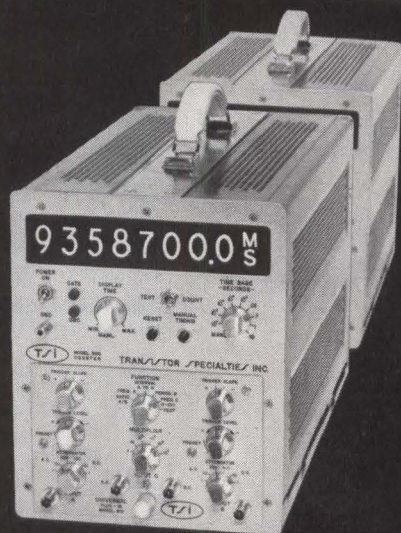

Model 500 Basic Counter (\$2,870) with 511 plug-in \$3,180  
Direct count capability to 100 MC

Model 500L Basic Counter (\$2,520) with 515 plug-in \$2,800  
Direct count capability to 20 MC\*

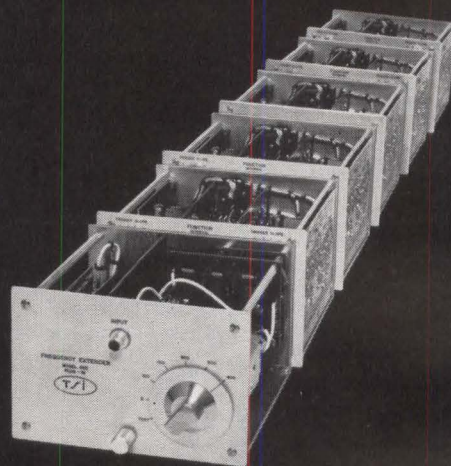

Model 520 Heterodyne Frequency Extender (\$680)  
Turret-tunes in 6 fixed steps to 500 MC  
5 other plug-ins available

## Match a TSI Counter To Your Needs—Select From 6 Standard Plug-Ins

### TSI's TRANSISTORIZED MODULAR COUNTERS FACILITATE:

- Precise Frequency measurement from DC to 500 MC
- Frequency Ratio measurements from 0-20 MC, measured over 1 to  $10^5$  periods for greater resolution
- Time Interval measurements from 0.1 micro sec. to 10 sec.

The eight digit, direct reading Nixie® display provides storage or count-display operation. Decimal point is automatically positioned and units as KC or MC are Nixie indicated.

Sensitivity is 100 MV for AC or DC signals, with stability better than  $\pm 2$  parts in  $10^8$  per week. Packaged in an engineered enclosure, the TSI 500 or 500L counter with plug-in weighs less than 45 pounds.

\*Factory conversion to 100 MC capability available for \$480

Plug-in	"A" input DC-20MC	"B" input DC-20MC	"C" input 1MC- 100 MC	"D" input 10 MC- 500 MC	Function †	used with Model 500	used with Model 500L	price
510	x	x	x		F, FR, P, TI, E	x		420
511	x		x		F, P, E	x		310
512			x		F	x		200
515	x	x			F, FR, P, TI, E	x	x	280
516	x				F, P, E	x	x	170
520				x	F	x		680

†F=Frequency • FR=Frequency Ratio • P=Period and Multiple period average • TI=Time Interval • E=Total Events

**WRITE FOR COMPLETE SPECIFICATIONS**



**TRANSISTOR SPECIALTIES, INCORPORATED**  
TERMINAL DRIVE, PLAINVIEW, L. I., N. Y. PHONE 516 WELLS 5-8700



AIDS TO CIRCUIT DESIGN

A valuable aid in many engineering problems is the fragmented or mechanized equation and a special form to routinize the design procedure. The method has long been used in transformer design and is here applied to transistor switches.

The developed design sheet is given in Fig. 2, with an example superimposed. The original form can be recovered either by redrawing or by making a redline copy and making the necessary deletions. The special graph with EIA resistor values superimposed should be made from a separate sheet of log-log graph paper

# Mechanizing Transistor Switch Design

Here's how to break down design equations into a step-by-step procedure and enter calculations in predesigned form. A plot of results yields optimum circuits quickly

By **THOMAS E. OSBORNE**  
Data Processing Systems Div. of SCM Corp.,  
Oakland, California

**A PROBLEM** frequently encountered in designing digital circuits is that of determining resistance values for the transistor switch of Fig. 1. Although the design is not complicated, it can be time consuming, especially if circuit equations are derived each time. The design equations can be broken down as indicated in Fig. 2, however, and then a complete worst-case d-c design of the transistor switch can be accomplished and checked in minutes. Multipliers used throughout Fig. 2 result from assumed worst-case deviations of  $\pm 10$  percent from nominal values in

all resistors and in the supply voltages. The calculated quantities in the form can be redone to accommodate other tolerances.

**Variables**—Before explaining the use of the form, the important variables must be defined. Also, since the technique applies equally well to *pnp* and *npn* transistors (*pnp* transistors are shown in the diagrams for convenience only), the adjectives of comparative measure, such as larger, smaller, maximum, minimum, must be interpreted as referring to the absolute value of the variable under question. For example, the maximum base voltage of a particular saturated *pnp* transistor may be stated as  $-0.6$  volt. This means that one would not expect to find a saturated *pnp* transistor of this type with a base voltage greater than  $-0.6$ ,—for example  $-0.7$  volt; however base voltages less than  $-0.6$  volt—for example  $-0.5$  volt—may be found.

The important parameters are defined in the table and also appear on the form (Fig. 2); a blank space is left in the form for the actual quantities that will be used in a design. The first step in filling out the

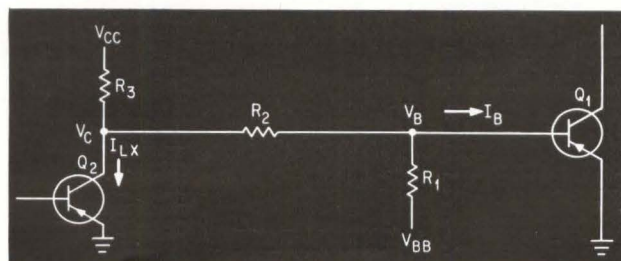

BASIC transistor switch circuit. Increased switching speed can be obtained by using a fast transistor, d-c overdrive or a speed-up capacitor—Fig. 1

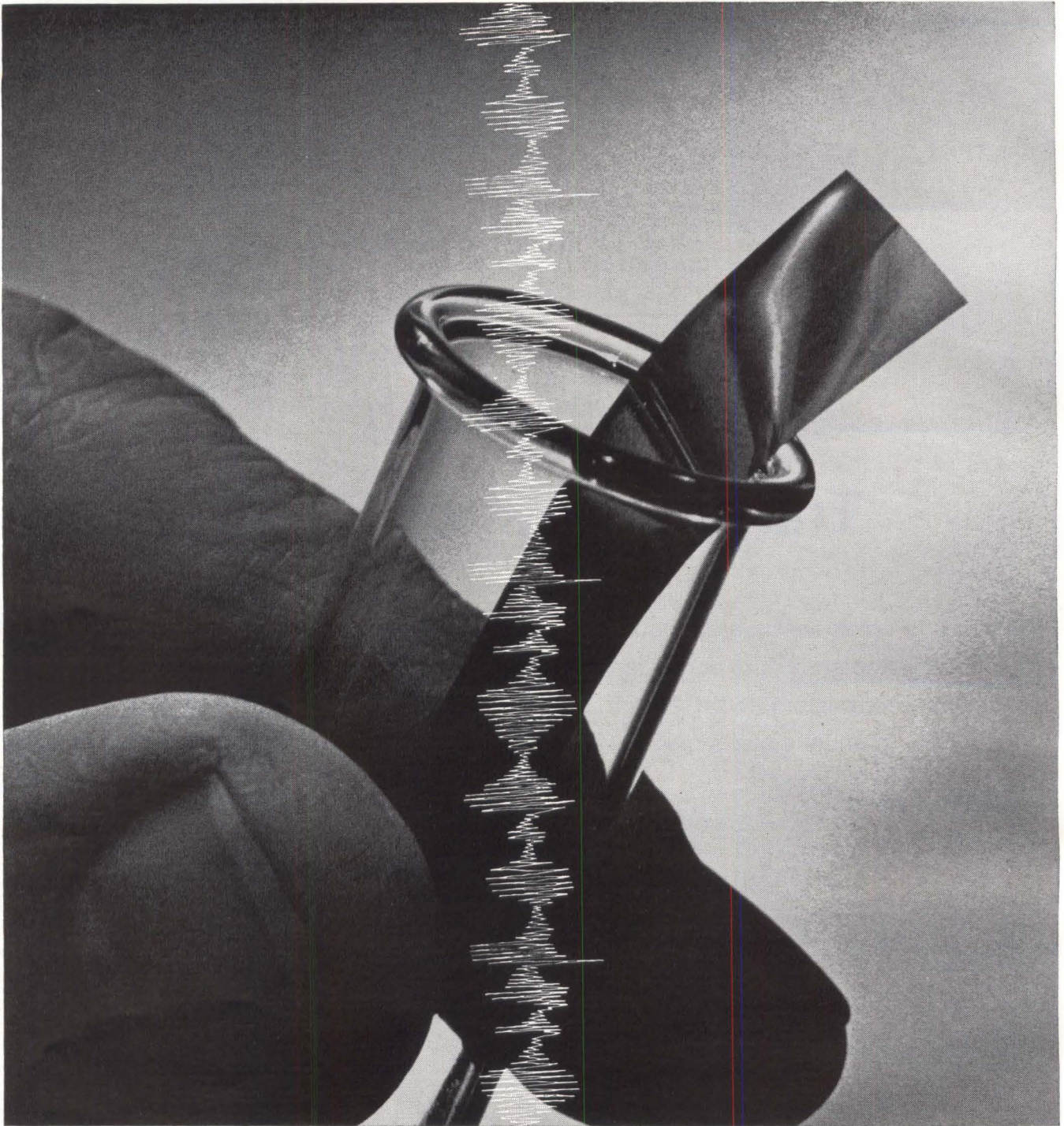

**Who set out to make longer-wearing A and B oxide tapes — and did? AMPEX**

For today's instrumentation applications, a demand exists for increasingly longer-wearing tapes. Ampex decided to meet the demand. Result? Two totally new instrumentation tapes formulated to meet A and B oxide MIL-SPEC and to provide longer wear characteristics. Not only do these new tapes offer far longer wear but also far superior performance. For example: Both new tapes are conductive and anti-static. They have less tendency to attract foreign particles. This makes for clean operation as

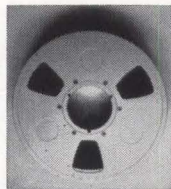

well as longer life. Due to the uniformity of the new formulation, the occurrence of dropouts is minimized. The new Ampex A and B oxide tapes provide higher resolution and improved general output characteristics. And each is application engineered. All this adds up to excellent performance, outstanding reliability. It has to add up to that. That's what Ampex set out to do. For more information write to Ampex Corporation, Redwood City, California. Sales and service offices throughout the world.

$V_{CC}$  = -15 COLLECTOR SUPPLY VOLTAGE  
 $V_{CF}$  = -1.0 MAXIMUM  $V_C$  WHEN  $Q_1$  IS CUTOFF  
 $V_{BB}$  = +5.0 BASE SUPPLY VOLTAGE  
 $V_{BF}$  = 0.0 VOLTAGE AT  $V_B$  REQUIRED TO CUTOFF  $Q_1$   
 $V_{BXN}$  = -0.6 MAXIMUM  $V_B$  WHEN  $Q_1$  IS SATURATED  
 $I_{BXF}$  = 0.2 MAXIMUM  $I_B$  WHEN  $Q_1$  IS CUTOFF  
 $I_{BXN}$  = -1.0 MAXIMUM  $I_B$  REQUIRED TO SATURATE  $Q_1$   
 $I_{LX}$  = -0.1 MAXIMUM LEAKAGE CURRENT OF  $Q_2$

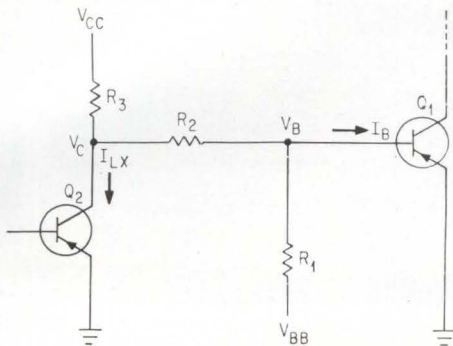

ROW 1		$1.1(V_{CF}-V_{BF})$ $1.1(-1.0) = -1.1$	$I_{BXF}$	$0.81V_{BB}-0.9V_{BF}$ $0.81 \times 5 - 0.9 \times 0.0 = 4.05$	$1.21V_{BB}-1.1V_{BXN}$ $1.21 \times 5 + 1.1 \times 1 = 6.71$	$I_{BXN}$	$I_{LX}$	$0.81V_{CC}-0.9V_{BXN}$ $-0.81 \times 15 + 0.9 \times 0.6 = -11.5$				
ROW 2	$R_2$	a	c	$R_1$	d	e	f	g	h	j	$R_3$	k
ROW 3		$\frac{(-1.1)}{a}$	$(0.2)-b$	$\frac{(4.05)}{c}$	$\frac{(6.71)}{d}$	$(-1.0)-e$	$(-0.1)+f$	a·f	$(-11.5)-h$	$\frac{j}{g}$		
	0.2	-5.50	5.70	0.710	9.45	-10.4	-10.5	-2.09	-9.41	0.892		
	0.4	-2.75	2.95	1.37	4.90	-5.90	-6.00	-2.36	-9.14	1.52		
	0.8	-1.38	1.58	2.55	2.63	-3.63	-3.73	-2.98	-8.50	2.28		
	2.0	-0.550	0.750	5.39	1.24	-2.24	-2.34	-4.48	-7.02	3.00		
	4.0	-0.275	0.475	8.52	0.798	-1.80	-1.90	-7.20	-4.30	2.26		
	8.0	-0.138	0.338	12.0	0.558	-1.56	-1.66	-12.4	—	—		
	6.0	-0.183	0.383	10.6	0.634	-1.63	-1.73	-9.80	-1.70	0.980		

CHECKING EQUATIONS

$R_1=5.6K, R_2=2.2K, R_3=2.7K$

$$I_{BXN} = \frac{0.81V_{CC}-0.9V_{BXN}-I_{LX}R_3}{R_2+R_3} + \frac{1.21V_{BB}-1.1V_{BXN}}{R_1} = -\frac{11.23}{4.9} + \frac{6.71}{5.6} = -2.29 + 1.20 = -1.09$$

$$I_{BXF} = \frac{1.1(V_{CF}-V_{BF})}{R_2} + \frac{0.81V_{BB}-0.9V_{BF}}{R_1} = -\frac{1.1}{2.2} + \frac{4.05}{5.6} = -0.500 + 0.725 = +0.225$$

RAPID CIRCUIT design is obtained by breaking down the equations as indicated. Form itself is in heavy line, example is in light line. Checking equations are given at bottom—Fig. 2

form is to enter the proper value in the blank space between each parameter and its abbreviated definition. The remainder of the form is filled out as described below. Calculations for a sample design are included in Fig. 2 in light line.

Values are entered into the parentheses of Row 3 according to the instructions found in Row 1: the parenthesis in column *b* should contain the numerical value of  $1.1(V_{CF} - V_{BF})$ , while the parenthesis in column *c* should have the value of  $I_{BXF}$ . The other quantities in Row 3 are calculated similarly, using the numbers developed from preceding columns.

**Assumed Resistance**—Next, a range of values is assumed for  $R_2$  and entered in successive rows of col-

umn *a*. Experience has shown that a two decade variation in  $R_2$  consisting of three points per decade is usually satisfactory. Good results are obtained when  $R_2$  is assigned initial values of 0.2, 0.4, 0.8, 2, 4, and 8 kilohms.

The remaining columns (*b* through *k*) are filled out in order for the assumed values of  $R_2$ , according to the instructions of Row 3 of each column. For example, column *b* is developed by dividing each entry of column *a* into the value of  $1.1(V_{CF} - V_{BF})$ , which was entered into the parenthesis in Row 3 in the first step. Column *c* now follows from column *b* by subtracting column *b* from  $I_{BXF}$ , etc.

A graph relating  $R_1$  and  $R_3$  (columns *b* and *k*, respectively; to  $R_2$  (column *a*) is now constructed from

**Definitions of Terms (see Fig. 1 or 2 to identify voltages) TABLE**

- $V_{CC}$  — Nominal collector supply voltage
- $V_{CF}$  — The maximum voltage at  $V_C$  (See Fig. 1) when  $Q_1$  is cut off;  $V_{CF}$  is assumed to have the same polarity as  $V_{CC}$
- $V_{BB}$  — Nominal base supply voltage
- $V_{BF}$  — Voltage required at  $V_B$  to cut off  $Q_1$
- $V_{BXN}$  — Maximum base voltage of  $Q_1$  when it is saturated
- $I_{BXF}$  — Maximum reverse base current required to cut off  $Q_1$
- $I_{BXN}$  — Maximum forward base current required to saturate  $Q_1$
- $I_{LX}$  — Maximum leakage current of  $Q_2$

TELEMETRY DOWN TO EARTH!

# THE HONEYWELL VISICORDER MEASURES STRAIN ON A ROTATING SCRUBBER MILL

\* \* \* \* \*

Telemetry is usually thought of as signal transmission across tremendous voids. Allis-Chalmers uses the Honeywell Visicorder oscillograph to bring telemetry down to earth.

At the Allis-Chalmers processing machinery department in Milwaukee, design engineers wanted to measure grinding mill stresses while the huge machines process metal ore, taconite, cement, and other materials. Large, costly slip rings and dismantling of the machinery had to be avoided, and if possible, all tests were to be made under actual operating conditions in the user's plant.

The problem was neatly solved with a telemetry system built around a Honeywell 906 Visicorder oscillograph and a Honeywell Bridge Balance Unit. With this system, stresses on the shell of the mill, torque on the shaft, and strain on the entire mill can be measured with the mill in operation, and with a minimum of inconvenience to the customer.

Strain gages are placed on the mill at points where stresses are to be measured. Multiplexed data from the gages are broadcast by an FM transmitter attached to the rotating mill, and are picked up by an FM receiving unit. The multiplexed signal is 'sorted out' by audio filters and discriminators, and sub-frequencies and frequency variations are changed to a varying DC voltage.

The Honeywell Visicorder was selected to record the data because Allis-Chalmers engineers wanted to measure even the slightest variation at high frequencies (in this case, as high as 1800 cps), and to measure and record all three data channels simultaneously. In addition, the immediately-readable record produced by the Visicorder gave the engineers an on-the-spot reading of stress variations as well as a permanent record for later use.

There is a Honeywell Visicorder to fit your test requirements. Six models offer frequency response from DC to 5000 cps, with paper speeds from .1 inch per hour to 160 inches per second. For complete specifications on all Visicorder oscillographs, call your nearest Honeywell Industrial Products Group office, or write: Honeywell, Denver Division, Denver 10, Colorado, where our number is: 303-794-4311. In Canada, contact Honeywell Controls, Ltd., Toronto 17.

HONEYWELL INTERNATIONAL Sales and Service offices in all principal cities of the world. Manufacturing in United States, United Kingdom, Canada, Netherlands, Germany, France, Japan.

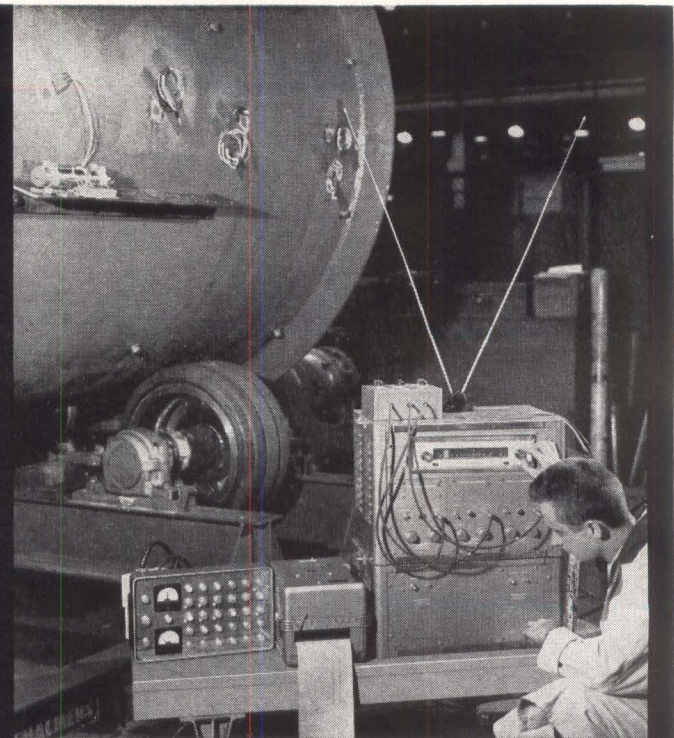

The Honeywell Model 906 Visicorder oscillograph and Honeywell Bridge Balance Unit used in a telemetry system for measuring stresses on a rotary scrubber mill manufactured by Allis-Chalmers, Milwaukee.

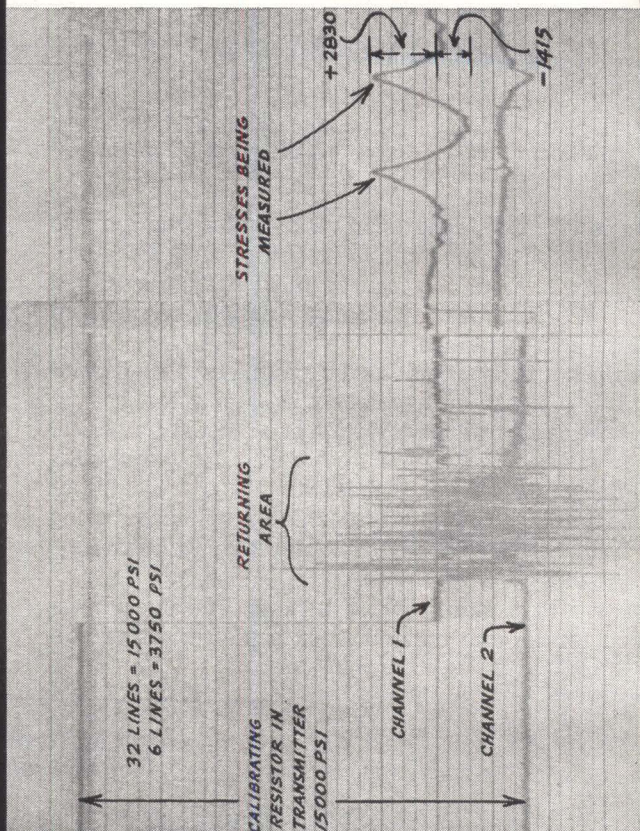

This Visicorder record of telemetered scrubber mill stress data is shown one-half actual size. Records of this type enable A-C to make necessary changes in their formulae for stresses on mill shells and heads.

DATA HANDLING SYSTEMS

# Honeywell

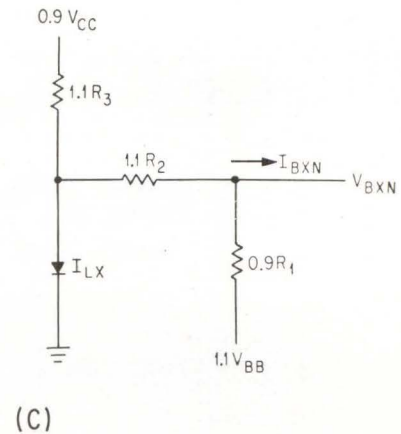
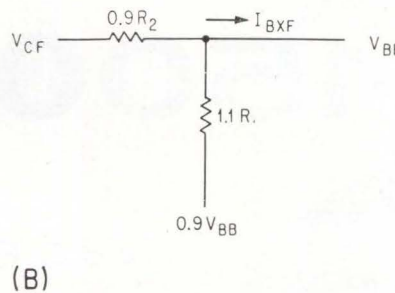
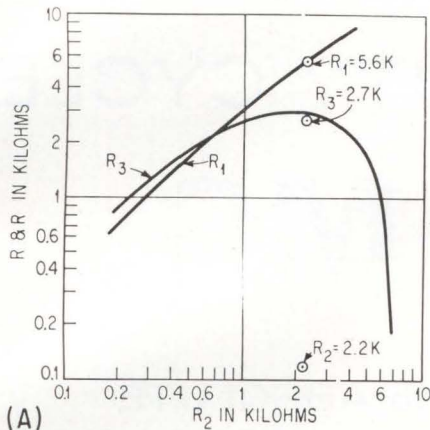

(A) DATA OBTAINED from example is plotted in (A). Dots corresponding to standard EIA resistors can be added to this graph to aid in selecting resistors. Worst-case conditions for  $Q_1$  cutoff (B), and worst-case for the circuit during saturation (C)—Fig. 3

the complete form. The problem of selecting the final EIA resistances is greatly simplified by plotting the graph on a copy made from a sheet of log-log paper which has had dots placed at coordinates that represent standard EIA resistance values. A graph of the data developed in Fig. 2 is shown in Fig. 3A. The design problem reduces to one of interpreting this graph.

**Interpretation**—In most instances it is desirable for  $R_3$  to be as large as possible to minimize the load on  $Q_2$ . (This corresponds to maximum current gain for cascaded switches.) It is seen in Fig. 3A that  $R_3$  has a maximum value when  $R_2$  is approximately 2-kilohms. Although Fig. 3A is a specific example, the maximum value occurring in the  $R_3$  versus  $R_2$  curve can be anticipated in all cases.

The value of  $R_3$  need not be limited to values on the  $R_3$  versus  $R_2$  curve. Any set of  $R_2, R_3$  values located under the curve is acceptable. This can be seen by allowing  $R_2$  to assume any value,  $R_2'$ . The corresponding  $R_3$  value,  $R_3'$ , as given by the curve, defines the maximum  $R_3$  that will still saturate  $Q_1$  when  $Q_2$  is cut off. Any  $R_3$  less than  $R_3'$  will guarantee proper operation. Some effects resulting from the selection of  $R_3$  less than  $R_3'$  are:  $Q_1$  is overdriven, which lengthens its storage time during turnoff; the interstage gain is reduced because of the increased collector load on  $Q_2$ .

A similar argument does not apply to the  $R_1$  versus  $R_2$  curve, so the value for  $R_1$  should be on, or slightly below the  $R_1$  versus  $R_2$  curve.

The resistances of  $R_1 = 5.6\text{-k}$ ,  $R_2 = 2.2\text{-k}$ , and  $R_3 = 2.7\text{-k}$  have been selected from Fig. 3A as the final solution to the example problem. As a final check on all calculations, it is worthwhile to compute the actual base currents during saturation and cutoff. The checking equations are located at the bottom of Fig. 2. Note that the numerators for many of the terms in these equations have been calculated in Row

1 of Fig. 2. The example problem shows that  $I_{BXN}$  and  $I_{BXF}$  are actually  $-1.09\text{ ma}$  and  $0.225\text{ ma}$ , respectively, which exceed the worst-case requirements of  $-1.00\text{ ma}$  and  $0.2\text{ ma}$ .

**Design Equations**—Worst-case conditions for  $Q_1$  cutoff are shown in Fig. 3B. All resistors and voltages have been assigned tolerances to force  $I_{BXF}$  to a minimum value. Equation (1) follows directly from Fig. 3B.

$$I_{BXF} = \frac{V_{CE} - V_{BF}}{0.9 R_2} + \frac{0.9 V_{BB} - V_{BF}}{1.1 R_1} \quad (1)$$

or, after rearranging

$$R_1 = \frac{0.81 V_{BB} - 0.9 V_{BF}}{I_{BXF} - \frac{1.1 (V_{CF} - V_{BF})}{R_2}} \quad (1A)$$

Equation 1 is the second checking equation used in Fig. 2, while columns *b*, *c*, and *d* of Fig. 2 follow directly from Eq. (1A).

Worst-case conditions for the circuit during saturation are shown in Fig. 3C. Tolerances have been selected so that  $I_{BXN}$  is at its minimum value. Equation 2 follows from Fig. 3C.

$$I_{BXN} = \frac{0.9 V_{CC} - 1.1 R_3 I_{LX} - V_{BXN}}{1.1 R_3 + 1.1 R_1} + \frac{1.1 V_{BB} - V_{BXN}}{0.9 R_1} \quad (2)$$

After rearranging, this becomes

$$R_3 = \frac{0.81 V_{CC} - 0.9 V_{BXN} - R_2 \left[ I_{BXN} - \frac{1.21 V_{BB} - 1.1 V_{BXN}}{R_1} \right]}{I_{LX} + \left[ I_{BXN} - \frac{1.21 V_{BB} - 1.1 V_{BXN}}{R_1} \right]} \quad (2A)$$

Equation 2 is the second checking equation in Fig. 2; columns *e* through *k* are developed from Equation 2A.

If tolerances other than  $\pm 10$  percent are to be used, they should be substituted into Eq. 1 and 2.

# MEASURE **PEAK POWER**

## INDEPENDENT OF DUTY CYCLE

# 150-1500 MC

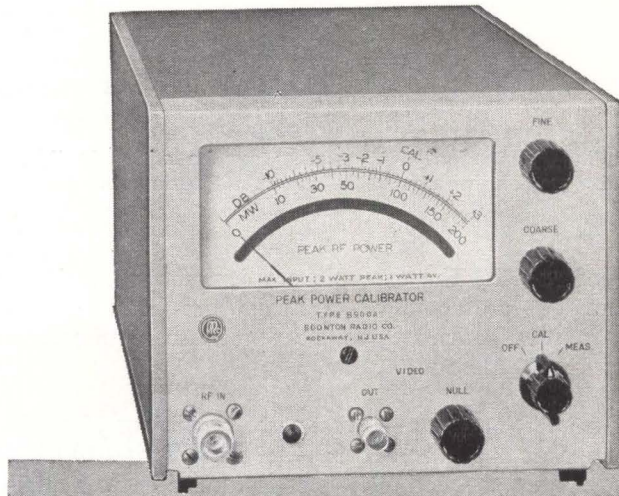

- $\pm 0.6$  db ABSOLUTE ACCURACY
- 0.1 db PRECISION
- READILY STANDARDIZED WITH EXTERNAL BOLOMETER

The Type 8900-A Peak Power Calibrator provides a convenient means for measuring the peak RF power of pulses in the range from 150 to 1500 MC. The power level is read out directly on the panel meter and is completely independent of repetition rate and pulse width ( $>0.25 \mu\text{sec}$ ). The instrument consists of a precision terminated input circuit, diode detector, DC reference supply, meter and a chopped video output system.

In operation, the RF signal is applied to the input circuit, which, through a power splitter, feeds the diode detector. The demodulated diode output and the output of the DC reference supply are simultaneously fed to the video output through a mechanical chopper.

In making a measurement, a suitable external oscilloscope is connected to the video output and the DC reference voltage is adjusted so that it is exactly equal to the peak value of the demodulated pulse. The level of the required DC reference voltage is then indicated on the panel meter, calibrated to read peak RF power. The diode is operated in a biased condition for maximum stability of calibration. Provision is made, however, for readily standardizing the instrument against an external bolometer or calorimeter by simply connecting to the input circuit in place of a standard termination.

The Peak Power Calibrator is completely self-contained and housed in a modular cabinet which may be readily rack mounted.

### SPECIFICATIONS

#### RADIO FREQUENCY MEASUREMENT CHARACTERISTICS:

RF RANGE: 150 to 1500 MC  
 RF POWER RANGE: 200mw<sup>+</sup> peak f.s.  
 \*May be readily increased through use of external attenuators or directional couplers.  
 RF POWER ACCURACY:  $\pm 1.5$  db\*  
 \* $\pm 0.6$  db with custom calibration curve.  
 RF POWER PRECISION: 0.1 db  
 RF PULSE WIDTH:  $>0.25 \mu\text{sec}$   
 RF REPETITION RATE: 1.5 MC max.  
 RF IMPEDANCE: 50 ohms  
 RF VSWR:  $<1.25$

#### PHYSICAL CHARACTERISTICS:

MOUNTING: Cabinet for bench use; readily adaptable for 19" rack mounting.  
 FINISH: Gray engraved panel; green cabinet (Other finishes available on special order).  
 DIMENSIONS: Height:  $6\frac{1}{8}$ ", Width:  $7\frac{3}{4}$ ", Depth: 11"  
 WEIGHT: Net: 10 lbs.

#### POWER REQUIREMENTS:

8900-A: 105-125/210-250 volts, 50-60 cps

#### PRICE:

8900-A: \$485.00 - F.O.B. Rockaway, N. J.  
 Custom Calibration Curve: \$75.00

## BOONTON RADIO COMPANY



A Division of Hewlett-Packard Company



GREEN POND ROAD, ROCKAWAY, NEW JERSEY

Tel. 627-6400 (Area Code 201) TWX: 201-627-3912 Cable Address: Boonraco



*with 1/4, 1/2, 1, and 2-watt  
COLDITE 70+ Resistors*

**STACKPOLE PINS DOWN ALL REQUIREMENTS**

IN ALL 4 RATINGS, Stackpole COLDITE 70+ Fixed Composition Resistors meet and exceed MIL-R-11 Specifications. They also provide extra margins of load life, moisture and humidity resistance and solderability in today's best-looking resistors for military and industrial applications. And, when you need them in a hurry, you can get them in 24 hours or less from leading distributors. Order 1/4-watt (RC-07), 1/2-watt (RC-20), 1-watt (RC-32), and 2-watt (RC-42) in all standard values and tolerances.

**STACKPOLE**

CARBON COMPANY, *Electronic Components Division*  
St. Marys, Pennsylvania.

# Squeezed by PW Assembly Headaches?

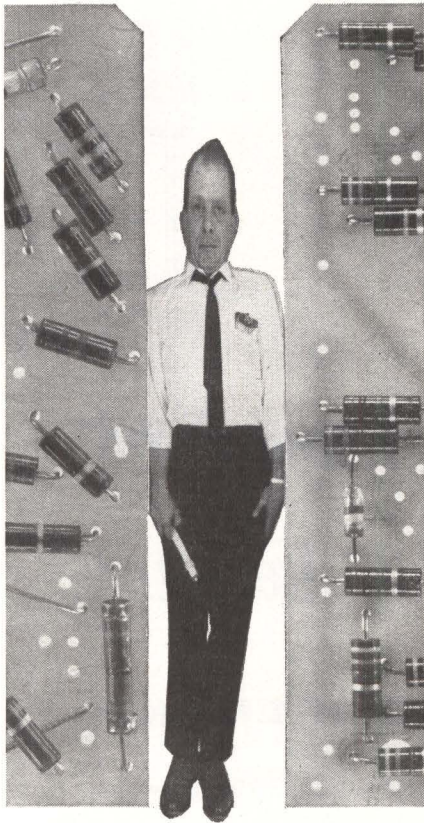

Look into **DYNASERT**® automatic inserting equipment for the fast, efficient, economical remedy. This is modern, automated, high-speed component inserting: up to 10 times faster than costly hand methods. Examples: a single machine can average 800 insertions per hour. A fully automatic system up to 1200 boards an hour with just two operators. Dynasert delivers product uniformity. Greater efficiency. Superior quality. Greater circuit design flexibility. It automatically feeds, cuts, and bends leads, inserts and clinches all types of axial lead components. Little operator training required. Changes made from one board or component type in seconds. Savings can pay for a Dynasert installation in less than a year. Want more facts? Send for a free copy of: Dynasert — Production Equipment for Electronics. Dynasert Dept. 2, United Shoe Machinery Corp., Boston, Massachusetts.



**United Shoe Machinery**  
BOSTON, MASSACHUSETTS

## Presenting Radar Targets

Scan converter puts ppi and targets in red and green on color-tv screen

By **CHARLES COHEN**  
McGraw-Hill World News

**TOKYO**—Radar display that shows moving targets and fixed targets in different colors on a tv receiver is being developed at Tokyo Shibaura Electric Company's Central Research Lab (see photo on cover).

The company says the contrasting color makes targets easier to see and that the display is bright and does not flicker. Engineering feature of the system is that only one scan-conversion storage tube is needed. The color-tv tube is a standard shadow-mask type.

Applications are seen in airport, harbor and weather radar. Weather radar could display land and clouds in different colors by making use of beam polarization by clouds or rain.

The principle could also be extended to three-color displays, reports Kaichiro Odagawa, of the electron tubes department at Toshiba's lab. The unused gun in the

color-tv tube could be used for alphanumeric indication, or all three guns employed to represent in color changes in aircraft or cloud altitude.

**Signal Processing**—In the lab model, simulated ppi and moving-target signals are used as inputs. To distinguish between the moving and fixed-target signals, the moving target symbols are written into the scan-conversion storage tube with an amplitude greater than the fixed target signals. The amplitude difference is used at the storage-tube output to separate the signals by slicing. The subtract circuit in front of the picture tube is for color purification.

The scan-conversion storage tube is a Toshiba M7024, which has writing and reading beams on either side of a target assembly. The writing beam puts a charge on a storage mesh. The reading beam is modulated as it passes through the storage mesh and then strikes a collector mesh to provide the output tv signal.

This tube has previously been used for black-and-white tv display of radar signals. Two such tubes could readily provide two-color display, if provision were made to keep the two images in registration. However, to keep costs down, development was concentrated on a

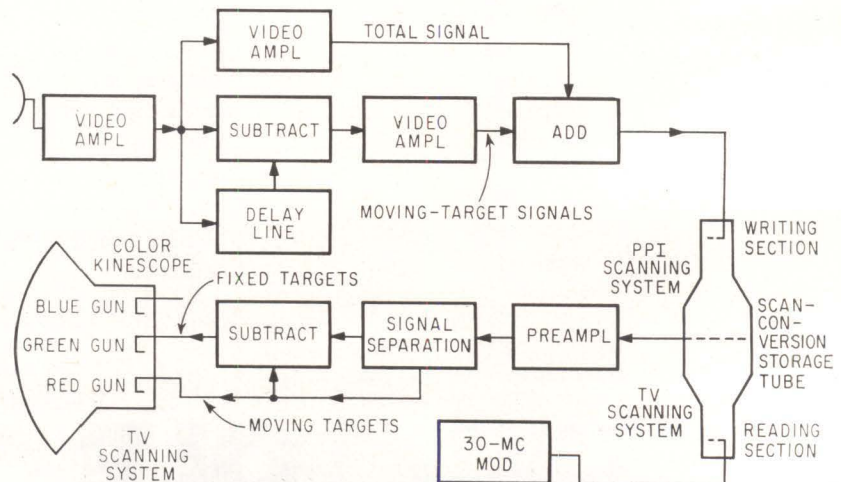

KEY COMPONENT in display system is scan-conversion storage tube. Circuits combine moving and fixed-target signals for conversion to tv signals, then separate them for presentation to crt guns



# in Color

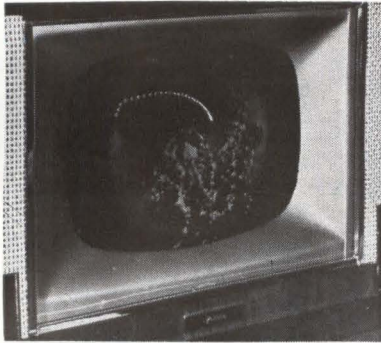

COLOR-TV TUBE used in the experimental display is the standard shadow-mask type. This display is actually on a color tv set

system requiring only one tube. This was possible, Odagawa says, because the tube has good signal-to-noise ratio and tonal gradation and because its decay time is controllable over a wide range.

In the one-tube system, the trail on a moving target changes color as it decays. A two-tube system would avoid this.

## Computer Figures Component Models

SMALL DIGITAL computer enables Burnell & Co. to predict toroid, filter and network job costs without building models and to solve problems in minutes that once took one man a full day, the firm said.

Burnell's device, following a trend toward low-cost all-purpose computers, was designed and programmed with the help of the Monroe Calculating Machine Co. It's 9,000-digit storage holds up to 2,000 instructions, stored programming, and performs 5,000 additions or 2,000 multiplications per minute.

The electronic components firm uses the Monrobot X1 to solve design problems and for inventory control. With it, Burnell can also quote price and performance figures without first building filter networks. Between jobs, it generates engineering tables.

# LAPP HEAVY-DUTY STAND-OFF INSULATORS

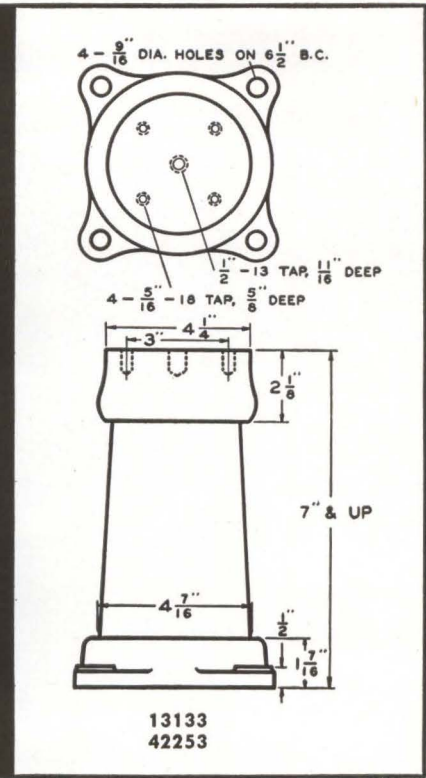

**...in all these  
standard sizes to save  
you time and money**

FLASHOVER AND RADIO RATINGS							
DRY FLASHOVER 60 kv eff.			RADIO RATING kv eff.				
Height in inches	13133 42253	9063 26006	13133	42253	9063	26006	
6	37	*48			12 1/2	23	
8	57	*62	13 1/2	25	15 3/4	29	
10	*71	*72	16	30	18	33 1/2	
12	*82	*80	18	33 1/2	20	37	
14	*92		20	37			
16	*101		21 1/2	40			
18	107		22 1/2	41			

NOTE: \*indicates in stock.

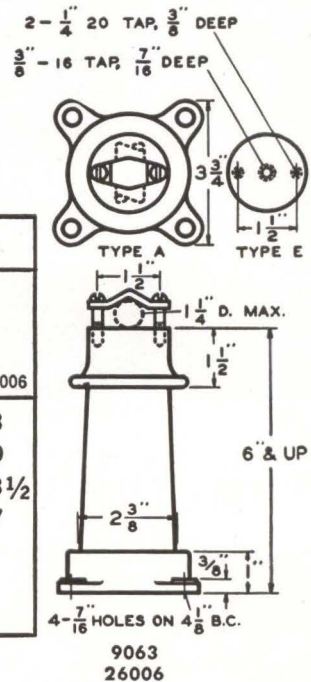

Other sizes available on special order, for fast delivery, and at a price you know is fair. Write for Bulletin 301-R.

Lapp Insulator Co., Inc.,  
210 Sumner Street,  
LeRoy, N. Y.



# NEW HEATING CABLE!

up to 500°F,  
thin-wall,  
flexible, inert  
Teflon\*  
insulation

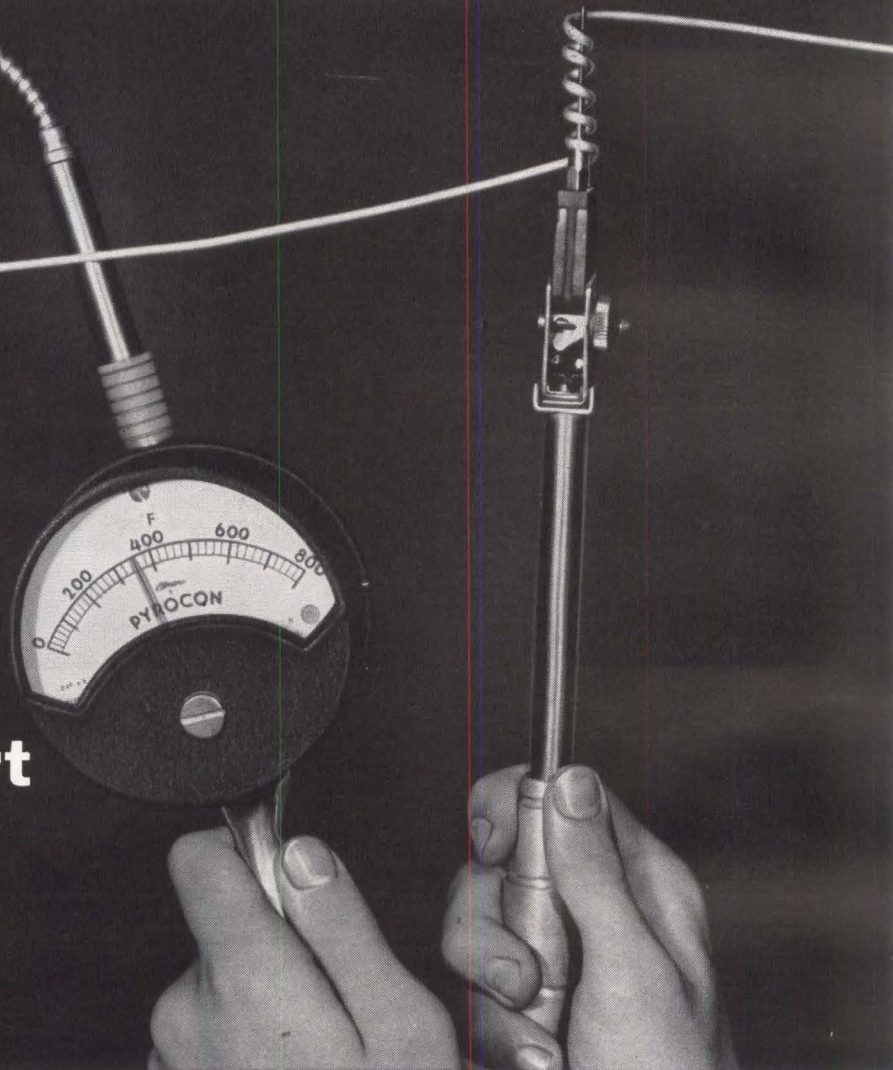

Because of its unique combination of properties, Hitemp Teflon Heating Cable brings many advantages to the resistance-wire system, permitting improved design and providing unexcelled performance. Longitudinal or spiral systems of Hitemp Heating Cable are easily installed, controlled and require minimum maintenance.

Light-weight, flexible and easy to handle, Hitemp Cable has a 45% smaller over-all diameter through comparable insulations, may be bent around 1½ to 2 times its own diameter, and maintains its trained form. There's no need for machine work (cutting, bending, threading or reaming) and simple electrical connectors speed installation. Quick ON-OFF response is practical with either manual or thermostatic control. Fast ON-OFF cycling can be assured with pro-

portional controllers, autotransformers, stepless temperature controls, etc.

Hitemp Teflon Heating Cable is inert to nearly all chemicals and solvents, and undamaged by any chemical or corrosive environment that electrical/electronic equipment must withstand. It's immune to weathering, oxidation and moisture as well.

For systems design information and specification of Hitemp Teflon Heating Cable, write for Technical Bulletin No. 105.

\*Dupont's Trade Name for Polytetrafluoroethylene

## HITEMP WIRES CO.

a Division of Simplex Wire & Cable Co.

1200 SHAMES DRIVE, WESTBURY, NEW YORK  
1532 S. CALIFORNIA AVE., MONROVIA, CALIF.



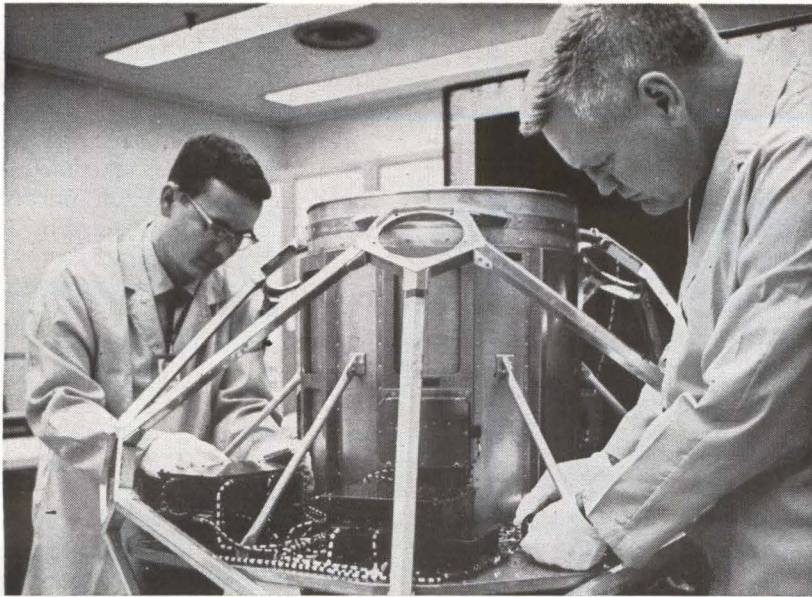

SANDIA LAB personnel install logic system in Vela Hotel satellite frame. X-ray detectors go into holes in triangular points of frame

## Test-Ban Monitors Set for Launch

Vela Hotel satellites  
will watch space for  
atomic weapon tests

By **JOHN W. WASIK**  
McGraw-Hill World News

**CAPE CANAVERAL**—A pair of secret satellites to be launched soon—perhaps this week—from Cape Canaveral are expected to play a

### HARD TO HIDE

X-ray detectors were chosen as the primary detection instruments on Vela Hotel because more than half the energy from a nuclear detonation in space will be released as x-rays.

X-rays travel faster and farther than other forms of energy released by a space blast and are easiest to detect. Sources at Cape Canaveral confirm that a 1-megaton detonation about 200 million miles from the satellites would provide 100 times the x-radiation needed for detection.

The range capabilities of the satellites' neutron detectors are reportedly 1 million miles and, for the gamma-ray detectors, about 50 million miles

vital role in the nuclear test ban treaty.

They are part of a highly classified program known as Vela Hotel—or as Project 823 among tight-lipped program officials. The system employs a network of earth-orbiting satellites designed to detect nuclear explosions in space.

Each spacecraft costs an estimated \$350,000. Vela Hotel funding since 1961 totals \$49 million. The fiscal 1964 budget stands at \$27.5 million. Yearly cost of an operational satellite system is estimated at \$20 million to \$30 million.

**Operational Plans**—The first two Vela Hotel satellites will not be operational. They will have an operational capability, but they will primarily gather data on natural, existing radiation at the orbital altitudes. This data is vital to an operational nuclear detonation detection system.

Extremely high orbital altitudes will place the satellites well beyond the Van Allen radiation belts and the perturbing effects of the earth's magnetic field. Orbital apogees will be 60,000 miles. To lessen chances



### NEW!

Smaller-than-a-dime,  
Bulova solid state sensor  
and feedback package  
assures electronic  
temperature  
control to  $\pm 0.1^\circ\text{C}$ .

Bulova design, circuit and production advances wrap-up in a  $\frac{5}{8}'' \times \frac{7}{16}''$ , 7 gram package, a precise electronic thermostat—the Bulova TRANSISTAT®. The TRANSISTAT uses an external thermistor for exact temperature control and a temperature sensitive resistance bridge, DC difference amplifier and silicon controlled rectifier switch (SCR) to replace conventional components. This solid state device is similar to the mechanical thermostats except on-off switching is accomplished electronically with no moving parts, therefore extending operating life and improving reliability. Factory set temperatures run from  $+25^\circ\text{C}$  to  $+100^\circ\text{C} \pm 2^\circ\text{C}$  with  $\pm 0.1^\circ\text{C}$  accuracy. Voltages range from 26 VAC to 120 VAC. Current output is held to 1 amp maximum.

Originally designed for a new line of Bulova high precision temperature controlled ovens, the TRANSISTAT assures accuracy wherever a controlled thermal source is required—wherever size, weight and reliability are critical. Meets environmental MIL specs, too. For technical data sheets or additional information write—Bulova Electronics Division, 40-02 61st Street, Woodside 77, New York.

\*Pat. Pending

INDUSTRIAL/DEFENSE GROUP

**BULOVA**

ELECTRONICS DIVISION

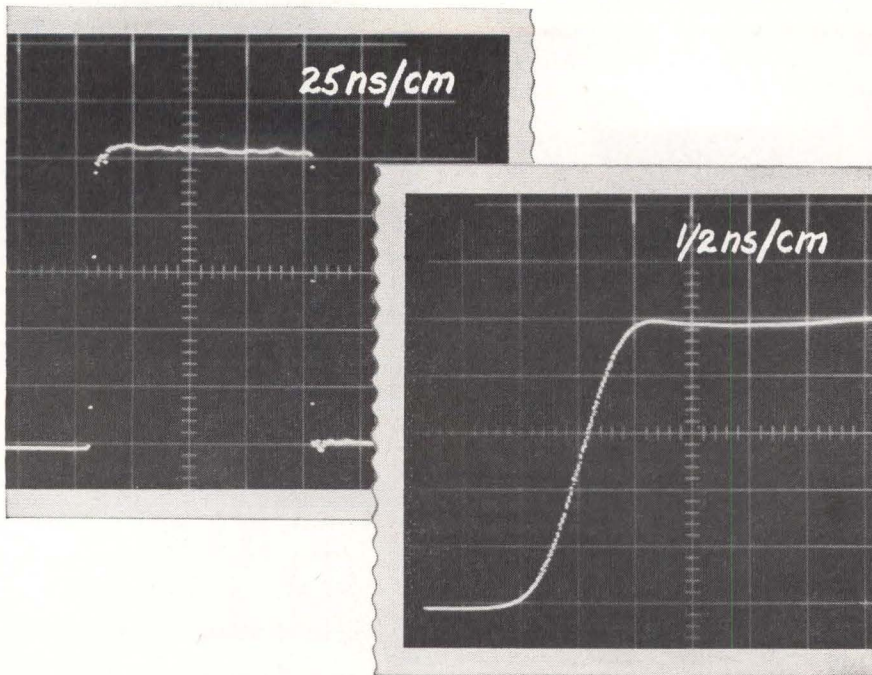

## Proof! 1 amp avalanching in less than 1 nanosecond at 1 megacycle with TI's 7101 Pulse Generator

High amplitude, high rep rate, fast rise/fall times are features of TI's Model 7101 Avalanche Pulse Generator. Voltage amplitude is variable to  $\pm 50$  volts into 50 ohms, rise/fall times are less than one nanosecond, repetition frequency is variable from 100 cycles to one megacycle. Ideal for advanced applications such as thin-film work, the 7101 furnishes selectable width pulses by means of plug-in modules from 5 to 100 nanoseconds or by external charge lines. Delay with respect to sync pulse is variable from 40 to 400 nanoseconds. Like all TI pulse generators, the Model 7101 is compact, lightweight and portable, extremely convenient to use. Circuitry is all solid-state. Write for complete information.

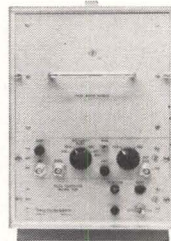

INDUSTRIAL  
PRODUCTS  
GROUP



**TEXAS INSTRUMENTS**  
INCORPORATED  
P. O. BOX 66027 HOUSTON 6, TEXAS

SENSING • RECORDING • TESTING • DIGITIZING INSTRUMENTS  
THE INSTRUMENTS OF TEXAS INSTRUMENTS

601

CIRCLE 58 ON READER SERVICE CARD

**WANT TO  
DO BUSINESS  
WITH THE  
GOVERNMENT ????????**

Then check the Military and Government Procurement Guide in the orange section of your **ELECTRONICS BUYERS' GUIDE**.

of a single satellite turning in a false alarm, they will be launched in pairs and will orbit at about 30 earth radii apart.

Two additional pairs of Vela Hotel satellites are scheduled for launch next year. Each pair will incorporate changes dictated by data received from the preceding pair. The operational system is expected to have six satellites in orbit.

Data-acquisition stations have been set up at Mahe, an island of the Seychelles group in the Indian Ocean, and at three other points. Incoming data will be sent immediately to the Air Force processing center at Sunnyvale, California, and thence to AEC's Sandia operations at Albuquerque for detailed analysis.

**Detectors**—Each 485-pound, 5-ft-diameter, icosahedron (20 faced) satellite has as its primary detectors 10 x-ray fluors. Mounted on each point of the satellite's 20 triangular sides, these thin plastic domes absorb x-rays and convert them into light energy for recording by a multiplier phototube.

These light pulses, AEC scientists say, will be shorter than 1  $\mu$ sec, directly proportional in intensity to the yield of the weapon and inversely proportional to the square of the distance from the blast. Sensitivity of the x-ray detectors can be set from earth to the desired triggering level. The fluors are protected by thin shields of beryllium that admit x-rays but prevent sunlight from triggering the phototubes.

Each satellite also carries beneath its skin six gamma-ray detectors similar in construction to the x-ray fluors. Aluminum shields keep out low-energy background radiation. A boron-trifluoride neutron counter inside the satellite detects slower-traveling neutrons emitted by the detonation. A common moderator of 10 pounds of  $\text{CH}_2$  slows down incoming neutrons.

**Preventing False Alarms**—Since solar plasma and cosmic-ray showers could trigger the sensitive detection instruments, considerable time was spent perfecting devices for preventing—or at least identifying—false alarms.

X-ray detectors are equipped with guard counters that identify cosmic-ray bursts originating within the satellite. A burst must pass a

Report from

**BELL  
LABORATORIES**

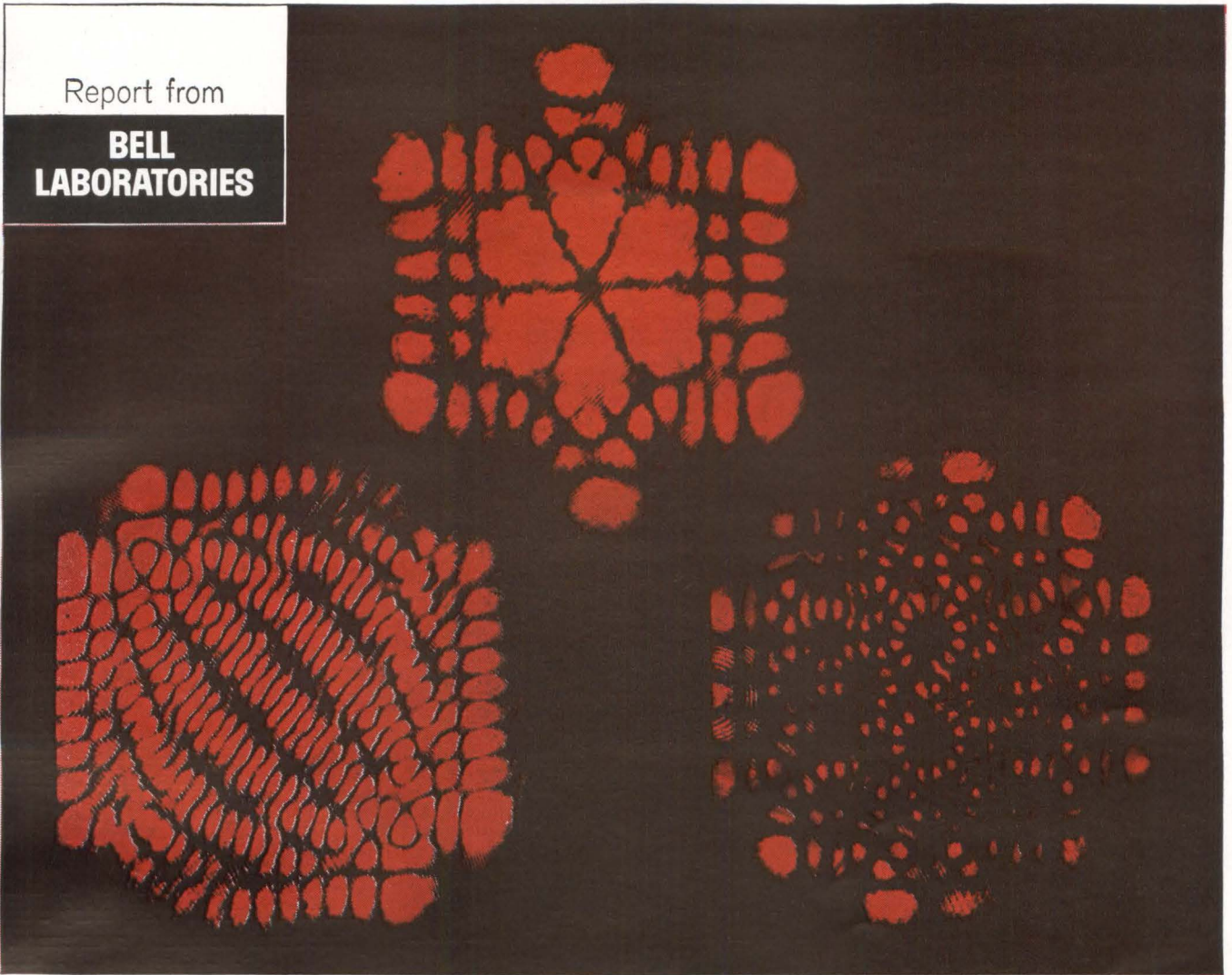

To produce these mode patterns, the normal operation of a helium-neon optical maser is perturbed by placing a pair of wire cross hairs in the cavity. These wires interact with the mode structure of the unperturbed cavity, suppressing some modes and, in certain cases, coupling others together. By changing the angle between the cross hairs, this interaction can be altered and different mode patterns, as shown, can be produced.

## A STEADILY GROWING FAMILY OF OPTICAL MASERS

Scientists at Bell Telephone Laboratories are continuing extensive research programs to gain increased knowledge about optical maser (laser) action. The immediate goal of these investigations is more complete understanding of the phenomenon itself. In the long run, however, this knowledge will help us to evaluate better the communications applications.

One aspect of optical maser research is the study of the mode structures in laser cavities. The modes excited in a particular experiment can be identified by mode patterns, shown above, produced by directing the emergent beam onto a photographic plate.

Optical maser research at Bell Laboratories has resulted in a broad new field of radiation science. For instance, discovery of gas lasers also provided the first continuously operating laser. The active medium in this device is a mixture of helium and neon; its

operation depends on the excitation of neon atoms by collision with excited helium atoms. Originally, this system emitted infrared light, but recently it has been made to produce visible red and yellow light.

More recently, in another significant advance, our scientists have discovered two other new mechanisms for creating maser action in gases. One depends on the dissociation of oxygen molecules in mixtures of oxygen and neon or argon. The other takes place in pure noble gases—helium, neon, argon, krypton and xenon—and depends on a direct transfer of energy from accelerated free electrons to the gas atoms.

With these mechanisms and various gases or gas mixtures, we have achieved maser action at approximately 150 different wavelengths extending from 0.594 microns in the yellow region of the spectrum to 34.5 microns in the far infrared—and more are in prospect.



**BELL TELEPHONE LABORATORIES**

World center of communications research and development

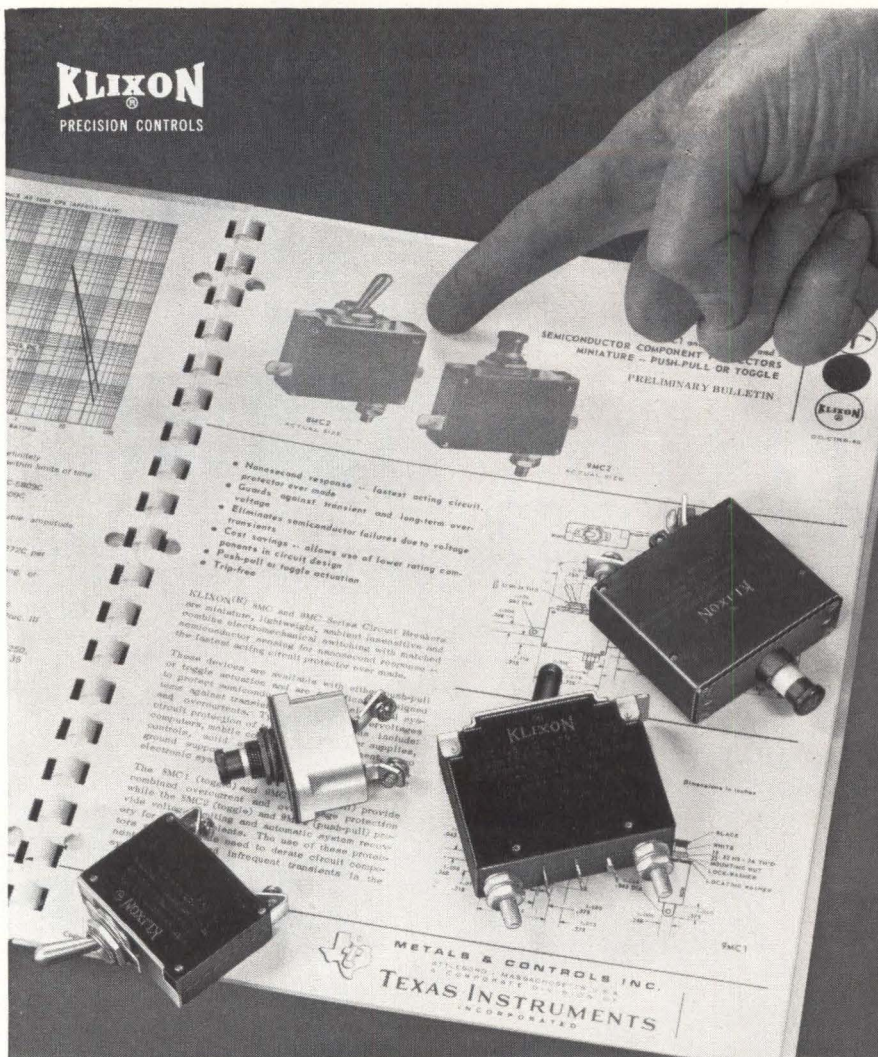

## Circuit breaker selection made easier!

New fact file describes distinctive advantages of all four types of KLIXON circuit breakers

For the first time, you can get all the data you need to evaluate thermal, thermal-magnetic, magnetic and magnetic-electronic types of circuit breakers . . . in one convenient package.

Only TI makes all four . . . and favors no particular type. So, you get unbiased help in selecting the type that best protects your circuits and/or systems from faults due to overcurrent or overvoltage.

**Compare!** Our SP-40 fact file shows that New KLIXON Magnetic-Electronic Circuit Breakers, with nanosecond response, are the fastest acting devices ever made for protecting transistorized equipment circuitry against transient and prolonged overloads.

**You'll also find** that New KLIXON Magnetic Circuit Breakers combine trip-free protection, fast response time and more design options than comparable units. As for KLIXON Thermal and Thermal-Magnetic Circuit Breakers, you'll see that their high rupture capacity and resistance to shock and vibration have no equals for protecting wire and cable in airborne applications.

**Write today** for our new SP-40 fact file . . . the quickest, easiest means of selecting the right circuit breaker from all four types.



**METALS & CONTROLS INC.**

5010 FOREST ST., ATLEBORO, MASS.  
A CORPORATE DIVISION OF

**TEXAS INSTRUMENTS**  
INCORPORATED

counter before reaching an x-ray detector.

Launching the satellites in pairs will also distinguish cosmic-ray bursts. These showers are isolated and chances of one triggering widely-separated satellites at the same time are remote. Simultaneous triggering, on the other hand, is practically a cinch for a nuclear blast.

All of the detection instrumentation is equipped with bias levels and multiple-coincidence circuits to prevent false alarms.

**Logic System**—Logic circuits, probably the most intensely-guarded secret of the system, will be able to identify cosmic radiation, solar radiation and high-energy plasmas of protons and electrons ejected from the sun as well as man-made nuclear detonations.

The most significant events will be recorded for later playback to stations on earth. If circuits become overcrowded, the least significant events will automatically be replaced with more important events detected subsequently.

Circuit redundancy insures reliable data acquisition.

Telemetry consists of a multi-channel digital system using a non-directional antenna or antennas.

Power is provided by onboard batteries and banks of solar cells. Solar cells cover 18 of the satellite's 20 sides—nearly 800 to a side for a total of 13,236 solar cells. Designers feared that radiation from a nuclear power source would interfere with the detectors.

**Five-Year Development**—The initial launch will culminate about five years of development by the AEC's Los Alamos and Sandia operations and subsequent hardware production by Space Technology Laboratories' Redondo Beach facility.

The satellites were prepared for launch in early September, but problems with the Atlas-Agena-B booster on Launch Complex 12 delayed launch. The launch may be on October 14 or 15, but a more conservative estimate is November.

The Air Force Space Systems Division is Project 823 manager. Advanced Research Projects Agency directs the spacecraft contractor STL and systems manager, Aerospace Corp.

# NEWS

## Boron nitride: the better solution to high-temperature dielectric problems

If you need just one of the exceptional properties of our boron nitride, chances are you'd be better off with another material. BN isn't cheap.

But when you need a material that gives you two or more exceptional properties like these—a 4+ dielectric constant and high dielectric strength and high thermal capability and excellent thermal shock resistance and easy machinability into the shape you want—then boron nitride becomes a bargain.

Some pertinent data:

A 1" diameter disc of our BN, 10 mils thick, gives you dielectric strength up to 1450 volts/mil.

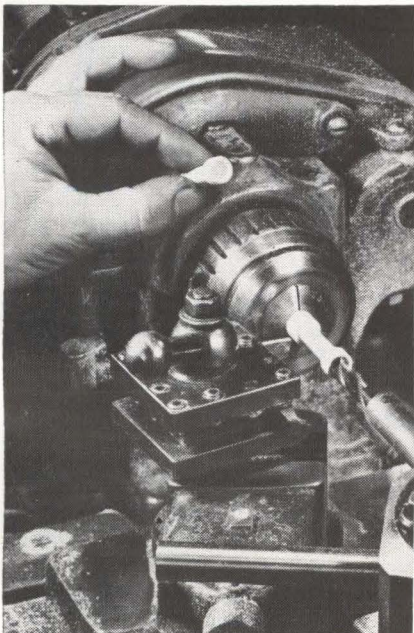

You can easily machine boron nitride into intricate shapes with standard tools.

In a non-oxidizing atmosphere, you can use our solid BN forms at temperatures as high as 5000 F. That's because it's a refractory. In an oxidizing atmosphere, the forms will work for you up to 1800 F.

You can just about forget thermal shock, because boron nitride has exceptionally low thermal expansion perpendicular to molding direction and exceptionally high heat conductivity and mechanical strength.

Match all these properties against what you'd ask for in a high-temperature dielectric and you'll see why boron nitride is at work now in tough applications—like these:

- **magneto hydrodynamic generator**—a BN tube encloses a beryllium oxide tube to insulate against 20,000-30,000 volts. Our material withstands the high temperatures generated through the beryllium oxide tube by jet engine thrust, and its lubricity permits slipping of the tubes as they expand and contract.

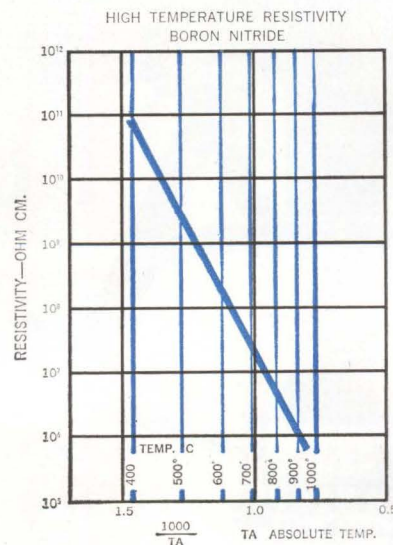

- **arc jet engines**—boron nitride finds varied uses in ion engine chambers, most of them involving its dielectric strength and its ability to stand up in the 3000 F range.

- **hydrogen gas heater**—boron nitride sections support and contain a tungsten element which heats the hydrogen to about 5000 F in an apparatus to test what happens to other materials at elevated temperatures. Portions of the boron nitride pieces reach 5000 F while other portions are at only 2000 F. No thermal failures.

- **electron beam gun spacers**—boron nitride spacers are used because of their thermal shock resistance, their electrical insulating properties, and because they're non-reactive with most vaporized metals.

- **coil form**—its electrical resistivity and thermal shock resistance made BN the choice for a wire-wound form that measures jet and rocket engine housing temperatures.

Can boron nitride solve a high-temperature dielectric problem for you? Does the fact you can machine it yourself into the part you want have interest? Write for our boron nitride technical bulletin to Electronics Division, Dept. E-10, The Carborundum Company, Latrobe, Pa.

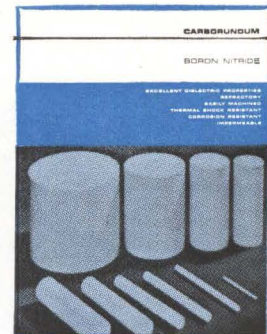

**CARBORUNDUM**

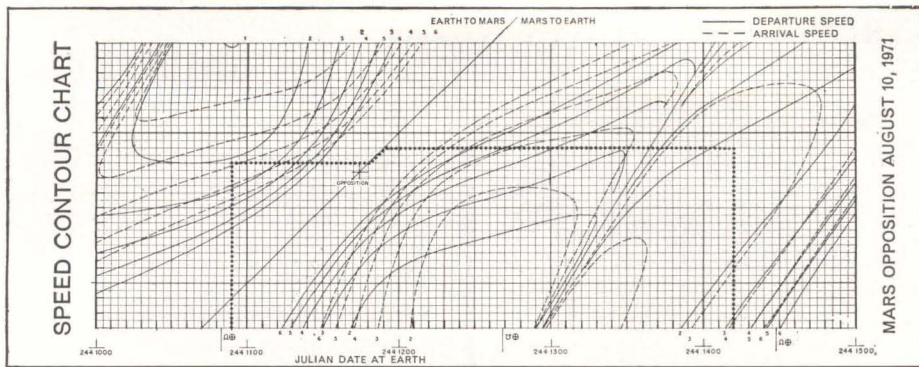

At Lockheed Missiles & Space Company, a dedicated team of scientists devotes its entire attention to problems in interplanetary navigation. Of particular interest are problems attendant to the guidance of a manned vehicle to another planet. With many successful accomplishments to their credit (such as the Polaris and various Agena missions), this group faces every new challenge with confidence.

A promising means for manned spacecraft guidance includes taking celestial and planetary optical sightings, feeding that information into an onboard computer, and computing the spacecraft's position and velocity to predict its future course. The computer will then calculate the predicted destination planet error, decide if a correction is necessary, and

compute its value. These procedures would be repeated continually until the planet is reached. The optimum timing and magnitude of correction, in view of the information obtained from the observations, is the subject of continuing study.

Even before work on hardware for an interplanetary mission is begun, orbit characteristics must be determined to set the requirements to be built into the spacecraft. An optimum trajectory must be shaped for the specific mission, in order to realize ultimate effectiveness. An outstanding accomplishment by Lockheed scientists is the computation of some 250,000 different orbits to Mars and a similar number to Venus. Each orbit varies as to speed, fuel, departure, arrival, and elapsed time.

**LOOK AT LOCKHEED...AS A CAREER**

Consider Lockheed's leadership in space technology. Evaluate its accomplishments — such as the Polaris missile, the Agena vehicle's superb record of space missions. Examine its outstanding advantages — location, advancement policies, creative climate, opportunity for recognition.

Then write for a brochure that gives you a more complete Look at Lockheed. Address: Research & Development Staff, Dept. M-47E, P.O. Box 504, Sunnyvale, California. Lockheed is an equal opportunity employer.

**SCIENTISTS & ENGINEERS:** In addition to positions relating to flight mechanics, such as mission & trajectory analysis, guidance & controls analysis, other important openings exist for specialists in: Orbit thermodynamics • Electromagnetics • Gas dynamics • Chemical & nuclear propulsion • Systems engineering • Computer research • Electronic engineering • Communications & optics research

**LOCKHEED**  
**MISSILES & SPACE COMPANY**  
A GROUP DIVISION OF LOCKHEED AIRCRAFT CORPORATION

Sunnyvale, Palo Alto, Van Nuys, Santa Cruz, Santa Maria, California • Cape Canaveral, Florida • Huntsville, Alabama • Hawaii

**LOOK AT LOCKHEED IN FLIGHT MECHANICS:**

*Further advances in space flight leadership*

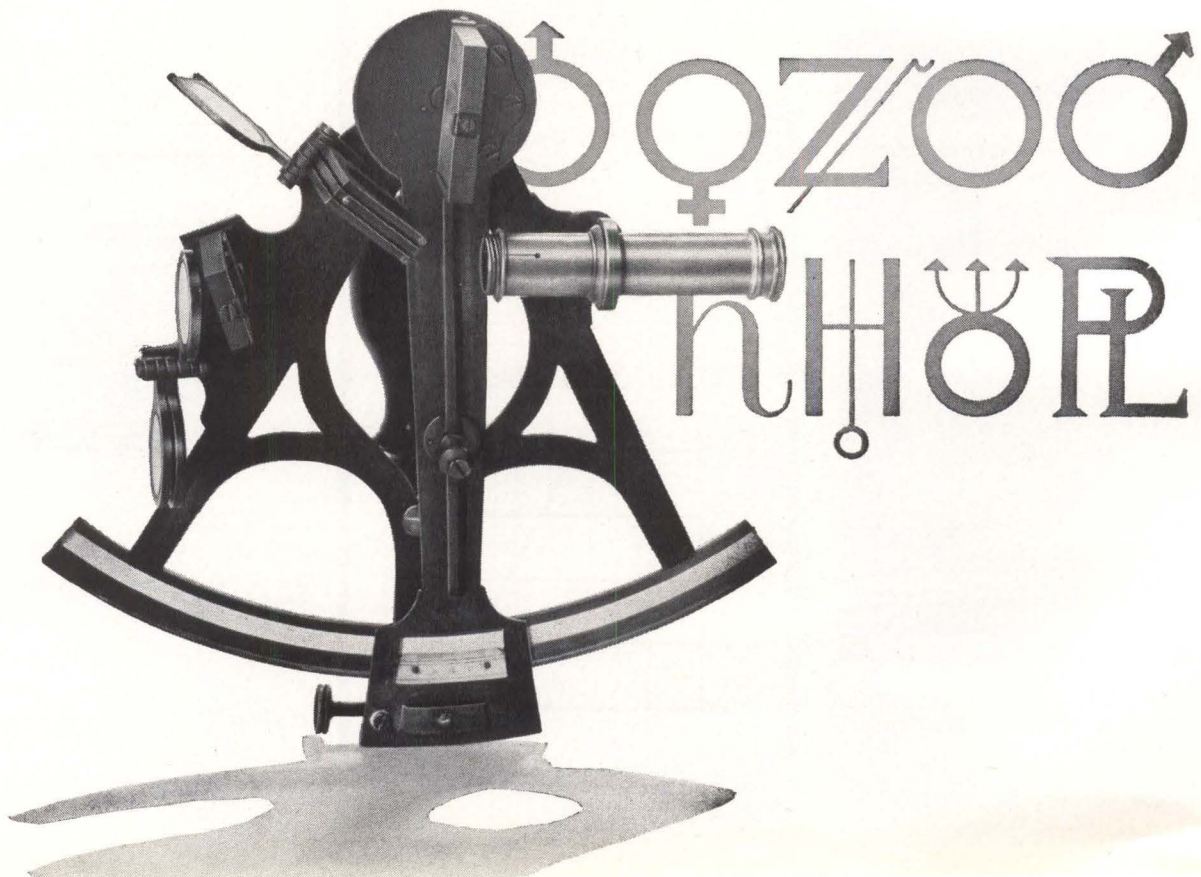



**WANTED** . . . and now available. The Durant Unipulser is creating intense interest because this high-speed decade counter with visual and electrical readout fills a very important functional need in the domain of automation systems, data processing machines, instrumentation and other control equipment.

## UNIPULSER INTERNAL CIRCUIT

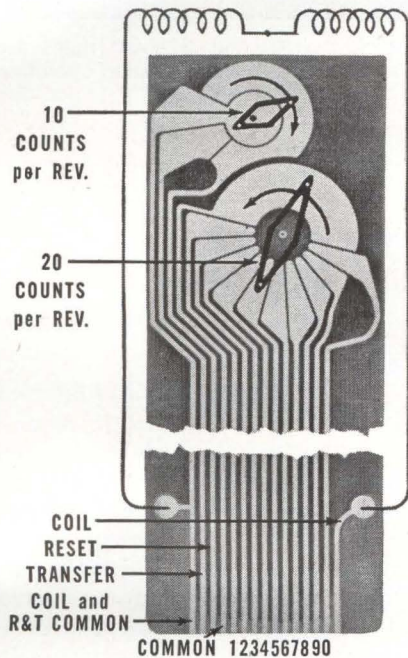

## UNIPULSER APPLICATIONS

- FLUID METERING
- PROPORTIONING
- DATA PROCESSING MACHINES
- AUTOMATION SYSTEMS
- MEDICAL INSTRUMENTS
- PROGRAMMING (PREDETERMINING)
- AEROSPACE INSTRUMENTATION
- REMOTE CONTROL PRODUCTION SYSTEMS
- WIRE PROCESSING

. . . and many more — from sophisticated systems to simple components — which only you, the designer, know as current problems.

Durant engineers will be pleased to make circuitry recommendations upon receiving your application specifications. Send them to: Durant Manufacturing Company, 1912 N. Buffum St., Milwaukee 1, Wisconsin.

# DURANT

**DID IT!**

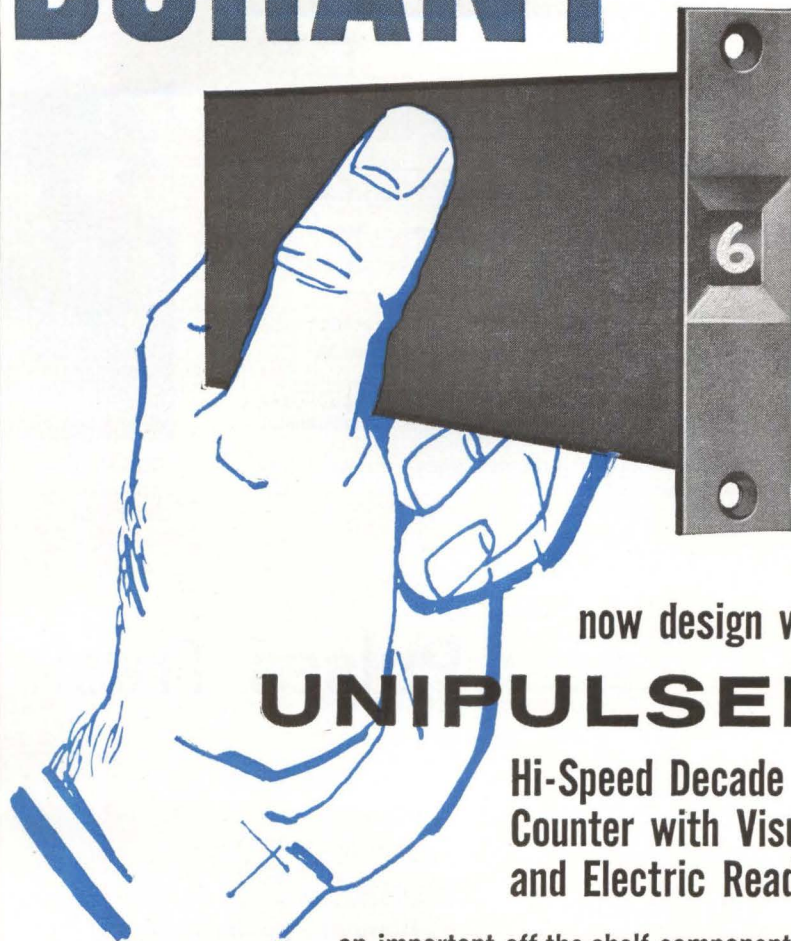

now design with

## UNIPULSER®

Hi-Speed Decade Counter with Visual and Electric Readout

- 1 Accumulated data retained, even if power fails.
- 2 Unit life not subject to hours of usage (as electronic units).
- 3 Printed circuitry permits high electrical loads without relays or amplifiers.
- 4 Performs counting, controlling and readout within itself.

an important off-the-shelf component providing Extreme VERSATILITY, Space-saving COMPACTNESS, Dependable LONG LIFE, plus Attractive LOW COST

This unique, high speed, decade counter of modular design combines visual readout on a printed number wheel and electrical readout by means of an internal printed circuit switch. Each unit incorporates switching methods for resetting to zero and for transferring the pulse from decade to decade in sequential counting. A Unipulser system can be adapted to Predetermined Counting (including automatic recycle), or for many other digital control requirements. A Durant Sales Engineer will be glad to show you the Unipulser. *Send for Catalog No. 90.*

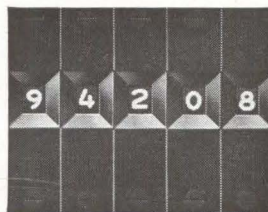

Mounted in banks . . . as many as required.

## DURANT MANUFACTURING CO.

1912 N. Buffum Street  
Milwaukee 1, Wisconsin

12 Thurbers Avenue  
Providence 5, R. I.

# DURANT®

## PRECISION COUNTERS

REPRESENTATIVES IN ALL PRINCIPAL CITIES

See us at Booth 837—NEC

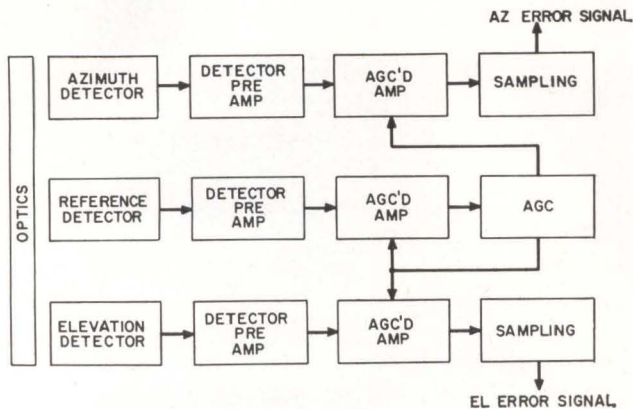

RECEIVER output amplitude indicates linear displacement of image. Transmitter is simply a pulsed laser and the necessary trigger circuit



EXPERIMENTAL transmitter (left) and receiver (right) are manually aimed. Servo coupling would make operation automatic

## Laser Pulses Track Targets

Transmitter illuminates target, receiver finds azimuth and elevation

**EXPERIMENTAL** optical-frequency system for angular tracking of laser-illuminated targets is now undergoing system and performance evaluation at Westinghouse Electric's Air Arm division near Baltimore.

An optical-frequency equivalent of microwave-tracking radar, the system consists of a laser transmitter and a monopulse optical receiver. It can measure line-of-sight angles in azimuth and elevation, with respect to the boresight axis, from a single pulse.

Although the target illumination is presently operator controlled, the system can be used for microwave radar augmentation and missile guidance in that both the transmitter and receiver can be coupled by a tracking servo. This will permit the system to perform overall functions automatically.

The receiver can remain physically separated from the transmitter. Since the receiver is passive, this would provide protection for the

operator if the system were used to track hostile targets.

As presently constructed, the system does not perform ranging. However, Westinghouse told ELECTRONICS, ranging could be done with slight modification to the system.

Range is over 1 mile.

**Transmitter and Receiver**—The transmitter operates at a 1.06-micron wavelength using a neodymium-doped calcium-tungstate laser. Laser output is 0.1 joule per pulse and pulse repetition frequency reaches 40 pulses per second with air cooling.

In the receiver, a pair of diffused-junction silicon detectors, used in conjunction with an optical encoder, provide an output whose amplitude is a function of the linear displacement of the image. An auxiliary or reference detector measures the image intensity directly, and error outputs are made independent of signal strength by automatic-gain-control-circuits.

The angular error readout is a sampled-and-held signal at the transmitter data rate. Its amplitude is a function of error magnitude, and its polarity is a function of the error direction.

## The High Fences at White Sands

Nike-Zeus radar uses fences to eliminate clutter, increase signal

By **W. G. CARLSON**  
**W. W. CANNAN**  
Burns and Roe, Inc.,  
New York, N. Y.

**TWO** concentric steel fences serve as an artificial horizon for the Nike-Zeus acquisition radar transmitter antenna at White Sands, N. M. This novel arrangement was adopted to increase the sensitivity of the high power radar; unattenuated transmission ground clutter would otherwise be strong enough to drown out weak signals returning from the

# KEPCO

## ADDS EXTRA VALUE

## VIX REGULATED POWER SUPPLIES

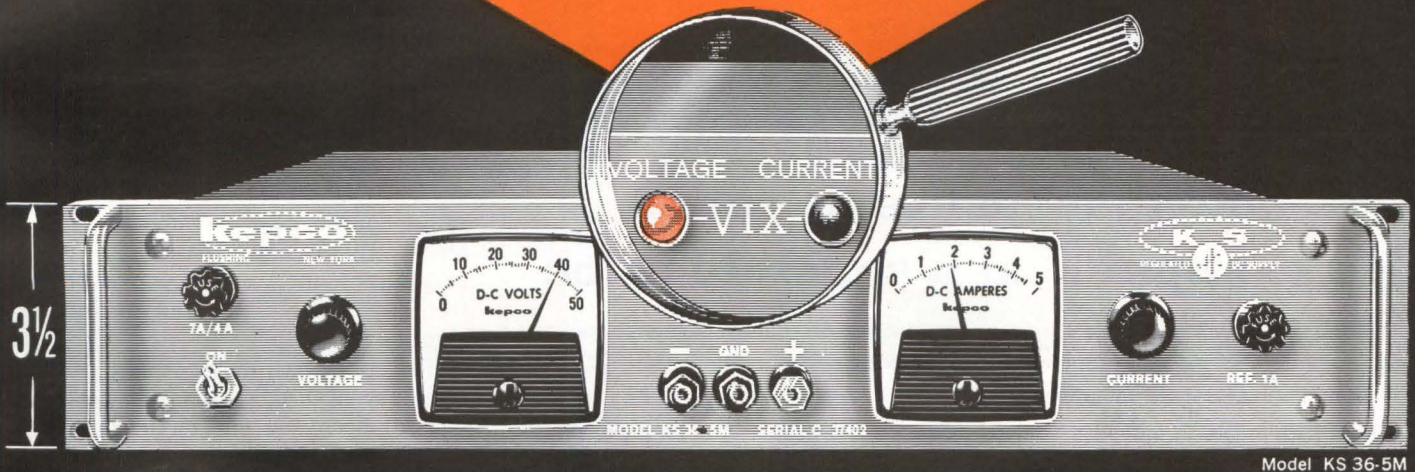

# NEW VIX\* INDICATORS AT NO EXTRA COST!

Kepeco voltage/current regulated power supplies in the KS series now come equipped with voltage/current mode indicators called "VIX". Time saving and added utility are provided by these indicators which show at a glance whether the power supply is in its voltage regulating mode or its current regulating mode. This indication is especially useful in the Kepeco KS Models since they have extremely sharp cross-over characteristics.

\* VOLTAGE/CURRENT CROSSOVER SIGNAL

Send for complete data on  
Kepeco KS Models  
featuring NEW "VIX" Indicators

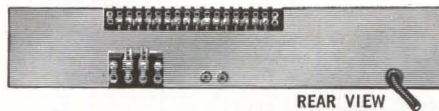

**KEPCO 3 1/2" K S MODELS**  
REGULATED DC SUPPLY

**0.01% REGULATION and STABILITY**

DC OUTPUT RANGE		MODEL	PRICE
VOLTS	AMPS		
0-8	0-15	KS 8-15M	\$595.00
0-18	0-10	KS 18-10M	550.00
0-36	0-5	KS 36-5M	495.00
0-60	0-2	KS 60-2M	495.00

**kepeco**  
Inc. ®

131-38 SANFORD AVE. • FLUSHING, N.Y. 11352  
Phone (212) IN 1-7000 • TWX # 212-539-6623  
Cable Address: KEPCOPOWER NEWYORK

**Other features include:**

- High Power in Compact Design  
3 1/2" H x 19" W x 14" D
- SCR Preregulation
- 10-turn-pot Resolution
- Flexible Programming
- Dual Kepeco "Bridge Circuitry"  
with Automatic Cross-over
- Remote VIX Signal
- Key Circuitry brought to rear  
Terminal Board
- Six Operating Modes with External  
Connections
- Series/Parallel Versatility

† Patents issued and pending.

See our complete  
Catalog in



CIRCLE 65 ON READER SERVICE CARD

**Fred  
Roberts  
can  
show  
you ...**

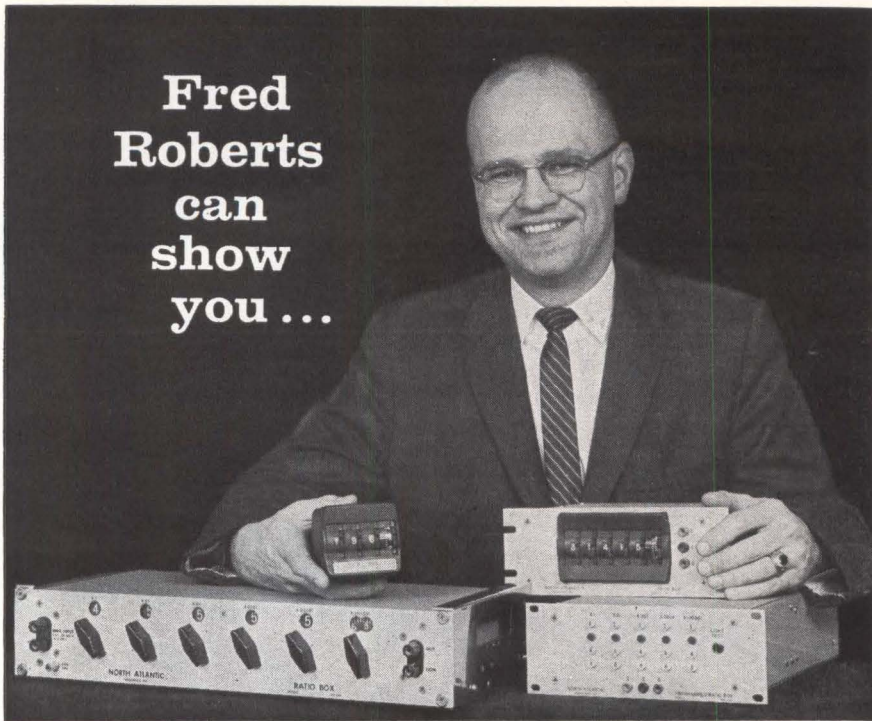

Director of Marketing, North Atlantic Industries

## how to measure ac ratios to 1.0 ppm ... at a sensible price

In fact, any of North Atlantic's field representatives can quickly demonstrate how NAI's Ratio Boxes will economically meet critical requirements for AC ratio measurements—in the laboratory, or in field and production testing.

These high-precision inductive voltage dividers are available in a complete range of models for particular applications. Standard types include Model RB-503 for bench or rack use, the miniaturized RB-521 for panel mounting in military specification equipment and PRB-506, a versatile system module programmable from punched cards or tape for automatic testing. Abridged specifications of these models are given below.

MODEL	RB-503	RB-504	RB-525	RB-521	PRB-506
	RACK OR BENCH	RACK OR BENCH	HALF RACK	MINIATURE PANEL MTD.	MINIATURE PROGRAMMED
Ratio Range	0.000000 to +1.111110	-0.111110 to +1.111110	0.000000 to +1.111110	0.0000 to +1.1110	0.0000 to +1.111110*
Nominal Accuracy (Term. Linearity)	10 ppm	1 ppm	10 ppm	10 ppm	10 ppm
Freq. Range (Useful)	50 cps-10 kc	50 cps-10 kc	50 cps - 3 kc	50 cps-13 kc	50 cps-3 kc
Input Impedance at 400 cps	> 60K	> 200K	>30K	> 50K	> 50K
Nominal Input Voltage Ratings (f in cps)	0.5f volts 350v max.	0.7 volts 350v max.	.35f volts 300v max.	.35f volts 300v max.	.35f volts 300v max.
Maximum Output Series Resistance	3.5Ω	8.5Ω	4.0 Ω	3.5Ω	3.4-3.9Ω*
Resolution	5 decades plus pot.	5 decades plus pot.	5 decades plus pot.	3 decades plus pot.	3, 4, 5 or 6 coded decades
Size	3½"x19"x8"d		3½"x9½"x7"d	27/8"x33/16"x6¼" L.	3½"x9½"x13"d
Price	\$295.00	\$450.00	\$375.00	\$275.00	\$900 to \$1500*

Abridged specification — send for full details

\*Depend on number of decades

Also from North Atlantic: Model RB-510 for 2.5ppm precision at 10kc; RB-503T and -504T with ratio ranges from -1.111110 to +1.111110, and a complete line of Phase Angle Voltmeters.

For complete technical and application data, write for Data File RB, or contact the North Atlantic man in your area.



**NORTH ATLANTIC industries, inc.**  
TERMINAL DRIVE, PLAINVIEW, L. I., NEW YORK • OVerbrook 1-8600

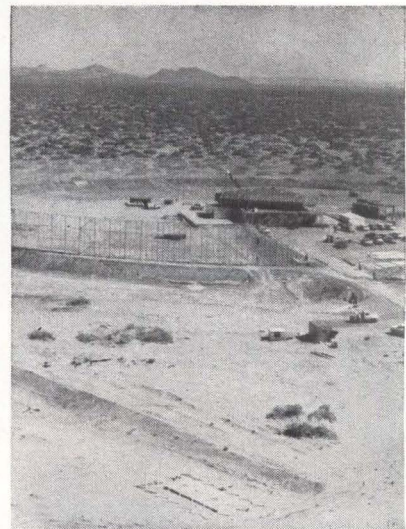

OVERALL VIEW of Nike-Zeus acquisition radar transmitter site at White Sands Missile Range during construction of main fence; auxiliary fence was added later—Fig. 1

target to the nearby receiving antenna. By masking these spurious emanations, the two fences prevent the loss of low-angle and horizon targets.

The principal, outer fence (see Fig. 1) is 27 ft high, on a 10-ft earth embankment, and 660 feet in diameter. To keep the primary fence as low as possible, an auxiliary fence was built inside it, nearer the transmitter. This 10-ft fence, 169 feet in diameter, intercepts low-angle signals near the antenna, preventing them from rebounding at a sufficient angle to pass over the main fence and cause random phase interference.

**Wavefronts** — Ideally, to simplify evaluation of signal echoes, the propagated acquisition wavefront from the transmitter should be straight. However, in practice the propagated field is curved, as in Fig. 2A because the signal source, a horn, (1) is virtually a point, and (2) is disturbed because ground clutter introduces spurious signals when there is no fence. Although the main fence eliminates clutter, it also injects additive and subtractive signal components into the main radar beam. The result is an r-field which, in the region near the top of the fence, may have a wavy front, see Fig. 2B.

The second fence effectively reduces the intensity of the out-of-



traveling under ice in the Arctic?

yes\*

Only a submarine can reach the North Pole by sea — with continuous Sonar operation to determine distances from sea bottom, ice ceiling and other hazards. In critical applications like this, where extreme accuracy in sending and receiving signals is required, Gamewell Precision Rotary Switches have proved completely dependable. Characteristics include: tolerance of  $\pm 0.5^\circ$  for any segment width over  $1^\circ$ ; phasing to  $\pm 0.25\%$ ; torque less than 1 oz. in. with sleeve bearings at room temperature; high resistance to shock, vibration, temperature and acceleration. For special switches to meet your circuit sampling, sequencing, programming or similar applications, take advantage of Gamewell's YES service — **\*your e**ngineered **s**pecials service. Send us details.

**GAMEWELL**  
ELECTRONICS DIVISION

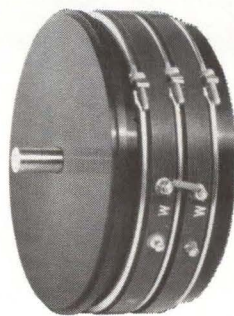

THE GAMEWELL COMPANY, 1609 CHESTNUT ST., NEWTON 64, MASS. A SUBSIDIARY OF E. W. BLISS COMPANY

# 20-YEAR HITCH IN DAVY JONES' LOCKER

*(Mycalex components are built to work on over 4,000 miles of ocean floor until at least 1983)*

These amplifiers will be spaced at 20-mile intervals along a single cable on the ocean floor to help the Bell System handle the growing number of inter-continental telephone calls—well over 4,000,000 last year alone.

In designing these new amplifiers the Bell System engineers aimed at developing a device that would stand up for at least 20 years under the extreme pressure. For failure of any of the complex components could interrupt vital transoceanic circuits.

They looked to Mycalex Corporation of America for 11 key parts—resistors, inductors and transformers—because Western Electric knows from over 20 years of materials testing and experience that our SUPRAMICA® 555 ceramoplastic is one of the most nearly perfect insulating materials. It can be precision molded for reliable operation. It is extremely stable. It has a thermal expansion coefficient close to that of stainless steel. It permits easy soldering of imbedded inserts.

SUPRAMICA (we make three kinds, 555, 560, and 620 "BB") is only one of the products we produce as the world's leading specialists in high-temperature, high-reliability ceramic insulation materials and components. If you'd like a sample of SUPRAMICA 555 plus our newest literature on this amazingly versatile engineering material, please fill out the coupon below.

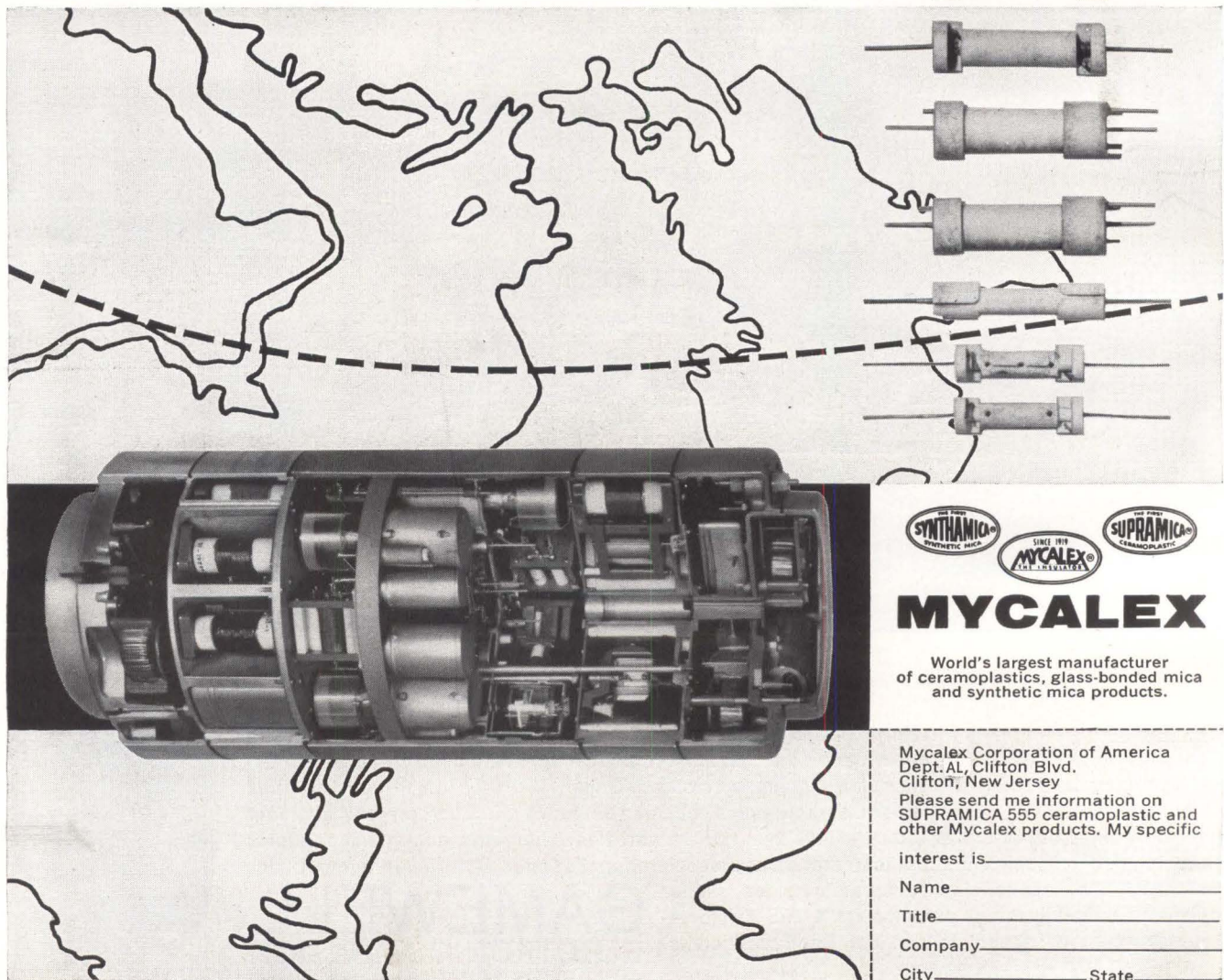
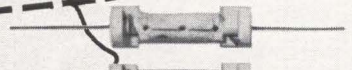
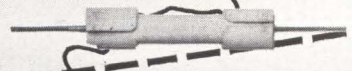
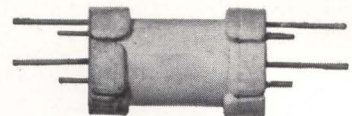
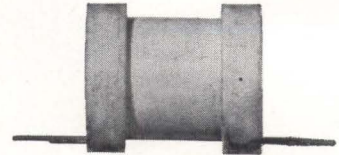

## MYCALEX

World's largest manufacturer of ceramoplastics, glass-bonded mica and synthetic mica products.

Mycalex Corporation of America  
Dept. AL, Clifton Blvd.  
Clifton, New Jersey

Please send me information on SUPRAMICA 555 ceramoplastic and other Mycalex products. My specific

interest is \_\_\_\_\_

Name \_\_\_\_\_

Title \_\_\_\_\_

Company \_\_\_\_\_

City \_\_\_\_\_ State \_\_\_\_\_

phase elements caused by the main fence, leaving a virtually uniform, uncluttered wave front; the slight distortion remaining poses no problem for the acquisition radar. As shown somewhat exaggerated in Fig. 2C, the final wave front has been smoothed, and now functionally approximates the ideal or desired field. No horizontal beam-shaping is needed for the ZAR signal because of the radiation pattern of the antenna. The low-cast

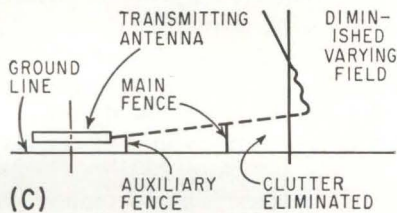
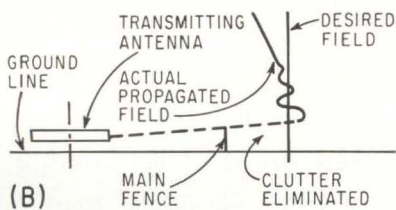
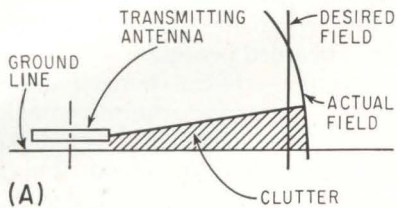

EFFECT of fences on r-f front shape: transmission without fences, (A); effect of main r-f fence, (B); effect of both fences together, (C)—Fig. 2

transmitting antenna radiates from three sides simultaneously; the main lobe is fully dominant, eliminating ambiguities over a very long range.

**Construction** — Both fences, designed and built by Burns and Roe, Inc., New York, are made of galvanized steel. The required beam attenuation is obtained by careful selection of fence material and mesh design. Every part of the fence either grounds or chokes the impinging radar energy. Where the beam strikes solid metal the effect is direct grounding; the voids were designed to act as waveguides operating below the radar's cutoff frequency. A suitable wire mesh was

# TERMINAL OR CONTACT SETTING PROBLEMS ?

**BLACK & WEBSTER SOLVES THEM QUICK AS a b c d!**

**a** Electroset — Model FST Automatic Terminal Setter — tube fed. Sets terminals at rates up to 4200 per hour. Precision-controlled impact (up to 3500 lbs.) eliminates rejects. All-electric operation. Ideal for turret type or seamed terminals, pins, shoulder studs, plug-nuts. High reliability — tested and proven by leading electronics firms.

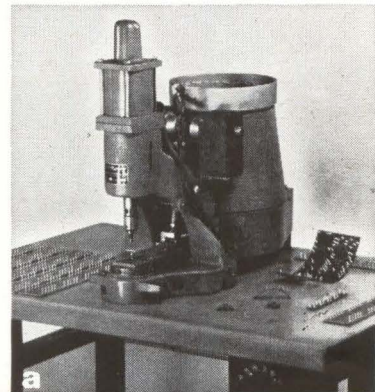

**b** Electroset — Model FST-1 Automatic Terminal Setter — raceway-fed, for split-lug, feedthrough and other terminals. Precision-impact up to 3500 lbs. All-electric operation. Capable of feeding more complex shapes than FST. Within limits, FST-1 can feed more than one type terminal in the same raceway.



**c** Electroset — Model FSTC Contact Setter — raceway-fed, for automatic contact setting. All-electric operation. Precision-controlled impact up to 3500 lbs. Adjustable rate of feed, up to 100 contacts per minute. This bench-mounted unit comes completely tooled and ready to operate on delivery.



**d** Electropunch — Model FJS — for short run terminal setting. Except for automatic feed and bench specifications are identical with those of automatic models. All electric operation. Accommodates tool holding bolster plate and variable transformer to assure precise impact control.

Whatever your terminal setting or contact setting problem, Black & Webster has the solution. Send sample terminals or contacts and requirements — we'll return suggestions with no obligation. Write today for catalog describing our complete line of all-electric production tools.

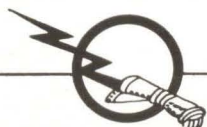

## BLACK & WEBSTER, INC.

Dept. E, 570 PLEASANT STREET, WATERTOWN, MASSACHUSETTS 02172—(617) WA 6-0100

# What's New In REED RELAYS?

Write for these two publications  
and see . . .

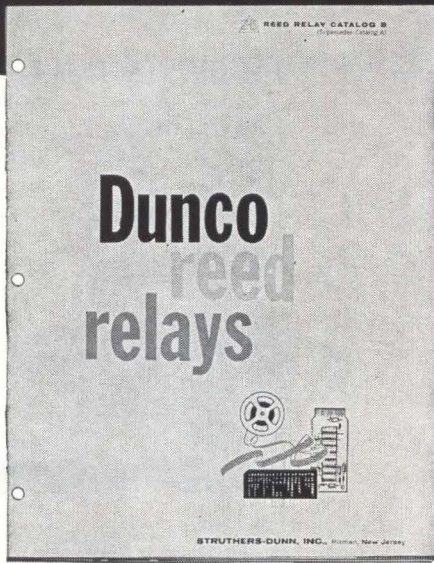

**JUST  
REVISED!**

**Reed Relay  
CATALOG B**

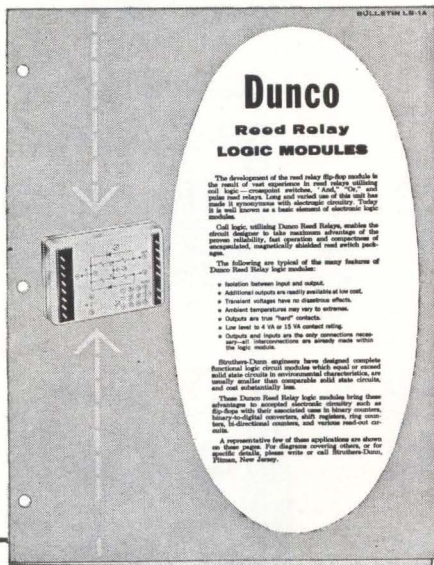

**UPDATED!**

**Reed Relay  
Logic Modules  
BULLETIN LB-1A**

For fastest service,  
send the coupon below to:

**STRUTHERS-DUNN, Inc.**  
Department 1063  
Pitman, New Jersey



Gentlemen:

- Please send me newly revised Reed Relay Catalog B.  
 Reed Relay Logic Modules Bulletin LB-1A.

Name \_\_\_\_\_ Title \_\_\_\_\_

Company \_\_\_\_\_

Street \_\_\_\_\_

City \_\_\_\_\_ Zone \_\_\_\_\_ State \_\_\_\_\_

Come chat about your relay problems at these 2 shows:  
National Electronics Conference—Booth 731

NEREM Meeting—Booth 249

selected on the basis of a study of acceptable diameter/spacing combinations. All parts of the fence are carefully grounded through a continuous ring of wire at the top of the fence; gates in the fence were carefully designed to maintain the required attenuation at radar frequencies.

The second, lower fence was added as a corrective measure after the facility had begun operation, when rebound transmission caused signal intensity to fluctuate in spite of the high fence. An alternative solution—raising the main fence—was discarded because it would have raised the artificial horizon excessively, limiting the acquisition angle.

A similar fence installation has been built by Burns and Roe at Kwajalein, using stainless steel because the tropical atmospheric conditions are highly corrosive.

## Firefly May Light Up New Areas of Knowledge

FULL-SCALE use of the Anna 1-B Firefly satellite for geodetic research and system calibration tests is expected to be resumed early this winter. The satellite malfunctioned early this year but on its own returned to service in July (ELECTRONICS, p 8, Aug. 23).

Its flashes, photographed at widely separated stations against a background of stars (ELECTRONICS p 27, Nov. 23, 1962), and doppler measurements of its signals are designed to permit calculations of extreme accuracy over great distances. The unique measurement systems also provide studies of the earth's shape and make available new basic information on the strength and configuration of the earth's gravitational field. Extremely accurate measurements of the earth's surface have already been made using the doppler method alone.

The doppler and flashing-light systems will be compared to discover biases in either. Incomplete data indicates the systems will compare favorably and differences in measurements will be on the order of meters. Using the doppler method, extremely accurate geodetic measurements have already been made.



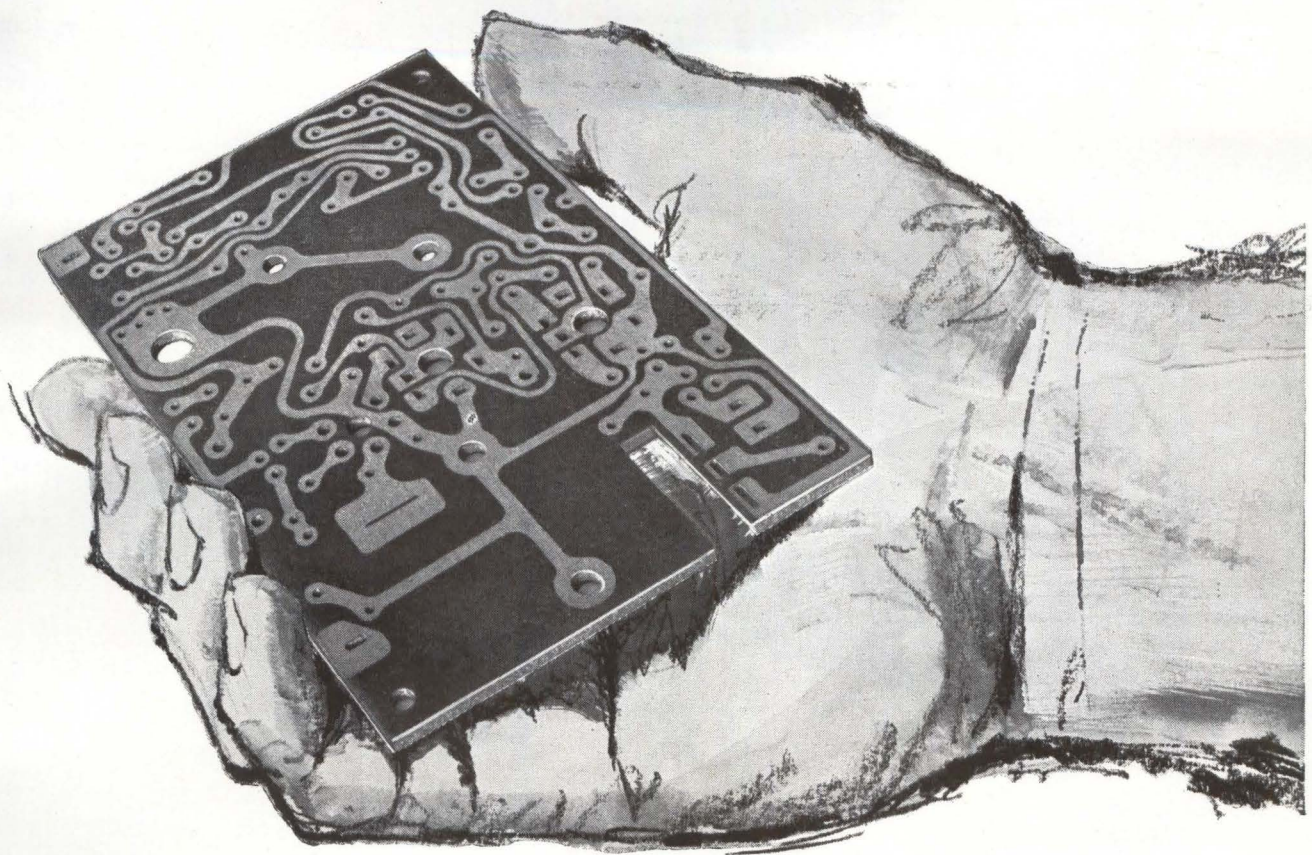

## Cu clad

10 different copper clad laminates are available from Formica . . . paper-phenolics, paper-epoxies, nylon-phenolics, glass-epoxies. Flame retardant materials—FR-2, FR-3, FR-4 . . . three grades accepted by UL for support of current-carrying parts at temperatures up to 105°C. Grades with MIL spec properties, NEMA properties . . . property combinations to meet any need.

WRITE FOR DATA ON:

- Copper clad laminates
- Electrical /electronic grades
- Mechanical grades
- Engraving stock

FORMICA CORPORATION  
DEPT. CS-623, CINCINNATI 32, OHIO

subsidiary of  **CYANAMID**



industrial plastics



**WE USE BOTH ENDS OF THE PENCIL...**

*to solve advanced systems research problems*



Out beyond the State-of-the-Art, original solutions to the formidable new problems of today's advanced electronic systems depend on the effective application of three important tools... the pencil, the eraser and man's brain. At Motorola, these factors have been successfully applied to the design and development of such major electronic systems as the NASA/Goddard Range & Range Rate Satellite Tracking System... the Air Force data acquisition and relaying system at the Edwards AFB high speed flight corridor... and the RADAS random access, discrete address system.

If you are interested in participating in these stimulating areas of systems research, write today describing your background and training in:

**Applied Systems Research** • conceptual design and equipment development, communications theory, coding theory, logic systems design, systems and analysis, and operations research as applied to both military and non-military systems.

**Systems and Sub-Systems Design** • antenna and microwave design, integrated circuit applications, stress analysis and heat transfer, digital and voice communications, command and control, telemetry and tracking systems design, data processing and display, ultrareliability design techniques, radar and guidance equipment.

We are particularly interested in programs on which this experience was obtained, and the extent of your technical responsibility. Address information to our Manager of Engineering at the location of your choice for immediate attention.

**MOTOROLA**  
An equal opportunity employer



**Military Electronics Division**

CHICAGO 51, Illinois, 1450 N. Cicero Ave./SCOTTSDALE, Arizona, 8201 E. McDowell Rd./RIVERSIDE, California, 8330 Indiana Ave.

## WORKHORSE

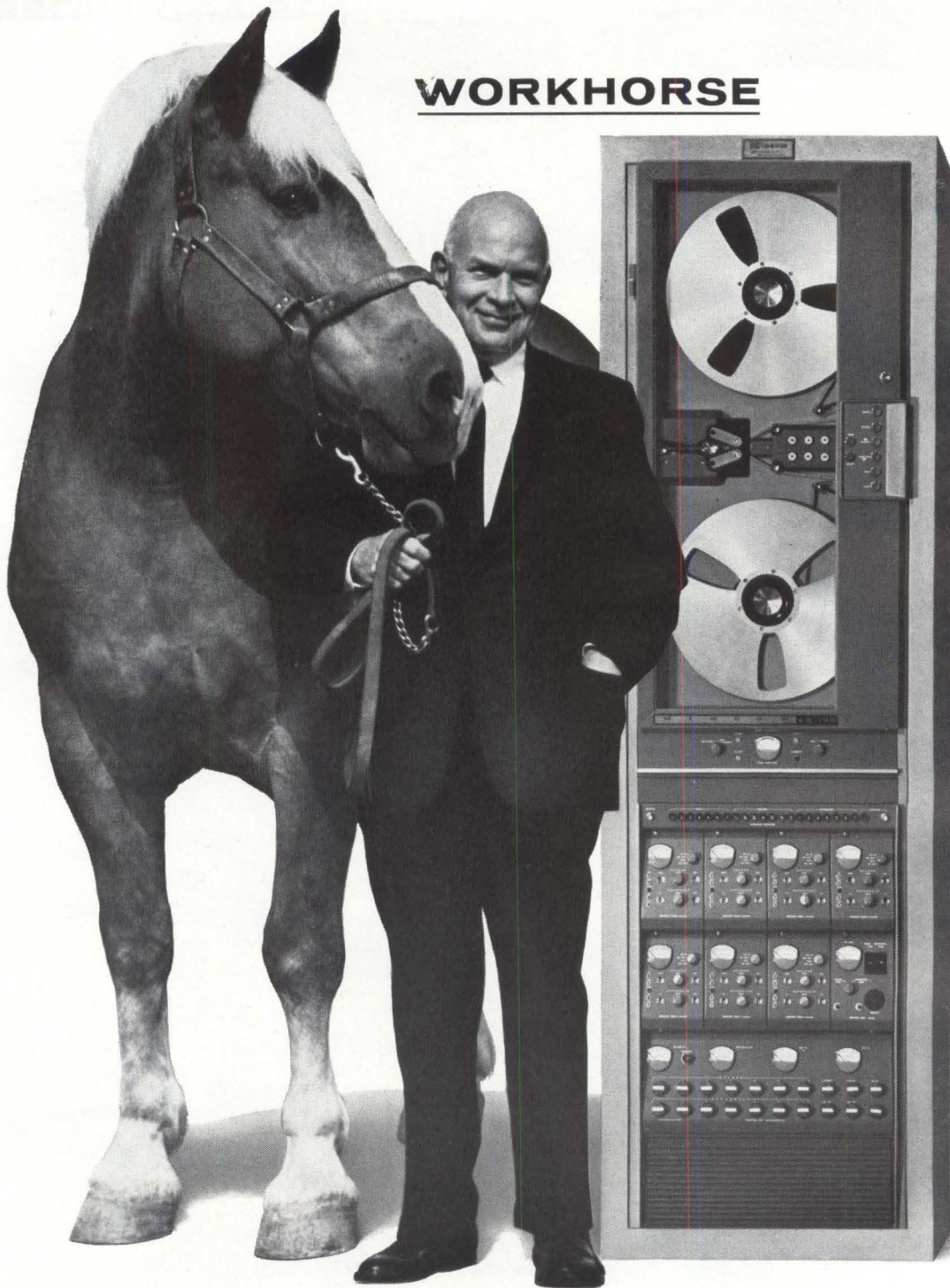

Downtime's nemesis, rugged and reliable as a purebred workhorse—that's Mincom. Common denominator of dependability in all four basic Mincom Recorder/Reproducers is the exclusive Mincom DC Top Plate. Here's a tape transport built with beautiful simplicity: Only 12 moving parts with four easy adjustments, full dynamic braking, instant six-speed pushbutton control, seven or fourteen tracks—plus tape speed accuracy within  $\pm 0.005\%$  using Mincom's Cyclelock®. Whether your specifications call for wideband predetection at 1.5 mc, or a comfortable 120 kc at 60 ips, there's a reliable Mincom workhorse to meet your facility's needs. Write today for details.

**Mincom Division** **3M**  
COMPANY

2049 South Barrington Avenue, Los Angeles 25  
425 13th Street N.W., Washington 4, D.C.

# How Good Are Beryllia Ceramics?

Although in widespread use, BeO physical properties are pretty much a mystery

By **PHILIP S. HESSINGER**  
 Manager of Research  
 National Beryllia Corporation  
 North Bergen, New Jersey

**BERYLLIUM OXIDE** is a material that insulates electrically like a ceramic, but conducts heat like a metal. The few available statistics on properties of BeO, however, have been mostly theoretical, based on a 100-percent pure/100 percent dense sample. The BeO data herein presented are not theoretical but are based on commercially available ceramic material of a grade usually recommended for electronic applications—at least 99.5 percent pure, and 95 percent of theoretical density. Safety aspects of BeO were covered in a previous report (Electronics, p 78, Oct. 13, 1961). Values for glass and alumina are not exact because of considerable variations in properties of available products,

**Properties**—A glance at Table I makes clear why the electronics industry has had such an interest in beryllium oxide ceramics. Here is a material with all the electrical characteristics of a high quality oxide ceramic, that equals the best metals in thermal conductivity. Electrically, a component insulated with beryllia is isolated; thermally, it is the same as though the component were grounded. Uniquely among practical insulators — although the diamond exhibits this same combination of properties—beryllia prevents electrical leakage from a component while promoting conduction of heat away from it.

**Relative Thermal Conductivities—TABLE I**

	(As Percentage of Thermal Conductivity of Copper)
Silver.....	105
Copper.....	100
Berlox high-purity BeO.....	62
Aluminum.....	55
Beryllium.....	39
Molybdenum.....	39
Steel.....	9.1
High-purity alumina.....	7.7
Steatite.....	0.9
Mica.....	0.18
Phenolics, epoxies.....	0.13
Fluorocarbons.....	0.05

Generally, it is the presence of free electrons in a material that accounts for thermal conductivity. Those same free electrons also account for electrical conductivity. Heat can also be conducted through a solid by phonons and by radiation as well as by excitation of free electrons. These methods usually aren't very efficient, however, and do not increase thermal conductivity to any degree. But in pure beryllia—because of light atoms, strong molecular bonds, and tight crystal structure — mechanical or phonon heat transfer between molecules is so efficient that it works better than transfer by free electrons in all other

good thermal conductors except gold, copper and silver.

This mechanical heat transfer efficiency falls off rapidly if materials other than BeO are present to disrupt the structure of the ceramic body. This is why 99+ pct purity, although difficult from the ceramic production standpoint, is recommended for electronics applications where heat transfer is important.

**Thermal Conductivity**—In Table II, the second column shows that conductivity does not fall off so rapidly with decreasing density as with decreasing purity. In general, this is because impurities surround the beryllia grains interfering with heat transfer everywhere, while beryllia surrounds pores, so that pores merely reduce the effective area through which efficient heat transfer proceeds. Ultra-high density is achieved by hot-pressing—which is costly and can mean a surface contamination. Unless porosity rises too high, proper manufacturing by cold-compacting and sintering techniques can insure that pores won't be interconnected and thus won't provide a path for gas flow through the body.

Since heat transfer in BeO depends on a tight structure rather than on the mobility of free electrons, it decreases rather than in-

**Effect of Porosity on Impurities on Thermal Conductivity of Beryllia—TABLE II**

Percent BeO	Percent of thermal conductivity of 100% pure, 100% dense BeO		
	BeO+ porosity	BeO+ alumina	BeO+ silica
100 (no porosity, no alumina, no silica).....	100	100	100
99.....	98.8	92.1	85.2
98.....	96.8	85.2	78.8
97.....	94.8	78.8	62.0
96.....	93.2	74.8	58.6
95.....	90.6	66.0	48.0

creases with temperature. However, even at 1000°F, beryllia is still a far better thermal conductor than any other electrical insulator at room temperature. The advantage over pure alumina (the next-best thermal conductor among common electrical insulators) is eight to one through the solid material. In practice, this advantage is reduced by the lower thermal conductivity at interfaces between the ceramic and other materials. The advantage of beryllia over alumina, under identical interface conditions, in electronics practice will thus be more like 5:1 or 6:1. Table III shows how certain beryllia properties vary with temperature.

**Dielectric Constant**—The values for

beryllia are lower than those for alumina. Both ceramics show a gradual rise with rising temperature. This is significant regarding capacitance at high frequencies.

**Electrical Resistivity**—The resistivity of high-purity beryllia at room temperature is so high it hasn't been precisely measured yet; it exceeds  $10^{16}$  ohm-cm. It decreases with temperatures but at 1000°F is still comfortably above the  $10^8$  figure usually used to define a good insulator. Alumina is comparable, somewhat less than  $10^{16}$  ohm-cm at room temperature and decreasing with temperature approximately as beryllia does until very high temperatures are reached. Then, beryllia outclasses alumina considerably

**Variation of Electrical and Thermal Properties With Temperature—TABLE III**

	70F	250F	500F	750F	1000F
<b>Thermal Conductivity</b>					
Heat Transfer in btu/sq ft/ft/hr/°F					
99.5% BeO.....	140	120	65	50	40
99.5% Al <sub>2</sub> O <sub>3</sub> .....	20	17	12	7.5	6
95% Al <sub>2</sub> O <sub>3</sub> .....	13.5				
Class.....	0.3				
<b>Power Dissipation</b> in watts/cm/°C					
BeO.....	2.4	2.1	1.1	0.9	0.7
<b>Electrical Resistivity</b> in ohm-cm					
BeO.....	>10 <sup>16</sup>	10 <sup>14</sup>	5×10 <sup>12</sup>	10 <sup>12</sup>	10 <sup>11</sup>
Al <sub>2</sub> O <sub>3</sub> .....	10 <sup>14</sup>	10 <sup>14</sup>	10 <sup>12</sup>	10 <sup>12</sup>	10 <sup>11</sup>
Glass.....	10 <sup>12</sup>	10 <sup>10</sup>	10 <sup>8</sup>	10 <sup>6</sup>	
<b>Dielectric Constant</b> at 8.5 Gc					
BeO.....	6.57	6.64	6.75	6.90	7.05
Al <sub>2</sub> O <sub>3</sub> .....	9.4	9.5	9.6	9.7	9.8
<b>Loss Tangent</b> at 8.5 Gc					
BeO.....	.00044	.00040	.00040	.00049	.00080

**Miscellaneous Properties—TABLE IV**

	BeO 4650F	Al <sub>2</sub> O <sub>3</sub> 3700F	Glass 1200F
Melting Point.....			
<b>Specific Gravity in gm/cc</b>			
Theoretical.....	3.008	3.96	
Commercial.....	2.85-2.90	3.70-3.90	2.2-8.0
<b>Specific Heat</b> btu/lb/°F at			
room temperature.....	.240	.180	.180
<b>Dielectric Strength</b> volts/mil.....			
	300	300	
<b>Hardness Mohs Scale.....</b>			
	9	9	
<b>Flexural Strength</b>			
psi at room temperature.....	25-30,000	30-50,000	<4000
<b>Compressive Strength</b>			
psi at room temperature.....	180-200,000	to 400,000	100,000
<b>Young's Modulus</b>			
psi.....	45.10 <sup>6</sup>	50×10 <sup>6</sup>	10×10 <sup>6</sup>
<b>Coefficient of Thermal Expansion</b> per °F, to 900°F.....			
	4.2×10 <sup>6</sup>	4.3×10 <sup>6</sup>	0.3-6×10 <sup>6</sup>

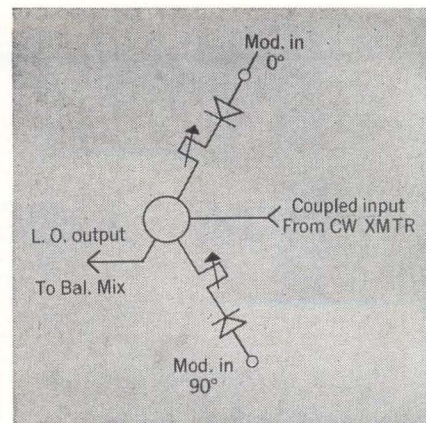

**From design idea  
to breadboard...  
faster**



**using TRI-PLATE®  
Microwave Modules**

The customer needed to quickly prove out a single-sideband modulator circuit. Less than 48 hours after his call, off-the-shelf TRI-PLATE modules were in his hands. Inside another 24 hours, he had assembled the breadboard circuit with TRI-PLATE modules, thoroughly tested electrical characteristics — and verified performance that exceeded design parameters!

TRI-PLATE strip transmission line modules enable you to test new microwave circuits conveniently, rapidly, economically — in an operating system. Over 600 types of compatible circuit modules — easily assembled — provide the most direct route from design idea to functioning breadboard . . . and ultimately to custom-designed TRI-PLATE assemblies. For detailed information write for Catalog TT-118, Sanders Associates, Inc., Microwave Products Dept., Nashua, N. H.



CREATING NEW DIRECTIONS IN ELECTRONICS  
SANDERS TRI-PLATE®  
STRIP TRANSMISSION LINE

® Reg. T. M. Extensive Patent Coverage, Sanders Associates, Inc.

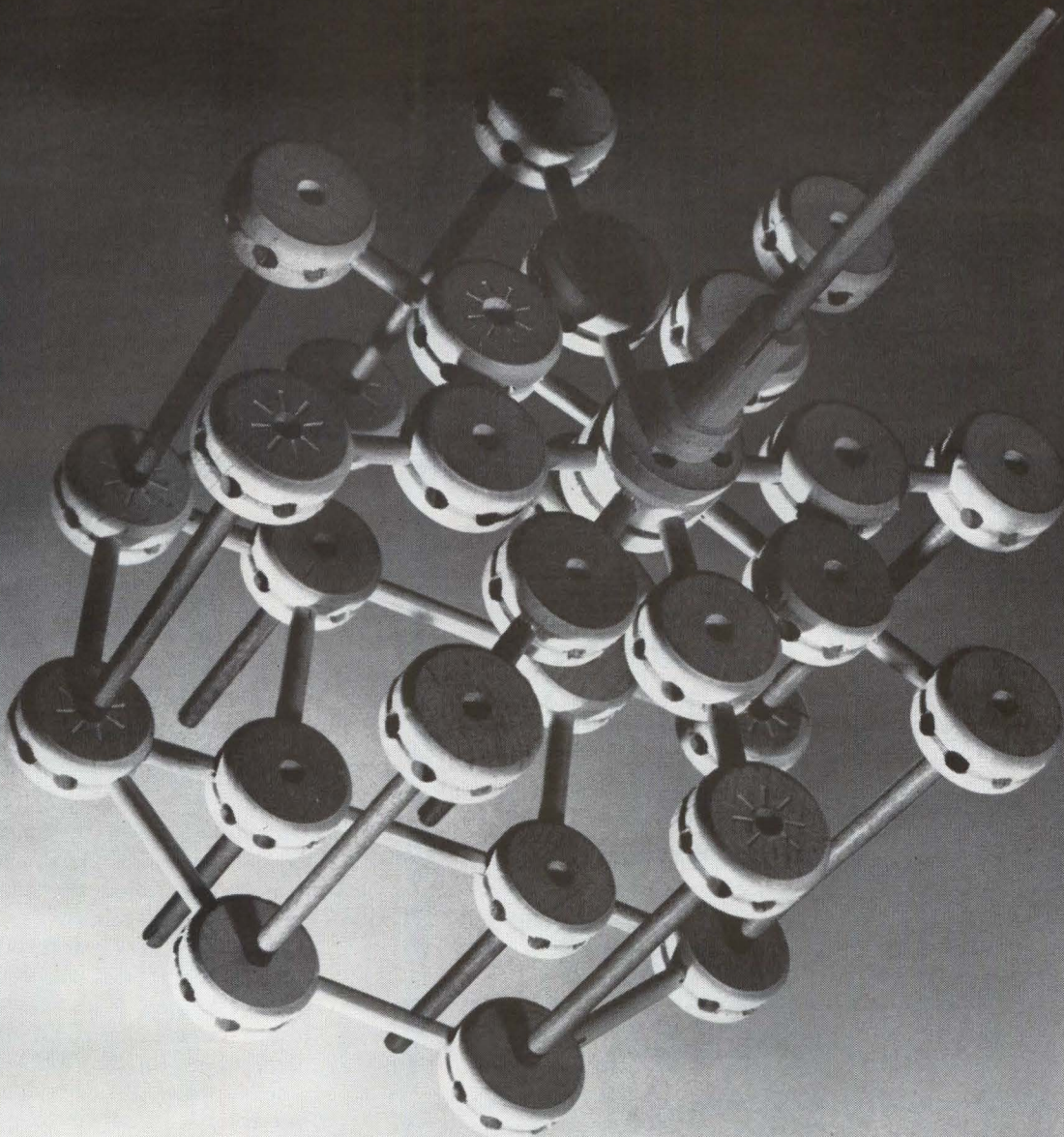

## Tinkering with airborne microwave systems?

TRI-PLATE® strip transmission line techniques take the uncertainty out of microwave system packaging — along with much of the size, weight and cost (compared with coax and waveguide). In addition, performance is optimum. □ Witness this probe coupler reflectometer for comparing space vehicle antenna reflections. Integrated with TRI-PLATE strip transmission line are four internally packaged diodes, dc blocking capacitors and bias terminals. The lines are wrapped

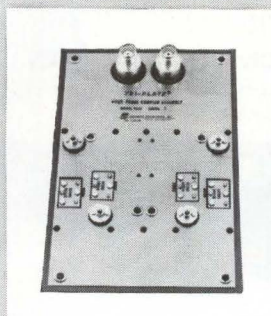

tightly with the four probes an  $\frac{1}{8}$  wavelength apart at 235 MC — the package measures only 7" x 4½" x ¼"! □ This is typical of the compact, reliable packages we design with TRI-PLATE techniques. We produce them in quantity, too. And offer a line of TRI-PLATE modules that let you breadboard entire functioning systems.

TRI-PLATE techniques help you simplify design — to create new directions. □ Sanders Associates, Inc., Microwave Products Dept., Nashua, New Hampshire.

® Reg. T.M.; Extensive Patent Coverage. Sanders Associates, Inc.

**CREATING NEW DIRECTIONS IN ELECTRONICS · SANDERS TRI-PLATE STRIP TRANSMISSION LINE**



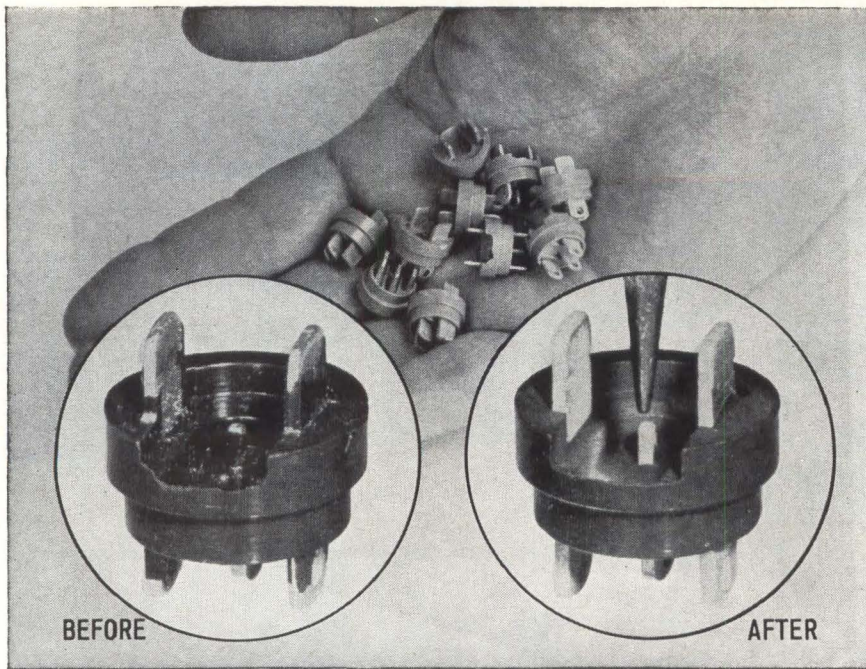

## Airbrasive® deflashing... reduced cost of this product 60%

It used to take nine weary-eyed girls a total of 72 hours of picking and scraping with hand tools to deflash and clean these tiny switch bases, according to Molded Insulation Company, Philadelphia, Pa. Now, with the S. S. White Airbrasive, *three* girls deflash the same number in only 24 hours!

What's more, the reject rate dropped from a burdensome 300% to practically nil. Result: the Airbrasive reduced the cost of producing the product by 60%.

Deflashing isn't the only use for this amazing industrial tool. It also cuts, scores, abrades, shapes, wire-strips... in fact, it has a real talent for solving all kinds of seemingly impossible production bottlenecks.

The secret is in the Airbrasive's precise, gas-propelled stream of microscopic particles that cut hard, brittle materials without heat, shock or vibration. Use it in the laboratory or in automated production. Glass, tungsten, ferrites, ceramics, germanium, and other fragile materials. For under \$1,000 you can set up your own Airbrasive cutting unit.

Send us samples of your "impossible" jobs  
and let us test them for you at no cost.

SEND FOR  
BULLETIN 6006  
... complete information

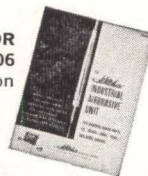

S. S. WHITE INDUSTRIAL DIVISION  
DEPT. EU, 10 East 40th St., N. Y. 16, N. Y.  
Telephone MU 3-3015 collect

for superfine cutting • deburring • cleaning

hard brittle materials

**S.S. White** INDUSTRIAL AIRBRASIVE

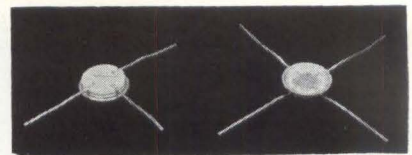

TRANSISTOR developed by Pacific Semiconductors uses package of Beryllia manufactured by National Beryllia Corporation

because of its much higher melting point. A typical glass used in electronics applications show significantly lower resistivity than beryllia.

**Loss Tangent**—As the figures in Table III indicate, beryllia is essentially transparent to microwave radiation, even at high temperatures. Alumina is comparable to beryllia in respect to loss tangent, when comparing bodies of equivalent purity.

**Specific Gravity**—That Table IV shows, 95-pct density beryllia offers a 30 percent weight saving as compared to alumina.

**Strength**—Beryllia is not quite as strong as alumina. The flexural and compressive strength figures for beryllia and alumina are essentially constant to at least 1500°F. At higher temperatures, suggested by its higher melting point, beryllia will lose strength less rapidly than alumina. In the Telstar power supply, which uses beryllia mounting boards for certain components, eyelets were inserted in holes in the usual manner without fracture, and thermal connections to the boards were made by running rods through holes in the beryllia boards, with aircraft-quality nuts tightened to 28 in.-lb of torque—again without fracture.

**Other Properties** — The melting point of beryllia is not significant in most electronics applications, except as it indicates a high order of dimensional stability. High thermal conductivity, and the regular structure of the high-purity material, give a thermal shock resistance far greater than would be expected of a ceramic. Melting point, hardness, and the superior thermal shock resistance of beryllia are among properties recommending it for nose cone window and similar applications.





# HIGH-RESOLUTION SAMPLING SYSTEM

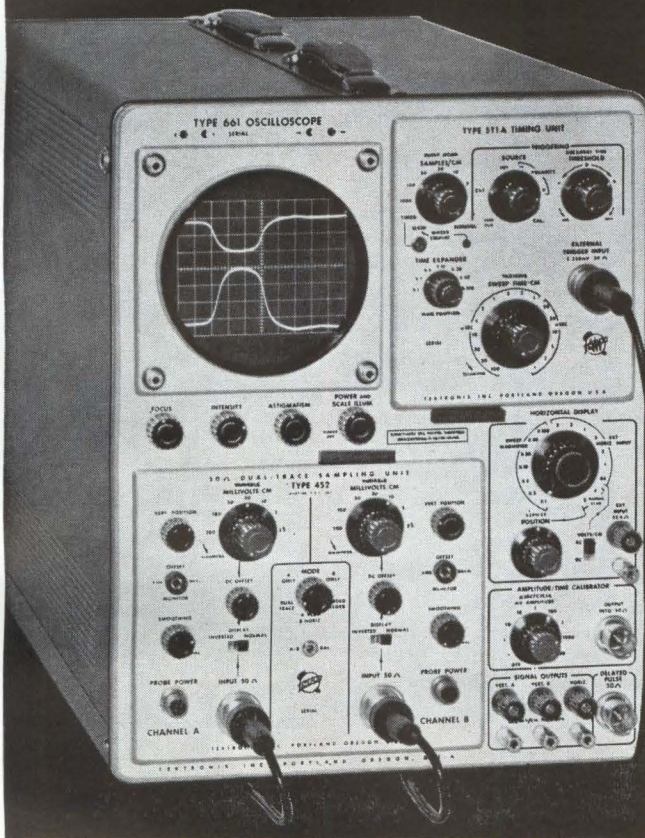

**RESOLVES** fastest present switching transistor risetimes, including commercially available avalanche types (usually limited by the transistor or the transistor case).

**RESOLVES** most tunnel diode switching times. (Only diodes with better than 3 ma/pf are faster.)

**RESOLVES** stored charge in switching diodes to the 0.01 picocoulomb/milliampere region (generally limited by diode capacity and turn-on capability).

**RESOLVES** 0.1% system discontinuities as reflectometer with centimeter separation capability (limited by external pulse generators, delay lines, attenuators).

**RESOLVES** fractions of a degree of relative phase shift to over 1 gigacycle frequency with lissajous-mode operation (usually limited by harmonic content or residual reflections to a few degrees absolute).

**RESOLVES** millivolts of information on top of signals hundreds of millivolts in amplitude (not limited by the usual amplifier overload problem).

## Additional Ways You Can Use the 661

- ... display repetitive signals on 16 calibrated equivalent sweep rates from 1 nsec/cm to 100  $\mu$ sec/cm, accurate within 3%. Magnifier provides display expansion from 2 to 100 times . . . time per dot remains the same for digital readout.
- ... change the probes' signal source without affecting the dot transient response.
- ... reduce time jitter and amplitude noise, if needed, on the more sensitive vertical ranges and faster sweep rates by means of a smoothing control.
- ... calibrate with amplitude and timing signals available at the front panel.
- ... show lissajous patterns in addition to single and dual-trace displays and signals added algebraically.
- ... drive X-Y plotters or similar readout accessories.
- ... drive external equipment, with fast delayed-pulse output.
- ... add plug-in units as they come along.

- Type 661 Oscilloscope (without plug-ins) . . . \$1150
- Type 5T1A Unit (required to provide time base) . . . \$ 750
- Dual-Trace Sampling Units (at least one required):
- Type 4S2—0.1-nsec risetime (illustrated) . . . \$1600
- Type 4S1—0.35-nsec risetime . . . \$1430
- Type 4S3—0.35-nsec risetime . . . \$1600  
(includes two direct-sampling probes)

U. S. Sales Prices f.o.b. Beaverton, Oregon

**SAMPLING NOTES** available—an informative 16-page booklet on concepts and systems—by writing to the Advertising Department, P. O. Box 500, Beaverton, Oregon.

## CHOICE OF THREE DUAL-TRACE UNITS

- 1 Type 4S1—with 0.35-nsec risetime, delay lines and internal triggering,
- 2 Type 4S2—with 0.1-nsec risetime, no delay lines or internal triggering, and
- 3 Type 4S3—with miniature low-noise direct-sampling probes, 0.35-nsec risetime, risetime control, and 100-k, 2-pf input impedance. In addition, each dual-trace unit features 2 mv/cm sensitivity, monitorable dc-offset, signal inversion, smoothing control, and 5 display modes.

Also, the Type 661 can be used with a wide range of Tektronix probes, sampling accessories, test jigs and associated instruments to utilize full capabilities of the compact and complete sampling oscilloscope.

**FOR A DEMONSTRATION, CALL YOUR TEKTRONIX FIELD ENGINEER.**

**Tektronix, Inc.** / P. O. BOX 500 • BEAVERTON, OREGON 97005 / Phone (Area Code 503) Mitchell 4-0161 • Telex: 036-691 • TWX: 503-291-6805 • Cable: TEKTRONIX • OVERSEAS DISTRIBUTORS IN 27 COUNTRIES

Tektronix Field Offices: in principal cities in the United States. Consult Telephone Directory • Tektronix Limited, Guernsey, Channel Islands  
Tektronix Canada Ltd.: Montreal, Quebec • Toronto (Willowdale), Ontario • Tektronix Australia Pty. Limited, Sydney, New South Wales

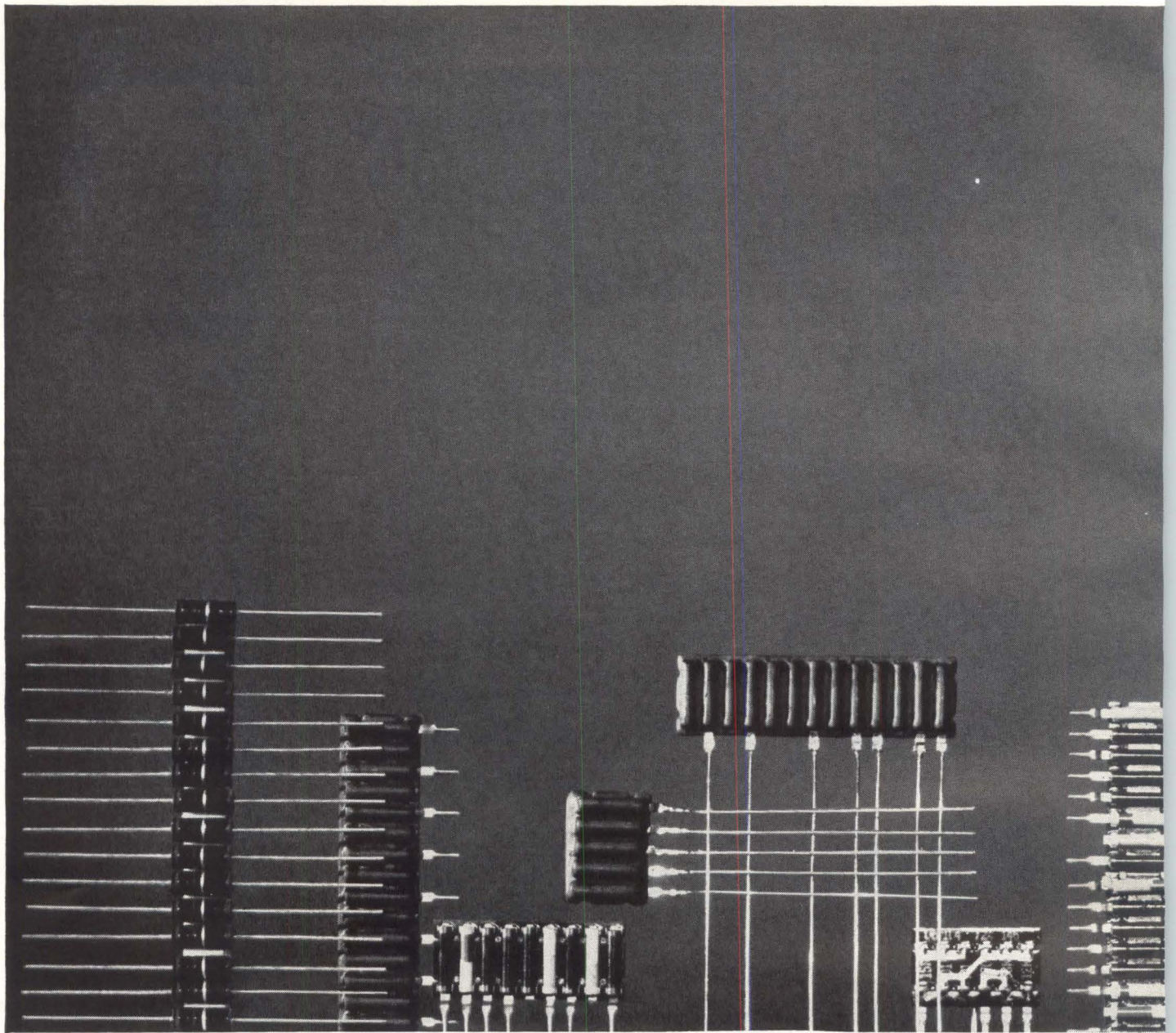

One good electronic component...

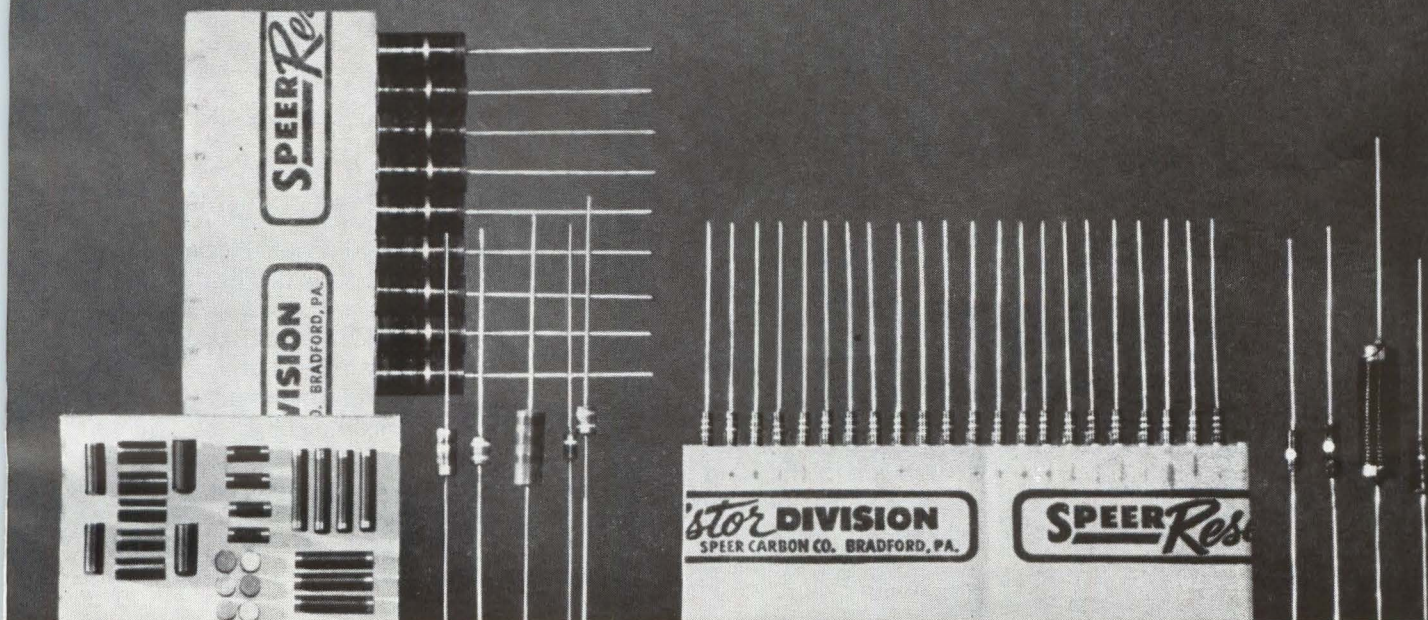

## leads to another at Speer

*(Thanks to a Multi-Million Dollar Research and Development Program)*

At our R&D Center in Niagara Falls we are constantly developing new types of electronic components and improving the performance characteristics of our present types. We are also continually improving our production and quality control facilities throughout our various divisions. If you have a circuit design problem and want the cooperation of a modern, progressive company employing over 2000 people in the design and production of high quality components, call on a Speer representative. The broad line of electronic components manufactured by Jeffers Electronics and Speer Resistor Divisions includes: 1. Speer 1 Watt body tape-packaged resistors; 2. Jeffers phenolic coated PAC's; 3. Jeffers clear-coated PAC's; 4. Speer special leadless resistors; 5. Speer 2 Watt carbon composition resistors; 6. Jeffers Types 09, 15, 19, 22, 24, 28 and 30 molded inductors; 7. Speer 1/4 Watt carbon composition resistors; 8. Jeffers special coils; 9. Jeffers JM 110 and 160 capacitors.



Dept. 418, St. Marys, Pennsylvania  
Speer Carbon Co. Is A Division Of Air Reduction Company, Inc.

# Flip Chips Easier to Connect

Put integrated-circuit connections on second substrate, improve yield

By **E. Q. CARR**  
 Light Military Electronics Dept.  
 General Electric Co.  
 Utica, N. Y.

**FLIP-CHIP** technique for interconnecting integrated circuits, or functional electronic blocks, avoids several of the yield and interconnection reliability problems that now exist when the interconnections are made directly on the integrated circuit.

In the flip-chip technique, interconnections are deposited separately as a separate thin-film circuit on an insulating substrate and the integrated circuit is bonded face down to the second substrate (see Fig. 1).

**Single-Crystal Problems**—As equipment assembled with integrated circuits becomes more complex, interconnection improvements provided by the controlled process steps of microelectronics may be wiped out.

At present, circuits on silicon-crystal substrates can involve 18 to 22 metallic interfaces when functional assemblies are interconnected on etched wiring boards. Welded assembly can reduce the number of

interfaces, yet the interconnection of components in the single-crystal substrate contains four metallic junctions.

An evaporated thin film of aluminum is deposited on the chip and alloyed for ohmic contact with the devices. The aluminum conductor also extends over the insulating oxide passivation to interconnect between devices.

Fewer interfaces could be achieved by using larger silicon surfaces and interconnecting a number of circuits on that surface. Ten or more circuits have been interconnected in this way, but as yet the yield of such a large assembly of circuits is low.

**Flip-Chip Process**—An extension of this simplified combination of evaporated thin metal films and single-crystal circuits comprises the flip-chip process.

Bonding the flip-chip to matching terminal pads of evaporated aluminum runs on the separate insulating substrate permits elimination of the weakest part of present planar passivated semiconductor assemblies; namely, the bonded lead from the device or circuit to the terminals of the enclosure. Further, this approach offers a solution to present yield problems of the previous method.

There are several methods of bonding the flip-chips to the substrate. Soldering and ultrasonic

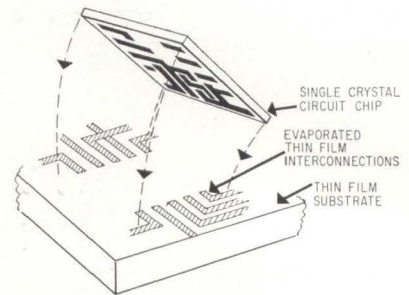

INTEGRATED-CIRCUIT chips are inverted and bonded to interconnections deposited as thin metal films on insulating substrate—Fig. 1

bonding methods have both been used successfully for complete circuits and individual devices.

Circuit chips bonded by these procedures have withstood shear forces approaching 2.5 pounds, permitting high shock stresses and accelerating forces of several thousand g's without additional bonding.

One of the objectives of this work is the in-process repair of the flip-chip assembly. Chips have been bonded, removed from assembly, and rebonded to simulate the repair of a malfunctioning chip.

Methods for hermetic sealing of large packages of the type illustrated (Fig. 2) are under development. Thermal cycling tests have demonstrated leak rates equal to those of a conventional TO-5 can.

Heat can be transferred efficiently with the flip-chip bonding method and temperature rises of less than 13 deg F have been calculated with more efficient transfer possible, if necessary.

**Advantages**—Complete development of this technique offers unique advantages not attainable in present microelectronic assemblies:

- Controlled process bonding can be achieved independent of operator variability
- Present bonding weaknesses in semiconductor assemblies can be

## HIGH-DENSITY PACKAGE

Latest report from GE is that the flip-chip process has been used to package up to 24 individual circuit chips in a single flat package. In another use, a four-stage counter involving 24 chips was assembled on a 1-inch-square interconnecting substrate and hermetically sealed in a package 1.2-inch square.

A report on the technique will be given by the author at the East Coast Conference on Aerospace and Navigational Electronics next week in Baltimore, Md.

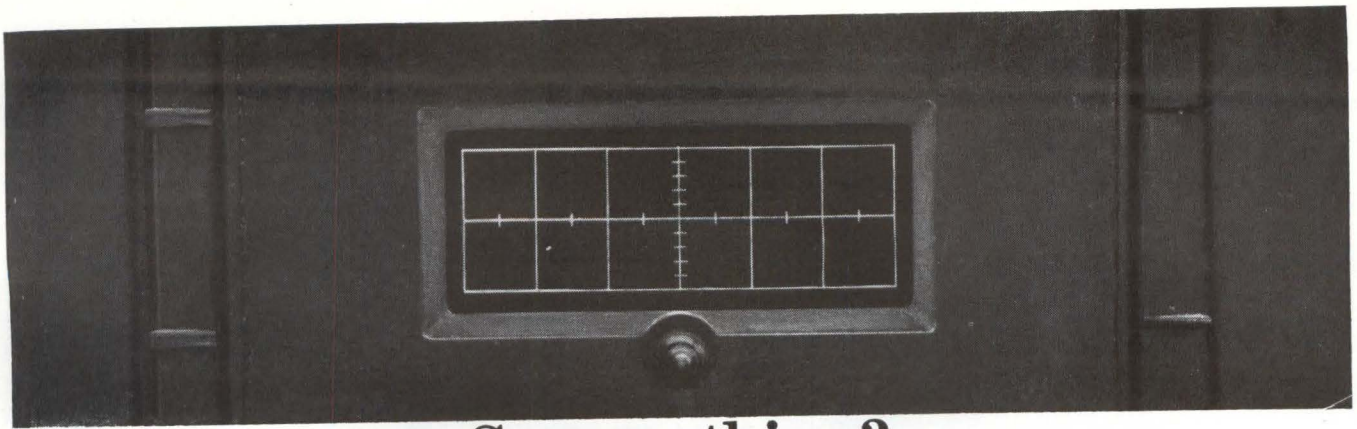

**See anything?**

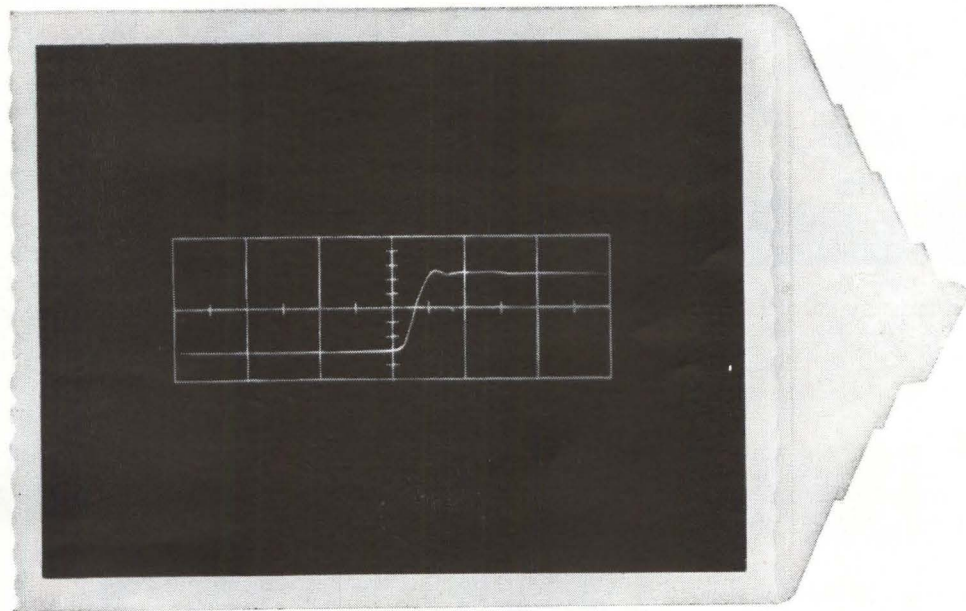

**This new film did.**

This new film saw something the eye couldn't: the rise time of a single pulse on a Tektronix 519 scope at a sweep rate of 2 nanoseconds/cm. The new film, Polaroid PolaScope Land Film, actually extends the usefulness of existing oscilloscopes by supplying "brightness" that the scope hasn't got!

The reason is that this PolaScope film has an ASA equivalent rating of 10,000, which means it can see things your eye cannot. It has about twice the writing rate of the Polaroid 3000-speed film, currently the standard for

high speed oscilloscope photography. (No other commercially available films come anywhere near the speed of PolaScope film.) And because it's made by Polaroid you get a finished usable print—see above—ten seconds after exposure.

PolaScope film will also give you better shots of slower pulses and stationary waveforms. So little light is required, camera aperture and scope intensity can be reduced considerably, and that's how to get really sharp oscilloscope pictures.

And wherever else light is at a premium—such as photomicrography and Kerr Cell photography—PolaScope film will make new applications possible, old applications more useful.

PolaScope Type 410 Film is packed 12 rolls to the carton. The price is about the same as the Polaroid 3000-speed film. For the name of the industrial photographic dealer nearest you, write to Technical Sales Department, Polaroid Corporation, Cambridge 39, Massachusetts.

POLAROID®

**New Polaroid Land 10,000-speed film for oscillography**

# Straits Tin Report

## New superconductive wire

is formed with a columbium-tin core. According to its developer, Superior Tube Co., Norristown, Pa., it offers designers significant advantages in the development and fabrication of supercooled magnetic coils.



Only 1/20 the diameter of 200-amp solid wire, yet it offers up to 2½ times greater field strength, 3-4 times greater critical temperature, and the same current-carrying capacity.

The superconductive powder core is 75% columbium, 25% tin. The core is encased in a barrier tube of high-purity columbium and an outer insulating sheath of Monel metal.

This new tin-containing wire affords field strengths of 80-200 kilogauss compared with 50-80 for solid zirconium-columbium alloy wire (15-30% zirconium). Maximum operating temperature is 18.5°K compared with a maximum temperature between 4 and 6°K. Current-carrying capacity is the same as 200 amp rubber-covered copper wire, although the diameter is only .015 in. compared with .325 in. Field experience indicates that supercooled magnets of 100 kilogauss can be made for a fraction of the cost of the old style.

This is one more example of the ever-new uses for tin in today's technology. Consider Straits Tin from Malaya—world standard for quality, purity, reliability.

### FREE BROCHURE

Write today for new, free colorfully illustrated brochure on mining, smelting and uses of Straits Tin from Malaya.

## The Malayan Tin Bureau

Dept. B-25K, 2000 K St., N.W., Washington, D.C. 20006

eliminated by the new process

- Different metallic interfaces in a complete functional assembly can be minimized
- Potential cost reductions are possible by eliminating the separate enclosures for individual circuits
- Component and circuit handling can be minimized
- Total number of interconnections can be reduced for present computer functions
- Precision, low-temperature-co-

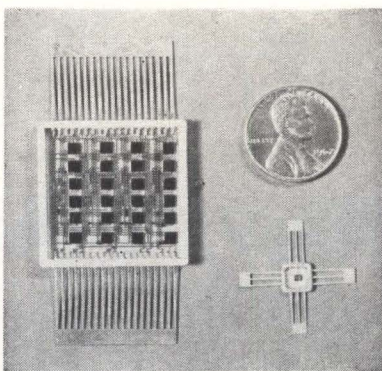

ASSEMBLIES of circuit chips are placed in cases that can be hermetically sealed—Fig. 2

efficient, thin-film resistors and large capacitors can be obtained on the relatively cheap real estate of the interconnecting substrate

• Individual component tests of a single crystal substrate can be made by depositing final crossover interconnections on the interconnecting substrate

• Simpler, higher-order sub assembly can be achieved with the package structure for improved equipment construction reliability.

## Automatic Welder Produces Matrices

MULTIPLE precision welding heads up to eight in number, commanded by punched paper tape, are used to produce 400 precise welds in one and one half minutes. Designed and produced for NASA by Raytheon Company's space and information systems Division, this machine is producing 290 computer matrices for NASA's Apollo computer pro-

## How high is your goal?

Ours are out of sight—in the labyrinth of space. But your opportunities are a tangible reality, here and now at North American's Space and Information Systems Division.

Trained, creative engineering minds, attuned to the research, development and production of manned spacecraft, large booster systems, inflatable winged recovery systems and missile weapon systems will find fertile fields to grow in at S&ID.

### COMPUTER SIMULATION

To analyze needs and requirements for simulated spacecraft trajectory and relation mechanics and simulated spacecraft systems. To evolve diagnostic and check out methods for simulation and trainer complexes (equations and programs). To design automatic process systems for operation and control of trainer and simulation complexes.

### LOGIC DESIGNERS

To perform conceptual analysis and trade-off studies resulting in logic designs of command data systems.

### ELECTRONICS CIRCUIT DESIGN

To carry out design and development of digital interface equipment required for controls and display compatibility.

Interested? Please Contact:

MR. P. K. MONAR  
ENGINEERING AND SCIENTIFIC  
EMPLOYMENT  
12214 LAKEWOOD BLVD.  
DOWNEY, CALIFORNIA

All qualified applicants will receive consideration for employment without regard to race, creed, color, or national origin.

SPACE AND INFORMATION  
SYSTEMS DIVISION

NORTH AMERICAN AVIATION



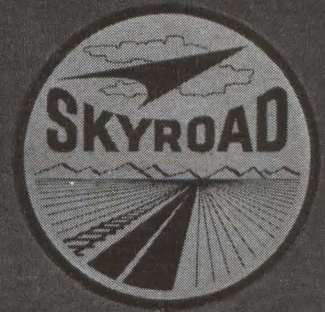

## These, too, are Tiger Tracks

The Tiger is blazing a new trail through the shipping business. The trail, railroad tracks. The railroad, New York Central, now part of Flying Tigers' Skyroad system.

For the first time in shipping history, Tigers' have combined air, rail and truck transportation to give you the finest freight service ever offered. That's Skyroad, now serving 2,451 U.S. cities.

When you ship the Skyroad way, your cargo is routed door to door by the origi-

nating rail or trucking company, or by Flying Tigers. It all goes on one bill of lading. It all travels at a single rate. This not only saves you time and paperwork, but in many cases costs less than you'd pay for air, rail and truck forwarding separately.

Call Tigers today. Get the whole story on Skyroad, the new air-rail-truck shipping combination. Another service pioneered by the Airfreight Specialist, Flying Tigers.

*first in airfreight with airfreight first* **FLYING TIGER LINE**





Far-field diffraction pattern produced from laboratory model using coherent light.

## Using coherent light to scale large antenna arrays down to laboratory size

You may find it useful to think of the coherent light output of a continuous wave gas laser as being extremely short radio waves, particularly if you are interested in applying laser technology to various electromagnetic radiation problems. This thinking has suggested, for example, a novel way\* to determine antenna directivity patterns based on scale models of antenna arrays.

Where an antenna is hundreds or thousands of wavelengths in diameter, it may be difficult or even impossible to make full-scale measurements of directivity, main-lobe width, side-lobe amplitude, or null spacing. But by using a laser beam to illuminate apertures representing elements in the antenna array being scaled, a far-field diffraction pattern can be generated on the laboratory workbench and directly recorded on photographic film. Such a pattern (as shown above) can be converted to a conventional plot simply by scanning the negative with a densitometer.

As other interesting studies and applications come to light, we will continue to report them to you. Meantime, may we send you a brochure on our new Model 130 "briefcase" laser, and details on other CW gas lasers for advanced laboratory work? Address your inquiry to 1255 Terra Bella Avenue, Mountain View 3, California (or call collect (415) 961-2550).

\*Reported in IEEE Transactions, Professional Group on Antennas and Propagation, September 1963, "A New Approach to Antenna Scaling," by Wright H. Huntley, Jr., Stanford Electronics Laboratories, Stanford, California.



**Spectra-Physics**

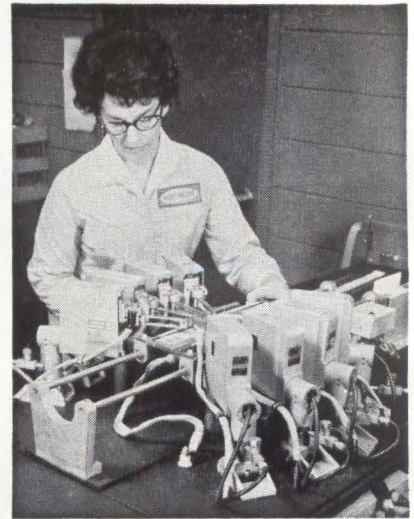

gram. All but 18 of these matrices are radically different from each other but the highly flexible automated machine handles the great variety of commands with no technical difficulties.

## Radio Receiver Detects Faulty Parts or Joints

GENERATION of r-f interference by faulty solder joints, dissimilar metals, relays, capacitors, switches, resistors, transformers and, more recently, by diodes and transistors can be used to advantage. Through r-f fault detection techniques, faults which cause failures or complete circuit breakdowns can be localized, and the components can be repaired or replaced, says F. Hagert, of Minneapolis Honeywell. The basis for r-f fault detection is in sensing, amplifying, detecting and measuring the radio-frequency impulse-noise transients generated by the fault or intermittent itself. This is accomplished by using a high-quality r-f receiver with adequate sensitivity to detect weak interference signals. The receiver must be capable of being calibrated to measure specific values of input impulse noise, tunable over the frequency range of 10 to 30 Mc, and provided with an adjustable bias voltage so that specific limits can be established.

**Theory**—With normal excitation applied, the supply voltage to a given circuit is monitored with a



## Kodak reports on:

whole needles evenly distributed in a lasting binder on a sensible base...  
processing and printing long film by dampness... why some people journey to Rochester

### Thoughts to buy tape by

There is a new magnetic tape. Intended for those who record sound for a living instead of just for fun, it is now coming into stock at electronics supply houses. These dealers, however, consider it none of their business whether the tape is needed for fun, profit, or the general betterment of the human race.

There are two main points of novelty:

1. We suspend our iron oxide needles in a new binder, which is adaptable only to our highly proprietary and unbeatably clean and uniform method of manufacturing sound tape. Excellent as the generally used poly(vinyl chloride) may be for the purpose, our binder seems not only to age with demonstrably more grace but it forms a smoother top surface (which is widely known to reduce intermodulation distortion, for reasons never wholly understood). The needles do not aggregate in it in the usual wood-grain-like pattern, nor do they get battered and fractured in the attempt at homogeneity of distribution. Therefore print-through measures a whole 55 db down from the recorded signal in the standard test, and this

in turn greatly extends the time between periodic rewindings that tape-recordings should get.

2. The support is not the super-strength kind but cellulose triacetate, treated to make it stronger than triacetate has any business being. Amateur recordists generally don't realize when they buy super-strength that the low-tension equipment used in the home never requires it, though it costs something in audio uniformity and money. Professionals with their high-tension equipment, on the other hand, have long known that in case of trouble, a clean break is instantly apparent, remediable, and preferable to the treacherous stretch—over 70% before breaking—of the super-strength stuff. (Our treated triacetate stretches no more than 0.5%. We trademark it DUROL Base.)

*Didn't you know we made magnetic tape? Ask for EASTMAN Type A303. (Type A304 has a thicker coating for higher output with less amplifier gain and its attendant noise. It is recommended only for commercial recording of originals on adjustable-bias equipment.)*

### Just roll them up together

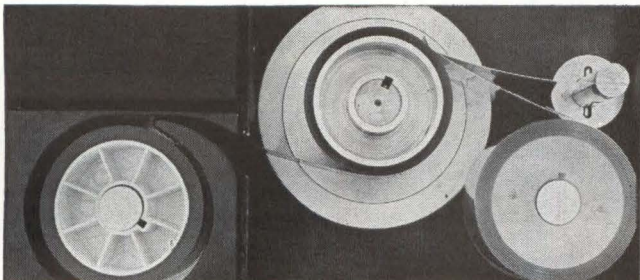

This represents the principle of either intermittent or non-intermittent processing and printing of long rolls of film by dampness—mere dampness. The principle is quite simple and not quite revolutionary any more. In its new manifestation it delivers not only an immediate positive but a first-class negative for future positives. Perhaps the message will strike right between the eyebrows of some reader who has been struggling hard with the pesky details of apparatus for photographing our too rapidly shrinking planet for the ultimate

purpose of making it more livable for our burgeoning species and/or of peace-keeping. (Probably the peskiness of the details has diverted his attention from ultimate purposes.)

We are wide open. We can play guiding angel to this new but well proved technique for broadening the scope and feasibility of photographic surveys, supplying nothing more billable than hospitality and encouragement, hoping that the eventual consumption of our negative materials will reward us for improving the quickness and quality of aerial photography. We can, on a special order basis, supply just the KODAK BIMAT Film, which imbibes solution, applies it to the negative film, and comes away bearing the positive image. We can similarly supply just the KODAK BIMAT Imbibant. We can likewise supply suitable negative films. We can supply the whole works. We can design the hardware, build the hardware, or shake the hand of him who intends to prosper by proving in fair competition that he can outdesign or outbuild us.

*Book an appointment for a preliminary discussion by a letter to Eastman Kodak Company, Special Sensitized Products Division, Rochester 4, N. Y.*

### Light-sensitive lacquers in spray cans and seminars

You can now buy light-sensitive lacquer in 1-lb spray cans. After a 10-min. bake at 140°F, you expose under your photo-master to a strong u-v source. Where the u-v can get through to polymerize, a subsequent wash with an organic solvent leaves the coating in place and strongly resistant to etchants for the underlying metal. Where the master has shielded from u-v, the unpolymerized lacquer is dissolved so that the etchants can dig there. Later another solvent removes the polymerized coating.

The product is called "Spray Resist Type-P." There is also a "Type-M." The former generally works best for copper, copper alloys, and anodized aluminum; the latter, for all other metals.

*Please send us no orders for such cans. Drop a postcard of inquiry to the manufacturer, Industrial Chemical Specialties Corporation, 79 Wall Street, New York City 10005.*

These lacquers sound as though they might be our cele-

brated KPR and KMER. Wrong. KPR and KMER are merely what we sell I.C.S. to make *their* products with. Get the distinction?

The smallest quantity in which we put up KPR and KMER is a full quart. That way you still have the problem of spray equipment, the problem which I.C.S. solves for you so simply. If it's problems you wish to grapple with, we can introduce you to a whole seminarful in the wise use of photo resists. From time to time we invite a few dozen individuals to spend two days in Rochester listening to us and each other bat around helpful hints on all the aspects—the optical considerations, what the photo-master should be like, metal preparation, number and thickness of coats, baking recipes, equipment for exposing and developing, etchants, etc.

*Would you be interested? If so, drop a note to Eastman Kodak Company, Graphic Arts Division, Rochester 4, N. Y. If you don't already know that these problems are worth grappling with, we hesitate to urge you to ask for the time and travel money.*

**This is another advertisement where Eastman Kodak Company probes at random for mutual interests and occasionally a little revenue from those whose work has something to do with science**

# ARGUMENT(?) ON THERMO- ELECTRICS

**Design Engineer:** "Thermoelectrics is here to stay. It's by far the best way to temperature-stabilize critical electronic components in the entire range of operating ambients."

**Management:** "Best—why?"

**Design Engineer:** "There's no maintenance problem with TE enclosures...less space...less weight...and better system performance."

**Management:** "Explain 'better performance'."

**Design Engineer:** "With TE temperature stabilization we gain higher operating efficiency, lower noise levels, greater frequency stability, longer component life."

**Management:** "But what about reliability?"

**Design Engineer:** "Thermoelectric enclosures have been and are now functioning without failure in commercial, industrial and military applications."

**Management:** "Aren't TE units expensive?"

**Design Engineer:** "Not when you consider the money we can save by simplifying system design. What's more, thermoelectrics can do an efficient stabilizing job in places where it would be impossible, or too costly, to use other equipment."

**Management:** "Good! How do we get these devices?"

**Design Engineer:** "Carter-Princeton is the leading manufacturer of TE products especially designed to solve cooling, heating and stabilization problems."

Carter-Princeton is the electronics division of Carter Products, Inc., established in 1880 and one of the world's leading manufacturers.

**FREE!** "When to Specify Thermoelectric Temperature Stabilization"...

...is the title of a new, authoritative, 12-page, fact-filled study just completed by Carter-Princeton's technical staff. Write for your free copy today: Carter-Princeton, 178-F Alexander Street, Princeton, N. J. 08540, Phone (609) 921-2880.

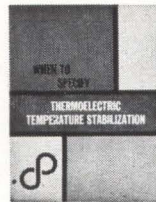

**CARTER-PRINCETON**

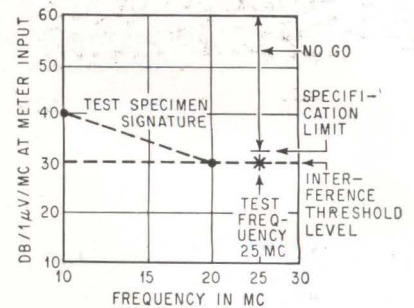

THE TEST SPECIMEN signature is measured and recorded at 10 and 20 mc for later reference when reject subassemblies are analyzed

sensitive r-f noise detector to determine the conducted noise levels. If a fault exists, the supply potential will be modulated with the r-f interference signal. Normal thermal and conductive noise levels exist in any operating electrical circuit and make it impossible to detect all fault transients that might be generated within the circuit. Experience, however, has shown that in most circuits where intermittents or other hard-to-detect marginal conditions exist, the r-f transients are from 3 to 30 db higher than the steady-state background noise of the circuit, and are easily detectable. The major portion of the energy is centered at about 25 Mc.

The impulse-noise generator becomes a signal standard and is used to set both the interference threshold level and the specification limit. The interference threshold level consists of the internal noise level of the receiver and the interference level of the device under test. The specification limit then is established after the first quantity of subassemblies have been tested and limits established which will allow a reasonable safety factor.

One of the procedures used in testing the subassemblies by r-f fault detection method is to apply a controlled, nondestructive mechanical shock to the unit. In some cases, it is desirable to add thermal shock to set up the proper conditions so that the fault or intermittent is more discernible on the r-f noise detector. Faulty components or connections are easily isolated by individually tapping with a phenolic rod and observing a peak in the generated r-f noise level. Time required for the average test is approximately two minutes.



# TRYGON Half Racks



Model HR40-5A

Model	Volt	Amps	Regulation	Ripple	Price
HR20-1.5*	0-20	0-1.5	0.01% line	0.25 mv	\$164
HR40-750*	0-40	0-0.75	0.05% load	0.15 mv	\$149
HR20-5A	0-20	0-5	0.01% line 0.01% load	0.5 mv	\$299
HR40-2.5A	0-40	0-2.5			\$299
HR40-5A	0-40	0-5			\$349
HR60-2.5A	0-60	0-2.5			\$379

\*Single Meter Units

## ... the most versatile power supplies going!

**In the lab**—you'll find you can't beat a Trygon Half Rack for versatility and low cost! Want constant voltage with adjustable current limiting? You've got it! Want constant current with adjustable voltage limiting? You've got it! Want to select voltage and current with a remote control? You've got this too!

But check the features at the right—and the prices—for yourself. And remember—every Trygon power supply, large or small, goes through the same test procedures before shipment. Each is aged—burned in; each is subjected to stability runs. Each must pass shock and vibration tests—your assurance of long, trouble free performance along with versatility.

**In a system**—you merely take off the Half Rack dust cover, reverse it, add an inexpensive Trygon adapter, and you have a unit that slides right into a rack. What's more, you can place two Half Racks in a 19" rack width, occupying only 5¼" of panel height.

**For complete specs**—on the Half Rack Series as well as our catalog showing the complete line of over 100 Trygon Power Supplies, write to us today. Address: Dept. E-7.



Two Trygon HR20-1.5's, rack-mounted side by side.

### FEATURES

- **CONSTANT VOLTAGE OPERATION** with adjustable current limiting.
- **CONSTANT CURRENT OPERATION** with adjustable voltage limiting.
- **COMPLETE RANGE REMOTE PROGRAMMING** furnishes voltage and current selection from a remote control.
- **REMOTE SENSING** provides rated regulation at the load, available at both front and rear terminals.
- **HIGH RESOLUTION** for setting current and voltage is provided by coarse and fine adjustments for both (4 controls).
- **AUTOMATIC OVERVOLTAGE PROTECTION**—Trygon's unique over-voltage protection is available as an option.

# TRYGON

## ELECTRONICS INC.

111 Pleasant Avenue  
(516) FReeport 8-2800

Roosevelt, L.I., N.Y.  
TWX (516) 868-7508



# THE MOST WELL BALANCED STOCK OF MICRO-DRILLS IN THE U.S.A.

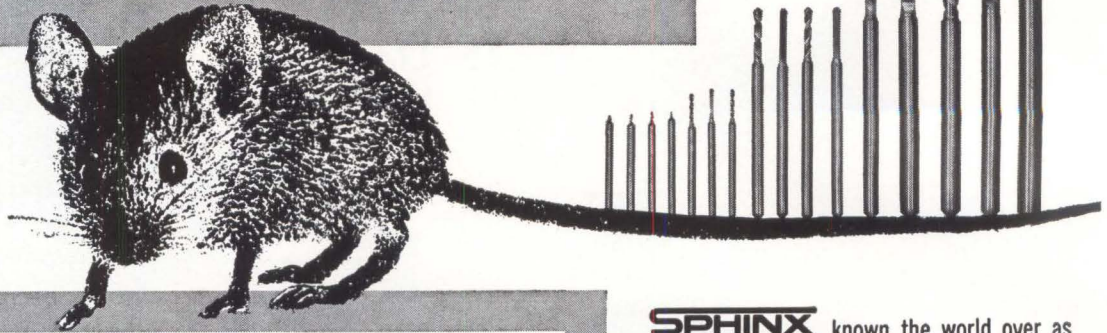

## IN STOCK FOR IMMEDIATE DELIVERY

TYPE	STYLE	STOCK SIZES
Spirec Pivot Drills	Right Hand	0.10mm to 3.00mm by 0.01mm increments
Flat Pivot Drills	Right Hand	0.04mm to 1.00mm by 0.01mm increments
Spirec Pivot Drills	Left Hand	0.10mm to 1.00mm by 0.01mm increments
Spirec Center Drills	Right Hand	0.10mm to 0.70mm by 0.05mm increments

Other sizes and styles available on special request.

**SPHINX** known the world over as the symbol of the finest in micro-drills. Insist on them by name. Your best assurance of quality and precision.

**SEND FOR COMPLETE DRILL CIRCULAR**

**LEVIN**®

LOUIS LEVIN & SON, INC.  
3573 Hayden Ave., Dept. E • Culver City, California

CIRCLE 90 ON READER SERVICE CARD

## HOW

often do 63,000 electronics engineers and purchasing agents use the **electronics Buyers' Guide**? 95%\* of them use their copy once a month, and 62%\* of them use it at least once a week. **Better budget space for the next electronics Buyers' Guide** / a McGraw-Hill publication.

\*Survey of August, 1963

**WANT  
TO DO  
BUSINESS  
WITH THE  
GOVERNMENT**

????????????

Then check the Military and Government Procurement Guide in the orange section of your **ELECTRONICS BUYERS' GUIDE**.

!!!!!!!!!!!!!!!!!!!!

# WORLD-WIDE ACCEPTANCE of STC MICROWAVE TUBES

## New tube development continues

STC have been leaders in the design and production of microwave communications for many years. Microwave tube development and production programmes have resulted in: improved gain, lower noise factor, higher synchronous saturated output level and phase modulation distortion, together with a high degree of reliability and simplicity of operation.

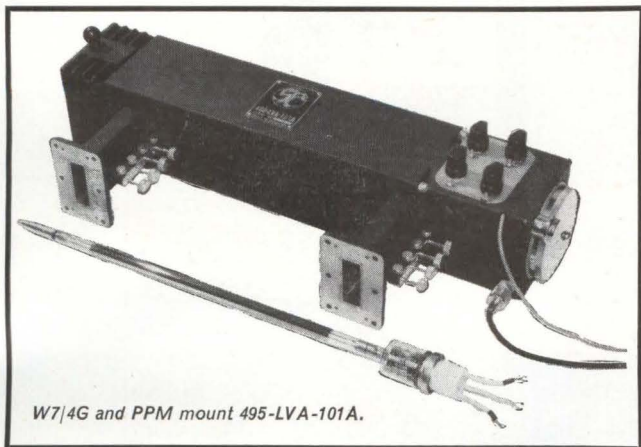

W7/4G and PPM mount 495-LVA-101A.

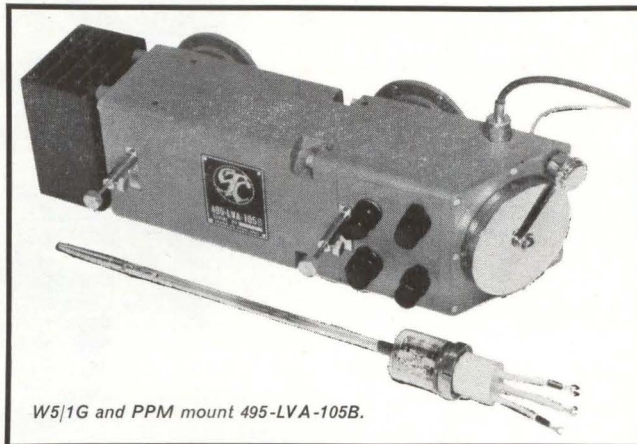

W5/1G and PPM mount 495-LVA-105B.

## C-band

Travelling wave tube type W5/1G has an established reputation in microwave link repeaters operating at about 5.0W output level in the 6.0 Gc/s band. A modified tube type W4/1G can be used in the same periodic permanent magnet mount as the W5/1G to cover the upper frequencies of this band (7.0 to 7.8 Gc/s). Type W5/2G has been especially designed for 1 800 channel link systems and is intended for operation with a 10 to 15W output.

## S-band

For the communication frequencies of this band (3.6 to 4.2 Gc/s) there are two STC travelling wave tubes:

Type W7/3G performance has been proved in national and international microwave systems in fourteen countries.

Type W7/4G is a higher gain version of the W7/3G. It is provided with a periodic permanent magnet mount which incorporates simple mechanical adjustments for obtaining the very best performance from any tube of this type.

### ABRIDGED DATA

Tube Type	Mount Type	RF Connexion (W.G. Flange)	Frequency Range (Gc/s)	Sync. Sat. Output (W)	Gain (db)	Noise Factor (db)
W7/3G	495-LVA-104	12A*	3.6 to 4.2	8 to 10	28	27
W7/4G	495-LVA-101A	12A*	3.6 to 4.2	10	42	27

\*Transition pieces to WR 229 available.

### ABRIDGED DATA

Tube Type	Mount Type	RF Connexion (W.G. Flange)	Frequency Range (Gc/s)	Sync. Sat. Output (W)	Gain (db)	Noise Factor (db)
W4/1G	As for W5/1G	As for W5/1G	7.0 to 7.8	8 to 11	37 to 40	26
W5/1G	495-LVA-105B 495-LVA-105C 495-LVA-105D	UG344/U CMR137 UG344/U	5.85 to 7.2	8 to 11	35 to 39	26
W5/2G	495-LVA-107B	UG344/U	5.925 to 6.425	16	37 to 41	27
LS985	WM108	UG51/U	7.0 to 8.5	8 to 11	36	26

Write, 'phone or Telex for leaflet

## COMPONENTS GROUP VALVE DIVISION



Standard Telephones and Cables Limited

FOOTSCRAY SIDCUP KENT

USA enquiries for price and delivery to

ITT COMPONENTS DIVISION, P.O. BOX 412, CLIFTON N.J.



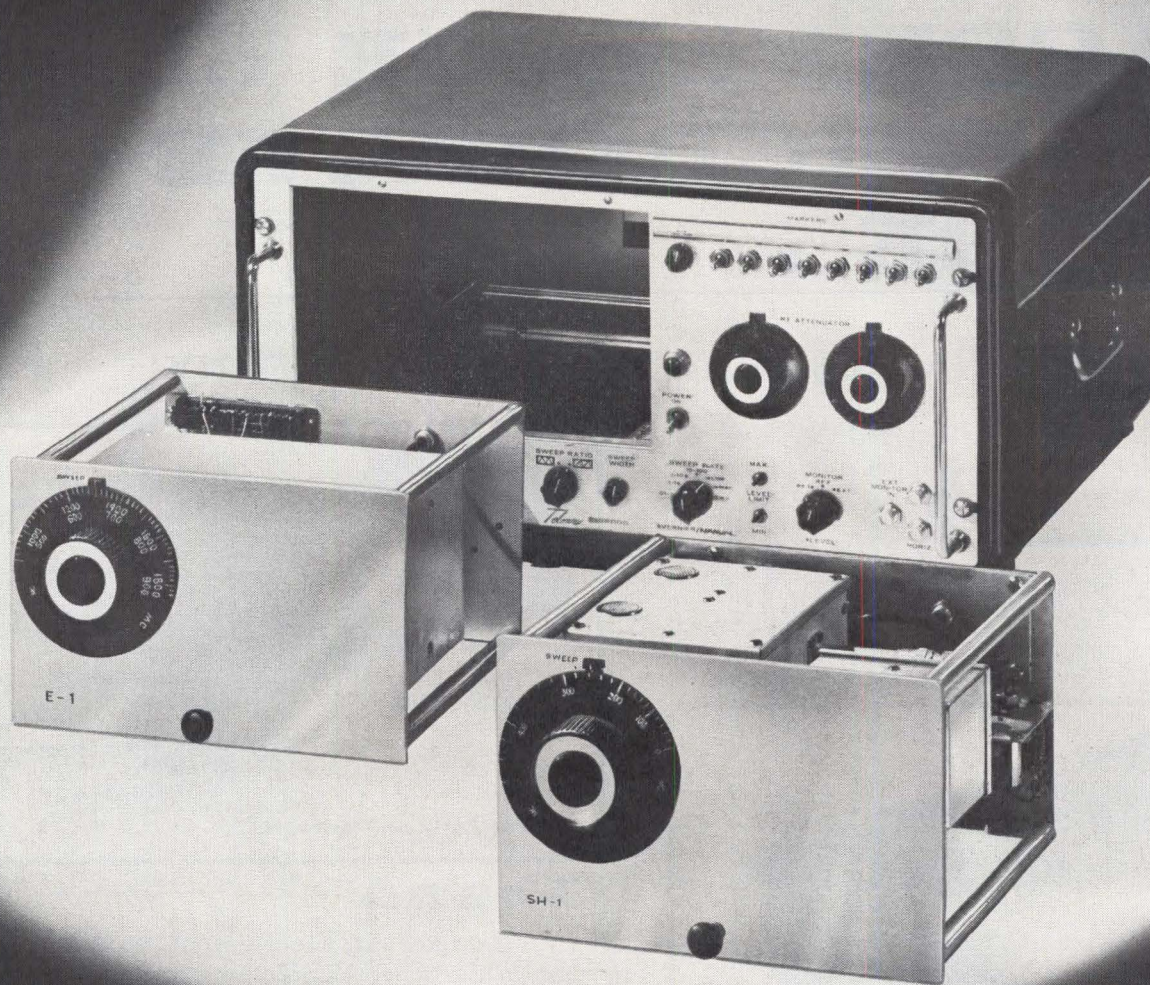

# 640,000,000 cycles-free!

The engineer who has determined the profitability of using sweep generator techniques now has another 22 pleasant discoveries awaiting him. That's the precise number of oscillator heads that conveniently plug into Telonic's SM-2000 Sweep Generator.

The trio shown above, for example, consists of an SM-2000 with just two of these heads, an SH-1 and an E-1. Together they cover a frequency range of 500 Kc to 1840 mc, over 600 mc further than any comparable instrument and at several hundred dollars less cost. Add to this the flexibility of being able to utilize any of 20 other oscillators and you have an instrument that obsoletes anything available for precise frequency generation and response testing.

#### General Specifications

Display linearity.....Better than 1.2:1  
 Source VSWR.....Below 1.3:1  
 Vernier attenuation.....0 to 10 db  
 Horizontal sweep.....Approx. 15 volts  
 Zero base line.....Oscillator off during return sweep  
 Frequency markers.....Birdy-By-Pass

Sweep rate.....Line frequency, 50-60 cps  
 Frequency range\*

SH-1 oscillator head (variable marker optional).....500 Kc to 460 mc  
 E-1 oscillator head (variable marker optional).....460 mc to 1840 mc

#### Prices

SM-2000 .....695.00  
 SH-1 .....400.00  
 E-1 .....750.00

\*There are 22 different plug-in heads available for the SM-2000 covering audio to 3000 mc in various frequency ranges and sweep widths. Prices range from 300.00 to 995.00. Complete catalog on request.



**INDUSTRIES, INC.**

60 NORTH FIRST AVENUE  
 BEECH GROVE, INDIANA  
 PHONE STATE 7-7241 AREA CODE 317

TWX 317-635 4748

Representatives in  
 Baltimore, Boston, Chicago, Cleveland, Dallas, Dayton, Denver, Huntsville,  
 Indianapolis, Los Angeles, New York City, Orlando, Philadelphia, San Francisco,  
 Seattle, St. Louis, Syracuse and principal cities throughout the world.

❖ SWEEP GENERATORS

❖ RF ATTENUATORS

❖ CW OSCILLATORS

❖ COAXIAL SWITCHES

## Plug-In Modules Increase DVM Flexibility

Instrument measures a-c and d-c volts, ohms and millivolts with 0.01-percent accuracy

**MODEL 5100** digital voltmeter is a high-precision instrument with full five-digit resolution. Using the null-balance potentiometric method of measuring unknown voltages against a known internal standard, the unit provides an accuracy of 0.01 percent of reading, common-mode rejection of 120 db (1,000,000) and an internal pcm telemeter link to transfer digital information from the shielded measurement circuits to a separate output compartment.

Spaces are provided in the instrument for up to 4 accessory cards. Modules are added by opening front-panel doors and inserting the printed-circuit cards into the appropriate plug-in spaces. No special wiring is required and the instrument does not have to be removed from the rack to make accessory



additions. With accessory cards in place and doors closed, selection of device function is accomplished merely by setting a front-panel switch to the appropriate position for the desired measurement. Moreover, a plug-in filter accessory is activated by a push-pull threshold knob control.

Model 5100 will measure d-c voltages to 999.99 in three ranges. Addition of accessory cards extend the instrument's range to include a-c voltages to 750, ohms to 999.99

K and millivolts to 1,000.

Accessories are completely interchangeable between dvm's of the same model number. This, according to the manufacturer, makes it possible for laboratories with several instruments to stock cards at a centralized point and use them in any instrument as required. Price: Between \$4,350 and \$4,650 depending upon model. Dana Laboratories, Inc., 630 Young St., Santa Ana, California.

CIRCLE 301, READER SERVICE CARD

## Slot-Array Reduces Grating-Lobe Problems

**DESIGNED** to operate between 134 and 151 Mc, this array is 28.7-feet square and uses dual-polarized slots rather than dipoles. Although well known, this principle has, according

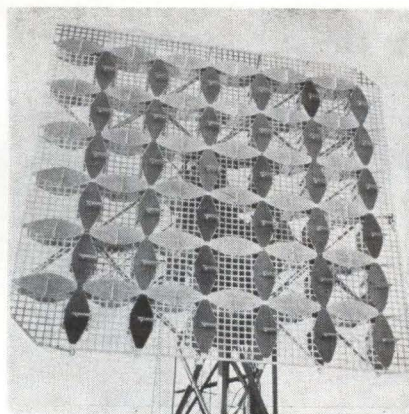

to the manufacturer, never before been used in an array of this size. The technique permits closer element spacings and yields higher gain. Moreover, it offers a definite reduction of grating-lobe problems. Orthogonally-polarized recessed slots permit independent control of both transmit and receive and horizontal, vertical, right and left-circular polarization. Antenna Systems, Inc., Grenier Field, Manchester, N. H. (302)

## Laminated Counter Top Solves RFI Problems

COPPER-SHIELDED laminated counter top is designed for use in areas

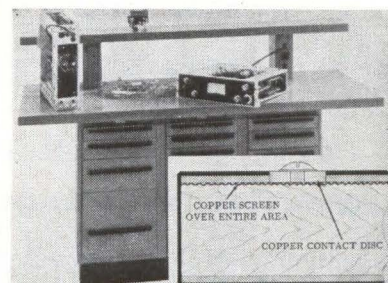

where radio frequency interference problems must be dealt with. It eliminates the need for makeshift applications, such as tacking a sheet of copper foil on a counter top. The grounded plane is not subject to eroding, denting or other damage because it is embedded within the laminated material. In tests conducted on a counter top 30 in. wide and 6 ft long, the following measurements were recorded: capacity—1710 pf per sq ft; insulation resist-

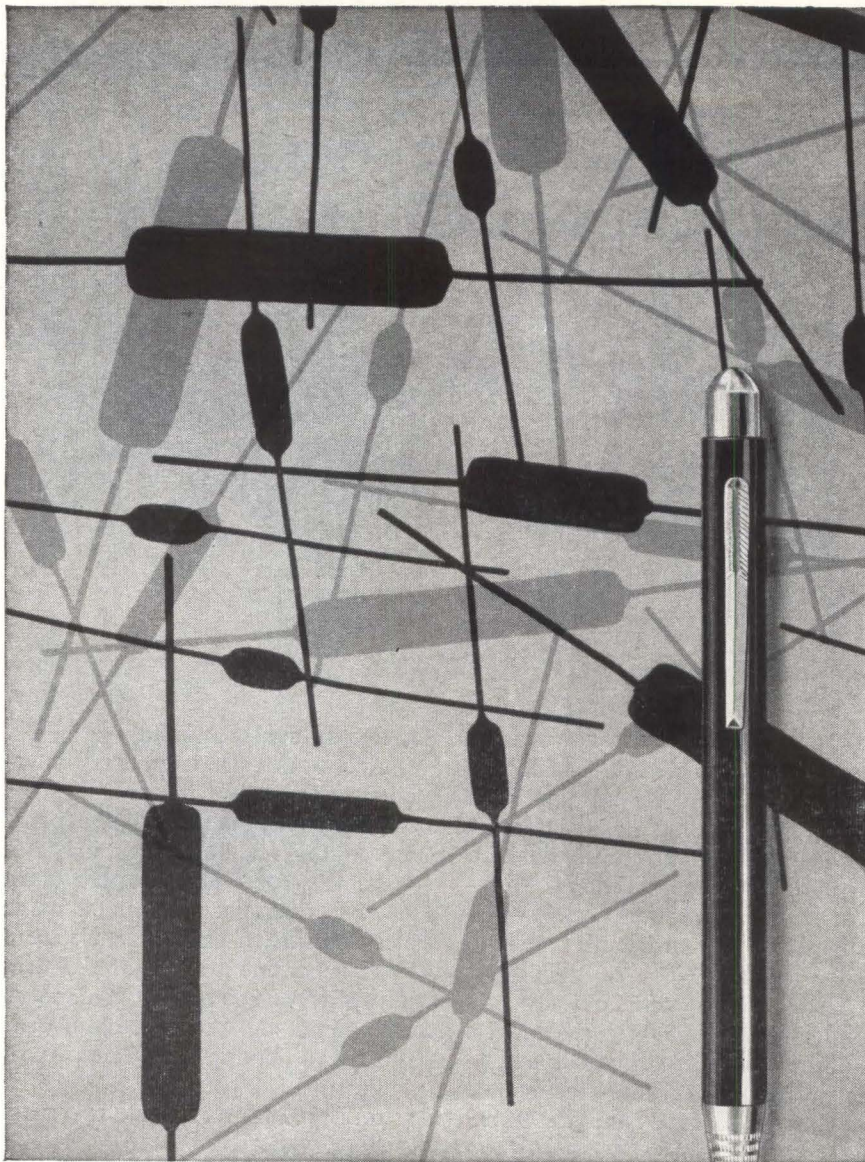

## What do you want in space-saving resistors?

- low TC    close accuracies    1000 V dielectric  
 wide resistance ranges    extremely high stability

You'll find all of these characteristics in Ward Leonard S-Coat (Silicone Coated) precision resistors. Ward Leonard offers eight standard types from 1 to 12.5 watts, in a wide range of resistance values.

S-Coat miniature resistors exceed MIL-R-26C requirements for characteristics G or V.

S-Coat wirewounds round out the comprehensive Ward Leonard line of axial lead resistors, power and precision. Write for Bulletin 45A, or evaluation samples.

Ward Leonard Electric Co., 30 South Street, Mount Vernon, N. Y.  
(In Canada: Ward Leonard of Canada, Ltd., Toronto.)



**WARD LEONARD**  
**ELECTRIC CO.** MOUNT VERNON  
NEW YORK

RESISTORS • RHEOSTATS • RELAYS • CONTROLS • DIMMERS

ance—greater than 50,000 megohms per sq ft; resistance—0.0012 ohm, between two five-way binding posts attached to soldered contact disks spaced 66 in. apart. Sturdilite Products, Inc., 3001 Palmolive Building, Chicago 11, Ill.

CIRCLE 303, READER SERVICE CARD

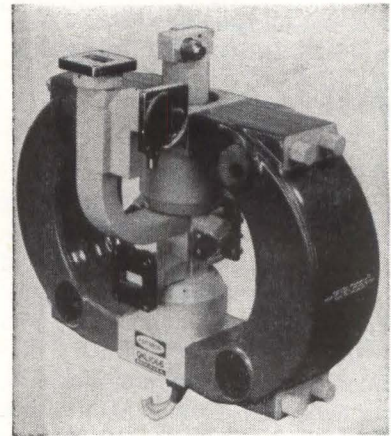

### Klystron-Amplifier Improves Radar-System Noise Figure

LOW-NOISE klystron amplifier operates between 10.2 Gc and 10.6 Gc for use in ground and airborne radar systems. The a-m noise level of the amplifier measured in a 1-kc bandwidth from 2 kc to 20 kc is specified at -115 db below carrier. Beyond 20 kc, this noise level drops to -125 db.

Called the QKL1066, the amplifier is tunable, liquid-cooled and weighs about 38 lbs. It can deliver 2,000 watts maximum and is fully compatible with similar klystrons in the company's line. Raytheon Company, Microwave & Power Tube Div., Waltham 54, Mass. (304)

### Strain-Gage Supply, Signal Container

ISOLATED strain gage power and flexible signal conditioning is provided by a new modular system. One 3 by 12-in. card contains a 0

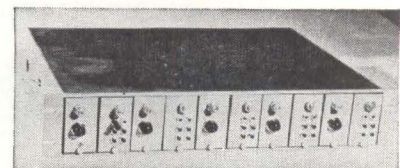



# Two Unique Reasons Why Hughes Can Offer You A Truly Rewarding Career In Systems Analysis

**1** Continuing responsibility throughout product development. The shaping of basic concepts is only the beginning of your contribution as a Hughes systems analysis engineer. It also includes systems and subsystems optimization, and responsibility for technical integrity of the system through prototype design and development, production design and testing, and operational phases. You monitor each stage of the program, evaluating all pertinent technical information and suggestions for refinement or possible modification. Your strong involvement from start to finish, and the responsibility you have for a successful outcome, provide the kind of incentives that inspire a man's best efforts.

**2** "Accent on enlightenment" among technical managers. From immediate supervision to the policy forming level, Hughes managers

are young, vigorous and technically oriented. A high percentage hold advanced degrees in science and engineering — an achievement encouraged and respected at Hughes. Many present technical managers began their careers just a few years ago as Fellows in the Howard Hughes Masters and Doctoral Fellowship programs. The resulting climate of rationality assures that your work and professional growth will be recognized and rewarded.

These policies have contributed measurably to the Hughes position of leadership in the systems industry. The company has grown rapidly from 2,000 employees in 1950 to over 30,000 in 1963. And this growth is continuing.

Hughes systems analysis is not limited to current programs. Much is directed toward the conception and development of advanced systems requiring such techniques as synthetic array radar, infrared sensors, LASERS and

MASERS, ion engines, television sensors, millimeter wave devices, inertial devices, digital computers, displays and controls.

If you are a graduate of an accredited engineering university, are a U.S. citizen, and have acquired some applicable technical experience, we would like to acquaint you with some of our hundreds of openings.

For immediate consideration, please airmail your resume to:

**MR. ROBERT A. MARTIN**  
Head of Employment  
Hughes Aerospace Divisions  
11940 W. Jefferson Blvd.  
Culver City 28, California

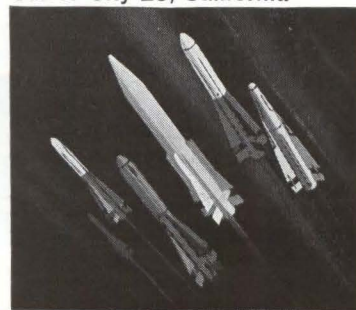

**WE PROMISE YOU A REPLY WITHIN ONE WEEK**

An equal opportunity employer.

*Creating a new world with electronics*

**HUGHES**

HUGHES AIRCRAFT COMPANY  
AEROSPACE DIVISIONS

all sizes  
for all jobs

**Waugh**

FREQUENCY TO DC  
CONVERTERS



One Frequency-to-DC Converter (handling input frequencies from 5 to 10 Kc) is a printed circuit card measuring three by four inches. Our solid state FR-500 series features modular construction for multi-channel operation in your instrument control room. In addition, a variety of Frequency-to-DC Converters are available that have been shaped, sized and engineered for virtually every type of application or environment—airborne, shipboard, field, plant or laboratory.

Typical applications include Frequency-to-DC conversion of symmetrical pulse trains from turbine flowmeters, tachometer generators, electro-magnetic coils, photocells and nuclear detection devices. Wherever incoming AC signals must be converted to a triggering or recording DC output with exceptional linearity, sensitivity and reliability, specify FOXBORO.

**FOXBORO**  
REGISTERED TRADEMARK

**WAUGH ENGINEERING DIVISION**  
7740 LEMONA AVENUE, VAN NUYS, CALIFORNIA • STATE 2-1710

Call or write regarding your current projects

to 15 v, 200 ma regulated power supply with 1  $\mu$ v of noise to ground, 0.05 percent regulation and time stability. The power supply may be used with internal or remote sensing, and utilizes a sensing line current of less than 50  $\mu$ a. A second card provides balance and calibration functions, with small internal cards for bridge completion and calibrating resistors. A complete single-channel package is \$160 and available from stock. Instrumentation Amplifiers & Supplies, Inc., 504 Canal St., New York 13, N.Y. CIRCLE 305, READER SERVICE CARD

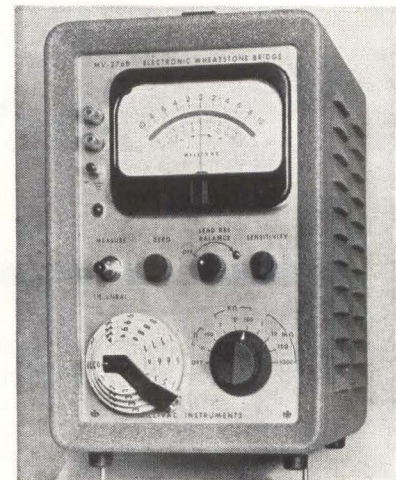

### Wheatstone Bridge Aids Quality Control

ELECTRONIC Wheatstone bridge has a total range of 1 milliohm up to 1,000 megohms with a basic accuracy of 0.05 percent. The null detector has instantaneous recovery and also has a built-in control to balance out lead resistances. A 1-percent unbalance switch feature permits rapid measurement of large quantities of similar resistors, making the instrument ideal for incoming inspection and quality control. Price is \$925. Millivac Instruments, Inc., P. O. Box 997, Schenectady, N. Y. (306)

### Universal Input Improves Recorders

UNIVERSAL input allows Servo-Riter recorders to have continuous span and zero suppression. The span is adjustable from 0.33 mv to 100 mv in 7 steps plus being continuously

# NEW ENCAPSULATED GAP-PAC\*

miniaturized transformer/spark gap package



**triggers  
EXPLODING  
BRIDGE WIRES**

**15-30 volt input reliably switches 5000 amp at 2.6 kv in 1  $\mu$ sec.**

Complete, epoxy-encapsulated unit contains highly efficient EG&G triggered pulse transformer and EG&G miniature triggered spark gap. Impervious to shock, humidity, vibration and temperature extremes encountered in missile and space vehicle environments. Incomparably more reliable than electrically detonated chemical explosives.

Low input voltage requirement permits use with transistorized input circuitry. Can be used to switch as much as 20 joules (5000 amp peak current) in 1 microsecond.

Ideal for missile-stage separation, missile destruct, fuel ignition, exploding wire plasma studies and similar applications in which extreme speed and dependability are essential.

The GAP-PAC is typical of EG&G's pioneering achievements in the development of fast switching devices. For information on similar units to satisfy your particular requirements, write to Sales Department.

\*EG&G trade-mark

#### FOR HIGHER ENERGY APPLICATIONS

EG&G has developed a complete line of glass-metal and ceramic-metal triggered spark gaps. All are compact, reliable and ruggedly constructed to withstand environmental extremes.



Typical configuration of EG&G glass-metal, triggered spark gaps. Total volume occupied by any of three models is little more than one cubic inch.

Model	Minimum Cut-Off Voltage	Maximum Hold-Off Voltage
GP-11	1.8 kv	3.5 kv
GP-16	1.0 kv	2.0 kv
GP-17	4.0 kv	10.0 kv



Typical configuration of EG&G ceramic-metal, triggered spark gaps. Largest (GP-15) measures only 3 1/2" x 3 1/8" diameter.

Model	Minimum Cut-Off Voltage	Maximum Hold-Off Voltage
GP-22	5.0 kv	15 kv
GP-12	8.0 kv	25 kv
GP-14	12.0 kv	40 kv
GP-15	30.0 kv	70 kv

EDGERTON, GERMESHAUSEN & GRIER, INC.



176 BROOKLINE AVE., BOSTON 15, MASS.

## Amplify 15 cps to 180 mc signals

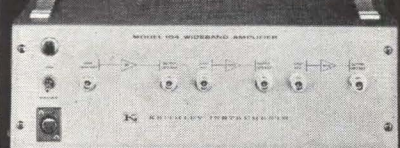
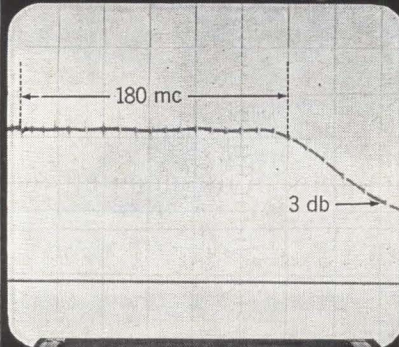

## WITH NEW KEITHLEY 104

The Model 104 contains three separate amplifiers. Two amplifiers, each with a gain of 10 into 50 ohms and input impedance of 50 ohms, may be used individually or cascaded for an over-all gain of 100. (Two 104's may be cascaded for a maximum gain of 10,000.) A third amplifier having unity gain and one megohm, 10 pf input impedance is provided for impedance matching. It allows use of the x10 gain amplifiers in high impedance circuits and permits them to be used directly with other coaxial systems. Applications include use as a low level oscilloscope preamplifier and wideband pulse amplifier.

### SPECIFICATIONS FOR EACH X10 GAIN AMPLIFIER

- Frequency: 3db, 15 cps to 180 mc;  $\pm 0.5$ db, 25 cps to 150 mc
- Gain into 50 ohm load: 10 (20db)
- Input impedance: 50 ohms
- Rise time: less than 3 nanoseconds
- Max. rms noise (referred to input): 35 microvolts (8db)
- Max. output into 50 ohm load: 1.4 volts, p-p

Price: \$675. Send for Engineering Note further describing the Model 104 Wideband Amplifier and accessories.



**KEITHLEY  
INSTRUMENTS**

12415 Euclid Avenue • Cleveland 6, Ohio

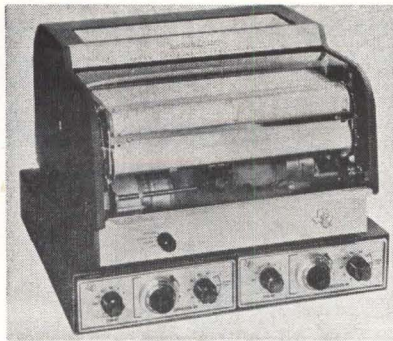

variable in each step. Zero suppression is adjustable to  $\pm 100$  mv in 10 steps plus being continuously variable in each step. All this is accomplished with off-balance impedance of 40,000 ohms and external circuit resistance of 10,000 ohms, overall accuracy of  $\pm 0.5$  percent plus  $5 \mu v$  and 0.5 sec span step response time. Texas Instruments Inc., 3609 Buffalo Speedway, CIRCLE 307, READER SERVICE CARD

## Motion Transducer Features Versatility

MOTION transducer is designed for a wide range of applications where minute movements of rhythmical or non-rhythmical characteristics have



to be recorded to determine motion potentials. Recording can be accomplished by numerous means. For example: meter readout or expression through recorders of the film strip or paper strip type as well as oscilloscope type displays can be utilized. The electronics, consisting of a hermetically sealed miniaturized proportional photon-controlled element, eliminates elaborate carrier amplifiers and demodulators. Among its many applications are as gyro-stabilizer, vibration transducer, muscular reaction measurements in myography, and electronic/dynamic dial indications in

## Acoustical Components of Superior Quality

JAPAN PIEZO supplies 80% of Japan's crystal product requirements.

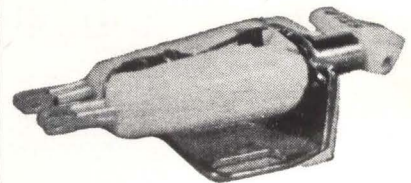
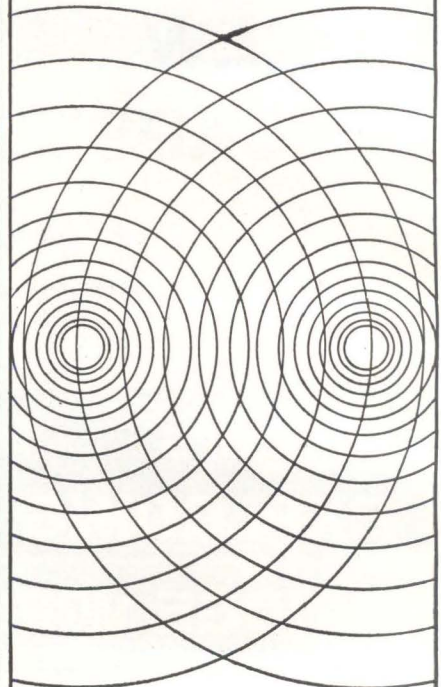

### STEREO CARTRIDGE Crystal — "PIEZO" Y-130 X'TAL STEREO CARTRIDGE

At 20°C, response: 50 to 10,000 c/s with a separation of 16.5 db. 0.6 V output at 50 mm/sec. Tracking force:  $6 \pm 1$  gm. Compliance:  $1.5 \times 10^{-6}$  cm/dyne. Termination:  $1M\Omega + 150$  pF.

Write for detailed catalog on our complete line of acoustical products including pickups, microphones, record players, phonograph motors and many associated products.



**JAPAN PIEZO  
ELECTRIC CO., LTD.**

Kami-renjaku, Mitaka, Tokyo, Japan

CIRCLE 211 ON READER SERVICE CARD  
October 18, 1963 electronics

## EC900 6HA5 TRIODE

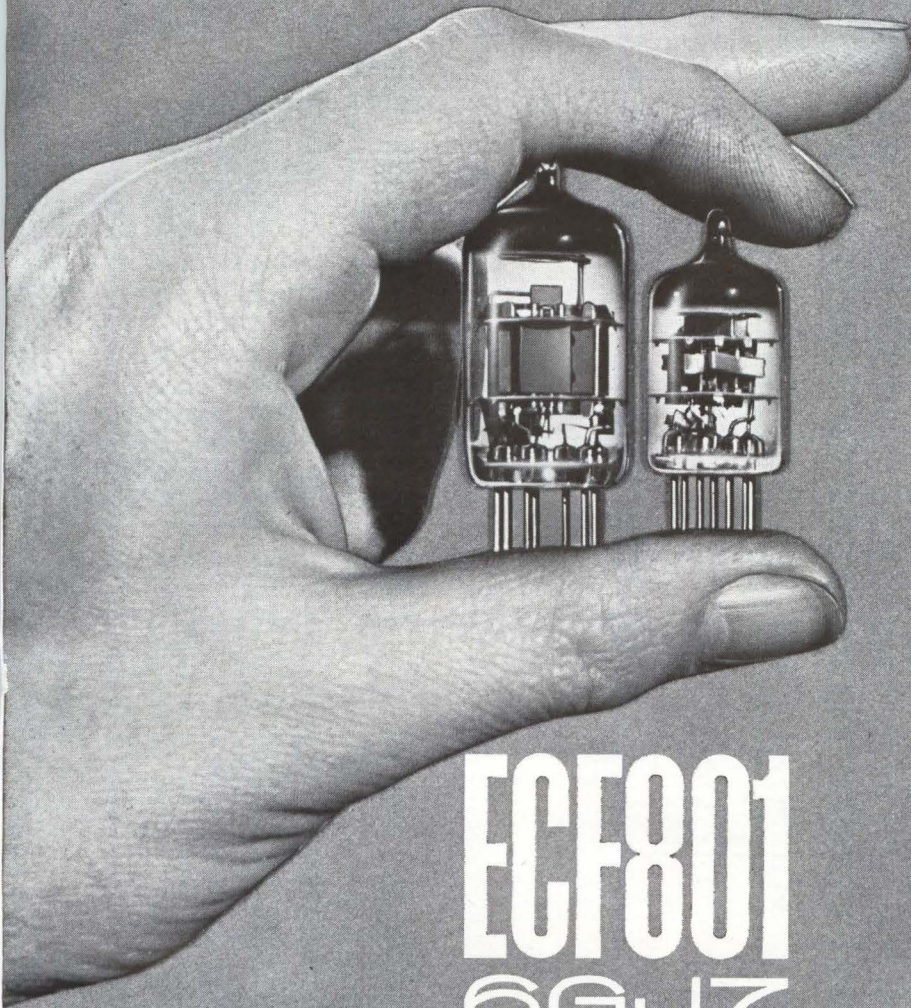

## ECF801 6GU7 TRIODE PENTODE

THE IDEAL COMBINATION FOR  
BETTER SIGNAL TO NOISE RATIO  
AND HIGH GAIN

Much of the ready acceptance by leading setmakers of these two new tuner tubes stems from the high signal to noise ratio and high gain of these types. Other benefits include reduced microphonics, low cross modulation and better oscillator stability. Both tubes are available with 6.3V, 0.45A or 0.6A heater ratings.

### CHARACTERISTICS

#### EC900

$g_m$	14.5	mA/V
$E_b$	135	V
$I_b$	11.5	mA
$E_c$	-1.0	V
$\mu$	72	
$r_p$	5.0	k $\Omega$
$E_c$ (10: 1 reduction in $g_m$ )	2.4	V
$E_c$ (100: 1 reduction in $g_m$ )	5.3	V

#### ECF801

Pentode Section			Triode Section		
$g_m$	11.0	mA/V	$g_m$	9.0	mA/V
$g_c$	5.0	mA/V	$\mu$	20	
$I_b$	10	mA	$E_b$	100	V
$E_b$	170	V	$E_c$	-3.0	V
$E_{c2}$	120	V	$I_b$	15	mA
$E_{c1}$	-1.2	V			

Full details on the Mullard range of tubes for television, stereo and high-fidelity available from:

INTERNATIONAL ELECTRONICS CORPORATION,  
81 SPRING STREET, NEW YORK 12, N.Y.

Worth 6-0790



# Mullard

ELECTRONIC TUBES

MULLARD OVERSEAS LTD., LONDON, ENGLAND

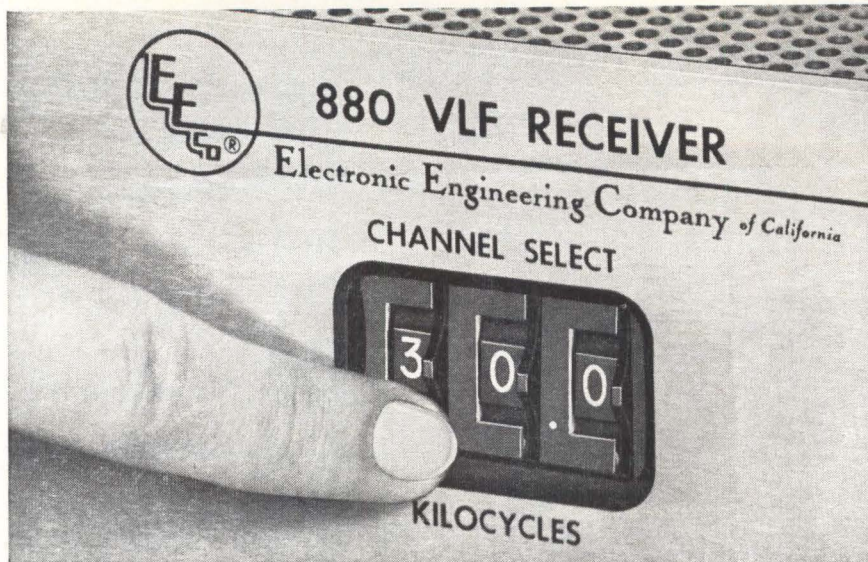

### All 181 channels at the flick of a switch

Put your finger on the problem of switching VLF channels on short notice with the EECO 880 VLF Receiver/Comparator. Digitally selects any frequency from 12.0 to 30.0 kc in 0.1 kc steps. Avoid loss of monitoring capability due to:

- Change in frequency allocation of a VLF transmitter.
- Shutdown of transmitter for extended maintenance.

■ Interference from stations on nearby frequencies.

■ Interference caused by two or more stations utilizing the same frequency. Send for EECO 880 brochure and technical paper, "VLF Approach to Absolute Time." Address: Pete Anderson, Mail Station 520, Post Office Box 58, Santa Ana, California, or phone 547-5501, area code 714.



EE 3-70

**ELECTRONIC ENGINEERING COMPANY** of California  
CIRCLE 201 ON READER SERVICE CARD

machining operations. Schoeffel Instrument Co., 355 Hillsdale Ave., Hillsdale, N. J.

CIRCLE 308, READER SERVICE CARD

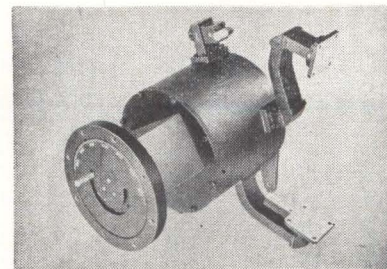

### Wavemeter Tunes from 8.765 to 8.835 Gc

MODEL G128 has a loaded Q of greater than 40,000 over the frequency range of 8.765 to 8.835 Gc. For full utilization of its capability and to assure maximum accuracy, a direct-reading dial has been coupled to a rugged, low-torque, anti-backlash gear drive. At room temperatures, accuracies within 0.01 percent are achieved. Resetability is better than 0.005 percent. Energy is sampled by transmission method and rectified by a sensitive detector matched to the wavemeter. This assures minimum variation in output. Gombos Microwave Inc., Webro Road, Clifton, N. J. (309)

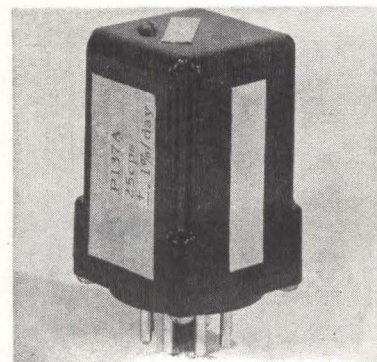

### Solid-State Oscillator Has High Stability

INDUSTRIAL TYPE solid-state oscillator, model P137A, has a frequency tolerance of  $\pm 1$  percent from 0 C to + 60 C and a frequency stability of  $\pm 0.1$  percent per day. Supply voltage is 12 to 18 v d-c. Frequencies are available from 10 to 3000 cps with a square wave output having less than 1  $\mu$ sec rise time. A screwdriver adjustment varies the

DIGI **TEC**

## LOW COST

### DC-DVM

.1% accuracy



base price \$287.50 portable model "200" shown

### 36 models

- New Styling
- Improved Mechanical & Circuit Details
- Higher Ambient Operating Temperature
- Increased Life & Reliability
- Single & Multi-Range Models from 0.0000 to 1000. V-DC
- Auto-Polarity—Optional

### AC-DC CONVERTER

portable model "900" shown



.3% Accuracy

base price \$285.00

DigiTec & Converter offered in Panel and Flange Models

**UNITED SYSTEMS CORPORATION**

918 Woodley Road, Dayton 3, Ohio (513) 254-3567

Stocking Representatives Throughout the United States and Canada

1N2482 • 1N2483 • 1N2484 • 1N2485 • 1N2486 • 1N2487 • 1N2488 • 1N2489 • TM125 • TM126 • 1N2266 • 1N2267 • 1N2268  
 1N2269 • 1N2270 • 1N2271 • 1N2272 • 1N2273 • 1N2274 • 1N2275 • 1N2276 • 1N2277 • 1N2278 • 1N2279 • 1N3670 • 1N3671  
 1N3672 • 1N3673 • 1N1046 • SL608 • 1N1028 • 1N1029 • 1N1030 • 1N1031 • 1N1032 • 1N1033 • ER1 • 1N1763 • 1N1764 • 1N547  
 ER11 • 1N2446 • 1N2447 • 1N2448 • 1N2449 • 1N2450 • 1N2451 • 1N2452 • 1N2453 • 1N2454 • 1N2455 • 1N2456 • 1N2457  
 1N547 • 1N1701 • 1N1702 • 1N1703 • 1N1704 • 1N1705 • 1N1706 • 1N1707 • 1N1708 • 1N1709 • 1N1710 • 1N1711 • 1N1712  
 1N253 • 1N254 • 1N255 • 1N256 • 1N1115 • 1N1116 • 1N1117 • 1N1118 • 1N1119 • 1N1120 • 1N1612 • 1N1613 • 1N1614  
 1N1615 • 1N1616 • 1N2216 • 1N2217 • 1N2218 • 1N2219 • 1N2220 • 1N2221 • 1N2222 • 1N2222A • 1N2223 • 1N2223A • 1N2224  
 1N2224A • 1N2225 • 1N2225A • 1N2226 • 1N2226A • 1N2227 • 1N2227A • 1N2228 • 1N2229 • 1N2230 • 1N2231 • 1N2232  
 1N2233 • 1N2234 • 1N2235 • 1N2236 • 1N2237 • 1N2238 • 1N2239 • 1N2491 • 1N2492 • 1N2493 • 1N2494 • 1N2495 • 1N2496  
 1N2497 • 1N440 • 1N440B • 1N441 • 1N441B • 1N442 • 1N442B • 1N443 • 1N443B • 1N444 • 1N444B • 1N445 • 1N445B • 1N2154  
 1N2155 • 1N2156 • 1N2157 • 1N2158 • 1N2159 • 1N2160 • 1N645 • 1N646 • 1N647 • 1N648 • 1N649 • 1N1108 • TR322 • TR323  
 TR324 • TR325 • TR326 • 1N1100 • 1N1101 • 1N1102 • 1N1103 • 1N1104 • 1N1105 • 1N2115 • 1N2117 • 1N1251 • 1N1252  
 1N1253 • 1N1254 • 1N1255 • 1N1256 • 1N1257 • 1N1258 • 1N1259 • 1N1260 • 1N1261 • 1N248 • 1N248A • 1N248B • 1N249  
 1N249A • 1N249B • 1N250 • 1N250A • 1N250B • 1N1692 • 1N1693 • 1N1694 • 1N1695 • 1N1696 • 1N1697 • 1N1169 • 1N1169A  
 1N588 • 1N589 • 1N3491 • 1N3492 • 1N3493 • 1N3494 • 1N3495 • TM155 • TM156 • 1N1443 • 1N1444 • 1N2103 • 1N2104  
 1N2105 • 1N2106 • 1N2107 • 1N2108 • 1N676 • 1N677 • 1N678 • 1N679 • 1N2858 • 1N2859 • 1N2860 • 1N2861 • 1N2862  
 1N2863 • 1N2864 • 1N2135A • 1N560 • 1N561 • 1N562 • 1N563 • 1N1486 • 1N1487 • 1N1488 • 1N1489 • 1N1490 • 1N1491  
 1N1492 • 1N3208 • 1N3209 • 1N3210 • 1N3211 • 1N3212 • 1N3213 • 1N3214 • 1N2793 • 1N2794 • 1N2795 • 1N2796 • 1N2797  
 1N2798 • 1N2799 • 1N2800 • 1N3072 • 1N3073 • 1N3074 • 1N3075 • 1N3076 • 1N3077 • 1N3078 • 1N3079 • 1N3080 • 1N3081  
 1N3082 • 1N3083 • 1N3084 • 1N3566 • 1N2373 • 1N2374 • ER21 • 1N1434 • 1N1435 • 1N1436 • 1N1437 • 1N1438 • 1N681  
 1N682 • 1N683 • 1N684 • 1N685 • 1N686 • 1N687 • 1N689 • 1N3189 • 1N3190 • 1N3191 • 1N1406 • 1N1407 • 1N1408 • 1N1409  
 1N1410 • 1N3775 • 1N1095 • 1N1096 • 1N3987 • 1N3988 • 1N3989 • 1N3990 • TP100 • TP101 • 1N3649 • 1N3650 • 1N550  
 1N551 • 1N552 • 1N553 • 1N554 • 1N555 • 1N3765 • 1N3766 • 1N3767 • 1N3768 • SL610 • SL612 • SL615 • 1N2501 • 1N2502  
 1N2503 • 1N2504 • 1N2505 • 1N2506 • 1N2507 • 1N2508 • 1N846 • 1N847 • 1N848 • 1N849 • 1N850 • 1N851 • 1N852 • 1N853  
 1N854 • 1N855 • 1N856 • 1N857 • 1N858 • 1N859 • 1N860 • 1N861  
 1N862 • 1N863 • 1N864 • 1N865 • 1N866 • 1N867 • 1N868 • 1N869  
 1N870 • 1N871 • 1N872 • 1N873 • 1N874 • 1N875 • 1N876 • 1N877  
 1N878 • 1N879 • 1N880 • 1N881 • 1N882 • 1N883 • 1N884 • 1N885  
 1N886 • 1N887 • 1N888 • 1N889 • 1N3659 • 1N3660 • 1N3661 • 1N3662  
 1N3663 • 1N3664 • 1N3665 • TK5 • 1N1581 • 1N1582 • 1N1583 • 1N1584  
 1N1585 • 1N1586 • 1N1587 • ER21 • 1N2847 • 1N2848 • 1N2849 • 1N2850  
 1N2851 • 1N2852 • ER31 • SL708 • 1N530 • 1N531 • 1N532 • 1N533  
 1N534 • 1N535 • 1N536 • 1N537 • 1N538 • 1N539 • 1N540 • ER41  
 1N1551 • 1N1552 • 1N1553 • 1N1554 • 1N1555 • 1N1556 • 1N1557  
 1N1558 • 1N1559 • 1N1560 • 1N3964 • 1N3965 • 1N3966 • 1N3967  
 1N3968 • 1N3969 • 1N3970 • 1N3971 • 1N332 • 1N333 • 1N334 • 1N335  
 1N336 • 1N337 • 1N338 • 1N339 • 1N340 • 1N341 • 1N342 • 1N343  
 1N344 • 1N345 • 1N346 • 1N347 • 1N348 • 1N349 • SL710 • SL712 • SL715  
 1N1644 • 1N1645 • 1N1646 • 1N1647 • 1N1648 • 1N1649 • 1N1650  
 1N1651 • 1N1652 • 1N1653 • SL91 • SL92 • SL93 • 1N359 • 1N359A  
 1N360 • 1N360A • 1N361 • 1N361A • 1N362 • 1N362A • 1N363 • 1N363A  
 1N364 • 1N364A • 1N365 • 1N365A • ER51 • 1N1124 • 1N1124A • 1N1125  
 1N1125A • 1N1126 • 1N1126A • 1N1127 • 1N1127A • 1N1128 • 1N1128A  
 ER61 • 1N1130 • TM11 • TM12 • TM13 • TM17 • TM18 • TM19 • TM21  
 1N2069 • 1N2069A • 1N2070 • 1N2070A • 1N2071 • 1N2071A • 1N2072  
 1N2073 • 1N2074 • 1N2075 • 1N2076 • 1N2077 • 1N2078 • 1N2079  
 1N2080 • 1N2081 • 1N2082 • 1N2083 • 1N2084 • 1N2085 • 1N2086  
 TP200 • TP201 • ER61 • ER81 • 1N1537 • 1N1538 • 1N1539 • 1N1540  
 1N1541 • 1N1542 • 1N1543 • 1N1544 • TK10 • TK11 • 1N2021 • 1N2022  
 1N2023 • 1N2024 • 1N2025 • 1N2026 • 1N2027 • 1N2028 • 1N2029  
 1N2030 • 1N2031 • TM31 • TM32 • TM33 • TM34 • 1N1341 • 1N1341A  
 1N1341B • 1N1342 • 1N1342A • 1N1342B • 1N1343 • 1N1343A • 1N1343B  
 1N1344 • 1N1344A • 1N1344B • 1N1345 • 1N1345A • 1N1345B • 1N1346  
 1N1346A • 1N1346B • 1N1347 • 1N1347A • 1N1347B • 1N1348 • 1N1348A  
 1N1348B • TP200 • TP201 • 1N1217 • 1N1217A • 1N1218 • 1N1218A  
 1N1219 • 1N1219A • 1N1220 • 1N1220A • 1N1221 • 1N1221A • 1N1222  
 1N1222A • 1N1223 • 1N1223A • 1N1224 • 1N1224A • 1N1225 • 1N1226  
 1N1227 • 1N1227A • 1N1228 • 1N1228A • 1N1229 • 1N1229A • 1N1230  
 1N1230A • 1N1231 • 1N1231A • 1N1232 • 1N1232A • 1N1233 • 1N1233A  
 1N1234 • 1N1234A • 1N1235 • 1N1236 • TM1 • TM2 • TM3 • TM4 • TM5  
 TM6 • TM7 • TM8 • TM9 • 1N253 • 1N254 • 1N255 • 1N256 • 1N316  
 1N316A • 1N317 • 1N317A • 1N318 • 1N318A • 1N319 • 1N319A • 1N320  
 1N320A • 1N321 • 1N321A • 1N322 • 1N322A • 1N323 • 1N323A • 1N324  
 1N324A • 1N325 • 1N325A • 1N326 • 1N326A • 1N327 • 1N327A • 1N328

## Pick a number... any number

And you will find a silicon rectifier made by Transistron. Only Transistron gives you over 750 different types — and gives them to you in such a wide variety of packages. The line features:

1. Epoxy Rectifiers  
— up to 750 mA — and up to 1000 volts
2. Top Hat and Flangeless Rectifiers  
— up to 1.6 amps and up to 1500 volts
3. 7/16" stud-mounted Rectifiers  
— to 12 amps and 1500 volts
4. 11/16" stud-mounted Rectifiers  
— to 50 amps and 800 volts
5. Industrial Rectifiers  
— up to 25 amps and 600 volts
6. Sub-miniature glass Rectifiers  
— up to 400 mA and up to 800 volts

Watch for 7/16" and 11/16" stud-mounted fast-recovery types, soon to be available. Whatever your need — Transistron can meet it. All of the popular rectifiers you need are available through your Transistron Distributor. You can't tell all the numbers above without a program — so send for our complete Alpha-Numerical Guide to Transistron Silicon Rectifiers. It's yours free. Just write:

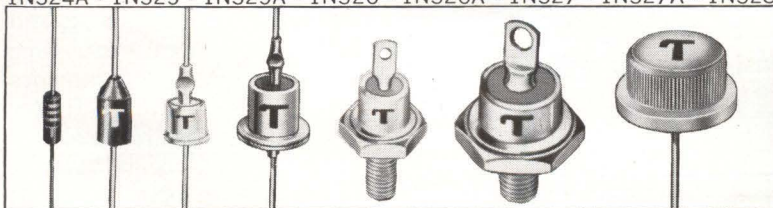

**Transistron T**  
 electronic corporation  
 wakefield, melrose, boston, mass.  
 Sales offices in principal cities throughout the U.S.A. and Europe.  
 Cable address: TRELCO

## FREDDY

by *RUPE*

...YOU SEE, ERNEST, A FREQUENCY STANDARD IS EXACKLY LIKE THIS...

...ER...AT LEAST IT TICKS, OR SUMPIN'...

ANYHOW, IT'S GOT SOME METAL IN IT... I THINK!



Well, you could say it just "ticks," Freddy, but it's more than metal! REEVES-HOFFMAN'S NEW FREQUENCY STANDARD is a highly reliable, ultra-stable oscillator with a basic frequency of 5 mc, available with circuitry for division to 100 kc and 1 mc and doubling up to 10 mc. Stability is up to 5 parts in  $10^{11}$  per day. Precision standards use crystals of our own manufacture and are packaged to your specifications. Write for bulletin QCO.



### REEVES-

### HOFFMAN

CARLISLE, PENNSYLVANIA

DIVISION OF DYNAMICS CORPORATION OF AMERICA

PRODUCERS OF PRECISION  
FREQUENCY CONTROL DEVICES...  
crystals • crystal-controlled  
frequency sources, standards,  
filters • component ovens.

CIRCLE 202 ON READER SERVICE CARD

## SERIES PS HIGH-VOLTAGE POWER SUPPLIES

**NOW**  
**LIGHTER**  
**LOWER**

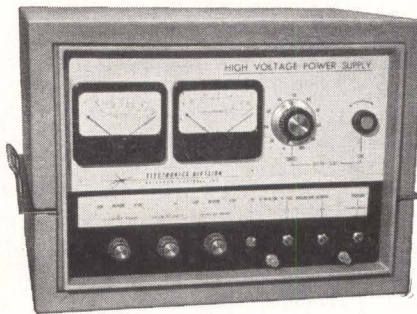

Weight has been cut from 175 pounds to as little as 70 pounds for most models of Series PS adjustable high-voltage power supplies. The height of these units has been reduced by as much as 30 per cent.

Important features of the PS Series: 29 Models Available • Range 1 to 400 KV, 1.5 to 3,000 MA • Simplified Controls: High-Voltage On-Off Push Buttons, High-Voltage Coarse and Fine Controls, Multiple Indicating Lights • Overload Protection • Triple-Range Current and Voltage Meters. For information on other standard and optional features, write for Bulletin ED-3.



### ELECTRONICS DIVISION

RESEARCH-COTTRELL, INC., BOUND BROOK, NEW JERSEY

RC 262E

102 CIRCLE 102 ON READER SERVICE CARD

output frequency  $\pm 2$  percent. Unit is  $1\frac{3}{8}$  in. square by 2 in. high with octal plug termination. Connor-Winfield Corp., Winfield, Ill.

CIRCLE 310, READER SERVICE CARD

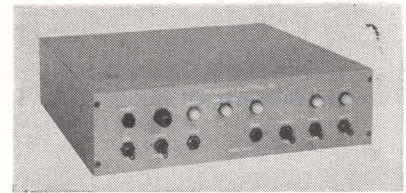

### Buffer Store Unit for Binary Data

SYSTEM stores data in serial or parallel form in a recirculating magnetostrictive delay line. Designed as a basic two-part system for military and commercial applications, the first section, or basic buffer logic, applies in general to all rate changing and storage systems. Logic to recognize the start of data, write control, read control, and buffer capacity indicators are contained in this section. The second section is applicable directly to the input and output specifications of individual customer requirements. Readout can have destructive or non-destructive capabilities. Ferranti Electric, Inc., Industrial Park No. 1, Plainview, L. I., N. Y. (311)

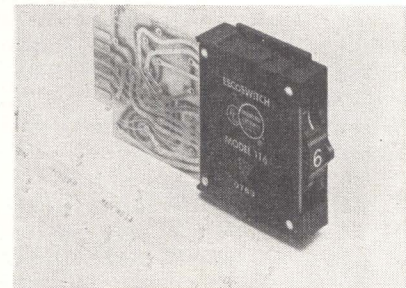

### Thumbwheel Switch Features Detent Design

THUMBWHEEL switch that functions as a digital voltage divider is available. Ten thumbwheel positions, 0 through 9, permit the operator to select the desired decimal fraction of an applied reference voltage, and a printed-circuit card extending from the back of the switch provides for the mounting of voltage-divider resistors. Provision is also made for an additional scale-factor resistor. Accidental hang-up between switch

October 18, 1963 electronics



-10db/decade

# LOG VOLTMETER - CONVERTER

70 db RANGE  0.2 db ACCURACY

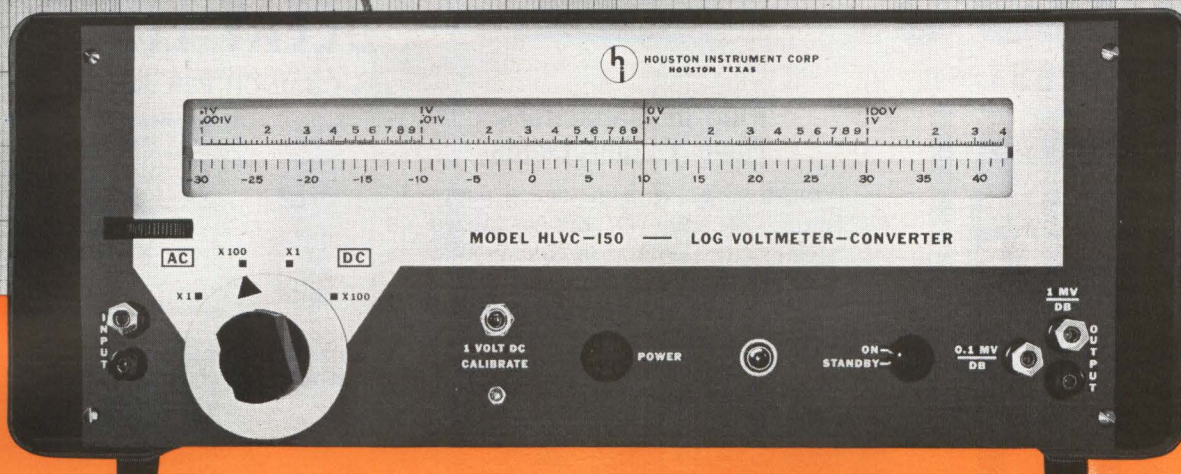

NEW DESIGN PRINCIPLE PERMITS MEASUREMENTS ACCURATE TO 0.2 db OF AC OR DC VOLTAGES OR VOLTAGE RATIOS ON TRUE LOGARITHMIC SCALE OVER 3160:1 OR 70 db CONTINUOUS RANGE

DC OUTPUT FOR RECORDING  60 db/sec SLEWING SPEED  MODEL HLVC150 \$1450.



**houston instrument** corporation

4950 Terminal Avenue / Bellaire 101, Texas

MOhawk 7-7403 / Cable HOINCO

TWX 713-571-2063

Write for 8-page Brochure

CIRCLE 203 ON READER SERVICE CARD

**Higher Reliability  
& Greater Stability**  
by Passivation.  
**Lower Price**  
by Resin Molding Process

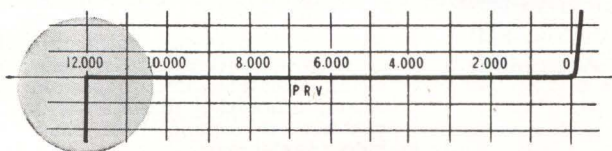

Sharp Reverse Breakdown.  
Unchangeable by Time  
or Environment.

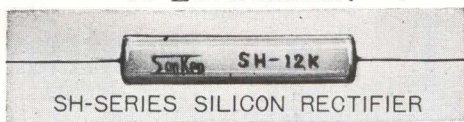

SH-SERIES SILICON RECTIFIER

For Low Power Supplies  
SD-1 Series

For High Power Supplies  
SH-Series

SD-1	400 PRV	500 mA
SD-1A	600 PRV	500 mA
SD-1B	800 PRV	500 mA
SD-1C	1000 PRV	500 mA

SH-6K	6000 PRV	30 mA
SH-8K	8000 PRV	30 mA
SH-10K	10000 PRV	30 mA
SH-12K	12000 PRV	30 mA

**SanKen SANKEN ELECTRIC CO., LTD.**

Daiwa Bldg., 1-11, Ikebukuro-Higashi, Toshima-ku, Tokyo

Cable: SANKEL TOKYO

CIRCLE 204 ON READER SERVICE CARD

**CHECK  
TENSION  
QUICKLY**

WITH THE  
**GENALEX  
TENSION  
GAUGE**

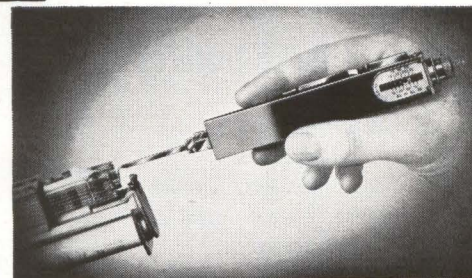

FOR checking the tension of springs or similar resistive forces.

- Most precise
- Easiest to read

Available in six tension ranges from 4 to 2500 grams

for free illustrated leaflet, write to



11 UNIVERSITY ROAD, CAMBRIDGE 38, MASS.

CIRCLE 103 ON READER SERVICE CARD

103

# WORLD'S SMALLEST DIGITAL VOLT- METER

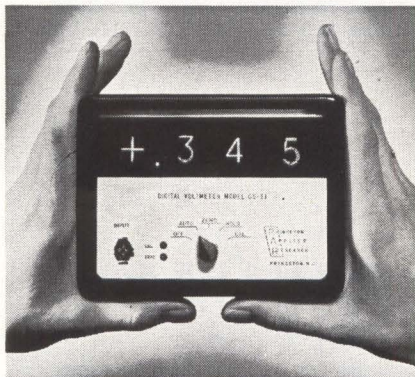

with all of these features:

- automatic ranging
- automatic polarity
- 10 meg input impedance
- >100 db common mode rejection
- truly floating differential input
- 0.1% absolute accuracy
- 1 millivolt sensitivity
- solid state / reed relay design
- rugged printed circuit construction
- no stepping switches
- price: \$995.00
- measures only 6½" wide, 5" high, 8" deep. Weighs 9 lbs. Model CS-3.1

Write for Bulletin No. 107

**PAR** PRINCETON APPLIED RESEARCH CORP.

Box 565, Princeton, New Jersey  
Tel: 799-1222, area code 609

positions is eliminated by a special detent design. Engineered Electronics Co., 1441 E. Chestnut Ave., Santa Ana, Calif.

CIRCLE 312, READER SERVICE CARD

## Plug-In Capacitors Have Radial Leads

CONSTRUCTED with metalized paper (series M and W) and metalized Mylar (series D), in rectangular epoxy-case styles, these capacitors are offered in voltage ratings of 100 to 600 v d-c. The 100 v, series D, utilizes new thin film 0.00015 in. Mylar, permitting even greater miniaturization. Operating temperature range is - 55 C to + 125 C. Capacitance values of 0.001 through 8.0  $\mu$ f, with tolerances of  $\pm$  1 percent are available. The capacitors are designed for a-c and d-c printed-

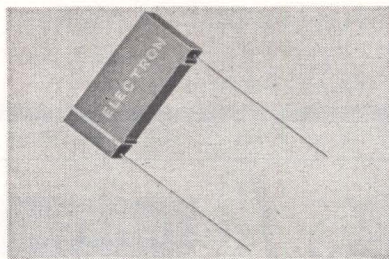

circuit applications, blocking, coupling, by-pass, filtering, power factor correction, and the like, where high reliability and excellent transfer characteristics are required. Electron Products Division of Marshall Industries, 1960 Walker Ave., Monrovia, Calif. (313)

## Teflon Terminal Doubles as Probe

PRESS-FIT Teflon feed-through terminal, FT-SM-16 L14, is announced. The upper portion of the brass lug (0.125 in. long) is designed to be used as a 0.040 in. diameter probe since its tolerance is held to  $\pm$  0.001 in. The feed-through has a Teflon bushing with a minor diameter of 0.093 in. and a major diameter of 0.125 in. Bushing material is virgin-pure Teflon and units are available in any of the ten standard EIA colors. Sealectro Corp., 139 Hoyt St., Mamaroneck, N. Y. (314)

## NEW MINIATURE DELAY LINES

¼ CU. INCH PER  $\mu$ SEC.

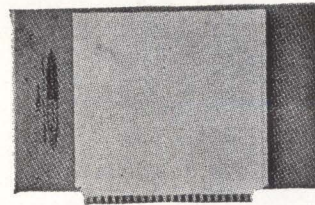

Total delay of 24.65  $\mu$ sec. in a 4½" x 4" package



- Total weight: 8½ oz.
- Total delay accuracy better than ½ of 1%
- Total delay to rise time ratio better than 40:1
- Distortion under 4%
- Temp. coefficient: 50 ppm  $\pm$  20 ppm/°C

WRITE FOR DETAILS

Opening exists for a Delay Line Design Engineer

**ADMIRAL PALO ALTO**

Palo Alto Division of Admiral Corporation  
Stanford Industrial Park, Palo Alto, California

CIRCLE 205 ON READER SERVICE CARD

- SCAN CONVERSION
- FLICKERLESS DISPLAY STORE
- VIDEO STORAGE

## RECORDING STORAGE TUBE SYSTEMS

Single-gun, dual-gun, multi-tube systems to convert scan for radar, sonar, television, and to perform analog processing, data analysis, contract or expand time scale, auto correlation.

- SLOWED TELEVISION TRANSMISSION

by telephone line or other narrow-band systems.

- IMAGE ENGINEERING

OPTICAL CHART READERS, FLYING SPOT SCANNERS, LOW-LIGHT-LEVEL CAMERAS, and IMAGE RECTIFICATION. Automatic inspection and recognition of size, shape, color, and texture.



Write or call for complete information:

**IMAGE INSTRUMENTS, Inc.**

2300 Washington Street  
Newton 62, Massachusetts  
617 WOODWARD 9-8440

CIRCLE 206 ON READER SERVICE CARD

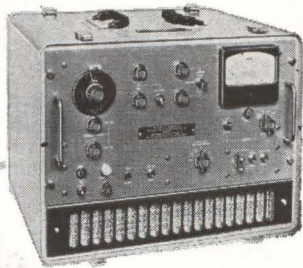

**ACTON**

**Precision Delay Transmitter 451-A**—Generates carrier frequency, automatically or manually swept from 200 cps to 12kc (extendable to 24kc with external oscillator), —20 dbm to +10 dbm output range into 600 ohm line.

**TELEPHONE**

**AND DATA LINE**

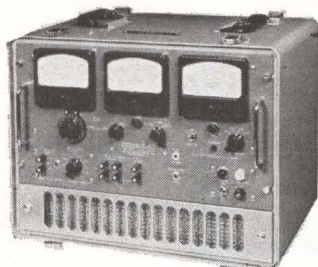

**Precision Delay Receiver 452-A**—Used with 451-A, measures relative delay and amplitude on direct reading scale. 2 millisecond scale conveniently positionable in 10x scale. 600 ohm input.

## Precision Delay Measurement

- 0-20, 0-2 millisecond delay ranges
- 200 cps to 12kc (extendable) frequency range
- Accurate to 50 microseconds
- Direct reading delay time

453-A Delay Transmitter-Receiver set available for applications where input and output are at same location.



Send for 451-2 Data Page

**ACTON**

533 Main Street  
Acton, Massachusetts

A Subsidiary of Bowmar  
Instrument Corporation

Laboratories, Inc. ©1963 ACTON LABORATORIES, INC.



CIRCLE 207 ON READER SERVICE CARD

electronics October 18, 1963

# FOUR NEW WAYS TO HOUSE MICROFUSES\*



Front panel mount (hexagon nut rear of panel). Aluminum body, knurled cap; can be anodized in color. Fungus, shock resistant. Sealing "O" rings in cap, on body.



Rear panel mount (round nut front of panel). Aluminum body, knurled cap; can be anodized in color. Fungus and shock resistant. Sealing "O" rings in cap, on body.



Front panel mount (hexagon nut rear of panel). Molded from dielectric material. Knurled cap. Rugged "Eye" type brass terminals; barrier provides full insulation.

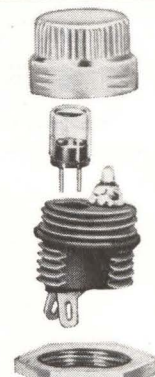

Indicating Microfuse holder—when the fuse blows indicating bulb glows. Serrated, transparent knob. Molded from dielectric material. Voltage ranges, 2½ to 125 volts.

Microfuses achieve low fuse resistance values with high reliability in ultra-fast blowing characteristics. Microfuses can be hermetically sealed, suitable for potting applications. Glass enclosed visible filament. Microfuses available in 1/500 through 5 amps at 125V. Short circuit interrupting capacity 125 V—10,000 amps. DC.

## LITTELFUSE

DES PLAINES, ILLINOIS

\*Products shown actual size

CIRCLE 105 ON READER SERVICE CARD

105

# DYNAMICS TEST INSTRUMENTS

—compact tape recorder monitor provides simultaneous voltage metering of 13 data channels

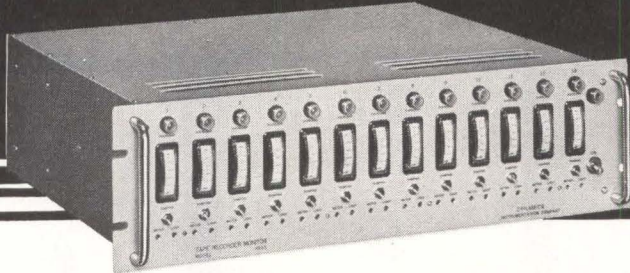

Model 4995 combines 13 ac voltmeters into a package only 5 1/4" high x 19" wide x 16" deep. Each meter reads 1 volt rms full scale. Peak rms signals in excess of 1 volt energize neon lamps—visually indicating an overscale condition. Isolated from power ground. All signal commons are tied together but floated from cabinet ground. Double-shielded transformers assure maximum isolation from the power line.

Input voltage range: 0-1 volt rms.  
Frequency range: 1.7 cps to 30 kc.  
Metering: 0-1 volt rms full scale indication.  
Overload neon indicators: illuminate on peak of rms signals in excess of 1.0 volt rms.

Write for literature on Model 4995, or the complete line of Dynamics test instruments and signal conditioning equipment.

**DYNAMICS INSTRUMENTATION COMPANY**  
583 Monterey Pass Rd., Monterey Park, Calif. • Phone: CU 3-7773

**CIRCLE 208 ON READER SERVICE CARD**

## CAPLEXER®

### Capacitive Sampling Multiplexer



Patent Applied for

#### Series OM2000

This unique technique provides the sampling and holding of each individual input signal.

- Full scale inputs of  $\pm 25$  mv to  $\pm 10$  volts
- Accommodates mixed input levels
- Single ended or balanced (floating) inputs
- High common mode rejection
- Integral sampling filters available
- Sampling rates as high as 200 kc
- Sampling apertures as low as  $0.25 \mu\text{sec}$
- Binary address, sequential or manual channel selection with active channel display
- Airborne or ground based models available
- Models for remote operation with full accuracy
- Simultaneous sampling can be included



Designers and manufacturers of CAPCODER and CAPLEXER Capacitive Charge devices

**TOWSON LABORATORIES, INC.**

200 E. JOPPA RD. • BALTIMORE 4, MD. • AREA CODE 301 • 825-6361

106 CIRCLE 106 ON READER SERVICE CARD

## —LITERATURE OF

**ENGINEERING HANDBOOK** Spaulding Fibre Co., Inc., 310 Wheeler St., Tonawanda, N. Y. A 24-page brochure reviews the company's entire spectrum of engineered material for industry covering applications and specifications in detail.

CIRCLE 400, READER SERVICE CARD

**SEMICONDUCTOR TESTERS** American Electronic Laboratories, Inc., Richardson Road, Colmar, Pa., announces a 4-page bulletin, No. 80-6, describing an integrated group of four semiconductor testers. (401)

**FILM SPROCKETS** Lavezzi Machine Works, 4635 West Lake St., Chicago, Ill. 60644. Brochure SP-55 deals with sprockets used to drive any type of film or tape with rectangular perforations. (402)

**MAGNETIC PROBE** FW Bell Inc., 1356 Norton Ave., Columbus, O., 43212. Bulletin describes the Magna-Probe which utilizes a high sensitivity Hall-Pak in a flux concentrator type of field probe to increase the sensitivity of Bell gaussmeters by 100 times. (403)

**TAPE SEARCH SYSTEM** Astrodata Inc., 240 East Palais Road, Anaheim, Calif. Four-page technical bulletin covers model 6222 universal automatic tape search system. (404)

**LIGHT-ACTUATED POTENTIOMETER** Gianini Controls Corp., 1600 S. Mountain Ave., Duarte, Calif. A 4-page bulletin describes Photopot, a light-actuated, frictionless potentiometer. (405)

**PORTABLE SERVO INDICATOR** General Precision Aerospace, 1150 McBride Ave., Little Falls, N. J. Catalog bulletin covers a portable servo indicator, which consists of an angle position indicator module together with supplementary switch gear and accessory cables. (406)

**VARACTOR DIODE HOUSINGS** Metalized Ceramics, 25 Acorn St., Providence 3, R. I. Bulletin M-911 describes metalized ceramic packages for high-reliability semiconductors. (407)

**ELECTRO-OPTICAL DEVICES** Radio Corp. of America, Harrison, N. J. Six publications covering injection-laser and optical-diode applications and data on a developmental line of optical devices are now available. (408)

**COMPONENTS** Cambridge Thermionic Corp., Cambridge, Mass., offers an engineering design catalog of the more than 15,000 types of guaranteed Cambion electronic components. (409)

**SYNCHROS** Vernitron Corp., 52 Gazza Blvd., Farmingdale, N. Y. Publication CS/TS-4-11-1 lists electrical and mechanical characteristics of a line of Thru-Bore synchros, size 11, 400 cycles. (410)

**SPACEBORNE INSTRUMENTS** The Scionics Corp., 8900 Winnetka Ave., Northridge, Calif. Data sheet describes a line of sensing and signal conditioning devices designed for spaceborne applications. (411)

October 18, 1963 electronics

## THE WEEK

**STRIP CHART RECORDER** Hagan Controls Corp., Box 11606, Pittsburgh, Pa. 15228. Two-page bulletin describes the Optimac miniature electronic strip chart recorder. (412)

**RESIDUAL GAS ANALYZER** Vacuum-Electronics Corp., Terminal Drive, Plainview, L. I., N. Y. Brochure on the GA-3 residual gas analyzer points out applications in R&D, solid-state physics, electronics, and aerospace. (413)

**TELEMETRY CATALOG** Sonex, Inc., 20 E. Herman St., Philadelphia, Pa., has published a 56-page catalog describing its entire line of telemetry components and systems. (414)

**AMPLIFYING SYSTEM** Hamner Electronics Co., Inc., P. O. Box 531, Princeton, N. J. A 2-page brochure covers a low-noise amplifying system for solid-state radiation detectors. (415)

**D-C VOLTAGE REGULATOR** Baldwin-Lima-Hamilton Corp., Waltham, 54, Mass. Data sheet illustrates and describes model 720 series miniature, high-performance d-c voltage regulator for aerospace and other rugged vehicular applications. (416)

**WIRE & CABLE** Tensolite Insulated Wire Co., Inc., West Main St., Tarrytown, N. Y. A 24-page facilities brochure uses 51 photos and captions to follow each step in the production of high temperature wire and cable. (417)

**UNREGULATED POWER MODULES** Valor Instruments, Inc., 13214 Crenshaw Blvd., Gardena, Calif. Unregulated power modules that feature capacitive filtering and low ripple are described in a catalog data sheet. (422)

**TRAVELING-WAVE AMPLIFIER** Watkins-Johnson Co., 3333 Hillview Ave., Stanford Industrial Park, Palo Alto, Calif. Technical bulletin covers the WJ-257 Ku-band low-noise traveling-wave amplifier. (423)

**TOROIDAL COILS** Collins Radio Co., 19700 San Joaquin Road, Newport Beach, Calif. Bulletin No. 520-6366-00, listing an extensive line of toroidal coils, is now available. (424)

**FREQUENCY METERS** Rohde & Schwarz, P.O. Box 148, Passaic, N. J. Four compact frequency meters, which provide accurate measurements from 10 kc to 4.2 Gc, are described in a 4-page bulletin. (425)

**POTENTIOMETERS** Borg Electronics, a division of Amphenol-Borg Electronics Corp., Janesville, Wisc. Short form catalog contains data on Micropot precision potentiometers, Micropot trimmers and Microdials. (426)

**PLUG-IN POWER SUPPLIES** Acopian Technical Co., 927 Spruce St., Easton, Pa. Bulletin covers dual output, a-c to d-c, all-transistor, regulated plug-in power supplies. (427)

**LASER SYSTEM** Maser Optics, Inc., 89 Brighton Ave., Boston 34, Mass., has released a bulletin describing the 3100 laser head and power supply. (428)

# NEW! BALLANTINE SENSITIVE TRUE-RMS RF MILLIVOLTMETER

Measures 300  $\mu$ V to 3 V  
from 0.1 Mc to 1,000 Mc

Measures True-RMS regardless of Waveform and Voltage

High, Uniform Accuracy and Resolution over entire 5-inch scale



Model 340  
Price \$760  
(with all accessories\*)

Ballantine's new Model 340 is an extremely sensitive RF millivoltmeter designed for accurate True-RMS measurements with high resolution. Its 5-inch voltage scale spreads out the readings logarithmically so that you can make measurements to the same high resolution and accuracy at the bottom as at full scale. This advantage means that you can not only measure voltages accurately, regardless of waveform, but also calibrate the 340 using a signal source that may be far from sinusoidal. The new 340 is now available in both portable and rack versions.

### SPECIFICATIONS

Voltage Range.....	300 $\mu$ V to 3 V	Crest Factor.....	100 to 3 depending on voltage range
Frequency Range.....	0.1 Mc to >1,000 Mc; calibrated to 700 Mc	Scales.....	Two logarithmic voltage scales, 0.95 to 3.3 and 3.0 to 10.6. One decibel scale, 0 to 10
Indication.....	True-RMS on all ranges, all voltages	Mean Square DC Output...	0.1 V to 1.0 V dc. Internal resistance 20 kilohms. (For connection to recorder.)
Accuracy...% of Reading	0.1 Mc - 100 Mc, 4%; 100 Mc - 700 Mc, 10%; above 700 Mc as sensitive indicator		

\*Accessories include a probe tip for in-circuit measurements, an adapter for connection to N or BNC, a T adapter for connection to a 50 ohm line, and a 40 db attenuator

Write for brochure giving many more details

- Since 1932 -

**B** BALLANTINE LABORATORIES INC.  
Boonton, New Jersey

CHECK WITH BALLANTINE FIRST FOR LABORATORY VACUUM TUBE VOLTMETERS, REGARDLESS OF YOUR REQUIREMENTS FOR AMPLITUDE, FREQUENCY, OR WAVEFORM. WE HAVE A LARGE LINE, WITH ADDITIONS EACH YEAR. ALSO AC/DC LINEAR CONVERTERS, CALIBRATORS, WIDE BAND AMPLIFIERS, DIRECT-READING CAPACITANCE METERS, AND A LINE OF LABORATORY VOLTAGE STANDARDS 0 TO 1,000 MC.

## GE Elects Borch President



R. J. Cordiner



F. J. Borch

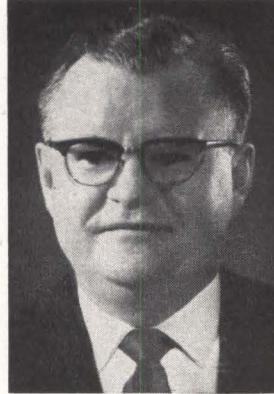

G. L. Phillippe

**GENERAL ELECTRIC** chairman Ralph J. Cordiner has announced that the board of directors has elected Fred J. Borch president and chief executive officer of the company and Gerald L. Phillippe chairman of the board, both appointments effective December 21.

Cordiner also announced that as of that date he will retire as chairman of the board after 13 years as General Electric's chief executive, initially in the capacity of president and since 1958 as chairman of the board.

In announcing the election of Borch and Phillippe, Cordiner said these appointments "represent an orderly succession in General Electric leadership" and pointed out that "both men have proved outstanding leaders in meeting a series of deliberately challenging assignments over a period of many years."

Borch is currently executive vice president-operations and a member of the board. In that capacity he has had responsibility for the operating components of the company on a world-wide basis.

Phillippe moves to the position of chairman from the post of president, to which he was elected in 1961. He has been a member of the board since that date.

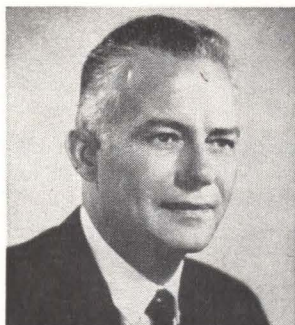

### Veeder-Root Names Kes Vice President

APPOINTMENT of William Kes as vice president of engineering and

research for Veeder-Root Inc., Hartford, Conn., manufacturer of counting, controlling, and recording instruments, has been announced.

Kes most recently had been vice president of manufacturing for the Hazeltine Corp., Little Neck, N.Y.

### Astro-Space Appoints Execs

ASTRO-SPACE Laboratories, Inc., Huntsville, Ala., has announced the appointment of Frederick K. Mueller as chairman of the board of

directors and Joseph C. Brenner as vice president and general manager.

Mueller will also continue in his present post as vice president of research and development. Brenner has, in addition, been appointed a member of the board of directors.

Mueller has been with Astro-Space since early 1960, when he resigned as deputy director of the Guidance and Control Laboratory, U.S. Army Ballistic Missile Agency to join the newly-formed company. He was a member of the German-born team of missile experts who worked at ABMA under Wernher von Braun and had been associated with the early development of rocketry in Germany.

Brenner, a new member of Astro-Space, was formerly vice president and general manager of Radio Receptor Co., Brooklyn, N.Y., and before that was associated with Sperry Gyroscope Co. for 23 years, the last six as vice president. Brenner, who is also German-born, came to this country prior to World War II.

Astro-Space Laboratories designs and develops gyroscopic devices, inertial navigation systems and medical electronic devices.



### Zillger Purchases Standard Electronics

STANDARD ELECTRONICS Corporation has been bought by William H. Zillger, its former vice president and general manager. Under the direction of its new owner, the corporation executive offices and production and research facilities will be located on or about January 1, 1964 in a new plant in Manalapan Township, Monmouth County, N.J. Tem-

# BENDIX-PACIFIC TXV-302 FM TELEMETRY TRANSMITTER

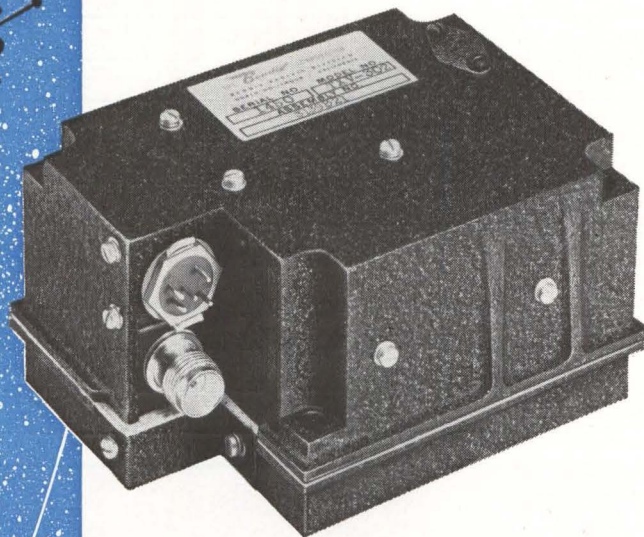

*WIDER RESPONSE  
FOR PROPOSED  
SUBCARRIER BANDS*

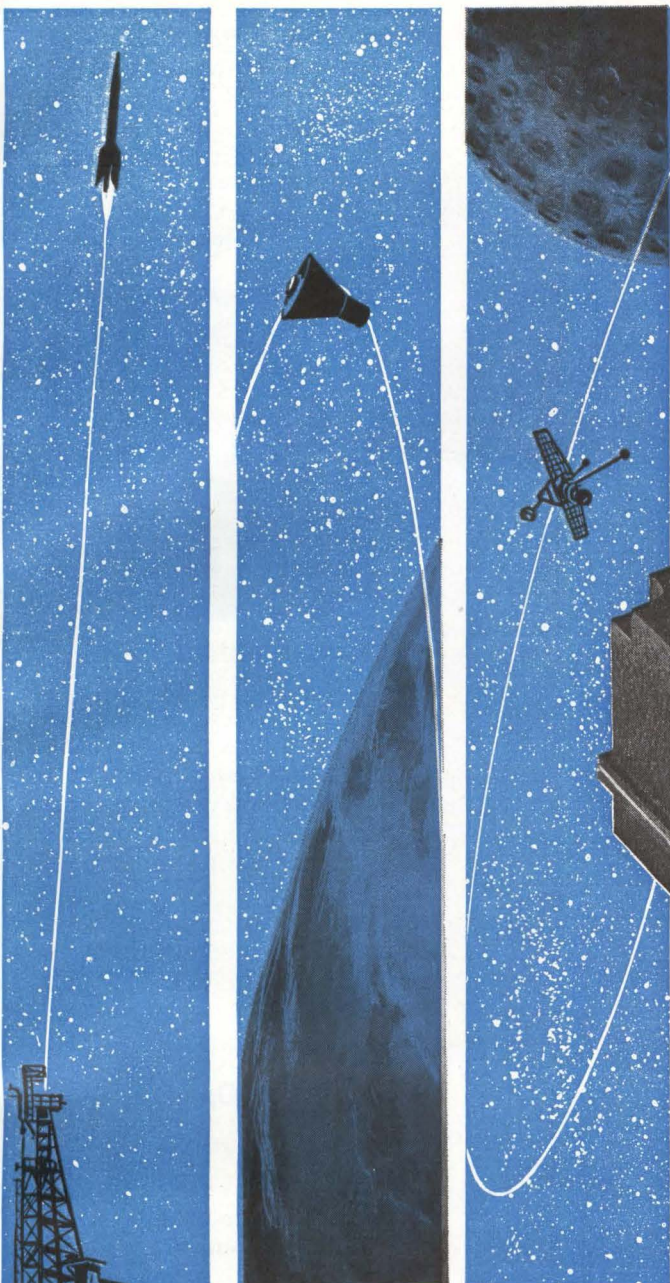

The Bendix TXV-302 is a solid state FM VHF transmitter designed for missile and space vehicle telemetry applications. The extended modulation frequency response will permit operation with the newly proposed high frequency subcarrier bands. Nominal power output is 2 watts in the 225-265 megacycle telemetering band.

Exact electronic and packaging design techniques assure precise operation under severe environmental conditions. Extensive use of cast aluminum structures gives the transmitter rigidity and excellent thermal characteristics.

*For detailed specifications, contact Bendix-Pacific, North Hollywood, California.*

#### BRIEF SPECIFICATIONS

Frequency Response	300 cps to 200 kcs
Deviation Sensitivity	100 kc/volt, adjustable
Distortion	Less than 1.0% for $\pm 150$ kcs deviation
Output Power	2.0 watt nominal
Power Supply	28 $\pm 1.5$ V DC at 700 ma max.
Temperature	-20°C. to +85°C.
Vibration	15g
Pressure-Altitude	Unlimited
Size & Weight	3.01 x 4.00 x 2.36 in. 1.3 lb.

**Bendix-Pacific Division**



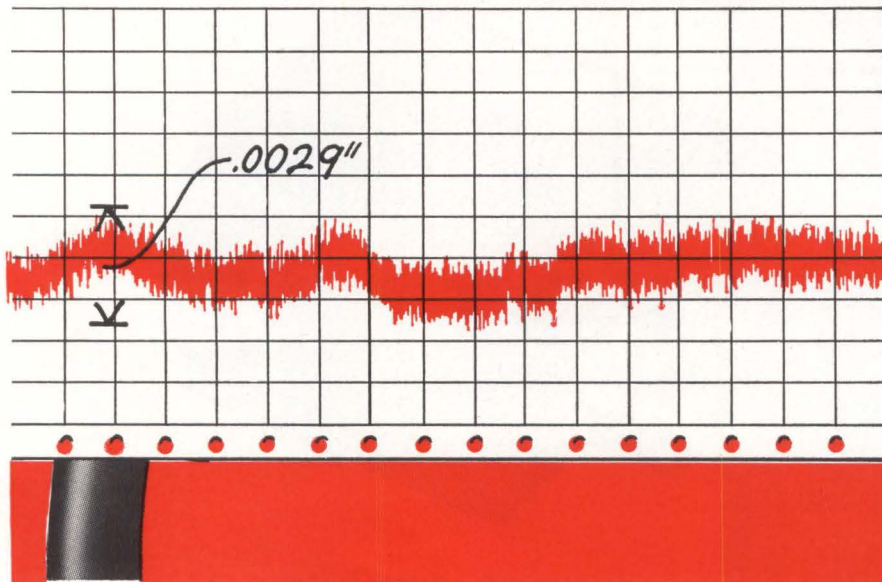
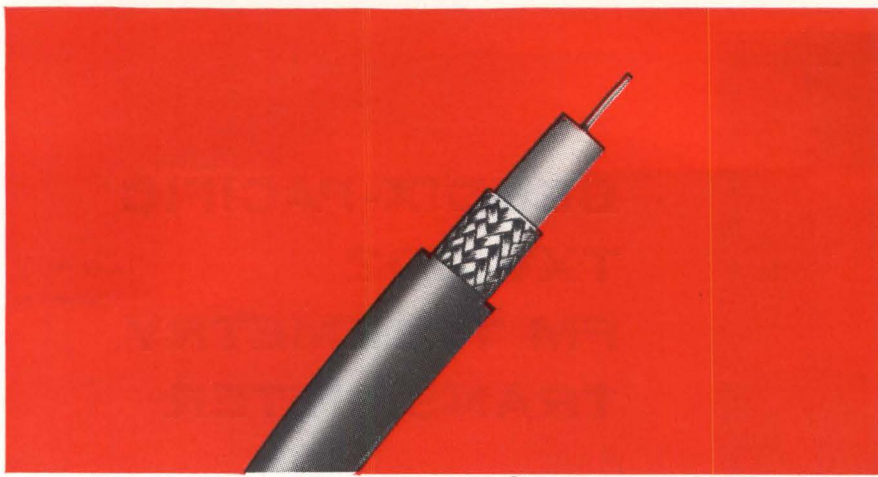

## Gov't spec tolerances $\pm .004$ ; Royal RG-59/U coax twice that good!

The graph above shows the variation in diameter for nearly one mile of ITT Royal coax, type RG-59/U. Over the entire length the maximum variation was less than  $\pm .0015$ .

This kind of mechanical perfection is important. Every variation in coax dimension means a variation in impedance and capacitance. Every impurity of materials or lack of homogeneity of the dielectric changes the specified electrical values of the cable.

Whether it's RG-59/U or any of the other 69 standard types of coax, ITT Royal consistently produces superior cable and wire at competitive prices.

Write for information, or see your nearest ITT distributor. Royal Electric Corporation, a subsidiary of International Telephone and Telegraph Corporation, Pawtucket, R. I.

# ITT ROYAL

porary headquarters are in operation now in Red Bank, N.J.

Standard Electronics specializes in the manufacture of television and radio transmitting equipment for the broadcasting industry and military use.



### Appoint Stephan Daven General Manager

GEORGE B. STEPHAN of General Mills has been named general manager of the Daven division of the company. He has assumed his new duties at the Livingston, N.J., headquarters of the division.

Stephan had been director of research and engineering for General Mills' Electronics division.

### Potter Opens New Plant

AN EARLY PIONEER in electronic component manufacturing, the 39-year-old Potter Company of Skokie, Ill., and Brookhaven and Wesson, Miss., has opened its new West Coast division headquarters at Anaheim, California.

John Ruane, company president, explained that the new facility includes a research and development section specializing in experimental electronics and custom circuit design; an electromagnetic compatibility laboratory, and complete manufacturing facilities for production of capacitors and filters of all types.

"Our West Coast division," he said, "is staffed by men who have been with the company for many years. They are all graduate engineers with special training in the area occupied by the company."

The executive staff includes David Youngquist, vice president; William Johnson, director of engi-



# BARKER & WILLIAMSON



## ELECTRONIC EQUIPMENT FOR COMMERCIAL APPLICATIONS



Models DL-2K and DL-6K



Model RDL-100



Model DL-500



Model BBC-3.5K



Model HFR-100A

PLEASE  
WRITE FOR  
FURTHER  
INFORMATION

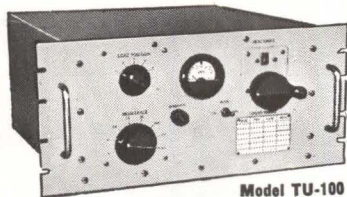

Model TU-100

### Dummy Loads and Antenna Terminators Models DL-2K and DL-6K.

Frequency range: DC to 30 MC. Power rating: 2 KW and 6 KW. Available nominal impedance values: 600 ohm balanced, 50-70-300 ohms unbalanced.

**Dummy Load and Antenna Terminator Model RDL-100.** Frequency Range: DC to 30 MC; Power rating: 100 watts. Available in nominal impedance values: 600-700 ohms balanced and 300 ohms unbalanced.

**Dummy Load and Antenna Terminator Model DL-500.** Frequency range: DC to 30 MC. Power rating: 500 watts. Available nominal impedance values: 600 ohms balanced, 50-70-300 ohms unbalanced.

**High Power Broadband R.F. Choke Model BBC-3.5K.** Designed for application in continuous coverage H.F. transmitters. Rated up to 2.5 KW (PEP or CW) output. Model BBC-5K for outputs up to 4 KW also available.

**H. F. Receiver Model HFR-100A.** Provides reliable reception of 1SB, SSB, DSB (AM), CW and FSK. Front end is continuously tunable from 2 to 30 MC. Input provided for external variable frequency oscillator or frequency synthesizer. Ideal for multi-channel narrow frequency shift, data handling systems, space and diversity operation.

**Whip Antenna Tuning Units—Models TU-100, TU-1K, TU-2.5K.** Designed for resonating electrically short vertical antennas in the 2-30 MC range. VSWR indicator for tuning a whip antenna is an integral part of the circuit. Suitable for mobile use in a communications shelter.

## BARKER AND WILLIAMSON, INC.

BRISTOL - PENNSYLVANIA  
Telephone: 215 - 788 - 5851

CIRCLE 209 ON READER SERVICE CARD

# Printed circuits that STAY STUCK

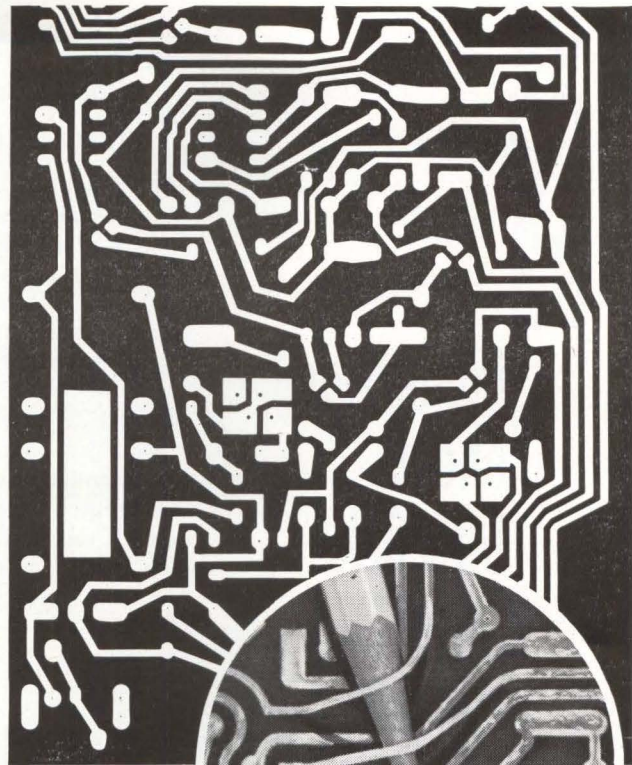

## NONE OF THIS

Printed circuits may pull away from the laminate during the soldering operation. To reduce this possibility—to practically eliminate it—Synthane produces a special glass epoxy base grade of copper clad—G-10R—with high HOT PEEL STRENGTH (2 to 4 lbs. per inch of width after immersion for 15 secs. at 500°F\* as compared with the usual 0.1 to 0.2 lbs. per inch of width). G-10R also meets or exceeds NEMA and MIL specs for Room Temperature Peel Strength. Write for folder of all Synthane metal-clad grades.

\*Tests made on 1/16" and 1/8" wires.

# SYNTHANE

CORPORATION **S** OAKS, PENNA.

Glendale 2-2211 (Area Code 215) TWX 215-666-0589

Synthane-Pacific, 518 W. Garfield Ave., Glendale 4, Calif. TWX 213-240-2104U

Synthane Corporation, 36 River Rd., Oaks, Pa.

Gentlemen:

Please send me your latest folder on Synthane G-10R and other Synthane copper-clad laminates.

Name \_\_\_\_\_

Address \_\_\_\_\_

City \_\_\_\_\_ Zone \_\_\_\_\_ State \_\_\_\_\_

CIRCLE 111 ON READER SERVICE CARD

111

90  
91  
92  
93

industries  
chose  
**SUFFOLK  
COUNTY**  
because

no other county in the rich, multi-billion dollar Tri-State-Market, offers such a unique spectrum of industrial assets. Want to know exactly WHY 93 industries chose Suffolk County since January 1962? Send for your FREE copy of the colorful, 44 page, INDUSTRIAL FACT FOLDER, today. It's crammed full of pictures—maps—vital statistics—everything you want to know. It's the complete Suffolk Story at your fingertips. Just write to:



Commissioner John H. Stevenson  
**SUFFOLK COUNTY**  
DEPARTMENT OF  
COMMERCE & INDUSTRY  
1135 Old Walt Whitman Road  
Melville, N. Y. • 516 HA 7-2540

neering and quality control; John Mulé, director of manufacturing; and Lanny Quigley, sales manager for the Potter Company.

**Philco Corporation**

**Hires Prihar**

APPOINTMENT of Zvi Prihar as director-advanced communications systems for Philco Corporation's Communications and Electronics division in Philadelphia is announced. His responsibilities will include the expansion of Philco's work in the fields of conventional and task-oriented communications.

Prior to joining Philco, Prihar was scientific advisor to the director of research and development of Page Communications Engineers, Inc., Washington, D.C., where he was also active in space communications and in complex network studies.



**Burke Accepts  
Additional Post**

APPOINTMENT of Richard J. Burke as manager of the Systems division of Huggins Laboratories, Inc., Sunnysvale, Calif., is announced.

Burke will also continue as president of Applied Systems Corporation, Palo Alto, Calif., which recently became a wholly-owned subsidiary of Huggins Labs.

**Announce Formation of  
New Company**

J. R. WOLTER, president of Ovenaire, Inc., Charlottesville, Va., and Croven, Ltd., Whitby, Ontario, Canada, has announced the forma-

**ELECTRICAL  
ENGINEERS**

Melpar's Engineering Division has immediate need for engineers in the areas noted below. These openings include positions of major responsibility for Senior Engineers as well as unusual opportunities for advancement for recent graduates.

**MICROWAVE  
RECEIVER DESIGN**

Specific problems include parametric amplifiers, varactor techniques, microwave filters, ultrastable programmable oscillators and dual and triple channel balanced receivers for monopulse and guard antenna gating.

**SYSTEMS DESIGN**

For the logic design of digital equipment, specifying necessary digital/analog interface equipment, the analysis of real-time flight simulation systems and the design of analog computer systems for flight simulators.

**ANTENNA DESIGN**

Working with modern techniques of achieving narrow beam, low side-lobe, d/f antennas in the microwave region. Must have a strong theoretical background.

**PROGRAMMING**

To write and debug programs for fixed-point real-time computers to be used with special purpose digital and analog equipment for the real time simulation of aircraft.

For further details, write in strictest confidence to:

**John A. Haverfield**

Manager, Professional Placement

**MELPAR INC.**

(A Subsidiary of Westinghouse  
Air Brake Company)

3428 Arlington Boulevard  
Falls Church, Virginia

(a suburb of Washington, D. C.)  
an equal opportunity employer

# SPECIFY HITACHI POWER TRIODES FOR THOSE SEVERE OPERATIONS

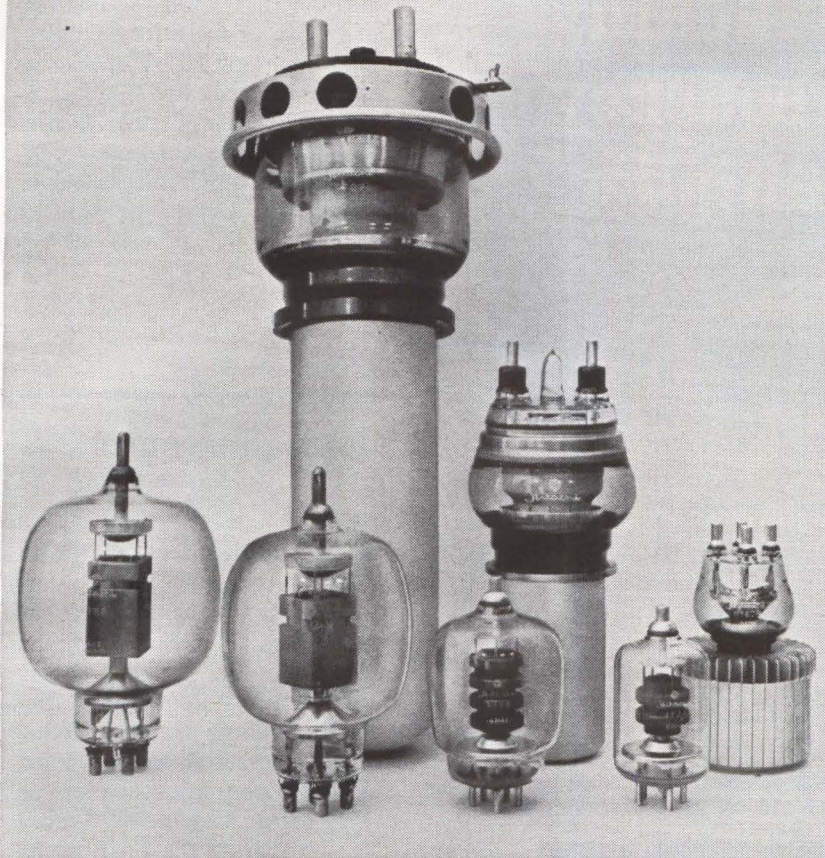

Here is a range of power triodes specially designed for tough industrial applications. They are all high-perveance types with outstanding safety factors, both mechanically and electrically, to provide stable and efficient performance under severe operating conditions such as widely varying loads and frequent on-off operations.

## ■ SPECIFICATIONS :

Characteristics		Type								
		4T22	5T23	6T40	6T50	7T62R	8T74	8T75	9T27	
Filament Voltage (V)		5	5	5	6.3	6.3	6	8	11	
Filament Current (A)		8	15	32.5	32.5	32.5	200	200	300	
Transconductance (m $\mu$ S)		6.7	8.3	3.3	5.1	5.8	25.0	30.0	55.0	
Amplification Factor		20	20	21	22	25	24	24	31	
Frequency for Max. Ratings (MC)		80	80	50	50	50	30	30	25	
Dimensions	Length (mm)	140	148	235	251	178	330	460	610	
	Diameter (mm)	68	99	126	150	106	140	170	234	
Max. Ratings for Class C Telegraphy	DC Plate Voltage (KV)	3.0	3.0	5.0	6.0	7.5	12.0	12.0	15.0	
	DC Grid Current (A)	0.12	0.18	0.21	0.30	0.30	0.85	1.25	1.6	
	Plate Dissipation (KW)	0.15	0.25	0.5	0.8	1.5	20.0	35.0	60.0	
Typical Operation for Class C Telegraphy	DC Plate Voltage (KV)	2.5	2.5	4.0	6.0	7.0	12.0	12.0	12.0	
	Power Output (KW)	0.41	0.76	1.65	2.84	3.7	43.0	67.0	105	

## ■ APPLICATIONS :

Types 4T22, 5T23, 6T40, 6T50 and 7T62R are medium power triodes, convection or forced air-cooled, for use as oscillator or amplifier valves in di-electric heating and ultrasonic equipment. They permit much higher ratings in intermittent operations.

Types 8T74, 8T75 and 9T27 are high power water-cooled triodes especially suitable for induction heating RF generators. Their special construction yields high perveance as well as superior mechanical ruggedness.

Power triodes are another example of quality electronics from Hitachi, manufacturer of more than 10,000 basic products for the home and industry.

### Hitachi New York, Ltd.

666, 5th Avenue, New York 19, N.Y., U.S.A. Tel: JUDson 6-4757

### Hitachi, Ltd., Chicago Office

333 N. Michigan Avenue, Chicago 1, Ill., U.S.A. Tel: 726-4572/4

### Hitachi, Ltd., Düsseldorf Office

Graf Adolf Strasse 37, Düsseldorf, West Germany Tel: 10846

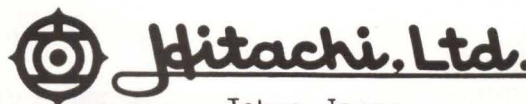

Tokyo Japan

Cable Address: "HITACHY" TOKYO

NOW  
AVAILABLE  
AT CEI

XXXXXX  
Type SFM-1  
Standard  
Frequency  
Multiplier



The SFM-1 Standard Frequency Multiplier is designed to take a 1-mc standard reference frequency signal and multiply it up to 50, 100, 500 and 1000 mc. This provides a VHF and UHF signal source with the same stability and accuracy as the reference source. All four output signals are available simultaneously at the rear panel.

**Communication Electronics Incorporated**  
4908 HAMPDEN LANE, BETHESDA 14, MARYLAND

CIRCLE 210 ON READER SERVICE CARD

from Stock...

**SOLID BEARING STEEL or  
New! EXTRUDED ALUMINUM  
BALL-BEARING SLIDES**

Slides for your every need—wide range, fully MIL spec, slim design, easy installation. Quick-release, tilt, tilt-lock or non-tilt models.

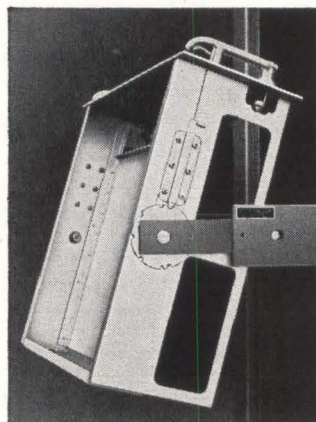

**ZERO-TRAK**

Extra strong construction. Exceptional rigidity. Endure high shock loads and vibration. 175 or 275 lbs capacity. 10"-24" long. With or without rollers.



**ALUM-A-TRAK**

Extruded Al alloy. 200-lb load. 15"-24" long. All-ball-bearing or quick-release ball-bearing-and-roller combinations. Clear anodize finish is standard.

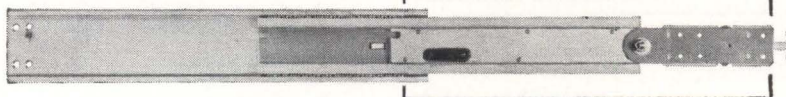

Check nearest "Rep" in E. E. M. or call factory "collect" for complete data and/or demonstration

area code 213-849-6825

Also available:

light, compact slides (50-lb load— $\frac{1}{4}$ " x  $1\frac{3}{4}$ " ) and extra-heavy-duty custom slides to 1,000 lbs capacity

**WESTERN DEVICES, INC.**

A subsidiary of Zero Manufacturing Co.  
555 FRONT STREET, BURBANK, CALIFORNIA

tion of Filtaire, Inc. in Charlottesville to manufacture crystal filters and low-frequency crystals.

Wolter is president of the new organization and Glen L. Brosius, formerly head of the filter engineering department of Hill Electronics, is chief engineer of the Filter division. Mike Gagnon, formerly chief engineer at Northern Electric Co., Ltd. of Montreal, Canada, is chief engineer of the Crystal division of the new firm.

**PEOPLE IN BRIEF**

**Joseph S. Imirie**, formerly Asst. Secretary of the Air Force, has joined Litton Industries as a corporate v-p. **Harry G. Turner** promoted to mgr. of mfg. operations for Motorola Solid State Systems div. **Robert E. Sollman** leaves Electro-Mechanical Research, Inc. to return to Colvin Laboratories, Inc. as chief engineer. **Melvin W. Tracey** advances to mgr. of the Instruments and Measurements dept. of Dynatech Corp. **Bernard F. McNamara**, exec v-p, appointed administrative v-p and g-m of Insulation Manufacturers Corp. **William C. Hoffart**, previously with American Machine & Foundry Corp., named director of operations control at Belock Instrument Corp. Promotions at Aerospace Corp.: **John Aseltine** and **A. J. Schiewe**, to asst. g-m and control systems dept. head, respectively, in the Systems Research and Planning div. **John L. Burns**, ex-RCA president, elected a director of General Battery and Ceramic Corp. **Donald MacGregor**, mfg. v-p for Zenith Radio, has retired but will continue as a consultant. National Research Corp. ups **G. Lloyd Martin** to g-m of its Research div. **Carl N. Pehlke**, formerly with ITT-Kellogg, named asst. g-m of Telonic Industries, Inc. **Gordon C. Butler**, from Sperry Rand Corp. to General Kinetics Inc. as a staff consultant. **Philip W. Schumacher** advances to v-p and g-m of the Glass-Tite Mfg. div. **Robert M. Engler** moves up to production mgr. for Barry Controls' Eastern Operations.

## WEEKLY QUALIFICATION FORM FOR POSITIONS AVAILABLE

### ATTENTION: ENGINEERS, SCIENTISTS, PHYSICISTS

This Qualification Form is designed to help you advance in the electronics industry. It is unique and compact. Designed with the assistance of professional personnel management, it isolates specific experience in electronics and deals only in essential background information. The advertisers listed here are seeking professional experience. Fill in the Qualification Form below.

#### STRICTLY CONFIDENTIAL

Your Qualification form will be handled as "Strictly Confidential" by ELECTRONICS. Our processing system is such that your form will be forwarded within 24 hours to the proper executives in the companies you select. You will be contacted at your home by the interested companies.

#### WHAT TO DO

1. Review the positions in the advertisements.
2. Select those for which you qualify.
3. Notice the key numbers.
4. Circle the corresponding key number below the Qualification Form.
5. Fill out the form completely. Please print clearly.
6. Mail to: Classified Advertising Div., ELECTRONICS, Box 12, New York, N. Y. 10036.

COMPANY	SEE PAGE	KEY #
ATOMIC PERSONNEL INC. Philadelphia, Penna.	115	1
LOCKHEED MISSILES & SPACE CO. Div. of Lockheed Aircraft Corp. Sunnyvale, Calif.	62	2
MELPAR INC. Sub. of Westinghouse Air Brake Co. Falls Church, Virginia	112	3
NORTH AMERICAN AVIATION INC. Space & Information Systems, Div. Downey, Calif.	84	4
SNELLING & SNELLING Boston, Mass.	115	5

(cut here)

(cut here)

## electronics WEEKLY QUALIFICATION FORM FOR POSITIONS AVAILABLE

(Please type or print clearly. Necessary for reproduction.)

### Personal Background

NAME .....

HOME ADDRESS .....

CITY ..... ZONE ..... STATE .....

HOME TELEPHONE .....

### Education

PROFESSIONAL DEGREE(S) .....

MAJOR(S) .....

UNIVERSITY .....

DATE(S) .....

### FIELDS OF EXPERIENCE (Please Check)

101863

- |                                              |                                              |                                       |
|----------------------------------------------|----------------------------------------------|---------------------------------------|
| <input type="checkbox"/> Aerospace           | <input type="checkbox"/> Fire Control        | <input type="checkbox"/> Radar        |
| <input type="checkbox"/> Antennas            | <input type="checkbox"/> Human Factors       | <input type="checkbox"/> Radio-TV     |
| <input type="checkbox"/> ASW                 | <input type="checkbox"/> Infrared            | <input type="checkbox"/> Simulators   |
| <input type="checkbox"/> Circuits            | <input type="checkbox"/> Instrumentation     | <input type="checkbox"/> Solid State  |
| <input type="checkbox"/> Communications      | <input type="checkbox"/> Medicine            | <input type="checkbox"/> Telemetry    |
| <input type="checkbox"/> Components          | <input type="checkbox"/> Microwave           | <input type="checkbox"/> Transformers |
| <input type="checkbox"/> Computers           | <input type="checkbox"/> Navigation          | <input type="checkbox"/> Other .....  |
| <input type="checkbox"/> ECM                 | <input type="checkbox"/> Operations Research | <input type="checkbox"/> .....        |
| <input type="checkbox"/> Electron Tubes      | <input type="checkbox"/> Optics              | <input type="checkbox"/> .....        |
| <input type="checkbox"/> Engineering Writing | <input type="checkbox"/> Packaging           | <input type="checkbox"/> .....        |

### CATEGORY OF SPECIALIZATION

Please indicate number of months experience on proper lines.

	Technical Experience (Months)	Supervisory Experience (Months)
RESEARCH (pure, fundamental, basic)	.....	.....
RESEARCH (Applied)	.....	.....
SYSTEMS (New Concepts)	.....	.....
DEVELOPMENT (Model)	.....	.....
DESIGN (Product)	.....	.....
MANUFACTURING (Product)	.....	.....
FIELD (Service)	.....	.....
SALES (Proposals & Products)	.....	.....

### CIRCLE KEY NUMBERS OF ABOVE COMPANIES' POSITIONS THAT INTEREST YOU

1 2 3 4 5 6 7 8 9 10 11 12 13 14 15

## Professional Services

### GIBBS & HILL, Inc.

Consulting Engineers

Systems Engineering

Operations Research • Development  
Field Studies • Design • Procurement  
Power • Transportation • Communications  
Water Supply • Waste Treatment

393 Seventh Avenue New York 1, N. Y.

## SEARCHLIGHT

**THIS WEEK 2C40 Lighthouse Cavities.**  
S Band \$77.50 ea. L Band \$125 ea.

RADAR AUTO-TRACK & TELEMETRY ANTENNA PEDESTALS 3 & 10 CM. SCR 584 AUTOTRACK RADARS. M-33 RADAR TPS-1D SEARCH. APS-45 TPS-10D HT. FINDERS. WX RADARS. PPN-32GCA. APS-10 APS-1JB. APS-27 (AMTI) SEARCH. ■ ■ ■ APN-102 DOPPLER. DOZENS MORE CARCINOTRONS. PFM'S. 25-51-2-3-6 MEGAWATT PULSE MODULATORS. CAVITIES. PULSE TRANSFORMERS. IF STRIPS. WAVEGUIDE. BENDS 200 MC. 1 KMC. 3 KMC. 6 KMC. 9 KMC. 24 KMC. RF PKGS.

**RADIO RESEARCH INSTRUMENT CO.**  
550 5TH AVE., NEW YORK 36, N. Y. JU 6-4691

CIRCLE 951 ON READER SERVICE CARD

## EMPLOYMENT OPPORTUNITIES



The advertisements in this section include all employment opportunities—executive, management, technical, selling, office, skilled, manual, etc.

Look in the forward section of the magazine for additional Employment Opportunities advertising.

ADDRESS BOX NO. REPLIES TO: Box No. Classified Adv. Div. of this publication. Send to office nearest you.  
NEW YORK, N. Y. 10036: P. O. Box 12  
CHICAGO, Ill. 60611: 645 N. Michigan Ave.  
SAN FRANCISCO, Cal. 94111: 255 California St.

### SELLING OPPORTUNITY AVAILABLE

Sales Representatives Wanted for New England, Mid-West and South. Sales of high-purity metals, rare and special chemicals, to the electronic, nuclear, chemical aerospace, ceramic and metallurgical industries. Submit details and experience. RW-3163, Electronics.

## ENGINEERS/SCIENTISTS\*

BS and/or Advanced Degree

- Radar • Microwave • Systems
- Computers • Circuitry • Logic

Salaries \$6,000 to \$25,000

Fee and relocation paid

## SNELLING & SNELLING

\* Scientific Placement Specialists  
581 Boylston St., Boston, Mass. 262-2660

Submit resume in confidence including current salary to Mr. Jerry Bartzoff. Openings at all levels. Offices coast to coast.



## E. E.'s

for FEE-PAID Positions  
WRITE US FIRST!

Use our confidential application for professional, individualized service . . . a complete national technical employment agency.

**ATOMIC PERSONNEL, INC.**  
Suite 1207L, 1518 Walnut St., Phila. 2, Pa.

# INDEX TO ADVERTISERS

• AMP Incorporated	7	Hughes Aircraft Co.		Struthers-Dunn Inc.	70
• Acton Laboratories, Inc.	105	Aerospace Divisions	95	Suffolk County Dept. of	
Admiral Corp.				Commerce & Industry	112
Palo Alto Div.	104	Image Instruments Inc.	104	• Synthane Corp.	111
Alcoa		• Imtra Corp.	103		
Rome Cable Division	22	Japan Piezo Electric Co., Ltd.	98	• Tektronix, Inc.	79
Allen-Bradley Co.	31			• Telonic Industries Inc.	92
Ampex Corporation	48	• Keithley Instruments, Inc.	98	Texas Instruments Incorporated	
Anso Div. of		• Kepco, Inc.	65	Industrial Products Group	58
General Aniline & Film Corp.	30	Kin Tel A Division of		• Texas Instruments Incorporated	
		Cohu Electronics Inc.	3rd cover	Metals & Controls Division	60
Babcock Relays, Inc.	27	Krohn-Hite Corp.	25	Towson Laboratories Inc.	106
• Ballantine Laboratories, Inc.	107			Transistor Specialties, Inc.	46
Barker & Williamson, Inc.	111	• Lapp Insulator Co., Inc.	55	Transitron Electronic Corp.	101
Bell Telephone Laboratories	59	Levin and Son, Inc., Louis	90	Triplet Electrical Instrument Co.	15
Bendix Corporation		Littelfuse	105	• Trygon Electronics Inc.	89
Bendix Pacific Division	109	Lockheed Missiles & Space Co.	62		
Black & Webster, Inc.	69			• United Shoe Machinery Corp.	54
• Boonton Radio Co.		Malayan Tin Bureau, The	84	United Systems Corp.	100
Div. of Hewlett-Packard	52	Mallory and Co., Inc., P. R.	12, 13	Vacuum Electronics Corp.	26
• Bulova Electronics Div.	57	Melpar, Inc.	112	Ward Leonard Electric Co.	94
		Minnesota Mining & Mfg. Co.		Waugh Engineering Division	96
Carborundum Company, The	61	Mincom Division	74	Wayne-George Corp.	32
• Carter-Princeton	88	Motorola		Western Devices, Inc.	114
Communication Electronics Inc.	114	Military Electronics Div.	72, 73	White S. S.	78
Corning Electronics		• Mullard Ltd.	99		
Div. of Corning Glass Works	14	• Mycalex Corp. of America	68		
Dow Corning Corp.	28, 29				
Durant Manufacturing Co.	63	• North Atlantic Industries, Inc.	66		
Dynamics Instrumentation Co.	106				
Eastman Kodak Co.	87	Polaroid Corp.	83		
Edgerton, Germeshausen		Princeton Applied Research			
& Grier	97	Corp.	104		
Electro-Nuclear Laboratories,		Radio Corporation of America			
Inc.	4	4th cover			
Electronic Engineering Co.		• Reeves-Hoffman Div. of			
of Calif.	100	Dynamics Corp. of America	102		
Flying Tiger Line	85	• Research-Cottrell Inc.	102		
Formica Corp.	71	Royal Electric Corp.	110		
Gamewell Co., The	67				
		SAAB Motors Inc.	16		
• Harrison Laboratories		Sanders Associates, Inc.	76, 77		
A Div. of Hewlett-Packard	23	Sanken Electric Co., Ltd.	103		
• Hewlett-Packard Company		Siliconix Inc.	21		
2nd cover, 8,	9	Space and Information Systems			
• Hitachi, Ltd.	113	Div. of North America Avia-			
• Hitemp Wires Inc.	56	tion	84		
Honeywell		Spectra Physics	86		
Denver Division	50	Speer Carbon Co., Inc.	80, 81		
Houston Instrument Corp.	103	Sprague Electric Co.	3, 6		
		Stackpole Carbon Co.	53		
		Standard Telephones & Cables,			
		Ltd.	91		

## CLASSIFIED ADVERTISING

F. J. Eberle, Business Mgr. (2557)

PROFESSIONAL SERVICES 115

EMPLOYMENT OPPORTUNITIES 115

## EQUIPMENT

(Used or Surplus New)

For Sale 115

## CLASSIFIED ADVERTISERS INDEX

Atomic Personnel Inc. 115

Radio Research Instrument Co. 115

Snelling & Snelling 115

• See advertisement in the July 25, 1963 issue of electronics Buyers' Guide for complete line of products or services.

This Index and our Reader Service Numbers are published as a service. Every precaution is taken to make them accurate, but **electronics** assumes no responsibilities for errors or omissions.

## electronics



Audit Bureau  
of Circulation



Associated Business  
Publications

AUDITED PAID CIRCULATION

**JAMES T. HAUPTLI (2210)**  
Advertising Sales Manager

**HENRY M. SHAW (3485)**  
Market Research Manager

### electronics Buyers' Guide

**R. S. QUINT (2335)**  
General Manager

**RICHARD J. TOMLINSON (3191)**  
Business Manager

**THEODORE R. GEIPEL (2044)**  
Production Manager

NEW YORK TELEPHONE: Dial Direct:  
971 plus number in parenthesis,  
Area Code 212

## ADVERTISING REPRESENTATIVES

ATLANTA, GA. 30009  
Michael H. Miller, Robert C. Johnson  
1375 Peachtree St. N.E.,  
Trinity 5-0523 (area code 404)

BOSTON, MASS. 02116  
William S. Hodgkinson  
McGraw-Hill Building, Copley Square,  
Congress 2-1160 (area code 617)

CHICAGO, ILL. 60611  
Harvey W. Wernecke,  
Robert M. Denmead  
645 North Michigan Avenue,  
Mohawk 4-5800 (area code 312)

CLEVELAND, OHIO 44113  
Paul T. Fegley  
55 Public Square, Superior 1-7000  
(area code 216)

DALLAS, TEXAS 75201  
Frank Le Beau  
The Vaughn Bldg.,  
1712 Commerce St.  
Riverside 7-9721 (area code 214)

DENVER, COLO. 80202  
John W. Patten  
Tower Bldg., 1700 Broadway,  
Alpine 5-2981 (area code 303)

HOUSTON, TEXAS 77025  
Kenneth George  
Prudential Bldg., Halcombe Blvd.,  
Riverside 8-1280 (area code 713)

LOS ANGELES, CALIF. 90017  
Ashley P. Hartman, John G. Zisch,  
1125 W. 6th St., Huntley 2-5450  
(area code 213)

NEW YORK, N. Y. 10036  
Donald H. Miller (212) 971 3615  
George F. Werner (212) 971 3617  
Donald R. Furth (212) 971 3616  
500 Fifth Avenue

PHILADELPHIA, PA. 19103  
Warren H. Gardner, William J. Boyle  
6 Penn Center Plaza,  
LOcust 8-4330 (area code 215)

SAN FRANCISCO, CALIF. 94111  
Richard C. Alcorn  
255 California Street,  
Douglas 2-4600 (area code 415)

LONDON W1:  
Edwin S. Murphy Jr.  
34 Dover St.

FRANKFURT/Main:  
Matthee Herfurth  
85 Westendstrasse

GENEVA:  
Michael R. Zeynel  
2 Place du Port

TOKYO:  
George Olcott,  
1, Kotohiracho, Shiba, Minato-ku

# KIN TEL introduces FIVE precision test instruments IN ONE

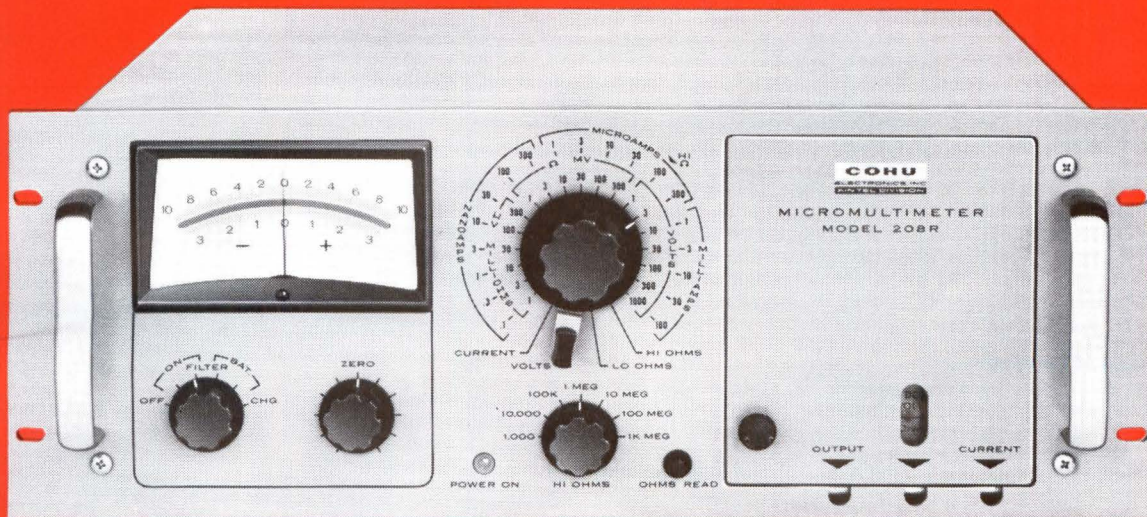

**Model 208R Micromultimeter**

AT LESS COST, IN FAR LESS SPACE than closest equivalent instrumentation, Model 208R combines performance not previously available in one device.

HIGH RANGES AND LOW RANGES in one instrument give you the advantages of a DC microvoltmeter with ranges to 1000 volts, a microammeter, a wide range ohmmeter, an electronic galvanometer, and a narrow-band DC amplifier.

CHECK THESE FEATURES. Available for rack mounting or bench-top use, Model 208R operates from 115 or 230 volts, 50 to 400 cps, and from optional nickel-cadmium battery pack. Circuitry is solid state, chopper stabilized. Electrical output is suitable for driving a strip-chart recorder. Extra-long probes are stored on plug-in holders in a handy internal compartment, accessible from the front panel. \$1495. Additional export charge.

**CHECK THIS PERFORMANCE.**

	VOLTAGE MEASUREMENTS	CURRENT MEASUREMENTS	RESISTANCE MEASUREMENTS
SCALES (full-scale indication)	10 <sup>-6</sup> to 10 <sup>3</sup> volts DC	10 <sup>-10</sup> to 10 <sup>-1</sup> ampere DC	10 <sup>-3</sup> to 10 <sup>9</sup> ohms
ACCURACY	1% of full scale or 10 <sup>-7</sup> volt, whichever is greater	1% of full scale or 10 <sup>-11</sup> ampere, whichever is greater	10 <sup>-3</sup> to 10 <sup>8</sup> ohms scales: 2% of full scale or 10 <sup>-4</sup> ohm, whichever is greater 10 <sup>9</sup> ohms scale: 3% of full scale
INPUT RESISTANCE	10 <sup>-5</sup> to 10 <sup>3</sup> volt scales: >10 <sup>8</sup> ohms 10 <sup>-6</sup> and 3 x 10 <sup>-6</sup> volt scales: >10 <sup>7</sup> and 3 x 10 <sup>7</sup> ohms	10 <sup>-10</sup> to 10 <sup>-5</sup> ampere scales: 10 <sup>4</sup> ohms 3 x 10 <sup>-5</sup> and 10 <sup>-1</sup> ampere scales: 10 <sup>1</sup> ohms	N/A
DRIFT (30 minute warmup)	<2 x 10 <sup>-7</sup> volts	<2 x 10 <sup>-11</sup> amperes	<2x10 <sup>-4</sup> ohms

Send for product information or demonstration of the KIN TEL Model 208R Micromultimeter, or any of KIN TEL'S line of precision instruments. Representatives located in all major cities.



5725 Kearny Villa Road, San Diego, California 92112 • Phone 277-6700 (Area Code 714)

**CIRCLE 901 ON READER SERVICE CARD**

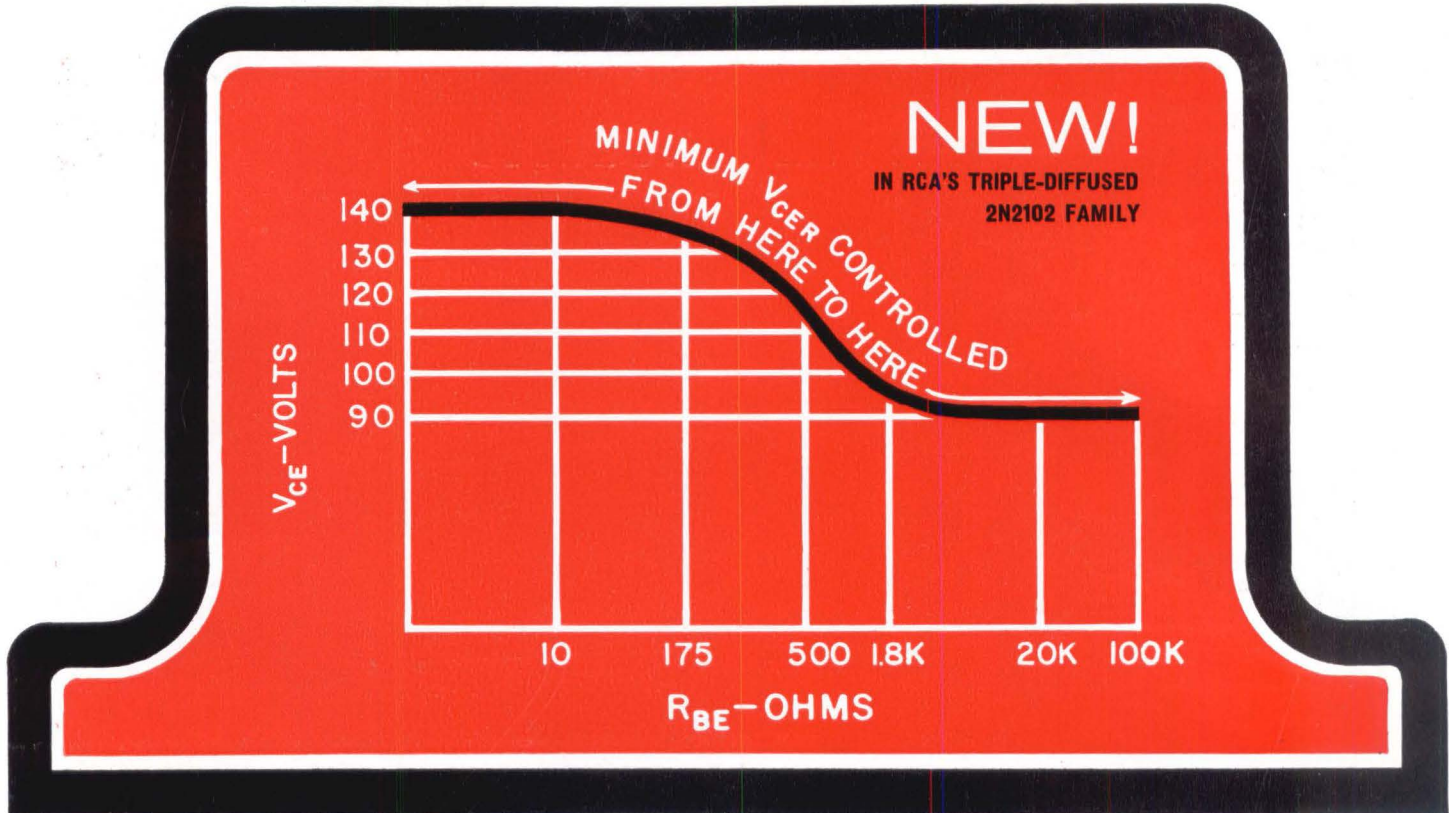

**RCA 2N2405 OFFERS 0.5 VOLT MAX.  $V_{CE(sat)}$  @ 150 Ma  
90-VOLT MIN.  $V_{CE0(sus)}$ ; 120 Mc  $f_T$**

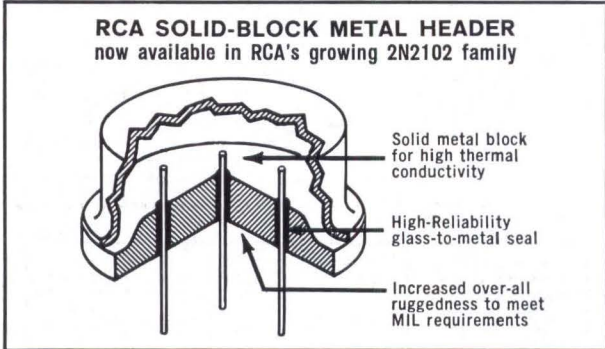

Out of RCA's revolutionary 2N2102, triple-diffused silicon transistor, comes the new high-voltage 2N2405. Using the same technique of multi-point control that defines the 2N2102 at six current levels—RCA CONTROLS MINIMUM  $V_{CE R}$  OF THE NEW 2N2405 ALONG THE FULL LENGTH OF THE CURVE FROM ZERO OHMS TO 100 KILOHMS.

Through the use of triple-diffused construction—precision manufacturing controls—and RCA solid-block metal header—RCA 2N2405 offers:  
Min.  $V_{CE0(sus)}$  of 90 Volts • Max.  $V_{CE(sat)}$  of 0.5V @  $I_C = 150\text{ ma}$  •  $f_T$  of 120 Mc • low leakage,  $I_{CBO}$  (max) = 10 nanoamp @  $V_{CB} = 90V$  • 5 watts max. dissipation • exceptional mechanical stability.

Check RCA 2N2405 today for your applications where supply-voltage transients are a problem—in video drivers, RF and AF power amplifiers, and high-voltage linear and switching amplifier applications. Ask your RCA Representative about the broad RCA 2N2405—2N2102 family and related types RCA 2N1893, 2N718A, 2N720A. Or write Commercial Engineering, Dept. IN-10 RCA Electronic Components and Devices, Harrison, N. J.

**RCA FIELD OFFICES**  
EAST: 32 Green St., Newark 2, N.J., 485-3900 • 731 James St., Rm. 402, Syracuse 3, N. Y., GR 4-5591 • 605 Marlton Pike, Erlton, N. J., HA 8-4802 • Greater Baltimore Area, 1725 "K" St., N.W., Washington 6, D. C., FE 7-8500 • NORTHEAST: 64 "A" St., Needham Heights 94, Mass., HI 4-7200 • SOUTHEAST: 200 East Marks St., Orlando, Fla., 425-5563 • CENTRAL: Suite 1154, Merchandise Mart Plaza, Chicago 54, Ill., 527-2900 • 2132 East 52nd St., Indianapolis 5, Ind., CL 1-1405 • 5805 Excelsior Blvd., Minneapolis 15, Minn., WE 9-0676 • 714 New Center Bldg., Detroit 2, Mich., TR 5-5600 • 7905 Carpenter Freeway, Dallas 7, Tex., ME 1-9720 • Continental Terrace Bldg., 2785 North Speer Blvd., Room 346, Denver 11, Colo., 477-1688 • WEST: 6801 E. Washington Blvd., Los Angeles 22, Calif., RA 3-8361 • 1838 El Camino Real, Burlingame, Calif., OX 7-1620 • 2250 First Avenue, S., Seattle 4, Wash., MA 2-8816 • GOVERNMENT: 224 N. Wilkinson St., Dayton 2, Ohio, BA 6-2366 • 1725 "K" St., N.W., Washington 6, D. C., FE 7-8500 • RCA INTERNATIONAL DIVISION, 30 Rockefeller Plaza, New York 20, New York, Cable Address: RADIOINTER, N. Y.

	T0-5	T0-18	T0-46
<b>HIGH-VOLTAGE TYPES</b> (min. $V_{CE0(sus)}$ = 90 volts)	RCA 2N2405	2N2896	2N2899
<b>UNIVERSAL TYPES</b> (Beta controlled over full current range)	RCA 2N2102	2N2895	2N2898
<b>ECONOMY VERSIONS</b> of RCA 2N2102	RCA 2N2270	2N2897	2N2900



**The Most Trusted Name in Electronics**

CIRCLE 902 ON READER SERVICE CARD