

A McGraw-Hill Weekly 75 Cents

# electronics®

June 28, 1963

## OPTO-TRONICS ON HORIZON

*Optical effects mean  
new circuit tricks, p 32*

## THE IMPACT OF MICROCIRCUITS

*New techniques set  
to rock industry, p 51*

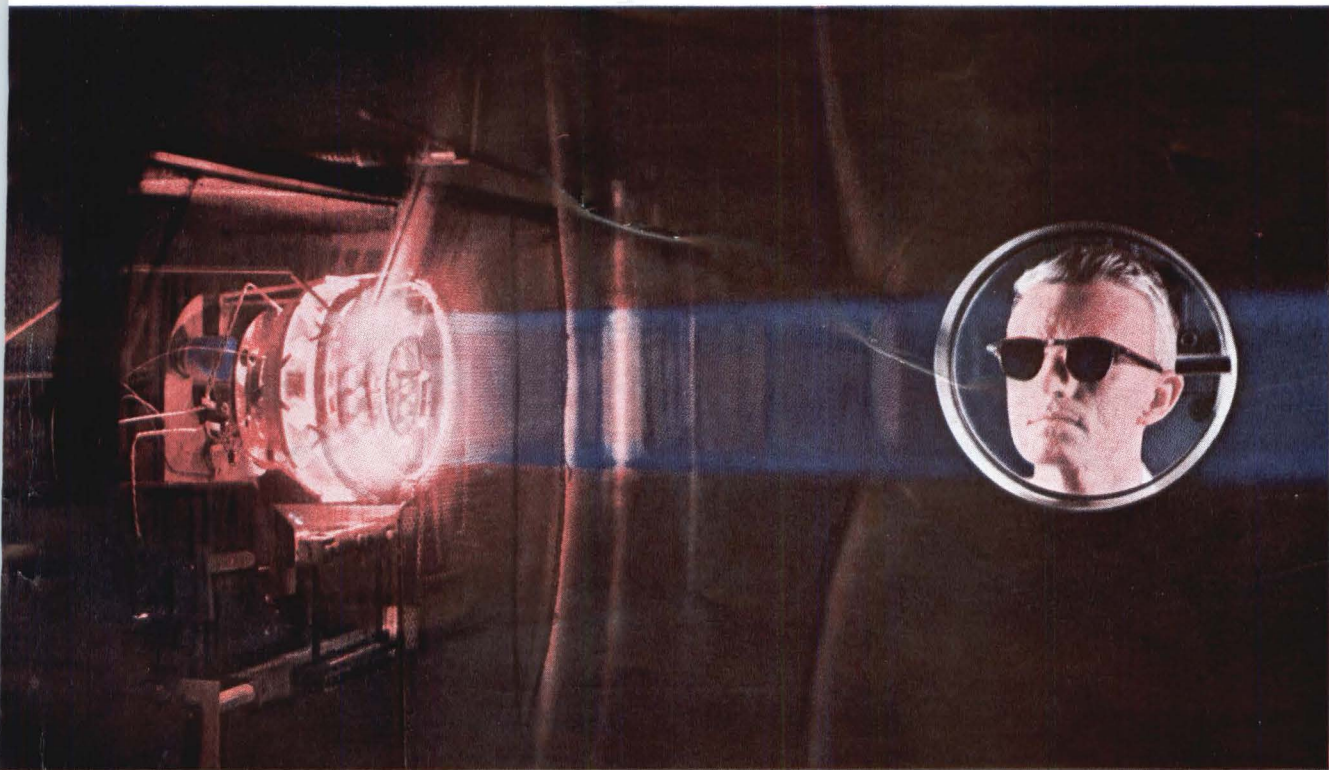

ION ENGINE TEST COMING.  
*Can it get men to Mars?*

## NEW PARAMP CUTS NOISE





*Four-to-one noise  
reduction at S-band, p 57*

R D SKINNER  
1020 GOVINGTON RD  
LOS ALTOS CALIF  
C 3-5  
L  
SUPPLY DEPT

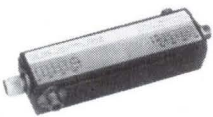

# in coaxial instrumentation from Hewlett-Packard

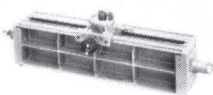
Frequency, price ranges

Instrument	Uses	Frequency, price ranges											
		10 dc	55 mc	215 mc	450 mc	500 mc	940 mc	1 gc	2 gc	3 gc	4 gc	10 gc	12.4 gc
 <p>Wavemeter</p>	Measure frequencies 960 mc to 4.2 gc with this reaction wavemeter, which indicates resonance by sharp output dip												← 536A (\$500) →
 <p>Dual Directional Couplers</p>	High directivity (> 30 db) makes these couplers especially useful in coax reflectometer uses; low insertion loss, high power handling capability make them suitable for permanent use in a transmission line for power monitoring; may be used to extend the range of hp power meters												← 774D → ← 775D → ← 776D → ← 777D → ← (\$200) →
 <p>VHF Detector VHF Bridge</p>	With suitable signal generator, (hp 608C, i.e.), permit direct measurement of impedance magnitude and phase, 2 to 2000 ohms, 0° to ±90°, avoiding bulk, awkwardness of slotted lines												← 417A (\$475) → ← 803A (\$1000) →
 <p>Slotted Lines</p>	Measure swr, determine reflection coefficient, return loss, mismatch loss, impedance												← 805C (\$525) → ← 805D (\$600) → ← 806B (\$200) →
 <p>Slide Screw Turner</p>	Impedance matching device, ideal for maximizing power delivered to a load; less loss than single or double stub tuners, non-interacting adjustments												← 872A (\$525) →
 <p>Terminations</p>	For termination of 50-ohm coax systems in characteristic impedance for swr measurements and as production line impedance standards; the 906A sliding load permits its small reflection to be separated from other reflections in a system												← 908A (\$35) → ← 906A (\$250) →

Data subject to change without notice. Prices f.o.b. factory.



**HEWLETT  
PACKARD  
COMPANY**

1501 Page Mill Rd., Palo Alto, Calif., (415) 326-7000.  
Sales and service representatives in principal areas.  
Europe, Hewlett-Packard S.A., 54 Route des Acacias,  
Geneva, Switzerland; Canada, Hewlett-Packard  
(Canada) Ltd., 8270 Mayrand St., Montreal, Quebec.



*full-range tested*

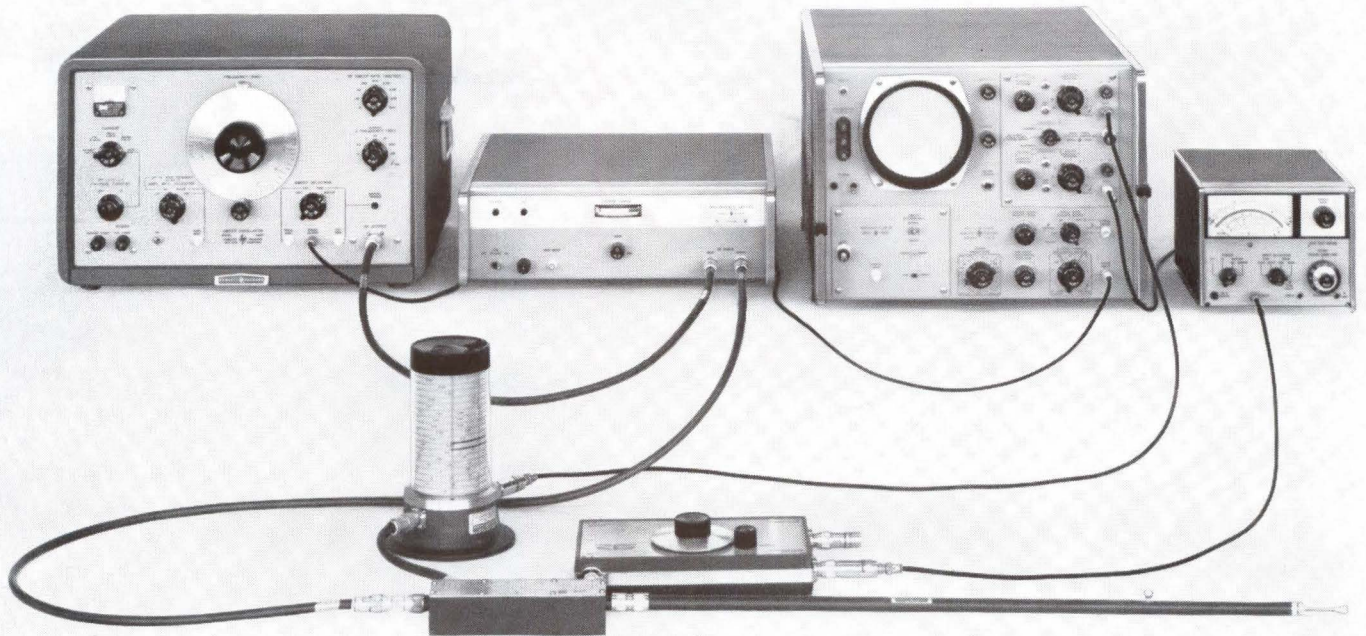

# COAXIAL MEASURING INSTRUMENTATION

DC to 12.4 GC

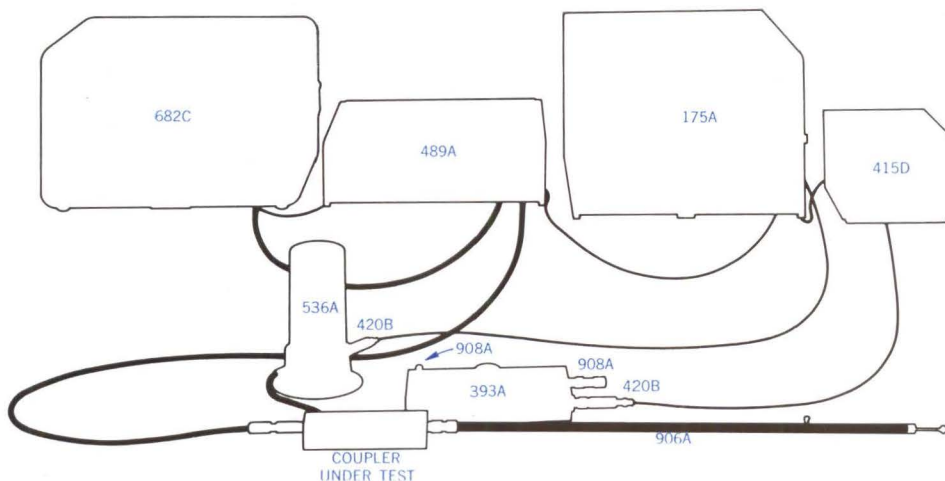

from 

Typical of the measuring setups possible with hp coaxial instrumentation is this arrangement for measuring directivity of the test coupler.

**Turn the page** for information on the wide array of precision coaxial measuring instruments available from Hewlett-Packard. Check the advantages of using compatible instrumentation from a single supplier offering high precision, maximum flexibility and top value.







# COMPATIBILITY, PRECISION, FLEXIBILITY, VALUE

Measurements to 12.4 gc are convenient and easy with coaxial microwave instrumentation from hp. Compatible characteristics make individual instruments ideal for use in a variety of flexible setups for wide-range, accurate measurements. Using swept frequency techniques, hp tests each instrument

over its entire frequency range, not just at random points. All hp instruments are warranted to conform with, or exceed, published specifications. Coaxial instruments are available for fast delivery at moderate cost. Complete information is available from your Hewlett-Packard representative.

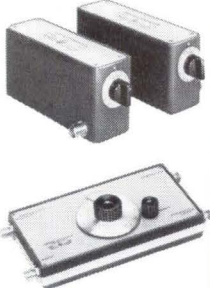
## Frequency, price ranges

Instrument	Uses	10 dc   55 mc   215 mc   450 mc   500 mc   940 mc   1 gc   2 gc   3 gc   4 gc   10 gc   12.4 gc
<b>Waveguide-to-Coax Adapters</b> 	Designed for connecting coaxial cables and waveguide systems; available in these frequency bands (in gigacycles): S: 2.6 to 3.95 G: 3.95 to 5.85   H: 7.05 to 10 J: 5.3 to 8.2   X: 8.2 to 12.4	<p style="text-align: right;">← 281A Series → (\$25 to \$50)</p>
<b>Low Pass Filters</b> 	Offering rejection of $\geq 50$ db at 1.25 times their cut-off frequency, these filters effectively eliminate harmonics, provide pure signals to prevent erroneous readings or to mask a null in swr measurements	<p>← 360A (\$70) →</p> <p>← 360B (\$60) →</p> <p>← 360C (\$50) →</p> <p>← 360D (\$50) →</p>
<b>Attenuators</b> 	Ideal for insertion loss measurements by the rf substitution method, in which power is fed through the attenuator to a detector and to a reference meter; replacement of the attenuator with the unknown permits determination of the difference in attenuation, and the insertion loss of the unknown; a sensitive detector (which may be a receiver) permits insertion loss measurements to 80 or 90 db; detector characteristics need not be known, since its input is constant	<p>← 355C (\$125) →</p> <p>← 355D (\$125) →</p> <p>← 393A (\$420) →</p> <p>← 394 (\$420) →</p>
<b>Detectors</b> 	Basically, square-law devices for demodulation of rf signals; 423A has $\pm 0.5$ frequency response; the 420B and 476A exhibit exceptional square-law properties, are particularly useful in reflectometer uses or for direct attenuation measurement with 415B,D SWR Meter or 416B Ratiometer	<p>← 420A (\$50) →</p> <p>← 420B (\$75) →</p> <p>← 476A (\$85) →</p> <p>← 440A (\$80) →</p> <p>← 423A (\$125) →</p>
<b>Thermistor Mounts</b> 	Used with the 430C and 431B Power Meters, to measure power in Type N systems; the 478A is temperature-compensated for measurements as low as $1 \mu\text{w}$ with the 431B	<p>← 477B (\$75) →</p> <p>← 478A (\$145) →</p>



# electronics

A McGraw-Hill Weekly 75 Cents



W. W. MacDONALD, Editor

J. M. CARROLL, Managing Editor

**SENIOR EDITORS**

Samuel Weber, George W. Sideris

**SENIOR ASSOCIATE EDITORS**

Michael F. Wolff, John F. Mason

**ASSOCIATE EDITORS**

Michael F. Tomaino, William P. O'Brien, Sy Vogel, George J. Flynn, Laurence D. Shergalis, George V. Novotny, Leon H. Dulberger, Alexander A. McKenzie

**ASSISTANT EDITORS**

Stanley Froud, Stephen B. Gray, Roy J. Bruun, Barry A. Briskman, Dan Smith, Joel A. Strasser

**REGIONAL EDITORS**

Harold C. Hood (Pacific Coast, Los Angeles), Thomas Maguire (New England, Boston), Cletus M. Wiley (Midwest, Chicago)

**ART DIRECTOR**

Howard R. Berry

**ASSISTANT ART DIRECTOR**

John C. Wright, Jr

**EDITORIAL ASSISTANTS**

Lorraine Rossi, Virginia T. Bastian, Lynn Emery, Ann Mella, Lorraine Werner, Alice M. O'Brien, Sharon Parks, Patricia Mitchell, Claire Benell, Kay Fontana

**FOREIGN NEWS BUREAU**

DIRECTOR, John Wilhelm;  
Alyne Elias, Laurence Mihlon  
LONDON—John Shinn, Derek Barlow, Nicholas Landon  
BONN—Bruce Bendow, Richard Mikton, Silke McQueen  
BRUSSELS—Peter Forbath  
PARIS—Robert Farrell, Arthur Erikson  
MILAN—Marc A. Messina  
MEXICO CITY—Wesley Perry, Jr  
RIO DE JANEIRO—Leslie Warren  
MOSCOW—Stewart Ramsey  
TOKYO—Richard Halloran, Charles Cohen, John Yamaguchi

**CIRCULATION MANAGER**

Hugh J. Quinn

W. W. GAREY, Publisher

**SCHEDULED FOR FLIGHT TEST** late this year, Hughes' ion engine opens up on the ground. Scout rocket may loft a capsule containing this engine and one developed in-house by NASA 5,000 miles for true space testing. *But bugs in the high-voltage power supply have engineers nervous about keeping on schedule*

COVER

**HOT LINE**—First Fruit of Disarmament Talks. U.S. and Soviet negotiators agree to emergency-only telegraph link between the two nuclear capitals. *Both sides will exchange equipment; the U.S. will provide the message encoders*

18

**AREA CODE FOR SPACE.** Command discrimination gear will prevent the newly launched Tiros 7 from getting Tiros 6's messages, and vice-versa. *Next: Tiros 8 and 45 ground stations*

18

**MICROELECTRONIC LORAN-C WILL Fly Next Year.** This new equipment was especially designed to use digital microcircuits. *Motors, gears, synchros are eliminated, weight is cut to 19 pounds*

22

**NEW COLOR-TV TUBE Bows This Week.** After two years and \$4 million for development, 23-inch rectangular, 92-degree color-tv tube goes to work. *It's used in eight new sets*

26

**WIRELESS MICROPHONES Get F-M Band.** FCC says anybody can use them in the 88 to 108-Mc f-m band, with just a few limitations, for talking or telemetry. *Broadcasters don't like it*

26

**PAPER PROTOTYPES Next for Command and Control.** Future systems will be designed with Adam, a new programming concept, in a computer. *This technique is already being used to develop two systems*

28

**OPTICAL SEMICONDUCTORS**—Look at What They Can Do Now. Solid-state optical devices and optically coupled circuits are coming out of the lab. *Devices can now do logic switching, amplification, oscillation, rectification, and more*

32

**NAVY PUSHES MICROCIRCUITS.** Easy-to-repair systems will help solve technician shortage while boosting system effectiveness. *At R&D clinic, Navy also listed development it most wants*

34

**THIN-FILM PROPULSION.** Pulsed plasma system deposits metal films on wheel, then explodes it in spark gap. *Lightweight control system is another space development*

40

**LOW-POWER DEVICES Are Going to Nanopower Levels.** Experts see power cuts of 10 to 100. *Very promising: field-effect devices*

38

Contents Continued



Published weekly, with Electronics Buyers' Guide as part of the subscription, by McGraw-Hill Publishing Company, Inc. Founder: James H. McGraw (1860-1948).

Title ® registered U.S. Patent Office; © copyright 1963 by McGraw-Hill Publishing Co., Inc. All rights reserved, including the right to reproduce the contents of this publication, in whole or in part.

Executive, editorial, circulation and advertising offices: McGraw-Hill Building, 330 West 42nd Street, New York 36, N. Y. Telephone Longacre 4-3000. Teletype TWX N.Y. 212-640-4646. Cable McGrawhill, N. Y. PRINTED IN ALBANY, N. Y.; second class postage paid at Albany, N. Y.

OFFICERS OF THE PUBLICATIONS DIVISION: Shelton Fisher, President; Vice Presidents: Joseph H. Allen, Operations; John R. Callahan, Editorial; Ervin E. DeGraff, Circulation; Donald C. McGraw, Jr., Advertising Sales; Angelo R. Venezian, Marketing.

OFFICERS OF THE CORPORATION: Donald C. McGraw, President; Hugh J. Kelly, Harry L. Waddell, L. Keith Goodrich, Executive Vice Presidents; John L. McGraw, Treasurer; John J. Cooke, Vice President and Secretary.

Subscriptions are solicited only from those actively engaged in the field of the publication. Position and company connection must be indicated on orders. Subscription rates: United States and Possessions, \$6.00 one year, \$9.00 two years, \$12.00 three years. Canada: \$10.00 one year. All other countries \$20.00 one year. Single copies, United States and Possessions and Canada 75¢. Single copies all other countries \$1.50.

THE PUBLISHER, UPON WRITTEN REQUEST TO OUR NEW YORK OFFICE FROM ANY SUBSCRIBER AGREES TO REFUND THAT PART OF THE SUBSCRIPTION PRICE APPLYING TO COPIES NOT YET MAILED.

Subscribers: Please send change of address notices, subscription orders or complaints to Fulfillment Manager, Electronics, at the address below. Change of address notices should provide old as well as new address, including postal zone number if any. If possible, attach address label from recent issue. Allow one month for change to become effective.

Postmaster: Please send Form 3579 to Fulfillment Manager, Electronics, P. O. Box 430, Hightstown, New Jersey.



Audited Paid Circulation

CONTENTS continued

**THE IMPACT OF MICROELECTRONICS.** This week, electronics engineers of every stripe gathered in Chicago to hear industry and government leaders tell what lies ahead because of the micro-circuit revolution. They spoke at a conference held jointly by ELECTRONICS and Armour Research Foundation (now ITT Research Institute). *Here's what they had to say* 51

**NEW PARAMETRIC AMPLIFIER** Approaches Noise-Figure Minimum. Completely packaged solid-state unit operates at S-band using a Ku-band pump. Noise reduction is better than four-to-one over early amplifiers. *Combining the latest design techniques optimizes the circuit.*  
By P. Koskos, D. Mamayek, W. Rumsey, C. L. Cuccia, RCA, Electronic Tube Division 55

**TUNNEL DIODES, Part III—Mixer and Converter Circuits.** Practical circuits include a host of converter applications including mobile communications and television systems. *Circuits are compact, temperature stable and require minimal power expenditure.*  
By E. Gottlieb and J. Giorgis, GE Semiconductor Products Dept. 61

DEPARTMENTS

Crosstalk. *One Customer Isn't Enough* 3

Comment. *Spare That Meter. Reliability Testing* 4

Electronics Newsletter. *DOD Awards Lag* 7

Washington This Week. *Experience—Not a Better Proposal—Wins Contracts. Russian Space Feat Helps NASA* 12

Meetings Ahead. *Electromagnetic Compatibility Conference. Plasma Phenomena and Measurements Symposium* 46

Research and Development. *Waveguide Telemeters Space-Chamber Data* 74

Components and Materials. *TWT Uses New Focusing Concept* 80

Production Techniques. *Electron Beam Welding Solves Relay Sealing Problem* 90

New Products. *Comparing Frequencies To 1 Part in 10<sup>12</sup>* 100

Literature of the Week 110

People and Plants. *IRC Plans Advanced R&D Center* 114

Index to Advertisers 122



# One Customer Isn't Enough

**SWEEPING** and sometimes unpredictable changes in Pentagon procurement policies and practices make it more and more apparent that it is unhealthy for electronics engineers and electronics companies to place too great a reliance on military contracting as a source of work and profit.

The present administration is becoming more selective about the number and kinds of contracts it awards, and seems bent on setting new records for speed of cancelling contracts on going projects it wants to drop.

In the abstract, these are praiseworthy trends, but they are creating serious problems for companies and men heavily committed to military contracting. The descent from the pinnacle can be swift, the climb back slow.

Military electronics dominates our industry. It is our mainstay. Military R&D provides technical advances and income, military production is a prime source of profit. But it is the prospect for the individual company that the individual company must be concerned with, not this generality.

**In military R&D, opportunities are being narrowed by such developing practices as:**

- Limiting competition on a project to just a few companies "best technically qualified." If a company doesn't win that title early, will it ever be able to compete? Can it maintain its competence without substantial military R&D funds?

- Breaking down R&D into shorter program stages. This has many advantages, but contract security is not one of them.

- Rapid disclosure and rapid dissemination of technical advances. This may be good for the military in general, but it decreases a major attraction of military R&D—getting a leg up, technically, on competition.

- Increasing use of military and not-for-profit R&D shops to plan, manage and build system prototypes. Even when these jobs are given to industry, the company is often barred from subsequent hardware contracting.

**Military production contracting, too, is becoming more chancy:**

- Equipment needs change rapidly today; military concepts and world politics are in flux. Only one major program need be cancelled to bring hard times to a cluster of contractors.

- Technology can take a radical turn, as it is now doing with microelectronics, and unprepared



companies can quickly go in the ditch.

- System complexity and the "best technically qualified" criterion can lead to more prime contracting by fewer companies. If microelectronics forces radical consolidation of systems and components manufacturing—as some believe it will in the next five to ten years—more and more small supplier will be in difficulty.

- Profits are less sure. The trend is away from fixed-fee toward fixed or incentive contracts, and from negotiated to competitive procurement. This means more risks for the contractor.

For each of these negatives, a positive can of course be found. Certainly the electronics industry should not curtail its military electronics support. But it becomes increasingly obvious that companies, also, must be more selective in the military contracts they seek. And they must channel more effort into civilian electronics, too.

Civilian electronics has its ups and downs and competition. But the trends toward more automation in industry and toward greater use of all types of consumer and professional electronic equipment are long-term, with fewer hazards than a munitions industry faces.

Even if peace never breaks out, a more balanced mix of civilian and military electronics is necessary for greater stability and growth for the electronics industry and the men and companies which comprise it.



# When You Need ELECTRIC WAVE FILTERS Depend on Sprague for

✓ SERVICE  
✓ DELIVERY  
✓ RELIABILITY



Sprague Electric Wave Filters for use in telemetry, telephony, and various types of communications systems and laboratory equipment which require selection and/or rejection of specific frequencies are now being designed by *Modern Network Synthesis*, which assures exact matching of wave filter characteristics to application requirements for Low Pass, High Pass, Band Pass, and Band Rejection filters.



Drawing on Sprague's long experience in component manufacture, wave filter engineers are able to employ capacitor, inductor and resistor production facilities for particular sizes, shapes, and materials best suited for specific filter applications. Unlike most filter manufacturers, Sprague is not dependent upon other component suppliers, therefore faster deliveries can be provided.



To further Sprague capabilities, wave filter design and field engineering offices as well as pilot production facilities are maintained in North Adams, Mass.; Vandalia, Ohio; and Los Angeles, Calif. Specialized mass production facilities are located at Visalia, Calif. and North Adams.

For additional information on Sprague Electric Wave Filters, write for Engineering Bulletin 46000 to Technical Literature Section, Sprague Electric Company, 35 Marshall Street, North Adams, Massachusetts.



## COMMENT

### Spare That Meter

In your April 19 issue, in an article titled, Building A Simple Transistor Tester (p 56), author Montgomery has included a rather clever range-changer switching circuit. However, since banging the pointer against the stop-pin in any meter is a function that is normally shunned by those of us who must finance our own efforts and equipment, I would like to suggest that he change the meter portion of one switch referred to, so that the shunt resistor is in the circuit while the button goes down, and out when the switch bottoms. In this way the high-current range is within the first function of the switch, and the low-current range is arrived at in the second position. Thus the meter is spared abuse. Alteration of the switch is simple, with the meter portion being changed to a close-then-open arrangement.

HARRY ALDEN LYON

Lyonart Industries  
Taos, New Mexico

### Reliability Testing

This year's IEEE International Convention presented particularly interesting exhibits. The accent appeared to be more on applications and improvements in already familiar instrumentation.

An impressive exhibit by Dupont Company demonstrated the "inertness" of their new cleaning and degreasing agent, Freon-TF. This exhibit consisted of an operating television receiver chassis completely submerged in a transparent tank filled with Freon-TF. As this agent has the appearance of water, it was impressive to note that all electrical connections were immersed in this liquid with no evidence of electrical leakage.

Another point of interest regarding this exhibit, was the thin stream of bubbles arising from certain components. Evidently, these components generated heat, which vaporized the Freon-TF and formed the stream of bubbles.

Understandably, heat is usually an unwanted by-product in an elec-

tronic device. However, a circuit designer cannot always predict localized hot-spots in an electronic chassis. These hot-spots may require a design modification or more likely, may be an indication of an approaching component failure.

After viewing this demonstration, it seems to me that this technique, when used as a test procedure, can be a powerful tool for reliability, testing of electronic equipment. This procedure may be used as a final test in a production line, or as an aid in determining the reliability of a new circuit design.

W. P. CZERWINSKI  
Shrewsbury, New Jersey

**An interesting idea that may find applications. Infrared inspection is already in use for manufacture checking. For more on ir inspection, see the Production Techniques articles on p 62, June 14, 1963 and p 72, July 6, 1962.**

### Edwin, not Edward

In the article, New Digital Conversion Method Provides Nanosecond Resolution (p 55, May 3), of which I am co-author, my name was spelled wrong.

Thank you for the excellent presentation of my article.

EDWIN JOHNSON  
Edgerton, Germeshausen  
& Grier, Inc.  
Santa Barbara, California

**It may come as a surprise to author Johnson that his name is given as Edward on the manuscript we received.**

### Laser Modulation

In the article, Field Modulates Laser (April 26), you quote on p 26 some of our results (center column, bottom). There is an error. For 100-percent a-m with a few hundred megacycles bandwidth, only a *few watts* (not a few hundred watts!) are required. Furthermore, the paper presented at the Symposium on Optical Masers is co-authored by K. Gürs, rather than by myself alone.

R. MÜLLER  
Siemens & Halske AG  
Munich, Germany



# SILICON FIELD EFFECT TRANSISTORS



**2N2386**



**2N2794**

These P-channel diffused silicon transistors embody all the desirable characteristics inherent in the field effect design—low input capacitance and high impedance. Use of an S-shaped gate configuration contributes to the exceptionally low capacitance ■ Tung-Sol's wide application experience with injection transistors and vacuum tubes—features of which are combined in the field effect transistor—is an important consideration for anyone seeking a competent source of this advanced semiconductor device ■ Write for complete technical information. Tung-Sol Electric Inc., Newark 4, N. J. TWX: 201-621-7977

TYPICAL ELECTRICAL CHARACTERISTICS (25°C)

	TEST	SYMBOL	CONDITIONS	MIN.	TYP.	MAX.	UNIT
<b>2N2386</b>	Drain Current	$I_{DSS}$	$V_{DS} = -10V, V_{GS} = 0$		3.0		mA
	Forward Transadmittance	$Y_{FS}$	$V_{DS} = -10V, V_{GS} = 0$ $f = 1Kc$	1000		3000	$\mu mho$
<b>2N2794</b>	Drain Current	$I_{DSS}$	$V_{DS} = -10V, V_{GS} = 0$	1.5		5	mA
	Forward Transadmittance	$Y_{FS}$	$V_{DS} = -10V, V_{GS} = 0$ $f = 1Kc$	1000		3000	$\mu mho$

 **TUNG-SOL**

CENTER LINE  
  
QUALITY



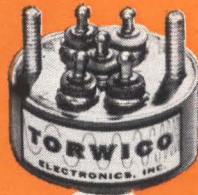

## TINYMAX 400 CYCLE MINIATURE POWER TRANSFORMERS

### TINYMAX

- Range from 1.5 VA to 75 VA with 115V primaries and secondary voltages from 6V to 300V
- Save weight, space and improve performance
- Are hermetically sealed, metal cased and stud mounted
- Are built to meet MIL-T-27A, grade 4, class S requirements
- Special designs up to 2.5 KVA.

DESIGNED  
TO YOUR SPECS,  
MANUFACTURED AND  
SHIPPED WITHIN

# 24 HOURS

Yes, its true TORWICO achieved the almost impossible. Now within 24 hours from the time you give us your order, TINYMAX, 400 cycle power transformers, will be shipped to your plant. Don't waste costly time — get peak efficiency — let TORWICO experts do the design work.

Wire, call or write for complete bulletin and price list!

**TORWICO**  
ELECTRONICS INC., LAKEWOOD, N. J. • 201-364-1800



## Red Tape Slows Up DOD Contracts

WASHINGTON—Barraged by industry complaints, the Pentagon has admitted that the volume of prime contracts will not come up to expectations for the fiscal year ending June 30. The slowdown was much discussed by representatives of the electronics industry at an EIA meeting here last week. Some firms reported layoffs because of the failure to land expected contracts.

The Pentagon says the awards will be several hundreds of millions of dollars less than the rate scheduled for the year, but insists "there are no policy reasons behind the delay." It attributes the lag to "mechanical reasons." DOD plans had called for placement of over \$31-billion worth of new orders, about \$2 billion more than last year.

One big reason for the delays, the Pentagon says, is the organizational overhaul the Army procurement agencies have been undergoing in the past year. The technical services were relieved of contracting responsibilities last year and a new Army Material Command set up to do all the Army's buying.

The Navy is also lagging. One reason may be Defense Secretary McNamara's decision to postpone building a \$300-million aircraft carrier authorized in the fiscal 1963 budget. The Air Force, however, is pretty much on schedule, according to Pentagon experts.

### Tungsten Bulb Pumps C-W Laser

C-W LASER pumped only by a tungsten bulb has been developed by RCA for the Air Force. Input power to stimulate the laser is only 15 w. The system has also been pumped continuously by the sun, Air Force said. The dysprosium-doped calcium-fluoride crystal can be as small as  $\frac{1}{16}$  inch in diameter and one inch in length and can operate in either a liquid neon or liquid nitrogen atmosphere.

To modulate the beam, a single crystal of cuprous-chloride is used (p 12, March 1). It is capable of 100-percent modulation of calcium fluoride crystal emission at 2.36 microns. Internal modulation of the energy levels within the crystal has also been accomplished using a very small magnetic field (p 26, April 26). The laser beam has been used as a carrier for audio frequency signals. The cuprous-chloride crystal and the magnetic field modulation technique were employed.

### NYU Study Gives Hope Of Cancer Prevention

RESEARCH with organic semiconductors that last week was reported to be providing clues to causes of cancer (p 7, June 21) may also show the way to prevention of the disease. Dr. Walter Brenner, who heads the NYU group conducting the study, told ELECTRONICS that if a solid-state conduction process is involved in the start of cancer then

### Self-Service Credit Card

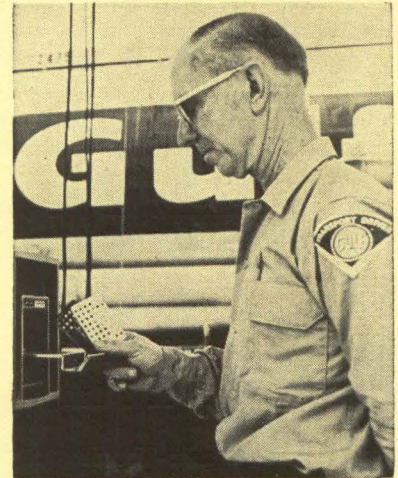

TELEMEMORY punched-card control system installed by Motorola at automated Gulf Oil terminal makes sure right truck driver picks up right load, verifies credit and, with data-processing equipment, handles record-keeping and billing

it may be possible to take advantage of another theory.

This holds that the semiconductor

### Learning Machine Winning Favor

EVANSTON, ILL.—Scientists are turning toward the learning-machine concept because of a growing realization that digital computers, with their dependence on precise and determinate programming, won't be able to handle in economic fashion highly complex tasks such as rapid interpretation of hundreds of thousands of photographically recorded 'events' taken from a cloud or bubble chamber, speech-handwriting conversions or translations.

Some feel that attempts to use digital computers as pattern recognizers is comparable to the engravers' trick of making a picture out of thousands of tiny dots. However, the cost of providing more and more 'dots', or memory cells, begins to rise exponentially as more and more information is required.

These were the impressions gained from speeches, both public and private, at a Computer and Information Sciences Symposium at Northwestern University here.

"The digital computer is too centralized in its concept; even if it works in nanoseconds it can accomplish only one computation at a time," said W. Ross Ashby of the University of Illinois. "There is no need to tolerate this type of organization when there is work to do calling for a simultaneous approach."



ing carcinogenous dyes used in the experiments prefer to form charge transfer complexes with substances other than living tissue and that it may be possible to introduce such substances into the tissue. The carcinogens would then not affect the tissue protein. At the Pasadena Foundation of Medical Research in Pasadena, Calif., scientists have found that living cellular tissue painted with a vinyl dye of low concentration is destroyed by laser beam radiation. Transparent cells are unaffected. Future applications in cancer treatment and research are indicated, researchers say, although the treatment has not yet been applied to humans.

## Nuclear-Powered Missile Program Given A Push

DALLAS—Ling-Temco-Vought says it has been awarded a \$10-million contract by the Air Force for "continuation of the technology for development of a nuclear-powered low-altitude supersonic vehicle (LASV)." This is "part of the AF's LASV program which includes consideration of both nuclear and chemical propelled vehicles," LTV says.

LTV has been working on a nuclear-powered ramjet project since 1958, and initiated studies on a project called SLAM (Supersonic Low Altitude Missile). It had invested some \$3 million of its own in this program, but for the past 18 months or so, the project has been wrapped up in security—even the name SLAM was taboo.

## Superconductive Memory Is 0.00012-Inch Thick

NEW YORK—Experimental, high-speed memory 120 millionths of an inch thick with a storage capacity of 16,384 bits was shown here this week by RCA's Sarnoff Research Center. Designed for computer and EDP applications, the memory has layers of tin, lead and silicon oxide deposited by evaporation on a 2-square-inch glass plate. Between the three layers are two conducting grids made up of 128 hair-thin

strips of lead deposited at right angles to each other. A film of tin is deposited between the grids and the insulator.

## Plasma Metal Junction Generates 29th Harmonic

PLASMA METAL junction harmonic generation is producing microwave outputs at frequencies of 1,015 Gc from a 35-Gc drive input. Even higher microwave frequencies than the 29th harmonic are expected to be produced in the next few months when the drive frequency is doubled.

Heart of the technique, developed by K. Froome of Britain's National Physical Laboratory, is a gaseous plasma in contact with a metal surface. Plasma density is such that it behaves electrically as a wire so that microwave energy fed in is conducted to the junction of the plasma and the metal electrode. By applying a d-c field to the region of intense positive ion space-charge at the actual point of contact, an electron emitting area—the cathode spot of a cold cathode arc—is formed, the electrons being extracted by field emission. Under simultaneous application of the d-c field and a microwave field, the cathode spot acts as a microwave rectifier generating harmonics. The microwave drive input power level is around 10 w at 35 Gc with a superimposed d-c current of 400-500 ma.

## Talking Bird Stands By On Kennedy European Tour

WASHINGTON—C-97 "Talking Bird" stratocruiser plane carrying a complete radio station and 18 communication specialists was sent to Dublin this week as a backup for the President's radio link with the Pentagon Command Post here. The plane, a unit of the Oklahoma National Guard, is equipped with a Collins ARC-58 ssb 28,000-channel transmitter and receiver as well as uhf and vhf, teletype, cryptographic, coding and decoding and telephone switchboard equipment.

## In Brief . . .

HOUSE Government Operations Committee has approved a bill providing for centralized management of government ADP (automatic data processing). It is claimed the plan would save \$100 million yearly.

TV SET manufacturers are stepping up the tempo of their changeover to all-channel TV receivers, EIA says. Industry estimates indicate that 20 percent of black-and-white sets produced this year will receive both vhf and uhf.

COMPUTER SYSTEM with a capacity of 800 million characters of data is scheduled for installation in late 1964 at Randolph AFB.

IN A SECOND TRY, Relay I was used to transmit signals from the U. S. for the automatic setting of type in England (p 7, June 21).

CONTROL DATA Corp. and Itek have signed an agreement under which Control Data will produce principal digital elements for Itek's Digigraphic system. Control Data will also market the device.

GENERAL DYNAMICS, North American and Douglas have each been awarded a \$500,000 Air Force contract to study a new piloted space plane. AF also wants Boeing to quote schedules and costs to develop pilot control of the Dyna-Soar booster.

LEAR SIEGLER has received a contract from NASA to study a system that would sense and record the various physical functions of an astronaut and his vehicle. First step will be development of a system mounted in the pilot's garment and headgear.

HAROLD S. GENEEN, president of ITT, has flatly opposed a suggestion by General Sarnoff, RCA chairman, that all international voice and record communications facilities be merged and placed under control of Communications Satellite Corp.

RUSSIAN SATELLITE was launched October 4, 1962 and decayed October 29, NASA says. Later reports indicated that 23 other pieces of the same unannounced spacecraft decayed between then and February, 1963.



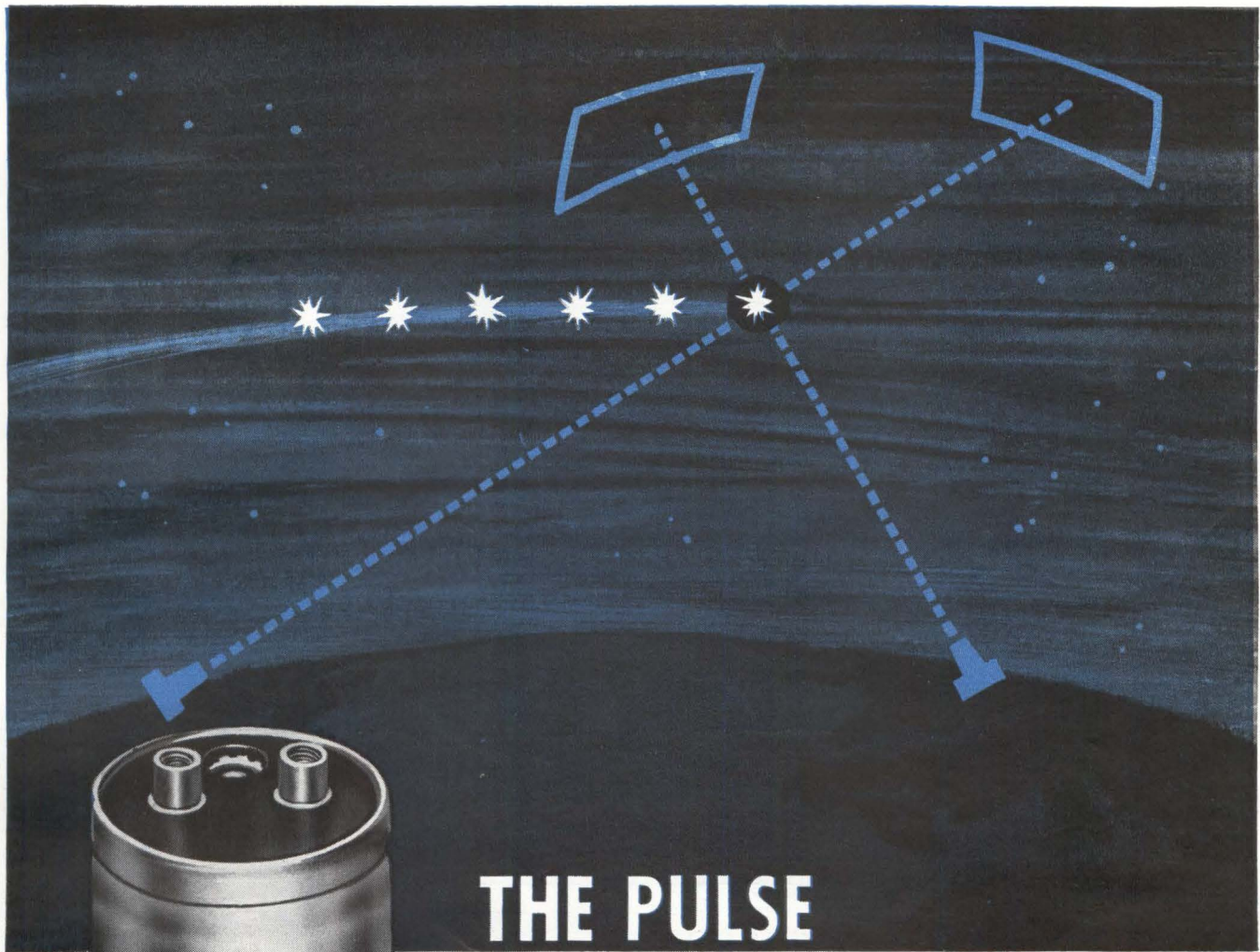

## THE PULSE OF ANNA

Now . . . for the first time . . . aluminum electrolytic energy-storage capacitors have been employed in an orbital satellite!

Satellite *Anna* is the world's first all-geodetic satellite. *Anna* opens the door to: more precise location of world-wide target areas; more accurate orbit planning; improvement of surface and air navigation. But perhaps the most useful aspect of *Anna* was the experience gained in developing "spaceworthy" components which can function in the difficult launch and orbital environment.

*Anna's* optical beacon, developed by Edgerton, Germeshausen & Grier, Inc., flashes sequential strobe signals from satellite to ranging station. *The heart of this beacon is a bank of Sprague Type 36D Powerlytic® Capacitors.* Powerlytics were chosen for their high capacitance, their compact physical size, and their ability to withstand the stringent demands of outer space.

An electrolytic capacitor specialist will be glad to discuss the application of these capacitors to *your* projects. For application engineering assistance without obligation, write to Electrolytic Capacitor Section, Field Engineering Dept. For complete technical data, write for Engineering Bulletin 3421 to Technical Literature Service, Sprague Electric Company, 35 Marshall St., North Adams, Mass.

### SPRAGUE COMPONENTS

CAPACITORS  
TRANSISTORS  
MAGNETIC COMPONENTS  
RESISTORS  
MICROCIRCUITS.

INTERFERENCE FILTERS  
PULSE TRANSFORMERS  
PIEZOELECTRIC CERAMICS  
PULSE-FORMING NETWORKS  
TOROIDAL INDUCTORS

HIGH TEMPERATURE MAGNET WIRE  
CERAMIC-BASE PRINTED NETWORKS  
PACKAGED COMPONENT ASSEMBLIES  
FUNCTIONAL DIGITAL CIRCUITS  
ELECTRIC WAVE FILTERS

**SPRAGUE®**  
THE MARK OF RELIABILITY

\*Sprague' and '®' are registered trademarks of the Sprague Electric Co.



*How much do you know about today's high-frequency scopes?*

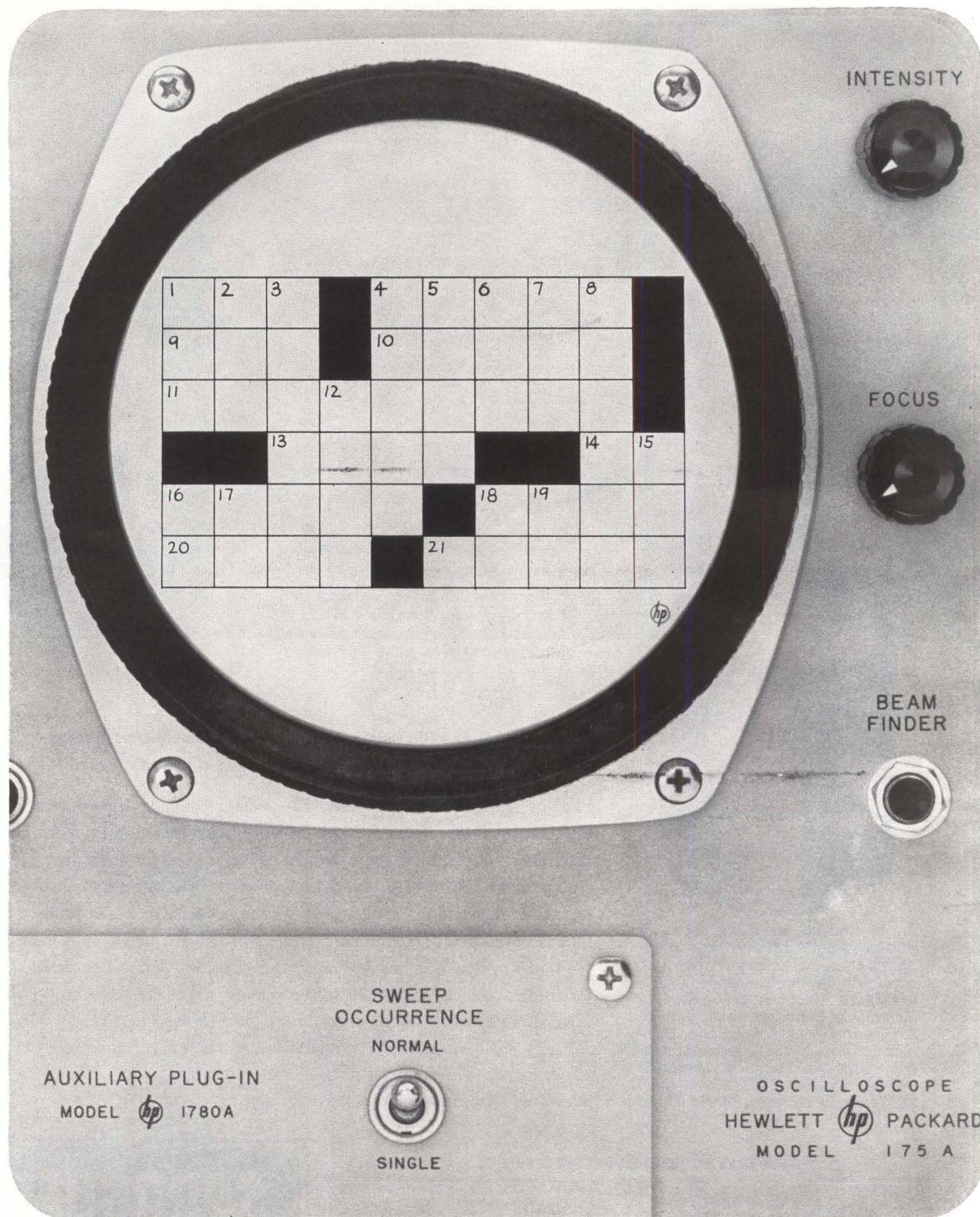

**6 down, 10 across**



## 6 down, 10 across . . . solution:

Divide a 12-volt pulse by 6 cm. Now divide the same pulse by 4 cm.

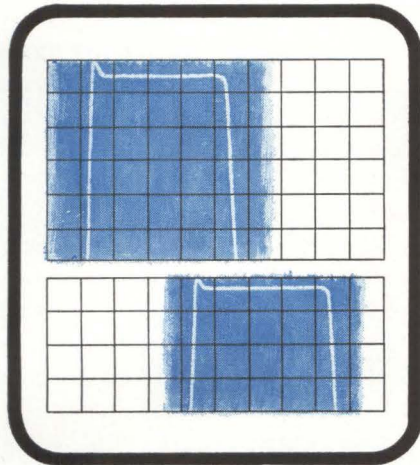

Puzzle: Estimate the amplitude of the overshoot. Two answers, please . . . one for each graticule.

There's the significance of a 6x10 cm crt — obviously more accurate, easier to read with greater precision, easier, on the 175A, to measure pulses with rise times to 7 nanoseconds.

Whether you measure high frequency signals yourself or merely depend on measurements made by someone else, do you know the significance of parallax error? Here is parallax error (top) as contrasted with a no-parallax crt. (bottom):

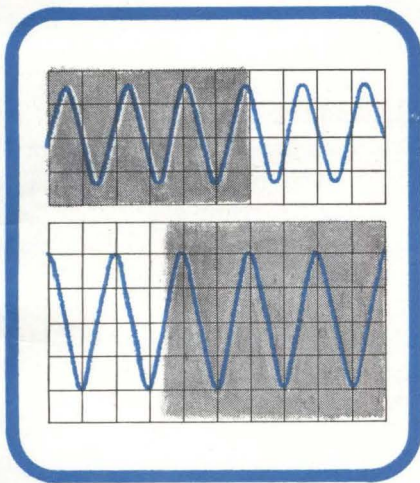

Camera or eye can be as much as 5% wrong unless able to view every part of a scope trace from directly in front of the graticule line. Wide-angle viewing in conventional scopes is distorted by separation between internal trace and external graticule. With an *internal* graticule, in the same plane as the trace, parallax is non-existent. Check the 175A.

Of course you're familiar with the problems of glare. You've had to turn off overhead lights, turn your scope away from windows, use viewing hoods, dim scope pictures with filters . . . and you've still had to fight glare.

If the trace were brighter, if the crt glass were non-glare, if . . . No such "ifs" with the 175A.

When you depend on scope photography, the comparison is simple: See the problems caused by black-and-white photo limitation, trace and graticule both white on black (top), especially as opposed to photo gradations, where trace, graticule and background are clearly separated (bottom). The 175A permits photos with trace, graticule and background of clearly different values:

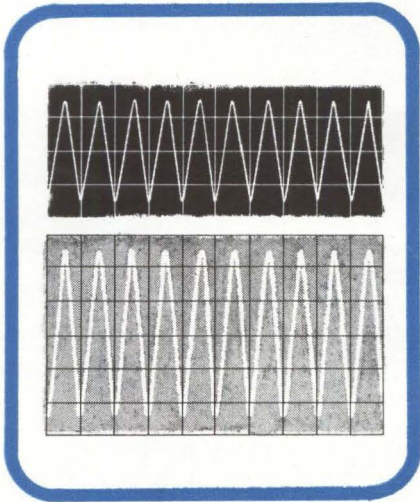

So far, almost everyone who's looked at the picture on the crt of the hp 175A 50 MC Oscilloscope has been convinced . . . not only of the quality of the picture but also of what that quality, what special characteristics can do for him: Unprecedented accuracy, easier viewing. It concerns a 12 kv post-accelerating cathode ray tube developed by hp . . . sensitive enough to make a 6x10 cm presentation to 50 mc, equipped with an internal graticule to eliminate parallax error and permit more readable photographs, topped off with a specially etched non-glare faceplate.

Then, one step farther . . . something you may not have thought about on the crt in your present scope. The sensitivity of the 175A crt minimizes deflection defocusing, so that the conventional front-panel astigmatism control can be eliminated. No more jockeying between focus and astigmatism controls to get a legible picture. Easier to depend on others to make the important measurements for you . . . get the job done faster and more accurately.

The man concerned with maintenance will be happy, too. The high sensitivity of the 175A crt eliminates the need for a complex distributed amplifier . . . and the service man knows how long it takes to adjust those, how a hairline turn of a trimming capacitor can force you to start back at the beginning . . . and how many tubes and mandatory adjustments are involved in trying to align any distributed amplifier.

We think it's a practical consideration . . . how to make the job easier, do it faster, make the results more dependable. And we didn't make the changes to be *different*. We made them to be *practical*.

Now consider these virtues: Horizontal and vertical plug-ins . . . such as dual- and four-trace and high-sensitivity vertical viewing, sweep delay and x-y recording capabilities . . . when, but not unless you need them. They're all available as plug-ins for the 175A Oscilloscope.

Positive preset syncing over the entire bandwidth, the easiest triggering and the most dependable triggering in scoppedom. Plus fewer controls, easier to understand than anything you're used to. You can teach a novice to use the 175A in half the time it'll take him to learn the intricacies of other scopes.

And back to the maintenance story: The 175A uses only 7 tube types and 5 transistor types . . . none "selected." Keep a small maintenance inventory, and if you need to replace a tube, *any* tube of the type will do . . . without elaborate realignment. Add this to your comparison of basic alignment time. You'll make someone happy, yourself or your service shop.

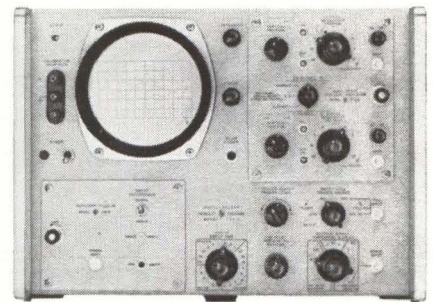

You can't know how practical all this is until you've thought about it, item by item. You can't know how practical it is until you've given it your own critical comparison, set the 175A alongside any high-frequency scope you're using . . . fiddle with it, noodle it, try it. Until you've fiddled with the 175A you probably don't know as much as you should about high-frequency scopes. Until the 175A, we didn't either. hp 175A, \$1325 (without plug-ins).

Data subject to change without notice.  
Price f.o.b. factory.

**HEWLETT  
PACKARD  
COMPANY** 

1501 Page Mill Rd., Palo Alto, Calif., (415) 326-7000.  
Sales and service representatives in principal areas.  
Europe, Hewlett-Packard S.A., 54 Route des Acacias,  
Geneva, Switzerland; Canada, Hewlett-Packard  
(Canada) Ltd., 8270 Mayrand St., Montreal, Quebec.



# WASHINGTON THIS WEEK

## EXPERIENCE— NOT A BETTER PROPOSAL— WINS CONTRACT

CHANGING GROUNDRULES in military procurement were again spotlighted by the Senate inquiry into the X-22 VTOL plane contract award (ELECTRONICS, p 12, June 21). Though a Navy source selection board picked Douglas Aircraft, Bell Aerospace got the contract because of "past performance and relevant experience." Bell is experienced in vertical lift research, Douglas has not been active in the field.

Harold Brown, director of defense research and engineering, shed some light on the latest Pentagon view of contract proposals. Asked by Senator Goldwater why Bell's design proposal had been rated lower, Brown said the connection between a proposal and a contractor's capabilities is often "loose." This comment reflects growing DOD concern that too much industry resources and brainpower are going into salesmanship—the effort to get new contracts—rather than into actual development work.

As for the "relevant experience" emphasis in new contract awards, observers see serious deficiencies. The argument against this is that it would maintain the dominance of experienced companies and tend to discourage other firms from expanding into new fields of military technology.

## BYKOVSKY AND TERESHKOVA— HAPPY LANDING FOR NASA, TOO

LIKE THE CAVALRY, the Soviet space twins arrived in the nick of time for NASA. U.S. space officials had \$500 million and a year's free rein riding on the male and female nose cones. The feat put an exclamation point on NASA's contention that its \$5.7-billion budget request is a bare minimum to keep the U. S. in the space race.

House budget watchers had determined on a 10-percent slash, were increasingly critical of the \$50-million electronics lab assigned to Massachusetts. The Senate has NASA's free-wheeling methods under fire.

Congress has now moved from carping at the growing cost of the moon race to less cutting issues. House members are taking exception to the personal frictions which led to the resignation of D. Brainerd Holmes (he gives other reasons, see ELECTRONICS, p 22, June 21). The Senate complains it wasn't consulted on minor program changes.

Still in trouble, though, is a \$55-million item for space communications research. Clinton P. Anderson, Senate Space Committee chairman says the work should be done by the Communications Satellite Corp. NASA says most of the money—\$40 million—is for the Syncom satellite, a research project, not a "working system" like Telstar.

## BAMBI'S DEAD, MIDAS IS ILL

HOUSE HEARINGS on the defense budget, just released, confirm that the Defense Department has halted feasibility studies on the Bambi satellite-based anti-ICBM system (ELECTRONICS, p 26, May 3) and has sharply reduced work on the Midas early-warning satellite (p 7, May 31).

Jack Ruina, outgoing ARPA director, said to implement a Bambi system would cost \$50 billion a year and require major advances in reliability, interceptor accuracy, discrimination of target signals from sunlit clouds and target assignment control. Bambi was to detect and intercept ICBM's during their launch phase.

Harold Brown said that about half the \$423 million spent on Midas development was "wasted on premature system-oriented hardware." On his recommendation, Air Force's \$190-million budget proposal was slashed 80 percent and the Midas project will move along more slowly next year.



**Western Electric  
carbon resistors  
now protected  
by Kynar®**



Latest refinement in carbon film resistors made by Western Electric is a sleeve of Kynar,\* Pennsalt vinylidene fluoride resin. Western Electric produces 30 million resistors of this type yearly for ANI (Automatic Number Identification) equipment.

Western Electric engineers selected Kynar for two principal reasons—strength and stability. Kynar won't melt, drip or burn, under the most severe overloads. Its superior stability assures freedom from degradation due to aging

or environmental conditions. Kynar is completely compatible with high-speed production. Extruded tubing feeds readily through forming equipment, cuts cleanly, heat-forms easily, takes marking inks.

Kynar offers a unique combination of electrical strength, mechanical toughness and stability. If you have a problem where you need extra performance, write or call us for data. Plastics Dept., PENNSALT CHEMICALS CORPORATION, 3 Penn Center, Philadelphia 2, Pa.

***Kynar...a fluoroplastic that's tough!***

\*Kynar is a Registered Trademark of Pennsalt Chemicals Corp.





NUMBER ONE IN ELECTRICAL CONNECTORS...

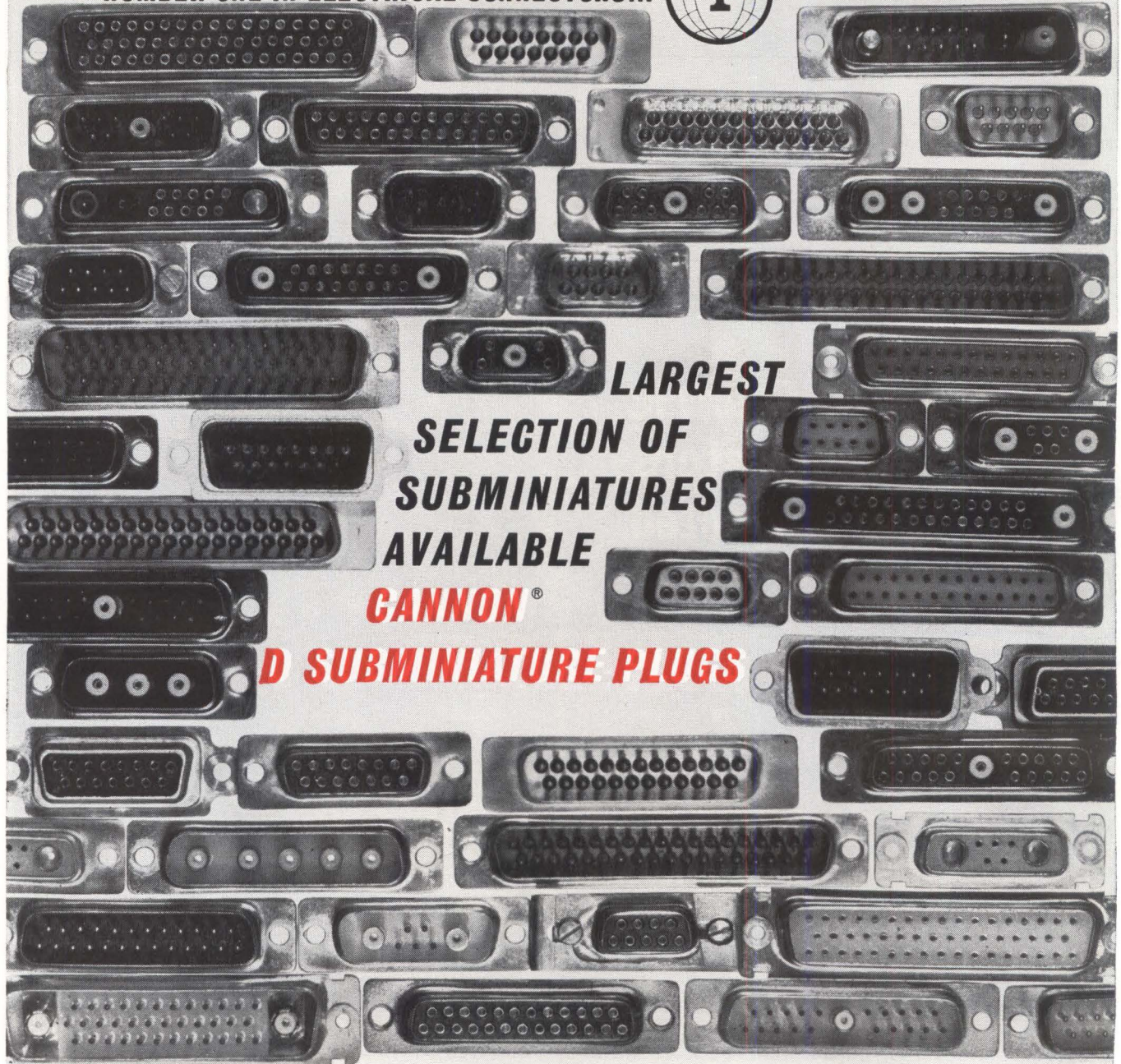

**LARGEST  
SELECTION OF  
SUBMINIATURES  
AVAILABLE**

**CANNON®  
D SUBMINIATURE PLUGS**

### SIZES FROM 9 TO 50 CONTACTS

- SOLDER POT CONTACTS
- CRIMP REMOVABLE SNAP IN CONTACTS
- CRIMP REAR-RELEASE CONTACTS
- HERMETICS
- COAXIAL INSERTS
- HIGH VOLTAGE INSERTS
- COMBINATION LAYOUTS
- MOISTURE RESISTANT
- VIBRATION RESISTANT
- HIGH ALTITUDE
- LOW MAGNETIC PROPERTIES
- CORROSION RESISTANT
- PRINTED CIRCUIT APPLICATIONS
- CUSTOM APPLICATIONS

Contact your Cannon Authorized Distributor or write to:

® "CANNON" IS A TRADEMARK REGISTERED IN U. S. PAT. OFF. AND FOREIGN COUNTRIES BY CANNON ELECTRIC COMPANY

## CANNON ELECTRIC COMPANY

3208 Humboldt Street, Los Angeles 31, California

ADDITIONAL PLANTS IN: SANTA ANA & ANAHEIM, CALIF. • PHOENIX, ARIZ. • SALEM, MASS. • TORONTO • LONDON • PARIS • BORNEM, BELGIUM • TOKYO • MELBOURNE

*Sales offices and representatives in principal cities of the world*



© 1963 CANNON ELECTRIC COMPANY



What's new  
behind the  
compact-TV  
camera lens?

## 3 New G-E Vidicons

High sensitivity, low lag, and more uniform photoconductive surfaces give broadcast-quality pictures in *any* television pickup function. New "Snow White" manufacturing facilities assure uniformity.



The GL-7038 vidicon is designed for televising live scenes and film pickup applications. Highly uniform photoconductive surface provides a uniform, high-quality picture across the scanned area. The GL-7038 will replace the 6198 and 6198A vidicons. Over-all length: 6¼".



The GL-7325's high sensitivity is ideal for televising live scenes, at lower light levels. The photoconductive surface provides low lag (20-30%) at these light levels. Over-all length: 6¼".



The GL-7226 is designed for transistorized camera chains. Featuring a low heater power cathode which operates at 90 ma, performance characteristics of the tube are the same as the GL-7325. Over-all length: 5½".

For specifications and data on the complete line of G-E vidicons and image orthicons, write to: General Electric Company, Room 8006A, Owensboro, Kentucky, or call your nearest G-E Industrial Tube Distributor, today!

*Dedicated to Broadcast Quality in Industrial Applications*

*Progress Is Our Most Important Product*

**GENERAL  ELECTRIC**

CIRCLE 15 ON READER SERVICE CARD



## WHERE SPACE-AGE RESEARCH IS IN ORBIT

Launching ships is an old story in Baltimore, which has built them by the thousands. The busy shipyards here are still building them, too. But another kind of launching preoccupies many Baltimore-area plants today . . . with electronics for guidance systems, chemicals for propulsion, hardware for the space vehicles themselves. Space-age research and

development, engineering and production are expedited by ideal sites, a profusion of **specialized** labor skills, major colleges and universities, proximity to NASA headquarters and Washington, D.C.

Added to these, in Baltimore and its neighboring counties, is fast, flexible transportation . . . by air, land and sea. Stable economy, too. When you want to think **big**, think **BALTIMORE**.

**PUT YOUR PLANT IN**

# BALTIMORE

For confidential information, write Robert J. George, BALTIMORE GAS AND ELECTRIC COMPANY, Baltimore 3, Maryland. Or call him at 301-539-8000.

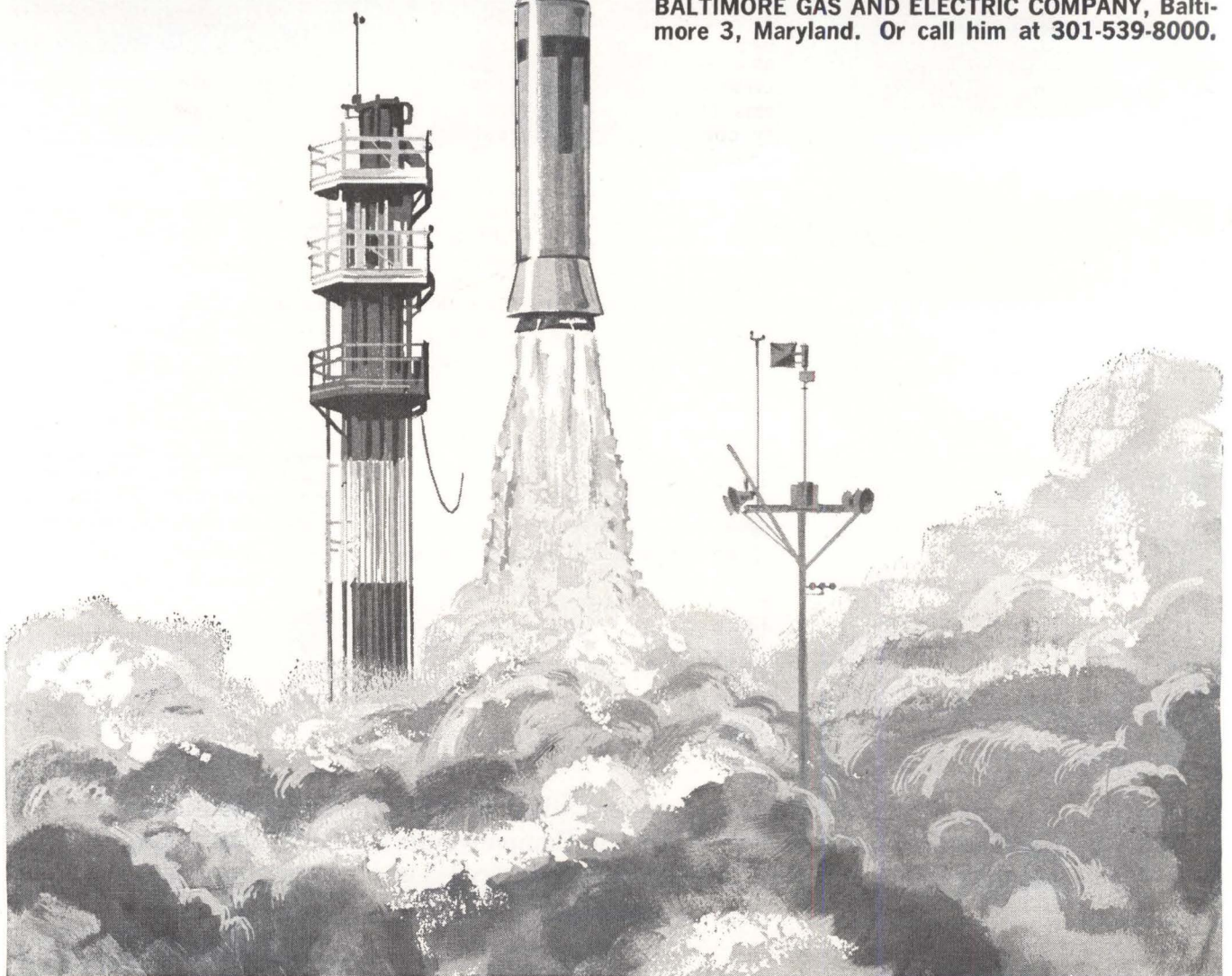



# NEWS

## Thermistors?—Nobody makes a wider variety than Carborundum.

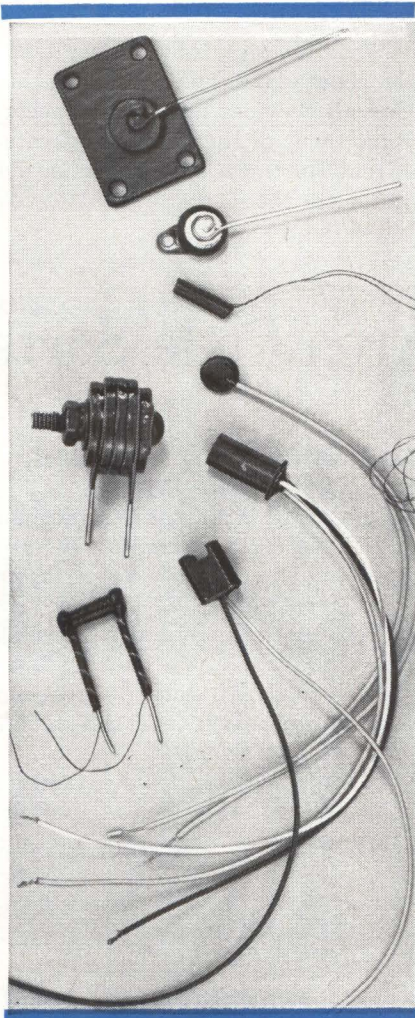

Carborundum is turning out thermistors in varieties undreamed of a short time ago—from sub miniature discs to complete assemblies.

**Special assemblies** can be manufactured to fit chassis and operating requirements. You can specify your electrical and dimensional needs and we'll design the assemblies to meet

them. They meet precise tolerances for temperature coefficient, dissipation constant and resistance at reference temperature. Can be potted in epoxy. Provide long-term stability.

**Discs and washers** are available in sizes from 1/10" to 1" in diameter. We supply them soldered to mounting plates or with special terminals to solve assembly problems. They're made of high-stability compositions. Beta values range from 2700 to 4800.

**Rods** can be purchased from Carborundum in the widest range of body sizes and temperature coefficients available to industry—in lengths from 1/4" to 12" and diameters from .05" to 1". Beta values from 1100 to 4600.

**PTC Thermistors** are new, positive-temperature-coefficient units with high sensitivity. Sensitivities as high as 12 percent per °C can be achieved. Use PTC's in combination with NTC's (negative coefficient units) and with linear resistors to construct an astonishing variety of temperature compensation curves for your circuits. We also manufacture PTC assemblies and probes for special needs.

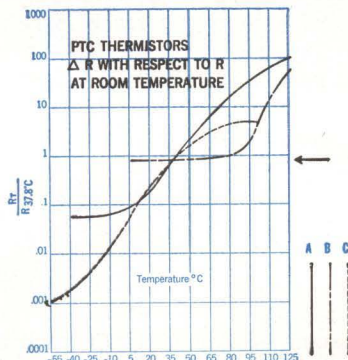

The graph shows resistance of three different PTC thermistors over a range of temperatures as a multiple of resistance at room temperature.

For more information on this complete thermistor line, write to: Electronics Division, Global Plant, Dept. ED-6T, Niagara Falls, N. Y.

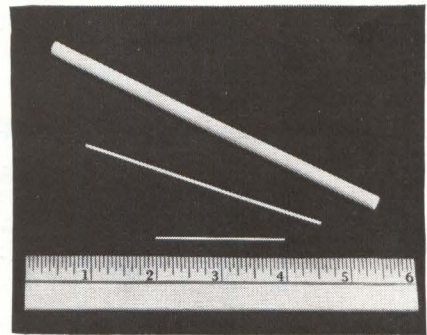

## Magnesium oxide crushable preforms now in longer lengths

High-purity (99.4%) MgO tubing is now available in lengths up to six inches. This is double the previous size available. Now you can produce swaged, high-precision thermocouple assemblies faster. Cut costs at the same time.

These ceramic preforms are available in 2", 4" and 6" lengths depending upon O. D. size. In addition, O. D., hole size, and camber tolerances have been tightened. They have an AQL (acceptable quality level) of 2.5% for O. D., hole size and camber. Using the longer lengths, you can produce thermocouples with fewer air gaps, better resistivity and lower fatigue factor. They're just what you need wherever rigidity, resistance to vibration and high reliability are a must. For our new literature on ceramic insulating tubing, write to: Electronics Division, Latrobe Plant, Dept. EL-6, Latrobe, Pa.

**CARBORUNDUM**®





*Washington and Moscow agree on duplex*

## HOT LINE: For

By ALEXANDER A. McKENZIE  
Associate Editor  
WARREN KORNBERG  
McGraw-Hill World News

**WASHINGTON** — Radio Moscow simply said, "This line is to be used in case of emergency." And a U.S. spokesman added, "We hope it never gets used."

Both were talking about the hot line—a constantly open link between the two nuclear capitals. The agreement signed in Geneva last week is the first concrete result of the disarmament talks there.

The accord, signed by Charles C. Stelle, for the U.S., and Semyon K. Tsarapkin, of the USSR, calls for a full-time duplex teleprinter cable circuit between Washington and Moscow backed up by a radio circuit. Brig. Gen. George P. Sampson, deputy director of the Defense Department's Defense Communications System, handled technical details with Ivan Kokov, Soviet Deputy Minister of Communications.

Washington terminal of the line will be the National Military Command Center in the Joint Chiefs of Staff area of the Pentagon. From Pentagon to President existing techniques will be used, depending upon where the chief executive is located. Telephone will not be used. The Moscow terminal has not been announced but the Soviet end of the circuit would probably be handled through the Ministry of Posts and Telegraphs.

**NO SATELLITES**—Standard communications procedures can still be glamorous in an age of communications satellites, as is pointed up by details in the agreement's technical annex. Although much of the hot line's significance is political, symbolizing a mutual concern for accidental military action, the 24-hour operation of the line

must be foolproof. So, engineers batted down exotic recommendations and are sticking to circuits that are already available or in daily operation.

**WHAT COMPANIES?**—Routes for the cable circuit are spelled out as Washington, London, Copenhagen, Stockholm, Helsinki, Moscow, and circuits over these routes do exist. What companies will be involved was not officially revealed at press time.

Long Lines officials of AT&T, for example, indicate that they are in the overseas telephone business, but that channels in their cables

leased to others could be put to any use without their knowledge. Ruling out AT&T as an active participant, those companies remaining who use identical New York-London facilities are Western Union, American Cable and Radio, and RCA Communications. Western Union spokesmen denied knowing the choice, but communications people feel Western Union will get the nod.

Existing circuits from London to Moscow via Helsinki are identical for all services and it is expected that those of the Finnish-operated Great Northern Telegraph Co. will complete the loop.

## Space Area Code Sorts

**CAPE CANAVERAL**—When the Tiros 7 weather satellite went up last week to join its long-lived brother, Tiros 6, it made the sky a bit crowded. NASA asked RCA to build Tiros 6 for a 3½-month mission requirement, but it is still transmitting after 9½ months.

Both satellites use the same command frequency. The problem of a mixup in transmission, however, is being solved by command discrimination gear—something like the area code in telephony. With telemetry frequencies becoming overworked, this technique will probably become a much more common practice.

The launch marked approximately the mid-point in the Tiros program. The next move, starting with Tiros 8, will be the use of Apt (Automatic Picture Transmission Cameras) and the use of numerous ground stations to receive televised weather pictures. Apt transmits in real time.

Some 45 Apt stations, each costing \$30,000, will be operating

around the world when Tiros 8 goes up this fall. They are being bought by NASA, the Weather Bureau, the military, and other agencies and will later be offered to foreign countries.

Apt stations, built by Fairchild Stratos, consist of a 12-db gain antenna that can cover 35 degrees while stationary, and 136-Mc and facsimile receivers.

Tiros 9 will have two cameras, one an Apt, rotating on a wheel-type configuration to take alternate

COMPONENTS of a Tiros are displayed at RCA plant

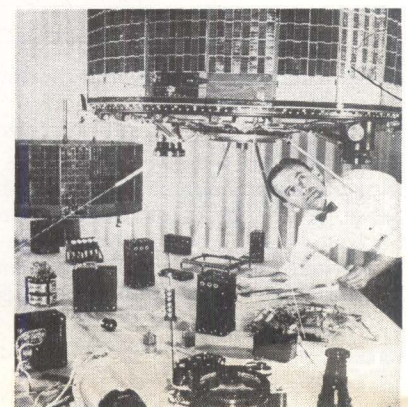



teleprinter for emergency use

## Cool Nuclear Decisions

Official announcement specifies a duplex radiotelegraph circuit via Tangier. RCA Communications has such a circuit in full-time operation serving both Tass, the Soviet news agency and the Soviet delegation to the United Nations.

In good position to furnish the backup circuit is RCA Communications.

**LANGUAGE AND SECRECY** — The language barrier will be partially overcome by having the Soviet Union send its messages in Russian and the U. S. in English. Sets of teleprinter equipment will be exchanged for installation at

the far end of each circuit. Another sticky problem, that of not washing one's diplomatic linen on a public circuit, has apparently been solved by agreement of the U. S. to sell the Soviets four encrypting machines that use what is known as a one-time tape. The code is used once and then the tape is destroyed. The Russians will send us tapes showing which of our coding arrangements they are going to use, we slip these on our decoders and the Washington machine then spells out straight Russian text. We'll furnish decoding tapes to the Russians. Deadline goal for the hookup is 60 days.

## Commands for Satellites

pictures (ELECTRONICS, p 7, May 31). Tiros 10 and 11 will provide information on possible synchronous-orbit weather satellites. Number 12 will go back to the wheel configuration and have an Apt and a picture-storing recorder. The last three will be regular types. They'll be used if earlier R&D types fail.

Then the Nimbus series of satellites will begin. Nimbus will not replace Tiros. Tiros is more flexible and will continue to be used to

supplement the Nimbus program. Chief feature of Nimbus is that it will take larger-area pictures and continually look at earth.

One of the Nimbus development problems is that the organic bonding materials used in the lenses are fogged by radiation. The satellite will have to pass through the artificial radiation belts.

A Nimbus-type infrared recorder is being carried by Tiros 7, the first Tiros to make infrared measurements in space.

*NEXT CONFIGURATION for Tiros is a wheel, so cameras alternate in taking and transmitting pictures. Nimbus follow-on is sketched at right*

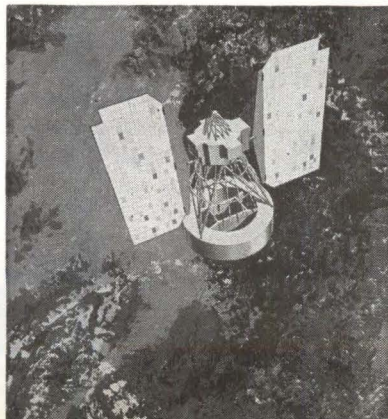
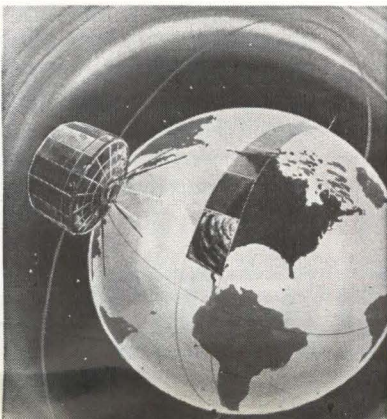

*the  
Last Word In*

# HIGH SPEED

printer systems

*from*



## POTTER

the  
**LP-1200 SYSTEM**  
provides:

- **LOW COST BUFFER STORAGE...**  
Computer proven Magnetostrictive Delay Lines are compatible with the fastest computer systems.
- **NEW DELAY LINE AMPLIFIER...**  
Peak Detection circuit improves reliability at higher frequencies.
- **QUALITY HIGH SPEED PRINT-OUT**  
Vacuum Paper control, coupled with high speed paper feed produces clean, sharp impressions.
- **HUMAN ENGINEERING provides...**  
quick, front paper loading, ease of ribbon change, access to drum and hammers, convenient operating controls.
- **ADDITIONAL FEATURES...**  
non-wearing Elastomeric torsion bearings assure long hammer life; low inertia drive belts minimize clutch and brake wear.
- **12 WEEK DELIVERY**

To learn how the Potter LP-1200 Printer System can reduce the cost of your computer time, write to the General Manager, Printer Division, today.



**POTTER INSTRUMENT CO., INC.**  
PRINTER DIVISION  
East Bethpage Road • Plainview, New York

CIRCLE 19 ON READER SERVICE CARD



# NEW MODEL 430A POWER SUPPLY

—a "first" for FLUKE in the high voltage field!

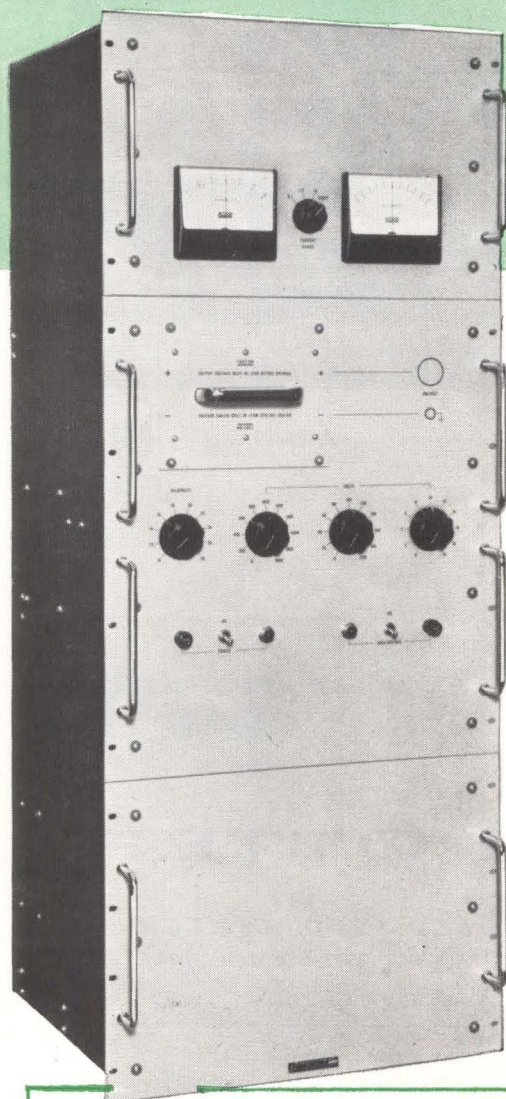

**10.00-30.22KV**  
**Line regulation, 0.005%**  
**Load regulation, 0.01%**  
**Stability, 0.005%**  
**Precision calibrated**



**Model 430A** fulfills exacting requirements for

*Electrostatic focusing in mass spectrometry*  
*Acceleration and focusing in high resolution cathode ray tubes*  
*Calibration of electrostatic voltmeters and high voltage dividers*  
*Pressurized ionization chamber experimentation*  
*High voltage research*  
*Charging high voltage capacitor banks*

Model 430A delivers calibrated DC from 10 kilovolts through 30.22 kilovolts, with an output current capability from 0 to 10 milliamperes. The supply may be operated with either a positive or negative output, with one side always grounded to the chassis. Polarity is easily changed by reversing a front panel polarity plug, which is interlocked for safety.

No oil-filled tanks and associated heaters and thermostats are used. The sampling string features stress-free encapsulation, reed relay switching and 100 millivolt resolution at any output voltage.

The high voltage output is developed from a conventional 50-60 cycle voltage doubler, free of interference associated with RF type supplies. Approximately 60 seconds after line power is switched on, the high voltage circuitry is armed, and the 430A is ready for use.

## BRIEF SPECIFICATIONS

	MODEL 430A	MODELS 413C, 413D
OUTPUT VOLTAGE	10 KV-30.22 KV	0-3111 VDC
OUTPUT CURRENT	0-10 ma	0-20 ma
LINE REGULATION, for 10% line change	0.005%	0.001% + 1 mv
LOAD REGULATION, for full load change	0.01%	0.001% + 2 mv
STABILITY		
Per hour	±0.005%	±0.005%
Per day after warmup	±0.03%	±0.03%
RESOLUTION, full range	100 mv	2 mv
RIPPLE	5 mv RMS	150 uv RMS
CALIBRATION ACCURACY	±0.25%	±0.25%
SIZE	48" high x 19" wide x 18" deep	19" wide x 5 1/4" high x 16" deep
WEIGHT	260 lbs.	50 lbs.
PRICE	\$3900.00	\$695.00—413C \$595.00—413D

**Models 430A, 413C and 413D may be used over a wide range of environmental conditions**

OPERATING TEMPERATURE RANGE	0°C to 50°C
TEMPERATURE COEFFICIENT, 10°C to 40°C	±0.002%/°C
STORAGE TEMPERATURE RANGE	-20°C to +60°C
HUMIDITY	0 to 80%
ALTITUDE	0 to 10,000 feet

## Other new Fluke power supplies:



**MODEL 413C**, shown above, offers 0-3111 VDC; ±0.001% line and load regulation; front panel polarity switch; virtually complete absence of noise; low ripple; no voltage overshoot, and high resistance to mechanical shock and vibration. Same specifications apply to Model 413D (with front panel polarity plug; without meters).

Before specifying any type of power supply, check the full range of Fluke models. Write for new Catalog Digest 3-63 showing complete line of Fluke test and measurement instruments, or ask your Fluke sales representative for complete technical data or demonstration.





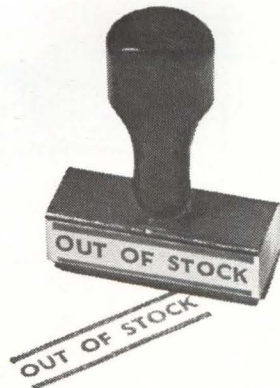

**But you can  
still make the sale**

### **Because Air Express delivers overnight...anywhere in the USA**

Why freeze money in inventory, when smaller stocks will do just as well? And they will...when you take planned advantage of Air Express.

Here's how easy it is to get fast stock replacement by Air Express: Phone your order to suppliers, specifying delivery by Air Express. We pick up your shipment from your supplier, wherever he may be...put it on the first flight out...and our trucks deliver it to you the next day.

Air Express alone can offer this service, because Air Express shipments have official priority with all 38 scheduled airlines—first cargo aboard after air mail. The cost is less than you think. For example, 10 lbs. travels 1,500 miles for only \$6.66.

You can switch to this fast-growing, cost-cutting modern practice of "stock when you need it"...simply by specifying Air Express. And for prompt service when you ship, call your REA Express office for Air Express service.

**AIR EXPRESS**  
DIVISION





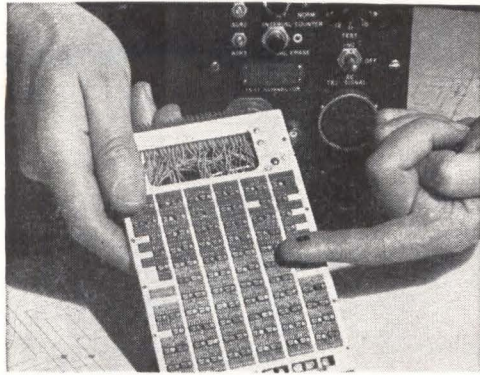

CARD HOLDS silicon microcircuits for receiver unit



ENGINEER Robert Hudelson points out readout display on mockup of ARN-76 control indicator. Below are antenna coupler and receiver, at left is Sperry's operational airborne Loran-C receiver weighing more than 100 pounds

*Reliability and accuracy  
are increased in  
new 19-pound receiver*

## Microelectronic Loran-C Will Fly Next Year

AIRBORNE Loran-C receiver using digital microcircuits will be flight-tested early next year. The 19-pound AN/ARN-76 receiver is expected to provide position fixes accurate to within a few hundred feet almost anywhere over the Northern Hemisphere.

Sperry Gyroscope Co. is developing the receiver with support from the Navy Bureau of Weapons. Containing more than 25,000 components and occupying 0.47 cubic foot, it is one of the first complete electronic subsystems designed specifically for microcircuits.

**INTEGRATED CIRCUITS** — The package is made up of an antenna coupler, receiver and control indicator. Ninety-five percent of the receiver circuits are silicon integrated circuits while the remainder (r-f amplifier, power supply and magnetostrictive delay line) are cordwood.

Sperry expects the digital ARN-76 to be an airborne replacement for bulkier analog Loran-C receivers in use on ships and planes since 1958. The ARN-76 will be one-fifth the size and weight.

Receiver reliability is being hiked by using only five different types of microcircuits, and eliminating gears, motors, fans, and synchros, Sperry says. First tests

of the microcircuits have shown that receiver mtbf will be more than 1,500 hours.

The five basic circuits are flip-flops, NAND gates, AND gates, dual AND gates and dual NAND gates. They can handle 1-Mc clock rates and are mounted in banks of 100 or more on postcard-size plug-in cards.

**APPLICATIONS** — ARN-76 has been in development for over a year and is intended for use where size, weight, operational simplicity and minimum power consumption are critical considerations. Range is 2,500 miles. Where existing receivers have a fix accuracy of 1,000 ft at 1,000 miles from the nearest transmitter, ARN-76 has an accuracy of 600 ft (0.1  $\mu$ sec).

In contrast to previous systems the 2.4-pound control indicator is the only component that has to be in the cockpit—remainder of the equipment can be located up to 100 feet away, permitting installation in small single-seat aircraft. Operator controls have been reduced from 29 to 5; operators can be trained in 15 minutes. A simplified time-difference display provides quick numerical readout in in-line decimal form. Fully automatic search of less than one-minute duration under signal-to-noise conditions of 1:1 or

better is provided. Automatic receiver operation can be maintained under s/n of 1/10, and also with c-w interference up to 35 db greater than the received Loran-C signal.

Other specs are: receiver sensitivity, nominal signal level  $5\mu$ v at antenna; agc and gain balance range, 132 db; antenna, effective height less than 15 inches and capacitance of 100 pf minimum; input power, 155 watts.

Designed by Sperry several years ago as a world-wide radio navigation system, Loran-C now covers the sea-land areas of the North Atlantic, North Pacific and Arctic Oceans and Bering and Mediterranean Seas.

Position fixes are calculated with the aid of the receiver which measures the time interval between the arrival of 100-Kc pulses broadcast from chains of strategically-located transmitters. Matching these measurements to special Loran map coordinates, the navigator then pinpoints his position.

The ARN-76 is expected to be used in long-range patrol aircraft, photo reconnaissance, counter-insurgency aircraft and antisubmarine warfare. Research is underway to evaluate its capability for tracking missiles and satellites. Sperry is also working on a microcircuit shipboard unit.



# How to put Siliconix UNIFETs\* to work . . .

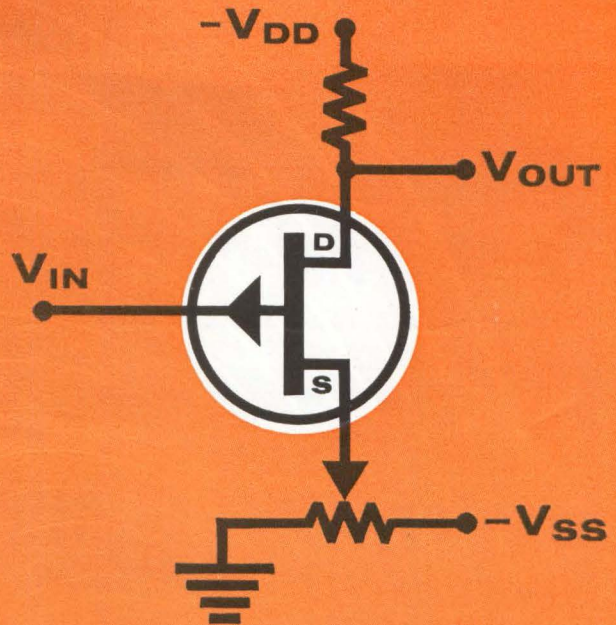
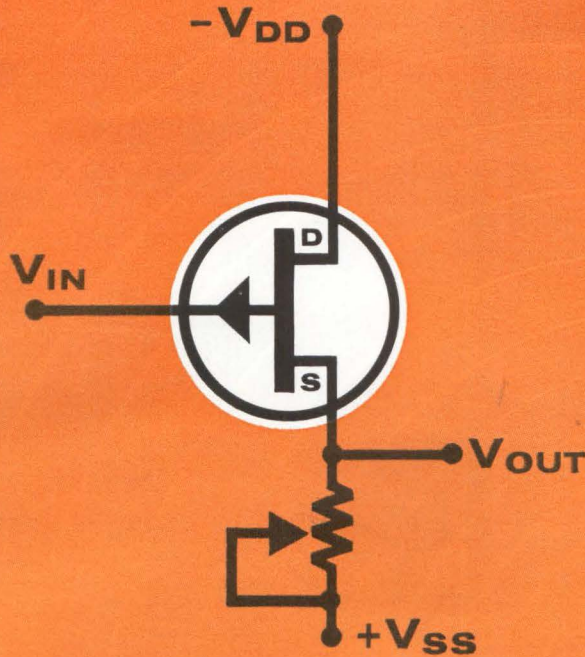

## DRIFT — LESS THAN 1 mv/100°C

DRIFT REFERRED TO THE INPUT

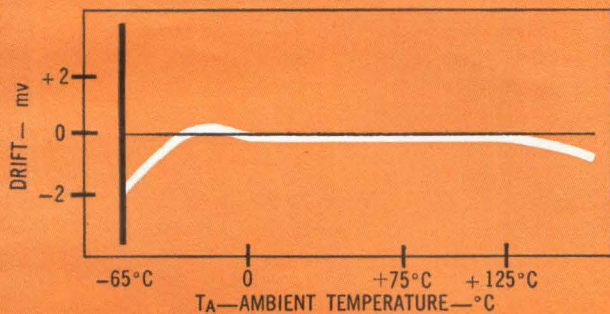

$V_{GS}$  TEMPERATURE COEFFICIENT vs NORMALIZED  $I_D$

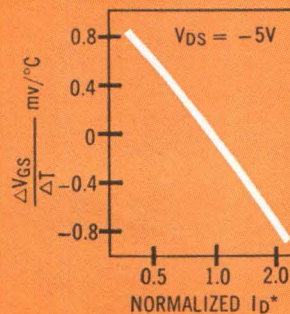

Typical Values of  $I_D$  and  $g_m$  for zero temperature coefficient of  $V_{GS}$ .

	$I_D$ ( $\mu A$ )	$g_m$ ( $\mu mho$ )		$I_D$ ( $\mu A$ )	$g_m$ ( $\mu mho$ )
2N2606	10.5	40	2N2841	14.0	50
2N2607	30.0	120	2N2842	40.0	140
2N2608	95.0	370	2N2843	125	450
2N2609	300	1100	2N2844	400	1300

\*Multiply scale by typical  $I_D$  above

YOU NO LONGER HAVE TO MONKEY WITH DIFFERENTIAL AMPLIFIERS, MATCHING TRANSISTOR PAIRS, BATTLING STEADY STATE AND TRANSIENT THERMAL GRADIENTS. HERE IS A HIGH-INPUT-IMPEDANCE D-C AMPLIFIER THAT CAN BE BIASED TO NEARLY ZERO  $\Delta V_{GS}/\Delta T$ . UNIFETS ARE RADIATION TOLERANT, TOO. WRITE FOR FILE 100C. IT EXPLAINS THE WHOLE THING.

\*Unipolar Field-Effect Transistors



**Siliconix incorporated**

1140 West Evelyn Ave. • Sunnyvale 33, California  
Telephone 245-1000 • Area Code 408 • TWX 408-737-9948







## SCIENTISTS AND ENGINEERS:

From undersea navigation equipment for test on the research vessel Trieste to the development of non-inertial systems for deep space rendezvous, Motorola performance spans the broad spectrum of environments in advanced systems.

In the area between, current programs include: advanced random access communications and side looking radar surveillance systems for the Army... air-to-air missile guidance and digital command systems for the Navy... data transfer and high speed teleprinting systems for the Air Force... satellite tracking, telemetry and instrumentation for NASA... and extensive company funded R&D projects. Scientists and engineers interested in joining an electronics company with versatile interests unbounded by narrow specialization write today describing your background and training in:

## ZERO TO INFINITY

**Systems Design** • operational and functional mission analysis, optimum time-bandwidth utilization, redundant system organization for reliability, phased arrays, digital and voice communications, and A-J secure communications.

**Equipment Design** • solid state receivers, transmitters and transponders, distributed parameter microwave equipment, digital Modems, controls and displays, low-level switching circuits, and digital data processing circuitry.

**Familiarity with State-of-the-Art** • spread spectrum techniques, visual spectrum intelligence transmission, statistical theory of communication, integrated circuit applications, multiple logic element techniques, organization of digital data handling systems, correlation and phase-lock techniques, and coding and modulation.

We are particularly interested in programs on which your experience was obtained and the extent of your technical responsibility. Please address this information to our Manager of Engineering for immediate and confidential attention.



**MOTOROLA**  
*An equal opportunity employer*

### **Military Electronics Division**

SCOTTSDALE, Arizona, 8201 East McDowell Road  
CHICAGO 51, Illinois, 1450 North Cicero Avenue



# Here's That New Color—Tv Tube

*This week, dealers see eight sets with 23-inch, 92-deg rectangular tube*

By CLETUS M. WILEY  
Midwest Editor

**CHICAGO**—Hottest news at the IEEE's Chicago Spring Conference on Broadcast and Television Receivers last week was the extra-curricular leak of Motorola's plans for introducing the 23-inch rectangular, 92-degree color tube, under development for the past two years.

An RCA representative commented "that 92-degree deflection will be a neat trick, if they can manage it."

Admiral board chairman Ross Siragusa provoked chuckles as he welcomed others to enter the color field where "profit margins offset lower averages from portable B & W sets." Just last month Siragusa's company cut the price of its basic color model to \$399.95.

**COLOR TUBE**—Motorola's long-awaited color set was to be introduced to dealers in New York and Chicago this Tuesday, June 25 with

prediction "tens of thousands of them will be placed in consumer homes by the end of the year."

Eight of Motorola's color introductions use the newly developed rectangular tube, allowing sets to be nearly six inches shorter than other color models. Three use RCA's 21-in. round, 70-deg tube.

Price of the rectangular tube models starts with a \$650 console, round-tube sets at \$450.

Advances in technology over past two years—while company's investment increased from more than \$100,000 to \$4 million—has mainly been in refining tolerances, assuring reproducibility and tooling up for production with supplier, National Video Company, tv engineer Garth Heisig told **ELECTRONICS**.

New rectangular tube still starts with a basic black-and-white type shell. Special deflection coils have been developed with Advance-Ross, Burlington, Iowa, to fit the smaller 1 $\frac{1}{8}$ -inch neck of this tube. Convergence circuits have been adapted for smaller color guns. A "dynamic pincushion" circuit straightens arcs at edges of the raster and a precision lens has been developed for the "lighthouse" which controls

masked deposition of color dots.

First of the new rectangular tube sets are expected to start reaching dealers in August, with "some sort of rationing appearing inevitable."

Company says it has not even started to think of making its new tube available to other firms.

**TRANSISTOR TV**—Cost crossover will make silicon transistors for consumer applications within the next couple of years, predicted L. A. Weldon, of Philco. Non-hermetic passivated packaging will help lower costs and will be adequate for consumer applications.

Transistor tv will never achieve large, efficient volumes until both price and performance compare with existing tube receivers, reported R. A. Santilli, of RCA. San-

## Wireless Mikes

**EFFECTIVE JULY 1**, the Federal Communications Commission is relaxing Part 15 of its Rules and Regulations, to let wireless microphones operate anywhere in the 88 to 108-Mc f-m band. By the same action, the band is also opened up to telemetering.

No licenses will be required, but manufacturers will have to have their equipment type-approved. The microphone or telemetering signal must stay within a 200-Kc band. Power will be limited to a field strength of 50  $\mu$ v/meter at 50 feet. Custom-built devices for experimental use by educational institutions need not be type-approved, but the nearest FCC field office must be notified and the user must certify compliance with technical regulations.

Since there are plenty of inexpensive f-m broadcast receivers, the new service can be expected to prove popular with the public.

**BROADCAST PROTEST** — The FCC action is expected to displease broadcasters and manufacturers of wireless microphones and telemetry equipment now operating under more stringent rules.

National Association of Broadcasters filed objections to the pro-

## Oiling Montreal the Easy Way

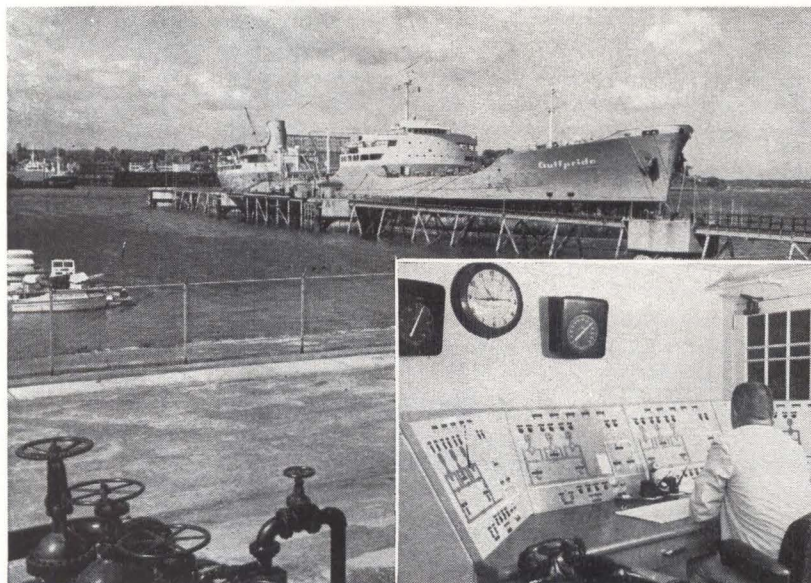

**TIME WAS** when ice blocking the St. Lawrence River prevented tankers from delivering oil to Montreal when it was most needed. So pipelines were built from Portland, Me., to Montreal. Four pumping stations are now run by remote controls installed at the Portland terminus, above, by Foxboro Co.



tilli and C. F. Wheatley cited circuitry from a 19-inch 114-degree line-operated all-transistor tv to illustrate development of two families of low-cost transistors. These included a germanium dot diffused mesa with low feedback capacity for tuner, picture, sound and i-f amplifiers, and a high-voltage diffused-collector graded-base power transistor for horizontal driver and vertical and audio output.

Glen Snyder, of GE, introduced a high-production flat-sided epoxy-housed silicon transistor for a-m radio and audio. It is designed to meet germanium competition.

R. L. Osborn, of Oak Mfg. Co., introduced a 4.14-cu-in. uhf tuner designed to keep pace with tv receiver evolution toward even more compact sizes. A stamped circular inductance ring whose tapering radial width provides straight-line frequency tuning is a central feature of the design.

## Get F-M Band

posal, but will sit back to see what interference develops. They are happy that at least two-way conversations are forbidden and say maybe it won't be as bad as the Citizen's Band (at last count, 430,-124 CB authorizations were issued, not counting limited-power kid-CB sets).

Because of the capture effect, whereby the desired, stronger, signal takes complete control of an f-m receiver, it is expected that a minimum of mutual interference will occur between the new service—with its weak signal—and f-m broadcasting. If there is trouble, the wireless mike must go off the air.

**MARKETS**—Potential users include clergymen, public speakers, nightclub entertainers and others who must talk or sing and move about unrestricted by wires. Telemetering devices should get a play from both industry and professions like medicine.

Besides an f-m receiver, the user will need a transmitter. Since technical requirements are lower than for existing wireless microphones, it is expected that tiny, battery-powered microphone-transmitters can be made cheaply.

## YOU NEVER HAD IT SO SIMPLE:

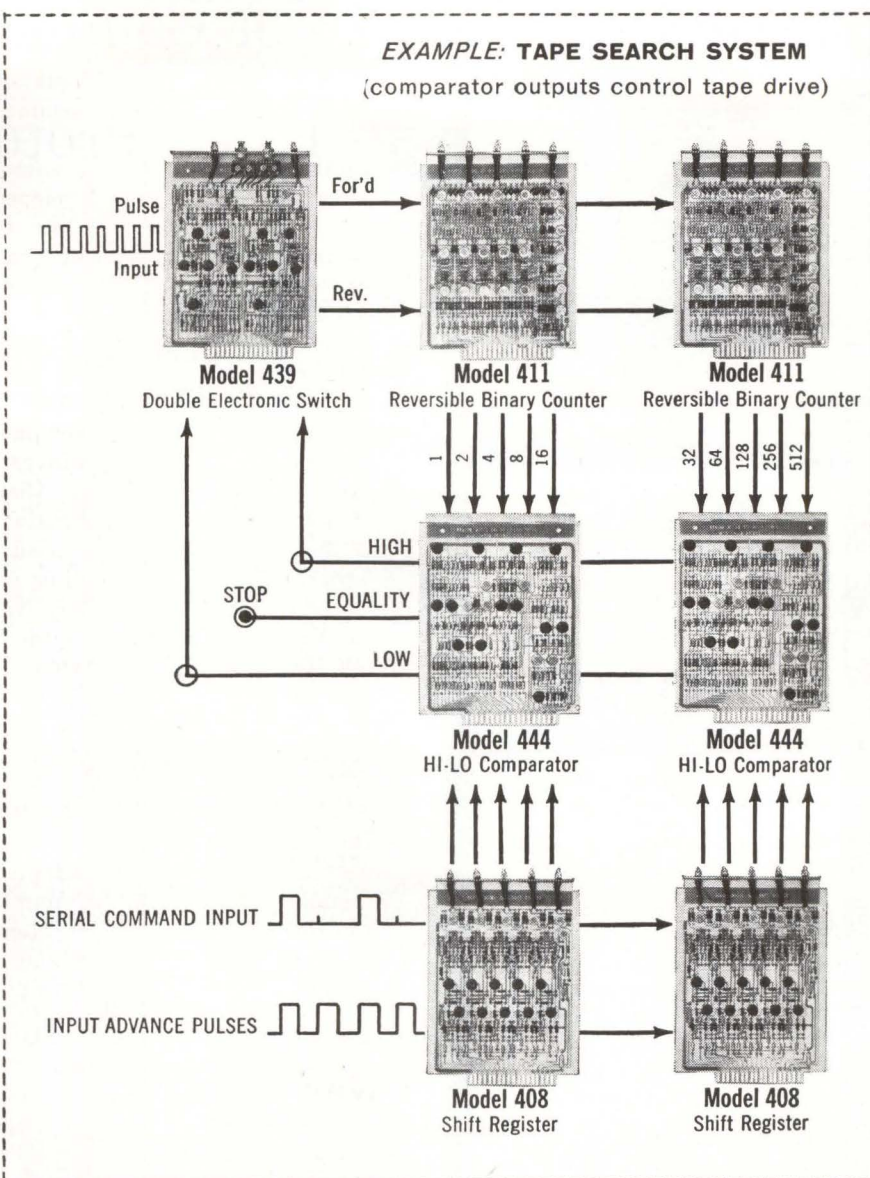

Navcor System Function Modules are the closest thing to a system designer's master block diagram: They're easier to follow, greatly reduce design time, utilize far less wiring, and require but a fraction of the checkout time. In the example above, system flow lines correspond exactly to the actual wiring of the system back plane. The Navcor 400 Series includes 55 MIL Standard System Function Modules.

# NAVCOR

VALLEY FORGE INDUSTRIAL PARK  
930 Rittenhouse Road, Norristown, Pa.  
215/GL 2-6531

219 SOUTH BRAND BOULEVARD  
Glendale 4, California

213/CH 5-7377



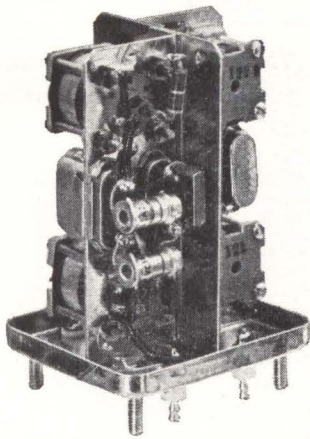

## BULOVA PRECISION CRYSTAL FILTERS

Bulova experience with prototype and production quantities of precision filters guarantees maximum sensitivity, stability — in "isolating" any frequency. These examples indicate Bulova mastery of difficult problems in high performance filter engineering.

**BAND PASS FILTERS** — In a band of 30 filters, insertion loss variation between filters, and over the temperature range 25°C to 75°C, held to .3db between highest and lowest.

Part #69-A-RP-13-2N (1 thru 30).

**SINGLE SIDE BAND FILTERS** — Band ripple held to  $\pm 1/2$  db, both 1 and 3db points defined, over the temperature range 0°C to 85°C, and 300 to 3000 cps vibration at 30G level

Part #117B-FC-22-4WU.

**DISCRIMINATOR** — Center frequency held to within 10 cps, frequencies equally spaced from center, held to 5.4v peak  $\pm 5\%$ . Part #186C-TN-22A-

**WD. BAND SUPPRESSION FILTERS** — 2kc wide band attenuated 60db, right next to it a pass band held flat to  $\pm 1/4$  db for 150kc.

Part #158-TF15-6R.

Contact Bulova engineering specialists to help you choose the right filters — when you have tough filtering problems, need additional information, or practical application assistance. Write Dept. 2702, Bulova Electronics, Woodside 77, N. Y.



INDUSTRIAL/DEFENSE GROUP

## BULOVA

ELECTRONICS DIVISION

# For Command & Control: Paper Prototypes Next

*Future systems will be designed with Adam, a new programming concept*

**AIR FORCE** command and control (C&C) systems will be designed more quickly in the future. They will cost less. And they will be capable of changing themselves as they operate, in response to any new user need that might emerge.

Responsible for this progress is an Advanced Data Management system called Adam, devised by the Mitre Corp. at Bedford, Mass. Using a 7030 Stretch computer, one computer program will serve as the experimental prototype system for future C&C L systems. In the past, each new L system required its own prototype.

The 7030 and its auxiliary equipment will be installed in the new System Design Laboratory (SDL) at Hanscom Field, the Air Force Systems Command's Electronic Systems Division. It will be operational by December.

An early version of Adam, developed in conjunction with Mitre's 473L Experimental Air Transport Planning Model, has already proved its usefulness by permitting Mitre to go into experimental operation of its 481L Paccs (Post-Attack Command and Control System) development with the same program used for the 473L model. The 481L model in Adam was in operation approximately one year earlier than a new computer program to do the same job could have been.

**SYSTEM FUNCTIONS** — Adam will consist of data-management functions common to almost all C&C systems plus an evolutionary capability of modifying itself while it is operating. With these capabilities it will be able to change

dynamically to meet the specific requirements of many C&C experimental models.

Functions common to almost all systems include: planning, maintenance of forces, drills, alerts, force commitments, monitoring of activities, replanning and recommitment. These common command functions, in turn, can be equated to a limited set of data-management functions, including: creating and updating a collection of data, querying these data, processing messages, reporting, displaying and controlling formats. Adam generalizes these common data management functions by performing them as functions, independent of the data form or content specific to an individual system.

**SYSTEM MODELS** — Because Adam can modify itself, it can accept the specifications for data form and content for a particular system and operate with them, thereby modeling the system. As the specs change, additions can rapidly be made to Adam. It provides for user specification of input and output data formats, reports and displays, for changes in message processing, and for inserting computer routines for calculations or processing specific to a particular system being modeled.

The design of Adam comprises data-structures, a pseudo-program technique, operator language, and dynamic computer-storage allocation.

Adam will be used for experimental modeling and design of C&C systems at Mitre. Design proposals and decisions for a system, rapidly inserted into Adam long before the system acquisition has begun, can be verified, changed and restudied under experimental operation. Adam will also be used to study Adam techniques for application to operational systems.



**DESIGN ENGINEERS VOTE FOR**

# Kester Solder

## 5 TO 1

**Nearly Double All Others Combined!**

<b>NO. 1</b>			64.2%			
<b>NO. 2</b>			11.7%			
<b>NO. 3</b>			7.7%			
<b>NO. 4</b>			4.6%			
<b>NO. 5</b>			2.2%			
<b>NO. 6</b>			1.9%			
<b>20 OTHER MAKES</b>			7.7%			

During a recent, independent, product-preference survey, leading Design Engineers in electrical work were asked this question: "When specifying Solder, what Brand would you request?" 204 of these 324 Engineers all gave the same name . . . "Kester."

Why do over 64% prefer Kester? There's only one reason—superior performance! Kester Solders are made exclusively from high purity 100% virgin metals, processed for maximum purity. They always are smooth, free-flowing, swift-acting . . . make strong and lasting connections.

Among the more than 165,000 different types Kester produces annually, there's the right combination of alloy, wire diameter, flux, and flux volume to satisfy any exacting requirement. And Kester prefabricated "Solderforms"—both Flux Core and Solid—provide

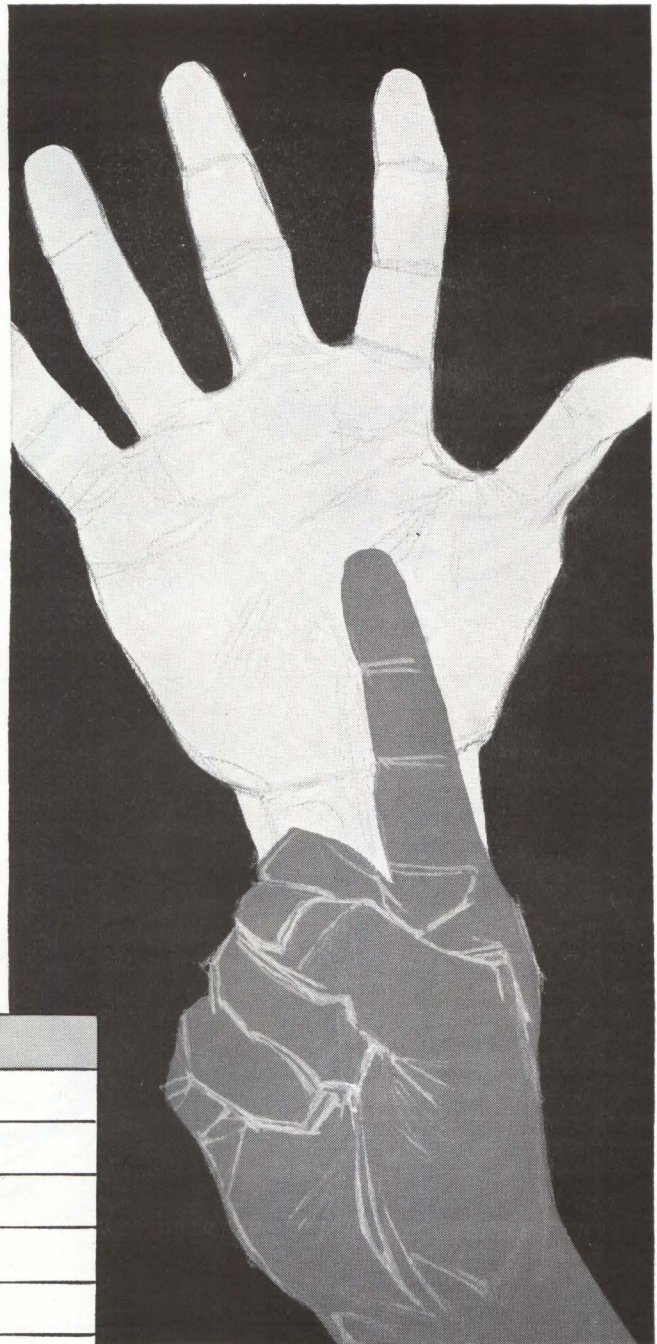

precise volume and placement control to speed quality mass-production.

For 64 years, Solders and Soldering Fluxes have been Kester's only business . . . an undivided and specialized interest in solving soldering problems. Write for free 84-page book, "Solder . . . its fundamentals and usage." There's nothing like it anywhere. Find out for yourself how Kester experience can help you produce better products.

## **KESTER SOLDER**

**KESTER SOLDER COMPANY**

4202 Wrightwood Avenue, Chicago 39, Illinois  
 Newark 5, New Jersey • Anaheim, California • Brantford, Ontario, Canada  
 Over 64 years manufacturing quality solders and fluxes



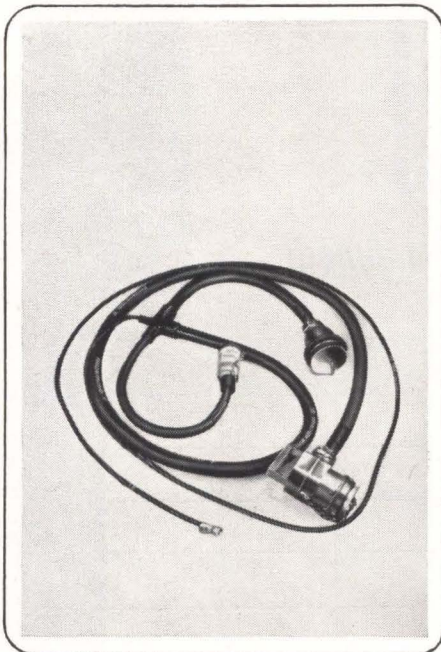
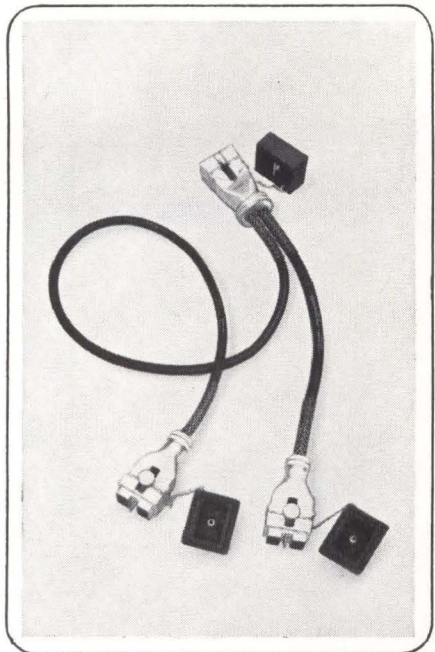
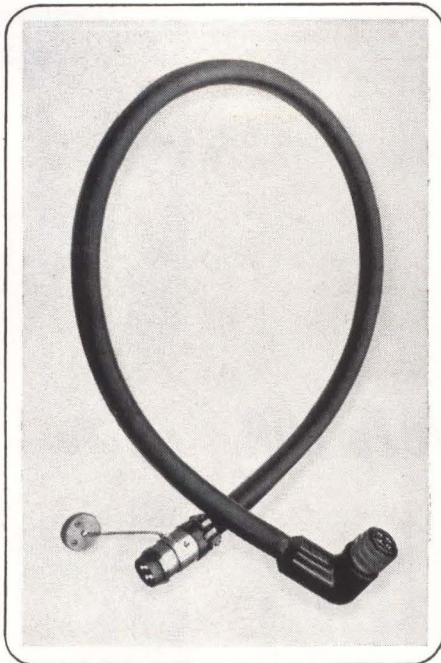
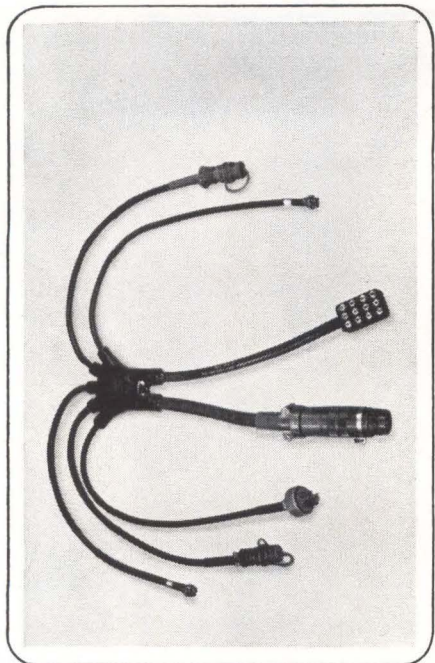

**Now  
let us  
solve  
your  
cable  
problem  
!**

You'll probably never need any of these five cables. But somebody did. And the same versatility and reliability-control which fit these special cables to special needs are now available to solve your cable problems. These are products of Rome's Special Products Facility, where unique cable constructions are everyday products. Cables like these can't afford to fail—there often isn't a second chance. So Rome insures reliability with a quality control program second to none. It tests each cable construction continuously throughout construction and inspection.

The program has been so successful that we recently won the first aerospace reliability contract ever awarded to a cable manufacturer. Its goal is to prevent cable assembly malfunctions in the Minuteman missile. Other cable constructions from Rome's Special Products Facility have proved themselves reliable on such projects as Hound Dog, Atlas, Mercury, and Sergeant. Our Special Products Facility brochure explains how you can fit Rome's unique experience, skills and equipment to your specific problems. Just send the coupon.



Special Products Facility  
Rome Cable Division of Alcoa  
2937 South Tanager Avenue  
Los Angeles 22, California

Please send my copy of your brochure describing how I can benefit from Rome's Special Products Facility.

NAME \_\_\_\_\_

COMPANY \_\_\_\_\_

ADDRESS \_\_\_\_\_

CITY \_\_\_\_\_ ZONE \_\_\_\_\_ STATE \_\_\_\_\_



SINCE 1946  
THE RECOGNIZED STANDARD

# BENDIX-PACIFIC TELEMETRY

## 300 SERIES AIRBORNE COMPONENTS



TOE-305  
High Level Oscillator



TOE-303  
Tape Recording Oscillator



TOE-320  
Multi-Range Oscillator



TOE-304  
Millivolt Oscillator



TAA-305  
Composite Signal Amplifier



TRE-315  
Reference Voltage Supply

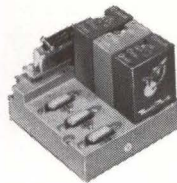

TJS-306  
Component Mounting Assembly

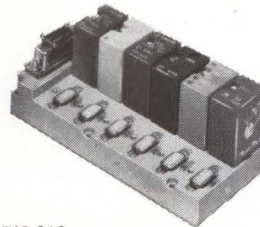

TJS-312  
Component Mounting Assembly

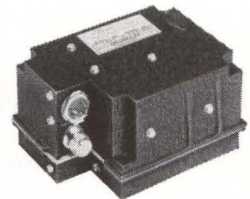

TXV-300/302  
Solid State Transmitter

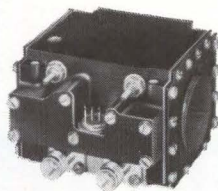

TAV-100  
R.F. Amplifier

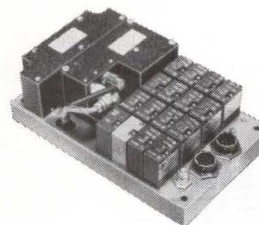

TATP-305  
Universal Telemeter



TXV-13/17  
VHF Transmitter

*In addition to the airborne components shown, Bendix-Pacific offers a complete line of analog (FM/IFM) and digital (PCM) receiving station equipment.*

*Bendix-Pacific telemetry experts are available to assist you in resolving your specific problems. Contact—*

**Bendix-Pacific Division**  
NORTH HOLLYWOOD, CALIFORNIA





# Look at What Optical Semiconductors Do Now

By MICHAEL F. WOLFF  
Senior Associate Editor

**EAST LANSING, MICH.**—New developments in optoelectronics indicate this 10-year-old field may soon assume a significant role in solid-state circuit design. Several papers at the Solid State Device Research Conference (*ELECTRONICS*, p 24, June 21) revealed both new optical devices and circuit applications of optical coupling.

It's a good bet that this is only the top of the iceberg—a lot is going on that is not talked about.

**DIODE DOMES**—Three applications of gallium-arsenide diodes to integrated circuits were described by E. L. Bonin, of Texas Instruments, Inc. These are four-terminal, multichip devices that use 30-mil-diameter gallium-arsenide hemispherical domes placed a short distance above a semiconductor device in a single header. The diodes convert an electrical input to an infrared output with 2 to 3 percent efficiency at room temperature.

First application is the four-

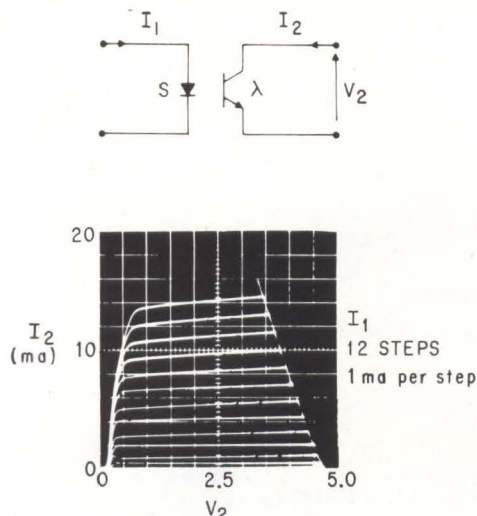

**BASIC FOUR-TERMINAL transistor** developed at Texas Instruments is shown with its V-I characteristics at left. At right is circuit for measuring the switching characteristics, and waveforms for input and output current

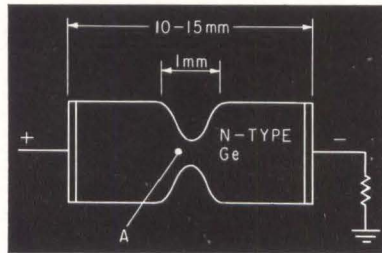

**NEW SEMICONDUCTOR oscillator** developed at Electrotechnical Laboratory, Tokyo

terminal transistor shown. It uses a silicon phototransistor and has unity current gain with currents typically exceeding 7 ma. Transistor rise and fall time is 6  $\mu$ sec and the device is considered a useful building block for logic circuits. OR fan-ins exceed 100 (even at elevated temperatures), AND fan-ins are about 30, and fan-outs greater than 10 can be obtained. Various logic configurations have been demonstrated, including a two-input EXCLUSIVE-OR circuit. Advantages in logic circuits include flexibility of inputs and ability to perform parallel logic.

Second application is to use the

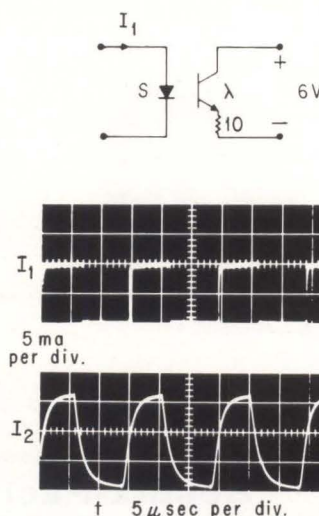

*Logic switching, chopping, amplification, oscillation, latching and rectification*

diode with a double-emitter transistor as a transformerless miniature chopper. For a 100-ma bias on the light source, transistor offset voltages are less than 1  $\mu$ V, impedance between the emitters is approximately 60 ohms and the maximum chopping current is 1 ma. Speed is determined by total circuit impedance: for 1 K it exceeds 5 Kc.

Power rectifiers and flexible small-signal logic elements are considered feasible if the gallium-arsenide diode is used to trigger a silicon *ppn* switch. Forward standoff voltage of the switch can be reduced from several hundred volts to a few volts with less than 10 ma diode current. On special headers these transistors can switch currents approaching 1 amp.

These four-terminal devices are considered to be possibly the most promising application for semiconductor light sources. In emphasizing their potential for c-w operation at room temperature with high efficiency and power, Bonin reported that with 1-ampere bias c-w outputs of 10 to 20 mw had been obtained from experimental power diodes. These diode domes have 72-mil-diameter bases with 20-mil mesa *pn* junctions.

**OPTICAL TRANSISTORS**—Construction of a three-terminal optical transistor using *pp<sup>n</sup>n* gallium-arsenide diodes (*ELECTRONICS*, p 88, April 12) was reported by R. S. Levitt, K. Weiser, A. E. Michel and E. J. Walker, of IBM Watson Research Center. The device is constructed as illustrated; *p<sup>o</sup>* represents a *p*-type region with excess carriers (in this case holes) frozen out onto manganese acceptors.

Typical current gains are five percent, and collector capacitance is 1 pf. This compares to 43 pf for the *ppn* optical transistor previously reported (*ELECTRONICS*, p 82, March 22). The low capacitance is



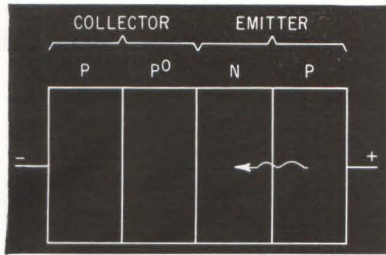

OPTICAL transistor reported by IBM has 1 pf collector capacitance

due to the wide  $p^\circ$  region (40 microns) and would suggest a potential for faster operation. However, nothing definitive can be said about speed until the internal effects in the transistor are evaluated. Currents on the order of 1 ma can be switched.

When the collector is forward biased the device will switch currents on the order of hundreds of milliamperes and then latch, switching back only when bias is removed.

Both devices operate at 77 K. Thus they might eventually find application in circuits required for space environments. Similarly operating devices could be developed for room temperature operation.

**THE SOGICON**—Light can trigger a new type of solid-state plasma device called the Sogicon (Semiconductor Oscillation Generator by Injection and Constriction). This semiconductor oscillator (see illustration) was described by M. Kikuchi and Y. Abe, of the Electrotechnical Lab., Tokyo.

The oscillator is a germanium device in which a voltage pulse above approximately 100 v will cause the current measured across the resistor to break into a coherent and stable oscillation. Frequency of oscillation ranges from several hundred to several thousand kilocycles and amplitude modulation can exceed 50 percent.

This oscillation can be enhanced by illuminating the channel with visible light at point A; that is, the light will cause it to oscillate when the pulse input is just below oscillating strength.

These effects occur at room temperature, and oscillation is enhanced by raising 10 deg above room temperature. At present, only pulsed operation is possible but it is hoped that an understanding of the operating processes will lead to ability to use the device as a d-c to

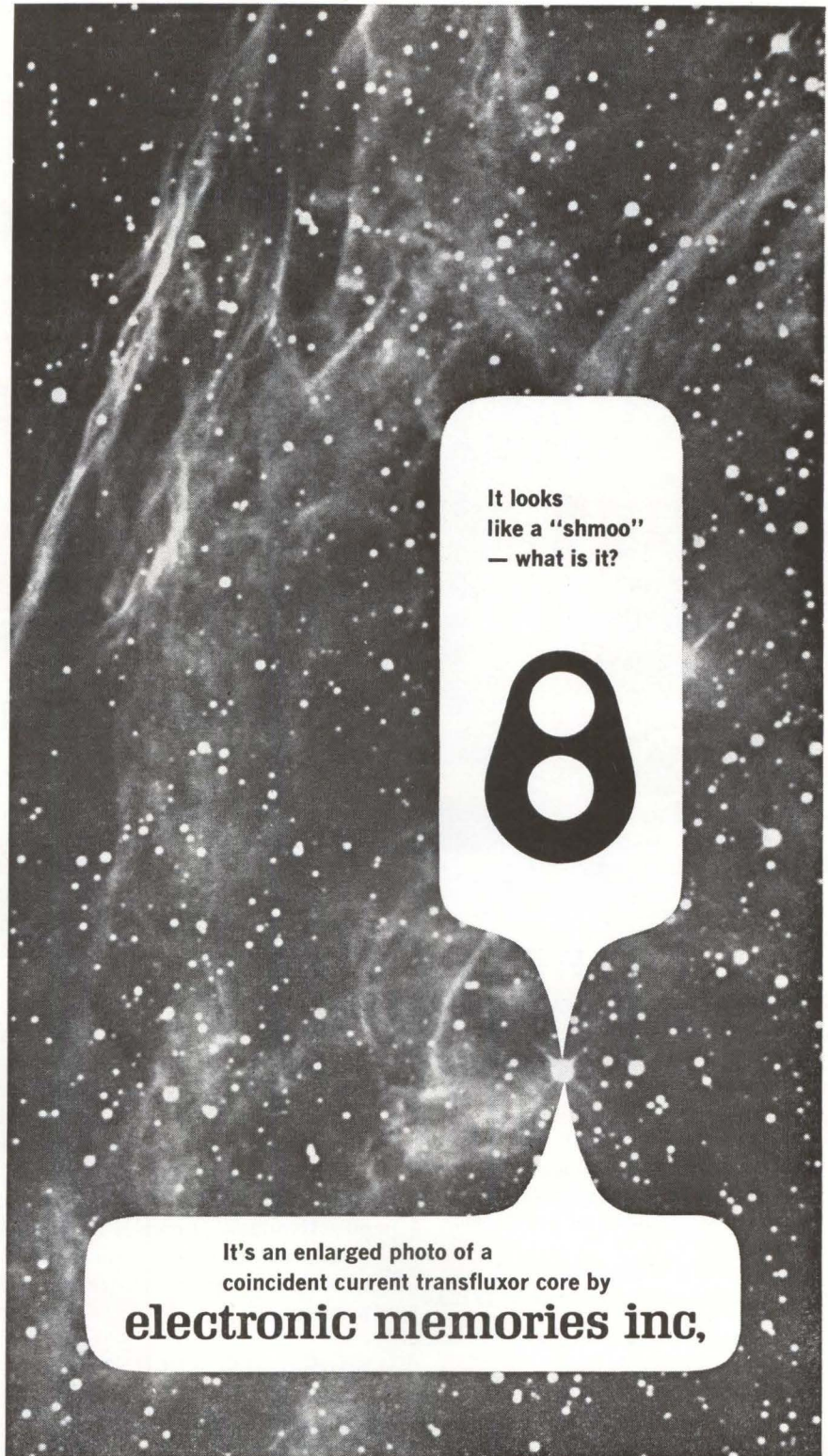

It looks like a "shmoo" — what is it?



It's an enlarged photo of a coincident current transfluxor core by **electronic memories inc.**

Want to use the same drive circuitry for a non-destructive, coincident current core memory or for a "scratch pad" memory? Need a two hole core that can be easily oriented for automatic stringing and testing? Looking for a multi-aperture core with Read hole physical and electrical characteristics that match a 50-mil toroid? ■ Better ask Electronic Memories about their 101-1002 transfluxor core. ■ The first customer to see this core said it looked

like a "shmoo." The name stuck. So next time you hear a memory man say "shmoo," you'll know he's talking about a multi-aperture core especially designed for non-destruct, coincident current memory applications. ■ The "shmoo"

is no scientific oddity. It's available, now, individually, in arrays and stacks, or in completely assembled memories. May we send you more complete information? Dept. T, 9430 Bellanca Ave., Los Angeles 45, California.

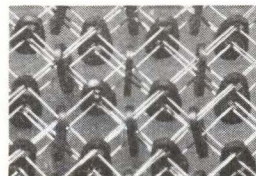



the versatile, **NEW**  
**ELECTROPUNCH**  
can increase your  
light assembly  
production as  
much as 100%

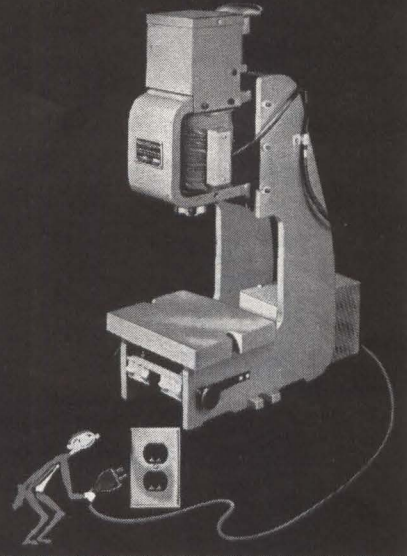

**BLACK &  
WEBSTER**  
INC.  
570 PLEASANT STREET,  
WATERTOWN 72, MASS.

Gentlemen:

Please send me information about the Black & Webster Electropunch (Model C) for light punching, heavy duty swaging, staking and riveting which:

1. delivers up to 75 blows per minute
2. has precisely controllable impact up to 10,000 lbs.
3. never needs air lines
4. doesn't require skilled labor
5. sets up easier and quicker
6. cuts costs, time, and labor
7. is bench mounted

NAME \_\_\_\_\_

COMPANY \_\_\_\_\_

STREET \_\_\_\_\_

CITY \_\_\_\_\_ ZONE \_\_\_\_\_ STATE \_\_\_\_\_

DEPT. E \_\_\_\_\_

a-c converter.

The applied pulses range up to 1 Kv with pulsewidths of 30 to 100  $\mu$ sec and repetition rates of 10 pps. Lower voltages are possible in silicon but here the device must always be intensely illuminated.

**THE FLEXODE**—Light can also control switching in the flexode. Operating mechanism of this reversible semiconductor rectifier (ELECTRONICS, p 16, Aug. 24, 1962) was explained by J. Blanc, J. O. Kessler and M. S. Abrahams, of RCA Labs. They said its ability to

convert from a resistor to a rectifier when heating current is applied is due to field-controlled lithium precipitation. Lithium is used to dope the *p*-type germanium and particles in the lithium precipitate move to short out the junctions when the electric field varies.

Switching time from resistor to rectifier is on the order of minutes; however, light can cause it to switch in the reverse direction in approximately 1 sec. Light generates an increase in saturation current which heats the device and allows large currents to pass.

## Navy Pushes Microcircuits, Reason: Technician Shortage

**COLUMBUS, OHIO**—Systems effectiveness will be the controlling element in future Navy contracts, Col. Arthur Lowell, of the Bureau of Naval Weapons, told the nine-state Great Lakes Navy R&D Clinic at Ohio State University June 13 to 15.

A comprehensive plan defining systems effectiveness — composed of maintainability, reliability and serviceability—will be issued by BuWeps in the next three months.

Explaining Navy's interest in microelectronics to boost systems effectiveness, Lowell said eight F4H's are required today to keep two operating at all-weather capability.

### SHORT ON TECHNICIANS —

With electronics maintenance requirements escalating 5 to 6 percent a year, Navy is now getting only half the technical skill levels it needs, he said. Only 10 to 30 percent of skilled technician requirements are expected to be available to the service by 1965 he said.

**MEETAT** (Maximum Improvement in Electronics Effectiveness Through Advanced Techniques) Program (ELECTRONICS, p 37, May 3) emphasizes solid-state reliability and go-no-go indicators at malfunction points for operators with mini-

mum skills. Micromodules with fewer interconnections, redundant and disposable units are expected to save from \$1 billion to \$10 billion over the next 10 years.

**NEEDED EQUIPMENT**—Among Navy's most urgent needs listed by Rear Adm. E. E. Fawkes, assistant chief for research, development test and evaluation, were:

- All-weather passive system for tracking air and surface contacts, without radiating energy from the control ship

- System that would accept direct-sampled data output from a general purpose digital computer, to drive a high-precision analog illuminating radar or missile launcher, without any intervening moving parts

- Novel, economical techniques and equipment to detect and classify submarines

- Device to indicate by flashing light or aural alarm when pre-selected radio-frequency field intensities are exceeded. The unit should be small, lightweight and low cost

- 10,000 hour solid-state gyros needed for ship and aircraft stabilization, and contactless potentiometers are on the components wanted list.



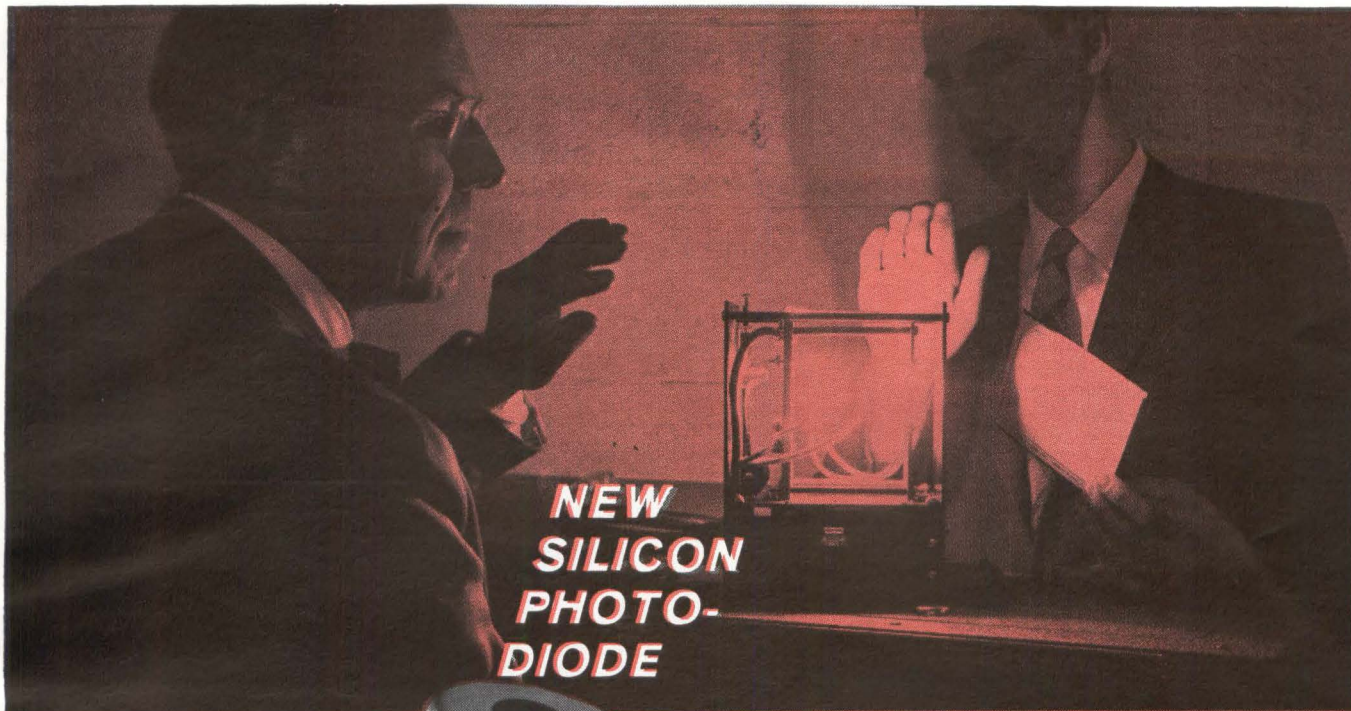

**NEW  
SILICON  
PHOTO-  
DIODE**



**SD-100:  
UNIQUE  
COMBINATION  
OF  
ADVANTAGES**

- (1) Fast response** / Rise time:  $4 \times 10^{-9}$  sec. @ 90v  
Fall time:  $15 \times 10^{-9}$  sec. @ 90v
- (2) Wide spectrum** 0.35 to 1.13 microns (10% points)
- (3) High sensitivity** 0.25 microamps per microwatt
- (4) Low noise**  $1 \times 10^{-12}$  watts  $\cdot$  (cps)<sup>-1/2</sup>
- (5) Wide dynamic range** 0.1 amp to approx.  $10^{-8}$  amp

Applications: receiving equipment for lasers and injection laser systems; measurements on modulator and pulsed light sources; measurements of light intensity and wave forms, detec-

tion of color changes. For information on the SD-100 Silicon Photodiode, write for Data Sheet #012. Edgerton, Germeshausen & Grier, Inc., 176 Brookline Avenue, Boston 15, Mass.



**Edgerton, Germeshausen & Grier, Inc.**

BOSTON • LAS VEGAS • SANTA BARBARA



# 15,219

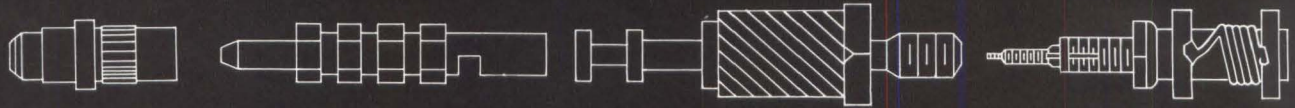

# WAYS TO



# BE BRIGHT

## ***We guarantee it***

You can't go wrong when you choose from the 15,219 *standard* electronic components in the CAMBION® line, which includes terminals, terminal boards, insulated terminals, coil forms, coils, capacitors, connectors, chokes, computer components and hardware. Why? Because they're manufactured under the constant supervision of CAMBION's independent Quality Control Department and in conformance to applicable military specifications. Many of them actually exceed MIL specs. What's more, they are immediately available from stock. Cambridge Thermionic Corporation, 437 Concord Avenue, Cambridge 38, Massachusetts. Phone: 617 876-2800.

Write today for your copy of our latest complete-line CAMBION catalog.

# **CAMBION**

STANDARDIZE ON CAMBION...THE GUARANTEED ELECTRONIC COMPONENTS



## Kodak reports on:

real gone absorption bands . . . a flare-up in europium . . . advice you may be wise to forget . . .  
Mr. Gibson's pictures . . . the kind of decision where we can help

### Announcement to the trade

Eastman Kodak Company, Special Products Division, Rochester 4, N. Y., announces with pleasure and anticipation its success in pushing up to 7 inches the maximum diameter for disks of hard, clean, heat-resistant, shock-resistant, non-cold-flowing, moderate index (2.4),  $1\mu$ -to- $20\mu$ -transmitting, polycrystalline zinc selenide KODAK IRTRAN 4 Optical Material. Buy some. Absorption bands now eliminated!

### Name your rare-earth chelate

The division mentioned above also offers KODAK Neodymium Glass Laser Rods (non-silicate). These are getting bigger and bigger while reports of low beam-divergence, low threshold, and high output grow more startling. Inquiries invited.

We think we are also getting involved with organic lasers but are not ready to boast of general expertise about them. All we say is: 1) business in europium chelates that customers could conceivably be dissolving in various plastics has suddenly flared up at Eastman Organic Chemicals Department, Distillation Products Industries, Rochester 3, N. Y. (Division of Eastman Kodak Company); 2) at the latter division further inquiries for any organic compound of europium or any other rare earth that a clever customer can think of will receive prompt and courteous attention.

### Stick fast fast

EASTMAN 910 Adhesive came along a few years ago and then it was no longer silly to think of constructing serious equipment by simply *sticking* metal parts together, to say nothing of sticking organic materials together. The adhesive sticks so fast (in both senses of that word) and so little goes so far that \$5 for a half ounce only *sounds* high.

It has proved a boon to scientific and industrial mankind, but sometimes it doesn't work. Maybe the mating surfaces are not clean. Maybe they do not fit close enough. Maybe too much adhesive has been applied. That is bad for the same reason that a bad fit is bad: little pools are bad. The adhesive should form a very thin, uniform film.

On some materials, polyolefins in particular, surface pretreatment is desirable. Some polystyrenes dissolve a little in the 910 monomer. The dissolved polystyrene sort of slows polymerization. We have also been politely informed that in the case of certain dissimilar or pickled metals a speedup would help.

All right, we'll tell you what to do in these cases. Apply EASTMAN 910 Adhesive to only one surface and wipe the other with a (non-aqueous) solution of phenylethylethanolamine, which we call EASTMAN 910 Surface Activator.

**WATCH OUT NOW.** For work where you have been getting along well with EASTMAN 910 Adhesive up to now and just want to hurry it along, forget you read this ad. What good would it do to have the bond form before the surfaces can be properly lined up?

*So ubiquitous has the little bottle of EASTMAN 910 Adhesive become that it is reasonable to broadcast here an offer of a one-ounce sample of EASTMAN 910 Surface Activator, with directions. Address Eastman Chemical Products, Inc., Kingsport, Tenn. (Subsidiary of Eastman Kodak Company). If you find we exaggerate the ubiquitousness, please so indicate and enclose \$5.*

*Price subject to change without notice.*

**This is another advertisement where Eastman Kodak Company probes at random for mutual interests and occasionally a little revenue from those whose work has something to do with science**

### Fluorescence in the infrared

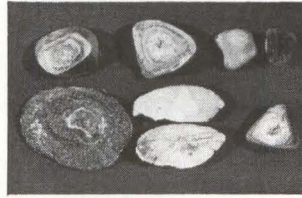

Here is an ordinary photograph of gallstones

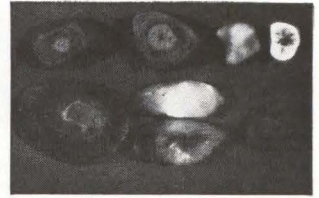

and here they are by fluorescence in the near infrared.

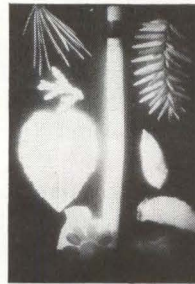

Here are some plant fragments and a chunk of greenockite by infrared fluorescence,

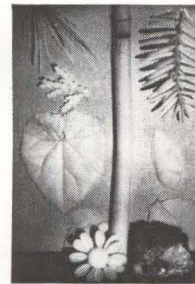

infrared reflection,

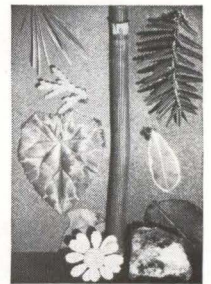

and visible.

Illumination for the fluorescence shots was blue-green light with all the infrared filtered out. In front of a KODAK RETINA Reflex Camera loaded with KODAK High Speed Infrared Film, a KODAK WRATTEN No. 87 Filter passed only radiation longer than  $740m\mu$ . To record infrared reflection instead of infrared fluorescence, we removed the blue-green-passing, infrared-absorbing filter from the lamp, left everything else the same, and cut exposure time 20,000 times.

*A man at Eastman Kodak Company, X-ray Sales Division, Rochester 4, N. Y., is the expert on this. His name is H. Lou Gibson. Write him if you like.*

### The latest copier

If among your burdens of office is the need to display wisdom in such decisions as choice of office copiers, we respectfully point out that our brand-new item in that line is the VERIFAX CAVALCADE Copier, that it involves no horses nor pouring of liquids, that it looks like this,

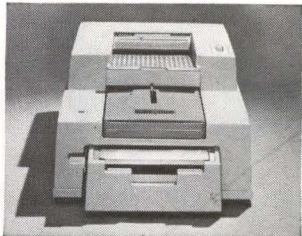

that it is as automatic as makes sense, that it gives up to seven copies of a document at as low a unit cost and as high a legibility and permanence as you'll find, and that we have too much of an investment in your esteem of us to risk our name on anything you or we might regret.

*For the actual pitch, preferably delivered live by a dealer, make your interest known to Eastman Kodak Company, Business Photo Methods Division, Rochester 4, N. Y.*

*If there is an offset duplicating machine in your department (or if there could be one) and if you had the KODAK EKTALITH Method working for you, you could turn out in quantity material enlarged, reduced, or for other reasons photographically copied from the original. About that, ask Eastman Kodak Company, Photo Reproduction Products Division, Rochester 4, N. Y.*



## SERVO IR Report

Select to Fit Your Need...

FROM MATERIALS, SHAPES, DEVICES, OPTICS:

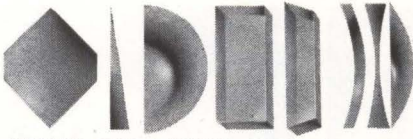

**WINDOWS, LENSES, PRISMS, DOMES**—A complete line of standard elements of all infrared transmitting materials is available from stock. Elements not listed in the catalog are available on special order with short delivery.

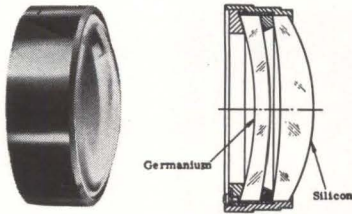

**MULTI-ELEMENT LENSES**—The SERVOCOM® Achromat lens shown is but one example of a complete line of standard two, three and four element lenses available. An established computer program also provides optimized designs for special applications over the infrared spectrum.

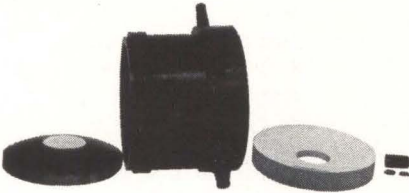

**OPTICAL SYSTEMS**—Refractive and reflective systems, and combinations thereof, are available as systems designed specifically for your applications. The Bouwers-Maksutov system pictured above is typical of the wide acceptance angle, high resolution systems which can be furnished.

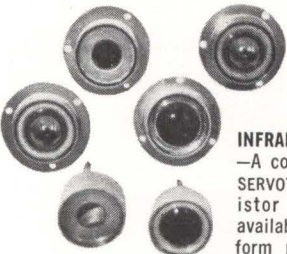

**INFRARED DETECTORS**  
—A complete line of SERVOTHERM® thermistor detectors is available in modular form permitting the fabrication of units

to a wide variety of specifications. Fast time constants, long wavelengths, and wide acceptance angles are now available as standard units.

**SERVO IR DATA**—Send for brochure and fact file folder on Servo's products and facilities.



**SERVO CORPORATION  
OF AMERICA**

111 New South Road • Hicksville, L. I., N. Y. • WEllS 8-9700

# Micropower Devices Are Going to Nanopower Level

*Speakers in NATO's  
road show see cuts of  
10 to 100 in power levels*

**PARIS**—NATO's nine-man team of micropower missionaries pinned down the state of the art and pulled back the curtain slightly on possible future developments at the team's first stop in the Agard (Advisory Group for Aeronautical Research and Development) sponsored four-country tour (ELECTRONICS, p 22, June 14).

More than 100 French engineers and scientists attended.

Digital circuits dominated the conference, chaired by American Bosch Arma's Edward Keonjian, pioneer in what he termed the fight against tyranny of power.

Already the fight is far enough along to allow CBS Laboratories' W. W. Gaertner to report on analog-to-digital converter integrated circuits requiring less than 10  $\mu$ w each (ELECTRONICS, p 8, June 21). Gaertner predicted that technology improvements would one day cut consumption by a factor of anywhere from 10 to 100 compared to levels in today's micropower equipment. As a potential solution to the problem of stray capacitance—a concern that popped up often throughout conference—he suggested three-dimensional filamentary geometry.

A. T. Watts, of England's Mullard Radio Valve Company, told how a digital integrator using 1,000 transistors had its power appetite tamed from 1.8 w to less than 50 mw by refinements in the direct-coupled-transistor-logic circuit (p 8, June 21). The module is 2 x 3 cm, with passive elements evaporated on a glass substrate and transistors mounted in holes cut out of glass.

A shift from germanium to silicon transistors shaved consumption to 600 mw for the three-channel integrator, which operates at a 100-Kc clock rate and has a package size of 17 cu in.

**FIELD EFFECT DEVICES**—The conference highlighted the bipolar junction transistor's advantages in micropower digital circuits. But a spate of other devices is forthcoming. G. E. Moore reported on insulated-gate field-effect semiconductors under development at Fairchild Semiconductor. The device acts as a planar silicon diode with no gate voltage. So standby power runs only 1 mw per stage. Switching time is 10 nsec.

Arrays of insulated-gate devices point the way to nanowatt memories, Moore said. As many as 2,500 memory units could be diffused into a wafer 1 inch square. Although Fairchild Semiconductor still has not fabricated one, integrated circuits based on the devices are possible. In fact, Moore maintained, interconnections between wafers is a bigger problem than developing devices themselves. No one dissented.

J. W. Moll, of Stanford University, discussed problems and limitations in micropower transistors. He described 100-Kc field-effect devices operating at 10  $\mu$ w, feels devices can do 100 times better than people are now getting for low power levels at highly repetitive frequency rates.

## Electronic Ticker Tape



**STOCK MARKET** display system developed by Ultronic Systems uses Nixie tubes to show quotes. Six-bit ticker code is input to display



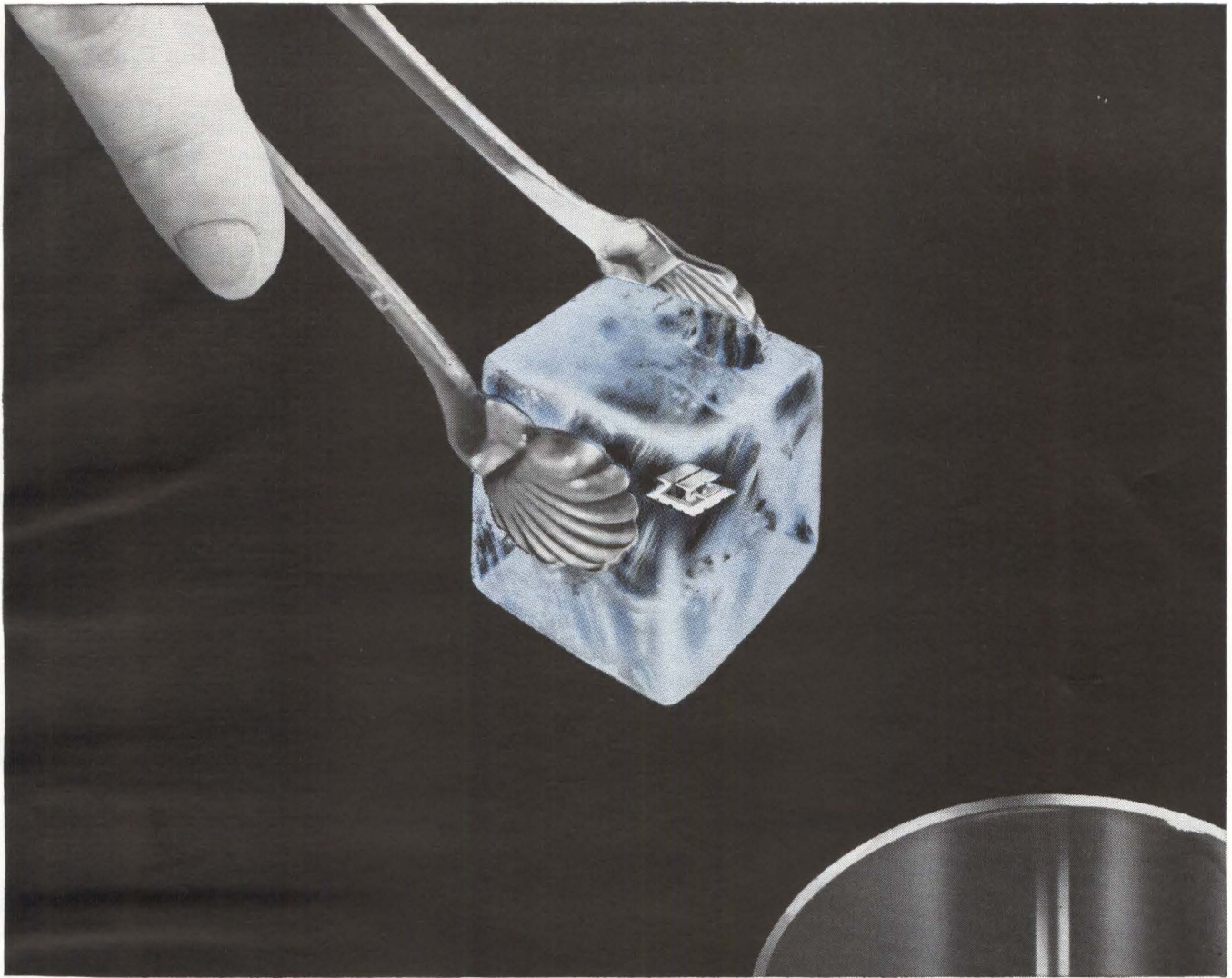

## WHAT TEMPERATURE IS A BREAKTHROUGH?

*This one is cold, and smaller than your thumbnail in size!*

Melpar's spacecraft thermo-electric cooler emerged from a team effort which included solid state physicists, chemical physicists and electronics engineers working in a splendidly equipped laboratory and developmental shop. Research on this device was deepened by hot debate during in-house seminars . . . seminars designed to sharpen and extend new ideas.

The project was initiated under Company sponsorship, then quickly given an additional push by Government support. Breakthroughs come in many temperatures. They almost always have this kind of complex, cross-disciplinary history.

Throughout Melpar you find a "live" atmosphere, stimulated by research, matured by an experienced engineering and manufacturing team, created by fast-reacting, long-term-conscious management.

Our programs in aerospace sciences and systems, in the physical and life sciences, and in advanced electronics are growing. Expanding research groups now require additional staff members to work in the following areas:

■ **CHEMISTS AND PHYSICISTS**—flash photolysis, low temperature phenomena, high vacuum technology, ionic crystals, semi-conductor compounds, thermo-electric materials, refractory metal alloys, kinetics of

gas solid reactions, gas phase kinetics, gas chromatography, thin film and monocrystalline microcircuits.

■ **MATHEMATICIANS**—the investigation of random function generators and the development of binary discreet and continuous random generators.

■ **ELECTRONICS ENGINEERS**—pattern recognition, signal signature analysis, data retrieval, speech processing and acoustic systems.

■ **BIOLOGISTS AND BIOCHEMISTS**—space biology and biological systems.

■ **OPERATIONS RESEARCH ANALYSTS**—model construction for special military operations and the quantitative analysis of detection, early warning and communications networks.

Write: Professional Employment Manager, 3800 Arlington Boulevard, Falls Church, Virginia.

*Serving Government and Industry*

**MELPAR INC**

A SUBSIDIARY OF WESTINGHOUSE AIR BRAKE COMPANY

3800 Arlington Boulevard, Falls Church, Virginia

An equal opportunity employer

Subsidiaries: Microwave Physics Corp., Garland, Texas • Television Associates of Indiana, Inc., Michigan City, Indiana • Melpar-Fairmont Corp., Fairmont, West Virginia



## NEW from DEI

FOR 1970 SPACE PROGRAMS...

The 2.2-2.3 Gc UHF Telemetry Receiver... Now!



- 2200-2300 Megacycle Tuning Range
- VFO or Crystal Controlled One Knob Tuning
- Complete Predetection Record and Playback Capabilities
- Plug-In Features for Economy and Versatility

The most versatile UHF telemetry receiver available *today* capable of fulfilling the frequency ranges assigned for 1970 space programs is the TMR-21, UHF Telemetry Receiver from Defense Electronics, Inc.

This unit has already been successfully used in all the Saturn rocket firings and will be employed in the Mariner B probes for Mars. It will not only meet standard FM/FM and PDM/FM applications, but PCM/FM requirements as well in systems using up to one million bits per second.

In addition to its tested frequency stability and flexibility in bandwidth selection, the unit employs one knob tuning for either VFO or crystal controlled mode of operation.

The TMR-21 can accept various DEI plug-in IF amplifiers to determine predetection bandwidth and, together with simultaneous FM and AM detection and adjustable FM video bandwidth, makes the receiver tailor-made for any ground station telemetry system now in use... or in 1970.

Write for DEI Bulletin TMR-21... or call:



**DEI**  
SERVING  
GOVERNMENT  
AND INDUSTRY

*Defense Electronics, Inc.*

Main Office:

5455 Randolph Rd. Phone: 301-WH 6-2600  
Rockville, Md. TWX: 301-949-6788

Regional Office: Sherman Oaks, Calif. Phone: 873-4322

## Sparking Thin Films Drive Plasma Engine

LOS ANGELES—Electric propulsion system that uses vapor-deposited, thin metal films to achieve pulsed plasma propulsion was described last week by General Motors at the Institute of Aeronautics and Astronautic's summer meeting. In experiments at Allison division, the accelerator's efficiency peaked at 50 percent.

Metal vapor from a resistance-heated boiler is deposited on a rotating wheel. As the film moves between rail-type electrodes in a capacitor-discharge circuit, it is exploded electrically. Velocity of the resulting plasma is in a single direction only.

Allison representatives said that the feed system for applying the propellant is unique.

In session on guidance and control, NASA representatives discussed an extremely simple control system for spin-stabilized vehicles.

Control logic and electronics requirements for the system are held to a minimum. A flight-tested version of the system used a total of only 13 transistors and two moving parts—a rate gyro and a solenoid valve. Total weight of the system was less than 18 pounds.

Control system uses horizon-detecting telescopes for absolute attitude reference. A single reaction jet provides control torque for two axes and the required stability augmentation (see diagram).

Called *Miniguide*, the lightweight control system is inexpensive and has high degree of reliability, says NASA.

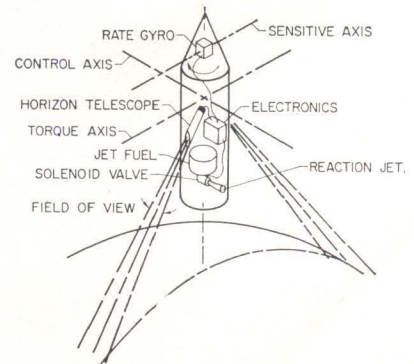

*MINIGUIDE* space control has only 2 moving parts



SANGAMO  
SANGAMO  
SANGAMO  
SANGAMO  
SANGAMO  
SANGAMO  
SANGAMO  
SANGAMO  
SANGAMO  
SANGAMO  
SANGAMO  
SANGAMO  
SANGAMO  
SANGAMO  
SANGAMO  
SANGAMO  
SANGAMO  
SANGAMO  
SANGAMO  
SANGAMO

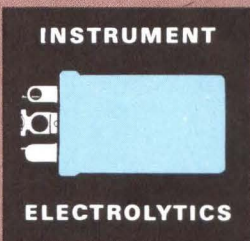

# Here is the **ONLY** **INSTRUMENT ELECTROLYTIC CAPACITOR** available... anywhere!

No other capacitor can match the performance of the new blue Sangamo Type 505 electrolytic. It's a twist-tab capacitor designed specifically for instrument manufacturers who will not compromise with quality.

Here's what the new blue 505 offers:

- **LONGER OPERATING LIFE (at 85°C)**
- **LONGER SHELF LIFE**
- **LOWER LEAKAGE**
- **LOWER ESR**
- **BETTER TEMPERATURE CHARACTERISTICS**
- **BETTER HIGH FREQUENCY CHARACTERISTICS**

Complete engineering test data is available. See for yourself how this Sangamo electrolytic has set new standards of quality and reliability. Write or call for this information today.

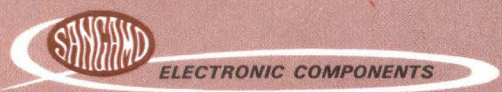

**SANGAMO ELECTRIC COMPANY**  
SPRINGFIELD, ILLINOIS





# TIME DELAY

## SANGAMO 480 SERIES DUAL-CAPSTAN RECORDER/REPRODUCER

### RECORD HERE

(or reproduce) with automatic switching of 4 speeds of FM or Direct electronics . . . 7 to 28 channels of data.

### DELAY HERE

in buffer storage bin with capacity of 125 feet, providing fixed or continuously variable delay up to 12 minutes . . . recording simultaneously at both head stations, then reproducing, you can achieve delays as short as *zero* seconds—even *negative* time delays.

### REPRODUCE HERE

(or record) with time-delay accuracies varying from .0004% to a maximum of  $\pm 25$  microseconds . . . record or reproduce at first head station, with simultaneous delayed reproduce or record at second station . . . speed ratio between capstans may vary as much as 16:1 for time-base expansion or contraction while continuing to record.

### FIXED OR VARIABLE TIME DELAY

The Sangamo 480 Series Recorder/Reproducer offers a totally new kind of application flexibility and reliability to the instrumentation field. The Model 480 is essentially two independent magnetic tape recorder/reproducers with a time-delay tape storage bin between the two capstans. Fixed or variable time delays can be achieved in either reel-to-reel or continuous loop applications.

Loop storage bin permits up to 250-foot loop for monitoring of infrequent data. Loop bin provides time delay between second capstan and first, in addition to providing any necessary delay to allow readout equipment to reach operating speed. Tape is continuously erased prior to passing the first head station.

Some operating features are shown above, but there's much more to tell. Write, wire, or phone us for the complete story.

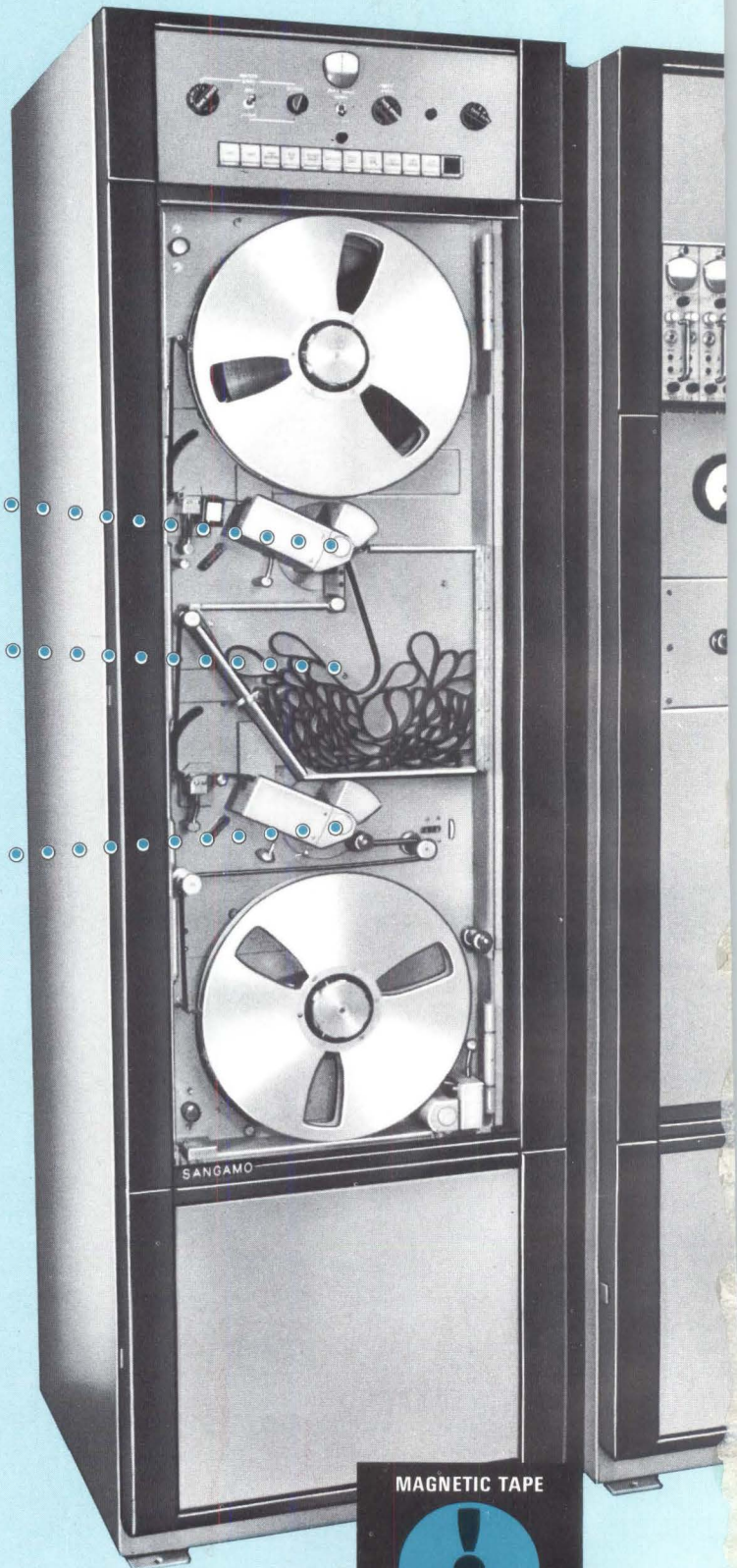

MAGNETIC TAPE



INSTRUMENTATION

SANGAMO  
SANGAMO  
SANGAMO  
SANGAMO  
SANGAMO

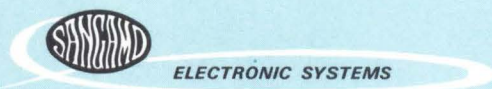

**SANGAMO ELECTRIC COMPANY**  
SPRINGFIELD, ILLINOIS



**SEE**  
**"impossible" welds**  
**in the making**  
**by electron beam...**

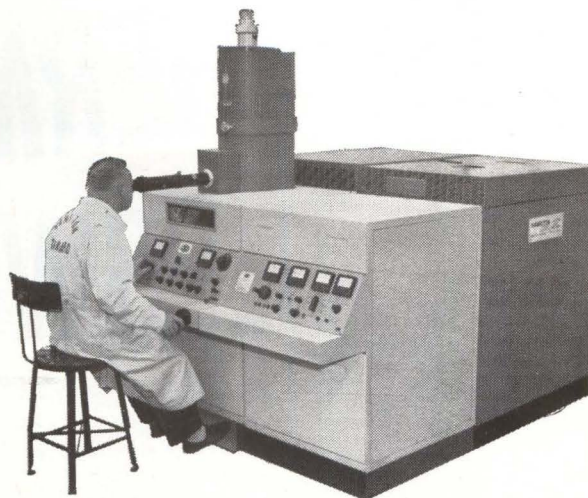

**EXCLUSIVE OPTICAL VIEWING SYSTEM** permits the operator to sight down the center line of the electron beam column and see a magnified view of the exact position of the beam on the work piece.

Welds that were once "impossible," like those shown, are now everyday occurrences—wherever Hamilton-Zeiss high energy-density electron beam welding machines are at work. These Hamilton Standard machines provide flexibility, repeatability, reliability. You can solve fabrication problems involving refractory materials, unequal thicknesses, deep penetrations, and hard-to-reach locations, with an ultraprecise electron beam focused through an exclusive magnetic optical system.

Hamilton-Zeiss electron beam machines produce welds in a vacuum, thereby eliminating contamination. Additional advantages include close control of dimensions and penetration, and low thermal distortion. Supporting metallurgical reports are available for your inspection. For complete information about Hamilton-Zeiss Electron Beam Welders, write or wire: Sales Manager, Electron Beam Machines, Hamilton Standard Division of United Aircraft Corporation, Windsor Locks, Connecticut.

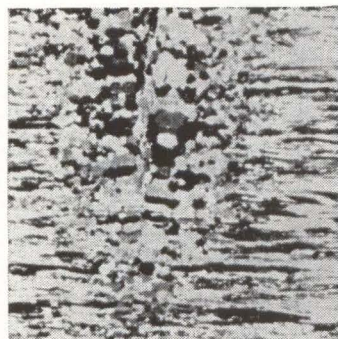

Weld on 0.1" tungsten shows no contamination, minimal grain growth. Reasons: welding time is extremely short, heat is localized, impurities are vaporized, no filler is used.

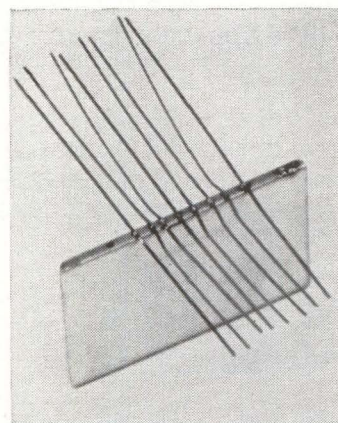

Copper ribbon wires (0.002" x 0.01") welded to edge of nickel-plated ceramic substrate. Shows wide range of thicknesses and materials which can be joined on the same machine.

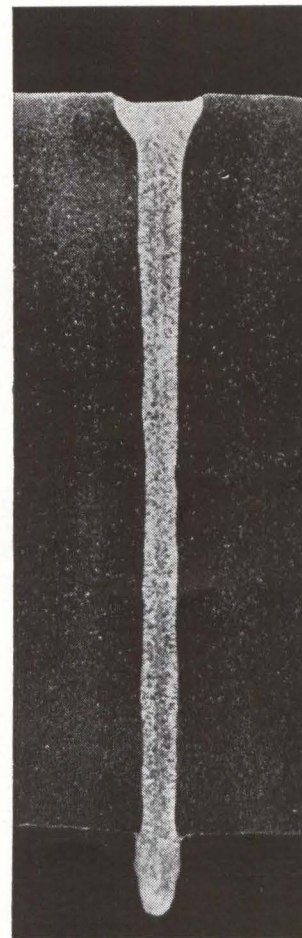

High energy density permits deep weld through 1" stainless steel with over 20:1 depth-to-width ratio. Weld is as strong as base material.

**Hamilton Standard** DIVISION OF UNITED AIRCRAFT CORPORATION





# THERMAL DELAY SWITCHES

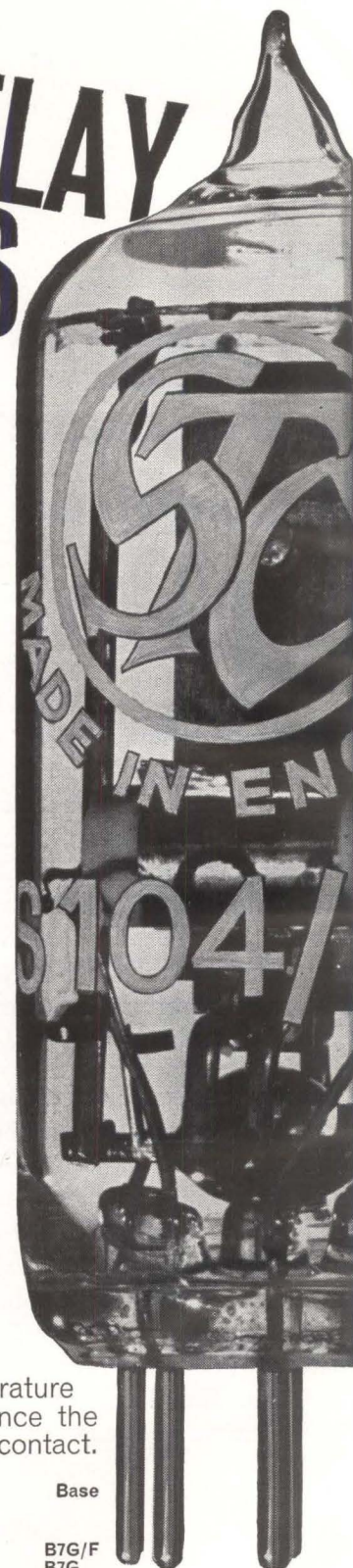

STC Thermal Delay Switches can be used for delaying the application of h.t. voltage to valves requiring preheat of cathode; are suitable for use with heavy duty relays to switch 3-phase circuits from star to delta arrangement for starting induction motors; for short circuiting surge limiting resistors; and for automatically reclosing a circuit breaker after a temporary surge has caused it to trip. These applications are described fully in booklet MS/117 available on request.

**EXTENDED DELAYS** can be obtained by cascade connexion. A circuit technique which sums closing and opening delay times yields an overall delay independent of normal heater voltage variations.

**AMBIENT TEMPERATURE COMPENSATION** Variations of ambient temperature within the range  $-35^{\circ}$  to  $+70^{\circ}\text{C}$  do not affect greatly the delay time since the 'stationary' strip is also bimetal and its contact shifts with the active contact.

Abridged Data	Type	Delay (seconds) at $20^{\circ}\text{C}$		$V_h$ (V)	Contact Rating		Base
		min.	max.		(V d.c.)	(V r.m.s.)	
	S102/1G	44	66	6.3	220	100	B7G/F
	S102/1K	44	66	6.3	220	100	B7G
	S103/1K	36	54	27	220	100	B7G
	S104/1K	25	35	6.3	220	100	B7G
	S105/1K	20	30	27	220	100	B7G
	S106/1K	44	66	19	220	100	B7G
	S107/1K	8	15	6.3	220	100	B7G

Send for data sheets



**Standard Telephones and Cables Limited**

COMPONENTS GROUP · VALVE DIVISION  
BRIXHAM ROAD · PAIGNTON · DEVON · ENGLAND

ITT COMPONENTS DIVISION · P.O. BOX 412 CLIFTON N.J.



USA Enquiries for price and delivery to:-

63/11MS



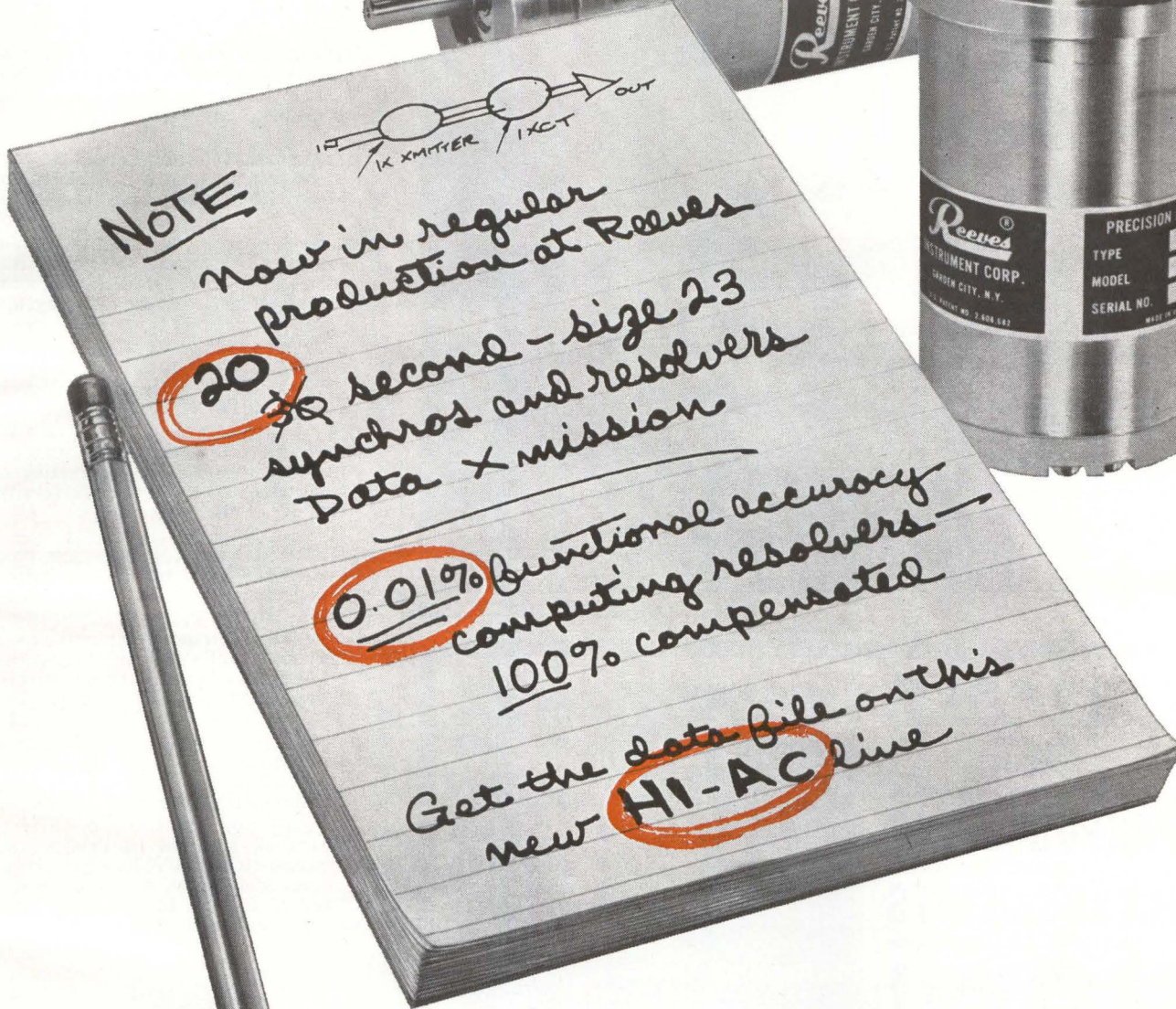

A little over a year ago, when Reeves first announced the production of Size 23 Synchros and Resolvers with 30 second accuracy, they were hailed as a major design breakthrough. Today, 20-second units are available in production runs in the new HI-AC series of data transmission resolvers and synchros... 0.01% functional accuracy in the HI-AC compensated computing resolvers.

These instruments permit the design of highly accurate, yet greatly simplified, data transmission systems. Elaborate two speed synchro systems, or equally complicated digital encoder systems, can be dispensed with, because the desired accuracy is inherent in the HI-AC synchros themselves. Reliability is immeasurably improved, maintenance cut to a minimum; and space, weight and cost greatly reduced.

The Reeves HI-AC Series are the only Size 23 Resolvers and Synchros currently available in production quantities with this high order of accuracy. For complete information, write for Data File 106.

Qualified engineers who are seeking rewarding opportunities for their talents in this and related fields are invited to get in touch with us.



**REEVES INSTRUMENT CORPORATION**

A Subsidiary of Dynamics Corporation of America, Roosevelt Field, Garden City, New York



MICROPIX® multi-purpose cathode ray tubes, used in high-resolution applications, are part of the extensive line of Litton display devices and microwave tubes. San Carlos, California. In Europe, Box 110, Zurich 50, Switzerland.

**LITTON INDUSTRIES**  
ELECTRON TUBE DIVISION

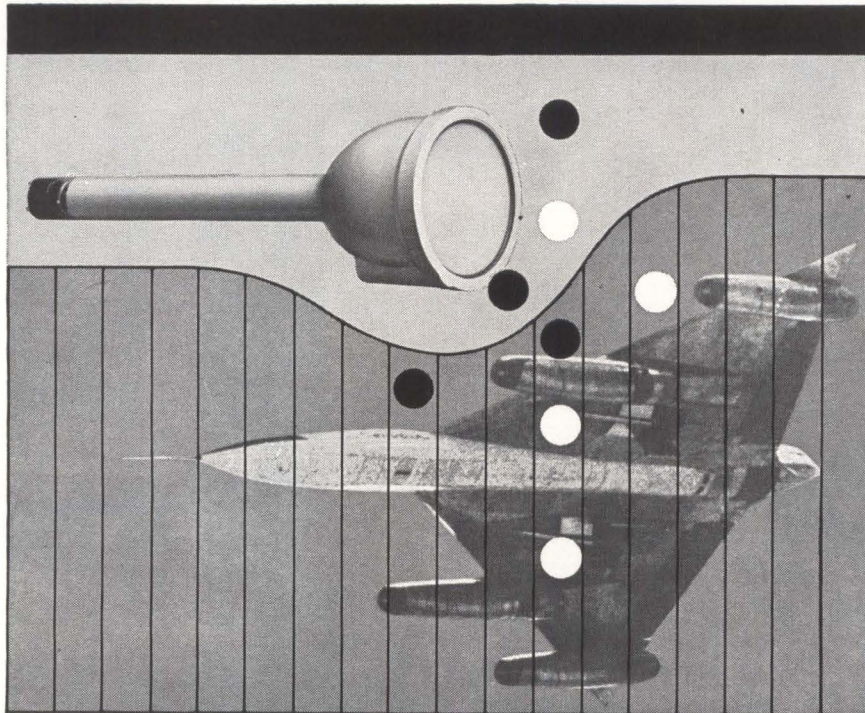

CIRCLE 202 ON READER SERVICE CARD

**RELIABLE**  
**HIGH**  
**PERFORMANCE**  
**MICROCIRCUITS**  
**NOW!**

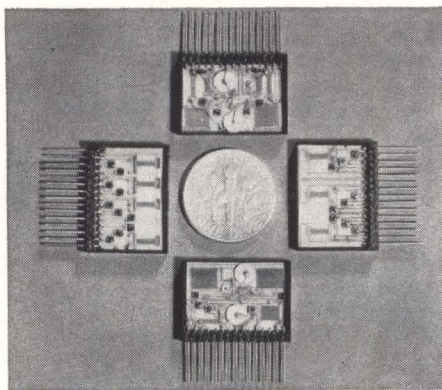

- ★ Direct conversion of your designs to thin film circuitry
- ★ Standard modules available for high speed digital circuits, counters, high resolution radar, stable video and audio amplifiers
- ★ Digital circuits to 50 Mc. clock rates, stable linear circuits to 60 Mc. and beyond
- ★ Specified performance over an ambient temperature range of -85° F. to 257° F.
- ★ Rapid delivery, reasonable pricing

Write, wire or phone today!  
J. L. DENNIS  
Special Products Division

**VARO** Inc.

2203 Walnut St., Garland, Texas  
Area Code 214 BRoadway 6-6141

**MEETINGS AHEAD**

**INFORMATION THEORY IN SCIENCE & ENGINEERING SEMINAR**, Dartmouth College; at Dartmouth, Hanover, New Hampshire, July 1-12.

**ADVANCED CONTROL THEORY AND APPLICATIONS**, Massachusetts Institute of Technology; at MIT, Cambridge, Mass., July 8-19.

**ANTENNAS & PROPAGATION INTERNATIONAL SYMPOSIUM, IEEE-PTGAP**; National Bureau of Standards, Boulder, Colo., July 9-11.

**MEDICAL ELECTRONICS INTERNATIONAL CONFERENCE, IFME**, University of Liege, Liege, Belgium, July 22-26.

**ELECTROMAGNETIC MEASUREMENTS & STANDARDS SEMINAR**, National Bureau of Standards; NBS Laboratory, Boulder, Colo., July 22-Aug. 9.

**AEROSPACE SUPPORT INTERNATIONAL CONFERENCE & EXHIBIT, IEEE, ASME**; Sheraton-Park Hotel, Washington, D. C., Aug. 4-9.

**INTERNATIONAL ELECTRONICS CIRCUIT PACKING SYMPOSIUM**, University of Colorado, et al; at the University, Boulder, Colo., Aug. 14-16.

**WESTERN ELECTRONICS SHOW AND CONFERENCE, WEMA, IEEE**; Cow Palace, San Francisco, Calif., August 20-23.

**AUTOMATIC CONTROL INTERNATIONAL CONGRESS**, International Federation of Automatic Control; Basle, Switzerland, Aug. 27-Sept. 4.

**INTERNATIONAL ASSOCIATION FOR ANALOG COMPUTING, AICA**; Brighton College of Technology, Lewes Rd., Brighton, England, Sept. 14-18.

**PHYSICS OF FAILURE IN ELECTRONICS SYMPOSIUM**, Armour Research Foundation and Rome Air Development Center, Illinois Institute of Technology, Chicago, Sept. 25-26.

**ADVANCE REPORT**

**ULTRASONICS SYMPOSIUM, IEEE-PTGUE**; Marriott Motor Hotel, Washington, D. C., Dec. 4-6. Aug. 15 is the deadline for submitting 3 copies of 200-word abstracts to: T. R. Meeker, Technical Program Chairman, Bell Telephone Laboratories, 555 Union Boulevard, Allentown, Pennsylvania. Contributed papers are sought in any of the various specialized areas of ultrasonics with microwave ultrasonics receiving particular attention.

**ENGINEERING IN MEDICINE & BIOLOGY CONFERENCE, IEEE, ISA**; Lord Baltimore Hotel, Baltimore, Md., Nov. 18-20. Aug. 1 is the deadline for submitting a 2-page digest manuscript. To properly do this, authors should write immediately for "An Application to Present Paper" to: 16th Annual Conference, Jenkins Hall, Johns Hopkins University, Baltimore 18, Md. Two fields are of special interest: creative evaluation of patient monitoring systems and operation details of analog-to-digital conversion systems.





**She's giving back the ring**

*Easily replaced circuits—great advantage of ITT Kellogg's new Electronic Telephone Exchanges—made possible by THIOKOL PANELYTE Copper-Clad laminated sheets*

ITT Kellogg's new Electronic Telephone Exchange Systems represent one of the great advances in modern telephony. If a malfunction occurs in any one of the circuits, an office secretary can handle the necessary maintenance. All that's required is the manual removal of the faulty circuit board and quick plug-in replacement with a handy spare.

ITT Kellogg selected Thiokol Panelyte Copper-Clad circuit board for this unique and vital application. Reason: Panelyte Copper-Clad combines the high electrical and physical properties required. The glass epoxy G-10 Thiokol Panelyte Grade 1635 flame retardant chosen provides both the insulation strength and solder resistance specified by ITT Kellogg. This Panelyte grade is one of 10 special copper combinations engineered for special requirements.

Panelyte Copper-Clad and other electrical grades meet NEMA and government specifications. For full information write to Panelyte. Or see Sweet's Catalog.



*Laminated Sheet, Rod, Tube, High Pressure Moldings, Elastomeric Compounds and thin copper-clad laminates for multi-circuit application.*  
Thiokol Chemical Corp., Panelyte Industrial Div., N. Enterprise Ave., Trenton 4, N. J.

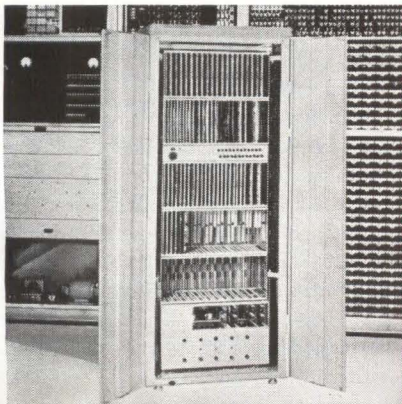

◀ Through use of transistors, other electronic inventions, and Thiokol Panelyte Copper-Clad printed circuit boards, ITT Kellogg has reduced to file cabinet size and to 425 pounds the private automatic telephone exchange. Shown here: KELEX compared to conventional electro mechanical system.

To the right is the ITT Kellogg ▶ printed circuit board made from Thiokol Panelyte Copper-Clad Sheet in comparison to the electro mechanical equipment which it replaces.

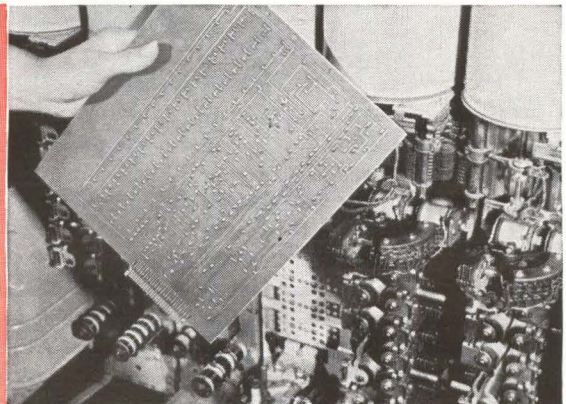



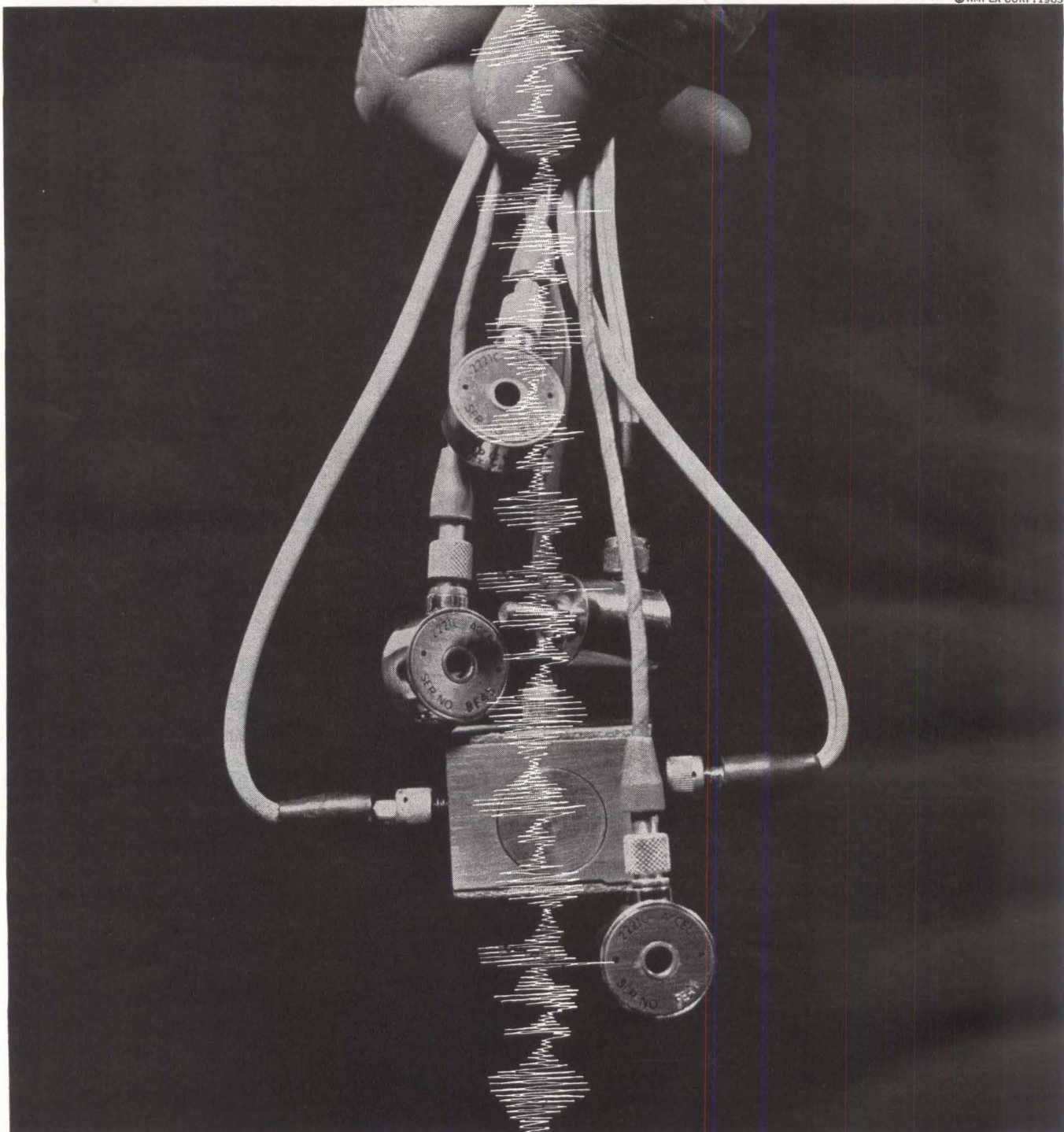

Who packs 7 tracks in a low cost instrumentation recorder?

**AMPEX**

Not long ago we introduced the 4-track SP-300—a portable recorder with true instrumentation performance. It gave modest-budgeted research operations the precision needed at a reasonable price. But we wanted to offer more data handling capacity without sacrificing performance—and still keep the price low. Now we can: the SP-300 gives you up to 7 tracks of true instrumentation recording. And the price? Under \$7000. No other instrumentation recorder on the market does so much for so little. Along with simultaneous recording of up to 7 separate tracks, the SP-300 gives you 4 speeds with electrical switching

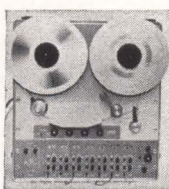

of both transport and electronics by a single control. It records FM at low frequencies from DC to 2500 cps. It records Direct at higher frequencies from 50 cps to 40 KC. It comes with built-in calibration and erase. It has printed circuit wiring and harnesses for greater reliability. And it uses the most thoroughly proved of all tape transports—specifically adapted for precise instrumentation applications. What about quality? Ampex through and through. For information about the 4- or 7-track SP-300 write to Ampex Corp., Redwood City, Calif. Term financing and leasing available. Worldwide sales and services.



# INJECTION LASERS

NOW AVAILABLE ON  
RAPID DELIVERY SCHEDULES

GaAs Injection Lasers . . . 8400 Å

GaAsP Injection Lasers . . . 6200 Å-8400 Å

Tiny p-n junction diodes emit coherent radiation by direct application of electric current. Standard configurations now available. Consultation and design services on custom configurations offered.



For illustrated brochure, write to:

**ELECTRO-NUCLEAR  
LABORATORIES, INC.**

GaP Injection Sub-Lasers . . . 6400 Å

GaAs Injection Sub-Lasers . . . 9100 Å

GaAsP Injection Sub-Lasers . . . 6600 Å-9100 Å

GaSb Injection Sub-Lasers . . . 16000 Å

Diodes operated beneath the laser threshold emit non-coherent light retaining the general spectral characteristic and fast time-constant of the Injection Laser. Sub-Lasers listed above are available, in standard configurations, on rapid delivery schedules. Other III-V sources available on special order.

2437 LEGHORN STREET, MOUNTAIN VIEW, CALIFORNIA

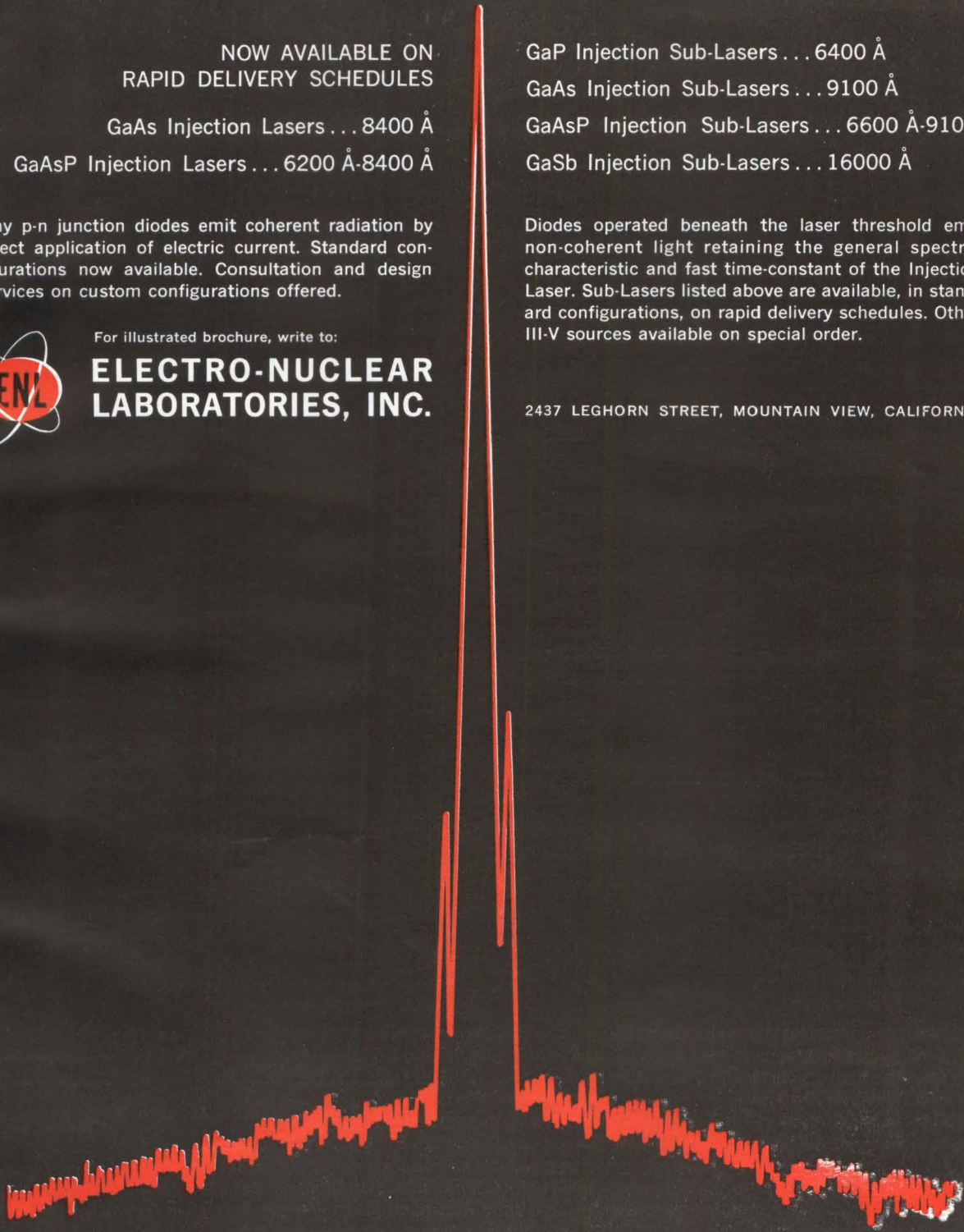



# Tektronix DUAL-BEAM Oscilloscope

*fits many scientific and  
industrial applications*

Type 502A



Here is a dependable laboratory oscilloscope you can use for medical, mechanical, many other applications. It is especially useful for dual-beam displays on linear time bases and X-Y presentations with either or both beams.

This dual-beam oscilloscope with 100  $\mu\text{v}/\text{cm}$  basic sensitivity offers many convenient features for quick and easy waveform analysis. Some of these features include: *differential input at all sensitivities*—for cancelling unwanted common-mode signals . . . *single-sweep operation*—for facilitating waveform photography . . . *push-button beam finders*—for indicating relative trace position when deflected from CRT screen . . . *intensity-balance control*—for equalizing trace intensity or identifying upper or lower beam when superimposed for comparison.

### Main Performance Characteristics Include:

- Passbands from dc-to-50 kc, minimum, to dc-to-1 Mc maximum.
- Calibrated Vertical Sensitivity in 17 steps from 100  $\mu\text{v}/\text{cm}$  to 20  $\text{v}/\text{cm}$ , both amplifiers
- Calibrated Sweep Range in 21 rates from 1  $\mu\text{sec}/\text{cm}$  to 5  $\text{sec}/\text{cm}$
- Variable, Uncalibrated, Sensitivity and Sweep Range Controls
- 2X, 5X, 10X, or 20X Sweep Magnification
- Flexible Trigger Facilities
- Amplitude Calibrator
- Electronically-Regulated Power Supplies

Type 502A Oscilloscope . . . . . \$1050

U. S. Sales Price f.o.b. Beaverton, Oregon

**FOR A DEMONSTRATION, PLEASE CALL  
YOUR TEKTRONIX FIELD ENGINEER**

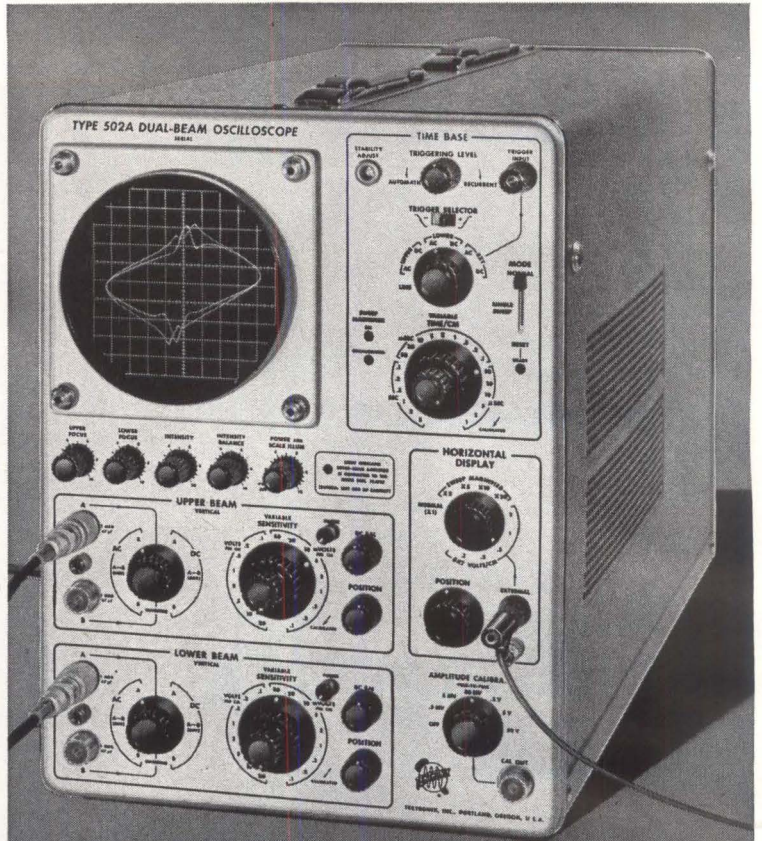

### Typical Applications of Type 502A

1. Comparison and measurement of stimulus and reaction on the same time base.
2. Comparison and measurement of two transducer outputs, such as pressure vs. volume.
3. Comparison and measurement of phase angles and frequency differences.
4. Comparison and measurement of X-Y curve-tracing presentations.
5. Comparison and measurement of general-purpose or special-purpose low-level displays.

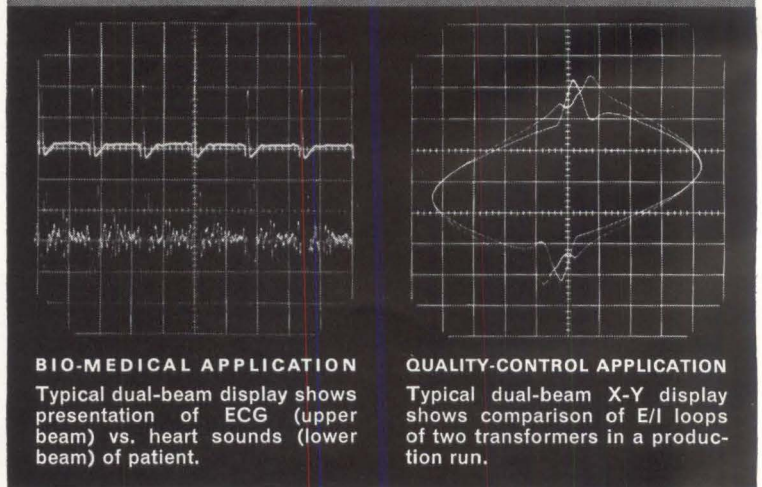

**BIO-MEDICAL APPLICATION**  
Typical dual-beam display shows presentation of ECG (upper beam) vs. heart sounds (lower beam) of patient.

**QUALITY-CONTROL APPLICATION**  
Typical dual-beam X-Y display shows comparison of E/I loops of two transformers in a production run.

**Tektronix, Inc.** / P. O. BOX 500 • BEAVERTON, OREGON / (Area Code 503) Mitchell 4-0161 • TWX: 503-291-6805 •  
Telex: 036-691 • Cable: TEKTRONIX • OVERSEAS DISTRIBUTORS IN 27 COUNTRIES

Tektronix Field Offices are located in principal cities throughout the United States. Please consult your Telephone Directory.  
Tektronix Canada Ltd: Montreal, Quebec • Toronto (Willowdale) Ontario • Tektronix Ltd., Guernsey, Channel Islands



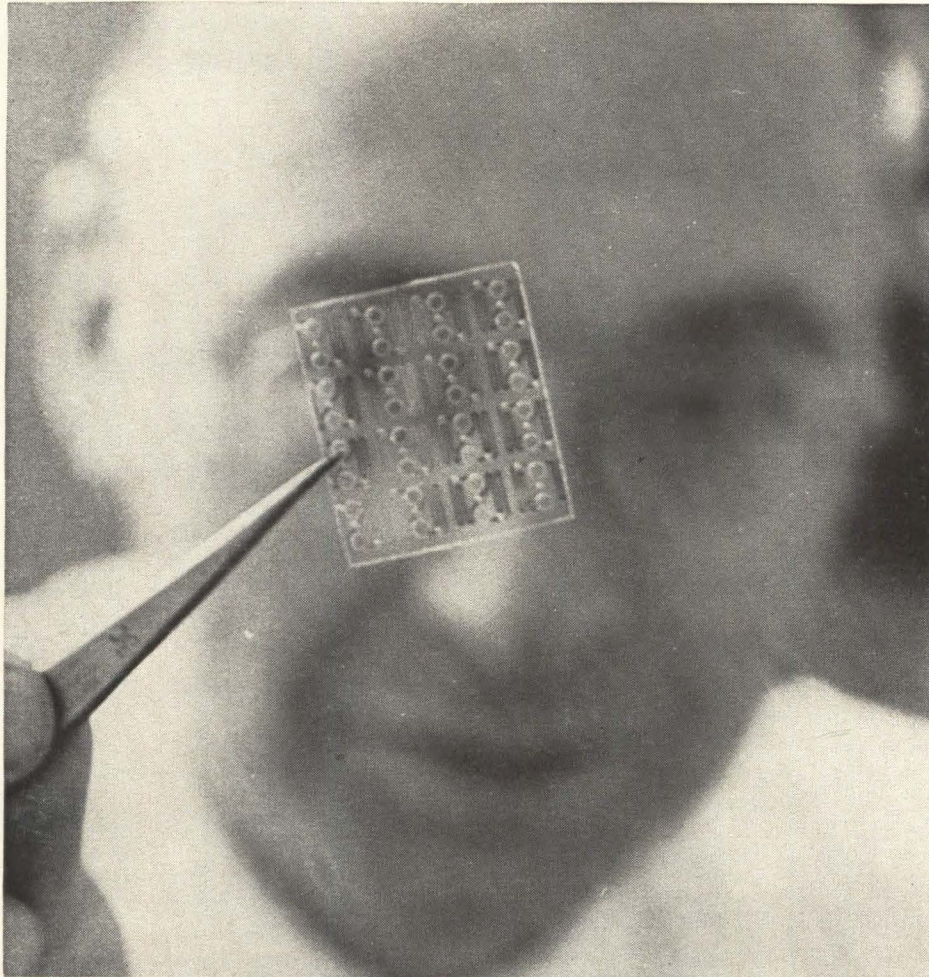

MICROCIRCUITS such as this one held by Arthur D. Little's H. G. Rudenberg will change more than the size and shape of equipment. The industry itself is changing

## THE IMPACT OF MICROELECTRONICS

*Some call it revolution, others evolution,  
but almost everyone agrees that  
microelectronics will profoundly affect  
our traditional way of doing business*

*An ELECTRONICS staff report*

**DEEP AND LASTING** changes in the electronics industry are slated to take place in the next decade as a result of the growth of microelectronics. That was the consensus of industry leaders gathered in Chicago this week to discuss the "Impact of Microelectronics" at a conference sponsored by ELECTRONICS and the Armour Research Foundation of the Illinois Institute of Technology.

The extent of the changes is still under dispute, but opinion appears unanimous that the influence of the new technology will be felt across the board, and





BRIDGES: "A comforting thought . . ."

will affect the industry's traditional way of doing business, not only with its biggest customer, the government, but eventually all purchasers of electronic equipment, large and small. Specific areas certain to be changed in scope and technique are:

- Circuit and system engineering
- Product specification and standardization
- Marketing methods
- Recruitment and training of technical people

Thus, virtually the entire economic structure of the industry may be overhauled in response to changes in the product and in the market place.

According to George T. Jacobi, Assistant Director of Electronics Research at ARF (now IIT Research Institute), the depth of the changes can be appreciated by considering the present relationship between the electronic component vendor and purchaser. "Under the present system," says Jacobi, "a purchasing agent is provided specifications by his engineering group. The quantities needed are determined by sales and issued by manufacturing control. The buyer now shops around for a vendor who can meet the specifications. They are based on price, delivery date and quality assurance. The final decision on purchase involves engineers, inspection personnel, quality control and cost accountants."

Under the present system, this procedure, involving systematic documentation of component performance, in brochures, catalogs, spec sheets, purchase orders and the like, works well. But in the era of microelectronics, Jacobi points out, no manufacturer will have such detailed data available, nor list prices for the more complex and perhaps lower volume items which replace conventional components.

"If the traditional vendor-buyer relationship were maintained, systems design would almost literally originate in the office of the buyer," states Jacobi.

But the traditional relationship is not likely to survive. Under strong pressure from government procurement agencies, more and more companies are becoming committed to microelectronics. And these

NOYCE: "Five times the money you think you need . . ."

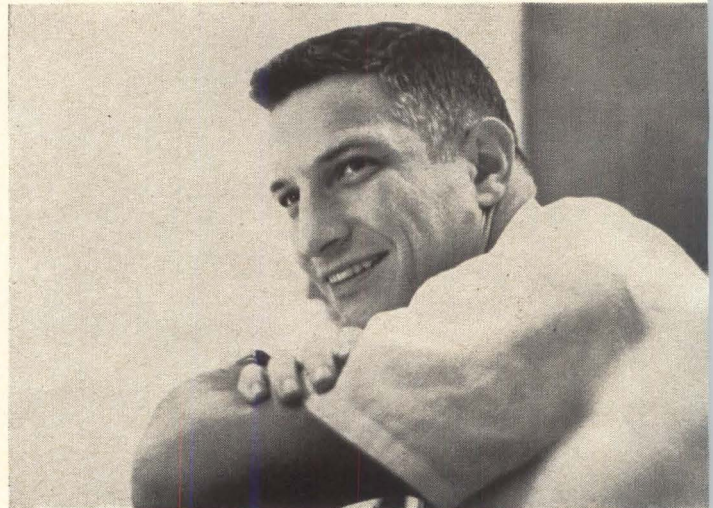

organizations are definitely not limited to those with a background of semiconductor manufacture. They include conventional component manufacturers, systems and equipment manufacturers, and a relatively new development, the small company devoted exclusively to microelectronics. With this new lineup, systems suppliers are bolstering their component manufacturing research and facilities, component manufacturers are seeking entry into the systems and subsystems fields, while the microelectronic specialist company must also fight for its place in the sun.

**PREDICTS REDUCTION**—Jacobi foresees a reduction in the number of companies able to participate in the electronics market, particularly in the area of military electronics. He predicts that the survivors will have in common an expansive R and D program, large sales volume and a modest return on the sales dollar.

According to James M. Bridges, Director of the Office of Electronics, Office of the Director of Defense Research and Engineering, Department of Defense, just such a "shakedown" in the industry may be necessary in order to realize the potential reductions in integral circuit costs.

While the advantages of microelectronics in reliability, and reduction in volume and weight of complex systems are cited most often as justifying the

---

### SPREADING THE WORD

The conference on "The Impact of Microelectronics" held this week in Chicago resulted from the deeply held conviction on the part of ELECTRONICS staffers and Armour Research Foundation scientists that, while the technological aspects of microelectronics were being adequately exposed in the literature and

---





SPRAGUE: "We are materials processors . . ."

feverish activity in this field, the substantial reduction in costs potentially afforded by the new technology is a prime mover in obtaining government support for microelectronics. Bridges likes to quote statistics from an industry source which estimate that by 1970 the government will be buying annually some \$10 billion worth of electronic equipments and systems. Of this, about one quarter, or \$2.5 billion, involves electronic circuits that could employ microelectronics. If microelectronics can be produced for one-half the cost of present electronics, the government would save \$1.25 billion in its electronics bill. "A comforting thought," says Bridges, "and I suspect that it may be reasonably true. Let me point out, though, that these reductions in integral-circuit costs will probably not be realized unless their production is concentrated in a few companies so that it will be economically feasible for them to spend the sums of money necessary to develop the methods and processes and purchase the automatic machinery needed for low-cost manufacture."

A reduction in manufacturing costs is by no means the total possible savings that are intriguing government procurement agencies. According to Bridges, even more important will be the savings from lower logistics and maintenance costs.

**SPARE PARTS**—Equally significant will be the impact on the traditional system of stocking spare

at technical meetings, little attention was being devoted to the possible changes that might be wrought in the industry itself by the "new circuits". These changes could affect all of us, from the most highly placed decision maker, to the freshman entering engineering school. The conference was designed to provide a forum to discuss the problems sure to accompany these changes.

parts for electronics equipment, lucrative for the contractor, often a headache for the agency. Bridges looks forward to the day when all spare modules needed for the life of an equipment will be furnished as an integral part of the equipment when it is originally produced.

"Some calculations recently made by a contractor for the Air Force, reveal some interesting results," Bridges says. "If an equipment must have a life of, say, 10,000 hours of continuous operation (more than a year) and it has, say 10,000 circuits of 500 different types, each having a failure rate of 0.0001 percent per 1,000 hours, then there is a 99 percent probability that no failure will occur—*so no spares would be needed.*" The required failure rate has not yet been achieved, Bridges is quick to point out, but he says there is every reason to believe that it will come about as more is learned about failure mechanisms and process controls.

Despite this emphasis on reduced stocking of spares, Bridges is firmly opposed to standardization of microelectronics, and he appears to be speaking for the Department of Defense, in this matter. "Many of us in Defense and in industry who have carefully studied microelectronics in relation to Defense applications are firmly convinced that any effort to bring standardization into microelectronics now would be premature, with the possible exception of early standardization of descriptive terms and common testing methods and characteristic methods."

Bridges holds that the characteristics of microelectronics make the values of standardization objectives used in conventional electronics quite different. These traditionally have been to limit the numbers of different types in the supply system, increase the quantities of each item produced to reduce costs and improve reliability, and to provide uniformity in military equipment design. But with the advent of microelectronics, it appears that the cost and the reliability are going to depend on the development of manufacturing processes and automatic production machines and the manufacture of large quantities of *similar* circuits rather than large quantities of the *same* circuit.

Bridges is emphatic on this point. "We just will not know the answers to these questions until we gain more experience with microelectronics. Until that happens, we feel strongly that we should oppose any kind of standardization."

The government is deeply conscious of the impact on industry of microelectronics, according to Bridges. "It is evident that this impact will depend

This article was derived in part from comments made by participants in the conference, and in part from interviews conducted by ELECTRONICS editors in the field. Coordinated by Senior Editor Samuel Weber in New York, contributions were made by Midwest Editor Cletus Wiley, New England Editor Tom Maguire and Ed Addeo of the McGraw-Hill San Francisco News Bureau



to a considerable extent upon the policies of the government, particularly with respect to such things as specifications, standards, and the support of manufacturing facilities. For this reason, the government must be most careful in developing those policies," he says.

Dr. E. R. Jervis, of ARINC Research Corporation agrees that the impact of microelectronics on maintenance and logistics will be very great if the potential reliability figures of a mean time to failure in the region of  $10^4$  to  $10^5$  for even relatively simple equipments of 100 or fewer components is achieved. "In fact," says Jervis, "this is the dream come true of all people struggling with the present problems of maintenance and logistics; that of an equipment that outlasts its useful life and on the average, does not need replacement, while the few equipments that break down don't require maintenance but can be disposed of."

However, Jervis points out that most equipments still are electromechanical and mechanical components, and the reliability will be limited in the final analysis by these. Moreover, more complex equipment, operating for longer time will still require maintenance. He therefore supports as an intermediate step (between present logistic methods and the ideal no-spare no-repairs condition) the logistic self-support method, which depends on each equipment carrying sufficient replacement parts for the expected life of the equipment. This plan has many advantages, according to Jervis, including the minimization of replacement problems due to mismatching of equipment, a relaxation of the need for strict specifications and standardization of replacement parts, standardization of circuits within the equipment with consequent simplicity of design, and adaptability of equipment to self-healing systems in which failing components are automatically switched out of the system and new components replaced. "But successful development of these concepts will require a broad knowledge of failure modes and failure rates of the various components used," Jervis cautions.

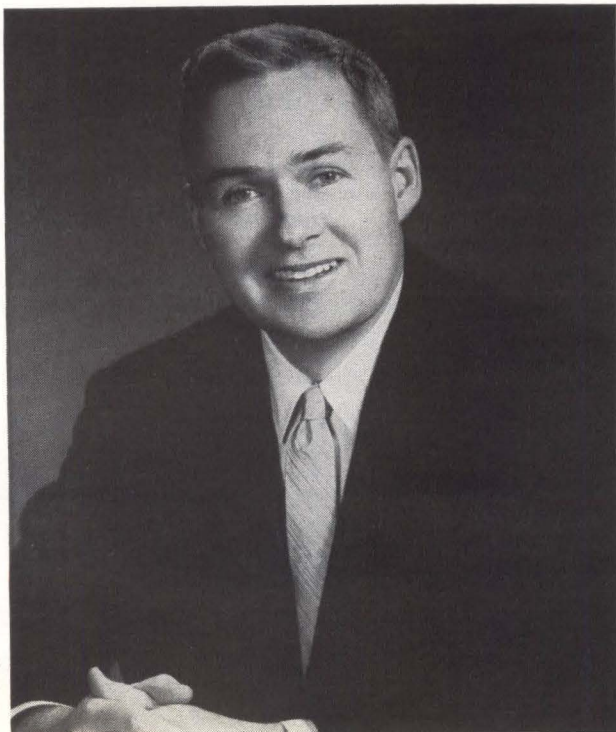

**INDUSTRY'S VIEW**—What do industry leaders think will be the impact of microelectronics on the market and on the industry as a whole? Robert N. Noyce, general manager of Fairchild Semiconductor, agrees with some recent studies which project the microelectronics business in the next five years into the hundreds of millions of dollars range. "Right now we're in the tens of millions category, so microcircuitry will continue to grow much faster than transistors did," he told ELECTRONICS.

"The big point to consider, though, is that the near future in this field will bring the opportunity for many firms to realign themselves as more and more firms dig into the market and claim their own chunks. Each firm's share of the market will surely change, some more, some less. Each manufacturer must watch the market closely in the next few years and be ready to realign himself to his best advantage."

Here is another allusion to the coming structural change in the industry. But Noyce doesn't think integrated circuits will drive out the conventional components business, either his own or the industry's as a whole. "Conventionals still have their own purpose," he says, and it will be quite a while before microcircuitry gets into all applications."

Is Fairchild concerned about its own conventional components business? "Well, microcircuitry is effecting our own business, yes, but then it's our policy here to consider microcircuitry over and above what we would be doing otherwise. Microcircuits have had less than a 10 percent effect on our conventional sales, so we're not worried about that point at all."

There will be definite shifts in personnel, Noyce predicts. "There will be more emphasis on fabrication personnel, as opposed to assembly personnel," he says. "This will come about in a gradual upgrading of the type of personnel required for microcircuitry, in terms of experience and training, because this business has an ultra-sensitivity to error. The yield factors because of all the individual steps involved, are fantastically high. You need almost 100 percent in all stages, or else you'll get nothing out at the end

#### PROJECTED SALES OF ELECTRONIC PARTS AND GROWTH RATES

	(in \$ millions and in percent)					
	1962 (Actual)	1959-62 Growth Rate (%/yr.)	1967 (Proj.)	1962-67 Growth Rate (%/yr.)	1972 (Proj.)	1967-72 Growth Rate (%/yr.)
Discrete Active Elements.....	\$1,252	10.9	\$1,490	3.5	\$1,755	3.3
Discrete Passive Elements.....	897	9.5	1,205	6.1	1,455	3.8
Filters and Networks.....	47	16.4	95	15.1	170	12.3
RCL Modules.....	16	9.9	23	7.5	30	5.5
Functional Assemblies	37	19.8	125	27.6	200	9.9
Microelectronic Circuits:						
Thin-film.....	5	.....	75	71.9	200	21.7
Semiconductor.....	10	.....	225	36.4	800	28.9
	\$15	.....	\$300	32.1	\$1,000	27.2
Electrochemical and other parts.....	1,076	9.4	1,432	5.9	1,835	5.1
Total Circuit Parts.....	3,340	10.2	4,670	6.9	6,445	6.6
TV Picture Tubes.....	175	(0.9)	205	3.2	265	5.3
Antennas, Loudspeakers, etc.....	195	(0.2)	235	3.8	290	4.3
Grand Total.....	\$3,710	8.8	\$5,110	6.6	\$7,000	6.5

(Courtesy Sprague Electric Co.)

**GALVIN:** "Component makers should effervesce.."



of the production line."

On custom versus standard modules, Noyce thinks that as advance systems come into being, they will probably become standard right away. "Most customs from here on will probably be retro-fit jobs, jobs to re-fit systems that have already been designed." Fairchild's business now is about 50-50 in dollars, but about 75-25 (standards to custom) in unit volume. This is because there is a one-to-three ratio in price.

Noyce doesn't look for much competition from new firms coming into the market. "The innocents have vastly underestimated the difficulties of getting into this business successfully," he says. There are probably four things needed to make it: five times the money you think you need; a reasonably healthy knowledge of the semiconductor industry; lots of experience in very tight control of manufacturing, and some good research behind you. And after five years, I'd list them in reverse order."

**COMPONENTS CHANGES**—In some quarters, microelectronics has been regarded as the death knell for the components industry as we know it today. Robert C. Sprague, Chairman of the Board and Chief Executive Officer of Sprague Electric Company emphatically disputes this view. At the Chicago conference this week, he explained some of the reasons why he believes that the radical changes in relationships among companies in the electronics industry, as forecast by some observers, may not come about. According to Sprague, people outside the components industry tend to look upon the components maker as a fabricator of bits and pieces by essentially very simple processes.

"Nothing could be further from the truth," says Sprague. "We are essentially in the materials processing business, in such fields as electrochemistry, metallurgy and solid-state physics; we use a wide variety of highly sophisticated processes such as controlled etching and plating, film deposition, diffusion, pressing and sintering and many others, most of which require very heavy capital investments." Sprague's implication is clear—who else is better prepared to meet the challenge of microcircuitry than the old-line components maker? In his view, for the component maker who has a broad base in all the important technologies of electronic circuits, assembled or integrated, the opportunities to share in the future growth of electronics are very good indeed. "To do this, however," Sprague told the conference, "he will have to be in a position to spend substantial sums of money on development work covering the entire spectrum of electronic materials and processes, and he will have to know enough about circuit design to work intelligently with the circuit developers in the systems field."

Sprague's own firm is heavily involved in microcircuits now, with 64 engineers and technicians directly involved in microelectronic circuitry R&D. But based on the projected figures derived by his market researchers, there will continue to be a market for discrete components for many years to come. (See Table) These figures show that the projected growth of microelectronics is part of a continuing



VAN POPPELE, JR: "The custom vendor is a subcontractor . . ."

evolution in the components area, and that while microelectronics will increase rapidly in volume, they will still not represent the dominant part of the total ten years from now.

**INTEGRATION**—Sprague disagrees with those who say either that the major systems supplier will have to integrate downward in order to avoid complete loss of his design prerogatives, or that the component manufacturer will have to integrate upward to the systems level. "I believe present well-established working relationships between the systems manufacturer and his suppliers will be maintained to the advantage of both, whatever physical form the circuit elements may take. I say this with confidence, because such relationships are already being established between my own company and certain system suppliers."

He looks upon the specialized supplier active in the field of microelectronics as a special kind of component maker, facing the same requirements for successful operation as the broad-based components maker, including the large investment needed in highly skilled personnel and elaborate processing facilities.

Robert Galvin, youthful president of Motorola, agrees with Noyce and Sprague that microelectronics will have little effect of consequence on conventional component manufacturers in the next five years. But he looks for new kinds of discrete conventional components—preserving the advantages of simplicity, low price and high volume—within ten years.

Galvin told **ELECTRONICS**, "A lot of component makers are going to be disturbed within the next ten years unless they can 'effervesce'—through parallel development of improved conventional components.





**BARDEEN:** "Countermeasures against becoming obsolete . . ."

For those who can, a big chunk of the market should remain. The general market should increase absolutely."

According to H. Gunther Rudenberg of Arthur D. Little, Inc. these parallel improvements in conventional components may be "forced" by the potential high reliability and low cost of microelectronics.

"Just as transistors forced improvements in tubes," he says, "They've become better and smaller and cheaper and use less power since transistors came in."

The advent of microelectronics, says Rudenberg, has already forced changes in the point of view of circuit designers. "Microminiaturization has shown them how to get rid of large expensive capacitors. Under its impact, some designers have designed ingenious circuits within the framework of conventional electronics to reduce size, improve reliability, lower costs, and in general use components more imaginatively."

**CUSTOM VS. STANDARD**—As vice president for marketing of Signetics, one of the few smaller firms specializing in semiconductor integrated circuits, F. J. Van Poppelen, Jr. holds that the buyer-vendor relationship depends on whether marketing of microelectronics goes one of three ways, which in his classification include the custom circuit, the customized circuit, and the standard circuit. He defined these as follows:

(1) The custom circuit—designed to the buyer's unique specifications starting from circuit analysis and proceeding through all stages of development, mask fabrication, diffusion, metalization and the rest.

(2) The customized circuit—a design to the buyer's circuit but based on a configuration of diffused components already being used by the vendor in the fabrication of his standard circuits.

(3) The standard circuit—an off-the-shelf circuit designed by the vendor to a set of specifications that represent his own best judgment on what circuit or circuits will find the greatest acceptance and widest application.

Van Poppelen is betting on the standard circuit as having the major short term impact in microelectronics because he believes the standard product

approach is the most economical in terms of cost and customer engineering. "Where custom circuits are concerned," he says, "the vendor is essentially a subcontractor—not a component supplier—and the preparation of a responsible bid on a custom integrated circuit is costly. It involves preliminary design and process evaluation, and may tie up a considerable amount of engineering time and talent—so much, indeed, that there is an increasing reluctance to bid on custom circuits for which the production potential is either small or indeterminate." The major weakness in the custom circuit approach, he feels, is the shortage of engineers competent in both circuit design and diffusion technology.

The customized circuit offers concrete advantages over the custom circuit in terms of cost, because the final product uses the same masks and diffusion steps as the vendor's standard product line up to the metalization step.

"Where time and volume production are concerned," says Van Poppelen, "the outlook for custom integrated circuits is quite favorable. But until process improvements are made, the short term solution to the buyer's need for small quantities of custom circuits lies in the customized circuit."

But the customized circuit still demands a cost premium and extra customer and vendor engineering time to achieve the optimum interconnection design. That's why Van Poppelen feels that the vendor with a good, extensive line of standard circuits will be in an advantageous position over the next two or three years.

**EDUCATION**—One of the chief effects of microelectronics on the engineering curricula will be a trend toward more basic science education for engineers—even at the expense of some current state-of-the-art courses. This was outlined to *ELECTRONICS* by Prof. John Bardeen, Nobel Laureate, co-inventor of the transistor, and now at the University of Illinois. The advent of microelectronics also emphasizes need for more interdisciplinary training for engineers and for closer interaction between industries and universities, according to Bardeen. "These would be countermeasures against becoming obsolete amid fast-changing technologies," he says.

Engineers in successful companies of the future will have to move knowingly among biological sciences, optics, physics, nucleonics, physical chemistry and metallurgy as well as in electronics, Bardeen predicts. Evolution of microelectronics is making materials research one of the most significant new trends in engineering promising growth potential for a whole new electronic generation over the next quarter century. "Understanding the nature and composition of materials has proved to be an essential foundation for breakthroughs in technology—particularly in electronics."

Bardeen calls for closer cooperation between industry and educational institutions to meet the demands imposed by the new technology. He suggests that updating should probably be a joint undertaking over the next decade, resulting in closer association between industrial and university research, including the exchange of information between both groups.



SOLID-STATE amplifier of unitized construction bolts directly to heat sink

# S-Band Paramp Approaches Noise-Figure Minimum

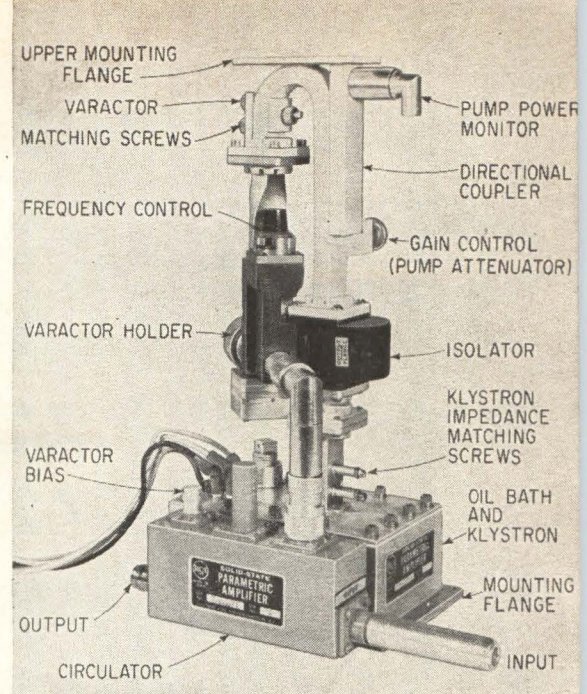

*Combining latest techniques produces better than four-to-one noise reduction over early parametric amplifiers and more than two-to-one improvement at 3 gigacycles over recently developed equipment. Amplifier also has a stable 2-percent bandwidth*

By P. KOSKOS, D. MAMAYEK, W. RUMSEY and C. L. CUCCIA  
Radio Corporation of America, Electron Tube Division, Los Angeles, California

**PARAMETRIC AMPLIFIERS** under development in several divisions of the Radio Corporation of America have been described in the literature<sup>1-9</sup>.

Signal-frequency amplification in the present developmental paramp is conventional. The device conforms basically to the classical three-frequency nondegenerate

model in which an r-f signal frequency and an r-f pump frequency are applied to a varactor in a circuit structure that also supports a difference or idler frequency across the varactor. A signal frequency of 3 gigacycles is used, a pump frequency of 17 gigacycles, and an idler frequency of 14 gigacycles. Because both idler and pump fre-

quencies are in Ku band, the circuits use Ku-band waveguide. The signal circuit at 3 gigacycles uses a coaxial-line structure.

Excluding the pump-circuit power supply, the structure is suitable for installation in an enclosure only 6 by 6 by 11 inches. The pump circuit includes a klystron, immersed in an oil bath on which the parametric amplifier is mounted.

The general circuit of the amplifier structure is shown as a block diagram in Fig. 1. The pump circuit includes a Ku-band klystron, a Ku-band isolator, an attenuator, directional coupler and crystal used to measure pump power. The pump filter and transducer couple the pump to the varactor. The idler circuit comprises a 14-gigacycle cavity resonator and tuner. The varactor is positioned at an optimum match point to enhance transmission of the pump signal through the cavity to the varactor.

## IMPROVEMENTS ADD UP

Noise figures are not reduced by quantum jumps—not even in parametric amplifiers! Improvements generally come in a series of small steps. Early parametric amplifiers had noise figures from 4 to 5 db at S-band, owing to lossy circulators, inadequate varactors and excessively complex circuits. Reproducible noise figures in the range 2.5 to 3.5 db resulted from circuit-design and component improvement. The developmental parametric amplifier described here further reduces the operational noise figure to the 1.5-2 db range at 3 gigacycles—close to theoretical minimum. Such performance, achieved over substantial bandwidths, is obtained with a low forward-loss garnet circulator and a Ku (17 gc) band pump, optimum circuit design, and excellent coupling to the varactor at signal, idler and pump frequencies

**A FOUR-PORT CIRCULATOR** of special design is included in the in-



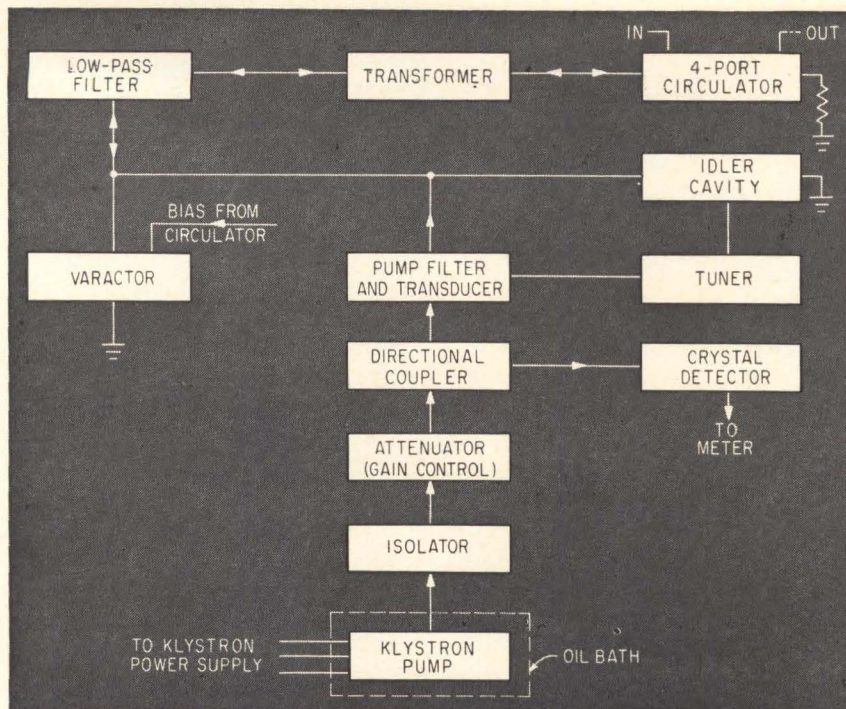

LOW NOISE AND STABLE BANDWIDTH are accomplished through a combination of improved techniques shown in block diagram—Fig. 1

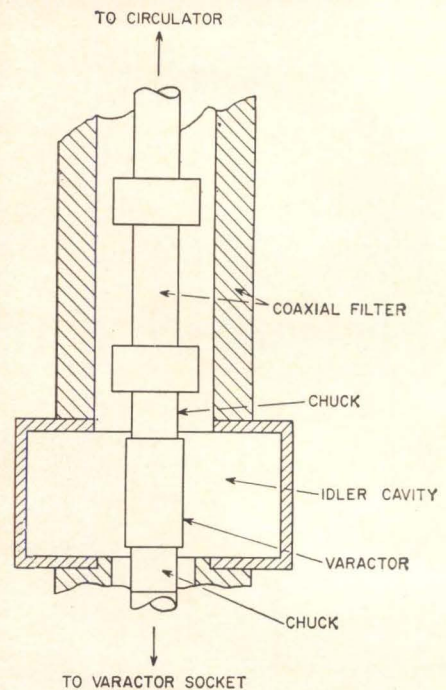

DISK-LOADED COAXIAL LINE prevents leakage of idler and pump energy into input signal circuit. Chuck permits rapid insertion of varactors—Fig. 2

put-signal circuit. The amplifier is coupled to the second port of the circulator through an impedance transformer and pump filter. The circulator includes a d-c block that allows bias voltage to be applied to the varactor. The circulator has a forward insertion loss in the order of 0.1 db. This low-loss performance, together with high reverse-insertion loss, is an important factor in the ultralow-noise characteristic of the parametric amplifier.

The input-signal circuit includes a coaxial low-pass filter described by Cuccia and Hegbar<sup>7</sup> and by S. Cohn<sup>8</sup> during the 1940's. This filter comprises a disk-loaded coaxial line with a cutoff frequency sufficient to prevent leakage of idler and pump energy into the input signal circuit.

The use of this filter in association with the varactor in a parametric amplifier, shown in Fig. 2, was first proposed by R. Kurzrok<sup>9</sup> at the RCA Surfcom Laboratories in 1959.

A ten-turn vernier dial tunes the idler cavity to change the frequency of amplification. This adjustment is the only tuning required.

**VARACTOR DIODE** replacement is facilitated by a large knurled knob opposite the coaxial input line. When the knob is unscrewed, the diode and its spring-chuck mounting can be removed. The parts are designed to insure positive seating and locking. The entire amplifier structure is bracketed together for rigidity, and can be bolted to a heat-transfer surface

that is in contact with the flanged bottom of the oil bath.

The parametric amplifier requires only the klystron power supply for stable, reliable operation at ultralow-noise figures substantially below 2 db at 3 gigacycles. Design of the amplifier permits operation at other frequencies in the range from 1 to 5 gigacycles.

**OIL-BATH IMMERSION** of the klystron, which operates at approximately 17 gigacycles with a power output of less than 50 milliwatts, stabilizes klystron frequency and power to the extent indicated by the graph in Fig. 3.

**VARACTORS** with extremely high cutoff were not required. This fact was evident after the design had been optimized and excellent matching to the varactor had been achieved in the signal, idler, and pump circuits of the parametric amplifier. Double-ended cartridge-type varactors that were used had cutoff frequencies in the order of 70 gigacycles at zero bias and capacitances of approximately 0.8 pf.

**NOISE FIGURE** of a parametric amplifier depends upon the insertion losses of the circulator and input circuit and also the noise contributed by the varactor and idler

#### NOISE FIGURE IS A TOTAL

Forward insertion loss of input port to the param port of circulator	0.15 db
Excess idler noise (from equation)	0.85
Input filter loss	0.10
Idler cavity wall loss (approximate)	0.05
Varactor resistive loss (approximate)	0.05
Miscellaneous connector losses in input circuit	0.05
<b>Total (param theoretical noise figure)</b>	<b>1.25 db</b>



circuit. These losses, in the order of one db, add to the fundamental minimum theoretical noise figure established by the ratio of idler frequency to signal frequency.

The lowest noise figure,  $NF$  that a parametric amplifier can provide when operated at ambient room temperature and with a lossless input circuit, circulator, and idler cavity can be calculated from the equation<sup>1</sup>

$$NF = 1 + \frac{W_s}{W_i}$$

where  $W_s$  and  $W_i$  represent the signal and idler frequencies, respectively. For a signal frequency of 3 gigacycles and an idler frequency of 14 gigacycles, the noise figure of the lossless parametric amplifier has the value

$$NF = 1 + \frac{3}{14} = 1.214 \text{ (0.85 db)}$$

This value is the excess idler noise. For a practical parametric amplifier circuit, the losses and noise that contribute directly to the noise figure are listed in the box.

Thus, the 1.3-to-1.9-db noise figures measured for the parametric amplifier, when the varactor is at room temperature, approach the theoretical optimum.

**PERFORMANCE** of the amplifier was measured with the three different varactors listed in the table. Gain measurements were made with a swept-frequency system in which the gain-frequency characteristics were displayed on the calibrated face of an oscilloscope.

Noise figure was measured in a circuit in which the parametric amplifier was used to drive an S-band low-noise traveling-wave tube. The traveling-wave tube was operated at substantial gain to minimize noise-figure deterioration in the stage following the parametric amplifier and to provide the amplifier with a stable load. Noise-figure was measured with a Hewlett-Packard Model 340E noise-figure meter operated with a calibrated noise source. The test setup was calibrated with ultralow-noise traveling-wave tubes having noise figures accurately determined by the hot-cold load method.

With the signal and idler circuits single-tuned, bandwidths in the 45-to-70 megacycle range were meas-

#### OPERATING CONDITIONS FOR THREE VARACTOR TYPES

Varactor Number*	Center Frequency in gc	Bandwidth in mc	Gain in db	Noise Figure in db	Varactor Bias in volts
685.....	3	53	17	1.9	+0.7
710.....	3	45	17	1.5	+0.7
709.....	3	60	17	1.5	+0.5

Varactor Number	Klystron		Reflector volts	Pump Frequency in Gc	Pump Power in mw
	Beam volts	ma			
685.....	570	52	175	17.05	40
710.....	570	52	175	17.05	40
709.....	570	51	175	17.05	15

\* Manufactured by Semiconductor Devices, Inc., Newport Beach, Calif.

ured. The bandwidth was extremely stable for normal operating temperatures of 40 C. With the amplifier heated to 70 C, no gain change was observed, and the shift in center frequency was less than 3 megacycles. During repeated tests of several models of the amplifier, valid single-channel noise figures as low as 1.3 db were measured under highly stable operating conditions with the amplifier operated for many hours.

When double tuning was used in the signal and idler circuits, bandwidths as great as 100 megacycles were observed without increase in noise figure, and bandwidths as large as 200 megacycles were measured with the noise figure still in the 2 db range. The latter measurements, obtained with a pill type varactor, indicate the capability of the amplifier.

The writers acknowledge the aid of A. Solomon and B. Bossard.

#### REFERENCES

- (1) S. Bloom and K. Chang, Theory of Parametric Amplification Using Non-Linear Reactances, *RCA Review*, Dec. 1957.
- (2) J. Luksch, E. Matthews, and G. VerWys, Design and Operation of Four Frequency Up-Converters, *IRE Transactions on MTT*, Jan. 1961.
- (3) R. Pettai, B. Bossard, and S. Weisbaum, Single-Diode Parametric Up-Converter with Large Gain-Bandwidth Products, *Proc. IRE*, July 1960.
- (4) R. Pettai and B. Bossard, Broadband Parametric Amplifiers, *Digest of 1962 PGMTT National Symposium*.

- (5) F. Sterzer and W. Eckhardt, Microwave-Carrier Modulation — Demodulation Amplifiers and Logic Circuits, *Proc. IRE*, Feb. 1962.
- (6) C. Cuccia and K. Chang, The Helix Parametric Amplifier—A Broadband Solid-State Microwave Amplifier, *RCA Review* June 1961.
- (7) C. Cuccia and H. Hegbar, An Ultra-High-Frequency Low-Pass Filter of Coaxial Construction, *RCA Review*, Dec. 1947.
- (8) Chapter 26 by S. Cohn of Vol. II, Very High Frequency Techniques by RRL of Harvard University, McGraw-Hill, 1947.
- (9) R. Kurzrok, U. S. Patent 2,970,275, Parametric Amplifier Device, issued Jan. 31, 1961.

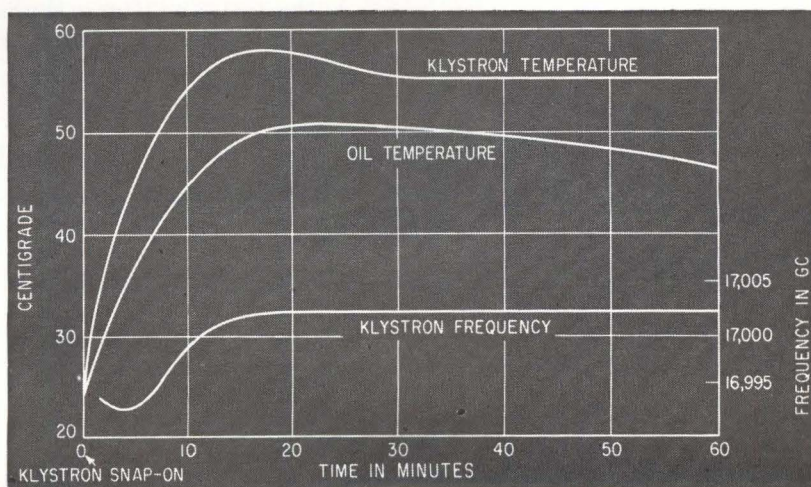

KLYSTRON FREQUENCY STABILITY is insured by oil bath—Fig. 3



# TUNNEL DIODES Part III

## Mixer and Converter Circuits

*Here tunnel diodes enter the highly competitive fields of mobile communications, t-v systems and related uses. Advantages of using tunnel diodes lie in the compactness of their circuits, wide operating temperature range, plus months of useful life from flashlight batteries*

By ERICH GOTTLIEB AND JOHN GIORGIS

Consultants,  
GE Semiconductor Products Department, Syracuse, New York

**TUNNEL DIODE** oscillator and amplifier function's may be combined and the device used as a frequency converter.

The amplifier section (Part II) shows that if the tunnel diode oscillates or is externally driven, its "time-average" or "large signal" conductance is made considerably smaller than its small signal value. Thus the converter gain will in general be smaller than the amplifier gain. As a result one cannot expect to obtain as low a noise-figure in the converter as in the amplifier, but at best, one can hope to approach the amplifier noise figure.

There are several ways to use the tunnel diode as a frequency converter, each having its distinct advantages and disadvantages. These configurations are

- Self-oscillating (autodyne) converter.
- Positive input-impedance driven-mixer.
- Negative input-impedance driven-mixer.
- Passive driven-mixer.

**SELF-OSCILLATING** — Needing only one active device, the self oscillating converter is the least expensive of the converter circuits. All other approaches use two active devices, one for the local oscillator the other for the mixer.

The tunnel diode, when biased in its negative conductance region, can

oscillate, mix, and amplify simultaneously, and can therefore operate as an autodyne (self-oscillating) converter with gain. Frequency conversion is achieved by the nonlinearity of the  $g$ - $V$  characteristic with the diode biased at points  $A$ ,  $B$ ,  $C$ , or  $D$ , Fig. 1A. The requirement of self-oscillation, however, eliminates bias point  $A$  since the diode must be biased in the negative conductance region to oscillate. Furthermore, since the slope of the region  $A$ - $C$  is steeper than  $C$ - $D$ , greater conversion gain and better oscillator stability can be obtained at point  $B$  than at point  $D$ . Operation at  $C$  yields a great deal of second harmonic output, hence this point is generally chosen for harmonic conversion.<sup>1</sup>

As the diode oscillates at the local-oscillator frequency, it swings over a large part of its nonlinear nega-

tive conductance characteristic. Mixing can thus take place if an r-f signal is fed into the circuit. Remarkably, while the diode oscillates at the local oscillator frequency, it can simultaneously amplify at both the r-f and i-f frequencies. Furthermore, since the tunnel diode conductance is "time-averaged" by its oscillator swing, small signal amplification can be accomplished more stably this way than in the straight tunnel-diode amplifier. However, frequency-stable conversion is the prime objective and amplification can therefore be kept small.

A single tunnel diode can provide stable performance in the simultaneous functions of r-f amplifier, local oscillator, mixer and i-f amplifier.

Mathematically this imposes certain requirements<sup>1</sup> on the relation-

---

### WHY A TUNNEL DIODE CONVERTER

Parametric amplifiers may have poor noise figures in "down converter" circuit; tunnel diodes work fine whether converting downwards or upwards. To detect high-frequency signals in the gigacycle range beyond reach of vacuum tubes, a crystal mixer is usually provided with output from a klystron or traveling-wave-tube local-oscillator. Tunnel diodes can do all this in one unit. The same tunnel diode acts as the local oscillator and mixer and throws in a little overall gain for good measure. Its noise figure is good too. Specially constructed tunnel diodes, known as backdiodes, offer very low forward resistance making them ideal for low-level and video detectors

---



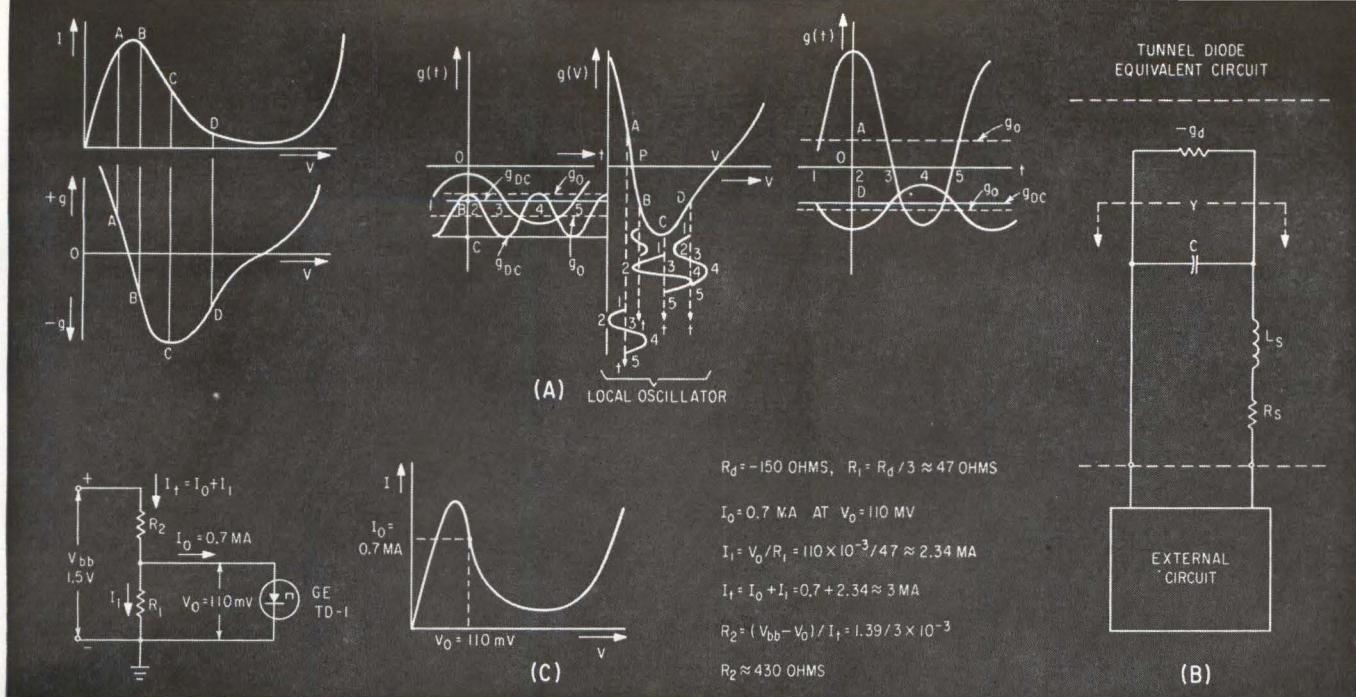

TUNNEL DIODE characteristic curves are used to determine best bias conditions for frequency conversion (A), generalized tunnel diode circuit pertaining to converter operation (B), derivation of bias circuit components from characteristic curve and operation conditions (C)—Fig. 1

ship of the external circuit to the equivalent circuit of the tunnel diode as seen in Fig. 1B.

Table I shows that the converter circuit will generally consist of three tank circuits resonating at the i-f, r-f and l-o frequencies respectively. The real termination or loading of these tank circuits must be satisfied in the following manner.

- At the l-o frequency the real part of the circuit admittance  $Re(Y)$ , (including the parasitic parameters  $C, L_s$  and  $R_s$  of the tunnel diode) must be equal or smaller than the absolute value of the negative tunnel diode conductance at the bias point ( $-g_{di}$ ).

- At the r-f frequency, the real part of the circuit admittance,  $Re(Y)$ , (including the parasitic diode parameters) must be larger than the time average negative conductance of the tunnel diode  $|g_o|$ .

- At the i-f frequency, the real part of the circuit admittance  $Re(Y)$ , (including the parasitic diode parameters) must be larger than the time average conductance  $|g_o|$ .

**CONVERTER DESIGN** — Basic parameters: the r-f and i-f frequencies, are established by application considerations. From these frequencies the l-o frequency is determined. If, however, the i-f frequency is small compared to the r-f, the l-o frequency would be awkwardly close to the r-f frequency.

For example, if the r-f frequency is 500 Mc and the i-f 10 Mc, then the l-o frequency would normally be either 510 Mc or 490 Mc. In a simple circuit like the autodyne converter, tank circuits resonating so close to each other would cause a great deal of tuning-interaction, oscillator pulling, and loss of gain. Therefore, when the r-f and l-o frequencies are too close, harmonic conversion can be used. This means that the l-o tank circuit is resonated at half its desired frequency, thereby removing it far from interference with the r-f tank circuit. The tunnel diode is then operated at its inflection point, generating a great deal of second-harmonic output for mixing with the r-f signal. After all operating frequencies are determined, the diode can be selected.

Choice of diode starts with selection of the diode package. If the converter is to operate in the microwave region, a pill-type unit with inductance in the 0.1-0.4 nh region should be selected. For frequencies at or below uhf, higher-inductance housings can be tolerated, but from a stability standpoint it is always preferable to keep this inductance as low as possible. Even an inexpensive general-purpose tunnel diode should exhibit low inductance typically: 0.5nh for an axial package and 0.1nh for a sandwich package. Choice of the tunnel diode housing will determine the shape and

make-up of the mount.

Once the tunnel diode package is determined the converter design will be derived from the operating parameters. For instance, if the circuit must handle source and load impedances of 50 ohms, the negative resistance of the diode must be high enough to abide by the stability criteria in Table 1. Secondly, for stable, low-noise performance, the resistive cut-off frequency ( $f_{ro}$ ) should preferably be at least three times the operating frequency. The self resonant frequency ( $f_{xo}$ ) should also considerably exceed the operating frequency.

When the diode is chosen, typical values and tolerances of negative conductance  $gd$ , capacitance  $C$ , inductance  $L_s$ , series resistance  $R_s$  as well as  $I_p, I_v, V_p, V_r$  and  $V_{ip}$ , will be defined. This knowledge permits the bias circuit to be designed.

A 1 ma tunnel diode, biased at operating point B, Fig. 1A, implies a voltage of approximately 110 mv at a current of 0.7 ma. At this operating point it exhibits a negative conductance of  $6.6 \times 10^{-3}$  mho, or negative resistance of -150 ohms, so that the parallel combination of  $R_1$  and  $R_2$ , Fig. 1C, may never exceed 150 ohms. The lower the series equivalent resistance the stiffer the voltage source. Unfortunately current consumption increases as this series equivalent resistance decreases. The numerical value of



equivalent resistance  $R_{eq}$  is given by  $R_{eq} = (R_1 \times R_2)/(R_1 + R_2)$ . A compromise value for  $R_{eq}$  is about one third of the negative resistance.

**EXAMPLE**—The bias network resistors, of Fig. 1C are calculated using a tunnel diode having a negative resistance at the operating point of  $-150$  ohms.

The next step is to design the oscillator tank circuit, with its  $L/C$  ratio selected for resonant impedance at all times larger than its effective negative resistance. (see Part I on oscillator design). The question of required frequency stability must also be considered. Is the inherent stability of the tunnel diode oscillator adequate for the application or must the oscillator be crystal controlled? The frequency stability of the simple oscillator can be made better than  $\pm 200$  parts/million by compensation. To ensure

this or better performance, crystal control should be used.

Now the r-f must be coupled-in and the resultant i-f coupled-out. Some operating conditions are:

- Absence of appreciable reduction in oscillator stability.
- No undesirable oscillation at r-f, i-f, or spurious frequencies.
- Some stable r-f and i-f amplification.
- Lowest possible noise figure.

It was established in Part I that when the tunnel diode oscillates (or is externally driven) the resulting average conductance ( $g_o$ ) and time average conductance ( $g_{at}$ ) become a function of the oscillation amplitude. Therefore, in a converter circuit, the conductances seen at both r-f and i-f frequencies are a function of oscillator amplitude.

It had also been established that the magnitude of these average conductances  $g_o$  and  $g_{at}$  are re-

duced as the oscillator amplitude increases. Therefore the smaller the oscillation amplitude the closer  $g_o$  gets to the small signal conductance at the operating point ( $g_{at}$ ). On the other hand if the oscillation amplitude is large (as can be in a driven mixer)  $g_o$  can even become positive. Thus, depending on oscillator amplitude, the r-f and i-f impedances exhibited by the tunnel diode can go from somewhat above  $r_{at}$  (normally around  $-150$  ohms for a 1-ma tunnel diode) to infinity and even become positive.

To obtain r-f and/or i-f amplification it is necessary to match the input and output terminations to the oscillator-dependant average conductance  $g_o$ , without introducing instability. Hence, the real value of admittance must be greater than  $|-g_o|$ , when the imaginary part of  $Y = 0$  to obtain stable gain. Unfortunately the average conductance is not given by the manufacturer as the measurement is involved and uses specialized equipment. Several papers have treated this subject.<sup>2, 3, 4, 5, 6</sup>

Basically data could be approximated from a graphical analysis of the diode characteristic. Here again, exact tunnel diode  $g-V$  curves are not conveniently available and it is generally more practical to derive these parameters experimentally. For a rough estimate of a  $g-V$  plot, the oscillation-amplitude and bias operating point will indicate the expected results.

Assuming a conductance  $g_o$  of  $-0.002$  (equivalent  $r_o = 500$  ohms) the r-f and i-f terminating impedances will have to be somewhat smaller than  $+500$  ohms and require adjustment in the r-f and i-f transformer turns ratios to present such impedances to the diode. If the reflected terminating impedances are too high, the oscillator will switch modes from l-o to r-f and/or i-f oscillations; conversely, if the reflected terminating impedances are too small, low gain can be expected. It is best to start from

CONVERTER OPERATING CONDITIONS—TABLE I

Operation	Requirements
Oscillation at $f_{i-o}$	$\text{Re}(Y) <  -g_{at} $ $\text{Im}(Y) = 0$
Stable Amplification at $f_{r-f}$	$\text{Re}(Y) >  -g_o $ $\text{Im}(Y) = 0$
Mixing	Proper bias point choice and sufficient oscillator swing to provide large conductance change
Stable Amplification at $f_{i-f}$	$\text{Re}(Y) >  -g_o $ $\text{Im}(Y) = 0$

PERFORMANCE DATA FOR TUNER, FIG. 2G—TABLE II

Frequency	Sensitivity	Noise Figure	Band Width	Overload Characteristics
	20 volts p-p, 400 cps at crt			Distortion and Sync. Clipping Across 300- ohm balun
850 Mc	10.3 $\mu\text{v}$	15.5 db	6 Mc	
820 Mc	8.8 $\mu\text{v}$	14.5 db		at 25 mv
700 Mc	8.1 $\mu\text{v}$	14.2 db	6 Mc	at 20 mv
500 Mc	5.9 $\mu\text{v}$	13.6 db	6 Mc	at 20 mv
470 Mc	6.9 $\mu\text{v}$	13.9 db		

Dynamic range to approximately  $-27$  dbm

COMPARISON OF BACKDIODE CHARACTERISTICS—TABLE III

	$R_s$ ohms	$C$ pf	$R_b$ ohms	13.5 Gc		6.0 Gc	
				$\beta$ at 1 $\mu\text{w}$ power	$M$ Calculated	$\beta$ at 1 $\mu\text{w}$ power	$M$ Calculated
MA408B No. 5	42	0.23	35,000	0.2	37	2.0	370
MA408B No. 6	32	0.32	20,000	0.2	28	2.0	280
BD No. 5	10	0.30	730	2.7	45	11.0	180
BD No. 7	8	0.50	880	2.4	47	7.5	145

$\beta$  = short circuit current sensitivity of the diode  
 $R_b$  = video impedance of the diode  
 $R_A$  = equivalent noise resistance of the video amplifier

And  $M$  is a figure of merit, where  $M = \frac{\beta R_b}{\sqrt{R_b + R_A}}$

**CONVERTER CIRCUITS**—A Civil Air Patrol converter<sup>7</sup> can be designed in a small dashboard-mounted-box operated by a single flashlight cell. It is connected between the car radio antenna and the receiver and receives CAP frequencies (4.465 Mc) and converts



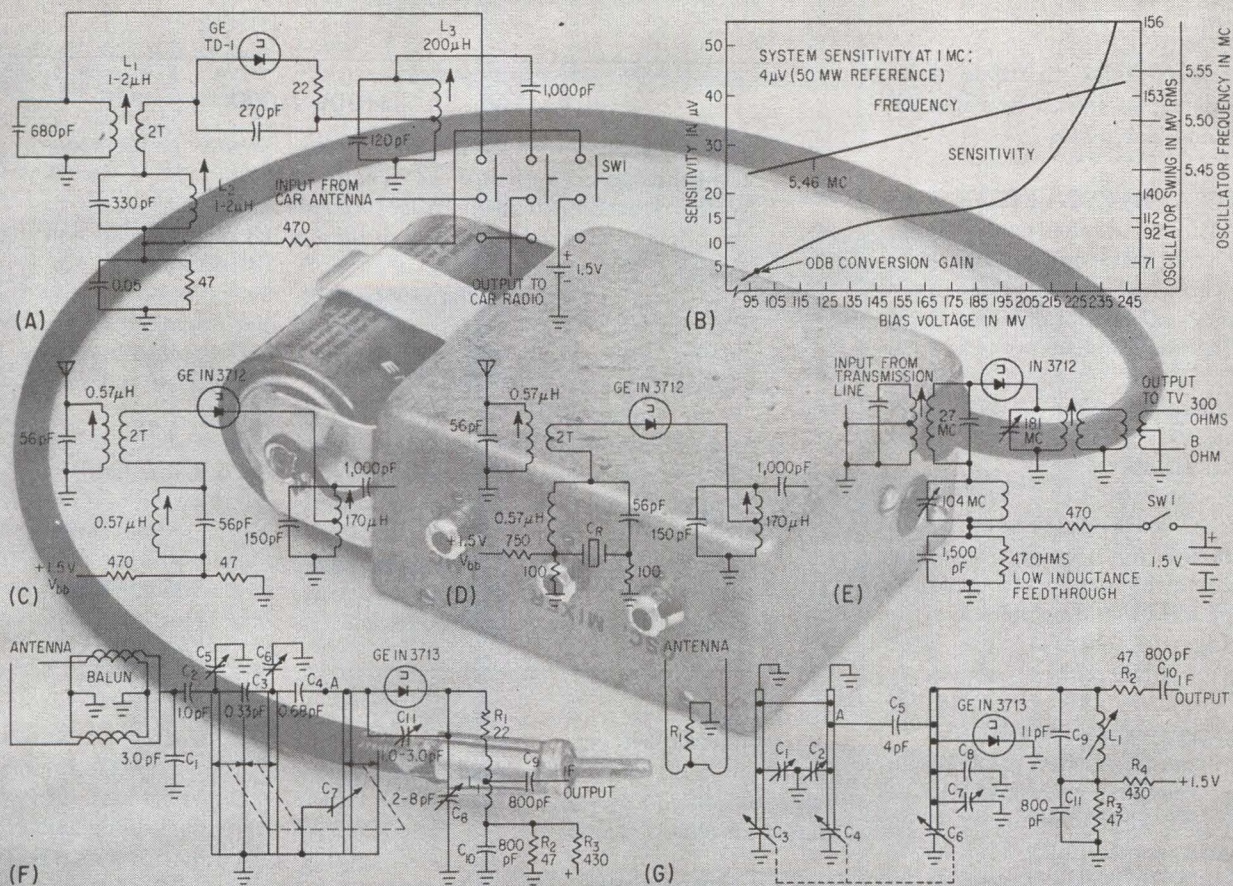

CIVIL AIR PATROL converter (A), performance curves (B) set against background photo; citizen's band converter (C), crystal controlled version of the citizen's band converter (D), tunnel diode "up converter" for community t-v (E), tunnel diode tuner (F), uhf tunnel diode tuner with capacitance tuning (G)—Fig. 2

them to the broadcast band. The circuit of this converter is shown in Fig. 2A, its performance in Fig. 2B and the finished converter in the background photograph.

The data, Fig. 2B, shows that 0-db conversion-gain can be obtained at close to 100-mv bias. In the range of 100 to 135-mv bias, the gain is less than unity but since this conversion loss is generally of little consequence.

Two types of citizens band converter circuits were investigated. The first is straightforward, and by ganging the r-f and l-o circuits, the converter can be made to tune over a moderate frequency band. The second converter circuit is crystal-controlled at fixed frequency.

The simple converter uses the same design procedure as the CAP version and is shown in Fig. 2C; its performance is similar to the CAP type.

The crystal controlled converter, Fig. 2D, differs only in the oscillator section, which uses the crystal controlled circuit discussed in the oscillator section, Part I. The

resonant resistance of the crystal  $R_{cr}$  reduces the oscillator amplitude, which in turn reduces the average negative resistance  $R_{dn}$ . Consequently, the turns ratio on input and output coils is increased over the values shown in Fig. 2C.

#### FIRE DEPT. CONVERTERS —

These automobile-mounted units enable volunteer firemen to get to the fire without first reporting to the station for information.

Some of these Fire Department converters operate in the 46-Mc range and thereby present an additional design problem. Operating at 46 Mc with a 1 Mc-i-f having a few kilocycles bandwidth puts a great burden on the frequency-stability of the oscillator. This is especially true for converters placed in a car, since they must operate stably over wide temperature ranges. Such applications require crystal control for best results. Although the transmitters are generally frequency modulated, slope detection in the car radio yields intelligible reception.

When operating at about 10 times the frequency of the CAP converter, both  $L$  and  $C$  may be divided by 10, thereby keeping the same  $L/C$  ratio at the new operating frequency. If this makes the input capacitance too small, the  $L/C$  ratio can be slightly altered.

#### COMMUNITY TV—

In many poor-reception rural areas, community t-v service organizations provide a remote master antenna located in a suitable reception area. A master subchannel converter converts the vhf channel frequencies down to lower frequency (subchannel) carriers for cable-transmission and distribution. Wide-band amplifiers keep the signal levels up along the way. In the individual subscribers home an "up-converter" returns the signals to their former channel frequencies. One such type of circuit is illustrated in Fig. 2E.

**UHF CONVERTERS —** Two versions of uhf television tuners were designed<sup>9</sup> with performance ap-



proximately equal to their tube counterparts, as shown by Figs. 2F and 2G and Table II.

### MICROWAVE CONVERTERS —

Before tunnel diodes came along, the conventional microwave converter consisted of a crystal mixer driven by an oscillator using such tubes as lighthouse or klystron types. Mixers generally exhibited less than unity gain ( $-6$  to  $-10$  db) and system noise figures ran in the 8 to 15 db range.

More recently, the parametric converter has provided useful gain and hence lower noise-figures. The parametric converter, however, can be an elaborate and complex circuit requiring an external oscillator (pump), refrigeration, extensive power supplies, and other auxiliaries.

The tunnel diode provides a simpler, smaller, and less expensive means of achieving conversion with gain above unity and hence reasonably low noise-figures. In the self-oscillating converter, for instance, no external pump (oscillator) is needed and the only power required is the small supply voltage and current for the tunnel diode, typically 0.15 volt and 1 to 3 ma.

**L BAND CONVERTER**—A 1 Gc converter, with 30-Mc i-f was designed with the following results: gain = 25 db, noise figure = 10 db, bandwidth = 3 Mc, saturation level  $\approx -30$  dbm and image rejection = 21 db.

The tunnel-diode converter gain was around 0 db but the converter assembly contained one stage of i-f with 25 db gain (noise figure  $\approx 4$  db). This arrangement had the added advantage that the first i-f stage served as a built-in buffer between the converter and the external i-f amplifier. The circuit is illustrated in Fig. 3A and 3B.

**CIRCUIT**—The circuit consists of a half-wave signal stripline shorted at both ends and serving as r-f pre-selector. Radio-frequency energy is coupled in at a low-impedance point A. It is then coupled by a movable arm to the open ended quarter wavelength oscillator stripline. The tunnel diode is seated at a high impedance point, such that it can oscillate stably, while the i-f

### PASSIVE BACKDIODE MIXER

A reverse-connected tunnel diode is used primarily for the negative-conductance portion of its forward characteristic. In the reversed direction, it exhibits a large conductance much closer to the origin than any other diode. If used in this reversed direction primarily, the tunnel diode is called a "backdiode".

In mixer applications, the device is usually subjected to zero d-c bias and driven by an oscillator equally about its origin. The first such device, fully characterized in both forward and reversed direction is the 1N4090 and it will be called a tunnel mixer' in this article.

Backdiodes in general are low-current devices (below 1.0 ma) while tunnel diodes have peak currents from 250  $\mu$ a into the ampere region. Only between 0.25 and 1.0 ma do the two devices overlap. Owing to their lower peak currents, backdiodes have much smaller junction areas and are more fragile than tunnel diodes. The lower-current-concentration material is generally used to make backdiodes mechanically strong

energy is coupled out at the local oscillator null. This i-f signal is then amplified by the low-noise buffer-amplifier transistor.

**3 Gc CONVERTER** — Another converter, Fig. 3C, was designed for  $f_{r-f} = 3,150$ -Mc,  $f_{osc} = 3,090$ -Mc, and  $f_{i-f} = 60$ -Mc. The built-in i-f amplifier buffer stage had the characteristics: power-gain  $\approx 18$ -db, bw  $\approx 20$ -Mc, NF  $\approx 4.0$ -db.

The converter i-f amplifier combination had a power gain of about 13-db, BW  $\approx 15$ -Mc, NF  $\approx 11$ -db and an image rejection of about 10-db.

A paper on a complete solid state s-band receiver<sup>10</sup> discusses a tunnel diode circulator reflection amplifier and a self-oscillating tunnel diode converter. In this receiver, covering a range from 2.0 to 3.0-Gc, the down-converter had noise figures in the range of 12 to 15-db.

**POSITIVE IMPEDANCE**—Tunnel diodes, when biased in the positive conductance region or subjected to the large-swing oscillations (producing positive average diode conductance) can exhibit a positive input impedance. If the conversion conductance  $g_c$  is made negative at the same time, conversion gain greater than unity can be obtained.

A low-gain tunnel diode converter<sup>4</sup> has claims for exceptional stability with variations of input impedance. This circuit exhibits lower conversion losses, lower noise figures, larger dynamic

range and greater resistance to burn-out than crystal-diode converters. Experimental uhf and microwave tunnel diode converters, stable with input vswr's exceeding 10:1 having 0-db conversion losses and 2.5 to 3-db noise figures are described.

While these noise figures were measured under idealized laboratory conditions with a second stage noise figure of 1.7 db, it should be feasible to attain about 6-db system noise figure in a stable fashion. It should also be possible to use another tunnel diode as local oscillator, although the oscillator drive power of several milliwatts entails the use of a high-current tunnel diode of about 100 ma  $I_p$ .

**NEGATIVE IMPEDANCE** — One design approach,<sup>11</sup> uses a bias operating point just below the peak current, and has a small oscillator-swing driving past the peak current into the negative conductance region. The resulting high-gain converter is sensitive to variations in input impedance and has a limited dynamic range owing to the small amplitude of oscillations. Operating in the negative conductance region, with negative values of  $g_c$ , gives high gain and good noise performance. Unfortunately, this condition is realized only at the sacrifice of stability and dynamic range; minimum noise figure is obtained at the minimum  $I_0/g_a$  operating point.

In a 1,200 Mc converter design<sup>12</sup>



the local oscillator was set at 1,170 Mc and produced a 30-Mc i-f. The tunnel diode, a 1-ma unit, was an early version of the 1N3218A.

Several noise figure calculations were made for various points of operation about the point of maximum positive slope of the conductance curve in the negative resistance region. Best noise figures were obtained when  $V_o$  was between 100 and 200 mv corresponding to the position of minimum  $IR_d$  product or minimum  $I/G_d$  ratio. With 50 mv peak local-oscillator drive, moderate values of  $G_1$  can be obtained with large negative values of  $G_o$ . The best calculated value for the noise figure was about 4.7 db. The relative merits of a tunnel diode converter versus by a standard converter require investigation. There is no generality that may be applied: the question must be resolved for each separate application, since each application will have a different set of rules governing stability, gain bandwidth, overall noise figure, and so forth. The noise figure of the converter is in general higher than that of the amplifier. If the gain of the converter is high the system noise figure may approach, or surpass, that of the system using the negative conductance amplifier, since in the process of converting from signal to i-f there is no lossy diode mixer.

**USING BACKDIODES** — A September 1961 article<sup>18</sup> describes the low-noise properties of backdiodes (see editorial box) used as driven mixers. The article discusses a 13.5 Gc doppler radar mixer (i-f  $\approx$  1 Kc) and a conventional 13.5 Gc — 30 Mc i-f system, and compares the performance of backdiodes to the best available point-contact mixer diodes in these applications.

In doppler radar systems the i-f frequencies are in the audio range. Here the  $1/f$  noise of the mixer is an important consideration. Measurements have shown that backdiodes have much better  $1/f$  characteristics than conventional point-contact mixers. This is primarily due to the fact that backdiodes are made with doping levels one to two orders of magnitude higher than conventional mixer diodes. A variety of experiments have indi-

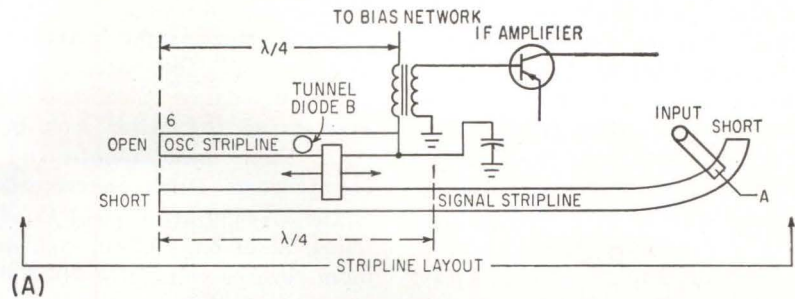

(A)

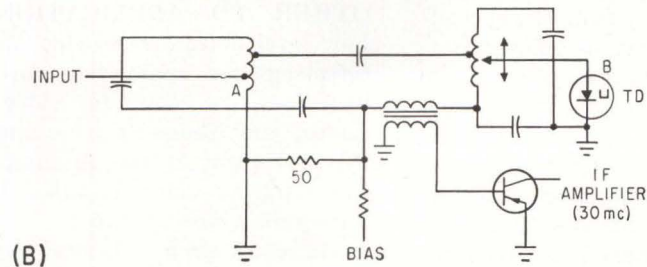

(B)

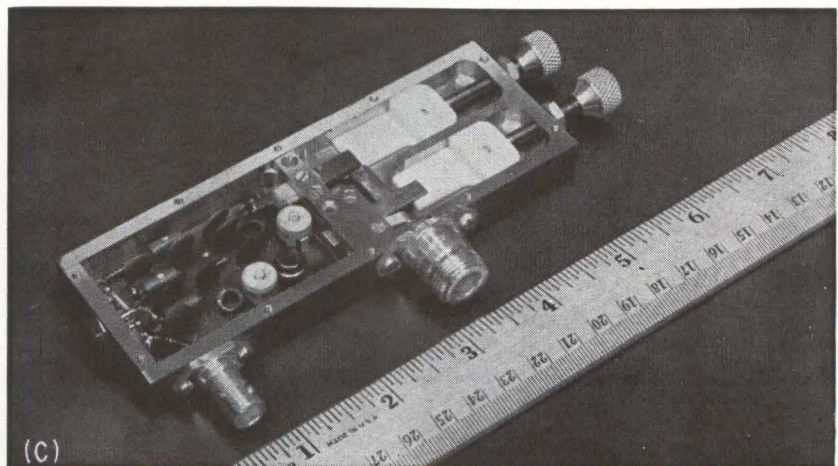

(C)

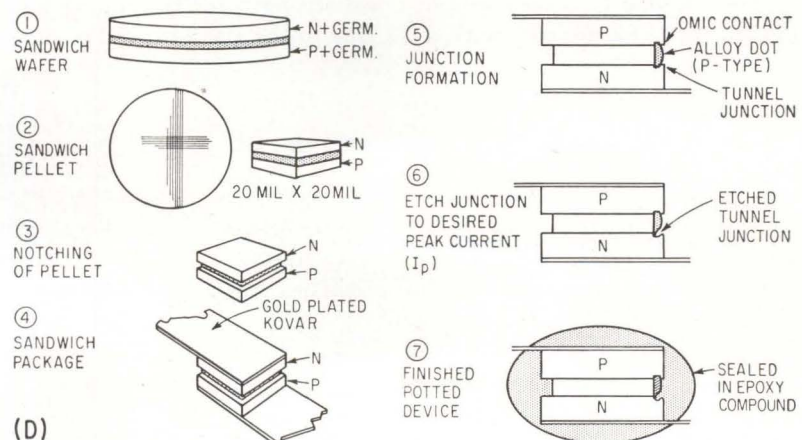

(D)

**TUNNEL DIODE L-band autodyne converter (A) and its equivalent circuit (B), converter for 3-Gc operation (C), backdiode uses sandwich structure to combine physical support with low inductance and capacitance (D)—Fig. 3**



cated that the surface plays an important part in connection with  $1/f$  noise. Since for nearly-degenerate materials the relative change in surface potential is less pronounced than in the nearly intrinsic case, the backdiode's  $1/f$  contribution should be smaller than that of the conventional mixer diode. Also, since the resistivity of the semiconductor is reduced, the thermal noise contribution from the spreading resistance may be smaller.

The  $1/f$  noise decreases when the rectified current through the device decreases. Investigations prove that the conversion loss of backdiodes can be kept small at very low levels of local oscillator power, a phenomenon not true for conventional mixers.

In another paper on this subject<sup>14</sup> a 100-Mc balanced mixer converting to 5-Kc obtained a double-channel noise figure of less than 7-dB. This is a 30-dB improvement over what would be expected from present-day mixers of the point contact variety.

Measurements were also performed from 500 to 2,000-Mc and at 8.9-Gc (with 35-Mc i-f). Noise figures obtained ranged from 5-dB at 500-Mc to 14-dB at 8.9-Gc.

**UHF-TV**—In uhf television tuners it is usual to use a vacuum tube oscillator and a diode mixer to perform the frequency conversion. Comparing the performance of backdiodes 1N4090 with conventional mixers (IN82A) at normal l-0 levels without bias or circuit change has shown the 1N4090 to perform at par with the best 1N-82A's. The 1N4090 is a germanium "Tunnel mixer" (backdiode) with a

typical capacitance of 1 pf. Somewhat better input and load matching of the circuit to the lower impedance backdiodes might even make the latter look better than their best point-contact counterparts. Other characteristics of the 1N4090 are typical  $R_s$  of 4.5 ohms,  $L_s$  of only 0.2-nh, and minimum reverse voltage of 500-mv.

#### OTHER TD APPLICATIONS—

Low level detectors provide an interesting c-w application for the backdiode. In a crystal video receiver, the incoming r-f signal is detected right at the antenna and the resulting video amplified by a high-gain video amplifier.

Although such a system is not very sensitive, there are applications where lower sensitivity is acceptable. Examples of such uses lie in beacon radar receivers, and instrumentation square-law detectors. Current sensitivity ( $\beta$ ) of the backdiode is better than that for the conventional MA408B detector diode at both 6 and 13.5-Gc.<sup>15</sup> The backdiode also has a wider square-law response as Table III shows. As a result the backdiode is usually more lightly doped than the tunnel diode. To combine low current and low capacitance in one backdiode unit, special packaging, designed for rugged mechanical support is needed. The sandwich structure, Fig. 3D fulfills this need. It consists of a glass layer sandwiched between two germanium wafers. The alloy dot is fused to the two germanium wafers and simultaneously adheres to the glass spacer, thereby providing mechanical strength for the tunnel junction. Due to the small overall package di-

mensions, the parasitic housing capacitance and inductance are only around 0.1 pf and 0.1 nh respectively.

For lower frequency application the sandwich package is furnished with gold-plated ribbon leads; at microwave frequencies, two metal plates provide a pill format to which pressure contact can be made. One suggested mounting method is to mount the pill on the tip of a gold-plated screw, as can be seen in Fig. 1, Part I. The resulting assembly is easy to handle, always properly polarized, can be screwed directly into a type N connector, or can be inserted into cavities and coaxial mounts.

Tunnel and backdiode low level detectors have appeared on the market<sup>16</sup> with their advertised features claiming the following advantages.

- Better input match for 50 ohm systems—tunnel diodes or backdiodes have low ( $\approx 10$  ohm) dynamic input resistance, compared to 4,000 to 20,000 ohms for a typical crystal diode.

- Tangential sensitivity—minus 58 to -60-dBm from 50-Mc to 2-Gc with 0.2-Mc video bandpass. Other models are available.

**CONCLUSION** — There are, of course, many more cw applications for tunnel and backdiodes. Some have already been explored, others will be in the future. Some of the applications that have been examined include frequency multipliers<sup>10</sup> (harmonic oscillators), super-regenerative detectors,<sup>15</sup> parametric motors,<sup>17</sup> pressure transducers<sup>18, 19, 20, 21</sup> radiation detectors,<sup>22</sup> and frequency dividers (Part I).

#### REFERENCES

- (1) C. S. Kim, Tunnel Diode Converter Analysis, *IRE Trans. on Electron Devices*, p. 394, Sept. 1961.
- (2) B. Christensen, Measurement of Tunnel Diode Conductance Parameters, *Proc. IRE, Correspondence Section*, p. 1581, Oct. 1961.
- (3) Semiannual Report of Advanced Equipment Studies, WDL Technical Report TR 1481 Contract AF04(647)-532.
- (4) F. Sterzer, A. Presser, "Stable Low Noise Tunnel Diode Frequency Converters" *RCA Review*, p. 3, March 1962.
- (5) R. A. Pucel, Measurement of the Conversion Conductances of Esaki Mixer Diodes, *IRE Trans. on Microwave Theory and Techniques*, MTT-9, 6, Nov. 1961.
- (6) R. A. Pucel, "Theory of the Esaki Diode Frequency Converter," *Solid State Electronics*, p. 167, Pergamon Press 1961, Printed in Great Britain.
- (7) E. Gottlieb, Practical Tunnel Diode Converter Circuit Considerations, *Solid State Design*, p. 31, Sept. 1962.
- (8) Hubbard, Pulse Counter F. M. Discriminator Design, *Electronic Equipment Engineering*, p. 44, July 1962.
- (9) E. Gottlieb and A. Wolfram, Design of Tunnel Diode UHF-TV Tuners, *Semiconductor Products Magazine*, p. 36A, March 1962.
- (10) J. Reindel, A Compact Tunable Tunnel Diode S-Band Receiver, *The Microwave Journal*, p. 92, Dec. 1961.
- (11) K. K. N. Chang, G. H. Heilmeyer, H. J. Prager, Low Noise Tunnel-Diode Down Converter Having Conversion Gain, *Proc. IRE*, 48, p. 854, May 1960.

- (12) L. E. Dickens, G. R. Gnetting, A Tunnel Diode Amplifying Converter, *IRE Trans. on Microwave Theory and Techniques*, p. 99, Jan. 1961.
- (13) S. T. Eng, Low Noise Properties of Microwave Backward Diodes, *IRE Trans. on Microwave Theory and Techniques*, p. 419, Sept. 1961.
- (14) W. C. Follmer, Low Frequency Noise in Backward Diodes, *Proc. IRE*, p. 1939, Dec. 1961.
- (15) "Tunnel Detector Models A and B," Reindel Microwave Engineering, San Diego, Calif.
- (16) F. S. Barnes, L. Morris, A Tunnel Diode Frequency Multiplier with Gain, *Proc. IRE*, p. 1940, Dec. 1961.
- (17) H. E. Stockman, Tunnel Diode Super Regenerative Parametric Motor, *Proc. IRE*, p. 1586, October 1961.
- (18) M. E. Sikorski, Sensitive Tunnel Diode Pressure Transducers, Digest of Technical Papers p. 74 and 106, International Solid State Circuits Conference, Feb. 15, 1962.
- (19) W. P. Mason, Semiconductor Devices as Pressure Transducers, *ELECTRONICS*, p. 35, February 23, 1962.
- (20) S. L. Miller, M. I. Nathan and A. C. Smith, Pressure Dependence of the Current-Voltage Characteristics of Esaki Diodes, *Physical Review Letters* p. 60, 4 No. 2, January 15, 1960.
- (21) E. X. Rogers, Experimental Tunnel Diode Electro-mechanical Transducer Elements and Their Use in Tunnel Diode Microphones, *Journal Acoustical Soc. America*, p. 888, 34, No. 7, July 1962.
- (22) J. H. Phelps, A Tunnel Diode RF Radiation Detector, G. E. Application Note 90.43, April 1962.



## Acoustical Components of Superior Quality

JAPAN PIEZO supplies 80% of Japan's crystal product requirements.

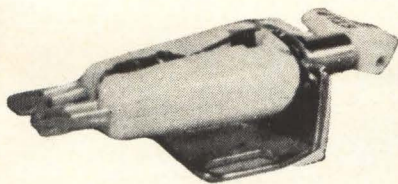
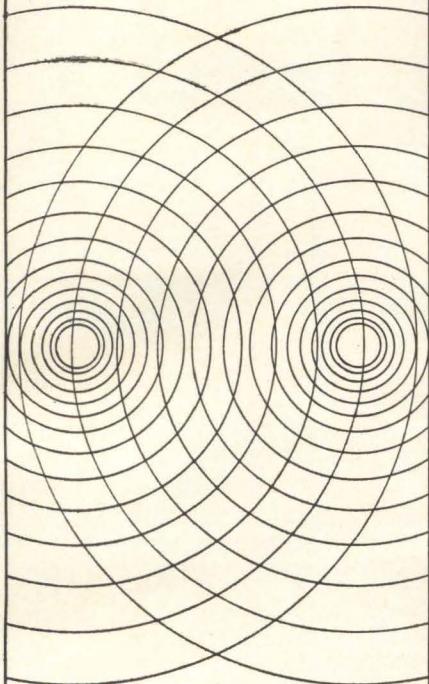

### STEREO CARTRIDGE

Crystal — "PIEZO" Y-130

#### X'TAL STEREO CARTRIDGE

At 20°C, response: 50 to 10,000 c/s with a separation of 16.5 db. 0.6 V output at 50 mm/sec. Tracking force:  $6 \pm 1$  gm. Compliance:  $1.5 \times 10^{-6}$  cm/dyne. Termination:  $1M\Omega + 150$  pF.

Write for detailed catalog on our complete line of acoustical products including pickups, microphones, record players, phonograph motors and many associated products.



# JAPAN PIEZO ELECTRIC CO., LTD.

Kami-renjaku, Mitaka, Tokyo, Japan

CIRCLE 203 ON READER SERVICE CARD

# JAPAN ELECTRONICS SHOW '63

## The Largest Annual Electronics Show



All the latest achievements  
by Japan's Electronics  
Industry will be on display

October 2 - 8 at Osaka  
International Trade  
Fair Grounds



#### Outline

Opening Hours: 9 a.m. to 5 p.m. daily  
Opening Day 12 p.m. - 5 p.m.

Show Site: Minato Fair Grounds  
(International Trade Fair Grounds), Osaka, Japan

Exhibit Halls: Pavilion No. 1  
200 Booths  
Pavilion No. 2  
200 Booths

Exhibitors: 180 manufacturers  
(limited to the members of the Electronic Industries Association of Japan)

Admission: Free

#### Classified Principal Exhibits

- Radio, TV receivers & other acoustic equipment and systems with related equipment and household electrical appliances included.
- Electronic components & parts—electron tubes and semiconductor devices, etc.
- Radio communications & measuring equipment, electronics-applied industrial & medical equipment with other associated electronic equipment and apparatus included.

This form entitles you to free literature on the forthcoming Electronics Show.

Just fill in and mail to:  
ELECTRONIC INDUSTRIES ASSOCIATION OF JAPAN The Tokyo Chamber of Commerce and Industry Bldg., 14 Marunouchi 3-Chome, Chiyoda-ku, Tokyo, Japan  
Cable: ELINDASO TOKYO

Your Name:

Organization:

Address:

I shall attend the Show.  
I shall not attend the Show.

Official Show Catalogue will be available at the Information Desk at the Show.

See us at JAPAN ELECTRONICS SHOW 1963, OSAKA, October 2-8



**muRata**

**Economy with  
Excellent Performance**

**CERAMIC  
FILTER**

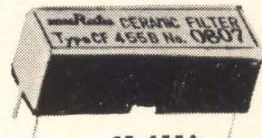

CF-455A  
CF-455B

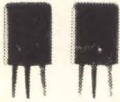

SF-455C

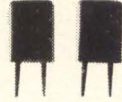

BF-455A

Murata offers three types ceramic filters: Series, By-pass and Ladder. Compactness, no need of alignment and tuning, flatness of temperature characteristic and negligible aging characteristics are their major features.

Combining economy with these features, Murata ceramic filters are designed to provide effectual operation which cannot be attained by usual IFT.

**MURATA MFG. CO., LTD.**  
KYOTO, JAPAN

CIRCLE 204 ON READER SERVICE CARD

**AROUND THE WORLD  
IT'S KEW**

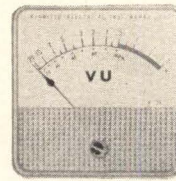

MODEL P-25

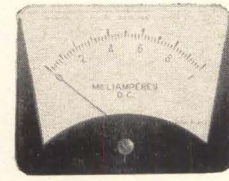

MODEL P-40

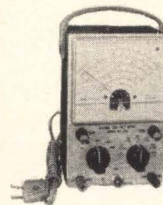

MODEL PV-202

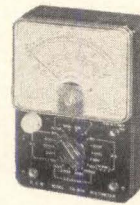

MODEL TK-90A

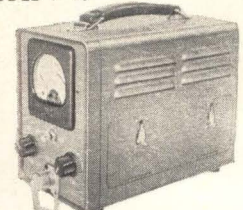

MODEL KHE-505



MODEL EW-8

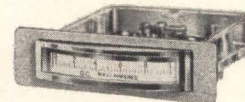

MODEL EW-16

**KYORITSU ELECTRICAL INST. WORKS, LTD.**

NO. 120, NAKANE-CHO, MEGURO-KU, TOKYO, JAPAN  
CABLE ADDRESS: "KYORITSUKEIKI TOKYO"  
TEL: (717) 0131-5 · 0151-3

CIRCLE 205 ON READER SERVICE CARD

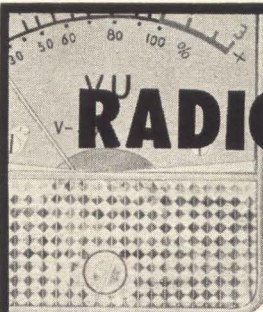

V-403

BEST MINIATURIZED INDICATOR

**RADICATOR**

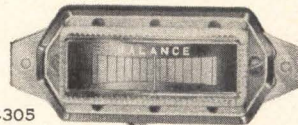

SB-305



R-201



R-101

- R-101 Tuning indicator and Battery residual capacity indicator
- F-102 FM tuning indicator
- V-103 Audio level indicator
- A-104 AM tuning indicator
- SB-105 Stereo balancing indicator
- B-106 Battery indicator
- R-201 Smaller type tuning and battery indicator
- V-203 Smaller type level indicator
- B-206 Smaller type battery indicator
- R-301 Larger type tuning and battery indicator
- V-303 Larger type level indicator
- SB-305 Larger type stereo balancing indicator
- V-403 VU meter
- V-403B Audio level indicator
- SB-405 Null indication stereo balancing indicator

ACCEPTABLE SPECIAL DIAL UPON YOUR REQUEST

DISTRIBUTOR

**ATAKA NEW YORK, INC. ATAKA & CO., LTD.**

633 THIRD AVENUE  
16TH FLOOR  
NEW YORK 17, N.Y., U.S.A.  
PHONE: OXFORD 7-7480

OHTEMACHI BLDG.  
1-CHOME, OHTEMACHI  
CHIYODA-KU, TOKYO  
PHONE: 201-6411

MAKER

**TOYO MUSEN CO., LTD.**

75, WAKABAYASHI-CHO, SETAGAYA-KU, TOKYO

CIRCLE 68 ON READER SERVICE CARD

SEE US AT JAPAN ELECTRONICS SHOW 1963, OSAKA, OCTOBER 2-8

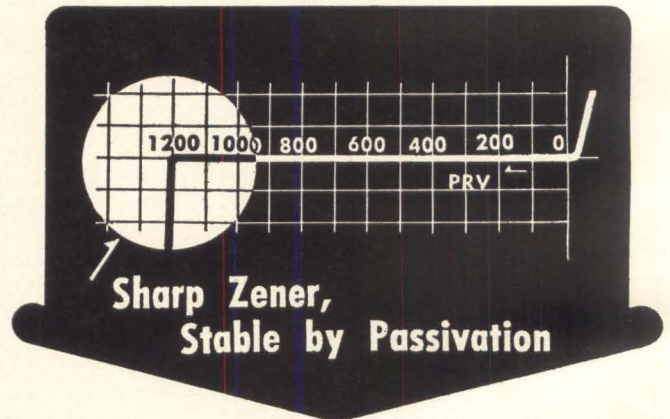

**Completely Passivated  
High Voltage Silicon RECTIFIERS  
Against Changes Due to Time**

For High Voltage Supplies  
**SH Series**

For TV Sets  
**SD-1 Series**

SH-6K	PRV 6,000 v	DC 30 mA
SH-8K	8,000	30
SH-10K	10,000	30
SH-12K	12,000	30

SD-1	PRV 400 v	DC 500 mA
SD-1A	600	500
SD-1B	800	500
SD-1C	1,000	500

**SANKEN ELECTRIC CO., LTD.**

Daiwa Bldg., 1-11, Ikebukuro-Higashi

Toshima-ku, Tokyo, Japan

Cable: SANKELE TOKYO

Phones: (983) 8251-5

**Sanken**

CIRCLE 206 ON READER SERVICE CARD



# HITACHI TRANSISTORS

SPECIFY "MESA" TYPE TRANSISTORS FOR HIGH FREQUENCY USE

## 2SA233, 2SA234, 2SA235

Hitachi PNP germanium diffused "Mesa" type transistors provide outstanding high frequency characteristics compared with conventional alloy junction or drift transistors.

Exclusive "Mesa" type transistors are indispensable for FM receivers used in tuner circuits and intermediate frequency amplifiers and also in TV receivers in intermediate

frequency amplifiers. They can be used effectively in short-wave converters, medium wave converters and all high frequency applications.

For superior performance, specify Hitachi "Mesa" type transistors . . . another engineering achievement from one of the world leaders in electronics.

### Maximum Ratings ( $T_a = 25^\circ\text{C}$ )

Items	Symbol	Unit	2SA233	2SA234	2SA235
Collector Voltage	$V_{CBO}$	V	-20	-20	-20
Emitter Voltage	$V_{EBO}$	V	-0.5	-0.5	-0.5
Collector Current	$I_C$	mA	-10	-10	-10
Emitter Current	$I_E$	mA	10	10	10
Junction Temperature	$T_j$	$^\circ\text{C}$	85	85	85
Collector Dissipation	$P_C$	mW	80	80	80
Ambient Temperature	$T_A$	$^\circ\text{C}$	60	60	60

### Characteristics ( $T_a = 25^\circ\text{C}$ )

Items	Symbol	Conditions for measurement	Unit	2SA233	2SA234	2SA235
Max. Collector Cut-off-Current	$I_{CBO}$	$V_C = -20V$ $I_E = 0$	$\mu\text{A}$	-30	-30	-30
Max. Emitter Cut-off-Current	$I_{EBO}$	$V_E = -0.5V$ $I_C = 0$	$\mu\text{A}$	-50	-50	-50
Current Amplification Factor	$h_{fe}$	$V_C = -6V$ $I_E = 1\text{mA}$		50	60	80
Alpha Cut-off Frequency	$f_{\alpha b}$	$V_C = -6V$ $I_E = 1\text{mA}$	Mc	90	110	125

### Typical Operation ( $T_a = 25^\circ\text{C}$ )

Items	Conditions for Measurement	Unit	2SA233	2SA234	2SA235
Power Gain at FM Radio Frequency	$V_C = -6V$ $I_E = 1\text{mA}$	db	—	—	12
	$f_s = 100\text{Mc/s}$				
	$R_g = 75\Omega$ $R_L = 2k\Omega$				
Mixer Gain at FM Radio Frequency	$V_C = -6V$ $I_E = 1\text{mA}$	db	—	—	13
	$f_s = 100\text{Mc/s}$ $f_{osc} = 110.7\text{Mc}$				
	$R_g = 3k\Omega$ $R_L = 15k\Omega$				

### 10.7 Mc Intermediate Frequency Amplifier Circuit

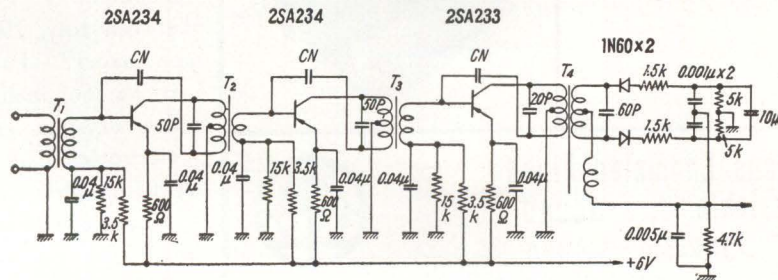

**Hitachi, Ltd., Chicago Office**  
333 N. Michigan Ave., Chicago 1, Ill. Tel: 726-4572/4  
**Hitachi New York, Ltd.**  
666, Fifth Ave., New York 19, N.Y. Tel: JUDson 6-4757  
**Hitachi, Ltd., San Francisco Office**  
100 California St., San Francisco 11, Calif. Tel. YUkon 1-7871

 **Hitachi, Ltd.**  
Tokyo Japan

SEE US AT JAPAN ELECTRONICS SHOW 1963, OSAKA, OCTOBER 2-8



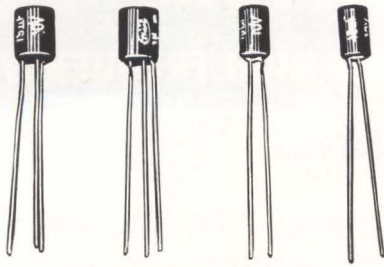

## High Quality Nichicon Capacitors for all electronic equipment

Nichicon research and experience assures remarkable strength and stability in all its capacitors. Nichicon produces a complete line of capacitors designed for every need.



MAIN PRODUCTS: Oil Paper Capacitor, Electrolytic Capacitor, Tantalum Capacitor, Metallized Paper Capacitor, Ceramic Capacitor, Mica Capacitor and Mylar Capacitor, etc.

### Nichicon Capacitor Ltd.

HEAD OFFICE : Uehara Bldg., Oikedori, Karasumahigashi-iru  
Nakagyo-ku, Kyoto, Japan  
CABLE ADDRESS : CAPACITOR KYOTO

CIRCLE 207 ON READER SERVICE CARD

# TDK-E 東電化

## Leading manufacturers of a comprehensive line of electronic parts in Japan

The fact that TDK's paramistor won a grand prix at the 1958 Brussels World's Fair shows only a part of the immense capabilities of the company.

Succeeded in the commercial production of a number of revolutionary inventions, T D K now enjoys the largest share of 60% in the ferrite core (for radio and TV use) market in Japan. As for ceramic capacitors and magnetic recording tapes, T D K accounts for 45% of their national production.

In the short period of the past five years, its capital has increased 7.5 times and its sales five times.

T D K's superior products are not only purchased by Government agencies and leading companies at home but exported to the United States, Europe, Asia, Africa, Latin America, Australia and elsewhere in the world.

With its highly advanced technical skills, T D K is forging further ahead to serve the world as leading manufacturers of electronic parts.

### TDK ELECTRONICS CO., LTD.

11, Kanda-Asahi-cho, Chiyoda-ku, Tokyo, Japan

CIRCLE 208 ON READER SERVICE CARD

## The most efficient, reliable RESISTORS for the Electronics Industry

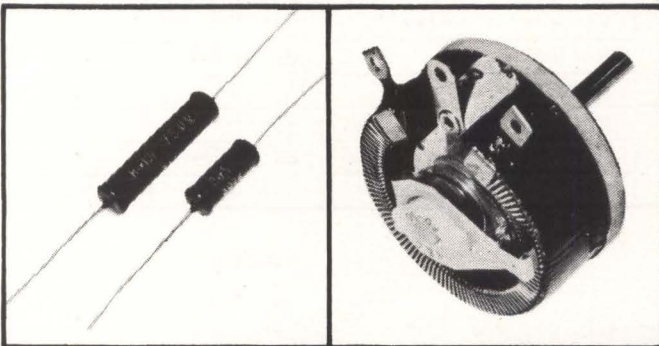

Vitreous Enameled Fixed  
Variable Wire-Wound  
Precision-Wound  
Silicone Cement-Coated  
Power Rheostat  
and Others



Come from YEC  
**YAGISHITA ELECTRIC COMPANY**

10, 7CHOME, SHIBA-SHINBASHI, MINATO-KU, TOKYO, JAPAN  
CABLE: YAGISHITATEIKO TOKYO

CIRCLE 70 ON READER SERVICE CARD

SEE US AT JAPAN ELECTRONICS SHOW 1963, OSAKA, OCTOBER 2-8

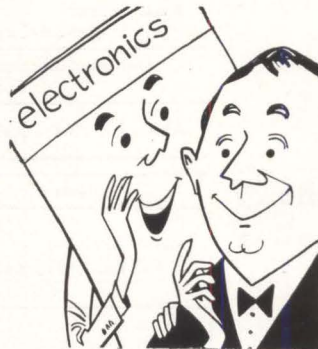

**electronics**  
IS EDITED  
TO KEEP YOU  
FULLY INFORMED  
— a "well-rounded"  
engineer

What's your *present* job in electronics? Do you work on computers? (**electronics** ran 158 articles on computers between July, 1961 and June, 1962!) Are you in semi-conductors? (For the same period, **electronics** had 99 articles, not including transistors, solid-state physics, diodes, crystals, etc.) Are you in military electronics? (**electronics** had 179 articles, not including those on aircraft, missiles, radar, etc.)

In all, **electronics'** 28-man editorial staff provided more than 3,000 editorial pages to keep you abreast of all the technical developments in the industry. No matter where you work today or in which job function(s), **electronics** will keep you fully informed. Subscribe today via the Reader Service Card in this issue. Only 7½ cents a copy at the 3 year rate.

# electronics



**Car-radio  
high-frequency  
semiconductors  
made  
to last  
nearly  
a lifetime**

**2SA29  
2SA72**

As one of the world's leading manufacturers of semiconductors Toshiba produces over 5 million high quality semiconductors per month. Included among these are 2 transistors ... 2SA29 and 2SA72 ... especially designed for use in high-frequency car-radio circuitry. These shock-proof and vibration-proof transistors, made under strict quality controls,

have high sensitivity which assures clear reception of distant stations and static-free performance in crowded modern cities. Increase the performance and dependability of car-radio circuitry with Toshiba semiconductors — respected around the world for their uniform quality and reliability. They are made to last nearly a lifetime.

Type	Package	V <sub>CB0</sub> max.	V <sub>EB0</sub> max.	I <sub>C</sub> max.	Power Diss. P <sub>c</sub>	Junction Temp. T <sub>j</sub>	Current Gain h <sub>fe</sub>		Cutoff Freq. f <sub>ab</sub>
							@ f=270 c/s min	V <sub>CE</sub> =-6V I <sub>E</sub> =1 mW max	
2SA29	T0-44	-18V	-0.5V	-5mA	55mW	75°C	20	60	40MC
2SA72	T0-44	-18V	-0.5V	-5mA	55mW	75°C	40	350	40MC

- 2SA29** Ge. PNP drift transistor for IF stage amplifier with 46 dB power gain at 455 KC.
- 2SA72** Ge. PNP drift transistor for RF stage amplifier and converter with 40 dB power gain at 1 MC.

Write for FREE CATALOG with helpful, comprehensive data, including specifications, suggested applications, etc. to Foreign Trade Division, Toshiba, Hibiya Mitsui Bldg., Yurakucho, Tokyo, Japan, or Toshiba New York Office, 530 Fifth Ave., New York 36, N.Y., U.S.A.

Tokyo Shibaura Electric Co., Ltd. Tokyo, Japan **Toshiba** Quality Since 1875

SEE US AT JAPAN ELECTRONICS SHOW 1963, OSAKA, OCTOBER 2-8



# Origin

**S**ilicon **C**ontrolled **R**ectifier

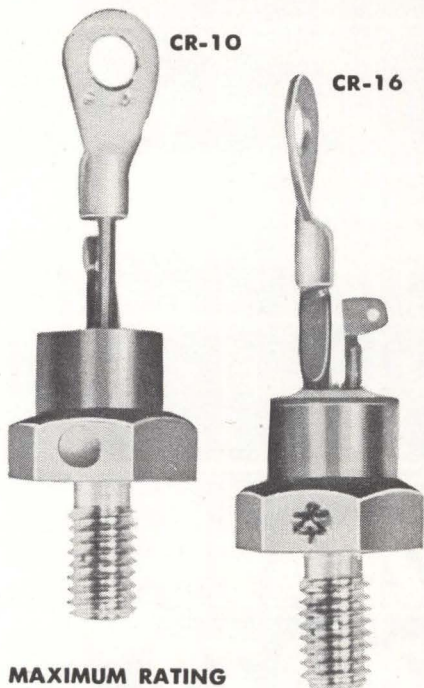

**MAXIMUM RATING**  
CR-10 CR-16

TYPE Specification	CR-10A CR-10A	CR-16H CR-10H	Units
Peak Voltage (Reverse biased)	25	~ 400	V
Peak Blocking Forward Voltage	25	~ 400	V
A.C. Input Voltage	17.5	~ 280	VRMS
Average Forward Current	(CR-10) 10	(CR-16) 16 (Ta=+20°C)	A
Surge Current	(CR-10) 100	(CR-16) 130	A
Peak Gate Power	5		W
Average Gate Power	0.5		W
Peak Gate Current	2		A
Peak Gate Voltage (Forward)	10		V
Peak Gate Voltage (Reverse)	5		V
Junction Temperature	100		°C
Storage Temperature	-40~ +125		°C

**Main Products:**

Semi-conductors, condenser type spot welder, synthetic enamel and miniature ball bearing.

**ORIGIN ELECTRIC COMPANY LTD.**

1-195 Takadaminami-cho, Toshima-ku, Tokyo, Japan  
Cable Address: "ORIGINELE TOKYO"

CIRCLE 72 ON READER SERVICE CARD

HERE IS THE WORLD'S SMALLEST MOTOR  
YET IT'S SO POWERFUL . . .

**MITSUMI MICRO MOTOR**



MODEL MI-100

Less than 20mm in diameter, the new Mitsumi Micromotor provides a startling efficiency of over 50%, the barrier which miniature motors are not allowed to pass.

A novel construction principle helped to make this accomplishment possible. The form is more simplified by setting all the terminals at one position. Because the entire mechanism is given full protection against irregular revolution and above all, electrical noise is entirely eliminated, you may call this the most perfect micromotor yet devised. Please write for complete information on Mitsumi Micromotor, and we will send you specifications and data.



**MITSUMI PARTS**  
**MITSUMI ELECTRIC CO., LTD.**

TOKYO · OSAKA · NEW YORK

CIRCLE 209 ON READER SERVICE CARD

**AM·FM Tuner Unit**

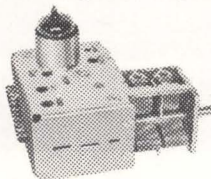

AM. SEC. CAPACITY: MAX. 377PF  
: MIN. 12PF  
TUBE: 6AQ8, 12DT8, 17EW8

**PLASTIC VARIABLE CONDENSER**

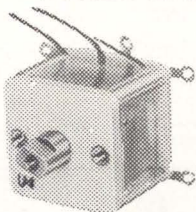

Square Size :  
15mm., 17mm.,  
20mm., 21mm.,  
Single band :  
2 band, 3 band  
and for FM only.



**SANKAISHA CO., LTD.**

Cable address: SANESVARICON TOKYO  
1425, 4-chome, Higashinakanobu,  
Shinagawa-ku, Tokyo, Japan.

CIRCLE 210 ON READER SERVICE CARD

SEE US AT JAPAN ELECTRONICS SHOW 1963, OSAKA, OCTOBER 2-8

**QUALITY METAL FILM RESISTOR  
MICROWAVE TEST EQUIPMENT AND  
ULTRASONIC APPARATUS**

Automatically feeding  
Ultrasonic Machine Tool

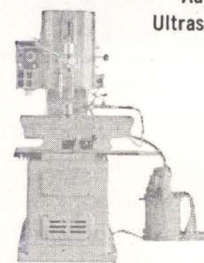

**Metal Film Resistor (Metalohm) HIL-R-10509D**

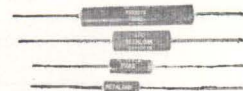

**MAIN PRODUCTS :**

- Channel Branching Waveguide Filter
- Test Equipment for Microwave Repeater System & Radar, etc.
- Ultrasonic Cleaner
- Ultrasonic Welder
- Ultrasonic Machine Tool
- High Frequency Machines
- Metal Film Resistor



**SHIMADA PHYSICAL & CHEMICAL IND. CO., LTD.**

415 Shibozaki-cho, Chofu-city, Tokyo, Japan  
Tel: (04229) 4101~4109

Cable Address: MICROWAVE TOKYO CHOFU

CIRCLE 211 ON READER SERVICE CARD



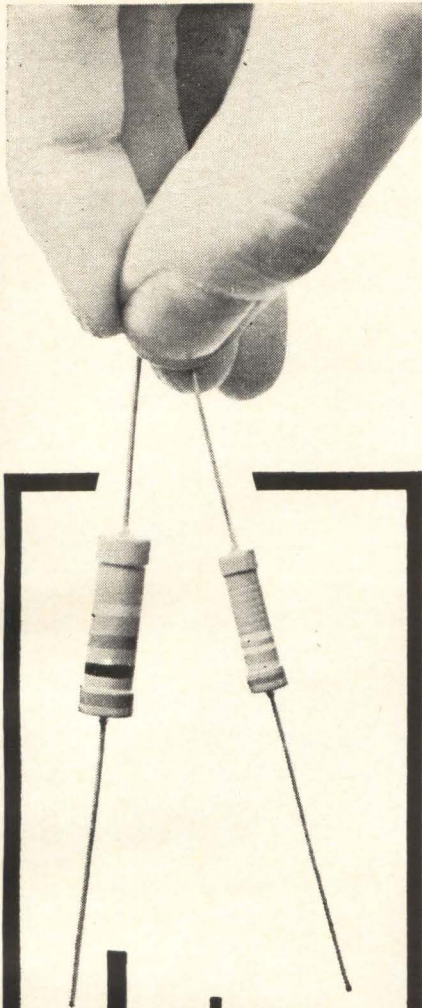

Let us  
help you  
cut costs!

CARBON FILM RESISTOR

**Rohm**

**TOYO  
ELECTRONICS  
INDUSTRY  
CORPORATION**

P, O, BOX 103 CENTRAL  
KYOTO JAPAN

CIRCLE 221 ON READER SERVICE CARD

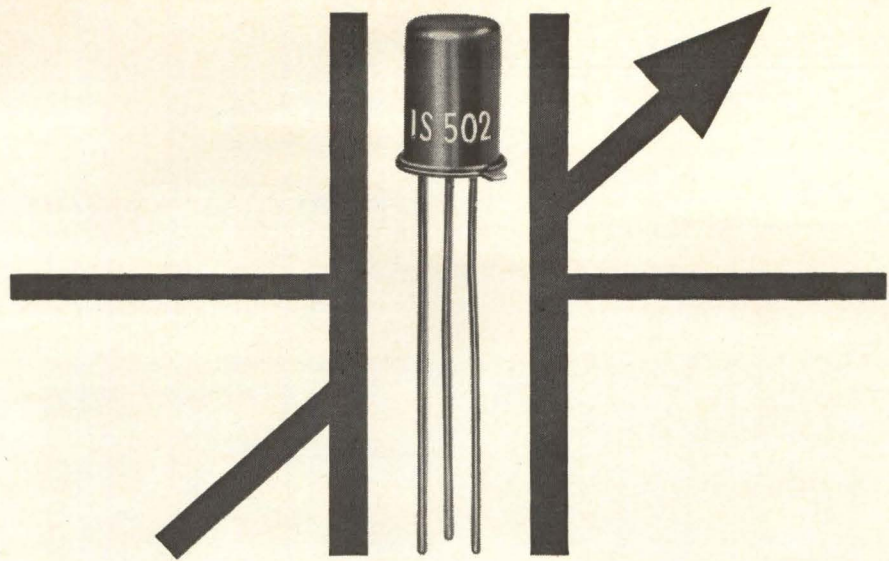

## WIDE-RANGE, HIGHLY-SENSITIVE VARIABLE CAPACITANCE DIODE

(Brand: Varipico)

Fujitsu Varipico is a new diode designed to serve especially as a variable capacitor. Having a "hyper-abrupt" junction, a wide range of capacitance variation is made possible by simply varying a small negative bias voltage. The relationship of capacitance to bias voltage is:  $C \propto \frac{1}{\sqrt{V}}$ . Since  $n$  can be set anywhere between 1 and 5, the capacitance range is very large. This makes the Varipico extremely useful in many applications such as frequency modulators, sweep generators, signal generators, frequency meters, phase shifters, converters and multipliers, and parametric amplifiers. The Varipico, hermetically sealed in a metal case, measures only 5.7 mm in diameter and 8mm in length, exclusive of leads. For full technical data and application information write to our representative shown below.



**FUJITSU LIMITED**

*Communications and Electronics*

Tokyo, Japan

Represented by: U.S.A. HAR-WELL ASSOCIATES, INC.: Southbury, Connecticut, Phone: 264-8222 THE NISSHO PACIFIC CORP. 120 Montgomery St., San Francisco 4, California, Phone: YUkon 2-7901, 7906 Canada: NISSHO (CANADA) LTD. 100. University Avenue, Toronto, Phone: EMpire 2-4794 United Kingdom: WALMORE ELECTRONICS LIMITED 11-15 Betterton Street, Drury Lane, London W.C. 2, Phone: TEMplebar 0201-5 Germany: NEUMÜLLER & CO. GMBH 8 München 13, Schraudolphstr, 2a, Phone: 29 97 24

CIRCLE 73 ON READER SERVICE CARD

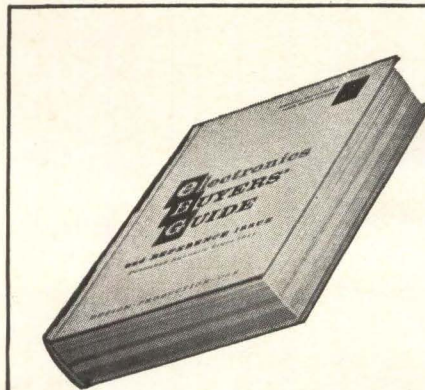

Your electronics BUYERS' GUIDE should be kept in your office at all times—as accessible as your telephone book.

SEE US AT JAPAN ELECTRONICS SHOW 1963, OSAKA, OCTOBER 2-8



# Waveguide Telemeters Space-Chamber Data

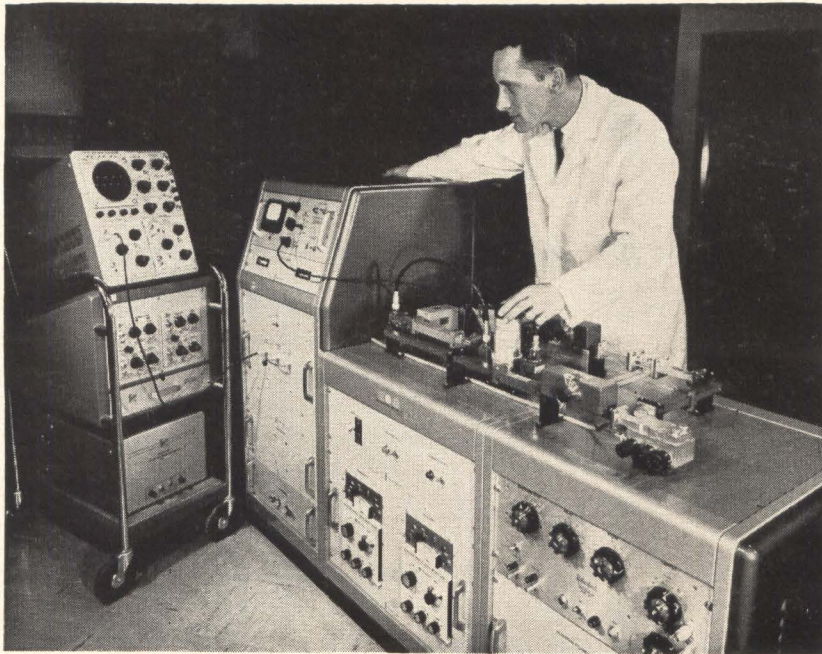

EXPERIMENTAL waveguide system for telemetering 3,000 channels from space vehicle in space-environment test chamber is demonstrated by feasibility model, above. Diagonal unit at right is model of waveguide network

*Space telemetry system handles 3,000 channels on X-band microwave link*

**ACCURATE DATA** transmission system that can sample and transmit 3,000 separate input signals with a transmission error of less than 2 percent has been developed by Electro-Optical Systems, Inc. in Pasadena, California.

Demonstration model has been delivered to Air Force's Arnold Engineering Development Center under \$133,000 contract for investigation of space-chamber data transmission problems. A fully operational model, based on this scheme, would answer an Air Force requirement for multi-sensor monitoring from a rotating test vehicle in a space chamber environment.

Using PAM/FM (Pulse amplitude modulation/frequency modulation), the system would be the first telemetry unit to operate with 3,000 separate sensors and transmit in space and radiation environments.

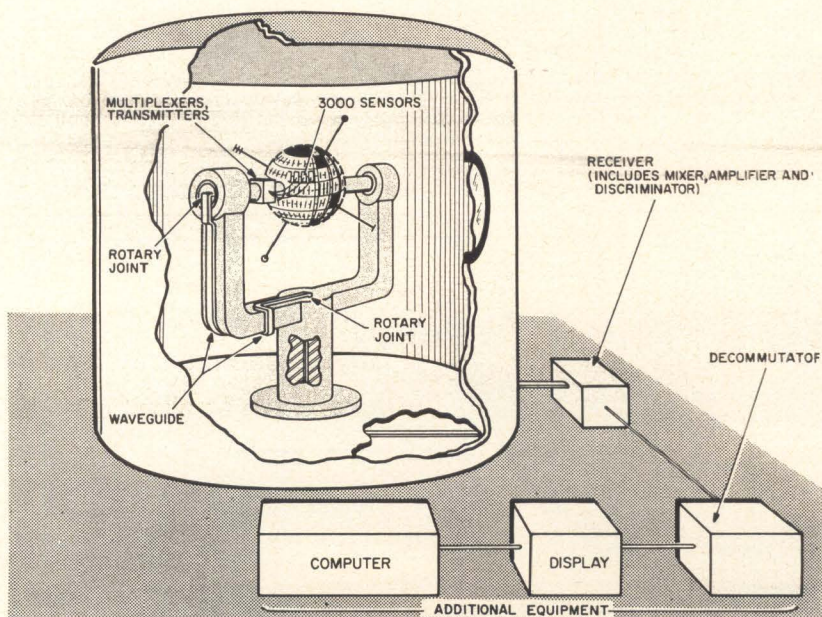

SPACE CHAMBER connection uses waveguide and rotary joint, to achieve 3,000 test connections without cables. With antenna instead of waveguide, system could be used in space

**MICROWAVE LINK** — To avoid cables and still afford signal connection to the test structure, system uses microwave relay, with two waveguide lines attached to moving test unit by rotary waveguide joints. To prevent outgassing and avoid space-environment effects, the joints are made free of dielectric materials, and rotate on metal bearings using a dry-film lubricant.

Reception from the waveguides is provided by a microwave super-heterodyne receiver, with an i-f amplifier and discriminator operating at nominal center frequency of 60 Mc, with a 10-Mc bandwidth. The resultant linearity of 0.5 percent is an order-of-magnitude im-



# NEW!

## MODE INDICATORS FOR VOLTAGE/CURRENT REGULATED POWER SUPPLIES

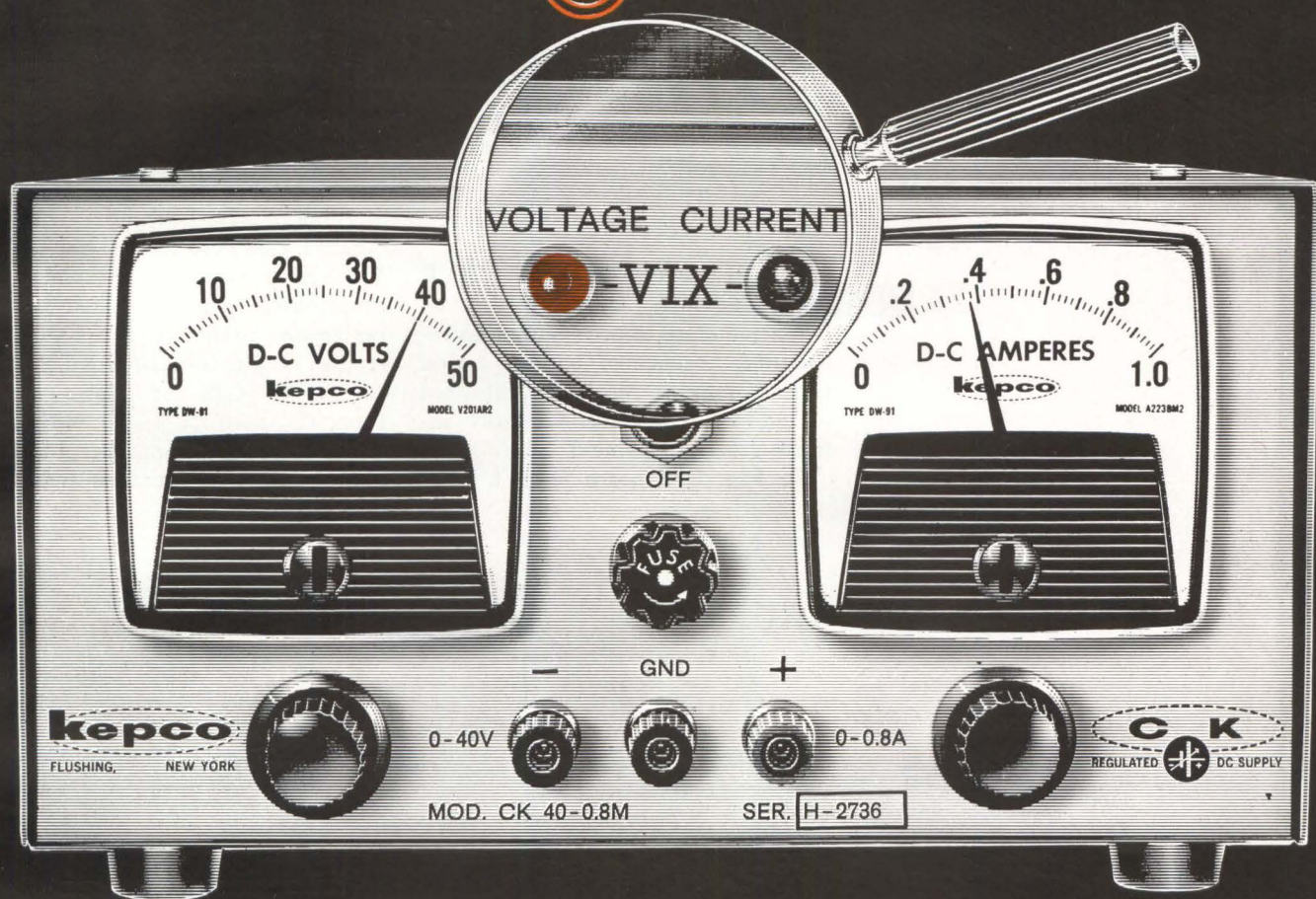

## KEPCO TIME-**VIX**\* INDICATORS

Kepco voltage/current regulated power supplies in the CK series now come equipped with voltage/current mode indicators called "VIX".\*

Time saving and added utility are provided by these indicators which show at a glance whether the power supply is in its voltage regulating mode or its current regulating mode.

This indication is especially useful in the Kepco CK Models since they have extremely sharp cross-over characteristics.

\*VOLTAGE/CURRENT CROSSOVER INDICATORS

Send for complete data on  
Kepco CK Models  
featuring NEW "VIX" Indicators.

**kepco**  
Inc.®

NEW **CK** SERIES  
REGULATED DC SUPPLY

0.01% REGULATION and STABILITY

DC OUTPUT RANGE		MODEL	PRICE
VOLTS	AMPS		
0-2	0-8	CK 2-8M	\$ 330.00
0-8	0-5	CK 8-5M	330.00
0-18	0-3	CK 18-3M	290.00
0-36	0-1.5	CK 36-1.5M	290.00
0-40	0-0.8	CK 40-0.8M	255.00
0-60	0-0.5	CK 60-0.5M	290.00

131-38 SANFORD AVE. • FLUSHING 52, N.Y.  
(212) IN 1-7000 • TWX# 212 539-6623  
Cable Address: KEPPOWER, NEWYORK



# Emergency!

When you're in an "EMERGENCY SITUATION" for delivery of terminals

**REMEMBER:**  
90% OF ALL ORDERS RECEIVED ARE SHIPPED THE SAME DAY

It is a good feeling to know that when you need terminals in a hurry, we can almost always ship them "right-off-the shelf."

Dependable quality — Competitive, or better, prices — Sudden service and 90% same-day shipment are advantages you should have.

Write for our Catalog  
It's Free!



## Electrix Division

NORTH AMERICAN  
PHILIPS CO., INC.

ASHTON • RHODE ISLAND

provement over commonly used wide-bandwidth discriminators.

Outputs from the 3,000 sensors attached to the test vehicle will be fed into solid-state multiplexers; 2,400 channels have an 0.5-cps bandwidth, 540 channels at 50 cps bandwidth, 30 channels at 1 Kc and 30 channels at 2 kc. In addition, one or two standard television channels at 4.5 Mc bandwidth and a command channel at

10 Kc can be provided.

Signals are then frequency-modulated in an X-band klystron for waveguide transmission. The system can be applied to all space and environmental test chambers requiring numerous and accurate sensor measurements; engineers said the unit would also perform in space vehicle flight if an antenna is substituted for the waveguide network.

## Light Beam Controls Potentiometers

By R. COLMAN

Consultant, New York, N. Y.

**USE OF PHOTOCONDUCTIVE** semiconductors in electro-optical potentiometers affords increased reliability, absence of wiping action torque, infinite resolution, absence of contact noise and virtually infinite resistive-element life.

In Fig. 1, a beam from a light

source strikes a photoconductive layer at a point determined by the angular shaft position. The increased conductivity of the photoconductive semiconductor under the illuminated area completes a low-resistance path between two electrodes. Light-to-dark conductivity ratios of CdS or CdSe range from  $10^6$  to  $10^8:1$ .

Selective illumination of the photoconductive surface can be

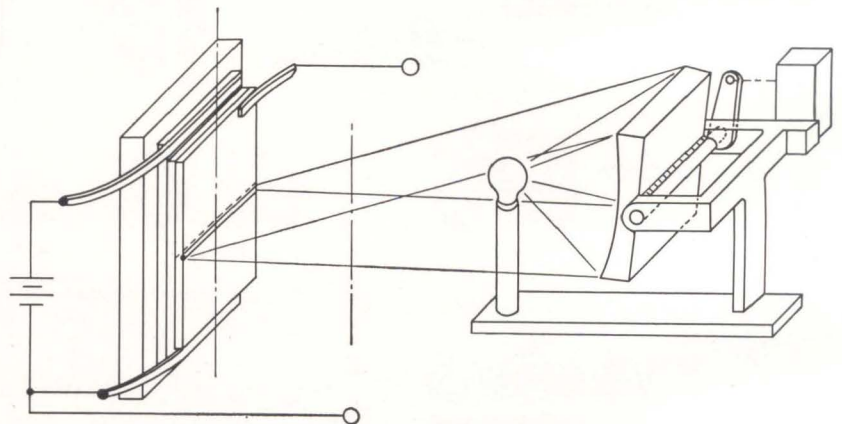

ROTATING SHAFT at right focuses beam onto narrow strip of photoconductor, thus effects variation of resistance—Fig. 1

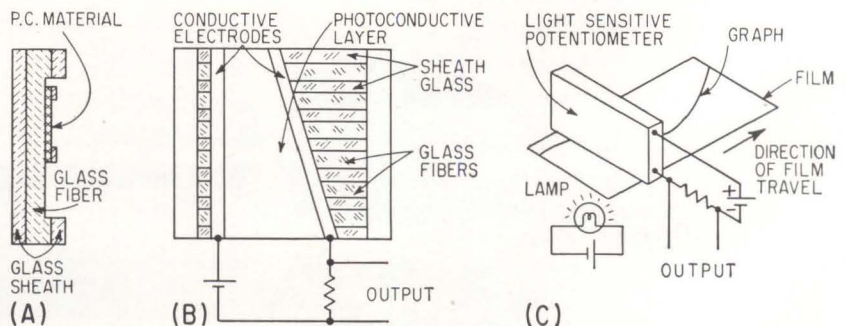

LIGHT SENSITIVE potentiometer can vary resistance according to any function photographed or drawn on transparent film—Fig. 2



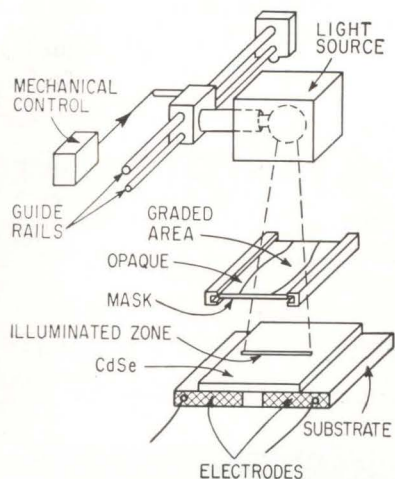

MOVING LIGHT focused to a fine line, projected through transparency of desired function, activates photosensitive resistor below—Fig. 3

achieved either by using a positioned optic fiber array (Fig. 2) or a focused moving cylindrical reflector (Fig. 1). In Fig. 2, light enters the input face of a flat fiber optic array, on one longitudinal face of which is deposited a coupled layer of photoconductive material such as Se, CdS, or AgSe. Since the photoconductive layer can be formed with predetermined longitudinal dimensions, the layer under control of light represents a number of selectively activated variable resistors<sup>2</sup>.

When operating as a line-follower data conversion system (Fig. 2C), an opaque film contains information in the form of a transparent graph. Light passing through the transparent graph enters one or more fibers in the fiber optic light guide, establishing a voltage between the output terminals corresponding to the value of the graph at that point.

The flexibility of functional control is shown by a potentiometer specially tailored to produce a required output function, Fig. 3. A light source is moved along guide rails, and control is accomplished by varying the intensity, or form, of the illuminated zone that acts as a potentiometer brush. By changing the image intensity along the photoconductive layer, the conductivity of the semiconductor is varied. With a suitably graded mask or filter in the beam path, the intensity can be any desired function of the longitudinal position of

Fred  
Roberts  
can  
show  
you ...

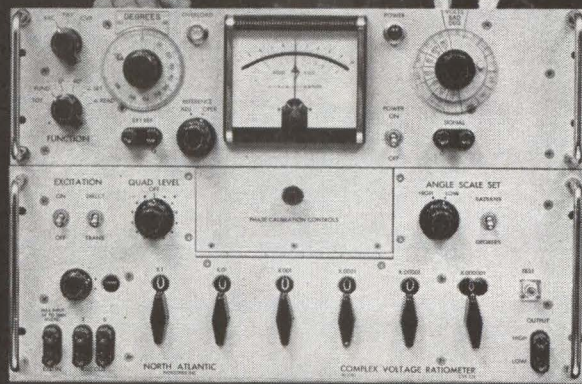

Director of Marketing, North Atlantic Industries

## how to measure ac ratios regardless of quadrature

North Atlantic's Complex Voltage Ratiometer is a completely integrated test set for measuring grounded 3 terminal networks. By providing self-calibrated quadrature injection, the Model CVR-551 permits calibrated meter readings of phase angle up to 30° or 300 milliradians full scale, and, in addition, provides direct readings of in-phase and quadrature voltages. As an added feature, the integral Phase Angle Voltmeter\* and AC Ratio Box can be used independently. Abridged specifications follow:

In-Phase Ratio Range, $R_I$ .....	.000000 to $\pm 1.111110$ with full accuracy
Phase Angle Range, $\alpha$ .....	$\pm 1.0$ to $\pm 300$ milliradians $\pm 0.1$ to $\pm 30^\circ$ (in 6 calibrated ranges)
Frequency .....	Any specified frequency, 50 cps to 3KC
Input Ratio Error, $R_I$ .....	$\pm (.001 + \frac{.0001}{R_I} + \delta \tan \alpha)$ % of reading
Phase Angle Error, $\alpha$ .....	$\pm .0003$ radians or $\pm .017^\circ$ (low ranges) $\pm 3\%$ full scale (high ranges)
Phase Angle Voltmeter* (independently used) .....	$\pm 2\%$ full scale 1 millivolt to 300 volts (in 12 calibrated ranges)
A.C. Ratio Box (independently used) .....	1 ppm terminal linearity .35f (300 volts max)

North Atlantic's CVR\* line includes 2 and 3 frequency models. All models available with optional 10 ppm Ratio Box control of quadrature injection.

Send for data sheet or contact your local North Atlantic sales representative now for complete information.

\*Trademarks



**NORTH ATLANTIC industries, inc.**  
TERMINAL DRIVE, PLAINVIEW, L. I., NEW YORK • OVerbrook 1-8600



MIL-C-19978B  
MIL-C-19978B  
MIL-C-19978B  
MIL-C-19978B  
MIL-C-19978B  
MIL-C-19978B  
MIL-C-19978B  
MIL-C-19978B  
MIL-C-19978B  
MIL-C-19978B  
MIL-C-19978B  
MIL-C-19978B  
MIL-C-19978B

Certifying data with respect to test qualifications available. All data compiled by a government approved testing laboratory.

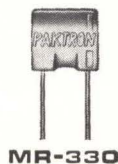

**Paktron MOLDED MINIATURE MYLAR\* CAPACITORS—MR330 and MR700—provide the widest possible capacitance range and most useful voltage ratings in the smallest physical size consistent with HIGH PERFORMANCE AND RELIABILITY.**

For specific information regarding performance characteristics, write today.

\*Dupont Polyester Film

**it** **PAKTRON**  
**iw** DIVISION ILLINOIS TOOL WORKS INC.  
1321 LESLIE AVENUE • ALEXANDRIA, VIRGINIA

the image. To change the form of the function it is only necessary to replace the mask.

**REFERENCES**

- (1) U. S. Patent 3,087,069 A. J. Moncrieff-Yeates, Radiation Controlled Variable Resistance (To Giannini Controls Corp.)
- (2) U. S. Patent 3,085,159 J. T. McNaney, Light Radiation Sensitive Variable Resistance Device.

**New Velocimeter Claims Increased Stability**

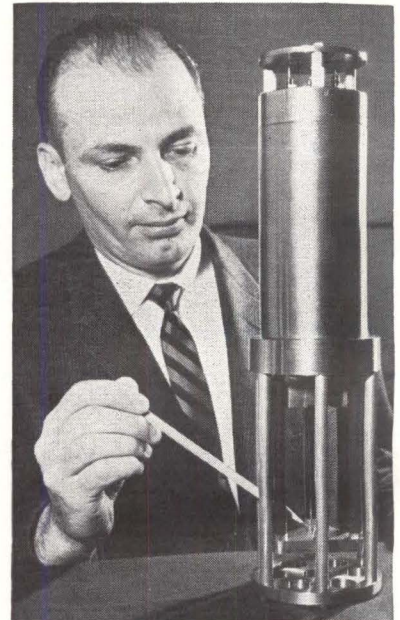

*SOUND SIGNALS emitted by two transducers at base of cylindrical section are bounced off reflecting plate, indicated with pencil tip, and their return time measured*

HIGH-PRECISION velocimeter with "complete temperature-pressure stability" for underwater use has been developed by ACF Industries, Inc. The accuracy of the unit, named the TR4, is unaffected for all practical purposes by pressure or temperature of water at the operating depth, claims ACF. The TR4 uses new metals having different rates of linear expansion and a redesigned sound path.

Velocimeters are used in submarine detection and in oceanographic research to provide continuous indication of the velocity of sound in water. The first TR4's, successors to an earlier version in use by Polaris submarines, will be used by Navy's Oceanographic Office in the Antisubmarine Warfare Environmental Prediction System program.





**Make the change to  
small capacitors**

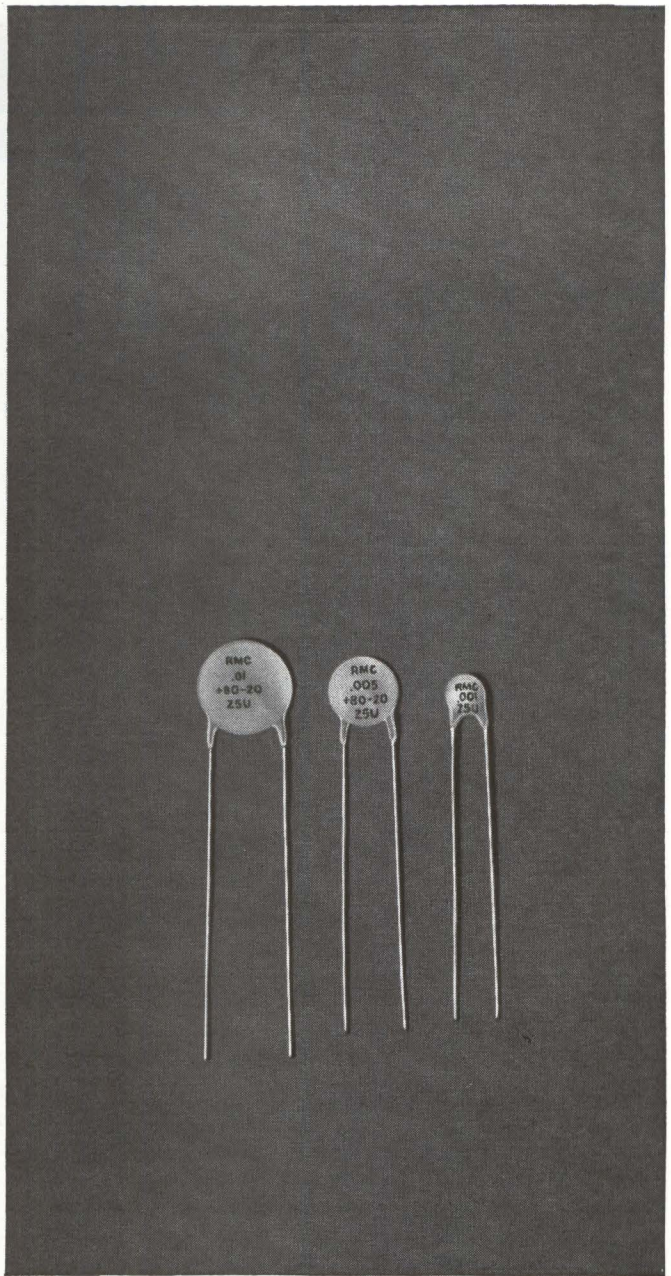

## RMC type SM DISCAPS

RMC Type SM DISCAPS are designed for use in applications where limited space is a prime consideration. Rated at 500 volts V.D.C., Type SM DISCAPS meet specifications of E.I.A. RS-198 for Z5U temperature characteristics. These subminiature capacitors can be specified with complete assurance of the quality, dependability and electrical performance built into all RMC DISCAPS. Write on your letterhead for additional information.



DISCAP  
CERAMIC  
CAPACITORS

**RADIO MATERIALS COMPANY**

A DIVISION OF P. E. MALLORY & CO., INC.  
GENERAL OFFICE: 4242 W. Bryn Mawr Ave., Chicago 46, Ill.  
Two RMC Plants Devoted Exclusively to Ceramic Capacitors  
FACTORIES AT CHICAGO, ILL. AND ATTICA, IND.



NEW PRINCIPLE of single reversal focused traveling wave tube is explained by General Electric's Karl B. Niclas



## TWT Uses New Focusing Concept

*Improved performance now claimed for traveling wave tubes*

**COMMERCIAL** availability of a new family of single reversal focused traveling-wave tubes may have a significant impact on the microwave industry.

The new tubes have been de-

signed to meet the increasing critical need for rugged, lighter weight and more compact traveling-wave tubes with low noise figures, a General Electric spokesman said. No other twt is presently able to meet this combination of requirements, he claimed.

Featuring a new method of beam focusing, the new tubes are expected to be especially suitable for military equipment where

close spacing of very low noise twt's is necessary. Applications include advanced radar, countermeasures and telemetry systems in satellites, aircraft, missiles and naval vessels. Initially, GE's Power Tube Department is introducing five X-band single reversal focused tubes. The company will shortly introduce additional X-band and C-band versions. The single reversal focusing principle is expected to apply also to millimeter tubes covering the frequency range of 12 to 40 Gc.

The new tubes were developed by Karl B. Niclas of GE's Traveling Wave Tube Products Section.

**FOCUS**—The new twt's use a new focusing concept. Instead of a single uniform magnetic field along the axis of the tube, the field is reversed at the center of the tube, Fig. 1. Instead of one permanent magnet, there are two main magnets and two ring shaped aiding magnets which control the focus of the electron beam. See Fig. 2 for comparison.

Although one uniform field is fine for low-noise characteristics, the flux pattern associated with one long straight magnet creates an external magnetic field which requires bulky shielding or adequate spacing between the tube and other magnetic materials or

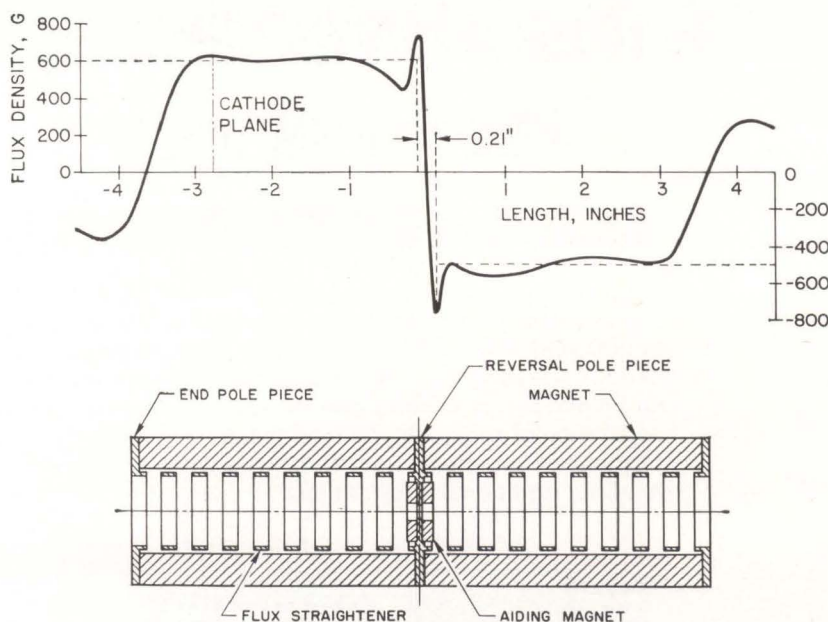

MAGNETIC field, plotted along the beam axis for a single reversal field twt (top). Bottom diagram shows schematic of a single reversal field pm circuit—Fig. 1





## Now you can stack 6 germanium 20-watt transistors where only 4 fit before

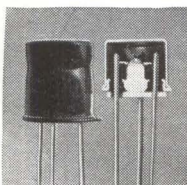

Why? We reduced the 2N1038 package from the big, old-fashioned top hat (.358" minimum height) to the smaller, standard TO-5 package. This means that higher-than-ever stacking densities will be possible in the next generation of computers and other equipment, using new Sylvania PNP transistors.

What makes this package-shrinking possi-

ble? Sylvania has developed a new construction which is far superior for heat dissipation. A copper heat sink, shaped like a rivet and mounted securely to the stem, carries heat out through its broad bottom surface. This new approach effectively lowers typical thermal resistance ratings—which can be further improved by using our small, streamlined accessory heat dissipators.

These transistors, of course, can be handled by automatic insertion equipment you

may have for putting standard TO-5 transistors into circuit boards. But there is one important difference from familiar TO-5's. The leads are thicker—a full .025", which can carry the rated 3.5 ampere current without any noticeable power drop.

Offering a new degree of miniaturization, the new 2N1038 series is typical of the way Sylvania looks to future as well as present needs of customers. Semiconductor Division, Sylvania Electric Products Inc., Woburn, Mass.

# SYLVANIA

SUBSIDIARY OF  
**GENERAL TELEPHONE & ELECTRONICS**





# THE NEW YEW 'WALKING' LAB

VERSATILE  
**DC 17  
RANGE**  
PORTABLE STANDARD  
VOLT-AMMETER

BASIC REQUIREMENT FOR ACCURATE READING

MODEL  
MPF-17R



- All Ranges at 0.5% fsd. • Multi-Range indicator at the accuracy of a Standard.
- Shunts and multipliers self-contained.
- Scale, hand calibrated, 5 1/4" long with anti-parallax mirror.
- Substitutes for many single range units.
- Self-shielded mechanism minimizes magnetic influence.

	Range
Voltage	1000/300/100/30/10/3V
Current	30/10/3/1A 300/100/30/10/3/1mA
	50mV (for external Shunts)

## AC13 RANGE VOLT-AMMETER MODEL SPF-13R

- All 13 Ranges at 0.5% fsd.
- Working principle: Moving Iron Type. Transformers self-contained.

	Range
Voltage	750/300/150/75/30V
Current	30/15/7.5/3/1.5/0.75/0.3/0.15A

See YEW—WESCON Show—Booth 4533

CONFIDENCE BEGINS WITH

# YEW®

**YOKOGAWA**  
ELECTRIC WORKS, INC.  
40 WORTH STREET · NEW YORK 13, N.Y.

sources, Niclas explained. Equally important, using two magnets reduces the volume of magnetic material in ratio of 4 to 1.

Twenty fields, or magnets, have been used in the periodic-permanent-magnet type of twt. But until the new twt was developed, technological requirements were such that a single uniform field was best for certain twt applications where extremely low noise figures were very important. General Electric has a complete line of low-noise periodic-permanent-magnet focused tubes which do use a number of magnets. These reverse the magnetic field many times, and can be placed in any system without shielding or the need for air spacing. These tubes are very light weight, but their noise figures are somewhat higher than the permanent-magnet-focused twt's.

**LOW-NOISE**—The new single reversal tube was introduced because it retains the low noise figures of straight permanent-magnet tubes, yet is much lighter

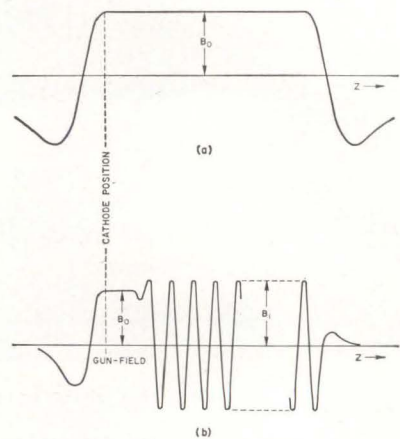

PLOT of magnetic field along a beam axis for a permanent magnet focused twt (top) and for a periodic permanent magnet focused twt —Fig. 2

and does away with the need for shielding.

Basically, the new tubes constitute an extension of the GE product line. In many cases they will replace the straight-field pm tubes. However, ppm tubes will be required for applications where low noise is not as critical and

## Laser Gyro's New Configurations

MIRRORS bounce counter-rotating laser beams around square (A) or triangle (B) to sense and measure direction. Photo and diagram show construction of Sperry Rand's developmental laser gyroscope (ELECTRONICS, p 8, June 21). Beam paths are shown off-center to illustrate direction of travel

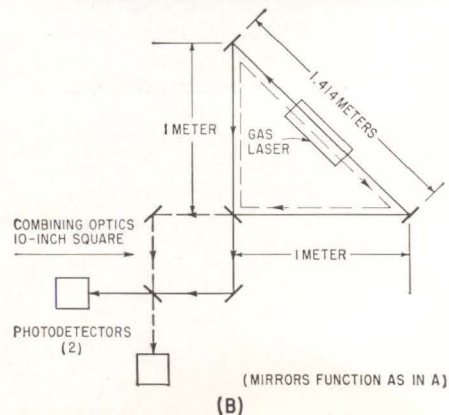
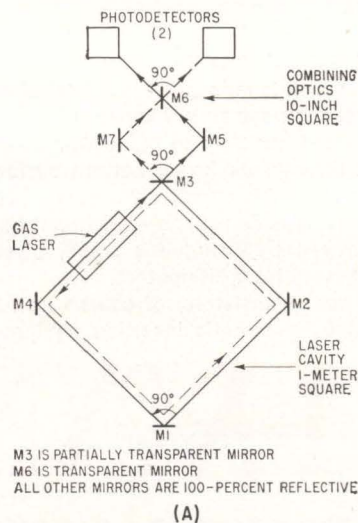



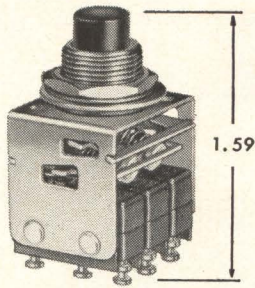

Series "PB11": Optimum feel of switching action.

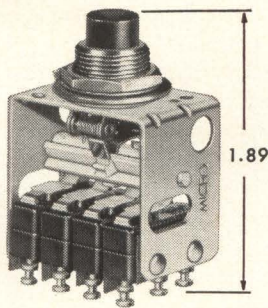

Series "80PB": Transfers circuit alternately with each operation.

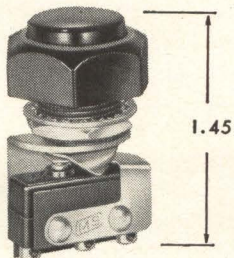

Series "PB4": Miniature, panel sealed.

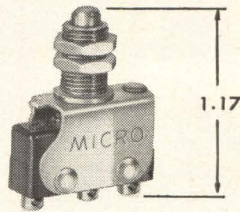

Series "PB5": Miniature, mounts in 1/4" hole.

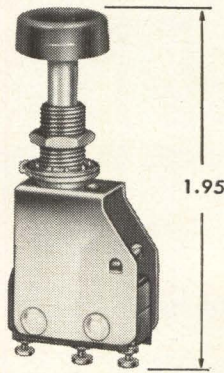

Series "PB81": Light force for rapid-repeat operation.

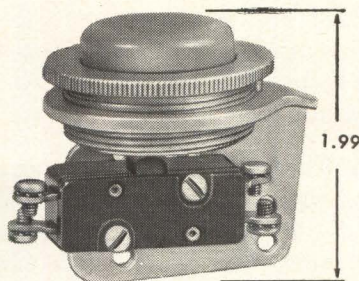

Series "12MA": One-inch concave button.

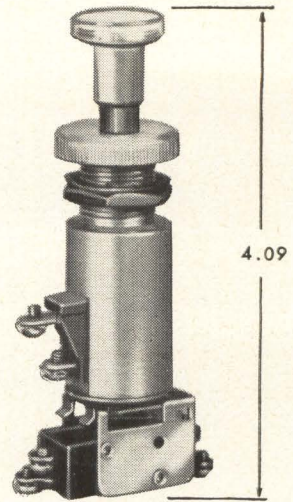

Series "5": Electrically held detent.

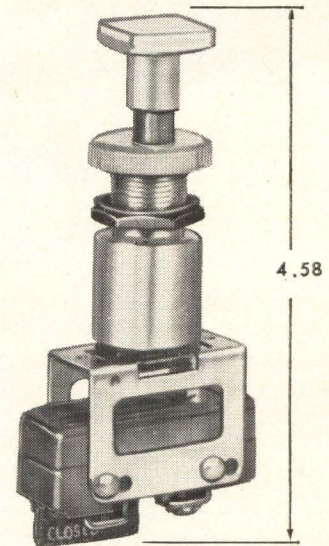

Series "5": 10 amp (125 v) d-c capacity.

## GROWING SELECTION OF COMPACT PUSHBUTTONS GIVES QUICK ANSWERS TO PANEL SPACE PROBLEMS

Whatever you need in a compact pushbutton switch—any type of action, any contact arrangement, or protection against liquids, dust, vibration or shock—check into the broad, growing line of MICRO SWITCH Pushbutton Switches.

There are now hundreds, so chances are you'll quickly select a switch with just the right combination of dimensional, mechanical and electrical characteristics. And you can be sure it will be the most compact switch of its type available. For example:

**New "Series 5" Modular, Sealed, Pushbutton Switches:** extra rugged, shock- and corrosion-resistant, and panel sealed for severe mobile and industrial applications. Modular

design—19 switch units, 5 operating actions—allows tailor-made assemblies.

For information, call our Branch Office (see Yellow Pages) or write for Catalog 68 on Series 5 Sealed Switches, and Bulletin 22 on miniature pushbutton switches.



### MICRO SWITCH

FREEPORT, ILLINOIS

A DIVISION OF HONEYWELL

IN CANADA: HONEYWELL CONTROLS LIMITED, TORONTO 17, ONTARIO

HONEYWELL INTERNATIONAL—SALES AND SERVICE OFFICES IN ALL PRINCIPAL CITIES OF THE WORLD. MANUFACTURING IN UNITED STATES, UNITED KINGDOM, CANADA, NETHERLANDS, GERMANY, FRANCE, JAPAN.



# NEW FROM NRC

## thin film vacuum coater



NRC's Model 3176 Vacuum Coater is a unique vacuum evaporation system for thin film deposition in R&D and production programs. Unmatched for versatility, reliability and ease of operation, the Model 3176 is used in the areas of solid state electronics, optics, magnetic films, memory planes and solar cells.

**Exclusive features include:** ■ **Fastest Useful Pumping Speed** . . . with high performance, lowest backstreaming NRC diffusion pump rated at 1500 liters/sec. ■ **Highest Conductance/Lowest Outgassing** . . . with the new NRC Slide Valve which was specifically developed for maximum pump efficiency. ■ **More Efficient Baffling** . . . with single circular chevron cold trap-baffle combination. ■ **Easy, Fast Operation** . . . with all controls (manual or automatic) conveniently mounted on front panel. ■ **Maximum Versatility** . . . used with 18" or 24" work chambers — electrical and mechanical feed-throughs interchangeable.

The Model 3176 has a new sophisticated appearance and is ready to operate. Merely connect power and water supply. Write or call for data sheet.

SYMBOL OF  
PROGRESS



IN VACUUM  
EQUIPMENT

### NRC EQUIPMENT CORPORATION

A Subsidiary of National Research Corporation

160 Charlemont Street  
Newton 61, Massachusetts

Area Code 617 DEcatur 2-5800

twt's that weigh less than 3 pounds are required, GE says.

The new tubes reportedly have a low-noise advantage of from 2 to 5 db over ppm's, and weigh about half as much as pm tubes with comparable performance characteristics.

Reliability of the new tubes is said to be comparable with existing tubes. Environmental test facilities are used to expose tubes to test situations corresponding to shock of 50 g's, vibrations from 5 to 2,000 cps; temperatures from -65 to 75 C; and altitudes of 100,000 feet.

At this point, costs will be comparable to the existing line of pm and ppm tubes. Ultimately, the new tubes will be cheaper, company says.

Designers are constantly seeking lighter and more compact components for advanced radar and space systems. At the same time, new applications require better performance characteristics for smaller units.

A single reversal twt with low-noise characteristics was developed in England, but it weighed 30 pounds. Although other manufacturers have done experimental work on such tubes, GE claims that their new line is the first single reversal low-noise type to be offered to U.S. system designers.

## Laminate Tailored For Space Needs

A NEW phenolic resin, developed by Union Carbide Plastics, is said to meet the increasing needs for high temperature-resistant laminating resins used in the electronics industry.

Company says laminates using the new resin, Bakelite phenolic BLSB-3536, are certified to exceed by a large margin the performance requirements of MIL-R-9299A, Type II, Class 2.

Flatwise tests on the new laminates show flexural strength of 70,000 psi, and modulus of elasticity of 3.47 psi x 10<sup>6</sup> after 100 hours at 500 F.

Suggested uses include circuit board applications, molded components, insulation, and structural parts.



**"ARE YOU SURE YOU CAN GIVE HIGH EFFICIENCY  
IN HIGH CURRENT SATURATED OPERATION?"**

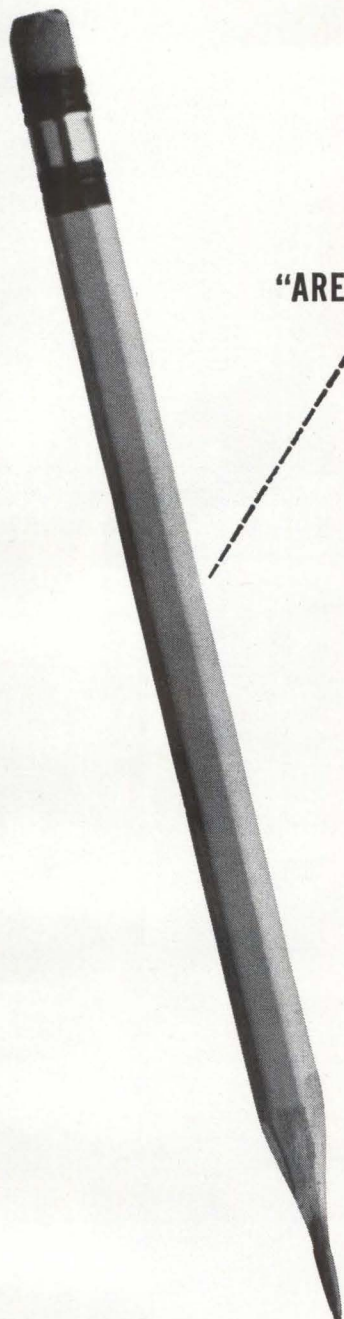

Type	VCEO @ Ic Volts @ Amps	VCBO @ IcBO Volts @ ma	hFE @ Ic Amps	VCE (sat) @ Ic Volts @ Amp	Thermal Resistance
2N1518	40 1.0	50 4	15/60 15	0.7 25	0.8° C/watt
2N1519	60 1.0	80 4	15/60 15	0.7 25	0.8° C/watt
2N1520	40 1.0	50 4	17/68 15	0.6 35	0.8° C/watt
2N1521	60 1.0	80 4	17/68 15	0.6 35	0.8° C/watt
2N1522	40 1.0	50 4	25/100 15	0.5 50	0.8° C/watt
2N1523	60 1.0	80 4	25/100 15	0.5 50	0.8° C/watt

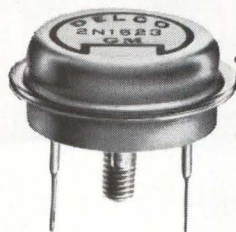

**NOW AVAILABLE AT HALF-PRICE:** A family of high current transistors that offers low saturation resistance for improved efficiency. You use fewer components in a circuit, get better reliability.

For additional information or applications assistance, write your nearest Delco Radio Semiconductor distributor or one of our sales offices listed below. Better yet, phone.



Division of General Motors, Kokomo, Indiana

Union, New Jersey  
324 Chestnut Street  
MURdock 7-3770  
AREA CODE 201

Detroit, Michigan  
57 Harper Avenue  
TRinity 3-6560  
AREA CODE 313

Palo Alto, California  
201 Town & Country Village  
DAvenport 6-0365  
AREA CODE 415

Santa Monica, California  
726 Santa Monica Blvd.  
UPton 0-8807  
AREA CODE 213

Syracuse, New York  
1054 James Street  
GRanite 2-2668  
AREA CODE 315

Chicago, Illinois  
5151 N. Harlem Ave.  
775-5411  
AREA CODE 312

Kokomo, Indiana  
700 E. Firmin St.  
GLadstone 2-8211, Ext. 500  
AREA CODE 317





## What do big carriers charge for little packages?

Answer: 25 lbs. Los Angeles to New York

Airline X	\$18.50
Airline Y	\$18.50
Airline Z	\$17.00
Flying Tigers	\$ 9.25

Your minimum shipment via Tigers costs about half of what most other airfreight carriers charge. Most carriers figure a

minimum shipment at 50 lbs. Tigers' minimum is 25 lbs. multiplied by the established commodity rate, or \$4.00 for the shipment . . . whichever is greater.

How can Flying Tigers do it? Simple. They're the Airfreight Specialists. Big shipment or minimum shipment, always specify Flying Tigers—world's largest all-cargo airline.

*first in airfreight with airfreight first* **FLYING TIGER LINE**





## Five things you should know about our four TYO capacitors

1

**Where to use them**—in printed or point-to-point applications in coupling, decoupling, filtering, timing, switching, and computer circuits. TYO's meet all performance requirements of MIL-C-11272B.

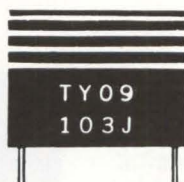

2

**Sizes**—four case sizes cover *pf* ranges between 1-560, 561-1000, 1001-2700, and 2701-10,000 at 300 VDCW from  $-55$  to  $+125^{\circ}\text{C}$ .



3

**What's inside**—capacitive element is glass and aluminum foil, fused into a monolithic element which holds D.F. to less than 0.001 and capacitance change in life to less than 0.5% or 0.5 *pf*. This is the same type element that has made CORNING capacitors the standard for reliability and stability for years.



4

**What's outside**—special case and potting compound give stand-off insulation, eliminate inter-component, wire, and chassis short circuits. Standard 1.25" gold plated Dumet leads are welded to capacitive element to make your welding or soldering safer, easier. Leads are spaced on .1" grids symmetrically with case for fast mounting.



5

**Where to get them**—your CORNING distributor stocks TYO's in all sizes and values. He's ready to give you fast service for small quantities. For large quantities, contact us directly.

If you have questions, ask him for TYO data sheets, or write us: Corning Glass Works, 3901 Electronics Dr., Raleigh, N. C.

# CORNING ELECTRONICS

A DIVISION OF CORNING GLASS WORKS



7½ TEST YEARS

CUT TO 18 MONTHS FOR

60 MILLION DATA TEST HOURS!

BETTER  
MEASURING  
FROM



In determinations of acceleration factors for metal and carbon film resistors for the high reliability MINUTEMAN Program, Electra Manufacturing Company uses an Automatic Resistor Data Logging System designed and built by Electro Instruments.

This system, in conjunction with other test equipment, has accumulated over 60 million resistor hours of data in the last 18 months. *Without this accelerated testing system, 7½ years of test time would have been required!* Most important, the EI system gives Electra the confidence that their products meet stringent government specifications.

As in this EI system created for Electra, EI *all solid state* Digital Multimeters are the basis for *better measuring* at greater speed, higher reliability, significant cost savings and a much lower investment.

Whether your interest lies in spacecraft, electronic components or industrial processes, we can demonstrate to you the advantages of EI digital instruments in measuring DC volts, AC volts, DC ratios, resistance, capacitance, inductance and impedance. Let EI *all solid state* Digital Multimeters or Complete Systems provide swift, accurate, low cost solutions to your measurement and display problems!

*For full details on EI's individual digital instruments, or our complete capabilities in the field of measurement, display and recording—write direct to Electro Instruments, Inc.*

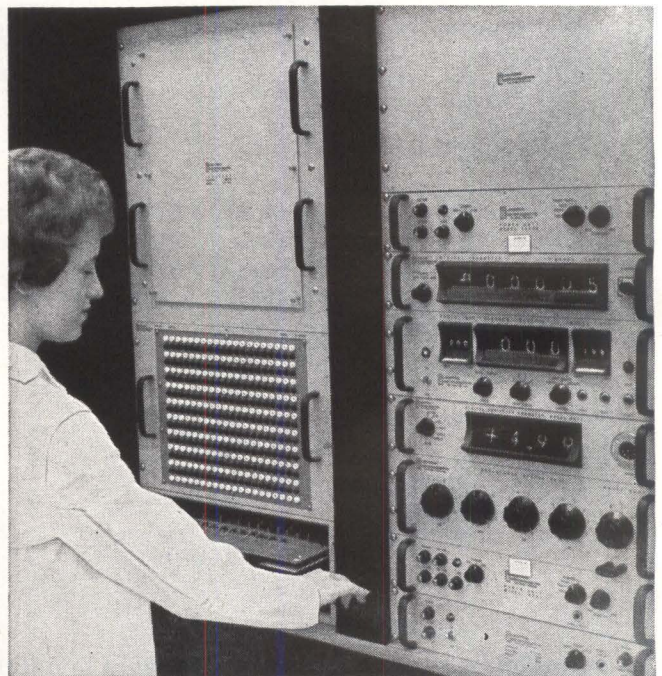

Technician at Electra Manufacturing Company inserts test resistors in the Automatic Resistor Data Logging System designed and built by Electro Instruments. Over 60 million resistor hours of data were accumulated in 18 months.



**Electro Instruments, Inc.**  
8611 Balboa Avenue, San Diego 12, California



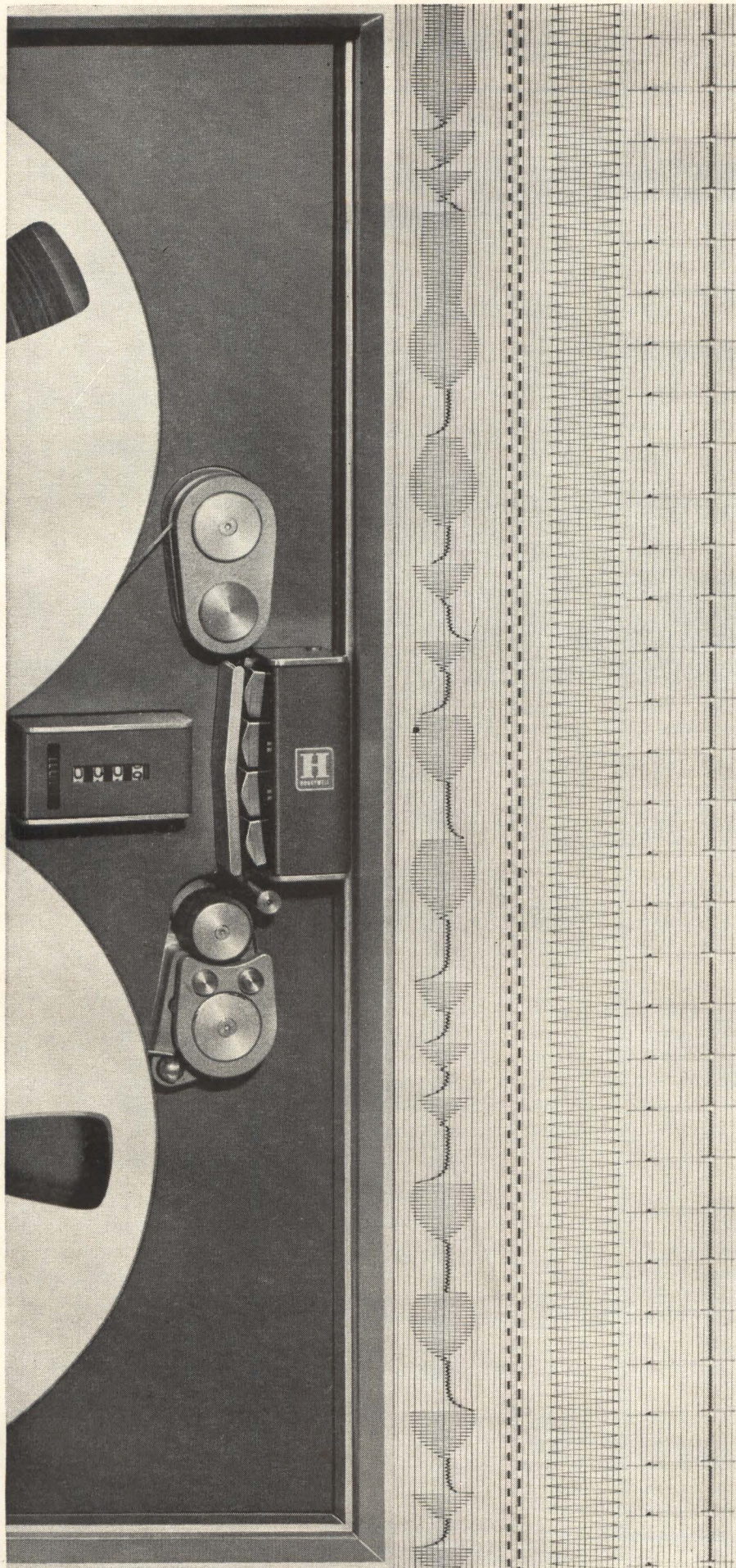

# NOW and/or LATER

To get the most out of analog data, you should be able to see it now or see it later, use it now or use it later.

The ideal combination of recording instruments for making the most of your analog data is a Honeywell tape recorder, such as the compact Honeywell 8100 portable instrumentation recorder/reproducer, used with the Honeywell Visicorder Oscillograph.

For immediate readout, the Visicorder gives you an instantaneous record of 1 to 36 channels of data from DC to 5000 cycles per second. A variety of paper speeds from .1 to 160 inches per second gives you the trace resolution you need. Five models of the Visicorder are available.

At the same time, you can record up to eight channels (plus voice and compensation) of data up to 10,000 cycles on the 8100 portable. Later on, you can play selected portions of your data into the Visicorder. Four tape speeds (1 7/8, 3 3/4, 15, and 30 ips) give you record and playback versatility for whatever frequency you're recording.

In the Honeywell 8100, several head and tape configurations are available (including IRIG). All models have a built-in calibration panel, automatic switching of center frequencies, and a new, improved tape drive that cuts flutter to a minimum and eliminates tape breakage. A built-in monitor scope and voice channel are optional. In addition, Honeywell manufactures complete laboratory tape systems with capacities of up to 60 channels on 2-inch tape.

For complete information about the Honeywell 8100, the Visicorder Oscillograph, and other recording equipment, contact your nearest Honeywell office, or write: Honeywell, Denver Division, Denver 10, Colo. Or call us direct at 303:794-4311. In Canada, contact Honeywell Controls, Ltd., Toronto 17, Ontario.

**DATA HANDLING SYSTEMS**

## Honeywell





POSITIONING FIXTURE is loaded with relays during welding of other relays. Inset shows multi-exposure photo of beam-impingement traverse on relay. Beam travel is controlled by specially-designed programmer unit in center

## Electron Beam Welding Solves Relay Sealing Problems

*Beam travel  
programmed by cam  
contour device*

By WERNER C. THEILER

Filtors, Inc.  
East Northport, N. Y.

SEARCH for a highly reliable technique for the hermetic sealing of miniature relays gave birth to a uniquely programmed electron beam welding process. This machine tool possesses high-production capabilities: it now seals a rectangular relay measuring 0.400 by 0.800 inch in about 6 seconds. Present operating conditions of pump-down and loading prevent full capitalization of this capability. With a little design modification, however, the process is expected

to yield as many as 250 welded assemblies per hour. Contributing to this output is a magnetic method of deflecting the beam in x-y coordinates using an especially-designed cam contour programming device.

Perusal of available welding information had not supplied a solution to the problem of getting high-reliability seals on a mass-production schedule. We were sure that electron beam welding was the answer, but the complex nature of subminiature relay design with its susceptibility to heat damage, demanded extensive research and development work to develop a system that accurately and automatically controls and restricts travel of the electron beam. This may be a major step in making what is now primarily a novel laboratory tool a high-production welding ma-

chine also having great research facility: reliance placed on operator skill has previously been a drawback to mass-production operation. Several fastening as well as sealing problems in relay manufacturing are expected to be solved using the process.

**ADVANTAGES** — One of the qualities of the electron beam suiting it for high production welding of subminiature relays is that the high energy densities at the impingement point reduces the need for heat sinking: fusion occurs with great concentration and at such a rapid pace that harmful thermal distortion has no time to develop. Heat-affected area is said to be about 1/25 that of the tungsten-and-inert gas welding process because of energy densities as high as 3.8 Kw per sq. in. for a weld



# A New Kind of Aluminum Electrolytic

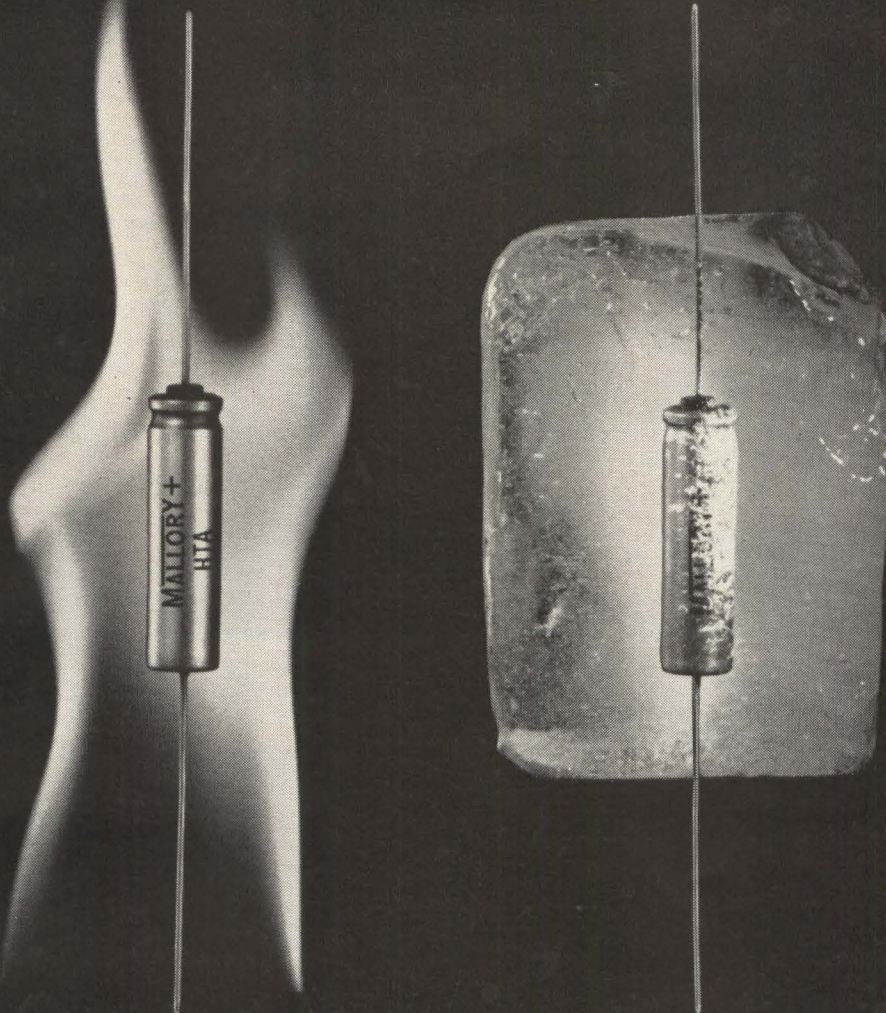

## Temperature Spread . . . 180°C

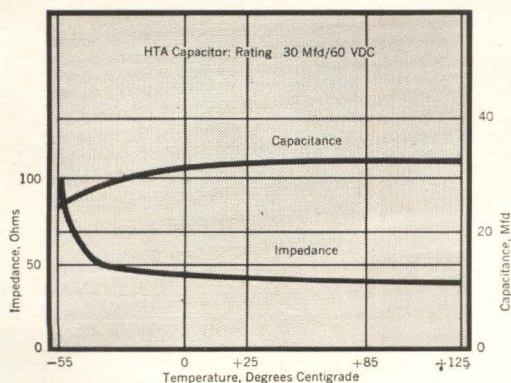

Typical stability of capacitance at low and high temperatures:

From  $-55^{\circ}\text{C}$  to  $+125^{\circ}\text{C}$ , Mallory HTA aluminum electrolytics retain capacitance stability, to a degree never before possible in an aluminum unit.

Here's a new kind of aluminum electrolytic capacitor with performance characteristics approaching those of tantalum. Type HTA gives you long life and dependability at  $+125^{\circ}\text{C}$  without voltage derating . . . yet they hold capacitance at  $-55^{\circ}\text{C}$  with negligible drop.

Take a close look at the HTA's temperature performance: you may find this unusual capacitor can fit spots in industrial and commercial equipment where you figured nothing but tantalum would do. Available in ratings of 8 to 300 mfd, 60 to 3 volts. Standard diameter is  $\frac{3}{8}$  inch. Case length is  $1\frac{3}{16}$  to  $1\frac{5}{8}$  inches. Tubular aluminum case, with axial leads. Supplied with Mylar\* sleeve if desired.

Call or write for technical data. Mallory Capacitor Company, Indianapolis 6, Indiana . . . a division of P. R. Mallory & Co. Inc.

\*Du Pont trademark

P. R. MALLORY & CO. INC.  
**MALLORY**

CIRCLE 91 ON READER SERVICE CARD



# INSTANT INSULATION

for

- development
- production line
- maintenance



- Pot connectors
- Secure wiring against vibration
- Insulate wiring and terminals
- Laminate sheet insulation
- Repair damaged insulation
- Fill voids
- Bond silicone rubber tapes
- Assemble insulating components
- And 1,001 other uses

Ready-to-use liquid silicone rubber for potting, encapsulating, sealing, bonding and void-filling. No pre-mixing or priming. RTV-102 silicone rubber adheres to almost anything—glass, metal, plastics, most insulating materials, silicone rubber. Sets in minutes, cures in a few hours, forms a resilient rubber that never dries out, cakes or cracks. Has excellent electrical properties. Resists moisture, weathering, and temperatures from  $-75^{\circ}\text{F}$  to  $+500^{\circ}\text{F}$ .

For free evaluation samples plus technical data, write on your letterhead describing your application to Section N692, Silicone Products Department, General Electric Co., Waterford, N. Y.

**GENERAL ELECTRIC**

diameter of 0.010 inch. (The Hamilton Standard electron beam machine, which was modified to perform process, is adjusted to a fine beam focus prior to welding using a target surface of pure tungsten coinciding with a plane described by weld lines.)

**BEAM TRAVEL**—Basically, two approaches could have been used to perform contour welding of relays:

- Conventional technique of guiding the work below the beam by mechanically tracing a template

- Magnetically deflecting the beam so that it follows preset path determined by programmed x-y coordinates while the work remains stationary.

The latter concept was adopted since it offered distinct advantages with respect to operational flexibility. A minimum of alterations were required to adapt the programming system to the Hamilton Standard electron beam welding machine. Two basic weld patterns have been stored in the programming system. Selection between the two is switch-controlled. Additional controls permit return to standard operator-controlled welding.

On initiation of the automatic weld cycle, the beam follows the preset pattern by being deflected

from its normal vertical orientation to a variable angular orientation so that beam impinges on designated and successive x and y coordinates in the welding plane. High stability d-c signals applied to welder's magnetic deflection lenses supply the exact signal value for each point of the weld line. Power sources supplying signals are controlled by high-linearity potentiometers. They, in turn, are actuated by precision cams driven by a variable gear motor to regulate welding speed from 5 to 60 inches per minute.

Since beam deflection is an angular function, it follows that the maximum distance the beam can be diverted from its vertical path depends on height of welding surface. With the long focal length lens system in the Hamilton Standard machine, the standard focusing range can be sufficiently extended to assure that each point of the pattern will be reached with pin-point accuracy. Generally, a shallow deflection angle is desired for programmed electron-beam welding to achieve maximum pattern repeatability. A sharply angled beam is of particular help where access to weld joint is obscured.

**BEAM CONFIGURATION**—The beam itself which can be varied in

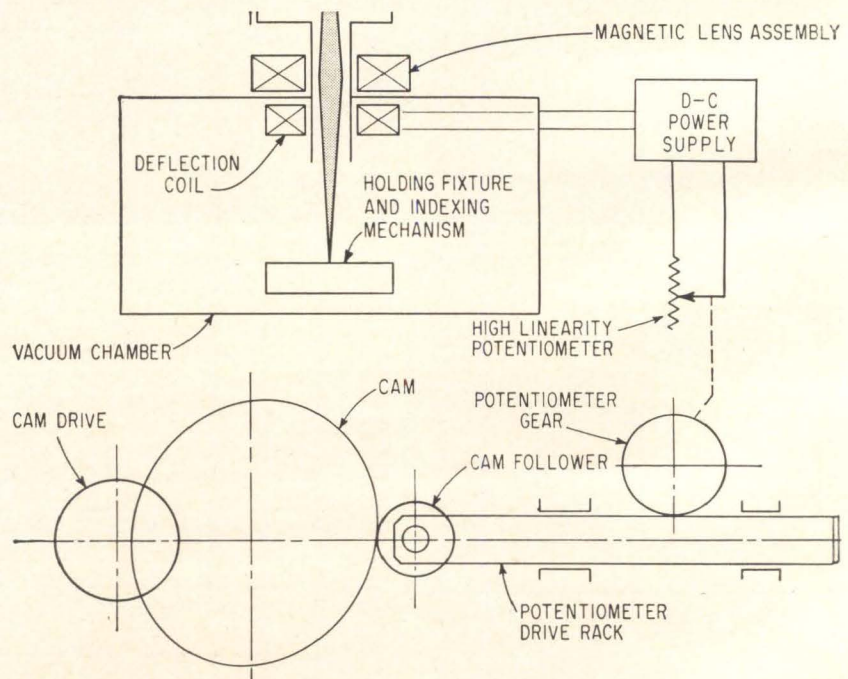

**PROGRAMMER UNIT** is based on cam-drive system that actuates high-linearity potentiometer controlling d-c power supply signals to deflection coils of electron beam welder



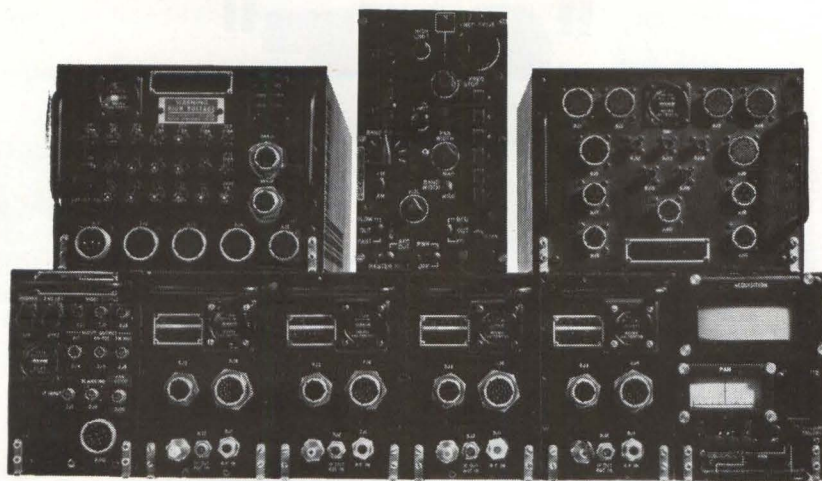

**The quality of our IF strips  
has been hidden within our systems...**

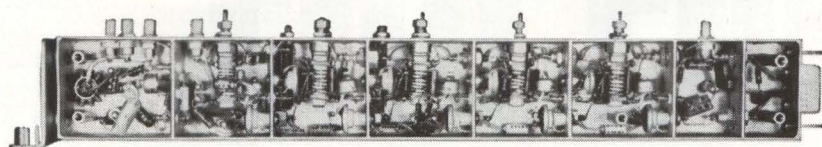

**until now.**

What's behind Loral's success in meeting—or exceeding—MIL-SPECS in the creation of “black boxes,” both systems and subsystems, for the military for over 15 years?

The quality built into components such as this IF amplifier.

This unit, one of a series of IF amplifiers operating at center frequencies from 30 to 160 megacycles, was developed for a Loral system that meets MIL-E-5400. It is now ready for YOU through our General Products Division.

Such amplifiers are available as virtually “off-the-shelf”

items and are representative of Loral's R & D capacity to create electronic components that are the best possible buy in the smallest, most reliable package—Value Engineered throughout.

We may have, right now, the electronic component that will help YOU do an important defense job while saving YOU the unnecessary time and cost of undertaking your own R & D. For further information on our complete line of amplifiers and other precision microwave products, write: General Products Division, LORAL ELECTRONICS CORPORATION, 825 Bronx River Avenue, The Bronx 72, New York.

MIL SPEC	MIL-E-5400	BANDPASS RIPPLE	0	GAIN CONTROL	Yes	INPUT IMPEDANCE	50 ohms
PART NUMBER	IF-301	WEIGHT	11.5 oz.	AGC	Yes	OUTPUT IMPEDANCE	50 ohms IF 91 ohms video
CENTER FREQUENCY (MCS)	100	TRANSISTOR COMPLEMENT	2N1195	POWER REQUIREMENTS	25v 110 ma		VOLTAGE GAIN
BANDWIDTH AT 3db (MCS)	20	NOISE FIGURE db	7 db	DIMENSIONS	11 x 1¼ x 1		





# EVER "SEE" A FLIP-FLOP i-dot-flop?

**NEW DIGITAL TRAINER** permits step-by-step assembly and demonstration of working digital techniques for intermediate/advanced teaching. The panel arrangement, controls and indicators are engineered for visual demonstration of circuit design and operation. The trainer is also an important laboratory tool for proving out circuitry designs.

Students make functional logic by patch cord connection of circuit elements. Logical elements can be combined into actual logical circuits such as shift registers, counters, analog-to-digital converters, arithmetic units, etc. A digital curriculum providing an equal ratio of training time between theory and practical application is available for classroom use of trainer.

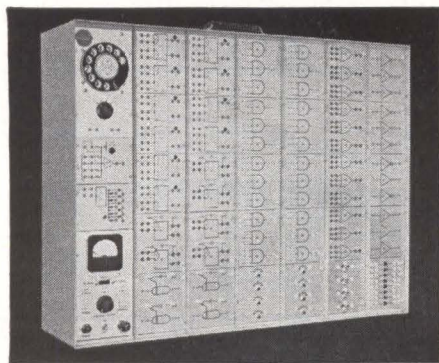

For further information write:  
Vitro Laboratories,  
200 Pleasant Valley Way,  
West Orange, New Jersey  
Phone: (Area Code 201) REdwood 1-3400  
A Division of Vitro Corporation of America

TYPICAL MODULE DISTRIBUTION	
Flip-Flops.....	10
AND Gates.....	24
OR Gates.....	12
Inverters.....	9
Single Shots.....	4
Emitter Followers.....	3
Delay Circuits.....	6
Diodes.....	8
Pulse Generator.....	1
OR Comparator.....	1
Reset Drive.....	1
Power Supply.....	1

**VITRO LABORATORIES**

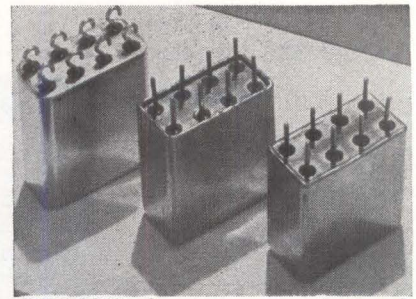

RELAYS shown are manufactured by electron-beam welding, tungsten-inert gas welding and soldering (left to right)

size and power by basic machine, can also be changed with the programmed deflection feature from a spot to an open circle and other shapes such as a sine wave. Circle generation—resulting in a welding motion analogous to that of a planet revolving on its own axis while circling the sun—has produced very successful welds.

Each miniature relay is placed in a specially designed holding fixture with relation to weld pattern described by beam. Fixture does this with two precisely machined locating surfaces and an indexing pin. Rotating each relay in turn to a proper position under beam, the fixture includes a time mechanism adjusted to beam travel time. At completion of weld, fixture is automatically actuated by this mechanism to place following relay in position. Necessary time for such indexing and welding is adjustable to suit various settings and weld lengths, averaging about 6 seconds. Upon completion of each run, the operator reloads the vacuum chamber with another fixture that has received relays during previous production welding operation. He then immediately starts pump-down cycle. The following idle period is used to inspect welded relays.

Sensing devices check the presence and correct position for each relay before initiating electron beam.

## Drill Puts 3,000 Holes In Stamp-Sized Mask

SPECIAL drilling equipment has been developed by Hewlett-Packard to achieve accuracies unavailable in



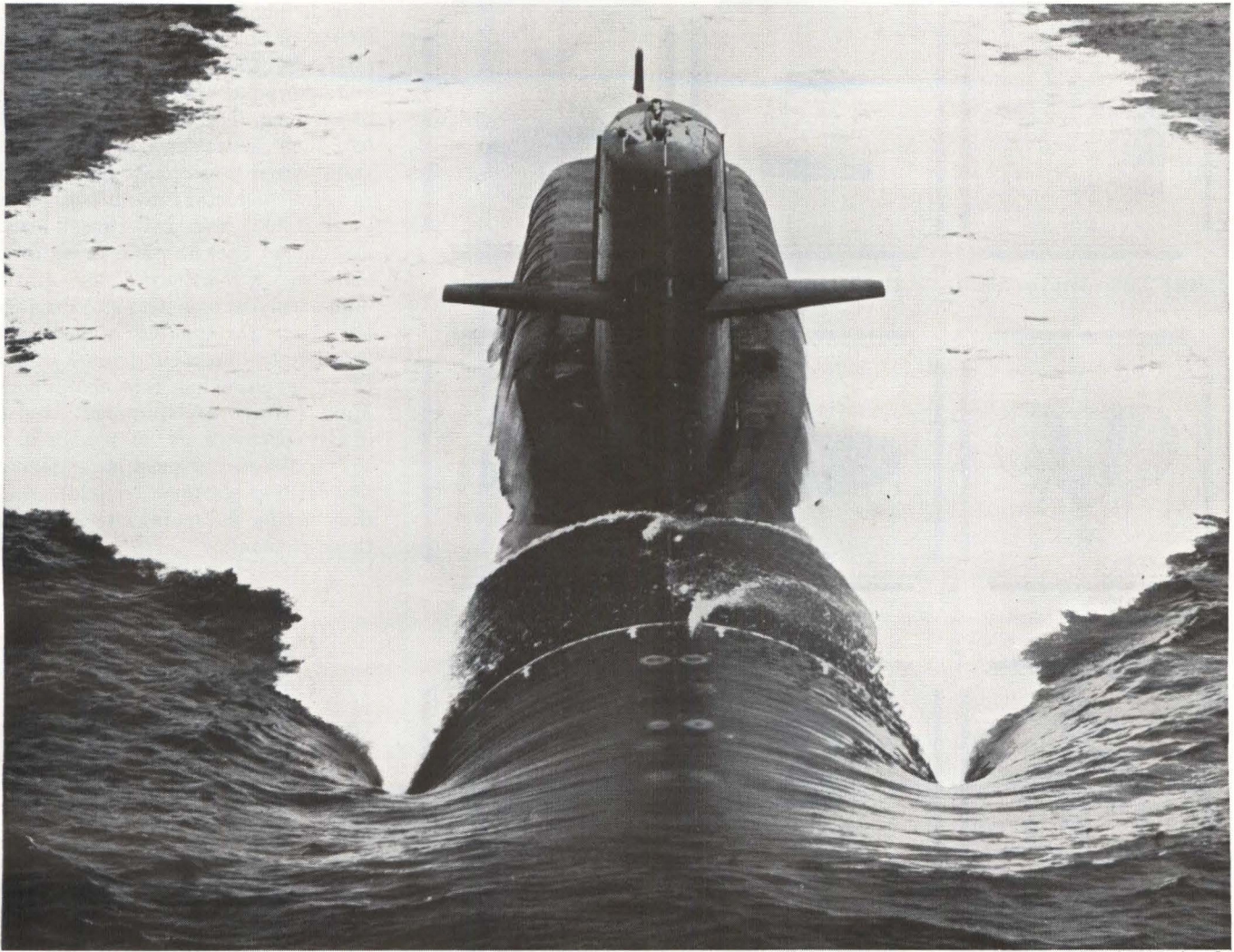

Official U.S. Navy Photograph

## CUBIC digital voltmeters check out Polaris weapons system

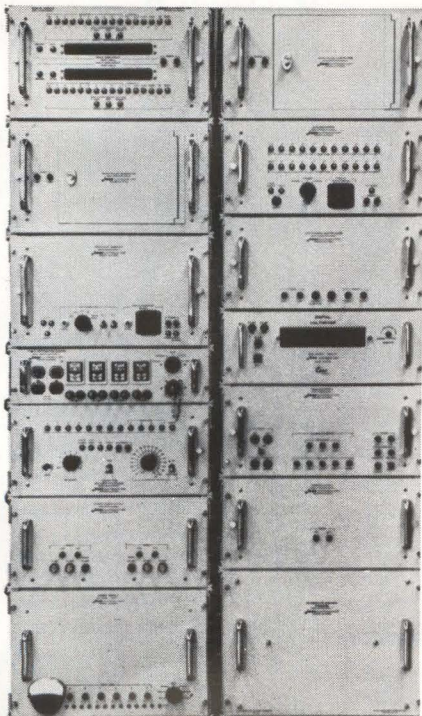

Cubic Corporation is proud to have had the opportunity to develop three distinct types of specialized digital voltmeters for use in the Polaris program. The instruments were developed by Cubic and supplied for three specialized applications for check-out functions in the Polaris Fleet Ballistic Missile Weapons System—a key element in the defense of the free world.

One of the major uses of Cubic digital voltmeters in the Polaris program is in the digital data acquisition system built by Interstate Electronics Corporation, Anaheim, California. This system is used in the submarines to acquire data regarding the weapon system performance. It is part of the calibration equipment whose purpose is to insure satisfactory operation of the Polaris missiles. The Cubic instrument is indicated by arrow at left.

The Cubic militarized digital voltmeter features all solid-state plug-in circuitry and lifetime reed relays used for bridge switching. Operating components are compact, rugged and lightweight. A special snap-out replacement readout is available to insure minimum downtime, should maintenance be required. Absolute accuracy of .01% of reading,  $\pm 1$  digit is provided. Sensitivity is 1 mv. MIL-STD's 16B, 167, 202B are met. For additional information, write to Department B-159.



**CUBIC**  
CORPORATION  
SAN DIEGO 23, CALIFORNIA

INDUSTRIAL DIVISION

LEADER IN INDUSTRIAL, GEODETIC AND AEROSPACE ELECTRONICS



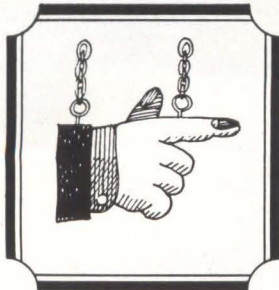

Meet "Therma-Snap" switches

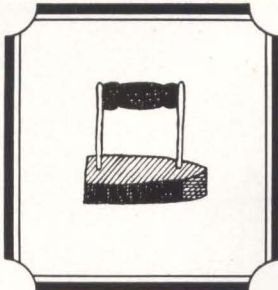

for heated surfaces ...

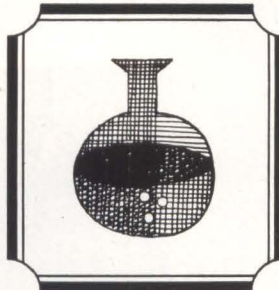

a variety of liquids ...

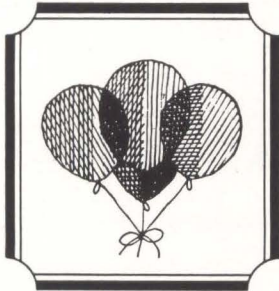

and aeroform environments.

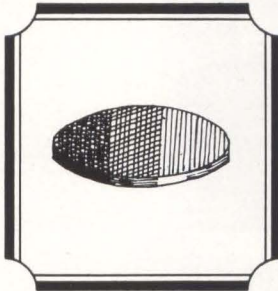

With a precise bimetallic disc



for long life, low drift

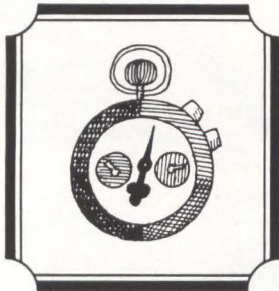

and fast "snap" action.

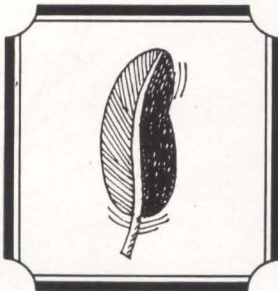

Therma-Snaps are light

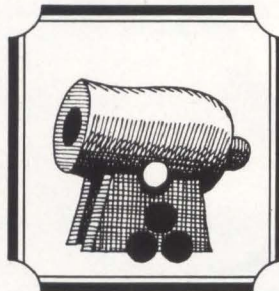

can withstand a 60g shock

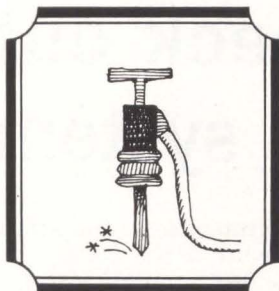

50g's vibration to 2,000 cps

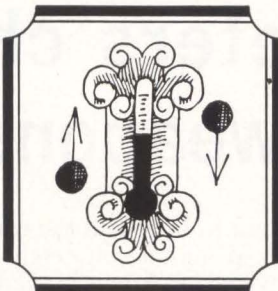

ambients -65° to +600° F



in small, smaller and smallest.

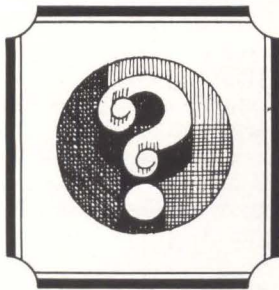

Need accurate thermal switches?

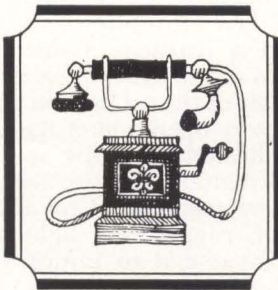

Call

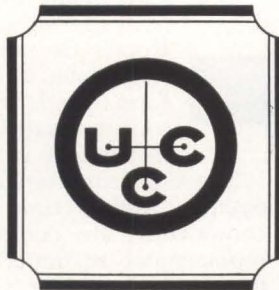

United Control

## UNITED CONTROL CORPORATION

Overlake Industrial Park, Redmond, Washington • Phone: 206-885-3711 • TWX: 206-999-1874  
United Data Control, Inc. and Palomar Scientific Corporation—Subsidiaries

outside shops. Holes obtained are 0.0016-in in diameter to within a tolerance of 50-millionths of an inch and are round to within 5-millionths of an inch. They are being spaced 0.02-inch apart on small postage stamp sized brass photo masks used in semiconductor manufacture—a total of 3025 holes cover mask area. Equipment uses an air-bearing drill and Pratt & Whitney Tape-O-Matic numerical control system. Production time for making a mask reportedly has been cut from 3 weeks to 5½ hours using this equipment. Main feature of equipment is use of air pressure at 90 pounds per sq. in. directed at machine's spindle and drilling platform from all sides, thus acting as springs to stabilize these elements.

### Compound Protects Cable Core

THREE ENGINEERS at Anaconda Wire and Cable Company of Hastings-on Hudson, N. Y. have patented a technique and apparatus that applies filler compound to cores of cable during manufacturing process. Cables, which can include as many as 7 or 8 conductors, are thus made moisture and vapor tight. Inventors are Kenneth R. Bullock, Samson Sortland and George Ansell.

### Making It Easy For Assembler



INSTRUCTIONAL work station for electronic assemblers is built in three sections: parts on left, instructions in center, tools at right. Two sections are at an "effective-vision" angle of 45 degrees. Developed by Otis Elevator's Defense & Industrial Division, the prototype shown was built by Banner Metals Corp.



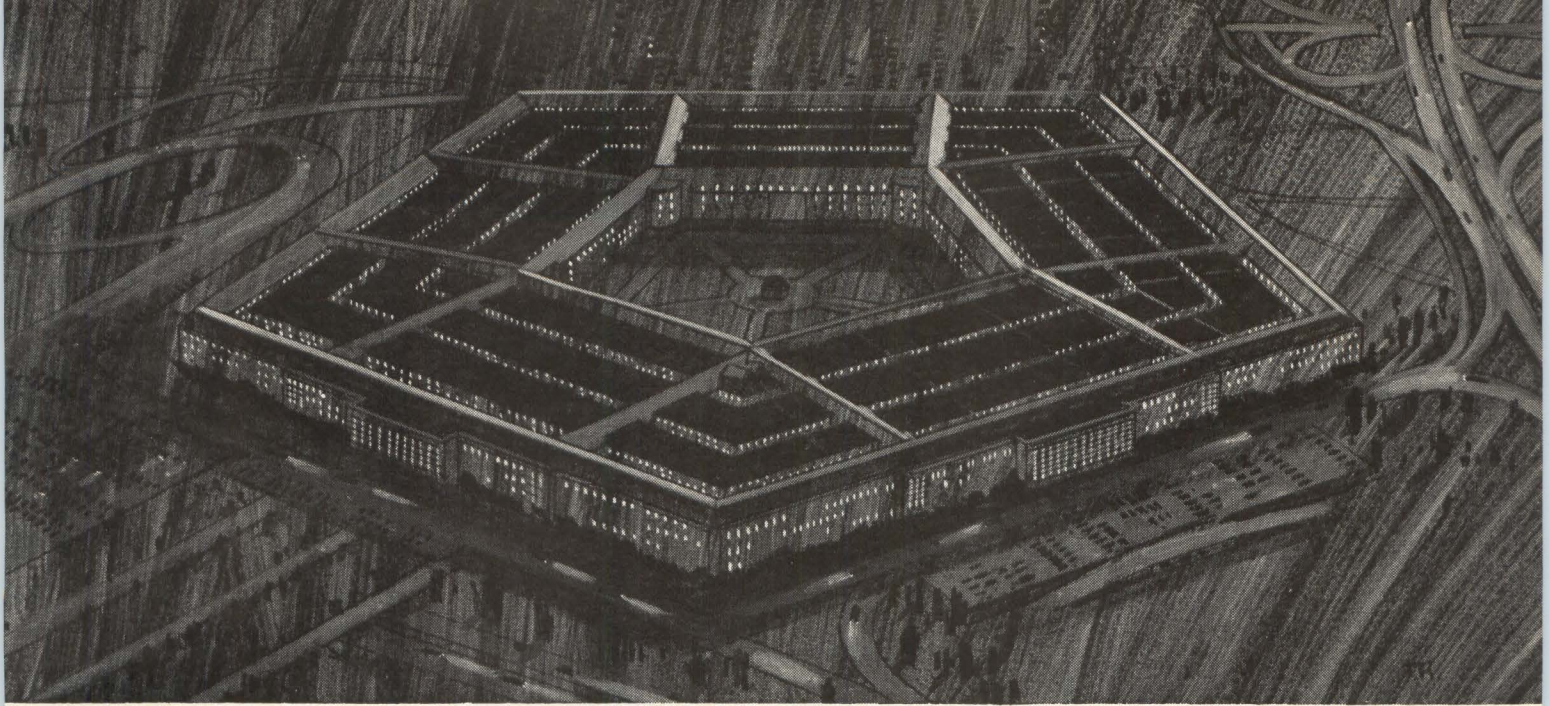

**Defense Center**

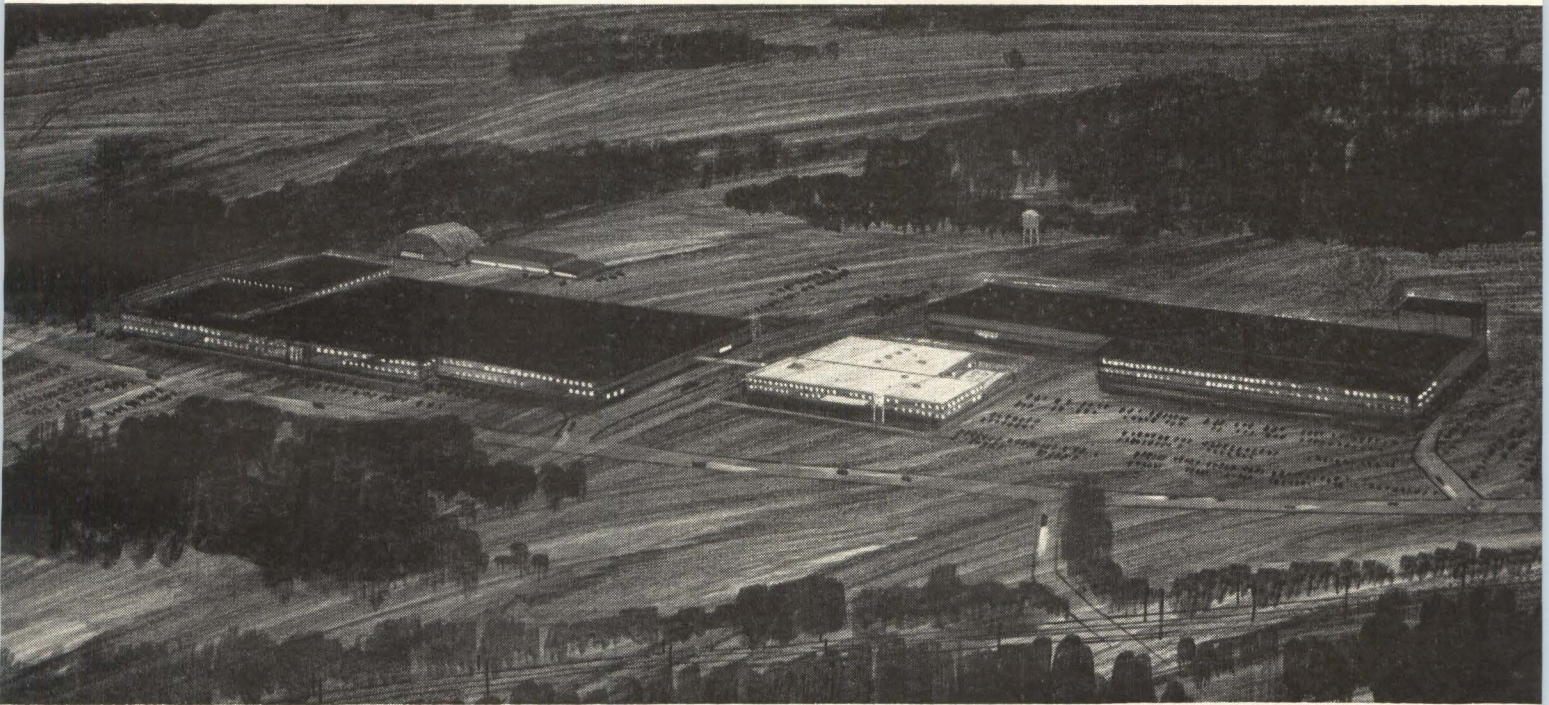

**Defense Center**

**In organization and basic purpose,** the Westinghouse Baltimore Defense Center effectively parallels the agencies it serves. It represents a unique concentration of defense and space contract capabilities including Systems Management. These capabilities embrace all environ-

ments, from undersea to deep space. They include every activity, from research and development to production. But the greatest strength is the wealth of scientific talent and technical skill in the Westinghouse organization.

For specific information on how the

broad capabilities of the Westinghouse Baltimore Defense Center can meet your requirements, phone or write to: Westinghouse Electric Corporation, P.O. Box 868, Three Gateway Center, Pittsburgh 30, Pennsylvania. You can be sure . . . if it's Westinghouse.

J-02349

**We never forget how much you rely on Westinghouse**



**CIRCLE 97 ON READER SERVICE CARD**





If microwave is your career . . .

## YOU SHOULD BE AT COLLINS

One reason is because we put a premium on seeing to it that our engineers work under the best of conditions. And it goes a lot deeper than our modern buildings, our fully-equipped R&D labs, our new manufacturing facilities and the high level of professionalism you'll find among our engineers. For instance. You don't work in a bull pen, you are in an office. Your support people are close at hand. We even see to it that you don't have to fight for a space in the parking lot. □ If your career is microwave — any phase — and if you are an E.E. or M.E. with a B.S. or advanced degree and 3 to 10 years' experience, we'd like to talk with you. The listings at right tell you what fields are open and where to write.

Current openings for qualified microwave engineers exist in the fields of:

Microwave Systems Design  
 Microwave Equipment R&D  
 Systems Installation  
 Design and Development of  
 Switching Systems for  
 Microwave Applications



Send your reply,  
 attention Dept. EL, to:

C. P. Nelson  
 Collins Radio Company  
 Dallas, Texas

L. R. Nuss  
 Collins Radio Company  
 Cedar Rapids, Iowa

E. D. Montano  
 Collins Radio Company  
 Newport Beach, California

An equal opportunity employer



**COPY**  
**CAT**



**TAPE COPY STATION FOR ATLANTIC MISSILE RANGE**

Six 1.5-mc Mincom CM-100 Recorder/Reproducers form the backbone of an extremely complex tape copy station recently delivered to the Atlantic Missile Range, through Defense Electronics, Inc., Rockville, Maryland. Set up at AMR last March, the station makes possible for the first time as many as five first-generation copies of prime data tapes in one operation. In addition to the six CM-100's, it also includes two 600-kc Mincom G-100's, two degaussers, and an advanced monitor alarm system policing forty-two 1.5-mc channels. The station is the result of Mincom's long experience with frequency responses of better than 1 mc—an outstanding reliability record since 1955.

**Mincom Division** **3M**  
COMPANY  
2049 South Barrington Avenue, Los Angeles 25  
425 13th Street N. W., Washington 4, D. C.



# Comparing Frequencies To 1 Part In $10^{12}$

*Comparator uses cascaded error magnifying circuits for highest resolution*

**SOLID-STATE** one-piece device performs frequency comparisons that formerly required a number of separate test instruments. The unit permits rapid evaluation of frequency difference between reference and unknown signals at 1, 2.5 and 5 Mc. Frequency difference is processed at an effective 10, 100 or 1,000 times referred to 1 Mc. Five front-panel outputs are provided for recording and display instruments in the model 102 comparator. Unit resolution is better than one part in  $10^{12}$  for 1-second

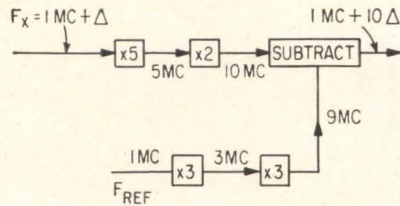

observation time. Observation times as short as 0.0003 sec are possible with corresponding precision.

The comparator obtains its precision by successively multiplying the incoming "unknown" signal (plus its error) by factors of ten, and then subtracting nine-times the reference signal from the result as illustrated in the block diagram.

According to Parzen Research, Inc., 48 Urban Avenue, Westbury,

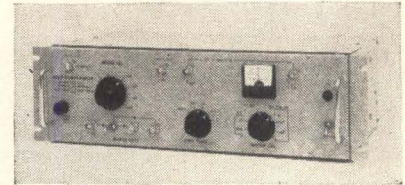

L.I., N.Y., who manufacture the comparator, its applications include measurements of long and short-term signal source stability, alignments of frequency sources for maximum accuracy and stability, evaluation of phase and frequency characteristics of four-terminal networks, and minimum noise adjustment of four-terminal networks.

CIRCLE 301, READER SERVICE CARD

## Sensitive Scope Uses Two Beams

**DOUBLE-BEAM** oscilloscope has a basic sensitivity of 100 microvolts/cm, variable to 50 volts/cm, with continuously variable sweep range from 1 microsecond to 12 seconds/cm. Additional facility is provision for one-shot time base with a "ready" light to facilitate

transient photography. Push button beam-finders are particularly useful for detecting traces at higher sensitivities.

Differential input feature eliminates common-mode signals in the ratio 40,000:1 at 0.1 volt/cm, falling to a 1,000:1-ratio at 0.2 mv/cm

at 50 Kc. Oscilloscope amplifier passbands are d-c to 50 Kc on the 100-microvolt/cm range, increasing to 1 Mc on the 0.2-volt/cm range. Horizontal deflection is calibrated in steps of 0.1, 0.2, 0.5, 1, and 2-volts/cm and is accurate to 5 percent. Controls include separate focusing for each beam, plus a balance control to equalize the intensities of the two traces. Tektronix Inc, P.O. Box 500, Beaverton, Oregon, manufacture the Type 502A oscilloscope. The illustration shows it being used to tune an electronic organ. (302)



## Polycarbonate Capacitor Gives High Stability

**CAPABLE** of maintaining stability within 1 percent over  $-55$  to  $125$  C, Series K polycarbonate film capacitors can be supplied with tolerances of  $\pm 1$  percent and capacitances be-



# JFD PRECISION TRIMMER PISTON CAPACITORS ENABLE MOTOROLA'S FREQUENCY STANDARD TO ACHIEVE $1 \times 10^{-11}$ SETABILITY



MODEL VCJ673 0.7 pf-12.0 pf ACTUAL SIZE

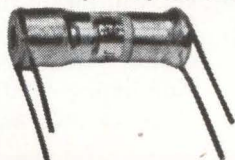

MODEL MC623 1.0-28.0 pf ACTUAL SIZE

The Motorola 1011 Silicon Solid State Frequency Standard provides precision tuning, navigational and communications systems measurements for military and industrial standards laboratories. With less than  $5 \times 10^{-11}$  crystal aging per day, the Motorola 1011 closely approaches atomic standard ultra-stability.

Because of its exceptional stability, the fine frequency adjust control is settable to 1 part in  $10^{-11}$ . To help achieve this value, the JFD VCJ673 trimmer, a special modification of the JFD Super MAX-C was selected. The sealed interior construction of the JFD VCJ673 locks out all atmospheric effects. C of the unit is 0.7 to 12.0 pf. It offers a capacitance variation of 0.6 pf per full turn. Such variation is, in effect, again demultiplied by the diameter of the geared tuning mechanism

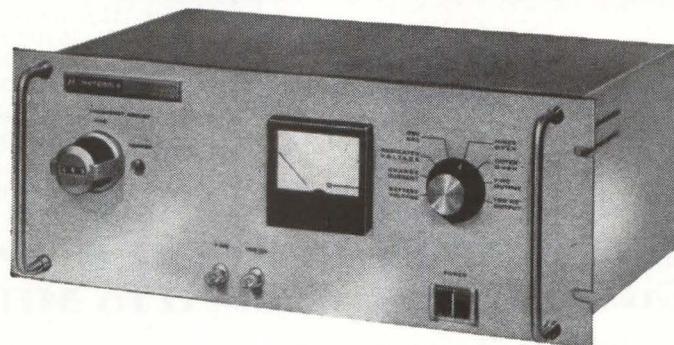

for extreme tuning sensitivity. Stability is  $\pm 50$  PPM/ $^{\circ}$ C. Its fine vernier adjustment is absolutely linear and repeatable to within  $\pm 1\%$ .

The coarse frequency adjustment uses a JFD MC623 MAX-C Trimmer Sealcap Capacitor for a C of 1.0 to 28.0 pf., in a very compact unit. JFD MAX-C Trimmer Capacitors meet or exceed all applicable performance or environmental requirements of Mil-C-14409A. The unit's rapid tuning characteristics speed setting to the required coarse tuning position.

Thousands of JFD trimmers are serving in demanding applications such as these. Why don't you put JFD trimmer experience to work in your present or projected products?

$1 \times 10^{-11}$   
SETABILITY

$5 \times 10^{-11}$   
AGING PER DAY

$5 \times 10^{-11}$   
SHORT TERM STABILITY, 1 SECOND COUNTS

LESS THAN  $2 \times 10^{-10}$   
 $20^{\circ}$  C  $\pm$   $20^{\circ}$  C

**JFD ELECTRONICS CORPORATION**  
THE  $\neq$  AMERICA KNOWS BEST!

Components Division

JFD ELECTRONICS CORPORATION, 15th Ave. at 62nd St., Brooklyn 19, N. Y. • DEWEY 1-1000  
 JFD NORTHEASTERN, Ruth Drive, P.O., Box 228, Marlboro, Mass. • HUNTLAY 5-7311  
 JFD MID-ATLANTIC, 313 E. Broad St., Palmyra, N. J. • 609-655-0788  
 JFD MIDWESTERN, 6330 Hermione St., Chicago 46, Illinois • 775-5424,5425  
 JFD MIDWESTERN-OHIO, 7415 Montgomery Road, Cincinnati 36, Ohio • 513-421-1166  
 JFD WESTERN, 9 Morlan Place, Arcadia, California, • 213 HI 6-0312  
 JFD CANADA, LTD., 51 McCormack Street, Toronto, Ontario, Canada • ROGER 2-7571  
 STANDARD TELEPHONE & CABLES LTD., Components Group, Capacitor Sales Dept., Footscray, Sidcup, Kent, England  
 LCC STEAFIX, 128 Rue de Paris, Boite Postale 51, Montreuil-sous-Bois, Seine, France  
 JFD ISRAEL, LTD., Bldg. 23, Industrial Area B, Azur, Israel  
 DUCON CONDENSER PTY. LTD., Christina Road, Villawood, N.S.W., Australia

Variable Trimmer Piston Capacitors ■ Metalized Inductors ■ LC Tuners ■ Fixed Capacitors ■ Fixed and Variable Distributed and Lumped Constant Delay Lines ■ Pulse Forming Networks

See What's New at JFD WESCON BOOTH No. 3212, 3213



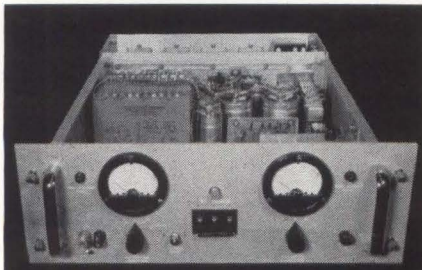

### COMPUTER SYSTEM SUPPLY

Input: 108/220 VAC., 60 cps  $\pm 10\%$  3 phase, 4 wire  
 Output: 4.4 VDC @ 0-12 amps. (overvoltage, overcurrent protection)  
 Regulation:  $\pm 0.1\%$   
 Ripple: 1 MV, peak to peak  
 Temp: 0-50°C  
 Mil Specs: Mil-E-4158, Mil-Q-9858

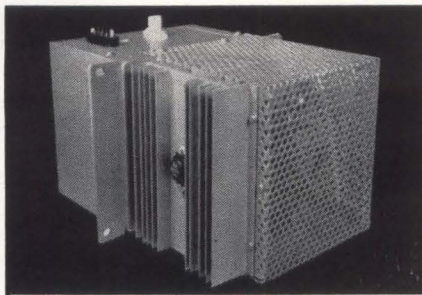

### ADJUSTABLE HIGH VOLTAGE SUPPLY

Input: +20 VDC @ 1.4 amps max.  
 Output: Adjustable 4 KVDC to 5 KVDC @ 2.0 ma.  
 Regulation:  $\pm 1\%$   
 Ripple:  $\pm 0.05\%$   
 Temp: 0-65°C

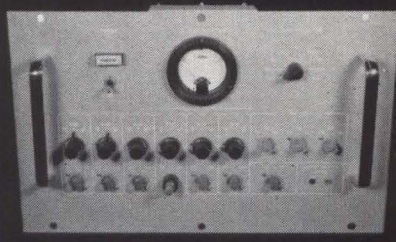
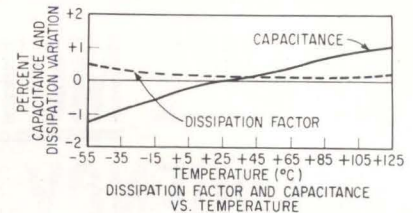
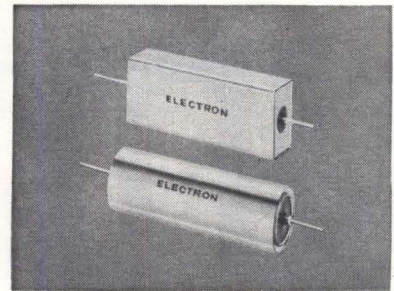

### MULTIPLE OUTPUT SYSTEM SUPPLY

Input: 115 VAC  $\pm 10\%$ , 400 cps  $\pm 10\%$ , 3 phase  
 Outputs: +50 VDC @ 0.25 amps  
 +10 VDC @ 3.0 amps  
 -5 VDC @ 12 amps  
 -10 VDC @ 8 amps  
 -12 VDC @ 0.75 amps  
 -30 VDC @ 1.5 amps  
 Regulation: 1%  
 Ripple: 8 MV, peak to peak  
 Temp: -29°C to +55°C  
 Mil Specs: Mil-I-945, Mil-Q-9858

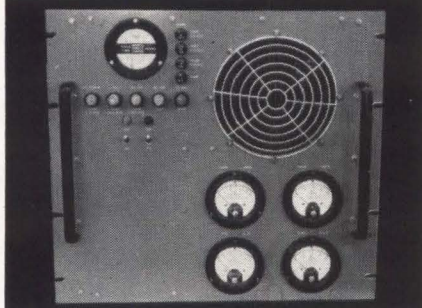

### GROUND SUPPORT POWER SUPPLY

Input: 120 VAC  $\pm 10\%$ , 48-62 cps. Single phase  
 Outputs: 145 to 155 VDC, 0-2.5 amps  
 10 to 16 VDC, 0-2.5 amps  
 6.2 to 6.8 VDC, 25 amps  
 Regulation: 1 and 2...0.15%, 3...2%  
 Ripple: outputs 1 & 2 less than 0.05%  
 output 3, less than 5%  
 Temp: 0-55°C  
 Mil Specs: Mil-E-4158, Mil-E-4970, Mil-R-26474

tween 0.001 and 1.5 microfarads. These capacitors are credited with the characteristics and performance of polystyrene dielectrics and have temperature ratings approaching those of Teflon.

Series K capacitors are intended for use in computers, discriminators, integrators, differentiators, and other circuits where, according to the manufacturer, Electron Products Division, Marshall Industries, 1960 Walker Avenue, Monrovia, California, their high stability, wide temperature range and excellent retrace characteristics provide improved circuit operation.

CIRCLE 303, READER SERVICE CARD

## HYPERION POWER SUPPLIES Custom Engineered to Mil Specs.

Hyperion's "custom engineered" power-supplies employ modular circuit techniques, easily accessible plug-in modules and internal modular construction, to increase mean time between failure figure and decrease mean time to repair figure. Power supplies of this construction have been manufactured and designed by Hyperion for such diversified fields as airborne, shipborne, satellite, ground support, missile support and applications which include TWT, Klystron, High Voltage, Computer and many others. Illustrated above are a few specific examples.

Write or call Hyperion for your Standard or Custom Mil Spec. Power Supply requirements.

# Hyperion

## INDUSTRIES, INC.

### • POWER EQUIPMENT DIVISION

127 COOLIDGE HILL ROAD, WATERTOWN, MASSACHUSETTS  
 TWXN: WTNW MASS 860 TEL: WA 6-0140



### Walnut Sized Amplifier Delivers Five Watts

TRANSISTOR amplifier is assembled in cordwood fashion using standard and miniaturized components. It comes epoxy potted to withstand arduous shock and environmental stresses. Amplifier is designed to drive 400-cycle servo motors and has built-in 90-degree phase shift. Output is linear to 1.5 volts rms and



remains effective to 6 volts rms maximum. Input impedance is around 50 kilohms with a gain of about 10; various models are available with gains ranging up to 1,000 for an input resistance of 4,000 ohms. Typical operating temperature covers  $-55^{\circ}\text{C}$  to  $125^{\circ}\text{C}$ ; input supply is 28 volts nominal with 11 watts consumption at maximum output. The amplifier is manufactured by Kearfott Division, General Precision, Inc., Little Falls, N. J. (304)

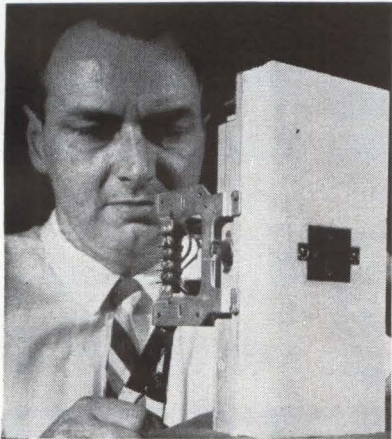

### Cascade Unit with Matched Power Supply

THERMOELECTRIC cascade unit with matched power supply—a complete two-stage heat pump that heats or cools to provide a constant temperature throughout a wide range of conditions—is now available. The W832G03 provides a  $-50^{\circ}\text{C}$  cold side temperature while cooling a 400-mw load. It is designed to operate with 24 amperes of d-c device current. The rating is based on an ambient temperature of  $24^{\circ}\text{C}$ . The cascade unit is ideal for use in apparatus for freezing-point measurements, dew-point meters, freezing traps, photomultiplier-tube coolers and many other low-temperature applications. Westinghouse Semiconductor Division, Youngwood, Pa. (305)

### Netic Containers Protect Tapes

TWO new round, sturdy, long life, simplified design, spun construction Netic containers,  $3\frac{1}{2}$  and 20 in. diameter, fully protect magnetic tapes, components and other mag-

netically affected devices from unexpected exposure to damaging magnetic fields during transportation or storage. Any in-between size or shape can be fabricated. The Netic S3-5 alloy's shielding effectiveness is not diminished by dropping, rough handling or proximity to magnetic fields as Netic is shock insensitive, non-retentive and does not require periodic annealing. Magnetic Shield Division Perfection Mica Co., 1322 No. Elston Ave., Chicago 22, Ill. (306)



### Instrument Panel Kit Saves Time and Expense

COMPLETELY self-contained panel production kit produces up to four color permanent aluminum panels in twenty minutes. No graphic skills are required; no dark room or other special equipment necessary. No dangerous chemicals are involved in the process. Complete operation can be performed on a table. Electro-Kits are priced from \$19.95. Halmar Electronics, Inc., 1544 W. Mound St., Columbus 23, Ohio. (307)

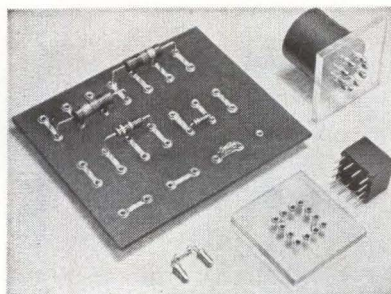

### P-C Board Jacks Are Reusable

REUSABLE printed circuit board jack prevents damage to components during "burn-in" testing and eliminates the costly replacement of printed board test fixtures. The jack consists of two parts, a drawn cup which is hand, dip or wave soldered

# HYPERION



## Model HI-316



The Model HI-316, Time Display Unit accepts in serial IRIG Format B or NASA 30 BIT, 1KC amplitude modulated time code and displays Time in Hours, Minutes, and Seconds.

#### SPECIFICATIONS

- Input:** IRIG Format B, 1KC amplitude modulated time code at 0.5 to 5.0 volts P-P
- Display:** UPDATED time of Day in decimal Hours, Minutes, and Seconds
- Output:** UPDATED BCD parallel time; Binary "0" = 0 Volts Binary "1" = -10 Volts
- Input Power:** 110 VAC, 45-440 cps.
- Size:**  $3\frac{1}{2}$ " High x 19" Wide x 17" Deep

The unit can accept other serial Time Code Formats on special order.

Write for Technical Bulletin 583

**Hyperion**  
INDUSTRIES, INC.

• DIGITAL PRODUCTS DIVISION  
127 COOLIDGE HILL ROAD, WATERTOWN, MASSACHUSETTS  
TWXN: WTVN MASS 860 TEL: WA 6-0140

CIRCLE 103 ON READER SERVICE CARD



# Cornered by PW Assembly Problems?

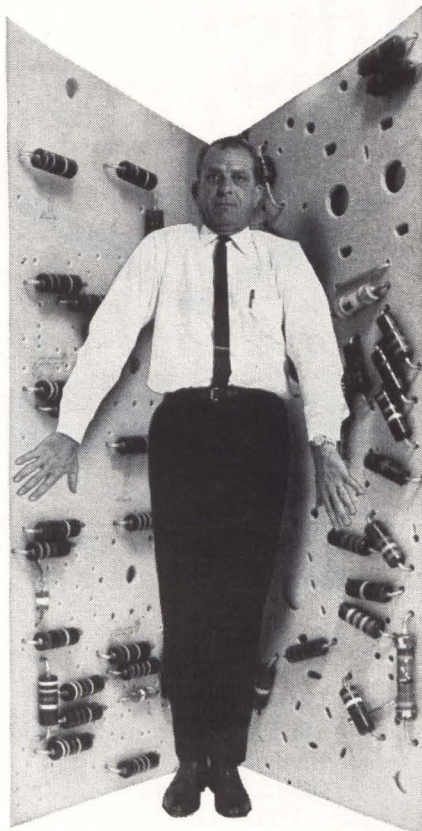

## DYNASERT®

Discover how automatic inserting equipment can open new ways to profit for you. This is modern, automated component insertion. Even if your production is as little as a few hundred insertions a week, Dynasert delivers a multitude of advantages. It's high-speed: up to ten times faster than costly hand methods. It delivers uniformly high product quality. It automatically feeds, cuts, and bends leads, inserts and clinches all types of axial lead components. Requires little operator training. Changes made from one board or component type in seconds. Money saved in direct labor costs and production time can pay for a Dynasert installation in less than a year. Get complete facts. Write for a free copy of: Dynasert — Production Equipment for Electronics. Dynasert Dept. 3, United Shoe Machinery Corp., Boston, Massachusetts.



**United Shoe Machinery**  
BOSTON, MASSACHUSETTS

in the board, and a spring receptacle in the cup which holds the component lead in place. Use of the reusable jack in the test board allows for mounting of various components by hand insertion without soldering of the component lead. One jack size accepts a wide variety of components with leads from 0.018 to 0.040. Only one hole size is necessary in the board to mount the jack. AMP Inc., Harrisburg, Pa.  
CIRCLE 308, READER SERVICE CARD

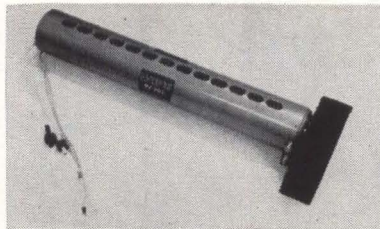

## Broadband TWT for UHF Microwave Use

HIGH POWER, broadband traveling wave tube for uhf microwave applications is available. The MA-2001C is an electromagnetically focused, forced air cooled twt designed for electronic countermeasure applications and for new phased-array radars. High power and gain performance are obtained over an octave bandwidth. Frequency range is 400 to 1,000 Mc with a nominal power output of 300 w c-w. Nominal efficiency is 25 percent. Tube weighs 31 lb. Microwave Associates, Inc., South Ave., Burlington, Mass. (309)

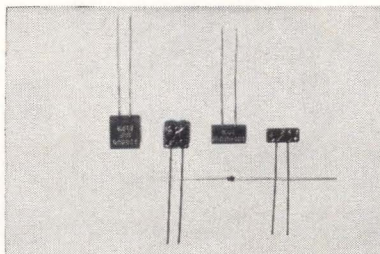

## Ceramic Capacitors Save Space

RESIN-ENCAPSULATED microminiaturized ceramic capacitors from 10  $\mu\mu\text{f}$  to 120,000  $\mu\mu\text{f}$  with 0.025 diameter radial leads are offered. Values to 10,000  $\mu\mu\text{f}$  also available with gold flash lumet 0.016 diameter axial leads. Working volt-

measure dc



100mv to 500v

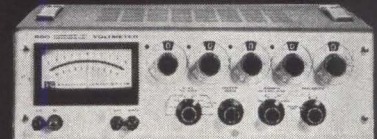

within 0.02%

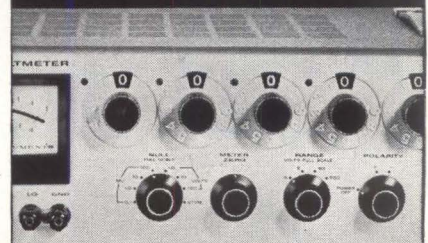

## New Differential Voltmeter

Keithley 660 measures dc voltages with the accuracy and stability of a laboratory standard and the ease and low cost of an ordinary VTVM.

### Features include:

- 0.02% limit of error
- reference supply stable to 0.005% indefinitely, without periodic re-standardization
- 100  $\mu\text{v}$  f.s. null range
- 2  $\mu\text{v}$  resolution
- infinite resistance at null, to 500v
- 0.005% repeatability
- 25 mv recorder output
- fully guarded input
- positive, negative or floating

Model 660 Differential Voltmeter . . . \$575  
Model 6601A Voltage Divider . . . \$175

Send for four page Engineering  
Note on the Model 660

latest catalog available  
upon request



**KEITHLEY  
INSTRUMENTS**

12415 Euclid Avenue • Cleveland 6, Ohio



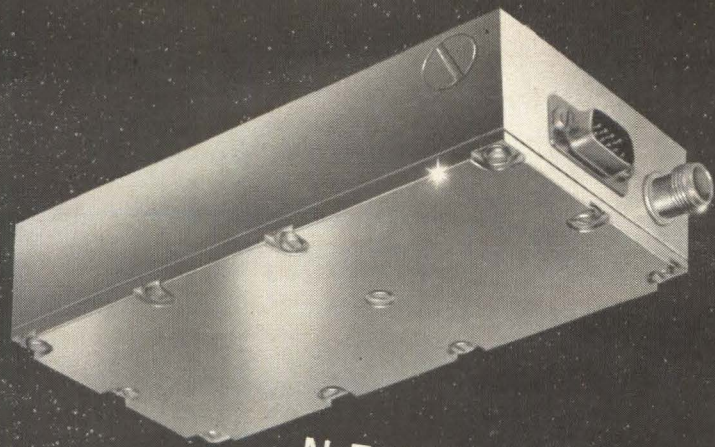

NEW  
LEACH  
TWO-WATT  
FM TELEMETRY  
TRANSMITTER HAS  
WIDEST FREQUENCY  
MODULATION RESPONSE  
IN OR OUT OF THIS WORLD!  
(5 cps to 125 kcps within 1.5 db)

And hear this! It performs to specs through 20 G's vibration and temperatures to +85°C. It's completely transistorized down to the final power amplifier. It's tiny - 1.3" x 2.9" x 5.75".

And this. The new Leach 2-watt Telemetry Transmitter has a low power consumption (655 milliamps maximum at 28 vdc) and because it's FM, it provides linear deviation with modulation signals.

This Leach Telemetry Transmitter has already passed stringent customer tests. Compare it to your requirements. A call or letter to Leach is the best way to begin.

**LEACH**  
CORPORATION

CONTROLS DIVISION: 717 N. Coney Ave.  
AZUSA, CALIFORNIA • Phone: 334-8211  
Export: LEACH INTERNATIONAL S. A.



# NEW! HIGH SENSITIVITY

## GENERAL PURPOSE 247A

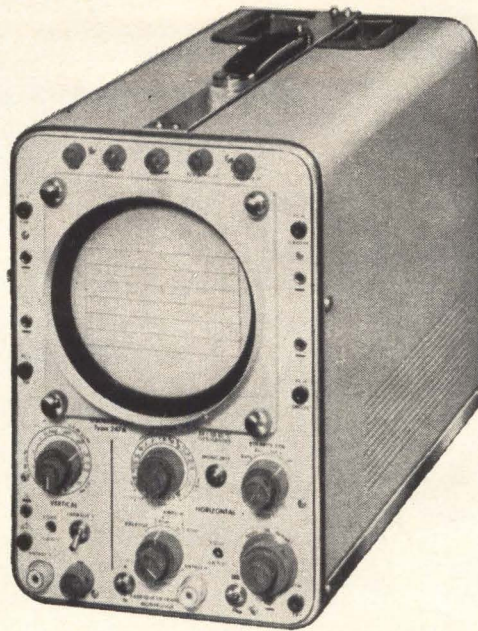

The type 247-A oscilloscope fully qualifies as a universal instrument because its performances and the size (13 cm (5") dia.) of its C.R. Tube authorize accurate measurements and tests in all fields of low-frequency instrumentation. Also, because of its simplicity of operation, the 247-A is ideally suited for practical laboratory work of an educational nature.

### TECHNICAL SPECIFICATIONS

#### Vertical amplifier

1 channel; Frequency range: DC to 1 Mc/s (-3 dB)  
Sensitivity: 50 mV/cm

AC: 10 c/s sine wave or 50 c/s square-wave to 100 Kc/s (-3 dB)  
Sensitivity: 5 mV/cm

Calibrated attenuator: step-adjustable from 5 mV to 20 V/cm  
in 12 positions

Sequence: 1 - 2 - 5 - 10 etc...

Attenuator vernier ratio 1/3

Constant input impedance: 1 M  $\Omega$  47 pF

#### Sweep

Free-running - triggered - single sweep

Duration: 1 s/cm to 0.5  $\mu$ s/cm in 20 calibrated positions

Vernier: 1:3 ratio -

x 5 magnification expanding  
sweep durations from 3 s/cm to 0.1  $\mu$ s/cm

#### Sync

5 positions: single-sweep, HF, LF, TV-line, TV-frame

Polarity: + or - internal or external

selection of triggering level

#### Horizontal Amplifier

Frequency range: 0 to 500 Kc/s (-3 dB)

Sensitivity: 1 V/cm or 10 V/cm (switch-selected)

Vernier: 0 to 1

Constant input impedance: 1 M  $\Omega$  and 47 pF

#### Cathode-ray Tube

5 ADP 2 or equivalent type

Screen: 13 cm (5") dia.

deflection factors:

X: 30 V/cm (approx.)

Y: 20 V/cm (approx.)

Direct drive of H and V plates

Acceleration voltage: 3 Kv

### MECHANICAL FEATURES

Light-alloy chassis, readily-detachable panel for easy access to circuits.

#### 1) Tube complement

9/ECF80 - 2 6X4 or equivalent types

#### 2) Power supply

105 - 115 - 127 - 220 - 240 V - 50 or 60 c/s

#### 3) Dimensions

Width: 20,5 cm - (8")

Depth: 38,5 cm - (15")

Height: 31 cm - (12")

Weight: 14 kg - (30 lbs)

### OTHER INSTRUMENTS

#### Oscilloscopes

204 A - High speed and fast rise oscilloscope

241 A - 242 A - 243 A, Multi-function osc. with  
plug-in preamplifiers.

255 B - Portable oscilloscope

245 A - High performance portable oscilloscope

246 A - High sensitivity low-frequency oscilloscope

248 A - Maintenance oscilloscope.

#### Sweep frequency Generators

411 A - Laboratory sweep frequency generator

410 B - TV - FM sweep frequency generator

476 A - Radio sweep frequency generator

#### Signal Generators

405 A - Low frequency RC signal gen. (30 c/s - 300 Kc/s)

428 A - HF constant amplitude signal generator

(100 Kc/s - 30 Mc/s)

458 - Pulse generator (5 c/s - 50 Kc/s),

#### TV pattern generators

465 C - Portable electronic pattern generator

464 A - Test - pattern generator

#### Regulated power supplies

117 A - Transistorised regulated power supply

114 A - Regulated power supply

#### Cameras

1000 A - oscilloscope camera with Polaroid

1001 B - oscilloscope recorder

age 200 d-c; temperature 150 C. All units are built to conform to MIL-C-11015 C. U. S. Capacitor Corp., 8917 Melrose Ave., Los Angeles, Calif.

CIRCLE 310, READER SERVICE CARD

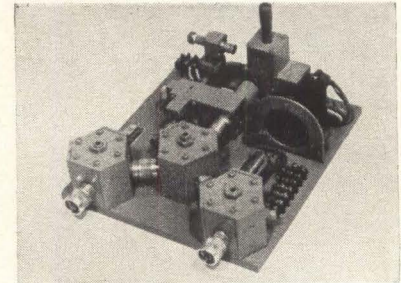

### Parametric Amplifier Has Low Noise Figure

A LOW-NOISE S-band solid-state parametric amplifier for applications as a preamplifier in radar, telemetering and satellite-tracking receivers is announced. Basic specifications: gain, 20 db; bandwidth, 50 Mc; noise figure, 2.0 db max, including a 10 db second stage; frequency tuning range, 2,900 to 3,100 Mc. Micromega Corp., 4134 Del Ray Ave., Venice, Calif. (311)

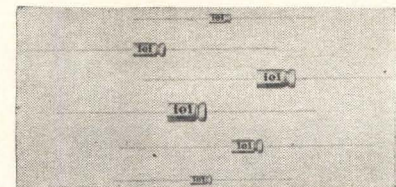

### Tantalum Wet Slugs Meet MIL-C-3965/4

TANTALUM wet slug electrolytic capacitors conform to MIL-C-3965/4. The CL64 and 65 subminiature capacitors are polar units suited for low voltage transistor applications such as filtering, coupling and bypass in both military and industrial electronic equipment. They offer high capacitance-to-volume and capacitance-to-weight ratios, yet are said to be substantially lower in cost than other types of tantalum capacitors. Voltage range is from 6 through 100 v d-c. Capacitance extends from 4.7 to 560  $\mu$ f, with  $\pm$ 20 percent tolerance. IEI Div., Standard Pressed Steel Co. Box 9036, Nashville, Tenn. (312)

INTER-PLANS

# RIBET-DESJARDINS

MEASURE & CONTROL DEPARTMENT, 13-17, rue Périer MONTRouGE/PARIS TEL: ALESIA 24-40  
CANADIAN BRANCH: RIBET-DESJARDINS (CANADA) Room 114, 5757 Decelles Avenue - MONTREAL.



**Silicon Choppers**

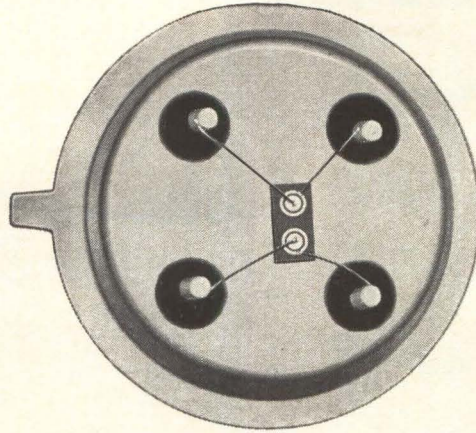

**Silicon Differential Amplifiers**

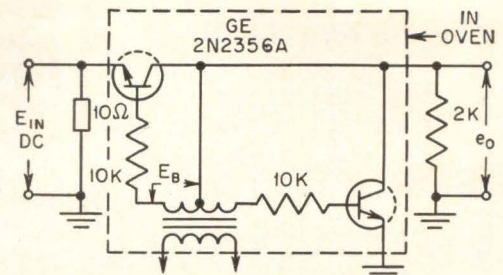
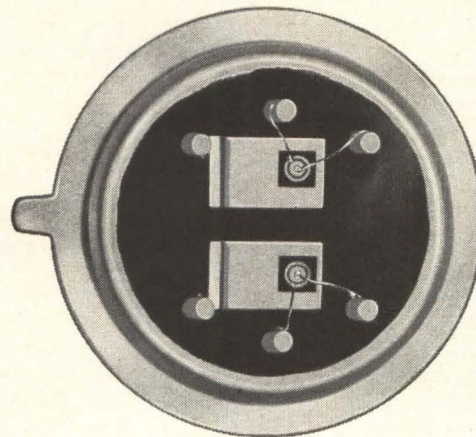

$E_B = 12 V_{P-P}, 400 \sim \text{SINE WAVE}$   
**Typical Low-Level Chopper**  
performance is  $0.6 \mu V/^{\circ}C$  from  $-55^{\circ}C$  to  $+155^{\circ}C$

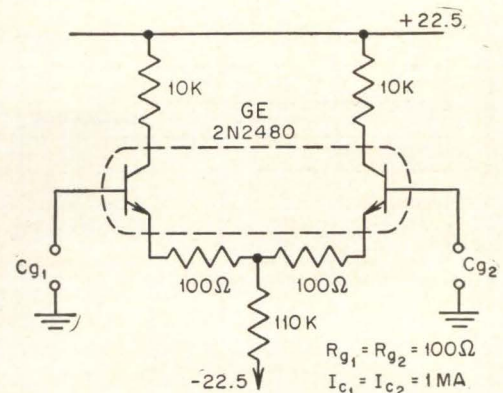

$R_{g1} = R_{g2} = 100 \Omega$   
 $I_{c1} = I_{c2} = 1 \text{ MA}$   
**Typical Low Drift Differential Amplifier**  
drift performance better than  $10 \mu V/^{\circ}C$

feature matched characteristics... extreme stability with life

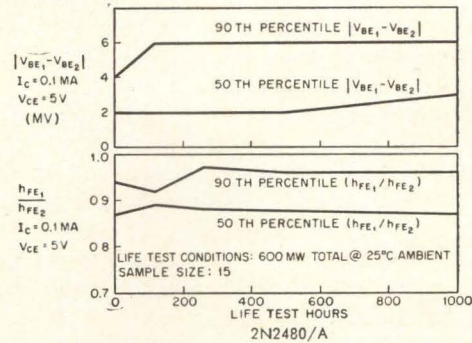
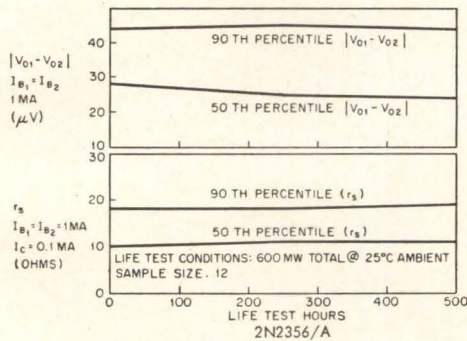

**SILICON NPN CHOPPERS**

Five-Terminal TO-5 Package Containing Two Planar Epitaxial Passivated Transistors

Type	Maximum	Minimum	Maximum	Maximum
	$V_o$ $I_{B1} = I_{B2} = 1 \text{ ma}$ $I_{E1} = I_{E2} = 0$ $\mu \text{ volts}$	$V_{E0}$ $I_{E1} = I_{E2} = 1 \text{ ma}$ $I_{B1} = I_{B2} = 0$ volts	$r_s$ $I_{B1} = I_{B2} = 1 \text{ ma}$ $I_{C1} = I_{C2} = 0.1 \text{ MA}$ ohms	$I_{CBO}$ OR $I_{CBO2}$ $V_{CB1}$ OR $V_{CB2} = 25V$ na
2N2356	50 @ $25^{\circ}C$	20	40	10
2N2356A	50 @ $-55^{\circ}C$ to $+125^{\circ}C$	20	40	10

**SILICON NPN DIFFERENTIAL AMPLIFIERS**

Six-Terminal TO-5 Package Containing Two Isolated NPN Planar Transistors

Type	Minimum	$h_{FE}$ $I_C = 1 \text{ ma}$ $V_{CE} = 5V$	$h_{FE}/h_{FE2}$ $I_C = 0.1$ or $1.0 \text{ ma}$ $V_{CE} = 5V$	Maximum
	$V_{CE0}$ $I_C = 20 \text{ ma}$ volts	$V_{BE1} - V_{BE2}$ $V_{CE} = 5V$ m volts	$I_C = 0.1$ or $1.0 \text{ ma}$ $V_{CE} = 5V$	$V_{BE1} - V_{BE2}$ m volts
2N2480	40	30 min	0.8-1.0	10
2N2480A	40	50-200	0.8-1.0	5
12A8	30	30 min	0.6-1.0	15

For complete details, call your local G-E Semiconductor District Sales Manager, or write Section 16F145, Semiconductor Products Department, General Electric Company, Electronics Park, Syracuse, New York. In Canada: Canadian General Electric, 189 Dufferin Street, Toronto, Ont. Export: International General Electric, 159 Madison Avenue, New York, New York.

**AVAILABLE THROUGH YOUR G-E SEMICONDUCTOR DISTRIBUTOR**

**GENERAL ELECTRIC**



# HOLD D.C. MOTOR SPEED TO 1%...AND BETTER

Globe set out to design a speed control precise enough to control d.c. motor speed exactly while line voltage and ambient temperature varied widely, and under high vibration, in a reasonably priced miniature package.

**We have accomplished just that.**

The Globe 1% Speed Control is conservatively named. What it does is to hold the speed of a motor within 1% of the speed you select **while** the ambient temperature is varied over the MIL-E-5272 range from  $-55^{\circ}\text{C}$  to  $75^{\circ}\text{C}$  **and while** the input voltage is varied from 22 to 32 v.d.c., **and while** the load is varied from zero to rated value.

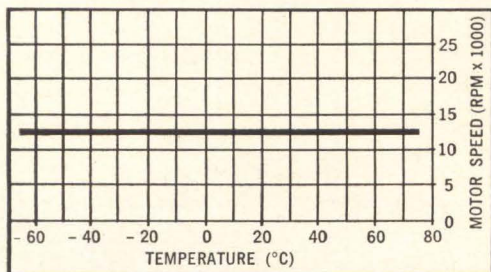
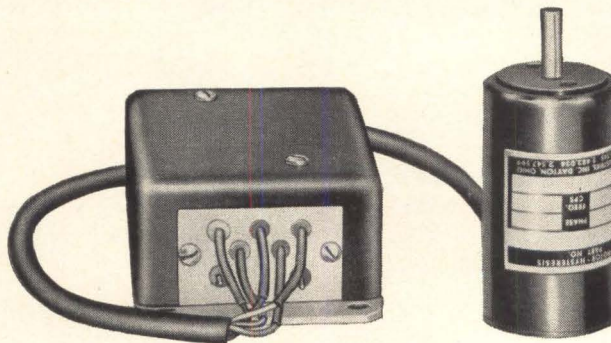

**TYPICAL MOTOR PERFORMANCE - 1% SPEED CONTROL**

■ The control is a solid state device in an 8 cubic inch package. Components are encapsulated to protect against vibration, shock, moisture and dust. Because there are no brushes, motor life can be as high as 10,000 hours at low speeds. The motor is any of several Globe frame size a.c. motors, wound for your application. You may specify any speed between 3,600 and 24,000 rpm (such as 12,027) and know that the motor speed will always be within 1%. But, if you can limit the environmental extremes, or regulate the voltage, control accuracy is improved well within the 1% range. At room temperature we have routinely held accuracies of 0.5% or better. Keep in mind, there are no moving parts to this control, and hence reduced shock and vibration vulnerability.

■ Where can you use it? Anywhere that you need accurate speed control. Various kinds of recorders are obvious applications. So are precise timers, samplers, and feed devices. By coupling a Globe gear reducer to the motor, you can specify and obtain literally **any** shaft speed from 1 revolution per day to 24,000 rpm.

■ Because the Globe 1% Speed Control is **designed** to be practical, you can specify reverse voltage polarity protection and transient protection in the same size envelope. Only minimum radio noise filtering is needed to meet specs. As a bonus you get all of the benefits of d.c. brushless motors—long life, no brush dust, no brush replacement, no arcing, no mechanical governor or contacts.

■ For the ultimate d.c. speed control, accurate within a few parts per million, we can also furnish a highly sophisticated crystal controlled error correcting feedback device, although the price is several times the modest price of the 1% Speed Control. Request Bulletin S-1.

Globe Industries, Inc., 1784 Stanley Avenue, Dayton 4, Ohio.

**GLOBE**



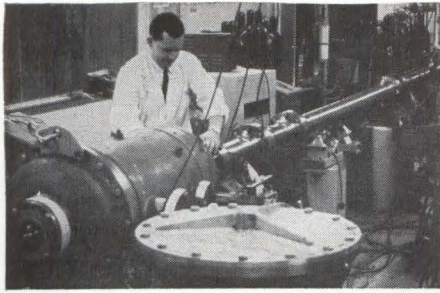

Super-orbital entry of a space vehicle—one returning to earth from a planet, rather than from an earth-orbiting mission—would result in searing *radiative* heating in addition to the more familiar *convective* type. As a spacecraft nose enters atmosphere, it pushes the thin air aside. A boundary layer is formed next to the skin. Ahead of that is a compressed mass of air; fronting that, a shock wave. The air behind the shock wave becomes incandescent, ionizes, and radiates to the heat shield. Within the boundary layer, friction heats the nose cone by convection.

Lockheed scientists believe that at higher than escape speed a blunt-nosed vehicle may be unable to sustain the radiative heating. Consequently, a return to the previously discarded sharp nose is

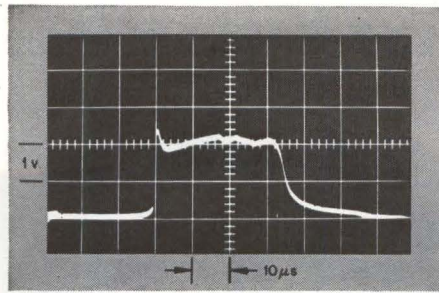

indicated. Fluid mechanicians are calculating the heat load, determining how rapidly the nose will ablate and how to keep it sharp. Current shock tube tests are providing some clues.

Another research project in Lockheed's Fluid Mechanics Laboratories relates to the flow of buoyant fluids. A typical study program is the determination of how liquid hydrogen, stored in a tank in space, stratifies. This, in turn, determines the level of pressurization required in order to extract all of the fluid. Scientists made a mathematical model of what they think occurs inside the tank. With this as a guide, an actual tank was constructed to obtain measurements and photographs of the flow to verify their theories.

## LOOK AT LOCKHEED... AS A CAREER

Consider Lockheed's leadership in space technology. Evaluate its accomplishments—such as the Polaris missile, the Agena vehicle's superb record of space missions. Examine its outstanding advantages—location, advancement policies, creative climate, opportunity for recognition.

Then write for a brochure that gives you a more complete Look at Lockheed. Address: Research & Development Staff, Dept. M-46B, P.O. Box 504, Sunnyvale, California. Lockheed is an equal opportunity employer.

**SCIENTISTS & ENGINEERS:** In addition to positions relating to fluid mechanics, other important openings exist for specialists in: Inertial guidance • Orbit thermodynamics • Electromagnetics • Mission & trajectory analysis • Gas dynamics • Chemical and nuclear propulsion • Systems engineering

**LOCKHEED**  
**MISSILES & SPACE COMPANY**  
A GROUP DIVISION OF LOCKHEED AIRCRAFT CORPORATION

Sunnyvale, Palo Alto, Van Nuys, Santa Cruz, Santa Maria, California • Cape Canaveral, Florida • Huntsville, Alabama • Hawaii

## LOOK AT LOCKHEED IN FLUID MECHANICS:

*Taming temperature extremes*

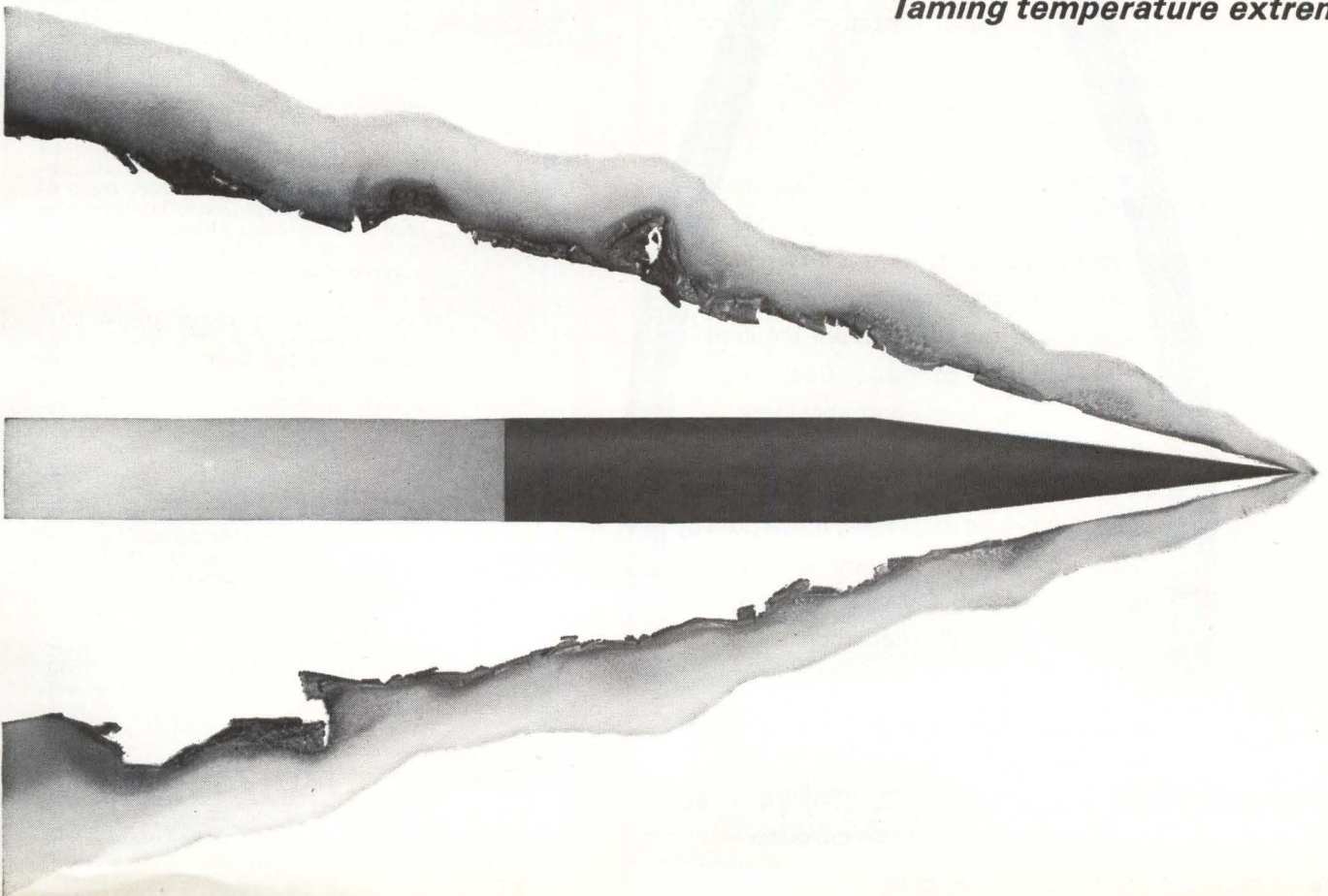



# UTICA

**NEW 34-6 ELECTRONIC PLIER**

**FOR LONG REACH AND SNAP CUT!**

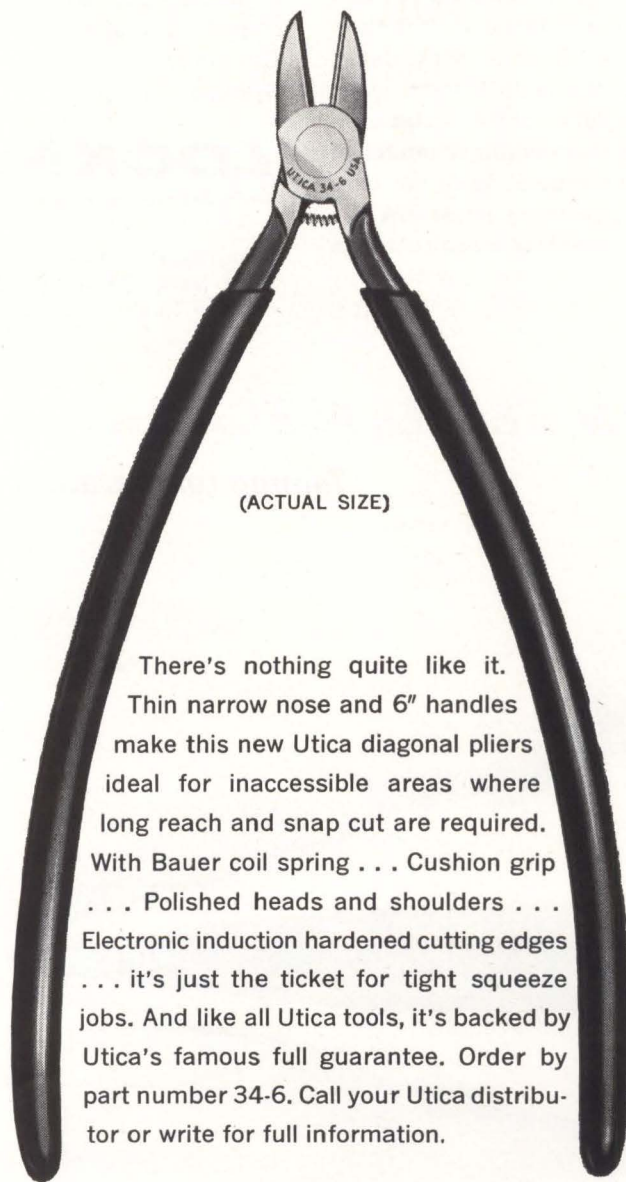

(ACTUAL SIZE)

There's nothing quite like it. Thin narrow nose and 6" handles make this new Utica diagonal pliers ideal for inaccessible areas where long reach and snap cut are required. With Bauer coil spring . . . Cushion grip . . . Polished heads and shoulders . . . Electronic induction hardened cutting edges . . . it's just the ticket for tight squeeze jobs. And like all Utica tools, it's backed by Utica's famous full guarantee. Order by part number 34-6. Call your Utica distributor or write for full information.

**Tools the experts use!**

**UTICA DROP FORGE & HERBRAND TOOL DIVISION • KELSEY-HAYES CO.**  
ORANGEBURG, SOUTH CAROLINA

## Literature of the Week

**PRECISION GLASS PARTS** Hanibal Glass, Inc., 3025 Kilson Drive, Santa Ana, Calif., has available a 4-page catalog describing the broad range of precision glass parts it produces for the electronics industry. CIRCLE 313, READER SERVICE CARD

**LABORATORY POWER SUPPLIES** Electronic Research Associates, Inc., 67 Factory Place, Cedar Grove, N. J., has available a catalog supplement covering its Magitran line of magnetic-transistor lab power supplies. (314)

**TEFLON** The Modern Industrial Plastics Division of the Duriron Co., 3337 N. Dixie Drive, Dayton 14, O., offers a brochure featuring applications for Teflon and other fluorocarbon products. (315)

**RPM CONTROL & MEASUREMENT** Airpax Electronics Inc., Fort Lauderdale, Fla. Catalog S1-1 describes the installation and operation of a comprehensive line of electronic tachometers developed for industrial and military use. (316)

**MICA CAPACITORS** Sangamo Electric Co., Springfield, Ill., has published bulletin 2321 describing a complete line of fixed terminal, molded mica capacitors. (317)

**OSCILLOGRAPH RECORDING SYSTEMS** Brush Instruments Division of Clevite Corp., 37th and Perkins, Cleveland 14, O. Brochure 1100 describes oscillograph recording systems for military, industrial, and scientific applications. (318)

**ELECTROLYTIC CAPACITORS** Standard Pressed Steel Co., Box 596, Jenkintown, Pa. A 12-page brochure contains application data, construction and performance characteristics on a line of solid tantalum dry slug electrolytic capacitors. (319)

**FLAME RETARDANT EPOXY** Union Carbide Plastics Co., 270 Park Ave., New York 17, N. Y. Product data folder describes the new Bakelite epoxy resin ERSA-2450 flame retardant laminates. (320)

**BOBBINS** Thermotech Industries, Inc., 1202 South Fifth St., Hopkins, Minn., offers a two-color 25½ in. by 22 in. chart suitable for wall mounting showing a complete listing of its line of molded coil winding bobbins. (321)

**TRANSFORMER DESIGNS** Aladdin Electronics, 703 Murfreesboro Road, Nashville, Tenn. Engineering bulletin No. 125 lists standard units in two new series of transformer designs. (322)

**DI-HEPTAL SOCKET** Connector Corp., 6025 No. Keystone Ave., Chicago 46, Ill. Data sheet 24A covers the





## Why Your Electronics Plant Belongs in Atlanta

Compute the unique combination of advantages listed below, and you'll see why Atlanta is an ideal location for today's electronics assembly operations.

**High productivity.** For every dollar of wages paid, an Atlanta manufacturer of electronic measuring instruments can expect \$3.76 in value added by manufacture. In Chicago he would gain only \$2.90; in New York-New Jersey, \$2.64 (U. S. Census figures). Atlanta's large labor pool also permits a high degree of selective hiring.

**Trained engineers and technicians.** In 1962 Atlanta's 19 colleges and universities granted over 1,000 Bachelor of Science degrees — more than 200 in electrical engineering and physics. Nearly 300 technicians graduate here yearly.

**Proximity to aerospace and atomic energy installations.** Atlanta is at the center of some 21 military, NASA, AEC, and airframe manufacturing installations, including Oak Ridge, Redstone Arsenal, Cape Canaveral.

**Transportation.** Close liaison between manufacturer and customer and rapid freight service are guaranteed by Atlanta's transportation facilities. Seven airlines offer non-stop service from Atlanta to more than 50 cities; 75 truck lines provide scheduled service to every major market in the nation; 7 railroads operate into and out of the city over 13 main lines.

**Independent research capabilities.** Georgia Tech's Engineering Experiment Station, Emory University, the University of Georgia, plus a number of private companies, offer a wide range of research capabilities on a contractual basis to business and industry.

Ask for an analysis of your company's probable success in Atlanta as prepared by Georgia Tech's 43-man Industrial Development Division. Check coupon; mail with your company letterhead. All inquiries confidential.

Please send me the following reports and other information as checked below.

1.  Calculators and Computers—A Manufacturing Opportunity in Atlanta
2.  Electronic Testing and Measuring Instruments—A Manufacturing Opportunity in Atlanta
3.  Electronics—A Manufacturing Opportunity in Georgia
4.  I would like information on the following aspect(s) of Atlanta's economic and general make-up (list) \_\_\_\_\_
5.  I want to know my company's prospects for success in Atlanta as analyzed by Georgia Tech's Industrial Development Division. We would be interested primarily in a new  plant  warehouse  sales office  other \_\_\_\_\_



"Forward Atlanta"  
Paul Miller, Industrial Manager  
Atlanta Chamber of Commerce  
1340 Commerce Building  
Atlanta 3, Ga. Phone: 521-0845

Name \_\_\_\_\_ Title \_\_\_\_\_  
Company \_\_\_\_\_  
Product \_\_\_\_\_  
Street \_\_\_\_\_  
City \_\_\_\_\_ Zone \_\_\_\_\_ State \_\_\_\_\_

CONFIDENTIAL



FOR MINIATURE CONTACT PARTS WRITE  
**GENERAL FINDINGS INC.**  
 Pearl Street, Attleboro, Mass.

# CONTACT MATERIALS

A complete selection of all mill shapes and types with a wide variety of laminations combining alloys of Gold, Silver, Platinum and Palladium.

**Semiconductor Materials**  
 also available

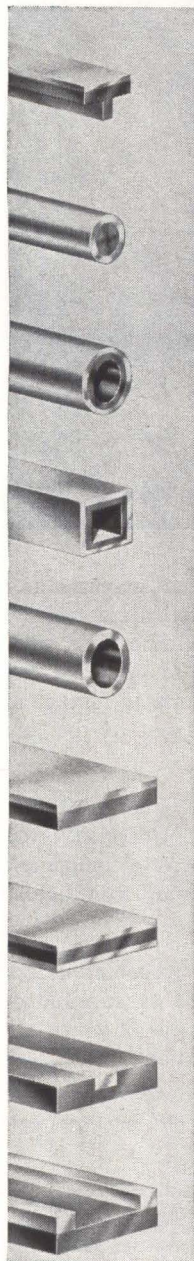

## WIRE TUBING SHEET

Engineering Assistance Available

Prompt Delivery

Competitive Prices

Low Cost!

**New ALLOY 239**

Gold Palladium Base Alloy

Send for free Technical Bulletin

## SILVER AND GOLD SOLDERS

Silver and Laminated Wave Guide Tubing

## SALES OFFICES

Chicago  
 Los Angeles  
 New York

INDUSTRIAL DIVISION

# LEACH & GARNER

Prompt quotes to your prints and specifications  
 52 Pearl Street, Attleboro, Mass.

type 545 miniature crt socket which mates with JEDEC B12-244 di-hedral base. (323)

**ACTIVE FILTER NETWORKS** Guillemin Networks, Inc., 381 Eliot St., Newton 64, Mass. Data sheet describes active filter networks with Q of 200 for l-f applications. (324)

**HYDROGEN THYRATRON** Calvert Electronics Inc., 220 E. 23rd St., New York 10, N. Y., has an *Application Report* on the English Electric hydrogen thyatron assembly for 75 mw pulse output. (325)

**THIN-FILM FLIP-FLOP** Halex, Inc., 139 Maryland St., El Segundo, Calif. Specification sheet on model 1010FF microminiature thin-film flip-flop provides complete specifications with diagrams. (326)

**TRAVELING WAVE TUBES** Sperry Electronic Tube Division, Gainesville, Fla., offers an informative technical paper entitled "Some Factors Affecting Size and Weight of Traveling Wave Tubes." (327)

**SERVO MOTORS** Kearfott Division, General Precision Aerospace, Little Falls, N. J. Technical data sheet covers the CZO 9634 001 size 40 high power servo motors. (328)

**REGULATED SUPPLIES** Alpha Scientific Laboratories, Inc., P.O. Box 333, Berkeley 1, Calif. Data sheet covers regulated power supplies for magnets and general purposes. (329)

**MAGNETIC CIRCUIT BREAKERS** Metals & Controls Inc., a corporate division of Texas Instruments Inc., Attleboro, Mass. Catalog data sheet describes the Klixon 4MC series trip-free magnetic circuit breakers. (330)

**OSCILLOSCOPES** Tektronix, Inc., Box 500, Beaverton, Ore., has published an 8-page brochure describing 14 types of oscilloscopes designed for rack and console service. Request on business letterhead.

**IRON CORE COMPONENTS** United Transformer Corp., 150 Varick St., New York 13, N. Y., announces release of its two new 1963-1964 catalogs of iron core components. (331)

**MICROWAVES** LP Associates, 11924 W. Washington Blvd., Los Angeles 66, Calif. Brochure describes the company's design, development and manufacturing capability in microwave electronics. (332)

**REFLEX KLYSTRONS** Raytheon Co., Waltham 54, Mass. Four-page, two-color brochure describes six new millimeter reflex klystrons. (333)

**VARIABLE RESISTOR** CTS of Berne, Inc., Berne, Ind. Data sheet 1400 covers the 1 1/8 in. diameter series 320 RV4 3-w variable resistor. (334)

**TELSTAR** Bell Telephone Laboratories Inc., 463 West St., New York 14, N. Y. A color reprint of the Bell Laboratories Record contains 10 semitechnical articles about the engineering that went into the Telstar project. (335)

## For a-c RELAY RELIABILITY:

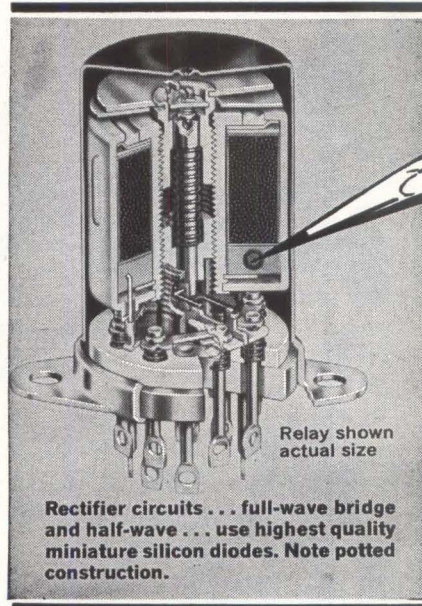

## HART SERIES RA and SA

These relays for 400 cps and 60 cps operation are identical in size and weight to Hart's widely specified Series R and S d-c relays and meet the same specifications\*. They provide the same shock resistance (to 50G), the same vibration resistance (to 20G-2000 cps), and the same performance under temperatures ranging from -65°C to +125°C. Contact ratings from dry circuit to 10 amps, 115 volts a-c resistive and 30 volts d-c resistive.

The Hart line includes hundreds of standard models, and special variations are possible. Ask for literature and specification list.

\*Like the R and S series, they meet the requirements of MIL-R-5757C. Models are also available to fill the requirements of MIL-I-6181.



HART MANUFACTURING CO

202 BARTHOLOMEW AVENUE  
 HARTFORD 1, CONNECTICUT  
 Telephone: Area Code 203: 525-3491

A SUBSIDIARY OF OAK MANUFACTURING CO.

CIRCLE 217 ON READER SERVICE CARD  
 June 28, 1963 • electronics



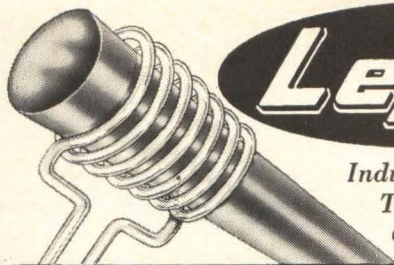

# Lepel

Induction Heating's Most  
Trusted and Creative  
Craftsmen Since 1926

## High Frequency INDUCTION HEATING UNITS

for

- BRAZING
- MELTING
- SOLDERING
- ZONE REFINING
- HEAT TREATING
- CRYSTAL GROWING
- BOMBARDING
- PLASMA TORCH

### ELECTRONIC TUBE GENERATORS

Kilocycle Frequency Units

Megacycle Frequency Units

Dual Frequency Units

- SPARK GAP CONVERTERS
- ACCESSORY EQUIPMENT

FREE APPLICATION ENGINEERING SERVICE—Our engineers will process your work samples and submit recommendations.

WRITE FOR NEW LEPEL CATALOG  
**Lepel** HIGH FREQUENCY LABORATORIES, INC.

55th St. & 37th Ave., Woodside 77, N.Y.C.

Chicago Office for Sales & Service: 6246 W. NORTH AVE.

CIRCLE 218 ON READER SERVICE CARD



## Are you a COMPLETELY INFORMED electronics engineer?

Today you may be working in microwaves. But on what project will you be working tomorrow? You *could* have read **electronics** this past year

and kept abreast of, say, microwave technology. There were 96 individual microwave articles between July, 1961 and June, 1962!

But suppose tomorrow you work in some area of standard electronic components, in semiconductors, in systems? Would you be up-to-date in these technologies? Did you read the more than 3,000 editorial pages that **electronics'** 28-man editorial staff prepared last year?

**electronics** is edited to keep you current *wherever* you work in the industry, *whatever* your job function(s). If you do not have your own copy of **electronics**, subscribe today via the Reader Service Card in this issue. Only 7½ cents a copy at the 3 year rate.

# electronics

## New FILM-THIN Copper-clad Laminates for space-saver or multi- layer printed circuits



Synthane copper-clad laminates are now being produced with a base laminate of only .0035" and up—with 1 or 2 oz. cladding available on one or both sides. A pre-impregnated glass cloth with epoxy resin filler is also available for bonding multi-layer circuits. These new materials are produced under clean room conditions. Property values are comparable to military specs for the same materials in standard thicknesses. Write for folder of Synthane metal-clad laminates.

# SYNTHANE

CORPORATION **S** OAKS, PENNA.

Glendale 2-2211 (Area Code 215) TWX 215-666-0589  
Synthane-Pacific, 518 W. Garfield Ave., Glendale 4, Calif. TWX GLDL 4417U

Synthane Corporation, 36 River Rd., Oaks, Pa.  
Gentlemen:  
Please send me Synthane metal-clad laminates folder.

Name \_\_\_\_\_

Address \_\_\_\_\_

City \_\_\_\_\_ Zone \_\_\_\_\_ State \_\_\_\_\_



## IRC Plans Advanced R&D Center

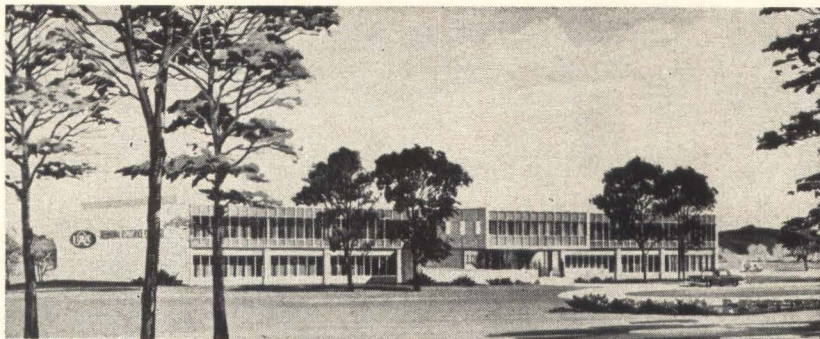

**INTERNATIONAL RESISTANCE** Company will start construction on a 72,200-square-foot advanced Research and Development Center in Worcester Township (near Norristown), Pa., in March, 1964. The building, to be situated on an 85-acre tract, will cost approximately \$2½ million, when completed.

Walter W. Slocum, president of the Philadelphia-based firm, said the laboratories will be equipped with the most modern scientific instruments for basic research and development in thin films, solid

state physics and microcircuitry.

The Center will be completely air-conditioned with special filtering to provide an over-all, dust-free, clean-room environment. To facilitate this environment, laboratories will be windowless, connected by passageways to the main corridors at the front and rear glass walls of the building. All utilities will be supplied through fixed mechanical cores located in the walls forming the passageways. Special ultra-clean white rooms will also be provided.

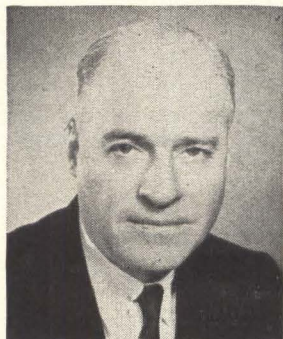

### Aeronutronic Made Division of Philco

**AERONUTRONIC** division of Ford Motor Co., Dearborn, Mich., has been transferred to Philco Corp., a wholly-owned subsidiary of Ford.

Aeronutronic, which is located in Newport Beach, Calif., and employs 2,500 becomes a division of Philco Corp. John B. Lawson (picture), Aeronutronic general manager,

continues in that position and has been elected a vice president of Philco

### Corning Announces Four Appointments

**KARL R. WUENSCH** has been named manufacturing manager of the Electronic Products division of Corning Glass Works, Raleigh, N. C. He had been plant manager of the division's capacitor plant there.

William F. Neuman, who had been manager of the Corning plant at Greencastle, Pa., was appointed to succeed Wuensch.

In other divisional appointments, Norman M. Edelson was named manager product and process development for microcircuits, and Edward A. Pagola was named pro-

duction superintendent of the division's Ceramic plant in Corning, N. Y. Edelson has been plant manufacturing engineer at Raleigh, and Pagola has been a department foreman at Corning's Greenville, O., plant.



### General Electric Elects Corbin

**S. WELLFORD CORBIN** has been elected a vice president of the General Electric Company, Schenectady, N. Y.

As general manager of GE's Industrial Sales Operation, Corbin heads an organization employing some 8,200 persons and selling hundreds of thousands of products.



### Nieminen Takes New Hickok Post

**ELECTION** of Robert A. Nieminen as executive vice president of the Hickok Electrical Instrument Co., Cleveland, O., is announced.

Nieminen, who has served as vice president of manufacturing since 1960, assumes the additional responsibilities of long-range cor-



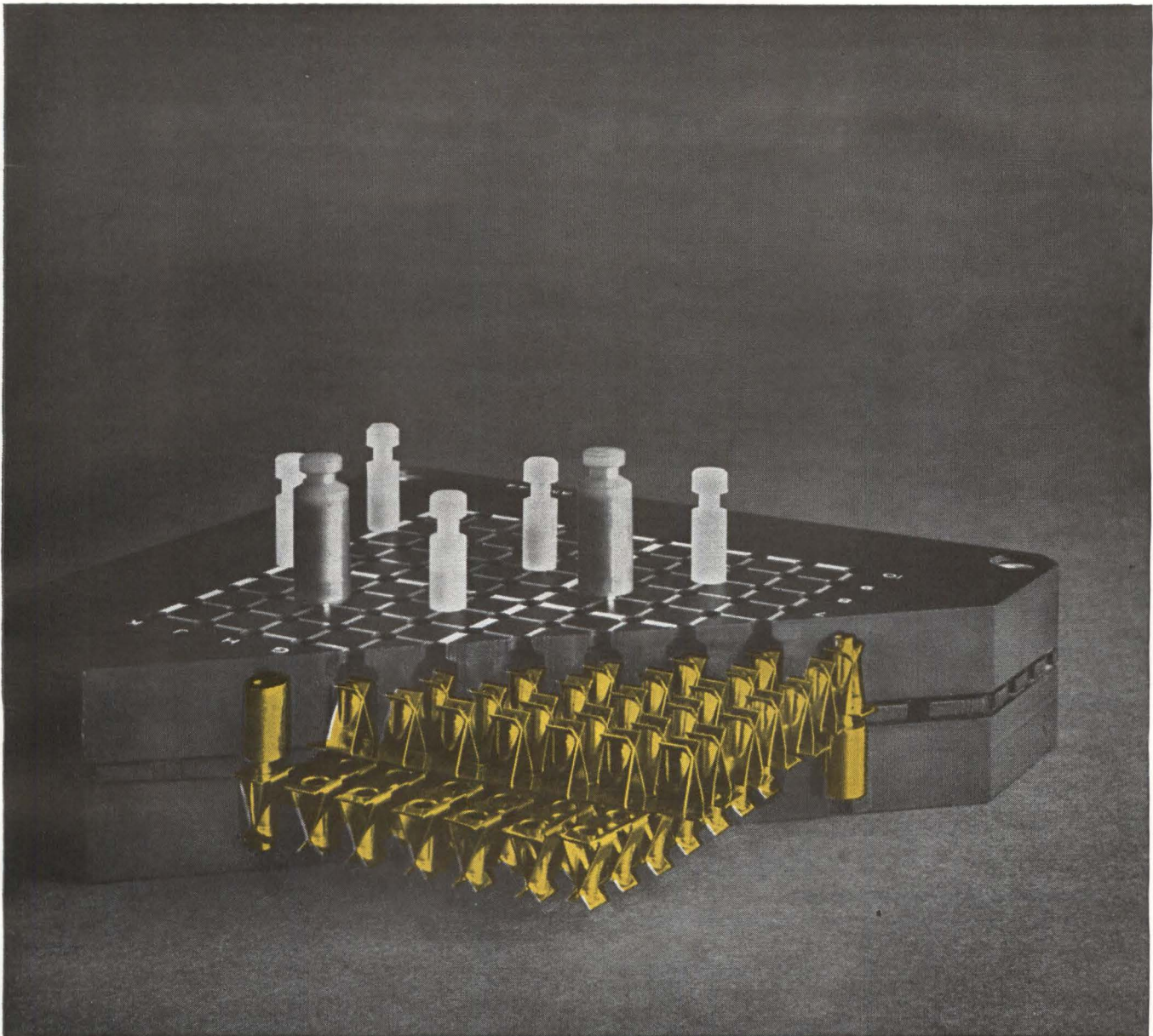

## Pin down reliability

Here's a **matrix pinboard** that pins down the most important element of all . . . reliability! We've made sure of this by building in quality "extras" to match the requirements of your most complex and costly equipments.

The pinboard assembly is made with rigid, solid phenolic blocks . . . precision made and fitted. The spring busses are precision formed . . . held in place by a phenolic "honey-comb" provided with a special funnel design at the X-Y co-ordinates—all to prevent misconnections and malfunctions. Pins are guided into exact position for positive connection and reliable performance.

As for the pins themselves . . . shorting, diode and other component carrying types—none bend or buckle regardless of repeated insertions and extractions. And there's never a chance of insulating-film buildup because we use a special hard gold alloy over nickel plating for both pin **and** springs.

Sound like quality? Good performance? Lasting reliability? Our pinboards give all these and more and here are more reasons why:

- permanent backboard connections made with crimp-type taper pins
- all standard sizes and configurations; special sizes on request
- pinboard panels with interchangeable templates which can be pre-programmed and stored.
- .095 diameter pins
- .250" x .250" grid design

Complete information is available on both standard and special size matrix pinboards.



AMP products and engineering assistance are available through subsidiary companies in: Australia • Canada • England • France • Holland • Italy • Japan • Mexico • West Germany



AGING  $3 \times 10^{-8}$  PER WEEK MAX.

BLILEY B27

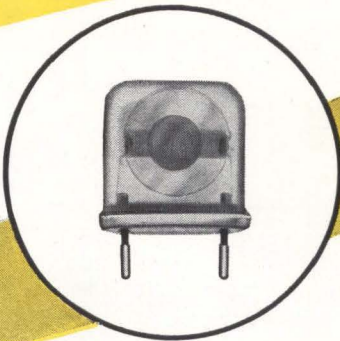

SHOWN ACTUAL SIZE  
(.757" x .725" x .317"  
excluding plug-in pins)

... WITH MINIATURE GLASS CRYSTAL UNITS

High precision glass sealed units, with optically polished gold-plated quartz elements, have short term stability  $1 \times 10^{-8}$  per day in range 1 to 5 mc. Bulletin 532A available.

**Bliley** if you buy quality

BLILEY ELECTRIC COMPANY • ERIE, PENNSYLVANIA  
CIRCLE 219 ON READER SERVICE CARD

**COMINCO**

HIGH PURITY METALS  
AVAILABLE FORMS

*clip and save*

Product	ALUMINUM	ANTIMONY	ARSENIC	BISMUTH	CADMIUM	GOLD	INDIUM	LEAD	SILVER	TIN	ZINC
BARS	✓	✓	✓	✓	✓	✓	✓	✓	✓	✓	✓
SHEETS	✓				✓	✓	✓	✓	✓	✓	✓
WIRE	✓				✓		✓	✓		✓	✓
POWDER		✓	✓	✓	✓	✓	✓	✓	✓	✓	✓
SHOT		✓		✓	✓	✓	✓	✓	✓	✓	✓
ROD	✓			✓	✓		✓	✓	✓	✓	✓
RIBBON							✓	✓			
PRE-FORMS	✓				✓	✓	✓	✓	✓	✓	✓
SALTS					✓		✓				

**COMINCO PRODUCTS, INC.**

electronic materials division

933 West Third Avenue, Spokane 4, Washington  
Phone Area Code 509 RI 7-7103 • TWX 509 328-1207

3402

116 CIRCLE 116 ON READER SERVICE CARD

porate planning.

Hickok manufactures electronic test and control equipment.

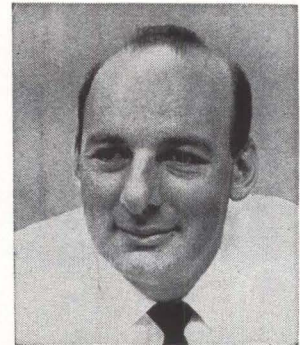

Pearce-Simpson  
Names Seiden

PEARCE-SIMPSON, INC., Miami, Fla., has announced the appointment of Stanford Seiden to the post of plant manager, electronics division.

Seiden, a 17-year veteran of the electronics industry, is former vice president, manufacturing, Crosby Electronics.



Power Designs  
Hires Hersh

JOSEPH B. HERSH has been named plant manager of the Power Designs, Inc., Westbury, N. Y., facility. He was formerly vice president-manufacturing of the Radio Receptor division of General Instruments Corp.

Power Designs manufactures precision low and high voltage electronic power supplies.

Schaevitz Engineering  
Appoints Mahler

RICHARD A. MAHLER, former president of Harvey-Wells Corp., has been appointed vice president of

June 28, 1963 • electronics



sales at Schaevitz Engineering, Pennsauken, N. J.

Mahler will be in charge of all sales programs at Schaevitz Engineering and its subsidiaries, including Measurement Control Devices, Philadelphia, Pa.; Burrrite Electronics Corp., Burbank, Calif.; Southern Electronic Engineering

Co., Warner Robins, Ga.; and Triconix, Inc., Waltham, Mass.

### Woodward Takes New Philco Post

CHESTER P. WOODWARD has been named manager-technical staff of

### RCA REALIGNS DIVISIONS

On July 1, Radio Corporation of America will put into effect a reorganization of its Electron Tube and Semiconductor and Materials divisions. They'll merge into a new organization with five major operating units, headed up by Douglas Y. Smith, vice president, Electronic Components and Devices.

His new staff, providing services to all five units, includes: G. C. Brewster, manager, operations planning and support; Alan M. Glover, division vice president, technical programs; Joseph E. Kelley, division vice president, general sales.

Operating units and their executives are:

- Commercial Receiving Tube and Semiconductor: William H. Painter, division vice-president and general manager. This unit will be responsible for sale of tv picture tubes as well

- Industrial Tube and Semiconductor: C. E. Burnett, division vice president and general manager

- Television Picture Tube: John B. Farese, division vice president and general manager, engineering manufacture and marketing of color and black-and-white picture tubes

- Special Electronic Components: Lloyd R. Day, general manager; development of new and advanced components and devices

- Distributor Products: Harold F. Bersche, division vice president; sale of all RCA electronic components and devices to authorized distributors.

### TI Building 435,000-Sq-Ft Plant



ARCHITECTURAL sketch of new multipurpose building of 435,000 sq ft now under construction in Dallas where Texas Instruments will produce future Shrike air-to-surface tactical missiles. Initial occupancy is scheduled to begin in October and be complete in December

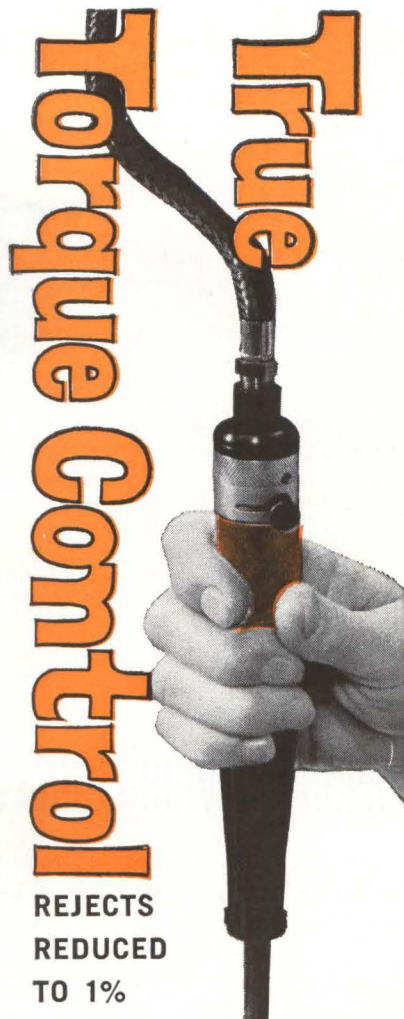

### ILLINOIS APPLIANCE MANUFACTURER USES NO. 3 CLECOMATIC\* BECAUSE,

(1) Quality control was rejecting up to 50 per cent. Model 3SA-10 CLECOMATIC reduced this to one per cent the first day on the line.

(2) Looseners and burred screw-heads had been a source of much concern. Automatic start/stop feature alleviated this problem.

(3) Many products had been returned by consumers because the base loosened from the chassis: CLECOMATIC precise torque control eliminated this.

This manufacturer believes the CLECOMATIC is the answer to the problem.

\*Fully warranted for one year by the GOLDEN CIRCLE guarantee



A DIVISION OF  
REED ROLLER BIT COMPANY  
P. O. Box 2541 • Houston, Texas



Gentlemen, the facts are it's...



## Florida's newest metropolitan industrial area

... and here are some of the reasons, the same reasons, that prompted General Electric's selection of Daytona Beach as Headquarters for their Command Systems Division: THE FRONT-DOOR LOCATION IN THE SPACE RACE; LOW-COST INDUSTRIAL SITES; FAVORABLE TAXES; AMPLE POWER, FUEL, AND WATER; MINIMUM ABSENTEE-ISM, THANKS TO A MILD YEAR-ROUND CLIMATE AND CLEAN OCEAN AIR WITH A POLLEN COUNT OF LESS THAN ONE; AND MOST IMPORTANT, AN INDUSTRY-MINDED COMMUNITY.

# DAYTONA BEACH INDUSTRIAL AREA THRESHOLD OF THE RACE TO SPACE

Ormond Beach • Holly Hill • Daytona Beach • South Daytona • Daytona Beach Shores • Port Orange

THE DAYTONA BEACH AREA COMMITTEE OF 100 pledges its complete cooperation in helping you find a profitable industrial site. Direct your inquiry to J. Saxton Lloyd, Chairman, who will hold all such inquiries in his personal file in the very strictest confidence.

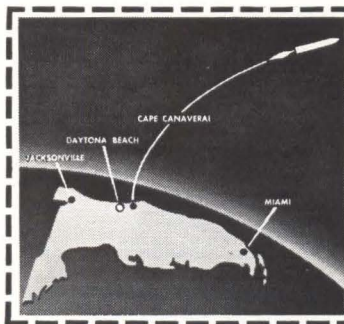

Mr. J. Saxton Lloyd, Chairman  
Committee of 100  
Daytona Beach Industrial Area  
Dept. C12 — Daytona Beach, Fla.

Please send detailed information on the  
Daytona Beach Industrial Area.

NAME.....TITLE.....  
COMPANY.....  
ADDRESS.....  
CITY.....ZONE.....STATE.....

All inquiries held in strict confidence

the Advanced Technology Laboratories of Philco Corporation's Communications and Electronics division, Blue Bell, Pa.

Formerly manager-technical staff of the division's radar laboratory, Woodward will be responsible for the coordination of plans and programs within the Advanced Technology Laboratories.

### PEOPLE IN BRIEF

Harry Altman promoted to director of the Range Systems laboratory of ITT Federal Laboratories. I. J. Steinhoff, formerly with G.M. Labs., appointed g-m of the Electro-Mechanical div. of Indiana General Corp. Norton F. Hight advances to executive engineer in the Systems Engineering dept. of the Government Products div. at Adler Electronics, Inc. Sanford Brown, Cleveland engineering consultant, has joined Assembly Products, Inc., as director of quality control. William C. Hauser, previously with Aerojet-General Corp., named chief engineer of R. O. Roberts Co., Inc. Lawrence F. Punte moves up at Fairchild Semiconductor to head the Process Engineering dept. Computer Instruments Corp. ups Jack Confredo to production control mgr. for all operations. Clary Corp. raises C. A. Christoff to v-p engineering. Paul D. Leeke elevated to research projects mgr. by Mincom div., 3M Co. William P. Bartley, with GE since 1949, named mgr. of advance engineering at the Communication Products dept. James M. Wright leaves North American Aviation Co. to join Edcliff Instruments as operations mgr. Vincent F. Procopio, from General Instrument Corp. to Platronics, Inc. as mgr. of the Hermetic Seals div. Dana K. Nance, ex-General Motors Corp., appointed chief engineer of SpaceK Corp. Donald L. Pyke leaves Systems Development Corp. to rejoin Thompson Ramo Wooldridge Inc. as asst. to the v-p, R&D. John Greksouk (Commander, U.S.N., Ret.) named mgr. of quality assurance at The Technical Material Corp. West Nyack transmitter plant.



# electronics

## WEEKLY QUALIFICATION FORM FOR POSITIONS AVAILABLE

### ATTENTION: ENGINEERS, SCIENTISTS, PHYSICISTS

This Qualification Form is designed to help you advance in the electronics industry. It is unique and compact. Designed with the assistance of professional personnel management, it isolates specific experience in electronics and deals only in essential background information.

The advertisers listed here are seeking professional experience. Fill in the Qualification Form below.

#### STRICTLY CONFIDENTIAL

Your Qualification form will be handled as "Strictly Confidential" by ELECTRONICS. Our processing system is such that your form will be forwarded within 24 hours to the proper executives in the companies you select. You will be contacted at your home by the interested companies.

#### WHAT TO DO

1. Review the positions in the advertisements.
2. Select those for which you qualify.
3. Notice the key numbers.
4. Circle the corresponding key number below the Qualification Form.
5. Fill out the form completely. *Please print clearly.*
6. Mail to: Classified Advertising Div., ELECTRONICS, Box 12, New York 36, N. Y. (No charge, of course).

COMPANY	SEE PAGE	KEY #
AEROSPACE PLACEMENT CORP. Philadelphia, Penna.	121	1
AMERICAN MACHINE & FOUNDRY CO. Alexandria Div. Alexandria, Va.	120	2
ATOMIC PERSONNEL INC. Philadelphia, Penna.	121	3
BELL AEROSYSTEMS CO., Div. of Bell Aerospace Corporation A Textron Company Buffalo, N. Y.	121	4
COLLINS RADIO COMPANY Dallas, Texas	98	5
GENERAL DYNAMICS/ELECTRONICS A Div. of General Dynamics Corp. Rochester, New York	81*	6
LOCKHEED MISSILES & SPACE CO. Div. of Lockheed Aircraft Corp. Sunnyvale, California	109	7
PAN AMERICAN WORLD AIRWAYS INC. Guided Missiles Range Div. Patrick AFB, Fla.	110**	8
UNION CARBIDE NUCLEAR COMPANY A Div. of Union Carbide Corporation Oak Ridge, Tennessee	79*	9

\* These advertisements appeared in the June 14th issue.  
\*\* This advertisement appeared in the June 21st issue.

(cut here)

### electronics WEEKLY QUALIFICATION FORM FOR POSITIONS AVAILABLE

(cut here)

(Please type or print clearly. Necessary for reproduction.)

#### Personal Background

NAME .....

HOME ADDRESS .....

CITY ..... ZONE ..... STATE .....

HOME TELEPHONE .....

#### Education

PROFESSIONAL DEGREE(S) .....

MAJOR(S) .....

UNIVERSITY .....

DATE(S) .....

#### FIELDS OF EXPERIENCE (Please Check)

62863

- |  |  |                                       |
|--|--|---------------------------------------|
| <input type="checkbox"/> Aerospace           | <input type="checkbox"/> Fire Control        | <input type="checkbox"/> Radar        |
| <input type="checkbox"/> Antennas            | <input type="checkbox"/> Human Factors       | <input type="checkbox"/> Radio—TV     |
| <input type="checkbox"/> ASW                 | <input type="checkbox"/> Infrared            | <input type="checkbox"/> Simulators   |
| <input type="checkbox"/> Circuits            | <input type="checkbox"/> Instrumentation     | <input type="checkbox"/> Solid State  |
| <input type="checkbox"/> Communications      | <input type="checkbox"/> Medicine            | <input type="checkbox"/> Telemetry    |
| <input type="checkbox"/> Components          | <input type="checkbox"/> Microwave           | <input type="checkbox"/> Transformers |
| <input type="checkbox"/> Computers           | <input type="checkbox"/> Navigation          | <input type="checkbox"/> Other .....  |
| <input type="checkbox"/> ECM                 | <input type="checkbox"/> Operations Research | <input type="checkbox"/> .....        |
| <input type="checkbox"/> Electron Tubes      | <input type="checkbox"/> Optics              | <input type="checkbox"/> .....        |
| <input type="checkbox"/> Engineering Writing | <input type="checkbox"/> Packaging           | <input type="checkbox"/> .....        |

#### CATEGORY OF SPECIALIZATION

Please indicate number of months experience on proper lines.

	Technical Experience (Months)	Supervisory Experience (Months)
RESEARCH (pure, fundamental, basic)	.....	.....
RESEARCH (Applied)	.....	.....
SYSTEMS (New Concepts)	.....	.....
DEVELOPMENT (Model)	.....	.....
DESIGN (Product)	.....	.....
MANUFACTURING (Product)	.....	.....
FIELD (Service)	.....	.....
SALES (Proposals & Products)	.....	.....

CIRCLE KEY NUMBERS OF ABOVE COMPANIES' POSITIONS THAT INTEREST YOU

1 2 3 4 5 6 7 8 9 10 11 12 13 14 15 16 17 18 19 20 21 22 23 24 25



## TO THE ENGINEER INTERESTED IN PROFESSIONAL ADVANCEMENT

We are addressing this to the Electronics Engineer who has been in research and development for some years and is now seriously assessing his long range goals and interests. We are particularly interested in the engineer who has a solid background in electronic circuitry and who is presently restricted in his opportunities for professional recognition.

If this strikes a responsive chord, we have a position which may be of more than casual interest to you. We are seeking a man well grounded in electronics, particularly in solid state circuit design, to work in a senior capacity as a member of our professional staff. He must be able to provide technical leadership in his area of research and to work closely with the program sponsor.

Like most positions of responsibility, there are demanding aspects of the job; some travel, proposal writing, pressure on occasion. However, the position offers immeasurable prospects for personal development, an excellent salary and the opportunity to contribute directly to the growth of the company, and furtherance of the national research effort in space.



**If you would like to explore this opportunity in detail, please call or write the Director of Personnel, King 8-7221**

### AMERICAN MACHINE & FOUNDRY CO.

Alexandria Division

1025 North Royal St., Alexandria, Virginia

AN EQUAL OPPORTUNITY EMPLOYER

## SEARCHLIGHT SECTION

(Classified Advertising)

BUSINESS OPPORTUNITIES

EQUIPMENT - USED or RESALE

### DISPLAYED

The advertising is \$27.25 per inch for all advertising other than on a contract basis. AN ADVERTISING INCH is measured 7/8" vert. on a column, 3 cols.—30 inches—to a page. EQUIPMENT WANTED or FOR SALE ADVERTISEMENTS acceptable only in Displayed Style.

Send NEW ADS or Inquiries to Classified Adv. Div. of Electronics, P. O. Box 12, N. Y. 36, N. Y.

### RATES

\$2.70 a line, minimum 3 lines. To figure advance payment count 5 average words as a line. BOX NUMBERS count as one line additional. DISCOUNT of 10% if full payment is made in advance for four consecutive insertions.

### UNDISPLAYED

WANTED:  
AN/TRC-24 RADIO SET COMPONENTS

AM-912/TRC  
AM-913/TRC  
AM-915/TRC  
PP-685/TRC  
R-417/TRC  
T-302/TRC

W-2402, Electronics  
Class. Adv. Div., P.O. Box 12, N.Y. 36, N.Y.

## U. S. MICROWAVE

AMERICA'S LEADING DISTRIBUTOR  
OF ELECTRONIC TUBES

Klystrons, Transmitting, Magnetrons, Amplitrons, Rectifiers, Thyratrons, BWO, TWT, Exotic Types, XFA, MBK, COAX Mag, Image converters, Orthicon, Photomultiplier, Transistor, Zener, Cathode-Ray, Storage.

Distributors of Specialized Electronic  
Equipment—Nuclear, Geophysical

EXPORT INQUIRIES INVITED—ALL LANGUAGES

## U. S. MICROWAVE

P. O. Box "G"

Collingswood, New Jersey

Call Collect, Area Code 609 - WO 6-2929

CIRCLE 950 ON READER SERVICE CARD

OVER 2,000,000

## RELAYS IN STOCK!

Send for Catalog 55

Universal RELAY CORP.

42 WHITE ST., N.Y. 13, N.Y. • WAlker 5-6900

CIRCLE 952 ON READER SERVICE CARD

## FOR SALE

Standard 3-channel open-wire Carrier  
Terminals and Repeaters.

Standard v-f carrier-telegraph terminals.

Standard v-f ringers, v-f repeaters,  
repeating coils, condensers, filters, re-  
tard coils, polar relays.

Complete list on request

FS-2435, Electronics  
Class. Adv. Div., P.O. Box 12, N.Y. 36, N.Y.

CIRCLE 953 ON READER SERVICE CARD

## RADIO RESEARCH INSTRUMENT CO.

AUTO-TRACK & TELEMETRY ANTENNA PEDESTALS  
3 & 10 CM. SCR. 584 AUTOTRACK RADARS.  
AN/TPS-10 SEARCH. AN/TPS-10 HT. FINDERS.  
AN/FPN-320CA. AN/APS-10 NAVIG. & WEATHER.  
AN/APS-15B PRECISION. AN/APQ-35B PRECISION.  
AN/APS-31A SEARCH. DOZENS MORE.  
.5-1.2 MEGAWATT HIGH POWER PULSERS.

RADIO RESEARCH INSTRUMENT CO.  
550 Fifth Ave., New York Judson 6-4691

RADAR SYSTEMS & COMPONENTS/ IMMEDIATE  
DELIVERY

CIRCLE 955 ON READER SERVICE CARD

## LOOKING FOR

USED/SURPLUS ELECTRONIC  
EQUIPMENT/COMPONENTS?

For an up-to-date listing of such  
equipment see Searchlight Sec-  
tion of June 14th issue.



## EMPLOYMENT OPPORTUNITIES



The advertisements in this section include all employment opportunities—executive, management, technical, selling, office, skilled, manual, etc.

Look in the forward section of the magazine for additional Employment Opportunities advertising.

### — RATES —

**DISPLAYED:** The advertising rate is \$40.17 per inch for all advertising appearing on other than a contract basis. Contract rates quoted on request.

An advertising inch is measured  $\frac{3}{4}$ " vertically on a column—3 columns—30 inches to a page.

Subject to Agency Commission.

**UNDISPLAYED:** \$2.70 per line, minimum 3 lines. To figure advance payment count 5 average words as a line.

Box numbers—count as 1 line.

Discount of 10% if full payment is made in advance for 4 consecutive insertions.

Not subject to Agency Commission.



### E. E.'s for FEE-PAID Positions WRITE US FIRST!

Use our confidential application for professional, individualized service . . . a complete national technical employment agency.

**ATOMIC PERSONNEL, INC.**  
Suite 1207L, 1518 Walnut St., Phila. 2, Pa.

### ENGINEERS

All Disciplines  
COMM SSB MUX  
MATHEMATICS  
DIGITAL RADAR

National Coverage No Fees

Send resume in confidence

**Dr. L. I. Gilbertson**

Aerospace Placement Corp.  
P. O. Box 2125, Phila. 3, Pa.

## PROFESSIONAL SERVICES

### GIBBS & HILL, Inc.

Consulting Engineers

Systems Engineering

Operations Research • Development  
Field Studies • Design • Procurement  
Power • Transportation • Communications  
Water Supply • Waste Treatment

393 Seventh Avenue New York 1, N. Y.

## ENGINEERS... PHYSICISTS...

# Can Your Professional Growth Keep Pace with Bell's Growth in Electronics?

## Avionics Division Shows 600% Sales Increase in Past 5 Years

If you are not certain how far your present position can take you, you may wish to consider a position with the Avionics Division of Bell Aerosystems Company.

This division is growing—and expects to continue—as a result of trail-breaking engineering concepts and performance in inertial guidance (a Bell digital velocity meter triggered the Mariner mid-course correction), and automatic landing systems (Bell's all-weather, automatic aircraft landing system can touch down 2 planes a minute even in dense fog).

Current contractual work involves controls for a lunar landing research vehicle, digital-to-voice converters, digital tie-in equipment and computers, sighting devices, exotic instruments, battlefield air traffic controls, learning machines, high precision gyroscopes and accelerometers, target locator systems, navigation systems, mapping systems and automatic landing systems.

To assure Bell's continuing progress and expansion in the electronics area, a few senior positions are available for experienced men interested in making significant contributions in the following areas:

### ADVANCED SYSTEMS ANALYSIS

Responsibility for analytical investigations associated with modern weapon systems involving problems in areas of fire control, guidance, radar, and communication systems using digital and analog computing facilities when required. Advanced degree in physics, engineering or math with minimum 8 years related experience required, of which 4 must be in one of the above specific areas. Salary to \$18,000.

### ADVANCED SYSTEMS DESIGN

Responsibility for analytical and preliminary design studies of command and control systems for terrestrial and orbital vehicles. Specific areas of investigation include position determination, vehicle control, data processing and transmission, and information display. Advanced degree in physics or EE with minimum 8 years related experience required, plus knowledge of military system design requirements. Salary to \$18,000.

### AIR TRAFFIC CONTROL SYSTEMS

Perform studies of advanced air traffic control problems, define system requirements, investigate various approaches to problem solution, perform analytical work to support system feasibility, optimize system performance, suggest means for reduction to practice, act as consultant in the fabrication of feasibility hardware. Advanced degree in EE or physics with minimum 5 years related experience in one or more of the following: radar systems engineering, closed loop control, aerospace vehicle dynamics, operation analysis. Salary to \$18,000.

### ADVANCED RESEARCH & DEVELOPMENT

Responsibility for determination of fruitful areas of research for advancing the state of the art, conducting original studies (both analytical and experimental), and acting as consultant in other communication and radar problems. An advanced degree in physics or EE with a communications specialty is required, plus the analytical ability to recognize problem areas, and the conceptual ability to determine solutions. Salary to \$18,000.

### SOLID STATE PHYSICS

Form and head up group to perform research and development in solid state to further basic physical solid state phenomena towards practical application in avionics systems. MS or PhD in physics required with experience in one or more of the following: stimulated emission of radiation, semiconductor devices, solid state devices for information storage and retrieval. Salary to \$18,000.

### INERTIAL SYSTEMS

Responsibility for inertial systems synthesis and analysis, including application to existing government requirements; and to establish new requirements, analyze existing systems and develop and apply new ideas in the field, including analysis of hybrid systems. Advanced degree in EE, physics or math with minimum 10 years related experience, 5 years of which must have been in inertial navigation. Salary to \$18,000.



Resumes are invited from qualified men.  
Please address Mr. Thomas Fritschi, Dept. G-24.

## BELL AEROSYSTEMS CO.

DIVISION OF BELL AEROSPACE CORPORATION—A **Textron** COMPANY

An Equal Opportunity Employer P.O. Box #1, Buffalo 5, New York



# INDEX TO ADVERTISERS

• AMP Incorporated .....	115	• Keithley Instruments, Inc.....	104	TDK Electronics Co., Ltd.....	70
Air Express .....	21	• Kepco, Inc. ....	75	Tektronix, Inc. ....	50
Ampex Corporation .....	48	• Kester Solder Co.....	29	Thiokol Chemical Corp.....	47
Atlanta Chamber of Commerce...	111	Kintel A Division of		• Tokyo Shibaura Electric Co., Ltd..	71
Baltimore Gas & Electric Co.....	16	Cohu Electronics Inc.....	3d cover	• Torwico Electronics Inc.....	6
Bendix Corporation, The		• Kyoritsu Electrical Instruments		• Toyo Electronics Ind., Corp.....	73
Bendix Pacific Division .....	31	Works, Ltd. ....	68	Toyo Musen Co., Ltd.....	68
• Black & Webster, Inc.....	34	• Leach Corporation .....	105	• Tung-Sol Electric, Inc.....	5
• Bliley Electric Co.....	116	• Leach and Garner Co.....	112	United Control Corp.....	96
• Bulova Electronics Div.....	28	• Lepel High Frequency		• United Shoe Machinery Corp....	104
Cambridge Thermionic Corp.....	36	Laboratories, Inc. ....	113	• Utica Drop Forge & Herbrand Tool	
Cannon Electric Co.....	14	• Litton Industries Electron Tube Div.	46	Division, Kelsey-Hayes Co. ....	110
Carborundum Company, The .....	17	Lockheed Missiles & Space Co.....	109	• Varo Inc. ....	46
Cleco Division of Reed Roller		Loral Electronics Corp.....	93	Vitro Laboratories.....	94
Bit Co. ....	117	Mallory and Co., Inc., P. R.....	91	• Westinghouse Electric Corp.....	97
Collins Radio Co.....	98	Melpar Inc. ....	39	Yagishita Electric Co.....	70
Cominco Products, Inc.....	116	• Microswitch Division of Honeywell	83	Yokogawa Electric Works, Inc....	82
• Corning Electronics Div. of		Minnesota Mining & Mfg. Co.			
Corning Glass Works.....	87	Mincon Division .....	99		
Cubic Corp. ....	95	Mitsumi Electric Co., Ltd.....	72		
Daytona Beach Industrial Area..	118	Motorola Military Electronics			
• Defense Electronics, Inc.....	40	Div. ....	24, 25		
Delco Radio .....	85	Murata Mfg. Co., Ltd.....	68		
• Eastman Kodak Co.....	37	NRC Equipment Co.....	84		
• Edgerton, Germeshausen &		• NAVCOR .....	27		
Grier, Inc. ....	35	• Nichicon Capacitor Ltd.....	70		
Electro Instruments Inc.....	88	North American Philips Co., Inc.			
Electro Nuclear Laboratories.....	49	Electric Div. ....	76		
Electronic Industries		• North Atlantic Industries, Inc....	77		
Association of Japan.....	67	Origin Electric Co., Ltd.....	72		
Electronic Memories Inc.....	33	Paktron Div. of Illinois Tool Works	78		
Fluke Mfg. Co., Inc., John.....	20	Pennsalt Chemicals Corp.....	13		
Flying Tiger Line.....	86	• Potter Instrument Co., Inc.....	19		
Fujitsu Ltd. ....	73	• Radio Corporation of America. 4th cover			
General Electric		Radio Materials Co.....	79		
Industrial Tube .....	15	Reeves Instrument Corp. Sub. of			
Semiconductor Products Dept..	107	Dynamics Corp. of America... 45			
Silicone Products Dept.....	92	Ribet-Desjardins .....	106		
• General Findings Inc.....	112	Rome Cable Div. of Alcoa.....	30		
Globe Ind., Inc. ....	108	Sangamo Electric Co.....	41, 42		
Hamilton Standard Div. of		Sankaisha Co., Ltd.....	72		
United Aircraft Corp. ....	43	Sanken Electric Co., Ltd.....	68		
• Hart Manufacturing Co.....	112	• Servo Corporation of America... 38			
• Hewlett-Packard Company		• Shimada Physical & Chemical Ind.,			
inside front cover, 10,	11	Co., Ltd. ....	72		
• Hitachi, Ltd. ....	69	Siliconix Inc. ....	23		
Honeywell Denver Division.....	89	Sprague Electric Co.....	4, 9		
Hyperion Ind., Inc.....	102, 103	Standard Telephones & Cables, Ltd.	44		
• J F D Electronics Corp.....	101	Sylvania Electric Products, Inc.			
• Japan Piezo Electric Co., Ltd....	67	Electron Tube Div.....	81		
		Synthane Corp. ....	113		

## CLASSIFIED ADVERTISING

F. J. Eberle, Business Mgr.

PROFESSIONAL SERVICES ..... 121

EMPLOYMENT OPPORTUNITIES ..... 120-121

## EQUIPMENT

(Used or Surplus New)

For Sale ..... 120

WANTED ..... 120

## CLASSIFIED INDEX

Aerospace Placement Corp..... 121

American Machinery & Foundry

Co., Alexandria Div..... 120

Atomic Personnel Inc..... 121

Bell Aerosystems Co., Div. of

Bell Aerospace Corp. A. Tex-

tron Corp. .... 121

• Radio Research Instrument Co... 120

• Universal Relay Corp..... 120

U. S. Microwave ..... 120

• See advertisement in the July 25, 1962 issue of Electronics Buyers' Guide for complete line of products or services.

This Index and our Reader Service Numbers are published as a service. Every precaution is taken to make them accurate, but electronics assumes no responsibilities for errors or omissions.

## electronics



Audit Bureau  
of Circulation



Associated Business  
Publications

Audited Paid Circulation

### JAMES T. HAUPTLI

Advertising Sales Manager

DAVID CUNNIFF

Promotion Manager

### Electronics Buyers' Guide

R. S. QUINT

General Manager

### RICHARD J. TOMLINSON

Business Manager

THEODORE R. GEIPEL

Production Manager

## ADVERTISING REPRESENTATIVES

### ATLANTA (9):

Michael H. Miller, Robert C. Johnson  
1375 Peachtree St. N.E., Trinity 5-0523  
(area code 404)

### BOSTON (16):

William S. Hodgkinson, Donald R. Furth  
McGraw-Hill Building, Copley Square,  
Congress 2-1160 (area code 617)

### CHICAGO (11):

Harvey W. Wernecke, Robert M. Denmead  
645 North Michigan Avenue, Mohawk 4-5800  
(area code 312)

### CLEVELAND (13):

Paul T. Fegley  
55 Public Square, Superior 1-7000  
(area code 216)

### DALLAS (1):

Frank Le Beau  
The Vaughn Bldg., 1712 Commerce St.  
Riverside 7-9721 (area code 214)

### DENVER (2):

John W. Patten  
Tower Bldg., 1700 Broadway,  
Alpine 5-2981 (area code 303)

### HOUSTON (25):

Kenneth George  
Prudential Bldg., Halcombe Blvd.,  
Riverside 8-1280 (area code 713)

### LOS ANGELES (17):

Ashley P. Hartman, John G. Zisch,  
William C. Gries  
1125 W. 6th St., Huntley 2-5450  
(area code 213)

### NEW YORK (36):

Donald H. Miller, Henry M. Shaw,  
George F. Werner  
500 Fifth Avenue, LO-4-3000  
(area code 212)

### PHILADELPHIA (3):

Warren H. Gardner, William J. Boyle  
6 Penn Center Plaza, LOcust 8-4330  
(area code 215)

### SAN FRANCISCO (11):

Richard C. Alcorn  
255 California Street, Douglas 2-4600  
(area code 415)

### LONDON W1:

Edwin S. Murphy Jr.  
34 Dover St.

### FRANKFURT/Main:

Matthée Herfurth  
85 Westendstrasse

### GENEVA:

Michael R. Zeynel  
2 Place du Port

### TOKYO:

George Olcott,  
1, Kotohiracho, Shiba, Minato-ku



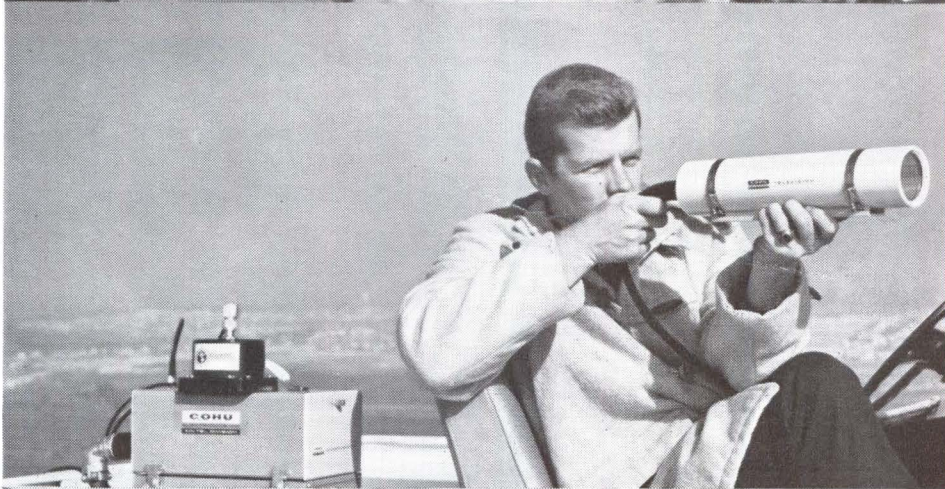

NEW  
KIN TEL TV CAMERAS  
LET YOU

send  
direct,  
visual  
reports  
from  
just about  
anywhere!

And under just about any kind of condition. In deep space. In explosive environments. In temperatures ranging from  $-17^{\circ}\text{C}$  to  $+70^{\circ}\text{C}$ . In water. In pipelines, deep wells, boilers (its 3-inch diameter barrel permits operation in restricted areas).

In addition, KIN TEL's new 2000 series cameras are available with a built-in 4-1 zoom lens; provide the clearest pictures available anywhere—up to 700 lines of horizontal resolution; and—thanks to all solid state circuits—are as trouble-free as you can buy.

*Send us your RFQ.* The 2000 series cameras are the newest addition to one of the industry's largest lines of television equipment. With KIN TEL's three basic TV systems and 207 separate in-stock components, KIN TEL can help you custom build a completely checked-out TV system to fit your exact needs. And do it faster and less expensively than you thought possible. Contact us or the KIN TEL representative near you.

5725 Kearny Villa Road,  
San Diego 12, California  
Phone 277-6700  
(Area Code 714)

**COHU**  
ELECTRONICS, INC.  
KIN TEL DIVISION

CIRCLE 901 ON READER SERVICE CARD



# NOW SWITCH WITH **RCA** SILICON CONTROLLED RECTIFIERS

## Here are 16 solid reasons why

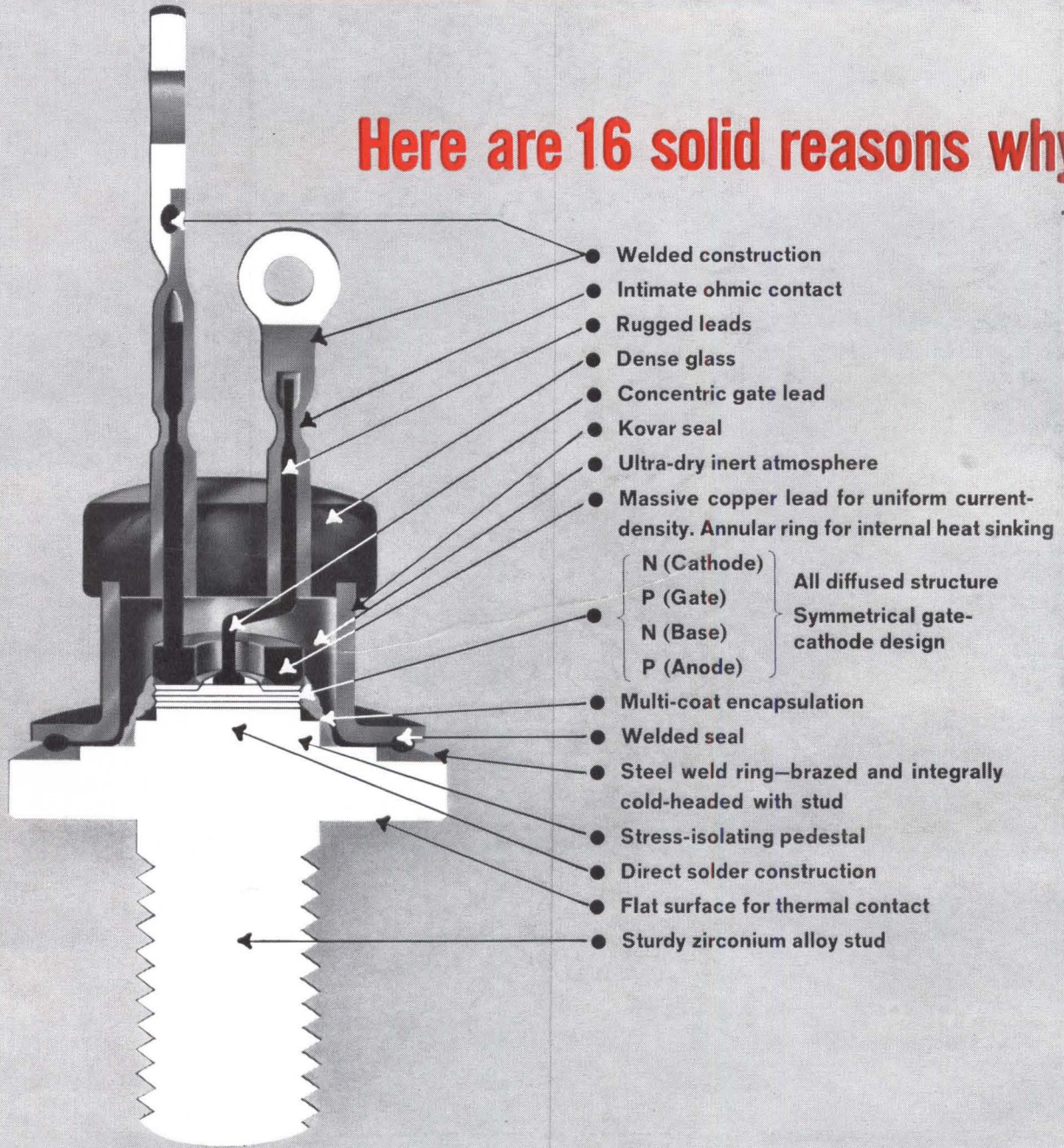

- Welded construction
  - Intimate ohmic contact
  - Rugged leads
  - Dense glass
  - Concentric gate lead
  - Kovar seal
  - Ultra-dry inert atmosphere
  - Massive copper lead for uniform current-density. Annular ring for internal heat sinking
  - N (Cathode)
  - P (Gate)
  - N (Base)
  - P (Anode)
  - Multi-coat encapsulation
  - Welded seal
  - Steel weld ring—brazed and integrally cold-headed with stud
  - Stress-isolating pedestal
  - Direct solder construction
  - Flat surface for thermal contact
  - Sturdy zirconium alloy stud
- } All diffused structure  
} Symmetrical gate-cathode design

**Check the outstanding** construction and operating features of RCA's two new families of silicon controlled rectifiers...RCA 2N681 to 2N689 and RCA 2N1842A to 2N1850A...all-diffused, SCR's for power control and electrical switching applications in industrial apparatus and military equipment.

FORWARD CURRENT	BLOCKING VOLTAGE								
25 Amp (RMS) 16 Amp (Avg) @ 65°C	25	50	100	150	200	250	300	400	500
	2N681	2N682	2N683	2N684	2N685	2N686	2N687	2N688	2N689
16 Amp (RMS) 10 Amp (Avg) @ 80°C	2N1842A	2N1843A	2N1844A	2N1845A	2N1846A	2N1847A	2N1848A	2N1849A	2N1850A

These RCA Silicon Controlled Rectifiers are designed for use in your circuits at their full ratings—full current at peak reverse and peak forward blocking voltage. And RCA brings you all these big operating advantages: • Application tested for 100% safety margin on surge current • Very low thermal resistance • Forward voltage drop measured at high current (100 Amps for 2N681 family) • Installation torque capability = 50 inch-lbs • Tight control of firing characteristics • Long term operating stability • 100% aging at maximum ratings and 100% dynamic testing.

Call your RCA Representative today for complete details on these rugged new RCA SCR's... or write RCA Semiconductor and Materials Division, Commercial Engineering, Section IN-7-4, Somerville, N.J.

Write today for your free copy of this new RCA Application Note, SMA-16... "Circuit Factor Charts For Use In Applications With RCA Silicon Controlled Rectifiers"

AVAILABLE THROUGH YOUR RCA DISTRIBUTOR



**The Most Trusted Name in Electronics**

CIRCLE 902 ON READER SERVICE CARD