

# Electronic Design 7

VOL. 26 NO.

FOR ENGINEERS AND ENGINEERING MANAGERS — WORLDWIDE

MARCH 29, 1978

'True' true rms doesn't cost an arm and a leg anymore. An ac DVM costs less than \$1000, thanks to a special IC thermal converter. The meter includes dB

readings — with three references to pick from — autoranging and an analog nulling or peaking meter. A linear analog output comes too. Get more details on p. 97.

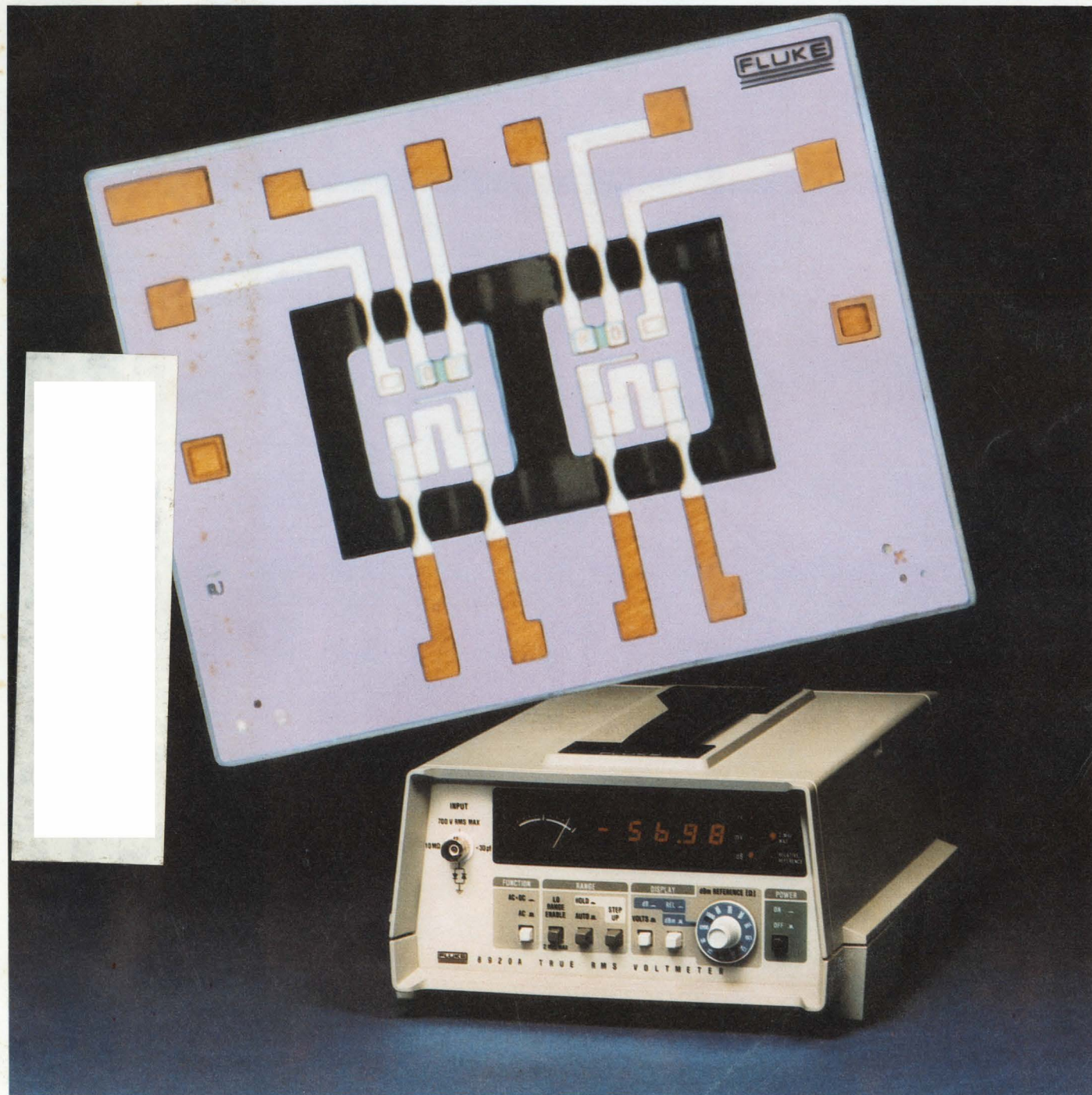

# A New Dawn In Trimmer/Resistor Technology...

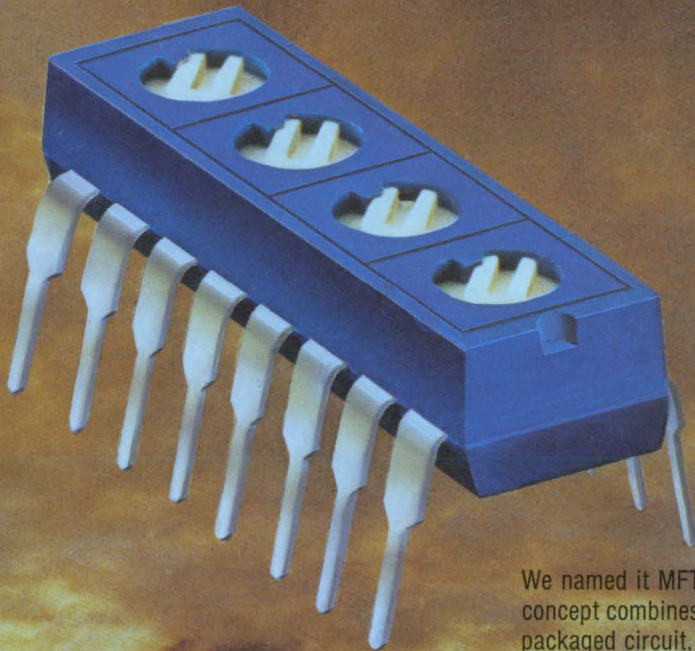

We've put it  
all together in  
one space/cost  
saving package.

We named it MFT™ . . . our multi function trimmer. This revolutionary concept combines cermet trimmers and fixed resistors into a single pre-packaged circuit. A consolidation of functions has been designed into a new product line of cost-effective DIP components.

All trimmer applications require a fixed resistor to either divide a voltage or limit a current. The nine MFT trimmer models will functionally satisfy almost any trimmer application.

**SAVES SPACE** — MFT trimmers drastically reduce PC board space required for the peripheral components of a linear IC.



**SAVES TIME** — MFT trimmers reduce the time and cost of designing circuits. It also saves production time as MFT trimmers are compatible with DIP automatic insertion equipment. And, there are less components to purchase and handle.

**SAVES MONEY** — MFT trimmers lower total "on-board" component costs. In addition, MFT trimmer DIPs are compatible with automatic test equipment, reducing inspection costs.

**INCREASES PERFORMANCE** — Temperature tracking is better than discrete components . . . 50 ppm/°C. Trimmers/Resistors are manufactured simultaneously on a common substrate. MFT trimmers are more reliable as a result of pre-tested circuitry and reduction of connections.

The sealed multi function trimmers are available in nine configurations of the multiple trimmer and network combinations. Call or write today for your MFT trimmer catalog.

TRIMPOT PRODUCTS DIVISION, BOURNS, INC., 1200 Columbia Avenue, Riverside, CA 92507. Phone: 714 781-5204. TWX: 910 332-1252.



For Immediate Application — Circle 130 For Future Application — Circle 230

**BOURNS**®

# SURPRISE!



Sundial courtesy of Frank's Antique Clock Shop, San Jose, California.

## The World's First LED Displays You Can View in Bright Sunlight.

Now available from Hewlett-Packard are displays designed for high ambient conditions. These seven-segment displays optimize the contrast between the digit segments and the background. A specially designed P-N junction and larger top contact metallization permit operation at high peak currents. This feature enhances display light output and permits strobed operation of long display strings. Combined with proper filtering these displays can be used under high ambient lighting as bright as 10,000 footcandles!!!

Available in High Efficiency Red and Yellow, the HDSP-3530/4030 series are designed for use in outdoor terminals, gas pumps, airplane cockpits, instruments, weighing scales, agricultural instrumentation and point-of-sale terminals.

The High Efficiency Red (HDSP-3530/3730 Series) displays are priced at \$2.05\* (7.6mm/0.3") and the Yellow (HDSP-4030/4130 Series) displays are \$2.25\* (10.9mm/0.43") in quantities of 1000.

For immediate delivery, call any franchised HP distributor. In the U.S. contact Hall-Mark, Hamilton/Avnet, Pioneer-Standard, Schweber, Wilshire or the Wyle Distribution Group (Liberty-Elmar). In Canada, call Hamilton/Avnet or Zentronics, Ltd. \*U.S. Domestic Prices Only.



1507 Page Mill Road, Palo Alto, California 94304

For assistance call: Washington (301) 948-6370, Chicago (312) 255-9800, Atlanta (404) 955-1500, Los Angeles (213) 877-1282

01803

CIRCLE NUMBER 2

## MIL-SSR UPDATE

# Another SSR first from Teledyne!

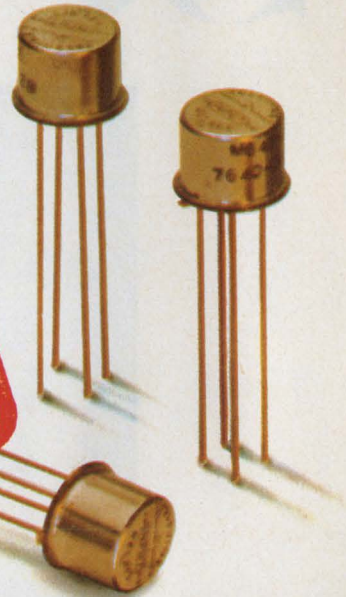

Experience, design know-how, and advanced solid state relay technology bring you another industry milestone with Teledyne's M640 Series — the first solid state relays to receive QPL approval to MIL-R-28750:

- M28750/5 (Teledyne P/N M640-1W)
- M28750/6 (Teledyne P/N M643-1W)
- M28750/7 (Teledyne P/N M643-2W)

These SSRs have already established a high reliability record that spans a broad spectrum of switching applications for both airborne and ground support equipment. Our M640 Series features all-

solid-state circuitry utilizing hybrid microcircuit techniques in a hermetically sealed TO-5 package. And they're available with bipolar output for AC or DC loads up to 60mA/40V and DC outputs for loads up to 300mA/40VDC or 100mA/250VDC.

For complete specification data, contact your nearest Teledyne Relays sales office listed in EEM, Gold Book or Electronics Buyers' Guide. You'll find we have the experience, products, and technical support to meet all your SSR needs — including a quick reaction capability to design SSRs specifically for your application.

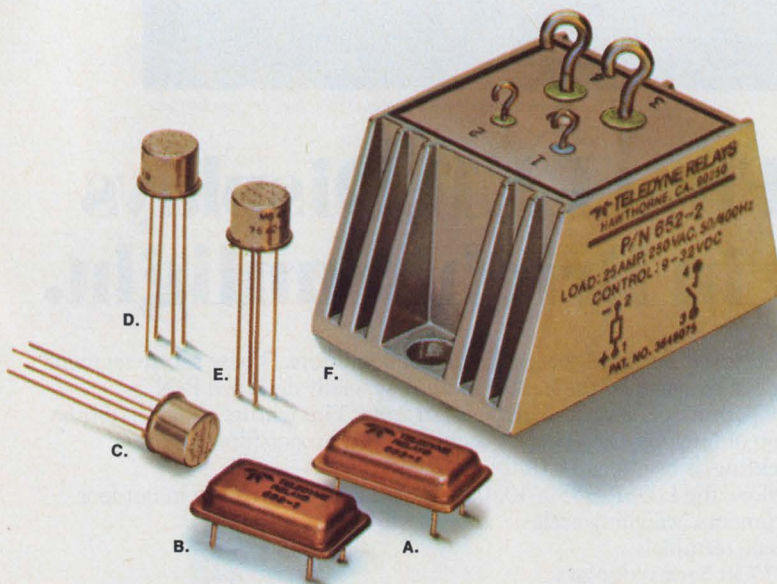

### TELEDYNE'S MILITARY SSRs

- A. **P/N 683-1 DC SSR**  
DIP package, with output rated at 600mA/50VDC
- B. **P/N 682-1 AC SSR**  
DIP package, with output rated at 1A/250VAC
- C. **P/N M640-1W Bi-polar SSR**  
Mil P/N M28750/5. TO-5 package, with bi-polar (AC/DC) output rated at 60mA/40V
- D. **P/N M643-1W DC SSR**  
Mil P/N M28750/6. TO-5 package, with output rated at 300mA/40VDC
- E. **P/N M643-2W DC SSR**  
Mil P/N M28750/7. TO-5 package, with output rated at 100mA/250VDC
- F. **652 Series AC Power SSR**  
Output rated at 25A/250VRMS

## TELEDYNE RELAYS

3155 West El Segundo Boulevard, Hawthorne, California 90250  
Telephone (213) 973-4545

CIRCLE NUMBER 3

## NEWS

- 23 **News Scope**
- 26 **Speed's up in 'fast' transistors**, but it's not the only improvement—An Electronic Design special report.
- 42 **VLSI devices are on the way** — and the first ones will be memorable.
- 50 **High-end  $\mu$ Ps don't exist**, are hard to define, but they're coming.
- 59 **Washington Report**

## TECHNOLOGY

- 66 **Schottky or high-speed pn rectifiers?** Schottky devices have low forward drops, but pn rectifiers offer higher reliability and lower cost.
- 72 **Boost high-voltage dc outputs:** Pair a TV-proven cascaded voltage multiplier with a switcher to ease high-voltage power-supply design.
- 76 **Measure SCR parameters automatically.** Avoid manual adjustments with a circuit that pins down holding current and other characteristics.
- 82 **Evaluate UV EPROM data retention** to get the best unit. By applying some simple tests you can easily determine temperature-related problems.
- 86 **Ideas for Design:**  
Get a controlled delay and ramp with a single CMOS inverter package. Plotting routine produces compact, high-resolution graph. Send out analog data on the same line that supplies power to a v/f converter.
- 92 **International Technology**

## PRODUCTS

- 97 **Instrumentation:** True-rms measurements come of age as new DVM cuts price, eases use.
- 100 **Instrumentation:** Serial-data analyzer preprograms all functions.
- 114 **ICs & Semiconductors:** DAC simplifies  $\mu$ P interface; it acts like a memory location.
- 116 **ICs & Semiconductors:** Fastest monolithic a/d delivers 8 bits in 50 ns.
- 118 **ICs & Semiconductors:** Speedy math circuits perform both multiply and divide.
- 106 Micro/Mini Computing
- 110 Modules & Subassemblies
- 112 Packaging & Materials
- 119 Power Sources
- 122 Components
- 124 Data Processing

## DEPARTMENTS

- 63 **Editorial:** Today's dreams. Tomorrow's reality?
- 7 Across the Desk
- 126 Application Notes
- 127 Bulletin Board
- 128 New Literature
- 133 Employment Opportunities
- 140 Advertisers' Index
- 140 Information Retrieval Card

**Cover:** Photo by Dudley, Hardin and Yang, Inc. courtesy of John Fluke Manufacturing Co.

# THE FIRST 70 VOLT TRANSISTOR

## THE 8063.

TYPICAL APPLICATION

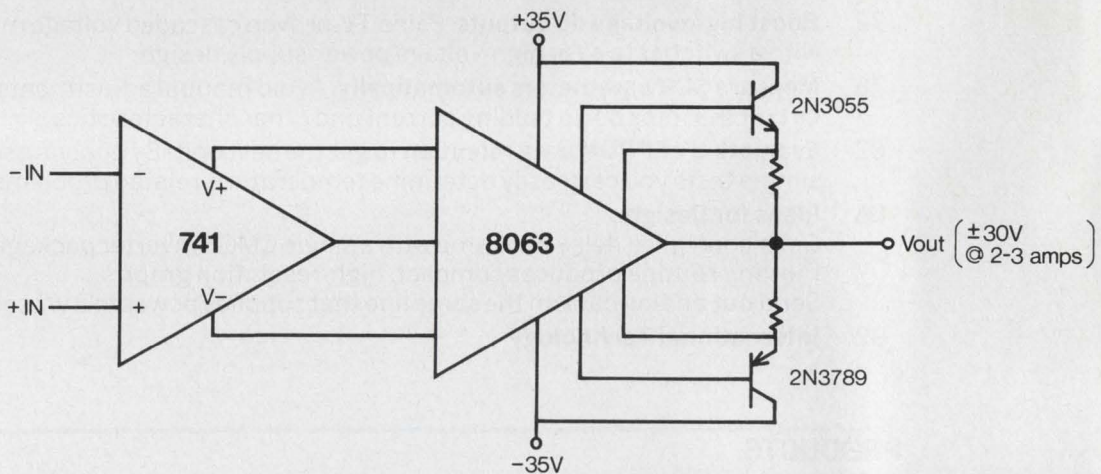

THE MONOLITHIC ICL 8063 HELPS DELIVER THE POWER IN 5 AMP OR HIGHER APPLICATIONS.

If your present power transistor driver circuit board looks like this...

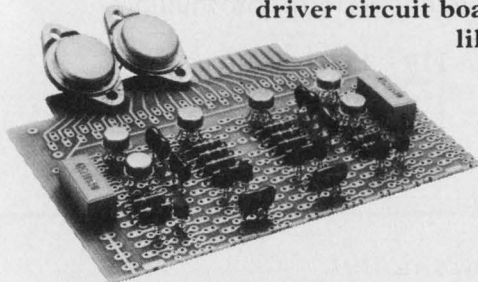

We can help you make it look a lot more like this.

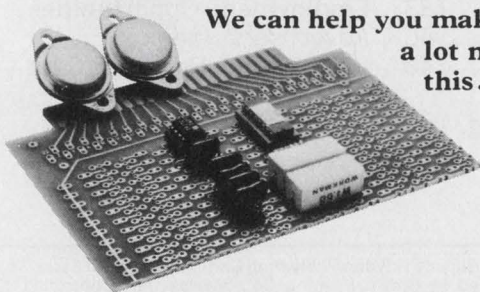

### LOSE DISCRETES. GAIN DESIGN TIME.

With the ICL 8063's, you'll spend more time designing systems — and less time designing circuits. And, by having the ICL 8063 perform the amplifying, regulating, buffering and protective functions, you'll increase reliability, reduce space requirements, and, lower system costs.

### ONE MONOLITHIC 16 PIN DIP.

- Converts op amp outputs into  $\pm 30V$  out;  $100Ma$  out.
- Safe operating area and short circuit protection are built-in.
- Built-in  $\pm 14V$  regulators allow you to supply local op amps (or other I.C.'s) without adding extra power supplies.
- $500K \Omega$  input impedance with  $R_{BIAS}$  equal to  $1 \text{ Meg } \Omega$ .

# MONOLITHIC POWER DRIVER:

## THE ICL 8063 HAS THE RIGHT PRICE.

Qty	0-70°C	0-70°C	-55°C to +125°C
1000	\$1.49	\$1.79	\$6.00
	Plastic DIP (ICL8063CPE)	CERDIP (ICL8063CJE)	CERDIP (ICL8063MJE)

## COMPATIBLE WITH YOUR OP AMPS AND POWER TRANSISTORS.

The ICL8063 operates from inputs generated by 99% of the op amps in use today... regardless of technology. The ICL8063 also operates from inputs generated by timers, comparators, and waveform generators. Further, it will drive 99% of the power transistors with breakdown voltages up to 70 volts. And last, the ICL8063 provides built-in low voltage power supplies.

## A COMPLETE POWER AMPLIFIER MADE EASY.

The addition of only two external power transistors, bias and current limiting resistors, and compensation capacitors to the ICL 8063 produces a system capable of safely delivering over 2 amps at 24V ( $\approx$  60 watts) to any resistive, capacitive, or inductive load. You now have a circuit that will not only drive solenoids, motors, coax cable, speakers, etc. — you also have a circuit with built-in safe-operating area and short-circuit protection.

## INTERSIL: THE SOURCE.

As leaders in precision analog device technology, we can offer you a broad range of operational amplifiers, analog switches, comparators, regulators, waveform generators, and timers — you name it. And now, we offer the ICL 8063 universal power transistor driver amplifier.

## SEND FOR ONE. FREE.

If you'd like to try the ICL 8063 in your appli-

CIRCLE NUMBER 4

cation, we'll help you. Just complete the coupon, attach it to your company letterhead, and return it to us.

## INTERSIL SALES OFFICES:

CALIFORNIA: Sunnyvale (408) 744-0618, Carson (213) 532-3544 • COLORADO: Denver (303) 750-7004  
FLORIDA: Fort Lauderdale (305) 772-4122 • ILLINOIS: Hinsdale (312) 986-5303 • MASSACHUSETTS: Lexington (617) 861-6220 • MINNESOTA: Minneapolis (612) 925-1844  
NEW JERSEY: Englewood Cliffs (201) 567-5585 • OHIO: Dayton (513) 866-7328 • TEXAS: Dallas (214) 387-0539  
CANADA: Brampton, Ontario (416) 457-1014

## INTERSIL FRANCHISED DISTRIBUTORS:

Advent/Indiana • Alliance • Arrow Electronics  
CESCO • Century Electronics • Component Specialties • Components Plus • Diplomat/IPC  
Diplomat/Southland • Elmar Electronics  
Harvey/Binghamton • Intermark Electronics  
Kierulff Electronics • LCOMP • Liberty Electronics • R.A.E. Ind. Elect. Ltd. • RESCO  
Schweber Electronics • Sheridan • Zentronics

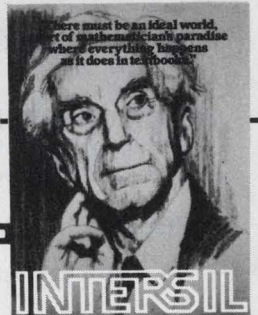

# INTERSIL

Analog Division — Linear Integrated Circuits  
10710 North Tantau Avenue, Cupertino, CA 95014  
Tel: (408) 996-5000 TWX: 910-338-0171  
(800) 538-7930 (outside California)

Gentlemen: I think you've got something there. Send me a free sample\* of your power transistor driver amplifier.

\_\_\_\_\_ ICL8063MJE; \_\_\_\_\_ ICL8063CJE; \_\_\_\_\_ ICL8063CPE;

\_\_\_\_\_ App Notes and Data Sheet.

\_\_\_\_\_ Send me your new 20 x 24 Bertrand Russell poster.

Name \_\_\_\_\_

Company \_\_\_\_\_

Address \_\_\_\_\_

City \_\_\_\_\_ State \_\_\_\_\_ Zip \_\_\_\_\_

\*To qualify for a free sample, attach this coupon to your company letterhead. Sample offer valid for the first 1000 industry requests received within 60 days of publication. One per person.

ED032978

ELECTRONIC INDUSTRY DECISION MAKERS:

# 6 WAYS TO IMPROVE YOUR PRESENT LED MOUNTING SYSTEM

## CLIPLITE™



PAT. PEND. U.S. & FOREIGN

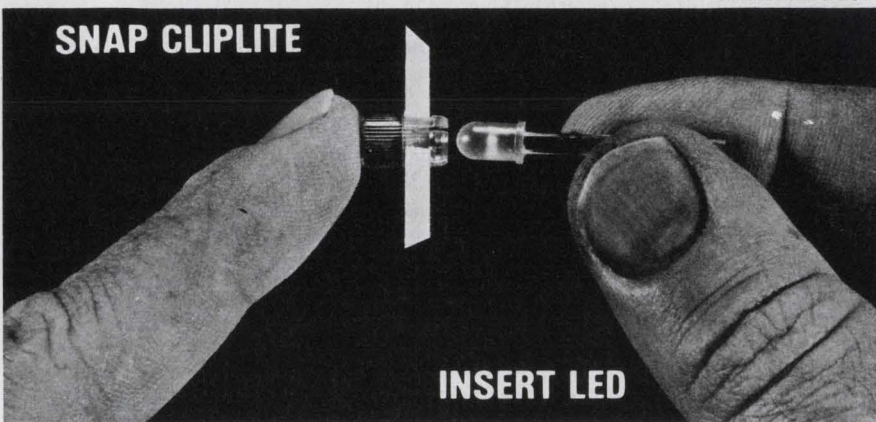

- 1. EASIER TO INSTALL** — Simple 2-step mounting requires no tools. Just snap CLIPLITE into panel hole and insert LED. That's all there is to it. . . . installs in just 6 seconds!
- 2. LOWER ASSEMBLY COST** — including installation and labor, you save 20% per unit.
- 3. 100% GREATER VISIBILITY** — CLIPLITE provides 180 degrees visibility using a point source LED and is 5 times brighter than normal diffused LED. Comes in 5 colors, red, amber, green, yellow and clear.
- 4. SECURE LED MOUNTING** — No LED back-out.
- 5. TOTAL LED PROTECTION** — CLIPLITE completely encloses LED.
- 6. MOISTURE SEALS** — No more worries about spilled liquids or water damage. No more logic failures due to static electricity.

Cliplites are also available in Incandescent and Neon models.

### SPECIAL OFFER!

PLACE YOUR TRIAL ORDER TODAY

#### Special Pricing for Trial Order Only

ED3-8

PLEASE SHIP:  100 CLIPLITES \$10.00  LITERATURE

NAME \_\_\_\_\_ COMPANY \_\_\_\_\_

ADDRESS \_\_\_\_\_

CITY \_\_\_\_\_ STATE \_\_\_\_\_ ZIP \_\_\_\_\_



**VISUAL COMMUNICATIONS COMPANY**

P.O. BOX 986 EL SEGUNDO, CALIFORNIA 90245 (213) 822-4727

CIRCLE NUMBER 5

### Publisher

William Maass

### Editors

Editorial Offices  
50 Essex St.  
Rochelle Park, NJ 07662  
(201) 843-0550  
TWX: 710-990-5071  
(HAYDENPUB ROPK)  
Cable: Haydenpubs Rochellepark

**Editor-in-Chief** George Rostky

### Managing Editors:

Ralph Dobriner  
Michael Elphick

### Senior Associate Editor

Stanley Runyon

### Associate Editors:

Sid Adlerstein  
Nicholas Bodley  
Dave Bursky  
Morris Grossman  
Gene Heftman  
Andy Santoni  
Max Schindler

### Contributing Editors:

Peter N. Budzilovich, Jules H. Gilder,  
Sidney Moskowitz, Nathan Sussman

### Editorial Field Offices

#### East

Jim McDermott, Eastern Editor  
P.O. Box 272  
Easthampton, MA 01027  
(413) 527-3632

#### West

Dick Hackmeister, Western Editor  
8939 S. Sepulveda Blvd., Suite 414  
Los Angeles, CA 90045  
(213) 641-6544  
TWX-1-910-328-7240

Dave Barnes, Western Editor  
465 S. Mathilda, Suite 302  
Sunnyvale, CA 94086  
(408) 736-6667

### Editorial Production

Marjorie A. Duffy, Production Editor  
James Keane, Copy Editor

### Art

**Art Director**, William Kelly  
Richard Luce, Anthony J. Fischetto

### Business Manager

Thomas E. Vachon

### Production

**Manager**, Dollie S. Viebig  
Nancy Hurey

### Circulation

**Director**, Barbara Freundlich  
**Senior Assistant**, Gail Stone

### Information Retrieval

Paula Greenleaf

### Advertising Promotion

**Director**, William Hussey  
**Assistant**, Judith Nappo

### Reprints

Maxine Sassano



# Across the desk

## Not that much money in aerospace design

Your News Scope article, "Electronics in Cars must be as Reliable as in Space" (ED No. 25, Dec. 6, 1977, p. 22), drew my attention. While I agree with the conclusion drawn by Eugene Karrer, (Vice President and General Manager of Ford Motor Co.'s Electrical and Electronics Div.) I believe his reference to aerospace engineering is misleading and unfair to the space industry.

You reported: "Karrer noted that aerospace designer can spend huge amounts of money to build a protective environment for his electronics as well as a fully redundant backup system." I take umbrage with the phrases "huge amounts" and "fully redundant." To the best of my knowledge, there have never been huge amounts of money that the aerospace designer could spend on building protective environments for his electronics, nor have there been fully redundant backup systems.

Based on my experience as an aerospace engineer over the past 25 years on such manned spacecraft programs as the Skylab and the current Shuttle, I believe that low cost has been one of the main drivers. Certainly, on the Shuttle Program it is the principal driver, consistent with adequate safeguards for crew life, vehicle integrity and operability, and mission success.

As a matter of fact, use of existing off-the-shelf, commercially available hardware was the first major consideration in selecting the necessary electronics equipment. The electronics for the data systems do not, in fact, have fully redundant backup. There are very few redundant black boxes in that system.

*Daniel Riegert  
NASA Engineer*

Johnson Space Center  
Houston, TX 77058

## Misplaced Caption Dept.

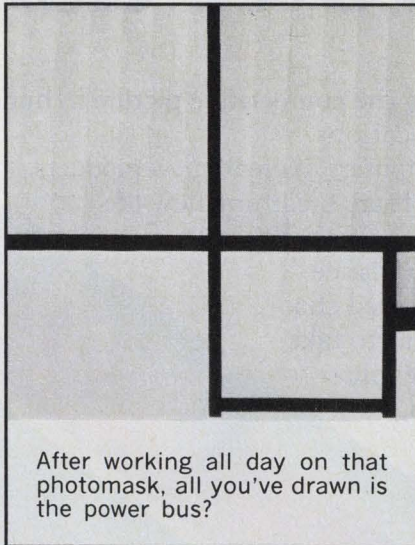

After working all day on that photomask, all you've drawn is the power bus?

Sorry. That's Piet Mondrian's "Composition with Yellow," which hangs in the collection of Jan Tschichold, Basel, Switzerland.

## Ideas too elaborate?

Aren't the two Ideas for Design on automobile voltage regulators (ED No. 15, July 19, 1977, p. 100, and ED No. 25, Dec. 6, 1977, p. 100) rather elaborate?

The shop manual for the 1965 Rambler (AM-65-4003) shows a simple voltage regulator that uses only two transistors, one zener, one thermistor and several resistors. Simple regulators like these have been working on my two Rambles for the last 12 years.

Furthermore, both Ideas for Design feature outputs that are almost independent of temperature. But my shop manual explains that the Rambler-circuit thermistor causes the output voltage to rise when the temperature falls: A higher voltage is needed to charge a lead-acid battery when it's

*(continued on page 20)*

Electronic Design welcomes the opinions of its readers on the issues raised in the magazine's editorial columns. Address letters to Managing Editor, Electronic Design, 50 Essex St., Rochelle Park, NJ 07662. Try to keep letters under 200 words. Letters must be signed. Names will be withheld upon request.



## DIP ISOLATORS DIP ISOLATORS DIP ISOLATORS DIP ISOLATORS

*OPTRON's complete line of optically coupled plastic DIP isolators offers immediate availability of standard devices for almost every application ... plus competitive pricing, high reliability and excellent customer service.*

*Check these features and choose the device best suited for your application.*

**GENERAL PURPOSE**  
A full selection of DIP isolators with transistor and darlington outputs to match all popular industry standards. Current transfer ratios range from 2.0% to 500%.

**HIGH VOLTAGE**  
For applications requiring an interface with high voltage circuits, select the OPI 6000 DIP isolator with a 300 volt output transistor.

**AC OPERATION**  
The OPI 2500 DIP isolator features two input LED's operating in inverse parallel and is ideal for applications where the LED is driven from an AC line.

**CUSTOM SELECTION**  
If your application demands "something a little different," OPTRON specializes in DIP isolators to meet special customer requirements.

*For reliability data and technical specifications on OPTRON's complete line of plastic DIP isolators, contact your nearest OPTRON sales representative or the factory direct.*

 **OPTRON, INC.**  
1201 Tappan Circle  
Carrollton, Texas 75006, U.S.A.  
TWX-910-860-5958  
214/242-6571

# What engineering about using micro

Microcomputers are changing the competitive picture in hundreds of industries, in thousands of applications.

Designers are using microcomputers to create new products, even new markets. Microcomputers are breathing new life into existing products and providing competitive advantages in both price and performance.

For management, there's an added challenge. What's the most *profitable* way to take advantage of the microcomputer revolution? Should you start from scratch, dedicating time and resources to component-level design? Or should you take advantage of fully assembled and tested "computers-on-a-board"?

You didn't have a choice until just two years ago. That's when we introduced the first single board computer. Like "super components," single board computers have made it easy to add intelligence to any system.

Sheer economics is one reason why. Up to 1,000 systems a year, you're money ahead with single board computers. That's based on a tradeoff formula that carefully considers amortized development and testing expenses, as well as direct material and labor costs.

Then, when production volume makes it more economical for you to switch to components, we'll provide all you need to do the job yourself—manufacturing drawings, pc artwork and a volume source for all the essential LSI components.

Time saved is another important reason single board computers make sense. You're into production sooner, without time spent developing the computer sub-system. Your engineers can go directly to the design of application-dependent hardware.

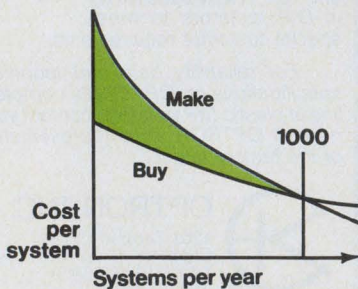

# managers should know computers profitably.

RMX-80™ Real-time Multitasking Executive gives you a head start in software development, without the need to reinvent system software for every application. Intellec®, our microcomputer development system, speeds application software development. It puts PL/M and FORTRAN-80 (ANS FORTRAN 77) high-level programming languages and a macro-assembler at your command. And supports full text editing, relocation and linkage capability. In-Circuit Emulation, with symbolic debugging, provides a diagnostic window

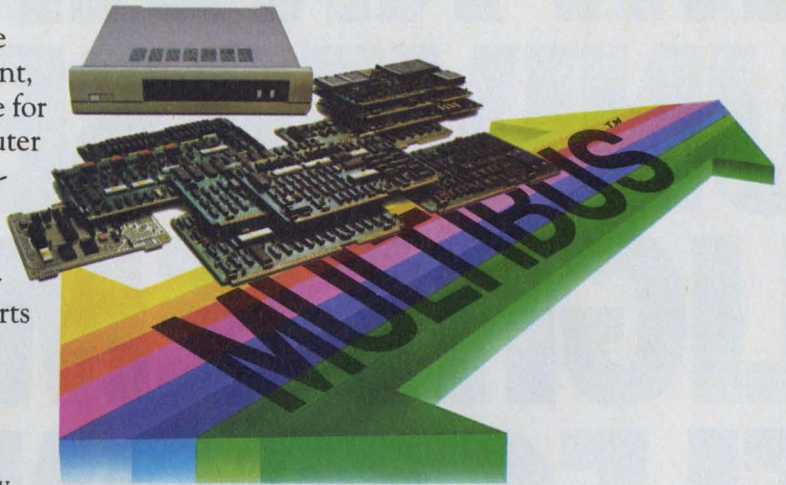

into your prototype to speed and simplify system development.

Our growing selection of iSBC™ products gives you the flexibility to tailor a system to your specific application, without compromise. Choose one of our five single board computers, starting at \$99.\* There's a full selection of memory expansion boards, communication interface boards, digital and analog I/O boards, mass storage systems and a high speed math processor. Or you can start with one of our packaged System 80's.

You're assured of the highest reliability when you build your system around an Intel single board computer. For example, MTBF for our iSBC 80/10 is 91,739 hours at 25°C. Ask for your copy of our iSBC Reliability Report.

There's also the security of Multibus™, the multi-processing bus architecture we developed for single board computers. Multibus has become such a widely accepted industry standard that today there are over a hundred Multibus-compatible products available from 42 independent companies. And Multibus is your guarantee of compatibility with future Intel iSBC products.

Get started with our comprehensive iSBC System Configuration Kit. It's a catalog of Intel single board computer products, with detailed configuration instructions and worksheets to help you define the optimum iSBC solution for your needs.

For your kit, or for on-site assistance in configuring and pricing your iSBC system, contact your Intel representative or distributor. Or write: Intel Corporation, 3065 Bowers Avenue, Santa Clara, California 95051. Telephone: (408) 987-8080. In Europe contact: Intel International, Rue du Moulin à Papier, 51-Boite 1, B-1160, Brussels, Belgium. Telex 24814. In Japan contact: Intel Japan, K.K., Flower Hill-Shinmachi East Bldg. 1-23-9, Shinmachi, Setagaya-ku, Tokyo 154. Telex 781-28426.

## intel® delivers.

FOR ISBC CONFIGURATION PLANNING KIT CIRCLE NUMBER 7

FOR PRICING AND CONFIGURATION ACCT. CIRCLE NUMBER 8

# **OUR EXPANDING UNIVERSE OF LIGHT-EMITTING ELECTRONICS**

**CHOOSE THE DEVICE YOU NEED FROM 310 TYPES**

Now Litronix offers an opto-electronic device for virtually every application. Over 300 LED displays, LED lamps, opto-isolators, IR emitters, photo-detectors and photo-voltaic cells. And more are coming every month.

You will find advanced products not available anywhere else. As well as widely-used standard devices at highly competitive prices.

Some highlights:

#### ALPHANUMERIC LED DISPLAYS.



Character sizes from 0.16" to 0.50" in end-stackable arrays of 1 to 4 red characters — including an intelligent display that interfaces just like a RAM to  $\mu$ P buses.

#### DIGITAL LED DISPLAYS.



Green, yellow and red digits. Nine sizes from 0.1" to 1" high. In DIPs of 1 and 2 digits. On PCBs of 2 to 6 digits with edge connectors. Both light-pipe displays with

very wide viewing angle and low-cost reflector displays. 70 different types.

#### LED LAMPS.



Red, orange, yellow and green lamps. T-1, T-1 $\frac{3}{4}$  and axial packages. Arrays of 2 to 10 lamps. With panel mounting clips. Lamps that flash on/off. Constant brightness lamps. Voltage-indicating lamps. 58 different types.

#### OPTO-ISOLATORS.

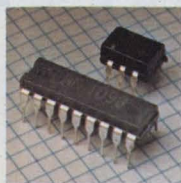

One, two and four-channel opto-isolators. Current transfer ratios up to 320%. Isolation voltages up to 5000v. Transmission rates as high as 4 megabits/sec. 15 JEDEC types. 25 different types in all.

#### IR EMITTING DIODES.



From medium to very high power. Beam widths from 6° to 60°. Hermetic and non-hermetic TO-18

size. Miniature with axial or radial leads. 30 different types.

#### PHOTO-DETECTORS.



Photo-transistors and photo-diodes with acceptance angles from 6° to 73°. Hermetic high-reliability devices and low-cost non-hermetic devices. TO-18 packages, ceramic packages and miniature radial lead configurations. Arrays of 2 to 10 detectors. 47 different types.

#### PHOTO-VOLTAIC CELLS.

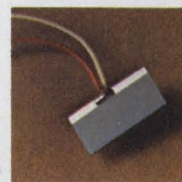

Silicon solar cells. Sensitivity from .04 microamperes to 2.8 microamperes. Twelve different types available.

#### SEND FOR FULL CATALOG.

Contains 32 pages on all devices in the product categories above. Phone your local distributor or contact Litronix at 19000 Homestead Road, Cupertino, CA 95014. Phone (408) 257-7910.

**litronix**  
AN AFFILIATE OF SIEMENS

## THE LIGHTS FANTASTIC

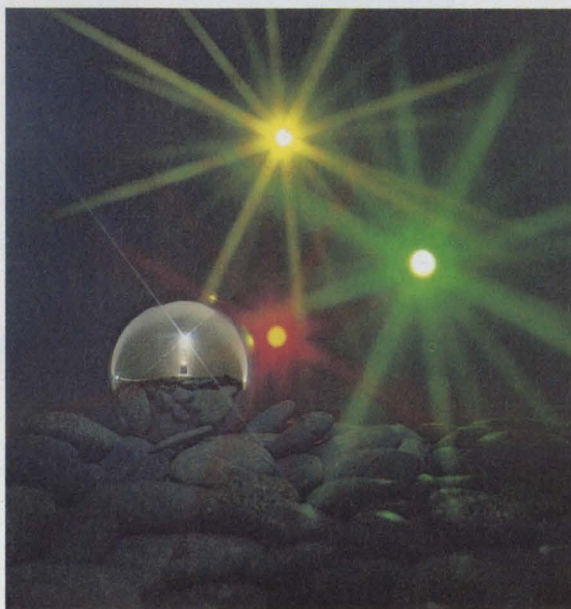

New cost saving devices for computer peripheral manufacturers.

# STANDARD MICROSYSTEMS' FAMILY OF MOS/LSI CIRCUITS.

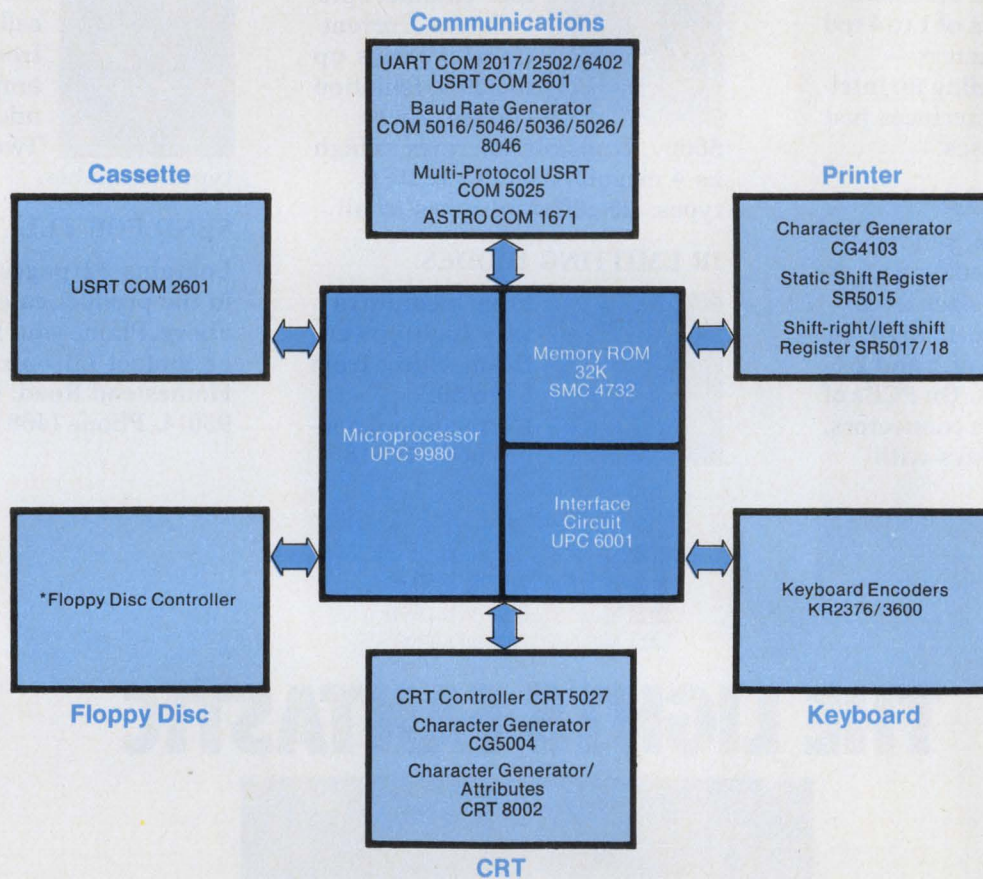

Now, with SMC's standard computer peripheral MOS/LSI circuits, most standard peripheral functions can be "plugged-in". Design is easier. Products are more reliable. Assembly is faster — and that keeps cost down. For details on our standard devices or for custom LSI requirements call today.



**STANDARD MICROSYSTEMS CORPORATION**

35 Marcus Boulevard, Hauppauge, N.Y. 11787  
(516) 273-3100 TWX-510-227-8898

The largest manufacturer of MOS/LSI data communication circuits

# NEW

## A way to sharply reduce power loss in switching power supplies.

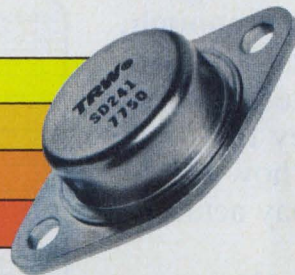

### Replace P-Ns with TRW's all-new Dual Schottky Power Diode

TRW's new SD-241 puts two Schottky power diodes in a single TO-3 package.

Ideal for rectification of center-tap transformers supplying 5Vdc or less and up to 20A...and for commutation/flyback of current where peak inverse voltage does not exceed 45V.

With a forward voltage drop of only 0.6V (at 20A), the SD-241 will give you up to twice the efficiency of two P-Ns and cut your heat sink requirements in half. You'll save space, lower your circuit costs and increase the reliability of your 50-150W switching power supplies.

For complete details of this new way to save power and boost efficiency in your switching power supply design, send us the coupon now.

**TRW** POWER SEMICONDUCTORS  
ANOTHER PRODUCT OF A COMPANY CALLED TRW

**TRW Power Semiconductors**

An Electronic Components Division of TRW Inc.  
14520 Aviation Boulevard, Lawndale, California 90260

**Please send me complete data on TRW's new SD-241 Dual Schottky Power Diode.**

Name \_\_\_\_\_  
Company Name \_\_\_\_\_  
Position \_\_\_\_\_  
Address \_\_\_\_\_  
City \_\_\_\_\_ State \_\_\_\_\_ Zip \_\_\_\_\_ ED

# Compare our SOA and $E_{S/b}$ to theirs and you'll understand why our high current/voltage transistors work.

**High voltage and high current specs aren't enough.**

If you've ever specified transistors above 50 amps, only to find they fail on the job, you know how high-current specs may actually be misleading.

The truth is, unless you see the SOA and  $E_{S/b}$  specs, there's no way of knowing whether a high-current device has the guts to withstand a surge, and not blow out.

That's why we publish both our Safe Operating Area and  $E_{S/b}$  specs.

We want you to see precisely the kind of super-ruggedness you can expect from PowerTech—and only PowerTech—high-current transistors. Compare our  $E_{S/b}$  ratings, from 1.5 to 6 joules, against the millijoules or unpublished ratings of other high-voltage/current devices.

**Copper makes the difference.**

We use extra-heavy copper-metalizing on our bigger, beefier chip—thereby assuring maximum thermal

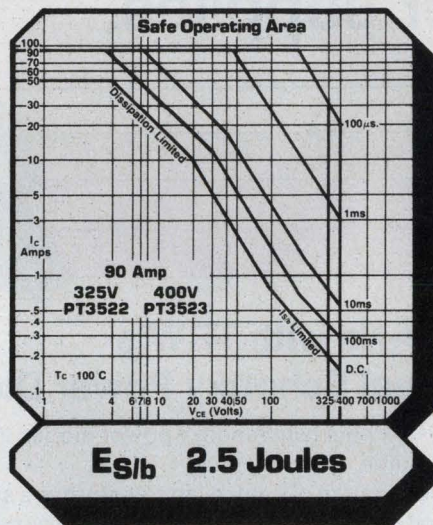
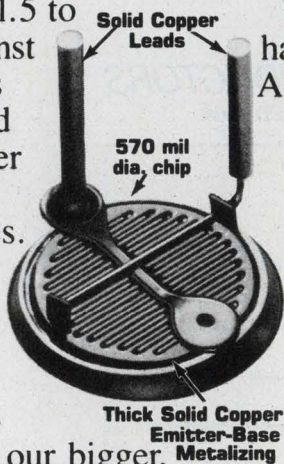

and electrical conductivity and yielding the highest resistance to second breakdown with the lowest  $V_{CE(sat)}$ . Their smaller chips use thin aluminum-metalizing with fragile, current-limiting wires (ours have solid copper posts).

Which would you rather have your circuit depend on? And we don't stop there. To guarantee rapid delivery, we pre-mount our chip on an integral moly-copper heat sink so we can categorize and pre-test the module at high currents to insure maximum reliability prior to mounting in the package of your choice (again 100% tested to the most stringent MIL/AERO specs).

They, on the other hand, must first mount their chip on the package, then test to determine if it's shippable.

**Delivery and prices.**

Our catalogs come complete with prices... we don't believe in secrets.

While our initial device cost may be slightly higher, in the long run we believe you'll find that it's less expensive to use transistors that keep on working.

We rely on direct factory-to-customer contact to ensure 100% responsiveness, backed up by the flexibility of chips already built, pre-tested and ready for whatever electrical/packaging requirements you may have.

But see for yourself: call for further information and applications assistance: Sales Engineering, PowerTech, Inc., 0-02 Fair Lawn Avenue, Fair Lawn, New Jersey 07410; Tel. (201) 791-5050.

## TYPICAL PRODUCTS

$I_C$	$V_{CE}$	$E_{S/b}$	Part No.
1200A	80V	6.0J	MT-5007
400A	120V	6.0J	PT-9503
150A	200V	1.5J	PT-4500
90A	400V	2.5J	PT-3523
40A	600V	2.5J	PT-3526

JAN-TX Types Also Available  
Guaranteed  
SOA

# PowerTech, Inc.

"BIG IDEAS IN BIG POWER"

CIRCLE NUMBER 12



# UNITRODE JUST CUT YOUR POWER TRANSISTOR COSTS IN HALF.

Introducing Unitrode's new transistors and Darlington's for pulse power applications. Rated up to 5A peak and up to 500 V. And priced as low as 18¢ – in quantities of 25,000 – half the cost of the competition.

But what you pay is just the beginning of what you save. Because we make our new transistors and Darlington's in TO-92 packages, they take up a lot less space on your circuit board. And because we can deliver them taped and reeled, you can use them with your automated insertion equipment.

It's time you heard the specs.

For our HV transistors: UPTA510-530,  
1A peak to 300V; UPTB520-550,  
.5A peak to 500V.

For the Darlington's:  
U2TA506-510, 5A peak  
to 100V.

The low cost, the current ratings and the convenient packaging make Unitrode's new power transistors and Darlington's perfect for high volume manufacturing applications such as: power supplies, hammer drivers, thermal printers, lamp drivers, relay replacements and chargers.

Best of all, Unitrode's new series are available right now, in the quantities you need.

The Unitrode TO-92 power transistors and Darlington's.

They save you money now and they'll save you money later.

For more information, call or write: Unitrode Corporation, 580 Pleasant Street, Watertown, MA 02172. 617-926-0404.



UNITRODE

**IN SEMICONDUCTORS, UNITRODE MEANS POWER.**

Your Guardian Angel invites you to  
**CHECK HER MEASUREMENTS**  
of these two "half-size" 13 amp relays.

These two small relays are about half the size of competitive relays that do the same job. The cost? About the same as those big competitive units. In many cases, a few cents less.

Choice of dual type (solder lug or 3/16" QC) or printed circuit termination. Choice of solder lug, printed circuit or screw mount sockets.

**I380**

4 Form C (4PDT)  
contact arrangement.

**I390**

2 Form C (2PDT)  
contact arrangement.



Get all the facts on both these "half-size" relays. Send today for special technical bulletins that are yours free for the asking.

**GUARDIAN**<sup>®</sup>

GUARDIAN ELECTRIC MANUFACTURING COMPANY—1550 W. Carroll Avenue, Chicago, IL 60607—312/243-1100

CIRCLE NUMBER 14

# CERAMIC SELECTION:

With KEMET Monolithic Ceramic Capacitors, you get a wide range of types, sizes and capacitances from a single, reliable source—to make specification and selection simpler and faster for you.

Take your choice of CK05-CK16, CKR05-CKR16, CDR Established Reliability Chips, MIL-C-20, Dipped, "Solder Guard" and "Gold Guard" Chips, or KEMET BX and NPO Monolithic Ceramic Capacitors.

Name the dielectric—Ultra-Stable NPO, Stable BX or General-Purpose Z5U—with radial or axial leads in the size you need.

Get complete selection data. Write today for your free copy of the KEMET Monolithic Ceramic Capacitors Catalog.

Components Department, Union Carbide Corporation, P.O. Box 5928, Greenville, SC 29606; phone (803) 963-6300, TWX: 810-287-2536, or Telex: 57-0496.

Or see your local KEMET Capacitors Distributor.

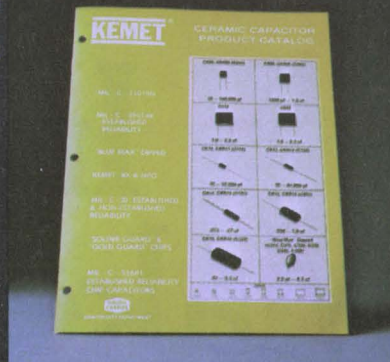

## KEMET<sup>®</sup> OFFERS YOU MORE.

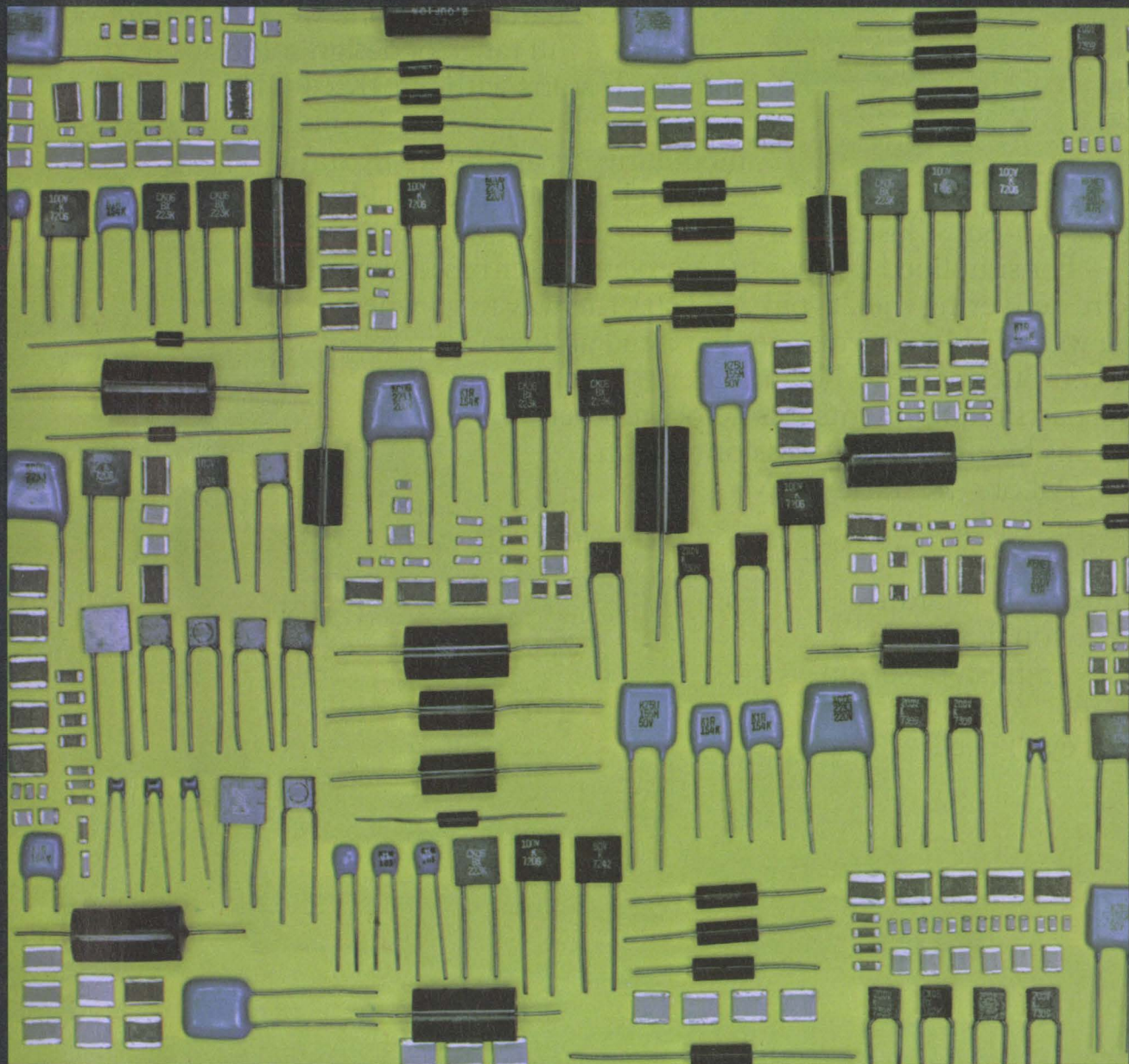

**UNION CARBIDE** COMPONENTS DEPARTMENT

KEMET is a registered trademark of Union Carbide Corporation.

CIRCLE NUMBER 15

In Europe: Union Carbide Europe, S.A. 5, Rue Pedro-Meylan, Geneva 17, Switzerland Phone: 022/47 4411 Telex: 845-22253

# Intel delivers the Make the move now

Now's the time to replace those 2102 1K designs with Intel's higher density 2114, the most widely sourced 4K static RAM. The 2114 is already less expensive at the board level than the 2102. You'll save power without compromising speed.

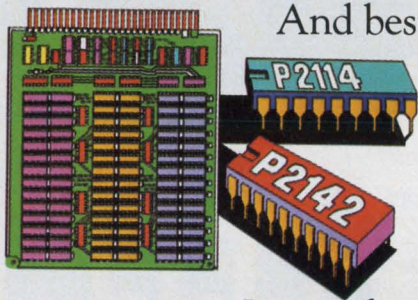

And best of all, we're delivering the 2114 in volume. We can ship up to 10,000 parts within one week of receipt of order.

There's a full range of design solutions in the 2114 family. It starts with our 1Kx4 2114, for the highest possible density and modularity in an 18-pin 4K static RAM. Then there's the 2114L.

Same pin-out. Just as fast. But 30% lower power.

For simplified designs in microcomputer-based systems, we're delivering the 20-pin 2142. It's the way to go when you want 2114 performance, but need an extra chip select and output enable. The output enable function cuts parts requirements in microcomputer systems by eliminating bus contention.

All our 4K static RAMs inherit the ease of use and low overhead of our industry-standard 1K 2102. You don't need a clock, refresh or set-up timing. You don't even need



# 2114 in volume. to 4K static RAMs.

pullup resistors or output gating. Our 4K static RAMs operate at TTL levels on a single +5V supply, and have buffered three-state outputs.

We guarantee identical access and cycle times on these parts, so you can surpass the performance of clocked static RAMs. For example, you can achieve a data rate of 20 megabits per second with the 200 nanosecond 2114-2 or 2142-2 parts. That's twice the data rate of clocked RAMs with a 200 ns access time. Intel specs guarantee that even at high throughput rates you'll need less than half the power of first generation static RAMs.

You can take advantage of 2114 and 2142 economy and Intel's production availability by ordering directly from: Almac Stroum, Component Specialties, Cramer, Hamilton/Avnet, Harvey, Industrial Components, Pioneer, Sheridan, Wyle/Elmar, Wyle/Liberty, L.A. Varah or Zentronics.

Or ask your Intel salesman how you can get an assembled and tested card, the Intel Memory System in-7000. It gives you up to 16K words on one card, up to 528K in one chassis.

Intel 1K x 4 MOS STATIC RAMs

	Access Time & Cycle Time (max) 0-70°C	I <sub>cc</sub> (max) @ V <sub>cc</sub> (max) 0-70°C
2114-2	<b>200ns</b>	100mA
2114L-2		70mA
2142-2		100mA
2142L-2		70mA
2114-3	<b>300ns</b>	100mA
2114L-3		70mA
2142-3		100mA
2142L-3		70mA
2114	<b>450ns</b>	100mA
2114L		70mA
2142		100mA
2142L		70mA

Our entire selection of static RAMs are in the Intel 1977 Data Catalog. For individual data sheets on the 2114 or 2142 components or the in-7000 static RAM memory system write: Intel Literature Department, 3065 Bowers Ave., Santa Clara, CA 95051.

In Europe: Intel International, Rue du Moulin a Papier, 51-Boite 1, B-1160 Brussels, Belgium. Telex 24814. In Japan: Intel Japan K.K., Flower Hill-Shinmachi East Building 1-23-9, Shinmachi, Setagaya-ku, Tokyo 154. Telex 781-28426.

**intel® delivers.**

# Across the desk

(continued from page 7)

cold. And the regulator circuit is installed near the battery, so that the battery's temperature is sensed. Test specs given in the manual show that the regulator's output should be 14.6 to 15.5 V at 0 C and 13.6 to 14.4 V at 120 C.

Incidentally, some of the old relay-type regulators also contained such temperature compensation.

*Marriott Dickey*

113 Hillcrest Dr.  
Orinda, CA 94563

## Negative exponents gone

I would like to call attention to some errors in Michael I. Distefano's otherwise useful article, "Adjust Ferrite-Core Constants to Suit Your Coil Design Needs" (ED No. 24, Nov. 22, 1977, p. 154). Eq. 3 should read

$$L = 4\pi N^2 \mu (10^{-9})/C_1,$$

if L is expressed in henries. In the article, the minus is missing from the nine exponent. Similarly, the derived expression for  $A_L$  also should have a negative-exponent nine.

In addition, although the result, Eq. 4, is correct, the integral expression for  $C_1$  for a uniform toroid should be

$$C_1 = \frac{1}{\int_{r_2}^{r_1} \frac{h}{2\pi r} dr},$$

not the expression shown. Core constant  $C_1$  is characteristic of the reluctance of a core; thus, it should be handled like resistances connected in parallel. Consequently, you must sum, or integrate, the reciprocal quantities of  $C_1$  in the example of the toroid shown in Fig. 2a.

*Keith L. Williams*  
Project Engineer

Adams Electronics  
Division of Tracor  
16 Charles St.  
Bangor, MI 49013.

Ed. Note: Reader Williams is correct. Negative signs are missing from both Eq. 3 and the expression for  $A_L$ .

Also, the equation for  $C_1$  was intended to be printed as

$$(C_1)^{-1} = \int_{r_1}^{r_2} [2\pi r / (h \cdot dr)]^{-1},$$

an integration of reciprocals. In this form it retains its graphical parallelism with the preceding equation,

$$C_1 = \sum_{i=1}^n d_i/A_i,$$

which, however, applies to series-connected sections of a core. Again, this is a case of missing negative exponents. Seems our printer has an aversion to minus signs.

*But to point up how easily you can make an error, reader Williams' integral expression for  $C_1$  has the limits  $r_1$  and  $r_2$  reversed, which he can't blame on the printer. That's only an editor's privilege.*

## More unloaded-board testing than you think

I read "Testing Circuit Cards Can Be a Monstrous Job" (ED No. 24, Nov. 22, 1977, p. 64) with great interest and was disappointed that your only reference to unloaded-board testing was that of Hughes Aircraft, whose contribution to this area of testing is less than 10% in any year. There are at least 10 other companies involved in this area.

ES•P has been supplying this type of equipment as well as interconnect verification for cables, backplanes, and complex aircraft for 10 years.

*Harold F. Gainey*  
President

Electronic Systems and Programming Inc.  
3355 W. El Segundo Blvd.  
Hawthorne, CA 90250.

## 99% good

In "Try a Wien-bridge Network..." (ED No. 3, Feb. 1, 1978, p. 80), Eq. 10 should read

$$R_f = \frac{b(R_1)}{3(2 - b)}$$

Otherwise, nice!

*Albert E. Hayes, Jr., PhD*  
Consulting Engineer

778 Town & Country Rd.  
Orange, CA 92668

## SALES OFFICES

**ALABAMA**  
Pen-Tech Assoc.  
Huntsville  
(205) 533-0090

**ARIZONA**  
Intel Corp.  
Phoenix  
(602) 242-7205

BFA Corp.  
Scottsdale  
(602) 994-5400

**CALIFORNIA**  
MAC-I  
Berkeley  
(415) 843-7625  
MAC-I  
Cupertino  
(408) 257-9880

MAC-I  
Fountain Valley  
(714) 839-3341

Earle Assoc.  
San Diego  
(714) 278-5441

Intel Corp.  
Santa Ana  
(714) 835-9642

Intel Corp.  
Sherman Oaks  
(213) 986-9510

Intel Corp.  
Sunnyvale  
(408) 738-3870

MAC-I  
Woodland Hills  
(213) 347-1374

**COLORADO**  
Intel Corp.  
Denver  
(303) 373-4920

Mountaintek  
Evergreen  
(303) 674-5255

**CONNECTICUT**  
Intel Corp.  
Danbury  
(203) 792-8366

CMA Corp.  
Fair Haven  
(203) 789-1013

**FLORIDA**  
Pen-Tech Assoc.  
Deerfield Beach  
(305) 421-4989

Intel Corp.  
Ft. Lauderdale  
(305) 771-0600

Pen-Tech Assoc.  
Maitland  
(305) 645-3444

Intel Corp.  
Orlando  
(305) 628-2393

**GEORGIA**  
Pen-Tech Assoc.  
Atlanta  
(404) 955-0293

**ILLINOIS**  
Dytek-Central  
Arlington Heights  
(312) 394-3380

Intel Corp.  
Oakbrook  
(312) 325-9510

**IOWA**  
Technical Reps.  
Cedar Rapids  
(319) 393-5510

**KANSAS**  
Technical Reps.  
Lenexa  
(314) 888-0212, 3, 4

**MARYLAND**  
Mesa, Inc.  
Rockville  
(301) 881-8430

Glen White Assoc.  
Timonium  
(301) 252-6360

Intel Corp.  
Timonium  
(301) 252-7742

**MASSACHUSETTS**  
Intel Corp.  
Chelmsford  
(617) 256-4131

CMA Inc.  
Waltham  
(617) 894-7000

**MICHIGAN**  
Lowry and Assoc.  
Brighton  
(313) 227-7067

Intel Corp.  
Southfield  
(313) 353-0920

**MINNESOTA**  
Intel Corp.  
Bloomington  
(612) 835-6722

**MISSOURI**  
Technical Reps.  
Hazelwood  
(314) 731-5200

**NEW JERSEY**  
Intel Corp.  
Edison  
(201) 985-9100

**NEW MEXICO**  
BFA Corp.  
Albuquerque  
(505) 292-1212

BFA Corp.  
Las Cruces  
(505) 523-0601

**NEW YORK**  
Measurement Tech.  
Great Neck  
(516) 482-3500

Intel Corp.  
Hauppauge  
(516) 231-3300

T-Squared  
Pittsford  
(716) 381-2551

Intel Corp.  
Poughkeepsie  
(914) 473-2303

Intel Corp.  
Rochester  
(716) 328-7340

T-Squared  
Syracuse  
(315) 463-8592

**NORTH CAROLINA**  
Pen-Tech Assoc.  
Highpoint  
(919) 883-9125

**OHIO**  
Lowry and Assoc.  
Cleveland  
(216) 464-8113

Intel Corp.  
Dayton  
(513) 890-5350

Lowry and Assoc.  
Dayton  
(513) 435-4795

Intel Corp.  
Euclid  
(216) 289-0101

**OREGON**  
ES/Chase  
Beaverton  
(503) 642-2732

**PENNSYLVANIA**  
Intel Corp.  
Ft. Washington  
(215) 542-9444

Q. E. D. Electronics  
Hatboro  
(215) 674-9600

Lowry and Assoc.  
Pittsburgh  
(412) 922-5110

**TEXAS**  
Intel Corp.  
Dallas  
(214) 241-9521

Mycrosystems Mktg.  
Dallas  
(214) 238-7157

Intel Corp.  
Houston  
(713) 784-3400

Mycrosystems Mktg.  
Houston  
(713) 783-2900

**UTAH**  
Mountaintek  
Salt Lake City  
(801) 266-9617

**WASHINGTON**  
ES/Chase  
Seattle  
(206) 762-4824

**CANADA HDQTRS.**  
Ottawa  
(613) 232-8576

Multitek  
Ottawa  
(613) 226-2365

**EUROPEAN HDQTRS. BELGIUM**  
Brussels  
Tel: (32-2) 660 30 10  
Telex: 24812

**ORIENT HDQTRS. JAPAN**  
Tokyo  
Tel: (03) 426-9261  
Telex: 781-28426

Intel's new in-7000 static memory system with Word/Byte Control delivers speed, convenience and design flexibility. It's the easiest way to get our high-density 2114 4K static RAMs into your system.

The in-7000 is a complete static memory with interface and control logic contained on a single 10.8" x 8.175" printed circuit card. The system requires only a +5V power supply, is TTL compatible, and needs no refresh. You can choose from two versions, differing only in speed: the 7000, with a

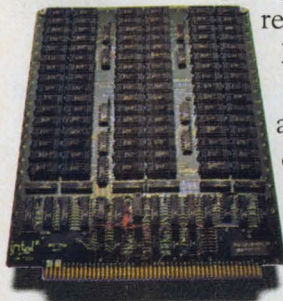

read and write cycle time of 250 ns; and the 7001 (350 ns).

The basic in-7000 card is available in four 16K configurations: 16K x 12, 16, 20 or 24 bits. Two chassis models are also available.

The in-Minichassis can house six in-7000 circuit cards, and the in-Unichassis has a 32-card capacity.

A unique feature called Word/Byte Control gives you the design flexibility to standardize on the in-7000 for all your systems applications. Word/Byte Control allows the Byte Control inputs to be used either

for reconfiguration or byte data control. In the Word mode, the Byte Control inputs select either or both halves of a word, effectively reconfiguring a 16K x 24 card to 32K x 12; a 16K x 16 card to 32K x 8; and so on. In the Byte mode, any combination of three bytes in a 24-bit word may be selected by the Byte Control inputs.

Get Intel 4K static RAMs into your system now with our in-7000. Phone your local Intel sales office or use the coupon below.

**intel delivers.**

CIRCLE NUMBER 17

Intel Memory Systems

ED 3/29/78

1302 N. Mathilda Avenue, Sunnyvale, CA 94086

Phone (408) 734-8102

Send me more information on Intel's in-7000 static memory system.

Name \_\_\_\_\_

Position \_\_\_\_\_

Company \_\_\_\_\_

Address \_\_\_\_\_

City, State, Zip \_\_\_\_\_

Call me \_\_\_\_\_ / \_\_\_\_\_

**“Our new 2114-based memory system gives you a head start with 4K static RAMs.”**



# VACTEC Photodetectors

The Industry's Broadest Line Provides More Semiconductor Detectors for More Design Applications

Vactec serves manufacturers of a wide range of modern electronic products. Pictured are a few examples. All these devices are both made and sold by Vactec, including complete lines of LDR's (photoconductive cells, CdS and CdSe); silicon solar cells, as well as silicon high speed and blue enhanced cells; NPN phototransistors and darlington's; opto-couplers (LED/LDR, lamp/LDR and neon/LDR); selenium photovoltaic cells; silicon photodiodes, blue enhanced and PIN; and custom C-MOS and bi-polar IC's. Write for technical bulletins on the types that suit your requirements. Or send your application, and Vactec will recommend the right cell for the job.

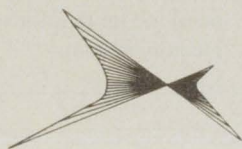

## Vactec, Inc.

2423 Northline Industrial Blvd.  
Maryland Heights, Mo. 63043  
(314) 872-8300

CIRCLE NUMBER 66

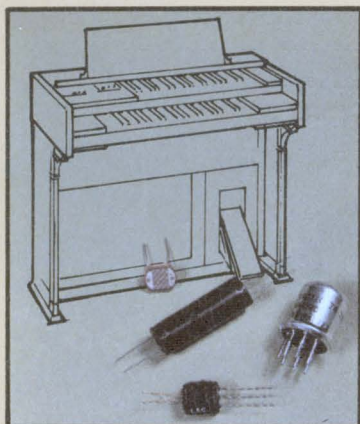

**Electronic Organs**

LED or lamp/LDR Vactrols for audio, and CdS cells for swell pedal controls.

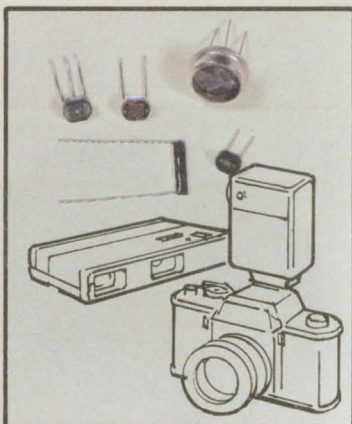

**Cameras and Projectors**

CdS or blue enhanced silicon photodiodes for automatic shutter timing; aperture servo systems for automatic projector focus; and slave flash controls.

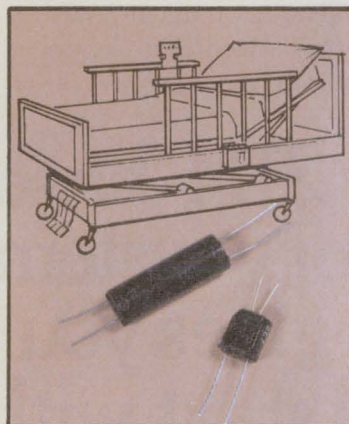

**Triac Motor Controls**

A special Vactrol gates a triac for forward and reverse motor operation as in hospital beds.

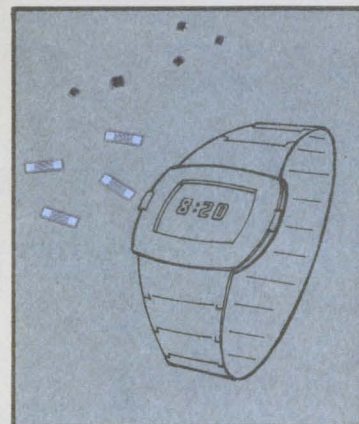

**LED Watches**

Photoconductive or phototransistor chip controls LED brightness.

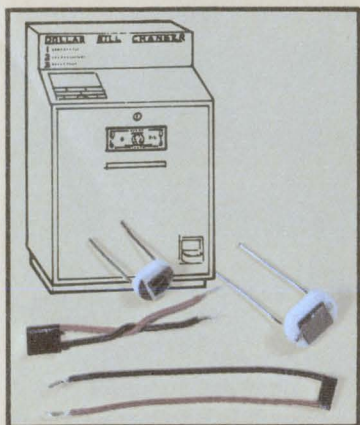

**Dollar Bill Changers**

Silicon photovoltaic cells analyze optical characteristics.

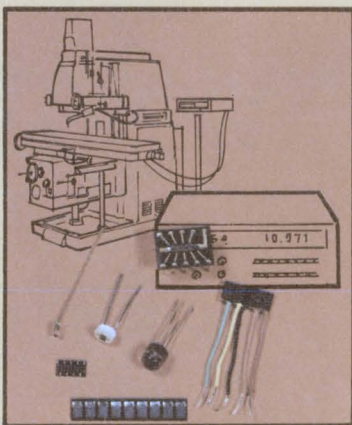

**Machine Tool Controls**

High-speed photovoltaic cells or transistor arrays help computer control repetitive operations, non-contact sensing, and counting and weighing.

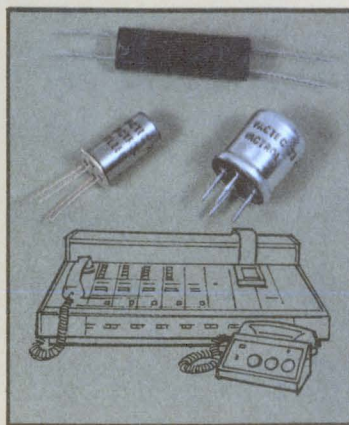

**Telephone Equipment**

Neon/LDR Vactrols sense ringing. Direct a-c coupling, slow LDR response isolates electronics from noise.

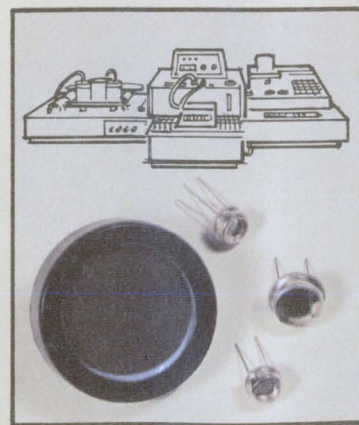

**Scientific Instruments**

Blue enhanced silicon or selenium photovoltaic cells detect solutions densitometrically for precise blood chemistry and other analyses.



## Fast-blowing PROM fuses may not grow back, either

Future PROM fuses may blow faster and cleaner, and leave 10-times wider gaps than most fuses in use today. And their material may be more resistant to later regrowth than gaps produced with the nichrome, titanium-tungsten, and polysilicon fuse materials currently used in PROMs. The reason? A bipolar PROM technology, reportedly as fast as or potentially faster than conventional Isoplanar.

The technology, developed by Advanced Micro Devices, Sunnyvale, CA, combines platinum silicide, a hard, inert fuse material with active-load circuits on a low-power-Schottky chip.

The new approach employs feedback-controlled programming circuits and sense amplifiers, and on-chip voltage and temperature compensation. Both techniques, first borrowed from ECL technology for use in AMD's RAMs, are being applied to PROMs for the first time to stabilize access times and other performance parameters over wide ranges of voltage and temperature.

More than 2-billion fuse-hours of life testing without a single fuse-oriented failure have shown platinum silicide's resistance to regrowth, according to Robert Lutz, the bipolar memory engineering manager who is responsible for developing the new technology.

The platinum silicide fuse produces typical gap lengths of 1 to 3 microns, compared to 0.1 to 0.2 microns for nichrome, still the most widely used fuse material, says Lutz. Since the gaps are 10 times longer, the field or gradient to produce regrowth is 10 times less. Moreover, platinum silicide, although a good electrical conductor, is much harder, less ductile, and more inert chemically than nichrome or titanium-tungsten. These factors also help retard regrowth, or "whisker," formations.

Recommended programming time for the platinum silicide fuse will be 50 microseconds, compared to two milliseconds for typical nichrome PROMs. This much faster time will speed pro-

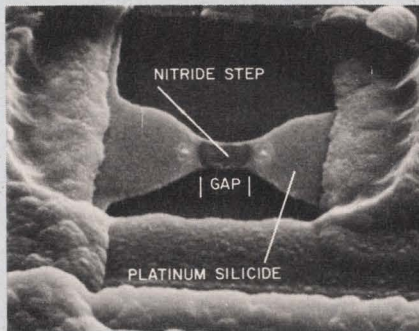

**Platinum silicide fuse link** spans opening atop nonconductive nitride step. Gap results when surface tension draws back molten fuse material.

duction significantly for large-storage PROMs.

The platinum-silicide-link material has advantages over other conventional materials as well. Polysilicon, which is doped with phosphorus for PROM use, does not have the silicide's chemical inertness, and thus may have lower long-term stability. Avalanche-induced migration, an approach that creates links during programming rather than blowing them, is tied to gold-doped processes, which are less suitable for extremely high-speed high-density designs, says Lutz.

The first products to use the new technology will be AMD's generic PROM family, to be available early in the second quarter of 1978, led by a 4-k ( $512 \times 8$ ) with maximum access times of 60 ns over commercial temperature and voltage ( $0$  to  $75$  C,  $5$  V  $\pm$  10%) and 90 ns under military conditions ( $-55$  to  $125$  C,  $5$  V  $\pm$  10%). Corresponding access times for smaller units are 50 and 60 ns for  $512 \times 4$ , 45 and 60 ns for  $256 \times 4$ , and 40 and 50 ns for  $32 \times 8$ .

For time, space and power savings in pipelined  $\mu$ Ps, AMD will offer another 4-k version with dual output registers.

The only other registered PROMs will be available soon from Monolithic Memories Inc. of Sunnyvale CA. These will be based on titanium-tungsten technology.

CIRCLE NO. 316

## Spec group may speed up military device approval

High-reliability, military-approved versions of large-scale integrated circuits will be available much sooner if a committee of manufacturers, users, and testers of the devices writes the chip's spec sheet. That's the hope of RCA's Solid State Division, Somerville, NJ, and its alternate sources for 1802 CMOS microprocessors—Hughes and Solid State Scientific.

"If the 1802 went through the traditional procedure, we would look for 12 to 18 months before it's released," says Gene Reiss, engineering manager for MOS high reliability ICs at RCA. "We're hoping a precoordination workshop will cut that to four to six months—three months if we're lucky."

Usually, an IC manufacturer seeking approval to mil standard 38510 writes a list of specifications and submits it to a government agency like NASA or one of the military services. That agency, in turn, submits the forms to a clearinghouse agency like the Rome Air Development Center or the Defense Electronic Supply Center, which calls for comments. Give-and-take on various aspects of the spec may stretch the time even more. The final spec sheet may come from DESC as much as a year later.

"But the government is recognizing that the problem is becoming increasingly complex because of the increasing complexity of the devices," says W. Richard Scott, manager of the parts engineering group at the Jet Propulsion Laboratory in Pasadena, CA. JPL is writing the test procedure for 1802 microprocessors and their peripheral circuits, and is a member of the committee that is precoordinating the acceptance procedure for the devices.

Besides the three manufacturers, users like NASA, Sandia, and General Electric, and test labs like Macrodata are characterizing the 1802.

## First DIP nickel-cadmium batteries for PC power

The first standardized DIP nickel-cadmium batteries for standby power on PC boards have arrived. Introduced by General Electric's Battery Business Department (Gainesville, FL), under the trademark of DataSentry, this family of batteries contains  $\mu$ P-80 cells, now the smallest sealed cylindrical cells in GE's line.

The DIP configuration eliminates all



the special accommodations—clips, brackets and angles—needed in the past to ensure secure and stable board mounting.

The batteries are rated 70 mA-h for a 15-mA load. With a small semiconductor memory drawing only 10  $\mu$ A, the battery will keep the memory's contents for almost three months. At 0.5 A, a larger memory will hold for more than 5 minutes.

The batteries will be offered in voltage modules of 2.4 or 3.6 V. With this modular approach, a system designer will be able to put together almost any voltage he needs.

Primary customers, according to GE, will be OEM memory and microprocessor users. In quantities of 100 to 999, the 2.4-V units sell for \$2.76 and the 3.6-V, \$4.14.

CIRCLE NO. 317

## New radiation standard for insulating materials

The first international radiation standard for insulating materials has been released by the International Electrotechnical Commission, which prepares world-wide standards in the electrical and electronic fields. The standard, IEC Publication 544—Part One, is called the *Guide for Determining the Effects of Ionizing Radiation on Insulating Materials—Radiation Interaction*.

The document also offers an international guide to dosimetry terminology and provides ways to determine and calculate insulating materials that have exposed and absorbed radiation dosages.

For more details, contact the International Electrotechnical Commission, 1, rue de Varembe, Geneva, Switzerland.

## $\mu$ P-based DVM offers a bundle of information

A digital voltmeter available in 5-1/2 and 6-1/2-digit versions uses a microprocessor to convert raw data into more useful units of measure and to generate statistical information. Able to measure resistance as well as ac and

dc voltage, the voltmeter can even be programmed to operate unattended for up to 96 hours.

The voltmeter is designed and built by Schlumberger's Solartron Electronic Group Ltd. of Hampshire, England, and is marketed in the United States by Guildline Instruments Inc. of Elmsford, NY.

Nine programs are built into the voltmeter. With these, input data can be multiplied by a 6-digit number and offset from zero to convert into units of measure such as psi or mph. A third program linearizes input data according to standard J, K, R, or T-type thermocouple curves for direct readout in degrees. The instrument can also calculate ratios and read out directly in decibels, and can calculate power and read out in watts.

The programs also yield statistical information. The microprocessor can calculate the deviation of any reading from the average, and can determine the variance and standard deviation of a series of readings, as well as recall the number of readings taken.

A real-time clock program sets times for starting and stopping a sequence of readings over a 96-hour period, and sets the frequency of readings. Other programs set limits and store minimum and maximum readings.

Calibration of the instrument's circuitry against internal standards is automatically performed every 10 s.

The 5-1/2-digit version of the voltmeter, Model 9575, is priced at \$2995 and the 6-1/2-digit version at \$3995. The processor is an option for \$990. Other options include digital interfaces: BCD, binary, RS-232, and IEEE-488.

CIRCLE NO. 318

## Mirror takes twinkle out of astronomer's eye

While the twinkle of stars has been romantic to lovers and poets, it's been downright maddening to astronomers trying to view stars through the earth's turbulent atmosphere, which puts the twinkle there in the first place.

Now, Jeffrey Everson a physicist at Itek Corp., Lexington, MA, has employed a unified approach to the design of a multielement piezoelectric mirror, which compensates for star twinkle better than earlier models.

The device, described this week at the Society of Photo-Optical Instrumentation Engineers' Technical Symposium East in Washington, DC, is a sandwich-type, multielement

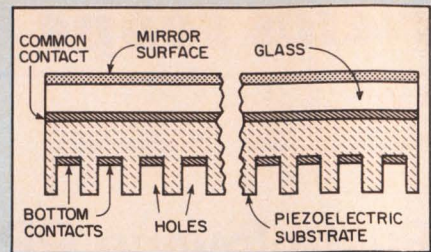

piezoelectric substrate with a glass mirror element bonded to it.

The variation in starlight as the star twinkles is monitored by a photosensor system connected to the deformable monolithic piezoelectric mirror in a closed loop. This corrects, in real time, for the aberrations caused by the air's turbulence.

Everson's improved device has a higher frequency response than earlier models. For piezo-mirror elements used in astronomical applications, the response has been typically below 1 kHz. But Everson has raised this from 10 kHz to as high as 60 kHz by dampening undesirable resonance modes, which prohibit operation in those ranges. As a result, these mirrors can now be used for the first time in closed-loop systems in high-powered lasers to maximize the power density in the laser's target area.

According to Everson, the piezoelectric mirror is typically 2 to 3-in. in diameter. Holes are drilled into the piezoelectric substrate (see Figure). A 3-in. disc might have as many as 100 of these holes. A common electrode is deposited on the upper side of the piezosubstrate while individual electrodes are deposited onto the upper inside ends of the holes.

When a voltage is applied to one of these multielectrodes, the surface in the vicinity of that electrode is displaced, which produces mechanical deformation of the glass mirror at that point. By feeding the numerous holes with varying voltages, wavefront aberrations can be compensated for.

## Bubbles store 2Mbits

A magnetic bubble memory that stores two-million bits of information in garnet chips has been delivered to the Air Force Avionics Laboratory at Wright-Patterson Air Force Base, Ohio.

The memory and associated electronics were developed by Texas Instruments' Central Research Laboratory in Dallas, under contract to the AFAL's Electronic Technology Division.

# MINI STIC

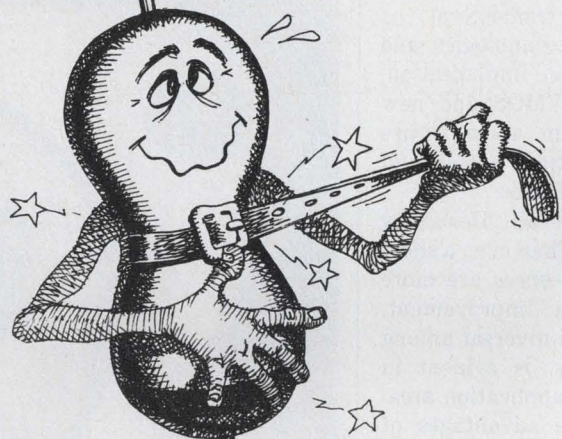

## HIGH VOLTAGE HERMETIC MULTI-JUNCTION RECTIFIERS FOR HIGH DENSITY PACKAGING

New Metoxilite MINI-STIC rectifiers are now available at competitive commercial prices. We have retained the superior technology and premium materials developed for aerospace programs. Stable electrical characteristics are maintained through Semtech's unique internal design. Ideal for high voltage high density packaging, these multi-junction devices are used successfully in single as well as polyphase high voltage rectifier circuits.

### Not epoxy! Our rectifiers are cased in Metoxilite.

To provide rugged minimum sized devices, metal oxides (Metoxilite) are fused directly to the junction pin assembly at high temperatures to form non-cavity hermetically sealed, monolithic rectifiers. Thermal expansion characteristics of Metoxilite are matched with the internal structure allowing

the rectifiers to withstand extreme thermal shock. Designed for use in encapsulated or oil environments.

### Used in CRT Power Supplies.

Our fast recovery multi-chip devices are especially designed for high voltage multipliers used in TV receivers and monitors.



Type: FM50, 75, 100 & 150  
PIV: 5,000, 7,500, 10,000 & 15,000V  
Average Rectified Current @25°C:  
25 & 10mA  
Static Forward Voltage, 10mA @25°C:  
10 & 20V  
Reverse Recovery Time (Max.): 300ns  
Case Size (Max.):

FM50 & 75; .300"L x .120"D  
FM100 & 150; .400"L x .120"D

CIRCLE NUMBER 19

### X-Ray Equipment applications.

Our Sub-miniature High Voltage Rectifiers are used in X-Ray equipment. These devices form the building blocks for high voltage sticks such as the "X-WAY STIC" developed by Semtech.



Type: SH75 & SH100  
PIV @25°C: 7500 & 10,000V  
Average Rectified Current @55°C in Oil: 200mA  
Static Forward Voltage, 100mA @25°C: 12V  
D.C. Blocking Voltage @25°C: 7500 & 10,000V  
Case Size (Max.): .450"L x .160"D

1975 NATIONAL SBA SUBCONTRACTOR OF THE YEAR



652 Mitchell Road, Newbury Park, California 91320  
(805) 498-2111 • (213) 628-5392 • TWX: 910-336-1264  
CHICAGO: (312) 352-3227 • DALLAS: (214) 234-6523  
DAYTON: (513) 274-8356 • FLORIDA: (305) 644-5404  
MARYLAND: (301) 937-0070 • NEW YORK/NEW JERSEY: (201) 964-9305  
SAN FRANCISCO: (415) 494-0113 • SEATTLE: (206) 455-4807  
CANADIAN SALES: Avotronics, Ltd. (416) 493-9711  
EUROPEAN SALES: Bourns AG Zug, Switzerland (042) 232-242

## Speed's up in 'fast' transistors, but...

Speed isn't the only plus in switching and wideband linear transistors.

Maturing bipolar technologies and new processes like ion implantation, new structures like VMOS and new materials like gallium arsenide are making transistors more stable and powerful as well as faster.

But that's still not all. Designing circuits is easier now than even a short year ago because the specs are more pertinent. This data improvement, though by no means universal among device manufacturers, is evident in every fast-transistor application area.

Spurred on by the advantages of smaller size, lighter weight and higher efficiency, switching power supplies continue to replace linears. And what makes these supplies work? Fast-switching power transistors.

In power switching, transistors—especially for switching power supplies—are now usually specified for inductive as well as resistive loads. But, at least one power-switching-transistor producer insists that resistive-only switching information is all anyone needs. Others still manage to forget that power switches work into inductive loads in switching power supplies. And some still don't specify switching behavior at any of a device's limits.

### Fast—not loose

Then along comes RCA, which now guarantees 800-ns rise and fall times and 4- $\mu$ s storage time at simultaneous voltage, current and temperature limits—for both clamped-inductive and resistive loads. Switching times for the 5-A RCA 8767 and the 15-A TA 9114 families are guaranteed at junction temps of 125 and 100 C, respectively.

Well aware that there's no correlation between switching times at room

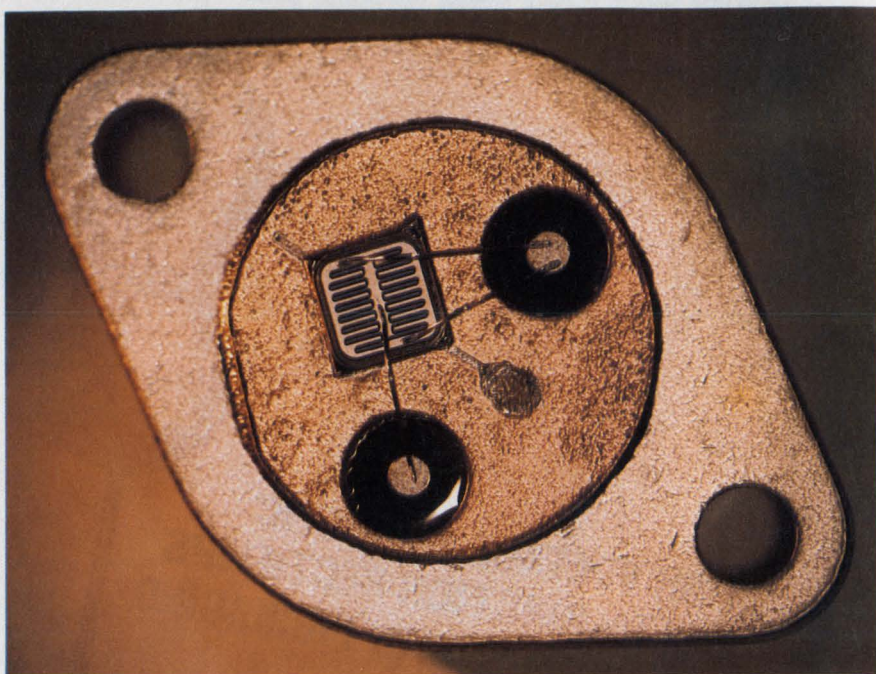

Capillary soldering in Ampere's Bux transistors forces out all the air from between the chip and its header for a thermal-stress resistant bond.

temperature and switching times at higher temperatures, RCA has recently developed and designed its own high-temperature testing apparatus. Though the engineering details are still secret, what it does isn't. The new equipment tests each device's switching times with the junction temperature, collector current, clamped voltage for inductive turn-off ( $V_{CEX}$ ), and collector-to-emitter voltage ( $V_{CEO}$ ) with the base open—all at their respective maximum values.

For further insurance against the dissatisfaction with power-switching-transistor reliability voiced by switching-power-supply designers in the last two years, RCA tests for collector-leakage current ( $I_{CEV}$ ) using 650 V.

Another safeguard that helps weed out devices weak in the field-intensity department is testing the 5-A units from 100-V supplies. Lower potentials, like the commonly used 10 and 20 V,

don't expose weak units before they find their way into equipment.

Where do RCA's power switching transistors get their combination of speed and ruggedness? From their semiconductor structure—a multiple-layer-epitaxial-collector and diffused-base affair—and also from proprietary metalization, which gives high conductivity. And to top everything off, their full passivation won't deteriorate—even at high temperatures.

Not surprisingly, then, 5, 10 and 15-A versions of these devices are imminent as JEDEC-registered "2N" devices. The MIL-approved ones will combine a  $V_{CEO}$  of 400 V and a  $V_{CEX}$  of 480 V in the same devices.

But improved fast-switching transistors are coming from many other sources. For the last four years, for example, Solid State Devices Inc. has been making fast-switching power transistors by the multiple-epitaxial

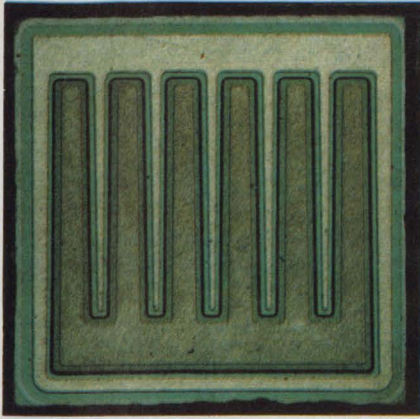

This micrograph shows the interdigitated chip (left) of Delco's fastest power switches, the DTS515-520 family.

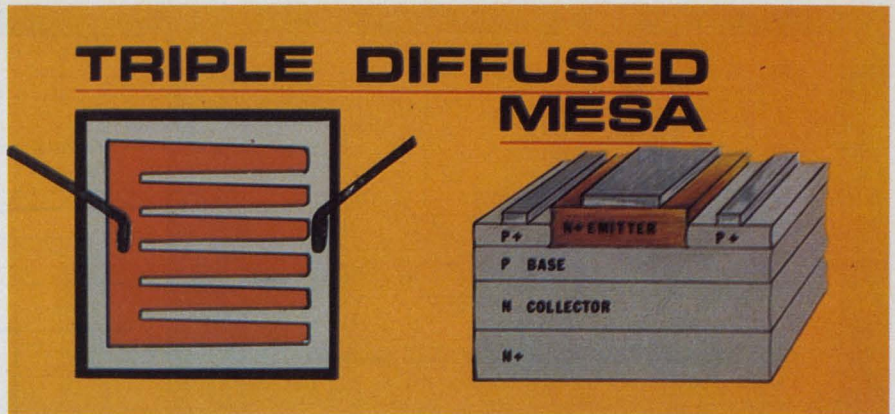

The triple-diffused-mesa structure (right) balances fall-time and gain against energy-absorbing capability.

process. The company's latest, the 1843, is its most powerful. The 1843 has a  $V_{CEO}$  of 350 V and handles continuous collector current of 30 A.

Faster and more powerful switching transistors continue to be introduced by Kertron. The past year has seen the KS 6200, KS 6300, KS 6400 and KS 6500 series, which combine double-diffused planar epitaxial and rf technologies to produce 10 to 20-A devices with rise, storage and fall times of 40, 150 and 50 nanoseconds, respectively.

### Switches crowd the floor

Older series of KS transistors (Kertron has been making fast-switching power transistors since 1969) handle 0.5 to 2 A with lamination-rattling 30-ns rise and fall times plus 100-nanosecond storage times.

And there are more Kertron switches on the way. In six months to a year, expect fast 5 to 10-A devices both in npn triple-diffused high-voltage and in pnp planar-rf versions. In the more distant future, the fruits of improved silicon-wafer processing and other dopants than the gold or platinum now used in Kertron's transistors may mean even faster power switches.

Right now, however, 14070 series of 80 to 120-V npn switching transistors from Semicoa can handle rivers of continuous collector current, up to 70 A. And they also boast mighty secondary-breakdown energy ratings ( $E_{s/b}$ ) of 140 mJ. These double-diffused planar devices have graded-collector regions. Their times for 50-A switching are blazing; rise, storage and fall times are 500, 500 and 100 ns, respectively. No wonder Semicoa has trouble finding magnetic components to match the speed of its transistors.

After eight years of using just the planar double-diffused, epitaxial-collector process for its power-switching transistors, General Semiconductor Industries is now concentrating on adding C<sup>2</sup>R (charge-control-ring) technology. This process adds the surface stabilization important for high-voltage operation while another feature, an interdigitated emitter, improves both gain and current-handling capability. All these improvements are evidenced in the GSDS50020, a 50-A, 200-V device with a typical 50-A saturation potential of only 0.5 volts.

Next on the list from GSI will be a wedding of C<sup>2</sup>R and a triple diffusion. A high safe-operating area should come from the triple diffusion. High speed and high current-handling ability plus low saturation voltages should result from the C<sup>2</sup>R processing.

Triple diffusion has made its mark already in other fast-switching lines. One example, the 6500 series of npn planar triple-diffused transistors from TRW Power Semiconductors, offers  $V_{CEO}$  ratings from 350 to 450 V. Geared

for off-line, 20-kHz switching supplies, these transistors pass continuous currents of 10-A and their switching speeds are 0.5  $\mu$ s for rise and fall times plus 2  $\mu$ s for storage. Commercial versions go from \$3.55 to \$7.71 (100 to 999).

Late this year, TRW plans to introduce three more series of power switching transistors. These will handle 15, 12 and 3 A at 400 V.

Another triple-diffused bipolar transistor family, the 8-A UMT 1008 from Unitrode, has a proprietary Barrier design. This prevents the normal current shift, from the emitter's periphery to its center, during the crucial turn-off period. In conventionally-structured high-voltage power-switching transistors, this shift degrades both the turn-off time and the  $E_{s/b}$ .

Aided by its Barrier, the UMT 1009 rises in 270 ns, stores for 1200 ns, and falls in 170 ns, when switching 5 A. So with only the simplest base-drive circuitry, this transistor switches off-the-line at 25-kHz.

Not only that, but the 1009 handles 5 mJ of  $E_{s/b}$ . Because the transistor itself can absorb this energy, it is suitable for many inductive-switching uses, without a clamping diode.

The UMT 1008 bipolars are triple-diffused mesas with glass passivation. They have been in production for 18 months. Later this year Unitrode will expand the line of Barriers to include 3 and 12-A versions.

Late last year, the newest member of Westcode Semiconductors' triple-diffused npn series was introduced. This powerhouse WT 5214 from the semiconductor division of England's Westinghouse Brake and Signal Co., boasts a  $V_{CEO}$  of 550 V and continuous collector current of 10 A. Its full-rated switching times are 2.5  $\mu$ s for the rise, 4  $\mu$ s for storage and 2.2  $\mu$ s for the fall.

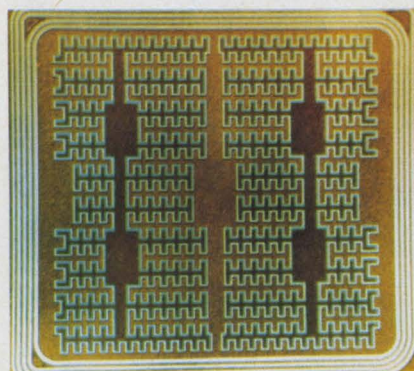

C<sup>2</sup>R surfaces add high  $V_{CEO}$  to General Semiconductor Industries' double-diffused epitaxial XGSR series of fast power bipolar transistors.

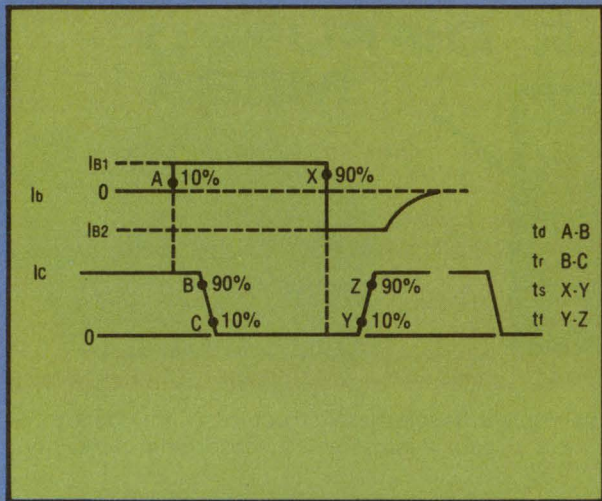

(a)

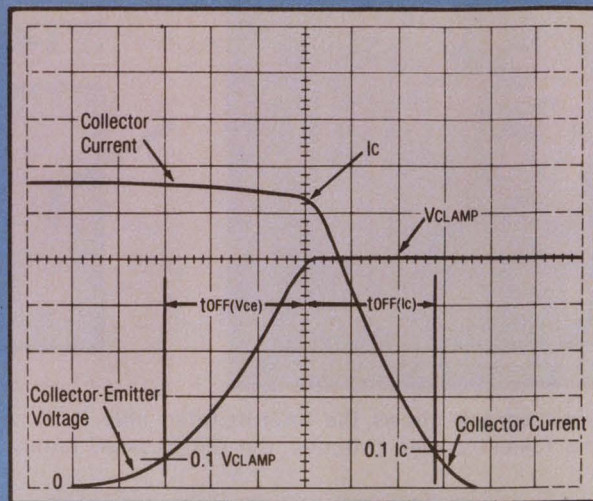

(b)

**Power-transistor switching characteristics** from TRW Power Semiconductors are based on 10 to 90% current

values for resistive loads (a). Inductive switching (b) times are measured to and from the clamped-load voltage.

Westcode is aiming an active development program at producing fast switches with 20 to 260-A capability. Of these, the 20-A types should be here by the end of 1978 and the 120-A types are expected about a year later.

Glass-passivated triple-diffused mesas have become available from Amperex in the last year. In its Bux series of npn switching transistors, a capillary-soldering technique reduces the thermal resistance between the chip and its header, which increases the permissible power dissipation. Thus the Bux 81, which arrived last September, has a  $V_{CE0}$  of 450 V, a continuous collector current of 10 A and a typical 5-A fall time of 300 ns.

### Switch floods of current

Silicon Transistor Corp. is looking forward to higher current and voltages in its double-epitaxial mesa and planar switching transistors in 1978. Also in the future at the company are high-

voltage, fast-switching pnp's. Currently, the newest switching transistor at STC is the 2N6547, a 400-V, 15-A unit with 10-A switching characteristics of 0.7, 4 and 0.8 microseconds, respectively, for rise, storage and fall times.

Though PowerTech's PT-4500 npn transistor handles 100 A of continuous collector current, the company considers its PT-3523 transistor even more important. This triple-diffused npn handles only 50 A, but that goes together with a  $V_{CE0}$  of 400 V. And the  $E_{s/b}$  is an impervious 2.5 J. This Goliath is nimble though—it switches 30 A with 0.5  $\mu$ s rise and fall times plus only 1.5- $\mu$ s of storage delay.

Ever since 1962, Solitron has been making planar epitaxial power-switching transistors, like the 2N2657-8 for 20-kHz operation. Since 1976, the company has been producing devices with higher  $V_{CE0}$  (up to 500 V), higher collector current (up to 20 A) and lower total resistive-switching speed (between 2.1 and 3.4  $\mu$ s maximum) by the triple-

diffused planar process. Currently, Solitron is developing both higher-voltage pnp's and higher  $E_{s/b}$  devices.

### VMOS: power-switch power

But even with all these performance improvements, bipolar power-switching transistors may eventually be replaced by a newcomer onto the power-device scene—the power VMOS FET. Originally offered in 1976, only in TO-3 and TO-39 package and ratings of up to 2 A and 90 V by Siliconix, they have recently become available in a less-expensive plastic TO-202. By mid-year, Siliconix plans to introduce higher-current VMOS FETs that are rated at 100 W and TO-3-packaged for 100, 200 and 400-V operation.

Fairchild, which is also producing VMOS FETs, has been second-sourcing Siliconix devices since late 1977.

Power VMOS FETs use a vertical V-groove metal-oxide-semiconductor structure that increases both the cur-

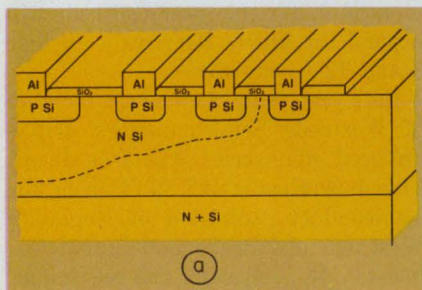

(a)

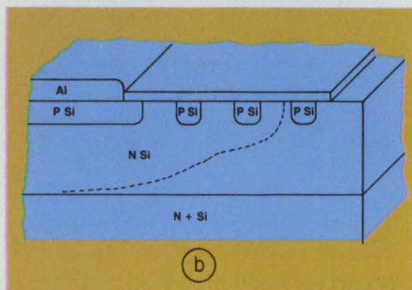

(b)

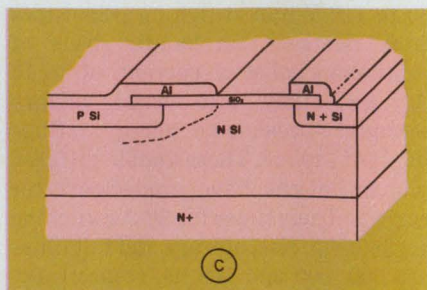

(c)

**Extending the base metalization into a field plate** alters the collector-base field in shallow-diffused high-speed npn power switches. Charge-control rings (C<sup>2</sup>R), acting as

depletion rings, block mobile-oxide charges for reliability. Diffused-p depletion rings (b) don't stop the charge migration. Neither do n+ channel-stop rings (c).

# PEOPLE WHO KNOW RELAYS COUNT ON STRUTHERS-DUNN FOR TIME DELAY

- New Design Concept** 1
- Broad Selection** 2
- Design Flexibility** 3
- Reduce Costs** 4
- Standard Voltages & Sockets** 5
- Timing & Setting Range** 6
- Reliability** 7
- Transient & Polarity Protection** 8
- False Contact Protection** 9
- Total Relay Capability** 10

The Struthers-Dunn line of standard tdrs was achieved by combining a proven hybrid solid state timing module with the entire line of standard general purpose relays. In most cases the module fits within the existing relay cover, and therefore does not affect unit size or ease of mounting.

Imagine, more than 6000 combinations of timing, voltage, contact arrangement and mounting. New concept permits any standard general purpose relay to be equipped with built-in time delay function. Standard off-the-shelf models are U.L. recognized. Hermetically sealed models meet the requirements of MIL-R-83726. It adds up to the most complete line available anywhere.

The versatility of these timing modules offers a wide variety of alternatives when the control circuit must include time delay. Instead of searching for a timer to fit the circuit, simply choose the type of relay you want with the assurance that it is available with time delay capability.

The new tdrs will cut costs in many applications. If, for example, a system now uses a conventional electromechanical timer and a separate relay as many circuits do, the designer may substitute a single tdr and cut his component cost in half. Cost of mounting and wiring the component is also reduced.

Forget previous voltage limitations. Our tdrs are available for all standard voltages from 12 VAC to 240 VAC and from 12 VDC to 125 VDC. Plug-in models available for most common sockets: Octal, square base, miniature or 12 pin rectangular plugs with quick connect, solder, printed circuit or front connect terminals.

Standard off-the-shelf models offer seven different timing ranges with adjustable setting: 0.1-1 second, 0.2-2, 1-10, 3-30, 6-60, 18-180 and 30 to 300 seconds. Settings are available three ways: Fixed (factory preset), knob adjustable or remote adjustable from a central control panel.

These tdrs incorporate two time-tested components—electromechanical relays and solid state timing modules. Thus there is no weak link to cause premature failure. Repeatability of  $\pm 3\%$  at 20 to 25°C and  $\pm 10\%$  accuracy within voltage and temperature range is assured. Life expectancy is 50 million mechanical operations or 500,000 operations minimum at full load.

Time delay operation is protected for transient voltages as long as 5ms duration with exponential slope from 0 volts to 20 microsecond peaks of  $\pm 2000$  volts. DC models are inverse polarity protected. Tdrs will not operate with polarity reversed, but will function normally once wiring is corrected.

Another added operational protection. With our on-delay relays, false transfer of contacts is prevented should the voltage be interrupted during timing cycle. With off-delay relays, if control switch closes during delay period, timing resets to zero and contacts do not transfer. Full timing is assured when control switch opens again.

Dependability and know-how, that's what you get from more than 50 years experience. You, too, can count on a relay line-up with unmatched diversification. We provide solutions to control problems with ten key relay functions: General Purpose, Latch Sequence, Sensitive, Reed, Solid State & Hybrid, Motor Control, Military, Special Assemblies and, of course, Time Delay.

**...we're in TOTAL CONTROL**

**STRUTHERS-DUNN, INC.**  
PITMAN, NEW JERSEY 08071  
Manufacturers of Relays and Solid State Controls  
Telephone: 609-589-7500 TWX: 510-686-7510



CIRCLE NUMBER 20



**NEWCOM'78**  
Las Vegas Convention Center, May 2, 3, 4  
See our diversified line of relays at Booth G31

Available Through 140 Stocking Distributors  
Canada: Struthers-Dunn Relay Div., Renrew Electronic Marketing, Ltd.

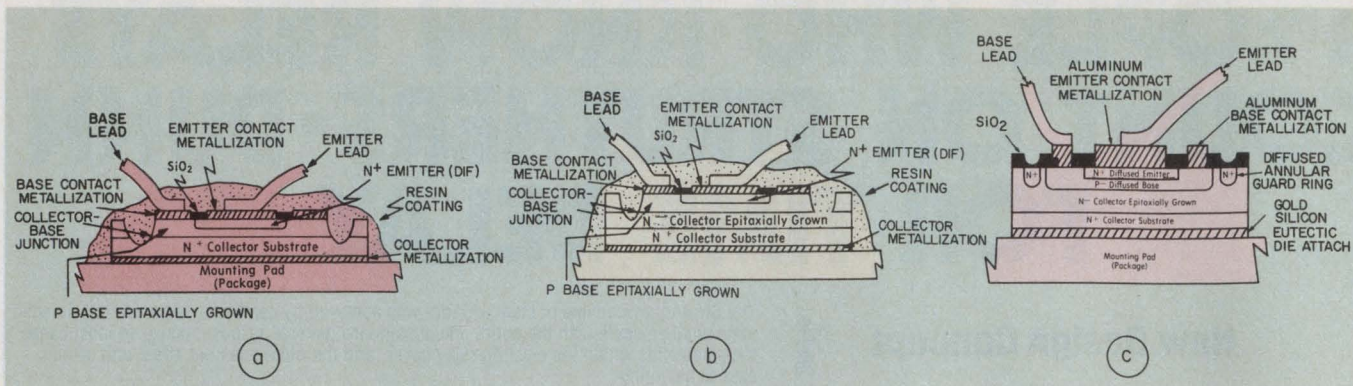

**Fast epitaxial-base switches** (a) control resistivity and base width for low saturation  $V$ . Double-exitaxials (b) produce

fast  $500\text{-}V_{CE0}$  transistors. Diffused anular guard rings keep channel leakage low in fast planar transistors (c).

rent and power capability of MOSFETs (see "Don't Trade Off Analog-switch Specs," ED No. 15, July 19, 1977, p. 56). Additionally, VMOS FETs retain the desirable characteristics of conventionally constructed MOSFETs:

- Switching times under 10 ns.
- No storage delay (all conduction is via electrons).
- No thermal runaway or secondary breakdown.
- High input impedance.

In MOSFETs, current flows via majority carriers (electrons) only. So, delays due to charge injection and conduction by minority carriers (holes), inherent in bipolar transistors, don't exist in MOSFETs.

Before VMOS came into being, the current and power-handling capabilities of the other FETs were low (see "Look Out, Power Transistors: Here Come the Power FETs," ED No. 22, October 25, 1977, p. 30). High internal impedance was another MOSFET limitation. Up to now, the best power FETs have been limited to on-resistances between 1 and  $2\ \Omega$ . But TI's entries into the VMOS FET derby reportedly have much lower on-resistances.

There must be something to VMOS FETs. Yet another supplier is coming on board. Intersil expects to be strongly in the business with at least six device families to be introduced this year alone. Among these: a 10-A, 90 to 100-V model, whose 400-MHz  $f_t$  allows switching to a  $0.3\text{-}\Omega$  on-resistance in under 100 ns; another device will have a 400-MHz  $f_t$ , but this one will stand-off 400 V. And smaller 0.5-to-1 A units are expected with 1.2-GHz  $f_t$ 's.

### It's raining linear data

Like fast-switching transistors, fast linear transistors are easier to design with, thanks to improved data. Micro-

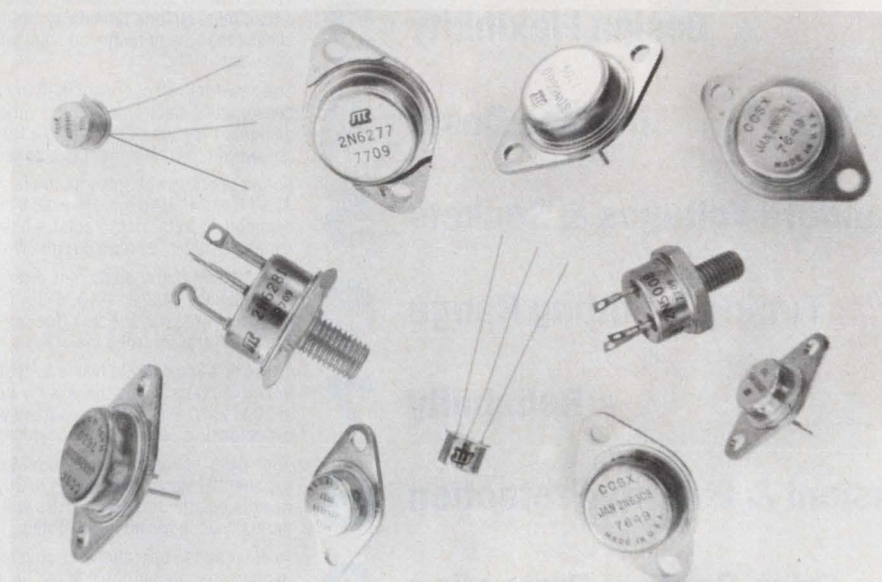

"Choice" is the byword at Silicon Transistor Corp. You can select the device you need from over 1000 metal-packaged devices. These bipolars cover currents ranging from 50 mA to 100 A and collector potentials from 20 to 800 V.

wave and rf-device producers have worked to alleviate the frustration—if not outrage—of high-frequency linear-circuit designers over nonexistent specifications for S-parameters.

Across the frequency spectrum, new linear spec sheets simply abound with polar plots of all four S-parameters. And many data sheets go so far as to tabulate the S-parameters, so now you don't even have to find the right circle.

Up at the stratospheric  $K\mu$  band, NEC's NE388 GaAs metal-epitaxy-semiconductor (MES)FET features tabulated S-parameters. At X band, NEC's 244, also a GaAs MESFET, offers both charts and tables of such parameters. At L and S bands, both charts and tables characterize NEC's npn NE021, SGS-ATES's pnp BFT 95 and Microwave Associates' npn

MA42110 and MA42160. Down in the uhf and vhf ranges, AEG-Telefunken's BF 679T and BF 479T present their S-parameters on polar plots.

But as with switching transistors again, it takes more than better device characterization for fast linear transistors to meet the performance demanded from new linear circuits. Obviously, better devices are the answer. And the answers keep coming.

### It's pouring linear devices

Since 1970, dual-gate MOSFETs have been Texas Instruments' response to the noise, distortion, and stability shortcomings of bipolars for rf amplifiers and mixers in receivers. The second gate isolates input from output—without neutralization. The result is



# Signetics Op Amps: Fast Performers Ready For Fast Delivery.

Choose from three new op amps with high slew rates. One specifies the industry's lowest noise:  $4nV/\sqrt{Hz}$ !

The next time you find yourself searching the specification tables for a high-performance op amp, be sure to search ours. You'll find a broad offering—more than 60 models, each with package and temperature options. You'll also discover three new entries, one of which is likely to provide that exceptional spec you need.

**Our Quiet Performer: SE/NE5534.**

If low noise is critical to your design, then you need our new SE/NE5534. There's not another op amp around with better noise performance. With input noise specified at  $4nV/\sqrt{Hz}$  at 1 kHz, this device can drive a 600-ohm load. Great for quality audio equipment and instrumentation/control circuits. Our quiet performer also offers a generous 10-MHz bandwidth and a respectable  $13V/\mu\text{sec}$  slew rate.

When you compare the SE/NE5534 with standards like the  $\mu A741$  and LM307, you'll find that it offers superior performance—spec for spec. This outstanding op amp is internally compensated for gains equal to, or greater than, 3. And if you want to optimize frequency response for unity gain, capacitive load, low overshoot, etc., you can do so easily with an external capacitor.

**Two For High Slew.** For those designs demanding high slew rates, you should look into our super-fast performers—the SE/NE530 or SE/NE538. Internally compensated, both of these devices have excellent input characteristics.

The SE/NE530 is a superior replacement for any device in the  $\mu A741$  family. With high slew rates of  $18V/\mu\text{sec}$  (+1 gain) and  $25V/\mu\text{sec}$  (-1 gain)—plus a small-signal bandwidth of 3 MHz—this op amp is a veritable workhorse for numerous applications. Selecting it over a 741-type device translates to improved performance, greater design flexibility and reduced inventory.

With the SE/NE538, you get  $40V/\mu\text{sec}$  slew at a minimum gain of +5/-4. This guaranteed speed comes without power penalty, as the maximum supply current required is just 3 mA. If you're using op amps like the  $\mu A741$ , LM301A or BiFETs, you could be getting better performance with our 530 or 538.

Move up to better op amp performance. Move up to Signetics. For complete details, use the coupon below or contact your local Signetics distributor.

**signetics**

a subsidiary of U.S. Philips Corporation

Signetics Corporation  
811 East Arques Avenue  
Sunnyvale, California 94086  
Telephone 408/739-7700

To: Signetics Information Services, 811 E. Arques Ave.,  
P.O. Box 9052, Sunnyvale, CA 94086

Please send technical data and sample(s) for the following op amp(s):

- Low-Noise SE/NE5534     High Slew SE/NE530  
 High Slew SE/NE538  
 My need is urgent; have an applications specialist  
phone me at once: (     )     ext.

Name \_\_\_\_\_ Title \_\_\_\_\_

Company \_\_\_\_\_ Division \_\_\_\_\_

Address \_\_\_\_\_ MS \_\_\_\_\_

City \_\_\_\_\_ State \_\_\_\_\_ Zip \_\_\_\_\_

I'm also interested in any other op amps you offer for this application: \_\_\_\_\_ ED329

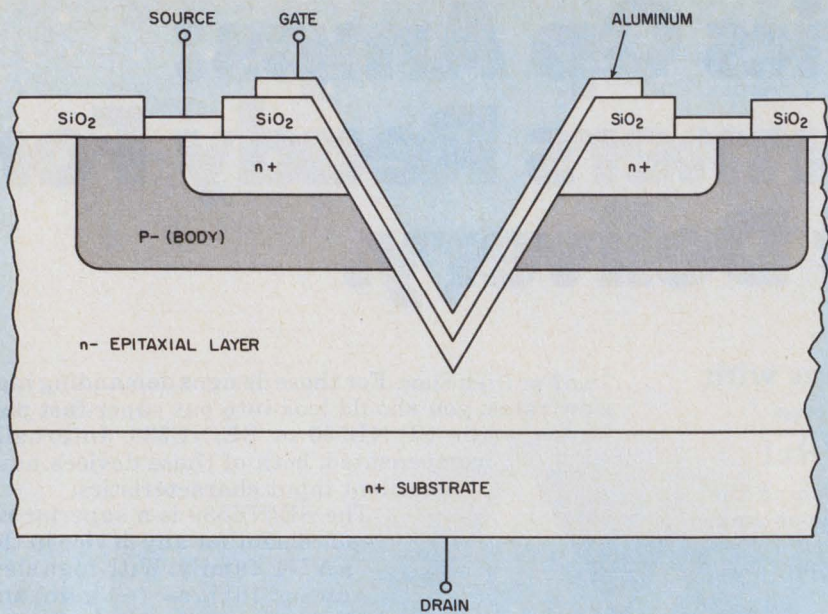

In vertical-MOS transistors current flows perpendicularly to the plane of the chip, rather than parallel to it as in conventional MOS structures. This gives VMOS higher current density, lower capacitance and saturation resistance.

better-than-bipolar stability. Also, the second gate is a convenient terminal for signal mixing and gain control.

TI's two latest dual-gate families, the 3N225 and the C3T225, offer high gain together with low noise—plus a low third-order-intermodulation product—all the way up to 1 GHz.

A device is expected from TI later this year that could end up being first choice for mixers—a high frequency

MESFET. This device will have an even lower third-order product than the dual-gate MOSFETs, which will help mixers tremendously, especially when they suffer overloads.

But bipolar linear transistors aren't fading from sight by any means. For rf amplifiers that work into the GHz range, AEG-Telefunken has two new complementary bipolar transistors, the pnp BFT 95 and the npn BFW 92. At 500 MHz, these planar devices have typical noise figures of 1.7 and 4 dB.

Up in the microwave region, SGS-ATES has a new bipolar device, the BFT 95, for wideband amplification up to 1.5 GHz. The T plastic-packaged pnp uses epitaxial-planar construction,

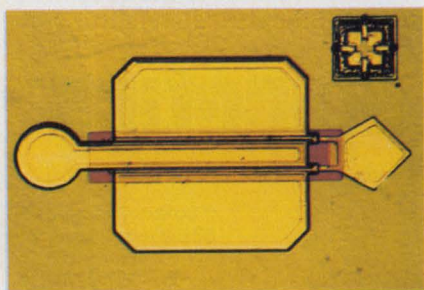

The Schottky gate is only one micron long in Aertech's AFT 2000 GaAs FET (left). A titanium/platinum/gold bonding pad mixes intermetallic compounds at the aluminum gate. Recessing the gate (bottom right) permits thickening of the epitaxial layer under source and drain contacts to reduce contact R.

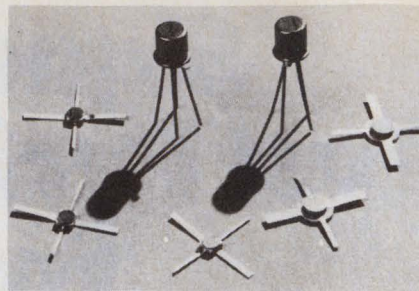
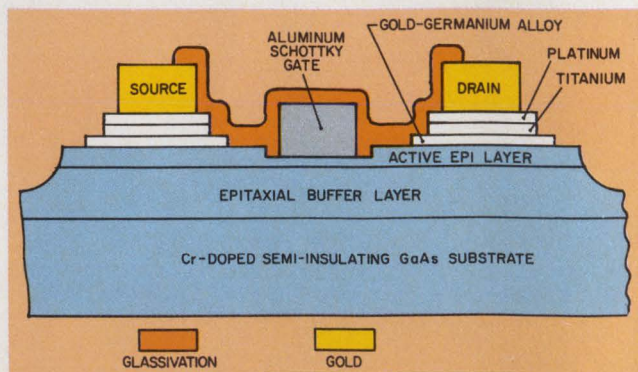
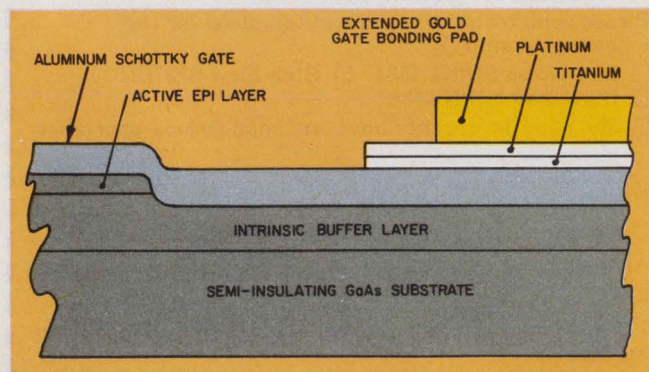

Packaging limits power in Microwave Associates' MA 42110 npn transistors. At 25 C, devices inside 509, 510 and 511-type cases dissipate 450, 1200 and 750 mW, respectively.

with a proprietary silicon-nitride passivation to minimize parasitic capacitances. At 1 GHz, the unit's maximum noise figure is 2.5 dB.

For even lower-noise amplification from 0.5 to 4 GHz, Microwave Associates' MA 42160 series of npn planar epitaxials boasts 1.5 dB maximum noise at 1 GHz. Implanted arsenic emitters assure consistent performance from unit to unit.

Ion implants also help reproduce consistently the shallow structure of Aertech's low-noise 4-GHz ABT 7700, the newest of this TRW division's bipolars. The implanted emitter stripes are less than a micron wide. For stability, oxide isolation is used to minimize the collector-base capacitance.

Highly reliable platinum-silicide/titanium/platinum/gold metalization forms the low-resistance contacts to emitter and base. The layers are deposited by rf sputtering and delineated by rf sputtering and etching.

All this effort produces devices with consistent minimized-noise-figures of 1.7 dB and associated gains of 12 dB at 2 GHz. At 4 GHz, the minimized

No. 5

IN A SERIES  
MICROWAVE TRANSISTOR  
UPDATES FROM AVANTEK

# Premium performance and proven dependability from two more Avantek transistors.

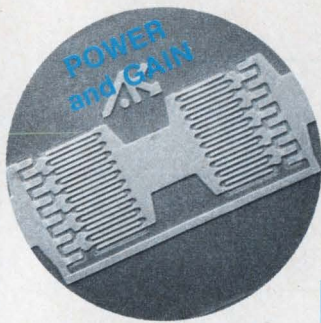

## 150 mW Output Power, 10 dB Gain @ 2 GHz AT-3850

The AT-3850 combines platinum silicide contacts, diffused emitter ballasting and gold metallization over  $1 \mu\text{m}$  thick for high gain and medium power capability. At 3 GHz, it's linear  $P_o = 100 \text{ mW}$  and it can dissipate 700 mW continuously at  $25^\circ\text{C}$  case temperature.

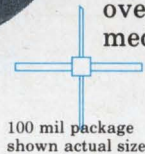

100 mil package shown actual size

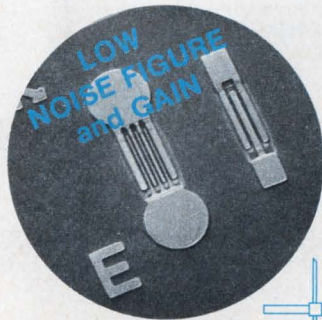
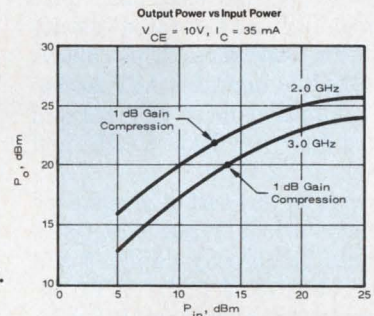

## 2.8 dB Noise Figure, 8.5 dB Gain @ 4 GHz AT-4680

The AT-4680 features an arsenic-doped  $0.5 \mu\text{m}$  emitter structure for very low NF and high associated gain through 6 GHz. At 2 GHz,  $NF_{opt} = 1.8 \text{ dB}$ ,  $G_{NF} = 13.6 \text{ dB}$  and  $G_{max} = 18 \text{ dB}$ . It's  $f_{max} = 15 \text{ GHz}$ .

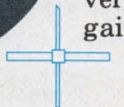

70 mil package shown actual size

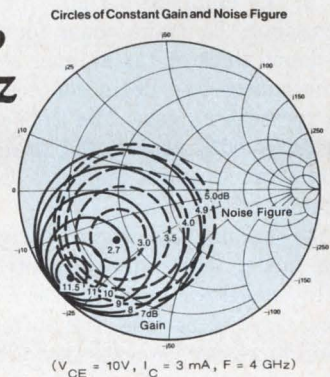

All Avantek transistors are gold metallized, hermetically packaged and 100% tested for hermeticity and both RF and DC performance. They are shipped quickly from a stock of over four million finished chips.

High reliability screening using MIL-STD-750 procedures is available. Contact Avantek Transistor Applications Engineering for fully characterized data sheets on either of these transistors.

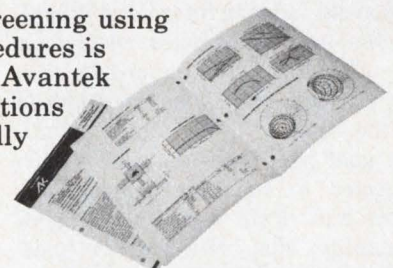

# Avantek

3175 Bowers Avenue, Santa Clara, CA 95051, (408) 249-0700.

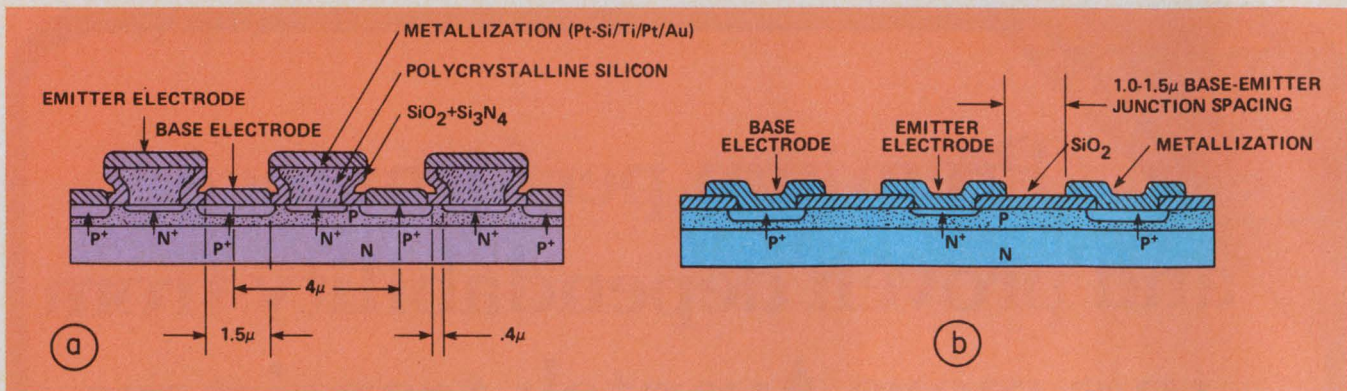

**Microwave stepped-electrode transistors** (a) from NEC reduce base-to-collector capacitance and base resistance with a virtually-zero gap between emitter junction and

base metalization. In conventional, fast, linear structures (b), usual production mask-alignment tolerances limit interelectrode spacings to approximately 1.5 microns.

noise figure rises to only 2.7 dB and its associated gain is 9 dB.

Above 4 GHz, GaAs FETs are all by themselves. GaAs electrons have higher mobility and saturated velocity than silicon electrons. This allows GaAs FETs like Aertech's AFT 2000 to deliver minimized noise of 3 dB and associated gain of 8 dB at 8 GHz, and 4 dB each at 12 GHz.

Of course, for any sort of consistency at these mysterious frequencies, GaAs FETs must be cleverly designed and carefully constructed. In the AFT 2000, for example, an aluminum Schottky gate, only one micron long, controls the current in the epitaxial 0.3 μm thick GaAs channel. To make room for a heavily-doped thick epitaxial layer beneath the source and drain contacts, Aertech recesses its gate. The thicker layer reduces both source and drain contact resistances and so improves the performance of this GaAs FET.

Both the channel layer and a nearly-intrinsic buffer layer are deposited epitaxially on a chromium-doped semi-insulating GaAs substrate. The buffer layer minimizes carrier traps between the active layer and the substrate, which reduces the noise figure.

### Quality makes the magic work

To avoid forming intermetallic compounds—such as the notorious “Purple Plague”—at the aluminum-gate contact, Aertech first bonds the gold lead to the gate to a titanium/platinum/gold pad. Only the pad is then connected to the gate contact. The source and drain contacts are gold-germanium alloy with titanium/platinum/gold metalization.

To prevent foreign particles from shorting the gate to the drain or source, the FET's active area is glassivated,

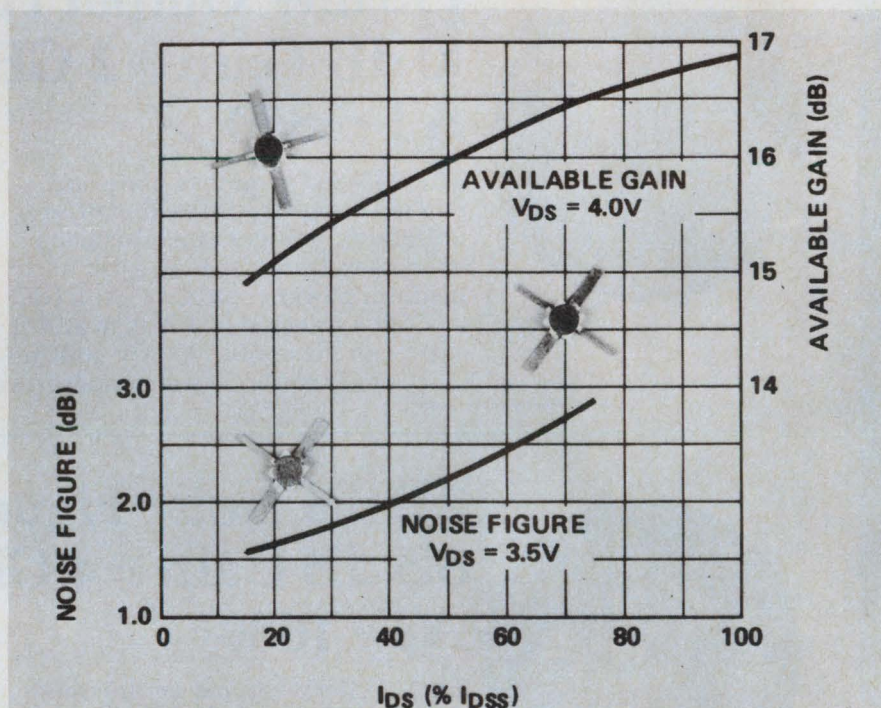

**GaAs FETs feature low noise** in the 2-to-12-GHz range. This HFET-1001 from Hewlett-Packard couples a noise figure of 2.5 dB with a available gain of 16 dB under 4-V and 60-mA drain-to-source bias conditions.

which also stabilizes the device. With all this care comes reliability.

Reliability, in microwave power transistors, is almost a religion at NEC. The company's intimate relationship with Japan's telecommunications industry (NEC is often called, “Japan's Western Electric”) has led to recent breakthroughs in three microwave-transistor areas:

- Packaging, that lowers cost while maintaining reliability.
- $K_{\mu}$  and X-band stable GaAs MESFETs.
- Inherently reliable stepped-electrode (SET) bipolars that deliver 5 W at 4.2 GHz.

In packaging, NEC's Micro-X process performs die attaching, bonding and

hermetic sealing automatically. And even though the devices are metalized with expensive platinum-silicide/titanium/platinum/gold for reliability, the high-volume process lowers cost significantly. For example, only last year an NE 64535 transistor, packaged in conventional metal-ceramic, cost over \$100. This year's Micro-X version costs \$17. Other Micro-X devices sell for as little as \$1.25 (100 qty).

Though they cost little, these transistors have nothing to be ashamed of in performance. The NE 64535 boasts low noise: Its tuned noise figure at 500 MHz is 0.7 dB and 1.8 dB at 2 GHz. It is wideband: Its crossover frequency is 8.5 GHz. It delivers high gain: Its associated gain at 2 GHz is 17 dB.

# Don't limit Mostek's new tone dialers and tone receivers to the telephone.

## Limit them to your imagination.

Applications for Mostek TONE II™ integrated tone dialers and the new MK 5102 integrated tone receiver are limitless. These two CMOS integrated circuits now create a multitude of possibilities for digital communications and control applications. Previously, these applications were impractical because of system design complexity and the resulting high system cost. But now, with encoding and decoding functions integrated onto single IC's, you can unleash your imagination.

Start with these facts: Mostek tone generators and tone receivers use the economical TV color crystal for reference. Both operate using the world-recognized TOUCH TONE\* DTMF system. Both meet or exceed most standards for stability, distortion and timing. Both are microprocessor

compatible and are in volume production today.

Additional features of the MK 5102 include 5-Volt  $\pm 10\%$  power requirement latched three-state outputs with data valid strobe, low pre-filtering requirements and superior talk-off protection — all in a 16-pin package. The MK 5087 through MK 5091 TONE II™ dialers provide simple, low-cost solutions for a wide variety of circuit designs ranging from fixed supply to direct phone line applications.

There's more information on Mostek's communications products. Contact Mostek at 1215 West Crosby Road, Carrollton, Texas 75006. Telephone:(214)242-0444. In Europe contact Mostek GmbH, West Germany Telephone: (0711) 701096.

# MOSTEK®

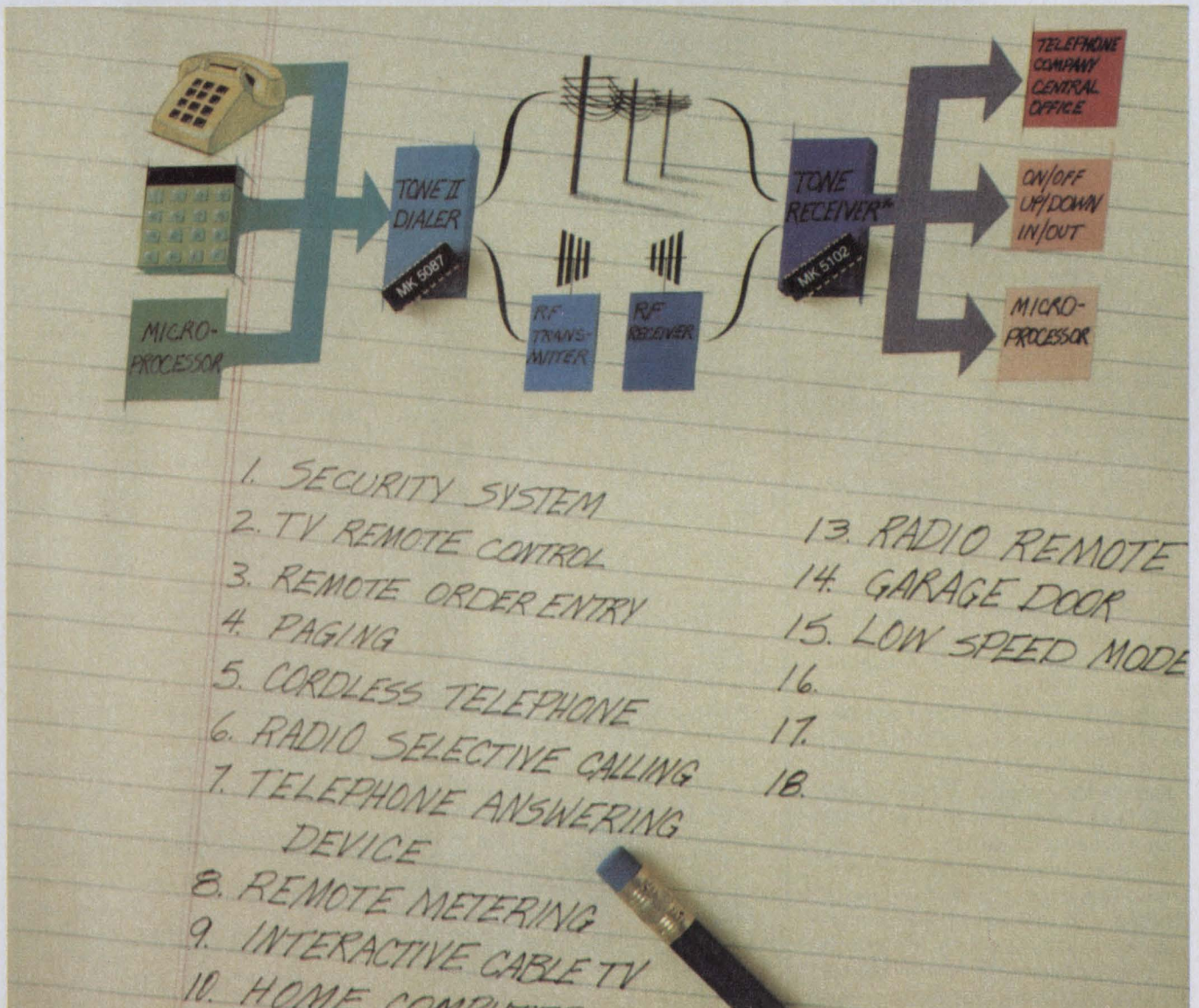

\*Touch Tone is a registered trademark of AT&T.

In GaAs FETs, NEC has just begun offering two n-channel standouts: The NE 388, with a 0.5-micron Schottky-barrier gate; and the NE 244, whose gate is 1 micron long. These 55-GHz maximum-oscillation-frequency FETs are respectively useful at 20 GHz (K $\mu$ -band) and at 12 GHz (X-band). Their high-frequency noise figures are something to shout about—1.3 dB at 4 GHz for the 244 and 2.5 dB at 8 GHz for the 388. These devices come in either of two metal-ceramic packages or as a chip.

For reliable bipolar transistors with 5-W outputs at up to 4.2 GHz, NEC is now delivering units of a line of SET devices. This structure, developed at the Musashino Electric and Communications Labs of Nippon Telephone and Telegraph Co., reduces base-collector capacitance and base resistance by making a "virtually-zero gap" between the emitter junction and the base.

### Microwaves demand the most

Also, the SET devices are made of several separate chips in the same package. Though previous attempts to make one transistor from several chips in the same package suffered from the effects of uneven power sharing—poor power output, high heat generation and wide impedance changes—the new SETs have overcome this with internal matching networks between the chips.

An example of how well the technique works is the NEM 4205, which, in its beryllium-oxide hermetically-sealed stripline package, delivers its 5 W at 4.2 GHz with 4-dB gain and 25% efficiency. And with all this performance comes reliability—reportedly orders of magnitude greater than other devices in this range.

Microwave-transistor designers at NEC foresee band saturation continuing to push up the operating frequencies of wireless-communication systems. More nonmilitary-satellite ground stations for data transmission and home TV are expected to contribute to the heavier traffic. For these, the crystal-ball gazers at NEC's American representative, California Eastern Laboratories, predict 1983's GaAs FETs will have noise figures lower than 1.5 dB at 12 GHz.

For now, low-noise microwave-transistor seekers can get the bipolar AT-4691 from Avantek. These hermetically-sealed-alumina stripline devices have typical noise figures of only 0.8 dB at 4 GHz over a collector-current range of 2.5 to 20 mA. ■

## Need more information?

Not every manufacturer of fast transistors has been cited in this report, nor has every fast transistor made by each of these suppliers been described in detail. For additional information circle the appropriate number on the reader service card and consult the GOLD BOOK.

AEI Semiconductors Ltd., Carholme Rd., Lincon, UK 0522-2992. W.W. Reid. **Circle No. 501**

Aertech, 825 Stewart Dr., Sunnyvale, CA 94086. (408) 732-0880. John Archer. **Circle No. 502**

Amperex Electronic Corp., Providence Pike, Slatersville, RI 02876. (401) 762-3800. Tom Perry. **Circle No. 503**

Amperex Electronic Corp., Hicksville, NY 11802. (516) 931-6200. Marty Burden. **Circle No. 504**

Avantek, 3175 Bowers Ave., Santa Clara, CA 95051. (408) 249-0700. William Berridge. **Circle No. 505**

California Eastern Laboratories Inc., 1 Edwards Ct., Burlingame, CA 94010. (415) 432-7744. Jerry Arden. **Circle No. 506**

Central Microwave, 1232M Harvestowne Dr., St. Charles, MO 63301. (314) 441-1455. **Circle No. 507**

Communications Transistor Corporation, 301 Indl Way, San Carlos, CA 94070. (415) 592-9390. M.J. Mallinger. **Circle No. 508**

Delco Electronics Div., 700 E. Firmin St., Kokomo, IN 46901. (317) 457-8461. Larry Nix. **Circle No. 509**

Dexcel, 2285C Martin Ave., Santa Ana, CA 95050. (408) 244-9833. **Circle No. 510**

Dionics Corporation, 65 Rushmore St., Westbury, NY 11590. (516) 997-7474. G.R. Seaton. **Circle No. 511**

Fairchild Semiconductor, 464 Ellis St., Mountain View, CA 94042. (415) 962-5011. C.J. Stoll. **Circle No. 512**

Ferranti Electric Inc., E. Bethpage Rd., Plainview, NY 11803. (516) 293-8383. B. Kutny. **Circle No. 513**

Ferranti Ltd., Hollinwood, Lancashire OL97JS, England. 061-681-2000. C. Hill. **Circle No. 514**

Fujitsu Ltd., 2-Chome 6-1 Chiyoda-ku, Tokyo, Japan. (03) 163211. S. Hara. **Circle No. 515**

Fujitsu America, 1251 W. Redondo Beach Blvd., Gardena, CA 90247. (213) 538-3397. **Circle No. 516**

General Electric, Semiconductor Products, Electronics Park, Bldg. 7 Rm. 237, Syracuse, NY 13201. (315) 456-2568. Rey Harju. **Circle No. 517**

General Instrument Corp., Semiconductor Products Div., 600 W. John St., Hicksville, NY 11802. (516) 733-3333. G.S. Stein. **Circle No. 518**

General Semiconductor Industries Inc., 2001 W. 10 Place, Tempe, AZ 85281. (602) 968-3101. James R. Williams. **Circle No. 519**

Hewlett-Packard, 1501 Page Mill Rd., Palo Alto, CA 94304. (415) 493-1501. R. Berg. **Circle No. 520**

Hitachi Ltd., 5-1 1-Chome Marunouchi Chiyoda-ku, Tokyo 100, Japan. 03-212-1111. T. Takahashi. **Circle No. 521**

International Devices, 3370 Livonia Ave., Los Angeles, CA 90034. (213) 559-4741. **Circle No. 522**

International Rectifier, Semiconductor Div., 233 Kansas St., El Segundo, CA 90245. (213) 678-6281. N. Cleere. **Circle No. 523**

Intersil Inc., 10900 Tantau Ave., Santa Clara, CA 95014. (408) 996-5406. **Circle No. 524**

ITT Semiconductors, 74 Commerce Way, Woburn, MA 01801. (617) 935-7910. W. Riner. **Circle No. 525**

ITT Semiconductors, Maidstone Rd., Foots Cray, Sidcup, Kent, England. 01-300-3333. **Circle No. 526**

Kertron Inc., 7516 Central Ind. Dr., Riviera Beach, FL 33404. (305) 848-9606. Annette Siviglia. **Circle No. 527**

Lambda Electronics, Power Semiconductors Div., 121 Intl. Dr., Corpus Christi, TX 78410. (512) 883-6251. M. Simon. **Circle No. 528**

Microwave Associates Inc., Corporate Advanced Div., South Ave., Burlington, MA 01803. (617) 272-3000. T. B. Ramachandran. **Circle No. 529**

Microwave Semiconductor Corporation, 100 School House Rd., Somerset, NJ 08873. (201) 469-3311. Richard Moffett. **Circle No. 530**

Motorola Semiconductor Prod. Inc., P.O. Box 20912, Phoenix, AZ 85036. (602) 244-6900. Lothar Stern. **Circle No. 531**

Narda Microwave, 75M Commercial, Plainview, NY 11803. (516) 433-9000. **Circle No. 532**

National Electronics, P.O. Box 269, Geneva, IL 60134. (312) 232-4300. **Circle No. 433**

National Semiconductor Corporation, 2900 Semiconductor Dr., Santa Clara, CA 95051. (408) 732-5000. C. Signor. **Circle No. 434**

NEC America Inc., 3070 Lawrence Expwy., Santa Clara, CA 95051. (408) 738-2180. S. Kirimoto. **Circle No. 435**

NEC Microwave Semiconductors, P.O. Box 915, Burlingame, CA 94010. (415) 342-7744. Jerry Arden. **Circle No. 436**

Panasonic Co., Industrial Components, 1 Panasonic Way, Secaucus, NJ 07094. (201) 348-7000. J. Dillon. **Circle No. 437**

Philips Inds., Electronic Components and Materials Div., Eindhoven, Netherlands. **Circle No. 438**

Plessey Microsystems, Plessey Semiconductors, 1674 McGaw Ave., Santa Ana, CA 92715. (714) 540-9945. D. Chant. **Circle No. 439**

Power Tech Inc., 0-02 Fair Lawn Ave., Fair Lawn, NJ 07410. (201) 791-5050. Alex M. Polner. **Circle No. 440**

Power Tech, 9 Baker Court, Clifton, NJ 07011. (201) 478-6205. **Circle No. 441**

RCA Solid State Div., Somerville, NJ 08876. (201) 685-6255. Dale Baucher. **Circle No. 442**

Semico, 333 McCormick Ave., Costa Mesa, CA 92626. (714) 979-1900. Robert Boughan. **Circle No. 443**

SGS Ates Comp. Electronic Spa, Via C. Olivetti 2, Agrate Brianza, Milan, Italy. 039-650-341. Carlo E. Ottaviani. **Circle No. 444**

SGS-Ates Semiconductor Corporation, 79 Massasoit St., Waltham, MA 02154. (617) 891-3710. Ruben Sonnino. **Circle No. 445**

Shigoto Industries Ltd., 350 Fifth Ave., New York, NY 10001. (212) 695-0200. **Circle No. 446**

Shindengem Electric Mfg. Co. Ltd., New-Ohtemachi Building, 2-1 2-Chome Ohtemachi, Chiyoda-Ku, Japan. 03-279-4431. M. Asahiya. **Circle No. 447**

Siemens Corporation, Components Group, 186 Wood Ave. S., Iselin, NJ 08830. (201) 494-1000. E. Young. **Circle No. 448**

Siliconix Inc., 2201 Laurelwood Rd., Santa Clara, CA 95054. (408) 998-8000. Gary Hess. **Circle No. 449**

Silicon Transistor Corporation, Katrina Rd., Chelmsford, MA 01824. (617) 256-3321. William Schromm. **Circle No. 450**

Solid State Devices Inc., 14830 Valley View Ave., La Mirada, CA 90638. (213) 921-9660. Dee Peden. **Circle No. 451**

Solid State Scientific, Commerce, Montgomeryville, PA 18936. (215) 855-8400. **Circle No. 452**

Solitron Devices Inc., Semiconductor Gr., 1177 Blue Heron Blvd., Riviera Beach, FL 33404. (305) 848-4311. Mike Giraud. **Circle No. 453**

Sprague Electric Co., 645 Marshall St., North Adams, MA 01247. (413) 664-4411. S. L. Chertok. **Circle No. 454**

Tecor Electronics, 1101 Pamela Dr., Eules, TX 76039. (817) 267-2601. R. L. Saunders. **Circle No. 455**

Teledyne Crystalonics, 147 Sherman St., Cambridge, MA 02140. (617) 491-1670. Raymond Moore. **Circle No. 456**

Teledyne Semiconductor, 1300 Terra Bella Ave., Mountain View, CA 94043. (415) 968-9241. C. Bigelow. **Circle No. 457**

AEG Telefunken Corporation, 570 Sylvan Ave., Englewood Cliffs, NJ 07632. (201) 568-8570. Manfred R. Duebner. **Circle No. 458**

AEG-Telefunken Serienprodukte AG, Geschäftsbe- reich Halbleiter, Theresienstrasse 2, Heilbronn D-7100, Germany. (07131) 8821. Mr. Neuhauser. **Circle No. 459**

Texas Instruments Inc., P.O. Box 5012, Mail Station 84, Dallas, TX 75222. (214) 238-2011. (214) 238-2481. Dan Garza. **Circle No. 460**

Thomson CSF, Semiconducteurs Sescosem, 50 rue JP Timbaud, Courbevoie 92, France. 788-5001. E. Codechevre. **Circle No. 461**

TRW Semiconductor, 14520 Aviation Blvd., Lawndale, CA 90260. (213) 679-4561. Jag Chopra. **Circle No. 462**

Unitrode Corporation, 580 Pleasant St., Watertown, MA 02172. (617) 926-0404. Frank Brunner. **Circle No. 463**

Varian Associates Inc., Electron Device Group, 611 Hansen Way, Palo Alto, CA 94303. (415) 592-1221. B. L. Algood. **Circle No. 464**

Watkins Johnson, 3333 Hillview Ave., Palo Alto, CA 94304. (415) 493-4141. K. Kennedy. **Circle No. 465**

Westinghouse Brake & Signal, Chippenham, Wilts SN 15 1JD, Great Britain. David W. Beattie. **Circle No. 466**

Westinghouse Electronic Corp., Semiconductor Div., Youngwood, PA 15697. (415) 925-7272. R. G. Freuler. **Circle No. 467**

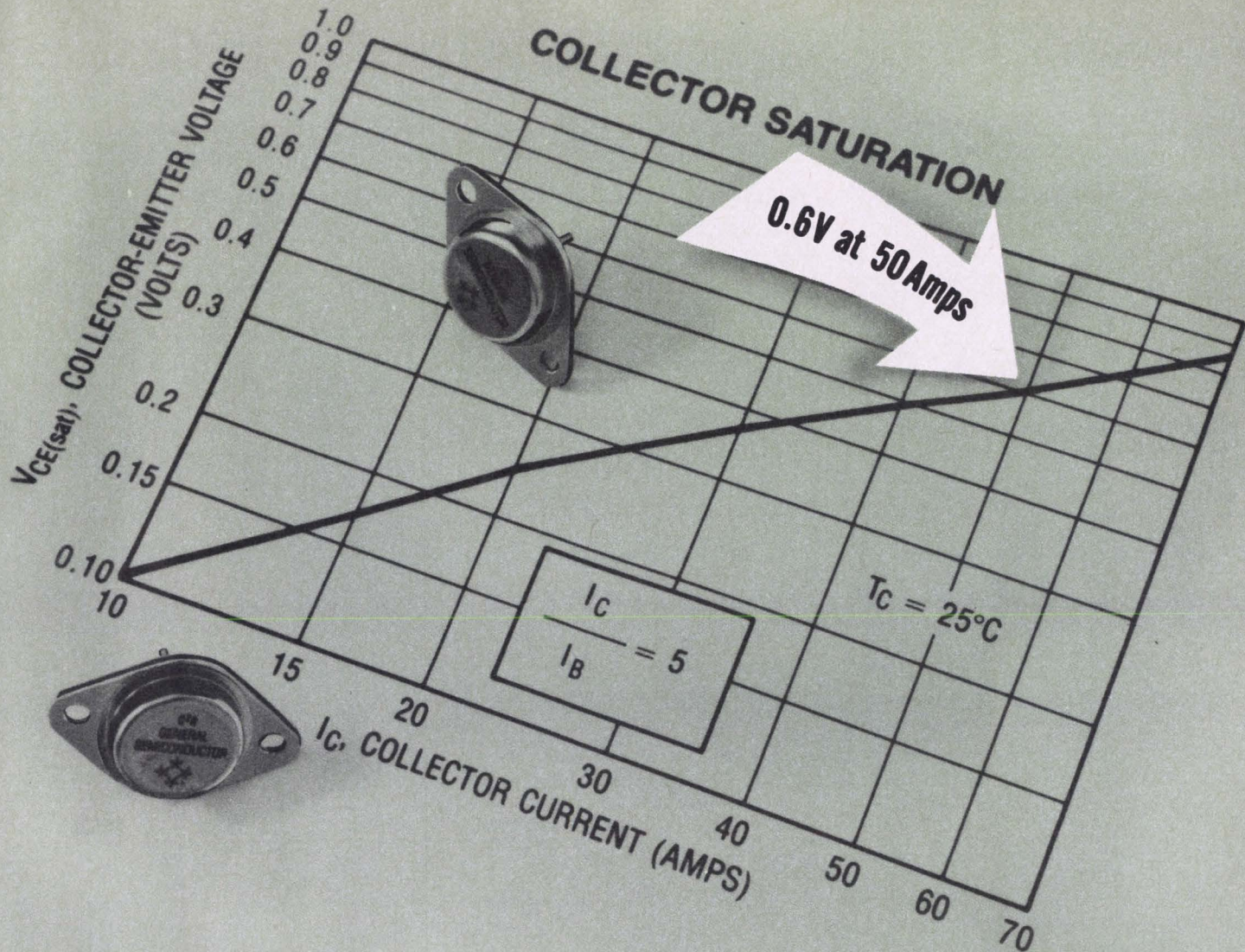

# Here's a new, fast-switching 50 Amp, 200 Volt Transistor with no surprises.

We designed our new 50 Amp, 200 Volt fast-switching power transistor to eliminate all the surprises... when you design it into your circuit, and afterward, too. We're proud of it, and rightfully so. Our unique C<sup>2</sup>R™ technology went into it to make it a *true* 50 Amp device. We believe it has the *fastest* switching speed and the *lowest* collector saturation voltage of any high-voltage, high-current transistor available. Typically, at the 50 Amp level, it has a total switching speed of less than 1 μSec, and a collector saturation voltage of just 0.6 Volts. V<sub>CEO</sub> is a full 200 Volts. And, the 50 Amps is *continuous* collector current. Peak is conservatively rated at a full 75 Amps. We could call it a 75 Amp transistor... others would... but we prefer to call it like it is. We've been doing that ever since we started making transistors.

You'll find, too, that the high switching speed and low saturation

voltage give you both higher efficiency and cool running. Cool running means increased reliability, and longer life. That's true of this device and the rest of our broad line of C<sup>2</sup>R power transistors. It's inherent in the design. And, they behave the way you expect them to, time after time, because our process remains the same. No changes from batch to batch, or over the years. No surprises after you've designed them in.

No matter which C<sup>2</sup>R transistor you choose, from 1 Amp to 50 Amps, and up to 450 Volts V<sub>CEO</sub>, you can count on maximum performance for your transistor dollar. You'll get high gains, low saturation voltages, low thermal losses, low leakage currents... with no surprises. For complete information, call or write General Semiconductor Industries.

C<sup>2</sup>R™ is a registered trademark of General Semiconductor Industries, Inc.

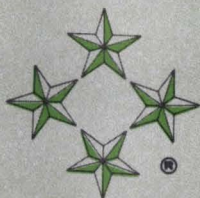

**GENERAL  
SEMICONDUCTOR  
INDUSTRIES, INC.**

2001 West Tenth Place • P.O. Box 3078 • Tempe, Arizona 85281 • 602-968-3101 • TWX 910-950-1942

From the makers  
of TransZorb™  
"The Volt Getter."  
™ Trademark  
General  
Semiconductor  
Industries, Inc.



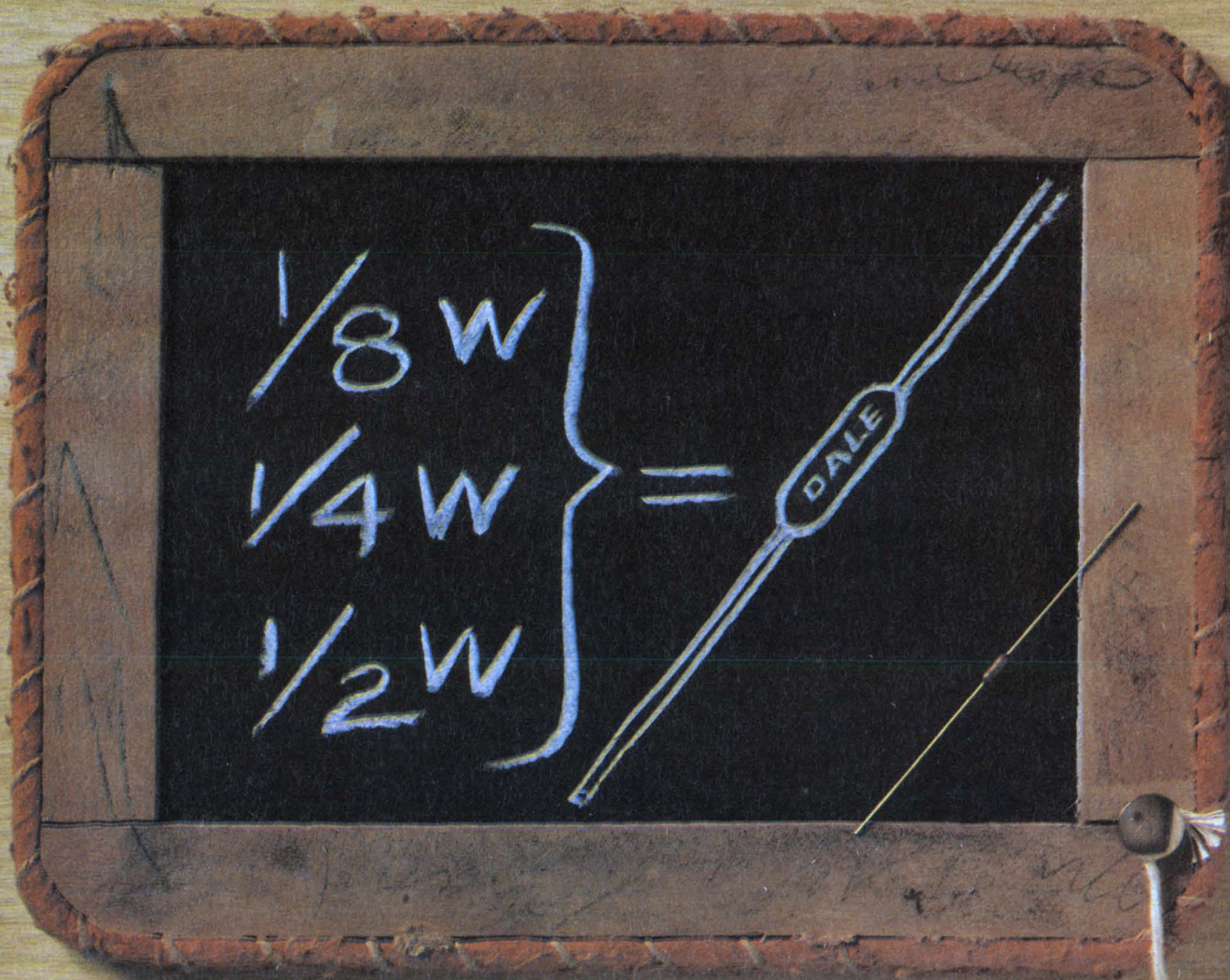

## How to uncomplicate your resistance.

1/8 watt, 1/4 watt, 1/2 watt—take your choice of three power ratings from one small (.250" x .098"), precise metal film resistor. It's easy with Dale's CMF-55.

The 3-in-1 capability of the CMF-55 plus its complete RN-55 qualification to MIL-R-10509 gives you the versatility to fit a multitude of applications. You gain all of the advantages of the so-called "universal resistors" including the ability to reduce your inventory, lower your purchasing costs and save on board space. In fact, the CMF-55's lower TCs (to 25 PPM) and tighter toler-

ances (to 0.1%) make it the closest yet to the "universal resistor".

The CMF-55 is competitively priced and ready to ship from either distributor or factory stock. Sounds great. But what if you need a higher working voltage, higher ohmic value, a higher power rating, a tighter tolerance or tighter T.C.? Dale has the answer. The fact is that Dale backs the CMF-55 with the industry's broadest line of film resistors. Simple or special, we can uncomplicate your resistance. Send for CMF-55 Test Report today.

**For price and delivery information,  
contact your Dale Representative  
or Phone 402-371-0080.**

DALE ELECTRONICS, INC., Box 74, Norfolk, NE 68701  
A subsidiary of The Lionel Corporation In Canada: Dale Electronics, Ltd.  
In Europe: Dale Electronics GmbH, 8 Munchen 60, Falkweg 51, West Germany





20-PINS—ONLY SLIGHTLY  
LARGER THAN THE 16-PIN  
OUTLINE BUT CAN  
ACCOMMODATE  
OCTAL FUNCTIONS.

ALMOST THE SAME  
FUNCTIONAL CAPABILITY  
AS THE 3 TIMES  
LARGER 24-PIN PACKAGE.

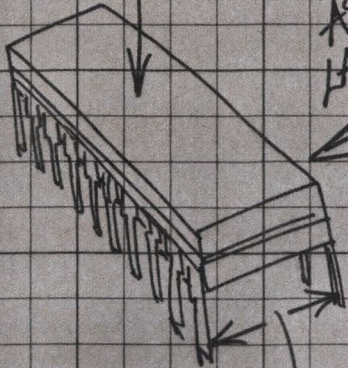

300 MIL  
ROW TO ROW LEAD SPACING  
FOR STANDARD PC BOARD  
LAYOUT.

Eighteen months ago, we announced the start of a whole new family of 20-pin parts.

We told you that the 20-pin configuration not only made better packages—it made better ideas.

We told you all about 8-bit low-power Schottky buffers, registers and decoders.

Remember? “Perfect for use with 8-bit 8080-type microprocessors—as well as 2900, 4-bit bipolar slices. No more trying to manage too-much 24’s and not-enough 16’s.”

Well now we have new ALU’s, counters, sequencers and more.

Fasten your seatbelt.

# THE TWENTIES TAKE OFF.

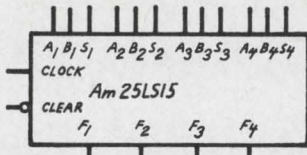

QUAD SERIAL ADDER/SUBTRACTOR FOR USE WITH AM25LS14 MULTIPLIER.

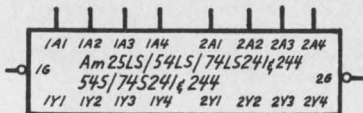

OCTAL 3-STATE BUFFERS, HIGH-SPEED & LOW-POWER VERSIONS.

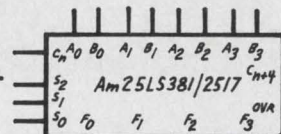

ARITHMETIC LOGIC UNIT/FUNCTION GENERATORS WITH 6, 8, 10, 12, 14 & 16 INPUTS.

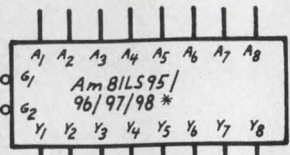

LOW-POWER OCTAL BUFFERS & INVERTERS WITH 3-STATE OUTPUTS.

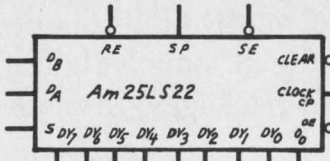

8-BIT SERIAL/PARALLEL REGISTER WITH SIGN EXTEND.

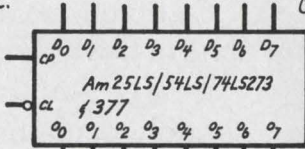

OCTAL REGISTERS WITH STANDARD OUTPUTS, COMMON REGISTER ENABLE & COMMON CLEAR VERSIONS.

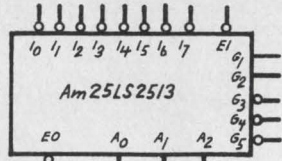

GATED 3-STATE PRIORITY ENCODER WITH NON-INVERTING OUTPUTS.

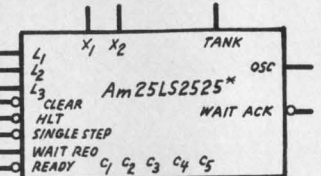

PROGRAMMABLE CLOCK GENERATOR/DRIVER.

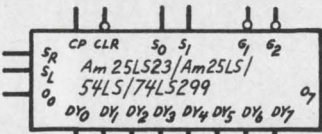

8-BIT SHIFT/STORAGE REGISTERS WITH CLEAR & 3-STATE OUTPUTS.

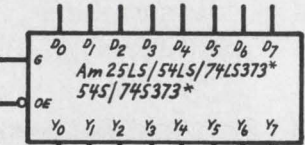

OCTAL LATCH WITH 3-STATE OUTPUTS, HIGH-SPEED & LOW-POWER VERSIONS.

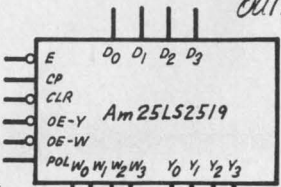

QUAD REGISTER WITH DUAL 3-STATE OUTPUTS & POLARITY CONTROL.

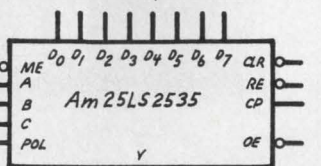

8-INPUT MULTIPLEXER WITH CONTROL REGISTER & POLARITY CONTROL.

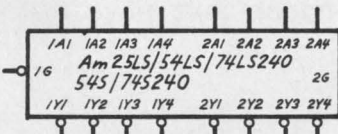

OCTAL 3-STATE INVERTERS, HIGH-SPEED & LOW-POWER VERSIONS.

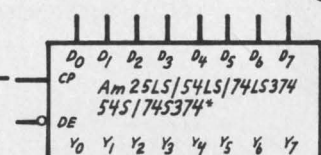

OCTAL REGISTER WITH 3-STATE OUTPUTS, HIGH-SPEED & LOW-POWER VERSIONS.

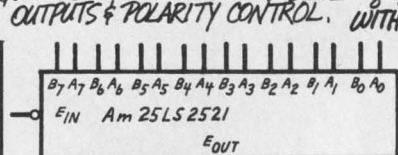

EXPANDABLE 8-BIT EQUAL-TO COMPARATOR.

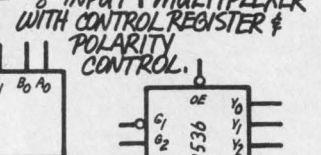

8-BIT DECODER WITH CONTROL STORAGE.

# THIRTY-NINE TWENTIES.

**AND A TWENTY-TWO, TOO.**

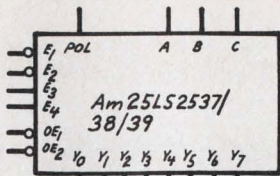

DECODERS WITH 3-STATE OUTPUTS & POLARITY CONTROL.

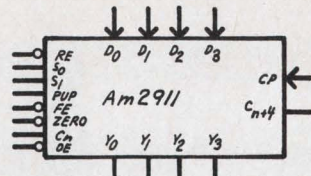

EXPANDABLE MICROPROGRAM SEQUENCER.

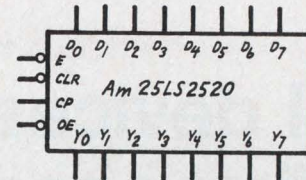

UNIVERSAL OCTAL REGISTER WITH CLEAR, CLOCK ENABLE & 3-STATE OUTPUTS.

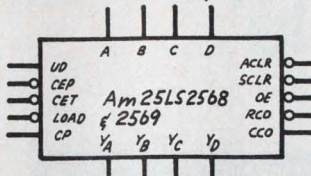

4-BIT PROGRAMMABLE UP/DOWN COUNTERS WITH 3-STATE OUTPUTS.

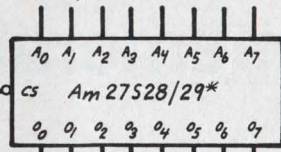

512x8 PROGRAMMABLE READ-ONLY MEMORIES.

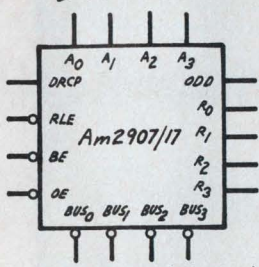

QUAD LSI BUS TRANSCEIVERS WITH OPEN COLLECTOR & 3-STATE OUTPUTS.

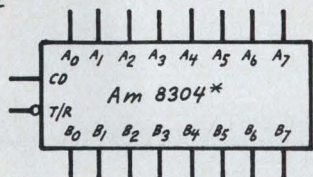

OCTAL BIDIRECTIONAL BUS TRANSCEIVER WITH 48mA DRIVE CAPABILITY.

\* AVAILABLE SOON.

For more pictures, just open your Advanced Micro Devices' Schottky and Low-Power Schottky Data Book. Or ask and we'll send you a beautiful wall chart, suitable for framing.

# Advanced Micro Devices



Multiple technologies. One product: excellence.  
901 Thompson Place, Sunnyvale, California 94086  
Telephone (408) 732-2400

CIRCLE NUMBER 85

Advanced Micro Devices, Inc. • France: Silic 314-Immeuble Essen, 20 Rue Saarinen, 94588 Rungis Cedex, France, Tel: (1) 686-91-86; Germany: 8000 Munchen 2, Herzog-Heinrich-Strasse 3, West Germany, Tel: (089) 539588; United Kingdom: 16 Grosvenor Place, London, SW1, England, Tel: (01) 235-6380; Belgium: 412, Avenue de Tervuren, B.P. 9, 1150 Brussels, Belgium, Tel: 32-2-771.99.93.

# VLSI devices are on the way—and the first ones will be 'memorable'

Are you ready for a 4-Mbit bubble-memory chip, a 256-kbit ROM, a 256-kbit CCD memory, and a 65-kbit dynamic RAM? These phenomenally high-capacity devices, now moving from the drawing boards to the development labs, are at most one to two years away from production, experts say. And these will just be the support chips for the even more complex microprocessors and digital peripheral chips that are on the drawing boards today. Every advance in processing, lithography, circuit design, and layout geometry is being exploited to pack more circuits on every new chip.

But the impressive accomplishments in high-density ICs—better performance at lower power and ever-diminishing cost—are not limited to digital circuitry. There are also many developments in analog products such as op amps, codecs, multiplexers and a/d converters.

"For eighteen years now, the complexity available in the most complex integrated circuits has about doubled every year," says Gordon Moore, president of Intel, Santa Clara, CA. "But I don't believe the industry can continue at quite that rate; I think the slope of the curve is changing to something like half that. Nevertheless, doubling every two years still leads to remarkable product possibilities."

Memory products afford the easiest density increase since their patterns are regular and repetitive. But in all other product areas companies are becoming design-limited, though not by the ability to make ICs. Laying out random-logic chips with 25,000 to 30,000 transistors per chip—very-large-scale-integration—is a very formidable design process.

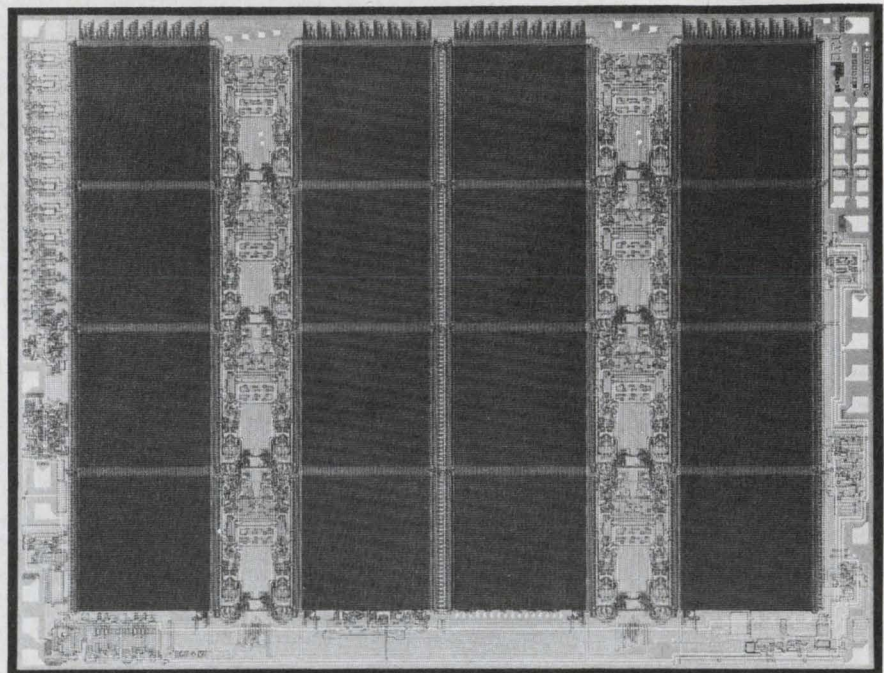

**This 175 × 228-mil, 65-k CCD memory** from Fairchild fits an industry standard 16-pin DIP. To reduce cell size, parallel data are shifted by eight-phase ripple clocks generated on-chip.

So, either memories will predominate the top end of VLSI, because of their regularity, or someone will have to come up with a way of getting regularity throughout a random logic structure.

## Repetition pays

New IC layout geometries are needed, based on parallel processing and regular, repetitious circuit patterns, according to Ivan Sutherland, director, and Carver Mead, professor of computer science at the California Institute of Technology. They assert that computer science has grown up in an era of computer technologies in which switching elements have been expensive and wires have been cheap. Integrated-circuit technology reverses the cost situation by making switching elements essentially free and by making the wiring the only expensive com-

ponent.

In an integrated circuit, the "wires," actually conducting paths, are expensive because they occupy most of the space and consume most of the layout time. Between ICs, the wires, which may be flat conducting paths on a PC board, are expensive because of their size and delaying effect.

The many competing forms of MOS and bipolar technologies all have a place in the future of VLSI. Calling I<sup>2</sup>L the ultimate technology, Siegfried Wiedmann, research staff member at IBM's Yorktown Heights Lab in New York, projects that when 5-micron design rules give way to the 3-micron design rules, a 16-kbit I<sup>2</sup>L bipolar memory can be put on a 5-mm square chip, and will have 50-ns access times and 100-ns cycle times. I<sup>2</sup>L also has low defect density, which leads to higher yield, Wiedmann points out, and makes it easy to mix all circuit types

**Dave Bursky**  
Associate Editor

**Dave Barnes**  
Western Editor

on the same chip—linear, high-speed digital, and special types.

"We'll see a thousand bipolar gates per chip with 400 to 500-picosecond stage delay in 1980, compared with today's 300 gates per chip and 700 to 900 ps," says Motorola's Bill Howard, vice-president of the IC division. "And with bipolar's high speed, ability to interface to the outside world with rugged powerful drivers, and 50  $\Omega$  outputs, I see bipolar doing special jobs like driving electromechanical transducers, sensing very small signals, and providing voltage protection, better than the other technologies can."

Even when a system is based on the low-power technologies like NMOS or CMOS, Howard says, they need to be interfaced to the real world and protected from the environment in which they work. "So bipolar can be like the shell of a walnut—the tough layer that shields a more vulnerable interior, in this case high-impedance, low-power MOS devices."

One potential competitor in the bipolar speed range, even at high densities, is CMOS/SOS (silicon-on-sapphire), which is emerging after several false starts. "We've seen 150-ps delays—and better, for short-channel devices, with CMOS on sapphire," says RCA's Andy Dingwall. "It's a dielectrically isolated structure, which results in minimum capacitances."

While bipolar dynamic RAM cell sizes are expected to drop from 3.3 to 1.1 square mils with the change from 5-micron to 3-micron design rules, today's NMOS cell size is already down to 2.7 square mils, and Dick Pashley, manager, Static RAM development at Intel, sees HMOS, the Intel version of scaled-down NMOS, giving a 64-k static RAM by 1984 that is only 215 mils square. The 16-k static at that time will be only 120 mils square, he predicts. "And I think scaled NMOS can give us the lowest internal gate delay within the chip, of any technology," Pashley asserts.

### The RAMs are coming

When it comes to RAMs, technology has started to play leapfrog with itself. Just as companies are starting to deliver production quantities of the 16-k dynamic RAM, one company, Fujitsu of Japan has announced a production 64-k RAM. Dubbed the MB8164, the RAM will be available in sample form this spring and in production quantities in the fall.

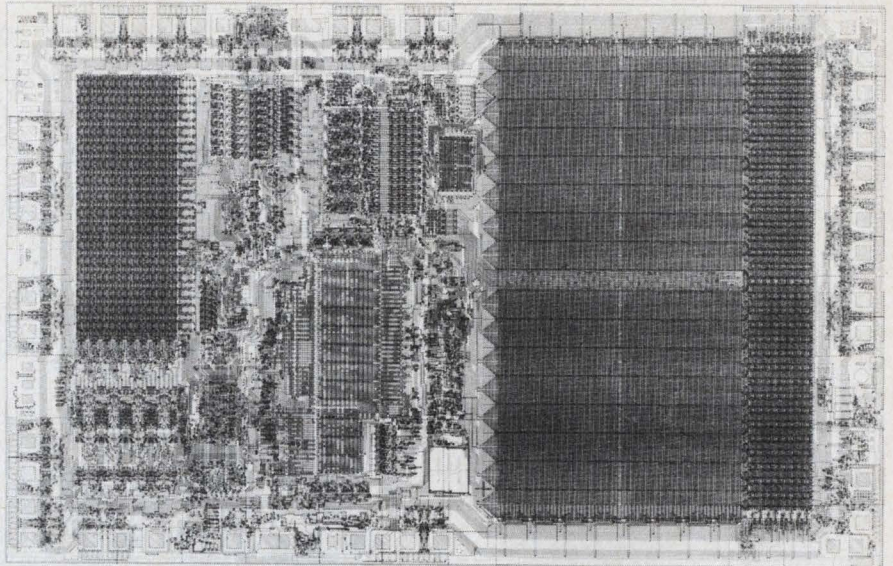

**The MK 3872 single-chip microcomputer** from Mostek retains commonality with the 3870, but packs twice as much RAM and ROM on the chip. RAM capacity is 128 8-bit words, ROM is 4032  $\times$  8.

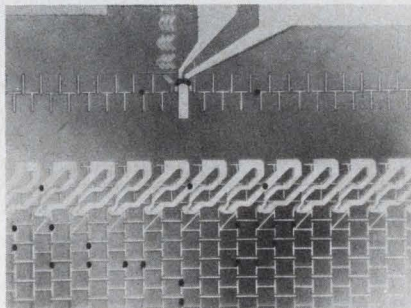

**This close-up of a portion of the transfer gates of the TIB0103 bubble-memory chip** from Texas Instruments shows the path through which bubbles enter and leave the storage area. The 92,304-bit memory fits in a 14-pin DIP, 1  $\times$  1  $\times$  1/2 in.

Organized as 65,536  $\times$  1 it uses conventional photolithographic techniques to put 150,000 circuit elements (transistors, resistors and capacitors) on a 33,500 square-mil chip—not much larger than Fujitsu's 16-k RAM. Typical access and cycle times are 110 and 300 ns, and power is 250 mW operating and 10 mW standby, from 7-V and -2-V supplies.

The chip uses the same basic technology as Fujitsu's 4-k and 16-k RAMs, a double-poly embedded field oxidation process, but makes use of 2- $\mu$ m line widths and channel lengths.

However, says Intel's Moore, "making a large RAM is actually a two-part job. The first part is simple engineering, the other is getting the design to the point where it is the most economical way to make a RAM." While the first part is possible today, for future memories such as a 256-k RAM, the

second half is still several years away.

To get to that economical fabrication stage, some companies are exploring production techniques such as electron-beam and X-ray lithography so line widths can be reduced. Other techniques such as device scaling are also being used. And since scaling requires that *all* device dimensions within a chip be reduced, there will be room for more transistors in the chip. And since the transistors will be closer, both speed and power reductions are possible.

However, such "economical" techniques, while promising, are also still unproven for a large-scale production program. As sizes decrease, some hitherto neglected device parameters that are size dependent must be considered.

The factors that brought density increases over the past eight years cannot be counted on for comparable increases in the future, according to Tom Klein, National's manager of memory development. According to Klein, the 120-fold density improvement for memories since 1970 can be broken down as follows: Design and process innovations contributed more than a 13-times improvement; larger fabricated wafer areas contributed a four-times improvement; and smaller feature sizes and tighter alignment tolerances contributed only 2.2-times improvement.

In Klein's opinion, continued improvement due to the first factor will slow down, since the memory cell is getting close to its theoretical limits. Wafer area will continue to increase at a gradual rate. And, as the log-linear

chart on p. 46 shows, feature-size decreases will have to be revolutionary, not evolutionary, to support continued increases in bit density.

Improved high-resolution photo resists and dry etching techniques will help reduce feature size. But Klein believes that electron beam and X-ray lithography for direct writing on wafers have both tactical and economic hurdles to overcome before they can make an impact on high-density integrated-circuit technology.

However, Klein does foresee improvements in technology for defining optical patterns that will yield a five to eightfold increase in batch density over the next five to eight years.

### Other limiting factors

Defining what he considers the main pacing items that control the rate of progress of VLSI in memories, Tom Longo, Fairchild's chief technical officer, observes: "My biggest concerns are the interconnects on the chip, the packaging problems, and the testing methods. In the next two years, I think we will see three levels of interconnect—perhaps using double-poly as in the RAMs—appearing in logic for the first time."

Three or four years from now, Longo goes on, three-layer metal will start to show up in bipolar chips. There will need to be some innovations in logic; more programmable chips are assured, and maybe arrays of processors on a chip, with some redundancy. Parallel processors for added performance are also a distinct possibility.

In testing, however, Longo isn't sure that the industry is keeping up. "We may have to put dedicated test pins on more chips in the future."

While Longo thinks error detection and correction will become part of memories, he also notes: "The reliability of the advanced technologies has consistently surprised the experts. The Government actually predicted a 17-minute MTBF for one famous super-computer, based on 200,000 sub-nanosecond ECL gates and 65,000 1-k ECL RAMs. And I can tell you it runs orders of magnitude longer than that, without a hitch."

The push for more and more density isn't confined to memory design by any means. Microprocessors and specialized peripheral circuits are also being squeezed. Intel, using its high-density MOS process called HMOS has developed its next microprocessor family,

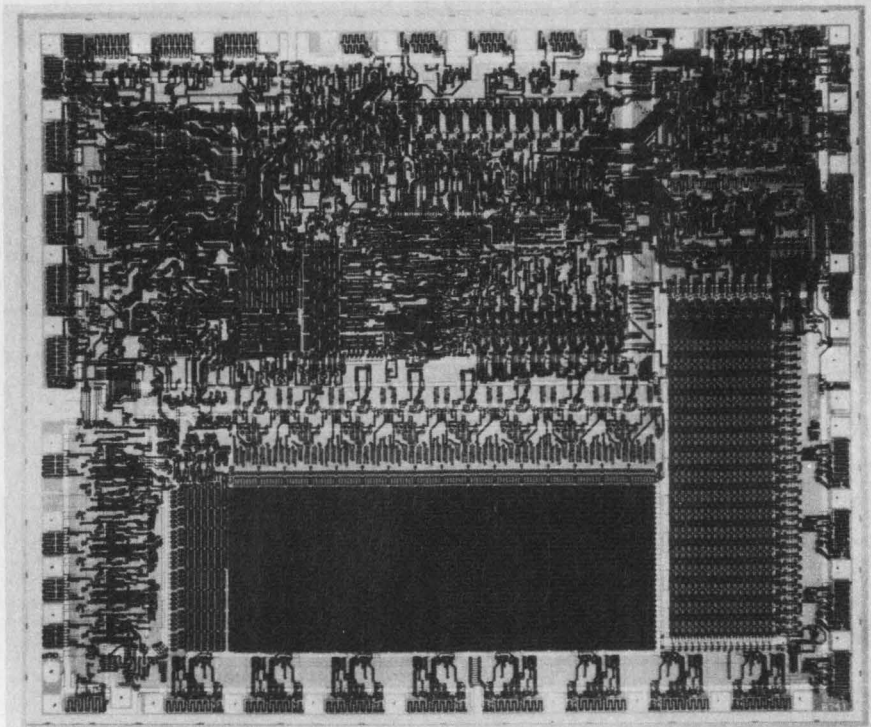

With more than 17,000 transistor equivalents on a 205-mil-square chip, Intel's UPI-41 master chip takes on a variety of peripheral-controller jobs, depending on ROM or EPROM program. The latest version, the 8294 Data Encryption chip, is a slave processor for the 8080, 8085 and 8048.

starting with the 8086. With 29,000 transistors on a chip, it is not only one of the densest circuits to date, it is also one of the most complex.

There are actually two processors on the chip, and microprogrammed instructions of the processors permit both 8 and 16-bit operations and multiply and divide routines. Because the chip uses HMOS, on-chip propagation delays are low and clock rates can be raised to 8 MHz. As a result, most instructions can be executed in less than a microsecond. High-speed performance such as this will be more commonplace as similar processes are developed by other manufacturers.

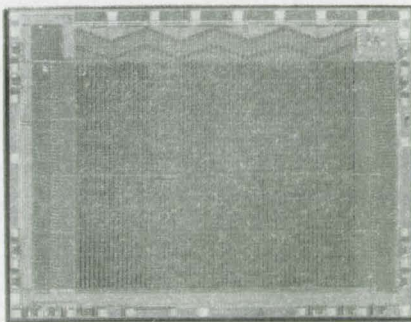

This 4-k static CMOS RAM from Harris, the HM-6514, contains 27,000 transistors and at 31,000 square mils, is about 15% larger than higher-power n-channel memories.

For an alternative, American Microsystems, in Santa Clara, CA, offers its VMOS technology. Building MOSFETs vertically instead of laterally, much smaller devices can be fabricated, thus yielding improvements in density and speed. Although not ready to talk about any forthcoming processor products, AMI is hard at work developing some custom VMOS processors for selected customers, and has already announced some fast static RAMs and large ROMs, the largest being a 64-kbit ROM.

Bipolar technology's integrated injection logic (I<sup>2</sup>L) is finding much wider use in processor design. Fairchild's Microflame, a 16-bit microprocessor that can execute the Nova minicomputer instruction set, uses a form of I<sup>2</sup>L patented by Fairchild called I<sup>3</sup>L (Isoplanar I<sup>2</sup>L). Texas Instruments (Dallas, TX) though, has had an I<sup>2</sup>L version of its 16-bit microprocessor, the SBP9900, available for about a year.

Fairchild is also experimenting with I<sup>3</sup>L in memory arrays, and expects to have a 16-k dynamic RAM available shortly. Following closely behind will be a 64-k RAM—a bipolar memory with the density previously attainable only with NMOS.

Ferranti, in Bracknell, England, has its own bipolar process called collector diffusion isolation. But CDI does more



## Data General. A la carte.

Now, you can buy our DASHER™ terminals, even if you don't own a Data General computer system. Select our fast impact printer and our user-oriented video display. Both are interface-compatible with any standard computer system.

Choose either 60 or 30 cps versions of the DASHER printer, which has a standard typewriter keyboard, u/l case, 132 columns.

DASHER display features a 1920 character screen, u/l case, convenient detached keyboard, programmable function keys, and a monitor that tilts and swivels.

Just as DASHER terminals' features make them easy to use, their attractive appearance makes them

easy to fit into any environment. And of course they are solidly reliable and easy to maintain, a Data General trademark. For more details call your Data General sales office or nearest independent supplier of Data General terminals. Or send the coupon. Even a bit of Data General in your computer system is better than none.

Send details on  DASHER printers  DASHER displays

Have salesman call.

I'm interested in \_\_\_\_\_ / \_\_\_\_\_ terminals.  
no. type

Name \_\_\_\_\_

Title \_\_\_\_\_

Company \_\_\_\_\_

Address \_\_\_\_\_ Tel. \_\_\_\_\_

City \_\_\_\_\_ State \_\_\_\_\_ Zip \_\_\_\_\_

Mail to: Data General, Westboro, MA 01581

DASHER is a trademark of Data General Corporation

© Data General Corporation, 1977

ED329

**Data General**  
It's smart business

Data General, Westboro, MA 01581, (617) 366-8911. Data General (Canada) Ltd.,  
Ontario. Data General Europe, 15 Rue Le Sueur, Paris 75116, France. Data General Australia, Melbourne (03) 82-1361.

CIRCLE NUMBER 25

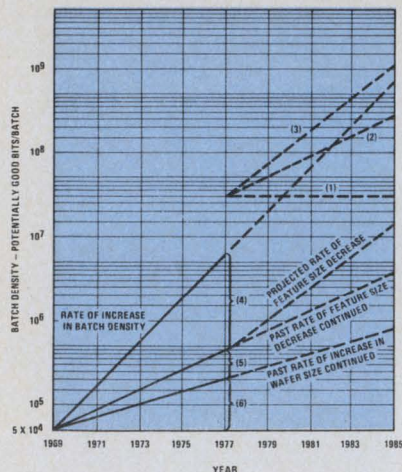

- NOTES:
- (1) Theoretical limit, current wafer and feature sizes.
  - (2) Theoretical limit, assuming continued improvements in wafer size increase and feature size reduction.
  - (3) Theoretical limit, assuming constant rate of wafer size increase and an increasing rate of feature size reduction.
  - (4) Increase due to design and process innovations.
  - (5) Increase due to feature size improvement.
  - (6) Increase due to wafer size.

**National Semiconductor projects memory yield per silicon wafer processed, for three possible futures.**

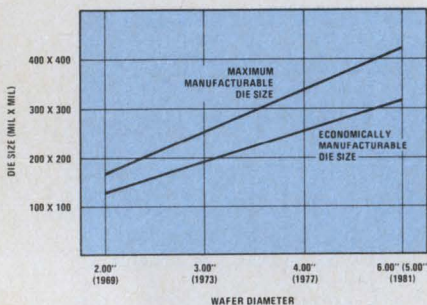

**Wafer size will continue to be improved** at an essentially constant rate, according to National Semiconductor. This chart shows increasing maximum and economic die sizes as a function of wafer diameter and time.

than permit high-density bipolar circuitry. It provides the density of CMOS with performance close to that of I<sup>2</sup>L.

As more and more circuitry is compressed into a chip, power constraints may make CMOS a key technology for VLSI. Double-poly self-aligned silicon-gate CMOS is currently being produced with logic functions that yield on-chip speeds equivalent to low-power Schottky.

To demonstrate the ability of CMOS to compete with NMOS, Harris Semiconductor (Melbourne, FL) has recently introduced a low-power (50  $\mu$ A) high-speed (200 ns), 4096-bit static RAM, which is available as 4-k  $\times$  1 (HM-6504) or as 1-k  $\times$  4 (HM-6514). Further, Harris indicates that CMOS functional

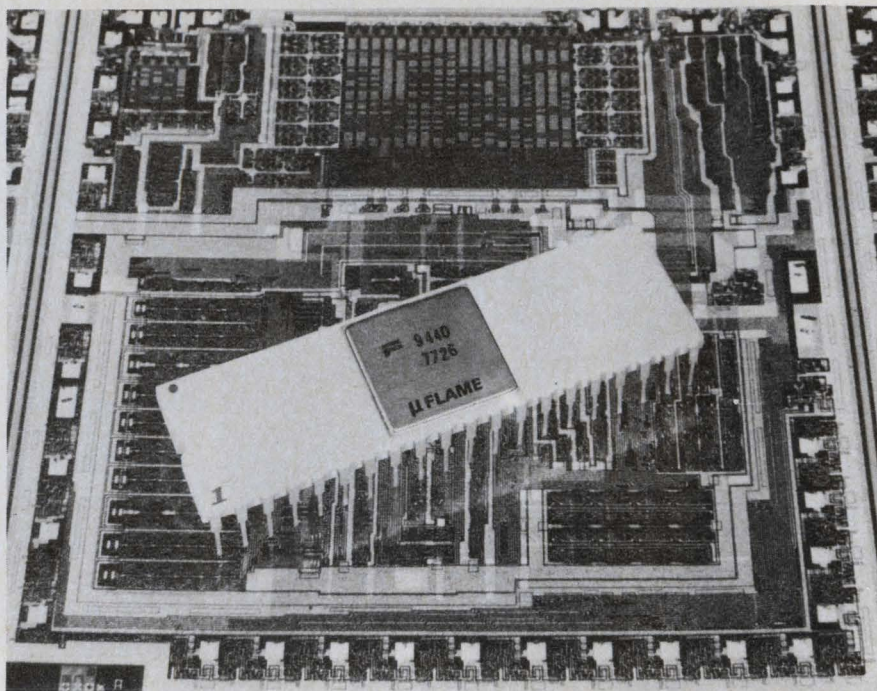

**A proprietary Isoplanar I<sup>2</sup>L process** permits 10 MHz operation of the 9440 microprocessor, software-compatible with the Nova minicomputer from Data General. This 27,000-sq-mil chip from Fairchild includes about 3000 gates.

density is far superior in some cases, and that CMOS can challenge n-channel densities by using NANDs, NORs, dynamic logic, and transmission gates.

As a matter of fact, Intersil, a company deeply involved with CMOS technology has gone one-up on the ultraviolet erasable PROMs by developing a CMOS 4096-bit UV EPROM. The IM 6603 and 6604, organized as 1024  $\times$  4 and 512  $\times$  8 bits, respectively, both operate from a 4 to 11-V supply and dissipate a mere 10 mW when accessed at a 1-MHz data rate.

Although the CMOS EPROMs are not as large as the currently available 16-k NMOS units offered by several companies, they're even smaller when compared to the 32-kbit UV EPROM recently announced by Texas Instruments. Pushing the EPROM technology to its current limit, TI has developed a 5-V, 4-k  $\times$  8 EPROM. Of course, TI won't be alone in the arena for long—Intel and other companies that have the 5-V EPROM technology will have their versions out shortly.

### Bubbles: nonvolatile but alterable

Meanwhile, back in the labs, a completely different type of memory is being readied for production by at least 10 companies. The magnetic-bubble memory offers not only the nonvolatility of EPROM, but also the alterability of a read/write memory.

Furthermore, bubble memories will compete on a cost basis with conventional rotating magnetic memories in 1980, when competition among the majors, notably TI, Rockwell, Intel, and National Semiconductor, drives the price below 0.05¢ per bit.

The capability of bubble technology in the near future is indicated by a 1-million-bit chip demonstrated by Rockwell International in 1977, and 4-million-bit chips under development at IBM in San Jose. The Rockwell chip, a hefty 10 mm  $\times$  9.5 mm, uses 1- $\mu$ m minimum lithographic features, producing bubbles of 1.8- $\mu$ m diameter on 8  $\mu$ m centers, and using half-disc (C-bar) propagators to move the bubbles along. Rockwell has demonstrated operation at bit rates up to 300 kHz over a range of -25 to 75 C.

But even smaller bubbles with 0.5  $\mu$ m diameters are being investigated in the lab today. To achieve significantly higher density than Rockwell has already demonstrated in C-bar devices, E-beam or X-ray lithography and perhaps single-level masking structures will be required, according to Emerson W. Pugh of the IBM Research Center. The half-disc or C-bar bubble structure requires about 63 squares per cell (a square is the area of intersection of two perpendicular lines, each having a width equal to the minimum lithographic feature size). And two unconventional magnetic bubble structures,



# CHERRY'S JUBILEE



We're having our 25th birthday party  
...and YOU get the gift.\*

Back in the beginning we had one product . . . one customer. Today, at age 25, we have a customer list of more than 5,000 . . . and a product line that's the pick of the component crop, worldwide: Snap action switches . . . automotive electronic devices . . . keyboards . . . rotary and thumbwheel switches with coded electrical output.

With the acquisition of Micro Components Corp.,† we've added semiconductor capability: Custom designed bipolar linear and digital integrated circuits, optical sensors and a line of off-the-shelf standard chips, diodes and integrated flip chips.

†Now Cherry Semiconductor Corp.

All from Cherry. All backed by know-how built on the production of over 300 million components . . . and Research and Development on dot matrix, solid state switching, data entry and display devices.

\*For a free gift jar of Cherry jam . . . plus our catalog and a brochure of our new semiconductor capabilities, just circle the reader service number below.



# CHERRY



**CHERRY ELECTRICAL PRODUCTS CORP.**  
3609 Sunset Avenue, Waukegan, Illinois 60085

PHONE: 312/689-7700

**SWITCHES and KEYBOARDS — Available locally from authorized distributors.**

CIRCLE NUMBER 29

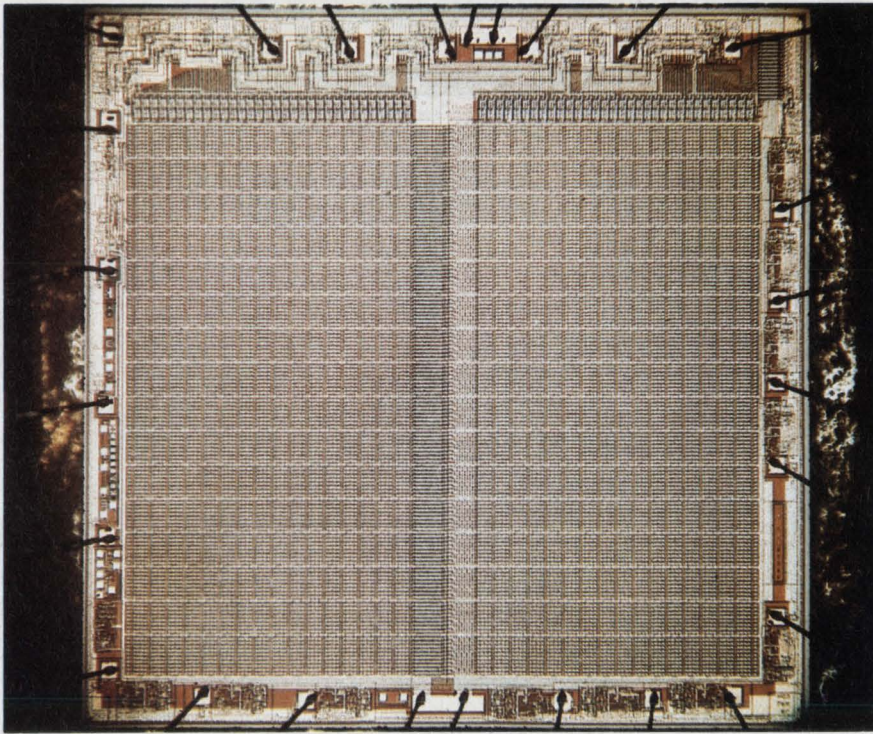

With a chip area of 43,000 square mils, the Harris 16-k bipolar PROM, HM-7616, has 20,000 transistors and over 17,000 fuses. Passive isolation, shallow devices, and multilayer metal contribute to its speed.

still at the development stage, require even less space.

These unconventional structures are contiguous disc (CD), with six squares per cell, and the bubble lattice file (BLF), with eight squares per cell. While CD and BLF appear to be more attractive than conventional bubble devices or CCDs, Pugh points out that the future of these unconventional high-density bubble approaches is uncertain because of unanswered questions concerning processing complexity and yield.

In contrast to the bubble devices, charge-coupled memories, such as the Fairchild 65-kbit chip, require an area of about 12 squares per bit. However, developments are under way to reduce device size so that a 256-kbit CCD will be available by 1980.

Rockwell's John L. Archer, who now heads the bubble memory products business group observes: "The competition coming from CCDs is not as strong as we might have expected. CCDs could make immediate inroads into established RAM markets if they had a four-to-one cost advantage per bit. But, every time the CCD manufacturers get to a two-to-one cost advantage, the RAM vendors borrow the same techniques and keep that gap from widening.

Analog as well as digital chips are taking advantage of new process tech-

nologies. Some recently developed circuit-design techniques often solve familiar analog problems in a new, digital way.

#### On the analog side...

High-order NMOS sampled-data ladder filters have been produced at the University of California at Berkeley. These filters realize long time constants in a small silicon area, and minimize the filter's sensitivity to component variations. Replacing the need for large accurate capacitors by the use of small capacitors with accurate ratios, the design provides a fifth-order Chebyshev low-pass filter in a die area of about 600 square mils. The measured characteristics include 0.11-dB pass-band ripple, 3400-Hz bandwidth, and maximum stop-band rejection of 80 dB.

Operational amplifiers for implementing these filters take up about 400 square mils using 10- $\mu$ m features. Monolithic-capacitor ratios can be very precisely controlled in NMOS technology. Since all capacitors are fabricated simultaneously, first-order process variations cancel, and the temperature and voltage coefficients are identical. This technique is well suited for designing monolithic high-performance filters requiring no external trimming. With modern NMOS technology, many

filter sections can be realized on a single chip.

Meanwhile, the problem of decoding telephone dialing tones has been moved from the analog domain and solved in the digital by a CMOS tone-decoder chip from Mostek (Carrollton, TX). In the past, sets of eight filters were used, whether LC filters, active RC filters, PLLs, or mechanically tuned reeds. But Mostek's monolithic approach substitutes a triple detection digital algorithm that requires only two inexpensive band-splitting filters outside the chip. Yet it adequately rejects the noise and speech, and detects tone frequencies that are within 2% of the nominal values stored in ROM.

As a matter of fact, the distinctions between analog and digital ICs are rapidly disappearing in telecommunications and in data-acquisition and conversion systems. So much so, that analog and digital circuits are being combined on the same chip (see ED No. 4, Feb. 15, 1978, p. 26).

Moreover, newer circuits can handle higher voltages. Now some products can directly drive plasma displays—handling voltage swings of 100 V or more on a monolithic chip. This is no easy feat, but today it is possible—companies like Texas Instruments and Dionics (Westbury, NY) have solved some of the problems of putting complex digital functions and drive capability on a single chip.

Still, the future is far from problem-free. According to Intel's Moore: "Electron-beam *per se* is absolutely no cure-all. In fact, it's easier for me to see a whole bunch of new problems that we'll have to live with, as we go to higher resolution. Learning to write narrow lines is no more than the tip of the iceberg.

"For example, today with 4- $\mu$ m lines, we like to align the whole wafer to 1- $\mu$ m accuracy; so when E-beam gives us 1- $\mu$ m lines, we'll want to have quarter-micron, or at worst half-micron alignment accuracy. But from the data I have seen, the stability of the silicon surface through the whole process may not be that good, itself."

What all this means, to Moore, is that either a good deal more must be learned—either how to cut down the instabilities of silicon, or how to use electron-beam writing with local alignment, so that the whole wafer doesn't have to remain stable.

"Either of those is a major new technology," notes Moore—"A lot more major than just learning how to write those narrow lines." ■

# Type A 1/4" trimmers. A reliable cure for cramped PCB's.

Our Type A 1/4" cermet trimmer gives you low profile, lowest TCR for a tiny package of high performance... and an ideal solution for cramped printed circuit boards. 10 ohms to 2.5 megs. 0.5 watt at 85°C. -55°C to +150°C temperature range. You get great variety plus greater savings, too. \$0.96 each—1000 piece lot. We have what you need; our distributors have it when your need is now. Ask for Publication 5238.

*Multi-finger contact*  
for low CRV and fine adjustability.

*Immersion sealed*  
for safe board washing.

*Exclusive cermet resistance material*  
on alumina substrate results in TCR of 35 PPM/°C typically.

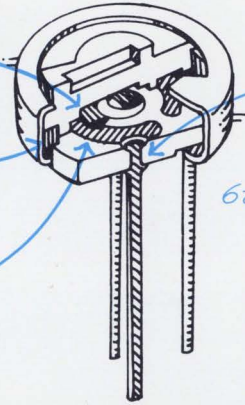

*Swaged terminals*  
securely anchored with redundant connections.

*6 terminal options*



*Actual size*

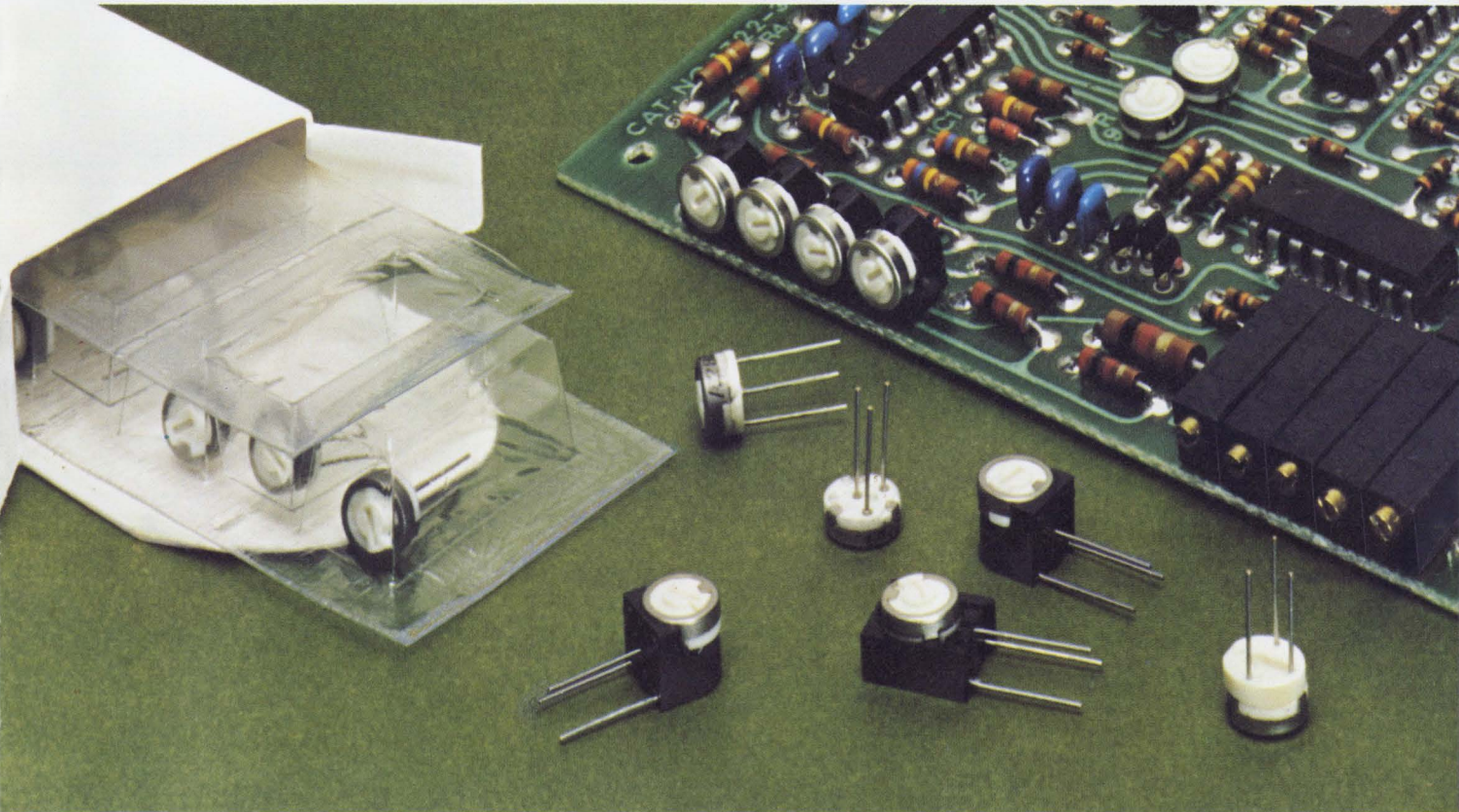

## Quality in the best tradition.



**ALLEN-BRADLEY**  
Milwaukee, Wisconsin 53204

CONTACT YOUR  
ALLEN-BRADLEY DISTRIBUTOR OR  
WRITE TO ELECTRONICS DIVISION

EC159

CIRCLE NUMBER 211

# FOR RENT

Intel's amazing new generation  
Intellec® Series II  
Microcomputer Development Systems  
... everything you'll ever need to  
develop a microcomputer-based product.

The Intellec Models 210, 220 and 230 are the first fully integrated, packaged tools for developing and testing your microcomputer-based products. They'll each fit easily on your lab bench to help cut months from your design cycle.

You can rent the newest generation microcomputer development systems today from REL and start taking advantage immediately of the fast, flexible and cost-efficient Intellec systems. Each can help you build a more reliable product. And because these new Intellec systems are so compact, they use less of your valuable laboratory bench space than any other microcomputer development aid on the market.

Model 230 is the most powerful member of the Intellec Series II family, providing you two double-density floppy diskettes with over 1-million bytes of on-line data storage, 64K bytes of RAM and an integral CRT.

The compact Model 230 also gives you a detachable, typewriter-style keyboard with upper and lower case characters and cursor controls. Its powerful ISIS-II Diskette Operating System has relocatable and linkable software and allows the use of two high-level programming languages, PL/M-80 and FORTRAN 80, plus the microcomputer industry's most comprehensive line of macro assemblers. The system has over 1-million bytes of on-line diskette storage and will support up to 2½-million total bytes. The System Monitor (in ROM memory) provides a Self-Test system diagnostic, and interfaces for a printer, paper tape reader/punch and universal PROM programmer are also provided. Model 230 gives you access to all the tools needed for your development work, including software editors, assemblers, compilers and debuggers, plus Intel's famous In-Circuit Emulators—ICE-80, ICE-85, and ICE-48.



# ...NOW...

**For medium-scale system development, you can rent the Model 220. Now.**

The Intellec Model 220 is also a complete packaged development system. It has an interactive, 2,000 character CRT with typewriter-style keyboard and a full-sized 256K byte floppy diskette drive and 6-slot MULTIBUS card cage in one compact unit. Model 220 gives you 32K bytes of RAM program memory and 4K bytes of ROM. The ISIS-II Diskette Operating System has a relocating 8080/8085 assembler, and the new system interfaces directly to the ICE In-Circuit Emulators.

**The Intellec Model 210 rents for the lowest price of any packaged, full support development system available—anywhere.**

Model 210 gives you the minimum system required for the rapid, efficient development of microcomputer software. It has a ROM-based editor/assembler combination which allows the development of small 8080 or 8085 programs completely in RAM memory, which minimizes your use of paper tape. Plus, you can also rent a ROM assembler/editor for Intel's family of MCS-48 single-chip microcomputers. The compact Model 210 has 32K bytes of RAM, 24K bytes of ROM and its own microprocessor. Self-test diagnostics capability is built-in. And it's easy to get started, too. All you have to do is interface the Intellec 210 to your terminal.

**You can extend the powerful resources of an Intellec Series II system into your own prototype for fast and efficient software debug in your product's final hardware environment. Just put your product on ICE . . . ICE-80, ICE-85, or ICE-48, all off-the-shelf at REI.**

To emulate your own CPU or your entire prototype system in real-time or single-step mode, simply rent the appropriate In-Circuit Emulator module to match your system's microprocessor. And you can begin software debugging as soon as your prototype has a processor socket and bus structure.

**Capability-enhancing peripherals are available for short-term rental, too.**

You can add to the already extensive capabilities of the Intellec Series II system with a variety of immediately available peripherals. These include two Intellec Printers, two diskette-based peripherals (one single-density with 1/2-million bytes of storage, the other double-density with 1-million bytes of storage). You can also choose a high-speed paper tape reader and a universal PROM programmer . . . all of which are for rent today from REI.

**Rental Electronics, Inc.**  
Another of the **AMERICAL** companies

**More than 12,871 state-of-the-art instruments . . . off-the-shelf, throughout North America.**

**I want to know more about the Intellec Series II now!**

Tell me more about:  Model 230  Model 220  Model 210

Call me at \_\_\_\_\_

- Send me a copy of your free illustrated Rental Catalog.
- I might be interested in buying—on a money-back guarantee—some of your late-model, well-maintained "previously owned" equipment. Send me your just-published Equipment Sales Catalog.
- Also, I have a pressing need right now for the following: \_\_\_\_\_

Please phone me immediately at \_\_\_\_\_

NAME \_\_\_\_\_ TITLE \_\_\_\_\_

COMPANY \_\_\_\_\_

ADDRESS \_\_\_\_\_

CITY \_\_\_\_\_ STATE \_\_\_\_\_ ZIP \_\_\_\_\_

PHONE NUMBER \_\_\_\_\_ EXTENSION \_\_\_\_\_

Complete this coupon and return it today to  
REI, 19347 Londelius St., Northridge, CA 91324. GSA #GS-04S-21963 Neg

Northridge, CA (213) 993-7368  
Anaheim, CA (714) 879-0561  
Mountain View, CA (415) 968-8845  
Dallas, TX (214) 668-8082  
Houston, TX (713) 780-7218  
Burlington, MA (617) 273-2770  
Oakland, NJ (201) 337-3757; Gaithersburg, MD (301) 948-0620  
Des Plaines, IL (312) 827-6670; Ft. Lauderdale, FL (305) 771-3500  
Cleveland, OH (216) 442-8080; Seattle, WA (206) 641-6444

© 1978 Rental Electronics, Inc.

Rexdale, Ontario (416) 675-7513  
Vancouver BC (604) 684-6623  
Montreal, Quebec (514) 681-9246

# NEC JUST MADE INTEL'S 8080A TWICE THE MICROPROCESSOR IT USED TO BE.

Introducing the  $\mu$ PD8080AF.  
From NEC Microcomputers.

Now you can get a microprocessor  
that's absolutely identical to Intel's  
8080A.

And we can prove it.

In three separate tests using  
standard Intel programs, conducted  
by three independent laboratories,  
the  $\mu$ PD8080AF was demonstrated  
to be, both parametrically and func-  
tionally, exactly the same as the  
8080A. (The certified results of the  
tests are available upon request).

Which means that now there's a  
microprocessor that's pin for pin and  
program compatible to the Intel 8080A.  
And available in plastic or ceramic.

Of course, we continue to offer

our original  $\mu$ PD8080A—a microproc-  
essor with enhanced arithmetic capa-  
bility and logical flags.

With either an  $\mu$ PD8080AF or  
 $\mu$ PD8080A comes our complete line  
of standard peripheral chips. Plus  
state-of-the-art support chips like the  
8K Electrically Erasable PROM  
( $\mu$ PD458), a Universal Synchronous  
Receiver/Transmitter Data Commu-  
nications Controller ( $\mu$ PD379), a  
450ns 32K ROM ( $\mu$ PD2332) and a  
Floppy Disc Controller ( $\mu$ PD372)

that can control up to four IBM 3740-  
compatible drives, and a complete  
line of the most reliable memories  
you can buy.

All backed up by applications sup-  
port available nationwide.

The  $\mu$ PD8080AF from us. And  
the 8080A from them.

Even with a program, you won't  
be able to tell them apart.

NEC Microcomputers, Inc., Five  
Militia Drive, Lexington, MA 02173.  
(617) 862-6410.

**NEC microcomputers, inc.**

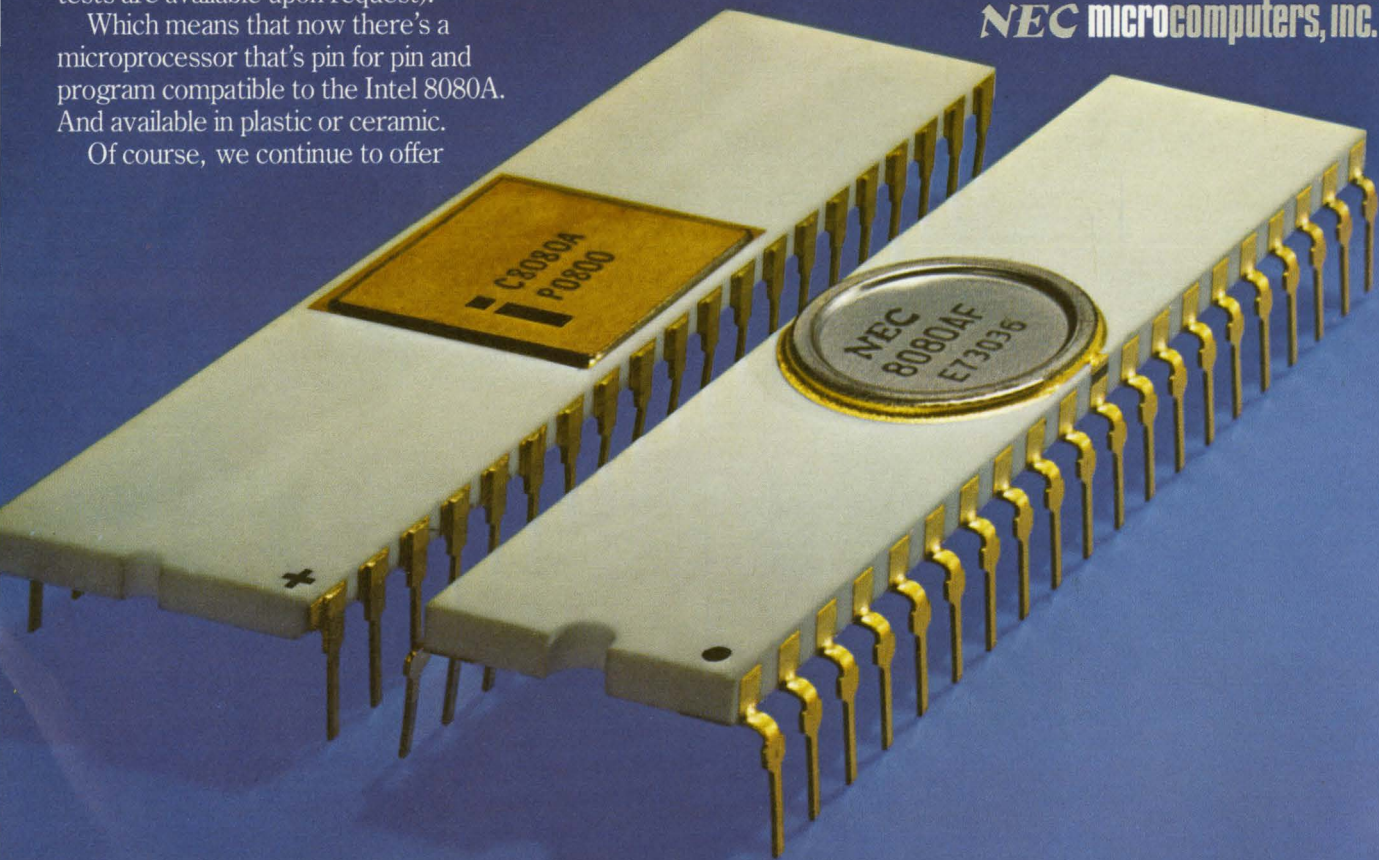

REPS: East—C&D Sales 301-296-4306, Contact Sales 617-273-1520, Harry Nash Assoc. 215-657-2213, Rome 516-249-0011, Tech-Mark 607-748-7473, 716-223-1252, 315-652-6229, Trionic Assoc. 516-466-2300, South—Perrott Assoc. 305-792-2211, 813-585-3327, 305-275-1132, 20th Century Mktg. 205-772-9237, Wolffs Sales Serv. Co. 919-781-0164, Midwest—Electronic Innovators 612-884-7471, W. Pat Fralia Co. 817-640-9101, 817-649-8981, 713-772-1572, Imtech 216-826-3400, 513-278-6507, K-MAR Eng. & Sales 816-763-5385, R.C. Nordstrom & Co. 313-559-7373, 616-429-8560, Technology Sales 312-438-3300, West—Cercro 714-560-9143, D/Z Assoc. 303-534-3649, Electronic Component Mktg. 714-879-9460, Summit Sales 602-994-4587, Trident Assoc. 406-734-5900, Tri Tronix 206-232-4993, 505-265-8409, Canada—R.F.Q. Ltd. 416-626-1445, 514-626-8324.

DISTRIBUTORS: ASI Electronics (Baltimore), Bell Ind. (Bellevue WA), Century Electronics (Albuquerque, Salt Lake City, Wheatridge CO), Diplomat (Chicopee Falls MA, Clearwater FL, Elk Grove Village IL, Farmington MI, Minneapolis, Mt. Laurel NJ, Salt Lake City, St. Louis, Sunnyvale, Totowa NJ, Woodbury NY), Future Electronics (Montreal, Ottawa, Rexdale Canada), Harvey Electronics (Fairfield NJ, Lexington MA, Norwalk CT, Woodbury NY), Intermark Electronics (San Diego, Santa Ana, Sunnyvale), G.S. Marshall (Sunnyvale), Mirco Electronics (Phoenix), Resco (Raleigh), R-M Electronic (Kentwood MI, Madison Hgts MI), Semicomp (Costa Mesa CA), Semiconductor Specialists (Burlington MA, Chicago, Dallas, Dayton, Farmington MI, Hazelwood MO, Indianapolis, Kansas City, Milwaukee, Minneapolis, Pittsburgh, Malton Canada), Sterling Electronics (Albuquerque, Dallas, Houston, New Orleans, Phoenix, San Diego, Seattle, Sun Valley CA, Watertown MA), Summit Distributors (Buffalo), Summit Electric (Rochester), Technico (Columbia MD, Roanoke VA), Western Microtechnology Sales (Sunnyvale), Zeus Components (Elmsford NY).

# OUR OS4000 TAKES OVER WHERE TUBE STORAGE LEAVES OFF.

The Gould OS4000 digital memory oscilloscope extends your capabilities beyond the limits of conventional storage tube technology.

With the OS4000, stored transients do not deteriorate and are clearly displayed at will indefinitely — as long as you choose to keep the data. Stored trigger points allow you to display pretrigger signals as well as the signal itself. You see what actually caused the signal.

Digital storage also offers you four useful options: 1) Fully automatic operation, 2) analog and digital output for hardcopy, 3) higher resolution through expansion of stored traces, 4) the ability to generate complex wave forms.

The OS4000 can enhance the effectiveness of traditional dual trace displays by simultaneously displaying real time and stored traces without the amplitude restrictions of a split beam storage tube. Both signals have optimum brightness to help you draw the critical inferences from close comparisons. At low

frequencies there is no irritating flicker or C.R.T. glow.

Rated at 10 MHz for conventional operation the OS4000 utilizes an 8 bit x 1024 word RAM, with a sampling frequency of 1.8 MHz. Normal/refreshed/roll modes are standard.

With a multitude of new applications in general electronics, medical electronics, research laboratories and transducer related measurement situations, Gould's OS4000 simply out-classes every tube storage scope on the market. But even though the OS4000 represents a step forward in storage scope technology, it is both easy to use and extremely affordable.

For more information contact Gould Inc., Instruments Division, 3631 Perkins Ave., Cleveland, OH 44114. In Europe contact Gould Advance LTD., Roebuck Rd., Hainault, Essex, CB10 1EJ, England.

**For brochure call toll free (800) 325-6400. Ext. 77. In Missouri: (800) 324-6600.**

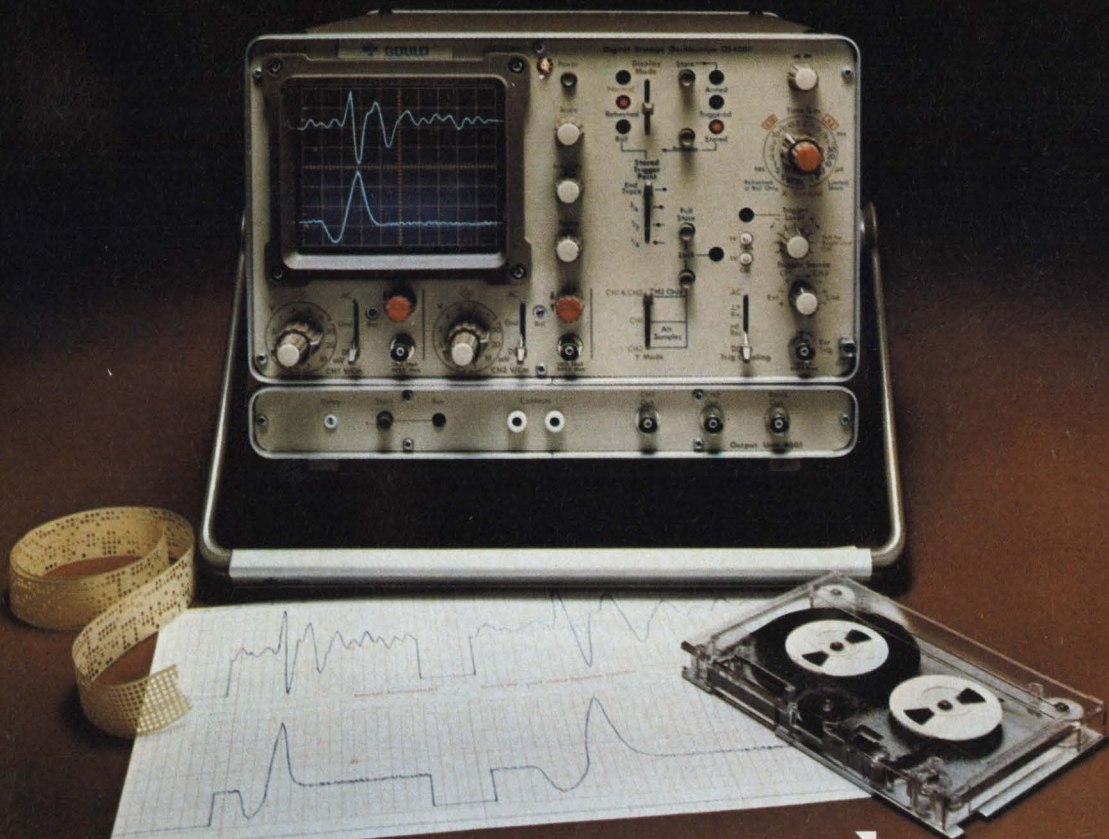

 **GOULD**

# High-end $\mu$ Ps don't exist, are hard to define, but they're coming

The high-end microprocessor doesn't exist yet. That's one of the few points panelists could agree on at the "High-End Microprocessors" panel session conducted at the 1978 International Solid-State Circuits Conference in San Francisco. As a matter of fact, they even had a hard time defining exactly what a high-end microprocessor will be and do. Still, based on predictions from the speakers, a general description emerges. A high-end microprocessor will

- Perform greater than a half-million instructions per second.
- Have an address space greater than a megabyte.
- Contain wide data paths on the chip (typically 16 bits wide).
- Handle a wide variety of data types with a very flexible instruction set.

Such a product isn't available just yet, but the speakers all feel that with technology improving at such a rapid pace—circuit complexities doubling every one to two years—it won't be long before such a microprocessor is available.

## The processor of the future?

What will all these theorized improvements lead to? To start with, the high-end microprocessor is expected to be consumer-oriented, in that it will have a high level of hardware and software reliability, with an architecture appropriate for the execution of high-level software. The processor will also have an efficient subroutine-call protocol, good block-oriented instructions, at least three levels of system control (supervisor, kernal and user), several privileged instructions (Halt, Wait, etc.) and special memory-management features.

Not only that, but with technology advancing, on-chip gate delays for ICs

**Dave Bursky**  
Associate Editor

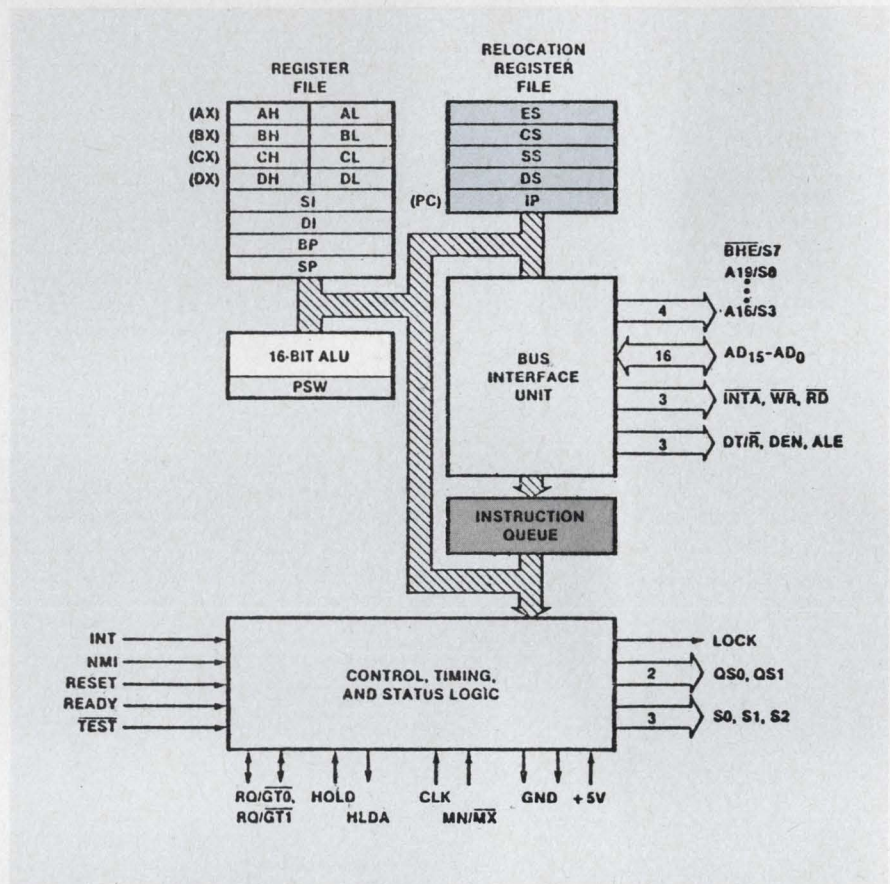

Using a dual-processor architecture, the 8086 handles bit, byte and dual-byte operations and performs multiply and divide algorithms. Intel's HMOS process lets the unit operate at clock rates to 8 MHz and perform most of its instructions in less than 1  $\mu$ s.

will drop from the current 2.5 ns to about 350 ps, predicts Larry Lopp, LSI facility manager of Hewlett-Packard (Cupertino, CA). And, while gate delays are dropping, the number of gates on a chip will be increasing—from today's 10,000 to about 1 million by 1982.

Warming to the subject of improved reliability, panelists foresee internal parity checking, self-testing, special trap routines, internal limit registers, "sanity" timing algorithms and more status information. And with the better reliability will come more dis-

tributed processing over serial channels, possible signal-processing features and higher speeds.

High-end processors will even be used as associated-processing systems, according to Carver Mead, professor of electrical engineering and computer sciences, of the California Institute of Technology in Pasadena. He believes that most current machine architectures are out of date for such use and that newer architectures will have some form of intelligence in the memory system itself. As the computer systems get larger, smaller and smaller



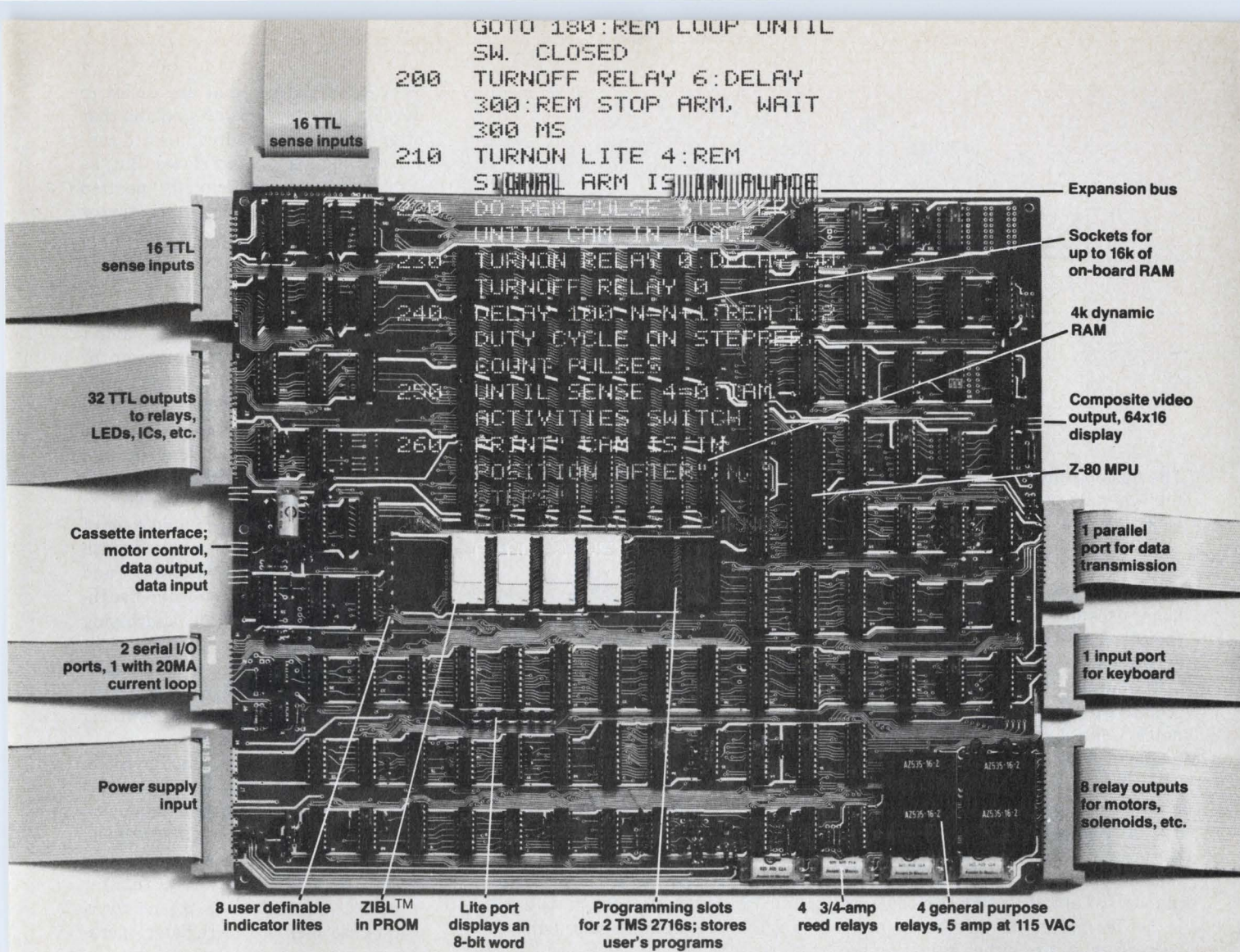

```

GOTO 180:REM LOOP UNTIL
SW. CLOSED
200  TURNOFF RELAY 6:DELAY
300:REM STOP ARM. WAIT
300 MS
210  TURNON LITE 4:REM
SIGNALL ARM IS
DO:REM PULSE
UNTIL CPU
230  TURNOFF RELAY 6:DELAY
240  DELAY 100:WAIT 1:REM
DUTY CYCLE ON STEPPER
250  COUNT PULSE 1:REM
UNTIL SENSE 4:0:RAM
260  ACTIVITIES SWITCH
PRINT #5:LN
PRINT #5:LN

```

# Dynabyte's new Basic Controller: Check out its capabilities and imagine your applications

The Basic Controller™ is a powerful, versatile and easy to use single board microcomputer system designed for control applications.

It is heavily into control I/O: relays, flags and sense inputs. What makes controlling these I/Os (and the external devices they control) so easy is our ZIBL™ (Z-80 Industrial Basic Language). It is a superset of NIBL, National Semiconductor's control BASIC, and was written by us specifically for control applications.

We've divided the control world into six categories: sense inputs, flag outputs, lites, relays, A/Ds and D/As. ZIBL implements 64 channels of each in such a way that you need not know anything more about them than their names.

In ZIBL it is valid to say:  
 100 IF TIME = 053010 AND SENSE (18) = 0 TURNON RELAY 5  
 Simple, isn't it!

Some but not all of the Basic Controller's mouth watering features

- include:
- File structures that allow multiple programs written in ZIBL to reside concurrently in RAM. Each program may be individually LOADED, RENAMED, or RUN. Any program may access another program as though it were a subroutine, while still retaining its own line numbers and variables.
  - Complete communication versatility. LISTING, PRINTING and INPUTING may be done to or from any serial or parallel I/O channel or the self-contained CRT I/O.
  - Single key SAVE or LOAD to and from cassette.
  - Single key SAVE to EPROM. No worry about PROM addressing or programming routines, it is handled by ZIBL — automatically — even if there are other programs already in PROM.
  - ZIBL in ROM: TURNON, TURNOFF, DELAY, TIME, REM, IF THEN, DO UNTIL, GOTO, GOSUB, @(exp), TRACE MODE, LINK, READ, DATA, DIR, RND(x,y), strings,

triple precision integer arithmetic, plus the usual statements.

• Onboard: Z-80 MPU, 32 flags, 32 sense, 8 relays, 8 lites, 2 serial, 1 parallel, cassette I/O, 64x16 video, keyboard port, two 2716 sockets with programming capability, up to 16k on-board RAM, up to 48k off-board RAM, real time clock, vectored interrupts, Lite Port on board, a kitchen sink, and an Expansion Bus.

\$750 assembled, tested, warranted 1 year. You add power supply, keyboard and monitor. Available now — see your computer retailer. **CIRCLE NUMBER 31**

4020 Fabian, Palo Alto, CA 94303; (415) 494-7817



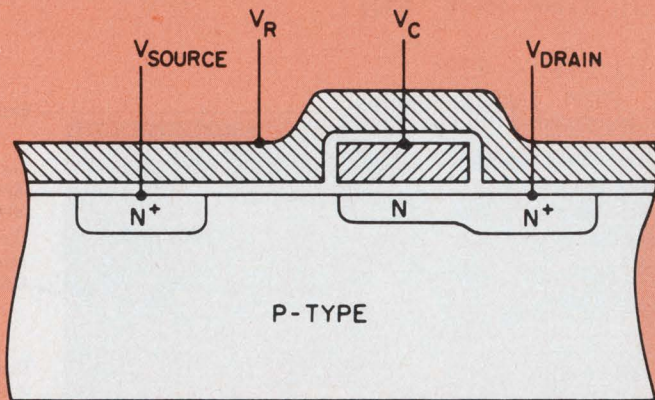

**The basic stratified-charge memory device** developed by Dr. Darrell Erb permits high-density memory arrays. Densities of up to 256 kbits are possible without straining the limits of optical technology.

portions of the over-all memory are being used during every operation. So the memory will be used in other applications.

The greatest problem in any associative or distributed system, though notes Colin Crook, group operations manager, micro products of Motorola (Austin, TX) is how to decompose the problem to be solved by the system. The microprocessors now used for multiprocessing provide only a three time improvement in processing performance. To obtain better performance is not a matter of just using more processors, but of either adjusting the hardware so that processors don't tie up master buses or possibly even going to associative processing.

### Solutions on the way

Although no final solution exists, almost to a man the speakers believe that the next generation of large microprocessors will have 16-bits with large amounts of on-chip RAM and ROM. Tom Miller, strategic marketing manager of Texas Instruments (Houston, TX), envisions a microcomputer CPU with 32 k of program memory—all on one chip. The biggest problem, as he sees it, is that the number of pins available on a processor's package is limited, typically to 40.

TI, of course, has introduced the 64-pin ceramic and plastic packages for its family of 16-bit processors. Additional techniques such as signal multiplexing and multifunction pins will provide solutions to some of the limitations.

Another possible solution is a single-chip microcomputer, which was brought out at a session devoted to "Single-chip Microcomputers and their

Applications." Because the memory is on-chip, pins normally used to provide address information can now be used for other purposes—I/O control lines, serial communications, display driving, etc.

In fact, single-chip microcomputer systems have already started one trend, according to Tom Longo, microprocessor chief technical officer of Fairchild Camera and Instrument (Mountain View, CA)—enormous ROM space. By 1985, in fact, a CPU system and 256 kbits of memory will reside together on a single chip, Longo predicts.

The market for single-chip systems, though, is cost-sensitive, cautions Ron Eufinger, Microprocessor Application Engineer for Rockwell International (Anaheim, CA). Costs per function are going down, but the number of functions on a chip are going up. So the over-all cost of a single-chip system won't change by much. For example, the Rockwell 6500/1, a single-chip version of the 6502 microprocessor, will contain RAM, ROM, I/O and CPU, and cost under \$10 in production quantities.

As in last year's panel sessions (see ED No. 7, March 29, 1977, p. 26) lack of standardization between processors and instruction sets was a sore point with users in the audience. However, as Adam Osborne, President of Osborne and Associates, Berkeley, CA, points out, product designers really shouldn't care about the instruction set—they should want a low final cost. Not only that, but he feels that there is really no hope of standardizing one-chip microcomputers since there is really no economic reason to do so.

Users in the audience didn't agree.

They want devices that are easier to develop their systems around and that offer specialized features like a/d converters and display interfaces. But, as some audience participants pointed out, most single-chip microcomputer vendors are not addressing that area.

### Help is on the way

Although this year's ISSCC didn't unveil any super microprocessor or microcomputer products, some rather interesting devices were introduced during the panel discussion. At the high-end microprocessor session, Intel provided some idea of what its powerful 8086 processor will be like.

The 8086 will offer a complete set of 8 and 16-bit signed and unsigned math operations, including multiply and divide; plenty of memory-reference instructions, including 24 addressing modes; extended address-space capability of over 1 Mbyte; position-independent code, which can be relocated dynamically, and byte, word or string operations.

Using a highly pipelined architecture, the 8086 speeds up internal operation by holding six instruction bytes queued in an internal register. Typical execution times at an 8-MHz clock rate range from 0.25  $\mu$ s for a register increment/decrement to 2.1  $\mu$ s for a worst-case memory to register operation.

Inside the 8086 are two independently controlled "processors." One, called the bus-interface unit, controls the instruction queue. The other called the execution unit, performs the instruction.

Over at the single-chip microcomputer panel session, TI introduced CMOS versions of its TMS1000 4-bit processor products. Some offer better I/O, more registers, and higher clock speed, among other improvements, while others are simply equivalent versions with just the lower operating power of CMOS. Typical operating power for the TMS1000C and TMS-1200C, and 1100C and 1300C, is 15 to 25 mW and drops to 15  $\mu$ W on standby. Subroutine nesting has been increased to three levels and maximum clock rates can now reach 1 MHz. Units can operate from supplies of 3 to 6 V.

### Bipolar $\mu$ Ps speed up

In a paper at Session 15 of the conference, Japanese engineers from Nippon Tel-Tel in Tokyo announced the development of a subnanosecond, 8-bit

# Sprague... Prime source for SOURCE DRIVERS

## HIGH-VOLTAGE, HIGH-CURRENT INTERFACE ICs

Sprague Source Drivers are "high-performance" integrated circuits targeted for low-level logic applications requiring interface to solenoids, MUXed LEDs, lamps, vacuum fluorescent displays, stepping motors, telecommunications relays, triacs, SCRs, PIN diodes, and other high-level peripheral loads. Inductive-load drivers incorporate internal diodes for suppression of voltage transients. All types have input current-limiting resistors for compatibility with standard logic families.

● Type UDN-2956A and UDN-2957A 14-lead DIP designs are customarily used for switching the ground side of telecommunications relays (usually -48V). Positive input and "enable" levels activate the output load.

● Series UDN-2980A 18-lead DIP devices are 8-channel source ICs for general applications, including MUXed LEDs (segment-driver/common-cathode; digit-driver/common-anode), lamps, relays, solenoids, motors, triacs, etc. An appropriate logic "1" on the input switches the output "on"; an input inverter buffers the high supply voltage from the logic circuitry. A prime application is the replacement of current-sinking ICs which may experience logic malfunctions associated with high ground currents (IR buildup) or ground noise.

● Type UDN-6118A and UDN-6128A 18-lead DIP devices are intended for vacuum fluorescent display interface. A positive input signal causes the driver outputs to switch high. Internal pull-down resistors minimize component count as well as reduce circuit cost.

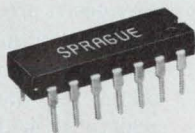

Application	Telecommunications Relays, PIN Diodes, & General-Purpose Power		LEDs, Relays, Motors, Lamps, Triacs, Solenoids, & General-Purpose Power		Vacuum Fluorescent Display Segment and Digit Driver	
	UDN-2956A	UDN-2957A	UDN-2981A/83A	UDN-2982A/84A	UDN-6118A	UDN-6128A
Type Number	UDN-2956A	UDN-2957A	UDN-2981A/83A	UDN-2982A/84A	UDN-6118A	UDN-6128A
Sustaining Voltage	80V	80V	50V (UDN-2981A) 80V (UDN-2983A)	50V (UDN-2982A) 80V (UDN-2984A)	85V	85V
Source Current	500mA	500mA	500mA	500mA	40mA	40mA
No. of Drivers	5	5	8	8	8	8
Input	6-15V	5V	5V	6-15V	5V	6-15V
Engineering Bulletin	29309		29310		29313	

For application engineering assistance on these or other interface circuits, standard or custom, write or call George Tully or Paul Emerald, Semiconductor Division, Sprague Electric Company, 115 Northeast Cutoff, Worcester, Mass. 01606. Telephone 617/853-5000.

For Engineering Bulletins and a 'Quick Guide to Interface Circuits', write to: Technical Literature Service, Sprague Electric Company, 347 Marshall Street, North Adams, Mass. 01247.

### FOR FAST INFORMATION, CALL YOUR NEAREST SPRAGUE SALES OFFICE:

ALABAMA, Sprague Electric Co., 205/883-0520 • ARIZONA, Sprague Electric Co., 602/279-5435 • CALIFORNIA, Sprague Electric Co., 213/649-2600. Wm. J. Purdy Co., 415/347-7701. KCE Corp., 714/278-7640 • COLORADO, Wm. J. Purdy Co., 303/777-1411 • CONNECTICUT, Sprague Electric Co., 203/261-2551 • DIST. OF COLUMBIA, Sprague Electric Co. (Govt. sales only), 202/337-7820 • FLORIDA, Sprague Electric Co., 305/831-3636 • ILLINOIS, Sprague Electric Co., 312/296-6620. D. Dolan Sales, 312/286-6200 • INDIANA, Sprague Electric Co., 317/253-4247 • MASSACHUSETTS, Sprague Electric Co., 617/899-9100. Sprague Electric Co., 413/664-4411 • MICHIGAN, Sprague Electric Co., 517/787-3934 • MINNESOTA, HMR, Inc., 612/920-8200 • MISSOURI, Sprague Electric Co., 314/781-2420 • NEW JERSEY, Sprague Electric Co., 201/696-8200. Sprague Electric Co., 609/795-2299. Trinkle Sales Inc., 609/795-4200 • NEW MEXICO, Wm. J. Purdy Co., 505/266-7959 • NEW YORK, Sprague Electric Co., 516/549-4141. Wm. Rutt, Inc., 914/698-8600. Sprague Electric Co., 315/437-7311. Mar-Com Associates, 315/437-2843 • NORTH CAROLINA, Electronic Marketing Associates, 919/722-5151 • OHIO, Sprague Electric Co., 513/866-2170. Electronic Salesmasters, Inc., 800/362-2616 • PENNSYLVANIA, Sprague Electric Co., 215/467-5252. Trinkle Sales Inc., 215/922-2080 • TEXAS, Sprague Electric Co., 214/235-1256 • VERMONT, Ray Perron & Co., Inc., 617/782-8114 • VIRGINIA, Sprague Electric Co., 703/463-9161 • WASHINGTON, Sprague Electric Co., 206/632-7761 • WISCONSIN, D. Dolan Sales, 414/482-1111 • CANADA (Ontario), Sprague Electric of Canada, Ltd., 416/766-6123 • CANADA (Quebec), Sprague Electric of Canada, Ltd., 514/683-9220

4SS-7136R1

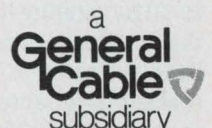

... and you thought we only make great capacitors.

CIRCLE NUMBER 32

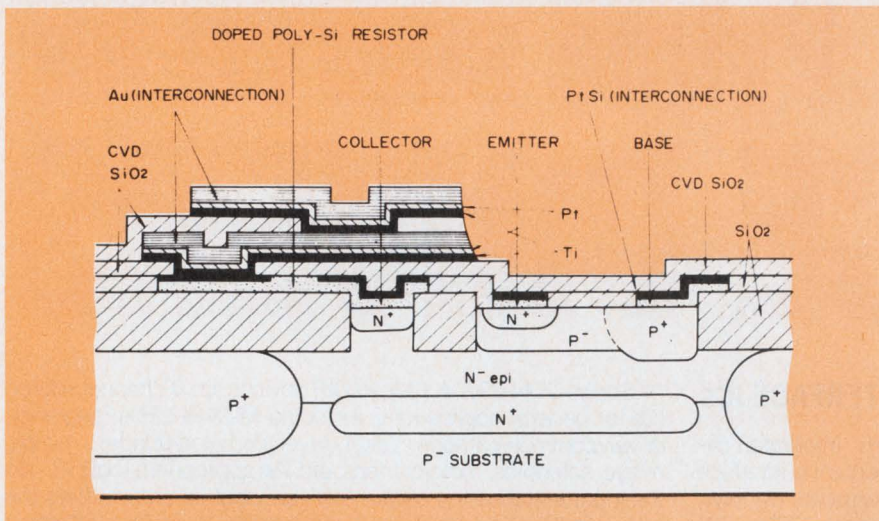

With internal propagation delays of less than 1 ns per gate, the polysilicon self-aligned process used by Nipon Tel-Tel permits the design of a bipolar 8-bit microprocessor on a 177-mil-square chip.

bipolar processor. Built using polysilicon self-aligned (PSA) techniques and three-layer metalization, the  $4.5 \times 4.5 \text{ mm}^2$  chip contains 1600 gates and uses a  $-3.3\text{-V}$  supply. The processor's internal ALU can perform six binary, six decimal and 16 Boolean functions. Housed in a 120-pin package, the processor draws only 1.43 W.

The PSA technology for fabricating this processor permits the lateral size of every element in the polysilicon layer to be reduced uniformly by thermal oxidation. And, the high resistance of polysilicon, which is needed to fabricate low-power LSI devices, is available in the same layer as the first interconnect. So no area is required for resistors in the transistor-array substrate. The three layers of interconnect consist of polysilicon, and then two layers of electroplated gold.

Microprocessors won't be the only thing to grow in the future. For example, memory densities may be quad-

rupled in size without straining the optical techniques in use today, promises Dr. Darrell Erb, an independent consultant. A dynamic RAM cell structure that Erb calls a stratified charge memory offers nondestructive read capabilities and has internal gain, eliminates the need for high-gain sense amplifiers, typically used in dynamic RAMs.

Cells are expected to be about  $10 \times 15 \mu\text{m}$ , typically, and eventually about a third the size of conventional dynamic-RAM cells. As a result, memory circuits may get to be as dense as 256 kbits per chip.

Other memory developments include a super-fast CMOS 4-k static RAM and a read-mostly 1-k memory. The static RAM, developed by Hitachi Central Research Laboratory in Japan, has a  $4\text{-k} \times 1$  organization, an access time of 43 ns and an operating power of less than 100 mW. Built from a combination of CMOS and bipolar technologies,

the RAM uses a four-transistor NMOS cell design with polysilicon load resistors. A combination of CMOS and npn bipolar devices are used on the output buffers to provide a three-state buffer with minimal power drain.

### The ovonic memory exists

Another memory, developed by Burroughs Corp. at its San Diego facility, uses amorphous memory switches in a  $256 \times 4$  array. The circuit acts as a very fast read-only memory or as a very slow read-write memory. Access time for read operations is 15 ns; for write operations, the time increases all the way to 15 ms.

Intended to be used as a reprogrammable ROM, the circuit can be switched between memory states by the use of current pulses. The ovonic-memory-switch element uses a phase change as the memory storage mechanism. Each memory cell consists of an OMS in series with a Schottky diode. The OMS itself consists of a layer of chalcogenide glass sandwiched between the first and second layers of chip metalization. Composed predominantly of tellurium and germanium, the glass exists in both amorphous and polycrystalline states. In the amorphous state, its resistivity is about  $10^5 \Omega\text{-cm}$  and in the polycrystalline state the resistivity drops to about  $0.1 \Omega\text{-cm}$ .

All is not bigger and better in the future. In fact, today's microprocessors face a speed penalty of about 10:1 each time a signal must be buffered and connected to real-world peripherals. Four more years of design will just make that margin worse—delays are expected to increase to 30:1 as devices get smaller. And, testing these speedy devices will get harder to do—more complex tests must be done, and at higher speeds. ■■

## Space diversity should open up K band to phone satellite links

Interstate telephone calls will roughly double to 9-billion per year by the mid 1980s, and the best way to handle the increased traffic is K-band (19 and 29-GHz) satellite links. There's a catch, though. Dense rainstorms attenuate K-band microwaves severely. However, spacing two antennas a few miles apart, and switching a satellite link to the antenna with less rain above it

should overcome the problem. Dense rainstorms don't cover a large geographical area, so it's quite unlikely that both antenna sites would be drenched at once.

At present, nobody knows exactly what effects rain would have on geographically separate sites at K band. To find out, GTE Labs, Inc., and the University of South Florida have set

up an experiment in Tampa, FL, in conjunction with the General Telephone Co. of Florida and the U.S. Army Research Offices, Research Triangle Park, NC. Tampa was chosen for its infrequent, but extremely dense, small-area rain cells and severe thunderstorms.

In this experiment, there are three sites spaced about nine miles apart in

# The function of this function generator is to make your job easier.

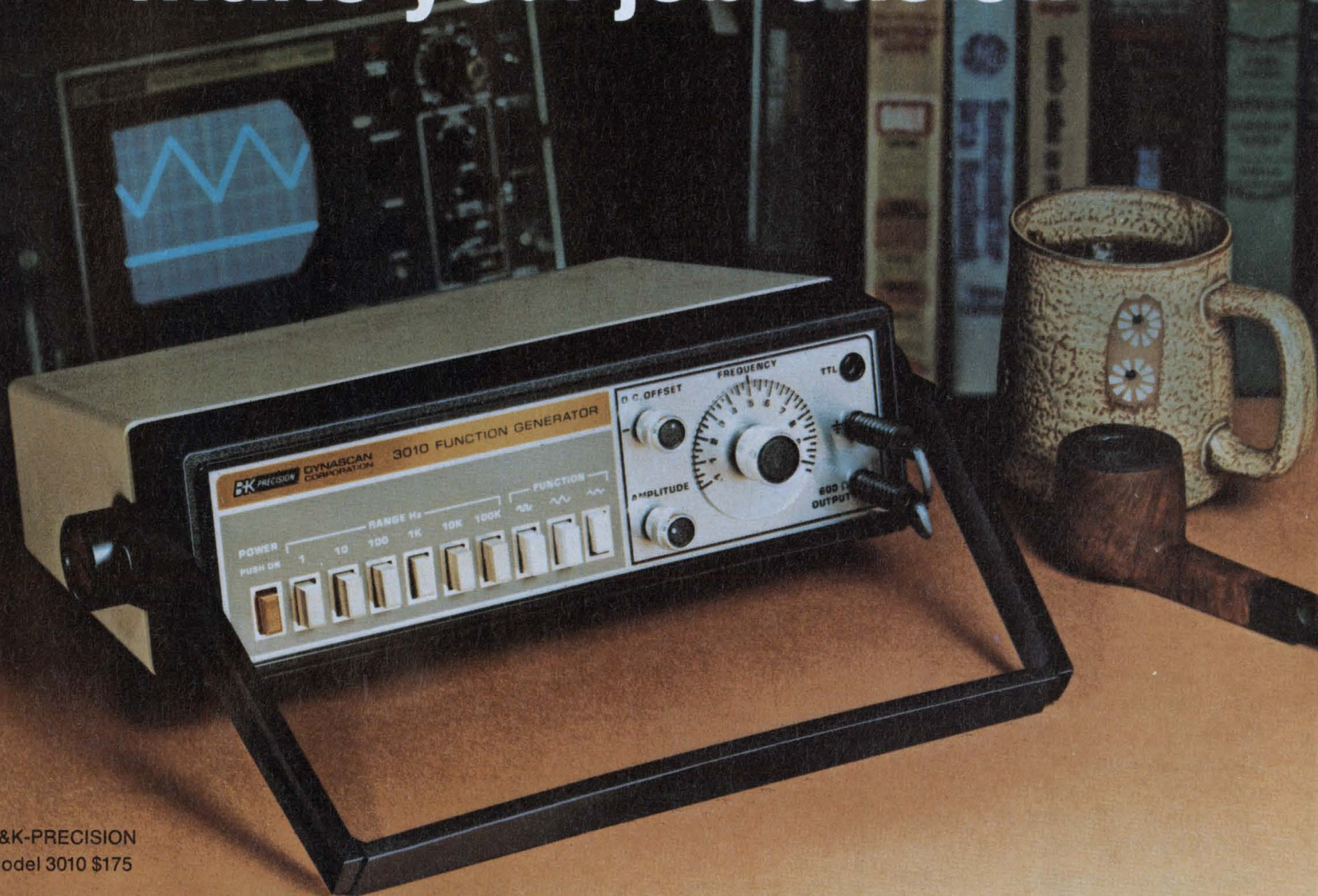

B&K-PRECISION  
Model 3010 \$175

If you stop and think about it, the function of any generator *should be* to make your job easier. When we at Dynascan designed our new Model 3010 function generator, that's exactly what we had in mind.

How did we achieve this? The 3010 was designed inside and out to be convenient and fast to use, and to provide years of trouble-free operation.

The 3010 generates all of the popular waveforms you're most likely to need, at only \$175. In addition to generating square, sine and triangle wave outputs, the unit offers a fixed TTL square-wave output. Sine-wave distortion is less than 1% and triangle-wave linearity and square-wave symmetry are a near perfect 99%. A convenient row of reliable pushbuttons provides fast, error-free selection of the appropriate range and output waveform.

For a chance to have your day run a little smoother, contact your local B&K-PRECISION distributor for immediate delivery or a demonstration.

The stable voltage-controlled oscillator (VCO) of the 3010 is varied on each range by the front-panel frequency control, or the VCO external input. A 0 to 5.5 volt ramp applied to the VCO external input will provide a 100:1 output frequency change. In this way, the 3010 can be used as a sweep generator for response tests. Other features that will help your job run smoothly include: .05% stability, a variable DC offset control for engineering and quality control applications, a convenient tilt-stand handle, and a detailed 38-page operations manual.

Because the B&K-PRECISION Model 3010 covers from 0.1Hz to 1MHz in six ranges, you'll probably be able to use it in more applications than you first guessed. These include IF response tests, test-instrument linearity measurements, transducer tests and digital clock-pulse substitution.

**B&K PRECISION** DYNASCAN CORPORATION

6460 West Cortland Street, Chicago, Illinois 60635 • 312/889-9087

In Canada: Atlas Electronics, Ontario • Intl. Sls: Empire Exporters, Inc., 270 Newtown Road, Plainview, L.I., NY 11803

# Keystone

## VERSATILE THERMISTOR PROBES



Get quick response for sensing temperatures of gases, liquids and surfaces with 23 thermistor probe styles and configurations. Probes with stainless steel tips can be ordered in lengths from 1" to 4", giving you an extra dimension to customize certain standard probes. Other features include:

**Sensitivity** . . . highly sensitive to minute temperature changes . . . fast response.

**Temperature range** . . . can withstand temperatures from  $-50^{\circ}\text{C}$  to  $260^{\circ}\text{C}$ .

**Resistance values** . . . from 1K to 1 meg at  $25^{\circ}\text{C}$  . . . also miniature discs and rods of 100 ohms to 1 meg at  $25^{\circ}\text{C}$  are available.

**Tolerance on resistance** . . .  $\pm 20\%$  at  $25^{\circ}\text{C}$  is standard;  $\pm 10\%$  and  $\pm 5\%$  or tighter tolerances if desired.

**Low-cost series** . . . three inexpensive probes to answer many requirements.

### Catalog TP-739

. . . gives details on 23 probe styles and ordering information. Circle reader service card.



# Keystone

CARBON COMPANY  
Thermistor Division  
St. Marys, PA 15857  
814/781-1591 • Telex 91-4517

CIRCLE NUMBER 34

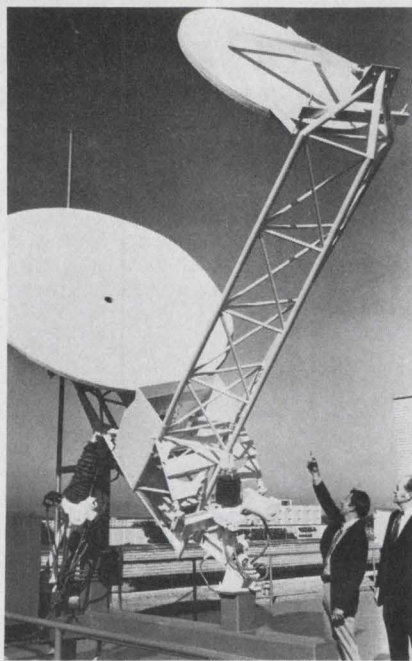

This K-band antenna picks up 19 and 29-GHz beacons on Comstar satellites to measure the effects of weather on signal strength and polarization. A feedhorn behind the main dish looks down at a third reflector in the "box."

a triangular array. Each site has a receiver and an antenna like the one in the photo. The antennas pick up microwaves at 19 and 29 GHz that are sent from beacons on the two Comstar synchronous satellites. Signal strength and polarization are measured and correlated with local weather.

Starting in May, time-lapse photos

of a color-PPI weather-radar display at a local TV station will provide detailed, calibrated pictures of the shape, intensity and movement of local rainstorms. These details will be correlated with the beacon data. The experiment will run for at least two years to accumulate enough data to ensure the reliability of the statistics.

Results of the experiment are expected to confirm that two antennas will be enough, and tell how far apart the antennas should be, according to Dr. Lee L. Davenport, Vice President and Chief Scientist of GTE, Stamford, CT.

If K-band links can't be used to handle the increased traffic, the alternatives would be more microwave relay towers or more satellite links, operating at lower frequencies like 4 and 6, or 11 and 14 GHz. The problem is, satellite links at 4 and 6 GHz use relatively costly 105-ft dishes. Finding a good site for more dishes of this size isn't trivial. Good supporting foundations are needed, there's a lot of potential interference from existing terrestrial 4 and 6-GHz links, and not everyone wants a big dish next to his backyard.

With K-band, on the other hand, the main reflector of an antenna needs to be only about 8 ft in diameter. With a dish that small, an antenna can be located in all sorts of places, even city rooftops. K-band provides four times the bandwidth of lower-frequency systems, and even five times, if the FCC permits. (Present systems handle



Control station for K-band propagation experiment includes 19 and 29-GHz receivers, antenna control panel and a minicomputer.

36,000 phone calls at once.) What's more, K-band frequencies aren't occupied by existing terrestrial systems, so there's no interference.

Present plans are to use 19 GHz for "up link" and 29 GHz for "down link." Polarization multiplexing will be used to double the capacity of the available bandwidth. Depolarization crosstalk, which is a problem in analog systems, isn't expected to bother these links, which will be digital.

The antenna (see photo), which is made by GTE Sylvania, Needham, MA, is designed for propagation measurements, rather than for an operating link. It has very low sidelobes and -40-dB cross-polarization. Its beamwidth is slightly less than  $0.3^\circ$  at 29 GHz, and gain is 54 dB. The main reflector (with the boresight telescope hole in it) is 8 ft in diameter, while the off-axis secondary is 3 ft across. The feedhorn, which is behind the main dish, looks down at a tertiary reflector inside the boxlike structure. This reflector permits the feedhorn to look down, which means that a window that covers its opening stays dry. Raindrops on the window would absorb the microwaves and invalidate the measurements.

So far, the antenna hasn't needed re-aiming to keep it pointed at the satellite, because the satellite's station-keeping has been very good—within  $\pm 0.05$  degrees.

The beacons transmit only a few milliwatts; with the distance involved (over 20,000 mi) and small antenna size, a narrowband (a few Hz) receiver is needed for sufficient signal-to-noise ratio. The receivers use AFC, which means that when a site is blanked out by rain, the local oscillator has to search for the beacon frequency once the rain clears. The search is slow at such a narrow bandwidth, but in the Tampa experiment, another receiver is still "seeing" the beacon and sends its frequency to the blanked site to speed up reacquisition tremendously.

### Digital beats depolarization

Polarization multiplexing permits a given frequency band to carry two sets of signals that are kept separated by transmitting them with rf polarizations  $90^\circ$  apart. Most of the time, the signals stay separated, but periodically there is crosstalk when they become depolarized, apparently when they pass through ice crystals in the upper atmosphere. The Tampa experiments include polarization measurements to find out more on this phenomenon. ■

# These custom IC's are not for sale!



## But the technology that created them is...

along with all the other capabilities you'll need for custom LSI from design through production.

Silicon Systems specializes in custom LSI... it's not a sideline. We're interested when others aren't because we've lowered the volume at which custom IC's become cost effective.

Over the years we have developed the world's most advanced IC design capability. A proprietary system, created in our own computer lab, helps us solve design problems in any technology—TTL, SCHOTTKY, ECL,  $I^2L$ , LINEAR, PMOS, NMOS, CMOS, whatever is best for you.

Our custom IC's are used in talking calculators, traffic controllers, code generators, garage door openers, automotive instrumentation, etc.

Are your products ready for state-of-the-art custom LSI?

For more information, phone or write Jim Meyer,  
(714) 979-0941 at 16692 Hale Ave., Irvine, California 92714.



**Silicon Systems**  
incorporated

# ferroresonant stabilized power supplies

- High efficiency: 75-80%
- Automatic current limiting (not foldback)
- Inherent overvoltage protection
- Wide source range
- Brownout protection to 90V a-c
- Source effect (line regulation)  $\pm 0.5\%$
- Low ripple — less than 50 mV
- 12V, 24V, 28V and 48V models
- Up to one kilowatt output

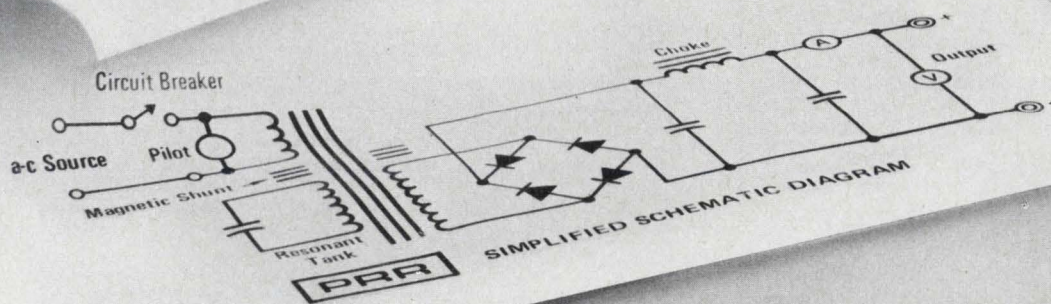
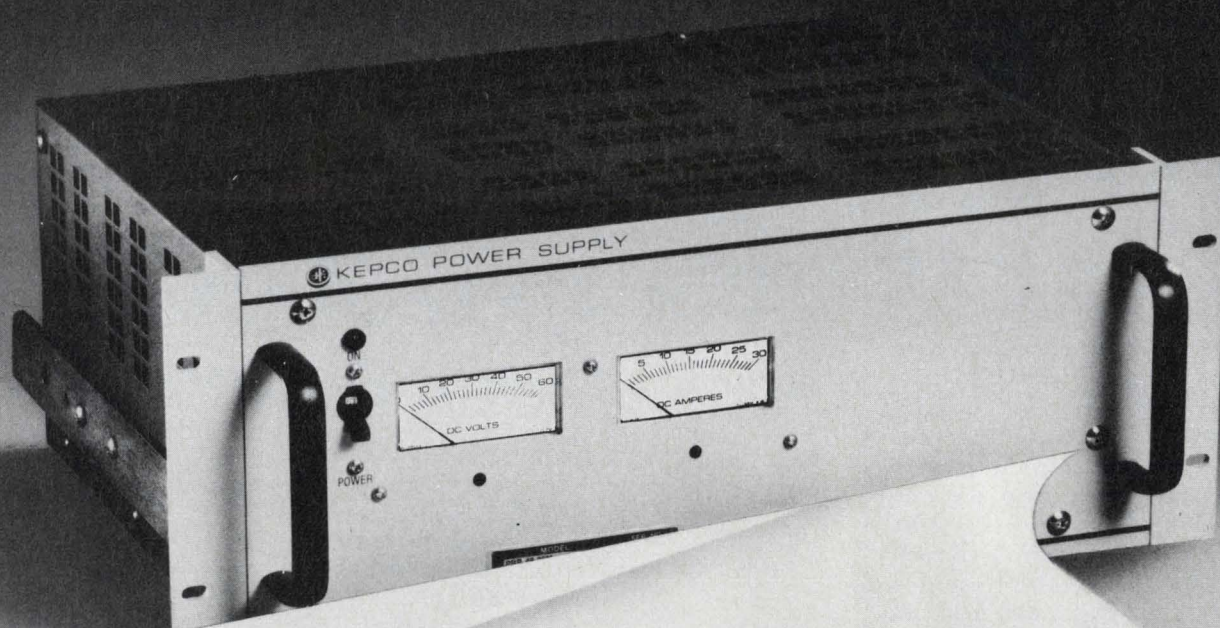

For complete specs,  
write Dept. CAF-05

CIRCLE NUMBER 36

**KEPCO**®

KEPCO, INC. • 131-38 SANFORD AVENUE • FLUSHING, N.Y. 11352 U.S.A. • (212) 461-7000 • TWX # 710-582-2631 • Cable: KEPCOPOWER NEWYORK



## Supersonic cruise missile eyed for 1986

The Air Force is accelerating development of a second-generation, supersonic cruise missile and may have it in operation by 1986, Lt. Gen. Alton D. Slay, deputy chief of staff for research and development, disclosed during testimony before the House Armed Services Committee.

The new cruise missile, as yet not approved by the Pentagon for engineering development, is called the Advanced Strategic Air Launched Missile (ASALM). It is being considered as a backup weapon in case the present cruise missiles, which are subsonic and lack electronic countermeasures to fool enemy radars, prove vulnerable to Soviet air defenses.

"The ASALM missile is a highly flexible weapon that will have both air-to-air and air-to-ground capability," Slay testified. "The air-to-air capability will contribute to the defense of our bomber and cruise-missile-carrier force against airborne threats. In the air-to-ground mode, the speed and small size of ASALM should allow the missile to penetrate heavily defended targets."

McDonnell Douglas Corp., St. Louis, and Martin Marietta Aerospace Corp., Orlando, FL, are competing in the initial development stages. The Air Force plans to award contracts to both firms next year to build prototypes for flight testing.

Funding for ASALM this year is \$37.2-million, with \$13.1-million of that "specifically earmarked" to accelerate development, according to Slay. The Air Force is requesting \$48.5-million more in fiscal 1979. However, if ASALM goes into production, it could become a multibillion-dollar program.

## Flying command post program faces interruption

Cuts in the funding of the Air Force's E-4 Advanced Airborne Command Post threaten to bring the program to a halt next year and increase costs. The aircraft is considered essential to national security because it permits national authorities (including the President) to command American forces from the air should the United States be under nuclear attack.

Prime contractor Boeing is due to deliver the fourth of the militarized 747 jumbo jets in April, 1979, but with present funding levels will have no work until after a Defense Systems Acquisition Review Council (DSARC) meeting on E-4 production in August of that year. Nor will its electronics subcontractors, which include the Collins Division of Rockwell International, E-Systems, RCA and Burroughs.

Boeing has already delivered three E-4A aircraft in which the airborne command and control equipment has been transferred from the present EC-135 flying command posts. The fourth aircraft is being built to the E-4B configuration with the additions of radiation-hardened electronic circuits, more advanced communications and aerial refueling ability.

The issue before next year's DSARC is whether to retrofit the first three E-4As to the B configuration and buy a fifth E-4, also a B model. (A sixth aircraft, an E-4B, is also envisioned, but that issue will be taken up later.) The Air Force is projecting \$233-million to fund the retrofits and \$135-million for the new aircraft in its fiscal 1980 budget, but has requested only \$32-million for fiscal

1979—all of it in the research and development category.

Pentagon sources say this means the program will come to a halt after the fourth aircraft is delivered next April and won't be able to start again until fiscal 1980, which begins October, 1979. In addition to disrupting the contractors, this program interruption may actually drive costs up. The Pentagon currently estimates the six aircraft will cost \$760-million, which would make the airborne command posts, at \$126.7-million apiece, the most expensive aircraft in history. Air Force sources have estimated the final costs may reach as high as \$900-million, or \$150 million each.

## **Air Force, Navy cooperate on new air-to-air missile**

The Advanced Medium Range Air-to-Air Missile (AMRAAM) is intended to replace the Raytheon AIM-7 Sparrow now used by both the Air Force's and Navy's fighter aircraft. The AMRAAM will be faster than and have twice the effective range of Sparrow, which is listed as having a speed of mach 4 and a range of 15 to 31 miles. The new missile is also supposed to have launch-and-leave and multiple-target capability, two features missing in the Sparrow, and to be particularly effective at low altitude and in an electronic-countermeasures environment.

However, Congress denied funds for AMRAAM for this fiscal year and has been skeptical that the two services need a replacement for Sparrow. Still, the Air Force and Navy are each requesting about \$13-million in next year's defense budget so that they can start funding companies to build testing prototypes.

## **Earth-resources satellite launch delayed again**

Development delays on the multispectral scanner (MSS) planned for the Landsat D earth-resources survey satellite have caused the launch date to be slipped back another six months, from early 1981 to later that year, according to the National Aeronautics and Space Administration (NASA).

The reason is that development of the satellite was funded this year, fiscal 1978, but funds for development of the MSS were held up until fiscal 1979 to determine whether it is needed as a backup for the thematic mapper, also planned for the Landsat series.

The recently launched Landsat C satellite has a five-channel MSS and high-resolution (40 meters), return-beam vidicon cameras that NASA estimates will permit the satellite to return 20 to 25% more data than previous Landsats.

**Capital Capsules:** The Air Force is asking for \$1-million in seed money in the new defense budget to study a **replacement for the O-2 and OV-10 forward-air-controller aircraft used in Vietnam.** The program, known as FAC-X, is intended to produce an all-weather aircraft for spotting targets behind enemy lines. The money sought will be used to evaluate advanced avionics. . . .The Defense Advanced Research Projects Agency (DARPA) is investigating an approach to **improving the reliability of militarized integrated circuits by providing a nitride layer on the chip as a sealant and then using plastic encapsulation for mechanical protection.** Militarized ICs cost on an average four times as much as commercial high-reliability devices, but have half the failure rate. DARPA's goal for the new circuits is 20% more cost but for one-tenth the failure rate.

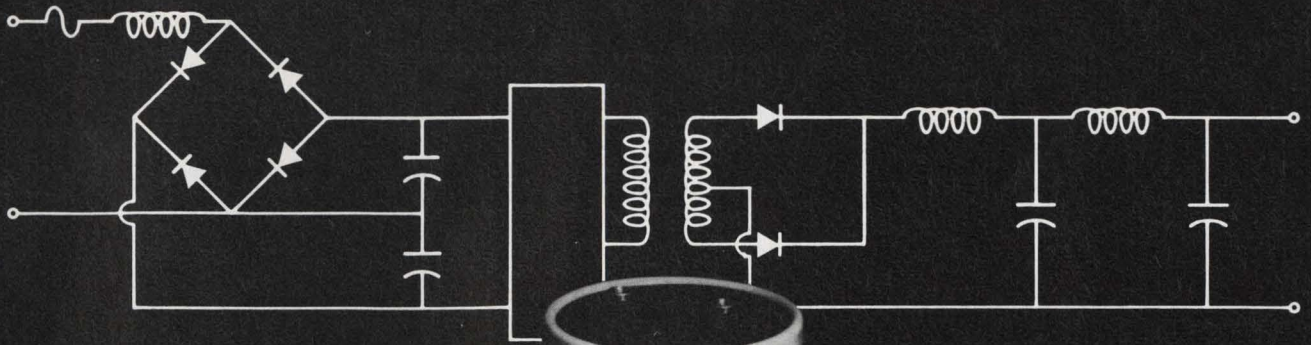

## Sangamo presents the "Designer Line"...the most complete selection of aluminum electrolytic capacitors in the industry.

Sangamo's "Designer Line" opens the door to a world of new design options for you. It's the industry's most complete line of capacitors for switching power supplies. With features and performance characteristics never before available from a single source.

The "Designer Line" includes five capacitor types for the input side... ten for the output side. All backed by Sangamo's reliability and technical expertise.

And we help still more. With engineering assistance and innovative application ideas whenever you want them.

Write for specs (refer to Catalog numbers included in listing, right), or call for a no-obligation consultation. Sangamo Capacitors Division, Box 128, Pickens, SC 29671; phone (803) 878-6311; TWX: 810-397-2496; Telex: 57-9441.

### Input Capacitors

#### Features:

- High voltage—150/200/250V
- High capacitance—to 7400  $\mu\text{F}$  at 200V
- \*Fourier compensated ripple current ratings to 10 amps at 85°C
- Operating temperatures to 125°C
- Up to 2,000 hours life at maximum temperatures

#### Types Available

DCM Thermal Pack—85°C/CAT. 2231F  
 500 Thermal Pack—85°C/CAT. 2236G  
 066 Computer Grade—85°C/CAT. 2241C  
 057 Premium Grade—105°C/CAT. 2244A  
 557 Premium Grade—125°C/CAT. 2240C

#### Temp. Range to:

\*Requires contact with Sangamo Engineers for special application assistance.

### Output Capacitors

#### Features:

- Low impedance to 100 kHz
- High capacitance to 465,000  $\mu\text{F}$
- 10 kHz to 100 kHz ripple current ratings to 40 amps
- Operating temperatures to 125°C
- Symmetrical tolerance for capacitance and ESR
- Up to 2,000 hours life at maximum temperatures

#### Types Available

500R Thermal Pack—85°C/CAT. 2236E  
 100 Power Pack—105°C/CAT. 2271C  
 101 Thermal Pack—85°C/CAT. 2272A  
 101X Thermal Pack—85°C/CAT. 2272A  
**NEW!** 139R Thermal Pack—85°C/CAT. 2273  
 300 Premium Grade—105°C/CAT. 2260A  
 301 Premium Grade—105°C/CAT. 2260A  
 301A Premium Grade—105°C/CAT. 2260A  
 057 Premium Grade—105°C/CAT. 2244A  
 557 Premium Grade—125°C/CAT. 2240C

#### Temp. Range to:

**SANGAMO WESTON**

**Schlumberger**

CIRCLE NUMBER 37

# Talk about a matched pair!

## Just 3mV gate source differential *off-the-shelf.*



It's our new series of N-channel dual monolithic J-FETs. And its available off the shelf with a gate source voltage differential of only 3mV.

That's right. Off the shelf. Never before has the designer been able to buy a device this closely matched without paying extra, and running the risk of delivery delays or defaults.

Not only do you get the close match, you get a lot more besides. For instance:

- CMRR: 100 dB minimum
- Input Impedance:  $I_G$  less than 25 pA
- Noise:  $10\text{nV}/\sqrt{\text{Hz}}$  Typ @ 10Hz
- gos: less than  $1\ \mu\text{mho}$
- Choice of hermetic TO-71 or 8-pin miniDIP with symmetric pinout for automatic insertion.

Typical applications for our new 2650 series of dual monolithic N-channel JFETs include low and medium frequency amplifiers, low noise input amplifiers, differential amplifiers, impedance converters, precision instrumentation amplifiers, and comparators.

For complete technical information, design assistance, or evaluation samples, contact us at the address below, or call Howard Bogrow, (415) 968-9241.

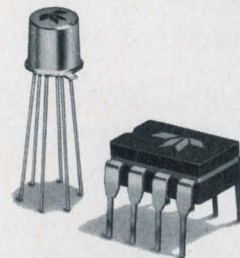

### TELEDYNE SEMICONDUCTOR

1300 Terra Bella Avenue, Mountain View, California 94043 • (415) 968-9241

**SALES OFFICES:** DOMESTIC: Salem, N.H. (603) 893-9551; Stony Brook, N.Y. (516) 751-5640; Des Plaines, IL (312) 299-6196; Los Angeles, CA (213) 826-6639; Mountain View, CA (415) 968-9241  
INTERNATIONAL: Hounslow, Middlesex, England (44) 01-897-2503; Tiengen, West Germany 7741-5066; Kowloon, Hong Kong 3-240122; Tokyo, Japan 03-403-8141

CIRCLE NUMBER 38

## Today's dreams. Tomorrow's reality?

My friend Roy was helping prepare me for a television interview on consumer electronics. He lent me two digital watches—a calculator/watch that he took about 20 minutes to explain, and a stop watch/watch that took another 10 minutes.

After a stretch of additional conversation, Roy said he had to be moving along and, without thinking, glanced at his wrist. No watch. I had all the watches—his two digitals, and my analog. So he borrowed mine and, as he was adjusting it on his wrist, I leaned over, pointed to the face, and advised: "Now the small hand. . ."

Well, we chuckled because I'm normally not that quick with spontaneous remarks. It often takes me hours to prepare them.

Later, in a more serious mood, I began to think of ways our technological revolution had already affected us and of ways it may affect us tomorrow.

Take the digital watch again. You can buy one for less than \$10, though it started at \$1500 only seven years ago. Already, this seven-year-old has begun changing the way people talk. People now tell you the time is 3:45 (or 3:46) instead of a-quarter-to-four. And tomorrow's dictionaries may carry "clockwise" as an archaic term.

Or take the calculator. You can buy one for less than \$10, though it started at \$395 seven years ago. Only a year later, Keuffel & Esser quit making slide rules. What a staggering thought. At one time, slide rules seemed an extension of our hands and K&E, the slide-rule king, seemed not to be a company but an institution.

And tomorrow? How will technology change the way we talk, the way we think, the way we live? Certainly some of tomorrow's commonplace will be today's undreamed of. But many of tomorrow's wonders will come directly from today's ideas. Your ideas.

We'd like you to share them with the rest of the electronics community. If you've an idea on something we'll see tomorrow—even if our technology isn't quite ready—send me some words about it. If I get enough interesting and challenging ideas, I'll publish a selection in these pages so that all of us can admire them. And dream of tomorrow.



GEORGE ROSTKY  
Editor-in-Chief

A technological breakthrough from International Rectifier . . .

# Power Schottkys for 175°C operation ...at full ratings!

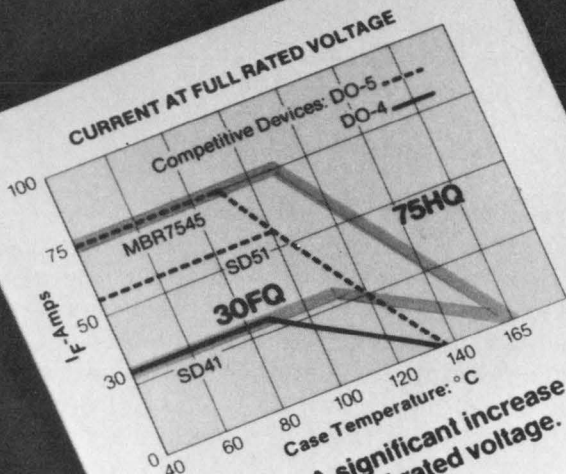

Figure A: A significant increase in current at full rated voltage.

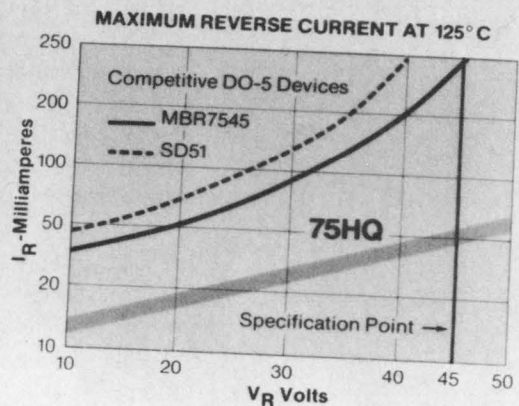

Figure B: A five-fold decrease in reverse current leakage.

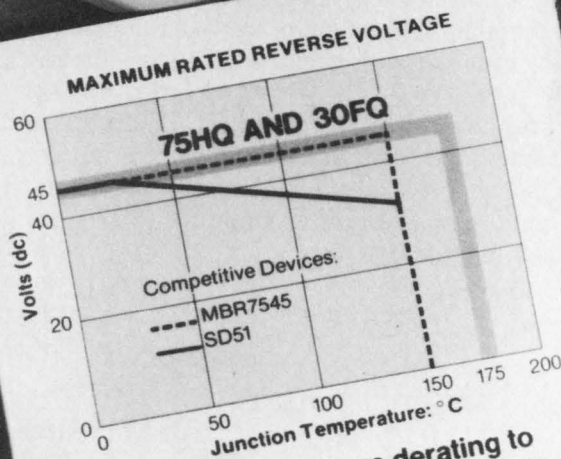

Figure C: No voltage derating to full 175°C junction temperature.

"630 Process" Series

Part No. 75HQ045 - 75 A/45 V (DO-5)

Part No. 30FQ035 - 30 A/45 V (DO-4)

# A new high in temperature handling capability that removes traditional design restrictions . . . adds a 25°C reliability factor . . . minimizes the possibility of thermal runaway.

Until now, only the temperature limited Schottky has kept switching power supplies from operating at high ambients, and gaining a big increase in power ratings.

Now, International Rectifier's "830 Process" removes the heat related design restrictions of yesterday. You can add a 25°C reliability "guard band" to existing designs now using 150°C rated devices. In new designs, heat sinks can be smaller or current ratings can be higher. Take your choice.

## Industry's highest junction temperature rating

New 175°C junction temperature Schottkys are the product of IR's new "830 Process", which produces a junction temperature capability 25°C higher than any other devices available (Figure A). At a given case temperature, you'll get more current and full rated voltage, or conversely, more reliability.

## A five-fold decrease in reverse current leakage

As plotted in comparison to other available types in Figure B at left, IR "830" Schottkys exhibit a five-fold improvement in reverse leakage at given junction temperatures. Note the maximum leakage of 50ma versus 250ma for competitive devices at 45V and 125°C. With lower leakage you can design for higher

temperature operation . . . with a significant reduction in the possibility of thermal runaway.

## No voltage derating vs. case temperature

Because of high leakage, it has been necessary in the past to derate voltage as case temperature increased. Not now. The "830 Process" junction carries rated voltage out to 175°C. The design advantages are obvious. See Figure C.

## 20% guaranteed transient voltage capability

Most manufacturers do not publish transient voltage ratings let alone guarantee them. The new "830 Process" 45V devices are guaranteed to withstand 20% repetitive transients, or 54V, without failure.

Contact your local IR Field Sales Office or Distributor, or contact us directly for complete data and test samples. "830 Process" Schottkys are a major development that you have probably been waiting for. They're here!

# International Rectifier

... the innovative semiconductor people



## Schottky or high-speed pn rectifiers?

The choice isn't easy. Schottky devices have low forward drops, but pn rectifiers offer higher reliability and lower cost.

Which rectifiers are better—the Schottky or the older high-speed pn units? Judge for yourself. The rectifiers listed in Table 1 are typical comparable units, and all are housed in DO-5 cases. The Schottky units have 20-to-50-V reverse-voltage ratings and the pn units, 200 V. Like most Schottkys, the types A and B are limited to 125-C maximum case temperatures, and a few, like the type C and the pn units, operate to 150 C.

Schottky power rectifiers have come of age. Their forward voltage drops are low, and their metal-to-semiconductor interfaces, constructed like the old point-contact diodes of earlier radio days, have no minority carriers. Thus, reverse recovery time is fast, and the Schottky units can operate at high switching speeds. But, unfortunately, Schottky reverse-voltage capability is lower than that of pn rectifiers; they're not as reliable; and they cost more.

Fast-switching pn power rectifiers, however, have served reliably for many years, especially in "free-wheeling" diode applications in switching regulators.<sup>1,2,3</sup> Switching-regulator power supplies, fast becoming the most popular type, especially in computers, are highly efficient, small and light. The rectifiers used in such supplies must operate efficiently at 20 to 60 kHz.

The most common way to get fast reverse recovery in pn rectifiers, and thus fast switching, is by gold-doping the junction. The gold reduces the minority-carrier lifetime. But this speed improvement usually must be traded off for increased forward-voltage drop,  $V_f$ , even though a thinner wafer and lower-resistivity silicon can somewhat offset the higher  $V_f$  of the gold.

### Forward drop: least ambiguous spec

Forward-voltage drop, a major factor determining rectifier efficiency, is the most clearly defined of all the rectifier specs. Even so,  $V_f$  can be measured in many ways. The  $V_f$  values in Table 1 are the peak

instantaneous forward-voltage drops for a single half-cycle pulse of 60-Hz current. Taking such instantaneous measurements prevents temperature changes from affecting the measurements. Although rectifiers are compared often at 25-C case temperatures, this value is not a practical operating temperature. Measurements made at 100 to 150 C give more valid results.

At most operating current levels, the  $V_f$  of a pn rectifier decreases as the temperature rises towards the maximum recommended value. Nevertheless, Schottky rectifiers, at the same current and temperature as pn units, always have lower forward voltages. Note, however, that the forward voltages vary considerably among manufacturers (see Table 1). Generally, Schottkys have between 0.1-and-0.4-V lower values than comparable pn rectifiers. In the table, however, at 150 A, notice the small  $V_f$  difference between manufacturer A's Schottky and the FMC pn unit at 25 C. Thus, look at manufacturer's claims carefully. It's even wise to make your own measurements.

The maximum current rating of a rectifier, although often specified at a 25-C case temperature, depends ultimately upon the maximum allowed junction temperature—about 200 C for silicon. Since the maximum current times  $V_f$  is the allowed power dissipation in the rectifier, for an allowed junction-to-case temperature drop of 175 C (200-C junction to 25-C case temperature), the maximum current is

$$I_{\max} = 175 \theta_{JC} / V_f,$$

where  $\theta_{JC}$  is the junction-to-case thermal resistance in °C/W.

Maximum current ratings of DO-5 Schottky rectifiers are generally close to those of pn rectifiers of the same class, despite the Schottky lower  $V_f$ . The lower Schottky power dissipation is offset by a lower allowable junction temperature—ranging from 150 to 175 C. Unfortunately, this lower-temperature spec makes a Schottky rectifier more vulnerable to failure than an equivalent silicon pn-junction unit at the same power dissipation.

Another spec where the Schottky falls short is in

**Paul Meisel**, Manager of Application Engineering, FMC Corp., Semiconductor Products Div., 800 Hoyt St., Broomfield, CO 80020.



REVERSE CHARACTERISTICS 25°C

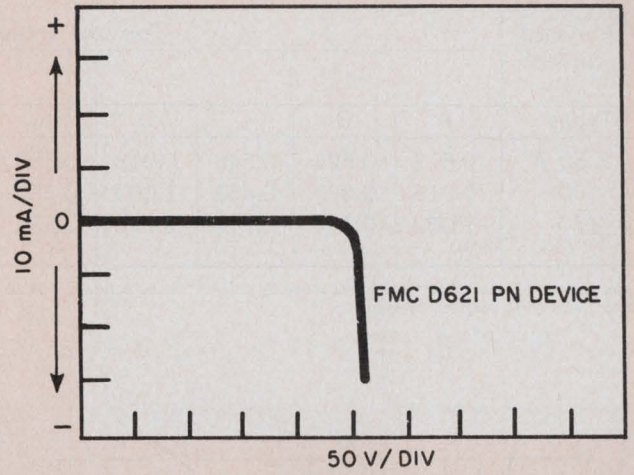
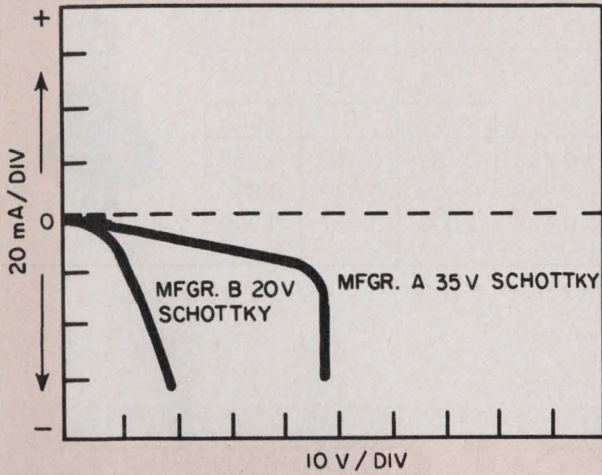

REVERSE CHARACTERISTICS 100°C

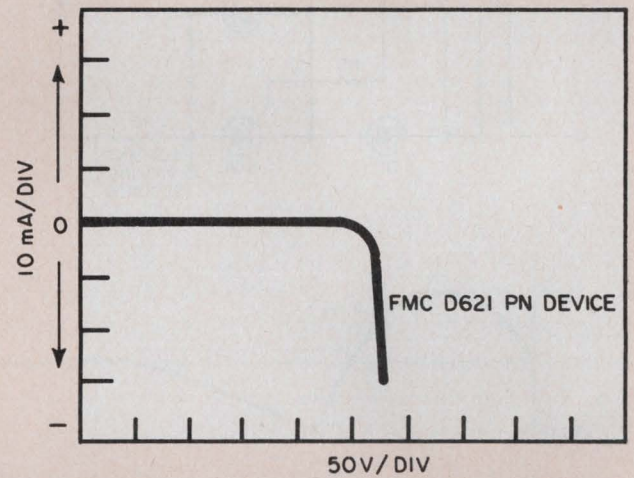
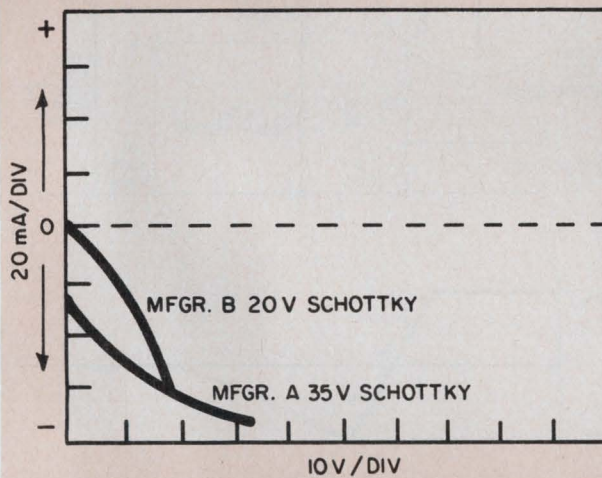

REVERSE CHARACTERISTICS 125°C

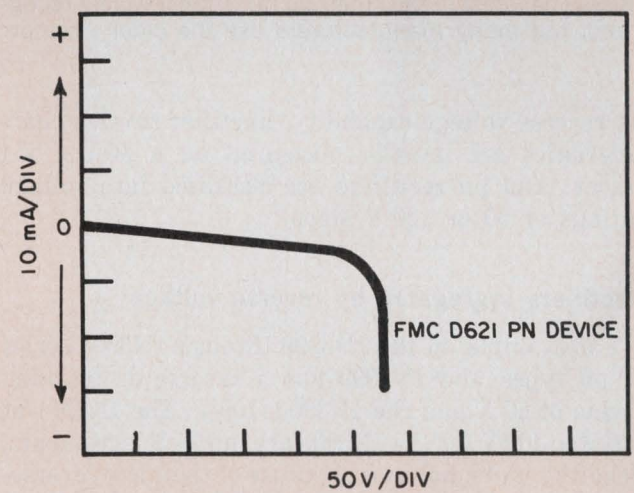
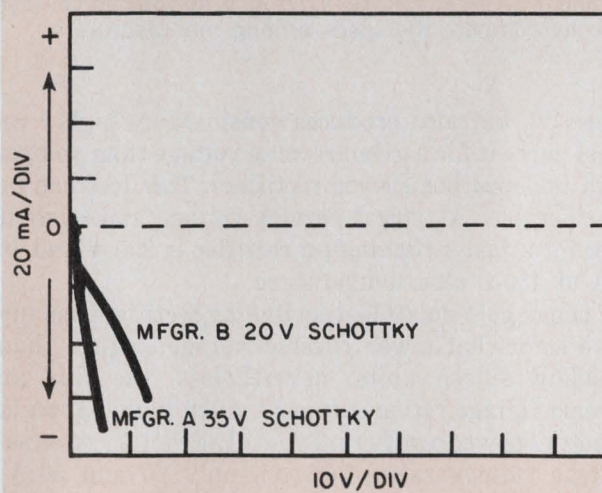

(a)

(b)

1. **Reverse-current characteristics** are strongly affected by temperature. Schottky reverse leakage (a) is higher than that of pn units (b), especially at low reverse voltages.

Pn units have a sharp "knee" beyond which leakage current rises steeply, and therefore should be operated well below the knee.

# Diode forward voltage drop

Forward current $I_f$	Forward voltage drops— $V_f$									
	25 C				125 C				150 C	
	Types	A	B	C	D	A	B	C	D	C
50 A	0.577	0.524	0.548	0.918	0.558	0.456	0.433	0.795	0.410	0.762
100	0.816	0.635	0.653	1.009	0.720	0.594	0.569	0.908	0.549	0.882
150	1.062	0.742	0.747	1.077	0.829	0.669	0.677	1.000	0.657	0.969



Types A, B and C are Schottky rectifiers made by different manufacturers; D is an FMC D621 pn-type rectifier. All types are in DO-5 packages. Temperatures are case temperatures.

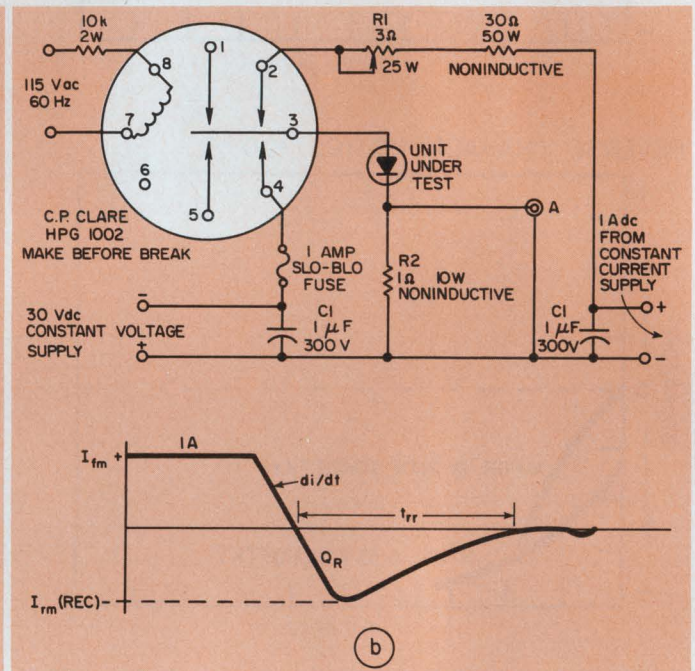
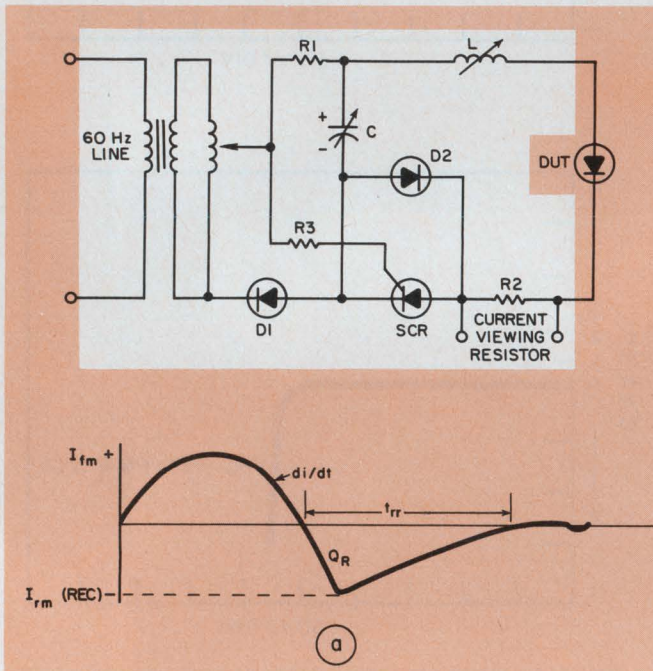

2. Many methods are used to measure reverse characteristics. The latest JEDEC method (a) is most widely recognized, but many manufacturers use the older vibrator-

input method (b), where forward current ( $I_f$ ) is set to 1A and the reverse voltage ( $V_r$ ) is 30 V, so you can't always directly compare the specs among manufacturers.

its reverse-voltage capability. Rectifier reverse characteristics are usually measured on a 60-Hz, V-I tracer. And pn rectifiers are classified into voltage ratings of 50 or 100-V steps.

## Rectifiers segregated by reverse voltage

For example, in the 1N3899 through 1N3903 series of pn types, the 1N3899 has a reverse dc blocking rating of 50 V and the 1N3900, 100-V. The 1N3901 at 200 V to 400 V for the 1N3903 are in 100-V increments. Schottky units, however, because of their low reverse-voltage ratings, are usually classified in steps of 10 or 20 V.

Of course, reverse-voltage ratings shouldn't be exceeded. But even when the rectifier operates within its rating, reverse voltage causes heating in direct proportion to reverse leakage current. Here, gold-doped pn units suffer again. Gold doping not only

raises  $V_r$ , but also produces considerably higher reverse current for a given reverse voltage than you get with undoped but slower rectifiers. This loss can be considerable: A typical reverse-voltage and current spec for a fast-switching pn rectifier is 200 V and 10 mA at 150-C case temperature.

Though gold-doped fast-switching rectifiers usually have somewhat lower reverse-voltage ratings than standard silicon units; nevertheless, the fast pn reverse-voltage ratings are still much higher than in Schottky power rectifiers. Typically Schottky reverse-voltage ratings range between only 20 and 50 V. Reverse leakage is high—about 100 to 200 mA at 125 C.

But the low forward-voltage drop of Schottky units makes them eminently suitable for today's high-current, low-voltage (5 to 15 V) supplies, where the Schottky low reverse-voltage ratings are no drawback. Figs. 1a, 1b and 1c illustrate I-V (current-voltage) curve tracings of leakage current versus reverse volt-

JEDEC TEST  $I_f = 50 \text{ A}$   $di/dt = 50 \text{ A}/\mu\text{s}$

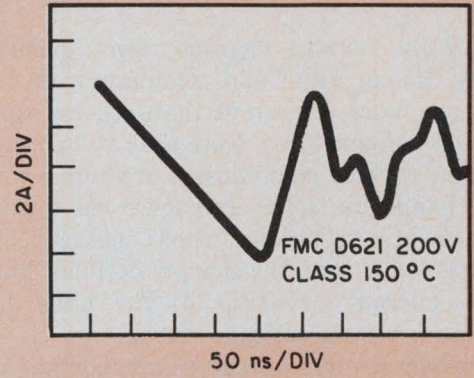
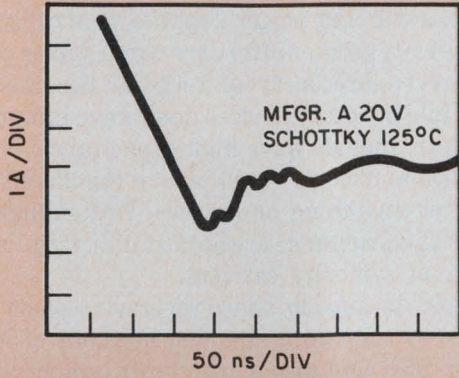

JEDEC TEST  $I_f = 50 \text{ A}$   $di/dt = 50 \text{ A}/\mu\text{s}$

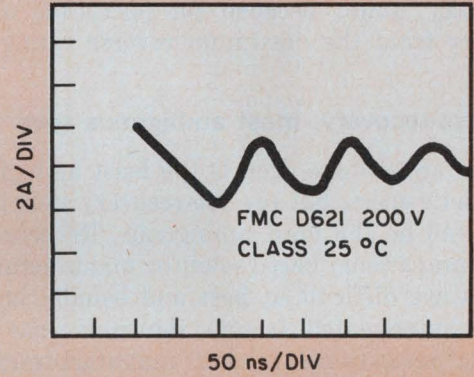
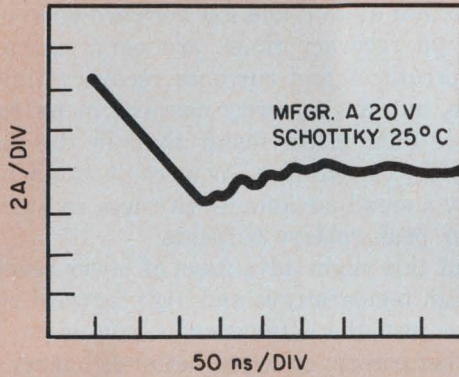

(a)

1A FORWARD - 30V REVERSE TEST REVERSE CURRENT LIMIT - 1A

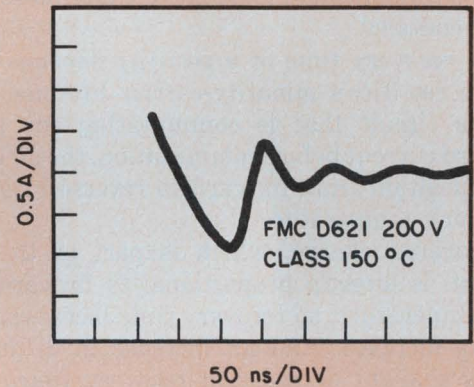
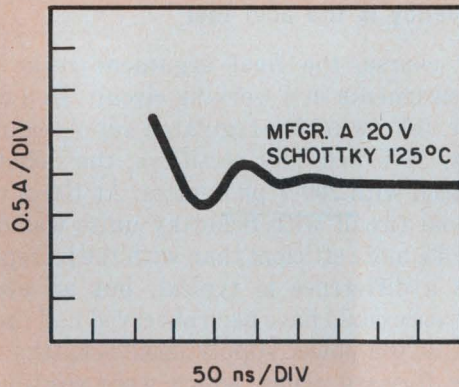

1A FORWARD - 30V REVERSE TEST REVERSE CURRENT LIMIT - 1A

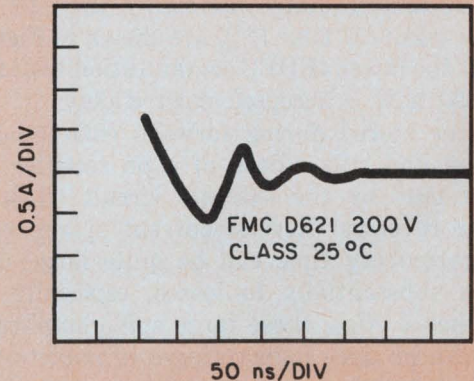
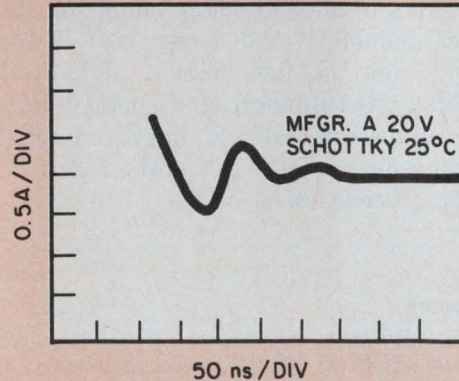

(b)

3. **Reverse recovery time** is strongly affected not only by forward current,  $di/dt$ , and temperature, but also by how you measure it. The results of using the JEDEC method

of Fig. 2a with an  $I_f$  of 50 A and  $di/dt$  of 50 A/ $\mu\text{s}$ , (a) and the results of the method of Fig. 2b with an  $I_f$  of 1 A and  $V_f$  of 30 V (b) show the differences.

age for typical Schottky and pn devices at 25, 100 and 125 C.

Schottky reverse characteristics generally vary widely among units and manufacturers. But some units are more consistent than others, especially at elevated temperatures. Note that at low reverse voltages, the reverse-power losses are higher in Schottky units than pn units. Reverse-power loss in pn rectifiers is relatively negligible, when operated at reverse voltages lower than the sharply defined "knee" in the reverse-current curve (Fig 1b). The "knee" defines the maximum reverse-voltage rating.

This high reverse voltage is an important advantage of pn units. For a given operating voltage, pn units are therefore more likely to be more reliable than Schottky units, because pn operation usually is further from the maximum reverse rating.

### Reverse-recovery: most ambiguous spec

Forward-voltage drop is the least ambiguous of a rectifier's specs, but reverse-recovery switching time seems to be the most ambiguous. Reverse-recovery time comparisons based solely on manufacturer's data sheets are difficult at best and usually impossible. Many interrelated factors figure in making such timing measurements, but manufacturers seldom spell them out. What it boils down to is this: You just can't pick what seems to be the fastest unit only from data on spec sheets. You must consider how the speed was measured.

The recovery time of a rectifier depends not only on the rectifier's minority-carrier lifetime, but also on the circuit that is commutating the unit, the forward current before commutation, the  $di/dt$  during the transition from forward to reverse bias and the rectifier's temperature.

Recovered charge, which is part of the reverse current, is directly proportional to forward current and temperature, so recovery time increases as these factors increase. And an increase in  $di/dt$  usually causes a slight decrease in recovery time, but this effect is difficult to measure and usually ignored. Two circuits, among many commonly used to measure reverse-recovery time ( $t_{rr}$ ), are shown in Figs. 2a and 2b, but the latest JEDEC commutation-testing circuit (Fig. 2a) now is accepted most widely.

Charge stored during forward conduction in the junction and bulk silicon of a pn rectifier must be "swept out" by the external circuit when applied voltage reverses. Reverse-current spikes generated during recovery time can be quite large, and contribute substantially to losses, especially at high frequencies. Also, these large spike amplitudes and  $di/dt$  can produce high voltages in inductors, which in turn create annoying noise or even damaging transients.

Because of their high-frequency operation (20 kHz and higher), switching power supplies suffer con-

siderable loss of efficiency when spike losses are high. Also, switching power supplies generally "noisy" become even greater offenders when spikes coming from the reverse-recovery of rectifier become excessive.

While Schottky devices don't have minority carriers to clear, they do have high capacitance—in the range of 5000 to 8000 pF—well above the 250 pF maximum for fast-switching pn devices. Unfortunately, the effects of capacitance are almost indistinguishable from those of minority carriers.

Figs. 3a and 3b show reverse-recovery-time plots made by the two measuring methods of Figs. 2a and 2b at 25 C and also at the limit temperatures of 125 or 150 C. The ringing in the recovery "tail" results from unavoidable circuit inductance and capacitance. Note that at 25 C and low forward current, Schottky and pn recovery times are very similar. At high temperatures and currents recovery times are still close, but the minority carriers in pn rectifiers increase their effect faster than in the already high Schottky capacitance. As a result, the Schottky units enjoy a small advantage with less recovery time and lower peak reverse currents.

But this slight advantage of lower reverse current at high temperatures and high forward current may make just the difference if you want to squeeze another percent or two of better efficiency out of your power supply and reduce transient problems.

### Efficiency is the acid test

Of course, the final argument rests in making measurements in a working circuit. In a commercial 1-kW, 5-V switching-regulated supply equipped with eight, 35-V Schottky rectifiers, the Schottkys were replaced with 200-V pn devices. At 100-A output, the original circuit with Schottky units was determined to be 3% more efficient than with the pn replacements. Such a difference is typical, but an even greater difference could have been observed had the manufacturer of the power supply used Schottky units with lower forward drops, which were readily available.

However, both pn and Schottky devices are still being improved. Although, today, pn devices have higher reliability and lower cost—often worth a tradeoff for the few percent higher efficiency of Schottky units—tomorrow, Schottky units may also have competing cost and improved reliability. But then, pn devices may get lower forward drops and higher efficiencies. ■■

### References

1. Galloway, J.H., "Application of Fast Recovery Rectifiers," *Application Note No. 200.38*, General Electric Co., Syracuse, NY, 1965.
2. *SCR Applications Handbook*, International Rectifier Corp., El Segundo, CA, 1970, Chapter 10.
3. Von Zastrow, E. E., and Galloway, J. H., "Commutation Behavior of Diffused High Current Rectifiers," *Application Note No. 200.42*, General Electric Co., Syracuse, NY, 1965.

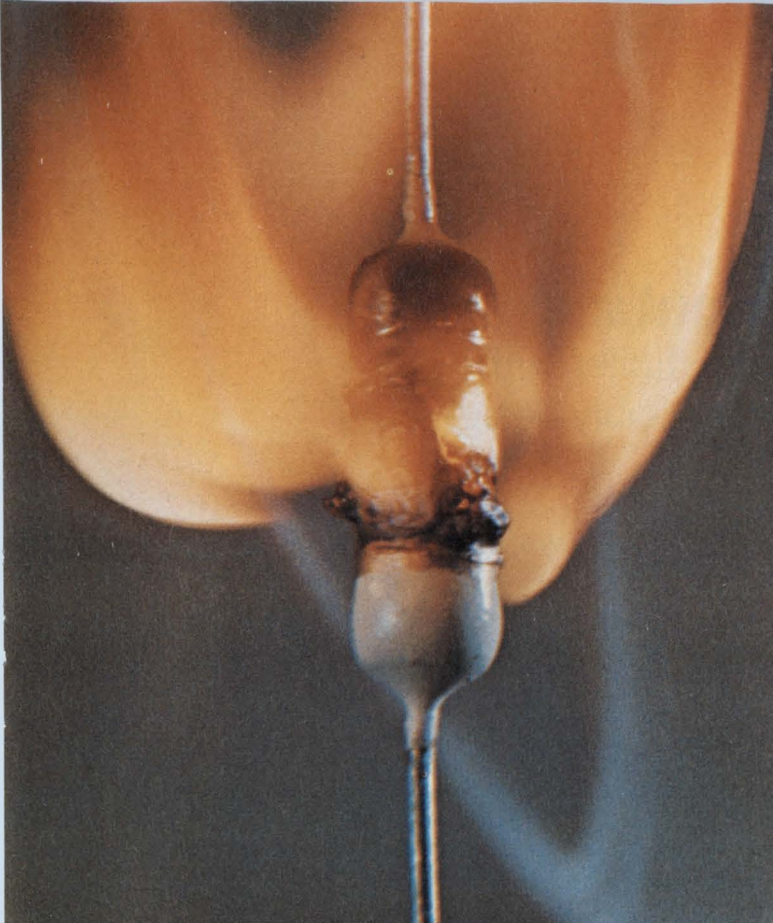

**The failure.** A 16 W overload causes this 1/2 W carbon film resistor to burst into flame. The initial failure mode is a short circuit, causing even more current to be drawn as shown on the meter.



**The successful failure.** The TRW 1 W rated BW-20F (1/2 W size) stays cool and fuses quickly and safely under identical power surge conditions. The failure mode, as shown, is an open circuit.

# A failure your circuit can live with.

**Failsafe, Fusible, Wirewounds Offer Built-In Circuit Protection.**

Cool wirewounds like our BW failsafe series have a dual personality.

They provide stable resistance to normal operating current. But at specific overloads, they open circuit like a good fuse. So, as shown above, they'll protect your circuit from excess heat and fire in places where severe fault conditions are encountered.

The BW failsafe series, UL listed per Document 492.2, can save cost by eliminating the need for both resistor

and fuse. Save space, too, because they're about half the size of standard 1 and 2 W devices.

Depending on your specific circuit parameters, other TRW film and wirewound resistors can be engineered to meet your requirements.

For more information on resistors your circuit can live with, contact TRW/IRC Resistors, an Electronic Components Division of TRW, Inc., 401 N. Broad St., Phila., Pa. 19108. Tel. 215-922-8900. Telex: 710-670-2286.

**TRW IRC RESISTORS**  
ANOTHER PRODUCT OF A COMPANY CALLED TRW

## Boost high-voltage dc outputs:

Pair a TV-proven cascaded voltage multiplier with a switcher to ease high-voltage power-supply design.

Make a simple, compact and efficient high-voltage supply by feeding a square wave into a cascaded voltage multiplier. Such multipliers, now used extensively for television receivers, owe a lot of their effectiveness to reliable and economical high-voltage diodes and capacitors. Not only that, but high-frequency square waves, with moderately high voltages at power levels high enough for a supply, are now available from the low-cost and dependable circuits developed for switching power supplies.

For the circuit in Fig. 1, the square-wave frequency ( $f$ ) is directly proportional to the dc input voltage. The transistors,  $Q_1$  and  $Q_2$ , act only to switch from one half of the center-tapped primary to the other half. This switching creates a voltage square wave across the secondary. This square-wave output is then fed into the multiplier cascade.

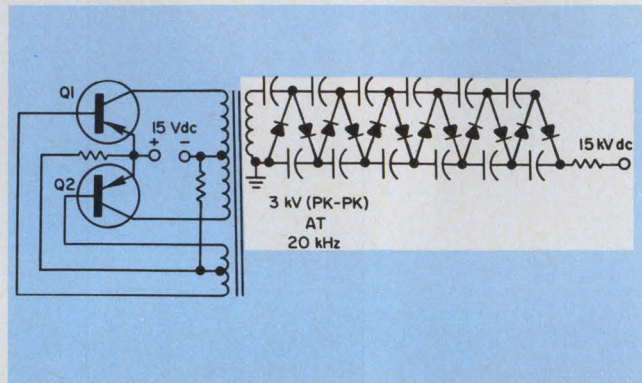

1. **The cascade multiplier** at the secondary raises the 3-kV input to 15 kV. Transistors  $Q_1$  and  $Q_2$  in the primary circuit, switch the applied 15-V dc source from one half of the primary to the other at 20 kHz.

### Everything affects performance

The performance of the multiplier depends mainly on four distinct factors:

- The square-wave frequency.
- The number of stages ( $N$ ).
- The capacitance ( $C$ ).
- The output current ( $I$ ).

To gauge the impact of each of these, examine the generalized  $N$ -stage multiplier in Fig. 3. Each two-diode two-capacitor stage doubles the peak input voltage,  $E$ . Theoretically, the cascade output is  $2NE$ . Actually, this output is reduced by the load drop,  $\Delta V_L$ , the ripple drop,  $\Delta V_r$ , and the drop across the diodes,  $\Delta V_d$ :

$$V_{out} = 2NE - \Delta V_L - \Delta V_r - \Delta V_d \quad (1)$$

Of these,  $\Delta V_d$ —generally the least significant—can be approximated by rounding the diode's peak-inverse rating to the nearest upward kV, multiplying the result by 1.5, then multiplying again by the number of diodes in the multiplier ( $2N$ ). For example, using diodes with 4-kV peak-inverse ratings:

$$\begin{aligned} V_d &\cong 4 \times 1.5 \times 2N \\ &= 12N \text{ V.} \end{aligned}$$

For a more accurate value, the diode's forward drop should be *measured* at the full-load current, and the value for this drop multiplied by  $2N$ .

A more significant quantity,  $\Delta V_r$ , is given by:

$$\Delta V_r = (I/f) (1/C_1 + 2/C_2 + \dots + N/C_N).$$

For equal-value capacitors,

$$\Delta V_r = N(N+1)I/(2fC).$$

The capacitors nearest the input are most responsible for the ripple. So, make the  $N$ th capacitance  $N$  times  $C_1$ , the  $(N-1)$ th capacitance  $(N-1)$  times  $C_1$  and so on, so that:

$$\Delta V_r = NI/(fC_1).$$

The third factor, that reduces the output,  $\Delta V_L$ , is the most complex. This loading drop is the sum of each capacitor's loading drop. For the  $N$ -stage multiplier in Fig. 2 with all capacitors equal:

$$\Delta V_L = \Delta V_N + \Delta V_{N-1} + \dots + \Delta V_1$$

where

$$\Delta V_N = IN/(fC).$$

$$\Delta V_{N-1} = [I/(fC)] [2N + (N-1)].$$

$$\Delta V_1 = [I/(fC)] [2N + 2(N-1) + \dots + 2(2) + 1].$$

As a result:

$$\Delta V_L = \sum_{N=1}^N N(2N-1) I/(fC)$$

$$= \left( \frac{2N^3}{3} + \frac{N^2}{2} + \frac{N}{6} \right) + \left( \frac{I}{fC} \right).$$

As with ripple, the capacitors nearest the input affect  $\Delta V_L$  most. So again, selecting capacitance values such that  $C_N = NC_1$ ,  $C_{N-1} = (N-1)C_1$ , etc., produces the lowest total drop:  $\Delta V_L = N^2 I / (fC_1)$ .

### Cascading indefinitely won't help

For large value of  $N$ ,  $\Delta V_L$  increases rapidly. So, cascaded multipliers do have practical output-voltage limits—no matter how many stages you use.

To determine the maximum output voltage for any number of stages, set Eq. 1 equal to zero and differentiate it with respect to  $N$ . For simplicity, ignore the last two terms,  $\Delta V_r$  and  $\Delta V_d$ . Then:

$$V_{\max} = 2NE - [ 2 / (3N^3) ] [ I / (fC) ]$$

$$dV_{\max} / dN = 2E - 2N^2 I / (fC) = 0$$

Now you can get the optimum number of cascaded stages from the following expression:

$$N_{\text{opt}} = (EfC/I)^{1/2} \quad (2)$$

Where capacitance decreases, going down the string, as a multiplier of  $C_1$  the optimum number of stages:

$$N_{\text{opt}} = EfC_1 / I$$

Again, today's multipliers are limited by their capacitors, which are usually high-voltage ceramics. The maximum-voltage-and-capacitance combination, available in production quantities, is about 1000 pF at a 20-kV rating. Also, today's circuits operate at 25

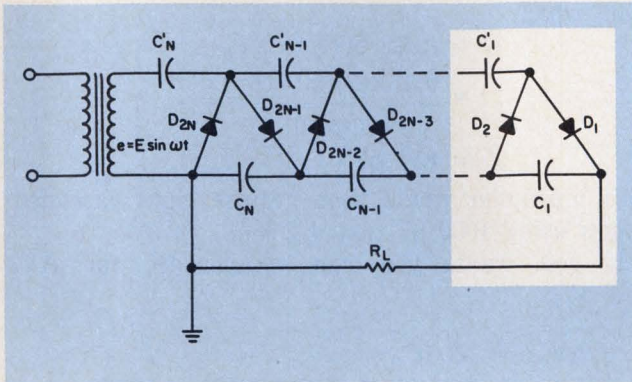

2. An  $N$ -stage cascade multiplier has a theoretical output of twice the number of its stages ( $2N$ ) times the peak input voltage ( $E$ ). Actually, the output is reduced by the load drop, the ripple drop and the diode drop.

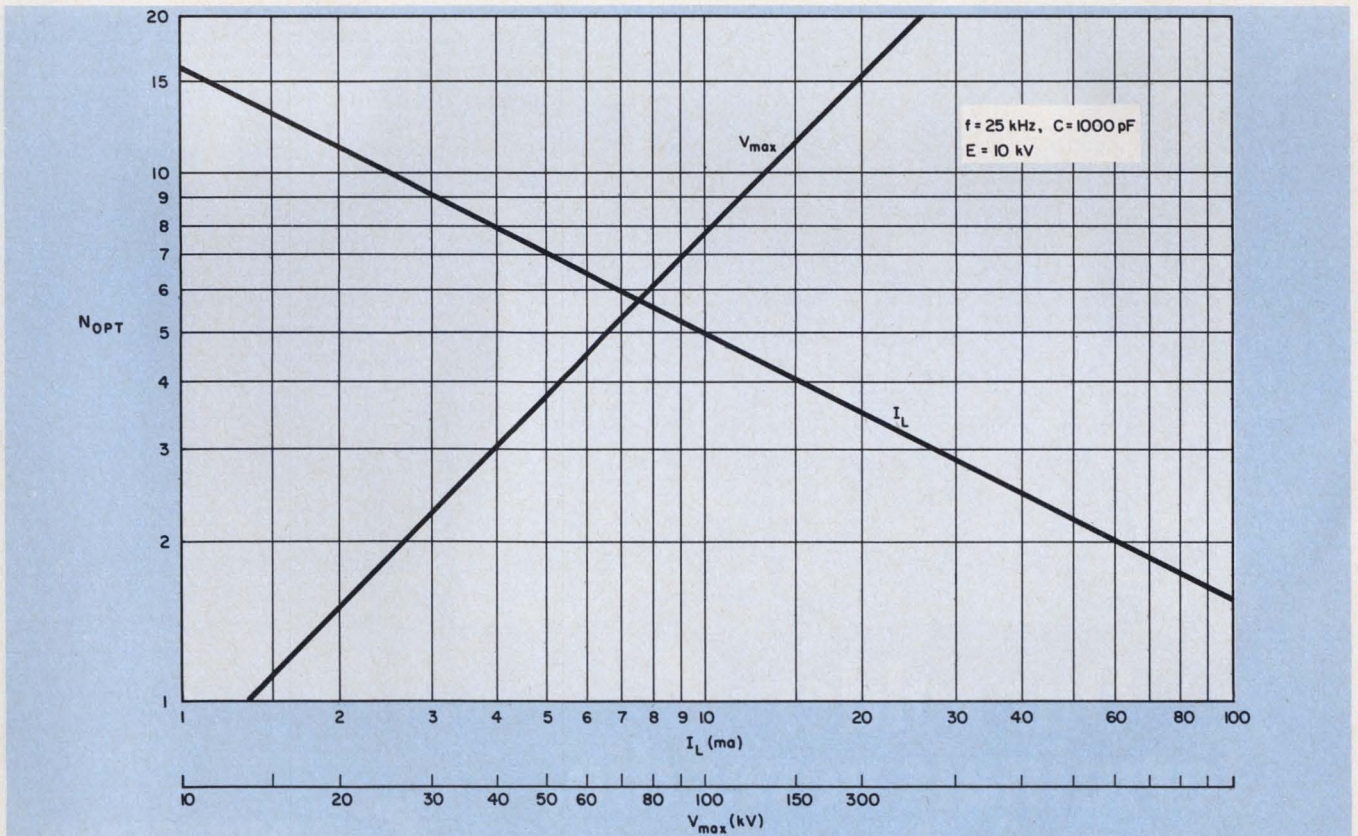

3. The curve for the optimum number of stages, ( $N_{\text{opt}}$ ) versus current ( $I$ ), shows that the number of stages decreases with load current. The curve for maximum

output voltage ( $V_{\max}$ ) versus number of stages shows that the output increases with the number of stages—briskly at first—then more slowly.

kHz. Although higher-frequency components are available, RFI reduction becomes a problem at higher switching frequencies.

The limits for  $f$  and  $C$  used in Eq. 2 give  $N_{opt}$  as a function of  $I$ :

$$N_{opt} = \left[ \frac{10^4 \text{ V} \times 25 \times 10^3 \text{ s}^{-1} \times 10^9 \text{ F}}{I \text{ A}} \right]^{1/2} \quad (3)$$

$$= 0.5/I^{1/2}$$

In Fig. 3, a curve for  $N_{opt}$  versus  $I$ , derived from Eq. 3, shows that for a load current of, say, 30 mA, the optimum number of stages is three. The maximum output voltage then is:

$$V_{max} = 2 \times 3 \times 10^4 - \frac{[2/(3 \times 3^3)] (30 \times 10^{-3})}{25 \times 10^4 \times 10^{-9}}$$

$$= 6 \times 10^4 - 2 \times 10^4$$

$$= 4 \times 10^4.$$

The maximum output voltage is then four times the peak input voltage,  $E$ . The ripple voltage, for this case is only 3.6 kV. Values of  $V_{max}$  for the conditions of Eq. 3 are shown on a separate curve in Fig. 4. If you use  $N=10$  and  $I=2.5$  mA, then  $V_{max} = 130$  kV.

#### Let's be practical

Take a case, where the capacitances and  $N$  must be determined for the following realistic conditions:  
 $f=20$  kHz,

$$E=1 \text{ kV(pk)},$$

$$V_{out} = 15 \text{ kV, and}$$

$$I_L = 50 \mu\text{A}.$$

Obviously, the least number of stages that can be used is eight. This gives 16 kV as the maximum theoretical voltage ( $2NE$ ):

$$2NE - V_{out}$$

$$= 16 \text{ kV} - 15 \text{ kV}$$

$$= 1 \text{ kV}.$$

So, let  $\Delta V_L$  be 1 kV (ignore  $\Delta V_r$  and  $\Delta V_d$ ) and solve for  $C$ :

$$\Delta V_L = (2/3)N^3I/(fC)$$

$$= 1 \text{ kV,}$$

from which

$$C = (2/3) N^3(I/f) \Delta V_L$$

$$= \frac{0.67 \times 8^3 \times 50 \times 10^{-6}}{2 \times 10^4 \times 10^3 \text{ V}}$$

$$= 857 \text{ pF}.$$

This multiplier would then require eight cascaded stages using 1000 pF (rated 2 kV).

If you want, you can compensate for  $\Delta V_r$  and  $\Delta V_d$ :

$$\Delta V_r = NI/fC$$

$$= 8 \times 50 \times 10^{-6} / (2 \times 10^4 \times 10^{-9}),$$

$$= 20 \text{ V}.$$

$$\Delta V_d = 2 \times 8 \times 2 \times 1.5$$

$$= 48 \text{ V.} \blacksquare$$



**Our solder terminals never die, never fade away.**

They are made of the finest materials, by people who care about quality and durability. CAMBION offers 96 basic styles, more than 400 types — the widest selection of off-the-shelf solder terminals you can get anywhere. Terminals come in swage, press and thread mount types. Single, double or triple turrets, pin types without turrets, feed-thru, double-ended, hollow, flared and forked types. Close tolerances, precision threads, durable finishes, the best quality base materials — all are standard from CAMBION. Try us. You will return. For a free catalog, write or call CAMBION. Cambridge Thermionic Corporation, 445 Concord Avenue, Cambridge, MA 02138. Phone: (617) 491-5400. In California, 2733 Pacific Coast Highway, Torrance, CA 90505. Phone: (213) 326-7822.

**CAMBION**  
 Guaranteed to be the right connection.



# Wow! Now you can multiply...or multiply and accumulate in 70 nsec

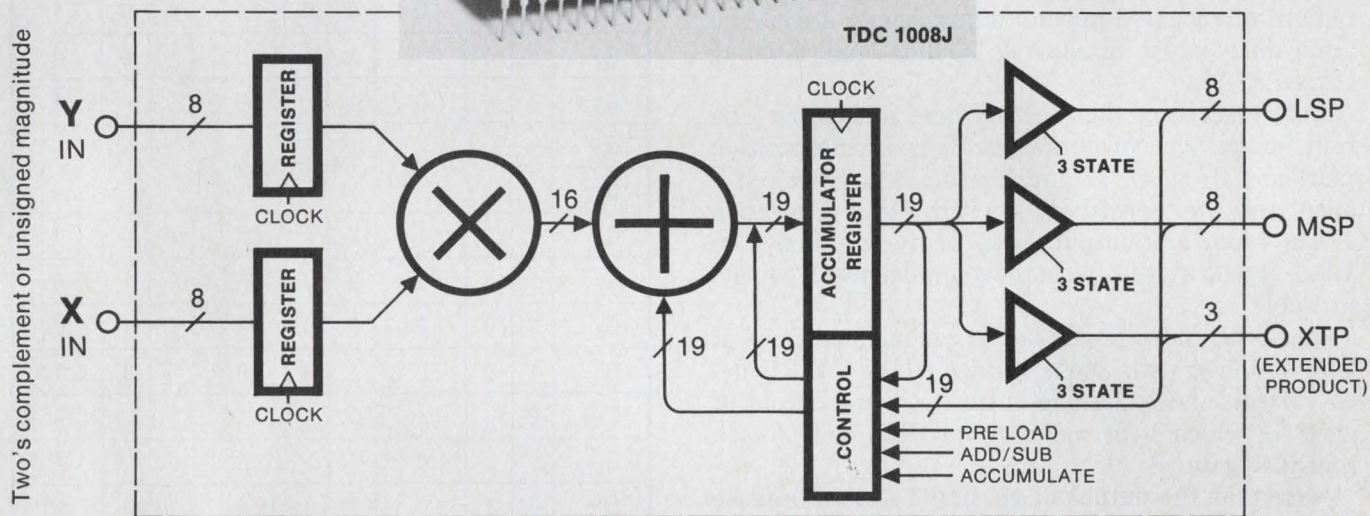
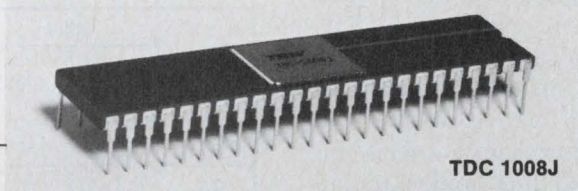

## TDC 1008J

### 70 ns, 8 bits—\$70 in 100's

- Controllable addition or subtraction in accumulator
- Round control
- Bipolar TTL monolithic technology
- Power dissipation of 1.2 watts
- Zero hold time
- Two's complement or unsigned magnitude
- Accumulator preloadable
- Cost effective as a 70 nsec multiplier
- Multiply-accumulate in 70 nsec
- Ideal for complex multiplying and filters (including FFTs)
- (Coming soon: 16 bit multiplier/accumulator)

Let us show you how you can add functions, simplify the design...and reduce total circuit cost. Available from stock from Hamilton/Avnet or contact your local TRW Electronic Components field sales office or call us at (213) 535-1831, or send the coupon.

#### TRW LSI Products

An Electronic Components Division of TRW Inc.,  
P. O. Box 1125  
Redondo Beach, CA 90278

**Please send data sheets on the new TDC 1008J 70 ns, 8x8 bit parallel Multiplier / Accumulator.**

NAME \_\_\_\_\_

COMPANY \_\_\_\_\_

DIV/DEPT \_\_\_\_\_

MAIL CODE \_\_\_\_\_

ADDRESS \_\_\_\_\_

CITY \_\_\_\_\_

STATE \_\_\_\_\_

ZIP \_\_\_\_\_ ED-3

**TRW** LSI PRODUCTS  
... for Digital Signal Processing

CIRCLE NUMBER 42

## Measure SCR parameters automatically.

Relieve the boredom of manual adjustments with a circuit that pins down holding current and other characteristics.

An automatic electronic circuit can easily, quickly and accurately measure an SCR's holding, latching and gate currents, its gate voltage, and its forward anode-to-cathode voltage. Currents can go as high as 500 mA and the measurement can reach 5 V. The circuit, slightly modified, can measure other SCR characteristics.<sup>1</sup> The automatic feature relieves the tedium of repeated manual adjustments, a common annoyance when measuring holding and latching currents.<sup>2,3</sup>

Before starting the measurement of holding current, make sure mode switch  $S_1$  is in the position marked  $I_H$  (Fig. 1). The pushbutton "start" switch is open, and the "sensitivity" switch,  $S_3$ , is in position 1. The input and output states of the gates,  $G_i$  ( $i = 1, 2, \dots, 14$ ), are indicated in the column marked "Quiet" in Table 1.

The SCR under test is not in conduction, then—it isn't supplied with anode voltage (relay RY-1 is de-energized), and triggering pulses from the output of gate  $G_6$ , which is permanently at ONE, don't reach the SCR gate.

Note that the output of op amp 4 is zero because capacitor  $C_2$  isn't charged. And FET 2 is in cut-off since the voltage at the comparator output and at point B is 5 V.

### Getting started

To start the measurement, simply press  $S_2$ . The outputs of the R-S flip-flop will change state, and change the output state of gate  $G_7$  from ZERO to ONE. The SCR is then triggered by pulses produced by the multivibrator via gate  $G_6$  and transistors  $T_8$ ,  $T_7$  and  $T_6$ . The voltage at point B is kept at 5 V until relay RY-1 energizes and supplies 15 V to the anode of the SCR.

At that moment—and before the SCR fires—the input and output states of the gates look like those in the column marked "Start" in Table 1. As soon as the SCR fires, the outputs of both the comparator and point B become zero and the input-output states of

**Table 1. Gate states for the three circuit modes.**

Gate	Quiet			Start			Measurement		
	Inputs		Output	Inputs		Output	Inputs		Output
	L	R		L	R		L	R	
G <sub>1</sub>	1	1	0	0	0	1	0	0	1
G <sub>2</sub>	0	0	1	1	0	0	1	0	0
G <sub>3</sub>	1		0	1		0	0		1
G <sub>4</sub>	Multivibrator								
G <sub>5</sub>									
G <sub>6</sub>	X	0	1	X	1	X	X	0	1
G <sub>7</sub>	1	0	0	0	0	1	0	1	0
G <sub>8</sub>	1	0	0	0	0	1	0	1	0
G <sub>9</sub>	1	0	0	1	0	0	0	0	1
G <sub>10</sub>	0		1	0		1	1		0
G <sub>11</sub>	1		0	1		0	0		1
G <sub>12</sub>	0	1	0	0	0	1	1	0	0
G <sub>13</sub>	0		1	1		0	0		1
G <sub>14</sub>	1	1	0	0	0	0	0	0	1

L: Left, R: Right, X: Don't care

the gates change (see the column marked "Measurement" in Table 1).

Now comes the holding-current measurement. Gate  $G_{14}$  supplies a 5-V step to the input of op amp 1, which in turn gives a -15-V step. FET 1 is cut off,  $C_1$  is no longer "shorted," and op amp 2 starts to integrate the -15-V step.

The voltage at the output of power transistors  $T_3$  and  $T_4$  is found with:

$$V_{AK}(t) = 15 - \int_0^t k dt \\ = 15 - kt; t(0, t_H),$$

where  $k$  is a constant that depends upon the RC value of the integrator, and  $T_H$  is the period of measurement. The curve corresponding to the relationship is indicated in Fig. 2, and is shaped like the curve of the voltage applied to the SCR's anode.

At the same time, transistor  $T_6$  energizes FET 2 (because of the zero voltage at point B) so the SCR

Dr. E.C. Servetas, Group Leader, and C.J. Precas, Technical Assistant, Electronics Div., Nuclear Research Center, Greek Atomic Energy Commission, Attiki, Athens, Greece.

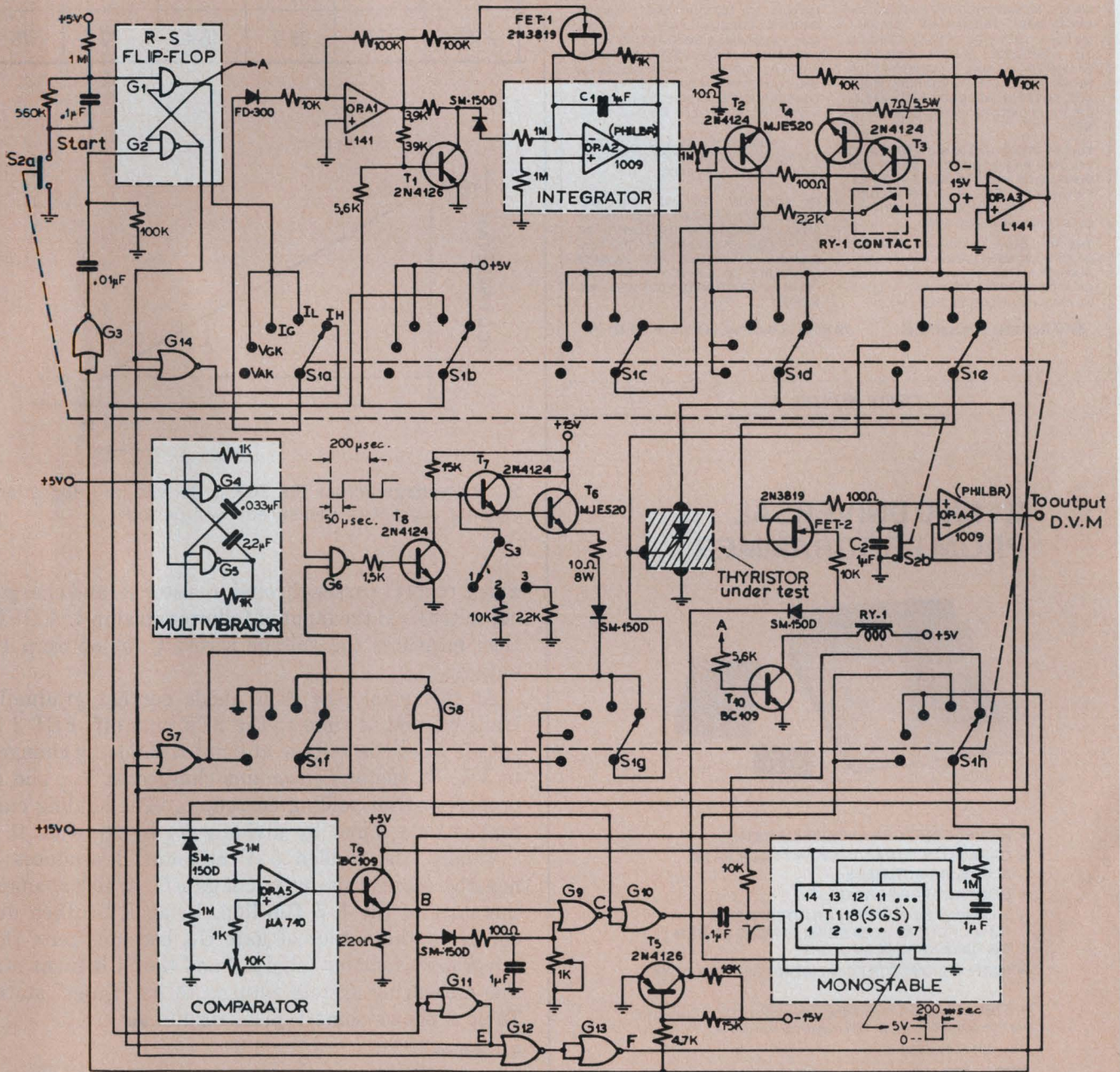

NOTE : ANDs & NORs ARE SGS 7400 AND 7402, RESPECTIVELY.

1. This automatic measuring system starts at the press of a button (S<sub>2</sub>). Results are registered on an external DVM.

small wonders

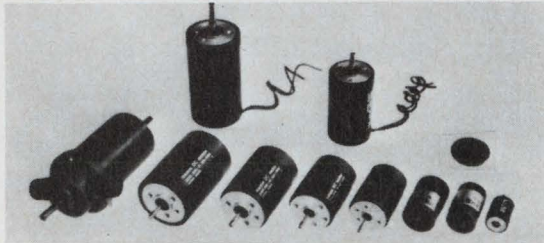

**HICO-maxon**

MINIATURE PRECISION DC MOTORS

**MAXON DC MOTOR**

MAXON DC MOTORS DIFFER FROM CONVENTIONAL PERMANENT MAGNET MOTORS. THEY ARE CONSTRUCTED ON THE IRONLESS ROTOR PRINCIPLE PATENTED IN MANY COUNTRIES, IN WHICH A HOLLOW CYLINDRICAL WINDING ROTATES AROUND A DIAMETRICALLY POLARISED PERMANENT MAGNET.

THIS FEATURE HAS A HIGH POWER TO VOLUME RATIO, GIVES A VERY LOW MOMENT OF INERTIA AND A HIGH EFFICIENCY OF MORE THAN 80% ACCORDING TO APPLICATION AT MINIMAL ELECTRICAL ENERGY LOSS.

THE HIGH QUALITY COMMUTATOR HAS UP TO 13 SEGMENTS AND IS OF MINIMAL DIAMETER. THE BRUSHES ARE MADE OF SPECIAL PRECIOUS METAL ALLOYS, WHICH ENSURE LONG LIFE.

MAXON DC MOTORS OFFER ULTRA SMOOTH TORQUE, FAST RESPONSE, QUIET RUNNING, LOW STARTING VOLTAGE AND A WIDE VOLTAGE RANGE. THEY ALSO HAVE LINEAR VOLTAGE, SPEED AND TORQUE CHARACTERISTICS, ENABLING THEM TO BE CONSIDERED IN A VERY WIDE FIELD OF APPLICATIONS.

THE RANGE ALSO INCLUDES MOTOR-TACHOGENERATOR ASSEMBLIES, AND A CHOICE OF GEARHEADS.

IN ADDITION TO THE STANDARD RANGE, AN EXTENSIVE PROGRAM OF SPECIALS HAS BEEN DEVELOPED TO CATER FOR SPECIFIC NEEDS. OUR CONSULTING ENGINEERS ARE ALWAYS AVAILABLE TO ASSIST YOU WITH AN OPTIMUM SOLUTION TO YOUR REQUIREMENTS.

HICO Horizons International

716 Willow Rd, Menlo Park, Ca. 94025 Ph: 415-328-1111

CIRCLE NUMBER 43

**IM1000 UNIVERSAL PROM PROGRAMMER**



- HIGHEST PERFORMANCE/PRICE RATIO
- CAPABILITY TO PROGRAM ANY PROM FROM ALL MANUFACTURERS
- COMPACT FOR PORTABILITY
- TWO RS232 I/O PORTS FOR INTERFACING TO MICROCOMPUTER DEVELOPMENT SYSTEM OR TIMESHARE COMPUTERS
- 32000 BIT RAM FOR FULL EDITING OF PROM DATA

The IM1000 sells for \$1695. Personality Modules \$330. Contact us for a demonstration by our nationwide representatives.

TEL: 301/340-7505

**IM** International Microsystems, Inc.  
638 Lofstrand Lane  
Rockville, Md. 20850

CIRCLE NUMBER 44

**Table 2. Typical SCR parameters measured at 25°C**

SCR	$I_H$ (mA) $V_{AK}=15V$ Open gate	$I_L$ (mA) $V_{AK}=15V$ Open gate	$I_{GT}$ (mA) $V_{AK}=15V$ $R_L=100\Omega$	$V_{GT}$ (volts) $V_{AK}=15V$ $R_L=100\Omega$	$V_{AK}$ (volts) $I_T=.15A$
2N1599	3.2	5.5	2.6	.64	.82
2N4172	27.0	46.9	24.0	.75	.83
2N688	11.5	17.1	6.8	.92	.75
2N6173	9.7	17.2	7.7	.68	.73
2N6169	17.6	35.0	16.4	.70	.76

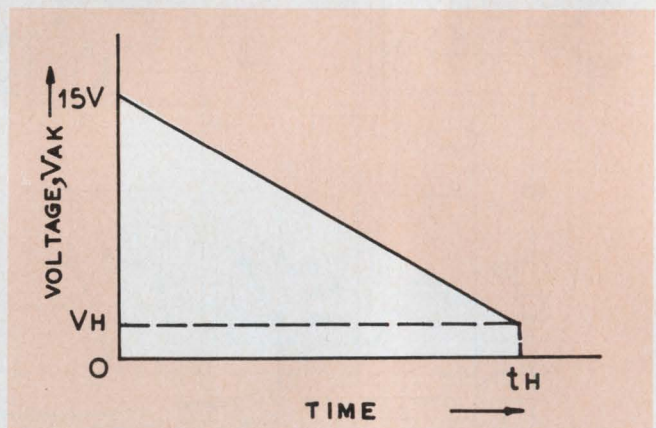

2. The voltage across the SCR is derived by integration. Holding current is measured over period  $t_H$ .

anode current passes through resistor  $R_1$  and charges capacitor  $C_2$  at the input of follower op amp 4. A DVM then measures the voltage across  $C_2$  at op amp 4's output.

At this point, the SCR anode current gradually trails off and at time  $t_H$  the SCR cuts off. FET 2 is cut off when the voltage at point B suddenly changes to 5 V. Capacitor  $C_2$  remains charged at  $V_H$ , and is proportional to holding current  $I_H$ . The holding current is then found by dividing  $V_H$  by  $R_1 = 10 \Omega$ .

Finally, the sudden 5 V at point B produces a negative pulse at the output of gate  $G_3$ , which changes the state of the R-S flip-flop. Relay RY-1 then de-energizes, the output of gate  $G_{14}$  becomes zero, the integrator capacitor "shorts," and the SCR turns off. The measuring system returns to its "Quiet" state. Table 2 shows some typical results. ■■

**References**

1. Tani, Tatsuo, et al, "Measuring System for Dynamic Characteristics of Semiconductor Switching Elements and Switching Loss of Thyristors," *IEEE Transactions on Industrial Applications (USA)*, Vol. 1A.11, No. 6, Nov.-Dec., 1975, p. 720-7.
2. Murray, R., Jr., Editor, *Westinghouse Silicon-Controlled Rectifier Designer's Handbook*, Youngwood, PA, April, 1964.
3. Grafham, D.R., and Hey, J.C., Editors, *SCR Manual*, 5th Edition, General Electric, Syracuse, NY, 1972.

CIRCLE NUMBER 45 ►

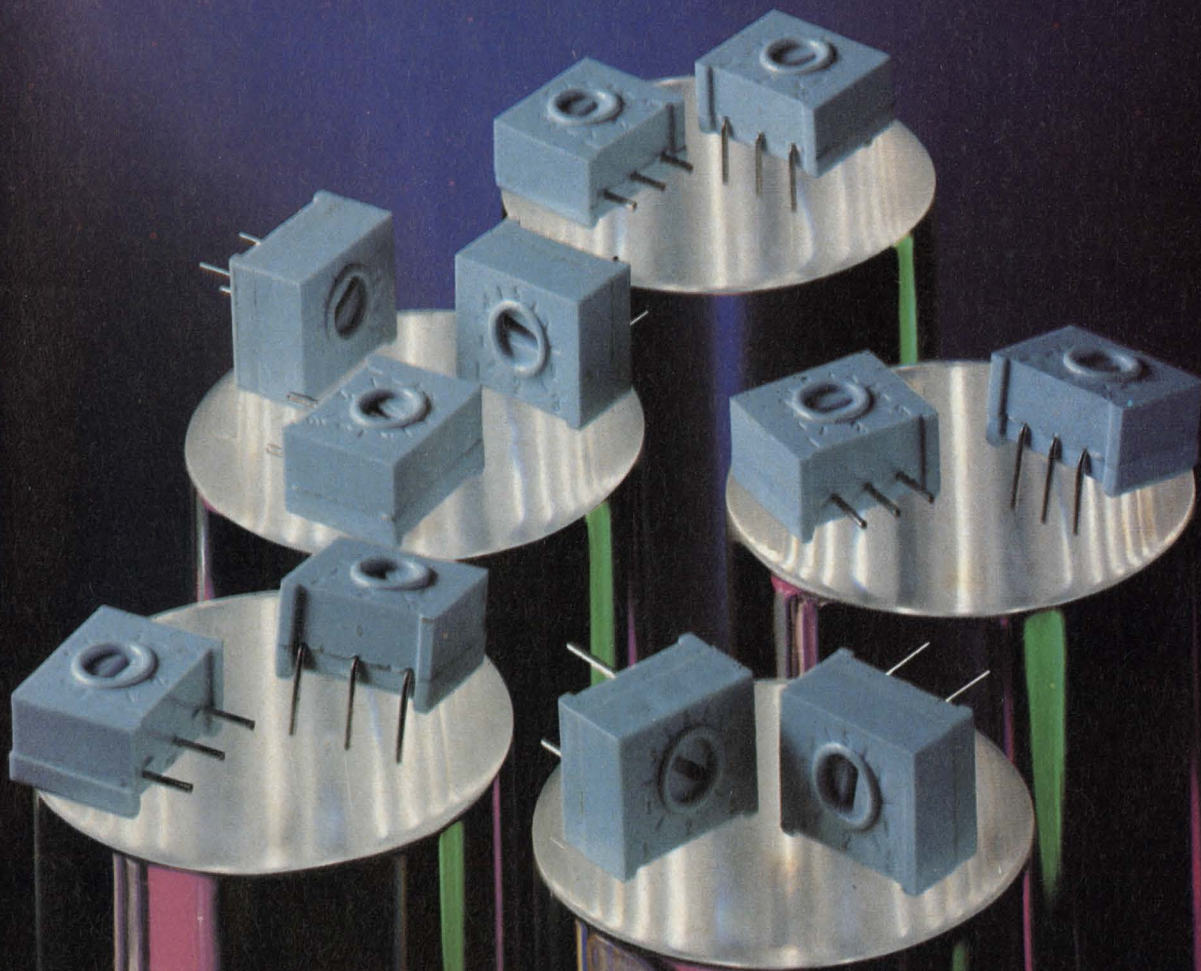

## Go the full 360 with CTS...

**Series 360 single turn cermet trimmers.** You couldn't travel in better trimmer circles than CTS. With the CTS Series 360 family, 1 of the 11 pin styles is sure to satisfy your trimmer needs. And that's especially true if you're designing for digital voltmeter-ammeter-ohmmeter applications, TWX equipment, sweep generators, oscilloscopes, aircraft radio and navigation equipment, computer peripheral equipment, automotive braking equipment, calculators, engine and emission control analyzers or fire detection equipment. Plus our latest application, the speaker phone.

How's that for a full circle of satisfied needs!

You get all-around performance from the CTS 360 cermet trimmers. Eleven popular grid spacings in-

cluding top and side adjust on .100", .125", .150" and T0-5 centers. Power rating 1 watt @ 25°C, ½ watt @ 85°C. Standard TC  $\pm 150$  ppm/°C throughout the resistance range. Settability .03%. New gold plated multicontact wiper for lowest possible noise level. Mini dimensions: .360" x .434" x .298"

The price of each 360 style is low; your CTS distributor's inventory is high—call him today; get it promptly.

For nonstandards—and for complete information—write directly to the company that has put millions into electronics for industry. **CTS of West Liberty, Inc., 6800 County Road 189, P.O. Box 266, West Liberty, Ohio 43357. Phone (513) 465-3030.**

**CTS CORPORATION**  
ELKHART, INDIANA



A world leader in cermet and variable resistor technology.

# A whole new connector series for I/O applications

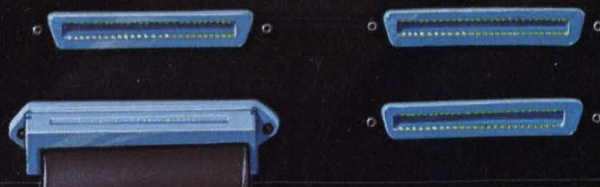

The introduction of our new BLUE MACS® Ribbon Connectors, designed in accordance with IEEE Standard 488, represents another Ansley engineering breakthrough in lower installed cost mass termination technology.

Ansley's BLUE MACS Ribbon Connector series terminates to standard 50 mil pitch cable which provides complete compatibility with all the other connectors in the system.

The Ribbon Connector incorporates all the BLUE MACS benefits, including the 4-point TULIP® contact for maximum termination reliability, and a one-piece design for fast, low cost assembly and positive cable-to-contact alignment.

This line is added to our complete family of "D" Series connectors now available from stock in 9, 15, 25 and 37 pin configurations. In addition, we offer a wide variety of UL listed jacketed cable for external use with these connectors.

This allows you more freedom when selecting connectors for future design.

All connectors are available with a broad selection of mounting hardware to various strain relief configurations. For the full reliability/cost effectiveness story and technical data, call or write:

## T&B / Ansley

The mass termination company.

T&B/Ansley Corporation • Subsidiary of Thomas & Betts Corporation  
3208 Humboldt St. • Los Angeles, CA 90031 • Tel. (213) 223-2331  
TELEX 68-6109 • TWX 910-321-3938

CIRCLE NUMBER 46

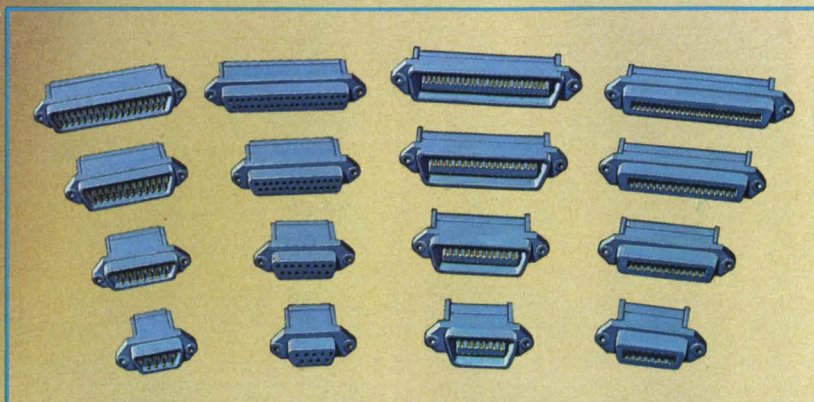

STOCKED AND SOLD THROUGH AUTHORIZED ANSLEY DISTRIBUTORS.

International T&B/Ansley Offices: AUSTRALIA, Brookvale, (02) 938-1713 • AUSTRIA, Vienna, (222) 6232365 • CANADA, Iberville, Quebec, (514) 658-6611 • ENGLAND, Luton, (0582) 597-271 • FRANCE, Rungis, 687-23-85 • HOLLAND, Zoetermeer, (79) 214688 • ITALY, Milano, 02-4986451 • JAPAN, Tokyo, 03-354-9661 • SINGAPORE (65) 2923711 • SOUTH AFRICA, Benrose 24-8134 • SPAIN, Barcelona, (93) 212-8607 • SWEDEN, Upplands Vasby, 0760-86140 • SWITZERLAND, Hombrechtikon, (04155) 422791 • WEST GERMANY, Dreieich bei Frankfurt, 06103-8 20 21 •

# Unimpeachable sources.



6010A

For frequency synthesizers and signal generators with outstanding spectral purity, come to Fluke—THE source for measurement dependability.

## The smart but friendly 6010A

The industry's first microprocessor-based signal generator has 10 Hz to 11 MHz coverage, resolution to 0.1 Hz and 3 ppm/year frequency accuracy. The keyboard lets you store up to 10 frequency, modulation and attenuator settings for instant recall. Easy to use and buy at \$2695.\*

## The multi-talented 6011A

Take the range, resolution and accuracy of the 6010A and add to it keyboard level entry in volts rms, volts peak-peak, or dBm—and you have the 6011A. Just right for general purpose or calibration laboratory use. And, with systems options, a real value! \$4195.\*

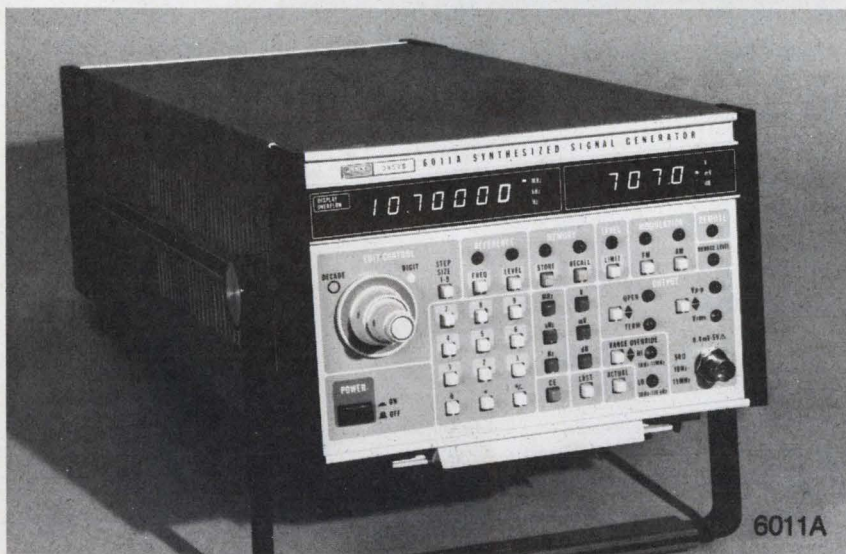

6011A

## For an outside reference, consult the 6039A

To select from 1 to 40 MHz in two ranges with 0.1 Hz resolution (low range) or 1.0 Hz resolution (high range), look to the 6039A. Perfect for auto-test systems, as a receiver stimulus generator, or as a replacement for local oscillators in receivers! Use your own external 5 MHz reference, or opt for ours, built-in. Base price: \$3995.\*

## Expect a clean output

Our 6160B frequency synthesizer features an industry-leading spur spec of greater than -83 dB. Covering 1 to 160 MHz in two ranges, the 6160B has switching speeds under one millisecond and BCD programmable frequency control with TTL logic levels. Impeccable performance for \$5995.\*

CALL (800) 426-0361, TOLL FREE, or write: John Fluke Mfg. Co., Inc., P.O. Box 43210, Mountlake Terrace, WA 98043. IN EUROPE: Fluke (Nederland) B.V., P.O. Box 5053, Tilburg, The Netherlands. Telephone: (013) 673973. Telex: 52237.

\*U.S. Price



FOR LITERATURE CIRCLE NUMBER 47

FOR DEMONSTRATION CIRCLE NUMBER 48



6160B

## Evaluate UV EPROM data retention

to get the best unit. By applying some simple math and tests you can easily determine temperature-related problems.

With over a dozen manufacturers of ultraviolet-erasable PROMs, a good way to determine a unit's quality is to measure its ability to retain data under varying external conditions, such as temperature. Of course, when you use any memory ICs, you would like to know that the data they hold will be retained no matter what the power supply or temperature does. But this is especially critical for UV EPROMs since stored data can readily be eliminated if the stored charge dissipates.

Data loss occurs most rapidly at elevated temperatures—so much so that memory degradation increases at an exponential rate as temperatures go up. However, you can turn this fact to an advantage, by performing accelerated testing to determine how well a UV EPROM will retain its data under normal conditions.

To guarantee that the data-retention capability is influenced by as few outside factors as possible it is essential that each unit to be tested be completely erased and then thoroughly programmed according to the manufacturer's directions even before you begin to test the memory chips.

### To determine retention, use MTBF

When an EPROM produces an incorrect output, you can say it failed. The mean time between failures (MTBF) then becomes a good measure of the retention capability, or reliability, of an EPROM. MTBF, in this case, refers to the amount of time that may be expected to elapse from the beginning of life until the first failure. From here on, a failure is defined as a loss or alteration of one or more bits of stored data.

The MTBF of a device is a function of the number of units being operated or tested, the elapsed time of the test and the number of failures that occur. For example, if 100 units are tested for 1000 hours and two failures occur, the observed MTBF is 100,000 hours divided by the two failures, or 50,000 hours.

Actually, failures tend to be distributed randomly over time. The confidence level that 50,000 hours is the true MTBF and that one or more additional

failures will not occur in the next few hours is low. For this reason some statistical treatment is usually performed to provide a more realistic MTBF at a specified confidence level.

One of the most common ways to figure MTBF statistically is the Chi-square distribution, tables for which are available in any standard handbook of statistics. The associated MTBF formula is simple:

$$MTBF = 2T/\chi^2,$$

where T is the number of device hours (number of units  $\times$  test time), and  $\chi^2$  is a value selected from the excerpted portion of the Chi-squared table shown.

To use the Chi-squared table, first determine the number of degrees of freedom, n, which is solely a

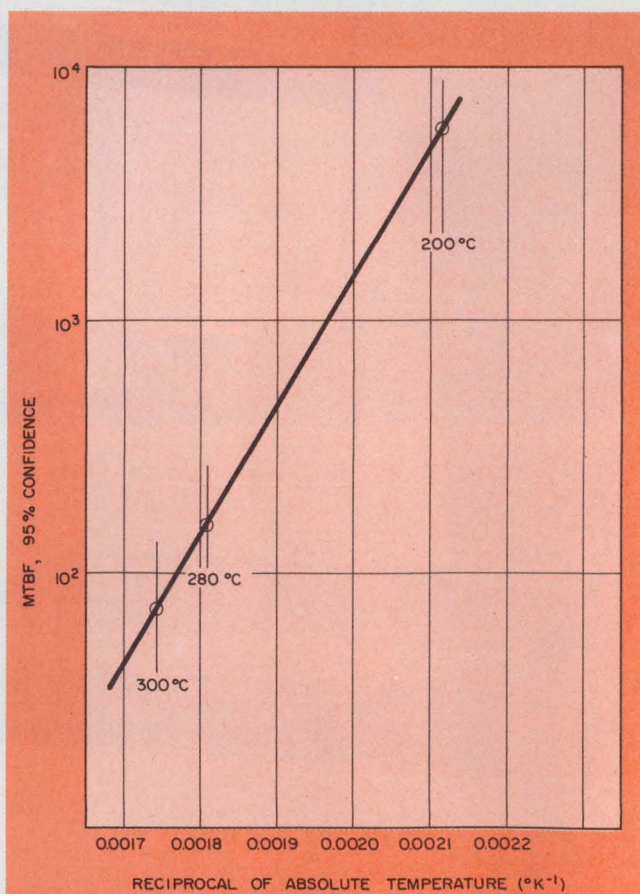

1. By plotting the log of the MTBF against the reciprocal of the absolute temperature, you get a linear graph. The slope is the failure-acceleration factor.

**Robert Woods**, Manager, Quality and Reliability Assurance, Electronic Arrays, 550 E. Middlefield Ave., Mountain View, CA 94043.



function of the number of failures,  $f$ , and equal to  $2f + 2$ .

In the example that had two failures,  $n=6$ . Look up the value of  $\chi^2$  for six degrees of freedom. The column in the table is determined by the confidence level you want. Normally used values in the semiconductor industry are 60 and 90%; however, to keep things conservative, pick a 95% confidence level. Thus, the value of  $\chi^2$  is 12.592.

You can now calculate, with 95% confidence, an MTBF of *no less than*  $2 \times 100,000/12.592$ , or 15,883 hours—less than one-third the observed MTBF of 50,000 hours.

Another term frequently used in reliability predictions is the failure rate—which is nothing more than the reciprocal of the MTBF. Thus, the failure rate of the devices tested in the example is  $1/15,883$  or  $6.3 \times 10^{-5}$ . Or you can multiply the value by  $10^5$  and express it as 6.3% per 1000 hours.

Armed with the MTBF and failure rate, you can quantify the effect of external conditions such as temperature on your data reliability. If tests are conducted at two or more temperatures, for instance, the MTBFs at specified confidence levels can be calculated and the results plotted (MTBF vs temperature). Remember: The thermal effect on reliability is exponential. Your best plot will be the log of MTBF vs reciprocal of absolute temperature.

### Run some tests

Now that you have the basic formulas, take a typical test situation to see what UV EPROM reliability looks like. The graph shown in Fig. 1 was generated from tests run on three test lots of EA2708 8-kbit EPROMs at 200, 280 and 300 C:

Lot 1: 14 units programmed and stored at 200 C for 1198 hours; no devices lost data. MTBF at a 95% confidence level is 5599 hours.

Lot 2: 30 units programmed and stored at 280 C for 24 hours; one device lost data. MTBF at a 95% confidence level is 151.8 hours.

Lot 3: 24 units programmed and stored at 300 C for 19.25 hours; two devices lost data. MTBF at a 95% confidence level is 73.4 hours.

The plot of the MTBFs follows the well-known Arrhenius relationship, which states that temperature accelerates failure rate by a factor,  $F$ , such that:

$$F = \exp \left( \frac{E}{K} \left[ \frac{1}{T_1} - \frac{1}{T_2} \right] \right), \quad (1)$$

where  $F$  is the acceleration factor, expressed as the ratio of MTBFs at two temperatures,  $E$  is the thermal-activation energy expressed in electron volts,  $K$  is Boltzman's constant ( $8.63 \times 10^{-5}$  eV/°K),  $T_1$  is the lower of the two temperatures expressed in °K, and  $T_2$  is the higher temperature, also expressed in °K.

As a result,  $E$  is the value that determines the

failure rate (MTBF) acceleration factor between any two temperatures. It also describes the slope of the curve in Fig. 1. Since the MTBFs have been empirically determined in each of the three lots,  $F$  can be found. And  $E$  can be determined by reversing the equation. Reshuffling the equation, to solve for  $E$ , you get:

$$E = (K / [(1/T_1) - (1/T_2)]) \ln(MTBF_1 / MTBF_2). \quad (2)$$

Plugging in the values for the MTBFs at 300 and 200 C, you get  $E = 1.014$  eV. To verify this answer, use the calculated value of  $E$  and compute the MTBF at the 280-C point. Substitute these values in Eq. 1, and  $F$  becomes 36.379. Now  $MTBF_2$  can be determined from the following relationship:

$$\begin{aligned} MTBF_2 &= MTBF_1 / F, \text{ or} \\ MTBF_2 &= 5599 / 36.379 \\ &= 153.9 \text{ hours.} \end{aligned}$$

The result is very close to the empirically calculated value for Lot 2.

Don't jump to conclusions, however: The activation energy determined in this example describes the effect of temperature on *one* type of EPROM's data retention. This value is associated with a specific combination of failure mechanisms that relate directly to the processing steps involved. Don't assume that the value applies to another device type, another manufactur-

### Sample Chi-squared table

$\epsilon$	0.75	0.90	0.95	0.975	0.99	0.995
1	1.323	2.706	3.841	5.024	6.635	7.879
2	2.773	4.605	5.991	7.378	9.210	10.597
3	4.108	6.251	7.815	9.348	11.345	12.838
4	5.385	7.779	9.488	11.143	13.277	14.860
5	6.626	9.236	11.071	12.833	15.086	16.750
6	7.841	10.645	12.592	14.449	16.812	18.548
7	9.037	12.017	14.067	16.013	18.475	20.278
8	10.219	13.362	15.507	17.535	20.090	21.955
9	11.389	14.684	16.919	19.023	21.666	23.589
10	12.549	15.987	18.307	20.483	23.209	25.188
11	13.701	17.275	19.675	21.920	24.725	26.757
12	14.845	18.549	21.026	23.337	26.217	28.299
13	15.984	19.812	22.362	24.736	27.688	29.819
14	17.117	21.064	23.685	26.119	29.141	31.319
15	18.245	22.307	24.996	27.488	30.578	32.801
16	19.369	23.542	26.296	28.845	32.000	34.267
17	20.489	24.769	27.587	30.191	33.409	35.718
18	21.605	25.989	28.869	31.526	34.805	37.156
19	22.718	27.204	30.144	32.852	36.191	38.582
20	23.828	28.412	31.410	34.170	37.566	39.997
21	24.935	29.615	32.671	35.479	38.932	41.401
22	26.039	30.813	33.924	36.781	40.289	42.796
23	27.141	32.007	35.172	38.076	41.638	44.181
24	28.241	33.196	36.415	39.364	42.980	45.559
25	29.339	34.382	37.652	40.646	44.314	46.928
26	30.435	35.563	38.885	41.923	45.642	48.290
27	31.528	36.741	40.113	43.194	46.963	49.645
28	32.620	37.916	41.337	44.461	48.278	50.993
29	33.711	39.087	42.557	45.722	49.588	52.336
30	34.800	40.256	43.773	46.979	50.892	53.672
31	35.887	41.422	44.985	48.232	52.191	55.003
32	36.973	42.585	46.194	49.480	53.486	56.328
33	38.058	43.745	47.400	50.725	54.776	57.648
34	39.141	44.903	48.602	51.966	56.061	58.964
35	40.223	46.059	49.802	53.203	57.342	60.275
36	41.304	47.212	50.998	54.437	58.619	61.581
37	42.383	48.363	52.192	55.668	59.892	62.883
38	43.462	49.513	53.384	56.896	61.162	64.181
39	44.539	50.660	54.572	58.120	62.428	65.476
40	45.616	51.805	55.758	59.342	63.691	66.766
41	46.692	52.949	56.942	60.561	64.950	68.053
42	47.766	54.090	58.124	61.777	66.206	69.336
43	48.840	55.230	59.304	62.990	67.459	70.616
44	49.913	56.369	60.481	64.201	68.710	71.893
45	50.985	57.505	61.656	65.410	69.957	73.166

# Pancake Resolvers

Custom-designed  
for complex  
applications.



Our special-design resolvers are today performing on missiles, aircraft, submarines, radar and satellite systems. Our pancakes, in sizes 16 through 134 and in single and dual speed configurations, are among the most reliable and accurate resolvers available. As are our standard resolvers. We deal in difficult, custom applications, using engineer-to-engineer contact with detailed technical interchanges to assure smooth production, delivery and absolute performance. As a result, American Electronics, Inc. has been, for over 15 years, one of the leading suppliers of custom resolvers. Call or write for our free data package with complete 20-page technical work on resolvers, including outline and performance details.

**AEI** AMERICAN ELECTRONICS, INC.  
ELECTRO-MECHANICAL INSTRUMENTS DIVISION  
1600 VALENCIA DRIVE, FULLERTON, CA 92631 TELEPHONE (714) 871-3020  
CIRCLE NUMBER 49

## Custom Services for the Device You Need

When your vendor parries your request for a transistor, diode or microcircuit of peculiar constraints, or refuses to modify the standard device you need to meet tough military requirements, give us a call.

Our special services—including special processing, special testing, and special packaging—let you design exactly the device you need.

No need to compromise. Call (617) 491-1670.

**TELEDYNE**  
**CRYSTALONICS**

147 Sherman Street, Cambridge, MA 02140  
Tel: (617) 491-1670 • TWX 710-320-1196



CIRCLE NUMBER 50

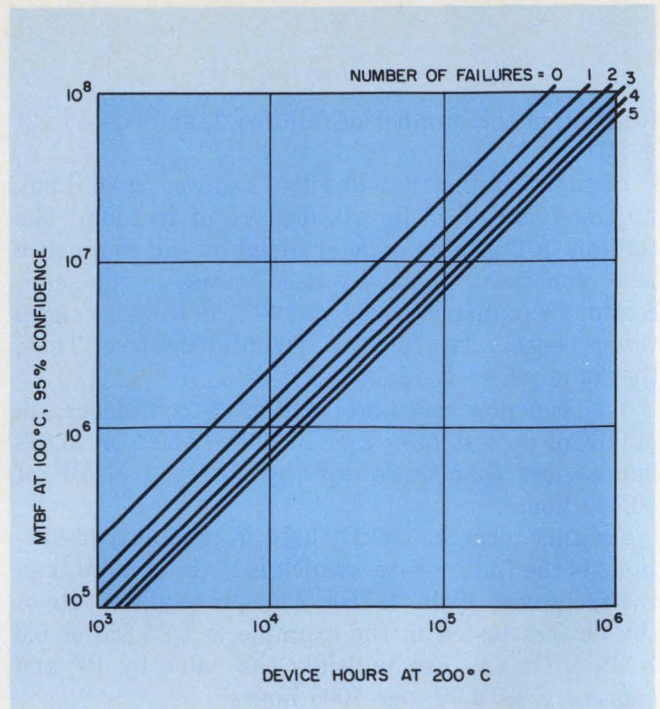

2. This nomograph of MTBF at 100 C vs hours at 200 C can be derived from the MTBF at 200 C multiplied by the acceleration factor.

er's EPROM or any other device attributes. However, the techniques used are universally applicable.

### Use the data to good advantage

You are now in a position to use the data generated to predict memory lifetimes at normal operating temperatures. Using the same EPROM as a model, you can find the acceleration factor from 200 C to 100 C (70-C ambient with a 30-C rise in junction temperature) with a thermal activation energy of 1 eV:

$$F = \left[ \exp \left( \frac{1}{8.63} - 10^{-5} \right) \left( \frac{1}{273+100} \right) - \left( \frac{1}{273+200} \right) \right] = 711.8$$

The MTBF at 100 C and a 95% confidence level is, thus,  $5599 \times 711.8$ , or  $3.99 \times 10^6$  hours (455 years)—a failure rate of 0.025% per 1000 hours. By plotting MTBF against device hours, as in Fig. 2, you can determine the EPROM reliability. For example, if 10 units are tested for 100 hours at 200 C and one failure occurs, the abscissa of the graph is entered at  $10 \times 100$  (1000) hours, and the ordinate value corresponding to one failure can be read out—about  $1.5 \times 10^5$  hours (the MTBF at 100 C with a 95% confidence level).

Using the same graphic procedure you can easily construct a graph that relates any two temperatures. Just bear in mind the following relationships:

$$MTBF = 2T/\chi^2$$

$$MTBF_1 = (F) (MTBF_2) = (2T_2/\chi^2)(F)$$

With the acceleration factor calculated by the Arrhenius relationship, the appropriate values of device hours and the Chi-squared value can be entered to provide the points for the graph. ■■

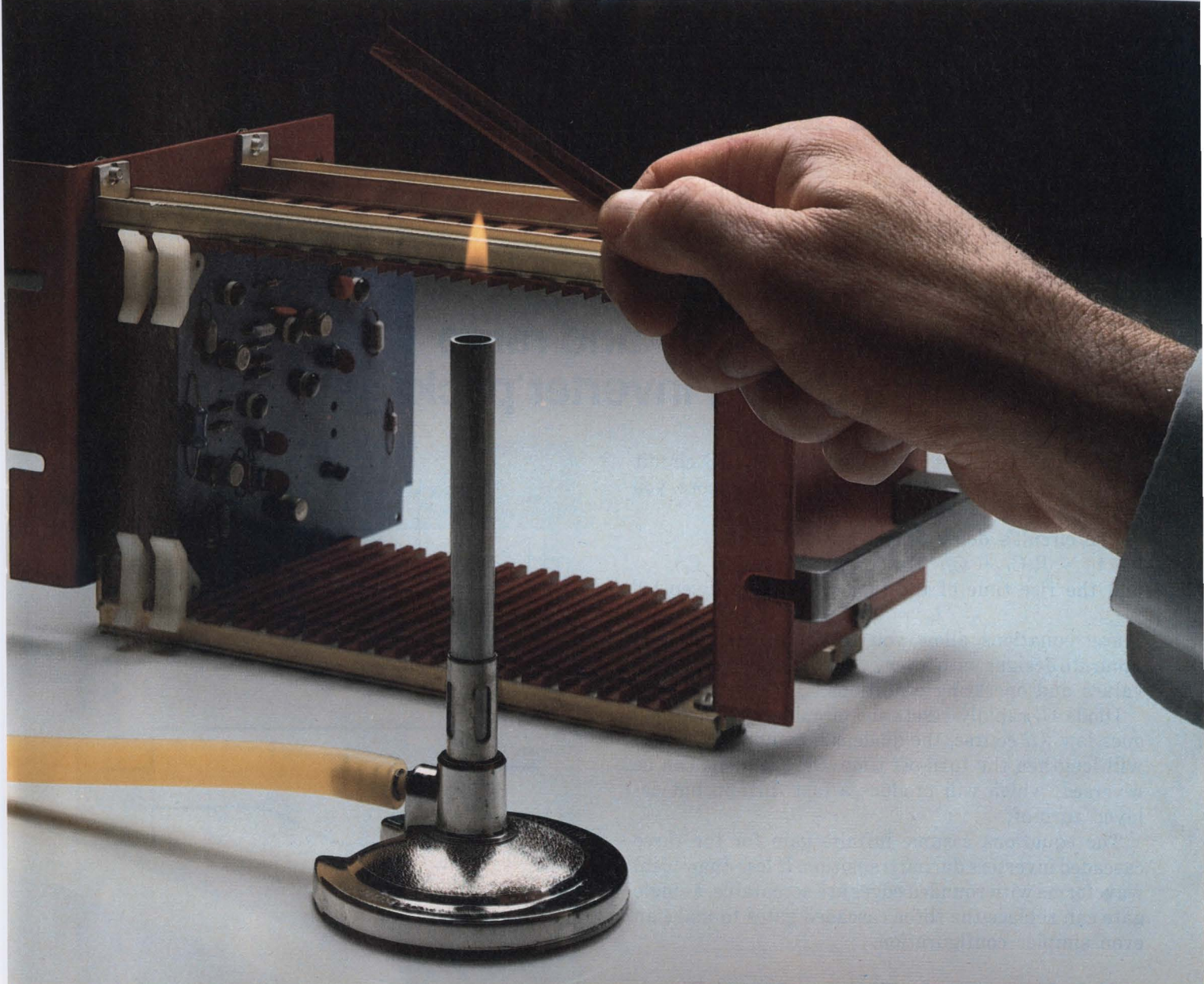

## Vydyne® M-340 nylon. It meets UL standards for fire-retardancy.\* And Bivar's standards for performance.

When Bivar, Inc., of Santa Ana, California, wanted to introduce a new line of PC board card guides, they looked into Monsanto's line of Vydyne® nylon resins. They required a material with good fire-retardant characteristics for the computer and instrumentation fields. Good enough to meet UL standards. Rigid enough for the application. Yet flexible enough for the required snap-in insertion feature.

Vydyne M-340 by Monsanto was the answer. It has a UL rating of 94V-0 down to 1/64 of an

inch, 94-5V down to 1/32 of an inch. Vydyne M-340 also offers natural lubricity for easy card insertion and a distinct color for easy identification as a fire-retardant.

The fact is, Monsanto standards for Vydyne M-340 are high enough to meet UL standards, and high enough to meet yours.

For information, write: Monsanto Plastics & Resins Co., an operating unit of Monsanto Co., Dept. 804, 800 N. Lindbergh Blvd., St. Louis, Mo. 63166.

**VYDYNE**  
NYLON RESIN BY MONSANTO

CIRCLE NUMBER 51

**Monsanto**

\*These UL numerical flame spread ratings are not intended to reflect hazards presented by this or any other material under actual fire conditions.

## Get a controlled delay and ramp with a single CMOS inverter package

One CMOS inverter package with an RC circuit makes a simple time-delay circuit. Furthermore, you get a controlled turn-on rise time,  $t_R$ .

The circuit's delay time is given by

$$t_D = R(C_1 + C_2) \cdot \ln 2 = 0.693 R(C_1 + C_2),$$

and the rise time of the turn-on ramp is given by

$$t_R = 2RC_2.$$

These equations allow you to get predictable and accurate designs with a very wide range of component values and operating conditions.

Diode  $D_1$  rapidly resets the circuit when the input goes low. Of course, the diode can be omitted, which will lengthen the turn-off time. Or, the diode can be reversed, which will produce a fast turn-on but delayed turn-off.

The equations assume infinite gain for the three cascaded inverters during transition. If less-than-ideal waveforms with rounded edges are acceptable, a single gate can replace the three cascaded gates to make an even simpler configuration.

*D. R. Morgan, Senior Engineer, General Electric Co., Electronic Laboratory, Syracuse, NY 13201.*

CIRCLE NO. 311

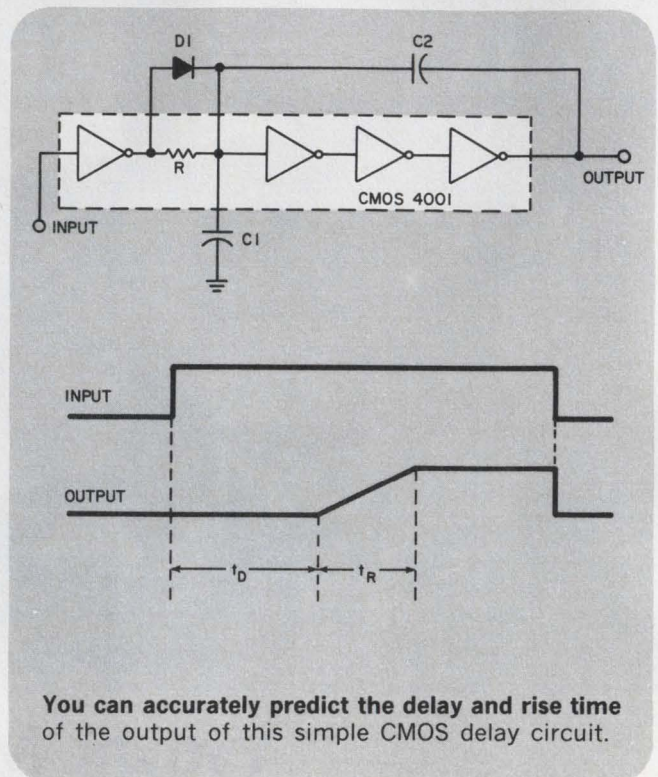

## Plotting routine produces compact, high-resolution graph

A special but simple routine written in BASIC can plot over 1000 points with a resolution better than 1% (see graph and program). Ordinary software routines for plotting graphs on conventional printers usually have limited resolution and number of points, or else the printers end up using miles of paper.

The graph is a typical plot generated by the BASIC routine, and you must draw a pencil line through the

digit printed in each column. Your line should touch an individual digit at a point which corresponds to its numerical percentage value. For example, your pencil crosses the digit 5 at 50% of the 5's height (roughly in the middle); it touches a 9 at 90% of the 9's height, or just about at the top.

The line is thus an accurate analog of the trend of the plot. Each digit represents the least-significant

If you need panel instruments with **custom** dials, cases, accuracy, tracking, resistance, response time, or practically any combination of unusual specs...

Buy **Triplett's** designed-for-you **Panel Instruments**

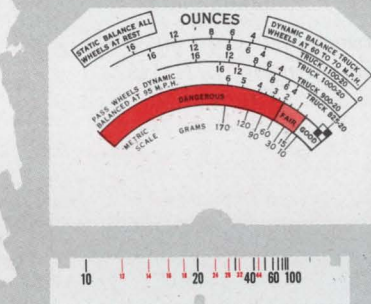
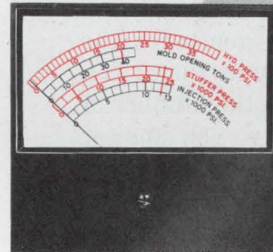
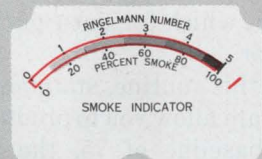
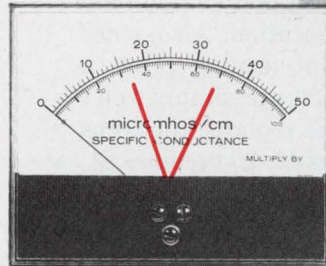
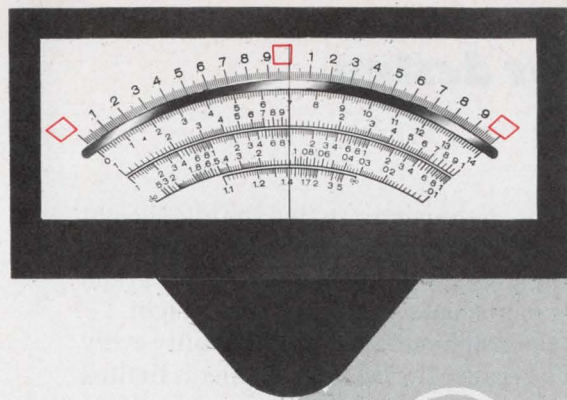

Although we stock some 1369 different styles, sizes and types of standard panel instruments, a very large proportion of our customers buy custom instruments.

Because they need:

**custom dials**

reading in such units as pH, roentgens, mm Hg, rpm, %, inches.

**custom cases**

square, round, rectangular, edge-wise (horizontal and vertical), wide, narrow, shallow.

**custom accuracy**

to within 1/2% with mirror scales and knife-edge pointers.

**custom tracking**

to match the specific needs of existing or new instrument designs.

**custom resistance**

for low circuit loading with tolerances as low as ±1%.

**custom damping**

to meet stringent electrical and vibration requirements.

For instance, one of our customers had us design and manufacture a custom instrument to replace — in every detail of physical and electrical specifications — one which he was using on a delicate piece of medical instrumentation. Rejects from his previous source had risen to over 20%. He rejected only 3 of the first hundred we shipped — with almost negligible rejections from the many hundreds we've shipped since.

What custom panel instrument specifications do you need to make your **CIRCLE NUMBER 52 FOR INFORMATION**

**CIRCLE NUMBER 28 FOR FREE DEMONSTRATION**

product more reliable, more accurate, more rugged and — in the long run — less expensive? For quick, dependable delivery of small quantities of Triplett's "designed-for-you" panel instruments, contact your Triplett Sales/Service/Modification Center. For prototypes or production quantities, contact your Triplett representative. He'll put you in touch with our Instrument Designers/Engineers who'll help you analyze the problem and suggest the optimum cost/result solution.

**TRIPLETT**  
BLUFFTON, OHIO 45817  
Manufacturers of the World's most complete line of V-O-M's

# Ideas for design

value of the point on the curve. To find the total height of any point, add the value of the ordinate number at which the digit occurs to the digit itself. The graph can show 150 increments in only a 3-in. height.

Notice that the graph contains a discontinuity every 15 steps. That's because the BASIC compiler is limited to a 15-bit word, but no values are missed and only a slight gap appears in the presentation. Also, since the BASIC compiler doesn't print leading zeros, a graph with only the values 10, 20, 30, etc. simply won't plot. To overcome this, the routine replaces the zeros with ones; accordingly 10 becomes 11, 20 becomes 21, and so on, which for most purposes introduces negligible error.

To try this routine, statements 200 through 380 of the program allow you to produce composite sinusoids. With a baseline of 75, the routine generates the number of sine waves specified and sums them. You answer the question WIDTH IS? with the number of values you want computed. Similarly, you answer PERIOD? with the number of values you want before the sinusoid repeats. An answer to the question START? allows the sine waves to be started at any point in its cycle.

Colin J. Shakespeare, Westinghouse Canada, Ltd.,  
Box 5009, Burlington, Ontario, Canada L7R 4B3.

CIRCLE NO. 312

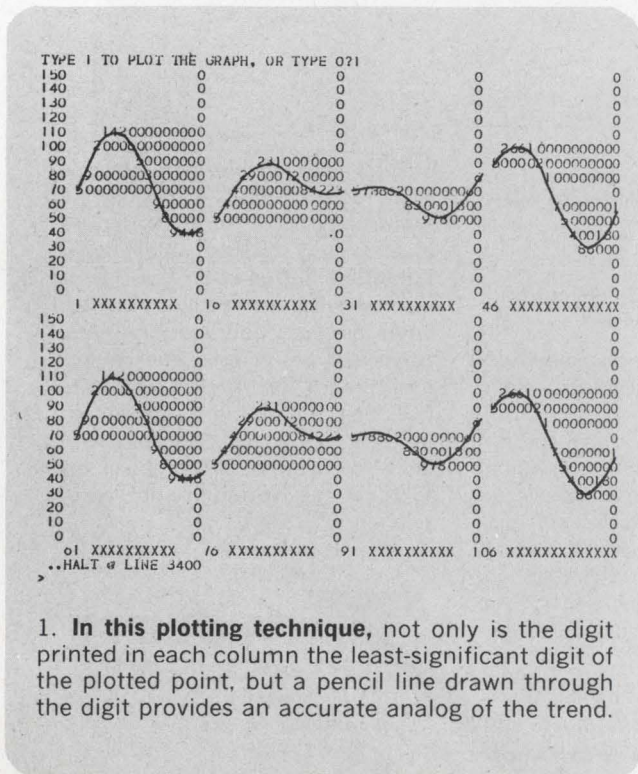

1. In this plotting technique, not only is the digit printed in each column the least-significant digit of the plotted point, but a pencil line drawn through the digit provides an accurate analog of the trend.

```

-BAS
>LOA/PLOT
>LIST
85 REM THE FOLLOWING NAMES ARE USED IN THE PLOTTING ROUTINE
88 REM
89 REM A8,B8,C8,D8=HORIZ AXIS VALUES
90 REM A9,B9,C9,D9= OUTPUT PRINT REGISTERS
95 REM G9=COUNTER FOR 15 WORD BLOCK
96 REM L1 = SCALE VALUE (STARTS AT 150)
97 REM
98 REM N= TOTAL SIZE OF VECTOR TO BE PLOTTED
100 REM I1,I2,I3,I4, = COUNTERS FOR PLOTTING
102 REM
105 REM P1= START OF 64 WORD BLOCK
110 REM P4= START OF 15 WORD BLOCK
115 REM Q4= END OF 15 WORD BLOCK
120 REM
125 REM T1= TEMP STORAGE FOR OUTPUT VALUE
130 REM T2= EXPONENT OF OUTPUT VALUE
135 REM X9= ANSWER FROM KEYBOARD TO QUESTION
140 REM
145 REM
190 REM WAVEFORM GENERATION ROUTINE STATEMENTS 200 THRU 380
195 REM
200 DIM U(10),V(10),W(10),T(2000)
201 MAT T=ZER
208 PRINT"MEAN VALUE =75"
210 DEMAND "WIDTH IS",N
220 DEMAND "NUMBER OF SINE WAVES IS",Z
225 MAT SIZE T(N)
230 FOR I =1 TO Z
235 DEMAND "PERIOD",U1
240 DEMAND "AMPLITUDE",V1
245 DEMAND "START",W1
260 U(I)=U1
270 V(I)=V1
280 W(I)=W1
290 NEXT I
300 FOR J=1 TO (N)
310 FOR I=1 TO Z
320 T(J)=T(J)+V(I)*SIN(2*PI/U(I)*(J-1+W(I)))
330 NEXT I
342 T(J)=T(J)+75
344 T(J)=T(J)+0.5
345 T(J)=INT(T(J))
350 IF T(J)>0 GOTO 370
360 T(J)=0
370 NEXT J
374 X9=0
375 DEMAND "TYPE 1 TO PRINT VALUES, OR TYPE 0",X9
377 IF X9=0 GOTO 3000
380 MAT PRINT T
1900 REM
1905 REM
1910 REM
1915 REM
1920 REM
3000 X9=0
3001 DEMAND "TYPE 1 TO PLOT THE GRAPH, OR TYPE 0",X9
3003 IF X9=0 GOTO 3400
3008 LET A9,B9,C9,D9=0
3020 FOR I1=1 TO ((N-1)/60)+1
3030 P1=1+60*(I1-1)
3040 L1=150
3050 FOR I2=1 TO 16
3060 FOR I3 = 1 TO 4
3070 P4=P1+15*(I3-1)
3080 IF P4>N GOTO 3280
3090 Q4=P4+14
3100 IF Q4<N GOTO 3120
3110 Q4=N
3120 G9=0
3130 FOR I4=P4 TO Q4
3150 IF T(I4)<L1 GO TO 3270
3160 T1=T(I4)-L1
3162 IF T1<9 GO TO 3165
3163 T1=9
3165 IF T1<> 0 GOTO 3170
3170 T(I4)=-1
3180 I2=I4-G9
3185 T1=T1*10^T2
3190 GO TO 3200,3220,3240,3260 ON I3
3200 A9=A9+T1
3205 A8=P4
3210 GO TO 3270
3220 B9=B9+T1
3225 B8=P4
3230 GO TO 3270
3240 C9=C9+T1
3245 C8=P4
3250 GO TO 3270
3260 D9=D9+T1
3265 D8=P4
3270 G9=G9+1
3272 NEXT I4
3280 NEXT I3
3290 PRINTUSING 3300,L1,A9,B9,C9,D9
3300 :### #####
3310 A9,B9,C9,D9=0
3320 L1=L1-10
3330 NEXT I2
3340 PRINTUSING 3341,A8,B8,C8,D8
3341 : ### XXXXXXXX ### XXXXXXXX ### XXXXXXXX ###
3345 A8,B8,C8,D8=0
3350 NEXT I1
3400 END
>

```

2. Statements 200 through 380 of this Basic program produce printouts of composite sinusoids. Starting from a baseline of 75, the routine generates the number of sine waves specified, and sums them.

# The Power E...

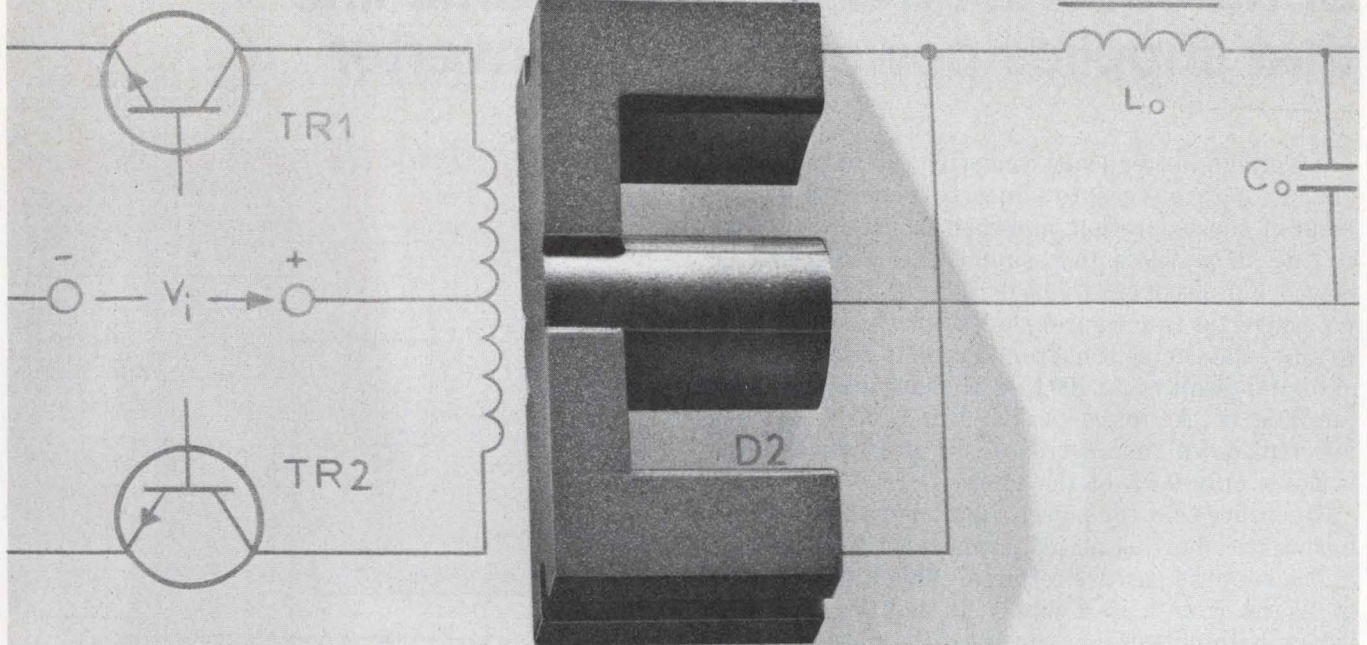

## Another small accomplishment from Ferroxcube ....with Guaranteed performance!

Manufacturing switch-mode power supplies? Inverters? Converters? Want to simplify transformer and filter design and fabrication? Then take a closer look at one of our latest accomplishments.

### Series EC—

### Power E Cores in 3C8 material

A transformer operating at high flux densities and high frequencies should be screened to minimize external fields and radiation. The usual method is to use a pot core design or an I and U core combination. But the Power E

Core design offers you the advantages of both the pot core and I and U combination.

First, the round center leg makes strip winding easy and insures a high copper or space factor, and the lowest DC resistance. Second, the winding geometry is configured for low-leakage inductance. And ...

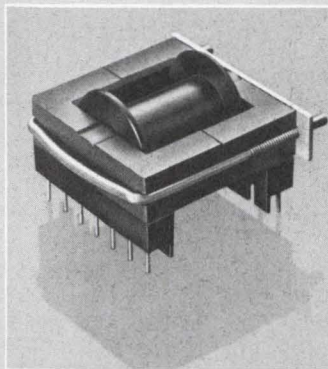
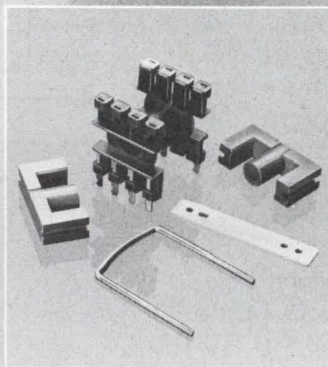

We guarantee the minimum flux density, at 100°C. will be 3300 Gauss. And a maximum loss of 100 milliwatts/cm<sup>3</sup> at 16 kHz, at 100°C. and 2000 Gauss.

The new core line has been IEC standardized in four sizes: Types EC-35, EC-41, EC-52 and EC-70, covering transformer throughput power to 1 Kw. We have slotted the cores to accept a mounting bracket that eliminates the assembly problems of the square-legged lamination cores. You also can choose a standard bobbin or PC bobbin for printed circuit board mounting.

Series EC—Power E Cores are fully described in the new Ferroxcube Linear Ferrite Catalog. For your free copy write or call:

Ferroxcube  
Division of Amperex Electronics Corp.  
5083 Kings Highway  
Saugerties, N.Y. 12477  
(914) 246-2811

## FERROXCUBE

A North American Philips Company



## Ideas for design

# Send out analog data on the same line that supplies power to a v/f converter

A voltage-to-frequency converter can change your analog input voltage into a linearly proportional pulse train of short duration, and then transmit this data on the same wires that supply the converter's dc power. For  $3\mu\text{s}$  of each time period, the Teledyne 9400 v/f converter (see figure) shorts out its supply lines to allow data to be sent from a remote site to analog or digital displays. At 100 kHz, the supply line is down for 30% of the  $10\text{-}\mu\text{s}$  period. But as frequency is lowered, down time decreases, so at 1 kHz the line is down only 0.3% of the time.

To ensure that the power supply is not overloaded during the shorting period, connect a  $1.5\text{-k}\Omega$  resistor at the supply's positive terminal. This limits current to 10 mA from a 15-V supply. In addition, the 9400 is kept within its output power rating, and the supply does not see a dead short. At the converter end, a  $1\text{-}\mu\text{F}$  capacitor keeps the device energized while power is down, and a diode prevents the capacitor from being discharged. Since a 9400 draws only 2 mA,  $1\text{ }\mu\text{F}$  ensures a stable supply voltage (only 6-mV ripple).

You can pick off the pulse train on the line side of the  $1.5\text{-k}\Omega$  resistor for conversion into either an analog or digital signal. If you want to display an analog output, use a 9400 in its frequency-to-voltage mode. Over-all linearity is about 0.03% when v/f and f/v are used, and 0.01% for v/f alone.

*Michael Paiva, Product Marketing Manager, Teledyne Semiconductor, 1300 Terra Bella Ave., Mountain View, CA 94043* CIRCLE NO. 313

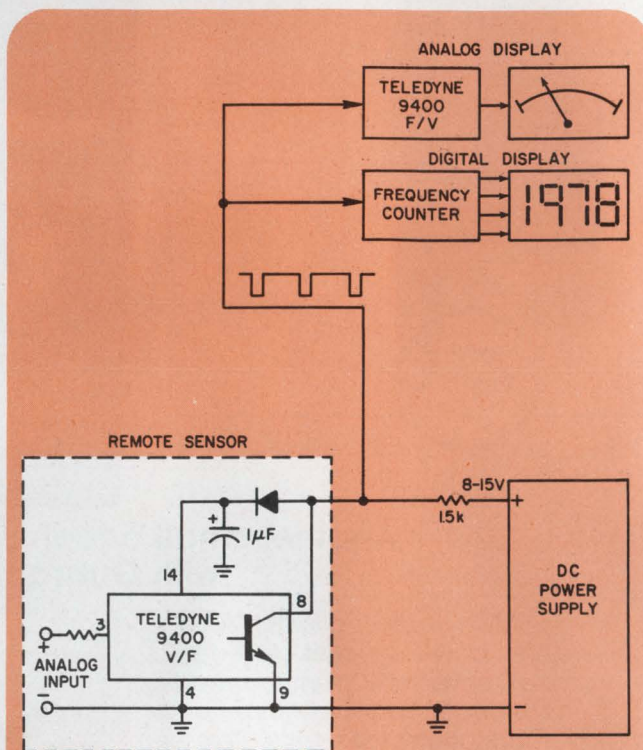

Analog data and dc power share this voltage-to-frequency converter's supply lines. During a  $3\text{-}\mu\text{s}$  interval, the power line is shorted, which allows data to pass from the converter to displays.

### IFD Winner of November 22, 1977

**Dan L. Vogler**, President, Lintech Electronics, P.O. Box 25124, Albuquerque, NM 87125. His idea "Precision Peak-to-peak AC-DC Converter Built with Single-supply Op-amp Circuit" has been voted the Most Valuable of Issue Award.

Vote for the Best Idea in this issue by circling the number of your selection on the Reader Service Card at the back of this issue.

**SEND US YOUR IDEAS FOR DESIGN.** You may win a grand total of \$1050 (cash)! Here's how. Submit your IFD describing a new and important circuit or design technique, the clever use of a new component or test equipment, packaging tips, cost-saving ideas to our Ideas for Design editor. Ideas can only be considered for publication if they are submitted exclusively to ELECTRONIC DESIGN. You will receive \$20 for each published idea, \$30 more if it is voted best of issue by our readers. The best-of-issue winners become eligible for the Idea of the Year award of \$1000.



# THE CENTRALAB EDGE in disc capacitors

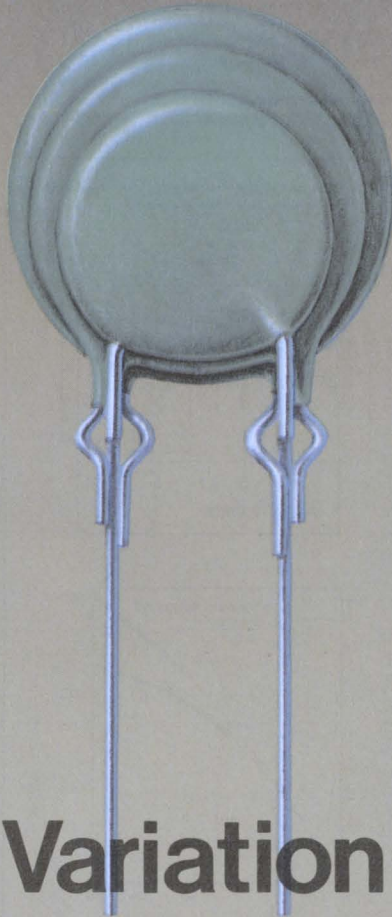

## Any Lead Variation You Need

At Centralab we are concerned with the same things you are – performance, reliability, on-time delivery. But any ceramic disc capacitor supplier can say that. We go that critical step further; we give you a choice of leads to help you cut your manufacturing costs.

Our standard leads include stand-off types to prevent solder damage; snap-in types to avoid fall-out during assembly; short leads for low profile; long leads for those hard-to-reach placements.

We'll go even further. On minimum OEM order, we'll make any lead configuration (under 3½") you need. Just tell us your manufacturing problem; we'll give you a cost-effective answer.

And don't forget our tape-and-reel packaging for automatic insertion.

Cost savings *in use*. That's the competitive edge you get from Centralab. The Centralab Edge.

*Products you need from people who care.*



**CENTRALAB/USCC**

Electronics • GLOBE-UNION INC.

7158 Merchant Ave., El Paso, TX 79915 (915) 779-3961

CIRCLE NUMBER 54

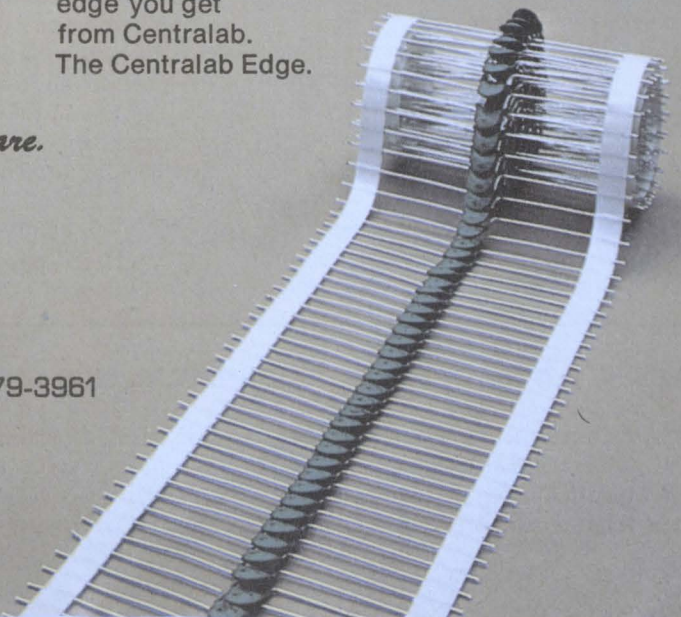

## Torque stays the same in variable-speed motor

An "inside-out" shunt-wound dc motor overcomes a conventional problem: how to change speed without varying the torque inversely. The inside-out machine, developed by Professor D. A. Bell at the University of Hull in England, provides a constant torque for varying speeds.

With a standard shunt-wound dc motor, the speed depends on the counter-EMF generated in the armature windings. Reducing the field excitation (current) lowers this back-EMF, and the armature rotates faster to return the EMF to its former value. But this speed increase reduces shaft torque.

If the voltage across the armature conductors could be increased, the armature current and torque could also be increased at the higher speed. Bell's motor does exactly that with stationary peripheral windings that correspond to the armature windings.

In Bell's configuration, the exciting field is developed by a rotating field assembly that has a winding or a permanent magnet. This field is surrounded by stationary windings that, like the armature, have back-EMF voltages induced into them that are proportional to the rotor speed (see Fig.).

The speed can be adjusted not only by varying the excitation voltage, but also by switching the stationary coils in series or parallel.

But in Bell's motor the maximum torque is independent of the switched configuration and hence the speed. The torque is proportional to  $Bj_v$ , where  $B$  is the magnetic flux density, and  $j_v$  is the current in the stationary windings and also their physical volume.

In a simple two-pole version, current is fed to the field winding via brushes

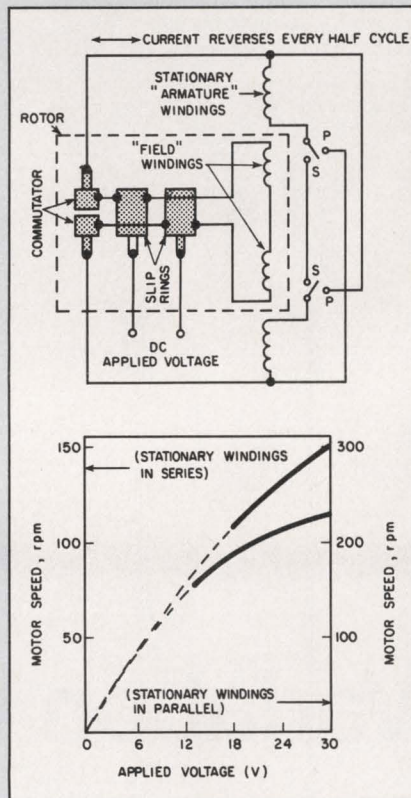

and slip rings. The rings are also connected to a commutator. Current from the commutator reverses every half cycle and is picked off and fed to the stationary windings.

A 2:1 speed ratio of series-to-parallel stationary-winding connections has been demonstrated experimentally for supply voltages of up to 16 V. Moreover, the basic concept can be extended to multipole machines. By using several of the switched windings on a machine, a range of speeds can be provided for a given torque.

For more information contact: Jim Strutt, Computers, Systems and Electronics Group, NRDC, Kingsgate House, 66-74 Victoria St., London SW1E 6SL.

## Laser + fiber optics = acupuncture, skin probe

A helium-neon laser and a fiber-optic probe are combined to provide a therapeutic system that can be used for acupuncture and treatment of larger

skin areas. The laser/probe, developed by Messerschmitt-Bölkow-Blohm GmbH, and called "akupLas," uses a Siemens HeNe laser with a 1-mm beam

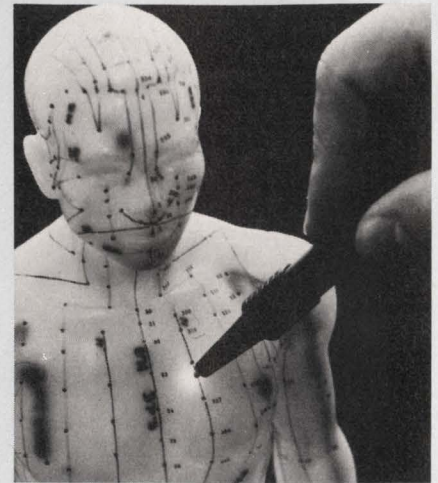

diameter and a power output of 2 mW.

Despite the low power, the laser's red-light wavelength of 632 nm passes readily through skin, which is most transparent in this wavelength region. The 2 mW of laser energy has been found to penetrate between 3 and 10 mm, depending upon skin characteristics.

The laser beam is guided via an optical-fiber hand probe that can be placed directly on skin points that are important in acupuncture treatments. To treat larger areas of the skin, the laser's output power can be increased to 100 mW. The laser light may be applied up to 60 seconds.

## Phone calls, color TV travel side by side

The world's largest-capacity undersea cable system a 250-nautical-mile link between Rome, Italy, and Palermo, Sicily, successfully carried color TV signals alongside 1800 telephone calls in system tests. The NG1-type system, manufactured and installed by Standard Telephones and Cables, Ltd., of London for the Italian public telephone system, is a 45-MHz system that can carry a maximum 5520 simultaneous telephone conversations.

The color test signals were, by arrangement with the Italian PTT, transmitted in a band set aside from the 1800, 4-kHz telephone channels. The TV signals were produced by 625-line PAL pattern and waveform generators.

# Half-size Amber R Relays

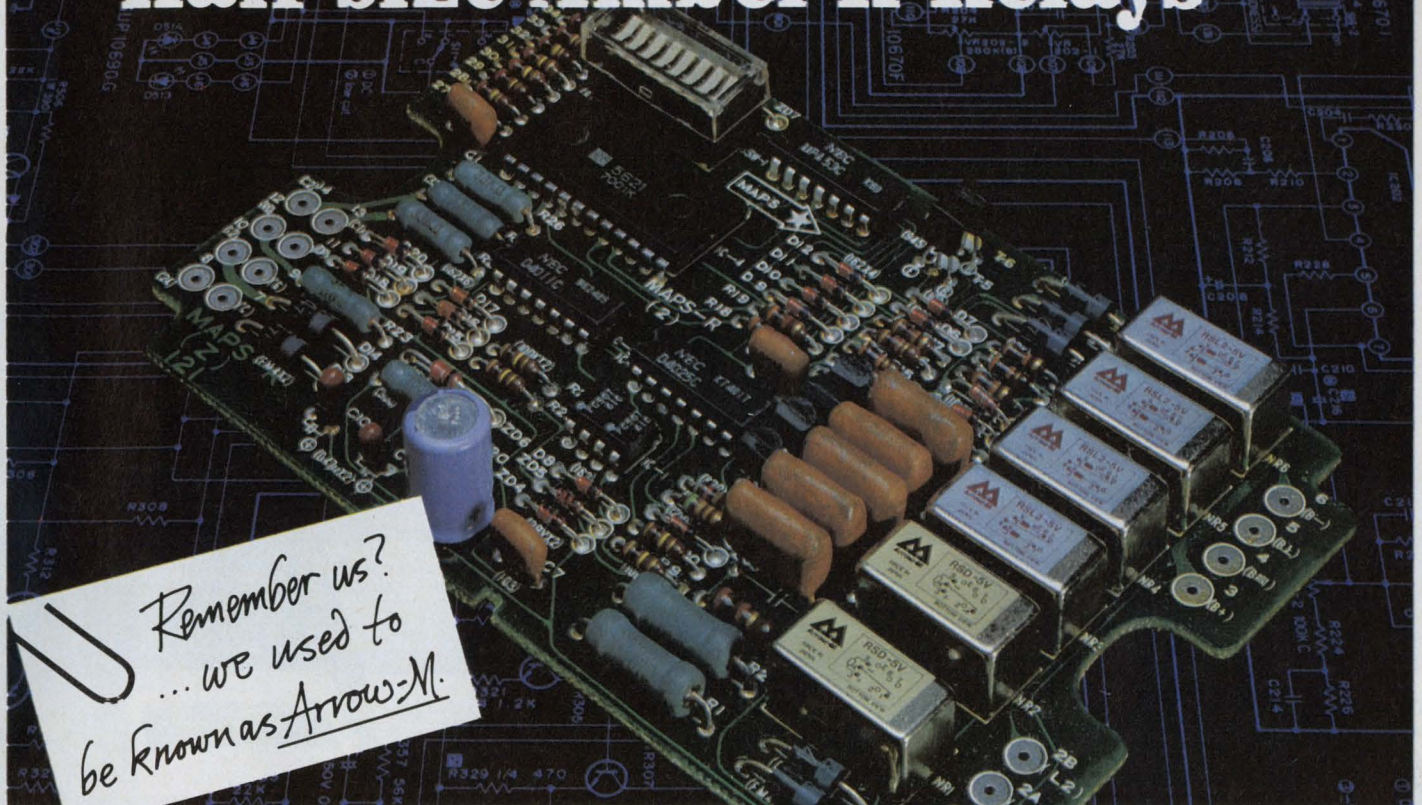

## High capacity, high sensitivity units can be driven by TTL and DTL.

For example: The minimum operating power for a single side stable type is 80mw, for a latching type 40mw.

- Aromat R Relays are available in 1 Form C contacts which can carry a high current capacity of 1 Ampere 20 watts, and are capable of resisting welding at higher inrush currents. The dry circuit type, which can switch current as low-level as 100uA, is available in addition to the power type.
- In addition to the standard, there are 1 coil and 2 coil latching types, which are useful for logic circuit design as a memory component.
- Not only can they be automatically wave soldered on PC boards with a high density of electronic parts, but they are simple to clean with most degreasers and detergents without affecting maximum contact reliability.

### Relays for Advanced Technology

More than 22 million R Relays in service around the world.



Member of Matsushita Group

Contact Your  
Aromat Representative  
or Distributor Today.

**Aromat Corporation:**  
250 Sheffield Street  
Mountainside, NJ 07092  
(201) 232-4260

**Mid-Western Office:**  
311 Lively Blvd.  
Suite 1  
Elk Grove, IL 60007  
(312) 593-8535

**Western Office:**  
22010 S. Wilmington Ave.  
Suites 300 & 301  
Carson, Calif. 90745  
(213) 775-3512



# DATA I/O PROGRAMS

**You can program every commercially available PROM on a Data I/O Programmer. What does that mean to you?** First of all, it means design freedom.

You can incorporate state of the art micro-processor and PROM technology in your designs with the assurance that the Data I/O PROM Programmer will meet your needs.

Second, it means security. You'll be able to designate second and third source PROM suppliers and know that you can program their devices.

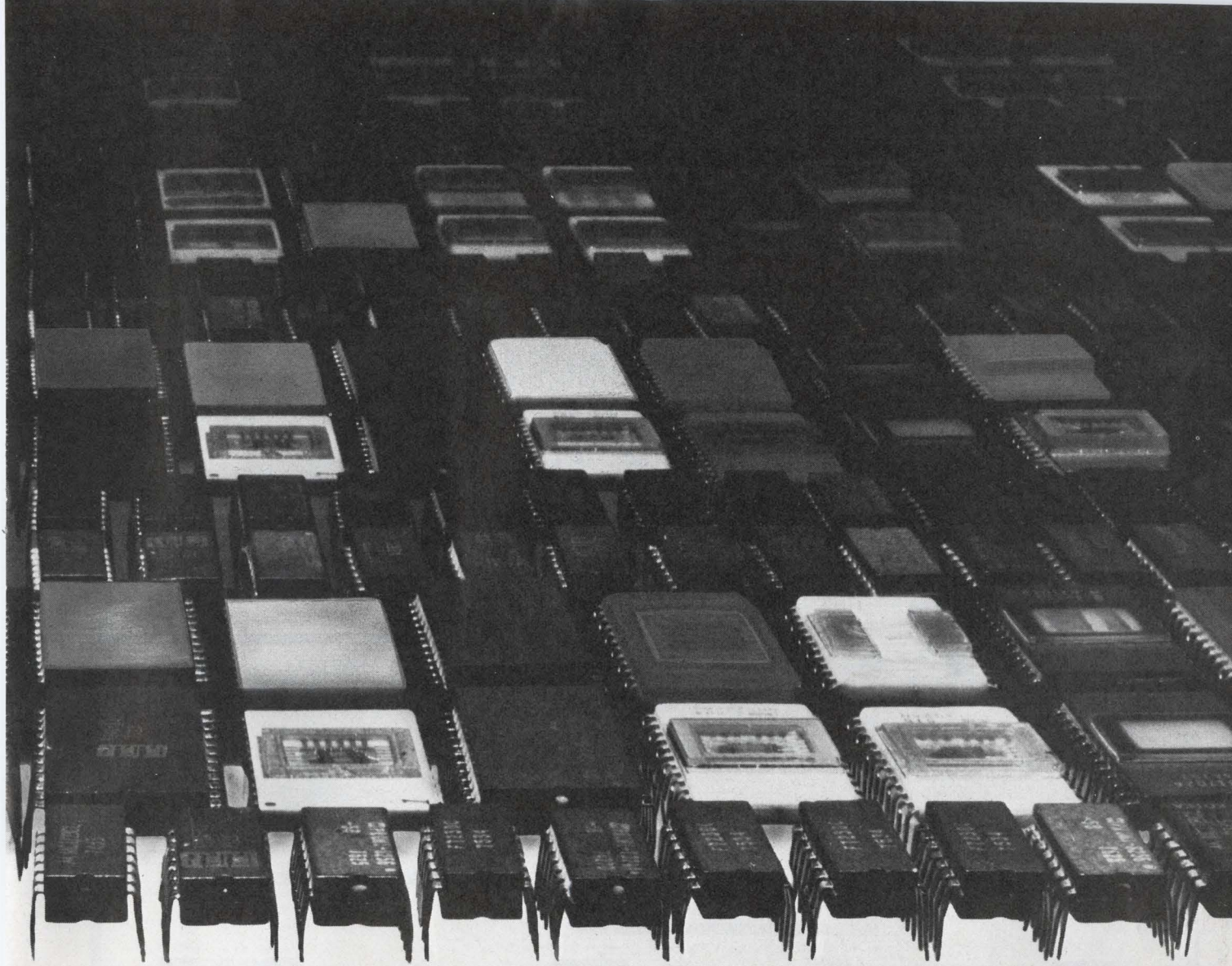

# THEM ALL.

Third, it means money. You won't have to purchase, or build, a new programmer every time you use a new PROM. You'll also be able to shop for best supplier prices.

If you'd like more good reasons for selecting

a Data I/O universal PROM Programmer, send for our free PROM Programming Handbook. Simply contact Data I/O Corporation, P.O. Box 308, Issaquah, WA 98027. Phone 206/455-3990.

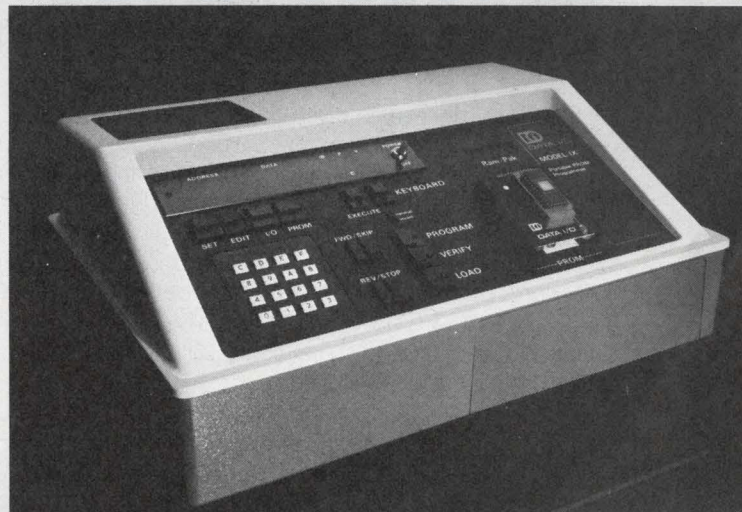
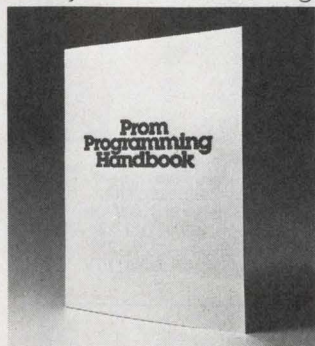

# DATA I/O

# You Don't Have To Beg, Borrow Or Buy...

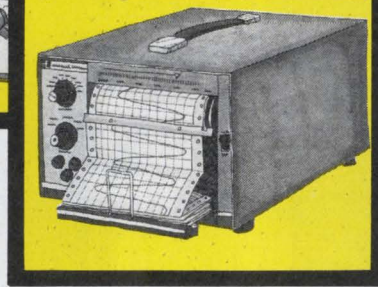
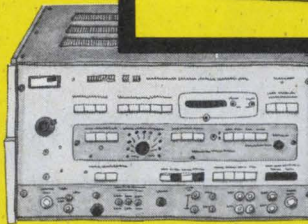
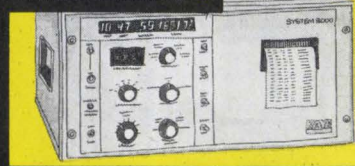
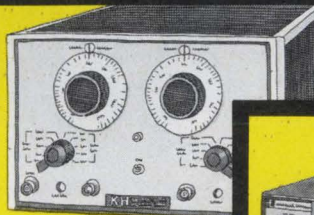
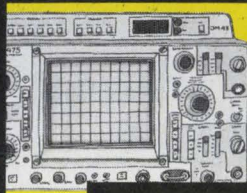
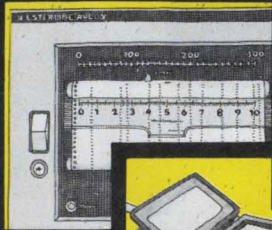
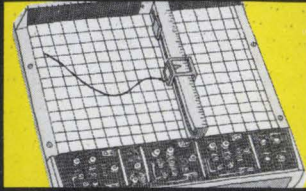

## Rent'em From GE

Short or long-term instrument rentals give you flexibility and economy.

GE has over 9,000 instruments available for immediate shipment: □ Tek Scopes □ Biddle Megger Insulation Testers □ H-P Signal Generators □ Honeywell Oscillographs □ Complete Data Systems □ Esterline Angus Recorders □ GE Chart Recorders □ Modems □ Communication Terminals ... all calibrated to the manufacturer's specs.

We have over 100 Sales/Service Centers,

and one of them is near you. In addition to maintaining our Rental Inventory, they can also repair and calibrate your own equipment.

Don't borrow someone else's GE Rental Catalog. **Call collect (518) 372-9900** or your nearest Sales/Service Center.

**Quick-rental<sup>®</sup>  
instruments**

ALA. BIRMINGHAM (205) 925-3101 • ARIZ. PHOENIX (602) 278-8515 or 8516, TUCSON (602) 294-3139 • CAL. LOS ANGELES (213) 642-5350, SAN FRANCISCO (415) 436-9260 • COL. DENVER (303) 371-1260 • CONN. SOUTHINGTON (203) 621-4059 • FLA. JACKSONVILLE (904) 751-0610 • GA. ATLANTA (404) 457-5563 • ILL. CHICAGO (219) 933-4500 • IND. INDIANAPOLIS (317) 639-1565 • KY. LOUISVILLE (502) 452-3311 • LA. NEW ORLEANS (504) 367-6528 • MD. BALTIMORE (301) 332-4700 • MASS. BOSTON (617) 396-9600 Ext. 160, SPRINGFIELD (413) 781-1111 • MICH. DETROIT (313) 285-6700 Ext. 208 • MINN. MINNEAPOLIS (612) 522-4396 • MO. KANSAS CITY (816) 231-4377, ST. LOUIS (314) 965-7115 • N.J. CLIFTON (201) 471-6556 • N.Y. BUFFALO (716) 876-1200, SCHENECTADY (518) 385-2195 • N.Y.C. CLIFTON, N.J. (201) 471-6556 • N.C. CHARLOTTE (704) 525-0311 • OH. CINCINNATI (513) 874-8512, CLEVELAND (216) 523-6382, TOLEDO (419) 691-3501 • OR. PORTLAND (503) 221-5101 • PA. PHILADELPHIA (609) 424-4450, PITTSBURGH (412) 462-7400 • TEX. DALLAS (214) 357-7341, HOUSTON (713) 672-3570 • VA. RICHMOND (804) 232-6733 • WASH. SEATTLE (206) 854-0211 • W.V. CHARLESTON (304) 345-0920 • WISC. MILWAUKEE (414) 744-0110 • PUERTO RICO PONCE (809) 843-4225.

GENERAL  ELECTRIC

# New products

## True-rms measurements come of age as new DVM cuts price, eases use

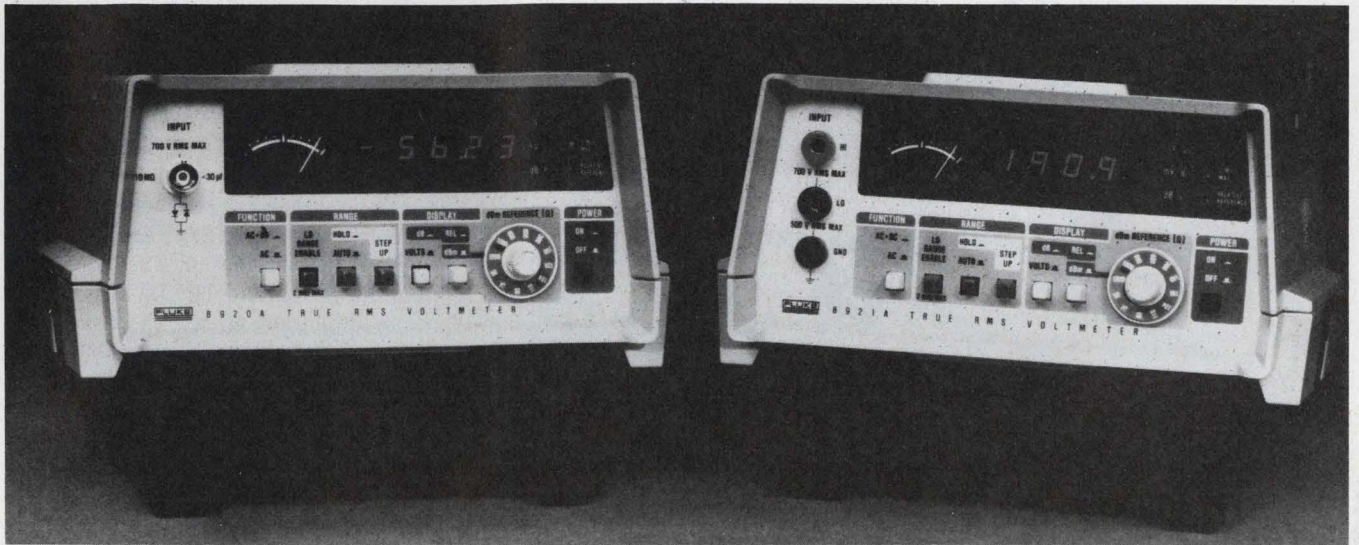

Fluke Manufacturing Co., 7001 1220th St. SW, Mountlake Terrace, WA 98133. (206) 774-2211. P&A: See text.

Thanks to a breakthrough in a monolithic true-rms converter, the Fluke 8920A ac DVM undercuts all others in cost, while packing in features that used to be optional or even unattainable. Its \$995 price tag includes autoranging, decibel readings—with three selectable references—ac + dc readings, an analog output, and an analog "trend" meter for nulling or peaking adjustments.

To put the 8920A into perspective, bear in mind that Hewlett-Packard's 3-1/2-digit 3403C sells for \$2600, with dB readings and autoranging optional at \$315 and \$156, respectively. Ballantine Laboratories offers two 4-1/2-digit meters: the 3620A and the 3630A. The 20A costs \$1595 without dB, which isn't available, and \$1890 with optional autoranging. The 30A includes dB and autoranging in its \$2450 price. And Boonton's 3-1/2-digit 93AD includes dB readings and autoranging are optional at \$165 each.

The Fluke meter provides seven voltage decades, ranging from 2 mV to

700 V. Its lowest calibrated reading is 180  $\mu$ V, its highest 700 V. Frequency response extends from 10 Hz to 20 MHz (at a full-scale crest factor of seven), with several restrictions: 1 MHz is the top frequency on the 200 and 700-V ranges, 2 MHz is the limit on the 2-mV range. An annunciator light warns of the limited bandwidth in the 2-mV decade.

On the 8920A's dB function, autoranging effectively spans a 132-dB range. Decibels can be read in three ways—a feature found on no other DVM. In the dBm reference-impedance mode, readings are referenced to any of 12 selectable impedances between 50 and 1200  $\Omega$ . In the relative-dB reference mode, any voltage input can be made the 0-dB point. And in the dBV-reference mode, the 0-dB point corresponds to 1 V at 1000  $\Omega$ .

Fluke specifies the ac accuracy of the 8920A as a percentage of reading, instead of sticking with the more prevalent two-part spec, for which it deserves credit. Until all DVMs are so specified, comparing accuracies remains tricky. Fluke's best accuracy of 0.5% occurs at midband; at other frequencies, and on the 2-mV and 20-mV

ranges, accuracy fades, until it reaches a worst case of 5% at the frequency edges. Accuracy of ac + dc measurements varies from 3% to 30%, again depending on input frequency and range. And with pure ac inputs, decibel accuracy stays between 0.1 and 0.5 dB.

Although the HP3403C costs almost three times more than the 8920A, it goes down to 2 Hz (slow mode) and up to 100 MHz in input frequency, at a full-scale crest factor of 10 beyond 25 Hz. It can measure dc alone, ac alone or ac + dc. And it handles 10  $\mu$ V to 1000 V in input level. But the HP's dB reading is referenced to a front-panel pot calibrated at just one point. And since the 3403C's six decade ranges run from 10 mV to 1000 V—and since its accuracy is stated as a percentage of range  $\pm$  a percentage of reading—its accuracy relative to the Fluke unit isn't easily stated.

Unlike the Fluke and HP units, which use thermal rms conversion (HP's is a thermopile arrangement), the Ballantine and Boonton units convert with calculating techniques. The Ballantine 3630 spans 1 Hz (slow mode) to 1 MHz on ac, with a \$250 option

(continued on page 98)



## Low Cost TO-3 Coolers

### Thermalloy Quality At NEW Lower Prices.

The 6051 Series offers the quality and performance that you expect from Thermalloy . . . at prices that will surprise you. With high volume, automated tooling we have lowered heat sink costs. Look at our numbers. Compare performance, compare value. Then specify Thermalloy.

Model	Fin Height	R <sub>θ</sub> @75°C Rise	5,000 Piece Price
6051B*	0.50"	7.4	18c
6052B*	0.75"	5.9	22c
6053B*	1.00"	4.4	24c
6054B*	1.25"	3.3	29c

\*Black Anodize

Number one in Semiconductor Accessories



### Thermalloy, Inc.

Post Office Box 34829  
2021 West Valley View Lane  
Dallas, TX 75234 • (214) 243-4321

Free sample and new 1978 catalog with your response

CIRCLE NUMBER 57

## INSTRUMENTATION

(continued from page 97)

stretching the bottom end to a low 0.1 Hz. It also measures dc alone, ac alone or ac + dc. Full-range crest factor of the 30A is just 5:1. Like the HP unit, the 30A has six voltage ranges spanning 10 mV to 1000 V, its front-panel dB reference control is calibrated in one detented position, and its accuracy is given with the two-part spec.

The Boonton 93AD covers the same frequency range as the Fluke, but only about half the voltage span—300 μV to 300 V. Its dB function comes with one fixed reference—50, 75 or 600 Ω. And it can't measure dc or ac with dc levels present. "Basic" accuracy of the 93AD is 1% of reading ±1 digit. But the 93AD includes a digital output, an analog output (as does the HP), an analog edge meter, and remote programming in its price. These are optional or not offered on the Fluke and HP DVMs.

In other key areas, the competing meters stack up as follows: The HP is the fastest reader at 4 readings per second (fast mode, 25-Hz bottom limit), the Ballantine 30A places second at 3 readings per second, and the Fluke trails at 2.5 readings per second. The Boonton spec sheet doesn't show any numbers. However, the Fluke and HP numbers are display rates. For best accuracy, there's a wait—or response time—of 1 second for the HP 3403C's fast-mode, 1.6 s for the Fluke 8920A and 1 to 2 s for the Boonton's fast mode. Ballantine's response time is listed as 300 ms. Remember, in the fast mode, the lowest input-frequency spec deteriorates.

Input-loading characteristics—an important error source—differ among the three units. Check the spec sheets for the full story. And while you're at it, check for other differences—like tempcos and calibration intervals needed to maintain rated accuracies.

The 8920A comes with isolated BNC inputs (the analog output comes only with the BNC version) for use at the higher frequencies. At lower frequencies, a floating banana-jack version (8921A) is available that can handle up to 500 V of common-mode voltage. The package, new for Fluke, measures 4×7×12-1/2 in., and allows piggyback interlockable stacking with similarly packaged instruments now in the offering at Fluke. Delivery takes 90 days.

Fluke **CIRCLE NO. 304**  
Ballantine **CIRCLE NO. 323**  
Boonton **CIRCLE NO. 305**  
Hewlett-Packard **CIRCLE NO. 306**

## for Low-Level Data Scanning

Ultra Low-Thermal EMF Reed Relays

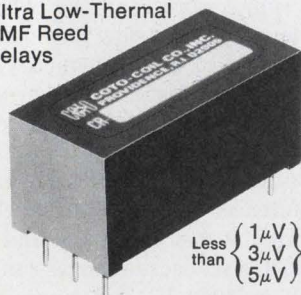

Less than  $\begin{cases} 1\mu\text{V} \\ 3\mu\text{V} \\ 5\mu\text{V} \end{cases}$  Take Your Pick!

Perfect for low-level scanners and multiplexers! Coto's new CR-3250 ultra low-thermal EMF reed relays include 2 low thermal contacts plus a third for guard switching . . . all specially conditioned and tested for reliable low-level switching. Relays are graded and priced according to magnitude of thermal offset; you pay for no more accuracy than you need! Write for new Bulletin MR-10.3.



**COTO-COIL COMPANY, INC.**  
59 Pavilion Avenue  
Providence, R. I. 02905  
Tel: (401) 467-4777

CIRCLE NUMBER 58

## GOOD TOOLS!

### Self-Adjusting Wire Stripper



Unique — just squeeze and pull! Many narrow blades close in around the wire, automatically providing the correct opening and the right tension. Operator adjustment not needed to change from one wire size to another. Requires no special "feel" nor getting used to. Strips clean without nicking the conductor.

### Lab Vacuum (Minivac) Cleaner



Just the thing for clean rooms, production and assembly lines, service and repair shops, model shops and labs. For business machines, computers, getting eraser crumbs out of typewriters. Variety of nozzles and brushes, and special nozzle that gets into every nook and cranny. Internal filter keeps dust and dirt inside the vacuum.

### Mini Soldering Irons are Low Voltage



Soldercraft Model 6A miniature low-voltage production soldering iron is designed for versatile microcircuit and fine instrument work. It is 6 in. long, weight 1/4 oz., and, when powered by a multi-tap 18 W low-voltage transformer, will provide controlled temperatures of 700 F at 6 V. If you can see it, you can solder it — pencil size. Heat is generated entirely within the tip which provides maximum efficiency and faster heat recovery.

FREE CATALOG!

Electronic Tools & Test Instruments



TELVAC INSTRUMENT COMPANY  
DIV. MITCHELL HUGHES CO.  
7534 Atoll Avenue  
North Hollywood, CA 91605  
(213) 983-2535

CIRCLE NUMBER 59



# The right PROM Programmer makes the job simple.

## Pro-Log's Series 90 means simple PROM programming.

Microprocessor control reduces operating steps and guides operators through the few steps that remain. The Series 90 verifies PROMs as they're being programmed and automatically weeds out bad or marginal parts. Separate sockets for master PROM and copy PROM protect your master PROMs from accidental programming. Users never need to calibrate a Series 90.



## This comparison guide makes selecting a programmer simple.

We've got a free full-color comparison guide to help you evaluate the leading PROM programmers side-by-side. Call or write for your copy. Pro-Log Corporation, 2411 Garden Road, Monterey, CA 93940. Phone (408) 372-4593.

## Simple means flexible, reliable and safe.

A Series 90 is a complete yet versatile programmer. It consists of a single master control unit, a plug-in PROM personality module and options.

The master control unit handles any of our personality modules. There are modules for all major MOS and bipolar PROMs and for some one-chip micro-

processors. The personality modules come in individual, generic family, or gang versions. Options include CMOS RAM buffer (to 4K bytes), TTY, parallel interfaces, paper tape reader, U.L. listed erase light, check-sum option, and RS-232 (terminal or modem) interface with Auto-baud.

Master control units are backed by a two-year parts and labor

warranty, PROM personality modules by a one-year warranty.

Pro-Log's programmers are U.L. listed for your safety.

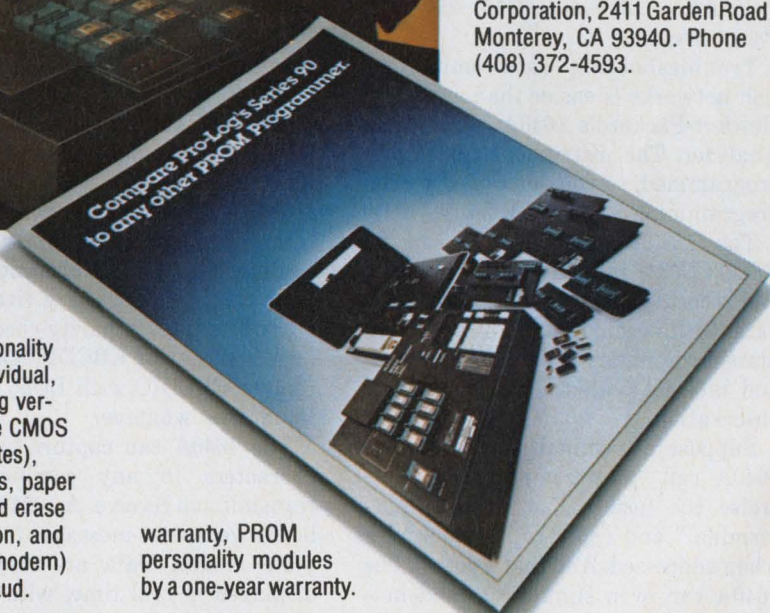

**PRO-LOG**  
CORPORATION

Microprocessors at your fingertips.

## Serial-data analyzer preprograms all functions



Hewlett-Packard, 1501 Page Mill Rd., Palo Alto, CA 94304. (415) 856-1501. P&A: See text.

Troubleshooting data-communication networks is easier than ever with Hewlett-Packard's 1640A Serial Data Analyzer. The instrument comes preprogrammed, so you don't need special programming skills to work with it.

The 1640A sits passively on an RS232C(V24) interface, and monitors and records both transmit and receive data. Or it becomes active—it can simulate a computer, modem or terminal, and interact with the network under observation.

Suppose a terminal is suspect. The 1640A can "play computer" and exercise the terminal; or it can "play terminal" and reply to the computer when addressed. And that's not all. The 1640A can even simulate a modem—a handy, often requested, troubleshooting feature.

To avoid programming, the 1640A provides a keyboard-controlled "menu" selection of all preprogrammed triggering (trap), format and simulation modes. The menu guides you through all operating choices, so you don't have to worry about which parameters to set or which combinations not to set. Initial settings can be recalled any time for review or modification. If you press

the wrong key, the 1640A not only says so, it tells you how to get out of the situation.

In the monitor or simulation modes, the 1640A can operate in full-duplex, half-duplex or simplex, on two or four-wire links. Transmission is synchronous at up to 9600 bits/s or asynchronous, with a choice of 15 internal clock speeds to 9600 bits/s, including standard European speeds. Data can be composed of five through eight bits, plus a parity-checking bit, in ASCII, hex or EBCDIC. Or you can replace EBCDIC with BCD, Selectric, Baudot or whatever.

The 1640A can capture up to 2048 characters in any combination of transmit and receive. A 1024-character buffer generates messages for the simulate modes. Data are trapped and displayed in real time, with transmit data displayed in video, and receive data in inverted (black on white) video on a 10 x 13-cm CRT. Full-duplex data are shown as interleaved characters in proper timing relationships.

Five triggering modes give the HP analyzer strong trapping power. You can set the 1640A to trigger:

- On any eight-character sequence, including "don't care" states.
- On any control-lead positive state.
- If and only if an error occurs.

- On a specified time interval between any two events up to six seconds apart ( $<T$ ,  $>T$ ,  $0<T<6$ ).

- On an external event.

The trigger can start or end the display mode. Or trigger occurrences can be counted continuously until you stop the analyzer. Then, the last 2048 characters are retained, and the total number of triggers is displayed.

Another mode, data suppression, lets you retain only data that you want. For example, you can suppress nulls, idles or syncs. Or you can suppress "all but the trigger plus  $n$  characters," where  $n$  is selectable from 0 to 99.

In the simulate mode, you can define a message of 1024 characters, which can be divided into as many as 11 blocks. Moreover, you can edit text without re-entering the entire message, and copy, or learn, both transmit and receive data for use in simulated messages.

For more simulation, a patch-panel matrix, located at the top of the 1640A, interconnects the analyzer to the interface. Thus, the interface can be tailored to simulate various terminal or computer configurations.

The matrix offers another benefit. Although a "rose may be a rose may be a rose," in the data-comm field the so-called RS-232C standard is more like a marigold, with its endless variations. With the matrix, you can adjust to your own hybrid RS-232. Mylar overlays can be punched for each configuration.

Many other features are included in the 1640A's \$5800 price, and several interesting extras are offered. For instance, with the HPIB option (about \$500), the 1640A works with a programmable calculator to give branching, data manipulation, automatic or remote measurements. With optional PROMs, up to eight different menus or test patterns can be entered automatically with a rear-panel pushbutton.

The HP analyzer does have competition. But the less expensive boxes don't do as much. And though there are units that do more, they cost twice as much and usually require programming. Among the contenders are instruments from Spectron (Moorestown, NJ), Halcyon, (Campbell, CA), and United Systems/Digitec (Dayton, OH).

Deliveries start in April.

Hewlett-Packard	<b>CIRCLE NO. 307</b>
Halcyon	<b>CIRCLE NO. 308</b>
Spectron	<b>CIRCLE NO. 309</b>
United Systems/Digitec	<b>CIRCLE NO. 310</b>

# Full control over signal measurement parameters = high measuring accuracy

- 80,520, and 1000 MHz Timer/Counters
- Measure single period, period average, time interval and time interval averaging, frequency, multiple frequency ratio and pulse totalizing
- 20 mV sensitivity
- Accurate trigger level setting with external monitoring and tri-state indication
- Gate monitor output to show measuring intervals
- Adjustable trigger hold-off
- PIN Diode attenuator to eliminate counting errors

The Philips PM 6620 Series of Timer/Counters with 3 models, 4 time bases and 7 options makes it possible for you to select the specific model that will make your most demanding lab measurements easier and more accurate.

You can choose a trigger hold-off which ignores false stop pulses such as those generated by contact bounce or ringing...and high stability time bases... and such options as BCD and analog outputs, IEEE Bus, internal battery and rack mounting. Prices start at \$965.00.\* \*U.S. Domestic price only.

For immediate information, use our toll-free Hotline number: (800) 631-7172. New Jersey residents, please call collect (201) 529-3800. Or contact Philips Test & Measuring Instruments, Inc.

In the U.S.:  
85 McKee Drive  
Mahwah, New Jersey 07430  
Tel. (201) 529-3800

In Canada:  
6 Leswyn Road  
Toronto, Canada M6A 1K2  
Tel. (416) 789-7188

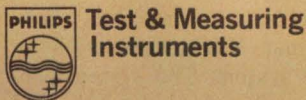

**PHILIPS**  
CIRCLE NUMBER 61

## Now...learn computer programming faster & easier with **HEATH'S BASIC PROGRAMMING COURSE!**

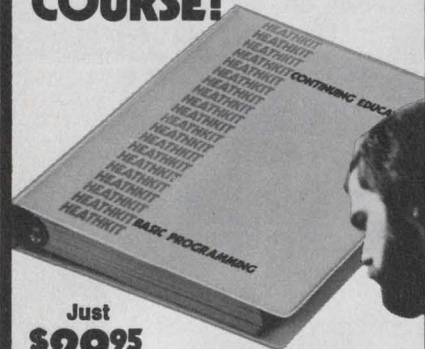

Just **\$29<sup>95</sup>**

plus \$1.69 shipping and handling

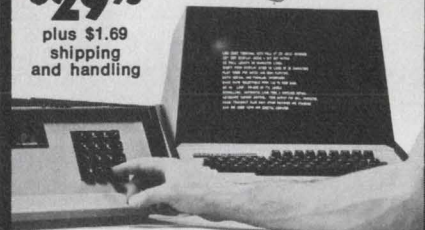

This self-instruction course uses proven programmed instruction methods to teach you BASIC... the most popular and widely used higher level programming language. With the help of this course, you'll learn all the formats, commands, statements and procedures... then go on to actually apply them with "hands on" experiments and program demonstrations on your own or any available computer. And unlike other courses or books on BASIC, we teach you problem solving as well as programming so you can apply what you learn. Self-evaluation quizzes and exams guarantee that you understand every detail and when you finish, you may take an optional examination to qualify for a Certificate of Achievement and 3.0 Continuing Education Units (CEU's), a widely recognized means of participating in non-credit adult education.

**MONEY-BACK GUARANTEE:** If for any reason you are dissatisfied, Heath Company will refund the full purchase price of the course.

HEATH Schlumberger	HEATH CO., Dept. 511-392 Benton Harbor, MI 49022
YES Please send me your EC-1100 BASIC Programming Self-Instructional Course.	
My <input type="checkbox"/> check <input type="checkbox"/> Money order for \$_____ is enclosed. Or please charge to my <input type="checkbox"/> VISA/ BankAmericard <input type="checkbox"/> Master Charge	
Account # _____	
Exp. Date _____ M.C. Code # _____	
Signature _____	(necessary to send merchandise)
NAME _____	(please print)
ADDRESS _____	
CITY _____	
STATE _____ ZIP _____	
<b>ORDER TODAY — PRICE GUARANTEED THROUGH APRIL 25, 1978 ONLY!</b>	
Price is mail order F.O.B. Benton Harbor, MI. Price subject to change without notice.	

## INSTRUMENTATION

### Digital thermometer has 0.5° accuracy

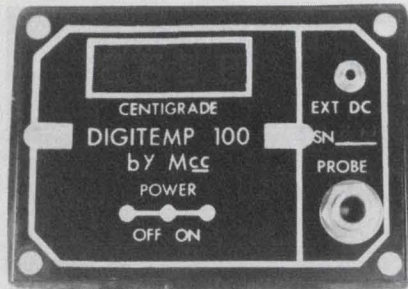

Mid-Continent Communications, 1103 Broadway, Oak Grove, MO 64075. (816) 625-4765. \$155 (display), \$25 (probe); 2 to 4 wks.

The Digitemp 100 digital temperature meter measures temperature from -55 to +150 C with an accuracy of  $\pm 0.5^\circ$ . Temperature is displayed on a 0.33-in. LED display. An electronic touch-control switch turns power on and off. Power is supplied by a 9-V transistor battery or a 110-V-ac adapter. When operating on battery power, an automatic adjustable power shut off prevents accidental discharge of the battery.

CIRCLE NO. 324

### Dual-mode logic probe has 5-ns response

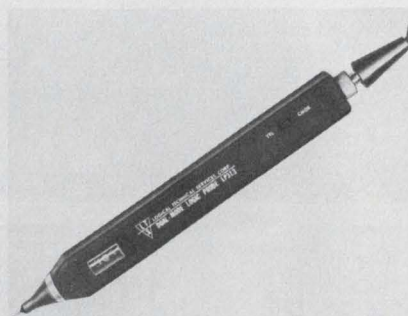

Logical Technical Services, 71 W. 23 St., New York, NY 10010. Graham Gross (212) 741-8340. \$110; stock.

The LP313 dual-mode logic probe has a 2-M $\Omega$ , 12.5-pF input impedance and a 5-ns, 200-MHz response. A three-color LED display and compact packaging make this TTL/CMOS probe easy to use with hard-to-reach chips. Pulses are stretched to 100 ms and displayed by a transition LED, or may be latched-on using the memory.

CIRCLE NO. 325

### Data generator spews out 400 Mbits/s

Tau Tron, 11 Esquire Rd., North Billerica, MA 01862. Jim Hanley (617) 667-3874. \$8740; 10 to 12 wks.

The Model DG-400YH programmable word generator operates from 1 bit/s to 400 Mbits/s and provides a 1-V, 500-ps rise/fall time signal in NRZ or RZ mode. The unit may be programmed for 4 words of 16 bits each, 2 words of 32 bits, or 1 word of 64 bits. True and complement data are simultaneously available. RZ or NRZ formats are individually selectable on each data channel.

CIRCLE NO. 326

### Tester for ECL devices gives 10-ps resolution

Teradyne, 183 Essex St., Boston, MA 02111. Fred Van Veen (617) 482-2700. See text; 26 wks.

The S357 pulse parametric subsystem is an add-on to the J325 digital IC test system. The tester provides 10-ps resolution over a 0-to-20-ns range and has fully programmable pulse sources with voltage resolution of 1 mV from 200 mV to 2 V. Pulse parameters are automatically and independently calibrated at their programmed values. Automatic deskew software corrects for system errors down to 50 ps. Time intervals are also automatically calibrated against NBS-traceable delay lines in the system. The system permits single-socket functional dc and pulse-parametric testing of devices with up to 48 pins. The S357 subsystem is priced at \$215,000.

CIRCLE NO. 327

### 35-MHz scopes give dual traces

Tektronix, P.O. Box 500, Beaverton, OR 97077. (503) 644-0161. \$1155/\$1435.

The dual-trace T932A oscilloscope has a 35-MHz bandwidth at 2-mV/div sensitivity and the T935A adds in a delayed sweep. Each model includes a differential display mode, full sensitivity X-Y, ac or dc trigger coupling, variable trigger holdoff, ch 1, ch 2 or composite triggering and selectable chop/alternate display modes. The CRTs are 3.2 x 3.9 in. and the instrument size is 10 x 7 x 18.7 in.

CIRCLE NO. 328

# RESISTS

ESSEX/SUFLEX Acryflex® FR sleeving is flexible 155°C.  
Underwriters Laboratories listed.

- RESISTS — solvent, varnish and oil attack.
- RESISTS — flame
- RESISTS — dielectric breakdown
- RESISTS — cracking from bending when hot or cold
- RESISTS — abrasion and cut through
- RESISTS — inventory build-up because it's used for Class 105, Class 130 and Class 155 applications

Acryflex FR — UL listed as FR-1 (VW-1) — is an outstanding sleeving for appliance, home entertainment and medical equipment manufacturers. All ASTM-D372 grades are available.

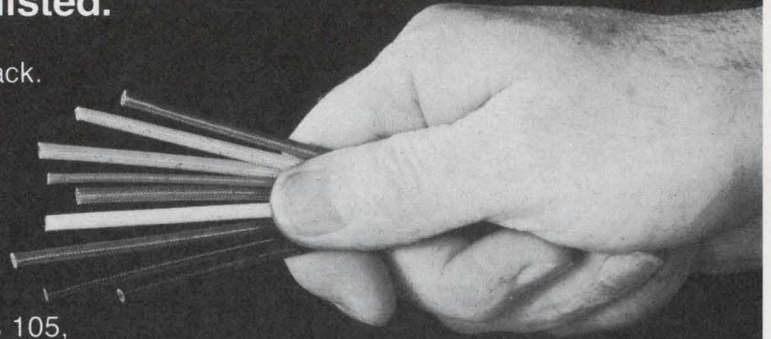

**ESSEX GROUP**  Subsidiary of **UNITED TECHNOLOGIES**

Samples, property data and prices available from 29 Essex/IWI Warehouse/Sales Centers and many independent distributors — or contact: Essex Magnet Wire & Insulation Division, Essex/Suflex, Newmarket, N.H. 03857, Phone: 603/659-5555.

CIRCLE NUMBER 62

## NEW *from the makers of high-reliability printers* AlphaNumeric Printers with a microprocessor brain!

This series of designer-styled Digitec printers delivers high contrast, easy-to-read, fade-free matrix printout and quiet operation. The "smart" microprocessor provides versatility by simplifying systems interface and using the universally accepted ASCII code set.

- Choice of serial (RS-232-C and 20mA current) with baud rates to 1200, or 8-bit parallel bus input with data rates up to 1000 characters/second.
- Up to 24 characters per line
- Double font printing for special emphasis and variable formatting for easy data analysis.
- 24-hour clock and day/month calendar.

Contact us now for more information on our complete line of numeric and alphanumeric printers.

#### ATTENTION OEM's:

As a leading supplier of OEM printers, we're flexible to your requirements and offer generous OEM discounts.

**Digitec** **UNITED SYSTEMS CORPORATION**

918 Woodley Road, Dayton, Ohio 45403  
(513) 254-6251, TWX (810) 459-1728



Model 6310 single quantity  
ready-to-print price

**\$595.**

DIGITEC: Precision measurements to count on.

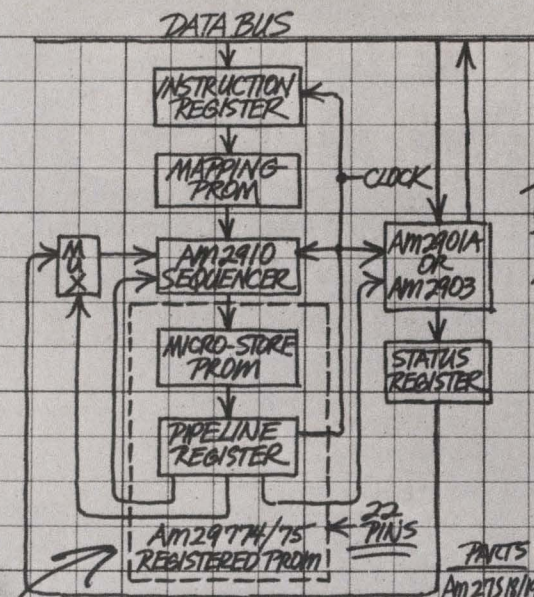

INCORPORATING THE PIPELINE REGISTER ONTO THE SAME CHIP AS THE PROM REDUCES INSTRUCTION SET-UP TIME, ALLOWING THE AM 2910 TO OPERATE AT ITS MAXIMUM CAPABILITY, ALSO SAVING BOARD SPACE, DESIGN TIME AND POWER!

PARTS	SIZE	ORGANIZATION	OUTPUTS	MAX ACCESS TIME	
				COM2	MIL
Am 2718/19	256	32x8	OC/3S	40ns	50ns
Am 2715/20/21	1024	256x4	OC/3S	45ns	60ns
Am 2712/13	2048	512x4	OC/3S	50ns	60ns
Am 2715	4096	512x8	3S only output latches	60ns	90ns
Am 2914/15	4096	512x8	OC/3S registered	N/A clocked through registers	

Advanced Micro Devices is in the PROM business. And what an opening!

# PROM'S: THE FIRST FAMILY.

## THE FAMILY.

There's a 256-bit, a 1K, a 2K and a 4K with output latches. Choose open-collector or three-state outputs. All have the same electrical characteristics. All are programmable from the same card set.

Are they fast? Are they fast! Just take a look at the chart.

Performance and reliability? MIL-STD-883 for free. Designed for military performance. Enough said.

And with every AMD PROM, you get one small miracle: After almost two billion fuse hours of testing, the fuse failure rate is zero. Zip. None.

The magic ingredient is platinum-silicide. The programming is fast. The yields high. And the long term reliability is excellent.

## ANOTHER FIRST.

In the family you'll find an Am29774/75, the world's first 512 x 8 registered PROM.

Make room for it. 35% less room. It's a 22-pin part. It's 35% smaller than 24-pin counterparts.

Here's yet a third first: easy pipelined microprogramming. The Am29774/75 has edge-triggered full master/slave registers built right into each output, eliminating an external 20-pin octal register and saving another 20% in board area.

All this means is that the next time you need high performance PROMs, call The First Family.

Call Advanced Micro Devices.

# Advanced Micro Devices



Multiple technologies. One product: excellence.  
901 Thompson Place, Sunnyvale, California 94086  
Telephone (408) 732-2400

## Industrial control unit doubles as learning aid

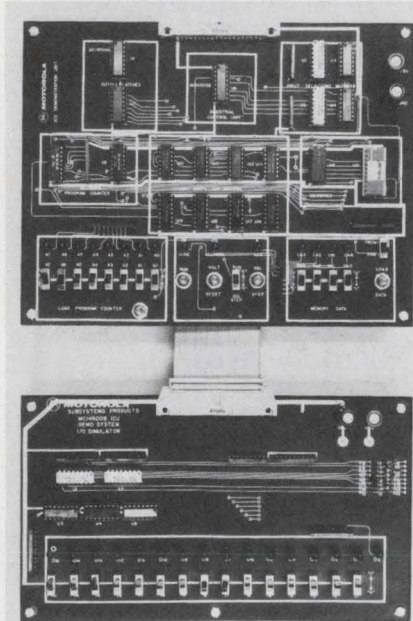

Motorola, P.O. Box 20912, Phoenix, AZ 85036. Chuck Kastner (602) 244-3103. \$295; stock.

The DS14500A 2-board industrial control system combines a programmable logic controller with an ancillary I/O simulator that serves as a system development tool and demonstration unit. The system serves as a learning tool to acquaint designers with the power of a 1-bit MPU and, thereafter, as a dedicated functional control system. As a functional system the I/O simulator is replaced by the actual I/O devices for the working system. The system has 15 inputs and 16 outputs and contains a RAM holding 128 ICU program instructions.

CIRCLE NO. 329

## Cassette cleaner renews Philips-style cassettes

Innovative Computer Products, 18360 Oxnard St., Tarzana, CA 91356. Lewis Whitaker (213) 996-4911. \$300.

The Model 100 digital-cassette cleaner is compatible with all Philips-style cassettes. The cleaner uses a long-lasting blade that removes partially imbedded or surface particles of foreign contamination. In addition to the cleaning blade, the device uses a cleaning and conditioning solution on a pad. The pad and solution removes oils and submicron size particles from the tape surface.

CIRCLE NO. 330

## Disc controller handles up to 20 Mbytes storage

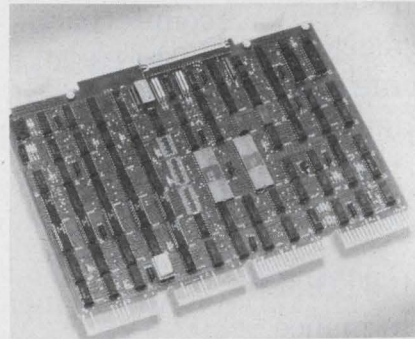

Dynus, 3198 G Airport Loop Dr., Costa Mesa, CA 92626. Paul Files (714) 979-6811. \$2500; 4 wks.

The Model DI-C03 moving head disc controller directly interfaces with LSI-11 backplanes and provides control for up to 20 Mbytes of on-line storage for standard 1500 or 2400 rpm disc drives. The controller uses DEC-approved circuit drivers and receivers along with an eight-word FIFO buffer for DMA latency. In addition, the device includes two additional address bits for up to 128 kwords of direct addressing. A DMA transfer rate of 6.4  $\mu$ s/word, cartridge capacity of 2.5 to 5 Mbytes and double-frequency recording on 2315 or 5540-type cartridges are provided.

CIRCLE NO. 331

## CMOS RAM board stores 8 kbytes

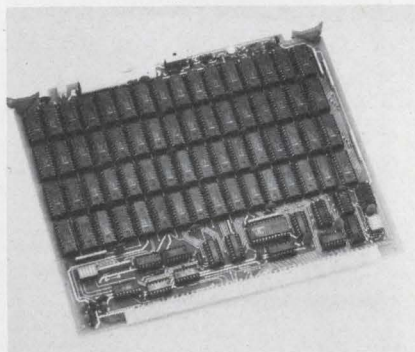

Process Computer Systems, 750 N. Maple Rd., Saline, MI 48176. (313) 429-4971. \$795/\$995; 4 wks.

The Model 1814 memory module contains 8 kbytes of CMOS RAM and has a 450-ns memory cycle. The module has built-in battery back-up and charger to retain information for a minimum of seven days. The basic module has 4 kbytes of RAM installed with sockets provided for an additional 4 kbytes. A second version has a full 8 kbytes of RAM installed.

CIRCLE NO. 332

## Moderate-price $\mu$ C has big-system features

Computer Systems Unlimited, P.O. Box 870, Milpitas, CA 95035. (408) 262-6271. \$9220.

The Zycon III microcomputer achieves big-system features at a moderate price. The standard system contains a 24  $\times$  80 high-resolution CRT and controller with character intensification, blinking, underscoring and reverse video. Using a 63-key alphanumeric keyboard, 16-key numeric and cursor cluster and 8-key alternate action pad, the system can support the use of high-resolution graphics and scientific or foreign alphabets. A 32-k RAM is expandable in 16-k increments to 65,536 bytes and is usable as either an 8 or 16-bit word memory. Also included are dual floppy discs with an intelligent controller. An 8085A processor board has space for an extra 6-k of EPROM, a TTY port, eight levels of interrupt, and special logic for an 8-channel bus controller.

CIRCLE NO. 333

## Boards isolate digital inputs to protect $\mu$ C



Burr-Brown, International Airport Industrial Park, Tucson, AZ 85734. C.R. Teeple (602) 294-1431. \$295 and \$355; stock.

These single-board microperipherals accept 24 digital inputs and isolate microcomputers from voltage, transients and other malfunctions. Model MP710 or MP810, with an on-board power supply, operates with dry relay contacts and the MP710-NS or MP810-NS with voltage input and wet relay contacts. Each group of eight inputs is isolated from other groups and from the computer bus for up to 600 V dc. In the MP710-NS and MP810-NS, isolation between inputs is 300 V dc. Because each input is isolated, the voltage to each line is not critical and ground loops are eliminated.

CIRCLE NO. 334



# WHY LIMIT YOURSELF TO LESS THAN 300 MHz?

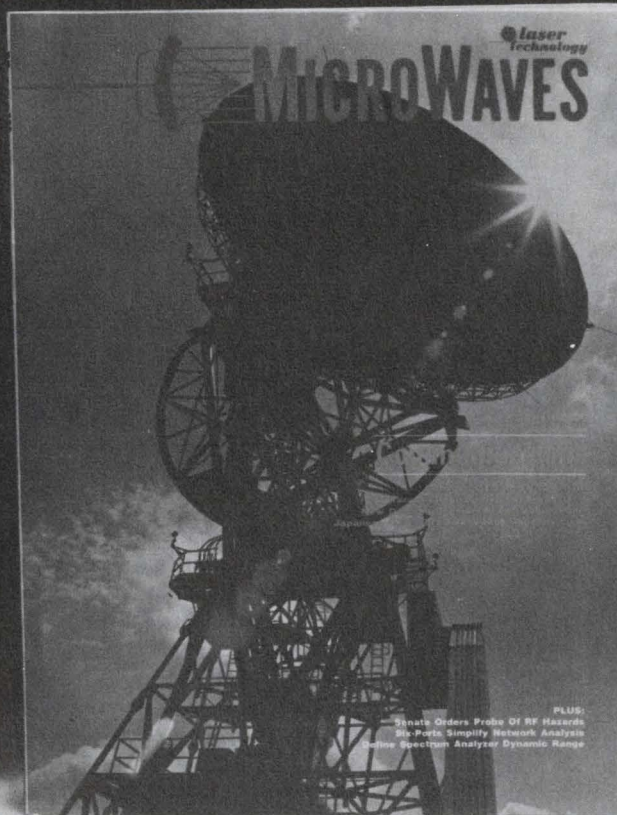

There's a lot going on these days above the 300 MHz range ... and there's a lot going on in *MicroWaves*.

A decade or so ago, microwave engineers were the "plumbers" of this industry. They worked in small groups in a machine-shop type atmosphere. Today it's different.

The machine shop is gone — replaced by a solid-state environment. The separate worlds are coming back together.

Even if your work involves frequencies below 300 MHz, don't

you owe it to yourself to keep up to date with what's happening in microwaves? Every month *MicroWaves* magazine delivers a balanced editorial package of news, technology and products for microwave specialists. It's *FREE* to qualified subscribers (who also receive our annual Product Data Directory — an invaluable aid in product sourcing).

To obtain an application form for your free subscription, just circle the number shown below on your Reader Service Card.

## KEEP UP TO DATE WITH



# MICROWAVES

### FREE TO SUBSCRIBERS WHO QUALIFY

JUST CIRCLE **67** ON READER SERVICE CARD

## Terminal develops and debugs 8080 systems

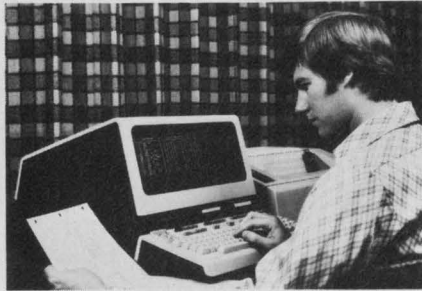

Hewlett-Packard, 1507 Page Mill Rd., Palo Alto, CA 94304. (415) 493-1501. \$6950.

A program development terminal, Model HP 13290B, aids programmers who develop, test and debug programs written for 8080-based systems. With debug/ assembler software that is loaded via tape cartridge into the RAM of the  $\mu$ P-controlled terminal, a programmer displays and changes an 8080's registers and any portion of a user-written program. Equipped with 64 kbytes of 400-ns RAM and 22 kbytes of ROM, the terminal takes programs of up to 44 kbytes.

CIRCLE NO. 335

## Connector device reduces glitches on S-100 bus

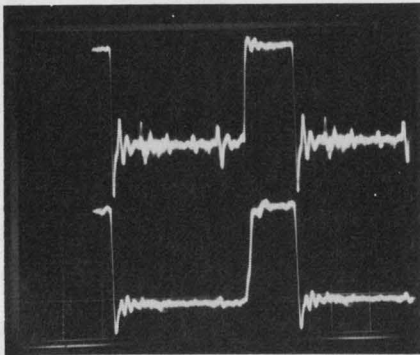

Extensys, 380 Bernardo Ave., Mountain View, CA 94040. Ed Hartnett (415) 969-6100. \$79.50; stock.

The Glitch Grabber, a printed-circuit card mounted circuit, maintains clean signals on a noisy S-100 bus. The device plugs into any open slot on the S-100 bus and uses a self-regulating transistor network to control voltages and modify circuitry to handle less or more voltage. The circuitry activates only when the glitch is there, so that bus signals are not loaded.

CIRCLE NO. 336

## Multiplexer board saves space in minis

Custom Systems, 2415 Annapolis Lane, Minneapolis, MN 55441. Dave Clinton (612) 553-1112. \$1800; stock.

Slot-Saver II is a general I/O-multiplexer board for Data General and Data General-emulating minicomputers. The board reduces the number of slots required for controller interface boards in minicomputer chassis. A user can employ a minicomputer with a smaller chassis at a lower cost. Included is all the necessary control logic on a 15 x 15-in. PC board to provide four channels of asynchronous multiplexing, a real-time clock, system console CRT plus a second serial port and a line-printer interface.

CIRCLE NO. 337

## Small briefcase contains portable $\mu$ C

Adaptive Systems, P.O. Box 1481, Pompano Beach, FL 33061. (305) 942-4000. \$1000 to \$3000.

The portable microcomputer is contained within a small briefcase and delivers full operation for 8 h using a self-contained battery with charger. Data can be stored up to one year in the standby mode. The system has two 40-key keyboards, an 8-digit display and other control switches. Clocking speed is 4 MHz with a 12-bit word size. The language is PDP-8 compatible and most instructions are single-cycle execute. Pricing depends on memory size.

CIRCLE NO. 338

## Emulation units check 8080A and 6800 $\mu$ Ps

Computer Automation, 18651 Von Karman, Irvine, CA 92713. Doug Cutsforth (714) 833-8830. See text.

Two logic simulation systems emulate the operations of the Intel 8080A and Motorola 6800 microprocessors. The Capable 4812 is a stand-alone logic simulation system, priced at \$71,000, and it consists of a minicomputer, 96 kwords of memory, emulation software, disc drive, documentation and support. The Capable 4852 provides a lower cost simulation capability by sharing processor and memory with a testing system. Priced at \$33,900, it incorporates emulation software and expansion of the tester memory to 96 kwords.

CIRCLE NO. 339

## 32-word ROM plugs into PDP-11 slot

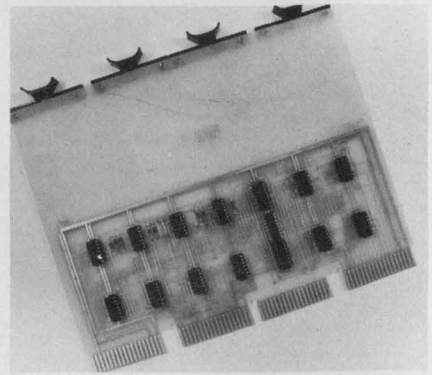

Computer Extension Systems, 17311 El Camino Real, Houston, TX 77058. Gary Wagner (713) 488-8830. \$285.

The ROM11-32 read-only memory plugs directly into the DEC PDP-11 small peripheral controller (SPC) slot. The memory is functionally equivalent to the DEC M792 PROM and is configured around two fusible-link 32 word by 8-bit PROMs of the 8223 type. The PROM ICs can be programmed to customer specs at no charge. The quad board operates from the existing PDP-11 power supply.

CIRCLE NO. 340

## Flexible-disc drive meets MIL-E-16400

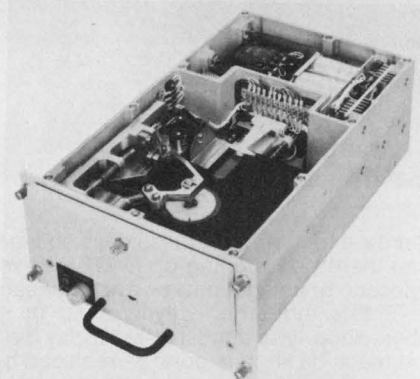

Miltope, 9 Fairchild Ave., Plainview, NY 11803. (516) 938-9500.

The DD 400 flexible-disc drive meets MIL-E-16400 and employs MIL-M-38510/MIL-STD-883 Class B micrologic. The drive provides over 3 Mbits of on-line storage on interchangeable floppy-disc media (over 6 Mbits with optional double density). Compatible with the IBM 3740, each diskette provides 77 data tracks with 3200 bits/in. data packing (6400 double density). Track-to-track access is accomplished within 6 ms.

CIRCLE NO. 341

# The 6800 A/D & D/A Advantage

super-software supplied • 2 optional D/A outputs • 80 A/D channels from just 2 cards.

Datel's SineTrac 6800 has it. SineTrac 6800 slide-in A/D and D/A I/O cards provide a complete analog "front end" inside your Motorola M6800 EXORciser microcomputer.

SineTrac 6800 is ideal for industrial data logging, process loops, automatic test, and fast data acquisition systems.

The A/D card contains 32 single-ended or 16 differential input channels, and A/D Expander cards offer 48 additional channels. Memory-mapped addressing expands up to 128 channels.

A/D throughput is 20 microseconds and A/D Masters may include 2 D/A outputs, 12-bit digital output ports or a  $\pm 15V$  DC/DC converter.

Eight A/D inputs include PC pads for resistors to accept 4-20 mA, 1-5 mA, and 10-50 mA process loop current inputs. The ST-6800 also accepts an external event command to start an interrupt beginning an A/D-D/A service routine.

SineTrac 6800 D/A cards contain either 8 or 4 channels with an optional  $\pm 15V$  DC/DC converter and a 12-bit digital output port. Each D/A channel includes a 2-bit output (Device Select) for pen up-down or write-erase commands. D/A Expanders accommodate 128 channels.

The paper tape diagnostic program supplied offers channel calibration, data printout on a TTY or CRT, and troubleshooting. A comprehensive user's manual is included with schematics, logic timing, calibration, and program listing.

Pricing for 16 A/D channels starts at \$419\* (singles) with D/A's and power converters optional. Write today for details.

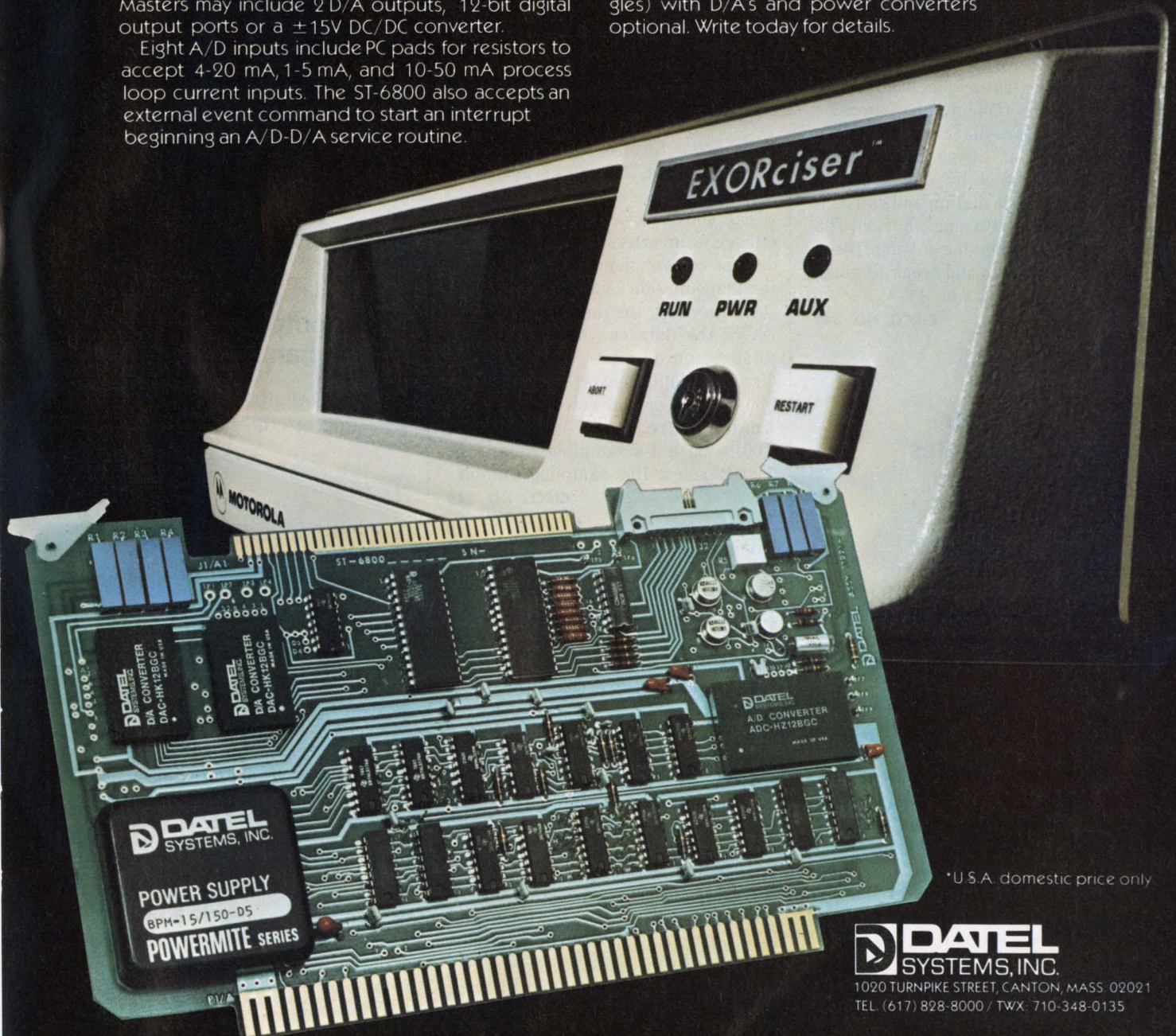

\*U.S.A. domestic price only

**DATEL**  
SYSTEMS, INC.

1020 TURNPIKE STREET, CANTON, MASS. 02021  
TEL. (617) 828-8000 / TWX: 710-348-0135

CA (714) 835-2751, (213) 933-7256 • (408) 733-2424 • MD (301) 840-9490 • TX (713) 932-1130 • (214) 256-4444  
OVERSEAS: DATEL (UK) LTD—TEL: ANDOVER (0264) 51055 • DATEL SYSTEMS SARL 620-06-74 • DATELEK SYSTEMS GmbH (089) 776095

CIRCLE NUMBER 68

## MODULES & SUBASSEMBLIES

### Touch-pad memory dialer mates with all phones



Teledial Devices, 8 Fairchild Court, Plainview, NY 11803. Paul Jacobs (516) 822-7631. \$90; stock.

The Model TD-10A memory dialer, a self-contained touch-pad dialer with a programmable memory, works with all rotary and tone-telephone systems. The device dials twice as fast as a rotary system with no circuit modifications. The features include: ten 20-digit programmable-number storage; ability to "pre-dial" a telephone number without lifting the handset; last-number redial by a single key-stroke; automatic dialing and call cancelling by pressing a single button. The unit has programmable pulsing speeds of 10 or 20 pulses/s and break-to-make pulsing ratios of 2:1 or 3:2.

CIRCLE NO. 342

### Crystal oscillator drives 10 TTL gates

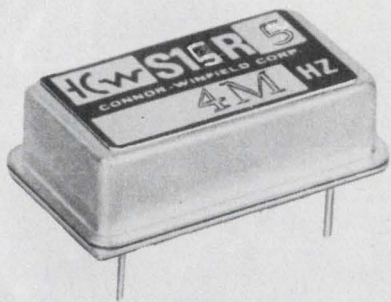

Conner-Winfield, W. Chicago, IL 60185. (312) 231-5270. \$30 to \$40; 8 wks.

The Model S15R5 hermetically sealed DIP crystal oscillator drives 10 TTL gates at any fixed frequency from 3.5 to 25 MHz. The total frequency tolerance is  $\pm 0.01\%$  from 0 to 70 C. Rise and fall times are less than 10 ns. The oscillator is in an all-metal welded package that measures  $0.82 \times 0.52 \times 0.2$  in.

CIRCLE NO. 343

### Fast a/d converters come in 8 to 12-bit models

Dynamic Measurements, 6 Lowell Ave., Winchester, MA 01890. \$230 to \$300.

Type 2813 ultra-high-speed a/d converters permit throughput rates of 1.33 MHz (8-bit), 1 MHz (10-bit) and 0.5 MHz (12-bit). Twelve-bit models with 0.4-MHz and 0.25-MHz throughput rates are also available. Max linearity and differential linearity is  $\pm 1/2$  LSB. Nonlinearity tempco is below  $\pm 10$  ppm/ $^{\circ}$ C (5 ppm/ $^{\circ}$ C for 12-bit models). Outputs are DTL/TTL compatible and unipolar or bipolar inputs are selected by pin connection. The modules are in metal cases measuring  $2 \times 4 \times 0.4$  in.

CIRCLE NO. 344

### V/f converters allow digital transmission

Solid State Electronics, 15321 Rayen St., Sepulveda, CA 91343. Ed Politi (213) 894-2271. \$268; 4 to 7 wks.

The 400VF series of voltage-to-frequency converters converts analog data or control signals to digital form for transmission over long distances. Once received, the data are in a form where the data can be sampled and totalized on an electronic counter for direct readout, converted to a digital binary code or converted back to dc. Analog-to-frequency resolution is 0.001% on a 1-s sampling counter or 0.0001% on a 10-s sampling counter.

CIRCLE NO. 345

### Double-balanced mixer covers 2-decade range

Anzac, 39 Green St., Waltham, MA 02154. Jim Leonard (617) 899-1900. \$39; stock.

Model MP-152 is a double-balanced mixer with greater than a two-decade frequency range (10 to 1500 MHz). The TO-8 plug-in package boasts typical isolations of 40-dB at midband for LO-to-rf and LO-to-i-f. The conversion loss at midband is typically 6 dB. Single-sideband noise figure is within 1 dB of conversion loss. Input for 1-dB compression is 0 dBm typical. Two-tone intermodulation ratio is 85 dB at 500 MHz, with a -30-dBm input for each tone and 50-MHz i-f.

CIRCLE NO. 346

### 12-bit a/d converts fast

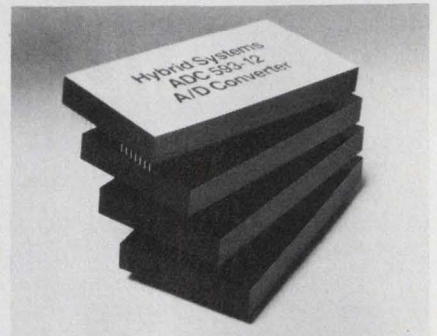

Hybrid Systems, Crosby Dr., Bedford, MA 01730. Larry Lauenger (617) 275-1570. \$199; stock.

The ADC593-12 is a high-speed, 12-bit a/d converter that operates in 3.5  $\mu$ s (typical) and 4  $\mu$ s (max) conversion time. The model has an accuracy of  $\pm 0.0125\%$  and a 250-kHz throughput rate. Four selectable input ranges and three digital-output codes provide versatility. The gain tempco is  $\pm 300$  ppm/ $^{\circ}$ C. The converter has a differential linearity of  $\pm 1/2$  LSB and is monotonic from 0 to 70 C. The size is  $2 \times 4 \times 0.4$  in.

CIRCLE NO. 347

### Digital output boards for $\mu$ Cs handle 10 W

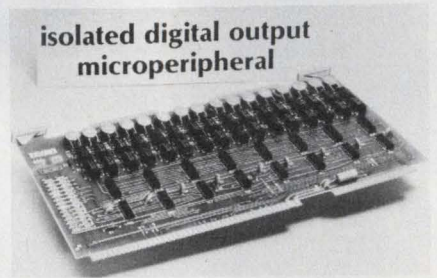

Burr-Brown, P.O. Box 11400, Tucson, AZ 85734. C.R. Teeple (602) 294-1431. \$295/\$475.

Digital-output systems, with 16 or 32-channels, plug into Intel SBC 80 and Intellec MDS  $\mu$ Cs. Memory-mapped MP801 (16-channel) or MP802 (32-channel) systems are on a single board and provide all control and timing circuitry. Channels are implemented by dry-reed relays that handle up to 10 W. The relays isolate output channels from the computer bus (to 600 V dc) and from channel to channel (300 V dc). The systems are treated as memory by the CPU; eight channels occupy one memory location. Outputs can switch inductive loads.

CIRCLE NO. 348

# POWER MISER DPM



Includes  
VOM, DVM  
Descriptors

19.99  $k\Omega$   
mA  
mV  
ACDC

## Datel's Battery- Powered Breakthrough



### Model DM-3100U1 DPM

- True balanced differential inputs
- 3½ digit Liquid Crystal Display
- User-installed mA,  $\Omega$ , mV ranges
- Includes VOM, DVM Descriptors: mA, mV,  $k\Omega$ , AC, DC
- Operates from 5 to 8 Vdc @ 6 mA or 9 to 15 Vdc @ 3 mA
- \$69 (singles)

**\$49<sup>00</sup>**  
(100's)

**D** **DATEL**  
SYSTEMS, INC.

1020 Turnpike St., Canton, MA 02021  
TEL (617) 828-8000 / TWX: 710-348-0135  
• Santa Ana, CA (714) 835-2751  
• LA Exchange (213) 933-7256  
• Sunnyvale, CA (408) 733-2424  
• Gaithersburg, MD (301) 840-9490  
• Houston, TX (713) 932-1130, 1132  
• Irving, TX (214) 256-4444  
• Tokyo, Japan 793-1031; Osaka, Japan  
(06) 354-2025 • Andover, UK (0264)  
51055 • Paris, Fr. 620-06-74  
• Muenchen, W. Ger. (089) 776095

# SIEMENS

## Economy DIP Tantalum Capacitors

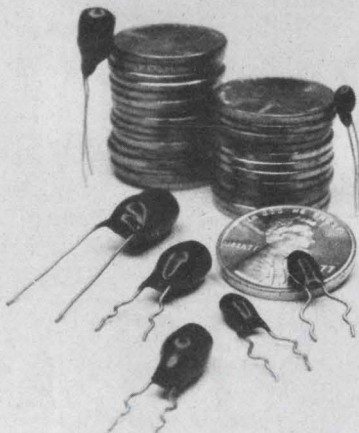

Siemens new ST841 and ST842 Sub-miniature Epoxy Coated Solid Tantalum Capacitors are the economical answer to Tantalum Capacitor applications.

### Features:

- Capacity Ranges from 0.1  $\mu$ F thru 680  $\mu$ F
- Tolerances of 5, 10, or 20%
- Eight categories from 3 to 50 Volt
- Lead Styles of straight or "Lock-in" crimp
- Lead Spacings of 0.1 or 0.2 inch are available
- Manufactured in U.S.

### Typical Impedance vs. Frequency @ 25°C.

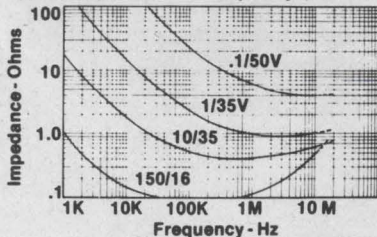

**Siemens Corporation**  
Components Group  
186 Wood Avenue South  
Iselin, New Jersey 08830

CIRCLE NUMBER 71

## PACKAGING & MATERIALS

### Cable-tying hand tool for right or left handed

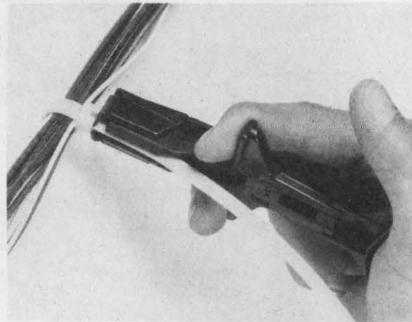

Thomas & Betts, 36 Butler St., Elizabeth, NJ 07207. (201) 354-4321. \$8.99; stock.

A lightweight hand-operated cable-tying tool, WT-2, installs cable ties up to 0.301-in. wide and 0.053-in. thick. This shirt-pocket-sized tool is made of high-impact plastic and steel and is convenient for both left and right-handed operators. The tool cinches up the tie with a squeezing action and then cuts away excess tail when twisted 180 degrees.

CIRCLE NO. 356

### Machine feeds, crimps loose contacts

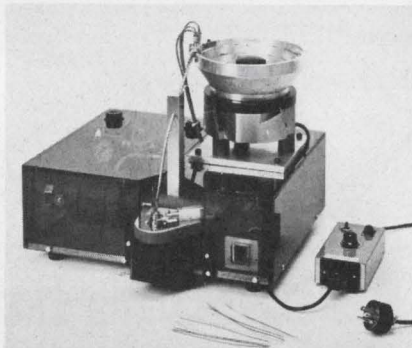

VIP Industries, 246 Knickerbocker Ave., Paterson, NJ 07503. Ed Nemeth (201) 345-5800. \$3975; 4 wks.

VIP crimping machines orient, position and feed loose cylindrical connector contacts without the use of tapes or bandoleers. The device automatically drops the contact into a crimping nest. As the stripped wire is inserted into the contact, a slight downward pressure on the wire by the operator activates the crimping die. A trained operator can crimp 1000 pieces/hr.

CIRCLE NO. 357

### Backpanel systems meet MIL-C-28754 spec

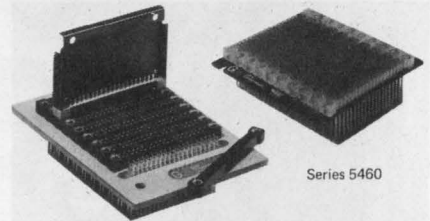

Series 8270

Series 5460

Elco Pacific, 2250 Park Pl., El Segundo, CA 90245. (213) 576-3311.

The Series 5460 metal-plate and Series 8270 press-fit backpanel systems have blade and tuning fork contacts that meet the MIL-C-28754 spec. The Series 5460 has 0.1 and 0.125-in. contact spacing. The assembly consists of a 0.08-in. aluminum plate with nylon insulators pressed into the hole pattern and the contacts pressed into the nylon insulators. The Series 8270 has 0.1-in. spacing and consists of a two-sided or multilayer PC board, 0.125-in. thick, with contacts pressed into plated-through holes.

CIRCLE NO. 358

### Device forms transistor leads at high speed

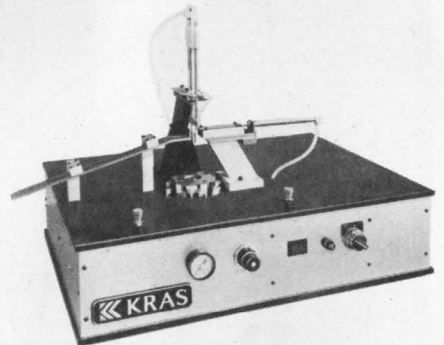

Kras, 99 Newbold Rd., Fairless Hills, PA 19030. Jack Demore (215) 946-8180. \$8900; 6 to 8 wks.

Model 5328 pin-circle forming machine lead straightens and reforms pins on TO-99 or other transistors with circular pin arrangements from 0.2-in. up to any required diameter. The device also cuts the leads to any desired length. The parts are loaded manually or automatically and off-loaded by an air cylinder to a slotted track. With manual load, the machine forms 1000/h, and with automatic load and offload, 2000/h. Dies are interchangeable for different pin counts or circles.

CIRCLE NO. 359

# Complete, 12-Bit Microcircuit Data Acquisition System

Datel has it...

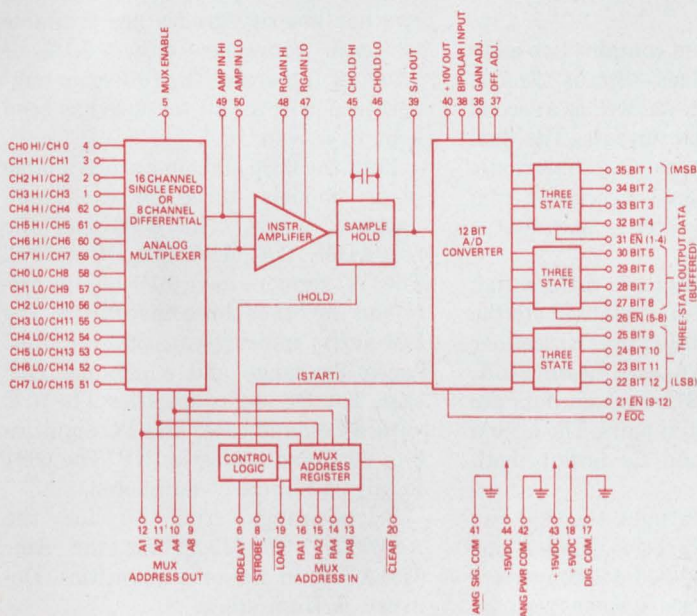

## HDAS-16 & HDAS-8

- ▶ 16 Channels, Single-Ended (HDAS-16)
- ▶ 8 Channels, Differential (HDAS-8)
- ▶ 12 Bits Resolution
- ▶ 50kHz Throughput Rate
- ▶ Internal Instrumentation Amplifier
- ▶ Three-State Data Outputs
- ▶ Military and Commercial Temperature Range available
- ▶ 62-pin Miniature Package
- ▶ Priced at \$295.00\* (1-9)

\*U.S.A. domestic prices only

Datel's HDAS—the first complete 12-bit data acquisition system in a single, miniature package. Using thin-film hybrid fabrication, it challenges modular data acquisition systems on performance and price. Its excellent performance and reliability are also available in versions for full MIL-Spec operation over  $-55$  to  $+125^{\circ}\text{C}$ . The HDAS 62-pin package measures only  $2.3 \times 1.4 \times 0.24$  inches ( $58 \times 36 \times 6$  mm).

**DATEL**  
SYSTEMS, INC.

1020 TURNPIKE STREET, CANTON, MASS. 02021  
TEL. (617) 828-8000 / TWX: 710-348-0135 / TELEX: 924461

Santa Ana (714) 835-2751, (L.A.) (213) 933-7256 • Sunnyvale, CA (408) 733-2424 • Gaithersburg, MD (301) 840-9490 • Houston, (713) 932-1130 • Irving, TX (214) 256-4444  
OVERSEAS: DATEL (UK) LTD—TEL: ANDOVER (0264) 51055 • DATEL SYSTEMS SARL 620-06-74 • DATELEK SYSTEMS GmbH (089) 77-60-95

CIRCLE NUMBER 63

# DAC simplifies $\mu$ P interface; it acts like a memory location

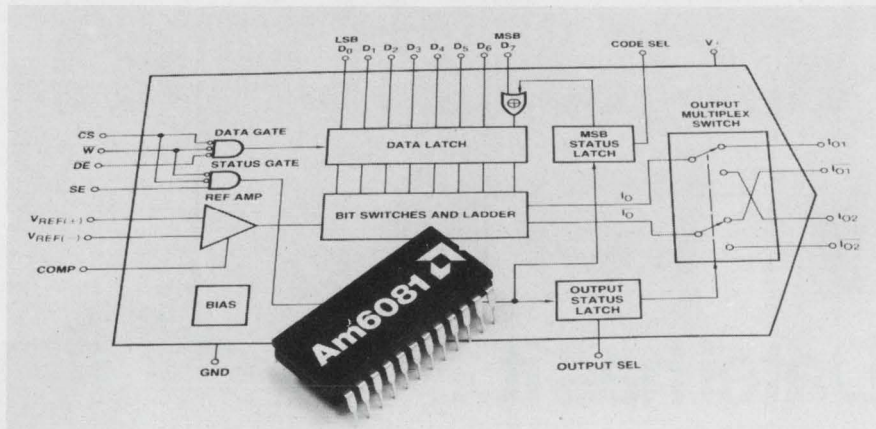

Advanced Micro Devices, 901 Thompson Pl., Sunnyvale, CA 94086. Ron Marfil (408) 732-2400. P&A: See text.

Able to mate with any micro-computer system, the Advanced Micro Devices 6080 d/a converters contain the data-bus input latches as well as special addressing and encoding circuitry to handle almost any micro-processor I/O requirement. Currently, there are no other available converters that offer such a versatile interface. Configured to act like a memory location, the Am6080 has Write, Chip-Select and Enable logic built-in. The only external components needed are a reference, a current-setting resistor, and, if desired, an output op amp for a voltage output.

The Am6080 converter accepts 8-bit inputs and delivers current outputs in 160 ns. The reference current can range from 40  $\mu$ A to 4 mA; however, most data-sheet values are guaranteed when the reference current is set to provide a 2-mA full-scale output current. Operating in a two-quadrant multiplying mode, the converter's reference input has a bandwidth of 1 MHz, and can handle a full-scale transition in just 250 ns.

Two versions of the converter are available. The 6080, housed in a 20-pin 300-mil-wide DIP, delivers a differential-analog output and has four control lines—MSB Select, Data Enable, Write, and Chip Select.

The 6081 offers more control, comes

in a 24-pin DIP and contains two additional control lines—Status Enable and Output Select—as well as a second pair of differential outputs. The dual differential outputs are internally multiplexed by signals generated from the Chip Select, Write, and Status Enable inputs.

Converter outputs are differential: For the 6080, the sum total of both the  $I_0$  and the  $\bar{I}_0$  outputs is 2 mA, with either output line able to handle the full 2 mA. Similarly, the 6081's four outputs are set up as differential pairs. The  $I_{01}$  and  $\bar{I}_{01}$ , and the  $I_{02}$  and  $\bar{I}_{02}$  outputs both handle 2 mA.

With its dual outputs, the 6081 can be used in dual-function applications—either to replace two d/a converters or to function as a d/a converter part of the time and as part of an a/d converter the rest of the time.

All popular coding formats can be input to the 6081—binary, complementary binary, sign-magnitude, complementary sign-magnitude, straight offset binary, one's-complement offset binary, offset binary and two's-complement offset binary. The sign-magnitude capability of the 6081 makes it a 9-bit converter (8-bit plus sign).

Except for the sign-magnitude forms of the coding, all the same codes are available on the 6080.

Input codes can either be permanently hardwired or programmed-in when the system is initialized. All digital inputs and outputs are TTL,

CMOS and NMOS-compatible. Data-hold time can be as little as zero since the on-chip latches can be made transparent. Typical data-set-up time and write-pulse width are both 30 ns, with a maximum of 80 ns.

Both the 6080 and the 6081 provide up to 4.2 mA of current output, although most specifications are guaranteed at 2 mA. The high-impedance output has a compliance from -10 to +18 V.

Converters require both a +5 V and a -5 to -15 V supply. Power consumption ranges from 86 mW (for  $\pm 5$ -V), to 160 mW (for +5, -15 V). In addition, two nonlinearity grades are available for each converter—either 0.1% or 0.19% of full scale. The full-scale temperature drift for all versions has been kept to 5 ppm/ $^{\circ}$ C.

Both the 6080 and 6081 are available in six models—three for each non-linearity grade. The 6080 has the 6080ADM, ADC, APC, DM, DC and PC. The "A" versions have 0.1% nonlinearity and the other three have 0.19%. The DM suffix indicates a -55 to +125- $^{\circ}$ C operating range and a ceramic DIP case. The DC suffix specifies 0 to 70  $^{\circ}$ C with a ceramic case, and PC signifies 0 to 70  $^{\circ}$ C and a plastic DIP. The 6081 family is similarly numbered.

Prices range from \$5 for the Am6080PC to \$19.50 for the Am6081ADM, in 100-unit quantities. Delivery is from stock.

CIRCLE NO. 301

## HV power transistors switch fast

Solitron Devices, 1177 Blue Heron Blvd., Riviera Beach, FL 33404. (305) 848-4311. \$2.25 to \$4.50 (100 qty); 3 to 4 wks.

SDT 40301 through 40305 are high-voltage, fast-switching planar power transistors that handle 5 and 10 A. The  $V_{CE0}$  ratings are from 150 to 350 V at 10 mA and  $h_{FE}$  is 20 to 80 at  $I_C$  of 2 A. Saturation voltage at 2 A is 300 mV and fall time is 500 ns at 2 A. Units are housed in TO-3 cases.

CIRCLE NO. 360



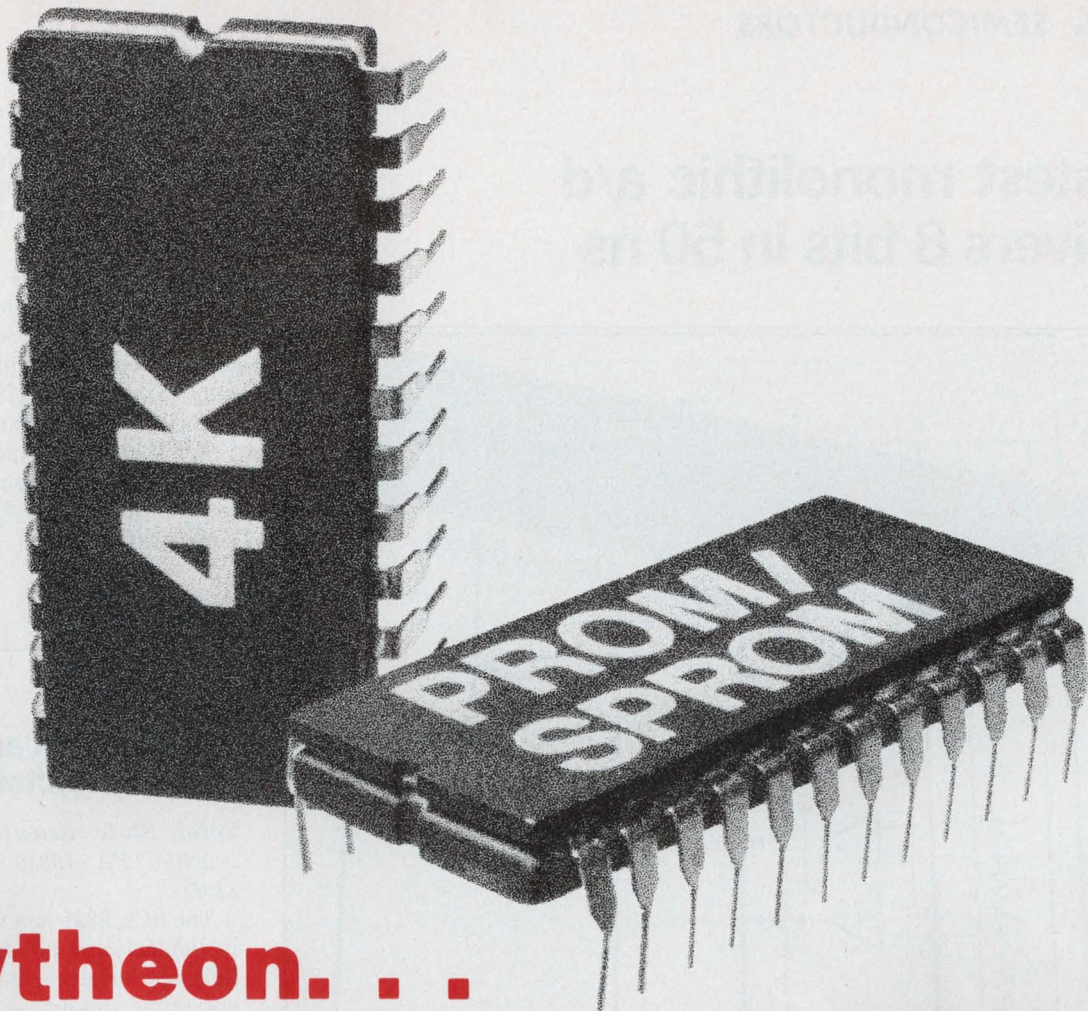

# Raytheon. . . gives you both **low power** and **high-speed** in one package. **The SPROM**

Raytheon has them both, standard PROM's and the new power-switched PROM's (SPROM). Just plug them into any existing large PROM array and you can reduce the overall power consumption by more than 50%.

Look over the table and see for yourself that Raytheon offers you more. If you need detailed information, give us a call. Raytheon Company, Semiconductor Division, 350 Ellis Street, Mountain View, CA 94042 (415) 968-9211



TEMPERATURE RANGE	NO. OF BITS	ORGANIZATION	PINS	OUTPUT	STANDARD PROM			SPROM*		
					PART NO.	TAA MAX.	PRICE 100+	PART NO.	TAA MAX.	PRICE 100+
0 - 70°C	1K	256 x 4	16	OC	29660 DC	70	\$ 2.75	29662 DC	60	\$ 3.30
	1K	256 x 4	16	TS	29661 DC	70	\$ 2.75	29663 DC	60	\$ 3.30
	2K	256 x 8	20	OC	29600 DC	75	\$ 5.20	—	—	—
	2K	256 x 8	20	TS	29601 DC	75	\$ 5.20	—	—	—
	2K	512 x 4	16	OC	29610 DC	55	\$ 5.00	29612 DC	60	\$ 6.00
	2K	512 x 4	16	TS	29611 DC	55	\$ 5.00	29613 DC	60	\$ 6.00
	4K	512 x 8	20	OC	29620 DC	65	\$10.00	29622 DC	70	\$12.00
	4K	512 x 8	20	TS	29621 DC	65	\$10.00	29623 DC	70	\$12.00
	4K	512 x 8	24	OC	—	—	—	—	—	—
	4K	512 x 8	24	TS	—	—	—	—	—	—
-55 - +125°C	1K	256 x 4	16	OC	29660 DM	80	\$ 5.75	29662 DM	75	\$ 6.90
	1K	256 x 4	16	TS	29661 DM	80	\$ 5.75	29663 DM	75	\$ 6.90
	2K	256 x 8	20	OC	29600 DM	90	\$12.00	—	—	—
	2K	256 x 8	20	TS	29601 DM	90	\$12.00	—	—	—
	2K	512 x 4	16	OC	29610 DM	70	\$11.00	29612 DM	75	\$13.00
	2K	512 x 4	16	TS	29611 DM	70	\$11.00	29613 DM	75	\$13.00
	4K	512 x 8	20	OC	29620 DM	80	\$21.00	29622 DM	85	\$25.00
	4K	512 x 8	20	TS	29621 DM	80	\$21.00	29623 DM	85	\$25.00
	4K	512 x 8	24	OC	—	—	—	—	—	—
	4K	512 x 8	24	TS	—	—	—	—	—	—

**COMING NEXT**

**COMING NEXT**

\*A SPROM is a PROM with a built-in power switch. By de-selecting the SPROM, a power savings of up to 70% can be achieved.

# Fastest monolithic a/d delivers 8 bits in 50 ns

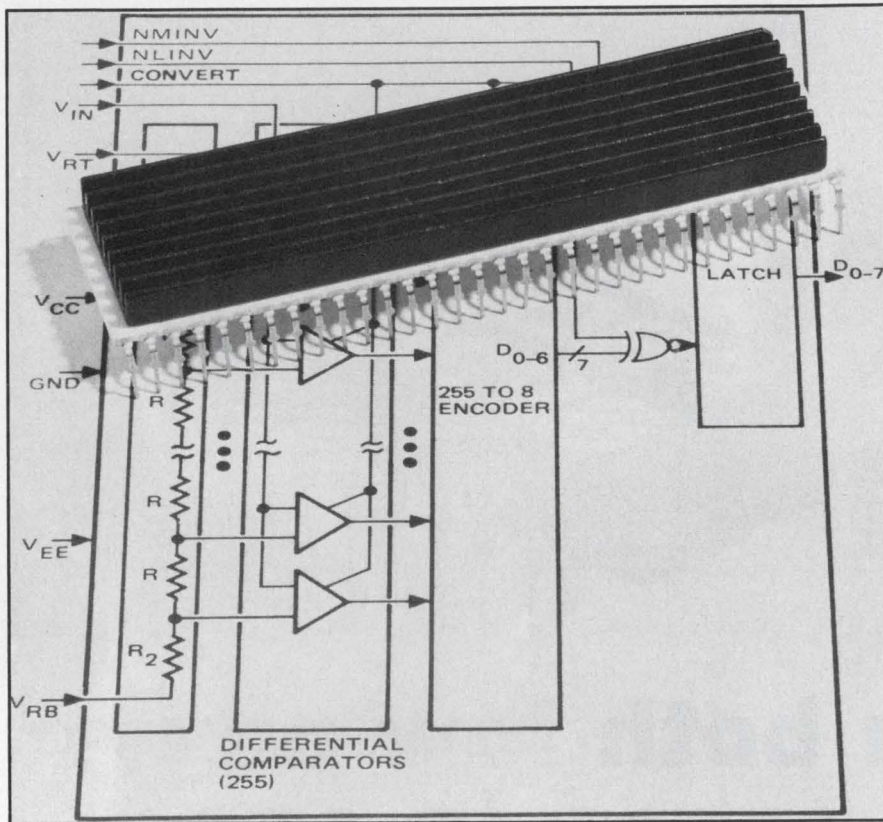

TRW LSI Products, P.O. Box 1125, Redondo Beach, CA 90278. Willard Bucklen (213) 535-1831. P&A: See text.

Setting the fastest pace yet for monolithic analog-to-digital converters, the TDC1007J can perform 20-million conversions per second. The 8-bit converter from TRW contains 255 differential comparators, a resistance ladder and an output buffer latch. Conversion typically takes 33 to 40 ns, but the *guaranteed* minimum is 50 ns.

Converter-input impedance is 5 k $\Omega$  shunted by 300-pF capacitance. A low-impedance buffer amplifier should be used on the input to optimize the matching of source to converter, but direct analog inputs of 0 to -2 V can be handled. All digital inputs and outputs, though, are TTL compatible.

To make the converter fully functional, external components such as a -2 V reference and a Start Convert signal are required. However, since the converter performs a full parallel conversion, it doesn't need an external

clock. In addition, the reference input can also be used in a multiplying mode, so AGC functions can be performed.

Input jitter—or aperture uncertainty—has been kept to  $\pm 50$  ps. Differential phase is 1° greater than the theoretical minimum, and the differential gain error is 1% above the calculated minimum. Both offset and gain errors can be trimmed to zero.

Since the converter is a speedy bipolar, it is pretty power-hungry—drawing about 2.5 W from its +5 and -6 V supplies. The additional peripheral circuitry required by the converter should demand about 1 W more.

Due to its specially designed package, the converter can operate at temperatures ranging from 0 to 70 C. With the built-in heat sink, the converter's 64-pin DIP measures 3.25 in. long  $\times$  1 in. wide  $\times$  0.5 in. high.

While no other available monolithic a/d converter even comes close to the TDC1007J's conversion speed, some modular 8-bit converters can perform

a conversion in about 50 ns. However, they require about 10 times the power and anywhere from three to 10 times the space.

The TDC1007J is more than fast enough for television systems requiring conversion rates four times the color subcarrier frequency (14.32 MHz for U.S. video and 17.73 MHz for PAL and SECAM systems).

For the speed, expect to pay a stiff price—\$485 if you're purchasing in 100 to 499 quantities. Delivery is from stock to two weeks.

CIRCLE NO. 302

## CMOS circuit acts as smoke detector

Solid State Scientific, Montgomeryville, PA 18936. (215) 855-8400. \$1.00.

The SCL 5331 is a CMOS IC for use in ionization-type smoke detectors. Suitable for either 9-V battery or line operation, the device draws less than 7  $\mu$ A at 9 V and the required input from the ionization chamber is 1 pA max. The circuit minimizes the number of external components needed and includes such on-chip functions as low-voltage detect, horn driver, status indication for flashing a LED every 40 s and I/O for use with multiple detector systems. The IC is in either a TO-100 can or 14-lead DIP.

CIRCLE NO. 361

## 256 $\times$ 4 static RAM available in CMOS

Motorola, 3501 Ed Bluestein Blvd., Austin, TX 78721. (512) 928-2600. \$5.00 to \$5.75; stock.

The MCM145101 MOS circuit is for uses requiring ultra-low power, fully static, 5-V random access memories. The memory, organized as 256 four-bit words, has separate data inputs and outputs. Battery backup for nonvolatility is enhanced by the part's ability to retain data at a power-supply level as low as 2 V. Speed selections are 450 to 800 ns.

CIRCLE NO. 362

# Every micro needs a ROM and so do you!



## The computer magazine for the curious

Computers Challenge America's Cup by Eben Ostby  A Beginner's Guide to Peripherals: Input/Output Devices Your Mother Never Told You About by Leslie Solomon and Stanley Veit  Computer Country: An Electronic Jungle Gym for Kids by Lee Felsenstein  The Best Slot Machine Game Ever by Tom Digate  The Micro Diet: Better Health through Electronics by Karen E. Brothers and Louise L. Silver  Come Closer and We Won't Even Have to Talk by Avery Johnson  The Kit and I, Part Four: Testing, Testing by Richard W. Langer  Computer Models in Psychology by Joseph Weizenbaum  Micro, Micro on the Wall, How Will I Look When I Am Tall? by Stuart Dambrot  Copycat Computer by Tom Digate  Talk Is Cheap by Hesh Wiener  Project Prometheus: Going Solar with Your Micro by Lee Felsenstein  BASIC from the Word GOTO by Eben Ostby  Chipmaker, Chipmaker, How Does Your Crystal Grow? by Sandra Faye  The Kit and I, Part Three: Personality Plus by Richard W. Langer  Make Me More Music, Maestro Micro by Dorothy Siegel  Wings in Wind Tunnels: Computer Models and Theories by Joseph Weizenbaum  What Is a Microcomputer System? by Leslie Solomon and Stanley Veit  Maintaining Your Micro by O.S. (The Old Soldier)  Time Sharing on the Family Micro by Barry Yarkon  The Wordslinger: 2200 Characters per Second by Stuart Dambrot  Light Fantastic: The Kinetic Sculpture of Michael Mayock by Tom Moldvay and Lawrence Schick  From Bombs to ROMs by Lavinia Dimond  Guard against Crib Death with Your Micro by Jon Glick  Home Computers: The Products America May Never Know It Needs by Martin Himmelfarb  Putting Two and Two Together by Tom Pittman  The Wonderful Dreams of Dr. K by Hesh Wiener  The Kilobyte Card: Memories for Pennies by Thorn Veblen  The Unlikely Birth of a Computer Artist by Richard Helmick  Scott Joplin on Your Sci-Fi Hi-Fi by Dorothy Siegel  Building a Basic Music Board by Eben F. Ostby  The Compulsive Programmer by Joseph Weizenbaum  The Very Best Defense (a short story) by Laurence M. Janifer  Chart Up and Flow Right by Eben F. Ostby  Computer Wrestling: The Program of Champions by Lee Felsenstein  Forget Me, Forget Me Not by Avery Johnson  PLATO Makes Learning Mickey Mouse by Elisabeth R. Lyman  Charged Couples by Sandra Faye Carroll  Xeroxes and Other Hard Copy off Your CRT by Bill Etra  The Kit and I, Part Two: or Power to the Computer by Richard W. Langer  How Computers Work by Joseph Weizenbaum  Personally Yours from IBM by Eben F. Ostby  A Payroll Program for Your Small Business by Robert G. Forbes  Memories Are Made of This by Lee Felsenstein  Memory Memory

Every monthly issue keeps you abreast of the latest microcomputer applications for home, school, and office. Written by professionals who know how to present microcomputing in a lively, readable, and understandable fashion, ROM is fun. ROM is instructive. The tutorials make ROM understandable for the beginner. The ideas stimulate the expert. ROM is everything you ever wanted in a computer magazine.

Look what you've been missing without your monthly ROM!

Plus columns by Ted Nelson, Andrew Singer, Bill Etra, and A. I. Karshmer, on Artificial Intelligence, The Future, The Human Factor in Computing . . . Plus practical software, listings, documentation, new peripherals, interfaces, games . . . And more, much more . . . even a centerfold to pin up above your computer.

**ROM**  
COMPUTER APPLICATIONS FOR LIVING

ROM Publications Corp.  
Route 97, Box ED  
Hampton, CT 06247

Name \_\_\_\_\_

Address \_\_\_\_\_

City \_\_\_\_\_

State \_\_\_\_\_

Zip \_\_\_\_\_

U.S.A.:  One year \$15  Two years \$28  Three years \$39

Canada & Mexico: Please add \$2/yr. additional postage

Europe & South America: Please add \$12/yr. additional postage

All other continents: Please add \$24/yr. additional postage

Check/money order encl.  Master Charge  BankAmericard

Exp. date \_\_\_\_\_ Card# \_\_\_\_\_

Please allow 4-6 weeks for delivery.

# Speedy math circuits perform both multiply and divide

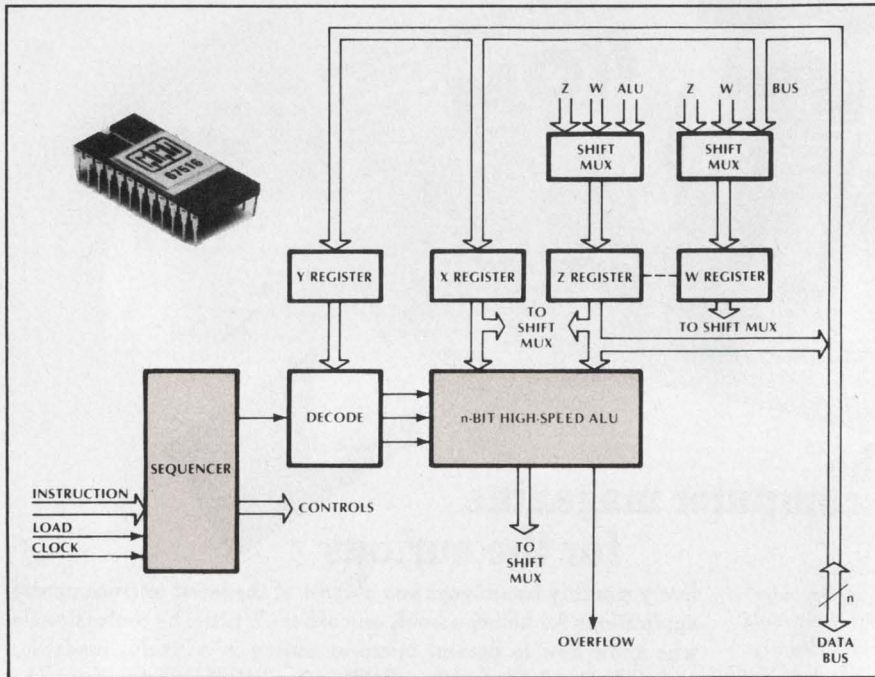

Monolithic Memories, 1165 E. Arques Ave., Sunnyvale, CA 94086. Shlomo Waser (408) 739-3535. P&A: See text.

For the first time, 16 or 8-bit multiplier and divide capabilities have been put into single chips. The circuits are the 16-bit 67516 and the 8-bit 67508 from Monolithic Memories, which perform multiply operations in just 800 and 400 ns, respectively. Divide operations require a minimum 2 and 1.2  $\mu$ s, respectively. Using a modified Booth algorithm, the circuits can work on either fractional or integral-number representations.

Both multiplier/dividers operate on two's complement 16 or 8-bit numbers. Both perform 16 different multiply operations, some of which include positive and negative multiply, positive and negative accumulation, and multiplication by a constant. They also do both single and double-length addition in conjunction with the multiplication.

The big news, however, are the divide options. They allow single or double-length division, division of a previously generated number, division by a constant, and continued division

of a remainder or quotient.

Requiring just a single-phase clock with a 100-ns minimum period, the timed-sequence multipliers load operands and present results over bidirectional 16 or 8-bit data buses. A 3-bit control field determines the operand loading, result outputs, and general control of the units. Results can be rounded if desired, and an Overflow output indicates whenever a result is outside normally accepted number ranges.

The math ICs are built with low-power Schottky technology and operate from a single 5-V supply. The 16-bit device requires less than 1 W, the 8-bit less than 0.75 W. Both are TTL-compatible. Control-bus lines require less than 1 mA of input current, while data-bus I/O lines have three-state capability and can sink up to 8 mA for a logic-low level.

Although about half a dozen other multipliers are available, none of them also offers the divide capability. Some of the multiply-only units, though, are faster than the 67516 and 67508 from Monolithic Memories—the MPY-8 and MPY-16 from TRW (Redondo Beach,

CA), for instance, perform their 8 and 16-bit multiplication in less than 100 ns. Other available parallel units include the 25S05 (a  $2 \times 4$ -bit multiplier) from AMD (Sunnyvale, CA) and the 8-bit, 100-ns 67558 from Monolithic Memories.

For serial/parallel operation, some slower units are available—the 25LS2516 and 25LS14 from AMD, for instance.

Available in both commercial and military-temperature ranges, the Monolithic Memories multiplier/dividers are housed in 24 and 16-pin DIPs, respectively.

In 100-unit quantities, the 16-bit device goes for \$120 and the 8-bit unit costs \$64. Delivery is from stock.

Monolithic Memories	<b>CIRCLE NO. 320</b>
AMD	<b>CIRCLE NO. 321</b>
TRW	<b>CIRCLE NO. 322</b>

## Op amp boasts low offset voltage drift

Precision Monolithics, 1500 Space Park Dr., Santa Clara, CA 95050. Donn Soderquist (408) 246-9222. \$2.75 (100 qty); stock.

When nulled at 25 C with a 20-k $\Omega$  potentiometer, the average input offset-voltage drift of the OP-05CP op amp will not exceed 0.4  $\mu$ V/ $^{\circ}$ C and the maximum drift is 1.2  $\mu$ V/ $^{\circ}$ C. Untrimmed offset voltage is typically 0.3  $\mu$ V at 25 C. Gain is 120,000 (min) and noise is 0.65  $\mu$ V pk-pk (max) from 0.1 to 10 Hz. Units are housed in 8-lead plastic DIPs.

**CIRCLE NO. 363**

## P-i-n diodes make good rf switchers

KSW Electronics, S. Bedford St., Burlington, MA 01803. (617) 273-1730. \$0.34 to \$9.50 (100 qty); 8 wks.

Nine types of p-i-n diodes are useful for rf switching because of their low series resistances of 0.5 to 1.5  $\Omega$  and corresponding capacitances of 2 to 0.2 pF. Types KS2243 and KS2244 are glass packaged, while the KS3522 is in plastic. The lowest possible capacitance is in the KS9302. The KS9342 and KS9343 types have a minority-carrier lifetime of 15 ns.

**CIRCLE NO. 364**

## POWER SOURCES

### Cost-effective switcher produces 200 W

*Keeco, 131-38 Sanford Ave., Flushing, NY 11352. Paul Birman (212) 461-7000. \$299; stock.*

The RMK size "C" switching power supplies produce 200 W at from 5 to 28 V. The RMK is a fully enclosed unit with built-in EMI filters, overvoltage protection, current limiting, soft start, remote on/off control and the efficiency (75% typically) of a 25-kHz switcher on a single PC card. Size "C" modules are 4.06 × 5.125 × 8.75 in. and weigh 5.25 lb.

CIRCLE NO. 365

### Power modules yield 250 mA to 2 A at 5 V

*Modular Power Converters, RFD Box 441, Fremont, NH 03044. (603) 642-5913. \$32 to \$59.*

With an input voltage of 105 to 125 V ac, the four power modules in the single 5-V dc series offer 250-mA, 500-mA, 1-A and 2-A outputs. Regulation is 0.05% for line and 0.1% for load. Overvoltage protection at 6.5 V is included. Dual 12 and 15-V units offer 100, 200 and 300-mA outputs with 0.05% line and load regulation. All are short-circuit protected, have 1-mV rms ripple plus noise.

CIRCLE NO. 366

### Line conditioners wipe out noise and spikes

*Pilgrim Electric, 29 Cain Dr., Plainview, NY 11803. John Alden (516) 420-8989. \$169 to \$327.*

The Voltector Series-5 ac-power conditioners protect minicomputers and other sensitive equipment from power-line noise and high-energy transients. The devices provide both common and transverse-mode protection against rf noise, surges, spikes and transients. Substantial attenuation of frequencies above the line frequency is provided and 2500-V spikes are limited to safe levels. The units are rated at 5, 10, 15 and 20 A at 120 V, from 50 to 400 Hz.

CIRCLE NO. 367

### Multi-output switchers keyed to add-on memories

*Powertec, 9168 DeSoto Ave., Chatsworth, CA 91311. Larry Keenen (213) 882-0004. \$650 (100 qty); 12 wks.*

The Model 8D436 multiple-output switcher provides voltages keyed to semiconductor add-on memory use. Adjustable output voltages of +5, +12 and -5 V dc are rated at 50, 10 and

1 A respectively. All outputs may be loaded from 0 to 100% rated current. The regulation-band limits provide outputs within 1.5% of the voltage setting when subjected to 93 to 125-V ac input variations, temperature from 0 to 55 C, static load-current variations and drift for 8 hr after warm-up. Ripple and noise to 30 MHz does not exceed 1% pk-pk. The size is 12 × 5 × 8 in.

CIRCLE NO. 368

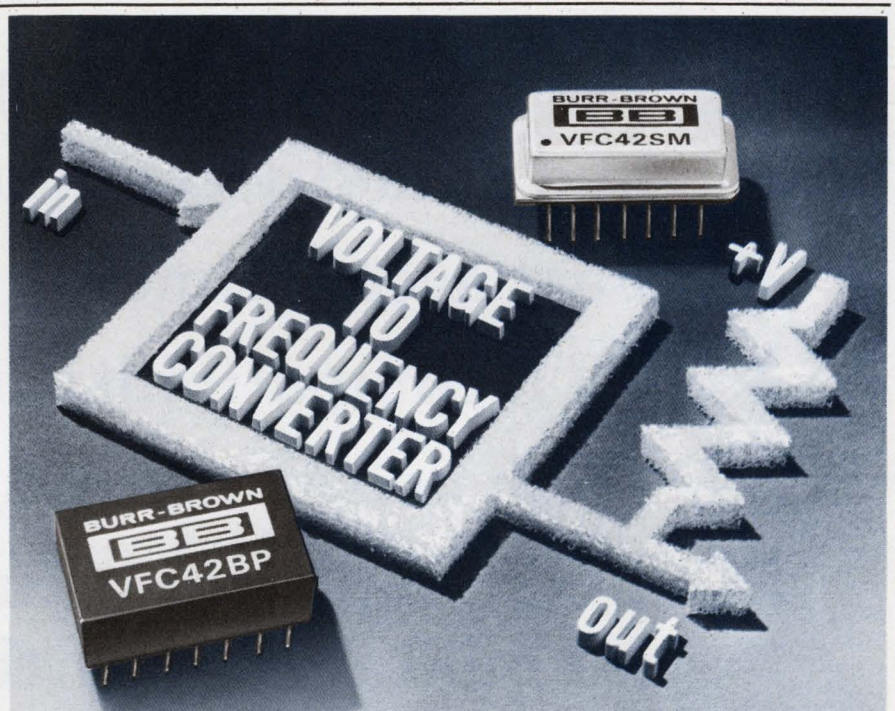

### THIS 0.01% ACCURATE VFC NEEDS JUST ONE EXTERNAL RESISTOR TO MATCH TTL/CMOS LOGIC!

Here's the first hybrid IC ... the first complete V/F-F/V converter that requires only a pull-up resistor to match logic. RC network design and assembly problems are eliminated.

We've taken our popular VFC32 and added laser trimmed offset (less than 0.1mv); stable, laser trimmed thin-film resistors; a low leakage ceramic capacitor; a low drift NPO ceramic capacitor and put it all in 14-pin plastic and metal packages.

**VFC42:** ±0.01% max non-linearity at 0-10kHz. **VFC52:** ±0.05% max non-linearity at 0-100kHz. You select the VFC and one resistor ... can we make it any easier for you? Priced from \$10.90 in 100's. Burr-Brown, P.O. Box 11400, International Airport Industrial Park, Tucson, Arizona 85734, Phone: (602) 746-111.





BURR-BROWN



Putting Technology  
To Work For You

CIRCLE NUMBER 77

# Check your memory system design requirements.

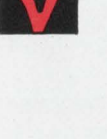
-  **Low power drain in both active and standby conditions**
-  **Fast access times**
-  **TTL compatibility in/out**
-  **High noise immunity**
-  **Full temperature ranges for military, industrial, and commercial**
-  **Guaranteed data retention**

# Now check Harris for 18 CMOS RAM options that provide just that.

Type Number	Organization	Pins	Speed*	Power*	Replaces
HM-6508B 1K RAM	1024 x 1	16	140 ns	25 $\mu$ W	74C929 Equivalent, 2125/93425 Pinout
HM-6508 1K RAM	1024 x 1	16	200 ns	250 $\mu$ W	
HM-6508D 1K RAM	1024 x 1	16	250 ns	5 mW	
HM-6518B 1K RAM	1024 x 1	18	140 ns	25 $\mu$ W	74C930 Equivalent
HM-6518 1K RAM	1024 x 1	18	200 ns	250 $\mu$ W	
HM-6518D 1K RAM	1024 x 1	18	250 ns	5 mW	
HM-6501B 1K RAM	256 x 4	22	170 ns	25 $\mu$ W	5101/2101 Pinout
HM-6501 1K RAM	256 x 4	22	240 ns	250 $\mu$ W	
HM-6501D 1K RAM	256 x 4	22	300 ns	5 mW	
HM-6551B 1K RAM	256 x 4	22	170 ns	25 $\mu$ W	74C920 Equivalent
HM-6551 1K RAM	256 x 4	22	240 ns	250 $\mu$ W	
HM-6551D 1K RAM	256 x 4	22	300 ns	5 mW	
HM-6561B 1K RAM	256 x 4	18	170 ns	25 $\mu$ W	2111 Pinout
HM-6561 1K RAM	256 x 4	18	240 ns	250 $\mu$ W	
HM-6561D 1K RAM	256 x 4	18	300 ns	5 mW	
HM-6562B 1K RAM	256 x 4	16	170 ns	25 $\mu$ W	2112 Pinout
HM-6562 1K RAM	256 x 4	16	240 ns	250 $\mu$ W	
HM-6562D 1K RAM	256 x 4	16	300 ns	5 mW	

\*Access Time and Standby Power Specified at 5.0v, 25°C Maximum

## YOUR CMOS RAM OPTIONS ARE AVAILABLE NOW!

For complete specifications, call the Harris Hot Line,  
or write Harris Semiconductor Products Division,  
P.O. Box 883, Melbourne, FL 32901

**HARRIS HOT LINE!**  
**1-800-528-6050, Ext. 455**

Call toll-free for phone number of your nearby  
Harris sales office, authorized distributor or  
expedited literature service.

*Harris Technology... Your Competitive Edge*



**HARRIS**  
SEMICONDUCTOR  
PRODUCTS DIVISION  
A DIVISION OF HARRIS CORPORATION

CIRCLE NUMBER 79

## COMPONENTS

### Micromini pots use O-ring seal

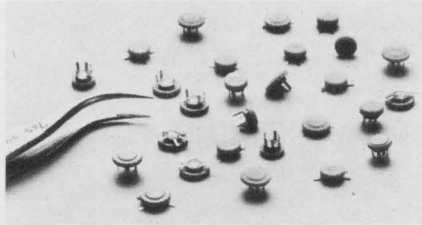

Bourns Inc., Trimpot Div., 1200 Columbia Ave., Riverside, CA 92507. (714) 781-5320. \$4.46 (1000 qty); stock to 4 wks.

Model 3391 and 3392 sealed microminiature, single turn potentiometers use an O-ring to provide a dust and moisture resistant seal. The pots have axial or radial leads and clockwise or counterclockwise tapers. An optional switch with positive detent and linear or nonlinear tapers are available. The size is 0.172-in. dia with a height of 0.1 in.

CIRCLE NO. 369

## VACUUM RELAYS. WHAT THEY CAN DO, AND WHAT WE CAN DO.

Over 30 years ago, ITT Jennings invented a series of vacuum relays to help solve high voltage relay problems in the 2 to 20 KV operating range. What we developed was a vacuum relay that offers extremely high withstand voltage (on the order of 1000 V/MIL), switching speeds from 6 MS, and continuous current ratings from 8 to 110 A RMS with operating frequencies from DC to 76 MHz. And, every vacuum relay has sealed contacts that maintain low resistance throughout its long, maintenance-free life.

The vacuum relay is ideally suited for digitally tuned RF communications gear, antenna tuners and couplers, radar pulse forming networks, power supply safety grounding, and many other demanding applications—ranging from airport runway lighting systems to oil well drilling control panels.

ITT Jennings is the world's leader in the development of vacuum relays. We can offer you the widest selection, the best availability, and the most experienced engineering and testing staff in the business. To find out more about our line of vacuum relays, contact us at 970 McLaughlin Avenue, San Jose, CA 95122, (408) 292-4025.

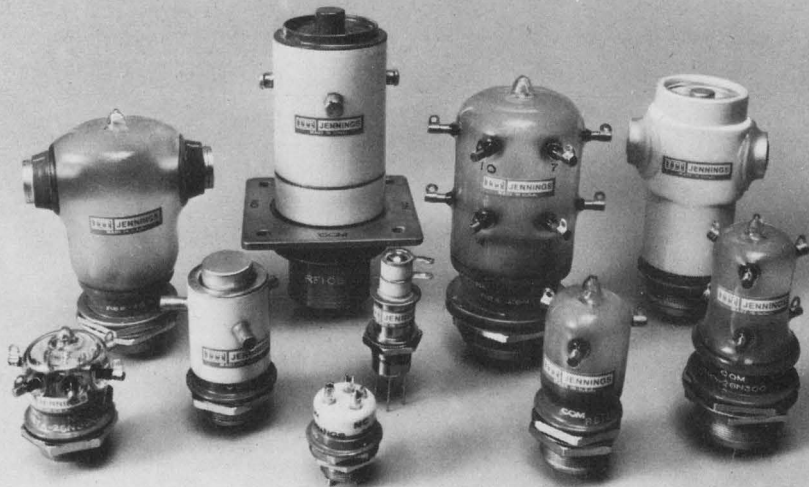

**JENNINGS ITT**  
VACUUM TECHNOLOGY FOR TOMORROW...HERE TODAY.

CIRCLE NUMBER 75

### Reed relays give choice of three packages

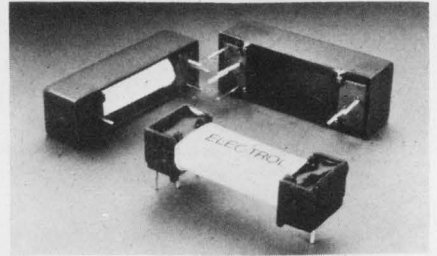

Elec-Trol, 26477 N. Golden Valley Rd., Saugus, CA 91350. (805) 252-8330. \$1.61 to \$1.80; 6 to 8 wks.

Tri-Pack reed relays are offered in three package configurations: open, enclosed, and fully sealed. The units are 1.25 x 0.35 in. and have a maximum contact rating of 10 W, 200 V and 0.75 A. They are available in 1A to 5A, 1B, 2B, 1A1B and 2A2B contact forms. Both standard and sensitive coil voltages range from 6 to 48 V dc.

CIRCLE NO. 370

### Bright LEDs replace unbased incandescents

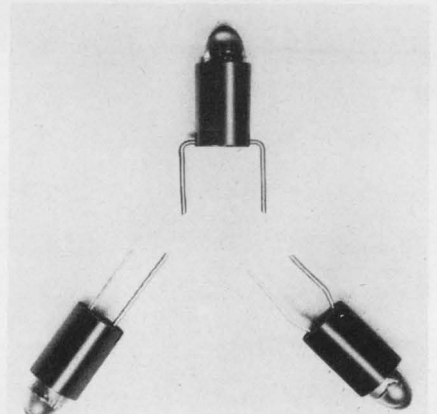

Data Display Products, 303 N. Oak St., Inglewood, CA 90301. (213) 677-6166. \$1.21 (1000 qty); stock to 5 wks.

The UB181 series of LEDs is available in red, amber and green and have variable terminal spacing so that they may replace unbased incandescents. The LEDs fit PC boards where the holes are apart as much as 5/8 in. By replacing unbased incandescents you can get the same brightness with 10 times the lifetime at only half the current requirement. At a drive current of 20 mA, the LEDs put out typically 50 mcd (red), 35 mcd (amber) and 24 mcd (green) with a clear tinted encapsulation. The lamps have built-in resistors for various voltages from 2.4 to 28 V dc or ac.

CIRCLE NO. 371



## LED indicators sealed in aluminum cases

Minelco, 135 S. Main St., Thomaston, CT 06787. (203) 283-8261. \$3/\$4 (100 qty).

Model 1600 and 1610 LED indicators are sealed in aluminum cases for service in hazardous areas. The indicators, threaded for front-panel mounting, are secured with a lockwasher and hex nut. Model 1610 has an "O" ring for effective panel seal. Red, amber and green colors are available with clear or diffused lenses. High or standard-intensity LEDs can be specified.

CIRCLE NO. 372

## Mini toggle switches meet UL and MIL-S-8805

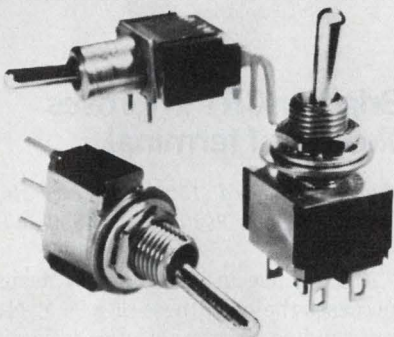

TEC, 2727 N. Fairview Ave., Tucson, AZ 85705. (602) 792-2230.

Construction and materials of TEC miniature toggle switches comply with UL spec 1054 and MIL-S-8805. The switches have nickel-plated brass handles and threaded or plain brass bushings with nickel-plated finish. Lubricated plastic actuator slides provide a smooth operating feel. The housing is molded thermostet plastic. An optional epoxy seal gives added protection from outside contamination.

CIRCLE NO. 373

## Blower delivers 515 cfm from 19-in. package

McLean Engineering Lab, 70 Washington Rd., Princeton, NJ 08550. Pete Stewart (609) 799-0100. \$121; 8 wks.

Model 1EB980B Sidewinder blowers (blower wheels mounted sideways) deliver 515 cfm from a compact 19-in. package. The airstream is 17-in. wide, which provides a wide distribution of filtered air across the entire system width. Slow blower speeds and high back pressures result in low noise levels.

CIRCLE NO. 374

# WHETHER YOU'RE COUNTING ONE THING EVERY NOW AND THEN OR FIVE HUNDRED MILLION EVERY SECOND, THIS CHIP CAN HELP YOU DO IT BETTER AND SAVE YOU MONEY, TOO.

It's the LS7031 6 decade MOS up counter with 8 decade latch and multiplexer.

It can count up to 5MHz on its own over its entire range of 4.75V to 15V.

It's the only MOS chip that allows you to attach prescalers and count up to 500 MHz.

But it's also so efficient and inexpensive that you'd do well to consider it when you're counting things that go a lot slower.

And it has power-saving features which make it suitable for portable instruments. Leading zero blanking and leading zero blanking override. Overflow outputs for 6, 7, or 8 decades.

Our customers—including some of the biggest manufacturers of frequency counters in the business—tell us it's the best counter chip they've ever seen.

We think you'll agree. Let us tell you more about it. Contact Ron Colino at (516) 271-0400.

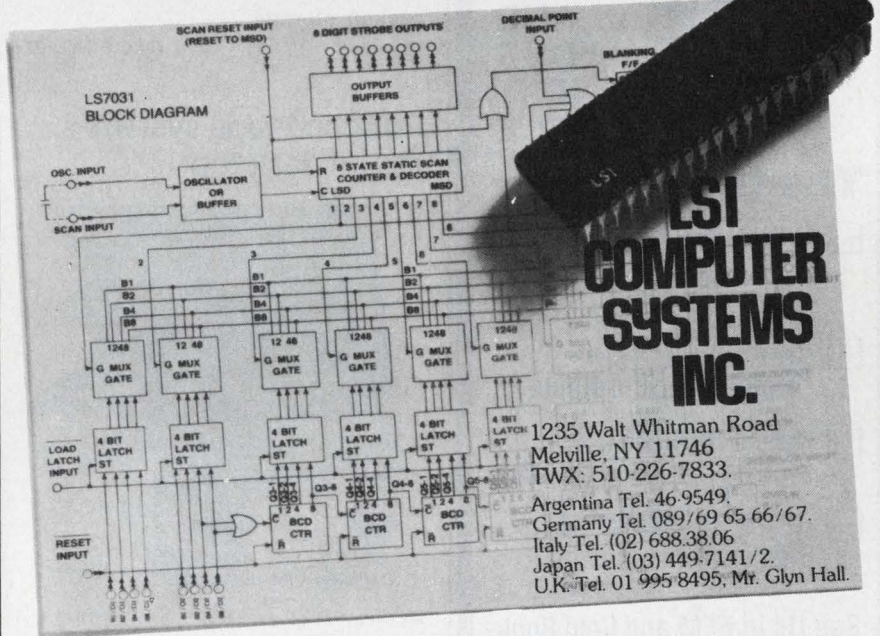

## LSI COMPUTER SYSTEMS INC.

1235 Walt Whitman Road  
Melville, NY 11746  
TWX: 510-226-7833.  
Argentina Tel. 46-9549.  
Germany Tel. 089/69 65 66/67.  
Italy Tel. (02) 688.38.06  
Japan Tel. (03) 449-7141/2.  
U.K. Tel. 01 995 8495, Mr. Glyn Hall.

## IF YOU COULD HAVE DESIGNED THIS CIRCUIT, WE CAN EXPAND YOUR FUTURE

We design and build MOS/LSI circuits.

Mostly we do custom circuits. When we have any spare time, we do standards. Outstanding standards like this one.

Our custom customers cut right across the industrial spectrum. We're in everything from musical instruments to satellites.

We're at the forefront not only of our own technology, but of everybody else's.

Right now we're a comfortable-size outfit, but we're growing. Fast.

And we need a few good men and women. To grow with us.

If you came with us you'd be doing some of the most exciting creative work being done today. Give it some thought.

Then call Al Kaplan, Vice President at (516) 271-0400. Complete confidence of course.

CIRCLE NUMBER 95

# true $\mu$ P DC/DC CONVERTERS

SAVE  
YOUR  
CHIPS...



...AND  
YOUR  
INPUT  
SOURCE

## The U, CU Series

- INPUT PROTECTION:  
Over/Under Voltage  
Shutdown-Standard
- CHIP PROTECTION:  
Clamped Logic Outputs
- INPUT RANGE TO 4:1:  
9-36V...18-72V...28-90V
- UP TO 25 WATTS OUT:  
Singles-Triples-Quads

See Us in EEM and Gold Book

Get The Facts Fast, Circle the number for Free Catalog. We'll also include the new issue of our power supply journal,

**WATTS UP** at sci



**SEMICONDUCTOR  
CIRCUITS, INC.**

218 RIVER ST., HAVERHILL, MA 01830  
Tel. (617) 373-9104, TWX. 710-347-0269

CIRCLE NUMBER 82

## DATA PROCESSING

### Mass storage available for Xerox computers

Telephile Computer Products, 17131 Daimler St., Irvine, CA 92714. (714) 557-6660. \$77,880; 25 wks.

Matchmaker II is a mass storage facility for Xerox computers. The storage is built around a  $\mu$ P-based device controller that can be used with disc drives and tape transports to provide billions of bytes of mass storage. The facility is plug compatible with any Sigma series computer, 5 through 9, and the total system can be expanded in modular increments. Up to eight devices can be connected to a single host computer. For maximum fast-access storage, 317.5-Mbit Winchester storage modules are normally specified. Drives can be combined in any mixture, along with 800/1600 and 1600/6250-bits/in tape transports to serve as on-line active or off-line backup storage.

CIRCLE NO. 376

### Punched-tape system fits on desk top



Remex, 1733 E. Alton St., Irvine, CA 92713. (714) 557-6860. From \$1900; 8 to 13 wks.

The Model 8050 desktop punched-tape systems are available in reader/perforator or perforator-only configurations. The perforator operates at 50 char/s and the circuitry includes a 128-byte buffer to allow true asynchronous operation in a parallel mode or burst operation up to 1200 baud in the serial mode. The reader processes standard 5, 7 and 8-channel tape and six/eight-channel typesetter tape in both directions at a rate of 300 char/s or up to 2400 baud with the serial interface.

CIRCLE NO. 377

### CRT terminal has 2000-char memory

Ann Arbor Terminals, 6107 Jackson Rd., Ann Arbor, MI 48103. Sarah Freeman (313) 769-0926. \$1200; 8 wks.

The Model 400E is a compact TTY-compatible terminal that contains a 2000-character memory. The display format is 24 lines by 80 characters, with an additional line of memory that can be accessed in either roll or scroll modes. Blink, dim and reverse-video are standard as are RS232 interface and RS170 video output for driving auxiliary monitors. A 72-key detachable keyboard generates the full 128-character ASCII set. The unit measures 15 x 14 x 13.6 in. plus keyboard.

CIRCLE NO. 378

### Brighter CRT improves viewing of terminal

Hewlett-Packard, 1507 Page Mill Rd., Palo Alto, CA 94304. (415) 856-1501. \$1475.

An advance in electron gun design increases the brightness of a 96 x 119-mm random-plotting electrostatic display to a minimum of 500 cd/m<sup>2</sup>. Option 530 of the Model 1332A CRT display is three times brighter to improve visibility in high ambient lighting. The brightness is specified at 2.5 mm/ $\mu$ s writing speed and 60 Hz refresh rate, with a spot size of 0.38 mm.

CIRCLE NO. 379

### Control interface unit enhances printer

Sheldon-Sodeco Printer, 4 Westchester Plaza, Elmsford, NY 10523. (914) 592-4400. \$210.

A printer control interface for PR-series 15 and 21-column impact printing mechanisms uses an F8 3-chip microcomputer set. The Model 4-621-9205 accepts ASCII serial, ASCII parallel (8-bit), RS-232 or BCD parallel (4-bit) data entry formats. The control and interface board contains a ROM character generator, a full-line buffer, timing control, full handshaking facilities, selectable parallel or serial speeds to 2400 baud and related logic to interface and control the printer mechanisms.

CIRCLE NO. 380

# Our 50-watt switch. The low-cost alternative.

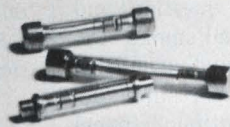

Switch up to 7 times the power of a similar-size reed switch with our new axial-travel switch. Handle inductive loads without arc suppression. Just like triacs.

Buy the 50-watt version with tungsten contacts for only 33¢ in quantities of 25,000. Or the 25-watt model with standard contacts for even less.

Call or write for details on the ATS.

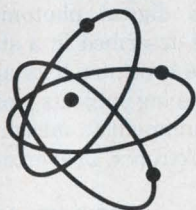

**EAC** Electronic Applications Company

4918 Santa Anita Avenue,  
El Monte, California 91734  
213/442-3212 TWX 910/587-3351

CIRCLE NUMBER 78

**1/4 TURN**

**NYLATCH**®

PATENTS PENDING

The Lowest Installed Cost, 1/4-Turn Fastener Available!

One Piece, One Tap... Installation's Complete!

1/4-Turn Unlatches Panel Hartwell's New HRN-6 1/4-Turn Nylatch

- Cuts installed costs to fraction of those for ordinary stud fasteners
- Ideal for quick access panels, doors or covers — appliances to computers

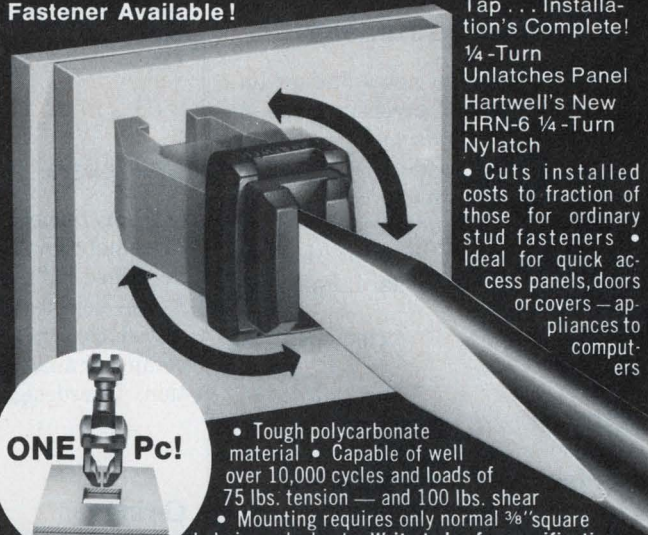

- Tough polycarbonate material
- Capable of well over 10,000 cycles and loads of 75 lbs. tension — and 100 lbs. shear
- Mounting requires only normal 3/8" square hole in each sheet
- Write today for specifications sheet and FREE sample.

Latching Specialists Since 1939



**THE HARTWELL CORPORATION**

900 S. Richfield Rd., Placentia, Calif. 92670  
(714) 993-4200. Branch Offices & Warehouses:  
Chicago, Ill. (312) 253-7820; Fort Worth, Tex. (817) 535-0824; Hackensack, N.J. (201) 342-2964

CIRCLE NUMBER 80

# PYROFILM MAKES IT!

## High Voltage FLATSO™ Resistors

- Four Sizes
- High Voltage Up to 20,000 Volts
- Resistance Range 50Ω — 300M
- Power Range Up To 2 Watts
- Temp. Coefficient 0 ± 250ppm/°C
- Radial Lead, Flat Profile



Setting New Standards in Reliability

**PYROFILM**

Engelmann Microwave Co. — Affiliate of Pyrofilm Corporation  
60 S. Jefferson Road • Whippany, N. J. 07981 • (201) 887-8100

# Application notes

## Time interval instruments

Three application notes discuss important aspects of precision time-interval measurements and generation. Each of the notes details the measurement set-up with appropriate block diagrams and includes special measurement considerations for that application. Hewlett-Packard, Palo Alto, CA

CIRCLE NO. 381

## Interfacing LED displays

Simple methods of interfacing LED alphanumeric displays with microprocessors, including the 8080, Z-80 and 6800 are included in a brochure. Litronix, Cupertino, CA

CIRCLE NO. 382

## Smoke suppressants

An eight-page brochure presents a comprehensive series of questions and answers about flame and smoke suppressants for filament winding, pultrusion, casting, hand lay-up, resin induction, spray-up and continuous-panel production. Solem Industries, Atlanta, GA

CIRCLE NO. 383

## Multipliers

A log/linear circuit, which achieves extremely low noise and distortion, is described in "Log/Lin Multiplier." The IC development is described from the initial concept and breadboarding to computer analysis, layout and integration. Interdesign, Sunnyvale, CA

CIRCLE NO. 384

## O-rings

A 140-page O-ring catalog includes a base-polymer selection guide and installation-design data. Minor Rubber, Bloomfield, NJ

CIRCLE NO. 385

## Breadboarding

Electronic prototyping, development and testing hardware are described in a 12-page catalog. Continental Specialties, New Haven, CT

CIRCLE NO. 386

## Battery charger

"Current Limited and Voltage Regulated Battery Charger" provides details on how a circuit is designed to properly rejuvenate a 44 A-h lead-acid battery from fully discharged to fully charged in three hours. Texas Instruments, Dallas, TX

CIRCLE NO. 387

## Photometer/radiometer

The characteristics and applications of the Model J16 digital photometer/radiometer are described in a six-page brochure. The brochure lists application notes, covering subjects from testing medical equipment to measuring laser output. Tektronix, Beaverton, OR

CIRCLE NO. 388

# Yours free, from Engelhard:

**Four helpful, fact-packed books** on how to save time, trouble, money . . . with unique electrical contact products and capabilities available only from Engelhard. Look into the many advantages of our RAISED LAY® permanently bonded contact strip, for example. Check our high quality, solderable, formable ECON-O-CLAD® contact strip. Consider our firmly bonded, close tolerance ECON-O-TAPE® coil strip, ideal for high-speed automation. And don't forget our Total PERFORMANCE in electrical contacts, contact assemblies and contact materials. It all adds up to the very best . . . in research, design, manufacture, service . . . to help you profit with better contacts. Write or call (617) 695-7811 for your free books today.



**ENGELHARD**

ENGELHARD/PLAINVILLE  
ENGELHARD INDUSTRIES DIVISION  
ENGELHARD MINERALS & CHEMICALS CORPORATION  
ROUTE #152, PLAINVILLE, MASSACHUSETTS 02762  
*An Equal Opportunity Employer*

CIRCLE NUMBER 87

# Bulletin board

Intel's 8080A microprocessor has become the first  $\mu$ P to win approval as a military-standard device.

CIRCLE NO. 389

Philips Test & Measuring Instruments has reduced prices on four pulse generators. The PM 5712, reduced in price from \$895 to \$850, is a 10-V pulse generator. The PM 5715, reduced from \$1115 to \$1050, is a 50-MHz pulse generator. The PM 5716 50-MHz, 20-V pulse generator has been reduced from \$2245 to \$1995. The PM 5771, originally \$2245, has been reduced to \$2195.

CIRCLE NO. 390

National Semiconductor's plastic-package INS8080AN  $\mu$ P is now listed at \$9.98 (1-24 qty.) reduced from \$15.50 each. In 100-up quantities, the device is \$7.10 reduced from \$10.80.

CIRCLE NO. 391

Monolithic Memories and Raytheon's Semiconductor Div. have agreed to alternate-source certain of each other's proprietary bipolar LSI integrated-circuit products.

CIRCLE NO. 392

Motorola is upgrading its high-speed ECL-logic lines to the LSI era by gradually phasing out the MECL II line (MC10000 and MC12000 series) and increasing the emphasis on new LSI capabilities, supported by the existing MECL 10k line.

CIRCLE NO. 393

Communications Transistor Corp. (CTC) has lowered prices on its balanced transistor line by 5 to 15%.

CIRCLE NO. 394

Prices of Texas Instruments basic Model 770/1 intelligent terminal and the Model 770/2 with built-in thermal printer have been reduced. The quantity-one, U.S. domestic price of the Model 770/1 has been reduced from \$6400 to \$4995 and the Model 770/2 has been reduced from \$7500 to \$6095.

CIRCLE NO. 395

# Bliley

first name in frequency control



## Our best is typical of our entire line



Regardless of price—and there is a wide range at Bliley—each of our components is designed and made for total reliability in its intended application.

Think about that the next time your budget threatens your design parameters.

Then, tell Bliley about your requirements. Meantime, update your files with our new catalog C/AR. It's yours for the asking.

Quartz Crystals • Crystal Oscillators

**BLILEY ELECTRIC COMPANY**

2545 West Grandview Boulevard,  
P.O. Box 3428, Erie, PA. 16508  
Tel. (814) 838-3571 TWX 510-696-6886

CIRCLE NUMBER 84

## Save Your Copies of Electronic Design in handsome library files or binders



Keep your valuable copies neat and organized for ready reference. Each rugged case or binder holds half a year's issues. Richly covered in dark green leatherette and embossed with 16K gold lettering — a handsome and practical addition to your bookshelf or desk.

Mail to: Jesse Jones Box Corp., Box 5120, Philadelphia, Pa. 19141

ED

Please send me: \_\_\_\_\_ Library Cases at \$4.95 each; 3 for \$14; 6 for \$24, postpaid.

\_\_\_\_\_ Binders at \$6.50 each; 3 for \$18.75; 6 for \$36, postpaid.

(Add \$1. each outside U.S.A. to cover additional postage and handling)

Check or money order (U.S. funds) for \$\_\_\_\_\_ enclosed.

Name (Print) \_\_\_\_\_

Title \_\_\_\_\_

Company \_\_\_\_\_

Address \_\_\_\_\_

City/Province \_\_\_\_\_

State/Country \_\_\_\_\_

Zip or Postal Code No. \_\_\_\_\_

Satisfaction guaranteed or money refunded. Allow 5 weeks for delivery.

# New literature



## Oscilloscopes

A specification folder describes accessories to extend the measurement capabilities of the company's products. Described is a complete line of voltage, current, temperature, FET, general-purpose modular, and logic probes. Tektronix, Beaverton, OR

CIRCLE NO. 396

## Transistors

Descriptions, parameters and part numbers for the company's line of high-power transistors, rectifiers, thyristors and assemblies can be found in a 20-page product guide. Westinghouse Electric, Youngwood, PA

CIRCLE NO. 397

## Bridges

Single-phase bridges rated at 10, 25, and 35 A to 1000 V are highlighted in a four-page bulletin. General Instrument, Discrete Semiconductor Div., Hicksville, NY

CIRCLE NO. 398

## Semi replacement guide

The 1978 300-page ECG Semiconductor Master Replacement Guide and Catalog cross references, in alphanumeric order, more than 137,000 industry part numbers to the Sylvania ECG semiconductor line. The guide costs \$2.95. GTE Marketing Services, West Seneca, NY

CIRCLE NO. 399

## Wire and cable

Technical data, specifications, useful tables and ordering information on electronic-instrument wire, thermocouple wire and thermocouple-extension wire and cable is given in a 64-page catalog. Delco Wire and Cable, Bristol, PA

CIRCLE NO. 403

## Rms-to-dc converter

*Analog Dialogue* contains application notes on a monolithic rms-to-dc converter that is laser-trimmed to 0.2% maximum error. Design notes include six pages on analog-signal handling to preserve IC-converter speed, resolution, and accuracy. Analog Devices, Norwood, MA

CIRCLE NO. 404

## Function generators

Specifications for function generators, waveform generators and frequency synthesizers are detailed in a 66-page catalog. Exact Electronics, Hillsboro, OR

CIRCLE NO. 405

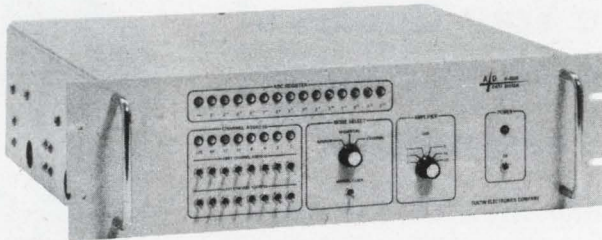

Tustin manufactures a wide variety of off-the-shelf Data Acquisition Systems utilizing a building block approach. Possibly one of our standard systems will fulfill your requirements. If not, because of the flexibility of our systems, we should be able to provide you with a non-standard unit with minimal engineering costs. We have provided systems with a combination of the following features:

- $\pm 10.0$  MV to  $\pm 10.0$  Volts Full Scale
- 8 - 16 Bit Analog-to-Digital Converters
- $\pm 0.01\%$  Full Scale Accuracy
- Scan Rates of 10 Hz/Ch to 1.0 MHz/Ch.
- 1 to 1024 Channels
- Instrumentation Amplifier per Channel — 100 KHz Bandwidth @ 140 DB CMRR
- Active Filters — 2 to 12 poles
- Simultaneous Sample & Hold Amplifiers
- Digital-to-Analog Converters
- Signal Conditioning

CIRCLE NUMBER 89

# DATA ACQUISITION SYSTEMS

Tustin has established a solid reputation based on:

- Reliability
- Specifications
- Flexibility
- Delivery

Contact us before you buy your next Data Acquisition System.

**TUSTIN**  
ELECTRONICS COMPANY

1431 E. St. Andrews Place  
Santa Ana, California 92705  
(714) 549-0391

## Satellite communications

A 16-page brochure describes the company's capabilities in satellite communications from providing earth-station products, to installation of complete earth stations on a turnkey basis. California Microwave, Sunnyvale, CA

**CIRCLE NO. 406**

## Flexible disc drives

An eight-page brochure highlights a family of flexible-disc drives. Pertec Computer, Chatsworth, CA

**CIRCLE NO. 407**

## Tantalum capacitors

Performance applications and mechanical characteristics for micro-miniature tantalum capacitors are listed in a four-page brochure. A total of 41 parts in five case sizes is described. Corning Glass Works, Corning, NY

**CIRCLE NO. 408**

## Tools

Hard-to-find tools are described in a 152-page catalog. Jensen Tools and Alloys, Tempe, AZ

**CIRCLE NO. 409**

## Recording charts

Precision-engineered recording charts for a variety of instruments are described in a 16-page brochure. The bulletin offers a description of accessories available, such as ink, pens and recording styli. Bristol Div., Acco, Waterbury, CT

**CIRCLE NO. 410**

## Semiconductors

Three short-form semiconductor catalogs are available. "Micro-miniature Semiconductors and Silicon Networks," a 24-page booklet, covers Micro-E and SOT-23 miniature encapsulated semiconductors. "Rf Diodes and Transistors," a 20-page booklet, includes capacitance tuner diodes, Schottky-barrier diodes, radio-TV-i-f low-noise uhf/vhf and power transistors. "Opto-electronic Devices" covers instrument photocells, phototransistors, photodiodes, solar-power modules and cells, and bipolar photoswitches. Ferranti, Chatterton Oldham, OL9 8NP England.

**CIRCLE NO. 411**

## Nylon bushings

Insulated bushings, strain reliefs, hole and vent plugs, cable and wire-fastening devices, cube taps, terminal bushings, adapters, assembly tools and lab kits are described in a 24-page catalog. Engineering data, application and installation instructions are also included. Heyman Manufacturing, Kenilworth, NJ

**CIRCLE NO. 412**

## Discrettes and hybrids

A broad range of discrete, hybrid and monolithic products—data-acquisition and computer I/O systems; data-conversion products; operational, isolation and instrumentation amplifiers; active filters; analog circuit functions; and modular power supplies—are described with essential specs in a 76-page catalog. Burr-Brown, Tucson, AZ

**CIRCLE NO. 413**

Designing a measurement and control application without all the facts makes as much sense as trying to pole vault with a yardstick. You need information. All of it. From Airpax. And the only way to get all our information is to get all our catalogs. Not just Meter and Pick-up catalogs, but our Tachometry catalog, too.

### Tons of tachs

If a designer needs anything he needs quality and variety in his tachometry. You get it with Airpax. Our Tachometry catalog lets you pick and

choose from dozens of configurations, including digital and analog instrumentation. All of it is engineered to overcome trouble areas like vibration, noise and rf interference. So send for our free Tach catalog. Then you'll have the whole story.

## AIRPAX™

Airpax Electronics, Incorporated  
6801 West Sunrise Boulevard  
Fort Lauderdale, Florida 33313  
305/587-1100

A Division of North American  
Philips Controls Corporation

**If you haven't got  
our Tachometry catalog,  
you haven't got the whole story.**

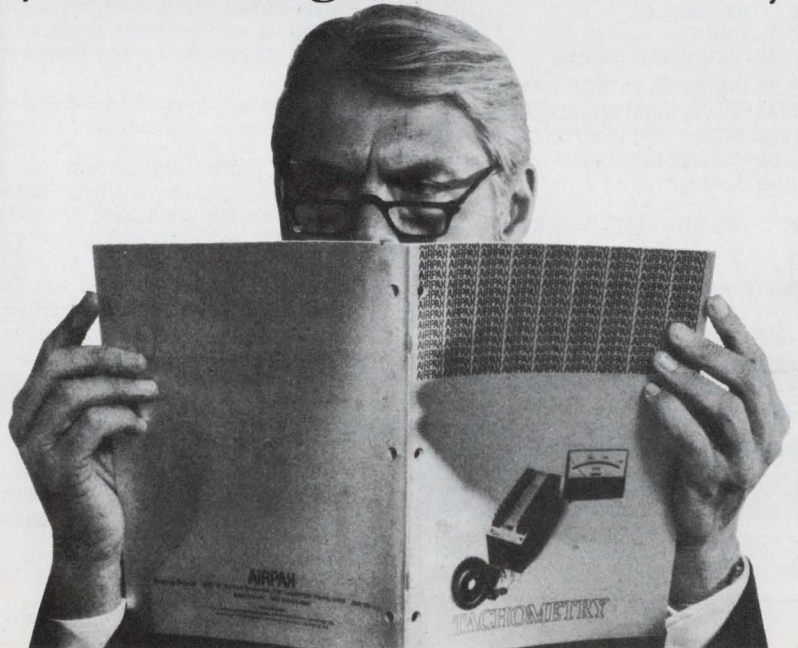

**CIRCLE NUMBER 90**

# SEMIPACK<sup>®</sup> is the answer!

## What was your question?

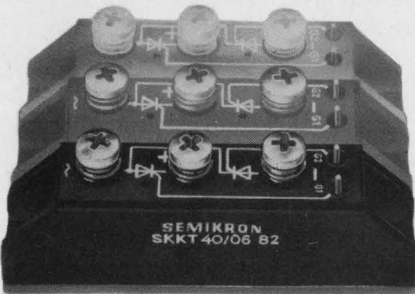

SEMIPACK is the standard multi-function power semiconductor building block for controlled and non-controlled systems. Standard circuit configurations are:

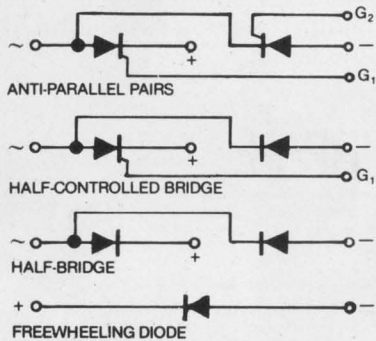

SEMIPACK is a modular concept, electrically isolated and mechanically compatible for simple assembly into single and three-phase bridges such as...

- HALF CONTROLLED
- FULLY CONTROLLED
- DIODE BRIDGES
- AC CONTROLLERS (2 to 4 wire)

Module rating: 25 to 160A per device to 1600 PIV. Typical applications include: phase and inverter motor controllers, electrical heating and lighting controls...

JEDEC registration UL recognized.

For further information or technical literature write or call...

Tel: 603 883-8102

\*MAXI-SEMIPACK now available.

# SEMIKRON INTERNATIONAL INC.

A MAJOR DESIGNER AND MANUFACTURER OF POWER SCR's, DIODES, AND MULTIFUNCTION ASSEMBLIES OF SEMICONDUCTORS

P.O. Box 83  
Hudson, NH 03051

CIRCLE NUMBER 83

# Electronic Design

ELECTRONIC DESIGN's function is:

- To aid progress in the electronics manufacturing industry by promoting good design.
- To give the electronic design engineer concepts and ideas that make his job easier and more productive.
- To provide a central source of timely electronics information.
- To promote communication among members of the electronics engineering community.

**Want a subscription?** ELECTRONIC DESIGN is circulated free of charge to those individuals in the United States and Western Europe who function in design and development engineering in companies that incorporate electronics in their end product and government or military agencies involved in electronics activities. For a free subscription, use the application form bound in the magazine or write for an application form.

If you do not qualify, paid subscription rates are as follows: \$30.00 per year (26 issues) U.S./Canada/Mexico, \$40.00 per year (26 issues) all other countries. Single copies are \$2.50 U.S. and all other countries. The Gold Book (27th issue) may be purchased for \$30.00 U.S./Canada/Mexico, and \$40.00 all other countries.

**If you change your address,** send us an old mailing label and your new address; there is generally a postcard for this in the magazine. You will have to requalify to continue receiving ELECTRONIC DESIGN free.

**The accuracy policy** of ELECTRONIC DESIGN is:

- To make diligent efforts to ensure the accuracy of editorial matter.
- To publish prompt corrections whenever inaccuracies are brought to our attention. Corrections appear in "Across the Desk."
- To encourage our readers as responsible members of our business community to report to us misleading or fraudulent advertising.
- To refuse any advertisement deemed to be misleading or fraudulent.

Individual article reprints and microfilm copies of complete annual volumes are available. Reprints cost \$6.00 each, prepaid (\$.50 for each additional copy of the same article), no matter how long the article. Microfilmed volumes cost \$23 for 1976 (Vol. 24); \$30 for 1973-75 (Vols. 21-23), varied prices for 1952-72 (Vols. 1-20). Prices may change. For further details and to place orders, contact Customer Services Dept. University Microfilms, 300 N. Zeeb Rd., Ann Arbor, MI 48106. (313) 761-4700.

**Want to contact us?** If you have any comments or wish to submit a manuscript or article outline, address your correspondence to:

Editor  
ELECTRONIC DESIGN  
50 Essex St.  
Rochelle Park, NJ 07662

# Electronic Design

## Advertising Sales Staff

Susan G. Apolant  
Sales Coordinator

## Rochelle Park, NJ 07662

Robert W. Gascoigne  
Thomas P. Barth  
Stan Tessler  
Constance McKinley  
50 Essex St.  
(201) 843-0550  
TWX: 710-990-5071  
(HAYDENPUB ROPK)

## Philadelphia

Thomas P. Barth  
(201) 843-0550

## Boston 02178

Gene Pritchard  
P.O. Box 379  
Belmont, MA 02178  
(617) 489-2340

## Chicago 60611

Thomas P. Kavooras  
Berry Conner, Jr.  
200 East Ontario  
(312) 337-0588

## Cleveland

Thomas P. Kavooras  
(312) 337-0588

## Los Angeles 90045

Stanley I. Ehrenclou  
Burt Underwood  
8939 Sepulveda Blvd.  
(213) 641-6544

## Texas

Burt Underwood  
(213) 641-6544

## San Francisco

Robert A. Lukas  
465 S. Mathilda, Suite 302  
Sunnyvale, CA 94086  
(408) 736-6667

## United Kingdom-Scandinavia

Constance McKinley  
50 Essex St.  
Rochelle Park, NJ 07662  
Phone: (201) 843-0550

## Europe

W. J. M. Sanders  
S.I.P.A.S.  
Raadhuisstraat 24 - P.O. Box 25  
1484 EN Graft-de-Ryp, Holland  
Tel: 02997-1303 and 3660  
Telex: 13039 SIPAS NL  
Telegrams: SIPAS-Amsterdam

G. Nebut  
Promotion Presse Internationale  
7 ter Cour des Petites Ecuries  
75010 Paris, France  
Telephone: 5231917, 1918, 1919

Dieter Wollenberg  
Erikastrasse 8  
D-8011 Baldham/Muenchen  
Germany  
Telephone: 0 8106/4541

Robert M. Saidel  
Technimedia International  
Via G. Fara, 30  
20124 Milan, Italy  
Tel: 65.72.765  
Telex: 25897 Utdioma

## Tokyo

Haruki Hirayama  
EMS, Inc.  
5th Floor, Lila Bldg.,  
4-9-8 Roppongi  
Minato-ku, Tokyo, Japan  
Phone: 402-4556  
Cable: EMSINCPERIOD, Tokyo

★ABP

BPA



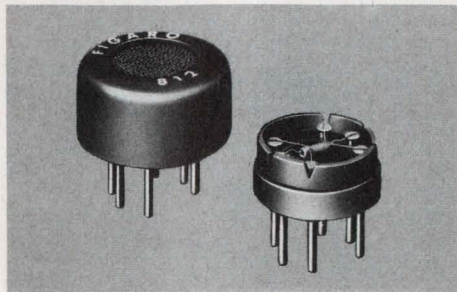

**FIGARO GAS SENSOR TGS** is a gas sensitive semiconductor. When combustible gas is absorbed on the sensor surface, a marked decrease of electrical resistance occurs. Major features of the sensor include high sensitivity, long term reliability and low cost. The applications are: GAS-LEAK ALARM, AUTOMATIC FAN CONTROL, FIRE ALARM, ALCOHOL DETECTOR, etc. Figaro Engineering Inc., North America Office-3303 Harbor Boulevard, Suite D-8, Costa Mesa, Calif. 92626 Tel: (714) 751-4103 Telex: 678396

GAS SENSOR

181

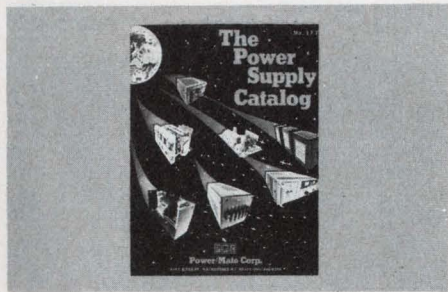

**Free New catalog** contains over 34,500 quality power supplies from the world's largest manufacturer, Power/Mate Corp. Power Supplies for every application including submodules, open frame, variorated, encapsulated, laboratory & system. All units UL approved and meet most military and commercial specs for industrial and computer uses. Power/Mate Corp., 514 S. River St., Hackensack, NJ 07601 (201) 343-6294

POWER SUPPLIES

187

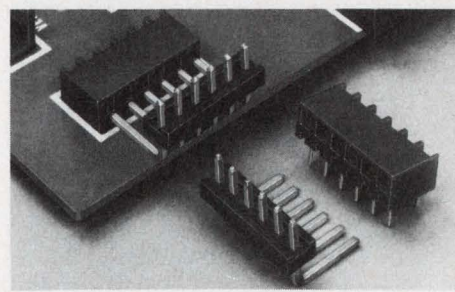

**NEW "PLATFORM CONNECTOR"** MOUNTS ANYWHERE ON PRINTED CIRCUIT BOARD & CARD EDGE LOCATION ISN'T NEEDED.

For fast assembly production usage in consumer electronic, communications and industrial control products. Contacts on .156" centers. Minimum withdrawal force 2.5 ozs. Twin terminations design for wave soldering to circuit board provides approximately 50% more current capacity. METHODE ELECTRONICS, INC., 1700 Hicks Road, Dept. PR, Rolling Meadows, IL 60008. (312) 392-3500.

PLATFORM CONNECTORS

183

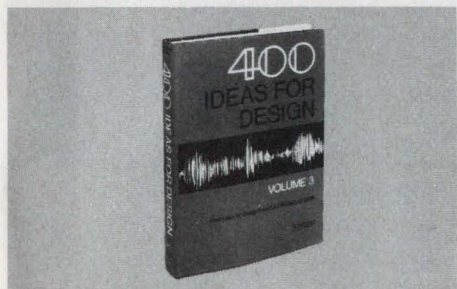

**400 IDEAS FOR DESIGN**, Volume 3, ed. by Morris Grossman. Brainstorm with the experts! Volume 3 of 400 IDEAS FOR DESIGN contains the best selections from *Electronic Design* that were published between 1971 and 1974. You'll find a wide range of ideas from very complicated to simple, but unique, approaches. #5111-5, 348 pp., \$13.95. Circle the Info Retrieval Number to order your 15-day exam copy. When billed, remit or return book with no obligation. Hayden Book Co., 50 Essex St., Rochelle Park, N.J. 07662.

IDEAS FOR DESIGN

197

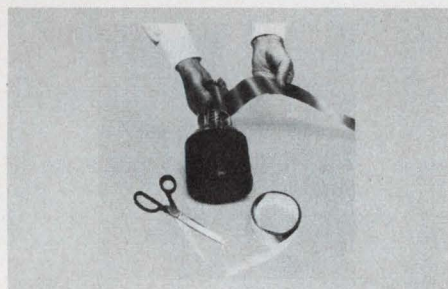

**FORM YOUR OWN MAGNETIC SHIELDS**

When you need only one or two magnetic shields, save time and money by shaping your own. All it takes is a scissors and our improved Eagle alloys for magnetic shielding. We'll gladly help. Check the card in this publication and we'll send full details on Eagle foil and sheet stock. Eagle Magnetic Co., Inc., Box 24283, Indianapolis, IN 46224 317/297-1030.

MAGNETIC SHIELDING

184

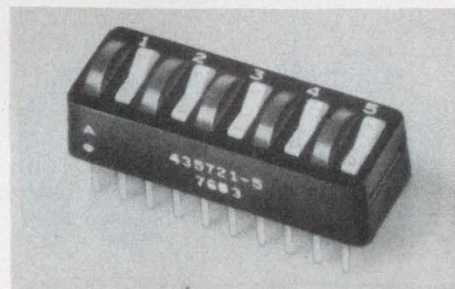

**LED Switches from AMP** give you immediate and continual visible indication of switch and circuit operation. Diagnosis is simpler. Servicing and downtime are reduced. And installation is easy. They have a cycle life of at least 7,000 cycles per pole and are really rugged. For more information, call AMP Customer Service at (717) 564-0100. Or write AMP Incorporated, Harrisburg, PA 17105.

LED DIP SWITCHES

185

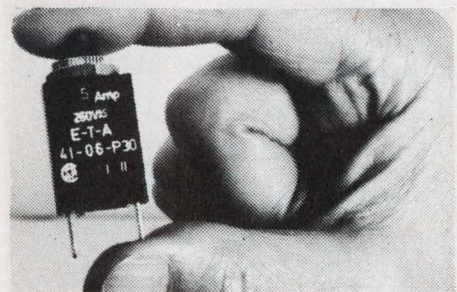

**Overcurrent Protector**, manual reset eliminates fuse replacement. Convenient panel mounting. 19 fractional ratings from 0.1 to 5 amp. Other models up to 400 amp. Trip-free and fool-proof, UL and CSA approved. High quality, low cost \$1.49 ea. in 1000 lots. E-T-A Circuit Breakers, 7400 N. Crounse Rd., Chicago, Ill. 60648. Tel: (312) 647-8303. Telex: 253780.

CIRCUIT BREAKER

186

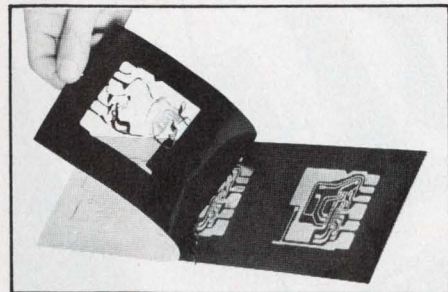

**STAMPED CIRCUITS** look like etched circuits, but they're not. They're stamped—and cost less. One oz., 2 oz., and up to 4 oz. copper available on all conventional PC board materials. Rogers Corporation, 5259 Minola Drive, Lithonia, Georgia 30058 (404) 981-9830

MEKTRON

182

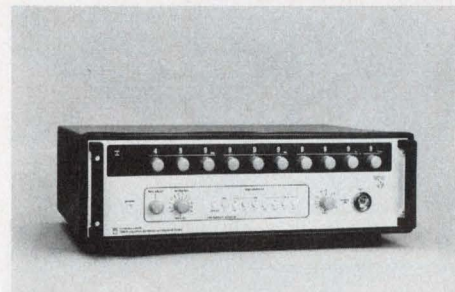

**FREQUENCY SYNTHESIZERS.** GenRad offers the best combination of low-phase noise, fast switching speed and price. Frequency range is dc to 500 MHz. Important features: non-harmonic spurs > 80 dB down; a-m, fm and pm capabilities; built-in search sweep; programmable (BCD parallel) frequency control; and optional resolution to 0.1 Hz. GenRad, 300 Baker Ave., Concord, MA 01742, (617) 369-8770.

FREQUENCY SYNTHESIZERS

188

# quick ads

New and current products  
for the electronic designer  
presented by their manufacturers.

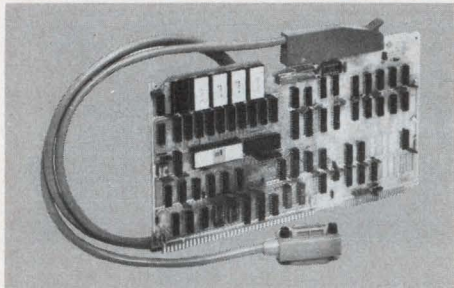

**IEEE 488 CONTROLLER FOR MICROCOMPUTERS.** The ZT 80, a self-contained intelligent controller, interfaces IEEE 488 bus instruments and peripherals to Intel SBC 80 (Single Board Computer) or MDS (Development Systems). ZT 80 fits in one SBC/MDS card slot and has a 1 KByte shared memory area to store programs and data. ZT 80 has complete controller, talker and listener capability. \$950 (unit qty), Self-test option \$75; Stock. ZIATECH Corporation, 10762 La Roda Drive, Cupertino, CA 95014. (408) 996-7082.

GPIB CONTROLLER

189



**NEW PRODUCT - UNIVERSAL 6 DIGIT COUNTER-TIMER-CLOCK.** IT counts up, down, stores, presets, compares, resets, sets off alarms, measures speed, time, length, volume, levels, frequency, rpm and DOES NOTHING if you tell him so, all with one SINGLE I.C. It is available through our WORLDWIDE DISTRIBUTION NETWORK after it has been BURNED-IN for 150 HOURS and passed ALL the TESTS. PRICED at \$79 unit quantity. IMC, 4016 E. Tennessee St., Tucson, AZ 85714 (602) 748-7900

COUNTER-TIMER-CLOCK

190



**Free 1978 Catalog of Recorder Products.** Complete description of all Memodyne incremental and continuous digital cassette recorders, data loggers, transports, universal readers and high speed recording system with illustrations, block diagrams, mechanical dimensions and timing sequences are contained in this new catalog. Accessories, supplies, cassettes and a price list are also included. Write for your free copy! Memodyne Corporation, 385 Elliot Street, Newton Upper Falls, MA 02164 (617) 527-6600

FREE RECORDER CATALOG

191



**RUBIDIUM OSCILLATORS** Series FRK are ultra stable, reliable, light (2.9 lb) small (4x4x4.5") and ideal for navigation/position location and communication systems. The unit provides 10 MHz; 5 and 1 MHz optional. Long-term stability  $1 \times 10^{-11}$ /month, short term  $1 \times 10^{-12}$ /100 sec. avg times and extremely low noise. Available commercial and MIL (radiation hardened) EFRATOM CALIFORNIA, INC., 18851 Bardeen Ave., Irvine, CA 92715 - (714) 752-2891

OSCILLATORS

192

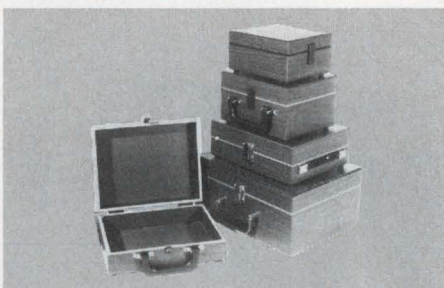

**STOCK CASES AND ENCLOSURES, OVER 600 SIZES,** ranging from 4" x 4" to 13" x 13". Depth variations to 12" in increments of 1/8". Laminated Formica®-mahogany-Formica® construction for utmost strength and attractiveness. Prices from \$35. to \$85., less quantity discounts. Choices of hardware. Modifications if required. Prompt off-the-shelf shipments. W. A. Miller Co., Inc., 36 Mingo Loop, Oquossoc, Maine 04964. (207) 864-3344

STOCK CASES/ENCLOSURES

193

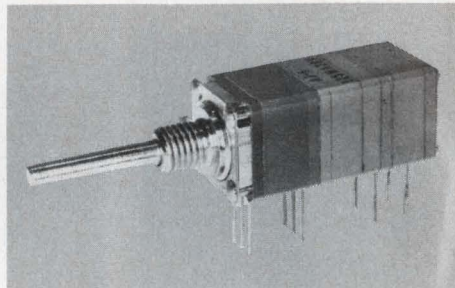

**Product for the month of March series 388 conductive plastic, series 389 cermet, potentiometer - rotary switch - push pull or momentary switch.** All modules operated by a single shaft, in a package only 1/2" square by 1 3/16 of an inch deep, available with many terminal configurations. Unit cost one thousand piece quantities series 388, \$3.85; series 389, \$4.00. For further information contact your local representative or Clarostat Manufacturing Company, Inc., Washington Street, Dover, New Hampshire 03820

SERIES 388-389 POTENTIOMETER

194

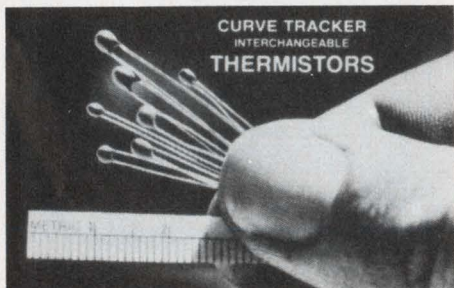

**CHIP THERMISTORS** combine small size with reliability and low cost. R @ 25°C 50Ω to 500Ω ±10% to ±1%. INTERCHANGEABLE tolerances ±1°C, ±.5°C or ±2°C. Point matched interchangeables to ±1%. HYBRID CHIPS and PROBES to your specs. WESTERN THERMISTOR CORP., 354 Via Del Monte, Oceanside, CA 92054. (714) 433-4484. TWX 910-322-1983

THERMISTORS

195

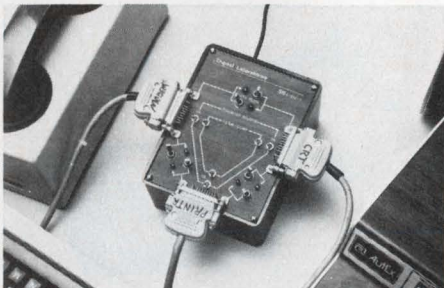

**UNIVERSAL JUNCTION UNIT . . .** for three devices, RS232C or current loop.

. . . Six switches provide all 63 interconnects that are possible between three I-O devices. LED's indicate data flow. . . . Designed to provide circuit compatibility and easy data routing between different manufacturer's devices. . . . \$350 (1-4) from DIGITAL LABORATORIES, 600 Pleasant St., Watertown, MA 02172 (617) 924-1680

3 PORT RS232 & 20 MA LOOP

196



**PROGRAMMING PROVERBS FOR FORTRAN PROGRAMMERS, H. F. Ledgard.** These 26 unique "proverbs," or rules and guidelines, are specially designed to help FORTRAN programmers upgrade the quality of their work. Comes with many sample programs. #5820-9, 144 pages, \$6.95. Circle the Info Retrieval Number to order 15-day exam copy. When billed, remit or return book with no obligation. Hayden Book Co., 50 Essex Street, Rochelle Park, N.J. 07662.

PROGRAMMING PROVERBS

198

# Electronic Design

## recruitment and classified ads

**HOW TO PLACE YOUR AD - CALL RECRUITMENT HOT LINE 201-843-0550**

### LATE CLOSING DATES

*Electronic Design* is mailed every two weeks. Because of its timeliness, personnel recruitment advertising closes only two weeks before each issue's mailing date.

Issue Date	Recruitment Closing Date	Mailing Date
Apr. 12	<b>Mar. 17</b>	Mar. 31
Apr. 26	<b>Mar. 31</b>	Apr. 14
May 10	<b>Apr. 14</b>	Apr. 28
May 24	<b>Apr. 28</b>	May 12
June 7	<b>May 12</b>	May 26
June 21	<b>May 26</b>	June 9
July 5	<b>June 9</b>	June 23
July 19	<b>June 23</b>	July 7

Camera-ready film (right reading negatives, emulsion side down) or camera-ready mechanicals must be received by deadline. Or, if you wish us to set your ad (typesetting is free) simply pick up the phone and call our RECRUITMENT HOT LINE:  
(201) 843-0550

PLACE YOUR AD AT ONLY

**\$55**

PER COLUMN INCH IN

## NUMERICAL CONTROL ENGINEER You're Going To Love Houston! It's Warm, It's Beautiful, It's Growing

In Houston, Texas, NL Atlas Bradford, a growth-oriented division of NL Industries, has an outstanding opportunity for the individual with 3 to 5 years experience as a N/C Engineer. 2 years experience on G.E. 550 TX controls and the ability to trouble-shoot N/C problems to the component level as well as diagnose systems problems are also required. Electronics degree is beneficial.

This position provides an excellent income commensurate with your experience, a generous benefits program that includes a full insurance program, pension plan, educational assistance, and complete relocation assistance, plus outstanding opportunities for both professional and personal growth. In addition, you'll find the lifestyle in Houston to your liking with excellent housing, schools, shopping and many outstanding cultural activities.

Interested candidates possessing the above qualifications should forward their resume and salary history to:

**Industrial Relations Department**

**NL Atlas  
Bradford**

P.O. Box 15197  
Houston, Texas 77020

All replies held in confidence.

We Are An Equal Opportunity Employer M/F

## U.S. and Overseas Employment with U.S. Foreign Service

The Department of State is recruiting experienced engineers for careers in the field of technical security. Applicants must be willing to accept world-wide assignments. Starting salary range is \$17,231 to \$22,381 plus housing and other appropriate allowances while overseas.

B.S. or M.S. in electrical/electronic engineering, and 3 to 5 years professional experience are required. American citizenship, excellent health and ability to qualify for a high level security clearance are also necessary. Send completed federal employment form SF-171 and resume to:

**OFFICER, EMPLOYMENT BRANCH  
EMPLOYMENT DIVISION  
DEPARTMENT OF STATE  
WASHINGTON, D.C. 20520**

An Equal Opportunity Employer

# ENGINEERS

## Design, Development, Testing

Due to the rapidly expanding use of electronic systems for convenience, entertainment and control devices, and the increasing sophistication of automotive electrical systems, Ford Motor Company has immediate opportunities offering excellent career development for graduate engineers.

Responsibilities will include areas of design, development release to production, and testing of components and systems in the areas indicated below. Positions offer excellent starting salaries and comprehensive employee benefits program. These positions are located in the Dearborn, Michigan area.

### COMPONENT ENGINEERING SUPERVISOR

Qualified candidate will have a MSEE or Ph.D. with specialization in physical electronics plus four to seven years experience in circuit design and process technology for bipolar and MOS large scale integrated circuits.

### COMPONENT ENGINEER

Experience in analog and digital circuit design, integrated circuit design and packaging or analytical laboratory techniques.

### ELECTRONIC CIRCUIT DESIGNER

Experience with design rules and limitations, semiconductor wafer fabrication, knowledge and skill in the interface/circuit/process trade off of microelectronic design.

### TEST ENGINEER

Experience in test procedures and test programs to determine functional and durability performance of sensor fuel control feedback system.

### PRODUCT DESIGN ENGINEER

Qualified candidate will have design and development experience in one or more of the following:

- Digital and analog servo-control systems
- Small mechanisms, electro mechanical devices, hydraulic and pneumatic valves and actuators, and electronic packaging
- Digital hardware and software design
- Vehicle instrumentation, packaging of gages, clocks, warning lights, etc.
- Small motors for vehicle applications

For immediate and confidential attention, please send your resume to:



## Electrical and Electronic Division

Product Engineering Office  
P.O. Box 2053, Rm. B-094  
EEE Building  
Dearborn, Michigan 48121

An Equal Opportunity/Affirmative Action Employer M/F

## ELECTRICAL DESIGN ENGINEER

We have a challenging position in the Controls Design field working with electronics, electrical, pneumatic, and micro-processor technologies. We design and manufacture control systems for the petrochemical pipeline transmissions industry, utility industries and turbo-machinery.

Prefer a candidate with a BSEE, 2 to 3 years experience or recent graduate. Company located in central Ohio is on an outstanding growth pattern offers stable position with excellent pay and complete benefit programs.

If you are qualified for a challenging position with a top quality organization send resume and salary history to:

### Cooper Energy Services

Manager Salaried Personnel

North Sandusky Street

Mount Vernon, Ohio 43050

Equal Opportunity Employer M/F

## R&D DESIGN QC/AQ

Confidential screening against National openings.  
IF YOU ARE EVEN THINKING OF A CHANGE, PLEASE CALL US.

CALL TOLL FREE 24 HOURS  
1-800-821-2270 X605  
(in Mo. 1-800-892-7655)

A&D Circuit Des.....	\$27-27K
IC Design.....	\$16-25K
Microprocessor apps.....	\$19-29K
Diagnostic Pgmng.....	\$20-30K
ME-Electronic Pkng.....	\$18-30K
Cmplr Image Gen.....	\$20-29K
FORTRAN.....	\$17-26K
Mini-computer Arch.....	\$20-30K
Med Electronics.....	\$18-27K
NDTE.....	\$16-28K
Comm Sys Des.....	\$18-28K

 **Ralph Stevenson, VP**  
**JIM KING**

438 Gulf Life Tower  
Jacksonville, Florida 32207

## TRANSFORMER ENGINEER

Audio and power design, 4 years minimum experience. Full benefits & pension and profit sharing. Salary open. Reply to:

### MICROTRAN

P.O. BOX 236  
VALLEY STREAM, NY 11582  
516-561-6050

Help your  
Heart...  
Help your  
Heart Fund

American Heart Association



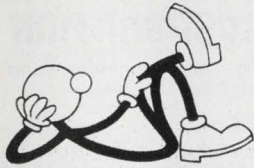

## EFFORTLESS . . .

If you're ready to move on with your career, it can be a lot easier than you expect.

We are the members of



who work extensively with electronics industry leaders. The companies we service have many openings and pay for us to search you out.

Send your resume to the office nearest you. Then sit back and relax while we do the work.

### BURTON PERSONNEL SERVICE

300 Walker Building  
120 Boylston Street  
Boston, Massachusetts 02116  
(617) 482-1950

### ANDERSON-TAYLOR

P.O. Box 21  
Exton, Pennsylvania 19341  
(215) 363-1600

### PETER A. KECHIK & ASSOCIATES, INC.

1420 Renaissance Drive  
Park Ridge, Illinois 60068  
(312) 298-1148

### STAFF DYNAMICS, U.E.

26 Sixth Street  
Stamford, Connecticut 06905  
(203) 324-6191

### CAREER SPECIALISTS, INC.

4600 El Camino Real, Suite 206  
Los Altos, California 94022  
(415) 941-3200

### BRENTWOOD PERSONNEL ASSOCIATES

Electronics Division  
1280 Route 46  
Parsippany, New Jersey 07054  
(201) 335-8700

*190 associates internationally*

# ENGINEERS

The Boeing Company in Seattle, Washington, has a variety of challenging career opportunities for experienced engineers on a wide-range of programs.

Enjoy the relaxed life-styles and unspoiled beauty of the Pacific Northwest in the "Nation's Most Liveable City." You won't find a better opportunity to combine career growth with a pleasing environment. We'd like to hear from you if you have a BS degree or higher in engineering or computer science and experience in any of the following areas:

- AUTOMATED TEST INSTRUMENTATION DEVELOPMENT
- COMPUTER AIDED DESIGN
- COMPUTERS AND DISPLAYS DESIGN
- DIGITAL CIRCUIT DESIGN
- ELECTRICAL/ELECTRONIC TEST
- ELECTRONIC MATERIALS AND PROCESSES
- ELECTRONIC PACKAGING DESIGN
- ELECTRONIC PARTS EVALUATION
- FLIGHT/MISSION/SYSTEMS TEST
- GUIDANCE AND CONTROL ANALYSIS
- NONDESTRUCTIVE EVALUATION
- OPERATIONAL SOFTWARE DEVELOPMENT
- SOFTWARE/COMPUTING SYSTEM DESIGN AND ANALYSIS
- SOFTWARE/COMPUTING SYSTEM TEST AND EVALUATION
- SOFTWARE QUALITY ASSURANCE
- TEST SYSTEMS SOFTWARE DEVELOPMENT
- TEST PROGRAM PLANNING
- SYSTEMS DESIGN ANALYSIS
- SYSTEMS REQUIREMENTS DEFINITION
- WIRING AND CONTROL DESIGN

Candidates must be U.S. citizens. Selected candidates will be offered an attractive salary, comprehensive fringe benefits package, and relocation allowances.

Send your résumé to The Boeing Company, P.O. Box 3707-LML, Seattle, WA 98124.

An equal opportunity employer.

**BOEING**  
*Getting people together*

# ENGINEERS

## RCA Consumer Electronics

... is interviewing for Engineering positions requiring experience in one or more of the disciplines listed below. Successful candidates will work on TV and other products or related systems planned for the consumer market.

- TV SYSTEMS
- POWER & DEFLECTION
- SIGNAL PROCESSING
- TUNER DESIGN
- DIGITAL SYSTEMS
- MICROPROCESSOR APPLICATIONS
- IC — LINEAR AND DIGITAL  
(Consumer Products)
- AUTOMATIC TEST EQUIPMENT  
DEVELOPMENT
- AUTOMATION TECHNIQUES
- MECHANICAL DESIGN —  
Electronic Products
- MANUFACTURING SYSTEMS  
& PROCESSES

Openings are all degree levels. Competitive salaries and benefits.

Send resume to: Professional Employment,  
M.S. 6-207, RCA Corporation, 600 N. Sherman  
Drive, Indianapolis, IN 46201.

# RCA

We are an equal opportunity employer F/M.

**Constance McKinley**  
RECRUITMENT ADVERTISING MANAGER  
ELECTRONIC DESIGN  
50 Essex Street, Rochelle Park, New Jersey 07662  
(201) 843-0550

I'm interested in placing recruitment  
advertising in *Electronic Design*

Issue \_\_\_\_\_ Size of ad \_\_\_\_\_

My copy is enclosed  I need more information

Name \_\_\_\_\_

Title \_\_\_\_\_

Company \_\_\_\_\_

Address \_\_\_\_\_

City \_\_\_\_\_ State \_\_\_\_\_ Zip \_\_\_\_\_

Telephone \_\_\_\_\_

## DYNALECTRON CORPORATION

Dynalectron is seeking candidates for immediate and anticipated openings in the Albuquerque area:

### Electrical Engineer

Must have a MSEE, with a minimum of six years in digital logic design, D/A and A/D, micro-processor systems, minicomputer/display system integration for work on R & D infrared, electro-optics laser instrumentation system, Fortran IV, basic and machine language programming for problem synthesis, diagnostic routine and data processing. Responsibilities to include design, analysis, brass board, packaging, parts and subassembly, specific testing procedures and documentation.

### Electrical Engineer

MSEE with a minimum of six years in analog/servo systems design, continuous and discrete time control systems, positive and negative feedback loop techniques, regulator circuits, power supply, low noise amplifier design, RF techniques, generalized video systems and associated experience in digital interface and data processing techniques.

Responsibilities to include design, time domain analysis, brass board, packaging, parts and instruments specifications, testing procedures and documentation.

### Electrical Engineer

BSEE with five years experience in fire control systems for modern aircraft weapon systems.

### Mechanical Engineer

BSME with three years experience in an applied research laboratory. Work experience should include gas dynamics, vacuum technology, optics, control instrumentation and high pressure gas systems.

### Systems Safety Engineer

BS in Science or Engineering with eight years experience in Systems Safety Engineering in R & D and testing activities. Experience should include: PHA, OHA and FTA.

### Mechanical Technicians

Associate degree is desirable. Minimum of two years experience in high pressure gas handling and/or cryogenic systems as well as pipe or tubing layout ability. Welding, machinist and electrical background is desired.

### Quality Assurance Inspectors

Associate degree desired with a minimum of five years experience in aerospace/aircraft quality control in areas of electro-mechanical systems, cryogenic systems and high pressure tubing. Must be familiar with MIL-I-45208A, MIL-Q-9858A, ASPRVII and ASPRXIV.

Qualified candidates are requested to submit a resume of work history, experience and salary requirements to:

## Dynalectron Corporation

Personnel Department  
P.O. Box 18068  
KAFB Branch  
Albuquerque, NM 87115

U.S. Citizenship Required  
We are an Equal Opportunity Employer M/F



**HOW TO PLACE YOUR AD**  
**CALL THE RECRUITMENT**  
**HOT LINE 201-843-0550**

## We're Seeking Engineers Who Are Special...

At HUTCHINSON we provide a variety of unique products for some of the best known names in the industry—chemically etched and milled parts which are used in computer and medical applications. Our ultra modern facilities are located in a clean air setting just an hour from the vibrant Twin Cities of Minneapolis & St. Paul, and our company growth is reflected by the profile of our engineering staff: aggressive, energetic, innovative. We're currently seeking to build for the future.

**MECHANICAL DESIGN ENGINEER:** The individual we're seeking will hold responsibility for the development and improvement of mechanisms and light machinery. Our ideal candidate must be able to work as an independent project engineer as well as advanced management.

**INDUSTRIAL ENGINEER:** Will involve development of work standards for computerized applications. A BSIE or BSME with five years' related IE production and operating program experience in a sophisticated light manufacturing environment is required.

To apply please submit letter or comprehensive resume with salary history, or call (collect) 612-879-2371.

Verne Meyer



40 W. Highland Park  
Hutchinson, MN 55350

An Equal Opportunity Employer

Engineer

## LOGIC DESIGN ENGINEER

At CRAY RESEARCH INC., we design, build, market and support Super Scale Computers used in scientific applications. We currently have an outstanding opportunity for a Logic Design Engineer.

The candidate we are seeking will have primary responsibilities for covering the specification and design of custom interfaces to the CRAY-1 computer. Preferred candidates have a BSEE or equivalent experience. A minimum of 2 years' logic design experience, and familiarity with IBM, DEC CDC, I/O design.

This position offers excellent growth opportunities, salary and company benefits. Send resume and salary history in complete confidence to:

Don Hable  
**CRAY RESEARCH INC.**  
Manufacturing Division  
Industrial Park  
Chippewa Falls, Wisc. 54729  
An Equal Opportunity Employer M/F

**CRAY**  
RESEARCH, INC.

## Electronic Design

BRINGS YOU THE HIGHEST  
NUMBER OF QUALIFIED EOEM  
ENGINEERS AND ENGINEERING  
MANAGERS ANYWHERE  
... AT THE LOWEST COST  
ANYWHERE!

## SOLID CAREER OPENINGS WITH HEATH Share Our Strong, Continued Growth and Expansion

You know us for our quality Heathkits—and for our reputation for "doing things right." Our progress story goes far back, and prospects are very favorable for the years ahead.

## SOFTWARE DOCUMENTATION WRITER

An effective, proven technical writer needed to write Heathkit computer systems operations manuals and applications procedures. A B.Sc./CS or equivalent is required. Candidates must be familiar with LSI-11/PDP-11, software and applications programming, higher level languages, and operating systems, principles and techniques.

## SOFTWARE DEVELOPMENT

### Broad Assignments

Several positions open requiring demonstrated ability to write operating systems, utilities, interpreters, compiler software; 8080 or PDP/11 systems background helpful. Opportunity to do applications for new personal computers, a rapidly growing product. Calls for BS or advanced degree in CS, or equivalent.

## WRITERS, TRAINING Create Learning Programs

Inviting chance to use your writing, training, or teaching skills and background in electronics. Unusual room to develop courses and individual learning materials. Technical writing or training experience required.

Salaries are competitive, with excellent benefits additional. Our ideal location is a pleasant, small community on Lake Michigan, 90 minutes from Chicago.

Please send resume in confidence, or phone collect to Ken Smith, (616) 982-3673.

HEATH

Schlumberger

## HEATH COMPANY

Benton Harbor, Michigan 49022

An Equal Opportunity Employer M/F

## JR. & SR. ELECTRONIC ENGINEERS

If you are a BS, MS or PhD in EE or computer science with 0-7 years experience, we would like to talk to you. You are in desperate demand by electronic firms throughout the country. **MAKE YOUR MOVE WHILE YOU ARE STILL YOUNG AND MOBILE.**

Predictions indicate 1978 to be the most dynamic year in a decade for engineering employment. **NOW IS THE TIME TO LAY THE GROUNDWORK FOR YOUR FUTURE.** Don't regard your present position as a temporary holding pattern or a place to wait for a lucky break. Present positions are the action base for future moves.

RCI is a technical search firm with an outstanding reputation representing a broad base of nationwide clients serving the Electronics industry. If you are interested in advancing your career, call us or send your resume or a brief hand written description of your background including present salary and geographic preferences in confidence to:

Search Director-Room D  
**Regional Consultants Inc.**  
213 West 9th Street  
Cincinnati, OH 45202  
513/579-1513

Representing EEO Clients Only

## SEMICONDUCTOR ENGINEERS

Everybody knows that NCR means Computers and Terminals. But, everybody doesn't know that NCR has a Microelectronics Division. Our division of NCR is responsible for designing and developing the unique custom devices used in most NCR systems. We do this because we can do it. We know what LSI is all about; we know how to achieve reliability, and we know what "yield" means.

We developed our own microcomputer chip set that contains electrically alterable ROM's, non-volatile RAM's, SDLC Communications, and direct memory access. And, it operates in a multi-processor environment.

We do all this because we have a competent technical staff, advanced equipment in a modern facility and the backing of a \$2-billion-a-year corporation.

Now we are growing—to do even more. To do this, though, we must add to our staff. We need

- **Design Engineers:** BSEE (MSEE preferred) with 2-3 years experience in digital circuit design including computer aided design.
- **Test Engineers:** BSEE (MSEE preferred) experienced with microprocessors and computer based test systems.
- **MOS Process Engineer:** BS (MS preferred) in Engineering Physics or EE, plus experience in P and N channel. A sound understanding of solid state semiconductor physics for process and device analysis is required for this manufacturing position.
- **QA Engineer:** BSEE plus experience in MOS/LSI technology, innovative and thoroughly grounded in advanced QA techniques and digital circuit design. This is not an ordinary QA responsibility; it requires development skills and experience.

Take the time to explore your career. And spread the word—NCR means complete systems ... and Microelectronics.

Reply in confidence to:

**T. F. Wade, Manager  
Personnel Resources  
Microelectronics Division  
NCR Corporation  
8181 Byers Road  
Miamisburg, Ohio 45342**

An Equal Opportunity Employer

KEEP ELECTRONIC DESIGN'S

GOLD BOOK HANDY

WHEN YOU CALL



## SYSTEMS ENGINEERING: FIRST IN TRUE 32-BIT MINIS FIRST IN REAL TIME SOLUTIONS FIRST IN CAREER OPPORTUNITY ALL IN FORT LAUDERDALE

We're putting more bytes to work in a real time environment than anyone else in the industry. For almost 2 decades, we've bred a family of pacesetter systems, culminating in the first true 32-bit super mini... not a bridge-the-gap system from 16 bit architecture, but a true 32-bit machine with richer instruction sets and larger directly addressable memory.

This kind of presence means opportunity is here... now... along with the resources to really make a name for yourself. If being on the cutting edge of technology, surrounded by year round warmth and swaying palms sounds inviting, consider the many ways available for you to grow at Systems Engineering.

We welcome the professional who is highly motivated in the direction of creativity, fresh conceptualization, and imaginative problem-solving in state-of-the-art design and software development of small to medium real time systems.

**CONTRACT ADMINISTRATOR** Senior Level. With Program Management Capability. We require experience, ability and effectiveness at all levels of management in negotiating, drafting, enforcing, and administering fixed-price government and industrial contracts and knowledge of ASPR, and computer systems. Background is essential in either legal, business, or engineering areas. Some travel.

**PROJECT ENGINEERS BSEE** and experience with job costing of custom computer systems.

**PROJECT LEADER BSEE** and minimum of four years experience as Group Leader involved in job costing for custom computer systems.

**MICROPROGRAMMER** Minimum of one year design experience in FIRMWARE design. Work involves state-of-the-art advanced concepts.

**SENIOR ENGINEERS (DIGITAL)** Four years experience in LOGIC DESIGN. Microprocessor or CPU experience highly desirable. Work involves Custom Systems Group.

**SOFTWARE TECHNICAL INSTRUCTOR** Two or more years teaching computer software courses in industry or academia. Must have knowledge of ASSEMBLY and FORTRAN language.

**MTS PROGRAMMER (DISTRIBUTIVE SYSTEMS)** Must have thorough knowledge of Assembly language programming and some background in FORTRAN. Real Time and inter-CPU COMMUNICATIONS and Data Base experience preferred.

**MTS PROGRAMMER (DATA BASE DESIGN)** D/B Generation software experience for data acquisition and applications programs. Assemblers and FORTRAN required.

**MTS PROGRAMMER (CUSTOMER SERVICE)** Minimum of three years in ASSEMBLY and FORTRAN LANGUAGE. Programming background in Real-time and applications environments. Customer contact experience desired. Some travel.

**TECHNICIANS DIGITAL** I/O and CPU experience desirable. Will work closely with digital design engineers. Two years experience in troubleshooting and testing preferred.

**DESIGNER** Three to ten years experience in electro-mechanical design for a computer manufacturer.

SYSTEMS offers top starting salaries, relocation to beautiful Fort Lauderdale, a full-range benefits program including dental insurance, savings/retirement plan and 100% tuition refund, and the opportunity to work and advance your career in a stable and stimulating professional environment. For immediate and confidential consideration, please forward resume or detailed letter of information, including current annual compensation to:

MR. FRED BRILLANTE, Dept. ED

# SYSTEMS

ENGINEERING LABORATORIES

6901 West Sunrise Blvd., Fort Lauderdale, Florida 33313

Equal Opportunity Employer Male/Female

## Recruitment Ads Pull



Engineering

**NORTHROP DESIGN ENGINEERING**  
*great purposes...  
greater achievements*

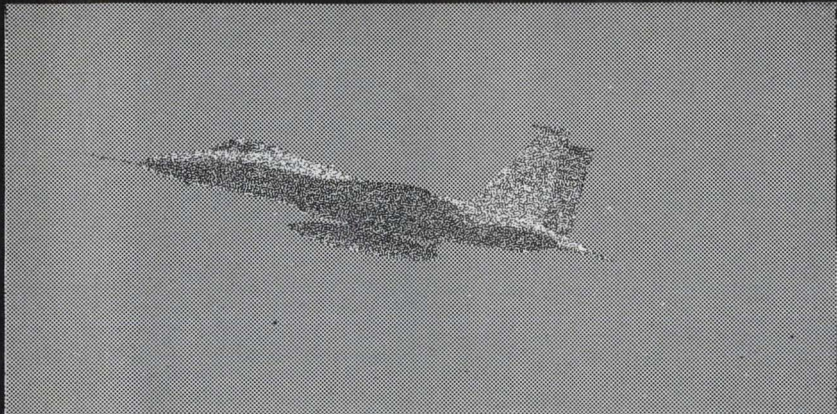

Establishing goals that challenge your ability. . . creates a sound beginning. Advancing beyond those objectives. . . instills pride.

At Northrop Defense Systems Division, a leader in advanced Electronic Countermeasure technology, we provide the guidance and professional freedom necessary for creative problem-solving and maintaining our leadership in the state-of-the-art.

If you are a Design Engineer with the following qualifications and possess a strong drive toward self-fulfillment, we invite you to consider an exciting career at Northrop.

- \*BSEE, familiar with design for AGE test equipment.
- \*Minimum of 5 years experience in Digital Design, using TTL-DTL, MOS and micro-processor in designing and testing computers.
- \*Design of Tuning Unit Analog and digital circuits. Familiarity with RF component interface circuits.
- \*Minimum 5 years experience in analog and/or digital design. Familiarity with microwave components preferred.
- \*PROJECT ENGINEER with analog/digital circuits and microwave components experience.

In addition to the opportunity to join one of the finest engineering teams in the nation, we offer an excellent salary/benefits program. Qualified individuals are invited to send brief letter or resume in confidence, to:

Director—Design Engineering  
Department EM  
**NORTHROP CORPORATION**  
Defense Systems Division  
600 Hicks Road, Rolling Meadows, Illinois 60008  
An equal opportunity employer m/f

**NORTHROP**

# WHY YOU SHOULD MAKE A CORPORATE CONTRIBUTION TO THE AD COUNCIL

The Advertising Council is the biggest advertiser in the world. Last year, with the cooperation of all media, the Council placed almost six hundred million dollars of public service advertising. Yet its total operating expense budget was only \$914,683, which makes its advertising programs one of America's greatest bargains . . . for every \$1 cash outlay the Council is generating over \$600 of advertising.

U.S. business and associated groups contributed the dollars the Ad Council needs to create and manage this remarkable program. Advertisers, advertising agencies, and the media contributed the space and time.

Your company can play a role. If you believe in supporting public service efforts to help meet the challenges which face our nation today, then your company can do as many hundreds of others—large and small—have done. You can make a tax-deductible contribution to the Advertising Council.

At the very least you can, quite easily, find out more about how the Council works and what it does. Simply write to: Robert P. Keim, President, The Advertising Council, Inc., 825 Third Avenue, New York, New York 10022.

**Ad Council** A Public Service of This Magazine & The Advertising Council.

The cost of preparation of this advertisement was paid for by the American Business Press, the association of specialized business publications. This space was donated by this magazine.

2 RECRUITMENT ADS FOR THE PRICE OF 1

**spill-  
proof  
power**



**for  
every  
stand-by  
emer-  
gency  
need**



**Our batteries are truly Carefree. They won't spill, never require maintenance, built with dual covers and they're completely rechargeable. We've got practically all sizes, but if you need a unique configuration that isn't on our shelf, we can probably build it for you. Call us. We're prompt and we're Carefree.**

**EAGLE P ICHER**  
SINCE 1843

**EAGLE-PICHER INDUSTRIES, INC.**  
Commercial Products Department ED  
P.O. Box 130, Seneca, Mo. 64865  
Telephone (417) 776-2258

CIRCLE NUMBER 88

# Advertiser's index

AMP, Incorporated.....	131	MicroWaves.....	107
Advanced Micro Devices. 39,40,41,104,105		Miller Co., Inc., W. A.....	132
Airpax Electronics, Cambridge Division.....	129	Monsanto Company.....	85
Allen Bradley Co.....	48A	Mostek Corporation.....	35
American Electronic Laboratories, Inc.....	84	NEC Micro computers, Inc.....	48D
Aromat.....	93	Optron, Inc.....	7
Avantek, Inc.....	33	*Philips CD/Elcoma.....	96
Bliley Electric Co.....	127	Philips ELA/MCR.....	108,110,112
Bourns, Inc., Magnetics Division.....	Cover II	Philips Test & Measuring Instruments, Inc.....	101
Burr-Brown Research Corporation.....	119	Power/Mate Corp.....	131
CTS Corporation.....	79	Power Tech, Inc.....	14
Cambion.....	74	Pro-Log Corporation.....	99
Centralab/USCC.....	91	Pyrofilm Corporation.....	125
Cherry Electrical Products Corp.....	47	RCA Solid State Division.....	Cover IV
Clarostat.....	132	Raytheon Company, Semiconductor Division.....	115
Continental Specialties Corporation.....	Cover III	Rental Electronics, Inc.....	48B,48C
Coto Coil Company, Inc.....	98	Rogers Corporation.....	131
Dale Electronics, Inc.....	38	ROM Books.....	117
Data General Corporation.....	45	Sangamo Weston, EMR Telemetry Division.....	61
Data I/O Corporation.....	94,95	Semiconductor Circuits, Inc.....	124
Datel Systems, Inc.....	109,111,113	Semikron International, Inc.....	130
Digital Laboratories.....	132	Semtech Corporation.....	25
Dynabyte.....	51	Siemens Corporation.....	112
Dynascan Corporation.....	55	Signetics Corporation.....	31
Eagle Magnetics, Inc.....	131	Silicon Systems, Inc.....	57
Eagle-Picher Industries, Inc.....	140	Sprague Electric Company.....	53
Efratom California, Inc.....	132	Standard Microsystems Corp.....	12
Electronic Applications Co.....	125	Struthers-Dunn, Inc.....	29
Engelhard Industries & Chemicals Corporation.....	126	T & B/Ansley Corporation.....	80
Essex International, Inc.....	103	TRW/IRC Resistors, An Electronic Components Division of TRW, Inc.....	71
E-T-A Circuit Breaker.....	131	TRW/LSI Products.....	75
Ferroxcube Corporation.....	89	TRW Power Semiconductors, an Electronic Components Division of TRW, Inc.....	13
Figaro Engineering, Inc.....	131	Teledyne Crystalonics.....	84
Fluke Mfg. Co., Inc., John.....	81	Teledyne Relays, A Teledyne Company.....	2
GenRad.....	131	Teledyne Semiconductor.....	62
General Electric Company, Instrument Rentals.....	96	Telvac.....	98
General Semiconductor Industries, Inc.....	37	Thermalloy Company.....	98
Gold Book, The.....	16	Triplett Corporation.....	87
Gould, Inc., Instrument Systems Division.....	49	Tustin Electronics Company.....	128
Guardian Electric Manufacturing Company.....	16	Union Carbide, Components Department.....	17
Harris Semiconductor, A Division of Harris Corporation.....	120,121	United Systems Corporation.....	103
Hartwell, Corp.....	125	Unirode Corporation.....	15
Hayden Book Company, Inc.....	131,132	Vactec, Inc.....	22
Heath Company.....	102	Visual Communications.....	6
Hewlett-Packard.....	1	Western Thermistor Corporation.....	132
Hico, Horizons International.....	78	Ziatech.....	132
IMC Magnetics Corporation.....	132		
ITT Jennings.....	122		
Intel Corporation.....	8,9,18,19		
Intel Memory Systems.....	20,21		
International Microsystems.....	78		
International Rectifier.....	64,65		
Intersil.....	4,5		
Kepeco, Inc.....	58		
Keystone Carbon Company.....	56		
LSI Computer Systems, Inc.....	123		
Litronix, Inc.....	10,11		
*Matsuo Electronics of America, Inc.....	103		
Memodyne Corporation.....	132		
Methode Electronics, Inc.....	131		

## RECRUITMENT

Atlas Bradford.....	133
Boeing.....	135
Cray Research.....	137
Dynallectron Corp.....	136
Ford Electrical & Electronic Div.....	134
Heath Company.....	137
Hutchinson Industrial Corp.....	137
NCR.....	138
Northrop.....	139
RCA.....	136
Regional Consultants.....	137
Systems Engineering Laboratories.....	138
U.S. Dept. of State.....	133

# IF YOU'RE WAITING FOR SOLDERLESS BREADBOARDS TO BE FASTER, EASIER, MORE VERSATILE AND LOWER-PRICED...

**Incredibly inexpensive.** EXPERIMENTOR solderless sockets begin at \$5.50\* (\$4.00\* for the 40 tie-point quad bus strip). A spool of solder costs more.

**Microprocessors and other complex circuits are easy to develop.** Each EXPERIMENTOR quad bus gives you four bus lines. By combining quads, 8-, 12- and 16-line address and data buses can be created, simplifying complex data/address circuits.

**Infinitely flexible.** Circuits can go in any direction, up to any size. All EXPERIMENTOR sockets feature positive interlocking connectors that snap together. Horizontally and/or vertically. And un-snap to change a circuit whenever you wish.

**Easy Mounting.** Use 4-40 screws from the front or 6-32 self-tapping screws from the rear. Insulated backing lets you mount on any surface.

**EXPERIMENTOR 350. \$5.50\*** 46 five-point terminals plus two 20-point bus strips. 0.3" centers;  $\frac{3}{8}$  x 3 $\frac{1}{2}$  x 2".

**EXPERIMENTOR 650. \$6.25\*** 46 five-point terminals plus two 20-point bus strips. 0.6" centers;  $\frac{3}{8}$  x 3 $\frac{1}{2}$  x 2 $\frac{1}{4}$ ".

**Mix and match.** Use large and small chips in the same circuit without problems. There are two sizes of EXPERIMENTOR sockets with 0.3" and 0.6" centers.

**Full fan-out. A CSC exclusive.** The only solderless breadboard sockets with full fan-out capabilities for **micro-processors** and other larger (0.6") DIP's.

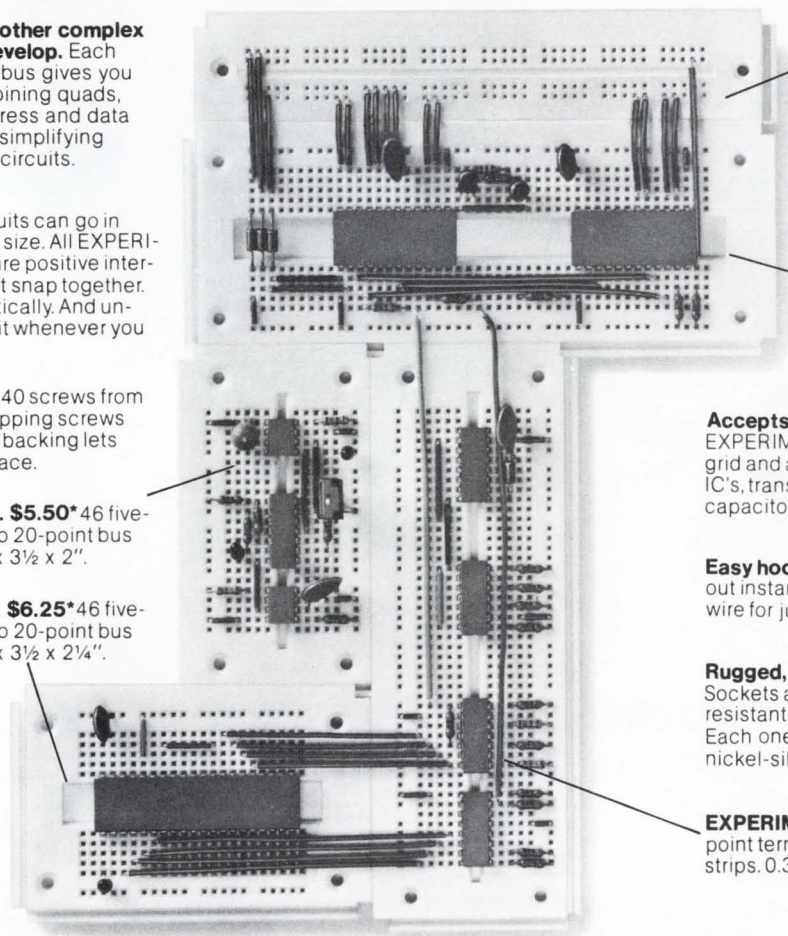

**EXPERIMENTOR QUAD BUS STRIP. \$4.00\*** Four 40-point bus strips.  $\frac{3}{8}$  x 6 x  $\frac{3}{4}$ ".

**Designated tie-points.** Simplify translation from breadboard to PC-boards or wiring tables.

**EXPERIMENTOR 600. \$10.95\*** 94 five-point terminals plus two 40-point bus strips. 0.6" centers;  $\frac{3}{8}$  x 6 x 2 $\frac{1}{4}$ ".

**Accepts all standard components.** EXPERIMENTOR sockets conform to an 0.1" grid and are DIP compatible. Also accept IC's, transistors, diodes, LED's, resistors, capacitors, transformers, pots, etc.

**Easy hookup.** Components push in and pull out instantly. Use #22-30 solid AWG wire for jumpers.

**Rugged, dependable construction.** Sockets are constructed from abrasion resistant materials and withstand 100°C. Each one features non-corrosive nickel-silver contacts.

**EXPERIMENTOR 300. \$9.95\*** 94 five-point terminals plus two 40-point bus strips. 0.3" centers;  $\frac{3}{8}$  x 6 x 2".

## WHAT ARE YOU WAITING FOR?

Discover today how solderless breadboarding can save time and money on every circuit you build. Get acquainted with EXPERIMENTOR™ sockets\* and how they simplify circuit design, assembly and testing. Eliminate the hassles and component damage of soldering. No special hardware or jumper cables required, either. And the price is so low, it's hard to believe.

**\*Order today.** Call 203-624-3103 (East Coast) or 415-421-8872 (West Coast): 9 a.m.-5 p.m. local time. Major credit cards accepted. Or see your CSC dealer. Prices slightly higher outside USA.†

CONTINENTAL SPECIALTIES CORPORATION



70 Fulton Terrace, Box 1942, New Haven, CT 06509, 203-624-3103 TWX 710-465-1227  
WEST COAST: 351 California St., San Francisco, CA 94104, 415-421-8872 TWX 910-372-7992  
GREAT BRITAIN: CSC UK LTD., Spur Road, North Feltham Trading Estate,  
Feltham, Middlesex, England, 01-890-8782 Int'l Telex: 851-881-3669  
CANADA: Len Finkler Ltd.; Ontario

\*Manufacturer's recommended resale.  
© 1977, Continental Specialties Corporation

†U.S. Patent No. D235,554

CIRCLE NUMBER 231

# RCA. Newsmaker in Linear.

## New BiMOS CA 3290. Low-cost single-supply dual comparator.

BiMOS does it again — creates new performance at cost-effective prices. The new RCA CA3290 dual comparator LIC beats Bipolar on performance and Bifet on prices.

### Compare comparators.

When it comes to accuracy, compare the high input impedance/low current of BiMOS with that of Bipolar: 50 picoamps input vs. at least 25,000. This means the CA3290 can be coupled directly to high-impedance sensors.

### Check prices.

Then compare the prices of our new CA3290 voltage comparator in any quantity you need. At a fraction of Bifet costs, the BiMOS comparator is better at sensing small signals close to ground potential. Because its common mode input voltage includes ground.

And you have the added convenience and flexibility of two single-supply comparators in one package with operation up to 44 volts.

Let us give you the details as well as information on how you can make your own first-hand evaluation of the 3290.

Contact your RCA Solid State distributor. Or contact RCA Limited/Solid State, Ste.-Anne-de-Bellevue, Quebec. Phone: (514) 457-9000.

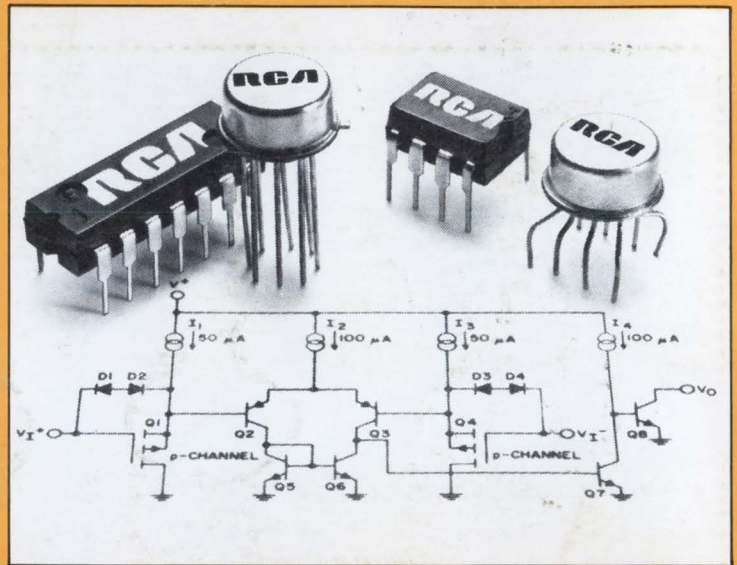

RCA Linear IC experience is working for you.

# RCA

CIRCLE NUMBER 232