

Connector selection shaking you up? Small wonder. Cable/panel connector specs are not readily unscrambled. Catalogs deliver all dimensions, not crucial derating

factors; splatter superlatives, not available tradeoffs. "Leave the choosing to us," say spec-stingy vendors. To see what information catalogs blur over, riffle to p. 54.

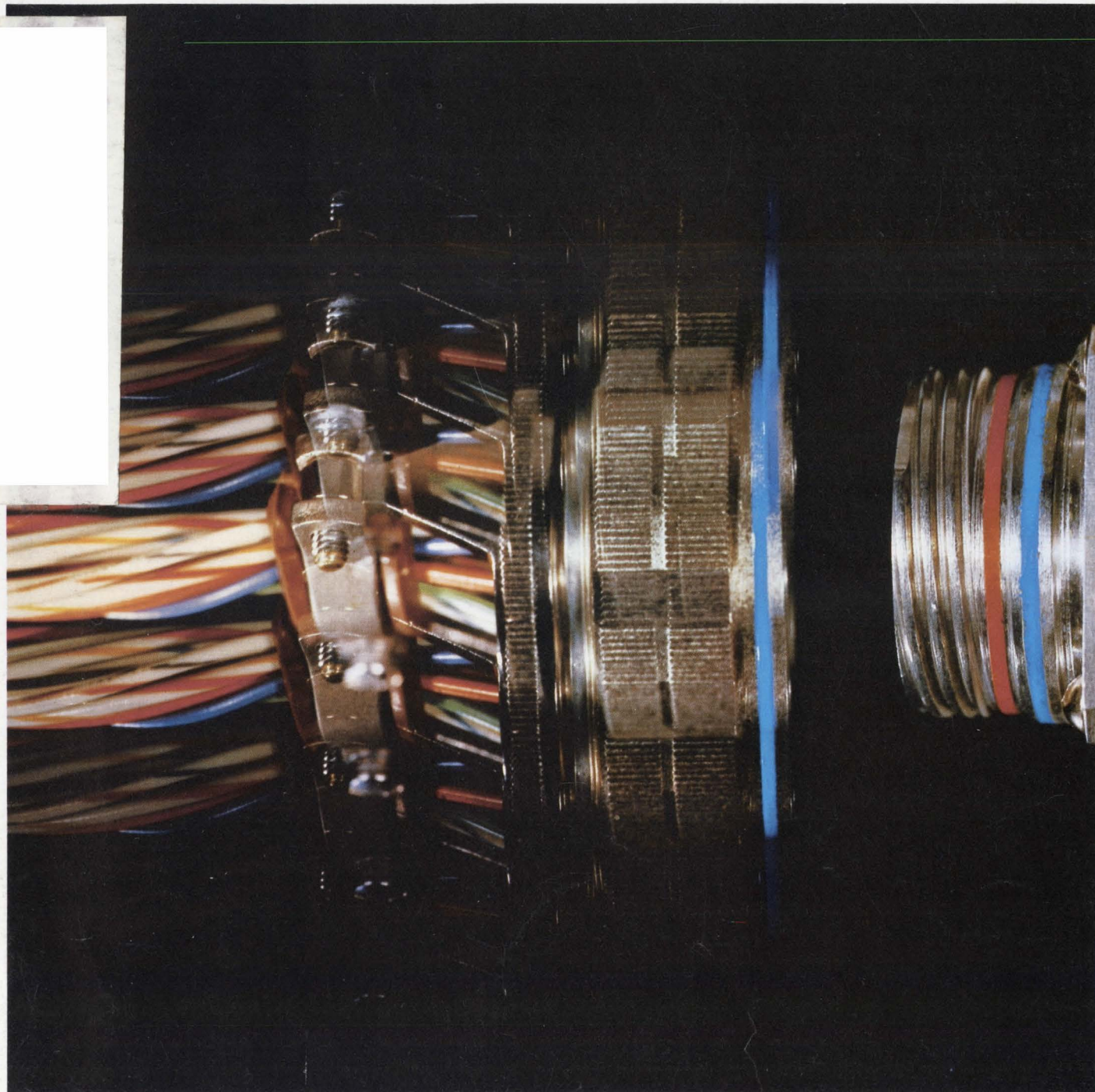

The First Modular Precision Pot...

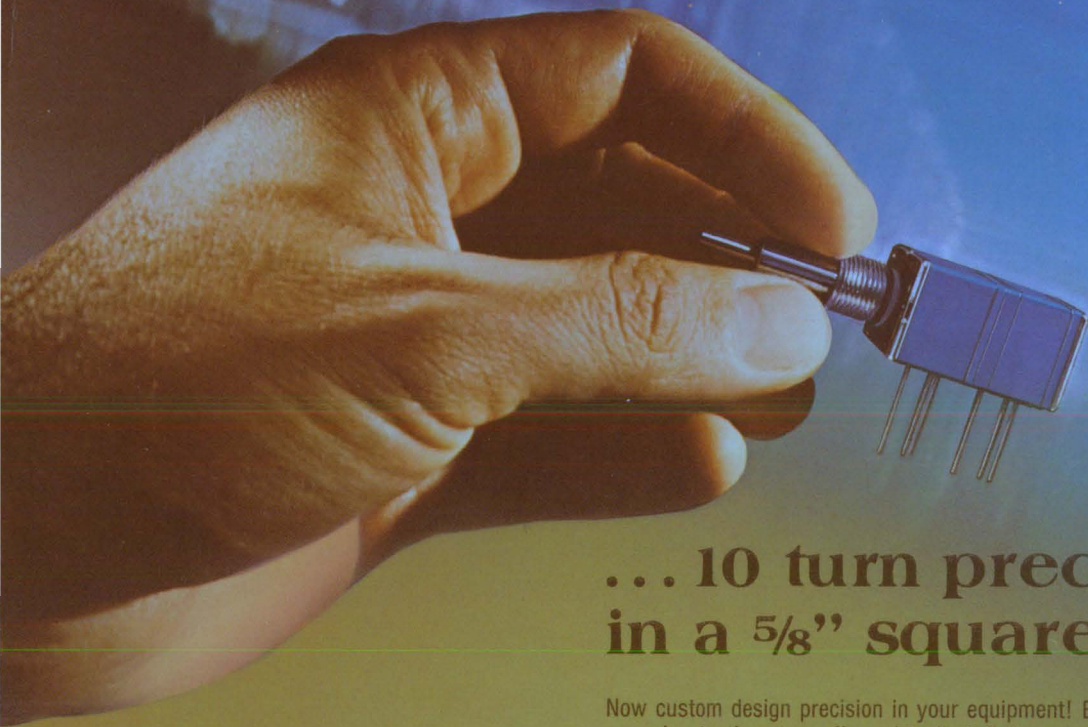

... 10 turn precision,
in a $\frac{5}{8}$ " square package.

Now custom design precision in your equipment! Bourns modular line of 10-turn wire-wound potentiometers offers virtually infinite selection of standard options, with specs that are unequaled in any other line of modular controls, potentiometers and switches.

SMALL SIZE—The $\frac{5}{8}$ " square design saves up to 35% of panel space compared to standard circular models. Position them closer or in an area simply not possible before now.

LOW ASSEMBLY COSTS—Easy and economical mounting on P.C. boards. Only Bourns offers a choice of P.C. pins or solder lugs!

MANY OPTIONS—Single shafts of $\frac{1}{8}$ " or $\frac{1}{4}$ " diameter are each available in 3 standard lengths, or choose dual concentric shaft options - all with plain or locking bushings. Specify to your application and gang up to two modules.

You'll find these smaller modular precision pots offer the same electrical specs as the larger circular types - such as independent linearity of only $\pm 0.25\%$.

"FEEL-APPEAL"—As with Bourns other styles of controls and switches, this precision line offers the same smooth, consistent feel. The low rotational torque is still only .3 to 2.0 oz. inch!

CALL TODAY—for complete information on this versatile off-the-shelf, modular constructed potentiometer. Find out how to custom design precision in your equipment at standard cost and leadtime.

MODULAR PRECISION... BEAUTIFUL!

TRIMPOT PRODUCTS DIVISION, BOURNS, INC., 1200 Columbia Avenue, Riverside, CA 92507, Telephone 714 781-5122—TWX 910 332-1252.

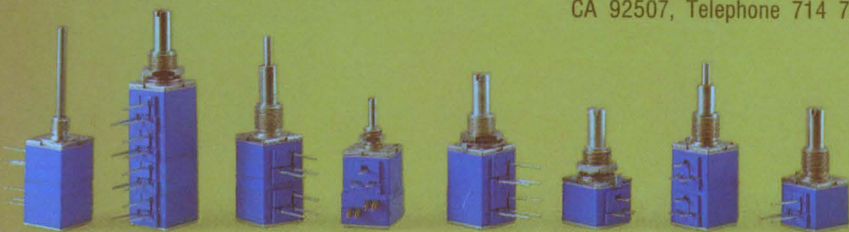

International Marketing Offices: European Headquarters — Switzerland 042/23 22 42 • Belgium 02/218 2005 • France 01/2039633 • Germany 0711/24 29 36 • Italy 02/32 56 88 • Netherlands 70/87 44 00 • United Kingdom 01/572 6531 • Norway 2/71 18 72 • Sweden 764/20 110 • Japan 075/921 9111 • Australia 02/55-0411 03/95-9566 • Israel 77 71 15/6/7

For Immediate Application — Circle 130
or for Future Application — Circle 230

SURPRISE!



Our New Display Can Say A Lot For You

Our new HDSP-2000 Alphanumeric Display can spell it out for you in bright, crisp LED characters. The full 5x7 dot matrix can display ASCII or custom character sets including lower case and symbols.

Compact and complete with on-board electronics, the HDSP-2000 dramatically reduces display system size and complexity. Each 12 pin DIP contains 4 characters with row drivers and storage. End stackable and easy to interface, they're ideal for "smart" instruments, medical systems or business terminals, military applications, and almost any mobile, portable or hand-held device.

The price is \$47.00* per 4-character cluster in quantities of 125 clusters. They're in stock today at HP's franchised distributors. In the U.S. contact Hall-Mark, Schweber, Wilshire or the Wyle Distribution Group (Liberty/Elmar) for immediate delivery. In Canada, contact Zentronics, Ltd. *U.S. Domestic price only.

HEWLETT  **PACKARD**

Sales and service from 172 offices in 65 countries.
1507 Page Mill Road, Palo Alto, California 94304

TO-5 RELAY UPDATE

Maglatch TO-5: the relay with a mind of its own.

Whenever critical switching circuits call for reprogrammable non-destructible memory, choose Teledyne's magnetic latching TO-5 — the relay that remembers. Once set with a short pulse of coil voltage, it will retain its state until reset or reprogrammed — even if system power fails or is shut off. And you get the added advantage of reduced system power demands, since conventional relay holding power is not required.

But reprogrammable memory capability and low power consumption are not the only advantages of our TO-5 maglatch relays. Their subminiature

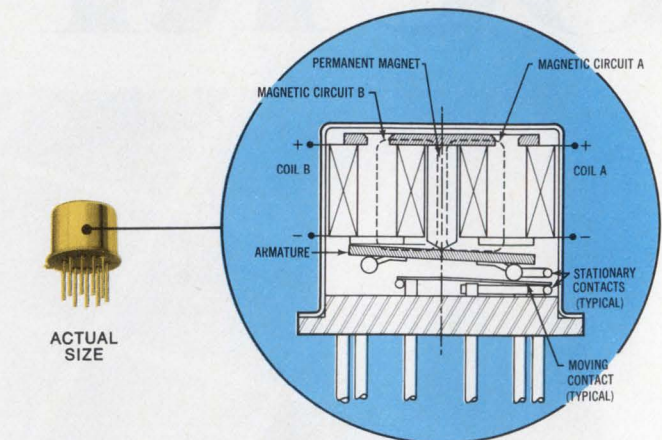

size makes them ideal for high density pc board packaging, and they're available in SPDT, DPDT and 4PST contact forms. And for RF switching, their low intercontact capacitance and contact circuit losses provide high isolation and low insertion loss up through UHF.

Our magnetic latching as well as our complete line of TO-5 relays includes military and commercial/industrial types with MIL versions qualified to "L" and "M" levels of established reliability specs. For complete data, contact Teledyne Relays — the people who originated the TO-5 relay.

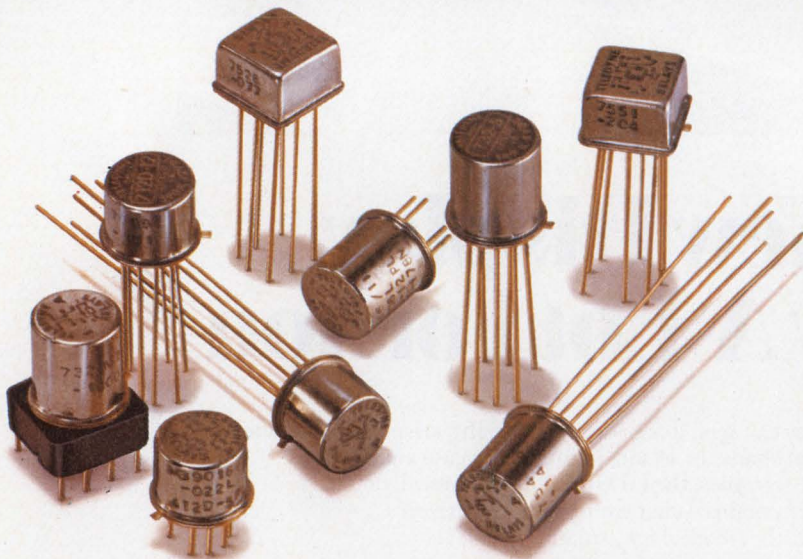

OTHER TELEDYNE TO-5 RELAYS

- **Hybrid "T" Series**
SPDT & DPDT types with internal transistor driver and suppression diode. Military and commercial/industrial versions.
- **"D" and "DD" Series**
With internal suppression and steering diodes. Military and commercial/industrial versions.
- **Centigrad® Series**
World's smallest relay—only .225" (5.72mm) high x .370" (9.40mm) square. DPDT, with optional internal suppression and steering diodes.
- **Hi-Rel Series**
Screened versions for space flight applications (NASA qualified).
- **High Environment Series**
Hi-temperature, Hi-shock, and Hi-vibration types.

 **TELEDYNE RELAYS**

3155 West El Segundo Boulevard, Hawthorne, California 90250
Telephone (213) 973-4545

CIRCLE NUMBER 3

NEWS

- 17 **News Scope**
- 26 **New hardware, memory and software** are giving microprocessor systems macro performance.
- 30 **Current-carrying rods** power backplane-less card assemblies.
- 34 **Bubble memories are going military** in a variety of air and space applications.
- 38 **Faster doping technique** promises better semi yields and performance.
- 43 **Washington Report**

TECHNOLOGY

- 54 **FOCUS on multipin cable panel connectors:** You can't select connectors properly with only the information found in catalogs. So you're forced to consult the manufacturers. Still you must understand the important specs.
- 66 **Selecting capacitors properly** requires an understanding of manufacturers' spec jargon. Generalized charts and tables guide you to rational choices.
- 76 **Choosing a signal source** isn't easy. With various generators looking a lot alike these days, selection leans heavily on your specific test requirements.
- 84 **Lock onto frequency** with frequency-lock loops. These simple-to-design tracking circuits can often tame signals that are too difficult for phase-locking.
- 90 **Analyze I²L accurately** by treating the merged structure as a four-terminal device. A graphic form simplifies analysis, and gives fan-in and fan-out.
- 96 **Webb Scroggin of Dana Labs** speaks on speeding from lab to marketplace.
- 102 **Ideas for Design:**
Digitally programmed oscillator is suitable for μ P control.
Programmable unijunction delay circuit features high noise immunity.
Bias-current cancellation easily implemented with matched op amps.
- 111 **International Technology**

PRODUCTS

- 115 **Packaging & Materials:** Plated-hole attachment method reduces shorts and leaks in ECL three-plane panels.
- 126 **Instrumentation:** Autoranging comes to low-cost vhf counter.
- 130 **Instrumentation:** Miniature DMM measures conductance, tests diodes.
- 134 **ICs & Semiconductors:** Combination circuit reduces part count with RAM and I/O on same chip.
- 142 Micro/Mini Computing
- 148 Data Processing
- 154 Components
- 158 Modules & Subassemblies
- 162 Power Sources

DEPARTMENTS

- 51 **Editorial:** Time for decisions
- 7 Across the Desk
- 164 Application Notes
- 164 Bulletin Board
- 166 New Literature
- 174 Advertisers' Index
- 176 Product Index
- 176 Information Retrieval Card

Cover: Photo by Lynn Weeks, courtesy of Bendix/Electrical Components Div., showing a MIL-C-38999, Series III Tri-Start connector.

**How
to do three
things at the
same part:**

Advanced Micro Devices, Inc. • 901 Thompson Place, Sunnyvale, California 94086 • Telephone (408) 732-2400 •
Distributed nationally by Hamilton/Avnet, Cramer and Schweber Electronics and regionally by Arrow, Bell,
Century Electronics, Future Electronics and RAE Electronics.

If you want a great 8-bit D-type register with common clear, get our Am25LS273. If you want one with three-state outputs, get our terrific Am25LS374. If you're looking for a sensational common enable, you want our Am25LS377. However, if you'd be willing to settle for all three, read on.

Advanced Micro Devices announces the Am25LS2520 8-bit D-type register. With common clock enable. With common asynchronous clear. With three-state outputs. With MIL-STD-883 for free. And all in a super-convenient 22-pin DIP. Look:

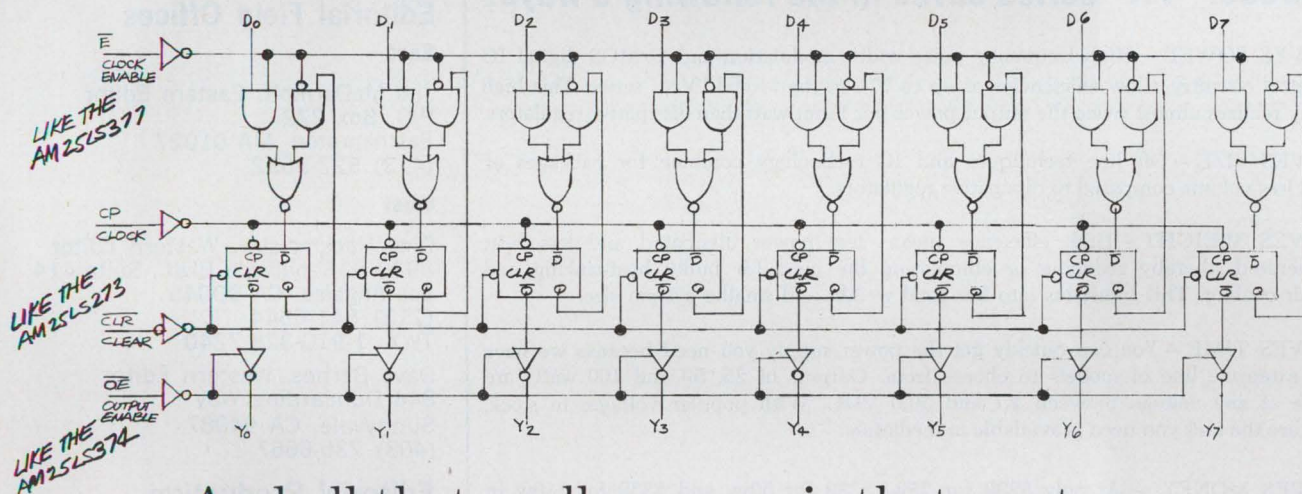

And all that really means is that next time you're thinking about registers, low-power Schottky and TI, you should also be thinking about AMD. Or calling. Or writing.

(After all, where else can you do three things at the same part?)

Advanced Micro Devices

Bipolar LSI. N-channel, silicon gate MOS. Low-power Schottky.
Multiple technologies. One product: excellence.



CIRCLE NUMBER 15

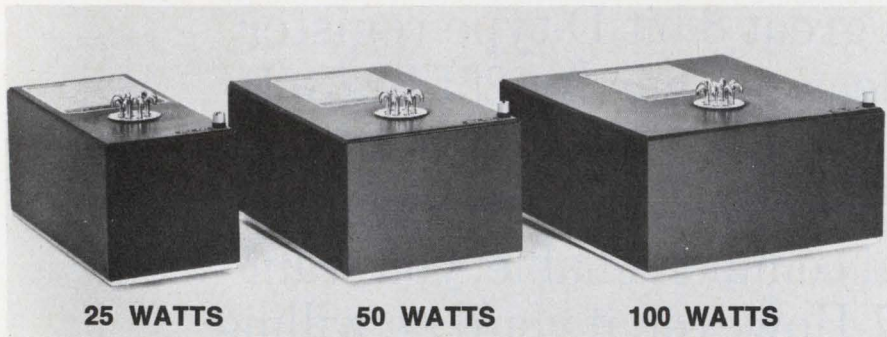

Save 5 Ways with Abbott's New 77% Efficient Power Supplies!

Abbott has a Hi-Efficiency series of power modules that can save 5 ways in your system. The Model "VN" series converts 47-440 Hz AC lines to regulated DC power and uses a new approach in switching technology that provides a highly reliable line or sixty-three high efficiency power modules.

The Model "VN" series saves in the following 5 ways:

- 1 SAVES POWER** — High frequency pulse width modulation and C/MOS digital IC control circuitry allow efficiencies of up to 77% in the Model "VN" series. This high efficiency realizes almost twice the output power per input watt than dissipative regulators.
- 2 SAVES SIZE** — Off line techniques and IC technology combine for packages of 70% less volume compared to dissipative regulators.
- 3 SAVES WEIGHT** — High efficiency means less power dissipated and less heat generated, thereby reducing or eliminating the need for bulky heat-sinking and forced air cooling. This translates into less total weight and smaller system size.
- 4 SAVES TIME** — You can quickly get the power supply you need because we have an extensive line of models to choose from. Outputs of 25, 50 and 100 watts are available at any voltage between 4.7 and 50.0 VDC. With popular voltages in stock, chances are the unit you need is available immediately.
- 5 SAVES MONEY** — At only \$299 for 25w, \$339 for 50w, and \$359 for 110w in small quantities, the "VN's" are among the lowest priced Hi-efficiency units on the market.

Abbott also manufactures 3,500 other models of power supplies with output voltages from 2.7 to 740 VDC and output currents from 4 milliamps to 20 amps. They are all listed, with prices, in the new Abbott Catalog. Included are:

60 A to DC
 400 A to DC
 28 VDC to DC
 28 VDC to 400 A
 12-38 VDC to 60 A

Please see pages 1037-1056 Volume 1 of your 1975-76 EEM (ELECTRONIC ENGINEERS MASTER Catalog) or pages 612-620 Volume 2 of your 1975-76 GOLD BOOK for complete information on Abbott Modules.

Send for our new 60 page FREE catalog.

abbott transistor

LABORATORIES, INCORPORATED
 general offices eastern office
 5200 W. Jefferson Blvd./Los Angeles 90016 1224 Anderson Ave./Fort Lee, N.J. 07024
 (213) 936-8185 Telex: 69-1398 (201) 224-6900 Telex: 13-5332
 CIRCLE NUMBER 4

Sr. Vice President, Publisher

Peter Coley

Editors

Editorial Offices
 50 Essex St.
 Rochelle Park, NJ 07662
 (201) 843-0550
 TWX: 710-990-5071
 (HAYDENPUB ROPK)
 Cable: Haydenpubs Rochellepark

Editor-in-Chief George Rostky

Managing Editors:

Ralph Dobriner
 Michael Elphick

Senior Associate Editor

Stanley Runyon

Associate Editors:

Sid Adlerstein
 Dave Bursky
 Morris Grossman
 John F. Mason
 Andy Santoni
 Max Schindler

Contributing Editors:

Peter N. Budzilovich, Jules H. Gilder,
 John Kessler, Alberto Socolovsky,
 Nathan Sussman

Editorial Field Offices

East

Jim McDermott, Eastern Editor
 P.O. Box 272
 Easthampton, MA 01027
 (413) 527-3632

West

Dick Hackmeister, Western Editor
 8939 S. Sepulveda Blvd., Suite 414
 Los Angeles, CA 90045
 (213) 641-6544
 TWX: 1-910-328-7240

Dave Barnes, Western Editor
 844 Duncardine Way
 Sunnyvale, CA 94087
 (408) 736-6667

Editorial Production

Marjorie A. Duffy, Production Editor
 James Keane, Copy Editor

Art

Art Director, William Kelly
 Richard Luce, Anthony J. Fischetto

Production

Manager, Dollie S. Viebig
 Helen De Polo, Nancy Hurey

Circulation

Director, Barbara Freundlich

Information Retrieval

Paula Greenleaf

Advertising Promotion

Susan G. Apolant

Reprints

Maxine Correal

Across the desk

Tribute to a mentor

I read with great interest your editorial in the February 15 issue ("The Good Word," p. 65). I sympathize with your regrets about Lotte Lehmann. I noted her passing, and also noted the great outpourings of sentiment that came from local sources here such as Kurt Herbert Adler, boss of the San Francisco Opera.

My own attachment is for a person in your neck of the woods. I think that the writings—and behind that, the thinking—of Dr. Margaret Mead have influenced my career greatly.

It was M.M. who reached me through her books when I was a college student pretending to study electrical engineering. She opened new vistas for me, and convinced me that engineering was far too confining a field. She studied people, and that's what I wanted to do.

Many times, when visiting New York, I thought of simply looking her up and shaking her hand. But I never did. I got caught up in the work of the moment. And with each passing year, my chances of meeting the good Doctor and telling her what she has meant to me become smaller.

I'm going to take some of your editorial's words to heart, and drop my idol a line. It won't do anything for her, but at least I will have paid a 20-year debt.

Name withheld

Me an editor?

Maybe. If you would enjoy interviewing industry authorities, and writing and editing articles on the latest technological developments, you might enjoy being an editor.

We have openings at our home office in New Jersey. Write to Mike Elphick, Managing Editor, Electronic Design, 50 Essex St., Rochelle Park, NJ 07662.

Misplaced Caption Dept.



Breaker, Breaker! This is Rameses of the upper Nile calling. Has Moses passed your observation post yet?

Sorry. That's "Girl with Lotus," a limestone relief from the Fifth Dynasty. It's on display at the Louvre in Paris.

Sorry: wrong address

The photo caption on page 56 of the April 12, 1977, issue gave the wrong address for Processor Technology Corp. The correct address is Box S, 6200 Hollis St., Emeryville, CA 94608.

Electronic Design welcomes the opinions of its readers on the issues raised in the magazine's editorial columns. Address letters to Managing Editor, Electronic Design, 50 Essex St., Rochelle Park, NJ 07662. Try to keep letters under 200 words. Letters must be signed. Names will be withheld upon request.



OPTRON OPTICALLY COUPLED ISOLATORS

NEW JAN 4N22A SERIES
OFFERS
HIGHEST RELIABILITY

You can't buy a more reliable optically coupled isolator than one of OPTRON's new JAN 4N22A series. The popular JAN 4N22A, 4N23A and 4N24A all feature fully qualified JANTX and JANTXV ratings.

These new OPTRON isolators consist of a high efficiency, solution grown gallium arsenide LED and a silicon N-P-N phototransistor in a hermetically sealed 6-pin TO-5 package. Minimum input-to-output isolation voltage for the series is 1000 volts and minimum current transfer ratios range from 25% for the 4N22A to 100% for the 4N24A.

New "A" version OPTRON isolators are a significant improvement over the older 4N22 series since the case is isolated from the sensor and LED to eliminate the need for an insulating spacer in many applications.

OPTRON also offers a new JEDEC registered series of high reliability isolators in a 4-pin TO-18 package. The 3N243 series includes three devices with the same reliability and similar characteristics as the JAN 4N22A TO-5 series, yet in a smaller package.



3N243

In addition, OPTRON's complete line of optically coupled isolators includes other immediately available standard devices in high-rel metal cans and low cost DIP and other plastic configurations for almost every application.

Detailed technical information on optically coupled isolators and other OPTRON optoelectronic products... chips, discrete components, limit switches, reflective transducers, and interrupter assemblies... is available from your nearest OPTRON sales representative or the factory direct.



OPTRON, INC.

1201 Tappan Circle
Carrollton, Texas 75006, U.S.A.
TWX-910-860-5958
214/242-6571

Portable 250 MHz Frequency Counter \$345.*

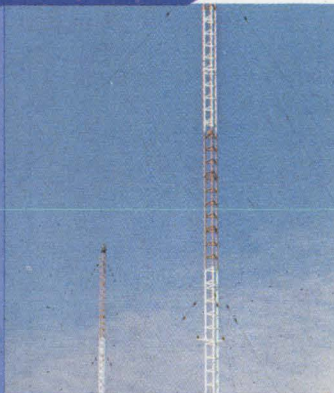
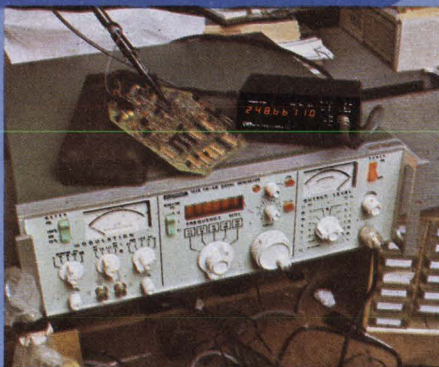

Actual size, front view.

...Goes Anywhere You Need It

Model 585 Meets Your Requirements

- In field service and maintenance
- In the development laboratory
- In quality control
- On the production line

The Model 585 Digital Frequency Counter is another Data Precision design breakthrough: remarkably low in cost, compact and easy to use, yet uncompromised in either reliability or performance.

Completely independent of the power line, the Model 585 is a full 8-digit frequency counter to 250 MHz. It is battery and line operated, fits in your hand, and its performance and value have been optimized, not by cutting corners, but by design innovation.

Exceptional Reliability

Data Precision proprietary LSI chip contains not only the front end signal conditioning circuitry, but the first counter decade as well. This allows Model 585 to provide exceptional reliability, laboratory performance and field portability — all at the remarkably low price of \$345.!



Features that make the Model 585 something special for you!

- **10Hz to 250MHz — Direct Counting, Direct Reading.** Always reads directly in MHz, with correctly positioned decimal point. No calculations, no interpretations, no heterodyning, and no prescaling.
- **High Sensitivity.** 10mVRMS to 50MHz, 50mVRMS to 250MHz! And the signal may be amplitude or frequency modulated, provided that the minimum-signal and frequency ratings are respected.
- **8-Digit Display — with Fully Compatible Stability.** Exceptionally High Resolution. Gate Time: 10 sec., 1 sec., 0.1 sec. Resolution: 0.1Hz, 1Hz, 10Hz.
- **Big, Bright Display.** Eight 0.3" LEDs, for optimum readability wherever you use it.
- **Dual Input Impedance.** Switch-selected, 1 megohm or 50 ohms.



- **Wide-Range Attenuator.** Three position front panel switch, x1, x10, x100, accommodates very wide input-signal range. Input protection circuits prevent damage from extra high signals.
- **Big-Chip Reliability, Economy, and Battery Longevity.** A Data-Precision LSI chip provides high performance in a miniature configuration. The 585 has the lowest

cost, the lowest component count, and the lowest battery drain of any comparable design!

Model 585, including rechargeable NiCd batteries, AC line/charger, and a vinyl carrying case is only \$345. This package also includes a full instruction manual, Certificate of Conformance, and final test data.

Optional Accessories available include: telescopic antenna, (TCXO) precision crystal oscillator, leather or fiberglass carrying case, panel mount adaptor, and bench stand.

All specifications guaranteed for a full year. Full-Year warranty for both parts and labor. Service is available from our worldwide service centers.



100 MHz Multifunction Counter/Timer — \$295.

If you need a bench counter/timer consider our Model 5740 which measures: Frequency, Period, Period Average, Total Events and Elapsed Time. Sensitivity to 10mV.

For further information or a demonstration, contact your local Data Precision representative or Data Precision Corporation, Audubon Road, Wakefield, MA. 01880. U.S.A. (617) 246-1600 TELEX (0650) 949341.

*Price USA

AL (205) 533-5896
AZ (602) 253-6104
CA (N) (408) 733-8690
CA (S) (714) 540-7160
CO (800) 528-4512
CT (203) 525-7647

FL (N) (813) 294-5815
FL (S) (305) 491-7220
GA (404) 945-4222
IL (312) 593-0282
IN (317) 293-9827
MA (617) 245-5940

MD (301) 622-4200
MI (313) 482-1229
MN (612) 781-1611
MO (816) 358-7272
NC (919) 787-5818
NJ (N) (800) 645-8016

NJ (S) (215) 674-9600
NM (800) 528-4512
NY (N) (315) 446-0220
NY (S) (516) 482-3500
NY (S) (212) 895-7177

OH (N) (216) 331-0900
OH (S) (513) 433-8171
OK (918) 936-3631
OR (503) 238-0001
TX (N) (214) 234-4137

TX (S) (713) 461-4487
TX (W) (512) 837-3881
UT (800) 528-4512
VA (800) 638-2720
WA (206) 763-2210

 **DATA PRECISION**® ...years ahead

FOR DEMONSTRATION CIRCLE 6
FOR ADDITIONAL INFORMATION CIRCLE 7

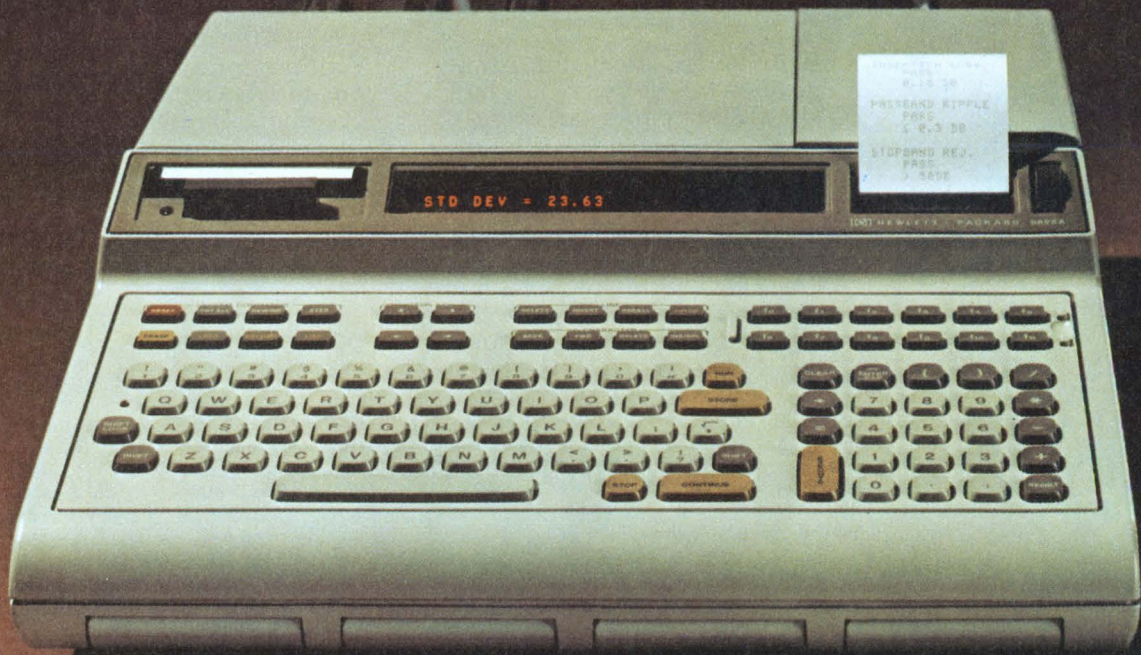
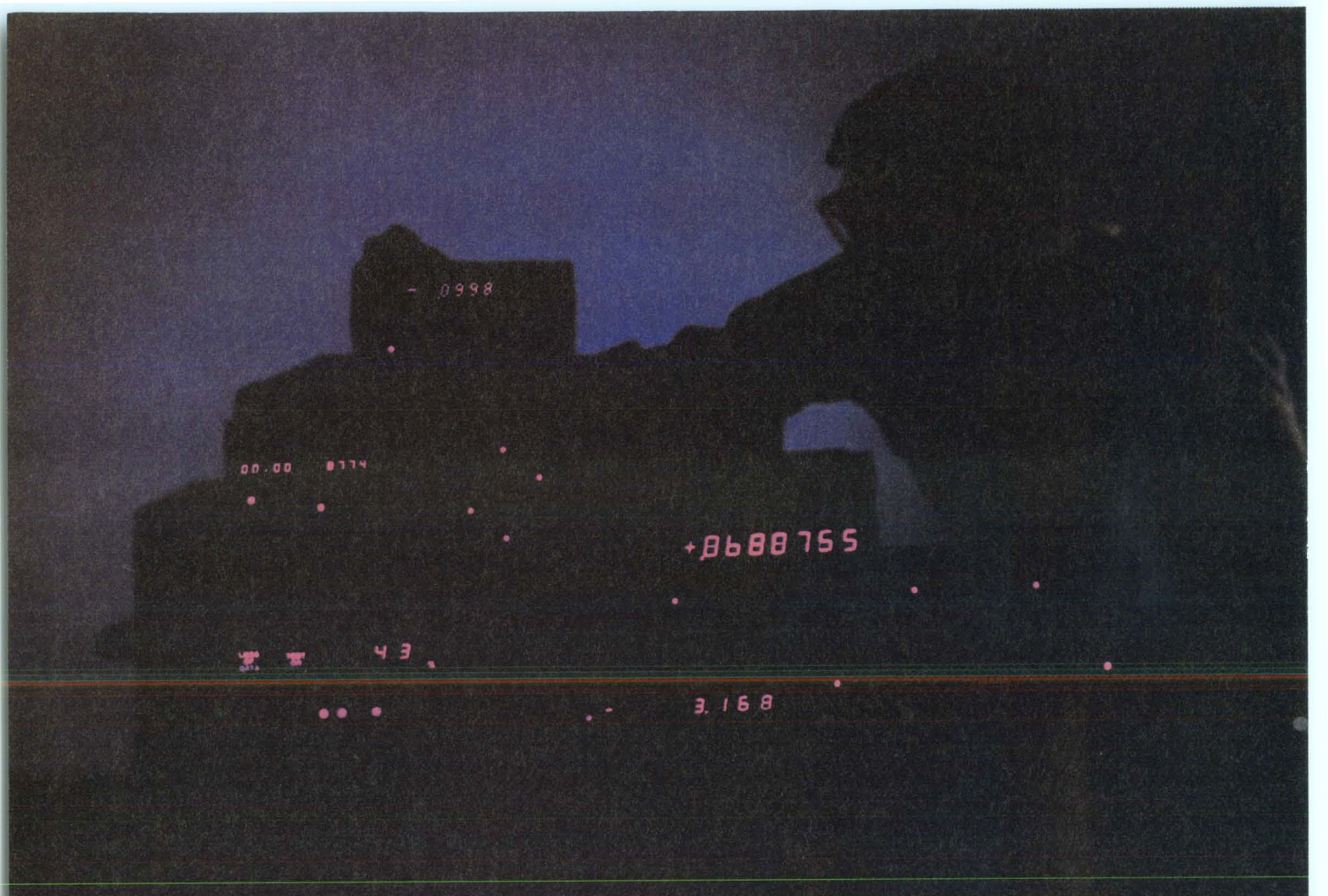

HP computing controllers.

12 reasons why they're ready-made for interfacing.

1. Direct memory access (DMA)
2. Vectored priority interrupt
3. Buffered I/O
4. High-level language
5. Plug-in interface cards
6. High-speed tape cartridge
7. Built-in printer
8. Preprogrammed I/O drivers
9. Keyboard programming
10. 32 character display
11. Live keyboard
12. Editing keys

An HP 9825 computing controller provides minicomputer-like performance in one complete easy-to-interface, easy-to-program, easy-to-use package. I/O is built-in. Software for the operating system, which includes high-level language and I/O drivers, is built-in. Interface cards just plug in. You get a cost-effective solution to instrument interfacing.

I/O cards and simplified programming make interfacing easy. You can choose off-the-shelf interfaces for BCD, bit parallel, bit serial, or HP-IB (HP's implementation of IEEE Standard 488-1975).

For many applications, interfacing can be just this simple. You plug the correct I/O card in the back of the computing controller that fits your needs. Then connect your instrument to the other end of the card. After programming the controller with a few simple commands, your automated system is ready for work.

Vectored priority interrupt, DMA (direct memory access), and buffered I/O allow the 9825 to do multiple interfacing jobs routinely.

The HP 9815 provides low cost interfacing. For applications that don't need interrupt and DMA, the HP 9815

computing controller offers a ready-made solution for data-logging and instrument control. It, too, has a self-contained printer, tape storage, display, easy-to-use language, and integrated keyboard. Auto Start allows your program to begin executing automatically when power is turned on. It provides a lot of performance for its low price.

Improve your system and become more productive. No matter what kinds of instruments you use—scanners, counters, spectrometers, meters, converters, chromatographs, or what have you—an HP computing controller can greatly enhance their performance—now. Find out more. Send for our interfacing brochure today.

407/3

*From computers-on-a-board to general-purpose systems,
HP can meet your interfacing needs.*



P.O. Box 301, Loveland, Colorado 80537

For assistance call: Washington (301) 948-6370, Chicago (312) 255-9800, Atlanta (404) 955-1500, Los Angeles (213) 877-1282

CIRCLE NUMBER 9

MOS MEMORY

A 16K RAM BY ANY OTHER NAME WOULD NOT BE A FAIRCHILD.

We understand there's already an industry standard 16K RAM—the 4116.

Okay. We're all for standardization.

You have to start someplace.

But, before you start designing it in, as if there were no other source, we'd like to offer a suggestion: Compare it against our new F16K RAM.

Form, fit and function, you'll find there's no difference.



TO THINE OWN SPECS BE TRUE.

We know. You'll need a little proof. So, here's a sample.

The F16K is a 16,384-word by 1-bit MOS RAM.

Random access speed ranges from 150-350ns, with faster access times available in page mode.

Power requirements are low — less than 600 mW. Of course, the outputs are in the standard unlatched configuration. All inputs are

low capacitance and TTL-compatible. The device

provides input latches for addresses and data-in, common I/O capability, two-dimensional selection using RAS and

CAS, plus flexible timing with Read-Modify-Write, RAS-only Refresh and Page-Mode capability. The F16K also

provides 3-state TTL-compatible output data valid to end of cycle. And, it features ± 10 tolerance on all power

supplies (+12V, +5V, -5V). The F16K comes in a standard 16-pin DIP with pinouts and timing suitable for easy upgrade of 4096 on 4027 based systems.

There's more. But we think these specs give you a pretty good idea of the potential cost-effectiveness of our new 16K RAM.



WHAT'S OURS IS YOURS.

At the very moment you are reading this ad, Fairchild is shipping prototype quantities of F16K to eager recipients throughout the industry. (The phone number or address at the bottom of this page will get you prototypes of your very own.) Once you try our new 16K RAM in your system, we know you'll want more. Which gets us to our next point:

When you're ready to order F16Ks in quantity, we'll be ready to ship them in quantity.

MUCH ADO ABOUT SOMETHING.

There are two very good reasons we're confident about our delivery capabilities.

First, we've got a three-year jump on the industry using the Fairchild double poly Isoplanar™ process. The remarkable manufacturing process gives us higher yields resulting in better delivery at lower cost.

Second, we've built another new domestic production plant. It is already turning out devices and is devoted 100% to MOS. Which tells you something about the importance we place on little numbers like our new F16K.

THE NOBLEST RAM OF THEM ALL.

Complete information on our new 16K RAM awaits your request. Use the direct line to our MOS Division at the bottom of this ad. Or call your favorite Fairchild distributor, sales office or office representative today. Fairchild Camera and Instrument Corporation, 464 Ellis Street, Mountain View, California 94042. Tel: (415) 962-3941. TWX: 910-379-6435.

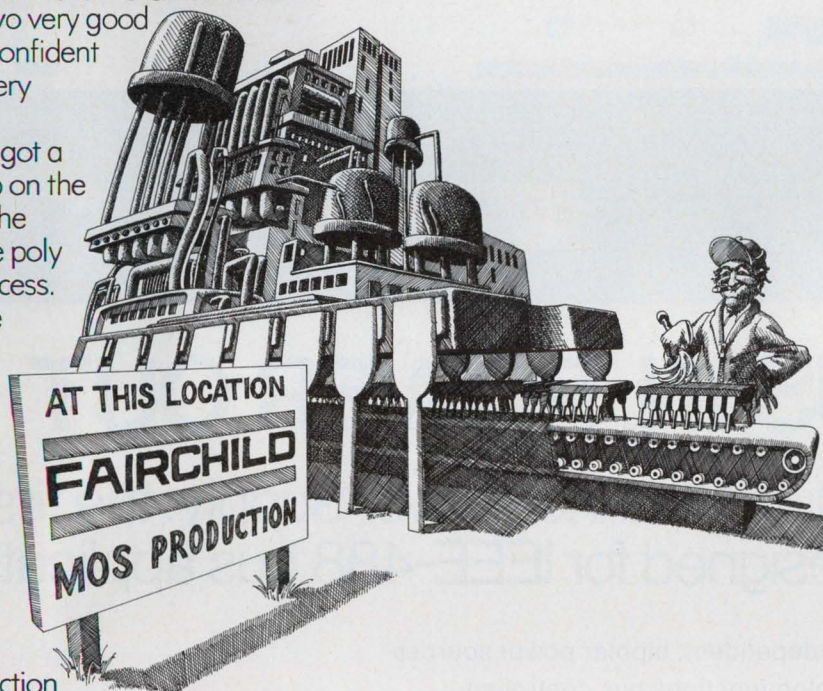

FAIRCHILD

**CALL US ON IT.
(415) 962-3941**

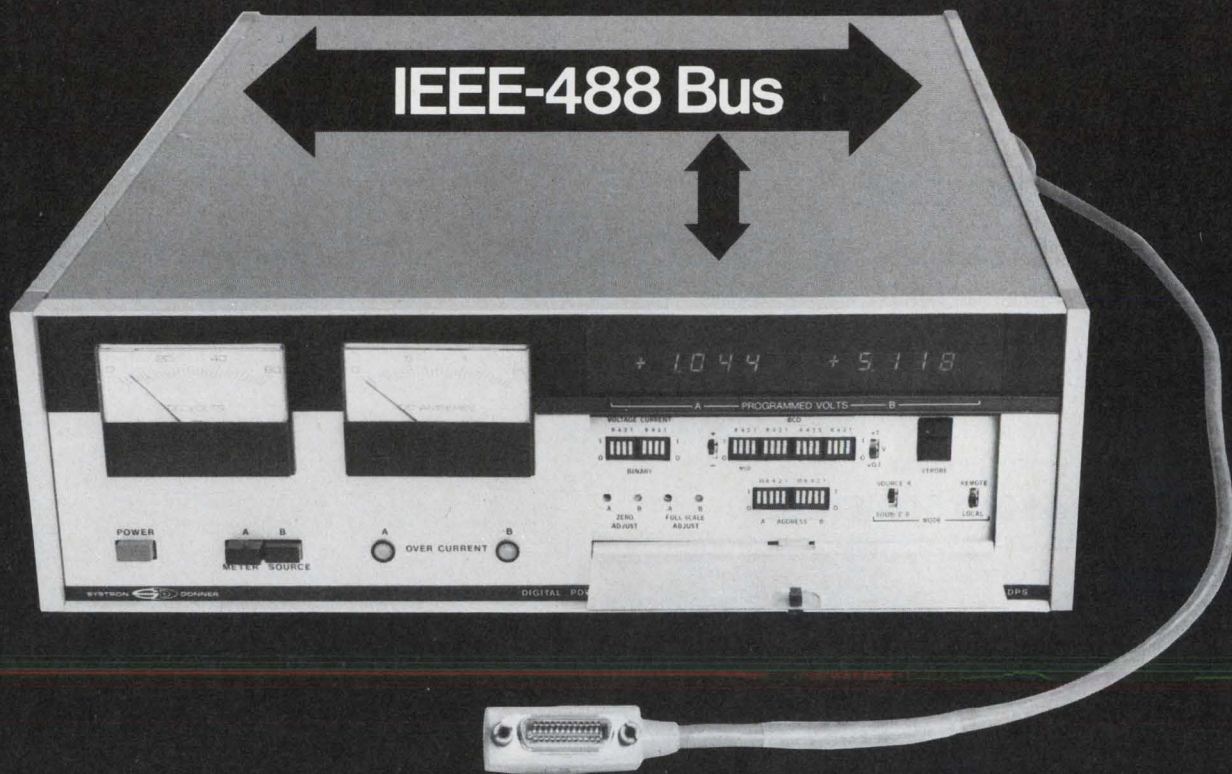

BUS IN, POWER OUT

S-D's Dual Channel Power Supply: the first supply designed for IEEE-488 bus applications.

- Two independent, bipolar power sources
- All analog functions bus controlled
- Programmable overvoltage and current limits
- Memory register displays

The industry's best dual channel power supply now includes the IEEE bus interface as **standard equipment!** With a single address, you can program **two** 50 volt, 1 amp bipolar supplies; set the voltages; limit the currents; assign trip points, and reverse polarities. (For faster systems, a BCD parallel bus version is available.)

Behind the hinged front panel of Model DPSD-50 sits a complete local control center. These local-mode switches provide a fast and easy way to set the address, step through a program sequence, or verify calibration. Key specifications: resolution, 1 mV; basic accuracy, 1 mV; stability, 300 μ V.

Instead of buying **two** expensive power supplies, you can now do the job with **one** DPSD-50 (\$3,000 in U.S., slightly higher outside U.S.). For more details, contact Scientific Devices or Systron-Donner at 10 Systron Drive, Concord, CA 94518. Phone (415) 676-5000.

SYSTRON  DONNER

CIRCLE NUMBER 11

ELECTRONIC DESIGN 13, June 21, 1977

How to get more mileage from discrete components.

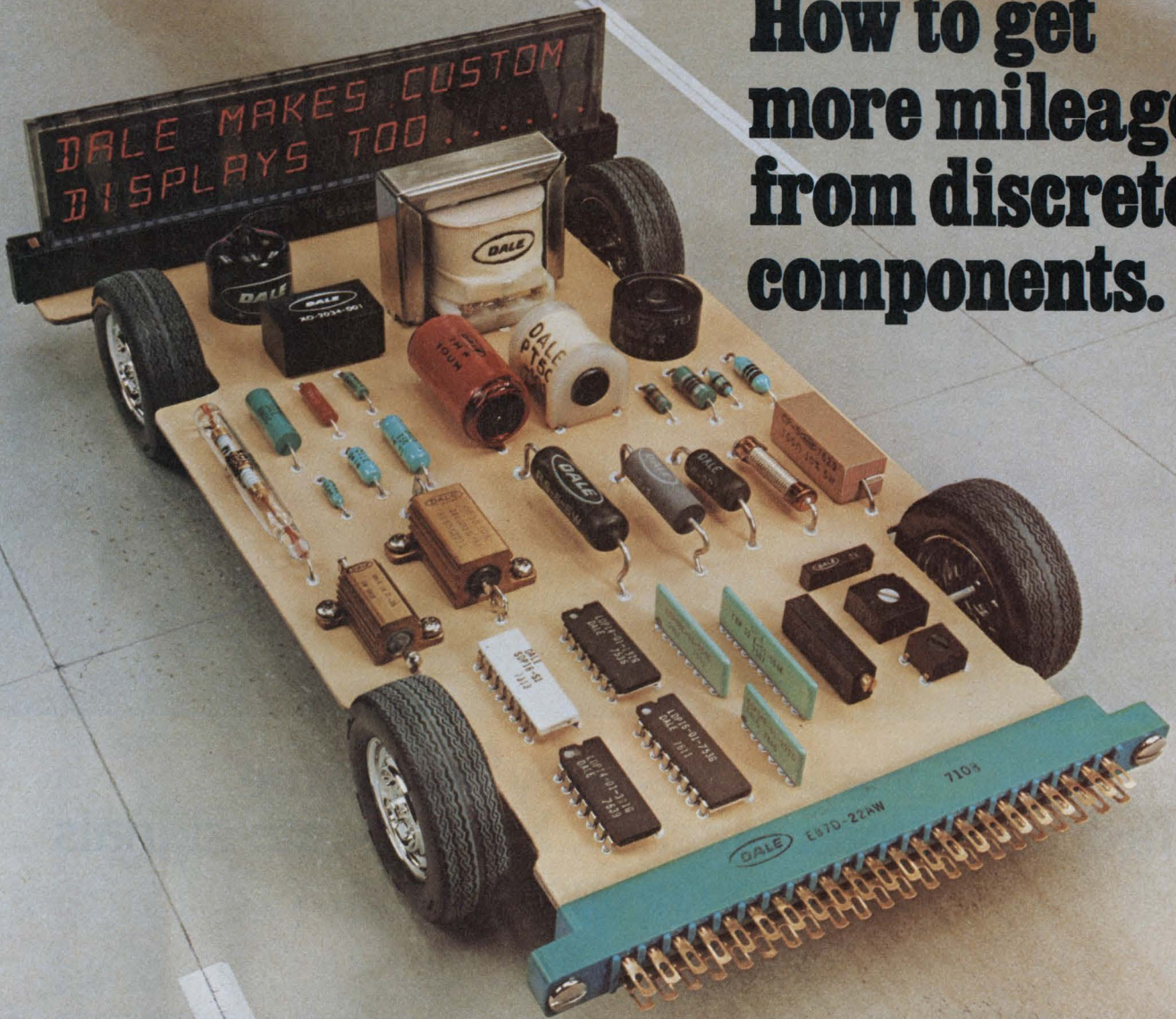

Start with Dale...

because we're making a lot more of the discretes you need on and around your board. And we're geared to save you time, energy and money with this growing family of products.

RESISTORS The industry's broadest line to meet commercial, industrial and military requirements...including everything from the most stripped-down wirewound to glass-enclosed metal film.

RESISTOR NETWORKS Space-saving SIP and DIP models, including the first DIP qualified to MIL-T-83401. Very competitive prices plus one-week delivery from stock.

TRIMMERS Dale's low profile 700 Series and single turn 100 Series ($\frac{3}{8}$ " square) interchange with all popular competitive models and give you performance advantages in a wide choice of pin spacings.

INDUCTORS Expanded production makes Dale a major supplier of roll-coated chokes. And, we're gaining steady acceptance as a source of filter inductors and low power laminated transformers.

CONNECTORS Get excellent price and delivery on .156" edge-boards and 2-piece rack and panel styles plus board interchangeability with a wide range of other styles.

ARRESTERS Dale offers over-voltage protection for everything from lightning to transients within a circuit. Exclusive patented design with Mil. qualification.

CRYSTALS Our newest line. Includes compact, low-cost clock oscillators for DIP applications plus temperature compensated oscillators, voltage controlled oscillators and a broad range of filter designs.

It's a fact. Dale has more of the discretes you need. More standard parts from a strong distributor network... more capability to meet your special needs... more of the quality you've come to expect from Dale. It adds up to more mileage for your efforts and your budget when you call your man who sells Dale.

Dale makes your basics better.



DALE ELECTRONICS, INC.
1300 28th Avenue, Columbus, Nebr. 68601
A subsidiary of The Lionel Corporation
IN CANADA: Dale Electronics Canada Ltd.
IN EUROPE: Dale Electronics GmbH, 8 Munchen 60,
Falkweg 51, West Germany

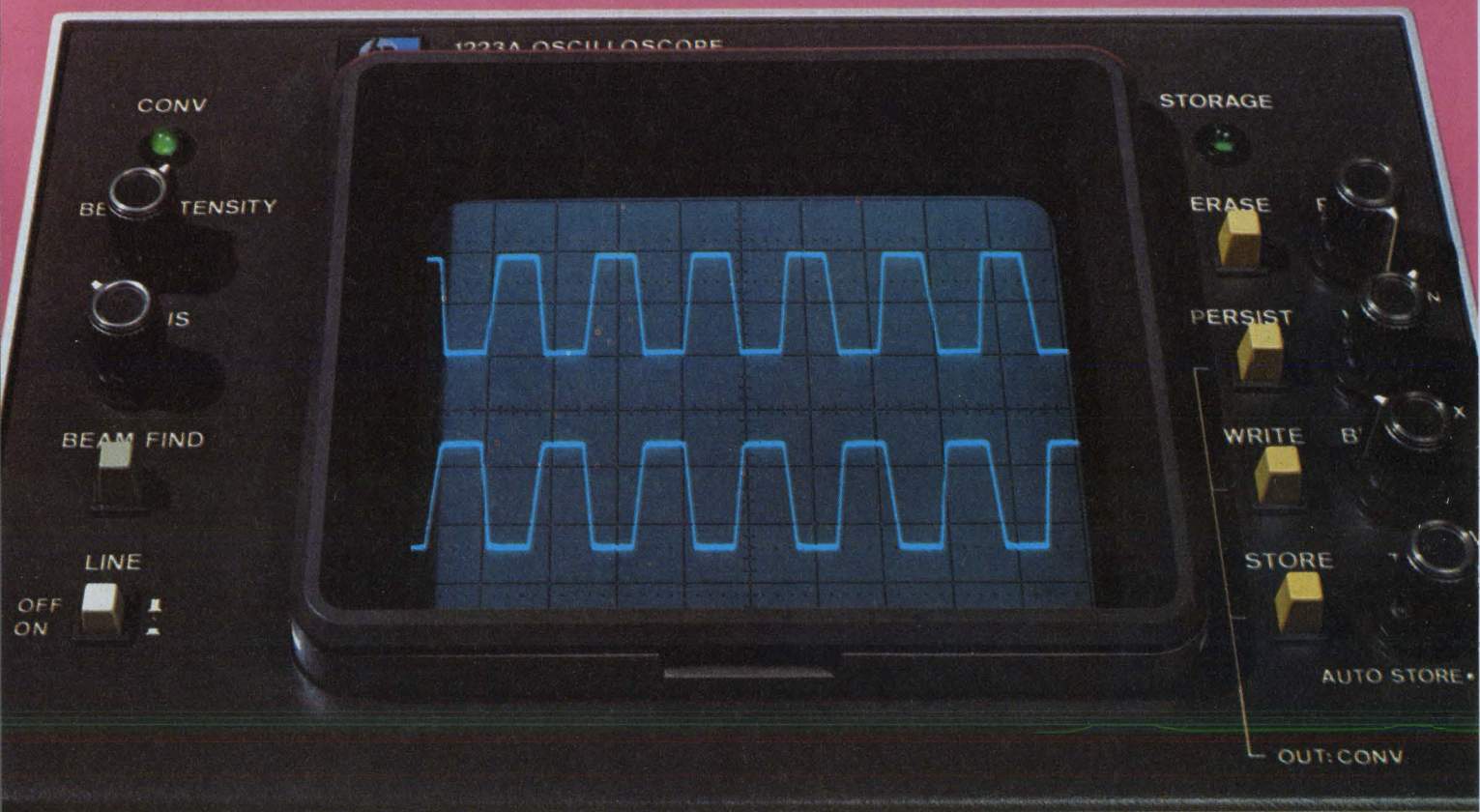

For a low cost way to capture fast transitions, glitches, low rep-rate signals and single-shot events...

HP's the Answer.

And the new **15MHz 1223A** with variable persistence/storage is your scope. Now, you don't need to pay for more capability than you need. Instead, you have the option of low-cost, variable persistence/storage scope that not only captures those elusive signals, but lets you see fast risetimes clearly for better glitch detection—something new for low-cost oscilloscopes. The 1223A provides variable persistence/storage and ease-of-use for only \$2250.*

Set it in Auto Store, walk away, and it's armed to capture and store an event for up to two hours. Vary the Brightness Control and you can optimize signal-to-background contrast. Vary the Persistence and you can integrate those glitches, very-low-frequency, and low-duty-cycle traces into clear displays or eliminate over-riding noise. Adjust auto erase to the desired rate and you can update the



display without even touching the scope. Of course you can store a trace or erase a stored signal with the touch of a button.

And there's more: 2mV/div sensitivity, TV Sync, selectable chop/alternate sweep operation, variable trigger hold-off, and calibrated X-Y display. And you get traditional HP after-sale support.

Here's an economical answer for industrial lab and production applications such as electromechanical, industrial control and medical equipment design, testing and troubleshooting. Excellent capability at low-cost for education too. Your local HP field engineer has all the details. Give him a call today. In addition to the 1223A, ask him about the variable persistence/storage in a high-performance 100MHz scope—HP's new 1741A.

*Domestic U.S.A. price only.

HEWLETT  PACKARD

1507 Page Mill Road, Palo Alto, California 94304

For assistance call: Washington (301) 948-6370, Chicago (312) 255-9800, Atlanta (404) 955-1500, Los Angeles (213) 877-1282

CIRCLE NUMBER 13

HP wristwatch—first with timely calculations

By feeding watch time directly into its computations, a new CMOS LED wristwatch calculator can figure for example, how much a telephone call is costing, and display the new total every second. The first calculator-watch to feature interaction between the time-keeping and calculation circuits, the 6-oz HP-01 from Hewlett-Packard contains 38,000 LSI transistors in a 6-chip hybrid assembly that is sealed between two multilayer ceramic substrates.

Calculator functions include add, subtract, multiply, divide, percentage, net amount, chain, and repeat operation on previous results or new information. While only seven rounded digits are displayed, the calculator has 11-digit internal accuracy.

The unit also has stopwatch features, two ways to set its audible alarms, four memory registers, and a 200-year calendar implemented in its program-controlled processor, which contains 4-k, 10-bit words of ROM.

The HP-01 can also calculate the number of days between two dates, find past and future dates—given the current date and the number of days—or determine the day of the week and day of the year for any date.

Three 0.08-oz standard silver-oxide cells power the unit—two for the LEDs



CMOS LED wristwatch contains hybrid with 38,000 LSI transistors.

and one for the rest of the electronics, which uses only 15 μ W. Twenty-eight tiny aluminum keys (6 finger-operated, 22 stylus-operated) transmit motion through a thin rubber membrane, to move a conductive foil layer into contact with the gold connection on the hybrid substrate.

Prices for the HP-01 are \$650 in stainless steel and \$750 in gold-filled case.

Circular-polarized beams will clear up TV picture

The Federal Communications Commission now permits television stations to broadcast circular-polarized beams, which should result in a better picture and less multipath interference—ghosting—than with the horizontal polarization now used by all U.S. stations.

A horizontally polarized signal produces a radiated field that has a field-voltage vector lying in the horizontal

plane. For best results, then, a receiving antenna must be horizontal. Any misalignment degrades picture quality.

In circular polarization, however, the electric field transmitted from an antenna has a field-voltage vector that rotates around the vector representing the direction of propagation. For best reception, an antenna must be perpendicular to the direction of propagation, but may be oriented at any angle in a plane.

Since the sense of rotation of a

circular-polarized signal is reversed when the signal is reflected from a surface, an antenna designed to receive signals of one sense will reject reflected signals. Ghosting will be reduced.

Circular-polarized transmission has been tested over WLS-TV, Chicago, and KLOC-TV, Modesto, CA. The greatest increase in picture quality, the tests show, is attained with simple indoor antennas such as rabbit-ear, bow-tie, and loop types.

Since half the power in a circular-polarized transmission is in the vertical plane, transmitter power must be doubled to achieve the same horizontal effective radiated power—hence the same signal strength received by a high-quality, properly oriented antenna. As a result, stations switching from horizontal to circular polarization will have to upgrade or replace transmitters as well as antennas.

UL 1244 will change instrument probe designs

Many test-probe connectors—notably the venerable banana plug—will have to be replaced in new instrument designs if the latest version of Underwriters' Laboratories' safety standard for test and measuring instruments goes into effect.

In its fourth draft, UL 1244 requires that accessible parts be fully insulated to protect against electric shock—and designates test connectors as accessible parts. Some steps toward solving the problem have already been taken. A recessed banana plug, for example, is used by Triplet Corp. in Bluffton, OH, on the face of some of its instruments, with a fully insulated banana-jack mating connector. Other approaches will be unveiled later this year.

The insulation requirement was added to counter criticism that UL 1244 did not address a common problem: connectors that pull out of the front panel of an instrument while the other end of the test probe assembly is connected to a high voltage (ED No. 9, April 26, 1977, p. 42).

Another change in UL 1244 simplifies testing of components in an instrument. Those components that are UL-listed need not be examined, while those not listed can be checked according to whatever standard (UL or other) is prescribed. For example, PC boards can be tested to UL 94.

The new wording permits instrument users outside the United States to apply the component standards of

the country where the instrument is to be sold—assuming UL 1244 is acceptable there, explains Donald Mader, associate managing engineer in the Electrical Department at UL's office in Melville, NY. If the wording of UL 1244 is accepted by the International Electrotechnical Commission as the next edition of its standard, IEC 348, then one instrument-safety standard will be applicable worldwide.

This fourth draft will also permit a user to adopt its wording as an internal document for incoming inspection, notes Mader.

Largest bubble chip developed by Rockwell

The largest bubble memory chip to date, a 1 Mbit device announced by Rockwell International, Anaheim, CA, is fabricated with conventional photolithographic processes that promise to reduce device cost and cut development time required to produce it in quantity (see also p. 34). The Rockwell chip, which has more than four times the capacity of 246-kbit chips announced by Bell Laboratories and Texas Instruments, is also expected to give the 65-kbit semiconductor RAMs stiff competition.

The 1-Mbit chip is 400 mils on a side. The memory has an average cell size of 8 μm and a bubble size of 1.8 μm . It is block-addressable with a minimum block size of 512 bits, and expandable in increments of that figure. Maximum asynchronous bit rate is 300 kHz.

Another significant advance in the Rockwell chip is a four-times increase in chip-circuit density over that of the company's earlier 100-kbit serial-memory chips produced for NASA, according to John L. Archer, manager of physical sciences at Rockwell International Research Div. in Anaheim, CA, at the recent International Magnetism Conference in Los Angeles.

Chips for the 100-kbit memories were 250 mils on a side and had 16- μm cells and a 3.7- μm bubble.

Ultimately, the higher chip density of the 1-Mbit unit will bring the costs down because the substrate of epitaxial garnet is a major element in device cost. The much higher density is achieved by a new propagation element design that permits fabrication with standard photolithography techniques having a 1- μm resolution.

Use of these standard techniques

provides substantial cost reduction over other fabrication technologies now used for bubble memories, such as electron beams or x-ray lithography—alternatives that are not yet mature production processes.

Optical recorder employs new storage medium

An optical recorder for storage and playback of archival information employs a laser to burn digital data into a new recording medium—thin tellurium films on 30-mm discs. As a result, the prototype recorder developed by Phillips Laboratories, Briarcliff Manor, NY, promises longer storage life at substantially lower costs than recorders currently using magnetic tape for permanent records.

Each Phillips disc can store 100-billion bits, enough to record a set of the Encyclopedia Britannica, and its life expectancy is greater than five years. For critical data, on the other hand, magnetic tape is rerecorded annually.

Tellurium is used because of its low laser-power requirements, consistent and reproducible burning of data in the film and long-term data retention. One micrometer pits, each equivalent to 1 bit have been recorded, at 1 Mbit/s with less than 10 mW incident power from the helium neon laser. The separation between recorded facts on the disc is 2 μm . The 30-cm discs contain 40,000 tracks.

The discs are mounted on a rotary air-bearing turntable driven by a dc pancake motor. Writing and reading are done from the underside of the disc assembly. The optical system is mounted on an air-bearing of rectangular cross-section and is driven from the outside to the inside of the disc by a linear motor stretched out on a flat bed.

Recorded data are protected from scratches, dust and fingerprints by a specially designed, air-sandwiched structure in which two discs are clamped back-to-back, with the tellurium film on the inside. The tellurium layers are sealed from the environment by gaskets at the inside inner and outer radii of the discs.

Vertical movement of the rotating discs—which might defocus the writing or reading beam—is compensated for by providing identical movements of the writing and reading objective lens.

Power-off switch saves watts in new PROM

A bipolar PROM with a built-in power-switch circuit uses 50 to 80% less power than ordinary unswitched PROMs. The SPROM (Switched Programmable Read-Only Memory) has a 10-ns switch that disconnects the memory from its 5-V power supply whenever the SPROM is not actually being accessed.

SPROMs can therefore be used in existing designs without wiring changes and can be programmed in existing PROM programmers by using the current MMI/Raytheon personality card.

Both 256 \times 4-bit and 512 \times 4-bit SPROMs will be offered in open-collector and three-state output configurations by Raytheon Semiconductor, Mountain View, CA. In addition, both versions will have popular industry-pinouts, with the power switch activated by the chip-select input.

Address-access times are 70 ns max for the commercial units and 60 ns max for the full MIL temperature range. Because the chip-select input operates the power switch, chip-select access times are 10 ns longer than the respective address-access times.

Some power is used even when the SPROM is unselected. But switching-off saves about 90% of the power and heat in open-collector units, and 75% in three-state versions. For example, the 256 \times 4-bit open-collector SPROM takes 450 mW on, and 50 mW off. The duty cycle of the full-power periods determines the over-all savings.

Currently PROMs are power-switched in many systems with discrete transistor switches. Since these PROMs don't include the switch circuit on the chip, most manufacturers do not specify PROM behavior under switched-power conditions. System designers have to deal with access-time uncertainties, variable input loading, and reduced supply-voltage tolerances. (See "Power Switch ROMs and PROMs Quickly," ED No. 9, April 26, 1977, p. 102.) The SPROM specifications cover these points, including full supply-voltage tolerances of $\pm 5\%$ for the commercial units and $\pm 10\%$ for the military units.

Pricing in 100-up quantities is \$3.95 and \$7.90 for the commercial and military 1-k devices, respectively, and \$7.25 and \$14.50 for the commercial and military 2-k devices, respectively.

CIRCLE NO. 319

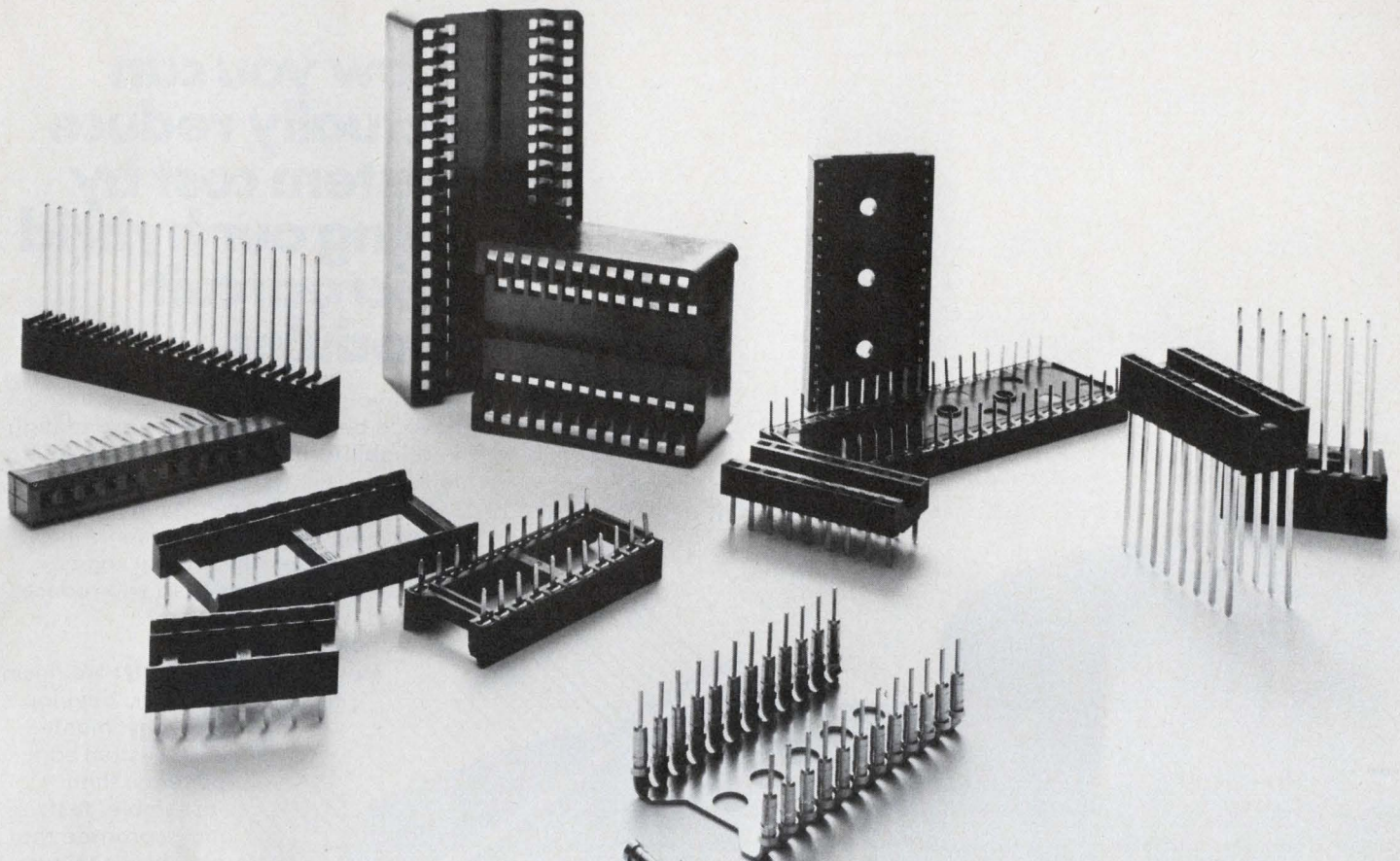

CONTACT OF THE A MEMBER BOARD

Circuit reliability takes more than a good IC. It takes an IC socket that establishes and maintains both mechanical and electrical contact between the device and the board.

That's why more designers are switching to SAE sockets.

Quality Fanatics

There aren't *any* measurable variables from piece to piece, because SAE does every step in-house, with quality checks at every station. We mold our own housings, stamp our own contacts and operate our own assembly ma-

chines. You get the same high quality socket every time.

Complete Selection

SAE sockets are available in every standard configuration. We make low-profile, standard-profile and high-reliability W-4000 series. We have a low-cost series 3600, and a new, high-temperature line of burn-in sockets good for 5000 insertions at temperatures as high as 200°C. And every line has every option: dip-solder or wire wrap; individuals or in strips; side or edge wipe; with or without insulators. You

can even specify type, depth and placement of plating.

Availability

The whole line of SAE IC sockets is in stock. Nobody makes as many types, and nobody else can match us for complete, in-house integration for absolute quality assurance.

Next time your ICs need to contact a member of the board, call Stanford Applied Engineering at 408/243-9200. Or write us at 340 Martin Avenue, Santa Clara, California 95050. TWX 910-338-0132.



The OEM Connection
CIRCLE NUMBER 14

Good news from Hughes:

Now you can actually reduce system cost by using our hybrid microcircuit modules.

If you're designing circuits that have to be both cost-effective and high in reliability, it will probably pay you to talk with us.

We've developed a system for condensing circuit requirements into the most efficient hybrid packages possible. And we can help you reduce size and weight as well as manufacturing costs.

Here's how we do it: We design the hybrid circuits, develop the prototypes, manufacture custom components, then assemble, test, and guarantee the total hybrid package. We make both thick film and thin film hybrids. We use hermetically-sealed metal and ceramic packages. And we make custom MOS devices and bipolar chips right here in-house.

We produce hybrid modules in volume quantities at competitive prices, as well as small quantities for product development.

Result: Now you can work with the one company best equipped and experienced to handle your job from concept through production.

We must be doing a lot of things right, because we're one of the leading producers of custom hybrid circuits.

So when it comes to hybrids, call on Hughes. Especially if quality is as important as price. Write for additional information: 500 Superior Avenue, Newport Beach, CA 92663, Att'n. Hybrid Dept. Or call (714) 548-0671, ext. 204.

HUGHES

HUGHES AIRCRAFT COMPANY
MICROELECTRONIC
PRODUCTS DIVISION

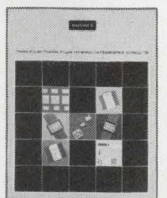

CIRCLE NUMBER 16

Introducing the intelligent LED display.

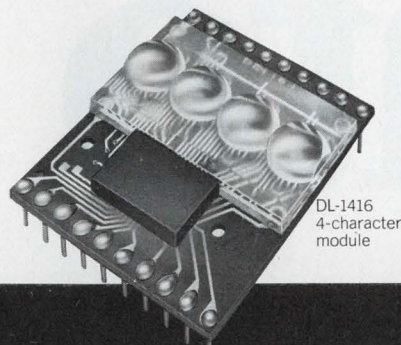

DL-1416
4-character
module

I I N T E R F A C E J U S T L I K E A R A M

Photograph of display actual size

Alphanumeric at the lowest cost ever.

This newest Litronix Alphanumeric display has built-in ASCII decoder, multiplexer, memory and LED drivers. That means it needs only the inputs you'd feed a RAM. Operates directly off a microprocessor bus. Creates all 64 ASCII characters 0.16" high — shown in actual size above.

No alphanumeric display has ever been so simple to use. Actuated entirely by TTL logic levels. Needs only a +5v supply.

And it's by far the most economical way to create alphanumeric displays as long as 80 characters. Because you don't need to supply all that built-in circuitry externally.

The DL-1416 4-character modules can be butted end-to-end to make displays of any length with equal spacing between all characters.

I'm in favor of intelligence. Tell me more.

For DL-1416 data phone (408) 257-7910 or send coupon.

NAME _____ TITLE _____

ORGANIZATION _____

ADDRESS _____

ZIP _____ PHONE _____

Mail to Litronix, Dept. D, 19000 Homestead Road,
Cupertino, CA 95014. Phone (408) 257-7910.

litronix

Going into business sale.

National Semiconductor is going into the microcomputer business.

And to celebrate, we're having a "sale."

10% off the Intel 80/10.

To get 10% off Intel's 80/10, don't buy Intel's 80/10. Buy National's 80/10.

We're able to sell the 80/10 for less because of our improved board layout which permits automated assembly (such as using axial leaded components)...the fact that we make not only the 8080, but also—unlike Intel—most of the rest of the ICs on the board...and, of course, National's

legendary competence in efficient manufacturing doesn't hurt either.

The industry standard.

Our second-sourcing of the 80/10 clears the way for the 80/10 to be the clear-cut standard of the microcomputer industry.

You can't effectively have an industry-standard without a second-source. Having two suppliers is a healthier competitive situation for you, the customer, and you have the security—and abuse-protection—of an alternate source.

What we make and how we make it.

What we're making is this:

Series/80 Cards:

BLC 80/10 BLC 104*
BLC 016 BLC 508*
BLC 406 BLC 416*
BLC 905

*Available 3rd quarter '77

Series/80 Systems:

BLC 80P BLC 614 BLC 604

Series/80 Firmware:

BLC 910

(With more, much more, to come
in the future.)

And how we're making them is this:

We're putting out the finest
quality available. A cleaner board—
better layout, all axial components,
plug selectable options rather
than wire wrap.

We "burn in" every board at
elevated temperature, and run
computer diagnostics during burn-in.

Think we're kidding about quality?
We're offering a one year warranty.
Which is just about four times longer
than Intel's warranty period.

A microcomputer company small enough to do business with.

We're not dummies.

We know that to break into a field
that somebody else has a lock on, we've
got to offer something extra.

And extra quality for less money
ain't a bad start.

But we're offering something else
extra, too.

Desire.

As the little guy we can't afford
a fat cat attitude.

We'll do our best to meet
impossible deadlines.

Our phone won't be busy. Etc.

In the microcomputer arena we're
young, small, and hungry.

So if you'd like to see what
you've been missing in 80/10's, see your

local distributor or use this coupon to
get our literature.

Help us celebrate our going into
business sale by helping us *stay* in
business.

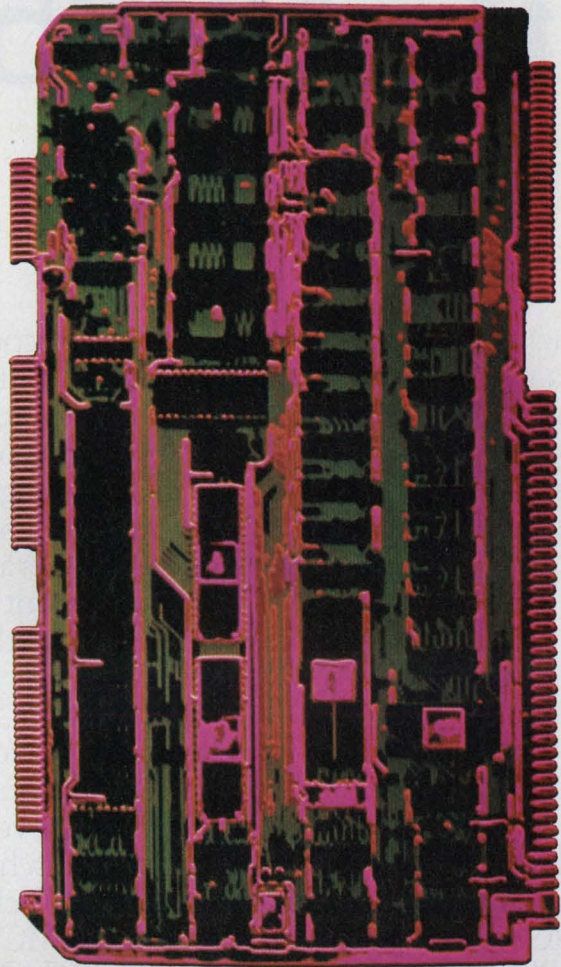

National Semiconductor Corporation
2900 Semiconductor Drive, Santa Clara, CA 95051

Gentlemen: You've got my interest. Please send me more
information on National's SERIES/80.
 I'm so turned on, I can't wait. Please have a
salesman call me immediately.

Name _____ Title _____

Company _____

Address _____

City _____ State _____ Zip _____

Telephone _____

My application is _____

- I'm presently using the other guy's 80/10.
 I'm not up to the 80/10 yet but I'm using the 8080.
 I have an 8080 software development system.
 Your BLC 80/10 will be used in house.
 I'm an OEM. Your BLC 80/10 will be shipped out as part of
my equipment.

 **National Semiconductor**

Intel delivers a unique the 8085. It's like the

Introducing the 8085, a unique new microcomputer that is part of a new Intel® microcomputer system—the MCS-85.™

The 8085 is both software and bus compatible with the 8080. So you can take full advantage of the wealth of software, peripherals and development tools that have helped make the 8080 the industry standard.



Yet the 8085 is 50% faster than the 8080. So your 8085-based products will enjoy a new level of performance at even lower cost.

All components in the MCS-85 system have higher level integration, making it possible to replace a 10-chip 8080 system with three MCS-85 chips. Components of the MCS-85 system include the 8085 CPU, the 8155 256-byte RAM with I/O and timer, and the 8755 16K EPROM with I/O and interchangeable 8355 ROM with I/O. All these components, including the 8755 EPROM, operate from a single +5V TTL supply enabling you to go from prototype to production without board or power supply changes.

It all adds up to faster, easier, more economical—and better—system design.

The 8085 is more than a faster, more efficient microcomputer. It's the newest example of Intel's total system commitment. Here's what that means for existing 8080 users and new microcomputer users.

Because the 8085 is fully compatible with 8080 software and 8200 series peripheral components, it protects your investment in existing designs and allows you to implement new designs without starting the development cycle all over again.

And now you can design your 8085 and 8080 systems around four new advanced peripheral controllers: the 8271 Floppy Disc Controller, the 8273 Synchronous Data Link Controller, the 8275 CRT Controller and the 8279 Keyboard/Display Interface. Like the other 8200 series peripherals, these new devices are fully programmable, single chip solutions to system interface requirements.



new microcomputer, 8080. Only better.



Intel's total system commitment means that the MCS-85 is being introduced as a fully supported, complete system. All the support that has helped 8080 users get

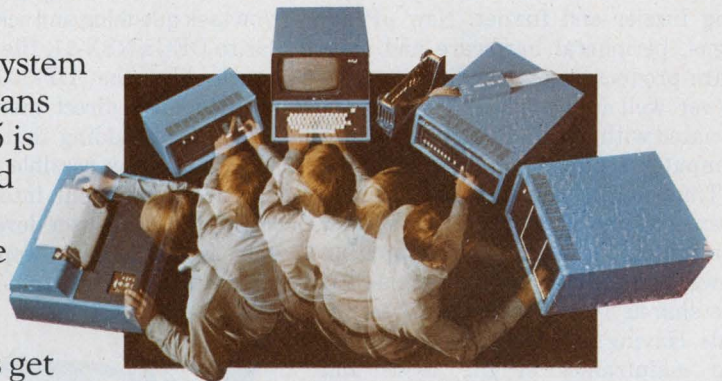

to market sooner now gives 8085 users a head start too.

To speed programming we provide PL/M, the high level programming language for microcomputers that can cut months off software development. The Intellec[®] microcomputer development system, with ICE-85[™] in-circuit emulation and symbolic debugging, helps reduce system integration and debug time. Then there's application assistance worldwide. Training classes and seminars to help you get the most from the MCS-85 system. And a comprehensive development software library at your disposal.

Total system commitment. It protects your investment. And gives you the jump in a competitive world. Because MCS-85 is a complete and fully supported system, comparing Intel with any other microcomputer supplier becomes an apples to oranges comparison.

The fastest way to get started is to order MCS-85 products from your local Intel distributor. Almac/Stroum, Component Specialties, Cramer, Elmar, Hamilton/Avnet, Harvey Electronics, Industrial Components, Liberty, Pioneer, Sheridan, L.A. Varah, or Zentronics.

Or, for our detailed MCS-85 brochure, use the reader service card or write us directly. Intel Corporation, 3065 Bowers Avenue, Santa Clara, California 95051.

intel[®] delivers.

CIRCLE NUMBER 18

New hardware, memory, software give μ P systems macro performance

The boundary line between minicomputers and microcomputers is getting fuzzier and fuzzier. New μ P designs, peripheral hardware and software products are extending the μ P's power well into applications long associated with minicomputers and large computer systems.

Time-sharing, for instance, has long been a prime example of big-system computing, whereby the computing power and the memory of a single CPU are shared among several user terminals. Having begun on the conventional big mainframes of the 1960s and spread to the minis in the early 1970s, time-sharing software is now coming out for micros.

In a multitasking time-sharing system from muPro of Sunnyvale, CA, three terminals operate concurrently on an 8080 while the CPU also executes batch programs in the background. This floppy-disc operating system takes 16 kbytes of memory and typically uses 3% of the 8080's time to manage all the system resources—the CPU time, disc space and input/output.

Three isn't all

But even more terminals might be added—the 8080 has time for them. Memory space, not 8080 speed, is the limiting factor, says Jim Moon, muPro's engineering vice president.

"We talk about only three terminals because we're looking first at uses where each terminal needs a large amount of memory, like 8 k for a text editor," Moon explains. "Our applications thrust is to use this package to substantially increase throughput in μ P development systems. Most such systems do just one thing at a time. If you're editing a program, the whole

system is tied up.

"The time-sharing software gives you task queueing and scheduling similar to DEC's RSX-11, file management much like the HP-3000, and disc transfers via direct memory access," notes Moon, adding that "it keeps the CPU as free as possible to respond to the next significant interrupt event."

But the multi-user development system isn't the only application that needs this kind of time-sharing. "We



This clipboard "Scorepad" μ C from Azurdata, which can be the key to solving inventory problems, comes with scanning wand, transmit muff for phone use, and battery recharger.

have had good response from small business, especially for key-to-disc and word processing," Moon reports. "In that field, people like the file orientation of our system, and the multiple-extent feature.

"Up to eight physically separate disc areas or "extents" can be used for a single file. After the disc space has become fragmented and no one contiguous area is large enough for the next file, the operating system automatically uses the smaller areas that are free."

Three terminals—or 30?

MVT Microcomputer Systems, Inc. of Agoura, CA, claims time-sharing is even practical with 30 terminals running simultaneously on one Z-80 μ P.

The multitasking disc-operating system from MVT includes a multi-user re-entrant BASIC compiler and password protection of files. MVT budgets a 10-terminal system with Z-80, 32-k RAM, dual floppy and custom cards at \$20,000 including software and 10 terminals.

In addition to a powerful time-sharing software system that's been running on the DEC PDP-11 for five years, Alpha Microsystems offers an advanced μ P for time-sharing use. The Irvine, CA, firm's 16-bit AM-100 μ P uses the same Western Digital 5-chip CPU set that DEC uses for the LSI-11 but incorporates about three dozen extra instructions.

These capabilities make the two-board, S-100-compatible processor "an order of magnitude more powerful than the other micros," according to president Dick Wilcox, noting; "In an average benchmark, we have 10 times the throughput of an 8080." The processor, which sells for \$1495 including software, can handle four to eight terminals doing various jobs, or 16 doing the same thing and sharing programs, Wilcox estimates.

"In a BASIC benchmark, comparing elapsed time for a single user, the AM-100 is typically 1.2 to 1.8 times as fast as a PDP-11/40. Our processor compiles, DEC's interprets. Of course, their disc is 40 Mbytes and ours is a dual floppy, and their total throughput is more. But their system is around \$100,000 and ours is about \$7000," says Wilcox, who designed the Alpha software and the hardware architecture.

Meanwhile, a big-software package gives the 8080 and Z-80 μ P's file-management power once found only on big computers. The CP/M disc-operating system from Digital Research, Pacific Grove, CA, has a dynamic named-file system and a command interface that's like the DEC TOPS-10, but not as complex.

CP/M has about 500 users, including



Introducing the hungry ECLIPSE.

Data General's new ECLIPSE S/130 computer has a bigger appetite for work than any other mid-range mini. And enough speed and versatility to wolf down any kind of data you have to dish out.

The hungry ECLIPSE computer is built around the same powerful architecture as our super high-speed ECLIPSE S/230. Added to that is a host of special features that make the hungry ECLIPSE unique. Like our fast micro-coded floating point and efficient character string instruction sets. And our second-generation WCS general-purpose user microprogramming ability that results in unmatched throughput in demanding applications. To top it off it also includes AOS, our amazing new heuristic multi-programming advanced operating system, and of course the full range of Data General's economi-

cal big-computer peripherals, software and worldwide support.

Now, you don't have to skimp along with an undernourished mini that's too limited for your work. Or splurge on one that's too fat just to get the performance you need. Just order an ECLIPSE S/130 computer. It will make your work load a lot leaner. Want more food for thought? Send for our brochure.

- Send your S/130 brochure.
 Send your S/130 brochure and have your sales representative call.

Mail to: Data General, Westboro, MA 01581

Name _____

Title _____

Company _____

Address _____ Tel. _____

City _____ State _____ Zip _____

ECLIPSE is a registered trademark of Data General Corporation.

© Data General Corporation, 1977

 **Data General**
 It's smart business.

CIRCLE NUMBER 19

Data General, Westboro, MA 01581, (617) 366-8911. Data General (Canada) Ltd., Ontario.
 Data General Europe, 15 Rue Le Sueur, Paris 75116, France. Data General Australia, Melbourne (03) 82-1361.

several large OEMs, according to Gary Kildall, author of Intel's PL/M and Signetics' PL/ μ S as well as CP/M, and a founding partner of Digital Research. "It is the file handler behind the scenes in a major word-processing system, an air freight inventory system, and some intelligent terminals. It's been up and running three years, and now we're ready to distribute and support the package for wider use."

Residing in 16 k, CP/M treats all peripherals as files, costs \$70 on a floppy, and according to Kildall, is "the only unbundled disc-operating system for the 8080 and IBM-compatible floppy. Users say it's a *de facto* standard." FORTRAN and BASIC can be run under CP/M.

Another "big" language may soon be run on a μ P. It combines three functions in one, a device-independent operating system, a file manager, and a high-level language.

"MUMPS is to data management what APL is to mathematical manipulation," says Tom Munnecke, a member of the MUMPS-development committee and president of Metasystems, Riverside, CA. Hoping for summer approval of the first ANSI standard on MUMPS, Munnecke observes: "MUMPS is the world's first self-teaching operating system. The MUMPS user group (MUG) has written a computer-aided-instruction program that teaches you all you need to know about MUMPS."

More software—more memory

To use big software, it helps to have big memory. Until lately, the biggest memory on the popular MOS microprocessors was 65 kbytes, because these μ Ps couldn't address any more. Now, several megabyte memories provide an impressive 16-fold increase in memory size.

An Intel 8048, used as a memory manager by Imsai of San Leandro, CA, provides 400-ns access to a megabyte. Refresh cycles are "hidden" so that no wait states occur to conflict with memory accesses by the CPU. Up to 1 Mbyte with 300-ns access time is provided by Prime Radix in Denver. Compatible with both the S-100 (Altair/Imsai) bus and the Digital Group bus, the design uses 16 boards with 65 kbytes of memory on each.

The S-100 bus-interconnection scheme appears to be winning out as the *de facto* standard of the μ P industry, according to Wilcox of Alpha Microsystems and Kildall of Digital

Research, among others. Although the Intel MDS or 80/20 bus and the Digital Group bus have better noise immunity, an estimated 150 manufacturers build S-100-compatible units ranging from a/d converters to speech synthesizers.

Big word size and big-machine emulation are features of VACUUM, a variable architecture microcomputer being developed by Davis Labs of Santa Clara, CA. That's right, variable architecture. This surprising two-board μ P, based on the AMD 2901 bipolar bit slice, will actually switch word length in 400 ns, from the 8-bit word used in many micros to 16, 32 or 36-bit words, or intermediate lengths. Moreover, the instruction set may also



A 64-k dynamic memory board from Prime Radix is a 300-ns-access building block for S-100 bus megabyte memory.

be changed at will. The instruction set is determined by microcode kept in a 64-bit by 4-k RAM.

"Most of the PDP-10 instruction set fits into 512 words of microcode. So with 4 k available you could have the PDP-10 and IBM 360 instruction sets at the same time," observes Davis Labs president Bob Davis. In addition, says Davis, VACUUM can emulate one's favorite μ P—but with a difference. "Now you can add those extra instructions you've always wished it had. Just microcode them in."

VACUUM is not yet available, but a starter kit may be offered this summer for under \$500, which would include the bare boards, PROMs with assembler and bootstrap, and manuals.

Clipboard data entry

A portable μ C in a turnkey package combines large data capacity with dial-up ASCII data transfer that's compatible with big mainframes. Scorepad, a 1-1/2-lb μ C that looks like a clipboard, is 9 x 13 x 1/2 in. thick,

including rechargeable batteries.

Made by Azurdata in Richland, WA, the unit collects and stores up to 88 kbytes of data from keyboard entries or scanning-wand input. Then it feeds data out through a plug-in acoustic coupler over phone lines to a distant computer. Check digits are sent along with the data at 120 characters/s.

Cost ranges from \$900 to \$3500 in single quantity as data memory increases from 4 k to 88 k. All versions include recharger, transmit muff, and self-contained keyboard and 20-character LED display. While present firmware and scanner standards particularly suit inventory applications in retail stores, other applications are feasible. For example, a predecessor of this unit was first used to take inventory of trees in our national forests.

Multiprocessors watch TV

When many events outside the computer system are to be monitored or controlled, or when system data rates are high, the conventional wisdom warns, "That's too much for μ Ps. Use a mini." But turnkey systems based on multiple micros are invading the mini's domains.

Multiprocessing systems are heading into telecommunications as well. In telephone-switching systems, dual computers are normally used to ensure reliability. In the hot-standby type of system, one computer is on-line and a second synchronized machine checks its operation, always ready to take over if the on-line malfunctions. At first, big mainframes were used in multi-million-dollar configurations. Then, in the early 1970s, minicomputer systems with the hot-standby feature came out. Now comes an operating prototype based on 8080 μ Ps and multiprocessing. The Model 580 digital switching system, developed by Wescom, Inc., Oak Brook, IL, switches 2400 lines and 576 trunks, handles voices in PCM form and provides such services as call forwarding, add-on conferences, and camp-on.

Control is taken care of with six hardware-identical dual-8080 processors on-line and six more for hot-standby backup. Each on-line processor has its own duplicated memory. Tasks aren't shared. Task partitioning makes the six on-line processors independent, although there is intercommunication among them. Maintenance processing in this system takes about 40% of the code for each processor, and uses 10% of real time. ■

This semiconductor plant ain't exactly two guys in a garage.

It takes a lot of research, development, design, and production know-how to turn out a good line of semiconductor devices . . . it also takes a lot of sophisticated equipment . . . plus a lot of specially-educated and skillfully-trained people mutually striving for product excellence.

At Sprague Electric's Semiconductor Division, we have accumulated over fifteen years of intensive experience in the manufacture of *innovative* semiconductor devices . . . devices making special contributions to technology . . . devices manufactured under the most exacting QAR program . . . devices that assure total customer satisfaction.

We have built the kind of operation it takes to produce semiconductors compatible with today's as well as tomorrow's requirements.

We proudly invite customers and prospects to tour our plant, the nation's finest semiconductor facility of its type. Here you will see the magnitude of effort that goes into properly designed and manufactured devices. You'll be pleasantly surprised!

Write or call George Tully or Bob Milewski to arrange a visit. You can reach them at the Semiconductor Division, Sprague Electric Co., 115 Northeast Cutoff, Worcester, Mass. 01606. Tel. 617/853-5000.

FOR FAST INFORMATION, CALL YOUR NEAREST SPRAGUE SALES OFFICE:

ALABAMA, Sprague Electric Co., 205-883-0520 • ARIZONA, Sprague Electric Co., 602-279-5435 • CALIFORNIA, Sprague Electric Co., 213-649-2600, Wm. J. Purdy Co., 415-347-7701; KCE Corp., 714-278-7640 • COLORADO, Wm. J. Purdy Co., 303-777-1411 • CONNECTICUT, Sprague Electric Co., 203-261-2551 • DIST. OF COLUMBIA, Sprague Electric Co. (Govt. sales only), 202-244-6006 • FLORIDA, Sprague Electric Co., 305-831-3636 • ILLINOIS, Sprague Electric Co., 312-678-2262 • INDIANA, Sprague Electric Co., 317-253-4247 • MASSACHUSETTS, Sprague Electric Co., 617-899-9100, Sprague Electric Co., 413-664-4411 • MICHIGAN, Sprague Electric Co., 517-787-3934 • MINNESOTA, HMR Inc., 612-920-8200 • MISSOURI, Sprague Electric Co., 314-781-2420 • NEW JERSEY, Sprague Electric Co., 201-696-8200, Sprague Electric Co., 609-795-2299, Trinkle Sales Inc., 609-795-4200 • NEW MEXICO, Wm. J. Purdy Co., 505-266-7959 • NEW YORK, Sprague Electric Co., 516-549-4141, Wm. Rutt Inc., 914-699-8600, Sprague Electric Co., 315-437-7311, Mar-Com Associates, 315-437-2843 • NORTH CAROLINA, Electronic Marketing Associates, 919-722-5151 • OHIO, ElectronicSalesmasters Inc., 800-362-2616, Sprague Electric Co., 513-278-0781 • PENNSYLVANIA, Sprague Electric Co., 215-467-5252, Trinkle Sales Inc., 215-922-2080 • TEXAS, Sprague Electric Co., 214-235-1256 • VERMONT, Ray Perron & Co. Inc., 617-762-8114 • VIRGINIA, Sprague Electric Co., 703-463-9161 • WASHINGTON, Sprague Electric Co., 206-632-7761 • CANADA (Ontario), Sprague Electric of Canada Ltd., 416-766-6123 • CANADA (Quebec), Sprague Electric of Canada Ltd., 514-683-9220

45S-6139R1



... and you thought we only make great capacitors.



CIRCLE NUMBER 20

Current-carrying rods power backplane-less card assemblies

The power-supply current delivered to printed-circuit boards can be increased by two-thirds or more by distributing it through the rods that hold a multicard assembly together instead of through card-edge connectors. The technique, developed by AMP Inc. of Harrisburg, PA, will complement the firm's backplane-less PC card interconnect system.

"Because individual contacts in card-edge and intercard connectors typically cannot carry more than 3 A, it is advantageous to introduce power and ground by an independent means capable of handling larger current requirements in a stack-up of boards," says AMP's Attalee Taylor. In the card-guide power-distribution system, the current-carrying rods are designed to carry 50 A, and the contacts inserted in the guides between the rods and the boards can deliver 5 A.

"These values can be increased by increasing the cross-sectional area of the rods, contacts, and pads on the PC boards," says Taylor, who described the system at the Electronic Components Conference in Arlington, VA, last month.

Current-carrying rods, along with plastic card guides and spring contacts,

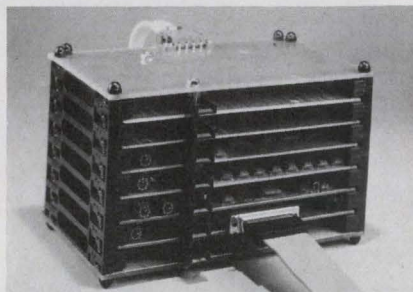

Eliminate the backplane from PC-board assemblies with surface-mount connectors and power-distributing card guides.

are the major components of the power distribution system, as shown in the diagram. Power is delivered to an assembly through the ends of the rods, which also tie the stack together. A wire may be connected under the end of the rod, or the end plate may be a PC board with traces on the inner surface to connect the rod and a connector that mates with a power cable.

Power rides the rods

Power is transferred from the rod to a PC board via spring clips that are installed in recesses in the plastic card

guides. To avoid circuit damage when a card is inserted or removed with system power on, the lengths and positions of contact pads on the circuit card's edge can be designed so that voltages are applied or removed in the proper sequence.

Tooling is being prepared for the current-carrying rods, the plastic card guides and spring contacts. Shipping can begin in a few months.

The power-distributing card-guide system is part of AMP's line of equipment for PC-card packaging without a backplane. Another packaging addition to the line, designed primarily for bus-organized circuitry like that of micro-processor-based systems, is a new zero-insertion-force connector that mounts on the surface of each card so that multiple cards in a system can stack one atop each other, instead of plugging into a backplane or motherboard that carries interconnecting wiring.

The connector, consisting of male and female halves mounted on each side of a board, is bolted to the card, bringing tin alloy plated segments of the connector's spring terminals into high-pressure contact with tinned pads on the board. The pressure is at least 260 g.

The terminals and pads are on 0.1-in. centers, so traces can be brought between adjacent terminals.

Stainless-steel support members in each half of the connector compensate for any board warpage and maintain the high-pressure surface contact between the connector contacts and the printed-circuit board over the length of the connector. When tied to the ground plane through a lanced, compliant spring section in the channel of the female connector, these structural members also create a 90-Ω controlled-impedance connector system.

Bus continuity is maintained with plated through-holes at the ends of the surface-mount pads on the board. A bus line can be ended on one side of a board and a new function begun on the other side of the board by eliminating the plated-through hole at any position. ■■

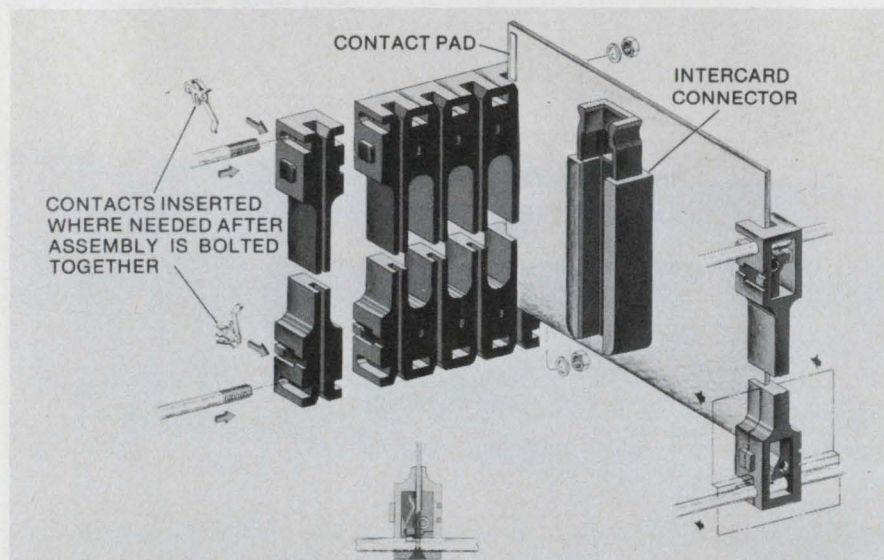

More power gets to the board via clips attached to the rods that hold the assembly together than can be delivered through a card-edge connector.

Coming through...

with a vital part in product design

It's what's up front that counts. That's why it pays off to involve Belden in the early stages of a project.

We know the codes, specs and electrical/environmental parameters you're faced with. We've come through with answers to some extraordinary new applications.

As much as any component, wire, cable and cord, can make a critical difference in your product's performance. And your costs. By drawing on thousands of high-quality standards—and a wealth of custom engineering knowhow—we can tailor an answer to fit your needs. Exactly.

We can even help you cope with the economics of wire processing, assembly and installation. Our problem solving experience ranges from innovative

packaging to total manufacturing analysis.

Whether you need cord sets, special harnesses, shielded cable construction, flat cable—or help putting it all together, involve a Belden Wire Specialist. He'll come through with everything we've got. For answers right now, phone:

317-966-6661 Electronic Division or mark 400 on reader service card.

312-986-1600 Electrical Division or mark 401 on reader service card.

312-887-1800 Transportation Division or mark 402 on reader service card.

Or write Belden Corporation, 2000 S. Batavia Ave., Geneva, IL 60134

BELDEN



Coming through...
with new ideas for moving electrical energy



SAY HELLO TO OUR MODEL 101. AND

Meet a new kind of instrumentation portable, one so self-contained that all the calibration equipment you'll ever need is built right in. Just press AUTO TEST and Honeywell's new Model 101 checks itself and tells you what, if anything, needs adjustment. You can do a complete calibration in about half the usual time, and do it with only a screwdriver or simple tweaking tool.

But don't think of the 101 as just a more portable portable. Because it's also a more advanced lab system.





GOODBYE TO CALIBRATION HASSLES.

One that comes with up to 32 data channels—wideband or intermediateband, speeds from 15/16 to 120 ips, programmable selective track sequencing, and large reels for up to 32 hours of recording time.

Compare the Model 101 with your present tape system and see what a difference a microprocessor makes. For complete details, or for a demonstration of the Model 101, contact: Darrell Petersen, Honeywell Test Instruments Division, Box 5227, Denver, CO 80217. (303) 771-4700.

WE'LL SHOW YOU A BETTER WAY.

Honeywell

Bubble memories are going military in air and space applications

Magnetic bubble memories, which have only recently taken on commercial applications, will replace recorders and computer-disc and drum memories in military aircraft and spacecraft as soon as possible. Several working systems are being readied for operational evaluation.

Both the Air Force and the National Aeronautics and Space Administration envision nonmechanical, nonvolatile memories as being part of digital data recorders in spaceborne sonobuoys; airborne warning, command and control systems; missiles; and even test sleds. The Navy is eyeing them for airborne surveillance systems and as computer mass memories in both surface ships and submarines.

"Bubbles can do the mass memory job faster, cheaper and more reliably than it has ever been done before," says E. Anne Buvinger, project engineer at the Air Force Avionics Laboratory, Wright-Patterson Air Force Base, OH.

The bubble memory is particularly attractive for long space flights because information can be stored in them for years. "Bubble memories never forget anything," Buvinger adds.

The cost of the bubbles will be similar to discs and drums—below .01 cent per bit. They also compare favorably with the cost of current military tape recorders, but will have a longer life.

The Air Force's first-generation bubble memories—soon to be delivered by their developer, Texas Instruments, Dallas, to the Avionics Laboratory—are expected to demonstrate successfully that magnetic bubbles can be applied to both airborne and spaceborne systems. These brassboard models will be used in an operational mockup on the ground.

A 5- μ m device technology is used to get a usable bit-capacity-per-chip of about 128 kbits. The device architec-

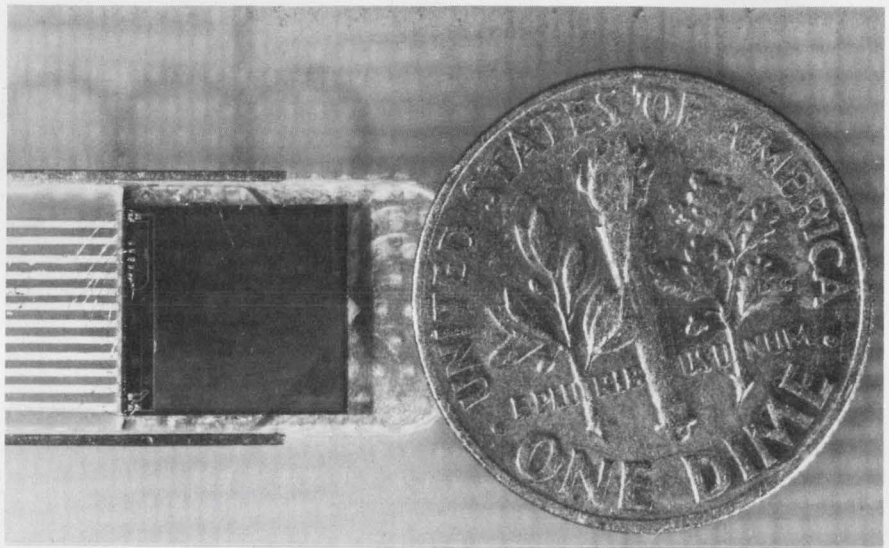

This bubble-memory chip from Texas Instruments is mounted on a board for test and evaluation by the Air Force Avionics Laboratory. The 0.30-in. \times 0.33-in. chip can store up to 100,000 bits of digital information in a rapid-access, major/minor loop configuration.

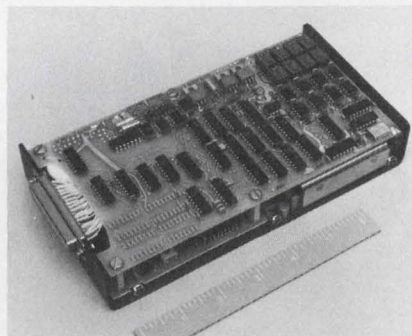

Prototype of a memory system using advanced bubble-memory-domain technology has a capacity of 800,000 bits of information in a 100,000-byte endless loop. Designated the POS/8, the device was developed by Rockwell International.

ture for breadboard models is a conventional major-minor loop design using the dollar-sign transfer. A block-replicate device, being developed concurrently for use in the brassboard and subsequent systems, will allow data

being read to remain in the minor loops and provide a protected data store. Bubbles need not be restored to the minor loops after being read.

It comes in a DIP

A two-chip, dual-in-line package, the result of the magnetic-module design undertaken in the development, has a volume of 6.5 cm (0.4 in.³), weighs 28 grams (1 oz), and runs at 250 kHz. Currently, eight of these two-chip packages are expected to be put on a circuit board. This "bubble data module" (BDM) would store about 2 Mbits, have a data-I/O rate of 2 MHz, and become a basic module in memory.

The breadboard system, now in the final stages of fabrication, will use two BDMs, with each BDM half-populated with four two-chip packages. This system will be a self-contained unit, and will include power-conditioner, timing and control circuitry, I/O buffering and microprocessor system-controller.

John F. Mason
Associate Editor

Put the world's largest CMOS capacity to work on your LSI needs.

What do you look for when choosing a CMOS LSI supplier? Probably a supplier with proven capability in CMOS and the resources to handle high-volume projects without jeopardizing deliveries. **That's Motorola.**

Motorola delivered more CMOS in '76 than anyone else, from an unmatched line of standard logic and special equipment-oriented functions. **That's proven capability.**

New capacity at our facility in Austin, Texas, gives Motorola the world's largest CMOS capacity. It's on board and ready to meet your needs for custom or standard LSI. **That's resources.**

Motorola was a pioneer in CMOS circuits for digital watches, and we're still state-of-the-art with our latest: MC14470, MC14480, 81, and 82. Our MC14433 single-chip 3½ digit A/D converter brought a new dimension to digital meters, and a new dimension to putting linear and digital CMOS together on one chip, with op amps alongside gates. We've continued this linear/digital combination, at even lower power, with the MC14461 CMOS smoke detector IC. Since these wafers roll off the same lines as our high volume digital CMOS, it's a high-confidence, high-reliability process.

When it comes to telephones, we've had the right numbers all along with our standard MC14408, 409, 410 and 419. Why not list yours with us, too. In support of the meteoric CB industry, we've supplied customs as well as the standard MC145104, 5106, 5107, 5109 and 5112 phase-locked loop frequency synthesizers.

It's already supporting these.

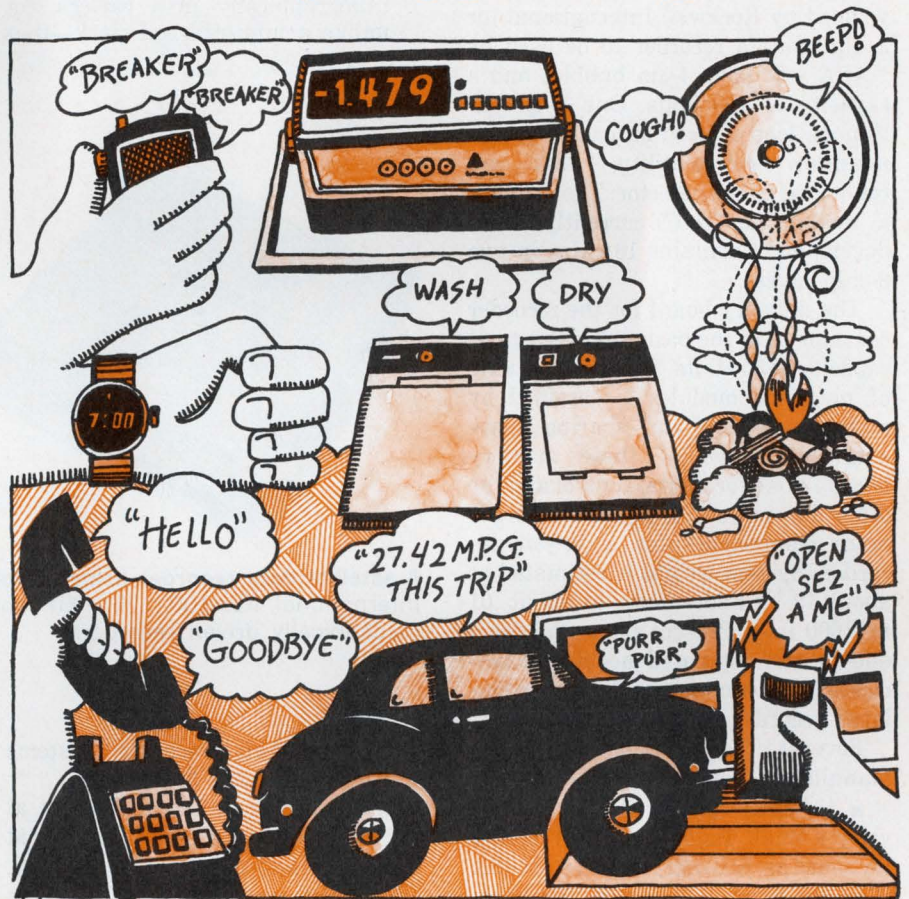

So it goes for things like garage door openers, in-dash and underhood automotive systems, and appliance controls. And, there's more just around the corner: internally programmed watch chips to keep your product current, an internally pro-

grammable processor, or one-chip microcomputer, to shorten design cycle times in many applications, and one kilobit RAMs for battery backup systems. You name it.

You name it. We'll build it. In CMOS, in volume.

**Call This Toll-Free Number Today
For Applications Assistance Tomorrow:
1-800-453-2400 (In Utah, 1-800-662-2500)**



MOTOROLA Semiconductors
The mind to imagine... the skill to do.

Once the breadboard system has been demonstrated satisfactorily and the block-replicate chip developed, several brassboard systems will be fabricated. The eight-package, 2-Mbit BDM will serve as a "standard" storage card for these systems.

Present plans call for the brassboard bubble-memory capacity to be 16-Mbit, the volume to be .025 m³ (9 ft³), and the weight to be 25 kg (56 lb). As a result, these memories will be smaller and lighter than existing military airborne disc or drum systems.

A bubble-memory recorder

Meanwhile, a serial chip being developed by Rockwell International for a digital-data recorder to be used by NASA will have 4- μ m bubbles and a capacity of 100 kbits. One long continuous loop is used on each chip. To maintain nonvolatility, data are replicated to the detector. The magnetic module (or "cell") currently under development contains 16 chips in two 8-chip layers.

The memory board for the recorder contains 32 of the basic cells for a total capacity of 50 Mbits. This close packing of magnetic modules is obtained by matrix selection and sharing sense amplifiers. Two of these memory boards—one for digital control and the other for power supply—provide the main components for a 10⁸-bit recorder. System weight is estimated at about 19 kg and volume at about .01 m³ (600 in.³). Present plans call for a one-quarter populated model to be fabricated this summer, and a fully populated recorder in 1978.

Several other programs are in the planning or near-contract stage:

- A jointly-sponsored effort to develop a small, flight-qualified recorder for space use is being planned by NASA (Langley Field, VA) and the Air Force Space and Missile Systems Office in Los Angeles. Existing bubble technology will be applied to build a number of 10-Mbit recorders for buffer or small-memory requirements.

- Work will soon commence at Rockwell International on second-generation magnetic bubble devices on 3-in. garnet wafers. The devices will combine 1 to 2- μ m magnetic bubbles and gap-tolerant propagation patterns to increase single-chip capacity to over 1 Mbit. Both fast-access and recorder-type operations are being considered. The resulting devices are expected to clear the way for the 16-Mbit fast-access systems weighing less than 10

Magnetic bubble basics

The storage medium of a bubble memory is a very thin layer of magnetic garnet material. This material has ribbon-shape stripes or "magnetic domains" in its natural state.

When an external magnetic field is applied to the material, the domains contract into stubby cylinders, and look and behave like bubbles when viewed from the top through a microscope.

Converting the bubbles into information bits basically takes two processes. On top of the garnet, a permalloy circuit is etched photolithographically in a pattern not unlike a mini-railroad track—that

is, Ts and bars that control the movement of the magnetic bubbles.

In a rotating magnetic field, the bubbles are alternately attracted to either the Ts or bars in the track. A bubble or the absence of a bubble can then represent one bit of information—"1" or "0."

When moved past a sensing element, the bubble produces a signal similar to the output from a tape, disc or drum—ruggedized, mechanical systems that don't have the high reliability of the nonmechanical bubble. Other virtues of the bubble are its smaller size, its reduced power requirement and its ability to operate over a wider temperature.

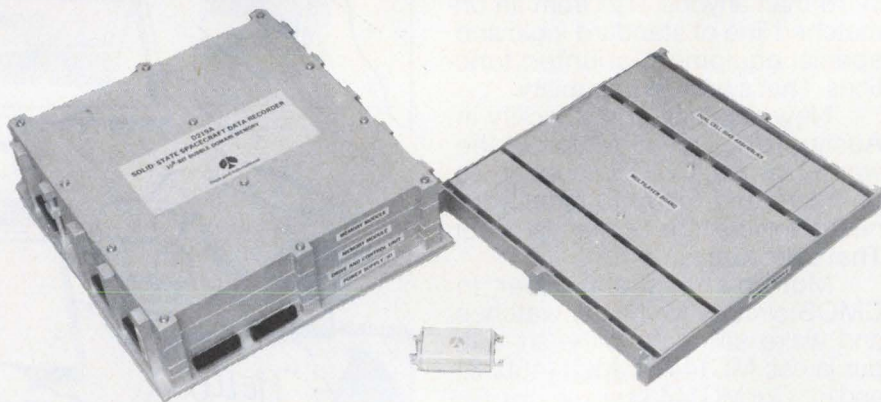

A satellite data recorder using bubble-domain technology, built by Rockwell International, has 100-million-bit capacity, and is 10 times more reliable than mechanically driven recorders.

lb and 10⁹-bit recorder systems weighing less than 30 lb.

- Another basic research effort at Rockwell International, aimed at third-generation bubble technology, will investigate such possibilities as two-layer bubble lattices, self-biasing structures, and the use of full-wafer devices for very-high-capacity bubble memories of up to 10¹² bits.

As demonstrated by the magnetic bubble memories being developed for the military, most of the characteristics that commercial users want are also required by the military, including nonvolatility, low cost, low power consumption and substantial capacity. However, the military has additional requirements: It wants its memories to be extremely small and lightweight, use less power—in fact, zero power for standby equipment, be capable of high reliability untended, and able to sur-

vive harsh environments. Considerable shock and vibration must be expected as well as temperatures of from -25 C to more than +75 C; they must be radiation-hard, possess vacuum/zero "g" capabilities and not be vulnerable to gyro effects.

In the case of a fast auxiliary memory, the bubble memory must be competitive with existing militarized disc/drum systems. Current 4 to 5- μ m bubble devices can meet or exceed the density and power goals for these systems right now.

For recorder applications, however, 4 to 5- μ m magnetic bubble devices do not yet offer systems that are size and weight-competitive. Reliability is the driving force for their development. Small, 1 to 2- μ m magnetic bubbles, however, offer competitive size and weight and improved reliability. ■

Burr-Brown announces the lowest cost Analog I/O Systems for Intel and Motorola microcomputers.

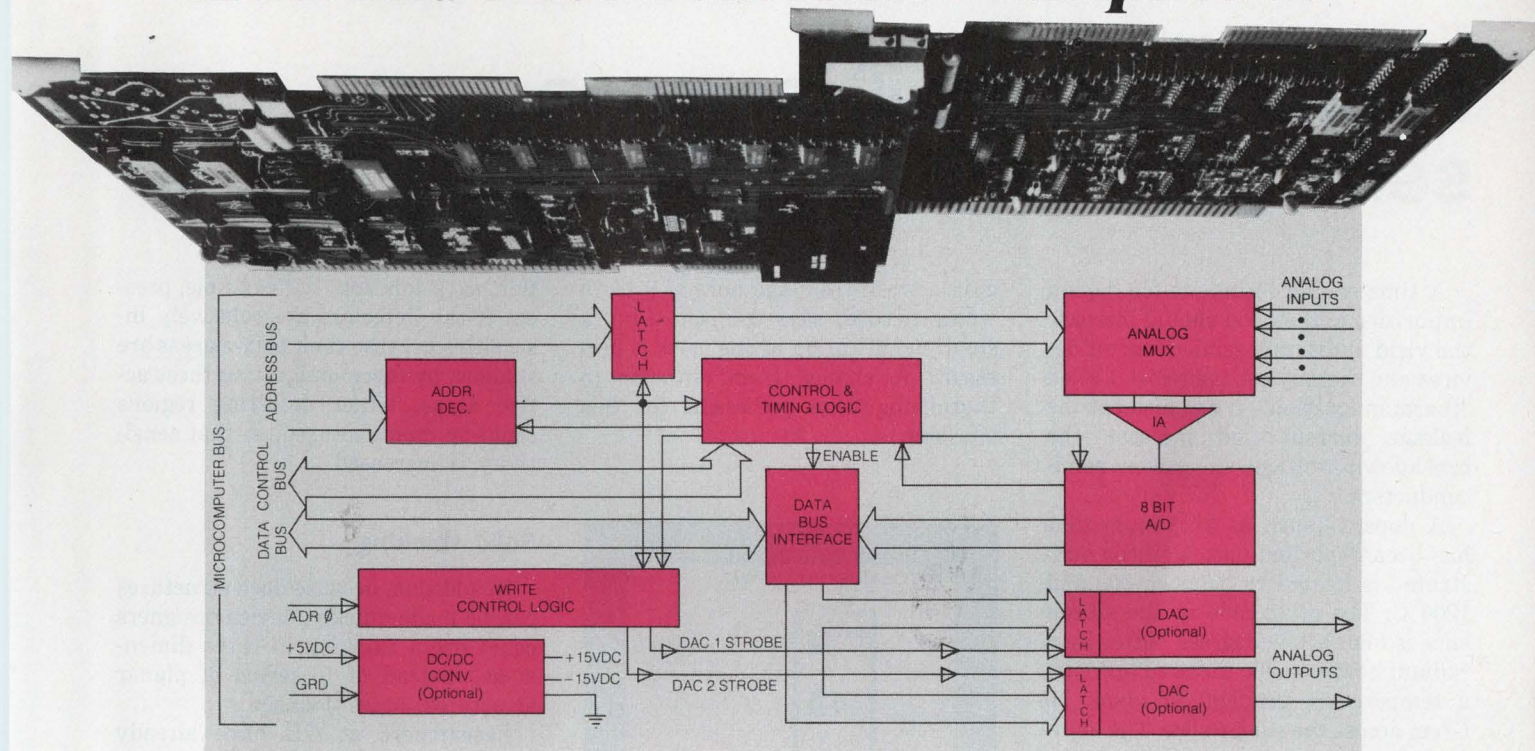

Prices start at \$198 in 100's. These new additions to Burr-Brown's growing family of Analog I/O Systems are designed specifically for Intel and Motorola microcomputer users. They're the only complete 8-bit systems available, and the lowest priced plug-compatible I/O systems offered for these microcomputers. Here's the complete hardware solution to your analog input and output interface problems. And it's a solution that simplifies system software too.

For the Intel SBC80 or Intellec[®] MDS user, our MP8600 series offers input and output on a single board which mates to either memory or I/O slots. These systems can provide up to 32 differential or 64 single-ended input channels. And they're adjustable from ± 10 mV to ± 5 V full-scale to handle low or high-level signals directly. The two optional output channels have strap selectable full-scale outputs ranging from ± 2.5 V to ± 10 V.

Motorola Micromodule or EXORciser[®] users can choose the MP7400 series and get up to 24 differential or 48 single-ended input channels. Like the MP8600 series, input and output levels

are field adjustable to meet your application needs.

All of Burr-Brown's Analog I/O Systems (including our 12-bit systems previously introduced for Intel and Motorola microcomputers and our new 8-bit Pro-Log compatible systems) can be treated as memory by the CPU. New versions offer you the options of interfacing in the interrupt mode and of conversion without halting the CPU. This means essentially unlimited channel expansion capability plus easy software implementation.

These I/O interfaces are system engineered and specified to ensure compatibility with your microcomputer. That means big savings for you in development time, in system debugging and in production start-up.

If you're using a microcomputer from Intel, Motorola or Pro-Log, it will pay you to find out about Burr-Brown's 8 and 12-bit Analog I/O Systems.

For more information, contact Burr-Brown, International Airport Industrial Park, Tucson, Arizona 85734. Phone (602) 294-1431.

Intellec[®] is a trademark of Intel Corp.

Micromodule and EXORciser[®] are trademarks of Motorola Semiconductor Products, Inc.

BURR-BROWN



*Leaders in
microcomputer I/O*



Faster doping will increase semi yields and performance

A time-saving technique for doping impurities into silicon should increase the yield of discrete semiconductor devices and thereby cut their cost. Called "thermomigration," it can also cut the leakage current and increase the breakdown voltage in power semiconductors.

A dopant—such as aluminum that has been deposited onto a silicon substrate—is heated to between 900 and 1200 C. The other side of the silicon slice is kept a few degrees hotter by a radiant heater inside the oven to create a temperature gradient of about 50 C/cm across the silicon slice. The liquified aluminum migrates through the substrate toward the hotter surface.

Using a liquid dopant driven by a temperature differential can cut substantially the time of some manufacturing steps for power semiconductors and other devices, says Lyman Johnson, manager of the properties branch of the metallurgy laboratory at the technique's developer, General Electric Research and Development Center, Schenectady, NY. In a power SCR, for example, an isolation region of P-type material must be doped completely through a wafer. With conventional diffusion techniques, this step can take a week, and requires a 1300-C furnace. With thermomigration, the process can be completed in a few minutes, and the temperature can be reduced by 100 to 200 degrees.

Less heating helps

Spending less time at high temperatures produces better devices with higher breakdown voltages and lower leakage currents, according to Johnson. These parameters are affected by temperature since semiconductor junctions can deteriorate at 1300 C.

By shortening one of the 30 to 40 steps needed to manufacture a semiconductor device, thermomigration

cuts a week from the normal 9 to 10 weeks needed, says Johnson. Only a small modification of one mask is necessary to change from diffusion to thermomigration processing for this one step.

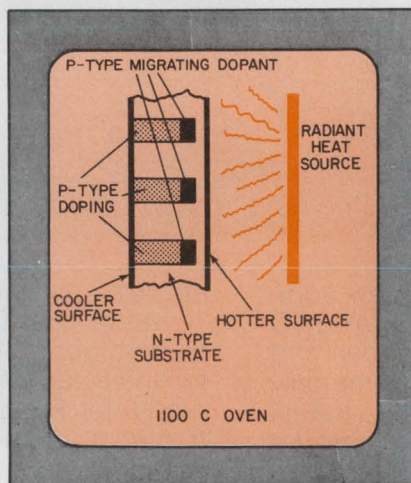

Since one side of the slice is hotter, dopant is drawn through faster, which should cut semi costs.

The impact on future products is more significant. "By changing the design of the device, one can replace almost all of the doping processes," says Johnson. Thus, total processing time might be cut in half.

ICs in the future

The technique may also be applied to integrated-circuit processing some time in the future. In principle, thermomigration can supplant doping steps in LSI devices, but so far cannot handle the fine line widths required. "That will take more technological developments," says Johnson.

New devices may also be developed to take advantage of the deeper penetration made possible by thermomigra-

tion, says Johnson. For example, present X-ray detectors are relatively insensitive because their active areas are shallow; by thermomigrating these active areas, larger detecting regions could be manufactured, so that sensitivity is increased.

Solid thinking

In addition, because deep structures can be made quickly, device designers could begin thinking in three dimensions, instead of in terms of planar structures, notes Johnson.

Researchers at GE have already doped P-type regions through silicon slices as thick as 1 cm—present diffusion techniques are limited to about 10 or 11 mils in depth, with 6 to 7-mil diffusion depths common in commercial devices, according to Johnson. In these diffusion steps, a gaseous dopant introduced on the surface of the silicon slice solidifies and is diffused through the wafer in the solid state.

Since solid-state diffusion tends to spread as the dopant migrates through the silicon, resolution is limited, says Johnson. Thermomigration and its liquid-state action make sharper definition of doped regions possible.

Deeper penetration with high resolution also makes it possible to use thicker silicon slices. "We can migrate through thicker wafers in a short time," says Johnson, adding: Thicker wafers are less likely to be damaged in handling. What's more, the small increase in raw-material cost resulting from the use of thicker wafers is more than offset by increased yields.

General Electric's Semiconductor Products Department in Syracuse, NY, is already using thermomigration to make power semiconductors that were uneconomical to build with older diffusion techniques. Sample quantities of the new devices have already been shipped to some customers. ■

LONG SCALE
3 1/2" Round
4 1/2" Century
3 1/2" Century



CENTURY SERIES
1 1/2", 2 1/2"
3 1/2", 4 1/2"



BOLD-VUE®
2 1/2", 3 1/2"



WIDE-VUE
1 1/2", 2 1/2"
3 1/2", 4 1/2", 8"

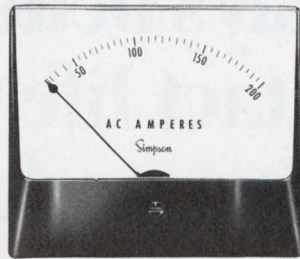

DIGITAL PANEL METERS
Low Cost series 2860
Deluxe series 2850, 2852

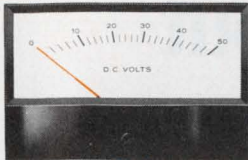

DESIGNER SERIES
3 1/2", 4 1/2"



RUGGED SEAL
(Metal Cased)
3 1/2", 4 1/2"
4x6"

Panel Meters Stock or Special SIMPSON has 'em!

Analog, digital, or Ana-Led®, if it's made, Simpson makes it. Over 1500 styles, sizes, ranges. If it's a special, we'll make it for you.

RECTANGULAR
2 1/2", 3 1/2"
4 1/2"



ROUND
(Commercial and MIL spec)
2 1/2", 3 1/2"
4 1/2"

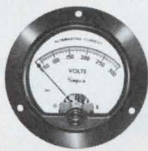

EDGEWISE
3 1/2"



EDGEWISE Barrel Type
1 1/2", 2 1/2"



STACKABLE EDGEWISE
1 1/2", 2 1/2"



ANA-LED SOLID STATE PANEL METERS
Bar or dot display

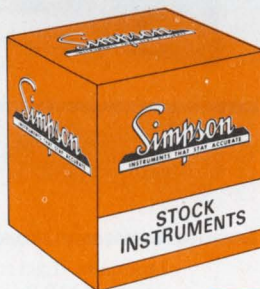

RUGGED SEAL
3 1/2", 4 1/2"
4x6"

EDGEWISE
3 1/2"

CONTACTLESS METER RELAYS
single or double setpoint models available in DC microamp, milliamp, millivolt, AC ampere, AC voltage and temperature ranges.



SEE YOUR SIMPSON DISTRIBUTOR OR WRITE FOR FULL-LINE CATALOG



SIMPSON ELECTRIC COMPANY
853 Dundee Avenue, Elgin, Illinois 60120
(312) 697-2260 • Cable SIMELCO • Telex 72-2416



CIRCLE NUMBER 26

AMP research discovered Bonded Lubrication 5 years ago.

It's now today's better way to extend contact life without compromising performance.

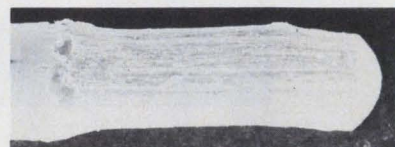
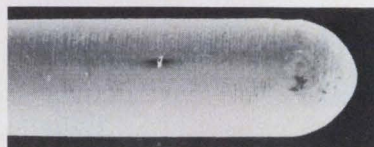
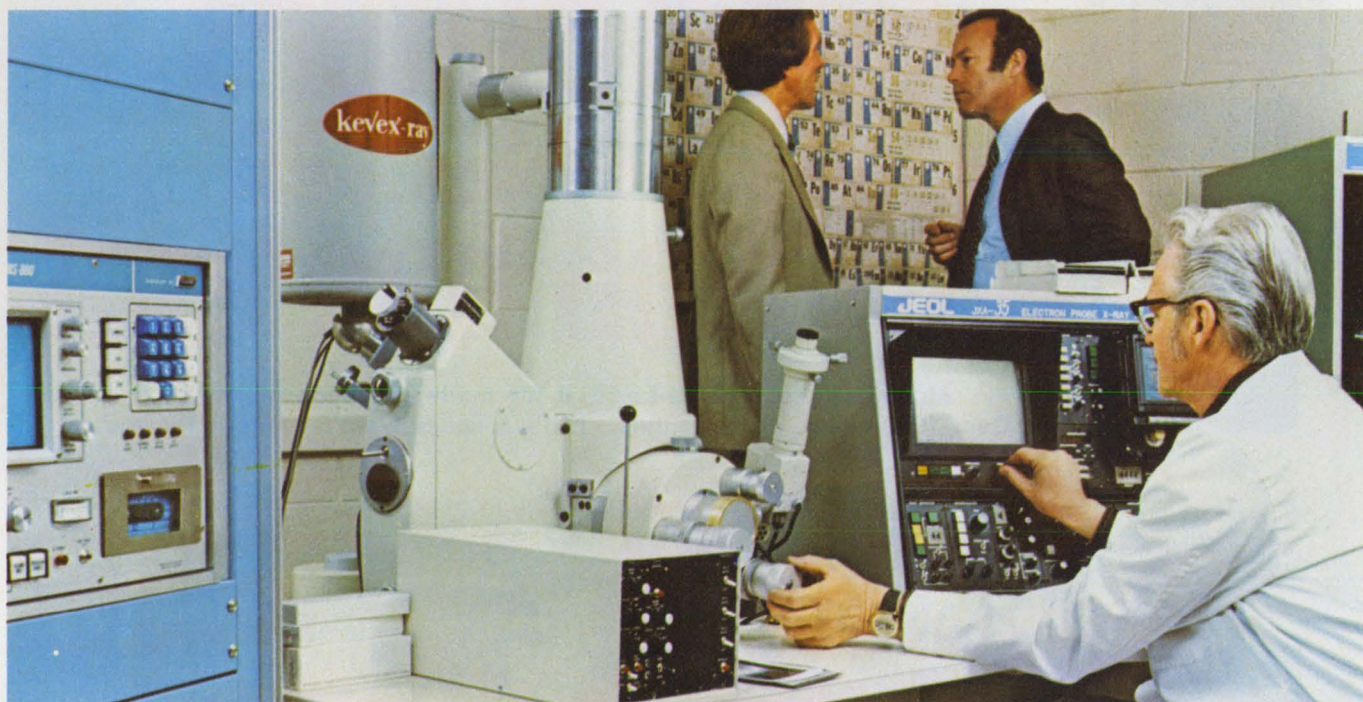

Through the electron microscope, the dramatic improvement AMP Bonded Lubrication makes in contact life and performance is clearly evident.

With the popular DUALATCH connectors, Bonded Lubrication has reduced plating thickness requirements and more than doubled the previously accepted cycle life of 10,000 insertions and withdrawals.

For example, look at the effect on the connector contact shown. Not only is wear to the plated surface greatly reduced by the permanent lubrication but it

Dramatic difference in wear between contacts utilizing the unique AMP Bonded Lubrication Process and ordinary contacts is shown by these electron images.

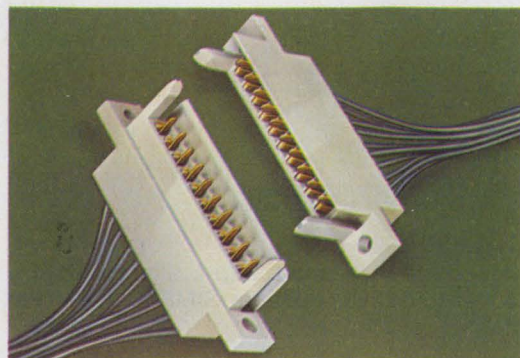

significantly lowers the insertion forces when mating high-pin count connectors. Now Bonded Lubrication can be applied to a variety of contact geometries without compromising electrical performance.

Or consider what AMP lubrication leadership has done for contacts used in our tin-plated products like surface mount ZIF connector and Bifurcated Leaf types. Their lubricated contact surfaces are protected from the detrimental effects of oxidation and fretting corrosion. Indeed, there are now applications where high performance tin-plating, with the correct contact design and Bonded Lubrication, can be used in place of noble metals.

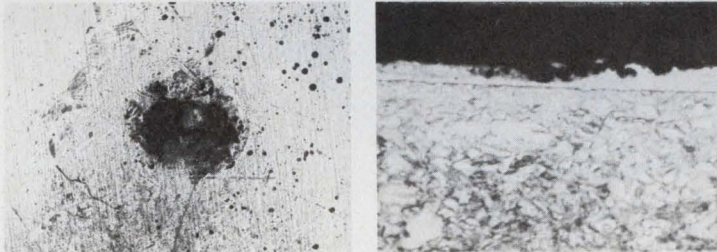
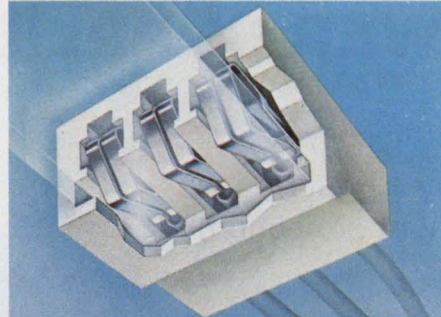

High Resolution scanning electron microscope at AMP's Materials Research Laboratories displays 3-dimensional pictures of surface oxidation and fretting corrosion on non-lubricated contacts.

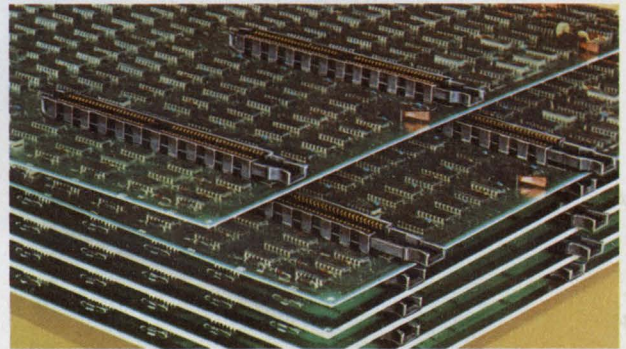

AMP lubricated contacts are today's answer to extended contact life and performance, and together we can search out better ways to assist your designs.

For more information on the products mentioned, circle the reader service number. For more technical information on lubrication just call Customer Service at (717) 564-0100, extension 8400. Or write on your Company letterhead to AMP Incorporated, Harrisburg, PA 17105.

AMP has a better way.

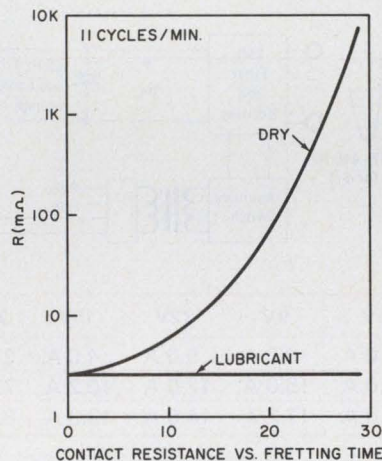

Flat, stable resistance of contacts with AMP lubrication compared to dry contacts.

SEE US AT
INELTEC, BASEL

AMP
INCORPORATED

CIRCLE NUMBER 27

from KEPCO by TDK

the series

RMK

25 KHz SWITCH-MODE POWER SUPPLIES

- 75% efficiency
- 90-130V a-c input (brownout protection)
- d-c input
- $\pm 10\%$ output adjustment
- adjustable current limit
- adjustable overvoltage
- logic level on-off
- 1 millisecond recovery

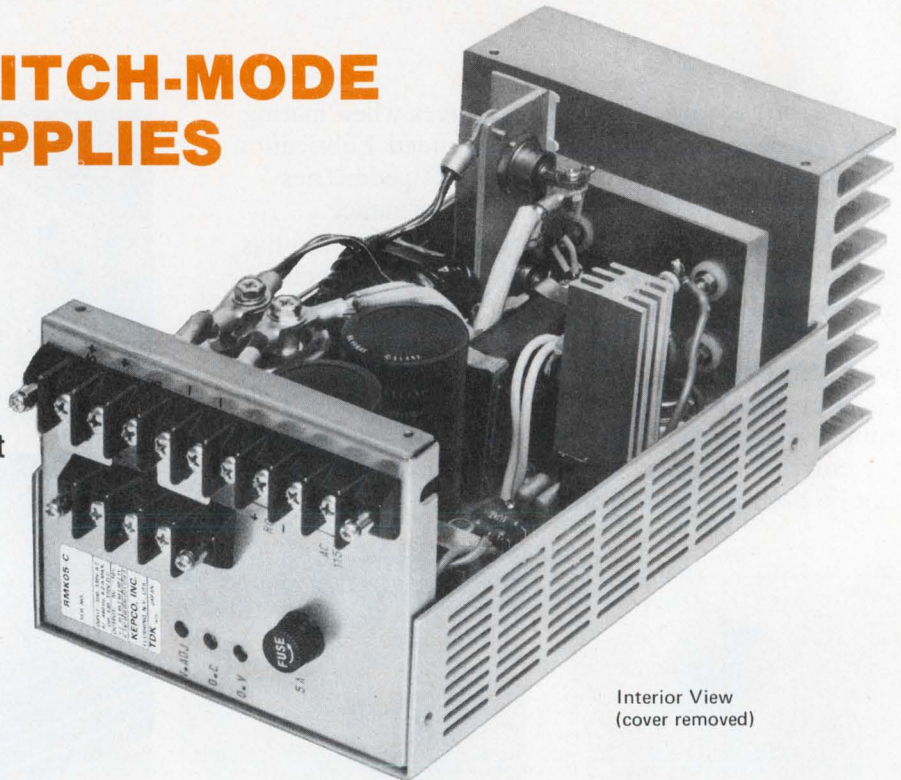

Interior View
(cover removed)

BLOCK DIAGRAM OF
THE RMK SWITCH-MODE
POWER SUPPLY

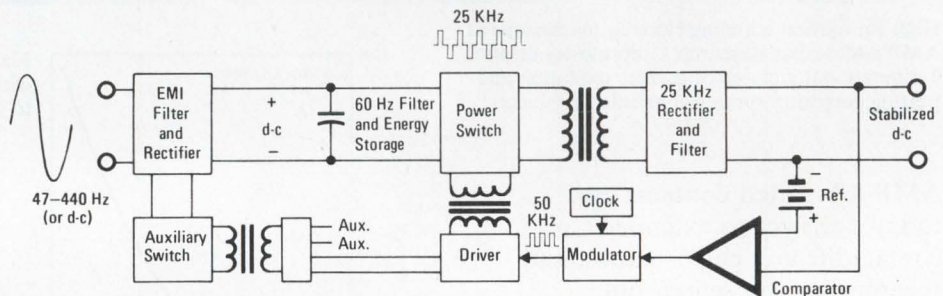

50°C OUTPUT
RATINGS FOR
THE KEPCO RMK
POWER SUPPLIES

PKG.	5V	9V	12V	15V	24V	SIZE	WGT.	PRICE
"A"	10.0 A	6.0 A	5.0 A	4.0 A	2.5 A	2 $\frac{7}{16}$ " x 5 $\frac{1}{8}$ " x 7 $\frac{1}{2}$ "	3.0 lbs.	\$179.00
"B"	26.0 A	15.0 A	12.0 A	10.2 A	7.5 A	3 $\frac{3}{32}$ " x 5 $\frac{1}{8}$ " x 8 $\frac{3}{4}$ "	4.75 lbs.	259.00
"C"	30.0 A	17.2 A	14.6 A	12.3 A	8.0 A	4 $\frac{1}{16}$ " x 5 $\frac{1}{8}$ " x 8 $\frac{3}{4}$ "	5.25 lbs.	299.00

other switching power supplies from **KEPCO/TDK**

- 115/230V a-c input switching power supplies, Series RMX offers the same outputs in the same package sizes as RMK.
- Triple output switchers, Series RMT combines a 5V, 10A output with your choice of: $\pm 12V @ \pm 1A$ or $\pm 15V @ \pm 1A$ or $+12V @ 1A$, $-5V @ 1A$ or $+15V @ 1A$, $-5V @ 1A$ or $+12V @ 1A$, $-9V @ 1A$.

Ask your Kepco Rep to show you the clean layout, and cool operation of the KEPCO/TDK switching power supplies. Compare performance, stability, noise, temperature rise . . . compare the Kepco 5-Year Warranty!

For complete specs,
write Dept. BTF-05

KEPCO

© 131-38 SANFORD AVENUE • FLUSHING, N.Y. 11352 U.S.A. • (212) 461-7000

CIRCLE NUMBER 28

Washington report

Electro-optical jamming system falls behind schedule

The program to develop a new airborne electro-optical jamming pod that would enable the Air Force's tactical aircraft to blind enemy ground-based optical detection systems has been reopened to bidding. As a result, the two original study contractors face another round of competition for the highly classified program known as Compass Hammer.

Westinghouse Electric Corp. and the Orlando, FL, division of Martin Marietta Corp. have parallel development contracts with the Air Force Avionics Laboratory. One was supposed to have been selected for prototype production and the whole program was supposed to have been given over to the Air Force Aeronautical Systems Div. six months ago. But the Air Force decided to take another look at the technical approaches.

Now, it is writing a new request for proposals based on the best features of each company's design and asking Westinghouse and Martin Marietta to rebid. The winning prototype will be tested on an F-4 for use on Air Force Tactical Air Command fighters initially, but later, perhaps, on Strategic Air Command bombers as well.

Fiber optics pushed for future avionics links

Fiber-optic data buses for linking avionics equipment in future aircraft have been tested at data rates much faster than the 1-Mbit/s rate for the military-standard 1553 coaxial-wire, multiplexed data bus specified for the Air Force's F-16 and the Navy's F-18 fighters.

The tests, conducted by Westinghouse Electric Corp. with one of its own modular electronic-countermeasures subsystems, produced data rates ranging from 15 to 30 Mbits/s with TTL interfaces and more than 100 Mbits/s with ECL interfaces. But the real advantage of fiber optics, Westinghouse claims, is its resistance to electromagnetic interference.

Typical interface problems of pickup, ground and sparking are eliminated, according to Westinghouse. And because there is no magnetic shielding and the glass fibers are inherently small, fiber optics can outdo coaxial cables in weight and size.

However, fiber optics cannot operate in a multiport, bidirectional mode without the necessary optical power dividers and combiners, which have yet to be developed. This limitation is expected to restrict fiber optics to point-to-point data links for the immediate future.

FAA 'accidentally' routes traffic with weather photos

Satellite weather maps are being used to guide air traffic around severe weather in a pilot program launched by the Federal Aviation Administration. But the experiment began almost by accident, according to William Flener, chief of FAA's air traffic and airways facility section.

A satellite picture receiver installed at the agency's DC headquarters received a photo of a long line of thunderstorms in the Midwest, and officials happened to notice a break in the storm line. So copies of the weather picture were transmitted to the FAA's Dallas air-traffic control center, which used the information to route air traffic through the break in the thunderstorms.

Now, FAA is considering installing one of the relatively inexpensive receivers in each of its centers. Pictures are received every 30 minutes, and night photos are produced in the infrared spectrum. Maps currently used are overprinted with an outline of the states, Flener says, but in an operational system the centers would also overprint airway and route structures.

Air Force seeks low-cost inertial guidance

The Air Force is in the market for a new low-cost inertial guidance system for its future missiles and other guided weapons. The first application is expected to be the GBU-15 glide bomb, a winged bomb that is guided to its target by a TV data link; other candidates include the Air Launched Cruise Missile (ALCM) and Remotely Piloted Vehicles (RPVs).

The new system should cost \$10,000 to produce in 1976 dollars, based on 1000 units a year for two years. It should be reliable enough so that the probability would be 95% that the system will turn on satisfactorily any time within a 10-year period and remain operating for two hours.

NBS claims success for cryoelectronic rf standard

A secondary standard for rf attenuation using cryoelectronic techniques to replace conventional waveguide-below-cutoff attenuators has been developed by the Boulder, CO, laboratories of the National Bureau of Standards.

The standard is a permanent-contact superconducting quantum interference device (SQUID) operating in a liquid helium bath at 4 K and consisting of a loop of superconducting metal closed by Josephson junction point contact. The SQUID converts variations in magnetic flux into periodic variations in impedance that can be sensed at rf or microwave frequencies in order to measure such electrical properties as attenuation, voltage, current and power.

Waveguide-below-cutoff attenuators operate at a single fixed frequency, but SQUID operates from tens of kHz to above 30 MHz. The system has measured attenuation over a dynamic range of 65 dB at 30 MHz, according to NBS, and is capable of measurements with an rms deviation of ± 0.002 dB from calibrations compared to NBS's highest accuracy 30-MHz conventional system.

Capital capsules: Boeing Wichita Div. and Singer Link Div. are the finalists in the **Air Force competition to develop a new family of flight simulators and trainers for the B-52 bomber and KC-135 tanker**. Each will deliver a prototype system in about two years, and the winning firm will receive a contract to build up to 45 production models. . . .Raytheon, winner over Hughes Aircraft in the **Navy's Design to Price Electronic Warfare Suite (DPEWS)**, has finally received its first \$47-million incremental payment under the \$200-million-plus program to outfit 284 ships with the SLQ-32 protection system over the next four years. The contract had been delayed pending approval by Defense Secretary Harold Brown. . . .**Tests of the competing tail-warning radars** being demonstrated by Westinghouse and the AIL Div. of Cutler Hammer at Eglin Air Force Base, FL, have gone so well that program officials are now considering splitting the procurement. At least 1000 F-15 and B-52 aircraft would be outfitted with the system, and source selection is scheduled for next March to be followed by full-scale development in June. Unit production price is estimated at \$100,000.

Now 1% time measurements are this easy...

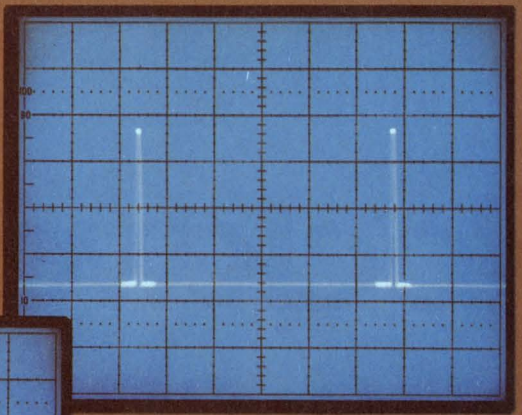
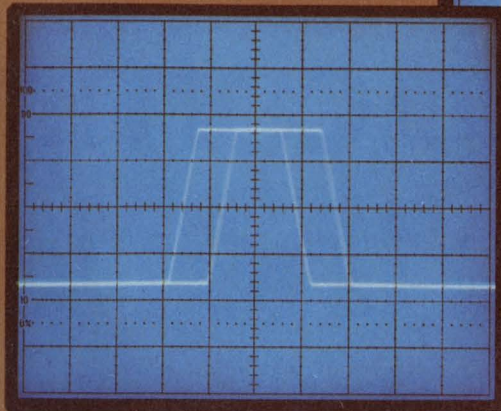

1 Position intensified spots at beginning and end of time interval.

2

Switch to delayed sweep mode and use Δ Time dial to superimpose beginning and end of interval.

1.132



3 Read time interval directly.

Faster Timing Measurement

Differential time measurements are made faster when the new DM 44 with *Delta Delayed Sweep** and direct numerical readout is included on a TEKTRONIX Portable Oscilloscope. At the same time, measurement repeatability is improved, the chance for computational errors is eliminated, and 1% accuracy is consistently achieved. Frequency measurement (on periodic waveforms) with 2% accuracy is obtained by simply pushing the 1/Time button.

Built-in DMM as a Bonus

There's no need to carry a separate multimeter. DM 44-equipped TEKTRONIX Portables also measure dc voltage with 0.1% accuracy and temperature from -55°C to $+150^{\circ}\text{C}$ simultaneously with oscilloscope display of related waveforms. And you get ohms measurement with 0.25% accuracy as well.

Your Choice of Oscilloscope Performance

The DM 44 is available on five high-performance portable oscilloscopes to best match your performance and price needs. Choose bandwidth of 100, 200, or 250 MHz. Or select from two fast storage models. One actually stores single-shot signals at its full 100 MHz bandwidth.

Due to highly cost-effective design, the outstanding DM 44 option adds only \$410 to the price of the basic portable oscilloscope chosen. All DM 44-equipped TEKTRONIX Portable Oscilloscopes, and seven more models as well, perform analysis on up to 16 channels in the digital domain by simply adding the

LA 501W Logic Analyzer. Capabilities of the DM 44 are also available in the TEKTRONIX 7000 Series of plug-in oscilloscopes.

Let Us Show You

To see how the DM 44 makes faster, more accurate measurements in your application, contact your Tektronix Field Engineer. Or write to Tektronix, Inc., P.O. Box 500, Beaverton, Oregon 97077 for complete information. In Europe, write to Tektronix, Limited, P.O. Box 36, St. Peter Port, Guernsey, Channel Islands.

*Two independently adjustable delayed sweeps.

U.S. Sales Price FOB Beaverton, Oregon

Tektronix®

COMMITTED TO EXCELLENCE

FOR TECHNICAL DATA CIRCLE #29
FOR DEMONSTRATION CIRCLE #30

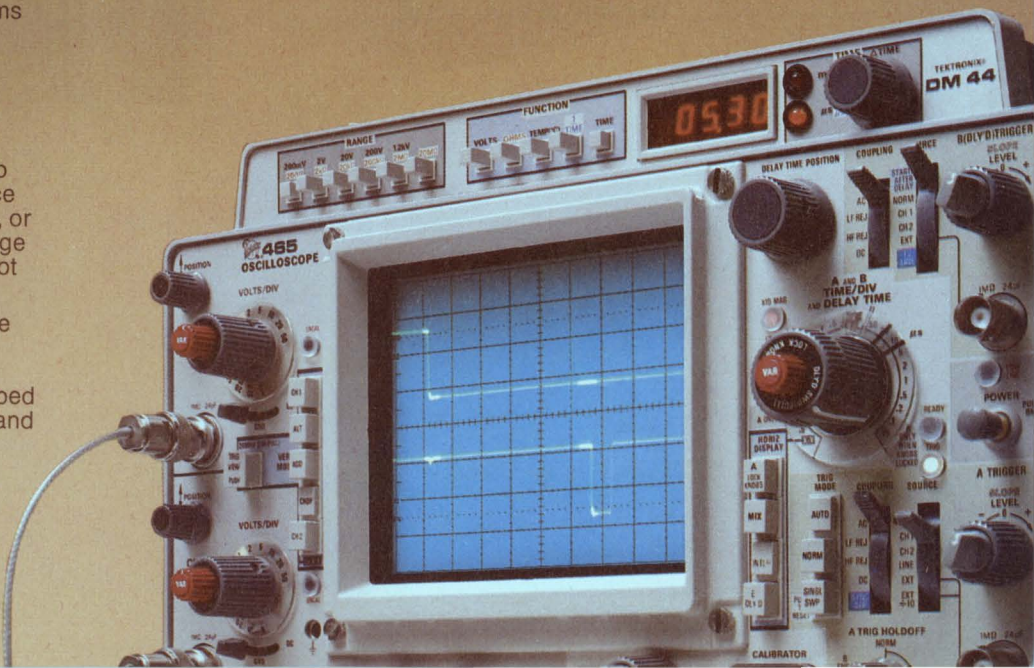

**Rockwell
one-chip computers
give you the right fit
at the right price.**

Right now.



If you're designing a system or subsystem requiring as few as 10 TTL circuits, cost alone is reason enough to consider a Rockwell one-chip computer.

A wide choice of Rockwell one-chip computers is available right now. And the line-up of compatible one-chips is growing fast.

From Rockwell's PPS-4/1 family, you select the most cost-effective computer for your application.

More on-chip I/O eliminates extra interface devices.

All of Rockwell's one-chip computers offer powerful, user-oriented I/O ports that eliminate costly interface circuitry in overall systems.

I/O features, including bidirectional ports, flexibly designed drivers and receivers, and serial input/output ports, provide you with powerful system options.

Many types of displays can be driven directly. Analog-digital conversion is easy. And serial I/O ports offer a new dimension of capability by giving you simple, "no-cost" interfacing for multi-computer systems.

Rockwell flexibility assures cost-effective design.

Rockwell's one-chip computers give you design options you couldn't afford with other logic approaches.

During the design stage you can add or reduce functions, allocate I/O differently and make dozens of other changes by simple reprogramming or by moving to another software-compatible chip within the family.

Powerful instruction sets increase efficiency.

Rockwell's instruction sets provide ROM efficiencies of typically 2 to 1 over other microcomputers. For example, some one-byte multi-function Rockwell instructions perform operations requiring five instructions in other systems.

More than 80% of Rockwell's instruction

types can be executed in one byte and in a single cycle. Special ROM instructions allow many subroutine calls to be handled in one byte. Table look-up instructions for MM77 and MM78 chips provide easy look up of stored data and easy keyboard decoding with minimal programming.

The PPS 4/1 family of one-chip computers.

Model	MM76	MM77	MM78	MM75	MM76C	MM76D	MM76E
Description	Basic 76	Basic 77	Jumbo 77	Economy 76	High speed counter*	12-bit A/D converter	Expand- ed 76
ROM (x8)	640	1344	2048	640	640	640	1024
RAM (x4)	48	96	128	48	48	48	48
Total I/O lines	31	31	31	22	39	37	31
Cond. Interrupt	2	2	2	1	2	2	2
Parallel Input	8	8	8	4	8	8	8
Bidirectional Parallel	8	8	8	8	8	8	8
Discrete	10	10	10	9	10	10	10
Serial	3	3	3	—	3	3	3
In-line package	42 pin quad	42 pin quad	42 pin quad	28 pin dual	52 pin quad	52 pin quad	42 pin quad
Availability	Now	Now	Now	2Q 77	2Q/77	3Q 77	16 wk ARO

Power supply is 15v except low voltage version of Basic 76 available 3Q 77. Typical power dissipation is 70mw.

*Two 8-bit or one 16-bit presetable up/down counter with 8 control lines.

Rockwell design aids also help lower your system cost.

To help control development costs, Rockwell makes available a universal Assembler that lets you assemble, edit, develop and debug programs, as well as load PROMs. Special development circuits enable prototyping.

Your Assembler can also handle incoming inspection and factory testing. And the same Assembler can be used to develop systems based on all Rockwell one-chip and multi-chip microprocessors.

For the full story on Rockwell one-chip computers, and how quickly they can be a part of your new product, write on your company letterhead to: Marketing Services, D/727-B, Microelectronic Device Division, Rockwell International, P.O. Box 3669, Anaheim, CA 92803, U.S.A. or phone (714) 632-3729.



Rockwell International

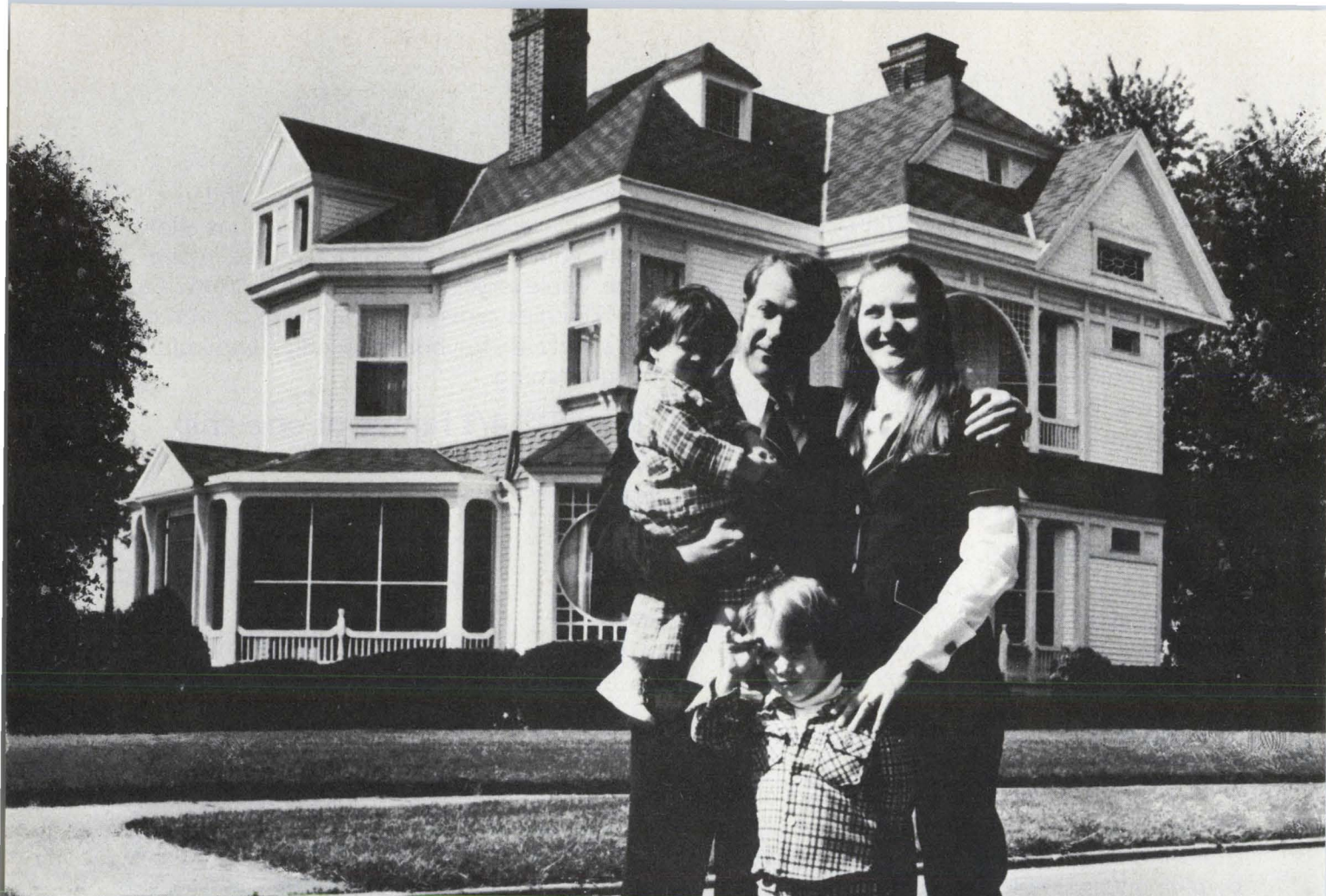

Tom and Barbara Herrold just bought their spacious Wabash, Indiana home for \$31,500.

What do you think relays are going for around here?

Ten rooms, 8 fireplaces, 6 porches, 11 foot ceilings, oak paneling, choice neighborhood, mint condition—all for \$31,500. That's Wabash value. And that's why our relays are in such demand. They are made right here—switches and all—to rigid specifications in a hospital-clean environment where heat, humidity and dust are controlled so quality can be assured. Just to be certain, 3 billion test cycles are run every day.

When you purchase Wabash relays you get the kind of quality the Herrold's got in their home. And at a price that gets you the kind of value the Herrold's got. We've got over 6,000 variations of dry reed relays for sale. Contact us. When you see the asking price, you will know you found a new home for your relay requirements.



The Econo-Miser. The most automatically manufactured dry reed relay available. 1 and 2 pole standard types. Less than one dollar in quantity.

Coils, Relays & Transformers
wabash
 of
Wabash, Indiana

and Huntington, Indiana; Farmington, Missouri; Tipton, Iowa and South Boston, Virginia

For information and quotes write or call:

Wabash, Inc., Dept. RA-8, 810 N. Cass St., Wabash, Ind. 46992 Tel: 219/563-2191 TWX 810-290-2722

CIRCLE NUMBER 31

Inherently rugged, these triple-diffused devices permit circuit operation directly from rectified 117V or 220V line—eliminating transformers. Ideally suited for inverters, converters, switching regulators, motor controls and wherever there's hi-rel applications. The exploded view demonstrates our single chip design and packaging

TYPE #	(pk.) I _c	V _{CE}	h _{FE} @ I _c	Switching Speed (Typ.)
PT-3512	70A	325	10 @ 30A	t _r = .5 μs
PT-3513	70A	400	10 @ 30A	t _s = 1.2 μs
PT-3522	90A	325	10 @ 50A	t _f = .5 μs
PT-3523	90A	400	10 @ 50A	
350 Watt Power Rating		Guaranteed SOAR		

concept which makes high-voltage, high-current transistors off-the-shelf availability possible. Pre-rating and pre-testing techniques of chip allows choice of solid copper packages. For further information

and application assistance, call Sales Engineering, PowerTech, Inc., 0-02 Fair Lawn Ave., Fair Lawn, N.J. 07410; Tel. (201) 791-5050.

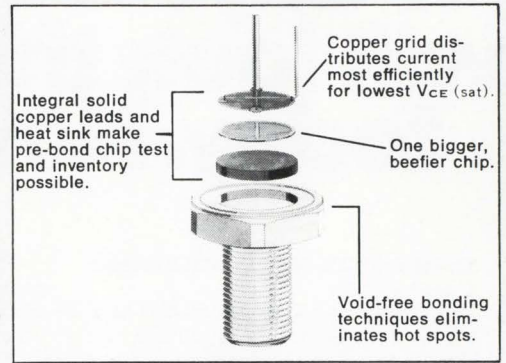

PowerTech, Inc.

"BIG IDEAS IN
BIG POWER"

400v90 AMP

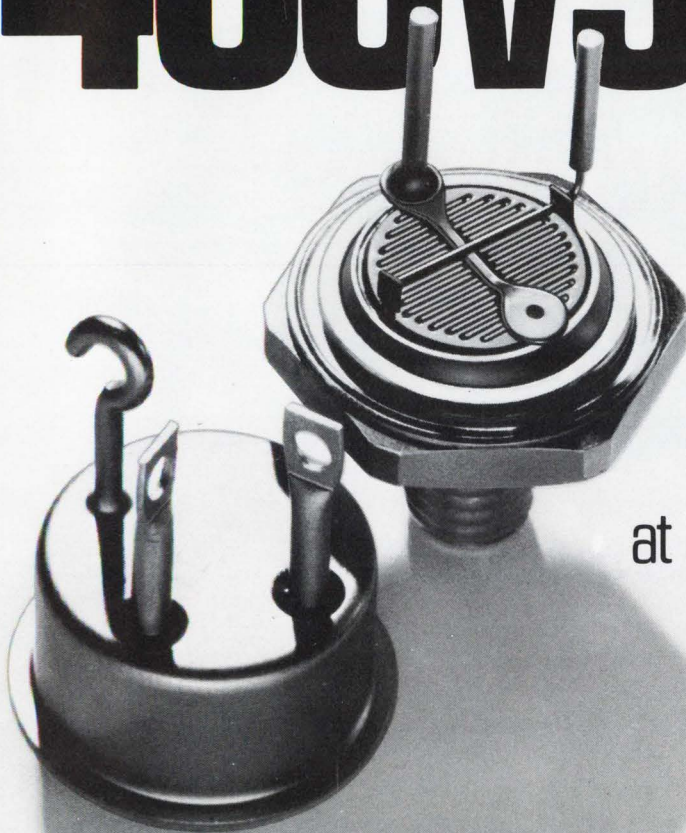

NPN Silicon
Power Transistor
Switch — Highest KVA
at lower cost,
weight & space.

17 days from now this trace will look the same as it does today. Now that's storage!

The Gould OS-4000 Digital Storage Oscilloscope . . .

will store any signal up to 450 kHz for as long as you need, while providing the performance of a conventional 10 MHz scope as well. The OS-4000 opens the door for entirely new viewing possibilities involving low frequency measurements. It is ideal for displaying and recording transient waveforms for medical, electrical, vibration, dynamic testing and pulse testing applications.

The digital storage capability provides a non-flickering, full trace at low frequencies and a unique "Dot Joining" technique.

The OS-4000 will allow you to simultaneously view stored and real time signals. These may even be superimposed to reveal small changes.

The OS-4000 also allows you to examine a single event trace prior to, as well as after, a trigger point; and it's stored indefinitely as long as power is supplied to the unit.

If you'd like a hard copy of a stored trace, you can record it in either analog or digital form on your recorder by using the Gould 4001 Output Unit.

Find out how the unique Gould OS-4000 Digital Storage Oscilloscope and the companion 4001 Output Unit can make your work more efficient and easier. Call your nearest Gould Sales Engineer for details. Or write Gould Inc., Instrument Systems Division, 3631 Perkins Avenue, Cleveland, Ohio 44114.

PHONE TOLL FREE FOR BROCHURE (800) 325-6400.
(In Missouri (800) 342-6600)

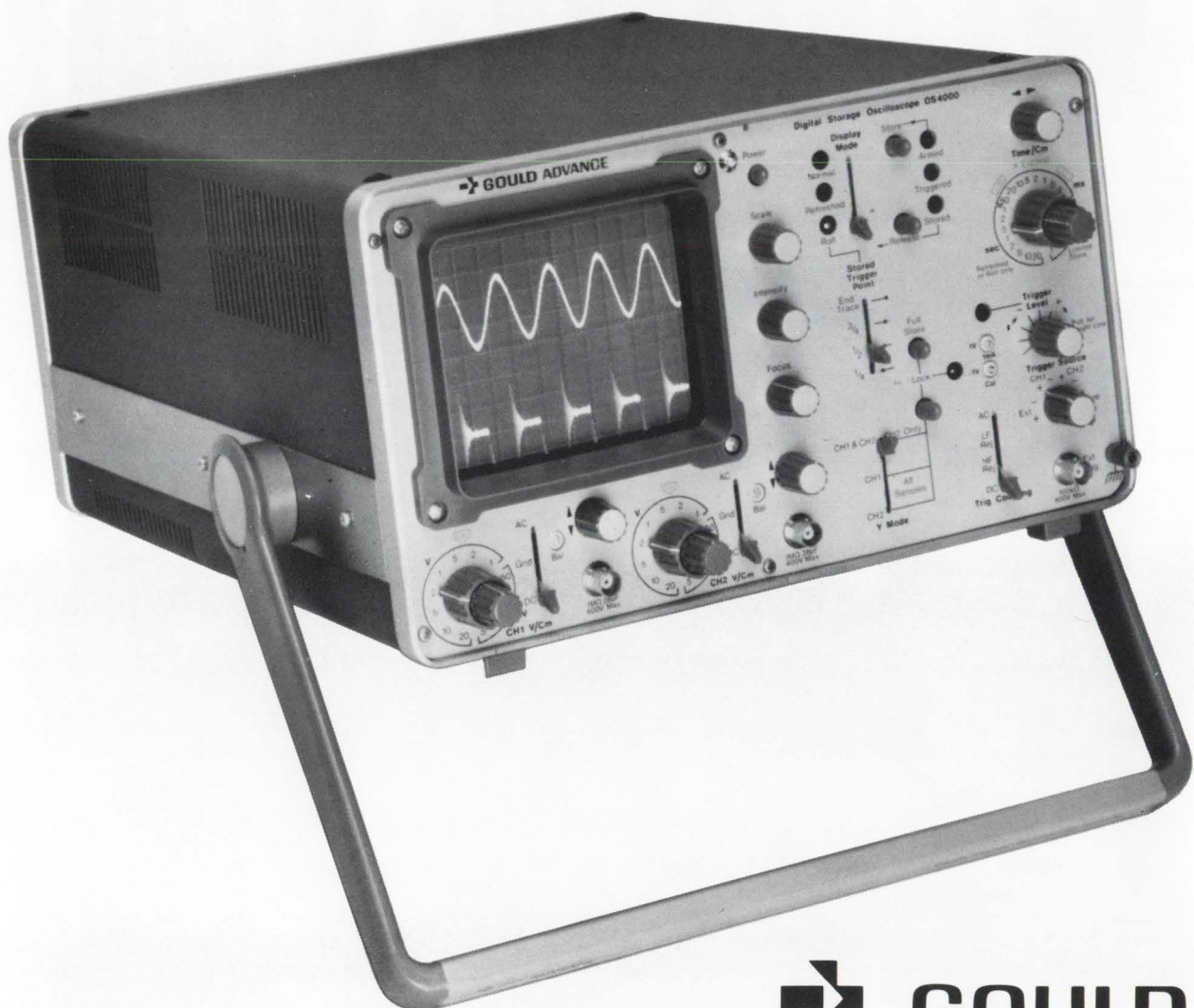

 **GOULD**
The product development company

CIRCLE NUMBER 142

Introducing push-button microprocessor system debugging.

HP's 1611A Logic State Analyzer ... Dedicated to all 8080 or 6800 based systems.*

View program flow in mnemonics. With CRT data and addresses selectable in either hexadecimal or octal formats and external lines in 1's and 0's.

Maintain testing control. LED indicators show status at all times. You can monitor system operation at normal speed or stop the microprocessor and give control to the 1611A for single or multiple keyed steps.

Enter data quickly and easily. The hexadecimal keyboard makes trigger and qualifier data entry as easy as operating a calculator. And the CRT display gives you a quick visual check on your entries.



Choose your display. Either mnemonic or absolute (op codes). Roll the display to view any 16-line slice of the 64-byte memory.

Pinpoint virtually any specific event. Trigger on address, data, or external signals... or on any combination of the three. You can also qualify the trigger by bracketing the address and opting to trigger on the nth occurrence of the trigger word. TRIGGER ENABLE and DISABLE keys act as arm and disarm circuits providing unparalleled pinpointing flexibility.

Move the display window. Delay up to 65,472 qualified clocks or memory transactions from the trigger word. Or, pre-trigger to see up to 63 bytes leading up to the trigger word (negative time).

Obtain program and timing data. Qualify the display with TRACE TRIGGER and see only those bytes that match your trigger inputs... all write instructions, for example. Press COUNT TRIGGERS and the 1611A displays the number of trigger occurrences between the TRIGGER ENABLE and TRIGGER DISABLE entries. Push TIME INTERVAL and you get a display of actual elapsed time between selected points in your program on your hardware.

The 1611A should be on hand when you start up your microprocessor-based system. Imagine the time you'll save with push-button operation and an unparalleled view of your system's operation; viewing things dynamically that you never could see before. And there's more... self test; trigger outputs to drive external equipment; error messages to warn of improper operation or setup; and the choice of two initial "μP personality modules" that let you tailor the 1611A to either 8080 or 6800 based systems.



Let HP's 1611A, priced at \$5,000**, help you speed development, production-line testing or service. Ask your local HP field engineer for all the details. Ask him about HP's digital seminars too. He can tell you when one will be held in your area and how you can attend.

*and more modules for other microprocessors to come.
**Domestic U.S.A. price only.

HEWLETT **hp** PACKARD

Sales and service from 172 offices in 65 countries.

1507 Page Mill Road, Palo Alto, California 94304
For assistance call: Washington (301) 948-6370, Chicago (312) 677-0400
Atlanta (404) 434-4000, Los Angeles (213) 977-1282

CIRCLE NUMBER 32

Managing the data domain.

Touch switches are

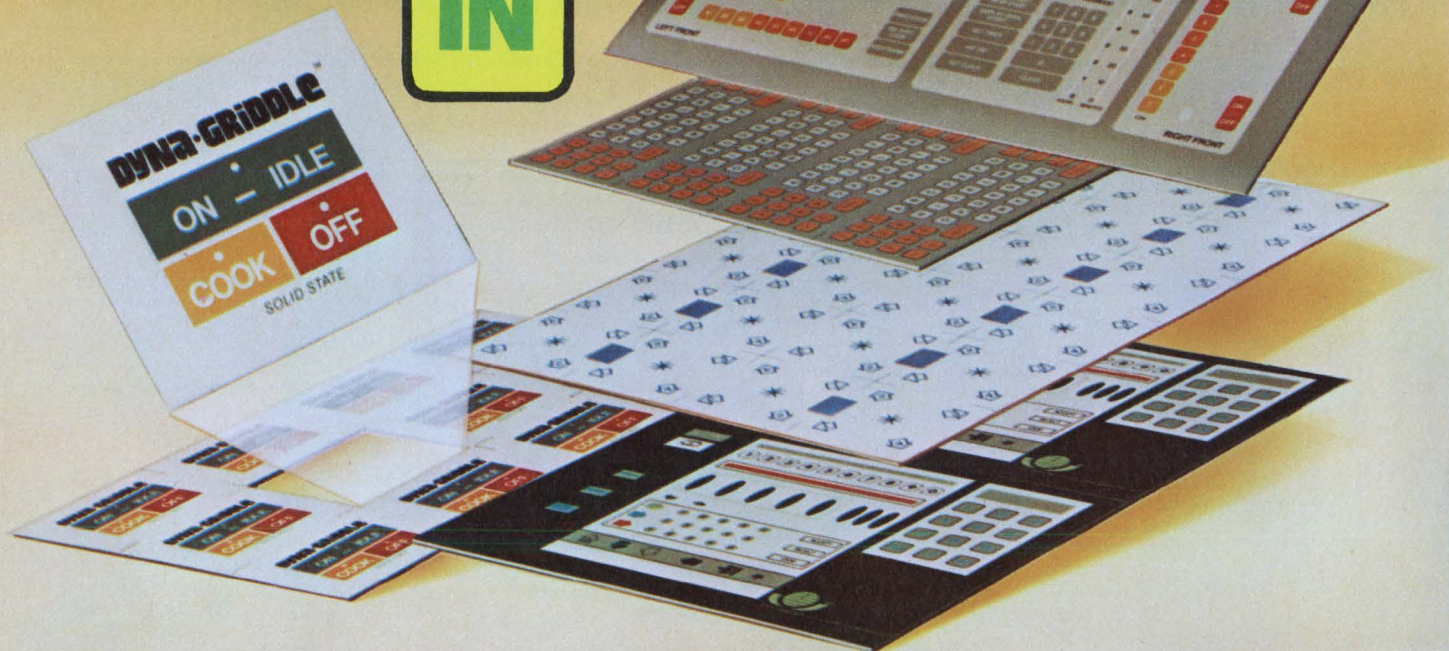

...and CENTRALAB has them NOW

When Centralab introduces touch switches you can be sure they're "In". Backed by 40 years of switch know-how, and after years of intensive research and testing, Centralab is now delivering, in batch-process volume, a complete touch switch system. We call it MONOPANEL.

MONOPANEL is a thin, light, flat, front panel subassembly containing micro-motion touch switches already mounted and interconnected . . . with LED's, nomenclature, graphics and colors to meet your functional and aesthetic requirements.

Batch-Processed For Economy With Quality

MONOPANELS are batch-processed as 11" X 17" master panels only .075" thick, each containing up to 700 switches. Every Monopanel is a complete, 100% pre-tested subassembly containing switches, front panel and graphics.

60,000,000 Cycles Without Failure!

The basic MONOPANEL switch has been operated for sixty million switching cycles without mechanical or electrical failure. And MONOPANEL has been tested and proven against 22 separate mechanical, electrical and environmental standards.

Custom Designed For Your Application

On each 11" X 17" panel you can custom-design individual boards to meet your front panel needs. The illustration

above shows just a few of the almost endless variations possible from each master panel.

Unlimited Graphics Available

The flat, smooth, front panel surface permits unlimited choice of graphics. Functions may be grouped by color, with 480 colors available. Thirty choices of type style and size. And whatever visual symbols meet your specific needs.

THIS IS MONOPANEL:

- A complete touch switch sub-assembly, ready to mount.
- All switches and graphics on a .075" thin panel.
- Flat, spill-proof surface wipes clean.
- Noiseless.
- 100% tested.
- Choice of terminations.
- Operating voltage: 50 V max.
- Operating current: 100 mA max.
- Contact resistance: 0.2 ohms typical.



CENTRALAB

Electronics Division
GLOBE-UNION INC.

5757 NORTH GREEN BAY AVENUE
MILWAUKEE, WISCONSIN 53201

Standard 12 and 16 position keyboards are available through Centralab Industrial Distributors. For more information on *custom* MONOPANELS, call Bill Klug, (414) 228-2604, or send for this **FREE** brochure today.



Quality Products For Your Design: Ceramic Capacitors • EMI/RFI Filters • Thick Film Circuits • Rotary, Slide and Pushbutton Switches
• Touch Switches • Potentiometers and Trimmers.

CIRCLE NUMBER 33

Time for decisions

When Charlie started his own company, he *was* everything and he *did* everything. During the day, he called customers and worked with vendors who kept "sensible" hours. At night, he designed, breadboarded, tested. People who knew him then deny it, but he must have found time to sleep once in a while and even to eat.

Those were maddening days. Even Charlie admits now that he worked awfully hard. But it was fun. It was exciting. And he built a fine, growing company. In time he was able to hire some engineers and technicians and secretaries. He even hired production-line workers so that he could do his own manufacturing instead of farming it out.

As his company grew, Charlie found himself doing less and less of the things he did in the early days. He spent very little time designing new instruments; he had engineers to do that. He didn't interview vendors; engineers did that. He didn't wire up breadboards; technicians did that. He didn't pitch customers; sales people did that. And he didn't type his own letters; a secretary did that. He spent his time making decisions. Or, rather, he was supposed to.

It didn't always happen. In the early days, Charlie made lots of decisions and he made them rapidly. He used the best information he had, knowing that the art of management is largely the art of making decisions with insufficient data. And he would decide.

Deciding wasn't a matter of choice. It was a matter of necessity. He had no one else to decide for him and if he couldn't make decisions—quickly—he couldn't survive in business. But things are different now. Since he doesn't have to design, breadboard, interview vendors or type letters, Charlie has lots of time to make decisions. Lots of time.

Of course, decisions are more important now; they're more weighty as they affect the success of scores of people, not just one. But they do take a long time. So lots of Charlie's people who can't sit around and wait are forced to guess what Charlie will decide on one matter so they can comply with his decisions on another. Thus, after Charlie has decreed that a new instrument must be ready for Wescon, his engineers may have to start designing while Charlie is still deciding whether the instrument should be a DVM or a counter. Or his people sit around and twiddle their thumbs.

Charlie's company isn't growing any more.



GEORGE ROSTKY
Editor-in-Chief

Go beyond the ordinary. Use Amphenol[®] connector systems.

Second best isn't good enough. Not when you have tough problems to solve. And solve right.

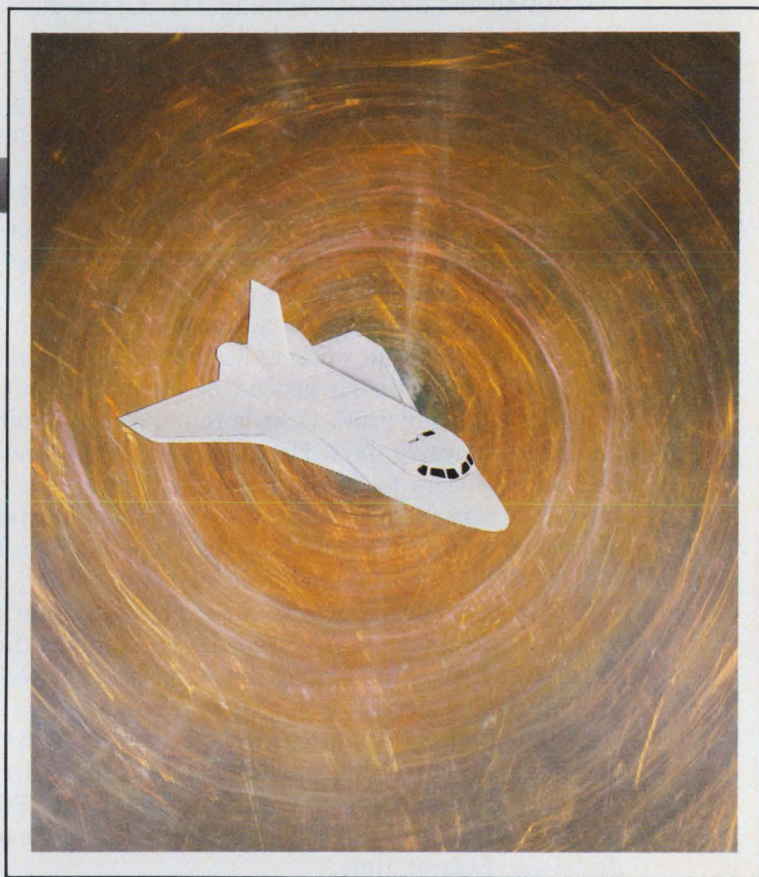

A connector's job isn't easy these days. Not with more stringent regulations to satisfy. More hazardous environments to face up to. And there are new and demanding kinds of products that use connectors.

Amphenol connectors help solve these problems. In thousands of ways. And every Amphenol connector solution is extraordinary in its own way, including presently available termination tooling.

That's how the connectors shown here do their work. Extraordinarily well. In consumer and business products. Data and word processing equipment. And aerospace

and military applications—and more.

It all happens because there's nothing ordinary about the way our connector specialists think. To them, your problem is their problem. To be solved swiftly, economically, completely. We'll even design specially required termination tooling.

The very best in connector solutions is yours for the asking. Just call us at (312) 986-2320 or write to: Amphenol North America Division, Bunker Ramo Corporation, Dept. C67B, 900 Commerce Drive, Oak Brook, Illinois 60521.



Three series of connectors qualified to MIL-C-26482/38999/83723. This family of 118, 418, and 518 Series use polymer discs for contact retention instead of troublesome metal clips.



Making the unmateable mateable. These input/output 17 Series connectors join two plug-ended or two connector-ended cables. Quick and easy.

Phase matching without the usual frequency range limitation. Broadband (dc-18 GHz) phase-adjustable SMA's. Easy screw adjustments instead of laboriously precise cable trimming.

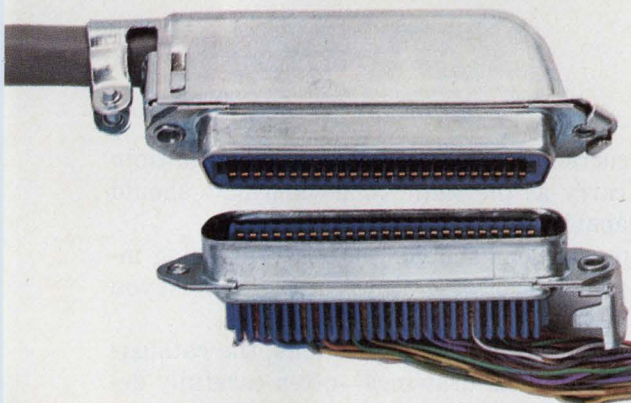
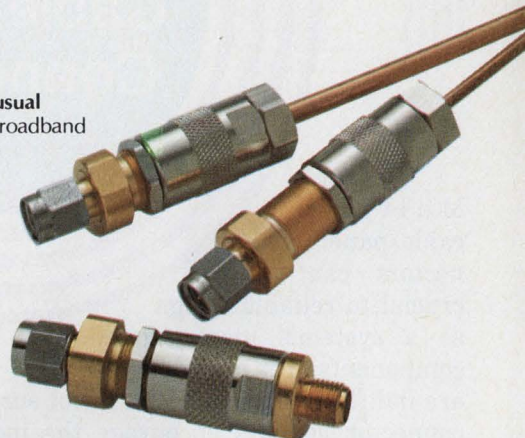

Beat the clock with solderless terminations. 157 Series Micro-Pierce® connectors. Proven reliability. Fast in the factory or the field.



Multiple optical interfaces in rack and panel configuration. Now the optical systems designer can put a variety of optical terminations together in a multichannel housing.



Sub-miniature connectors with a whole new kind of low-cost contact. The 223 Series with new machine-applied Econo-Tac™ contacts means rapid assembly and greater reliability.

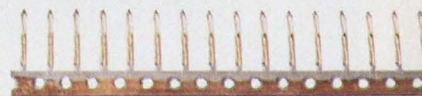
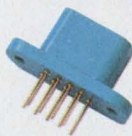

The right idea
at the
right time.

AMPHENOL



FOCUS

on Multipin Cable/Panel Connectors

Multipin cable/panel connectors can be as crucial to reliable design as a system's more exotic components. Yet many engineers are indifferent to connectors. Not surprisingly, some connector vendors encourage the indifference with glossy catalogs that say almost nothing about performance.

To predict performance and learn a connector's capabilities, there are several related questions that should be answered in the catalogs:

- What are the derating factors for high altitude, high ambient temperature and other extreme environmental conditions?
- What are the available material and design tradeoffs, and how do they affect contact resistance, life, voltage rating, mating forces and price?

Morris Grossman
Associate Editor

- What current can all the contacts in a multipin connector carry at the same time—and how should the load capability be derated?

- What precautions should you observe during installation; what special assembly procedures must you follow?

Instead of answering these questions, the catalogs are full of mechanical drawings—often carefully detailed down to the pin tolerances—which don't do you much good.

One notorious example is a well known connector company's catalog, which contains 30 pages of promotional puffery and only a three-page selection guide.

"When the engineer attempts to find the right product based only upon catalog information over or underspecification results," advises John Cameron,



The future is now with fiber-optics connectors. Four-channel PV-style connectors made by ITT Cannon (right) and multiple and single-channel units from AMP (left) are only a few of the available types in this promising field. About 10 companies have, or will soon have, connectors for fiber-optic systems. But sloppy quality will not do: Precision alignment of mating optical-fiber cables is a prime requirement for low-loss coupling.

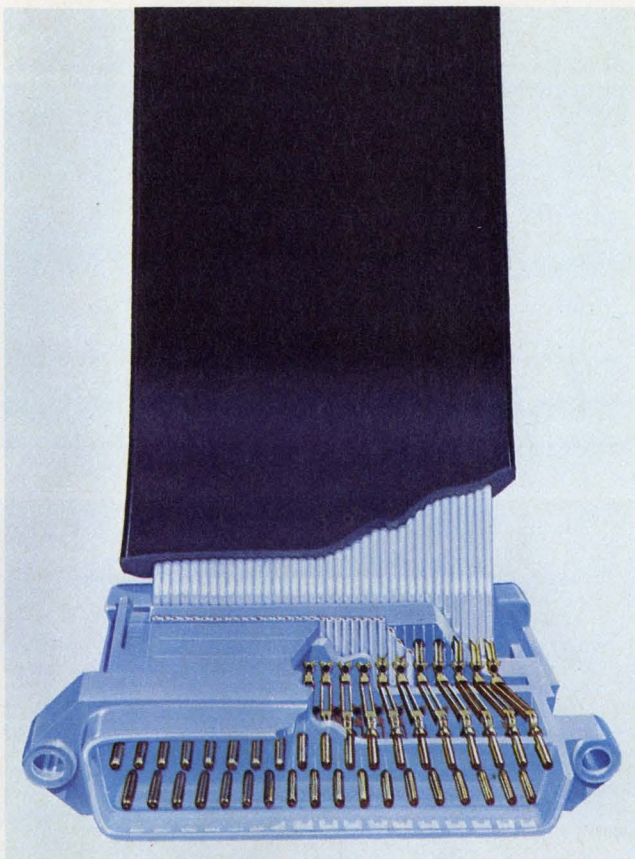

Insulation-displacing, wire-terminating methods for attaching connectors offer many advantages: rapid, solder-free connections made with mass-termination tools in the factory, or with simple hand tools in the field, and easy field repairs and reduced labor costs. Flat cables in T&B/Ansley's Blue Macs D connectors (above) help avoid wiring errors and simplify the termination tooling. But conventional round wires fit neatly into Amphenol's 157 Series Micro-Pierce connectors (top right), TRW Cinch's Superibbon connectors (middle right) and Viking Industries' Thorkom circular thermoplastic-shelled and Snap-Lock metal-shelled units (bottom right).

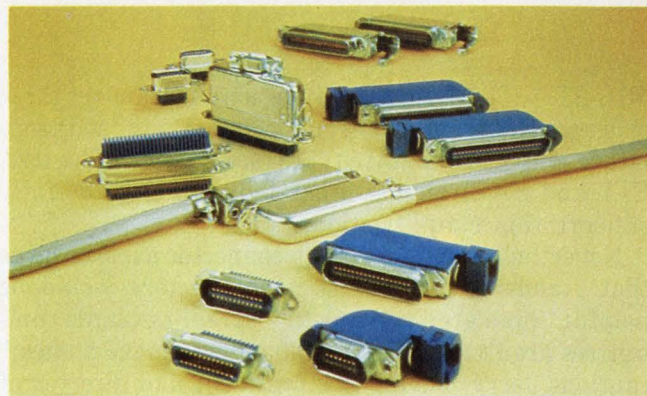

engineering manager at Amphenol, Bunker Ramo Corp. "Catalogs don't always include data on performance under actual operating conditions."

Papa knows best?

Many connector manufacturers answer criticism of their catalogs this way: "We have tons of data that define life, environment, plating and other specs. However, we don't put them in the catalog because it would be too thick; nevertheless, the information is still available.

"We invite the user to come out and meet our engineers and study our test data. And we have applications engineers ready to travel all over the country. Why don't design engineers take advantage of our experts more often?"

Engineers retort: "We aren't interested in a sales snow job. Give us the facts in written form. Verbal blandishments don't impress us. We are professionals

trained to make up our own minds based upon published data; we're not afraid of thick catalogs."

But even with thick catalogs, a serious problem would still exist: There are no standard definitions, standard tests or standard terminology for industrial connectors. Consequently, interpreting the data and comparing among competing designs remains a formidable task.

What's worse, a widely acceptable set of standards isn't on the horizon, despite the continuous efforts of standards committees from the International Electrotechnical Commission (IEC), Society of Automotive Engineers (SAE), Electronic Industries Association (EIA) and other industrial groups. Corporate self-interest seems to get in the way. Even the military, with its tremendous purchasing clout, has a difficult time setting standards.

Only recently, after years of spec proliferation, has the government reduced the large number of connector specs to a manageable few. Under Section 101 of

MIL-STD-1353A, four surviving standards cover three classes of round multipin connectors—standard, miniature and subminiature types (see Table 1). The IEC, EIA and SAE, among other industry groups, fully support this simplification.

Nevertheless, though many connector experts agree that standards for industrial connectors would be helpful, some aren't completely sure. Standards committees aren't restrained by "having to make a buck," cautions Jerry Selvin, vice president and director of engineering at ITT Cannon. Consequently, standardized specs have been known to force costs up unnecessarily, or even make the connector impossible to manufacture.

"And despite the large amount of work that has been done to establish test conditions, especially by the military, little correlation exists between almost any test conditions and the actual working environment," Edward Rowlands, director of research and design at TRW Cinch, points out.

Cannon engineers agree. Most of the problems with life and reliability result from the inability to fathom what the actual environment is, they say. Standard tests are performed in a certain sequence—salt-spray, durability, vibration, shock, etc.—but these stresses don't occur in a set order in real life.

In use, the various stresses can occur simultaneously or in random sequences. Consequently, individually sequenced tests in the laboratory don't simulate reality closely and can provide highly unrealistic results.

For example, if you test for contact resistance first, then run through a thermal-shock test, your connector may pass both tests easily. Reverse the sequence—test for resistance after the shock test—and the connector may fail the resistance test miserably.

Fewer and better connector types

Even though plant and lab test conditions almost never exactly simulate real conditions, they're better than nothing. Standardization could force industrial-connector makers to concentrate on improving reliability and lowering cost—like the military-connector makers—instead of proliferating new types. And, of course, marketing and distributing problems also would be reduced: Less inventory, more availability—all types could be more readily second-sourced—and higher production volume can lower prices further.

The reduction in military-connector types already has resulted in concentrated improvement efforts. One major investment, according to Cameron of Amphenol, is in polymer development to improve such dielectric specs as voltage-breakdown, mechanical-strength, creep and aging characteristics.

Pioneered by Amphenol, polymers, such as polyarylsulfone (see Table 2), are now widely used in contact-retention systems in place of conventional



Strip-form-contact techniques allow rapid wire-to-pin termination for industrial-grade multipin connectors. Burndy's rectangular Hyfen Series (top) and Molex's line of nylon and phenolic-housed connectors exemplify these ways to make and terminate pins at low cost and with minimum manual labor.

clips—particularly in circular and to a lesser degree in rack and panel units. The polymer reduces not only size and weight, but also cost.

Another trend is toward leaded nickel/copper as a base material for contacts in place of brass, beryllium/copper and phosphor/bronze. Less expensive and more easily machined, leaded nickel/copper also resists the effects of films and oxidation (its oxide comes off easily), solders readily and produces low contact resistance, according to Cameron. Its spring stability is on a par with beryllium/copper.

Brass spring material is conventional for long-term ambient temperatures to about 70 C for environmentally undemanding applications. Phosphor/bronze, which is more expensive, can take temperatures to about 100 C before it starts losing its spring tension. And beryllium/copper, still more expensive, can tolerate about 125 C.

With the high price of gold, the era of 100-millionths gold-plating thickness is over: The military now accepts 50-millionths and may, within a few years, go as low as 30—or even accept selective plating.

Already, 20-to-30-millionths gold plating is wide-

ENVIRONMENTAL SIMULATOR TEST CYCLE

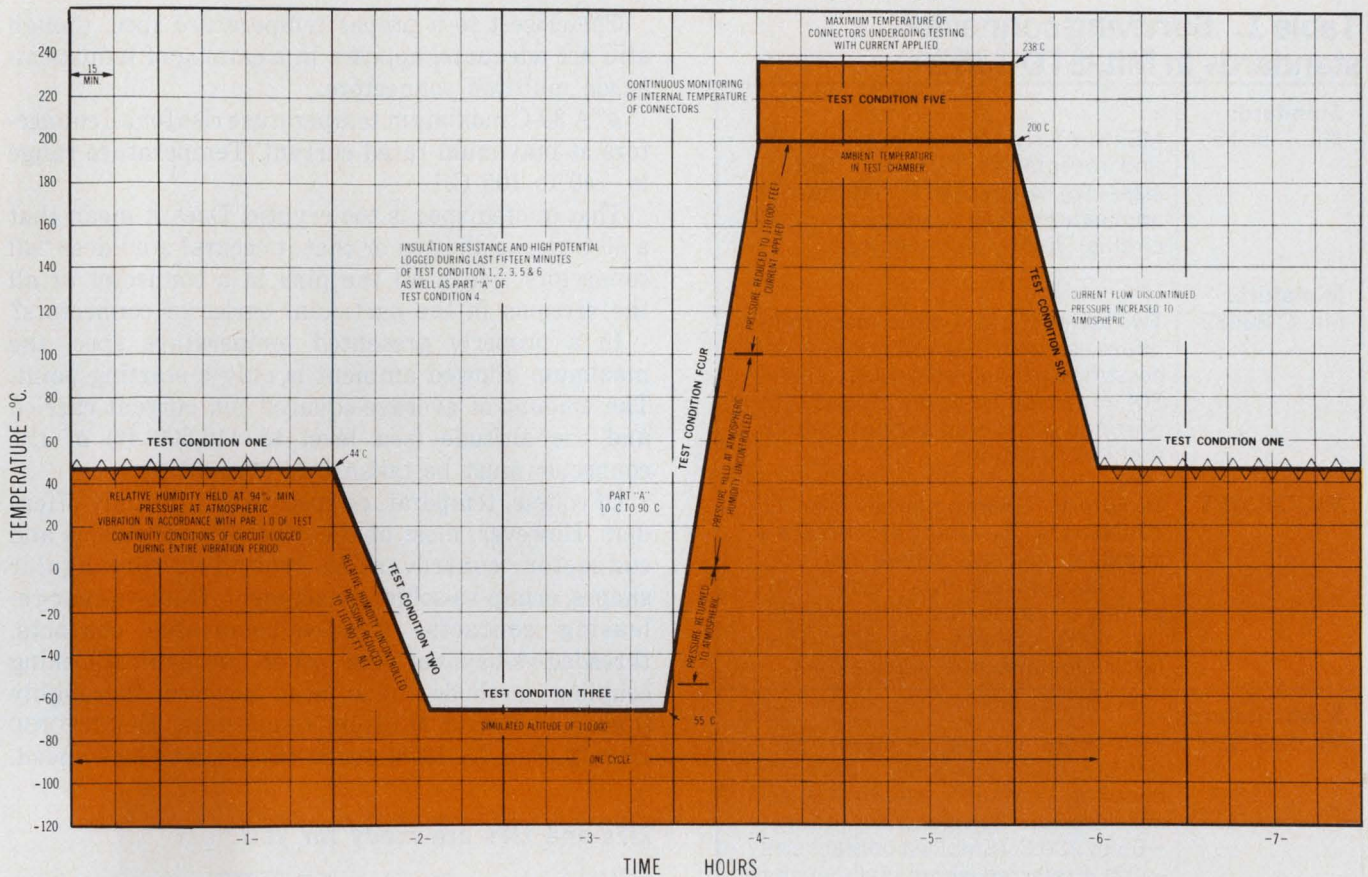

In the absence of widely accepted standard industrial test procedures, many connector manufacturers establish their own tests to maintain the quality of their products, as illustrated by this thermal and environmental test cycle

(furnished by the Amphenol Connector Div.). In addition, mechanical-stress testing—shock and vibration—also must be performed to simulate as closely as possible the physical impact of field conditions.

spread for high-quality industrial applications, and bright-tin/lead plating is catching on. A line of round environmental connectors from Amphenol for the trucking and marine industry features bright-tin/lead contacts.

"It is better left to the connector manufacturer to select the particular contact and plating material to meet the customer's need," advises Martin C. Sposili of Bendix. "The customer should specify the performance required." And Donald J. Levine, director of engineering of Kings Electronics, agrees: "It's possible for two connectors to have the same base metal, platings and contact dimensions, and yet the contact resistance can be widely different. The variables are many and the interrelationships complicated, so let the vendor make the choice."

Who can you trust?

But can the manufacturer be objective? What if he doesn't market what you really need? Will his salespeople tell you to go elsewhere, or will they try to sell you what they have? You won't know, unless you educate yourself to at least understand what's possible

and available.

Consider temperature specs, for example. A favorite ploy reads as follows:

- "This series is manufactured to the highest class within MIL-C-83723, and the shell operates in the temperature range of -65 to 200 C."

What about the pins and insulating material? Not a word is mentioned anywhere.

Another maneuver simply goes like this:

- "Operating temperature per MIL-C-26482 is -55 to 200 C."

But what you should know, and are not clearly told, is that this spec merely means that the connector has passed some thermal tests—perhaps, a thermal shock test, cycled five times between -55 and 200 C and kept only about a half-hour at each extreme, without any load current. Or maybe the spec is a so-called "life test" that consists of exposing a connector for 1000 h at 200 C—again with no load current. Such a spec is hardly an assurance that the connector can operate indefinitely at 200 C with maximum load.

This temperature spec incorrectly implies that the connector can be used at the extremes of -55 C and 200 C under full load. But even the best

Table 1. Surviving connector standards in MIL-STD-1353A

Standard: MIL-C-5015	MS (formerly AN) connectors, plugs and receptacles. (Smallest contact size—16). Often used in commercial applications. The granddaddy of all circular military connectors.
Miniature: MIL-C-26482	Two series of quick-disconnect, miniature, circular connectors and accessories. (Smallest contact size—20). Preferred for many ground support and also some airborne equipment applications.
MIL-C-83723	Miniature environmental circular connectors, bayonet or threaded coupling and associated contacts and accessories over same temperature range as MIL-C-38999. (Smallest contact size—20). Preferred for airborne applications.
Subminiature: MIL-C-38999	Two series of subminiature, high-density, quick-disconnect, bayonet-coupling, circular, environmental connectors. Temperature range: -65 to 200 C. (Smallest contact size—22). Preferred where high-density connectors are needed.

Table 2. Cost / life comparison of connector insulating materials

Material	*Reliable life at 200 C hours	Material cost/lb	Cost/life cost/lb/hr
Diallyl phthalate	45	\$ 0.75	\$0.01670
Glass-filled epoxy	1500	1.75	0.00117
Polyarylsulfone	70,000	25.00	0.00036
Silicone	**7500	3.00	0.00040

Courtesy of Amphenol Connector Div.

*The time to lose 8% of original weight—Amphenol TM-282.

**The time to lose 50% of original elongation—Dow Corning.

beryllium/copper materials can't take more than 125 C for extended periods. Thermal tests—brief compared to the expected current-carrying life of most connectors—may produce only about 15% spring relaxation. Moreover, connector contacts are usually pre-tensed an extra amount during fabrication to account for this expected initial relaxation during testing. But over a long period at 200 C, excessive relaxation can occur.

The closest to a proper temperature spec, though still not adequate, appears in a catalog of industrial-grade multipin connectors:

■ "A 30-C maximum temperature rise for all connectors at maximum rated current. Temperature range is -40 to 105 C."

That quoted spec is too cryptic. Does it mean that a 30-C rise is allowed or that it occurs? And does "all connectors" mean all the pins in a connector or all the versions in the particular series of connectors?

In a properly presented temperature spec, the maximum allowed ambient is only a starting point. The amount of average-squared pin current carried and the altitude (sea level to 110,000 ft) of the connector must be taken into account.

Of course, temperature specs aren't the only offenders. However, most of the other spec problems and connector controversies—round-vs-rectangular shapes, crimp-vs-solder attachment, front-vs-rear-releasing contacts, fixed-vs-removable contacts, threaded-vs-bayonet and other mechanical-locking coupling methods—have been covered thoroughly (Focus on Round Multipin Connectors, *ELECTRONIC DESIGN*, Feb. 15, 1974, pp. 54-62). So, let's look ahead.

ZIFs and LIFs are ready for you

Although zero-insertion-force (ZIF) connectors have been around for many years, high cost has restricted their application. Nevertheless, where you'll need many pins, as in computers and data processing, and especially where the connectors must be easily and reliably mated—and frequently—look into the ZIF approach.

The low coupling durability of low-cost connectors—about 50 mating cycles—may be adequate for a majority of cable/panel-connector applications. Once connected, they come apart only for occasional maintenance. Military-type connectors usually spec out at 500 cycles. But ZIFs can take tens of thousands of matings—50,000 isn't unreasonable.

During insertion or withdrawal of mating units, a ZIF's contacts don't rub against each other, which accounts for their high coupling durability. And when ZIFs link units, their lever and cam mechanisms can apply high normal forces and wiping action to opposing contact surfaces and ensure reliable connections.

For example, the CR series of rack-and-panel ZIFs by AMP incorporates a mechanical-advantage, lever-actuated device. Contacts withdraw behind a protective barrier when the connector is open for insertion. Mated-contact forces are typically 150 g for 40, 120 or 156 contacts, and several thousand mating cycles produce no degradation.

ITT Cannon's DL Instamate rectangular connectors handle 60, 96 or 156 pins, use hermaphroditic contacts, can be machine wire-wrapped, come in both cable-to-cable and cable-to-panel versions, and can handle

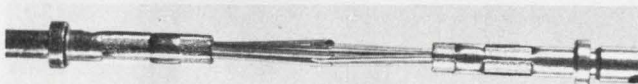
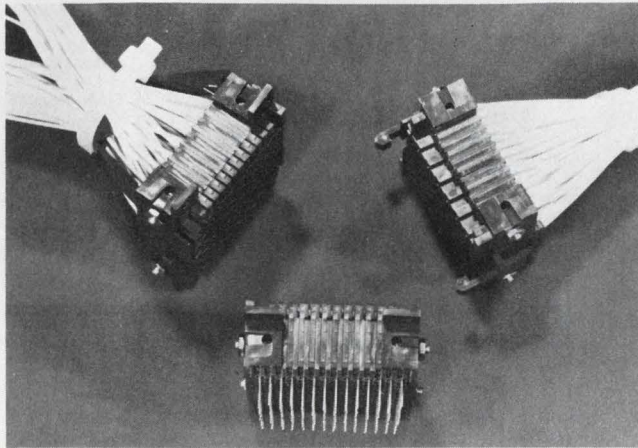
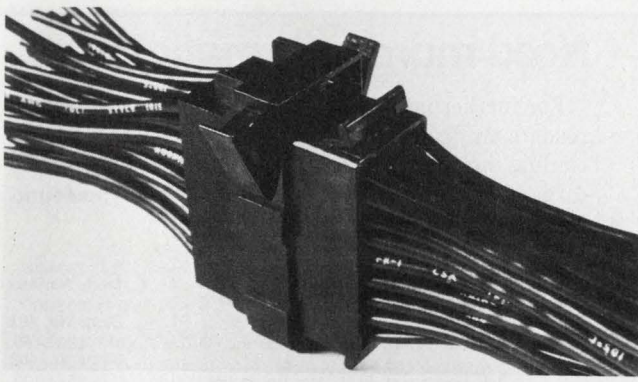

Zero-insertion-force and low-insertion-force connectors by Molex (top) and Bendix (center and bottom) allow high mating-cycle capabilities. In ZIF connectors, the mating contacts don't touch during insertion and removal. With no rubbing, mating life is very long. And when actuating cams are closed, the two connector housings lock together positively. The LIF connectors have low mating forces, yet the brushlike contacts provide reliable multipoint electrical paths.

thousands of mating cycles.

Other companies—like Burndy, Dale, GTE-Sylvania and Molex—are in (or will soon enter) the ZIF market. Bendix, however, has taken a different tack—low-insertion-force (LIF) connectors—with B³ (bristle-brush-bunch, say it fast) contacts. Multiple-wire brush contacts allow engagement with only about 0.8 oz per contact—less than 10 lb are needed for a 200-contact unit—and have at least a 20,000 mating-cycle capability. As pin numbers increase, the market for both LIF and ZIF connectors should prosper.

Mass termination is pushed

ZIF lines may languish for now, but mass-termination connectors, also far from new, are being pushed vigorously. At the same time, however, this push is

being resisted by many designers who are reluctant to switch to flat cable and to accept the idea that insulation-displacement contacts (IDCs) are reliable.

Multibreakout harnesses don't fit into flat-cable systems neatly. Flat-cable systems require rather drastic changes from individually wired packages. And though sharp terminals poking through the wire insulation have proved very reliable in extensive testing by many companies, it's difficult for many designers, brought up on soldering and wire wrapping, to accept them.

Nevertheless, T&B/Ansley offers the Blue Macs series of mass-terminated "D" connectors, whose one-piece design quickens installation and features self-aligning cable grooves over their Tulip contacts. The contacts have four mating points per conductor. Connectors, male and female, come in 9, 15, 25 and 37-terminal versions.

ITT Cannon with its Mas/Ter system, Kings Electronics with its Series-050 flat-cable system and many other companies market mass-termination systems. While each company has proprietary tooling for terminating, designers prefer to second-source without having to use a different set of tools for each system.

Vector Electronics satisfies this preference with its P187 terminating system. It can accommodate many IDCs from companies like T&B/Ansley, 3M, Stanford Applied Engineering and AMP.

1980 advances to 1978 in fiber optics

While ZIFs and mass-terminated connectors move up from the back burner, gradually, connectors for fiber-optic systems are taking giant steps forward. Early predictions (about 1970) put fiber optics in wide use by 1980, but rapid advances in LED technology, lasers and fiber-optic materials have moved those predictions up to 1978, according to L. Wayne Oliver, vice president of ITT Cannon. "Today, no fewer than 10 firms offer commercial single-fiber LED systems, compared to only three firms last year."

Single-fiber cable development has brought loss levels down to about 10 dB/km, but commercially available connectors still lose about 1 dB (though figures like 0.1 dB are reported in lab setups). However, 1 dB is attained only when the optic fibers are precisely aligned: An axial displacement in a splice or connector of half the fiber diameter (measured in μm) causes losses of as much as 6 dB.

Consequently, fiber-optics connectors must have very tight tolerances. Furthermore, the gap between mating fiber surfaces must be less than half a fiber diameter or the losses will be even greater than 6 dB.

ITT Cannon, particularly active in the fiber-optics connector field, now offers several multichannel systems. Its DPK (D-shaped) and PVF (round) connectors specify optical-coupling losses of 3 dB for fiber-to-fiber, 6 dB for LED-to-fiber, and 8 dB for fiber-to-



In the round, multipin military-connector field—MIL-C-26482/38999/83723—Amphenol (top) and Bendix (bottom) compete head on, and both feature dielectric pin-retention methods.

detector interfacing. Complete cable assemblies handle up to 30 Mb/s over 250-ft lengths; higher rates and greater distances can be traded off.

AMP, Amphenol, Burndy, Deutch and others all make a good case for the future of fiber-optic systems. Fiber-optics connectors are immune to stray RFI/EMI fields, provide security (difficult to tap) and eliminate rf-radiation and cross-talk problems. Further improvements in price and performance, and the firming up of standards, currently under way, will open up the market very soon. ■■

Bibliography

Buszkiewicz, B., "Don't Overload Those Connectors," *Electronic Design*, Sept. 27, 1973, pp. 90-910.

Crane, J., "Performance and Fabricability Requirements for Copper-Base Alloys," Society of Manufacturing Engineers, Dearborn, MI 48128, MS 76-363, 1976.

Grossman, M., "Focus on Round Multipin Connectors," *Electronic Design*, Feb. 15, 1974, pp. 54-62.

Lawrence, R., *Electrical/Electronic Interconnection Systems*, Deutch Electronic Components Division, Municipal Airport, Banning, CA 92220, Third Edition, 1975.

"Wire-Brush Connector Contacts Mate Easily," *Electronic Design*, Mar. 29, 1977, p. 128.

Need more information?

For further information on cable/panel connectors readers may consult the manufacturers listed here by circling the appropriate numbers on the reader service card. More vendors and information may be found in **ELECTRONIC DESIGN'S GOLD BOOK**.

- Aid Electronics Inc., 2618 Rock Island, Irving, TX 75060. (214) 259-4761. **Circle No. 480**
- Airborn Inc., 4321 Airborn Dr., Addison, TX 75001. (214) 233-2000. **Circle No. 481**
- Alden Products Co., 117 N. Main St., Brockton, MA 02403. (617) 583-0160. **Circle No. 482**
- AMP Inc., 449 Eisenhower Blvd., Harrisburg, PA 17105. (717) 564-0100. **Circle No. 483**
- Amtronics Inc., 247-27 St., Brooklyn, NY 11232. (212) 768-9300. **Circle No. 484**
- Armel Electronics, 1601 75, North Bergen, NJ 07047. (201) 869-4300. **Circle No. 485**
- Avid Electronics Corp., Box 426, Baldwin, NY 10505. (914) 628-6952. **Circle No. 486**
- Belling & Lee Ltd., Great Cambridge Rd., Enfield EN 13 RY, England. 01-363-5393. **Circle No. 487**
- Bendix Corp., Electrical Components Div., Sherman Ave., Sidney, NY 13838. (607) 563-9511. **Circle No. 488**
- Breeze-Illinois Inc., Main & Agard St., Wyoming, IL 61491. (309) 695-2511. **Circle No. 489**
- Bud Radio Inc., 4605 E. 355 St., Willoughby, OH 44094. (216) 946-3200. **Circle No. 490**
- Bunker Ramo, Industrial Div., 1830 S. 54 Ave., Chicago IL 60650. (312) 242-1000. **Circle No. 491**
- Bunker Ramo Corp., Amphenol Connector Div., 2801 S. 25 Ave., Broadview, IL 60153. (312) 345-9000. **Circle No. 492**
- Burndy Corp., Richards Ave., Norwalk, CT 06856. (203) 838-4444. **Circle No. 493**
- CEM Co. Inc., 24 School St., Danielson, CT 06239. (203) 774-8571. **Circle No. 494**
- Circuit Assembly Corp., 3169 Red Hill Ave., Costa Mesa, CA 92626. (714) 540-5490. **Circle No. 495**
- Cole-Hersee Co., 20 Old Colony Ave., South Boston, MA 02127. (617) 268-2190. **Circle No. 496**
- Continental Connector, 34-63 56 St., Woodside, NY 11377. (212) 899-4422. **Circle No. 497**
- Control Data Corp., 31829 Latienda Dr., Westlake Village, CA 91361. (213) 889-3535. **Circle No. 498**
- Craig Systems Corp., 360 Merrimack St., Lawrence, MA 01842. (617) 688-6961. **Circle No. 499**
- Cupwine Electronics, 7970 Hollywood Way, Sun Valley, CA 91352. (213) 768-0667. **Circle No. 500**
- Dale Electronics, 1376 28 Ave., Columbus, NE 68601. (402) 564-3131. **Circle No. 501**
- Detoronics Corp., 10660 E. Rush St., South El Monte, CA 91733. (213) 579-7130. **Circle No. 502**
- Deutsch Co., 700 Hathaway St., Banning, CA 92220. (714) 849-7844. **Circle No. 503**
- DuPont De Nemours El., 1007 Market St., Wilmington, DE 19898. (302) 774-2421. **Circle No. 504**
- H.H. Eby Co., 4701A Germantown Ave., Philadelphia, PA 19144. (215) 842-3000. **Circle No. 505**
- Elco Corp., 2250 Park Pl., El Segundo, CA 90245. (213) 675-3311. **Circle No. 506**
- Elecpac Inc., Main 1 St., Cary, IL 60013. (312) 639-2307. **Circle No. 507**
- Electronic Data Controls Corp., 715 N. Cherry St., Winston-Salem, NC 27101. (919) 722-6156. **Circle No. 508**
- Electronic Seals Co., 13760 Saticoy St., Van Nuys, CA 91402. (213) 873-4982. **Circle No. 509**
- Empire Products Inc., CAM-LOK Div., 10540 Chester Rd., Cincinnati, OH 45215. (513) 771-3171. **Circle No. 510**
- Ercona Corp., 2492 Merrick Rd., Bellmore, NY 11710. (516) 781-2770. **Circle No. 511**
- Excel Products Co., Inc., 401 Joyce Kilmer Ave., New Brunswick, NJ 08903. (201) 249-6600. **Circle No. 512**
- General Connector Corp., 81 Bridge St., Newton, MA 02158. (617) 244-5706. **Circle No. 513**
- General Staple Co., Inc., Autosplice Div., 220 E. 23 St., New York, NY 10010. (212) 674-4369. **Circle No. 514**
- G & H Technology Inc., 1649 17 St., Santa Monica, CA 90404. (213) 451-1631. **Circle No. 515**
- GTE Sylvania Inc./Parts Div., 816 Lexington Ave., Warren, PA 16365. (814) 723-2000. **Circle No. 516**
- Gulton Industries Inc., Connector Div., 6400 Roland St., Buena Park, CA 90621. (714) 523-3480. **Circle No. 517**
- Hermetic Seal Corp., 4232 Temple City Blvd., Rosemead, CA 91770. (213) 283-0411. **Circle No. 518**
- Hoffman Engineering Corp., 183R Sound Beach, Old Greenwich, CT 06870. (203) 637-1719. **Circle No. 519**
- Hughes Aircraft Co., Connecting Devices Div., 17150 Von Karman Ave., Irvine, CA 92714. (714) 549-5701. **Circle No. 520**
- Hypertronics Corp., 154 Great Rd., Stow, MA 01775. (617) 897-3236. **Circle No. 521**
- Industrial Elec. Hardware Corp., 109 Prince St., New York, NY 10012. (212) 677-1881. **Circle No. 522**

ITT Cannon Electric, 666 E. Dyer Rd., Santa Ana, CA 92702. (714) 557-4700.
Circle No. 523

Jan Hardware Mfg. Co. Inc., 47-27 36 St., Long Island City, NY 11101. (212) 361-0800.
Circle No. 524

Javex Electronics, 9509 Oak Glen Rd., Cherry Valley, CA 92223. (714) 845-3986.
Circle No. 525

E. F. Johnson Co., 299 Tenth Ave. SW, Waseca, MN 56093. (507) 835-2050.
Circle No. 526

Kings Electronics Co. Inc., 40 Marbledale Rd., Tuckahoe, NY 10707. (914) 793-5000.
Circle No. 527

Kolton Electric Mfg., 135 NJ Railroad Ave., Newark, NJ 07105. (201) 344-4622.
Circle No. 528

Lemo USA Inc., 2015 Second St., Berkeley, CA 94710. (415) 548-1966.
Circle No. 529

Malco-A Microdot Co., 12 Progress Dr., Montgomeryville, PA 18936. (215) 628-9800.
Circle No. 530

Matrix Science Corp., 435 Maple Ave., Torrance, CA 90503. (213) 328-0271.
Circle No. 531

Methode Electronics Inc., 7447 W. Wilson Ave., Chicago, IL 60656. (312) 867-9600.
Circle No. 532

Microtech Inc., 777A Henderson Blvd., Folcroft, PA 19032. (215) 532-3388.
Circle No. 533

Molex Inc., 2222 Wellington Ct., Lisle, IL 60532. (312) 969-4550.
Circle No. 534

3M Co., Electronic Prod. Div., 3M Center, St. Paul, MN 55101. (612) 733-1100.
Circle No. 535

D. G. O'Brien Inc., 500 Cochituate Rd., Framingham, MA 01701. (617) 872-6596.
Circle No. 536

Philips Inds., Electronic Components and Materials Div., Eindhoven, the Netherlands.
Circle No. 537

Positronic Inds., Inc., 208 W. Center, Rogersville, MO 65742. (417) 753-2851.
Circle No. 538

Richey Electronics Inc., 10871 La Tuna Canyon Rd., Sun Valley, CA 91352. (213) 768-3800.
Circle No. 539

Ronor Systems Inc., 321 Sandbank Rd., Cheshire, CT 06410. (203) 272-6847.
Circle No. 540

Milton Ross Co., 511 Second St. Pike, Southampton, PA 18966. (215) 355-0200.
Circle No. 541

Rowe Industries Div., 6225 Benore Rd., Toledo, OH 43612. (419) 729-9761.
Circle No. 542

Seaelectro Corp., 225 Hoyt St., Mamaroneck, NY 10543. (914) 698-5600.
Circle No. 543

Seaelectro Ltd., Walton Rd., Farlington Portsmouth Hants, P.O. 61TB, England. 070-187-3211.
Circle No. 544

Sealtron Inc., 9705 Reading Rd., Cincinnati, OH 45215. (513) 733-8400.
Circle No. 545

SGL Industries Inc., SGL Electronics Div., 300 Harvard Ave., Westville, NJ 08093. (609) 456-7300.
Circle No. 546

Showa Musen Kogyo Co., Ltd., No. 5-5 6-Chome Togoshi, Shinagawa-Ku, Japan. (03) 785-1111.
Circle No. 547

Stanford Applied Engineering Inc., 340 Martin Ave., Santa Clara, CA 95050. (408) 243-9200.
Circle No. 548

Superior Electric Co., 3000 Middle St., Bristol, CT 06010. (203) 582-9561.
Circle No. 549

Symbolic Displays Inc., 1726 McGaw Ave., Irvine, CA 92714. (714) 546-0601.
Circle No. 550

T&B/Ansley Corp., 3208 Humboldt St., Los Angeles, CA 90031. (213) 223-2331.
Circle No. 551

T&E Industries Inc., 422 Alden St., Orange, NJ 07050. (201) 672-5454.
Circle No. 552

Teradyne Inc., 183 Essex St., Boston, MA 02111. (617) 482-2700.
Circle No. 553

Testron Inc., 2204 Foster Ave., Wheeling, IL 60090. (312) 775-2477.
Circle No. 554

Thomson-CSF, 23 rue de Courcelles-BP 96-08, 75362 Paris Cedex 08, France. (1) 25652-52.
Circle No. 555

T.J. Electronics, 2300A Baird Rd., Box 5281, Arlington, TX 76011. (817) 469-1521.
Circle No. 556

Triangle Electronic Mfg. Co. Inc., 182 N. Hamilton St., Poughkeepsie, NY 12602. (914) 471-5020.
Circle No. 557

Tri State Electronics Corp., Stiles & Park Aves., P.O. Box 236, Maple Shade, NJ 08052. (609) 779-2440.
Circle No. 558

TRW, Cinch Connector, 1500 Morse Ave., Elk Grove Village, IL 60007. (312) 439-8800.
Circle No. 559

Ultra Electronics Components Ltd., Fassetts Rd., Loudwater, Bucks, England. 0494 26233.
Circle No. 560

Union Carbide Corp., Metals Div., 270 Park Ave., New York, NY 10017. (212) 551-3763.
Circle No. 561

Vector Electronics Co., 12460 Gladstone Ave., Sylmar, CA 91342. (213) 365-9661.
Circle No. 562

Vero Electronics Inc., 171 Bridge Rd., Hauppauge, NY 11787. (516) 234-0400.
Circle No. 563

Viking Inds. Inc., Standard Products Div., 21001 Nordhoff St., Chatsworth, CA 91311. (213) 341-4330.
Circle No. 564

Viking Inds. Inc., 9324 Topanga Canyon Blvd., Chatsworth, CA 91311. (213) 882-6275.
Circle No. 565

Waldom Electronics Inc., 4637 W. 53 St., Chicago, IL 60632. (312) 585-1212.
Circle No. 566

Western International Inc., Connector Div., 72 N. Broadway, Yonkers, NY 10701. (914) 969-5888.
Circle No. 567

Wilhelm Harting, Werk für Elektrotechnik und Mechanik GmbH, Postfach 104-106, 4992 Espelkamp, Germany. 057-72 3071.
Circle No. 568

Winchester Electronics, 2 Main St./Hillside, Oakville, CT 06779. (203) 274-8891.
Circle No. 569

STAMP OUT "almost right" Trimmer Capacitors

—specify all-sapphire
units that never vary!

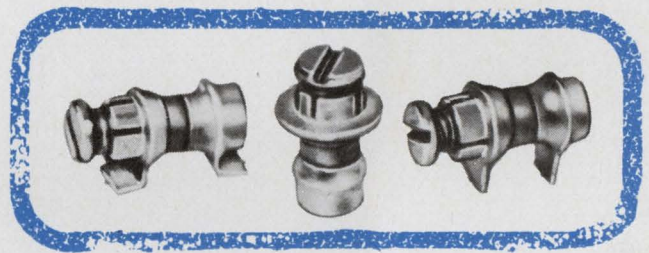

When you need superior performance at microwave frequencies, Voltronics' new precision sapphire dielectric trimmer capacitor is the only answer. You can't settle for a unit that's "almost right" or even "almost" all sapphire.

Only the Voltronics unit achieves the *entire* capacitance with a sapphire dielectric—the best dielectric material known! (Other, so-called sapphire units achieve almost one-fourth of the capacitance with mica—producing a non-linear curve.)

What's more, you can count on this new unit to give unvarying, reliable long life. The dielectric constant of the Voltronics sapphire does not vary with frequency, and its loss tangent is constant and below 0.0003, out to 10 GHz. It's chemically inert, totally moisture resistant, and one of the strongest materials known!

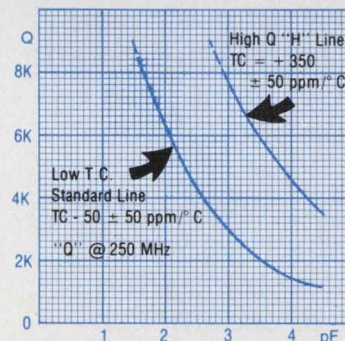

Other Voltronics advantages include metallized electrode bands fired into the sapphire, for lowest loss and no chance of slippage; and positive stops at each end to prevent disassembly or breakage.

Two types are available—a high-Q and a standard line (see curves at left).

Cost? \$5 to \$3 in quantities of 50 to 1,000. Designer kits are available at reduced prices. For complete information, use the Reader Service Card, or write to us at Dept. ED-3.



Voltronics

West Street, East Hanover, N.J. 07936
telephone: 201-887-1517 twx: 710-986-8253

If a switch in your product fails, the switch company doesn't get blamed. You do.

Every time you use someone else's product in yours, you're putting your company's reputation on the line. Even with something like a switch.

Because the things that are minor components to you could cause major problems for your customers.

For many companies, seeing the MICRO SWITCH name on a component is reason enough for them to use it.

For example, when our engineers design a product, it's with the most suitable, not necessarily the cheapest, materials to accomplish the job.

We actually produce most of what goes into our products. And since we don't rely on outside sources, you can rely on us as your source. In fact, many companies don't even inspect MICRO SWITCH products when they receive them.

All because our people feel



that quality is everybody's responsibility, not just our inspectors'. And the results speak for themselves.

You see, when you buy a MICRO SWITCH product, you're buying more than a component. You're buying a company. A company with capabilities to help solve your



problems. Whether through research and development. Innovation. Availability. Reliability. Or Quality Assurance.

MICRO SWITCH. Consider what it would cost to have anything less.

For more information, write for our Quality Assurance booklet.

MICRO SWITCH, Freeport, Illinois 61032. Or call 815/235-6600.

MICRO SWITCH products are available worldwide through Honeywell International.

MICRO SWITCH
Can you afford anything less?

CIRCLE 37 FOR DATA

CSC's done it again.

Broken the price and performance barriers with new MAX-100. The multimode, professional portable frequency counter that gives you more range, visibility, accuracy and versatility than any comparable unit at anywhere near its low, low price.

MAXimum performance.

MAX-100 gives you *continuous readings* from 20Hz to a *guaranteed 100MHz*, with 8-digit accuracy. Fast readings with 1/6-sec. update and 1-sec. sampling rate. Precise readings, derived from a crystal-controlled time base with 3ppm accuracy. High-sensitivity readings from signals as low as 30mV, with diode overload protection up to 200V peaks.

Input signals over 100MHz automatically flash the most significant digit. And to indicate low-battery condition and extend remaining battery

life, the *entire* display flashes at a 1Hz rate.

MAXimum versatility. MAX can be used with clip-lead cable supplied. Mini-whip antenna. Or low-loss in-line tap with UHF connectors. For AM or FM; CB, ham, business radio and R/C transmitter or receiver alignment. Monitoring audio and RF generators. Checking computer clocks and other digital circuits. Repair of depth sounders and fish spotters. Troubleshooting ultrasonic remote controls. And hundreds of other applications.

MAXimum visibility. MAX-100 features a big, bright 0.6" multiplexed 8-digit LED display, with leading-zero blanking. So you don't have to squint, or work up close. And, MAX's flip-up stand is *built-in*.

MAXimum flexibility. MAX-100 operates from *four* power sources,

for use in lab or field. Internal alkaline or NiCad batteries. 110 or 220V with charger/eliminator. 12V with automobile cigarette-lighter adapter/charger. And external 7.2-10V power supply.

MAXimum value. Accurate enough for laboratory or field-service applications, MAX is surprisingly economical. At \$134.95*, complete with clip-lead cable, it's priced low enough for educational or hobbyist use.

For more information, see your CSC dealer or contact us directly.

CONTINENTAL SPECIALTIES CORPORATION



44 Kendall Street, Box 1942, New Haven, CT 06509
203-624-3103 TWX 710-465-1227
West Coast: 351 California St., San Francisco, CA 94104
415-421-8872 TWX 910-372-7992

SPECIFICATIONS FOR MAX-100

Frequency Characteristics Range: 20 Hz to 100 MHz (guaranteed); 110 MHz typical. **Gate time:** 1 sec. providing 1 Hz resolution throughout freq. range. **Accuracy:** ± 1 count + Time Base error.

Input Characteristics Impedance: 1 M Ω shunted by 56 pf. **Connector:** phone jack. **Coupling:** AC **Sine Wave Sensitivity:** 30 mVRMS; 10 Hz-50 MHz; 100 mVRMS, 50 MHz to 80 MHz; 300 mVRMS, 80 MHz and above. **Maximum Input:** 200 V Peak, 20 MHz-500Hz; 100 V Peak, 500 Hz-1 KHz, 75 V Peak, 1 KHz-10 MHz; 50 V Peak, 10 MHz and above.

Internal Time Base Characteristics Frequency: 3.579545 MHz crystal oscillator. **Stability:** ± 3 ppm @ 25°C. **Trimmer Adjustment:** ± 4 ppm. **Temperature Stability:** Better than 0.2 ppm/°C, 0 to 50° C. **Maximum Aging Rate:** 10 ppm/year.

Display Characteristics Display: Eight .6" high LED digits, with anti-glare window. **Lead-zero blanking:** decimal point automatically appears between

sixth and seventh digit when input frequency exceeds 1 MHz. **Overflow:** When input signal exceeds 99,999,999 Hz, the most significant (left hand) digit flashes, allowing user to read in excess of 100 MHz. **Display update:** Fixed 1/6-second plus 1 second gate time. **Low Battery Indicator:** When batteries or power supply falls below 6.6 VDC, all eight display digits flash at a one-Hz/second rate. During battery operation, flashing display extends operating time of unit.

GENERAL Power Requirements: 6 AA Alkaline or NiCad batteries (internal battery compartment); **External:** 110-220/AC Battery Eliminator charger; Automobile cigarette lighter adapter for both charging and operating: 7.2 to 10 VDC external power supply; **Battery Life:** Alkaline, 3 hrs., cont. use; 8 hrs. intermittent use. NiCad, 3 hrs., cont. use, 6 hrs. intermittent use. **Battery Charging:** 12-14 hours required for full charge. **Size (HWD):** 1.75" \times 5.63" \times 7.75" (4.45 \times 14.30 \times 19.69 cm). **Weight:** Less than 1.5 lb. (0.68 kg) with batteries. **Accessories Included:** 100-IPC clip-lead input cable; detailed applications/instruction manual.

FREQ. OUT.



*Manufacturer's suggested retail

CIRCLE NUMBER 38

ELECTRONIC DESIGN 13, June 21, 1977

The only Double-Balanced Mixers with a 2-YEAR GUARANTEE*

featuring Hi-Rel tested diodes-

still only

\$7.95

(500 pieces)

\$9.95 (1-49)

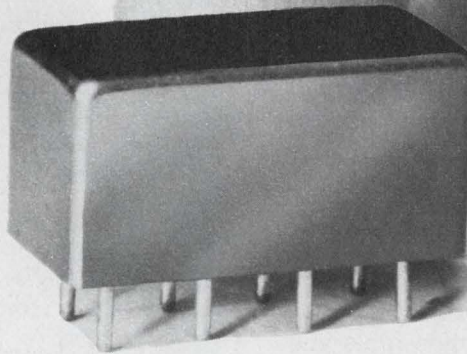

*including diodes!

Yes, a two-year guarantee for DBM's is now a reality . . . made possible by an accelerated-life diode screening program adopted at Mini-Circuits.

Each Schottky diode used in Mini-Circuits' SRA-1 mixers is now preconditioned by the HTRB (High Temperature Reverse Bias) technique, previously reserved almost exclusively for semiconductors assigned to space applications. With HTRB testing, each diode is operated for 168 hours at 150°C with one volt reverse bias applied.

To screen out "infant mortality", the diodes are deliberately stressed to accelerate aging and to force time-related failure modes to take their toll. In conventional testing or "baking", the diode does not experience anywhere near the stress encountered with the HTRB program. Hence, the ability at Mini-Circuits' to locate the potentially-unreliable diodes before they are assembled into SRA-1 units. And, with double-balanced mixers, the overall reliability hinges almost entirely on the diodes used.

Yes, the HTRB procedure costs us more and screens out more devices. But our goal is to improve reliability to a level unmatched for off-the-shelf DBM's at no increase in cost to our customers. You — our customers by your overwhelming confidence in our product line have made us the number one supplier of DBM's in the world.

To earn your continuing support, we are now employing HTRB Hi-Rel testing for every diode used in the SRA-1, at no increase in cost to you. So, for the same low price of \$7.95, you can purchase our SRA-1, with a two-year guarantee, including diodes.

To ensure highest system reliability demand highest quality diodes on your source-control drawings and purchase orders. Specify SRA-1 mixers, with HTRB tested diodes from Mini-Circuits! . . . where low price now goes hand-in-hand with unmatched quality.

MODEL SRA-1

Freq. range (MHz) LO - 0.5-500, RF 0.5-500, IF dc-500

Conversion loss (dB)	Typ.	Max.
One octave from band edge	5.5	7.0
Total range	6.5	8.5
Isolation (dB)	Typ.	Min.
Lower band edge to one decade higher	LO-RF 50	45
	LO-IF 45	35
Mid range	LO-RF 45	30
	LO-IF 40	25
Upper band edge to one octave lower	LO-RF 35	25
	LO-IF 30	20

Min. Electronic attenuation (20 mA) 3 dB

Signal, 1 dB compression level + 1 dBm

Impedance all ports 50 ohms



World's largest manufacturer of Double-Balanced Mixers

Mini-Circuits
MINI-CIRCUITS LABORATORY A Division Scientific Components Corp

837-843 Utica Avenue, Brooklyn, NY 11203 (212) 342-2500 Int'l Telex 620156 Domestic Telex 125460
International Representatives: □ AUSTRALIA: General Electronic Services, 99 Alexander Street, New South Wales, Australia 2065 □ ENGLAND: Dale Electronics, Dale House, Wharf Road, Frimley Green, Camberley Surrey □ FRANCE: S.C.I.E. - D.I.M.E.S. 31 Rue George - Sand 91120 Palaiseau, France □ GERMANY, AUSTRIA, SWITZERLAND: Industrial Electronics GMBH, Klüberstrasse 14 □ EASTERN CANADA: B.D. Hummel, 2224 Maynard Avenue, Utica, NY 13502 (315) 736-7821 □ NETHERLANDS, BELGIUM, LUXEMBOURG: Cormex, Veldweg 11, Hattem, Holland □ NORWAY: Datamatik AS, Ostensjoveien 62, Oslo 6, Norway □ SWEDEN: Integerad Elektronik AB, Box 43, S-182 51, Djursholm, Sweden □ AFRICA: Afitra (PTY) Ltd., P.O. Box 9813, Johannesburg 2000, S. Africa □ SINGAPORE & MALAYSIA: Electronics Trading Co. (PTE) Ltd., 87, Bukit Timah Road, Singapore 9, Malay Peninsula □ INDIA: Gaekwar Enterprise, Kama Mahal, M.L. Dananukar Marg, Bombay 400 026, India

U.S. Distributors: □ NORTHERN CALIFORNIA: Cain-White & Co., Foothill Office Center, 105 Fremont Avenue, Los Altos, CA 94022 (415) 948-6533 □ SOUTHERN CALIFORNIA, ARIZONA: Crown Electronics, 11440 Collins Street, No. Hollywood, CA 91601 (213) 877-3550

Selecting capacitors properly

requires an understanding of manufacturers' spec jargon. Generalized charts and tables guide you to rational choices.

When selecting a capacitor, don't merely "fish" in your junk box until you come up with a suitable value and solder it in. New capacitor types—not likely found in your junk box—offer such benefits as low cost, high reliability, and small size. But if you don't review and update your expertise in capacitor selection for both conventional and new types, you won't know what to choose or what to choose from.

The application determines the selection

Selecting a capacitor for a particular application breaks down into three steps:

1. Examine the capacitor-selector-guide table and locate the candidates recommended for the application.
2. Study the curves and charts in this article to help narrow the choice to your circuit's needs—stability, life, temperature and other variables that affect the capacitor.
3. Consider both the general and fine points of the different capacitor types to be described.

The charts and tables are generalized to provide over-all guidelines for initial capacitor selection. Armed with this preliminary information you'll know what to ask, and, in some detail, what answers to expect. Once you've selected a type, ask potential vendors for specific data and test information on their units.

In particular, when you go shopping be prepared with numbers for at least the following spec parameters:

- Temperature.
- Humidity.
- Working voltage.
- Ac ripple.
- Capacitance range.
- Frequency.
- Life.

A number, or range of numbers, for each of these specs takes on meaning only if you understand how a "real" capacitor behaves. Real capacitors provide not

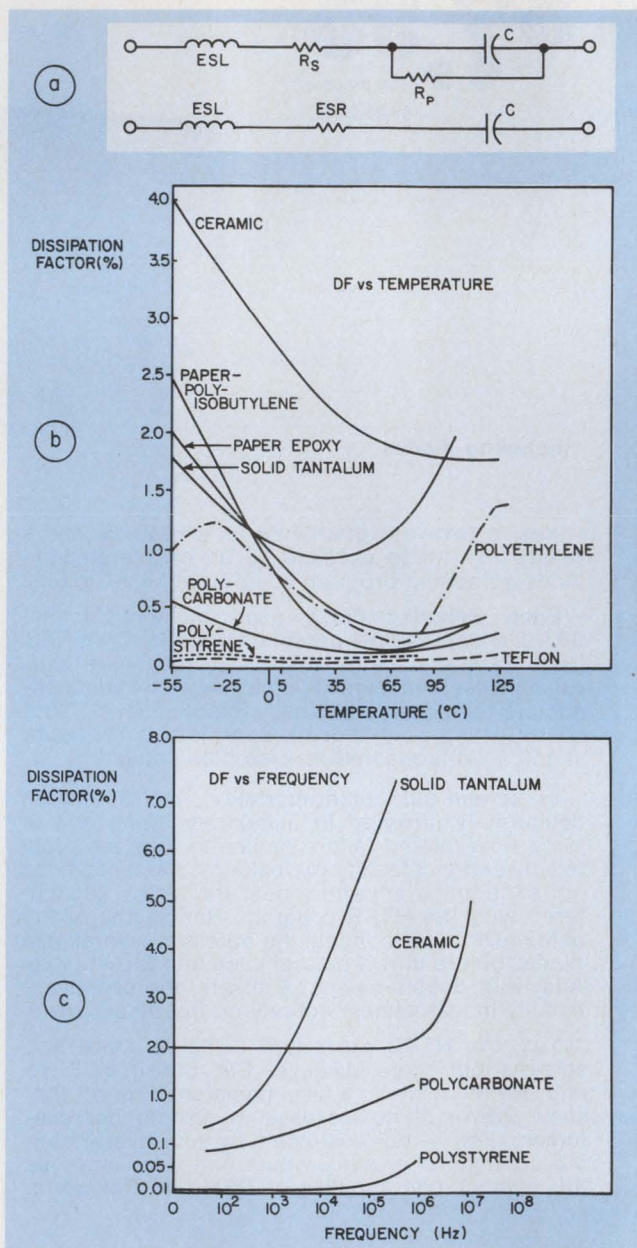

1. A practical capacitor can be represented by an equivalent circuit (a), where ESR (equivalent series resistance) includes all resistive losses and ESL (equivalent series inductance) accounts for the inductance in a capacitor. The dissipation factor, DF, which partially defines the quality of a capacitor, varies with both temperature (b) and frequency (c).

Donald Epand and Ken Liddane, Siemens Corp., 186 Wood Ave. South, Iselin, NJ 08830.

only capacitive reactance, but also inductive reactance and resistance. An equivalent circuit of a real capacitor (Fig. 1a) includes an equivalent series resistance (ESR), an equivalent series inductance (ESL) and a parallel leakage resistance, or insulation resistance (IR), in addition to the "ideal" capacitance part.

Moreover, capacitor manufacturers have their own jargon for calling out specifications. So before you can make a rational selection, review and understand the following list—it relates the spec terminology to capacitor performance:

1. *Ac-ripple* specs apply when a capacitor handles both dc and ac voltages, as in power-supply filters. Note, then, that capacitor working voltage is the sum of both the dc and peak ac voltages on the capacitor.

2. *Dielectric absorption* causes inaccuracies and waveform distortion in timing, integrator and non-sinusoidal oscillator circuits. When a charged capacitor is discharged, it fails to return all the charge initially put into the capacitor. The unreturned charge—dielectric absorption—"soaks" into the dielectric.

3. *Dissipation factor*, important in ac applications, is the ratio of effective series resistance, ESR, to the capacitive reactance, X_c (Fig. 1a). The dissipation factor (DF) is usually expressed as a percentage,

$$DF = \frac{ESR}{X_c} \times 100\% \quad (1)$$

$$= \tan \delta \times 100\%.$$

Generally, DF varies with temperature, humidity and frequency. Increasing humidity tends to increase the DF in unsealed capacitors. And changing the frequency and temperature causes highly nonlinear effects (Figs. 1b and 1c): both numerator and denominator in Eq. 1 are affected by temperature and frequency in complicated ways.

4. *Humidity coefficient* of a capacitor—especially important with unsealed capacitors, in which water vapor can be absorbed by the dielectric, and pockets and capillaries in the foil windings—is expressed as

$$(HF) = \frac{2(C_2 - C_1)}{(C_2 + C_1) (\Delta \text{ rel hum})}, \quad (2)$$

Capacitor selector guide

	Aluminum electrol.	Tantalum			Polycarbonate		Polystyrene metallized	Polyester		Mica	Ceramics	Paper
		foil	wet	solid	M	F		M	F			
Capacitance μF	10 ⁶	1500	1500	1000	100	0.01	10	10	0.01	0.01	1	100
WVDC, volts	500	300	125	100	1000	400	1000	1500	400	800	10,000	5000
DF in % at 25 C at 120 Hz	—	10	15	10	0.5	0.1	0.03	1.0	0.5	<2	<2	<1
Temp. range °C	-40 → +85	-40 → +125			-55 → +125		-40 → +85	-55 → +125	+125	+125	+125	-30 → +100
Temp. derating from X by %	60°(50%)	85°(30%)					not required	85° (50%)	not required			75° (30%)
Volume per CV	very small	very small			sm	sm	large	sm	sm	sm	sm	large
Stability	low	good	excellent		med	med	exc	med	med	exc	med	med
Load Life	good	excellent			very good		very good	very good	exc	exc	exc	very good
Rel. cost/CV	lowest	high	med	med	med	low	med-low	med	low	med	low	low
Summary of application areas												
Blocking, dc	—	—	—	yes	yes	yes	yes	yes	yes	yes	yes	yes
Bypass & filter	yes	yes	yes	yes	yes	yes	yes	yes	yes	—	yes	yes
Commutation	—	—	—	—	yes	yes	yes	yes	yes	yes	yes	—
Coupling	—	—	—	—	yes	yes	yes	yes	yes	yes	yes	—
Discharge (fluoresc.)	—	—	—	—	—	—	—	—	—	—	—	yes
Energy storage	—	—	—	—	—	—	—	—	—	—	—	yes
Freq. determin.	—	—	—	—	yes	yes	yes	yes	yes	yes	yes	—
Motor capac.	yes	yes	yes	—	yes	yes	yes	yes	yes	—	—	yes
Power factor	yes	yes	yes	—	yes	yes	yes	yes	yes	—	—	—
Timing	—	—	yes	yes	yes	yes	yes	yes	yes	yes	yes	—
Trans. suppr.	yes	yes	yes	yes	yes	yes	yes	yes	yes	—	—	—
Trans. voltage	yes	yes	yes	yes	yes	yes	yes	yes	yes	—	—	—

Notes: M - metallized (film)
F - film (foil)
sm - small
med - medium
exc - excellent

Each value in the table is a maximum under the most favorable conditions. For example, don't expect maximum capacitance, and simultaneously, maximum temperature.

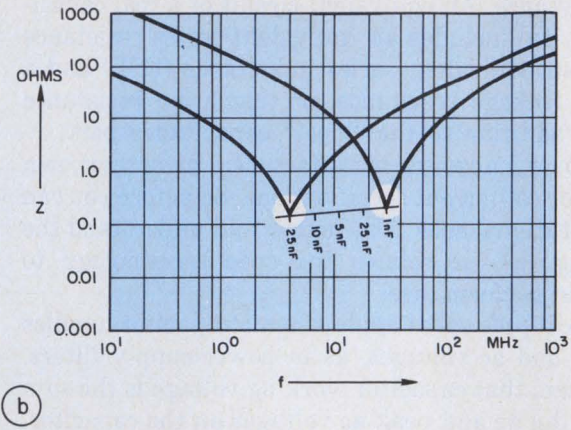
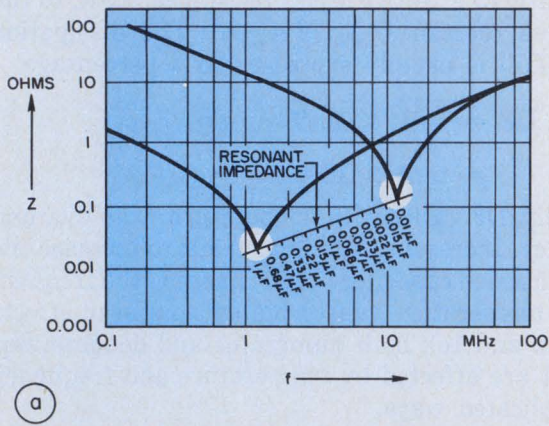

2. The impedance of a capacitor shows the resonance dip of a series-tuned circuit. Typical curves for polycarbonate (a) and polyethylene-film (b) capacitors display the dip.

At frequencies past the dip, the capacitor has the reactance of an inductance, which increases with frequency and can disrupt circuit performance.

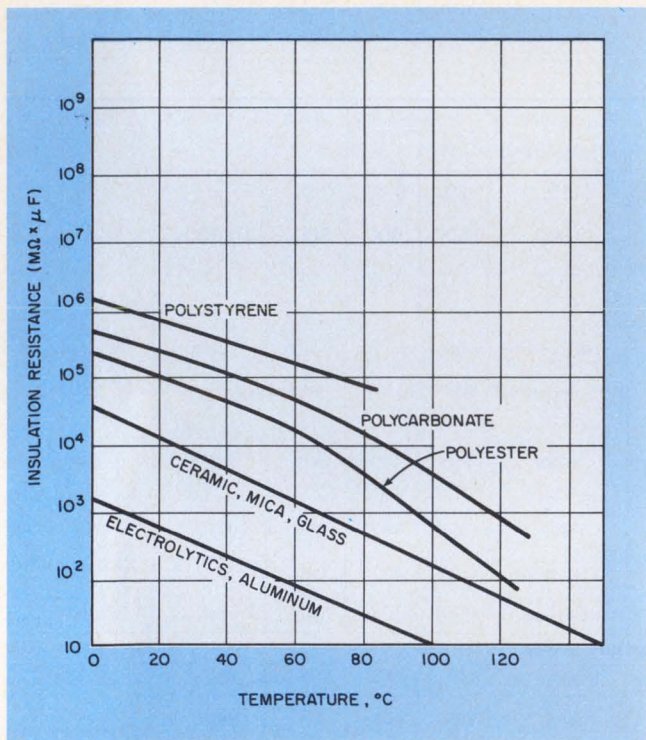

3. The insulation resistance of most capacitors decreases rapidly as temperatures rise.

where C_1 = capacitance when dry.
 C_2 = capacitance after humidity exposure.
 $(\Delta \text{rel hum})$ = change in relative humidity ($H_2 - H_1$).

The humidity coefficient becomes particularly significant in small capacitors to about 250 pF, when the relative humidity exceeds 80%.

5. Impedance of a capacitor is mathematically approximated by

$$Z = \sqrt{(ESR)^2 + [X_c - (ESL)]^2} \quad (3)$$

Because of the complex dependencies of the ESR (equivalent-series-resistance) and ESL (equivalent-

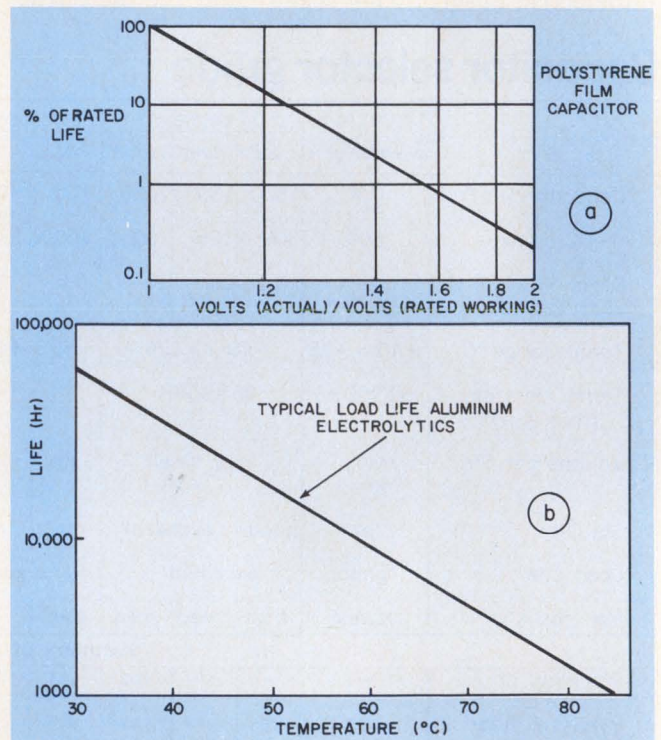

4. Capacitor life drops rapidly with both overvoltage (a) and temperature increase (b).

series-inductance) factors, many manufacturers resort to measured curves to show how capacitor impedance varies with frequency (Fig. 3). Note the resonance dip that results from the $[X_c - (ESL)]$ series-tuning effect.³

6. Insulation resistance is a measure of a capacitor's insulation quality. Specified either directly in megohms or as a time constant, RC, in seconds, the value determines the capacitor's leakage current for a continuously applied dc voltage, when a capacitor is fully charged. A fixed leakage-current value takes time to achieve: Electrolytic capacitors need about 15 minutes to stabilize. Insulation resistance can vary

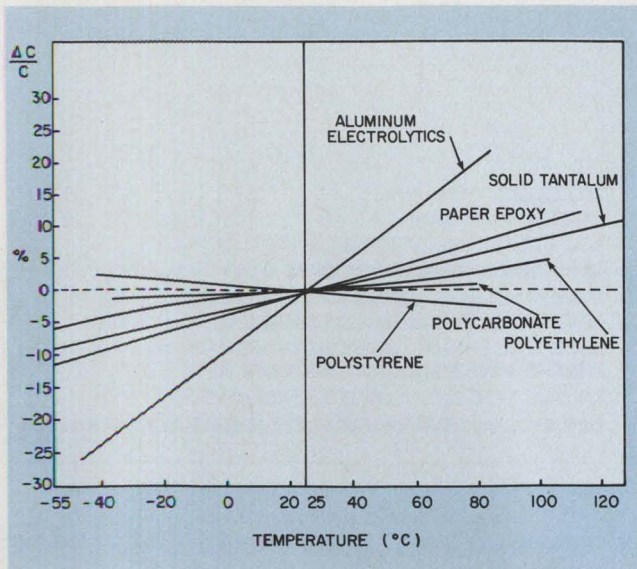

5. Because of a capacitor's temperature coefficient, its capacitance value may deviate substantially from the published nominal value, which is usually rated at 25 C.

over several orders of magnitude with temperature changes (Fig. 3).

7. *Load life*, expressed in thousands of hours, is the **expected life** of a capacitor under specified conditions of voltage, temperature and ripple current. The derating effects of excess working voltage and temperature on life are shown in Fig. 4 for typical capacitor types.¹

8. *Power factor* is the ratio of ac power losses and reactive volt-amperes in a capacitor, expressed mathematically as

$$\begin{aligned}
 (\text{PF}) &= \frac{\text{power loss}}{\text{reactive power}} \\
 &= \cos\theta \\
 &= \frac{(\text{ESR})}{Z}
 \end{aligned}
 \quad (4)$$

Obviously, a good capacitor has a small power loss. For good capacitors, therefore, PF becomes nearly equal to DF (Z approaches X_c), and both factors are similarly affected by temperature.

9. *Surge voltage* is the maximum short-duration voltage that a capacitor can withstand under worst-case conditions, including temperature, humidity and frequency.

10. *Temperature coefficient* expresses a capacitor's change in capacitance value per °C at a reference temperature, usually 25 C:

$$(\text{TC}) = (C_2 - C_1) / [C_3(T_2 - T_1)], \quad (5)$$

where C_1 = capacitance at temperature T_1 .

C_2 = capacitance at temperature T_2 .

C_3 = reference capacitance at 25 C.

Fig. 5 compares the TC of common capacitor types identified by the dielectrics used. Because the differences are considerable, the TC can be crucial to your capacitor selection.

11. *Temperature-voltage derating* specs must be

carefully evaluated if a temperature higher than specified (usually 65 to 85 C) is expected. To avoid premature failure, you must reduce your capacitor's working voltage according to the derating specs.¹

12. *Working voltage* (WVDC) is the maximum dc voltage that a capacitor can withstand continuously for its specified lifetime. Clearly, an operating voltage higher than the WVDC will result in a shorter life—permissible in some applications. Fig. 6 compares the typical WVDC of different capacitor types.

13. *Quality factor* is a figure of merit employed mostly in tuned-circuit applications and defined as

$$\begin{aligned}
 Q &= 1/(\text{DF}) \\
 &= X_c/(\text{ESR}) \\
 &= 1/\tan\sigma.
 \end{aligned}
 \quad (6)$$

Selection requires more than specs

Understanding capacitor-spec jargon may help you read catalogs, but to select a capacitor, you will need to know more than bare spec numbers and definitions. Here are some of the "finer" points, arranged by capacitor type—not always available in the catalogs. Considering these points while studying the capacitor selector guide, should make you an "expert"—no longer a junk-box aficionado:

1. *Aluminum electrolytics* are widely used because of their low cost and high capacitance \times voltage (CV) product for a given physical volume. The large CV product derives from the thin dielectric film—about 10^{-9} cm—obtained when 99.99% pure aluminum foil is oxidized. While the dielectric film is strong, imperfections in the oxide allow substantial leakage.² Electrolytics, in addition, are highly sensitive to temperature, and have a limited operational and shelf life. With time, their DF can rise as much as 50%, and the capacitance can drop substantially—to 10% rated. If left without voltage, the oxide film deteriorates.

2. *Solid-tantalum* capacitors are constructed of sintered tantalum powder particles packed around a tantalum anode, which makes a rigid assembly, or slug (Fig. 8a). They have a higher CV product per unit volume than the aluminum electrolytics, are more temperature-stable, and usually have hermetic seals to eliminate humidity effects. Furthermore, both their shelf and operating lives are superior to aluminum electrolytics. But as you might suspect, tantalum capacitors are also several times more expensive.

Tantalum capacitors can be obtained as either polar or nonpolar types. Although even a small reverse voltage applied to a polar tantalum can significantly increase its leakage current, nonpolars can sustain ac operation without any appreciable degradation—if the rms voltage is within the unit's ratings. Nonpolar tantalum capacitors are constructed with two polar capacitors—back to back—with their cathode leads connected.

3. *Wet-slug tantalum* capacitors have the highest volumetric efficiency and lowest leakage per CV of

any electrolytic capacitor; they use a porous anode, or slug, immersed in a liquid electrolyte. Since they are expensive, they are limited to high-reliability, small-space military, aerospace and critical industrial applications.

4. *Tantalum-foil* capacitors have characteristics similar to aluminum electrolytics, but can operate at higher temperatures and have longer shelf and load life. Unfortunately, tantalum-foil units are very expensive.

5. *Computer-grade electrolytics* are high-quality aluminum electrolytics used primarily in computer power-supply filters. Moderately priced, they come in very high capacitance values—to 1 farad, for example—and their shelf and load life are longer than standard commercial-grade electrolytics.²

6. *Paper-dielectric* capacitors use a special thin paper, impregnated with a dielectric wax or fluid, such as mineral oil or PCB (in ill repute, environmentally), which bolsters the dielectric properties of paper and seals out moisture. Metal foil is used in high-current and high-voltage paper capacitors. Good-quality units provide high capacitance stability, however, DF varies considerably as the temperature changes.

Metalized-paper capacitors—the paper is coated with a thin layer of zinc or aluminum—are considerably smaller than metal-foil units, but suffer from poor surge-handling capability. A tiny defect in the dielectric can result in an arc that will quickly and permanently short the capacitor.

Because paper is a cheap material and large quantities are used, paper capacitors—foil or metalized—are relatively low-cost.

7. *Plastic-film capacitors* employ a thin film—polystyrene, polyester, Mylar, polycarbonate, polysulfone, polypropylene—as the dielectric. As with paper units, both film-and-foil and metalized-film constructions are also used. In a film-and-foil capacitor, plastic film is interleaved with aluminum foil. Practically all plastic film-and-foil capacitors are circular. One exception is a new stacked unit by Siemens in which rectangular sheets of film alternate with rectangular sheets of metal foil.

Metalized-film versions are made by vacuum-depositing a thin metal film on the plastic film. The thin metal results in both high volumetric efficiency, and another happy result—self-healing. Unlike metalized-paper capacitors, in metalized plastic-film units an arc can rapidly vaporize the thin metal in the immediate vicinity of the breakdown point and clear the short. The arc then extinguishes, and the capacitor becomes open-circuited again—or self-healed.

Since some energy is lost during each such self-healing, a voltage-spike drop is generated,

$$V_c = V_o - \sqrt{V_o^2 - 2(E_c/C)}$$

where V_c = the voltage drop on a clearing.

V_o = initial voltage on the capacitor.

E_c = energy required for a clearing (watt-seconds).

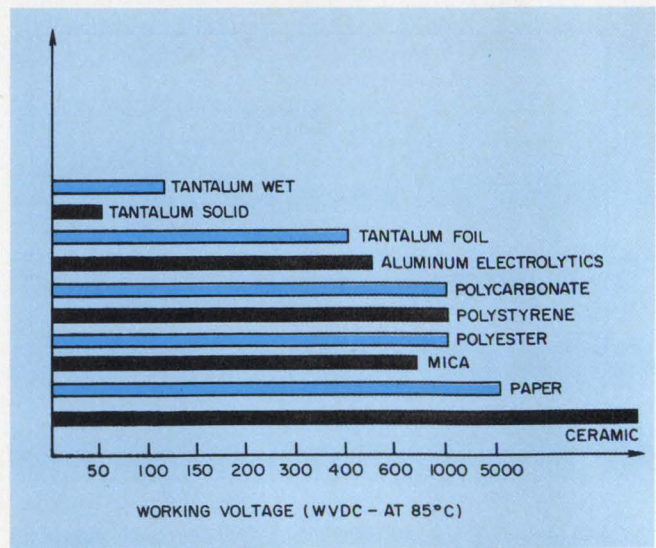

6. Most capacitor types span a wide working-voltage range. Since size and cost increase with WVDC, you should select the lowest WVDC rating the circuit allows.

C = capacitance (farads).

These negative-voltage spikes are small—about 0.1 to 1 V—and in most cases, you don't have to worry about them. However, in digital circuits, they may be troublesome, since a clearing spike may be counted as a data pulse. Consequently, when using plastic metalized-film capacitors in digital circuits, choose units whose voltage rating is substantially above your circuit's working voltage.

Plastic-film capacitors are nonpolar and excellent for ac applications. They have high insulation resistance, low DF and—particularly in polystyrene units—good volumetric efficiency. In fact, they have a higher volumetric efficiency than paper, mica or ceramic units.

Unfortunately, except for Teflon, plastic-film capacitors can't handle the temperature range that inorganic dielectrics can. For example, although polystyrene is stable with temperature, its operating range extends only to 85 C; polypropylene displays good temperature stability to 105 C; and polycarbonates have slightly higher to 125 C.

Polyester (Mylar) films are very popular, because they are inexpensive. And even though most of their characteristics are very good, they fail in an important one: Their capacitance varies drastically with temperature—about as badly as aluminum electrolytics.

8. *Mica capacitors* use the natural mineral mica as a dielectric. Metalized-film techniques are now being applied very effectively to the mica dielectric. Originally, silver was the only metalization material used; however, base metals are now employed without detracting from performance.

Mica capacitors are very reliable and stable and particularly good for high-frequency work. Mica, a very stable material, provides high-Q, but capacitance values, generally, don't go above 0.1 μ F, because the units become bulky and expensive.

9. *Ceramic capacitors* can replace mica units at high

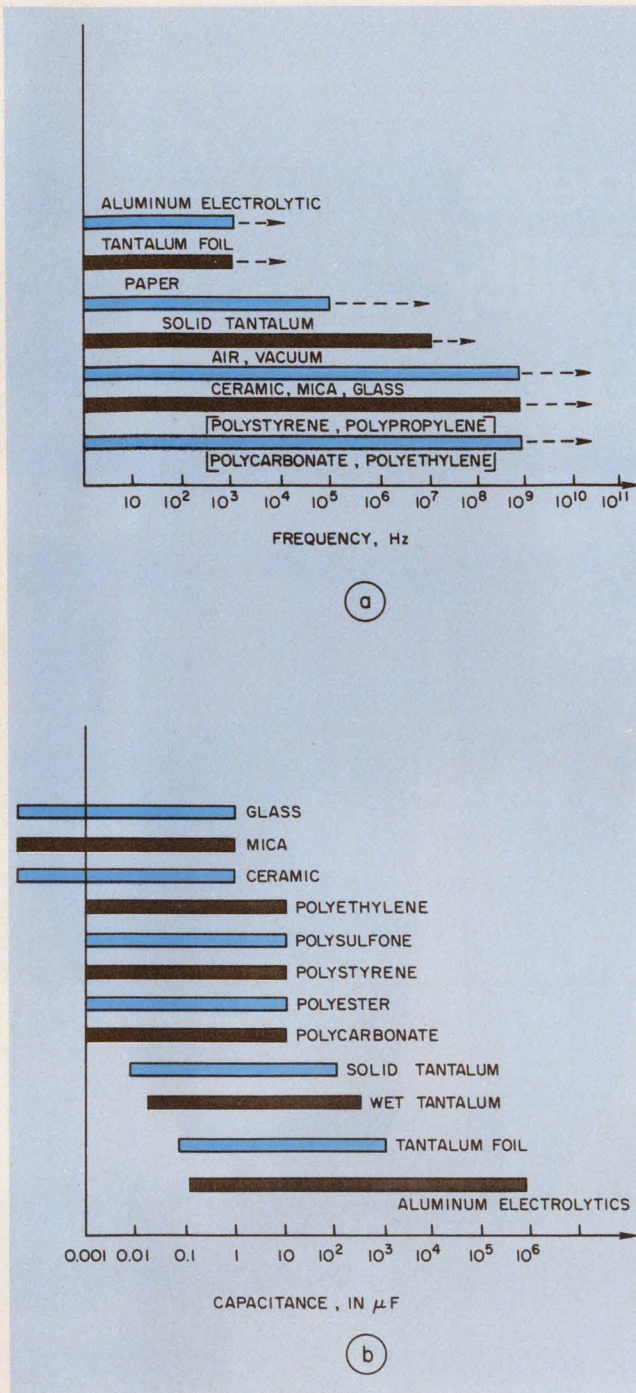

7. The high end of a circuit's operating frequency defines fairly precisely the type of capacitor needed (a). Of course, high capacitance values aren't available in all types (b), so paralleling two types may be necessary.

frequencies—to 1000 MHz—but don't have mica's stability or Q. They can be found in EMI/RFI filters, bypass circuits and decouplers; precision-tuned high-Q circuits should use mica units. ■■

References

1. Eimar, B., "Stretch Electrolytic Capacitor Life," *Electronic Design*, April 1, 1975, pp. 124-127.
2. Forssander, P.H., "Aluminum Electrolytics Are Hard to Beat," *Electronic Design*, Oct. 11, 1974, pp. 78-82.
3. Bowling, E.L., "Look Out! All Electrolytic Capacitors Are Not Alike," *Electronic Design*, Jan. 4, 1974, pp. 138-140.

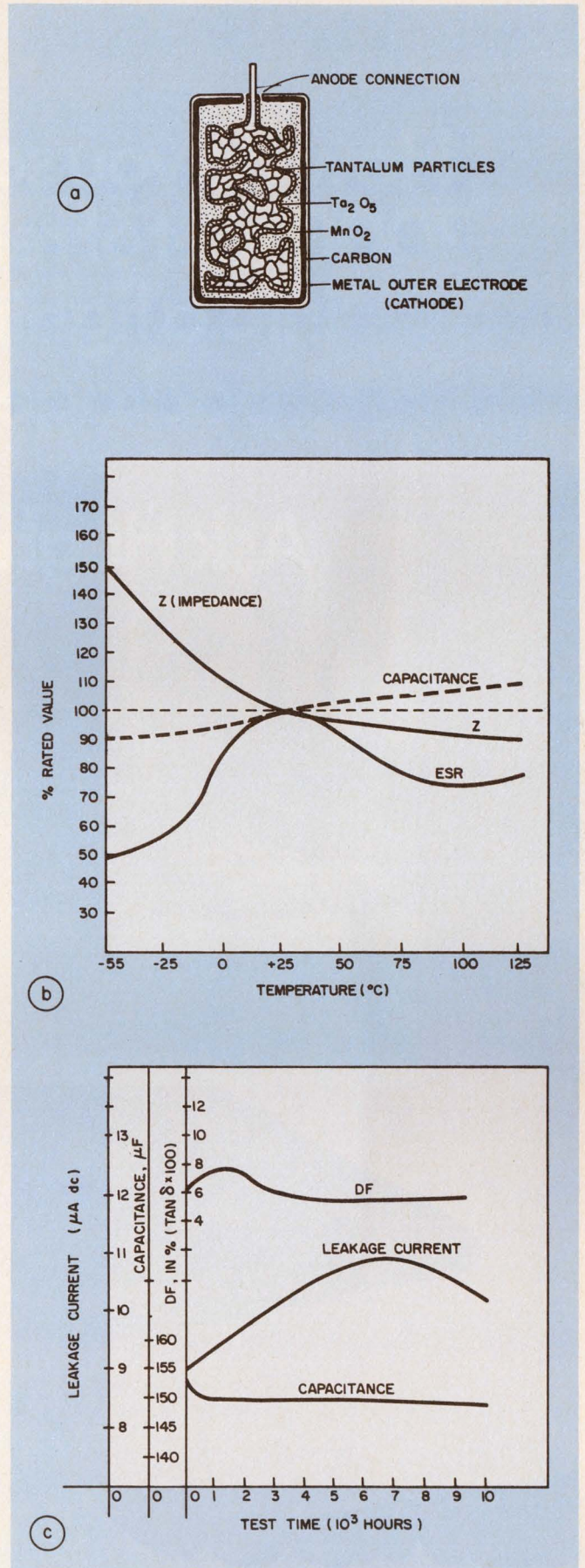

8. Solid-tantalum capacitors (a) feature stable capacitance not only over a wide temperature range (b), but also over their long life span (c).

How do you squeeze
7000 feet of reliability
into a fighting
package?

Ask Hughes.





Total interconnection technology.

When it's a complex fighting machine like the Navy's A-6E and its TRAM target-sensing system's highly sophisticated avionics, you connect with Hughes capability. Hughes, because of our deep involvement in high-technology military and aerospace programs: Phoenix, Maverick, Lance, Minuteman, AWACS, F-14, F-15, Space Shuttle, Viking, Sonobuoy, F-4, A-7, Condor, Standard Missile, F-8, Trident, Hobo, Sprint, and many more.

With all that experience, we've developed not only the hardware and the circuitry, but also the concepts and design capability to solve the toughest interconnection problem. And the techniques to make it work. Aside from our design-to-system advanced packaging, we also offer umbilical and special connectors and off-the-shelf connectors.

Umbilical and other special connectors. Our umbilical on the new laser-guided Maverick is typical of our specials; we also have connectors on many of the country's airborne missiles where sure-fire operation is critical to national defense. Meeting your requirements is the challenge to us. We give priority to your special-connector problems. Solutions are just part of what we offer.

Off-the-shelf connectors. The new C-21 (MIL-C-85028) is another typical example of Hughes hi-rel technology. For high-altitude applications the C-21 has individual seals for up to 250 psi on the contacts, preventing altitude breathing and consequent contamination. It's a Hughes exclusive.

Our standard line also features subminiature rectangulars, standard size, subminiature circulars, and miniature rectangulars—better because they're super hi-density connectors. Our exclusive PolarHex™ Center Jackscrew coupling device makes it all possible. Another Hughes first is our HAC PAK™ connector (MIL-C-28804), the simplest way to connect round to flat cables.



Ask Hughes. Squeezing reliability into any sophisticated machine is no problem for you. Just ask Hughes Connecting Devices, 17150 Von Karman Avenue, Irvine, CA 92714, or call (714) 549-5701.



HUGHES

HUGHES AIRCRAFT COMPANY
CONNECTING DEVICES

**Total interconnection technology:
the hardware, the circuitry, and the concepts.**

Intel delivers MOS RAM's

Convert to the Intel® 2115A and 2125A and enjoy MOS economy, bipolar speed and power savings up to 50%. These new NMOS RAMs offer 45 nsec worst case access time and a 100 quantity price of only \$6.90. And that's just the beginning of the cost/performance advantages you can expect from Intel's new +5 volt, silicon gate static MOS RAMs.

The new 2115A and 2125A RAMs are pin for pin, plug-in replacements for the popular 93415 and 93425 bipolar RAMs. They offer all the same advantages. No need for external clocks or refresh circuits, fully TTL compatible, 16mA output sink current and operation from a single +5 volt supply.

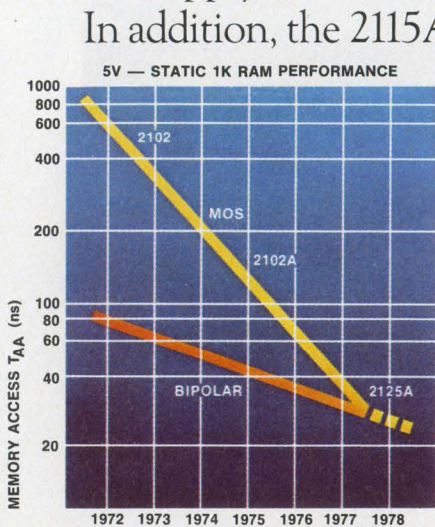

In addition, the 2115A/2125A dissipate 20% less power and the 2115AL/2125AL 50% less power than the 93415/93425. This saves power supply and cooling costs which all adds up to additional savings in the cost of your system. And there's more. Unlike bipolar RAMs, the 2115A/2125A use only a single layer of metalization which means lower manufacturing cost and a more reliable process. So you can look for continued improvement in cost/performance. To put the cost potential in proper perspective, consider this: The 2115A/2125A chip is 35% smaller than Intel's industry standard 2102A. And the

to match bipolar speeds.

2115A/2125A are made on the same manufacturing line and with a process similar to the 2102A. If you've been following the 2102A price curve you'll understand the significance.

PROJECTED 2115A VOLUME PRICE CURVE, BASED ON THE PRICE HISTORY OF THE 2102A

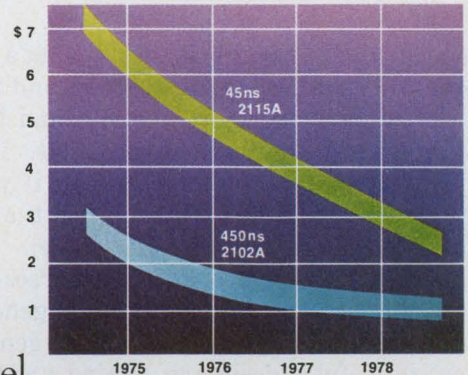

Today Intel technology delivers MOS RAMs to match bipolar speed. Tomorrow look for greater speed, higher densities, and even lower cost. Order 2115A's and 2125A's from your local Intel distributor and take advantage of MOS economy and bipolar speed. They're in stock.

Contact: Almac/Stroum, Component Specialties, Cramer, Elmar, Hamilton/Avnet, Harvey Electronics, Industrial Components, Liberty, Pioneer, Sheridan, L. A. Varah or Zentronics.

For your copy of our new 2115A/2125A brochure, write: Intel Corporation, Literature Department, 3065 Bowers Avenue, Santa Clara, California 95051. In Europe, contact Intel International Corp. S.A., Rue du Moulin à Papier, 51-Boite 1, B-1160, Brussels, Belgium. Telex 24814. In Japan, contact Intel Japan Corporation, Flower Hill-Shinmachi East Bldg. 1-23-9, Shinmachi, Setagaya-ku, Tokyo 154.

intel® delivers.

Choosing a signal source isn't easy.

With various generators looking a lot alike these days, selection leans heavily on your specific test requirements.

Which signal source is best? That's a question frequently asked today, as sweepers and synthesizers take on signal-generator functions and blur distinctions between the various products. Determining which source is best is much easier if you examine the characteristics of each source in the light of the measurements to be made (see table).

Basically, three types of signal sources exist today: test oscillators and sweepers, signal generators, and synthesizers and synthesized signal generators. All three are useful in designing, testing, and maintaining communication equipment.

Sweepers find a niche mostly in the design and testing of filters, mixers and the other active and passive components that make up the rf chain of systems and transceivers. With extremely high-Q components, you may need a synthesizer with digital sweep to maintain the required stability.

Signal generators simulate transmitted signals, so they dominate subassembly and system tests of receivers. Economy generators, with modest spurious and phase-noise specifications, serve well for "usable sensitivity" and "quieting sensitivity" measurements. Synthesizers and heterodyne units can also work here.

High-performance generators are the only acceptable instruments for measuring adjacent-channel selectivity, spurious, image and i-f rejection, and intermodulation spurious tests.

Synthesizers and synthesized generators also serve in simulation, with their own stability, resolution, and programmability trade-offs. For automatic testing, synthesized generators can handle most jobs. Certain tests, however, still require that you roll-up a high-performance generator.

Test oscillators and sweepers, generally the least complex of the signal sources, fulfill the simpler testing requirements of filters, rf circuit modules and other passive components. Sweepers are preferable for component testing because both in-band and out-of-band effects and interactions can be analyzed.

Modern sweepers exhibit 10-mW high-level outputs, amplitude stability of 0.1 dB, frequency stability of 100 ppm/°C, 0.1% frequency accuracy, convenient

frequency control, low output distortion, low hum and noise, and harmonics greater than 25 to 35-dB below the carrier. However, calibrated modulation and low-leakage, microvolt-level outputs are usually not available in sweep generators.

The ubiquitous signal generator

Signal generators are heavily involved in measurements of receiver sensitivity, selectivity or rejection, signal-to-noise ratio, gain-bandwidth characteristics, conversion gain, and antenna gain among many others. They are also used to drive bridges and slotted lines in component testing. A signal generator generally has all of the following capabilities:

- Output frequencies that are accurate, stable to 10 ppm/10 min, easy to set, and variable over a wide range.

- Output signal levels that are accurately calibrated to ± 1 to 2 dB, stable to 0.1 dB, level, variable over a wide dynamic range (at least 100 dB), with leakage low enough to permit signal outputs as low as 0.1 to 1 μ V.

- A range of low-distortion modulation that is calibrated and easy to set.

- Signals that have spectral purity greater than 130 dB/Hz at 20-kHz offset, harmonic content less than 30 dBc, and nonharmonic spurious-signal content greater than 100 dBc.

Signal generators range from economy L-C tuned or synthesized models, to high-performance, cavity-tuned generators that achieve low spurious components and, with a phase lock and counter, low drift. Both synthesizers and synthesized signal generators are top-of-the-line signal simulators for specialized measurements, and offer exceptional 1×10^9 /day long-term stability, high (0.01 ppm) resolution and programmability.

Frequency synthesizers are signal sources whose spectral characteristics are a primary consideration. Their place is primarily in local-oscillator chains on satellite ground stations, where multipliers or up-converters provide the final signal characteristics.

On the other hand, synthesized signal generators offer the additional advantages of modulation (AM, FM or phase), accurate and programmable signal control, and low leakage. Along with those advantages

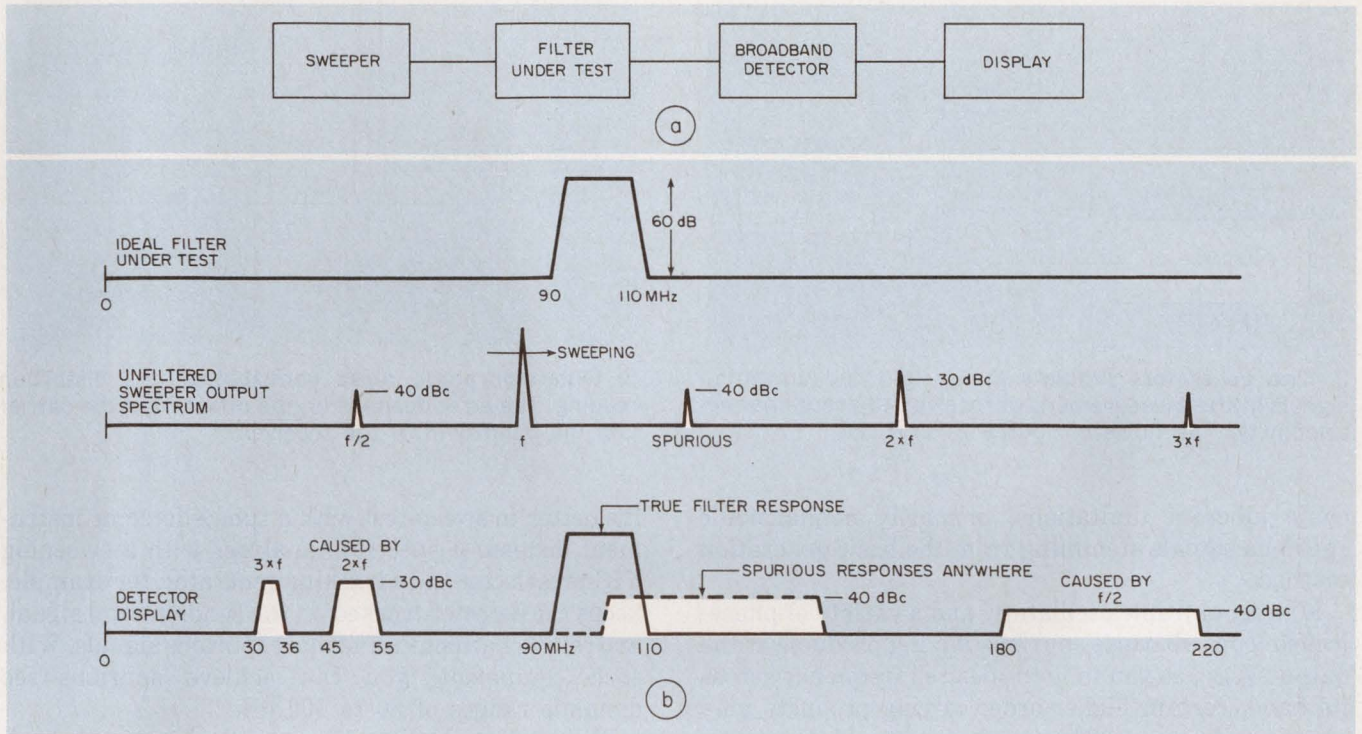

1. With the usual swept filter-test arrangement (a), unwanted spurious and harmonic components originating in the sweep-generator signal source can contribute false responses, even with an ideal filter (b).

Summary of receiver tests and requirements

Test	Important source characteristics	Typical product used
Component design	Linear sweep, flexible sweep controls, flat output, low spurious and harmonics	Sweeper
Least usable sensitivity	Low leakage, $\leq 1 \mu V$ accurate attenuator, accurate power. ± 1 to 2 dB.	"Economy" generator, maybe with phase lock. For programmable, use synthesized generator.
Quieting sensitivity	Low leakage, $< 1 \mu V$ accurate attenuator, ± 1 to 2 dB low residual FM, 10 ppm	"Economy" generator. For programmable, use synthesized generator.
Adjacent-channel selectivity	SSB noise < 140 dB/Hz at 20 kHz low drift, 1 ppm/5 min.	High-performance generator
Spurious attenuation, image and i-f rejection	Low spurious, < 100 dB. High output, > 1 V, broadband noise floor, < 140 dB/Hz	High-performance generator
Intermodulation spurious attenuation	Switch for disabling ALC loop and detector. > 1 V output. Low drift, 1 ppm/5 min.	High-performance generator

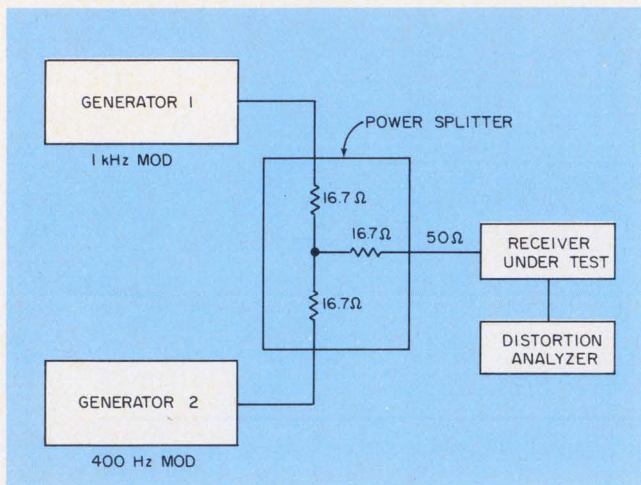

2. Two generators simulate the desired and unwanted signals in the measurement of receiver adjacent-channel selectivity. The noise of source 2 is crucial.

come inherent limitations, primarily nonharmonic spurious signals stemming from the basic generation method.

Mixers, multiple oscillators, and a variety of phase-locked loops all cause spurious mixing products at the output. Also, as you tune the desired frequency across its band, certain higher-order mixing products may appear and cross under the carrier at certain points. Satellite and space-communication simulations and automatic test systems are primary applications of synthesized generators.

With care, spurious crossovers can be reduced. For example, you can carefully choose internal oscillator bands so that third-order ($2f-f$) mixing products never occur closer than 50 MHz to the carrier (although higher-order products do actually cross over).

Which source to choose? Let your testing requirements dictate.

Filtering through filter specs

When you sweep-test filters, pay close attention to the signal characteristics, the unit under test and the detector. For example, if a sweeper excites a filter with a 60-dB stop band, further filtering is needed to prevent spurious and harmonic-output errors (Fig. 1).

While the source's fundamental signal sweeps the stop band, other spurious or harmonics may pass directly through the test filter's passband to the broadband detector. Generally, this is not a serious problem with narrowband components—those in which signals can be restricted. It is, however, on multiple octaves.

Fig. 1b shows the effect of sweep testing an ideal filter having 60-dB rejection bands. The test is conducted with a broadband detector and a sweeper with harmonics that are only 30 dB down, and spurious signals, 40 dB down. A bandpass filter on the sweep setup could eliminate some of the false responses, but

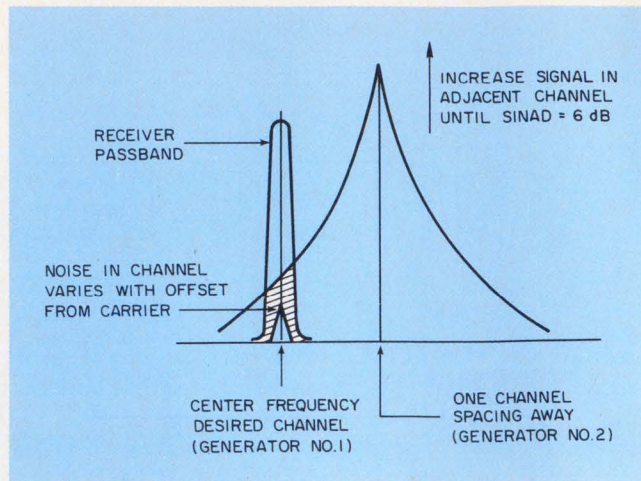

3. Generator phase noise contributes to a distortion reading. The error depends on the offset from the carrier and the bandwidth of the receiver.

it's better to sweep-test with a tuned-detector instrument instead. A spectrum analyzer with a sweeping YIG preselector and a tracking generator, for example, keeps the detector tracked on the fundamental signal, and rejects harmonics and most spurious signals. With such equipment, you can achieve spurious-free dynamic ranges of 80 to 100 dB.

Still another solution: Use a network analyzer, such as the HP 8410, which down-converts the microwave test signal to i-f frequencies. A sweeping local oscillator in the network analyzer also locks the detector to the sweeping signal, and rejects harmonics and most spurious components.

Modern receivers create particularly stringent test-generator requirements. Many, if not most, receivers now use synthesized local oscillators for digital read-out and high stability. Channel spacings are split again and again to stretch band-carrying capacity. Thus, a generator's signal purity and spurious characteristics must be sufficient to meet the adjacent-channel requirements and to reject spurious signals.

One measurement, for sensitivity, is often conducted in terms of SINAD—the ratio of the signal + noise + distortion to noise + distortion at the output of a receiver.

SINAD—an important parameter

A broadband voltmeter in a distortion analyzer at the receiver output measures the three components—signal, noise, and distortion—at the output. A notch filter then removes the audio signal component, and the resulting ratio is SINAD. The usable sensitivity is defined as that level of rf input giving a 12-dB SINAD.

The signal-generator characteristics important in measuring usable sensitivity are attenuator accuracy, leakage and modulation distortion. Most commercial generators, including the economy models, do this test

quite adequately. However, leakage does vary from generator to generator.

Most sweepers—even those with output attenuators—are not adequately shielded for leakage, usually do not have modulation, and therefore are not suitable for sensitivity tests.

Quieting sensitivity, another method of measuring receiver sensitivity, uses the same test setup as for SINAD. With the generator carrier off, adjust receiver volume for a noise-output level equal to 25% of rated audio-output power. Then, increase generator output (unmodulated) until the receiver output noise drops by 20 dB. This input rf is the quieting sensitivity level.

Generator specifications important to the quieting test are the same as those for usable sensitivity, except there is a greater need for low residual FM. Residual FM on the carrier appears as a small amount of detected noise that the distortion analyzer sees as receiver noise. Residual AM does not normally affect the SINAD test for FM receivers.

Handling adjacent-channel tests

Adjacent-channel selectivity measures a receiver's ability to differentiate between a desired signal and other signals in adjacent channels. For this test, you'll need two generators, one to simulate the desired signal and the other to simulate the adjacent-channel signal (Fig. 2).

With Generator 2 off, tune Generator 1 to the desired channel and modulate with a 1-kHz tone at 2/3 maximum rated deviation. After setting up a 12-dB SINAD, modulate Generator 2 at 400 Hz and 2/3 maximum deviation, then tune it to either adjacent channel and adjust the level to reduce the 1-kHz SINAD to 6 dB. The ratio of Generator 2's level to that of Generator 1 gives the selectivity.

The most important generator specification for the adjacent-channel test is the total noise of Generator 2. As you increase the level of Generator 2, its phase noise appears within the bandwidth of the desired channel and contributes to the distortion (Fig. 3). For example, in testing a receiver with 10-kHz bandwidth and 90-dB selectivity, Generator 2 requires a phase noise lower than 140 dB/Hz.

Selecting a generator for adjacent-channel testing is not so easy. Receiver characteristics, such as channel spacing and adjacent-channel rejection, figure significantly in your selection. Other important specifications for Generator 2 are low spurious signals and low FM distortion. Fig. 4 compares typical SSB-noise performance in several available generators.

Additional requirements for adjacent-channel selectivity emerge as more channels are allocated to established service bands. Some split arrangements now provide mobile FM channels with only 12.5-kHz spacing (mostly in Europe). Hence, frequency drift must be small enough to keep both generators tuned to their respective channels. Phase-lock techniques

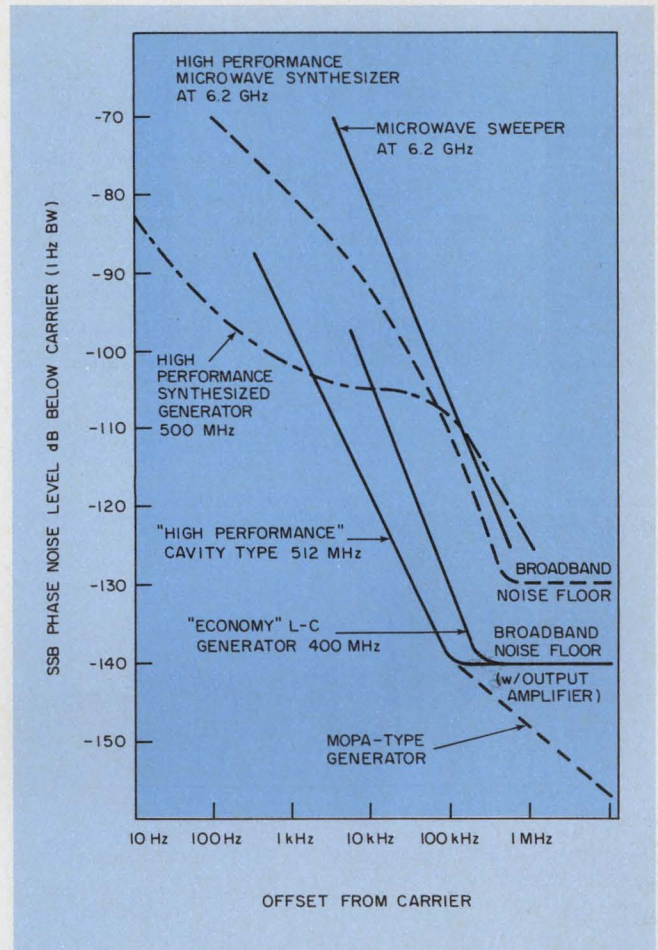

4. Phase-noise performance of various sources: Lowest noise is still provided by older designs.

can achieve drifts of 0.1 ppm/h yet preserve the basic spectral purity of the cavity or L-C oscillator.

Another important test, for spurious attenuation, measures how well a receiver can discriminate between a desired and an undesired signal, either in-band or out-of-band, as well as image and i-f responses. Using the test setup for quieting sensitivity, measure the receiver for 20-dB quieting sensitivity. Then with no change in the receiver settings, apply the maximum signal-generator output, and search across the receiver band. Whenever you note a response, reduce the generator level until 20 dB of quieting returns. The ratio between the first and second-generator settings represents the receiver's spurious attenuation at that frequency.

Noise and other problems

A signal generator's own spurious signals and its broadband noise floor are particularly important in measuring spurious attenuation. For example, as the generator signal searches the receiver band (Fig. 5), its spurious component may indicate a response that can be falsely attributed to the receiver. Fig. 5b shows the variety of signals that might be present at the

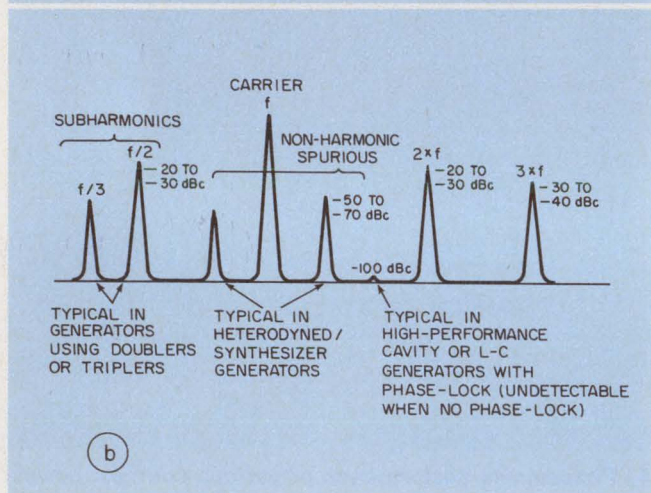
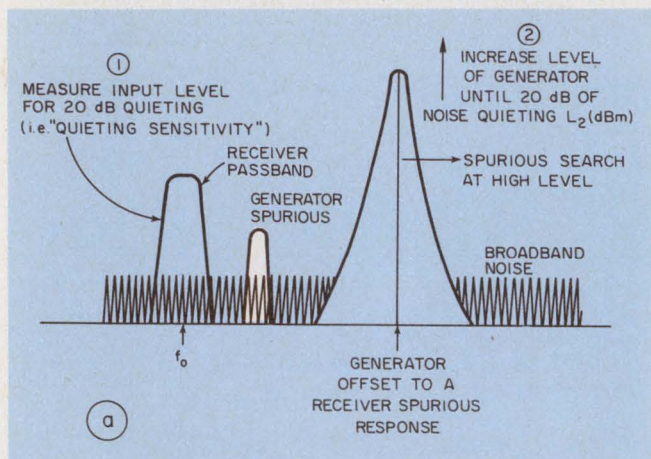

5. A generator's spurious components directly affect the measurement of receiver spurious attenuation (a). Any one of a variety of unwanted generator outputs can complicate the measurement (b).

output of different generators.

Spurious signals are very common in synthesizer and heterodyne generators, especially at the 1.0-V output levels required for the search. Because of spurious higher-order mixing products, synthesizers shouldn't be used for spurious search. Harmonics and subharmonics can be reduced with low or bandpass filters because they are predictable, but nonharmonic spurious are unpredictable and even cross under the carrier.

The other important characteristic in spurious measurements, the broadband noise floor, is noise generated primarily in the generator's power amplifiers. If a receiver has a 12-kHz bandwidth, and the noise floor of the generator is 120 dB/Hz, the receiver will see a generator noise that is 78 dB below the carrier. For some receivers, that number is too high.

For especially crucial tests, you may have to resort to the older, MOPA (master oscillator-power amplifier) generator. The HP 608E MOPA dates back to 1950, yet still provides the lowest noise floor of

current generators because of its tracking, tuned-power-amplifier design.

The receiver must also distinguish between a desired signal and certain combinations of two or more undesired high-level signals at the input. The ratio of desired to undesired signals is called the intermodulation spurious attenuation. To make the measurement, combine three generators (Fig. 6).

First, set Generator 1 to f_0 and modulate it with a 1-kHz tone at 2/3 maximum deviation. Adjust the rf level for 12-dB SINAD. Next, tune Generator 2 to the adjacent channel (unmodulated), and Generator 3 to the next adjacent channel (same side as 2).

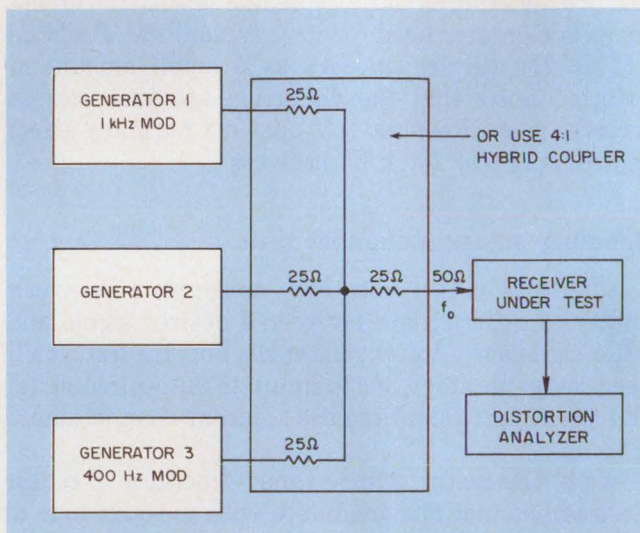

6. You'll need three generators to pin down a receiver's intermodulation spurious attenuation. Two of the three sources require modulation capabilities. The method of generator coupling is crucial to avoid cross products.

Modulate No. 3 with 400 Hz at 2/3 maximum deviation. Increase the levels of Generators 2 and 3 together until the SINAD degrades to 6 dB. Intermodulation spurious is then the ratio of the levels of either 2 or 3 to the level of Generator 1.

Cross-products created in the coupling of two or more signal generators cannot be separated from the intermodulation products of the receiver. Therefore, pay special attention to the coupling methods. The primary cause of spurious intermodulation products is the leveling detector in the generator-output circuitry. At the high level required by the tests, some of Generator 2's output signal reaches the nonlinear detector of Generator 3.

For modern, high-performance generators coupled with a three-way splitter, typical third-order products are only 30 dB down at rated +13-dBm output. If you open the leveling loops and disable the detectors inside Generators 2 and 3, you can drop the third-order products by approximately 60 dB. Hybrids and balanced mixers or couplers can better isolate the generators and reduce the effects of intermodulation. ■

The system
builder's sensible
display.

Everything
you need and
not one piece
more.

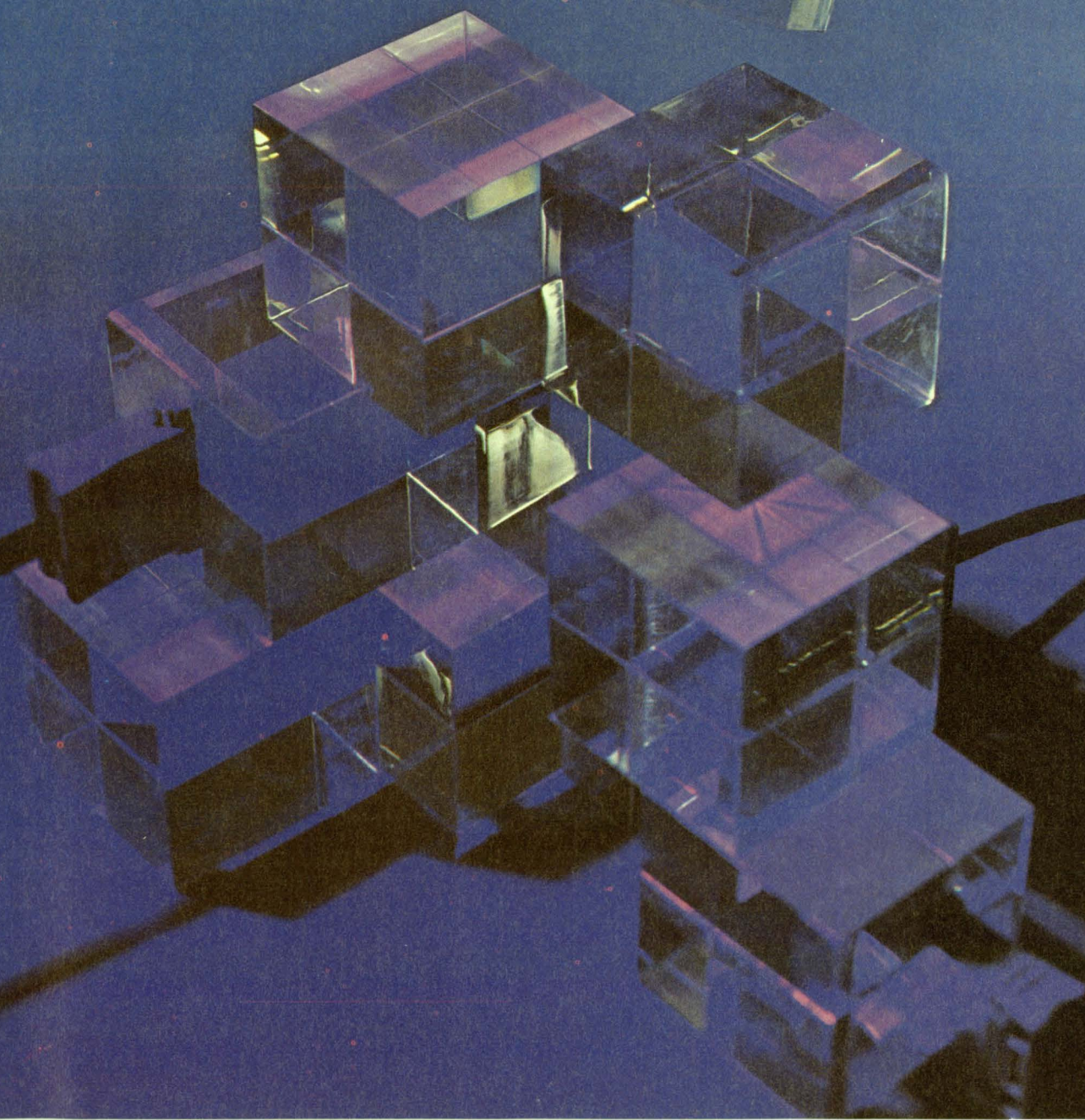

We've combined refresh with storage in a new modular graphics display.

You build from there.

Suddenly state-of-the-art display technology comes built for the OEM.

Tektronix' new GMA display modules let you integrate into your system our most impressive display capabilities ever. Including refresh and storage graphics in one tube. Complete character and vector generators. Big 19" screen and fine resolution.

It's exactly what you need, because you can specify exactly what you want. Order CRT and power supply only, or select from a range of performance and packaging options in our extensive product line.

You can integrate other products from our graphics family, like hard copy modules. Or talk to us about other special product configurations, like our 11" storage-only components.

No other package lets you pick such comprehensive graphic display capability at anywhere near the price.

It figures, because Tektronix has been the worldwide low-cost graphics leader for years. No matter what unique and unusual systems you're working with, we can help with manufacturing flexibility, engineering assistance, and a passion for excellence.

Get capability you can build with. From a supplier you can work with. Get your Tektronix OEM Sales Engineer on the phone today. Or write us for more information.

Tektronix, Inc.
Information Display Group
OEM Components
P.O. Box 500
Beaverton, OR 97077



CIRCLE NUMBER 42

Tektronix
OEM components:
the perfect fit.

Tektronix[®]
COMMITTED TO EXCELLENCE

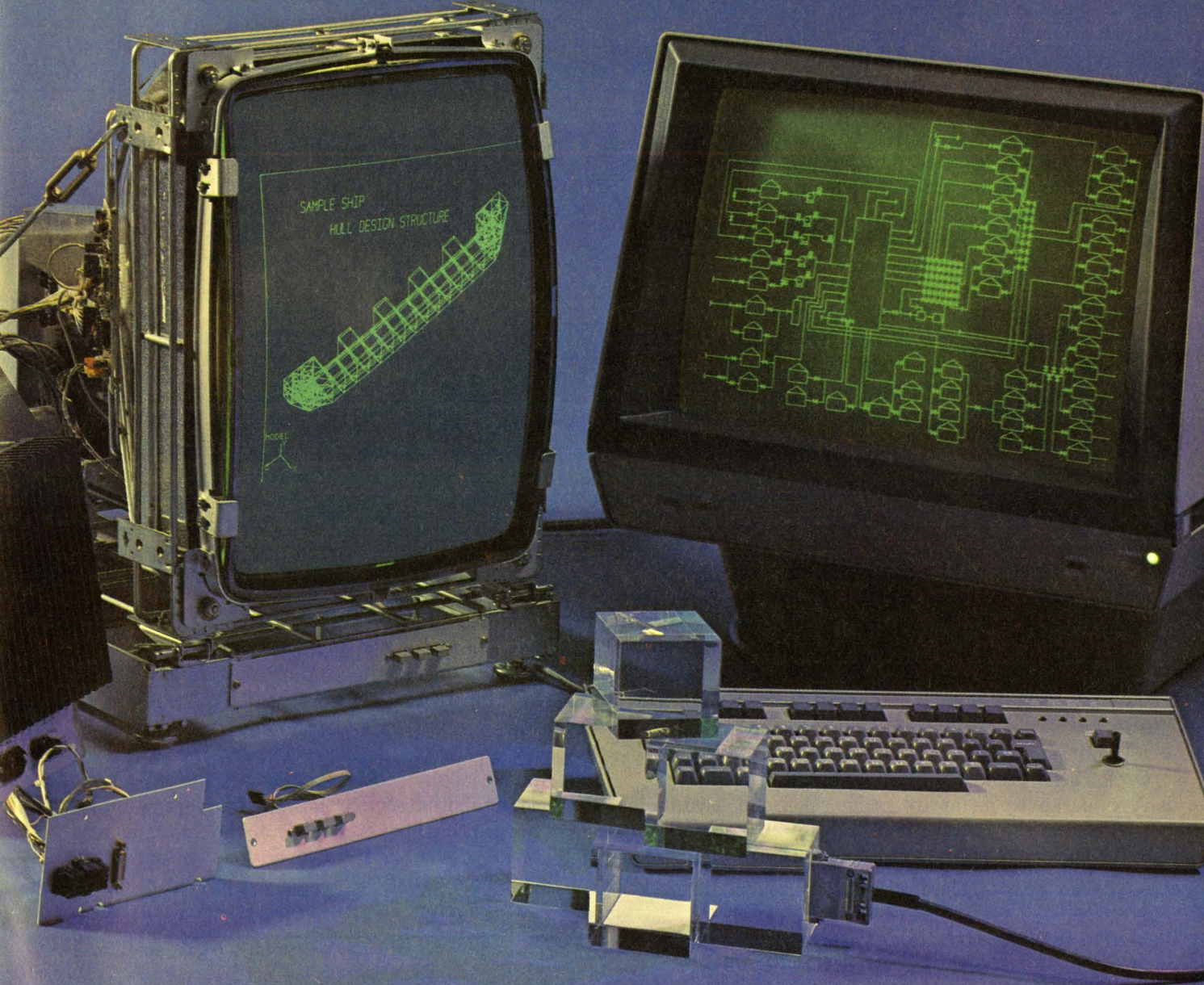

Lock onto frequency with frequency-lock loops. These simple-to-design tracking circuits can often tame signals that are too difficult for phase-locking.

A little known circuit, the frequency-lock loop (FLL), can simplify tracking of some signals. When frequency—not phase—is your concern, FLLs can often outperform the widely used phase-lock loop (PLL).

For intermittent signals or those with either phase or frequency discontinuities, the FLL offers characteristics that a PLL can't match. An FLL's frequency-acquisition range is much wider than a PLL's. Where a PLL suffers from sharp transition between its lock and out-of-lock modes, an FLL is never out of lock; so you don't have to contend with mode transitions. And the need to restabilize a PLL after a signal-phase inversion simply doesn't apply to an FLL.

Therefore, frequency-lock loops can be just the thing for the cumbersome processing of signals encountered in suppressed-carrier AM, frequency-shift keying, Rayleigh-fading channels and sonar reverberation. In addition, you can use these rather simple devices to demodulate sonarlike narrow-band noise or even design a frequency offset into your tracker.

Three blocks make an FLL

Basically, a frequency-lock loop contains just three elements (Fig. 1): a *frequency-difference detector* (FDD) that generates an error voltage proportional to the difference between the input and output frequencies; an *integrator* that ramps the error voltage; and a *voltage-controlled oscillator* (VCO).

The VCO's output frequency varies with the integrator's output voltage. When the frequencies of the VCO and input match, the error voltage shrinks to zero.

Transfer functions for each of the three basic blocks are expressed in terms of frequency. The integrator's transfer function is $1/\tau S$, where τ is the time constant and S is the generalized frequency variable of the Laplace transform.

Assume that the VCO's control characteristic is linear. Its "gain," K_O , is therefore fixed and expressed in Hz/V.

On the other hand, the transfer function of the FDD isn't linear over its entire range. You can assume, however, that the error voltage does vary linearly with the difference frequency up to some maximum. The

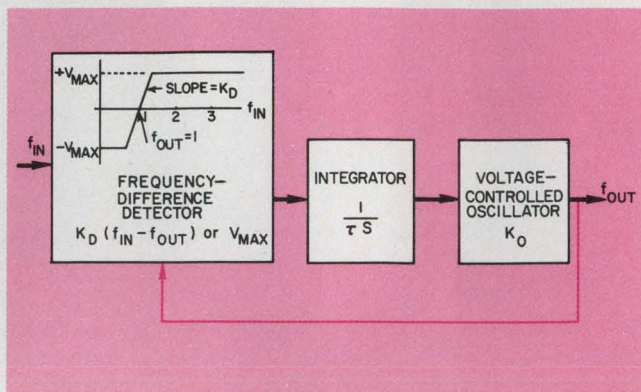

1. Just three functions make up an FLL. The frequency-difference detector's characteristic has a linear slope, K_D , until it reaches saturation at $\pm V_{max}$.

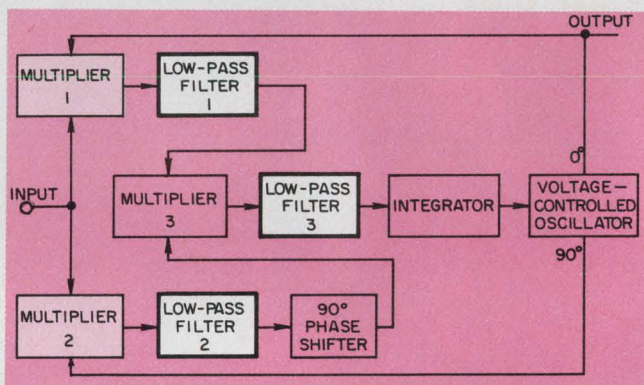

2. Theoretically, three low-pass filters are needed in an FLL that uses digital multipliers at its input.

"gain" factor, K_D , for the FDD's linear region is given in V/Hz. In saturation, the output voltage is V_{max} .

FDD works in two states

As you can see in Fig. 1, the transfer function for the FDD depends on the state of the system. There are two states, which form the FLL's regions of operation—acquisition and tracking. The detector is saturated in the acquisition region and operates linearly in the loop's tracking region.

In the acquisition region, the VCO frequency simply slews toward the input frequency at the constant rate of $K_O \times V_{max}/\tau$. In the tracking region, loop feedback comes into play, and the transfer function is

$$\frac{f_{out}}{f_{in}} = \frac{K_D K_O / \tau S}{1 + K_D K_O / \tau S} = \frac{1}{1 + S(\tau / K_D K_O)}$$

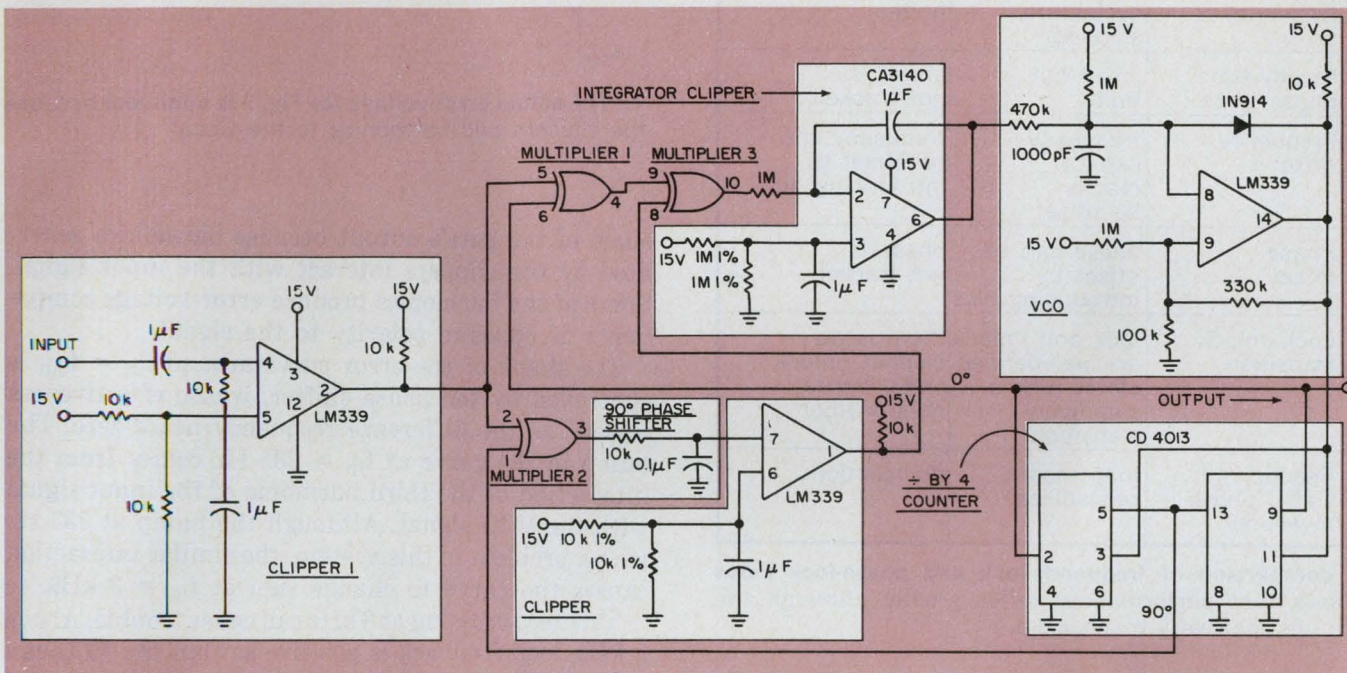

3. No separate low-pass filter stages are required in the actual circuit for this multiplier-input FLL.

In the linear region, the system is a simple first-order loop. For a step change in frequency at the input, the output frequency changes exponentially with a time constant of $\tau/K_D K_O$.

Fig. 2 blocks out an FLL in concept. Here, the input signal is multiplied by quadrature phases of the reference frequency from the VCO.

For a sine-wave input, the outputs of multipliers 1 and 2 are quadrature phases of the sum and difference frequencies. Low-pass filters 1 and 2 eliminate the sum-frequency components. One of the difference-frequency signals is phase-shifted by 90° so that the difference frequencies are either in-phase or 180° out of phase with each other. The relative phases depend on whether the input or the reference is of higher frequency.

Multiplied together by multiplier 3, these two signals produce a double-frequency component and a dc error signal. The double-frequency component is eliminated by low-pass filter 3. The dc can be either positive or negative, again depending on whether the input frequency is higher or lower than the reference. This error signal drives the integrator, which in turn drives the VCO. Let the phases make the loop feedback

negative—the frequencies of the input and VCO then track, thereby zeroing the error signal.

Four ICs make an FLL

Fig. 3 shows a practical circuit stemming from the concept outlined in Fig. 2. The entire FLL uses four ICs:

- A CD 4030 quad Exclusive-OR.
- A CD 4013 dual D-flip-flop.
- A CA 3140 op amp.
- An LM 339 quad comparator.

As is often done in the better known phase-locked loop, the input to the frequency-locked loop is clipped (clipper 1). In the FLL, a comparator does the clipping. Because the clipped signals are digital, Exclusive-OR gates are used as multipliers.

An R-C pseudo-integrator then adds approximately 90° of phase shift. A second clipper reconverts the result to a digital signal.

The loop integrator is a conventional op-amp type. For the VCO, all you need is one of the quad comparators. A divide-by-four, shift-register counter provides the quadrature phases of the reference frequen-

Table 1. Comparison of PLL and FLL

Property	Phase-lock loop	Frequency-lock loop
Frequency acquisition range	relatively narrow	relatively wide
Pull-in voltage	decreases with increasing frequency error	increases with increasing frequency error
Steady-state frequency error	zero (if no cycles are skipped)	small but finite
Steady-state phase error	small but finite	phase is not tracked
Frequency offset	frequency cannot readily be offset	frequency can be offset by introducing bias
Phase offset	phase can be offset by introducing bias	phase is not tracked
Lock-unlock transition	lock and unlock are well-defined states with a significant transition	there is no distinct unlock state, hence no transition
Reaction to signal phase inversion	loop must re-stabilize	no reaction

A comparison of frequency-lock and phase-lock loops shows that performances differ greatly although the circuits look very much alike.

cy needed to complete the circuit.

Actually, the practical circuit in Fig. 3 is even simpler than the block diagram of Fig. 2—The three low-pass filters are superfluous. Low-pass filter 3 in Fig. 2 is unnecessary here because the integrator itself is a low-pass filter. Low-pass filter 2 is also unnecessary because of the pseudo-integrator. Even low-pass filter 1 is unnecessary because the double-frequency component is eliminated from the output of multiplier 2—multiplier 3 doesn't generate any extraneous dc. What's more, the high-frequency component is eliminated by the integrator.

FLL digs the signal out of noise

With a signal-to-noise ratio as low as -10 dB and a noise bandwidth of 20 kHz, this simple FLL tracks signals from 500 Hz to 2 kHz. When used for sonar, the circuit in Fig. 3 can track narrow-band noise—sonar reverberation—that PLLs can't handle.

The Exclusive-OR multipliers respond to input noise as well as to signals. Since input noise not only lowers the error voltage but also makes it noisy, the loop responds slowly and fluctuates around the correct frequency.

The actual error-voltage curve for this circuit (Fig. 4) differs considerably from the straight-line approximation because of the clippers. The error voltage falls

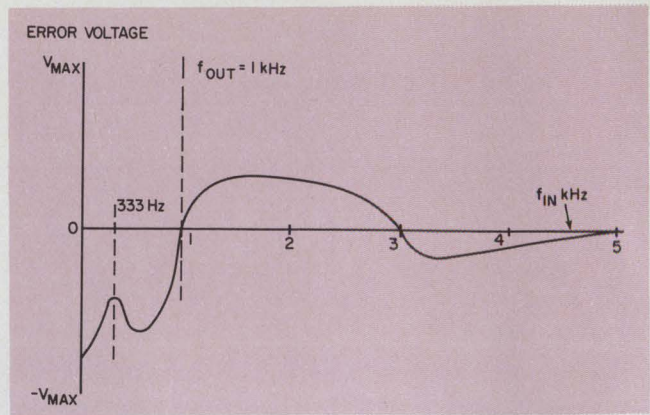

4. The actual error voltage for Fig. 3 is nonlinear because the clippers add harmonics to the signal.

short of the gate's output because harmonics generated by the clippers interact with the input signal. Some of the harmonics produce error-voltage components of opposite polarity to the signal.

The shape of the error curve around $f_{in} = f_{out}$ is controlled by the phase shifter, whose effectiveness lessens as the difference frequency nears zero. The bump in the curve at $f_{in} = 333$ Hz comes from the interaction of the third harmonic of the input signal with the VCO signal. Although the bump at 333 Hz isn't a problem in this system, the similar interaction causes the curve to change sign at $f_{in} = 3$ kHz.

This zero crossing at 3 kHz can cause trouble. Above 3 kHz, loop feedback is positive so that the VCO can drive farther and farther away from the signal until its fifth harmonic locks onto the signal.

Take care that the input frequency doesn't exceed three times the output frequency—you must sense for this condition and reset the loop to a higher frequency when it occurs. An equivalent problem occurs with clipping in a PLL—the loop locks onto odd-order harmonics or subharmonics.

FLL tracks frequency with an offset

Another sonar application, the output frequency tracking the input with a controlled frequency offset, calls for a different type of FLL (Fig. 5). This scheme is useful only for low-noise inputs. Instead of multipliers, this system uses a digital FDD.

Each time the output of the VCO "slips" past the input by a complete cycle, the detector triggers a precision one-shot, whose pulse is steered to the appropriate side of a differential integrator. The DI then forces the VCO's frequency (either higher or lower) toward the input frequency.

To offset the VCO frequency, just add dc bias to the integrator. The VCO then "slips" just enough for the correction pulses to balance the bias.

The circuit (Fig. 6) for the offsetting FLL uses three digital ICs, two op amps and one timer. A CD 4013 "D" flip-flop generates the difference between the VCO and the input frequencies. The flip-flop's

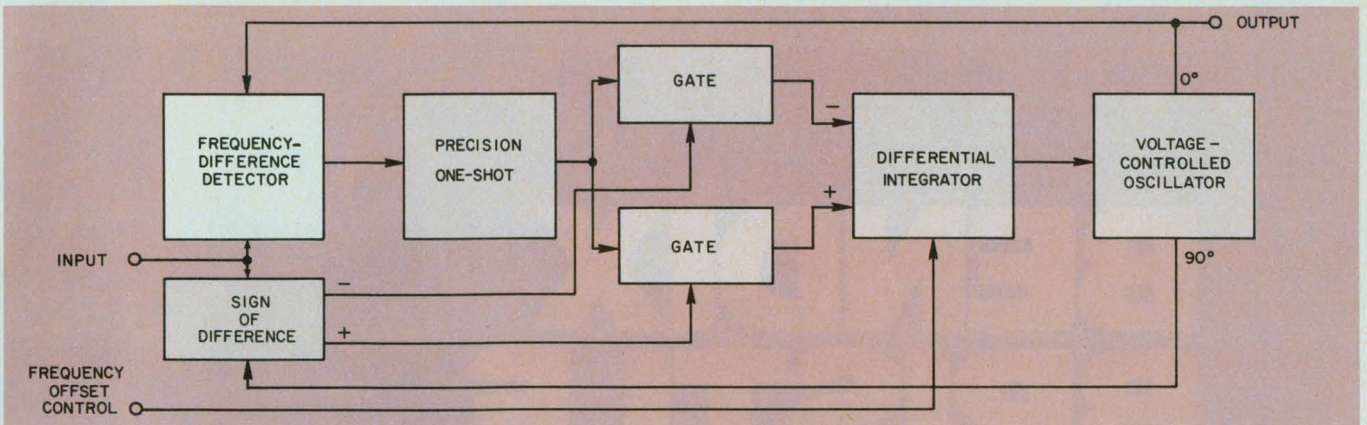

5. Frequency offset is dc-controlled in this FLL, which uses digital frequency-difference detection to sense any

deviation between input and output frequencies. The loop processes only low-noise inputs.

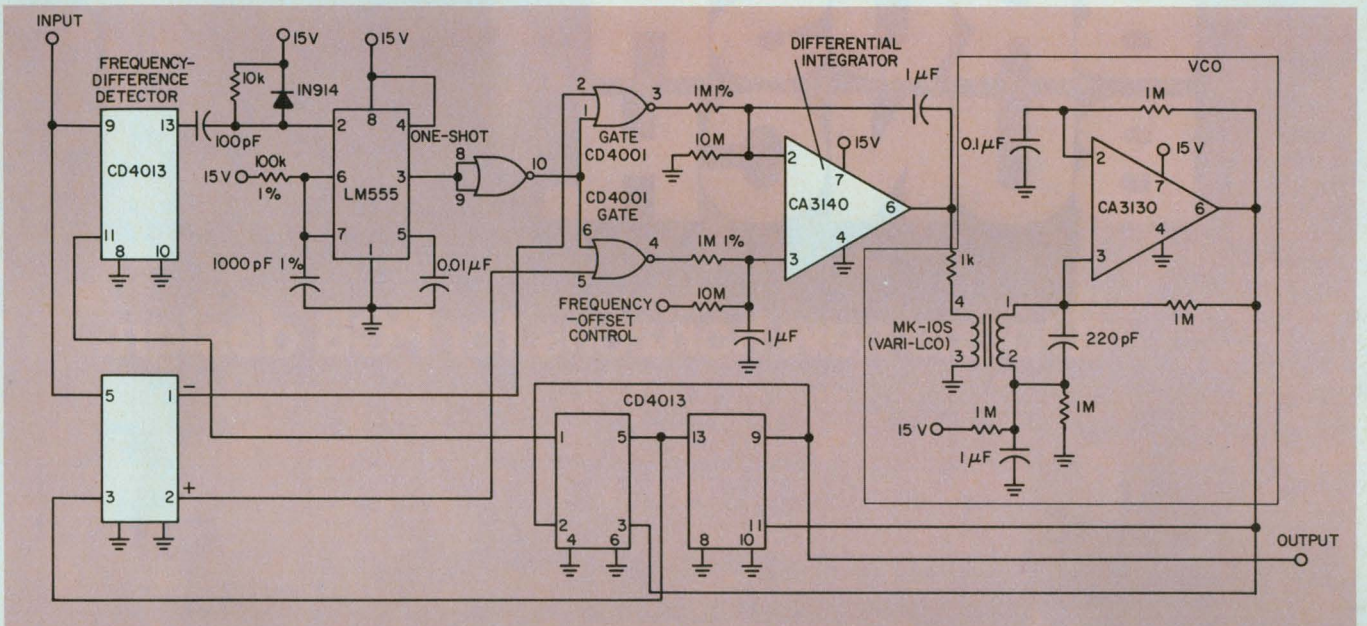

6. A "D" flip-flop indicates a frequency difference from input to output. Another flip-flop (on the same chip) steers

the pulse to the differential-integrator input. The differential-integrator, in turn, controls the VCO.

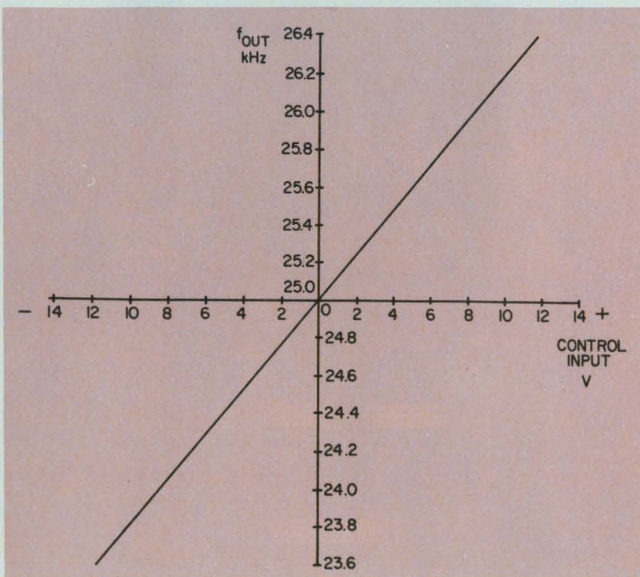

7. The frequency offset for Fig. 6 is linear because of feedback in the frequency detector.

negative transition produces a precise-width pulse by triggering a 555 timer.

A second "D" flip-flop, driven from the quadrature phase of the VCO, determines whether the input frequency is higher or lower than that of the VCO. This flip-flop then gates the pulse to the proper integrator input, which in turn controls the VCO (an LC oscillator featuring low jitter and noise). A divide-by-four counter provides the quadrature phases.

The third input to the integrator is the frequency-offset-control voltage. The frequency-offset-control characteristic for this system (Fig. 7) is linear because the frequency detector uses feedback balancing. The detector is linear so long as the difference frequency is less than one-quarter of the reciprocal of the correction-pulse width.

Warning: Don't let the difference frequency exceed half the reciprocal of the pulse width. At that point, the error voltage abruptly changes sign and the system becomes unstable. ■■

BENDIX BRISTLE BRUSH BUNCH.

Opens new horizons for PCB design.

Free and easy are now the bywords for board and board support design with the 70% to 90% reduction in mating and unmating forces offered by the new Bristle Brush Bunch connector series from Bendix.

The need for costly board support systems is minimized.

You get extended interconnection contact counts and versatility—up to 400 contacts per connector.

You can choose from a broad product line:

- 2-, 3- and 4-row Mother Board, Daughter Board, PC receptacle and Input/Output body styles.
- Removable crimp, solderless wrap, straight or 90-degree PC stud and willowy tail termination.

For complete information, contact The Bendix Corporation, Electrical Components Division, Sidney, New York 13838.

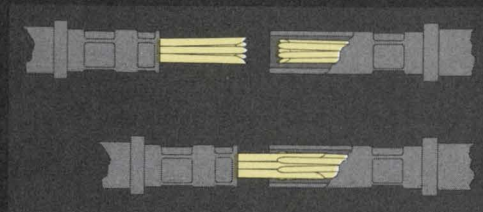

CONTACT INNOVATION

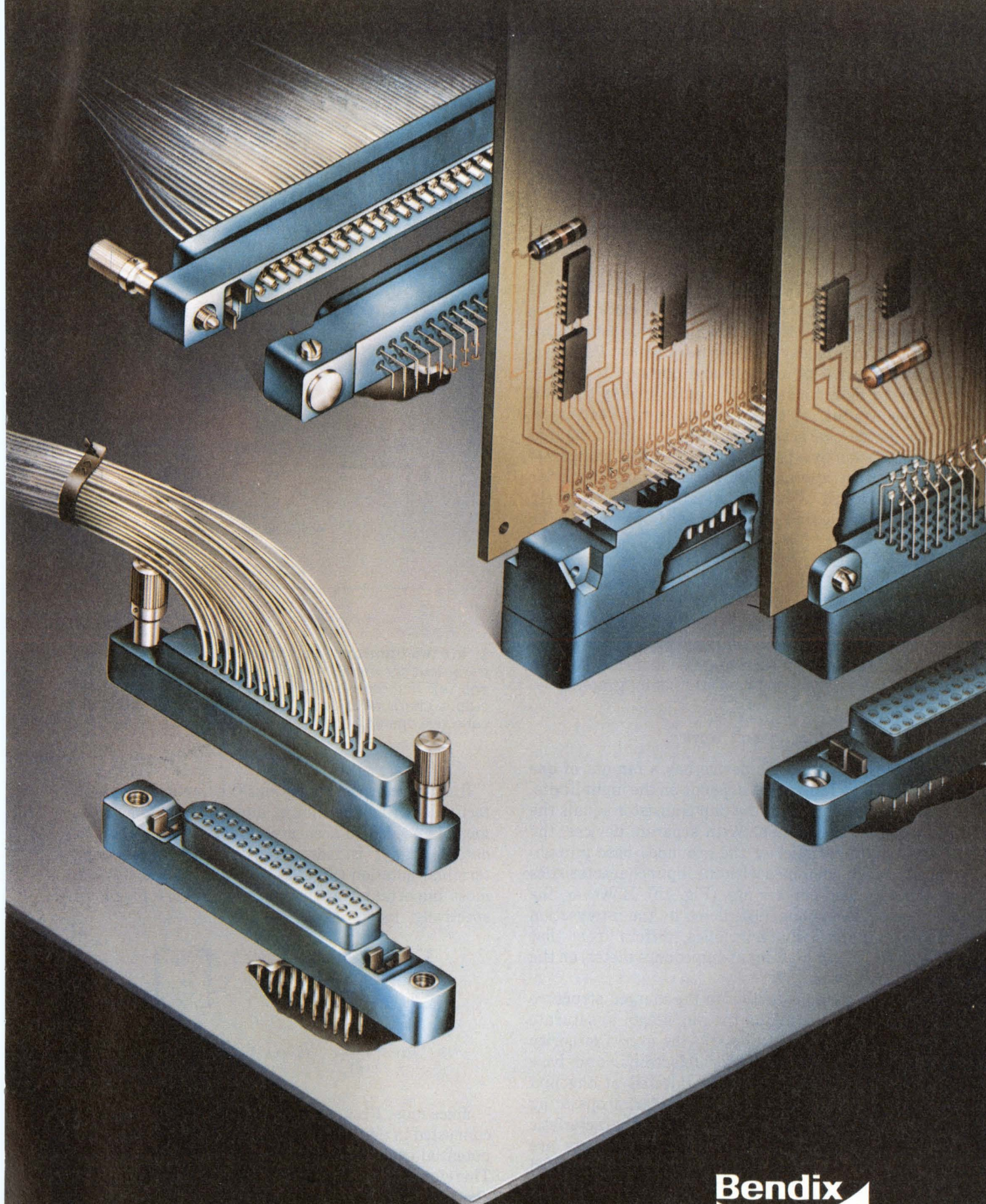

Bendix

Analyze I²L accurately by treating the merged structure as a four-terminal device. A graphic form simplifies analysis, and gives fan-in and fan-out.

To predict or measure large-signal I²L circuit behavior accurately, you must treat the merged structure as a four-terminal device. Even the simplest I²L device—a combination of one pnp and one npn transistor—calls for better measuring accuracy when the gain approaches unity at the operating-current extremes. If the device characteristics (Fig. 1a) are measured separately—as in a two or three-terminal analysis—no more than approximate combinational behavior can be predicted. A four-terminal analysis definitely shows that the gain can be increased by reducing the fan-out.

When you treat the merged structure as a four-terminal device, the structure characteristics—like any four-terminal circuit—can be explained with hybrid circuit parameters, rather than device parameters. To fully understand large-signal performance, including voltage and current-noise margins, you can present the analysis, or measurements, graphically.

Why superposition doesn't work

The simplest I²L logic device has a fan-out of one collector and a fan-in that depends on the input limits. The collector current of the pnp transistor equals the base current of the npn. With separate devices, the output characteristics of the grounded-base pnp obviously can be combined with the input characteristics of the grounded-emitter npn (Fig. 1b). However, the composite base voltage, predicted by the intersection of the unmerged characteristics, differs from that measured (with a high-input-impedance meter) on the merged structure.

Note that the npn portion in the merged structure begins to turn on only as the pnp starts to saturate (collector-base forward biased)—the excess minority carriers in the pnp collector (electrons) and base (holes) are the same as those injected at the npn emitter-base junction (Fig. 2a). The internal operating point is outside the three-terminal characteristic curves, and the pnp excess minority carriers are represented by the area between A and B, and bounded by C (Fig. 2b).

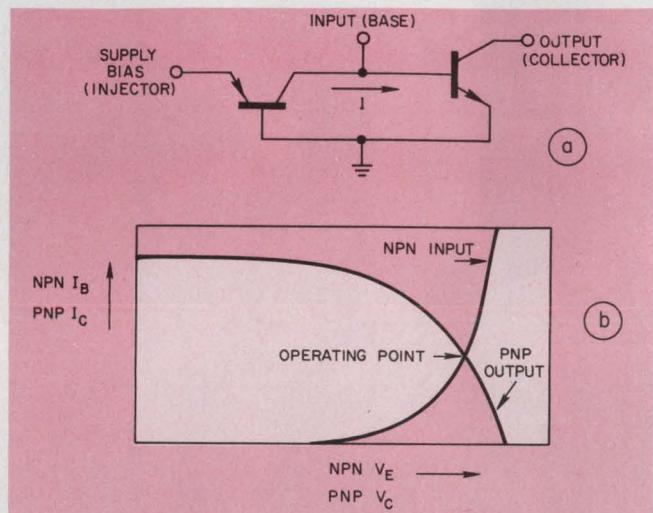

1. In a two-transistor I²L arrangement, the base current of the output npn equals the collector current of the injector pnp (a). If these were conventional ICs, the input and output characteristics could be merged to obtain the collective operating points (b).

It now becomes obvious that the unmerged characteristics can be misleading, and four-terminal treatment is needed to accurately define fan-in and fan-out. So Fig. 1 is redrawn with conventional four-terminal notation (Fig. 3a). The matrix and h_{21} —the most important transfer parameter—are given, respectively, by

$$\begin{bmatrix} I_1 \\ V_2 \\ I_3 \end{bmatrix} \begin{vmatrix} h_{11} & h_{12} & h_{13} \\ h_{21} & h_{22} & h_{23} \\ h_{31} & h_{32} & h_{33} \end{vmatrix} = \begin{bmatrix} V_1 \\ I_2 \\ V_3 \end{bmatrix} \quad (1)$$

$$h_{21} = \frac{\partial I_2}{\partial I_1}; \quad V_2, V_3 = \text{constant}. \quad (2)$$

Since most I²L applications require many injectors connected in parallel, the injectors will be at the same potential even though the supply is a current source. Therefore, V_3 is constant in all measurements. Fig. 3b shows the output characteristics V_2 vs I_2 when $I_1 = 0$ —the current-sinking capability independent of fan-in and fan-out. Only one point on the curve is an operating point.

The input-characteristic curve is added in Fig. 3c

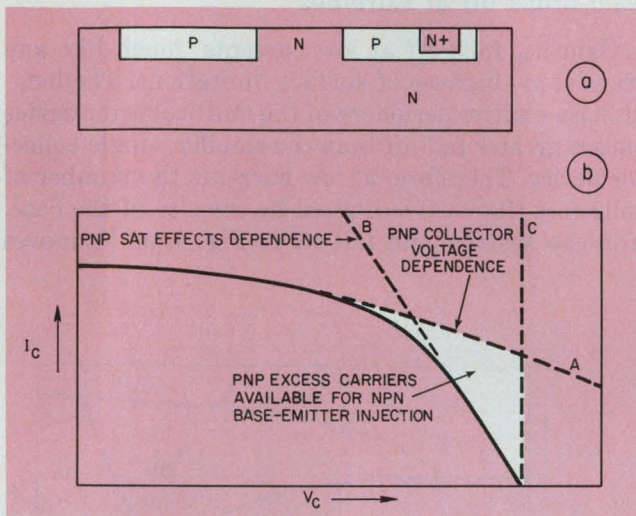

2. The physical configuration of the merged structure (a) and a graphic representation of the structure's operation (b) show why superposition can't be applied. The operating point falls outside when using the conventional three-terminal characteristic curve.

for a constant V_3 and V_2 . The curve is not very sensitive to V_2 because the transfer curve (Fig. 4) must be measured at V_A . Note that I_1 is negative. At $V_1 = V_A$, there is no input current, and V_A represents the maximum V_1 .

Similarly, at $V_1 = V_B$, $I_1 = \text{maximum}$, and V_B is the smallest input voltage for a fan-in of one. The horizontal dashed line in Fig. 3c is the maximum current, $I_2 = I_1$ (input current of next stage), that can flow without extraneous noise. The vertical dashed line is the maximum $V_1 = V_2$ with no extraneous noise sources. All points on the input curve are operational.

Obtaining a figure of merit

In Fig. 4, a transfer curve is added to the input and output curves. Since the curve is obtained with V_2 equal to V_A , it should be valid near that voltage. Point C in the figure is not sensitive to V_2 . Point V_C is the input voltage at which $I_2 = 0$ independently of V_2 . The ratio of output current to input current equals the device gain. Thus,

$$\text{Large signal } h_{21} = h_{FE} = \frac{I_2}{I_1}$$

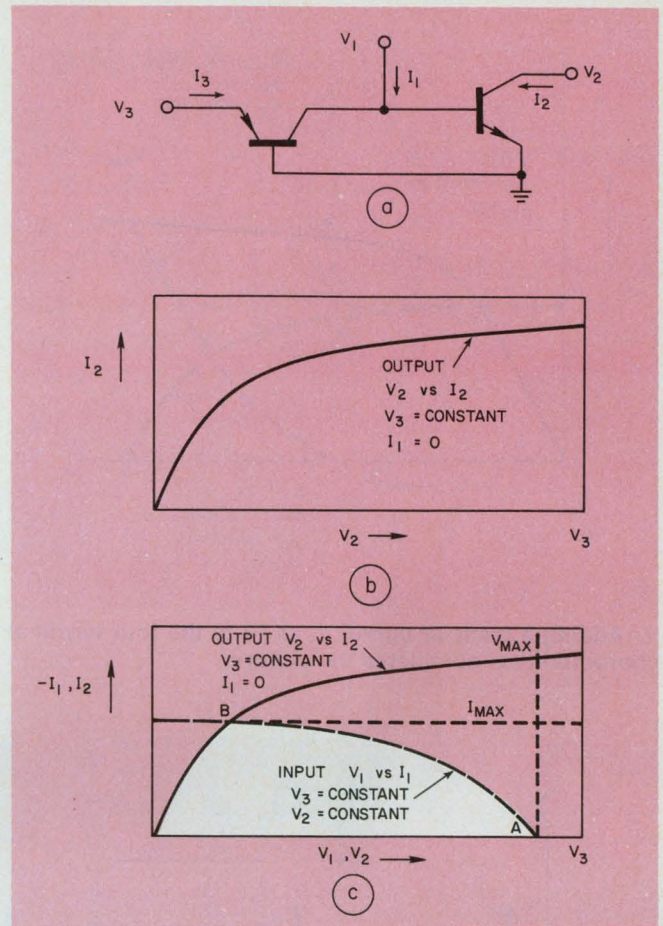

3. To obtain accurate I²L characteristics, first draw the device with four-terminal notation (a). A curve of output current-vs-output voltage shows the current-sinking capability (b). Adding the input characteristics yields the correct operating point (c).

while V_2 and V_3 are constant.

Fig. 4 shows a gain of 1 at operating point $V_1 = V_2 = V_B$. A gain figure of merit can be established at $V_2 = V_1 = V_C$:

$$h_{FE} = \frac{I_E}{I_D} \quad (3)$$

Keep in mind that except where points B, D and E coincide, C and E are not operating points, but only convenient reference points. In Eq. 3, h_{FE} is always negative, and since the term can also be confused with the three-terminal gain, a modified term, always positive, is substituted:

$$\overline{h}_{FE} = \frac{I_E}{-I_D} \quad (4)$$

In determining noise margins, note that a positive noise voltage tends to turn on a device operating at input voltage V_B (Fig. 5). Since the device remains off until the input voltage reaches V_D , the voltage noise margin is $V_{CDE} - V_B$, and the corresponding current-noise margin is $I_E - I_D$. Note also that the noise causes

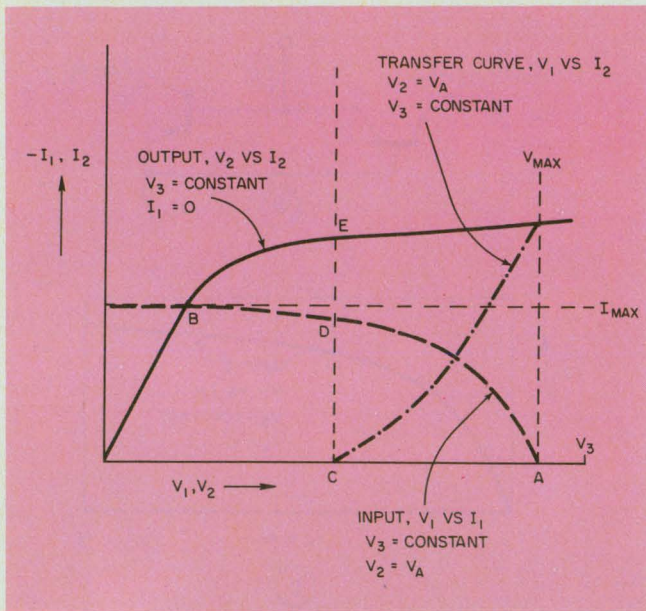

4. Adding a transfer curve (V_1 vs I_2) to the four-terminal characteristics completes the picture.

the circuit to use up the excess current ($I_E - I_D$), and reduces \bar{h}_{FE} to 1.

As shown in Fig. 6, a negative noise pulse tends to turn off a device operating at input V_A . This tendency changes the output curve, so that the excess current ($I_E - I_D$) is again reduced until $\bar{h}_{FE} = 1$ (Fig. 6b). Input limits are approximated with the transfer curve, which is valid near V_A . The voltage noise margin is $V_A - V_F$, and the corresponding current noise margin is I_F . Observe that the I_{max} line can also approximate the noise margin.

Gain drops off at extremes

Gain \bar{h}_{FE} falls off at low currents, much like any transistor—because of surface limitations. The longer, base-emitter periphery of the multicollector device causes greater fall-off than the smaller, single-collector device. Therefore, at low currents the number of collectors (fan-out) is limited by the size of the base. You can see the gain fall-off in Fig. 4, as V_C moves

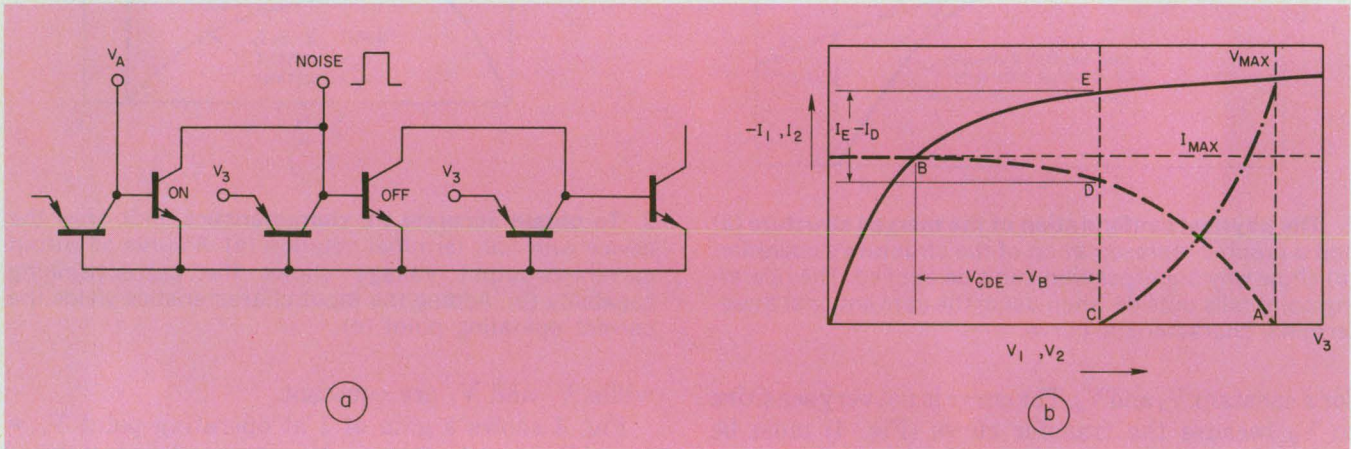

5. To determine noise margin, draw the circuit as shown (a), and measure margin (b) on the curves as $(V_{CDE} - V_B)$.

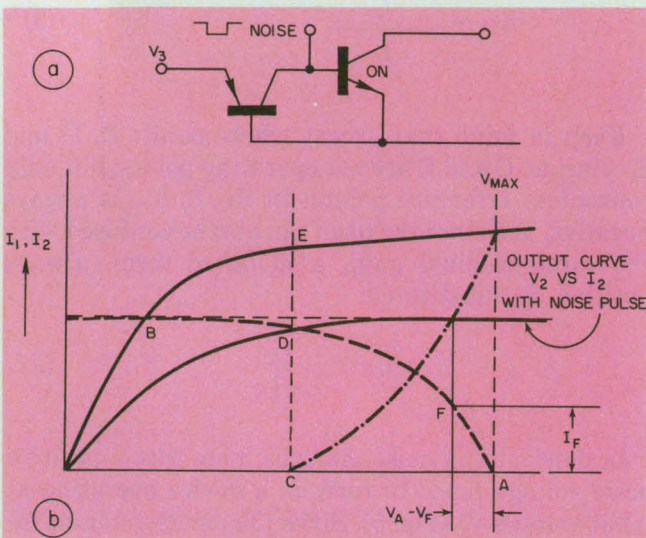

6. A negative noise pulse at the input can turn on the I^2L device (a). When this occurs, the output curve changes and reduces the excess current (b).

to the left and $(I_E - I_D)$ decreases.

At high currents, \bar{h}_{FE} falls off because of space-charge limits, again like any transistor. The gain of the remote collectors drops more rapidly than those near the injector because of the lateral drop in the base. Keep in mind that since the pnp portion is saturated, the npn is driven by a voltage source.

If there were no lateral base current, the entire base would be at an equipotential. The lateral voltage drop is caused by a recombination resulting from a transport-opposing field and a poor collector-to-emitter area ratio. While each collector receives most of the carriers injected directly under its location, most carriers injected into other areas will recombine.

If a collector is left open, it will reinject carriers, and they will recombine unless they are collected by an adjacent collector. Therefore, the worst-case gain at any collector occurs when all other collectors in the same base are open. In Fig. 4, the gain fall-off is seen as V_B moves right and $(I_E - I_D)$ decreases. ■■

40 Column Alphanumeric Printer Microcomputer Compatible

\$425 (singles)

Datel has it . . .

model AIP-40, a complete stand-alone Alphanumeric Impact Printer. It's ideal for teleprinter use with mini- and microcomputers or as a print-only 40-column teletypewriter. It includes a printhead, paper feed mechanism, electronics, and power supply.

The AIP-40 prints the standard 64-character ASCII set. Characters are formed within a 5 x 7 dot matrix with logic controlled printing of 10 x 7 double-width characters, corresponding to a 20-column line.

Both 8-bit parallel and full serial interfaces are offered on the AIP-40. The 8-bit parallel interface is asynchronous and offers the lowest cost at \$425.* It is user connectable to many microprocessor systems and most mini-computers. Serial interfaces, starting at \$625,* offer simpler wiring to the teletypewriter (TTY) or EIA RS-232-C peripheral module offered by most computer manufacturers.

AIP-40 features excellent speed and reliable, low maintenance operation for terminal and development applications. Average printing rate is 50 characters per second (1.25 lines per second). Serial interfaces can sustain a continuous 300 BAUD printing rate due to internal line buffering. AIP-40's impact mechanism prints directly onto conventional adding machine paper. An AC synchronous motor controls printhead motion, paper advance, ribbon feed and automatic ribbon reversing. A triple-voltage power transformer accepts 100, 115 or 230 VAC, $\pm 10\%$ at 50 or 60 Hz which is field-changeable. The mechanism life is rated at 400 million characters.

For your free 12-page 4-color brochure on AIP-40, contact Datel or your nearest Datel Representative listed in EEM or Gold Book.

*U.S.A. domestic prices only.



DATEL
SYSTEMS, INC.

1020 Turnpike St., Canton, MA 02021 • Tel. (617) 828-8000

Santa Ana, CA (714) 835-2751, (L.A. Exchange) (213) 933-7256 • Sunnyvale, CA (408) 733-2424 • Gaithersburg, MD (301) 840-9490

CIRCLE NUMBER 44

Look at data in different ways.

The 7D01F lets you choose from five display modes: maps; state tables in hexadecimal, binary, or octal code; or timing diagrams. How often have you encountered a problem you knew you could spot just by scanning overall program flow? How often have you wished you could compare state tables in the hexadecimal code you work with as well as the binary code your microprocessor knows? How often have you wanted to switch from a state table display to its corresponding timing diagram? The 7D01F can help at each step of this troubleshooting procedure.

You've designed, debugged, and loaded your system software. Now you need several powerful capabilities to ensure trouble-free execution on the prototype: the ability to look at data in different ways . . . to compare known good data with new data quickly and easily . . . to analyze both system and peripheral-interface timing.

The TEKTRONIX 7D01F Logic Analyzer offers you all those capabilities in a single instrument.

Troubleshooting a microprocessor-based system is easier...

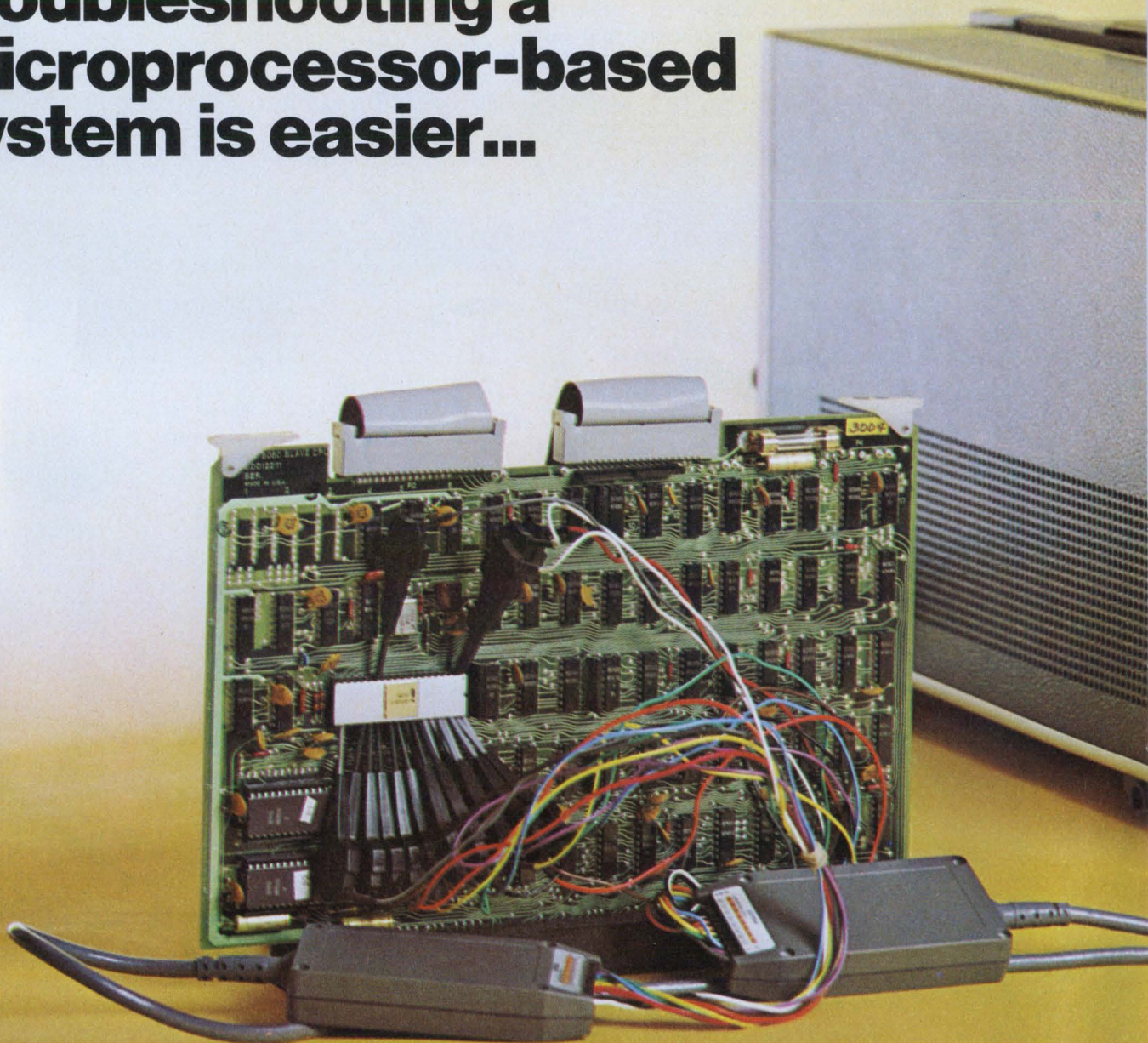

Compare known good data with new data.

The 7D01F features two comparison modes which facilitate in-depth software/hardware debugging. The EXCLUSIVE-OR and RESET-IF modes speed up what would otherwise be a very tedious process: checking the program flow chart against what falls out when the program is run.

For an EXCLUSIVE-OR comparison, simply verify known good data, store it in reference memory; acquire new data, and select a table comparison mode. The reference table and the compared table (which may be in hex, octal, or binary) will be displayed side by side, and the differences between the two will be highlighted for ready identification.

Use RESET-IF to track down an intermittent fault. In this mode the 7D01F can automatically acquire and compare up to 4096 bits of new data to 4096 bits of reference data. Data is continually reacquired until a mismatch occurs. If there is a mismatch, the instrument holds the display, highlights the differences, and displays the number of resets that occurred. This frees the operator from continually monitoring for wandering programs, intermittent loops, or ragged-edge timing problems.

Analyze system and interface timing.

The 7D01F offers synchronous data acquisition at speeds up to 50 MHz. But it is sometimes necessary to view microprocessor operation with increased timing resolution, as well as to locate timing discrepancies in the system's interface with the outside world. You may, for example, need to asynchronously examine data coming into the I/O port before you can determine whether incorrect information is coming from the I/O port itself or the hardware on the other side. The 7D01F offers asynchronous data acquisition at sample intervals of up to 100 MHz.

...with the Tektronix 7D01F Logic Analyzer.

All these unique features are available only in the TEKTRONIX Logic Analyzer. To find out more about how the 7D01F can simplify your work with microprocessor-based systems, just call your local Tektronix Field Engineer. He'll demonstrate the 7D01F in your application, and acquaint you with its many other features, including 16-channel word recognition, 1M Ω /5 pf logic probes, 16-channel data acquisition, 4k formattable memory, and 7000-Series mainframe compatibility.

You should also send for our newest application note, describing in detail how a 7D01F can be used with microprocessor-based systems. Write Tektronix, Inc., P.O. Box 500, Beaverton, Oregon 97077. In Europe, write Tektronix Limited, P.O. Box 36, St. Peter Port, Guernsey, Channel Islands.

Tektronix
COMMITTED TO EXCELLENCE

FOR TECHNICAL DATA CIRCLE 171
FOR DEMONSTRATION CIRCLE 172

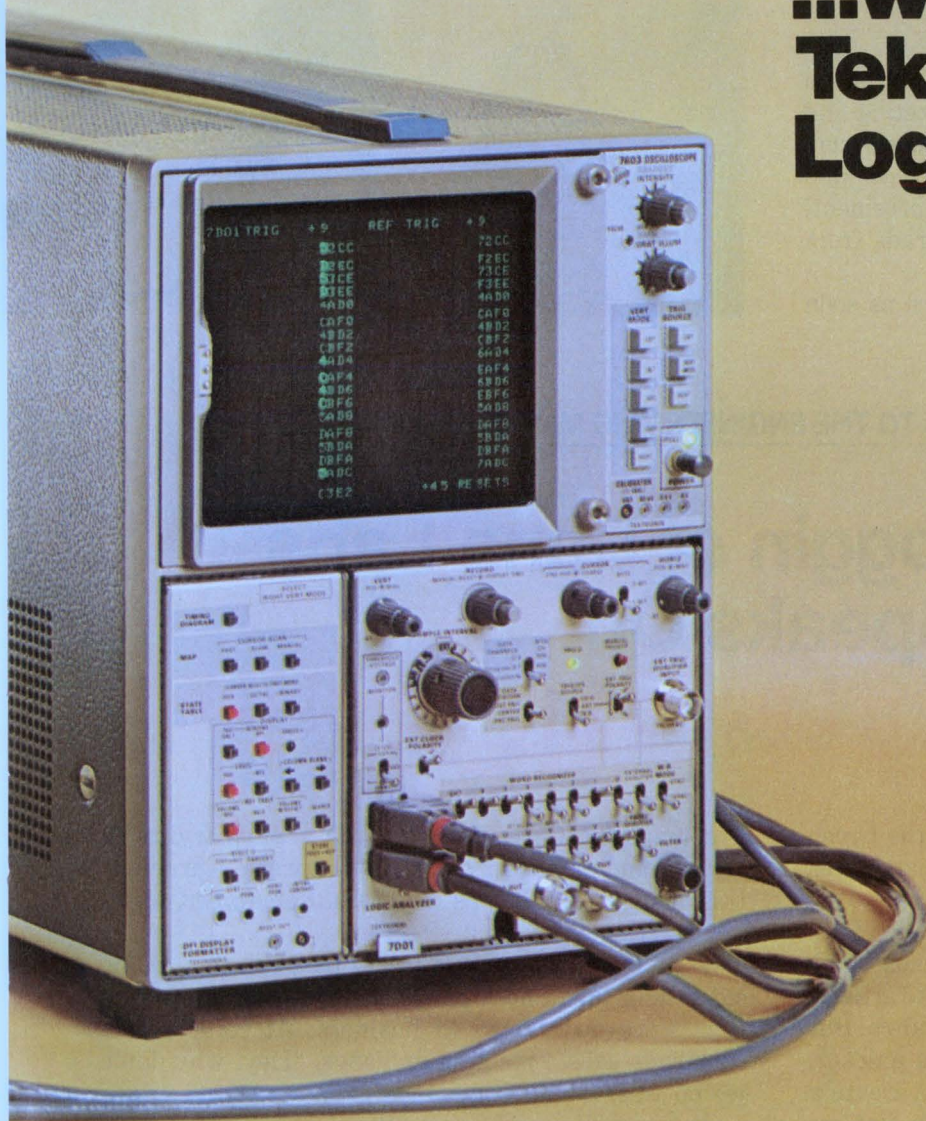

In the instrument business, as in many others, your success depends on how fast you can move a product from your lab to the customer.

Every day this becomes more important because products seem to have a shorter lifespan than they did in the past. And it becomes more difficult because you seem to need more lead time to design and build them. Further, unless you're fortunate enough to have a great deal of surplus funds, you can't afford lots of mistakes, nor lots of uncommitted development resources.

The key to moving your products quickly from conception to customer is the classic one—communications. If you communicate well, you'll have fewer false starts and fewer people charging off in the wrong direction. But communications don't happen by accident. You have to plan for them. You have to set up a good communications structure.

Communications start with the customers. We try to listen to them. We try not to preach. From these conversations we try to learn their real needs.

We use project engineers, development engineers and engineering managers, as well as marketing and sales people, to gather information. We expose everybody on our engineering force to the customers, and I mean everybody from our engineering vice president, down to our junior engineers—the June grads from engineering colleges.

We expose these people to our customers as soon

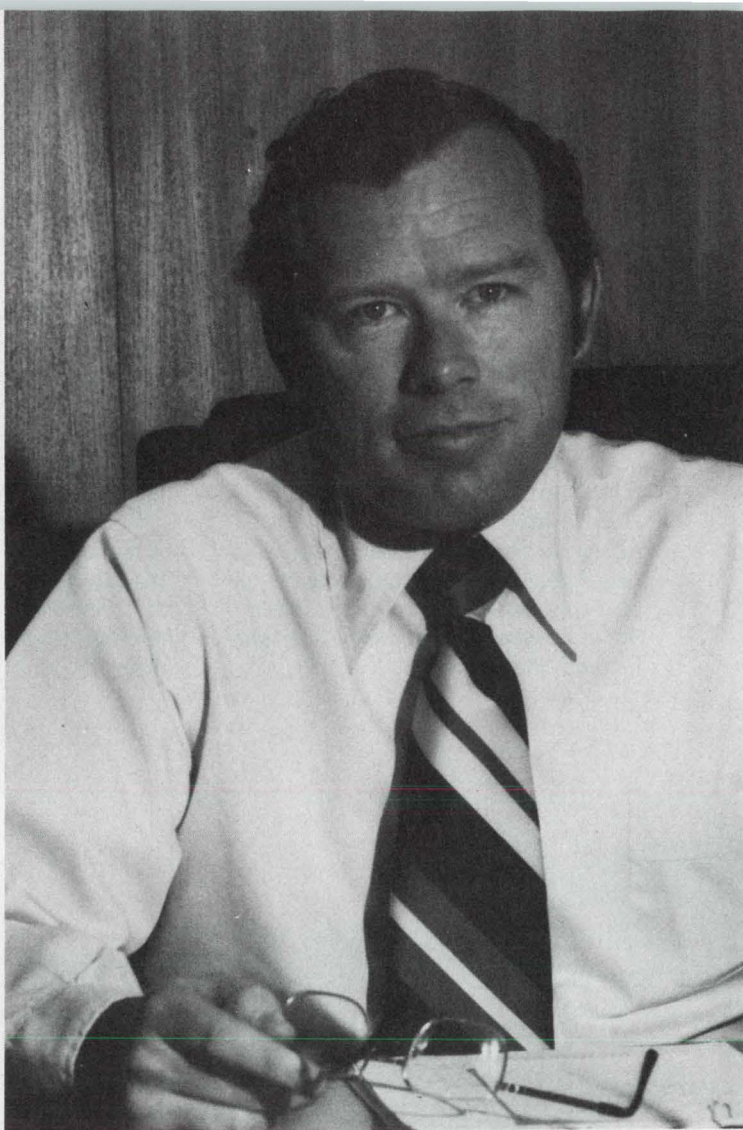

CHALLENGES TO THE ENGINEER WHO MANAGES

Webb Scroggin of Dana Labs Speaks On Speeding from Lab to Marketplace

as possible. We want an engineer to go to the bench with fresh design ideas and with clear, first-hand ideas about the customer's applications.

We run a risk when we expose these people. They might be picked off by our competition because they are very visible. They present papers or write articles for *Electronic Design* and get themselves known. But the exposure makes them more useful to us quicker.

Let me give you some idea as to how we create a new design idea and the levels of communication we use before we market a product.

A particular project might start with our product-

line manager, Chris Everett. He's always trying to solidify and make sense out of what we've learned in this business for the past 15 years. Remember, we're not starting from ground zero.

So a "spontaneous" idea might be a culmination of something that's been going on for a year or two or even since we started in business. At some point, somebody calls a meeting and says, "Hey, why don't we do this?"

Or somebody might say, "We're in the third year of this product and we'll soon need a new one." Well, that can be a signal for a product-line manager to come

up with some new specifications.

Or a project might start with our gut feelings and experience we've accumulated while chasing other business. Then we develop questionnaires and try to get answers from customers and prospects. When we think we have enough information to write preliminary specs, we have what we call a design review.

Now that's a broad term and everybody in this business has some form of design review. We like to think ours is particularly productive because we do it early in the game. And we do it frequently after that, throughout the conceptual phases of a design as well as the hardware effort.

The design review is controlled by engineering and designed to help engineers complete their projects on time. Basically it involves six steps; (1) the idea "turn on," (2) feasibility study, (3) bread-board, (4) engineering model, (5) prototype stage and (6) pilot. What it comes down to is "we spend time to save time."

Right from the beginning the design review helps us filter out ideas that are too blue sky or that don't fit in with our business plans. It helps us formalize what we want to accomplish and avoid a lot of emotionalism.

Before we start work on any important new instrument, we gather a mass of data and present them to a group that includes our VP Marketing, VP Engineering, manufacturing manager, controller, two or three development managers and our regional sales managers. This is our first design-review meeting. We haven't yet committed ourselves to the product. We are merely asking ourselves if it's worth considering.

The function of the early design-review meeting is basically to find out what we still need to find out. We commit a small amount of money to finding out. That minimizes our loss because we might come back with the thought that it's a terrific idea but it won't sell because we can't make it for a target cost. The design review provides an inexpensive culling.

Let's say we like a proposal. But there are a few "goosey" things about it that disturb us. Maybe some of the development managers think it's going to take a lot of work. Maybe we'll need some state-of-the-art developments, perhaps some special chips. If we're not entirely comfortable we'll put together a feasibility study and, hopefully, get some useful answers.

During the feasibility study, we try to define the engineering job, estimate the cost of the product and compare that with what we think the market value will be. And we try to develop ideas about the product complexity with regard to production and processing.

To make sure our feasibility study doesn't get caught in somebody's intense enthusiasm, we use a document we call SOPO—Summary of Project Objectives. This summary is quite extensive, and might be backed up by half an inch of paper. The SOPO is managed by the marketing department and is updated once each 90 days. It acts with the design review as

an independent "check and balance" on the program.

The summary and backup contained in the SOPO would contain everything we know about a machine—the original idea, the market by segment, the anticipated specifications, and a five-year projection of the product's expected sales life and return on investment.

At the end of the paperwork presentation and at the end of our feasibility study, if we still feel a product is worth while, we'll have another design review to discuss what we've done and we'll involve people from all departments that might be concerned with the project. Then we present the SOPO document to our management staff and if it is approved, we'll fund the project.

Now all our design-review meetings and all our paperwork might lead you to believe that it takes a long time for anything to happen. Well, that's not so. We recently funded a product within four months after it was first proposed.

Once a project is funded, we'll have a design review after the breadboard phase. Here we ask ourselves if we've found anything bad, difficult or surprising. Then we'll have another design review after our engineering-model phase—where we make a working model. It's haywired but it gives us a close idea of electrical performance and the approximate mechanical configuration.

Then we'll build a prototype—a box made to engineering drawings. It will look as much as possible like the instrument we hope to sell to the customer. And then we'll have still another design review before we go to a pilot run, where we might make five or six, or maybe 10 units, and try them out.

And after we finish the pilot run, we'll do some real soul searching. Should we re-lay out the board? Does the harness work? Should we commit ourselves to hard tooling? Do we have good production-control data? Are we satisfied that all specs are met? How does the machine look?

All these milestones are in the engineering-design plan. And of course, two of the most significant things we check along the way are price and time.

We've just about never had a failure in terms of an engineer being unable to solve technical difficulties. The real problem is whether he can bring out the product at the right price. So something we check at every design review is the price. And the time needed to conclude the effort.

An engineer can always make a product if you don't mention bucks. Or if you're willing to give him another six months.

Now here's where we need an important ingredient—honesty. I spend a lot of time talking to our people, and hoping that if they have any fears, we'll get them

Who is Webb Scroggin?



When he was six, W.L. "Webb" Scroggin left his birthplace, the small town of Nevada, MO, for the large town of Los Angeles, CA. Eleven years later, in 1955, he interrupted his studies at UCLA to join the Navy. Then, in 1958, he joined Gertsch Products, where he remained after it was acquired by the Singer Co. In 1969, he was named vice president and general manager of Singer Instrumentation.

He left Singer in 1972 to become president of Dana Laboratories, a subsidiary of Dana Electronics that now enjoys an annual sales volume of about \$8 million, mostly in digital multimeters and counters. Two years later he went to Pepperdine University in Malibu, CA for his Masters in Business Administration.

Scroggin and his wife, the former Jody Metzger have been married 17 years and have a 15-year-old son, Jeffrey, and a 13-year-old daughter, Lori.

In his spare time, Webb does some small-game hunting and plays some golf, but he's not an addict. He prefers tennis, which he plays with his wife, who, he admits, is his match.

out in the open instead of having them closeted.

The company can't launch a half-million dollar project and find, all of a sudden, that the engineer can't do it. You have to know the ability and confidence of your people by talking to them.

I don't get too upset with a fellow who gets into a project, and discovers he has problems—as long as he's honest about it.

The problem we face is that, at the end of the development cycle, there is a public-introduction date. So there's pressure on the engineer. We know that sometimes things happen that can't be controlled or anticipated, but when something unforeseen does happen, we want to learn about it very fast.

One of the tools that helps us communicate is the design-review meeting itself. Believe it or not, we have meetings in which a design engineer will spell out his problems and six or eight people might criticize and help him without getting emotional.

Generating that kind of working condition and feedback is an important and difficult part of a manager's job. I haven't mastered it yet by a long shot, but I sure try. I want to create the mood, atmosphere, working conditions and smooth environment that make a guy honest.

There's also something that helps generate this honesty. Our projects are not imposed on the engineer. The engineer himself is involved in the market studies. He provides inputs for them. He tells what's feasible and he tells what he thinks the customers need.

He's in touch with the customers, so he's very much a part of all these decisions. It's not as if he's carrying out somebody else's decisions. We don't have the traditional sharp lines between manufacturing, engineering and marketing. People help each other. And they feel a commitment to work together.

There's a great deal of emotion in a project. And that's good. You need champions or friends of a project if it is to be successful. And I'm trying to have many champions.

Our 9000 microprocessing timer/counter was a great example. My God! Everybody and his brother was interested in getting that instrument into production. That project took a long time—about four years. But everybody in this whole company loves that box.

The point is that you can have all kinds of work disciplines, but if there's no emotion, and no love, and no interest in a project, you're going to get a piece of junk at the end of the design effort.

Our engineer knows he's not alone. He knows that there are people who know what he's doing and are rooting for him. That's the best communications in the world.

Notice that we have lots of communications. We have frequent design reviews tied to events, rather than the calendar. And we have monthly progress reports. So there's an obvious situation. You might think our people are so tied up in meeting that they wouldn't have time to make anything go.

But in fact, these meetings actually speed things up. They tie people together. They help us make fewer mistakes. So we don't lose the time that might be needed to bring them back on target. The net result is that the total time required for a project is reduced. We spend time to save time. ■■

REQUIRED READING

**if you buy
or specify
threaded
fasteners**

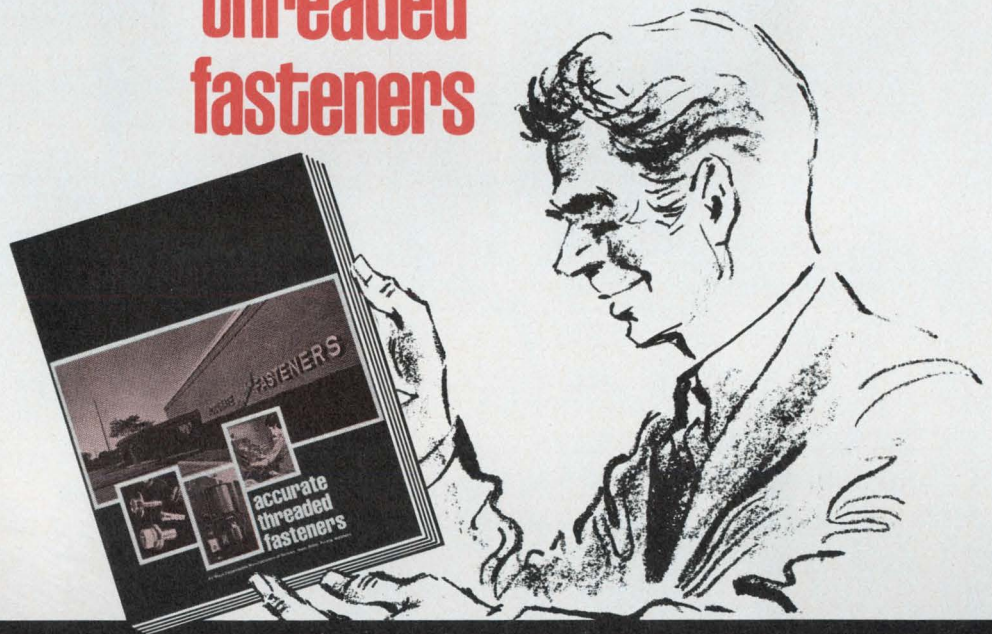

**IF WE
DON'T MAKE
THE FASTENERS
YOU NEED
(UNLIKELY!),
WE'LL CUSTOM-MAKE
THEM FOR YOU**

Ordinarily, it might simply be called a catalog. Actually, it's a Fastener Reference Guide. If you haven't read it yet, you might be paying more than necessary for fasteners—and getting less quality than you deserve. Whatever your requirements.

Send for a copy for your own business library.

accurate
THREADED FASTENERS, INC.
Division of Beatrice Foods Co.
3550 West Pratt Avenue
Chicago, Illinois 60645
(312) 583-5300

TWIST 'N' FLAT

BREAKTHROUGH!

MASS TERMINATION WITH TWISTED

LOW CROSSTALK AND LOW INSTALLED COST!

Part No.	AWG Strand	Centers	Impedance (ohms)	Capacitance pf/ft (pf/m)	Propagation Delay ns/ft (ns/m)	*Cross-talk %	
						NE	FE
455-248-XX	28 7/36	.050	105	22.0 (72.2)	1.7 (5.6)	6.0	5.3
455-338-XX	26 Solid	.050	82	28.0 (92.0)	1.7 (5.6)	4.5	4.6
455-249-XX	26 7/34	.085	100	24.0 (78.7)	1.7 (5.6)	3.2	3.7
455-337-XX	24 7/36	.085	80	28.0 (92.0)	1.7 (5.6)	2.3	3.5

*10 ft. sample, 5ns rise time with 2 lines driven

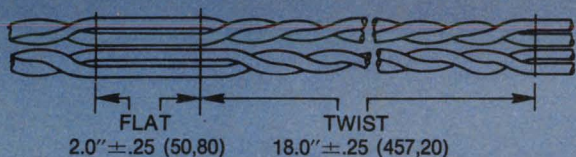

Standard cables have 18" twists, 2" flats.
Custom twist lengths (10" to 100" or more) available
size range to 64 conductors (32 pairs), 28, 26 and 24 gauge.

Used with Spectra-Strip 802 Series IDC mass termination connectors, Twist'N'Flat planar cable provides 50% — 70% reduction in total installed cost with reliable terminations. Available with or without external strain relief.



**Now, with the termination costs of twisted pair flat cables neatly solved, why not purge crosstalk from your entire system?? Standardize on Twist'N'Flat. It's available today from local distributor stocks.*



SPECTRA-STRIP

an **Eltra** company

FLAT PLANAR CABLE

PAIR CABLE!



WANT SOME
REALLY USEFUL
AND UNIQUE
INFORMATION?

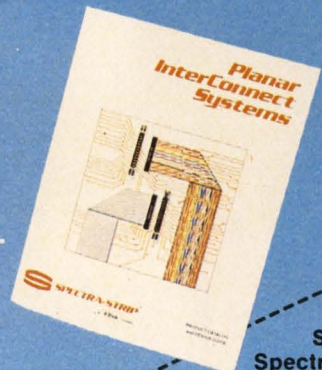

Send for Spectra-Strip's NEW
DESIGN GUIDE and CATALOG.
86 pages of useful technical and
ordering material on Twist'N'Flat,
802 Series Connectors, Flexible
Etched Circuits, and the widest
range of planar interconnect
systems and products available today.

Gentlemen:
Send me your free 86 page
Planar Interconnect Systems Catalog and
Design Guide

Do you want a Spectra-Strip
representative to call? Yes No
Do you specify or buy planar cable or connector products?
 Yes No

Attn:
Mktg.
Services
Spectra-Strip
P.O. Box 415
Garden Grove, CA 92642

Types _____
Name _____
Title _____ Phone No. _____
Company _____
Address _____
City _____ State _____ Zip _____

Digitally programmed oscillator is suitable for μP control

Here's a digitally controlled oscillator that covers an 8159-to-1 frequency range—from 2.5 Hz to 20 kHz—and is designed to be controlled by a microprocessor. The circuit provides instantaneous monotonic frequency changes over this 78-dB range with the dynamic-range equivalent of 13 bits but with only 8 bits of control. And it can be constructed for less than \$20.

An exponential current-output d/a converter, operating as a programmable current source, alternately charges and discharges the timing capacitor, C, be-

tween precisely controlled upper and lower limits (Fig. 1). The exponential d/a converter provides an output in eight steps, or chords, or current ranging between 250 nA and 2 mA (Fig. 2). The three most-significant-bit inputs to the d/a select one-of-eight binarily related chords; the five least-significant bits select one-of-32 linear steps within each chord. Output current is switched between the $I_0 (+)$ output and the $I_0 (-)$ output under the control of the d/a pin labeled SB. *(continued on page 104)*

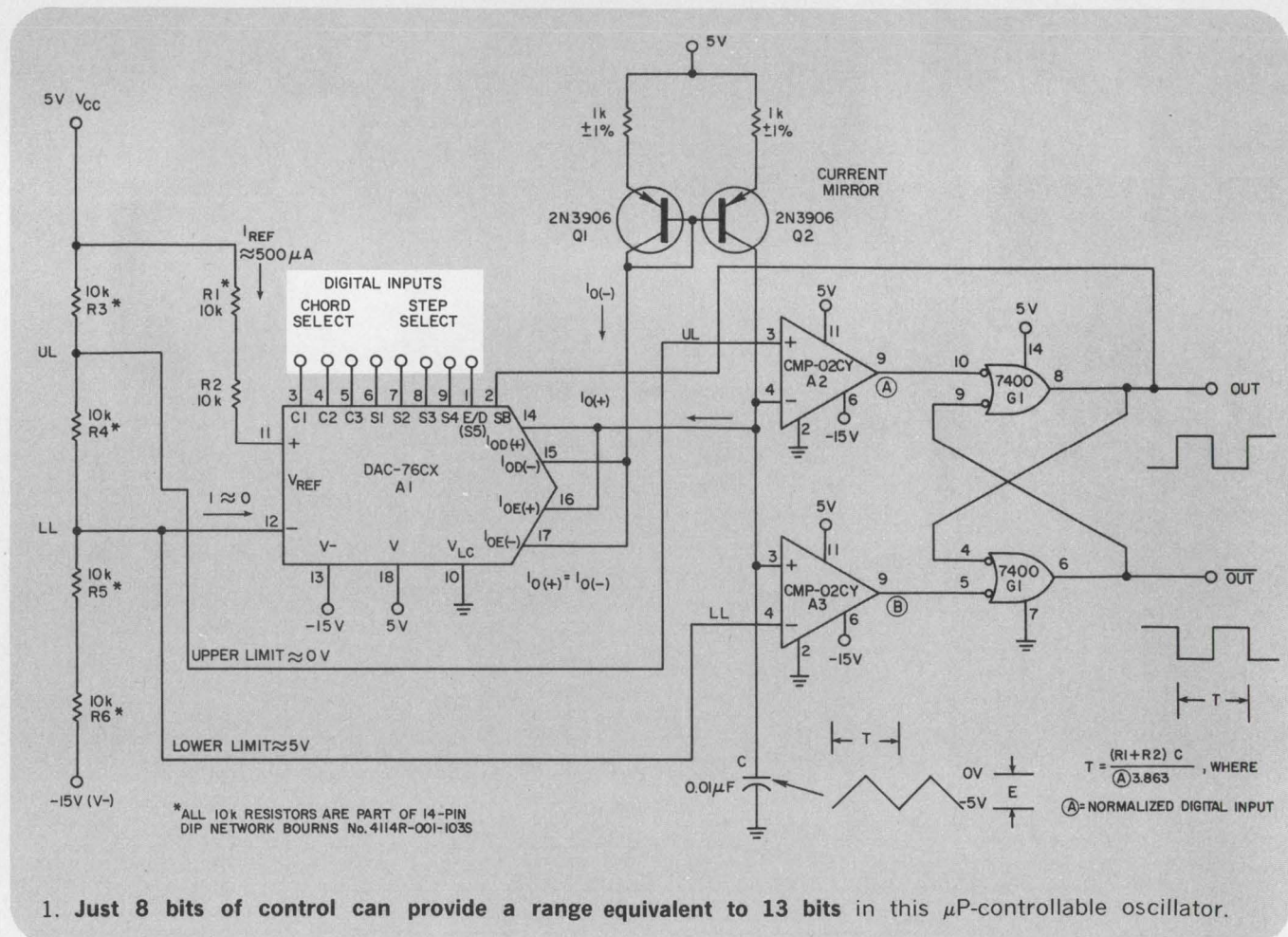

If you need panel instruments with **custom** dials, cases, accuracy, tracking, resistance, response time, or practically any combination of unusual specs...

Buy **Triplett's** designed-for-you Panel Instruments

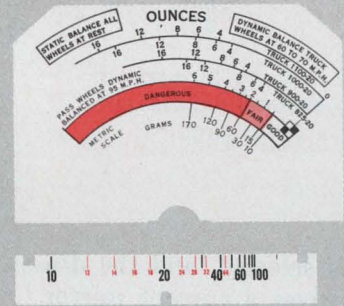
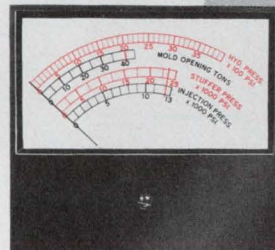
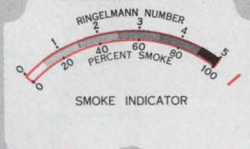
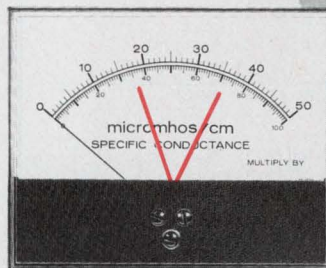
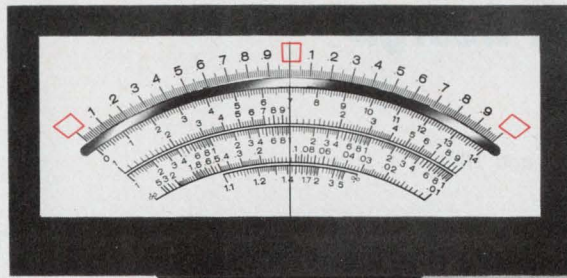

Although we stock some 1369 different styles, sizes and types of standard panel instruments, a very large proportion of our customers buy custom instruments.

Because they need:

custom dials

reading in such units as pH, roentgens, mm Hg, rpm, %, inches.

custom cases

square, round, rectangular, edge-wise (horizontal and vertical), wide, narrow, shallow.

custom accuracy

to within 1/2% with mirror scales and knife-edge pointers.

custom tracking

to match the specific needs of existing or new instrument designs.

custom resistance

for low circuit loading with tolerances as low as $\pm 1\%$.

custom damping

to meet stringent electrical and vibration requirements.

For instance, one of our customers had us design and manufacture a custom instrument to replace — in every detail of physical and electrical specifications — one which he was using on a delicate piece of medical instrumentation. Rejects from his previous source had risen to over 20%. He rejected only 3 of the first hundred we shipped — with almost negligible rejections from the many hundreds we've shipped since.

What custom panel instrument specifications do you need to make your

product more reliable, more accurate, more rugged and — in the long run — less expensive? For quick, dependable delivery of small quantities of Triplett's "designed-for-you" panel instruments, contact your Triplett Sales/Service/Modification Center. For prototypes or production quantities, contact your Triplett representative. He'll put you in touch with our Instrument Designers/Engineers who'll help you analyze the problem and suggest the optimum cost/result solution.

TRIPLETT
BLUFFTON, OHIO 45817
Manufacturers of the World's most complete line of V-O-M's

CIRCLE NUMBER 50 FOR INFORMATION
CIRCLE NUMBER 51 FOR FREE DEMONSTRATION

Ideas for design

(continued from page 102)

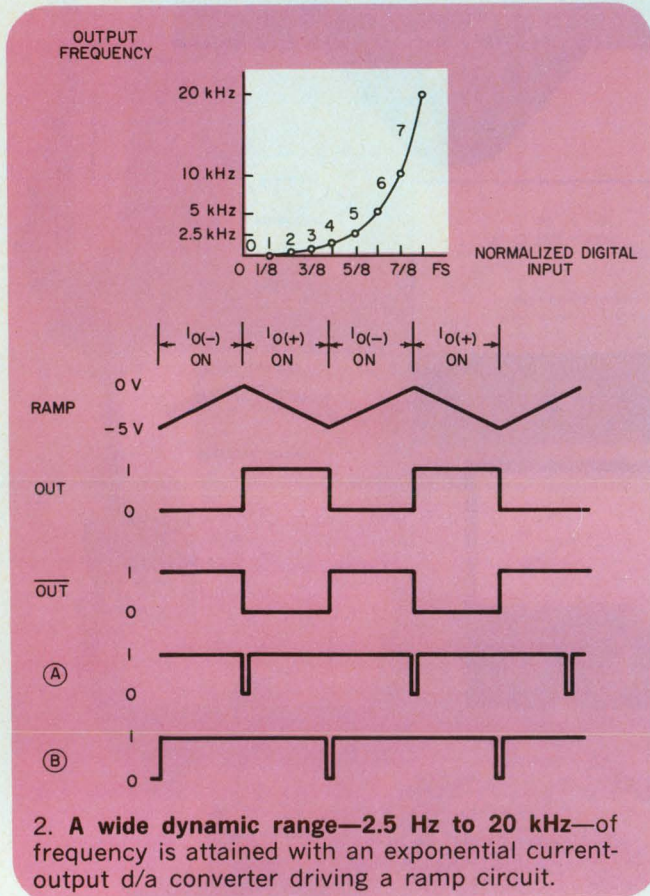

When SB is low, $I_0(-)$ is selected, and the d/a converter's output current drives a current mirror that ramps C in a positive direction until an upper limit of zero volts is sensed by A_2 (Fig. 2). At this time, the set/reset flip-flop, G_1 , sets, SB goes HIGH and the d/a converter's output current switches to the $I_0(+)$ output. Now, the capacitor is charged to a lower limit of -5 V, the flip-flop is reset and the cycle repeats itself.

The multiplying relationship between the reference current, I_{REF} , and the full-scale output of the d/a is 3.863. Current I_{REF} is determined only by the voltage between V_{CC} and the lower limit (≈ -5 V), divided by $R_1 + R_2$. The lower limit at pin 12 "sees" the high-impedance noninverting input of an op amp in the d/a. Since both I_{REF} and the upper and lower limits are all derived from the same power supply, the frequency of oscillation remains substantially independent of power-supply changes.

Table 1 lists the ideal output frequencies at the lowest and highest codes of each chord, and the average change in frequency produced by a one-step

Table 1. Ideal output frequency

Chord (segment)	Digital input code	Normalized digital input A	Output frequency A	Average step size
0	000 00001	$\frac{1}{8159}$	2.45 Hz	2.3 Hz
	000 01000	$\frac{8}{8159}$	19.6	
	000 11111	$\frac{31}{8159}$	76.0	
1	001 00000	$\frac{33}{8159}$	80.9	4.8
	001 11111	$\frac{95}{8159}$	233	
2	010 00000	$\frac{99}{8159}$	243	9.5
	010 11111	$\frac{223}{8159}$	547	
3	011 00000	$\frac{231}{8159}$	566	19
	011 11111	$\frac{479}{8159}$	1.17 kHz	
4	100 00000	$\frac{495}{8159}$	1.21	38
	100 11111	$\frac{991}{8159}$	2.43	
5	101 00000	$\frac{1023}{8159}$	2.51	76
	101 11111	$\frac{2015}{8159}$	4.94	
6	110 00000	$\frac{2079}{8159}$	5.09	152
	110 11111	$\frac{4063}{8159}$	9.96	
7	111 00000	$\frac{4191}{8159}$	10.3	303
	111 11111	$\frac{8159}{8159}$	20.0	





change (LSB change) within each chord. For highest accuracy in chord 0—especially between 2.5 and 19.6 Hz—comparators with low input current such as PMI's CMP-02CY are recommended.

Donn Soderquist, Precision Monolithics Inc., 1500 Space Park Dr., Santa Clara, CA 95050.

CIRCLE NO. 311

THE HIGH VOLTAGE SUPER GROUP.



Type	Resistance Range	Power Rating At 70 C	Max Operating Volts	Temp. Coef. Rating (-55 C to +125 C)	Maximum Dimensions (Inches)
Slim-Mox 	1 M Ω to 5000 M Ω	5W	18,000 V	± 250 ppm	Length 2.08 Height .84 Thickness .860
Mini-Mox 	100 k Ω to 10,000 M Ω	.25 W to 1.4 W	1000 V to 5000 V	± 100 ppm to ± 1000 ppm	Length .470 to 1.310 Dia. .140 or .165
Divider-Mox 	4.5 M Ω to 2000 M Ω	1.5 W to 6.0 W	7.5 kV to 30kV	± 100 ppm to ± 1000 ppm overall TCR Tracking ± 25 ppm	Length 2.2 to 5.2 Dia. .345
Maxi-Mox 	10 k Ω to 5000 M Ω	1.5 W to 12.5 W	7.5 kV to 37.5 kV	± 100 ppm to ± 500 ppm	Length 1.122 to 5.2 Dia. .310 or .345
Power-Mox 	20 k Ω to 7000 M Ω	22.5 W to 45 W	20 kV to 45 kV	± 100 ppm to ± 300 ppm	Length 3.96 to 6.96 Dia. .89

MOX resistors from Victoreen. The high voltage experts.

What's your problem? Space? Economy? Stability? Better tolerance? Here's one solution to all of the above. The Victoreen MOX high voltage resistor line.

From Mini-MOX to Power-MOX, you'll find that the people at Victoreen know how to make you happy. We know how to give you resistor performance that allows more design flexibility. And product reliability.

MOX resistors are the high voltage designer's solution to problems caused by other resistors.

The tougher your high voltage resistor requirements, the more you need our advanced, reliable MOX magic.

Send for complete technical data. Write: Victoreen Instrument Division

VICTOREEN
 10101 Woodland Avenue, Cleveland, Ohio 44104

SG SELLER-GLOBE CORPORATION

Ideas for design

Programmable unijunction delay circuit features high noise immunity

A time-delay circuit built with a programmable unijunction transistor (PUT) features noise-input threshold control, a switchable voltage source and a saturating output stage (Fig. 1). The circuit provides flexibility in setting the delay time, immunity to noisy inputs and easy interfacing with other circuits.

If the input voltage, V_{in} , exceeds the input-threshold level set by the input network D_1 , D_2 , R_1 and R_2 , then transistors Q_1 , Q_2 and Q_3 are switched sequentially to activate the time-delay components— Q_4 , R_5 , R_6 , R_8 and C_1 . When Q_3 conducts, C_1 begins to charge to V_{cc} . The voltage drop across R_8 , derived from the charging current through C_1 , keeps Q_4 off—creating the desired delay. When V_g is approximately equal to V_a , the PUT fires and latches on.

Current through R_7 drives Q_5 into saturation to provide a logic ZERO at the output (Fig. 2). When V_{in} falls below the input threshold, the output immediately returns to logic ONE.

The time delay may be determined approximately by the following equation:

$$t = R_8 C_1 \ln \frac{1}{[R_6 / (R_5 + R_6)] - [0.7 / V_{cc}]}$$

With the values shown in Fig. 1, the time delay calculates to be 1 s; the measured value is 0.98 s. Other delays are easily obtained by changing the values of C_1 and R_8 .

Bruce Patterson, Associate Engineer, IBM, General Systems Div., P.O. Box 1328, Boca Raton, FL 33431.

CIRCLE NO. 312

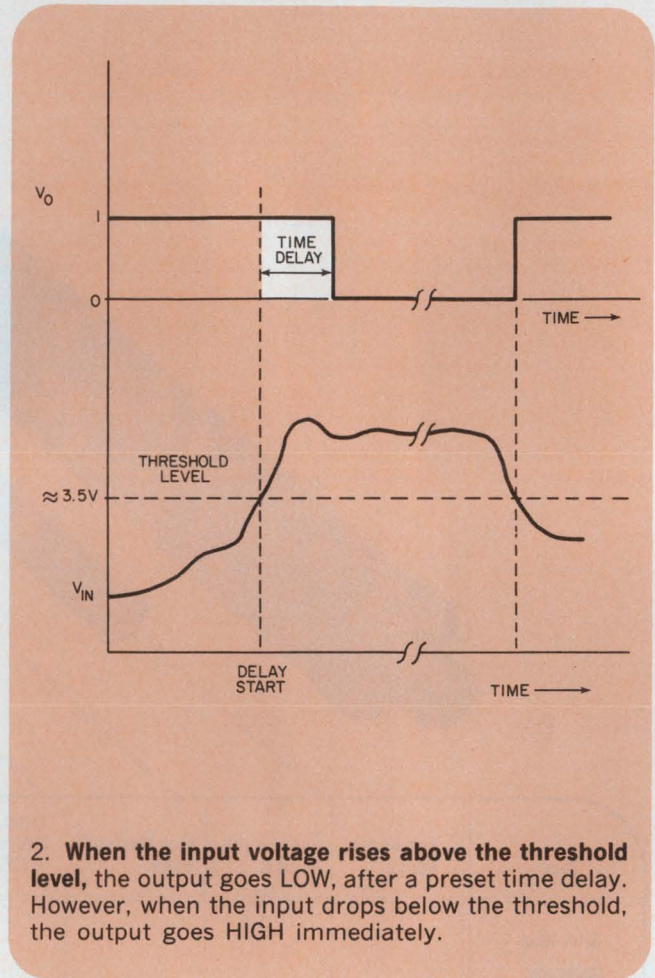

2. When the input voltage rises above the threshold level, the output goes LOW, after a preset time delay. However, when the input drops below the threshold, the output goes HIGH immediately.

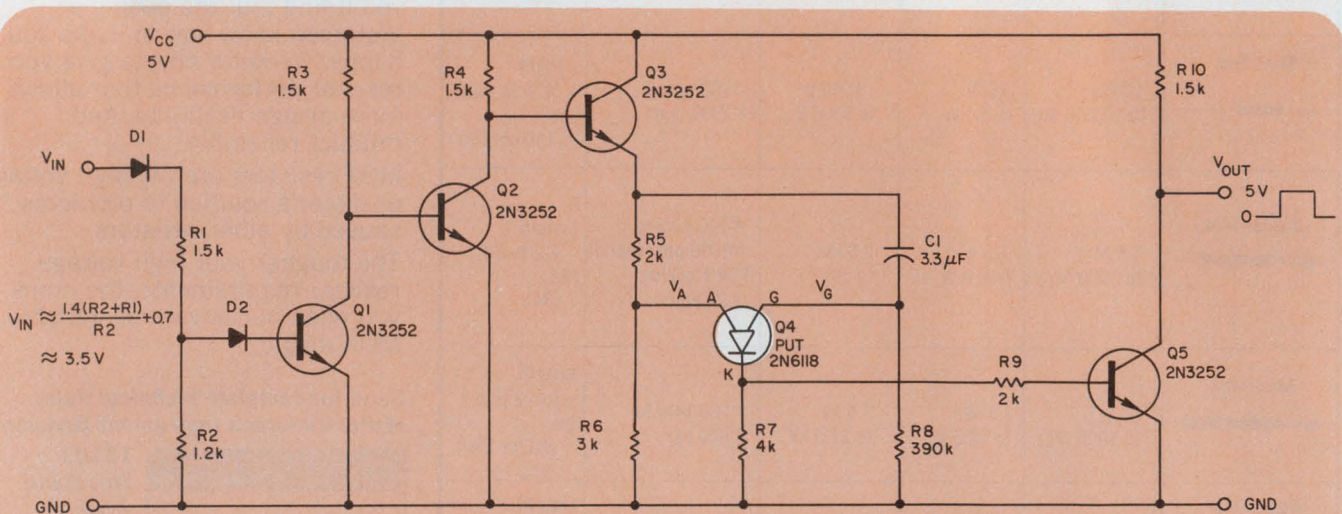

1. A PUT time-delay circuit allows easy adjustment of time delay and trigger-threshold level.

I.F. A-to-D, P.D.Q.

We may have just come up with the triple play of the century, an instant IC IF-to-video-to-digital system.

And we've done it with proven, plug-in Plessey products.

The Plessey SL1550 is a low-noise, high-gain AGC-able front-end amplifier that's not only unique, but superb.

The SL1521 is the simplest, easiest-to-use and least expensive wideband amp you can buy for your log IF strips.

And the SP750 is the world's fastest IC comparator, with a bonus batch of features that reduce your hardware count and increase your reliability.

They all plug together as if they were made for each other and they're available now, so send for all the details.



We'll get back to you, P.D.Q.

PLESSEY SEMICONDUCTORS

1674 McGaw Avenue, Irvine, CA 92714
Tel: (714) 540-9945. TWX: 910-595-1930
Represented world-wide.

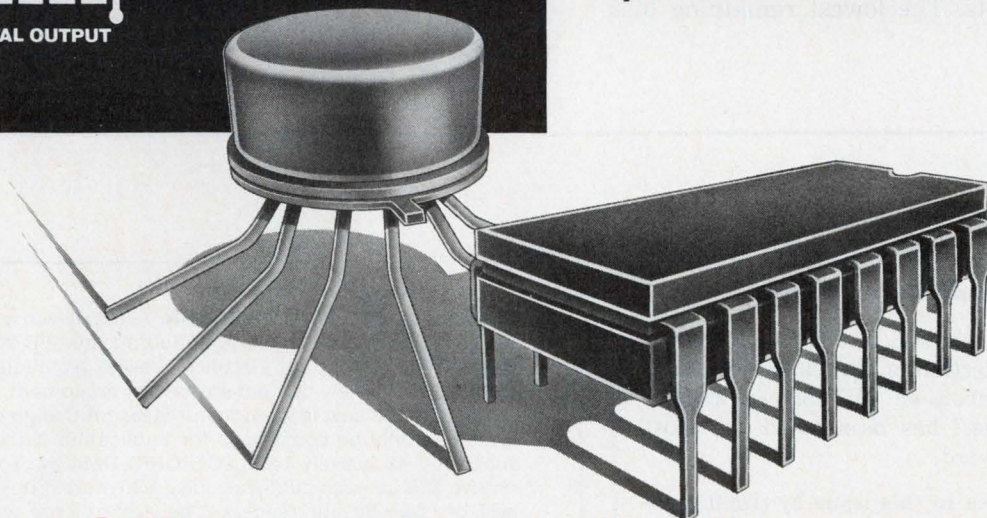
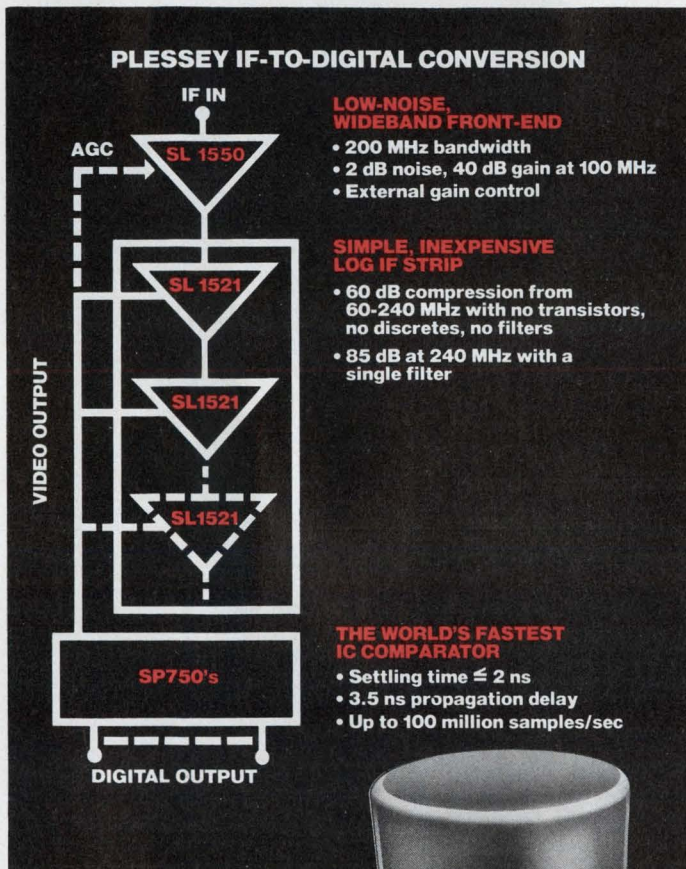

State-of-the-art brought down to earth

Limiting wideband amplifiers TV, radio & telephone communications circuits High-speed dividers

CIRCLE NUMBER 53

Ideas for design

Bias-current cancellation easily implemented with matched op amps

The circuit in the figure is a technique for reducing, or even canceling, the bias currents of bipolar input-stage op amps. The method is simply applied, but works best on multiple op-amp chips and uses an op-amp as a floating sink to reduce the bias current of the operational amplifier circuit. The scheme depends on the premise that the currents to all the inputs on a multiple op-amp chip are matched—a reasonable assumption for bipolar pnp-input-stage units fabricated on the same chip.

With all the input currents matched in the figure and R_2 equal to $2R_1$, the current flowing in R_1 is twice that in R_2 ; therefore, half of $2I_B$ comes from A_1 . Consequently, A_2 acts as a floating current sink that absorbs a current, I_B , which ideally is equal to the bias current of A_1 .

For best cancellation when operating with typical bias-current levels, the voltage drop across resistors R_1 and R_2 should be set at least 10 times higher than the expected input-offset voltage of the op amps. Generally, the voltage drop will be around 100 mV. Also, the quiescent input current should be low to help attain low offset currents. Of course, it is desirable that bias and offset currents remain stable with changes in temperature and common-mode and supply voltages.

Op amps particularly suited for canceling bias current are the dual LM358 (National) and electrically identical LM324 quad unit; another is the Fairchild $\mu A798$.

When tested with several quad op amps such as the LM324, MC3403 (Motorola) and HA 4741 (Harris), the circuit reduced bias currents from 1/4 to 1/20 of uncompensated circuits. The lowest remaining bias

current flowing in the signal source was obtained with the 324 and measured only 3 nA.

The bias current in the source can be trimmed to zero by adjusting the R_1/R_2 ratio. But readjustment is needed if the op amp is changed.

This bias-canceling circuit was designed into a long-period timer, where the timing network is the source impedance and A_1 is a buffer feeding a voltage-threshold comparator, such as a 555. However, circuits for RC sine-wave oscillators, instrumentation amplifiers and many other applications also can profitably use the bias-current canceling technique.

Walter Jung, Consultant, Pleasantville Laboratories, 1946 Pleasantville Rd., Forest Hill, MD 21050.

CIRCLE NO. 313

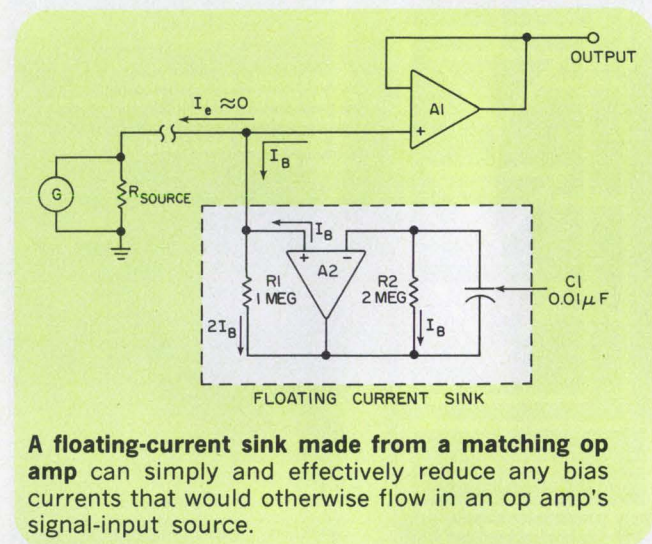

A floating-current sink made from a matching op amp can simply and effectively reduce any bias currents that would otherwise flow in an op amp's signal-input source.

IFD Winner of February 15, 1977

Marco Barnig, Swiss Federal Institute of Technology, Department of Electronics, Zurich, Switzerland. His idea "Trace Symbols on CRT Screen without Access to the Z Axis," has been voted the Most Valuable of Issue Award.

Vote for the Best Idea in this issue by circling the number of your selection on the Reader Service Card at the back of this issue.

SEND US YOUR IDEAS FOR DESIGN. You may win a grand total of \$1050 (cash)! Here's how. Submit your IFD describing a new or important circuit or design technique, the clever use of a new component or test equipment, packaging tips, cost-saving ideas to our Ideas for Design editor. Ideas can only be considered for publication if they are submitted exclusively to ELECTRONIC DESIGN. You will receive \$20 for each published idea, \$30 more if it is voted best of issue by our readers. The best-of-issue winners become eligible for the Idea of the Year award of \$1000.

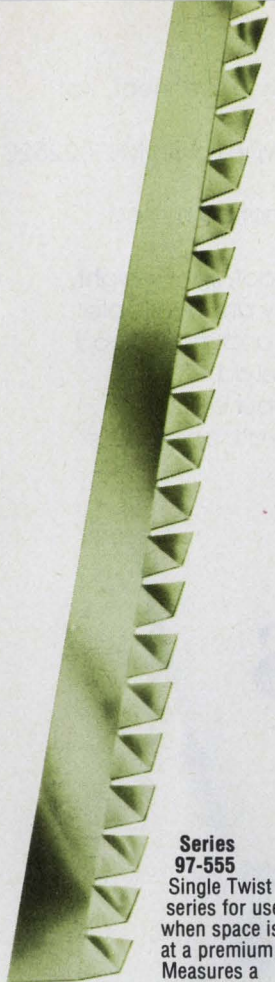

Series 97-555
Single Twist series for use when space is at a premium. Measures a scant 3/8" wide.



Series 97-520*
A smaller size Sticky Fingers for high shielding effectiveness in less space.

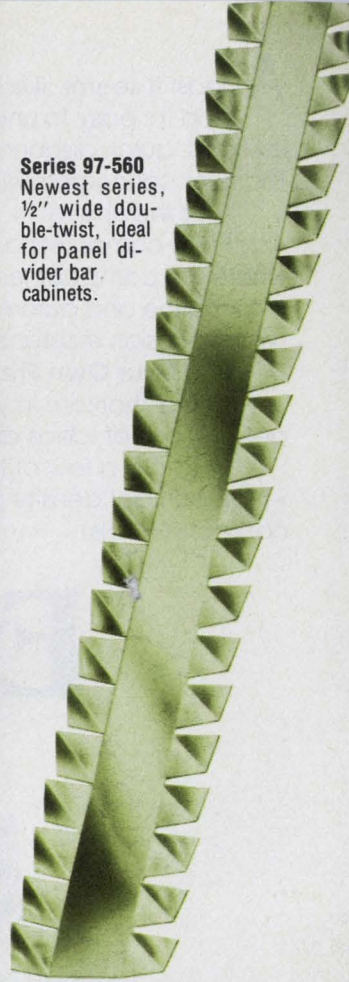

Series 97-560
Newest series, 1/2" wide double-twist, ideal for panel divider bar cabinets.

stickn fingers®

RFI/EMI SHIELDING from Instrument Specialties attaches faster, shields better than anything else!

Instrument Specialties line of Sticky-Fingers beryllium copper gaskets provides *the* answer for just about every RFI/EMI problem.

Each strip is backed with a strong, *really* sticky self-adhesive that attaches quickly, grips and holds securely. There's no need to drill holes, no need for metal fasteners. You merely cut the strip to the desired length, peel the backing, and apply.

What's more, you get shielding effectiveness of up to 126 dB at 10 GHz plane wave, or greater than 90 dB at 1 MHz magnetic. Whether you want to keep interference in or out—in new installations or retrofits—with standard or narrow flanges—there's a Sticky Fingers contact strip to do your job *better!*

Our complete catalog of RF shielding strips and rings is available free. Write today to Dept. ED-85.

INSTRUMENT SPECIALTIES CO., INC.
Little Falls, New Jersey 07424
telephone: 201-256-3500 twx: 710-988-5732
Specialists in beryllium copper since 1938

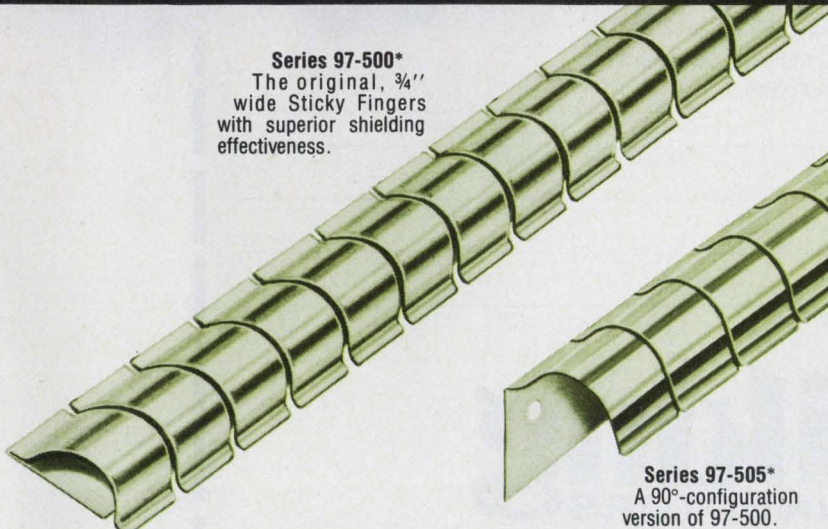

Series 97-500*
The original, 3/4" wide Sticky Fingers with superior shielding effectiveness.

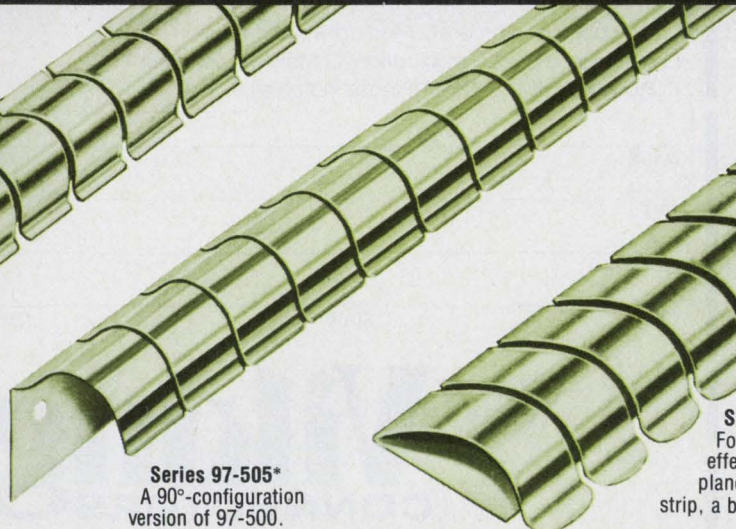

Series 97-505*
A 90°-configuration version of 97-500.



Series 97-538*
For maximum effectiveness at 10 GHz plane wave, specify this strip, a bit less than 1" wide.

*patented

At least it seems like everybody wants a sample. And it's easy to understand why. These miniature low cost, quick disconnect, high-contact-density Thorkom connectors will go just about anywhere. And they have.

From computers and medical instrumentation, where the compactness and reliability are essential – to marine and automotive use, where the ruggedness, corrosion resistance and low cost are critical.

Get Your Own Free Sample

Get a Thorkom in your hands and we think you'll get all kinds of ideas as to how you can use them.

Here are a few of the specifics you'll notice:

- high contact density (there are 7, 12 and 24 contact models)

- positive lock, yet with quick, easy disconnect; just squeeze and pull
- crimp removable contacts (all types) with MIL-T-22520 crimp tool
- positive polarization – they cannot be mated incorrectly

Plus – they're tough, shock-proof, light weight, can be mounted quickly and they are available with or without cable assembly – and more good things than we can cover with one ad.

So use the coupon and get your own free Thorkom. Or, if you don't want to wait, call us. The number: (213) 341-4330.

Everybody wants a sample.



7 pin plug and receptacle shown life size

12 pin, square flange receptacle

24 pin receptacle, shown with dip solder contacts

Send me one. I'm thinking of using a Thorkom connector in:

- Computer equipment Medical instrumentation
- Automotive Communications Marine Aviation
- Process control Other (Please indicate) _____

NAME: _____

TITLE: _____

COMPANY: _____

CITY: _____

STATE: _____

ZIP: _____



Viking
CONNECTORS

Viking Industries, Inc. • 21001 Nordhoff Street
Chatsworth, CA 91311 U.S.A.

Double-oxide-layer process to make GaAs more useful

A new processing technique may help extend the applications of GaAs to charge-coupled devices having a high yield. The technique overcomes a major problem in producing GaAs MOSFETs—the instability of anodically grown oxide layers in the presence of processing chemicals.

Developed at the University of Newcastle-upon-Tyne, England, the technique employs an Al_2O_3 layer together with native GaAs oxide.

To produce a double-oxide layer on GaAs, a known thickness of Al is evaporated onto a GaAs substrate and the structure is then anodized with a constant current and a glycol/water electrolyte. The first oxide to grow is Al_2O_3 , followed by a GaAs native oxide. The most important feature of the process is that the native oxide can be grown either above or below the Al_2O_3 layer, depending upon the current density and the thickness of the

Al_2O_3 layer. For a current density below $20 \mu\text{A}/\text{cm}^2$, a superior native oxide is formed underneath the Al_2O_3 layer, which acts as a diffusion barrier against impurities in the electrolyte. If the Al_2O_3 layer is made thick (above 500 \AA), it will improve the oxide's high-temperature stability.

With this double-oxide structure, uniform reproducible metal- Al_2O_3 -oxide-semiconductor diodes (MAOS) exhibiting strong charge-storage characteristics can be built. Since it is essential that the thickness of the native-oxide layer be extremely uniform, current densities must be below $20 \mu\text{A}/\text{cm}^2$. This coincides with the condition for producing the native-oxide layer under the Al_2O_3 .

It isn't possible to dispense with the Al_2O_3 and use just the low-current density because at that level of current density, the native oxide dissolves in the electrolyte as fast as it is formed.

mean pedestal current of 30 nA can be produced. The tube's efficiency is further improved by replacing the standard TGS target with one of deuterated TGS isomorph, which has a lower relative permittivity than TGS. These modifications reduce the minimum resolvable temperature difference, at 3 line-pairs per mm, from 2 C to 0.3 C.

Hot wire makes cleaner cut on optical fibers

Cutting optical fibers with a hot wire eliminates not only the glass debris left by the conventional score-bend-and-break method but also, the need for second-fiber alignment. The mirror-quality finish obtained on the fiber ends makes such alignments unnecessary. This high-quality finish, the result of a hot-wire cutting technique developed by Philips Eindhoven Laboratories, is essential to low-loss fiber joining.

A wire is heated with an electric current controlled by a timer. Then, the hot wire is used to make a permanent bend in the fiber. An imprint of the wire left in the hollow of the bend functions as a score to produce a stress point at which the fiber will break under pressure.

Image improved in pyroelectric Vidicons

The relatively poor resolution of uncooled pyroelectric Vidicon tubes employed in thermal-imaging technology has been upgraded with new readout circuitry and improved target materials. Right now, a major limit of a standard pyroelectric Vidicon's performance is that the target—usually triglycine sulphate (TGS)—upon which the image is focused isn't completely discharged by the scanning electron beam.

Readout efficiency is determined by the pedestal voltage—the magnitude of the positive swing of the target potential between scans. A gas introduced to increase sensitivity is ionized by the scanning beam. Positive ions accumulate on the target surface to neutralize the built-up surface charge.

Raising the pedestal voltage by increasing beam strength causes defocusing and emphasizes target defects.

This defocusing is minimized by a joint development of EEV, Ltd., Chelmsford, and the Ministry of Defense in England. Their solution sets the pedestal level independently of the readout beam by generating most of the pedestal during the flyback period.

While positive-going pulses applied to the cathode during flyback prevent electrons from reaching the target, ions can still reach it. If simultaneous positive pulses are applied to the tube's grid, the beam is momentarily increased, and extra ions are generated to increase the pedestal.

With a 10- μs flyback, an equivalent

CCD image sensor improves the picture

One of the largest integrated circuits fabricated so far, a 25-mm long sensor array with four CCD readout registers, can upgrade the images from facsimile transmitters and photocopiers. Like the smaller light-sensitive sensor arrays currently in use, the circuit created by Siemens, West Germany, researchers scans documents one line at a time. But with two more registers, the Siemens circuit improves picture quality by doubling the amount of picture elements scanned per line.

In the four-register circuits, the CCD shift registers are arranged in pairs on each side of the sensor array. Each sensor element is given a CCD element.

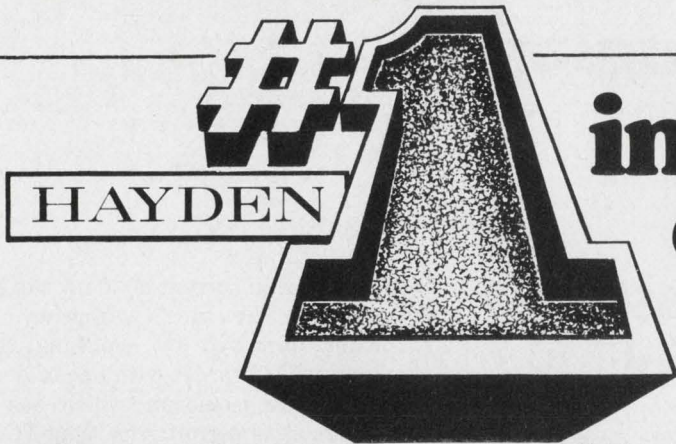

in personal computing books!

See for yourself the reasons why:

1. MICROPROCESSORS: New Directions for Designers by Edward A. Torrero, #5777-6, paper, 1975, 144 pp., 8½ x 11, illus., \$10.95.

2. GAME PLAYING WITH COMPUTERS Rev. 2nd Ed., by Donald D. Spencer, #5103-4, cloth, 1976, 320 pp., 6 x 9, illus. \$16.95.

3. FUNDAMENTALS AND APPLICATIONS OF DIGITAL LOGIC CIRCUITS by Sol Libes, #5505-6, paper, (\$6.95), #5506-4, cloth, (\$9.95), 1975, 192 pp., 6 x 9, illus.

4. COMPUTERS IN ACTION: How Computers Work by Donald D. Spencer, #5861-6, paper, 1974, 160 pp., 6 x 9, illus., \$5.50.

5. COMPUTERS IN SOCIETY: The Wheres, Whys and Hows of Computer Use by Donald D. Spencer, #5915-9, paper, (\$5.50), #5916-7, cloth, (\$7.50), 1974, 208 pp., 6 x 9, illus.

6. PROGRAMMING PROVERBS by Henry F. Ledgard, #5522-6, paper, 1975, 144 pp., 6 x 9, illus, \$6.50.

7. PROGRAMMING PROVERBS FOR FORTRAN PROGRAMMERS by Henry F. Ledgard, #5820-9, paper, 1975, 144 pp., 6 x 9, illus., \$6.50.

8. COBOL WITH STYLE: Programming Proverbs by Louis J. Chmura, Jr., and Henry F. Ledgard, #5781-4, paper, 1976, 144 pp., 6 x 9, illus. \$5.45.

9. MINICOMPUTERS: Structure and Programming, by T.G. Lewis and J.W. Doerr, #5642-7, cloth, 1976, 288 pp., 6 x 9, illus., \$12.95.

10. PATTERN RECOGNITION by M. Bongard, #9165, cloth, 1970, 256 pp., 6 x 9 illus., \$14.90.

11. DIGITAL SIGNAL ANALYSIS by Samuel D. Stearns, #5828-4, cloth, 1975, 288 pp., 6 x 9, illus., \$19.95.

12. BASIC BASIC: An Introduction to Computer Programming in BASIC LANGUAGE by James S. Coan, #5872-1, paper, (\$7.95), #5873-X, cloth, (\$9.95), 1970, 256 pp., 6 x 9, illus.

13. ADVANCED BASIC: Applications and Problems, by James S. Coan, #5856-X, cloth, (\$8.95), #5855-1, paper, (\$6.95), 1976, 192 pp., 6 x 9, illus.

14. FORTRAN FUNDAMENTALS: A Short Course by Jack Steingraber, #5860-8, paper, 1975, 96 pp., 6 x 9, illus., \$4.95.

15. DIGITAL TROUBLESHOOTING: Practical Digital Theory and Troubleshooting Tips by Richard E. Gasperini, #5708-3, paper, 1976, 180 pp., 8½ x 11, illus., \$9.95.

16. DIGITAL EXPERIMENTS by Richard E. Gasperini, #5713-X, paper, 1976, 192 pp., 8½ x 11, illus., \$8.95.

Write for 15-day examination copies of any of these books!

At the end of 15 days, please remit payment plus postage and handling, or return the books and owe nothing. Prices subject to change without notice. If payment

accompanies order, we pay postage and handling. Outside USA, cash must accompany order — include \$2.00 per book for shipping and handling.



Hayden Book Company, Inc.

50 Essex Street, Rochelle Park, New Jersey 07662

phone: (201) 843-0550



The 150 volt rectifier that performs like a low voltage Schottky.

If you want to design an efficient higher voltage switching power supply with the low forward voltage drop and fast recovery time you get with Schottky's in 5V supplies, you ought to take a look at our line of 50-100-150V industrial rectifiers.

Unlike the so-called fast-switching (250ns) rectifiers, Unitrode's rectifiers deliver real Schottky-like features:

1. Low forward voltage drop — typically .7V under maximum operation conditions.
2. Fast recovery times — reverse, typically 30ns;

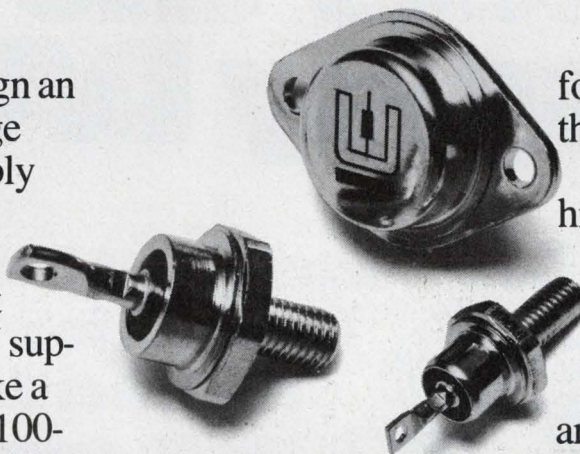

forward, typically 15ns.

3. Low thermal resistance — less than 1.2°C per watt for our DO-4, .8°C for the TO-3, and .6°C for the DO-5.

4. High junction temperature of 175°C maximum.
5. Highest ratings — 25A for the DO-4, 30A

for the TO-3 and 70A for the DO-5.

Best of all, Unitrode's high voltage rectifiers are priced competitively with the less efficient high voltage types.

For complete specs plus an application note on the benefits of speed and low voltage drop for high voltage applications, just call or write: Unitrode Corporation, 580 Pleasant St., Watertown, MA 02172, 617-926-0404.

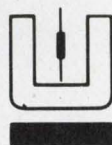
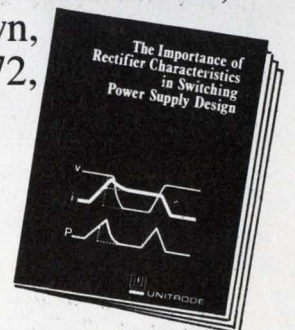

UNITRODE

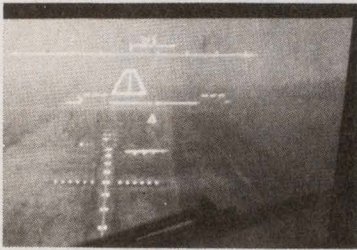

HEAD-UP DISPLAY SYSTEM

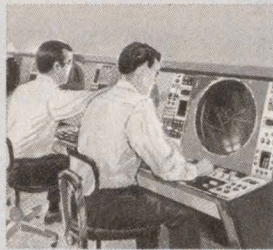

GROUND STATION DISPLAY SYSTEM

DDC has done it again . . . putting together a series of high reliability, ultra low-glitch display DACs that out-perform any others.

These low-noise, high-quality thick-film D/A converters are all processed in accordance with the exacting requirements of MIL-STD-883 . . . and are actively at work in such demanding environments as

head-up display systems, ground station displays, video processing systems and others where ruggedness and reliability are important! All are proven performers.

If your requirements are for the best possible display DACs, let us send you full details on these perfect problem solvers.

- ADH- 030 — high-speed 50MHz 12-bit thick-film hybrid in a 24-pin DDIP configuration. Features include current output with a settling time of 50ns for full-scale changes and 20ns for 1 LSB changes. Input is ECL logic compatible.
- DDAC — Ultra-low glitch available as two DDIP packages, plus TO-3 case with 13-bit output, programmable ± 2.5 , ± 5 or $\pm 10V$ outputs with 500 mA coax drive capability. 25ns one LSB settling, internal or external reference with short circuit protected output.
- SDAC — Compact 13-bit, 24-pin DDIP with settling times to $\pm 0.1\%$ 500ns at $\pm 2.5V$, 1 μ sec. at $\pm 5V$ and 1.6 μ sec. at $\pm 10V$.

DDC sets the pace in display DACs...

with the first hybrid, low glitch ^(500 mV•ns), high performance ^(update rates to 50MHz) converters.

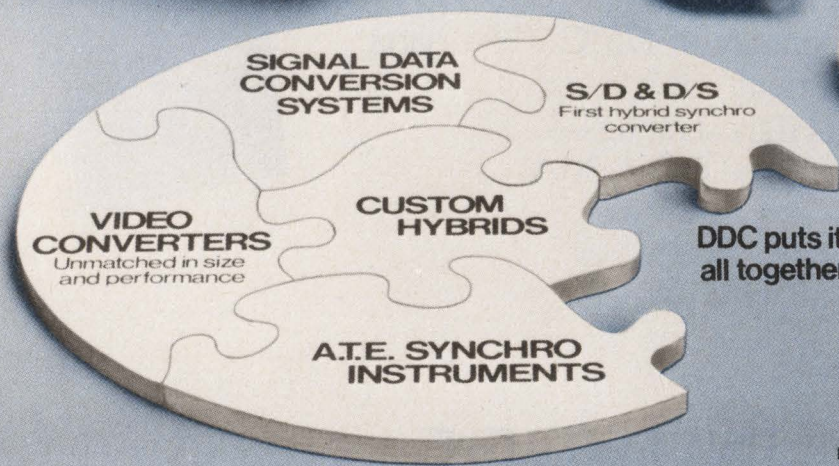
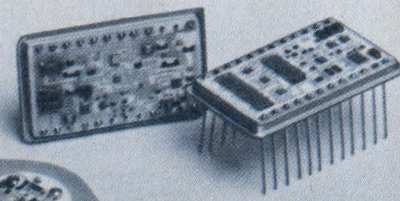
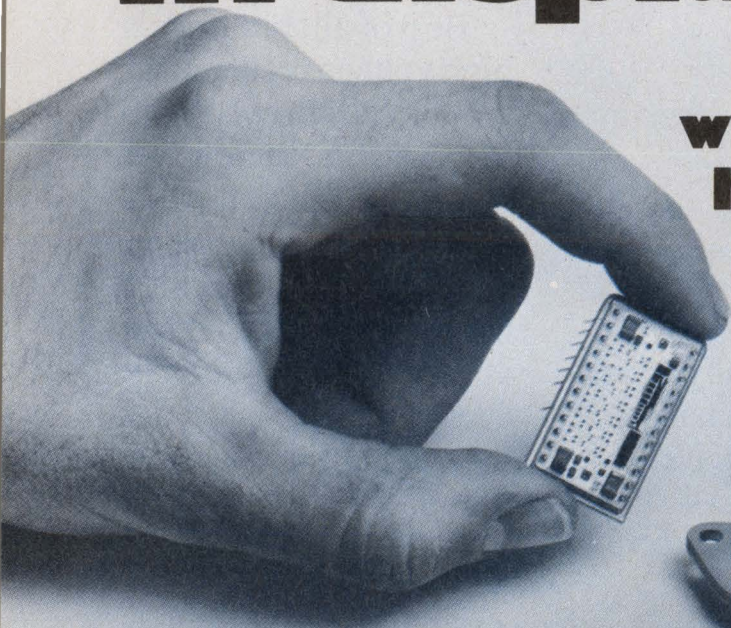

DDC puts it all together

ILC DOVER is the sole designer and manufacturer of the Apollo, Skylab and Space Shuttle space suits.



ILC DATA DEVICE CORPORATION

A Wholly Owned Subsidiary of ILC Industries, Inc.
AIRPORT INTERNATIONAL PLAZA
BOHEMIA, LONG ISLAND, N.Y. 11716 • (516) 567-5600

West Coast: 7337 Greenbush Ave., N. Hollywood, CA 91605 • (213) 982-6454
Interested engineers, write or call Harry Lewis or request data sheets.

New products

Plated-hole attachment method reduces shorts and leaks in ECL three-plane panels

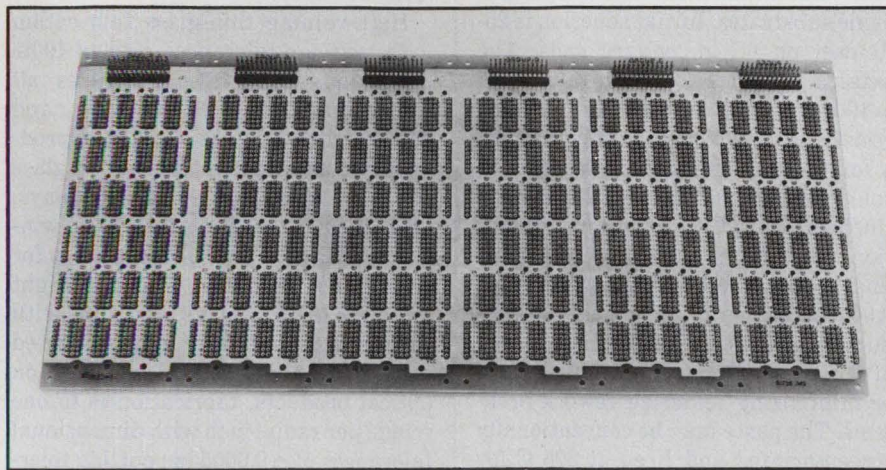

This ECL three-plane wire-wrapping panel, the 9173S-349, contains 180, 16-pin positions for DIP/ECL devices and 144, 8-pin positions for SIP resistor networks, which terminate lines.

Electronic Molding Corp., 96 Mill St., Woonsocket, RI 02895. (401) 769-3800. See text; 4 to 6 wks.

Plagued with shorts and leaks to the middle plane of your ECL three-plane wire-wrapping panels? EMC has found a simple way to eliminate this problem—move the attachment point of component/socket pins to the lower (V_{EE}) plane from the middle (V_{TT}) plane (see illustration).

The EMC solution, although simple, isn't found in competing DIP wire-wrapping panels made by Augat, Excel Products, Gary Mfg. and others. A plated-through hole between V_{TT} and V_{EE} —with V_{EE} copper removed around the hole—allows the pins to be soldered at the more accessible V_{EE} plane and connect to V_{TT} . The conventional method solders the pins directly to the V_{TT} plane via an access hole drilled through the V_{EE} plane.

Such an access hole can collect flux and dirt, which cause shorts and leaks. Furthermore, the solder joint buried deeply in the hole is difficult to inspect.

Soldering the pins at the V_{EE} plane not only eliminates the access hole and its problems, but also makes auto-

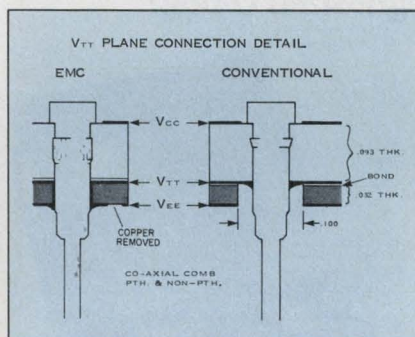

The middle (V_{TT}) plane of EMC's three-plane circuit board is connected to a component pin without using an access hole. Instead, the V_{TT} plane is brought out to V_{EE} with a plated-through hole.

mated board fabrication easier and provides better conditions for making good solder joints.

The pins are mechanically held in the 0.093-in. thick upper glass-epoxy insulating layer and don't depend on the plated-through hole in the lower 0.032-in. layer for any support. Plated-through holes aren't recommended for mechanical support: Their tolerances are too loose and their metal won't cold-

flow around pin splines to hold securely. The splines tear and damage the plating.

EMC accurately locates the pins—within 0.020 in.—as required for automatic wire wrapping. Pin configurations and board sizes can be varied in an almost unlimited number of ways. The photo of a 9173S-349 panel shows a particular arrangement; which sells for \$329 in quantities of one to four, dropping to \$169 in quantities of 1000.

Three-plane boards, increasingly popular for ECL circuits, can also be used with Schottky circuits. They require a similar, three-plane (GND- V_{CC} -GND) sandwich construction.

Electronic Molding **CIRCLE NO. 302**
Augat **CIRCLE NO. 303**
Excel Products **CIRCLE NO. 304**
Gary Mfg. **CIRCLE NO. 305**

Socket strips snap-off easily to needed length

Samtec, Inc., 810 Progress Blvd., New Albany, IN 47150. (812) 944-6733. From \$0.65; stock.

Socket strips to mount ICs, relays, op amps, and as interconnects are available in 20-contact lengths with a choice of wire wrapping, solder-pin or solder-shell termination styles. Mating male-pin terminal strips come with solder-pin, solder-pot, or solder-head connections. All strips feature easy snapping off of strips into shorter lengths with no tools or cutting. Socket/terminals are on a 0.1-in.-spaced in-line arrangement, and strips can mount spaced 0.1-in. side-by-side to form a grid pattern. Socket shells and terminals are made of brass and contacts are beryllium-copper with a choice of a gold or tin finish. Strip insulation is glass-filled polyester.

CIRCLE NO. 309

HEAT COLD LCD'S



PTI HEATERS

Fast
Efficient
Inexpensive

4041-034
80 Ω Heater
300 Ω RTD

- Simple self-adhesive installation adds only 0.005" behind LCD.
- Uses spare LCD pins for connections.
- Optional sensor (RTD) for temperature control.
- Priced from \$2. @ 5000 quantity.

Photofab Tech., Inc.
Grenier Industrial Village
Londonderry
NH 03053



Phone
603 668-4002

CIRCLE NUMBER 59

PACKAGING & MATERIALS

Conductor paste sticks to beryllium oxide

Cermalloy, Cermet Div. of Bala Electronics Corp., West Conshohocken, PA 19428. Frank Buzan (215) 825-6050. Under \$20/oz (OEM qty).

A thick-film platinum (2%)/silver conductor-paste system, Series 4570, adheres, solders and conducts well on both aluminum-oxide and beryllium-oxide substrates. Initial adhesion is 25-lb peel on 0.1-in. square pads. The material retains 80% of this value after a 1000-h ageing test at 125 C. Leach resistance is typically greater than 25 s for 0.01-in.-wide conductor lines at soldering temperatures of 240 C (62% tin/36% lead/2% silver solder). In addition to dense, pinhole-free conductor lines with a resolution capability of 0.004 in. on beryllium oxide, the conductor pastes offer a soldering speed of 3 s for 100% coverage, eliminating or minimizing soldering rework problems. The paste may be conventionally screen-printed and fired at 875 C for 7 min.

CIRCLE NO. 320

Looking for that right-sized O-ring



Auburn Manufacturing Co., Stack St., Middletown, CT 06458. (203) 346-6631. \$27.50.

A 380-ring assortment of Buna N Superior O-rings contains the 30 most popular sizes from 1/8 in. to 1-3/4-in. inner diameter. Boss seal kits are also available, as are standard and boss kits in Viton. All kits have color-coded posts and built-in-thickness gauges.

CIRCLE NO. 321

Thin-glass fabricated to extreme tolerances

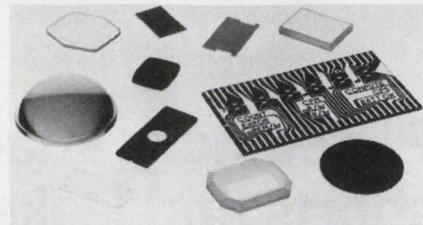

Continental Industries Corp., 800 S. Claremont St., San Mateo, CA 94402. (415) 348-2420.

High-volume thin-glass fabrication with extreme tolerances receive 100% inspection. Glass stock includes all thicknesses from 0.01 to 0.25 in. and various filter glasses. Standard products include conductive-coated glass cut to size for LCD displays, hermetically sealed ultraviolet windows for PROM lids, platen glasses for microfiche readers, reflective light pipes for LCD displays, and glass with conductive display already sputtered on. Flatness is to 50 microinches; on optical products, fabrication is to one fringe per radial inch with dimensional tolerances of ± 0.0005 in.; cutting tolerance is as low as ± 0.001 in.; and chemical tempering of glass in thicknesses from 0.005 to 0.125 in. for 15 times the strength of untempered glass is provided.

CIRCLE NO. 322

Strain-relief bushing eases lazy bend in cable

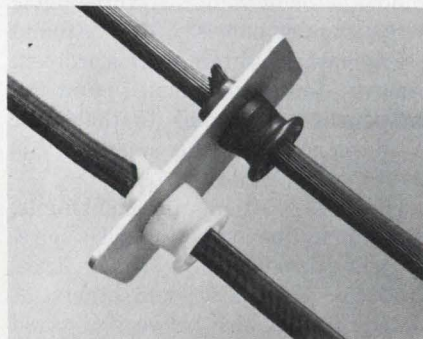

Heyman Manufacturing Co., P.O. Box 160, Kenilworth, NJ 07033. (201) 245-2345.

A new Bell-Mouth bushing absorbs cable flexing and provides strain relief. Widely flared exit hole protects the cable from bending sharply; the cable is eased into a lazy bend to assure a long life. Made for both flat and round cables, they are available for holes of 3/8, 7/16 and 1/2 in. dia. Samples are available.

CIRCLE NO. 323

AUGAT MAKES IT EASY TO BUY THE BEST.

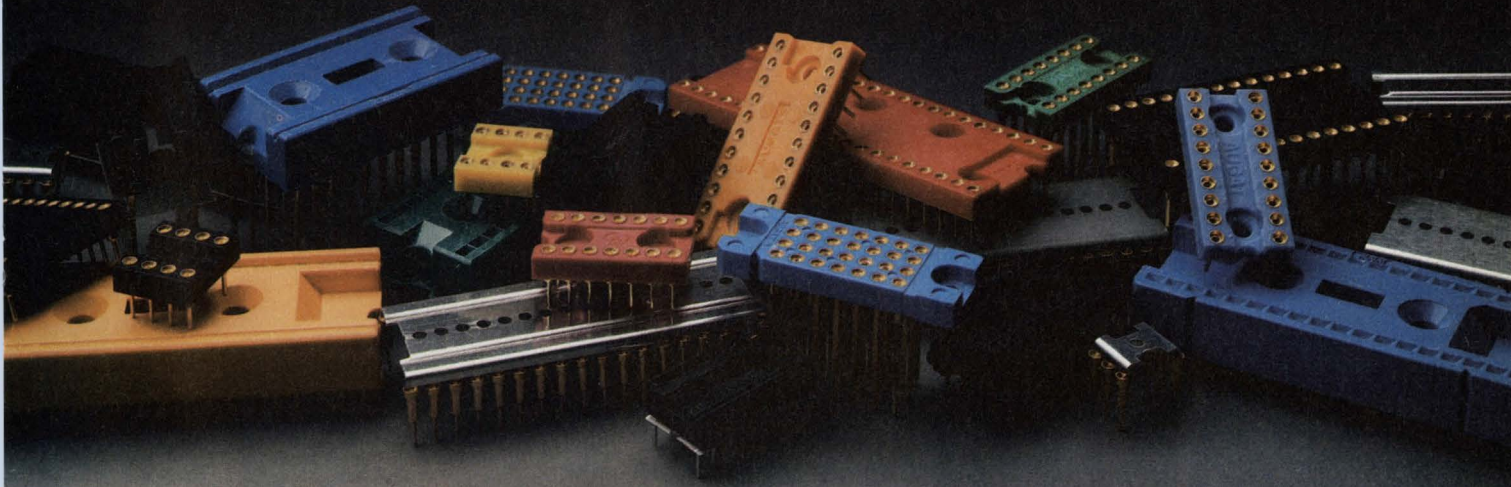

One of the biggest reasons Augat sockets outsell all others is that we make Augat sockets the easiest to buy. Augat offers IC sockets for off-the-shelf delivery from hundreds of worldwide distributor locations. So you have it easy when you buy the best. And here are some of the best you can buy.

Our Series 300 low-profile sockets excel over competitive types with their superior beryllium copper side-wipe contacts that handle all com-

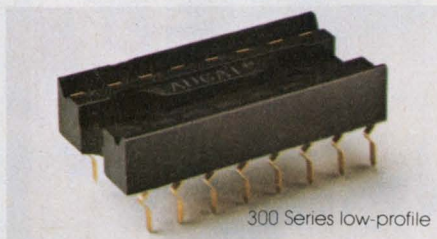

300 Series low-profile

ponent lead sizes with better retention and longer contact life. They are available in all sizes from 8 to 40 contacts.

Our 300 Series wire wrap sockets are the best buy in the industry today. Their special pin taper locks them in place without bonding or soldering, and

they're very attractively priced.

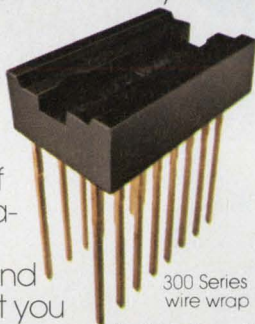

300 Series wire wrap

Our 500 Series sockets are the industry's "premium grade", the ones to use when high reliability and exceptional performance (at a reasonable price) are a must. They come in 12 sizes between 8 and 40 contacts.

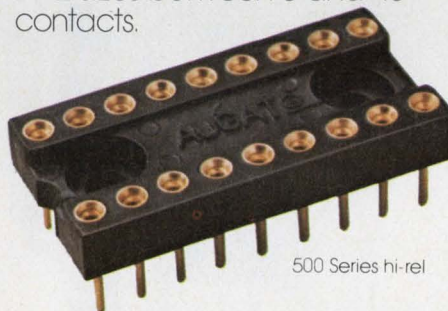

500 Series hi-rel

Our 700 Series lead socket carrier is a new concept of growing popularity. The metal carrier holds the individual contacts in place through assembly and soldering, and is then removed. Advantages: improved airflow and complete topside accessibility for inspection and solder rework. Available in 14 sizes.

Beyond that, of course, is our

broad selection of standard profile and test sockets, LED sockets, and numerous accessories.

So the next sockets you buy, make them Augat. They're not only the best you can get, but getting them is a breeze... just about anywhere. Write us for a condensed socket selection guide with prices and a list of our distributors.

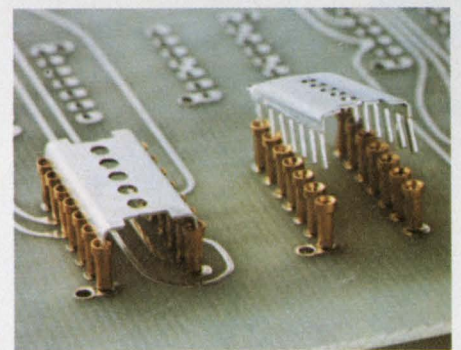

700 Series lead socket carrier

Augat, Inc., 33 Perry Avenue, P.O. Box 779, Attleboro, Mass. 02703. Tel. (617) 222-2202

AUGAT®

Augat interconnection products, Isochronics microcircuit packaging, and Alco subminiature switches.



Digital introduces DECstation. A big computer system that's small enough for anyone.

Digital put an amazing LSI version of the PDP-8 inside a DECscope, added some ingenious interconnecting devices and created something new. The DECstation. A complete computer system big enough to do all kinds of work and small, simple and inexpensive enough to do it for almost anyone.

DECstation. A complete computer system in disguise. It looks like a terminal, but look again. The DECstation has a powerful general purpose computer, a video terminal, a dual diskette drive, and its own special operating system. What's more, you can hook up two different printers and a second dual diskette drive. Then put the whole thing in a mini-desk, and when you're done you'll have the smallest big computer you've ever seen.

The Video Data Processor. It's the big reason the DECstation's so small. The VT78 Video Data Processor is a computer wrapped in a terminal. Inside the familiar DECscope you'll find an LSI version of the PDP-8 with 16K words (32K characters) of MOS memory and built-in interfaces. Two serial asynchronous ports feature speeds from 50 baud to 19.2 kilo-

baud. A disk port interfaces with up to 4 diskette drives. A parallel I/O port for printers and custom interfacing provides data transfer rates up to 180 kilobits/sec. All standard.

You can go from carton to computer in less than an hour. If you can push a button, you can run a DECstation. Because one button is all it takes to start things up. The bootstrap and self-test routines are built in.

Put it together, plug it in, and immediately you can begin to run anything from the PDP-8 software library. Which means you start with one of the most comprehensive sets of software tools available in a small system. Including two proven operating systems: OS/78 for stand alone applications and RTS/8 for real-time. OS/78, an extension of

OS/8, supports a number of languages, including FORTRAN IV and BASIC. So all you have to do is load the operating system and start programming your application.

Whatever that application, if you're looking for a sophisticated little system, at the right price, and a remarkable OEM tool, consider DECstation. \$7995 each. \$5436 OEM quantity 50.

For our free brochure, write Digital Equipment Corporation, Parker Street, Maynard, MA 01754. European headquarters: 81 route de l'Aire, 1211 Geneva 26. Tel: 42 79 50. In Canada: Digital Equipment of Canada, Ltd.

digital

PDP-8 Marketing Communications
Digital Equipment Corporation, Parker Street, PK3-1, M34
Maynard, MA 01754.

Send me the free DECstation brochure. (please print)

Name _____

Company _____

Address _____

City _____ State _____ Zip _____

Phone _____ OEM _____ End-user _____

Application _____

_____ Please send additional information about the PDP-8 family.

Now!
25/35 Amp
PRESSFIT
SCRs...
 with any
 gate sensitivity
 you want...
 voltages
 to 800V.
 unsurpassed
 surge current
 capability...
 and glass
 passivation...
 priced as low
 as \$1.15!

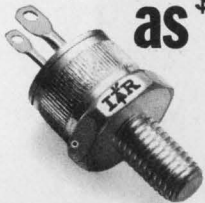
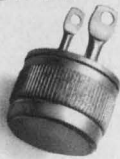

Type IR30, IR32, 20RA, 21RA, 22RA and 23RA with voltages to 800V and minimum I_{GT} from 1 to 100 mA. Unsurpassed surge capability and high temperature stability from hard glass passivation to help make them the most reliable pressfits around. Delivery from stock! Call your IR Distributor or Sales Office today. International Rectifier, 233 Kansas, El Segundo, CA 90245. Phone (213) 322-3331, Telex: 66-4464.

International Rectifier
IR ... the innovative semiconductor people

CIRCLE NUMBER 62

PACKAGING & MATERIALS

Ceramic adhesive in kit bonds to 2800 F

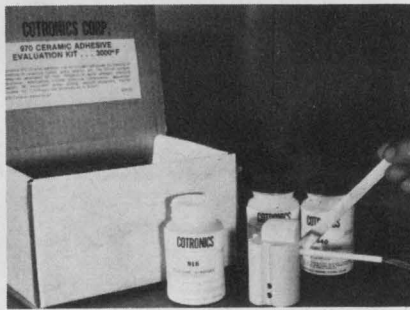

Cotronics, 3379 Shore Parkway, Brooklyn, NY 11235. (212) 646-7996. \$24.95 (unit qty.).

Ceramic-adhesive selector kit 970, for use to temperatures in excess of 2800 F, bonds ceramics to metals, glass, electric components, other ceramics and many other materials. The kit offers the adhesives in a convenient and economical form. The adhesives and coatings are resistant to oxidizing and reducing atmospheres, most chemicals and solvents.

CIRCLE NO. 332

Need flat-cable clamps that don't burn?

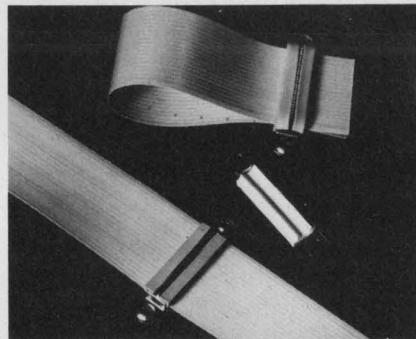

TA Manufacturing Corp., 375 W. Arden Ave., Glendale, CA 91203. (213) 240-4600. \$0.20 (1 in.), \$0.35 (3 in.), (1000 qty); stock to 3 wks.

Flat-cable clamps that won't burn are suitable for UL or FAA-approved equipment. The clamps are reusable and keep cables from slipping once secured. Cushion material in the clamps meet UL-94 V-O and FAA-FAR 25.853, appendix F, specifications—the key specs that relate to burning. The clamp has a metal frame covered with a nitrile-butadiene or silicone-rubber cushion. Both materials are self-extinguishing, but some MIL programs require the silicone rubber. The metal part of the clamp comes in either aluminum or stainless steel.

CIRCLE NO. 333

Plastic pad heats when water is added

3M Co., TelComm Product Div., Box 33600, St. Paul, MN 55133. (612) 733-1110.

A water-activated chemical package, Heat Pack 4620, is a flexible plastic pad, 9 x 15 in., with an insulated outside surface. Loosely wrapped around an encapsulated splice, the pack reduces curing time, especially in adverse environments. The pack produces 93 C within 3 min after water is added, and maintains a temperature of at least 77 C for an hour or more. A disposable water-measuring cup is supplied for convenience; the only other material necessary is sufficient tape to hold the pad in place. Each Pack can handle a cable splice up to 2-in. dia; for cables 2-to-4 in., two heat packs can be combined.

CIRCLE NO. 334

Wire dispenser cuts and strips

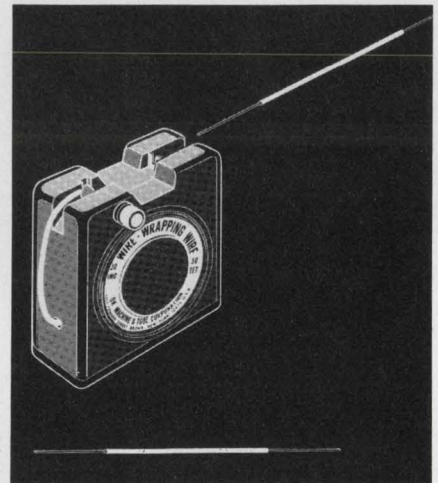

OK Machine & Tool Corp., 3455 Conner St., Bronx, NY 10475. (212) 994-6600. Stock.

WD Series wire dispensers cut a strip after wire is drawn out to the required length. A built-in plunger cuts a length from the roll, and a gentle pull through the stripping blade removes the insulation without nicking the wire. Repeat procedure removes insulation from second end. Designed particularly for wire-wrapping, the inexpensive dispenser contains 50 ft of AWG 30 industrial-quality Kynar-insulated OFHC silver-plated solid-copper wire. Insulation colors are blue, white, yellow or red.

CIRCLE NO. 335

8-Bit high-speed monolithic A/D

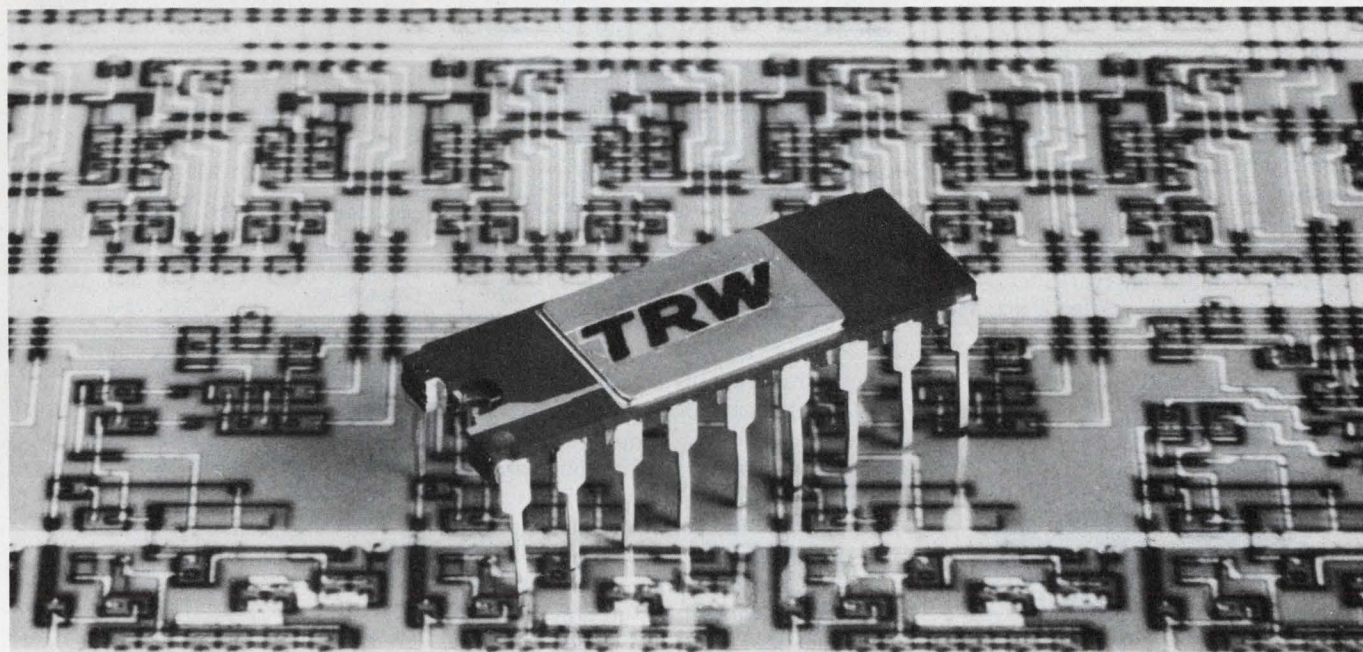

Priced under \$100

TDC-1002J	1000 ns	\$75 in 100's
TDC-1001J	400 ns	\$175 in 100's

Two performance ranges—400 and 1000 ns conversion times: two price ranges for a wide variety of high-speed A/D applications.

Linearity is $\pm 1/2$ of LSB. Nine clock periods per conversion. All output bits are ready one clock period after the status signal indicates "ready to convert!" There are no missing codes — ever!

TDC-1001J and TDC-1002J are supplied in an 18-pin ceramic DIP package designed to operate at a commercial temperature range of 0° to 70° C.

For more information and complete specifications, call (213) 535-1831, or use this coupon.

TRW LSI Products
E2/9085 • One Space Park
Redondo Beach, CA 90278

Please send data sheets on your 8-Bit A/D Converters.

NAME _____

COMPANY _____

DIV/DEPT _____

MAIL CODE _____

ADDRESS _____

CITY _____

STATE _____

ZIP ED _____

TRW LSI PRODUCTS

...from a company called TRW

PACKAGING & MATERIALS

Epoxy/glass laminate is punchable

New England Laminates Co., Continuous Prod. Div., Elm St., Walden, NY 12586. R. Schor (914) 778-5583. See text.

A punchable epoxy/glass PC laminate for high-quality two-sided boards with plated-through-holes, GEM (glass/epoxy mat), is equal to FR-4 systems; however, the punching and plating characteristics of GEM are unmatched by any known PCB laminate, according to the manufacturer. Market introduction is planned for later this year at an estimate price of about \$1.60/ft² for 0.059-in.-thick, 1-oz copper-foil bonded on two sides.

CIRCLE NO. 328

Indicator lights allow lens rotation

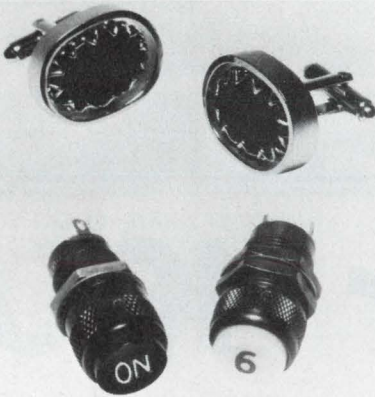

Dialight, 203 Harrison Pl., Brooklyn, NY 11237. (212) 497-7600. \$1.54 to \$1.79 (1000 up); stock.

Subminiature indicator lights offer rotatable lenses to permit legend alignment after installation on a panel. Anti-rotation construction provides secure locking of the socket-terminal assembly, but a specially designed spring mounting allows the lens to be turned. The indicator lights are available with T-1-3/4 incandescent bulbs and flat lenses, or either standard or high-brightness T-2 neon glow lamps with flat-end cylindrical lenses. Designs are available for mounting from panel back or front; all styles allow lamp change from the front. The units meet or exceed the environmental and operational requirements of MIL-L-6723 and MIL-L-3661B and are UL and QPL approved.

CIRCLE NO. 329

Wire-wrapping panels hold 180, 16-pin ICs

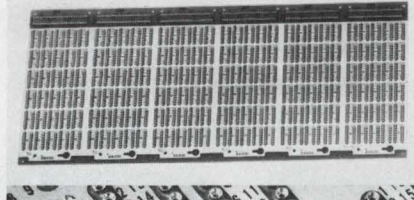
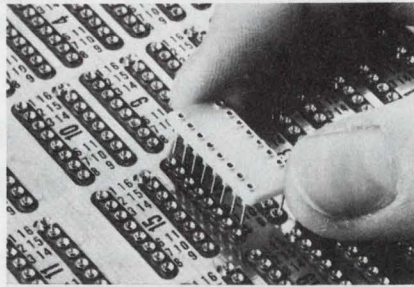

EECO, 1441 E. Chestnut Ave., Santa Ana, CA 92701. (714) 835-6000. \$243.25: 7.5 x 16-in. board (unit qty); stock.

For wire-wrapping interconnections—automatic or hand—the PG series panels feature 2-oz copper circuitry with solder coated on both ground and V_{cc} planes. Available panel sizes can hold from 30-to-180, 16-pin ICs. Both power-connected and custom panels are available. Large ground and V_{cc}-plane areas allow control of the impedance for high-speed logic. The panels come in three I/O connector-area patterns. The socket terminals are beryllium-copper with gold-over-nickel plating, which provide low contact resistance and gas-tight connections. Panels are available with two or three-level WW pins and power bypass capacitors.

CIRCLE NO. 330

Rack PC-board assemblies allow design flexibility

Mupac Corp., 646 Summer St., Brockton, MA 02402. (617) 588-6110. \$120.25: no connectors (10 qty); stock.

A family of rack assemblies for circuit boards and accessories provide 13 socket positions spaced on 1.2-in. centers, which can be expanded to 26 positions on 0.6-in. centers. Half racks that accommodate six panels on 1.2-in. centers and 11 panels on 0.6-in. centers are also available. The connectors can be easily removed from the power panel without desoldering because of multiple-voltage connectors to the power panel. End plates can be reversed for front or rear loading of panels.

CIRCLE NO. 331

Connect with the A P rep nearest you.



ALABAMA

Macro-Marketing Assoc. (205) 883-9630

ARIZONA

Piper Sales (602) 946-4437

CALIFORNIA

Mission Marketing (714) 833-1802
Brooks Technical (415) 328-3232
Daniels & Doty San Diego (714) 560-6266

COLORADO

Piper Sales (303) 420-4646

CONNECTICUT

Tri-Com Assoc. (203) 868-7748

FLORIDA

G. F. Bohman Assoc. Ft. Lauderdale (305) 564-3081
G. F. Bohman Assoc. Orlando (305) 855-0274

ILLINOIS

Coombs Assoc. (312) 298-4830

INDIANA

Temple Engineering (219) 743-0362

MASSACHUSETTS

Tri-Com Assoc. (617) 272-8163

MICHIGAN

Enco Marketing (313) 642-0203

MISSOURI

Kebco (314) 576-4111

MARYLAND

Compar Chesapeake (301) 484-5400

MINNESOTA

Charles E. Bohlig (612) 922-7011

NORTH CAROLINA

Macro-Marketing Assoc. (919) 788-8145

NEW JERSEY

Cambridge-Allen Assoc. (212) 682-5844
Sunday—O'Brien (609) 429-4013
(215) 923-5195

OHIO

Norm Case Assoc. (513) 433-0966
Norm Case Assoc. (216) 333-4120

OKLAHOMA

Allied Components (918) 492-7771

TEXAS

Allied Components (512) 459-0761
Allied Components (214) 238-0408
Allied Components (713) 960-1962

WASHINGTON

Freed Assoc. (206) 822-8223

WISCONSIN

Coombs Assoc. (414) 671-1945

CANADA

Weber Electronics 1111 Finch Ave. W. Downsview, Ontario M3J 2E5 (416) 638-1322

EUROPE

A P Products Ulmenweg 7 D-7031 Weil 1 Germany (07157) 62424

If no rep in your area call toll free 800-321-9668.



A P PRODUCTS INCORPORATED

Box 110•72 Corwin Drive Painesville, Ohio 44077
Phone: (216) 354-2101
TWX: 810-425-2250

**If you are using
flat cable and
connectors from 3M.
AMP · Berg · CW.
SAE · Spectra-Strip.
ITT Cannon · Ansley,
etc... switch to
Great Jumpers
and save up to 50%.**

If you're buying complete assemblies you can save even more.

Great Jumpers not only cost less, they come to you fully assembled and completely tested. Available with socket, PCB, or card-edge connectors in 20, 26, 34, 40 and 50 conductor widths. Cable strain reliefs are integral to the molded-on connectors, and all assemblies offer line-by-line probeability.

Great Jumpers are available with solid or stranded conductor cable, single-ended, double-ended or daisy-chained using any mix of connector types and sizes.

It's all up to you. Would you rather spend more and put it all together? Or save more and get it all together. There's only one way to make your green go farther.

Think pink.



Faster and easier is what we're all about.



AP PRODUCTS INCORPORATED

Box 110 • 72 Corwin Drive, Painesville, Ohio 44077 • (216) 354-2101 TWX: 810-425-2250

Now you can mass terminate with ribbon connectors.

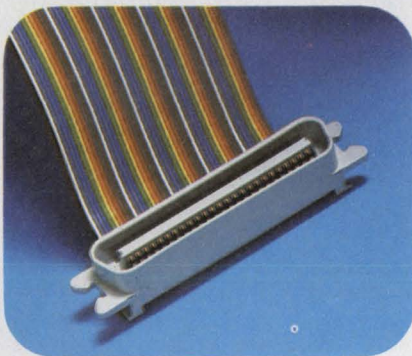

Here's another industry first from 3M that's good news for you: the Scotchflex brand Delta Ribbon Connector System for intra-system or I/O interconnections. In computer applications, in telecommunications, in any place or any way you want to use flat cable and ribbon connectors, this versatile system can do the job at sharply reduced assembly time and labor costs.

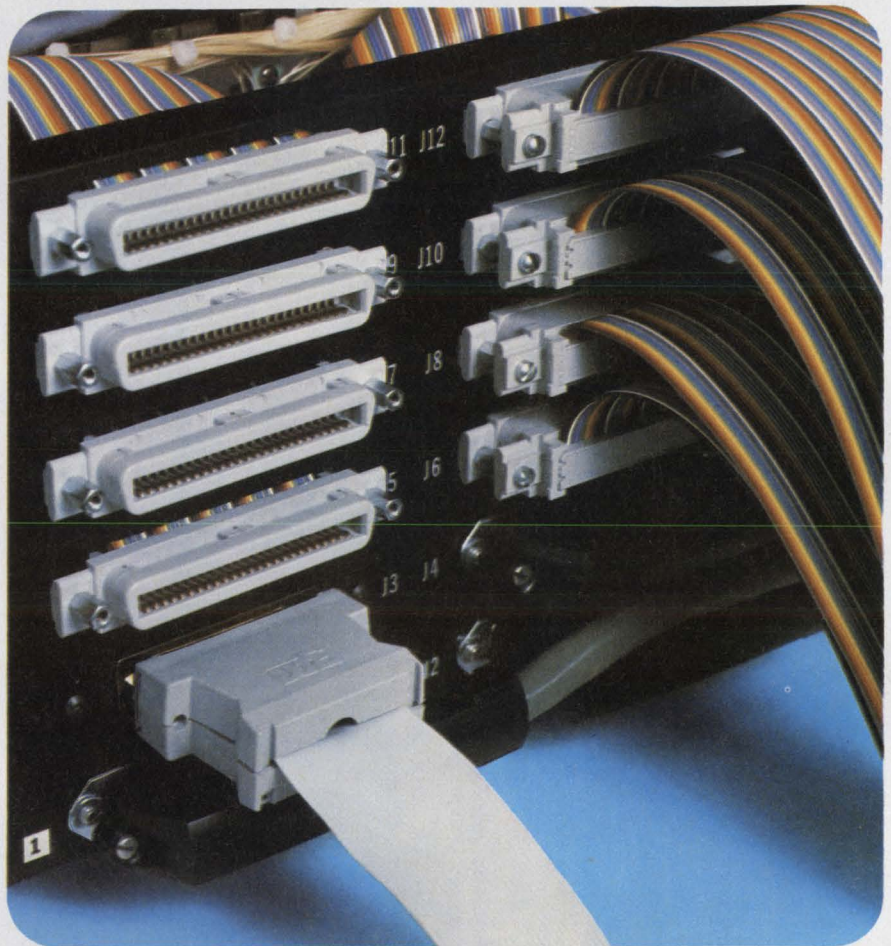

With Scotchflex Delta Ribbon Connectors, no stripping, soldering or other wire preparation is necessary. You can mass terminate a parallel-lay 50-conductor (25-pair) .0425" center-spaced flat cable in less than 30 seconds with one step. That's about ten times faster than other available methods. And thanks to 3M's field-proven, gold-plated beryllium copper U-contacts,

all connections are reliably corrosion-resistant and gas-tight.

After termination, there are more savings. You can buss from point to point without disassembling or breaking existing cables. And there's no need to redesign or rework first generation components. This Scotchflex system mates perfectly with all standard miniature ribbon connectors.

..in 30 seconds or less!



There's no costly investment to make in equipment or training. All you need are two locator plates and the Scotchflex manual or pneumatic assembly press. You can start mass terminating assemblies quickly and economically. No special operator skills are required. Rejects and reworking are greatly minimized.

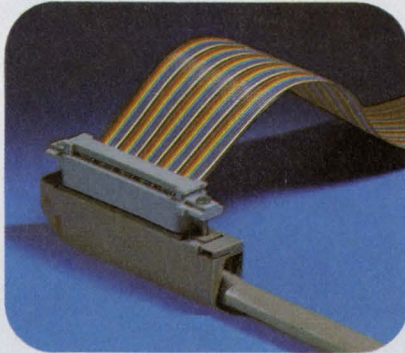

The Scotchflex Delta Ribbon system includes 50-position male and female connectors, plus appropriate bail mount, screw mount and jack screw kits, strain relief clips and dust covers. Color-coded flat cable is available in parallel-lay conductors #28 AWG stranded or #26 AWG solid.

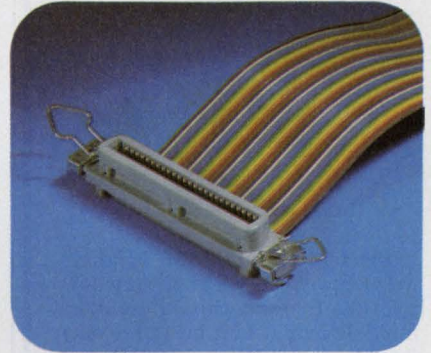

Only 3M offers you so broad a range of flat cable and system components. A nationwide network of stocking distributors. Best off-the-shelf availability. Proven performance. And the unmatched experience of the people who pioneered mass terminations.

"Scotchflex" is a registered trademark of 3M Co.

Scotchflex[®]
systems
from 3M.
The source.



Amazing! 3 output, 375 watt switcher

in a package smaller
than a briefcase!



LH's Model MM730 Mighty-MITE switcher keeps a very low profile. In fact, this "Flat Pak" multiple-output unit measures only 3.00"H x 9.50"W x 12.20"D and weighs only 12.5 lbs. Yet it can provide three outputs and 375 watts of power — all for only \$560.* Major specs are:

- Primary voltage — 5V, 75 amps.
- 2nd and 3rd voltages — Choice of 2V, 12 amps; 5V, 12 amps; 12V, 10 amps; 15V, 10 amps; 18V, 8 amps; 24V, 5 amps. Total output 375 watts, max.
- Line regulation — 0.4% (on primary output) over entire input range.
- Load regulation — 0.4% from no load to full load.
- Ripple and noise — 1% or 50 mv peak-to-peak.
- Response time — 200 μ sec to 1% after 25% load change at 5 amp/ μ sec.
- Operating temperature — 0°C to 40°C, derated to 70°C.
- Forced air cooling.

*1 to 9 pieces.

**World's
largest
switcher
manufacturer!**

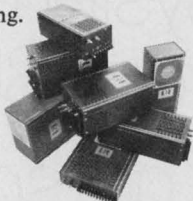

The MM730 typifies the high-reliability switchers LH Research offers. Nobody packs more power in smaller packages or offers a broader line. 1 through 7 outputs. Up to 2.26 w/in.³ 80% efficiency. At less than 65¢/w in quantity.



LH RESEARCH, INC.
1821 Langley Avenue,
Irvine, CA 92714
(714) 546-5279

CIRCLE NUMBER 67

INSTRUMENTATION

Autoranging comes to low-cost, vhf counter

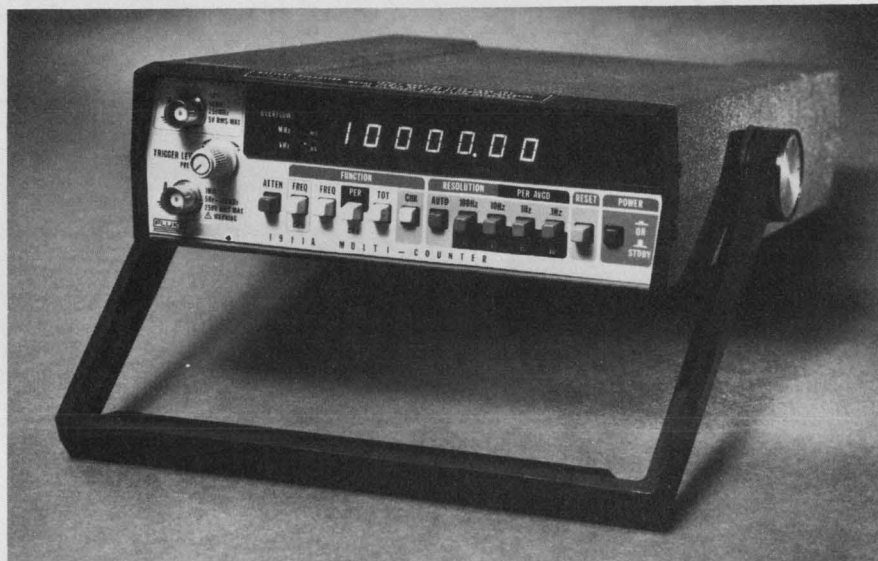

John Fluke Manufacturing, 7001 220th S. W., Mountlake Terrace, WA 98043. (206) 774-2211. P&A: See text.

You can buy a 250-MHz counter with more digits than the Fluke 1911A. You can buy one with better sensitivity. And better price. But you can't get any other for under \$500 that gives you autoranging or full trigger-level control or measurements other than frequency. For \$495, the seven-digit 1911A gives all that, plus period, period-average and totalize—and doesn't stop there.

Fluke's "clean dropout" is also included, a feature that avoids erroneous counts by reading zero whenever signal strength drops below a predetermined reliable level. "Auto-reset" ensures a correct first reading by starting a new measurement sequence whenever you push any front-panel button (excluding the 10X attenuator.)

To pack that much into a box with the same price as its closest competitor—the 225-MHz 5382A from Hewlett-Packard—Fluke has lopped off one digit and relaxed its time-base tempo by a factor of two (± 5 ppm from 0 to 50 C vs ± 2.5 ppm from 0 to 40 C for the 5382A). The 1911A ages faster, too— ± 0.5 ppm/month vs ± 0.3 ppm/month.

The 1911A does have some operating limitations: Its period mode extends

from just 5 Hz to 2 MHz, not across the entire range. Like many other counters, but unlike the HP5382A, the 1911's input is split—a "high"-impedance (1 M Ω /30 pF) channel covers 5 Hz to 125 MHz, and a 50- Ω , preselected input covers 50 to 250 MHz.

On the other hand, the 5382A counts directly across its entire range (10 Hz to 225 MHz) with one input jack, and so can resolve 1 Hz in 1 s (10-MHz time-base). In autorange, the Fluke unit automatically tries to fill all seven digits, but won't select a gate interval greater than 1 s. In the manual mode, the 1911A offers four gate intervals: 0.01, 0.1, 1.0 and 10 s. The 5382A offers three: 0.1, 1 and 10 s.

On channel A (1 M Ω), the 1911A's sensitivity is specified as 15 mV rms from 5 Hz to 100 MHz and 25 mV rms to 125 MHz. On channel B (50 Ω), sensitivity is 15 mV rms from 50 to 175 MHz and 30 mV rms beyond. The 5382A needs 30 mV rms from 30 Hz to 10 MHz and 50 mV rms elsewhere.

The 1911A is a member of a new family of Fluke counters, all with many of the 11A's features. So far, the group includes the 1910A (125 MHz, seven digits, \$395) and the 1912A (520 MHz, 7 digits, \$620); more units are on the way. Delivery of the 1911A is from stock to 30 days.

Fluke
Hewlett-Packard

CIRCLE NO. 306
CIRCLE NO. 307

A digital F.R.A. with an exciting new feature.

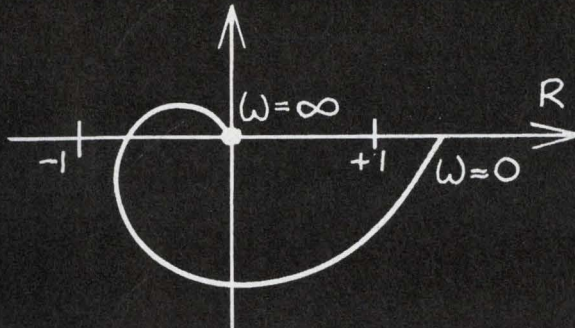

Simplicity.

EMI has taken the complexity out of digital F.R.A. operation. In fact, our SM2001A is so simple that, in effect, all the operating instructions are on the front panel, reducing test time from minutes to seconds.

But don't think that simplicity means a sacrifice in performance. The SM2001A has complete harmonic analysis capability, so it's a frequency response analyzer in the fullest sense. Innovative digital techniques ensure high stability, resolution and accuracy. And a range of custom-built accessories provides unique flexibility.

Accessories include facilities for frequency

extension, two-channel operation, plotter and computer interfaces. There are also modulator/demodulator and reference synchronizer units.

Frequency range is 0.00001 Hz to 999 Hz (up to 999 kHz with frequency extension).

The price is easy, too. The SM2001A costs far less than competitive equipment.

Contact EMI for complete information.

EMI Technology Inc., Instrumentation Division,
55 Kenosia Avenue, Danbury, CT 06810 (203) 744-3500,
TWX: 710-456-3068



EMI Technology Inc., Instrumentation Division.
A member of the EMI Group. International leaders in music, electronics and leisure.

makes your life easier

RONICS MANUFACTURERS DIRECTORY IN THE WORLD!

CATALOG PAGES AVAILABLE IN SECTION 2

Boldface type and page reference numbers steer you toward the company's catalog pages in Section 2.

KEY PERSONNEL FINANCIAL DATA

Many companies have included financial data. You can tell the size of the company from dollar volume, number of employees and number of engineers.

SALES OFFICES & REPS — USA AND FOREIGN

A total of 83,930 sales outlets are listed under manufacturers. Both U.S. and foreign sales offices and reps are included.

COMPLETE

Company name, street address, city, state, zip and phone. If provided by the company, you'll also find TWX, TELEX, cable address, toll-free numbers, facsimile equip.

LOOKING FOR ELECTRONICS MANUFACTURERS?

LOOK FIRST in Electronic Design's

GOLD BOOK

DAYTON ELECS PRODS CO

87	DATRONIC ASSOC INC, DEPT G, Rt 4 Flemington NJ 08822; Tel: (201)782-0077; HL Herman pres; Herman sec-treas; 6 emp; 4 eng; \$A	59	DATRON SYS INC, 20716G Plummer St Cheshamworth CA 91311
61	DATRON SYS INC, ELEC SPECIALTY DIV, DEPT G, 18900 NE Sandy Blvd Portland OR 97220; Tel: (503)665-0121; TWX: (910)469-8782; Telex: 36-0453; Fax: (503)665-0127 ext 214 XEROX M-400; F Brodie vp mgr; RS Lisdoro sales mgr; RS Lisdoro adv mgr; 475 emp; 20 eng	85	SALES OFFICES & REPRESENTATIVES
87	AZ Scottsdale: Goodreau Assoc (602)994-9909	87	GA Smyrna: B-C Elcs (813)993-5402
85	KS Lawrenceville: Eng Svc Co (404)436-5169	80	MA Brockton: Forberg Eng Svc Co (913)649-4000
81	MD Luthersville: LD Lowery Inc (615)522-6300	52	MI St Paul: Countryman Assoc Co (313)923-2172
51	MO St Louis: Eng Svc Co (314)645-9151	24	NY Smithtown: T-X Sls (314)997-1515
79	NY Syracuse: CW Floring & Assoc (315)478-9750	86	PA Broomall: Lowery Ind Co (315)478-2149
86	TX Dallas: Blackburn Assoc Inc (214)396-5300	01	WA Seattle: HS Thorpe (206)784-3333
33	FR AUSTRALIA: Mosconi Victoria	89	CA Anaheim: Electric Pty
61	FR CANADA: Ottawa: Wilson Enter (416)224-9878	96	FR CANADA: Toronto: Wilson Enter (416)495-1266
77	FR CANADA: Toronto: Wilson Enter (416)495-1266	90	GERMANY: Frankfurt: N Elec (03-281-0583)
92	FR JAPAN: Tokyo: Wake Ind Co	93	FR UK: Crawley: Electro Match Ltd
00	DATRON SYS INC/ELEC SPECIALTY DIV LOCAL DISTRIBUTORS	61	FR INDIA: Bombay: Cosmics Electroni
11	FR ISRAEL: Tel Aviv: Vectorics Ltd	81	DATTELLO ENTPR INC, 9405G Doran Ct Louisville KY 40220; Tel: (502)491-6262; DP Dattilo pres; 47 emp; 5 eng; \$D
11	SALES OFFICES & REPRESENTATIVES	57	IN Indianapolis: Needles Sls (317)255-8056
80	NY Louisville: Custom Component Sls (502)929-1713	400	OH Cleveland: Comp/Insul Corp (216)521-3570
66	DATUM INC, DEPT G, 1363 S State College Blvd Assisierville, CA 92806; Tel: (714)533-6333; TWX: (910) 592-1289; Telex: 935-399; WE Randa pres; NI Davis vp mktg; P Sheets mktg svcs; FSCM 31160; 350 emp; 50 eng; \$E	61	SALES OFFICES & REPRESENTATIVES
90	AL Huntsville: Leo Assoc Inc (205)533-5896	56	CA San Jose: Datum (408)245-3370
401	CO Denver: BFA Corp (303)744-3301	091	FL Ft Lauderdale: Leo Assoc Inc (305)525-9767
051	FL Winter Haven: Leo Assoc Inc (813)928-3311	160	IL Chicago: SEA Inc (312)282-6694
86	IL Hoffman Estates: Datum (312)298-1244	451	KS Wichita: Winco Inc (317)846-2593
394	MA Waltham: Digital Sls (617)246-1590	174	MD Silver Spring: K-G Elcs (301)487-6522
011	MI Ann Arbor: EMA Corp (313)962-6104	189	TX Dallas: Data Aids Assoc (714)255-2931
340	TX Houston: Data Aids Assoc (713)862-6655	658	WA Seattle: Comp/Insul (206)284-4842
312	WA Washstate: SEA Inc (414)547-6637	001	FR ENGLAND: Harington Middlesex: Datum Elcs Ltd 01-897-0456
711	DAVCO MFG CO, 169G Ridgedale Av Morristown NJ 07960; Tel: (201)267-4990; JC Lawless Jr pres; 6 emp; 1 eng; \$B	5721	FR CANADA: Montreal: PQ Solid State Eng'g Co 514-481-3313
045	DAVEK SYS, 12740G Dean Pl Granada Hills CA 91344; Tel: (213)641-6544; D Keyte pres	DRP	DAVIDSON ELEC DEVELOPMENT, 2211G Peninsula Dr Erie PA 16506; Tel: (814)833-9818; AR Davidson pres; 10 emp; 2 eng; \$B
240	SALES OFFICES & REPRESENTATIVES	18	MI Detroit: WKM Assoc (313)992-2500
0	OH Cleveland: WKM Assoc (313)992-2500	0	OH Dayton: WKM Assoc (513)344-7500
0	PA Pittsburgh: WKM Assoc (412)892-2953	0	DAVIDSON OPTRONICS INC, 2223G Ramona Blv West

MA	Lexington: Zieco Inc (617)861-8300	NY	Fairfax: Willrich Precision Instrus (201)791-6696	
NW	Albuquerque: Southwestern Eng & Equip (505)265-6775	NY	Rochester: Irondequoit Ind (716)544-6257	
OH	Cleveland: H Tapitz Co (513)277-6531	VA	Vienna: Applied Science Mkt (703)281-3638	
FR	CANADA: Ville LaSalle, Quebec: Electrodesign Ltd (514)363-5120	H DAVES MOLDING CO, DEPT G, 4920 W Bloomingdale Av Chicago IL 60639; Tel: (312)622-8966; RC Appley pres; LA Serra sales mgr; RC Appley adv mgr; FSCM 72512; 160 emp; 3 eng; \$D	CA	Los Angeles: Littrell Western Sls (213)261-0164
CT	Meriden: PR Sturgeon (203)237-1112	FL	Fort Lauderdale: W Chester Smith (305)564-1477	
IA	Des Moines: Clancey Co (515)278-1331	IL	Chicago: Kruse Corp (312)736-9546	
IN	Clemmont: CT Clower Co (317)293-3998	KS	Shawnee Mission: Clancey Co (913)432-8550	
MA	Babson Park: PR Sturgeon Co (617)237-3506	MI	Bloomfield Hills: Gttr Co (313)945-1777	
MO	St Louis: Clancey Co (314)432-3833	NY	Syosset: Rywel Sls (516)364-0888	
OH	Westlake: JJ Foley Co (216)871-8830	PA	Pack: WG Walker (215)967-8146	
TN	Memphis: LE Offutt Co (901)789-1210	TX	Dallas: Commercial Plastics & Supply (214)631-8170	
WA	Seattle: Northwest Plastics Ind (206)763-0441	WI	Milwaukee: Clague Sls (414)721-1951	
FR	CANADA: Toronto: Atlas Elcs Ltd (416) 781-6174	DAVIS ELECTRIC CO, DEPT G, PO Box 38 Cape Girardeau MO 63701; Tel: (314)335-5547; 80 Davis pres; BD Davis sales mgr; 50 emp; 1 eng; \$C	SALES OFFICES & REPRESENTATIVES	
CA	Los Altos: Schwen Assoc (415)941-3737	IL	Norridge: Guarnas Sls Co (312)774-4600	
MA	Sotavite: NEAR Inc (617)845-4327	MO	Kansas City: Automatic Gen Elc (816)332-8206	
OH	Cleveland: Components Inc (216)243-8200	W	W Carrollton: Components Inc (513)866-0661	
PA	Radiant: WH Conrady Sls Co (215)875-5476	TX	Dallas: Stevens Sls Co (214)358-4476	
WI	Cedarburg: TPL Assoc (414)377-7030	DAVIS & HEMPHILL INC, 5710G Furnace Av Elkridge MD 21227; Tel: (301)796-2290; SH Balderson pres; NJ Williams sales mgr	SALES OFFICES & REPRESENTATIVES	
MD	Baltimore: JA Maguire & Co (301)377-0223	NC	Winston Salem: JA Maguire & Co (919)723-5980	
NJ	Pennsauken: JA Maguire & Co (609)965-5136	NJ	Plainfield: JA Maguire Co (201)754-6400	
DAVIS JK & CO, DEPT G, 9212 Denton Dr Dallas TX 75235; Tel: (214)352-8405; MH Exp pres and chrm; W Heyron ex vp; JM Haerle sales mgr; 42 emp; 1 eng; \$D	SALES OFFICES & REPRESENTATIVES	IL	Chicago: B Burns & Assoc (312)775-1233	
KS	Overland Park: T Dowell & Assoc (913)328-8200	PA	Broomall: LD Lowery Inc (215)356-5300	
TX	Dallas: Crockett Sls Co (214)748-8209	TX	Dallas: Lund & Co (214)358-4335	
DAVIS & SANFORD CO INC, 24G Pleasant St New Rochelle NY 10802; Tel: (914)632-1636; B Resk pres; EE Resk vp mktg; HE Dunn sales mgr; 35 emp; 1 eng; \$C	DAY-LIGHT DISPLAY CORP, 11G Fairfield Pl W Caldwell NJ 07006; Tel: (201)375-1045; D Rovine sales mgr; 12 emp; 4 eng; \$B	DAYMARC CORP, 301G Second Av Waltham MA 02154; Tel: (617)890-2345; TWX: (710)324-6469; Cable: DAYMARC, NJ Cedron pres; 100 emp; 10 eng; \$D	SALES OFFICES & REPRESENTATIVES	
CA	Orange (714)532-1212	CA	San Jose (408)244-8297	
FR	AUSTRALIA: Greystairns 2145: Coltronic Trading Co 392135	FR	BELGIUM: Brussels: CN Rood SA 51431	
FR	ENGLAND: Weybridge: Surrey D Newth 2657262	FR	FRANCE: Paris: A Renaud 021 9517341	
FR	GREECE: Athens: Morket 021 9517341	FR	INDIA: Ludhiana 141001: Bharat Sls (Int'l) of Biv 427 5915780	
FR	ITALY: Roma: E Ferradino (03)4084021	FR	JAPAN: Shibuya-Ku Tokyo: S Psters 088511956	
FR	NETHERLANDS: Gennep: Heijnen 2153543	FR	SPAIN: Madrid: Atao ingenieros SA 08/802548	
FR	SWEDEN: Stockholm: Erik Ferner AB 08/802548	FR	SWITZERLAND: Mutschellen: Stoiz AG (057)54655	
FR	W GERMANY: Munich: P Bette 089/335061	DAYTON AIRCRAFT PRODS, DEPT G, PO Box 14070 Ft Lauderdale FL 33302; Tel: (305)463 5451; FC Cline pres; JD Cline vp mktg; JD Chapelaine sales mgr; 100 emp; 5 eng; \$C		

CAPACITORS TOO BIG?

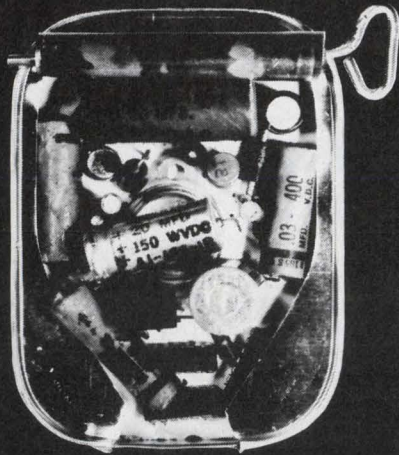

Suffering from the "Squeezies" (PCB too small, capacitors too big)? RELCAP™ hi rel Mylar™, Metalized Mylar, Polystyrene, Polycarbonate and Metalized Polycarbonate capacitors give quick relief. We've earned our reputation for squeezing lots of capacitor into tiny packages. Pick from over 7,000 different capacitors, from .001 pF @ 100 V to 100 μF @ 600 V. All at highly competitive prices.

An example of our capability is pictured below. It's from our new EFX Metalized Mylar line. Packed into just .40" in length and .14" thick you can have from .15 μF to .25 μF @ 50 V. And with hi rel specs! Use the coupon below to request evaluation samples and our complete catalog.

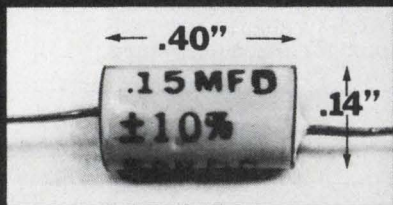

New EFX Metalized Mylar Capacitors

- Send me an evaluation sample from your EFX line, ___ μF @ ___ V.
- Send me your complete catalog.

NAME _____
 COMPANY _____
 STREET _____
 CITY _____ STATE _____ ZIP _____

**reliable
capacitors**

7409 Bellaire Avenue
 No. Hollywood, California 91605
 (213) 983-1970
 CIRCLE NUMBER 71

INSTRUMENTATION

Miniature DMM measures conductance, tests diodes

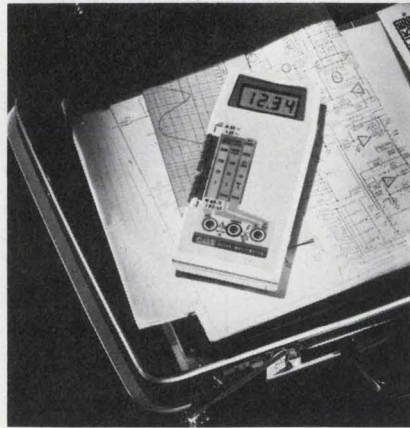

John Fluke, P. O. Box 43210, Mountlake Terrace, WA 98043. (206) 774-2211. P&A: See text.

The smallest member of the Fluke family of DMMs wraps a new identity around new features. Along with the 8020A's 3-1/2-digit (2000-count) liquid-crystal display, you get not just the usual functions—ac and dc voltage, current and resistance—but also conductance measurements in units of

Siemens ($1/\Omega$), as well as an in-circuit diode test mode.

Thus, you can measure leakage of cables, boards or capacitors—or, with an adapter, transistor beta or leakage—with less noise susceptibility than in the ohms mode.

Although the 8020A's maximum reading is 20 MΩ in the resistance mode, you can stretch this to an equivalent sky-high peak of 10,000 MΩ by going to the conductance mode. But then the unit displays inverses: 1 kΩ reads as 1.000, 500 Ω as 2.000, and so on. At the top value, 10,000 MΩ reads as 1 nS—you get one-digit resolution (no room for a ± one-count error here).

The \$169 price of the 8020A includes an impressive lineup of other features: autopolarity, autozero, overrange and low-battery (9-V, 200-h operation) indicators, and overload protection. All in a package that weighs a featherlike 13 oz and measures just $7 \times 3\frac{1}{2} \times 1\frac{1}{2}$ in.

CIRCLE NO. 308

Microwave counter locks external source



Dana/EIP, 3230 Scott Blvd., Santa Clara, CA 95051. (408) 244-7975. \$6800; 90-120 days.

Model 371 combines an 18-GHz automatic microwave frequency counter with a locking mode that can phase lock any swept external signal source from 10 MHz to 18 GHz. Only two interconnections are required between the 371 and the source: a sample of the source output and the frequency-modulation input to the source. Operation is controlled with a front-panel, μP based keyboard and displayed on a separate 6-digit LED display.

CIRCLE NO. 337

Scope weighs 3 lb, works to 15 MHz



Non-Linear Systems, P.O. Box N, Del Mar, CA 92014. (714) 755-1134. \$289.

The MS-15 Miniscope weighs only 3 lb and measures just $2.7 \times 6.4 \times 7.5$ in. Vertical bandwidth is 15 MHz. The graticuled rectangular viewing area is four-divisions high by five-divisions wide. Division spacing is 0.25 in. Power is from batteries or a line cord. Internal and external triggering are provided along with automatic and line synchronization modes as well as a horizontal input. Twelve vertical gain settings range from 0.01 to 50 V per division.

CIRCLE NO. 338

Berg Right-Angle Headers are the smart choice for Raytheon Intelligent Terminals.

Berg Shielded Right-Angle Headers consist of glass-filled polyester housings having .025" square pins (on .100", .125" or .150" grid) which are molded in position for maximum strength. They have an integral top shield to protect the pins from damage.

Raytheon Data Systems likes these headers and uses them, as well as Berg female receptacles and other .025" sq. connectors, in their programmable terminal systems. Raytheon has found that it can rely on Berg Electronics to supply the con-

nectors and equipment that precisely meet interconnection needs.

Berg is experienced. We read interconnection needs like Raytheon reads alpha-numeric displays. We have the products, the background, and the back-up to do the job. Your job. Let's work on it, together. Berg Electronics Division, E. I. du Pont de Nemours & Company, New Cumberland, PA 17070. Phone 717-938-6711.

 **BERG ELECTRONICS**
REG. U.S. PAT. & TM. OFF.

CIRCLE NUMBER 65

We serve special interests—yours!

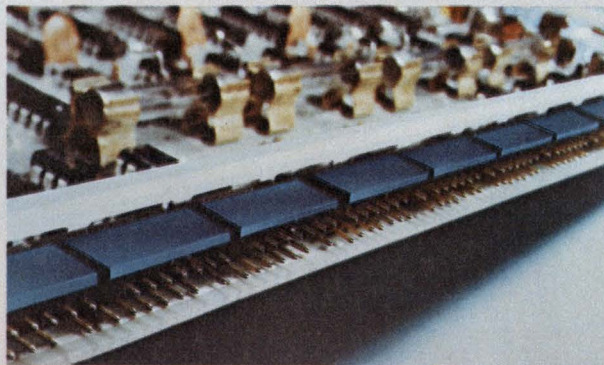

Interested in network variety? Select from a spectrum of 540 standards.

Allen-Bradley has the popular configurations you need. Pull-ups, Pull-downs. Line Terminators. Networks to complement Core Memory Sense Amplifiers. TTL to ECL Translators. O-Pad Attenuators. All styles available from your Allen-Bradley *Electronic Distributor*. Call for specs or check your EEM Catalog. If you need specials, contact your local Allen-Bradley district office for fast turn-around. Ask for Publication 5840. A-B is an experienced twin-film manufacturer, i.e. precision thin film and thick film.

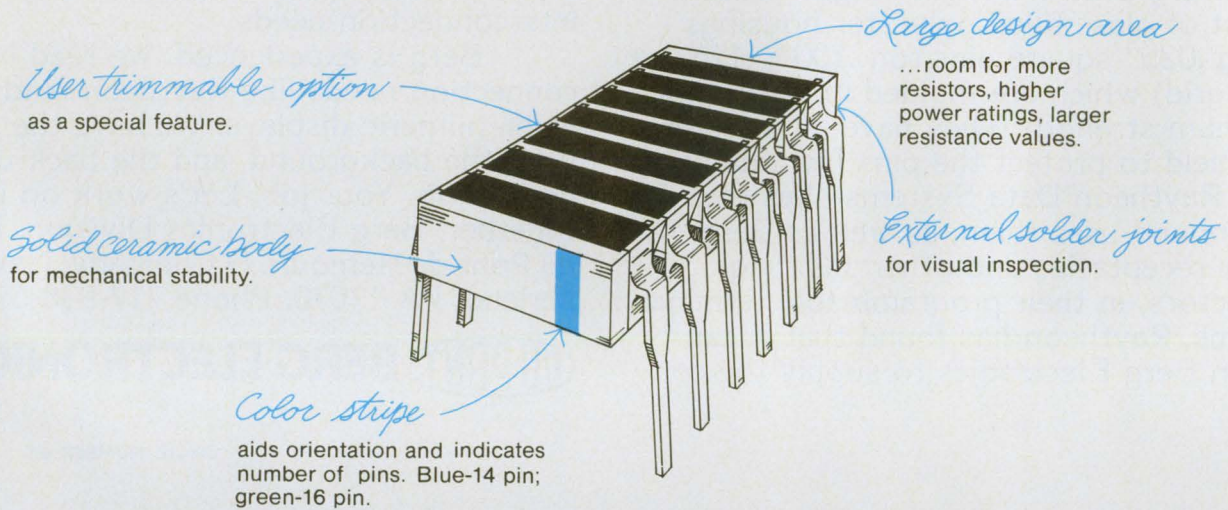

0540

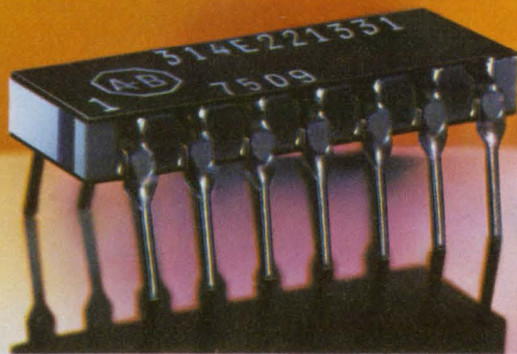

Quality in the best tradition.



ALLEN-BRADLEY
Electronics Division
Milwaukee, Wisconsin 53204

CIRCLE NUMBER 72

EC149

Broad range of I-DIP standards

PULL-UP/PULL-DOWN

Two basic configurations (314A-14 pin; 316A-16 pin). Each available in 81 resistance values for unused TTL gates, parallel high speed circuitry, wired OR circuits, TTL-MOS interfacing and pulse squaring.

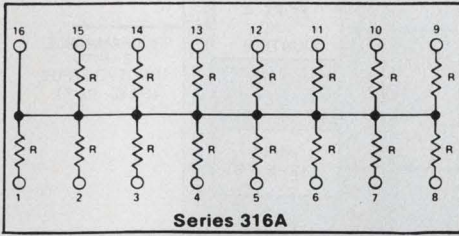

LINE TERMINATION

Two basic configurations (314B-14 pin; 316B-16 pin). Each available in 81 resistance values for transmission line termination, power gate pull-up, current limiting and logic level translation.

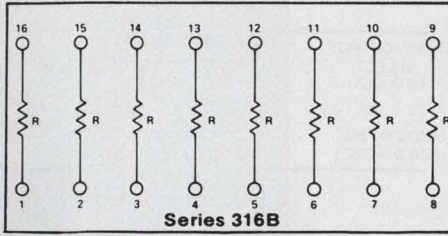

PARALLEL TERMINATION

Two basic configurations (314E-14 pin; 316E-16 pin). Each available in eight R1/R2 combinations for a wide range of impedance values.

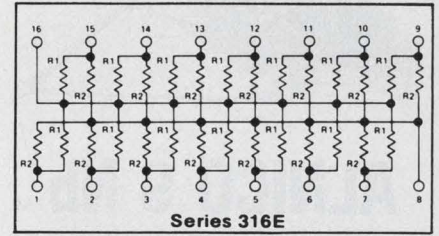

Standard Resistance Values R (Ohms), $\pm 2\%$ Tolerance

22	51	120	300	680*	1600	3900	8200	20K	47K*	120K	680K*
24	56	130	330*	750	1800	4300	9100	22K*	51K	150K*	1M*
27	62	150*	360	820	2000	4700*	10K*	24K	56K	180K	
30	68	160	390	910	2200*	5100	11K	27K	62K	220K*	
33	75	180	430	1000*	2400	5600	12K	30K	68K*	270K	
36	82	200	470*	1100	2700	6000	13K	33K*	75K	330K*	
39	91	220*	510	1200	3000	6200	15K*	36K	82K	390K	
43	100*	240	560	1300	3300*	6800*	16K	39K	91K	470K*	
47	110	270	620	1500*	3600	7500	18K	43K	100K*	560K	

Characteristic Impedance Z_0

R1/R2	Z_0	R1/R2	Z_0
81/130	50	220/330	132
120/200	75	330/390	179
90/660	80	330/470	194
130/210	80	330/680	222
160/260	100	1.5K/3.3K	1.03K
220/270	121	3K/6.2K	2.02K
180/390	123		

$\pm 1\%$ TOLERANCE

The values marked with an asterisk of Series 314A, 314B, 316A and 316B in the table above are available with $\pm 1\%$ tolerance. Add the letter "F" on the end of the part number to indicate the optional $\pm 1\%$ tolerance.

SENSE AMP TERMINATOR

Three basic configurations complement the 7520 series of core memory sense amps.

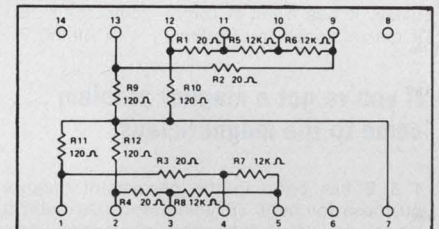
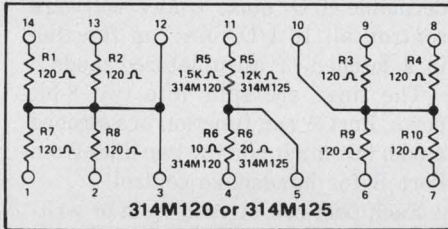
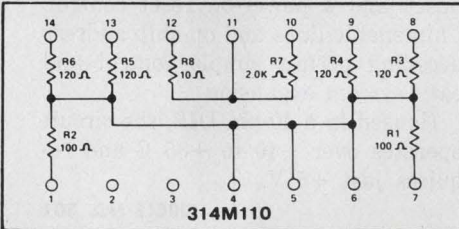

8 BIT R/2R LADDER NETWORKS

Designed for use with D/A and A/D converters with bipolar or CMOS switches.

Part No.	R Value
316L08253	25K
316L08503	50K
316L08104	100K

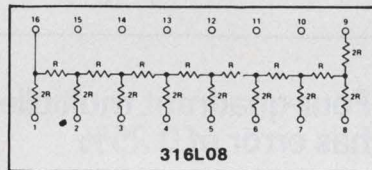

O-PAD ATTENUATOR

Two basic circuits for fixed voltage attenuation with impedance matching.

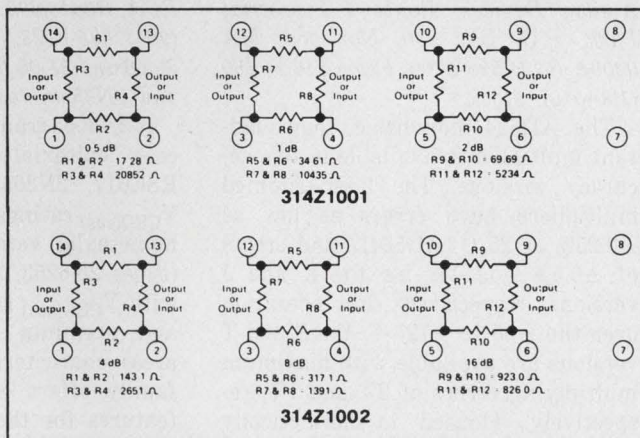

TTL to ECL TRANSLATOR

Contains six TTL to ECL translators.

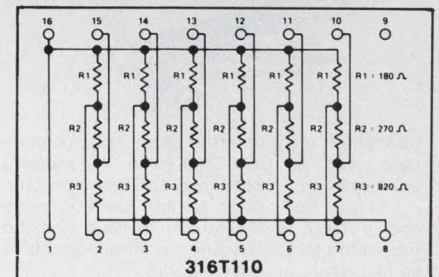

INTERCONNECT NETWORKS

For shorting and matrix interconnections, 14 pin, 314X101; 16 pin, 316X101. Other configurations available.

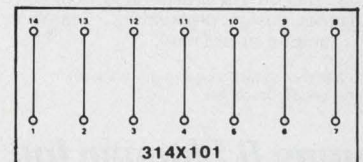

ALLEN-BRADLEY

Electronics Division
Milwaukee, Wisconsin 53204

CIRCLE NUMBER 73

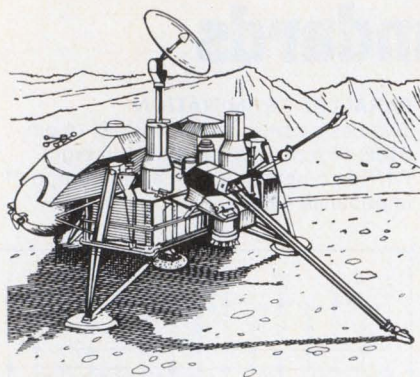

ALNICO 9 Nb™ where performance is super-critical!

Like on the Viking Mars Landers! And on such other space projects as the Lunar Excursion Module of the Apollo Program, Alnico 9 magnets have performed faultlessly with proven stability since the development and introduction of the alloy by Thomas & Skinner over ten years ago.

Alnico 9 offers a high coercive force and high energy product... with a typical peak energy product of 10.5-12.5 m.g.o. ... approaching that of the rare earth materials. It has low temperature coefficients and extreme magnetic stability*. It is easy to magnetize and stabilize. It has a lot of things going for it. So it makes sense to "Redesign with Alnico 9".

If you've got a magnet problem . . . come to the magneticians!

T & S has been in the permanent magnet business for over 75 years, and has been a leader in developing and pioneering new magnetic alloys and concepts . . . and in producing reliable products. T & S made the



permanent magnet in the earth inductor compass used on Col. Charles A. Lindbergh's pioneer flight . . . New York to Paris Non-Stop . . . in the "Spirit of St. Louis." Even 50 years ago in 1927, T & S products have had the reputation for quality and performance that is so necessary in today's world.

BEFORE YOU DESIGN . . . Send for Bulletin M-304 CR which gives details on all T & S metallic alloy permanent magnets. Or better yet, call on T & S experts to help solve your magnet design problems . . . large or small . . . unique or ordinary.

*Alnico 9 has the highest stability of all known permanent magnet materials.

Thomas & Skinner Inc.
MAGNETICIANS



P.O. BOX 150-B, 1120 EAST 23RD ST.
INDIANAPOLIS, IND. 46206
PHONE: (317) 923-2501

CIRCLE NUMBER 74

ICs & SEMICONDUCTORS

Combination circuit reduces part count with RAM and I/O on same chip

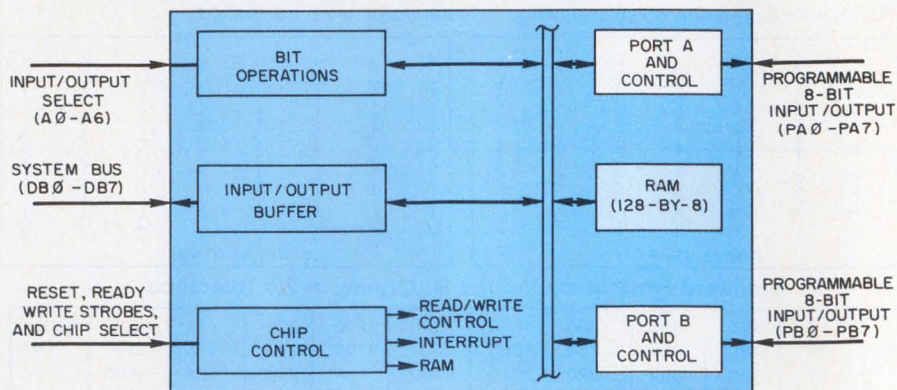

National Semiconductor, 2900 Semiconductor Dr., Santa Clara, CA 95051. Hash Patel (408) 737-5000. 100 qty. prices: \$7 (plastic), \$9 (ceramic); stock.

Helping to cut the circuit count for a minimal system, the INS57112 combines RAM and I/O lines on a single chip. The circuit contains 128 bytes of static RAM as well as 16 software-definable I/O pins. Under software control, all 16 I/O lines can function in a latched or an unlatched mode.

The lines are split into two 8-bit ports. Port A can function in a strobed mode, but must borrow two lines from Port B for handshake control.

Each port can be read from or writ-

ten to by using a single load or store instruction. Moreover, each output pin of either port can be set or reset, as indicated by the five lowest-order address bits, by a store instruction.

All I/O pins are TTL-compatible and can directly interface with most μ Ps. The pins also have three-state-output capability to simplify interfaces to buses and a power-on reset control. Chip-enable lines and on-chip address decoding permit simple control and easy system expansion.

Housed in a 40-pin DIP, the circuit operates over -40 to $+85$ C and requires just $+5$ V.

CIRCLE NO. 301

Four-quadrant multiplier has error of 0.25%

Analog Devices, Route 1 Industrial Park, P.O. Box 280, Norwood, MA 02062. (617) 329-4700. From \$16 to \$60 (100-qty); stock.

The AD534 monolithic, four-quadrant multiplier is available in five accuracy versions. The laser-trimmed multipliers have errors as low as $\pm 0.25\%$ at 25 C (AD534L) and errors of $\pm 0.5\%$ and 1% for the K and J versions, respectively. For operation over the -55 to $+125$ C, the S and T versions are available with maximum multiplying errors of 2% and 1% , respectively. Housed in hermetically sealed TO-100 cans, the multipliers have a maximum offset of 10 mV, a noise of only 1 mV rms and a variable scale factor, from 3 to 10.

CIRCLE NO. 339

Epitaxial versions of 2N3055 added to family

RCA, Route 202, Somerville, NJ 08876. (201) 685-6423. 100 qty prices: \$0.60, \$0.66 and \$1.06 for the RSC617, 2N3055 and 2N6569, respectively; stock.

A 2N3055 transistor family with low-cost epitaxial construction, types RSC617, 2N3055 and 2N6569, have $V_{CE0(sus)}$ ratings from 40 to 80 V. The homotaxial version is also available (types 2N6253, 2N3055H and 2N6254) with $V_{CE0(sus)}$ ratings from 45 to 80 V and premium SOA (safe operating area) characterization. The epitaxial family offers economy with 2N3055 features for those users who do not need as much safe operating area. All three epitaxial devices have an SOA of 2.87 A at 40 V and come in hermetic TO-3 packages.

CIRCLE NO. 340

IN WIRE-WRAPPING  HAS THE LINE.....

MODEL WD-30



PATENT PENDING

WIRE DISPENSER

- 50 FT. ROLL OF 30 AWG. KYNAR® WIRE-WRAPPING WIRE
- CUTS THE WIRE TO LENGTH
- STRIPS 1 INCH OF INSULATION

AVAILABLE IN FOUR COLORS

- WD-30-B BLUE WIRE
- WD-30-Y YELLOW WIRE
- WD-30-W WHITE WIRE
- WD-30-R RED WIRE

\$345 EACH

MINIMUM BILLING \$25.00
ADD SHIPPING CHARGE \$1.00
NEW YORK STATE RESIDENTS
ADD APPLICABLE TAX

®KYNAR PENNWALT

OK MACHINE & TOOL CORPORATION

3455 Conner St., Bronx, N.Y. 10475 (212) 994-6600 / Telex 125091

CIRCLE NUMBER 92

COST-CUTTING WESTON BREAKTHROUGH!

3/8" MULTITURN CERMET TRIMMER

FOR ONLY **99¢**

(1,000-Pc. Price)

Same High Weston Quality At A Real Savings In Price!



Weston has done it with the new #850! We took this widely used square multiturn trimmer, and by radically improving manufacturing techniques have been able to trim the price without sacrificing quality, performance or uniformity. It can give you an important new competitive edge.

WRITE FOR SPECS AND DETAILED PRICE INFORMATION.

SANGAMO WESTON Schlumberger

WESTON COMPONENTS & CONTROLS
A Division of Sangamo Weston, Inc.
Archbald, Pa. 18403
Tel. (717) 876-1500
TWX 510 656-2902
Telex 83-1873

CIRCLE NUMBER 93

ELECTRONIC DESIGN 13, June 21, 1977

MORE INTERESTING NEW PRODUCTS FROM TEC FOR YOUR NEW IDEAS

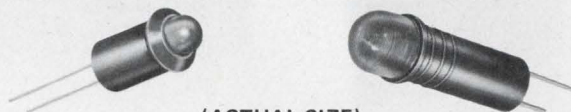

L-105

(ACTUAL SIZE)

L-107

The L-105 and L-107 low cost LED indicators are available in four colors, Red, Green, Yellow and Amber. Internal resistoring is available for 5 volt operation. Either unit may be panel mounted with a press fit or an optional spring retaining clip.

Please have your local representative send me a sample of the L-105 _____ L-107 _____

My Application is: _____

Name _____

Company _____

Address _____

City _____ State _____ Zip _____



TEC, Incorporated

2727 North Fairview Ave., Tucson, Az. USA 85705
(602) 792-2230 TWX 950-952-1377

AN EQUAL OPPORTUNITY EMPLOYER M/F
COMMITTED TO AFFIRMATIVE ACTION —
A TEC, INCORPORATED CORPORATE POLICY

CIRCLE NUMBER 94

Bridge rectifiers come with 50 to 1 kV ratings

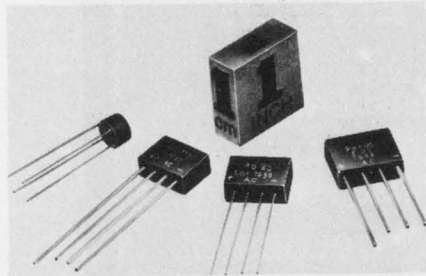

Electronic Devices, 21 Gray Oaks Ave., Yonkers, NY 10710. Dennis Dean (914) 965-4400. From \$0.29 (5000 qty); stock.

Single-phase, full-wave bridges, the PF, PD, PE and PH series, are available in 50, 100, 200, 400, 600, 800 and 1000 V ratings. Models capable of handling 1.5, 2, and two physical sizes of 5 A come with surge ratings from 50 to 150 A. The bridges come in packages designed for PC-board mounting.

CIRCLE NO. 341

Hex digit driver sinks 90 mA, runs from 3 V

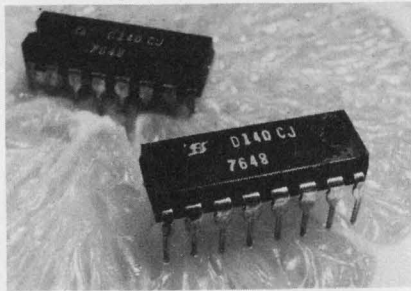

Siliconix, 2201 Laurehwood Rd., Santa Clara, CA 95054. Jim Graham (408) 246-8000. \$1.56 (100 qty.); stock.

A hex digit driver, the D140, can directly interface low voltage MOS LSI to high-current display loads. Each of the six independent drivers combines a Darlington stage and an input-current limiting resistor network. The D140 can operate from a supply voltage as low as 3 V and can sink up to 90 mA per driver. Standby power is less than 1 μ A and switching speed is less than 250 ns. The D140 comes in a 16-pin plastic DIP and operates over 0 to 70 C.

CIRCLE NO. 342

High-voltage transistors come in plastic TO-92s

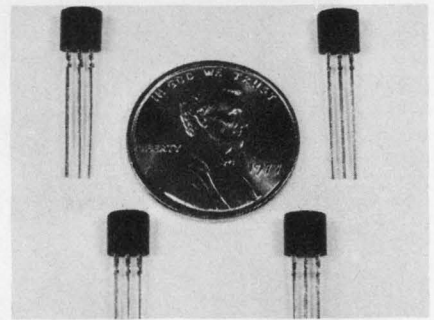

Solitron Devices, 1177 Blue Heron Blvd., Riviera Beach, FL 33404. (305) 848-4311. From \$0.43; 6 wks.

Complementary pnp and npn silicon transistors in TO-92 plastic cases are available with breakdown voltages as high as 450 V. The SP5415 and 16 pnp units are similar to the 2N5415 and 16 versions and have V_{CEO} 's of -250 V and -300 V, respectively. The npn complements are the SP3439 and 40, which are similar to the 2N3439 and 40. However, V_{CEO} 's are 450 V and 300 V. Both series have an f_T of 15 MHz at an I_C of 10 mA and a V_{CE} of 10 V.

CIRCLE NO. 343

WHO NEEDS A VIDEO OP AMP

With 1 GHz Gain Bandwidth Product and 70 Nanosecond Settling to 0.01%?

Far more people than you would have imagined! People who require the performance of a true differential input op amp at frequencies from DC to beyond 100 MHz, with the ease of using a 741 at 100 kHz. Those who want a ± 5 volt output to reach an accuracy of 0.01% in 70 nanoseconds. Others who require this state-of-the-art performance from -55°C to +125°C, and many more who require the high reliability provided by MIL STD 883 processing.

Your application may not need the full temperature range or the hermetically sealed DIP, but for many industrial applications these and other features of the new Video Op Amp offer you vital reliability.

All of this and more is available to you off-the-shelf with the 1435 - The op amp that solves problems you didn't even try to solve before!

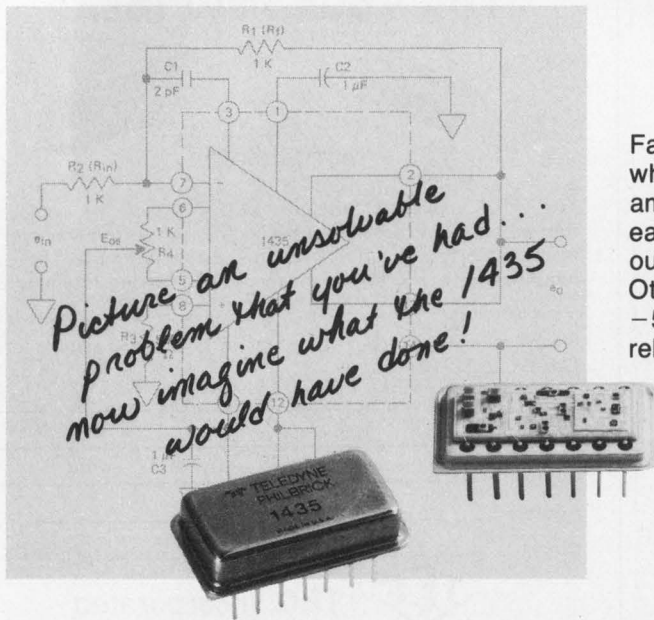

TELEDYNE PHILBRICK

Allied Drive at Route 128
Dedham, Massachusetts 02026
Tel: (617) 329-1600

TWX: (710) 348-6726
Telex: 92-4439
Cable: TELEPHIL

7 trimmers handle 95% of your applications.

Single-turn

With these industry standard cermet trimmers, you're assured design versatility, high quality, and fast delivery.

Just decide what you need regarding: (1) single- or multiturn; (2) sealed or not; (3) size; (4) resistance; (5) pin spacing; and (6) price.

Then call your local Beckman Helipot distributor for *free* evaluation samples. To get his number, or immediate technical literature, call (714) 871-4848, ext. 1776. See how fast and easily you can solve trimmer problems.

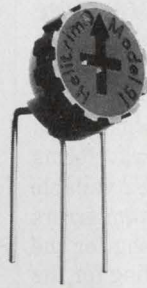

Model 91

- High quality—low price
- Unique brush contact
- Excellent setability
- Protective dust cover
- Top or side adjust
- Standoffs prevent rotor binding, permits board washing
- Small 3/8" dia. size



Model 72

- 3/8" square
- Sealed for board washing
- Available in flame-retardant SEO housing
- Top or side adjust
- Brush contact
- Excellent setability
- 2 ohms of end resistance



Model 82

- 1/4" dia. by 0.150" max. height
- Sealed for board washing
- Flame-retardant SEO materials
- 82P—top adjust; 82PA—side adjust
- Brush contact for excellent setability
- Resistance range: 10 Ω to 1 meg Ω

Multiturn

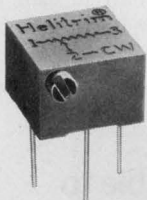

Model 64

- Miniature, sealed
- 22 turns of adjustment
- 0.25 watt at 85°C
- Resistance range: 10 Ω to 1 meg Ω
- 1/4" square for tight P.C. board packaging
- Unique brush contact
- Adjustability—voltage ratio within 0.01%

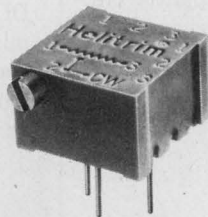

Model 68

- Low-cost
- Sealed for board washing
- 18 turns for adjustment accuracy
- 3/8" square housing
- Brush contact
- 3 pin styles for efficient packaging
- Broad resistance range: 10 Ω to 2 meg Ω
- Operates with 1/2 watt at 25°C

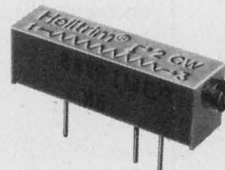

Model 89

- Our lowest cost multiturn
- Sealed for board washing
- 3/4" rectangular, 0.250" high
- 15 turns for accurate adjustment
- 7 pin styles for mounting versatility
- Panel mount available
- Resistance range: 10 Ω to 2 meg Ω

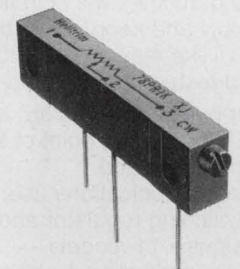

Model 78

- Military performance, industrial price
- 1 1/4" rectangular, 0.195" wide
- Sealed
- 3 terminal styles: flex leads, P.C. pins, solder lugs
- Power rating: 0.75 watt at 70°C
- 22 turns of adjustment
- Resistance range: 10 Ω to 2 meg Ω

BECKMAN®

HELIPOT DIVISION
CIRCLE NUMBER 75

KEEP THE HORSE BEFORE THE CART!

You've probably known design engineers who are half-way through a project before they realize the power supply that could have come from a standard line must all of a sudden be a customized design. And you also know what that means in the way of extra costs. It's the old cart before the horse theory.

Call us when you are in the embryonic stages of your design and we'll work with you in your primary important stages. And not only will you like the fact that our standard lines will both fit your supply and keep you in budget. . . you'll like the idea of our already field-tested dependability.

Our power supplies are available for OEM computer, point of sale, EDP, bank telling and telecommunications use:

- Switching regulator and linear designs • 11 models — single/multi-output • Voltage ranges, from 2 to 30V • 50 current levels from .01 to 225 amps • Overcurrent/overvoltage protection • Filtering to meet world-wide EMI requirements • Designed and built to UL, CSA and European safety requirements.

Dependability. That's a word we define as quality and reliability. It's also what design engineers define as our reputation!



NCR POWER SYSTEMS DIVISION

formerly Scott Electronics
584 S. Lake Emma Road, P.O. Box 898
Lake Mary, Florida 32746

Telephone (305) 323-9250

CIRCLE NUMBER 78

ICs & SEMICONDUCTORS

True-rms-to-dc converter accurate to within 0.2%

Analog Devices, Rte. 1 Industrial Park, P.O. Box 280, Norwood, MA 02062. (617) 329-4700. 100 qty prices: \$9.95 (J), \$18.50 (K); stock.

The AD536 series of rms-to-dc converters offers accuracies down to 0.2%. The units can also measure waveforms with crest factors up to six. Available in J and K versions, maximum errors are ± 5 mV $\pm 0.05\%$ of reading for the J and ± 2 mV $\pm 0.2\%$ of reading for the K. No external trimming components are required for the stated accuracies. And, these accuracies can be improved by a factor of two with external trimmers. Only a single external capacitor is needed to set the low-corner frequency and determine the low-frequency accuracy and ripple level, as well as the response speed and settling time. The bandwidth of the AD536 extends the measurement capability to 100 kHz with 1% error for signal levels above 100 mV. The AD536 operates from either a dual or single power supply, with total supply levels from 5 to 36 V. Quiescent supply current is 1 mA. Also available is an auxiliary dB output, with an externally supplied reference current, the 0-dB level can be set by the user to correspond to any input level from 0.1 to 2 V rms.

CIRCLE NO. 344

Character generator has built in blank spacing

Texas Instruments, P.O. Box 5012, Dallas, TX 75222. (214) 238-2011. From \$10.66 (100 qty.); stock.

A monolithic ASCII character generator, the TMS4710, is organized as a 1024-word by 8-bit ROM. Housed in a 24-pin plastic or ceramic DIP, the TMS4710 outputs information for a full set of upper and lower case ASCII characters, as well as other characters. All displayed characters have automatic spacing since they use 5×7 spaces of the 8×8 block format. The circuit has a maximum access time of 450 ns and a minimum cycle time of 450 ns. Power dissipation is typically 310 mW and operation is possible over a 0 to 70-C range.

CIRCLE NO. 345

Just add transistor to electronic ignition ckt

Motorola, P.O. Box 20912, Phoenix, AZ 85036. Lothar Stern (602) 244-6900. \$2.25 (100 qty); stock.

Forming the basis of an advanced automotive electronic ignition system, the MC3333 is intended for designs using a flux-averaging sensor. Called a Vari-Dwell ignition circuit, only an additional Darlington driver transistor (such as the MJ10012) is needed to supply the current required by a high-energy ignition coil. The circuit can operate at battery voltages ranging from 4 to 24 V and is housed in a 14-pin, plastic DIP.

CIRCLE NO. 346

Multiprotocol controller handles 500 kbits/s

Signetics, 811 E. Arques Ave., Sunnyvale, CA 94086. Norm Rothstein (408) 739-7700. Under \$30 (100 qty); stock.

Capable of formatting, receiving and transmitting serial digital data the 2652 operates at data rates up to 500 kbits/s. The multiprotocol communications controller needs a 5-V supply and supports bit-oriented protocols such as SDLC, HDLC and ADCCP and byte-oriented protocols such as BISYNC and DDCMP. Both receiver and transmitter sections are double buffered and operate in either half or full duplex modes. The 2652 can be interfaced with an 8 or 16-bit data bus.

CIRCLE NO. 347

P-i-n diodes able to dissipate up to 10 W

Unitrode, 580 Pleasant St., Watertown, MA 02172. Ken Murphy (617) 926-0404. \$1.65 (10,000 qty.); stock.

The UM9415 p-i-n diode can dissipate up to 10 W and has an rf resistance, R_D , of less than 0.1 Ω . Able to safely handle transmitted power of up to 1 kW, even for infinitely mismatched antennas, the diodes can be used in antenna switches. Typical performance of switches using the UM9415 diodes, over 20% bandwidths up to 500 MHz, includes a receive isolation of 30 dB and transmit insertion loss of 0.2 dB, for a 100-mA bias. Receive insertion loss, at zero bias, is less than 0.3 dB.

CIRCLE NO. 348

What this country needs is a good \$39 DPM.

And we've got it. The AD2026 from Analog Devices. Priced at \$39 in hundreds*, it's the first real alternative to the measurement grade analog panel meter. And the first to give you all the advantages of a DPM at a practical price. Advantages like visual appeal, accuracy, resolution, small size and reliability.



The AD2026 is a three digit, logic powered DPM that measures and displays voltages from -99mV to $+999\text{mV}$ on 0.5" LEDs. It consumes only $\frac{3}{4}$ Watts of 5V power. And because the AD2026 can be scaled with a simple resistive divider on its input pins, you can get direct readout in any engineering unit with equal or better resolution than APMs.

With an accuracy of 0.1% of reading ± 1 digit, the AD2026 is again far superior to conventional APMs, where their inherent inaccuracy usually limits the total performance of the instrument.

The AD2026 conserves on space, too. Its small front panel size of 3.4" x 2.0" and only 0.64" needed behind the panel makes it smaller than $3\frac{1}{2}$ " scale APMs. But its performance outclasses $4\frac{1}{2}$ " APMs.

When it comes to reliability, the AD2026 is unsurpassed. Its I²L technology combines most of the active analog and digital circuitry on *one* chip. The AD2026 has only 14 components and a MTBF of 250,000 hours at 25°C. In a 24-hour-a-day application, you shouldn't expect a failure for 28 years.

A new commercial tester automatically tests all AD2026's for defects such as bad components and solder shorts. It also fully tests both the LSI chip and the complete DPM. Following 168 hours of failure free burn-in, the units are again 100% tested.

The AD2026. Its low price (\$39/100s), small size, superior performance, and remarkable reliability make it the only sensible alternative to APMs. Which is just what this country needed.

Check it out. Return the coupon with your check or money order today to order an evaluation sample at the low 1-9 quantity price of \$62. And when you receive your evaluation samples you will also receive a Credit Certificate for \$23 redeemable when you place your order for the first hundred or more AD2026's.

ANALOG DEVICES

The real DPM company.

Box 280, Norwood, MA 02062
Telephone: East Coast: (617) 329-4700,
Midwest: (312) 894-3300,
West Coast: (213) 595-1783,
Texas: (214) 231-5094.



Please send me _____ AD2026 for testing and evaluation at the low (1-9) price of \$62. (Enclose check or money order.)

Enclosed is my purchase order for 100 AD2026 DPMs at the unbelievably low price of \$39 in 100s.

I'm not ready to order my AD2026 DPM for testing and evaluation, but I would like to receive all available technical information.

ED 6/21

P.O. # _____

Name _____

Company _____

Telephone _____

Address _____

City _____

State _____

Zip _____

*Substantial quantity discounts available.

Designers'

Toggle Switches

Bat, lever lock, Designer Line, sealed. Big, broad choice.

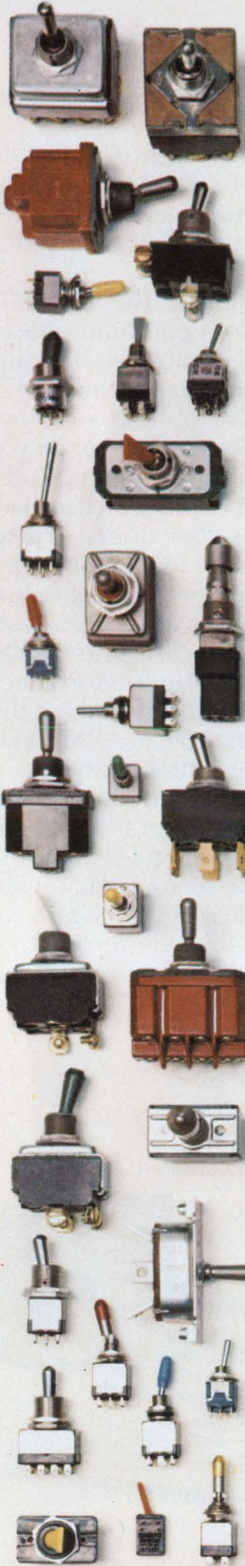

Rocker Switches

Singles and multiples. Wide, colorful selection range. Legends, too.

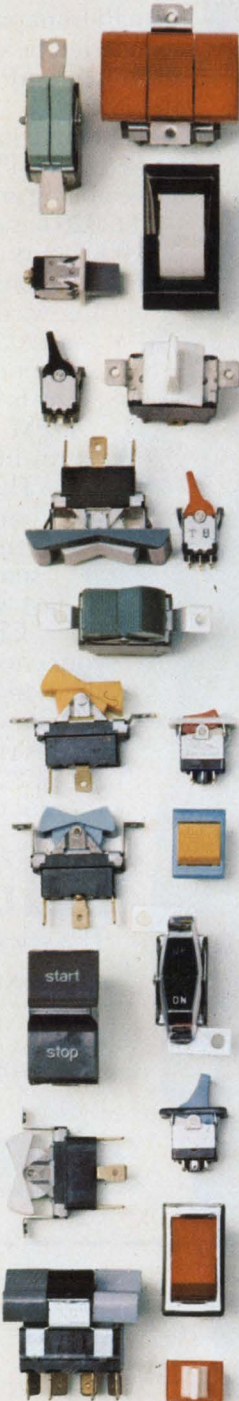

Cutler-Hammer, of course! The broadest line. Styled to meet today's and tomorrow's requirements. They're solid quality, look great, work long and hard. Carried in stock for local availability by Switch Distributors. Backed by Cutler-Hammer sales engineers who can deliver innovative design help for

Pushbutton Switches

Choice of sizes, colors, circuits, ratings. Styled to "turn you on".

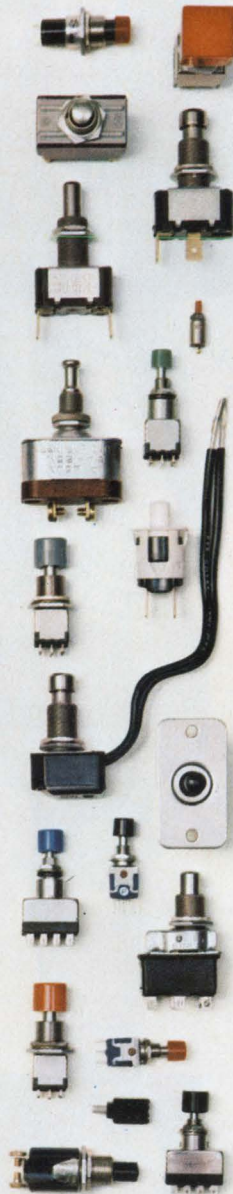

Tool Handle & Slide Switches

Variable speed, reversing. Double insulated.

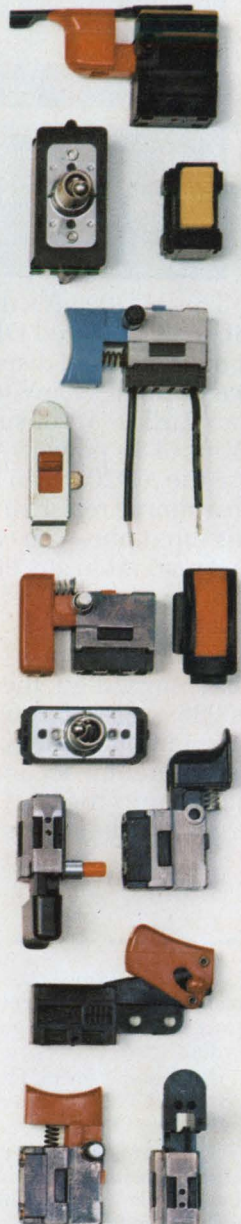

 **Switch to No.1**

Choice.

the exact switch or relay you need—
when you need it.

It's no wonder so many designers specify
Cutler-Hammer. For quality, reliability,
availability, and style. For commercial,
industrial, and military applications.

We simply offer more—of everything!

Snap Switches

Lever, roller, leaf, and
pushbutton actuators.
Four terminal styles.



Rotary Switches

Precision and general
purpose. Single and
multiple wafer.

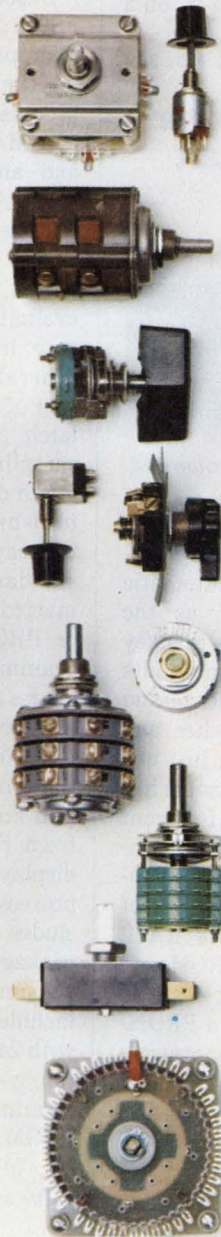

Switch Accessories

Guards. Boots. Seals.
Caps. Decorator
facenuts. And much
more to protect, code
or customize.



Illuminated Switches

Rockers, paddles,
pushbuttons, indicators.
Snap-in and bushing.

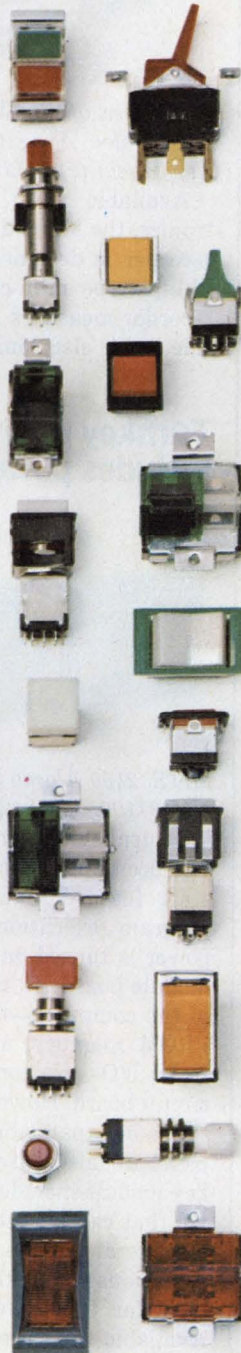

Relays

Hermetics, non-sealed,
potted. Power, latching,
and timing functions.



CUTLER-HAMMER

SPECIALTY PRODUCTS DIVISION, Milwaukee, Wis. 53201



CIRCLE NUMBER 80

SAVE!

Only Beau puts 16 contacts in the space of 12.

The interconnection company that innovates to serve you better.

BEAU

 Beau Products Division
Vernitron Corporation
P.O. Box 10, Laconia, N.H. 03246
N.H. tel.: 524-5101
CALL TOLL FREE: (800)258-0370

CIRCLE NUMBER 81

BEND!

Thermoplastic
2-row
barriers—
priced
like fragile
phenolics.

The interconnection company that innovates to serve you better.

BEAU

 Beau Products Division
Vernitron
Electrical Components
P.O. Box 10, Laconia, N.H. 03246 / N.H. tel.: 524-5101
CALL TOLL FREE: (800)258-0370

CIRCLE NUMBER 82

MICRO/MINI COMPUTING

Data recorder uses mini Philips cassettes

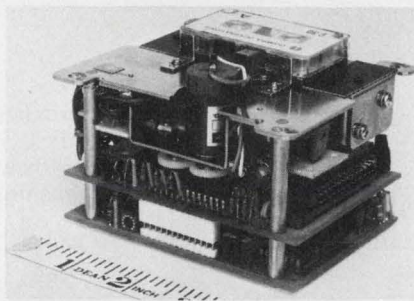

C.M.I. Div. of Star Mfg. Co. Ltd., 20725 S. Annalee Ave., Carson, CA 90746. Ken Izuchi (213) 537-1478. \$190; stock.

Available with read/write electronics, the MD-1 digital cassette data recorder is designed for use with the Philips-type mini-cassettes. The data recorder measures less than 4 in. on a side, with electronics.

CIRCLE NO. 349

Turnkey microcomputer includes power-on start



MITS, 2450 Alamo S.E., Albuquerque, NM 87106. (505) 243-7821.

A turnkey version of the Altair 8800b microcomputer includes a power-on-start feature that allows automatic program execution as soon as the power is turned on. With the turnkey module board, all the functional units of the computer—the CPU, RAM and PROM memory, sense switches and serial I/O—are contained on just one circuit board. However, the system has the same expandability as the full front panel Model 8800b computer. The turnkey module includes a serial I/O channel that can operate with a variety of peripheral devices, 1 kbyte of RAM, provisions for 1 kbyte of PROM and logic for the power-on-start feature. Available software includes a PROM-resident multipurpose bootstrap loader and a monitor PROM and, of course, all Altair system software. The front panel has a key-lock power switch which prevents accidental or unauthorized turn-on or turn-off.

CIRCLE NO. 350

μ P development system supports the TMS 9900



Texas Instruments, P.O. Box 1444, Houston, TX 77001. Dan Fullerton (713) 494-5115. \$13,600 (base price); 2 to 4 wks.

Based upon the recently announced FS990 software development system, a Microprocessor Development System for the TMS 9900 μ P includes microprocessor emulation, logic state trace, PROM/ROM implementation, Fortran and an interactive control language called AMPL. The TMS 9900 emulation feature provides support during the entire design phase—design evaluation, emulation, and testing and evaluation. The logic-state trace feature includes up to 20 channels of general-purpose TTL signal trace with four of the channels available for glitch latch (spike detection). The trace sampling rate is to 10 MHz, with the glitch detection for pulse-widths down to 10 ns. PROM/ROM support includes the capability to generate industry-standard BNPF and High/Low formatted output, or to generate EPROMs or PROMs with the 990 PROM programming unit. Fortran support includes the capability to generate stand-alone routines, which can be compiled to 990 computer object code for execution on a 9900 target system. Emulation and trace modules are controlled from the company's Model 913 video display terminal by AMPL. The microprocessor development system includes the TMS 9900 Emulator/AMPL package and the FS990 software development system. The base system includes a Model 990/4 microcomputer with 24-k words of 16-bit memory, dual floppy-disc drives and a Model 913 terminal. Available as options are the PROM programmer, trace data module kit, Model 810 printer and Fortran software license.

CIRCLE NO. 356

High-Current, High Voltage DARLINGTON ARRAYS

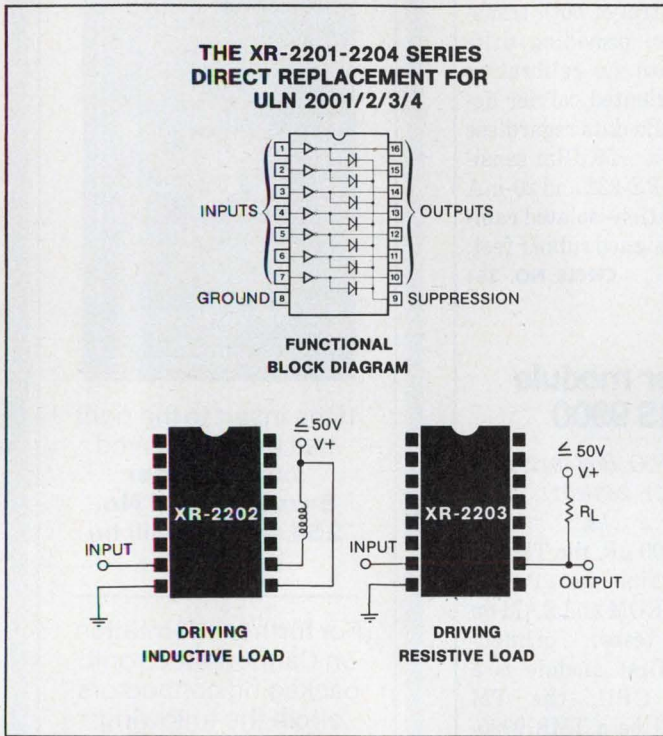

Darlington Array Descriptions

- The XR-2201 is a general purpose array compatible with most logic forms, including PMOS, CMOS and TTL, but requires an external current limiting resistor in series with the input to limit base current to less than 25mA.

- The XR-2202 is designed for direct compatibility with 14-25V PMOS devices. This device features an internal zener diode and a resistor at each input to limit the current to a safe value.

- The XR-2203 is directly compatible with TTL or CMOS operating at 5V. This device features an internal series base resistor at each input to limit the input current.

- The XR-2204 is designed for direct operation from CMOS or PMOS outputs with supply voltages from 6V to 15V. This device features an internal series input resistor for current limiting purposes.

Applications

- Driving inductive or resistive loads
- Logic level shifters from 5-25V and vice versa
- Hammer drivers for printing calculators
- 7 segment displays driver
- Drive relays, solenoids, coils
- Telephone relay switching
- Alarms
- Games with multiple relays
- Voltage interface
- Test instrumentation
- Electronic scales

The XR-2201-2204 series are unique, high-voltage, high-current Darlington Transistor Arrays that have output current capability of 500mA and are directly interchangeable with Sprague types ULN-2001A, 2002A, 2003A and 2004A. Although the maximum continuous collector current rating is 500mA for each driver, the outputs may be paralleled to achieve higher load current capability.

These transistor arrays are comprised of seven silicon NPN Darlington pairs on a single monolithic substrate. All units feature open-collector outputs and integral protection diodes for driving inductive loads. Peak inrush currents of up to 500mA are allowable, making these also ideal for driving tungsten filament lamps.

For prompt delivery of these products, or for more information, call or send in the coupon today.

EXAR—FOR INTELLIGENT ALTERNATIVES

XR-2201, XR-2202, XR-2203, XR-2204.

I would like to know more about these products. My application or end product is _____.

Name _____ Title _____

Company Name _____

Company Phone _____

Company Address _____

City _____ State _____ Zip _____



EXAR INTEGRATED SYSTEMS, INC. P.O. Box 62229, Sunnyvale, California 94088 • Phone (408) 732-7970

CIRCLE NUMBER 83

Programmer/simulator works with UV EPROMs

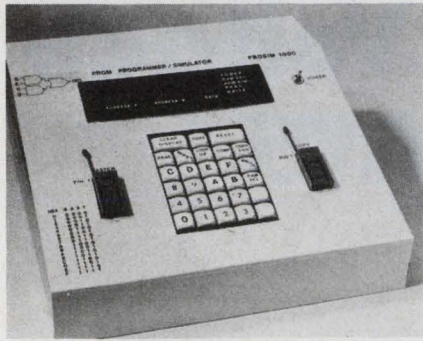

GECO, Inc., 145 Penn St., Millheim, PA 16854. (814) 349-5555. \$1295; stock.

The PROSIM 1000—a UV EPROM programmer and simulator—offers complete keyboard control. It is a microprocessor-based unit that programs the 2704, 2708 and 2716 UV EPROMs. The programmer can duplicate PROMs or simulate them with its built-in RAM.

CIRCLE NO. 359

Diagnostic package adds hardware and software



Eagle Signal Div., 736 Federal St., Davenport, IA 52803. Ken Jannotta (319) 326-8113. \$600; stock.

An error detection and indication package locates and identifies potential or actual failures of the company's EPTAK microprocessor controller. The hardware/software package, available with new systems and for those already installed, provides early warning of system degradation, immediate alarm in case of actual failures, indication of system self-correction when it occurs, and simplified software debugging and system installation. The package consists of factory programmed software, an operator's manual, and watchdog timer and error indicator modules.

CIRCLE NO. 360

Acoustic data coupler operates to 450 baud

Anderson Jacobson, 521 Charcot Ave., San Jose, CA 95131. Eric Lane (408) 263-8520. \$365; stock.

The A242A acoustic coupler operates at up to 450 baud in the originate mode. Features of the coupler include: flush mounted acoustic cups to lock-in the handset; crystal control of both transmitter and receiver, providing drift free frequencies with no calibration necessary; a user oriented carrier detector that senses valid data regardless of the carrier level; a -50 dBm sensitivity; and both EIA RS-232 and 20-mA interfaces. The vibration-isolated cabinet uses specially designed rubber feet.

CIRCLE NO. 361

Microcomputer module series uses TMS 9900

Texas Instruments, P.O. Box 5012, Dallas, TX 75222. (214) 238-2011. \$450 (TM990/100M); 2 to 4 wks.

Using the TMS 9900 μ P, the TM 990 series modules combine the μ P, I/O circuits and both EPROM and RAM on a pre-assembled, tested, printed-circuit board. The first module is a TMS 9900-based CPU, the TM 990/100M. Next, will be a TMS 9980-based CPU, TM 990/S180M, available by the third-quarter, 1977. The TM 990/100M includes 1 k \times 16 bits of EPROM that has a self-contained software monitor (TIBUG). The on-board EPROM capacity is expandable to 4 k \times 16 bits. The 256 word by 16-bit static RAM, included on the board, is expandable to 512 \times 16 bits. Sixteen lines of programmable parallel I/O and a selection of either a TTY current loop or a RS-232 terminal interface is possible. Further, the TM 990/100M offers two programmable interval timers, 15 external hardware interrupts, and a blank board area for user prototyping. A line of accessories and peripherals for the TM 990 series will include the TM 990/301, handheld microterminal that will allow hexadecimal entry of program data as well as the capability to display and modify the internal registers and memory under software (TIBUG) control. Other accessories are a four-slot OEM chassis, a connector kit, and cables to interface to selected EIA terminals.

CIRCLE NO. 362

Reader Service Index

Electronic Packaging Connectors

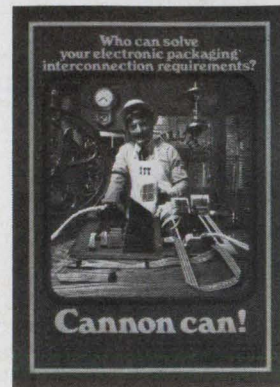

If the insert to the right has been removed circle **Reader Service Card No. 251** and one will be sent to you.

For further information on Cannon® electronic packaging connectors circle the following:

- #252 DL "ZIF" (DL)
- #253 Adapta-Con (ACBP)
- #254 Press-T-Mate (PTM)
- #255 Metal Back-planes (ECS)
- #256 Mas/Ter-UND (UND)

ITT Cannon Electric, 666 East Dyer Rd., Santa Ana, Ca. 92702. Toll-free 24 hrs. (800) 854-3573; in California, (800) 432-7063. (And be sure to check EEM for all your Cannon connector needs.)

Six decades on the leading edge of interconnect technology.

CANNON ITT

Who can solve
your electronic packaging
interconnection requirements?

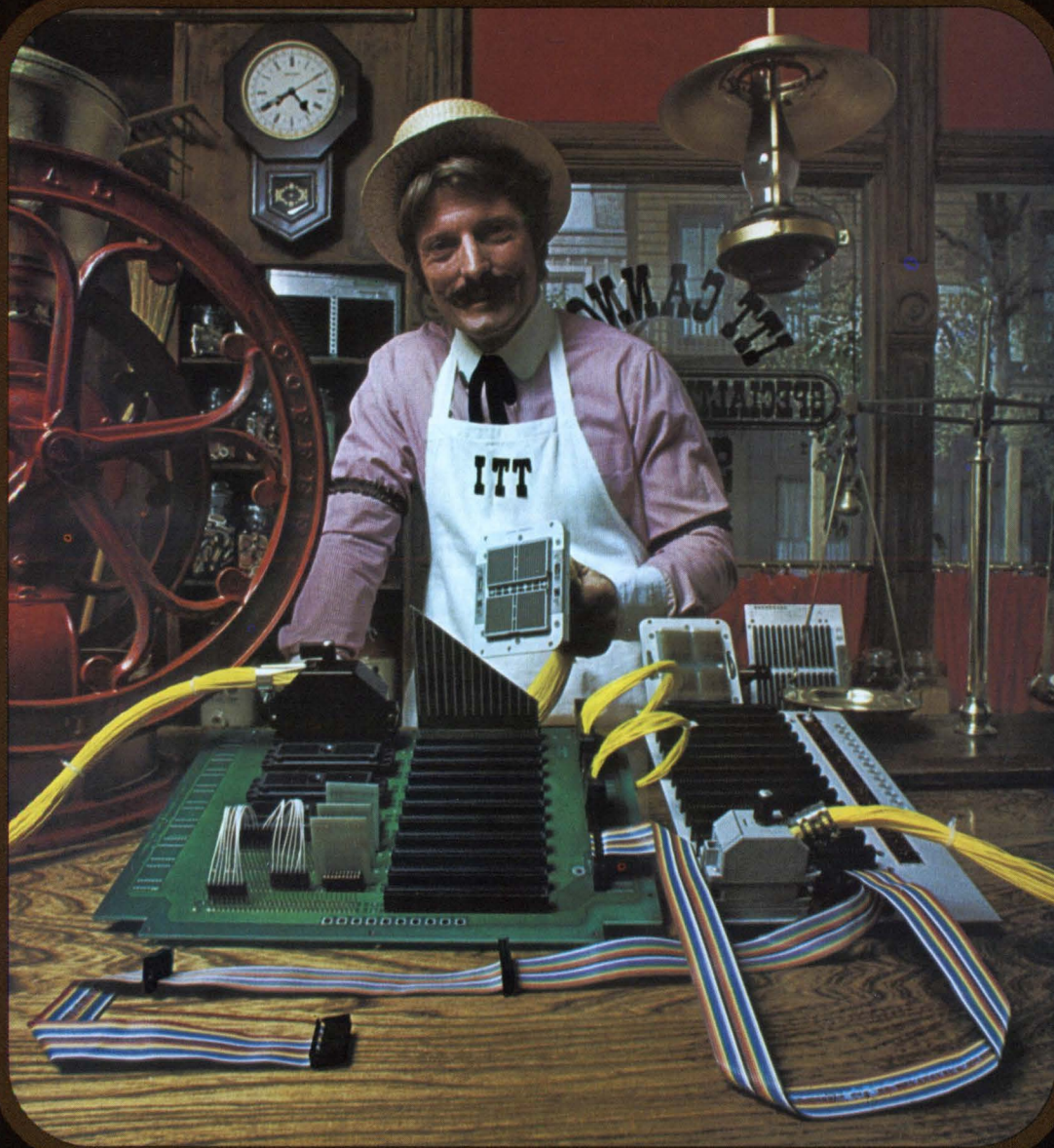

Cannon can!

Six decades on the leading edge of interconnect technology.

CANNON ITT

The Cannon Electronic Packaging Interconnect Store

PRODUCT OFFERING

CANNON'S GOT IT

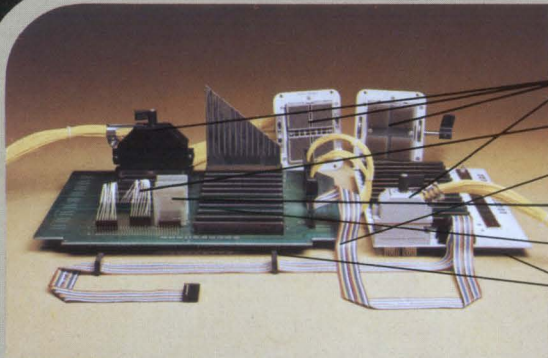

- DL Zero Insertion Force connectors (ZIF)
- Adapta-Con
- Mas/Ter-UND
- ECS edgecard connectors
- Press-T-Mate
- Complete backplane assemblies

ELECTRONIC PACKAGING FROM INITIAL DESIGN TO FINAL ASSEMBLY

Welcome to the ITT Cannon Electric electronic packaging store. Cannon's electronic packaging capability was specifically organized to serve the needs of the data processing industry with high performance products at low cost. The success of our electronic packaging interconnect products and systems is reflected in their widespread use in all kinds of data processing systems, ranging from computer mainframes to such peripherals as reservation terminals.

Cannon® electronic packaging interconnect devices are modular, building-block system concepts that are compatible with standardized industry hardware. Our building-block approach

to interconnect devices helps OEM's design systems with a high degree of electrical and mechanical integrity within OEM design parameters, and results in truly cost-effective systems. End users benefit equally from Cannon interconnect products and systems. Flexibility of user systems is assured, thanks to the virtually infinite electrical and mechanical interconnect configurations available from Cannon.

A final word—about quality: from the president to the assembly worker, we've a dedication to doing things right the first time. That's why our Quality Assurance department guarantees the high reliability of our products in meeting industry standards and MIL-Spec demands. And we're proud that this dedication is reflected in the numerous customer awards for excellence that we've received.

DL ZERO INSERTION FORCE CONNECTORS

DL "ZIF" connectors are a series of low-cost, high-performance multiple wire power and signal connectors that have found broad use in many applications, particularly in computer and peripheral equipment systems. Featuring zero mating force via cam-actuated contacts, they offer exceptional durability and the ability to withstand thousands of mating/unmating cycles with no performance loss. Available with semi-automatic crimp, wrappable post and other terminations, DL "ZIF" connectors mate positively with no force and are securely locked into place with a simple 1/4 turn of a cam. The connectors,



with 60 to 2496 contacts, cannot be mismated, and represent an outstanding combination of high quality and an attractive low cost.

ADAPTA-CON: A SPECIAL APPROACH TO PC AND I/O PACKAGING DESIGNS

For PC and I/O interconnects, the Cannon Adapta-Con series offers one of the most versatile male/female contact approaches in the state of the art. Available with flow solder, crimp and wrappable post terminations, Adapta-Con connectors may be installed to match any user configuration. Rugged and reliable, they offer outstanding price/performance benefits.

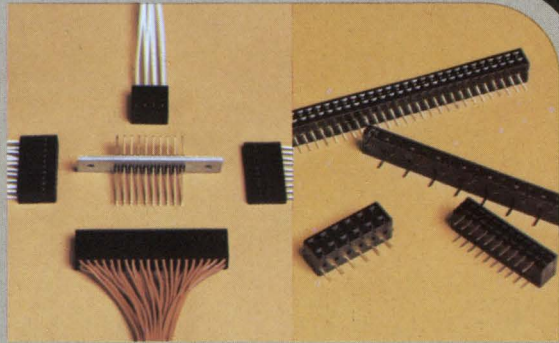

PRESS-T-MATE™ PRESS-FIT CONNECTOR SYSTEM

The Press-T-Mate™ connector system means solderless, ultra-reliable backpanel packaging at a lower system cost. Press-T-Mate combines the inherent reliability of printed circuit interconnections with the latest cardedge connector design. Press-T-Mate connectors are available in standard and custom lengths.

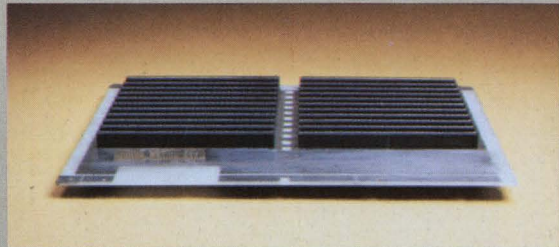

METAL BACKPLANES

Metal backplane systems are ideal for use in applications where the requirement calls for high power transfer with low noise characteristics. Backplanes are offered in .100, .125 and .156 grids in unlimited lengths. All of them are designed to accept .062 logic cards. Metal backplane connectors are available in standard and custom lengths.

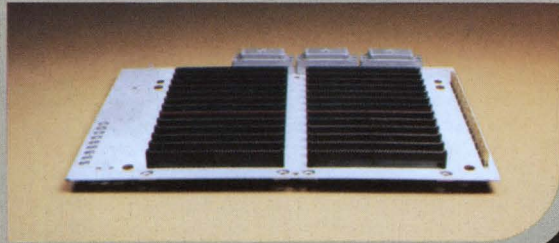

SOMETHING INNOVATIVE
CANNON'S GOT IT

MAS/TER-UND MASS TERMINATED INTERCONNECT SYSTEM

Cannon Mas/Ter-UND connectors provide reliable high-speed mass termination at a lower total installed cost than conventional techniques. A single stroke of a small hand press mass terminates up to 50 wires at once, whether flat cable or individual wires. Cables may be terminated or daisy-chained with no cable breaks.

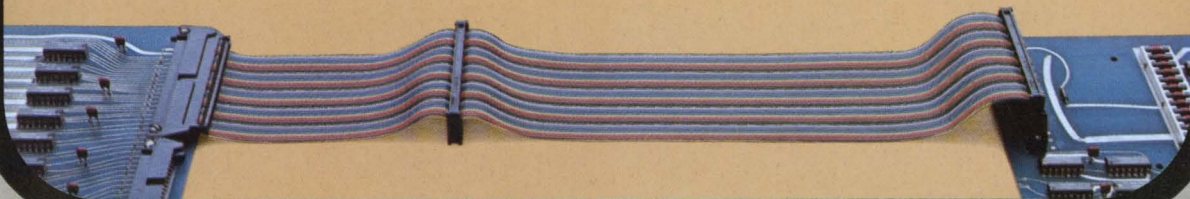

AVAILABILITY

CANNON'S GOT IT

Devices and systems in the ITT Cannon electronic packaging series are available throughout the world. Some products in the series are immediately available off-the-shelf from numerous Cannon distribution centers across the United States and in 24 other countries. Specialized needs are filled at our several engineering and manufacturing centers, where they are given full priority. This complete capability assures you of a system of interconnect technology unparalleled in the marketplace, guaranteeing



you on-time delivery, high quality and an attractive price.

PRODUCT SUPPORT

CANNON'S GOT IT

CUSTOMER TOOLING

Our engineering department works closely with our customer tooling group to develop the insertion, extraction and crimping tools necessary for implementation of all on-premises assembly. Both standard and customized tooling is available from Cannon, from simple hand tools to high-speed automatic machinery.

TECHNICAL SUPPORT

Our large technical sales staff is thoroughly trained to work with you through your complete development program. From early preliminary design stages right through to production, you can count on Cannon to support your electronic packaging programs with the full resources of our interconnect expertise. It's all found at the Cannon store.

QUICK ACTION GETS YOU ALL THIS...

Got an interconnect problem? Let us help you solve it. Send today for complete product literature and a Cannon Quick Action card. Once you've returned it to us, we'll send you a free, old-fashioned apothecary jar filled with Cannon candy. So take action today and send for our Quick Action card. And see for yourself that Cannon can! ITT Cannon Electric, 666 E. Dyer Rd., Santa Ana, CA 92702. Toll-free, 24-hr. (800) 854-3573; in Calif., (800) 432-7063. (Check the EEM Directory for all your Cannon Connector needs.)



Cannon can!

Six decades on the leading edge of interconnect technology.

CANNON ITT

Bipolar microprocessor cycles in a mere 250 ns

Signetics, 811 E. Arques Ave., Sunnyvale, CA 94086. Dr. John Nemecek (408) 739-7700. From \$48.75 (100 to 999 qty); stock.

The only monolithic bipolar microprocessor with a fixed instruction set, the 8X300, handles 8-bit parallel data at a cycle time of 250 ns. The μ P has eight 8-bit working registers, a separate instruction address, instruction and I/O data buses, an on-chip oscillator, TTL-compatible input and output, a three-state I/O data bus, and a dedicated program counter. These features, combined with the partitioning of the address/data bus into right and left banks, make it possible for 8-bit parallel data to be rotated or masked, to undergo arithmetic or logic operations, and then to be shifted and merged into any set of from one to eight contiguous bits at the destination—all in a 250-ns cycle. The 8X300 operates from a 5-V supply.

CIRCLE NO. 452

Complete data recorder handles 500 words/s

Memodyne Corp., 385 Elliot St., Newton Upper Falls, MA 02164. Kevin Corbett (617) 527-6600. \$1630; 2 to 4 wks.

A complete high-speed cassette recording system can receive data for storage at up to 500 words/s. Consisting of a constant-speed drive with only two moving parts, servo card, read and write electronics card, control card, buffer card, power supplies, front-panel controls and rear-panel input/output connectors, the 3773 comes in a 5.25 x 17 x 15-in. cabinet. The system controls include Tape, Tape, X_{ON}, X_{OFF}, Rewind, Load, Forward and Backspace. Accepting or delivering 8-bit parallel data words can be done asynchronously at 500 words/s. A 1000 word/s model, the 3773H, is also available. The recording format is bit-serial CNRZ, dual track. Read and write speeds are 20 ips while search and rewind speeds are 100 ips. The bit error rate is 1 in 10⁷, maximum.

CIRCLE NO. 453

Two-sided disc drives store up to 12.8 Mbits

California Computer Products, 2411 W. La Palma Ave., Anaheim, CA 92801. Ron Cook (714) 821-2541. \$785; stock.

With an unformatted capacity of 12.8 Mbits, the 143M two-sided floppy-disc drive offers a wide range of multi-function capabilities: some are built-in and others are switch or jumper selectable. Features of the 143M include user selection of up to four internal drive addresses and one of four independent head-load addresses. A 50-pin cable interfaces the drives to the system controller. On the controller, two hardware ports are available: a direct memory access and an RS-232. The unit can be used to control up to four Model 143M double-sided floppy-disc drives. An internal phase-lock oscillator is included for precision data recovery, with other features including continuous automatic drive status-checking and automatic error detection.

CIRCLE NO. 454

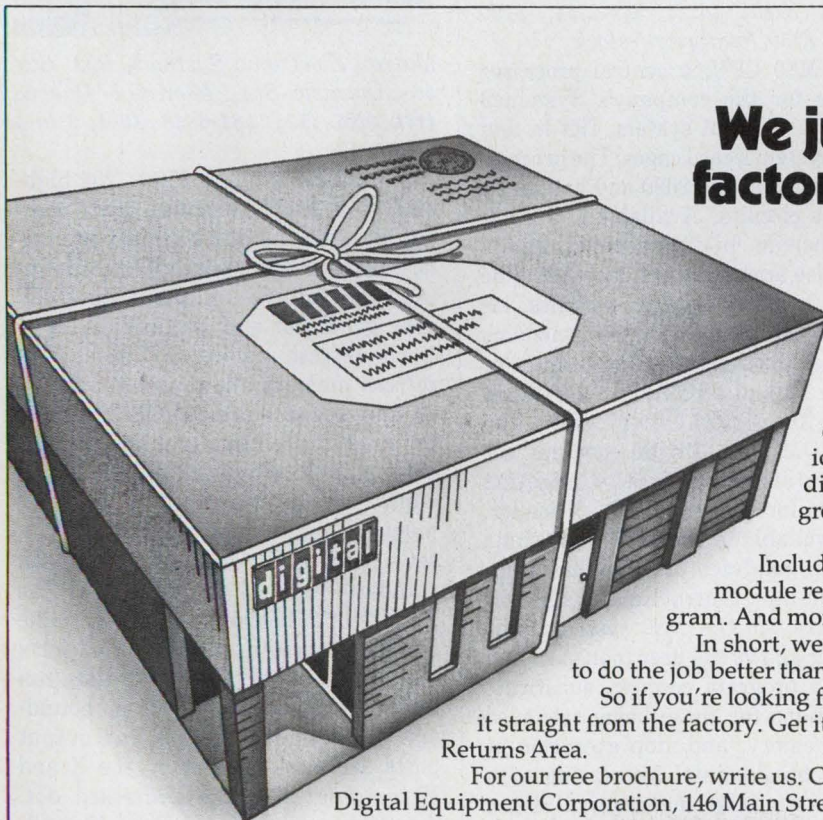

We just brought Digital factory service one step closer to the field.

Announcing the Customer Returns Area. The major off-site repair center for Digital Equipment Corporation.

The Customer Returns Area offers all our customers direct access to factory service. We have our own parts inventory, diagnostic and test center, and engineering group.

We also have a number of service plans. Including subassembly contracts, individual module repair, our unique Module Mailer™ program. And more.

In short, we have everything it takes to do the job better than anyone else.

So if you're looking for off-site service, get it straight from the factory. Get it from the Customer Returns Area.

For our free brochure, write us. Customer Returns Area, Digital Equipment Corporation, 146 Main Street, Maynard, MA 01754.

digital

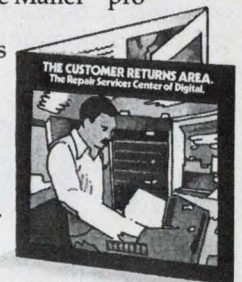

CIRCLE NUMBER 123

an investment in capitol buys rugged switch design and long, trouble-free life

For Example!
Our Extremely Dependable, Multiple-Position Push Button Strip Switches

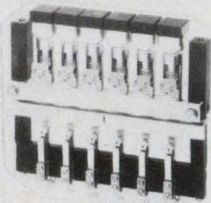

Basic frames are anodized aluminum. Plungers are 5/32" square brass with a nylon actuator molded on them. Hence, they will not bend or warp.

Mechanical linking of all switch positions prevents operation of more than one position at a time. A released button will return to the "up" position before the next button can be actuated. These switches can be illuminated either by an external circuit or directly from the switch. Lamps do not travel when positions are engaged, eliminating shock to the bulb.

Capitol switches are tested with 2 to 3 million operations to assure life-long, trouble-free performance.

Our 28-page catalog will give you all the "specs" on CAPITOL's entire line of quality switches. **CAPITOL SWITCHES are rated at 3 Amps, 110 Volts AC, non-inductive.**

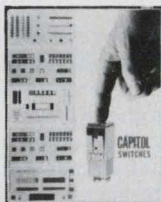

CAPITOL manufactures a complete, high-quality line of push button and lever switches — illuminated if desired — standard and custom designs to fit your every need.

CAPITOL

The Capitol Machine and Switch Co.
87 Newtown Road, Danbury, Conn. 06810
Phone: 203-744-3300

CIRCLE NUMBER 84

MICRO/MINI COMPUTING

RAM/PROM board mates with Intel systems

Monolithic Systems, 14 Inverness Drive East, Englewood, CO 80110. Read Ahlquist (303) 770-7400. \$1095 (less EPROM); 30 days.

Totally hardware and software compatible with the Intel SBC 80 family of microcomputers and Intellec MDS systems, the MSC 4502 provides both high density RAM and EPROM on the same board. The RAM section of the MSC 4502 can be expanded in 4-k increments up to 16 k × 8. Four EPROM sockets can be used to expand, in 1 k × 8 or 2 k × 8 increments, up to 8 k × 8. The board has 16 switch-selectable address start locations for RAM, and 16 switch selectable address start locations for EPROM. Cycle times of the MSC 4502 include a 350-ns read cycle time and a 500-ns write cycle time.

CIRCLE NO. 363

CPU module and analyzer based on 8080 μ P

Warner & Swasey, 7413 Washington Ave., South, Minneapolis, MN 55435. Robert Kiehl (612) 941-4454. \$190 (M80), \$750 (analyzer); stock.

The M80 CPU, a central processor module for the company's System 8 industrial control system, fits in any of the system's card cages. The processor is based on the 8080 and has many support circuits. Available I/O modules include bi-directional counters and pulse accumulators, 24 to 120 V ac and dc input and output modules, 12-bit a/d and d/a converters, modems and many others. Memory modules include 1-k and 4-k RAMs, a 1-k CMOS RAM with on-card battery, and a 1 to 4-k PROM card. PROM modules are self-programming, thus eliminating the need for a separate PROM loader. Also available is the M80 front panel program analyzer. It provides complete on-line control and diagnostic capability for the M80 systems. The analyzer allows the user to inspect and load the program counter, substitute instructions for those being retrieved from memory, and stop execution at specific breakpoints. Interfacing with the System 8 by means of a 60-pin connector, the analyzer operates on either the system supplied +5-V or an external 5-V supply.

CIRCLE NO. 364

Memory extender adds up to 19 Mbytes to 8080

Quantex, Div. of North Atlantic Industries, 200 Terminal Drive, Plainview, NY 11803. Leon Malmel (516) 581-8350. \$595; 60 days.

The QIM-1/MX interface allows extended memory capacity for Intel SBC 80/10, 80/20 and Intellec MDS computers. Memory can be upped by 2.32 to 19 Mbytes depending on the 3M data cartridge drive selected. The interface consists of a single card, which is designed to connect the Intel bus and use Quantex Models 2200, 2400 or 2710. On the QIM-1/MX is an independent 8080 μ P to do parallel processing, thus relieving the main CPU of performing tape-drive data and control functions while the tape drive is running.

CIRCLE NO. 365

Graphics generator board plugs into Altair/Imsai

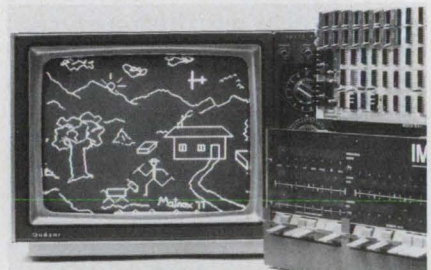

Matrox Electronic Systems, P.O. Box 56, Ahuntsic Stn., Montreal, Quebec H3L 3N5. (514) 481-6838. \$395; 2 to 4 wks.

The ALT-256**2, a 256 × 256 high-resolution graphics device, is pin compatible with the Altair, Imsai or similar microcomputer buses. The card contains all interface electronics, a TV sync generator and its own 65,536 × 1 bit refresh memory. The built-in refresh memory allows great flexibility and speed since no CPU time is required to refresh the screen. The output is a composite video signal which can be connected to any TV monitor or the video portion of a TV set. Both American and European standard versions are available. The ALT-256**2 board occupies a single bus slot and requires four output ports and one input port (port addresses can be positioned on any 4 location boundary via on board jumpers). Two output ports are used for storing the X and Y coordinates of the addressed dot. Another output port turns the addressed dot on or off. A fourth port is used to clear or preset the entire screen.

CIRCLE NO. 366

BEST COST/PERFORMANCE

resin-coated SOLID-TANTALUM

CAPACITORS

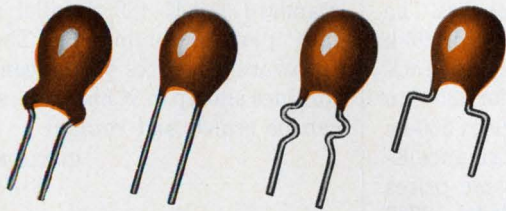

New Sprague Type 199D Capacitors Give You the Most for Your Money

LOWEST COST, YET IMPROVED PERFORMANCE. Prices competitive with any other capacitors of this type, domestic or offshore. Max. impedance in ohms @ 10 kHz guaranteed for every capacitor. Lower d-c leakage currents, lower dissipation factor.

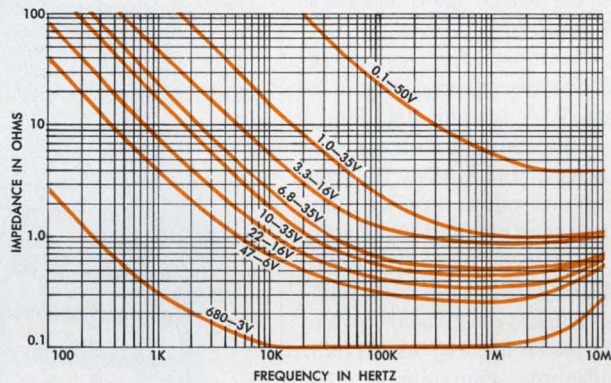

Plus these additional advantages . . .

SUPERIOR EPOXY ENCAPSULANT

Flame-retardant, moisture-resistant resin will not crack or chip under temperature extremes.

CHOICE OF LEAD CONFIGURATIONS

Straight (2 configurations), hockeystick, or lock-in crimp with .100", .200", .250" lead spacing.

STANDARD TOLERANCES: $\pm 20\%$, $\pm 10\%$
 $\pm 5\%$ available on special order.

PROVEN CAPACITOR TECHNOLOGY

From the pioneer in solid-electrolyte tantalum capacitors.

RAPID DELIVERY

Up to 999 pieces off-the-shelf from Sprague Industrial Distributors. Larger quantities 4 to 8 weeks ARO.

For price and availability information call your Sprague district office or sales representative. For complete technical data, write for Engineering Bulletin 3547B to: Technical Literature Service, Sprague Electric Company, 347 Marshall Street, North Adams, Mass. 01247.

THE BROAD-LINE PRODUCER OF ELECTRONIC PARTS

CIRCLE NUMBER 85



DATA PROCESSING

Data serializer spans wide baud rate

Science Accessories Corp., 970 Kings Highway West, Southport, CT 06490. Rolf Kates (203) 255-1526.

The Model DC-6 data serializer accepts parallel input data and generates serialized output data, compatible with modems, acoustic couplers, programmable calculators, CRT terminals, time-sharing networks, and any other RS-232 or current-loop device. The amount of data transmitted in response to one data-ready pulse may contain up to 34 characters, and up to eight special characters can be inserted anywhere within the sequence. Available baud rates range from 112.5 to 9600, with any specific baud rate available.

CIRCLE NO. 367

Floppy-family packs up to 630 k into 5-1/4 in.

Micropolis Corp., 9017 Reseda Blvd., Northridge, CA 91324. (213) 349-2328. From \$945 (unit qty); 4 wks.

A family of complete floppy-disc systems packs the storage capacity of 8-in. discs into 5-1/4 in. The 1043-Mod I is a single-drive, using a 35-track disc with a capacity of 143 kbytes. Its price of \$945 includes power supply, controller, interface cable, and Basic software. The 1043-Mod II has 315 kbyte capacity (\$1095); the dual unit 1053-Mod I stores 286 kbytes (\$1545) and the 1053-Mod II packs 630 kbytes (\$1795). The MetaFloppy controller plugs directly into MITS 8800, Imsai 8080, COMPAL, or Polymorphic 88 microcomputers.

CIRCLE NO. 368

Heavy-duty terminal doubles as typewriter

CPT Corp., 1001 S. 2nd St., Hopkins, MN 55343. (612) 935-0381. \$2125 (unit qty); 8 wks.

A heavy-duty, μ P-based I/O typewriter uses RS232 interface for asynchronous entry of ASCII data, and is plug-compatible with most computer and calculator systems. Called the Rotary II, it offers interchangeable type styles and prints at 15 char/s. In the off-line condition it can be used as a standard office typewriter.

CIRCLE NO. 369

Expansion kits add memory inexpensively

Hewlett-Packard, 1501 Page Mill Rd., Palo Alto, CA 94304. (415) 493-1501. See text; 6 wks.

Three kits provide inexpensive memory expansion of as many as 96-k words, at 350-ns cycle times, for HP 1000, DISComputer and 21MX K, M, and E-Series computers. They combine mapping hardware, dynamic mapping instructions and 16-k memory modules at savings of up to 41% over the previous price of similar components. The Model-12763 kit provides 32-k to 96-k words of 650-ns memory for the 21MX K and M-Series computers for \$3500 to \$9300, while the 12766 provides 560-ns memory for standard-performance E-Series computers at the same prices and memory sizes. The Model 12767 offers memory increases from 32 k to 96 k, with 350-ns cycle times, at \$4500 to \$12,300 for 21MX E-Series including the HP 1000.

CIRCLE NO. 370

Hand-held terminal never forgets



MSI Data Corp., 340 Fischer Ave., Costa Mesa, CA 92627. R. F. Roper (714) 549-6000. From \$990; Oct., 1977.

For mobile data entry, the programmable MSI/77 provides unusual features. The 4-k character memory is protected by a backup battery if the four AA cells fail, or are changed. The MSI/77's memory can be dumped through a small acoustic coupler into a remote computer. Self-blanking of the 12-character display, and CMOS chips provide 64-h operation without recharging, or battery replacement. An 8-k memory version is scheduled for Jan., 1978.

CIRCLE NO. 371

Intelligent interface for CalComp plotters

CalComp, 2411 W. LaPalma Ave., Anaheim, CA 92801. Ron Cook (714) 821-2541. \$3500; July, 1977.

A low-cost on-line plotter controller (OPC) has been added to CalComp's line of graphic controllers. Operating functionally as an intelligent interface, the OPC permits specified CalComp plotters to be driven locally or remotely by converting computer output, in standard RS-232-C serial format and standard IEEE 488 parallel format, into plotter commands. The OPC firmware generates plotter commands for lines and up to 96 characters, which can be scaled and rotated.

CIRCLE NO. 372

Smart terminal boasts expandable memory

Telera Div., Research Inc., P.O. Box 24064, Minneapolis, MN 55424. Jerry Medley (612) 941-3300. \$1750 (unit qty).

Features of the 4041 CRT terminal include block mode, multipage storage, editing, 1920-character display, 3640-character memory (two pages), upper and lower case, transmit line, page, and partial page, tab forward or backward, columnar tab, protected fields, cursor control, self-testing, blink, and inverse field. Baud rates to up to 19,200 are provided. Buffer and firmware storage can be expanded. The 4041 has a 12-in. tube with anti-reflective faceplate, weighs 43 lb and measures 13-1/2 x 15-1/2 x 21 in.

CIRCLE NO. 373

Language aids software design for major minis

Zeno Systems, 2210 3rd St., Santa Monica, CA 90405. (213) 396-6020. \$1250.

DASL is a general-purpose micro-programming tool that can also be used to construct an assembler for fixed or variable word length machines. DASL uses ANSI Fortran and is available for most IBM, DEC, or Data General computers. DASL features include free format input, decimal, binary, octal, and hex numbers up to 180 bits long, symbolic labels, field overlap, default, instruction widths up to 180 bits, and a library. DASL is available under license and on time-sharing systems.

CIRCLE NO. 374

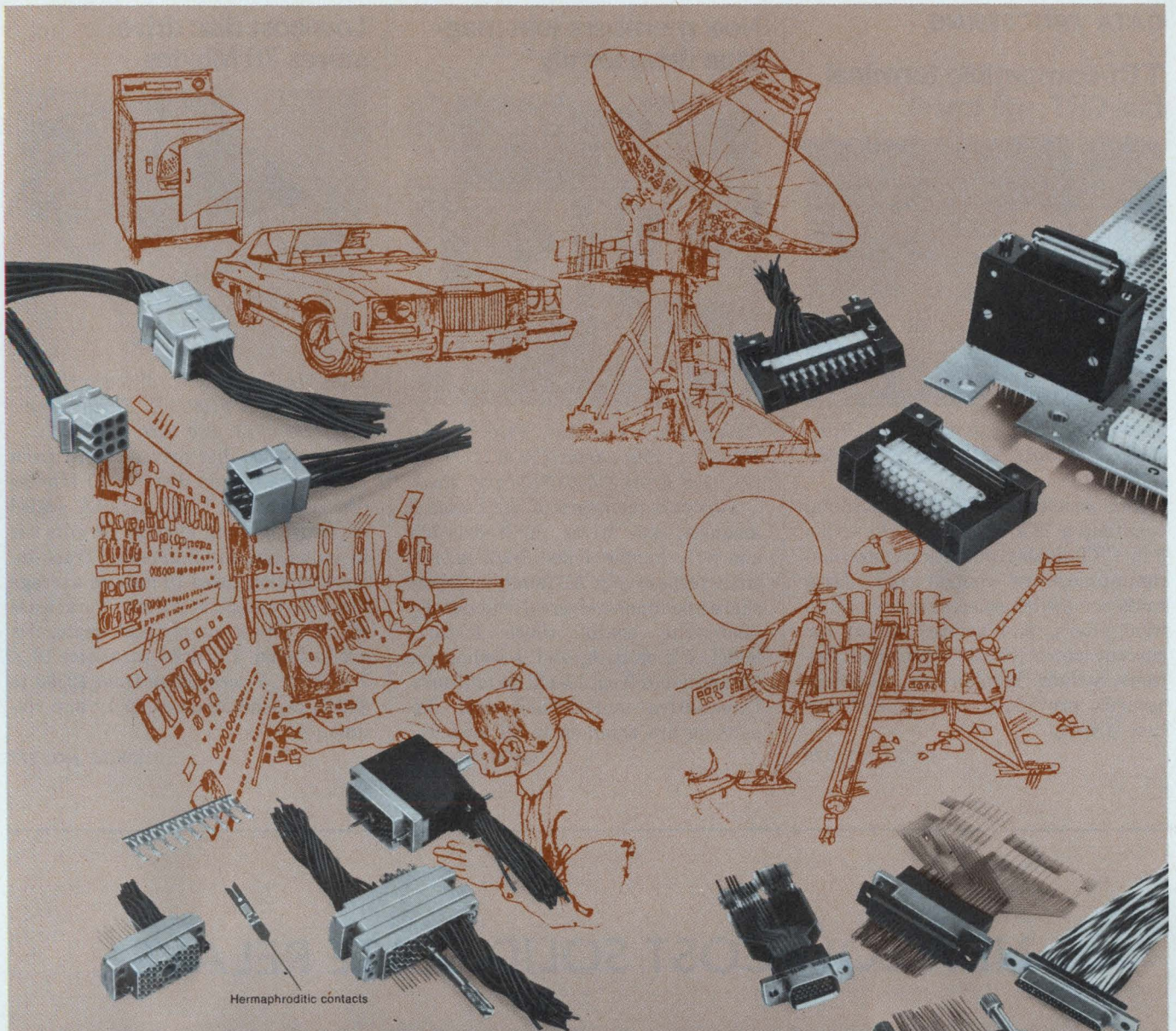

Rack and panel connectors for unlimited applications... **only from Malco**

You can get some of these connectors from other manufacturers, but *only* Malco offers a complete line of rack and panel connectors for any design situation. It's the broadest line of rack and panel connectors in the industry. Everything from high density spacing of .050 to our Thrift-Mate™ with spacings of .200 and .250. All with the dependability and quality you demand for superior performance. Whether your application is commercial, military or industrial, Malco has rack and panel connectors for you. Whether

your designs call for pin and socket, blade and tuning fork or hermaphroditic, Malco has it. Only Malco has it all. Write for prices and information. Malco, 12 Progress Drive, Montgomeryville, PA 18936. Phone: (215) 628-9800

MALCO
A Microdot Company

DATA PROCESSING

TTY-compatible terminal has CRT, will travel

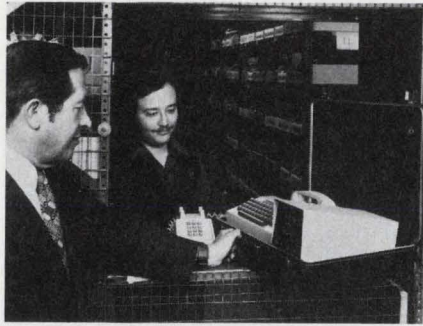

Digi-Log Systems, Babylon Rd., Horsham, PA 19044. (215) 672-0800. \$2000 (unit qty).

This briefcase-sized 21-lb terminal combines a TTY-style keyboard with a 5-in. CRT display, acoustic coupler, and communications control unit. Data rates are switch-selectable from 50 to 9600 bits/s, and printer output for current loop or RS232 is provided. Options include highlighting, blinking, security provisions, and upper/lower case display.

CIRCLE NO. 375

New members join mag-tape drive family

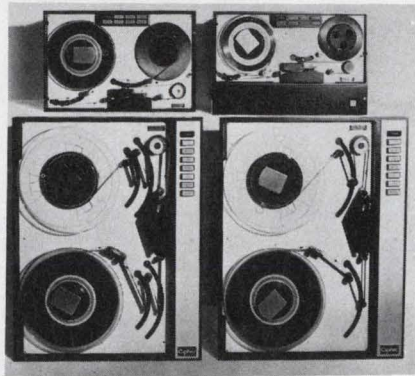

Cipher Data Products, 5630 Kearny Mesa Rd., San Diego, CA 92111. (714) 279-6550. From \$1600 (OEM qty); stock.

Two new members of the Series X magnetic tape drives, the Models 70X and 80X, handle 7 and 8-1/2 in. reel sizes, respectively. All family members share a common universal dual-density read/write board, which features NRZI, PE or both, and is switchable for any speed from 12-1/2 ips to 75 in/s. Direct-drive motors and dual formatting are common to all models.

CIRCLE NO. 376

Low-cost disc drive stores 70 Mbytes

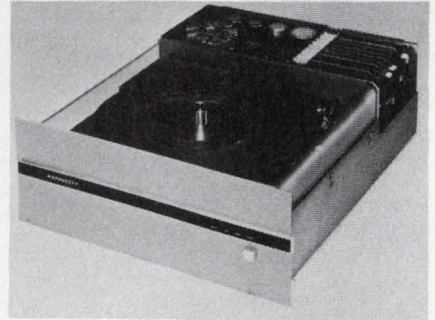

Kennedy Co., 540 W. Woodbury Rd., Altadena, CA 91001. R. Bartholomew (213) 798-0953. See text; 12 wks.

Series-5300 disc drives record from 14 Mbytes (single disc) to 70 Mbytes (three discs) at 1 Mbyte/s. A sealed enclosure without blowers permits use in industrial environments. Track-to-track motion takes 10 ms and average head movement is 45 ms (worst case 80 ms). Power supply and electronics are included. The drive measures 19 × 7 × 22 in. Prices range from \$2500 to \$4000, depending on capacity and volume.

CIRCLE NO. 377

NEW LOW COST SOLID STATE RELAYS

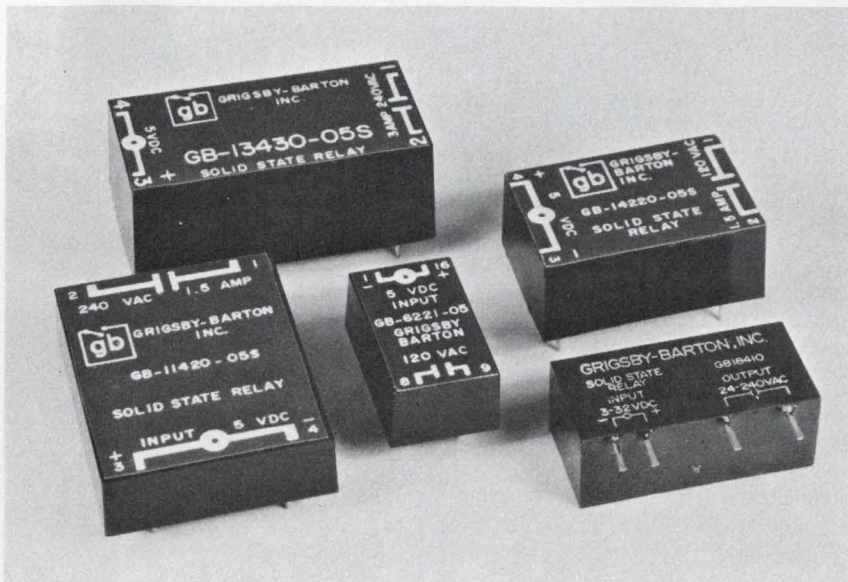

Our new line of PC mount solid state relays offers you the largest selection of circuit configurations and standard industry package options available. Whether you want all solid state or hybrid, zero voltage or random turn-on, we have it and at a very competitive price. Output ratings up to 5 amps at 280 VRMS are standard. 3 to 32 VDC inputs and output RC networks are available options.

Want to talk about your application or find out more about our quality line of products? Contact us or your local GB Representative for a fast reply.



GORDOS/GRIGSBY-BARTON INC.

1000 N. Second Street, Rogers, Arkansas 72756, U.S.A. • Telephone (501)636-5000; TWX: 910-720-7998

CIRCLE NUMBER 87

MEPCO/ELECTRA

SPR 5000 Y

**RESISTOR...
ONE SIZE
ONE STYLE**

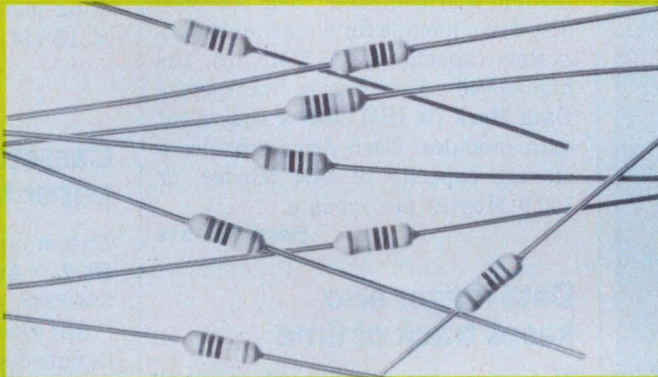

For all standard precision applications

You're looking at the state-of-the-art in discrete film resistor technology. Mepco/Electra's SPR 5000 Y—the only resistor that gives you everything you need for all your 1%, 100 PPM applications ... in one size, one style.

Whether you're building automotive, instrumentation or communications equipment, with all the tight space requirements high power handling capabilities, and broad range of values these applications require, you'll find what you need in SPR 5000 Y ... with this big plus—reduced resistor inventory.

MEPCO/ELECTRA SPR 5000 Y:

DUAL RATED—1/4W & 1/2W.

One resistor can be used in both 1/4 and 1/2W applications, which means dual power handling capability in the smallest possible size.

BROADER RESISTANCE RANGE—10 Ω to 22.1M Ω

Widest resistance range for any resistor with comparable tolerance and T.C.'s.

REPLACES RN55, RN60 and RN65—

Perfect replacement for these MIL styles with the added plus of a broader resistance range, dual rated ... and at a better price.

CWV—350V Max.

STANDARD TOLERANCE—1%

STANDARD T.C.— ± 100 PPM (± 50 PPM available)

In the market for a standard precision resistor that offers better than standard specs? Find out about SPR 5000 Y. For more information ... Call M/E at (817) 325-7871. Or write Mepco/Electra Inc., P. O. Box 760, Mineral Wells, Texas 76067.



Industry's First Comanding A/D In a DIP

- 7 Bits plus sign
±72 dB dynamic range
- Follows Bell μ 255 law
- +5-V input range
- Low Power
660 mW
- Adjustment free
- Small
18-pin hermetic DIP

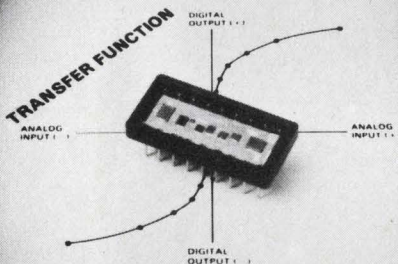

MN 5110
\$55.00*

* in 100 quantity



Micro Networks Corporation
324 Clark Street, Worcester, MA 01606
(617) 852-5400 TWX 710-340-0067

CIRCLE NUMBER 89

DATA PROCESSING

Disc-drive subsystems mix freely with IBM

Memorex Corp., San Tomas at Central Expressway, Santa Clara, CA 95052. Charles O. Meyer (408) 987-2203. \$1355/month.

A functional replacement for the IBM 3340 direct access storage facility, the Model 3640 subsystem provides enhanced capabilities like faster access time, improved cost/performance, and more flexible configuration. When used with S/3 computers, the 3640 subsystem consists of a 3643 disc-drive module and controller, and one 3640 disc-drive module for a maximum subsystem capacity of 205.8 Mbytes. The high-speed disc drives incorporate Data Mark 70, IBM 3348 or equivalent data modules. Each drive provides a storage capacity of 51.4 Mbytes, or 102.9 Mbytes per module.

CIRCLE NO. 378

Data logger also keeps track of time

Memodyne, 385 Elliot St., Newton Upper Falls, MA 02164. (617) 527-6600.

Designed for remote, unattended operations, the Model 3243 uses standard Philips cassettes as a storage medium and records multiple analog data channels with periodic real time indexing, auxiliary header inputs and calibration information. The system records up to 16 analog input channels, at selectable scan rates from 2 to 50 min, with 12-bit resolution. The capacity of a 300-ft Philips cassette is over 1.5-million bits.

CIRCLE NO. 379

Transceiver mimics modem but costs less

Spectron Corp., Church Rd. & Roland Ave., Mount Laurel, NJ 08057. Boyce M. Adams (609) 234-5700. \$540; 2-4 wks.

The DT401 stand-alone digital transceiver provides low-cost transmission and reception of full-duplex digital data between computers and terminals over distances up to 10,000 ft at 9600 bits/s, or up to 7000 ft at 19,200 bits/s. Both multipoint and point-to-point arrangements can be accommodated. The digital transceiver can be connected to any terminal or port with an EIA RS-232C interface. Three loopback switches and four indicator lamps help diagnosing communications problems.

CIRCLE NO. 381

Polling terminal has built-in editor

EECO, 1441 E. Chestnut, Santa Ana, CA 92701. Jerry Pisano (714) 835-6000. \$1500 (OEM qty).

A smart, stand-alone, polling terminal, the D400 is compatible with Burroughs, Lear Siegler and TEC equipment. It features absolute cursor addressing, field protect format, edit package, audible alarm, roll/page mode, and blink character. The detachable keyboard generates a full 128 ASCII set and has typewriter layout with 16 special function keys, 15-key numeric cluster and 15-key text handling pad. The terminal measures 19 × 13-1/4 × 16-1/2 in.

CIRCLE NO. 382

Cassette system beats paper tape to the punch

Datum Inc., 1363 S. State College Blvd., Anaheim, CA 92806. (714) 533-6333. \$3650.

The Delta 111 cassette I/O system is designed specifically for users of DEC PDP-11 computers. Delta 111 performs the functions of the DEC PC-11 high-speed paper-tape punch and reader and is compatible with existing DEC PDP-11 software—but at nine times the data transfer speed, and with 300 kbytes of storage, equivalent to 1/2-mile of paper tape. Delta 111 allows bi-directional searching and rewind. Control and status registers are the same as those of DEC PC-11, with the addition of some special features. The Delta 111 is rack-mountable and available in either single or dual-transport configurations.

CIRCLE NO. 383

Proprietary oxides yield better mag cards

Information Terminals Corp., 323 Soquel Way, P.O. Box 9077, Sunnyvale, CA 94086. Paul Ward (408) 245-4400.

Designed for data and word-processing applications, the Verbatim magnetic cards provide long life, low abrasion characteristics, and improved magnetic qualities. The cards are interchangeable with IBM MC/ST cards and can be used on Xerox, Sperry Remington, and Redactron-type word processing systems. All magnetic cards are 100% certified at time of manufacture.

CIRCLE NO. 384

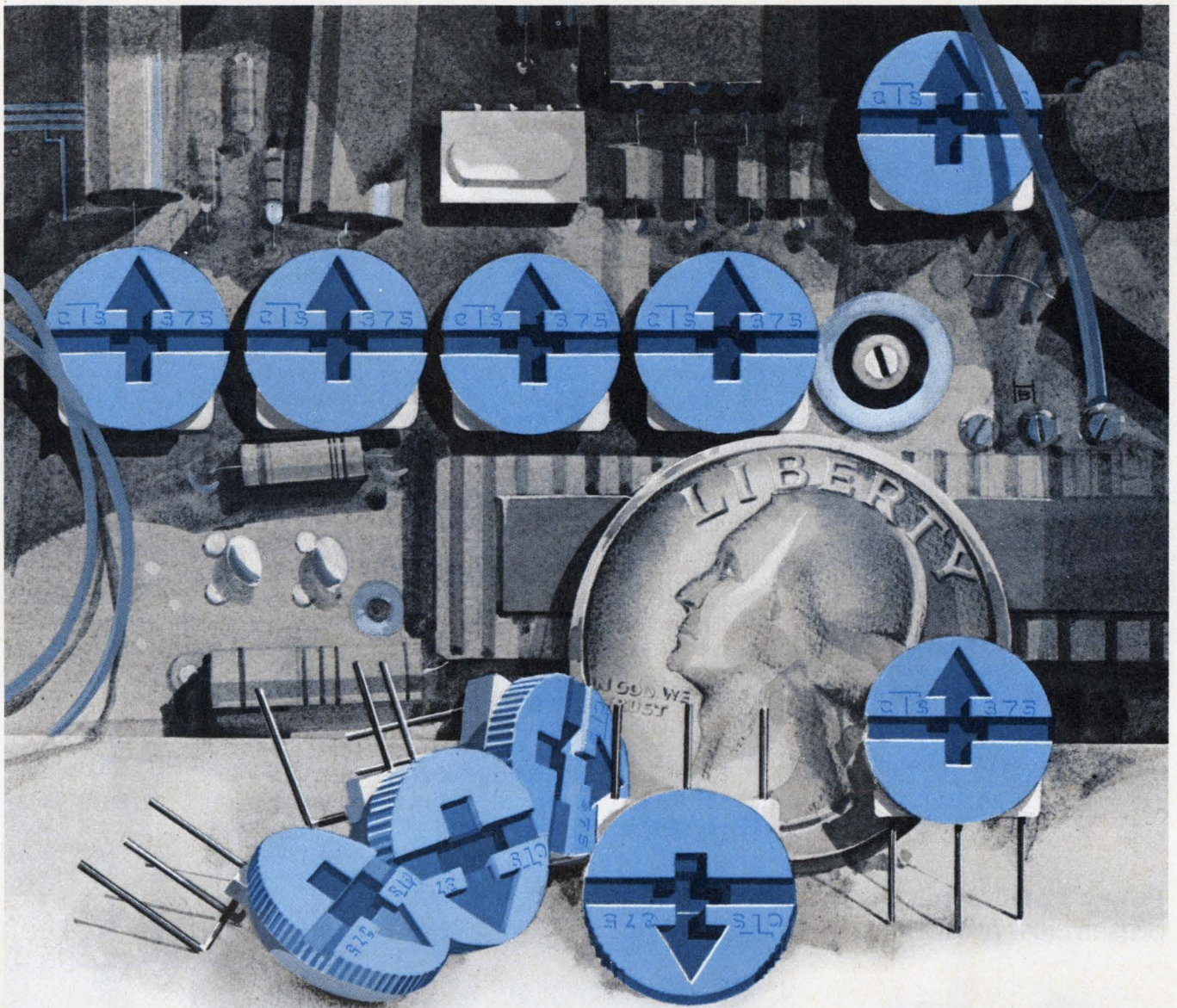

CTS mini cermet trimmers... low in price, high in performance.

Fantastic! Small $\frac{3}{8}$ " dia. (10mm), great performance and CTS reliability are only three reasons you should use our NEW series 375 single turn cermet trimmers. The low 25¢ price tag is still another.

CTS 375's, in six popular terminal styles, feature a low ± 100 ppm/ $^{\circ}$ C standard temperature coefficient—throughout the resistance range. Power rating, 1 watt at 40 $^{\circ}$ C; $\frac{1}{2}$ watt at

70 $^{\circ}$ C. CRV of 2%. Settability of .03%.

And the serrated adjustment knob doubles as a dust cover to protect the element from dirt, oil and other contaminants. It's a lot for so little. But you expect that from a company that's put millions into electronics for industry. For complete information, write **CTS OF WEST LIBERTY, INC.**, 6800 County Road 189, West Liberty, Ohio 43357 or phone (513) 465-3030.

CTS CORPORATION

ELKHART, INDIANA

A world leader in cermet and variable resistor technology.

CIRCLE NUMBER 90



COMPONENTS

Capacitor withstands pulse 6× rated volts



American Radionic, 51 Austin St., Danbury, CT 06810. R. Stockman (203) 743-6308.

A capacitor for heavy-duty pulsing applications, as in automotive timing-lights, designated PulseCap, is made with Mylar-film dielectric. The capacitor can be repeatedly subjected to voltages six times its nominal rating without damage. Available with voltage ratings of 200, 400 or 600 V, the capacitors range from 1 to 2.5 μF with tolerances from 1 to 20%. Other values and tolerances are available on special order. Round with axial leads, body length is 1.875 in. exclusive of leads, and diameters range from 0.7 to 1.07 in. An outer Mylar jacket and epoxy end seals allow meeting MIL-STD-202C.

CIRCLE NO. 385

Power transformers present low profiles



Abbott Transistor Labs., Inc., Transformer Div., 639 S. Glenwood Place, Burbank, CA 91506. W. Lovett (213) 841-3630. \$60.00 (1 to 9); stock to 10 days.

Model 6LP6-6 low-profile power transformers supply 6-W outputs of 6.3 V ac at 0.95 A or 12.6-V-ac center-tapped at 0.47 A. Output voltage keeps within 5% at full load and 115-V-ac input; voltage regulation, within 20% no load to full load. Insulation test voltage is 1000 V ac, and maximum operating ambient temperature is 85 C. For PC-plug-in applications, the height is only 1.31 in.

CIRCLE NO. 386

Mercury-wetted contacts switch 100 VA at 500 V

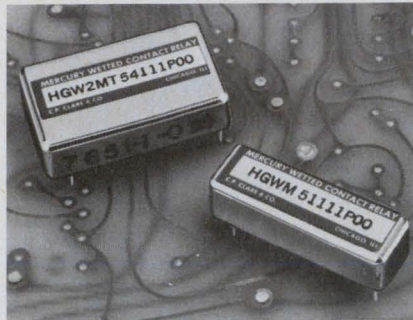

C. P. Clare & Co., 3101 W. Pratt Ave., Chicago, IL 60645. (312) 262-7700. \$14.45: HGWM, \$27: HGWM2MT (unit qty).

Miniaturized mercury-wetted contact relays, the HGWM series, for PC boards have a 100-VA rating and multi-billion operation reliability. Both latching and nonlatching versions are available. Contact ratings, with proper contact protection, are 500 V dc or ac max, 2-A-max switched and 5-A-max carry only. Contact resistance is 12 to 25 m Ω over a life expectancy of 10×10^9 operations at rated load. Operating time is 1.25 ms, operable to 200 Hz.

CIRCLE NO. 387

High voltage capacitors show 50,000-h MTBF

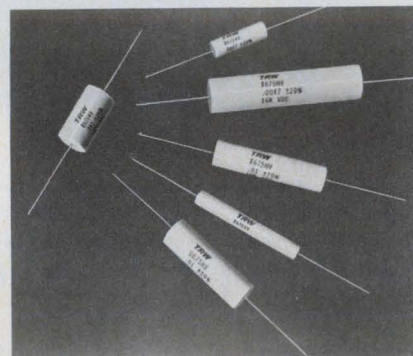

TRW Capacitors, 301 West O St., Ogallala, NE 69153. (308) 284-3611. \$1.10 (500 qty); 6 to 8 wks.

Metallized polyester capacitors, X675HV, provide an MTBF of 500,000 h at a 90% confidence level, when tested at 85 C with 75% of the rated 16 kV. The failure mode includes degradation of insulation resistance and any capacitance change greater than 10%. At 100% rated voltage, MTBF is still more than 250,000 h. Dissipation factor is less than 1% measured at 1000 Hz and 25 C, and capacitance values to 0.68 μF are available. Operating temperature range is -55 to 65 C with a 25% voltage derating at 85 C.

CIRCLE NO. 388

Sealed relay processed like other components

American Zettler, 16881 Hale Ave., Irvine, CA 92714. (714) 540-4190. 60 days.

Sealpak Series 2500 miniature sealed relays can be processed like any other components on the circuit board. The relays are encased in a fiberglass-filled (Valox) self-extinguishing polyester material with UL rating 94V-0. And the enclosures are filled with dry nitrogen. The relay cases are unaffected by solvents and fluxes. After a relay has been mounted and cleaned, it can be opened to air by puncturing a pinhole in a specially prepared area on the case. In SPDT to 4PDT versions with up to 5-A contacts, the relays feature gold-plated or silver/cadmium-oxide self-wiping contact buttons, bifurcated springs, insulation resistance of more than $10^{10} \Omega$ and up to 10^6 operations at rated load.

CIRCLE NO. 389

Tiny crystal for watches features Q of 90,000

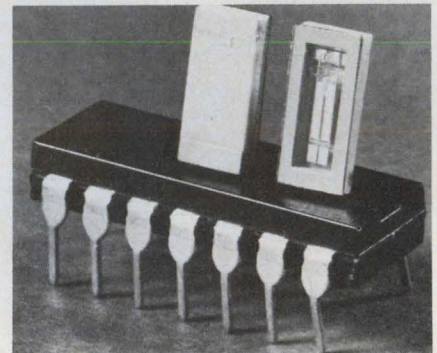

Statek Corp., 1233 Alvarez, Orange, CA 92668. (714) 639-7810. \$1 (100,000 qty); stock.

The WX-6 tiny 32,768-kHz watch crystal provides a Q of 90,000. The crystal is of conventional two-lead design $1/3 \times 1/6 \times 6/100$ -in. in a ceramic flatpack package with glass lid. The glass lid permits fine tuning after the package is sealed. The crystal is sealed in a high vacuum, which accounts for the unit's low motional resistance of 50,000 Ω and the high Q factor. Turning point temperature is 25 ± 5 C and temperature coefficient is -0.033 ppm/ $^{\circ}\text{C}$. Aging is only 3 ppm max at 25 C, because of pre-aging by high-temperature vacuum baking. Shock resistance is 3-ppm max shift when dropped on a hard board from 1-m height.

CIRCLE NO. 390

Need ROM retention and RAM alterability?



Design in Nitron Non-Volatile Memories.

Our Metal Nitride Oxide Silicon NVM are fully reprogrammable in-circuit. They offer long-duration storage security without battery backup or "power-on" auxiliaries.

HIGH DATA RETENTION

Data is secure for a minimum of 10,000 hours and can be read 10^{10} times between refresh cycles.

PROGRAM VERSATILITY

Nitron NVMs offer entire memory or word alterability. And it can all be done in-circuit a minimum of 10^5 times. Millisecond write times are ideal for applications in the human-response range.

SYSTEM COMPATIBILITY

We built in on-chip decoding, and TTL and CMOS compatibility. Plus, Nitron NVMs can be reprogrammed without additional power supplies or power supply switching.

PRODUCT AVAILABILITY

Nitron NVMs are available off-the-shelf for parallel data applications in 64x4 and 256x4 configurations;

and for serial data applications in 16x16, 16x18 and 1024x1 configurations. If you don't see what you need, tell us about it. We custom design NVMs, too.

Unique Nitron process puts silicon nitride and silicon dioxide layers between MOS gate and substrate. When voltage is applied, trapped charge offsets threshold voltage. Charge remains after voltage is removed.

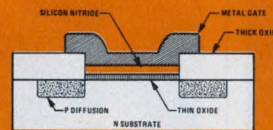

Need information fast? Call Nitron NVM Marketing at (408) 255-7550. Or fill in the coupon below for your NVM Fact Kit.

NITRON

A DIVISION OF MCDONNELL DOUGLAS

Mail to:
NITRON NVM Marketing
10420 Bubb Road
Cupertino, CA 95014

TELL ME MORE!

I'm interested in (check box):

- | | |
|---|---|
| <input type="checkbox"/> 64x4
NC7040 | <input type="checkbox"/> 16x16
NC7033 |
| <input type="checkbox"/> 256x4
NC7050 | <input type="checkbox"/> 16x18
NC7035 |
| <input type="checkbox"/> 1024x1
NC7051 | <input type="checkbox"/> Complete
NVM Fact Kit |

Send to:

name & title

company

address

city

state

zip

ED-6

The Seastrom Touch

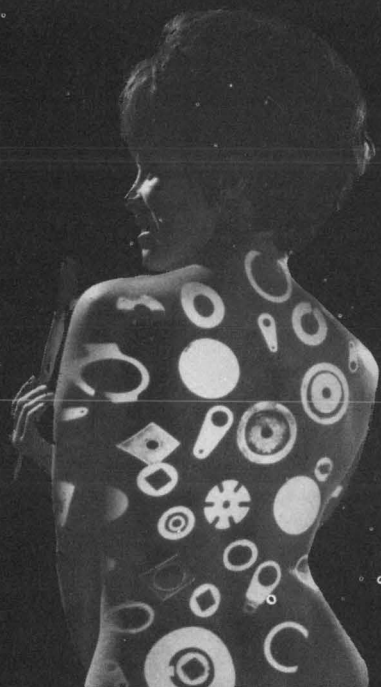

30,000 part numbers in stock for immediate delivery. . . all types of washers, shims, spacers, lugs, clips, clamps, plugs, insulators, military standards, etc.

TRY US FOR SIZE!

Send for your FREE 250 page fully illustrated 40B catalog.



SEASTROM

MANUFACTURING CO., INC.

701 Sonora Ave. • Glendale, Calif. 91201
(213) 245-9121 TWX 910-497-2271

CIRCLE NUMBER 95

COMPONENTS

Trimmer potentiometers feature low cost

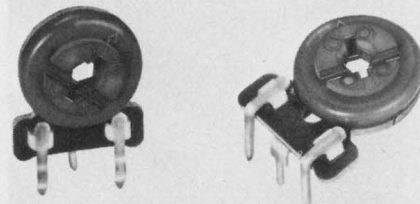

CTS of Elkhart Div., 1142 W. Beardsley Ave., Elkhart, IN 46514. R. McCuddy (219) 295-3575. \$0.12 (OEM qty.)

Series 278 composition trimmer potentiometers, with a 17/32-in. dia adjustment knob, allow vertical or horizontal mounting. Features of the 278 include a semi-enclosed construction, a double-paddle contact for low noise and long life and hex-hole and screwdriver-slot combination for tool adjustment. Power rating is 1/4 W at 55 C, derated to no load at 100 C; voltage rating across the end terminals is 350 V dc. Its resistance range of 100 Ω through 5 M Ω (linear) has a standard resistance tolerance of $\pm 30\%$.

CIRCLE NO. 448

Low ESR capacitors exceed 10-yr life



Cornell-Dubilier Electric, 150 Avenue L, Newark, NJ 07101. (201) 589-7500.

Aluminum electrolytic low-impedance capacitors, Type FAM, have screw terminals, and range in diameter from 1.375 to 3.031 in. in insulated and uninsulated cans. The capacitors can operate at 85 C max with full rated dc voltage and ac ripple current. A modified capacitor can be furnished for lower than -40-C applications. Capacitance tolerance is -10 to +100% at 25 C, and typical operating life exceeds 10 yrs. A shelf life of 3 yr doesn't affect the characteristics.

CIRCLE NO. 449

Small toggle switch snaps up and down

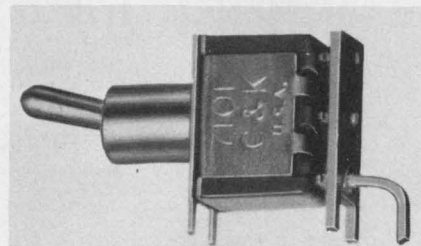

C&K Components, 103 Morse St., Waveretown, MA 02172. Stan Trocki (617) 926-0800.

According to C&K research, most people expect up-down action on a toggle switch—even on a horizontal mounting. The tiny VW (vertical-mount) PC switch provides a vertical-action toggle even when mounted on a horizontal PC board. The switch has a melamine case, a chrome-plated brass handle and housing of stainless steel. Electrical life is 100,000 make-and-break cycles at full load (for SPDT models ending in -01), insulation resistance is 1000 M Ω minimum and dielectric strength is 1000 V at sea level. Free engineering samples are available.

CIRCLE NO. 450

Encapsulated reed relay compatible with TTL

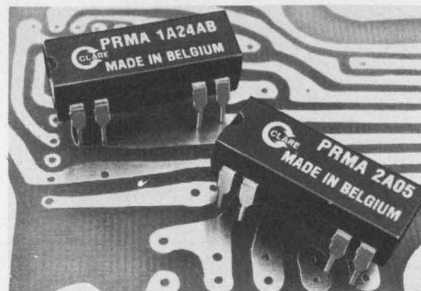

C. P. Clare & Co., 3101 W. Pratt Ave., Chicago, IL 60645. (312) 262-7700. \$1.15 (1000 qty); stock.

DIP PRMA reed relays feature 5-V form-A contacts compatible with TTL and operate from nominal coil voltages of 5, 12 or 24 V dc. An additional coil termination available on pin 13 provides flexibility on PC-board layouts. Diode clamps and electrostatic-shield options are available. Operating speeds at nominal voltage, including bounce, range from 0.5 to 1.5 ms. Insulation resistance is $10^{10} \Omega$ and the storage temperature ranges from -40 to 85 C. Encapsulation in a molded epoxy package allows total immersion during cleaning.

CIRCLE NO. 451

with **MINI/BUS**[®]

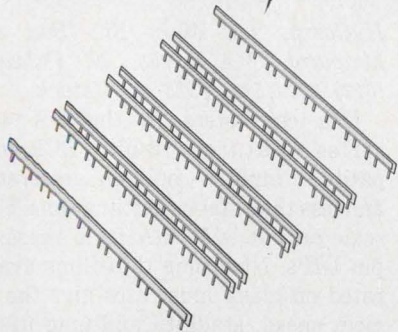

all these
MOSTEK MK 4096
memory packages

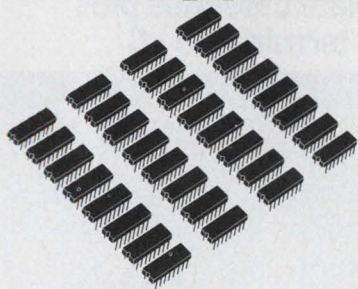

go on this 2-layer board

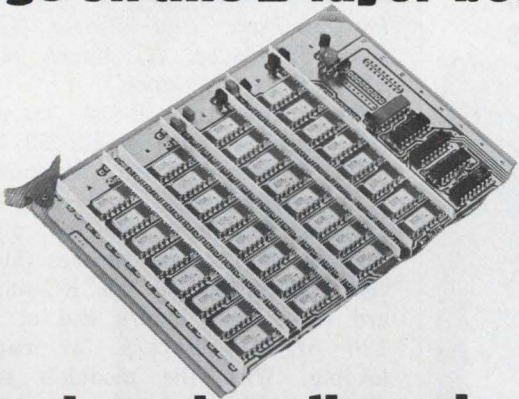

and work as they should!

... and these weren't needed!

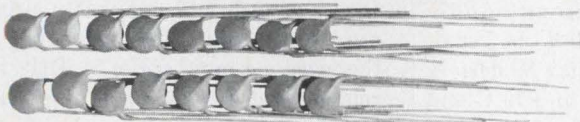

Rogers Application Note No. 1976 tells the full story of how Mini/Bus makes PCB space-saving design easier, eliminates multi-layer PCBs, drastically reduces use of de-coupling capacitors. Write or call for a copy, so you'll know what others know!

© Rogers Corporation 1976



ROGERS CORPORATION

Chandler, AZ 85224 (602) 963-4584

EUROPE: Mektron NV, Ghent, Belgium JAPAN: Nippon Mektron, Tokyo

CIRCLE NUMBER 96

ELECTRONIC DESIGN 13, June 21, 1977

How do you
resolve two signals
spaced 1 Hz apart
at 2 MHz?

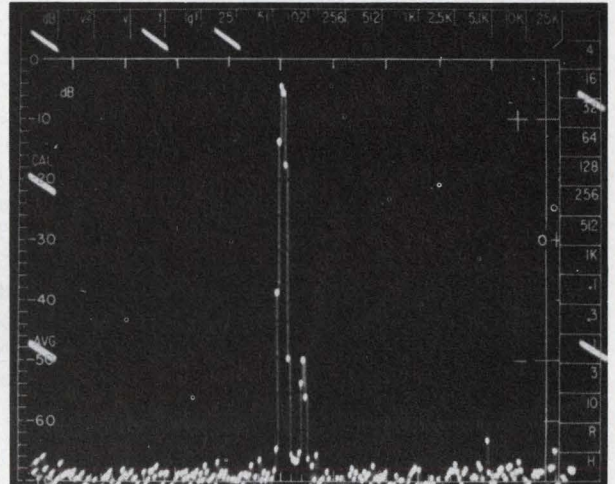

With an EMR Model 1510 Digital Real-Time Spectrum Analyzer and EMR Model 1520 Digital Spectrum Translator. Simply add the optional EMR Model 1521 Range Extension Module to the 1520 Translator, and you have real-time spectrum analysis at frequencies up to 2 MHz!



The CRT photograph illustrates the result. The input signal consisted of two discrete frequencies spaced 1.0 Hz apart, with a 50 dB difference in amplitude. The frequency range covered is 25.6 Hz centered about 1.990000 MHz, and the frequency resolution is 0.1 Hz!

Only EMR offers that much resolution at frequencies up to 2 MHz in real time.

So if you have an analysis problem requiring high-resolution/high-frequency real-time spectrum analysis, contact EMR... we will arrange for a demonstration or detailed information.

Sangamo Weston, EMR Telemetry Division
P.O. Box 3041, Sarasota, FL 33578
813-371-0811

SANGAMO WESTON

Schlumberger

CIRCLE NUMBER 97

MODULES & SUBASSEMBLIES

Tiny converter packs reference, ranging

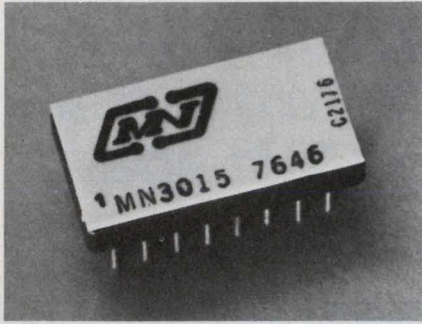

Micro Networks, 324 Clark St., Worcester, MA 01606. (617) 852-5400. \$16 (100 qty); 4 wks.

The MN3015, a current-output d/a converter in a 16-pin DIP, comes with an internal reference and range resistors. Electrical specifications from 0 to 70 C, without calibration or adjustment, include: linearity of $\pm 1/2$ LSB, compliance of ± 12 V, output of 0 to -2 mA, and power consumption of 420 mW. Internal laser-trimmed range resistors, used with an external high-speed op amp, provide voltage outputs of 0 to ± 10 V, 0 to -10 V, ± 5 V, and ± 10 V. A version of the converter costing \$39 (100 qty) operates from -55 to $+125$ C.

CIRCLE NO. 391

Small DPM keeps down the power drain



Analogic, Audubon Rd., Wakefield, MA 01880. (617) 246-0300. \$49 (100 qty); stock.

Drawing 800 mW at ± 5 V, the 3-1/2-digit, AN2575, bipolar digital panel meter mounts in a 3.25×1.28 in. panel cutout and extends 1.8 in. into the case. The input withstands continuous ± 300 V, dc or ac. The unit features absolute accuracy of $\pm 0.05\%$ of reading, ± 1 count; bipolar differential input; and a built-in input-signal-enhancement filter. Bias current is 50 pA, input resistance is 1000 M Ω , range tempco is ± 35 ppm-of-reading/ $^{\circ}$ C, and automatic zeroing in each conversion holds zero drift to ± 1 μ V/ $^{\circ}$ C. The instrument operates from -10 to $+65$ C.

CIRCLE NO. 392

Transducer display conditions input



Schaevitz Engineering, P.O. Box 505, Camden, NJ 08101. R. Anderson (609) 662-8000. \$315 (unit qty.); stock.

Connect the Model MDTR-350S single-channel readout directly to a transducer and to the ac line and you've got a complete measurement system. The panel-meter display reads out directly in engineering units to ± 1999 counts (3-1/2-digits). The DIN-size unit boasts $\pm 0.1\%$ linearity. Additional features include: 115 or 220-V, 50 to 60-Hz input power; $\pm 30\%$ zero adjustment; gain control; and 5-V-dc transducer excitation.

CIRCLE NO. 393

Tiny voltage reference gives you four choices

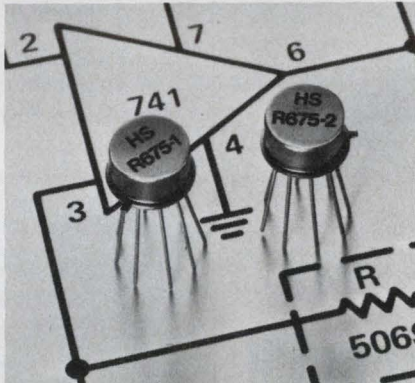

Hybrid Systems, Crosby Dr., Bedford, MA 01730. L. W. Peacock (617) 275-1570. From \$13 (1-9 qty.); stock.

Four TO-99 models make up the R675 series of precision 10-V buffered, reference-voltage circuits. Models -1 and -2 operate from 0 to $+70$ C and feature max tempcos of ± 5 and ± 25 ppm/ $^{\circ}$ C, respectively. Models -1B and -2B are processed to MIL-STD-883A, level B and operate from -55 to $+125$ C. The worst-case tempco for the -1B is ± 10 ppm/ $^{\circ}$ C, and for the -2B is ± 45 ppm/ $^{\circ}$ C. Other specifications include a pretrimmed $+10$ -V ± 0.005 -V output up to 15 mA and a 0.0005 V/V power-supply-rejection ratio.

CIRCLE NO. 394

Fast d/a squeezed into 24-pin DIP

HyComp, 146 Main St., Box 250, Maynard, MA 01754. N. Palazzini (617) 897-4578. \$325 (1-9) stock.

D/a converters in the DA 4000 series feature: 12-bit, ECL-compatible inputs; built-in reference; and less than 100-ns settling time. Full-scale output is 16 mA from these 24-pin DIPs. Nichrome thin-films evaporated on glass substrates give the devices speed, stability and long life. A 10-bit version is also available.

CIRCLE NO. 395

Mate cassettes plus a terminal to μ C

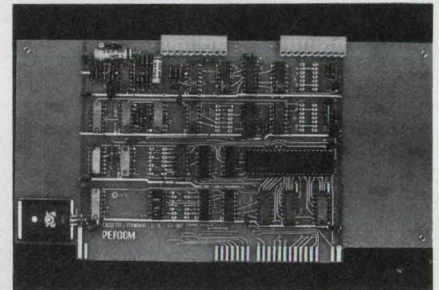

Percom Data, 4021 Winsor, Garland, TX 75042. H. Mauch (214) 276-1968. \$119.95; stock.

One card, the CI-812, marries two cassettes and the RS-232 terminal interface to your Altair-8800 or Imsai-8080 μ C's S-100 bus. The cassette interface, on the dual-function card, phase encodes (Manchester/Biphase) at the KC-standard rate of 30 byte/s and at 50, 120 or 240 byte/s for rapid loading. With the module's self-clocking encoding you can use audio cassette recorders at fast data rates. The self-clocking feature virtually eliminates tape-speed errors. The cassette-interface's record and playback circuits are completely independent, and the card accepts optional DIP reed relays—which may be ordered as a kit—for program control of two recorders or players. This permits operations such as cross-filing. The RS-232 terminal interface is full-duplex and provides for data exchange at 300 to 9600 baud. The unit operates with existing user's software with little or no modification. The module is available as a kit priced at \$89.95.

CIRCLE NO. 396

Now you can get 3 different types of solid-state relays from P&B.

That's P&B solid-statesmanship.

Specify P&B solid-state relays for wide choice, top performance, fast delivery. Three designs—103 ratings and voltages—now available from your local distributor. Get P&B experience—nearly two decades of designing solid-state devices.

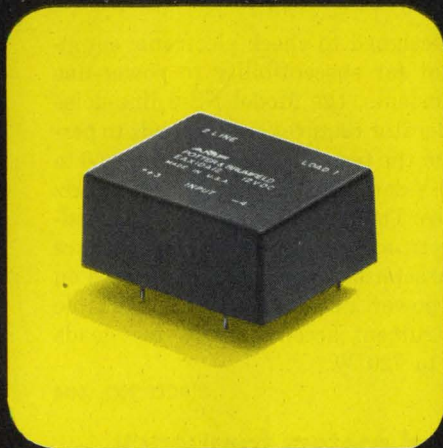

New EAX Series. Solid-state 1.2 ampere AC relay. Transformer coupled. Zero current turn-off.

Low cost, solid-state relays that can be driven directly by logic circuitry (TTL, MOS, HTL, and others). For switching solenoids, fractional hp motors, heating elements, contactors and small lamp loads.

Thyristor switch controlled and isolated by a pulse transformer circuit. Terminals for printed circuit board mounting (0.1" grid).

Expected life of over 100 million operations. Temp. range: storage, -40°C to $+85^{\circ}\text{C}$. Operating ambient, -10°C to $+55^{\circ}\text{C}$.

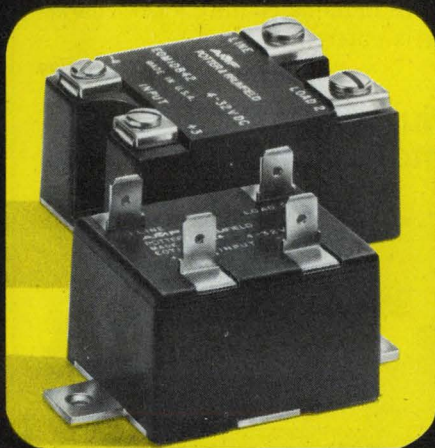

EOM/EOT Series. 0.1 to 20 amperes. All solid-state opto-coupled AC relays.

Medium power, 120/240 VAC 50/60 Hz switches. Controlled and isolated by opto-electronic coupler. For use as ON/OFF switch for loads through 20 amperes. EMI and RFI are greatly reduced due to zero voltage turn-on and zero current turn-off.

An ideal component for interfacing between the logic output of TTL, HTL, or MOS circuitry and such AC loads as solenoids, motors, lamps and transformers.

Expected life greater than 100 million operations. Temp. range: storage, -40°C to $+85^{\circ}\text{C}$. Operating ambient, -10°C to $+55^{\circ}\text{C}$.

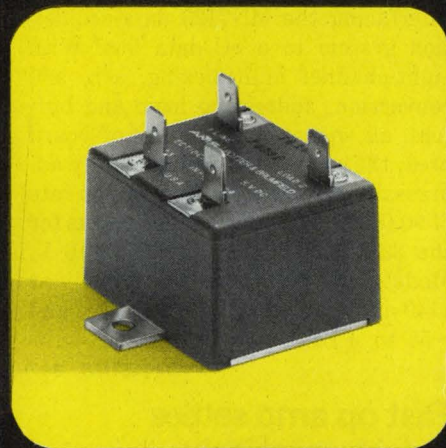

ECT Series. Solid-state Hybrid relay. Reed triggered triac. 0.1 to 32 amperes.

Medium power, 120/240 VAC 50/60Hz solid-state switches controlled and isolated by a reed relay, packaged for direct chassis mounting. Intended for switching AC loads such as solenoids, motors, lamps and transformers through 32 amperes. AC and DC actuation available.

Advantages: long life, high inrush switching capacity and input/output isolation provided by the reed relay.

Expected life greater than 10 million operations. Operating ambient, -10°C to $+55^{\circ}\text{C}$.

Standard models have .250" quick-connect terminals. .187" and .205" also available.

Ideal applications for P&B solid-state relays include process controls, instrumentation, life support equipment, alarm devices, machine tools, vending machines, dryers, photocopiers, lighting and traffic controls.

See your P&B representative or authorized P&B distributor for specifications on his 103 off-the-shelf solid-state and hybrid relays. Or, write Potter & Brumfield Division AMF Incorporated, 200 Richland Creek Drive, Princeton, Indiana 47671. 812/386-1000.

AMF
Potter & Brumfield

Potter & Brumfield

MODULES & SUBASSEMBLIES

8-input data-acquisition DIP plugs into μ C bus

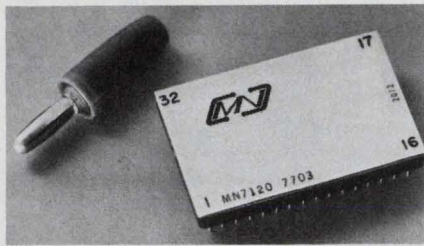

Micro Networks, 324 Clark St., Worcester, MA 01606. J. Munn (617) 852-5400. See text; stock to 4 wks.

Three-state, eight-bit outputs ease interfacing the MN7120 data-acquisition system to a μ C data bus. With eight-channel multiplexing, s/h, a/d conversion, addressing logic and buffers, all squeezed into 2 in.² of board area, the sequentially or randomly addressable unit boasts a conversion rate of 90,000 channels/s. Analog inputs for the 32-pin DIP can range to ± 10 V. Models, 100-qty priced respectively at \$140 and \$280, span both 0 to 70-C and -55 to +125-C ranges.

CIRCLE NO. 397

Fast op amp settles quickly, precisely

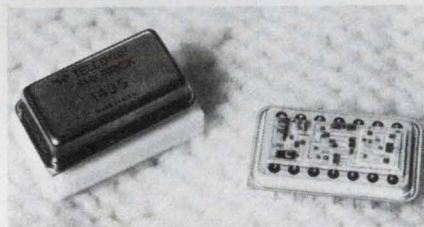

Teledyne Philbrick, Allied Dr. at Rte. 128, Dedham, MA 02026. F. Goodenough (617) 329-1600. From \$127; stock.

Precise amplification of fast pulses and high frequencies is what the 1453 op amp is all about. Typical gain-bandwidth product of 1000 MHz plus settling time to 0.025% (for a 10-V step) of 60 ns or to 1% (for a 1-V step) of 10 ns let you use conventional op amp designs for pulses with 100-MHz components. Unlike feed-forward op amps this device can be differentially or follower connected. It also has no ringing or thermal tail. Features include typical offset of 2 and max of 5 mV, offset tempco of $5 \mu\text{V}/^\circ\text{C}$ and, CMRR at 1 MHz of 70 dB and operation from -55 to +125 C (with a heat sink). The op amp is processed to MIL-STD-883. The 1435-83, a high-rel version, costs \$169.

CIRCLE NO. 398

Smart LED display mates like a RAM

Litromix, 19000 Homestead Rd., Cupertino, CA 95014. D. Tetschlag (408) 257-7910. \$22 (1000 qty); stock.

Built-in ASCII decoder, multiplexer, memory and LED drivers let the fully buffered DL-1416 interface with μ Cs or logic as would a RAM. The display produces all 64 ASCII characters, is actuated by TTL levels and requires only a ± 5 -V supply. One module displays four 0.16-in. characters. The 1×1.2 in. modules can be butted end-to-end. Each character is accessed independently and asynchronously, and remains illuminated until a new character is entered.

CIRCLE NO. 399

Plug your Intel μ C into the analog world

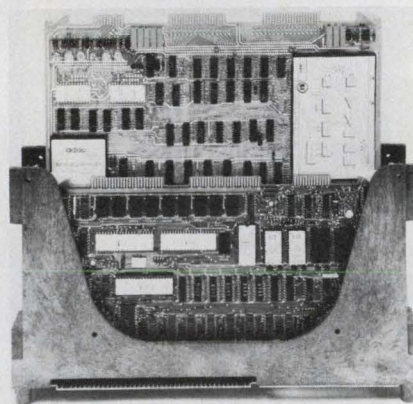

Adac, 15 Cummings Park, Woburn, MA 01801. (617) 935-6668. \$495 (1-9 qty); stock to 4 wks.

Data-acquisition systems of the 735 series are mounted on a PC board that plugs directly into the same card cage as Intel's SBC-80/10 and SBC-80/20 single-board computers and MDS-800 μ C development system. The module's bus interface includes a software choice of program control or program interrupt and a jumper choice of memory-mapped I/O or isolated I/O. The basic system consists of: 16 single-ended or 8 differential analog input channels; a 12-bit, high-speed a/d converter; a sample and hold circuit; and the bus interface. The throughput rate is 35 kHz. On the same card, as options, you can have: 64 single-ended or 32 differential inputs; up to two, 12-bit d/a converters; a software-programmable amplifier with an auto-zero circuit; scope control and third-wire sensing.

CIRCLE NO. 403

Make line noise tests in seconds

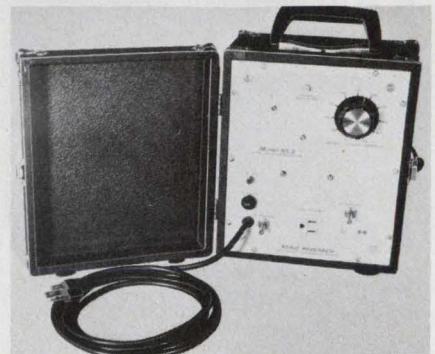

Beall Research, Box 183, Glendale, CA 91209. (213) 243-9954. \$395; stock to 3 wks.

Designed to check electronic equipment for susceptibility to power-line transients, the Model NS-2 line-noise generator requires only seconds to perform the test. The unit generates 50 to 800-V damped sinusoidal pulses at kHz rates. The unit's arc-generated, broad-spectrum, transient waveforms are characteristic of those encountered on ac power lines. The 10.5-lb portable instrument accommodates test loads up to 720 W.

CIRCLE NO. 404

Card meters frequency for mating micros

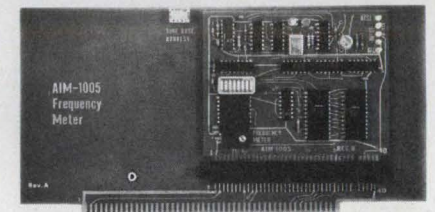

Automated Industrial Measurements, P.O. Box 125, Wayland, MA 01778. B. Hilton (617) 653-8602. \$178 (1-9 qty); stock.

An f/d converter, AIM 1005, on a 4×4.5 -in. board, interfaces with the S-100 bus of 8-bit μ Cs. It has 13 bits of resolution plus overrange, and 11 time-base ranges, from 10 μ s to 1 h. The frequency metering device is accessed by the μ C as one of 14 switch-selectable memory locations. Frequency measurement is accurate to within ± 1 count from 0 to 70 C for dc to 25 MHz. External reset and status flags in the first data byte inform the μ C that a real-time measurement is in progress. For \$30 extra the unit comes mounted as a daughter board on larger Altair or IMSAI μ C cards. The standard unit fits any 4.5-in. card-cage such as the Zilog Z80 or the Pro-Log systems.

CIRCLE NO. 405

NEW FROM INDUSTRIAL TIMER



SERIES 2400
Digital Clocks
12, 24 or 100 hours



SERIES 2320
Industrial Counters
Unidirectional 3-6 digit



SERIES 2500
Comparators
Parallel BCD tracking



SERIES 2600
Stopwatches
Microseconds to minutes



SERIES 3500
D.C. Voltmeters
5999 count full-scale

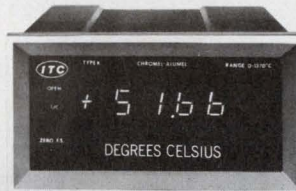

SERIES 9500
Thermometers
Thermocouple indicators

DIGITAL PANEL INSTRUMENTS

Designed and built to highest laboratory standards for Testing Procedures and Systems.

Our new line of Digital Panel Instruments consists of: Clocks, Counters, Comparators, Stopwatches, Voltmeters and Thermometers. Their solid state design and construction reflect the ultimate in engineering sophistication and physical excellence.

For testing procedures and systems they supply the utmost reliability and accuracy attainable with large LED displays, rugged compact size, binary code decimal (BCD) outputs, remote control option and solid aluminum enclosures.

Now you can buy them all from one source. Let us send you our 1977 catalog. For special information call us at 201-887-2200. Ask for Tom ReCasino and your nearest Digital Instrument Rep.



INDUSTRIAL TIMER

AN ESTERLINE COMPANY

Industrial Timer Corporation, U.S. Highway 287, Parsippany, N.J. 07054

CIRCLE NUMBER 101

ELECTRONIC DESIGN 13, June 21, 1977



Three ways to get a good CRT yoke



Call
Syntronic
(312) 543-6444



Write
Syntronic

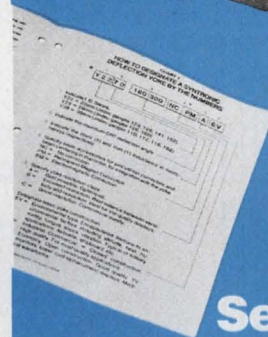

Use
our Yoke
Selection Guide

It shows a simplified way to specify the best yoke for your CRT display. Our engineers have developed a unique concept—the yoke energy constant—as a way to estimate yoke inductance and current. From there, it's an easy step to specify a yoke "by the numbers". Try it. Call or write for your copy.* See for yourself how Syntronic's years of experience can add up to getting a better yoke for your display.



syntronic

Syntronic Instruments, Inc.
100 Industrial Road, Addison, IL 60101
(312) 543-6444

*Or see Pages 405 to 408 in EEM

CIRCLE NUMBER 102

GOOD BOOKS ARE HARD TO FIND.



WHY HIDE YOURS?

We are always looking for well-written manuscripts, or book proposals, for works on topics of interest to professional engineers that will advance their understanding of the state of their art.

What have you been working on?

What can we do for each other?

Let me know.

S. WILLIAM COOK
EDITORIAL DIRECTOR



Hayden Book Co., Inc.
50 ESSEX STREET
ROCHELLE PARK, N.J. 07662

POWER SOURCES

Save your IEEE bus slots for instruments

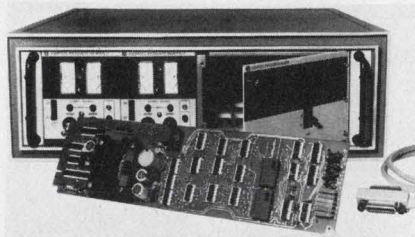

Kepeco, 131-38 Sanford Ave., Flushing, NY 11352. (212) 461-7000. See text; stock to 30 days.

Rather than fill up all the slots in your system's IEEE 488 bus with programmable power supplies, handle them with the SNR-488 internal power-supply-bus system. The -4 model, costing \$490, addresses four program cards while the -8 model, costing \$690, addresses eight. Each card, costing \$690, programs one power supply's V and I. An interface implements the three-wire handshakes and the control protocols required by the 488 bus. The interface also performs an eight-line ASCII-to-hexadecimal conversion. The bus can also be programmed by an optional keyboard, SN 488-K.

CIRCLE NO. 406

12-V inputs come to 50-W dc/dc converters



Etatech, Inc., 187-M West Orange-thorpe, Placentia, CA 92670. J. Grant (714) 996-0981. From \$195; 30 days.

In addition to models using 28 and 48-V inputs, the B-Series of 50-W dc/dc converters includes units that operate with 10 to 14-V (12-V nominal) inputs. Efficiency for these 12-volters ranges from 60 to 65%, ripple and noise is 0.4% or 100-mV pk-pk, line regulation is $\pm 0.05\%$ or 10 mV, regulation for 10 to 100% of full load is 0.1% or 10 mV. Standard 5-V at 10-A to 48-V at 1-A outputs carry overload and overvoltage protection. Input overvoltage protection is a standard feature.

CIRCLE NO. 407

Three- Φ breakers have adjustable delay

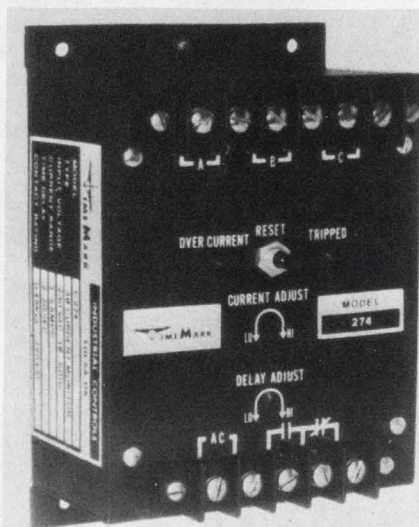

Time Mark, P.O. Box 15127, Tulsa, OK 74112. L. R. Fawcett (918) 939-5811. \$77.02 to \$97.50; stock to 2 wks.

The Model 274 monitors each leg of a three-phase line or three separate single-phase lines. An overcurrent condition trips the output relay and disconnects the load. Nuisance tripping is prevented by an adjustable time delay of 0.2 to 20 s. Two ranges, 1 to 5 A and 2 to 10 A, are standard. Matching current transformers increase the operating range up to 1000 A. Frequency range is 50 to 400 Hz. Offered in manual or automatic-reset types, the units contain indicator lights.

CIRCLE NO. 408

Wide UPS line powers circuit-level loads

Semiconductor Circuits, 306 River St., Haverhill, MA 01830. F. Frontiero (617) 373-9104. \$148-\$205 (10 qty.); stock to 2 wks.

You can choose from 36 models of UPS-Series uninterruptible four-output supplies. One output float-charges either a 12 or a 24-V backup battery; dual outputs of either ± 12 or ± 15 -V-dc supply 100, 200 or 300 mA; a ± 5 -V-dc logic output pumps out 1, 2 or 3 A. The $\pm 1\%$, 12 and 15-V outputs are regulated to 0.05% for line and load and keep ripple and noise down to 1 mV rms. The 5-V-dc output is regulated to 0.2% and 0.5% for line and load respectively and the ripple and noise are 7 mV. All outputs are short-circuit protected. The supplies operate from 105 to 125-V-ac inputs at 50 to 440 Hz without derating from -25 to $+71$ C.

CIRCLE NO. 409

Industrial revelation.

If you're buying Industrial Grade Can Capacitors from a number of different sources we have some good news for you. Nichicon has a complete line of High-and Low-Voltage Industrial Grade Aluminum Electrolytics that offer outstanding accuracy and hard-working durability. We have the right unit for all your design and specification needs with quality you can depend on.



Free Catalog.

To receive complete catalog information and engineering samples, write to us on your company letterhead.



The pulse of the industry.

nichicon

NICHICON (AMERICA) CORPORATION
6435 N. Proesel Ave. • Chicago, IL 60645 • (312) 679-6530
Division of NICHICON CAPACITOR LTD., Kyoto, Japan

CIRCLE NUMBER 104

ALCOSWITCH®

HIGHEST QUALITY
MINIATURE TOGGLES

Our premium Green Series inherently contain many quality features — all included at no extra cost.

During the past 16 years we've listened to customers. The result is a product that is indisputably the #1 miniature switch line in the industry.

Of importance, our terminals have bonded fine silver contacts which are gold flashed to retard oxidation and facilitate soldering, furthermore, the terminals are Molded-In SE-0 diallyl phthalate cases.

We urge you to call Customer Service at (617) 685-4371. Our sales people would like to tell you why ALCOSWITCH is your best buy.

P.S. Don't forget to ask for our new 76-page catalog and free samples, too!



ALCO ELECTRONIC PRODUCTS, INC.
1551 OSGOOD STREET, NORTH ANDOVER, MA 01845 U.S.A.

Tel: (617) 685-4371

TWX: 711 342-0552

A SUBSIDIARY OF

AUGAT INC.

CIRCLE NUMBER 105

ELECTRONIC DESIGN 13, June 21, 1977

ECL* Packaging Panels

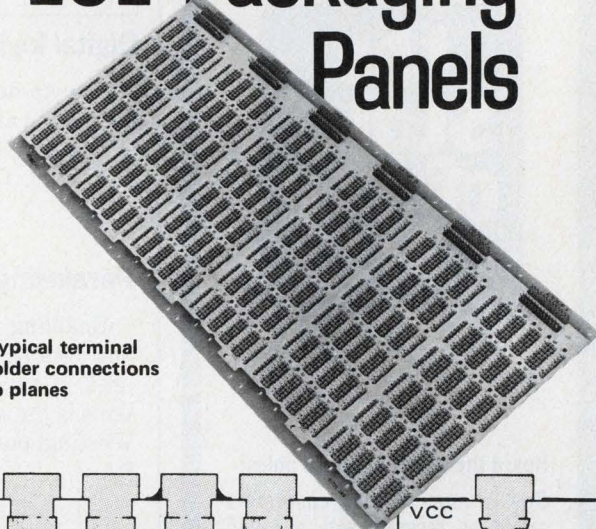

Typical terminal solder connections to planes

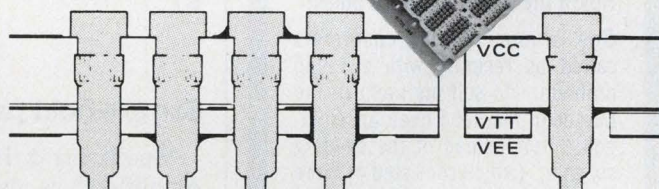

EMC's co-axial plated - thru and non - plated - thru hole design.

Competitor's solder Joint - in - the - hole. Potential flux contamination.

*Eliminate Contaminated Layers

Packaging panels for ECL do work!

Typical of EMC . . . a clever, unique solution to an annoying problem. Soldering terminals to the top (VCC) and bottom (VEE) voltage planes is easy, but reaching the middle (VTT plane) requires an enlarged hole through the bottom plane. Result? The inconvenience of working in a confined recessed hole, contamination caused by flux entrapment, and the difficulty of inspection.

EMC solves the problem by selective plating thru of the holes needed to reach the middle plane, so that the soldering job is on the surface . . . simple, clean, easy to check. And it's ideal for installing decoupling capacitors, too. EMC's design also provides maximum metal plane coverage, and of course, uses the patented Nurl-loc terminal. Interested? Contact Electronic Molding Corp., 96 Mill Street, Woonsocket, R. I. 02895. (401) 769-3800.

EMC®
Interconnection Specialists

CIRCLE NUMBER 106

MONOLITHIC
CRYSTAL FILTERS

the
state
of the
Art

Heard the one about the 8 poles?

One of our regular customers called us recently with a tough problem. "To sell my radio in the European market I need an eight-pole filter instead of the existing six-pole," (which consisted of three two-pole monolithics mounted on his P.C. board). "And oh, yes! We don't want to make any changes to our board."

Further requirements included a change in bandwidth and a low cost objective. What to do? Fortunately we were able to help (or we wouldn't be writing this). By switching from board-mounted filter components to a P.C. filter assembly which plugs into the same space we came up with an economical eight-pole answer — and in jig time. Result: An improved product and a satisfied customer. We're happy too, with a substantial production order.

This is just one of many cases where by working closely with a customer we apply our knowledge of monolithic filters to the improvement of his products. May we help you? Drop us a line and we promise no more pole-ish jokes.

Pi

Piezo Technology Inc.

2525 Shader Road, Orlando, FL 32804
(305) 298-2000

The standard in
monolithic crystal filters.

CIRCLE NUMBER 107

Application notes

Digital logic circuits

How to design digital logic circuits for testing and fault isolation is shown in a 12-page booklet. Hewlett-Packard, Palo Alto, CA

CIRCLE NO. 410

Paralleling semiconductors

Enabling designers to determine how many semiconductors must be used in parallel for high-current systems is the aim of a seven-page article. Westinghouse Electric, Youngwood, PA

CIRCLE NO. 411

Sample-hold parameters

"Specifying & Testing Sample-Hold Amplifiers" is designed to improve user understanding of parameter definitions and measurement techniques. Teledyne Philbrick, Dedham, MA

CIRCLE NO. 412

Project planning

"Developing Project Plans" explains the EZPERT alternative to the tedious, error-prone process of manually drafting a project-network diagram to show planned-work sequence and dependencies among activities. Systonetics, Anaheim, CA

CIRCLE NO. 413

Resistor networks

The advantages of precision film-resistor networks as replacements for discrete resistors (specifically RN50, RN55 and 1% resistors) in op-amp circuits is explained in a six-page application note. Beckman Instruments, Helipot Div., Fullerton, CA

CIRCLE NO. 414

8-bit a/d conversion

"Software-Controlled Analog-to-Digital Conversion using the DAC-08 and the 8080A Microprocessor" describes a simple, low-cost method of software-controlled, 8-bit, a/d conversion that eliminates the need for peripheral isolation devices. Precision Monolithics, Santa Clara, CA

CIRCLE NO. 415

Bulletin board

American Microsystems has reduced prices 30 to 35% on its family of S6800 microprocessor parts.

CIRCLE NO. 416

The Solid-State Operation of TRW Capacitors offers a customized testing service tailored to specific transient-voltage-suppressor (TVP) stress conditions.

CIRCLE NO. 417

National Semiconductor has lowered bipolar-FET op amp prices from 25% to 70%.

CIRCLE NO. 418

Data General has added a DOS (diskette-based Disc Operating System) Basic programming language on its microNOVA family of microprocessor-based computers.

CIRCLE NO. 419

Solid State Scientific is an alternate source for the RCA CDP1800 COS-MAC microprocessor family.

CIRCLE NO. 420

Hewlett-Packard has reduced prices on its family of DISComputers. The HP 2124B, with a 16-kbyte 2108 computer and 4.9-Mbyte 7900 disc, is reduced from \$17,250 to \$15,500; the HP 2125A, with a 16-kbyte 2108 computer and a 14.7-Mbyte 7905 disc, from \$22,500 to \$20,000; and the HP 2126A, with a 32-kbyte E-Series 2113A computer and a 14.7-Mbyte 7905 disc, from \$24,000 to \$22,400.

CIRCLE NO. 421

Precision Monolithics has announced a new grade DAC-01D 6-bit d/a converter. The DAC-01D is specified from 0 to 70 C. Maximum nonlinearity, over the temperature range, is $\pm 0.78\%$ of full scale, and full-scale tempo is ± 160 ppm/ $^{\circ}$ C.

CIRCLE NO. 422

Computer Devices nonimpact Q-3 printer is available in APL for OEM applications. The Q-3 APL is priced less than \$890 in OEM quantities of 25 units or more.

CIRCLE NO. 423

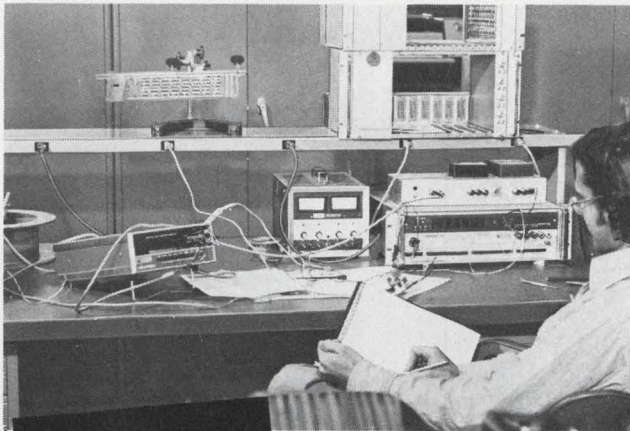

THE QUIET BUNCH

Specify Plugmold® multioutlet strips with noise reducing insulated/isolated grounding receptacles for your lab or test bench and eliminate problems with electromagnetic noise and spurious signals.

Easy to install, easy to use. Available in various lengths and receptacle centers.

For free information contact



THE WIREMOLD COMPANY
West Hartford, Connecticut 06110

CIRCLE NUMBER 108

WHO MAKES WHAT & WHERE TO FIND IT

Volume 1 of **Electronic Design's** GOLD BOOK tells all. And, when you look up an item in its PRODUCT DIRECTORY you'll find each manufacturer listed COMPLETE WITH STREET ADDRESS, CITY, STATE, ZIP AND PHONE. Save time. There's no need to refer elsewhere to find missing information.

IT'S ALL THERE
in
**Electronic Design
GOLD BOOK**

ELECTRONIC DESIGN 13, June 21, 1977

19¢^{*} ea.

An integrated
bridge rectifier in a
miniature
dual in-line package

D I B

DUAL IN-LINE BRIDGE

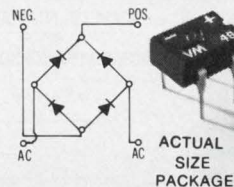

- 4-pin, low-profile DIP
- Leads on standard .10" (2,54 mm) grid
- Compatible with automatic testing, handling and inserting
- 1 Amp at 40°C (I_o)
- 25V to 1000V (V_{RRM})
- 25A Peak One-Half Cycle Surge (I_{FSM})
- Two devices will fit into standard 14-pin DIP socket
- Moisture resistant epoxy package
- Call Lee Miller 214/272-4551, Ext. 206 for more information.

* 100V; 100,000 qty.



Design us in . . . we'll stay there
VARO SEMICONDUCTOR, INC.

P.O. BOX 676, 1000 N. SHILOH, GARLAND, TEX. 75040
(214) 272-4551 TWX 910-860-5178

EUROPEAN OFFICE: UK: VARO SEMICONDUCTOR INTERNATIONAL, INC.
Deepdene House, Bellegrave Road, Welling, Kent, England DA163PY, 01-304-6519/0

CIRCLE NUMBER 109

BUCKEYE

Buckeye knobs are in all types and sizes to enhance your instrumentation. Skirts and special markings are Buckeye specialties. Our catalog and samples of specific items will be sent upon request.

BEAUTY and the BEST!



the BUCKEYE stamping co.
555 Marion Rd., Columbus OH 43207
Phone 614/445-8433

CIRCLE NUMBER 111

The connector.

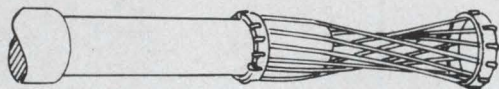

- Hypertac.** Much Lower Contact Resistance Much Lower Insertion-Extraction Forces Greater Reliability Higher Current Ratings Less Wear and Much Longer Life Greater Integrity Under Shock & Vibration Higher Uniformity

Hypertac's patented design assures performance surpassed only by hard wiring. Wires strung at an angle to the socket's axis form a hyperboloid sleeve that wraps the pin providing numerous linear contact paths. This complete encirclement of the pin provides the ultimate in connector performance. Standard designs include P.C. connectors up to 160 contacts, unique modular connectors for customized configurations up to 204 contacts, plastic circular connectors up to 6 contacts, plus many others.

Call or write for complete information and free brochure.

"New Horizons in Connectors"



HYPERTRONICS CORPORATION

154 Great Road, Stow, Massachusetts 01775
Tel. (617) 897-3236 Telex: 94-8338

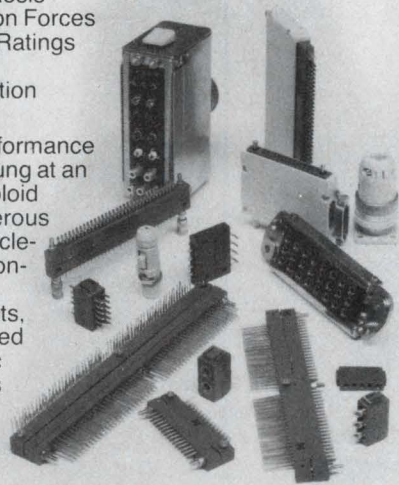

CIRCLE NUMBER 112

New literature

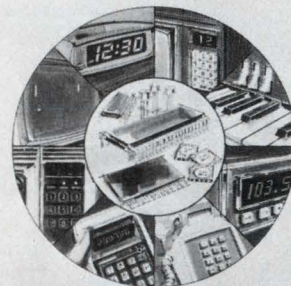

1977 PRODUCT GUIDE
MICRO
ELECTRONICS
ORIGINAL INSTRUMENT CORPORATION MICROELECTRONICS

Microcircuits

Over 250 MOS/LSI, I²L, hybrid and MOSFET microcircuits are listed in a 12-page guide. General Instrument, Microelectronics, Hicksville, NY

CIRCLE NO. 424

Electronic weighing

A 40-page guide describes equipment and systems for electronic weighing and batching. Philips, Eindhoven, the Netherlands

CIRCLE NO. 425

Small computers

Computers, computer systems, peripheral equipment and software are illustrated in a 22-page catalog. Processor Technology, Emeryville, CA

CIRCLE NO. 426

SC/MP

"SC/MP (PACE) PROM Programmer Users Manual Pub #420305 306-001A" looks interesting. National Semiconductor, Santa Clara, CA

CIRCLE NO. 427

Readout displays

Incandescent, neon and LED readout displays are described in a 54-page catalog. The catalog provides selection information including dimensional drawings, circuit and connection diagrams and tables and curves of operating specifications and characteristics. Dialight, Brooklyn, NY

CIRCLE NO. 428

Circuit protection devices

Technical and ordering information on circuit protection devices, relays, switches, buzzers and flashers are contained in a 60-page catalog. Littelfuse, Des Plaines, IL

CIRCLE NO. 429

Mass-terminated connectors

Performance data, assembly procedure, mechanical and electrical features of cable connectors and headers plus specifications for ribbon cables (both flat and twisted pair) are included in a 12-page catalog. ITT Cannon Electric, Santa Ana, CA

CIRCLE NO. 430

Solvent cleaners

"Evaluation and Selection of Solvent Cleaners for Rosin-Flux Removal" describes cold cleaning and vapor cleaning, solvency for ionic and nonionic soils, solvent-polymer compatibility, importance of azeotropes, solvent-vapor condensation time, and evaporation losses. Alpha Metals, Jersey City, NJ

CIRCLE NO. 431

Control systems

Articles and applications notes on electronic devices for measurement and control instrumentation and μ P-based control systems are features in a 20-page publication. Analog Devices, Norwood, MA

CIRCLE NO. 432

Electron tubes, semis

A 66-page catalog describes electron tube and semiconductors. Quantity prices are included. Alpha Electronics, Brooklyn, NY

CIRCLE NO. 433

Enclosures

Features and options for Unilock enclosures for hazardous locations are explained in a four-page brochure. Allen-Bradley, Milwaukee, WI

CIRCLE NO. 434

Headers

Specifications and options for male and female, single and double-row headers are given in a brochure. A P Products, Painesville, OH

CIRCLE NO. 435

CLAIREX OPTO-ISOLATORS

5 darlington, 10 transistor, 4 with a-c input

- For logic functions
 - 2500V PAC isolation
 - Characterized CTRs @ 1 ma and/or 10 ma
 - A-C input units utilize 2 IREDS in inverse parallel
- Call (914) 664-6602

The image shows several overlapping product data sheets for Clairex Darlington Opto-Isolators. The sheets are yellow and white, with technical specifications and diagrams. The top sheet is for CLI-10, CLI-11, CLI-12, CLI-13, and CLI-14. It includes a table of electrical characteristics and a diagram of the device.

Model	Min. CTR	Max. CTR	Min. I _{sat}	Max. I _{sat}	Min. I _{off}	Max. I _{off}
CLI-2	1.0	1.5	100	1000	1.0	1.0
CLI-3	1.0	1.5	100	1000	1.0	1.0
CLI-7	1.0	1.5	100	1000	1.0	1.0
CLI-8	1.0	1.5	100	1000	1.0	1.0
CLI-9	1.0	1.5	100	1000	1.0	1.0
CLI-10	1.0	1.5	100	1000	1.0	1.0
CLI-11	1.0	1.5	100	1000	1.0	1.0
CLI-12	1.0	1.5	100	1000	1.0	1.0
CLI-13	1.0	1.5	100	1000	1.0	1.0
CLI-14	1.0	1.5	100	1000	1.0	1.0

CLAIREX ELECTRONICS

A Division of Clairex Corporation

CIRCLE NUMBER 113

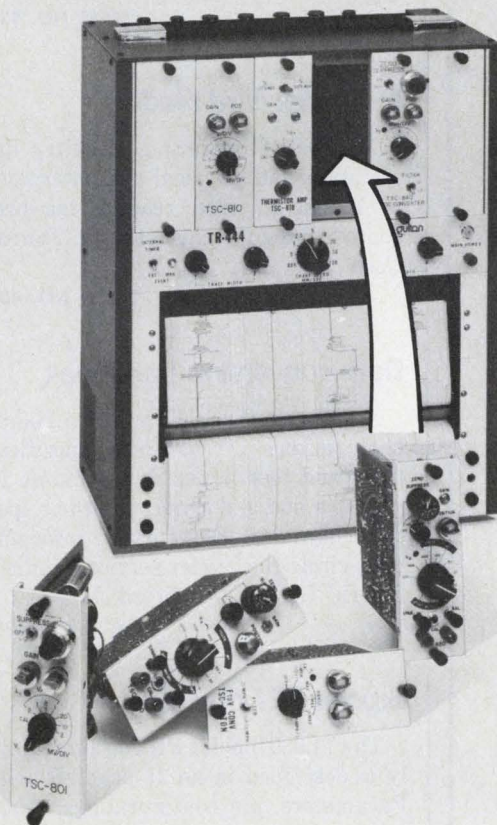

GULTON'S "fast change" artist

Lets you change or replace signal conditioners in seconds. Use your Gulton portable recorder to chart volts, amps, temperature, EKG, strain, ac to dc, log to dc and more . . . simply by plugging in appropriate signal conditioners.

Should any signal conditioner require testing or service, just slide it out and slide in a spare. It's as easy as it sounds.

Gulton portable recorders with plug-ins are available in 2, 4, 6 and 8 channel models. Write or call for 12 page portables catalog.

gulton[®]

Measurement & Control Systems Division
Gulton Industries Inc., East Greenwich, Rhode Island 02818
401-884-6800 • TWX 710-387-1500

CIRCLE NUMBER 114

Cost Effective Data Scanning

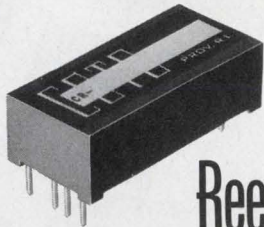

Reed Relays

**NEW GENERATION
LOW-COST, ULTRA
LOW-THERMAL EMF**

- New simpler design reduces cost, maintains performance and reliability
- Switches signals to 1 μ V resolution
- Low, stable contact resistance
- High control/signal circuit isolation
- Graded and priced to the thermal offset you need . . . pay no more.

Write or Call for Bulletin 10.4



**COTO-COIL
COMPANY, INC.**
59 Pavilion Ave.
Providence, R. I. 02905
Tel: (401) 467-4777

CIRCLE NUMBER 116

KEEP

Electronic Design's

GOLD BOOK HANDY

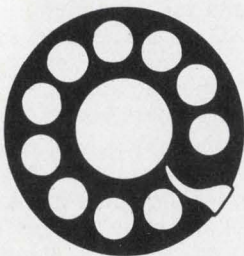

When You Call

Save time when you contact suppliers. Check their catalog pages first in *Electronic Design's GOLD BOOK*. Maybe the information you need is right at your fingertips.

NEW LITERATURE

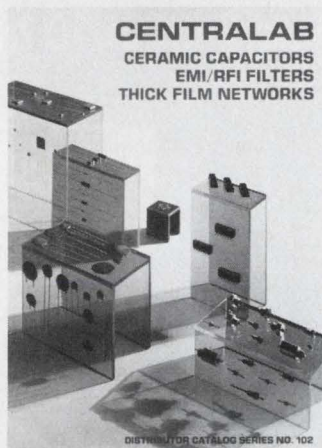

Capacitors

A 40-page catalog describes standard ceramic capacitors, EMI/RFI filters and thick-film networks. Detailed electrical and test specifications, dimensional drawings, product performance data and installation instructions are included. Centralab, Milwaukee, WI

CIRCLE NO. 436

Minicomputers

Features and qualities of the PDP-11/70 minicomputer are described in a 15-page brochure. Digital Equipment, Northboro, MA

CIRCLE NO. 437

Industrial card readers

Method of operation, circuitry description and physical characteristics of industrial card readers are presented in a four-page catalog. Taurus Corp., Lambertville, NJ

CIRCLE NO. 438

Data-conversion handbook

A 175-page Data Conversion Handbook defines the qualities, specifications and techniques that combine to give d/a and a/d converters their special character. For further information, circle the reader service number. Hybrid Systems, Bedford, MA

CIRCLE NO. 439

Bipolar FET op amps

The TL080 bipolar FET op amp family is described in an 18-page booklet. Parameters, pin configurations, schematics and typical characteristics are given. Texas Instruments, Dallas, TX

CIRCLE NO. 440

MOS/LSI circuits

A 16-page catalog covers MOS/LSI circuits. The catalog contains a complete cross-reference table including second sources for the company's products. Standard Microsystems, Hauppauge, NY

CIRCLE NO. 441

Multiple-output switches

Dual, triple and four-output switchers in the 100-to-475-W range are covered in a four-page brochure. Trio Labs, Plainview, NY

CIRCLE NO. 442

Process instrumentation

Process control and analysis, air and water quality, vehicle analysis, automotive test and occupational safety instrumentation are illustrated in a 16-page catalog. Beckman Instruments, Fullerton, CA

CIRCLE NO. 443

Electronic packaging

Electronic packaging, including modular card frames, breadboards and accessories, plastic boxes, wire and enclosures are covered in a 16-page brochure. Vero Electronics, Hauppauge, NY

CIRCLE NO. 444

Indicating controllers

Standard and optional features, specifications and ranges of indicating controllers are described in a four-page catalog. Jewel Electrical Instruments, Manchester, NH

CIRCLE NO. 445

Inverter ballasts

Applications and specifications of the Tran-Bal inverter ballast are described in an eight-page brochure. The Bodine Co., Collierville, TN

CIRCLE NO. 446

Oscillographic recorders

Specifications on 2, 4, 6 and 8-channel portable oscillographic recorders with plug-in signal conditioners and 1 and 2-channel fixed-range portable recorders are provided in a 16-page catalog. Gulston Industries, East Greenwich, RI

CIRCLE NO. 447

RELEASE HINGES



Over
7,500
Combinations
Available

KWIK Release Hinges From Our Newly Formed BURKLYN HINGE DIVISION

H Hinge Specialists Since 1939
THE HARTWELL CORPORATION
900 South Richfield Road, Placentia, California 92670
Phone: (714) 993-4207

Branch Offices and Warehouses: Hackensack, N.J. (201) 342-2964
Fort Worth, Tex. (817) 535-0824 • Chicago, Ill. (312) 253-7820

CIRCLE NUMBER 117

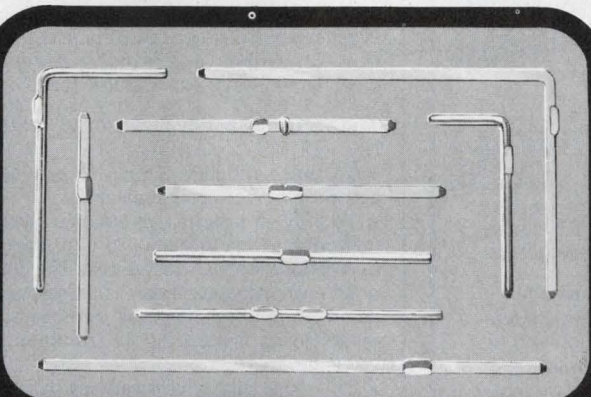

FLAT CABLE CONNECTORS

Auto-Swage low cost, precision fit square connector pins provide smooth mating in female connectors without scoring, scaling or shiving. Connector lead-in angles in both flat and diagonal planes can be uniformly blended together. Round pins and connectors with wrap tips or mating tips are available. High speed production with in-house gold plating is our specialty. Write for free samples, or, send drawings and prototypes for a fast accurate quotation.



auto-swage
PRODUCTS, INC.

726 River Road, Shelton, CT 06484 Tel. (203) 929-1401

CIRCLE NUMBER 118

ELECTRONIC DESIGN 13, June 21, 1977

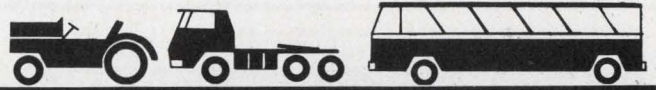

LOW COST MAGNETIC SENSORS

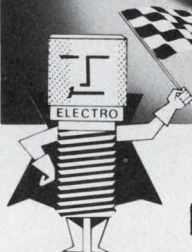
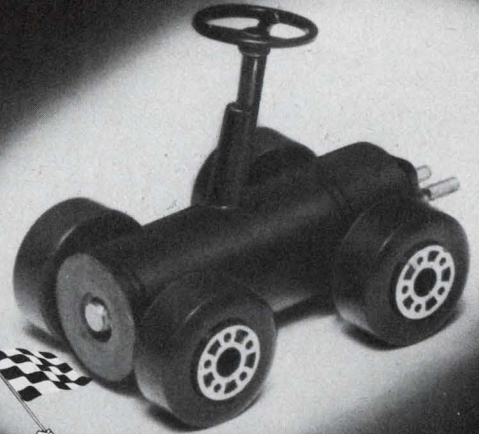

Total Automotive Design Capability!

Electro Corporation has designed more magnetic sensors (transducers) for automotive-type applications than any other manufacturer.

Many of Electro's designs have been selected for use in typical applications listed below:

- Wheel-speed sensing for truck anti-skid control systems
- Piston TDC position sensing
- Ignition timing diagnostic equipment for diesel and gas engines
- Diesel and gas engine RPM monitoring systems
- Automatic and semi-automatic transmission speed synchronization.

Electro's magnetic sensors provide many advantages including: low cost; non-contact sensing of any ferrous metal object; trouble-free operation under all conditions such as dust, dirt, oil and other adverse environments; -65°F to $+400^{\circ}\text{F}$ operating range.

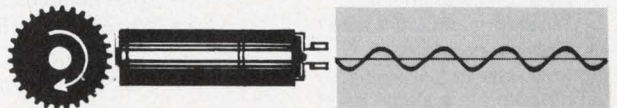

Send us your system input sensing specifications. We will provide you with the most economical solution!



ELECTRO
CORPORATION

1845 57TH STREET

P.O. BOX 3049, SARASOTA, FLORIDA 33578

AREA CODE (813) 355-8411 • TELEX 5-2683

CIRCLE NUMBER 119

ELECTRONIC DESIGN's function is:

- To aid progress in the electronics manufacturing industry by promoting good design.
- To give the electronic design engineer concepts and ideas that make his job easier and more productive.
- To provide a central source of timely electronics information.
- To promote communication among members of the electronics engineering community.

Want a subscription? ELECTRONIC DESIGN is sent free to qualified engineers and engineering managers doing design work, supervising design or setting standards in the United States and Western Europe. For a free subscription, use the application form bound in the magazine. If none is included, write to us direct for an application form.

If you do not qualify, paid subscription rates are as follows: \$30.00 per year (26 issues) U.S./Canada/Mexico, \$40.00 per year (26 issues) all other countries. Single copies are \$2.50 U.S. and all other countries. The Gold Book (27th issue) may be purchased for \$30.00 U.S./Canada/Mexico, and \$40.00 all other countries.

If you change your address, send us an old mailing label and your new address; there is generally a postcard for this in the magazine. You will have to requalify to continue receiving ELECTRONIC DESIGN free.

The accuracy policy of ELECTRONIC DESIGN is:

- To make diligent efforts to ensure the accuracy of editorial matter.
- To publish prompt corrections whenever inaccuracies are brought to our attention. Corrections appear in "Across the Desk."
- To encourage our readers as responsible members of our business community to report to us misleading or fraudulent advertising.
- To refuse any advertisement deemed to be misleading or fraudulent.

Individual article reprints and microfilm copies of complete annual volumes are available. Reprints cost \$6.00 each, prepaid (\$.50 for each additional copy of the same article), no matter how long the article. Microfilmed volumes cost \$23 for 1976 (Vol. 24); \$30 for 1973-75 (Vols. 21-23), varied prices for 1952-72 (Vols. 1-20). Prices may change. For further details and to place orders, contact Customer Services Dept. University Microfilms, 300 N. Zeeb Rd., Ann Arbor, MI 48106. (313) 761-4700.

Want to contact us? If you have any comments or wish to submit a manuscript or article outline, address your correspondence to:

Editor
ELECTRONIC DESIGN
50 Essex St.
Rochelle Park, NJ 07662

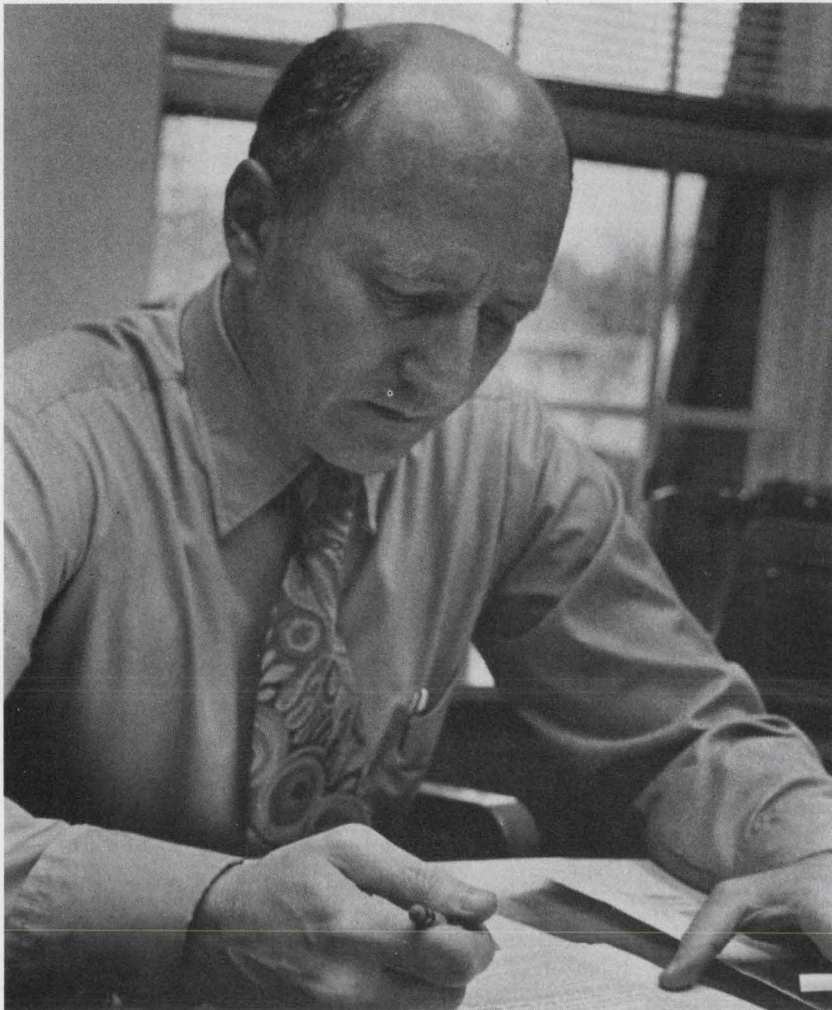

George Rostky, Editor-in-Chief, *Electronic Design*

Electronic Design WANTS YOU

If you have solved a tricky or unusual design problem... if you have experience in a special area that will aid the design process... if you have simplified a circuit or developed a practical design aid *why not share it with your fellow engineers of Electronic Design?*

Each man has his own motivation for writing an article. Here are just a few:

- To help other engineers do their jobs better.
- To help build your company's image.
- To raise your professional status and speed your advancement.
- To increase your own knowledge.

To encourage authors to submit material to us, and to make it easier, we've prepared a special AUTHOR'S GUIDE that's yours for the asking. Contents include:

- Why write?
- Why write for *Electronic Design*?
- Which articles will *Electronic Design* accept?
- How long should it be?
- What form should it take?
- Tips on structure.
- Tips on writing.
- Tips on getting it done.
- 7 Tests you can apply to your article.
- What happens to your article?
- Where to send it.

Why not get started today? Payment can range as high as \$200 for an article contributed in a single issue.



FOR FREE
Electronic Design
AUTHOR'S GUIDE
CIRCLE NUMBER 300

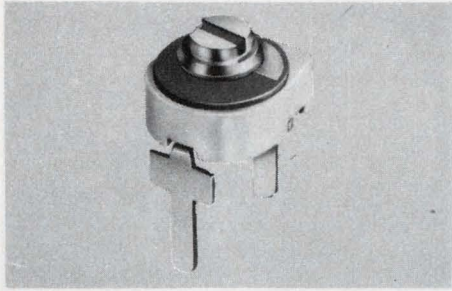

MINIATURE CERAMIC TRIMMER CAPACITORS 9371 series of ceramic trimmer capacitors are compact, economical and rugged. They are 50% smaller than other trimmers of this type yet provide high capacitance values. Available in 4 capacitance ranges, 1.5 to 4, 3.0 to 10, 3.5 to 18 and 5.0 to 25 pf with Q's > 300 at 10 MHz. They have an overall diameter of .225" with .215" above board height. JOHANSON MANUFACTURING CORPORATION, Rockaway Valley Road, Boonton, N.J. 07005 201-334-2676

TRIMMER CAPACITORS

181

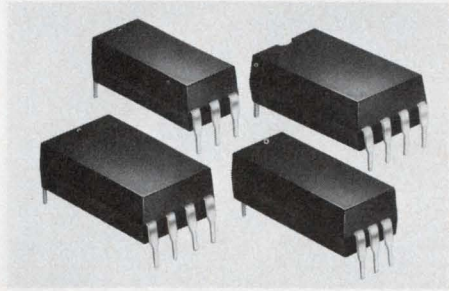

MOLDED-EPOXY MINIATURE REED RELAYS. Meet PCB packaging requirements with three basic series of standard and high-voltage dry reed and mercury-wetted reed versions, including a low-cost dry reed design. Form A, B and C models; 1 and 2-pole options. All are logic-compatible, environment-immune. Mercury-wetted contact models feature fastest no-bounce operation, superior contact resistance, longest life. Request Bulletin RR408: Gordos Corp., 250 Glenwood Ave., Bloomfield, N.J. 07003; (201) 743-6800

MINIATURE REED RELAYS

184

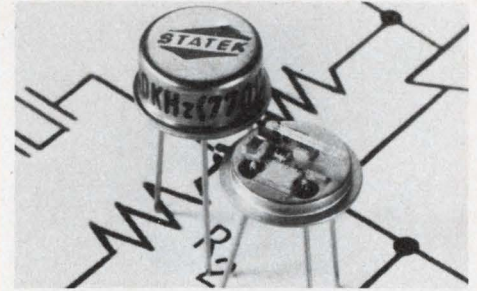

CMOS Crystal Oscillators in Low profile TO-5. Frequency range is 10 kHz to 300 kHz (divided outputs to 1 kHz, low as one cycle per month available). Low milli-amp current consumption. Accuracy $\pm 0.01\%$. Shock 1000 g. Hybrid thick and thin film chip and wire design is rugged and ideally suited for portable equipment. Details in Gold Book & EEM * STATEK CORP * 512 N. Main, Orange, Ca. 92668 * (714) 639-7810 * Telex 67-8394.

CRYSTAL OSCILLATOR

187



DIGITAL DISPLAY ELECTRONIC SWEEP Generator WS8-10D. Three stepless noise-free ramp functions. Eight sweep rates (.5 minutes to 100 minutes std.), two continuously adjustable ranges (0 to $\pm .2V$, 0 to $\pm 2V$), automatic sweep centering. "Hold" feature. Digital readout of output or %, either range. Digital signals for computer analyzer, analog signals for recorder. X-Y recorder drive independent of range setting. Remote or cabinet-mounted. Write Walker Scientific, Inc., Rockdale Street, Worcester, MA 01606.

SWEEP GENERATOR

182

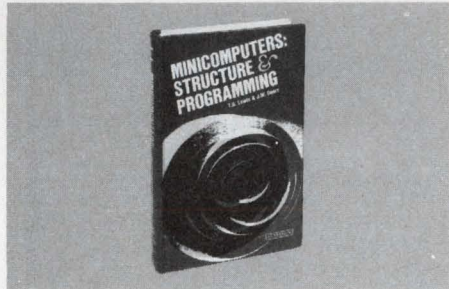

MINICOMPUTERS: Structure and Programming, by T. G. Lewis and J. W. Doerr. An introduction to computer science using small computers, this book thoroughly covers all the essentials needed to understand and use minicomputers: assembly language, machine architecture, and small machine algorithms. #5642-7, 288 pp., \$12.95. Circle the Info Retrieval Number to order your 15-day exam copy. When billed, remit or return book with no obligation. Hayden Book Co., 50 Essex St., Rochelle Park, N.J. 07662.

MINICOMPUTERS TEXT

185

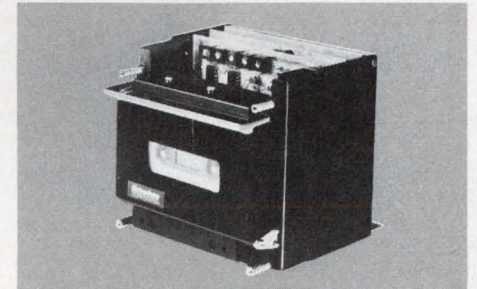

HIGH SPEED RECORDER FOR MICRO-PROCESSORS Model 764 has a patented constant speed tape drive using only 2 moving parts. No capstans, tachometers or clock tracks are necessary. Records up to 32,000 bits per second. Searches at 100 inches per second. Can store up to 5 megabits per 300 foot cassette. ANSI/ECMA compatible. Priced under \$500.00/OEM quantities. MEMODYNE CORPORATION, 385 Elliot Street, Newton Upper Falls, MA 02164. Telephone (617) 527-6600.

MICROPROCESSOR RECORDER

188

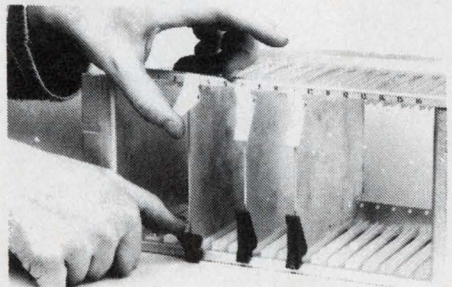

FREE SAMPLES of low-cost Electro-Flex card guides and ejectors. Guides in 3", 4", 6" and 8 1/2" lengths have built-in bow to aid card retention. Ejectors feature longer sure-grip handle for greater strength, improved leverage and damage-free extraction; stainless roll pins included. Both in UL-approved nylon. Card rack and complete metal fabricating literature also available. Electro-Space Fabricators, Topton, Pa. 19562. (215) 682-7181.

CARD GUIDES - EJECTORS

183

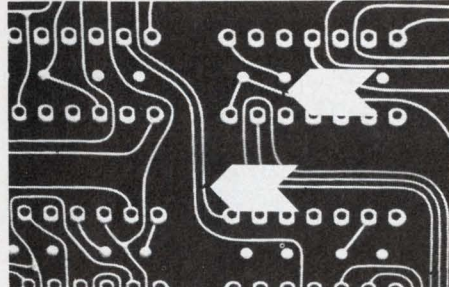

ID/INSPECTION ARROWS Identify problem and action areas at a glance with colorful pressure sensitive arrows. Use for inspection, QC, flagging, repair identification, assembly drawings and instruction. Permanently affix or reposition. Die cut from paper or vinyl tape. Won't fade, dry out, or lift. Standard and fluorescent colors in 1/4", 3/8", and 3/4" lengths. As low as \$2.40/M. Webtek Corporation, 4326 W. Pico Blvd., Los Angeles, CA 90019

ID/INSPECTION ARROWS

186



The Sulzer Model 1115 5 MHz Crystal Oscillator was specifically designed for undersea applications where high stability and minimal power drain are of prime importance. Hermetically sealed in a precisely machined cylinder, its small size and light weight also make it ideal for portable applications. Power drain is 150 Milliwatts at 25°C and 300 Milliwatts at -5°C. AUSTRON, Inc., 1915 Kramer Lane, Austin, Texas 78758 (512) 836-3523

CRYSTAL OSCILLATOR

189

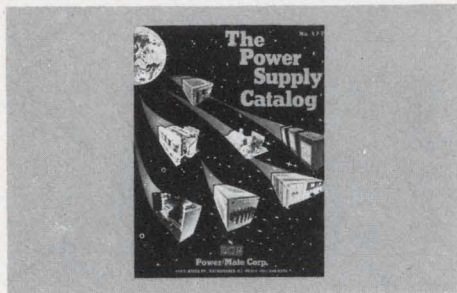

Free New '77 catalog contains over 34,500 quality power supplies from the world's largest manufacturer, Power/Mate Corp. Power Supplies for every application including submodulars, open frame, variorated, encapsulated, laboratory & system. All units UL approved and meet most military and commercial specs for industrial and computer uses. Power/Mate Corp., 514 S. River St., Hackensack, NJ 07601 (201) 343-6294

POWER SUPPLIES

190

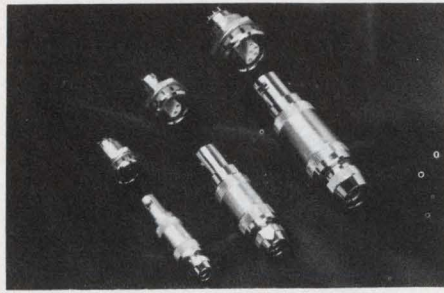

LEMO CONNECTORS are perfect for front panel applications. Superb design and craftsmanship complement any front panel design. The Quick Lock mechanism allows easy connection & disconnection. Panel space is saved because finger clearance is required on only two sides. The all metal shell is rugged and an effective strain relief grips the cable securely. Coax & multipin types from 2-18 pins are available from stock. Lemo U.S.A. Inc., 2015 2nd St., Berkeley, Ca 94710. Tel: 415/548-1966, Tx 335-393.

CONNECTORS

193

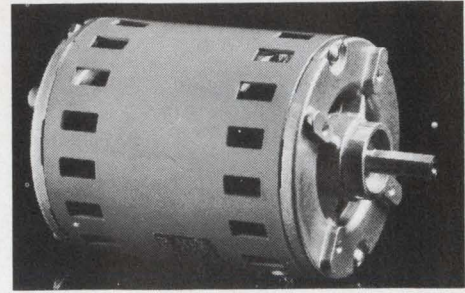

A Precision Drive Priced for OEM Users. EAD's new Size 39 is a 3-7/8" diameter, high performance drive designed and priced for computer peripherals and other demanding applications. Available in synchronous, polyphase, permanent split capacitor, split phase and capacitor start types. Ratings from 1/40 through 1/2 HP. Speeds from 600 to 3600 RPM. Self-ventilated or totally enclosed. For prices and specifications, contact EAD/Eastern Air Devices, Holtzer-Cabot/Janette, Dover, N.H. 03820 (603-742-3330).

DRIVE MOTOR

196

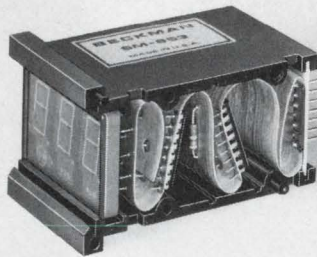

New way to pack added security into your design. R/flex circuits do several jobs at once and accordion fold to fit. Eliminate multiple circuit boards and jumpers; mount components directly on circuit. Made in 1 to 6 layers, various sizes and shapes, with or without plated-through holes. Rogers Corp., Chandler, AZ 85224 (602) 963-4584. (EUROPE: Mektron NV, Ghent, Belgium; JAPAN: Nippon Mektron, Tokyo)

FLEXIBLE CIRCUITS

191



INTEGRITY AND RECOVERY IN COMPUTER SYSTEMS, by T. K. Gibbons. Here is a step-by-step guidebook that places at your fingertips all the techniques and strategies you need for locating and correcting errors and failures and for re-establishing complete system integrity and reliability as quickly as possible. #5454-8, 144 pp., \$9.95. Circle the Info Retrieval Number to order your 15-day exam copy. When billed, remit or return book with no obligation. **Hayden Book Co., 50 Essex St., Rochelle Park, N.J. 07662.**

INTEGRITY & RECOVERY

194



NEW PRODUCT - INDUSTRY'S FIRST MASS PRODUCED DPM. Through ingenious design IMC is offering the series B500 .5" LED $\pm 3\frac{1}{2}$ DIGIT DPM. Specifications are: AUTO ZERO, BIPOLAR, 1000M Zin, 50pA Ibias, 10 RANGES, 5Vdc or 115/230Vac DIFFERENTIAL, RATIO-METRIC, 200-800mW power consumption 150 HOUR BURN-IN and fully GUARANTEED for 2 YEARS. IT COST LESS TO MAKE, SO WE SELL IT FOR LESS. \$39/100. IMC, 4016 E. Tennessee St., Tucson, AZ 85714 (602) 748-7900.

MASS PRODUCED DPM - SERIES B500 197

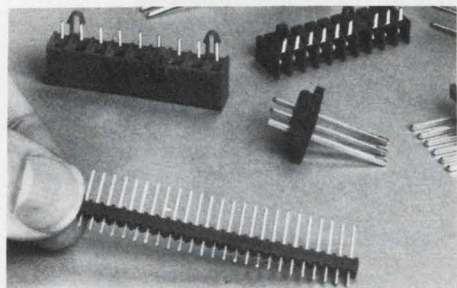

NEW FAMILY OF MINIATURE TERM-ACON SERIES CONNECTORS will solve majority of PC board interconnect problems. Moderately priced reliable designs for .100", .200" and .156" center pin spacings for hi-density to general purpose usage. U/L flame retardant Nylon material conforms to MIL-STD-202E. Polyester 94V-0 rated connectors are also available. METHODE ELECTRONICS, INC., 1700 Hicks Road, Dept. PR, Rolling Meadows, Illinois 60008. (312) 392-3500.

PC BOARD CONNECTORS

192



MINIATURE HIGH VOLTAGE POWER SUPPLIES • Output: 0.15 KV @ 10 μ a. • Input: 0-15 V @ 50 ma. • Available in Sync or Astable Modes. • Operates from -40°C. to +52°C. • Miniature (1.56" x 1.18" x 0.93"). • 24 Hour "Burn-in" Cycle Prior to Shipment. • For additional information or special requirements, please contact: Galileo Electro-Optics Corporation, Galileo Park, Sturbridge, MA 01518. 617-347-9191.

POWER SUPPLIES

195

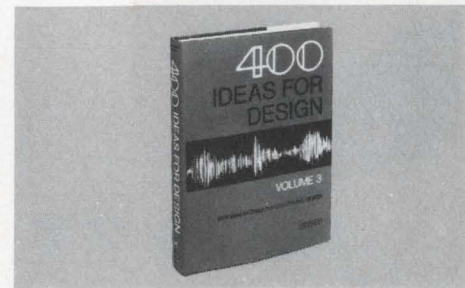

400 IDEAS FOR DESIGN, Volume 3, ed. by Morris Grossman. Brainstorm with the experts! Volume 3 of 400 IDEAS FOR DESIGN contains the best selections from *Electronic Design* that were published between 1971 and 1974. You'll find a wide range of ideas from very complicated to simple, but unique, approaches. #5111-5, 348 pp., \$13.95. Circle the Info Retrieval Number to order your 15-day exam copy. When billed, remit or return book with no obligation. **Hayden Book Co., 50 Essex St., Rochelle Park, N.J. 07662.**

IDEAS FOR DESIGN

198



Short Runs-Best Deliveries-Expertise. After many years selling thru distributors, we now also sell direct. **RETRACTIBLES FOR:** Coaxial requir. — Data Processing Equip. — Medical electronics — Heater cords — Communication-Modular — Electronic Control — Hand held camera (TV) — Automated Banking — Studio cameras — Microphone cords. "MADE TO YOUR SPECIFICATIONS" Meyer Wire Co., Inc., 1074 Sherman Ave., Hamden, Conn. 06514 (203) 281-0817.

COILED CORDS-MODULAR

199

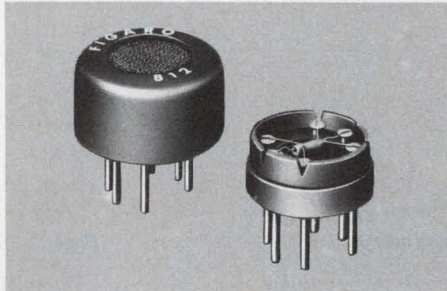

FIGARO GAS SENSOR TGS is a gas sensitive semiconductor. When combustible gas is absorbed on the sensor surface, a marked decrease of electrical resistance occurs. Major features of the sensor include high sensitivity, long term reliability and low cost. The applications are: GAS-LEAK ALARM, AUTOMATIC FAN CONTROL, FIRE ALARM, ALCOHOL DETECTOR, etc. Figaro Engineering Inc., North America Office-3303 Habor Boulevard, Suite D-8, Costa Mesa, Calif. 92626 Tel: (714) 751-4103 Telex: 678396

GAS SENSOR

202

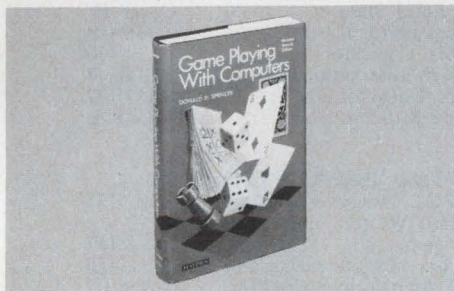

GAME PLAYING WITH COMPUTERS, Revised Second Edition, by Donald D. Spencer. This volume presents over 70 games, puzzles, and mathematical recreations for a digital computer. The reader will also find brand-new "how to" information for applying mathematical concepts to game playing with a computer. #5103-4, 320 pp., \$16.95. Circle the Info Retrieval Number to order your 15-day exam copy. When billed, remit or return book with no obligation. **Hayden Book Co., 50 Essex St., Rochelle Park, N.J. 07662.**

GAMES-PLAYING GUIDE

200

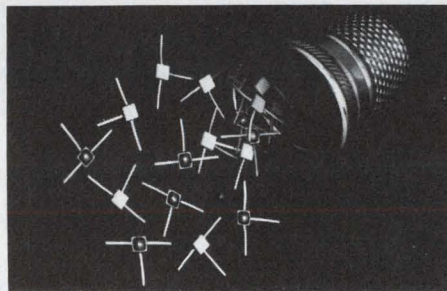

TaNFilm™ precision subminiature resistor networks from TRW, the world's smallest 1/4-watt resistor, has proven its performance, reliability and space-saving design in ultra-high-speed computers, line terminations and microwave attenuation. Useful at frequencies up to 2 gigahertz, the network offers low noise and excellent high-frequency characteristics for RF or high-speed switching operations. TRW/IRC Resistors, an operation of TRW Electronic Components, 4222 S. Staples St., Corpus Christi, TX 78411. (512) 854-4872.

RESISTOR NETWORKS

203

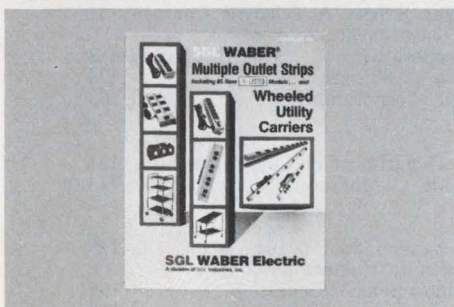

New! SGL WABER® CATALOG. Featuring multiple electrical outlet strips and wheeled carriers. New! 85 new UL LISTED outlet strips with circuit breaker protection • New engineering applications information • New custom design information • 24 illustrated fact filled pages • 240 multiple outlet strips • 15 wheeled utility carriers. Send for it! SGL WABER Electric, A division of SGL Industries, Inc. 300 Harvard Ave. • Westville, N.J. 08093 • (609) 456-5400.

ELECTRICAL OUTLET CATALOG

201

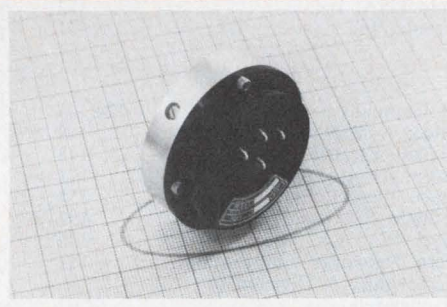

LOW COST PENDULUM CP17-0601-1 provides vertical references for monitoring and control of pitch and roll angular displacements. Replaces expensive vertical gyros for many instrument and control system applications. Potentiometric output; hermetically sealed; fluid damped; range of $\pm 45^\circ$; resolution less than 0.20° ; linearity within 0.5; total error band of $\pm 1\%$ full scale. Wide range of models available. Humphrey, Inc., 9212 Balboa Ave., San Diego, CA 92123. Tel. (714) 565-6631

PENDULUM

204

Advertising Sales Staff

Tom W. Carr, Sales Director
Robert M. Lepore,
Sales Coordinator

Rochelle Park, NJ 07662

Robert W. Gascoigne
Thomas P. Barth
Stan Tessler
50 Essex St.
(201) 843-0550
TWX: 710-990-5071
(HAYDENPUB ROPK)

Philadelphia

Thomas P. Barth
(201) 843-0550

Boston 02178

Gene Pritchard
P.O. Box 379
Belmont, MA 02178
(617) 489-2340

Chicago 60611

Thomas P. Kavooras
Berry Conner, Jr.
200 East Ontario
(312) 337-0588

Cleveland

Thomas P. Kavooras
(312) 337-0588

Los Angeles 90045

Stanley I. Ehrenclou
Burt Underwood
8939 Sepulveda Blvd.
(213) 641-6544

Texas

Burt Underwood
(213) 641-6544

San Francisco

Robert A. Lukas
3579 Cambridge Lane
Mountain View, CA 94040
(415) 965-2636

England

Constance McKinley
50 Essex St.
Rochelle Park, N.J. 07662
Phone: (201) 843-0550

Europe

Sanders, W. J. M.
Raadhuisstraat 24
Graft-De Ryp, Holland
Phone: 02997-1303
Telegrams: Euradteam-Amsterdam
Telex: 13039-SIPAS

G. Nebut

Promotion Presse Internationale.
7 ter Cour des Petites Ecuries
75010 Paris, France
Telephone: 5231917, 1918, 1919

Dieter Wollenberg

Erikastrasse 8
D-8011 Baldham/Muenchen
Germany
Telephone: 0 8106/4541

Tokyo

Haruki Hirayama
EMS, Inc.
5th Floor, Lila Bldg.,
4-9-8 Roppongi
Minato-ku, Tokyo, Japan
Phone: 402-4556
Cable: EMSINCPERIOD, Tokyo



Advertiser's index

Advertiser	Page	Advertiser	Page	Advertiser	Page
A P Products Incorporated.....	122, 123	Gordos Corporation.....	171	OK Machine & Tool Corporation....	135
AMP, Incorporated.....	40,41	Gordos/Grigsby-Barton, Inc.....	150	Optron, Inc.....	7
Abbott Transistor Laboratories, Inc.....	6	Gould, Inc., Instrument Systems Division.....	48B	*Philips Electronic Components and Materials.....	137,139
Accurate Threaded Fasteners, Inc.....	99	Gulton Industries, Inc., Measurement & Control System Division.....	167	*Philips Industries, Test and Measuring Instruments Dept.....	128,129
Advanced Micro Devices.....	4,5	Hartwell Corporation, The.....	169	Photofab Tech., Inc.....	116
Alco Electronic Products, Inc.....	163	Hayden Book Company, Inc.....	112,*112H,171,172,173	Piezo Technology, Inc.....	164
Allen Bradley Co.....	132,133	Hewlett-Packard.....	1,10,11,16,49	Plessey Semiconductors.....	107
Amphenol North America Division, Bunker Ramo Corporation.....	52,53	Honeywell Test Instruments Division.....	32,32A-B,33	Potter & Brumfield, Division of AMF, Incorporated.....	159
Analog Devices, Inc.....	139	Hughes Aircraft Company, Connecting Devices.....	72,73	Power/Mate Corp.....	172
Augat, Inc.....	117	Hughes Aircraft Company, Microelectronic Products Division....	20	PowerTech, Inc.....	48A
Austron, Inc.....	171	Humphrey, Inc.....	173	RCA Solid State.....	Cover IV
Auto-Swage Products, Inc.....	169	Hypertronics Corporation.....	166	Reader Service Card.....	176A-B
*BEPI (Electronics) Ltd.....	112H	ILC Data Devices, Inc.....	114	Reliable Capacitors.....	130
Beau Products Division, Vernitron Corporation.....	142	ITT Cannon Electric, International Telephone and Telegraph Corporation.....	144,144A-D	Rockwell International.....	46,47
Beckman/Helipot Division.....	137	Industrial Timer, A Unit of Esterline Corporation.....	161	Rogers Corporation.....	157,172
Belden Corporation.....	31	Instrument Specialties Company.....	109	*Rohde & Schwarz.....	112I,J,K,L
Bendix Corporation, The, Electrical Components Division.....	88,89	Intel Corporation.....	24,25,74,75	SGL Waber Electric, A Division of SGL Industries, Inc.....	173
Berg Electronics, Inc.....	131	International Microtronics Corporation.....	172	Sangamo Weston, EMR Telemetry Division.....	157
Bourns, Inc., Trimpot Products Division.....	Cover II	International Rectifier.....	120	Seastrom Manufacturing Co., Inc.....	156
Buckeye Stamping Company, Inc., The.....	166	Johanson Manufacturing Corp.....	171	Signal Transformer Co., Inc.....	Cover III
Burr-Brown Research Corporation.....	37	Kepeco, Inc.....	42	Simpson Electric Company.....	39
CTS Corporation.....	153	LH Research, Inc.....	126	Spectra-Strip, An Electra Company..	100,101
Capitol Machine & Switch Co., Inc., The.....	146	Lemo USA, Inc.....	172	Sprague Electric Company.....	29,147
Centralab, The Electronics Division of Globe-Union, Inc.....	50	Litronix, Inc.....	21	Statek Corp.....	171
Clairex Electronics, A Division of Clairex Corporation.....	167	3M Company.....	124,125	Stanford Applied Engineering, Inc.....	19
Continental Specialties Corporation....	64	Malco, A Microdot Company.....	149	Syntronic Instruments, Inc.....	161
Coto Coil Company, Inc.....	168	*Matsuo Electric Co. Ltd.....	143	Systrom-Donner.....	14
Cutler-Hammer, Specialty Products Division.....	140,141	Memodyne Corporation.....	171	TEC, Incorporated.....	135
Dale Electronics, Inc.....	15	Mepco/Electra, Inc.....	151	TRW/IRC Resistors, an operation of TRW Electronic Components, Inc.....	173
Data General Corporation.....	27	Method Electronics, Inc.....	172	TRW LSI Products.....	121
Data Precision Corporation.....	8,9	Meyer Wire Co., Inc.....	173	Tektronix, Inc.....	45,81,82,83,94,95
Datel Systems, Inc.....	93	Micro Networks Corporation.....	152	Teledyne Philbrick.....	136
Digital Equipment Corporation....	118,119	Microswitch, A Division of Honeywell.....	62,63	Teledyne Relays, A Teledyne Company.	2
EMI Ltd. SE Labs.....	127	Mini-Circuits Laboratory, A Division of Scientific Components Corp.....	65	Texas Instruments, Incorporated.....	64A thru BB,96A-B
Eastern Air Devices.....	172	Motorola Semiconductor Products, Inc.	35	Thomas & Skinner, Inc.....	134
Electro Corporation.....	169	NCR Power Systems Division.....	138	Triplett Corporation.....	103
Electro Space Fabricators, Inc.....	171	National Semiconductor Corporation.....	22,23	*U.S. Department of Commerce.....	121
Electronic Design.....	170,175	Nichicon Corporation.....	163	Unitrode Corporation.....	113
Electronic Molding Corporation.....	163	Nitron, a division of McDonnell Douglas.....	155	Varo, Semiconductor, Inc.....	165
Exar Integrated Systems.....	143			Victoreen Instrument Division, Shellar-Globe Corporation.....	105
Fairchild Semiconductor, A Division of Fairchild Camera and Instrument Corporation.....	12,13			Viking Industries, Inc.....	110
Figaro Engineering, Inc.....	173			Voltronics Corporation.....	61
Galileo Electro-Optics Corp.....	172			Wabash, Inc.....	48
Gold Book, The.....	128,129,*132,*133,145,165,168			Walker Scientific, Inc.....	171

*Advertisers in non-U.S. edition

WHAT'S NEW
IN IC
MEMORIES?

I DON'T
KNOW...I'VE
JUST BEEN
HATCHED.

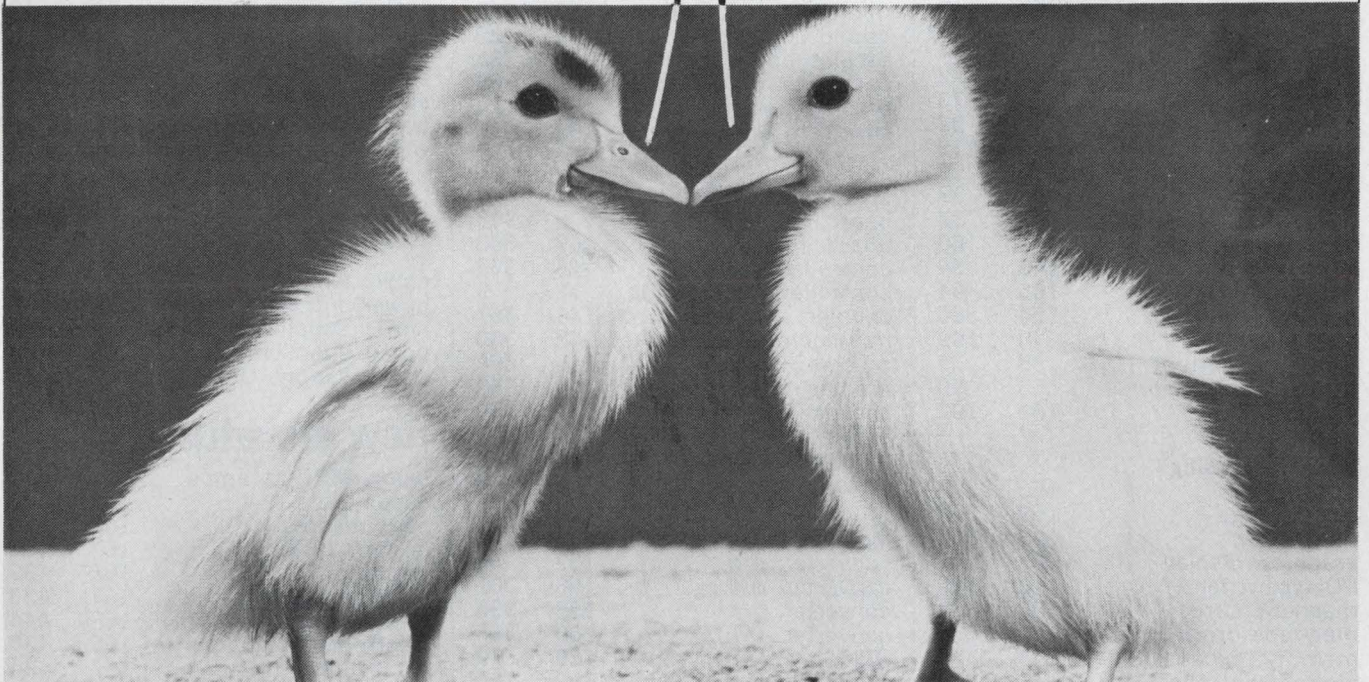

Semiconductor memories are without a doubt one of the fastest evolving products anywhere. Five years of product lifetime is a real accomplishment — many products don't make it beyond a year or so.

Where does the technology stand today? What products are becoming obsolete? What will replace them? What must a designer consider before he commits his firm to a component that could grow up to be a Dodo?

**FIND OUT ON AUG. 16 IN
Electronic Design's FOCUS REPORT
"INTEGRATED CIRCUIT MEMORIES"**

Product index

Information Retrieval Service. New Products, Evaluation Samples (ES), Design Aids (DA), Application Notes (AN), and New Literature (NL) in this issue are listed here with page and Reader Service numbers. Reader requests will be promptly processed by computer and mailed to the manufacturer within three days.

Category	Page	RSN	Category	Page	RSN	Category	Page	RSN
Components			SCRs			connectors, ribbon		
capacitors	147	85	semiconductors	29	20	fabrication, thin-glass	116	322
capacitors, trimmer	61	35	trans., high-voltage	136	343	fastener guide	99	47
coils, relays, xfmr	48	31	transistors, power	134	340	gaskets	109	54
contacts	142	81	Instrumentation			headers, right-angle	123	65
contacts, lubricated	41	27	analyzer, freq. resp.	127	68	heat packs, chemical	120	334
displays	1	2	analyzer, logic-state	49	32	hinges	169	117
filters, crystal	164	107	counter	126	306	indicator lights	122	329
magnets	134	74	DMM	130	308	interconnections	73	296
relays	2	3	frequency counter	64	38	knobs	166	111
relays, mercury	154	387	logic analyzer	95	171	laminate, epoxy/glass	122	328
relays, reed	156	451	microwave counter	130	337	O-rings	116	321
relays, reed	168	116	oscilloscope	45	29	sockets	19	14
relays, sealed	154	389	oscilloscope	130	338	sockets	117	60
relays, solid-state	150	87	panel instruments	103	50	strain-relief bushing	116	323
resistor networks	132	72	recorder, portable	167	114	strips, multioutlet	165	108
resistor networks	133	73	spectrum analyzer	159	97	strips, socket	115	309
resistors	105	52	Micro/Mini Computing			wire dispenser	120	335
sensors, magnetic	169	119	board, graphics	146	366	wire dispenser	155	92
switch, toggle	156	450	board, RAM/PROM	146	363	Power Sources		
switches	50	33	controller, memory	146	365	bus-programmable p.s.	162	406
switches	63	37	controllers, computing	11	9	circuit breaker	162	408
switches	141	80	coupler, acoustic	144	361	converters, dc/dc	162	407
switches	146	84	microcomputer, turnkey	142	350	power supplies	6	4
switches, toggle	155	94	module, CPU	146	364	power supplies	42	28
transformers	154	386	module, microcomputer	144	362	power supplies	138	78
transformers	III	159	package, diagnostic	144	360	power supply, UPS	162	409
trimmers, cermet	135	75	programmer, PROM	144	359	new literature		
trimmers, cermet	153	90	recorder, data	142	349	bipolar-FET op amps	168	440
yokes, CRT	161	102	system, development	142	356	capacitors	168	436
Data Processing			Modules & Subassemblies			card readers	168	438
disc drive	150	377	converter, a/d	152	89	control systems	167	432
disc storage	152	378	converter, d/a	158	391	data-con. handbook	168	439
floppy disc	148	368	converter, d/a	158	395	electron tubes, semis	167	433
graphics, display	83	42	converter, f/d	160	405	electronic packaging	168	444
I/O typewriter	148	360	DPMs	139	79	electronic weighing	166	425
magnetic card	152	384	DPMs	163	104	enclosures	167	434
mag-tape drive	150	376	data acquisition	160	397	hardware catalog	156	95
memory, expansion	148	370	data acquisition	160	403	headers	167	435
plotter controller	148	372	display, alphanumeric	160	399	indicating controls	168	445
software	148	374	display, transducer	158	393	inverter ballasts	168	446
terminal	148	373	generator, line-noise	160	404	MOS/LSI circuits	168	441
terminal	152	382	I/O systems	37	25	mass-termination	167	430
terminal, glass	150	375	interface card	158	396	microcircuits	166	424
terminal, hand-held	148	371	op amp, video	136	76	minicomputers	168	437
transceiver	152	381	op amps	160	398	multiple-V switcher	168	442
ICs & Semiconductors			panel meter, digital	158	392	oscillographic rec.	168	447
amplifier, front-end	107	53	reference, voltage	158	394	protection devices	167	429
bridge, dual-in-line	165	110	Packaging & Materials			readout displays	166	428
circuit, ignition	138	346	barriers, 2-row	142	82	SC/MP	166	427
circuit, RAM & I/O	134	301	buses	159	98	small computers	166	426
controller, protocol	138	347	cables, jumper	131	71	solvent cleaners	167	431
converter, rms-to-dc	138	344	conductor paste	116	320	application notes		
Darlington arrays	143	83	connector systems	53	34	digital logic circuit	164	410
diodes, p-i-n	138	348	connectors	88	298	paralleling semis	164	411
driver, digit	136	342	connectors	110	55	project planning	164	413
generator, character	138	345	connectors	144	251	resistor networks	164	414
ICs	IV	161	connectors	149	86	sample-hold	164	412
isolators	7	5	connectors	166	112	8-bit a/d conversion	164	415
memories	137	77	connectors, flat-cable	169	118			
multipliers	134	339						
opto-isolators	167	113						
rectifiers, bridge	136	341						

Announcing Split/Tran[®]— high isolation at prices lower than standard PC board transformers.

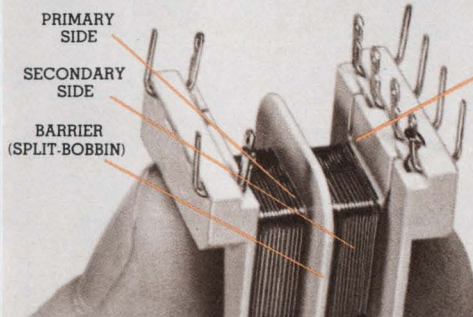

Split bobbin design makes the difference

• 2500V RMS HIPOT • NON-CONCENTRIC WINDINGS New from Signal—miniature PC board transformers with high isolation (2500V RMS HIPOT standard) and low capacitive coupling. All this and lower than standard transformer prices, too. Split/Tran is available with single 115V or dual 115/230V primaries. Secondary windings are split, so they can be series or parallel connected. Like all our other transformers and chokes, Split/Tran is always ready for Pronto delivery. Write or call: Signal Transformer Co., Inc., 500 Bayview Ave., Inwood, N.Y. 11696; Tel. (516) 239-7200.

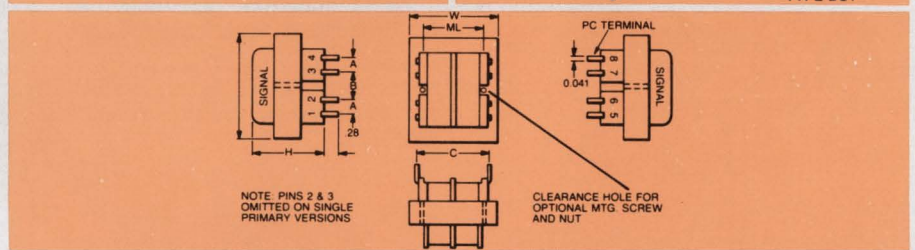
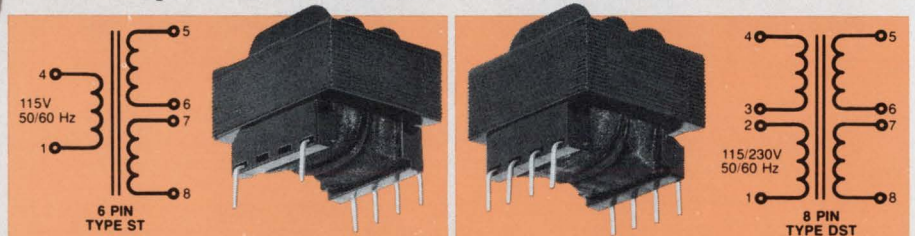

Size	VA	L	W	H	ML	A	B	C	Optional Mtg. Screw & Nut*	Lbs.
3	2.4	1 3/8	1 1/8	1 3/16	1 15/16	.250	.250	1.200	None	0.25
4	6	1 5/8	1 9/16	1 5/16	1 1/16	.250	.350	1.280	4-40 x 1 3/8 Nylon	0.44
5	12	1 7/8	1 9/16	1 7/16	1 1/4	.300	.400	1.410	4-40 x 1 3/8 Nylon	0.70
6	20	2 1/4	1 7/8	1 7/16	1 1/2	.300	.400	1.600	4-40 x 1 3/8 Nylon	0.80

*Available from Signal: Part No. ST-MS (Screw) & Part No. ST-MN (Nut).

PART NUMBER*		SECONDARY RMS RATING		PART NUMBER*		SECONDARY RMS RATING	
Single 115V 6 Pin	Dual 115/230V 8 Pin	Series	Parallel	Single 115V 6 Pin	Dual 115/230V 8 Pin	Series	Parallel
ST 3-10	DST 3-10	10V C.T. @ 0.25A	5V @ 0.5A	ST 3-28	DST 3-28	28V C.T. @ 0.085A	14V @ 0.17A
ST 4-10	DST 4-10	10V C.T. @ 0.6A	5V @ 1.2A	ST 4-28	DST 4-28	28V C.T. @ 0.2A	14V @ 0.4A
ST 5-10	DST 5-10	10V C.T. @ 1.2A	5V @ 2.4A	ST 5-28	DST 5-28	28V C.T. @ 0.42A	14V @ 0.84A
ST 6-10	DST 6-10	10V C.T. @ 2A	5V @ 4A	ST 6-28	DST 6-28	28V C.T. @ 0.7A	14V @ 1.4A
ST 3-12	DST 3-12	12.6V C.T. @ 0.2A	6.3V @ 0.4A	ST 3-36	DST 3-36	36V C.T. @ 0.065A	18V @ 0.13A
ST 4-12	DST 4-12	12.6V C.T. @ 0.5A	6.3V @ 1.0A	ST 4-36	DST 4-36	36V C.T. @ 0.17A	18V @ 0.34A
ST 5-12	DST 5-12	12.6V C.T. @ 1.0A	6.3V @ 2.0A	ST 5-36	DST 5-36	36V C.T. @ 0.35A	18V @ 0.7A
ST 6-12	DST 6-12	12.6V C.T. @ 1.6A	6.3V @ 3.2A	ST 6-36	DST 6-36	36V C.T. @ 0.55A	18V @ 1.1A
ST 3-16	DST 3-16	16V C.T. @ 0.15A	8V @ 0.3A	ST 3-48	DST 3-48	48V C.T. @ 0.05A	24V @ 0.1A
ST 4-16	DST 4-16	16V C.T. @ 0.4A	8V @ 0.8A	ST 4-48	DST 4-48	48V C.T. @ 0.125A	24V @ 0.25A
ST 5-16	DST 5-16	16V C.T. @ 0.8A	8V @ 1.6A	ST 5-48	DST 5-48	48V C.T. @ 0.25A	24V @ 0.5A
ST 6-16	DST 6-16	16V C.T. @ 1.25A	8V @ 2.5A	ST 6-48	DST 6-48	48V C.T. @ 0.4A	24V @ 0.8A
ST 3-20	DST 3-20	20V C.T. @ 0.12A	10V @ 0.24A	ST 3-56	DST 3-56	56V C.T. @ 0.045A	28V @ 0.09A
ST 4-20	DST 4-20	20V C.T. @ 0.3A	10V @ 0.6A	ST 4-56	DST 4-56	56V C.T. @ 0.11A	28V @ 0.22A
ST 5-20	DST 5-20	20V C.T. @ 0.6A	10V @ 1.2A	ST 5-56	DST 5-56	56V C.T. @ 0.22A	28V @ 0.44A
ST 6-20	DST 6-20	20V C.T. @ 1A	10V @ 2A	ST 6-56	DST 6-56	56V C.T. @ 0.35A	28V @ 0.7A
ST 3-24	DST 3-24	24V C.T. @ 0.1A	12V @ 0.2A	ST 3-120	DST 3-120	120V C.T. @ 0.02A	60V @ 0.04A
ST 4-24	DST 4-24	24V C.T. @ 0.25A	12V @ 0.5A	ST 4-120	DST 4-120	120V C.T. @ 0.05A	60V @ 0.1A
ST 5-24	DST 5-24	24V C.T. @ 0.5A	12V @ 1.0A	ST 5-120	DST 5-120	120V C.T. @ 0.1A	60V @ 0.2A
ST 6-24	DST 6-24	24V C.T. @ 0.8A	12V @ 1.6A	ST 6-120	DST 6-120	120V C.T. @ 0.16A	60V @ 0.32A

*Explanation of Part Number: Series—ST; Size 4; Series Secondary Volts—36

Special variations will be quoted and shipped promptly.

NET PRICES (1-4 pcs.)

signal
TRANSFORMER

ALL	ALL
ST-3	\$4.90
ST-4	5.00
ST-5	5.50
ST-6	6.90
DST-3	\$5.80
DST-4	5.90
DST-5	6.50
DST-6	7.90

Designer's guide to the hot numbers in LICs.

BiMOS Op Amps: they mix technologies to match circuit needs.



CA3140

Most useful op amp since the 741. MOS/FET input plus bipolar speed and 4-44 V supply voltage. Does most jobs better than 741 or many premium op amps — at far less cost.

CA3160 CA3130

Universal op amp, available with compensation (3160) or without (3130). Very low priced, yet with features for general purpose, FET input (1,500,000 M Ω), wideband (15 MHz), micropower and high current uses.

CA3100

Wideband op amp (40 MHz) for both large and small signals. High open-loop gain, slew rate (25 V/ μ sec) and output current, plus fast settling time.

BiMOS combines the best of Bipolar and MOS in versatile, easy-to-use, low-cost op amps that are simple to manufacture in high volume. It's the op amp technology of today — and tomorrow. Millions of BiMOS devices have been produced and sold. Most are available off the shelf.

CIRCLE NUMBER 161

Variable Op Amps: as easy to use as a transistor.

CA3080

Programmable op amp: differential voltage input, current output. Variable voltage, power, bandwidth, slew rate, input and output current. \$0.59 @ 1K.

CA3094

Programmable power switch/amplifier. Adds integral Darlington output to CA3080 circuit to provide 300 mA peak current.

CA3060

Variable op amp array: 3 variable op amps plus zener bias regulator to use as current control or voltage reference source. All on one chip.



CIRCLE NUMBER 162

Micro Power Op Amp.

CA3078

Delivers up to 6.5 milliamps with standby power as low as 0.7 microwatt. Programmable input terminal for tailoring response and slew rate without sacrificing power.

CIRCLE NUMBER 163

Gold CHIP



The metalization is gold, and the chip is hermetically sealed with a layer of silicon nitride. The result is corrosion-free, extended life added to the economy of an advanced, rugged plastic package. In short, Gold CHIP (Chip Hermeticity In Plastic) gives you better than standard plastic reliability at the same price as plastic.

There are over 25 Gold CHIP types including these popular numbers: CA301A, CA307, CA311, CA324, CA339, CA555, CA741, CA747, CA748, CA1458, CA3401, CA3724, CA3725.

CIRCLE NUMBER 164

ARRAYS

RCA amplifier, diode and transistor arrays help you reduce parts cost, save space, cut insertion costs and increase reliability. Choose from 24 different arrays that allow you to create new circuit designs and do the jobs you want done.



RCA Array circuit diagrams and free sample offer

CIRCLE NUMBER 165

For more information, contact your local RCA Solid State distributor.

Or write: RCA Solid State, Box 3200, Somerville, NJ 08876; Sunbury-on-Thames, Middlesex TW16 7HW, England; Ste.-Anne-de-Bellevue, Quebec, Canada; Fuji Bldg., Tokyo, Japan.

RCA Linear experience is working for you.

RCA