

Electronic Design[®]

FOR ENGINEERS AND ENGINEERING MANAGERS

VOL. 23 NO.

1

JAN. 4, 1975

What's in the cards for 1975?

Despite some economic jokers in the deck it still looks like a winning hand for the industry. The stakes include bipolar LSI,

faster MOS, smarter instruments, hand-held computers, improved calculators and digital watches. For admission to the game, turn to the special report on p. 34.



Top Ten Contest!
Important you Enter
See Page 192

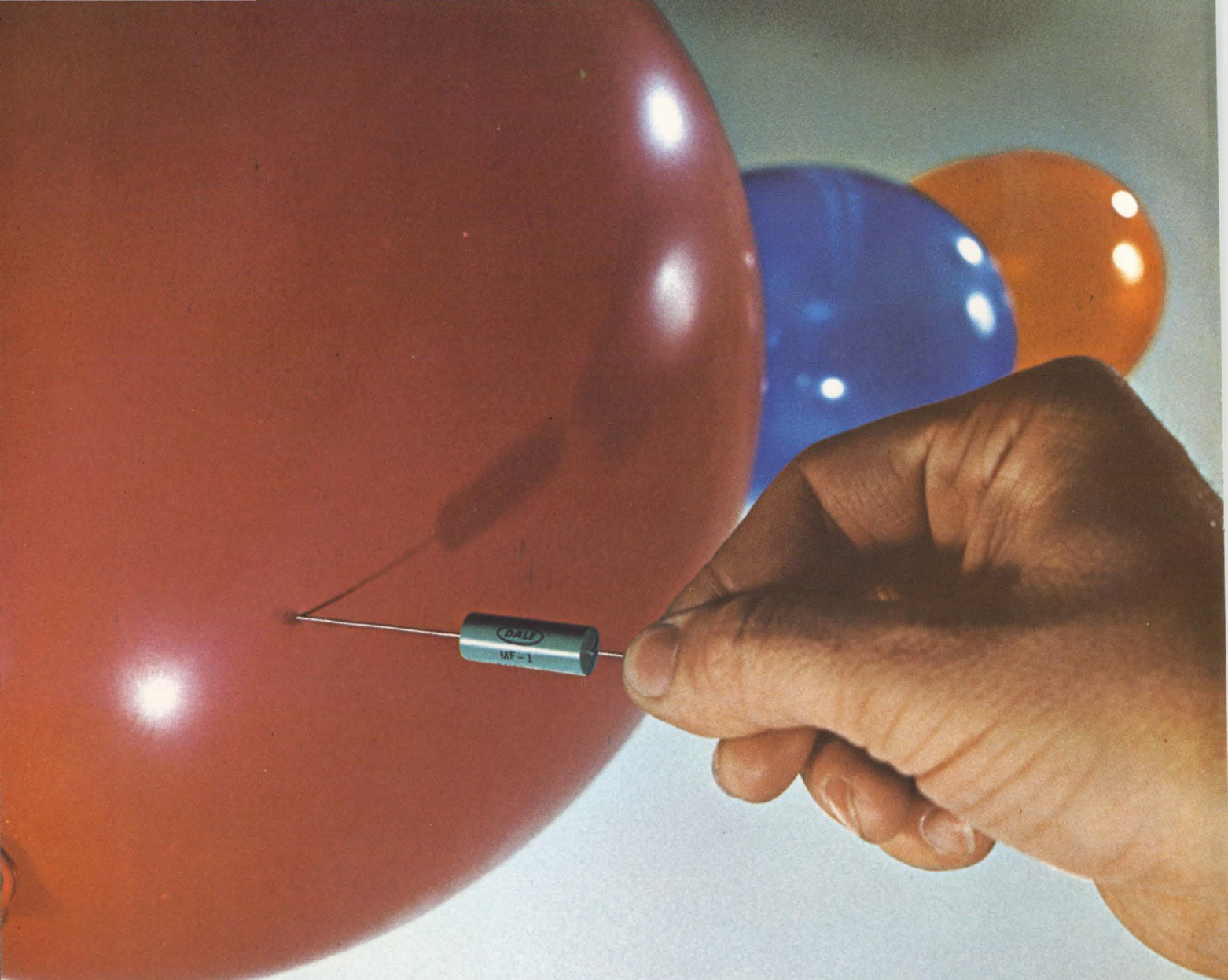

Sellers' markets don't last.

Dependable suppliers do.

Here are four positive steps Dale has taken to help end the seller's market in metal film resistors:

1. INCREASED PRODUCTION: In the past 2½ years Dale has more than tripled its metal film resistor production.

2. BROADENED CAPABILITIES: No one in the industry offers a broader spectrum of film resistors, including: ■ Standard Metal Film styles to MIL-R-10509 and MIL-R-22684 ■ E-Rel styles to MIL-R-55182 and MIL-R-39017 ■ Beyschlag Carbon Film ■ Metal Oxide and High Voltage Resistors ■ Thick Film Networks including MIL-R-83401.

3. STRONGER DISTRIBUTION: Many Dale distributors can ship metal film resistors off-the-shelf in quantity, including RN-55 and RN-60 models.

4. AND SPECIALS, TOO: In the face of record demand, we have continued to respond to customer requests for non-standard parts.

**Sellers' markets don't last.
Dependable suppliers do.
Call Dale at 402-371-0080.**

INFORMATION RETRIEVAL NUMBER 282



DALE ELECTRONICS, INC.
P.O. Box 74, Norfolk, Nebraska 68701
In Canada: Dale Electronics Canada Ltd.
In Europe: Dale Electronics GMBH
8 Munchen 60, Falkweg 51, West Germany
A subsidiary of The Lionel Corporation

Our complete product line can be found in Electronic Design's GOLD BOOK.

Meet our new 2-18 GHz sweeper plug-in.

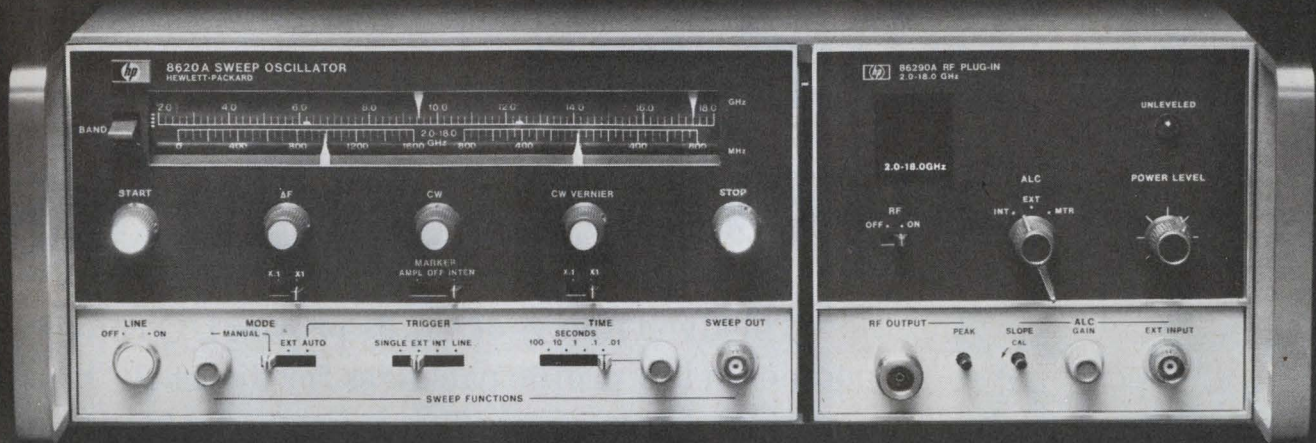

Broadband coverage with narrowband precision is here!

There's never been a more compact, convenient, and accurate way to go from 2 to 18 GHz. In fact, HP's 8620A sweeper with the new HP 86290A RF plug-in is the best buy on the market, whether your need is for broadband sweeping or narrowband precision over a wide range.

Never before has one broadband sweeper combined so many desirable features:

- Frequency accuracy is ± 20 MHz at 18 GHz — more precise than a wavemeter.
- Linearity is 0.1% — more than five times better than most octave band sweepers.
- CW stability typically is 50 ppm/10 minutes — comparable to cavity-tuned sources.
- 5 dBm output, with internally leveled flatness of ± 0.9 dB over the entire band — the best flatness available.
- Excellent signal purity — harmonics typically 35 dB down, low residual FM.
- Small and light — $5\frac{1}{4}$ " high; 33 lbs. (133 mm., 15 kg.); convenient for field use.
- Start/Stop and ΔF sweeps plus CW. Calibrated ΔF 's as wide as 1.6 GHz, as narrow as 1 MHz. Calibrated CW vernier can set 1 MHz increments.
- Phase locking is simple and inexpensive. Full range sweeping with fixed offset tracking now possible.

- Remote digital programming option can program up to 3000 frequencies simply — gives you versatility for ATE applications.

You can get all these features and performance at a value price — \$13,250* for the plug-in; \$1750* for the mainframe. Write for complete details or contact your nearby HP field engineer. *US Domestic Prices.

New Capabilities in Network Measurements

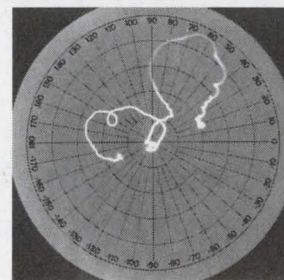

Reflection plot of broadband circulator, 2-18 GHz. (Full scale, $\rho = 1.0$)

When you use the HP 86290A with the new HP 8410B Network Analyzer, it is now possible to measure and display from 2 to 18 GHz in one continuous sweep! Network Analyzer/Sweeper tracking assures spurious free 60 dB dynamic measurement range.

When you use the 86290A with the HP 8755 Frequency Response Test Set, direct modulation of sweeper makes full power available at test device for greater measurement range. The HP 86290A/8755 swept measurement system is an economical, versatile, and accurate way to make wideband measurements in production, lab, and field.

HEWLETT  PACKARD

Sales and service from 172 offices in 65 countries.
1501 Page Mill Road, Palo Alto, California 94304

Get on board with Teledyne I/O converter modules



Now Teledyne Relays offers its proven I/O converter modules in low profile packages for direct PC board mounting. The versatile Teledyne 675 series allows you to design programmable controllers, process and machine tool controls with flexible and economical I/O interface circuitry. The full line includes both ac and dc, input

and output modules. All versions are optically isolated, with 1500 VRMS isolation, to protect logic lines from ac or dc power circuits. The AC output modules feature zero voltage turn-on to reduce switching noise and high dv/dt ratings to prevent false triggering in tough industrial environments.

Get on board with Teledyne Relays. We've got thousands of I/O modules at work in the field. Call your nearest Teledyne Relays office for location of your local representative or distributor.

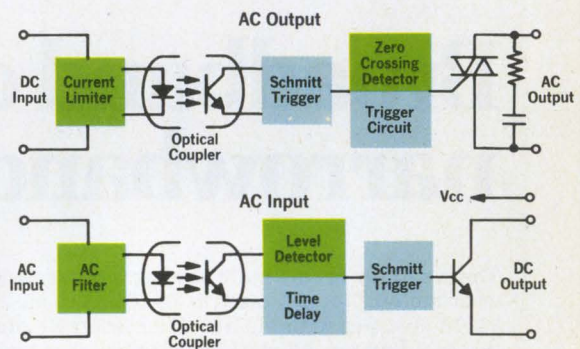

Typical Functional Diagrams

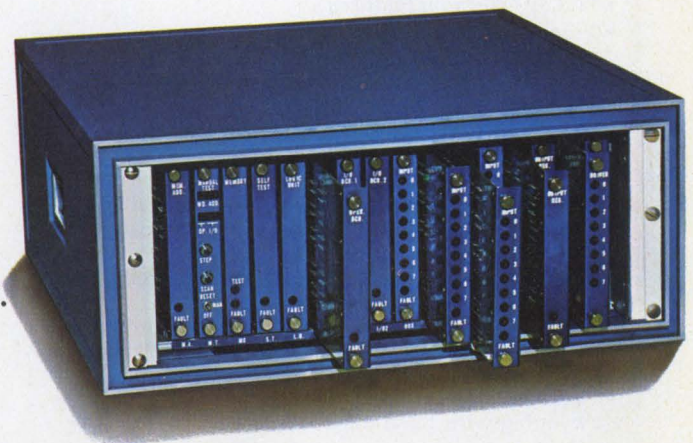

TELEDYNE RELAYS

3155 West El Segundo Boulevard, Hawthorne, California 90250
Telephone (213) 973-4545

Photo courtesy of Datametrics
a subsidiary of ITE Imperial Corporation.

Burgstrasse 6-8, 62 Wiesbaden, West Germany
Telephone: 06121-30231/2 Telex: 04-186851 (Trel-D)

Heathrow House, Bath Road, Cranford, Hounslow, Middlesex, U.K.
Telephone: 01-8972501 Telex: 935008

INFORMATION RETRIEVAL NUMBER 3

NEWS

- 21 **News Scope**
- 26 **Bipolar integrated circuits are due for broad advances** with improved large-scale integrated circuit technologies.
- 34 **Instruments with improved 'minds'** will be taking over dedicated jobs.
- 38 **Smaller, less expensive peripherals** will be created with new LSI circuits.
- 42 **Semiconductor makers push new technologies** to raise performance and drop cost.
- 46 **From managers viewpoint, efficiency is a key word** in production and hiring.
- 52 **Consumer products to grow in sophistication** with SOS and I²L and DMOS.
- 56 **Industrial electronics will be working a lot smarter** with microprocessors.
- 58 **Government spending for electronics** over the next 5 years will rise by a third.
- 67 **Washington Report**

TECHNOLOGY

- 74 **Build compact modems** into digital equipment. An LSI circuit does most of the signal handling, except for a few external analog circuits.
- 84 **Be kind to your pulse generator!** Unless you use extra care with today's complex pulser, you may end up with baffling test results.
- 94 **Improve analog data transmission** with two-wire transmitters. You can send the signals without shielding, and even multiplex the sensors.
- 104 **Beware those FET op-amp specs!** Though this type of IC amplifier excels in low bias currents, self-heating and nulling effects can alter the other specs.
- 110 **Stop burnout in rf power amplifiers.** Sense the current, temperature, VSWR, or peak voltage. Control the drive level or the collector voltage.
- 118 **Ideas for Design:** Circuit eliminates switch bounce in keyboards and gives latched output . . . Add-to-accumulator circuit uses a minimum of external hardware . . . Divide a digital signal by any digit from 1 to 9.
- 124 **International Technology**

PRODUCTS

- 127 **Packaging & Materials:** Losses in flyback transformers halved by new ferrite core.
- 128 **Packaging & Materials:** Static electricity discharged from quick-access panels.
- 130 Data Processing
- 136 Modules & Subassemblies
- 142 Instrumentation
- 148 Components
- 156 Integrated Circuits
- 160 Discrete Semiconductors
- 166 Power Sources
- 171 Microwaves & Lasers

DEPARTMENTS

- 71 **Editorial:** Ups and downs
- 7 Across the Desk
- 172 Application Notes
- 173 Design Aids
- 176 New Literature
- 182 Bulletin Board
- 188 Advertisers' Index
- 190 Product Index
- 192 Information Retrieval Card

Cover: Photo by Art Director, Bill Kelly

Intel's 2107B. The edge on speed,

Intel's new 2107B n-channel 4K RAM, with a 200 nanosecond access, is available now in production quantities. And because the 2107B chip is almost as small as a 1K RAM chip, we can

assure you it is the most producible 4K RAM with the lowest future cost potential.

The 2107B is already being shipped in quantities and replacing cores in many random access

memory applications. Because of its low cost, it's also being used in serial memory applications. Intel distributors now stock two types: the basic 2107B accesses in 200 ns and cycles in 400 ns; the 2107B-4 runs at 270 ns access and 470 ns cycle times (all worst case from 0 to 70°C).

Our advanced, single-transistor cell design eliminates critical clock tolerances, special substrate voltage levels and double clocks. Like the 2107A, the 2107B has a single clock with solid $\pm 1V$ margins, operates on standard -5 , $+5$ and $+12V$ supplies, and comes in the industry standard, 22-pin configuration

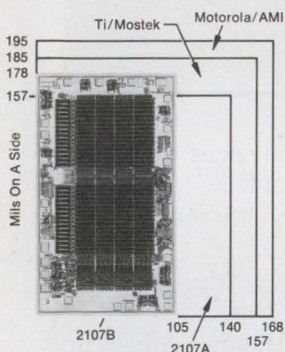

4K RAM CHIP SIZE COMPARISON WITH INTEL'S NEW 2107B.



new 4K RAM with price and delivery.

for single-clocked, fully decoded, 4K dynamic RAMs.

These new 4K RAMs improve your speed while reducing your system overhead costs by as much as 300% whether you're using 1K dynamic RAMs or core. Typical overhead is only .05¢/bit. To further reduce system

INTEL'S NEW 2107B 4K RAM FAMILY			
PART	MAX. ACCESS TIME (ns) ^[1]	MIN. CYCLE TIME (ns) ^[1]	AVAILABILITY
2107B	200	400	Now
2107B-4	270	470	Now
2107B-6	350	800	Now

[1] (All worst case from 0 to 70°C.)

overhead, both the three state output and all inputs are TTL compatible. Intel also offers a low cost 3235 quad clock driver designed to drive the 2107B. And economical battery backup can be imple-

mented because of the 2107B's low standby power.

The smaller die size of the 2107B means higher yields, lower cost and a more producible product. In comparison, competitive 4K RAMs are 55% to 75% larger than the 2107B.

Yet, the 2107B is processed with Intel's standard n-channel silicon gate MOS technology. The same process Intel has been using to produce high performance memory products with for over 3 years.

So put the 2107B or 2107B-4 in your memory system. You'll gain the edge in Speed, Price and Delivery right now, and for the future. Write Intel for 4K RAM family details. Or buy these new 4K RAMs from stock at Intel distributors: Almac/Stroum, Cramer, Hamilton/Avnet, Sheridan Sales, Industrial Components, and L. A. Varah.

Intel Corporation, 3065 Bowers Avenue, Santa Clara, California 95051 (408) 246-7501.

U.S. AND INTERNATIONAL SALES AND MARKETING OFFICES

U.S. MARKETING HEADQUARTERS

3065 Bowers Avenue
Santa Clara, California 95051
Tel: (408) 246-7501
TWX: 910-338-0026
TELEX: 34-6372

U.S. REGIONAL OFFICES

EASTERN

2 Milita Drive
Suite 4
Lexington,
Massachusetts 02173
Tel: (617) 861-1136
TELEX: 92-3493

MID-ATLANTIC

520 Pennsylvania Ave.
Fort Washington, PA 19034
Tel: (215) 542-9444

GREAT LAKES REGION

856 Union Rd.
Englewood, Ohio 45322
Tel: (513) 836-2808

MID-AMERICA

6350 L.B.J. Freeway
Suite 178
Dallas, Texas 75240
Tel: (214) 661-8829
TWX: 910-860-5487

WESTERN

1651 E. 4th St.
Suite 228
Santa Ana, California 92701
Tel: (714) 835-9642
TWX: 910-595-1114

EUROPEAN MARKETING HEADQUARTERS

BELGIUM

Intel Office
216 Avenue Louise
Brussels B1050
Tel: 649-20-03

ORIENT MARKETING HEADQUARTERS

JAPAN

Intel Japan Corporation
Kasahara Bldg.
1-6-10, Uchikanda
Chiyoda-ku
Tokyo 101
Tel: 03-295-5441
TELEX: 781-28426

intel® delivers.

When You Buy a Power Supply, Why Not Get the Best?

Vice President, Publisher
Peter Coley

Editors

Editorial Offices
50 Essex St.
Rochelle Park, NJ 07662
(201) 843-0550
TWX: 710-990 5071
Cable: Haydenpubs Rochellepark

Editor-in-Chief George Rostky

Managing Editors:
Ralph Dobriner
Michael Elphick

Associate Editors:

Dave Bursky
Jules H. Gilder
Morris Grossman
Seymour T. Levine
John F. Mason
Stanley Runyon
Edward A. Torrero
Richard L. Turmail

Contributing Editors:

Peter N. Budzilovich
Alberto Socolovsky
Nathan Sussman

Editorial Field Offices

East
Jim McDermott, Eastern Editor
P.O. Box 272
Easthampton, MA 01027
(413) 527-3632

West
David N. Kaye, Senior Western Editor
8939 S. Sepulveda Blvd.,
Suite 510
Los Angeles, CA 90045
(213) 641-6544
Northe K. Osbrink, Western Editor
112 Coloma St.
Santa Cruz, CA 95060
(408) 426-3211

Editorial Production

Marjorie A. Duffy

Art

Art Director, William Kelly
Richard Luce
Anthony J. Fischetto

Production

Manager, Dollie S. Viebig
Helen De Polo
Anne Molfetas
Christopher G. Hill

Circulation

Manager, Evan Phoutrides

Information Retrieval

Peggy Long

Promotion

Manager, Walter G. Salm
Karen Kerrigan (Reprints)

ELECTRONIC DESIGN 1, January 4, 1975

IN STOCK

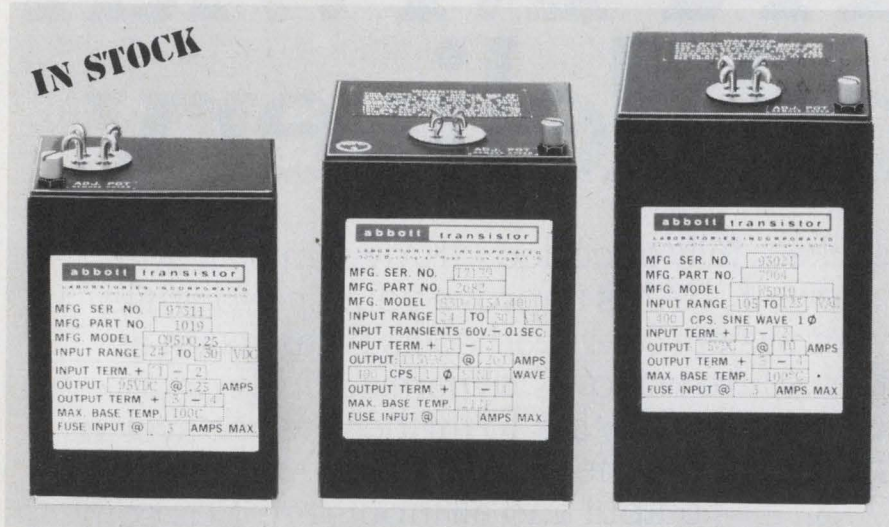

28 VDC to DC
(55,463 Hrs.)
Model C95D

28 VDC to 400 A
(61,387 Hrs.)
Model S3D

400 A to DC
(56,148 Hrs.)
Model W5D

Abbott's New Hi-Performance Modules

are designed to operate in the stringent environment required by aerospace systems — MIL-STD-810B and MIL-STD-461A for electromagnetic interference.

RELIABILITY — MTBF (mean time between failures) as calculated in the MIL-HDBK-217 handbook can be expected in excess of 50,000 hours at 100°C for all of these power modules. The hours listed under the photos above are the MTBF figures for each of the models shown. Additional information on typical MTBF's for our other models can be obtained by phoning or writing to us at the address below.

QUALITY CONTROL — High reliability can only be obtained through high quality control. Only the highest quality components are used in the construction of the Abbott power module. Each unit is tested no less than **41 times** as it passes through our factory during fabrication — tests which include the scru-

tinizing of the power module and all of its component parts by our experienced inspectors.

NEW CATALOG—Useful data is contained in the new Abbott Catalog. It includes a discussion of thermal considerations using heat sinks and air convection, a description of optional features, a discussion of environmental testing, electromagnetic interference and operating hints.

WIDE RANGE OF OUTPUTS — The Abbott line of power modules includes output voltages from 5.0 volts DC to 740 volts DC with output currents from 2 milliamperes to 20 amperes. Over 3000 models are listed *with prices* in the new Abbott Catalog with various inputs:

- 60A to DC
- 400A to DC
- 28 VDC to DC
- 28 VDC to 400A
- 12-28 VDC to 60 A

Please see pages 307-317 Volume 1 of your 1974-75 EEM (ELECTRONIC ENGINEERS MASTER Catalog) or pages 853-860 Volume 3 of your 1974-75 GOLD BOOK for complete information on Abbott Modules.

Send for our new 60 page FREE catalog.

abbott transistor

LABORATORIES, INCORPORATED
general offices

5200 W. Jefferson Blvd./Los Angeles 90016
(213) 936-8185 Telex: 69-1398

INCORPORATED
eastern office

1224 Anderson Ave./Fort Lee, N.J. 07024
(201) 224-6900 Telex: 13-5332

INFORMATION RETRIEVAL NUMBER 5

Much work reported on echo cancellation

With respect to the short article "Satcom Echoes Tamed by Siemens Research" (ED No. 21, Oct. 11, 1974, p. 66), you may be interested to know that the techniques of echo cancellation first emerged at Bell Telephone Laboratories as early as 1963. The first theoretical basis for a solution to the echo problem was published by M. M. Sondhi in the Bell System Technical Journal, Vol. XLVI, No. 3, March, 1967.

Since that time a great deal of work has been performed by Comsat Laboratories; Nippon Electric Co., Ltd., under contract for Intelsat, and the Australian Post Office. Two papers by Comsat on the theory and operation of echo cancellers were published, one in the Comsat Technical Review (spring, 1972) and one at the AIAA fourth Communications Satellite Systems Conference in Washington, DC, in April, 1972. The Comsat echo canceller was demonstrated on a satellite circuit.

Extensive field trials have subsequently been conducted in the Intelsat network for the past two years, using the Comsat and Intelsat echo cancellers in commercial service. The countries involved have been Australia, Brazil, France, West Germany, Japan, Britain and the United States. Reports on the results of the field trials have been submitted to Study Group XV of the CCITT. In addition the Australian Post Office has also built and tested an echo canceller for its telephone system.

A major effort is being directed toward product-engineering the echo canceller into an economically viable device. The presently applied solution to the echo problem by the communications entities is the echo suppressor, which has been in use in various forms since the advent of long-distance communications.

H. G. Suyderhoud, Manager and

M. Onufry, Assistant Manager
Comsat Laboratories
Signal Processing Dept.
Clarksburg, MD 20734

Join the IEEE? He asks, 'Why?'

A letter by Robert Bruce says the IEEE is not responsive to the needs of the engineer, so join his organization and help him fix it. I ask: Why? Straighten out your organization, and then if you have something of value for the engineer, try to enlist him.

Better yet, the present members should quit. Then the IEEE would have to fix itself if it wished to survive. I dropped out of the IEEE 10 years ago when it became apparent that it did not have my interests in mind. Other professional organizations offer most engineers much more. They are the ones the engineer should join and support. This may be the year of the tiger, but he still can't change his stripes.

William B. Adams, P.E.

P. O. Box 324
Fishkill, NY 12524

(continued on page 17)

Electronic Design welcomes the opinions of its readers on the issues raised in the magazine's editorial columns. Address letters to Managing Editor, Electronic Design, 50 Essex St. Rochelle Park, N.J. 07662. Try to keep letters under 200 words. Letters must be signed. Names will be withheld on request.

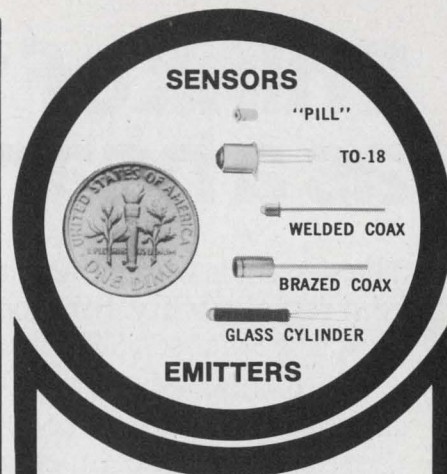

OPTRON OPTOELECTRONIC COMPONENTS

STANDARD DISCRETE PACKAGES
IMMEDIATE DELIVERY
COMPETITIVE PRICING

OPTRON'S competitively priced broad line of standard optoelectronic components range from solid state gallium arsenide emitters to silicon photodiodes, phototransistors, and photodarlington. They are immediately available in microminiature "pill," TO-18, welded or brazed coax, and glass cylinder packages.

OPTRON silicon photodetectors are compatible with either tungsten light sources or infrared LED's. The solution-grown epitaxial gallium arsenide LED's offer high efficiency and compatibility with the silicon photodetectors.

All OPTRON discrete components are available in other packages in moderate scale line quantities using standard chips. In addition, these units may be purchased as either standard or custom chips, monolithic arrays, printed circuit board assemblies, or molded assemblies.

Detailed technical information on discrete components and other OPTRON optoelectronic products . . . chips, assemblies and PC board arrays . . . is available from your nearest OPTRON sales representative or the factory direct.



NEW CONDENSED CATALOG

contains technical data on these and other OPTRON products. Request your copy today!



OPTRON, INC.

1201 Tappan Circle
Carrollton, Texas 75006
214/242-6571

Think of yourself as a heart specialist

The system is your patient and its power supply is your responsibility. For a long, happy system life, prescribe Sorensen STM modular switchers.

Compared to equivalent series-pass power supplies, STMs are twice as efficient, less than half the size, and price competitive. Yet they offer all of the inherent advantages of series-pass.

We've got a catalog that describes all 40 models, from 3.0 to 56 Vdc. It even has a prescription form ready to fill out. Simply circle the inquiry number. Sorensen Company, a unit of Raytheon, 676 Island Pond Road, Manchester, N.H. 03103. (603) 668-4500.

Sorensen
POWER SUPPLIES

INFORMATION RETRIEVAL NUMBER 8

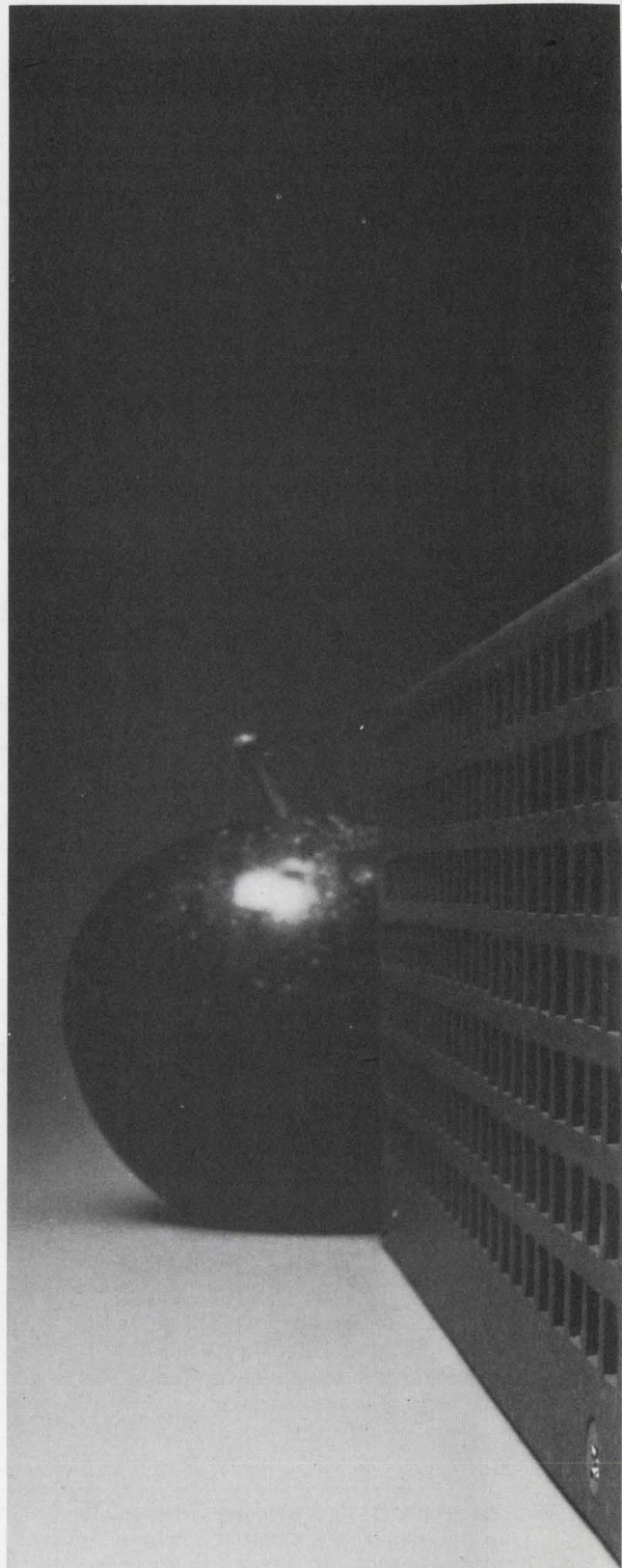

OUTPUT

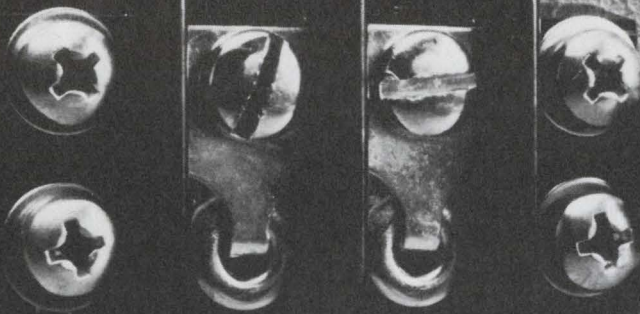

6A

CORENSEN
POWER SUPPLIES

STM

12-12

FUSE
FUSE

GND

INPUT

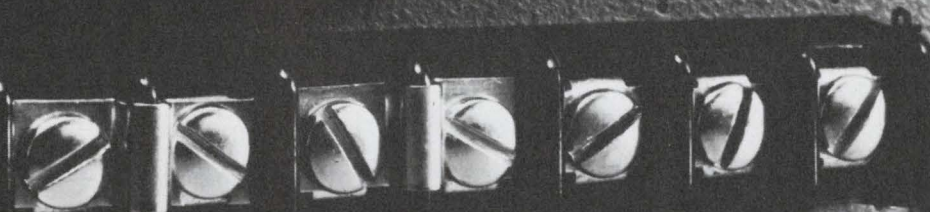

VOLT

1

2

3

4

5

6

7

**Reliability is 756 little dents
and one big one.**

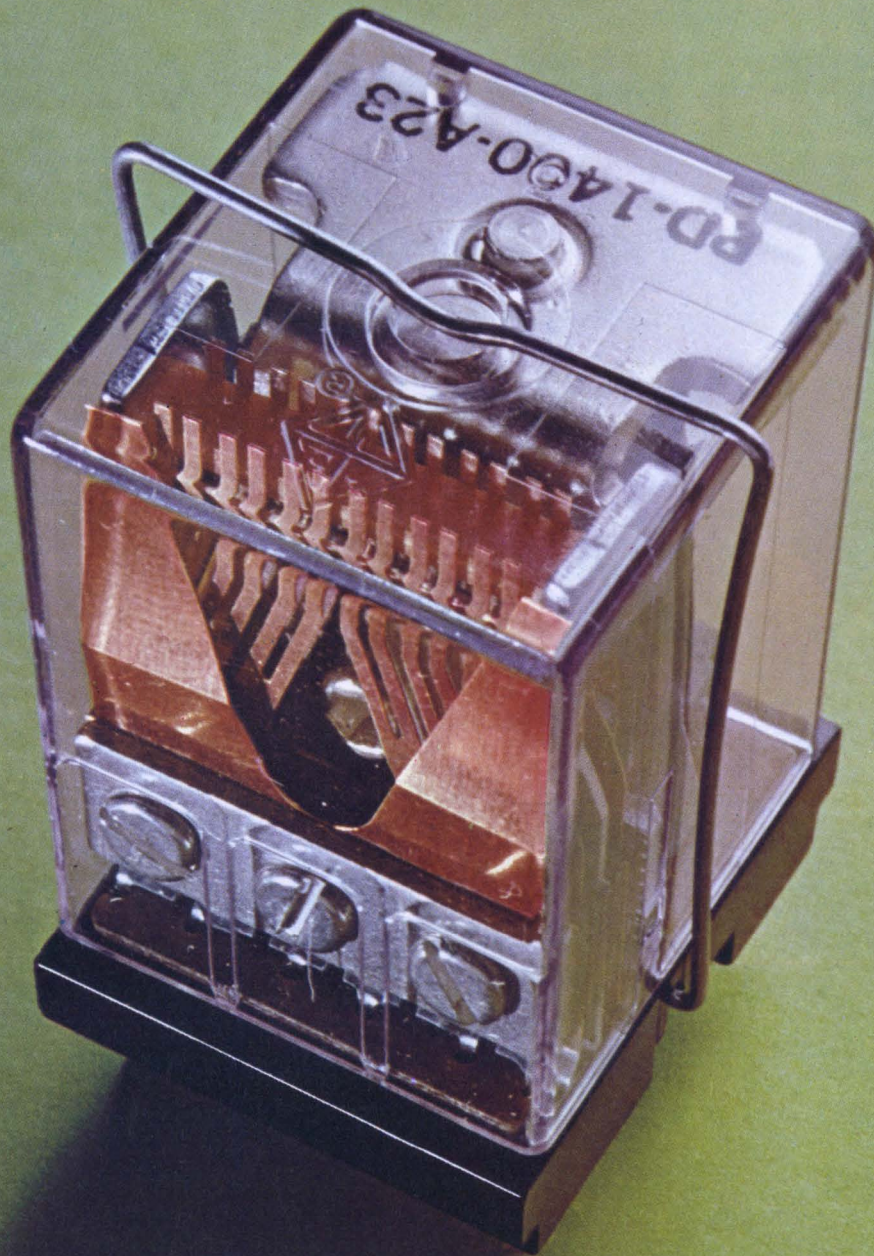

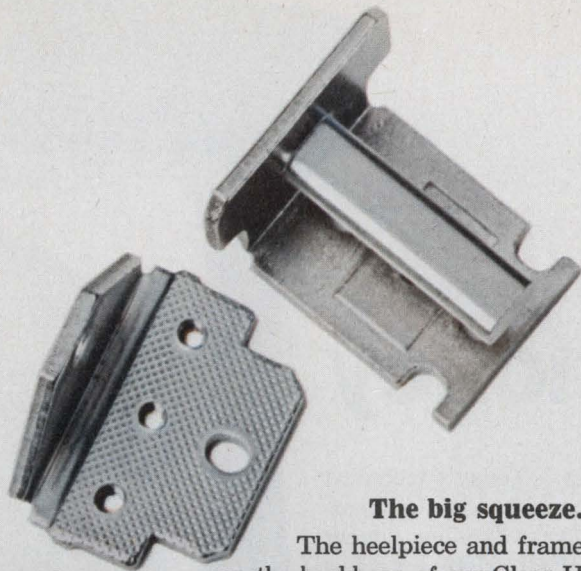

The big squeeze.

The heelpiece and frame are the backbone of our Class H relay. The slightest squiggle or shimmy out of either and the whole relay is out of whack.

756 tiny dents on the heelpiece, plus one big one on the frame, make sure this'll never happen.

They're the result of planishing, a big squeeze. Planishing is an extra step we go through in forming the pieces to add strength and stability by relieving surface strain. It also makes the parts extra flat.

This takes the biggest press in the industry and the biggest squeeze. Both exclusively ours.

A different kind of coil.

The heart of a relay is the coil. If ours looks different, it's because we build it around a glass-filled nylon bobbin. It costs us more, but you know how most plastic tends to chip and crack.

Also, moisture and humidity have no effect on glass-filled nylon. No effect means no malfunctions for you to worry about. No current leakage, either.

The coil is wound on the bobbin automatically. No chance of human error here.

Springs and other things.

We don't take any chances with our contact assembly, either. Our contact springs are phosphor-bronze. Others use nickel-silver. Our lab gave this stuff a thorough check, but found nickel-silver too prone to stress-corrosion. Atmospheric conditions which cause tarnish and ultimately stress corrosion have almost no effect on phosphor-bronze.

Even things like the pileup insulators (those little black rectangles) get special attention. We precision mold them.

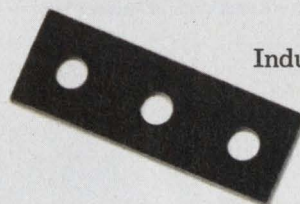
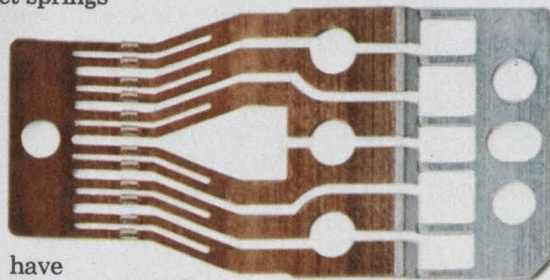

Other manufacturers just punch them out.

It makes a lot of difference. They're stronger, for one thing; and because they're molded, there's no chance of the insulators absorbing even a droplet of harmful moisture. Finally, they'll withstand the high temperatures that knock out punched insulators.

Two are better than one.

Our next step was to make sure our contacts give a completed circuit every time. So we bifurcate both the make and break springs.

Each contact works independently to give you a completed circuit every time. Contact material is pure palladium with a gold overlay because no alloy works as well.

Edge-tinned contact springs save you the job of solder tinning them later. Also, edge-tinning enables you to safely use the same relay with sockets or mounted directly to a printed circuit board. A simple thing, but it takes a big chunk out of the inventory you have to stock.

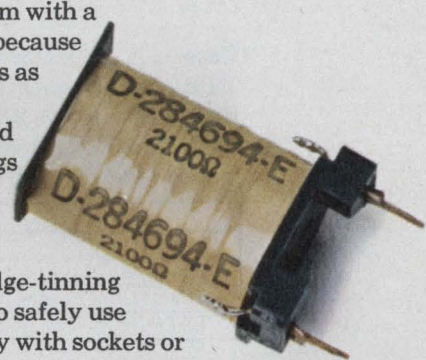

Finally, superior protection.

Out of the dozens of plastics to choose from for our dust cover, we picked a durable polycarbonate. The same material used for plastic windshields and special vehicle bodies. It's strong, resists high temperatures, and is unaffected by most cleaning solvents.

Then, for extra safety, we put a disposable cap over the cover's open end. This seals out dirt and dust while preventing damage to the terminals during shipping and handling.

Etc. Etc. Etc.

There's a lot more to tell about what makes our Class H relay reliable. Now we're waiting to hear from you.

GTE Automatic Electric,
Industrial Sales Division, Northlake,
Illinois 60164.

GTE AUTOMATIC ELECTRIC

Time is money

An old proverb states "Time is Money." Today's technical jargon might express this as: The logic which does the greatest work per unit time, per dollar, *can reduce equipment costs*. Naturally, we feel the logic is MECL. Here are a few actual case histories illustrating just that.

Case 1. A processor was designed in three ways: A. Schottky TTL, performance level X; B. MECL 10,000, same structure, performance 2X; C. MECL 10,000 architecture modified to exploit ECL speed and other design advantages, performance level X. The design team discovered the following:

	TTL (Schottky)	MECL 10,000
Performance	X	X
Package Count	Y	Y-25%
Power Consumption	P	P-28%
TOTAL SYSTEM COST	Z	Z-22%

Case 2. Existing equipment used 3 TTL (7400 series) boards (~100 packages each) to process 9 input lines of 2 to 10 MHz data streams. The system was redesigned and the 3 boards replaced with *one* MECL 10,000 board (~100 packages) which worked more than 3 times faster.

Design results: A. A small saving in basic IC component costs; B. A huge reduction in system complexity, together with increased reliability, smaller size, reduced power consumption, lighter weight, and reduced assembly costs.

Case 3. A memory system was designed which would have required high performance NMOS memories and would have used TTL control logic. In analyzing the system, designers realized that delay time subtracted from control logic operation could be added to NMOS cycle time specs. Thus, the use of cheaper, lower performance NMOS memory elements were combined with ECL control circuits. Design goals were met and the same level of performance was obtained — at reduced cost.

MECL and MECL 10,000 are trademarks of Motorola Inc.

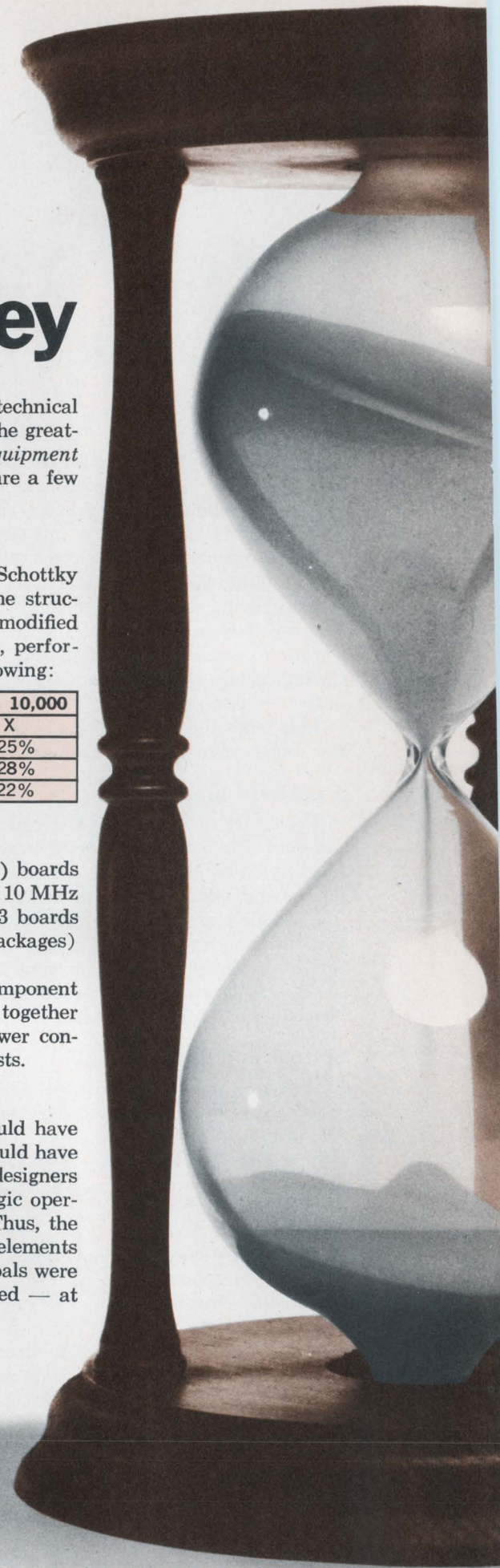

MECL saves time

MC10149AL 256 x 4 PROM
The fastest, large field programmable ROM available today. A quick way to simulate logic, micro-programming, look-up table storage, and high speed code conversion.

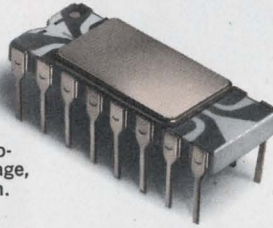

MC10183 4 x 2 (2's complement) Multiplier
Multiply more with fewer packages. Ideal for high speed computers, image transfer equipment, digital filters, correlators, and "smart" instrument signal processing.

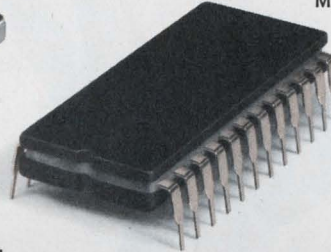

MC1699 ÷ 4, 1-GHz Counter
A low cost IC approach to high frequency counting problems by reducing IC and discrete component count. Applications include digital TV tuners, frequency synthesizers, and high performance instruments.

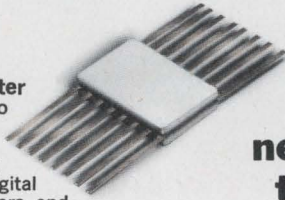

Six new ways to save time



MC1601
Quad 2-Input OR/NOR Gate

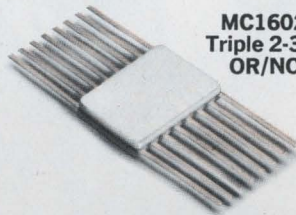

MC1602
Triple 2-3-2 OR/NOR Gate

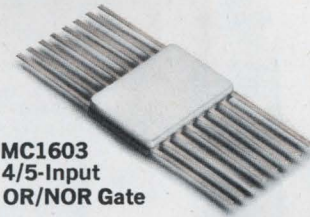

MC1603
4/5-Input OR/NOR Gate

High-bandwidth devices designed for systems requiring up to 500 MHz bandwidths. Communicate more data with fewer packages — faster.



MOTOROLA MECL
—A fast way to save time

Evaluate and receive a free copy of the new MECL Data Book.

Evaluate one or more of the new devices and receive a free copy of the recently published MECL Data Book. Just list your name, company, and tentative application on your company letterhead, and attach it to your purchase order. Your local franchised Motorola distributor will include the book with your devices. This offer is limited to one book per order and expires March 31, 1975.

For device specifications, write to Motorola Semiconductor Products Inc., P.O. Box 20912, Phoenix, AZ 85036. And if you haven't viewed the MECL seminar, call your Motorola distributor or OEM sales office for a presentation. "Time is Money." Invest in a MECL evaluation. It could return a handsome profit.

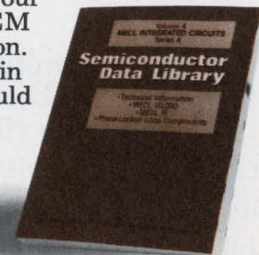

Your Guardian Angel
(and dramatic engineering
developments) bring you

solenoids



NEW! If the solenoid you're now using in your product lasts five years... you can now figure on 500 years.

These new Guardian solenoids perform the 1 million operations you expect of a traditional-life tubular solenoid . . . and keep right on . . . and on. For 100 million operations. Making them ideal for business machines, computers, testing equipment, medical electronics equipment, anyplace where a life expectancy of 1 million operations just won't do. Where 100 million is more like it.

NEW! This unique design increases mechanical life from 1 million to 100 million... at just a little more cost.

The amazing part is how little more cost for so much more life! Only about 25% more than our traditional-life tubular solenoids. Yet you get 10,000% more life! The secret is in the cost saving design of the new steel shell.



Get all the long-life facts.

in this brand new 72-page Guardian Solenoid Catalog. It's proof Guardian's No. 1 in solenoids... and plans to stay there.

that last 100 times longer*

*And that's a minimum. Life tests have already gone past 100 million operations ...and are still running!

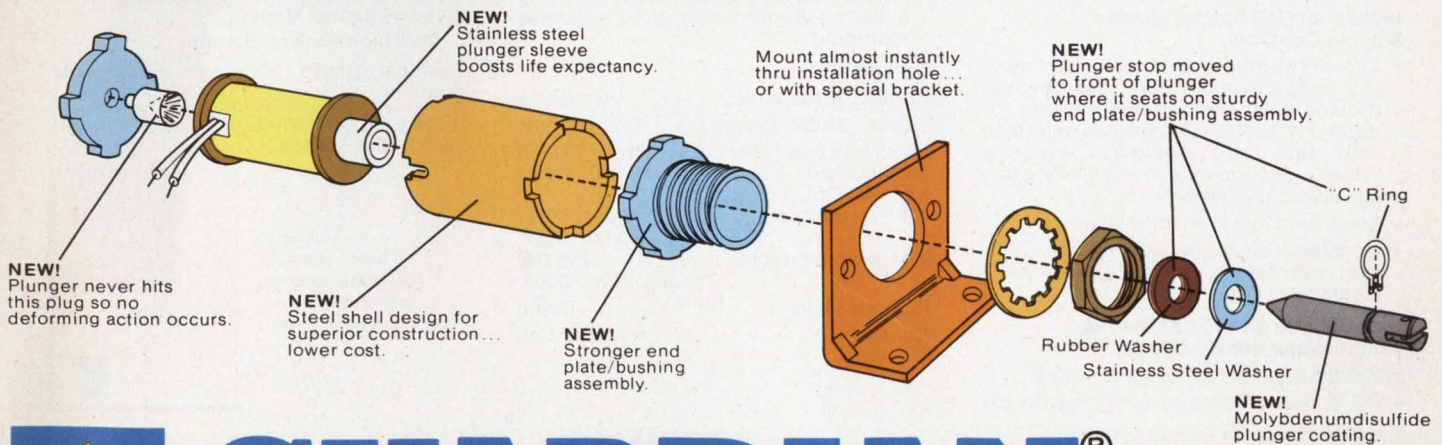
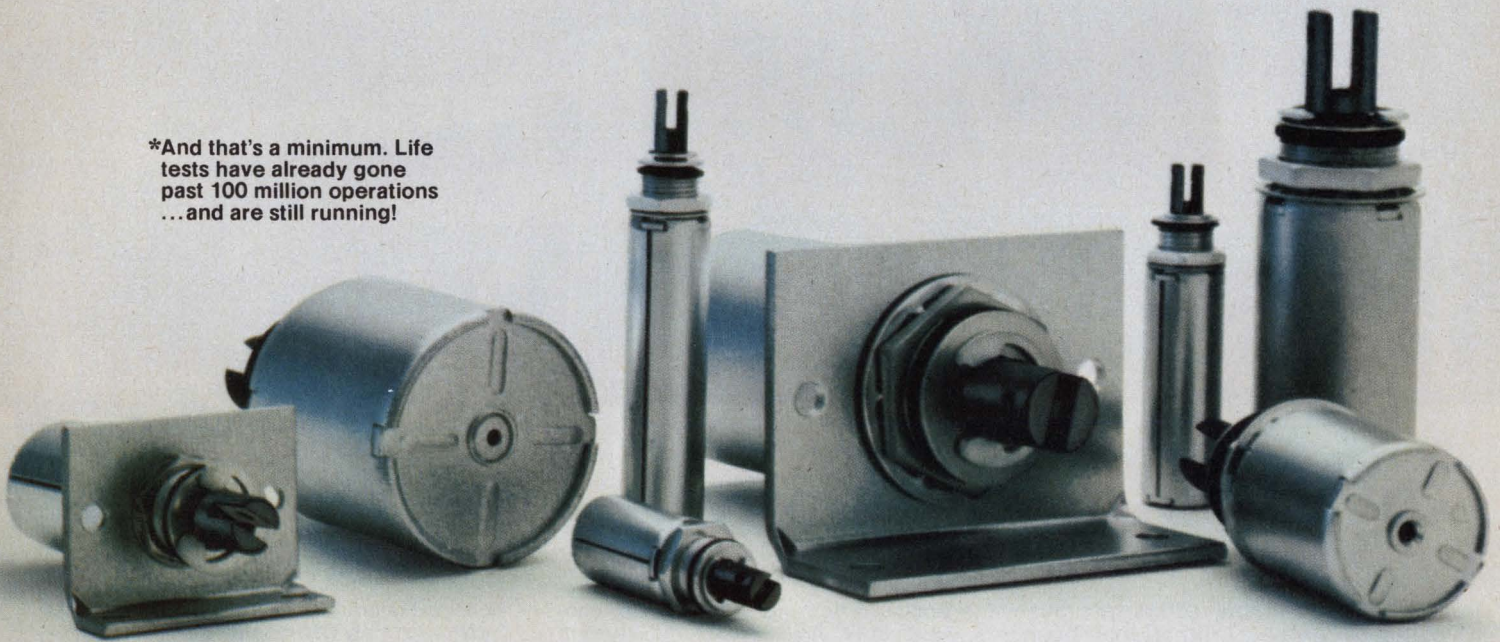

GUARDIAN®

GUARDIAN ELECTRIC MANUFACTURING CO. • 1572 West Carroll Ave., Chicago, Illinois 60607

SCHADOW

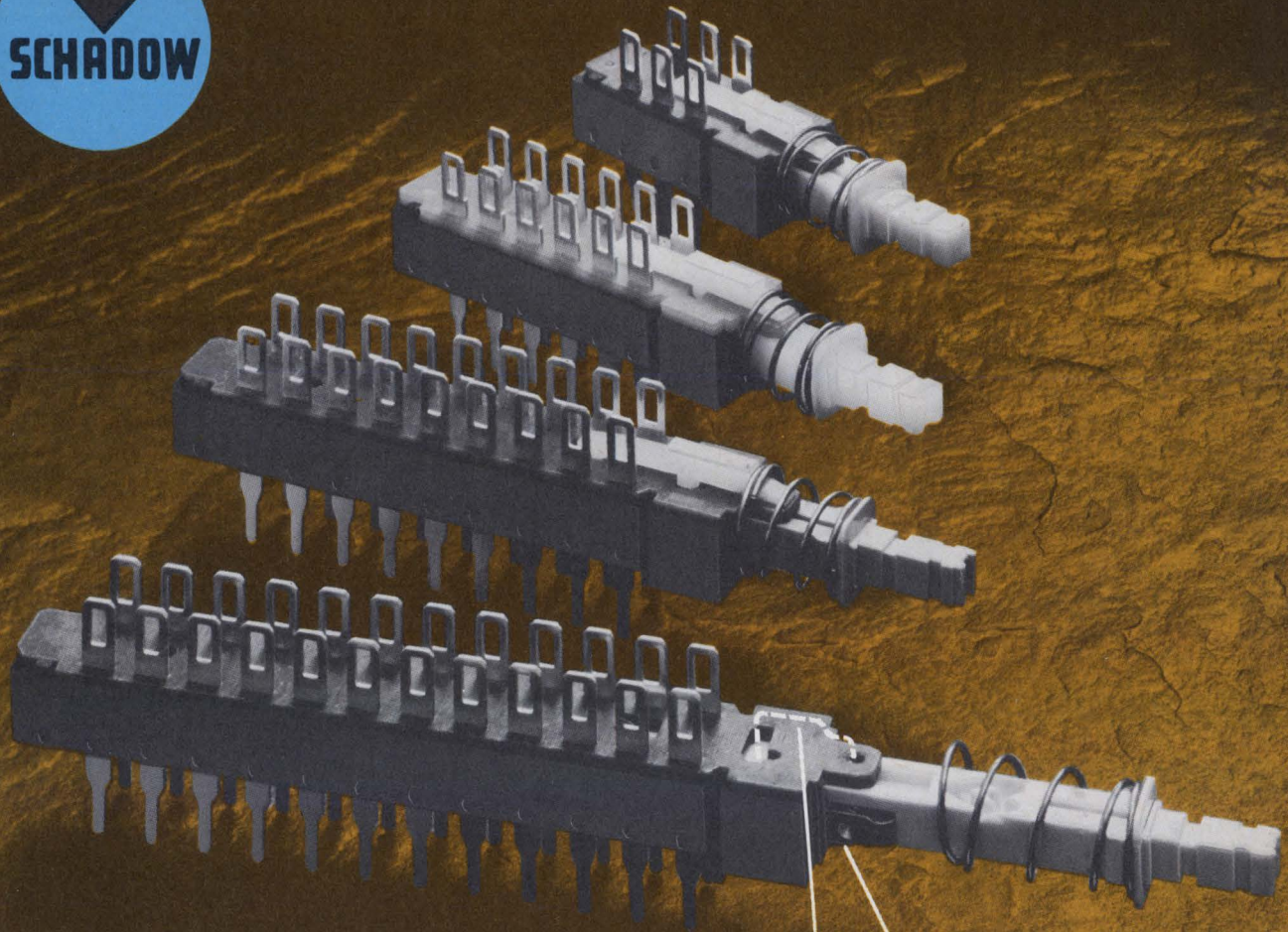

better switch...here's why...

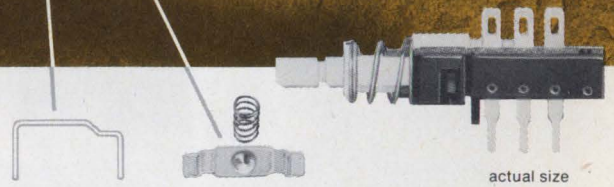

Yes, IEE/Schadow offers an outstanding array of functional push buttons including mechanical reflector indicators... and behind each one of them is the best engineered switch mechanism available today.

Individual Coil Spring Loaded Moving Contacts

- The coil spring-loaded contoured moving contacts have been designed to provide balanced contact pressure for optimum surface to surface interface with the fixed contacts... assuring reliable performance in low voltage (dry circuit) applications
- Long term low contact resistance
- Constant coil spring tension at the contact points provides positive self-cleaning action

Hand Wiring and Flo-Soldering Connections are Standard

- Solder lugs on top for hand wiring
- PC spikes at bottom for flo-soldering

Superior Modular Construction

- Ease of maintenance... switch plunger with sliding contacts is removable from the front without disturbing electrical connections

- Enclosed housing protects inner contact area from dust and foreign intrusions
- Fixed terminals are "staked" in position, providing an extra seal to help prevent wicking of solder or flux
- Molded PC Board Standoffs, front and back, on bottom side, assure parallel mounting

Technical Data

Contact Resistance 4-6 mOhms
 ... after 25,000 cycles 6-20 mOhms
 Lifetime Expectation Interlocked (50,000)
 Momentary, Push Push (100,000) cycles
 Material Of Construction
 Fixed contact Brass/Silver
 Plated .0002"
 Moving contact Bimetal
 Brass/Silver .0004"
 Plunger Material Delrin
 Contacts Non-shorting

Housing Material Glass Reinforced
 Nylon/or Poly Carbonate
 Terminal Board

Material . . . High Grade Paper Phenolic
 NOTE: In circuits imposing unusual demands for insulation resistance and dielectric strength, we offer these alternates: Housing Material:
 Makrolon (Polycarbonate)

Terminal Board Material: Hard paper grade IV

If it's a better switch you need... better switch to Schadow.

Full color switch selection guide available free when requested on your business letterhead.



IEE/SCHADOW inc

8081 Wallace Road, Eden Prairie, Minn. 55343
 612/944-1820 • TWX 910-576-2469

Manufacturing facilities in Minneapolis, Minnesota, Einbeck, W. Germany and W. Berlin

(continued from page 7)

About that postal alphabet soup

As you may have noticed, ELECTRONIC DESIGN is now using the Postal Service's two-letter abbreviations for states when they are part of an address. Though they may strike some readers as unwieldy and unrecognizable in a profession already awash with acronyms and jargon, the new style appears inevitable. (Remember what a pain it was to use zip codes at first?)

Because some of us still stumble on encountering such shorties as UT, HI, MI and MN (Utah, Hawaii, Michigan and Minnesota), here's the key to the entire postal code. Clip it out. Paste it up. And don't forget to give yourself a gold star when you learn it.

ABBREVIATIONS

Ab- brev. State	Ab- brev. State
AK Alaska	MT Montana
AL Alabama	NC N. Carolina
AR Arkansas	ND N. Dakota
AZ Arizona	NE Nebraska
CA California	NH N. Hampshire
CO Colorado	NJ New Jersey
CT Connecticut	NM New Mexico
CZ Canal Zone	NV Nevada
DC Dist. of Col.	NY New York
DE Delaware	OH Ohio
FL Florida	OK Oklahoma
GA Georgia	OR Oregon
GU Guam	PA Penn.
HI Hawaii	PR Puerto Rico
IA Iowa	RI Rhode Island
ID Idaho	SC S. Carolina
IL Illinois	SD S. Dakota
IN Indiana	TN Tennessee
KS Kansas	TX Texas
KY Kentucky	UT Utah
LA Louisiana	VA Virginia
MA Mass.	VI Virgin Islands
MD Maryland	VT Vermont
ME Maine	WA Washington
MI Michigan	WI Wisconsin
MN Minnesota	WV W. Virginia
MO Missouri	WY Wyoming
MS Mississippi	

Decoder chip converts 7-segment to BCD

The New Product item "7-Segment Display Decoder Has BCD, Too" (ED No. 21, Oct. 11, 1974, p. 149) should have said "7-Segment-to-BCD Decoder." Our SC-426 IC was erroneously described

as having seven-segment outputs to drive LED displays in addition to providing BCD outputs. Instead, it accepts seven-segment inputs and converts them back to BCD format.

The device was designed to take advantage of the powerful computing capability of low-cost calculator chips, which, in their present form, have an output that dead-ends into a visual digital

display. By decoding the outputs back into BCD, the engineer can break out this extraordinarily economical data-reduction ability into useful computer, controller or printout functions.

Thomas J. Scarpa
President

Scarpa Laboratories, Inc.
46 Liberty St.
Metuchen, NJ 08840



Let's face it.
People do judge by the cover.

Even the most sophisticated customers can't help being influenced by the way a product looks. That's why we're so careful about the design of our Optima enclosures. Because first impressions count.

Of course, we think about more than styling when we build our enclosures. We also design them with enough strength to last indefinitely. And we provide for just about any optional feature you might want. Detachable panels, chassis slides, hinged doors and the like.

The point of it all is real, honest quality. Optima enclosures are probably the very best you can buy. And they look it. And most important, that's how they can make your product look.

For a better idea of the broad range of Optima enclosures, ask for our color catalog.

OPTIMA

Write Optima Enclosures, a division of Scientific-Atlanta, Inc.
2166 Mountain Industrial Blvd., Tucker, Georgia 30084 or call (404) 939-6340

INFORMATION RETRIEVAL NUMBER 13

Designers'

Toggle Switches
Bat, lever lock, Designer
Line, sealed. Big, broad
choice.

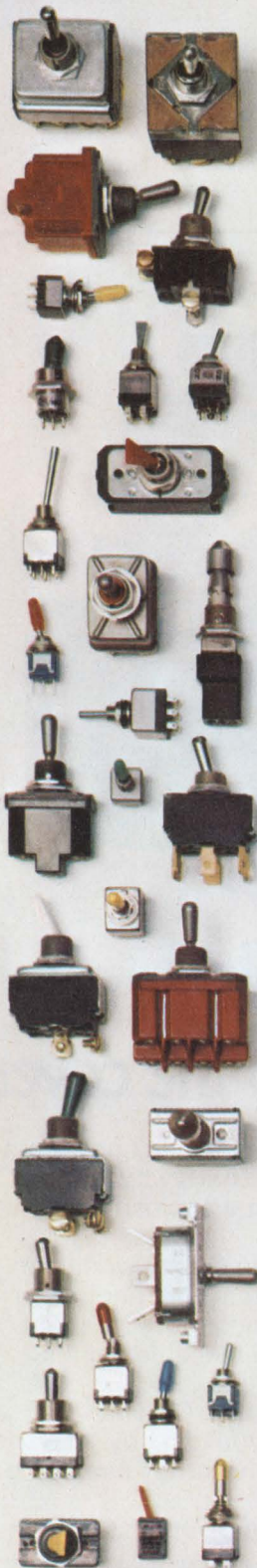

Rocker Switches
Singles and multiples.
Wide, colorful selection
range. Legends, too.

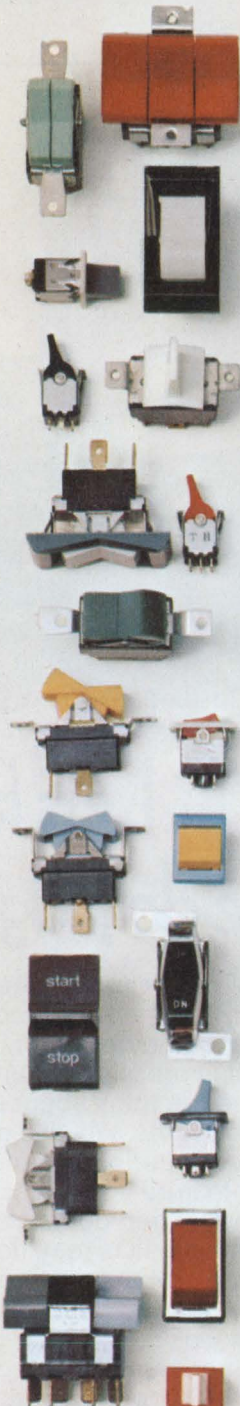

Cutler-Hammer, of course! The broadest line. Styled to meet today's and tomorrow's requirements. They're solid quality, look great, work long and hard. Carried in stock for local availability by Switch Distributors. Backed by Cutler-Hammer sales engineers who can deliver innovative design help for

Pushbutton Switches
Choice of sizes, colors,
circuits, ratings. Styled
to "turn you on".

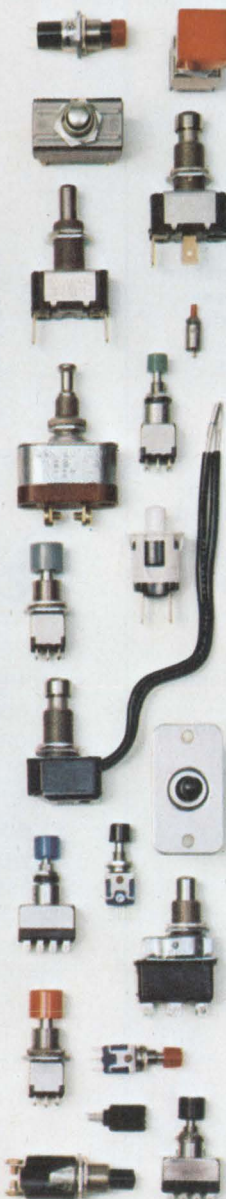

**Tool Handle &
Slide Switches**
Variable speed, reversing.
Double insulated.

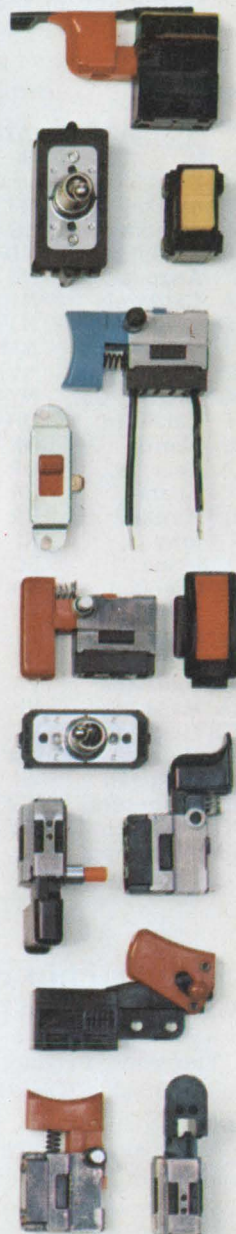

 **Switch to No.1**

Choice.

the exact switch or relay you need—when you need it.

It's no wonder so many designers specify Cutler-Hammer. For quality, reliability, availability, and style. For commercial, industrial, and military applications.

We simply offer more—of everything!

Snap Switches

Lever, roller, leaf, and pushbutton actuators. Four terminal styles.



Switch Accessories
Guards. Boots. Seals. Caps. Decorator facenuts. And much more to protect, code or customize.



Rotary Switches

Precision and general purpose. Single and multiple wafer.

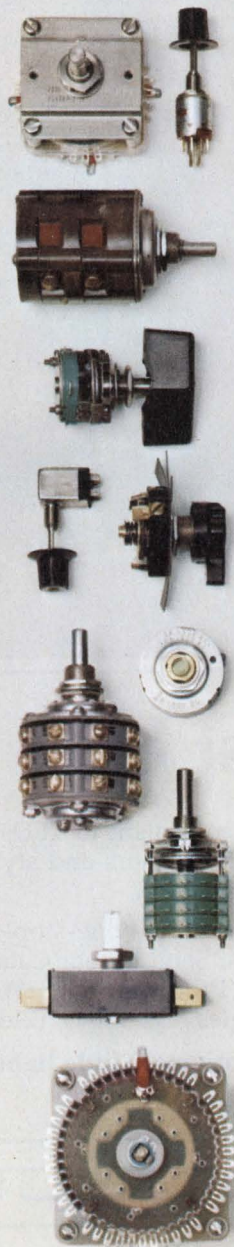

Illuminated Switches

Rockers, paddles, pushbuttons, indicators. Snap-in and bushing.

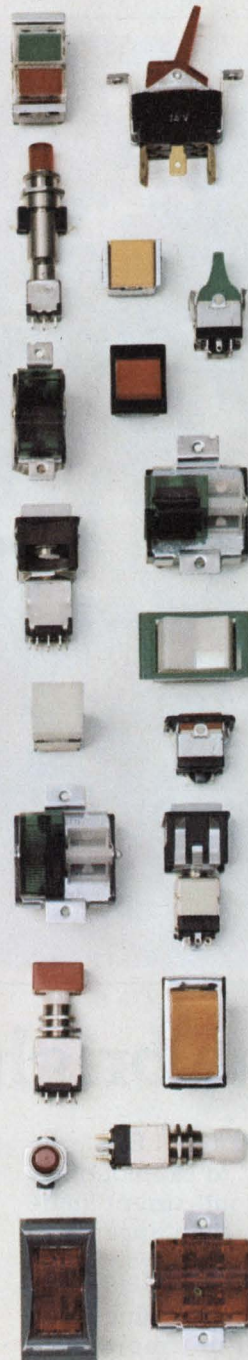

Relays

Hermetics, non-sealed, potted. Power, latching, and timing functions.



CUTLER-HAMMER

SPECIALTY PRODUCTS DIVISION, Milwaukee, Wis. 53201



Our Cup Runneth Over



...with the brightest LED lights.

Green, yellow, amber and red LEDs . . . panel or PCB types . . . $\frac{3}{16}$ " to $\frac{3}{8}$ " mounting diameters . . . with or without current limiting resistors . . . brighter than incandescents at $\frac{1}{2}$ the current.

Incandescents and neons too (including green neons) . . . some with built-in lamp drivers and keep alive bias . . . some with life rat-

ings equivalent to LEDs . . . all with a wide choice of colors and styles, plus unmatched performance.

We're your "one-stop-shop" for indicator lights. Send for our Catalog today: Data Display Products, 5428 W. 104th Street, Los Angeles, Ca. 90045, (213) 641-1232.

The original "little light" people.



I²L densities shooting up as speed power declines

An improved form of integrated injection logic that promises even higher packing densities, lower speed-power products and simpler fabrication was described at the International Electron Devices Meeting in Washington, DC.

Other developments covered included the following:

- A low-noise input structure for charge-coupled devices that reduces device sensitivity to threshold voltage.

- A new submicron emitter formation, with reduced base resistance, for ultra-high-speed devices.

The improved form of I²L was developed at Plessey, Northamptonshire, England. V. Blatt, an engineer for the company, reported:

"We can achieve gate densities approaching 1000 per mm² and speed-power products approaching 0.02 pJ. And these values are close to the physical limits without device cooling."

Blatt delivered a paper on "Substrate-Fed Logic—an Improved Form of Injection Logic," which described the new technique and reported on initial circuits built with substrate-fed logic (SFL).

Already the leading bipolar technology to challenge MOS, I²L achieves MOS-level densities by using planar npn transistors upside down. A direct result is an automatic isolation of all collectors, while all emitters are common. In operation, lateral npn transistors inject current directly into the base of a multi-emitter npn transistor operating in the inverse mode.

"But there are difficult compromises to be made," Blatt said, because semiconductor regions of the same doping density act as an emitter of one transistor and base of another."

To get around this problem (and increase densities, while reducing

speed-power products), SFL arranges npn transistors vertically above the injector. The substrate forms the emitter of a npn transistor whose base and collector are two epitaxial layers. These layers also are used for the emitter and base of the npn transistor, while diffused n regions form the transistor's collector.

The equivalent SFL gate consists of a conventional I²L gate plus Schottky inputs. A lightly doped p-type epitaxial layer permits Schottky-barrier diodes to be used for the base contacts.

"Consequently gates can be driven from two or more isolated lines, and their input behaves like a conventional NAND gate." Blatt said, "while the structure retains the multiple-output capability inherent to I²L."

Among the SFL circuits developed by Plessey is a content-addressable memory cell. Compared with an equivalent I²L gate, Blatt said, the SFL cell has only a single equivalent gate delay instead of two.

Another developmental SFL circuit, which employs V-groove isolation and ohmic base contacts, is a nine-stage rising oscillator. "For a high proportion of its range," Blatt said, "the speed-power product is less than 0.05 pJ."

In CCD analog signal processing applications, an IGFET structure is most frequently used to control injected charges electrically. Variations in the threshold voltage of the IGFET affect the stability and interchangeability of serial devices and introduce pattern noise in parallel devices.

To overcome these problems, S. P. Emmons, an engineer from Texas Instruments, Dallas, described a new input structure that derives the injected charge from the difference between two voltage

levels on a capacitive node. Since both levels are set with use of the same IGFET Emmons noted, almost perfect threshold voltage cancellation is possible.

The new input circuit promises at least an order of magnitude improvement in threshold voltage variations—reducing them from 140 mV to 15 mV.

Another refinement in semiconductor technology that could make it easier to produce better microwave transistors and ICs is a self-aligning method of bipolar transistors in submicron sizes.

Developed by the Semiconductor IC Div. of Fujitsu Ltd., Kawasaki, Japan, the technique was described by H. Kamioka.

According to Kamioka, the new fabrication method makes it possible to control a transistor's outer base region, which is the distance between the emitter and base contact region. Emitter widths of less than 0.5 μm have been routinely achieved, he noted.

In addition this method permits the reduction of the base resistance to less than a quarter that of conventional methods, Kamioka reported. By reduction of this resistance, the noise figure improves from 4 dB for the conventional transistor to 1.7 dB with this side-etched technique.

The improved noise figure also results in better switching characteristics, Kamioka reported. Whereas the f_T of a conventional transistor was 5.3 GHz, the same transistor made with the new method yielded a 7.5 GHz f_T , the researcher said.

Oscillators calibrated with TV color signal

Engineers who need a highly accurate frequency standard no longer need invest in an expensive atomic clock. For as little as \$50 worth of parts and a color TV set, an engineer can put together a unit with which he can "borrow" the rubidium-controlled frequency standard of any of the major television networks.

Researchers at the National Bureau of Standards Laboratory in Boulder, CO, have developed four techniques that use the 3.58-MHz clock signals generated by the TV

networks to calibrate oscillators. Accuracies approach 1×10^{-11} .

The highly accurate 3.58 MHz forms the color burst signal and is present only in live color broadcasts.

The four techniques, in order of increasing complexity, are:

1. Rf color-bar comparator.
2. Video color-bar comparator.
3. Digital subcarrier comparator.
4. Digital offset computer.

The rf color-bar technique achieves accuracy of 1×10^{-9} in less than five minutes and requires no modification of the TV set. A small electronic circuit that can be built for less than \$50 is attached to the antenna terminals of the set, and it causes a vertical rainbow-colored bar to appear on the TV screen.

When the oscillator to be calibrated is plugged into the circuit, the bar moves across the screen at a rate that is proportional to the test frequency and the network frequency. If the difference is small, motion is slow and the bar changes color at a rate that is proportional to the difference. By timing the number of seconds required for the colors to change, the difference between the two frequencies can be calculated.

The video color-bar technique is similar to the rf color bar, except that it requires the addition of a resistor and two capacitors to the TV set. Accuracy is improved one order of magnitude 1×10^{-10} .

For accuracy of two parts in 10^{11} , the digital subcarrier comparator can be used. It generates a narrow vertical line that moves slowly across the screen and acts as an analog indicator of the phase difference between the two signals. A four-digit counter also indicates the period of the phase difference.

The most accurate technique takes a series of average readings, automatically computes the difference between the test and reference signals and displays the difference in 10 four-digit numbers on the TV screen. The numbers are averaged to get accuracy of 1×10^{-11} .

Home printer to extend capabilities of cable TV

A graphic printer may soon sit alongside the cable-television sub-

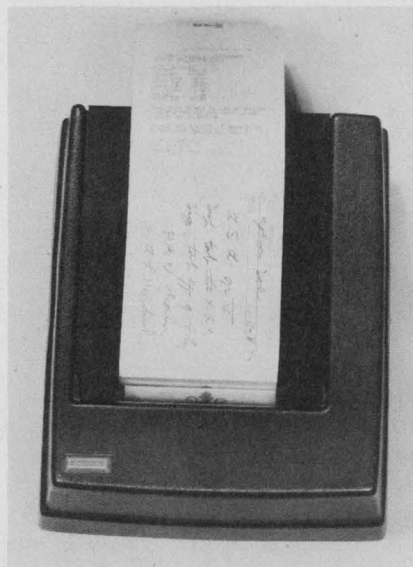

Graphic printer is designed for use with cable TV subscriber's unit.

scriber's unit and print out educational material that you'd like to study after the program is over. Or it could print out your utilities bill. The value would not be to get the bills to you faster but to spare the overburdened Postal Service from processing several million letters a year.

The printer was built by Repco, Inc., Orlando, FL. Help with the specifications, as well as with the research and development funds, came from TelePromTer Corp. and Jerrold Electronics. Repco has now finished several prototypes and is preparing to ship them to TelePromTer and Jerrold Electronics for tests.

The printer is small, quiet and automatic, Repco says. Its largest dimension is 12 inches, and it uses dry electro-sensitive paper, producing immediate and indelible marks without any processing chemistry.

Marks are arranged in a 64-to-the-inch dot-raster format, which permits unrestricted use of the data field. Graphics may include alphanumeric, line drawings, symbology and hand signatures. The only required input signals are those of input data, a data clocking signal and a control signal.

The printer, which uses a static recording process, employs an array of 256 fixed, adjacent styli. Current pulses directed to these styli alter the paper surface coating to reveal the black layer underneath.

Data rate is 10 to 50 kbits per second, continuously variable with-

out modification to the printer.

With the addition of an interface unit, the Repco printer will be usable with home-transmitter equipment when these systems become available according to a company spokesman.

The Federal Communications Commission is striving to initiate such a capability by rules now in effect: New cable TV companies must install only systems with two-way capability. Companies in business prior to 1972 must update their systems for two-way capability by March 1977.

Two memories coming for ECL 10,000 logic

Two 1024-bit memories will become available soon to spur use of the ECL 10,000 logic family. Growth of the logic has been impeded by lack of a variety of memories, designers widely agree.

Motorola of Phoenix, AZ, is about to introduce the MCM 10149AL, a fusible link PROM with a maximum access time of 25 ns at 25 C. It has not yet been characterized over the entire temperature range of -30 to $+85$ C.

Signetics of Sunnyvale, CA, will introduce in March a similar part. Michael Hackword, the company's marketing manager, says: "We are sampling the part. It will have a maximum access time over temperature of 20 ns."

Signetics earlier had introduced a 256-bit ECL 10,000 PROM. However, Hackworth concedes that until recently Signetics was unable to produce the part in quantity.

The format of the PROMs is 256×4 bits. The Motorola unit will sell for \$54.37 (1-24) and \$43.50 (100-999). Signetics reports its price will be in the \$40-to-\$50 range.

The Motorola part will be in a 16-pin ceramic package.

According to Edmund C. Tynan, product planner at Motorola: "The main applications of the MCM-10149AL memory should be in microprogram storage, random logic simulation, look-up table storage and code conversion.

(Motorola)

(Signetics)

CIRCLE NO. 319

INQUIRE DIRECT

Surprise! \$2.95

(10-49)

Wideband Transformers

SURPRISE! Wide bandwidths, .015-600 MHz
SURPRISE! Low insertion loss, 0.5 dB
SURPRISE! Microminiature, .230" x .270" x .300"
SURPRISE! One week delivery

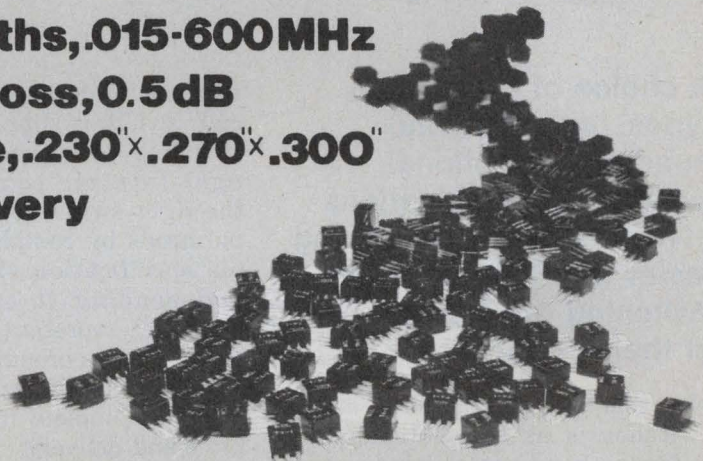

DESIGNERS KIT AVAILABLE:
 2 TRANSFORMERS OF EACH TYPE
 T1-1, T2-1, T4-1, T9-1, T16-1
 KIT # TK-1... **\$32.00**

NO "MAKE OR BUY" DECISION HERE... it costs less to buy Mini-Circuits wideband transformers and there's no delivery delay. Impedance levels from 12.5 to 800 ohms with insertion loss typically less than 0.5 dB

MODEL	T1-1	T2-1	T4-1	T9-1	T16-1
Impedance Ratio (50 Ω pri. imp.)	1	2	4	9	16
Bandwidth (MHz)	1 db loss	2-50	.05-200	2-100	2-40
	3 db loss	.15-400	.015-600	.2-350	.15-200
Price (10-49)	\$2.95	\$3.45	\$2.95	\$2.95	\$3.45

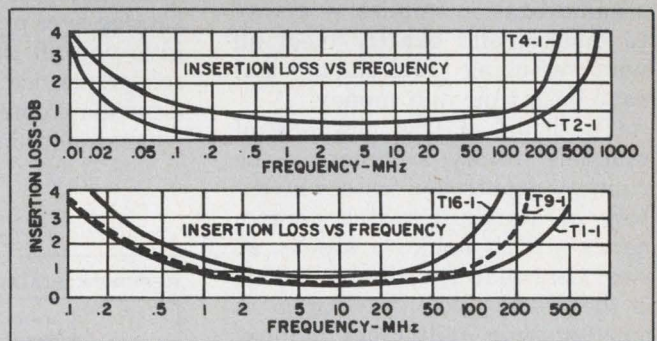

WE'VE GROWN

Customer acceptance of our products has been so overwhelming, we've been forced to move to larger facilities — THANKS.

Mini-Circuits Laboratory
 A Division Scientific Components Corp

OUR NEW ADDRESS IS: 837-843 Utica Avenue, Brooklyn, NY 11203 (212) 342-2500

Foreign Sales Representatives:

AUSTRALIA — General Electronic Services, 99 Alexander Street, New South Wales, Australia 2065; ENGLAND — Dale Electronics, Dale House, Wharf Road, Frimley Green, Camberley Surrey; FRANCE — S.C.I.E.-D.I.M.E.S., 31 Rue George-Sand, 91120 Palaiseau, France; GERMANY, AUSTRIA, SWITZERLAND — Industrial Electronics GMBH, Klüberstrasse 14, 6000 Frankfurt/Main, Germany; ISRAEL — Vectronics, Ltd., 69 Gordon Street, Tel-Aviv, Israel; JAPAN — Densho Kaisha, Ltd., Eguchi Building, 8-1 1 Chome, Hamamatsucho Minato-ku, Tokyo. **EASTERN CANADA** — B. D. Hummel, 2224 Mayard Avenue, Utica, NY 13502 (315) 736-7821 **Italy** — Microel Italia S. R. I. via M. Loria 50, 20144 Milano via Senape 27, 00199 Roma **NETHERLANDS** Coindex Vlaardingem, Veldweg 11, Hatten, Holland

U. S. Distributors:

NORTHERN CALIFORNIA — Cain-White & Co., Foothill Office Center, 105 Fremont Avenue, Los Altos, CA 94022 (415) 948-6533; SO. CALIFORNIA, ARIZONA — Crown Electronics, 11440 Collins Street, No. Hollywood, CA 91601 (213) 877-3550.

For complete U.S. Rep listing and product line see MicroWaves' Product Data Directory

Centralab perspectives

FOR USERS OF ELECTRONIC COMPONENTS

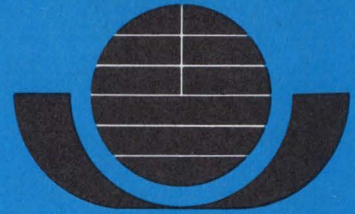

CENTRALAB

Electronics Division
GLOBE-UNION INC.
5757 NORTH GREEN BAY AVENUE
MILWAUKEE, WISCONSIN 53201

There's no easier way to select rotary switches – and Centralab's standardization program proves it.

A choice of four switch types, ten series and hundreds of optional switch-part combinations gives engineers a new and faster way to meet exact switching requirements of their designs.

No other line of standard rotary switches is as complete as the extensive new Centralab industrial line. It's everything that the word standardization implies – a way to quickly and exactly meet all your switching requirements and save both time and money.

The heart of this new line of standard rotary switches is the computer controlled factory inventory of standard switch components – with back-up stocks at local Centralab Distributors. This is the "bank" you draw upon in meeting your individual requirements. It assures you of the right switch, faster delivery and competitive prices.

Here's how the unique Centralab standardization concept works for you. The key to instant switch selection is our new 40 page catalog that gives complete specifications for sub-miniature, miniature, heavy-duty and power switches. It also details the wide choice of options available in shafts, bushings, indexes, spacers and standard

sections. Ordering your own "special" switch is simply a matter of checking off your requirements right from the catalog. You get the right switch for your individual needs by completing the simple specification sheet supplied and sending it to your local Centralab representative. Gone is the need to consult the factory. Your local representative can also provide complete information on price and delivery.

Before you specify another rotary switch send for the most helpful catalog ever printed. Its 40 pages give you all the details. Use the reader service card or call your Centralab representative. Discover what standardization really means.



The wealth of engineering data in this new catalog on Centralab's unique line of standard industrial rotary switches makes it a real specifier's handbook. It is graphically simplified and color keyed for ease of use and contains reference charts like the one reproduced below, specifications, dimensional drawings, application data and easy ordering instructions. Ask for Catalog 1611S.

REFERENCE CHART

AVAILABLE FROM CENTRALAB DISTRIBUTORS

STANDARD INDUSTRIAL ROTARY SWITCHES	DIAMETER	ELECTRICAL SWITCHING CAPACITY		MAXIMUM POSITION & THROW IN DEGREES	INSULATION	INDEX	STOPS	SHAFT TYPE	OTHER FEATURES	
		BRASS SILVER								SILVER ALLOY
		0.17 amp @ 115 VAC 0.56 amp @ 28 VDC	0.29 amp @ 115 VAC 1.5 amp @ 28 VDC							0.34 amp @ 115 VAC 1.1 amp @ 28 VDC
SERIES 140	1 1/16"	•	•	8 x 60°	Phenolic		•	•	53	
SERIES 160	1"	•	•	8 x 45° 19 x 30° 13 x 30°	Ceramic Glass Epoxy		•	•	38	
SERIES 050	1 1/2"	•	•	18 x 22 1/2° 18 x 20°	Diallyl Phthalate		•	•	53	
SERIES 500	1 1/2"	•	•	24 x 15°	Stainless Steel Hill & Wiley Cord Springs		•	•	53	
SERIES 550	1 1/2"	•	•				•	•	53	
SERIES 670	2 1/4"	•	•				•	•	53	
SERIES 710	1 1/2"	•	•				•	•	53	
SERIES 300	1 1/2"	•	•				•	•	53	
SERIES 650	2 1/4"	•	•				•	•	53	
SERIES 230	2 1/4"	•	•				•	•	50	

Centralab
perspective:

New ULTRA-KAP II[™] capacitors

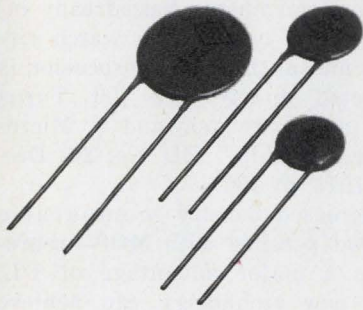

improved 3 ways

Ultra-Kap II doesn't replace our present Ultra-Kap line — it expands it. You still get more capacitance in less space, low dissipation and Y5F stability. In addition you enjoy these benefits:

NEW 75V SERIES in addition to 12, 16, 25 and 50V types. There are 3 standard values (.01, .05 and 0.1 μ F) to meet today's need for decreased size in this higher voltage rating.

INSULATION RESISTANCE that is 100 times better! On a 12V .05 μ F capacitor, for example, insulation resistance increases from 2 megs to 200 megs.

DIELECTRIC STRENGTH on the new Ultra-Kap II is rated at twice the working voltage. A 12V type can be used in applications having peak voltages of 24 volts. That's an added safety factor.

For details about new
ULTRA-KAP II, see your
Centralab Representative.



CENTRALAB
Electronics Division
GLOBE-UNION INC.
5757 NORTH GREEN BAY AVENUE
MILWAUKEE, WISCONSIN 53201

Centralab
perspective:

Trimmer resistors.

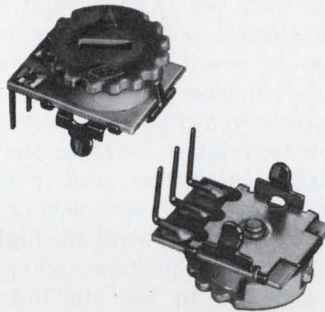

Now, with new Snap-Tite[®] rigid PC mounts.

When you specify the new Snap-Tite rigid mount you can simplify both installation and assembly. Available on both Centralab Series S carbon and cermet trimmer resistors, it lets you snap them into a PC board. Easy. The mount locks the trimmer securely into the board prior to soldering.

Centralab gives you more of the things you want in trimmers. Ceramic bases for higher wattage in a smaller space. Smooth positive adjustment. A variety of choices in mountings, terminations and knobs. And multiple sections too.

Send for Bulletin 1549T
so you'll have all the
specs.



Centralab
perspective:

Transmitter Capacitors

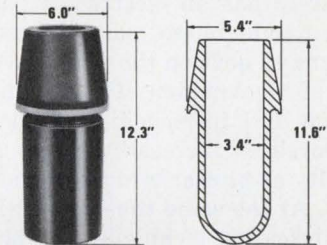

*Ceramic
dielectric
insert.*

Meet Specs For Extra Reliability and Save 50%.

When selecting capacitors for transmitter equipment, Centralab can help. Example: one ceramic dielectric type can replace two vacuum types — increase reliability — yet reduce both weight and cost by 50% or more. The cup type shown, meets specs calling for 6000 pf, 10 kV and current ratings of 100 amps at 500 kHz.

Centralab's line of special capacitors includes header, feed-thru, tubular, slug and water-cooled types — plus custom designs to meet any spec.

All it takes is a call to
Marty Hedrich at
414/228-2033.



CENTRALAB
Electronics Division
GLOBE-UNION INC.
5757 NORTH GREEN BAY AVENUE
MILWAUKEE, WISCONSIN 53201

Bipolar ICs due for broad advance with improved LSI technologies

Rarely has an electronics battle been fought on so many fronts as the one to develop the next generation of bipolar logic ICs. A number of new LSI technologies are being employed to increase the size and density of bipolar circuits economically. At the same time conventional fabrication techniques are being modified to develop the next industry standards.

Virtually the entire spectrum of bipolar speed ranges is likely to be affected. Here are some of the dominant trends:

- At the lowest speeds—gate delays of 10 ns or more—an emerging technology promises to fill the gap between standard TTL and high-speed MOS. IC manufacturers are turning to integrated-injection logic (I²L) to build LSI microprocessors, high-density memory chips and watch circuits. They also are looking at other technologies long used for specialized applica-

tions—such as TRW's and Bell Laboratories' triple-diffusion processes—as possible complements to I²L for bipolar/LSI circuits.

- Improvements in passive-isolation techniques—such as the oxide-isolation process used in Fairchild's 1-k RAM—are paving the way for memories with the highest densities yet. The new techniques are expected to lead to 16-k bipolar ROMs and 4-k bipolar RAMs from several manufacturers.

- At the highest speeds—gate delays of 2-to-3 ns or less—existing logic families—such as Texas Instruments' 54S/74S Schottky-TTL series and Motorola's ECL 10,000 and MECL III lines—are moving toward LSI circuits for applications ranging from mainframes to microcomputers.

I²L races to the forefront

The fastest-growing technology is I²L. Most IC manufacturers have at least development work under way with I²L, while many say they will have products within a year.

Texas Instruments has already introduced a custom I²L watch circuit, and an LSI microprocessor is expected shortly (see "I²L Turns Up in Wristwatch and a Microprocessor Chip," ED No. 26, Dec. 20, 1974 p. 19).

Increased density—comparable to that possible with MOS—represents a major advantage of I²L. The new technology can achieve greater densities than p-channel MOS, higher speeds than n-channel MOS and lower power dissipations than complementary MOS. In fact, the initial I²L circuits, for watches, are competing with equivalent CMOS products.

"Even with silicon-gate and ion-implant techniques," says Gene Carter, director of marketing for National Semiconductor, Santa Clara, CA, "CMOS thresholds are about 1 V. So the supply must run at about 3 V."

With I²L circuits, 1-1/2 V-batteries can handle the 0.7-V levels. Since logic levels and supplies are lower, dissipation can be less, observes Carter, who believes appli-

Edward A. Torrero
Associate Editor

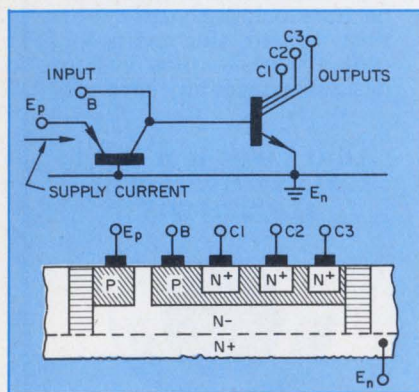

A new technology challenges MOS. Integrated-injection logic (I²L)—also known as merged-transistor logic, or MTL—employs a simple, self-isolating structure (above). Power-delay curves (right) compare I²L to MOS.

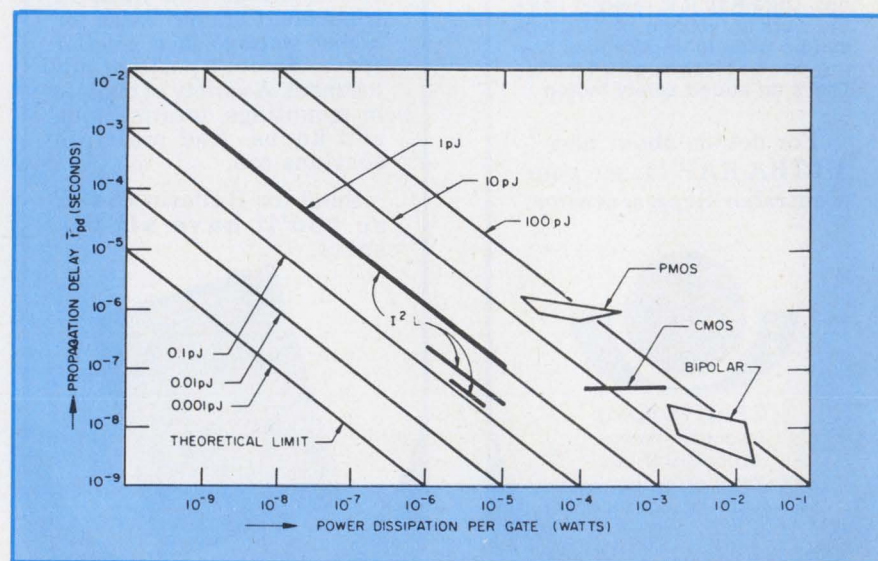

8-BIT ADDER ACCUMULATOR

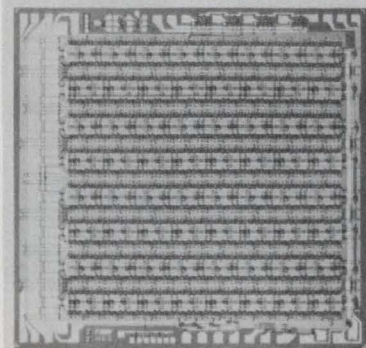
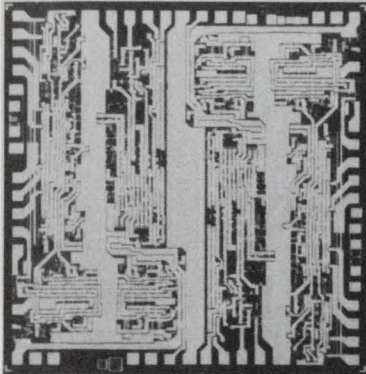

64-BIT CORRELATOR

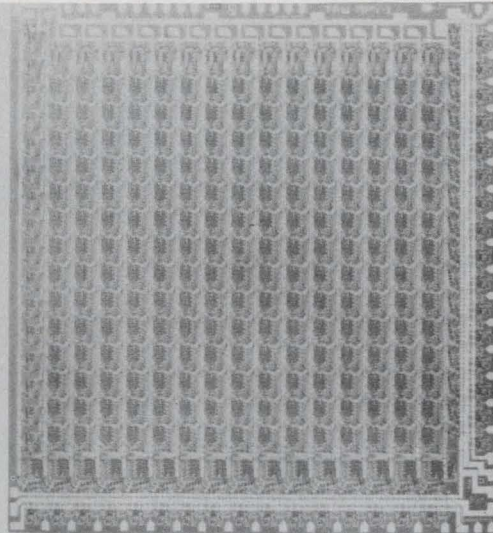

16 x 16-BIT MULTIPLIER

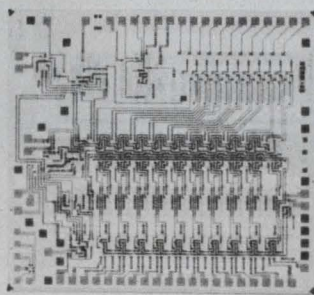

10-BIT A/D CONVERTER

The largest bipolar chips employ triple-diffusion processing and emitter-follower logic. These 3D/EFL circuits have been built by TRW for military and aerospace applications. Chip sizes reach 300 mils on a side.

cations requiring portability will be a major beneficiary of I²L circuits.

As such a new digital circuit technique as a new technology, I²L employs vertical npn transistors with multiple collectors and lateral pnp transistor current sources as loads. Supply current feeds into the switching transistor by carrier injection.

The relatively simple configuration produces directly these density-enhancing benefits: no need to isolate devices, elimination of resistors and no chip-area waste for metalization ground lines. And an inverter is simply two transistors, while a two-input gate is just three transistors.

Another advantage of I²L is simpler processing. Only five masking steps are required. And I²L products can be manufactured on any standard production line. Other technologies—including TTL, ECL and linear—can be combined with I²L on a monolithic chip. In this case, however, seven masks would have to be used.

"The mixing of I²L and linear is

possible," says Al Sheng, manager of linear circuit development at RCA, Somerville, NJ, "because I²L uses precisely the same processing steps as those needed for linear circuits."

The only major difference, according to Sheng, is that I²L operates transistors in an inverse mode.

At RCA, a development program seeks to combine I²L and linear circuits on the same chip. The manufacturer has already introduced a monolithic op amp that combines complementary MOS (for digital processing) and bipolar circuitry (for linear processing). I²L could be used to replace CMOS on similar linear chips for high-density circuits aimed at consumer applications.

"Theoretically I²L is denser than CMOS," says Sheng, who adds that products won't be available for at least a year.

Of course, I²L does have limitations. "Products using I²L would probably be limited to gate-propagation delays in excess of 10 ns," says Jim Dunkley, project scientist at Motorola, Phoenix, AZ. "At 10

ns, the speed-power product of I²L can increase to the point where it's not as good as low-power Schottky."

Also, the multiple-output characteristic of I²L would necessitate a change in standard interconnect rules, which are based on multiple inputs.

In addition, Dunkley notes, I²L has low noise margins. The low logic levels—0.7 V—produce a noise margin of about 200 mV, or less than ECL and TTL. However, new I²L circuits can be expected to contain internal TTL buffers, so the tolerance against noise would increase to that typical of TTL.

Nevertheless Dunkley agrees that "I²L will bridge the gap between present low-speed bipolar circuits and the high-speed MOS ICs," especially for the 25-to-50-ns gate-delay range. NMOS circuits usually exhibit propagation delays at the higher limit. And an attempt to develop LSI circuits with conventional TTL processing would lead to prohibitive speed-power values in the delay range. With I²L, however, the "speed-power product is typically 1 pJ," Dunkley says, "and low-performance I²L doesn't need the usual epi layer."

A 1-k gate for \$10

In the 25-to-50 ns range, a 1000-gate array would cost as little as \$10 to \$15, or about 1 cent a gate, according to Barry Werner, a product marketing manager at Motorola. Werner assumes that the usual semiconductor competition would prevail and that volume production would be possible. The 1000-gate array would be on a chip measuring about 150 x 150 mils—large for bipolar ICs—and it would consume only about 40 μW per gate, or 40 mW for the whole chip.

At present, however, most manufacturers say they cannot mass-produce I²L circuits. For some vendors, the problem is one of optimizing speed, density and power dissipation. For others, the answer is simpler: low yields.

"Ultimately, yield will probably be limited by emitter-to-collector pipes—defects that short the emitter to the collector," Dunkley says. But this problem is typical of bipolar circuits, which have traditionally been more sensitive to

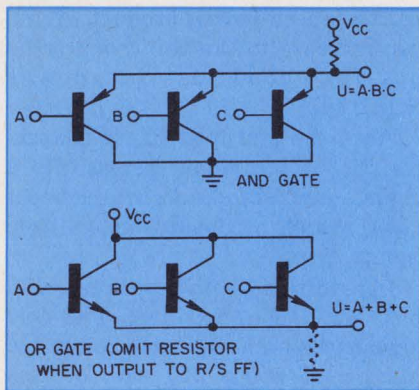

Typical 3D/EFL circuit elements (above) allow wire-AND and wire-OR connections. A speed-power plot (right), prepared by TRW, compares several LSI technologies.

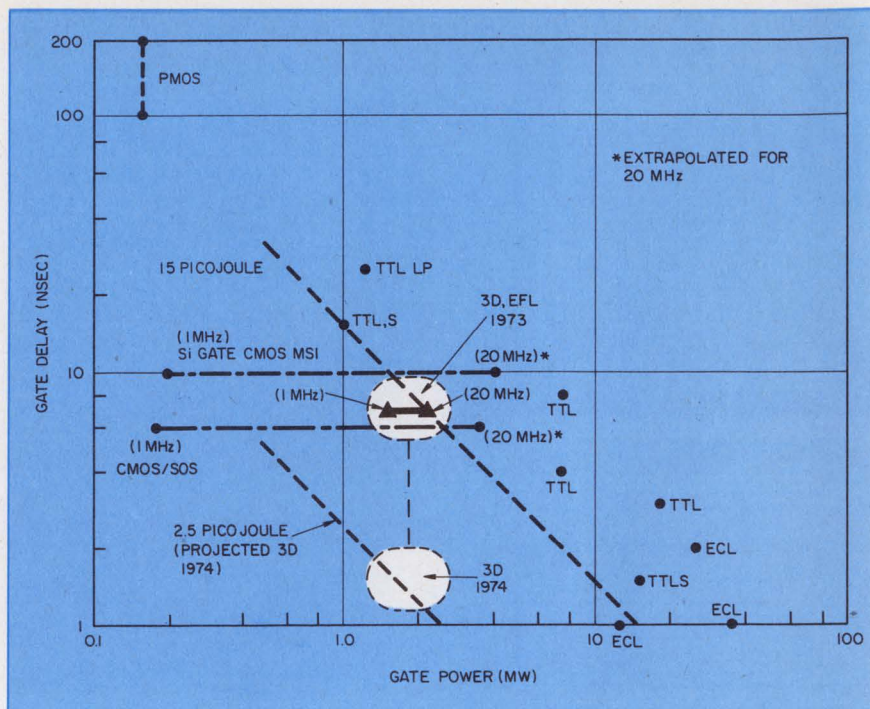

crystal defects than MOS circuits have been.

The largest bipolar chips have been built with triple-diffusion (3D) processing and emitter-follower logic (EFL). Developed by TRW, Redondo Beach, CA, the ICs measure up to 300 mils on each side, and they have been used in military and aerospace applications.

Though 3D/EFL circuits aren't commercially available, other manufacturers—Motorola, for one—see the technology as a possible way to build LSI complements to existing high-speed lines. With 3D/EFL, gate delays are typically 5-to-10 ns—the range of standard, high-speed TTL and ECL.

TRW uses the designation VLSI (for very large-scale integration) to indicate that 3D/EFL circuits contain in excess of 10,000 devices per chip. For example, a 16×16 -bit digital multiplier contains 17,000 devices on a 279×301 -mil chip. The IC can multiply two 16-bit numbers and produce a 32-bit result in 300 ns.

"And 300 mils isn't the end of the line for chip size," reports Barry Dunbridge, laboratory manager of TRW's microelectronics center. He believes that extensions of current processing techniques could lead to chips as large as 400 mils.

As the name triple-diffusion implies, the 3D process diffuses collector, base and emitter. It requires only five masks, and it doesn't rely on epitaxial material. Increased densities are achieved by elimination of the usual isolation

diffusion between transistors.

"Also, it's a merged-transistor logic of sorts," Dunbridge explains, "since pnp devices used for AND gates, for example, can be merged in the same collector tube as npn's."

Still, "I²L does have the higher density by a factor of 2 or 3," the TRW lab manager observes, "but it's not as compatible as 3D for large chip size." He doubts that I²L chips larger than, say, 175 mils square can be achieved.

The low current levels of I²L could lead to greater yield problems than those encountered with 3D/EFL, according to Dunbridge. With 3D, those levels are 1/4 to 1 mA in a voltage range of 3 to 5 V—which allows direct interfacing with TTL circuits. By comparison, I²L operates in the 100-to- μ A range at a voltage level of 0.7 V or less, so I²L becomes more sensitive to low-level defects that cause leakage.

3D + ECL = higher speed

TRW is also seeking to combine 3D with emitter-coupled logic for higher speeds than those attainable with 3D/EFL. "However, we're not sure 3D/EFL is compatible with large chip size," Dunbridge says. The high current gain obtained by use of emitter-followers in a logic gate aren't available in the ECL circuit form. "Also, ECL

isn't quite as detuned as EFL," Dunbridge observes.

While TRW has emphasized EFL for triple-diffusion, Bell Laboratories has been using TTL for a similar process. Like the TRW circuits, these versions aren't commercially available.

However, Bell's latest development—called GIMIC-O (or GO)—can be applied to LSI circuits with low-power Schottky-TTL at "wafer costs below those of MOS technologies," according to Paul Gary, head of Bipolar Device Dept., Bell Laboratories, Allentown, PA. And in conjunction with I²L, he says, "you could essentially cover the waterfront for bipolar/LSI in the delay range of 10-to-100 ns."

Like triple diffusion, GO requires neither an epitaxial nor buried layer. In addition ion implantation of both the collector and base reportedly provides parameter control not possible with conventional triple diffusion.

The major differences between GO and earlier technologies arise from the decreased doping levels in GO. Schottky diodes can be formed in ion-implanted, self-isolated collector regions, which are lightly doped to provide reduced size and lessened capacitance.

"GIMIC-O results in a 2:1 increase in packing density over standard buried-collector techniques," Gary reports. "And cost

BOURNS
INTRODUCES THE

FIRST INTEGRAL PUSHBUTTON POTENTIOMETER

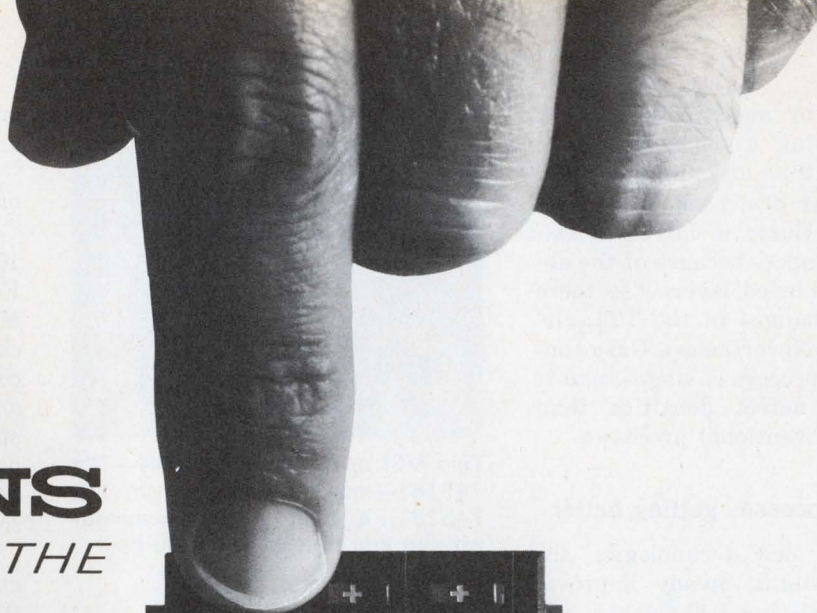

If you're designing panels with precision data entry or set-point controls, consider the BOURNS Model 3680 KNOBPOT® Digital Potentiometer . . . another innovative idea from Bourns. The 3680 integrates a precision incremental decade potentiometer with an easy-to-read digital display, AND a speedy pushbutton control action. It is handsome, extremely accurate, and a "snap" to install. Everything is INSIDE the Model 3680 . . . no resistors or mini-PC boards are required . . . nothing clutters the back of the unit to steal precious space.

PUSHBUTTON ACTION

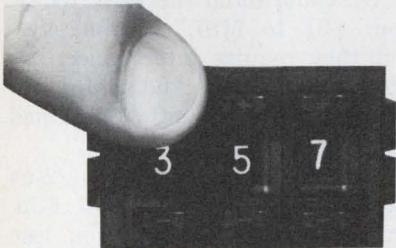

Simple, fast, precise. Push the PLUS button to increase; the MINUS to decrease. Rated life is 100,000 operations per decade.

IN-LINE DIGITAL READOUT

Large, easy-to-read numbers enable fast, "squint-free" data entry and information readout.



ACCURATE

You get what you set with the 3680 . . . every time. The unique Bourns design integrates precision laser-trimmed cermet resistor technology with a positive pushbutton detent action. The result is resolution of output of 1 part in 1000 discrete steps, and dependable repeatability of $\pm 0.1\%$.

COSTS LESS TO INSTALL

Snap-in mounting cuts installation time, eliminates mounting hardware. Integral bezel covers irregular panel cut outs and minor edge blemishes. Terminals match the AMP Series 110 receptacle . . . or can be soldered in the standard fashion.

FEATURES AND SPECIFICATIONS

- stable built-in cermet resistance elements
- 100 PPM/ $^{\circ}$ C tempco • 2 watts power rating
- standard resistance range (3 decade unit) 5K ohms to 1 megohm • $\pm 1.0\%$ resistance tolerance • resolution 0.1%.

COMPACT SIZE

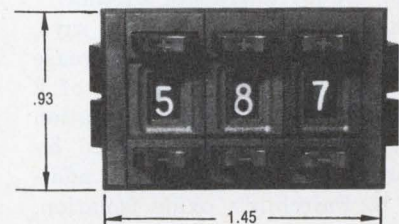
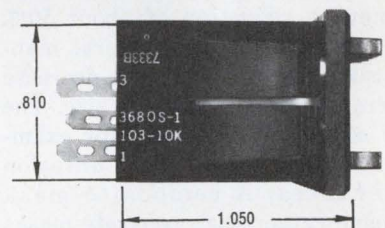

For the name and number of your nearest Bourns representative, dial EEM toll-free 800-645-9200.

when innovation counts, count on...



is reduced by another factor of 2 for processing a nonepitaxial device rather than an epitaxial type."

The major drawback of GO, according to Gary, is increased collector resistances because of the absence of a buried layer—"so there are some changes in the TTL circuit form." Nevertheless, Gary continues, the process is simple, and it has lower defect densities than those of conventional processes.

Existing processes getting better

Although new technologies are in the spotlight, steady improvements in existing technologies are forming the springboard for an advance in high-speed bipolar products. Bipolar memories are a case in point. Most observers see the industry moving up to 16-k ROMs and 4-k RAMs.

"These products need a high-density process, but not necessarily something like I²L, which doesn't give the necessary speed," says Ralph Kaplan, a manager of bipolar memories at Signetics, Sunnyvale, CA.

"Standard Schottky processing can provide the needed density for, say, a 4-k PROM," he observes, but for higher densities—or for chips larger than about 160 mils on a side—"defect densities eat into the yield."

The solution is passive-isolation techniques, says Kaplan, who sees this as a two-step development. The first step, he believes, will achieve a reduction of about 50% in chip size through several manufacturing techniques that decrease tolerances and, hence, die size. The use of ion-implantation, for example, would lower the usual diffusion tolerances. A composite-mask scheme rather than separate masks would reduce tolerances further.

The second step, Kaplan says, would employ isolation to increase density further—by a factor of 2 or more. Several passive-isolation techniques are being pursued by different manufacturers. In addition to Fairchild's oxide isolation, Motorola has VIP and Raytheon (Mountain View, CA) has V-ATE, for example.

The result of passive isolation, according to Kaplan, will be a 16-k ROM with an access of 100 to 125 ns and a 4-k RAM that could have

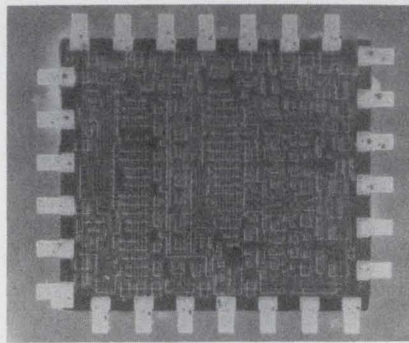

This MSI arithmetic logic unit—TI's 74S181—now has an LSI cousin: TI's 74S281, a 4-bit slice accumulator with an add time of about 30 ns.

access times of 16 ns or less.

Meanwhile, Texas Instruments plans to introduce a new generation of Schottky-TTL circuits having LSI complexity by the end of the year. The new circuits will include a Schottky-TTL microprocessor and a number of LSI support circuits. And they will employ advanced processing techniques to obtain performance levels normally associated with systems using ECL circuits, according to Dick Horton, TI's manager of Bipolar Product Development in Houston.

Presently, two manufacturers—Intel, Santa Clara, CA and Monolithic Memories, Sunnyvale, CA—offer bipolar/LSI processors. (The introduction of TI's I²L microprocessor, featuring submicrosecond execution times, is expected later this month.) Both the Intel microprocessor and the Monolithic Memories unit, a microcontroller, employ standard Schottky processing to achieve execution times of about 200 ns.

"But we expect the new Schottky-TTL/LSI microprocessor will have execution times that are three or four times faster," Horton says. The increased speeds will be obtained by a modification of the standard Schottky process to include such techniques as passive isolation, ion implantation and double metalization.

ECL/LSI emerging, too

Similarly, steady improvements in ECL technology have increased densities to LSI levels in circuits offered by Motorola in the company's MECL 10,000 series. Recent additions to the line—like a 16-bit

multiport register file (MC10143) and an 8-bit multiplier (MC10183)—have a gate equivalence of 100 or more.

Further additions to the MECL 10,000 line will continue the trend. For example, within a few months, Motorola will offer an 8-bit d/a chip (MC10318). It will be able to convert a digital input to a settled analog output in about 5 ns. And since the d/a chip will be compatible with other ECL 10,000 circuits, a complete a/d ECL system could be built with just a few ICs.

In memories, Motorola is introducing the largest ECL 10,000 PROM, a 256 × 4-bit circuit (MCM1049) with a maximum access of 25 ns. Within a few months, Motorola expects to introduce the first 1-k ECL 10,000 RAM, which will have a typical address-to-output access of 25 ns.

Higher speeds on the way

In the company's MECL III series—the fastest standard logic line—recent additions have emphasized subnanosecond gates and gigahertz counters for communications systems.

But "we have the technology to reach higher speeds and LSI functions," says Jack Burns, Motorola's manager of Strategic Planning for Digital ICs. In fact, Burns believes the next step in subnanosecond logic must be directly to LSI circuits.

"We could build the logic today, from SSI to MSI," Burns says, "but they require interconnections between packages." And wiring can offset any system gains obtained with faster circuits.

"If you interconnect a 1/2-ns gate to a package that's 6-in. away," observes Burns, "you lose as much in the wiring as you have gained over products currently available."

Then what's holding up subnanosecond LSI? According to Burns, it's primarily a lack of standards in specific circuits that the industry would accept. But Burns believes that picture could change dramatically in the near future.

"We see an underlying trend toward standardized LSI for mainframe computers," says Burns, who cites the growth of LSI microprocessors as the major cause. ■■

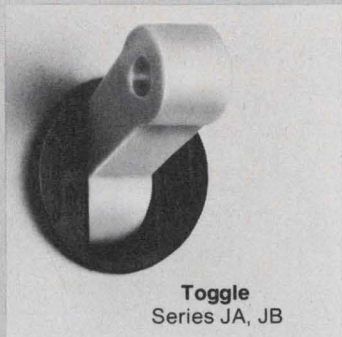

Toggle
Series JA, JB



Rocker handle
Series JC



Environmentally sealed
Series JE

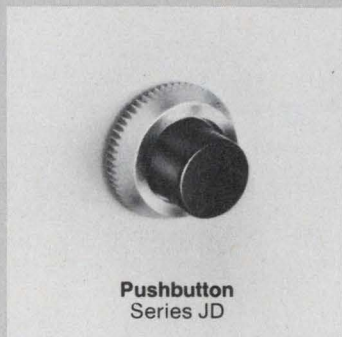

Pushbutton
Series JD



**Multipole
companion-trip**
Series JA, JB, JC

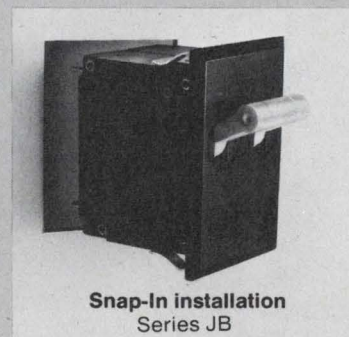

Snap-In installation
Series JB

UP FRONT.

**That's where Heinemann Type J breakers
look best on your equipment.**

If a circuit breaker looks this good, why not put it on your equipment's front panel, where it can double as a power switch? It's an ingeniously simple way to cut component and assembly costs.

To meet the widest possible range of application requirements, Type J breakers are offered in any integral or fractional current rating from 0.020 to 30 amp at 240V 60Hz or 400Hz, or 65V DC. With a choice of four time delays and seven special-function internal circuits. With quick-on or screw terminals. And in one, two, three, or

four poles.

What about delivery? Well, we now have a Quick-Draw procurement program, under which the most frequently specified Series JA breakers are stocked for shipment within a few days of your order, sometimes overnight.

One final point. Though Heinemann Type J breakers are modestly priced, please don't confuse them with breakers of other types. All Heinemann breakers operate on a totally different, hydraulic-magnetic principle that

permits close-tolerance protection with complete freedom from nuisance tripping and other ambient temperature effects. To this day, they're the only circuit breakers good enough to be covered by a five-year warranty.

We'd like you to have our 16-page Bulletin J-3333, which will tell you almost everything you need to know about these breakers. Get it from your nearby Heinemann representative or Heinemann Electric Company, Trenton, NJ 08602. Phone (609) 882-4800.



HEINEMANN

We keep you out of trouble.

INFORMATION RETRIEVAL NUMBER 18

Kurz-Kasch offers refreshing style

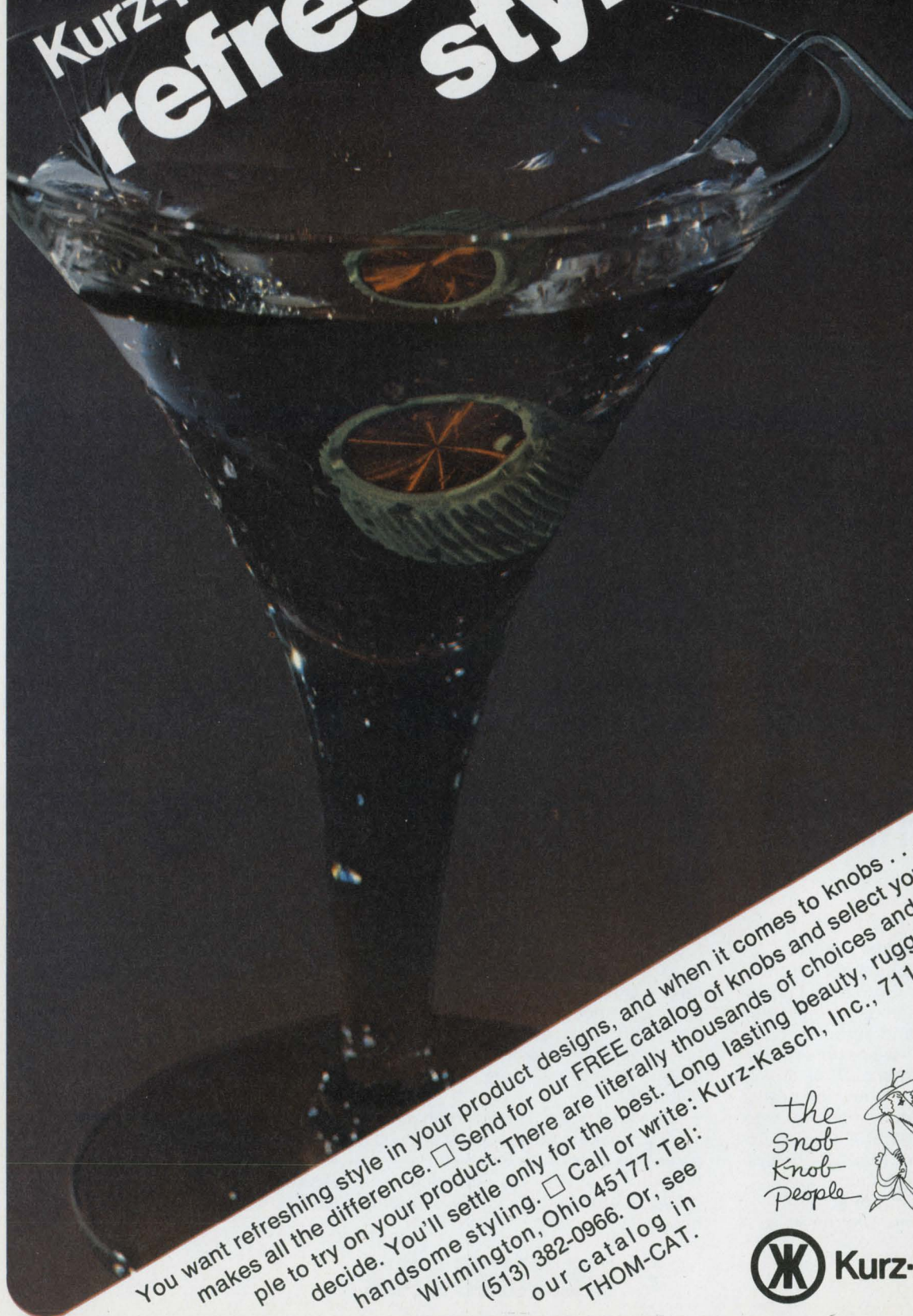

You want refreshing style in your product designs, and when it comes to knobs . . . that certain look makes all the difference. Send for our FREE catalog of knobs and select your prototype sample to try on your product. There are literally thousands of choices and we can help you decide. You'll settle only for the best. Long lasting beauty, rugged durability and handsome styling. Call or write: Kurz-Kasch, Inc., 711 Hunter Avenue, Wilmington, Ohio 45177. Tel: (513) 382-0966. Or, see our catalog in THOM-CAT.



Our 31 Programmable Calculator.

Computer capabilities right at your desk.

The 31 rivals the mini for pure problem-solving power. But no mini can match the 31 for ease of use and low-cost operation. Its expandable memory (up to 8192 program steps or 1010 data registers) auxiliary plug-in mag tape, and optional flexible disc provide storage traditionally reserved for mini applications.

The 35 built-in functions and 24 user-definable keys let you tackle complex variables with natural math. No computer languages to learn. And no computer price either: just \$3550, including silent alphanumeric printer.

Use the 31 with other data tools. We have three new interfaces (like the 154 RS-232-C shown) that work with most instrumentation and I/O devices on the market. Then there's our Tektronix peripherals you can interface with. Like our digital plotter, graphic terminals. And software packages you add as you need.

But there's still more to the story on the 31. More interfaces, more peripherals, more power. And information on OEM and quantity discounts. Get it by calling your local Tektronix sales engineer. Or write us.

Tektronix, Inc.
Information Display Division
P.O. Box 500
Beaverton, Oregon 97077

Our programmable calculators. Natural. Powerful. Significantly less expensive.



TEKTRONIX®

INFORMATION RETRIEVAL NUMBER 20





Instruments with improved 'minds' will be taking over dedicated jobs

Stanley Runyon
Associate Editor

Spurred by fast-moving developments in semiconductor technology and components—and by pressures for more efficient industrial production to offset inflation—instruments for 1975 will be more intelligent, have better memories and, increasingly, be dedicated to single jobs. Look for these developments in the coming year:

- *Built-in computation and control.* Microprocessors will continue to move into test, measurement and process-control equipment.

- *Internal data storage.* Memories will turn up in more and more equipment, as ROMs, RAMs and other memories drop in price and become easier to get.

- *Dedication.* Special-purpose test equipment will grow in importance as instrument vendors continue to put together test packages to handle one job.

- *Communications.* The field of communications will stand out as one of the strongest of 1975 and will spark new activity in instruments to check voice and data networks.

Instant intelligence arrives

Without a doubt, the most significant and exciting movement in instruments today is the march toward intelligence. Smart instru-



Dedicated instruments, such as found in the Tektronix TM 500 Series, reflect the trend toward units blended to meet special tasks.

ments—ones that have buried processors, LSI logic or memories—not only make measurements but can also store, analyze, manipulate, calculate and make decisions. The user's benefits: more functions per dollar and faster, more accurate—and even fully calibrated—results.

Dr. Eberhardt Rechlin, chief engineer for Hewlett-Packard, Palo Alto, CA, and a former Assistant Secretary of Defense, considers the rapid addition of intelligence to instruments as a technical highlight of 1974 and one that will continue in the year ahead.

Developments such as HP's recently unveiled smart oscilloscope spotlight the push to instruments with high IQs. Using the microprocessor from the company's cele-

brated HP-35 calculator, the 1722A scope gives a direct digital readout of time interval, frequency, dc voltage, instantaneous voltage and relative amplitude. The result: greater accuracy and resolution than possible with measurements based on CRT readings alone.

Perhaps more important than the increased measuring power is the greater capability per dollar offered by smart equipment. As Dr. Rechlin notes, economic changes are increasing the pressures for more efficient production in industry—pressures that can be relieved by instruments, especially smart ones.

Henry Reinecke, vice president of engineering for Wavetek, San Diego, sees the primary function of intelligence as not just to collect data but also to make conclusions and to present the facts in a form the user really wants—the end results, or total picture. To illustrate, Reinecke points to the electrocardiogram, a technique that's changed little over the decades.

With the present method, voluminous records are made of heart activity, and a doctor must then pore over the charts. But, Reinecke speculates, a smart instrument could read the peaks and wave-shapes, compare the readings with established patterns and then point to deviations from acceptable tolerances. Thus the tester interprets

and draws conclusions.

The ability to store data and then manipulate the information "at leisure" greatly enhances equipment performance. And indeed more and more instruments are coming off assembly lines with the ability to remember.

Instruments that don't forget

There's no doubt that tiny semiconductor memories on a chip are appealing and that engineers will find ways to use them in established products. And as the prices of ROMs, RAMs and even core memories drop, the appeal becomes greater.

With memory, a product such as a transient analyzer can capture a super-fast event and analyze the components more accurately and easily than if it tried to follow and analyze the transient as it changed. Similarly a spectrum analyzer with storage can separate the display and analysis functions, so the CRT can be swept independently for a brighter, clearer, flicker-free display.

Such instruments have appeared recently, and more memory-based equipment is sure to follow. One fertile area: graphic recorders.

Paul Sawall, marketing manager for Esterline Angus, an Indianapolis-based recorder vendor, says to look for core-memory storage of fleeting phenomena to increase the fast-response capability of recorders. Another possibility, Sawall asserts, is the use of a microprocessor in multipoint recorders to replace hundreds of ICs or thousands of components, with consequent reduction of costs.

But microprocessors and compact memories, though the most glamorous, aren't the only components that are having significant impact on instruments. Advances in such areas as hybrid ICs, couplers and YIG oscillators are also playing a major role.

Progress in basic devices

To see what's happening to test equipment, Ed Niebhur, marketing manager for Systron-Donner's Instrument Group, Concord, CA, suggests a look at the progress in the underlying technology—the basic

devices that go into equipment. Developments in YIG oscillators and refinements in couplers, Niebhur says, are boosting power outputs and stretching the frequency range of signal sources.

And, he adds, "the small physical dimensions of microwave ICs allow performance we simply couldn't get before." Niebhur concludes that one design that will certainly be affected by the refinements is the sweep generator.

William Walker, vice president of engineering at Tektronix, Beaverton, OR, agrees. Performance of instruments is limited by components, he says, and improvements are directly related to developments in ICs, particularly hybrid ICs. But Walker stresses that economics, not just technical feasibility, will be the final judge.



Microprocessors are sure to pop up in more and more instruments, as one did in this Hewlett-Packard calculating scope—the 1722A.

Thus he hints that it may now be possible to leapfrog the present 500-MHz bandwidth limit of oscilloscopes. But he points pragmatically "to the enormous development cost of another generation of bandwidths, compared with the total dollar market for such benefits."

Both Walker and Niebhur feel that a strong need today is for special-purpose equipment rather than products that work at the acme of performance. Walker notes the invasion of electronics in industrial areas: "Sophisticated controls for air-conditioning, automated equipment and the like need to be tested—and in terms of equipment that nonelectronics-oriented people can relate to."

Thus expect more single-minded

packages—instruments such as those in the Tektronix TM 500 line—blended to attack one problem area. A likely candidate for dedicated machines is the communications industry.

Communications: A bright star

Interest in both voice and data communications continues to swell, and riding the coming flood tide will be related test gear. Systron-Donner, for one, expects communications to be one of the strongest segments of the 1975 test-equipment picture. And, says Systron, there are going to be requirements for new types of equipment: In data communications, for example—where pulses are propagated—instrument makers become interested in such things as propagation delay as a function of frequency or rise time.

Special problems in communications may call for special-purpose equipment, and Systron envisions combinations of instruments—perhaps under control of a microprocessor—to do the different jobs. One possibility: a test set that will check out communications gear completely in the field.

Wavetek's Reinecke sees the need for testers that will search out problems in transmission networks and tell the end user—who may have no electronics training—what's wrong in a clear, nontechnical manner. Such a tester would have to be semi or fully automatic and remain on line at all times.

But Rehtin of HP foresees at least some transmission problems solved in the near future by optical-fiber communications. Long explored for wideband, long-distance communications, optical fibers, he says, now have sufficiently low attenuation and price tags to become practical in industrial, medical and military environments.

Components for optical communication are also becoming available, and Rehtin expects applications to increase markedly in the next few years. The advantages of optical transmission? Rehtin lists them as negligible EMI, high common-mode rejection, exceptional personnel safety, high security, little chance of damage to connected equipment and minimal distortion at multimegabit rates. ■■

The squeeze is on.

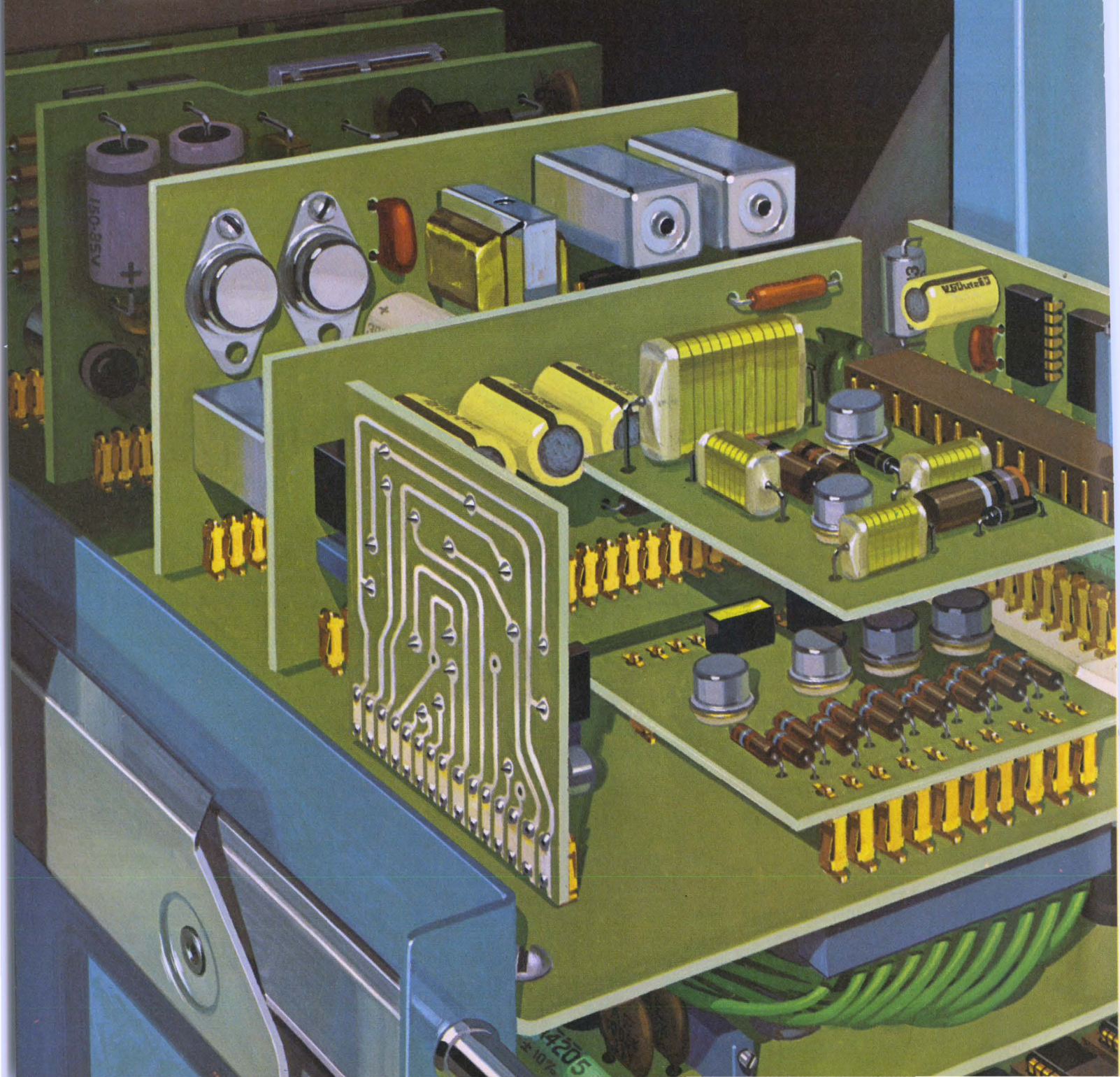

Now, to meet your tightest packaging requirements, there are five AMPMODU contact types—including two with high-pressure contacts for positive mating to short posts. The AMPMODU system now gives you greater interconnection versatility with proven reliability. Here's how:

Unique design permits repeated post/receptacle matings.

AMPMODU contacts are designed with dual cantilever spring beams in the receptacles. These spring members ensure uniform, positive electrical contact with mating posts, every time. This same design feature also compensates for misalignment of staked posts and receptacles, and allows for greater assembly tolerances.



Wide range of types and sizes.

Five basic AMPMODU contact types provide post and receptacle size selection to meet specific packaging requirements. Mod I types, for example, combine .031 x .062-inch rectangular post and mating receptacles for a wide variety of applications where spacing between contacts from .125 to .156-inch is required. Mod II types offer miniature .025² post and receptacles, permit mounting clearances as close as .100-inch. Mod III types provide high-pressure receptacles for use with .025² posts. For special applications, shorter receptacle lengths are available to mate with .025² posts in a selection of Mod IV sizes. Mod V types provide high-pressure receptacles which permit mating with short posts. Each is a complete electromechanical module, designed to give almost unlimited positioning versatility and circuit flexibility.



Board-to-board, board-to-wire versatility.

Receptacles can be staked up, down or sideways, to module boards or grid panels. Receptacle designs are also available for crimping onto individual wires or for staking into flat flexible cable conductors. Others can be used to connect coaxial wires. Terminated receptacles may also be housed in a wide range of multiple-position connector blocks for both 90° and parallel connections to boards or grid panels. AMPMODU connector posts are preassembled in insulating nylon blocks or in strip form for machine insertion. They can be wired automatically by AMP's TERMI-POINT clip point-to-point method, or by wrap-type techniques.

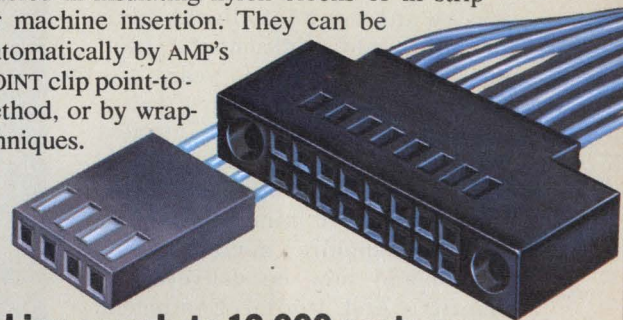
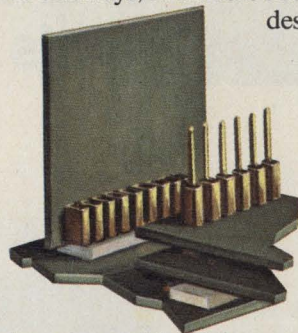

Staking speeds to 12,000 posts or receptacles an hour.

Our new strip-fed multi-head pantograph matches post and receptacle staking speeds to your high-volume production needs. Each applicator head stakes up to 4,000 insertions an hour, either horizontally or vertically, into pc boards from .062-inch up. Any pattern can be staked into 5 x 13-inch to 16 x 13-inch boards. AMP automatic tooling is unequalled for reducing applied interconnection costs.

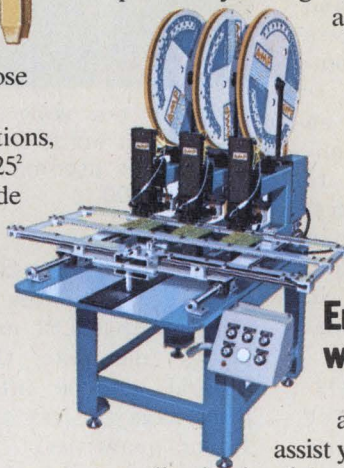

Engineering backup...

worldwide. At AMP Incorporated, more than 700 application, service and sales engineers are prepared to assist you with every design and production application involving AMPMODU interconnection systems. At your domestic manufacturing plant or wherever you use AMP products and machines throughout the world. You'll find AMP manufacturing and service facilities in 16 major international markets. In the United States, district offices are located in California, Georgia, Illinois, Massachusetts, Michigan, Minnesota, New Jersey, Ohio, Texas, and the District of Columbia.

For more information on AMPMODU connector system products, circle Reader Service Number 240, or write AMP Incorporated, Harrisburg, Pa. 17105.

AMP

INCORPORATED

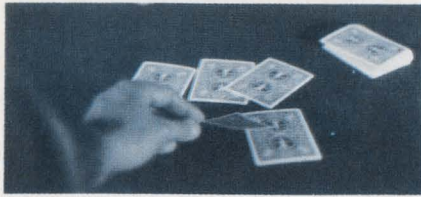

LSI to help create a new range of smaller, less expensive minis and mini peripherals

David N. Kaye
Senior Western Editor

With microprocessors, 4-k RAMs and increased use of custom LSI, a whole range of smaller, less expensive and more intelligent minicomputers and minicomputer peripherals are coming this year.

Computer Automation, Irvine, CA, led the field last year into less expensive, LSI-oriented minis. General Automation, Anaheim, CA, followed with a mini based on a silicon-on-sapphire microprocessor that should now be delivered in quantity. And Digital Equipment Corp., Maynard, MA, finally gave its stamp of approval with a microprocessor-based PDP-8. A similar version of Digital's 16-bit PDP-11/05 is expected this year, and other major mini manufacturers are expected to introduce comparable machines.

Microprocessors showed up en masse in 1974 in intelligent terminals, a trend that is destined to grow. More advanced microprocessors will be turning up rapidly in terminals, to give them processing power heretofore found only in minis and programmable calculators.

Custom LSI is making its biggest inroads in minicomputer printers. Irving L. Wieselmann, vice president for product programs at Dataproducts, Woodland Hills, CA, notes: "Anyone with the volume to justify it in the printer field is going to LSI. Companies such as Centronics [Hudson, NH] and Teletype [Skokie, IL] have done it already. Some others are looking at standard microprocessors as an alternative to going the custom route."

Minis growing in two ways

Most minicomputer development in 1975 will be either at the low end (\$3500 or less with 4 to 8 k of memory) or the high (\$24,000

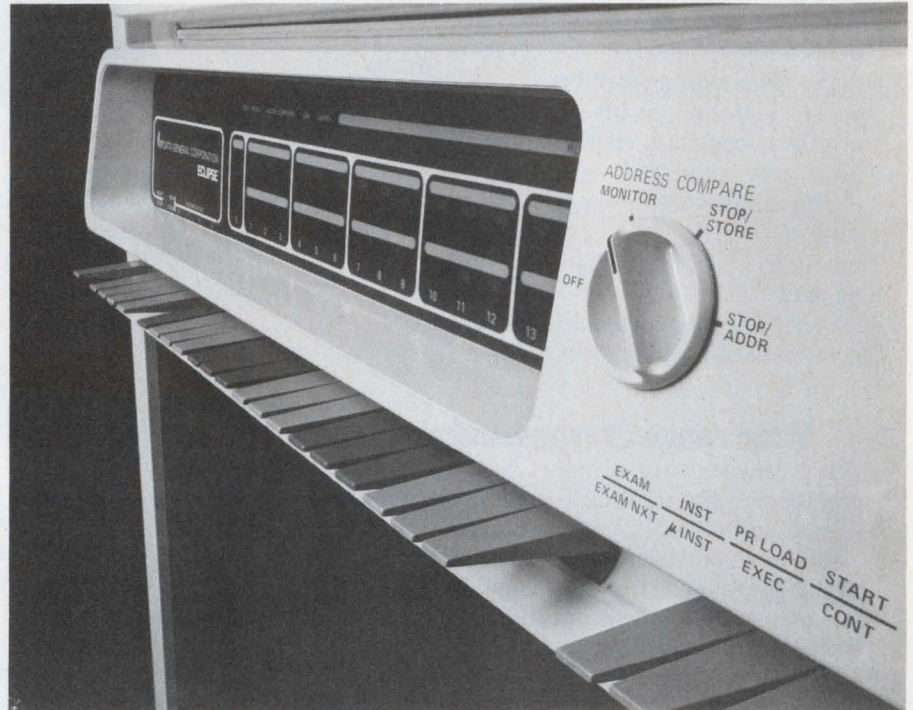

Eclipse is the newly introduced "midi" computer from Data General. It accepts 16-bit words and features error-correction circuitry in the memory. This computer is user-microprogrammable and has writable control store. Shown is the S/200.

or more with 64 to 200 k of memory). There is a wide feeling in the industry that LSI minis will ultimately dominate the low end. Several will be introduced with price tags of less than \$2000 in 100-up quantities.

The high end includes such machines as the new Eclipse from Data General, Southboro, MA, the recently improved Series 3000 from Hewlett-Packard, Cupertino, CA, and the soon-to-be improved PDP 11/45 from Digital Equipment. These machines can be considered "midi" computers. Although the size of the box is about the same as that of the mini, the power and price of the computer is a step above.

Edward R. McCracken, marketing manager for HP's Data Systems Div., reports: "These larger minicomputers will have very efficient and sophisticated memory

management techniques incorporated as well as a great deal of 4-k RAM semiconductor memory. Techniques such as virtual memory will become common, as will memory mapping, interleaving and a variety of other procedures."

Many of these techniques are already in minis. But in 1975 they should move from the exception to the rule.

Memory reliability will also become a feature in 1975. Ronald Gruner, Eclipse systems manager at Data General, explains: "In the Eclipse series of computers, we have incorporated main-memory error-correction circuitry. This idea, first used by Texas Instruments in the 980A, is a key feature."

Eclipse is a series of 16-bit computers, each with a 16-bit bipolar cache and either semiconductor or core main memory. Gruner

expects more use of cache memories in minis in 1975: "We expect to be going to 1-k bipolar caches by the end of '75."

The Eclipse systems manager also looks for fast bipolar microprocessors to take over an ever-increasing portion of the random logic in minis: "I expect to see 2-bit slice bipolar microprocessors used for random-logic substitution. They are a logical extension of MSI."

Terminals get smarter

A "definite trend" this year toward graphics in computer terminals, along with more intelligence and larger size, is expected by Claude Tucker, engineering manager for the Tektronix Information Displays Div., Beaverton, OR.

With intelligence, the data from the computer can be presented to the operator in more simplified form. With graphics, it is much easier to analyze the data. And the cost of graphics is finally dropping to the point where it will not be too much more expensive than alphanumeric.

The microprocessor is a cost-effective way to add intelligence to terminals. Nearly every terminal manufacturer now offers a microprocessor-based model. With terminals offering user-definable keys and external memory in the form of floppy discs or cassettes, terminals are approaching programmable calculators in power. On the other hand, with programmable calculators now available with data-communication interfaces, calculators are starting to look like terminals.

Teletype—with its model 40 designed for the Bell System—may be pointing the way to development of a group of CRT terminals with built-in printers. The 40 has a 300-lpm printer as well as keyboard and CRT display.

Tucker of Tektronix thinks that an electrostatic hardcopy unit is a better approach. "We can also display and copy graphics with the copier," he notes.

With the introduction of the Tektronix 4014 terminal, the way has been cleared for large-screen alphanumeric, and ultimately graphic, terminals. The 4014, with a 19-in. screen, can display 8000

characters. Others in the field see displays for terminals going to 25 in. and larger in the next year.

Lots of new printers

Many types of minicomputer printers are available. A shakeout may occur in 1975, with a few of the more successful companies left to do battle.

The printers that survive, says Wieselmann of Dataproducts, will embody cost-cutting designs without sacrifice in reliability. LSI will

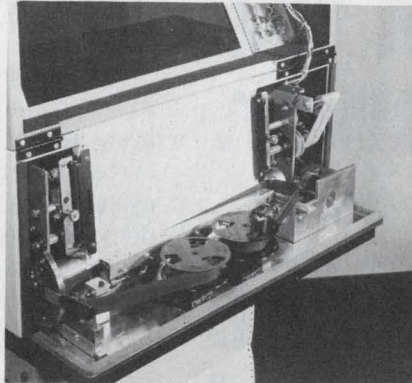

A low-cost dot-matrix line printer is aimed for the minicomputer market. The Printronix 300 prints at 300 lpm and makes its characters with a 9×7 dot matrix. The dots are closely spaced and overlap to create characters that are almost fully formed. In 100-up quantities, the 300 sells for about \$3000.

become a key to printer design, as will automated production equipment. Printers will tend to use more plastics in their construction.

Dot-matrix printing techniques are moving strongly to the fore. IBM recently endorsed the technology in a line of new terminals. Centronics has been one of the most successful builders of dot-matrix serial printers, and Tally in Kent, WA, is a leader in dot-matrix line printers. The most recent entrant into the printer field is Printronix in Irvine, CA.

The Printronix 300 is a 300-lpm printer that is similar to the Tally printers. It makes characters with a 9×7 dot matrix. A bank of 44 hammers, spaced 0.3 in. apart, is held in a shuttle mechanism. The mechanism oscillates 0.3 in. horizontally while the hammers fire on command. After all the dots in a single row are made, the paper increments one row vertically and the

operation starts over again.

Tally also uses a shuttle mechanism, but it has 132 hammers spaced 0.1 in. apart. Whereas Printronix overlaps dots to give an almost fully formed character, Tally leaves the dots separate. Tally's printer operates at 200 lpm. A 400-lpm version is expected from Tally this year.

The year of the floppy

"Floppy discs will really move in 1975," says Robert Koontz, engineering manager at Pertec, Chatsworth, CA. Others agree. Most think that the main markets will be with intelligent terminals and programmable calculators. Some companies will introduce two-sided floppy discs and some dual-density discs.

Hard discs will move in data density to 4400 bpi. Track densities of 200 tpi will finally become readily available, and Joe Godbout, engineering manager at Data General, expects to see track-following servo information on small cartridge discs in 1975.

In tape, the move seems to be towards increasing the data density to the new IBM standard, 6250 bpi. Pertec will have such a drive in 1975, as will others. These drives will probably range in tape speed from 45 to 75 ips.

Work will begin on minicomputer versions of the new IBM 3850 tape-cartridge library. This uses cartridges that can store 50 million bytes of information. Several manufacturers are looking into this.

And Hewlett-Packard will introduce a tape cartridge that is the size of a Philips cassette but that uses the technology of a 3M data cartridge.

Paper tape is settling down to a stable market of 150 cps readers, and Robert Malone, vice president of marketing at Tally, sees the price falling to less than \$500.

Godbout of Data General sees advances in controller design. He feels that microprogrammable controllers that are based on microprocessors will become common. A single microprogrammable controller might be able to handle several different peripherals, while allowing communication between peripherals without burdening the CPU. ■■

The fastest single clock 4K NMOS RAM operates on the least power.

It's the only one with a second source.

There's just no doubt about it. Motorola's new MCM6605L NMOS 4K RAM is the coolest in operation, and the fastest single clock design available.

The tables tell the story. One makes device vs. device comparisons and the other shows what the differences mean in system applications.

It's a good idea to have a questioning attitude in this day and age, so we've provided the system power equations. Apply them to your own system size requirements, to any hypothetical system, or simply check the accuracy of our demonstrated figures. Go ahead, prove to yourself that the MCM6605 has the lowest system power requirements by a wide margin.

Results of these comparisons are significant for several reasons. The most obvious is probably the smaller battery required for battery back-up for non-volatile operation. Reduced cooling requirements and the ability to operate with smaller, less expensive standard power supplies are also important factors.

4K NMOS RAM COMPARISON

Device	MAX I _{DD} (Active) (mA)	MAX I _{DD} (Standby) (mA)	V _{DD} (Volts)	Number of refresh cycles/2 ms	Memory access time (ns)	Memory cycle time Read/Write (ns)
MCM6605	36	0.020	12	32	210	370/490
MK4096P	30	1.0	12	64	350	500/500
TMS4030	41	0.5	12	64	300	470/470
2107A	34	0.1	12	64	300	500/700

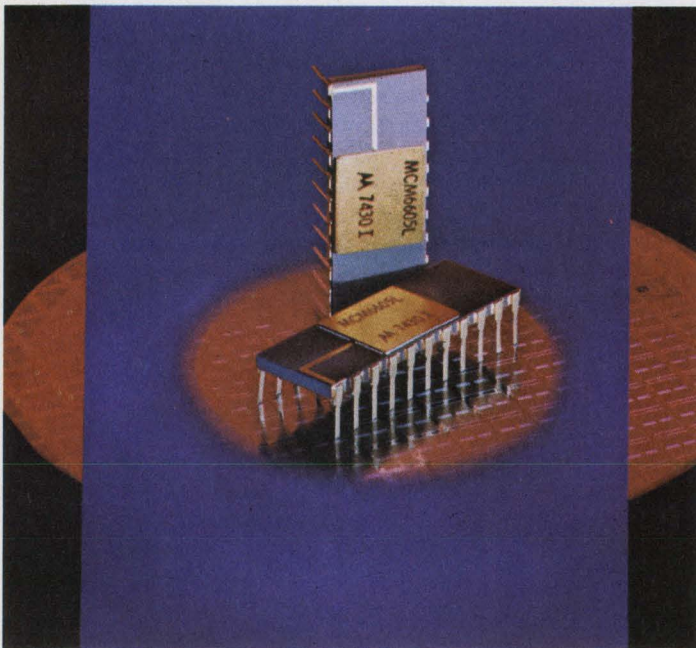

THE EQUATIONS FOR POWER

1. Active memory system power:

$$P_D = M \left(\frac{MCT}{SCT} \right) (I_{DDA}) (V_{DD}) + (N-1) (M) \left[\left(\frac{MCT}{T} \right) (I_{DDA}) (V_{DD}) + \left(\frac{T-MCT}{T} \right) (I_{DDs}) (V_{DD}) \right]$$

2. Standby memory system power with refresh:

$$P_D = (N) (M) \left[\left(\frac{MCT}{T} \right) (I_{DDA}) (V_{DD}) + \left(\frac{T-MCT}{T} \right) (I_{DDs}) (V_{DD}) \right]$$

Where: $N = \frac{\text{System word size}}{4096}$
 $M = \text{Number of bits}$
 $MCT = \text{Memory cycle time}$
 $SCT = \text{System cycle time}$

$T = \text{Period between refresh cycles} = \frac{2\text{msec}}{\# \text{ of ref cycles}}$
 $I_{DDA} = \text{Active } I_{DD}$
 $I_{DDs} = \text{Standby } I_{DD}$

There are subtleties involved, too, such as the number of refresh cycles required, which can significantly increase standby power. But the best way to illustrate is with the tables. All pertinent dc parameters are taken directly from the most recently available data sheets of the manufacturers, themselves.

Plenty of MCM6605 Advantages

Speed: The device comparison table tells it all. With an access time of 210 ns and read/write cycle times of 370/490, none of the major competitive devices are as fast.

Optimized Pin-Outs: Voltages are on the corner pins, an advantage for several reasons. It's easier to lay out the PC board, and the larger allowable bus lines make line impedance lower, very important in dynamic memory systems because of the high dynamic surge currents. Bypassing is easier, too, which reduces the capacitance required.

New Interface Parts designed for 4K RAMs: Motorola circuit designers have recognized the unique interface requirements of NMOS memory systems. The first in a new family of interface devices is the MC3459, a Quad NMOS Memory Address Driver. The MC3460 Quad NMOS Memory Clock Driver will follow.

Only the MCM6605 Has a Second Source

Mere pin compatibility isn't interchangeability. As the photograph of an operational 16K by 16 bit add-on PDP-11 memory system demonstrates, the 6605 type RAMs supplied by AMI are direct, electrical, plug-in replacements for Motorola's MCM6605. No other 4K NMOS RAM has that type of second source. No other.

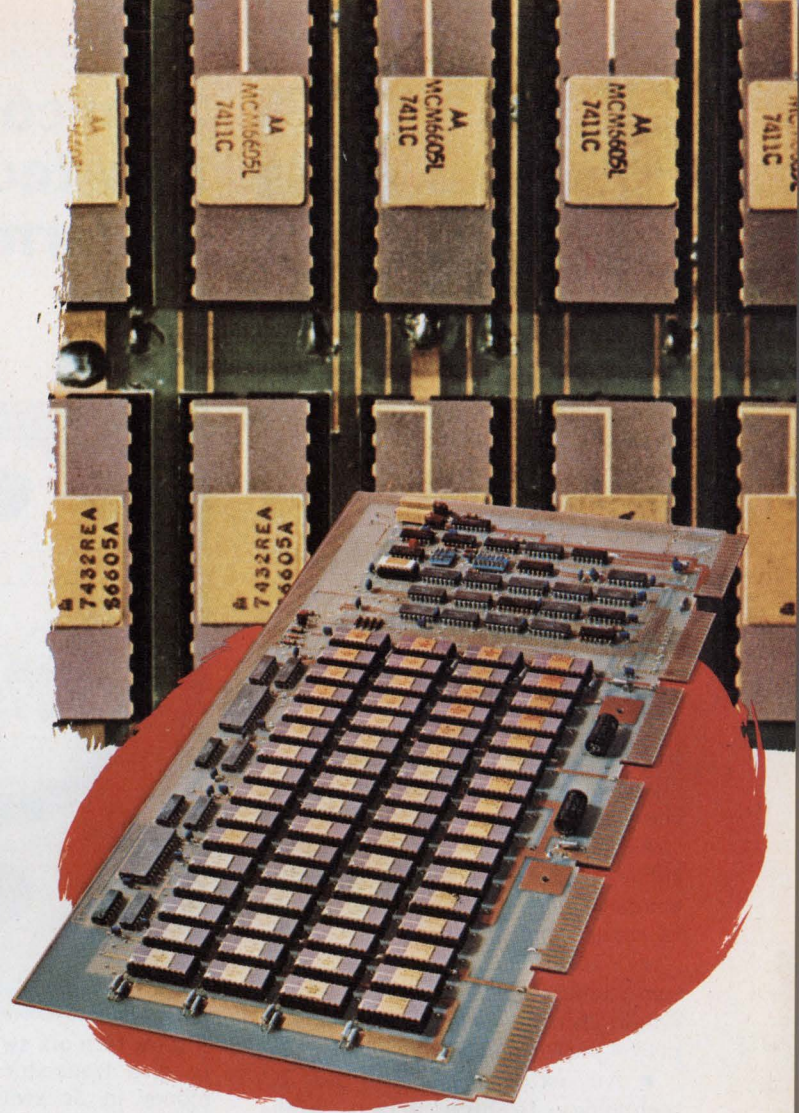

NMOS MEMORY SYSTEM COMPARISON

Memory System Organization	32 K Words X 8 Bits			256 K Words X 32 Bits		
	MCM6605	MK4096	TMS4030	MCM6605	MK4096	TMS4030
Semiconductor* Memory	MCM6605	MK4096	TMS4030	MCM6605	MK4096	TMS4030
Memory cycle time	490 ns	500 ns	470 ns	490 ns	500 ns	470 ns
Memory system cycle time	600 ns	600 ns	600 ns	600 ns	600 ns	600 ns
System power	3.0 Watts	3.4 Watts	3.8 Watts	18.6 Watts	45.1 Watts	39.2 Watts
	Standby (with refresh)	0.23 Watts	1.13 Watts	0.85 Watts	7.4 Watts	36.0 Watts

*2107A comparison is not shown because the write cycle time is not fast enough to meet the chosen system cycle time.

Where to use the MCM6605

The MCM6605 will go just about anywhere there is a memory system. It's ideal for large main memories, for small main RAM memories, for microprocessors used with smart or POS terminals, and as a small buffer memory. We've indicated its application in add-on memories, and the MCM6605 can even be used as erasable ROM for debugging microcomputer system programs. How's that for usefulness. At this time, the MCM6605 is available only from the

factory on orders placed through a Motorola Sales Office.

Applications and additional technical information is now available on request from Motorola Semiconductor Products Inc., P.O. Box 20912, Phoenix, AZ 85036, or by circling the reader service number. Your reward will be well worth your effort. MCM6605 . . . the fastest single clock 4K NMOS RAM. It has the lowest power requirements and it is the only one with a second source.



MOTOROLA MOS
— for the advantage in memory systems.

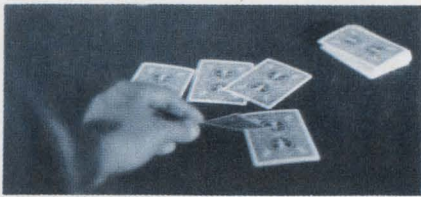

Semiconductor makers push new technologies to raise performance and drop costs

Jules H. Gilder
Associate Editor

In spite of predictions by some industry spokesmen that 1975 is going to be a down year, many semiconductor companies are planning to develop new technologies and devices this year.

New developments are due on all fronts—from discrete semiconductors to LSI devices. According to industry experts, among the more significant things to expect will be these:

- The development of a gate turn-off SCR that will provide stiff competition for power transistors in many applications.

- Widespread use of multiple semiconductor technologies on a single chip, to reduce cost and improve performance.

- An extension of linear IC technology to high-current, high-power devices, spurred by their demand in consumer products.

- The introduction of commercially available integrated-injection logic ICs that will provide stiff competition for MOS devices in density, speed and power dissipation.

- The availability of 1-k CMOS RAMs and 2-to-4-k CMOS PROMs. The CMOS area will also see some standardization of some of the more complex functions.

Power transistors challenged

A new device that could take over many dc applications now being handled by power transistors has been developed by RCA's Solid State Div., Somerville, NJ. According to Carl Turner, vice president of the Power Device Div., the device, called a gate turn-off switch, is being made in sample quantities and will be in production by the second quarter of 1975.

Although the gate turn-off switch is outwardly similar to an SCR—it's a three terminal device with

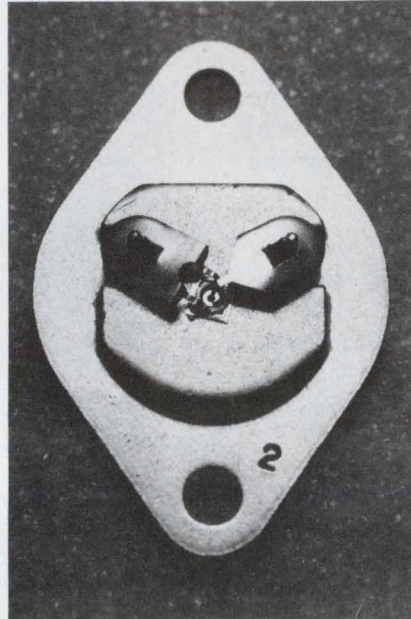

A gate turn-off switch that promises to give transistors a run for their money in dc switching applications will be available from RCA.

a cathode, anode and gate—internal construction differs. Where the SCR is a four-layer device, the gate turn-off switch is a five-layer one.

In describing the device, Turner notes that to turn it on, a positive voltage must be applied, just as with a regular SCR. To turn it off, however, it's no longer necessary to have commutating circuitry or to break one of the power-supply lines momentarily. Instead, says Turner, it is only necessary to apply a negative voltage to the gate.

As for the transistor/thyristor race, the new device would seem to have an advantage over transistors in dc switching applications. The reason, Turner explains, is that the expensive turn-off circuitry is no longer needed. Also, for a given chip size, thyristors can traditionally handle more power than transistors can.

Citing another advantage of the gate turn-off switch, the RCA vice

president notes that unlike transistors, it needs only a control pulse to switch and no signal to maintain the state it's in.

Another development in power semis is the multistage Darlington. This device, which is also scheduled to appear in 1975, would contain at least three transistors in a Darlington or pseudo-Darlington configuration, Turner says.

This device would alleviate the turn-off problems normally encountered by engineers who try to build multistage Darlington from discrete components. The multistage Darlington, Turner reports, contains additional monolithic transistor and diode combinations that provide built-in turn-off switching enhancement.

Multiple technologies on a chip

Wider use of multiple semiconductor technologies on one chip can be expected in 1975. According to Frank Abreu, linear products marketing manager for Harris Semiconductor, Melbourne, FL, the combination of MOS and bipolar devices on one chip can improve device performance, reduce power consumption and often decrease the size of the chip required.

When the dielectrically isolated MOS and bipolar technologies are combined, Abreu says, it is possible to produce more complex devices. Examples of products that are being planned by Harris for introduction in the coming year are high-performance versions of a quad comparator and two quad op-amp devices. The most dramatic linear development for 1975, however, will come toward the end of the year, Abreu notes. While he did not give any details, it is believed that Harris will introduce at that time a monolithic 16-bit analog-to-digital converter that combines MOS and bipolar.

Abreu points out that most of

this year's linear progress will be toward a higher level of integration rather than higher performance.

Another believer in multiple technologies per chip is Richard Santilli, RCA's vice president of bipolar ICs and special products. Of the innovations in bipolar ICs over the last five years, Santilli says they have been primarily stretching of the technology that has resulted in small improvements in performance or price.

The limited progress, he notes, can be attributed to the less than desirable characteristics of some bipolar devices, such as lateral pnp transistors. These are fairly poor performers compared with other devices and have in the past hindered bipolar IC improvements.

But with multiple technologies on a single chip, it is now possible, Santilli says, for the IC designer to pick the optimum devices for the best price and performance; the low-performance devices can be eliminated.

Another big trend in 1975 will be the extension of linear IC technology to high-current, high-power devices, Santilli reports. The linear area has traditionally been associated with small-signal devices that would typically dissipate 0.5 W. With the development of efficient power transistors that use planar technology, and the ability to combine them with small-signal circuitry at reasonable yields, it is now possible to produce linear ICs that handle 5 to 10 W. Opportunities for linear power ICs in 1975 lie in consumer products—such as radios, TV sets and automobiles—and industrial applications where control amps are required.

Abreu at Harris also sees a large demand for linear ICs in consumer products (see p. 52), particularly in communications gear, such as marine radio telephones, pocket pagers, portable radios, TV sets and Citizens Band equipment. Competition for the end user in these applications is fierce, and manufacturers are being forced to go to ICs to reduce costs. In particular, Abreu notes that modulator and receiver ICs are being developed by National Semiconductor and RCA. An entire receiver, he says, can be built with one or two ICs at most.

For several years now, engineers have been saying that integrated circuits would have a big impact on analog-to-digital and digital-to-analog converters. But somehow it never happened. It is going to happen in 1975, says Stan Harris, director of product operations and marketing for Analog Devices, Norwood, MA.

According to Harris, ICs will be turning up in converters because of the microprocessor. Before microprocessors came on the scene, the computer was the most expensive part of a system; digital processing of information was

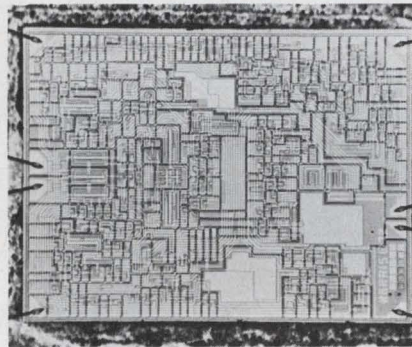

Bipolar and dielectrically isolated NMOS technologies are combined to produce this chopper stabilized op amp from Harris.

often too expensive to justify for some applications. With the microprocessor, computer power is cheap, and it looks as if it may cost more to get information into the computer than to process it. Hence the effort towards cheaper IC converters.

Although there are a few converter ICs already on the market, the demand will increase greatly in 1975, Harris says. The world is essentially an analog one, he explains, and most data must be converted before they can be processed in a computer. This year's outpouring of converter products, Harris says, should include items from Analog Devices, Motorola, National and Precision Monolithics.

I²L for linear and digital ICs

Integrated-injection logic (I²L), a new high-density bipolar technology, is being looked at by both linear and digital designers. The interest of the linear people stems

from the fact that linear ICs are no longer really linear. Nor are they necessarily even analog, says RCA's Santilli.

He says that between half and three-quarters of today's linear circuits can be digital. I²L is a bipolar logic technology that is very compatible with linear technology. For linear devices that require counters, such as a/d and d/a converters, I²L is very attractive.

I²L is also expected to make significant progress in digital electronics this year. A custom watch circuit has already been announced by Texas Instruments, and a microprocessor is scheduled to appear later this month. The processor, according to industry reports, will be a 4-bit slice machine with an execution time of 800 to 900 ns. TI is not the only maker of semis pushing I²L. Virtually every manufacturer has some sort of effort in this area.

For CMOS: SOS and 1-k RAMs

The biggest development in CMOS this year is expected to be the commercial availability of 1-k RAMs. The first device to be announced is likely to be from RCA. This 1-k-word-by-1-bit device will be announced in the first quarter and will be available in production quantities by the third quarter. It will be housed in a 16-pin DIP, with power dissipation of only 15 mW. The access time will be about 125 ns.

Harris Semiconductor is also planning to introduce a 1-k CMOS RAM. It will be introduced in late 1975, says Ed Fernandez, product marketing manager. The unit, he says, will be made with self-aligned-gate technology.

Another memory being worked on by Harris is a CMOS PROM. According to Fernandez, the first entry will be either a 2-k or a 4-k device. Fabrication of CMOS PROMs is not easy, Fernandez points out, because CMOS devices can't stand the high currents generally used to blow the links in bipolar PROMs.

The big thing for digital electronics this year is memories, he says. Microprocessors are opening new markets, and for every \$1 in microprocessor sales, there is \$2.50 in memory generated. ■■

HIGH RELIABILITY



Get the **high reliability** that eliminates trouble. RN DIP sockets make contact with the wide, flat sides of your IC leads. This provides **100% greater surface contact** for positive electrical connection.

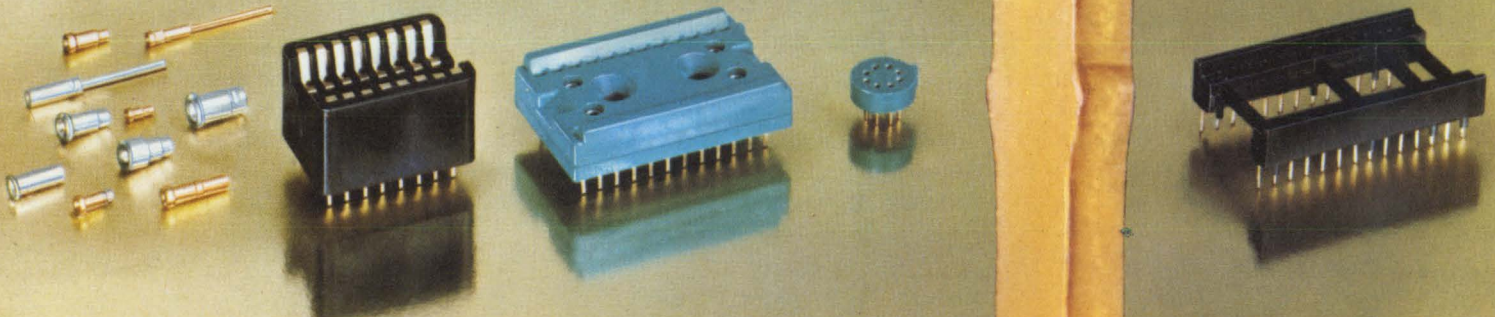

DIP SOCKETS **for the price you're paying for junk!**

Robinson Nugent "side-wipe" DIP sockets make 100% greater contact than any edge-bearing socket on the market.

This 100% greater contact with the wide, flat surface of your IC leads is your guarantee of unmatched reliability. This RN "side-wipe" contact provides constant low contact resistance. No edge-bearing contact can possibly deliver this long term dependability. This designed-in reliability of RN DIP sockets is your assurance of trouble-free IC interconnects—yet they cost no more than ordinary sockets.

Put an end to troublesome junk sockets! Write today for catalog and informative book "What to Look for in IC Interconnects." It's free from RN—the people who make more kinds of high reliability IC sockets than anyone.

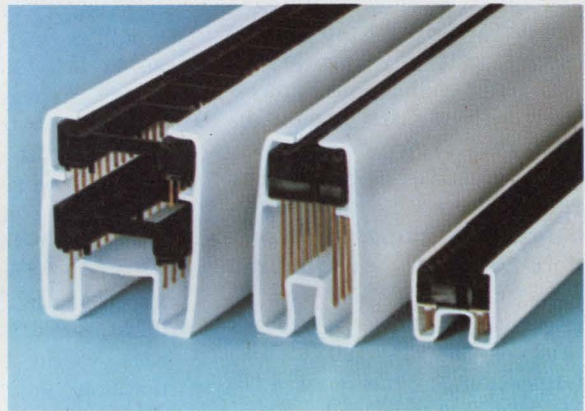

They're even packaged for high reliability.

"Protecto-pak"® packaging delivers consistently perfect RN sockets to your production line—for automated or manual assembly.

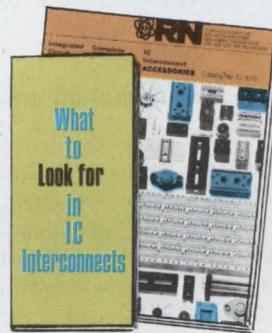

RN ROBINSON NUGENT, INC.

800 East Eighth Street • New Albany, Indiana 47150 • Phone: (812) 945-0211

INFORMATION RETRIEVAL NUMBER 23



High reliability IC sockets . . . we've got 'em all!



From managerial viewpoint, efficiency will be a key word in production and in hiring

Richard L. Turmail
Associate Editor

What will the new year bring to managers of electronics companies? What changes will it bring in the management of engineers, projects and companies? According to a half dozen company presidents, 1975 will bring changes in management that will require special attention to the following:

- Supervision of projects by corporate officers.
- Automated testing.
- More efficient production methods.
- Selective hiring.

In answer to ELECTRONIC DESIGN's question, "What does 1975 mean to you?", the presidents described it as "a banner year" . . . "more sluggish than 1974" . . . "a good year" . . . "a slow-growth period" . . . "an uncertain time" and "not so bad."

They also disagreed sharply on how best to survive the year. Half are expecting their company's European business to help pull them through the next 12 months. Some believe that they're better off producing high-technology products, while others are shifting to high-volume, low-priced products.

More selective hiring

Don Bruck, who founded Hybrid Systems, Burlington, MA, with a capital base of only \$500 in 1967, says that there's a definite trend toward selectivity of personnel because of the tightening economy.

"Where our department managers had autonomy in hiring before," he says, "they are now required to define the mandatory qualifications they're looking for, and then I interview the candidates myself."

Bruck says that he is looking for employees who are capable of riding herd on projects. The company produces a range of products from

thick and thin-film microelectronics to discrete component modules.

He has also improved the company's information-gathering and processing techniques, because he believes that companies outgrow their paperwork; fluctuating costs, schedules and parts make the industry less tolerant of "seat of the pants" management.

According to Bruck, 1975 will be a period of readjustment, self-analysis and reorganization. Undercapitalized companies will be weeded out, he believes.

"During the heyday of the op-amp industry," Bruck says, "if you didn't make any mistakes, your sales would triple. If you made mistakes, your sales would double. 1975 is going to be the antithesis of this."

'Automation fever' expected

Andy Kay, inventor of the digital voltmeter and president of Non-Linear Systems, Inc., Del Mar, CA, near San Diego, is preparing for more productivity.

"We're shifting from low-volume, high-priced products to high-volume, low-priced products," he says.

"because we feel that we can compete best in the marketplace."

Kay's management plans include additional tooling for production and a priority on keeping the company's best engineers. The engineer's reasoning power is still the key to optimum component design, he says.

Kay has been able to hire more production people from minority groups than ever before, because, he says, they don't seem to be as hesitant about their ability to do the work as they once were.

The company introduced recently the first digital panel meter in Europe, and Kay says: "We're expecting our European business to help make 1975 a banner year for us."

Peter Bartlett, president of Automation Systems, Inc., Eldridge, IA, says: "Our management strategy is very simple. We produce more technology in bad times and less in good times."

Bartlett's company covers all phases of solid-state control of industrial automation equipment—both hard-wired and programmable



"Where our department managers had autonomy in hiring before . . . I now interview candidates myself." Don Bruck, president, Hybrid Systems, Burlington, MA.

computer controls. He says that 1975 will be a good year for his company, pointing out that when the economy is tight, many companies turn to automation in design and production to save on payroll. He explains that when times are generally good, companies can afford to pay high salaries and they're much more careful how they automate.

"Automation fever was rampant during the downturn in 1970—our best year," Bartlett says.

Business was slow for many automation-equipment makers while the automobile industry decided what automated systems it wanted.

Now that the car czars are ready, they're pushing companies like Automation Systems to produce. Bartlett, a former college professor, says he finds that the quickest way to get the product out of house is to train his designers to admit what they don't know about a customer's product, so they can ask all the questions they must to really know the product.

'Hong Kong automation' favored

Dick Petritz, president of Linolex, a maker of small computer systems in North Billerica, MA, says: "Our company is growing so fast

that one of our management goals in 1975 is to automate more fully our product-testing procedures."

However, Petritz, an early forecaster of the importance of LSI, is a "poo-pooer" of automation across the board, particularly mechanical automated production lines. He notes that semiconductors have already cut the number of parts that have to be assembled.

Automation costs too much to set up, he says, is too hard to get working properly, and when it finally is working right, is often too late to meet market needs.

"I believe in Hong Kong automation [low-cost people assemblers]," Petritz says. "We're strong believers in the cottage industry."

Linolex farms out its assembly work to local housewives who work in their homes. Petritz says that this takes the production load off the company, allows it to adjust its production level and gives it more flexibility.

"We are a high-technology company," says Petritz, "which makes us less susceptible to price cutting. But I don't think that 1975 is going to be as bad as many people think; the Government is going to prime the pump. Electronics has inherent growth, because it's more cost-effective than any other industry in the country."

Government business stressed

Ballantine Laboratories, Boonton, NJ, a producer of precision meters, calibrators, scopes and counters, is also going to use more automation in testing in 1975.

"We're trying to improve our service too," says President Fred Katzmann, "by adding more quality-assurance people to help make ourselves less wasteful."

Katzmann believes that the new year will be more sluggish than 1974, with not too much business growth in the industrial and commercial sector for the first six to eight months. He decided this year to bid for Government business that would keep the company busy for the next two to three years. Now over a third of his business is with the Government. A fifth of Ballantine's business is overseas, and this will remain level, Katzmann says.

(continued on next page)

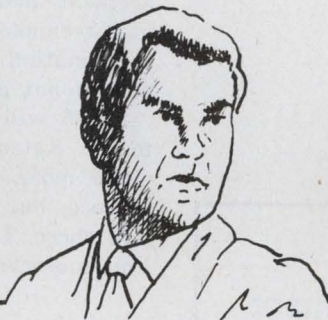

"We're shifting from low-volume/high-priced products to high-volume/low-priced products." Andy Kay, president, Non-Linear Systems, Del Mar, CA.



"We produce more technology in bad times and less in good times." Peter Bartlett, president, Automation Systems, Inc., Eldridge, IA.

"... one of our management goals in 1975 is to automate more fully our product testing procedures." Dick Petritz, president, Linolex, North Billerica, MA.



"I decided this year to bid for Government business that would keep the company busy for the next two or three years." Fred Katzmann, president, Ballantine Laboratories, Boonton, NJ.



"We're multiplexing on the production line and we're strengthening our overseas business." Hal Goldberg, president, Data Precision, Wakefield, MA.

Because of the uncertain times, the company has changed its management plans to concentrate on high-technology products and the rejuvenation of products that have peaked but are still marketable.

"1975 will be what we make it to be," Katzmann says. "It will require more skill and planning to succeed, but the opportunities are still there. I guess you'd say that I'm conservatively bullish."

Slow growth anticipated

Harold Goldberg, president of Data Precision, Wakefield, MA, and a member of the IEEE board of directors, says that 1975 means slow growth for existing products. But the slowdown will not be as deep as it was in 1970, he adds.

"In 1970," Goldberg says, "industry people panicked because the Government cut back on aerospace. But now the Government is opening up again, and although the consumer market is getting tight, this is the same kind of recession we've had before—which means that new industrial products have a place in the market."

Data Precision's management plans for this year include continuing its R&D, pushing the products it has in production and paring its inventory.

"We're hiring less often," Goldberg says, "trying to make more efficient use of the people we have. We're also multiplexing on the production line, and we're strengthening our overseas business."

Goldberg says that he won't make any serious change in management, unless there's a major erosion of the market or a sudden upsurge of some market he hasn't anticipated. ■■

ERIE RESPONDS. that's why WE'RE NO. 1 WORLDWIDE in Ceramic Capacitors



Forty years ago, ERIE foresaw a need and introduced the first ceramic capacitor to U.S. markets. Today, more than 7000 people—working in a million-plus square feet of plant space—in seven nations . . . are still dedicated to fulfilling customer needs. Our state-of-the-art ceramic technology continues to lead the way in the development of smaller, more efficient ceramic capacitors, both fixed and variable. And ERIE's line of high quality components is as broad as the markets we serve. So when knowledgeable people think ceramic capacitors, increasingly, they think ERIE. To remain number one in our competitive industry, we *have* to be responsive to your needs. We think we are. Try us.

ERIE TECHNOLOGICAL PRODUCTS, INC.
Erie, Pennsylvania 16512
INFORMATION RETRIEVAL NUMBER 24



Collection of
The Art Institute of Chicago
"Brussel's Construction," 1958
Jose di Rivera



new dimensions in Bodine drive capabilities

For office machines / machine tools / industrial equipment / processing apparatus / electronic equipment /
electrical control devices / medical apparatus / data processing equipment /
recording instruments / graphic arts equipment / scientific apparatus / and many other uses.



The people at Bodine are doing exciting things in fractional hp drives. Putting more power into smaller, lighter packages. Creating greater control capabilities than you might believe possible. Developing "specials" to meet the most demanding design criteria. Motors that keep their cool in hottest application environments. That run whisper quiet. And

deliver long-haul reliability and economy. Adding to an extensive line of standards to provide a virtually unlimited range of fhp motors, gearmotors and speed/torque controls. Talk to Bodine about your stock and built-to-order fhp drive requirements. We can help you get what you need. Over 3500 catalog specifications, 340 stock types and sizes. Ratings from

1/2000 thru 1/2 hp . . . torques from 0.18 oz.-inches to 350 lb.-inches . . . speeds from 0.6 to 10,000 Rpm. Write or call Bodine Electric Company, 2500 W. Bradley Place, Chicago, Ill. 60618. Phone 312/478-3515. Telex: 25-3646.

BODINE
ELECTRIC
COMPANY

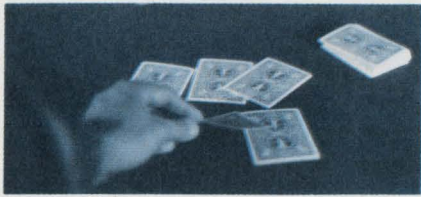

Consumer products to grow in sophistication with SOS and I²L and DMOS

Jim McDermott
Eastern Editor

Consumer versions of silicon-on-sapphire chips, integrated injection logic (I²L) and double-diffused MOS (DMOS) devices will be turning up increasingly in products this year, along with improved discrete components, IC packages and LSI chip systems.

The developments will include these:

- The use of SOS for analog timepieces and I²L for digital watches.
- Substitution of DMOS IC packages for discrete components in vhf-FM front ends.
- Incorporation of DMOS in hi-fi systems for all-electronic switching of panel controls.
- Use of microprocessor-oriented LSI arrays for fully electronic TV channel tuning and display.
- Widened use of programmed LSI systems in household appliances.
- Combined analog and digital microcircuits on the same chip for TV circuitry.
- Improved power switching devices for ranges and ovens and a variety of other new applications, such as fish-tank warmers.

New chips for watches

Electronic watch design will be influenced by two recent developments. One is the production of a 4-MHz SOS CMOS chip by RCA—an oscillator/ripple-counter circuit for analog watch movements. The second is the fabrication of an I²L bipolar chip by Texas Instruments for Benrus Watch Co.

RCA's SOS chip—the TA 6778—is designed to operate at 4 MHz with essentially the same drain now required for a CMOS 32-kHz circuit, according to Henry S. Miller, director of MOS IC products, RCA Solid State Div., Somerville, NJ.

RCA converted a proven bulk silicon circuit to a sapphire and silicon-gate version to provide higher operating speed with only a small increase in operating current, Miller reports. Typical drain is 9 μ A at 4 MHz for the counter-oscillator chip, and this drops to 5 μ A at 1 MHz.

Designed to operate between 1.45 and 1.6 V from a single silver cell, the TA 6778 is intended to provide the advantages of high-frequency, AT-cut crystals. These are, Miller points out, lower temperature coefficient, greater shock resistance and lower cost than the standard 32 or 64-kHz bar crystals now used.

Miller notes that SOS packing density is about twice that of bulk-silicon CMOS devices. Ultimately SOS circuitry will be cheaper than the present 32-kHz watch chips, Miller says.

"One change that will affect the development of consumer products in 1975 is an apparent trend from

MOS circuitry back to bipolar," says Douglas Taylor, manager of consumer marketing, Motorola Semiconductor Products, Phoenix, AZ. "The universal assumption that LSI circuits for consumer products would use MOS is no longer a foregone conclusion."

The development of I²L bipolar watch chips for LED wristwatches by TI is one indicator of this trend. The circuits have a higher packing density and are about 25% smaller than their CMOS forerunners.

The prime advantage of I²L is its ability to incorporate high-power bipolar digits and segment drivers for the LED display. CMOS can't do this.

The I²L chip, which uses a 32-kHz crystal, draws 8 μ A in the standby mode and 30 mA when the display is energized.

There are other consumer uses for the I²L chip, says Charles M. Clough, vice president of marketing at TI. These include use in TV



The first all-electronic tuning system with random selection of all 82 TV channels is the Magnavox Star system. Selected channels are briefly shown.

sets, cameras and autos.

Clough points out that the I²L chip is a custom component now, with a price of \$10 to \$20. It has been under development for nearly two years, and TI expects it to capture about 10 to 20% of the CMOS market within a year.

RCA's SOS oscillator counter chip is priced at \$11.60 in sample quantities. But in 250,000 lots the price is about \$3.50, Miller says.

"I feel that pricing on these circuits will follow an 80% learning curve," he adds, "so that every time the volume doubles, the price automatically drops by 20%. We believe that the sapphire technology will beat out some of these new bipolar technologies that people keep talking about."

DMOS good for vhf

The use of DMOS will alter the design of FM receiver front ends as well as the switching systems in entertainment centers, predicts Don Willett, marketing manager of consumer products for Signetics, Sunnyvale, CA.

DMOS provides isolation in the form of very low capacitances between devices.

"This permits us to put two devices in one IC package, whereas formerly use of discrete transistors was necessary," Willett says.

He sees receiver designers applying an eight-pin dip DMOS package that contains an FM-rf amplifier and mixer—like the Signetics SD 6000—in place of discrete.

DMOS devices also have low ON resistance and low cross-talk, which makes them ideal for the switching in hi-fi entertainment systems, Willett notes. With the present mechanical switches on the systems, cross-talk arises between connecting wires and cables.

The use of Dolby noise-reduction ICs will increase substantially in '75, Willett says. A major influence is recent authorization by the Federal Communications Commission for all FM stations to broadcast "Dolbyized" music.

"The coming year will see greater use of programmed LSI in consumer electronics," says Motorola's Taylor. One area will be in electronic tuning, he says, and another in appliance control. And the auto-

mobile computer—despite the cut-back in car production—is still of great interest to Detroit, Taylor insists.

"Electronic tuning," he explains, "takes different forms, depending upon whether you're talking about radio or TV sets. But the basic control is through the action of a phase-locked loop, which is essentially a digital technique."

Digital information, which can be reconstructed from the tuning action, may be used for display of frequency or channel number, Taylor points out. Typical of this trend is the recently announced Magnavox Star ("Silent tuning at random") tuning system for TV sets.

According to the maker, Star is "the world's first completely random-access, pushbutton tuning system." In less than one second any of the 82 channels can be tuned in. No fine tuning is necessary because the TV oscillator frequency is electronically controlled by the output of an LSI crystal-controlled frequency synthesizer. The selected channel is briefly displayed on the screen in six-inch digits.

Taylor also sees large-scale integrated digital circuits being applied on a substantially broader scale in programmable controls for such home appliances as ranges,

dishwashers and laundry equipment. One example he points to is in Frigidaire's new Touch-N-Cook electric ranges and wall ovens.

These incorporate a solid-state, LSI-programmed, touch-control system that sets baking and broiling temperature, turns the ovens on and off, times self-cleaning functions and oversees a variety of other range activities.

For lower-cost appliances, Joseph Obot, consumer product manager of National Semiconductor, Santa Clara, CA, looks for expanded development of relatively simple IC interval and programmable timers.

Merle Hoover, manager of linear IC applications for the RCA Solid State Div., sees the appearance of ICs that use CMOS digital circuitry and op amp circuits on the same chip.

"The vertical circuitry of TV receivers can profit from this kind of technology," Hoover says.

"The digital circuits can be used for counting and synchronizing, while the amplifiers can drive the vertical output," he points out.

Hoover also sees more penetration of discrete audio circuitry by monolithic devices. The use of ICs with op amps capable of driving the output stages will be on the increase, he says.

Better calculators coming

Manufacturers of hand-held calculators predict substantial improvements.

"The breakthrough that I see in the next 12 to 18 months will be in the operation of a calculator from a single, low-voltage—6 to 9 V—supply," says Michael Ebertin, director of product development for the Rockwell International Micro-electronic Device Div., Anaheim, CA.

"This will include display drivers built into the chips themselves. This will minimize the total hardware content—and the price—of the calculator.

"The next advance in calculators will be the incorporation of a non-volatile memory. In other words, you can switch the calculator off, and when you turn it back on, you haven't lost the numbers. One possible approach would be the use of CMOS." ■■

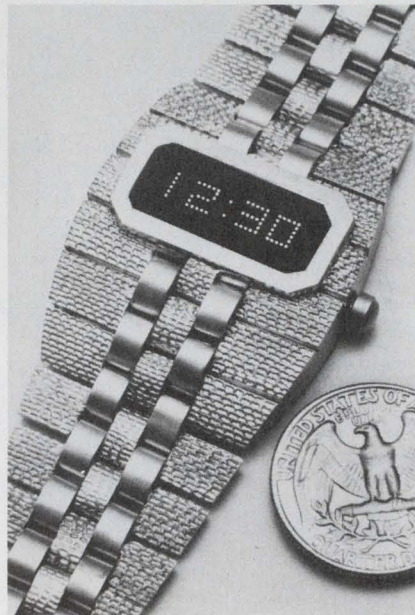

New SOS and I²L watch technologies will compete with present CMOS designs. This Accuquartz, by Bulova, has a 78.6-kHz crystal and a LED display.

Meet the first scope with a microprocessor.

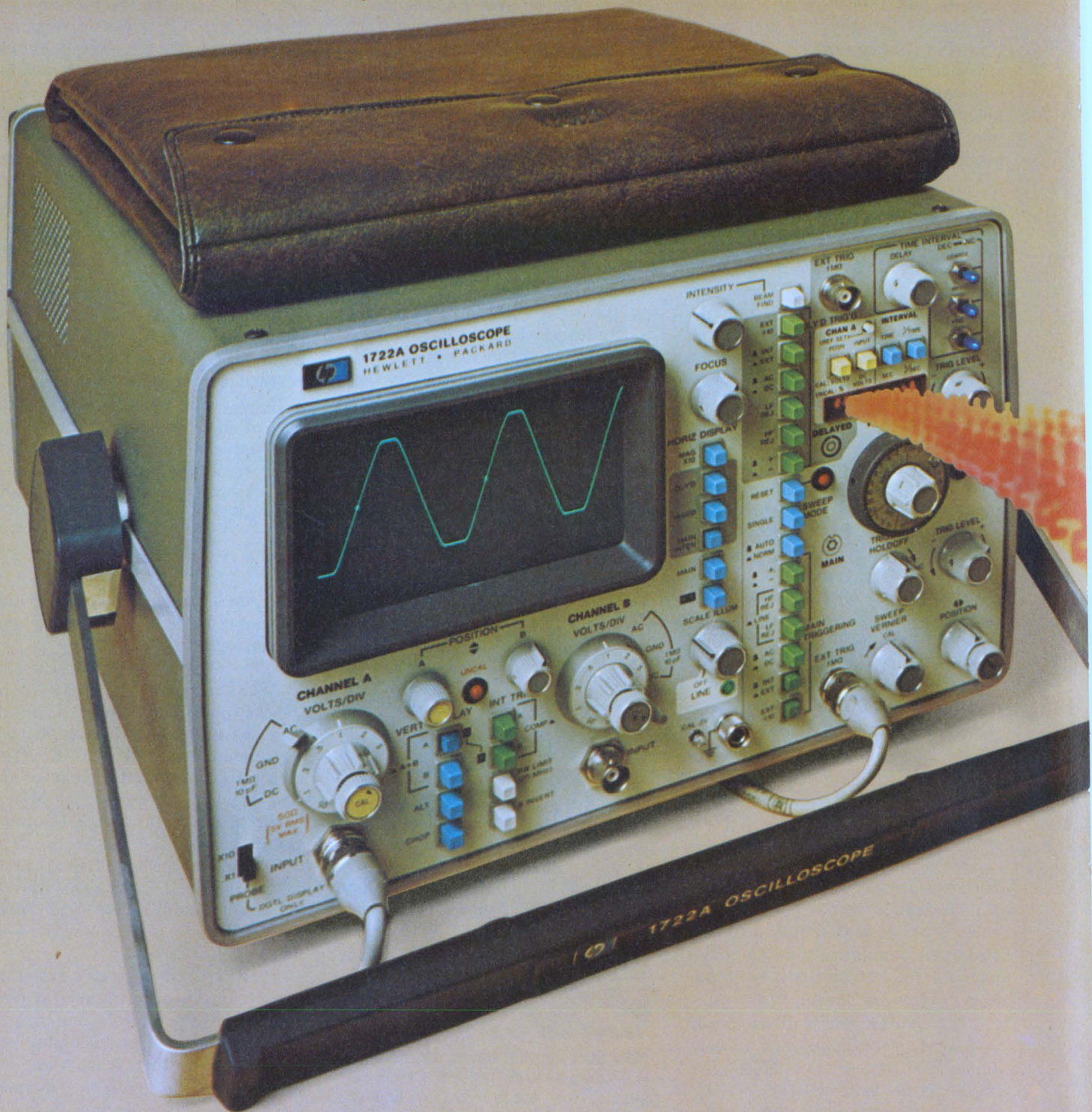

It counts, calculates, and improves accuracy too.

Now, HP has combined a high-performance scope, a microprocessor, and an LED display to put an end to graticule counting, mental calculations, and the conventional 5% scope error. The 1722A gives you a giant leap in measurement accuracy and convenience. It's a working lab partner that speeds measurements of time intervals, frequency, instantaneous or dc voltage levels, and relative amplitude. It allows you to make all these measurements more accurately...with less chance of human error.

The microprocessor takes over several tasks you used to perform. It keeps track of

ing of your measurements...in seconds, hertz, volts, or percent. Working with the 1722A is like having an assistant that takes care of the mental gymnastics.

There's another reason for easier, more accurate measurements—HP's unique Dual Delayed Sweep. It gives you two adjustable intensified markers for displaying the start and stop points of a time interval. The microprocessor then gives you an automatic read-out of the time interval between the markers. This speeds digital timing measurements and simplifies the adjustment of circuits to meet a timing spec.

The combination of a proven 275 MHz dual-channel scope, microprocessor, LED display, and Dual Delayed Sweep gives you faster, more complete waveform characterization than you'll get from conventional scopes costing twice as much.

And instead of the conventional 3 to 5 percent reading errors typically associated with voltage and time

measurements, the 1722A puts you in the 0.5 to 1 percent range.

The 1722A begins a new era of measurement technology by giving you faster answers, more accurate answers, even answers you couldn't get before. And at a price of just \$4,500.*

Let your local HP field engineer introduce you to the new scope generation. Call him today. Or, write for our informative 8-page brochure.

*Domestic USA price only.



dial settings, automatically computes time intervals and voltage levels, converts time measurements to frequency, and calculates percent. It even signals if you make an erroneous setting. In addition, the microprocessor drives a 3½-digit LED display to give you a direct digital read-

HEWLETT  PACKARD

Sales and service from 172 offices in 65 countries.
1501 Page Mill Road, Palo Alto, California 94304



With the microprocessor, industrial electronics will be working a lot smarter

John F. Mason
Associate Editor

In the midst of a recession and the normally fluctuating cyclical demands, industrial electronics is steadily undergoing radical changes in design—due, to a great extent, to the growing acceptance of the microprocessor.

More machines are being built “smart”—with computational capability provided by microprocessors. And the cost for such performance is one tenth or potentially one fiftieth that of a minicomputer.

The sectors of the electronics industry that will suffer from this invasion of the tiny, cheap, intelligent chips include the manufacturers of conventional TTL circuits and the small signal resistors and capacitors that are used with these circuits on PC boards. Except for high-speed applications, these components just won't be needed.

But emerging from the financially painful demise of these and other components there is good news for the design engineer. With microprocessor chips he is finding that he can produce a much better product more quickly than before, at a lower cost. He has more design flexibility and much shorter design cycle times.

Equipment benefiting from the microprocessor chip sets include instrumentation, communications, process-control systems, industrial machine tools and a vast number of small “dedicated” tools—tools that can perform one specialized function.

But the invasion of microprocessors is far from complete. General Electric, an established stronghold for the manufacture of numerical control (NC) equipment, has introduced its newest softwired numerical control system, the Mark Century 1050 series, which uses microprocessors. Using advanced diagnostic techniques,

the 1050 is built for use in machining centers that use high speed machines. But according to the company's James Connolly, product manager for numerical control in Waynesboro, VA, hard wire numerical control will be around for a long time.

Westinghouse is looking toward microprocessors, too, but says: “Minicomputers are coming down in price and will continue to be used for some time.”

Robert Morgan, marketing manager for the company's industrial equipment division in Buffalo, NY, sees that technology in 1975 will evolve slowly without many surprises. He says: “We're continuing to move more into solid state—thyristors—and diodes—a change

that has been slightly slower than we'd expected.”

Because of the business climate and the environmentalists, Morgan continues, “We're going to start making use of a lot of technological developments we've already got—particularly in the area of energy conservation.”

Morgan continues: “Rather than innovation, we're going to take a hard look at the way our equipment is built and the power sources it uses. We'll take SCRs, for example, and convert them a bit and apply them in different ways.”

“Conditions in 1975 are going to force a lot of technology that's been around a long time to be used in quite a number of new

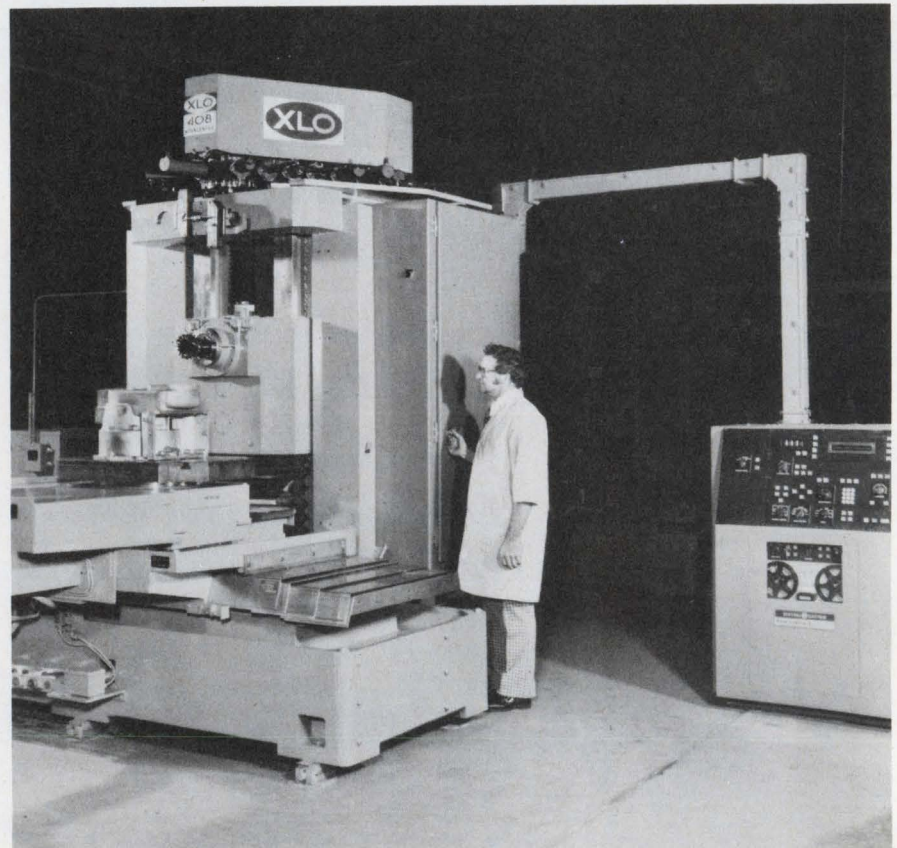

General Electric's 1050 softwired numerical controller—which employs the latest in microprocessors—operates a multi-axis machine-tool work center.

ways," Morgan concludes.

Allen-Bradley looks forward to a bumper year for computerized numerical control (CNC). "We began to get a foothold in this market in 1973," says Mike Gregory, product manager for numerical control equipment, Cleveland, OH. "It expanded in 1974 and will grow even more in '75."

People are familiar with the equipment now, Gregory explains, and they no longer fear abandoning hardwire numerical control for a more "intelligent" system. And also the cost of CNC is coming down. "The price of CNC is really approaching that of hardwire NC," Gregory says. "To give a hardwire system the flexibility that CNC has would cost far too much."

Allen-Bradley continues to build Direct Numerical Control (DNC) systems but does not expect to see growth in that particular sector this year.

Gregory reports: "At the simpler end of the spectrum, programmable controllers, which began to catch on in 1972, are expected in 1975 to outstrip their tremendous growth of the past year."

One drawing card of the programmable controller, of course, is its use of microprocessors and its sequencing and computing functions. The machines are becoming cheaper as well as more powerful.

Allen-Bradley believes the capital-goods market is going to remain strong throughout 1975. "The growth won't equal that of past years but we do expect sales in 1975 to be better than 1974—especially for CNC systems," Gregory says.

Cincinnati Milicron sees more use for microprocessors in 1975, particularly in programmable controllers that require a lot of relays, according to Charles F. Carter, the company's director of Product Development for the Machine Group.

Carter sees gains in '75 by both CNC, computerized numerical control and hardwire NC. CNC offers more than NC, and its cost is coming down. But on the other hand, some of the sophisticated features of CNC are being incorporated into NC.

Adaptive control—publicized at

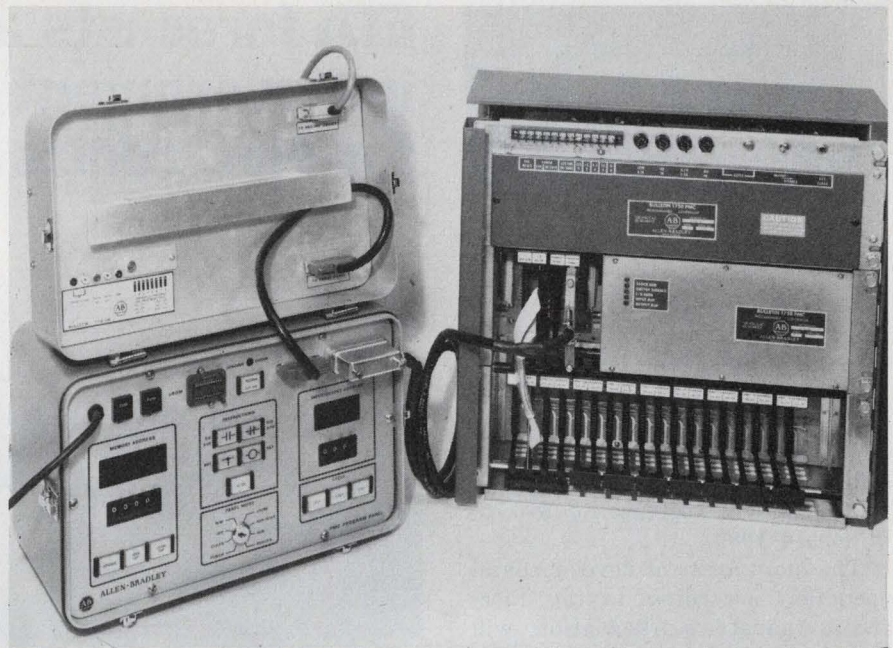

Programmable controller from Allen-Bradley offers a convertible memory system. Either a programmable read-only memory processor or a read/write memory processor may be used interchangeably. Shown are the program panel (left) and basic controller system.

the last three Machine Tool Shows in Chicago—is still just getting off the ground. Its main acceptance thus far, Carter says, is by the aerospace industry.

As for new markets, U.S. companies do not seem to be looking toward the oil-producing countries as aggressively as the European electronics industry does. Many Americans queried feel that the

market is not big enough yet. They say the Arabs' needs at this time won't make up for the declining needs of such former big spenders as England and Japan. Europeans, on the other hand, seem willing to cultivate the Arabs and wait. Companies such as Bruel & Kjaer in Copenhagen, for example, say they are already looking at new designs for their equipment, to simplify it for operators who are not skilled.

The first big sales to the oil producers will probably be consumer products—black and white television sets. But Iran and Saudi Arabia plan to import entire industrial plants. This market won't burst wide open in 1975, but Europe is waiting to step in when it does.

As for the cyclical demands for industrial equipment—a concept respected by many: Spending is expected to continue through March, drop down for the second and third quarters and rise slightly in the fourth. Consumer buying will pick up in early 1976, bringing capital-goods spending up by the second half of '76. So the end of the dark tunnel we're in now will bring us out happy and prosperous right in the midst of the nation's bicentennial anniversary celebration—just as if the whole thing had been planned. ■■

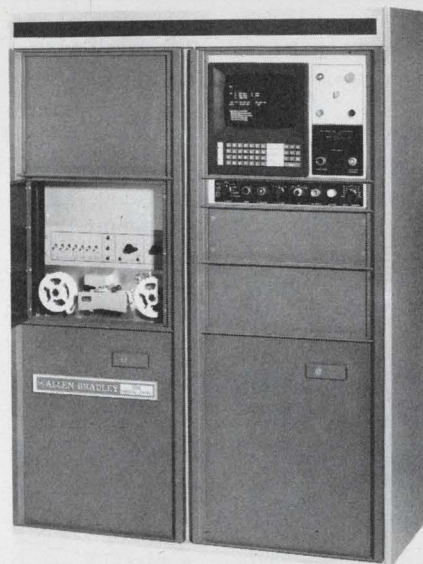

Computerized numerical control systems, such as the 7360 model from Allen-Bradley, can be readily shifted from one type of machine operation to another without hardwiring changes.



EIA forecasts a 33% rise in Government spending for electronics over 5 years

An EIA projection of Government spending for electronics through 1980 shows that outlays for defense will increase 33% in five years.

The study estimates that \$12.52-billion will be spent in 1975 and that this will increase to \$16.75-billion in 1980.

The main areas of developmental spending, according to the Electronic Industries Association, will include memories, computers, data communications, displays and electro-optical imaging.

In general-purpose forces, defense needs center on electro-optics and data communications. For example, with combat vehicles, better night-vision devices at lower cost are required.

Air defense has a primary need for electro-optical/visual backups for radar controls, the EIA says. Real-time use of sensor data and cheap, effective data links are needed for battlefield surveillance and target acquisition.

With submarines getting quieter, the Defense Dept. is rapidly financing development of more sensitive sensors.

Hardened equipment needed

The main needs of the strategic forces, the study finds, are hardened MOS computers and high-reliability, S-band, solid-state radar systems.

In electronic warfare, the most significant needs appear to be these: self-protection jammers for aircraft; radar-warning systems for a dense, agile threat; naval detection and jamming of long-range missiles; pinpointing and jamming of enemy communications; electronic countermeasures and counter-countermeasures; protection of aircraft against infrared-seeking missiles, and electro-optic countermeasures. Electronic warfare should see the expanded use of micro-processors for control of rf countermeasures equipment, the



Protection of aircraft, such as this F-14 fighter, against infrared seeking missiles is expected to get increased funding.

EIA says. Better voltage-controlled oscillators are also needed.

The efforts in data-communication development seem to focus on packet switching and data security. Better data links and lightweight troposcatter equipment are key concerns.

Charge-coupled devices and more reliable ICs lead the developmental thinking in electron devices, according to the EIA, and improved CMOS ICs and dual-mode and crossed-field traveling-wave tubes are also sought. Further back on the burner are picosecond signal processing, lead-tin-telluride infrared detectors and gallium-arsenide bulk-effect devices.

For information processing and display, memories and liquid-crystal displays are in demand. The key memory-development projects will be in magnetic bubbles, CCDs and MNOS semiconductor memor-

ies, the study reports.

In computers, the Defense Dept. would like to standardize architecture and specify low-cost, off-the-shelf computers.

Jam-proof transmission sought

Secure communications—such as spread-spectrum and frequency-hopping techniques—are costly. The Defense Dept. would like a cheaper method that offers jam-proof data transmission. CMOS technology is being considered.

Fiber optics, the EIA says, will solve many problems of ship, aircraft and Army communications. This technology offers low weight, is insensitive to interference and has a potential for megabit data rate. Packet transmission of data, now in early stages of development, is seen as a reliable, lightweight and space-saving technology.

With command and control applications requiring cheaper and more secure data links, CCD and acoustic surface-wave devices are being pushed. Cheap data links are also needed for control of remote pilotless vehicles.

All-weather radar is still too costly, the Defense Dept. believes, as are synthetic-aperture-array and forward-looking-infrared radars. The chief thrust will be toward cost reduction without a compromise in reliability. ■■

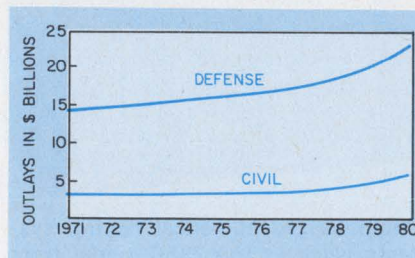

Defense Dept. electronics spending is expected to rise from \$12.52-billion in 1975 to \$16.75-billion in 1980.

Dialight sees a need:

(Need: The widest choice for your every application.)

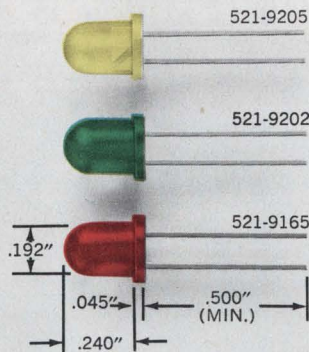

Now available in green, yellow and red. Mini-sized for maximum front panel density and easy panel mounting. High luminous intensity, low cost. Vibration/shock resistant. Solid state for long life. Wide viewing angles. Ideal for applications like panel lighting, film annotation and alpha-numeric displays.

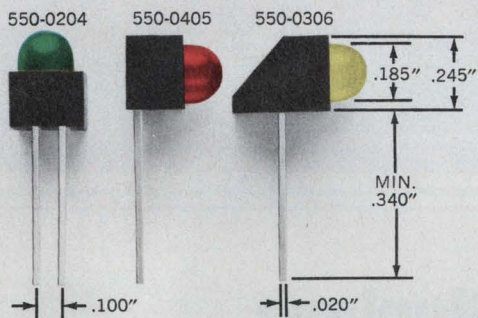

Mix 'em or match 'em. LED logic state fault indicators are available in red, yellow and green, in a variety of shapes, some with a built-in integral resistor. Can be driven from DTL and TTL logic. Designed for easy alignment on PC boards so that multiple functions can be displayed.

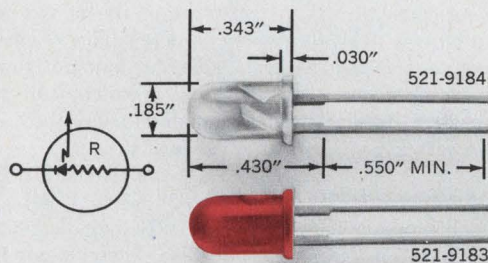

Available in red or clear LED packages with or without a built-in current limiting resistor. Red LED is also made without resistor. Suitable for circuit status indication, alpha-numeric displays and visual indicators. Features long wire-wrappable leads. IC compatible with solid state reliability. High luminous intensity, low power consumption, low cost.

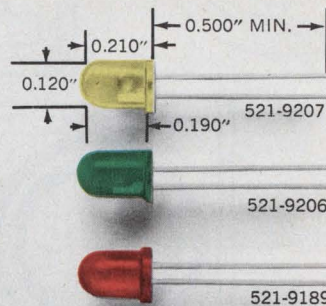

Your choice of green, yellow and red, with axial leads for dense packaging requirements. Wide viewing angle for easy readability. Low power consumption, low cost, IC compatible. 10mA operation for typical brightness. Size is identical to the most popular red LEDs.

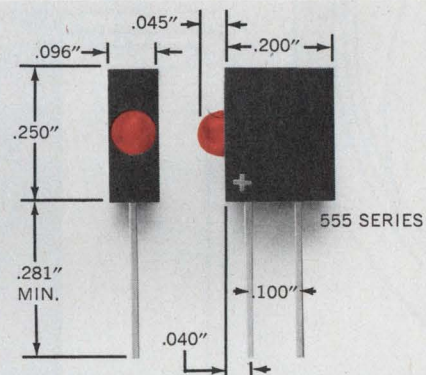

LED logic state fault indicators available in 14 models with voltage ratings from 1.7 to 14. Suitable for dense packaging on printed circuit boards—up to 10 units to the inch—IC compatible. With built-in series resistor. Polarity identified. Low power consumption.

Dialight, the company with the widest choice in switches, LEDs, indicator lights and readouts, looks for needs . . . your needs . . . and then they develop solutions for your every application. No other company offers you one-stop shopping in all these product areas. And no other company has more experience in the visual display field. Dialight helps you do more with these products than any other company in the business, because we are specialists that have done more with them. Talk to the specialists at Dialight first. **DIALIGHT** You won't have to talk to anyone else.

Dialight, A North American Philips Company
203 Harrison Place, Brooklyn, N. Y. 11237
(212) 497-7600

See Dialight.

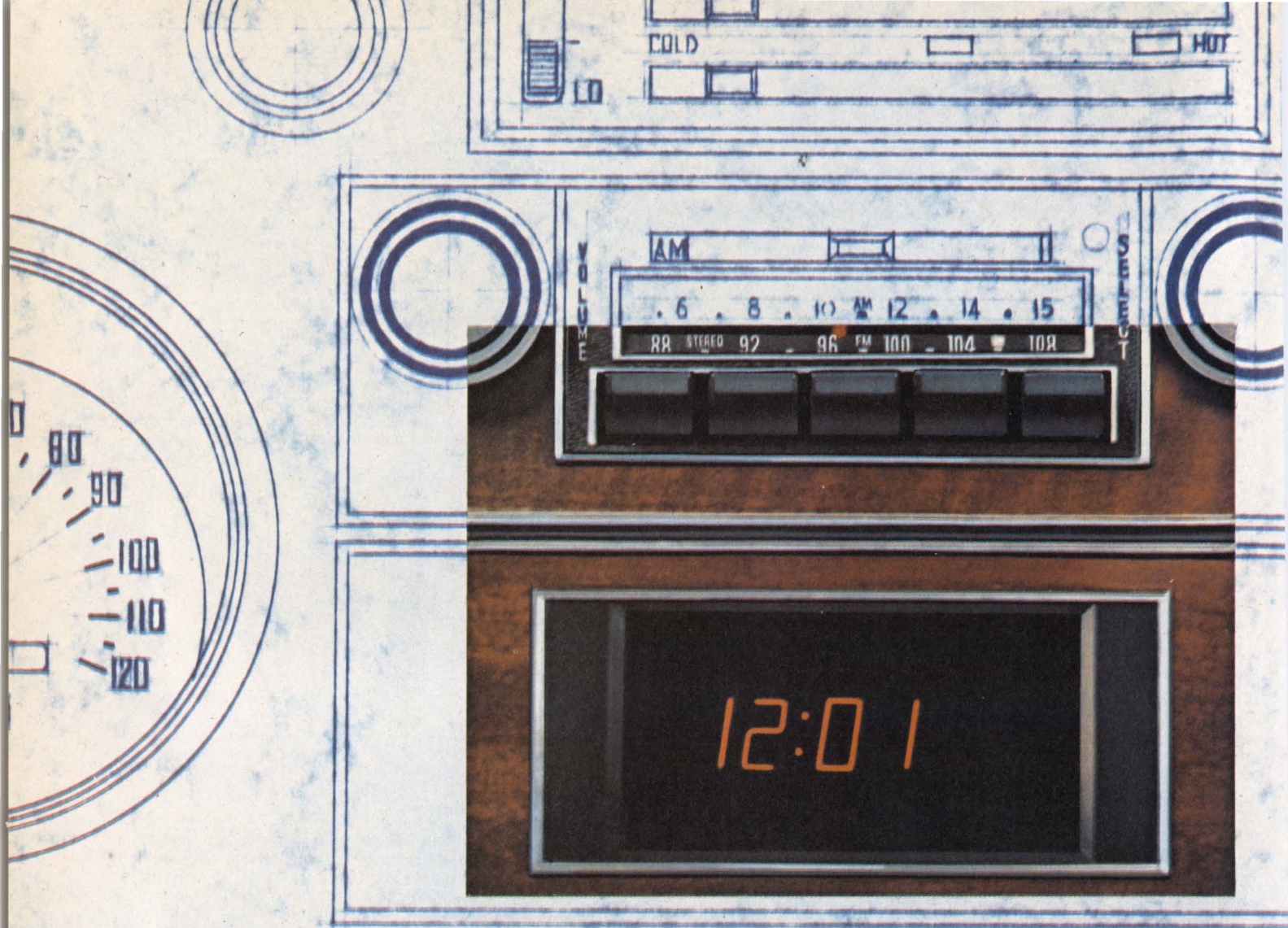

Better looking Beckman Displays are right for today's automobiles



Beckman customer introduced an automotive clock utilizing Beckman Displays.

There are many reasons why Beckman Displays are being selected for automotive applications. First, of course, is their appearance. Beckman Displays produce characters which are crisp, clean and unbroken. They have a neon orange color that is

easy to read and a brightness range that can be seen in all automotive ambient light conditions, even in direct sunlight. What's more, the cost is low. As little as \$0.70 per digit in large OEM quantities for the SP-151 automotive clock display.

easy to read and a brightness range that can be seen in all automotive ambient light conditions, even in direct sunlight. What's more, the cost is low. As little as \$0.70 per digit in large OEM quantities for the SP-151 automotive clock display.

easy to read and a brightness range that can be seen in all automotive ambient light conditions, even in direct sunlight. What's more, the cost is low. As little as \$0.70 per digit in large OEM quantities for the SP-151 automotive clock display.

easy to read and a brightness range that can be seen in all automotive ambient light conditions, even in direct sunlight. What's more, the cost is low. As little as \$0.70 per digit in large OEM quantities for the SP-151 automotive clock display.

easy to read and a brightness range that can be seen in all automotive ambient light conditions, even in direct sunlight. What's more, the cost is low. As little as \$0.70 per digit in large OEM quantities for the SP-151 automotive clock display.

easy to read and a brightness range that can be seen in all automotive ambient light conditions, even in direct sunlight. What's more, the cost is low. As little as \$0.70 per digit in large OEM quantities for the SP-151 automotive clock display.

Beckman

INFORMATION DISPLAYS OPERATIONS

There's more eye appeal in Beckman Displays!

Lasers help engineers to locate dummy position in auto crash tests

Lasers are helping automotive safety engineers to "hold the pose" of test dummies in simulated crash tests. At General Motors Research Laboratories, Warren, MI, scientists have developed a simple and convenient method to pinpoint the initial seated position of a test subject on a crash sled.



General Motors researcher adjusts one of the lasers to help position an anthropomorphic dummy on a test sled. Multiple-exposure photo shows actual low-power laser beams used to pinpoint location of the test subject.

Low-power (0.7 mW) helium-neon lasers are used to align the test dummy with an accuracy of one-tenth of an inch. The lasers are magnetically locked at predetermined positions on large vertical surface plates fastened to the floor on each side of the crash simulator.

Targets on the test subject are lined up with the laser beams to put the body in the correct position for the test. As many as 10 lasers can be placed on each side of the test sled. Another laser, mounted overhead, throws a fan of light rays along the centerline of the sled to provide a lateral plane of reference. ■■

Rugged...versatile

New!

"The Persuader"

*The S190 switchlight outguns everything its size...costs only \$1.62**

In every era, new products come along to keep the competition honest, with all the cards on the table. So we invite you to compare our S190 series with other switchlights. Check our variety of lens colors and easy mount panel adaptors...our wide terminal spacing for easy and fast wiring: solder, quick connect, PCB...our no-tool lamp replacement, long life wiping contacts, rugged molded case. Consider the low cost when you realize that the S190, with its 2 Form C action, has greater circuit flexibility than most switchlights on the market. And it's easily available at your local distributor! Call our sales office in your area for applications assistance...we're located in major cities, world wide. Clare-Pendar Co., Box 785, Post Falls, Idaho 83854, (208) 773-4541.

*In quantities of 1000



CLARE-PENDAR
Switchlights & Keyboards





We help keep your world turned on.

Call on Nichicon for performance, dependability, quality,
full-line warehousing and delivery dates you can count on.

PRODUCTION ITEMS FOR THE HOME ENTERTAINMENT, COMPUTER AND INDUSTRIAL ELECTRONIC INDUSTRIES:

Electrolytic Capacitors, Ceramic Capacitors, Film Capacitors, Oil Filled Capacitors—without
P.C.B., Metallized Paper Capacitors, Wax Paper Capacitors, Mica Capacitors, Hybrid IC's,
P.T.C. Thermistor.

REPRESENTATIVES

ALABAMA

Interep Assoc., Inc.
(205) 881-3677

CALIFORNIA (Northern)

PM Sales
(415) 941-4444

CALIFORNIA (L.A.)

Varigon Associates
(213) 679-0621

CALIFORNIA (San Diego)

Varigon Associates
(714) 299-5413

COLORADO

Component Products
Sales
(303) 444-2730

FLORIDA (Southern)

Repronics, Inc.
(305) 251-5478

FLORIDA (Northern)

Repronics, Inc.
(813) 522-8220

GEORGIA

Interep Assoc., Inc.
(404) 394-7756

ILLINOIS

Midwest Electronic Sales
(312) 626-0030

INDIANA

Midwest Electronic Sales
(317) 926-3736

IOWA

Midwest Electronic Sales
(319) 362-4410

KANSAS

Mid-America Electronics
(913) 236-4800

MARYLAND

Component Sales
(301) 484-3647

MASSACHUSETTS

Component Specialist
(617) 667-4181

MICHIGAN

Greiner Assoc.
(313) 499-0188

MINNESOTA

Robert W. Marshall
Co., Inc.
(612) 929-0457

NEW YORK STATE

Quality Components, Inc.
(716) 839-4170

NORTH CAROLINA

Component Sales
(919) 782-8433

OHIO

G & H Sales Company
(513) 771-8231

TEXAS

William Reese Assoc.
(214) 638-6575

WASHINGTON

Ray Over Sales
(206) 454-4551

WISCONSIN

Midwest Electronic Sales
(414) 542-5129

DISTRIBUTORS

WEST COAST

SEATTLE, WASH.

Bell Industries
(206) 747-1515

LOS ANGELES

JACO Electronics
(213) 887-6400

MID WEST

MINNEAPOLIS, MINN.

Hall Mark Electronics
(612) 925-2944

CHICAGO, ILL.

Hall Mark Electronics
(312) 437-8800

CHICAGO, ILL.

Midwest Electronic Sales
(312) 626-0030

DALLAS, TEXAS

Hall Mark Electronics
(214) 231-5101

EAST COAST

BOSTON, MASS.

BEC Electronics
(617) 667-4181

NEW YORK CITY

BEC Electronics
(516) 567-6060

BALTIMORE, MD.

BEC Electronics
(301) 730-2255

PHILADELPHIA, PA.

Hall Mark Electronics
(215) 355-7300

HUNTSVILLE, ALA.

Hall Mark Electronics
(205) 539-0691

ORLANDO, FLA.

Hall Mark Electronics
(305) 855-4020

CANADA

TORONTO, ONTARIO

Audio Electronics, Inc.
(416) 495-0720

MONTREAL, QUEBEC

Audio Electronics, Inc.
(514) 735-6197



NICHICON (AMERICA) CORP., 6435 N. Proesel Ave., Chicago, Ill. 60645 • 312/679-6530
Division of NICHICON CAPACITOR LTD., Kyoto, Japan

ECL design just became a three-layer piece of cake.

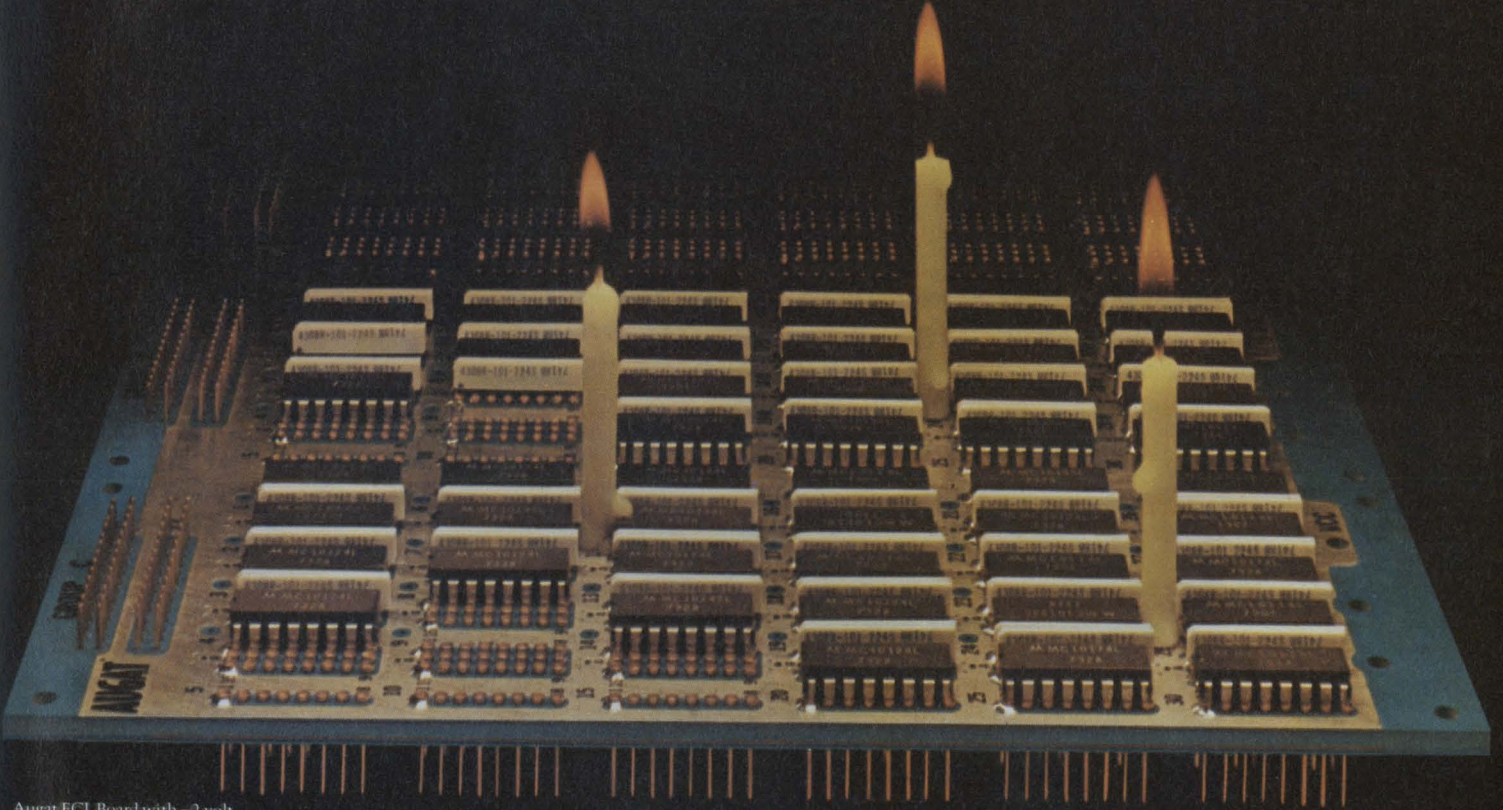

Augat ECL Board with -2 volt bus for terminating single in-line package (SIP) resistor network.

Compared to methods of the past, the Augat series of socket, Wire-Wrap® ECL boards makes ECL design a piece of cake. Even for circuits in the 125 to 500+ MHz range. They can save you 90 percent or more in breadboarding and prototyping time. Tens of thousands of dollars in start-up costs. And many costly hours in field maintainability. With this proven advance in three-layer interconnection technology you don't have to design in controlled impedance interconnections, mess around with transmission lines, or commit power connections for different ECL logic modules. All of which frees you to concentrate on the partitioning of logic functions and the preparation of a wiring list.

And unlike a multi-layer P.C. board, there is no loss in planar density. Two 16-pin ECL and associated pull down and decoupling components fit into one square inch on every Augat ECL board.

The nice thing, too, is that Augat ECL boards are standard catalog items available in any quantity at any time from Augat distributors around the world. You can contact them directly or write Augat, Inc., 33 Perry Avenue, Attleboro, Mass. 02703. Tel. 617-222-2202. TWX 710-391-0644.

AUGAT®

Registered TM of Gardner-Denver Company

When "off the shelf" won't do, call us!

If you're talking precision pots, then talk to Duncan. For the past 15 years, Duncan's crack engineering team has designed literally thousands of 'specials.' We're proud to have some of the nation's finest technical minds to help solve your engineering problems. And a short step away is Duncan's modern production and testing facilities. Since 'specials' are a major part of our regular business, you'll be equally impressed by our competitive prices and unusually quick delivery schedules.

Duncan is keeping up and ahead of our times to meet

your growing requirements for better more reliable products; including non-wirewound Resolon® Conductive Plastic elements and single-turn or multi-turn precision wirewound pots, both available with linear or non-linear functions. Call us for design assistance or write today for technical literature.



DUNCAN ELECTRONICS
SUBSIDIARY

SYSTRON  DONNER

2865 Fairview Road • Costa Mesa, California 92626
PHONE: (714) 545-8261 □ TWX 910-595-1128



**Duncan: Your prime source for
custom designed pots.**

There's only one cermet film resistor with enough design improvements to set a new standard of quality.

Ultra thick solder coated wire leads are both weldable and solderable.

Capless design does away with problems associated with end cap construction.

Conformal coating provides outstanding insulation properties.

Alumina core is physically and thermally strong to resist fractures.

Crisp, clear, dual markings for easy identification.

We blended our extensive fixed resistor knowhow with 15 years of cermet experience to produce an outstanding cermet film resistor. And we've developed unique manufacturing techniques that let us provide consistent quality.

Available in preferred resistance values (E96 Series) from 10 ohm to 1 meg; higher values available on special order. 1/4 watt at 70°C; 1/8 watt at 125°C; 1% tolerance; 100 PPM. Size 0.250 L. by 0.090 D.

Available in tape reels if you prefer.

Approved to MIL-R-10509 for Style RN55, Characteristic D. Write Allen-Bradley Electronics Division, 1201 South Second Street, Milwaukee, Wisconsin 53204 for complete technical details on Type CC. International Division, Milwaukee, Wisconsin 53204. Canada: Allen-Bradley Canada Limited, Cambridge, Ontario. United Kingdom: Allen-Bradley Electronics, Limited, Jarrow, County Durham NE32 3EN.

If you're really serious about cost, be serious about quality.



ALLEN-BRADLEY

Milwaukee, Wisconsin 53204

INFORMATION RETRIEVAL NUMBER 151

EC69

We couldn't have said



"Standing out among the industry giants—in both analogs and digitals—is Weston, a company that pioneered many of the advances in APMs. From optical indicators, to p & j's, to taut band; and from commercial to aerospace, you'll find it at Weston.

it better.



"If it's a DPM you're looking for, chances are you'll also find it at Weston: The company kicked off the industry when it introduced the first DPM just seven years ago."

Electronic Design, August 2, 1974

INFORMATION RETRIEVAL NUMBER 152

We're either first or best. Or both.

WESTON WESTON
Schlumberger

Weston Instruments, Inc.
614 Frelinghuysen Ave., Newark, N.J. 07114

In Europe: Schlumberger Instruments and Systems,
12 Place Des Etats Unis, 92120 Montrouge, France

I want to know more about:

Weston APMs Weston DPMs

I'm also interested in:

Weston DMMs Weston VOMs

Weston Frequency Counters

Name _____

Company _____

Address _____

City _____ State _____ Zip _____

Phone _____ Have salesman call.



We feel a little flag-waving is called for

After all, it's not every day a Spanish company opens a manufacturing plant in the USA. Especially in the highly competitive world of electronics.

But that's just what we've done. Bearded the electronic giants in their own dens.

Our new American den is in Boston. Right now we're manufacturing carbon film resistors – with other component lines to follow – on our own specially designed machines, drawing on the identical advanced technology and production techniques that have taken us to the top in Europe.

And we know this little bit of flag-waving will catch the eye of our European customers. They'll appreciate how the extra production from our US plant will ease their own deliveries in Europe. We will no longer have to divert so much of our European capacity across the

Atlantic. So everybody benefits.

To our American friends we say, "Happy to be in the USA". We know *all* our customers are going to be happy we are.

Find out more about Piher. A leader in component technology.

PIHER International Corp., (Sales Office)
1239 Rand Road, Des Plaines, Illinois 60016.
Tel: 312-297 1560 Telex: 282514

PIHER Corp., (Manufacturing Plant)
399 Washington Street, Woburn, Mass. 01801
Tel: 617-935 8750 Telex: 94-9382



Still fighting snap, crackle and pop?

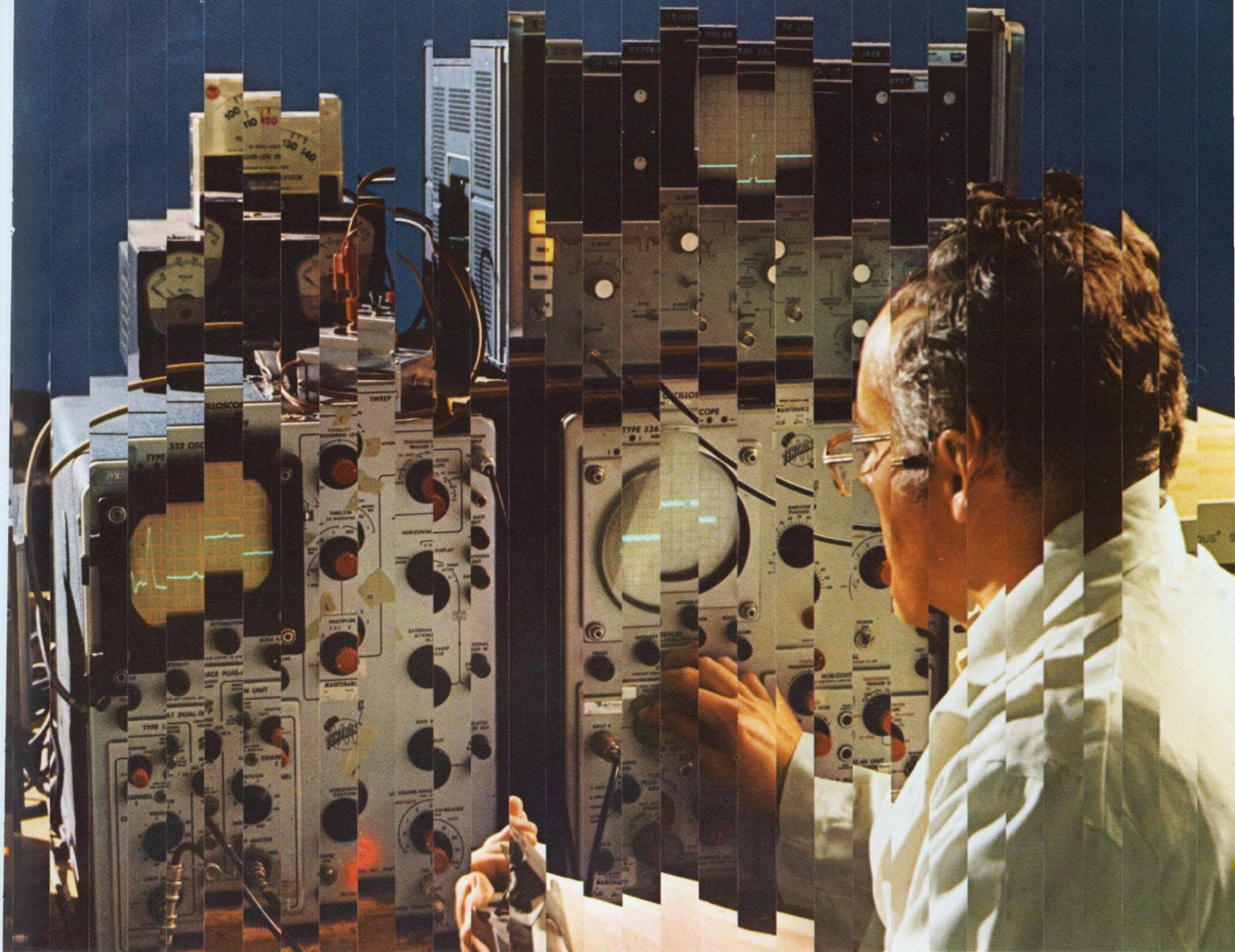

Noise has a way of showing up in circuits. Bendix has a way of preventing it. Filter connectors. Boasting some of the best attenuation curves available, Bendix filter connectors solve a wide range of low-pass filter problems. Small wonder Bendix is first choice in the fight against snap, crackle and pop.

These versatile connectors, production tooled, are available in a wide range of cylindrical and rectangular configurations designed to meet most any industrial, commercial and military application.



Configurations that can be intermateable with most MIL-Spec and popular commercial connectors and special designs for advanced state-of-the-art equipment. There's sure to be one that meets your attenuation and frequency requirements. You'll like what you hear when it comes to the price, too. And that goes for delivery as well.

Write for our new catalog. It's yours for the asking. The Bendix Corporation, Electrical Components Division, Sidney, New York 13838.

Bendix

INFORMATION RETRIEVAL NUMBER 154

DO COLLEGES HELP BUSINESS AS MUCH AS BUSINESS HELPS COLLEGES?

Yes, they do. But not in the same proportion. Business contributes about 15% of the total voluntary support received by colleges.

But today, business gets half the college-trained men and women who are employed. Tomorrow, it will need even more.

As a result, businessmen should think seriously about increasing the level of corporate giving to education. Can you think of a better investment?

For the latest national figures on corporate giving to higher education, write on your letterhead for "CFAE Survey of Corporation Support of Higher Education," and enclose \$2.00 to help cover costs. Mail to: Council for Financial Aid to Education, 6 East 45th Street, New York, N.Y. 10017.

Give to the college of your choice. Now.

Advertising contributed for the public good.

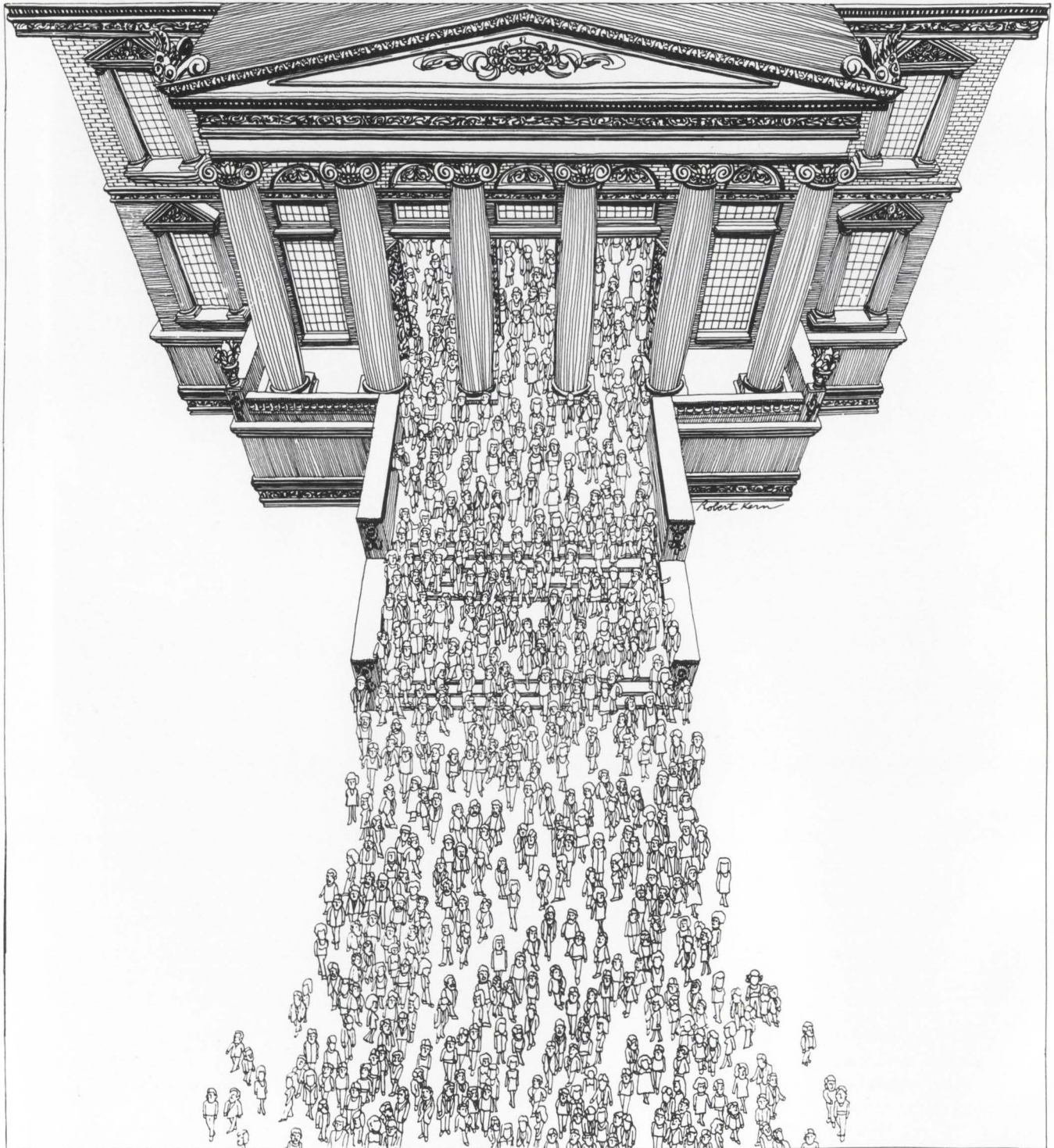



Behind every Rotron fan and blower... Application Engineering

No product is any better than the job it will do for you.

That's why Rotron's staff of Application Engineers are always available to help you use air most effectively—avoiding the potential problems of incorrect choice of fan or blower—assuring you the most for your air moving money.

They know their business. They draw upon more than 25 years of experience in the application of precision air moving devices. They have available to them the best equipped laboratories for testing and evaluation of specific air mover to system combinations. And, of course, they know their product.

That doesn't mean you'll need a factory-based application engineer every time you use a Rotron fan and blower. The variety and quality of products available to you, the wealth of knowledge that exists throughout the sales and distributor organization—and your own knowledge—will usually combine to provide just the right air mover for you.

But when a question does arise . . . when you *do* need help . . . your Rotron Application Engineer is there . . . on the phone or at your plant . . . with the answer.

Why settle for less when the best costs no more?



ROTRON INC.

Woodstock, N. Y. 12498 □ 914 • 679-2401 □ TWX 510-247-9033

Pacific Div., Burbank, Cal. 91506. 213-849-7871 • Rotron B.V., Breda, Netherlands, Tel: 79311, Telex: 844-54074

INFORMATION RETRIEVAL NUMBER 33



KEPCO

OPERATIONAL POWER SUPPLIES

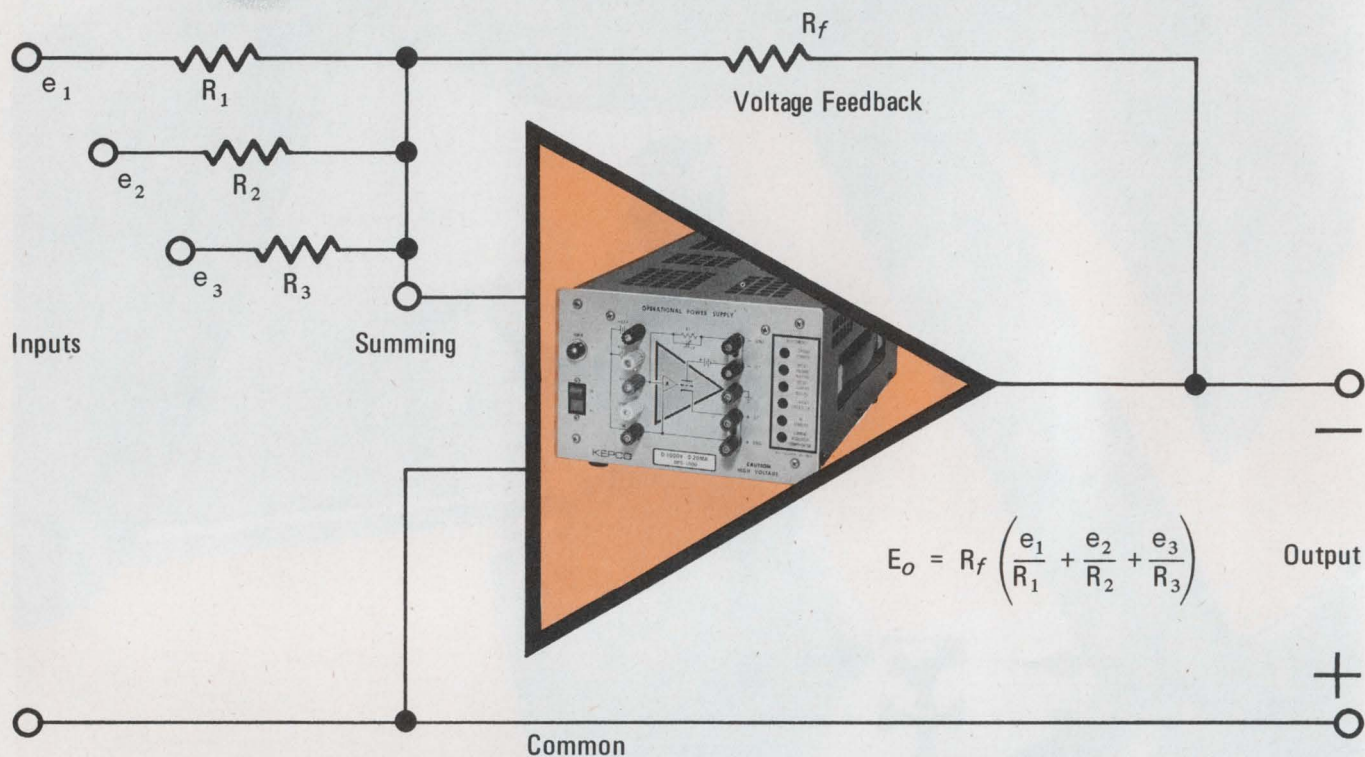

A Kepco **Operational Power Supply** is capable of producing more than mere voltage *stability* (though it does that admirably, too). An **Operational Power Supply** offers voltage *agility*. These unique power supplies allow you to exercise subtle, precise, rapid control, closed loop control, even digital control. They'll respond with better than 0.01% linearity to the most complex programming instructions, will slew to a new setting at speeds up to 1V/microsecond, and allow you to set zero with millivolt resolution. Kepco's Operational Power Supplies are most useful instrumentation for:

- **AUTOMATIC TEST EQUIPMENT (ATE)**, where the ability to rapidly settle at a programmed level, speeds your test cycle.
- **PROCESS CONTROL SYSTEMS**, where the **Operational Power Supply's** high gain and linear response permits you to close a variety of feedback loops.
- **THE STABILIZATION OF CURRENT**, where minimum offsets allow small currents to be effectively controlled and where *capacitorless* output circuits offer the dynamic compliance to track a varying load.
- **MEASUREMENTS**, where an **Operational Power Supply's** ability to sum, scale and integrate, permits the complex combination of inputs.
- **OPERATIONAL POWER SUPPLIES** are made *only* by **KEPCO, INC.**

Ask for your free copy of "Using Operational Power Supplies," our 32-page booklet that will open your eyes to what a power supply can do, besides producing a stable voltage.

Write Dept. EU-05

KEPCO®

KEPCO, INC. • 131-38 SANFORD AVENUE • FLUSHING, N.Y. 11352
(212) 461-7000 • TWX #710-582-2631 • Cable: KEPCOPOWER NEWYORK

INFORMATION RETRIEVAL NUMBER 34

washington report

Export licenses: Expedited or slowed?

The verdict is far from in regarding the real impact of a recently passed amendment to the Export Administration Act. It gives the Dept. of Defense 30 days, in most cases, to make a judgment on requests for export licenses submitted by the Dept. of Commerce. The amendment serves a mandate on Commerce's Office of Export Administration to make such decisions within 90 days. In the past industry has complained that delays from Washington have put it at a distinct disadvantage in competing with other industrialized nations for Communist Bloc business.

Ostensibly the new time limitations will accelerate Defense Dept. decisions, but there is genuine concern in business circles that this could lead to Commerce running more requests through the Defense Dept. for approval than it did before. Rather than expedite the over-all decision time, they predict it may slow the process. Reportedly the commerce and defense agencies are working up procedures and establishing areas of responsibility so this won't happen. Both are hopeful that when the dust settles U.S. sellers will have more equitable bargaining capability.

U.S. to stress computer output on microfilm

Look for more emphasis within the Federal Government on use of microfilm to record output from its 7000 computers. The impetus comes from a General Accounting Office study of eight Federal activities that showed potential annual savings of nearly \$1-million. The GAO findings indicated that 1.2 million of the 3.9 million pages of reports produced monthly by the eight organizations could be converted to COM—Computer-Output-Microfilm.

To make Federal managers more aware of the potential savings, the General Services Administration is preparing a handbook on the analysis and design of COM information systems and will promote COM-sharing. A Defense Supply Agency study indicates that producing computer output data on microfilm costs one-fourth as much as producing the data on paper.

New standards to enhance component exports

U.S.-made electronics components should become more promising for export by the third quarter of 1975. That's when an international certification plan for components and their electromagnetic compatibility with power networks is expected to be structured and operational. The Electronics Industries Association is the prime mover for the plan, which

has been formulated by the International Electrotechnical Commission (IEC), whose standards are a key factor in international trade.

The component certification system is expected to have a significant impact on the future design and construction of every electrical device connected to a power line. The standards will cover not only the interference between equipment connected to the same line but also disturbances that the equipment causes to the power system itself.

The United States National Committee of the 45-member nation IEC is an independent body affiliated with the American National Standards Institute.

A 3-MW windmill that would blow good

The windmills planned by the Federal Government for wind-energy studies may make present versions look like Erector-set creations. The National Aeronautics and Space Administration and the National Science Foundation have awarded contracts to General Electric and Kaman Aerospace Corp. for preliminary designs of windmills that could produce from 100 kW to 3 MW of power.

The wind-energy system to produce 3 MW, it is estimated, will have rotor vanes that are approximately 200 ft in diameter, which would make it the largest windmill ever constructed. NASA already has a 100-kW system under development with 120-ft vanes. It is expected to be in operation by mid-1975 at the Lewis Research Center's Plum Brook Test Area near Sandusky, Ohio.

Capital Capsules: The Air Force is testing an airborne screener that automatically detects man-made objects on the ground with an infrared line scanner. Thus far the device has picked up 90% of valid targets and is said to be three times as effective as a human photo interpreter. A promising use will be for operation of camera systems in flying drones. . . . **Got a design for a 10.6- μ laser target designator that weighs no more than 15 pounds?** See the Army. Pulse energies of up to 200 mJ in a near-diffraction-limited beam are required, with pulse lengths of less than 50 ns as a goal. . . . The Navy is interested in developing an exploratory four-element adaptive array for eventual application to shipboard/aircraft communications with the Fleet Satellite Communications and Line-of-Sight Task Force Communications systems. The operating frequency range is 225 through 400 MHz. . . . **Techniques for fabricating compact, high-isolation, low-insertion-loss microwave frequency-switching matrices** are being sought by the Air Force. The switches, 16 input/one output and 16 input/eight output, are to operate over the minimum frequency range of 950 to 1220 MHz at a maximum switching time of 1 μ s. All switches are to be fabricated on a chip 1.8 cm² and 1 mm thick. . . . Senate Majority Leader Mike Mansfield of Montana has strongly urged the Energy Research and Development Agency to give "highest priority" to development of magnetohydrodynamics (MHD) electrical power-generation systems. The plants would be expected to produce 50% more power per pound of fuel than conventional steam-turbine plants. . . . The 560-member National Electrical Manufacturers Association, presently located in New York City, will start transferring functions and personnel to Washington, DC, within a year or two. . . . An advanced inertial navigation system carried onboard the first test model of the B-1 bomber contains, what is said to be, the first gyro that does not require continuous spin power. Once spinning action is started it would take five to 10 years for the gyro to run down on its own.

PICK A PERFORMER

Select any of 5 display modules...
15 plug-ins...
convert to cabinet or rackmount

Measurement capabilities, application flexibility and a conservative price tag are three sound reasons for specifying Tektronix 5100 Series low-frequency oscilloscopes.

Designed to keep pace economically with changing measurements and applications, the 5100 Series offers a choice . . . five display units featuring dual and single beam, storage and non-storage displays . . . fifteen low-cost, interchangeable plug-ins with 1-8 traces . . . normal and delayed sweep . . . bench or rackmount models. Designed for operation from DC to 2 MHz. Depending upon plug-in selection, the 5100 provides conventional or differential measurement capabilities, curve tracing, and even sampling to 1 GHz. The scope buyer may now select the exact configuration and capabilities to meet his present needs, and be confident

that future measurement applications can be accommodated by adding other plug-ins or display units. The cost? As low as \$765 for a complete oscilloscope.

For detailed specifications contact your local Tektronix Field Engineer or write: Tektronix, Inc., P.O. Box 500, Beaverton, Oregon 97077. In Europe, write Tektronix Ltd., P.O. Box 36, St. Peter Port, Guernsey, C.I., U.K.



TEKTRONIX®

committed to technical excellence

INFORMATION RETRIEVAL NUMBER 35
FOR DEMONSTRATION 201

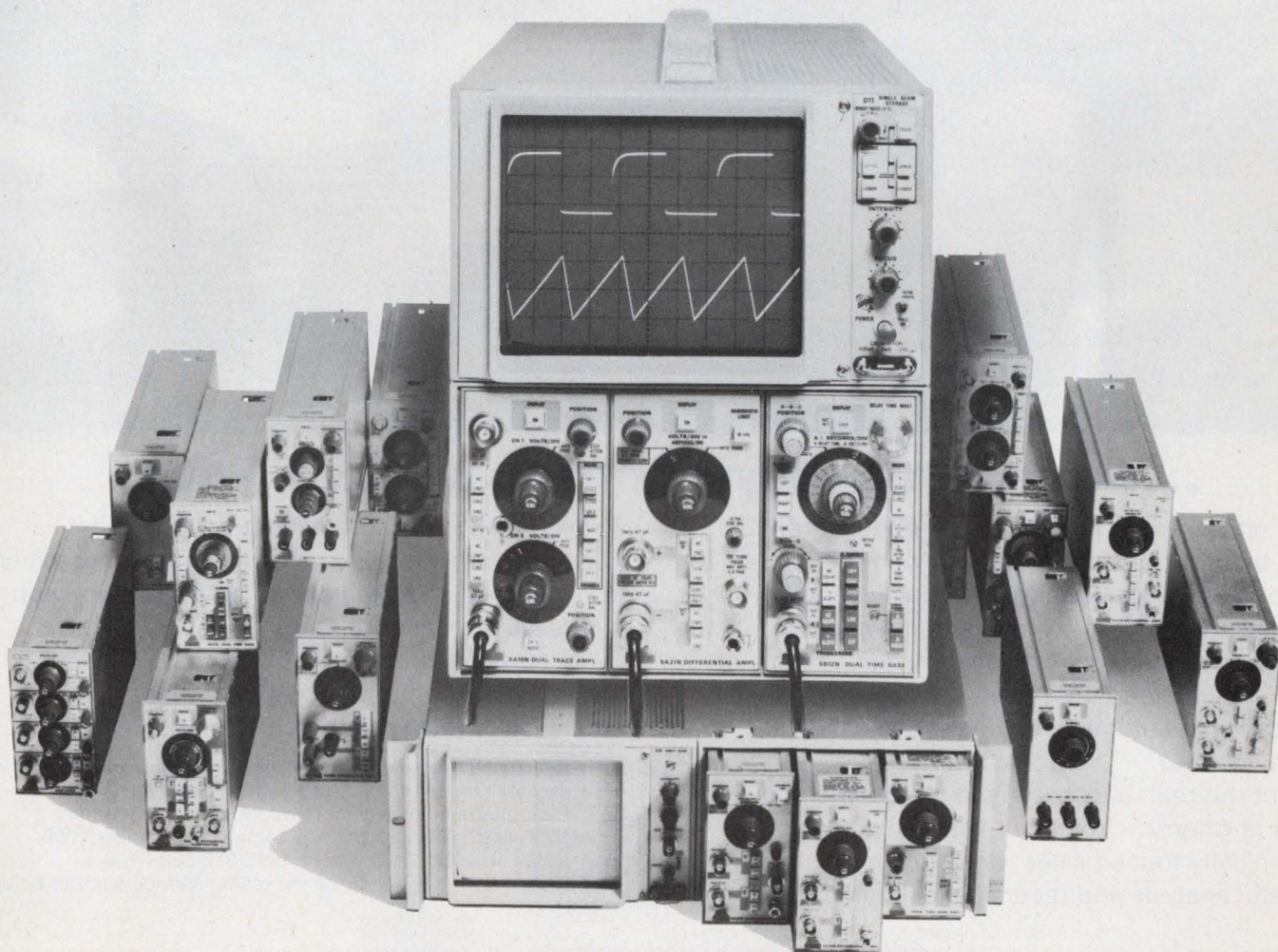

There's a little tiger in every Cherry switch

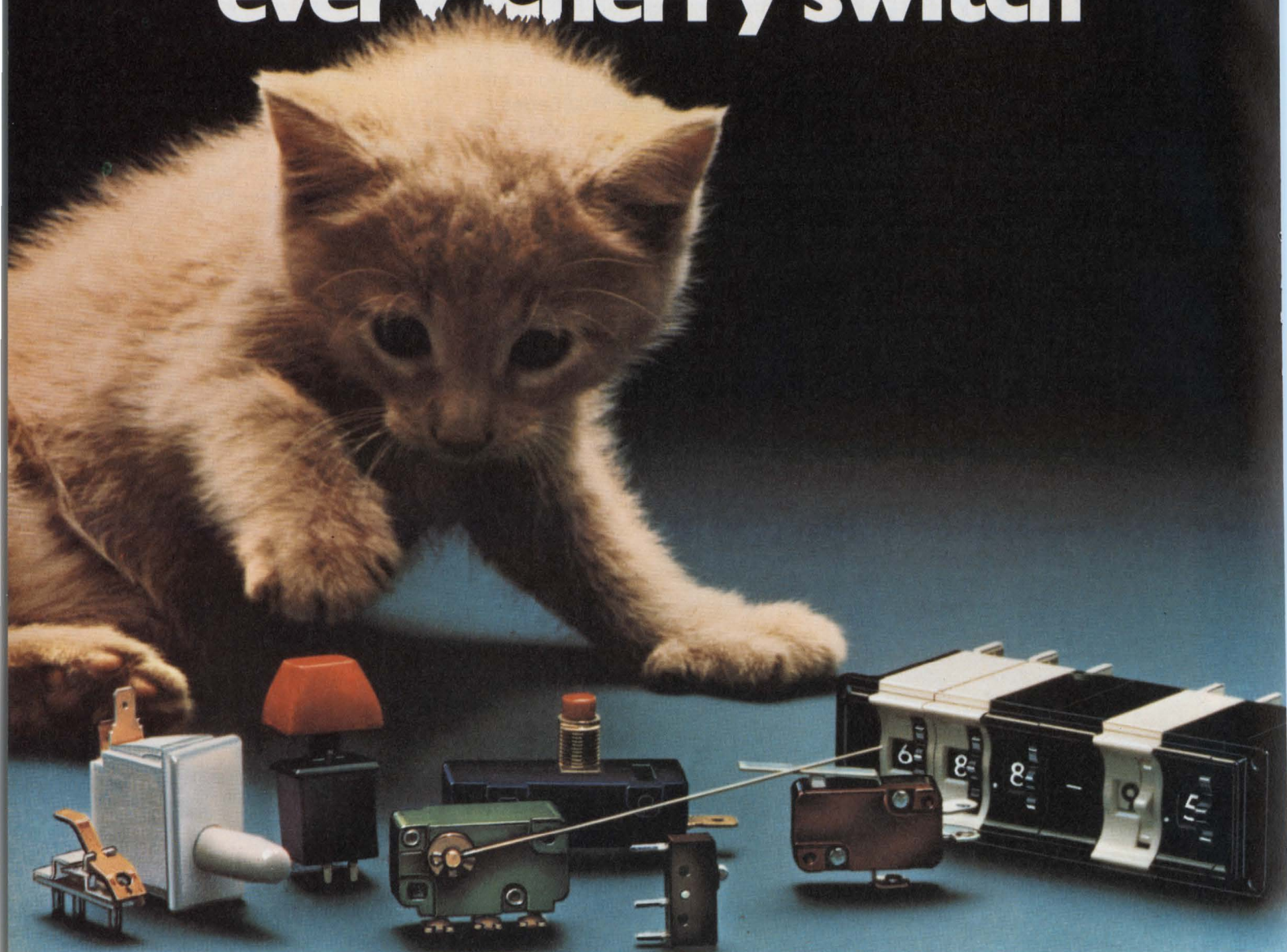

...but we're pussycats to do business with

Our products are tough, but our people aren't... and that's the beauty of dealing with Cherry.

You see, we can control the quality of our switches because we fabricate most of our own parts (moldings, stampings, springs, printed circuits, etc.) And we can keep the price down because we're loaded with automatic equipment to handle high volume.

But the real difference is in the *people* you work with at Cherry...from your first contact with a technically trained sales representative...through careful analysis and recommendations by engineers

who are really concerned about *your* problem... to production scheduling and customer service men who follow-up and expedite to make sure we keep our delivery promise to you.

Of course we're proud of our modern facilities and equipment...but what we're proudest of is our reputation for customer service. Try some.



Test a free sample "tiger" from the pussycats at Cherry. Ask for our latest catalog which contains complete information on all our switches and keyboards, and we'll include a free sample switch. Just TWX 910-235-1572...or PHONE 312-689-7700... or circle the reader service number below.

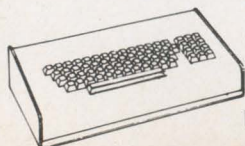

CHERRY

CHERRY ELECTRICAL PRODUCTS CORP. • 3609 Sunset Avenue, Waukegan, Illinois 60085

ELECTRONIC DATA ENTRY KEYBOARDS • ELECTRONIC DESK TOP CALCULATORS

INFORMATION RETRIEVAL NUMBER 36

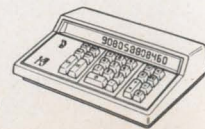

Ups and downs

You don't have to be a shrewd observer to notice that the stock market didn't fare too well last year. If you work for a public company, you may still be recovering from the shock of seeing your stock selling at four or five times earnings, though, a few years ago, it might have sold for 20 to 50 times earnings.

Well, you might say, that's the stock market—irrational. But what about the companies themselves? If you were rating company performance and prospects, how many companies would earn the rating today that you would have awarded five years ago? Didn't many companies, five years ago, give you the impression of fantastic management, astuteness, unerring judgment, great products, brilliant futures? Didn't many of these companies, five years ago, leave you wanting to invest in them to the extent that you would have considered mortgaging your home and pawning your mother-in-law? How many left you with the same feeling last year?

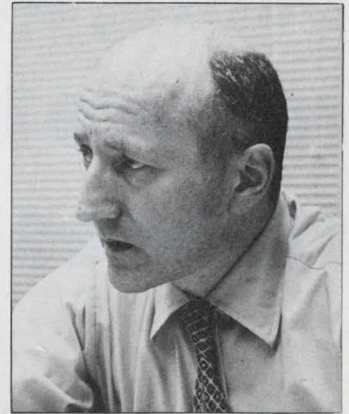

It's unfortunate that most of us fall into the old trap: We buy high and sell low. Stocks look attractive when they cost a lot and they look rotten when they're cheap. But the companies? They don't look so great either, though some, in fact, will do superbly. Others—heroes of the past—will be in trouble for years. Some may die. Other companies—yesterday's bums—may become tomorrow's stars.

Much of what happens to these companies depends on us. We can't quit while we're ahead. And we must not despair when we're behind. Things simply don't continue, endlessly, in straight lines. Stocks don't go up—or down—forever. Great companies don't always stay great. And poor ones don't always stay poor.

We all know that engineering is not the sole influence on a company's future. But it can be powerful and critical. A company can have the most astute financial management and the most intelligent and aggressive marketing organization, but if its engineers don't design products that meet the demands of the marketplace, the company's future can't be great.

The turbulent days we're living in provide a rare opportunity. If we're working for historically weak companies, we can seize the challenge to turn them around with well-conceived, innovative products. If we're working for historically strong companies, we must stay alert to the challenge of those who would unseat us.

GEORGE ROSTKY
Editor-in-Chief

Introducing Reliability Services, a revolutionary plan for all IC users, designed to dramatically reduce IC & Semiconductor failures in the field.

1.

Our Microelectronic Testing Laboratories have proven that testing isn't enough

Testing isn't enough!

This we've learned over a 5 year period at our Microelectronic Testing Laboratories (MTLs) where IC's & semiconductors are subject to extensive thermal shock & burn-in before screening.

The industry is starting to agree with us. This year alone, our 3 regional MTL centers will precondition & test over 20,000,000 components for over 100 electronic companies, large and small.

Why precondition before testing?

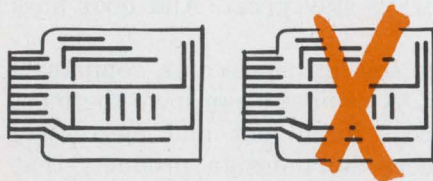

Take two identical boards, each with 100 IC's. If the IC's are routinely tested before the board is assembled a couple of bad ones will be uncovered. However, another 2 or 3 weak IC's will slip through, yet will likely fail within a few months.

Suppose these bad IC's found their way into your product. Even if the board failed in your plant it could cost \$50 for rework. And a field service call might run into the hundreds.

Preconditioning before testing can catch these culprits before they get into your product or system.

How preconditioning works

At MTL we've streamlined military "high reliability" testing for commercial use by choosing 3 phases which yield the best cost/value ratio.

These are: (1) Thermal shock (2) Burn-in (3) Testing

Phase One: Thermal Shock



Thermal shock, which consists of alternately immersing IC's in 0°C to 100°C liquid to liquid (5 min dwell, 10 sec transfer) from 3 to 15 times, duplicates in minutes the mechanical stress devices would experience in a lifetime. Mechanically sound components show no ill effects. Weak IC's develop broken bonds, chip fractures, poor passivation, etc., which would never have been uncovered by testing alone.

Phase Two: Burn-in



Next, devices are aged in a burn-in chamber for up to 168 hours at 100°C with bias applied. Both thermal shock and passivation problems will be activated during burn-in and will show up in testing. By compressing 8 months into a week, failure trends are spotted.

Phase Three: Testing



Now devices are thoroughly tested using high speed computer controlled test systems

(like our Hustlers) & specialized equipment such as analog testers, curve tracers, sampling scopes, etc. Tests can be functional, parametric or whatever is required.

Devices which fail the tests are shipped back for credit, which is better than having them end up in your product.

The importance of preconditioning

Component quality fluctuates widely from month to month as seen on the graph. Can you afford to gamble on a batch of bad IC's or discretes ruining your product?

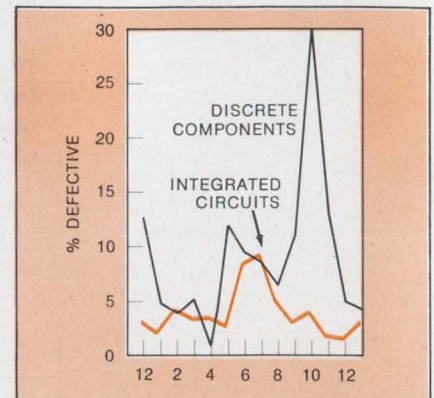

2.

Our "Hustler" automatic testers have fastest throughput & easiest programming

We know testing. We also build testers. Our Hustler line is great, according to our many customers who include the largest IC makers & users.

CMOS measurements to 1 nanoamp.

Why are Hustlers preferred?



Hustler 44

For one thing, Hustlers test more IC's in less time than our competitors. Up to 120,000 MSI devices per hour. That's because of our unique DC/functional parallel test

technique with separate force & monitor cards (PECs) for each pin of the device under test.

Also, Hustlers are the easiest to program using simple English language software which doesn't require a computer programmer.

Our Hustler 44 can make parametric & functional tests on a wide variety of ICs, including CMOS with 1 nanoamp leakage measurement resolution.

Micro-programmable pattern generator for RAMS

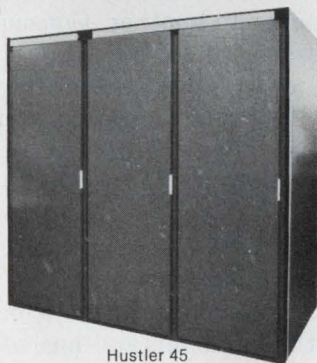

Hustler 45

Our Hustler 45 is a 10MHz clock rate tester with a built-in programmable pattern generator for making functional & dynamic tests on RAMs & LSI logic.

When it comes to testing our Hustler 44s, 45s & 50s have put it all together.

3.

Introducing Reliability Services — a revolutionary new plan for anyone who uses IC's & semiconductors

Why re-invent the wheel?

Hundreds of companies use our MTL centers. Maybe you should. But possibly your volume warrants in-house preconditioning & testing.

So what do you do?

Scour the market for thermal shock & burn-in equipment? Evaluate all kinds of special test equipment? Spend months deciding on the right IC test system. More months writing test programs & debugging software?

There's no need to. We've already done it for you.

How our Reliability Services plan works



One of our experienced Reliability Services analysts will visit your plant. He'll analyze your needs, based on the type & volume of IC's, the tests required and other criteria.

At Datatron, this information will be fed into a specially programmed computer, carefully analyzed and a detailed report prepared.

The report will show monthly savings using our Reliability Services

plan, whether you should use our Microelectronics Test Lab, or set one up in your own facility, and the improvement in failure rate you can expect.

Your decision will be easier now that you have all the facts.

Setting up an operation MTL in your own facility



If "in house" is the way to go, Datatron will install a complete Microelectronic Testing Lab in your own facility. Tailor made to fit your needs.

We'll lease & maintain the right IC test system & specialized test equipment.

From our vast Reliability Services library, we'll provide field-proven programs to test your IC's & semiconductors. Plus new programs as you need them.

We'll provide all thermal shock equipment, burn-in chambers & burn-in fixturing. We build it all ourselves.

A Reliability Service expert will train your people at your plant. And will be on call when needed.

We'll take care of all hardware — preventative maintenance & emergency service as well.

We'll even provide a semi-annual audit to see if your needs have changed.

That's why our Reliability Services program is revolutionary. If you're using IC's it can improve your product's reliability and save you money besides.

Datatron — We've Put It All Together.

Mail this VIC* today

*Very important coupon

- Send Reliability Services data
- Send Hustler literature
- Send MTL brochure
- Contact me regarding _____

Name _____

Company _____

Address _____

City _____

State/zip _____

Phone _____

datatron inc.

1562 Reynolds Ave., Santa Ana, California 92705 • (714) 540-9330
Mailing Address: P.O. Box 11427, Santa Ana, California 92711

Build compact modems into digital equipment. An LSI circuit does most of the signal handling, except for a few external analog circuits.

Using commercially available large-scale-integration (LSI) chips, you can build a compact 0-to-600-bit/s modem that fits onto a small area of a PC board. Thus you can reduce the size of a stand-alone modem or build the entire modem into a digital device.

A key feature of the LSI approach is digital synthesis of the FSK sine wave, a method that affords frequency accuracies of better than 0.1% with low harmonic content. In fact, a number of modem manufacturers, including DataServ, Burlingame, CA, and Sanders Data Systems, Nashua, NH, have chosen this route in their own circuits. The approach also eliminates the need for manual adjustments.

An NMOS LSI chip encodes digital data to conventional frequency-shift-keying (FSK) levels and demodulates data to digital levels. The only components left to design are active front-end filters, line couplers and a simple limiter (Fig. 1).

A chip such as the Motorola MC6860 provides full duplex operation (two independent channels) on a single wire pair—such as that used on the direct-distance-dial (DDD) network.

Low-speed modems like these operate in pairs: One is the “originate” modem and the other the “answer.”

The originate modem transmits on the low-frequency channel (mark 1270 Hz and space 1070 Hz) and receives on the high-frequency channel (mark 2225 Hz and space 2025 Hz). The answer modem transmits on the upper channel and receives on the lower.

A buffer and duplexer provide the modem interface to the transmission network. The bandpass filter allows only the desired receive signals to be seen by the limiter and demodulator.

Mark/space information that is presented to the Transmit-Data input of the modem is converted to an FSK signal for transmission. The modulator output is an approximated sine wave

derived from a digital-to-analog converter within an MC6860 modem chip. There are eight amplitude levels per cycle. Each amplitude step is set so that the composite waveform has a maximum amount of signal energy at the fundamental frequency (Fig. 2).

Crystal clock drives synthesizer

A 1-MHz crystal provides the clock signal. The target frequencies required are 1270, 1070, 2225 and 2025 Hz. These are industry standards for this type of modem and assure compatibility with most low-speed data channels—for example, time-sharing services.

The 1-MHz clock provides approximations as close as -0.481 Hz (Table 1). However, even better accuracy is achieved if the 1-MHz clock is designed for a 50% duty cycle. The effect is that of a 2-MHz clock—if both leading and trailing edges are used—and the frequency accuracy is improved almost 10 times for the 2225-Hz signal.

Because the data are asynchronous with respect to the modem time base, the counter must allow a modulus change at any point in time. Phase continuity must also be observed when a change is made from one frequency to another. Consequently a memory with associated control logic is used to implement these characteristics in the programmable counter, instead of a simple variable-modulus counter (Fig. 2a). The latter can only change divisor when in the all-ZERO or all-ONE state and will therefore introduce phase jitter.

The desired output of the modulator is a good sine wave—one with low harmonic content. This is especially important for the originate modem which transmits on the low band and has second-harmonic output near the passband of the return channel.

Energy outside the telephone bandwidth must also be kept below a prescribed level. The output of the divide-by-N counter is digital with high harmonic content. A filter can be used to clean up the square wave. But a d/a converter is very effective; the low-order harmonic content is 30

Garth Nash, Section Manager, Computer Systems Engineering, Motorola Semiconductor Products, Inc., 5005 E. McDowell Rd., Phoenix, AZ 95008

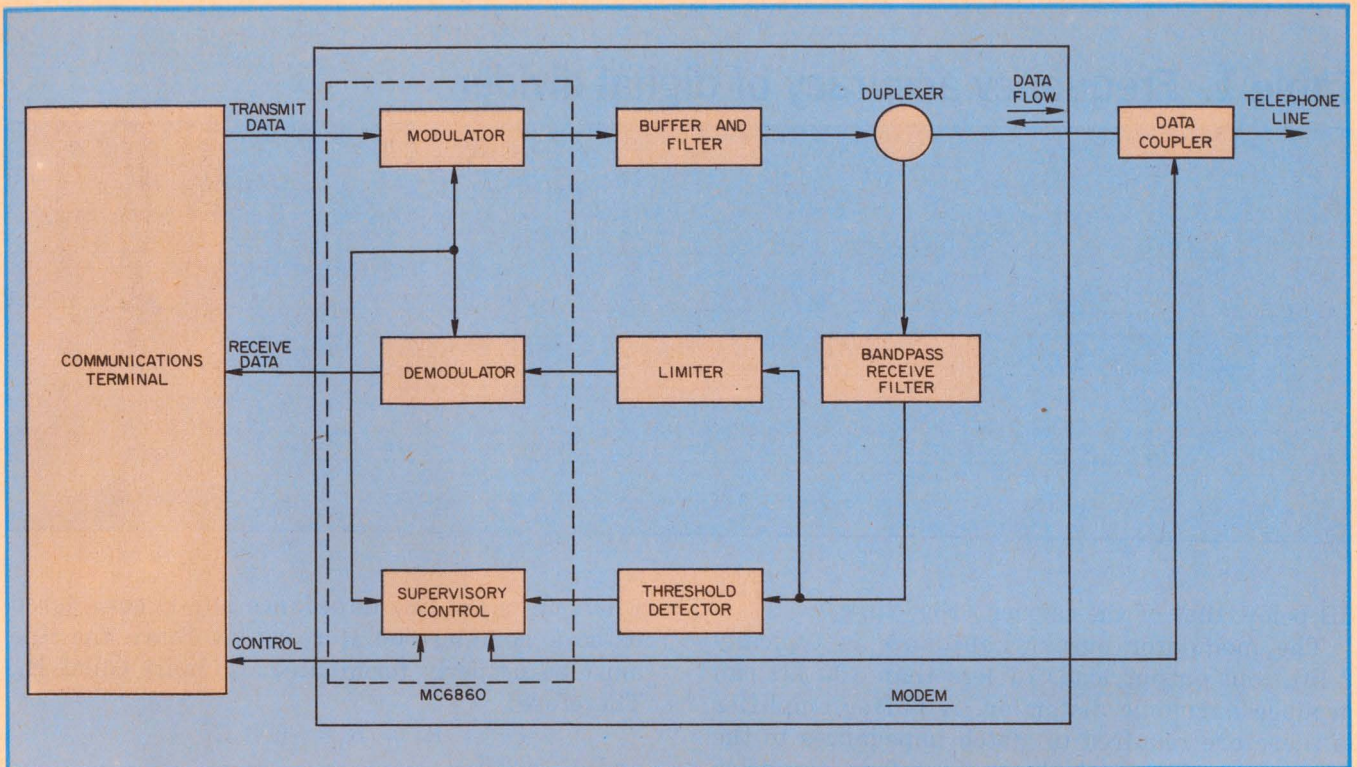

1. Low-speed modems usually offer simultaneous transmission and reception of data over a single phone-line

pair. A duplexer minimizes interaction between modulator and demodulator.

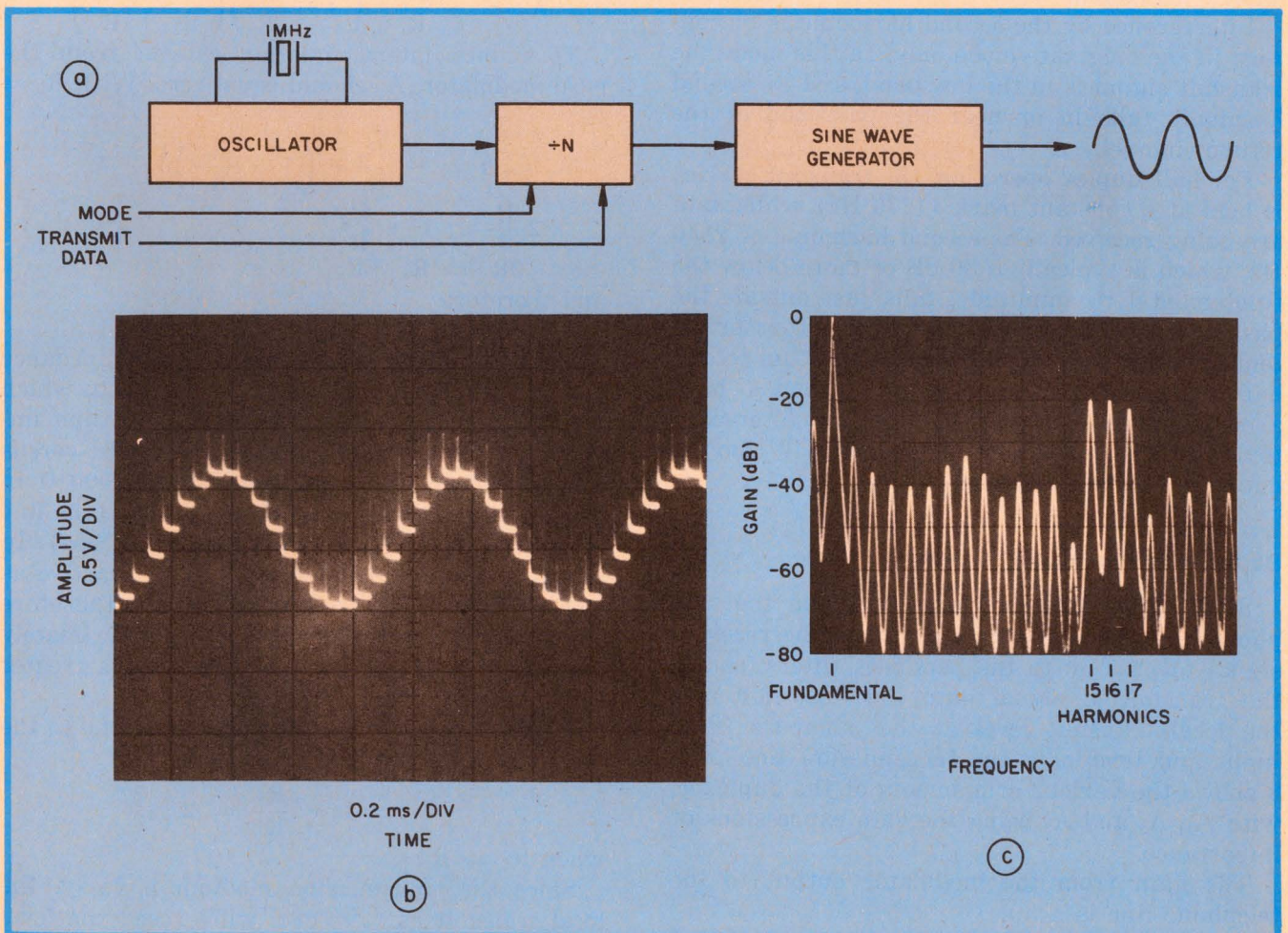

2. Digital generation of modulator output (a) provides a discrete approximation to a sine wave (b). The step

size is chosen to minimize harmonic energy (c). The low-order harmonic content is 30 dB down.

Table 1. Frequency accuracy of digital divider

Mode	Data	Transmit Frequency (Hz)	Error with 1-MHz Clock (Hz)	Error with 2-MHz effective rate (Hz)
Originate	Mark	1270	+0.648 (+787)	-0.159
	Space	1070	-0.481 (+935)	+0.091
Answer	Mark	2225	+2.171 (+449)	-0.306
	Space	2025	-0.709 (+494)	-0.709

dB below that of the carrier (Fig. 2b, c).

The modulator output impedance is typically 2 kΩ, and output loads of less than 100 kΩ can produce harmonic distortion. A buffer amplifier is therefore required to match impedances to the duplexer and the telephone line. This amplifier may also provide filtering if additional cleanup of the transmitted signal is required for full duplex operation.

Interference by the second harmonic is of concern in the originate mode only. In this mode the transmit signal is in the low band, and its second harmonic falls in or near the passband of the return channel.

For half duplex operation, the transmit carrier is held at a constant mark (1270 Hz) while data are being received. The second harmonic of 2540 Hz, which is typically -30 dB or more below the fundamental in amplitude, falls just outside the passband of the receive filter and is further attenuated. In full duplex operation, the second harmonic and the modulation sidebands have about equal energy. And the transmit filter used to reduce the modulation sidebands will also reduce the second harmonic.

Duplexer routes analog signals

Since signal flow is bidirectional on the telephone line, the duplexer must allow the received signal to pass on to the bandpass filters, couple the transmitted signal onto the line, minimize the local transmit level at the bandpass filter input and terminate the transmission line. Fig. 3 shows the various components of the duplexer, with A_1 , A_2 and A_3 being the gain expressions of importance.

The gain from the modulator output to the telephone line is

$$A_1 = \frac{R_4}{R_3 + R_4},$$

where R_1 is the line impedance and is considered to be a nominal 600 Ω resistive. Since the line must be properly terminated, R_3 must equal R_1 . Therefore:

$$R_3 = R_1 = 600 \Omega$$

and $A_1 = 0.5$.

The gain from the buffer output to the bandpass filter input is

$$A_2 = -\frac{R_2}{R_1} + \left(1 + \frac{R_2}{R_1}\right) \left(\frac{R_4}{R_3 + R_4}\right)$$

To reduce intermodulation effects from the local modulator, A_2 should equal zero. With $R_3 = R_1$:

$$A_2 = 0 = -\frac{R_2}{R_1} + \left(1 + \frac{R_2}{R_1}\right) \frac{1}{2}$$

$$2 \frac{R_2}{R_1} = 1 + \frac{R_2}{R_1}$$

$$2R_2 = R_1 + R_2$$

and therefore

$$R_2 = R_1.$$

Since all impedances except the line impedance can be accurately controlled, the degree to which A_2 is nulled becomes a function of the line impedance. The duplexer gain, A_2 , is plotted versus line-impedance variation from 200 to 1000 Ω in Fig. 3b. A well-defined notch exists when the line is a pure resistance of 600 Ω (the ideal case). In practice, the line impedance can have reactive as well as resistive component variation; therefore the duplexer should be rated for approximately -10 dB, even though in many connections greater attenuation will be achieved.

Finally, the gain from the telephone line to the bandpass filter input is given by

$$A_3 = 1 + \frac{R_2}{R_1} = 2$$

when $R_1 = R_2$.

Since the transmission medium is lossy, the local transmit carrier level will exceed the level of the received signal.

The bandpass filter must have enough selectiv-

ity to reject the local carrier to an acceptable level. Modems that are designed for a wide dynamic range of input signal levels (-15 to -55 dBm) require better than 70-dB rejection of the local transmit carrier. Most of this rejection must come from the selectivity in the bandpass filter.

A narrow filter bandwidth also reduces the effects of band-limited white noise. The minimum bandwidth depends on the received signal characteristics. The transmitted data can be recovered from binary FSK by proper detection of the carrier and the first sidebands (first Bessel function).¹ With a data rate of 300 bit/s and a data format of alternate marks and spaces, the first Bessel function occurs at ± 150 Hz from the carrier. All other data formats have sidebands within the ± 150 -Hz limit. A minimum bandwidth of 300 Hz is therefore required of the bandpass filter.

Filter phase linearity is critical

The bandpass filter output is fed to an amplitude limiter, so passband ripple is not of major concern. But phase linearity is. All frequency components that pass through the filter must be equally delayed in time or jumbling and smearing of the data will occur. This is known as intersymbol or interbit interference. The performance of the communication system is degraded under

these conditions by bias distortion and excessive phase jitter at the demodulator output. Intersymbol interference can be reduced if the plot of phase vs frequency is linearized. The slope of this transfer function is termed envelope delay and is given by

$$T_d = \frac{\Delta\phi}{\Delta f} \frac{1}{360 \text{ deg/cycle}}$$

where $\Delta\phi$ = change of phase in degrees,
 Δf = change of frequency in Hz.

Minimizing the distortion of the envelope delay is relatively easy over the center two-thirds of the passband. However, keeping constant delay near the band edges is quite hard, if not impossible. For this reason, the optimum bandwidth is not determined according to the data rate but according to achievable linear-phase characteristics. Bias distortion of one-tenth of the bit period at 300 bps typically requires a -3-dB bandwidth of 450 to 500 Hz.

Bandpass filters for the MC6860 are designed to have approximately a 450-Hz, -3-dB bandwidth with a Chebyshev response (Fig. 4). With standard filter components, the -3-dB bandwidth of the Answer filter is calculated as 486 Hz and measured as 448 Hz. There is approximately 0.7-dB ripple over the center 300 Hz of the passband, with 0.4-ms envelope delay distortion. This filter attenuates the local transmit carrier of 2225 Hz by -35 dB relative to the passband gain.

The originate bandpass filter (Fig. 5) attenuates the 1270-Hz local transmit carrier by 43 dB relative to the passband gain. The envelope-delay distortion for both of these filters can be reduced if the passband is widened and the envelope-delay curve thus flattened (Fig. 6).

The threshold detector is used to determine if the input signal to the limiter is above the maximum detectable signal level of the modem. This is an amplitude measurement; the period of the output is not critical. A comparator does the job. One side of it is biased to the peak amplitude of the desired minimum detectable signal at the bandpass filter output.

The demodulator in the MC6860 requires accurate symmetrical limiting of the received signal to produce equal half-cycle periods. (Each period is measured in reference to an accurate time base to determine if the received frequency is a mark or a space.) Accurate limiting must also be achieved over the expected input dynamic range. Equal terminating resistors on both the inverting and noninverting outputs reduce the effect of input offset (Figs. 4, 5). An input coupling capacitor blocks any dc bias from the output of the last amplifier of the bandpass filter. The desired ac signal is now properly centered about

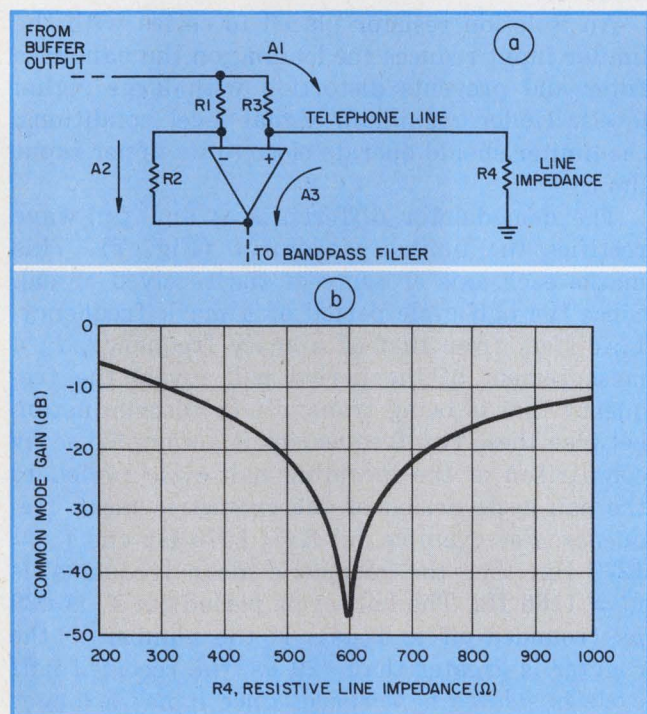

3. The duplexer circuit provides minimum feedthrough from modulator to receiver bandpass filter (a). This common-mode gain, A, is least for a 600-Ω resistive load.

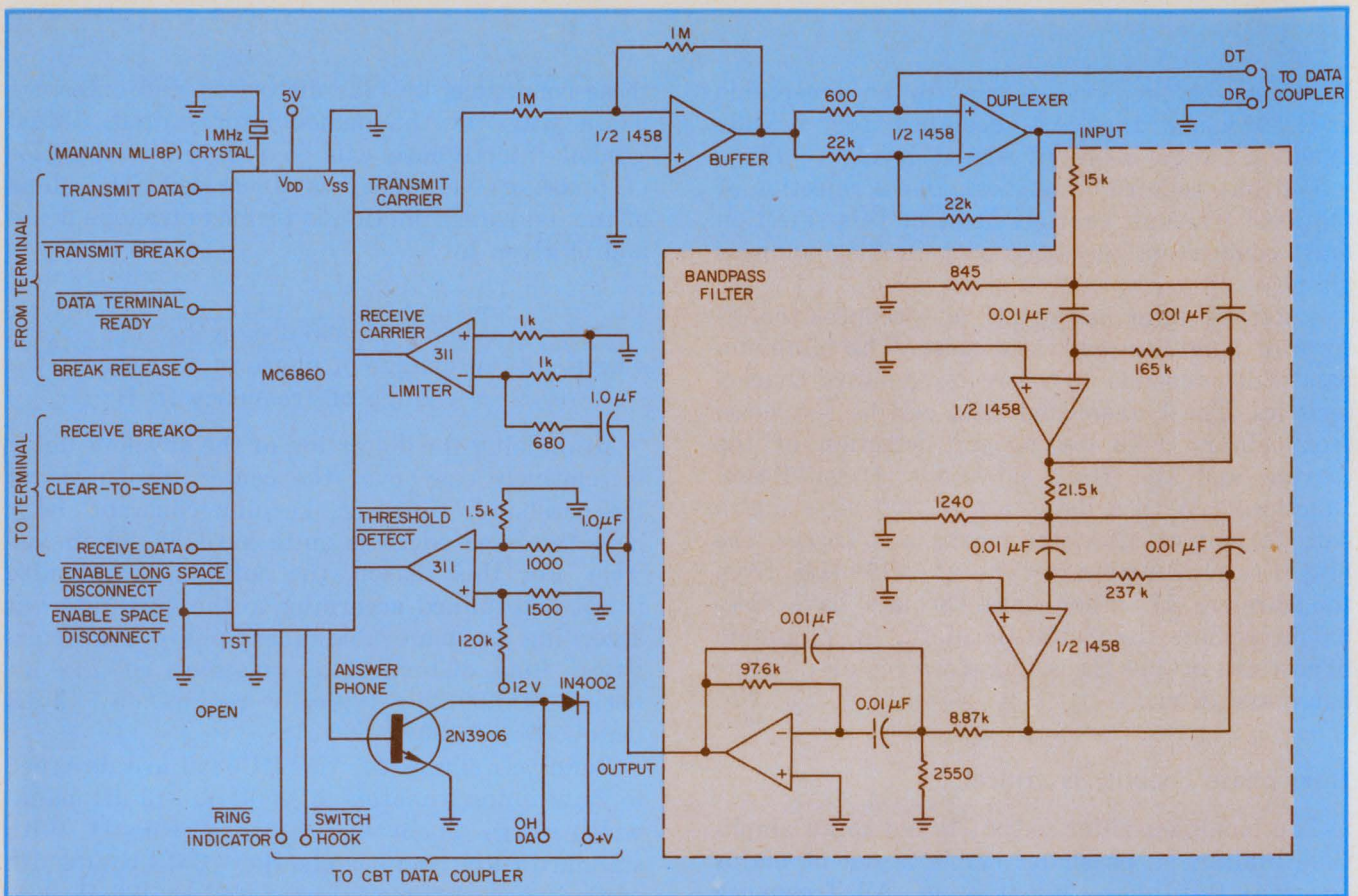

4. An active Chebyshev filter is used with the answer modem. The filter provides 35-dB attenuation for the

local 2225-Hz carrier and also reduces the effects of band-limited white noise.

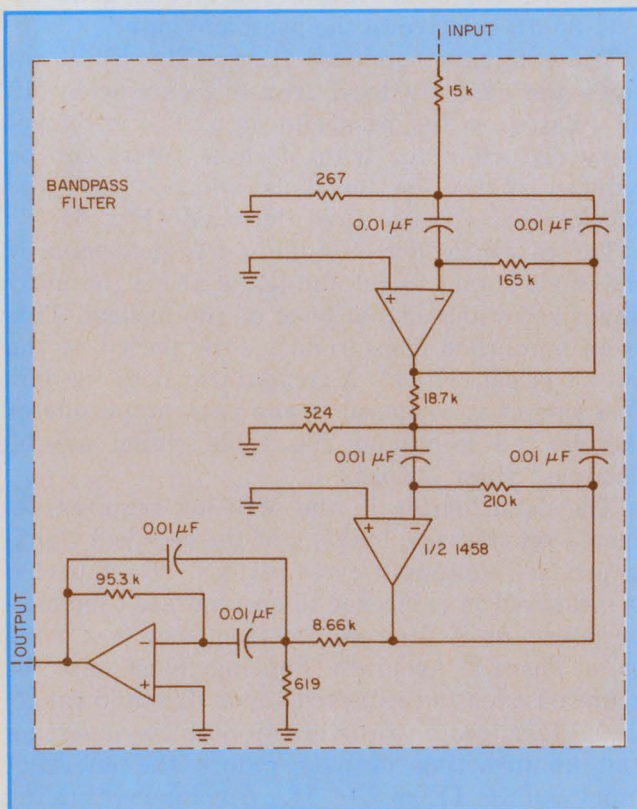

5. The originate and answer modems use the same circuit, except that the bandpass filter attenuates the 1270-Hz local carrier.

the input bias level of the limiter, and the maximum input dynamic range of 40 dB can be achieved.

An isolation resistor placed in series with the limiter input reduces the loading on the bandpass filter and prevents distortion with large signal levels. Under maximum signal level conditions, the limiter should operate close to its upper input limit.

The demodulator differentiates and full-wave rectifies the limited waveform (Fig. 7). This marks each axis crossing of the received signal. Since the half-cycle period of a mark frequency, f_m , differs from that of a space frequency, f_s , a measurement of the period will reveal the frequency that is being transmitted. Discrimination between these two frequencies is accomplished by comparison of the incoming half-cycle period to the half-cycle period of the geometric mean frequency. For example, let $f_s = 1070$ Hz and $f_m = 1270$ Hz; then the geometric mean frequency is $f_c = 1166$ Hz. The half-cycle period for f_c is 429 μ s (rounded off to 1 μ s). If the number in the counter is greater than 429 μ s, the received half cycle is said to be a space, since it has a longer period than the mark.

Several cycles of the incoming waveform are present for each bit period; therefore greater

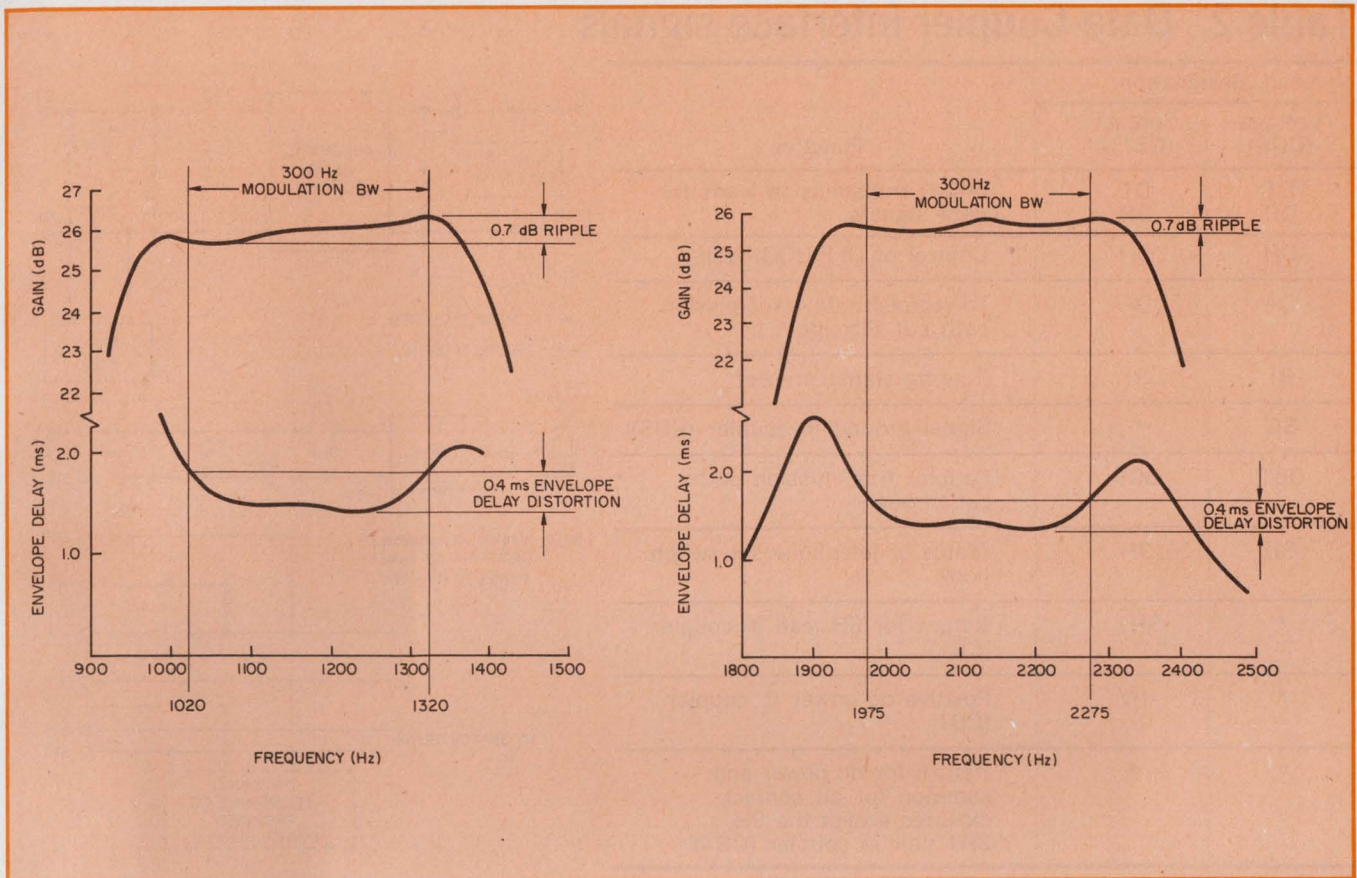

6. Originate and answer filters have minimal delay distortion. With standard components, the distortion is 10%

of the bit period at 300 bit/s. Wider passbands can be used for flatter envelope delay.

noise immunity is achieved when the half-cycle period information is averaged over a portion of the bit period. This is the purpose of the post-detection filter.

Digitizing a linear signal produces a quantization error. This error appears as phase jitter and bias distortion at the demodulator output of the MC6860. The inherent phase jitter of the demodulation process is approximated by

$$\text{Peak } \phi_j \approx \frac{\text{data rate}}{4 \times \text{space frequency}} \times 100\%$$

The receive space frequency for the answer modem is 1070 Hz and the data rate is 300 bit/s, giving a peak phase jitter of 7%. This corresponds to 0.233 ms. The output mark/space transition will occur within 0.233 ms of the actual data transitions, if we neglect bias distortion.

The receive space frequency for the originate modem is 2025 Hz. The peak phase jitter is 3.7% (0.123 ms) at a data rate of 300 bit/s.

Bias distortion inherent in the demodulation process can be found by:

$$\% \text{ bias distortion} \approx \frac{1}{2T} \left(\frac{1}{f_s} - \frac{1}{f_m} \right) 100,$$

where T = data bit period in seconds,
 f_s = space frequency in Hz,
 f_m = mark frequency in Hz.

Thus the originate modem has a bias distortion of 0.67%, and the answer modem has 2.2%. This is called a "marking bias" (mark period greater than a space period) for both modems. Total distortion equals percent peak jitter plus percent bias distortion.

The two data couplers commonly used with low speed modems are the CBS and CBT.² Each contains a data-access arrangement (DAA) and the necessary telephone network control signaling functions (Table 2). Supervisory control signals from the CBS comply with the RS-232 interface specifications, whereas the CBT control signals are contact closures and relay drive currents. The 6860 provides the control functions for automatic answer, data transmission protocol and automatic disconnect.

Data plus noise used in evaluation

Evaluation of the MC6860 in a typical system, with an Originate-only and Answer-only design, is shown in Fig. 8. A 600- Ω termination simulates the characteristic impedance of the transmission line and provides an input for the gaussian noise generator.

A word generator that produces a 255-bit pseudorandom pattern at 300 bit/s provides

Table 2. Data-Coupler interface signals

Lead Designation		Function
Voltage (CBS)	Contact (CBT) [†]	
DT DR	DT DR	600-Ω transmission leads for data signals
OH	OH	Control of OFF-HOOK relay
DA	DA	To request data transmission path cut through
RI	RI	Ringing signal present
SG	*	Signal ground in coupler (CBS)
CCT	CCT	Coupler transmission path cut through
SH	SH	Status of telephone set switch hook
*	SH1	Return for SH lead in coupler (CBT)
*	+V	Positive dc power to coupler (CBT)
*	-V	Return for dc power and common for all contact closures except the SH, SH1 pair in coupler (CBT)

* Not used in this unit
[†] Schematic shown

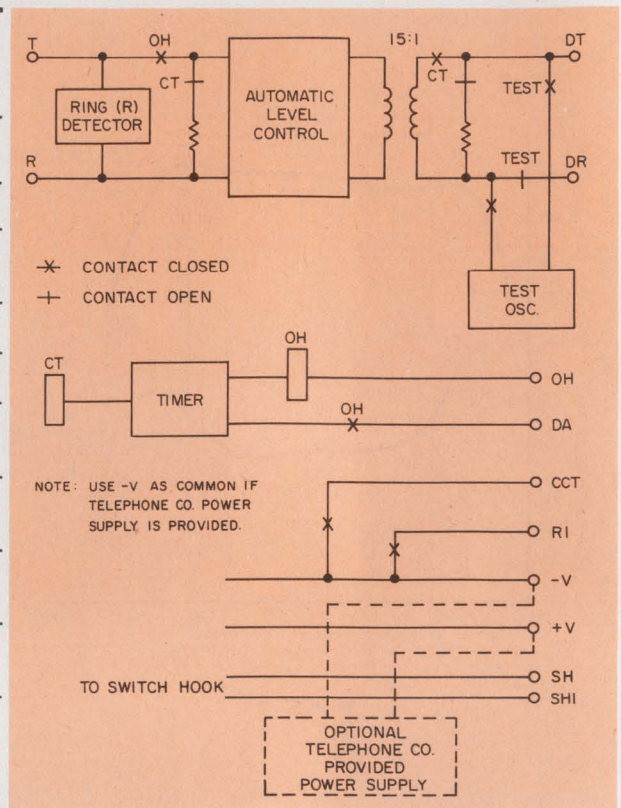

Transmit-Data input to the originate modem. The return channel is held at a constant mark condition. The received data from the answer modem are compared for errors on a bit-by-bit basis with the transmitted data.

Since the received data are delayed by the time delay of the bandpass filter and the demodulator, the transmit data must be delayed an equal time before a meaningful bit-by-bit comparison is made—hence the delay between the data generator and the comparator. Sampling by the comparator occurs at the center of the data bit. The number of bits used to determine the probability of error (P_e) is:

$$\text{number of bits} \geq \frac{100}{P_e}$$

Both the lower channel, F_L , and the upper channel, F_U , are present, along with the additive noise. The bandpass filter, centered on F_L , attenuates signals outside the passband.

The total amount of noise and F_U energy relative to the energy of F_L is reduced, and the signal-to-noise ratio is improved. The improvement of F_L to noise can be found by the following formula:

$$\Delta(S/N) = 20 \log \sqrt{\frac{BW_1}{BW_2}} = 10 \log \frac{BW_1}{BW_2}$$

where BW_1 = bandwidth of input noise,

$$BW_2 = \text{filter bandwidth.}$$

For the system in Fig. 8:

$$BW_1 = (3000 - 300) \text{ Hz} = 2700 \text{ Hz}$$

$$BW_2 = 448 \text{ Hz}$$

$$\Delta(S/N) = 10 \log \frac{2700}{448} = 7.8 \text{ dB.}$$

Thus a signal-to-noise ratio of 12 dB at the filter output corresponds to 4.2 dB at the filter input:
 $(S/N)_{BW_2} = (S/N)_{BW_1} + \Delta(S/N)$.

Fig. 9 shows the result of the performance tests. The theoretical probability of error, P_e , for noncoherent FSK¹ is determined from

$$P_e = 0.5 \exp \left[-0.5 \left(\frac{V_s}{V_n} \right)^2 \left(\frac{BW_n}{BW_s} \right) \right]$$

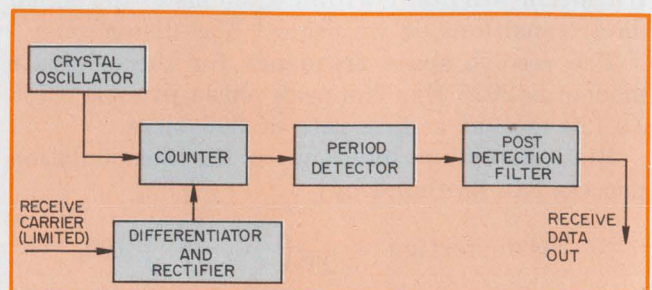

7. The demodulator identifies a mark or space from measurement of the signal period. Differentiation and full-wave rectification mark the signal-axis crossings.

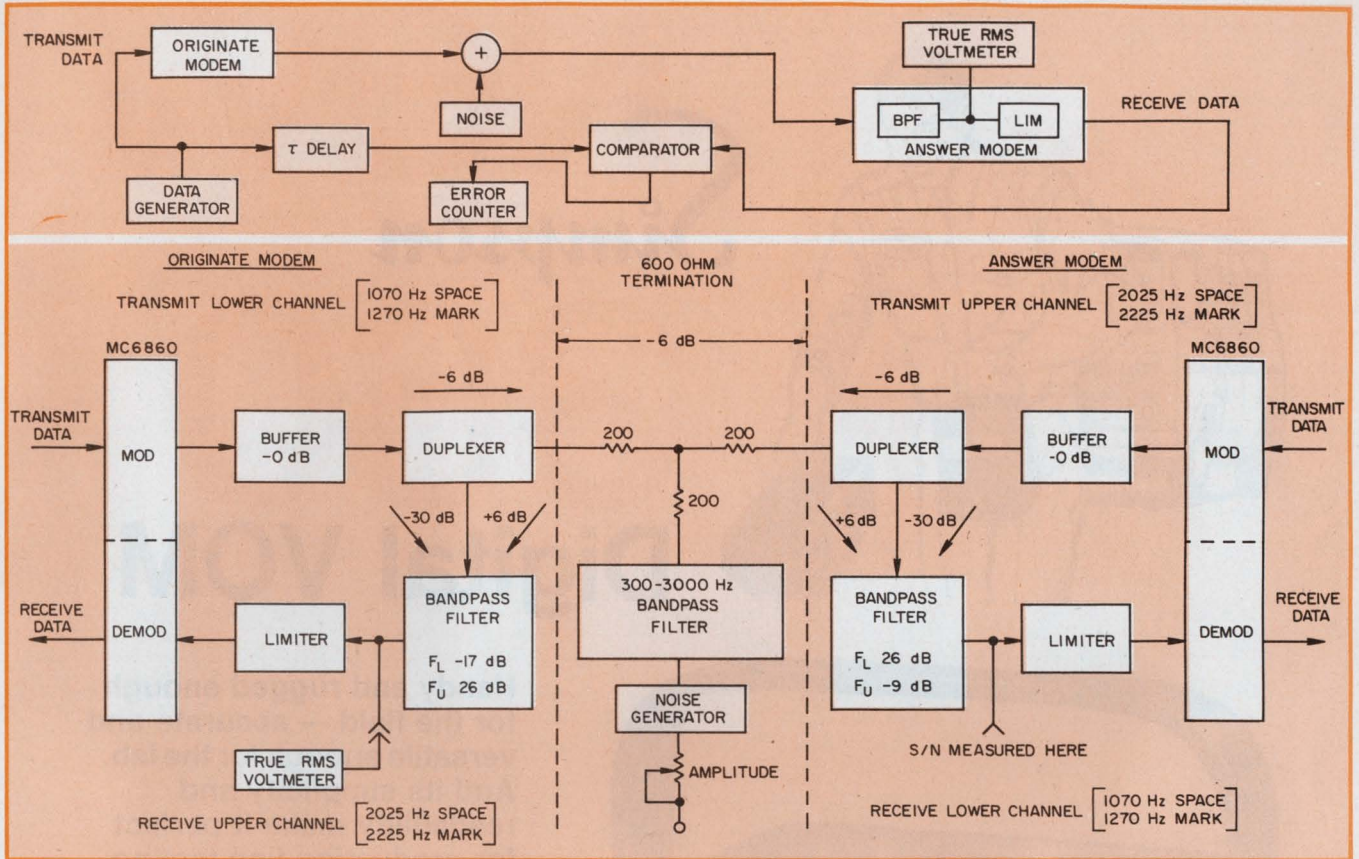

8. The operational test includes simulated data plus broadband noise. An error counter logs the number of

incorrect bits received. The simulated noise has a flat spectrum from 300 to 3000 Hz.

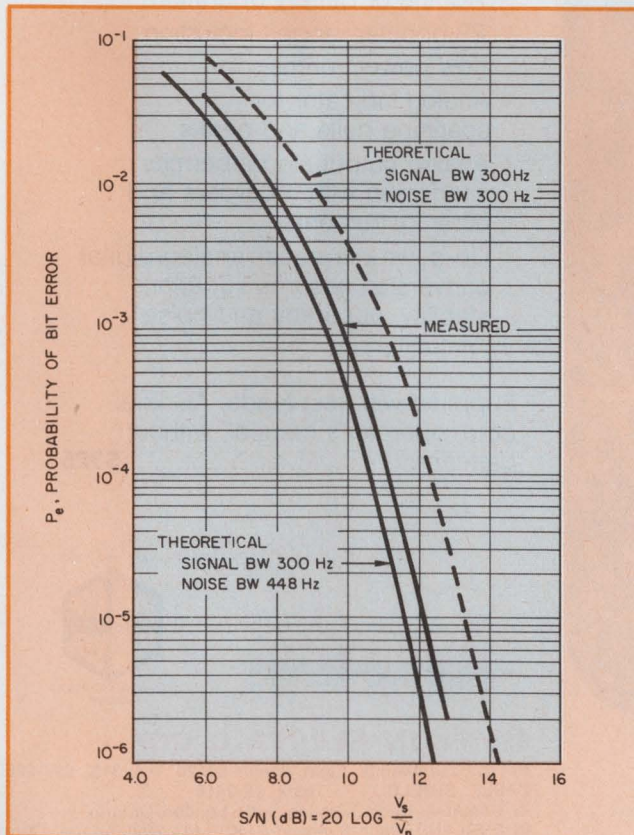

9. Measured error probability differs from the theoretical value by about 0.5 dB. For a $P_e \leq 10^{-5}$, the S/N at the limiter must exceed 12.2 dB.

where V_s = signal level,
 V_n = noise level (true rms),
 BW_n = rectangular noise bandwidth,
 BW_s = signal bandwidth = $1/\text{bit time} = 1/T$.

The dashed curve in Fig. 9 assumes that signal bandwidth and rectangular noise bandwidth are equal. Since the signal bandwidth is 300 Hz (300 bit/s) and the bandpass filter of the test circuit has a measured bandwidth of 448 Hz, the theoretical P_e curve now shifts to the left by the following amount:

$$\Delta(S/N) = 10 \log \frac{448}{300} = 1.74 \text{ dB}$$

The measured P_e curve deviates from the theoretical by approximately 0.5 dB. To maintain a $P_e \leq 1 \times 10^{-5}$, a signal-to-noise ratio at the limiter input must be greater than 12.2 dB. This corresponds to a signal-to-noise ratio on the telephone line of 4.4 dB in a 2700-Hz bandwidth or a signal-to-noise ratio of 3.94 dB in a 400 Hz-bandwidth. ■■

References

1. Panter, P.F., "Modulation, Noise and Spectral Analysis," McGraw-Hill, New York, 1965.
2. "Data Couplers CBS and CBT for Automatic Terminals," Bell System Technical Reference Pub. 41802, August, 1970; Pub. 41802 A, March, 1971.



NEW Simpson 360 Digital VOM

Handy and rugged enough for the field — accurate and versatile enough for the lab. And its simplicity and readability make it perfect for production line testing.

- 3-1/2" digit, non-blinking, auto-polarity 0.33" LED display
- AC line or battery operation
- 29 popular ranges including "low-power" ohms
- Analog indicator for scanning nulls and peaks
- Analog output signal permits interfacing with recorders and other instruments
- Up-down integration analog/digital conversion assures superior stability, accuracy and noise immunity

Supplied with test leads, AC line cord, operator's manual, without batteries **\$325**



Simpson
INSTRUMENTS THAT STAY ACCURATE

KATY INDUSTRIES



ELECTRICAL EQUIPMENT GROUP

SIMPSON ELECTRIC COMPANY

853 Dundee Avenue, Elgin, Illinois 60120 • (312) 697-2260
CABLE: SIMELCO • Telex: 72-2416
IN CANADA: Bach-Simpson, Ltd., London Ontario
IN ENGLAND: Bach-Simpson (U.K.) Ltd., Wadebridge, Cornwall
IN INDIA: Ruttonsha-Simpson Private, Ltd., Vikhroli, Bombay

ORDER NOW FROM YOUR LOCAL ELECTRONICS DISTRIBUTOR OR WRITE FOR NEW CATALOG 4400

INFORMATION RETRIEVAL NUMBER 38

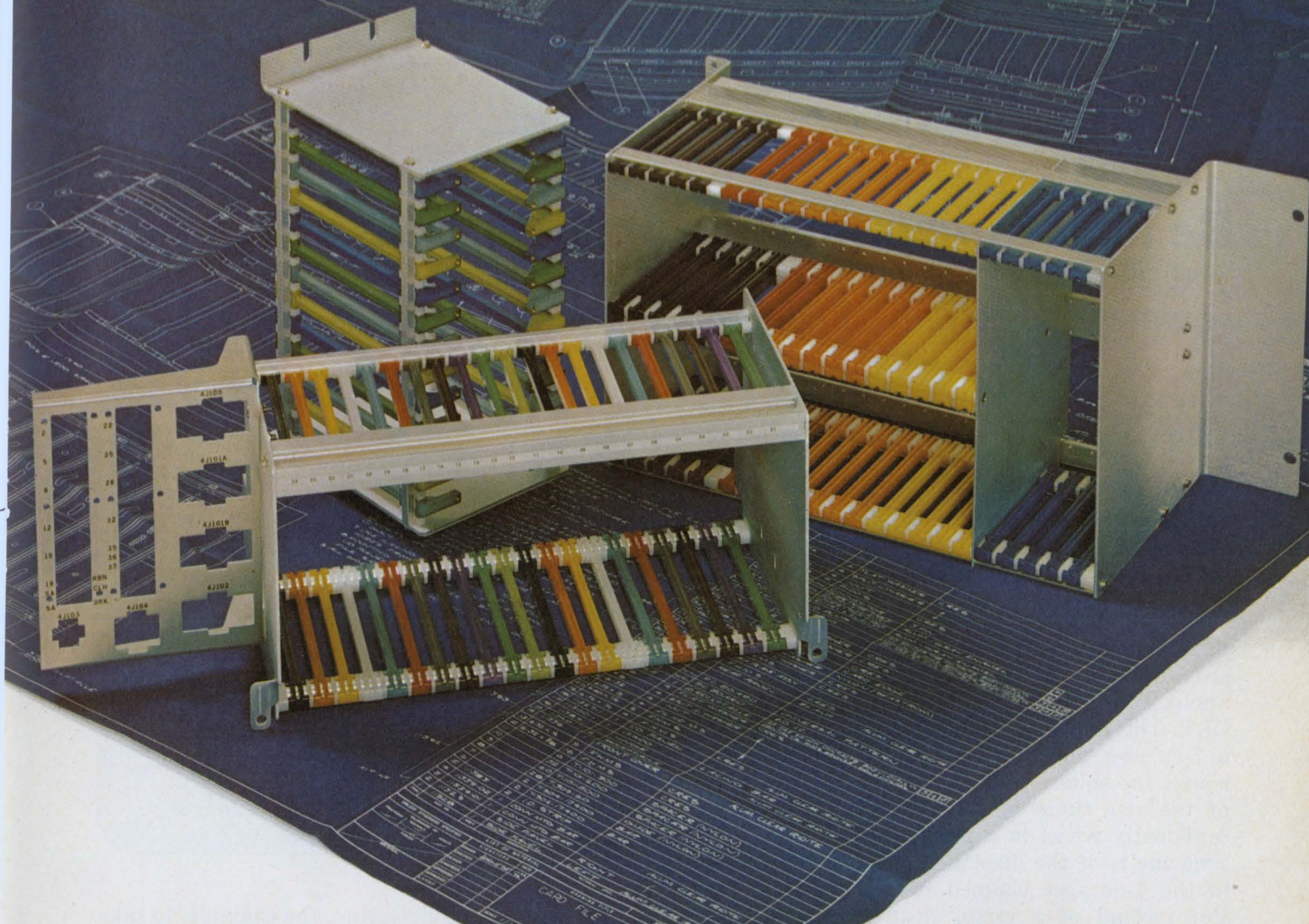

Card Files made to Order

Let us design and build card files to meet your card packaging demands. Whether you need a multi-row file, a drawer or a complex custom-made file...let us help.

We can make files for lots of cards or just a few. We can give you a connector mount right on the card guide, on aluminum bars or on separate nylon feet. We can punch, bend and cut sheet metal to meet any situation. We can provide mounting for I/O connectors, wire harnesses or any auxiliary components. We can make a card file to do just about anything.

The guides in our files are molded of high strength U.L. approved nylon and provide a strong durable holder for your cards. The nylon guides

protect cards and components from shock and vibration while their narrow profile allows for system cooling. Rigid extruded aluminum mounting bars hold guides in place and provide a rugged lightweight package. Aluminum or steel sheet metal designed for your particular need completes the system.

Before you start engineering your next card packaging system call us...let us help.

Scanbe Manufacturing Corp.
3445 Fletcher Ave. / El Monte, Ca. 91731
(213) 579-2300 / 686-1202 TWX (910) 587-3437



Be kind to your pulse generator! Unless you use extra care with today's complex pulser, you may end up with baffling test results.

Are you an absent-minded pulse-generator abuser?

You plug your 15-V pulse generator into a carefully prepared prototype. Everything works fine, except you forget to hook-up a X10 attenuator at the output. Result: A fried bipolar device.

Or you buy a super-subnanosecond-rise-time pulse generator. You hook the unit up to your scope and, lo, no matter how you fiddle with the knobs, you get only a 7-ns rise-time pulse on the CRT. The problem: Your 50-MHz scope has only a 7-ns rise time. OK, since displayed rise time equals the square root of the sum of the squares of the rise times of the scope and pulser, you confidently wheel in a 1-GHz, 350-ps scope. This time the t_r of the displayed pulse is much closer to the 1-ns spec claimed by the manufacturer. But instead of a crisp, clean trace, the pulse top appears to oscillate like the gong in a J. Arthur Rank movie.

What went wrong now?

A glance at the setup reveals that you used a T-pad connector and piped part of the pulse-generator output into a 50- Ω setup and part into the scope.

But the scope's impedance is 1 M Ω . Result: reflections along the line that show up as ringing on the CRT screen. The solution is simple: Just terminate the scope signal with a 50- Ω feed-through termination and the ringing disappears.

Fat cabling is better

Since the introduction of the first off-the-shelf pulse generators in the 1940s, engineers have been inventing more and more complex ways to misuse the instruments or to specify them wrongly. Take cabling, which causes its share of pulse-generator problems.

The physics of fast pulse transmission favor large-diameter cable (RG213) over smaller, such as RG58. GR connectors are also favored over BNC types for fast pulses.

Martin Marshall, Senior Writer, E-H Research Laboratories, 515 Eleventh St., Oakland, CA 94607

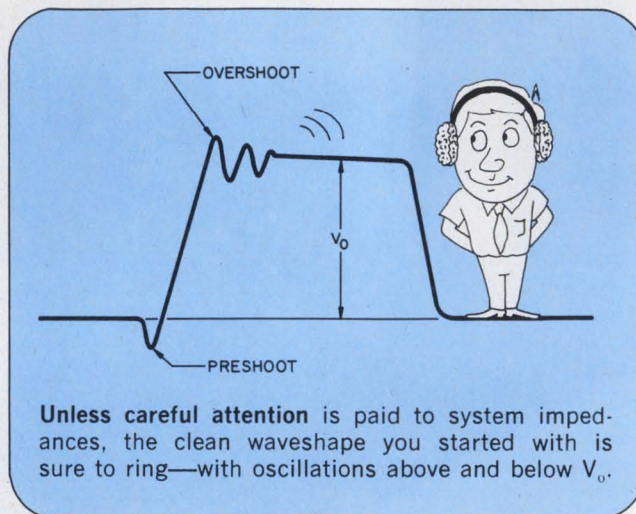

Unless careful attention is paid to system impedances, the clean wavelshape you started with is sure to ring—with oscillations above and below V_0 .

It would be self-defeating, for example, to take a pulse generator with a rise time of 300 ps or less and hook it up with BNC connectors and RG58 cabling. The connectors are sure to cause reflections, and the cable will add capacitive loading.

For general laboratory work, though, RG58 cabling and BNC connectors are the most convenient. An engineer working on a bench with three feet of cable can probably expect a 1-ns rise-time pulse to degrade by a few percent—an amount he can live with. But if longer cables, faster pulses or more exact measurements are required, you'll have to go to RG213 cable and GR connectors.

Even with the right cables, you can still run into problems. Sometimes the problem is bad cable—something you suspect after you're sure the setup is OK. If you don't have a time-domain reflectometry setup (TDR), the only way to spot bad cable is to plug in another length of cable and see if it works. More often, you'll run into terminations that distort the waveform. A 52- Ω termination, for example, has a built-in distortion of 4%. With the 52- Ω unit in a setup, it isn't easy to see that the fault is not in the pulse generator.

The least you can do—and the most if you don't have a TDR setup—is to measure the dc resistance of the termination with an ohmmeter.

But with a TDR, you can measure directly the dynamic characteristics of terminations, pads, cables—and the pulser—to get more exact readings. When an engineer who works with TTL makes his own fixtures, the process of terminating and channeling pulses can drive him right up the wall if he can't adequately measure the fixturing. For very fast, accurate work, TDRs directly traceable to the National Bureau of Standards are available, with tolerances of around 10 ps.

Another incentive to climb walls: a train of pulses that suddenly disappears from a CRT screen. The fault is not in the scope—it lies in your failure to understand what the manufacturer meant when he limited the pulser's output

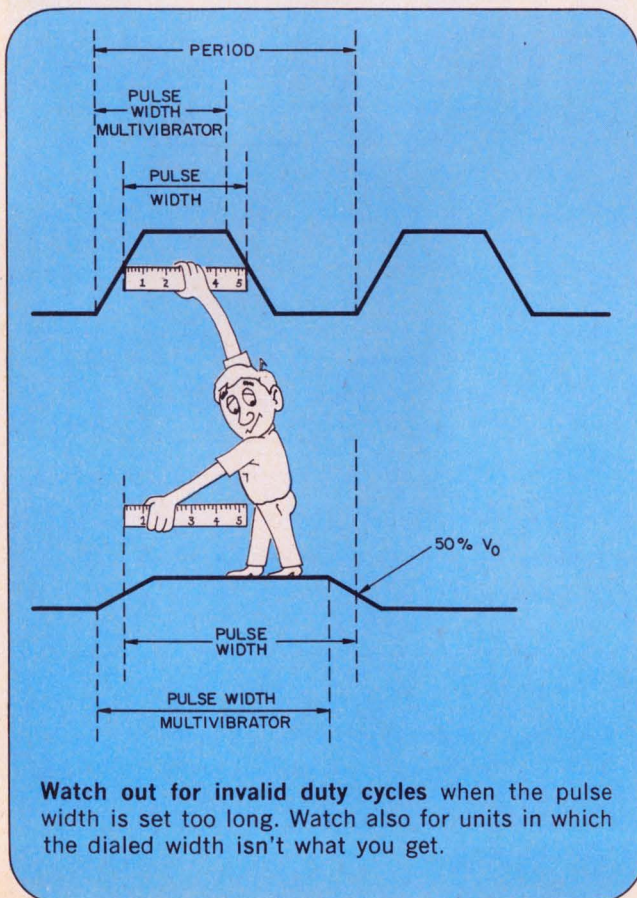
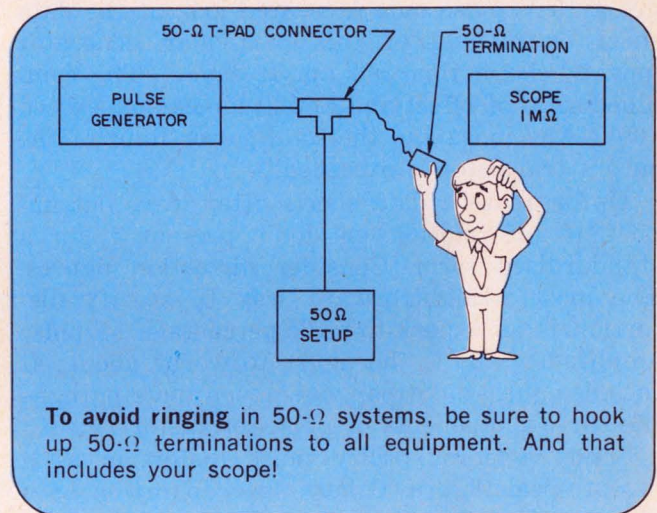

to a 50% duty cycle.

Duty cycle is the ratio of pulse width to period, with the widths measured between the 50%-of-rise and 50%-of-fall points. If the pulser's dials are set so that $T_r + T_f$, plus the pulse width, is greater than the period, then clearly an invalid setting has been dialed.

Another important factor: In some generators, the rising and plateau portions of a pulse are controlled by the pulse-width multivibrator, which must have enough time to discharge before it can generate another pulse. This time constant determines a pulse generator's maximum duty cycle. If the multivibrator's "on time" plus recovery time is greater than the period, then the next pulse will not trigger.

Watch these settings!

Ten or 15 minutes with the manual of some pulsers is enough to make you sensitive to pulse-width and duty-cycle problems. So much so, in fact, that you may notice that the pulse width—as measured on the CRT—is not the same as that set on the pulse generator. Quickly returning to the manual, you discover that the pulse-width knob actually controls the pulse-width multivibrator, so that the knob doesn't directly control the width—it controls $t_r + T_{\text{pulse top}}$. The actual

width is given by the pulse-width setting plus $1/2 (T_r - T_f)$.

Similarly you may discover other invalid settings. For instance, if you want to hook up two or more pulse generators to the same trigger source—with one unit delayed with respect to the other—with some units you must be careful that the delay is not greater than 50% of the period. If it is, with these units expect internal triggering problems that result in missing pulses.

Or you may finish adjusting the pulse width and delay and then wonder why, if the pulser has a 5-V offset and a 10-V amplitude, you can't get a 15-V pulse out. A belated look at the data sheet or manual of this particular generator quickly clears this one up. It says: "The combined total of offset and amplitude cannot exceed 10 V. Any more and the total-power limit of the output transistor is exceeded."

Unfortunately, data sheets often leave out important information or don't present it in a standardized form. Consider distortion figures. The most straightforward way to specify distortion is as a peak-to-peak percentage of pulse amplitude. This is the figure to worry about: It includes pulse-top droop, overshoot and ringing—the three components of pulse-top distortion.

Some vendors specify pulse distortion as a peak-to-peak figure. Others spec distortion as a plus-or-minus figure, or one-half of peak-to-peak. And still others list preshoot, overshoot and ringing separately, and don't mention pulse-top droop. In the worst case, the components of distortion must be added algebraically to obtain a total distortion figure.

Another important factor—mean-time-between-failure (MTBF)—is very difficult to specify on a data sheet. The military calculates MTBF by measurement of power dissipation of components and voltages across capacitors. But the real test is the MTBF a unit demonstrates in the field. For this, the engineer must rely mostly on what he knows of the manufacturer.

A look inside opens your eyes

You can, however, look inside the pulse generator for a couple of MTBF indicators. First, check the number of components and connections. Each junction and every active device is a possible source of failure. Then, see how many internal adjustments are necessary. Generally the more pots to keep tuned, the more likely a unit will go out of spec. Finally, since silicon devices generate heat, check for good thermal efficiency.

Specification of a pulse generator can be a problem if you don't know what your applications will be a year from now. A unit bought for a TTL application may not be adequate for ECL. Generally, three specs (besides distortion and

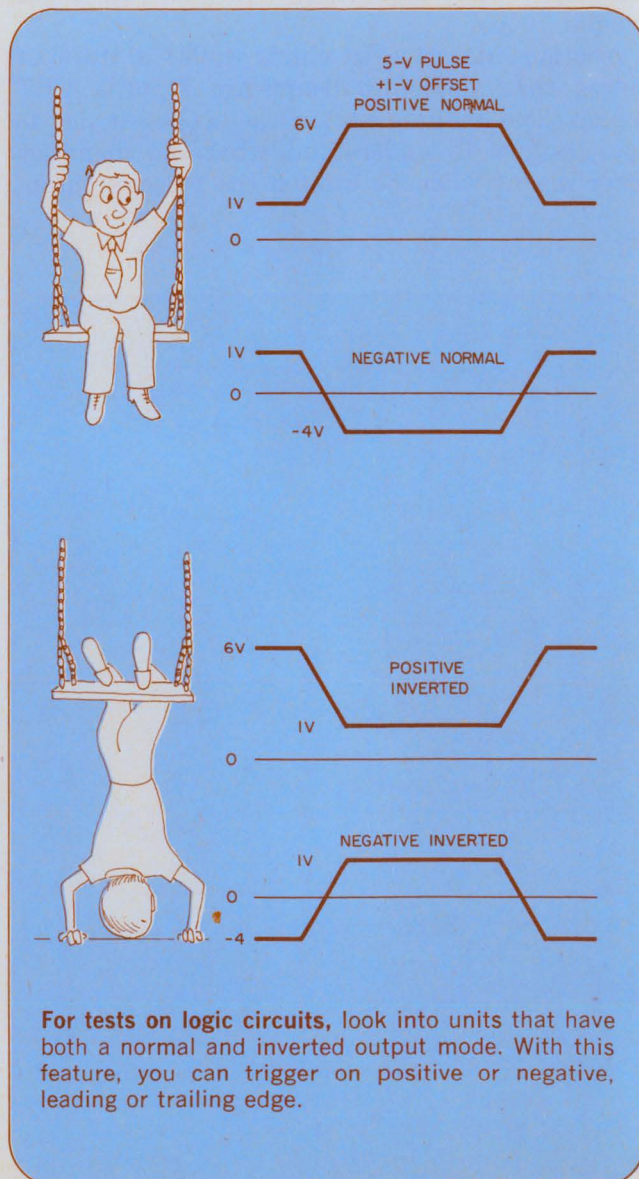
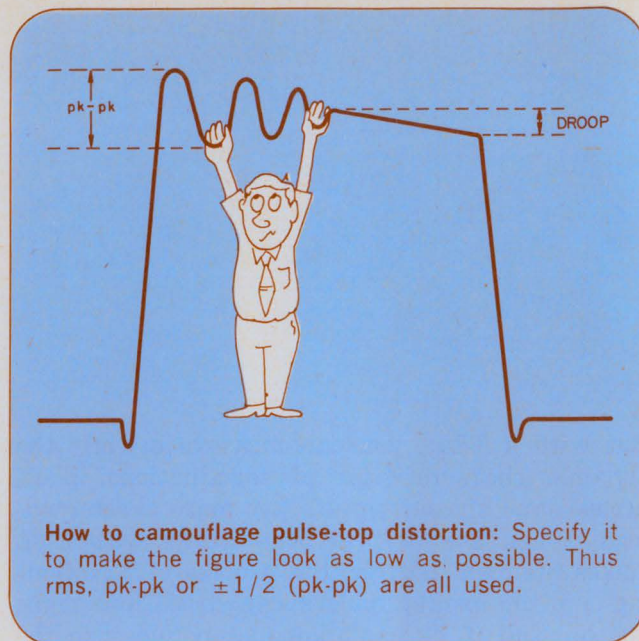

MTBF) will be the most important: frequency, amplitude and rise time.

A high-frequency pulse generator, for example, will be needed to test ECL devices. For tests on a pulse transformer or a magnetic-memory device, high current demands require the pulse generator to deliver a large amplitude. And to check fast-recovery-time diodes, get the fastest available rise times.

Less frequently, four other specs—baseline offset, pulse width, variable rise/fall and variable pretriggering delay—become crucial. Baseline offset becomes important in tests of transistors, ECL and other devices that require off-ground voltages. Pulse width is important in tests of pulse transformers, in which the width is varied until the pulse droop shows the transformer's primary and leakage inductance.

Variable rise and fall times, among other things, allow you to minimize reflections on a transmission line and to simulate IC-device specs. Finally, variable pretriggering delay is useful for oscilloscope measurements or to synchronize pulse generators.

Of tertiary importance, but still necessary for some applications, are such auxiliary pulse-generator functions as external drive, gating, single-cycle operation and the double-pulse mode.

External drive is standard on most pulse generators. It allows you to slave pulse generators or to drive a unit with the stabilized frequencies of a crystal-controlled source. With gating, a pulse generator can deliver a burst of pulses—for example, to simulate radar returns or to specify the number of pulses in a burst fed through a digital counter. One caution: Make sure the gating circuitry of the pulse generator is isolated, so you don't wind up with a half pulse when the gating signal goes off. Most older generators had this problem.

Another function—single-cycle operation—allows the pulse generator to increment counters. Just push a button, and exactly one pulse comes out. In the double-pulse mode, the generator emits closely spaced pulse pairs, and its frequency range is extended by as much as a factor of two. Here, too, care should be taken to determine the maximum frequency of the double-pulse mode—often it's different from that of the single-pulse mode.

Decisions, decisions

Every special application carries its own set of pulse-generator specs. But some recur frequently. MOS and magnetic devices, for instance, generally require high pulse amplitudes, while logic devices, such as ECL, need both fast rise times and high frequencies. In linear circuit testing, the variability and linearity of leading and

trailing edges, as well as low pulse distortion, are essential.

And for logic circuit and data-transmission tests, you should have an external drive and gating capability, as well as both normal and inverted output modes. This is so you can choose leading or trailing edges, either positive or negative.

Be aware of tradeoffs when you specify a pulse generator. Some are caused by technological limits. One tradeoff is between frequency and pulse amplitude. A pulse generator can deliver up to 500 MHz if you need only 2 V into 50 Ω . But if you want 50 V into 50 Ω , the highest frequency you can find is around 25 MHz.

Other tradeoffs involve money. You can save \$300 to \$400 by foregoing variable rise and fall times. You can save another \$300 to \$1000 by de-

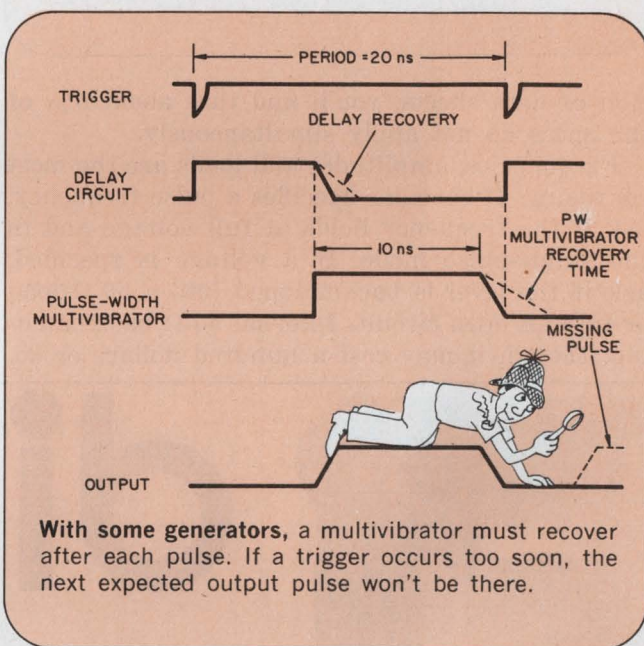

With some generators, a multivibrator must recover after each pulse. If a trigger occurs too soon, the next expected output pulse won't be there.

creasing the pulse-generator's flexibility. Without the gating, double-pulse mode, external drive or baseline offset, deduct \$200 to \$300 for each. Be sure, though, that you won't need these features on your next application.

The trouble with economic tradeoffs, however, is that many costs are hidden. A pulse-generator's inadequacies generally are either missing from the data sheet or are open to misleading interpretation. Many an engineer has been burned, where a few questions or a little benchtop work could have saved him.

Ask, ask, ask

First and foremost, ask the salesman if all the specs apply simultaneously. If they don't, ask if the data sheet tells where the compromises are made. Then pry the instrument loose from the salesman and check the specs. From a cross-sec-

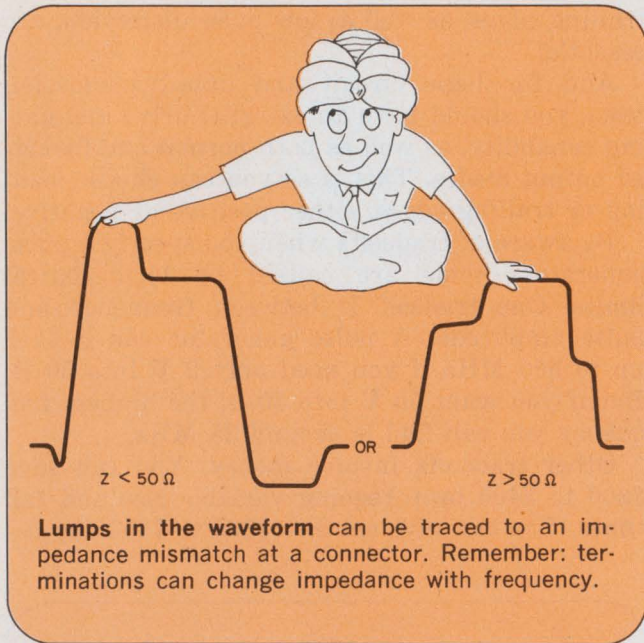

tion of data sheets, you'll find that about 5% of the specs do not apply simultaneously.

Frequencies, amplitudes and loads are the most confusing. If someone specifies a pulse frequency, ask if the frequency holds at full voltage and in the single-pulse mode. If a voltage is specified, ask if the level is backmatched into a 50-Ω load or into an open circuit. Internal 50-Ω backmatching, though it may cost a hundred dollars or so.

minimizes reflections when the pulser encounters loads other than 50 Ω. However, backmatching does limit the frequency.

Check that temperature coefficients of drift are specified in %/°C over the range of interest, and also see if any combination of front-panel control settings can damage the instrument.

Even with bench checkout, you can make purchasing mistakes. The most common, in these times of tight budgets, is to underspecify the pulse generator. Many an engineer has bought a pulser without baseline offset for TTL tests, and then had to turn around six months later and buy a unit for ECL testing.

Others buy pulsers with fixed rise/fall times to test fast ECL, and then try to plug the generator into a PC board containing CMOS input buffers and a non-50-Ω mismatched line. It's found very quickly that the fast rise times result in an abundance of reflections along the line.

Finally, regardless of what technology you work in, you're sure to run into an application that calls for off-beat specs. In that case, contact the vendor—a slight adjustment or modification of an existing pulser may give the specs you need.

But if you're looking for a 2-GHz pulser that delivers 1000 V and costs just \$395, you'll have to wait until the semiconductor field catches up with your ambitions. ■■

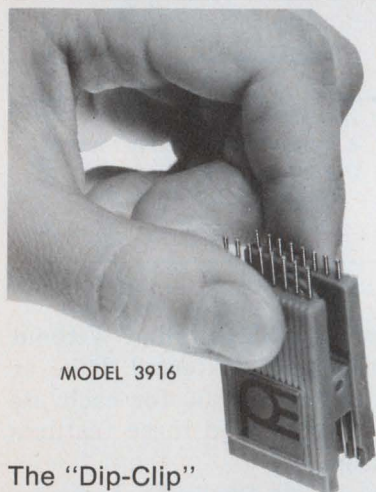

MODEL 3916

The "Dip-Clip" is specially designed to allow the attachment of test probes to 14 or 16 lead DIPs. The unique patented design greatly reduces the possibility of accidental shorting while testing live circuits. Numerous test probes may be quickly connected for hands-free testing.

dip clip

T.M.

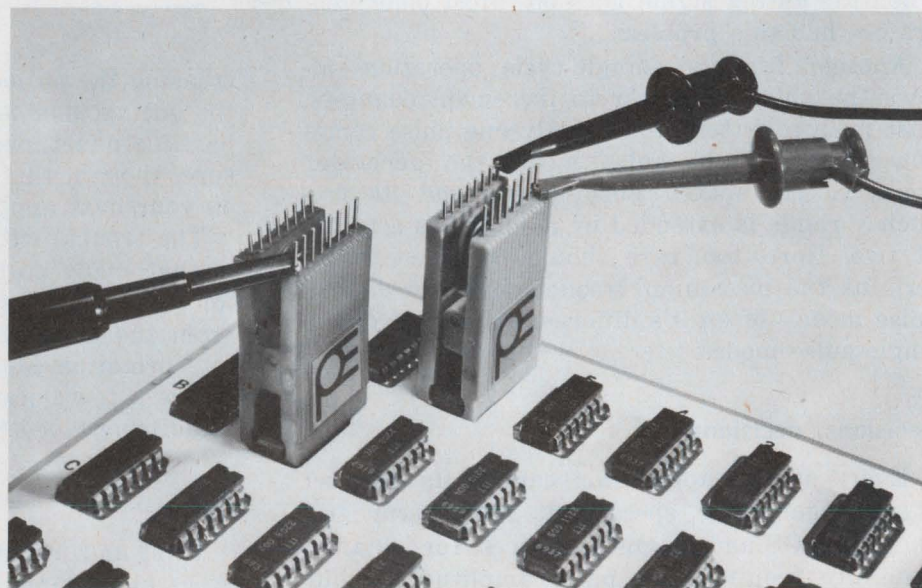

POMONA ELECTRONICS

A Division of ITT

1500 E. Ninth St., Pomona, Calif. 91766 • Telephone: (714) 623-3463

INFORMATION RETRIEVAL NUMBER 40

1+1=10

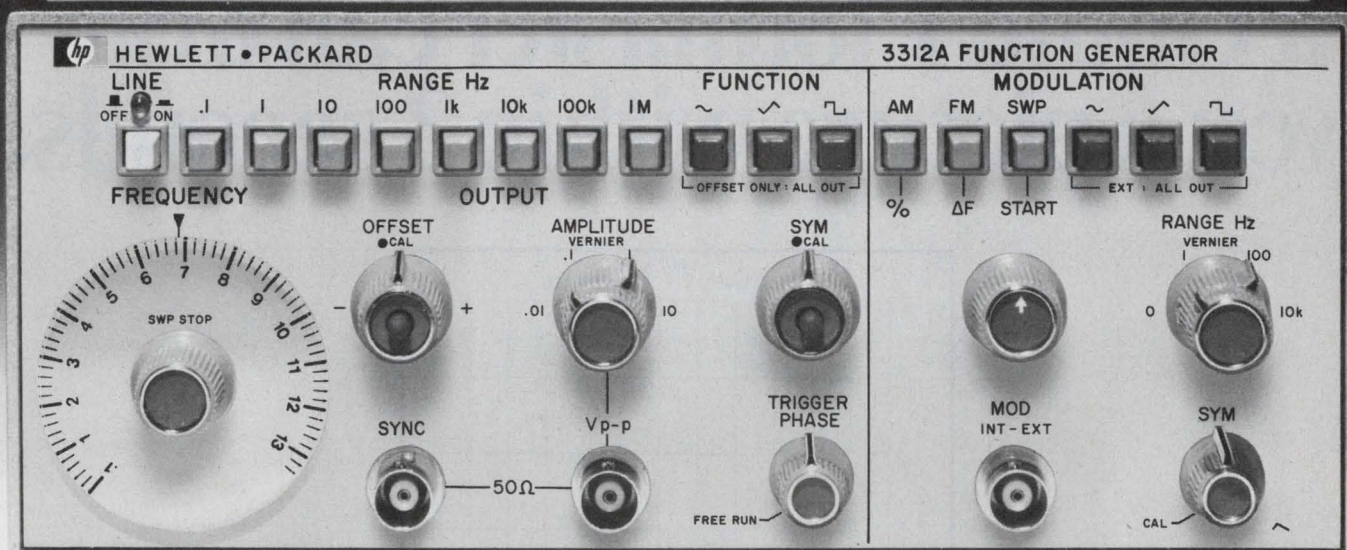

Two function generators in one box equals ten good reasons to buy one.

This new function generator gives you FM signals, AM signals, dc levels, sweeps, sine waves, square waves, triangle waves, ramps, tone bursts and single or multiple pulses. You get all these functions for only \$900* plus many other

output waveforms. And you get top performance too... like square waves that don't become sine waves above 10MHz. For all the details on this dual function generator—HP's 3312A—give your local HP field engineer a call today.

*Domestic USA price only.

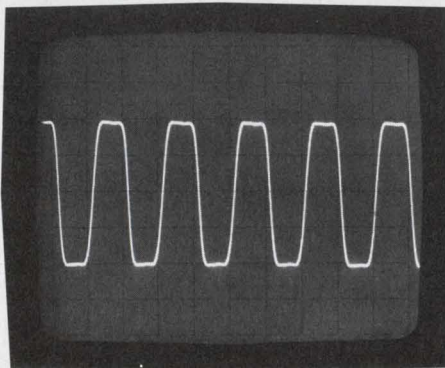

Unretouched scope display of the 3312A's 10 MHz square-wave output, showing 18 nsec rise time.

HEWLETT  PACKARD

Sales and service from 172 offices in 65 countries.
1501 Page Mill Road, Palo Alto, California 94304

INFORMATION RETRIEVAL NUMBER 41

09472

After your 360/370 massages the information, a Gould Plotmaster can draw you a picture within 3 seconds.

If alphanumeric information is what you want, a Gould Plotmaster can print it for you. At speeds up to 3000 lines per minute. But there are times when alphanumeric listings are just too much. Too much paper to handle, too tough to read, too difficult to digest.

And it's at times like these that a Gould Plotmaster can draw you a picture. A line chart, a bar chart, a pie chart, a graph. A picture that tells your story at a glance.

Employing high-speed electrostatic printer/plotters, Gould Plotmaster Systems give you power and versatility for both on-line and off-line operation. And they're designed to run on any IBM System/360 or 370 operating under DOS or OS, real or virtual.

Easy-to-use software packages help our Plotmaster Systems do the whole job. There's our DISPLAY package that provides even non-programmers with the capability of easily generating line, bar and pie charts. And there's our PLOT package which, due to the speed

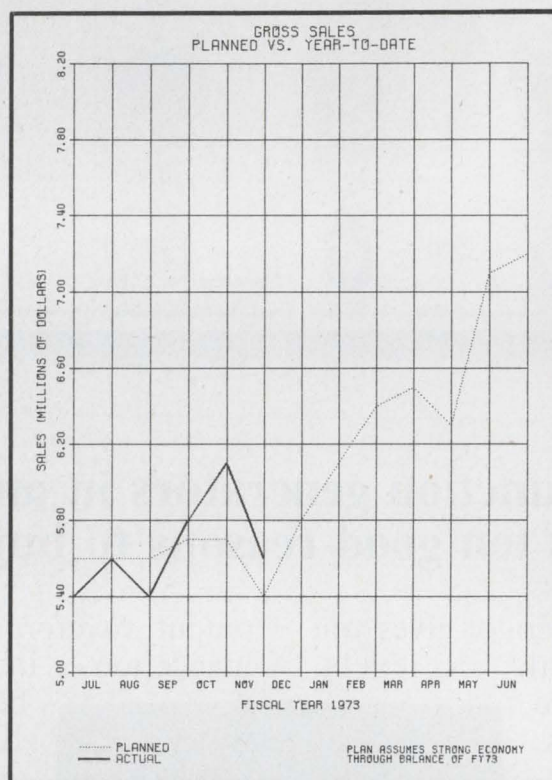

and flexibility of our printer/plotters, lets you do background grids, variable line weights, automatic stripping, text annotation, and allows you to erase previously programmed line segments.

In addition to business graphics, a Gould Plotmaster

can add engineering/scientific graphics and computer-aided-design capabilities to your operation. These optional software packages include DADS (Data Acquisition Display), PAL (Precision Artwork Language) and FAST-DRAW. As for the hardware itself, our Plotmaster Systems can provide on-line/off-line operation, paper widths up to 22 inches, resolution up to 100 dots per inch, output speeds up to 7 inches per second. And, of course, a printing capability, as well.

Get all the facts on Plotmaster Systems from Gould Inc., Instrument Systems Division, 20 Ossipee Road, Newton, Mass. 02164 U.S.A. or Kouterveldstraat 13, B 1920 Diegem, Belgium.

 **GOULD**

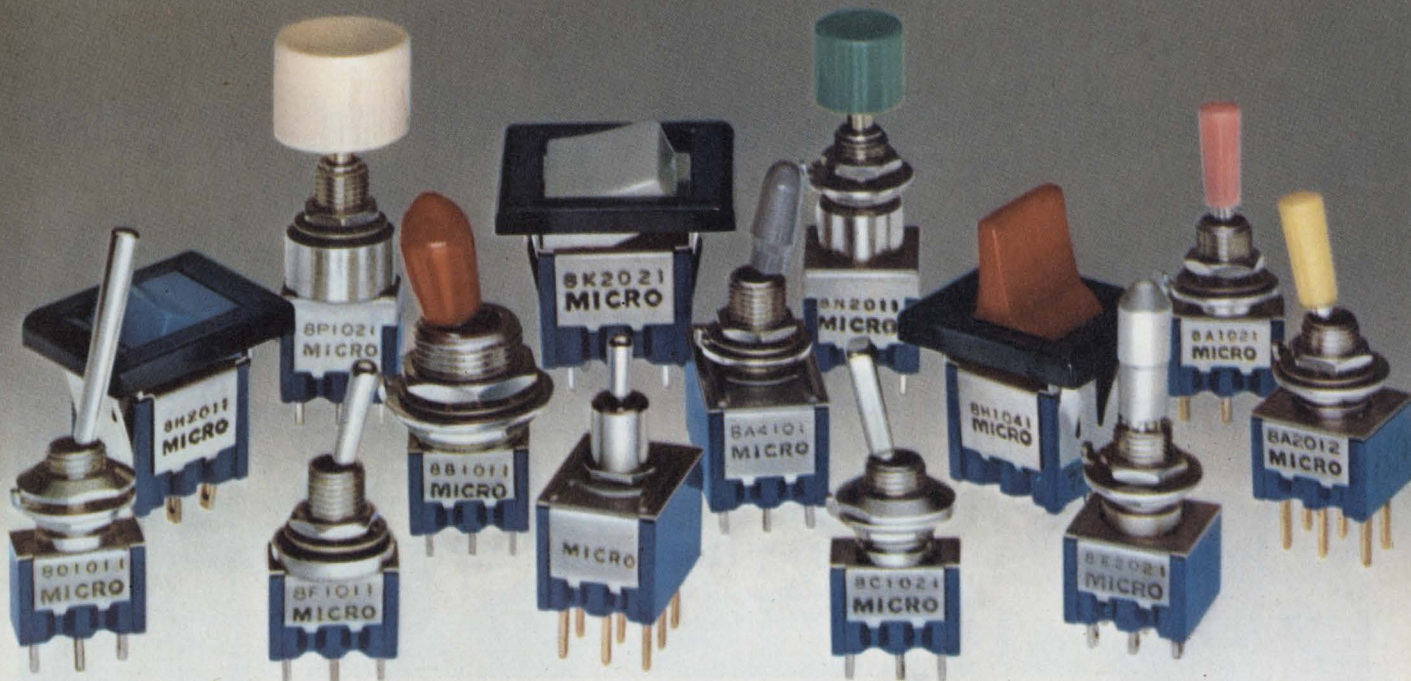

They look like miniature manual switches. But they're really just responses.

Every one of the miniature manual switches in the MICRO SWITCH Series 8 line is the direct result of a design need.

And, because design needs change continually, so do the miniature manuals we offer.

In the last year alone, we've added hundreds.

So you can choose from toggles, paddles, rockers — lighted and unlighted — and pushbuttons. With terminal variations that include solder, quick-connect, PC board and wire wrap.

They're all U.L. listed at 6 amps, 125VAC. With low energy versions available in every design.

And they all come with standard features like traditional MICRO SWITCH quality. Including inspection to a one percent Acceptable Quality Level. And nationwide, off-the-shelf availability, so there's no waiting.

They're also available with new features, like panel and bushing-sealed pushbuttons and toggles. A non-threaded bushing on PC mounted toggles. And colored sleeves for the 15/32-inch diameter bushing toggles.

If you'd like more information on the MICRO SWITCH Series 8 miniature manual switches, call, toll-free, 800/645-9200 (in N.Y., call 516/294-0990, collect) for the location and phone number of your nearest MICRO SWITCH Branch Office or Authorized Distributor.

Find out why you need only one source for the right miniature manual switch, at the right price, at the right time.

And how that source will work with you, just in case it doesn't make exactly what you need. Yet.

MICRO SWITCH products are available worldwide through Honeywell International.

MICRO SWITCH

FREEMONT, ILLINOIS 61032
A DIVISION OF HONEYWELL

“Scotchflex” Flat Cable Connector System makes 50 connections at a time.

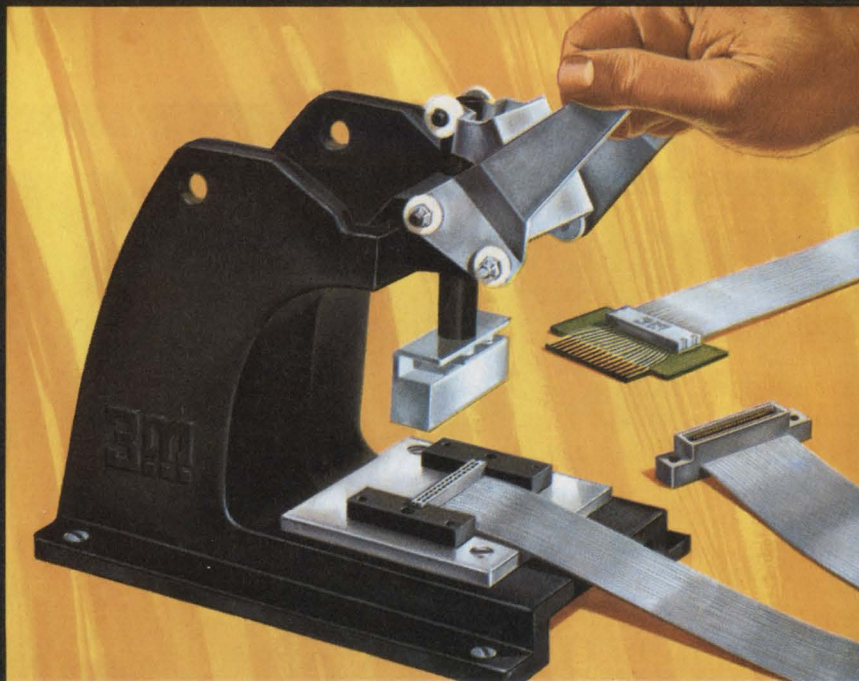

“SCOTCHFLEX” IS A REGISTERED TRADEMARK OF 3M CO.

Build assembly cost savings into your electronics package with “Scotchflex” flat cable and connectors. These fast, simple systems make simultaneous multiple connections in seconds without stripping or soldering. Equipment investment is minimal; there’s no need for special training. The inexpensive assembly press, shown above, crimps connections tightly, operates easily and assures error free wiring.

Reliability is built in, too, with “Scotchflex” interconnects. Inside of connector bodies, unique U-contacts strip through flat cable insulation, grip each conductor for dependable gas-tight connections.

“Scotchflex” offers you design freedom, with a wide choice of cable and connectors. From off-the-shelf stock you can choose: 14 to 50-conductor cables. Connectors to interface with standard DIP sockets, wrap posts on standard grid patterns, printed circuit boards Headers for de-pluggable connection between cable jumpers and PCB. Custom assemblies are also available on request.

For more information, write Dept. EAH-1, 3M Center, St. Paul, Minn. 55101.

**“Scotchflex” Your
systems approach
to circuitry.**



VACTEC Couplers

**For putting it together, VACTEC
is second only to RODIN*.**

Vactec Optical Couplers (T.M. Vactrols) put together incandescent lamps, neon lamps or LEDs with photoconductors or phototransistors in a wide variety of packages and capabilities.

Couplers using photoconductive cells are useful for isolation where speed requirements are in the order of milliseconds. Applications include noiseless switching, noiseless potentiometers, signal modulators for audio, triac firing, and low cost RMS regulators.

Couplers using LEDs and phototransistors or photodarlington provide higher speed for output sensing, input driving, interfacing and coupling, solid state relays, and switching.

VACTEC really does put them together—we make our own photoconductive cells, phototransistors and photodarlington and do the assembly at our only factory near St. Louis. Write for all Vactrol bulletins.

*Reproduction of The Kiss by Rodin.



Vactec, Inc.
2423 Northline Industrial Blvd.
Maryland Heights, Mo. 63043 U.S.A.
(314) 872-8300

Improve analog data transmission with two-wire transmitters. You can send the signals without shielding, and even multiplex the sensors.

Many analog long-distance signal-transmission problems—noise, signal loss, ground-potential differences—can be overcome with two-wire transmitters built from op amps.

Much industrial-process instrumentation is monitored and controlled by remote signals. As the distance increases between a monitor point and the processing system, problems begin to mount.

Costs of the system grow rapidly with distance—even the quantity of wire needed can be a major expense, especially if the wire must be shielded against noise pickup. Long lines introduce resistances that can absorb a significant portion of the signal voltage. And the longer the lines, the greater the likelihood of large differences in ground potentials; values approaching several hundred volts are common.

For hard-wired remote monitoring, you need a signal line and a ground return as the minimum to transmit a signal. A third wire would normally be required to supply power to the monitor, unless you use batteries.

You can keep the number of required wires to two by use of two-wire transmitters that combine the signal and power lines into one. Only the power supply line and its return are then required. The signal can be transmitted as a change in supply-current drain.

A two-wire transmitter is a voltage-to-current converter that transmits its signal current on its own supply lines (Fig. 1). The output current consists of a quiescent level, I_0 , and a signal current related to the input signal, e_i , by a transconductance, g_m . In process-control systems, I_0 and g_m are generally set for current ranges of 4 to 20 or 10 to 50 mA. You derive an output voltage from this current by connecting a load resistor, R_L , in series with the return line.

The input signal must be referenced to one of the two lines and not to its own ground reference. This is because with a separate ground return, a current will circulate between the two ground

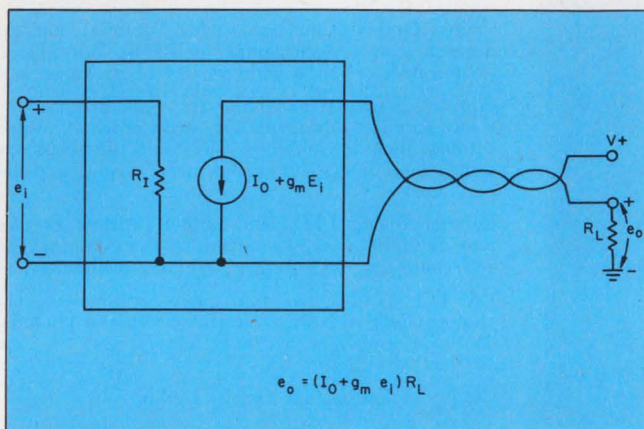

1. In response to a floating-signal voltage, the two-wire transmitter produces a signal-dependent, supply-current drain that changes the voltage on a load.

connections and create an error voltage on R_L . Thus e_i must be supplied from a floating sensor. Fortunately sensors like thermocouples are floated readily.

Other sensors—ones that require bias—can be connected in bridge circuits that are biased from the two-wire transmitter for the desired floating connection. If the input signal must have its own ground return, an isolating two-wire transmitter can be used.

In addition to the reduction in the number of wires required for signal monitoring, two-wire transmitters permit less-expensive wire to be used. If a signal is transmitted as a voltage, shielding is often needed to limit pickup and wire of larger diameter is necessary to reduce errors from signal voltage drops on the line resistance. But signals in current form are nearly immune to noise-voltage pickup, so shielding is not needed. In addition, line resistance does not reduce a signal current as it does a signal voltage, so smaller-gauge wire can also be used. Generally a twisted pair can be used instead of a more costly shielded cable.

Basic two-wire transmitters

The basic two-wire transmitter consists of an amplifier biased from a floating zener power sup-

Jerald Graeme, Manager, Monolithic Engineering, Burr-Brown, International Airport Industrial Park, Tucson, AZ 85706.

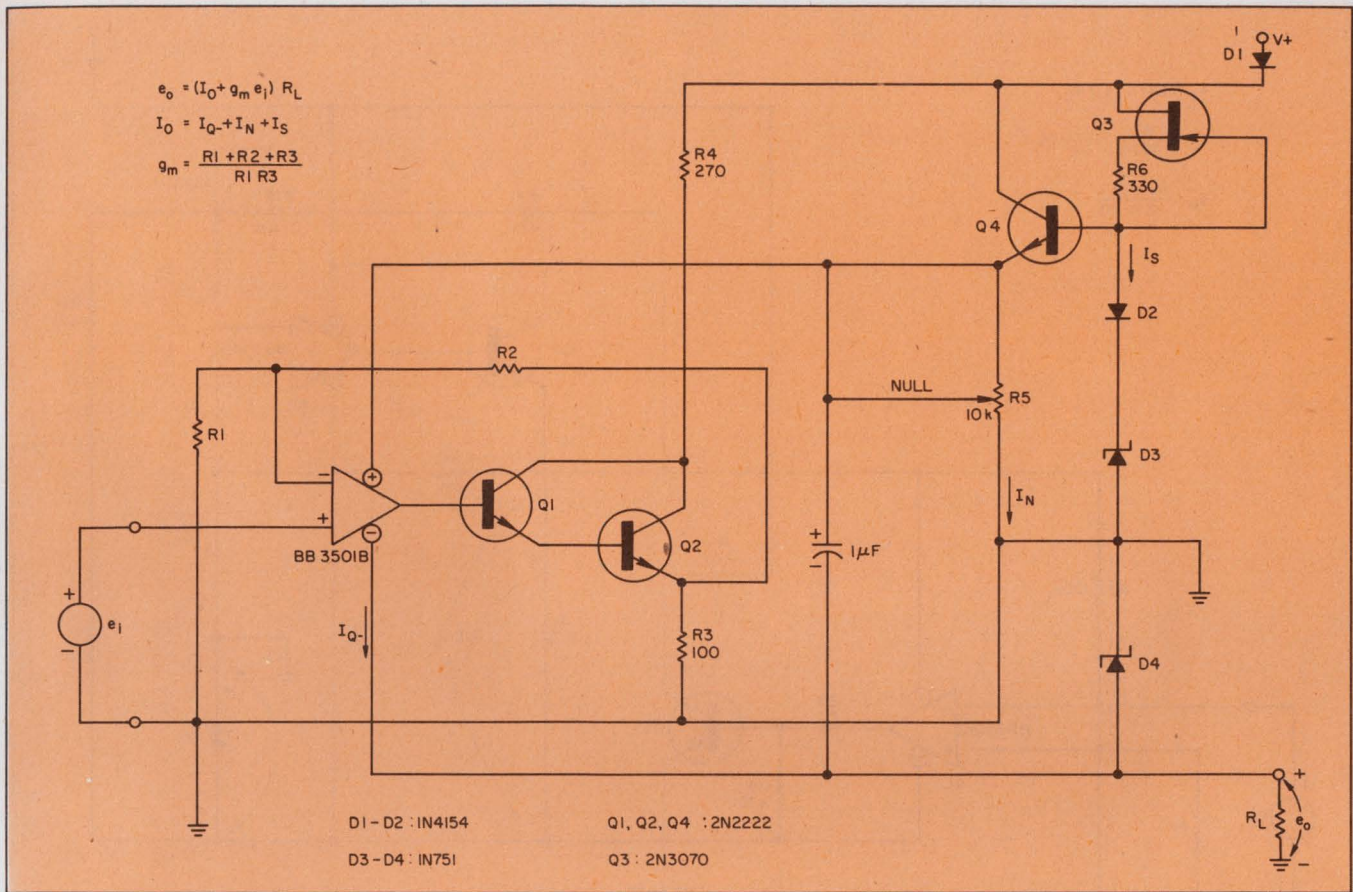

2. The amplifier within the two-wire transmitter supplies the load current in response to an input signal.

ply (Fig. 2), a noninverting op amp and current-boosting transistors Q_1 and Q_2 . Positive input signals are amplified by a gain of $1 + R_2/R_1$ to develop a current in the amplifier load resistor R_3 . This current and the amplifier feedback current are returned through D_4 to the transmitter load R_L . The transconductance relates the combined signal current to the input signal e_i :

$$g_m = \frac{R_1 + R_2 + R_3}{R_1 R_3}$$

Resistor tolerance, amplifier loop gain and signal-dependent quiescent currents limit the low-frequency accuracy of the transconductance equation. Both the quiescent current of the op amp, I_{Q-} , and that of the floating supply, I_S , vary with the output signal e_o . The signal varies the drain-source voltage of Q_3 and thus modulates I_S slightly. Similarly the associated op-amp output signal is accompanied by internal current modulation.

In addition current drawn from the op-amp output lowers I_{Q-} directly. To limit the lowered I_{Q-} , a Darlington current booster is used. Combined transconductance error from signal-dependent quiescent currents is typically 0.3% of full scale. At higher frequencies the amplifier bandwidth limitation will limit g_m similarly.

A floating zener-diode power supply, used to limit feedback effects from the output swing, e_o ,

supplies bias for the amplifier. Since the amplifier is bias-referenced to the output terminal, the output swing appears at the amplifier input. The swing gets absorbed by current source Q_3 and emitter-follower Q_4 rather than by the amplifier, since the derived floating power supply is also referenced to the output terminal.

A voltage approximately equal to that of the two zener diodes is impressed across the amplifier power-supply terminals. This voltage holds as long as the voltage drop of D_2 counteracts the drop of the emitter-base junction of Q_4 . The derived supply voltage can also provide the required floating bias for a resistance bridge. The zener voltage should be chosen large enough for amplifier bias and swing requirements, but not so large as to limit the transmitter output, e_o .

Limiting of e_o occurs when it exceeds the portion of the external supply voltage, V_+ , that is not required by the floating supply. Diode D_1 protects the circuit from possible damage caused by reverse connection of the external supply.

To set the quiescent output current, I_o , at its desired level, add a null current, I_N , from R_5 to the quiescent currents, I_{Q-} , of the op amp and I_S of the floating supply. This gives

$$I_o = I_N + I_{Q-} + I_S$$

If the needed I_o is 4 mA, a low-quiescent-drain op amp and low-current zener diodes are desir-

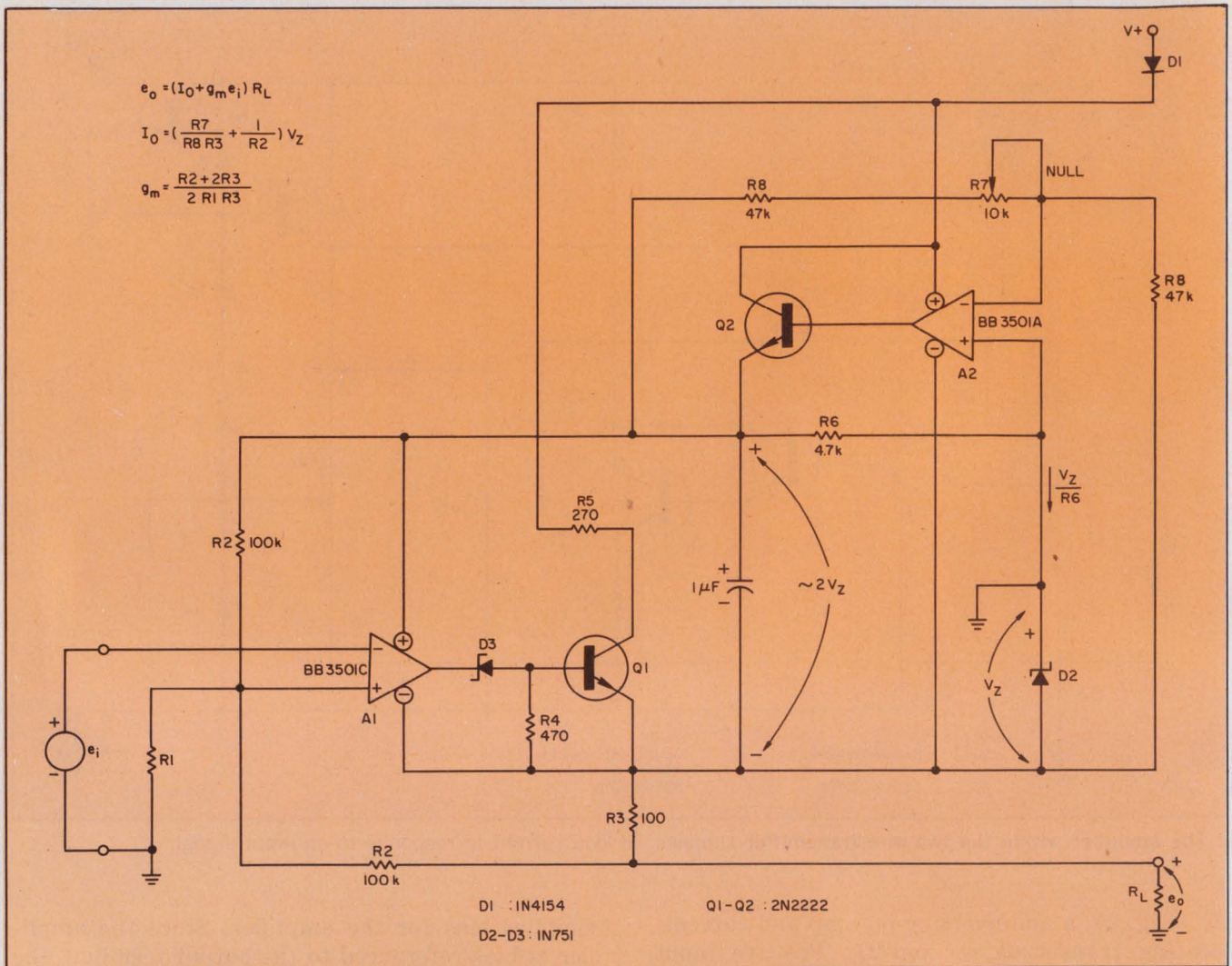

3. To improve transmitter accuracy, return all quiescent circuit currents as part of the feedback-controlled cur-

rent in the amplifier load, R_L . The feedback is routed to the amplifier's noninverting input.

able. A low-quiescent-drain op amp also helps to reduce the thermal variations in I_o .

All three components of I_o vary with temperature and represent a major source of circuit error. The quiescent current of an op amp typically varies 20% over the amplifier's operating temperature range. To minimize the I_s variation, set the bias field-effect transistor at its nominal zero-temperature coefficient point (but this is an approximation). The null current varies with the zener voltage drift, and the drift is increased by the need to maintain low zener current. Add to these quiescent current drifts the effect of the op amp's input offset voltage drift. The drift, multiplied by the circuit g_m , creates a further drift in I_o . The combined thermal variations result in an output current drift of about $(0.03 + 0.02 g_m)$ in percentage of FS/°C.

Refinements improve stability

A number of circuit refinements can be made to reduce the thermal and signal-induced changes

in I_o . Rather than stabilize each component of I_o , you can make corrections at the amplifier load resistor. The total current in this resistor is controlled by the op-amp feedback, so any change in quiescent current is compensated by a feedback adjustment of load-resistor current. Both thermal and signal-induced I_o variations are thus compensated for, and drift and transconductance errors are reduced.

One feedback-controlled circuit uses a second amplifier along with the earlier version (Fig. 3). Circuit quiescent currents are conducted through the amplifier load resistor, R_3 . This connection, however, requires feedback and bias modifications.

Since the negative side of the floating supply is now connected to the emitter of the current booster, Q_1 , the emitter voltage does not swing with respect to the floating circuitry. Instead the signal swing appears at the opposite end of R_3 , and feedback returns from that point. This inverts the phase of the signal and requires feedback to the noninverting input of A_1 .

V_z . Thus the regulator stabilizes the bias for its own reference diode and avoids the need for a current source to absorb signal swing.¹

Output voltage from the floating power supply can be adjusted by a null potentiometer to set the transmitter quiescent output current I_0 . The pot adjustment forces the gain of A_2 to values greater than 2 and makes the magnitude of the positive supply greater than that of the negative. Because of this difference, the current supplied through the R_2 input bias resistor develops a voltage on the R_2 feedback resistor that exceeds the negative supply voltage. This, in turn, forces a voltage on R_3 and sets a quiescent output of:

$$I_0 = V_z \left(\frac{R_7}{R_8 R_3} + \frac{1}{R_2} \right).$$

As mentioned, the thermal drift of I_0 drops considerably when you include the quiescent currents of the circuit in the feedback-controlled path. The remaining I_0 drift is associated with that of the zener reference, the input offset voltage, V_{OS1} of A_1 and A_1 's input bias current, I_{B1} .

Zener drifts can be significant unless you select the diode for a low temperature coefficient at the lower current available for its bias. The thermal drift of V_{OS1} is multiplied by the circuit transconductance and produces the dominant drift at higher gain levels. Generally the drift of I_{B1} is negligible compared with the feedback current. When combined, these drift sources result in:

$$\frac{\Delta I_0}{\Delta T} = \left(\frac{R_7}{R_8 R_3} + \frac{1}{R_2} \right) \frac{\Delta V_z}{\Delta T} + g_m \left(\frac{\Delta V_{OS1}}{\Delta T} + \frac{R_2}{2} \frac{\Delta I_{B1}}{\Delta T} \right).$$

With careful design, this drift can be controlled to equal:

$$(0.003 + 0.02 g_m) \text{ in percentage of FS}/^\circ\text{C}.$$

Biased bridge transmitters needed

Each of the preceding two-wire transmitters have been designed for unbiased, floating-signal sources, such as those encountered with thermocouples. Transducers that require bias, like variable-resistance types, must have a floating bias referenced to the transmitter circuitry. Only then will the floating transmitter circuitry monitor the transducer signal that is separated from the transmitter output signal and from ground potential differences. Fortunately the required bias can be derived from the floating power supply used to excite the transmitter circuitry.

Either of the circuits described previously can be used with a biased transducer, and the choice is determined by the accuracy requirements. But in addition to superior response accuracy, the circuit of Fig. 3 has a more precise floating supply available for transducer bias. To use this circuit with a resistance bridge, you can modify

it (Fig. 4). The bridge bias is set by the R_9 and $R_9/2$ resistors for an approximate transducer current of V_z/R_9 . To bias the inputs of A_1 within their common-mode voltage range, place the $R_9/2$ resistor in series with the bridge. An imbalance in bridge currents will be produced by the null potentiometer for an output null current of:

$$I_0 = \frac{V_z R_2 R_7}{2 R_9^2 R_3}.$$

While this expression is approximate, the actual current is stable.

Also, I_0 is under the feedback control of A_1 . Variations in I_0 are essentially those caused by the thermal variations in the zener voltage and resistances. This thermal variation can readily be limited to 200 ppm/ $^\circ\text{C}$.

Changes in transducer resistance further unbalance the bridge currents. Again, the difference current flows in the R_2 resistors and produces a differential signal that is matched across R_3 by feedback. The currents that produce these signal voltages flow through the transmitter load, R_L , to produce an output voltage of

$$e_o = (I_0 + I_1 \Delta R_1/R_1) R_L,$$

where

$$I_1 = \frac{V_z R_2}{2 R_9 R_3}$$

for

$$R_9 \gg R_1, R_1 \gg \Delta R_1, R_2 \gg R_9.$$

How well the circuit responds to this approximation is limited primarily by the accuracy of the expression. Because of bridge-response non-linearity, the transmitter response deviates from the approximation when the assumptions are less valid. However, the inherent circuit accuracy does permit operation to within 0.1% of the exact response relationship. Since most variable-resistance transducers lack this degree of accuracy in their own responses, the approximate expression can often be used with confidence.

Specialized two-wire transmitters

More specialized two-wire transmitters can be used to reduce wiring further or to accommodate a nonfloating signal source. These are a modulated-carrier type, which permits common use of one wire pair by many monitors, and an isolated circuit configuration, which accommodates grounded signal sources. Wiring to several monitors can be reduced with a modulated-carrier, two-wire transmitter that has a current-mode output.

Theoretically any number of signal currents can be summed on a common line. If these currents are modulated carriers of differing frequencies, they can be separated at the line end. As a result, the wiring to monitor numerous re-

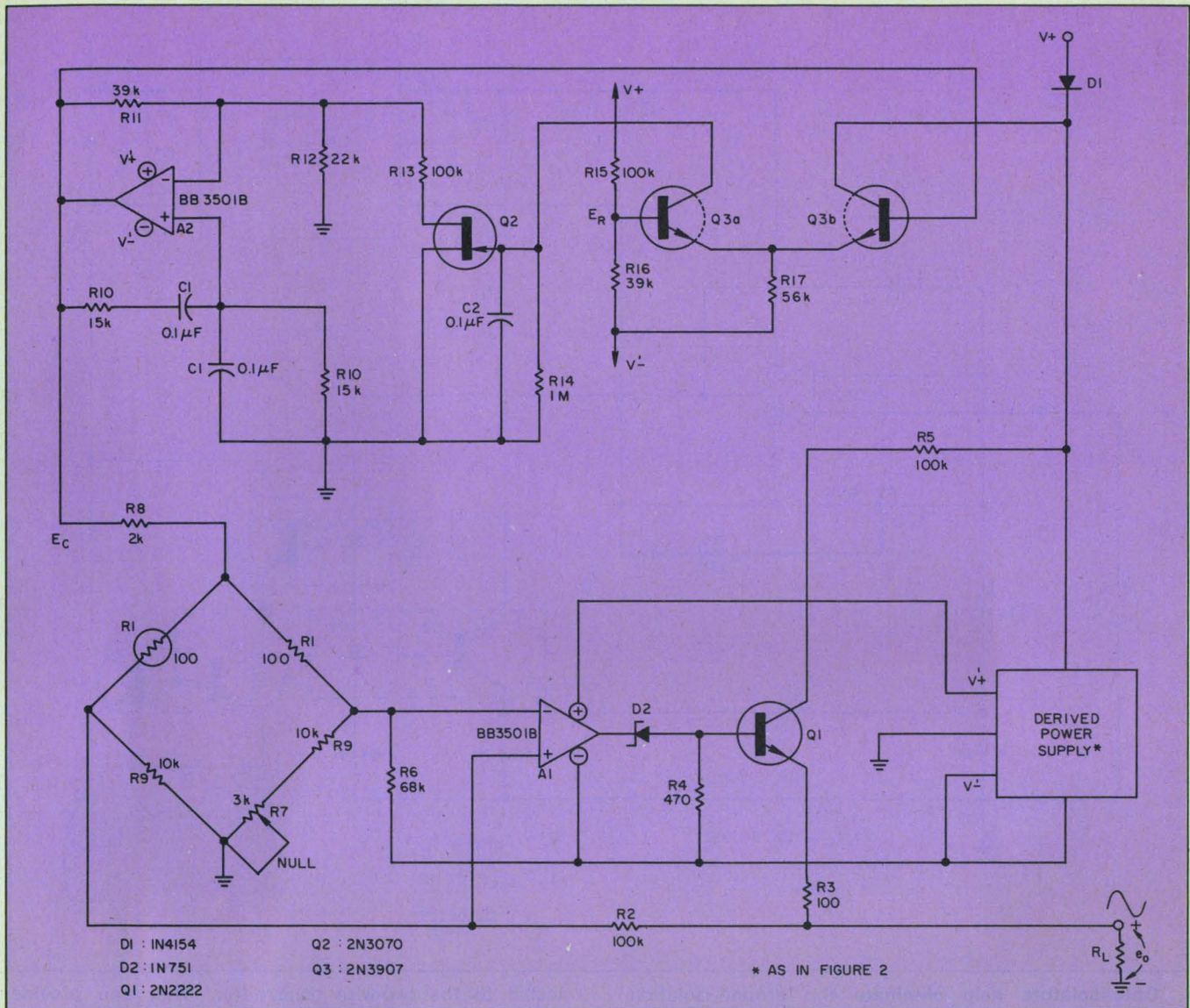

5. Multiple transmitters can be connected on a single two-wire system, if a Wien-bridge oscillator is used to

produce a modulated carrier signal. Each transmitter is just tuned to a different frequency.

mote signals can be reduced to a single twisted pair.

A modulated-carrier output can be achieved with a bridge-sensing, two-wire transmitter. As explained earlier, the output of the circuit in Fig. 4 is proportional to the product of the bridge imbalance and the bridge bias voltage. If you replace the bridge bias with a carrier signal, the transmitter output is modulated by the bridge imbalance (Fig. 5). This circuit resembles that of Fig. 4, with the addition of a Wien-bridge oscillator to drive the transducer bridge. The result of the associated carrier signal E_c is a modulated-carrier output of

$$e_o = (I_0 + I_1 \Delta R_1 / R_1) R_L,$$

where

$$I_1 = \frac{E_c R_2}{(R_8 + R_9 / 2) R_3}$$

for

$$R_9 \gg R_1, R_2 \gg R_9, R_1 \gg \Delta R_1.$$

Added to the ac output signal is a dc bias of about 30 mA, as set by the imbalance between R_2 and R_6 . These resistors also create an ac imbalance that is counteracted by the null potentiometer that sets I_0 . In this case I_0 represents the output carrier at null, which can be set for a 4-mA amplitude. The 30-mA dc bias permits an increase in the output-carrier amplitude to 20 mA for a consistent output range.

Response to the output expression is limited by the approximations, as before. Circuit-oriented error is determined primarily by the amplitude stability of the Wien-bridge oscillator. For this reason, an automatic-gain-control (agc) loop should be used to control the oscillator amplitude. The basic oscillator consists of A_2 , the R_{10}/C_1 Wien bridge and the gain setting feedback of R_{11} and R_{12} .^{1,2} The frequency is set by the Wien bridge at $f = 1/2\pi R_{10} C_1$.

The output amplitude of the transmitter is de-

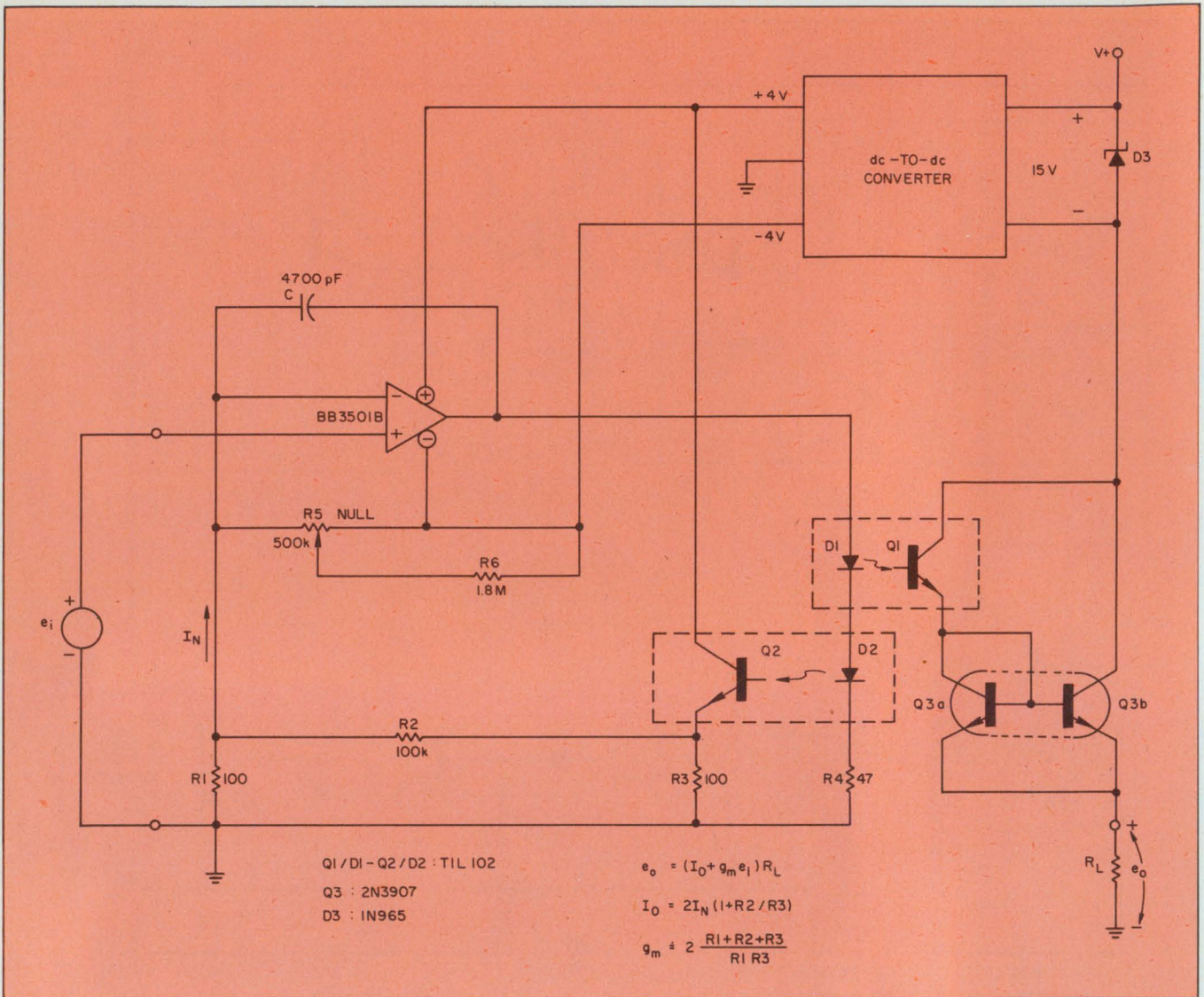

6. Opto-isolators help eliminate the ground-isolation problems present when grounded transducers are con-

nected to the two-wire transmitter. They can provide isolation of up to several thousand volts.

terminated by critical control of the oscillator gain, and agc is applied to fine-tune that gain through FET Q_2 . The FET acts as a voltage-controlled resistor that shunts R_{12} to raise the gain. If the gain set by R_{11} and R_{12} is slightly below that required for oscillation, that added by the FET shunt will start and control the amplitude of oscillation.

The actual signal amplitude can be detected by the comparator formed from Q_{3a} and Q_{3b} . When the amplitude falls below the reference level, E_R , at the base of Q_{3a} , the transistor won't turn on. When this happens, no signal is supplied to the FET gate, and the gate-source bias is zero. At this bias minimum FET resistance is achieved for maximum oscillator gain. The high gain level causes the amplitude to increase until it reaches the reference level. In turn, the negative sine-wave peaks turn on Q_{3a} so it applies bias to the FET gate. Under this bias, the FET begins to turn off and lower the gain, until the FET

reaches an equilibrium amplitude. The result is 0.2% amplitude stability for similar two-wire transmitter accuracy.

Handling grounded transducers

Each of the two-wire transmitters discussed accepts only floating signal sources. While floating-source capability is compatible with most transducers, it is not suited for more general instrumentation. The systems to be interconnected by the transmitter usually have individual ground references, which can be separated by large potential differences. Such differences can exceed the voltage-handling capability of the transmitter, as well as overshadow the signal to be transmitted. The signal would be lost in resulting ground-circulation error currents.

To handle the separate signal and load ground references without difficulty, use an isolating two-wire transmitter. With an opto-coupler, you

can reject the ground-difference signal and block ground-circulating error currents. Then only the desired signal is transmitted by the coupler (Fig. 6). A signal amplifier drives a LED-phototransistor coupler, while a dc-to-dc converter powers the amplifier from the transmission wires. Sometimes the amplifier can be powered from the system supplying the input signal to eliminate the dc-to-dc converter.

The operation of the isolating two-wire transmitter is similar to that of the previous circuits, except for the linearizing feedback of the LED-phototransistor couplers.² To satisfy feedback requirements, the signal current in Q_2 must be related to the input signal by e_i/R_1 . If the couplers are matched, the same current will flow in the output phototransistor, Q_1 .

Current from Q_1 is doubled by Q_{3a} and Q_{3b} , and thus accommodates the less-than-unity transfer efficiencies of the couplers and the dc-to-dc converter. From Q_1 , current flows through Q_{3a} , which then biases Q_{3b} at an equal current. The result is a current gain of 2. Even greater gain can be achieved by addition of ratioed resistors in series with the emitters of Q_{3a} and Q_{3b} . This gain boosts that of the coupler to more than the less-than-unity gain of most LED-phototransistor pairs.

As a result, the power efficiency required of the dc-to-dc converter is lowered. More current is still required from the converter output than is available to its input, but this is permitted by a large decrease in voltage from input to output. Transmitter output current, not required by the dc-to-dc converter, is conducted by D_3 . This zener diode regulates the converter input voltage.

The net result is that current is supplied to the transmitter load for an output voltage of:

$$e_o = (I_o + g_m e_i) R_L,$$

where

$$I_o = 2 I_N (1 + R_2/R_3),$$

and

$$g_m = 2 \frac{R_1 + R_2 + R_3}{R_1 R_3} \text{ for } R_5 \gg R_1.$$

The accuracy of this response is limited by about a 1% error from the mismatch instability and noise of the LED-phototransistor couplers. The couplers must be matched over the full signal dynamic range, so reduction of nonlinearity is difficult. In addition the time stability of the match is degraded by the decay in transmission efficiency to which these couplers are prone. Opto-couplers also have high noise content in their output currents—another limit to signal sensitivity. ■■

References

1. Tobey, G., Graeme, J., Huelsman, L., "Operation Amplifiers: Design and Applications," McGraw-Hill, 1971.
2. Graeme, J., "Applications of Operational Amplifiers-Third-Generation Techniques," McGraw-Hill.

YEW's POWERFUL FAMILY!



AC WATTS

And, that's a lot of accuracy, even with low power factors and distorted waveforms. The YEW 2885 is renown throughout the world as the AC power measuring instrument. YEW's APR-2, on the right is used as a standard by many countries in the world.



TRUE RMS V-A-W

Accuracy and versatility have generated a reputation for the YEW 2503 True RMS V-A-W instrument that's hard to beat. Distorted waveforms and low power factor hardly phase it at all.



Model 2041

PORTABLE WATTMETERS

YEW has made more precision analog portables than anyone else in the world . . . and they're usable to 2 KHz and not expensive.

To find out all about YEW's extensive family of power instrumentation, just write or call. We'll be happy to prove why we're #1 in power.

YEW

YEWTEC CORPORATION

1995 Palmer Avenue
Larchmont, N.Y. 10538

® Yokogawa Electric Telephone: 914-834-3550

60 Years of Measuring and Recording Instrumentation

REVIEW

JUNE 17 1974
 monday
256x4 STATIC RAM WITH POWER DOWN
 24 PIN DIP (RA-3-4256)

Ideal for small stand-alone systems requiring battery backup.

SEPTEMBER 30 1974
 monday
STATIC ROMS
 5K (RO-3-520) 4K (RO-3-4096)
 512x10 512x8
 Single+5V supply Single+5V supply

The best cost vs. performance 4K/5K ROMs available. Five dollars (in 50,000 piece quantities) buys 500 ns maximum Access Time with a single +5 supply.

NOVEMBER 4 1974
 monday
256x4 STATIC RAM WITH ADDRESS/CHIP SELECT LATCH
 22PIN DIP (RA-3-4256B)
 Designed in a 22 pin DIP for applications requiring minimum board space — eliminates the need for an external Address Register.

DECEMBER 2 1974
 monday
16K STATIC ROM
 4Kx4 (RO-3-16384)
 Single+5V Supply
 Contains programmable Chip/Selects with latches on all Addresses and Chip/Select Inputs — 1 μ s maximum Access Time.

PREVIEW

*Coming
early in* **1975**

STATIC ROMs

64x5x7 row Char. Gen. (2513)

16K, 900ns 2Kx8 (8316)

64x5x7 col. Char. Gen. (2516)

8K, 950ns 2Kx4 (2580)

STATIC RAMs

1Kx1, 160ns access TTLout (1217)

1Kx1, 135ns access TTLout (1217A)

1Kx1, 120ns access diff. out (1218)

1Kx1, 100ns access diff. out (1218A)

256x4 with output latches,
single+5V

PLUS

1024 bit S/R, DC-2MHz (2533)

UAR/T, 60kbaud, single+5V

For complete information
call toll-free 800-645-9247
(In New York State
call 516-733-3107) or write,
General Instrument Corporation,
Microelectronics, 600 W. John St.,
Hicksville, N.Y. 11802

GIANT II™

GENERAL INSTRUMENT ADVANCED N-CHANNEL ION IMPLANT TECHNOLOGY

GENERAL INSTRUMENT CORPORATION
MICROELECTRONICS



INFORMATION RETRIEVAL NUMBER 47

Beware those FET op-amp specs!

Though this type of IC amplifier excels in low bias currents, self-heating and nulling effects can alter the other specs.

Integrated circuit FET-input op amps have become the preferred choice in applications calling for very low input-bias currents. Bipolar amplifiers just can't compete with the picoampere and even sub-picoampere bias levels offered by the FETs. But it takes a bit of doing to pick the right FET op amp.

Data sheets abound with misleading and omitted specifications, making evaluation and selection a tough nut. Scratch the surface, and you'll find facts like these:

- The offset voltages of FET op amps—typically higher than those for bipolar types—become much higher as the chip warms up to its equilibrium temperature. But most FET op-amp specs, including bias currents, are likely to change with increases in temperature and time. And don't bother to check the data sheet for worst-case warmed-up values; they often won't be there.

- Nulling out a FET's offset via the designated null terminals—internal nulling—can actually destroy the balance, or match, designed into the circuit. As a result, several significant input parameters can deteriorate severely. Because of this, few data sheets give complete specifications for a nulled FET amplifier.

- The data sheets for IC FET op amps are often based on high-speed automated measurements, in which many tests are performed in less than a second. This fast testing sequence allows for little self-heating of the circuit. Hence wide differences will exist between the spec that you see on the data sheet and the one that you measure during your own bench tests.

These and other problems can be overcome by careful analysis of capabilities and limitations. Let's begin with a closer look at the effects of self-heating.

The mechanism for offset-voltage warmup in a FET op amp resembles closely that of a bipolar unit. In both cases, offset changes following turn-on can be found directly from multiplication of

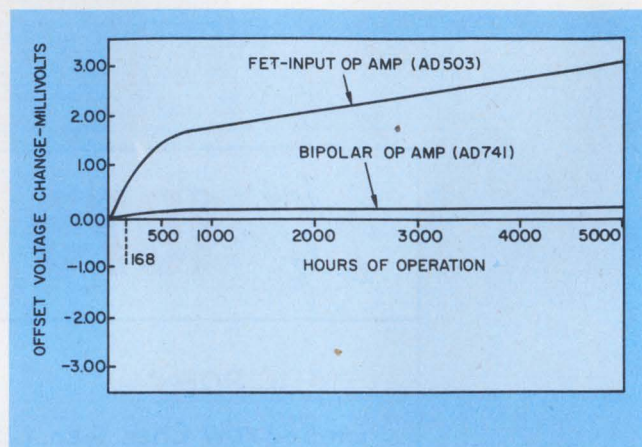

1. A typical FET op amp exhibits a greater change in offset voltage with time than a corresponding bipolar amplifier does. The model numbers refer to Analog Devices products.

the chip's temperature rise and the unit's temperature coefficient (usually in $\mu\text{V}/^\circ\text{C}$). Temperature gradients on the chip cause a second-order effect that often can be neglected.

A FET-input op amp has a greater warmup offset increase than an equivalent bipolar amplifier for three reasons:

1. The temperature coefficient of a FET amp often significantly exceeds that of a bipolar unit.
2. Typically more supply current is required for a FET-input op amp than a corresponding bipolar type.
3. A high-performance FET amp sometimes consists of two chips on a substrate. While the package may be the same as that for the bipolar, the substrate increases thermal resistance and contributes to the chip's temperature rise.

These factors combine to produce warmup offset-voltage changes as high as several millivolts in FET amps, compared with a few tenths of a millivolt in bipolar units. A typical FET-input op amp can have offset-voltage drifts ranging from 1 to 50 $\mu\text{V}/^\circ\text{C}$; a typical warmup temperature rise of 15 to 20 C therefore results in a worst-case offset change of about 20 μV to 1 mV, respectively.

Besides having less stability with temperature, FET op amps also have less stability with time

Jerry Fishman, Product Manager, Analog Devices Semiconductor, Route 1 Industrial Park, P.O. Box 280, Norwood, MA 02062.

than their bipolar counterparts (Fig. 1). This occurs because gate-to-source voltage in a FET depends more critically on geometry than does a transistor's corresponding voltage from base-to-emitter. The latest FET op amps, however, have considerably more stability than earlier models.

Of course, other characteristics change following the warmup period. The changes tend to be larger for FET units than for bipolar because of the higher operating temperatures of FET op amps. However, certain parameters—like voltage gain and supply current—generally don't differ significantly from one type to the other.

Bias current and warmup

The bias-current warmup performance of a FET front end differs radically from that of a bipolar design. The FET op amp input current approximately equals the leakage current of a reverse-biased junction—it doubles every 10 C (Fig. 2). The bipolar device, on the other hand, derives its temperature coefficient primarily from the h_{FE} vs temperature characteristic of the input transistors. Typical variations are 0.5% to 1%/°C (Fig. 3).

From Figs. 2 and 3, note that the temperature coefficient of the FET design has an opposite polarity from that of the bipolar device. Bias current is maximum at 125 C for the FET and at -55 C for the bipolar device. Thus, while FET performance is consistently superior at low and medium temperatures, it's possible that bipolar devices may display tempcos equivalent to FETs at elevated temperatures.

However, ultra-low current IC FET op amps display such low initial bias currents that they are still superior to the best bipolar amplifiers—even at 125 C.

There are two solutions to the warmup problem. First, recognize that bias current can increase by a factor of four and offset voltage can go up many millivolts. Then specify both parameters low enough at 25 C so that they will not exceed your error budget after warmup. Or, secondly, ensure that the manufacturer is guaranteeing bias current and offset voltage *under warmed-up conditions*.

More subtly, changes in FET op-amp performance occur as a direct result of nulling at the designated null terminals. The resulting interaction between the FET-input pair, the remainder of the circuit and the package often produces a circuit that behaves very differently from an undisturbed circuit.

A similar condition exists with bipolar units. However, the changes in performance reflect the degree of unbalance. FET offset voltages extend over a larger range, so that correspondingly

larger disturbances in the input-circuit balance are needed for nulling.

Several feedback mechanisms combine to produce the altered characteristics. Standard nulling creates these feedback problems: thermal, inter-stage common-mode and—the most common—positive or negative output-stage on either supply rail.

In a standard two-stage op amp, for example, parasitic resistance on the negative power supply alters the initial unbalance created by nulling.

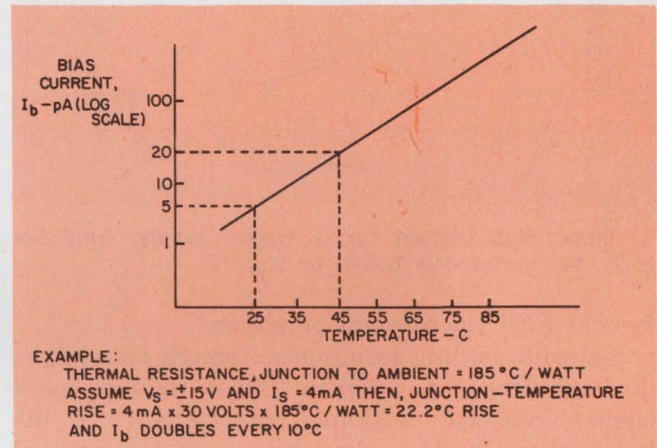

2. The warmup period can drastically alter bias current in a FET op amp (AD 540). This example reveals a doubling of bias every 10 C, and maximum bias levels are reached at maximum temperatures.

The disturbance, in turn, causes a reduction in open-loop gain, as well as CMRR and PSRR. Thus, when you use internal nulling, ask the manufacturer for the key specs with the device already nulled. You will then know the worst-case spec under normal device operation.

When you null at the manufacturer's suggested null terminals, you may drastically degrade the temperature coefficient of the offset voltage (Fig. 4). And the greatest changes in tempco characteristics occur when the nulling technique disturbs the FET's operating currents.

Despite this problem, many commercially available FET amps use this nulling technique. The technique can introduce as much as 25 $\mu V/°C$ for each millivolt of offset nulled. A 50-mV trim, for example, could result in 1.25 mV/°C of additional drift.

Logically, the FET null function should be performed in a stage that is buffered from the FET currents. FET amps that employ this approach typically vary the stored offset voltages in a second-stage pnp transistor pair. This technique uses the pair's zener-stabilized current source to achieve an order-of-magnitude less drift than that obtained with the bias-current method. Fig. 5 shows the drift before and after the nulling of a

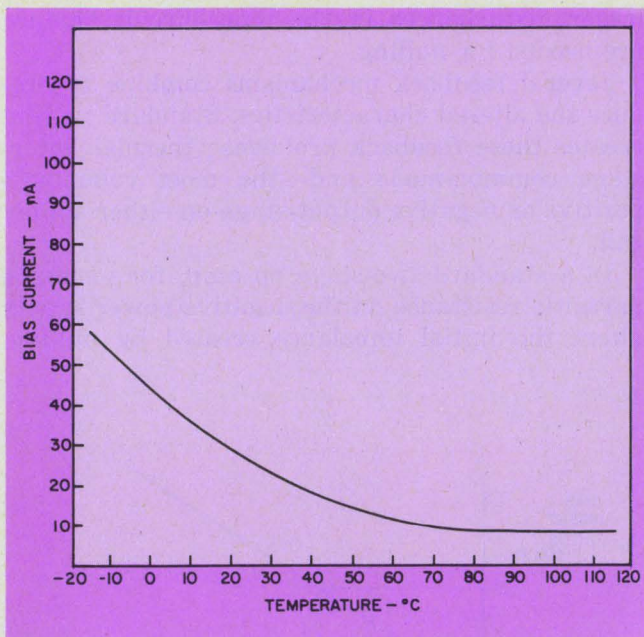

3. Input bias current for a typical bipolar amplifier (AD 741) varies only 0.5% to 1%/°C.

typical FET operational amplifier.

External nulling techniques, though not simple, do overcome the problem. They require more components than a simple potentiometer at the null terminals—the only requirement for internal nulling. But with external nulling, the circuit retains its internal balance, and input characteristics undergo minimal deterioration.

Testing entails other tradeoffs

Unlike modules, which are tested by relatively slow techniques, ICs employ a high-speed, computerized test system. The difference stems from the large price gap between average modules and typical, lower-priced ICs.

But automatic systems don't always test characteristics that may change after the chip warms up or after an IC amplifier has been nulled. If they did, increased testing time and labor could heighten IC costs.

The limitations of high-speed testing are especially troublesome for FET op amps, whose characteristics vary sharply after warmup and nulling. Also, the bias currents to be measured may be as much as four orders of magnitude lower than those for corresponding bipolar circuits. Moreover the slow charging rates associated with FET bias currents can increase testing time still further.

Obviously the only sure way to specify warmup parameters is to allow the amplifier to settle fully at its equilibrium temperature and then perform the measurements. But some manufacturers do not test in this way. And the most you can expect from many data sheets is a list of initial, unwarmed values of key specifications,

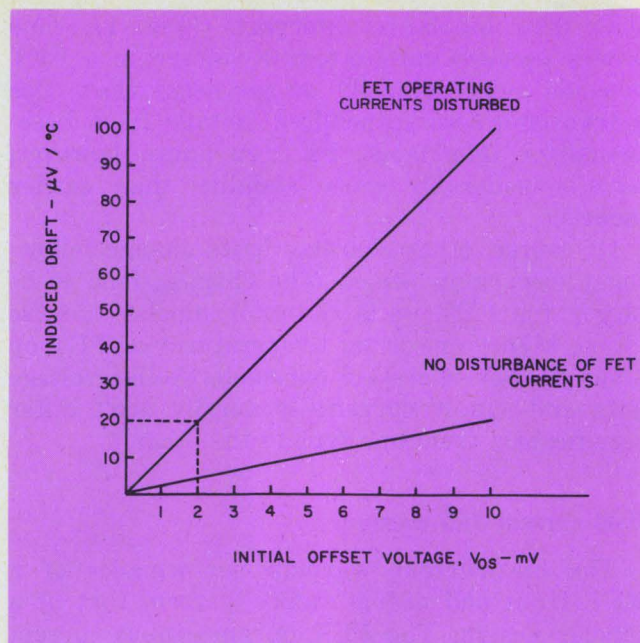

4. Internal nulling results in a severe disturbance of FET operating currents, as in this typical example.

such as bias current and offset voltage.

An automated extrapolation technique is sometimes used to specify bias-current maximum values over the temperature range. In this case bias current is measured at the highest rated temperature. Extrapolation of the data to other temperatures yields bias ratings. The technique has proved accurate for bias levels down to just below 5 pA. However, for currents below about 1/4 to 1 pA, manual testing at several discrete temperatures must be performed. This accounts for the increased cost of very-low-bias amplifiers.

In the functional testing of thin-film FET op amps, it's possible to obtain automatically the warmed-up characteristics of a nulled circuit. A special subroutine nulls the op amp, remembers the values of resistor-null settings and offset voltage and resets these values at a higher temperature. Only then does the automated system proceed to calculate drift and perform the necessary trimming. The procedure adds only milliseconds to the over-all test time.

Similarly drift tests can be performed with the amplifier nulled to zero via its own null terminals. Thus the additional introduction of drift can be accounted for in the specification. However, gain at all temperatures must be measured under nulled conditions. If the data sheet doesn't state this condition, you can't be sure worst-case values are really given.

Traditionally the noise of FET op amps has been much higher than that of bipolar amplifiers. But the increased noise has developed more from popular internal designs and applications than from any inherent problem.

Early FET op-amp design raised second-stage

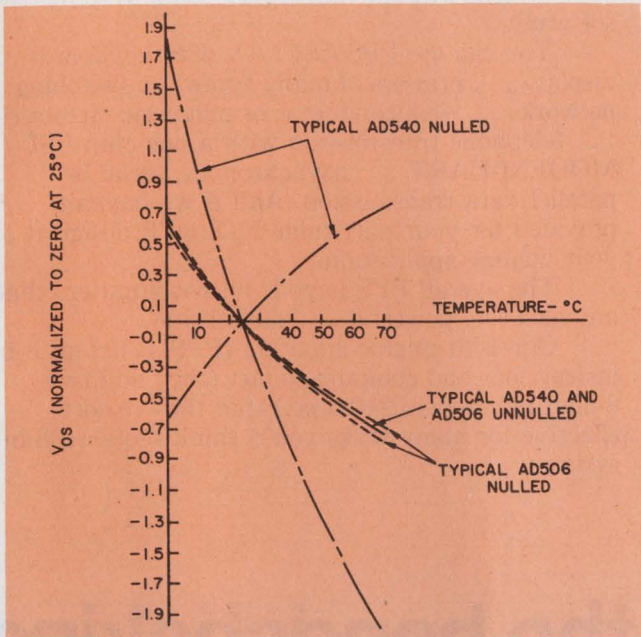

5. Nulling alters the offset-voltage drift of a FET-input op amp (AD 540).

currents to achieve increased slew rates while retaining ultra-low input currents. Thus FET op-amp slew rates have been typically an order of magnitude faster than those of general-purpose bipolar op amps.

However, increased second-stage currents have increased noise, and typical FET-amplifier applications have heightened noise further. Circuit designers often reduce amplifier gain to allow for compensations with a 30-pF capacitor and to reduce second-stage conductance. However, a conductance decrease means an increase in resistance. Since the stored voltage across the resistors has a noise source, over-all circuit noise increases.

The newer FET op amps are using different internal designs to achieve low noise. For example, a recent version has a guaranteed maximum noise level of 5 μ V, pk-pk—a spec that's comparable to that of bipolar op amps.

Besides noise, input currents might cause circuit problems when they vary significantly with power-supply common-mode voltages. To prevent this and to reduce subsequent testing problems, circuit designers use bootstrapping techniques.

With bootstrapping, the voltage across the FET input remains relatively constant as long as the op amp operates in its linear range, regardless of the common-mode or power-supply voltage. However, several available FET op amps maintain flat input current, despite voltage variations.

And don't forget that a lowering of the power-supply voltage linearly reduces power dissipation. The reduction directly reduces the temperature rise of the chip. Since input-current variations depend exponentially on chip temperature, input current can be slashed. ■■

With HEATH STRIP CHART RECORDERS you don't pay extra for the extras.

When you buy one of our strip chart recorders, you get standard features that are strictly extra-cost options with other manufacturers. Features like multiple input spans as low as 1 mV full scale... multiple chart speeds using a precision digital chart drive... precision multiple span offset... remote control capability for all recorder functions... fast, easy paper loading... and many more. One look at the recorders below and you'll be convinced the best buys in strip chart recorders come from Heath/Schlumberger.

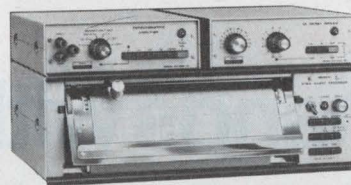

Our research-quality EU-205B Recorder System provides true potentiometric input on 9 spans from 1 mV to 500 mV full scale... 10-megohm impedance on 9 spans from 1 to 500 V full scale... 15 precise scales of suppression,

positive or negative, with 0.1% accuracy... 23 digitally-controlled chart speeds from 30 in/min to 0.2 in/hr... complete remote programmability by external logic signals or contact closures. Just \$795*.

The SR-201A is a versatile recorder for low budgets featuring 10 mV input, 1 second balance time and easy operation... digital chart drive circuits... 12 chart speeds from 5 sec/in to 200 min/in... high input impedance to prevent circuit loading... 130 dB common mode rejection... disposable pen... gearless servo drive system for quiet operation. All for only \$255*, assembled and calibrated.

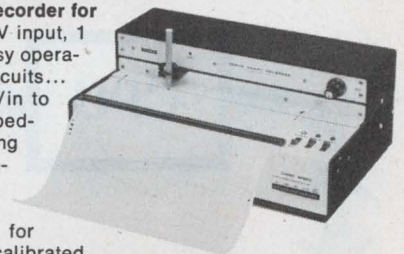

Our best recorder value... the SR-255B. It offers a full 10-inch chart width... pushbutton selection of 10 mV, 100 mV, 1 V, and 10 V full scale spans with variable control for expansion to 100 V full scale... 10

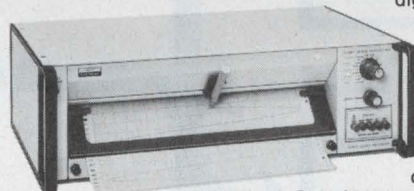

digitally-derived chart speeds from 10 to 0.01 in/min with accuracy to 0.5% or better... floating input with better than 10 megohms impedance to minimize source loading... complete remote control capability of all functions is standard. Only \$365*, calibrated and ready for use.

The latest Heath/Schlumberger Assembled Instruments Catalog has complete specs for all of the above recorders, along with many other high performance, low cost instruments for research, design and teaching applications. Send for your free copy today.



Heath/Schlumberger Instruments
Dept. 511-01
Benton Harbor, Michigan 49022

HEATH
Schlumberger

Please send my free Heath/Schlumberger Assembled Instruments catalog.

Name _____

Title _____

Company/Institution _____

Address _____

City _____ State _____ Zip _____

*Mail order prices; F.O.B. factory.
Prices & specifications subject to change without notice.

EK-440

Rockwell Parallel Processing Systems (PPS) are more than CPU-ROM-RAM microprocessors. They're full-fledged microcomputers—with 12 LSI I/O controller options that not only shake hands with your peripherals, but introduce a lot of advantages in the process.

Example: With so many LSI I/Os to perform the complex but absolutely necessary functions of interfacing with or controlling peripherals, you need fewer circuits. And that saves you design time. Lets you use fewer parts per system. Lowers your design costs. And your production costs.

What's more, we've system-designed our LSI I/O controllers. They're intelligent controllers. You use the CPU to solve problems, not service peripherals. Result: easy software generation. And you can add or change I/Os to expand or modify

your system without redoing the total system software.

You can use PPS LSI I/Os with keyboards . . . displays . . . printers of many types . . . switching networks . . . semiconductor or magnetic memories . . . telephone transmission with a one-chip LSI MODEM-UART . . . asynchronous, serial or parallel data transmission. And if we haven't provided for your particular I/O, we'll design it for your volume application.

The overall PPS payoff: microcomputers that are versatile, powerful . . . and thrifty.

Our 4-bit microcomputers (PPS-4) accept 8-bit instructions and compute so fast (they add two 8-digit numbers in 240 usec.) that they're cost effective for many tasks you'd think required 8-bit systems.

Shake hands with the handshaking

(12 LSI I/Os are ready to shake)

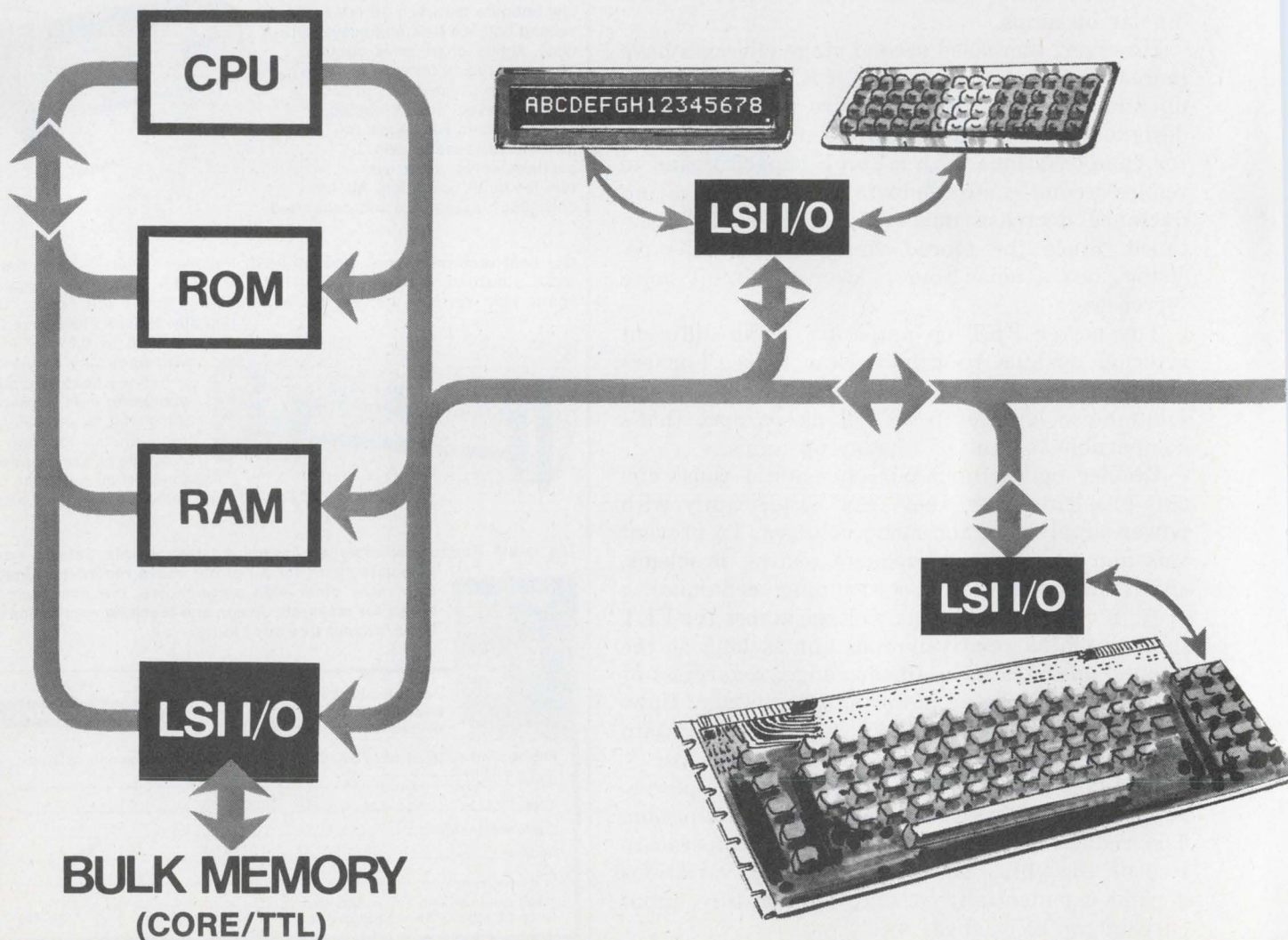

Availability? We're producing PPS-4 circuits in volume. (More than 225,000 PPS-4 microcomputer circuit sets have been delivered.) Design aids? Everything you need is waiting for your call—wherever you are in the world.

System compatible with our PPS-4 are our new 8-bit microcomputer circuits. (All PPS-4 I/Os are directly applicable.) PPS-8 software is complete. You can begin now defining your PPS-8 microcomputer, using our assembler-simulator design aids to take advantage of its 90 instructions.

Because we offer so many microcomputer options, we've streamlined our get-acquainted procedure. We now have a new brochure that tells you in minutes the data sheets you want for your application. To get your copy, phone (714) 632-3729, or TWX or TELEX (910) 591-1179,

or write: R. F. Voigt, PPS Marketing Services, Microelectronic Device Division, Rockwell International, P.O. Box 3669, Anaheim, CA 92803. Or circle the Reader Service Number below.

Ask now for a private PPS demonstration during National Computer Conference, Anaheim; or Paris Components Show, France; or Hannover Fair, Germany; or Tokyo Business Equipment Show, Japan.



Rockwell International

...where science gets down to business

INFORMATION RETRIEVAL NUMBER 50

experts: our PPS Microcomputers.

hands with your peripherals.)

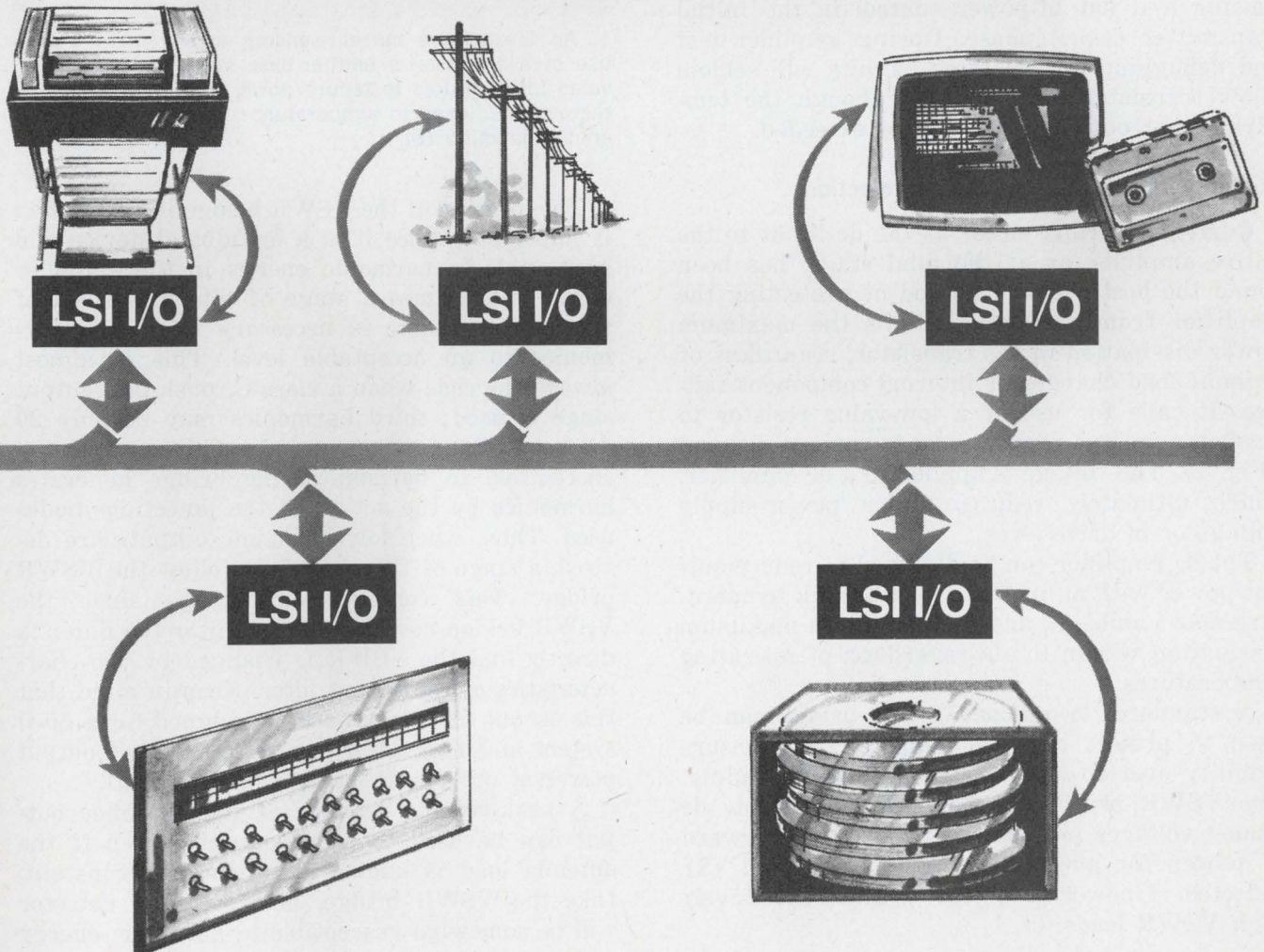

Stop burnout in rf power amplifiers.

Sense the current, temperature, VSWR, or peak voltage.

Control the drive level or the collector voltage.

Solid-state amplifiers have brought vast improvements to high-frequency, high-power commercial and military transmitter equipment. But an old problem persists: transistor failure in the driver and output stages.

To minimize transistor burnout caused by input-level variations, antenna load shifting or VSWR changes, overload sensing circuits must be included in the design. Once adequate sensing is provided, output power control arrangements can be added to protect the transistors.

There's an added bonus for including overload sensing and output-power control in the initial transmitter design phase. During amplifier test and debugging stages, these circuits will seldom allow transistor burnout, even though the temperature or output levels may be exceeded.

Current limiting, the simplest protection

Current limiting, either at the dc input to the entire amplifier or at the final stage, has been found the best over-all method of protecting the amplifier from damage. It limits the maximum power dissipation in the transistor, regardless of antenna-load changes or internal component failure. It calls for use of a low-value resistor to develop a voltage proportional to current demand (Fig. 1). The voltage is applied to a dc amplifier, which ultimately reduces either power-supply voltage or rf drive level.

The dc amplifier can be designed to reduce output power with an increase in heat sink temperature above ambient, and thus maintain maximum dissipation within limits regardless of operating temperatures.

A standard, two-diode VSWR bridge can be used to protect a power amplifier and ensure stability over a wide range of antenna loading. The VSWR bridge can be used to generate dc analog voltages proportional to (1) the forward rf power for automatic level control, and (2) reflected rf power to protect against excessively high VSWR loads.

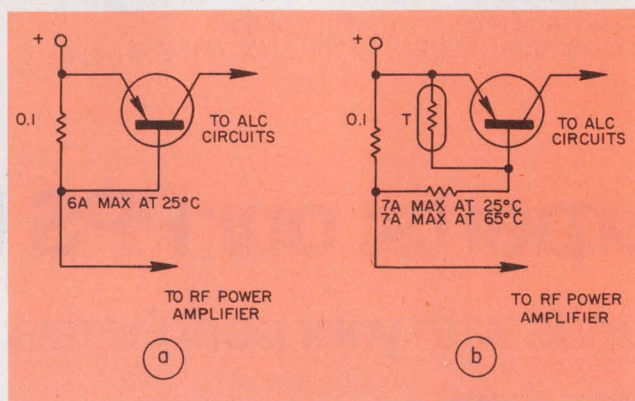

1. An inexpensive current-sensing arrangement makes use of a transistor's emitter-base voltage drop at elevated temperatures to reduce power output (a). An NTC thermistor is used to temperature-compensate the base-emitter junction (b).

The location of the VSWR bridge in the system is important, since it is a broadband device and susceptible to harmonic energy in the amplifier output. Sometimes a stage of filtering ahead of the VSWR bridge is necessary to reduce harmonics to an acceptable level. This is almost always the case when a class-C, push-pull output stage is used; third harmonics may be only 20 dB below the fundamental. In addition to being susceptible to harmonics, the bridge generates harmonics by the action of the detecting diodes used. Thus, when low harmonic outputs are desired, a stage of filtering must follow the VSWR bridge. This complicates matters, since the VSWR bridge now does not monitor the antenna directly and the VSWR is changed by the characteristics of the output filter. Keep in mind that this output filter is generally designed for a 50- Ω system and may affect operation at full output power at other antenna load impedances.

A peak-voltage detector at the amplifier output can be used to sense output power if the antenna load is known and relatively constant. Like the VSWR bridge, however, this detector will be somewhat susceptible to harmonic energy and generate harmonics of its own. The peak detector output can be applied to appropriate power-control circuits to maintain amplifier

Frederick W. Hauer, Senior Engineer, IEC Electronics Corp., East Rochester, NY 14445.

power dissipation within limits. However, it cannot operate properly under changing antenna conditions, because of the peak voltage variation caused by reflected power.

A thermostat offers another approach to reduce amplifier output power/dissipation at elevated temperatures. Because of the time lag involved (usually several minutes), the thermostat will not control transistor dissipation rapidly enough to prevent destruction in all cases. However, the thermostat can be combined with other protection schemes, such as current limiting or a VSWR bridge, to produce a virtually burnout-proof amplifier.

P-i-n diodes control drive level

A p-i-n diode, placed at the rf input to the power amplifier, can reduce the drive level to the amplifier and decrease output power. The diode can serve as a current-controlled resistor at rf frequencies. The dc control power required is relatively small, and rf resistance can be varied from over 10 k Ω to typically 1 Ω .

Normally a single p-i-n diode on the center leg of a T-pad provides enough control for most applications (Fig. 2). The series resistors on either side of the diode help to stabilize the input impedance of the amplifier and reduce the possibility of spurious oscillations, by lowering the Q of the input circuits.

If the rf resistance of the p-i-n diode is reduced sufficiently by the control current, rectification of the rf signal will occur in some applications. This is highly undesirable, not only because of the distortion introduced but also the instability produced in the control loop. As the control signal reduces the resistance of the diode, a threshold is reached where rectification occurs. This reduces the resistance of the diode further until control overshoot occurs; now the dc control signal is removed by the feedback loop, and diode resistance increases. The cycle repeats as the control signal again reduces the resistance of the diode. The frequency of oscillation depends on the response time of the control loop.

To reduce the possibility of rectification, select

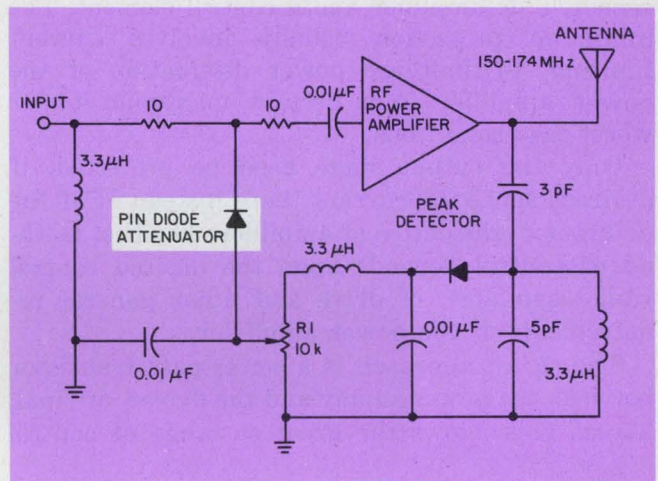

2. A p-i-n diode attenuator is driven directly from a peak-voltage detector to control the rf amplifier input level.

a p-i-n diode that has a minority carrier lifetime as great as possible. Diodes with a carrier lifetime of 1 μ s or more are useful at frequencies down to about 10 MHz. With shorter lifetimes, the diodes can be used at higher frequencies.

The p-i-n diode should be used only when limited control is required and when the dc control current can be kept low enough so the total current is below the rectification level. A very effective way to control output power involves decreasing the collector-supply voltage to one or more amplifier stages. This accomplishes two goals: (1) It reduces the gain of the amplifier stage, and (2) It allows the stage to operate in a saturated condition, resulting in high efficiency and good stability.

The power-control device is usually a power transistor placed in series with the collector-supply voltage. Experiments have shown that if the first driver stage of the rf amplifier is controlled in this way, rf instability can occur under varying supply-voltage and antenna-load conditions on the final stage. This instability usually takes the form of low-frequency oscillations at a subharmonic of the output frequency. The solution to this problem varies, depending upon the rf power-amplifier design. Generally, it involves the use of such amplifier design techniques as rf

feedback, low-frequency collector bypassing and base-impedance stabilization.

The amplifier will exhibit better stability if the final stage (or second stage of a three-stage amplifier) is controlled by reduced collector-supply voltage. With this approach, the first stages, which have the highest gain, operate at full supply voltage. The characteristics of the devices used in these stages are not shifted appreciably by changes in supply voltage and rf levels.

Sensing and control combined

A complete control loop consists of a suitable sensor, a dc amplifier and a control element. The minimum protection usually involves current limiting, to limit the power dissipation of the power amplifier to a certain maximum under worst-case conditions.

Only the output stage need be protected, if desired; sense the current there instead of at the dc input to the entire rf amplifier. The best method of control depends upon the desired control range available, rf drive and other general requirements of the power amplifier.

The safest approach is a series-pass transistor between the power supply and the driver, or final, stage. This allows the greatest range of control

with a minimum of power-amplifier difficulties. A plastic Darlington power transistor is a good choice, since it's small, inexpensive, easy to heat sink and offers high gain, thereby simplifying the design of the dc amplifier. If additional control is desired, a VSWR bridge or peak-voltage detector can be coupled to the dc amplifier.

If only limited control is desired (about 3 to 6 dB), connect a p-i-n diode to the control loop instead of using the series-pass transistor.

A low-power switch can be added easily if the sensitivity of the control loop is increased. And a thermostat or thermistor can be added to decrease rf output power to a preset level above a certain temperature. This technique is very useful in military radio designs, where complete shut-down of the equipment is not allowed.

A control circuit for a three-stage, 45-W, rf power amplifier operating in vhf land-mobile communications frequencies is shown in Fig. 3. This control loop includes current limiting, a thermostat and a peak detector at the rf output for control of high and low power output levels.

The current-limiting circuit responds to the total power-amplifier current demand. A pnp transistor is used as a threshold detector to sense the voltage drop across the 0.1- Ω resistor. At approximately 7 amps, this transistor passes a con-

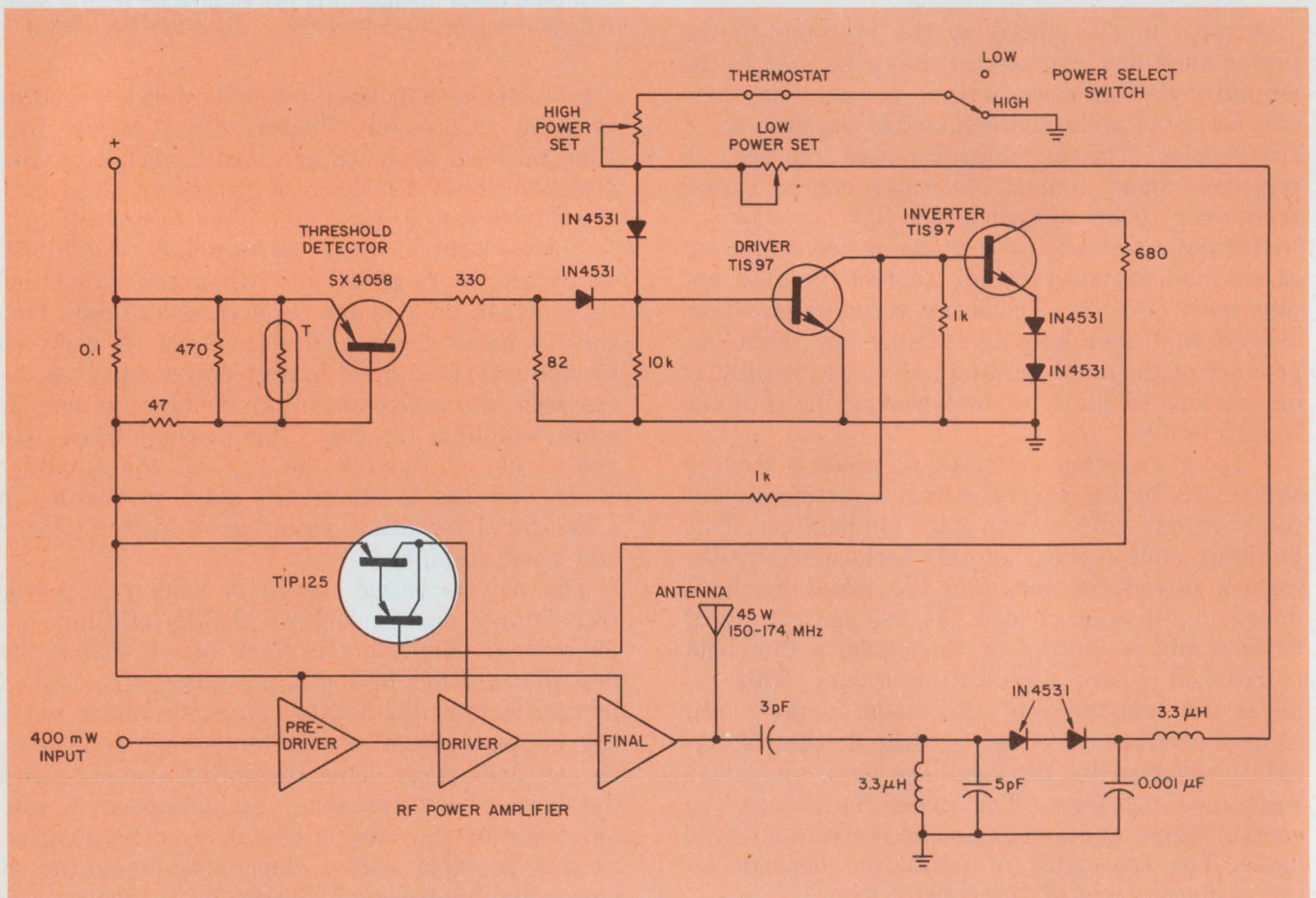

3. A power-control feedback loop is used with a 150-to-174-MHz radio that delivers 45 W of output power.

trol current to the dc amplifier. This amplifier controls the bias current to the Darlington amplifier that supplies the collector voltage for the rf power amplifier drive stage. The collector voltage for this stage is reduced to maintain total power-amplifier current at not more than 7 amps. Current is reduced, partly because of the lower current in the driver stage but mainly because the lower collector voltage results in less driver gain (as well as some clipping), and this lowers the output of the driver to the final stage. Most of the current reduction takes place in the final stage of the power amplifier.

It's not necessary to include all stages of the power amplifier in the current-limiting control loop, but it was done in this case to simplify chassis wiring. Note that the pre-driver is not protected by this design; the intent here was to limit the power dissipation of the driver and final stages only.

The thermistor is used to temperature-compensate the SX4058 base-emitter junction. Select a type that allows the desired output power reduction as temperature increases. Omit this thermistor if a large roll-off in output power is needed to protect an amplifier operating very close to maximum allowable power dissipation.

The peak detector shown operates from a ca-

pacitor voltage divider, with an inductor for dc ground return. The detected rf output is supplied to the dc amplifier through a variable 10-k Ω resistor that functions as a low-power set control. Note that blocking diodes are needed to isolate the current-sensing circuit from the output-sensing circuit. A 1-k Ω variable resistor is used as a high-power set control, and it is connected, through the thermostat, to the high-low power-select switch. If the thermostat opens, the output of the rf power amplifier will be reduced to a level determined by the low-power adjustment.

The equipment will remain in the low-power mode until the thermostat cools and its contacts close. The output-power adjustment range for this circuit is approximately 15 to 45 W in the high-power mode and 0.5 to 10 W in the low-power.

Fig. 4 is a simplified schematic illustrating the application of a VSWR bridge to rf power-amplifier control. The basic approach can be used with a variety of devices capable of sensing and providing separate samples of forward power and reflected power. Separate adjustments are required for both of these detected samples.

The forward power adjustment at the VSWR bridge serves as a low-power set control in the Fig. 4 layout. The high-power adjustment is con-

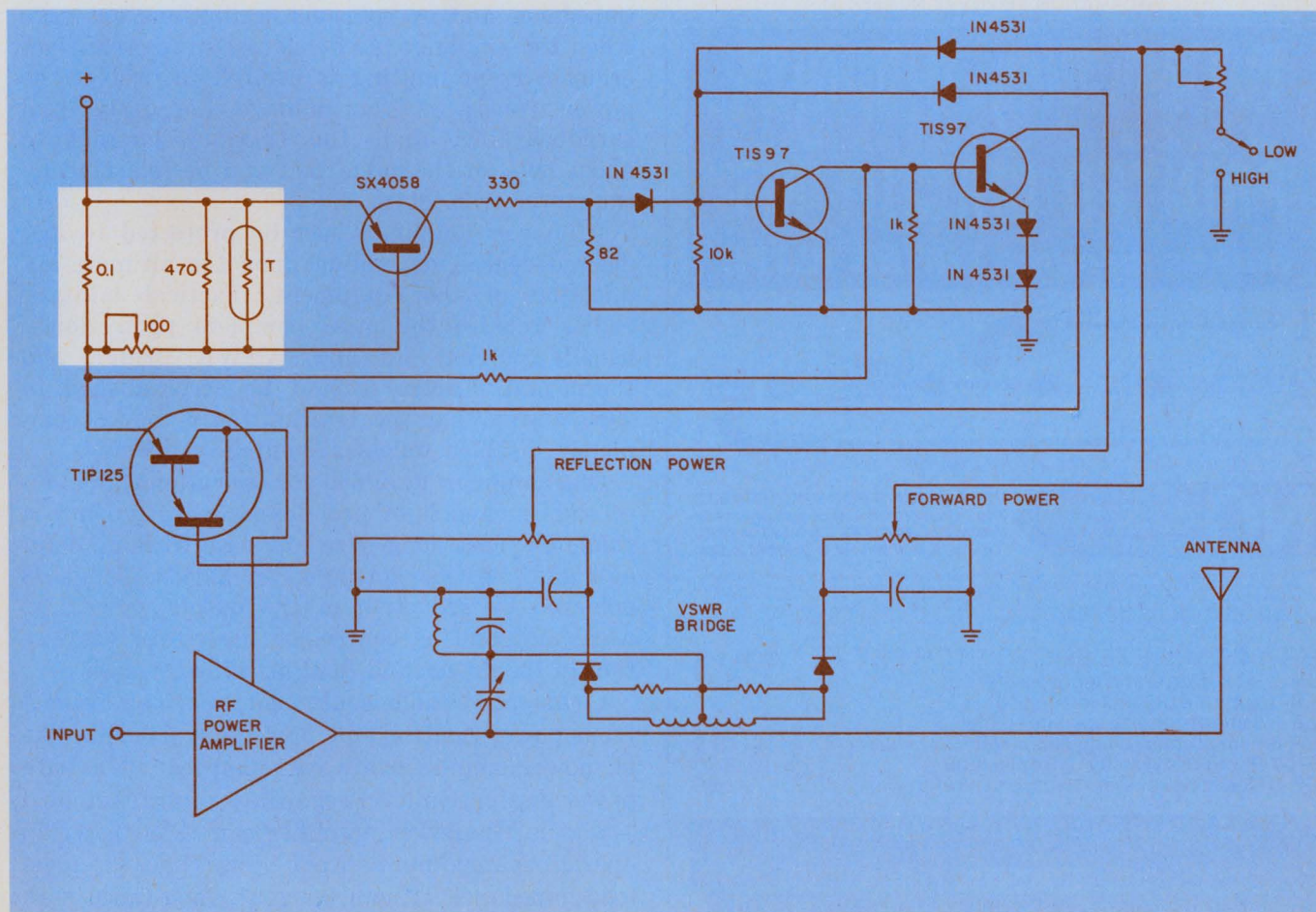

4. A VSWR bridge and current limiting are combined to sense overload and protect rf amplifier designs.

GAUSSMETERS



model 811

high accuracy
excellent repeatability
rugged

Bell gaussmeters measure magnetic field strength from .0001 gauss to 100,000 gauss. There are six gaussmeter models and 110 probe models for each gaussmeter. The resulting combinations meet the challenging requirements of all magnetic field measurement applications.

F. W. Bell has the experience and know-how to offer you the best instruments that are available. Your local representative is equipped to give you a demonstration. Use the inquiry card to find out how these instruments can benefit you.

4949 Freeway Drive East
Columbus, Ohio 43229
Phone: 614/888-7501
TWX: 810-337-2851

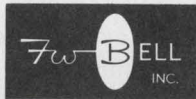

a subsidiary of Arnold Engineering

INFORMATION RETRIEVAL NUMBER 51

PHOTO ETCH™

PRINTED CIRCUIT KIT

Makes circuits THREE WAYS

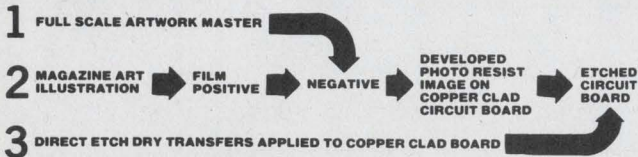

NO CAMERA DARKROOM FILM CUTTING TRACING

USES DATAK'S POS-NEG™ PROCESS
The revolutionary photographic way that makes **PERFECT** printed circuits from original art or a printed page.

KIT CONTAINS 5" x 6" steel printing frame, 4 sheets 5" x 6" photocopy film, yellow filter, chemicals for 1 pint film developer and 1 pint film fixer, 5" x 6" copper clad board, 3" x 4 1/2" copper clad board, spray can of photo etch resist, 1 pint resist developer, 2 sheets 8 1/2" x 11" layout film, 1 roll 1/16" printed circuit tape, 1 roll 1/32" printed circuit tape, 8 sheets dry transfer direct etch PC patterns including pads, transistors round can and flat pack ICs, DIP ICs, edge card connectors, lines, circles, jogs, etc. * to anhydrous ferric chloride to make 1 pint etchant, instructions.

- ER-4 COMPLETE PHOTO ETCH SET \$24.95
- ER-2 PC patterns and tapes — refill 3.39
- ER-3 1/4 pound dry etchant — refill 1.25
- ER-5 6 sheets photocopy film — refill 3.39
- ER-6 Film process chemicals — refill 1.79
- ER-7 Photo resist spray, 2.5 oz. — refill 2.95
- ER-8 Resist developer, 16 oz. can — refill 2.95

AT YOUR DISTRIBUTOR OR DIRECT

the **DATAK** corp.
65 71st St. • Guttenberg, N. J. 07093

INFORMATION RETRIEVAL NUMBER 52

nected to the high-low power switch, as in Fig. 3. The reflected power-control sample usually does not require switching for low-power operation; rf power-transistor dissipations are so low that reflected power is no longer a problem, regardless of the antenna VSWR.

Spurious oscillations should not be a serious problem either, because rf amplifier stability is generally very good at reduced power levels when the driver or final stage is controlled by the collector-supply voltage. Note the blocking diodes used in each control input to the dc amplifier. Also, note the adjustment in the current-sensing circuit—very useful to compensate for component tolerances in this threshold-detector design.

Use protection at the breadboard stage

The control and protection circuits should be designed simultaneously with the rf power-amplifier development, while the greatest design freedom is available. The amplifier, together with its control circuits, should be tested under all conditions that the radio is likely to encounter in normal operation. (The control loop can be used very effectively to protect the power amplifier during design and debugging steps.)

It is possible to design and breadboard an rf power amplifier with only one set of transistors, since failures caused by changes in antenna load impedance and by spurious oscillations are rare when the amplifier is adequately protected. Generally current limiting is enough to protect the power transistors from damage. For design and breadboarding, limit the collector current to about 80% of the value that can be tolerated by the power transistors.

Rf power amplifiers can be protected to any desired degree, depending upon the ultimate application of the equipment. Tactical military radios require the most complete protection—usually current limiting, VSWR bridge and thermostat. Control should be accomplished in such a way that the transmitter is never completely disabled unless absolutely necessary.

One amplifier, designed for operation into a 50-Ω load, is capable of broadband operation into a random-length, long-wire antenna without damage and without spurious oscillations. This is achieved by reduction of the output power, as necessary, and by control of the power dissipation in the driver and final amplifier stages.

Commercial radio equipment, too, can benefit from power control and protection, because the rf power amplifier always operates at a safe power dissipation level regardless of antenna load—that is, the power amplifier can be adjusted to operate at maximum output power into the ideal load impedance without burnout when faced with a 4:1 VSWR. ■■

The perfect video noise analyzer

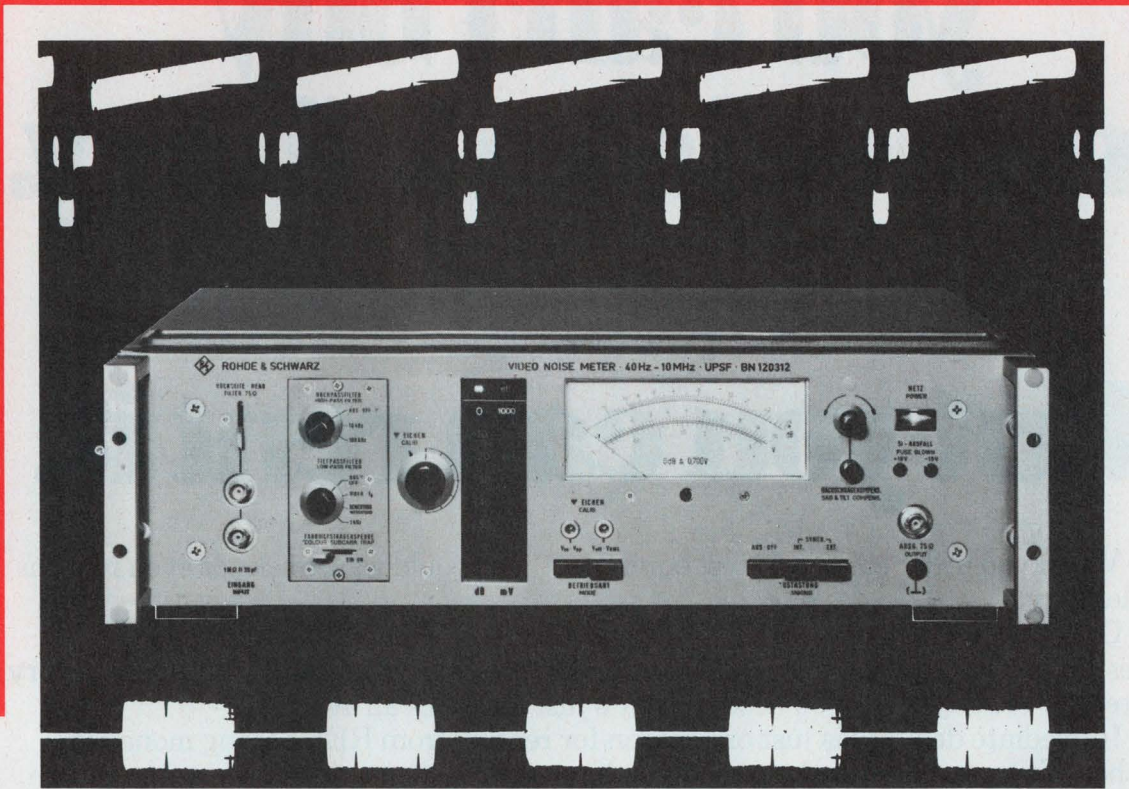

Measures and Analyzes Video Noise Accurately (0.5 dB) Video Noise Meter Type UPSF

FEATURES:

- Widespread usage and acceptance has made Type UPSF *the industry standard*; it meets requirements of all U.S. B&W and NTSC color systems.
- Measures noise voltage in presence of sync and blanking signals.
- Measures to -85 dB S/N (40 Hz-10 MHz frequency range).
- True rms measurement using solid state detector.
- Easy to read linear scale for both p-p and rms modes.
- Use for NTSC or PAL by changing plug-in filter.
- Completely solid state; drift free.
- Built-in sag and tilt compensator.
- Built-in calibrator and scope output for noise analysis.
- The UPSF can also be used as a true rms/p-p voltmeter (10 Hz - 17 MHz).

APPLICATIONS

Measure video noise voltage on:

- TV Cameras • Film Scanners • Video Tape • Video Tape Recorders • TV Transmitters • TV Receivers • TV Transposers.

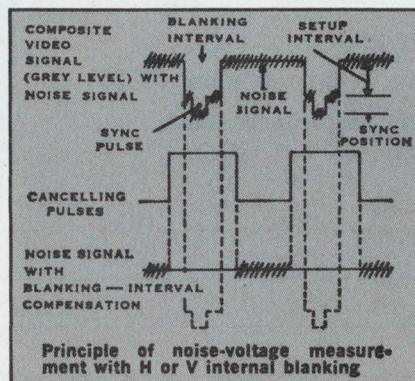

Type UPSF Video Noise Meter is designed to measure unweighted and weighted noise voltages occurring in 525-line or 625-line TV transmission systems. It measures low level components in the presence of high level horizontal or vertical sync and blanking pulses (see line drawing).

Upper waveform shows presence of noise in sync and video together with tilt. After passage through UPSF, signal is shown in lower waveform. Sync, blanking and part of video have been gated out. Remaining video shows noise without any trace of tilt.



Arrange for a demonstration. Call or write:



World Leader in Test Inst. & Communications for Over 40 Years

ROHDE & SCHWARZ

14 Gloria Lane, Fairfield, N.J. 07006 ■ (201) 575-0750 ■ Telex 133310

INFORMATION RETRIEVAL NUMBER 53

Nowadays, you can't buy immediate delivery.

But you can rent it.

When you order electronic test equipment, you could wait weeks or even months for delivery.

Or, you could rent from REI, and have what you want within hours. With the largest inventory in the business, it's a safe bet that your local REI Instant Inventory Center has exactly what you need. And it's just a phone call away.

Immediate delivery is just one reason for renting from REI. Saving money is another. You pay only for the period you have your instruments, and you can return them anytime... so you get more mileage from your equipment budget.

REI stocks 8,137 fully checked-out test instruments. And they're ready whenever you are. For the full story on renting, as well as prices, send in the coupon for prompt delivery of our free illustrated catalog. Or, call us now for your immediate requirements.

Burlington, MA (617) 273-2770 • Gaithersburg, MD (301) 948-0620 • Oakland, NJ (201) 337-3757 • Ft. Lauderdale, FL (305) 771-3500 • Des Plaines, IL (312) 827-6670 • Dallas, TX (214) 661-8082 • Mountain View, CA (415) 968-8845 • Anaheim, CA (714) 879-0561 • Rexdale, Ontario (PLC Leasing Ltd.) (416) 677-7513

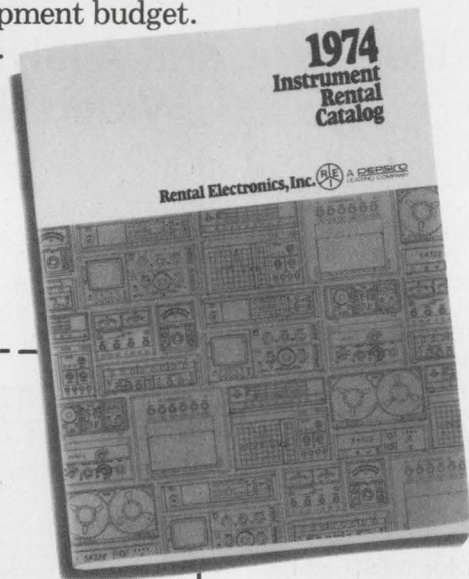

Rental Electronics, Inc.
99 Hartwell Avenue, Lexington, Mass. 02173
Please send me your free, 78-page rental
equipment catalog:

Name _____ Title _____
Company _____
Address _____
City _____ State _____ Zip _____

Rental Electronics, Inc.
A PEPSICO LEASING COMPANY



Sample and hold on a chip!

Harris' new HA-2420 gated op amp permits applications not possible before with a single device.

It heralds a whole new generation of linear IC's. It is the result of Harris' advanced linear technology that will permit creation of devices unavailable before in IC form.

Basically, the HA-2420 is a monolithic circuit consisting of a high performance op amp with its output in series with an ultra low leakage switch and a MOSFET input unity gain amplifier.

With an external holding capacitor connected to the switch

output it forms a versatile high performance sample-and-hold or track-and-hold circuit. When the switch is closed, the device functions as an op amp and any standard op amp feedback network may be connected around it to control gain, frequency response and the like. When the switch is opened, the output remains at its last level.

Without a holding capacitor the device serves as a versatile gated

output op amp for such applications as analog switches and peak holding circuits. For details see your Harris distributor or representative.

Features: (+25°C unless specified)

Input Offset Voltage	4mV (MAX)
Input Bias Current	200nA (MAX)
Slew Rate (C_H = 1000pF)	5V/μs (TYP)
Open Loop Gain	50K (TYP)
Input Voltage Range	± 10V (MIN)
Output Voltage Swing	± 10V (MIN)
Output Impedance	5ohms (TYP)
Drift Current on C_H (+125°C)	.5nA (TYP)
Acquisition time (C_H = 1000pF)	4 μs (TYP) to 0.1% of final value
Control Input	TTL Compatible: [L sample H hold
Aperture time	50 ns (TYP)
	100-999 units
HA-2425 0°C to +75°C	\$14.85
HA-2420 -55°C to +125°C	\$29.70
Hermetic 14 pin DIP package	

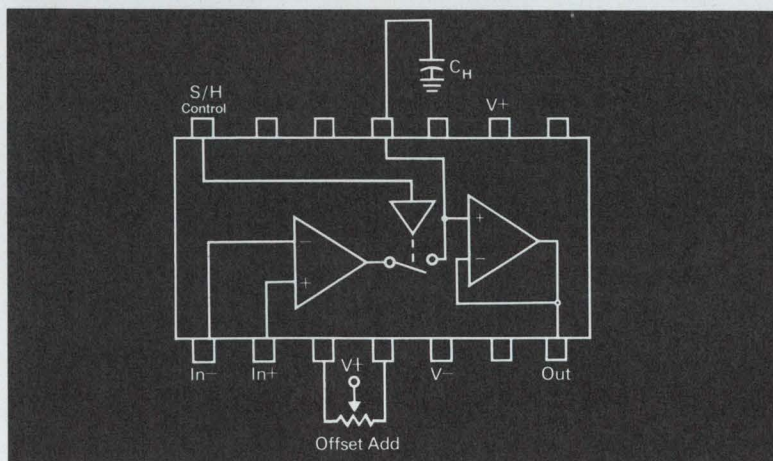

HARRIS
SEMICONDUCTOR
A DIVISION OF HARRIS CORPORATION

P.O. Box 883, Melbourne, Florida 32901 (305) 727-5430

WHERE TO BUY THEM: OEM SALES OFFICES: ARIZONA: Scottsdale, (602) 946-3556 **CALIFORNIA:** Long Beach, (213) 426-7687; Palo Alto, (415) 964-6443 **FLORIDA:** Melbourne, (305) 727-5826 **ILLINOIS:** Schaumburg, (312) 894-8824 **MASSACHUSETTS:** Wellesley Hills, (617) 237-5430 **MINNESOTA:** Burnsville, (612) 432-6111 **NEW YORK:** Endwell, (607) 754-5464; Melville, L.I., (516) 249-4500 **OHIO:** Dayton, (513) 226-0636 **PENNSYLVANIA:** Wayne, (215) 687-6680 **TEXAS:** Richardson, (214) 231-9031.

SALES REPRESENTATIVES: CALIFORNIA: San Diego, (714) 279-7961 **COLORADO:** Denver, (303) 771-4920 **KANSAS:** Olathe, (913) 782-1177 **MARYLAND:** Randallstown, (301) 922-1248 **NORTH CAROLINA:** Raleigh, (919) 828-0575 **NEW YORK:** Buffalo, (716) 633-7970 **OREGON:** Beaverton, (503) 643-1644 **TENNESSEE:** Shelbyville, (615) 684-4544 **VIRGINIA:** Falls Church, (703) 534-1673; Troutville, (703) 345-3283; Virginia Beach, (804) 481-7200 **WASHINGTON:** Bellevue, (206) 454-0300.

ideas for design

Circuit eliminates switch bounce in keyboards and gives latched output

A one-shot eliminates switch bounce in a keyboard circuit. The circuit uses 10 single-pole, normally open switches connected with pull-up resistors, A₁, to a priority-encoder IC and a one-shot, IC₅.

When a keyboard switch is depressed, the 74147 priority encoder converts the input to an inverted BCD output. At the same time the one-shot generates a pulse whose duration is set by R and C to exceed the duration of any switch bounce.

The 74175 is a quad, positive-edge-triggered

latch that transfers the information at the end of the one-shot pulse. The latch provides both normal and complemented BCD outputs.

The priority encoder serves a dual function: conversion of the 10-digit input to BCD and protection against problems that result from the depression of more than one key at a time.

James deHaan, Design Engineer, Barber Colman Co., Park Plant, 1354 Clifford Ave., Rockford, IL 61111 (formerly with MGD Graphic Systems).

CIRCLE No. 311

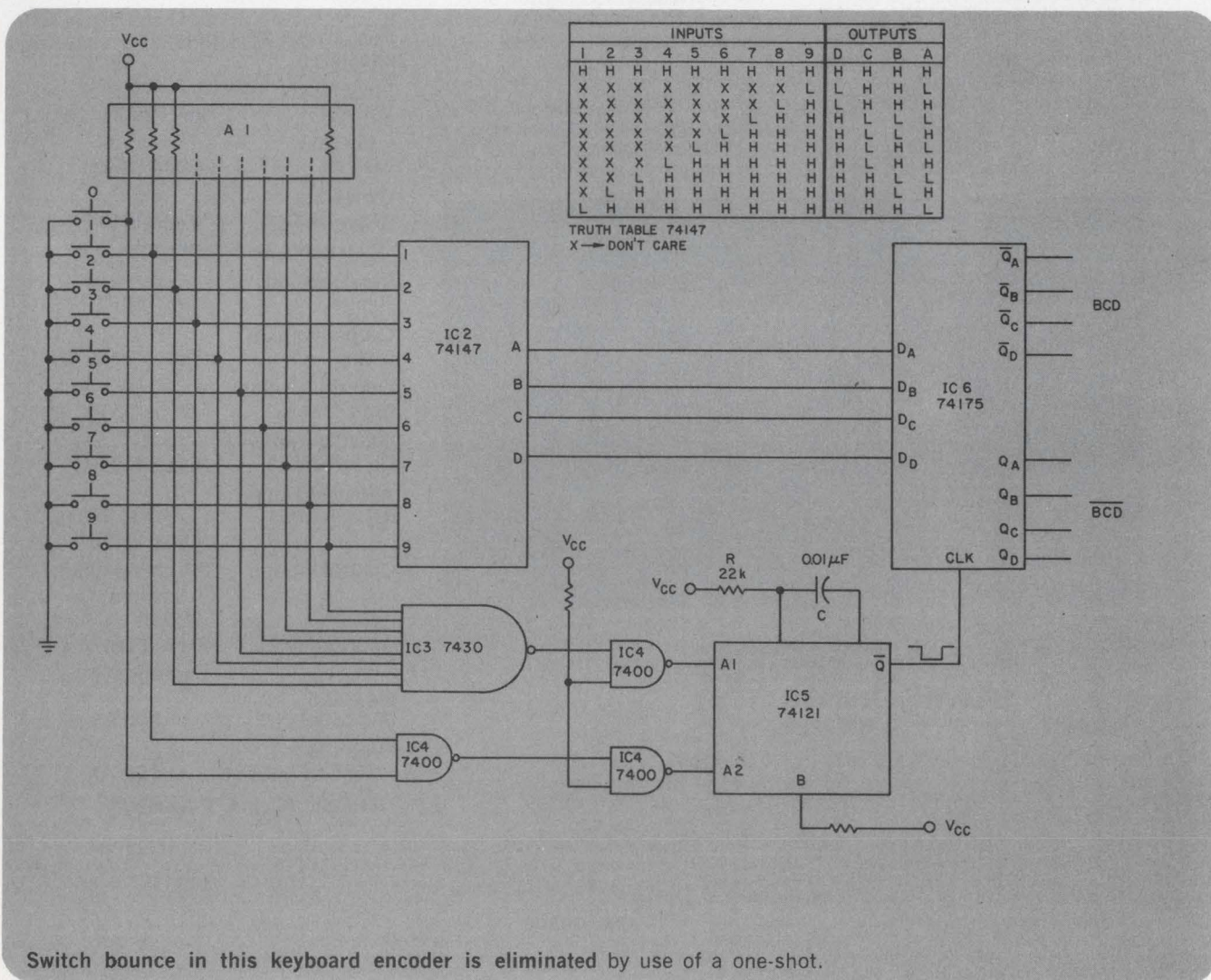

The reader that can stay on, and on, and on. The 603.

The price of the Model 603 V-O-M is only \$173.

The one V-O-M you can forget about forgetting to turn off. The incredible Model 603 FET V-O-M with exclusive Triplet Micro-Power™ draws only 10 μ A, can stay on indefinitely without impairing performance. Ideal wherever frequent test changes, interruptions, distractions—or gremlins—keep your V-O-M working when you're not.

Truly outstanding features:

1. Exclusive Triplet Micro-Power (TMP™) provides battery life in excess of a year for carbon batteries with unit left on continuously 24-hours a day.
2. Low-Power Ohms (LP Ω ™)—6 ranges with 70 mV power source for in-circuit measurements without damage to components.
3. FET V-O-M with Patented Auto-Polarity—convenient and time-saving, always reads up scale.

Accurately measures electric and electronic circuits on production lines, in quality testing, during maintenance, in service shops and on calls, in the laboratory or classroom, in the field.

One range selector switch operates the unit. One probe handles all functions—AC, DC, MA, Ohms—and a simplified scale utilizes only 4 arcs for all 44 ranges. The Low Power Ohm circuit permits fast circuit measurements without biasing semiconductor device junctions. The

Model 603 also has a unique, Patented Auto-Polarity circuit: push a button, measure either plus or minus voltages without switching leads. Make very fast voltage checks where polarity is known or doesn't matter.

For more information or a free demonstration, call your Triplet distributor or sales representative.

For the name of the representative nearest you, dial toll free (800) 645-9200. New York State, call collect (516) 294-0990. Triplet Corporation, Bluffton, Ohio 45817.

TRIPLETT
ALL YOU'LL EVER NEED IN V-O-M's.

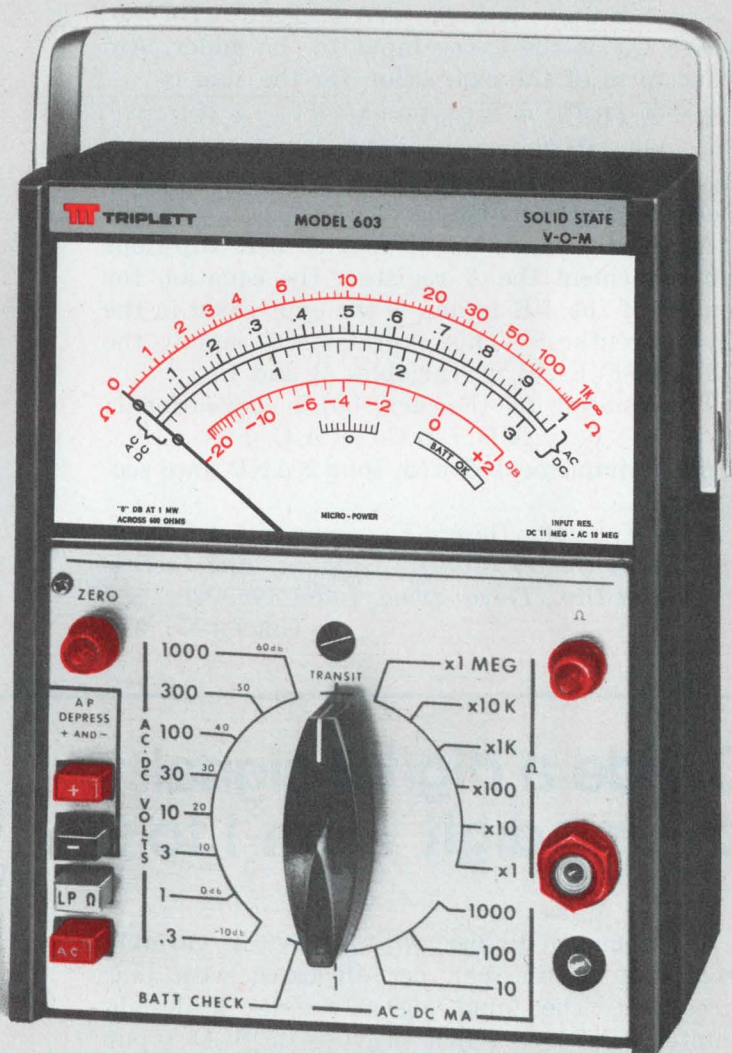

Triplet. The easy readers.

Add-to-accumulator circuit uses a minimum of external hardware

You needn't build a full adder for a digital application that requires the augmentation of a register, A, by the contents of a second register, B (see Fig. a). A pair of two-input NAND quads suffices, if toggled J-K flip-flops are used for the A register (Fig. b).

The sum for a conventional three-input, two-output adder with binary inputs A and B is $S = \bar{A} B \bar{C}_{IN} + \bar{A} \bar{B} C_{IN} + A \bar{B} \bar{C}_{IN} + A B C_{IN}$, where C_{IN} is the carry input to the adder. Another form of the expression for the sum is

$$S = \bar{A} (B \bar{C}_{IN} + \bar{B} C_{IN}) + A (\bar{B} \bar{C}_{IN} + \bar{B} C_{IN}).$$

The value of the sum is either \bar{A} or A, depending on whether the expression in the first parenthesis is ONE or ZERO.

A register made up of toggled J-K flip-flops can implement the A register; the equation for control of the J-K inputs is the expression in the first parenthesis. This expression is simply the EXCLUSIVE-OR of variables B and C_{IN} .

The equation for the carry-out is conventional:

$$C_0 = A B + B C_{IN} + A C_{IN},$$

which is implemented with four NAND gate sections.

Ajay K. Gupta, Design Engineer, Vikram Sarabhai Space Center, Control Guidance and Instrumentation Div., Trivandrum, India 695022.

CIRCLE No. 312

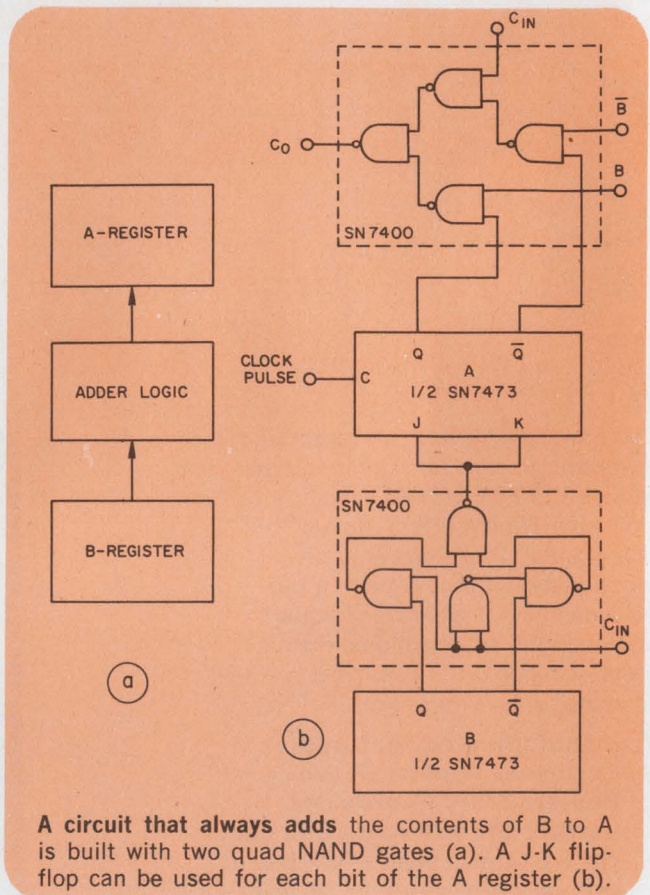

A circuit that always adds the contents of B to A is built with two quad NAND gates (a). A J-K flip-flop can be used for each bit of the A register (b).

Divide a digital signal by any digit from 1 to 9

A frequency divider with a divisor variable from one to nine can be fabricated with just three ICs. The input signal toggles a decade counter, SN7490, which provides a BCD input to an SN7442 four-to-ten-line decoder.

Any of nine possible divisors can be selected by the inputs to the SN74150 data selector. The selected output feeds back to reset the counter at the end of each count cycle. Cascade this divider with another, or with a straight binary or decade counter, and you can get many divisors.

The output pulse is approximately 60-ns wide. This width represents the propagation delay of the circuit.

Ed Woodward, Engineer, Eastern Specialty Co., 3617 N. 8th St., Philadelphia, PA 19140

CIRCLE No. 313

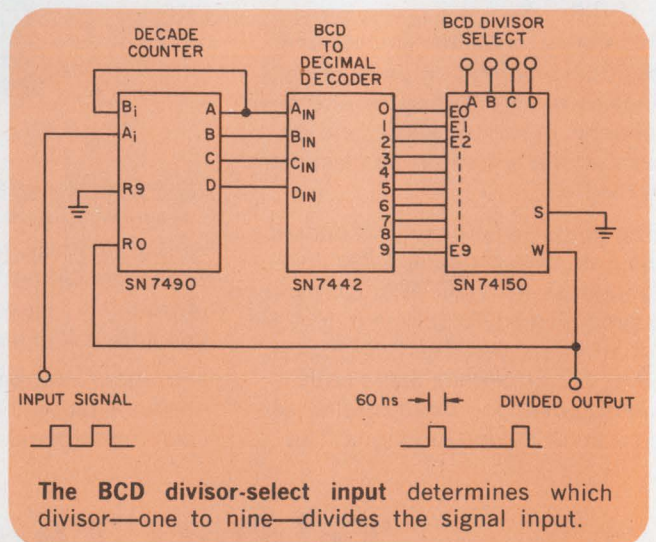

The BCD divisor-select input determines which divisor—one to nine—divides the signal input.

now...

**WHAT THIS COUNTRY
NEEDS IS A GOOD**

**5^C *Glass*
RECTIFIER***

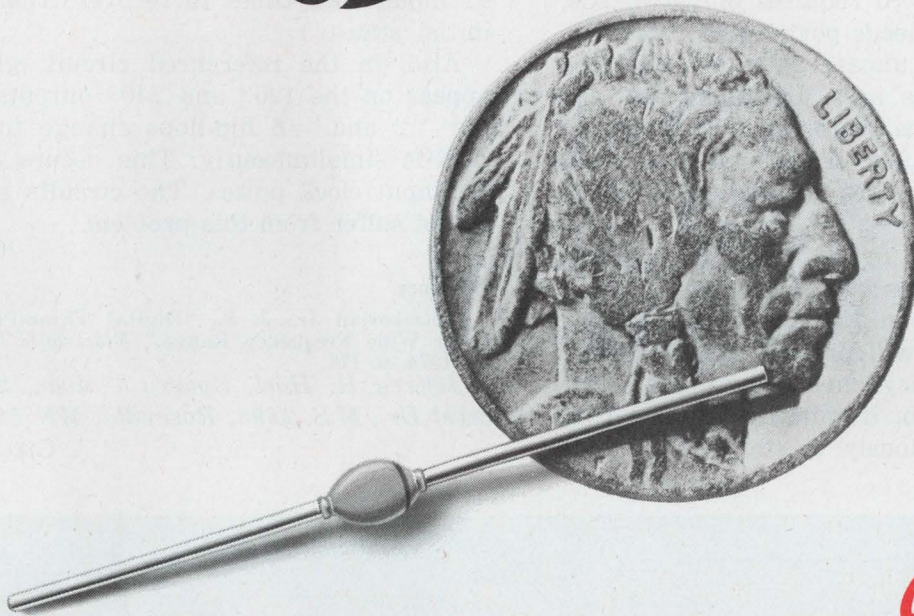

glass

HERE IT IS...GENERAL INSTRUMENT'S 1N4002

FEATURES

- High temperature metallurgically bonded—no compression contacts as found in diode-constructed rectifiers
- 1 ampere operation @ $T_A = 75^\circ\text{C}$ with no thermal runaway
- 30 to 40 ampere surge capability
- Patented glass passivated, voidless, hermetically sealed package
- 300°C storage with no degradation
- Available in 1N4001 thru 1N4007, PIV 50—1000V, typical I_s less than 1 μA
- Exceeds environmental standards of MIL—STD—19500/228

***Conditions of Sale**

Minimum Order Quantity : 50,000 units scheduled within 60 days
Minimum Delivery : Minimum Shipment 25,000 pcs.
Packing : Bulk Packing, 1000 unit/box
Marking : Cathode Band, 4002
AQL : 1%
Specifications : per EIA

For complete information write: General Instrument Corporation, Dept. G, 600 West John Street, Hicksville, N.Y. 11802, or call, in New York: 516-733-3333; in Chicago: 312-338-9200; in Los Angeles: 213-781-0489. In Canada, call or write: General Instrument Canada, Ltd., 61 Industry Street, Toronto 337, Ontario, Canada, Tel: 416-763-4133. In Europe, write: General Instrument Europe S.P.A., Piazza Amendola 9, 20149 Milano, Italy. In Germany, General Instrument Deutschland, Neumarkter Strasse 61, 8-Munich 80, West Germany. In France, 11/13 Rue Gandon, 75 Paris 13e France. In the U.K., write General Instrument (U.K.) Ltd., Cock Lane, High Wycombe, Buckinghamshire, England. In the Far East, write General Instrument of Taiwan Ltd., P.O. Box 22226, Taipei, Taiwan. In Japan, General Instrument International Co. Ltd., Fukide Building No. 17 Shiba Fukide-Cho, Minato-Ku, Tokyo 106, Japan.

**GENERAL INSTRUMENT CORPORATION
SEMICONDUCTOR COMPONENTS**



Simplified three-phase generator has improved characteristics

Three-phase timing signals can be implemented with very simple circuits (Figs. 1a and 1b). Both circuits shown are three-stage Johnson counters. They differ only in the mechanism used for recovering from initial unwanted states.

The circuit in Fig. 1b requires only two ICs, while that in Fig. 1a needs portions of three ICs. In applications where unused gates and flip-flops can be used elsewhere in a digital system, the triple-IC design may be preferred. These circuits are much simpler than a previous Idea for Design circuit, which requires approximately seven ICs.¹

Both circuits in the figure count through the following cycle of states: 000, 100, 110, 111, 011 and 001. The circuit in Fig. 1a, if initially in unwanted state, 010, will proceed synchronously to state 101 and then asynchronously to state 111. The circuit in Fig. 1b, if initially in state 010, will proceed synchronously to state 001, and if

initially in state 101, it will proceed synchronously to state 110.

Thus both circuits will recover from unwanted initial states within one input clock time. On the other hand, the referenced circuit requires up to 11 input clock times to recover from unwanted initial states.

Also, in the referenced circuit, glitches can appear on the 120° and 240° outputs whenever the ÷2 and ÷6 flip-flops change to ONEs or ZEROs simultaneously. This occurs once every six input clock pulses. The circuits shown here do not suffer from this problem.

Reference

1. Krikorian Jr., J. S., "Digital Three-Phase Signals Cover Wide Frequency Range," *Electronic Design*, Sept. 13, 1974, p. 178.

Jeffrey H. Hoel, Sperry Univac, 2276 Highcrest Dr., M.S. 4693, Roseville, MN 55113.

CIRCLE NO. 314

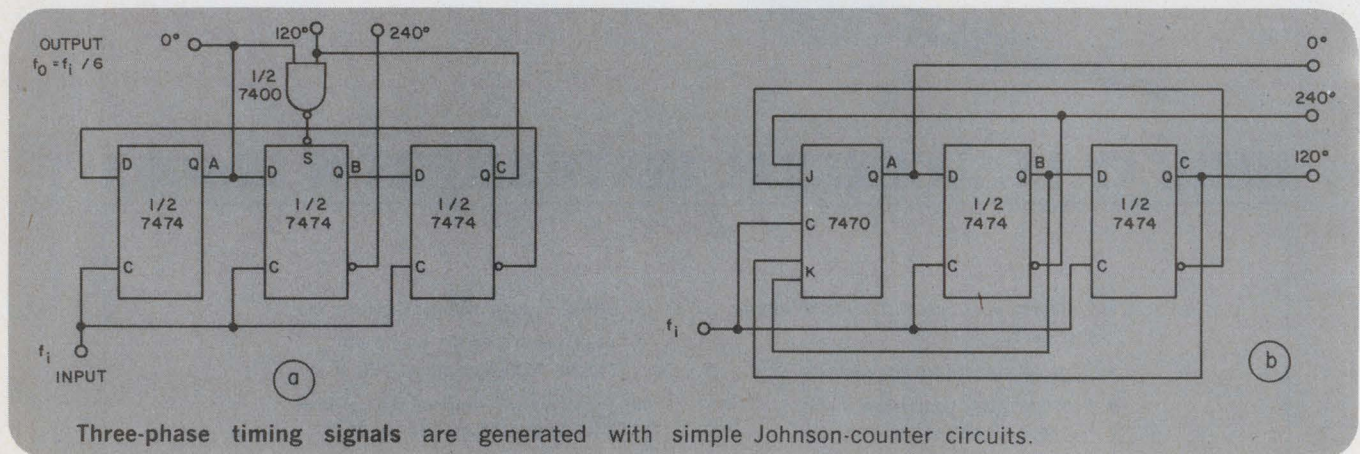

IFD Winner of September 1, 1974

Gary S. Vandeman, Associate Engineer, Burroughs Corp., 6300 Hollister Ave., Goleta, CA 93017. His idea "Programmable Frequency Multiplier Uses Octave Scaler to Simplify Programming" has been voted the Most Valuable of Issue Award.

Vote for the Best Idea in this issue by circling the number for your selection on the Information Retrieval Card at the back of this issue.

SEND US YOUR IDEAS FOR DESIGN. You may win a grand total of \$1050 (cash)! Here's how. Submit your IFD describing a new or important circuit or design technique, the clever use of a new component or test equipment, packaging tips, cost-saving ideas to our Ideas for Design editor. Ideas can only be considered for publication if they are submitted exclusively to ELECTRONIC DESIGN. You will receive \$20 for each published idea, \$30 more if it is voted best of issue by our readers. The best-of-issue winners become eligible for the Idea of the Year award of \$1000.

ELECTRONIC DESIGN cannot assume responsibility for circuits shown nor represent freedom from patent infringement.

±15 VOLT POWER MINI'S FOR OP AMPS



ALL MODELS U.L. RECOGNIZED

PC-BOARD MOUNTING

OUTPUT CURRENT MA	SIZE INCHES	PRICE	MODEL
25	2.3 x 1.8 x 1.00	\$24	D15-03
50	2.3 x 1.8 x 1.00	39	D15-05
100	3.5 x 2.5 x 1.00	49	D15-10A
200	3.5 x 2.5 x 1.00	69	D15-20
300	3.5 x 2.5 x 1.25	105	D15-30
500	3.5 x 2.5 x 2.00	130	D15-50

CHASSIS MOUNTING

OUTPUT CURRENT MA	SIZE INCHES	PRICE	MODEL
100	3.5 x 2.5 x 1.38	\$55	DB15-10
150	3.5 x 2.5 x 1.38	65	DB15-15
200	3.5 x 2.5 x 1.38	75	DB15-20
300	3.5 x 2.5 x 1.63	105	DB15-30
350	3.5 x 2.5 x 1.63	110	DB15-35
500	3.5 x 2.5 x 2.38	135	DB15-50

Line/load regulation, $\pm 0.1\%$ or better; ripple, 1 mv; input, 105-125 VAC. Other single and multiple output models from 1 to 75 volts, to 2.5 amps. Liberal quantity discounts. Three-day shipment guaranteed.

Complete details on these plus a comprehensive line of other power supplies and systems are included in the Acopian 74-75 catalog. Request a copy.



Corp., Easton, Pa. 18042. Telephone (215) 258-5441.

INFORMATION RETRIEVAL NUMBER 58

Vibrating glass 'striker' holds down the bounce

A "striker" to produce mechanical vibration in the cilia of certain animals in biomedical research has been designed at the University of Bristol in Britain. The striker is a glass microneedle, which is fastened to the armature of a small relay that is driven in a square-wave, bounceless mode.

A voltage square-wave drive to the relay gives slow transition of the armature between end positions. A current square wave provides fast transition, but it also produces an unwanted bounce on the end stops. In the Bristol circuit, a current-wave source uses clamping diodes to hold the voltage on the flats of the waves to con-

stant values. Critical damping is thus achieved at times when bounce would tend to take place.

The waveforms in the diagram show the successive damping in the driving circuit. D_1 and D_2 are the clamping diodes. Resistor R_2 is set so that pulses just sufficient to saturate transistor T_1 do not overdrive the relay. Typically R_2 is 2 k Ω . Zener Z_1 , normally nonconducting, is included to protect T_1 from accidental inductive "kickback" from relay malfunction. Resistor R_3 can be adjusted to give a fast relay pull-in with minimum bounce. As the tap on R_3 is moved towards the negative end, increased damping results.

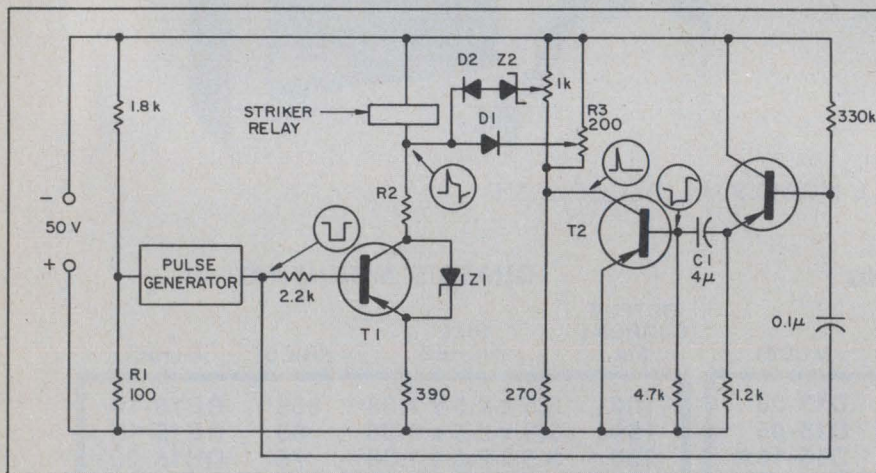

Capacitance transducer measures sealed fluid

Simultaneous readings of the displacement and velocity of fluid in a sealed system are provided by a capacitance transducer developed

at the University of Manchester in England. The transducer is formed by three coaxial cylinders that are electrically equivalent to two capacitors. The outer cylinder is the common plate for both an inner fixed cylinder and an intermediate short cylinder.

The intermediate cylinder moves with the fluid. When the cylinder moves, the capacitance change is converted into simultaneous velocity and displacement measurements. A push-pull input from the transducer balances out changes common to both capacitors, such as the use of different fluids in the cylinders.

To prevent the velocity signal from affecting the displacement signal, a high-pass filter is used in the input to a phase-sensitive detector. The bridge is driven from a 1-V, 0.5-MHz supply. The amplified bridge output is fed through a phase-sensitive detector to provide a dc displacement signal. A low-pass filter rejects the displacement signal to give velocity output.

Acoustic surface-wave amplification

Parametric amplification and attenuation of surface-wave signals over a 30-dB range have been experimentally observed by researchers at the Centre d'Etudes d'Electronique des Solides at Montpellier in France. In their study two simultaneous signals were applied to one end of a photoconducting cadmium-sulfide crystal structure, launching interacting surface waves. One high-level signal—the pump—was at 40 MHz and had a duration of 1.5 μ s. The second and low-level signal—the one to be amplified—was transmitted at 70 MHz with a duration of 4 μ s.

Measurements of the signal reaching the far end of the crystal—both with and without a pump frequency present—were made. At 16 dBm, the highest pump-signal level, a parametric gain of 10 dB was obtained.

The interaction between the signals takes place through the second-order electric field produced by bunching of the carriers, the researchers determined. The parametric amplification varied with the length of interaction and with the level of the pump voltage. The parametric interaction permits a 100% modulation of the output signal.

Fold along dotted line, staple together, and mail.

FIRST CLASS
PERMIT
NO. 16
MARLBOROUGH
MA. 01752

BUSINESS REPLY MAIL
POSTAGE WILL BE PAID BY ADDRESSEE

digital
COMPONENTS
GROUP

ONE IRON WAY
MARLBOROUGH, MASS. 01752



What's the use?

Tell us what you'd like to use a \$476 micro-processor for, and we'll send you, free, our 160-page "Microprocessor Series (MPS) User's Handbook."

It contains complete details on all the MPS hardware, including user-oriented aids like the programmer's panel, plus extensive software description, covering programming examples and de-bugging information.

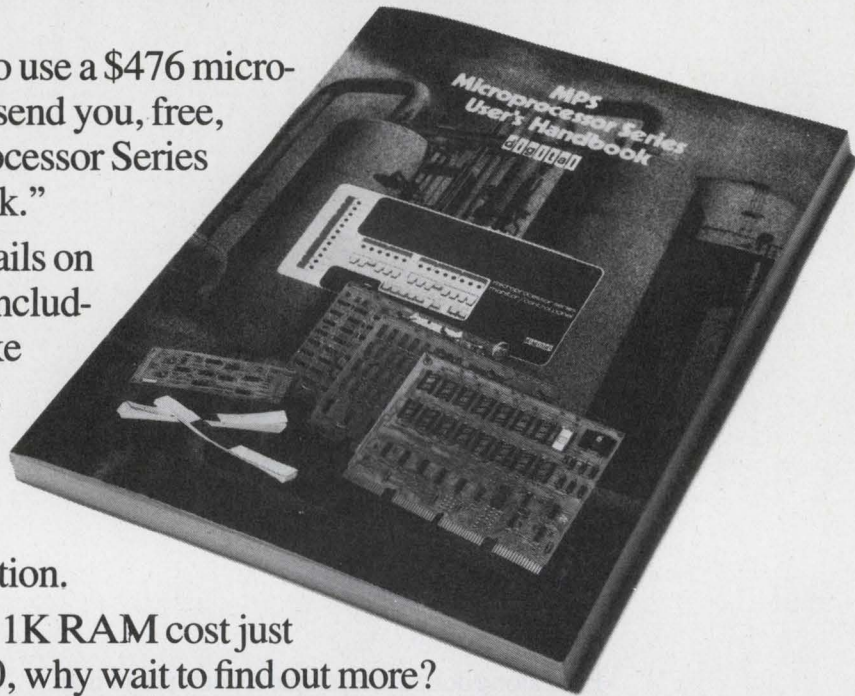

And since the CPU and 1K RAM cost just \$476 in quantities of 100, why wait to find out more?

Rip out this page, fold it in half, staple and mail. Now.

Application (please give specific details): _____

(All information must be filled in to qualify for free handbook.)

Production needs: 50-100 100-150 over 500

How soon: now 3 months 6 months 9 months a year

NAME

TITLE

COMPANY

ADDRESS

CITY

STATE

ZIP

TELEPHONE

digital
COMPONENTS
GROUP

new products

Losses in flyback transformers halved by new ferrite cores

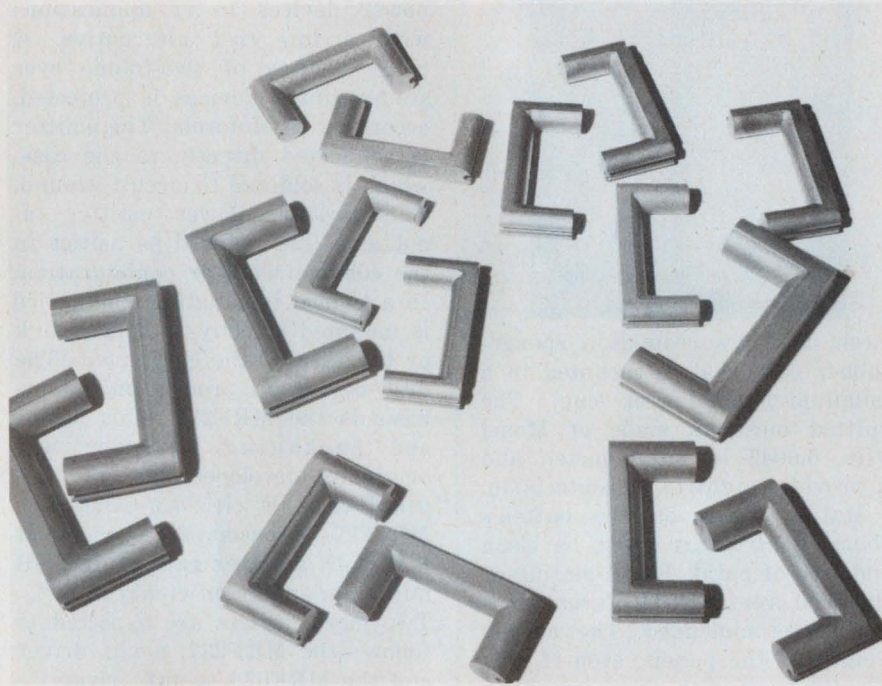

Indiana General, Crows Mill Rd., Keasbey, NJ 08832. (201) 826-5100. See text.

The new series CP-11000 Cool-Power ferrite materials, developed specifically for cooler flyback-transformer operation, cut core loss and heat generation in half, when compared with Ferramic-05 material. Ferramic-05 was considered previously the most efficient material made by Indiana General. Cool-Power materials also provide one-third more inductance than other ferrites under flyback-transformer conditions.

When used as direct replacements for conventional flyback cores, the CP-11000 ferrites thus provide a large margin of operational safety and reduce significantly the heat build-up in TV circuits. In new designs, the increased efficiency and higher inductance allows the use of smaller flyback units. And fewer turns for a given inductance results in about 30% savings in copper.

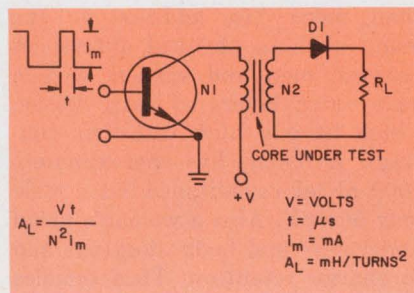
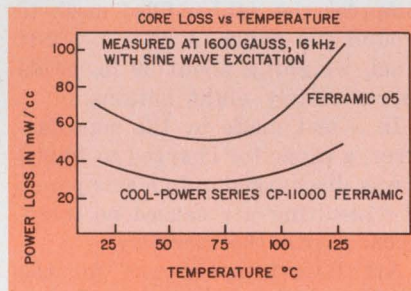

The Cool-Power cores are specified in practical parameters that relate directly to flyback operation. A guaranteed minimum inductance factor, A_L , is provided for high

and low pulse-time drive values. For example, the minimum inductance factor for a CP-1104/5 U/I core combination is 1500 nH/turn² with a 7- μ s-drive pulse width and 1260 nH/turn² for a 9- μ s pulse width (see figure). The corresponding peak drive currents are 1.5 and 1.39 A, respectively.

Five core sizes in the series can meet most flyback requirements. Sample quantities are shipped from stock, and production volumes are available in four to six week. The cost of a CP-1104/5 set is \$0.48 in quantities of 10,000, which compares favorably with conventional flyback cores.

CIRCLE NO. 302

Ceramic substrate has micro-smooth surface

3M Co., 3M Center, Box 33660, St. Paul, MN 55133. (617) 733-8830. See text.

A ceramic substrate with an as-fired surface finish of 1 microinch has been developed for thin film and microwave applications. Called AlSiMag brand No. 805 ceramic substrate, it is based on a 99.9% pure alumina, and is the smoothest as-fired polycrystalline ceramic substrate available today, according to the 3M Co. Typical properties include: an as-fired surface finish of 1 microinch center-line average, or better, a surface crystal size of less than 1.0 micron, a specific gravity of 3.96 g/cm³; flexural strength of 100,000 psi and a dielectric constant of 10.1 at 1 MHz and 25 C. Substrates can be polished to approximate polished sapphire. Test kits of 10 as-fired substrates measuring 2 × 2 × 0.025 in. are available for immediate shipment at a cost of \$50.

CIRCLE NO. 303

Static electricity discharged from quick-access panels

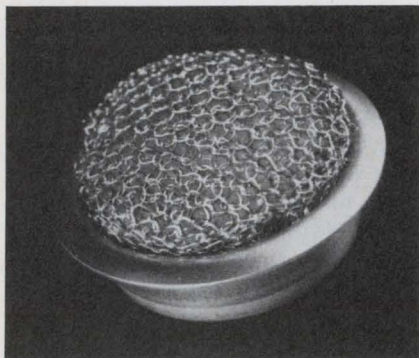

Cal-Metex Corp., 509 Hindry Ave., Inglewood, CA 90301. (213) 641-8000. Approx. \$0.75 (OEM qty).

Walk across a carpeted floor on a dry winter's day and touch a metal panel. The result is invariably a static-electricity discharge to the panel. A millisecond arc of static discharged to an improperly grounded computer panel can introduce errors, stop computer processing or obliterate or alter the contents of some memory units.

A static discharge button, developed by Cal-Metex, provides a simple, inexpensive way to ground access panels on commercial computers and still allow for easy panel removal.

Most computer-packaging philosophies require quick access to all areas needed for repair and adjustment. Thus many panels are loosely hung with metal or even plastic pressure clips and secured only with permanent magnets or half-turn fasteners. And often panels are completely painted and electrically insulated from ground.

Metex's discharge buttons help solve the problem of both easy access and adequate grounding. The buttons can accomplish this with a minimum of retrofit work on existing systems and with very little effort on systems specially designed for them. The button fits into a 3/4-in. punched or drilled hole on the flange of a panel or frame support.

The static discharge buttons are made from a knitted-metal wire

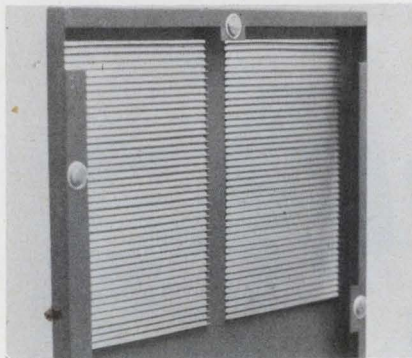

mesh, which surrounds a sponge-rubber core that is mounted in a cadmium-plated steel cup. The knitted mesh is made of Monel wire, 0.0045 in. in diameter, and it provides eight to 12 contacts/in.

Mating areas on the button's abutting structure must be clean and free of paint. Brush plating or chemical treatment to prevent rusting is recommended. The normal weight of the panels, even if only gravity hung with clips, can easily compress the rubber-filled mesh to ground the panel. A 5 x 3-1/2-ft panel, weighing about 30 lb, needs approximately eight buttons.

In a test made by the manufacturer, a capacitor charged to 10,000 V was discharged onto a side panel. The resulting arc caused no interference with the circuitry.

Art Bajart, spokesman for the Cal-Metex Corp., points out that women have the potential to generate 150% more static electricity than men: "In addition to the many obvious physical differences between men and women, women have extra layers of fatty tissue, which have a high dielectric constant. A female has approximately 1000 pF of capacitance but a male only 600 pF. Also a woman's nylon underwear and body stockings add to charge retention. Thus females can charge to potentials of about 25,000 V, but males generally only develop about 10,000 V. The discharge buttons can handle either sex."

CIRCLE NO. 301

New TO-39 package enhances rf applications

Motorola Inc., P. O. Box 20924, Phoenix, AZ 85036. (602) 244-6900. \$2.00 (100 up).

A unique beryllia-insulated die mounting technique is used to significantly improve the power dissipation and gain capabilities of a TO-39 package. These improvements enable a designer to replace expensive stud-mounted, medium-power devices in rf applications with a low cost alternative. A price savings of two-to-one over stud-mounted devices is projected, according to Motorola. The emitter is connected directly to the case, which is soldered to circuit ground. This provides lower emitter inductance and reduced parasitics in the common emitter configuration. In a typical installation, the device is mounted directly to a heat sink or the case of the equipment. The first device on production volume basis is the MRF227. This device and packaging technique was originally developed for the proposed class E citizens band. The MRF227 is conservatively rated at 3 W with a power gain of 13.5 dB minimum and an efficiency of 60%. Two more devices are expected to follow: the MRF237, a vhf driver and the MRF629, a uhf driver.

CIRCLE NO. 304

Miniature fans provide 4 to 15 cfm of air



Hico, 716 Willow Rd., Menlo Park, CA 94025. (415) 328-1111. V241-L: under \$14 (OEM qty).

A family of subminiature fans, from about 1 to 1-1/2-in. dia., provides air volumes of 4 to 15 cfm. Dc motors quietly drive dynamically balanced nylon impeller blades at 13,500 rpm. The motors operate on a nominal 6 V dc and consume as little as 0.3 W. The fans are frequently connected directly into a circuit, so that under an overload or transmission mode, they operate to cool the associated electronic gear.

CIRCLE NO. 305

The case for Liquid Crystal Displays

Dynamic Scattering or Field Effect

Liquid Crystal Displays; light emitting diodes; incandescent and fluorescent displays and "Nixie" tubes are becoming solidly established in circuit design as the trend to digital readout continues. The design engineer faces an unusually formidable task in determining the type of display most suitable and practical for his product. We make liquid crystal displays — dynamic scattering and field effect.

The display of the future? Our displays are as sandwiches of two glass plates, spaced typically about .0005" apart with a nematic liquid crystal solution between them and hermetically sealed at the perimeters.

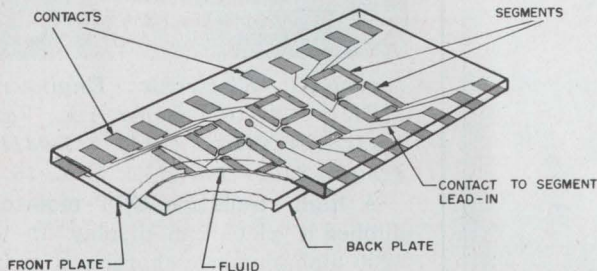

How they work. When the liquid is not electrically excited, its long cigar-shaped molecules are parallel to one another in a position perpendicular to the plates. The liquid appears transparent. When an electric current is applied, ion activity of the molecules leads to turbulence causing the liquid to scatter incident light. Depending on the type of nematic liquid used, either a dynamic scattering or field effect display results.

Dynamic scattering. We use a nematic liquid crystal solution in our dynamic scattering displays. This nematic liquid crystal is conductive, has negative dielectric anisotropy, and is oriented in either a homeotropic or homogeneous alignment. In either case the liquid is clear in the absence of an electric field. When an electric field is induced, the molecules scatter, giving the visual effect of a frosted piece of glass.

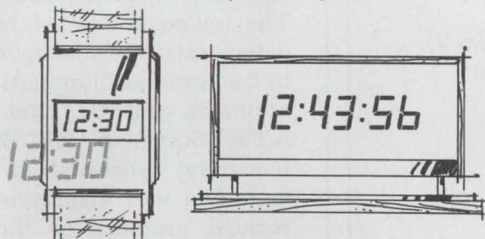

Field effect. These displays also utilize a nematic liquid crystal but with a different molecular orientation. The molecules are arranged in a helical stack, like a spiral staircase. The liquid is also sandwiched between two polarizers which are at right angles with each other. When current is applied the molecules rotate 90° so that they become perpendicular to the front polarizer. Light that passes through them is not rotated and therefore is absorbed by the rear polarizer. The result is a dark image on a light background. The image also can be reversed — light on dark.

Producing an image — digital or other — simply requires a conductive surface the shape of the desired image on the front glass plate. Current flowing from the conductive image through the liquid crystal to the common ground back plate causes the liquid to change from clear to a frosted appearance in the current-carrying areas.

The images almost always are in the form of seven segments formed on the front glass with transparent oxide and each with its own electrical lead. Energizing the proper segments produces the desired numerals. Lead-ins connect the segments to external contacts on the sandwich (display).

Consider the advantages. Liquid crystal displays have a number of distinct advantages. Simplicity is the reason for several of these. The elements are few and passive — very little can go wrong with an LCD and this means reliability and long life. Simplicity means low cost too — lower than that of most similar displays. Packaging costs are low because LCD's can be driven directly by MOS and C/MOS circuits. Very narrow character widths are possible and still provide a good viewing angle — 60 degrees in many cases.

Low power consumption makes LCD's a logical choice where power limitations rule other displays out. They do not generate light as do other displays so use no power for that purpose. Watch type field effect LCD's use only 3μW. for example with all segments energized at 7 Volts.

LCD's offer the greatest flexibility of any display type. Several standard displays, dynamic scattering or field effect, are immediately available from Hamlin's stock. Special displays with virtually any type of image can be produced with surprisingly low preparation or "tooling" cost. Because of the LCD's simplicity, lead time on specials is only a matter of weeks.

DYNAMIC SCATTERING

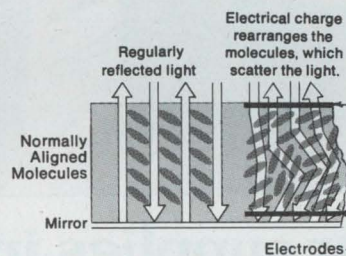

FIELD EFFECT

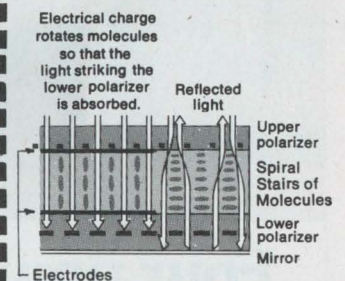

A few limitations. LCD's have limitations too. Operating temperature range is one. Liquid crystals slow down and may even cease to function at temperatures below 0°C. Above 50-60°C, crystals go into solution and will not function properly. But extremes do not damage LCD's. Once the temperature returns to normal, operation is automatically resumed.

LCD's are somewhat difficult to read under low ambient light conditions. (Side or back lighting can remedy this.) Visibility under medium to high ambient light conditions is excellent.

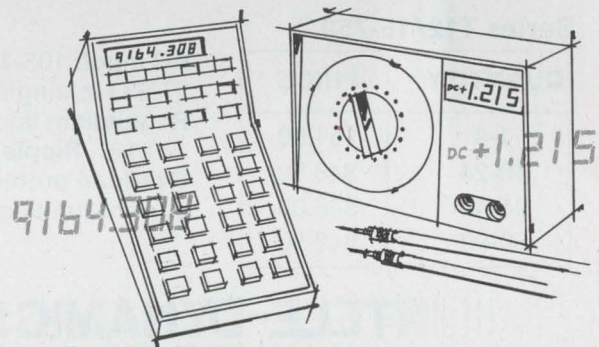

Conclusion. In the majority of display applications, MOS and C/MOS compatibility, reliability, flexibility and low power requirements are important considerations. No other display can match the liquid crystal display on these jobs. They could be the display of the future.

And that's the case for the LCD. For specifications, and application data, write Hamlin, Inc., Lake Mills, WI 53551 • 414/648-2361. Or dial toll-free 800-645-9200 for name of nearest representative. (Evaluation samples are available at moderate cost.)

HAMLIN

INCORPORATED

INFORMATION RETRIEVAL NUMBER 61

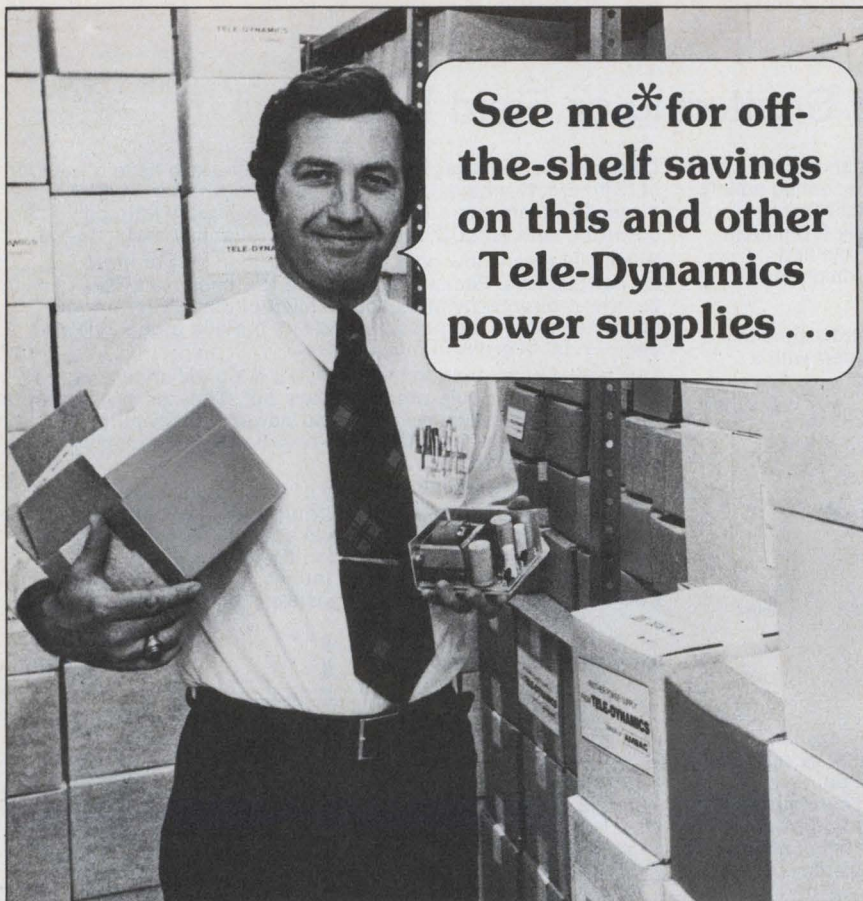

See me* for off-the-shelf savings on this and other Tele-Dynamics power supplies...

Four power supplies in one

- Two 750-mA outputs—each independently adjustable from 11.7 to 15.3 V
- Can be series-connected for double voltage (23.4-30.6 V)
- Can be parallel-connected for double current (1.5 A) utilizing single voltage control
- Master-slave tracking for op-amp applications

Series T12/15-750

QUANTITY	PRICE
1-9	\$51.00
10-24	\$48.50
25-49	\$46.00
50-99	\$43.50

AC input: 105-125/210-250 V, 57-63 Hz, single phase.

Regulation: line and load each $\pm 0.1\%$. **Ripple:** 0.05% rms.

Overload protection: foldback current-limiting.

TELE-DYNAMICS DIVISION OF AMBAC
WANLASS POWER SUPPLIES AND LINE CONDITIONERS

525 Virginia Drive, Fort Washington, PA 19034 • (215) 643-3900

Career opportunities for power supply engineers—an equal opportunity employer M/F

*110 STOCKING DISTRIBUTOR LOCATIONS

- Allied • Arrow-Angus • Cramer • Newark • Olive Radio • Philadelphia Electronics • Pioneer Standard • RPS Electronics • Ralph's • Stark • Sterling (Calif.) • Summit • Testco • T. I. Supply • Zack • Texas Instruments, Ltd. (Europe) • Tisco (Europe)

Call toll-free (800) 645-9200 for the one nearest you. In N.Y. State, call collect (516) 294-0990.

©TELE-DYNAMICS

6081A

DATA PROCESSING

CRT display has 3200-character capacity

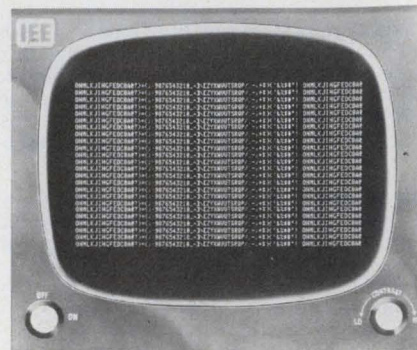

Industrial Electronic Engineers (IEE), 7720-40 Lemona Ave., Van Nuys, CA 91405. (213) 787-0311. \$250 to \$300 (100 qty); Feb., 75.

A high resolution CRT monitor dubbed Cyclops can display up to 3200 alphanumeric characters and/or symbols in a 40-line, 80-character format. This is double the capacity of standard CRT terminals. The monitor has single-control operation: Automatic dynamic focusing minimizes peripheral display distortion due to tube geometry, and provides uniform character shape and size over the entire face of the screen. A video clamp filters extraneous interference that can affect contrast and brightness. The image is free of blooming or deterioration of display quality due to background illumination or variations in contrast. Cyclops accepts NTSC Standard (EIA RS-170), or industrial synchronized input format, and will display either free-formed graphics or linear alphanumeric data as commanded.

CIRCLE NO. 306

Tape storage for Nova handles 23 Mbytes

Quantex, 200 Terminal Dr., Plainview, NY 11803. (516) 681-8350. from \$2550; 45 to 60 days.

A plug-compatible tape provides over 23 Mbytes of storage for Nova computers. The Series 2400 uses the 3M data cartridge as the storage medium and is offered in a variety of configurations with from one to eight tape drives, each with one to four tracks. The 3M data cartridge has an unformatted capacity of 720 kbytes per track, or 2.88 Mbytes per cartridge. Data transfer is 6 kbyte/s.

CIRCLE NO. 307

Burndy's tin-plated answer to the gold crisis.

Good-as-gold connections at a lower installed cost.

In 1971 gold sold for about \$46 an ounce. In 1972 the average price reached \$85 an ounce. In 1973 gold prices rose to over \$150 an ounce. Tomorrow, who knows?

Since gold has always been considered indispensable in making reliable connector contacts, connector prices have also been rising steadily. Something had to be done about it. And Burndy has done it.

We couldn't control the price of gold. So we came up with the first high reliability connector system that doesn't require gold. It's the revolutionary new Burndy GTH principle and it uses tin instead of gold—without sacrificing performance or reliability.

How did we do it? By substituting the principle of plastic deformation for the traditional wiping mode of making electrical contact. Utilizing the plastic deformation principle the hard, sharp, tin-plated tip of our contact penetrates the soft solder target of the mating component. The result is a gas-tight, high-pressure connection which prevents the formation of oxides. With no possibility of oxidation, there's no need for gold. Either in the connector or the mating component. *With no need for gold in the connector we can show you how to cut your interconnection costs by 33%. And with no need for gold in the mating component you can save a considerable amount of money here as well.* And the Burndy GTH connector permits a virtually unlimited number of mating and unmating operations without sacrificing reliability.

Burndy GTH connectors are available in all types of designs for all types of applications. IC, printed circuit and input/output to name just a few. And they're now being used by some of the most famous names in electronics.

For more information on how our new GTH connectors can help save you money, write Burndy Corporation, Norwalk, Connecticut 06856. Or call (203) 838-4444. We'll show you how we turned gold into tin. And how it can turn tin into gold for you.

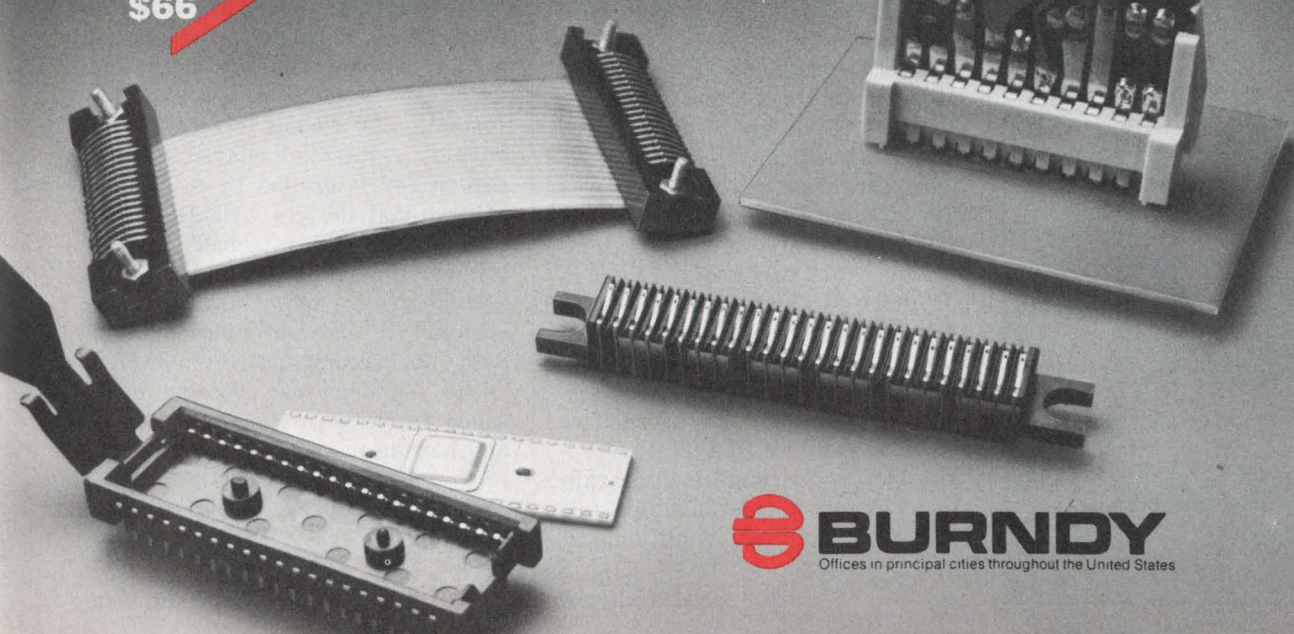
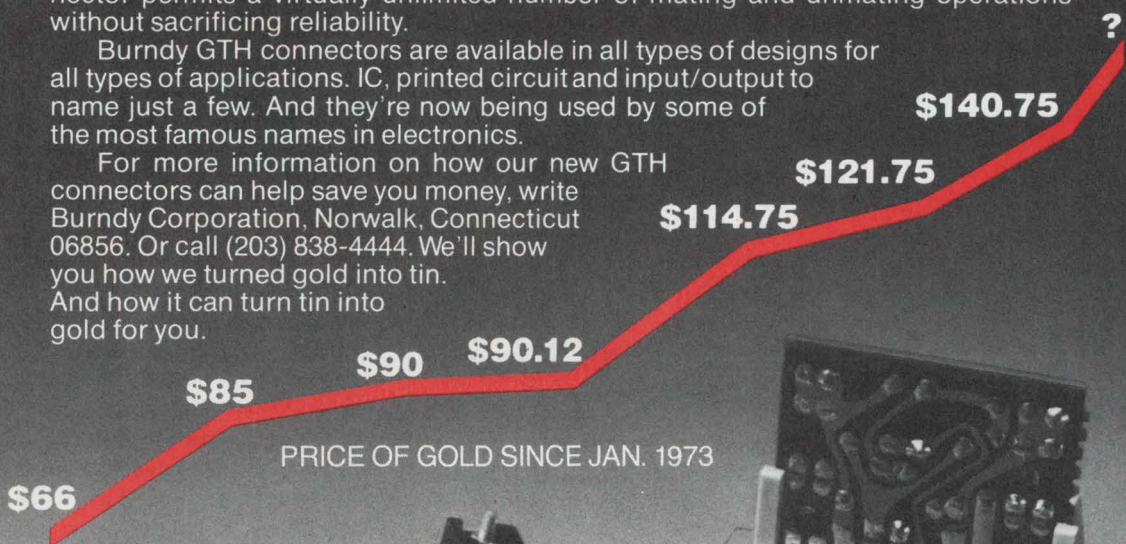

International Sales and Manufacturing: Brussels, Barcelona, Paris, Rotterdam, Stockholm, Stuttgart, Turin, Zurich, St. Helens (Eng.), Toronto, Sydney, Tokyo, Mexico City, Sao Paulo.

BURNDY CONNECTS

PHILIPS



Simplify testing of ECL and TTL components with PHILIPS PM5715 and PM5712 · 50MHz pulse generators

The PHILIPS PM5715:

- 1 Hz to 50 MHz frequency range
- Up to 10V into 50 Ohms
- Rise, fall time \leq 6 ns to 500 msec
- 10 ns to 100 msec pulse delay/duration
- Baseline offset \pm 2.5 V for PM5715
- Baseline offset -5V to +2V for PM5712
- Auxiliary TTL output
- Synchronized gating from external signal
- Single pulse, double pulse, square wave modes
- Compact and lightweight

The PHILIPS PM5712:

- Basically the same unit as the PM5715 with the main difference in the fixed risetime of \leq 4 ns.

For additional information, contact Philips Test & Measuring Instruments, Inc.
400 Crossways Park Drive
Woodbury, New York 11797

SPECIAL APPLICATIONS
INFORMATION 'HOT LINE
DIAL TOLL FREE NUMBER
(800) 645-3043
NEW YORK STATE, CALL
COLLECT (516) 921-8880

Philips Test & Measuring Instruments, Inc.
A NORTH AMERICAN PHILIPS COMPANY

DATA PROCESSING

TV camera uses CCD image element

Fairchild Camera & Instrument Corp., 300 Robbins La., Syosset, L.I., NY 11791. (516) 931-4500. See text.

A miniature, cylindrical, solid-state TV camera uses charge-coupled device (CCD) technology. Second in a planned series of TV cameras using this technology, the MV-101 has a 3-in. diameter, is 1-7/8-in. deep and weighs 11 ounces. The MV-101 incorporates all necessary electronics within its case and can operate up to 100 ft from the TV receiver. The camera uses a CCD element that contains 10,000 photosensors. The unit responds to as little as 0.2 foot-candles of illumination at the CCD element, and its sensitivity extends into the near IR range. It has 100-line horizontal resolution, a bandwidth of 1 MHz and requires 1.5 W of power for operation. The MV-101 will interface with conventional television receivers by means of a simple adjustment of the sweep rate. Standard lens included with the camera is a 25 mm f/1.4 C-mount type. The unit price of the camera and lens is \$4000. Additional lenses are priced separately.

CIRCLE NO. 308

Controller adds floppy disc to Nova minis

Minicomputer Technology, 1901 Old Middlefield Way, Mountainview, CA 94043. (415) 965-4567. See text.

The FD102 floppy disc controller interfaces a Data General Nova or DDC D-116 to up to four floppy disc drives. Drives supported include the Calcomp 140, Innovex 220, Orbis 74B, and Shugart SA901. A hard sector format allows over 342 kbytes of usable data per drive for a maximum on-line storage capacity of over 1.3 megabytes. The controller comes complete with interrupt and noninterrupt drivers, a disc formatter program, and a diagnostic program. Other software is also available. The price: \$950 in single unit quantities; \$760 in 100 unit quantities.

CIRCLE NO. 309

Short-haul wire modems provide 19.2 kbaud rate

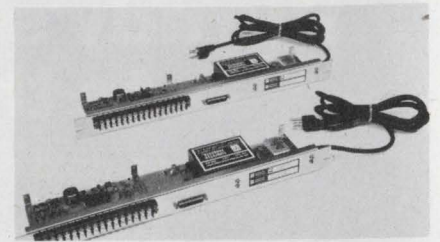

Computer Products, 1400 NW 70 St., Fort Lauderdale, FL 33309. (305) 974-5500. \$295 (each unit); stock to 60 days.

The RTP7420 Series asynchronous modems are capable of full-duplex data transmission over twisted pair lines up to 20,000 feet in length. Data rates from 75 to 19.2K baud can be handled by the units without adjustment. The transmitter input of each unit accepts RS-232-C, TTL, or current loop signals and the receivers provide RS-232-C, TTL or current loop outputs. Overload protection is provided for both transmitter and receiver.

CIRCLE NO. 310

Dot on TV screen gives two-way communications

Atlantic Research Corp., 5390 Cherokee Ave., Alexandria, VA 22314. (703) 354-3400. From \$10,000; stock.

With the Data-Dot system changes in TV broadcast signals cause a small dot to appear in a corner of television screens. This small dot contains one or more channels of data, each equivalent to a telegraph line. The data are received by a peanut-sized optical sensor placed over the dot. The user can select the type of information he wishes to receive and have it printed, displayed, or recorded for later use by a variety of terminal devices. All Data-Dot devices can be attached quickly without modification to the TV set. There are many uses for the system. It can provide printed data to accompany a televised event. Children can receive messages from their television heroes and heroines. And homeowners can receive discount coupons for merchandise, delivered electronically to their homes—if they choose to accept them.

CIRCLE NO. 320

Modular device controls phone use automatically

Carroll Telcom, 597 N. Mathilda Ave., Sunnyvale, CA 94086. (408) 732-4563. From \$145 to \$230; 30 days.

The TC-5000 is a multicode programmable, processor-oriented toll control system designed to provide comprehensive restriction of unauthorized telephone calls. Its modular design allows both tone and rotary dial detection, as well as easy expansion to meet system growth and changing customer requirements. This system can restrict calls on the basis of any of several options: standard "0" and "1" restriction, number of digits dialed (more than seven or eight digits), selected three-digit area codes and local prefixes, programmed control by time of day and area dialed, access code control. Standard configurations consist of eight-line register modules (TC-101), and one processor (TC-102). Interfaces are available for key systems, PABX and Telco interfaces (ZZAGM). A rack with power supply (C-201) will hold two groups of eight lines and their processors. Each processor may be programmed for one or two groups of codes.

CIRCLE NO. 321

Cross-assembler available for PDP-11

Compta, Inc., 6150 Canoga Ave., Woodland Hills, CA 91364. (213) 884-5400. See text; 2 wks.

A PDP-11 cross-assembler, called the X-11, permits PDP-11 programs to be assembled on a variety of host computers. X-11 is syntax-compatible with Monitor Version VO9 of the PDP-11 DOS Batch Assembler (MACRO). The cross-assembler is designed to run on any machine that supports an ANSI Fortran compiler with 24-bit or larger integers. Input to the assembler, in the form of card images and a macro library, produces an output listing in Macro-11 format and a binary file suitable for input to Link-11, DEC's linkage editor. Annotated source code and test programs are delivered on magnetic tape along with installation and use instructions. The one-time license fee is \$3500.

CIRCLE NO. 322

PHILIPS



BEST IN ITS CLASS

Compare the 120 MHz PM3260E with your scope
Ask us to prove that its better than yours !

- Intensified Zone is never lost in a bright trace ! . . . IS YOURS ?
- Extremely light — only 19.8 pounds ! . . .
WHAT DOES YOUR PORTABLE WEIGH ?
- Power consumption 45 Watts ! . . . COMPARE !
- Line voltage 90 - 250 volts and 46 - 440 Hz . . . NO ADJUSTMENTS !
- Is delayed sweep easy to use on your scope ? . . . IT IS ON OURS !
- Separate front panel sections for each timebase avoids confusion . . .
EASIER TO LEARN, EASIER TO USE, AND EASIER TO TEACH.
IT REDUCES ERRORS !

- 5 mV/cm sensitivity
- Triggering typically 1 cm at 200 MHz
- Only 18 calibration adjustments
- 20 KV accelerating voltage and a sharp trace give a better graph . . .
SEEING IS BELIEVING !
- Here's genuine price/performance at an economical price
and QUICK DELIVERY !
- For additional information, contact

Philips Test & Measuring Instruments, Inc.
A NORTH AMERICAN PHILIPS COMPANY

400 Crossways Park Drive Woodbury, New York 11797
Telephone: (516) 921-8880 Twx: 510 221 2120

- SPECIAL APPLICATIONS INFORMATION ' HOT LINE '
DIAL TOLL FREE NUMBER (800) 645-3043
NEW YORK STATE, CALL COLLECT (516) 921-8880

Philips Test & Measuring Instruments, Inc.
A NORTH AMERICAN PHILIPS COMPANY



hot stuff

or cold, CHR's family of TEMP-R-TAPE of Kapton provides outstanding endurance. They retain their excellent mechanical and electrical properties over a wide temperature range, -100 to +500F.

Available in thicknesses from .001" to .0045" with a choice of several adhesive systems including adhesive two sides.

Find your CHR distributor in the Yellow Pages under "Tapes, Industrial" or in industrial directories. Or write for complete specification kit and sample. The Connecticut Hard Rubber Company, New Haven, Conn. 06509.

CHR

an ARMCO company

INFORMATION RETRIEVAL NUMBER 66

DATA PROCESSING

Controller helps replace slow line printer



Spur Products Corp., 2928 Santa Monica Blvd., Santa Monica, CA 90404. (213) 828-8924. \$17,000; 90 days.

A controller, the Model S1403/1130, enables IBM Model 1403-N1 or -3 printers to be operated by IBM 1130 or Digital Scientific META IV computers. These computers were originally designed to operate the slower IBM 1403-6 or -7 printer. The 1403-N1 and -3 print 1130 lines/min compared with 600 lpm for the 1403-6 or -7. A fast paper-slew feature adds additional speed. The controller is plug-compatible with either computer through its storage access channels. The faster print speed can be achieved immediately without computer program changes. However, minor program changes are necessary for the other operating advantages of the 1403-N1 or -3 such as a wider (130 vs 120 cols) print line.

CIRCLE NO. 323

Serial printer offers 120 lines/min

Centronics Data Computer Corp., 1 Wall St., Hudson, NH 03051. (603) 883-0111. \$4675; 60 days.

The Model 102AL is a 132-column, serial impact printer capable of printing 330 char/s and 125 lines/min. LSI circuitry contained on a single PC board performs all logic functions. The printer can produce an original plus up to four carbon copies; the last printed line is visible for immediate reading. A dot matrix technique generates characters in a 9 x 7 pattern. Popular computer and communications interfaces (up to 9600 baud) are available as options. The printer is also plug-compatible with all Centronics printers.

CIRCLE NO. 324

Medium speed mini added to LSI family

Computer Automation, 18651 Van Karman, Irvine, CA 92664. (714) 833-8830. \$1750 (4k); 30 days.

The introduction of the LSI Type 2/10 medium-speed machine gives users a broad range of interchangeable computer power. The new computer, with an internal cycle time of 600 ns, is about half as fast and slightly less expensive than the high speed LSI Type 2/20, introduced in January, 1974, and about twice as fast and costs slightly more than the LSI Type 1 machine introduced in May, 1973. Any component from any model LSI machine can be used in any other. All the varieties of memories can be intermixed and interleaved in the same mainframe with any LSI processor, using the same software. Memories include 980-ns, 1200-ns, and 1600-ns core and 1200-ns semiconductor (MOS) ROM, RAM and pROM. The LSI Type 2/10 offers input/output rates from 40,000 words/bytes per second in the direct memory channel (DMC) mode to 1,020,000 in a standard DMA mode. Hardware priority interrupts provide automatic handling without the use of polling.

CIRCLE NO. 325

Cassette recorder has FM or direct modes

Dallas Instruments, 10205 Plano Rd., Dallas, TX 75238. (214) 341-2990. \$2700; 6 to 8 wks.

A two-channel, FM and direct analog recorder, the Model T5-2, uses cassette tapes and has both record and reproduce capability. FM record/reproduce frequency response is dc to 1000 Hz (with dc coupling) and direct record frequency response is 100 to 10,000 Hz. Voice comments may be recorded on one channel by interruption of the analog data. Ac and dc input coupling is provided. Signals in the range of 100 mV to 2-V peak may be recorded, with proper range setting. The T5-2 operates from standard dry cells or an external power source. Options include rechargeable batteries which also allow the unit to operate on ac power.

CIRCLE NO. 326

MICROPAC 80. THE FIRST COMPLETE MICRO-COMPUTER DEVELOPMENT SYSTEM. Here it is: all it takes to prototype, develop or support a microcomputer-based system.

All the hardware. Logic (incorporating the Intel 8080 micro CPU), memory and communications interfacing, of course. But you also can order all the process interfacing you'll need for any application.

And all the software. So that you can develop your microcomputer program on the microcomputer. You don't need any other computers at all.



Once you've completed your development programs, you can put your MicroPac 80 to work in production, using the programs you developed.

We'd like to tell you more. A whole lot more. Write PCS, 5467 Hill 23 Drive, Flint, Michigan 48507.

Suddenly, the whole business of industrial control has changed.

PCS

Multiplying DACs have 500-ns settling times

Teledyne Philbrick, Allied Dr. at Rte. 128, Dedham, MA 02026. (617) 329-1600. From \$230 (unit qty.); stock.

Models 4070 (8-bit), 4071 (10-bit), and 4072 (12-bit) are fast multiplying d/a converters. These precision devices settle to 0.01% of span in 500 ns typical. The 4070 series converters have an analog input range from -1 to +10 V with a maximum frequency of 7 MHz (small signal). The outputs can deliver -10 to +10 V at 40 mA max. Power requirements are ±15 V at 50 mA and the operating temperature range spans 0 to 70 C.

CIRCLE NO. 327

Precision timer delivers dual output pulses

Control Interface, 975 Corbindale, Suite 202, Houston, TX 77024. (713) 464-6571. From \$75 (1 to 9); stock to 8 wk.

A precision timer, Model PT-1, delivers an output of one pulse per minute. The unit is designed for use with battery powered recorders, calendars, event timers, samplers and additive controllers. It is entirely digital, crystal controlled, accurate to ±0.02% and uses less than 10 mA dc power. The output pulse duration is continuously adjustable from 50 to 350 ms and an auxiliary one-pulse-per-second output is available. Operating temperature range spans -20 to +140 F while the unit weighs just 6 oz.

CIRCLE NO. 328

Electro-optical modules couple to T-19H optics

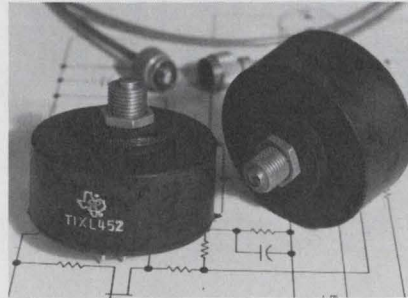

Texas Instruments, P.O. Box 5012, Dallas, TX 75222. (214) 238-3741. \$375 (452), \$230 (472); 4 wk.

Two electro-optical modules are designed for use with optical waveguide fiber bundles. The TIXL452 and TIXL472 photodetector and transmitter modules couple directly to Corning T-19H optical waveguide terminations. The TIXL452 is a complete avalanche photodetector module that contains a silicon avalanche photodiode, a voltage-reference diode, a broadband amplifier and a bias circuit. It is designed for 0.6 to 1.06 μm wavelengths and has a typical responsivity of 200 mV/μW at 0.9 μm radiation. The TIXL472 is a complete optical waveguide transmitter module compatible with TTL positive logic input. It contains an infrared-emitting diode with a wavelength of 0.9 μm and requires only a single 5-V power supply. It has a typical rise time of 15 ns and an external resistor permits adjustment of the peak optical power level. Each module is housed in a cylindrical aluminum case with an extended chip package threaded to align directly with the T-19H optical waveguide termination.

CIRCLE NO. 329

Programmable active filters span wide range

Frequency Devices, 25 Locust St., Haverhill, MA 01830. (617) 374-0761. \$58 (100-up); stock.

The Series 744 programmable active filter product line has been expanded by the addition of binary programmable four-pole low-pass Butterworth and Bessel filters. The new models cover 0.05 Hz to 51.2 kHz. Typical specifications include passband insertion loss of 0.02 dB, 3% cutoff frequency accuracy, 1-Ω output impedance, 10⁹-Ω input impedance and f_c stability of ±0.02%/°C. Attenuation floors of -90 to -100 dB and output noise of less than 75 μV rms are also typical.

CIRCLE NO. 330

Synchro amplifiers uses Scott-T configuration

Singer, Kearfott Div., 1150 McBride Ave., Little Falls, NJ 07424. (201) 256-4000. \$280 (100-up); stock to 90 day.

The C70 3 185 101 is a Scott "T" buffer amplifier designed to accept ac inputs proportional to sine and cosine of an angle. It provides a three-wire, 400 Hz, 11.8 V line-to-line synchro stator output equivalent to the input angle. The outputs are protected against short circuits or overloads. Input impedance is 100 kΩ nominal and accuracy is within ±2 min. Operating temperature range of the unit is -55 to +105 C. It is designed to operate from ±15 V dc at 5-A surge and 400-mA steady-state average current. The amplifier is packaged in a potted 3.05 × 2.62 × 0.82 in. case.

CIRCLE NO. 331



ANALOG
STAY IN CONTROL WITH INTECH'S INDUSTRIAL CONTROL IC'S THE 3050 AC DETECTOR, DIFFERENTIAL OR SINGLE ENDED TO 1MHZ, 3040 QUAD MONITOR ALARM DRIVES, EXTERNAL SPEAKER DIRECTLY, 3030 TEMPERATURE ALARM SETS OFF BELLS AND WHISTLES, EXCELLENT REPEATABILITY, THE 3020 TRI-STAGE ALERT/ALARM AND 3010 TONE ALARM DRIVE LEDs OR LAMPS. ALL 14-PIN DIP TTL COMPATIBLE. STOCK DELIVERY. LOW PRICES. WRITE US!

intech INCORPORATED
(408) 244-0500
1220 COLEMAN, SANTA CLARA CA. 95050

**For PBX, computer memory
and instrument power
supply applications**

turn to CTS

for cermet resistor networks

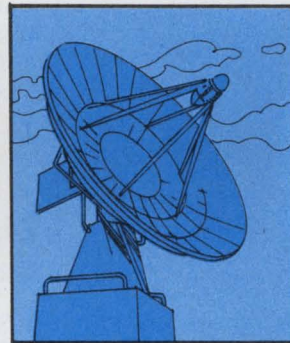
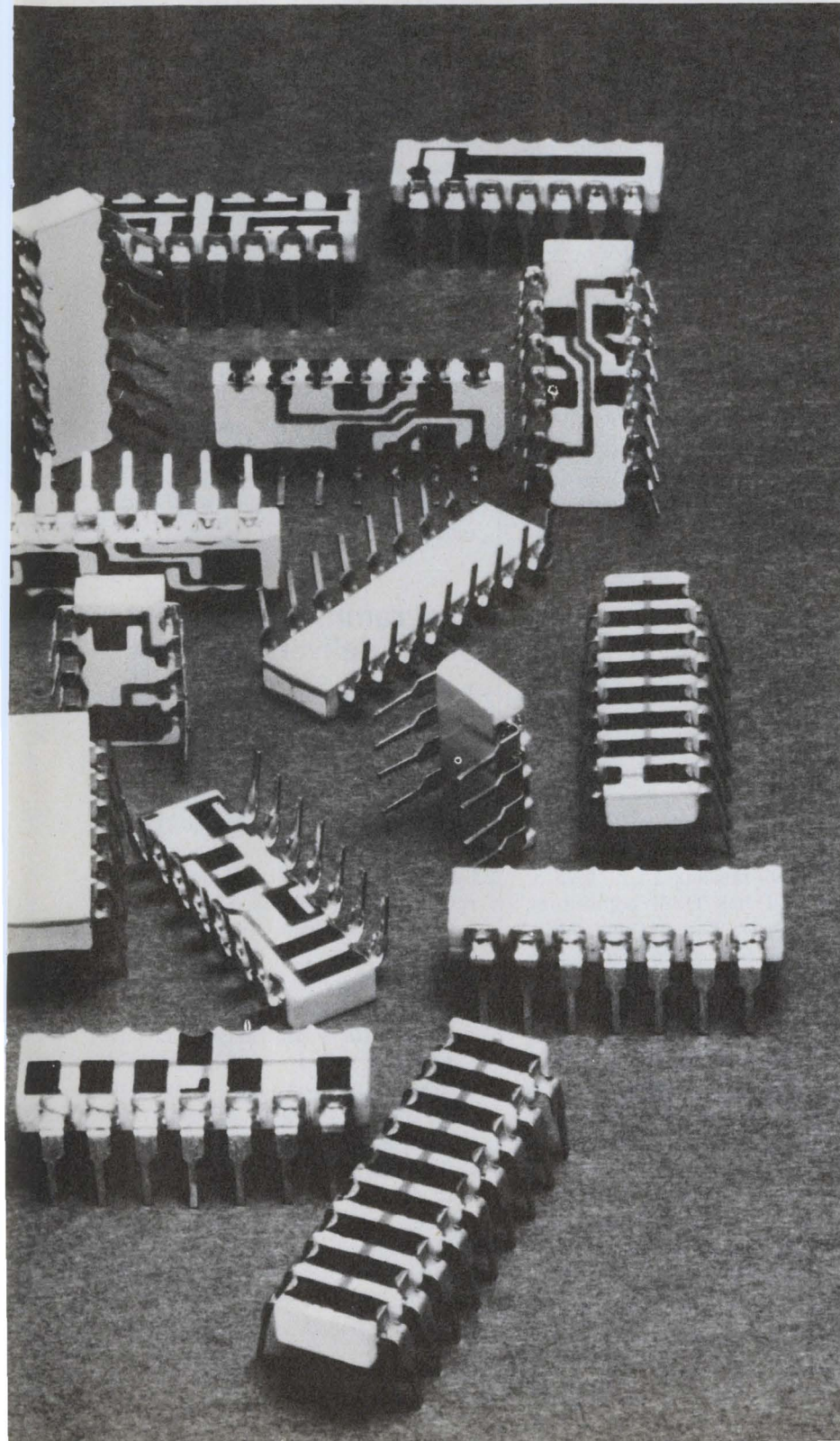

Save Space. Money. Time. It's easy with CTS Series 760 DIP Cermet Resistor Networks. Four popular packages . . . 8, -4, -16 and -18 lead styles . . . provide an infinite number of circuit combinations.

Compact, low profile design puts the squeeze on PCB space. Cost cutters, too. All designs eliminate lead forming and lead trimming for low cost automatic insertion along with IC's and other DIP components. Time saving? One 18-lead CTS 760 Series package can replace up to 32 separate components.

Available without organic cover coat, so you can trim for circuit balance. Precision .100" leads; rated up to 2 watts on 18 lead style; 5-lbs. pull strength on all leads.

Immediate delivery on standards. Custom designs to specifications. Be a saver. Turn to CTS of Berne, Inc., 406 Parr Road, Berne, Indiana 46711. Phone: (219) 589-3111.

CTS CORPORATION
ELKHART, INDIANA



the facts about E.M.I. SHIELDING

Design information from Mag-Shield's
30 years experience in E.M.I. shielding.

HOW DO I AVOID E.M.I. PROBLEMS WITH REACTIVE CIRCUIT COMPONENTS?

Give early consideration to the proximity of all E.M.I. sources and magnetically sensitive components. Repositioning the components may reduce the effect of radiation. However, enclosures fabricated of special shielding alloys are often required to provide sufficient E.M.I. protection.

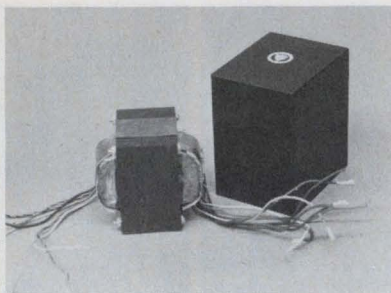

Standard shield enclosures save tooling expense and assure maximum E.M.I. protection.

HOW COSTLY ARE SHIELDS FABRICATED OF SPECIAL ALLOYS?

The cost will vary with the complexity of the shield required to provide sufficient attenuation. A simple wrap of shielding foil will effectively attenuate low intensity E.M.I. fields. A more costly multiple-layer shield may be required to attain the desired attenuation at high field intensities.

ARE STANDARD SHIELD ENCLOSURES AVAILABLE?

Mag-Shield stocks many standard shields that accommodate a wide variety of components. We also have the design capability and production facilities to quickly and economically produce prototype or production quantities of special designs.

For more information on Mag-Shield's standard magnetic shields, just circle the reader service number.

MAGNETIC SHIELD DIVISION



Perfection Mica Company
740 Thomas Drive
Bensenville, Illinois 60106
(312) 766-7800 TWX (910) 256-4815

INFORMATION RETRIEVAL NUMBER 70

MODULES & SUBASSEMBLIES

12-bit a/d converter delivers in 2.5 μ s

*Teledyne Philbrick, Allied Dr. at
Route 128, Dedham, MA 02026.
(617) 329-1600. \$585 (unit qty.);
stock.*

The Model 4133 12-bit a/d converter features 2.5 μ s maximum conversion time. The low drift performance (± 10 ppm/ $^{\circ}$ C) ensures accurate linear operation over a 0 to +70 C temperature range. Model 4133 is packaged in a low profile 0.375 in. high metal case. The converter is available in several versions, each with different input voltage ranges. The 4133-11 handles 0 to -5 V or ± 2.5 V while the 4133-22 handles 0 to -20 V or ± 10 V.

CIRCLE NO. 332

Digitally controlled delay steps at 250 ns

*Walter M. A. Anderson & Associates, 4 Main St. Extension,
Tariffville, CN 06081. (203) 658-
7666. \$285; stock.*

The Model BID-300 i-f delay line, available in binary increments, is a low-loss wide-bandwidth device. Available in binary increments up to a maximum of 8 μ s with 250 ns as the least significant bit. Other delay values can be furnished on special order and the line is available singly or in matched sets. Other options include provisions for unity gain devices and manual or electronic switching. The BID-300 measures 2 \times 0.75 \times 0.75 in and has OSM connectors. (BNC special). The BID-300 has a center frequency of 30 MHz and a 3-dB bandwidth of 15 MHz. It has a ± 0.2 dB maximum amplitude ripple across the bandwidth and 20 dB maximum attenuation. Both input and output VSWR is 1.4:1. Input and output impedances are 50 Ω . Singly, delay tolerance of the BID-300 is ± 0.005 μ s, while in matched sets tolerance is ± 0.001 μ s. Other specifications are ± 0.005 μ s delay variation, 0-to-50-C operating temp range and delay values of 0.25 to 8 μ s in binary steps.

CIRCLE NO. 333

Signal conditioning units span wide range

*Dynamics, 12117 E. Slauson Ave.,
Sante Fe Springs, CA 90670.
(213) 945-2493. \$675; stock to 30
day.*

The 7600 series isolated signal conditioner comes with a high-gain differential dc amplifier and allows the user a choice of 10 different front panel plug-in signal conditioning modules. The amplifier features include: gains to 2500, 120 dB CMRR at ± 20 V common-mode, 125-kHz bandwidth, filter, offset control, output level controls and tape, galvo and VCO outputs. The 10 signal conditioning modules include: isolated strain-gauge power supply, (constant current or voltage with remote sensing), with autobridge balance, built-in reference junction and linearization for thermocouples, linear, two, three, or four-wire system for RTDs, servo, pot, piezoresistive, EMF, carrier amp, charge amp and designers card for complete universal system operation. The instrument is 8.75 \times 1.75 \times 18 in. Ten Model 7600 conditioners mount into a standard cabinet for EIA rack mounting.

CIRCLE NO. 334

Programmable current driver delivers 100 mA

*Pulse Instruments, P.O. Box 1655,
San Pedro, CA 90733. (213) 541-
3204. \$80 (1 to 4); 4 to 6 wk.*

The PI-1000 is a programmable current source driver that can deliver 100 mA into a 0-to-150- Ω load. Its output current can be controlled by a reference voltage, current or resistance. When used in a 50- Ω system, the output rise and fall times are less than 3 ns, the maximum repetition rate is greater than 50 MHz, propagation delays are less than 10 ns and maximum output offset is ± 10 V. The PI-1000 differential inputs are compatible with TTL and ECL circuits. The output is both open and short-circuit proof, and the outputs of several drivers can be ORed to increase the output current. The driver operates from a single 10-to-20-V supply. Over-all dimensions are 2.45 \times 1.625 \times 0.55 in. Pins are spaced on 0.1-in. centers.

CIRCLE NO. 335

**TO SPECIAL OFFER
ELECTRONIC DESIGN
SUBSCRIBERS**

Now \$49.95

The scientific calculator that has just solved your biggest problem--price

The Sinclair Scientific was originally introduced at \$119.95 and was recently advertised at \$99.95. Now under a special arrangement, the same calculator is available in limited quantities to ELECTRONIC DESIGN subscribers at \$49.95. This is half the cost of most other scientific calculators. Additionally, each purchase of a \$49.95 calculator brings you a \$5 bonus certificate good toward the purchase of any other Sinclair calculator.

The Sinclair performs logarithmic and trigonometric functions, as well as displaying scientific notation on all calculations.

What's more, the Sinclair Scientific isn't just portable. It's pocketable.

Less than 3/4 inch thin. And 3 3/4 ounces light. It's the world's thinnest, lightest scientific calculator.

Just look at some of its essential functions, and you may never use your slide rule or log tables again:

- | | |
|--------------------------------------|--|
| log and anti-log
(base 10) | automatic doubling
x^2 , including square
and other roots |
| sin and arcsin | plus the four
basic arithmetic
functions |
| cos and arccos | |
| tan and arctan | |
| automatic squaring | |

What makes a scientific calculator scientific?

There are many calculators that call themselves "scientific." But most, frankly, don't measure up.

To be a really valuable tool for engineers, scientists, technicians and students, a calculator must provide all of the following: Log functions. And trig functions. And scientific notation (10^{-99} to 10^{+99}).

Specifications

- | | |
|--|---|
| Functions:
4 arithmetic
2 logarithmic
6 trigonometric | Logic:
Reverse Polish, with
post-fixed operators
for full flow chain
calculations. |
| Keyboard:
18 key format with
4 "triple-action"
function keys using
standard, upper and
lower case operation. | Power Source:
Battery operated with
4 inexpensive AAA
penlight batteries,
providing over 25
hours of use. |
| Display:
5-digit mantissa
2-digit exponent
(both signable) | Size:
4 1/8" high;
2" wide; 1 1/16" thick. |
| Exponent:
300-decade range,
from 10^{-99} to
10^{+99} | Weight:
3 3/4 oz. |
| | Warranty:
1 year. |

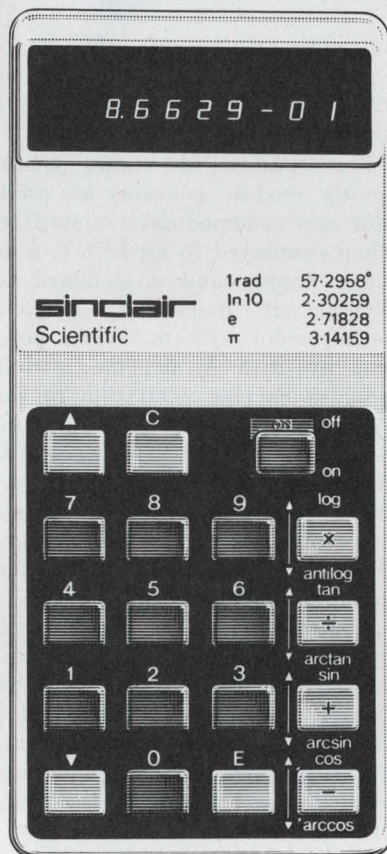

actual size

Clearly, a scientific calculator without scientific notation severely limits the size of numbers with which you can work easily. And scientific notation without transcendental functions is little more than window dressing on an arithmetic calculator.

What it all adds up to is this: Only Sinclair provides truly scientific capacity at a truly afforded price.

What makes the Sinclair Scientific so inexpensive?

Two important technological breakthroughs.

First, the British-built Sinclair Scientific has a *single* integrated circuit. Engineered by Sinclair. And exclusive to Sinclair. (Competitive units require more than one chip. Their chips are larger. And also more expensive.)

Second, Sinclair's exclusive keyboard has only four function keys, which provide "triple-action" by changing from standard to upper or lower case mode.

Extra keys mean extra cost. (Not to mention size and weight.) And fewer keys mean a simpler format to memorize—for increased speed and fewer entry errors.

Old hands at small miracles.

Sinclair has been an innovator in calculator miniaturization right from the start. And it's now Europe's largest manufacturer of pocket calculators.

Naturally, Sinclair maintains a service-by-return mail operation in the U.S. (and everywhere else in the world) to handle any product problems, should they develop. And the Sinclair Scientific is backed by an unconditional one year replacement warranty.

How to get your Sinclair Scientific.

To order your Sinclair Scientific today, just fill out the coupon below.

**sinclair™
SCIENTIFIC**
The logical choice.

ORDER FORM

To: Hayden Mail Order
50 Essex St., Rochelle Park, N.J. 07662

Individual Orders must be accompanied by check or money order.

Please send me _____ Sinclair Scientific(s) at \$49.95 (plus \$3.50 per unit, shipping and handling) including batteries, carrying case, instruction booklet and warranty. (New Jersey residents add sales tax.)

Enclosed is my check or money order for _____

Signature _____

Name _____

Company _____

Address _____

City _____ State _____ Zip _____

Company Purchase Orders for 6 or more calculators are accepted for D&B rated accounts.



AMPERITE

THERMOSTATIC DELAY RELAYS

For **LOW COST,**
LONG LIFE,
Maximum Stability

Delays: 2 to 180 Sec.*

Hermetically sealed — not affected by altitude, moisture, or climate changes... SPST only — normally open or normally closed... Compensated for ambient temperature changes from -55° to +80°C... Rugged, explosion-proof, long-lived... Standard radio octal and 9-pin miniatures.

Price, standard or min., under \$4.00 ea.

*Miniatures delays: 2 to 120 seconds.

PROBLEM? Send for Bulletin No. TR-81.

New! LONG DELAYS

240 & 300 Sec.

Same rugged construction, hermetic sealing and stability as the shorter Delay Relays described above... For delays beyond 300 seconds, these Relays may be used in series.

Price, under \$6.00 ea.

Write for Bulletin No. LD-73.



DIFFERENTIAL RELAYS

For automatic overload, over-voltage or under-voltage protection... Made only to specifications for 70V, 80V, 90V and 100V.

Price, under \$6.00 ea.

AMPERITE BALLAST REGULATORS

Automatically keeps current and voltage at a definite value. For AC or DC... Hermetically sealed, rugged, vibration-resistant, compact, most inexpensive.

Price, under \$3.00 ea.

Write for 4-p. Bulletin No. AB-51.

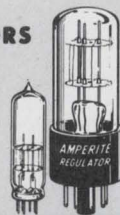

AMPERITE

600 PALISADE AVE., UNION CITY, N.J. 07087

Telephone: 201 UNion 4-9503

In Canada: Atlas Electronics, Ltd.,
50 Wingold Ave., Toronto 19

MODULES & SUBASSEMBLIES

Signal conditioner has built-in LVDT excitation

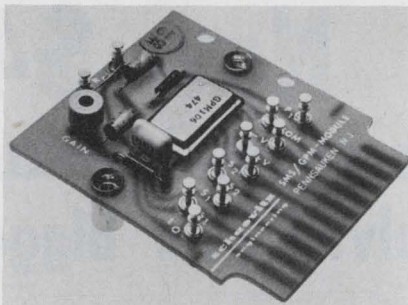

Schaevitz Engineering, U.S. Route 130 & Union Ave., Pennsauken, NJ 08101. (609) 662-8000. \$98 (unit qty); stock.

The SMS/GPM signal conditioning module contains an oscillator and a demodulator/amplifier. When connected to an LVDT, a dc power supply and a standard dc readout, it makes a complete measurement system. When powered by ± 15 V dc, the module provides carrier excitation to the LVDT and converts the output into a filtered, high level dc signal which can drive meters, high response recorders or other dynamic indicators. All circuits except filtering, span and excitation limiting components are housed in a single hybrid thick-film circuit. Typical specifications include outputs up to ± 5 V dc, 2.5 kHz or 10 kHz transducer excitation at 3 V rms, dc to 100 Hz (within ± 3 dB) frequency response and non-linearity and hysteresis less than 0.1% full scale.

CIRCLE NO. 336

Tone encoder spans 20 to 3000 Hz

Alpha Electronic Services, 8431 Monroe Ave., Stanton, CA 90680. (714) 821-4400.

The Model 501 tone encoder delivers stable tones over the 20-to-3000-Hz frequency range. Frequency stability is $\pm 0.5\%$ over a temperature range of -40 to +100 C. Current requirement is less than 4 mA at 12.6 V dc, however, the unit will function to specification from 11 to 30 V dc. Output is adjustable to 2.5 V rms.

CIRCLE NO. 337

Temperature controller works with RTDs

Thermalogic, 241 Crescent St., Waltham, MA 02154. (617) 891-9496. \$34 (unit qty); stock.

The 4000 series modules are proportional temperature controllers. They are designed for use with either nickel-iron or platinum RTDs and are compatible with international DIN standards. The controllers provide logic voltage outputs suitable for driving solid-state, optically isolated relays. Adjustable temperature settings are provided by an integral control with a high-visibility dial. Each series 4000 unit is isolated from line voltage by a proprietary Iso-guard construction, ensuring maximum protection against shock and ground faults. A number of standard temperature ranges and resistance ranges are available.

CIRCLE NO. 338

Telephone tone decoder has volume of 0.5 in.³



Tone Technology, 599 N. Mathilda Ave., Sunnyvale, CA 94086. (408) 739-4791. \$80 (1000-up); stock to 4 wk.

The TT800B tone receiver/decoder detects the 2-of-8 tone signals generated by tone-dialing telephones. It can decode them into either discrete digital 1-of-16 or BCD logic level outputs. The 0.5 in.³ assembly combines MOS/LSI and thick-film hybrid circuits in a 32-pin DIP that measures approximately $0.3 \times 0.9 \times 1.9$ in. The input of the TT800B has a 40-dB dynamic range of -32 to +8 dBm with a capacitively coupled, 50- Ω impedance suitable for line-bridging connection to ordinary voice circuits. Operating voltage range is 9 to 18 V dc and the temperature range is -45 to +85 C. Frequency stability is assured through the use of an internal quartz crystal. The outputs, which are MOS and bipolar compatible, are easily interfaced to RTL, DTL, and TTL logic.

CIRCLE NO. 339

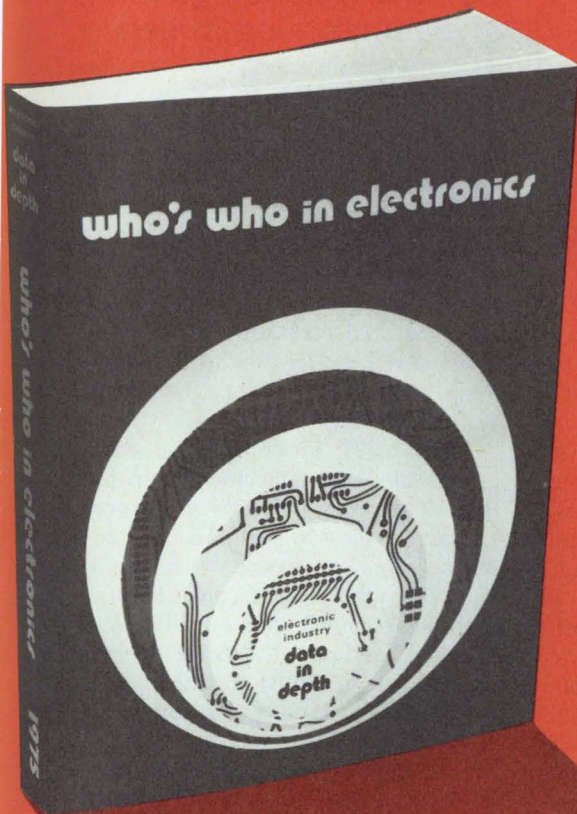

An Industry **FIRST...**

Have all the facts
on electronic firms
at your fingertips

data in depth

...7,500 Manufacturers
...2,500 Distributors
...3,500 Representatives

**who's who
in electronics**

The most comprehensive directory
in the electronic industry.

exclusive!

Manufacturers Section

Companies are listed in alpha sequence under city headings within states. More information is shown on these manufacturers than all other industry directories combined.

Alpha & Geo Sections

Each major section is organized into alpha-numeric and geographic segments. Data-in-Depth appears in geographic, while alpha contains: name, address and direct dial phone number.

Purchasing Index

Contains over 600 separate product classifications. Listings include: name, address and telephone number.

Distributors Section

Lists over 2,500 electronic industrial distributors. Data include: key personnel, number of employees, annual sales, major lines stocked and much more.

Representatives Section

Over 3,500 electronic representatives are listed with: lines handled, territory covered, type of industry served and much more.

- Division
- Toll free phone
- TWX, Telex
- Key personnel
- Number of employees
- Annual sales
- Plant size
- Foreign trade
- S.I.C., major products

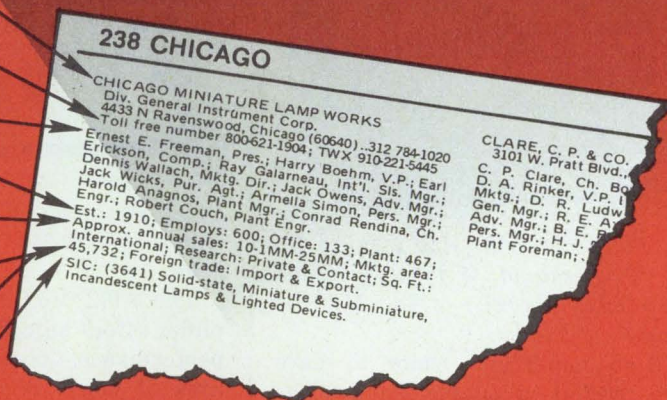

- Vastly expanded data (600 pages)
- Dozens of uses by: buyers, sellers, & marketing oriented management.
- Accurate & authoritative.
- Easy to use

\$49.50

Plus \$2.50 for postage and handling.

Send Check Today To...



harris publishing Co.

33140 AURORA ROAD • CLEVELAND, OHIO 44139
PHONE 216 248-8540

ALL AMERICAN LINE

ULTRA - GLOW[®] ILLUMINATED PUSHBUTTON

Available 1 to 15 stations, 1 to 3 poles and multiple actuations. Basic switch U.L. listed at 3 or 6 amps, 125v.

As low as **54c**
per station including bulb.
Miniature or rectangular
knobs in colors.

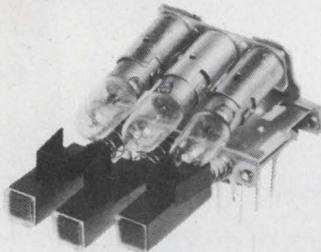

ULTRA-GLOW[®] ILLUMINATED ROCKER AND SLIDE

Select 1 to 3 poles and a variety of colors. U.L. listed 1 to 10 amps, 125v.

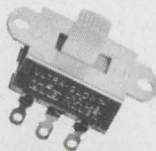
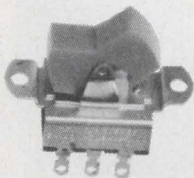

AMF

UID Electronics

UID Electronics Division
AMF Incorporated
4105 Pembroke Rd.
Hollywood, Florida 33021
Phone (305) 981-1211
TWX 510-954-9810

INSTRUMENTATION

Universal counter works to 50 MHz

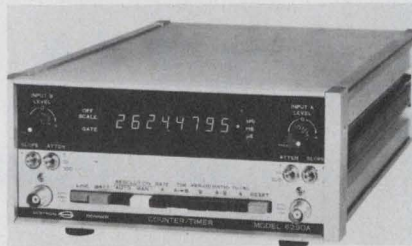

Systron-Donner, 10 Systron Dr.,
Concord, CA 94518. (415) 682-
6161. \$740; 60 days.

This 50-MHz counter-timer, Model 6250A, performs frequency, multiple period, time interval, ratio and totalizing measurements. The unit's features include an autoranging function that selects a maximum display resolution, both preset and manual trigger level selection, leading zero suppression, 25-mV rms input sensitivity, an 8-digit display and BCD output of all measurements. Each input channel has selectable attenuator and slope controls.

CIRCLE NO. 340

Amplifiers stretch bw to a wide 100 MHz



R. F. Power Labs, 11013-118th Pl.
N. E., Kirkland, WA 98033. (206)
822-1251. M102L: \$795, M125L:
\$2495; 3-5 wks.

Two amplifiers claim to have the widest available bandwidth: 10 Hz to 100 MHz. Model M102L delivers 2 W min and offers a gain of 40 dB \pm 1 dB. Model M125L puts out 25 W at a gain of 50 dB \pm 1.5 dB. Input and output impedance of both models is 50 Ω . Input and output VSWR is 1.5 and 2, respectively. Harmonic distortion is 30 dB at 2 W for the 102, and 20 dB at 20 W for the 125.

CIRCLE NO. 341

20-MHz function gen gives linear/log sweep



Interstate Electronics, 707 E. Ver-
mont Ave., P. O. Box 3117, Ana-
heim, CA 92803. (714) 772-2811.
\$1095; 60 days.

Model F77 kicks off the com-
pany's 20-MHz function generator
line. The unit delivers waveform
signals over the 20- μ Hz to 20-
MHz frequency range, with ampli-
tude of up to 15-V peak-to-peak
into 50 Ω (30-V open circuit), and
offers a variety of special operat-
ing modes. In addition, this instru-
ment has a true pulse-generator
output with pulse widths down to
30 ns, and is said to be the only
20-MHz function generator with
both linear and logarithmic fre-
quency sweep.

CIRCLE NO. 342

Precision amplifier exhibits low noise



Ortec Inc., 203 Midland Rd., Oak
Ridge, TN 37830. (615) 482-4411.
\$995.

The 9452 Mod 13 precision ampli-
fier offers significantly improved
performance, particularly in the
area of noise. Shorted-input noise
of the unit is typically 2.5 nV $\sqrt{\text{Hz}}$
at 1 kHz, and 5 nV $\sqrt{\text{Hz}}$ at 10 Hz.
The amplifier is fitted with a spe-
cial twinax/triax connector to pro-
vide high immunity to ground-loop
pickup and radiated electrical in-
terference. Other specs include
linearity of better than 0.001%
and a gain accurate and stable to
 \pm 1% over the entire 19-to-100-dB
range. Input impedance is 1 G Ω .

CIRCLE NO. 343

Tiny DMM weighs only 1.76 lb



T.R.I. Corp., Suite 550, 505 W. Olive, Sunnyvale, CA 94086. (408) 733-9080. \$279.

Weighing only 1.76 lb with batteries, this mini multimeter, the 6355, offers autoranging on its five functions (dc V, ac V, R, dc I and ac I), and has a sensitivity of 10 μ V on dc V. The seven-segment LED display has a maximum count of 1999. Basic accuracy of the unit is 0.15% rdg \pm 1 digit. The unit's price includes the ac adapter and alkaline battery cartridge. NiCd batteries are optional.

CIRCLE NO. 416

Logic analyzer shows circuit conditions

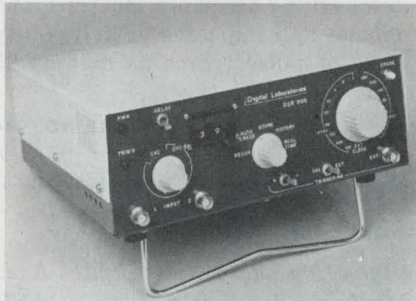

Digital Laboratories, 377 Putnam Ave., Cambridge, MA 02139. (617) 876-6220. \$975; stock.

The DSR-505 logic analyzer is said to have all the key features found in the new class of equipment called logic analyzers, digital logic recorders or logic scopes. The unit not only shows the conventional binary highs and lows, but also displays "in between" and open-circuit conditions. The DSR-505 monitors its two independent channels continuously, storing each input signal in 512-bit shift registers until a trigger occurs, and thus allows display of signals that occurred prior to the trigger.

CIRCLE NO. 417

SLIM-MOX

NOW VICTOREEN QUALITY COSTS LESS THAN A DOLLAR.

Victoreen announces SLIM-MOX, our new, thick-film, flat substrate resistor. Compact in design, it carries with it all the quality and dependable performance you have come to expect from Victoreen.

SLIM-MOX, right now, is available from stock in a wide range of standard resistance values. More important, SLIM-MOX will deliver the same proven performance in high-voltage applications that you find in more expensive resistors with more bulk.

Specify SLIM-MOX in any standard resistance value and your unit cost will be less than one dollar in OEM quantities. Truly a major cost breakthrough for resistors designed for miniaturized

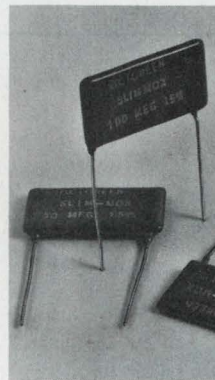

electronic networks and equipment, or other critical applications that demand stability and reliability.

Standard tolerance is \pm 15% for all standard resistance values which include 1, 2,

5, 10, 20, 50, 100, 200, 500, 1000, 2000, and 5000 megohm. All in stock. With a voltage coefficient of better than 5 ppm/volt, full-load drift typically less than 0.5% in 1000 hr at 70°C, and 250 ppm TCR or less to 5000 megohm, SLIM-MOX is a little, big performer. For less than a buck. From a name you know you can count on. Victoreen.

**Victoreen Instrument Division,
Sheller-Globe Corporation,**



SG
SHELLER-GLOBE CORPORATION

**10101
Woodland
Avenue,
Cleveland,
Ohio 44104**

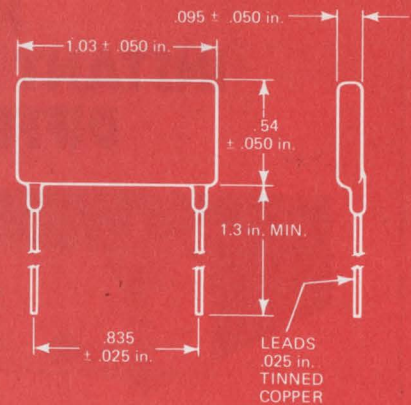

SLIM-MOX SPECIFICATIONS

Resistance Range	1M-5,000M
Power Rating @ 70°C	2W
Maximum Operating Volts (Applicable above critical resistance)	10,000V
Available Tolerance	15%
Critical Resistance	50M
Max. Service Temperature	150°C

TWO IN ONE

YOU GET PRECISE DIGITAL & ANALOG OUTPUT POWER

The new triple output LT series Lab Power supply offers you the most popular voltages required for both

digital & discrete circuits. Compare performance/price ratio to the competition.

SHORT CIRCUIT & OVER VOLTAGE Protected

INPUT ISOLATION 50 Meg

SIZE 5" w x 4.5" L x 1.25" H

LT 151-5
± 15v@ 100MA
5v@ 500MA
\$96

LTV-1
± 9to ± 18v@100MA
5v@1000MA
\$129

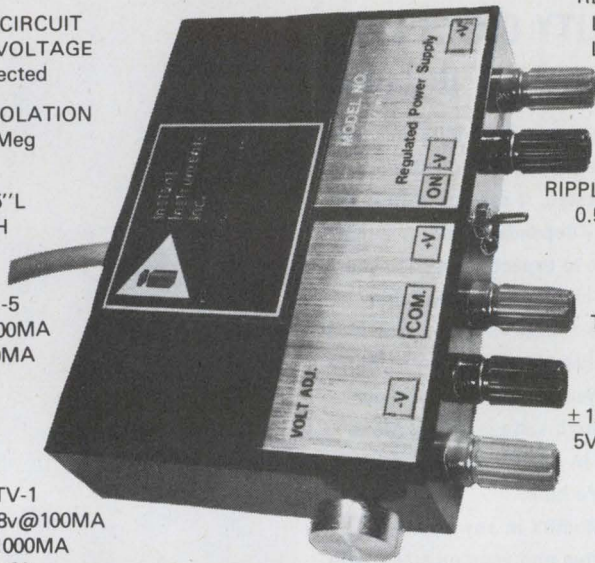

REGULATION
Line: 0.01%
Load: 0.05%

RIPPLE & NOISE
0.5mVrms

TEMP. COEF.
0.015%/°c

LT152-1
± 15V@200MA
5V@1000MA
\$137



Instant Instruments Inc.

306 RIVER STREET ■ HAVERHILL, MASSACHUSETTS 01830
TEL: (617) 373-9260

INFORMATION RETRIEVAL NUMBER 76

NEW! INSTANT FREQUENCY DIFFERENCE!



Tracor Model 527A measures frequency difference instantly, precisely. For precisely \$2,950.

Front-panel meter reads directly to parts per 10¹¹. Allows adjustment of two oscillators to the same frequency, adjustment to a specific offset, determination of offset — all instantly. Plus both short-term and long-term stability analysis. Internal oscilloscope extends precision to 1 x 10⁻¹². Reference and signal frequencies need not be the same. Write or call for full technical and application information.

Tracor

Industrial Instruments

6500 Tracor Lane • Austin, Texas 78721 • AC 512/926-2800

INFORMATION RETRIEVAL NUMBER 77

INSTRUMENTATION

Logic probe indicates levels of 'poor quality'



Hunnicut Digital Electronics, 2800 Shamrock Ave., Fort Worth, TX 76107. (817) 336-5449. \$69.50; stock to 2 wks.

LCA-2 analyzes 5-V TTL/DTL logic systems. The unit is said to be the only probe that offers an active indication of the quality of the logic condition of the test point. The combined indications of the indicator lamps define four voltage/logic levels: good 0, bad 0, bad 1, good 1. The input can withstand repeated contact with voltages as high as 200 V ac or dc. Overvoltage protection is provided electronically, no fuses to replace. The power-supply input is protected against accidental polarity reversal. The unit also detects and indicates polarity of single pulses as short as 10 ns (5 ns typ) and detects and indicates polarity/duty cycle of pulse trains as fast as 25 MHz (50 MHz typ).

CIRCLE NO. 344

Production PC tester sells for only \$7500

Fluke Trendar, 500 Clyde Ave., Mountain View, CA 94040. (415) 323-2133. \$7500; 60 days.

Model 1010 test station is for production testing of digital logic boards. The unit is said to cost three times less than the closest competing model. The unit incorporates 128 digital signal sources which generate input patterns for the board being tested. Signals are generated at selectable rates up to 4,000,000 patterns per second. Test length settings range from 40,000 to 40,000,000 patterns. The new tester accepts up to 60 output signals from the board to be tested and combines these into one digital bit stream which represents the "signature" of the unit under test.

CIRCLE NO. 345

WHY USE SILVER

...IF EVERYDAY WILL DO

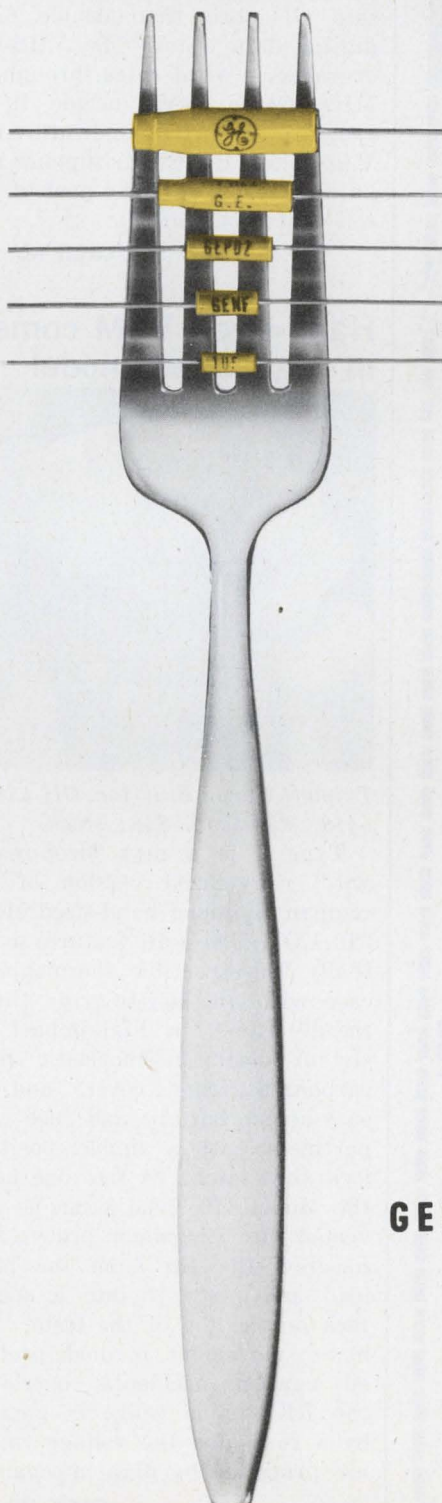
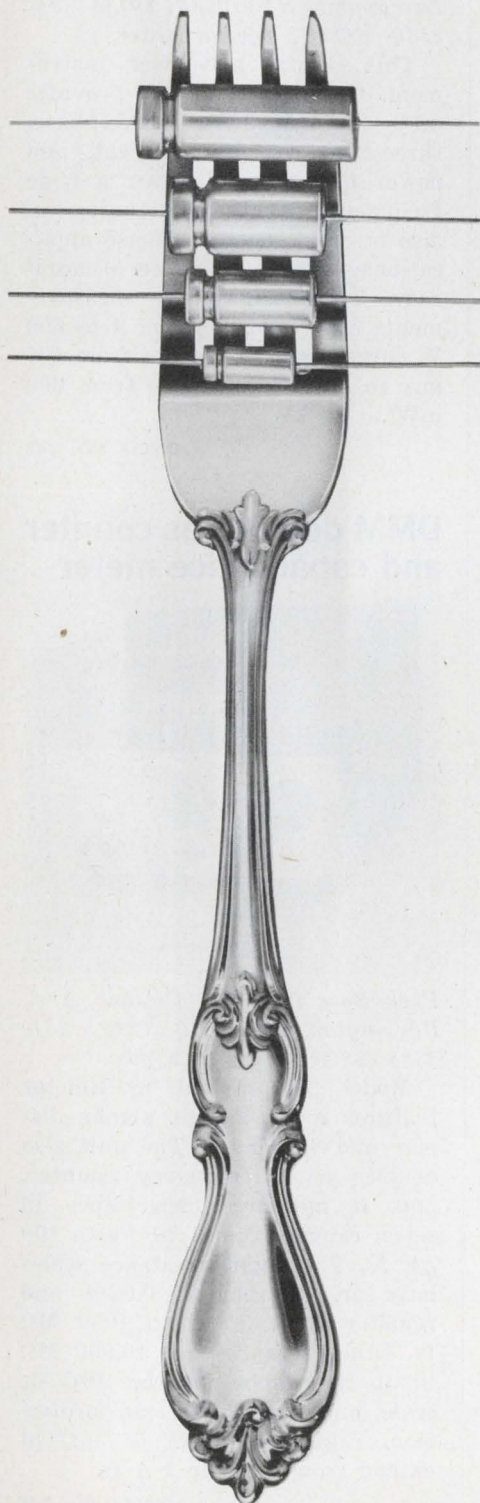

BEAT THE HIGH COST OF SILVER WITH GE 62F TANTALUM WET-SLUG CAPACITORS

At a time when increasing silver prices are sending wet-slug costs out of sight, General Electric's 62F capacitor line can save 20 to 40 percent* of your purchase dollar.

By using a nickel case instead of costly silver, General Electric keeps prices down and quality up; making the 62F a perfect choice for wet-slug applications up to 60 volts at 85°C maximum operating temperature.

Other features of the 62F line include:

- Short shipping cycles
- Fully insulated case
- Low leakage current
- Nonacid gelled electrolyte
- Very high available volt x microfarad per weight and volume
- High shock resistance

For more information on these, or any of General Electric's wide range of capacitors, call your nearest GE sales office today, or write Section 430-56, Schenectady, N. Y. 12345

*Depending on case size

GENERAL  ELECTRIC

free The "NEW LOOK"
1975
LAFAYETTE
ELECTRONICS
CATALOG

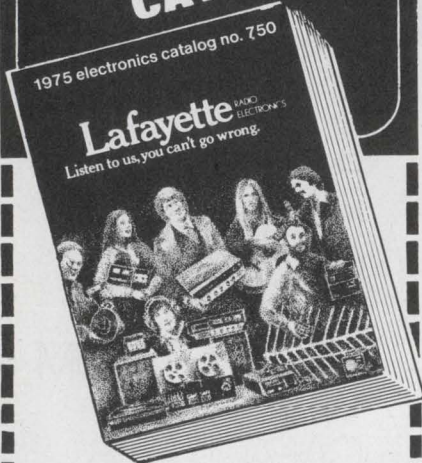

NEW! Larger Page Size
NEW! More Full Color
NEW! Easy-Read Type

SAVE ON LAFAYETTE
 PRODUCTS PLUS BEST
 MAJOR BRAND NAMES

The catalog you **NEED** if you're interested in electronics! Filled with colorful, accurate, interesting descriptions of all the latest electronics products, plus the "bits and pieces" you need to keep everything in top shape. It's the "energy saving" way to shop too—order by mail from your easy chair!

Lafayette

Listen to us, you can't go wrong.

Mail this coupon today **FREE!**

DEPT. 45015

Lafayette Radio Electronics
 111 Jericho Tpk., Syosset, LI, NY
 Send me your **FREE** 1975 Catalog

Name Apt.
 Street
 City State
 Zip

Send a 1975 Catalog to my friend

Name Apt.
 Street
 City State
 Zip

INFORMATION RETRIEVAL NUMBER 79

INSTRUMENTATION

6-bit a/d converter zips along at 75 MHz

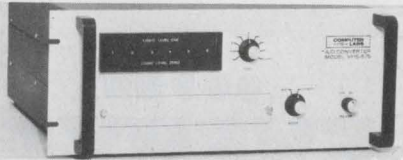

Computer Labs, 1109 S. Chapman St., Greensboro, NC 27403. (919) 292-6427. \$14,000; 8-10 wks.

Model VHS-675 a/d converter is said to more than double 6-bit digital data rates. The VHS-675 operates at word rates through 75 MHz. Other specs include 10 ps aperture; 80-MHz bandwidth; 500 V/ μ s slew rate. Power supplies and built-in test words are part of the self-contained unit.

CIRCLE NO. 346

Hand-sized VOM comes in ruggedized model



Triplet Corp., Bluffton, OH 45817. (419) 358-5015. \$48; stock.

Type 3 is a new "drop-resistant," ruggedized version of the company's famed hand-sized Model 310 VOM. The unit features a virtually indestructible thermoplastic case with an easy-to-grip "finger tread" finish, a high-impact resistant clear thermoplastic polycarbonate front cover, and an easy-access battery and fuse compartment with a simple, positive-lock slide latch. To free one hand, the Model 310 Type 3 can be converted into a common probe: Just unscrew the tip from the black lead and place it into a special jack on the top of the tester. The meter movement is diode-protected against accidental overloads, the RX1 ohms range is guarded by a fuse, and the voltage ranges are protected by high impedance.

CIRCLE NO. 347

True-rms meter reads to 0.1% in 3- ϕ systems



Yewtec Corp., 1995 Palmer Ave., Larchmont, NY 10538. (914) 834-3550. \$6850; special order.

This digital ac power instrument, the Model 2503-03, provides 0.1% accuracy for three-phase, three-wire voltage, current and power measurements over a wide frequency range. The unit can also be used in single-phase applications without sacrifice of accuracy. True-rms voltage measurements can be made from 3 to 600 V, current measurements from 100 mA to 30 A and power from 600 mW to 30 kW.

CIRCLE NO. 348

DMM doubles as counter and capacitance meter



Peck/Boss Inc., 845 Dundee Ave., Barrington, IL 60010. (312) 381-3388. \$329; stock to 2 wks.

Model 390 digital multimeter features a 4-1/2-digit planar display and 36 ranges. The unit also doubles as a frequency counter, plus it measures capacitance in seven ranges from 1 nF fs to 100 μ F fs. The eight resistance scales have an accuracy of 0.02% and register from 0.1 Ω to 1000 M Ω fs. Other features are 10,000 M Ω input impedance on the 10-V-dc scale and fused overload protection. Eight ranges of dc current extend from 1 μ A to 1 A fs.

CIRCLE NO. 349

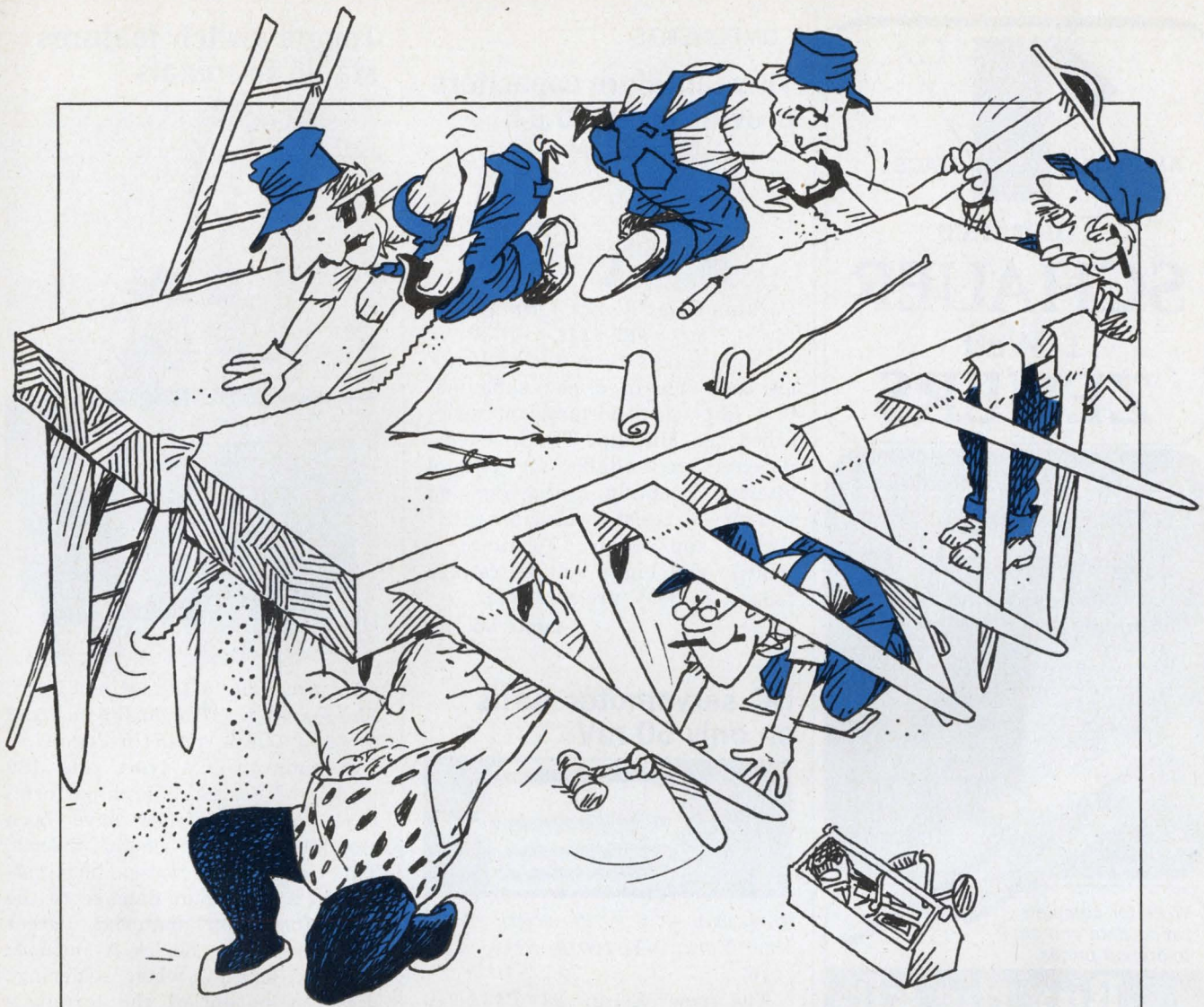

Our DIP crew makes great SIP resistor networks, too.

Leave it to our guys. They know you need a variety of space-stretchers to make your circuit-board packaging easier. And that's why these DIP experts also make Beckman RESNET™ standard SIP networks in 30 popular varieties.

These thick-film, cermet SIPs (.780" wide, .350" high, .090" thick) are standard 8-pin types, dimensionally uniform and ideal for automatic insertion techniques. Laser-tailoring assures precise resistance values, and every part is 100% tested.

Two convenient networks (see schematics)

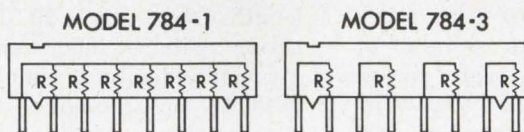

give you a 7-resistor model for applications like pull-up or pull-down networks, and a 4-resistor model for such typical uses as line termination and LED current limiting.

Resistance values available in both versions are 100, 150, 220, 330, 470, 680, 1K, 1.5K, 2.2K, 3.3K, 4.7K, 10K, 15K, and 22K.

And now for more good news. They're all stocked locally by your Beckman/Helipot distributor, ready for immediate delivery.

Cost? Truly competitive, actually giving you cermet quality at plastic prices.

Why wait? Let the new Beckman SIP line start making things a lot easier for you. For immediate literature or the phone number of your Beckman/Helipot representative, call toll-free (800) 437-4677. Right now.

Beckman®
HELIPOT DIVISION

1%

AMERICAN MADE

Tolerance SCHAUER 1-Watt ZENERS

Immediate Shipment Low Prices

ANY voltage from 2.0 to 16.0

Quantity	Price each
1-99	\$1.07
100-499	.97
500-999	.91
1000-4999	.86
5000 up	.82



All welded and
brazed assembly

No fragile
nail heads

Gold
plated
leads

Write for complete
rating data and other
tolerance prices.

Buy the kit- Save a lot



Kit contains a 51-piece assortment of SCHAUER 1% tolerance 1-watt zeners covering the voltage range of 2.7 to 16.0. Three diodes of each voltage packaged in reusable poly bags. Stored in a handy file box. Contact your distributor or order direct.

A \$54.57 value for
ONLY \$24⁵⁰

Semiconductor Division

SCHAUER

Manufacturing Corp.

4511 Alpine Ave. Cincinnati, Ohio 45242
Telephone: 513/791-3030

COMPONENTS

Tiny tantalum capacitors provide up to 10 μ F

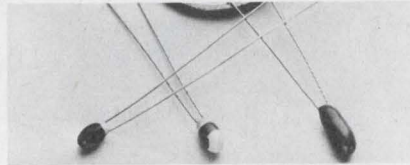

Corning Glass Works, Corning, NY 14830. (607) 962-4444.

Capacitances from 0.10 to 10 μ F are available in a new subminiature, dipped, solid-tantalum series called the Minidip. The tiny components are suitable for general filtering, coupling, by-passing and noncritical resistor-capacitor (RC) timing applications. Tolerance is $\pm 20\%$, and eight voltage ratings from 2 to 35 V are available.

CIRCLE NO. 350

DC servomotor turns on only 50 mV

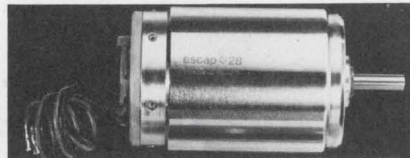

Portescap U.S., 730 Fifth Ave., New York, NY 10019. (212) 245-7716.

The new Escap 28 PL11-219 miniature dc servomotor in a frame of 28 mm at nominal 9 V has a no-load speed of 4500 rpm and a stall torque of 3.9 oz-in. Armature resistance is 5.95 Ω . Torque constant is 0.0189 Nm/A. The unloaded mechanical time constant is 17 ms. The motor uses an ironless rotor with a cylindrical self-supporting skew-wound coil that tolerates a maximum temperature of 90 C. The speed-torque characteristic is linear and, on average, the motor starts turning with a voltage as low as 50 mV. A considerable torque is developed at a relatively low supply voltage, yet the starting current is kept to a reasonably low value, which helps to increase lifetime in start-stop operation. The particular advantage of this motor is its excellent regulation, with a value of 0.000165 rad/sNm. This means that a load variation of 0.01 oz-in. causes a speed variation of only 11.4 rpm.

CIRCLE NO. 351

Toggle switch features stable terminals

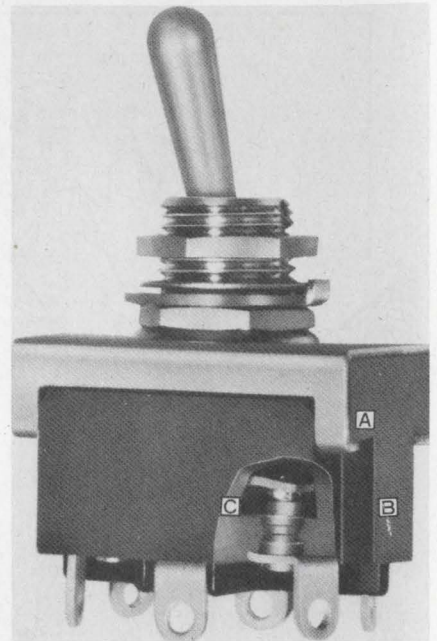

Ohto Co., Ltd., 5-18-1 Minami Ohi, Shinagawa Ku, Tokyo, Japan. \$0.53 to \$2.64 (OEM qty-FOB Japan).

A total of six types and 180 models of Series A, high-performance toggle switches have been standardized with metal inserts. This eliminates loose terminals caused by aging or damage to the case insulation material. Other features of the Series A include: no flux flow-in, when soldering; direct mounting of the terminals to the conduction hardware to assure stable electrical performance; increased terminal mounting strength, high insulation between frame and conduction section; UL Standards Approved Materials 94V-1 and 94V-0 are employed for the case; a full choice of terminals—solder, screw AMP 187 or 250.

CIRCLE NO. 352

Low-profile switch in dual in-line package

Duncan Electronics, 2865 Fairview Rd., Costa Mesa, CA 92626. (714) 545-8261.

The Duncan DIP-500 is a high-density, low-profile switch in a standard machine-insertable DIP configuration. Varying package lengths contain up to 10 SPST slide-action switches. They can be actuated individually or simultaneously with a programming tool. The switch allows topside access for test probes.

CIRCLE NO. 353

A GOLD MINE OF INFORMATION & DATA

- **520 CATALOG PAGES ON
ICs & SEMICONDUCTORS**
- **300 CATALOG PAGES ON
INSTRUMENTS**
- **290 CATALOG PAGES ON
POWER SUPPLIES**
- **210 CATALOG PAGES ON WIRE
& CONNECTOR PRODUCTS**
- **150 CATALOG PAGES ON
SWITCHES**
- **2800 CATALOG PAGES ALL
TOLD IN 52 PRODUCT
CATEGORIES**

Electronic Design's GOLD BOOK puts the entire electronics industry at your fingertips. Use it for product search, selection, specification and purchase. It's the most thorough industry master catalog & directory ever compiled.

When you need information . . .

Electronic Design's
GOLD BOOK
IS THE PLACE
TO LOOK

DATA PROCESSING

Minis boast 32-k boards and network software

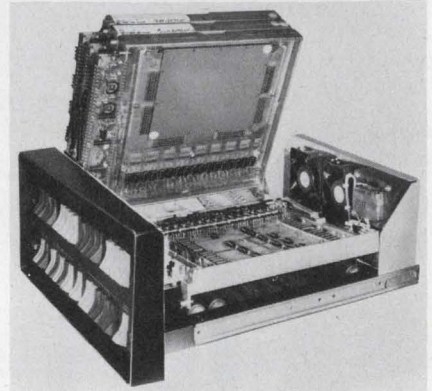

Modular Computer Systems, 1650 W. McNab Rd., Fort Lauderdale, FL 33309. (305) 974-1380. See text; 30 days.

Six minis and an operating system for distributed network configurations complement the company's 32-kword, 1- μ s core-memory board. The board, said to be the world's first 32-k core unit, is used in the six minis which range in price from \$13,000 to \$30,000. All minis are expandable to 64-k words but differ in options and range of interfaces provided. The II/12 (\$13,000) is a basic machine with operators console, hardware multiply/divide, 15 registers and eight interrupts. The II/221 (\$30,000) includes a 2.5-Mword disc multiplexer controller peripheral controller interface, direct memory processor and system protect. The intermediate models include the II/26 (\$16,000) with controller for console and paper tape reader; the II/26CP (\$20,500) with control logic for communications; the II/201 (\$16,500) with DMA and peripheral controller interface and the II/231 with 2.5 Mword disc and universal multiplexer. A software package named Maxnet III allows the user to start with one hot satellite (\$3000 charge) and add more machines for a nominal charge of \$500. The software isolates the programmer and operator from communication and system protocols. All network functions are interfaced through executive service programs, Fortran-callable subroutines or operator commands. Resources are sharable by all machines in the net.

CIRCLE NO. 415

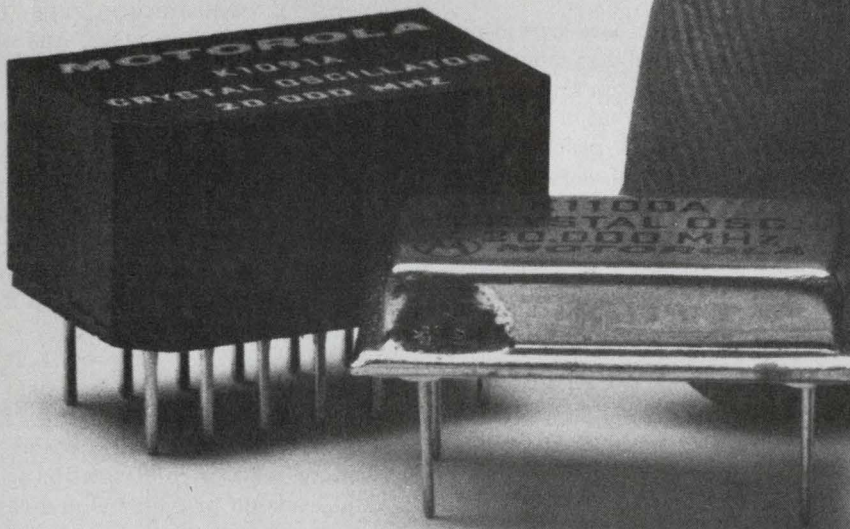

hybrid
Think small.

Here's a crystal clock oscillator that's even smaller than our K1091A. Fits the same circuits, same sockets. And even costs less in volume quantities. The K1100A is available from 250 kHz to 20 MHz, and, like the K1091A, is TTL compatible, has $\pm 0.01\%$ stability from 0°C to $+70^{\circ}\text{C}$, and uses the standard +5V dc input.

Rush delivery now available.

Now you can take advantage of 4-week

volume delivery of the K1100A in stock frequencies (4.0, 4.9152, 5, 10, 20 MHz). 6 week delivery for any discrete frequency from 4 to 20 MHz. And 8 week delivery for any discrete frequency from 250 kHz to 4 MHz.

For full specifications and prices on both the K1091A and K1100A, write Motorola, Component Products Department, 2553 N. Edgington, Franklin Park, Illinois 60131. Or call (312) 451-1000.



MOTOROLA
Communications and Electronics Inc.

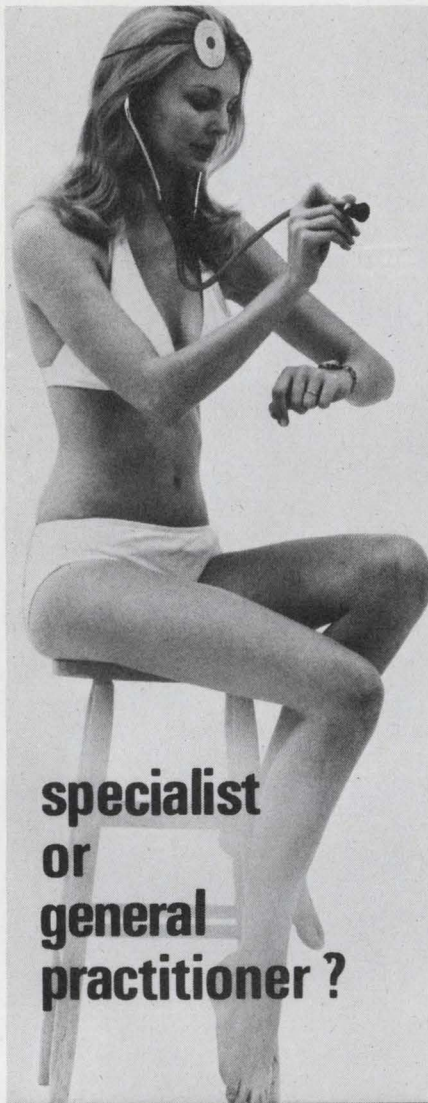

**specialist
or
general
practitioner?**

Specialist, of course... in the art of reducing or eliminating unwanted, troublesome signals from electronic circuits. Rtron specializes in the design and manufacture of RFI/EMI filters to cure virtually every electronic interference problem. UL Recognized data processing filters, MIL-F-15733 types and filters for every industrial application are readily available... from stock to custom designed, tubular, rectangular or bathtub types, in single or multi-circuit units.

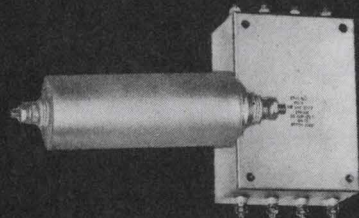

If you like our specialist, you'll like our treatment... phone or write...

Rtron

Dept. ED-1

P.O. Box 743 Skokie, Illinois 60076

Phone 312 • 679-7180

INFORMATION RETRIEVAL NUMBER 85

COMPONENTS

Altitude switch mounts on PC board



Inertia Switch Inc., 311 W. 43rd St., New York, NY 10036. (212) 586-5880.

Model 6UC-552 low-cost miniature altitude switch can mount on a PC board. The switch contains NC contacts that open at a predetermined altitude and reclose within 10% of the initial setting upon descending (within 5%, on special order). The unit's contacts are rated at 0.5 A, 28 V dc; terminals are 0.031-in. dia, gold-plated; insulation resistance is 200 M Ω at 500 V dc; and environmental specifications conform to MIL-E-5272.

CIRCLE NO. 354

Edge meters conserve panel space

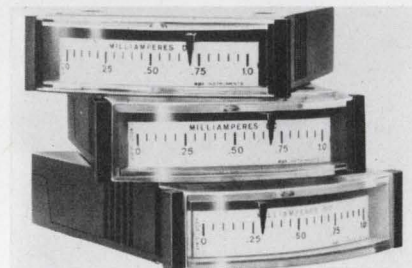

Process Control Div., 1601 Trapelo Rd., Waltham, MA 02154 (617) 890-2000.

A new Series 1000 line of edge-mount panel meters satisfies the demand for minimum use of panel space. Two mounting clips are attached without screws to the meter case, after the meter is inserted through its cutout. The clips are then tightened against the panel. The case itself—clear front window and black base—are molded from high-impact polycarbonate. The flat d'Arsonval mechanism with pivot-and-jewel suspension provides 2% accuracy for either vertical or horizontal scale orientations. The meter's stability makes a front zero adjust unnecessary. The case design permits snap-together access for convenient dial changing.

CIRCLE NO. 355

Temp-sensitive resistor varies linearly

Corning Glass Works, 550 High St., Bradford, PA 16701. (607) 974-8147. \$1.23: 1% units; \$0.49: 5% units (10,000 up).

Temperature-sensitive nickel-film resistors offer linear resistance change with increasing temperature for use in electronic temperature control, compensation, indication or protection systems. Operating temperature range is -55 to 250 C. Between 0 and 100 C, resistance will increase from 880 to more than 1400 Ω . At 25 C, resistance is 1000 Ω . Temperature coefficient of resistance is +5900 ppm/ $^{\circ}$ C. Corning assures part interchangeability because of a continuous manufacturing process. Tolerances are $\pm 1\%$ or $\pm 5\%$. The resistors can dissipate up to 1/2 W and self-heat at a rate of 6 mW/ $^{\circ}$ C in an air flow of 1 ft/s, 10 mW/ $^{\circ}$ C in 25 ft/sec and 30 mW/ $^{\circ}$ C in an agitated liquid. The resistors are sold in the standard Corning resistor configuration with axial leads on press-fitted end caps.

CIRCLE NO. 356

Low-profile relay allows 1/2-in. board spacing



AMF Inc., 1200 E. Broadway, Princeton, IN 47670. (812) 385-5251. \$3.06 (OEM qty); samples available.

A lightweight, low profile relay, Model T10, for use on PC boards allows board spacing as close as 1/2-in. center-to-center. The relay is a permissive-make, 4-Form-C relay with a pick-up point 75% of rated voltage and a power requirement of 800 mW. The contacts are made of gold-flashed silver and they are rated from 0.1 to 3 A at 30-V-dc resistive. Contact-life expectancy is a minimum of 50-million operations, mechanical, to 50,000 operations at full rated load. Initial contact resistance is 50 m Ω , or less. Coil voltage ratings are 6, 12, 24, 36, and 48 V dc.

CIRCLE NO. 357

**RF Microwattmeters—
Analog and Digital—
FS Sensitivities from
10 nW to 10 mW**



MODEL
42B/42BD

Boonton rf microwattmeters offer unrivalled sensitivity: 10 nW fs to 10 mW fs; from 200 kHz to 18 GHz, at highest stability ever attained at these sensitivities. Analog (42 B) or digital (42 BD) versions, both with linear DC outputs and logic-level programmability. BCD outputs are standard on digital version, auto-ranging and dB display (0.01 dB resolution) optional. Boonton Electronics, Parsippany, N.J. 07054

INFORMATION RETRIEVAL NUMBER 255

**Wide-Range
Programmable
Capacitance Meters**



MODEL
72B/72BD

Boonton analog (72B) and digital (72BD) provide rapid, accurate, 3-terminal and differential measurements, at 1 MHz, from 1 pF fs. Measures semiconductor-junction capacitance at low (15 mV) test level, with provision for external DC bias. Phase-sensitive detector measures accurately even at $Q=1$. Logic-level range programmability and fast-tracking DC output are ideal for ATE. Model 72BD has standard BCD output and autoranging. Boonton Electronics, Parsippany, N.J. 07054

INFORMATION RETRIEVAL NUMBER 256

**Direct Capacitance Bridge
0.00005 to 1000 pF
and 0.01 to 1000 mho**



MODEL
75D

Boonton Model 75D Direct Capacitance Bridge is designed for 1 MHz capacitance and loss measurement. Capacitance range, 0.00005 pF to 1000 pF; basic accuracy, 0.25%. Conductance range: 0.01 mho to 1,000 mho, basic accuracy, $\pm 5\%$. Internal bias from -6 V to +150 V. Adjustable test level, 1 mV to 250 mV, at 1 MHz. Two modes of operation allow either conventional capacitance and loss measurements or one-control balance for capacitance only. 3-terminal input configuration. Boonton Electronics, Parsippany, N.J. 07054

INFORMATION RETRIEVAL NUMBER 257

INFORMATION RETRIEVAL NUMBER 258 ▶

Happy birthday, price-less.

Introduced just one year ago, our 102A FM/AM Signal Generator is celebrating a well-earned sales success against the HP8640B that once had the market sewn up. It's no wonder when you can save thousands of dollars and still get all you really need.

With our generator you get a well shielded, low noise source from 4.3 to 520 MHz that is both stable in frequency and accurate in level. We've shrunk warmup to 15 minutes and weight to 30 lbs.

We have the best residual FM spec around: 100 Hz resolution with a 6-digit display, individual metering of modulation and RF output, true peak monitoring, and 0-300 kHz internal FM deviation on all bands—external FM deviation can be as wide as 2 MHz peak-to-peak even at the lowest frequencies.

The 102A is engineered for your convenience. That's why we've designed a front panel that is easy-to-use and understand, why we have the specifications decal on the top of the instrument in plain view, why we've added a unique adjustable "feel" main drive mechanism for easy narrow-band receiver setting, and why we have a full list of optional goodies—like a detected AM output to verify our negligible phase-shift for VHF omnitesting, fused RF output with replaceable elements, and external clock input.

Call or write today for data and/or a demo and you'll call the 102A price-less, too. Boonton Electronics Corp., Rt. 287 at Smith Rd., Parsippany, N. J. 07054; (201) 887-5110.

Price \$3575.

BOONTON

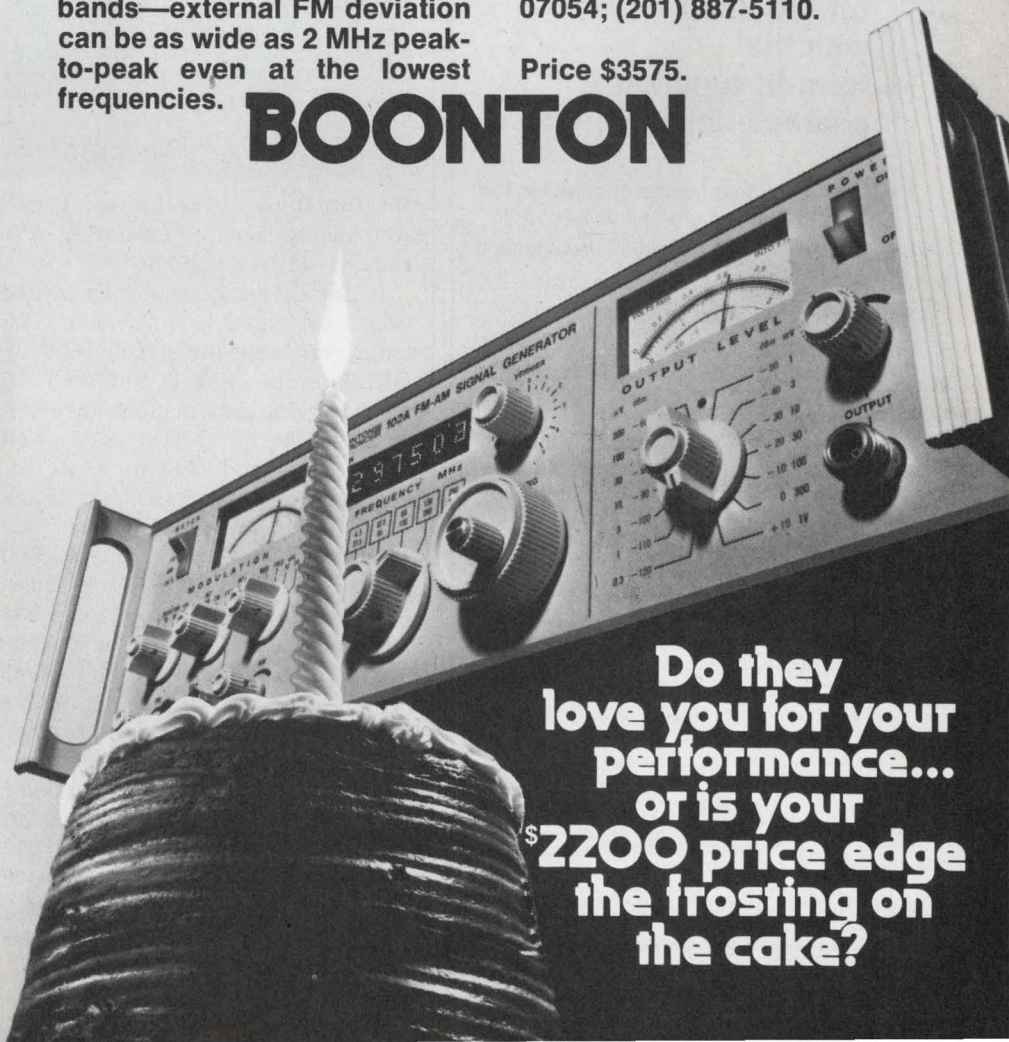

Do they
love you for your
performance...
or is your
\$2200 price edge
the frosting on
the cake?

immediate prototype delivery on Grayhill rotary switches



Adjustable stop switches off-the-shelf with the form-fit-function characteristics you need

- Simple pin adjustment provides the right number of positions per pole
- Over 100,000 possible combinations
- Available now from your local Grayhill distributor

Here's the fast route to rotary switches for prototypes or small production runs. Grayhill Adjustable Stop switches, available from your local Grayhill distributor, cut procurement lead time. You no longer need to wait for even small quantities to be built to order. The Adjustable Stop feature is available in one-inch and half-inch diameter, single deck and multi-deck versions. Your distributor can supply 1-and 2-deck Adjustable Stop switches from stock (one or two poles per deck) and can quickly secure other variations from factory stock. Write for complete literature.



561 Hillgrove Avenue • LaGrange, Illinois 60525
(312) 354-1040

INFORMATION RETRIEVAL NUMBER 87

COMPONENTS

Single-tone speakers deliver 105 dB of sound

Quam-Nichols Co., 234 E. Marquette Rd., Chicago, IL 60637.
(312) 488-5800.

A complete line of single-tone loudspeakers can be used in intrusion detectors, smoke and gas detectors and other alarm systems. They also are suitable where fidelity of reproduction over a range of frequencies is not important, as in annunciators. The speakers are available in a wide variety of frequencies between 500 and 3000 Hz. The units can handle power to 25 W and provide loudness levels to 105 dB. Weatherproofing or other special environmental characteristics can be incorporated.

CIRCLE NO. 358

TO-5 relay versions for military/industrial use

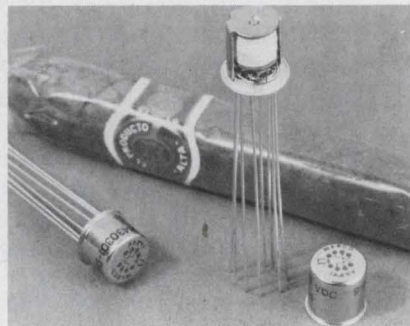

Westinghouse Air Brake Co., Aerospace Dept., Pittsburgh, PA 15218. (412) 242-5000.

A family of hermetically sealed relays packaged in all-welded TO-5 transistor enclosures includes four DPDT units. Models 914 and 916 meet or exceed performance requirements of MIL-R-5757 and Models 934 and 936 are their industrial counterparts. The military versions withstand 80-G shock for 11 ms and 30-G vibration at 3000 Hz. Models 916 and 936 are sensitive versions of Models 914 and 934 and operate on only 60 mW. The power consumption of the other models is about 120 mW. All relays have a mechanical life expectancy exceeding one million operations. Models 914 and 934 are available in operating voltages of 6, 9, 18, and 26.5 V; sensitive Models 916 and 936 in operating voltages 6, 12, 26.5, 36 and 48 V.

CIRCLE NO. 359

Dc tachometer uses brushless design

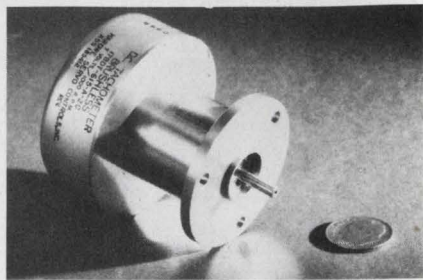

Harowe Servo Controls, Inc., Westtown Rd., West Chester, PA 19380. (215) 692-2700. \$65 (500 up); 6 to 8 wks.

Series BDT dc tachometers use a permanent-magnet rotating field with a multiphase rectifier output instead of brushes and commutators. The manufacturer states that its brushless design results in the complete elimination of spikes, and provides a clean, noiseless signal with virtually zero RFI emission. Dc output in linear to 0.2% over a range of 1000 to 3000 rpm. Specifications include: 7 V/1000 rpm output, 50 mV p-p ripple at 100 rpm, detent torque of 0.25 oz in. and over-all envelope dimensions of 2.015 in. dia by 2.051-in. long.

CIRCLE NO. 360

Cooling fan claims 100,000-hour life

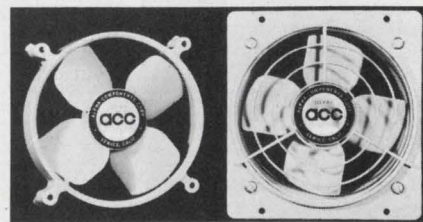

Alpha Components Corp., 115 Eucalyptus Dr., P.O. Box 947, El Segundo, CA 90245. (213) 322-7780. \$7.25. (1000 up); stock.

Model No. B100, B101 and B102 ac cooling fans are guaranteed for 100,000 hours of operation. The fans supply 150, 130 and 90 cfm, respectively, at a nominal 115 V ac input. The new line uses a unique unibearing rotor, which reduces friction, noise and vibration to a minimum. Weighing only 24 oz complete with grille and venturi, this axial type fan is 5-in. dia by 2-3/8-in. deep and mounts on 4.125-in. industry-standard mounting centers.

CIRCLE NO. 361



KEMET tantalums stand up in tough emission control circuits. They've had a lot of military experience behind them. Stand easy.

KEMET tantalums put more quality in your entertainment-grade radio and stereo circuits by providing point-to-point wiring and greater PC board density. That's the news.



KEMET solid tantalum capacitors have the electrical characteristics and operating temperature range needed for fuel metering, air bag, speed sensor, crash sensor and other automotive circuits that you are designing.

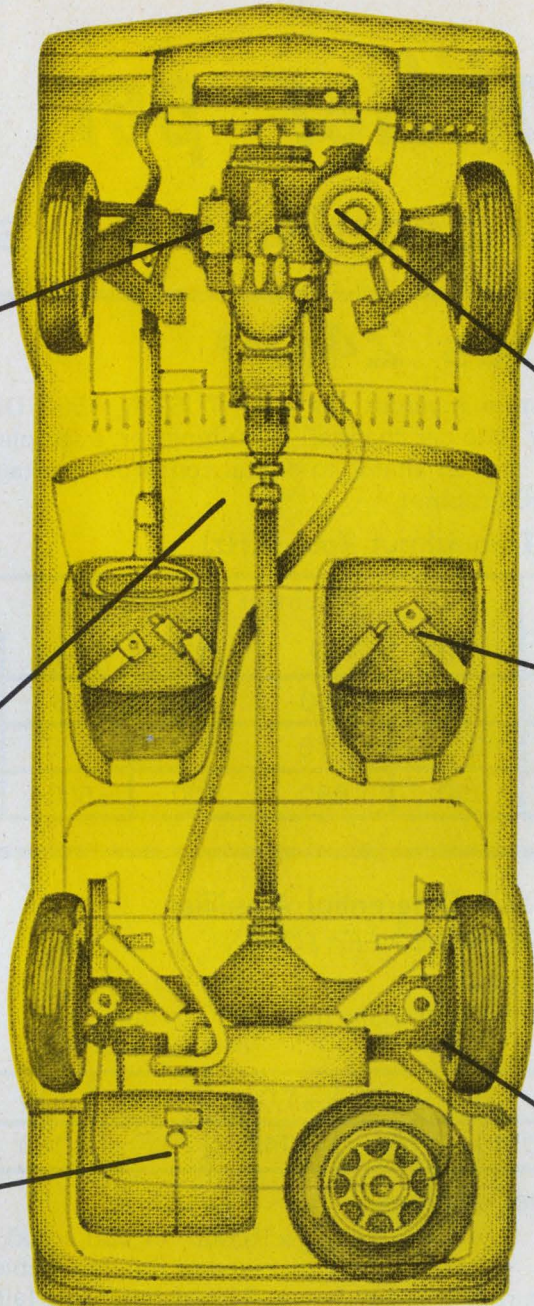

Electronic ignition systems last longer when they contain KEMET solid tantalum capacitors. They display excellent stability and withstand mechanical stress. Fire up.



Reliability is paramount for seat-belt interlock circuits. That's why KEMET solid tantalums are specified. Start now.

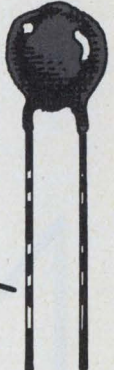

KEMET solid tantalum capacitors are great for anti-skid device circuits. They resist shock and vibration.



KEMET[®] tantalum capacitors put you in the driver's seat.

When designing reliable circuits for critical automotive electronics applications, take command.

Specify KEMET Polar Solid Tantalum Capacitors.

They're available now for prompt delivery in two low-cost, highly reliable families that are made for your mobile circuits. With capacitance range from 0.1 to 330 uF, for operation on 6 to 50 VDC, with $\pm 20\%$ and $\pm 10\%$ capacitance tolerance standard ($\pm 5\%$ also available on special order).

The KEMET T362/T368 epoxy-dipped, radial-

leaded series is available in six popular case sizes.

For automated PC board insertion techniques, try KEMET T310 "bullet" axial-leaded series with the shape that reveals polarity. Their transfer-molded epoxy case provides precise dimensional tolerances and excellent environmental resistance.

For complete specifications and free engineering samples, write to Union Carbide Components Department, P.O. Box 5928, Greenville, SC 29606; phone: (803) 963-6300 or TWX: 810-287-2536.



COMPONENTS DEPARTMENT

amplifier per channel

data acquisition systems

Series 2400

Each system includes the new TUSTIN 1560 Differential Amplifier (one per channel), a multiplexer, a sample and hold amplifier and an analog-to-digital converter, packaged in the A/D x-1500 cabinet.

System Throughput Rate (KHz)

ADC Series	Number of Binary Bits				
	10	12	13	14	15
2415	110	100	80	75	70
2421	325	275	250	225	200
2420	750	650	600	500	500

Model 1560 Differential Amplifier

OUTSTANDING FEATURES

- Bandwidth: 100 KHz (all gains)
- Common Mode Rejection: (DC to 60Hz with a 1.0 Kohm source unbalance)

Gain	x10,000	x1,000	x100	x10	x1
CMR (DB)	160	140	120	100	80

Brief Specifications

Gain: x10,000, x1,000, x100, x10, x1
(Fixed or Programmable Gains)
Gain Accuracy: $\pm .01\%$ of Full Scale (all gains)
Temperature Coefficient: $.5\mu\text{v}/^\circ\text{C}$ & $.5\text{na}/^\circ\text{C}$ RTI
Offset @ 25°C: $1\mu\text{v}$ & 1na RTI
Input Resistance: 50 megohms
Active Filter: 2 through 6 poles (as specified)
(Butterworth, Bessel etc.)

TUSTIN ELECTRONICS COMPANY manufactures a wide variety of systems and related products for use in computer controlled data acquisition and process control applications.

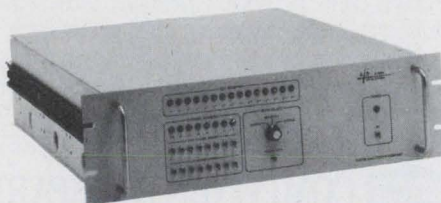

TUSTIN
ELECTRONICS COMPANY

1431 E. St. Andrews Place, Santa Ana, CA 92705 (714) 549-0391

INTEGRATED CIRCUITS

8-bit NMOS processor has 72 instructions

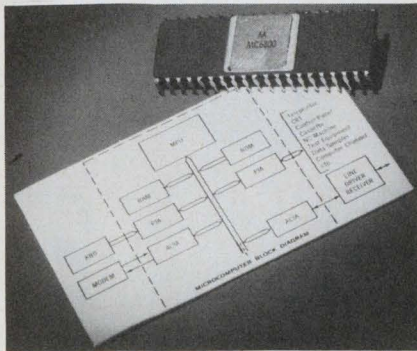

Motorola Semiconductor Products, P.O. Box 20924, Phoenix, AZ 85036. (602) 244-3466. \$360 (1-24).

The MC6800 is an eight-bit parallel processor with bidirectional data-bus capability. A 16-bit address bus provides access to 65-k-bytes of memory, and three-state operation of the data and address lines is permitted. The MPU (microprocessing unit) responds to a set of 72, variable-length instructions. This repertoire includes binary, two's complement and decimal arithmetic, logical, shift, rotate, load, store, conditional or unconditional branch, interrupt and stack-manipulation instructions. In addition, the MC6800 has seven address modes; the type and coding of the instruction fetched determines the address mode for that instruction. Single, two or three byte (8-bit) instructions are used in the following address modes: Direct, Relative, Immediate, Indexed, Extended, Implied and Accumulator. The MPU contains three two-byte and three single-byte registers. The two-byte registers (and their functions) are: program counter (points to the current program address); stack pointer (contains the address of the next available location in an external push-down/pop-up memory stack); index register (stores data or a 16-bit Address for the indexed mode of memory addressing). The single-byte registers (and their functions) are: two accumulators (to hold operands and results from an internal ALU, or arithmetic logic unit), and condition-code register (contains the results of an ALU operation). Timing of the MPU is accomplished with a two-phase clock at rates of up to 1.0 MHz.

CIRCLE NO. 362

GREAT TIMING!



**Series 2200
Precision Timers**
Microseconds to
999.99 Seconds



**Series 2400
Digital Clocks**
12, 24, or 100 Hours



**Series 2440-2450
Calendar Clocks**
Seconds to Months



**Series 2600
Stopwatches**
Microseconds to Minutes

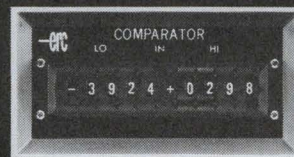

**Series 2500
Comparators**
For timing decisions

All have BCD outputs, all-aluminum enclosures, and ERC accuracy and dependability.

Telephone: (913) 631-6700
TWX: (910) 749-6477

electronic research co. • a textron div.

Mail to: P.O. Box 913
Shawnee Mission, Kansas 66201

erc

Visitors welcome at 7618 Wedd, Overland Park, Kansas



**our products
are more fully
developed...**

Standard Condenser capacitors are indeed fully developed to produce the optimum in performance and durability. Standard is in one business only, the design and manufacture of the world's finest capacitors. We have designed and delivered thousands of specialized capacitors for industry. In fact, what you think of as "special" may be among the many designs already available from stock at Standard. However, if you require capacitors of unusual shape, size, value and material, our engineering department will help you design and produce them to your exact specifications at stock prices. For immediate action, send us a sketch and complete details.

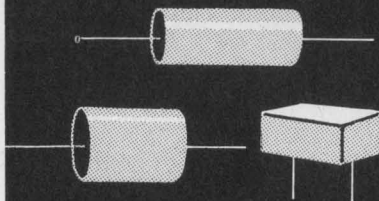

Write or phone for catalog and details.

Standard

CONDENSER CORPORATION

Dept. ED-1 1065 West Addison Street
Chicago, Illinois 60613 • (312) 327-5440

INFORMATION RETRIEVAL NUMBER 91

INTEGRATED CIRCUITS

**1-k static RAMs
access in 450 ns**

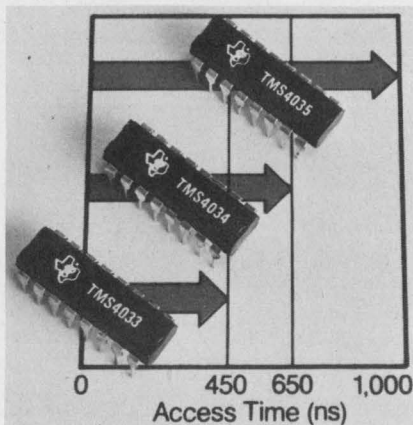

Texas Instruments, P.O. Box 5012, M/S 308, Dallas TX 75221. (214) 238-3741. \$13.36 to \$19.20 (100 up); stock to 3 wks.

Three n-channel static MOS RAMs—the TMS4033, TMS4034, and TMS4035—are organized as 1024-bits of one word each. They are pin compatible with the popular 2102-1, 2102-2, and 2102 RAMs, respectively, and they have access times of 450, 650 and 1000 ns, accordingly. Other features include full 74-TTL series compatibility, single 5-V supply and three-state outputs. The new RAMs come in a 16-pin plastic DIP (NL suffix), or in a 16-pin ceramic DIP (JL suffix).

CIRCLE NO. 363

**Three-chip set holds
4-bit microprocessor**

National Semiconductor Corp., 2900 Semiconductor Dr., Santa Clara, CA 95051. (408) 732-5000. \$150 (sample quantities).

A 4-bit microprocessor chip set employs the same 4-bit slices used in the company's previously introduced IMP-8 and IMP-16 microprocessors. Called the IMP-4, the three-chip set provides improved interrupt structure for speedy response, allows increased operating speed, and permits microprogramming, so instruction sets can be tailored to the application. The IMP-4 chip set is supported by an IMP-4P prototyping system, similar to those National provides for its 8 and 16-bit chip sets. Also available is an IMP-4 cross-assembler on G.E. Information Services.

INQUIRE DIRECT

**Low-power Schottky
adds AND gates**

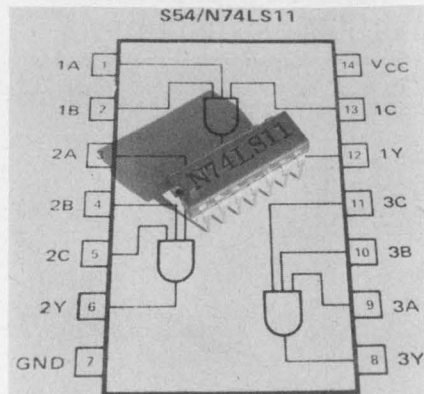

Signetics, 811 E. Arques Ave., Sunnyvale, CA 94086. (408) 739-7700. 50¢ to \$2.20 (100).

Six positive AND gates, part of the company's 54/74LS series, save power while speeding data. Propagation time is typically 12 ns and the average power consumption is only 4.25 mW per gate when operating at a duty cycle of 50%. Models cover MIL and commercial temperature ranges, and they come in both plastic and ceramic DIPs.

INQUIRE DIRECT

**Amp/detector limiter
has many facets**

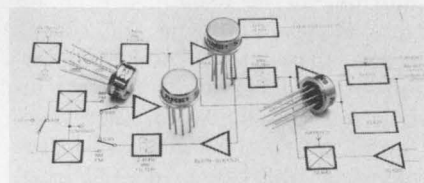

Plessey Semiconductor, 1674 McGaw Ave., Santa Ana, CA 92705. (714) 540-9979.

An IC that can be used as an rf clipper, i-f limiter stage, or rf compressor in SSB transmitters also includes an agc detector for AM signals. The new circuit features a broadband amplifier with 3-dB points of 5 and 150 MHz, a noise figure of 4.5 dB and a gain of 4. Called the SL613, the detector begins operation with an input of 10 mV rms, and it limits, with the broadband amplifier, at 120-mV rms input, providing an output of 1 mA. The circuit has internal bias and supply decoupling and it consumes 15 mA with a 6-V supply. Simple voltage is 6 to 9 V, and the unit comes in an 8-lead TO-5 can. The SL613 operates over the -55 to 125 C temperature range.

CIRCLE NO. 364

Remember the time you wanted something special in 3½ digits?

Your time has come.

When we at Analog Devices introduced the 5-volt digital panel meter, we said there'd be more—a lot more. Look what we can offer you in 3½ digits alone.

Why so many? To give you a choice. So you won't have to order or build specials anymore. Because now we've made what you need a standard.

Let's say you need 3½ digit resolution. You can get it displayed in Numitron, LED, or even Sperry.

In Numitron, we can even give you a choice of green or red.

Now you have to power it. Most of our meters are 5 volts DC

because so much of what you're working on is in TTL logic. But if you need one that can run on 115 volts AC, you've got it. The AD2006 with Sperrys—in AC or DC. It's our latest DPM. But not our last.

You may even be designing something that will end up in another country. We can help you there too. With meters that will operate on voltages in Europe, the U.K., Japan, and just about anywhere else.

If you look closely, you'll see that one meter isn't a meter at all. It's a remote display. Sometimes you need that kind of thing.

But then giving you what you need is what it is all about. Like reliability. And extra features like card edge connectors. Ratiometric inputs. .05% accuracy. And low prices. Ours start at \$49 in hundreds for the remote display.

Now, would you like to see what we can do for you in 4½ digits—or 2½ digits? Give us a call. We'll see that you get a copy of the "Designer's Guide to Digital Panel Meters." And any other help you may need.

Analog Devices, Inc., Norwood, Mass. 02062. On the East Coast, call (617) 329-4700. In the Midwest, (312) 297-8710. And on the West Coast, (213) 595-1783.

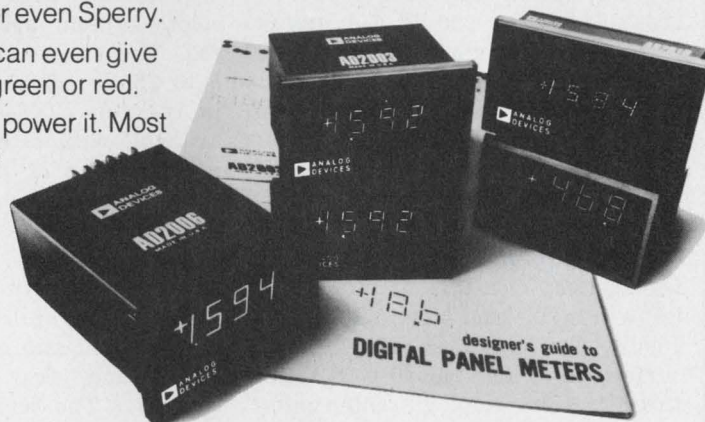

 **ANALOG
DEVICES**

Then it was special. Now it's a standard.

BIG POWER SUPPLIES



IN LITTLE PACKAGES

**AC-DC and DC-DC
miniaturized power converters
that deliver 3.9 watts
per cubic inch.**

- AC inputs: 115VAC, 50-500Hz
- DC inputs: 12, 28, 48 & 115VDC.
- 1 to 6 isolated and regulated DC outputs from 4.2 to 300VDC.
- Line and load regulation to 0.1%.
- Up to 120 watts per output.
- Efficiencies to 85%
- Design-As-You-Order construction from standard sub-modules . . . over 1200 possible configurations.
- Completed converters provided in tested and encapsulated, conduction cooled packages in just days.

See for yourself how we've packed the power and performance in . . . request our actual size "little black box" punch out kit and catalog today!

Call us collect . . . ask for Jim Dunn.



ARNOLD MAGNETICS CORPORATION

11520 W. Jefferson Blvd.
Culver City, Ca. 90230 • (213) 870-7014

DISCRETE SEMICONDUCTORS

Zener diodes available in overlapping ranges

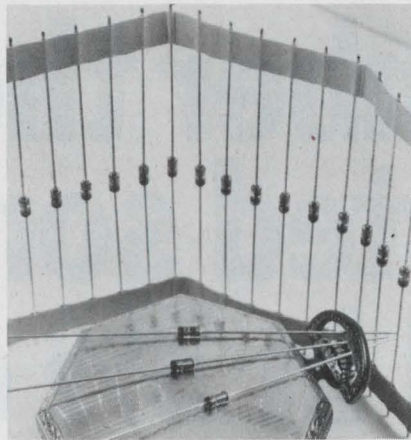

Hitachi, International Importers, 2242 S. Western Ave., Chicago, IL 60608. (312) 847-6363. \$85 per 1000 (10,000 pc lots); stock.

The HZ series of zener diodes covers the range of 4.6 to 36 V at 400 mW. The units are available in overlapping voltage ranges to provide more flexibility for new circuit designs and cover all voltage values over the total range. The HZ6A, for example, operates over the range of 5.2 to 5.7 V, while the HZ6B is designed for 5.5 to 6 V. This overlapping system enables the design engineer to choose the exact zener needed to optimize his circuit.

CIRCLE NO. 365

Tab mounting triacs rated for up to 15 A

Thyrotek, P.O. Box 5407, 611 109th St., Arlington, TX 76011. (817) 265-7381. For a 200 V, 6-A unit: \$1.50 (1 to 99); stock.

The Thyrotab series of tab-mount triacs is designated the TB, TBT and TC series. The TBT series units are electrically isolated by an internal trigger diac. The TB series also has an electrically isolated case and the TC series is nonisolated. The TBT and TB series will withstand a minimum of 1600 V ac from leads to mounting surface for 1 min. at 80 C T_C. All three series employ center-gate geometry and dense glass-passivated chips for 5 V/μs dv/dt ratings and 2.5-μs turn-on time. The Thyrotab series has units rated for 50-to-600-V-dc blocking with 6, 8, 10 and 15-A rms current ratings.

CIRCLE NO. 366

Microwave transistor delivers 12.5 W

RCA Solid State Div., Rte. 202, Somerville, NJ 08876. (201) 722-3200. \$238 (1 to 24 pc).

The RCA2023-12, a 12.5-W, 2-to-2.3-GHz transistor, is designed for use in high-power broadband microwave amplifiers. The transistor has a gain of 7 dB and a collector efficiency of 40%. The company's Gigamatch stripline package contains an internal input-matching network (50 Ω, nominal) and internal shunt tuning at the collector. Other construction features are integral emitter-site ballasting resistors and low thermal resistance.

CIRCLE NO. 367

LED cartridge lamps available in four colors



Data Display Products, 5428 W. 104 St., Los Angeles, CA 90045. (213) 641-1232. From \$1.19 (1000-up); stock to 3 wk.

A series of cartridge lights (industry standard), including a model with a large (0.4 in. dia.) lens, is available with LEDs in four colors—green, amber, yellow and red. The choice of voltages spans 5 to 28 V and higher, with built-in resistors. These units are also available without built-in resistors. A full range of incandescent and neon lights, including a green neon, is also available in the same styles. Lenses in all colors are available with 3 levels of light transmission—full diffusing (for incandescent and neon), and translucent and clear (for all light sources). The lens styles offered are: Model 91—short cylindrical; Model 96—dome shaped; and Model 961—large diameter cylindrical lens, which is an integral part of the cartridge rather than a separate screw-on lens cap.

CIRCLE NO. 368

The IC Troubleshooters show it like it is.

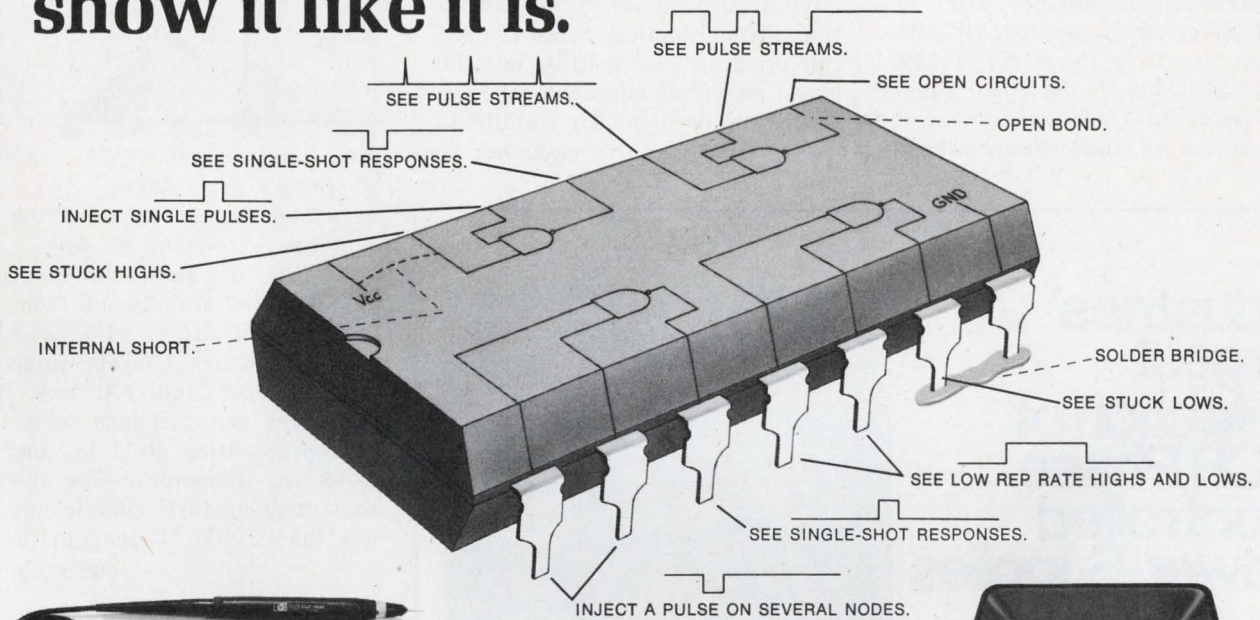

SEE logic highs, lows, in-between bad levels and open circuits with the Logic Probe. Capture one-shot pulses as narrow as 5 nsec with the ECL model, 10 nsec with the TTL model. Pulse streams to 50 megabits/sec are also displayed. All ruggedly built. All with line-voltage protected probe tips. Models for TTL, ECL and HTL.

- PRICES**10525T \$ 99.
 10525H \$125.
 10525E \$150.



THE MINI-KIT PUTS IT ALL TOGETHER.

Order the Logic Probe, Logic Pulser and Logic Clip together as the HP 5015T Mini-kit. Save \$38.

PRICE \$275.*

*U.S. domestic prices only

INJECT a pulse into a circuit without trace cutting or unsoldering pins with the 10526T Logic Pulser. Automatically drives low nodes high or high nodes low with a single 300 nsec pulse.

PRICE \$115.*
 Use with Logic Probe for dynamic, in-circuit pulse testing. Use with Logic Clip to see proper operation of sequential devices.



READ the state of all 14 or 16 pins on IC's simultaneously with the 10528A Logic Clip. No cables. No power connections. See static highs and lows or slowly changing states. Auto-seeking of V_{cc} and ground. Clips directly to the IC being tested.

PRICE \$99.*



FREE DIGITAL TROUBLESHOOTING APPLICATION NOTE.

28 Pages of the latest techniques in digital troubleshooting. Just mail the coupon.

Mail to: Hewlett-Packard, 1501 Page Mill Road Palo Alto, Calif. 94304.

() Send Digital Application Note. () Send details on IC Troubleshooters.

Name _____

Company _____

Address _____

City _____ State _____ Zip _____



Sales and service from 172 offices in 65 countries.
 1501 Page Mill Road, Palo Alto, California 94304

02404A

DISCRETE SEMICONDUCTORS

High voltage rectifiers withstand up to 3 kV

Sensitron Semiconductor Div. of RSM Electron Power, 221 W. Industry Ct., Deer Park, NY 11729. (516) 586-7600. From \$0.80 (100-up); stock to 1 wk.

A series of high-voltage silicon

rectifiers, the 1N3643 to 1N3647, is available in voltage ratings from 1000 to 3000 V. Current ratings span 0.3 to 1 A at 25-C ambient free air temperature. These diodes are housed in a specially formulated hyperpure hard glass fused to the silicon junction. Since the silicon junction sees nothing but this glass, electrical characteristics are said to be permanently stabilized.

CIRCLE NO. 369

Stabistors provide high voltage tolerances

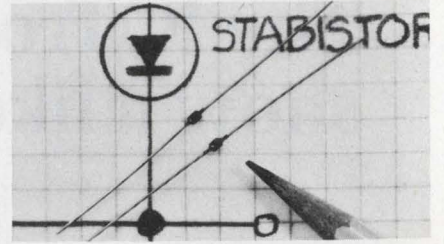

Microsemiconductor Corp., 2830 S. Fairview St., Santa Ana, CA 92704. (714) 979-8220. From \$1 (100-up); stock to 45 day.

A line of stabistors provides voltage level adjustment from 0.5 to 5 V with either $\pm 1\%$ or $\pm 5\%$ tolerance. Current levels range between 1 μA and 100 mA. The stabistors are packaged in a DO-34 configuration (0.11 in. long by 0.065 in. diameter). The devices have temperature coefficients of less than 2 mV/ $^{\circ}\text{C}$ per junction.

CIRCLE NO. 370

industries' largest selection of SCR Phase Controlled Power Supplies

CALL TOLL FREE 800-631-4298

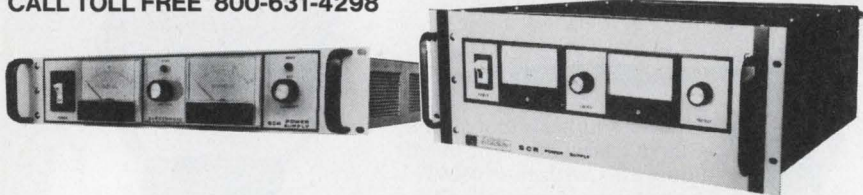
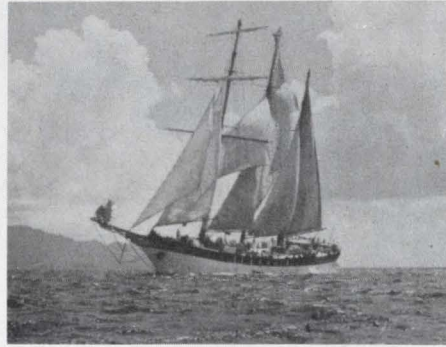

E/M has expanded its former 2.5, 5.0 and 10.0 kw SCR Models to now include 27 new models with power ratings of 600w, 1200w and 2000 watts. All models are 0.1% regulated in both the voltage and current mode of operation with automatic crossover. Remote programming and sensing are standard on all models as well as forced air cooling and automatic over-temperature protection. The three lower power ratings are all single phase input, while the three higher power ratings are all three phase input. As expected, E/M has maintained its position of providing the highest power output per mechanical volume in the industry for equipment of this type. Front panel heights being 3 1/2" on 600w, 5 1/4" on 1200w, 7" on 2000w and 2500w, 8 3/4" on 5000w and 12 1/4" on 10,000w models.

Volts	600w		1200w		2000w		2500w		5000w		10,000w	
	Amps	\$	Amps	\$	Amps	\$	Amps	\$	Amps	\$	Amps	\$
0-6									600	2200		
0-7.5	85	500	125	850	200	1000	300	1400				
0-10	60	500	100	850	150	1000	250	1400	500	2200		
0-20	30	425	50	750	90	900	125	1300	250	1800	500	2700
0-30							100	1300	200	1800		
0-40	16	425	30	750	50	900	60	1300	125	1700	250	2500
0-50											200	2700
0-60	11	425	20	750	35	900						
0-80	8	425	14	750	25	900	30	1300	60	1700		
0-100											100	2700
0-120							20	1300	40	1700		
0-150	4	425	7	750	13	900						
0-160							15	1300	30	1700	60	2500
0-250							10	1300	20	1800	40	2700
0-300	2	450	3.5	850	6	1000						
25-500							5	1600	10	2200	20	2700
10-600	1	450	1.5	850	3	1000						

SEE EEM VOL. 1-418-420 FOR ADDITIONAL PRODUCT INFORMATION

ELECTRONIC MEASUREMENTS INC.

405 ESSEX ROAD, NEPTUNE, NEW JERSEY 07753
 Phone: (New Jersey) (201) 922-9300 • (Toll-Free) 800-631-4298
 Specialists in Power Conversion Equipment



INFORMATION RETRIEVAL NUMBER 95

Field-effect transistors made in rectangular case

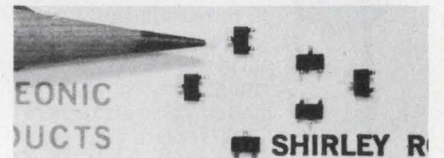

Nucleonic Products, Div. Thompson-CSF, P.O. Box 1454, Canoga Park, CA 91304. (213) 887-1010. From \$0.23 (10,000-up); stock.

A series of n-channel field-effect transistors in the company's Mini-Mold package is designed as FM/ rf amplifiers. The devices have rectangular leads, each with a bonding surface of 0.4 mm². The semiconductor packages are also rectangular, 2.9 x 1.5 x 1.1 mm, and are housed in a plastic holder so they can be removed one by one for easy mounting. Three new units complement an existing line of 32 other epoxy molded discretes—including npn amplifiers, mixers, and switches, pnp amplifiers and drivers, and dual diode limiter switches and clippers. The three junction FETs: Models K-1, K-2 and K-3 all have I_{GF} currents of 10 mA with the voltage from gate to source 4 V maximum. Model K-1 at 5 V has an average current drain from 0.5 to 1.5 mA; K-2, a current drain from 1 to 3 mA; and K-3, 2 to 6 mA.

CIRCLE NO. 371

Stripswitch.™

Not much to you.

But big to us.



If we had to design a new switch for circuit board applications, we'd design Stripswitch again.

Not some other switch. Stripswitch.

The one with coded output—decimal, BCD, complimentary, special binary, and 1-, 2-, 3-, and 4-pole.

The one with 1 to 11 stations, each with 8, 10, 12, or 16 positions, actuated by thumb, finger, or screwdriver.

The one that mounts both horizontally and vertically, and reads out on the front or the side.

The one you wave-solder to your

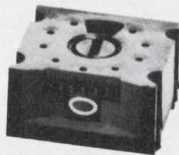

Actual size.

board, or plug into DIP sockets and strips.

The one made of durable Valox*, with lots of legends and markings, colorcodings, and rotation limit stops.

The one that costs less than \$1.00 per station if you order enough stations.

That's little enough, whether you buy Stripswitch from us or our distributors—G. S. Marshall, Hall-Mark, or Schweber.

And *that* makes it big.

EECO

FOR SWITCHES

1441 East Chestnut Avenue, Santa Ana, California 92701
Phone 714/835-6000

*Registered General Electric trademark

Announcing the Battery Status Indicator— a new LED/IC combination

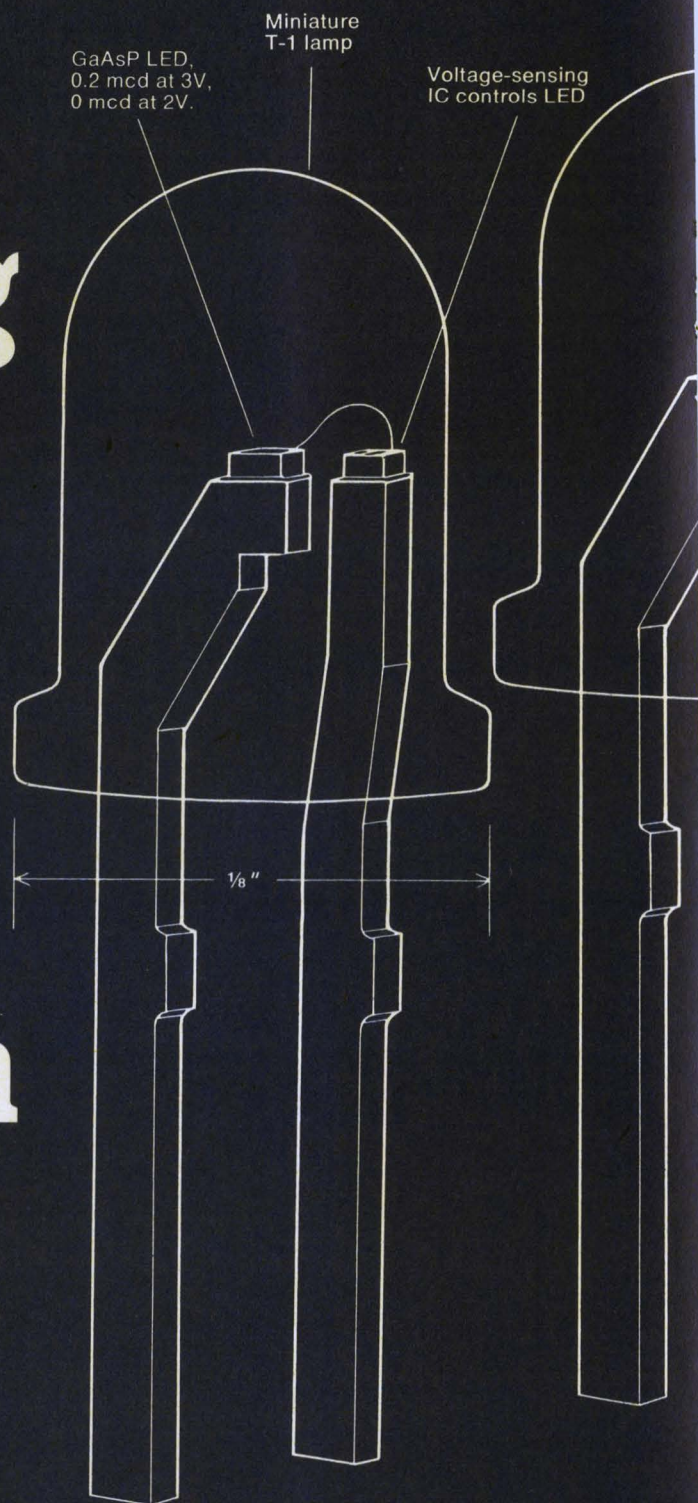



Dead batteries! Everyone hates 'em. And most battery powered equipment—cameras, tape recorders, calculators—don't warn you until it's too late.

Now Litronix—the world's largest manufacturer of LEDs—introduces the RLC-400 Battery Status Indicator. It's a red GaAsP warning light and voltage-sensing IC combined in one little T-1 lamp package. The light is on at 3V, off at 2V.

One of the nation's most prominent camera manufacturers uses it. Any battery-powered device that uses it may acquire an important competitive advantage at low cost.

The Litronix Battery Status Indicator will cost you only 60¢ in quantities of 1000. And you keep production costs down because you don't have to test, assemble and inventory several components.

If you need a warning light that goes on and off at different voltages, get in touch with us. We may be able to help you.

You can get a free sample of the Battery Status Indicator by writing us on your company letterhead. Or if you want more information quick, contact Litronix, 19000 Homestead Road, Cupertino, California 95014. Phone 408-257-7910. TWX 910-338-0022.

**No wonder
we're No.1
in LEDs**

litronix

INFORMATION RETRIEVAL NUMBER 97

Make the big change-over to the new DMM from T.R.I.

High performance, low cost (\$279) and compact size, 10 μ V Resolution.

10 μ V resolution, \$279

Model 6355 is a portable DMM having a 10 μ V (DC voltage) resolution. It is comparable to DMM's for laboratory use, priced at an economical \$279, and sets a new standard of performance for portable DMM's.

Fully automatic

Operation is as simple as selecting the function and signal connection. The measured value is displayed

through the automatic selection of 5 functional modes: range selection, unit display, polarity, over-range indication and overload protection.

True portability

It measures 4-3/8" (W) x 2-7/8" (H) x 6" (D) and is a light-weight 1.8 lbs for complete portability. The shock-resistant design even protects the unit against accidental drop damage.

Rechargeable battery (Option)

Besides the AC power supply, the standard composition includes an alkaline battery. Optionally available is a rechargeable battery. Standard accessories include a battery charger.



505 West Olive Avenue
Sunnyvale, CA 94086
(408) 733-9080

New



Model: 6355 Mini-multimeter \$279

INFORMATION RETRIEVAL NUMBER 98

POWER SOURCES

Open-frame chargers handle NiCd, lead-acid

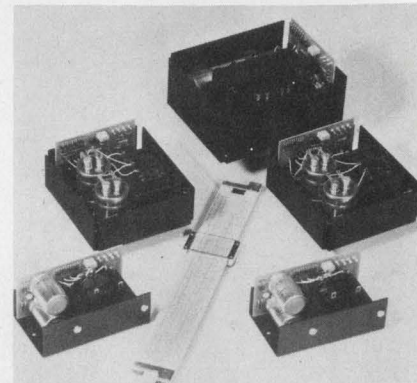

Cellmate Div. of Seven Sciences, 1405 Civic Center Dr., Santa Clara, CA 95050. (408) 249-8400. \$59.

These OEM open-frame chargers include models for 12-V sealed lead-acid and nickel-cadmium batteries with ratings to 40 A-h. Charging currents are step-selectable for any battery size, and voltages are adjustable to battery manufacturer's recommendations. Designed into portable instruments, Models 2210 and 2410 will charge cyclic lead-acid batteries. Full recharge is completed in 16 hours or less, and temperature compensation protects against overcharging in field ambients. The Model 2610 charges float lead-acid batteries for uninterruptible power. The 2220 and 2420, for nickel-cadmium cells, may be used in any portable, standby or uninterruptible applications.

CIRCLE NO. 372

5-V modular supply isolates heat sources

Analog Devices, Rte 1 Industrial Park, P.O. Box 280, Norwood, MA 02062. (617) 329-4700. \$89; stock.

Model 922 5-V-dc power supply features a thermal barrier to completely isolate the heat generating components from those that are heat sensitive. The unit packs 2000 mA into a 3.50 x 2.50 x 1.62-in. modular case. The Model 922 uses current limiting for complete short-circuit protection. It provides 0.02% maximum line and 0.05% maximum load regulation. Rms ripple and noise is limited to 0.5 mV maximum. Tempco is 0.015%/°C.

CIRCLE NO. 373

IMC FAN FACTS

LARGE

or small... 
we make them all!

When your space is at a premium and performance requirements are 6 CFM up to 12,000 CFM, count on an IMC VANEAXIAL fan for highest efficiency. Send for free size selector-brochure for your answer! For immediate service please call Gene Egan, V.P. Sales—516/334-7070 or write:



IMC MAGNETICS CORP.

EASTERN DIVISION

570 MAIN STREET, WESTBURY, NEW YORK 11590



LARGE AND SMALL - 400 HZ

INFORMATION RETRIEVAL NUMBER 99

Take any situation where you must go from DC to AC... talk to us.

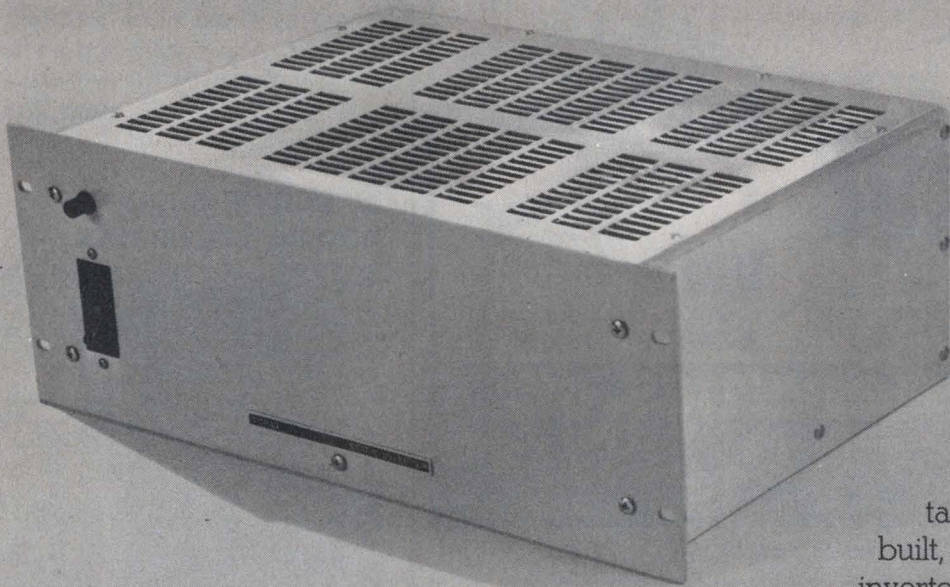

If you're a power company operating AC equipment from DC power sources... talk to us. If you're involved with DC mobile systems, telecommunications, test vehicles, or other areas requiring AC power from DC sources, talk to us about our ruggedly built, reliable DC to AC inverters... inverters with more than ten years proven field performance.

Consider these features. Output voltage regulation $\pm 3\%$. Frequency stability $\pm 0.05\%$ of fixed frequency, and total harmonic distortion less than 5%.

With Topaz, you'll have the best DC to AC inverters you can buy. And this is not just talk. There's a reason why our inverters are the best... we take the trouble to build them better.

So write for our brochure or give us a call. You'll find Topaz a good company to do business with.

Topaz inverters can take you there.

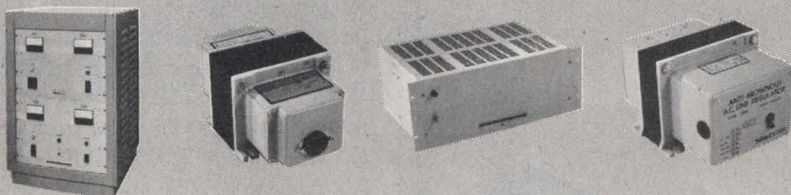

Other Products • Uninterruptible Power Systems • Ultra-Isolation Transformers
• Frequency Changers
• AC Line Regulators

Topaz is also a major supplier of **custom** power conversion equipment. Contact us.

TOPAZ

ELECTRONICS 3855 Ruffin Road, San Diego, California 92123 • Phone: (714) 279-0831. TWX (910) 335-1526

INFORMATION RETRIEVAL NUMBER 100

MAGNETIC SHIELDING FOR ANY CONFIGURATION

Ad-Vance reduces your shield costs because it already owns tooling for most standard shields. Or, our Magnetic Shielding Specialists will custom fabricate shields to your exact specifications.

- Magnetic Shields for 312 Types of Photomultiplier Tubes.
- AD-MU Sheet Stock.
- AD-MU Tape Data Protectors assure full fidelity of valuable tapes.
- Unequaled engineering & design service.
- In-house quality control.
- Fast delivery, competitive pricing.

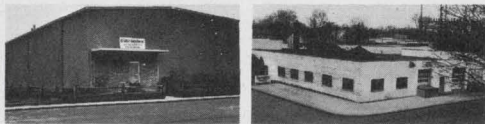

2 Modern Plants with complete facilities for quality shield manufacturing

Ad-Vance Magnetics, Inc., the Old Firm with the New Name, is the industry's largest, oldest and most experienced independent firm exclusively manufacturing magnetic shielding.



AD-MU Foils Cut, Wrap, Easily & Quickly



Typical Custom Fabricated Shields For Components & Systems



Send for 16-page catalog

AD-VANCE MAGNETICS, INC.

226 E. SEVENTH ST., ROCHESTER, IND. 46975

(219) 223-3158 TWX 810 290 0294

The Magnetic Shielding Specialists



INFORMATION RETRIEVAL NUMBER 101

WHY IS THIS THE BEST

SELF-AMPLIFYING PRESSURE SENSOR FOR RANGES FROM .01 to 50,000 psi

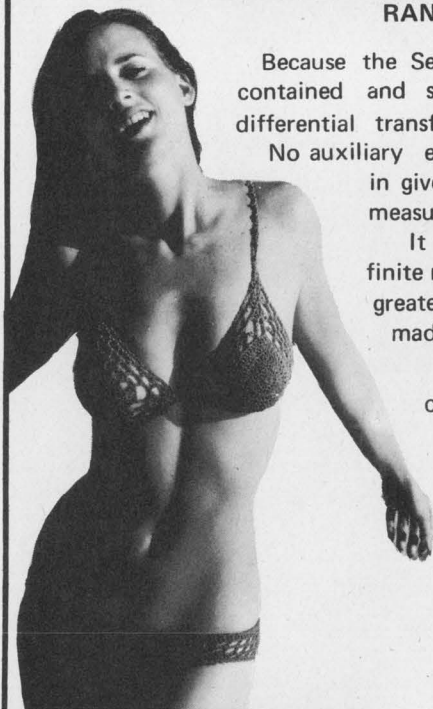

Because the Series DDC & PDC are completely self-contained and self-amplifying units. A linear variable differential transformer is used as the sensing element.

No auxiliary electronics are required—a DC voltage in gives a DC voltage out—for the electrical measurement of pressure and displacement.

It features virtually unlimited life and infinite resolution at low cost with an accuracy greater than any other industrial transducer made.

COLUMBIA RESEARCH LABS., INC.

Call or Write: Woodlyn, Pennsylvania 19094
Telephone: (215) 532-9464

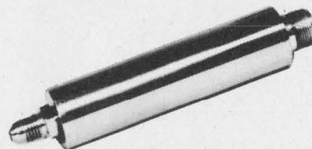

 **columbia** first for transducers and control

INFORMATION RETRIEVAL NUMBER 102

POWER SOURCES

Open-frame units keep ripple to 500 μ V

Electrostatics, Inc., 7718 Clairemont Mesa Blvd., San Diego, CA 92111. (714) 279-1414. \$72, single; \$85, double stock.

Model 100 line of 100-W dc power supplies features single and dual units with ripple of 500 μ V at full load, regulation of 0.005% line and 0.05% load, and full rating to 71-C ambient. Any voltage output from 3 to 30 V can be furnished.

CIRCLE NO. 374

Switching supplies handle brownouts

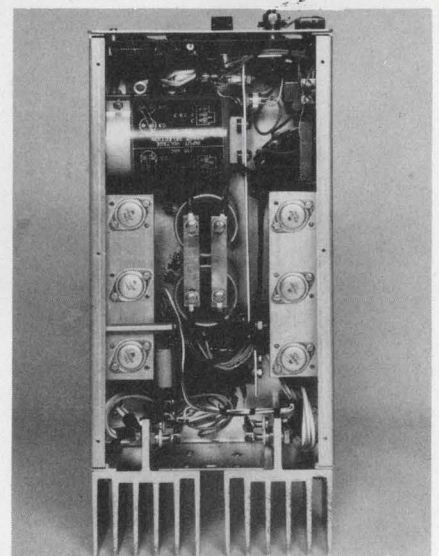

NJE Corp., 103 Culver Rd., Dayton, NJ 08810. (201) 329-4616. \$595 (ES-EE-5-OVP); stock to 6 wks.

The "ES" (energy saver) Series of switching power supplies features light-weight construction. Efficiencies of 65 to 85% are standard with an HE (higher efficiency) option also available. To combat brownout, the unit allows output voltage to remain in full power for 20 ms after line failure below the range of 88 to 132 V. Within 88 to 132 V, the unit delivers full power. The ES-EE-5-OVP provides 5 V at 100 A, measures 4-29/32 \times 7-1/2 \times 16-1/2-in., weighs only 16 lbs, has 0.1% line and load regulation, 0.2% rms ripple, and is supplied with OVP with automatic recycling after failure.

CIRCLE NO. 375

One for All and Four for One

Because magnetic tape recording needs differ, Bell & Howell has four precision laboratory-grade instruments to handle data acquisition and reduction requirements. • From the laboratory to remote locations, from airborne applications to submarine data collection, these Bell & Howell recorders meet the most stringent environmental and military standards. • Bell & Howell's M-14 Series meets Navy standards for use in ELINT (electromagnetic intelligence) activities. Compact, lightweight and reliable, these 14 or 28 track recorders are at home in the instrumentation laboratory or in nuclear submarines. • The CPR-4010, a 14-channel recorder/reproducer, has many of its big brothers' features. Expandable to 28 tracks, it is completely self-contained, portable and is one of the most cost-effective tape recorders available. • For performance and dependability, few recorders match the VR-3700B. Its performance specifications and characteristics are unmatched by any competing recorder. It can also record up to 80 million BPS over 28 tracks. • STARR, the State-of-the-Art Recorder/Reproducer, was designed to handle virtually every difficult data reduction task. Wide dynamic range, data integrity, spectral purity and ease of operation are major design considerations of STARR. • These, like all Bell & Howell recorders, are backed by nearly 30 years in the design and development of quality instrumentation. • For more information on how we can help you handle your recording requirements, contact William Zondler at (213) 796-9381 or circle the information retrieval number. • We have four good solutions to your magnetic tape recording problems.

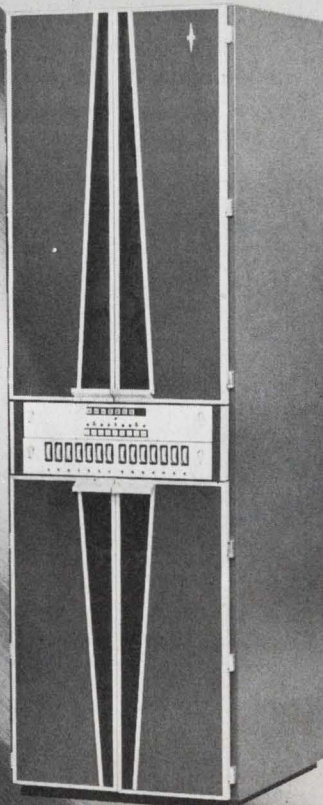
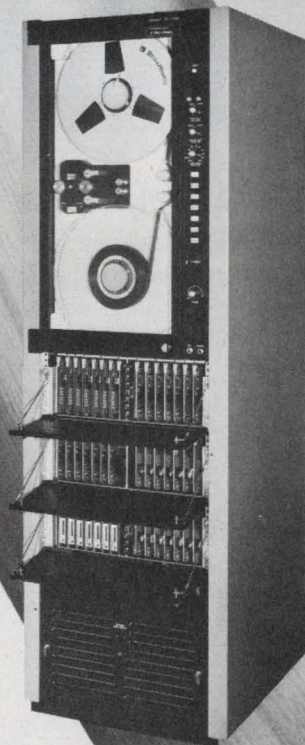
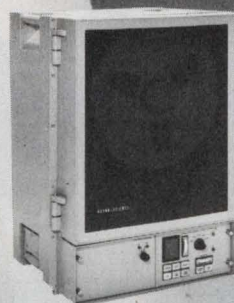

CEC/INSTRUMENTS DIVISION

360 Sierra Madre Villa, Pasadena, California 91109



BELL & HOWELL

INFORMATION RETRIEVAL NUMBER 103

M-14 and STARR are trademarks of Bell & Howell Company

QUALITY IN VOLUME

When you achieve it, you can offer true competitive value. That's just what we're doing at USCC/Centralab for 1975. MONO-KAP™ radial, and MONO-GLASS axial monolithic ceramic capacitors are now available to volume users *from stock* to eight weeks. Our investment and "learning curves" last year guarantee competitive responsiveness — USCC will welcome your specials and non-stock orders. Here's an offer you haven't heard lately — your money is going to buy more at USCC. Cash in on the best values in monolithic ceramic capacitors.

DISCRETE ASSEMBLY

MONO-KAP™ radial-leaded epoxy coated capacitors are reliable performers; they're rugged enough to work in MIL environments. 4.7 pF to 10 Mfd., 50 to 200 WVDC in 4 dielectrics, including Z5U, in a variety of case sizes featuring meniscus control to 0.032 inches. Large quantity orders from stock.

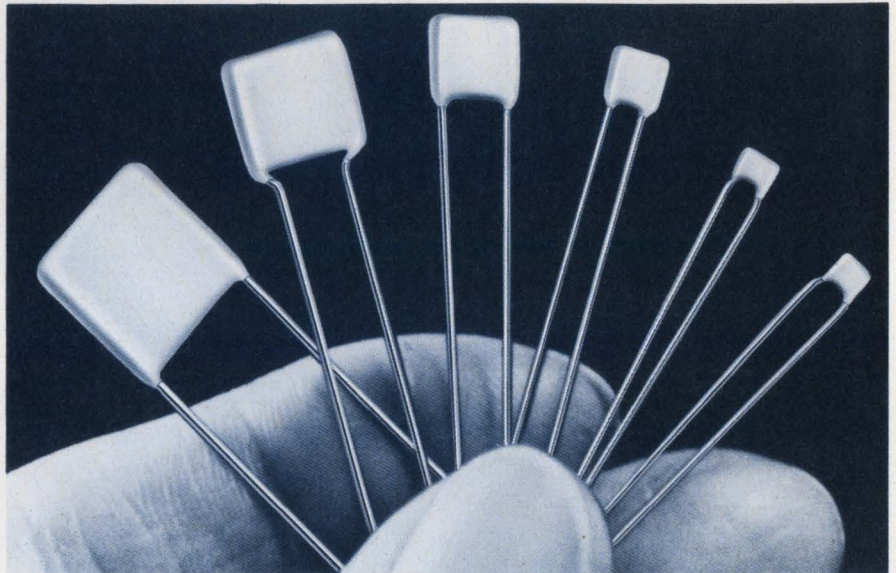

AUTOMATIC INSERTION

MONO-GLASS axials are glass encapsulated, designed for automatic PCB insertion; furnished reel-packed for high volume applications. They're available in 50 and 100 WVDC from 1 pF to 1.0 Mfd.; four dielectrics: COG, X7R, Z5U and Y5V.

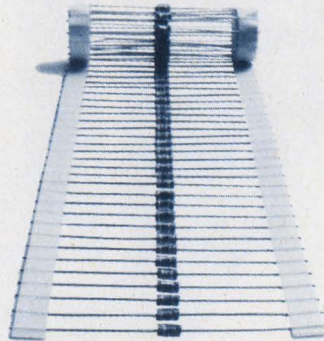

CUSTOM DESIGN

We're responsive to your design requirements; get USCC's new expanded 1975 catalog.



If you need a special call (213) 843-4222 or your nearest overseas location for assistance or evaluation samples.

Remember. USCC/Centralab. Value.

FOR QUICK REFERENCE, SEE OUR PRODUCTS IN YOUR EEM, GOLD BOOK OR EBG PAGES.



USCC/Centralab

Electronics Division • Globe-Union Inc.

2151 North Lincoln Street ■ Burbank, California 91504

(213) 843-4222 ■ TWX: 910-498-2222

INFORMATION RETRIEVAL NUMBER 104



Circulators cover communication bands

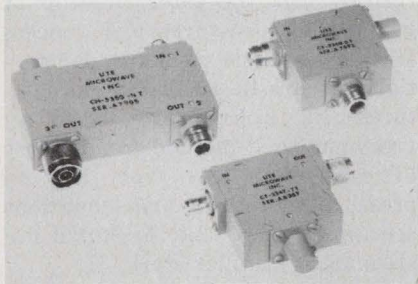

UTE Microwave, Inc., 3500 Sunset Ave., Asbury Park, NJ 07712. (201) 922-1009. Stock to 4 wks.

Three and four-port circulators provide a minimum isolation of 20 dB over the 1.7-to-2.4-GHz frequency range. The new units have a maximum insertion loss of 0.4 dB and a VSWR of 1.25. Standard connectors are Type N and SMA. Other units are offered in the 4, 6, 8, 11 and 13-GHz communication bands.

CIRCLE NO. 376

Tune phase-locked sources in the field



Communication Techniques Inc., 1279 Route 46, Parsippany, NJ 07054. (201) 263-7200.

The PLO Series of fundamental oscillators and PLOM Series of oscillator/multipliers span the 0.5-to-18-GHz frequency range. The phase-locked signal sources have a stability of $\pm 0.05\%$ over the rated operating temperature range of -30 to 60 C. The new units can be tuned in the field to any frequency within the band by two simple adjustments and a VOM. As an option, the sources can be packaged to meet MIL-spec environmental and interference requirements. Other standard options include FM capability, phase-lock limit alarm and one integrated isolator on the output.

CIRCLE NO. 377

Nd:YAG lasers boost energy and brightness

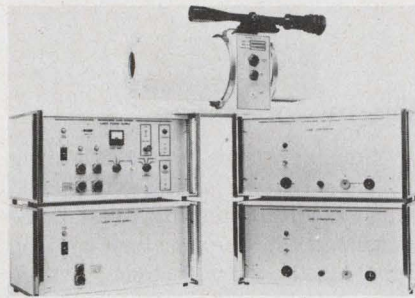

International Laser Systems, Inc., 3404 N. Orange Blossom Trail, Orlando, FL 32804. (305) 295-4010. \$50,000 up; 5 months.

A line of high-energy Nd:YAG laser systems—the Series NT-570—is offered in two versions: The Model NT-572 emits 500 mJ at 10 pulses/sec, while the Model NT-574 emits 500 mJ at 20 pps. Both systems feature a small beam divergence of 0.25 mr that combines with the high-pulse energy to yield high-output brightness. Both the NT-572 and NT-574 consist of a transmitter, containing a laser oscillator and two laser amplifiers, and a power supply. Also both specify an output wavelength of $1.064 \mu\text{m}$, pulse width of 15 ns (nominal), beam diameter of 3.0 in. and interpulse jitter of $\pm 1 \mu\text{s}$ (maximum).

CIRCLE NO. 378

Coax loads terminate 150 W

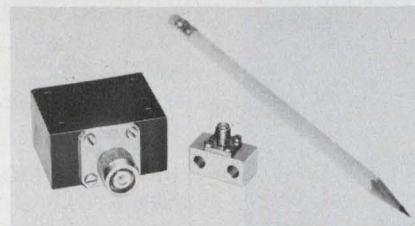

Pyrofilm Corp., 60 S. Jefferson Rd., Whippany, NJ 07981. (201) 887-8100.

High-power conduction-cooled broadband dummy loads are offered through Ku band with power levels up to 150 W. The compact units are available with three connector types: SMA, TNC, or Type N. A typical 3-mm package is matched to less than 1.35 within the frequency range of 12.4 to 18 GHz. It has a power capability of 20 W at a maximum heat-sink temperature of 125 C.

CIRCLE NO. 379

Hardy LO operates at 16 GHz

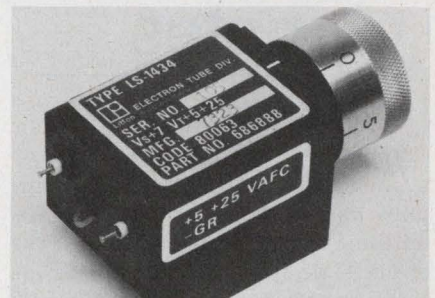

Litton Industries, 960 Industrial Rd., San Carlos, CA 94070. (415) 591-8411. \$500 (1-10); 90 days.

A Gunn local oscillator, the LS-1434, operates over the frequency range of 15.94 to 16.44 GHz with a power output of 2 to 8 mW. Qualified for stringent MIL environments, the source permits simple mechanical tuning over the frequency range by a single revolution of a calibrated knob. Electronic tuning is provided for a minimum of ± 20 MHz afc with 5-to-25-V-dc tuning voltage applied. The unit has a WR-62 waveguide rf output. The source weighs less than 10 oz and measures about $1.5/16 \times 1.3/8 \times 3$ in.

CIRCLE NO. 380

Phase shifters span 1-18-GHz band

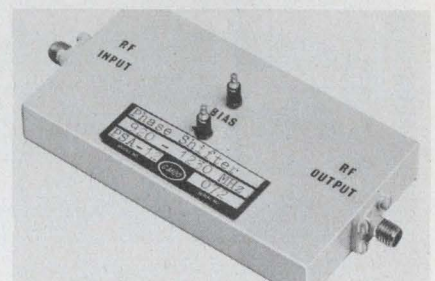

Englemann Microwave Co., Skyline Dr., Montville, NJ 07045. (201) 334-5700.

The PS-A series of 5% frequency-bandwidth analog phase shifters is available with any center frequency from 1 to 18 GHz. Continuous voltage-tuned phase shift can be provided from a fraction of a degree to 360 degrees. A typical unit, the PS-A05, has a frequency range of 10.2 to 10.5 GHz, phase shift of 0 to 25 degrees, maximum VSWR of 1.35 and maximum insertion loss of 1.6 dB. Input voltage range is 0 to 50 V dc.

CIRCLE NO. 381

application notes

Ferrite components

Improved efficiency and lower system cost for inverter power supplies using ferrite components are outlined in a design guide. Test circuits, design examples, specifications and 24 design nomographs allow rapid and precise evaluation of circuit parameters. Indiana General, Keasbey, NJ

CIRCLE NO. 382

MOS RAM drivers

An application report compares the performance of the SN75363 and SN75322 in driving the chip-enable of TMS4030 RAMs. The eight-page report explains the characteristics, TTL-compatible inputs and chip-enable requirements of the TMS4030. Diagrams are included. Texas Instruments, Dallas, TX

CIRCLE NO. 383

Thermistor testing

"Considerations in the Testing of Thermistors" includes material such as R-T testing, resistance measurement, temperature control, unbalanced thermocouple voltage error, self-heating errors, determining bridge supply voltage, accuracy of measurement and other associated topics. Fenwal Electronics, Framingham, MA

CIRCLE NO. 384

Phase encoding data

"Phase Encoding Digital Data" provides an explanation of phase encoding technique, also known as Manchester encoding. Data are identified on the magnetic tape by flux reversals rather than the steady-state conditions defined by NRS. Quantex, Plainville, NY

CIRCLE NO. 406

Gas measurements

A 14-page brochure helps to solve problems associated with the reading and the interpretation of gas partial pressures and concentrations. A table (water vapor partial pressure in saturated gas mixtures), a schematic drawing (recommended method for delivery of calibration gas from a high pressure cylinder) and equations accompany the text. Beckman Instruments, Schiller Park, IL

CIRCLE NO. 407

Copper-nickel alloys

Basic engineering data on copper-nickel alloys is contained in a 12-page catalog. Included are information on compositions of the major cast and wrought alloys, applicable specifications, maximum allowable stresses under ASME codes, physical and mechanical properties, corrosion behavior and fabrication characteristics. The International Nickel Co., New York, NY

CIRCLE NO. 408

The New Brush 2400: the best performing, most versatile wide channel recorder you can buy.

It is available in 2, 3 and 4 channel configurations utilizing combinations of 50 mm and 100 mm channels totalling 200 mm. It had a 99.65% linearity over the full 100 mm channel. Its frequency response is an outstanding 30 Hz at 100 mm, 50 Hz at 50 mm and up to 125 Hz less than 3dB down. It has a full range of plug-in signal conditioners for just about any industrial-scientific-medical application.

For full details on why the new Gould 2400 is the best performing direct writing recorder you can buy, write Gould Inc., Instrument Systems Division, 3631 Perkins Avenue, Cleveland, Ohio 44114. Or Kouterveldstraat 13, B 1920 Diegem, Belgium.



 **GOULD**

INFORMATION RETRIEVAL NUMBER 106

MINI-THUMBWHEEL SWITCH

FOR
COMPUTERS.
NUMERIC CONTROLS.
IN-FLIGHT GEAR.
MANY OTHER
SMALL-SPACE
INPUT SWITCHING
OPERATIONS.

RETROFITS MOST
MINIATURE
THUMBWHEEL
SWITCH PANEL
OPENINGS.

CDI Series TSM mini-thumbwheel switches mount on 1/2-inch centers . . . can be furnished with decimal, binary, or binary with complement output—or with specified code characters. Available with extended PC boards for mounting additional components if desired. Large, easily-read numerals . . . positive detent . . . 8, 10 and 12 positions. Completely O-ring sealed against hostile operating environments.

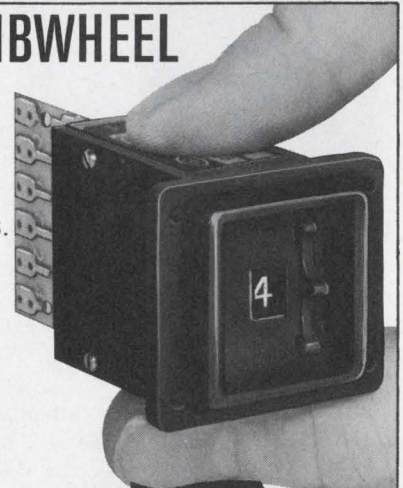

**.900" x .980"
FRONT PANEL SIZE
FOR SINGLE
MODULE ASSEMBLY:**



CHICAGO DYNAMIC INDUSTRIES, INC.

PRECISION PRODUCTS DIVISION
1725 Diversey Blvd., Chicago, Illinois 60614
Phone (312) 935-4600

INFORMATION RETRIEVAL NUMBER 107

ELECTRONIC DESIGN 1, January 4, 1975

design aids

KESTER SOLDER ALLOYS GUIDE

%Sn	%Pb	%Ag	%Cu	%Bi
0	100			
5	95			
10	90			
15	85			
20	80			
25	75			
30	70			
35	65			
38	62			
40	60			
45	55			
48	52			
50	50			
55	45			
60	40			
63	37			
65	35			
70	30			
75	25			
80	20			
85	15			
90	10			
95	5			
100	0			
95		5		
35	63		2	
27	70		3	
40	57		3	
50	47		3	
61.5	38.5		3	
62.5	36.1	1.4		
96		4		
95		5		
97.5		2.5		
98		5		
0.75	97.5	1.75		

Temperature at which solder becomes plastic °C / °F
 Temperature at which solder becomes liquid °C / °F
 Eutectic 310 / 590

A eutectic alloy is that composition of one or more metals that has one sharp melting point and no intermediate phases to be solid. Ag Silver, Sn Antimony.

Flux choices for 22 metals are shown with diagrams of solder joints.

KESTER SOLDER
 Litton
 CHICAGO, ILLINOIS 60639
 (312) 235-1601
 Newark, New Jersey 07102 • Anaheim, California 92818 • Mount Airy, Ontario, Canada

Slide rule

A handy slide rule provides comprehensive flux selector data on one side and offers a solder alloys guide on its flip-side. The pocket-sized slide rule gives flux choices for 22 metals. Thirty-six solder alloys also are listed, along with temperatures at which the solder becomes plastic or liquid. Kester Solder Div.

CIRCLE NO. 409

Relay cross-reference

A relay cross-reference list provides a handy guide to industrial and general-purpose relay interchangeability. Users of the most popular models—A283 frame, A314 frame and 425 frame—can find the model numbers of direct and exact replacements. Struthers-Dunn.

CIRCLE NO. 410

Metric converter

A slide chart converts units of weight, length, volume and area from the U.S. standard measure to metric equivalents. The slide chart is capable of 24 conversions and can be easily carried in a coat pocket or purse. It costs \$2. The Billian Co., Box 8504, Sta. A, Greenville, SC 29604

INQUIRE DIRECT

Now...Eternacell[®] lithium primary batteries in 10 off-the-shelf sizes

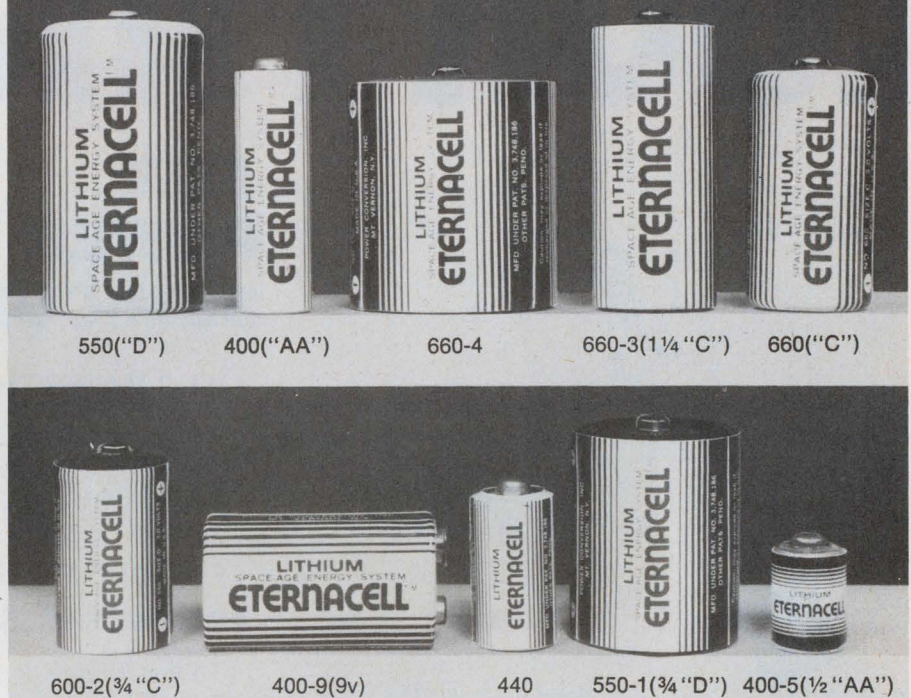

There's a lithium primary battery for fast delivery in a cell size for practically every portable-power application — from 1/2 to 10 ampere-hours capacity. Including "AA", "C", "D" cell sizes and a new 9-volt transistor-size.

Every cell delivers the remarkable performance that has become a new standard for the industry:

- 2.8 volts-per-cell nominal operating voltage, twice that of ordinary cells
- highest energy per unit weight and volume
- greater than 5-year shelf life
- outstanding adaptability to temperature extremes (-65F to +160F)

PCI specializes in the design and manufacture of multi-voltage lithium battery packs for varied industrial, consumer, and military applications.

Write for our catalog or contact our Applications Department to discuss your specific design requirements.

SPECIAL OFFER

New lithium-powered light



To acquaint design engineers with the exceptional shelf life and high energy capability of Eternacell[®] batteries, we're offering for a limited time a lightweight, rugged, reliable single-"D"-cell flashlight for only \$5.95, plus 50 cents handling.



Power Conversion, Inc.
 70 MacQuesten Parkway South
 Mt. Vernon, N.Y. 10550
 Telephone: 914-699-7333

Enclosed is my check or money order for \$6.45 postpaid for my lithium-powered light.

NAME _____

TITLE _____

COMPANY _____

ADDRESS _____

CITY _____ STATE _____ ZIP _____

LOOK FIRST IN

FOR POWER SEMICONDUCTORS

■ WHO MAKES THEM

You'll find 97 manufacturers of power semiconductors beginning on pages 353, 428 and 457 of *Electronic Design's* GOLD BOOK (Volume 1—Product Directory). For your convenience, each manufacturer is listed with complete street address, city, state, zip and phone number.

■ SALES OFFICES—REPS DISTRIBUTORS

To find information about each power semiconductor manufacturer, turn to the *Manufacturers Directory*. Whenever possible it lists names of key officials, sales offices, export offices, foreign offices, U.S. and foreign reps followed by a list of U.S. distributors. In many cases there is additional data, when provided by the company: TWX, TELEX, cable address, facsimile equipment (make and call number), 800 (toll-free numbers) as well as number of engineers, number of employees and financial data.

■ CATALOG PAGES

Here's a rundown of the catalog pages you'll find on power transistors in *Electronic Design's* GOLD BOOK.

Manufacturer	Starts in Vol. 2, Page:	Manufacturer	Starts in Vol. 2, Page:
DELCO ELECTRONICS	379	RCA SOLID STATE	511
GENERAL ELECTRIC	414	RSM SENSITRON	537
INTERNATIONAL RECTIFIER	451	SEMTECH	542
MOTOROLA	471	SOLITRON	545
POWER TECH, INC.	507	TEXAS INSTRUMENTS	547
		TRW	554

KEEP *ELECTRONIC DESIGN'S* GOLD BOOK
HANDY WHEN YOU CALL

Refer to your copy of *Electronic Design's* GOLD BOOK before you dial your next vendor. Referral to specific product pages can shorten your long distance phone calls. LOOK FIRST in *Electronic Design's* GOLD BOOK.

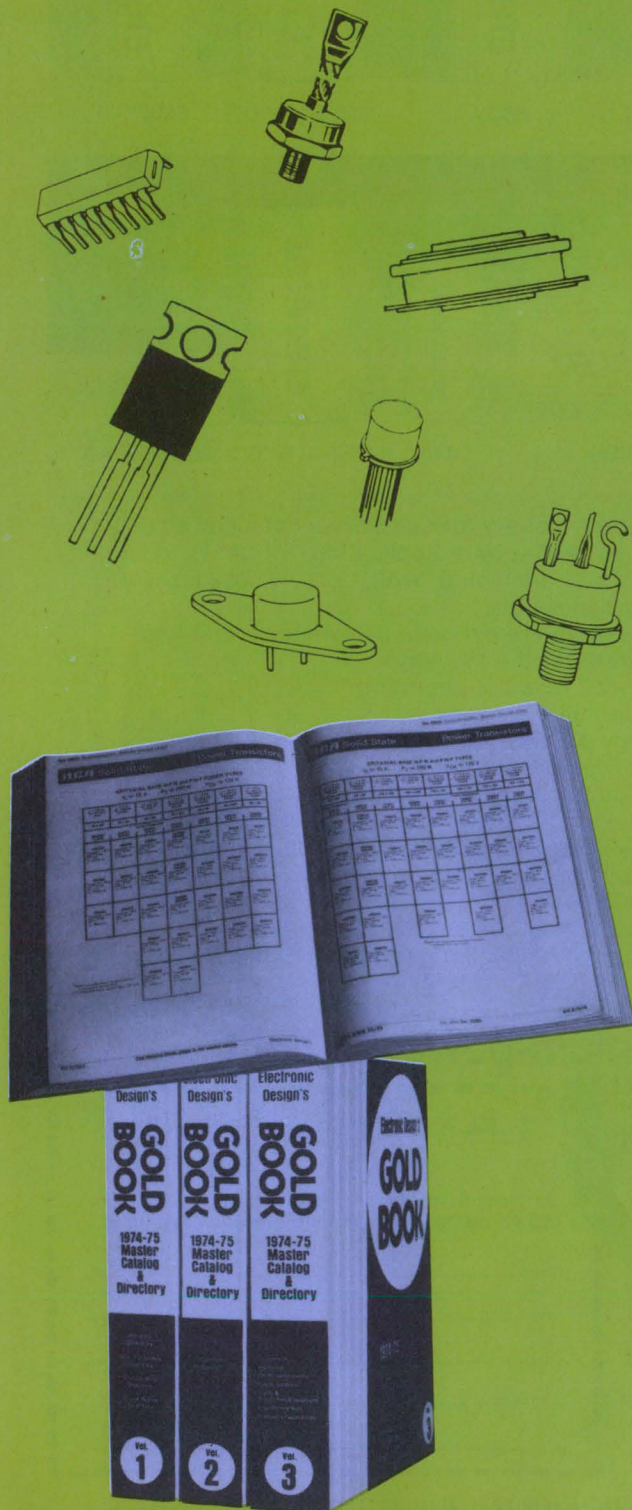

Electronic Design 's

GOLD BOOK

FOR COOLING EQUIPMENT

WHO MAKES IT

You'll find eleven categories of cooling equipment and related products listed in the *Product Directory of Electronic Design's GOLD BOOK*. For blowers and fans 38 manufacturers are listed. For thermoelectric cooling/heating modules, 17; circulating liquid cooling units, 21; heat sinks and dissipators, 50; thermal conductive coatings, 23; insulators and insulating hardware, 52; transistor mounting pads, 23; epoxy potting compounds, 41; silicone greases, 17; and washers, 18. As with power semiconductors, data about each manufacturer, his reps and distributors can be found by referring to the *Manufacturers Directory*.

HERE'S A RUNDOWN OF THE CATALOG PAGES YOU'LL FIND ON HEAT SINKS AND DISSIPATORS ALONE

Manufacturer	Number of Catalog Pages	Starts On Page:
AHAM	3	Vol. 2, 1286
Hughes Aircraft Co.	4	Vol. 2, 1289
Hughes Connecting Devices	2	Vol. 3, 1264
Intl. Elec. Research	4	Vol. 2, 1291
Intl. Rectifier	2	Vol. 2, 458
Jermyn	1	Vol. 2, 1295
Thermalloy Inc.	1	Vol. 2, 1304
Unitrack	1	Vol. 3, 271
Wakefield Engr. Inc.	42	Vol. 2, 1307

TAKE WAKEFIELD ENGINEERING, FOR EXAMPLE

Wakefield Engineering's 42 page catalog of semiconductor cooling products begins on page 1307 of Vol. 2. In addition to detailed specs and information about its heat sinks and thermal cooling products (most show curves of natural and forced convection characteristics) the pages include diagrams of 99 heat sink extrusion shapes with dimensions, surface area, and thermal characteristics. Wakefield's unit also provides guides on HOW TO SELECT HEAT SINKS, ENGINEERING DATA, HEAT SINK MOUNTING SPECIFICATIONS, HOLE PATTERNS, U.S. DISTRIBUTORS, EUROPEAN SALES AGENTS, U.S. FIELD SALES ENGINEERS, and lists other available Wakefield catalogs.

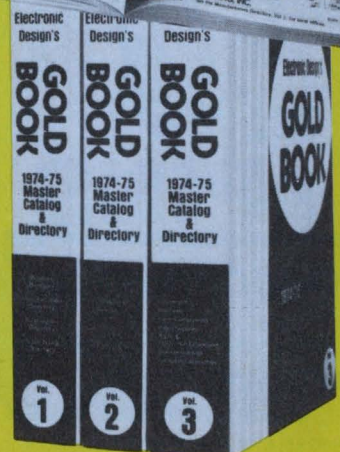
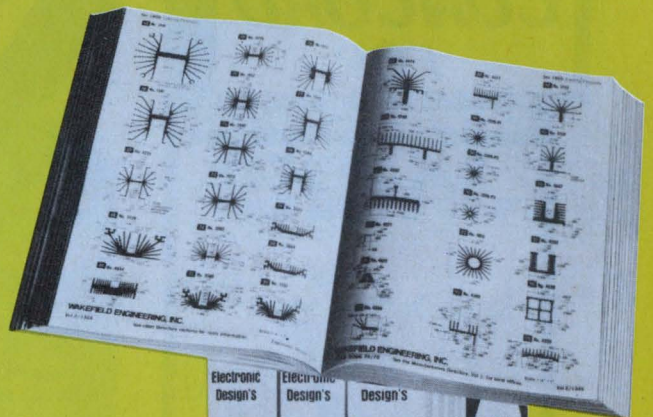
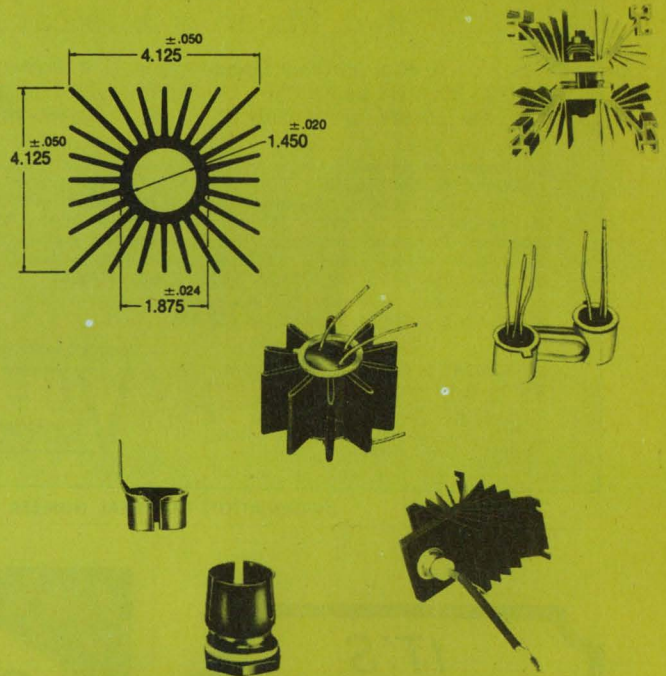

WORLD'S LIGHTWEIGHT CHAMP!

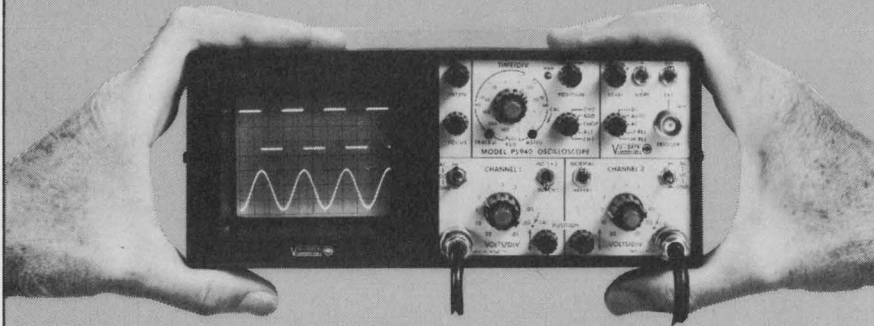

A 9½ pound, dual-trace 20 MHz scope that fits in a briefcase . . .

- Mini-portable Oscilloscope
- Battery, AC or DC powered
- DC - 20 MHz bandwidth
- Computerized triggering
- Delay line
- 10 mV/div sensitivity
- 21 sweep ranges to 100 nsec/div

If you're tired of working with the "Heavyweights," but still need a high performance portable scope that can handle your trouble-shooting needs, then consider Model PS940A. This dual-trace "mini-scope" provides all the basic features and quality of a sophisticated lab scope, yet its weight and size make it easy to carry to every job—at the plant or in the field. And it is simple to operate. Computerized triggering guarantees a stable CRT display at all times. Also, both traces can be vertically positioned in the DC coupled trigger mode without the need for trigger level readjustment.

AVAILABLE NOW FOR ONLY **\$1095**

INTERESTED? Call Hal Wardein at (714) 279-6572, or write to us at 7170 Convoy Court, San Diego, California 92111. For local ordering information, dial TOLL-FREE 800-645-9200; in N.Y. State call collect (516) 294-0990.

From a Leader in Mini-Portable Oscilloscopes



INFORMATION RETRIEVAL NUMBER 111

new literature

DELTAVERTA™ systems / components
a new digital concept in analog data acquisition, transmission and retrieval

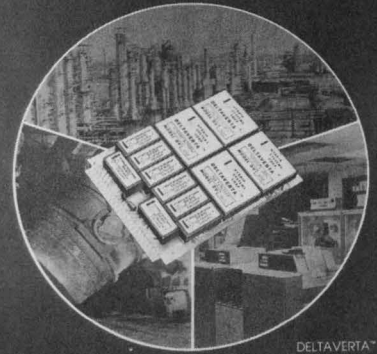

DELTAVERTA™
Product Brochure

Fall

'74

Data-transmission system

A 20-page brochure describes building blocks for multichannel analog data acquisition, transmission and retrieval. Included are encoders, multiplexers, clocks and address generators to acquire analog data; binary-to-biphase and biphase-to-binary converters to condition the digital data for single line transmission; and address detectors, decoders and demultiplexers to retrieve the analog data. Hybrid Systems, Burlington, MA

CIRCLE NO. 411

Digital readout devices

Designed to assist potential users in making effective trade-off comparisons to best meet their requirements, an eight-page catalog highlights the company's digital readout devices and information display systems. IEE, Van Nuys, CA

CIRCLE NO. 412

Rechargeable batteries

Typical applications for the Gel/Cell rechargeable battery, including uninterruptible power supplies, telephone interconnect systems, portable lighting, small engine starting, trolling motors and scuba sleds, are given in a brochure. The literature offers dimensional data, ambient capacities, terminal details and specifications for the 12-V, 20-h rated battery. Globe Battery Div., Milwaukee, WI

CIRCLE NO. 413

IT'S
CONCORD
FOR...

CONNECTORS/P.C.

JACKS

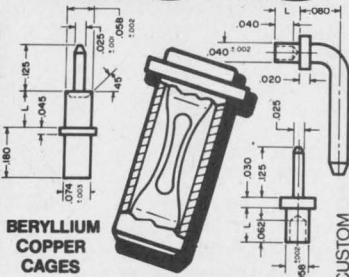

BERYLLIUM
COPPER
CAGES

& PINS

STANDARD & CUSTOM

CONCORD ELECTRONICS CORPORATION

37 GREAT JONES STREET • NEW YORK, N.Y. 10012
(212) 777-6571 • TWX 710-581-4930

FREE CATALOG AVAILABLE.

INFORMATION RETRIEVAL NUMBER 112

DIGITAL
DISPLAY

WHEN
THE BLOCK
READS
"DIGITAL DISPLAY"

...don't get
involved!

Let us fill the block for you.

When your lead time is short, our off-the-shelf PDC series display modules can save you time and money on moderate volume or prototype applications. We have modules in a wide range of digit sizes. They include LED, incandescent, and seven-segment numeric as well as dot-matrix alphanumeric. They're pre-wired for BCD logic and are ready to mount to your panel with just two screws. Ask for our catalog.

In fact, contact us whatever the requirements of that digital display block may be; we also design and produce custom systems. We are digital display specialists and thrive on involvement.

Precision Dynamics Corporation
3031 Thornton Ave. • Burbank, CA. 91504
(213) 845-7606

INFORMATION RETRIEVAL NUMBER 113

CHIP TIP

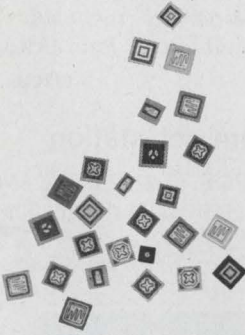

Sprague Silicon Transistor and Zener Diode Chips are 100% D-C Parameter Probe-Tested and 100% Visually Inspected.

- Choose from a broad, diversified line of drivers, switches, choppers, general-purpose transistors, and Zener diodes.
- Standard types on the shelf, non-standard types on special order.
- Gold backed for easy die-bonding to substrates.
- Packaged and shipped four different ways: (1) as whole wafers in padded boxes, ready for scribing in your plant; (2) as expanded wafers (all chips cut apart and slightly separated, but wafer retains complete traceability) in cushioned outer cases; (3) in compartmented plastic boxes with see-through covers; (4) bulk-packed in glass vials.

For more information, write for Short-Form Catalog CN-164C to: Technical Literature Service, Sprague Electric Company, 347 Marshall St., North Adams, Mass. 01247.

455-4125



*Sprague and ® are registered trademarks of the Sprague Electric Co.

INFORMATION RETRIEVAL NUMBER 114
ELECTRONIC DESIGN 1, January 4, 1975

Relay sockets

Specifications, prices and illustrations of 84 sockets with relay hold-down springs are contained in a 12-page catalog. Included are sockets with screw terminals, solder, PC board and quick-connect terminals. For solder-terminal sockets, chassis cutout dimensions are provided. For PC-board sockets, pin layouts are given. Potter & Brumfield, Princeton, IN

CIRCLE NO. 385

Solid-state products

An updated 36-page guide lists ICs, power transistors, MOSFETs, rf and microwave power devices, power hybrid circuits, thyristors and rectifiers. RCA Solid State Div., Somerville, NJ

CIRCLE NO. 386

Polymer connectors

Miniature circular polymer connectors are featured in a six-page catalog. Plugs, receptacles and shell sizes are described and illustrated as well as specifications, performance and characteristics. Types of contacts are shown along with insertion/extraction tools. Dimensions are given in metric and English units. Viking Industries, Chatsworth, CA

CIRCLE NO. 387

High purity metals

The fifth edition of the company's standard products catalog, available in English, French and German. It features more than 1000 items, including high purity metals in rod, wire, foil and evaporation charge forms and a variety of ceramic powders, alumina substrates, evaporation boats and filaments. Materials Research, Orangeburg, NY

CIRCLE NO. 388

Electromechanical products

More than 4000 product listings, any one of which can be located in a matter of a few seconds through a numerical-alphabetical index, are illustrated in a 42-page booklet. Product data and prices of telephone jacks, plugs, switches, connectors, molded cable assemblies and audio accessories are provided. Switchcraft, Chicago, IL

CIRCLE NO. 389

Unsurpassed on Hybrid Circuits

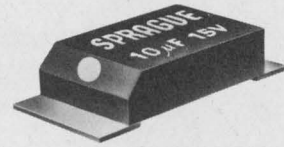

3X actual size

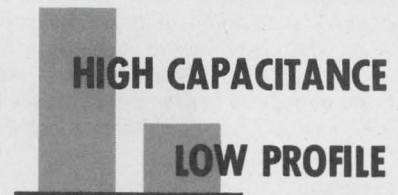
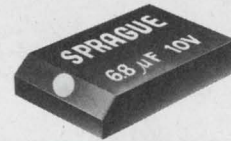

DOMINO[®] molded solid-tantalum CAPACITORS

- Fully-molded construction . . . eliminates possibility of mechanical damage during handling and mounting.
- Excellent stability . . . undesirable parametric changes and catastrophic failures due to mechanical degradation are minimized.
- Two standard terminal configurations . . . leadless with flush solderable pads, or extended tabs.
- Capacitance values from .082 to 100 μ F. Voltage ratings from 3 to 35 VDC.
- Standard capacitance tolerances, $\pm 20\%$, $\pm 10\%$, $\pm 5\%$.
- Designed for -55°C to $+85^{\circ}\text{C}$ operation. May be operated at $+125^{\circ}\text{C}$ with voltage derating.

For complete technical data, write for Engineering Bulletin 3532A to: Technical Literature Service, Sprague Electric Company, 347 Marshall Street, North Adams, Mass. 01247.

45E-4122



*Sprague and ® are registered trademarks of the Sprague Electric Co.

INFORMATION RETRIEVAL NUMBER 115

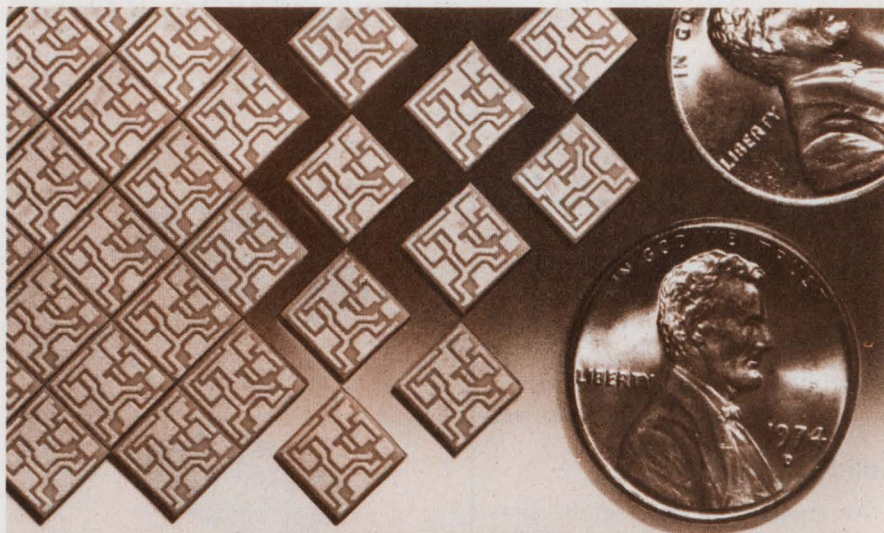

"Snappit" Circuits... little substrates that save big pennies.

Gone are the pattern alignment problems. We print the circuit before firing the ceramic. Also gone are the problems of flatness control... for the same reason. And, when it comes to repairing a bad chip-termination on a substrate, the circuit won't lift off anywhere near as quickly, because the pattern has been homogeneously fired into the surface of the substrate. So, if you have a problem, call us... we have some snappy answers.



CERAMIC SYSTEMS

Telephone: (714) 459-2935
3422 Tripp Court San Diego, CA 92121

INFORMATION RETRIEVAL NUMBER 116

Eliminate Interference-Induced Errors in your Measurements...

by removing spurious components from the signal of interest *before* you measure it. The Model 189 Selective Amplifier provides a choice of narrow-band, lowpass, highpass and notch filtering to eliminate interfering signals and wideband noise. The corner/center frequency is continuously variable between 0.1 Hz and 110 kHz with equivalent circuit Q switch-selectable from 1 to 100.

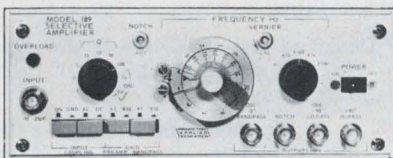

To find out how the Model 189 can eliminate errors from your measurements, write Princeton Applied Research Corporation, P.O. Box 2565, Princeton, New Jersey 08540, or telephone (609) 452-2111. In Europe, contact Princeton Applied Research GmbH, D8034 Unterpfaffenhofen, Waldstrasse 2, West Germany.



**PRINCETON
APPLIED
RESEARCH**

259

INFORMATION RETRIEVAL NUMBER 117

178

PINPOINT HEAT

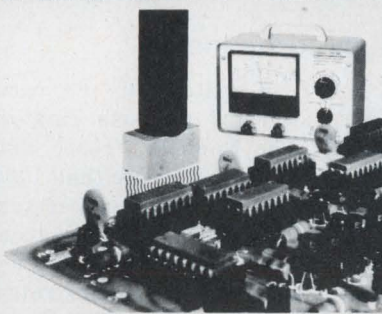

Heat any I. C. or semiconductor component to its rated temperature with a heat probe. Accuracy $\pm 1/2^\circ\text{C}$. Or check the component's temperature with a thermocouple probe. Accuracy $\pm 1^\circ\text{C}$. Model 810 Thermo-Probe does both. Reads out directly in $^\circ\text{C}$ and $^\circ\text{F}$ on a large $4\frac{1}{2}$ -inch meter. Temp. Range $+25^\circ\text{C}$ to $+250^\circ\text{C}$.

PRICE \$272.50 F.O.B. South Laguna

Models with other temperature ranges available. For details write to:

MTI MICRO-TECHNICAL INDUSTRIES

P. O. Box 287 South Laguna, CA 92677
(714) 545-3734

INFORMATION RETRIEVAL NUMBER 118

NEW LITERATURE

Chromatography

A 76-page catalog describes chromatography instruments, accessories and supplies. The catalog details features and specifications for gas and liquid chromatographs, data-handling equipment, valving, detectors and columns. Hundreds of accessories, parts and various hardware items are described. Prices and ordering information are included. Varian, Instrument Div., Palo Alto, CA

CIRCLE NO. 390

Program set station

The PGS program set station is described in a bulletin. The bulletin discusses other programmed batch control systems available from the company. The Foxboro Co., Foxboro, MA

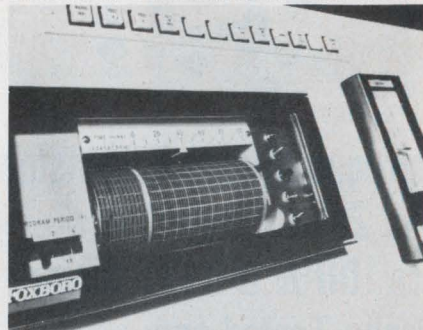

PGS Program Set Station
for programmed batch control

FOXBORO

tin discusses other programmed batch control systems available from the company. The Foxboro Co., Foxboro, MA

CIRCLE NO. 391

Capacitors

How high reliability, temperature stability and moisture resistant self-encapsulation are built into the Filmatic capacitor is told in a 24-page booklet. Engineering, life test and moisture resistance summaries are reported along with characteristics, configurations, tempcos, standard values and dimensions. Paktron, Vienna, VA

CIRCLE NO. 392

Terminals

A two-page bulletin covers thru-lug terminals for high rate staking through printed circuit and terminal boards. Berg Electronics, New Cumberland, PA

CIRCLE NO. 393

WHAT HAVE YOU GOT TO LOSE?



WIN A FREE CARIBBEAN WINDJAMMER CRUISE PLUS \$1,000 CASH

Once again, by reader demand, a week's Windjammer Cruise for two in the fabulous blue Caribbean is waiting for the lucky winner of *Electronic Design's* TOP TEN CONTEST. And that's not all! The first prize winner gets \$1,000 in cash, round-trip air transportation for two, plus a free ad re-run worth thousands of dollars for his company.

Think of it . . . warm sun . . . bright blue water . . . easy carefree days cruising among the Bahama Out-Islands, the Virgin Islands, or the exotic Windward/Leewards. Visit foreign ports. Swim . . . snorkel, or just relax.

IT'S EASY TO ENTER. Nothing to write, nothing to buy, no slogans, no gimmicks. All you have to do is select the TOP TEN ads in the January 4 issue, as measured by *Reader Recall* (*Electronic Design's* method of gaging readership). It's a

*Free reruns awarded only if the company has an advertisement in the January 4 issue.

once-a-year chance to test your skill as well as win valuable prizes for yourself and for your company.

100 PRIZES IN ALL. Portable color TV; Bulova electronic timepieces and technical books broaden your chance to win, make it even more worthwhile to enter.

SEPARATE CONTEST FOR ADVERTISERS

Advertisers, marketing men and advertising agencies can enter too. Duplicate awards are given to the top three winners (Windjammer Cruise, cash, air transportation, free ad re-run; Color TV; Bulova timepiece).

Remind your advertising people that it's the issue of the year for readership . . . the issue of the year for prizes. Put your hard-earned degrees or just plain common sense to work. This year you can be the winner!

THIS YEAR TRY YOUR LUCK!

SEE NEXT TWO PAGES FOR DETAILS



WIN A BUNDLE!



WIN THE EVER-POPULAR CRUISE

READER CONTEST

1st PRIZE

Windjammer Cruise for two.
Air transportation for two.
\$1,000 cash.
Free ad rerun.

2nd PRIZE

Portable color TV.
Free ad rerun.

3rd, 4th & 5th PRIZES

Bulova electronic timepieces.
Free ad rerun (3rd prize only):

6th THRU 100th PRIZES

Technical Books
(Title to be announced.)



PRIZES

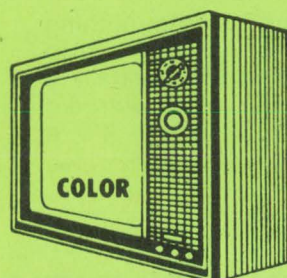

ADVERTISER CONTEST

1st PRIZE

Windjammer Cruise for two.
Air transportation for two.
\$1,000 cash.
Free ad rerun.

2nd PRIZE

Portable color TV.
Free ad rerun.

3rd PRIZE

Bulova electronic timepiece.
Free ad rerun.

WAKE UP AND JOIN THE FUN AND EXCITEMENT!

100 VALUABLE PRIZES!

ENTER Electronic Design's 1975 TOP TEN CONTEST

HERE'S ALL YOU HAVE TO DO

- (1) Read this issue with extra care. Then select the ten ads that you think will be best SEEN AND READ by *Electronic Design's* 85,900 subscribers.
- (2) List the ten ads by COMPANY NAME and INFORMATION RETRIEVAL NUMBER on the contest entry card or a reasonable facsimile (cards are bound in the front and back of this issue). Do not give the page number.
- (3) Fill in your complete name and address and mail. Your entry must be postmarked before midnight February 28, 1975.

Your entry will be compared with *Reader Recall* scores — *Electronic Design's* method of rating readership. However, this year the scores will be weighted. 1 point for every percentage point for "Recall Seen" and 2 points for every percentage point for "Recall Read Most." See rule 6 of the contest rules. This means you will have to look carefully for ad content as well as visibility.

**SEE LAST PAGE IN THIS ISSUE FOR COMPLETE RULES
AND ENTRY BLANKS**

NEW "FLAT PACK" ELECTRONIC PHASE SHIFTERS

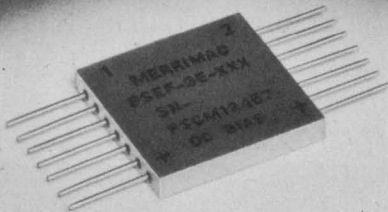

- Center frequencies from 10 to 500 MHz
- Phase range 0° to 180° continuous*
- Compact and lightweight
- Custom models available

The new PSEF-3E Series of electronically controlled phase shifters is ideal for automatic phase control applications, such as steering electronically scanned antenna arrays. These networks can be easily mounted on PC boards for airborne, space, and "back pack" applications.

Key specs include: bandwidth 10%, typical insertion loss 0.8 db, impedance 50 ohms, VSWR 1.6:1, temperature range -20°C to +85°C, size 0.14" x 0.83" x 0.83", and weight 9 grams.

Contact Merrimac today for more details on standard and custom-engineered PSEF-3E phase shifters.

*Units may be cascaded for additional phase shift range.

**MERRIMAC
INDUSTRIES
INCORPORATED**

41 FAIRFIELD PLACE, WEST CALDWELL, N. J. 07006
(201) 228-3890 • TWX 710-734-4314

U.S. EXPORT REPRESENTATIVE:

Dage Corporation, 203 324 3123

INTERNATIONAL SALES REPRESENTATIVES:

Brussels, Belgium — Eleutron, S.p.r.l., tel: 513 7384, tlx: 25437 **Montreal, Canada** — Mitec Electronics, Ltd., tel: 514 334 9140, twx: 610 421 3572 **London, England** — C. T. London Electronics Ltd., tel: 369 050, tlx: 15052 **Paris, France** — Datron, tel: 808 02 60, tlx: 68135 **Munich, Germany** — Selectron, GmbH, tel: 392 048, tlx: 215791 **Tel-Aviv, Israel** — Dage Israel Ltd., tel: 415645/410988, tlx: 34424 **Breda, Netherlands** — Datron, B.V., tel: 41152, 41153, tlx: 54512 **Stockholm, Sweden** — Ajgers Electronic AB, tel: 08 88 03 20, tlx: 10526 **Zurich, Switzerland** — Invertag, SA, tel: 65 56 30, tlx: 52896

bulletin board

Intertel has announced a low-cost modem equipment leasing package that is intended to allow OEM buyers to obtain a full line of modems, network testing equipment and central control hardware with a minimum of advanced development, capital expenditures and ongoing support costs.

CIRCLE NO. 394

Communications, optical character reading capabilities and a new remote terminal have been added to Lockheed Electronics' data management/entry systems product line.

CIRCLE NO. 395

California Computer Products has announced an 8% increase in lease prices, a 10% increase in purchase prices and an 8% increase in maintenance rates for end-user disc and tape memory products.

CIRCLE NO. 396

MIL-C-55514 CFR02 established reliability film capacitors—Series F310 and F311—are available from the Components Dept. of Union Carbide. The capacitors use parylene on ultra-thin dielectric film and special thermosetting resin impregnants to provide stability and predictable temperature characteristics in a compact size.

CIRCLE NO. 397

Burroughs has announced price increases of 1 to 10% on its range of computer systems, terminal products, peripheral equipment and maintenance.

CIRCLE NO. 398

National Semiconductor, 2900 Semiconductor Dr., Santa Clara, CA 95051 has announced that it has extended the standard temperature range of its entire 74C commercial CMOS line to -40 to +85 C. It was formerly specified at 0 to 70 C.

INQUIRE DIRECT

PULSE AMPS

C-COR

**Fast Rise Time
High Output
PULSE AMPLIFIERS
ARE the best.**

Performance is why!

FOR EXAMPLE:

MODEL	3310	3370-P	3374-P
Risetime	0.95 ns	0.6 ns	1.1 ns
Gain	30dB	20dB	20dB
Z In/Out	50/50 ohms	50/50 ohms	1m/50 ohms
Output	± 9 Vp into 50 ohms	± 3 Vp into 50 ohms	± 3 Vp into 50 ohms

For a complete amplifier catalog call, write, or wire:

**C-COR
Electronics, Inc.**

60 Decibel Road
State College, PA 16801
814-238-2461
TWX 510-691-1933

INFORMATION RETRIEVAL NUMBER 121

SUBSCRIBER SERVICE For prompt service include the addressed label when writing about your subscription.

CHANGE OF ADDRESS

city	company address	division/department	company	name	NEW ADDRESS
state					
zip					

If you're moving, please let us know six weeks before changing your address. If you have a question, place your magazine address label here and clip this form to your letter.

MAIL TO: ELECTRONIC DESIGN Circulation Dept. Hayden Publishing Co., Inc., 50 Essex Street, Rochelle Park, NJ 07662

INFORMATION RETRIEVAL NUMBER 120

The Ultimate in Ignition Systems!

★ **ELIMINATES BREAKER POINTS.**
Perfect Timing and Dwell never change!

★ **Eliminates Tune-ups.**
Never wears out or needs any Maintenance.

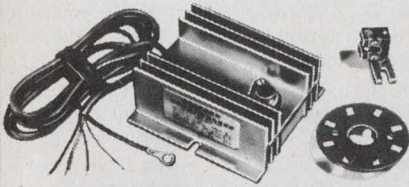

★ **The Most Advanced**
"OPTO-ELECTRIC SYSTEM"

● The Allison Breakerless System eliminates the Points and Condenser, replacing them with an Opto-Electronic Trigger, using a Light-Emitting Diode and Phototransistor. Also completely eliminates wiper-arm "friction" wear. The only "TRUE" Electronic Ignition ... that you can install for under \$100. Gives 40-times more Timing Accuracy than ANY system using mechanical Breaker-Points! Unlimited RPM. Smoother running. (No timing fluctuation as with Magnetic units). Unaffected by Temperature, Moisture, or Vibration! All Solid-State Components. Easier Starting under any condition! Increased Horsepower. Sparkplugs last longer. Perfect timing increases engine Efficiency and Gas Mileage up to 30%!

● **Quick and Easy Installation!**

★ **Tested and Proven reliability.**

Only **\$49.95** ● **SATISFACTION GUARANTEED!**

● Complete. ● **1-YEAR FACTORY WARRANTY.**

(State Make, Year, Engine Size). (Calif. Res. add Tax).

● **CONVERT YOUR "C-D" UNIT TO BREAKERLESS!**
"TRIGGER-UNIT" ONLY \$34.95

★ **Send Postcard for FREE BROCHURE Today.**

ALLISON AUTOMOTIVE CO.

P.O. Box 881-F, TEMPLE CITY, CAL. 91780

INFORMATION RETRIEVAL NUMBER 122

ONLY SCHAEVITZ MAKES HERMETICALLY SEALED DC LVDT'S WITH ALL THESE SPECS

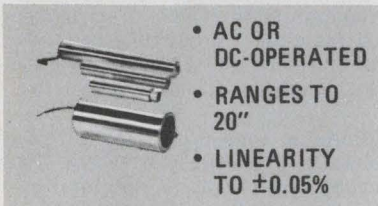

- AC OR DC-OPERATED
- RANGES TO 20"
- LINEARITY TO $\pm 0.05\%$

- ● ● OP AMP OUTPUT $\pm 10V$ DC
- ● ● STOCK DELIVERY

WRITE FOR
24 PAGE
LVDT
APPLICATION
BULLETIN
AND
SELECTION
GUIDE

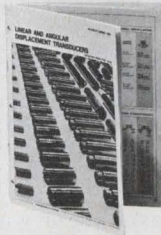

schaevitz

engineering

(609) 662-8000

P.O. BOX 505, CAMDEN, NEW JERSEY 08101

INFORMATION RETRIEVAL NUMBER 123

ELECTRONIC DESIGN 1, January 4, 1975

Honeywell has announced two computer program packages designed to simplify maintenance and to improve transaction processing capabilities for its large-scale computer customers. HEALS II (Honeywell Error Analysis and Logging System) provides advance warning of potential hardware malfunctions. TDS (Transaction Driven System) provides Series 60 Level 66 and Series 6000 users with communications programs.

CIRCLE NO. 399

A computer program that enables a host computer and sensor-based satellite processors to operate in a highly responsive hierarchical network has been announced by IBM.

CIRCLE NO. 400

Periodic summary reports of electronic component screening results are available from the Continental Testing Laboratories. The reports include part type, quantity screened and the number failing each type of test.

CIRCLE NO. 401

Motorola has signed an agreement with Nitron (a division of McDonnell-Douglas Corp.) to second source Motorola's MOS-ROM devices.

CIRCLE NO. 402

Price reductions

Price reductions ranging from 19 to 30% on main memory units for PDP-15 computers have been announced by Digital Equipment Corp.

CIRCLE NO. 403

CTS of Berne has lowered the prices of CTS 345 Series 0.25-in. round cermet trimmers an average of 12% for production quantities of 10,000 pieces and above. The Series 345 sells for \$0.70 (10,000) and under \$0.60 (50,000).

CIRCLE NO. 404

True Data has reduced prices an average of 40% on its Series I optical data readers and now offers its products to the end-user market, dropping its exclusive concentration on OEMs.

CIRCLE NO. 405

Dual visual recognition switches with versatility and economy— that's yankee ingenuity.

Switchcraft's unique and highly versatile DVR Switches give you the advantage of advanced DUAL VISUAL RECOGNITION. When the pushbutton is "out," the black color band contrasts with the recognition cap; in the "in" position, only the colored recognition cap shows. It means we've made it easier to see the switch position, eliminating false indications.

This kind of advanced "human engineering"—plus its low cost—makes DVR ideal for applications in EDP, computer systems and peripheral equipment, sound and communications equipment, and telephone equipment. You get reliability and economy in one little package.

DVR Switches in either momentary or push-lock/push-release functions offer up to 4-C switching. Standard silver-plated, U-shaped bifurcated sliders are rated at 0.5 amp D.C., or 3 amps A.C., 125 V non-inductive load are ideal for dry circuit use. An 11 amp power module is offered with 1-C switching (depth: $1\frac{1}{2}$ "), plus additional 1-C or 2-C of standard bifurcated switching (depth: $2\frac{1}{2}$ "). Solder lug terminals are standard; P.C. or wire wrapping terminals are available. DVR switches mount in a single $1\frac{1}{2}$ " hole and offer a variety of colors, styles, mounting hardware and legends.

Only Switchcraft—and a little Yankee Ingenuity—gives you all this for so little. Contact your Switchcraft Representative or Switchcraft, 5555 N. Elston Avenue, Chicago, Illinois 60630.

SWITCHCRAFT®

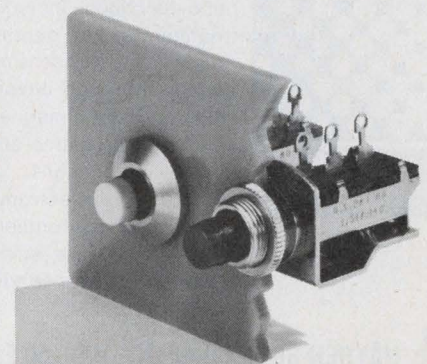

INFORMATION RETRIEVAL NUMBER 124

Design Data from Manufacturers

Advertisements of booklets, brochures, catalogs and data sheets. To order use Reader-Service Card
(Advertisement)

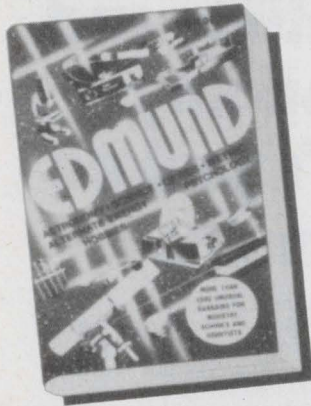

GIANT FREE CATALOG

New 180-page catalog! Packed with 1,000's of hard-to-find buys in Optics, Science, Electronics. Loaded with optical, scientific, electronic equipment available from stock. Rare surplus buys. Many "one-of-a-kinds". Ingenious scientific tools. Components galore: lenses, prisms, wedges, mirrors, mounts, accessories. 100's of instruments: pollution test equipment, lasers, comparators, magnifiers, microscopes, projectors, telescopes, binoculars, photo attachments, unique lighting. Shop, save by mail! Request free Catalog "DA".

CIRCLE NO. 171

Edmund Scientific Co.

America's Largest Science-Optics-Electronics Mart
300 Edscorp Bldg., Barrington, New Jersey 08007 (609) 547-3488

PRACTICAL RELAY CIRCUITS

By Frank J. Oliver

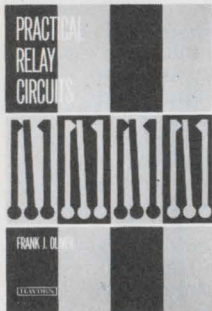

Uniquely groups various relay circuits according to the functions they perform, enabling the systems designer to quickly select the best circuit for his specific purposes. Includes arc and RFI suppression systems; time delay function; audio tone control and resonant-reed relays; sequential relays; protective functions of relays against overload overvoltage, and overcurrent, pulse generation and detection; logic circuits; and more. Particularly important is coverage of pulse-operated relay systems now extensively used with automated control systems. Illustrated with many circuit diagrams using the latest American National Standard graphical symbols. 363 pp., 6 x 9 1/4, illus., cloth, \$17.20. **Circle the reader-service number to order a 15-day examination copy.**

CIRCLE NO. 172

 HAYDEN BOOK COMPANY, INC., 50 Essex St., Rochelle Park, N.J. 07662

MATERIALS FOR MAGNETIC FUNCTIONS

by Fennimore N. Bradley

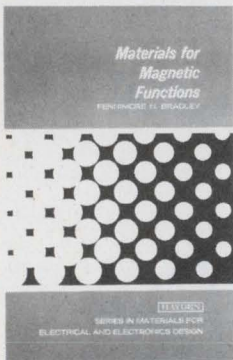

This valuable reference provides a thorough background as well as practical design techniques for the materials needed for magnetic functions. Included in its exhaustive coverage is detailed treatment of key parameters of about 30 classes of ferrite materials relating processing to costs and design trade-offs . . . and equally thorough coverage of about 40 classes of both conventional and exotic magnetic metals and processes. The book focuses on design problems encountered in a wide range of permanent-magnet applications . . . pinpoints design problems in nearly 30 categories of electromagnetic devices . . . and concludes with coverage of environmental influences such as corrosion, magnetic field, temperature, stress, etc. 360 pp., 6 x 9, illus., cloth, \$17.20. **Circle the reader-service number to order a 15-day examination copy.**

CIRCLE NO. 173

 HAYDEN BOOK COMPANY, INC., 50 Essex St., Rochelle Park, N.J. 07662

Electronic Design

ELECTRONIC DESIGN's function is:

- To aid progress in the electronics manufacturing industry by promoting good design.
- To give the electronic design engineer concepts and ideas that make his job easier and more productive.
- To provide a central source of timely electronics information.
- To promote communication among members of the electronics engineering community.

Want a subscription? ELECTRONIC DESIGN is sent free to qualified engineers and engineering managers doing design work, supervising design or setting standards in the United States and Western Europe. For a free subscription, use the application form bound in the magazine. If none is included, write to us direct for an application form.

If you do not qualify, you may take out a paid subscription for \$30 a year in the U.S.A., \$40 a year elsewhere. Single copies are \$1.50 each.

If you change your address, send us an old mailing label and your new address; there is generally a postcard for this bound in the magazine. You will have to requalify to continue receiving ELECTRONIC DESIGN free.

The accuracy policy of ELECTRONIC DESIGN is:

- To make diligent efforts to ensure the accuracy of editorial matter.
- To publish prompt corrections whenever inaccuracies are brought to our attention. Corrections appear in "Across the Desk."
- To encourage our readers as responsible members of our business community to report to us misleading or fraudulent advertising.
- To refuse any advertisement deemed to be misleading or fraudulent.

Microfilm copies are available of complete volumes of ELECTRONIC DESIGN at \$19 per volume, beginning with Volume 1, 1961 through Volume 20. Reprints of individual articles may be obtained for \$3.00 each, prepaid (\$5.00 for each additional copy of the same article) no matter how long the article. For further details and to place orders, contact the Customer Services Department, University Microfilms, 300 North Zeeb Road, Ann Arbor, Michigan 48106 telephone (313) 761-4700.

Want to contact us? If you have any comments or wish to submit a manuscript or article outline, address your correspondence to:

Editor
ELECTRONIC DESIGN
50 Essex Street
Rochelle Park, N.J. 07662

IT'S REALLY NO SECRET-

But did you know that the greatest growth in the world's professional electronics industry is in the sector of communications?

We did, and that is why we have produced-

communications international

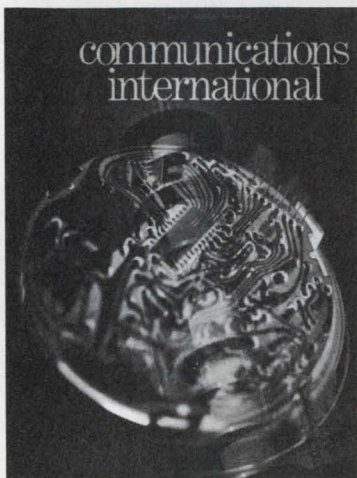

the new monthly journal for the world's manufacturers, designers & users of systems, equipment & components in the field of communications.

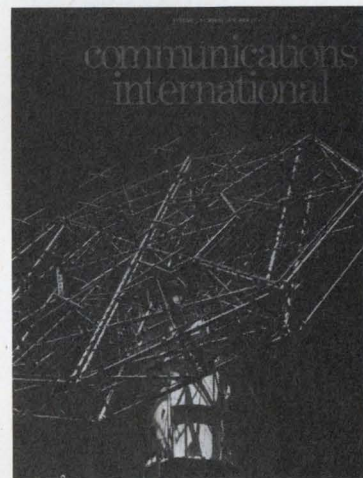
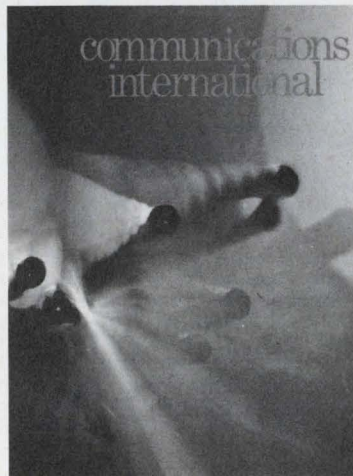

Circulation: Communications International has a circulation of 5,000 copies in the UK, 9,000 copies on the mainland of Europe and 4,000 copies are sent to countries throughout the rest of the world.

Advertising: The Publication offers highly competitive advertisement rates ranging from £340 for a whole page black and white to £94 for a quarter page in black and white. Series discounts are available and colour is charged extra. Communications International is published from the UK but its readership is global and its editorial coverage is carefully

selected from material provided by a worldwide network of foreign correspondents and articles from eminent international technologists. Communications International concerns itself with four broad editorial areas of communication and these are line and data, mobile radio, fixed radio and defence. Within these

areas it provides up-to-the-minute news of the world industry, its business aspects and in depth technical information aimed at aiding engineers to solve specific problems. Communications International also presents regular international features on the most technically efficient and economic options available to managers and purchasers of communications equipment and it includes a meticulously screened and researched section which every month is devoted to new products appropriate to the communications industry.

Mail this form today to: The Publisher, COMMUNICATIONS INTERNATIONAL
49-50 Hatton Garden London EC1N 8XS ENGLAND. Telephone: 01-278 6571

Please send:

- Advertisement Rates & Data
 Subscription Details

Name _____

Status _____

Company/Address _____

Country _____ ED

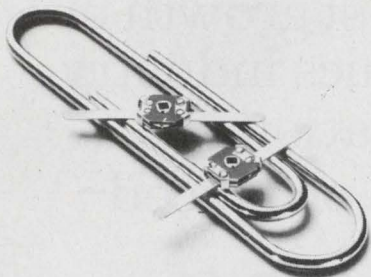

Thin-Trim variable capacitors provide a reliable means of adjusting capacitance without abrasive trimming or interchange of fixed capacitors. Series 9401 has high Q's and a range of capacitance values from 0.2-0.6 pf to 3.0-12.0 pf and 250 WVDC working voltage. Johanson Manufacturing Corporation, Boonton, New Jersey (201) 334-2676.

INFORMATION RETRIEVAL NUMBER 601

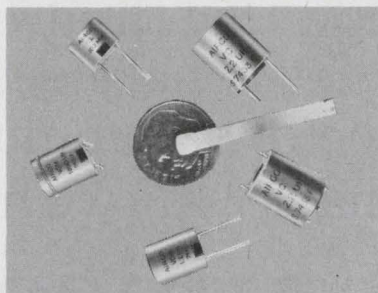

Variable Inductors Versacoil® VCM Shielded Series 0.1 to 100,000 uH VC Unshielded Series 0.1 to 4700 uH Unique unitork design provides uniform torque, no more broken cores. Available stock. Airco Electronics, P.O. Box 547 Bradford, Pa. 16701 814-362-5536.

INFORMATION RETRIEVAL NUMBER 604



Free catalog of 34,500 power supplies from the worlds largest manufacturer of quality Power Supplies. New '74 catalog covers over 34,500 D.C. Power Supplies for every application. All units are UL approved, and meet most military and commercial specs for industrial and computer uses. Power Mate Corp. (201) 343-6294.

INFORMATION RETRIEVAL NUMBER 607

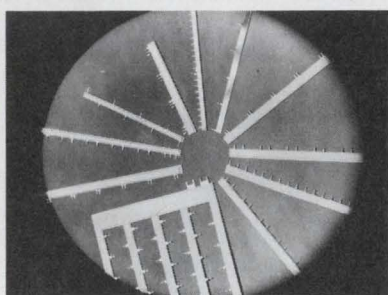

Mini/Bus® Evaluation Kit, \$25, in stock. Lets you try Rogers' low-cost, noise attenuating, high packaging density power distribution system for PC boards. Millions in use. Standard parts on 2 weeks delivery, or less! Customer parts 4 to 6 weeks delivery. Rogers Corporation, Chandler, Ariz. 85224. Phone (602) 963-4584

INFORMATION RETRIEVAL NUMBER 602



Basic Engineering Sciences & Structural Engineering for E-I-T Exams. Sampling for test problems makes the best preparation yet for exams. #5712-1, 424 pp., \$17.20. Circle the Info Retrieval No. to order 15-day exam copy. When billed, remit or return book with no obligation. Hayden Book Co., 50 Essex St., Rochelle Pk., N.J. 07662

INFORMATION RETRIEVAL NUMBER 605

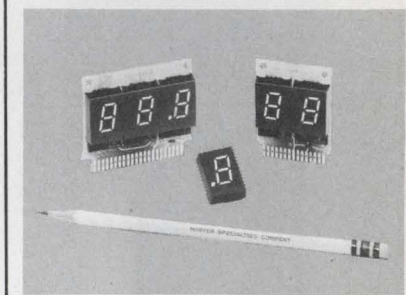

Plug-in LED Display Assemblies with decoder/driver circuits already assembled, ready to plug-in and read-out. Accepts 4-line BCD input. Operates from 5 VDC. Utilizes 0.6" high red numeric LED display. Master Specialties, 1640 Monrovia, Costa Mesa, Calif. 92627. (714) 642-2427.

INFORMATION RETRIEVAL NUMBER 608

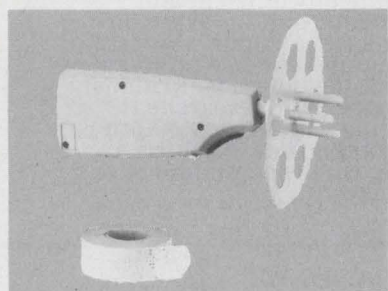

High-Speed Cordless Paper Tape Winder features light weight, portability and convenience. Powered by its own internal battery pack (supplied) the winder can be attached to its stand/recharger (also included) when not in use. Model 1000-1. \$100. A-B Supply Co., P.O. Box 5609, China Lake, CA 93555 (714) 375-7079

INFORMATION RETRIEVAL NUMBER 603

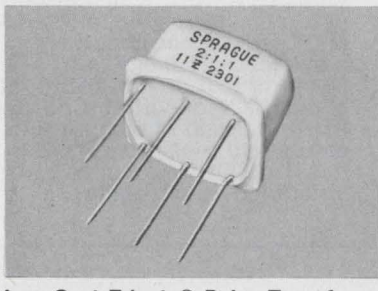

Low Cost Trigate® Pulse Transformers. The industry's most economical SCR triggers. Single-ended with pin leads for printed boards. Protected by thermoplastic sheath. Balanced pulse characteristics, minimum saturation effect, fast pulse rise time. Axial-lead and pre-molded case designs "also available." Sprague Electric Co., 347 Marshall St., No. Adams, MA 01247. (413) 664-4411.

INFORMATION RETRIEVAL NUMBER 606



Now . . . your solution to finding unique electronic components. Free catalog lists 1,000's of hard-to-find parts. Audio amplifier circuits, tone generators, keyboards, breadboards, latest unique circuits. Call, TWX or write KA for your component needs. KA Electronic Sales, 1220 Majesty Drive, Dallas, Texas 75247. (214) 634-7870. TWX 910-861-9028.

INFORMATION RETRIEVAL NUMBER 609

Electronic Design

Advertising Sales Staff

Tom W. Carr, Sales Director

Rochelle Park, N.J. 07662

Robert W. Gascoigne

Daniel J. Rowland

(Recruitment, Quick Ads, Classified)

50 Essex Street

(201) 843-0550

TWX: 710-990-5071

Philadelphia

Thomas P. Barth

50 Essex Street

Rochelle Park, N.J. 07662

(201) 843-0550

Boston 02178

Gene Pritchard

P.O. Box 379

Belmont, Mass. 02178

(617) 489-2340

Chicago 60611

Thomas P. Kavooras

Berry Conner, Jr.

200 East Ontario

(312) 337-0588

Cleveland

Thomas P. Kavooras

(Chicago)

(312) 337-0588

Los Angeles 90045

Stanley I. Ehrenclou

Burt Underwood

8939 S. Sepulveda Boulevard

Suite 510

Los Angeles, Calif.

(213) 641-6544

San Francisco 94022

Jerry D. Latta

P.O. Box 1248

Los Altos, Calif.

(415) 965-2636

London, Amsterdam, Tokyo, Seoul

John Ashcraft

12, Bear St.

Leicester Square

London WC2H 7AS England

Phone: 01-930-0525

W. J. M. Sanders

John Ashcraft & Co.

Herengracht 365

Amsterdam C., Holland

Phone: 020-24-09-08

Haruki Hirayama

Electronic Media Service

5th Floor, Lila Bldg.,

4-9-8 Roppongi

Minato-ku, Tokyo, Japan

Phone: 402-4556

Cable: Electronicmedia, Tokyo

Mr. O-kyn Park, President

Dongbo International

Corporation

1.P. O. Box 4010

Seoul, Korea

Phone: 28-1911

Cable: Dongbo Seoul

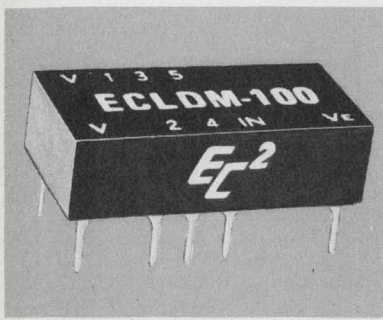

EC's new ECL compatible Logic Delay Module features ECL input and outputs; 16-pin DIP package (.250 high); precise delays from 25ns to 250ns; and with 20% taps—each isolated with 70 ECL dc. fan-out capacity. Engineered Components Company, 3580 Sacramento Drive, San Luis Obispo, CA 93401 (805) 544-3800.

INFORMATION RETRIEVAL NUMBER 610

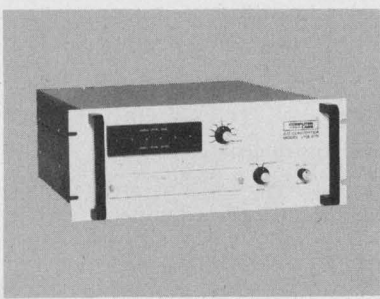

Model VHS-675 High-Speed A/D Converter. Digital data with 6-bit resolution at any random or periodic word rate from DC through 75 MHz. Track-and-hold, test words, and power supply included. 10 ps aperture time; 80 MHz BW. Computer Labs, 1109 S. Chapman St., Greensboro, N.C. 27403.

INFORMATION RETRIEVAL NUMBER 613



A collector's item . . . 20th anniversary issue of Electronic Design (11/23/72) salutes 25th anniversary of the transistor, features milestones in design over past quarter century. Rare nostalgic view of industry. Fascinating reading. \$2 per copy pre-paid. Checks, money orders: Electronic Design, Promotion Mgr., 50 Essex St., Rochelle Park, N.J. 07662.

INFORMATION RETRIEVAL NUMBER 611



Ultraminiature switching power supply brings high reliability. Tens of thousands are now used in Japanese industry. MTT-15/100, Size: 2 x 1.2 x .5 in.; 18 oz. AC Input 115V ±10%, Output ±15V 100mA operating 0-60°C. No derating, Price \$39.00 (100). Other models also. MTT Co Ltd. Sugiura Bldg. No. 10-2 Daikyo-Cho Shinjuku-ku Tokyo 160 Japan

INFORMATION RETRIEVAL NUMBER 614

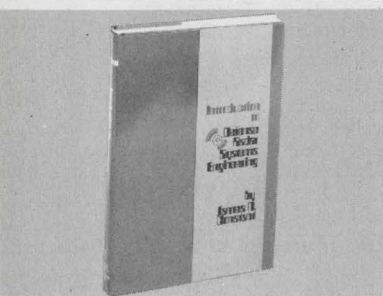

Introduction To Defense Radar Systems Engineering. Excellent introduction and practical reference to radar systems design and applications. #9194, 260 pp., \$22.95. Circle the Info Retrieval No. to order 15-day exam copy. When billed, remit or return book with no obligation. Hayden Book Co. 50 Essex St. Rochelle Park, N.J. 07662

INFORMATION RETRIEVAL NUMBER 612

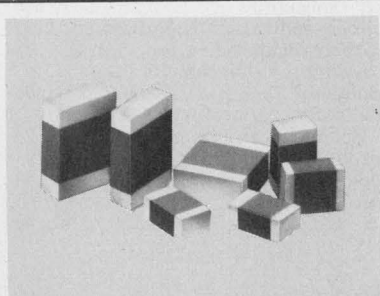

HIGH Q MULTILAYER CAPACITORS feature very high quality factors at microwave frequencies. Offered in three standard sizes: .050 x .040, .080 x .050, .125 x .095. Capacitance values from 0.1 pf to 1000 pf with close tolerance and voltages to 1000 VDCW. Johanson/Monolithic Dielectrics Div., Box 6456, Burbank, Ca. 91510, (213) 848-4465.

INFORMATION RETRIEVAL NUMBER 615

advertiser's index

Advertiser	Page	Advertiser	Page	Advertiser	Page
A-B Supply Co.	186	General Instrument Corporation	102, 103, 121	Piher International Corp.	64D
AMP, Incorporated	36, 37	Gold Book, The	150, 174, 175	Pomona Electronics	88
Abbott Transistor Laboratories, Inc.	6	Gould, Inc., Graphics Division	172	Power Conversion, Inc.	173
Acopian Corp.	123	Gould, Inc., Instrument Systems Division	90	Power/Mate Corp.	186
Ad-Vance Magnetics, Inc.	168	Grayhill, Inc.	154	Precision Dynamics Corporation	176
Advertising Council	64F	Guardian Electric Manufacturing Company	14, 15	Preston Scientific, Inc.	156
Airco Speer Electronics	186			Princeton Applied Research Corp.	178
Allen Bradley Co.	64A				
Allison Automotive Co.	183	Hamlin, Incorporation	129	RCA Solid State	Cover IV
Amperite Co., Inc.	140	Harris Publishing Co.	141	Reader Service	192A, 192B
Analog Devices, Inc.	159	Harris Semiconductor, A Division of Harris Corporation	117	Rental Electronics, Inc.	116
Arnold Magnetics Corp.	160	Hayden Book Company, Inc.	184, 186, 187	Robinson Nugent, Incorporated	44, 45
Augat, Inc.	63	*Hayden Book Company, Inc.	11, 147	Rockwell International	108, 109
		Hayden Mail Order	139	Rogers Corporation	186
B & K Precision Products of Dynascan	149	Heath/Schlumberger Instruments	107	Rohde & Schwarz	115
Beckman Instruments, Inc. Helipot Division	147	Heinemann Electric Company	31	Rotron, Inc.	65
Beckman Instruments, Inc., Information Displays Operations	60	Hewlett-Packard	1, 54, 55, 89, 161	Rtron Corporation	152
Bendix Corporation, The Electrical Components Division	64E				
Bell & Howell	169	IEE/Schadow, Inc.	16	Scanbe Manufacturing Corp.	83
Bell, Inc., F. W.	114	IMC Magnetics Corporation	166	Schaevitz Engineering	183
Bodine Electric Company	50, 51	Instant Instruments, Inc.	144	Schauer Manufacturing Corp.	148
Boonton Electronics Corporation	153	Intech, Incorporated	136	Simpson Electric Company	82
Bourns, Inc. Trimpot Products Division	29	Intel Corporation	4, 5	Sinclair Radionics, Inc.	139
Burdyn Corporation	131			Sorenson Company, A Unit of Raytheon Company	8, 9
*Business Publications Audit of Circulation	14	Johanson Manufacturing Corp.	186	Sprague Electric Company	177, 186
		Johanson/Monolithic Dielectrics	187	Standard Condenser Corporation	158
C-Cor Electronics, Inc.	182			Switchcraft, Inc.	183
CTS Corporation	137	KA Electronic Sales	186		
Centralab, The Electronics Division of Globe-Union, Inc.	24, 25	Keithley Instruments, Inc.	Cover III	T.R.I. Corporation	166
Ceramic Systems	178	Kepeco, Inc.	66	Tektronix, Inc.	33, 69
Cherry Electrical Products Corp.	70	Kurz-Kasch Inc.	32, 191	Tele-Dynamics/Wanlass Division of Ambac	130
Chicago Dynamic Industries, Inc.	172			Teledyne Relays, A Teledyne Company	2
Clare-Pendar	61	Lafayette Radio Electronics	146	Topaz Electronics	167
Columbia Research Labs, Inc.	168	Litronix, Inc.	164, 165	Tracor, Inc.	144
Communications International	185			Triplett Corporation	119
Computer Labs, Inc.	187	3M Company	92	Tustin Electronics Co.	156
Concord Electronics Corporation	176	MTT Co. Ltd.	187		
Connecticut Hard Rubber Co., The	134	Master Specialties	186	USCC/Centralab Electronics Division, Globe-Union, Inc.	170, 171*
Cutler-Hammer, Specialty Products Division	18, 19	Merrimac Industries, Incorporated	182	UID Electronics Division	
		Micro-Technical Industries	178	AMF Incorporated	142
Dale Electronics, Inc.	Cover II	Microswitch, A Division of Honeywell	91	Union Carbide, Components Department	155
Data Display Products	20	Mini-Circuits Laboratory, A Division of Scientific Components Co.	23		
Datak Corporation, The	114	Motorola Components Products Dept.	151	Vactec, Inc.	93
Datatron, Inc.	72, 73	Motorola Semiconductor Products, Inc.	12, 13, 40, 41	Victoreen Instruments, Div. of VLN Corp.	143
Dialight Corporation	59			Vu Data Corporation	176
Digital Components Group	125, 126	Nichicon Corporation	62		
Duncan Electronics, Subsidiary of Systron-Donner	64	Optima Enclosures, A Division of Scientific Atlanta, Inc.	17	Weston Instruments, Inc.	64B, 64C
		Optron, Inc.	7		
				Xenon Corporation	191
EECO	163	PCS	135	Yewtec Corporation	101, 191
Edmund Scientific Company	184	Perfection Mica Company	138		
Electronic Design	179, 180, 181, 187, 192	Philips Test & Measuring Instruments, Inc.	132, 133		
*Electronic Design	10, 15				
Electronic Measurements, Inc.	162				
Electronic Research Co.	157				
Engineered Components Company	187				
Erie Technological Products, Inc.	49				
French Trade Shows	191				
GTE Automatic Electric	10, 11				
General Electric Company	145				

*Advertisers in non-U.S. edition.

SAME DAY SHIPMENT
Minis & Peripherals
PRINTERS
 Some "BRAND NEW"
DATA PRODUCTS
 2440— 700 LPM
 2470—1250 LPM \$9500
MOHAWK DATA SCIENCES
 4320—300 LPM
 4330—380 LPM
CONTROL DATA CORP.
 9322—200 LPM \$2500
 9352—600 LPM
ALSO CENTRONICS, POTTER,
A. B. DICK, IBM, HIS, UNIVAC
 617-261-1100
Send for Free Report
"Maintenance of Computers"
AMERICAN USED
COMPUTER CORP.
 P.O. Box 68, Kenmore Sta.,
 Boston, MA 02215
 member
COMPUTER DEALERS ASSOCIATION

CIRCLE NO. 267

EMITRONICS, INC.

FIELD ENGINEERS

The success of the EMI-Scanner, a new computerized X-ray system has opened up exceptional opportunities for Field Engineers in the local area.

Immediate vacancies exist for Technical Service Engineers. Experience in analog and digital systems, electro-mechanical systems, mini-computers and X-ray systems preferred.

Liberal company benefits for all employees.

Send resume, including salary requirements and availability to:

HAYDEN PUBLISHING
DEPT. CM
 50 ESSEX ST., ROCHELLE PK., N.J. 07662

KEEP

Electronic Design's

GOLD BOOK

HANDY

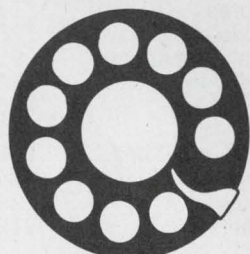

When You Call

Save time when you contact suppliers. Check their catalog pages first in *Electronic Design's* GOLD BOOK. Maybe the information you need is right at your fingertips.

FREE ALARM CATALOG

Full line of professional burglar and fire alarm systems and supplies. 96 pages, 450 items. Off the shelf delivery, quantity prices.



 **mountain west alarm**
 4215 n. 16th st., phoenix, az, 85016

CIRCLE NO. 269

FREE CATALOG

The 1974 Tucker Electronics Company General Catalog includes 160 pages of electronic test instruments, 16 lines of low cost distributor products and thousands of reconditioned instruments



TUCKER
 ELECTRONICS • COMPANY
 P.O. Box 1050 • Garland, Texas 75040

Protect Your Heart
HAVE REGULAR MEDICAL
CHECK UPS



Give Heart Fund 

REPRESENTATION IN INDIA. Electronic Engineers, manufacturers representatives would like to represent manufacturers of electronic instruments, equipment, devices. Good sales force. Write terms: **GALAXY ELECTRONICS, Post Box 9316, Bombay 36, India.**

HERMETIC SEALING

Connectors • Headers • Relay Bases
 Terminals • Custom Seals • Testing
 Glass/Ceramic To Metal • Since 1959

DETORONICS CORPORATION
 10660 E. Rush • S. El Monte, CA 91733
 (213) 579-7130 • TWX 910-587-3436

CIRCLE NO. 268

product index

Information Retrieval Service. New Products, Evaluation Samples (ES), Design Aids (DA), Application Notes (AN), and New Literature (NL) in this issue are listed here with page and Information Retrieval numbers. Reader requests will be promptly processed by computer and mailed to the manufacturer within three days.

Category	Page	IRN	Category	Page	IRN	Category	Page	IRN
Components			Discrete Semiconductors			op amps	IV	284
capacitors	25	272	couplers	93	45	RAM, static	158	363
capacitors	49	24	diode chips	177	114			
capacitors	158	91	diodes, zener	160	365	Microwaves & Lasers		
capacitors	170	104	LED/IC indicator	165	97	circulators	171	376
capacitors	177	115	LED lights	20	15	laser	171	378
capacitors, tantalum	148	350	LEDs	59	27	load, coax	171	379
capacitors, tantalum	155	88	lights, panel	160	368	oscillator, local	171	380
circuit breakers	31	18	optoelectronic			phase shifters	182	120
clips	88	40	components	7	6	source, phase-locked	171	377
display modules	176	113	rectifiers, high-voltage	162	369			
displays	60	28	transistors, field-effect	162	371	Modules & Subassemblies		
fan, cooling	154	361	transistor, μ W	160	367	ac detector	136	68
flashtubes	191	129	triacs, high current	160	366	amplifier, buffer	136	331
illuminated pushbuttons	142	74	zeners	148	81	conditioner, signal	138	334
LVDTs	183	123				conditioner, signal	140	336
liquid crystal displays	129	61	Instrumentation			controller, temperature	140	338
meter, edge reading	152	355	a/d converter	146	346	converter, a/d	138	332
motor, servo	148	351	amplifier	178	117	converter, multiplying	136	327
motors	51	25	amplifiers	142	341	decoder, tone	140	339
potentiometer	29	17	capacitance bridge	153	257	delay line, digital	138	333
potentiometers	64	32	capacitance meter	153	256	driver, current	138	335
pressure sensors	168	102	chart recorders	107	48	filters, active	136	330
RFI/EMI filters	152	85	counter/timer	142	340	ignition system	183	122
relay, PC board	152	357	DMM	146	349	modules, electro-optical	136	329
relay, TO-5	154	359	DMM	166	98	oscillator, clock	135	67
relays	11	9	DMM, autoranging	III	285	timer, precision	136	328
relays, delay	140	72	DPM, 3-1/2-digit	159	92			
resistor networks	137	69	digital logic tester	144	345	Packaging & Materials		
resistor networks	147	80	front panel meter	144	77	ceramic substrate	127	303
resistors, film	II	282	function generator	142	342	circuit boards	63	31
resistors, temp-sens.	152	356	function generators	89	41	connectors	37	240
rotary switches	154	87	gaussmeters	114	51	cores, flyback Xformer	127	302
solenoids	15	20	heat probe	178	118	DIP sockets	45	23
switch	65	33	IC and semiconductor			EMI shields	138	70
switch, DIP	148	353	testing	73	37	enclosures	17	3
switch, altitude	152	354	IC troubleshooter	161	94	fans, cooling	128	305
switch, toggle	148	352	logic probe	144	344	flat cable connectors	92	44
switches	16	12	logic probes	191	126	industrial tapes	134	66
switches	19	14	meters	191	128	jacks	176	112
switches	24	271	microwatt, meters, rf	153	255	knobs	32	19
switches	70	36	oscilloscope	133	65	magnetic shielding	168	101
switches	183	124	oscilloscopes	69	35	PC kits	114	52
switches, miniature	91	43	plotter	90	42	rf package	128	304
switches, thumbwheel	172	107	pulse amplifiers	182	121	substrates	118	116
switchlights	61	29	pulse generators	132	64			
timers	157	90	rental equipment	116	54	Power Sources		
transformers, wideband	23	16	signal generator	153	258	batteries	173	108
trimmer resistor	25	273	sweeper	1	2	inverters	167	100
			transistor testers	149	82	modular switches	8	8
Data Processing			true rms meter	146	348	modular unit	166	373
camera, CCD image	132	308	VOM	146	347	open frame supply	168	374
communicator, TV	132	320	VOM, digital	82	38	power supplies	6	5
controller, disc	132	309	VOMs	119	56	power supplies	66	34
display, CRT	130	306	wattmeters	101	46	power supplies	123	65
minicomputer	134	325				power supplies	160	93
minicomputers	109	50	Integrated Circuits			power supplies	162	95
modem, local	132	310	amplifier, limiter	158	364	power supply	144	76
printer, serial	134	324	microprocessor	157	362	switching supply	168	375
recorder, analog	134	326						
software, assembler	133	322						
storage, cartridge	130	307						
toll control system	133	321						

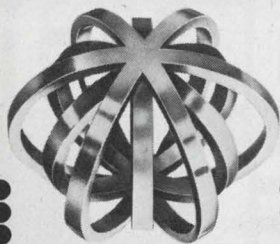

1203
electronic engineers
from Germany
in 1974.

Salon international des
**composants
électroniques 75**

Paris
2-8 April

For you, this year again,
Paris is a must

French Trade Shows
1350 Av. of the Americas
New York N.Y. 10019
☎ (212) 582.49.60

C 3

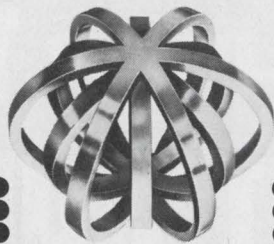

648 electronic
engineers from Spain
in 1974.

Salon international des
**composants
électroniques 75**

Paris
2-8 April

For you, this year again,
Paris is a must

French Trade Shows
1350 Av. of the Americas
New York N.Y. 10019
☎ (212) 582.49.60

C 4

INFORMATION RETRIEVAL NUMBER 126

new

C/MOS Logic Probes Available Now

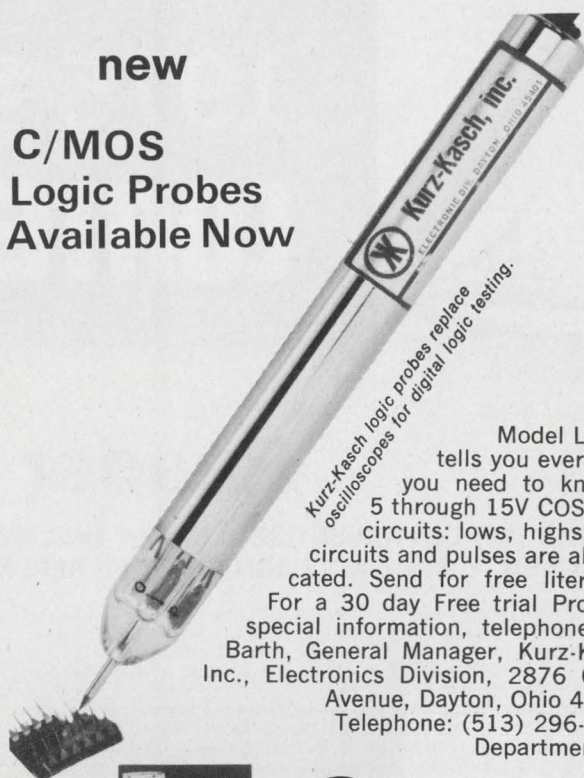

Kurz-Kasch logic probes replace
oscilloscopes for digital logic testing.

New
Model LP-576
tells you everything
you need to know in
5 through 15V COS/MOS
circuits: lows, highs, open
circuits and pulses are all indi-
cated. Send for free literature.
For a 30 day Free trial Probe or
special information, telephone Tom
Barth, General Manager, Kurz-Kasch,
Inc., Electronics Division, 2876 Culver
Avenue, Dayton, Ohio 45401,
Telephone: (513) 296-0330.
Department ED.

Free
test
data



Kurz-Kasch, Inc.

ELECTRONICS DIVISION
2876 Culver Avenue
Dayton, Ohio 45401
Telephone 513/296-0330

INFORMATION RETRIEVAL NUMBER 128

THE 25 YEAR METERS...

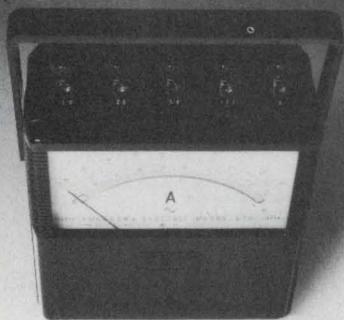

10/20/50/100 A AC: \$130.00

YEW's Precision Portables!

95% of all YEW precision portables that are returned for calibration certification are within original specifications, even after 25 years of use. We have even had instruments dating back 50 years within original specifications. *That is long term reliability* and that is why YEW is the world's largest manufacturer of precision portables.

Add taut band 0.5% accuracy, high quality and low cost, fast service, a vast selection of models and 25 years from now, you'll be glad that you tried a YEW portable. Prices start at \$120.00.

1% Portables also available. Prices start at \$50.



Yewtec Corporation
1995 Palmer Ave., Larchmont, N. Y. 10538
Telephone: 914 834-3550

60 Years of Measuring and Recording Instrumentation

INFORMATION RETRIEVAL NUMBER 127

ELECTRONIC DESIGN 1, January 4, 1975

XENON corporation

FLASHTUBES and RELATED EQUIPMENT

Lamps and Equipment for the Generation of Light.

FEATURES: High Volume Production Reliability

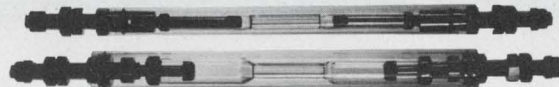

We can deliver a reliable product in the quantities required by the OEM user. Our lamps have consistently higher quality, with longer and more uniform life.

In addition, we can solve the problem of having to build your own circuitry with our:

- Trigger Transformers
- Chokes
- Trigger Modules
- Power Modules

All are part of the engineering and manufacturing package Xenon can deliver and we can offer the most advanced technical assistance in the industry.

NEW PRODUCT ANNOUNCEMENT

Contact our factory for information on our new inner seal design. Its unique insulating and cooling properties have solved problems in many OEM application areas:

SEND FOR OUR COMPLETE PRODUCT
CATALOG. XENON ASSURES
QUICK DELIVERY.

39 Commercial St., Medford, Mass. (617) 395-7634.

INFORMATION RETRIEVAL NUMBER 129



1975 SUPER TOP TEN CONTEST RULES

Reader Contest

PICK THE TOP TEN ADVERTISEMENTS IN THIS ISSUE . . . WIN A WINDJAMMER CRUISE FOR TWO . . . \$1,000 CASH . . . FREE JET FLIGHT . . . FREE RERUNS OF YOUR COMPANY'S AD . . . 100 PRIZES IN ALL.

Examine this issue of *Electronic Design* with extra care. Pick the ten advertisements that you think will be best SEEN AND READ by your fellow engineer-subscribers. List these ten advertisements on the special entry form bound in at right. (Be sure to check the box marked "Reader Contest.")

This year, your selections will be measured against the ten ads ranking highest in a weighted combination of both "Recall Seen" and "Recall Read Most" categories of Reader Recall — *Electronic Design's* method of measuring readership — see item 6 in contest rules.

In making your choices do not include "house" advertisements placed by *Electronic Design* or Hayden Publishing Company, Inc. (such as this ad describing the contest). Don't miss your chance to be a Top Ten Winner! All entries must be postmarked no later than midnight, February 28, 1975. Winners will be notified in March 1975.

READER CONTEST RULES

1. Enter your *Top Ten* selections on the entry blank provided, or on any reasonable facsimile. Be sure to indicate the name of the advertiser and *Information Retrieval Number* for each of your choices. Do not use page number. (Ads placed by Hayden Publishing Company in *Electronic Design* should not be considered in this contest.)
2. No more than one entry may be submitted by any one individual. Entry blank must be filled in completely, or it will not be considered. The box on the entry blank marked "Reader Contest" must be checked. *Electronic Design* will pay postage for official entry blanks only.
3. To enter, readers must be engaged in electronic design engineer-

ing work, either by carrying out or supervising design engineering or by setting standards for design components and materials.

4. No cash payments, or other substitutes, will be made in lieu of any prize, (except the \$1,000 prize).

5. Contest void where prohibited or taxed by law. Liability for any taxes on prizes is the sole responsibility of the winners.

6. Entries will be compared with a weighted combination of both the "Percent Recall Seen" and the "Percent Recall Read Most" scores for each advertisement. Each percentage point for "Recall Seen" will count 1 point. Each percentage point for "Recall Read Most" will count 2 points. The ten ads having the highest point scores will be declared the winners. Example: an ad with 40% "Seen" score and 12% "Read Most" score counts $40 + (2 \times 12) = 64$ points.

7. In case of a tie, the earliest postmark will determine the winner. Decisions of *Top Ten* contest judges will be final.

8. Free reruns of any advertisement will be made only from existing plates or negatives. If the advertisement qualifying for a free rerun is an insert, the winner's company may run a two-page spread from existing plates or negatives in up to 4-colors.

9. Hayden Publishing Company, Inc. reserves the right to schedule reruns at its discretion.

**FOR A COMPLETE DESCRIPTION OF PRIZES
FOR BOTH READER AND ADVERTISER CONTESTS
SEE PAGES 180 AND 181**

USE SPECIAL ENTRY BLANK BOUND IN AT RIGHT

(Additional entry blanks are bound inside the front cover)

Advertiser Contest

PICK THE TOP TEN ADVERTISEMENTS IN THIS ISSUE . . . WIN A WINDJAMMER CRUISE FOR TWO . . . \$1,000 CASH . . . FREE JET FLIGHT . . . COLOR TV . . . BULOVA TIMEPIECE.

There's a separate contest open to all marketing and advertising personnel in companies, and to advertising agencies.

Examine this issue of *Electronic Design* with extra care. Pick the ten advertisements that you think will be best SEEN AND READ by *Electronic Design's* readers. List these ten advertisements on the special entry blank bound in the front or back of this issue. (Be sure to check the box marked "Advertiser Contest".)

In addition to valuable prizes, all ads that place in the Top Ten will be given free reruns. If you are a winner in the advertiser contest, and if you ran an ad in the January 4 issue that did not place in the Top Ten, that advertisement, or a like ad of your choice, will be given a free rerun. See rules if the winning ad is an insert.

ADVERTISER CONTEST RULES

1. All rules for the Reader Contest will similarly apply for this contest, with two exceptions: readers engaged in electronic design engineering work, as defined in the reader contest rules, are not eligible to participate in this special contest. The box on the entry blank marked "Advertiser Contest" must be checked.

2. Entrants in this contest may use the official reader contest entry blanks or any reasonable facsimile.

3. This special contest is open to marketing and advertising personnel only at all manufacturing companies and advertising agencies whether or not their companies or agencies have an advertisement in the January 4, 1975 issue. However, only those companies (or divisions thereof) advertising in the Jan. 4 issue, and the advertising agencies placing such advertisements are eligible for a free rerun of their advertisement should a member of their organization win.

4. Free reruns of any advertisement will be made only from existing plates or negatives. If the advertisement qualifying for a free rerun is an insert, the winner may run a two-page spread from existing plates or negatives in up to 4-colors.

5. Hayden Publishing Company, Inc., reserves the right to schedule reruns at its discretion.

**FOR A COMPLETE DESCRIPTION OF PRIZES
FOR BOTH READER AND ADVERTISER CONTESTS
SEE PAGES 180 AND 181**

USE SPECIAL ENTRY BLANK BOUND IN AT RIGHT

(Additional entry blanks are bound inside the front cover)

The new Keithley Model 168 autoranging DMM... ...vive la différence!

There really is a difference in Digital Multimeters, and once you've experienced Keithley's 168 you'll know why we say *vive*! If you're tired of "general-purpose" promises that turn into run-of-the-mill

performances; if you want that bit extra that'll make your job easier, then *vive la différence*... here's the DMM for you! Send for our DMM Selector Guide or call us for demo now. **Phone (216) 248-0400.**

AC VOLTS
DC AMPS OHMS

5 functions

100 μ V to 1000 V dc
100 μ V to 500 V ac
0.1 μ A to 1 A dc
0.1 μ A to 1 A ac
100 m Ω to 20 M Ω

two-terminal input

Simple to connect. You can't get it wrong. Eliminates the word "whoops" from your vocabulary. Saves temper, too.

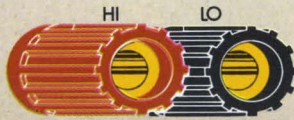

options & accessories

Rechargeable batteries that you can install anytime. An RF probe for high frequencies. Test leads. A 50-amp current shunt too.

hi-lo ohms

Select either of two voltage levels, 1 V or 100 mV, for ohms measurements. You can have your PN junctions either way you want 'em... on or off.

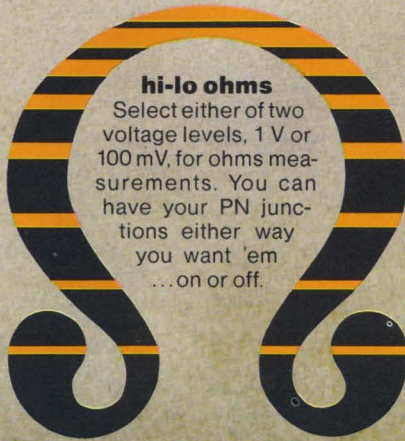

price

Enough said? Order one... or two... or three now!

\$299⁰⁰



automatic ranging

You just connect the signal and push the function. The decimal point pops into position automatically and the display is direct reading. That does save time!



KEITHLEY INSTRUMENTS
U. S. A.: 28775 AURORA ROAD, CLEVELAND, OHIO 44139
EUROPE: 14, AVENUE VILLARDIN, 1009 PULLY, SUISSE

A surprise offer from RCA ...

Try a package of our op amps.

We've put together an assortment of 20 different devices that cover most of the things you want to do with op amps. With this package at your elbow you will be able to reduce your idea-to-breadboard time from days, or even weeks, to minutes.

Here are some of the reasons we think it will be useful to you:

First, it contains the CA3130, our new device that combines MOS/FET, bipolar and CMOS on the same chip and gives you a lot of performance for a low price.

Second, you will have a number of RCA versions of industry standard types that will let you evaluate and compare them with what you are now using.

Third, you can get first-hand experience with some of the new devices that could soon become industry standards — they're the types we've developed over the past 12 months to help you design for improved performance and lower cost.

In addition to general-purpose, precision and high current types you will get wideband and operational transconductance amplifiers, as well as RCA micropower programmable op amps. And we've wrapped up this neat little package with both a data book and applications manual.

For specific information about the Op Amp Selector, contact your local RCA Solid State distributor or write RCA Solid State, Box 3200, Somerville, N.J. 08876. Phone (201) 722-3200, Ext. 3142.

RCA Solid State
A full house in Linear ICs.

