

FOR ENGINEERS AND ENGINEERING MANAGERS

Transducers get an uplift with new materials and circuitry. Their accuracy has improved and cost has dropped. Sensors measuring temperature, pressure, fluid flow

or other physical quantities use new active components. Solid-state circuits are now displacing simple passive transducers. For a look at what's new, see p.30.

94086CALC05B10N96 24/74 ED  
E F BIONDI-PROJ ENG  
CALMA COMPANY  
707 KIFER RD  
SUNNYVALE CA 94086



# Can your resistors handle emergencies?

## Here's how to make sure:

When a resistor is confronted by a high energy pulse current, it should do one of two things: "Open"...in order to protect valuable circuit components or shrug off the pulse to assure that the circuit remains functional.

In a simple "open or shut" case like this, it's not hard to decide which choice is best for your product. But the going gets tougher when you try to match your "worst case" requirements with a resistor that's functional in performance, size and price. At this basic selection level, you often find you need to know a lot more about a resistor's emergency capabilities than most companies can tell you.

Which is why we get a lot of phone calls at Dale... and also why we've prepared some helpful new information on resistive pulse handling and fusing.

Let's say, for example, that you're planning to use one of Dale's 5-watt RS wirewounds in a transistor emitter circuit. These

new tables and formulas will show that it can

withstand millisecond pulses up to 24,000 watts! However, if you want the same circuit

**24,000 Watts**  
...learn how to figure the pulse handling capability of your resistors.

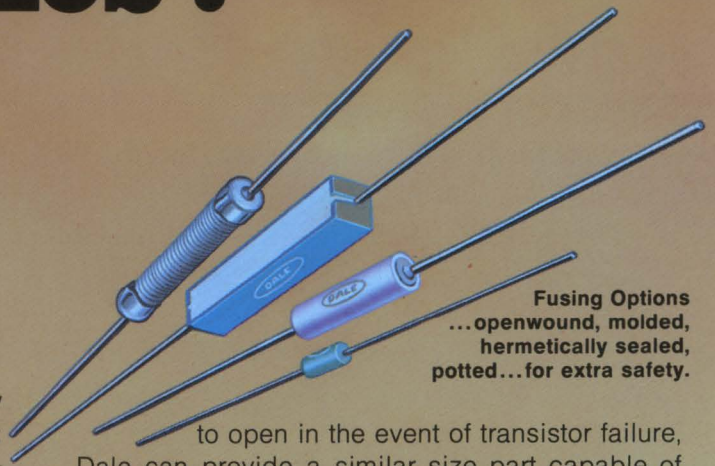

**Fusing Options**  
... openwound, molded, hermetically sealed, potted... for extra safety.

to open in the event of transistor failure, Dale can provide a similar size part capable of opening in milliseconds at a pulse time/size level you specify.

This kind of "open or shut" option lets you be certain you're designing in the kind of extra protection that can make your products more valuable...and it's available throughout Dale's broad resistor line. Drop us a line or give us a call. In this sophisticated world, you'll be glad to find that someone is working at making the basics better.

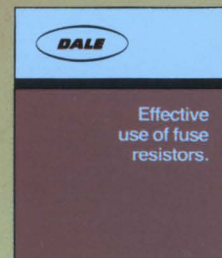
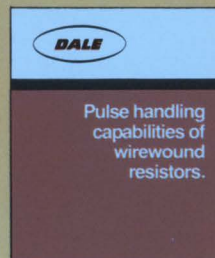

Write for these new publications.

### DALE ELECTRONICS, INC.

1300 28th Avenue, Columbus, Nebraska 68601

A subsidiary of The Lionel Corporation In Canada:

Dale Electronics Canada Ltd. In Europe: Dale Electronics GMBH, 8 Munchen 60, Falkweg 51, West Germany

INFORMATION RETRIEVAL NUMBER 246

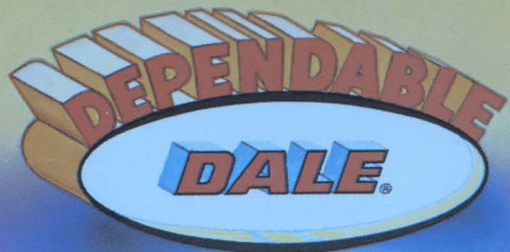

# SURPRISE!



**2½ times  
brighter green.**



**6 times  
brighter yellow.**



**6 times  
brighter red.**

HP brings you three new LED's that are many times brighter than our standard T-1 red lamps. All offer a 180° viewing angle, plus high axial luminous intensity and a good on-off contrast ratio. Ideal for front panel applications.

Our new green lamp (5082-4984) uses high-efficiency gallium phosphide to generate a typical luminous intensity of 2 mcd at 20 mA.

Our new yellow LED's are really yellow.

The 5082-4584 lamp offers 2.5 mcd typical at 10 mA.

And red has been dramatically brightened six times in output using non-saturating gallium arsenide phosphide. With a luminous intensity of 2.5 mcd at 10 mA our 5082-4684 high-efficiency red is unbeatable.

Just \$0.80\* in 100 quantities.

Contact Hall-Mark, Schweber or the Wyle Distribution Group for immediate delivery. Or, write us for more details.

They're the brightest way to improve your product.

01405

\*Domestic USA price only.

**HEWLETT  PACKARD**

Sales and service from 172 offices in 65 countries.  
1501 Page Mill Road, Palo Alto, California 94304

INFORMATION RETRIEVAL NUMBER 2

# Solid state power

**25 AMPS, 140/250 VAC, optically isolated**

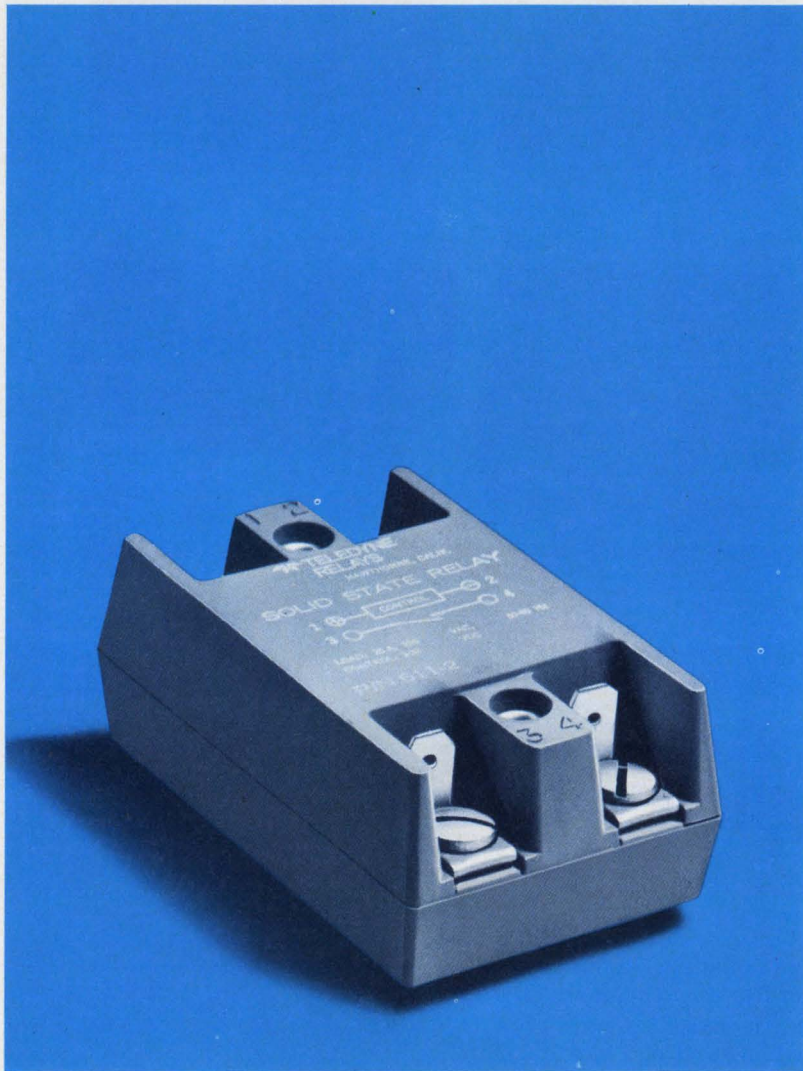

Using sensitive low level IC logic to control brute force loads like motors, solenoids and actuators demands a whole new class of devices.

Teledyne, the world leader in solid state relays, introduces the 611. All the toughness of electromechanicals — 25 AMPS, 250 VAC rms; a THOUSAND PERCENT OVERLOAD surge rating on "contacts" for lamps and motor starting. All the sensitivity and quiet of good solid state design — compatible with TTL and most logic families (3-32VDC) the 611 will turn on with as little as 3VDC. TOTAL (optical) ISOLATION control to load; High Output Transient Immunity — 200V/ $\mu$ sec; zero voltage switching for RFI quiet; no arc or spark in explosive or hazardous environments.

All in a compact, functional and attractive package too — barriered quick disconnect and screw terminals and rugged case.

If you use or design for process or machine tool control, computer peripherals, business machines, or maybe traffic control systems — the Teledyne 611 can open up entirely new performance specs.

Ask your nearest Teledyne relay rep or call us direct for applications engineering help and immediate delivery.

 **TELEDYNE RELAYS**

3155 West El Segundo Boulevard Hawthorne, California 90250  
Telephone (213) 973-4545

INFORMATION RETRIEVAL NUMBER 3

ELECTRONIC DESIGN 15, July 19, 1974

---

## NEWS

- 27 **News Scope**
- 30 **Sensors in 5 areas are getting tinier**, cheaper and more precise than ever—An Electronic Design special report.
- 40 **London conference points to inflation, energy, and semiconductors** as dominating tomorrow's electronics.
- 48 **Picosecond timing sharpens laser-range-finder resolution.**
- 57 **Washington Report**

---

## TECHNOLOGY

- 64 **Taming noise in IC op amps:** Signal-source impedance and operating-frequency band are keys to selection of the right bipolar or FET-input op amp.
- 74 **Multiplex signals the analog way**, and save on parts. High-speed analog multiplexers provide the same accuracy as the converter-per-sensor scheme.
- 80 **Why complicate frequency synthesis?** A direct digital method not only controls frequency, but also phase and wave shape—difficult with analog circuits.
- 86 **Design with lockout logic** and get control of data lines. The circuits use as little as one contact per subscriber to prevent multiple use of a line.
- 92 **Interpolate sampled data rapidly.** Discrete Fourier transforms provide a mathematical short cut due to a quirk in classical sampling theory.
- 96 **Drive fiber-optic lines at 100 MHz.** To achieve high data rates at low cost, use ECL gates instead of discrete component drivers for the LEDs.
- 102 **The case for unstructured management:** job titles, organizational charts and other managerial trappings may hinder engineering in a new company.
- 108 **Ideas for Design:** Coupling circuit ensures drive current from op amp to emitter-follower booster . . . Single part minimizes differences in monostable and astable periods of 555 . . . Voltage probe uses five LEDs to indicate highest level reached.
- 116 **International Technology**

---

## PRODUCTS

- 119 **Integrated Circuits:** Bipolar op amp matches specs of chopper units.
- 122 **Integrated Circuits:** Static 1-k RAM accesses in 80 ns and has chip select.
- 126 **Instrumentation:** Solid-state panel meter fills the gap between analogs and digitals.
- 130 **Components:** Uncased ceramic disc filters boost available capacitance.
- 123 Power Sources
- 140 Modules & Subassemblies
- 136 Microwaves & Lasers
- 144 Discrete Semiconductors

---

## Departments

- 63 **Editorial:** Too many foreigners
- 7 Across the Desk
- 156 Advertisers' Index
- 146 New Literature
- 158 Product Index
- 149 Bulletin Board
- 160 Information Retrieval Card

**Cover:** Photo by Art Director Bill Kelly. Transducers supplied by (left to right) Omega Engineering, Foxboro, National Semiconductor and Statham Instruments.

# Announcing the Battery Status Indicator— a new LED/IC combination

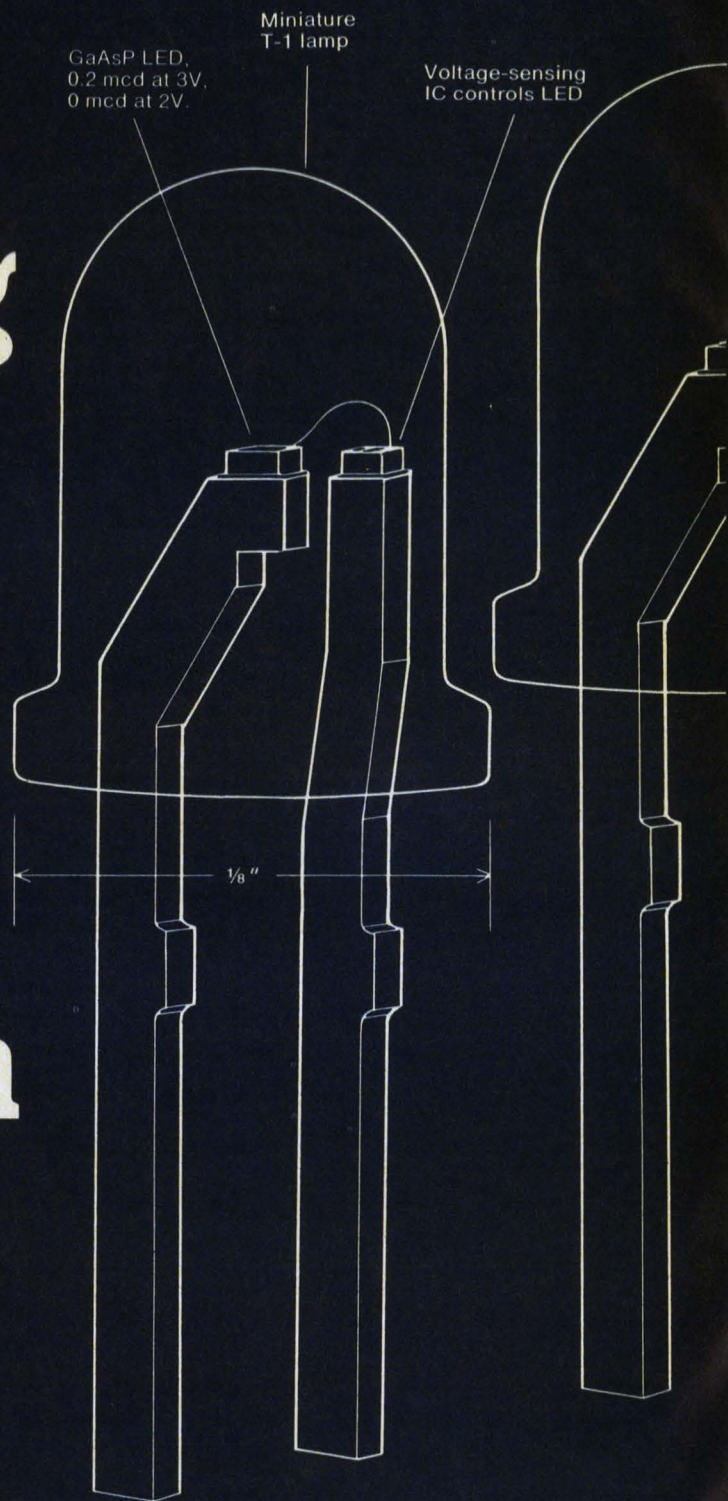

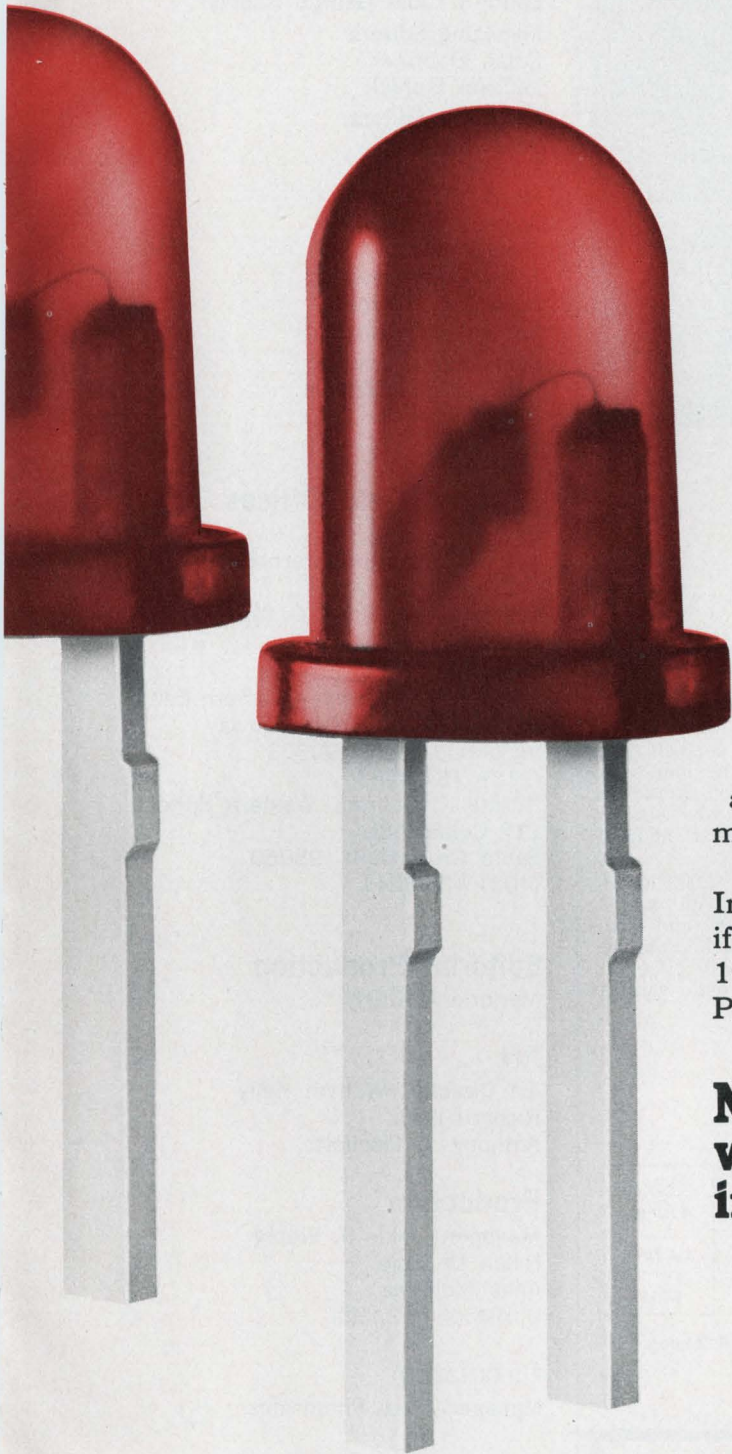

Dead batteries! Everyone hates 'em. And most battery powered equipment—cameras, tape recorders, calculators—don't warn you until it's too late.

Now Litronix—the world's largest manufacturer of LEDs—introduces the RLC-400 Battery Status Indicator. It's a red GaAsP warning light and voltage-sensing IC combined in one little T-1 lamp package. The light is on at 3V, off at 2V.

One of the nation's most prominent camera manufacturers uses it. Any battery-powered device that uses it may acquire an important competitive advantage at low cost.

The Litronix Battery Status Indicator will cost you only 60¢ in quantities of 1000. And you keep production costs down because you don't have to test, assemble and inventory several components.

If you need a warning light that goes on and off at different voltages, get in touch with us. We may be able to help you.

You can get a free sample of the Battery Status Indicator by writing us on your company letterhead. Or if you want more information quick, contact Litronix, 19000 Homestead Road, Cupertino, California 95014. Phone 408-257-7910. TWX 910-338-0022.

**No wonder  
we're No.1  
in LEDs**

**litronix**

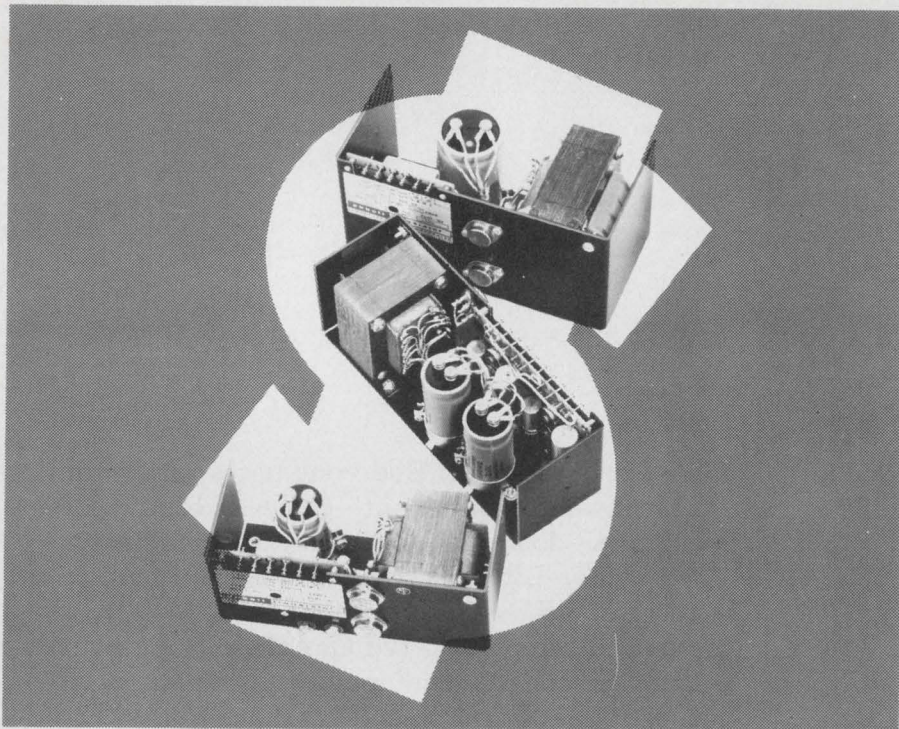

# Start Getting Your Money\$worth Out of Power Modules





Now, you can really start getting your moneysworth out of power modules with Abbott's new LOW COST series. Designed to give you 100,000 hours of trouble-free operation (that's 11½ years), these reliable units meet the needs of OEM engineers. Their purchase price is about \$7 per year of service. The model LC series feature:

- 47-420 Hz Input Frequency
- 0.1% Regulation
- +50°C. Ambient Operation
- Single and Dual Outputs
- 1 Day Stock Delivery

These units provide more quality per dollar compared to similar items on the market. See table below for prices on some of our LC models. Many other LC models are listed in our catalog.

If analyzing the many similar power supplies on the market is confusing; if you are concerned about the long-term reliability of those units, then decide on an Abbott power supply for your system. Your best buy in OEM power modules is ABBOTT.

Abbott also manufactures 3,000 other models of power supplies with output voltages from 5 to 740 VDC and with output currents from 2 milliamps to 20 amps. They are all listed with prices in the new Abbott Catalog with various inputs:

60  to DC  
 400  to DC  
 28 VDC to DC  
 28 VDC to 400   
 12-24 VDC to 60 

5V @ 6 Amps	5V @ 10 Amps	12V @ 10 Amps	15V @ 4 Amps	28V @ 1 Amp	±12V @ 1.2 Amps	±15V @ 4 Amps
LC5T6	LC5T10	LC12T10	LC15T4	LC28T1	LLC12T1.2	LLC15T4
\$72	\$81	\$99	\$81	\$72	\$99	\$135

Please see pages 581-593 of your 1973-74 EEM (ELECTRONIC ENGINEERS MASTER Catalog) for complete information on Abbott Modules.

Send for our new 56 page FREE catalog.

**abbott transistor**  
 LABORATORIES, INCORPORATED  
 general offices eastern office

5200 W. Jefferson Blvd./Los Angeles 90016  
 (213) 936-8185 Telex: 69-1398

1224 Anderson Ave./Fort Lee, N.J. 07024  
 (201) 224-6900 Telex: 13-5332

INFORMATION RETRIEVAL NUMBER 5

**Vice President, Publisher**  
 Peter Coley

## Editors

Editorial Offices  
 50 Essex St.  
 Rochelle Park, N.J. 07662  
 (201) 843-0550  
 TWX: 710-990 5071  
 Cable: Haydenpubs Rochellepark  
**Editor-in-Chief George Rostky**

## Managing Editors:

Ralph Dobriner  
 Michael Elphick

## Associate Editors:

Dave Bursky  
 Jules H. Gilder  
 Morris Grossman  
 Seymour T. Levine  
 John F. Mason  
 Stanley Runyon  
 Edward A. Torrero  
 Richard L. Turmail

## Contributing Editors:

Peter N. Budzilovich  
 Robert Wollins

## Editorial Field Offices

### East

Jim McDermott, Eastern Editor  
 P.O. Box 272  
 Easthampton, Mass. 01027  
 (413) 527-3632

### West

David N. Kaye, Senior Western Editor  
 2930 West Imperial Highway  
 Inglewood, Calif. 90303  
 (213) 757-0183  
 Northe K. Osbrink, Western Editor  
 112 Coloma St.  
 Santa Cruz, Calif. 95060  
 (408) 426-3211

## Editorial Production

Marjorie A. Duffy

## Art

Art Director, William Kelly  
 Richard Luce  
 Anthony J. Fischetto

## Production

Manager, Dollie S. Vieblg  
 Helen De Polo  
 Anne Molfetas  
 Christopher G. Hill

## Circulation

Manager, Evan Phoutrides

## Information Retrieval

Peggy Long

## Promotion

Manager, Jeffrey A. Weiner  
 Karen Kerrigan (Reprints)



## across the desk

### No shortage of solutions to the paper shortage

Your "Good News Bad News" editorial about the paper shortage (ED No. 10, May 10, p. 47) is duly noted. God makes trees and He forgets nuthin! Some people keep forgetting to recycle our newsprint, magazines, forms, letters, etc., into paper so the limited tree supply can be turned into high-class coated and uncoated stock.

As many other smaller and more ecologically motivated mags than ED have already switched, you will find sympathy scarce until you clean up your own nest. Like the man said, "You ain't seen nuthin yet!"

*Jon Ramer  
Staff Engineer*

Martin-Marietta  
Orlando, Fla. 32805

Your May 10 editorial amused me. You, the main culprit, complaining about a paper shortage? How many tons of paper does your magazine consume each month? An impressive number of trees must become victims of your unsatiable appetite. Your magazine is putting on weight like a middle-aged engineer—obviously a sign of prosperity.

I know you like to eat, too. We engineers must be updated by magazines like yours—which, by the way, is the best of its class. And I intend to cash in on another series of articles. But let us review the present method of disseminating information with respect to efficient use of paper.

Think of what happens to your portly magazine when it reaches its destination. Let me tell you what I do with it, which may be

quite typical. I page through the issue and tear out all the articles, news items and ads of interest—10 to 15 pages at most. The rest—more than 90%—ends up in the basket. What a waste of resources! What a waste of energy! What a waste of money! Of course, it's all for a good cause.

There must be a better, more efficient and more economical way.

As a starter, here is my idea. In place of sending the complete issue, send your subscribers only the magazine cover with the contents and news items. More specifically, make the whole cover a reusable envelope. The inside pages can accommodate the contents, laid out like a shopping list. The back cover should have both your address and mine. Upon receipt, I would mark off the items of interest and promptly return it to you. First manually, later by machine, you would fill the envelope with material requested and mail it again.

Obviously all technical material must still be profusely padded with voluptuous blondes to display their wares. However, only subject-related advertisements are needed, since the clientele's interest is considerably narrowed.

It is all so simple. The engineer still receives his info. The advertiser still contacts his clientele. You and your staff can still feed your families; only your shipping clerks may need a little retraining.

*Hermann Schmid*

General Electric  
Box 5000  
Binghamton, N.Y. 13902

Regarding your May 10 editorial, the solution is simple. Bring out a microfiche ELECTRONIC DESIGN.

*(continued on page 14)*

Electronic Design welcomes the opinions of its readers on the issues raised in the magazine's editorial columns. Address letters to Managing Editor, Electronic Design, 50 Essex St. Rochelle Park, N.J. 07662. Try to keep letters under 200 words. Letters must be signed. Names will be withheld on request.

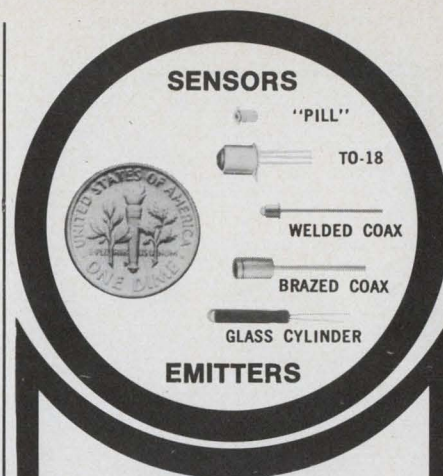

### OPTRON OPTOELECTRONIC COMPONENTS

STANDARD DISCRETE PACKAGES  
IMMEDIATE DELIVERY  
COMPETITIVE PRICING

OPTRON'S competitively priced broad line of standard optoelectronic components range from solid state gallium arsenide emitters to silicon photodiodes, phototransistors, and photodarlingtons. They are immediately available in microminiature "pill," TO-18, welded or brazed coax, and glass cylinder packages.

OPTRON silicon photodetectors are compatible with either tungsten light sources or infrared LED's. The solution-grown epitaxial gallium arsenide LED's offer high efficiency and compatibility with the silicon photodetectors.

All OPTRON discrete components are available in other packages in moderate scale line quantities using standard chips. In addition, these units may be purchased as either standard or custom chips, monolithic arrays, printed circuit board assemblies, or molded assemblies.

Detailed technical information on discrete components and other OPTRON optoelectronic products . . . chips, assemblies and PC board arrays . . . is available from your nearest OPTRON sales representative or the factory direct.



#### NEW CONDENSED CATALOG

contains technical data on these and other OPTRON products. Request your copy today!



**OPTRON, INC.**

1201 Tappan Circle  
Carrollton, Texas 75006  
214/242-6571

# McMOS is the MSI supply...with

Logic functions with three-state outputs have achieved popularity because they permit multiplexing schemes which use a single element to drive a common bus line, while disabling all other drivers on that line.

Because the need is there, Motorola's MC14500 Series MSI offers more CMOS three-state logic functions, covering a wider range of system requirements, than you can find anywhere else.

From the beginning, Motorola's commitment has been to build the most useful CMOS logic family in the industry, based on the needs of the systems being designed for the marketplace. And, as the opportunity for new standard three-state functions arises, we will add them to the line. Several are in planning or under consideration at this time.

The broad McMOS\* line does offer more, and not only in three-state. MSI functions serve logic system needs with shift registers, timers, counters, decoders, latches, buffers, data routers, arithmetic functions,

and analog multiplexers. There are ROMs and RAMs, and specialized functions such as the dual schmitt trigger, priority encoder, and parity tree. Since the world still needs simple gates and flip flops, the McMOS line includes them, too.

were reduced significantly in May, with the biggest savings showing up on the MC14500 MSI Series. Naturally, the three-state logic types featured here are included. Don't take our word for it, though. Ask someone who's tried us recently.

## McMOS Three-State Logic Functions

MC14502	Strobed Hex Inverter/Buffer
MC14506	Dual Expandable AND-OR-INVERT Gate
MC14508	Dual 4-Bit Latch
MC14512	8-Channel Data Selector
MC14534	Real Time 5-Decade Counter
MC14580	4 X 4 Multiport Register
MC14583	Dual Schmitt Trigger
MC14034	8-Bit Universal Bus Register

## McMOS RAMs With Three-State Outputs

MCM14505	64-Bit Random Access Read-Write Memory
MCM14537	256-Bit Static Random Access Memory

## Excellent availability... and the lowest prices ever

Availability is now excellent across the entire line, including the broad range of MC14500 Series MSI functions. Many types are available off-the-shelf, and we are quoting short 6 week delivery on most others. That's CMOS availability! And don't forget, McMOS prices

For applications information on three-state CMOS, respond to Motorola Semiconductor Products Inc., P. O. Box 20912, Phoenix, AZ 85036, or circle the reader service number. We'll send you AN715, "Introduction to CMOS Integrated Circuits With Three-State Outputs," and a McMOS selector guide for reference.



# more three-state CMOS.

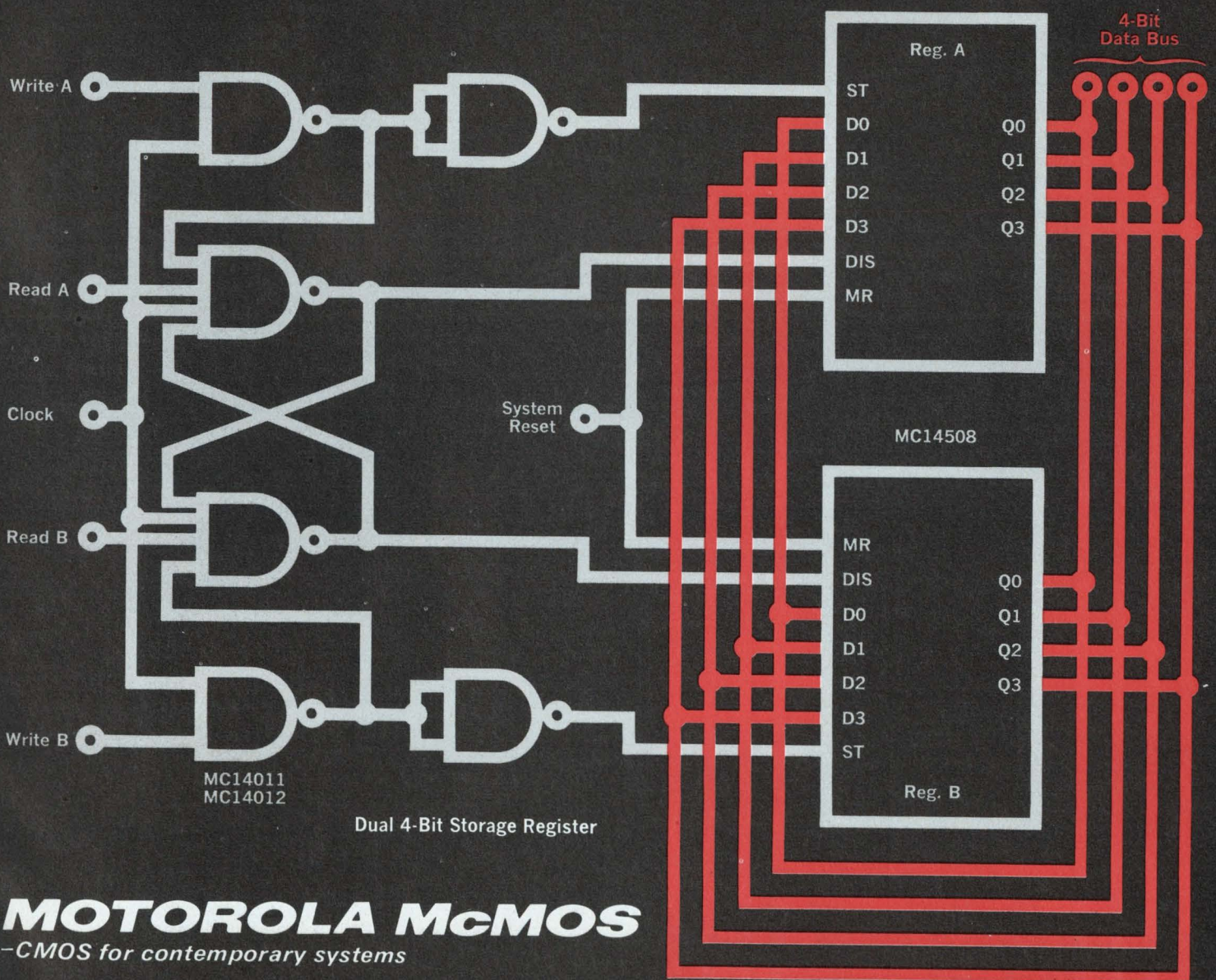

**MOTOROLA McMOS**  
 -CMOS for contemporary systems

**Who do you call for  
fast delivery  
of tantalums?**

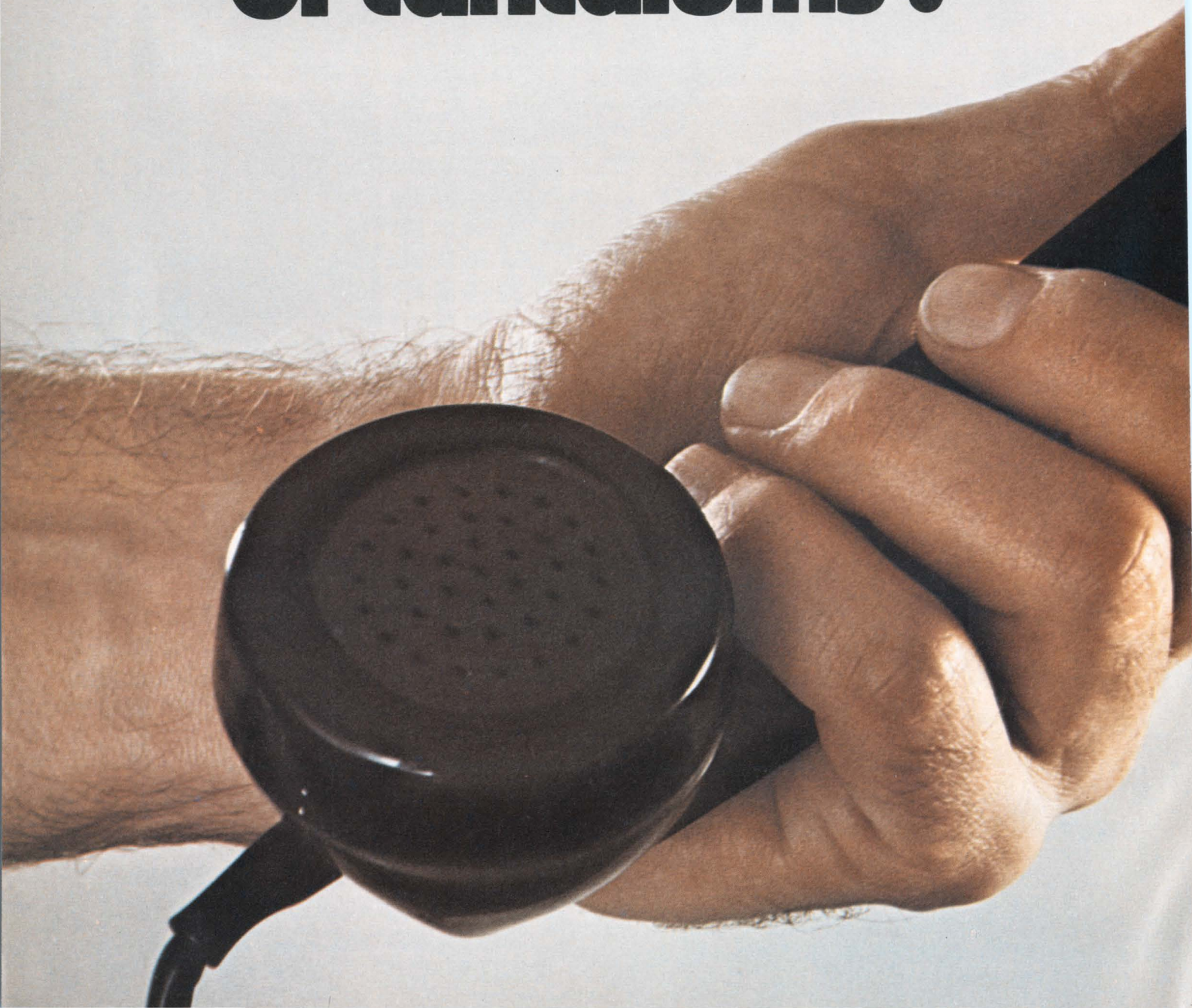

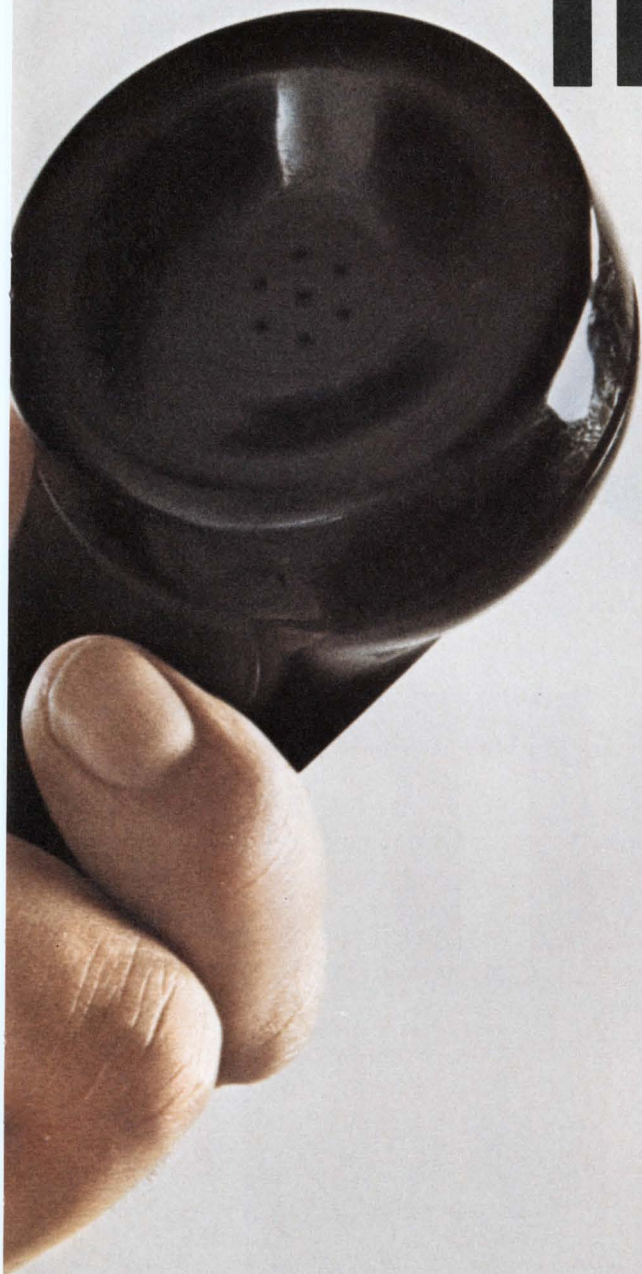

# The man who has them. Your Corning distributor.

He can give you immediate delivery on our TK line and our MINITAN<sup>®</sup> line of solid tantalum capacitors.

Our TK line of low-cost, radial-leaded, epoxy-dipped solid tantalum capacitors has capacitance values in the 0.1 to 330MFD range with working voltages of 6 to 50VDC and tolerances of  $\pm 10\%$  and  $\pm 20\%$ . Low-profile configurations and availability with a choice of lead bends make the TK capacitors well suited for convenient insertion and assembly.

Our MINITAN<sup>®</sup> microminiature solid tantalum capacitors are epoxy-sealed in a polyester sleeve. They're available in both cylindrical cordwood and rectangular modular form, with a choice of axial or radial leads. Capacitance values are 0.001 to 220MFD, working voltages are 2 to 50VDC, and tolerances are  $\pm 10\%$  and  $\pm 20\%$ .

Both lines are in good supply. Call your Corning distributor now.

**CORNING**  
ELECTRONICS

**ALABAMA:** Huntsville; Cramer/EW (205)539-5722. **ARIZONA:** Phoenix; Liberty Electronics (602)257-1272. **CALIFORNIA:** Culver City; Avnet Electronics (213)836-7200. Gardena; Bell Industries Electronics Corp. (213)321-5802. Los Angeles; Liberty Electronics (213) 322-8100. Mountainview; Elmar Electronics (415)961-3611. San Diego; Liberty Electronics (714)565-9171. Sunnyvale; Acacia Sales, Inc. (408)735-0100. **COLORADO:** Commerce City; Elmar Electronics (303)287-9611. Denver; Cramer Electronics (303)758-2100. **CONNECTICUT:** North Haven; Cramer Electronics (203)239-5641. **FLORIDA:** Hollywood; Cramer/EW (305)923-8181. Hamilton/Avnet Electronics (305)925-5401. Orlando; Cramer/EW (305)894-1511. **ILLINOIS:** Chicago; Bell Industries (312)282-5400. Schweber Electronics (312)593-2740. **MARYLAND:** Baltimore; Radio Electronics Service Company (301)823-0070. **MASSACHUSETTS:** Watertown; Sterling Electronics (617)926-9720. Newton Centre; Cramer Electronics (617)969-7700. **MINNESOTA:** St. Paul; Ragon Electronics (612)488-0201. **NEW JERSEY:** Cherry Hill; Cramer Electronics (609)424-5993. Somerset; Schweber Electronics (201)469-6008. **NEW MEXICO:** Albuquerque; Cramer Electronics (505)265-5767. **NEW YORK:** Freeport; Milgray Electronics (516)546-6000. Hauppauge; Cramer/Long Island (516)231-5600. Rochester; Cramer/Rochester (716)275-0300. Syracuse; Cramer/Eastern (315)437-6671. **Westbury;** Schweber Electronics (516)334-7474. **Woodbury;** Harvey Electronics (516)921-8700. **NORTH CAROLINA:** Winston-Salem; Cramer/EW (919)725-8711. **OHIO:** Cincinnati; Sheridan Associates (513)761-5432. **Cleveland;** Schweber Electronics (216)464-2970. **PENNSYLVANIA:** Philadelphia; Almo Electronics (215)676-6000. **TEXAS:** Dallas; Solid State Electronics (214)352-2601. **Houston;** Hamilton/Avnet Electronics (713)526-4661. **UTAH:** Salt Lake City; Cramer Electronics (801)487-4131. **WASHINGTON, D.C.:** Cramer/EW (301)948-0110. Milgray/Washington (301)864-1111. **WASHINGTON:** Seattle; Liberty Electronics/NW (206)763-8200. Almac/Stroun (206)763-2300. **CANADA:** Montreal; Cesco Electronics, Ltd. (514)735-5511. Toronto; Cesco Electronics, Ltd. (416)661-0220.

**THE  
START OF  
SOMETHING  
BIG...**

**GIANT II™**

GENERAL INSTRUMENT ADVANCED N-CHANNEL ION IMPLANT TECHNOLOGY

**JUNE**

**monday** **1974**

**17**

**256x4  
STATIC  
RAM**

Stocked at distributors this date!

- \* Single +5V supply
- \* TTL Compatible
- \* 1 μsec typical Access time / 1 μsec Write Cycle
- \* "Power Down" capability

**NOW.**  
THE FIRST IN  
THE **GIANTII**  
FAMILY

**NEXT.**  
5K ROM  
500 ns

**NEXT.**  
16K ROM  
1.5 μs

**NEXT.**  
1024 BIT S/R  
DC - 2 MHz

**NEXT.**  
UAR/T  
60 kbaud

**AND MORE  
GIANTIIs  
COMING ...**

For complete information  
call toll-free 800-645-9247  
(In New York State  
call 516-733-3107) or write,  
General Instrument Corporation,  
Microelectronics, 600 W. John St.,  
Hicksville, N.Y. 11802

**GENERAL INSTRUMENT CORPORATION  
MICROELECTRONICS**



ACROSS THE DESK

(continued from page 7)

Mail costs go down. Printing costs go down. Storage space goes down. You can thumb your nose at the paper problem. All you need is a mailing envelope with the cover on the front and the index on the back, a bingo card and the microfiche inside. Why not?

Scott Campbell

Scott Campbell Engineering  
343 W. Patrick Circle  
Melbourne, Fla. 32901

And here's another portable circuit tester

Your report on portable circuit testers (see "For Fast Digital Troubleshooting, Low-Cost Detectors Can't Be Beat," ED No. 5, March 1, 1974, p. 26) was brought to our attention by a user of our Dy-Nos-Stick Digital Test Probe. We agree with your basic theme. However, we feel that you made a serious mistake in not mentioning one of the more versatile products—namely, Dy-Nos-Stick.

Since the inception of our patented Dy-Nos-Stick Digital Test Probe, we have sold thousands in the domestic and foreign markets. Our product is used and re-ordered throughout the electronics industry by such customers as Univac, Bell Telephone, the major automobile manufacturers and the numeric-controlled tool industry.

H. F. Vandermark  
President

Nu-Concept Computer Systems  
Inc.  
306 W. Logan St.  
Norristown, Pa. 19401

A word about Eq. 2 in air-cooling guide

In reference to "A Guide to Good Air Cooling" (ED No. 4, Feb. 15, 1974, p. 76), the author is to be commended for his useful hints to the designer. But let me comment briefly on Eq. 2:

$$CFM = 1.76Q/\Delta T \text{ (ft}^3\text{/min)}$$

The equation holds only for air at a base temperature of approx-

imately 25 C at sea level. If the equation is rewritten as

$$CFM = kQ/\Delta T \text{ (ft}^3\text{/min)}$$

some values for k at sea level can be selected from the following table:

Medium	Temp °C	k (ft <sup>3</sup> C) W min
Air	24-3/4	1.76
Air	35	1.989
Air	40	2.1
SF <sub>6</sub>	15	0.506
Oil	30	0.00141

Casjen F. Hardens

D852 Erlanger  
Sieglitzhof  
Lange Zeile 115  
West Germany

You're wrong; that wrong was a right

I found a mistake on the front cover of ED No. 10, May 10, 1974. In the first square in second row the digits number is 3, and the fingers show four.

Merla Rumold

Hewlett Packard  
Bldg. 170  
1601 California Ave.  
Palo Alto, Calif. 94304

Are you illustrating errors in digital equipment or did your Art Dept. let you down?

John Davidson Fogarty  
Professional Engineer

5130 Rondel Pl.  
Columbia, Md. 21043

(continued on page 25)

## Electronic Design 10

FOR ENGINEERS AND ENGINEERING MANAGERS

Can you count on your digits? With counters, that's what you'd like to know. But the last few digits in that long display may be meaningless. Crystal aging,

temperature drift and trigger errors can clobber accuracy. And inputs that fall under 100 Hz or zip past 0.5 GHz bring new trouble. Check into counters on p. XX.

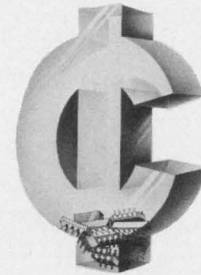

Your closest SIGNETICS distributor is...

- ARIZONA  
Phoenix: Hamilton/Avnet Electronics (602) 275-7851  
Phoenix: Kieruff Electronics (602) 273-7331
- CALIFORNIA  
Culver City: Hamilton Electro Sales (213) 870-7171  
El Segundo: Liberty Electronics (213) 322-8100  
Los Angeles: Kieruff Electronics (213) 685-5511  
Mountain View: Hamilton/Avnet Electronics (415) 961-7000  
Palo Alto: Kieruff Electronics (415) 968-6292  
San Diego: Cramer Electronics (714) 565-1881  
San Diego: Hamilton/Avnet Electronics (714) 279-2421  
San Diego: Kieruff Electronics (714) 278-2112  
Sunnyvale: Cramer Electronics (408) 739-3011
- CANADA  
Downsview: Cesco Electronics (416) 661-0220  
Downsview: Cramer Electronics (416) 661-9222  
Montreal: Cesco Electronics (514) 735-5511  
Montreal: Hamilton/Avnet Electronics (514) 735-6393  
Ottawa: Cesco Electronics (613) 729-5118  
Ottawa: Hamilton/Avnet Electronics (613) 725-3071  
Quebec City: Cesco Electronics (418) 524-3518  
Vancouver: Bowtek Electric Co. Ltd. (604) 736-7677
- COLORADO  
Denver: Cramer Electronics (303) 758-2100  
Denver: Hamilton/Avnet Electronics (303) 534-1212
- CONNECTICUT  
Hamden: Arrow Electronics (203) 248-3801  
Georgetown: Hamilton/Avnet Electronics (203) 762-0361  
North Haven: Cramer Electronics (203) 239-5641
- FLORIDA  
Hollywood: Hamilton/Avnet Electronics (305) 925-5401  
Hollywood: Schweber Electronics (305) 927-0511  
Orlando: Hammond Electronics (305) 241-6601
- GEORGIA  
Atlanta: Schweber Electronics (404) 449-9170  
Norcross: Hamilton/Avnet Electronics (404) 448-0800
- ILLINOIS  
Eik Grove: Schweber Electronics (312) 593-2740  
Elmhurst: Semiconductor Specialists (312) 279-1000  
Schiller Park: Hamilton/Avnet Electronics (312) 678-6310
- INDIANA  
Indianapolis: Semiconductor Specialists (317) 243-8271
- KANSAS  
Lenexa: Hamilton/Avnet Electronics (913) 888-8900  
Lenexa: Hall-Mark Electronics (913) 888-4747
- MARYLAND  
Hanover: Hamilton/Avnet Electronics (301) 796-5000  
Rockville: Pioneer Washington Electronics (301) 424-3300  
Rockville: Schweber Electronics (301) 881-2970
- MASSACHUSETTS  
Burlington: Hamilton/Avnet Electronics (617) 273-2120  
Newton: Cramer Electronics (617) 969-7700  
Waltham: Schweber Electronics (617) 890-8484
- MICHIGAN  
Detroit: Semiconductor Specialists, Inc. (313) 255-0300  
Livonia: Hamilton/Avnet Electronics (313) 522-4700  
Troy: Schweber Electronics (313) 583-9242
- MINNESOTA  
Edina: Hamilton/Avnet Electronics (612) 941-3801  
Minneapolis: Semiconductor Specialists (612) 854-8844
- MISSOURI  
Hazelwood: Hamilton/Avnet Electronics (314) 731-1144  
St. Louis: Hall-Mark Electronics (314) 521-3800
- NEW MEXICO  
Albuquerque: Cramer Electronics (505) 265-5767  
Albuquerque: Hamilton/Avnet Electronics (505) 765-1500
- NEW YORK  
Buffalo: Summit Distributors (716) 884-3450  
Farmingdale, L.I.: Arrow Electronics (516) 694-6800  
Rochester: Schweber Electronics (716) 328-4180  
Syracuse: Hamilton/Avnet Electronics (315) 437-2642  
Westbury: Hamilton/Avnet Electronics (516) 333-5800  
Westbury: Schweber Electronics (516) 334-7474
- NORTHERN NEW JERSEY  
Cedar Grove: Hamilton/Avnet Electronics (201) 239-0800  
Saddlebrook: Arrow Electronics (201) 797-5800
- SOUTHERN NEW JERSEY AND PENNSYLVANIA  
Cherry Hill, N.J.: Milgray-Delaware Valley (609) 424-1300  
Moorestown: Arrow/Angus Electronics (609) 235-1900  
Mt. Laurel, N.J.: Hamilton/Avnet Electronics (609) 234-2133
- CENTRAL NEW JERSEY AND PENNSYLVANIA  
Somerset, N.J.: Schweber Electronics (201) 469-6008
- NORTH CAROLINA  
Greensboro: Hammond Electronics (919) 275-6391
- OHIO  
Beechwood: Schweber Electronics (216) 464-2970  
Dayton: Hamilton/Avnet Electronics (513) 433-0610  
Cleveland: Arrow Electronics (216) 464-2000  
Cleveland: Pioneer Standard Electronics (216) 587-3600  
Kettering: Arrow Electronics (513) 253-9176
- TEXAS  
Dallas: Cramer Electronics (214) 350-1355  
Dallas: Hamilton/Avnet Electronics (214) 661-8661  
Houston: Component Specialties (713) 771-7237  
Houston: Hamilton/Avnet Electronics (713) 526-4661
- UTAH  
Salt Lake City: Alta Electronics (801) 486-7227  
Salt Lake City: Hamilton/Avnet Electronics (801) 262-8451
- WASHINGTON  
Bellevue: Hamilton/Avnet Electronics (206) 746-8750  
Seattle: Cramer Electronics (206) 762-5722



# Super speed in plastic: Finally, ECL 10k you can afford.

## 35 economy devices to double or triple your system performance.

For super-speed logic you can't beat ECL 10k. But until now, cost has been the problem. Just the kind of problem we like to sink our teeth into.

Plastic's the ticket. It makes ECL 10k a standard in your budget. Because we've put so many low-cost plastic devices into low-cost volume production, our super-speed prices are competitive with other high-speed alternatives at last.

Now, in designing high performance systems for today's and tomorrow's market, you've got a choice. Before you might have designed with standard high-speed TTL logic costing 50¢/gate (100-up). Now you're suddenly able to design with super-speed ECL 10k logic in plastic costing 55¢/gate.

Variety? You bet. Early on we recognized the diversity you'd need—to cover design requirements of terminals, minicomputers, add-on memories . . . you name it. Signetics offers you a complete standard logic family of ECL 10k in plastic. And there's more to come, including the higher power MSI counters, shift registers and adders.

Here's the clincher: availability. Everything listed is in production. Everything in production—on our distributors' shelves. NOW. Should a local run clean a device out of stock, it's only temporary.



We can expand availability on short notice—meaning days or a few weeks, not months.

Enough said—it's your move. The parts list is here; your distributor's number is on the facing page. Take it from there.

<b>GATES</b>	10111	10116	10135
10101	10112	10124	
10102	10113	10125	<b>ENCODERS &amp; DECODERS</b>
10103	10117	10190	
10104	10118	10216	10132
10105	10119		10134
10106	10121	<b>LATCHES &amp; FLIP FLOPS</b>	10158
10107			10159
10108	<b>INTERFACE</b>	10130	10171
10109	10114	10131	10172
10110	10115	10133	10173

CLIP AND ATTACH TO YOUR LETTERHEAD FOR FAST ACTION.

Signetics—Plastic ECL 10k  
P.O. Box 3004-35  
Menlo Park, California 94025

Rush me your line card, and application information on Signetics economical ECL 10k in plastic.

Name \_\_\_\_\_

Title \_\_\_\_\_

Signetics Corporation, a subsidiary of Corning Glass Works, 811 East Arques Avenue, Sunnyvale, California 94086 (408) 739-7700.

## signetics

110010101001010011001011000011

# Synchronous and Asynchronous

10000010 11001010 10011010 01110010



It makes no difference to the MC2260L terminal transmitter. This newest Motorola MOS subsystem for digital data communications operates equally well in either mode. And,

the MC2260L perfectly complements the popular MC2257/59L transmitter/receiver pair it joins in the line, while offering several output functions not provided by the MC2257, such as synchronous transfer, internal clock, and word complete.

Typically, data communications devices of this complexity must be encapsulated in large, non-standard packages, but not with Motorola's approach to these functions. Because the receiver and transmitters are separate units, handling and insertion procedures are kept simple by use of standard dual in-line packages — 28-pin for the MC2259 receiver and the MC2260, 24-pin for the MC2257 transmitter.

Consistent yields from dedicated production facilities allow excellent availability of these types. The same factors help keep prices down. In 100-999 quantities, the MC2257 is \$9.00, the MC2259 is \$10.75, and so is the MC2260. For technical information, including an applications note on the operational aspects of these transmitter/receiver types, circle the bingo number or write to Motorola Semiconductor Products Inc., P.O. Box 20912, Phoenix, AZ 85036. For products, contact any franchised Motorola distributor or your Motorola sales office.

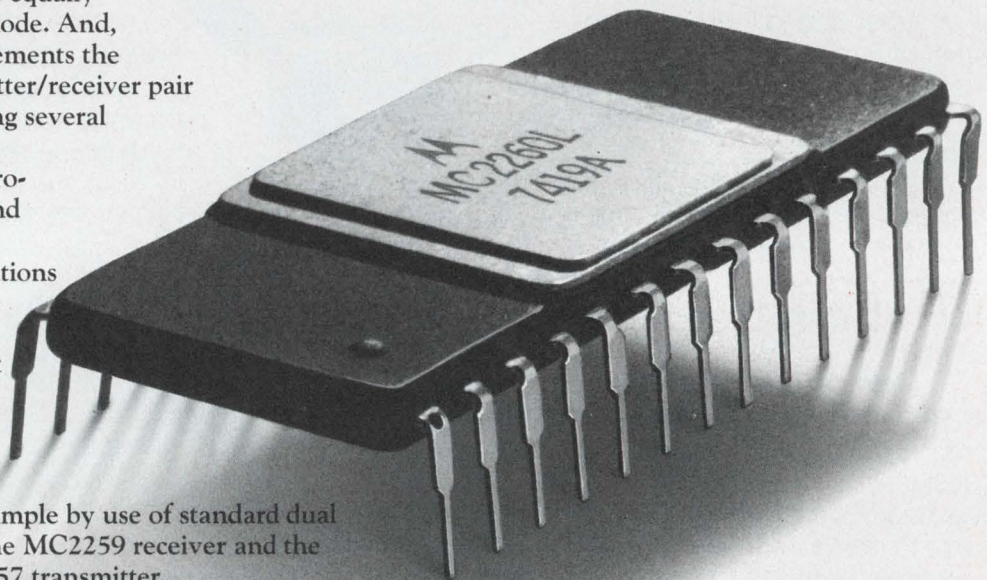

**MOTOROLA MOS**  
— designed for communications systems!

**Meet a  
brand new company  
with a 15-year reputation  
for reliability.**

**The Components Group  
of  
Digital Equipment  
Corporation.**

**Now you can buy  
the components  
and peripherals  
that support the world's  
most popular  
minicomputers.**

# Separately. In quantity. At extremely low prices.

From us. The Components Group of Digital Equipment Corporation. A new group, formed to supply proven, reliable computer components to the volume buyer at the lowest possible prices.

The products, described in detail on the following pages, are all used by Digital as components and peripherals in the PDP-8 and PDP-11 minicomputer systems, the most popular minis in the world. Our components—like our computers—are designed to deliver maximum price/performance.

Our peripherals can be interfaced readily with all commonly-used minicomputers. Additional products will be available in the near future; product families are planned to provide a range of capabilities.

Until now, if you wanted Digital components, you had to buy an entire system.

Not any more.

Now, if you order fifty pieces or more, you can buy any of these components completely unbundled. Volume buying will get you price breaks you won't believe—just check out the prices on the next couple of pages.

And you can have our components off the shelf. When we've established our nation-wide network of warehouse/depots (due this fall), volume deliveries will be made as fast as we can process your order.

Behind our commitment to deliver stands the entire Digital manufacturing capability—over



two million square feet of manufacturing space in the United States, Puerto Rico, Canada and other countries overseas. These are the same facilities that have produced more minicomputers than anyone else, the facilities that manufacture and test the peripherals that support these computers. To meet your demands in the next year alone, we're planning several new plants in the United States and Canada and retooling present production lines to Components Group specifications.

To deliver these components quickly and to maintain our high standard of reliability, the Components Group is planning a network of warehouses. At these depots, products meeting our rigid specifications will be stocked for off-the-shelf delivery.

Our warranty is simple: all hardware is fully warranted for a specified time. If, during this period, any product should prove defective, you simply return it to the nearest depot for fast repair or exchange.

Over the next few years, we expect the cost of computer hardware—especially the cost of the computer itself—to keep going down. Entirely new applications will open up. Volume production of proven components and peripherals enables us to sell at greatly reduced prices. Our low-cost, high-quality products will provide our customers with an opportunity for enhanced profits and a competitive edge in an increasingly price-conscious market.



# Terminals and peripherals.

## **Our cassette mag tape system. Under \$1600 in quantities of 100.**

Priced below even paper tape, the TU60 is a truly reliable dual cassette system. We designed it to stand up to repeated use — with cassettes spec'd at a minimum of 1000 passes, and an error rate that's a full order of magnitude lower than most other systems.

Our proprietary cassette design reduces the possibility of hard error. The extra-thick 1 mil mylar tape is specially coated to resist extreme temperature and humidity.

The TU60's reel-to-reel drive increases tape life even more — there are no capstans, pulleys, pinch rollers, or brakes. DC servo-controlled motors reduce stretching and provide precise start/stop characteristics.

To reduce noise interference and ensure that even very low data levels will be read accurately, the TU60 employs an independent high-threshold data block detector and low-threshold data peak detector.

And the TU60 can't accumulate error from tape-speed fluctuation due to power variation or mechanical difficulties: the read electronics adapt themselves to the tape speed by means of a phase lock loop. Other error-reducing features include redundant dual-track recording, automatic leader detection, and CRC-type error control.

Because the TU60 places the burden of recording-reliability on its electronics, not its mechanics, less maintenance is required to keep the system in good working condition. And when maintenance is necessary, it's no problem. The top flips open, everything is accessible, and the two main modules can be replaced in minutes.

## **Our new DECscope video terminal. Under \$950 in quantities of 100.**

The VT50 is the most inexpensive CRT display terminal in the world. It'll give you fast, quiet alphanumeric video capability for the cost of a slow, noisy teletypewriter. Hardcopy output is available too, with our optional low-cost copier.

For a groundlevel budget price, you get 12-line, 80-column good-quality display — 64 ASCII-

standard upperface characters, each on a 5x7-dot matrix. After displaying 12 lines, the page scrolls upward from the bottom; its speed can be adjusted by the user.

The keyboard is an easy-to-use, audible, typewriter-style board, with 3-key rollover to permit fast typing. Our optional copier fits right into the desktop display cabinet.

The VT50 is fast — a full range of baud rates are switch-selectable up to 9600. Interfacing is with a standard 20mA current loop, with inexpensive EIA option.

Installation is easy, just plug it in. The VT50 has few moving parts, so maintenance is simple. Its keyboard is the same field-proven model we use on the LA36 teletypewriter. And its low heat output means no fans, less noise, and low power consumption.

At such an incredibly low price, the VT50 will go far. And fast.

## **Our remote terminals. Starting at less than \$600.**

The RT01 and RT02 terminals provide easy, low-cost interactive data entry and retrieval.

Uncomplicated keyboards make it easy for untrained personnel to enter or retrieve data. There's no need for confusing, numerically-coded instructions. The RT02 will even prompt the inexperienced operator by spelling out on the display what information is needed next.

The RT01 displays up to 12 digits of data in a Nixie™ numeric readout. For non-numeric response, it has programmable status indicators. The 16-key pad will input 30 ASCII characters.

The RT02 costs more and gives you more. A 64-character gas-discharge alphanumeric readout that displays up to 32 characters at once. 16-key or 58-key input. Interactive display prompting.

Both terminals are ASCII-compatible, so you can interface them to any computer with a Teletype™ port. EIA modem interface is also available.

Both have simple displays and few moving parts, for built-in reliability and ease of maintenance.

# Logic modules and interfacing.

Digital is the world's largest seller of solid-state modules. We give you the widest choice you can get — over 400 pretested modules, most of which we use ourselves, in our computers and controllers. We also carry a full line of compatible hardware, power supplies, plug-in boards, cabinets, racks and related equipment.

If you do your own interfacing, our Logic Products Handbook and Logic Systems Design Handbook will provide general support and solutions to specific standard problems. The Components Group will also supply, in volume, custom interfaces, custom modules, and custom variations of our standard terminals. Complete descriptive literature on any of these topics is available.

## **M Series modules.**

These high-speed logic modules for computer interfacing use monolithic TTL circuitry to give you high speed, high fanout, large capacitive drive capability and excellent noise margins, in frequencies up to 6MHz. Some of our newer M Series modules also employ current MOS technology.

## **K Series modules.**

These noise-resistant modules are principally used for industrial control applications where noise-resistance is more important than speed. Frequencies from DC to 100KHz are typical, 5KHz frequencies can be obtained. K Series modules are designed for easy system checkout and troubleshooting and will fit both standard NEMA enclosures and computer mounting racks.

## **A Series modules.**

For communications between the computer and the outside world, these analog modules give 10-bit and 12-bit performance in a family of mutually compatible functions — multiplexers, operational amplifiers, sample-and-hold circuits, A/D and D/A converters, reference voltage sources, and multiplying A/D converters.

## **DECKit interfaces.**

Our DECKits provide pre-tested, fully-documented interfaces for a number of common interfacing situations. Basically just a few modules and a prewired systems unit, they eliminate design time, breadboarding, and wirewrapping in a number of areas. Complete descriptions of the specific interfaces are available.

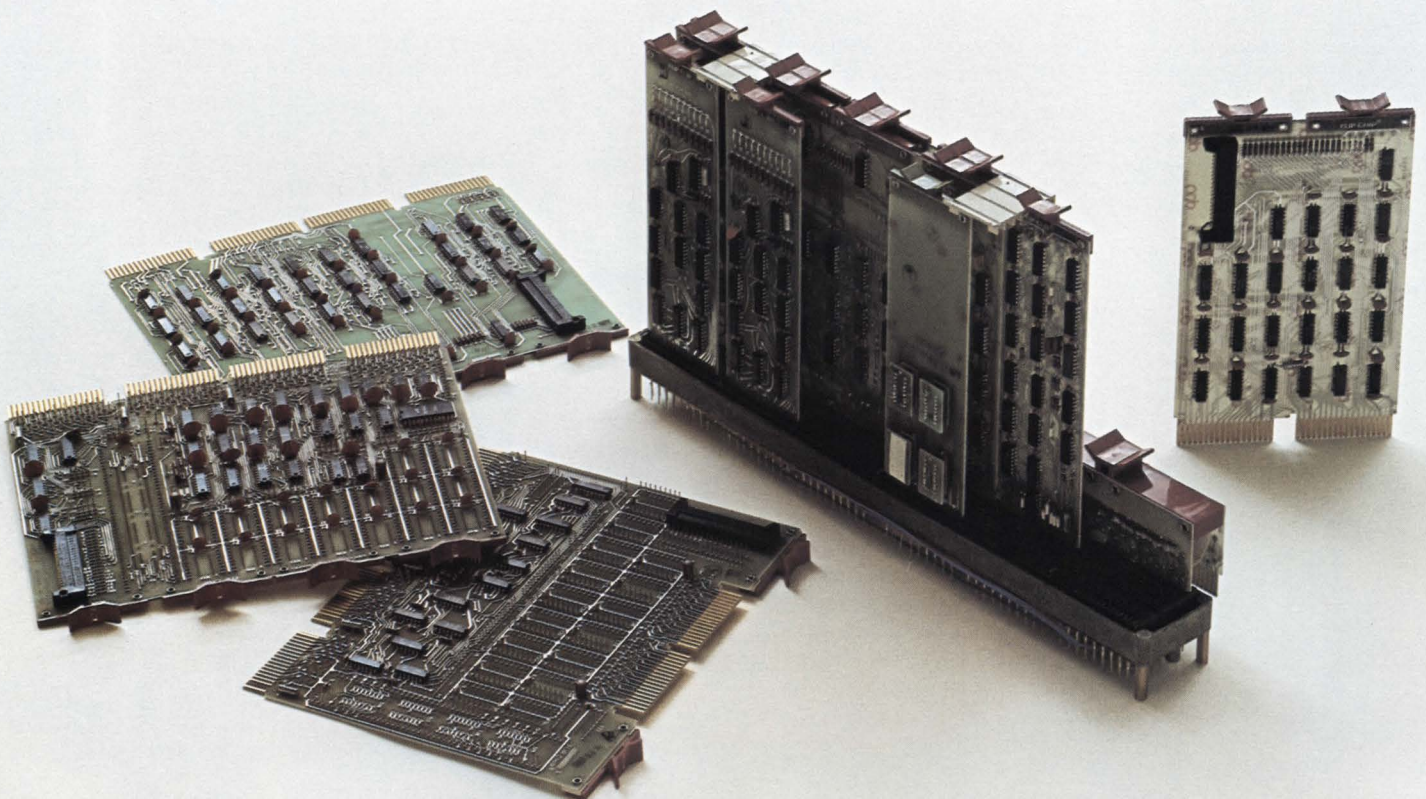



# The start of a new family of component computers.

## The PDP-8/A. \$572 in quantities of 100 (CPU & 1K RAM).

For minicomputer applications, the PDP-8/A computer-on-a-board gives you speed and performance at an extremely low price.

The newest, smallest member of the PDP-8 family of minicomputers, the 12-bit PDP-8/A uses only proven, readily available, multi-source MSI semiconductor technology. We know it's reliable, and we can deliver in quantity, starting in late 1974.

To reduce the size and enable low-cost, user-tailored memory capacity, we've added expandable semiconductor memories: ROM, RAM, PROM, and ROM/RAM combinations, expandable from 1K to 32K words. Cycle time is 1.5 $\mu$ sec.

The PDP-8/A uses the same powerful instruction set as the PDP-8/E and is fully compatible with other PDP-8 family hardware, operating systems, and high level languages (such as BASIC, FORTRAN IV, FOCAL).

The PDP-8 Omnibus™ backplane facilitates direct interface with more than 60 PDP-8 options and peripherals. Seven commonly-used options are available on two option boards: serial-line interface, 12-bit parallel I/O, front-panel control, and real-time clock on one board; powerfail/auto-restart, memory extension, and bootstrap loader on the other.

The PDP-8A gives the user the flexibility, reliability, and expansion capability of a minicomputer at an extremely low price.

## The MPS microprocessor series. \$476 in quantities of 100. (CPU & 1K RAM).

The MPS microprocessor series of modules gives you a simple, versatile 8-bit controller that's inexpensive and easy to use. It will replace hard-wired logic in control applications and perform processing tasks in many new applications.

The MPS consists of four building-block modules and an optional control panel. A basic fully operational processor can be assembled from as few as two modules: the CPU and a memory module.

The CPU module with 8-bit parallel processor, 48 data-oriented instructions, and 12.5  $\mu$ sec cycle time, can directly address up to 16K words of memory. There are two memory modules: the Read-write Memory module consists of a fully-self-contained random access memory (1K, 2K or 4K words) and all address decoding logic; the Programmable Read-only Memory module contains up to 4K words of UV-eraseable, completely reprogrammable semiconductor memory. The External Event-Detection module provides power-failure detection and automatic start, with 6 interrupt request inputs. The Monitor/Control Panel, which can be cable-interfaced to the CPU, will perform such typical functions as monitoring data paths, memory, and addresses, handling general system operational and diagnostic checks, and entering programs.

We designed the MPS to be immediately available, using proven P-channel MOS/LSI silicon gate technology.

Control programs are prepared on a small, low-cost PDP-8 minicomputer, using the MPS software-development kit of six basic programs.

The MPS will give you processor hardware with the convenience of building-block modularity and a design-development package that allows you to customize to your application. And all MPS modules are completely compatible with Digital's logic modules, programmable controllers, and minicomputers.

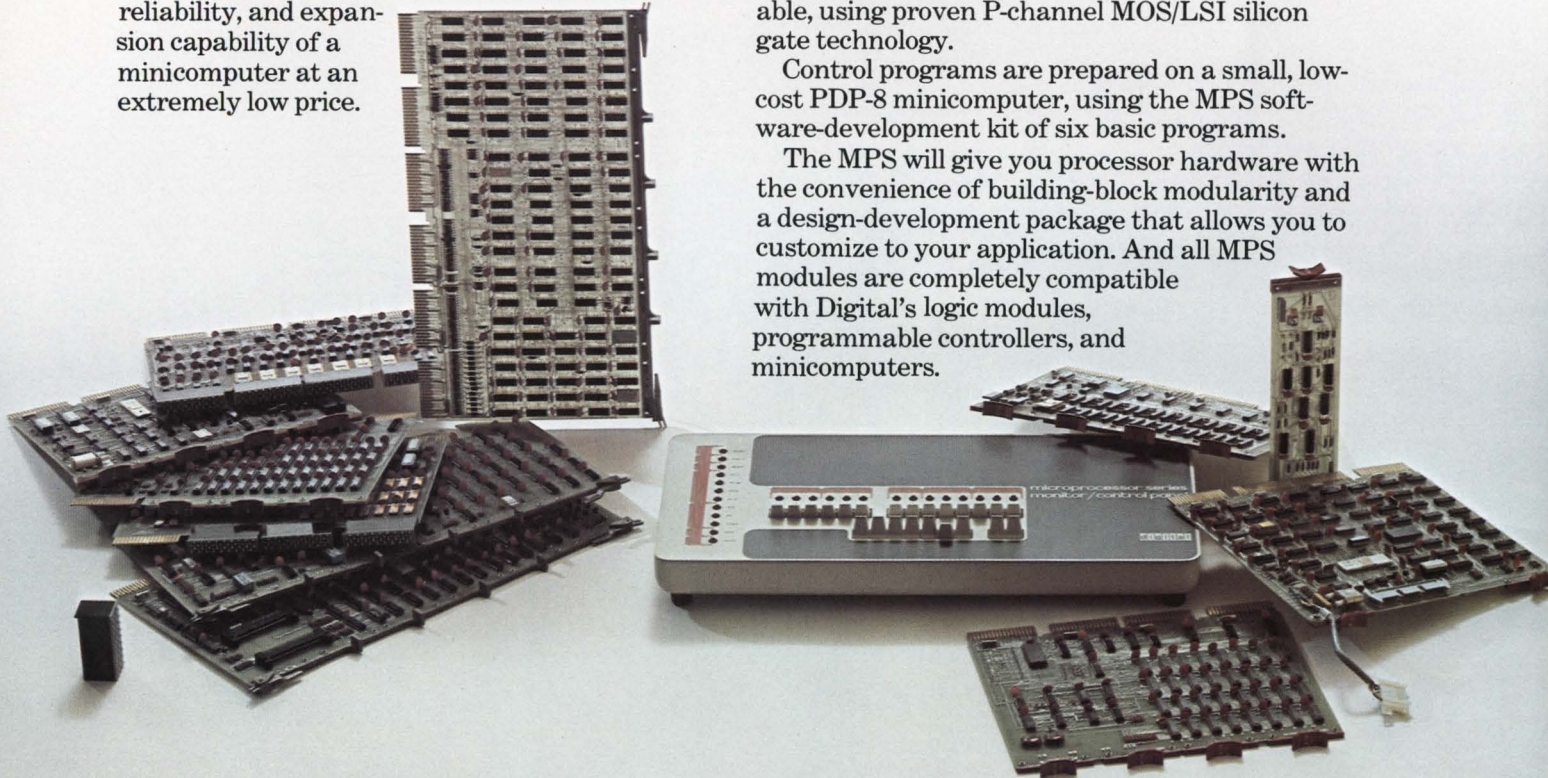

**digital**  
**COMPONENTS**  
**GROUP**

**Unbundling the world's  
most popular minicomputers.**

Meet the Components Group now  
— we've got a lot to talk about. Call us direct at

**800-225-9480**

Toll-free from 8:30AM to 5:00PM your time.\*

\*US only. Massachusetts residents, please dial (617) 481-7400.

Digital Equipment Corporation, Components Group,  
One Iron Way, Marlborough, Massachusetts 01752.

In Canada: Digital Equipment of Canada Limited,  
P.O. Box 11500, Ottawa, Ontario, K2H8K8, (613) 592-5111.

Prices quoted are in US dollars and will vary outside the United States.

# Fast and easy... MOSTEK's MK4102-6 static 1K RAM.

## 275 ns!

MOSTEK's MK4102P-6 is fast—275 ns access time! But speed is only one of its features. Just as important, it's easy to use, requiring only one +5 V power supply. All inputs are TTL compatible. And the processing technology is strictly state-of-the-art utilizing a combination of N-channel silicon gate plus ion implantation.

Also, you can accomplish large memory array construction with a minimum of additional circuitry because of the high impedance "off state" coupled with "chip select" input.

What else? Well, the MK4102P-6 is a pin - for - pin alternate for the 2102. But there's no comparison in access time. Check for yourself.

MOSTEK's line of 1K RAMs gives you plenty to select from, static or dynamic. They range from the MK4008-9 (at 800 ns) through two other versions of the MK-4102 (450 ns or 1  $\mu$  sec) up to the popular MK4006 (at 400 ns). Check the table below for the part number you need.

When your design requires an MOS memory, remember MOSTEK. Call your nearest MOSTEK distributor or representative or contact MOSTEK, 1215 W. Crosby Road, Carrollton, Texas 75006, (214) 242-0444. In Europe contact MOSTEK GmbH, TALSTR. 172, 7024 Bernhausen, West Germany, Tel. 798038.

**MOSTEK**®

MOSTEK moves forward...in memories.

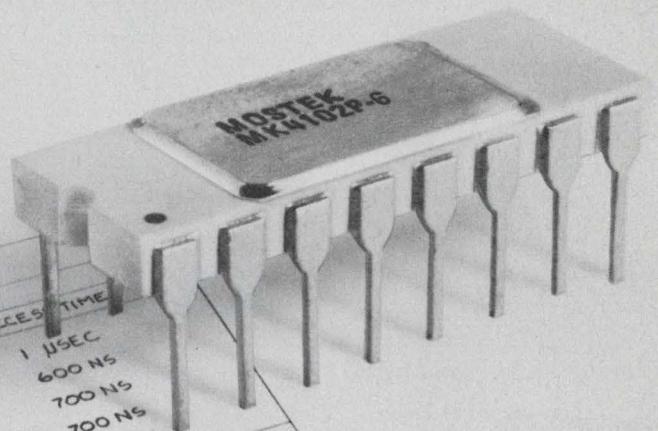

MOSTEK MEMORIES		MAX. ACCESS TIME
ROMS		1 $\mu$ SEC
TYPE		600 NS
2240-BIT CHARACTER GENERATOR		700 NS
2560-BIT ROM		700 NS
4096-BIT ROM (REPLACES MM 5232)		900 NS
4096-BIT ROM (REPLACES F5C 3514)		
16K-BIT ROM (REPLACES EA 4800)		
RAMS		900 NS
1024-BIT DYNAMIC RAM		900 NS
256-BIT STATIC RAM		500 NS
1024-BIT DYNAMIC RAM		800 NS
1024-BIT STATIC RAM		1 $\mu$ SEC
1024-BIT STATIC RAM		450 NS
1024-BIT STATIC RAM		275 NS
4096-BIT DYNAMIC RAM		350 NS
CIRCUIT		
MK 2300P		
MK 2400P		
MK 2500P		
MK 2600P		
MK 28000		
MK 4006P		
MK 4007P		
MK 4008P		
MK 4008P-9		
MK 4102P		
MK 4102P-1		
MK 4102P-6		
MK 4096P		

# SIEMENS

## The unvarying ingredient in every Siemens component: batch-to-batch quality.

Even though Siemens makes 50,000 different shapes and sizes of components, to meet virtually any need *and* the reality of your economics, we're best known for the efforts we devote to quality. Year after year, batch after batch. (We've made 500 million pot cores in the last 5 years alone.)

One of the reasons for our high level of quality and reliability is the two million dollars we invest every working day in research and development. Our R&D program has paid off well—90% of the components we offer today were not available 10 years ago.

R&D has also enabled Siemens to pioneer metallized polyester-film (MYLAR\*) capacitors, tuning-diodes, gas-filled SVP's® and cradle relays. And there are more innovations on the way.

If you depend on electronic components, you can depend on Siemens. Batch after batch, the quality never varies.

\*DuPont registered trademark.

For details, get in touch with your local Siemens specialist, or fill in the coupon below.

Please indicate your specific area of interest and mail to:  
Siemens Corporation, Components Division  
186 Wood Avenue South, Iselin, N.J. 08830

- |   |   |   |
|---|---|---|
| <input type="checkbox"/> BWO's  | <input type="checkbox"/> LCD's          | <input type="checkbox"/> Semiconductors   |
| <input type="checkbox"/> Capacitors                                   | <input type="checkbox"/> LED's          | <input type="checkbox"/> Opto-Electronics |
| <input type="checkbox"/> Ferrites                                     | <input type="checkbox"/> Planar Triodes |   |
| <input type="checkbox"/> Gas - Filled Surge Voltage Protectors (SVP®) | <input type="checkbox"/> Relays         |   |

Name \_\_\_\_\_ Title \_\_\_\_\_

Company \_\_\_\_\_ Tel. \_\_\_\_\_

Address \_\_\_\_\_

City \_\_\_\_\_ State \_\_\_\_\_ Zip \_\_\_\_\_

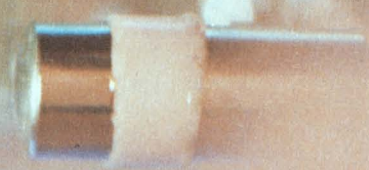
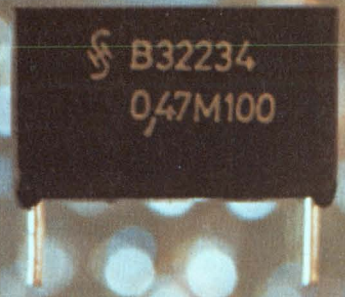
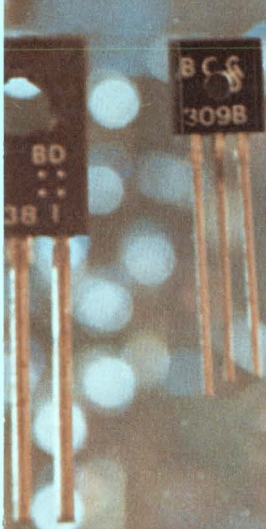
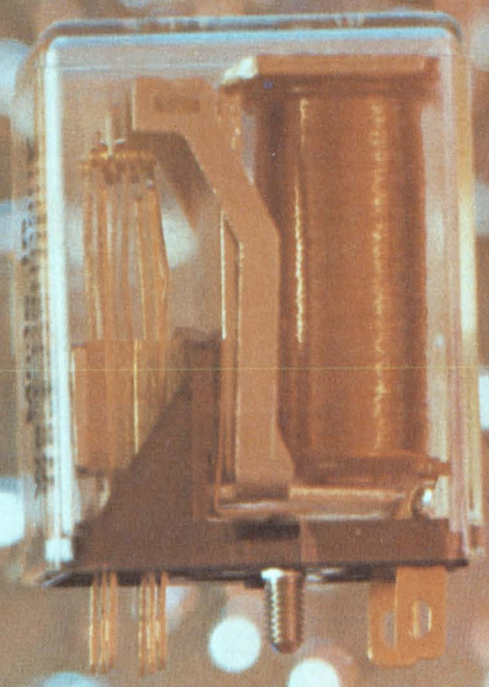
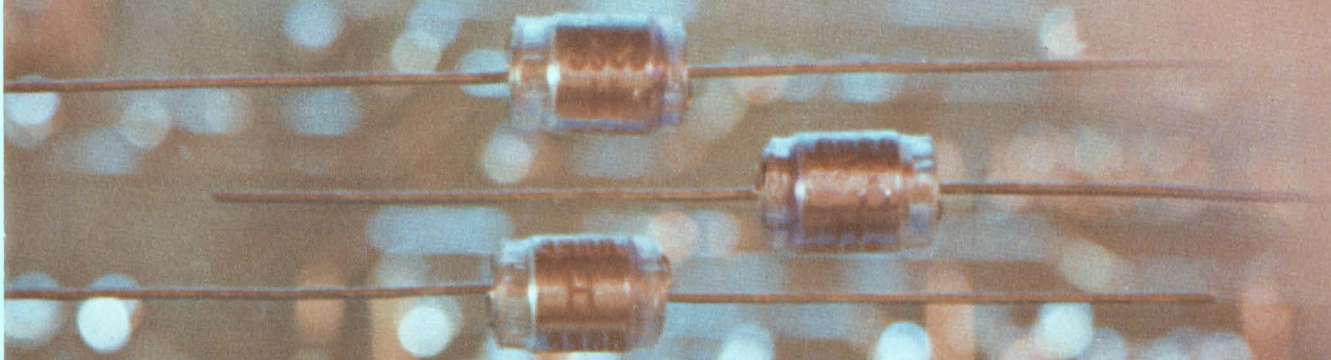

**Siemens Corporation  
Components Division**

186 Wood Avenue South, Iselin, N.J. 08830 (201) 494-1000

  
**BOURNS**  
**PANEL**  
**POWER**



whether you count,  
set, or display...

# BOURNS has a dial for you!



Improve your PANEL POWER with Bourns unique KNOBPOT® integral dial/potentiometer designs. Saves space behind the panel . . . eliminates dial-potentiometer assembly costs . . . reduces panel assembly time . . . assures precise output-to-readout ratio . . . and looks great on your panel!

Need maximum component flexibility? You can count on Bourns! Our separate dial and precision potentiometer combinations are the best you can get . . . and very competitively priced.

## KNOBPOT® DIGITAL DIAL POTENTIOMETERS

Bourns unique manufacturing time-saver that integrates a precision potentiometer and digital dial in one compact, factory-phased package. Model 3610 features superfast snap-in mounting . . . the 3650 is bushing mounted. Accuracy to  $\pm 0.1\%$ , choice of  $\frac{7}{8}$ " or  $1\frac{1}{4}$ " dials.



Actual Size

## KNOBPOT® CLOCKFACE POTENTIOMETERS

For those who prefer a clockface readout, our Models 3600 and 3640 KNOBPOT® potentiometers come in two sizes —  $\frac{3}{4}$ " and  $1\frac{1}{4}$ " — and extend only  $\frac{3}{8}$ " to  $\frac{1}{2}$ " behind your panel.



## URNS COUNTING DIALS

Good looking 10-turn dials . . . simplified mounting — no special panel holes required; mounts directly to potentiometer shaft. For  $\frac{3}{32}$ ",  $\frac{1}{8}$ " and  $\frac{1}{4}$ " diameter shafts . . . with or without brake. Models H-490, H-510.

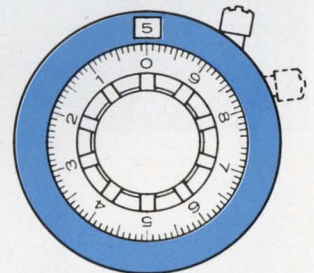

Actual Size

## DIGITAL COUNTING DIALS

Contemporary digital-style readout in our new H-357 KNOBPOT® Digital Dial. Ten-turn range, 100 counts per turn. Connects to any standard  $\frac{1}{4}$ " shaft potentiometer or similar rotating device. Only \$5.00 in production quantities.

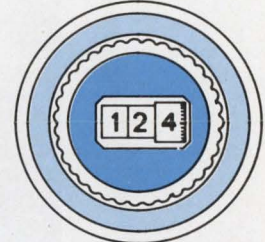

## DIALS COUNT BETTER ON BOURNS PRECISION POTENTIOMETERS

We back-up our turns counting dials with a broad line of superlative precision potentiometers. Choose from over 20 standard models . . . from our low cost Model 3540 wirewound family, to our super-smooth, superlonglife INFINITRON® conductive plastic models. If you have custom requirements, Bourns has a separate, full-time engineering and manufacturing operation devoted exclusively to custom work.



## IT'S NEW!

### KNOBPOT® DIGITAL PUSHBUTTON POTENTIOMETER

Great new innovation from Bourns! A precision decade potentiometer **inside** a handsome pushbutton digital selector/display. The Model 3680 is extremely accurate, and a "snap" to install. Everything is **INSIDE** . . . no resistors or mini-PC boards are required.

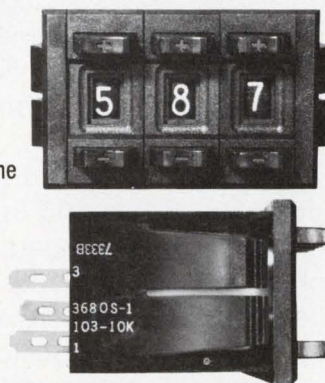

For a close-up look at Bourns PANEL POWER, dial EEM 800-645-9200 (toll-free) and ask for the name and number of your nearest Bourns sales representative.



TRIMPOT PRODUCTS DIVISION • 1200 COLUMBIA AVE., RIVERSIDE, CALIF. 92507

INFORMATION RETRIEVAL NUMBER 14

# For built-in reliability, design with "Scotchflex" Flat Cable/Connector Systems.

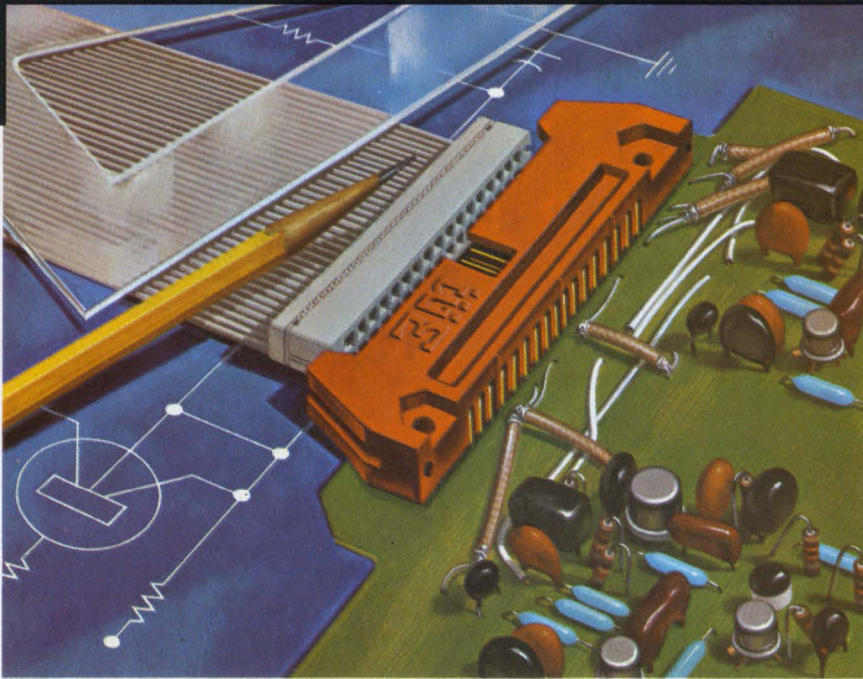

"SCOTCHFLEX" IS A REGISTERED TRADEMARK OF 3M CO.

"Scotchflex" Flat Cable and Connectors can offer you trouble-free packaging for your next generation equipment.

There's built-in reliability for your circuit inter-connects. Our flat, flexible PVC Cable has up to 50 precisely spaced conductors. The gold plated U-contacts are set into a plastic body to provide positive alignment. They strip through the insulation, capture the conductor, and provide a gas-tight pressure connection.

Assembly cost reductions are built-in, too. "Scotchflex" Connectors make up to 50 simultaneous connections without stripping or soldering. No special training or

costly assembly equipment is needed.

Off-the-shelf stock offers you flat cable in a choice of lengths and number of conductors from 14 to 50. Connector models interface with standard DIP sockets, wrap posts on .100 x .100 in. grid, or printed circuit boards. Headers are available to provide a de-pluggable inter-connection between cable jumpers and printed circuit boards (as shown). Custom assemblies are also available on request.

For full information on the "Scotchflex" systems approach to circuitry, write to Dept. EAH-1, 3M Center, St. Paul, Minn. 55101.

**3M**  
COMPANY



# The best ultra-precision resistor value

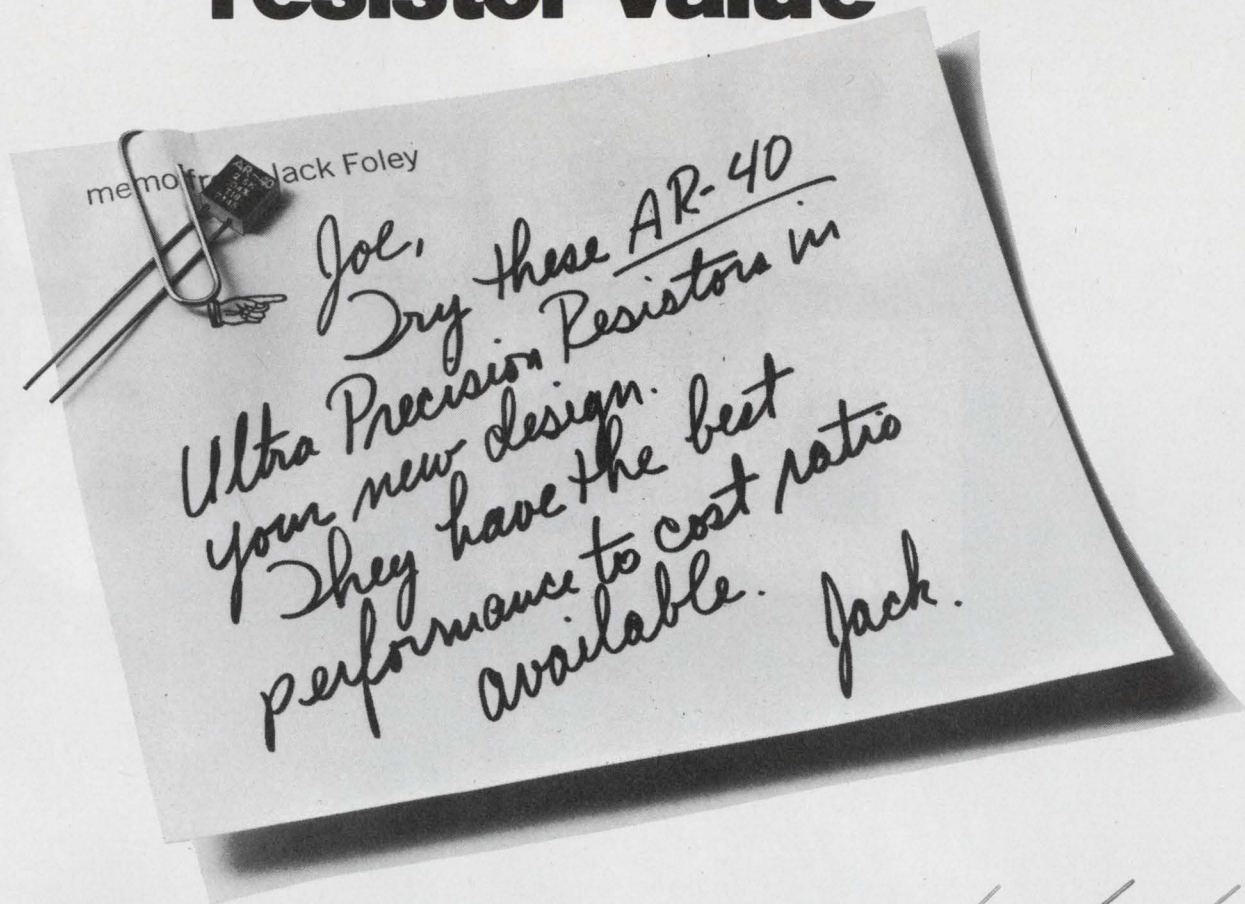

Hung up on resistor performance vs cost? Then check the AR40 metal film resistor—sophisticated, ultra-precision resistors from TRW's precision resistor technology.

With the AR40, you get ultra-precision, exceptional stability, and documented reliability. Temperature coefficient to  $\pm 2$  PPM/ $^{\circ}\text{C}$  and tolerances to .01% are standard. High frequency characteristics are outstanding and noise levels are not even measurable on commercially available equipment.

Additional value is provided by the AR40's rugged construction which withstands normal production handling. The AR40 is available now to solve your ultra-precision resistor problems at a cost you can afford.

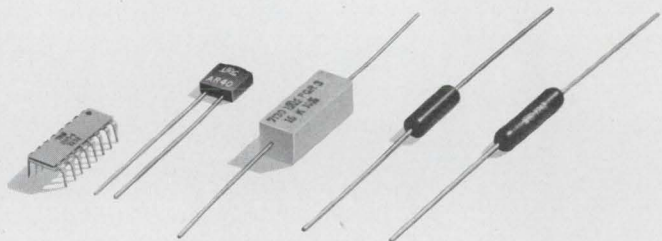

*Complete resistor choice.* TRW offers you a total resistor capability—carbon comp., thin-film, Metal Glaze™, wirewound, networks. For specs and application data on the AR40, contact your local TRW sales representative. Or write TRW/IRC Resistors, an Electronic Components Division of TRW, Inc., 2850 Mt. Pleasant St., Burlington, Iowa 52601. (319) 754-8491.

## Performance and dimensions

TCR CLASS	STANDARD TEMP. COEFF. ( $^{\circ}\text{C}$ )	RESISTANCE RANGE* (Ohms)	STANDARD TOLERANCE RANGE ( $\pm\%$ )	WATTAGE $85^{\circ}\text{C}$	DIMENSIONS IN INCHES
T-18	2 ppm 0 to $60^{\circ}\text{C}$ 5 ppm $-55$ to $125^{\circ}\text{C}$	20 to 100K	.01 to 1.00	.3 watts	Height .320 $\pm$ .020
T-16	5 ppm 0 to $60^{\circ}\text{C}$ 10 ppm $-55$ to $125^{\circ}\text{C}$				Length .295 $\pm$ .010
					Width .100 $\pm$ .010
					Lead spacing .150 $\pm$ .010
					Lead gage #22 .0253**

\*Wider ranges available, contact factory. \*\*Lead length 1.00 minimum.

## TRW<sup>®</sup> IRC RESISTORS

INFORMATION RETRIEVAL NUMBER 16

# 85 amp DO-5



The ratings are back and even we're a little amazed at the fantastic results. We knew our upgraded DO-5 was a honey, but an 85 amp rating is (to say the least) a major breakthrough in power semiconductors.

Here's how it tested:

- Dimensions as per JEDEC DO-5 outline.
- Maximum Recurrent Peak Reverse Voltage . . . 100-1600 volts.
- Maximum Average Forward Current, Single Phase Half Wave Rating at 115°C. Case Temperature . . . . . 85 amps.
- Maximum Surge Current (One Cycle) . . . . . 1500 amps.
- $\Theta$  JC . . . . . 0.6

For detailed information, contact:  
FMC Corporation  
Semiconductor Products Operation  
Homer City, Penna. 15748  
(412) 479-8011

**FMC** Special  
Products

# THE NATIONAL ANTHEM



A review of New Products and Literature from National

## RUMORS TRUE! Thermostatted Pressure Transducers Are Here!

To all of you out there who have heard the rumors, and to all of you who have been waiting anxiously for the word, your wondering and waiting are over. Yes, transducer lovers, there really are thermostatted IC pressure transducers, and National makes them.

We call our new, high-performance (1%) transducers the LX3700 series. These transducers incorporate a temperature sensor and diffused heater resistors. The sensor thermostatically

controls the heating elements, which means that the entire transducer is temperature controlled. The scheme regulates transducer temperature to 170°F, the upper limit of control; the lower limit is -10°F - a 180°F range of temperature control.

The LX3700's temperature performance is spectacular: over the 180°F control range, the transducer's temperature coefficient is only 0.278 mV/°F (0.5 mV/°C) out of a 10-V full-scale output; and the temperature range over which we guarantee a tight spec is twice that of our LX1700 series. Further, you can extend the low end of thermostatic control by wrapping the transducer in a thermal insulating material (e.g., styrofoam).

Performance of the LX3700 over time is just as exciting: 30 seconds after power is applied the output voltage

(continued on page A3)



## Count 'em, Bunky! Now there's 21 JAN & JAN TX JFETs from National!

Starting in June, National Semiconductor will have available - off the shelf and in sizeable quantities - a complete series of JAN and JAN TX JFETs qualified to MIL-STD-19500. JAN TX processing goes one step beyond JAN processing and adds 100 percent reliability preconditioning.

We'll be offering 21 different types, all but two of which will qualify to both JAN and JAN TX specifications, and here they are:

- p-channel amplifiers—  
JAN2N2608-09
- p-channel switches and choppers—  
JAN/JANTX2N5114-16
- n-channel general purpose amps—  
JAN/JANTX2N3821-22
- n-channel vhf/uhf amplifiers—  
JAN/JANTX2N3823  
JAN/JANTX2N4416A
- n-channel choppers and switches—  
JAN/JANTX2N4091-93  
JAN/JANTX2N4856-61
- n-channel dual JFETs—  
JAN/JANTX2N5545-47

Circle No. 302 on Bingo Card

## "PICK A CARD...



## ANY CARD." The IMP-8C/200: a Programmable, De- bugged Microprocessor

There are games that start with someone telling you, "Pick a card. . . any card." And in these games the dealer always wins; he knows what card you're going to pick because the deck is rigged - you don't have a chance.

In the microprocessor card game, however, the deck can't be rigged. But the only way you can win is to pick the one card that you can use the way you want to use it.

And this is why we strongly suggest that you take a close look at our IMP-8C/200 integrated microprocessor card. A flexible, self-contained, low cost, eight-bit processor, the IMP-8C/200 is designed for computer oriented equipment such as data terminals, test systems, communications equipment, machine tool controllers, process control systems and peripheral device controllers.

(continued on page A3)

# NATIONAL STANDS ALONE

## MIL TTL? NSC is OPL.

In a bind for MIL-spec, low power TTL parts? Then hear this: National Semiconductor can help you. We can supply the parts you need. And what's more, we're the *only* vendor who can do so.

That's right. National Semiconductor is the only vendor qualified to MIL-M-38510 for low power TTL parts. For example, we are currently qualified under DESC QPL 38510-13, Part 1, for 11 different parts, and are in process of qualifying for another eight types — all low power, series 54L TTL. For TTL in general, we currently are fully qualified under DESC 38510-13, Part 1, for 28 different parts and we are in process of qualifying for another 44 types. Further, our MIL TTL is available to you in either dual-inline packages or flatpacks — from us, both styles qualify.



NSC also meets the Level B and Level C requirements of MIL-M-38510. So when you need MIL TTL — especially low-power types — come to us. We have what you need.

Circle No. 303 on Bingo Card



## ULTRA-LOW LEAKAGE! A Process-84 Dual FETs Feature!

National Semiconductor rounds out its complete line of FETs with the introduction of the 2N5902 series. Fabricated by National's Process 84, a 2N5902-series device is a glassivated, monolithic, n-channel dual JFET with a diode-isolated substrate.

In other words, the new FETs have subpicoamp leakage over wide input swings, low capacitance, high CMRR and are tightly matched over a wide current range. They are thus eminently suitable for the most critical op amp input stages and electrometer single-ended preamps. They are, in fact, ideal wherever *sub-picoamp* inputs are important.

The 2N5902-09 have gate currents of 0.1 pA (typ.) even at  $V_{DG} = 25V$  (the curve is flat). Tracking is also excellent — units can be selected that show less than  $5 \mu V/^\circ C$  even at drain currents of only a few microamps.  $V_{GS}$ ,  $g_{fs}$  and  $g_{oss}$  are also matched, and the CMRR exceeds 110 dB. The FETs are housed in a seven-pin TO-78 package.

Circle No. 305 on Bingo Card

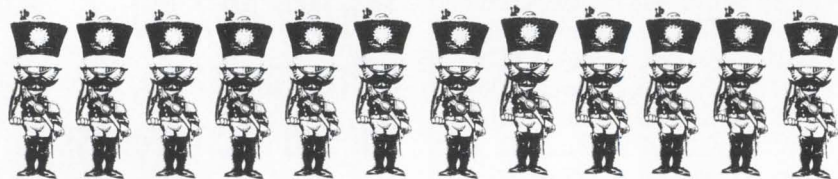

## Some Old Friends Still at Your Beck & Call

Every now and then we like to take some Anthem space to remind you about some not-so-brand-new products that still find wide use in a variety of applications.

Take our MM5202A and MM5203, for example: these silicon-gate MOS PROMs have been around for a little while now. They're non-volatile, bipolar compatible, 2048-bit static memories organized as 256 eight-bit words. (The MM5203 also can be organized as 512 four-bit words.)

You'll find that these memories have many uses in such applications as code conversion, random logic synthesis, table look-up, character generation and microprogramming. They're easily programmed in the field, and the quartz-

lid versions are erasable with ultraviolet light (at 253.7 nm).

The MM5202A and MM5203 feature 1- $\mu s$  (max.) access times for high-speed operation, common data busing with Tri-State® outputs and a chip-select control. (An additional feature of the MM5202A is that in the read-only memory mode, it is pin-compatible with Intel's 1602A and 1702A.)

Housed in 24-lead DIL packages, the MM5202AD (metal lid) and MM5202-AQ (quartz lid, silicon seal) are for  $0^\circ$  to  $70^\circ C$  operation. The corresponding D and Q versions of the MM5203 are also for the commercial temperature range. And for  $-55^\circ$  to  $85^\circ C$  ambients, try the MM4203D (metal lid) or MM4203Q (quartz lid, hermetic) variants.

Circle No. 304 on Bingo Card

## Apply your LED Lamp!

National Semiconductor's solid state, GaAsP lamp series — NSL000/100, NSL5020 and NSL5050 — are characterized by red light emission at 670 nm (typ.). Because the lamps function with as little as one to three milliamperes of forward current, they are ideal for use in low power, low voltage circuits.

The advantages of our solid state lamps are many, and include, among others, sub-microsecond rise/fall times; low impedance for compatibility with most semiconductor circuitry; low heat generation; life in excess of 100,000 hours; and low, low cost.

From simple on/off status indicators to complex-array displays, there are a multitude of applications for our solid-state lamps, including uses in anemometers, annunciators, appliances, cameras, computers, contactless pots, go/no-go gauges, ignition systems, medical instrumentation, numerical control equipment, remote control toys, space vehicles, telephones, test instruments, toll booths, TVs, vending machines, etc., etc. and so on; the list is virtually endless.

So we're pretty sure that somewhere, in something you're doing, a solid-state lamp can help you. And National makes solid-state lamps.

*Circle No. 311 on Bingo Card*

## NATIONAL SEMICONDUCTOR hits the road.

In the seven-week interval between April 25 and June 12, National Semiconductor will be showing lots of wares at a number of shows both at home and abroad.

The Hanover Trade Fair, for example, runs from April 25 to May 3. And at this fair — the industrial show of shows — we will announce our entry into the European consumer market with a booth display of our consumer calculator products.

A few days later, from May 6 to May 9, the National Computer Conference

## LITERACY TEST. 54C/74C Line Adds Read/Write RAM

National Semiconductor's expanding family of CMOS digital products has grown again, this time by the addition of a 16-word by four-bit random access memory. Called the MM74C89, the new RAM features a fast, 130-ns (typ.) access time at  $V_{CC} = 10V$ . The supply voltage can range from 3V to 15V, and dissipation at TTL supply-voltage levels is only 100 nW (typ.) per package.

Inputs to the memory consist of four address lines, four data lines, a write enable line and a memory enable line. An internal address register shifts the address data into the RAM only on the positive-to-negative transition of the memory enable input. This input, together with the four Tri-State® output lines, provides easy memory expansion.

The RAM has a fan-out of two low-power TTL (74L) loads. Noise margin is guaranteed to be at least one volt, and noise immunity is 45 percent (typically) of  $V_{CC}$ .

Both the MM74C89 (0° to 70°C) and the MM54C89 (-55° to 125°C) are packaged in 16-lead DIPs.

*Circle No. 313 on Bingo Card*

will have Chicago's McCormick Place humming. And National Semiconductor will be busy too, with a prominent display island (Booth 753) to show and demonstrate our wide line of microprocessors and microcomputers; and we'll be showing our memory systems, too.

Finally, there's a double-feature running in Chicago between June 9 and June 12. Between these two dates, McCormick Place will play the Chicago Consumer Electronics Show, as brought to you by the Consumer Electronics Group of the EIA. We'll be there too, with a grand booth to display our pocket calculators.

The second feature of the double bill is sandwiched in on June 10 and June 11,

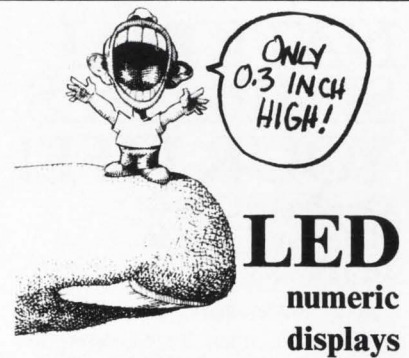

## LED numeric displays use reflective techniques.

Optical reflective techniques give National's NSN71 and NSN74 numeric displays uniformly intense segments. The same techniques also contribute to the displays' low cost relative to their height.

Features of the new GaAsP displays include common-anode (NSN71) and common-cathode (NSN74) construction, fast switching/multiplexing and a 150° viewing angle.

Low cost and large size mean that the displays will find wide usage in new designs for desk-top calculators, digital clocks, point-of-sale equipment, DPMs, TV channel indicators, elevator floor displays and in any redesigns that previously had no display or used mechanical or gas-tube display devices.

National's NSN71, in right- and left-hand decimal versions, directly replaces the DL-1, -10, -410 and -707; the HP5082-7730; the MAN-1, -4, -10, -71 and -72; and the TIL-302 and -303.

Similarly, the NSN74 directly replaces the DL-4 and -704; the MAN-74; and the FND70. Though this last device is sole sourced and mechanically different from the NSN74, a redesign to use the National product gives you not only a larger digit but a multi-sourced product as well.

*Circle No. 314 on Bingo Card*

over at the Marriott Motor Hotel. This one is the Chicago Spring Conference on Broadcast and Television Receivers. We're looking forward to our booths (nos. 7 and 8) being busy with people interested in our wide range of products for the BC/TV RX industry.

We at National highly recommend that you pick the show (or shows) of your choice and do your thing; you can bet that we'll do ours.

*Circle No. 312 on Bingo Card*

# NATIONAL SIMPLIFIES YOUR LIFE!

## Our New Cross-Reference Guide to JFETs.

Can a simple chart be a cost-saving device? Yes, when it's National's deceptively simple, new, cross-reference guide to JFETs. The guide leads you to readily-available parts from a major supplier (us), and helps you to reduce the variety of JFET type numbers you need for any project. In addition, the new guide works beautifully with our earlier JFET Selection Guide, which we published last year (see *The National Anthem*, No. 13, Nov. 1973.)

The new guide — a handy, looseleaf-punched foldout — has two sections. One section lists 31 cost-effective, preferred JFET types. These will satisfy 95 percent of new design requirements. The JFETs in this section are categorized by application. Key parameters of each device are listed and, wherever possible, equivalent metal can and epoxy types are shown.

The second section of the new guide lists nearly 1300 JFETs, and shows the status of each type (stock or special-order item, special mark and/or electrical selection, JAN or JAN TX, etc.). All of these devices are available from National, and are listed by their NSC-available type number (the original designation, according to the original manufacturer), and cross-referenced to an alternate National stock type (which may or may not be the same as the original number). The 2N JFET types are listed regardless of current industry acceptance.

In short, our new cross-reference guide steers you to the more popular, stock, lower-cost, standard JFETs from the literally thousands of types available from a variety of manufacturers.

For types missing from the list, the probability is quite high that we can meet your needs. So if you're having delivery, price, quality or performance problems, or simply desire a major source, take a peek at the JFET cross-reference guide from National — the JFET people.

Circle No. 308 on Bingo Card



## More Reasons To Go National 54C/74C

By now you know that National's CMOS digital products form a nearly ideal logic family: low power dissipation (10 mW/gate at 1 MHz with a 50-pF load); short propagation delays (25 to 50 ns); controlled, ramp-like rise and fall times (20 to 40 percent longer than the gate delays); high noise immunity (45 percent of VCC); and a guaranteed noise margin (1.0V) two-and-a-half times that of TTL.

And by now you also know that our 54C/74C product line is alive and well, growing all the time, and gives you pin and functional CMOS equivalents of all the most popular 5400/7400 TTL parts.

Okay. But what you may not know is that our 54C/74C products are not only second sourced, but doubly second sourced. Teledyne Semiconductor has been supplying 54C/74C since last November. And now, Harris Semiconductor too is supplying 54C/74C.

So if you insist on buying only second-sourced products, that's fine with us. Because you can get all the features of 54C/74C parts from three sources. Or, to put it another way, now you have two more reasons to go to National for your CMOS logic needs.

Circle No. 309 on Bingo Card

# HERE COME DEBOUNCER!

Just as fish have to swim and birds have to fly, mechanical switch contacts have to bounce. Contact bounce has been and probably always will be a fact of life. In digital systems, particularly, contact bounce can be very nasty and give rise to temporarily-indeterminate inputs.

To eliminate bounce, you've probably had to resort to special networks — like, say, a couple of TTL gates and eight resistors for every four switches.

Now there's a better way: National's new DM8544 replaces those ten components, and does their job better and more cheaply.

The DM8544 quad switch debouncer is a contact-bounce eliminator par excellence: it's a single package that debounces four switches and needs no external components; is Tri-State® connectable to buses; has a strobe input for greater control; interfaces to all TTL; and is available in both commercial (8544) and military (7544) temperature versions. In addition, you have your choice of three package styles: molded DIL; *Ceramil* DIL; and flat-pack.

There's nothing else on the market quite like the DM8544. So try it; you'll like it.

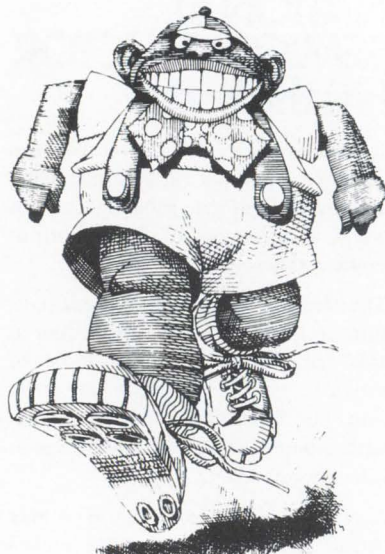

Circle No. 310 on Bingo Card

## Thermostatted Pressure Transducers (Cont'd)

is within  $\pm 150$  mV of the spec'd nominal value; and in the interval from 120 seconds after power-up to shut-down, the output voltage remains within  $\pm 25$  mV of its value at the 120-second point — even after temperature cycling ( $-10^{\circ}$  to  $170^{\circ}$ F), pressure cycling and so forth.

The LX3700's long-term lack of drift is just as astounding: after a 120-second warmup, the output voltage will be within  $\pm 50$  mV of the output voltage of the previous powered period regardless of time, temperature and

pressure exposure between the powered periods.

You can reap the rewards of LX3700 operation anywhere that you operate a transducer over a wide range of temperature ambients. You now can add altitude reporting capability to a transponder, for example, that will meet the necessary requirements at altitudes to at least 30,000 feet. Altimetry and barometry are only two of many applications areas for thermostatted transducers.

The LX3700's sensitivity in the differential mode, for example, lends itself well to use in vehicular fuel control systems. There's a good, solid output signal available even at tenths of psid,

because the LX3700's full-scale output can be reached at a differential of only 1–1.5 psi.

The LX3700's interchangeability, nominal end-points, linearity, hysteresis and so forth are the same as those of our LX1700 series, and you have your choice of differential, absolute, or gage units. The LX3700's outer housing is nylon. Please contact us for detailed specifications.

As for the price. . . well, let's just say that you'd be hard pressed to find a transducer competitively specified for less than \$600. For that much money, you can walk away with a fist full of LX3700s.

Circle No. 306 on Bingo Card

## IMP-8C/200: (Cont'd)

The major functional units of the IMP-8C/200 consist of:

- a CPU;
- a clock generator;
- an input multiplexer;
- a data buffer;
- control flags;
- a conditional jump multiplexer;
- on-card memory;
- address latches;
- a page counter; and,
- a data multiplexer.

The IMP-8C/200's CPU supports a basic set of 38 instructions. There are provisions for plugging in a second

CROM, which will double the size of the basic instruction set.

And memory isn't limited. The IMP-8C/200 card itself contains 256 bytes of read/write memory, which you can expand to 2304 bytes by adding up to 2048 bytes of read-only memory. You can expand the total system memory to 65,536 bytes maximum. (The IMP-8C/200 interfaces to our 8192-by-eight-bit dynamic memory modules.)

Buffered data are available over an eight-bit, buffered-data-out bus for peripheral devices, control panel and add-on memory. Addresses are taken from a separate, 16-bit bus. A system

clock is provided for distribution outside of the IMP-8C/200 for synchronization of peripheral units.

In summary, the IMP-8C/200 offers you, on one 8-1/2-by-11-inch printed-circuit card, a proven, totally debugged processor that you can customize to your immediate application by programming, rather than by hard wiring. The technique is flexible and saves you considerable cost in terms of both money and development time. Remember, we want you to win. So ask us about the IMP-8C/200. Or ask the man who owns one.

Circle No. 307 on Bingo Card

**WITH TYPICAL MODESTY NATIONAL ANNOUNCES A NEW METHOD OF MEASURING TEMPERATURE THAT MAKES EVERY OTHER WAY LOOK SICK.**

You're lookin' at it. The world's first I.C. temperature transducer. On a single monolithic integrated circuit chip, we've measure temperature, an amplifier for adjusting span and offsetting the output of the sensor, and a stable voltage reference so the transducer can be a real temperature controller. It reads out in  $\mu$ V, not Ohms or microvolts. And comes calibrated to  $\pm 4^{\circ}$  C over a  $-55^{\circ}$  C to  $125^{\circ}$  C range.

Stack that up against the other ways to measure and control temperature: Thermocouples that have the problem of low output, non linearity, and require a cold junction reference. Resistance sensors and Thermistors that need a stable excitation, and are non-linear.



And all three of those other ways need an electronic box to translate the sensor output into the size and cost of the units. Pretty sick.

For all you people dying to your distributor, the numbers to order are LX5600AH, LX5600H (the 4-lead TO-5 package) and LX5700AH, LX5700H (4-lead TO-46 package).

Or for those not convinced yet, you can get details by calling out nearest branch listed below or write National Semiconductor Corporation, 2900 Semiconductor Drive, Santa Clara, California 95051.

With new, better products like this the time, it's sort of hard to remain humble.

**NATIONAL**

**HOW TO TRANSMIT THERMOCOUPLE, STRAIN GAGE AND PRESSURE GAGE SIGNALS WITHOUT A LOT OF SWEAT, HOURS, DOLLARS, INCHES AND OUNCES.**



Introducing National's new 2-Wire Transmitter. It converts the voltage from a sensor to current, and sends it through a receiver, utilizing the same simple twisted pair as the supply voltage.

**No sweat.** You buy it off the shelf, instead of having to juryrig your own transmitters.

So naturally you save a lot of size, weight, effort, time, and since time is money — money.

**Goodbye noise.** But the 2-Wire Transmitter eliminates more than juryrigging hassles. It also eliminates line drops and voltage noise.

Line drops and voltage noise can only happen when your signal is being transmitted in the voltage mode. But we transmit in current mode — which is immune to either resistance in the wire or voltage noise spiking. So you get fewer bugsos all the way around.

Available in 8 lead TO-3 and 12 lead TO-8 packages. For the full story call our nearest office or write National Semiconductor Corporation, 2900 Semiconductor Drive, Santa Clara, California 95051.

**National**

# Use FUBES NOT TUBES



National's new Fube is the lowest price FET vacuum-tube replacement on the market. When you replace a tube with a Fube your equipment shows:

- Inherently higher (JFET) stability—your gear stays calibrated and you save maintenance and repair costs;
- Higher performance—reduction in error-zone means greater accuracy and repeatability than possible with tubes;
- Lower noise, fewer and smaller distortion products — JFETs are quiet, true square-law devices;
- Reduced power demand — save 2-2.5W for each tube replaced with a Fube (do your bit for the energy crisis);
- Tremendously increased life — all components run cooler when you get rid of the tubes.

While not a universal replacement, only a few Fube types replace a great variety of tube types. Fubes will be available to replace most of the popular

pentodes such as the 6AG5, 6AK5, 6AM6, 6AU6, 6BH6, 12AU6, 5654 6028, 403B, 408A and 415A, among others. Twin-triode replacements cover the 6BC8, 12AT7, 12AU7, 12AV7, 12AX7, 12AZ7, 6680, 60201, 396A, 407A, 407B and so on.

Laboratory test instruments (HP400-series VTVMs, Tektronix CA-type plug-ins, etc.) and telephone equipment, for example, benefit greatly from the use of Fubes. Because some changes require minor device selections, we are making available conversion kits, which include full instructions.

Until our Fube came along, there was only one source of FET tube replacements on the market. Now you've got a choice. But consider this: National's Fube is a cost-effective device; we combine unsurpassed processing capability with volume production and pass the savings on to you. So maybe you really don't have a choice after all.

Circle No. 315 on Bingo Card

# Tick Tock.



## Two-Phase Oscillator Clock Driver

National Semiconductor's brand new MH8803 is a totally self-contained clock and clock line driver. You needn't add a thing — neither crystal nor any other external timing component.

While not designed for systems that require a highly accurate frequency source with a tightly spec'd tolerance, the new oscillator/clock driver is well qualified for a number of applications, such as calculators and even mini-computers.

The MH8803 generates one of three primary frequencies and pulse widths. Both output frequency and pulse width are voltage controlled, so you can easily set your requirements by programming the input control voltages. You also can precisely tweak the frequency and pulse width with a potentiometer.

Outputs are non-overlapping, and adjustable in frequency from 100 to 500 kHz and in pulse width from 260 ns to 1.4  $\mu$ s. There are damped and undamped MOS outputs, and a TTL monitor output as well. The MOS outputs can drive 500-pF loads and still maintain rise and fall times within 150 ns. In addition, the outputs are current limited to protect against momentary shorts to the supplies.

The 14-lead, commercial temperature range MH8803 is available in both cavity and molded DIPs. For full military temperature range operation, we have the MH7803 in a cavity DIP.

Circle No. 316 on Bingo Card

Complete card and mail to  
**NATIONAL SEMICONDUCTOR**  
 2900 Semiconductor Drive, Santa Clara, Ca 95051  
 Attn: Marketing Services

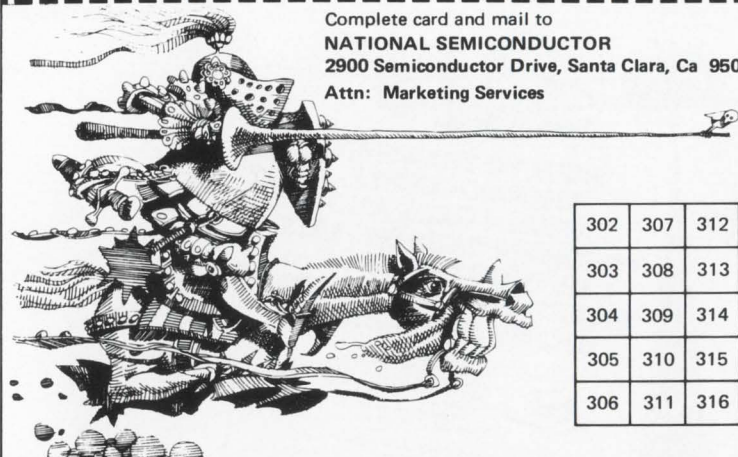

302	307	312
303	308	313
304	309	314
305	310	315
306	311	316

BINGO

For FREE technical data, circle the numbers that correspond to the Bingo numbers at the bottom of the articles.

Please print clearly. This will be used as a mailing list.

NAME \_\_\_\_\_ TITLE \_\_\_\_\_  
 COMPANY \_\_\_\_\_  
 ADDRESS \_\_\_\_\_  
 CITY \_\_\_\_\_ STATE \_\_\_\_\_ ZIP \_\_\_\_\_



Really now! New math? Useful for WOM's? EOM's?

George K. Gastler

6609 Foxhall Lane  
Huntsville, Ala. 35806

*Ed. Note: Wrong count? Yes it was. Our "error" on the May 10 cover was deliberate. Many readers caught it and asked if the second picture in the first column was caused by a goof in our Art Dept. or by a deliberate miscount. We merely were trying to reinforce the first line in the cover text: "Can you count on your digits?" So we buried a miscount in the photographs while making a pun on "digits."*

*Incidentally, readers who caught the "goof" weren't alone. When we asked Systron-Donner to take the picture for us, their people thought we had made a mistake. Then our engraver called to inform us that there was a mistake in one picture. And later the printer called to notify us of the error. Finally many of our editors who weren't involved in the story came screaming about the error when they saw proofs of the cover.*

## Ohm's law upstaged by Murphy's law

I would like to know how  $100 \Omega$  in parallel with  $200 \Omega$  is equal to  $6 \Omega$ . Please note third paragraph of article entitled "Subnanosecond Transients Detected With ECL Logic," printed in the June 7 issue, p. 156.

G. Robert Bosworth  
Design Engineer

Eudaemonic Electronics  
Los Angeles, Calif. 90066

*Ed. Note: Simple. All it takes is a typographical error. The correct value is, of course, 66. Thanks for the eagle eyes.*

## Streakers defined

A streaker, we learned recently, is a fellow wearing a striped shirt and running through a parking lot at IBM.

Rugged...versatile

New!

# "The Persuader"

The S190 switchlight outguns everything its size... costs only \$1.62\*

In every era, new products come along to keep the competition honest, with all the cards on the table. So we invite you to compare our S190 series with other switchlights. Check our variety of lens colors and easy mount panel adaptors... our wide terminal spacing for easy and fast wiring: solder, quick connect, PCB... our no-tool lamp replacement, long life wiping contacts, rugged molded case. Consider the low cost when you realize that the S190, with its 2 Form C action, has greater circuit flexibility than most switchlights on the market. And it's easily available at your local distributor! Call our sales office in your area for applications assistance... we're located in major cities, world wide. Clare-Pendar Co., Box 785, Post Falls, Idaho 83854, (208) 773-4541.

\*In quantities of 1000



CLARE-PENDAR  
Switchlights & Keyboards



# you can see why...



## the time is right with **PANAPLEX™** clock panel displays

PANAPLEX clock panels are designed to be read. These large, bright, easy-to-see, pleasing numerals are easily read in any light — even bright sunlight.

These four- and six-digit clock panels are compatible with MOS clock chips, and have the high reliability and quality that has made the PANAPLEX family of displays the choice of calculator manufacturers.

PANAPLEX clock panels can display either 12- or 24-hour time systems and have integral AM/PM indicators and colors.

Available in two standard sizes (0.5 and 0.7 inch), these thin panels (0.2 inch excluding tubulation) offer design flexibility that's hard to beat

The soft, neon-orange color is easy to read at a glance: — no magnifier

needed, no eyestrain, no LED-red fatigue factor.

For additional information on the PANAPLEX clock panels, write Burroughs Corporation, Electronic Components Division, P. O. Box 1226, Plainfield, New Jersey 07061, or call (201) 757-3400 or (714) 835-7335.



### You can see the difference

## Burroughs

**DISTRIBUTORS:** Hamilton Electro Sales/Culver City, Cal.; Hamilton/Avnet Electronics/San Diego, Seattle, Mountain View, Cal., Phoenix, Denver, Salt Lake City, Albuquerque, Houston, Dallas, Prairie Village, Kan., Hazelwood, Mo., Schiller Park, Ill., Livonia, Mich., Minneapolis; Arnold Barnes Associates, Inc./Richardson, Tex.; Schweber Electronics/Hollywood, Fla., Rockville, Md., Westbury, N.Y.; Cramer Electronics/Syracuse, N.Y., Newton, Mass.

## A CCD memory emerging, an alternate for DEC

For several years now, semiconductor experts have been saying that charge-coupled devices could be used to replace disc and drum memories. Bell Northern Research in Ottawa, Canada, has decided that actions speak louder than words in constructing a CCD memory system that can replace the Digital Equipment Corp. RS64 disc, a peripheral to the PDP 11 minicomputer.

The CCD system is designed to have an average latency—the time required to reach the desired memory address—of 128  $\mu$ s. This is about two orders of magnitude better than the disc performance.

According to Chris Robinson, manager of device applications at Bell Northern, the new memory will be completed by the end of this month and will prove that CCDs can perform satisfactorily in a systems environment. Like the RS 64, the all-solid-state CCD memory will have storage capacity of 1 megabit—64,000 16-bit words—and a maximum data rate of 1 MHz.

In describing the new memory, Robinson notes that it is constructed with 8-k CCD chips, arranged on printed-circuit boards in sets of 16, so that each board stores 64,000 words. Each word is 2 bits long. A total of 8.5 boards are needed to form the memory. The extra half board provides error-correcting bits.

In explaining how the CCD memory works, Robinson points out that initially the memory is in an idle mode, where data are constantly being refreshed at a frequency of between 10 and 100 kHz. Once a transfer request comes along from the controller, the system goes into a race mode. The system then races at 1 MHz until its memory address coincides with the required address.

At this time, Robinson continues,

the system will go into a wait mode and then transfer the data asynchronously. If the cpu is too busy to transfer the data right away, the memory will automatically refresh the data until the cpu is ready.

Since fixed-head rotating memories generally store data in blocks of 256 words, the CCD memory was arranged this way, too, Robinson says. The organization of the CCD memory is such that an address pointer can be used to select the particular block of interest. To transfer integral blocks of data, the system then races until it reaches the zero address.

What appears to be the most interesting aspect of the CCD memory is what Robinson calls a "wrap-around" feature. What this means, he says, is that it is not necessary to start the transfer of data at the beginning of a block. Instead, it is possible to start at any memory location—22 for example—transfer information stored in locations 22 to 255 and then from 0 to 21. The wrap-around feature is interesting, Robinson says, because it means that the latency is reduced to the time it takes to transfer one bit. It is not the latency of the complete block of data. If this advantage is not used—and today's systems aren't geared for it—then the average latency is 128  $\mu$ s, he notes.

Robinson reports that in its current configuration, the memory is not a salable item, because parameters were not optimized.

### Kodak video player televises 8-mm film

A video film player that plays standard 8-mm film, with or without a magnetic sound track, on standard television sets has been announced by Eastman Kodak,

Rochester, N.Y.

Described as a miniature TV station by Arthur Sweeney, director of sales, the system uses a flying-spot scanner that converts 8-mm film movies into standard signals. The signals are televised over Channel 3 of a TV set.

One model of the video player has its own internal synch signals. A second model has provision for external synch signals, so it may be operated as a studio unit in community-cable or regular TV stations. In the latter case, Sweeney sees the player being used to televise 8-mm film of extraordinary news events photographed by amateurs.

Developed for training and entertainment use by commercial, medical and government markets, the Kodak system can reproduce both color and black and white film. It provides video pictures at either 18 or 24 frames a second.

At present, Sweeney points out, there is little equipment available to enable a station to play 8-mm film. Costly 16-mm camera setups are now common.

Deliveries of the Kodak player, which carries a suggested list price of \$1095, are to begin the end of this month.

### Sound sensor detects hard-to-find heart ills

A new technique that quickly pinpoints heart defects that may escape detection during routine electrocardiographic examinations has been developed by the General Electric Research and Development Center, Schenectady, N.Y.

Using a minicomputer and a super-sensitive "ear," the device can also evaluate the severity of the irregularities without resorting to complicated catheterization procedures that require the injection of chemicals through tubes inserted into the heart.

The key to the new technique is a small electronic sound sensor about the size of a silver dollar; it is placed on the patient's chest. The sensor detects sounds in the frequency range of 1 to 1500 cycles per second, compared with the 30 to 500 heard with an ordinary stethoscope.

The sounds detected by GE's sensor are converted to digital sig-

nals, fed into a computer and analyzed, and the results are printed out immediately. The physician then interprets the data and makes the diagnosis.

The system will help eliminate many variables that can produce inconclusive, stethoscope findings, GE says. For example, the pressure with which a stethoscope is placed against the patient's chest can affect the heart sound. By contrast, the GE transducer rests on the patient at a constant pressure.

In tests made at four teaching hospitals, the GE method has been reported instrumental in detecting restricted blood flow, abnormal muscle contraction, arterial blockage and the very early states of weakening heart valves.

The system is not intended to replace electrocardiograms but to supplement them. ECG's measure the electrical functions of the heart while the phonocardiogram tests, by contrast measure mechanical functions such as valve openings and closings and blood flows.

GE says the technique should be clinically qualified and ready for wide-scale application in two to five years.

## First 'Mill Run' ICs come off the line

The first ICs produced under the Government's Mill Run program are emerging from Signetics' plant in Orem, Utah.

The program provides for continual assembly-line monitoring by a Government Quality Assurance Representative to ensure that manufacturers are meeting the specs for JAN (military-qualified) semiconductors.

Before Mill Run there sometimes were delays of several months in deliveries while manufacturers waited for the Defense Supply Agency to send an inspector to check the finished ICs. With Mill Run, there is continuous production of inspected ICs, which can then be stockpiled for immediate delivery.

The program applied originally only to the aluminum industry but has now been extended to semiconductor manufacturers. Signetics, which negotiated with the Government for more than a year to put

Mill Run in operation, is making JAN 5400 and 54H ICs in Utah.

Mill Run ICs are specially marked by the Quality Assurance Representative to indicate that they meet all source inspection requirements and no further verification is necessary.

Frank Jelenko JAN product manager of Signetics notes: "Mill Run negotiations are still rather complex. They require a new facilities survey and other Government paper work. The results are certainly worth it, though. With the program, JAN customers can see, by a mark on the IC packages, that the products have been source-inspected at no additional cost to them. It should create a higher confidence level for all JAN customers buying the parts—and save them both time and money."

## Custom IC technology 'for sale' to users

Design assistance and the manufacturing technology to produce custom MOS/LSI circuits are being offered to all comers by a prototype semiconductor house. Until now, circuit manufacturers requiring custom ICs were dependent on semiconductor companies for their supplies.

The rules for laying out LSI circuits, the manufacturing technology and a technical assistance program are available from Mosfet Micro Labs, Inc., Quakertown, Pa. C/MOS, silicon and metal-gate PMOS and even CCD technologies are provided. The service costs about \$300,000. Production machinery and expendables add another \$100,000.

William Witmer, president of the company, says: "Now any firm can get into production with its own IC for about \$400,000—about a third of what it would cost to develop it in house."

The circuit-layout package is offered by the company to develop the art work for custom circuit masks, and contains background information on electrical parameters and topology. The production technology program explains how to produce IC wafers with a minimum of equipment and investment.

Mosfet Micro Labs has been in the business since 1969, assisting in the design of custom ICs and

doing prototype production. Witmer explains the company's decision to sell its technology this way.

"It has become very difficult for a small company to find a manufacturer for its custom IC. The big IC houses are producing so many stock parts that they are not interested in any short-run work. It used to be that they were happy to do a 50,000-part run for a customer; now even \$2-million contract doesn't generate much interest."

## X-ray imaging method improves crystal growth

An X-ray imaging technique that promises improved monitoring and control over crystal growth has been announced by two Western Electric scientists.

Developed by Harold D. Pruett and Swei Yuen Lien of Western Electric's Engineering Research Center in Princeton, N.J., the method was described at a recent International Conference on crystal growth in Tokyo.

The technique will be used at the company's Reading, Pa., plant to monitor and control the growth of gallium-phosphide crystals for the manufacture of light-emitting diodes. The method could also be used for other crystalline materials as well.

"The key advantage of the X-ray imaging system over the alternate optical viewing method is that the X-ray system allows the crystal to be observed from a side view throughout the growth cycle," Pruett said.

"An operator can see and even anticipate changes in crystal diameter and make adjustments to minimize them," he noted.

An X-ray source on one side of the growing chamber emits X-rays that pass through the crystal-growing apparatus to form a silhouette image on a fluorescent screen on the opposite side. A highly sensitive TV camera transmits the image to a monitor for remote viewing.

The system also offers better control of the growth process because it provides an accurate means to estimate the critical melt temperature, co-developer Lien said.

# The last time someone announced 74C, it was a national campaign.

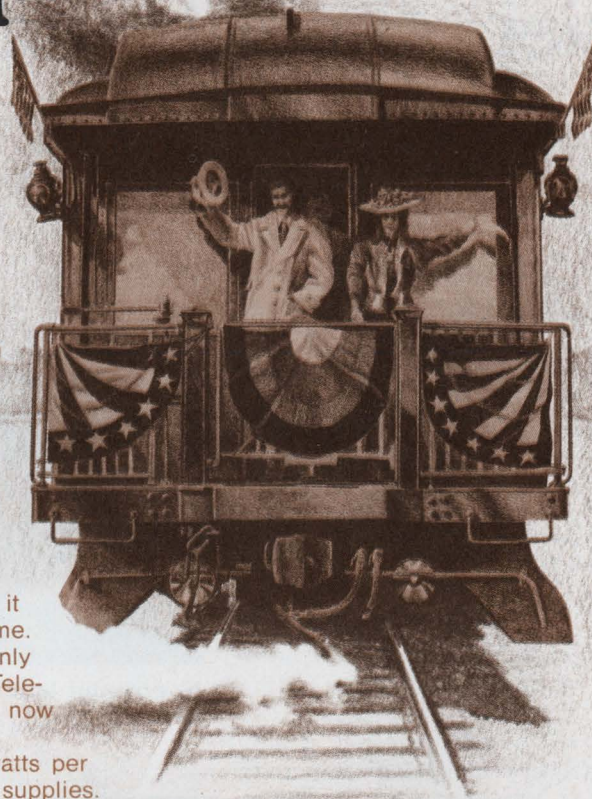

When we saw 74C coming down the tracks, we knew it would be the hottest and most logical CMOS line in a long time. Flags waved, bands played, and thousands of engineers suddenly found CMOS easier to design in. The only thing missing was Teledyne's big production volume and competitive pricing, and now you've got that too.

Here's what Teledyne 74C delivers: A mere 10 nanowatts per gate typical power dissipation. Operation on 3V to 15V power supplies. A big, guaranteed 1V noise margin. Typical noise immunity 45% of the supply voltage. Hefty outputs that drive MOS and bipolar logic (at least two LPTTL loads).

And 74C really simplifies design. 74C logic functions, pinouts and even numbers are identical to 7400 TTL, and every 74C device is compatible with every other 74C device. I/O specs are consistent (no interpreting a pile of data sheets to calculate what's compatible with what). Not to mention drastic cuts in the need for supply regulation, bypass capacitors and noise filtering.

The first batch is available now.

MM74C00	Quad 2-Input NAND Gate	MM74C107	Dual J-K Master-Slave Flip-Flop
MM74C04	Hex Inverter	MM74C160	Synchronous Decade Counter
MM74C20	Dual 4-Input NAND Gate	MM74C161	Synchronous 4-Bit Binary Counter
MM74C42	BCD-to-Decimal Decoder	MM74C192	Synchronous Up/Down Decade Counter
MM74C74	Dual D Flip-Flop	MM74C195	4-Bit Parallel-Access Shift Register

That's our national platform for 74C. But Teledyne's CMOS campaign has just begun. We'll soon be speaking softly about big values in proprietary devices compatible with 74C and custom CMOS for linear and digital applications. All with ultra-low power dissipation and high noise immunity.

 **TELEDYNE  
SEMICONDUCTOR**

1300 Terra Bella Avenue Mountain View, California 94043  
(415) 968-9241 TWX: 910-379-6494 Telex: 34-8416

INFORMATION RETRIEVAL NUMBER 20

# Sensors in 5 areas are getting tinier, cheaper and more precise

Sensing transducers, which are turning up on production lines, are smaller, more accurate and lower in cost than ever before.

Some are almost invisible to the human eye. Errors of less than 1% are common. And prices have plunged from the hundreds of dollars to the tens.

At the same time R&D is producing changes in design and new applications are being found. Some of the more outstanding advances are reported in these areas:

- **Temperature:** Monolithic ICs are becoming the actual sensing element. The chip contains all of the sensor's conditioning circuitry.

- **Pressure:** Hybrid ICs are now combined into a tiny sensor, with all the electronics.

- **Strain:** Semiconductor strain elements are replacing the foil gauges in some areas.

- **Acceleration:** New materials are giving the sensors higher outputs and new applications are generating more interest.

- **Displacement:** The linear-displacement variable transformer is still the most widely used, but magnetic flux, optical, rf and ultrasonic schemes are appearing.

One of the largest measurement areas—temperature—has seen the most significant change.

National Semiconductor has developed a complete temperature transducer on a single chip less than 100 mil<sup>2</sup>. This sensor, Model LX5600/5700 measures temperatures from -55 to +125 C with a calibration accuracy of  $\pm 4$  C.

On a single chip, the National LX5600 transducers have the temperature sensor, a voltage regulator, an output amplifier and a

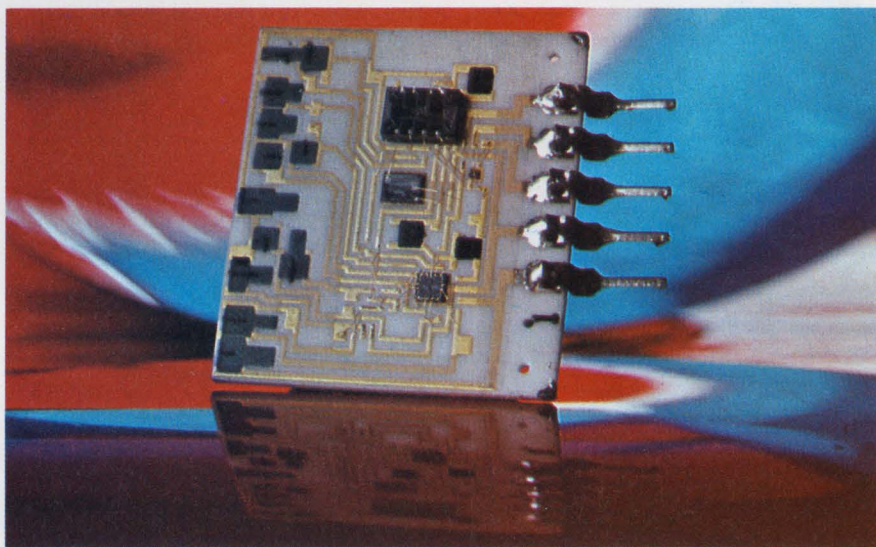

**IC pressure transducer** made by National Semiconductor uses three different circuit chips and an array of thick-film resistors on a ceramic substrate.

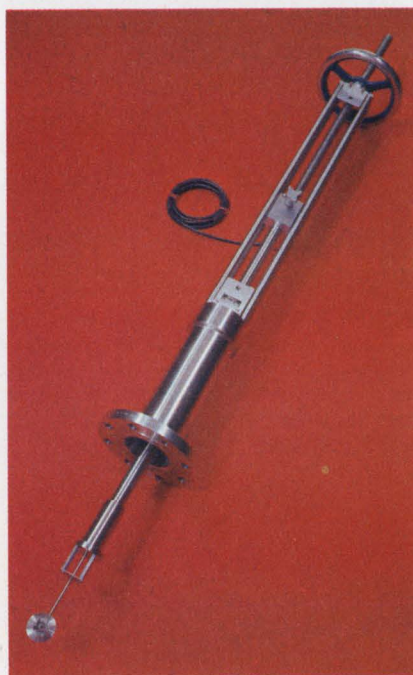

**Mark V flowmeter probes** by Ramapo Instruments are retractable and can thus be moved from line to line for sampling and spot-checking flows in various size pipes.

driver transistor.

The internal op amp can modify the sensor output to almost any form, but ideally it delivers a linear 10 mV/°K voltage change. The IC sensor costs \$13.35 (100-up).

Thermocouples are not without their own unique advantages: They require no power source, cover a much wider temperature range and are just as small. They do, however, require special wiring methods, reference-temperature junctions and additional signal conditioning. Thermocouples cover a very wide range. For instance Chromel/Constantan spans 32 to 1800 F while 95% tungsten, 5% Rhenium/74% tungsten, 26% Rhenium covers 32 to 5000 F:

"Even though thermocouples have been around for many years, engineers still make some mistakes when connecting them," says Earl McKinley, director of engineering for Omega Corp. "For instance, the thermocouple should feed into a

(continued on page 34)

**Dave Bursky**  
Associate Editor

# MONO-GLASS... A JEWEL OF A CAPACITOR

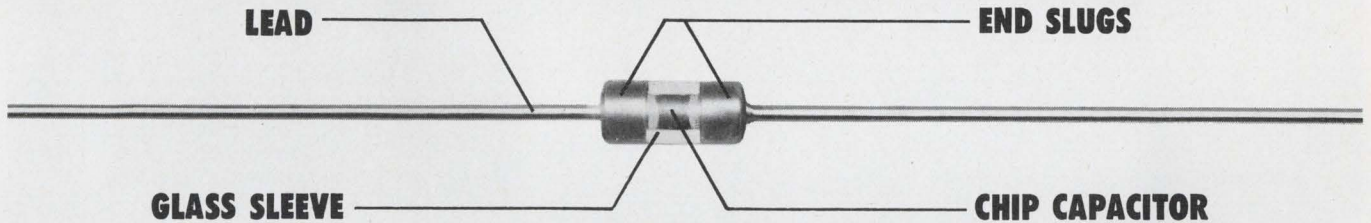

U.S. Capacitor Corp. has done something elegant for high volume capacitor users . . . MONO-GLASS.

This glass encapsulated monolithic ceramic capacitor offers something special: for the Design Engineer looking for cost reduction and dependability; for the purchasing agent looking for low price with fast delivery; for the incoming Q.C. inspector who is looking for reliability.

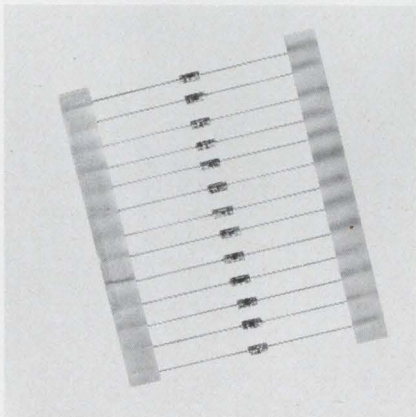

## AUTOMATIC INSERTION:

If you use it, you know the substantial savings in time and cost. MONO-GLASS is designed for automatic insertion with the same equipment used for diodes and resistors. Reel packed and ready for your machines.

## DURABILITY:

Our hermetically sealed, glass-to-metal construction offers these advantages: solderless internal contacts that won't reflow in your wave-soldering process; no glass fracturing during lead forming—stress is transferred to the end slugs rather than the glass sleeve.

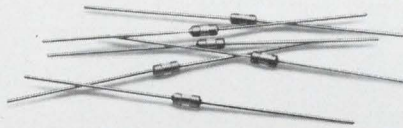

## HIGH VOLUME; LOW PRICE

USCC's production capability for chip capacitors is second to none. MONO-GLASS is produced by a simple assembly technique. Combine these two and you get the best possible delivery for high quantity requirements, at a budget price.

## WIDE SELECTION:

Four case sizes are available . . . .200 x .100; .250 x .100; .300 x .150 and .400 x .150. The 50 and 100 WVDC units offer up to .01 mfd in COG dielectric, to .18 in X7R and up to 1.0 mfd in the Y5V dielectric.

## RELIABILITY:

USCC is the proven leader in state-of-the-art, demonstrated on N.A.S.A. life support and guidance systems. Commercial as well as military aerospace applications benefit from the high reliability features of our products—the best available.

MONO-GLASS is our lowest priced ceramic axial lead capacitor, offering a new quality capability for communications, navigation and guidance, computer business machines or anywhere that high volume, low price is required.

Write or call for an evaluation sample, more technical data or applications help for your special requirements. Remember, USCC-Centralab.



**USCC/Centralab**

Electronics Division • Globe-Union, Inc.

2151 North Lincoln Street • Burbank, California 91504

(213) 843-4222 • TWX: 910-498-2222



INFORMATION RETRIEVAL NUMBER 21

# Transducers: You name it, they make it

There are so many different types of transducers that it would take several books to explain how all work. Here are just a few of the different parameters that are measured and how:

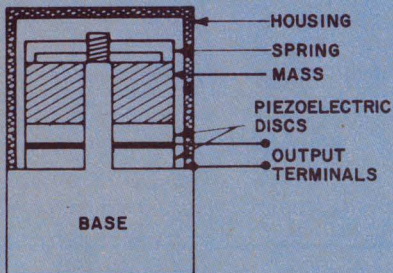

**Acceleration:** Devices that measure acceleration provide an electrical output when subjected to vibration. The electrical output is linearly proportional to the vibration over a limited frequency range. Accelerometers use techniques that are similar to those employed by pressure transducers—a crystal to generate the signal. Acceleration is usually measured in g's.

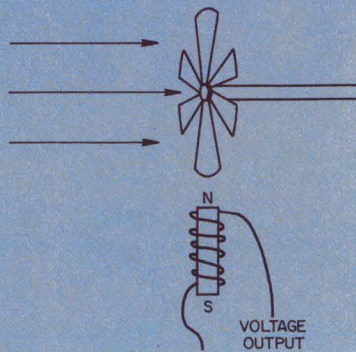

**Flow:** There are many different flow-measuring methods. Some of the more common use differential pressure transducers, tiny turbine rotors and magnetic pickups. The magnetic sensors are sometimes used in conjunction with the rotor. When the rotor turns, it produces a magnetic flux change that is converted into a pulse output that can drive other measuring or recording instruments. Flow is usually measured in gallons per minute.

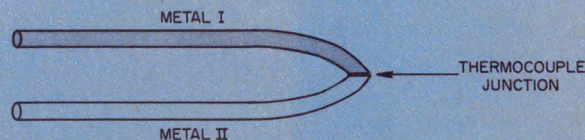

**Temperature:** The most common device used is the thermocouple. Two dissimilar metals that are connected generate a voltage that is temperature-dependent. The voltage is usually several millivolts and needs special conditioning amplifiers and temperature reference points. Temperature is measured in degrees centigrade, Fahrenheit or Kelvin.

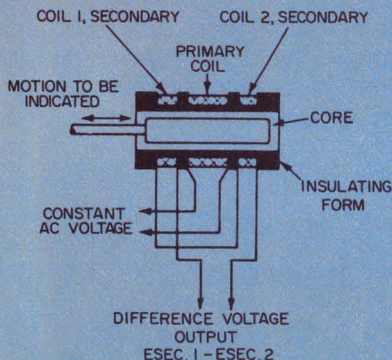

**Displacement:** The most common device to measure displacement is the linear variable differential transformer (LVDT). It produces an electrical output proportional to the internal displacement of a moveable core. LVDTs are also used to measure pressure. Other devices used for displacement measurement are the various forms of potentiometric circuits. These devices change resistance linearly as a slide is moved or a shaft rotated. Some change resistance when compressed and are used as load-measuring devices. Both LVDTs and the potentiometric devices require excitation voltages. Displacement is measured in inches, microinches or arc-seconds.

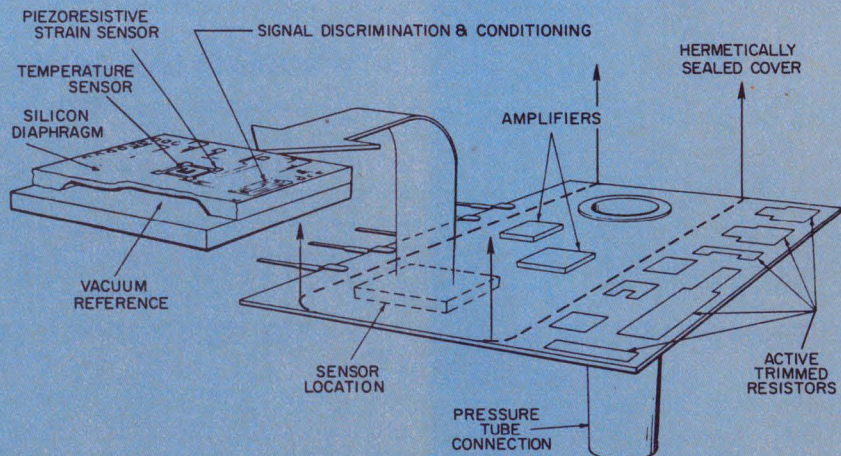

**Pressure:** Two basic types of devices measure pressure. Piezoelectric devices use a piece of crystal—usually lead-titanate-zirconate—that generates a voltage when compressed. But this voltage needs special charge amplifiers and other signal conditioning to be useful. Piezoresistive materials are also used in some pressure transducers. These materials change resistance when compressed. To be used, they are usually connected into a balanced-current bridge circuit. If the bridge unbalances, an amplifier can convert the unbalance into a voltage output. Pressure is usually measured in pounds per-square inch.



# Still fighting snap, crackle and pop?



Noise has a way of showing up in circuits. Bendix has a way of preventing it. Filter connectors. Boasting some of the best attenuation curves available, Bendix filter connectors solve a wide range of low-pass filter problems. Small wonder Bendix is first choice in the fight against snap, crackle and pop.

These versatile connectors, production tooled, are available in a wide range of cylindrical and rectangular configurations designed to meet most any industrial, commercial and military application.



Configurations that can be intermateable with most MIL-Spec and popular commercial connectors and special designs for advanced state-of-the-art equipment. There's sure to be one that meets your attenuation and frequency requirements. You'll like what you hear when it comes to the price, too. And that goes for delivery as well.

Write for our new catalog. It's yours for the asking. The Bendix Corporation, Electrical Components Division, Sidney, New York 13838.



(continued from page 30)

high-impedance input or you can lose the signal, since the output is typically a few millivolts."

Some engineers, though, feed the thermocouple output into an analog panel meter after they run 30 to 50 ft. of wire. This will damp out and load down the thermocouple output to the point where the signal is wiped out.

Noncontacting temperature sensors are also gaining popularity. These devices use infrared sensitive semiconductor materials to generate linear output voltages. Spectran Instruments, for example, manufactures a noncontacting sensor that can measure temperatures of several thousand degrees, has a 1-s response time and is completely self-generating. Full-scale outputs of this device, depending upon the model, range from 2 to 10 mV. Prices for the units start at about \$350. All units have provision for water cooling.

### New uses for pressure transducers

Pressure transducers also are undergoing substantial change.

One of the more outstanding developments, though over a year old, comes from National Semiconductor. The company has succeeded in reducing the strain element in the transducer and all of the required circuitry to three IC chips—a piezoresistive strain chip, complete with vacuum reference and two op-amp chips. These chips are mounted on a ceramic substrate that contains thick-film resistors. The substrate can then be placed in any desired package style.

Just released from National is an improved pressure transducer, the LX3700. The units in this series offer a sevenfold reduction in temperature coefficient—down to 0.5 mV/°C—and a doubling of the operating temperature range over which a tight spec is maintained to cover -25 to +75 C.

LX3700 units use a heating element to keep the internal temperature almost constant and to minimize drift. With the drift kept low, errors can be held to 1%. But these thermostated units draw more power—about 400 mA total, compared with 15 mA for the older LX1700 units.

Pressure transducers are finding

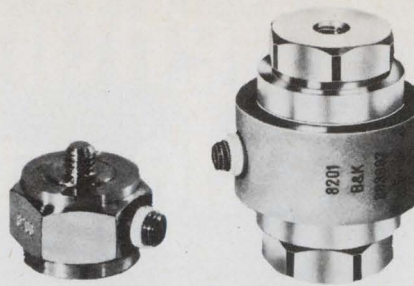

**Force transducers**—Models 8200 and 8201, made by B&K Instruments—can handle forces of -1000 to +5000 N or -4000 to +20,000 N, respectively.

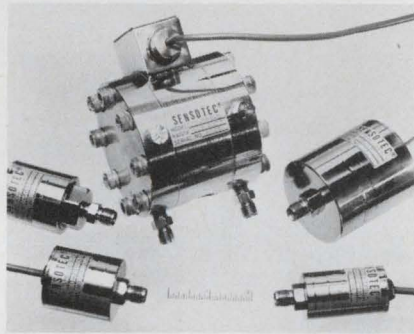

**The TJE series of pressure transducers** feature a 0.1% static error band. These units, made by Sensotec, cover pressures as low as 20 in. of water to over 30,000 psi.

new applications in the automotive industry, where "engineers are taking good, reliable designs and reducing the cost tremendously through high-volume production," says John Hayer, director of marketing for Gulton Industries, Servionic/Instrumentation Div. Cast-metal housings are used instead of the finely machined cases required in military applications. Inside, though, the circuits are almost identical—and just as reliable.

In automotive applications pressure transducers will be used to measure manifold pressure—a part of electronic fuel-injection systems now being tested.

An example of where this change is occurring is in the GS-100 series of pressure transducers made by Gulton Industries. The GS series units are LVDT (linear velocity displacement transformer) pressure transducers. Some units include not only the signal conditioning electronics, but a voltage-regulator circuit. High-volume prices for these units are projected in the \$30-to-\$50 range.

Pressure transducers are constructed in many different ways. Some use piezoelectric crystals, piezoresistive materials or bonded strain elements. BLH Electronics and Genisco Technology use the bonded type. The full line of models offers full-scale ranges typically from 50 to 100,000 psi.

Schaevitz Engineering, on the other hand, uses the LVDT as a pressure transducer. Columbia Research Labs uses piezoelectric and piezoresistive materials to obtain pressure information.

All these older transducers require signal conditioning. Manufacturers such as Statham, Columbia, BLH, Schaevitz are including the signal conditioning circuitry inside the metal cases.

### Two types of strain gauges

Strain gauges have excellent dynamic response, long life, low hysteresis and good repeatability. Both foil or semiconductor types are used extensively, and each has its own advantages.

The life of metal-foil gauges depends upon the operating strain level; typically it is  $2 \times 10^6$  cycles when they are stressed by 1000 microinches/in. Piezoresistive semiconductor gauges have comparable lifetimes if large strains are avoided.

Although both have the same expected lifetime, the foil gauges are still preferred at high temperatures.

Semiconductor strain elements, although limited by their usable operating temperature range, are employed by such companies as Ramapo, Entran and Sensotec in various transducers that range from flow to acceleration.

Piezoresistive gauges have a resistance variation that is more than a hundred times greater than that of the foil type. Thus if the piezoresistive elements form the arms of a Wheatstone-bridge circuit, large output-voltage changes can be produced. However, these large swings also result in very nonlinear output variations.

Integrated strain elements have improved the resolution of strain gauges. The strain elements usually are mounted on a diaphragm that distorts under pressure. But there are problems with this scheme: It's hard to bond the foil elements onto the diaphragm; the bonding com-

# ERIE RESPONDS. that's why WE'RE NO. 1 WORLDWIDE in Ceramic Capacitors



Forty years ago, ERIE foresaw a need and introduced the first ceramic capacitor to U.S. markets. Today, more than 7000 people—working in a million-plus square feet of plant space—in seven nations . . . are still dedicated to fulfilling customer needs. Our state-of-the-art ceramic technology continues to lead the way in the development of smaller, more efficient ceramic capacitors, both fixed and variable. And ERIE's line of high quality components is as broad as the markets we serve. So when knowledgeable people think ceramic capacitors, increasingly, they think ERIE. To remain number one in our competitive industry, we *have* to be responsive to your needs. We think we are. Try us.

ERIE TECHNOLOGICAL PRODUCTS, INC.  
Erie, Pennsylvania 16512  
INFORMATION RETRIEVAL NUMBER 23



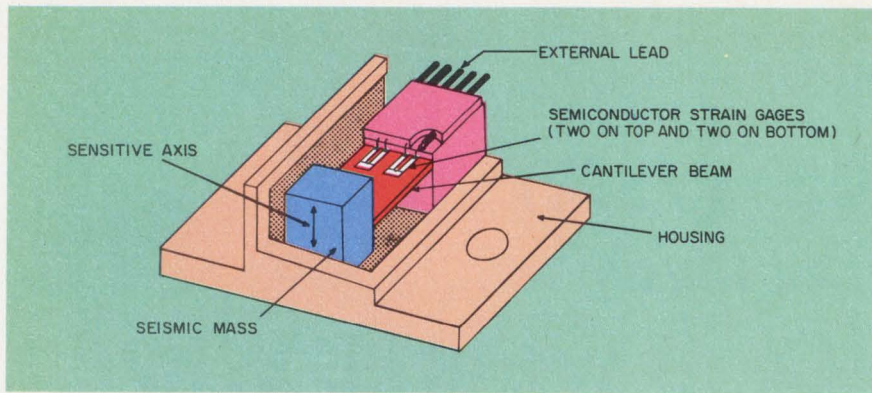

The ECG-240 accelerometer from Entran uses semiconductor strain elements within a cantilevered beam and has a piezoresistive output.

pound loosens at high temperatures; strain elements may change position on the diaphragm's surface and the discrete strain elements are limited in frequency range.

To avoid some of these problems, strain elements are now diffused right into a silicon chip, which is then mounted on the diaphragm or, in some cases, becomes the diaphragm itself. Hayer of Gulston predicts that in "four years or so, strain-gauge diaphragms will have the conditioning circuits diffused into them along with the strain elements." These strain transducers should cost about \$5 each in million-piece orders, he says.

### Accelerometer applications grow

Sensors for measuring acceleration are also finding new applications. For instance, nuclear-powered generating plants are using them to detect shaft vibration in generating equipment and thus to help prevent massive generator failures. Several new piezoceramic materials can operate at high temperatures and radiation levels.

Accelerometers, such as those made by B&K Instruments, use piezoelectric materials to measure shock, vibration and, of course, acceleration. Most accelerometers require special signal-conditioning equipment, but this extra equipment is slowly disappearing as more manufacturers include the circuitry inside the sensor case.

Three materials, developed by B&K Instruments, cover a very wide range of applications: MT-8, lead-titanate-zirconate compound, has a high sensitivity (about 300 picocoulombs per newton) and can be used up to 260 C; MT-40, a

ceramic, is useful up to 400 C and has a very flat response curve; and MT-100, a quartz crystal, has the best long-term stability available and is used where low temperature coefficients are needed.

Piezoelectric accelerometers, still the most widely used, have a lot going for them:

- Different models can measure g forces from 0.001 to 100,000.
- Frequency responses can vary from 2 Hz to over 50 kHz.
- Accuracies range to within 3 to 5% of reading.
- Operating temperature ranges cover -425 to +1400 F.
- Prices range from about \$125 to over \$500.

Solid-state strain-gauge accelerometers, in comparison, cover forces from 5 to 1000 g's, frequencies from dc to 10 kHz and work with temperatures from -65 to 250 F. Prices for these devices typically range from \$225 to \$400.

### LVDTs: Old reliables

One of the oldest and still most widely used transducers is the linear velocity displacement transformer (LVDT). There have been many developments that have kept them in the forefront of the field:

- Conversion circuitry to permit operation from dc or ac.
- A tertiary winding that improves resolution.
- Special impregnation compounds for critical environments.
- Better core alloys and better annealing processes to give very smooth magnetic characteristics.
- Internal electronics that does away with all supporting circuitry except the power supply.
- Spun magnetic shields to

eliminate interference from external fields.

The LVDTs provide frictionless measurement—there is no contact between the movable core and the coil structure.

Since there is no mechanical contact, the mechanical life is almost infinite. In addition, because of the physical separation of coil and core, a nonmagnetic material can be interposed. And, since LVDTs operate on an induction principle, they can respond to the most minute motion of the core and produce an output. The symmetry of the LVDT's coils also has another plus—null repeatability.

LVDTs are available for almost any application and at just about any price. Typical specs might read as follows: Input voltage, 6 V rms; frequency range, 50 Hz to 10 kHz; temperature range, -65 to +300 F; null voltage, less than 0.5% full scale output; linear range (depending upon model)  $\pm 0.05$  to  $\pm 25$  in.; sensitivity, typically 0.1 mV/0.001 in./V input and carrier phase shift, at 400 Hz, anywhere from +11 to +45°. Prices for units vary from \$15 to \$550.

Other types of displacement sensors include magnetic-flux sensing devices such as those manufactured by Electro Corp. The units can sense a change in the magnetic flux surrounding a permanent magnet and coil. When the flux changes, the coil delivers an electrical signal. Airpax and others also make these units.

Some of these flux sensors also include special circuitry that shapes the coil output into transistor-transistor logic-compatible pulses. This circuitry appears either as an IC chip, a hybrid or a discrete component array.

As light-emitting diodes are approaching the cost of incandescent lamps, more circuits that use the spectrally pure characteristics of the LED are being used to measure distance or displacement. A number of companies, including Scientific Technology and Controlcraft, make LED displacement sensors.

Other techniques such as rf or ultrasonic doppler circuits are being developed by Controlcraft to detect motion or displacement. New components are also helping to reduce the size of the complex circuits needed for these methods.

One of the hardest measurements

# SUPER CHIPS!

Look to Varadyne for the best ceramic chip capacitors in the business . . . they're super!



## Complete Ceramic Chip Capacitor Capability!

**RANGE** — Our chips are offered in capacitances from 1.0 pF to 4.7 mFd.

**SIZE** — We offer nine standard sizes, 30 special sizes, plus micro-miniature chips for integrated circuits.

**MIL APPROVAL** — We have MIL approved chips qualified to MIL C-55681.

**FORMULATIONS** — Our four ceramic formulations range from K 30 to over K 7,000 — Type BN (Frequency Stable) NPO, Type BP (Ultra Stable) NPO, Type BX (Stable) X7R and Type GM (General Purpose) X5V/Z5U — one of which can solve your capacitor problems.

## Super Specs?



Lay 'em on Varadyne! We'll come back, in no time at all, with super chips that meet or exceed the standards you set. Our Q/C people won't settle for anything less.



## Fast Delivery!

We've made long lead times obsolete. Does six weeks sound good? Four weeks? Two weeks? In stock? If we agree on a date, we'll meet it!

## Need more data?

We'll send you technical literature on our chip line — both capacitors and resistors. We'll even include our leaded capacitor literature if you like; axial "G2-Cap" or radial "Clover Cap."

## Super Chip!

We'll perform where it counts! In planning, production and quality control.

We've set records with innovative packaging and volumetric efficiency since the introduction of the ceramic chip!

## Big order?

Hand it to us. We'll cut it down to size.

Our expanded production lines move out even the largest orders with ease!

OVER 350 MILLION SOLD

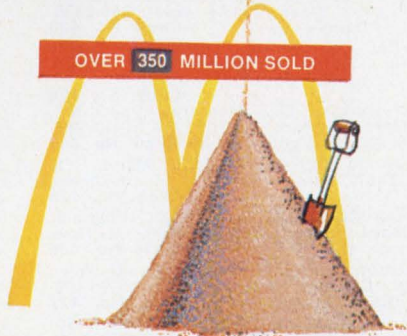

*We're on the move!*

## VARADYNE

Varadyne Industries, Inc.  
Capacitor Division  
2110 Broadway, Santa Monica, California 90404  
Phone (213) 829-2984 • TWX (910) 343-6856



*We've learned a lot!*

INFORMATION RETRIEVAL NUMBER 24

to make without affecting what you are measuring is flow. There are many methods, including orifice plates, turbine generation, variable area, magnetic fluids, vortex precession, target area and strain gauge. Many different measuring methods are available from companies like Foxboro, Ramapo and Fluidyne.

### Flow measurements made easy

Ramapo, for example, uses foil strain gauges attached to a target within the flow stream. Typical flowmeters for a 1-in. diameter

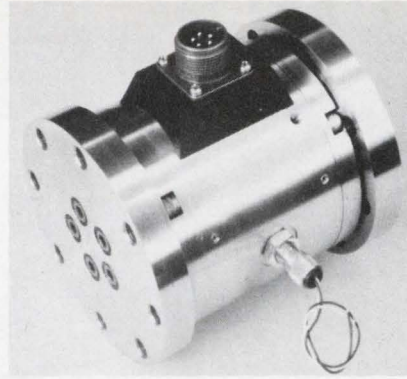

**Noncontacting foil strain gauge transducers** from S. Himmelstein & Co. have a 200% overload capacity and a linearity of 0.1% of full scale.

tube and that cover a measurement range of 4 to 15 ft./s (equivalent water flow) cost about \$500. They are also usable over temperatures that span -65 to +300 F. Options for the flowmeters permit operation down to -320 F and add anywhere from \$75 to \$300.

Advances in optical design have led to the development of flowmeters that use LEDs and photosensors to determine flow. For instance, SpaceKom has developed an optical flowmeter that can convert fluid flow into equivalent units, in say, miles per gallon or any other scalable unit. ■■

## Need more information?

The companies and products cited in this report have been selected for illustrative qualities. The transducers of these and other companies are identified below. The code to these products indicates what functional area they cover: (A)—acceleration, (D)—displacement, (F)—flow, (L)—load, (P)—pressure, (S)—strain and (T)—temperature.

Acurex Corp., 485 Clyde Ave., Mountain View, Calif. 94042. (415) 964-3200. (T. Tilton). (D) **Circle No. 400**

Airpax Electronics, Inc., Controls Div., 6801 W. Sunrise Blvd., Fort Lauderdale, Fla. 33313. (305) 587-1100. (P. Webster). (D) **Circle No. 401**

Astrosystems, Inc., 6 Nevada Dr., Lake Success, N.Y. 11040. (516) 328-1600. (G. Steinberg). (D) **Circle No. 402**

B & K Instruments, Inc., 5111 W. 164th St., Cleveland, Ohio 44142. (216) 267-4800. (B. Rhodes). (A) **Circle No. 403**

BLH Electronics Inc., 42 Fourth Ave., Waltham, Mass. 02154. (617) 890-6700. (H. Owens) (D,L,P,S,T) **Circle No. 404**

Bell & Howell, 360 Sierra Madre Villa Ave., Pasadena, Calif. 91109. (213) 796-9381. (R. Batiste). (A,P) **Circle No. 448**

C. J. Enterprises, P.O. Box 4134, Panorama City, Calif. 91412. (213) 764-2529. (M. Cantor). (P,S) **Circle No. 405**

Climatronics Corp., 1324 Motor Pkwy., Hauppauge, N.Y. 11787. (516) 234-2772. (T. Schreiber). (D,T) **Circle No. 406**

Columbia Research Labs., MacDade Blvd. & Bullens La., Woodlyn, Pa. 19094. (215) 532-9464. (J. Sarty). (A,L,P,S) **Circle No. 407**

Computer Conversions Corp., 6 Dunton Ct., East Northport, N.Y. 11731. (516) 261-3300. (S. Renard). (D) **Circle No. 408**

Controlcraft Corp., 213 Main St., West Chicago, Ill. 60185. (312) 231-7511. (R. Warner). (D) **Circle No. 409**

Crystal Technology Inc., 2510 Old Middlefield Way, Mountain View, Calif. 94043. (415) 961-9311. (L. Castelli). (A, P) **Circle No. 410**

Davco Manufacturing Co., 169 Ridgedale Ave., Morristown, N.J. 07960. (201) 267-4990. (J. Pappas). (D) **Circle No. 411**

Electro Corp., 1845 57th St., Sarasota, Fla. 33580. (813) 355-8411. (G. Gee). (D) **Circle No. 412**

Endevco, Rancho Viejo Rd., San Juan, Capistrano, Calif. 92675. (714) 493-8181. (R. Quackenbush) (A) **Circle No. 413**

Entran Devices, Inc., 145 Paterson Ave., Little Falls, N.J. 07424. (201) 785-4060. (W. Caplan). (A,L,P,S) **Circle No. 414**

Figaro Engineering, 3-15-6 Higashitoyonaka, Toyonaka City, Osaka, 560, Japan. (K. Tsukada). (Gas) **Circle No. 415**

Fluidyne Instrumentation, 1631 San Pablo, Oakland, Calif. 94612. (415) 444-2376. (R. Jennings). (F) **Circle No. 416**

Foxboro, Foxboro, Mass. 02035. (617) 543-8750. (E. Seifert). (F,L,P,S,T) **Circle No. 417**

General Eastern Corp., 36 Maple St., Watertown, Mass. 02172. (617) 923-2386. (T. Richardson). (T) **Circle No. 418**

Genisco Technology Corp., 18435 Susana Rd., Compton, Calif. 90221. (213) 537-4750. (J. Muhleman). (A,P) **Circle No. 419**

Gilmore Industries, Inc., 3355 Richmond Rd., Cleveland, Ohio 44122. (216) 464-1200. (W. Heisler). (S) **Circle No. 420**

Gulton Industries, Inc., Metuchen, N.J. 08840. (201) 548-2800. (A. Orlacchio). (A,D,P,S) **Circle No. 421**

Gulton Industries, Inc., P.O. Box 4300, Fullerton, Calif. 92634. (714) 871-2150. (C. Edmiston). (A,D,P,S) **Circle No. 422**

HH Controls Co., Inc., 16 Frost St., Arlington, Mass. 02174. (617) 646-2626. (W. Edins). (D) **Circle No. 423**

Hy-Cal Engineering, 12105 Los Nietos Rd., Santa Fe Springs, Calif. 90670. (213) 698-7785. (A. Bowman). (T) **Circle No. 424**

ITT Barton, 580 Monterey Pass Rd., Monterey Park, Calif. 91754. (213) 283-6501. (G. Mechelin). (F) **Circle No. 449**

Keystone Carbon Co., St. Marys, Pa. 15857. (814) 781-1591. (T. Krellner). (T) **Circle No. 425**

Massa Corp., 280 Lincoln St., Hingham, Mass. 02042. (617) 749-4800. (M. Howard). (D) **Circle No. 426**

Metritape, Inc., 77 Commonwealth Ave., W. Concord, Mass. 01742. (617) 369-7500. (D.F.) **Circle No. 427**

Micro-Radian Instruments, 116 Main St., Seal Beach, Calif. 90740. (213) 598-2722. (T. Thurston). (D) **Circle No. 428**

National Semiconductor Corp., 2900 Semiconductor Dr., Santa Clara, Calif. 95051. (408) 732-5000. (B. Hess) (P,T) **Inquire Direct**

Non-Linear Systems, Inc., 533 Stevens Ave., Solana Beach, Calif. 92075. (714) 755-1134. (P) **Circle No. 429**

Omega Engineering, Box 4047, Springdale Station, Stamford, Conn. 06907.

(203) 359-1660. (C. Gessner). (T) **Circle No. 430**

Ormond, Inc., 11969 East Rivera Rd., Santa Fe Springs, Calif. 90670. (213) 698-0641. (J. Wilbur). (L) **Circle No. 431**

PCB Piezotronics, Inc., P.O. Box 33, Buffalo, N.Y. 14225. (716) 684-0001. (J. Lally). (A) **Circle No. 432**

Ramapo Instrument Co., Bloomingdale, N.J. 07403. (201) 838-2300. (G. Anderson). (F) **Circle No. 433**

Relco Products, Inc., 2133 S. Bellaire St., Denver, Colo. 80222. (303) 756-1143. (R. Ruehle). (T) **Circle No. 434**

S. Himmelstein & Co., 2500 Estes Ave., Elk Grove Village, Ill. 60007. (312) 439-8181. (J. Hall). (S) **Circle No. 435**

Schaevitz Engineering, U.S. Rte. 130 & Union Ave., Pennsauken, N.J. 08101. (609) 662-8000. (H. Schaevitz) (A,D,P) **Circle No. 436**

Scientific Technology, Inc., 1157 San Antonio Rd., Mountain View, Calif. 94043. (415) 965-0910. (D. Persen). (D) **Circle No. 437**

Sensors, Inc., 3908 Varsity Dr., Ann Arbor, Mich. 48104. (313) 973-1400. (D. Giles). (T) **Circle No. 438**

Sensotec Inc., 1400 Holly Ave., Columbus, Ohio. 43212. (614) 294-5436. (C. Easton). (L,P) **Circle No. 439**

Singer, 1150 McBride Ave., Little Falls, N.J. 07424. (201) 256-4000. (D. Katz). (A,D) **Circle No. 440**

SpaceKom, Inc., P.O. Box 10, Goleta, Calif. (805) 967-7114. (G. Spacek). (F) **Circle No. 441**

Spectran Instruments, P.O. Box 891, La Habra, Calif. 90631. (213) 694-3995. (T) **Circle No. 452**

Statham Instruments, 2230 Statham Blvd., Oxnard, Calif. 93030. (805) 487-8511. (G. Bourke). (P) **Circle No. 442**

Tempo Instruments Inc., E. Bethpage Rd., Plainview, N.Y. 11803. (516) 694-4402. (H. Pinto). (D) **Circle No. 452**

Tensitron, Inc., Harvard Depot Rd., Harvard, Mass. 01451. (617) 456-3511. (E. Saxl). (D,L,P) **Circle No. 443**

Thermo Electron Corp., 101 First Ave., Waltham, Mass. 01451. (617) 890-8700. (J. Beville). (P) **Circle No. 444**

Transducers Inc., 12140 East Rivera Rd., Whittier, Calif. 90606. (213) 945-3741. (H. Nielsen). (L,P) **Circle No. 445**

Trans-Tek Inc., Rte. 83, Ellington, Conn. 06029. (203) 872-8351. (S. Scyocurra). (D) **Circle No. 446**

Tyco Instrument Div., 4 Hartwell Pl., Lexington, Mass. 02173. (617) 861-7450. (R. Cerchione). (L,P) **Circle No. 447**

Vibra-Metrics, Inc., 150 Bradley St., East Haven, Conn. 06512. (203) 467-6335. (J. Judd). (A) **Circle No. 450**

West Coast Research Corp., P.O. Box 25061, Los Angeles, Calif. 90025. (213) 478-8833. (A,D,P,S) **Circle No. 451**



**Put it all together  
with Buchanan  
Printed Circuit Board  
Connectors – and  
eliminate 4 connection  
points per circuit!**

Here's a new solderless printed circuit connector that eliminates hybrid interfaces between electrical and electronic circuitry. It replaces costly interwiring between terminal blocks, barrier blocks, and internal electronics... saves you up to 4 or more separate connection points per circuit!

With only a screwdriver and this new Buchanan one-piece connector, you can quickly connect solid or stranded wires, #12 through #30 AWG, to standard .200" contact-spaced printed circuit boards. The connector block is available for 12, 18, 24, 30 and 36 circuits; provides 300V insulation spacing between circuits; can carry up to 5 amperes per circuit; and is flame-retardant.

A unique right-angle design provides mounting flexibility and increased density, and the block can be mounted against any two adjacent panel sides if desired, since wire entry is all on one side. You can even "daisy chain" two or more conductors!

For complete engineering, pricing and ordering information, write us at Dept. ED-4.



**CONTROL PRODUCTS  
DIVISION**

Amerace Corporation  
Control Products Division  
2330 Vauxhall Road  
Union, New Jersey 07083

# Inflation, energy, semiconductors to dominate tomorrow's electronics

Almost every industry and government leader who spoke at a recent London conference emphasized three key factors that will dominate the electronics industry in the coming decade. In one way or another, they said, the industry will be affected dramatically by inflation, energy consumption and all-pervasive semiconductors.

The first speaker at the conference "Tomorrow in World Electronics," sponsored by ELECTRONIC DESIGN, the Financial Times, Electronics Weekly and British Airways, set the stage. Sebastian de Ferranti, chairman and managing director of Ferranti Ltd. pointed out that the recent fuel crisis drew attention to the fact that the era of very cheap fuel is finished. A more energy-conscious economy, he said, will develop energy by more capital-intensive means that will be initially more expensive, but will produce over-all economy.

While such schemes develop, Ferranti continued, applied electronics will grow rapidly, unaffected

by temporary or longer term alarms about energy economy. This is because most electronic devices use little energy so they provide good value for fuel. Further, a move towards real economy in energy consumption would stimulate electronic expansion.

## Energy quality vs. quantity

Taking a different tack, Dr. Edward David, Jr., executive vice president of Gould Inc., and former science advisor to President Nixon, made two basic assertions. First, he said, our post-Industrial society is moving from an energy-intensive society to an information and data-intensive one. And second, we will see greater emphasis on energy quality rather than quantity.

This progression comes about because, as a country develops, it tends to spend more on services—education, medical care, travel—and less on material goods. The evolution, David continued, is from machinery for manufacturing, mining and other production of goods, toward measurement, control and communications.

Actually, he went on, there is no

shortage of energy. The shortage is of energy available where and when it is required, in the form needed, and convertible to useful work efficiently. There are, in fact, vast amounts of energy available from unconventional fossil sources, the sun and the oceans. But the quality of these resources makes the energy available only with difficulty and at high cost because of expensive extraction techniques, low energy density, inconvenient location and form.

As an example of what remains to be done, David showed (Fig. 1) that the volume and weight of a battery in an electronic watch exceed that of the other components. There is great progress, though, in developing higher-energy-density battery systems. Two very promising examples lie in the zinc air battery, which uses air as one reactant, and the lithium battery, which uses highly reactive and light lithium as an anode.

More advanced battery systems (Figs. 2 and 3) may furnish even greater advantages in specific applications.

## The driving force: inflation

As the electronics industry expands, and all speakers at the conference agreed that it would, its biggest cause for anxiety will be the general problem facing industry in all advanced countries. That problem, according to David Price, Member of Parliament, chairman of the Parliamentary and Scientific Committee, and a founder of the Committee on Science and Technology, will be how to live with and adapt to mounting inflation and the inevitable oscillations of governments in their counter-inflationary policies.

Most industries, Price pointed

George Rostky  
Editor-in-Chief

Component	Minimum	
	Dimen., cm	Volume, cm <sup>3</sup>
Battery	0.42	0.88
Quartz Crystal	0.28	0.13
Electronics	0.13	0.016
Display	0.09	0.21

1. Space required by the battery is out of proportion to that needed by other components in an electronic watch. This is an area that needs improvement.



Even when it was only \$35 an ounce, gold was expensive. That's why we started long ago to reduce the amount of gold in our contacts to a minimum.

In 1958 we developed a really reliable gold dot contact. And no matter what anyone else says, only silver and copper are better electrical conductors than gold

(but gold doesn't oxidize or corrode).

Over the years we've been able to reduce the cost because we reduced the gold.

And we've been reducing the amount over the years without reducing the mechanical or electrical quality of our connectors.

Now, after all these years, we

find out that we not only reduced cost but we've been making our own small contribution to solving our country's gold problem.

And all because we wanted to design a more economical, more reliable gold-contact connector.

**GTE SYLVANIA**

INFORMATION RETRIEVAL NUMBER 26

## Our small contribution to solving the gold problem.



Battery	Wh/Lb	W/Lb	\$/kWh	Life Cycle	Projected Availability
<b>Group I</b>					
Lead-Acid	16-18	25	20-50	300-2000	Now
Nickel-Iron	20-30	60	20-30	300-400	1976
Nickel-Zinc	30-40	75	20-25	250-350	1977
<b>Group II</b>					
Zinc-Chlorine (Hydrate)	60	60	10-20	500*	1978-79
Lithium-Sulfur	60-80	100	15-20	1000*	1980-85
Sodium-Sulfur	80-100	100	15-20	1000*	1980-85

\*Nominal life based on current experimental models.

## 2. Characteristics of today's lead acid battery and other energy sources that are likely to be available in the future.

out, have learned to adapt to some inflation without too many tears. But the rates of inflation currently being experienced are of a new and punishing order. All, he said, were much higher than have been experienced in previous years. He cited figures based on cost-of-living indices for the past 12 months and for the preceding year.

A few years ago, Price reminisced, we worried about a 3% continuing inflation. But today, he said, "I know of no government which knows how to keep inflation down to an annual rate of 3%—and get itself elected. For the electronics industry," he continued, "my message is very simple: Fasten your seat belts; we're expecting turbulence ahead."

### Role of government profound

Government is important—not only in its role as inflation fighter. The electronics industry, Price pointed out, depends largely on government purchasing and on government specifications and standards. This point was emphasized by Dr. Ieuan Maddock, chief scientist of the British Department of Trade and Industry. "In nearly every country in the world," he pointed out, "you'll find government, in one form or another, provides a considerable amount of research and development funding of the electronics industry." And government is a very large customer of the industry—in defense, in those matters that concern safety, like

air-traffic control, and in telecommunications and broadcasting.

The deep involvement, said Maddock, creates a special problem, as it may have overemphasized R&D. We tend to look at the future of our industry in terms that outdate the product we are producing now. We persuade our customer that the thing he must buy now is out of date by 1980. We have an enormous technological push constantly to outdate the present. So every product has a limited lifetime.

### Electronics bucks inflation

The electronics industry has certainly contributed to the "constant outdating" problem. But it has added little to inflation. In fact, many components and equipments have successfully resisted or, at times, overcome, the inflationary tide—directly and indirectly.

Earl Wantland, president of Tektronix, Inc., pointed out that a dc-to-20 MHz oscilloscope sold, in 1950, for \$1650—roughly \$3350 in today's dollars. Today, for \$3350 you can buy a scope with 10 times the bandwidth and 50 times the sensitivity. And it could include new features like delaying sweep, CRT readout of measurement parameters and greater display brightness, along with other convenience features.

He gave a further example, based, largely, on the marriage of the computer with instruments. The average salary of an engineer runs to about \$15,000 to \$20,000. The

installed value of his complement of instruments is about \$15,000 to \$20,000. But his salary is an annual expense, while the cost of his equipment is a one-time expenditure. And instruments that allow an engineer to do his work faster pay off handsomely.

One of the key responsibilities of instrumentation companies, Wantland suggested, is to supply the measurement tools for developing advanced technologies—a never-ending requirement.

The art of waveform measurements has made substantial progress already, Wantland said. But we are now on the threshold of even greater advances. A waveform has a lot of information that is not apparent from viewing it alone. So we'll need further computer processing and, in turn, smaller digitized increments for a computer to process. Digitization is relatively easy for waveforms that change slowly. It is far more difficult with incredibly fast waveforms like those encountered in nuclear physics and laser physics.

Today we can capture an event that lasts only 5 ns and hold the waveform in digitized form so that we can divide it into 500 slices, each representing 10 ps. But in the area of fast transient phenomena, we can't stop. Each achievement calls for the next, as scientists and engineers demand to see and understand more.

Further, when we take a digitized pulse waveform, we can perform the mathematical conversion from time domain to frequency domain via the Fourier transform. This technique is particularly useful in transmission systems as it provides a "signature" of the system that can be used for later troubleshooting.

Such an application is characteristic of the instrumentation industry; instruments extend the human mind by an easy-to-use interface to electronic calculations.

### Instruments to become smarter

John Fluke, chairman of John Fluke Mfg. Co., emphasized some of the points made by Wantland. Tomorrow's instruments, he said, will increasingly relieve the engineer of calculation burdens. In addition more of them will be capable of operation by remote control.

The instrument manufacturer will be called upon to provide better service, Fluke said, today's being inadequate. Because of the lower cost of instrument, he will have to learn to distribute them better; he still doesn't know how.

Instruments will show greater emphasis on low power, small size and portability. So the use of rechargeable batteries will give way to disposable batteries.

Because of increasingly stringent reliability requirements, instruments, like other manufactured products, will increasingly be checked by something sufficiently stupid not to ask questions—something like automatic test equipment. So the cost of an instrument's labor content will be reduced. LSI will help reduce the cost and it will help improve reliability.

As LSI technology settles, instrument manufacturers will have to develop their own LSI-design capabilities. Because the instrument represents a considerable amount of originality, reliability and usability, and because of the close coupling required between instrument and LSI designer, the instrument manufacturer won't be able to relegate LSI design to outsiders.

### Integrating up and down

While Fluke saw instrument manufacturers driven to downward integration, another speaker, Dr. Morris Chang, group vice president of Texas Instruments, saw semiconductor manufacturers integrating upward. Chang pointed out that momentum has increased for semiconductor manufacturers to expand into systems business, but he argued that the reverse motion is less likely.

The first barrier to downward integration is that the systems manufacturer may not have semiconductor technology, and would require considerable time, investment and talent to develop it. The second barrier is that a systems manufacturer would have to develop a large production base in semiconductors and sufficient research and development to remain competitive.

On the other hand, said Chang, the drive to integrate upward is easier and it can be very fruitful.

# Which Heinemann overvoltage protector should watch over your electronics?

**Below 5 amp dc** Our tiniest hybrid (a thick-film microcircuit) packs a sensing amplifier, control circuit, and SCR "crowbar". When voltage equals the protector's rating, the SCR fires, shunting the load to ground in 500 nanoseconds—before any damage can be done.

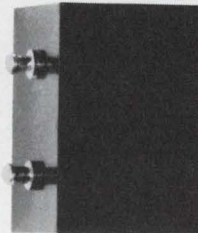
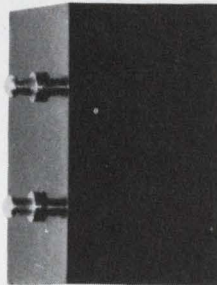

**5-30 amp dc** These protectors are made from discrete electronic components, but they offer the same protection and economy as the hybrids. Series 10 can handle up to 10 amp. Series 30 is good for 30 amp. Both are available in a range of trip voltages.

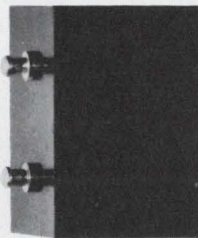

**Up to 1 amp ac** A 200V trip rating makes our Series 1 protector ideal for electronic equipment operating from a 117V line.

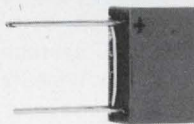

**Transient clipper** This device absorbs the energy of a transient while clamping the line to a predetermined voltage, allowing your circuits to continue operating during a voltage transient.

You can't build protectors like these for anywhere near our low prices. And our single-package design eliminates all the multi-component assembly and mounting problems of do-it-yourself units. For complete technical data, have us send you Bulletin 3372. Heinemann Electric Company, Brunswick Pike, Trenton, N.J. 08602.



## HEINEMANN

The most important motivation is higher growth resulting from increased value added for products where the principal function is already performed by semis.

As an example, consumer calculators have a semiconductor content of 30-35%. So if the manufacturer sells semiconductors to a calculator manufacturer he gets, say, \$15 of sales. But if he makes and sells the calculator himself, he gets \$45 of sales. Similar increases in value added exist, said Chang, in minicomputers with semiconductor memories. For data terminals, point-of-sale systems and electronic watches, the multiplying factor is even larger.

In other areas, however, the arithmetic is not so encouraging. Semiconductor manufacturers don't really know picture-tube technology, for example. So color TV is not an easy candidate for vertical integration by semiconductor manufacturers in the near term.

Similarly, the systems marketing, software and other technologies required in mainframe computers constitute great barriers to upward integration.

Another reason for upward integration is that the rapid advance of semiconductor technology has shrunk the product lifetime of end equipment, and this demands close coupling between the device manufacturer and the end market.

This rapid advance is best illustrated in the electronic calculator. In 1966 a four-function calculator sold for almost \$1500 and used more than 1000 transistors and diodes. In 1968, integrated circuits made calculators with transistors and diodes obsolete. In 1970 the MOS LSI calculator hit the market. And in 1971 a single MOS chip was sufficient for a four-function calculator. So the average life of a calculator has been no more than one or two years.

Similar changes can be seen in minicomputers and in electronic timepieces. So the rapid pace demands that the design of the semiconductor component, if it can still be called a component, proceed in parallel with the design of the end equipment.

While such parallel development can be done between a component vendor and a systems customer, trade secrets and proprietary inhibitions tend to make parallel de-

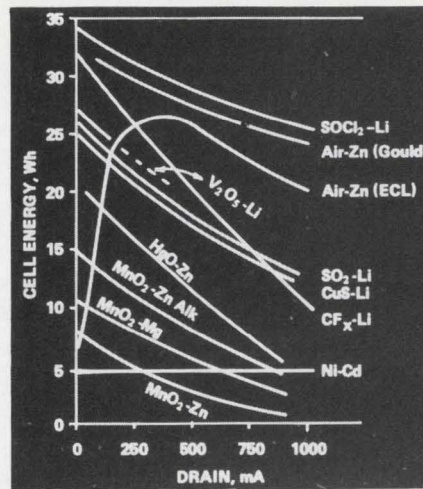

3. Cell energy as a function of current drain for several battery systems in D-cell size.

velopments between two companies less satisfactory than parallel developments within the same one.

Further, as semiconductor components become more complex, the investment required becomes more substantial. Rapid product obsolescence allows only a short time window in which to recover the investment. It thus becomes essential for the semiconductor manufacturer to use this window to the maximum by getting the end equipment to the market as early as possible.

Vertical integration doesn't benefit the semiconductor manufacturer alone. It provides a new element of competition in the end-equipment market, so it gives end customers a more competitive supply situation and gives them an advantage in cost and in wider choice of equipment.

The traditional systems manufacturer derives benefits, too—lower component cost and broader markets resulting from lowered semiconductor cost. As an example, it was estimated in 1971 that a portable calculator retailing for \$200 would open the large consumer market. It did. When the price was cut to the \$150 range, the market more than quadrupled. And it took another dramatic spurt when the price dropped to less than \$100.

### Semis to grow even faster

The growth of semiconductors suggested by Chang was made more explicit by Dr. C. Lester Hogan, president, Fairchild Cam-

era and Instrument Corp. Hogan argued that the greatest growth years of semiconductors lie ahead.

While the semiconductor market outside the United States is now larger than that within the U.S. and will continue to grow in comparison, the over-all market will continue to grow so rapidly that the U.S. total market will increase, despite the fact that its percentage of the total will decline.

The mix of semiconductor usage will change, too. By 1980 sales of discrete semiconductors will decrease from 51% to 39% of the total. But because total semiconductor usage will increase dramatically, discrete volume will actually increase—from \$2.7 billion to \$4.5 billion.

Percentagewise, bipolar digital ICs won't grow as fast as MOS, but each should enjoy an annual market of about \$2.5 billion in 1980. Today's projections don't include new technologies—like charge-coupled devices, which should reach some significant volume in 1980. The CCD is slower than MOS, but it can be a lot cheaper, perhaps 1/10 the cost.

### 100,000 bits per chip

The CCD may open up many new applications. It has already found a place in imaging devices. And it may find a place as a replacement for fixed-head disc memories—though it seems unable to compete with floppy discs, which appear much cheaper. But the whole architecture of computers might change as charge-coupled devices become available with complexities of, say, 100,000 bits on a chip, speeds that may be 10 to 20 times faster than today's fixed-head discs, and with 1/10 the cost.

So the semiconductor industry will expand, not only because of the normal expansion of its traditional customer base, but also by technological substitution—where solid state replaces electromechanical devices. Further, it will grow in applications not possible with other technologies—timepieces, calculators, appliances and what have you.

Dr. Robert Heikes, managing director of Motorola Europe, underscored Hogan's optimism. He pointed out that the world electronics industry is growing about 50% faster than the world economy.

# SPECIAL STYLES. ENDLESS CHOICE. CUTLER-HAMMER.

Cutler-Hammer has responded strongly to the new emphasis on styling in appliances and other equipment with fresh new design in switches.

Our unique rocker and paddle type switches have a new look. They're not only the finest in performance, but smartest in styling compared to traditional toggle and rotary operators.

From a simple one pole Rockette® switch to a specifically designed unit combining a variety of features, Cutler-Hammer can solve your special problem. Illuminated, snap-in, nest-, sub-panel- or flush-mounted, sealed miniature, multi-pole, you name it. AC and DC ratings. Up to 20 amps. The choice has to be Cutler-Hammer!

And when you need an *extra special* special design, we'll work with you to make just what you want.

Call your Cutler-Hammer Sales Office or Stocking Distributor. Or write for full-line catalog LD 110A.

**CUTLER-HAMMER**

SPECIALTY PRODUCTS DIVISION, Milwaukee, Wis. 53201

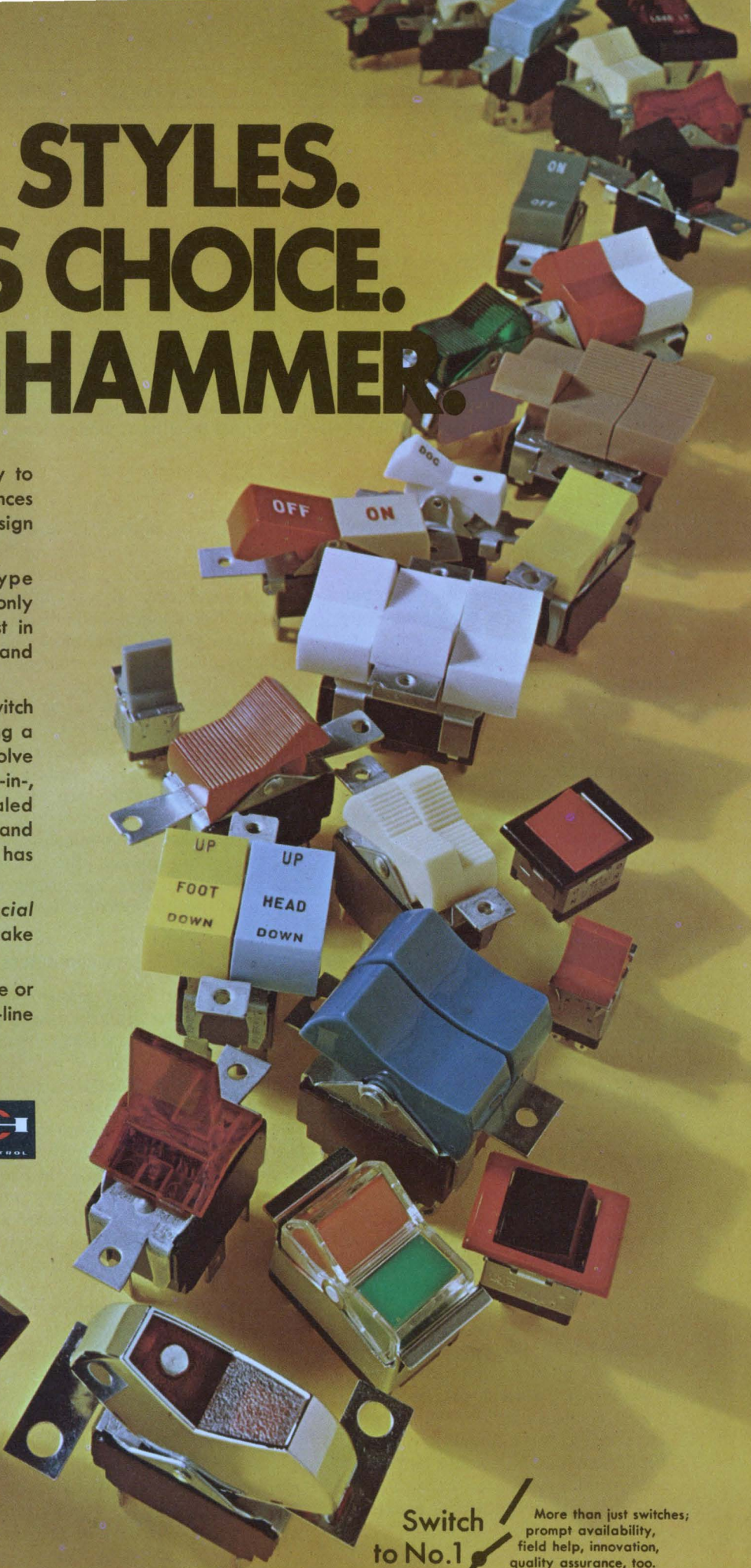
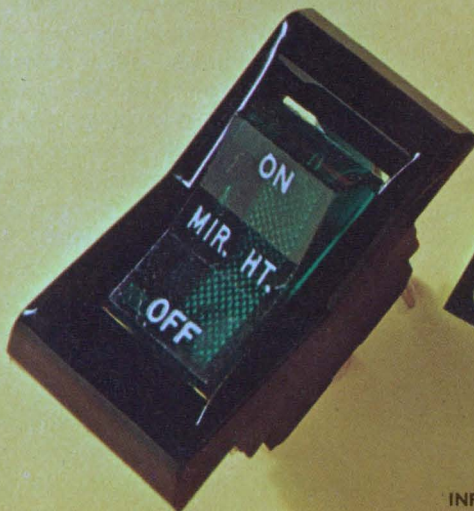

Switch  
to No.1

More than just switches;  
prompt availability,  
field help, innovation,  
quality assurance, too.

Year	1950	1955—1955		1965—1965		1970
Device	Thermionic valves	Better Valves	Transistors	Better Transistors	Integrated circuits	Better Integrated circuits
Speed	1 $\mu$ s	100 ns	200 ns	10 ns	25 ns	2 ns
Signal size	$\approx$ 50 V	$\approx$ 50 V	<5 V	<5 V	<5 V	$\approx$ 1 V
Power dissipation	1 W	5 W	100 mW	100 mW	15 mW	30 mW
Gate packing density	< 50/ft <sup>3</sup>		$\approx$ 500/ft <sup>3</sup>		$\approx$ 5000/ft <sup>3</sup>	
Mean life	$\approx$ 10 <sup>4</sup> Hr		$\approx$ 10 <sup>7</sup> Hr		$\approx$ 10 <sup>8</sup> Hr/Circuit	

4. Component progress has been startling in a mere two decades. Speed, density and life have soared while power and signal level have plummeted.

And the semiconductor industry, in turn, is growing about 50% faster than that.

This almost explosive growth has been a result of a repeating cycle to increase volume and lower costs through applications leading, in turn, to increased volume and lower costs. The semiconductor industry, in fact, has been one of the few in which price per function has steadily decreased in spite of continuing inflation. It now appears though, Heikes conceded, that world leaders have finally designed an inflation rate that we may not be able to beat.

Because of the rapid pace of technological development, the semiconductor business is quite unforgiving to managerial errors. So the business has two main needs—speed of entry and access to the largest possible market. These create an impetus for semiconductor manufacturers to integrate upward.

#### Semis vs software

Equipment manufacturers can integrate downward into semiconductors, but Heikes felt this would have little likelihood of success. Or, he said, they could concentrate more on software, marketing and other aspects of the business while maintaining tight coupling with existing semiconductor manufacturers. Taking such a scenario a step further, Heikes concluded that any country lacking a competitive semiconductor business would be forced more and more into the software and marketing end of the electronics business.

The choices, then, boil down to encouraging the formation of indigenous competitive suppliers, encouraging the formation of foreign competitive suppliers and adjusting conditions so that local electronics manufacturers can get semiconductors at the same price as U.S. manufacturers so as to be competitive on a world market.

The multinational semiconductor companies, despite the emotionalism they may provoke, are the instruments for assuring the most rapid diffusion of semiconductor technology throughout the world. And semiconductors are basic to almost all technological progress.

#### Dramatic progress in computers

The contribution of semiconductors has been particularly dramatic in computers. Gordon Haley, manager of systems technology, ICL Computer Development Div., pointed to dramatic examples. From 1950 to 1970 (Fig. 4) semiconductors provided a 500:1 improvement in component speed while slashing component cost 20:1. And they provided other dramatic advances as well. Their contributions haven't stopped. We can expect further improvements (Fig. 5).

We can evaluate computer progress, said Haley, on the basis of user needs. These include more processing power, more throughput per unit cost, faster response time per transaction, reduced overhead in data-base management, higher reliability and systems resilience, distributed facilities with adequate intercommunications, growth and continuity, and better man-machine

communications.

The last depends on humanizing the input and output with visual-display output, pattern recognition on input, condensation and selection of output documents, voice input and output, privacy and improved languages.

The obstacles to technological progress, Haley pointed out, are cost, speed of light, thermal considerations, reliability, noise immunity, the lack of standards and complexity.

While superficially the hardware structure of computers has changed little in 20 years, the packaging has changed dramatically. Components are still mounted on packages that are plugged into backplanes, an assembly of which constitutes the complete functional unit. But the logic content of the units and subunits has changed. Packages in one generation become standard components in the next. A complete CPU of the early 1950s is now realizable on a single chip of silicon.

#### Consumer electronics, too

While the impact of semiconductors on computers has been most dramatic, semis had a profound effect, too, on consumer products like radio, tape products, audio products, video recorders and players. But only recently, said Dr. William Hittinger, executive vice president, RCA Corp., has there been a major shift away from vacuum-tube or hybrid sets to all solid state.

The consumer-electronics market, said Hittinger, breaks down into two categories—entertainment and non-entertainment—which are bound to become more fuzzy as we go along. While both areas will grow substantially in the years to come, each will be faced with problems of standardization. There are today, for example, various techniques for home video recording and for preparing pre-recorded video material from a disc or record. Both types of products should find a substantial market in a few short years, but their growth could meet considerable problems. This is especially true for video disc.

"I wish I could hold out hope," Hittinger said, "for early standardization of video disc, but it just is not so and is not likely to take place." The answer, he said, will

# Dialight sees a need:

(Need: The widest choice for your every application.)

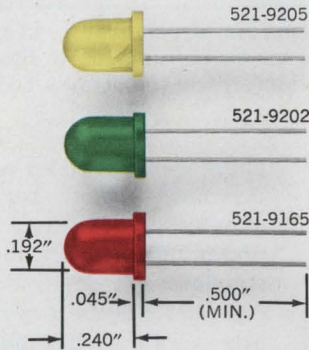

Now available in green, yellow and red. Mini-sized for maximum front panel density and easy panel mounting. High luminous intensity, low cost. Vibration/shock resistant. Solid state for long life. Wide viewing angles. Ideal for applications like panel lighting, film annotation and alpha-numeric displays.

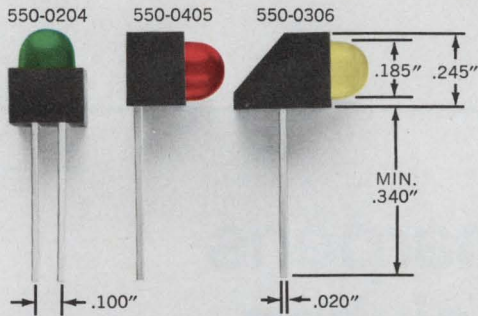

Mix 'em or match 'em. LED logic state fault indicators are available in red, yellow and green, in a variety of shapes, some with a built-in integral resistor. Can be driven from DTL and TTL logic. Designed for easy alignment on PC boards so that multiple functions can be displayed.

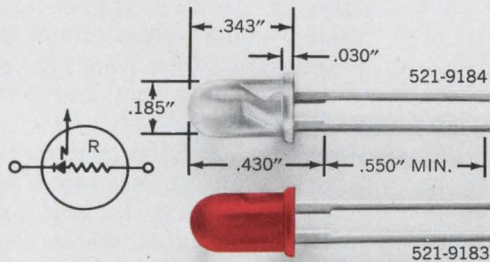

Available in red or clear LED packages with or without a built-in current limiting resistor. Red LED is also made without resistor. Suitable for circuit status indication, alpha-numeric displays and visual indicators. Features long wire-wrappable leads. IC compatible with solid state reliability. High luminous intensity, low power consumption, low cost.

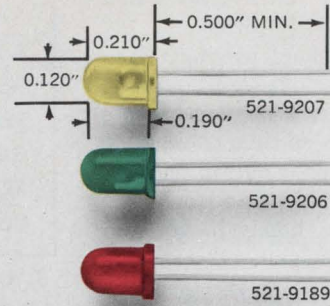

Your choice of green, yellow and red, with axial leads for dense packaging requirements. Wide viewing angle for easy readability. Low power consumption, low cost, IC compatible. 10mA operation for typical brightness. Size is identical to the most popular red LEDs.

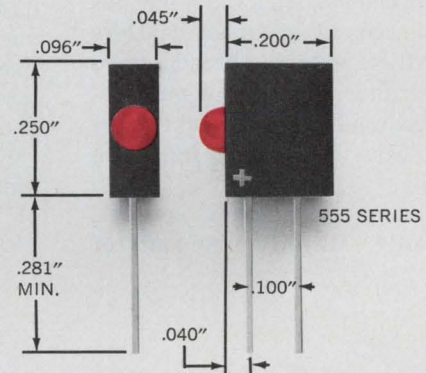

LED logic state fault indicators available in 14 models with voltage ratings from 1.7 to 14. Suitable for dense packaging on printed circuit boards—up to 10 units to the inch—IC compatible. With built-in series resistor. Polarity identified. Low power consumption.

Dialight, the company with the widest choice in switches, LEDs, indicator lights and readouts, looks for needs . . . your needs . . . and then they develop solutions for your every application. No other company offers you one-stop shopping in all these product areas. And no other company has more experience in the visual display field. Dialight helps you do more with these products than any other company in the business, because we are specialists that have done more with them. Talk to the specialists at Dialight first.

**DIALIGHT**  
 Dialight, A North American Philips Company  
 203 Harrison Place, Brooklyn, N. Y. 11237  
 (212) 497-7600

You won't have to talk to anyone else.

# See Dialight.

come on the basis of who can bring a product to the market first and demonstrate that it works.

There are other products for which the technology exists today, but the limits are socio-economic and legal. Such products include the TV home-information center, computer terminals and facsimile sets in the home, home library and the home newspaper.

As an example of the type of problem one can anticipate, one can look at cable television. It has been with us for many years—first, for remote areas with poor off-the-air reception, then later, in large cities, where image reflection for color transmission has been a major problem. This industry has been slowed by complex matters like conflicts with the broadcasting industry and copyright of material being rebroadcast over cable systems. These issues are far from resolved.

According to another speaker, Dr. Ferdy Mayer, president of

	1950	Improvement factor	1970	Improvement factor	1990
Speed	1 $\mu$ s	500	2 ns	40	.05 ns
Signal size	50 V	50	1 V	5	0.2 V
Power dissipation	1 W	33	30 mW	30	1 mW
Gate packing density	50/ft <sup>2</sup>	100	5000	1000	5 $\times$ 10 <sup>6</sup>
Mean life	10 <sup>4</sup> Hr	10,000	10 <sup>8</sup>	1000	10 <sup>11</sup>
Cost	1	20	1/20	50	1/1000

**5. Our components are likely to improve dramatically.** Even where the progress in the next two decades is not as startling as it has been in the past the progress should have profound effects on tomorrow's computers.

Laboratoire d'Electronique et d'Automatique Dauphinois, electronics has just begun to penetrate the automobile. Mayer showed dozens of possible applications beyond the widely publicized ones like electronic ignition, seat-belt interlocks, pollution controls and anti-skid systems.

One of the most intriguing is a system that would store the profile of an ideal driver and provide a "standard driver's index." A com-

puter would prepare a "driver performance index" for the person driving the car and compare the driver performance index with the standard driver's index. The concept here is to reward the good driver, rather than punish the bad one.

The remaining papers at the conference dealt mainly with political and economic problems associated with electronics in Europe and the rest of the world. ■■

## Picosecond timing sharpens laser-rangefinder resolution

A novel method of picosecond timing is reported to give laser rangefinders such accuracy that measurements of continental drift and the wobble of the earth on its axis will be possible.

Resolution of 1 to 3 cm at distances up to 3000 km is listed by the designer, Aerospace Corp., of El Segundo, Calif., and the current program objective is to achieve resolution of  $\pm 0.7$  cm.

"The best laser rangefinders to date have only about 15-cm resolution at satellite-to-earth distances," says Kurt Golden, staff scientist at Aerospace.

Golden reports that NASA will experiment with the new timing in four laser rangefinders on the ground and one on a satellite. Those on the ground will be placed at different locations and used to position the satellite by triangula-

tion. The rangefinder on the satellite will measure the distance to any point on the earth. By measuring the distance to several points on the ground over a period of time, the relative motion of those points relative to each other can be determined. Golden notes that continental drift is on the order of 5 cm a year.

### Picosecond timing essential

Timing accuracy of  $\pm 40$ -50 ps is necessary to get range resolution of  $\pm 0.7$  cm. Conventional time-interval measurement techniques can't even come close to that. Typical timing accuracies with conventional techniques are on the order of  $\pm 1$  ns.

The timing technique used by Golden makes use of an image converter tube with rapidly driven de-

flection plates. Timing is related to the deflected position of the return laser pulse relative to the position of the transmitted pulse.

A Q-switched, mode-locked ruby laser at 6943 Å is fired to initiate the ranging operation. A trigger pulse is then delivered to the master timing control circuitry for a reference. The ranging pulse travels to the target and returns to the receiving optics.

Samples of the transmitted and received optical pulses are diverted by beam splitters to fast photomultiplier detectors, whose electrical outputs are used to start and stop a commercial time-interval meter (Golden is using a Model 536 meter from NanoFast, Chicago). The time-interval meter indicates pulse transmission time or range.

Start and stop enable gates are



# The N-Channel RAM you've been waiting for.

**Simple to use.  
Fast. Low cost.**

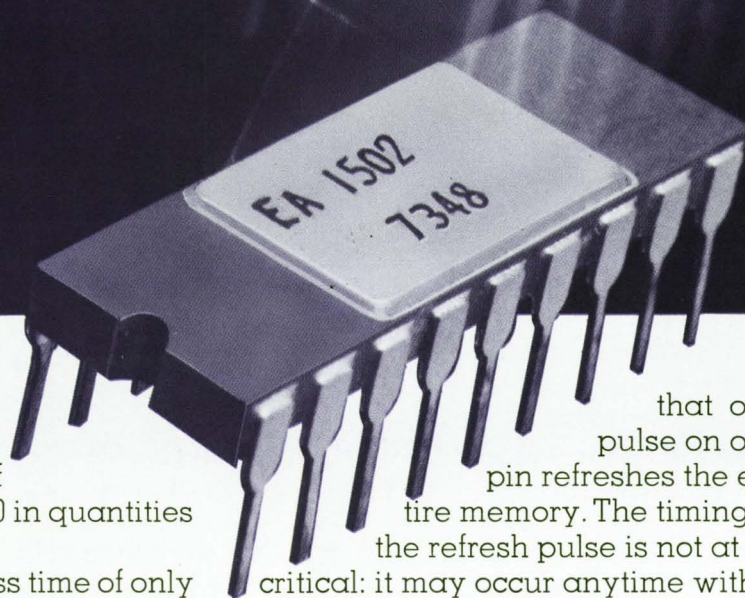

Here's the first 1024-bit MOS RAM to combine speed with simplicity of use at a low cost—\$13.50 in quantities of 500.

With a typical access time of only 130 ns and guaranteed maximum of 200 ns, the EA 1502 RAM is about five times as fast as the popular 2102.

And consider how simple it is to use:

Data and address pins wire directly to TTL logic without level shifters or pull-up resistors. The RAM needs only two supplies: +12v and -12v. It can be OR-wired to expand capacity. And it dissipates only 0.16 mW/bit power.

To achieve low power dissipation we made the RAM dynamic. But to keep use simple, we designed it so

that one pulse on one pin refreshes the entire memory. The timing of the refresh pulse is not at all

critical: it may occur anytime within a 2-millisecond interval. And refreshing does not interfere with read/write cycles—your memory is never busy.

The pin-out of this 18-lead DIP is identical to the 1103. Although signal levels and shapes are different, you can replace 1103s with this speedier RAM without a total rework of your PC board.

The EA 1502 is in stock right now at our nationwide distributor, Cramer Electronics, and at Electronic Arrays, Inc., 550 East Middlefield Road, Mountain View, Calif. 94043. Phone (415) 964-4321.



**electronic  
arrays**

# Plug-in transformers specifically designed for telephone interconnect!

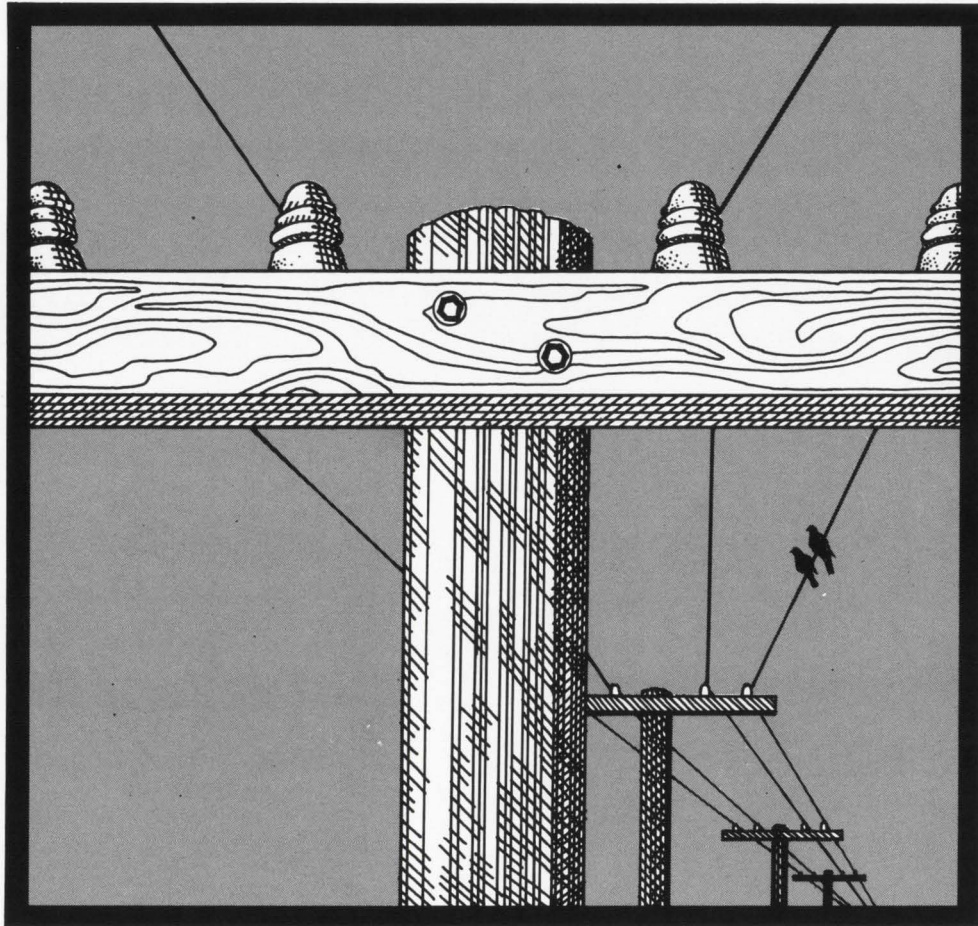

**Low-profile line meets or exceeds all modem and voice transmission impedance-matching requirements.**

If you're designing modem or voice interconnect equipment you now have a complete line of TRW/UTC plug-in transformers to work with.

They are specifically designed for the telephone interconnect market, meeting or exceeding all specifications for low distortion, longitudinal balance, insertion loss and return loss balances. What's more, our low-profile Ouncers, Subouncer and Sub-subouncer units are designed for wave

soldering and quick insertion on card mounts.

TRW/UTC is the leader in transformer miniaturization. With our new plants in North Carolina and Illinois, we'll have the capacity to produce almost any transformer you need—in any quantity—at very competitive prices.

For complete information, call or write TRW/UTC Transformers, an Electronics Components Division of TRW, Inc., 150 Varick Street, New York, N.Y. 10013. Tel: (212) 255-3500.

**TRW<sup>®</sup> UTC TRANSFORMERS**

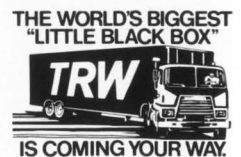



## Discover how these auto-multimeters keep you out of trouble.

On the surface they may look like any well-designed digital multimeters.

Now look closer. What else do you see?

There... the Fluke name!

That indicates unusual performance.

We designed both the Fluke 8600A and the 8800A with auto range, auto zero, and auto polarity. **And every parameter is fully protected.** This means you can accidentally overload the instrument with too much current... too much voltage... or too much resistance... and you're still okay.

Another way you stay out of trouble: MTBF on each instrument is a minimum of 10,000 hours.

Now, the specs.

**The 26-range Fluke 8600A, \$599.** We packed this 20,000 count multimeter with five

ranges of volts from 200 mV through 1200 V ac and dc. Five ranges of current, 200  $\mu$ A to 2 A ac and dc. And six ranges of resistance from 200 ohms to 20 megohms.

Basic dc accuracy is a fully credible 0.02%. Options include built-in automatic rechargeable battery pack for up to 8 hours off-line operation. Digital output is also offered.

**The 0.005% Fluke 8800A, \$1099.**

This digital multimeter features five ranges of dc volts from  $\pm$ 200 mV

to  $\pm$ 1200 V. Four ranges ac from 2 V to 1200 V. And six ranges of four terminal resistance from 200 ohms to 20 megohms. For complete isolation the input resistance is better than 1,000 megohms on lower ranges and 20 megohms on the higher ranges.

For critical resistance measurements the instrument provides completely isolated four terminal ohms with less than 4 volts open circuit from 200 ohms through 20 megohms.

So there are the specs.

Impressive? We think so. But remember—specs are one thing. That name on the panel, however... It's what makes a Cadillac a Cadillac.

And a Fluke a Fluke.

For details, call your nearest Fluke sales engineer. Or simply dial our hot line.



**For data out today, dial our toll-free hotline, 800-426-0361**

In the continental U.S., dial our toll free number 800-426-0361 for the name and address of your nearest local source. Abroad and in Canada, call or write the office nearest you listed below, John Fluke Mfg. Co., Inc., P.O. Box 7428, Seattle, Washington 98133. Phone (206) 774-2211. TWX: 910-449-2850. In Europe, address Fluke Nederland (B.V.), P.O. Box 5053, Tilburg, The Netherlands. Phone 013-67-3973. Telex: 844-52237. In the U.K., address Fluke International Corp., Garnett Close, Watford, WD2 4TT. Phone, Watford, 33066. Telex: 934583. In Canada, address ACA, Ltd., 6427 Northam Drive, Mississauga, Ontario. Phone 416-678-1500. TWX: 610-492-2119.

**FLUKE**®

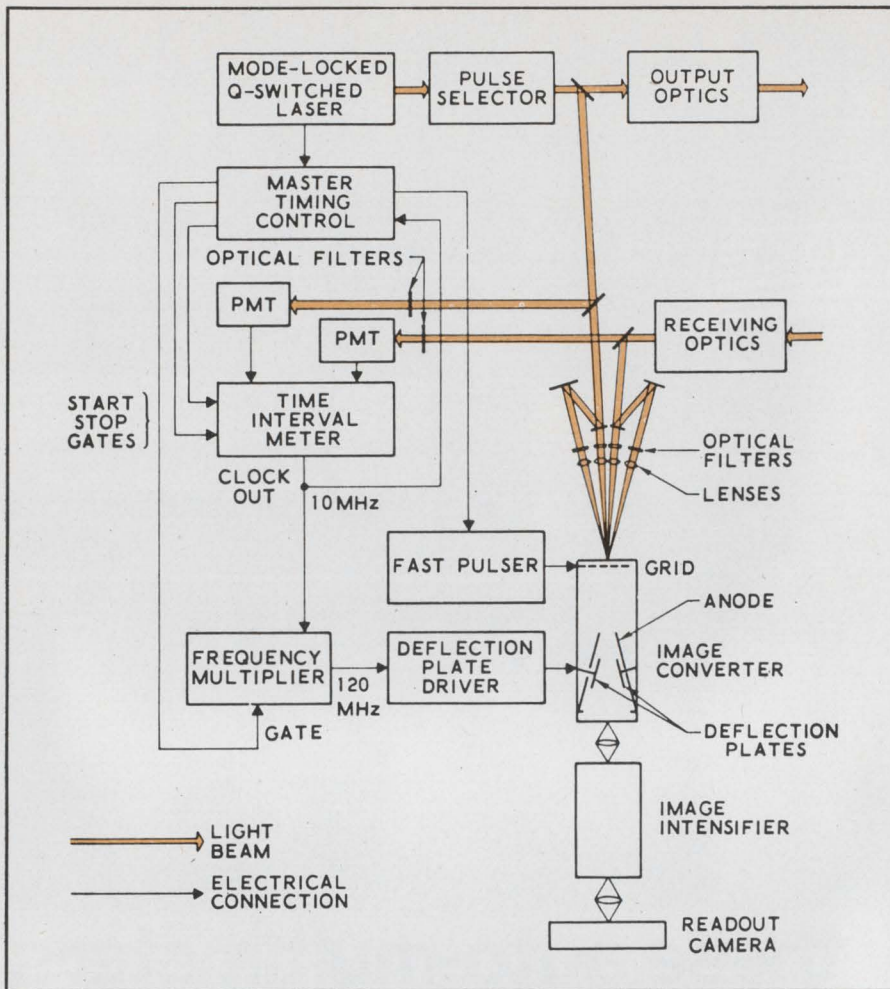

**Laser-range finder resolution** of 1 to 3 cm at distances of 3000 km is reported with the picosecond timing scheme shown here. Coarse ranging is done with a timer-interval meter, and fine ranging by measurement of the relative positions of spots of light created by an image converter.

provided to the time-interval meter by the master timing control to minimize any effect of spurious pulses. These gates are provided at approximately the expected times of arrival of the start and stop pulses and are long enough to compensate for uncertainties in the expected arrival times. In a satellite-to-earth system, says Golden, atmospheric range uncertainties go from 1 cm when the satellite is at its zenith to about 6 cm when it is 15 degrees above the horizon.

With the time-interval meter, coarse range measurements of  $\pm 15$ -cm resolution are possible. To get finer resolution, a vernier system is used. Samples of the transmitted and received light pulses are focused on the photocathode of an image-converter tube equipped with a pair of deflection plates.

Each of these pulses is split fur-

ther by an optical beam splitter, and half the energy of each pulse is optically delayed before being focused on the image-converter photocathode. These four different light beams are arranged to produce four small spots of light, one above the other, on the photocathode. The line of spots is perpendicular to the direction in which the image-converter deflection plates deflect photoelectrons.

#### Timing by deflection position

Each of the four pulses of light hitting the photocathode gives rise to a bundle of photoelectrons. These bundles are first accelerated by a potential of about 2000 V, applied to a grid in front of the photocathode, and later by a potential of about 15,000 V on the anode. The accelerated photoelectrons pass between the deflector

plates and are deflected by a 120-MHz sinusoidal voltage derived by frequency multiplication, from the stable 10-MHz master oscillator of the time-interval meter. At the other end of the tube, the electrons strike a phosphor screen, and much of their energy is converted to optical photons.

If a spot on the photocathode were illuminated steadily, the sinusoidal deflection voltage would cause the resulting beam of electrons to move back and forth across the phosphor and to trace out a straight line. A short pulse of light at a point on the photocathode produces a short segment of the full-deflection straight line. The segment's position is determined by the time of arrival of the originating light pulse, and its length by the duration of the light pulse.

Thus, the arrival of the four incident pulses of light at the image-converter photocathode, at four different times, results in the appearance of four differently positioned line segments on the output phosphor.

The time interval between transmitted and reflected pulses is some large multiple of the period of the 120-MHz deflection sinusoid plus an additional fraction of a period.

"From the relative positions of the line segments produced by the transmitted laser pulse and those produced by the reflected pulse," Golden notes, "one can make a very precise determination of the magnitude of this additional fraction of a period."

#### Systems to use CCDs

In the current experimental system, the output of the image intensifier is read by a camera. In future systems, the image intensifier will be replaced with a charge-coupled-device array on the output of the image converter. The position of the light spots will then be automatically determined by a controller based on the output of the CCD array.

Golden is also trying to eliminate the requirement for four spots by going to a circular or polar deflection. Then only the position of two spots on a circle will determine the required fraction of a period without ambiguity. ■■

# EXPLORE "DOUBLE INTEGRATION" the low-cost path to new Digitizing Product Designs

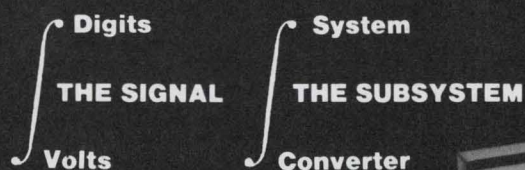

4.

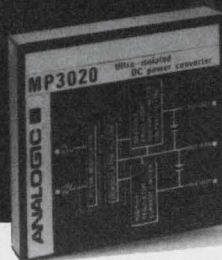

1.

3.

2.

5.

**Compatible integrating conversion modules or complete data-translation subsystems... either way, we'll give you optimum performance, reliability, and "value-added."**

OEM designers everywhere choose ANALOGIC—for advanced technology... for lowest overall system cost... for highest "value added" profits. Here are just 6 of over 100 Analogic products designed specifically for industrial and analytical digitizing:

**1. Integrating A/D Converters.** We make more different price/performance "mixes" than anyone else. The MP2344 uses propriety technology to achieve state-of-the-art performance at low cost. (0.01% accuracy, 3-phase auto-zeroed stability, >100dB CMRR, and 16-bit or 40,000-count bipolar resolution.) Essentially a voltage-to-count (dual-slope) converter, the MP2344 lets you supply the counters, displays, power, and master logic—for maximum value added. For a complete converter system, specify AN2344.

**2. MP2321/2322** low-cost, premium-grade "universal" integrating converters give you maximum design freedom... without design headaches. 600V CMV range! nA bias current! Drift-free auto-zeroing! "Logic-powered" from +5V DC, with built-in, highly regulated, isolated analog supply! Choose 3½ digit BCD, or 12-bit binary. DTL/TTL compatibility with computers, modems, control systems, displays.

**3. Signal Conditioning:** MP221 is a potentiometric, ultra-low-noise, ultra-stable amplifier. Its low-level, performance can't be matched, at twice the price. Not just low drift, but low noise, too: DC to 1 Hz, <0.1  $\mu$ V p-p; DC to 10 Hz, <0.3  $\mu$ V p-p; DC to 100 Hz, <1  $\mu$ V p-p. Noise current, DC to 1 Hz, <3 pA, Drift, <0.03  $\mu$ V/°C!

**4. Power Supplies:** MP3020 system-grade system-compatible, DC/DC Converter (5V DC in,  $\pm$ 15V DC out @ 150 mA): very low reflected input noise current; ultra-guarded I/O isolation and noise attenuation; tight static and transient regulation; exceptional efficiency.

**5. Complete Subsystems:** The AN5351 is the industry's most complete and versatile load-cell digitizing subsystem. Priced so low that your system profits will soar, it provides: multiple-load-cell excitation; six-wire (auto-tracking) ratiometric input; active multipole filtering; ultra-stable preamplification; autozero/autotare computation; dual-range units conversion; data/result display; count-resolution scaling; over load and limit sensing; data transmission/printout capability; and optimum industrial-environment reliability. Buy it, or build it yourself from our modules.

**Choose the Analogic path** of "double-integrated" modules or subsystems—for the most competitive, most profitable end product. Write today for free Design Kit, or call Guy Wilson, at (617) 246-0300.

Analogic, Audubon Rd., Wakefield, Mass. 01880.

**SEND FOR FREE DESIGN KIT**



**ANALOGIC** ■

... The Digitizers

INFORMATION RETRIEVAL NUMBER 33

# Not just a second source. But a Introducing Harris'

Here they are—22 device types offering true alternate-source availability for 54C/74C CMOS. Combined with our existing 4000 series and custom LSI capability, addition of these new units makes Harris one of the few suppliers with total CMOS capability. So, choose from our 54C/74C series—44 devices with more on the way.

**Our 54C/74C series**, designed to reduce system costs, is pin-for-pin and function-for-function equivalent to T<sup>2</sup>L 7400 devices. Among their cost-saving features are low power supply requirements, less power supply regulation, fewer bypass capacitors, simpler design, and simplified power

distribution. The units also offer high noise immunity—typically 45% of supply voltage, and they have a guaranteed 1V noise margin. This means that 1V of noise at the input will not cause the output to rise beyond T<sup>2</sup>L levels. As a result, logic errors are less likely.

Applications are easy, too, with industry standardized input and output characteristics. Experience acquired with the 7400 series can also be applied directly to use of the 54C/74C's. For details, see your Harris distributor or representative.

	100-999 UNITS	
	-55°C to +125°C	0°C to +70°C
HD-54C00/74C00 Quad 2 NAND Gate _____	2.98	.69
HD-54C02/74C02 Quad 2 NOR Gate _____	2.98	.69
HD-54C04/74C04 Hex Inverter _____	3.30	1.04
HD-54C10/74C10 Triple 3 NAND Gate _____	2.98	.69
HD-54C20/74C20 Dual 4 NAND Gate _____	2.98	.69
HD-54C42/74C42 BCD to Decimal Decoder _____	7.15	3.30
HD-54C73/74C73 Dual J-K Flip Flop with Clear _____	4.75	2.26
HD-54C74/74C74 Dual D Flip Flop _____	4.20	1.45
HD-54C76/74C76 Dual J-K Flip Flop with Clear and Preset _____	4.75	2.26
HD-54C107/74C107 Dual J-K Flip Flop with Clear _____	4.75	2.26
HD-54C151/74C151 8 Channel Digital Multiplexer _____	6.40	3.95
HD-54C154/74C154 4-Line to 16-Line Decoder/Demultiplexer _____	16.20	5.40
HD-54C157/74C157 Quad 2 Multiplexer _____	5.10	2.88
HD-54C160/74C160 Decade Counter with Asynchronous Clear _____	10.40	5.70
HD-54C161/74C161 Binary Counter with Asynchronous Clear _____	10.40	5.70
HD-54C162/74C162 Decade Counter with Synchronous Clear _____	10.40	5.70
HD-54C163/74C163 Binary Counter with Synchronous Clear _____	10.40	5.70
HD-54C164/74C164 8-Bit Parallel Out Serial Shift Register _____	11.00	4.35
HD-54C173/74C173 Three State Quad/D Flip Flop _____	9.15	3.80
HD-54C192/74C192 Synchronous 4-Bit Up/Down Decade Counter _____	10.30	5.65
HD-54C193/74C193 Synchronous 4-Bit Up/Down Binary Counter _____	10.30	5.65
HD-54C195/74C195 4-Bit Register _____	5.70	3.75

**WHERE TO BUY THEM:** ARIZONA: Phoenix—Hamilton, Liberty, Weatherford, Scottsdale—HAR (602) 946-3556 CALIFORNIA: Anaheim—Weatherford, El Segundo—Liberty, Glendale—Weatherford, Long Beach—HAR (213) 426-7687, Mountain View—Elmar, Palo Alto—Weatherford, HAR (415) 964-6443, Pomona—Weatherford, San Diego—Liberty, Weatherford COLORADO: Commerce City—Elmar, Denver—Hamilton, Englewood—Weatherford CONNECTICUT: Danbury—Schweber, Norwalk—Harvey FLORIDA: Hollywood—Hamilton, Schweber, Melbourne—HAR (305) 727-5430 GEORGIA: Atlanta—Schweber, Norcross—Hamilton ILLINOIS: Elk Grove Village—Schweber, Schaumburg—HAR (312) 894-8824, Schiller Park—Hamilton INDIANA: Indianapolis—Pioneer KANSAS: Lenexa—Hamilton MARYLAND: Baltimore—Hamilton, Rockville—Schweber MASSACHUSETTS: Burlington—Hamilton, Lexington—Harvey, Wellesley—HAR (617) 237-5430 MICHIGAN: Livonia—Hamilton, Troy—Schweber MINNESOTA: Edina—Hamilton, Schweber, Minneapolis—HAR (612) 432-6111 MISSOURI: Hazelwood—Hamilton NEW JERSEY: Cedar Grove—Hamilton, Mt. Laurel—Hamilton, Somerset—Schweber NEW MEXICO: Albuquerque—Hamilton, Weatherford NEW YORK: East Syracuse—Hamilton, Melville—HAR (516) 249-4500, Syracuse—HAR (315) 463-3373, Rochester—Schweber, Westbury—Schweber, Woodbury—Harvey NORTH CAROLINA: Raleigh—Schweber OHIO: Beachwood—Schweber, Cleveland—Pioneer, Dayton—Pioneer, HAR (513) 226-0636 PENNSYLVANIA: Wayne—HAR (215) 687-6680 TEXAS: Dallas—Hamilton, Weatherford, HAR (214) 231-9031, Houston—Hamilton, Weatherford UTAH: Salt Lake City—Hamilton WASHINGTON: Seattle—Liberty, Weatherford WASHINGTON, D.C.: HAR (202) 337-3170 CANADA: Mississauga, Ontario—Hamilton, Montreal, Quebec—Hamilton, Ottawa, Ontario—Hamilton.

**LEGEND FOR HARRIS SALES OFFICES & DISTRIBUTORS:** Elmar Electronics (Elmar); Hamilton Avnet Electronics (Hamilton); Harris Semiconductor (HAR); Harvey Electronics (Harvey); Liberty Electronics (Liberty); Pioneer Standard Electronics (Pioneer); Schweber Electronics (Schweber); R. V. Weatherford Co. (Weatherford).

source with total CMOS capability.

# New 54C/74C Series

**Our 4000 (S) series** offers you the fastest, low-power logic devices available today. With 10-volt power supplies, speeds are typically twice that of comparable IC's. Power supply range is 3 to 15VDC, while noise immunity is typically 45% of supply voltage. Other advantages are low power dissipation and elimination of SCR latch-up problems. All units are pin-for-pin compatible with the CD-4000A series. And you have a choice of high-speed or direct CD-4000A replacement characteristics. To order a high-speed unit just add the suffix "S" to the HD-4000 part number (HD-4000S). For a direct CD-4000A replacement add an "A" to the number (HD-4000A).

In addition to the HD-4000 series, we offer the HD-4800 group of Harris proprietary devices. Among these devices are six units which together comprise the first family of three-state CMOS interface circuits available. By providing the ability to regulate the state of hard wired outputs, these interface circuits permit an extremely high level of flexibility in buss oriented systems design. These units also have buffered outputs for driving high capacitive lines and T<sup>2</sup>L directly. When four circuits are utilized, they permit the user to perform logic translation (i.e. MOS to T<sup>2</sup>L) directly at the buss line. For complete details on our 4000 and 4800 series, see your Harris distributor or representative.

	100-999 UNITS			
	-40°C to +85°C		-55°C to +125°C	
	A	S	A	S
HD-4000 Dual 3 NOR Gate plus Inverter, 14 pin DIP	.78	1.86	1.17	3.10
HD-4001 Quad 2 NOR Gate, 14 pin DIP	.78	1.98	1.17	3.30
HD-4002 Dual 4 NOR Gate, 14 pin DIP	.78	2.04	1.17	3.40
HD-4007 Dual Complementary Pair plus Inverter, 14 pin DIP	.78	1.59	1.17	2.65
HD-4009 Hex Inverter/Buffer, 16 pin DIP	1.69	3.15	2.54	5.25
HD-4010 Hex Buffer, 16 pin DIP	1.69	3.15	2.54	5.25
HD-4011 Quad 2 NAND Gate, 14 pin DIP	.78	1.98	1.17	3.30
HD-4012 Dual 4 NAND Gate, 14 pin DIP	.78	2.07	1.17	3.45
HD-4013 Dual D Flip Flop, 14 pin DIP	1.62	2.85	2.43	4.75
HD-4019 Quad AND/OR Select Gate, 14 pin DIP	1.91	3.03	2.87	5.05
HD-4023 Triple 3 NAND Gate, 14 pin DIP	.78	2.06	1.17	3.44
HD-4025 Triple 3 NOR Gate, 14 pin DIP	.78	2.06	1.17	3.44
HD-4030 Quad Exclusive OR Gate, 14 pin DIP	1.63	2.27	2.45	3.79
HD-4804 Three State Hex Buffer with Level Translator, 16 pin DIP	-	6.15	-	7.67
HD-4805 Three State Hex Buffer Inverter with Level Translator, 16 pin DIP	-	6.15	-	7.67
HD-4806 Three State Triple True/Complement Buffer with Disable, Independent Level Translator, 16 pin DIP	-	6.15	-	7.67
HD-4807 Hex Buffer with Disable, 16 pin DIP	-	6.15	-	7.67
HD-4808 Three State Hex Buffer with Disable, 16 pin DIP	-	6.15	-	7.67
HD-4809 Triple True/Complement Buffer, 16 pin DIP	1.69	3.15	2.54	5.25
HD-4810 Three State Triple True/Complement Buffer with Disable, Common Level Translator, 14 pin DIP	-	6.15	-	7.67
HD-4811 Quad Exclusive NOR Gate, 16 pin DIP	1.63	2.27	2.45	3.79
HD-4814 Hex Inverter, 16 pin DIP	.97	2.27	1.45	3.80

# Harris



**HARRIS**  
SEMICONDUCTOR  
A DIVISION OF HARRIS CORPORATION

P.O. Box 883, Melbourne, Florida 32901 (305) 727-5430

INFORMATION RETRIEVAL NUMBER 118

# Hewlett-Packard presents a small miracle, the HP-65:

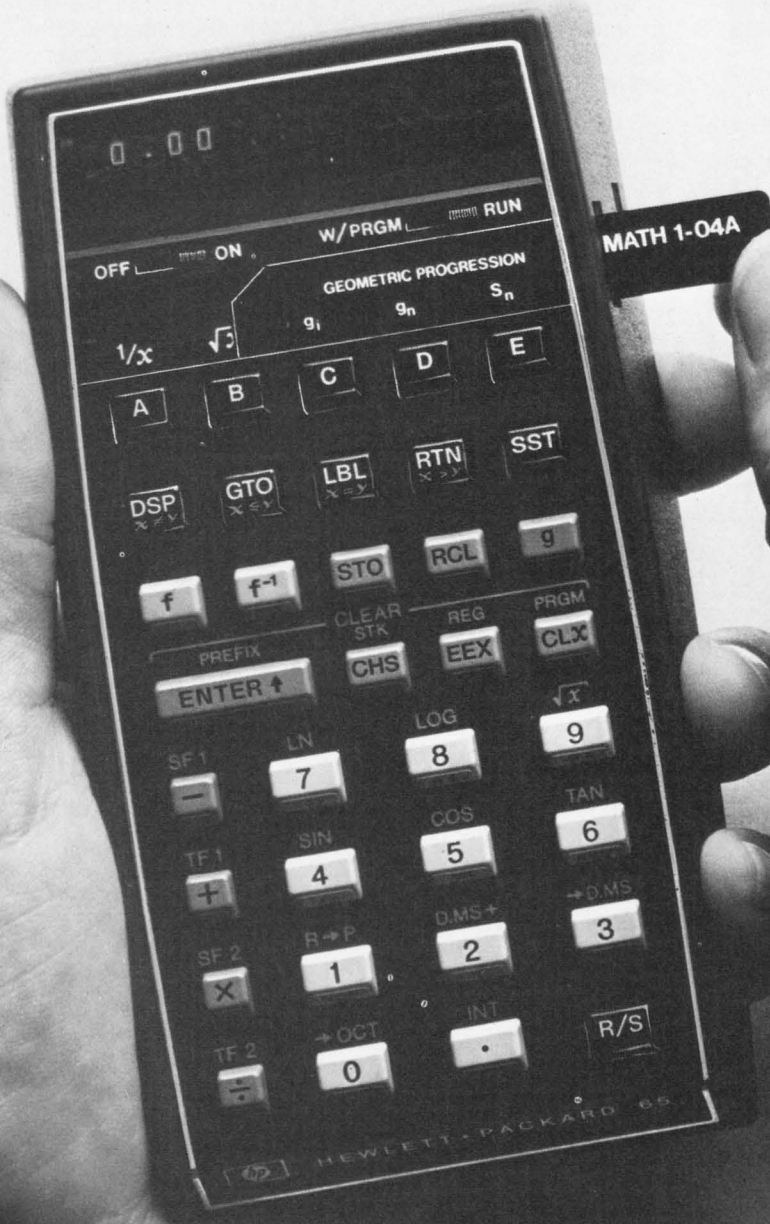



# the only fully programmable pocket-sized computer calculator, \$795.

Once you had to know a "computer" language, work at a desk and have a large budget to use programming. No longer.

## The HP-65 is fully programmable.

It's the first fully programmable pocket-sized computer calculator in the world.

With an HP-65 you can write programs just by pressing the keys in sequence, without using a special "computer" language. You can edit programs, i.e. add or delete steps at will. And you can record your programs on magnetic cards for subsequent use anywhere.

The HP-65's 100-step program memory, in combination with its 51 pre-programmed arithmetic, logarithmic, trigonometric and exponential functions, its operational stack and its nine addressable memory registers, permits you to write exceedingly complex programs.

Its user definable keys let you program up to five routines using any of the machine's pre-programmed capabilities. You can also label portions of your program so the calculator can branch to a specific instruction or choose between alternate computational paths based on logical comparisons ( $x=y$ ,  $x \neq y$ ,  $x > y$ ,  $x \leq y$ ) or the condition of the HP-65's two flags.



## The HP-65 also lets you use pre-recorded programs.

HP offers a series of pre-recorded program packages called Application Pacs at \$45\* each. Each Pac contains as many as 40 programs dedicated to a specific discipline (currently Electrical Engineering, Mathematics, Statistics, Medicine and Surveying, with more to come).

We also maintain a Users' Library of owner-contributed HP-65 programs which are itemized in catalogs distributed periodically to subscribing owners. Programs may be ordered from the Library for a small handling fee.

## The HP-65 is a powerful pocket-sized calculator.

The HP-65 ranks with our popular and powerful HP-45 as a keyboard-operated calculator. It's pre-programmed to handle 51 functions and operations.

## The HP-65 is priced at just \$795.\*

What you gain in time, precision and flexibility may well save you that amount in a matter of weeks. The price includes one 11-ounce HP-65 with rechargeable battery pack, AC adaptor-recharger, carrying cases, a year's subscription to the Users' Library, Owner's Handbook, Quick Reference Guide and a Standard Application Pac that contains 17 representative pre-recorded programs, 2 diagnostic cards, 20 blank cards, a head-cleaning card and instruction booklet.

The HP-65 may be ordered on a 15-day trial basis. For details send the coupon. Or call Customer Service at (408) 996-0100 for the outlet nearest you.

**Hewlett-Packard makes the most advanced pocket-sized computer calculators in the world.**

614/18



Sales and service from 172 offices in 65 countries  
Dept. 232J, 19310 Pruneridge Ave., Cupertino, CA 95014

Hewlett-Packard  
Dept. 232J  
19310 Pruneridge Ave., Cupertino, CA 95014

Please send me:

- HP-65(s) including Standard Application Pac at \$795 (domestic U.S.A.) each plus applicable state and local taxes. (Check enclosed.)
- Detailed specifications on your HP-65 and available Application Pacs.
- Detailed specifications on your full line of pocket-sized and pre-programmed desktop calculators.

Name \_\_\_\_\_

Address \_\_\_\_\_

City \_\_\_\_\_

State/Zip \_\_\_\_\_

\*All prices domestic U.S.A., not including applicable state and local taxes.

# interface- ability

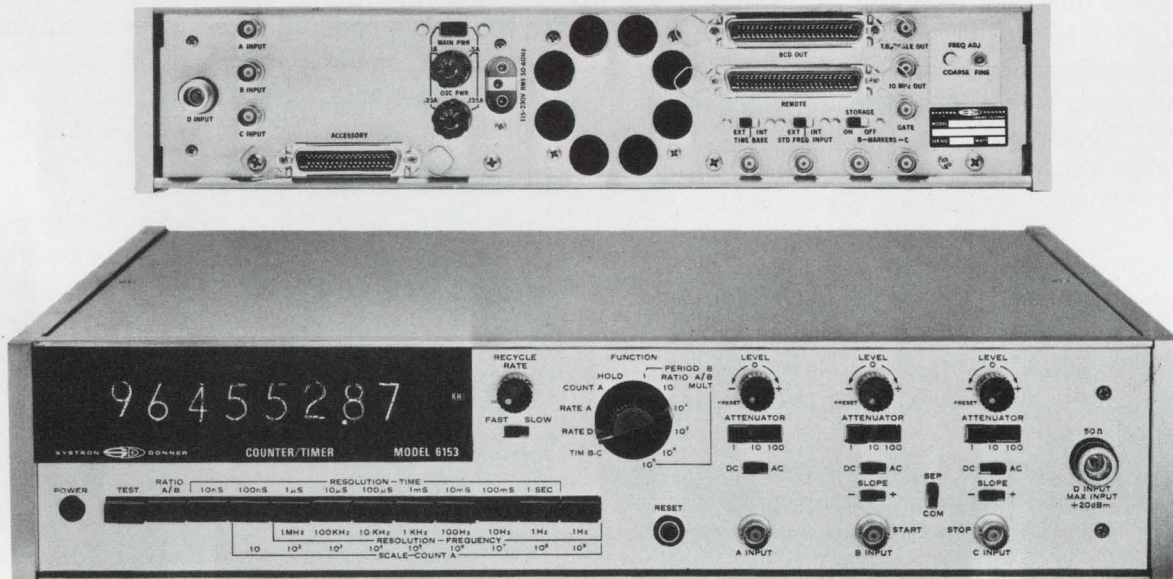

## Or why **systems people** buy more S-D counters

- 6 remote **programming** options
- 4 **BCD** outputs (low and high level)
- Special codes, formats, logic levels
- Universal counter/timer functions
- 50, 200, 512 MHz, 3 GHz

For details or a demo on series 6150 counters, call your Scientific Devices sales and service office (listed below). Or contact Concord Instruments Division, 10 Systron Drive, Concord, CA 94518. Phone (415) 682-6161. In **Europe**: Systron-Donner GmbH, Munich, W. Germany; Systron-Donner Ltd., Leamington Spa, U.K.; Systron-Donner S.A. Paris (Le Port Marly) France. **Australia**: Systron-Donner Pty. Ltd., Melbourne.

SYSTRON  DONNER

Albuquerque, (505) 268-6729; Baltimore, (301) 788-6611; Boston, (617) 894-5637; Burlington, NC (919) 228-6279; Chicago, (312) 297-5240; Cleveland, (216) 261-2000; Denver, (303) 573-9466; Dayton, (513) 298-9904; Dallas, (214) 231-8106; Detroit, (313) 363-2282; Ft. Lauderdale, (305) 721-4260; Hamden CT (203) 248-9361; Huntsville, AL (205) 536-1969; Houston, (713) 623-4250; Indianapolis, (317) 783-2111; Kansas City, KS (913) 631-3818; Los Angeles, (213) 641-4800; Minneapolis, (612) 544-1616; New York City area (201) 871-3916; Norfolk, (703) 499-8133; Orlando, (305) 424-7932; Philadelphia, (215) 825-9515; Phoenix, (602) 834-1682; Rochester, NY (716) 334-2445; San Antonio, (512) 694-6251; San Diego, (714) 249-6642; San Francisco area (415) 964-4230; Seattle, (206) 454-0900; St. Louis, (314) 731-2332; Syracuse, (315) 457-7420; Washington, DC area (703) 451-6500.

# washington report

## **Senate bill aims to adjust contracts for inflation**

Prodded by the growing number of small businesses that are being driven to bankruptcy by inflation and materials shortages, Sen. William D. Hathaway (D-Me), chairman of the Senate Small Business Procurement Subcommittee, has introduced a relief bill. Joined by three other Senators—Alan Bible (D-Nev.), Jacob Javits (R-N.Y.) and William Scott (R-Va.)—Hathaway says the bill would require greater use of contract price-adjustment clauses to protect both the Government and the small-business contractor. The measure would permit contract prices to be amended in accordance with price rises that the contractor encountered. It would also recognize the energy and material shortages as excuses for delay rather than causes for default on a contract. "The Government should not be adding to the difficulties of the contractor by declaring him in default of his contract for a cause which was clearly beyond his control," Senator Hathaway says.

## **Satellite TV capacity doubled in Canadian test**

Digital TV transmission, as opposed to conventional FM, has doubled the Canadian ANIK-1 satellite's TV capacity through a single transponder. Tests of the new digital system were carried out jointly by Telesat Canada and Comsat Laboratories of the Communications Satellite Corp. (U.S.). The tests also demonstrated that the antenna-gain to system-noise temperature (G/T) at the receiving station could be lowered several decibels without loss in high-quality transmission. The system uses a transmission rate of 67.2 megabits per sec—the equivalent of sending more than 100 newspaper pages a minute. Transmission was from a 98-ft antenna in British Columbia through the ANIK-1 communications satellite to a 33-ft receiving antenna in Quebec. According to Comsat, the successful experiment points to increased TV capacity in the proposed U.S. satellite program.

## **More powerful lasers for nuclear fusion on the way**

Lasers with power 100 to 1000 times that of present units, and with power-generating efficiency still in the 25-50% range, are now feasible, according to physicists at the National Bureau of Standards. The bureau's researchers moved the quest for laser-fusion energy sources from the infrared and visible bands of the spectrum down into the far ultraviolet to attain successful excitation of krypton and xenon gas atoms. The Optical Physics Div. team, headed by Dr. Chris Kuyatta, concentrated on this ultra-low end of the energy spectrum after deciding that low-energy electron scattering had a high probability of exciting xenon gas. The gas

exhibits a strong resonance near its excitation threshold.

The work was undertaken for the Atomic Energy Commission's Los Alamos Laboratory, which is exploring ways to produce thermonuclear power from the laser-induced fusion of deuterium-tritium. The AEC has announced that it can undertake no further contracts to supply nuclear fuel because of diminishing sources of uranium and saturation of its processing capacity. But the sea is full of deuterium, and the tapping of this vast energy source appears on the horizon.

## Billions in electronic exports could be endangered

Up to \$5-billion a year in foreign sales of aircraft and electronic equipment could go down the drain if Senate Bill S 1541, now in a Senate-House Conference, should be passed.

Initiated by Sen. William Proxmire (D-Wisc.), the bill would require the Export-Import Bank to pay into the Treasury its income from loans, and loan disbursements would be treated as expenditures that required annual Congressional authorizations and appropriations. This year-to-year cycle (contracted with export financing, which runs for five to 10 years), together with vulnerability to budget cutbacks and constraints, would virtually eliminate the bank as a major source of long-term export financing. Such financing is important in selling jet aircraft and associated electronic equipment.

At present the Export-Import Bank is not only self-supporting but returns an annual profit of \$50-million to the Treasury through sale of its debentures and the purchase of discounted notes. The bank has financed the overseas sale of more than 1000 commercial jet aircraft, containing an estimated \$3-billion in electronic equipment, plus another \$3-billion in private jets, helicopters, navigational and landing aids and flight simulators.

**Capital Capsules:** FAA Administrator Alexander P. Butterfield wants to stick with Loran A as the basic transocean navigation system at least through July, 1979. U.S. Coast Guard, which must fund and man the stations, is anxious to get on with Loran C. . . . NASA has selected Odetics Corp., Anaheim, Calif., to design, develop and produce new tape recorders for future spacecraft. The \$4-million contract is for 30 units with  $10^9$  data-bit storage. . . . The Government Renegotiation Board, perennially slated for termination, has gotten a further lease on life, at least to 31 Dec 1975, by the House Ways and Means Committee. Critics argue that the Board costs government and industry far more than it collects but it is confounding its critics by collecting an estimated \$70-million the current fiscal year, well over double last year's forfeits. . . . After reviewing a wide variety of proposals for monster "flying trucks" from airframe manufacturers, foreign firms and just plain "inventors", NASA has decided simply to buy a used Boeing 747-100 from American Airlines for \$16-million. The jumbo jet will have fittings installed so it can carry piggyback the giant Space Orbiter and related hardware weighing up to 775,000 lb. . . . The Air Force has awarded a \$14.3-million contract to Magnavox Co., Ft. Wayne, Ind., for production of 16,000 ARC-164 aircraft communications sets—one of the largest and most hotly contested procurements for airborne radio since World War II. The solid-state units are uhf with 10 W of power output and 7000 channels with 25-kHz spacing, yet each weighs only 10 lb. The new sets will replace ARC-27 and ARC-34 sets. . . . The Senate Judiciary Subcommittee on Antitrust has resumed hearings on alleged infringements by the communications industry. The subcommittee will look at alleged anticompetitive practices by AT&T, particularly its prohibition against the use of non-Bell interconnect with Bell installations.

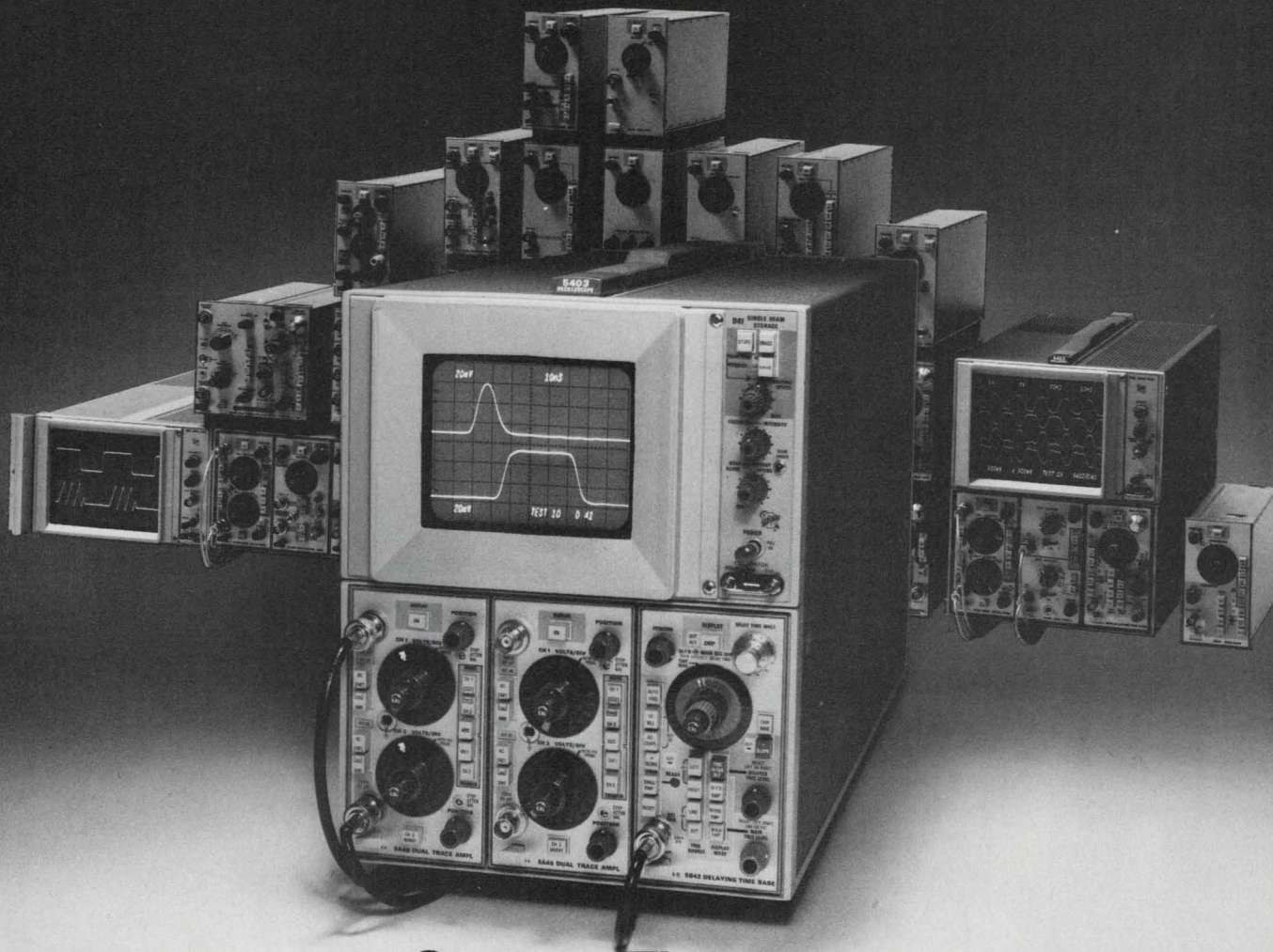

## Capture Those Hard to View Signals at Low Cost

Single shot events; high speed, low repetition rate signals; changes in successive sweeps, very slow signals; repetitive signals obscured by random noise—all of those hard to display waveforms are easy to view using the new 5403/D41 Variable Persistence Storage Oscilloscope from Tektronix.

You vary waveform storage time for the 5403/D41 simply by turning a dial. Normal intensity viewing time ranges from milliseconds up to 5 minutes and a waveform can be saved for up to an hour by simply pushing a button.

With a writing speed of 5 div/ $\mu$ s, 60 MHz bandwidth and the added convenience of a 3 plug-in mainframe, the 5403/D41 saves you hundreds of dollars over the price of other variable persistence storage oscilloscopes. Complete with 60 MHz vertical amplifier and 10 ns/div time base, the 5403/D41 is priced from only \$2450. What's more; with the flexible, easy-to-use 5403/D41 you can add unique

convenience features: CRT readout of deflection factors, and user programmable CRT readout of test identification data.

**Versatile, Modular Family.** The 5403/D41 Variable Persistence Storage Oscilloscope is the latest addition to the versatile, modular 5000 Series. With this flexible family you can tailor the oscilloscope best suited to your measurement needs by choosing from 2 mainframes (60 MHz or 2 MHz bandwidth), 7 display modules, and 21 diverse plug-ins. 5000 Series measurement flexibility includes a 60 MHz dual trace amplifier, a 10 ns/div sweep rate delayed time base, an easy-to-use dc to 1 GHz sampler, a dc to 100 kHz spectrum analyzer, a 10  $\mu$ V/div differential amplifier, a differential comparator accurate to 0.20%, a four trace amplifier (8 traces with two amplifiers), and a semiconductor curve tracer.

The flexible 5000 Series is designed to handle your present measurements and is expanding to meet your future needs.

To learn more about the new 5403/D41 Variable Persistence Storage Oscilloscope and how this low cost instrument can make difficult signals easy to measure, contact your local Tektronix Field Engineer or write Tektronix, Inc., P.O. Box 500, Beaverton, Oregon 97005. In Europe write Tektronix, Ltd., P.O. Box 36, St. Peters Port, Guernsey, C.I., United Kingdom.

INFORMATION RETRIEVAL NUMBER 36  
FOR DEMONSTRATION, CIRCLE 209

  
**TEKTRONIX®**  
committed to  
technical excellence

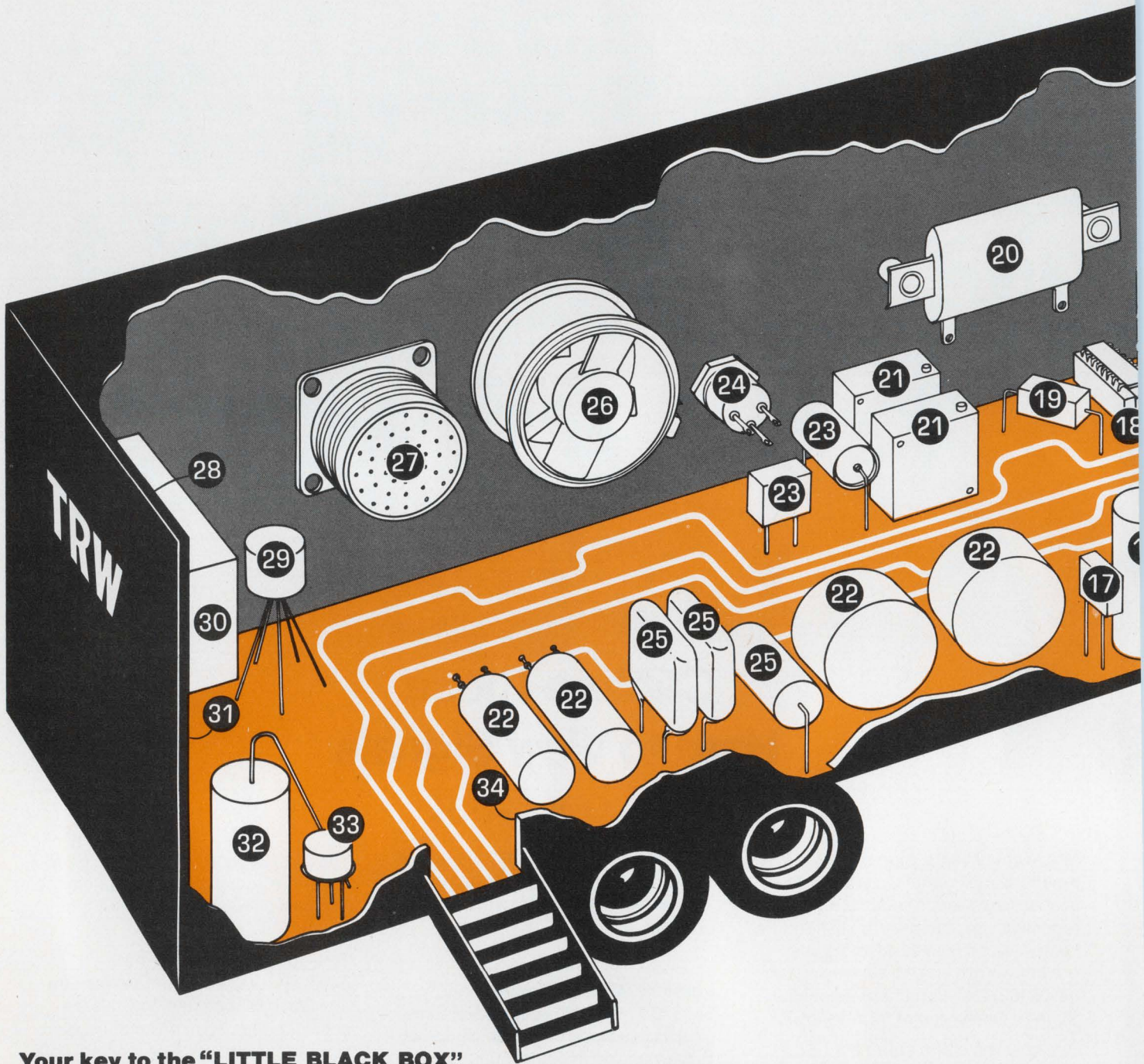

## Your key to the "LITTLE BLACK BOX"

- |  |   |  |
|--|---|--|
| <b>1. CONNECTORS</b> , Printed Circuit           | <b>13. CAPACITORS</b> , Solid Tantalum              | <b>24. TRANSISTORS</b> , Power, Switching        |
| <b>2. PRINTED CIRCUITS</b> , Multilayer          | <b>14. SOCKETS</b> , Transistor                     | <b>25. CAPACITORS</b> , Film                     |
| <b>3. CONNECTOR SYSTEMS</b> , IC Logic           | <b>15. TRANSISTORS</b> , RF Communications          | <b>26. FANS</b> , Miniature Precision, AC or DC  |
| <b>4. SOCKETS</b> , Tube                         | <b>16. RESISTORS</b> , Wire Wound, Molded           | <b>27. CONNECTORS</b> , Cylindrical              |
| <b>5. BARRIER TERMINAL BLOCKS</b> , "Jones" Type | <b>17. RESISTORS</b> , Thick Film (Metal Glaze)     | <b>28. FASTENERS</b>                             |
| <b>6. FILTERS</b> , RF Bandpass                  | <b>18. SOCKETS</b> , Integrated Circuit             | <b>29. TRANSFORMERS</b> , Pulse                  |
| <b>7. CONNECTORS</b> , Rack and Panel            | <b>19. RESISTORS</b> , Flame Proof                  | <b>30. MOTORS</b> , Miniature                    |
| <b>8. DIODES</b> , High Speed Power              | <b>20. RESISTORS</b> , High Voltage, High Frequency | <b>31. POWDERED METAL PRODUCTS</b>               |
| <b>9. DARLINGTONS</b> , Monolithic               | <b>21. TRIMMERS</b> , Wire Wound                    | <b>32. RESISTORS</b> , General Purpose           |
| <b>10. AMPLIFIERS</b> , Magnetic                 | <b>22. POTENTIOMETERS</b> , Multi Turn              | <b>33. TRANSISTORS</b> , Single Sideband, Linear |
| <b>11. TRANSFORMERS</b> , IF and RF, TV          | <b>23. CAPACITORS</b> , Metallized Film             | <b>34. CABLE HARNESS &amp; ASSEMBLIES</b>        |

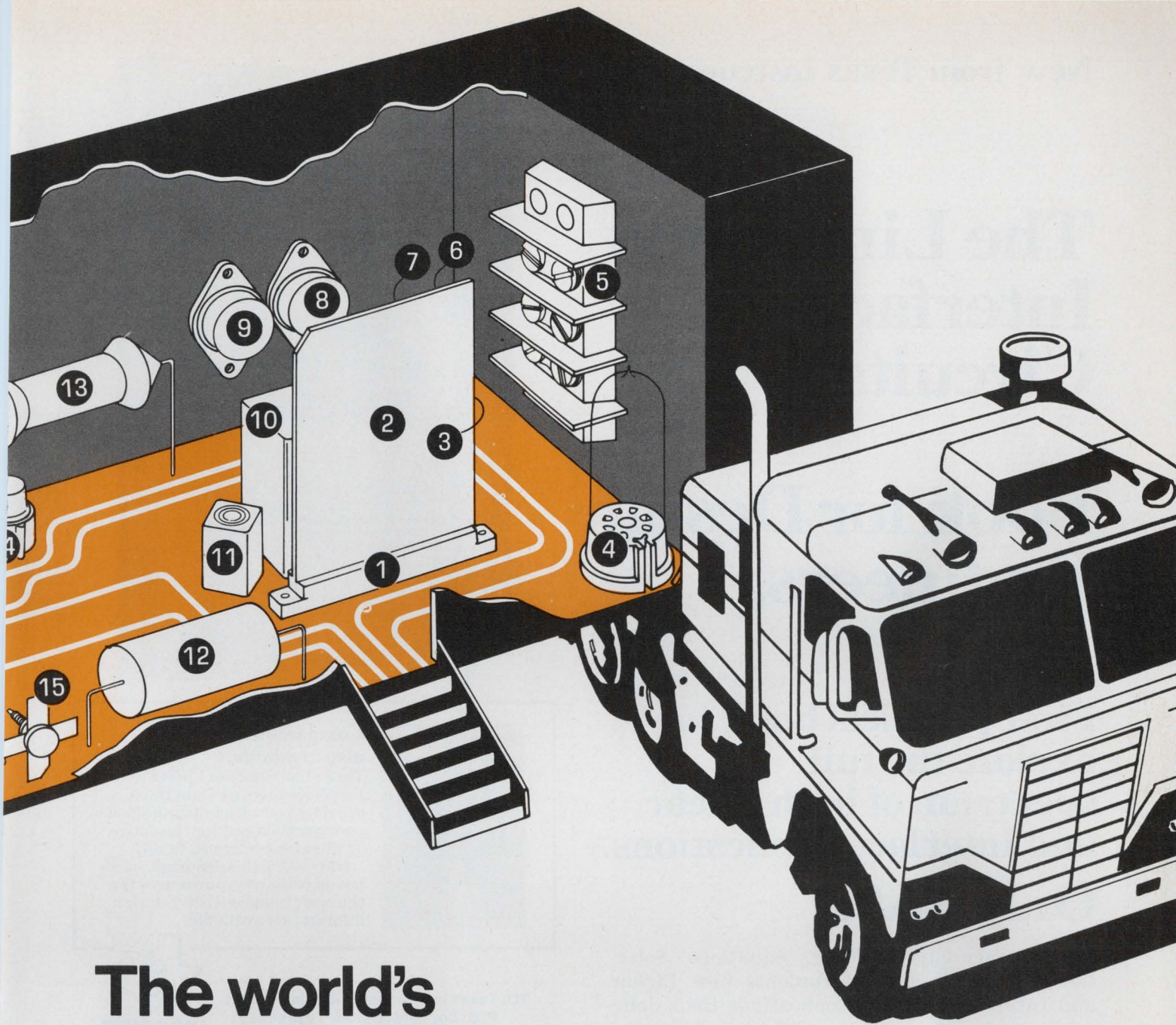

# The world's biggest "little black box" is heading home.

We're about ready to wrap up our road show on state-of-the-art electronic components. By the time we're through, we'll have visited over 150 plants in 27 states and had a chance to meet thousands of people. Executives, design engineers, manufacturing and purchasing managers.

Hopefully, you've had a chance to see our display of over 1,000 different circuit components from the 14 separate divisions which form TRW Electronic Components.

We also hope you've had a chance to ask questions, found the answers you needed, and proved to yourself that TRW is doing things — the right things — to help you solve your problems quickly and efficiently.

If you missed our "little black box," we're sorry. In that case, the above sketch should give you a general idea of what it was all about.

We're always ready to show that we want — and deserve — your business. And we'll do almost anything to prove it. Because we *are* TRW.

**TRW** ELECTRONIC COMPONENTS  
10880 Wilshire Boulevard, Los Angeles, CA 90024

For a free copy of our DIRECTORY OF OPERATIONS, write TRW Electronic Components at the above address.

INFORMATION RETRIEVAL NUMBER 37

New from Texas Instruments...

# The Linear and Interface Circuits Application Book for Design Engineers.

First practical book to explore the full spectrum of both linear and interface applications. Only \$6.95

Performance curves. Design equations. Selection criteria. Texas Instruments new Linear and Interface Circuits Applications Book delivers the information you need to stay abreast of current applications and plan cost-effective systems.

Arranged for time-saving convenience, chapters discuss vital factors concerning each device category—from product characteristics to frequently used applications and alternate circuit approaches.

Subjects include: operational amplifiers • comparators • video amplifiers • special functions • voltage regulators • peripheral drivers • MOS interface circuits • Core Memory circuits • line transmission circuits.

384 pages. Over 400 illustrations. A Texas Instruments Learning Center publication.

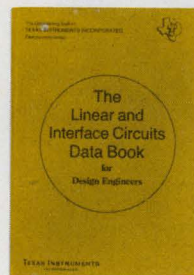
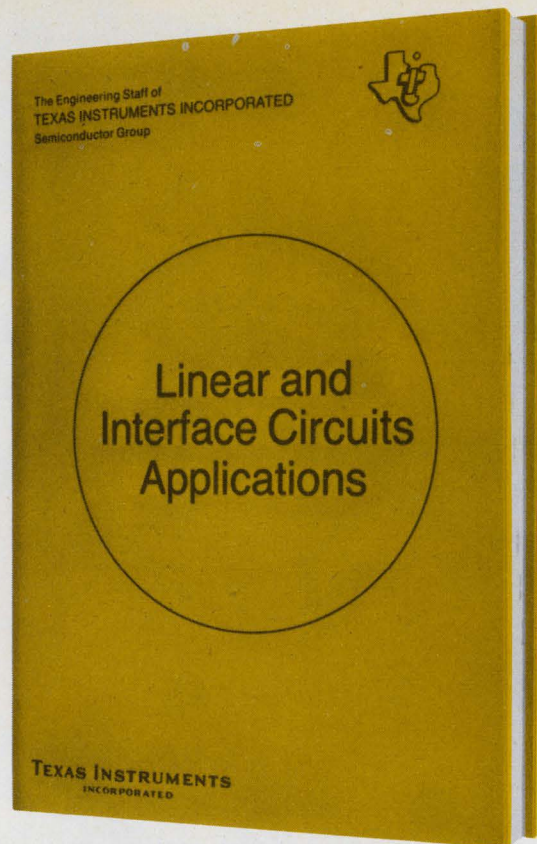

Companion data book also available.

Texas Instruments Linear and Interface Circuits Data Book provides you with full data sheets and specifications for the entire TI linear/interface IC family.

Only \$3.95, this 688-page, hard-bound edition is your source for the most comprehensive design information available.



TO: Texas Instruments Learning Center  
P. O. Box 3640, Dallas, Texas 75221

Please send:

- Linear and Interface Circuits Applications Book \$6.95
- The Linear and Interface Circuits Data Book \$3.95

Enclose check or money order. Please add state and local taxes where applicable.

Name \_\_\_\_\_ Company \_\_\_\_\_

Address \_\_\_\_\_

City \_\_\_\_\_

State \_\_\_\_\_ Zip \_\_\_\_\_

ED

**TEXAS INSTRUMENTS**  
INCORPORATED



## Too many foreigners

I envy these fellows who can feel at home anywhere in the world. For me, foreign travel is traumatic. Most of Europe is bad enough, as I get lost almost immediately in French, German, Dutch or Italian. But Japan is terrifying, as I can't read the signs (except those that say "Drink Coca Cola"), let alone understand them.

I don't mind England so much because I can pretty much cope with the language. But even there, the left-side drive scares the life out of me when I look the wrong way while crossing a street. I feel a stranger, even there, when I ask somebody for directions and learn that she's a foreign tourist.



I was particularly distressed at London's Heathrow airport. While waiting for another plane to Amsterdam after my original flight was canceled, and while waiting for the excitement over a nearby bomb explosion to subside, I was struck by a remarkable example of fine design. I guess it was my engineering background and journalistic eye for detail that made me admire and smile at this young lady, whose surface geometry left nothing to be criticized.

We didn't exchange a word, but fortune led us aboard the same plane and, purely by chance, of course, I found a seat beside her. Being shy, I didn't speak until she offered me a cigarette. When I tried to strike up a conversation, she smiled beautifully, then, in tones of velvet, exhausted her supply of English: "I speak only German."

And so it was throughout Europe. I was continually frustrated except when I was with those, in many countries, who spoke a common language—engineering. For engineering, like art and music, knows no language barriers. The components, circuits and equipment designed by engineers in one country can be understood and used by engineers in all countries. Resistors and capacitors in France are like resistors and capacitors in Germany, Italy or England. So are ICs and DVMs.

While politicians throughout the world, however well schooled in language arts, seem unable to communicate, engineers can understand each other with little difficulty. In the engineering community there are no foreigners.

Perhaps we should subject our politicians to the disciplines of engineering. And perhaps our engineers should devote themselves more to politics. Politics certainly wouldn't suffer. And engineering . . . well, a small setback might not hurt too much.

GEORGE ROSTKY  
Editor-in-Chief

# Taming noise in IC op amps: Signal-source impedance and operating-frequency band are the keys to selection of the right bipolar or FET-input op amp.

The selection of IC op amps for very-low-signal applications depends primarily on two parameters: the impedance of the signal source used and the operating-frequency band. Careful attention to these parameters can help overcome the noise limitations of the otherwise extremely versatile monolithic op amp.

Op amps generally employ bipolar transistors at the input, although a growing number of newer amplifiers have FET inputs. Both types are prone to the same sources of noise as discrete amplifiers that use such devices.

For a differential-input configuration, op amps use at least two, and sometimes four, input transistors that increase noise levels over those for a single-transistor input stage. Generally noise levels increase with the square root of the number of transistors.

Moreover IC op amps are usually internally biased, so designers cannot alter bias currents to reduce noise. However, newer programmable amplifiers return this option to the designer. (Programmable here means the ability to change internal operating currents by selection of an external resistor.)

## Rules help reduce noise

The problems caused by noise can be reduced by following these major design rules:

- Use bipolar-input op amps when source impedances are low and operating currents are high. Applications with very high impedances generally favor use of FET or super-beta transistor inputs operating at low current levels.

- Select bipolar-input op amps for moderate to low-impedance sources, particularly if the operating frequency band lies below 100 Hz.

- Expect burst, or "popcorn," noise when bipolar op amps operate at high input-bias currents. This type of noise is also more likely to occur when source impedances are high than when they are low.

- Limit circuit bandwidth to that necessary to process the desired signals. Unnecessary bandwidth increases noise voltages at the output.

## Bipolar model pinpoints noise sources

A typical op-amp circuit containing equivalent noise sources appears in Fig. 1. The sources are referred to the input and specified by their 1-Hz-bandwidth values. The term  $\sqrt{4kTR_s}$  represents the thermal noise voltage of source resistor  $R_s$ , while  $E_n$  is the noise voltage caused by the amplifier when  $R_s$  is zero. Current  $I_n$  represents noise contributed by the amplifier in addition to

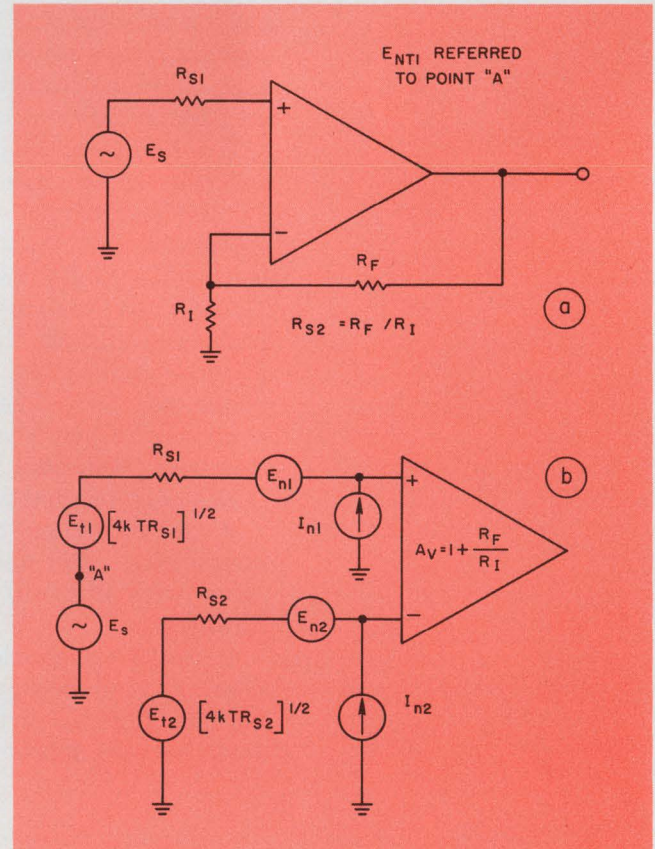

1. A typical op-amp circuit (a) is terminated at its input by source resistors  $R_{s1}$  and  $R_{s2}$ . The equivalent circuit (b) exhibits the major sources of noise.

Tom Robe, Member of Technical Staff, RCA Solid State Div., Route 202, Somerville, N.J. 08876

$E_n$  when  $R_s$  doesn't equal zero.

Since these sources are at random phase with one another, they must be added in rms fashion to obtain the total input-referred noise voltage. The total voltage per  $\sqrt{\text{Hz}}$  of bandwidth can be expressed as follows:

$$E_{nti} = \sqrt{4kTR_{S1} + 4kTR_{S2} + E_{n1}^2 + E_{n2}^2 + \overline{I_{n1}R_{S1}^2} + \overline{I_{n2}R_{S2}^2}}^{1/2}$$

If  $R_{S1} = R_{S2}$  and the  $E_n$  and  $I_n$  generators are combined, the equation simplifies to

$$E_{nti} = [8kTR_s + E_{nT}^2 + \overline{I_{nT}R_s^2}]^{1/2}, \quad (1)$$

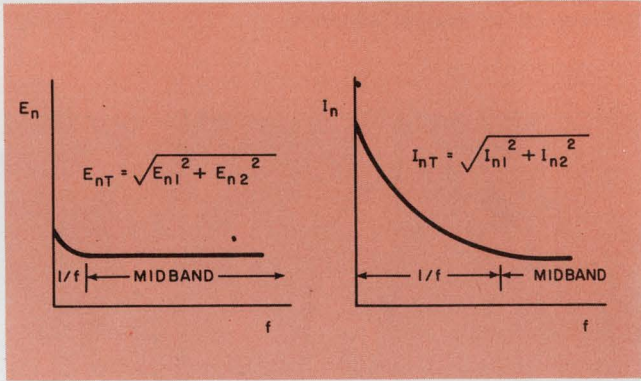

2. Typical  $E_n$  and  $I_n$  spectral density curves in bipolar op amps show greater  $1/f$  sensitivity for  $I_n$ .

where  $E_{nT} = (E_{n1}^2 + E_{n2}^2)^{1/2}$  and  $I_{nT} = (I_{n1}^2 + I_{n2}^2)^{1/2}$ .

Op-amp data sheets usually provide information on  $E_n$  and  $I_n$  in terms of  $E_{nT}$  and  $I_{nT}/\sqrt{2}$ , the approximate noise current at each input terminal.

Total noise voltage  $E_{nti}$  over a band of frequencies can be found by a plot of the noise spectral density,  $\overline{E_{nti}^2}$ , vs frequency and integration over the required frequencies. If the noise spectral density is fairly constant with frequency, as it is for "shot" noise, wideband  $E_{nti}$  can be found simply by multiplication of the narrowband, 1-Hz, value in Eq. 1 by the square root of the bandwidth.

### Three noise sources in bipolar op amps

A bipolar transistor contributes to  $E_n$  and  $I_n$  from three major sources:

1. Thermal noise from the base-spreading resistance  $r'_{bb}$ :

$$E_t = \sqrt{4kTr'_{bb}} \text{ in units of } V_{rms}/\sqrt{\text{Hz}},$$

where  $k$  is Boltzmann's constant,  $1.38 \times 10^{-23} \text{ W/}^\circ\text{K}$ , and  $T$  is temperature in degrees Kelvin.

2. Shot noise from dc-current flow in the emitter and base. This noise source can be modeled by two shot-noise current generators:

$$I_{se} = \sqrt{2qI_E} \text{ in } A/\sqrt{\text{Hz}}$$

and  $I_{sb} = \sqrt{2qI_B} \text{ in } A_{rms}/\sqrt{\text{Hz}}$ ,

where  $q$  is the electronic charge  $1.59 \times 10^{19}$

coulombs.

3. Flicker or  $1/f$  noise from the flow of base current through the emitter-base depletion region. This noise source can be modeled by a noise-current generator:

$$I_f = \frac{\sqrt{2qI_B f_L}}{f} \text{ in } A_{rms}/\sqrt{\text{Hz}}.$$

In Fig. 1b, voltage  $E_n$  represents the combined effects of the three noise generators when  $R_s = 0$ . With  $R_s$  still zero,  $r'_{bb}$  contributes its full thermal noise,  $E_t$ . Emitter shot-noise current  $I_{se}$  flows

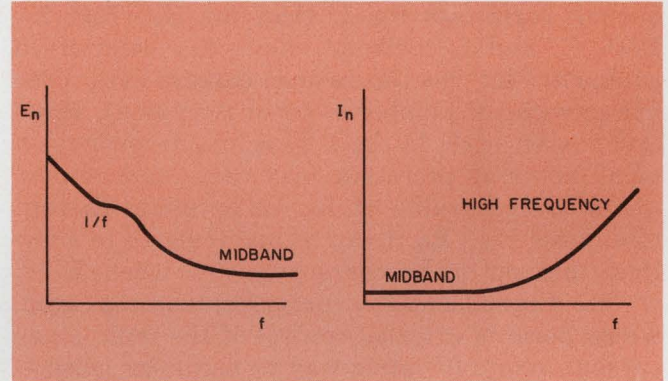

3. Corresponding curves for a FET-input op amp reveal differences in magnitude and spectral responses.

through the emitter dynamic resistance  $r_e$  and so generates an equivalent input-noise-voltage term:

$$E_s = I_{se} r_e = \frac{kT}{qI_E} \sqrt{2qI_E} = \sqrt{\frac{K_E}{I_E}} = \frac{14.2 \times 10^{-12}}{\sqrt{I_E}}$$

in  $V_{rms}/\sqrt{\text{Hz}}$ .

Base shot-noise current  $I_{sb}$  flows through  $r'_{bb}$  and generates a noise voltage  $I_{sb} r'_{bb} = \sqrt{2qI_B} r'_{bb}$ , which is usually insignificant compared with  $E_t$  and  $E_s$ . Flicker-noise current generator  $I_f$  also flows through  $r'_{bb}$ , generating a  $1/f$  noise-voltage component of  $E_n$ . This component of  $E_n$  is only appreciable at frequencies below about 100 Hz, unless the operating current level is relatively high.

Hence the total value of  $E_n$  can be expressed as follows:

$$E_n = E_t^2 + E_s^2 + I_{sb}^2 r'_{bb}{}^2 + I_f^2 r'_{bb}{}^2 \text{ in } V_{rms}/\sqrt{\text{Hz}}.$$

At frequencies above 100 Hz, the equation has a uniform spectral value that allows the following approximation:

$$E_n = (E_t^2 + E_s^2)^{1/2} = (K_t r'_{bb}{}^2 + K_E/I_E)^{1/2} \text{ in } V_{rms}/\sqrt{\text{Hz}}. \quad (2)$$

Noise contributed by this source can be minimized if the amplifier is designed with transistors that have low  $r'_{bb}$  and the transistors are operated at relatively high emitter-current levels.

Remember that each input transistor of the differential amplifier contributes an  $E_n$  term. For

a two-transistor differential amplifier, the total  $E_n$  would be  $\sqrt{2}$  times the  $E_n$  of each transistor, if equal voltage for each is assumed.

The  $I_n$  term of Eq. 1 is simply the rms sum of  $I_{sb}$  and  $I_f$ :

$$I_n = \sqrt{I_{sb}^2 + I_f^2} = \sqrt{2qI_B[1 + f_L/f]} \\ = \sqrt{K_I I_E (1 + f_L/f)} \text{ in } A/\sqrt{\text{Hz}} \quad (3)$$

Of course,  $I_n$  can be minimized through a reduction in base-bias current. The reduction can be achieved by use of input-stage transistors that have high dc betas at microampere collector currents.

Typical noise spectral-density curves for an op amp with bipolar input show greater frequency variations for  $I_n$  than for  $E_n$  (Fig. 2). Both  $E_n$  and  $I_n$  midband values are determined primarily by the operating current ( $E_n$  also varies with the number of input junctions). However, noise levels in the  $1/f$  region, dependent on manufacturing processes, may vary considerably.

For a fixed value of  $R_s$ , an optimum current minimizes  $E_{nti}$ . Eq. 1 can be manipulated to show that this optimum current occurs when  $E_n/I_n = R_s$ . Consequently a programmable op amp, which permits external control of the input-stage current, offers a simple way to minimize noise.

### Noise sources in FET op amps

The noise model for bipolar-input op amps applies also to amplifiers with FET inputs. Only the magnitudes and spectral responses are different. Typical FET spectral responses appear in Fig. 3.

The three sources of noise in a FET are as follows:

1. Thermal noise from channel conductivity.
2. Shot noise from gate-leakage current.
3. Flicker or  $1/f$  noise.

Here again,  $E_n$  represents the amplifier-contributed noise when  $R_s = 0$ , and  $I_n$  represents additional noise when the source impedance isn't zero.

Because of the exceedingly small gate-leakage current of FETs, particularly MOS types, the midband  $I_n$  term usually is small enough, relative to  $E_n$ , to be neglected. This approximation is especially valid in the  $1/f$  region at frequencies below 100 kHz. In this low and mid-frequency area,  $I_n$  results mainly from the shot noise generated by the reverse-diode gate-leakage current,  $I_{GL}$ , and it has the form  $I_n = \sqrt{2qI_{GL}}$ . Noise voltage  $E_n$  in the midband region results from the thermal noise of the channel resistance, and it has a noise resistance  $R_n$  of

$$R_n = \frac{2}{3} \frac{1}{g_m},$$

so that

$$E_{n(\text{midband})} = \sqrt{4kTR_n} = \sqrt{\frac{8}{3} \frac{kT}{g_m}} \quad (4)$$

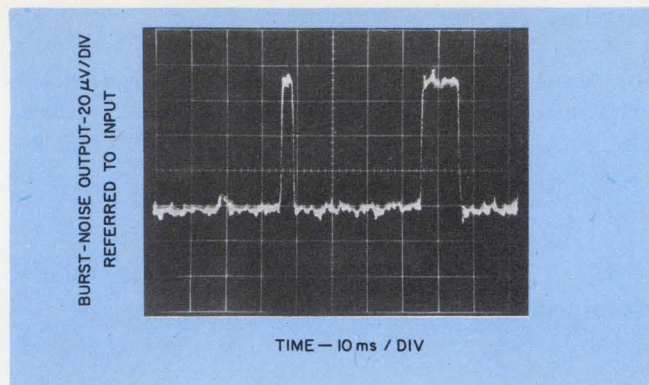

4. The characteristics of burst noise include random, abrupt changes in output level that can last from about 0.5 ms up to several seconds.

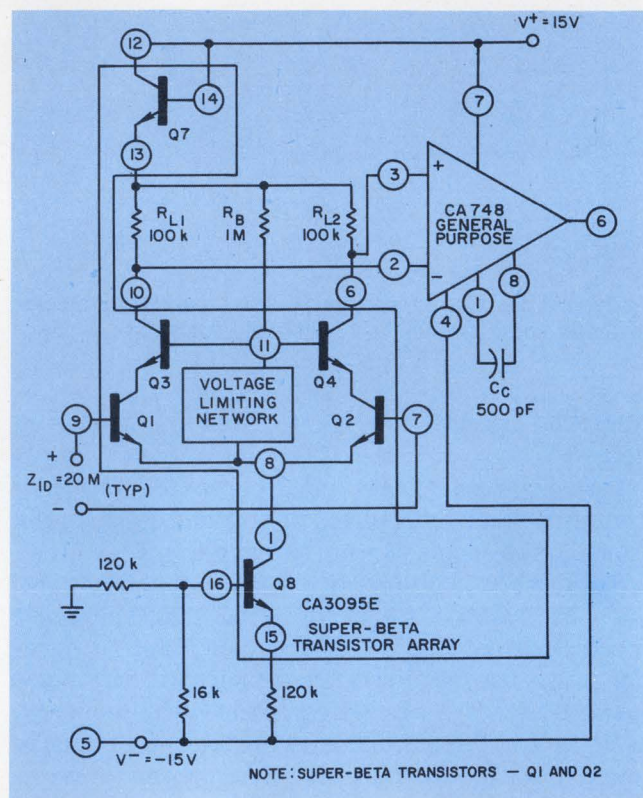

5. Op-amp circuit employs super-beta transistor array. The array serves the function of a programmable preamp to achieve low-noise characteristics.

The equation<sup>1</sup> suggests that midband-noise voltage falls off at high drain currents because of the inverse relation to  $g_m$ . However,  $g_m$  depends on  $\sqrt{I_D}$  while  $E_n$  is related to  $\sqrt{1/g_m}$ . Hence  $E_n$  approximately decreases as the fourth-root of an increasing  $I_D$ , so that  $E_n$  is relatively insensitive to  $I_D$  variations.

The increase in  $I_n$  at higher frequencies results from a capacitive coupling of channel thermal noise into the gate circuit through the feedback capacitance,  $C_{gd}$ . Essentially  $C_{gd}$  reflects a parallel resistance,  $R_i$ , into the gate circuit. The resistance increases with frequency and contributes

the following thermal noise current at the input:

$$I_n = \sqrt{\frac{4kT}{R_i}} \text{ in } A/\sqrt{\text{Hz}} \quad (5)$$

This noise component can be obtained from a measurement of the real part of the input admittance at high frequencies.<sup>2</sup>

Unlike the situation with bipolar-input op amps, the  $E_n$  of FET-input amplifiers has a significant  $1/f$  characteristic; the  $1/f$  noise of a bipolar op amp occurs primarily in its  $I_n$  characteristic. The midband  $I_n$  of a FET op-amp is generally negligible, while the midband  $I_n$  for an op-amp with a bipolar input may be significant, depending on the source impedance used.

### 'Popcorn' noise a problem, too

In low-signal-level applications, burst noise, or popcorn noise, should be considered (Fig. 4). The characteristics include abrupt changes in output level that persist from about 0.5 ms to several seconds. And they occur at random rates from less than one per minute to several hundred per second.<sup>3</sup> This type of noise becomes most objectionable in very-low-frequency narrowband applications, because pk-pk noise levels are very low and burst-noise peaks may dominate the total noise output.

In the popcorn-noise model, the current generator has a magnitude that is proportional to the square root of the input-bias current. Hence the generator's effect can be reduced by use of op-amps with FET inputs or amplifiers with bipolar inputs in which the bias current is very low—such as those operating at very low collector currents with high dc beta. And since burst noise is an input-current noise, the amplitude of the bursts varies proportionally to the magnitude of the terminating source impedance,  $Z_s$ . Therefore to minimize burst noise, maintain  $Z_s$  as low as possible. Several available ICs are fully tested for popcorn noise at various source impedances.<sup>3,4</sup>

### Noise isn't everything

Of course, parameters other than noise enter into the selection of an op amp. They include offset voltage, offset-voltage drift, input-offset current and bandwidth.

Consider an application that calls for a low-level dc amplifier operating from a low-impedance sensor, such as a thermocouple. The best choice is probably an amplifier with a bipolar transistor input. This type of op amp has a lower offset drift than one with FET inputs, and at low source impedance,  $E_n$  is the dominant noise source.

For ac-coupled applications, where dc drift is not critical, the choice between bipolar and FET input depends largely on the source impedance

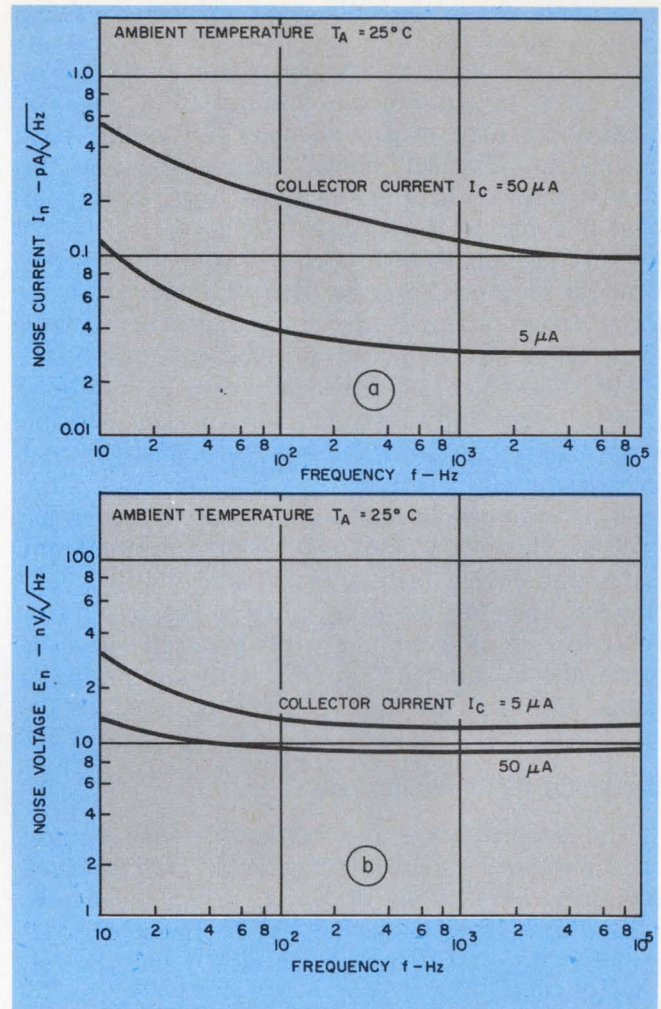

6. Noise-frequency characteristics for the super-beta op-amp circuit of Fig. 5 are shown for noise current  $I_n$  (a) and noise voltage  $E_n$  (b). The super-beta input transistors operate at collector currents of  $5 \mu\text{A}$  in Fig. 5.

of the sensor. At very high source impedances—greater than  $1 \text{ M}\Omega$ —op amps with FET inputs are probably the best choice; their exceptionally low  $I_n$  currents result in a lower  $I_n R_s$  product.

Low-source-impedance applications favor the use of op amps with bipolar inputs that operate in the 50-to-200- $\mu\text{A}$  collector-current range (to minimize  $E_n$ ). Higher-source-impedance applications favor the use of op amps with FET inputs or with bipolar inputs that can operate at low collector currents—less than  $10 \mu\text{A}$ —and that can still retain high dc beta. This mode of operation indirectly minimizes  $I_n$ .

Op amps that allow the current to be programmed are especially useful for applications with high source impedances. Input-transistor collector currents for these amplifiers can be altered externally to provide the best  $E_n$  vs  $I_n$  tradeoff for  $Z_s$ . (This point occurs when  $E_n/I_n = Z_s$ .)

Moreover the use of super-beta input transistors provides an  $E_n$  with low  $1/f$  characteristics (for bipolar transistors) along with  $I_n$  levels that

are much lower than those of conventional bipolar transistors. For example, the circuit in Fig. 5 shows a super-beta transistor array<sup>5,6</sup> coupled as a programmable preamp to a general-purpose op amp to provide very low noise characteristics. Typical noise parameters for the circuit appear in Fig. 6. (The 5- $\mu$ A curves of Fig. 6 apply to the circuit of Fig. 5.)

Low-frequency noise, such as 1/f or burst noise, depends on the IC process used. It varies substantially from manufacturer to manufacturer, and even from lot to lot of a given manufacturer. When this type of noise becomes critical, one solution is to use fully tested units. Another solution is to examine several vendors' op amps and test them yourself.

Midband noise doesn't depend heavily on the IC process. Rather it primarily reflects bias-current levels and device geometries; essentially it is contingent upon device design. As a result, only a relatively small sample of units generally need be examined to select an op amp with low midband noise.

### Designing for minimum noise

The general steps for minimum noise design, or maximum signal-to-noise ratio, are derived from an examination of Eq. 1. When the device is shot-noise limited—when the  $E_s$  term primarily determines the value of  $E_n$ —Eq. 1 has the following form:

$$E_{nti} = \sqrt{8kTR_s + 2 \frac{K_E}{I_E} + 2K_I I_E R_s^2}, \quad (6)$$

where  $I_E$  is the emitter dc current of the input transistors. Noise voltage  $E_{nti}$  has a minimum value at an  $I_E$  for which

$$\frac{K_E}{I_E} K_I I_E R_s^2 = E_{nT}^2 = I_{nT}^2 R_s^2. \quad (7)$$

Hence for a given value of  $R_s$ ,  $E_{nti}$  is minimum when  $E_n/I_n = R_s$ .

The circuit noise factor, defined by the ratio

$$NF = \frac{E_{nti}^2}{8kTR_s} = 1 + \frac{E_{nT}^2}{8kTR_s} + \frac{I_{nT}^2 R_s^2}{8kTR_s}, \quad (8)$$

is also minimized when  $E_n/I_n = R_s = R_{OPT}$ . For this condition, the optimum noise figure,  $F_{OPT}$ , becomes

$$F_{OPT} = 1 + \frac{E_{nT} I_{nT}}{4kT}. \quad (9)$$

The minimum value of  $F_{OPT}$  is independent of operating current, so long as the current is low enough to make  $E_n$  shot-noise limited. This current level depends on the magnitude of  $r'_{bb}$  but generally operating-current levels below about 200  $\mu$ A yield minimum  $F_{OPT}$ .

The procedure then for the design of a minimum-noise system consists of the following six steps:

*Step 1.* With the sensor source impedance fixed

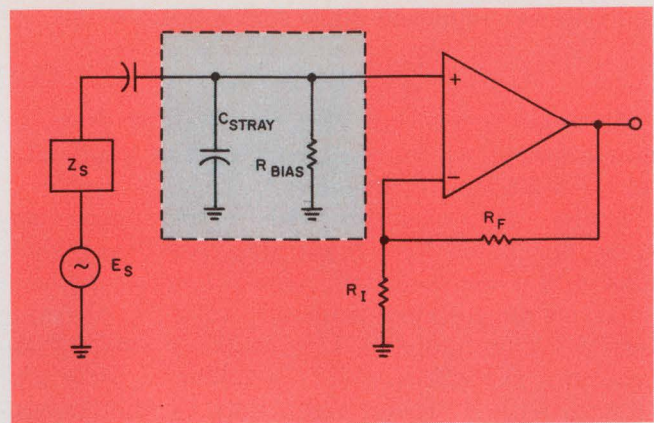

7. Stray capacitance and bias resistance degrade signal-to-noise ratios.

at  $Z_s$ , select an op amp that has  $E_n/I_n$  approximately equal to  $Z_s$  at the frequency for which noise is most critical. Alternatively, a programmable op amp adjusted to a current level for which  $E_n/I_n = Z_s$  can be used.

For very low source impedances—less than 100  $\Omega$ —the adjustment may not be possible without operation at very high current levels. There the base-resistance factor of thermal noise dominates  $E_n$ .

In this case  $F_{OPT}$ , corresponding to  $E_n/I_n \approx Z_s$ , is high because the  $I_{nT} R_s$  product matches the base-resistance factor of the thermal noise,  $\sqrt{4kTr'_{bb}}$ , rather than  $E_s$ , the shot-noise component of  $E_n$ . Noise-figure minimization results when the  $I_n (R_s + r'_{bb})$  product equals the shot-noise component of  $E_n$ , or when

$$I_{nT} (R_s + r'_{bb}) = \frac{(14.2 \times 10^{-12})}{I_E}. \quad (10)$$

One of two designs may be used. First, a transformer can be employed at the input to raise the source impedance. If this is not practical, adjust the operating current of the input stage to satisfy Eq. 10. Generally, this occurs at collector currents in the range of 0.1 to 1.0 mA.

*Step 2.* If the first-stage op amp forms a low-gain stage, such as a follower, use a low  $E_n$  second stage as well. The  $I_n$  of the second stage is not as important normally, because the output impedance of the first stage is very low. Second-stage  $E_{nt2}$  affects the total input referred noise,  $E_{nti}$ , as follows:

$$E_{nti}^2 = E_{nt1}^2 + \frac{E_{nt2}^2}{A_{V1}^2}, \quad (11)$$

where  $A_{V1}$  is the voltage gain of the first stage.

*Step 3.* Resistors connected to the input terminals and which have dc voltage across them should be of a low-noise type, such as metal-film resistors. The requirement also applies to bias and feedback resistors connected to the op-amp input terminals. Most resistors generate noise in excess of the thermal noise,  $4kTR$ , when dc volt-

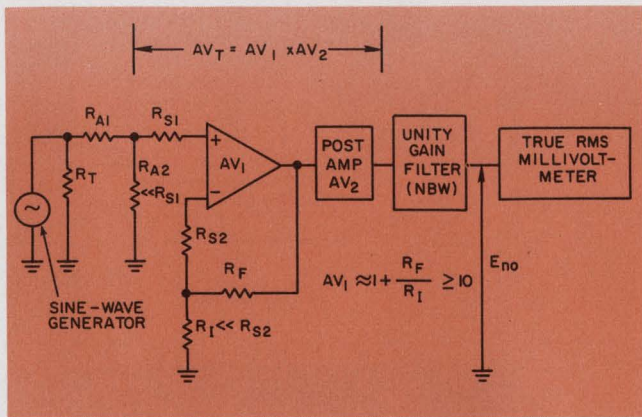

8. Measurement of  $E_{nT}$  and  $I_{nT}$  with this test system allows a variety of source impedances to be used.

ages are impressed upon them. The excess noise increases with voltage and has a  $1/f$  characteristic. The resistor figure of merit for this characteristic is called its noise index: the excess noise voltage it generates in microvolts per volt-dec per decade of bandwidth. A noise index of zero dB is poor, while a 20-to-30-dB index is good.

**Step 4.** The input-bias resistance ( $R_{BIAS}$  in Fig. 7) should be as large as possible, compared with the magnitude of  $Z_s$ . Because the resistor shunts the input,  $R_{BIAS}$  adds noise as a current source that is inversely proportional to the square root of its resistance value. Also, any attenuation of signal voltage  $E_s$ , resulting from the voltage division between  $Z_s$  and  $R_{BIAS}$ , degrades the signal-to-noise ratio. Voltage  $E_n$  is not similarly attenuated.

**Step 5.** The shunt capacitance ( $C_s$  in Fig. 7) should be kept as low as possible, to minimize its attenuation of  $E_s$ .

**Step 6.** Keep system bandwidth as narrow as possible, consistent with signal requirements, to minimize the total noise at the load. All the noise expressions given are based on a per-unit-bandwidth (1 Hz). However, the total noise power delivered to the load is proportional to the square root of the system's noise-power bandwidth.

### Measuring op-amp noise

Several methods can be used to measure the noise characteristics of different op amps. One measures total input noise voltage, with the input terminated by source impedances that are typical for the application. The measurement should use a filter to limit frequencies to those for which the op amp is intended. When several op amps are tested, the filter also ensures a consistent noise bandwidth. Otherwise comparative noise voltages read at the output may be as much a measure of differences in amplifier bandwidth as they are of amplifier noise.

A more general method measures  $E_{nT}$  and  $I_{nT}$

separately. This permits the calculation of noise performance for a variety of source impedances. Fig. 8 shows the test system.

The input sine-wave oscillator,  $R_{A1}$ - $R_{A2}$  attenuator and millivoltmeter measure the over-all test-system voltage gain,  $AV_T = AV_1 AV_2$ . They also measure the response characteristic of the system, including the filter. The filter has unity gain in the passband, and it has a noise-power bandwidth (NBW) that is not the same as the filter's 3-dB bandwidth. Rather, NBW represents the width of a rectangle on a frequency plot of voltage gain squared. The rectangle has the same area as that under the actual response curve and a height equal to the peak height of the actual response (Fig. 9). For example, a single-pole low-pass filter with a 3-dB frequency of  $f_p$  has a noise bandwidth of about  $1.57 f_p$ .

The post-amplifier in Fig. 8 ensures a total output-noise signal that is large enough for measurement with a true rms millivoltmeter. The voltage gain ( $AV_1$ ) of the op amp under test should be at least 20 dB, so that post-amplifier noise can be neglected. Also, meter bandwidth should be substantially wider than the filter NBW, so the filter remains the only factor in limiting bandwidth. If the meter used is an average detecting type, calibrated to read the value of a sine wave, multiply the output noise-voltage readings by 1.13 to obtain true rms noise voltage.

When noise must be measured at very low frequencies—less than 10 Hz—accurate rms readings on a meter are difficult to obtain. The best approach in this case is to view the noise at the filter output with an oscilloscope, so that pk-pk rather than rms noise can be measured. A storage oscilloscope with a sensitive plug-in is well suited for this measurement; it's also a good instrument for detection of burst noise, because it stores the burst.

For the total input-referred noise over the full filter bandwidth, disconnect the signal generator and measure the total output rms noise-voltage,  $E_{no}$ . Then calculate  $E_{nti}$  as follows:

$$E_{nti} = \frac{E_{no}}{AV_T} \text{ in } V_{RMS}$$

The average noise spectral density per  $\sqrt{\text{Hz}}$  is

$$\frac{E_{nti}}{\sqrt{\text{Hz}}} = \frac{E_{no}}{AV_T \sqrt{\text{NBW}}} \text{ in } V_{RMS}/\sqrt{\text{Hz}}$$

To measure the  $E_n$  component of op-amp noise, short out resistors  $R_{s1}$  and  $R_{s2}$ . Then calculate  $E_{nt}$  as follows:

$$E_{nT} = (E_{n1}^2 + E_{n2}^2)^{1/2} = \frac{E_{no}}{AV_T \sqrt{\text{NBW}}} \text{ in } V_{RMS}/\sqrt{\text{Hz}}$$

In this measurement, resistance  $R_{A2}$  and resistance ratio  $R_F/R_I$  must be sufficiently low so their thermal noise voltages are much lower than  $E_n$ .

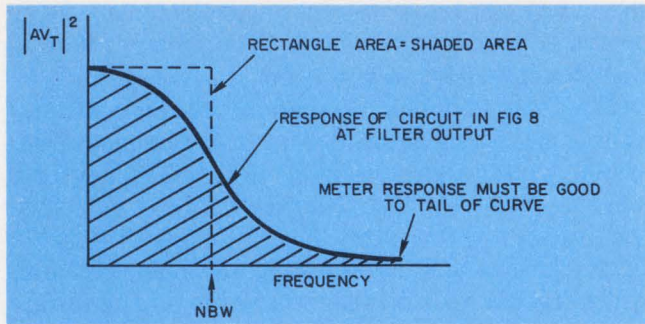

9. The filter noise-power bandwidth (NBW) isn't the same as its 3-dB bandwidth.

To measure the total input noise current of the op amp,  $I_{nT} = (I_{n1}^2 + I_{n2}^2)^{1/2}$ , let  $R_{s1}$  and  $R_{s2}$  be equal and sufficiently high in value so  $I_n R_s$  is at least four times larger than  $E_n$  plus  $4kTR_s$ . An estimate of  $I_{nT}$  can be made by calculation of the theoretical value of  $I_n$  at midband from the relation

$$I_{nT} \approx 1.4 \sqrt{2qI_{IB}} \approx 1.4 I_{n1},$$

where 1.4 accounts for the fact that there are two noise-current generators, one at each input.  $I_{IB}$  is the input bias current. With the measured value of  $E_{no}$ , calculate  $I_n$  as follows:

$$I_n \approx \frac{E_{nti}}{R_s} = \frac{E_{no}}{AV_T \sqrt{NBW} R_s} \text{ in } A/\sqrt{Hz}.$$

If  $E_n$  and  $4kTR_s$  are not negligibly small compared with  $I_n R_s$ , then  $I_n$  can be calculated from the measurement of  $E_{nti}$  as follows:

$$I_{nT} = \frac{\sqrt{E_{nti}^2 - E_{nT}^2 - 8kTR_s}}{R_s} \text{ in } A/\sqrt{Hz}.$$

Measurements of  $I_n$  when the values of  $R_s$  are very high must be performed carefully. Any shunt capacitance across  $R_s$ , including its own stray capacitance, can reduce the impedance of  $R_s$ , thereby reducing thermal noise and the  $I_n R_s$  product. The reduction results in an erroneous measurement of  $I_n$ . In addition instabilities might result from stray capacitance from the inverting terminal to ground or from the stray feedback capacitance to the noninverting input. Finally measurements of  $E_{nti}$  should be carried out in a well-shielded enclosure, because inputs terminated with high impedance are susceptible to hum pickup.

These problems are most severe when attempts are made to measure the very low midband noise currents of op amps with FET inputs or of op amps with bipolar transistor inputs and exceptionally low input-bias currents. Midband noise results primarily from shot noise, caused by input bias current flow ( $I_{IB}$ ) in the bipolar op amp or by gate-leakage current ( $I_{GL}$ ) in the FET op amp. Hence a simpler method to determine midband  $I_n$  is to measure  $I_{IB}$  and  $I_{GL}$  and then calculate  $I_n$ .

For op amps with bipolar-transistor inputs,

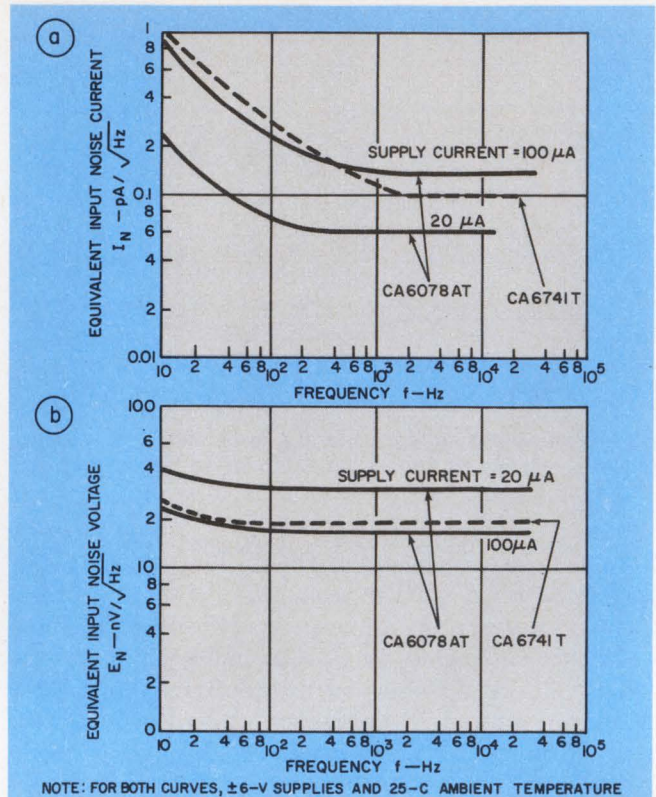

10. Compare noise characteristics of a programmable op amp, the CA6078T with a more conventional bipolar type, the CA6741T. Note the tradeoff between  $I_n$  (a) and  $E_n$  (b) for the same supply current.

use these formulas:

$$I_{n1} = \sqrt{2qI_{IB1}},$$

$$I_{n2} = \sqrt{2qI_{IB2}},$$

$$I_{nT} = \sqrt{I_{n1}^2 + I_{n2}^2} \text{ in } A/\sqrt{Hz}.$$

For FET inputs, these are the corresponding formulas:

$$I_{n1} = \sqrt{2qI_{GL1}},$$

$$I_{n2} = \sqrt{2qI_{GL2}},$$

$$I_{nT} = \sqrt{I_{n1}^2 + I_{n2}^2} \text{ in } A/\sqrt{Hz}.$$

Fig. 10 shows the noise-current and noise voltage spectral-density curves for two bipolar-input op amps. Curves for the programmable amplifier exhibit the tradeoff between  $E_n$  and  $I_n$  as a function of operating current. ■■

#### References

1. Van Der Ziel, A., "Thermal Noise in Field Effect Transistors," *Proc. IEEE*, August, 1962.
2. Motchembacker and Fitchem, "Low Noise Electronics Design," John Wiley & Sons, New York, 1973, pp. 103-106.
3. Robe, T. J., "Measurement of Burst (Popcorn) Noise in Linear Integrated Circuits," *RCA Application Note ICAN-6732*, or *RCA Solid State DATABOOK Series SSD-202B*.
4. *RCA Data Bulletins CA6741T and CA6078T*, File No. 592, or *RCA Solid State DATABOOK Series SSD-201B*.
5. *RCA Data Bulletin CA3095E*, File No. 591, or *RCA Solid State DATABOOK Series SSD-201B*.
6. Robe, T. J., "Designing with an IC Transistor Array Containing Matched Super-Beta Transistors," *RCA Application Note ICAN-6222*.





## **Hundreds of thousands of model 33s have got to tell you something.**

What it tells you is that the model 33 is very popular in both message and data communications.

And the reasons behind this popularity are important to the hearts of most businessmen. Economy. Reliability. And versatility.

These are the three product qualities we started with when the model 33 was first introduced. And over the years we haven't forgotten them. That's why we've always had a team of engineers assigned to the model 33. Their job: make the model 33 even more economical, more reliable and more versatile.

They've sure succeeded. Because the model 33 is still the most economical, reliable and versatile terminal on the market today. Nowhere else can you get so much for so little.

How much longer will we continue selling the model 33?

For as long as there's a market for economy, reliability and versatility. And the way things look today, that's going to be for a long, long time.

It takes more than manufacturing facilities to build the terminals Teletype® Corporation offers. It also takes commitment. From people who think service is as important as sales. In terminals for computers and point-to-point communications.



**The computercations people.**

For more information about any Teletype product, write or call: TERMINAL CENTRAL, Teletype Corporation, Dept. 89S, 5555 Touhy Avenue, Skokie, Illinois 60076. Phone 312/982-2500. Teletype is a trademark registered in the United States Patent Office.

# **FINALLY. A LOW NOISE GUARANTEE COMES TO IC FET OP AMPS.**

**The Analog Devices AD514 and how it came about.**



While everyone else was neglecting FET op amp noise performance, we were paying attention.

First we talked to people who worked with EKG amplifiers, pH electrode amplifiers, long term integrators— wherever noise was a problem.

Then we went to work.

The result is the AD514. An IC FET-input op amp carefully designed and processed for low noise. So you get a noise voltage level below  $5\mu\text{V}$ (p-p) max. And that's guaranteed. Because every AD514 is tested for noise parameters.

You also get a low bias current of  $10\text{pA}$  max, and a low  $V_{os}$  drift of  $25\mu\text{V}/^\circ\text{C}$ . And you'll find versions of the AD514 priced from \$5.90 to \$9.90 in hundreds.

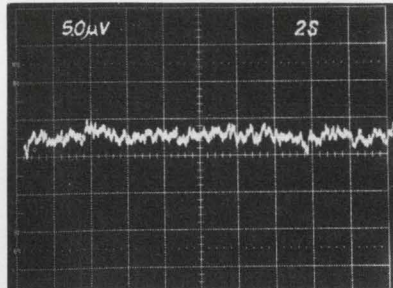

AD514 noise performance.

**But this isn't our first FET op amp.**

It all began back with our original, general purpose, low bias current IC FET op amp. It was the first IC FET op amp ever introduced anywhere by anyone.

That became the prototype for the AD523. An IC J-FET op amp with a  $0.25\text{pA}$  max bias current and a cost of \$18.75 in hundreds. Which was one-third to one-half the cost of conventional low bias current op amps.

You liked the idea. So you asked for another one. This time with low drift.

That's when we gave you the AD506L. It offers you  $10\mu\text{V}/^\circ\text{C}$  max drift.

Along with  $1\text{mV}$  max offset voltage to maintain that low drift— even after nulling. All for only \$16 in hundreds.

High speed came next in the AD528. With a unity gain slew rate of  $70\text{V}/\mu\text{sec}$ . that needs no external compensation. Plus a bandwidth of  $10\text{MHz}$  and a price of \$12 in hundreds.

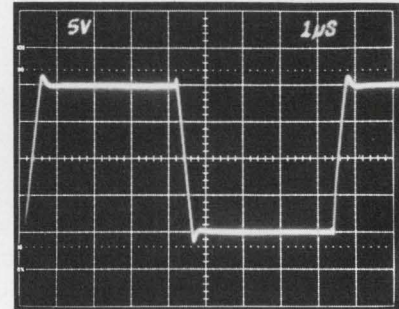

AD528 transient response.

Sometimes though, your budget is low and you're willing to trade off some speed to find a lower price. That's when the AD540, with a slew rate of  $6\text{V}/\mu\text{sec}$ . and a price of only \$4.45 in hundreds goes to work.

As you can see, we're prepared to give you the IC FET op amp performance you need in the quantities you want.

Now, if you'd like to know more, write for our IC FET op amp evaluation starter kit. Or call Analog Devices Semiconductor, Norwood, Mass. 02062. East Coast, (617) 329-4700. Midwest, (312) 297-8710. West Coast, (213) 595-1783.



INFORMATION RETRIEVAL NUMBER 39

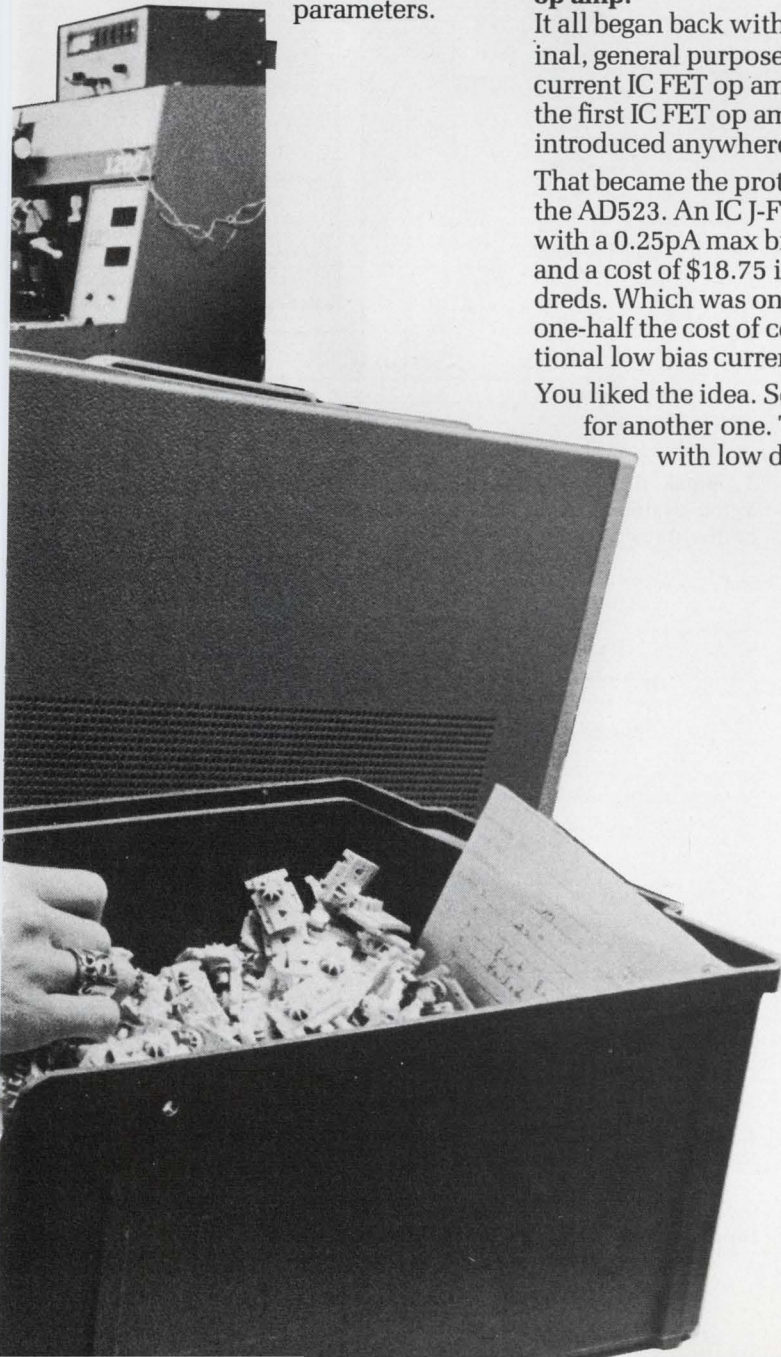

# Multiplex signals the analog way, and save on both parts count and cost. High-speed analog multiplexers provide the same accuracy as the converter-per-sensor scheme.

To reduce system complexity and cost, use analog signal multiplexing instead of digital. For many high-speed data-acquisition applications, the new analog signal-multiplexers are a low-cost alternative to schemes that use digital multiplexing and many analog-to-digital (a/d) converters.

Digital multiplexing circuits do, of course, have the highest speed, and their accuracy is almost assured—the signals are converted right at the source. However, today's analog signal multiplexers are just as accurate and almost as fast as the older multiconverter systems.

As an example, assume you must digitize 10 data channels, each of 250 kHz, to 8 bits a piece. A digital multiplexed system would require 10 converters, each capable of 0.5-MHz operation and each with a matching sample-and-hold (s/h) circuit. On top of this, add the costs of a high speed digital multiplexer and the control logic, and you get a system cost well over \$10,000.

If you use an analog system, all you need is one a/d converter capable of operation at 5 MHz and a matching sample-and-hold. In front of this combination, you put the high-speed analog multiplexer. The cost for a system like this is less than half that of the digital multiplexing system.

In operation, the analog multiplexing system is similar to the digital, but it has fewer sub-systems. Let's compare the two.

## A glimpse at digital multiplexing

The multichannel data-acquisition system in Fig. 1 can handle  $N$  channels of data. If we assume that each of the channels has a maximum frequency content of  $f_o$ , then each must be sampled at  $2f_o$ , as a minimum (which satisfies the Nyquist criterion for undistorted recovery of sampled data).

The computer must generate a binary address at a rate of  $N \times 2f_o$ . Then, under control of a decoding network, the respective channel will be sampled and the conversion process initiated.

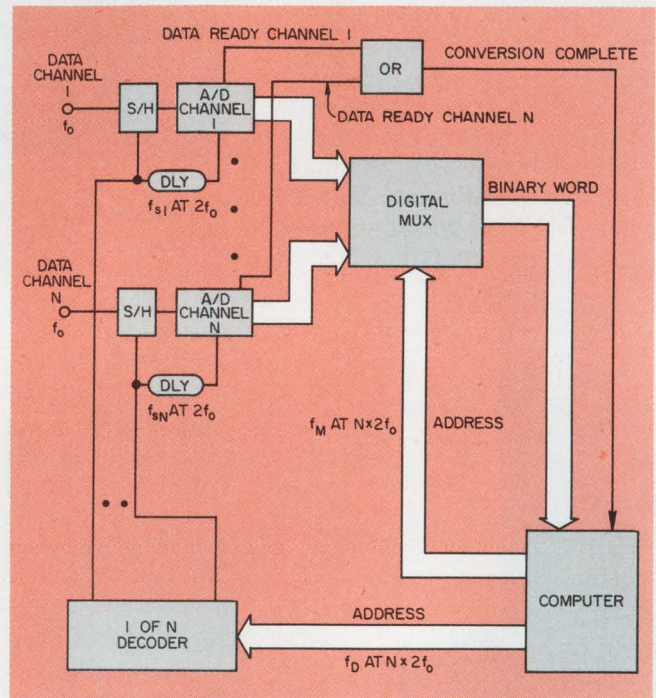

1. Block diagram of a digitally multiplexed data-acquisition system shows duplication of components for each of the data channels.

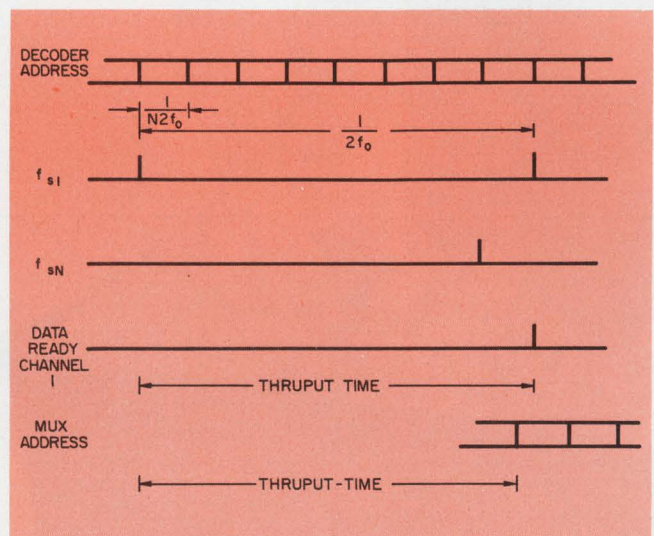

2. The timing sequence of the digital system has many delays associated with the addressing and decoding of the converters by the computer.

Lou Ruggeri, Senior Engineer, Inter-Computer Electronics, Subsidiary of American Electronic Laboratories, P.O. Box 507, Lansdale, Pa. 19446.

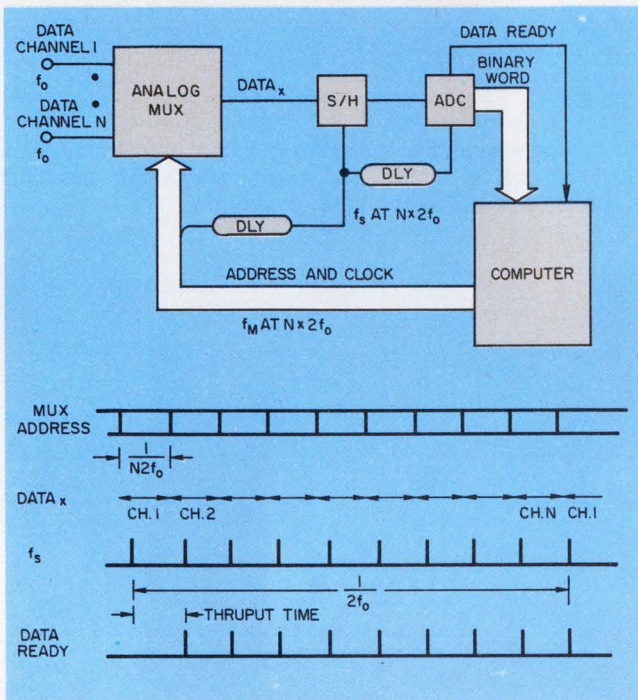

3. An analog multiplexer system is much less complex than its digital counterpart. Even the timing waveforms are much simpler for the analog system.

Typically the throughput time of the digitizing process is fixed; it depends directly upon the s/h circuit and the a/d converter selected.

Based upon this value, the computer issues another set of address commands. These instructions follow the same sequence as those presented to the decoder, but shifted in time (Fig. 2). The second address, when presented to the digital multiplexer, selects the channel that will next complete its conversion cycle.

A data-ready pulse, generated by the a/d converter, signals conversion completion and tells the computer that the data on the signal lines are valid. The same pulse can also be used to clock the data word into the computer.

You can build a simpler, equivalent system that does analog signal multiplexing (Fig. 3). In this case, a control unit must also generate address words and a synchronous clock signal. Each of these signals will cause a particular data line to

be connected onto the input line of the s/h circuit. After sufficient time has elapsed to allow for settling of the multiplexer output, the data can be sampled. Once the signal is sampled, it is encoded by the a/d converter and is delivered to the computer for analysis or storage.

For the analog system to handle the data as fast as the digital system does, all of its components must be capable of operation at the higher  $N \times 2f_0$  rate. You have only to choose the analog multiplexer with the range you need.

### Analog multiplexer error sources

Obviously when you place an analog multiplexer in series with the signal flow, additional error sources can creep in (Fig. 4). When a multiplexer channel is selected, the analog signal sees the ON resistance of the switch and any load impedance in series with it. This impedance network forms a voltage divider that causes an error in the transfer accuracy. The ohmic value, especially in MOS switches, is often a function of the input signal level, but it can be minimized with some extra buffering. If a FET amplifier is used as a buffer/driver, it affects the over-all impedance transformation through the multiplexer.

In the switch, you also have a feedthrough capacitance,  $C_i$ , that allows a portion of the signal to be coupled through the OFF switch. This occurs in spite of a typical OFF impedance of 1 GΩ or so. The capacitance forms another voltage divider, combining with  $C_{sum}$  and  $R_{on}$  of the addressed channel, and causes crosstalk.

The capacitance of the multiplexer output,  $C_{sum}$ , becomes the total capacitive load to ground.  $C_{sum}$  is the amplifier input capacitance plus the sum of each component contributed by the OFF channel. The total channel OFF capacitance in this case is  $N-1$  times the output capacitance of one channel. This capacitive reactive component forms a time-constant with the ON resistance, and along with the amplifier's slew rate, it can be the limiting factor in the multiplexer's ability to settle quickly.

Even with these different error sources, you have analog devices available that can provide 16-

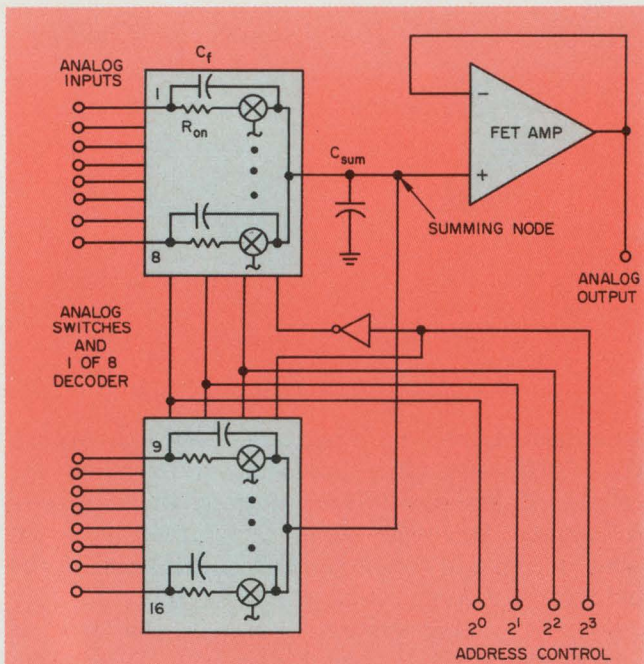

TRUTH TABLE				
2 <sup>0</sup>	2 <sup>1</sup>	2 <sup>2</sup>	2 <sup>3</sup>	CHANNEL SELECTED
0	0	0	0	1
1	0	0	0	2
0	1	0	0	3
1	1	0	0	4
0	0	1	0	5
1	0	1	0	6
0	1	1	0	7
1	1	1	0	8
0	0	0	1	9
1	0	0	1	10
0	1	0	1	11
1	1	0	1	12
0	0	1	1	13
1	0	1	1	14
0	1	1	1	15
1	1	1	1	16

4. The internal circuitry of an analog signal multiplexer has many possible error sources. Internal resistance and capacitance creates many leakage paths.

channel operation with 10-to-12-bit precision. Some of these units have settling times of 300 ns to  $\pm 0.01\%$  of full scale. When multiplexers like these are used with an addressing scheme called "preaddressing," you can convert your system to analog multiplexing with no loss in accuracy or conversion rate.

#### Preaddressing: A faster way to get data

Analog multiplexers can interface with the input of any sample-and-hold system or with the output of a bank of low-droop, high-accuracy sample-and-holds. Each method provides an N-level-to-1 translation and enables many channels of data to be processed by a single a/d converter.

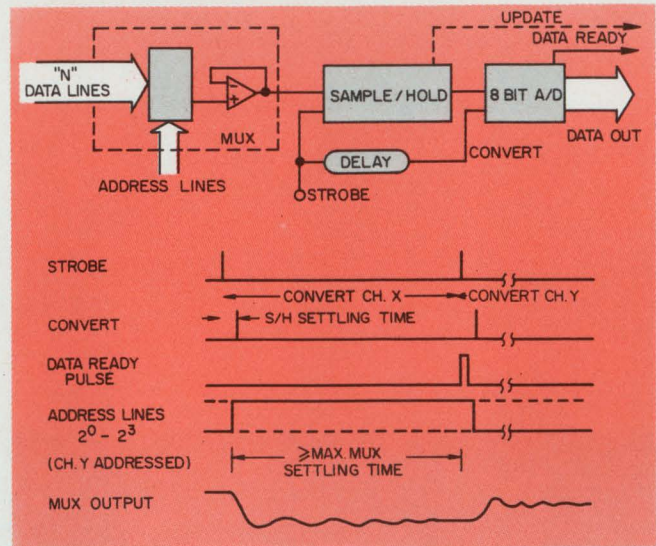

5. Preaddressing the multiplexer helps to maintain the high conversion rate of the combined sample-and-hold amplifier and analog-to-digital converter.

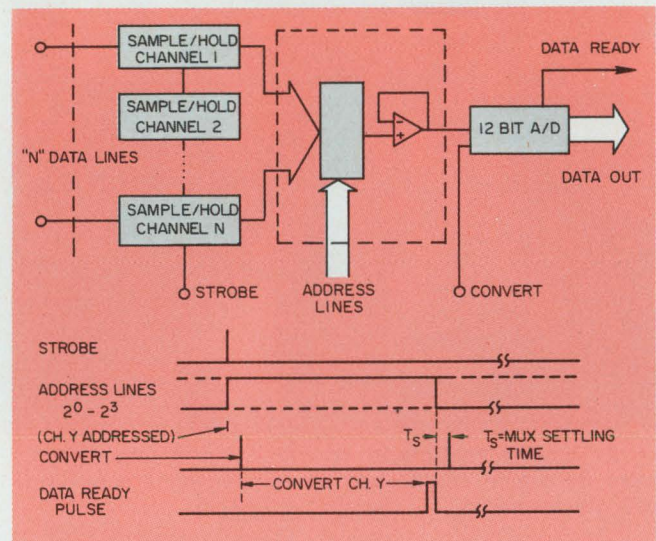

6. For multichannel sample-and-hold applications, add the multiplexer settling time to the converter throughput time to find the maximum conversion rate.

The circuit in Fig. 5 shows a method of preaddressing the multiplexer in which the address gets updated shortly after the previously selected channel is sampled. This updating can be done either by programming control of the timing sequence or by the sample-and-hold update signal. While conversion of the previously selected channel's data is being performed, the multiplexer is allowed to settle to whatever desired accuracy you need prior to the next strobing.

As long as the reciprocal of the combined conversion rate of the s/h circuit and the a/d converter is greater than the maximum settling time of the multiplexer, the over-all system throughput isn't degraded.

Fig. 6 shows another method of data multiplex-

SYSTEM ADDRESS WORD					MASTER CHANNEL SEL.	SLAVE CHANNEL SEL.	SYSTEM CHANNEL SEL.
2 <sup>0</sup>	2 <sup>1</sup>	2 <sup>2</sup>	2 <sup>3</sup>	2 <sup>4</sup>			
0	0	0	0	0	1	1	1
0	0	0	0	0	2	2	2
0	0	0	0	0	3	3	3
0	0	0	0	0	4	4	4
0	0	0	0	0	5	5	5
0	0	0	0	0	6	6	6
0	0	0	0	0	7	7	7
0	0	0	0	0	8	8	8
0	0	0	0	0	9	9	9
0	0	0	0	0	10	10	10
0	0	0	0	0	11	11	11
0	0	0	0	0	12	12	12
0	0	0	0	0	13	13	13
0	0	0	0	0	14	14	14
0	0	0	0	0	15	15	15
0	0	0	0	0	16 (EXPANDER)	1	16
0	0	0	0	0	EXPANDER	2	17
0	0	0	0	0	EXPANDER	3	18
0	0	0	0	0	EXPANDER	4	19
0	0	0	0	0	EXPANDER	5	20
0	0	0	0	0	EXPANDER	6	21
0	0	0	0	0	EXPANDER	7	22
0	0	0	0	0	EXPANDER	8	23
0	0	0	0	0	EXPANDER	9	24
0	0	0	0	0	EXPANDER	10	25
0	0	0	0	0	EXPANDER	11	26
0	0	0	0	0	EXPANDER	12	27
0	0	0	0	0	EXPANDER	13	28
0	0	0	0	0	EXPANDER	14	29
0	0	0	0	0	EXPANDER	15	30
0	0	0	0	0	EXPANDER	16	31

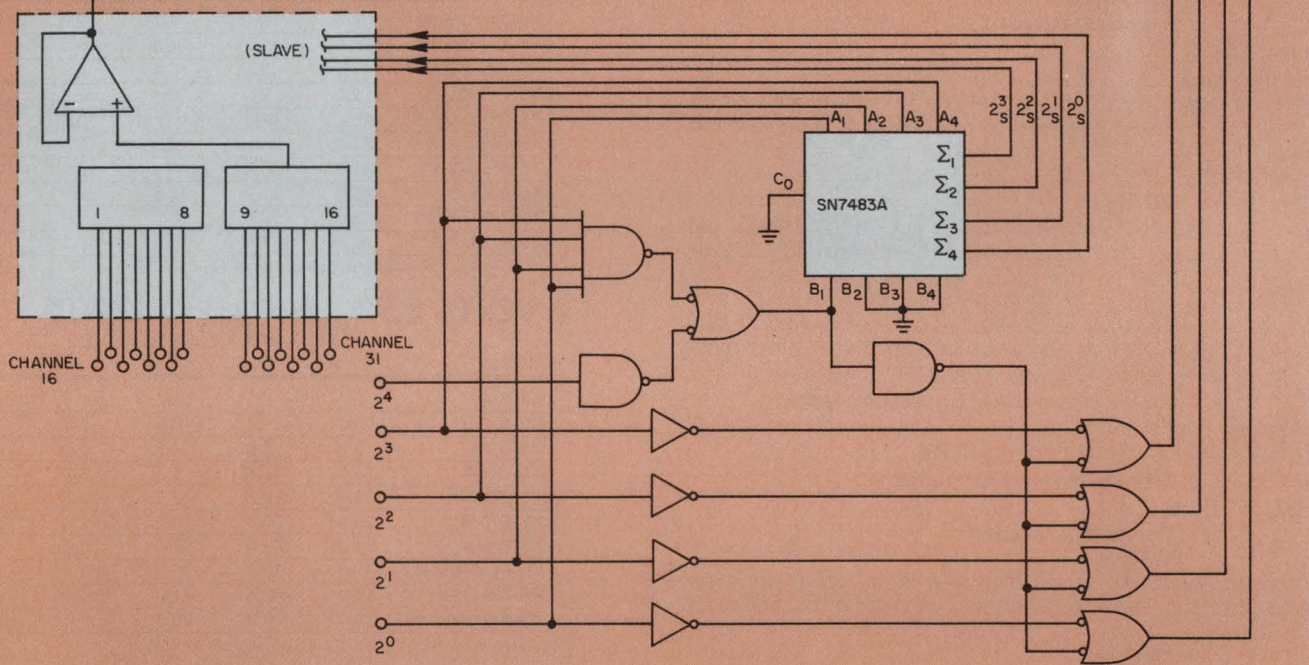

7. The basic 16-channel multiplexer can be expanded, if you use one of the 16 inputs as the input from another multiplexer and add some minor logic.

ing when you have a bank of sample-and-hold circuits. Pulsed occurrences, where many readings must be taken coincidentally (or nearly so), use these multichannel s/h systems. After the s/h circuits have been updated, conversion takes place in a multiplexed pattern prior to the next event.

If you need more than the basic number of channels that the multiplexer offers, many methods allow expansion in daisy-chain fashion. One method is sub-multiplexing, in which a single multiplexer becomes the master and controls one or more slave units.

The sub-multiplexing approach may result in lower interchannel crosstalk and greater signal bandwidth than might otherwise be accomplished by direct multiplexing. The circuit of Fig. 7 shows

how you can expand a 16-channel multiplexer into 31 channels by use of external logic. To decode the address of the 31 channels, a 5-bit digital word is needed. This word, generated by either the computer or panel switches, gets decoded by the control logic, as defined by the table in Fig. 7.

In a similar way, you can construct a 136-channel unit by using one 16-channel unit and eight others as slaves. ■■

#### Bibliography:

1. "High Speed Analog Multiplexing Using the IAM-3216," Application Note, Inter-Computer Electronics, Inc.
2. Gordon, Bernard M. "The ABC's of A/D and D/A Converter Specifications," *EDN*, August, 1972.
3. "Analog-Digital Conversion Handbook," Analog Devices, Inc., Norwood, Mass.

Do you face  
a make or buy  
decision on  
power supplies?

# BUY LAMBDA'S 5-YEAR 11 POWER PACKAGES. ALL 1-DAY

## SPECIFICATIONS FOR LX SERIES

### DC Output

#### Regulated Voltage

regulation, line . . . . . 0.1%  
regulation load . . . . . 0.1%  
ripple and noise . . . . . 1.5 mV RMS, 5 mV pk-pk with either  
positive or negative terminal grounded  
temperature  
coefficient . . . . . 0.03%/°C

### AC Input

line . . . . . 105-132 VAC; 47-440 Hz. For 187-242 VAC, add  
suffix "V" to model numbers and add 12% or  
\$30.00 to the price, whichever is greater. For  
operation of LX-D, LXS-E, LX-EE, LXS-7, and  
LXS-8 units at 50 Hz or at 400 Hz, consult factory.  
Ratings apply to 57-63 Hz. For all other models  
delete 40°C rating for 50 Hz operation.

### Ambient operating temperature range

continuous duty from 0° to + 71°C with corresponding load  
current ratings for all modes of operation.

### Storage temperature range

-55°C to +85°C

### Overload protection

#### Thermal

thermostat, automatic reset when over-temp. condition is removed.  
(Not applicable to LX-D-3); circuit breaker must be reset on LX-8 models.

#### Electrical

external overload protection, automatic electronic current limiting  
circuit limits the output current to the present value,  
thereby providing protection for load as well as power supply.

### Overshoot

no overshoot on turn-on, turn-off or power failure.

### Input and output connections

through terminal block on chassis; output terminals on LX-7,  
LX-8 models are two heavy duty studs.

### Power hybrid voltage regulator or integrated circuit regulation

some models have Power Hybrid Voltage Regulator providing  
complete regulation system while others have an integrated  
circuit providing regulation system except for input and output  
capacitors, rectifiers and series regulation transistors.

### Controls

#### DC Output Control

simple screwdriver voltage adjustment over entire range.

#### Remote sensing

provision is made for remote sensing to eliminate effect of  
power output lead resistance on DC regulation.

### Transformer

MIL-T-27C, Grade 6

### Tracking accuracy (dual models)

2% absolute voltage difference; 0.2% change for all conditions  
of line, load and temperature.

### Fungus proofing

All fungi nutrient components are rendered fungi inert with  
MIL-V-173 varnish—Standard on all LX models and is included  
in price.

## 5 VOLTS ±5% SINGLE OUTPUT

MODEL	MAX. AMPS AT AMBIENT OF:				PRICE
	40°C	50°C	60°C	71°C	
LXS-A-5-OV-R*	4.0	3.4	2.7	2.0	\$ 95.
LXS-B-5-OV-R*	5.8	5.0	4.0	3.0	130.
LXS-4-5-OV-R*	7.4	6.5	5.4	3.9	145.
LXS-C-5-OV-R*	9.0	8.0	6.8	5.3	160.
LXS-CC-5-OV-R*	16.0	14.5	12.7	10.5	220.
LXS-D-5-OV-R*	27.5	24.2	20.5	16.5	260.
LXS-E-5-OV-R*	35.0	30.0	24.0	17.5	320.
LXS-EE-5-OV-R*	45.0	39.0	32.0	25.0	445.
LXS-7-5-OV-R**	65.0	56.0	46.0	35.0	535.
LXS-8-5-OV-R**	85.0	77.0	68.0	56.0	580.

\*Includes fixed overvoltage protection at 6.8V ±10%

## 6 VOLTS ±5% SINGLE OUTPUT

MODEL	MAX. AMPS AT AMBIENT OF:				PRICE
	40°C	50°C	60°C	71°C	
LXS-A-6-R	3.7	3.1	2.5	1.9	\$ 95.
LXS-B-6-R	5.5	4.7	3.8	2.9	130.
LXS-4-6-R	6.6	5.8	4.8	3.5	145.
LXS-C-6-R	8.8	7.8	6.7	5.2	160.
LXS-CC-6-R	15.2	13.8	12.1	10.0	210.
LXS-D-6-R	26.5	23.4	19.8	16.0	260.
LXS-E-6-R	34.0	29.0	23.0	16.5	320.
LXS-EE-6-OV-R†	42.0	36.0	30.0	22.0	445.
LXS-7-6-OV-R**	59.0	50.0	41.0	32.0	535.
LXS-8-6-OV-R**	70.0	70.0	68.0	56.0	580.

†Includes fixed overvoltage protection at 7.4V ±10%

## 12 VOLTS ±5% SINGLE OUTPUT

MODEL	MAX. AMPS AT AMBIENT OF:				PRICE
	40°C	50°C	60°C	71°C	
LXS-A-12-R	2.7	2.2	1.8	1.5	\$ 95.
LXS-B-12-R	3.8	3.6	3.0	2.2	130.
LXS-4-12-R	4.4	3.8	3.1	2.5	145.
LXS-C-12-R	6.5	6.1	5.5	4.6	160.
LXS-CC-12-R	10.5	9.4	8.2	5.0	210.
LXS-D-12-R	16.0	14.0	11.9	8.0	260.
LXS-E-12-R	21.0	18.0	15.0	12.5	320.
LXS-EE-12-R	32.0	27.0	22.0	16.0	420.
LXS-7-12-OV-R**	40.0	36.0	30.0	23.0	535.
LXS-8-12-OV-R**	50.0	45.0	40.0	34.0	580.

## 15 VOLTS ±5% SINGLE OUTPUT

MODEL	MAX. AMPS AT AMBIENT OF:				PRICE
	40°C	50°C	60°C	71°C	
LXS-A-15-R	2.4	2.0	1.6	1.3	\$ 95.
LXS-B-15-R	3.2	2.8	2.5	1.5	130.
LXS-4-15-R	4.0	3.5	2.8	2.3	145.
LXS-C-15-R	6.0	5.6	5.1	4.5	160.
LXS-CC-15-R	9.5	8.6	7.4	4.8	210.
LXS-D-15-R	14.0	12.3	10.4	7.5	260.
LXS-E-15-R	19.0	17.0	14.0	12.0	320.
LXS-EE-15-R	28.0	24.0	19.5	14.0	420.
LXS-7-15-OV-R**	36.0	32.0	26.0	20.0	535.
LXS-8-15-OV-R**	45.0	41.0	36.0	30.0	580.

\*\*Built-in continuously adjustable overvoltage protection crowbars output  
when trip level is exceeded. Included on all LXS-7, LXS-8 models.



# GUARANTEED LX SERIES. DELIVERY.

## 20 VOLTS $\pm 5\%$ SINGLE OUTPUT

MODEL	MAX. AMPS AT AMBIENT OF:				PRICE
	40°C	50°C	60°C	71°C	
LXS-CC-20-R	7.7	7.2	6.5	4.4	\$210.
LXS-D-20-R	11.5	10.2	8.6	6.8	260.
LXS-E-20-R	15.0	13.0	10.5	7.0	320.
LXS-EE-20-R	22.0	18.5	14.5	10.0	420.
LXS-7-20-OV-R**	28.0	25.0	20.5	15.5	535.
LXS-8-20-OV-R**	32.0	29.0	25.0	17.0	580.

## 24 VOLTS $\pm 5\%$ SINGLE OUTPUT

MODEL	MAX. AMPS AT AMBIENT OF:				PRICE
	40°C	50°C	60°C	71°C	
LXS-CC-24-R	6.8	6.4	5.7	4.4	\$210.
LXS-D-24-R	10.0	8.8	7.5	6.0	260.
LXS-E-24-R	13.0	11.0	9.5	6.0	320.
LXS-EE-24-R	19.0	16.5	13.0	9.5	420.
LXS-7-24-OV-R**	25.0	22.0	18.0	14.0	535.
LXS-8-24-OV-R**	30.0	27.0	23.5	17.0	580.

## 28 VOLTS $\pm 5\%$ SINGLE OUTPUT

MODEL	MAX. AMPS AT AMBIENT OF:				PRICE
	40°C	50°C	60°C	71°C	
LXS-CC-28-R	6.0	5.6	5.0	4.3	\$210.
LXS-D-28-R	9.0	8.0	6.8	5.5	260.
LXS-E-28-R	11.0	10.0	8.5	5.5	320.
LXS-EE-28-R	17.0	15.0	12.0	9.0	420.
LXS-7-28-OV-R**	22.0	19.5	16.0	12.5	535.
LXS-8-28-OV-R**	28.0	25.5	22.5	17.0	580.

## $\pm 15$ TO $\pm 12$ VOLTS DUAL OUTPUT <sup>(1)</sup>

MODEL	ADJ. VOLT. RANGE VDC	MAX. AMPS AT AMBIENT OF:				PRICE
		40°C	50°C	60°C	71°C	
LXD-3-152-R	$\pm 15$	0.400	0.370	0.340	0.300	\$ 90.
	to $\pm 12$	0.400	0.370	0.340	0.300	
LXD-A-152-R	$\pm 15$	1.0	1.0	0.9	0.7	130.
	to $\pm 12$	0.8	0.8	0.7	0.6	
LXD-B-152-R	$\pm 15$	1.6	1.4	1.2	0.7	160.
	to $\pm 12$	1.4	1.3	1.1	0.6	
LXD-C-152-R	$\pm 15$	2.5	2.3	1.9	1.5	170.
	to $\pm 12$	2.0	1.8	1.5	1.2	
LXD-CC-152-R	$\pm 15$	4.0	3.7	3.2	2.4	255.
	to $\pm 12$	3.0	2.7	2.3	1.8	
LXD-D-152-R	$\pm 15$	6.2	5.6	4.9	4.0	300.
	to $\pm 12$	4.5	4.1	3.7	3.0	
LXD-EE-152-R	$\pm 15$	12.5	11.0	9.0	7.0	455.
	to $\pm 12$	10.0	9.0	7.8	6.0	

Oversvoltage protector accessory available for all models without built-in oversvoltage protection.

(1)  $\pm 15$  to  $\pm 12$  and  $\pm 6$  to  $\pm 3$  volts are each dual tracking outputs; dual outputs can be connected in series for 30-24 volts and 12-6 volts, respectively.

## $\pm 6$ TO $\pm 3$ VOLTS DUAL OUTPUT <sup>(1)</sup>

MODEL	ADJ. VOLT. RANGE VDC	MAX. AMPS AT AMBIENT OF:				PRICE
		40°C	50°C	60°C	71°C	
LXD-B-062-R	$\pm 6$	2.7	2.4	1.9	1.4	\$170.
	to $\pm 3$	2.1	2.0	1.6	1.2	
LXD-C-062-R	$\pm 6$	3.5	3.3	2.7	1.7	180.
	to $\pm 3$	2.6	2.4	1.9	1.3	

## 5 VOLTS $\pm 5\%$ , $\pm 15$ TO $\pm 12$ VOLTS TRIPLE OUTPUT

MODEL	ADJ. VOLT. RANGE VDC	MAX. AMPS AT AMBIENT OF:				PRICE
		40°C	50°C	60°C	71°C	
LXT-D-5152-R	5 $\pm 5\%$ *	12.0	11.5	11.0	9.5	\$395.
	to $\pm 15$	3.1	2.7	2.2	1.7	
	to $\pm 12$	2.3	2.0	1.7	1.3	

\*5 volt output has fixed oversvoltage protection at 6.8V  $\pm 10\%$ .  $\pm 15$  to  $\pm 12$  output is dual tracking output.

## NEW LX-7 DESIGNED TO MEET MIL ENVIRONMENTAL SPECIFICATIONS.

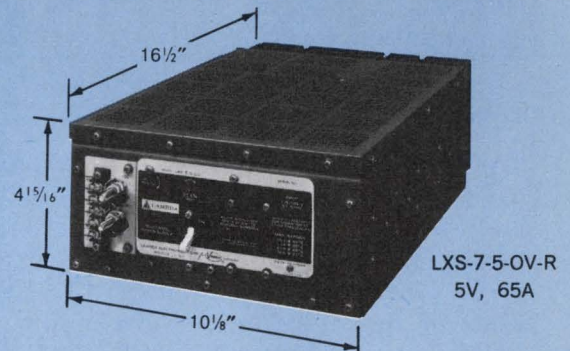

**\$535**  
**5-YEAR GUARANTEE**

Send for free copy of  
1974 Power Supply Catalog and Application Handbook

**LAMBDA**  
ELECTRONICS CORP.

A  Company

MELVILLE, NEW YORK 11746 515 Broad Hollow Road Tel. 516-694-4200 ARLINGTON HEIGHTS, ILL. 60005 2420 East Oakton St., Unit Q Tel. 312-593-2550 NORTH HOLLYWOOD, CALIF. 91605 7316 Varna Ave. Tel. 213-875-2744 MONTREAL, QUEBEC 100C Hymus Blvd., Pointe Claire, Quebec 730 Tel. 514-697-6520 HIGH WYCOMBE, BUCKS, ENG. Abbey Barn Road, Wycombe Marsh Tel. High Wycombe 36386/7/8 ORSAY, FRANCE 91 Gometz le Chatel. ACHERN-FAUTENBACH, W. GERMANY 1m. Holzbosch 14 Tel. 078-41-5527

INFORMATION RETRIEVAL NUMBER 40

# Why complicate frequency synthesis?

A direct digital method not only controls frequency, but also phase and wave shape—difficult with analog circuits.

Complicated mixers, discriminators and oscillators can be eliminated from frequency synthesizers if you use digital, rather than analog, techniques.

Unlike an analog frequency synthesizer, the digital, when supplied with a clock frequency and a binary frequency-control number, computes digital samples of the output frequency directly and continually. These samples are then converted into a continuous analog signal by a digital-to-analog (DAC) converter and a low-pass filter (Fig. 1).

Once the basic principle of operation is understood, the designer can easily modify the circuit to select his own frequency range, frequency step size and maximum distortion. The frequency stability of the output signal is the same as that of the clock.

The synthesizer's first part, called the phase accumulator, determines the frequency range and resolution. The second part, called the phase-to-amplitude converter, converts the phase representation of the sine wave into an amplitude representation.

## Digital samples are accumulated

As shown in a simplified 4-bit example (Fig. 2a), the wave shape to be synthesized—say, a sine wave—is broken down into a number of equally spaced phase points, and each point is represented by a binary number. The 16 phase points of the sine wave need a minimum four-bit binary word to represent them (Fig. 2b).

The phase accumulator is simply an N-bit binary accumulator. The output of the accumulator at any time corresponds to a phase of the wave shape between 0 and 360 degrees. The frequency control number, K, represents a small phase-angle step that is added to the accumulator by each clock pulse every  $1/f_c$  seconds. Periodically the accumulator overflows. This occurs between 359 and 0 degrees. The rate of

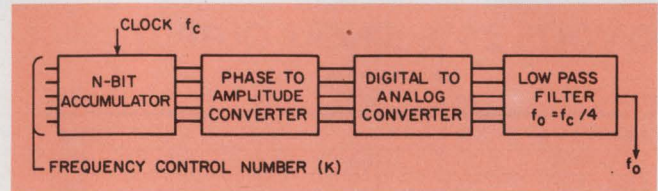

1. A direct digital frequency synthesizer needs inputs of a clock frequency and a binary control number to generate a controlled output frequency.

overflow is equal to the output frequency,  $f_o$ . When N is the accumulator length,

$$f_o = Kf_c/2^N.$$

Since K can occur only in integer values, the frequency steps are in increments of  $f_c/2^N$ . Thus with a 20-bit accumulator and when  $f_c = 1.048$  MHz,  $f_o$  is in 1-Hz steps.

The phase-to-amplitude converter is basically a read-only-memory (ROM) that is programmed to contain amplitude values for the desired wave. To address the ROM by M bits is equivalent to dividing the 0-to-360-degree phase circle into  $2^M$  parts. It doesn't matter what angles are selected to be stored in the ROM; they need only be uniformly spaced. But if the wave shape has symmetry with the 180 and 0-degree axis and also the 90 and 270-degree axis (Fig. 2a), then, with some additional logic, a 0-to-90-degree ROM can be used to give values throughout the 0-to-360-degree range. The symmetry decreases the size of the ROM by a factor of four.

In this technique the two most-significant-bit outputs from the phase accumulator determine the quadrant of the signal, and the remaining bits address the 0-to-90-degree ROM (Fig. 2c). Note that the address of the ROM is inverted by bit "B" when the signal is in quadrant II or IV and the output of the ROM is TWOs-complemented by bit A when the signal is in quadrant III and IV. Also, the A signal is inverted to become the sign bit to the DAC.

## A 20-bit design example

A practical example of this synthesizer technique uses a clock frequency of 1.048 MHz and

Hamil W. Cooper, PE, Consultant, P.O. Box 9691, Austin, Tex. 78766.

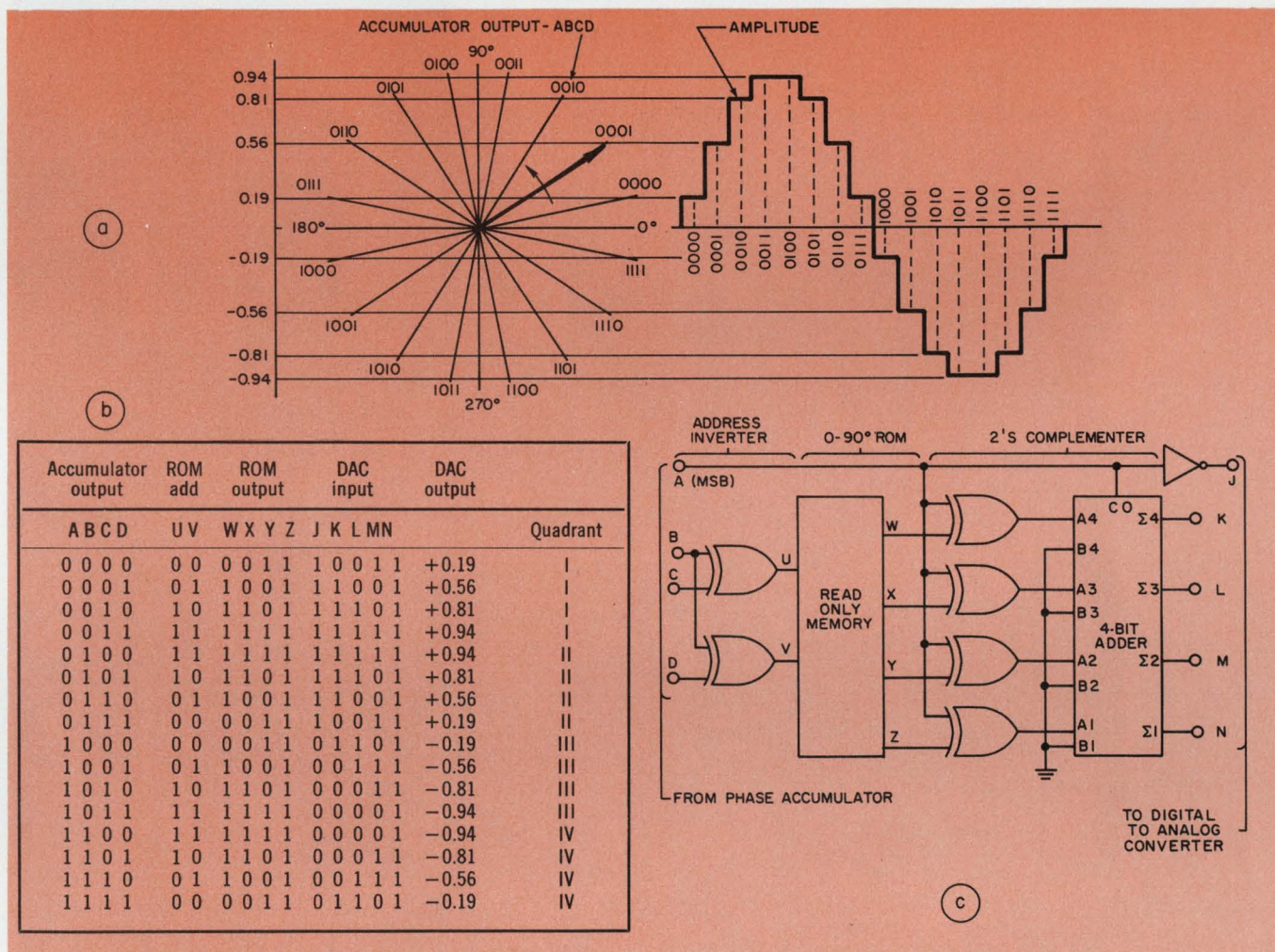

2. A simplified synthesizer for sine waves takes advantage of symmetry of the wave shape so that values for

only 0 to 90 degrees need be stored. A d/a converter and filter (not shown) provide the final output.

a 20-bit accumulator (Fig. 3). The frequency resolution is therefore 1 Hz, and the maximum practical frequency is  $1.048 \times 10^6/4$ , or 262 kHz. Although TTL is used in this circuit, CMOS or DTL would work equally well. The accumulator consists of five 4-bit adders (SN7483) and 10 dual-D flip-flops (SN7474). The ROM is an AMI S8771 sine/cosine lookup table—a commercially available device. This particular ROM, however, divides the 0-to-90-degree quadrant into only  $2^7 - 1$  segments instead of  $2^7$  segments—

which would be preferred—but the error is insignificant.

The digital-to-analog converter is a 10-bit Datal DAC-I-10B, which has a settling time of 150 ns. The ONES-complement of the output of the ROM is used directly, instead of the TWOS-complement, as in Fig. 2, because this greatly simplifies the circuit and introduces very little error. The five dual-D flip-flops that precede the DAC are used to hold the DAC input during accumulator transitions to reduce output glitches.

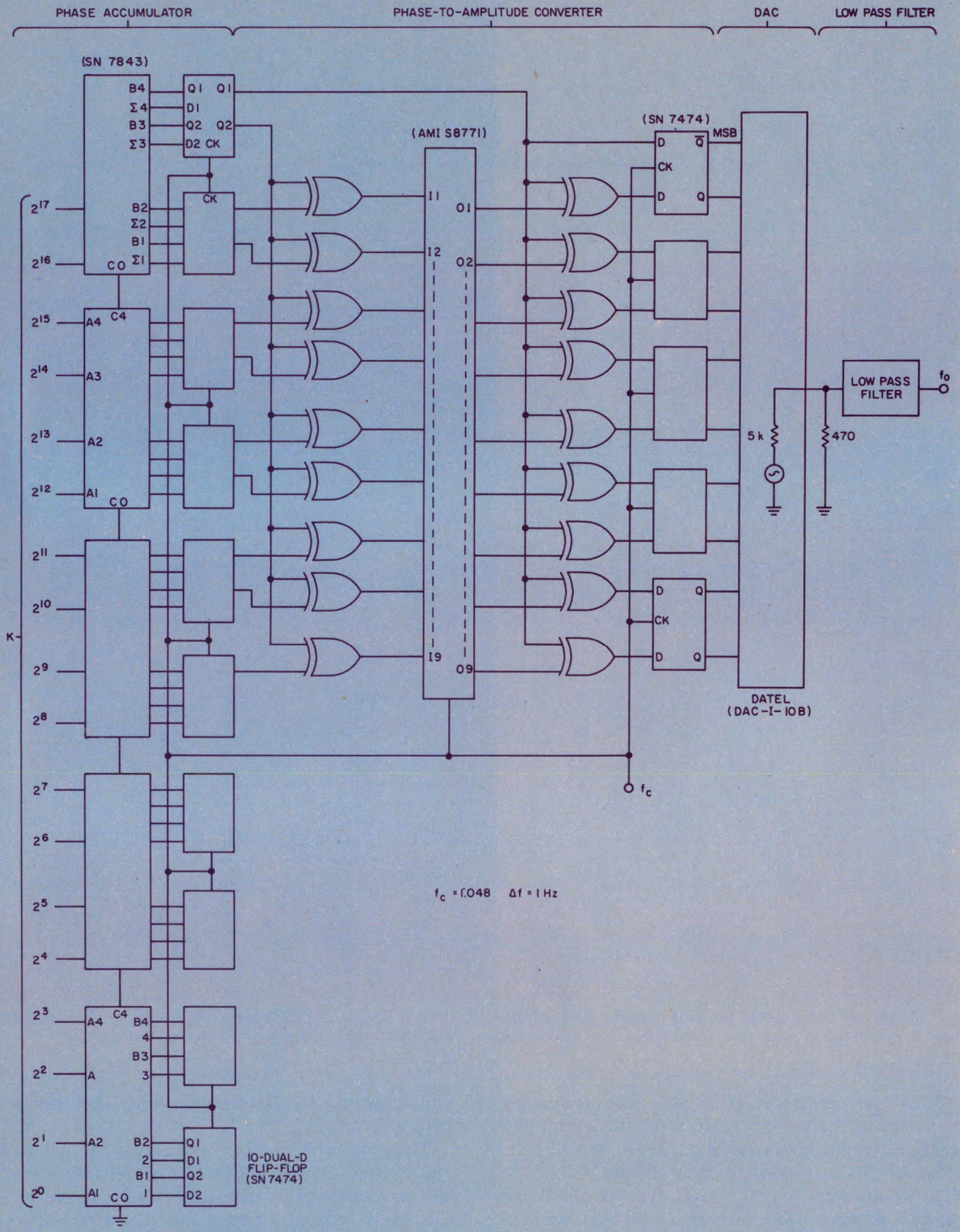

3. This 20-bit design example can supply sine-wave outputs in 1-Hz steps to 262 kHz, with a clock frequency

of 1.048 MHz. An output filter helps eliminate aliasing frequencies and quantization noise.

The flip-flops can be eliminated with DACs that have internal storage.

Even though the synthesizer can generate frequencies to 262 kHz, a filter ( $f_c = 100$  kHz, four-pole Krohn-Hite Model 3202) ensures that the alias frequencies are at least 70 dB down from the fundamental. Also, output noise then is mainly from quantization and not from alias distortion.

The signal-to-noise ratio table shows measured and calculated distortion values for the 20-bit circuit over the frequency range of 10 to 60 kHz.

### Digital synthesis has advantages

The primary advantage of this digital synthesizer over most analog versions is its positive control over the output. There is no question that the output frequency is specific for a given frequency control number and clock frequency. A linear FM sweep can be fashioned simply by the use of a binary counter to generate the control number. The start and stop count and the rate at which the counter is clocked will determine the sweep's characteristics.

For a random sequence, a custom programmed ROM can be addressed by the counter, and this ROM's output will supply frequency-control numbers. A very linear voltage-controlled oscillator can be made by the use of an a/d converter to generate the control numbers.

But no matter what the source of instruction is for the frequency changes, no phase discontinuities occur in the direct digital synthesizer.

Very accurate phase control is also possible. At any time the phase of the signal may be set to any desired value; the appropriate binary number is fed into the accumulator flip-flop clear and preset inputs. And the phase could be shifted by insertion of another adder between the output of the phase accumulator and the phase-to-amplitude converter. The size of the phase shift would depend on the number added to the accumulator output.

The output level of the synthesizer may be controlled by the use of a multiplying DAC or by an attenuator in the output.

The direct digital synthesizer also could synthesize signals other than sine waves. If the output of the accumulator is directly applied to the DAC, a saw-tooth wave results. If the most-significant bit of the accumulator is then used to complement the subsequent outputs of the accumulator, the result, when applied to the DAC, would be a triangular wave.

A square wave is obtained by use of only the most-significant bit of the accumulator as the output. And any arbitrary waveform can be produced if the entire phase-to-amplitude converter section is replaced with an appropriately pro-

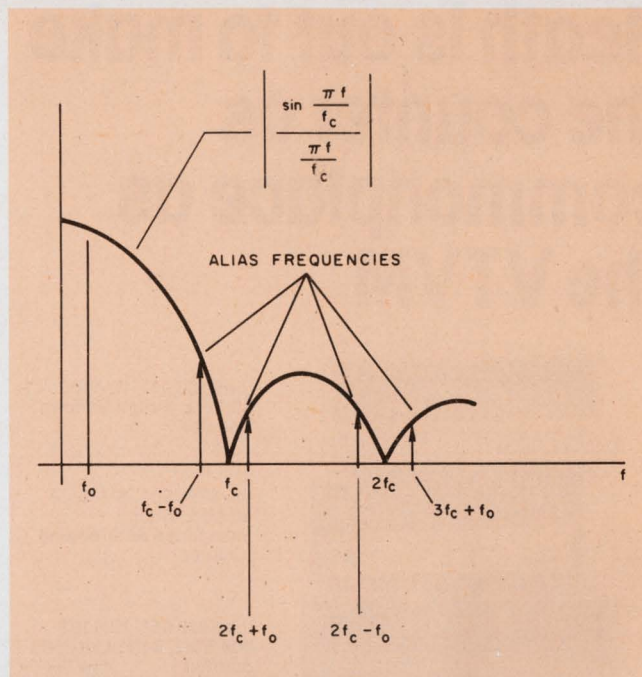

4. Frequency-aliasing of a synthesizer limits the upper output frequency to about  $f_c/4$ .

grammed ROM that contains equally spaced values of the signal from 0 to 360 degrees.

### Quantization is a problem

But digital synthesizers have their problems, too. The designer must contend with phase and amplitude-quantization noise, noise generated by the digital-to-analog converter and alias frequencies that pass through the nonideal low-pass filter. In general, phase and amplitude-quantization noise is constant and independent of the output frequency, while noise from the digital-to-analog converter increases with frequency.

For the sine-wave circuit in Fig. 3, the signal-to-noise ratio (SNR) that results from amplitude quantization can be expressed as<sup>1</sup>

$$\text{SNR} = 1.5 (2^A - 1)^2, \quad (1)$$

where A is the number of bits of amplitude quantization.

When expressed in decibels, the SNR becomes

$$\text{SNR}_{\text{dB}} \approx 6A + 1.75. \quad (2)$$

Experimental data taken on the synthesizer in Fig. 3 show that phase-quantization noise can be expressed approximately as

$$S/N \approx 6.8(2^{2B}),$$

where B is the number of bits of phase quantization. When expressed in decibels, the SNR becomes

$$\text{SNR}_{\text{dB}} \approx 6B - 8.3 \quad (3)$$

When Eqs. 1 and 2 are combined vectorially, the approximate relationship between the number of bits of phase and amplitude quantization and the output SNR is obtained (see table):

# Heath is out to make the counter as commonplace as the VTVM



the \$169.95\*, IB-1100  
30 MHz, 5-digit kit-form  
counter

the \$225.00\*, SM-118A  
30 MHz, 6-digit  
assembled autoranging  
counter

the \$229.95\*, IB-1101  
100 MHz, 5-digit kit-form  
counter

the \$299.95\*, IB-1102  
120 MHz, 8-digit kit-form  
counter

the \$325.00\*, SM-128A  
110 MHz, 7-digit  
assembled autoranging  
counter

the \$379.95\*, IB-1103  
180 MHz, 8-digit kit-form  
counter

the \$395.00\*, SM-128B  
110 MHz, 7-digit,  
assembled high stability,  
autoranging counter

the \$495.00\*, SM-110A  
180 MHz, 7-digit,  
assembled counter

the \$625.00\*, SM-110B  
180 MHz, 7-digit,  
assembled high stability,  
programmable counter

the \$795.00\*, SM-110C  
600 MHz, 7-digit,  
assembled high stability,  
programmable counter

**HEATH  
Schlumberger**

Heath Company  
Dept. 531-267  
Benton Harbor, MI 49022

- Please send latest Heathkit catalog.
  - Please send latest assembled instruments catalog.
  - Enclosed is \$\_\_\_\_\_ plus shipping.
- Please send model(s) \_\_\_\_\_

Name \_\_\_\_\_

Address \_\_\_\_\_

City \_\_\_\_\_ State \_\_\_\_\_ Zip \_\_\_\_\_

Prices & specifications subject to change without notice. TE-307  
\*Mail order prices; F.O.B. factory.

## Measured and calculated signal-to-noise ratios

Measured S/N dB	Bits of phase quantization (B)					
	7	8	9	10	11	
Bits of amplitude quantization (A)	6	33.2	36.8	38.0	38.2	38.2
	7	33.4	37.0	37.7	37.7	37.7
	8	33.6	39.2	42.6	44.0	44.4
	9	33.7	39.4	43.0	43.7	43.7
	10	33.8	39.7	45.2	48.8	50.3
11	33.7	39.7	45.4	49.0	49.7	
	33.5	38.8	46.0	52.5	55.2	
12	33.7	39.7	45.7	51.4	54.0	
	33.6	39.2	46.0	52.2	58.0	
13	33.7	39.7	45.7	51.7	57.0	

$$S/N \text{ dB} = -10 \log \sqrt{\frac{0.44}{2^{1A}} + \frac{46.0}{2^{1B}}}$$

$$SNR_{dB} \approx -10 \log \sqrt{\frac{0.44}{2^{1A}} + \frac{46.0}{2^{1B}}} \quad (4)$$

DACs add noise to the signal whenever a switching transient occurs. Therefore fast-setting DACs that have shorter transients introduce less noise. Further noise reduction results when the DAC is followed by a sample-and-hold circuit, where sampling occurs after the transients have subsided. And, finally, a large amount of this noise is also eliminated by the low-pass filter.

If the signal-to-noise ratio of the circuit is limited by quantization, greater spectral purity can be obtained only by use of more bits of quantization. Noise purity of 70 dB requires about 12 bits of amplitude quantization and 13 bits of phase quantization. However, the circuit requires a 2048 12-bit ROM.

A better alternative perhaps would be to use a ROM with only 64 12-bit words, and use linear interpolation to determine the amplitudes for intermediate values of phase. In Fig. 3 the eight most-significant bits of the accumulator would select the coarse phase points and the ninth through 13th bits would be interpolated.

Since this synthesizer provides an output sample every  $1/f_c$  seconds, the DAC output spectrum contains alias frequencies at  $f_c \pm f_o$ ,  $2f_c \pm f_o$ , ... etc., with amplitudes as shown in Fig. 4. A low-pass output filter must pass the output frequency,  $f_o$ , and reject the alias frequencies. Such a filter becomes quite complex when  $f_o$  approaches  $f_c/2$ . Therefore  $f_o$  should be less than  $f_c/4$ . ■■

### Reference

1. Stein and Jones, "Modern Communications Principles," McGraw-Hill, 1967, p. 208.

# MAKING SOLID STATE RELAYS SECOND TO NONE

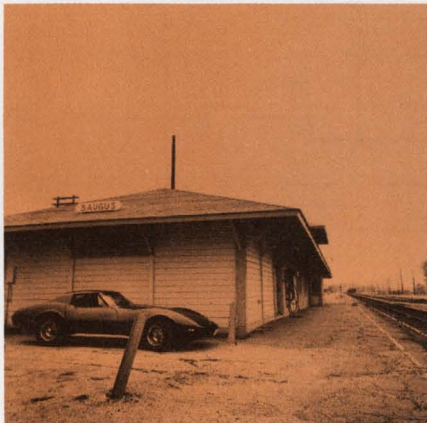

You know us mostly for our reed relays — the best darn relays in the country. We earned that reputation by tackling the toughest applications problems we could find, and solving them. Solving them with gutsy engineering plus painstaking quality control. And building that into a line of standard and custom products that could deliver superior performance and cost effectiveness.

Now we've applied that same state-of-the-art kind of thinking to solid state relays . . . and come up with another winner. Or rather a whole family of winners for AC switching with either DC or AC inputs. All our DC input models operate anywhere between 3 and 32 VDC, and all our AC input models operate anywhere between 90 and 280 VRMS. Both types include models which switch either 140 or 280 VRMS, at 6 or 10 amps maximum. When you put this matrix together, you'll find a model to meet almost any power switching application.

All our solid state relays feature zero crossover switching. They switch on when the load voltage is at the zero crossover point, avoiding instantaneous high surge current into capacitive or lamp loads. And they switch off when the load current is at the zero crossover point, doing away with high voltage kick-backs and resultant RF noise from inductive loads.

Some other good things: 1500 VRMS photo isolation between input and output. A new input current limiter on all DC models which makes them insensitive to input voltage transients, and keeps input current constant across the wide input voltage range. They are protected against input voltage polarity reversal. And they can be driven directly from TTL logic. And, of course, all models feature the long life, silent operation and immunity to shock and vibration inherent to solid state relays.

If you'd like specific technical information, call or write us at the address below, and we'll be happy to send you our new, updated Solid State Relay Catalog by return mail.

## ELEC-TROL INC.

26477 North Golden Valley Road  
Saugus, California 91350  
Telephone: (805) 252-8330  
(213) 788-7292 TWX 910-336-1556

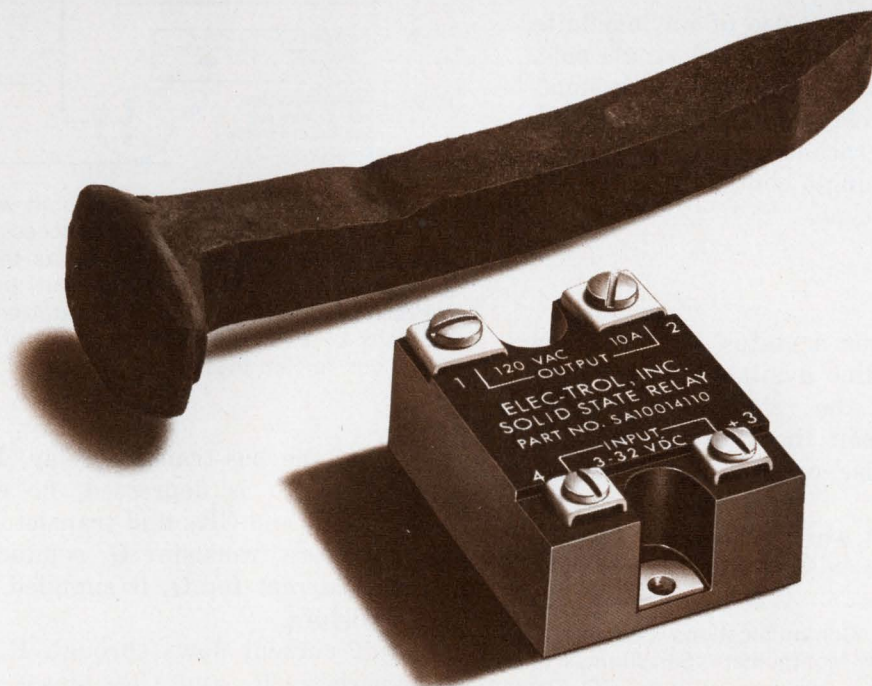

INFORMATION RETRIEVAL NUMBER 42

# Design with lockout logic and get control of data lines. The circuits use as little as one contact per subscriber to prevent multiple use of a line.

When data must be transmitted over a party telephone line, the designer who understands lockout circuitry can prevent multiple use of the line. This also prevents eavesdropping, of course.

The simplest circuits can be built with relays (Fig. 1). To understand the circuit operation, assume that all relays are initially de-energized. If  $S_2$  is now depressed, an electrical circuit is completed between bus 1 and ground. The path is via the normally closed contacts of  $K_2$ , the coil of  $K_2$ , the button, the common wire and finally  $CR_1$  and  $CR_2$ . Because of the control relay,  $K_C$ , the 24-V-dc source is connected to bus 1 through the normally closed contact. Current therefore flows through  $CR_1$  and  $CR_2$ . The resulting voltage drop allows  $Q_1$  to turn on and thereby energize  $K_C$ .

Once  $K_C$  closes, the dc source is transferred from bus 1 to bus 2. And since the capacitors delay operation of relays  $K_1$  to  $K_N$ ,  $K_2$  will remain shut.

The necessary lockout has occurred. None of the other relays can operate until  $S_2$  is released. Only then will the control relay release and restore power to bus 1.

The circuit scheme allows use of an indefinite number of control relays,  $K_1$  to  $K_N$ . A single pole, double-throw contact is necessary for lockout. The remainder of the relay contacts perform the required switching operations. Delay capacitors needn't be used if the single control contacts are the make-before-break type.

## Lamps show line status

You can give the user a status signal in one of two ways: (1) A "line available" lamp, such as  $L_1$  is lighted when the relay closes. (2) A "busy" lamp lights when the user depresses a button and someone else on a different circuit has the line.

The transistor circuit use for the second method requires a voltage to exist on bus 2. This indi-

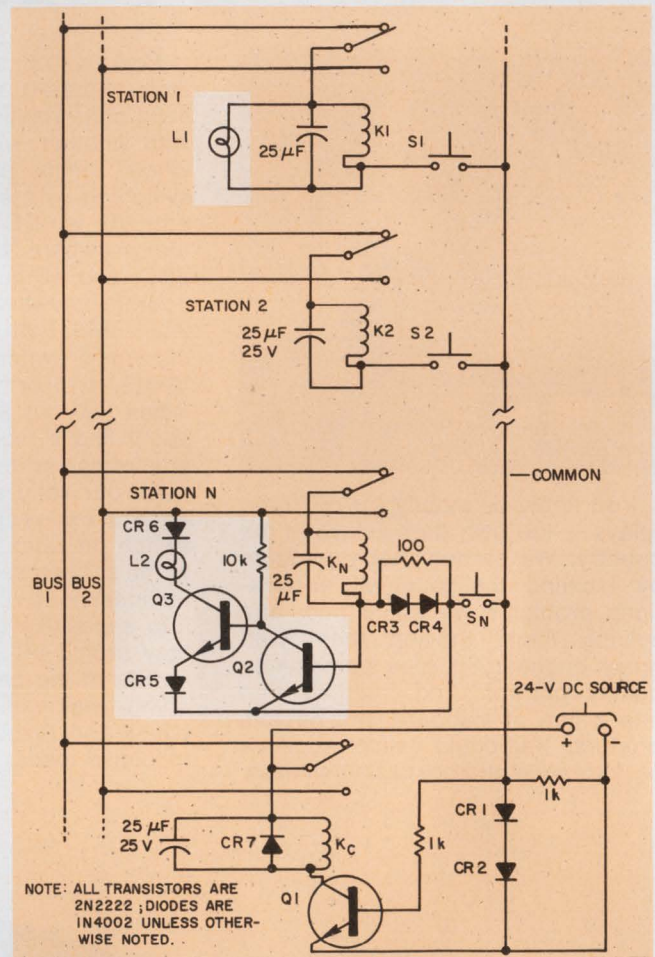

1. **Simple lockout circuits** can be built with relays. Only one station at a time can gain access when its corresponding relay operates. As long as the station is active, the other stations are locked out, because the control relay,  $K_C$ , has transferred power from bus 1 to bus 2. Lamps  $L_1$  or  $L_2$ , and associated circuitry provide busy indications for the user.

icates that the bus-transfer relay,  $K_C$ , has operated. When  $S_n$  is depressed, no current flows through  $CR_3$  and  $CR_1$ , and transistor  $Q_2$  is biased off. Therefore transistor  $Q_3$  conducts and lights  $L_2$ ; bias current for  $Q_3$  is supplied by the 10-kΩ base resistor.

But if current flows through  $K_n$ , the voltage drop across  $CR_3$  and  $CR_1$  biases on  $Q_2$  which

Dr. Walton N. Hershfield, Communications Consultant, Bentley Engineers, 149 New Montgomery, San Francisco, Calif. 94105.



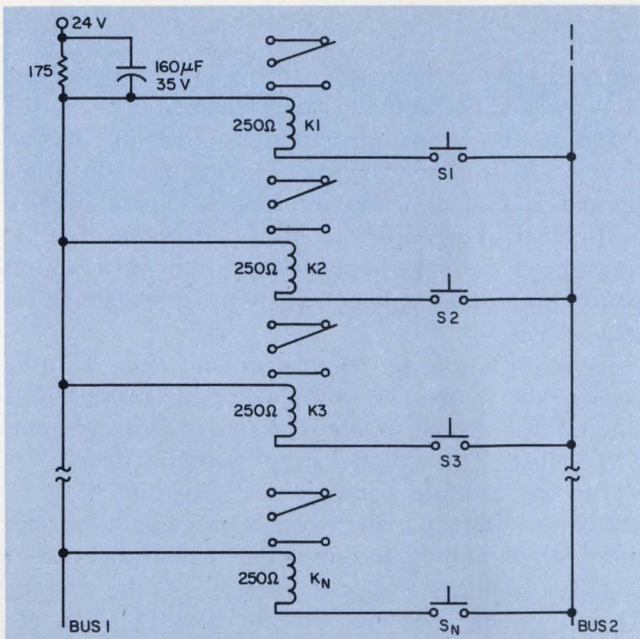

2. No extra contacts are required in a lockout circuit, if you select relays for their pull-in and hold voltages. The initial current surge from  $C_1$  closes a relay when the station button is depressed. Once the capacitor charges, the voltage between bus 1 and bus 2 is less than that required for the other relays to operate.

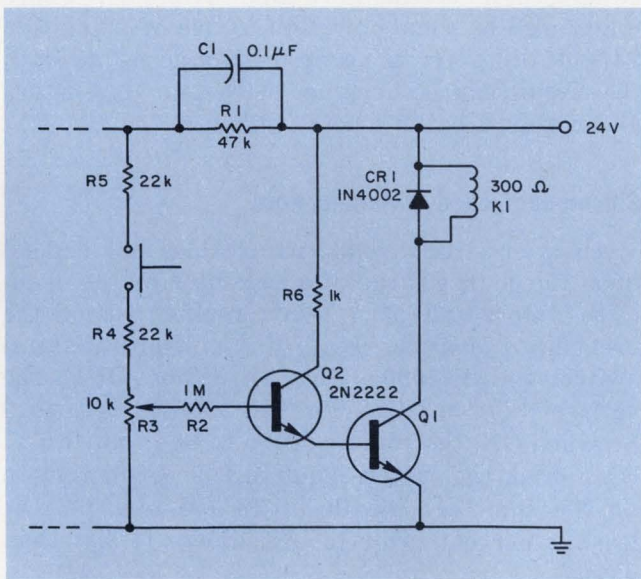

3. Relay driver built with a Darlington amplifier helps reduce control current and gives adjustable relay differentials between the operate and hold conditions. The hold voltage is set with  $R_3$ .

in turn keeps  $Q_3$  off. And the busy lamp will not operate.

### Capacitor scheme eliminates contacts

Another type of lockout circuit that does not require relay contacts takes advantage of the difference in pull-in (closing) and release (open)

voltage of the relay (Fig. 2). With 24-V relays of certain mechanical design you should be able to select some that operate at 18 V and release at 5 V. This would be for a 250- $\Omega$  coil.

If  $R_1$  is selected as 175  $\Omega$ , then with a 24-V well-regulated power supply, the voltage drop across the relay would be 14.12 V. Obviously this is not large enough to pull the relay closed. That's where capacitor  $C_1$  comes into play. If its value is large—160  $\mu\text{F}$  at 35 V dc—and it has discharged to zero volts through the 175  $\Omega$  resistor, the closing of pushbutton switch (for example  $S_1$ ) will start a current charge surge through  $C_1$ . The surge will exceed the 18-V pull-in voltage of the relay and allow the relay to close. However, as  $PB_1$  is held shut, the dc condition of the relay stabilizes, and the voltage across  $C_1$  settles to approximately 10 V, thereby ensuring that the relay stays closed.

If while  $S_1$  is closed, another pushbutton—say,  $S_3$ —is also closed, the associated relay will not close. Why? Because the voltage between bus 1 and bus 2 is below the nominal 18-V pull-in voltage of the relay. Hence the other relays are locked out.

There is, however, one defect to this circuit. If too many pushbuttons are depressed, the closed relay may drop out. In the case of the circuit shown in Fig. 2, an excess of four relays across the line—the control and three others—would cause the control relay to fall open. But in circuits that are subject to random use of a single line—say, from five or 10 points—such multiplicities of simultaneous use seldom occur.

A more sensitive lockout circuit results if you use the current gain of a two-transistor Darlington circuit (Fig. 3). The parameters of  $K_2$  are selected as follows: 300- $\Omega$  coil resistance, pull-in at 18.0 V, release at 6.0 V. Each transistor has a nominal current gain of 250; the circuit provides a total current gain of 62,500.

For purposes of calculation, use an average current gain of 60,000. To have the relay pull in, the circuit must develop 18 V across a 300- $\Omega$  load, which means a 60-mA relay current. With a nominal current gain of 60,000, the control current to the base of  $Q_2$  equals 1  $\mu\text{A}$ .

A little arithmetic will show that with the contact potential of a silicon transistor, the total voltage drop at the base of  $Q_2$  is approximately 1.2 V dc. To limit the current flow to 1  $\mu\text{A}$ , the 24-V supply source would require a 22.8-M $\Omega$  series resistor. Since this value is quite large, a series resistance of 1 M $\Omega$  should be selected instead and the potentiometer in Fig. 3 should be used.

If 15 V were the hold voltage for the relay, you could adjust potentiometer  $R_3$  so the relay would pull in and then back off to get 15 V across the coil. In this case  $Q_1$  is not saturated

and will dissipate 9 V at 60 mA, or 720 mW. So pick  $Q_1$  to dissipate the power.

Notice that there is the same capacitor as in Fig. 2, but because the currents are lower, a 0.1- $\mu$ F capacitor is more than adequate. The discharge time (RC constant) is only one-half second for  $R_1$  and  $C_1$ .

Operation of the pushbutton will cause a current surge through capacitor  $C_1$ . The surge into  $Q_2$  will be adequate for pull-in. When  $C_1$  is

charged, the circuit will settle and supply the 15 V needed to hold the relay closed.

Fig. 4 shows one practical application of the circuit. A common balanced transmission line,  $L_1$  and  $L_2$ , is used. It could be a typical 600- $\Omega$  0-dBm telephone line, a 45- $\Omega$  intercom line, a slow-speed data-transmission system or a 25 or 70.7-V audio-transmission system. Operation is as follows:

Assume that  $S_1$  is closed and that lines  $L_1$  and  $L_2$  are not in use. A voltage surge through  $R_1$ ,  $C_1$  and the 22-k $\Omega$  bridge resistors will trigger  $K_1$  to close. The driver circuit then settles to 15 V for the holding condition. If circuits 2 to  $N$  try to use the line, the voltage developed across their relays will be too low for them to operate.

This circuit is really a version of the one in Fig. 2, except that the current amplification allows use of 22-k $\Omega$  resistors. These are quite large compared with the 600- $\Omega$  line impedance; hence the line (equivalent to 22 k $\Omega$ ) is quite small. In addition the control current is limited to approximately 300  $\mu$ A, a value that normally will not damage small transformers. The circuit of Fig. 4 requires three wires and a ground. This is sometimes cumbersome, particularly if a twisted pair is the only line available. There might also be some objection to use of a positive 24-V-dc line. (If a negative ground is desired, the circuit can be designed with pnp transistors and reversed battery polarity.)

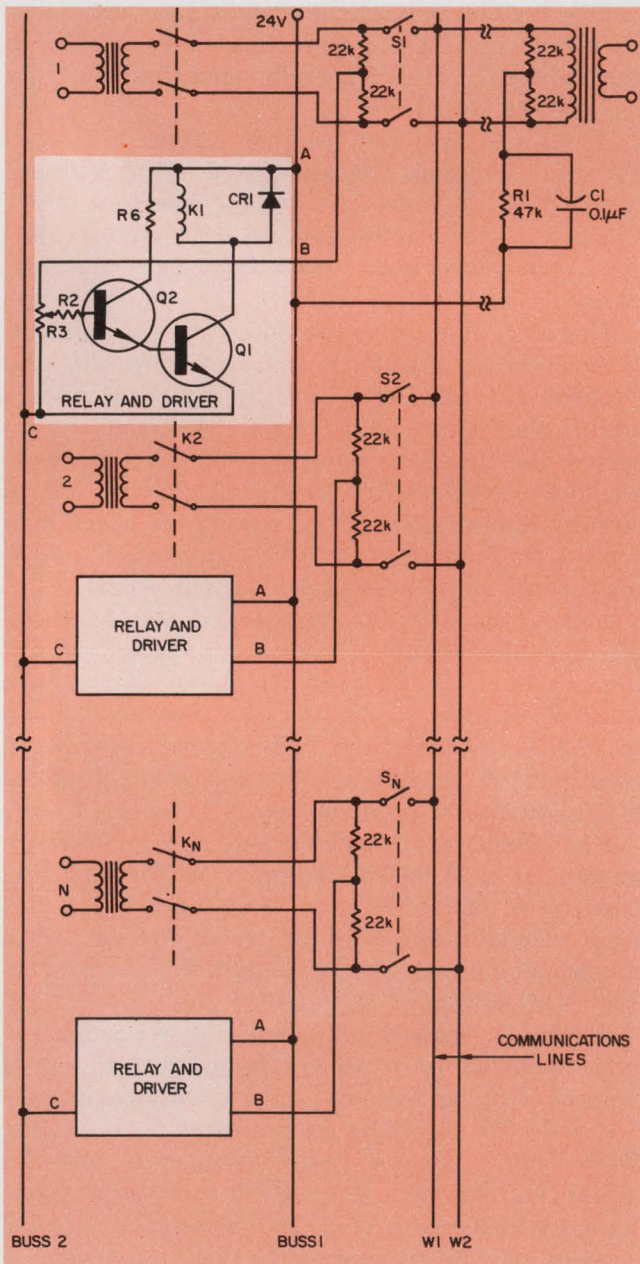

4. Stations 1 to  $N$  are connected to a data or phone line. The Darlington drivers, in conjunction with  $R_1$  and  $C_1$ , allow operation of only one station at a time. The 22-k bridge resistors provide sufficient control current, approximately 300  $\mu$ A, yet present a negligible load to the communications line.

### Silicon-controlled-switch lockout

An interesting circuit, which does not depend upon the charge surge of a capacitor or the open-close differential of a relay, makes use of the breakdown characteristics of a silicon unilateral switch, the 2N4990 (Fig. 5). When OFF, the voltage differential across the 2N4990 is 7 to 9 V; when ON, the voltage drops to less than 1.0 V. Once fired, the switch requires 200  $\mu$ A to remain on. The unit can handle up to 175 mA, yet the leakage current prior to breakdown is less than 0.2  $\mu$ A.

To provide the 200- $\mu$ A sustaining current with a 24-V supply, the total circuit resistance cannot exceed 120 k $\Omega$ . For safety, the sustaining current of 325  $\mu$ A is selected. The total resistance used, 70.3 k $\Omega$ , takes account of voltage drops across  $CR_1$  and  $Q_1$ .

For correct operation in a lockout circuit, the voltage at test-point TP must drop to less than 7 V after  $CR_1$  turns on, so any circuits in parallel with TP will not turn on their respective relays. The voltage drops across  $CR_1$  and  $Q_1$  add up to 1.2 V in the ON condition. The drop across  $R_2$  is set for 1.07 V with a 325- $\mu$ A maintenance cur-

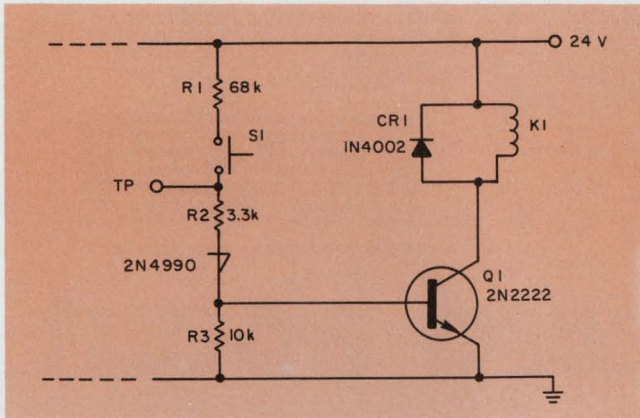

5. Lockout relay driver built with a silicon switch diode does not depend on relay characteristics or use an RC discharge. The switch provides the necessary differential between pull-in and hold voltages.

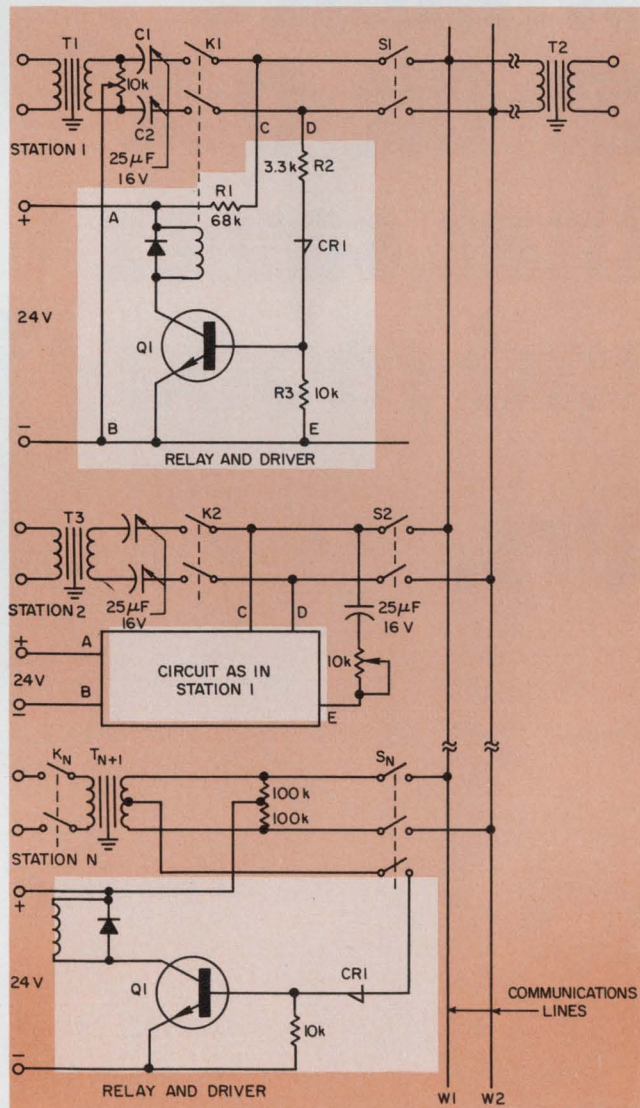

6. Use of the silicon switch circuit allows lockout operation with the twisted-pair alone. Circuits to balance the line are recommended. The first two use a 10-k potentiometer (stations one and two) and the third scheme requires a three-pole switch.

rent. If the pushbutton is closed with  $CR_1$  ON,  $R_1$  has 22 V across it. Its value, 68 k $\Omega$ , gives the 325- $\mu$ A maintenance current. The value of 3.3 k $\Omega$  for  $R_2$ , assures low voltage at the test point. Under ideal conditions 1.07 V is dropped across  $R_2$  and 1.2 V across  $CR_1$  and  $Q_1$  to make the total voltage at TP 2.27 V.

Conductors  $W_1$  and  $W_2$  represent an ordinary twisted-pair transmission line; transformer  $T_1$  is the common circuit (Fig. 6). If switch  $S_1$  is closed, the 24-V supply is applied to  $R_1$ . Diode  $CR_1$  conducts, and  $Q_1$  is biased on. Relay  $K_1$  closes to complete the balanced-line circuit between  $T_1$  and  $T_2$ . If the dc primary resistance of  $T_1$  is small compared with the 68-k $\Omega$  and 3.3-k $\Omega$  resistors, the voltage on the line,  $L_2$ , will be less than the turn-on voltage of  $CR_1$  in circuits 1 to N.  $L_2$  feeds the other selector switches,  $S_2$  to  $S_N$ . Therefore the closure of any switch  $S_2$  to  $S_N$  will not make the corresponding relay operate.

The dc load current caused by operation of any switch is approximately 0.2  $\mu$ A, or the equivalent of 70 M $\Omega$ . Such current levels are certainly not enough to turn  $Q_1$  on. Hence this circuit does not require additional conductors.

### Keep the lines balanced

Without additional corrective circuitry, the 68-k $\Omega$  and 3.3-k $\Omega$  resistors—one on each line—could unbalance the line and degrade the common-mode rejection. A typical value for such lines is 40 dB—which represents a ratio of 100:1 between the in-phase, common-mode voltages, applied to both sides of  $T_2$ , and the out-of-phase voltage across the transformer. With balanced IC inputs, the ratio increases to 60 or 70 dB—more than 1000:1.

There are at least three different ways to correct this condition. A 10-k $\Omega$  balance potentiometer can be added, as shown, for  $T_2$ . Potentiometer  $R_4$  in conjunction with  $C_3$  can be used, or a three-pole switch and a pair of 100-k $\Omega$  resistors will do the job.

These circuits will prevent incompatible use of the line—such as between data exchange, TTY, remote tone controls and analog data transmission. In coded fire-alarm systems such circuits prevent simultaneous transmission of signals.

In addition the circuits can be expanded to furnish dc remote control of various functions at the same time that superimposed ac signals transmit other data. And there are a variety of forms. For example, time-division multiplexers have lockout properties if you have exclusive access to a line. A voltage applied to a clamp circuit in an IC will stop transmission until the line is free. ■■

What's so good about our 12-bit DAC85 D/A converter? For one thing, it has its own internal reference and output amplifier. It guarantees laser trimmed linearity to  $\pm 1/2$  LSB, gain drift as low as  $\pm 10$ ppm/ $^{\circ}$ C, and maximum bipolar offset drift as low as  $\pm 5$ ppm/ $^{\circ}$ C. Voltage output models settle to  $\pm 0.01\%$  in  $5\mu$ sec; current output models in just 300 nsec. Throughput rates can be as high as 3 MHz for full scale ranges. And, these tiny hermetically sealed 24-pin dual-in-line units offer nonlinearities of  $\pm 0.012\%$ .

**You do have alternatives.** You can design a 12-bit DAC from commercial IC or discrete parts, but it will cost 2 or 3 times as much and might take up to 6 months from design to plug-in. If you have space, you could buy the popular  $2'' \times 2''$  modules. We sell those too. Or, you can buy a 10-bit CMOS DAC from somebody else, add 2 bits of R2R ladder network with very tight tracking and good absolute accuracy, if you can find them and get delivery. Then, add on an external amplifier. Careful though, CMOS is hard to handle and static discharge can blow a switch.

Yes, you have alternatives, but why waste your time when the DAC85 offers the best 12-bit price/performance/size relationships on the market. **Prices start as low as \$62.00 in 100's.** Write or call us for complete details. Burr-Brown, International Airport Industrial Park, Tucson, Az. 85734. Telephone (602) 294-1431.



INFORMATION RETRIEVAL NUMBER 43

# Have you heard about the Complete, high performance Hybrid IC 12-Bit D/A Converter that saves time, space, and money?

## It's ours.

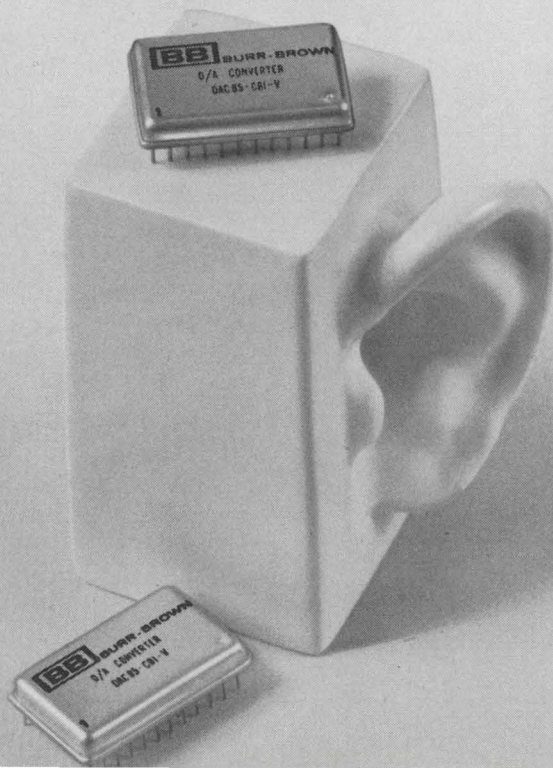

# Our YIG is up



With four furnaces dedicated to the growth of YIG crystals, and with the current capability to produce in excess of twenty thousand highly polished spheres a month, Watkins-Johnson Company is in a unique position to supply the needs of this expanding market.

Spheres can be supplied from 200 to 1800 Gauss ( $4\pi$ ms) with diameters ranging from 0.037 to 0.012 inches. Sphericity is guaranteed to 0.0001 and diameter accuracy to  $\pm 0.0005$ . The finish is typically 0.15 microns.

To discuss your YIG sphere application, contact the Watkins-Johnson Field Sales Office in your area or phone YIG Sphere Applications Engineering at (415) 493-4141. Delivery from stock can normally be made within two days of receipt of order.

# to your most stringent filter and oscillator applications



WATKINS-JOHNSON

**Watkins-Johnson—U.S.A.:** 3333 Hillview Ave., Palo Alto, CA 94304 • (415) 493-4141 • TWX: 910-373-1253 • Telex: 34-8415 • Cable: WJPLA • 700 Quince Orchard Rd., Gaithersburg, MD 20760 • (301) 948-7550 • TWX: 710-828-0546 • Telex: 89-8402 • Cable: WJCEI • **United Kingdom:** Shirley Ave., Windsor, Berkshire SL4 5JU, England • Tel: Windsor 69241 • Cable: WJUKW-WINDSOR • Telex: 847578 • **West Germany:** 8033 Planegg, Muenchenerstr. 17 • Tel: (089) 859-9441 • Cable: WJDBM-Muenchen • Telex: 529401 • **Italy:** Piazza G. Marconi, 25 00144 Roma-EUR • Tel: 59 45 54 • Cable: WJROM-ROMA • Telex: 60117

INFORMATION RETRIEVAL NUMBER 44

# Interpolate sampled data rapidly.

Discrete Fourier transforms provide a mathematical short cut due to a quirk in classical sampling theory.

You can interpolate sampled data rapidly—to find values between the sampled points—by using Discrete Fourier Transforms (DFTs). With these transforms, data sampling allows what amounts to a mathematical short cut—one that automatically generates results as precise as conventional, and lengthy, interpolation techniques. But there are a few restrictions.

The short cut can be applied only when the sampled function is band-limited. Fortunately most practical interpolation tasks—such as those for synthesized speech data or geophysical phenomena—involve band-limited signals.

## The flip side of Nyquist

The interpolation technique is based on an unstated corollary of the Nyquist sampling theorem. The theorem states that the sampling frequency must be at least twice the highest frequency component of the signal if one is to faithfully represent the signal. This implies that nothing is gained by sampling at a frequency above the Nyquist rate. But though no new information is developed, rapid sampling does allow interpolation of the existing data.

To sample at a higher-than-necessary rate, you must artificially add zeros (zero-amplitude frequencies) outside the spectrum under study. Then you can recover data in the amplitude domain. These data points are interstitially positioned and therefore not present in the original sampled data.

If the sampling rate satisfies the Nyquist criterion, the sampled function may be entirely reconstructed by use of DFTs. The process consists of three steps:

1. Calculation of the function's DFT.
2. Addition of a number of zero-amplitude frequencies to the resulting spectrum.
3. Calculation of the Inverse Discrete Fourier Transform (IDFT) of the combined spectrum.

The last step yields interpolated data points

**Richard D. Angelari**, Electronic Engineer, and **Joseph A. Calabria**, Electronic Engineer, Naval Navigation Laboratory, Naval Air Development Center, Warminster, Pa. 18974.

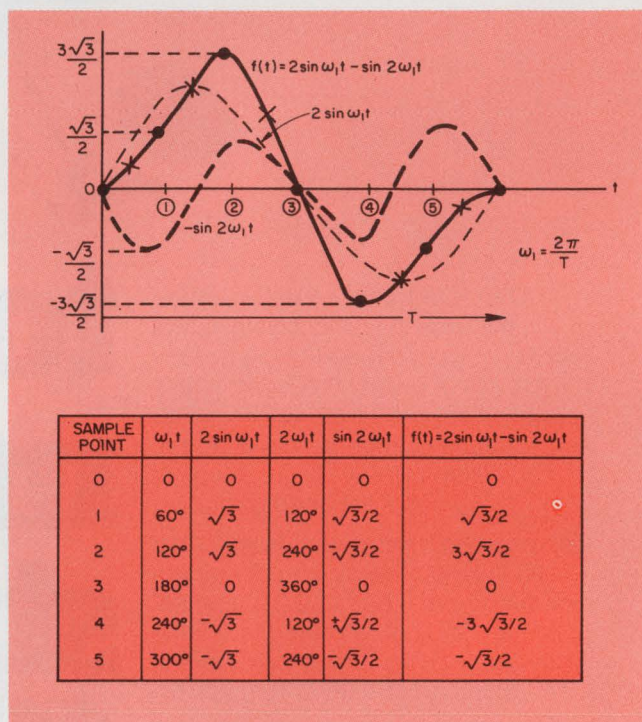

1. In this simplified analysis of the rapid interpolation technique, a function  $f(t)$ , consisting of two sine waves, is bandwidth-limited. The table shows how the curves are derived at the sampling points, 1 thru 5. The dots on the resultant curve represent the actual sampling points for the data, while the X's indicate the locations of interpolated points.

between the sampled data points. Any desired interpolation resolution can be achieved.

## Restrictions of rapid data sampling

There are two restrictions when interpolation is used:

1. The signal must be bandwidth-limited.
2. The sampling frequency must be at least twice the highest-frequency component,  $\omega_0$ , of the signal.

A function is bandwidth-limited if the Fourier transform

$$F(\omega) = (1/2\pi) \int_{-\infty}^{\infty} f(t) e^{-j\omega t} dt; \quad (1)$$

is zero outside the interval  $(-\omega_0, \omega_0)$ . In other

words, the Fourier transform,  $F(\omega)$ , is zero for  $\omega \cong \omega_0$ .

The second restriction is dictated by the Nyquist criterion. In the frequency domain, this requires that  $N$  (number of samples per unit time)  $\cong \omega_0/\pi$ .

What happens if you disregard the Nyquist restriction? An error, called aliasing distortion, results. This is an amplitude distortion that is most apparent in the frequency domain.<sup>1</sup> To ensure that aliasing does not occur, increase the number of data samples—or, in effect, increase the sampling rate. Another approach is to diminish the effects of aliasing by low-pass filtering the data to attenuate all harmonics above the sampling frequency.

### Algorithm for discrete Fourier transforms

The algorithm for the discrete Fourier transform is as follows:

$$F(n) = 1/N \sum_{i=0}^{N-1} f(i) e^{-j i n 2\pi/N} \quad (2)$$

and its inverse is given by

$$f(i) = \sum_{n=0}^{N-1} F(n) e^{j i n 2\pi/N}, \quad (3)$$

where  $F(n)$  is the frequency-domain function,  $f(i)$  is the time-domain function,  $j = \sqrt{-1}$ ,  $N$  is the number of sampled points and  $i$  is the sampled number. In general,  $F(n)$  and  $f(i)$  are complex numbers. Eqs. 2 and 3 are based on the standard Fourier integrals:

$$F(\omega) = 1/2\pi \int_{-\infty}^{\infty} f(t) e^{-j\omega t} dt; \quad (4)$$

$$f(t) = \int_{-\infty}^{\infty} F(\omega) e^{j\omega t} d\omega. \quad (5)$$

The derivations of Eqs. 2 and 3 from Eqs. 4 and 5 have been demonstrated by Bice.<sup>2</sup>

For a simplified illustration of the interpolation technique, let's sample a known bandwidth-limited function. All the functions will be assumed to be periodic. The basic transforms used are programmed in Fortran IV and are useful for relatively low values of  $N$ . For larger values, a Fast-Fourier-Transform (FFT) subroutine is appropriate.

Consider the function  $f(t) = 2\sin \omega t - \sin 2\omega t$ . This is bandwidth-limited, since it consists of only two sine waves, the second having half the amplitude and double the frequency of the first. Fig. 1 shows the function and its frequency components. The table shows the sample points (the dots on the curve) together with the associated sample data. The X's in Fig. 1 indicate the location of the interpolated points, whose values are to be determined.

The problem, of course, is to find the amplitude of the function  $f(t)$  at points between the sampled data points. The procedure to find the interpolated points is as follows:

1. Calculate the DFT of the function from Eq. 2. Fig. 2a represents the sampled function and Fig. 2b its DFT.

2. Determine the number of zero-amplitude frequencies to be added. Then insert  $(r-1)N$  zeros<sup>3,4</sup> in the middle of the frequency sequence, where  $r$  is the number by which we must multiply  $N$  to get the desired number of interpolated data

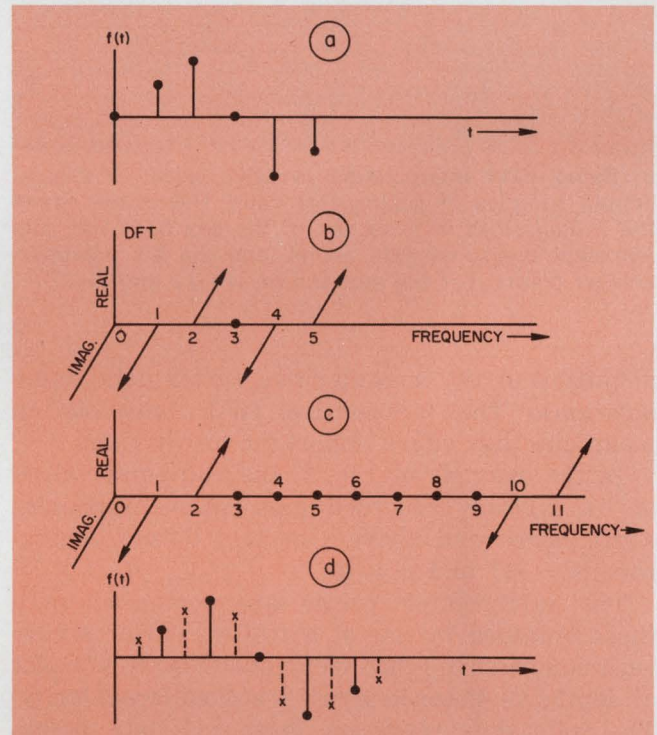

2. The sampled function (a) yields discrete Fourier transforms (b). When extra zeros are added (c) the DFT has the same four values but more points. Then the inverse transformation yields the original curve plus the interpolated points (d).

points. In Fig. 2c,  $N = 6$  and  $r = 2$ . (This says that we started with six data points and desire 12.)

3. The inverse DFT, shown in Fig. 2d, indicates a total of 12 points. If more resolution is required, increase  $r$  accordingly. Note that the original data points are preserved with this technique.

### Important applications in oceanography

Both the commercial and scientific communities show interest in ocean-bottom bathymetry—the measurement of irregularities in shape of the ocean floor. To minimize surveying data-acquisition costs, the number of samples taken should be no more than is needed to achieve the required

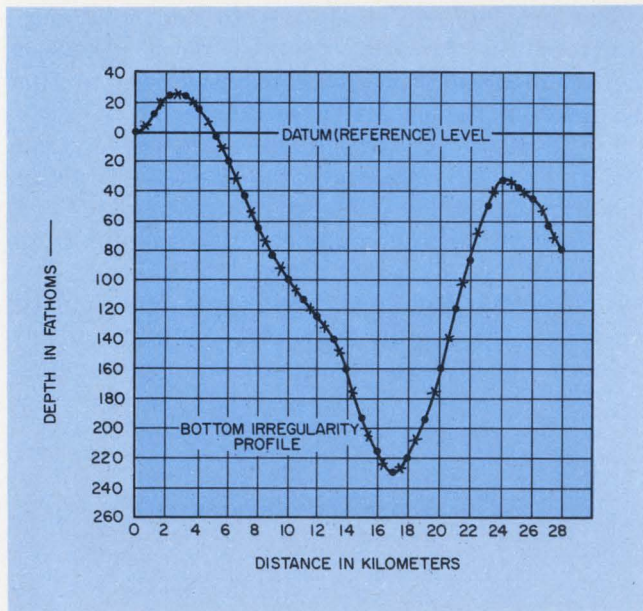

3. Rapid data interpolation is often used to expand limited samples of geophysical data. This curve shows the irregularities in a section of the sea bed. The dots represent measured data points, and the X's are interpolated points. For the plot shown,  $N=31$  and  $r=2$ .

definition of the irregularities (after data interpolation). The inexpensive DFT interpolation technique thus offers important cost savings.

In the example of Fig. 3, the mid-point values of 31 digitally recorded data values represent depth below and above a certain datum. Therefore  $N = 31$  and  $r = 2$ .

The interpolated points are compared with those obtained by use of a finite Fourier series, least-square-difference technique. Fig. 3 is a plot of depths vs distance across a seabed irregularity. The solid dots represent measured data points and X's are interpolated points. A mean error of 0.1 fathoms with a standard deviation of 0.43 fathoms was achieved for the interpolated values. The difference is due to the restriction placed on the finite Fourier series program, used to terminate the calculation when a predetermined minimum-squares difference was realized. Theoretically identical results would have been achieved had the program been permitted to continue. In both methods the original data were recovered. ■■

#### Acknowledgment

The authors wish to thank Richard Kaufman of the Naval Navigation Laboratory for the computer program and the resulting plot shown in Fig. 3.

#### References:

1. Cochran, Cooley et al, "What is the Fast Fourier Transform," *IEEE Trans. Audio*, Vol. 15, No. 2, June, 1967, pp. 45-55.
2. Bice, Peter K., "Getting Accurate Fast Fourier Transforms," *Electronic Design*, May 10, 1973, pp. 84-87.
3. Gold and Radar, "Digital Processing of Signals," McGraw-Hill Book Co., 1969.
4. Schafer and Rabiner, "A Digital Signal Processing Approach to Interpolation," *Proceedings of the IEEE*, Vol. 61, No. 6, June, 1973.

## ITT STOCKING DISTRIBUTORS

- |  |   |   |
|--|---|---|
| <b>ALABAMA</b><br>Birmingham<br>ACK Radio Supply Co.<br>Tel: 205-322-0588<br>Huntsville<br>Cramer/EW Huntsville, Inc.<br>Tel: 205-539-5722   | <b>MASSACHUSETTS</b><br>Burlington<br>Hamilton/Avnet Electronics<br>Tel: 617-273-2120<br>Newton<br>Cramer Electronics<br>Tel: 617-969-7700<br>Cramer/International<br>Tel: 617-969-7700<br>Greene-Shaw Co., Inc.<br>Tel: 617-969-8900   | Dayton<br>Hamilton/Avnet Electronics<br>Tel: 513-433-0610<br>Dayton-Cleveland<br>Hamilton/Avnet Electronics<br>Tel: 216-289-0550<br><b>OREGON</b><br>Seattle-Portland<br>Hamilton/Avnet Electronics<br>Tel: 503-224-9450<br><b>PENNSYLVANIA</b><br>Philadelphia-Mt. Laurel<br>Hamilton/Avnet Electronics<br>Tel: 215-831-1300<br><b>TEXAS</b><br>Dallas<br>Cramer/Texas<br>Tel: 214-350-1355<br>Texas WATTS 800-492-6940<br>Hamilton/Avnet Electronics<br>Tel: 214-661-8661<br>Dallas-Ft. Worth<br>Hamilton/Avnet Electronics<br>Tel: 817-275-6561<br>Houston<br>Hamilton/Avnet Electronics<br>Tel: 713-526-4661<br>Richardson<br>Altair Co., Inc.<br>Tel: 214-231-5166<br><b>UTAH</b><br>Salt Lake City<br>Cramer/Utah<br>Tel: 801-487-4131<br>Hamilton/Avnet Electronics<br>Tel: 801-262-8451<br><b>WASHINGTON</b><br>Bellevue<br>Hamilton/Avnet Electronics<br>Tel: 206-746-8750<br>Seattle<br>Cramer/Seattle<br>Tel: 206-762-5755<br><b>WASHINGTON, D. C.</b><br>Baltimore<br>Hamilton/Avnet Electronics<br>Tel: 301-953-7010<br><b>WISCONSIN</b><br>Oak Creek<br>Cramer/Wisconsin<br>Tel: 414-764-1700<br><b>CANADA</b><br>Downsview, Ontario<br>Cramer/Canada, Ltd.<br>Tel: 416-661-9222<br>Halifax, Nova Scotia<br>Consolidated Supply Co. Ltd.<br>Tel: 902-454-8581<br>Mississauga, Ont.<br>Hamilton/Avnet Electronics<br>Tel: 416-677-7432<br>Montreal, Quebec<br>Hamilton/Avnet Electronics<br>Tel: 514-735-6393<br>Ottawa<br>Hamilton/Avnet Electronics<br>Tel: 613-725-3071<br>Vancouver, B. C.<br>Cam Gard Supply, Ltd.<br>Tel: 604-291-1441<br>Winnipeg, Manitoba<br>Cam Gard Supply, Ltd.<br>Tel: 204-786-8401<br><b>ITALY</b><br>Roma<br>Cramer/Italia<br>Tel: 51-393-87<br>and 51-393-90<br><b>PUERTO RICO</b><br>De San German<br>Cramer/Puerto Rico<br>Tel: 809-892-1130<br>San Juan<br>ITT Caribbean e<br>Sales & Service<br>(P.R.) Inc.<br>Tel: 809-767-5050<br>809-766-2408 |
| <b>ARIZONA</b><br>Phoenix<br>Cramer/Arizona<br>Tel: 602-263-1112<br>Hamilton/Avnet Electronics<br>Tel: 602-275-7851  | <b>MICHIGAN</b><br>Detroit<br>Semiconductor Specialists<br>Tel: 313-255-0300<br>Livonia<br>Cramer/Detroit<br>Tel: 313-425-7000<br>Hamilton/Avnet Electronics<br>Tel: 313-522-4700   | <b>MINNESOTA</b><br>Edina<br>Cramer/Bonn<br>Tel: 612-835-7811<br>Hamilton/Avnet Electronics<br>Tel: 612-941-3801<br>Minneapolis<br>Semiconductor Specialists<br>Tel: 612-854-8841   |
| <b>CALIFORNIA</b><br>Chatsworth<br>Westates Electronics Corp.<br>Tel: 213-341-4411<br>Culver City<br>Avnet Electronics<br>Tel: 213-836-7200<br>Tel: 714-522-8220<br>Hamilton Electro Sales<br>Tel: 213-870-7171<br>Tel: 714-522-8200<br>Irvine<br>Cramer/Los Angeles<br>Tel: 714-979-3000<br>& 213-771-8300<br>Los Angeles<br>Radio Products Sales, Inc.<br>Tel: 213-748-1271<br>Menlo Park<br>Bell Electronic Corp.<br>Tel: 415-323-9431<br>Mountain View<br>Hamilton/Avnet Electronics<br>Tel: 415-961-7000<br>San Diego<br>Cramer/San Diego<br>Tel: 714-565-1881<br>Hamilton/Avnet Electronics<br>Tel: 714-279-2421<br>Sunnyvale<br>Cramer Electronics<br>Tel: 408-739-3011 | <b>MISSOURI</b><br>Hazelwood<br>Hamilton/Avnet Electronics<br>Tel: 314-731-1144<br>Kansas City<br>Semiconductor Specialists<br>Tel: 816-452-3900<br>St. Louis<br>Olive Industrial Electronics<br>Tel: 314-863-7800<br><b>NEW JERSEY</b><br>Cedar Grove<br>Hamilton/Avnet Electronics<br>Tel: 201-239-0800<br>Cherry Hill<br>Cramer/Pennsylvania, Inc.<br>Tel: 609-424-5993<br>Clifton<br>Wilshire Electronics/N.J.<br>Tel: 201-365-1150<br>Moonachie<br>Cramer/New Jersey<br>Tel: 201-935-5600<br>Mt. Laurel<br>Hamilton/Avnet Electronics<br>Tel: 609-234-2133<br>Pennsauken<br>Resco Electronics<br>A Div. of Astrex, Inc.<br>Tel: 609-662-4000<br><b>NEW MEXICO</b><br>Albuquerque<br>Cramer/New Mexico<br>Tel: 505-265-5767<br>Hamilton/Avnet Electronics<br>Tel: 505-765-1500<br><b>NEW YORK</b><br>East Syracuse<br>Cramer Electronics<br>Tel: 315-437-6671<br>Hamilton/Avnet Electronics<br>Tel: 315-437-2642<br>Endwell<br>Cramer Electronics<br>Tel: 607-754-6661<br>Freeport<br>Milgray Electronics<br>Tel: 516-546-6000<br>Hauppauge, L. I.<br>Cramer/Long Island<br>Tel: 516-231-5600<br>Rochester<br>Cramer Electronics<br>Tel: 716-275-0300<br>Westbury L.I.<br>Hamilton/Avnet Electronics<br>Tel: 516-333-5800 | <b>NEW JERSEY</b><br>Cedar Grove<br>Hamilton/Avnet Electronics<br>Tel: 201-239-0800<br>Cherry Hill<br>Cramer/Pennsylvania, Inc.<br>Tel: 609-424-5993<br>Clifton<br>Wilshire Electronics/N.J.<br>Tel: 201-365-1150<br>Moonachie<br>Cramer/New Jersey<br>Tel: 201-935-5600<br>Mt. Laurel<br>Hamilton/Avnet Electronics<br>Tel: 609-234-2133<br>Pennsauken<br>Resco Electronics<br>A Div. of Astrex, Inc.<br>Tel: 609-662-4000<br><b>NEW MEXICO</b><br>Albuquerque<br>Cramer/New Mexico<br>Tel: 505-265-5767<br>Hamilton/Avnet Electronics<br>Tel: 505-765-1500<br><b>NEW YORK</b><br>East Syracuse<br>Cramer Electronics<br>Tel: 315-437-6671<br>Hamilton/Avnet Electronics<br>Tel: 315-437-2642<br>Endwell<br>Cramer Electronics<br>Tel: 607-754-6661<br>Freeport<br>Milgray Electronics<br>Tel: 516-546-6000<br>Hauppauge, L. I.<br>Cramer/Long Island<br>Tel: 516-231-5600<br>Rochester<br>Cramer Electronics<br>Tel: 716-275-0300<br>Westbury L.I.<br>Hamilton/Avnet Electronics<br>Tel: 516-333-5800<br><b>NORTH CAROLINA</b><br>Winston-Salem<br>Cramer/EW Winston-Salem<br>Tel: 919-725-8711<br><b>OHIO</b><br>Cincinnati<br>Cramer/Tri-States<br>Tel: 513-771-6441<br>Cleveland<br>Cramer/Cleveland<br>Tel: 216-248-8400  |
| <b>CONNECTICUT</b><br>Georgetown<br>Hamilton/Avnet Electronics<br>Tel: 203-762-0361<br>North Haven<br>Cramer Electronics<br>Tel: 203-239-5641  | <b>FLORIDA</b><br>Hollywood<br>Cramer/EW<br>Tel: 305-923-8181<br>Hamilton/Avnet Sales<br>Tel: 305-925-5401<br>Orlando<br>Cramer/EW Orlando<br>Tel: 305-894-1511   | <b>GEORGIA</b><br>Atlanta<br>Cramer Electronics<br>Tel: 404-448-9050<br>Norcross<br>Hamilton/Avnet Electronics<br>Tel: 404-448-0800   |
| <b>ILLINOIS</b><br>Des Plaines<br>Edmar Electronics Co.<br>Tel: 312-298-8580<br>Elmhurst<br>Semiconductor Specialists<br>Tel: 312-279-1000<br>Mt. Prospect<br>Cramer/Chicago<br>Tel: 312-593-8230<br>Schiller Park<br>Hamilton/Avnet Electronics<br>Tel: 312-678-6310  | <b>INDIANA</b><br>Indianapolis<br>Semiconductor Specialists<br>Tel: 317-243-8271  | <b>KANSAS</b><br>Lenexa<br>Hamilton/Avnet Electronics<br>Tel: 913-888-8900  |
| <b>MARYLAND</b><br>Baltimore<br>Arrow Electronics, Inc.<br>Tel: 301-247-5200<br>Gaithersburg<br>Cramer/EW Washington<br>Tel: 301-948-0110<br>Hanover<br>Cramer/EW Baltimore<br>Tel: 301-796-5790<br>Hamilton/Avnet Electronics<br>Tel: 301-796-5000  |   |   |

**ITT**  
SEMICONDUCTORS Worldwide



# In Rectifier reliability, Nobody trumps our lead

When you need reliable rectifiers, take your lead from ITT. The latest technology makes our products both reliable and cost-competitive. For example, consider the leads on our 1-amp glass-passivated device. They're weldable, bendable, and they pass tough pull tests with ease. You can specify our 1-amp rectifiers with confidence for the cut-and-bend operations of automated insertion equipment. Our technology results in high reliability for 400 mA and 1A glass as well as 1A and 3A plastic. For a good deal, go with the reliable people who hold all the cards—including zeners, diode arrays, silicon transistors and silicon, germanium and tuner diodes. Write today for our handy cross-reference guide.

## ITT...Logically

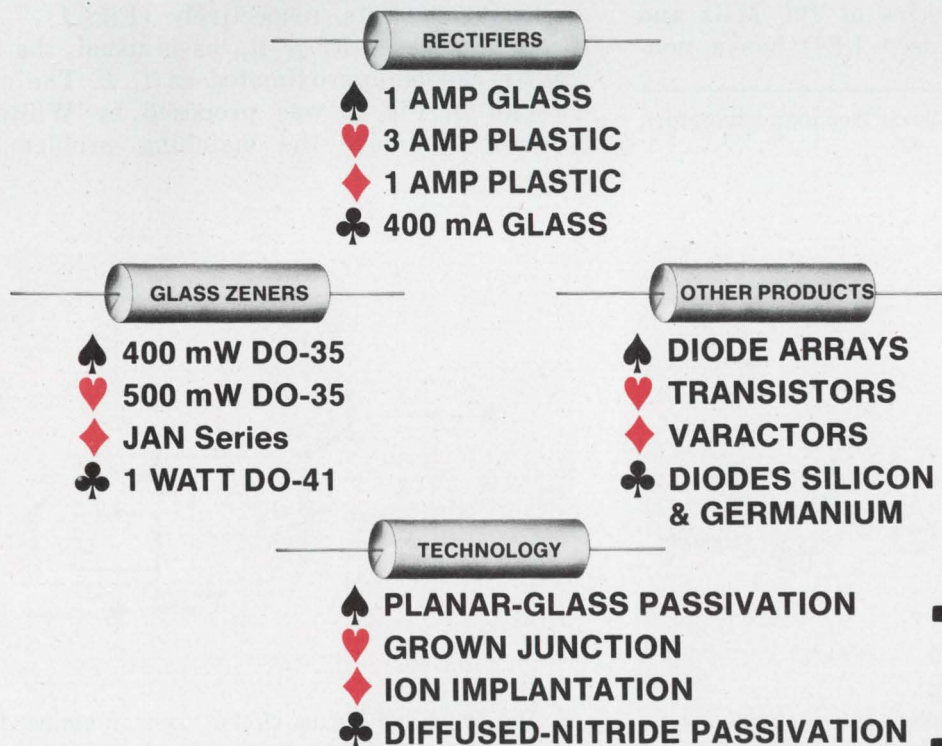

# semiconductors

ITT Semiconductors is a division of International Telephone and Telegraph Corporation, 500 Broadway, Lawrence, Mass. 08142 Phone 617-688-1881. Factories in West Palm Beach, Florida • Lawrence, Massachusetts • Footscray, England • Colmar, France • Freiburg, Germany • Cascais, Portugal • Taipei, Taiwan • Sydney, Australia

# ITT

# Drive fiber-optic lines at 100 MHz.

To achieve high data rates at low cost, use ECL gates instead of discrete component drivers for the LEDs.

Replace discrete-component LED drivers with high-speed ECL gates, and you can transmit data at rates up to 100 MHz through fiber-optic cables. The method makes it feasible to use these cables, instead of wire, for the transmission of digital data, with savings in weight and improvements bandwidth.

The maximum data rate for a LED depends on the drive circuit's ability to supply charging current to the LED's capacitance. With presently available diodes, carrier lifetime  $f = 1/(2\tau_c)$ , theoretically allows operation at more than 200 MHz. But the data rates for practical circuits, so far have been only about 100 MHz maximum.<sup>1</sup>

The capacitance of high-frequency LEDs may vary, typically from 200 to 1000 pF during the switching time. Currents of 100 to 200 mA are required to charge this capacitance at 100 MHz (1000 pF is about 1.6  $\Omega$  reactive at 100 MHz), although the capacitance is shunted by an equally small dynamic resistance ( $r_d$ ).

LEDs can, of course, be modulated directly by step-recovery diodes, Gunn-effect diodes or Trapatt diodes at frequencies of 100 MHz and higher. But a forward-biased LED has a non-

linear low impedance. One way to achieve maximum speed is to drive the LEDs directly from a low-impedance source. However, such a brute-force method is not ideal for solid-state circuits—the efficiency is necessarily low.

If you want to prevent the LED rise time from limiting the system bandwidth, use the following rule of thumb:

$$t_r(\text{LED}) = 0.35 / (2.2 \text{ BW}_{\text{rcvr}}).$$

Usually the bandwidth restriction should be assigned to the photoreceiver to maximize signal-to-noise ratio and sensitivity.

Two LED-driver approaches are possible: constant-current and nonconstant-current operation. Constant-current operation avoids the large  $dI/dt$  currents otherwise encountered in ground planes and bias lines.

## The approaches: You have a choice

The two best circuits for high-speed LED driving are the emitter-follower and the emitter-coupled video stage. These draw nonconstant and constant currents, respectively (Fig. 1).

In Fig. 1a, if  $R_s > R_1$ , as is usual, the bandwidth can be approximated as  $f_t/\beta$ . The circuit design in Fig. 2 was proposed by White and Burrus<sup>2</sup> to solve the matching problem. The

**Bob Jarrett**, Senior Engineer, Naval Weapons Laboratory, Dahlgren, Va. 22448.

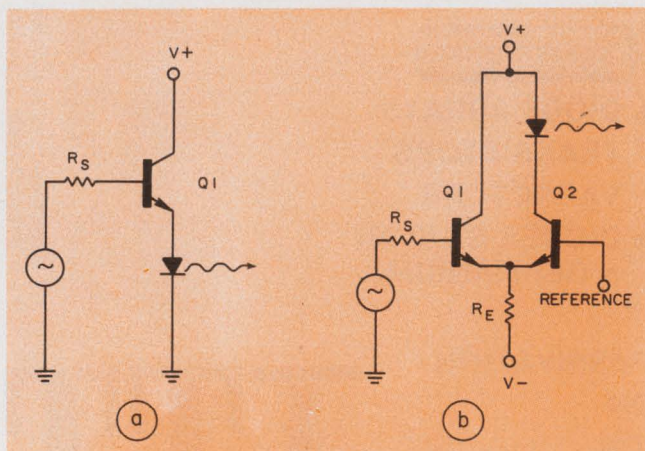

1. Two of the simplest LED-driver configurations include the emitter-follower (a) and the current-switch (b).

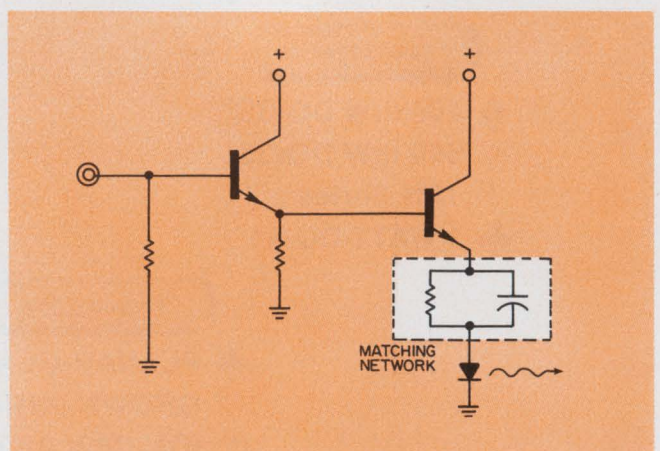

2. The White and Burrus circuit<sup>2</sup> uses an emitter-follower but adds a matching network in series with the LED.

emitter-follower input stage decreases the effective value of source impedance, and the addition of the parallel RC combination ahead of the diode increases the load impedance. The capacitor provides a compensating zero for the additional pole introduced by the series resistance.

It would seem that emitter-coupled logic (ECL) with its emitter-follower outputs would be ideal for the emitter-follower configuration. However, the 0.8-V pk-pk output swing of standard ECL gates is not optimum. But resourceful

supplies current to the output drivers, while  $V_{CC2}$  is connected to the circuit's logic transistors. The 10210 device, designed for clock driving, has three emitter-follower outputs for each of its two OR gates. Each output group of three drivers has its own  $V_{CC1}$  pin. Thus you have free access to the collectors of the output transistors for connection of the LED in a current-switch configuration.

By wire-ORing the output emitters, you can obtain the full current drive capability of the

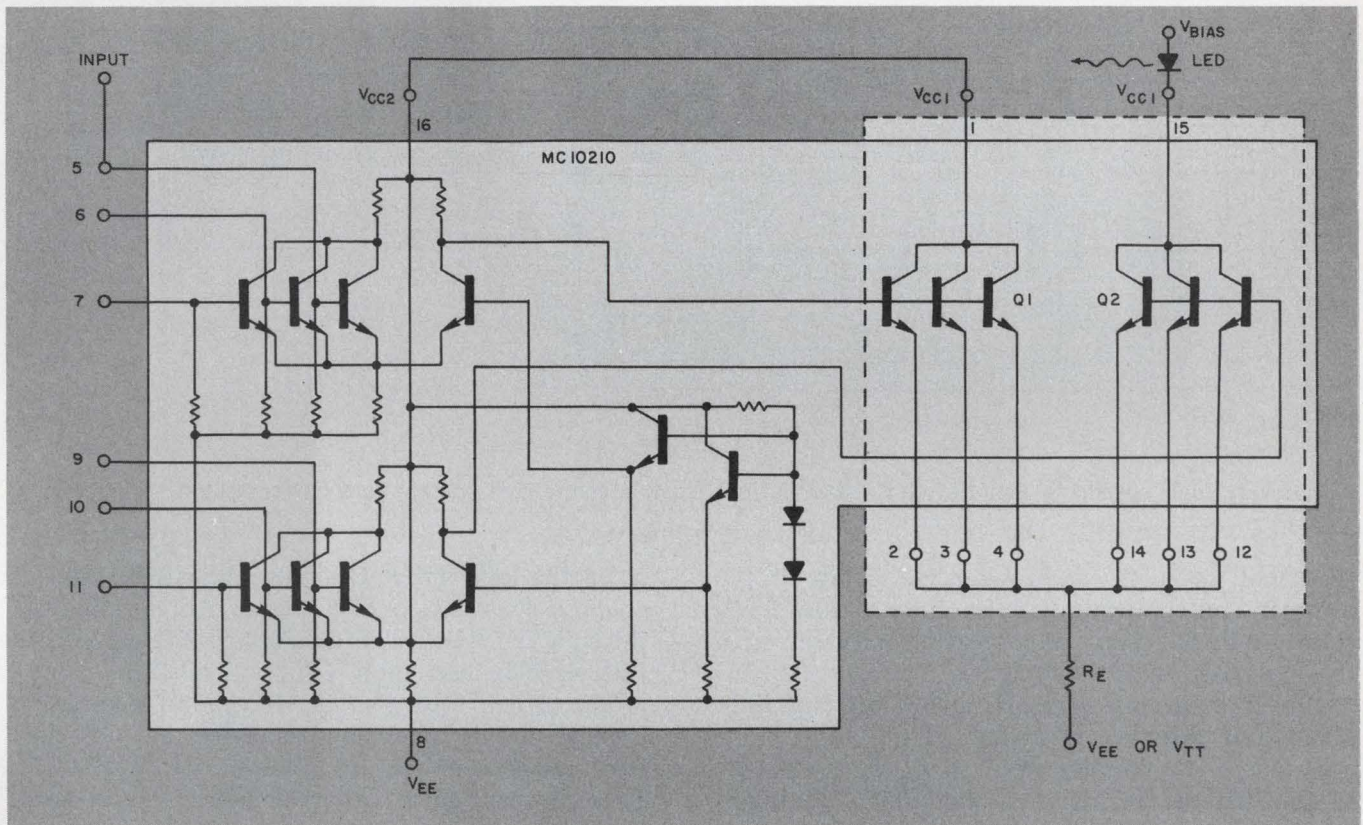

3. The 10210 OR gate can be connected as a current switch to drive a LED. All you need is a single external

resistor for emitter bias. This configuration also preserves the normal logic function.

design allows use of a standard ECL circuit as a LED driver.

There are several ways to drive a LED at high speed with a \$2 circuit such as the MC10210—dual three-input/three-output OR gate.<sup>3</sup> This gate has a typical propagation delay of 1.5 ns.

The basic video stage of Fig. 1b is well known for its properties as a current switch. When using the discrete version of the video stage (or the circuit of Fig. 1a), you might normally select a relatively expensive device to obtain high speed in the 50-to-200-mA range. Or you would parallel two or more devices to obtain a composite  $Q_2$  stage, in which the current load would be shared.

Fortunately, most ECL circuits have two  $V_{CC}$  leads. These reduce cross-coupling and  $V_{BB}$  spiking when the ICs drive heavy loads. The  $V_{CC1}$  pin

multiple OR-gate output structure.

Fig. 3 shows one LED-driver configuration in which the normal logic function is preserved. This allows the gate inputs on the LED-driving half of the IC to be left open (logic ZERO), while the logic signal can be applied to the other gate. Thus the output transistors function as a composite emitter-follower,  $Q_1$ , which drives a composite common-base amplifier  $Q_2$ .

#### The basic drive circuits

The circuit can also be driven differentially by complementary operation of the two gates. The circuit of Fig. 3 would be expected to have slightly better frequency performance than the differential-drive circuit. This stems from the

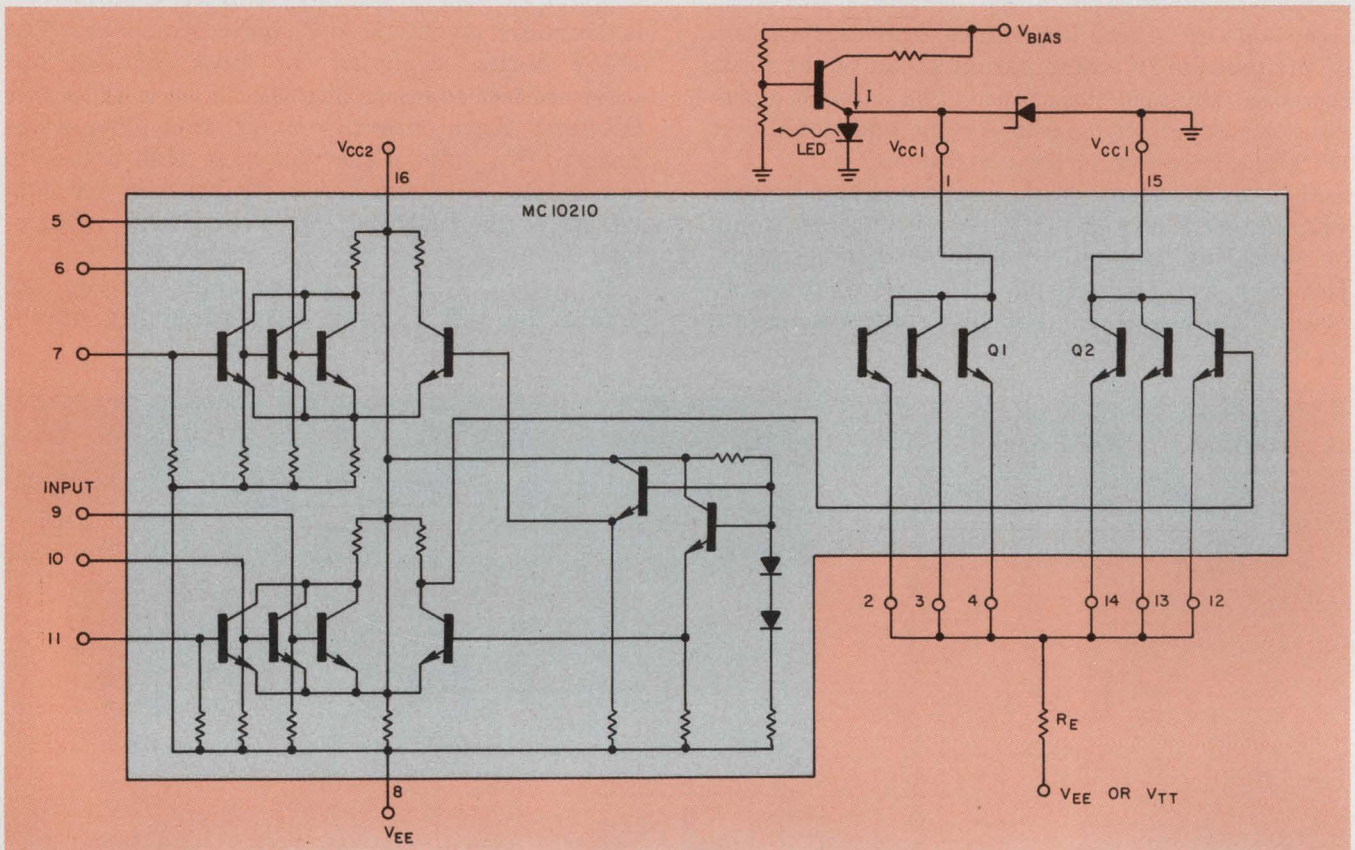

4. For very high speeds, a Schottky diode and current source let the gate operate as a current shunt.

fact that there is no propagation delay in the common-emitter/common-base circuit that feeds the base of  $Q_2$ . Thus turn-on time is faster with the composite emitter-follower.

However,  $Q_1$  will never be turned off, and only about half the current swing,

$$(V_{OL} - V_{EE})/2R_E \text{ vs } (V_{OH} - V_{EE})/R_E,$$

of the differential drive is available. Maximum speed can be obtained when the LED supply,  $V_{CC1}$ , is higher than  $V_{CC2}$ . But reasonable results are obtained if the  $V_{CC}$  supply is increased to above 6 V and used for both  $V_{CC1}$  and  $V_{CC2}$  bias.

For the nominal 5.2-V  $V_{CC} - V_{EE}$  differential, the  $Q_2$  emitter voltage will be about -1.7 V. With a 1.3-V drop across the LED, the base-collector junction becomes forward-biased by 0.3 to 0.4 V, and the transistor approaches saturation.

An alternate approach to the logic-gate drive method is to shunt a constant-current source on or off the LED, depending on the gate-logic input. The circuit of Fig. 4 uses a Schottky or other fast diode to pull the LED's anode potential below ground when the composite  $Q_2$  emitter is at  $V_{OL}$  (logic ZERO), thereby back-biasing the LED and shunting the constant-current source through  $Q_1$ .

The current demand through  $Q_1$ , established by  $R_E$ , should be slightly higher than the constant-current source value. This will guarantee that the Schottky diode has some drive. Then

when the logic input changes,  $Q_1$  will be cut off and the constant-current source will be shunted through the LED. The available LED current is just slightly less than  $(V_{OL} - V_{EE})/2R_E$ .

The circuit can also be driven differentially. Fastest circuit operation, as before, is obtained for common-emitter/common-base operation. True constant-current performance results from the differential drive, and the current through  $R_E$  is halved. The LED current doesn't change appreciably, but the output power dissipation gets cut in half because either  $Q_1$  or  $Q_2$  is always off.

#### Higher drive currents can be obtained

To get higher current drive, all six output driver transistors can be connected to form one composite device. The circuit can then drive a 100-to-150 mA load. At only a small sacrifice in speed, two of the 10210 ICs can be connected in tandem to form the differential drive circuit of Fig. 3.

The 10210 can also be connected as one composite device and used single-ended for applications where high speed isn't critical but high current drive is (Fig. 5). The standard termination potential,  $V_{TT}$ , of -2 V proves useful, since it allows a large current swing in the LED.

The emitter-coupled, current-switch configura-

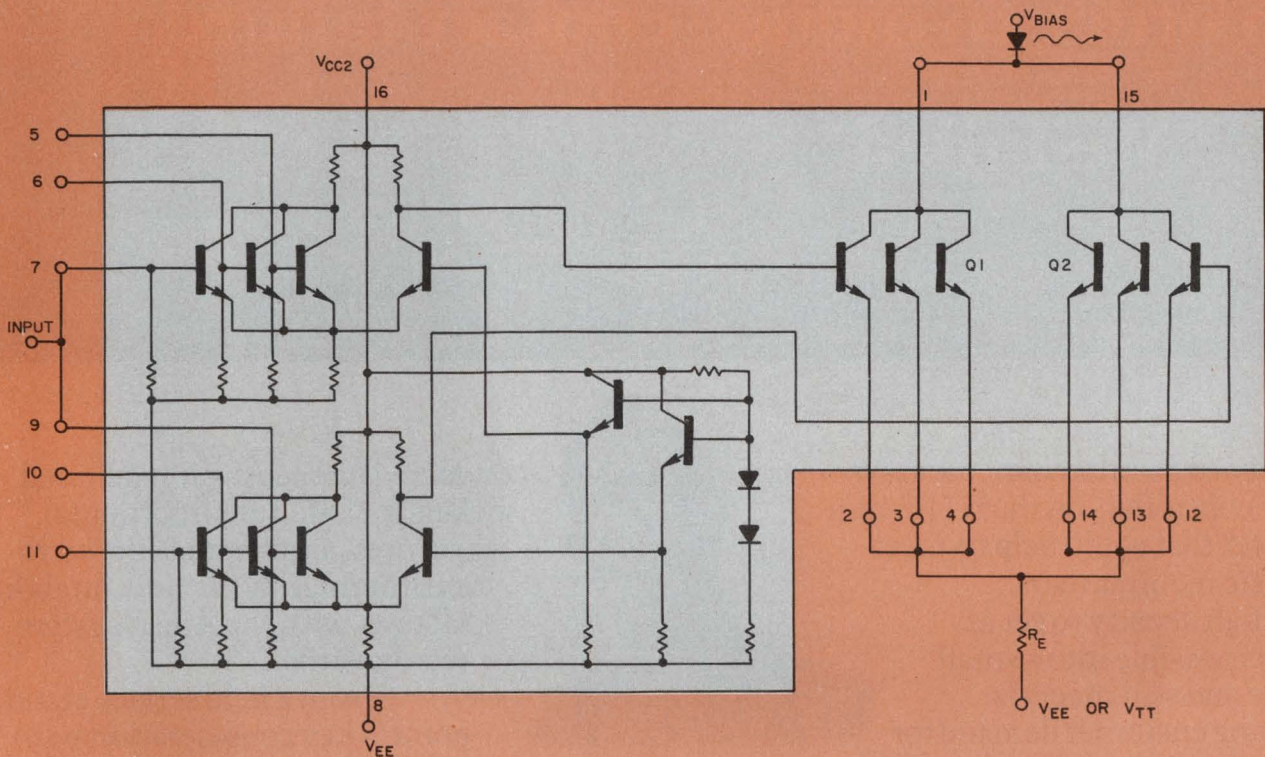

5. A tandem hookup of the ECL OR gate doubles the drive current you can supply to the LED.

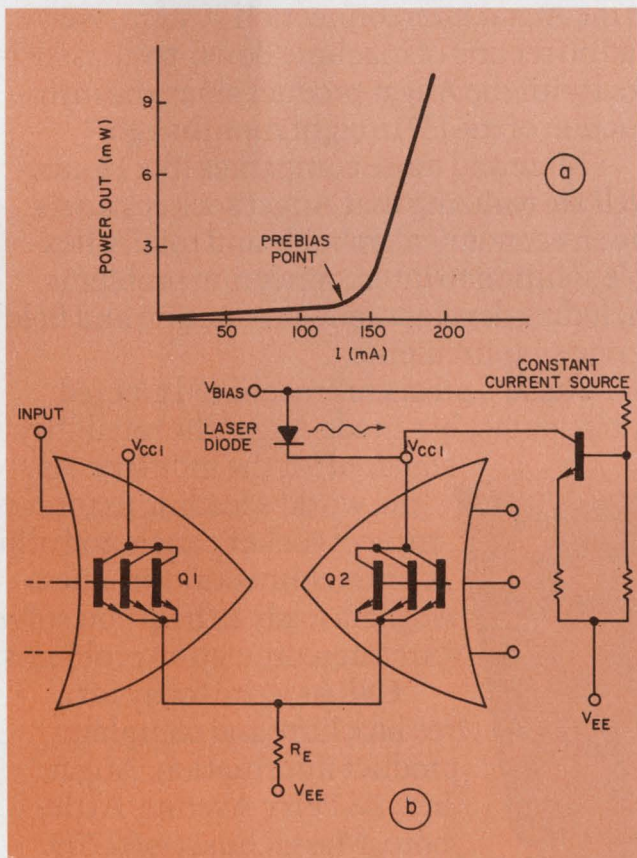

6. The typical power output characteristics of a double-heterostructure injection laser diode (a) makes it necessary to prebias the diode to a point just below the threshold level.

tions can also drive double-heterostructure, Al-GaAs, diode injection lasers. Such laser diodes have a power output that typically has a threshold level, but they can reach bit rates of 1 GHz (Fig. 6a). The diode should be prebiased to just below threshold to avoid the time delay associated with population inversion buildup when the current is switched on.

You can use the circuit of Fig. 3, with the addition of a discrete component current source as shown in Fig. 6b. The current through the laser diode is increased by  $(V_{OL} - V_{EE})/2R_E$  when the input goes low. The idling current is established by the current source but can also be produced by an inductively coupled bleed.

The 10210 is rated at 40 mA maximum for each output driver and should be capable of providing 150 mA total for all six drivers. If even more power is needed the tandem connection or a discrete component emitter-coupled current switch can be used. The recently introduced 10123 type device can supply a full 40 mA per output emitter-follower and might be more useful in some applications. ■■

#### References

1. Taylor, H.F., "Transfer of Information on Naval Vessels Via Fiber Optics Transmission Lines," NELC Technical Report No. 4763, 1971.
2. Burrus, C.A. and White, G. *International Journal of Electronics*, Vol. 35, No. 6, 1973, pp. 751-754.
3. "MECL Integrated Circuits Data Book," Motorola Semiconductor, 1972, pp. 389.

# "We subjected the Augat plug-in socket panel to an accelerated-life test in order to induce contact failure."

## "We failed."

Dave Fillio  
Principal Engineer, Component & Materials Engineering  
Honeywell Information Systems

"We needed an interconnection system for controllers on the H716 mini-computer that could help us meet four basic requirements:

"High density to get as much as possible into a small package and still meet the increasing customer demand for a broad range of peripherals, each requiring a separate controller.

"The capability of automatically wiring, with a minimum of two-levels.

"Flexibility to permit anticipated design changes and still allow us to meet a very tight schedule.

"And finally, all these features had to be available in a standard product.

"The most logical approach seemed to be printed wiring boards. But to accommodate all our controllers could have required as many as eight boards. And we couldn't afford the room. Also, when recycling changes are taken into consideration, the design cycle of printed wiring boards becomes too long and, consequently, too costly.

"Multi-layering offered a minimum of flexibility, and it, too, was rejected.

"The only practical solution was the plug-in socket panel. And of all the vendors, Augat was the only manufacturer that could provide a completely uniform, broad range of standardized products, the lowest possible profile and maximum reliability.

"The reliability tests we

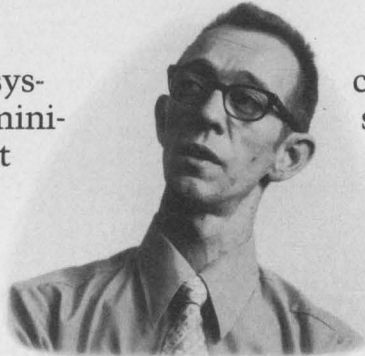

Dave Fillio

conducted on the Augat machined sockets included environmental exposures, accelerated-life, vibration, thermal shock, and durability. All tests with the Augat system were positive.

"From a field service standpoint, a key consideration with increasingly complex and flexible systems like the H716 is keeping them on the air at all times. Because of the reliability of the Augat interconnection system, we've had no reports of machine down-time associated with the Augat product since the introduction of the H716 eight months ago."

More and more companies like Honeywell are realizing that Augat socket-panels are an economical, reliable and totally flexible solution to interconnection problems, including development, production and field service requirements.

Augat's precision-machined tapered entry contact has made Augat the reliability standard for the industry. As

the world's leading manufacturer of socket panels and other IC interconnection products, Augat is ready to help you solve your interconnection problems.

Call or write today for a free brochure and complete product information. Augat, Inc., 33 Perry Avenue, Attleboro, Massachusetts 02703. Represented and distributed internationally.



The H716

# AUGAT®

Europe—Augat International, Inc., Boulevard A. Reyers, 103, 1040 Brussels, Belgium, Tel. (02) 36-93-99.

Japan—Kyokuto Boeki Kaisha Ltd., New Otemachi Bldg., 2-1, 2-Chome Otemachi, Chiyoda-Ku, Tokyo 100-91, Japan, Tel. (03) 244-3788.

# Why square ferrite cores?

save up to 40% in space  
save up to 40% in assembly time  
save up to 30% in inventory

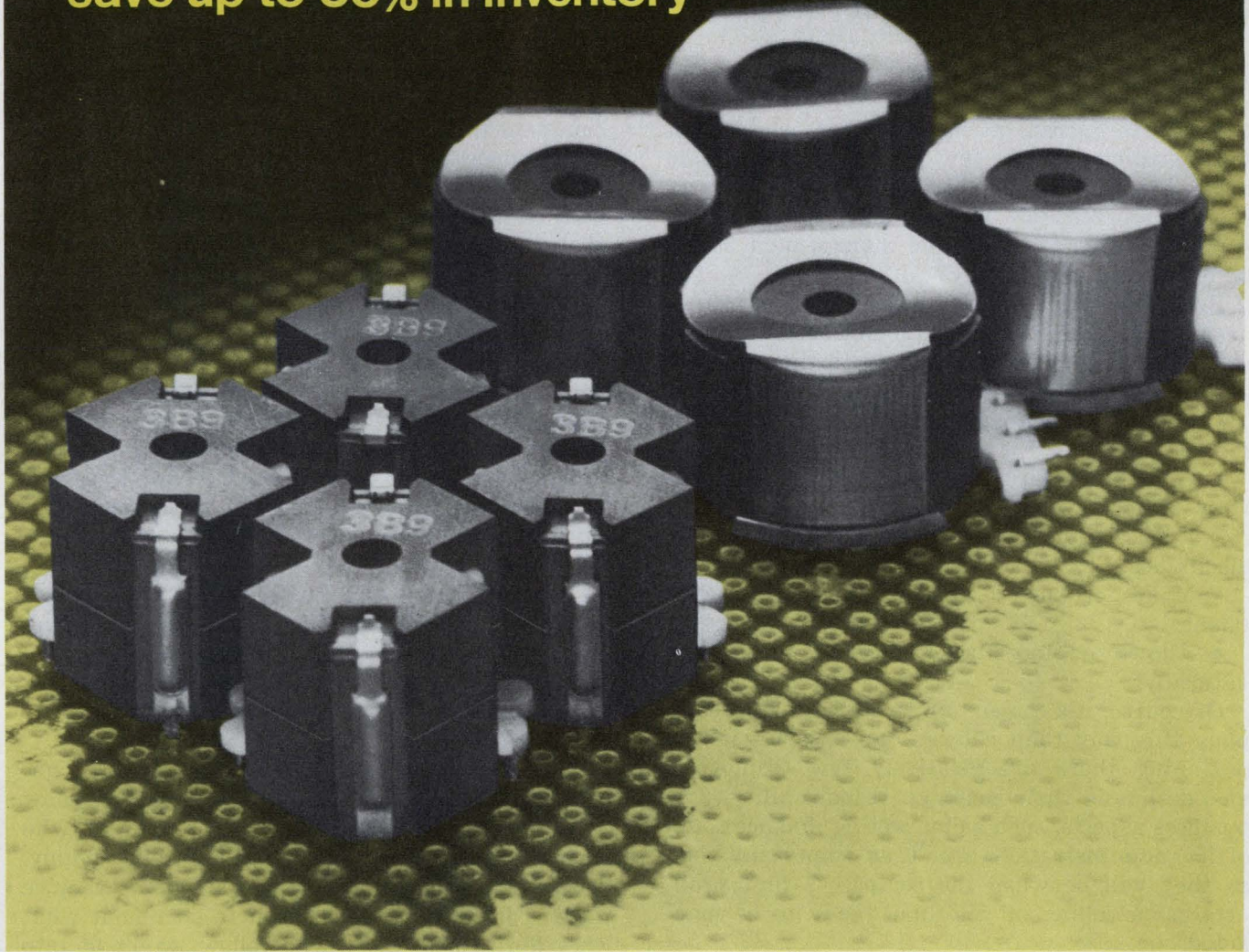

Ferroxcube's new RM Series square cores save up to 40% in pc board space over round pot cores. Furthermore, RM Series saves up to 40% in assembly and mounting time. Two simple, gold-plated clips hold them together and readily snap them into place on the pc board.

Your parts inventory is reduced since the economical mounting clips replace more expensive pot core mounting assemblies.

Ferroxcube's RM cores are available

with a choice of ferrite material: choice of ungapped, fixed-gap or adjustable-gap types, with smooth precise tuning of inductance to an accuracy of better than 0.03% in adjustable models.

RM cores now in stock. For complete information call 914•246-2811, TWX 510-247-5410 or write Ferroxcube, Saugerties, N.Y. 12477.

Ferroxcube linear ferrites—made in Saugerties, N.Y. and stocked in seven U.S. locations.

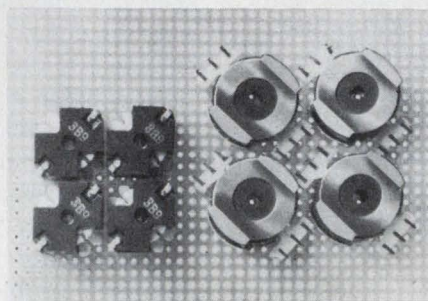

**FERROXCUBE** CORPORATION, SAUGERTIES, N.Y. 12477 • 914•246-2811  
A NORTH AMERICAN PHILIPS COMPANY

Distributed through North American Philips Electronic Components Corporation with warehouses in Boston, 617 • 899-7100; New York, 516•538-2300; Saugerties, 914•246-5861; Philadelphia, 215•836-1616; Chicago, 312•593-8220; San Diego, 714 • 453-5440

16404

INFORMATION RETRIEVAL NUMBER 48

## The case for unstructured management:

job titles, organizational charts and other managerial trappings may hinder engineering in a new company.

I help to operate a company that, aside from top management, has few job titles, few middle managers, and no organizational charts or personnel department. We're small but growing rapidly. We use just enough management structure to avoid chaos. Why?

Because we don't want to bog down our engineers and programmers with duties that really are subsidiary to their main role in the company—to design products.

Unstructured management does the following for us:

- Gives engineers freedom to work on a variety of jobs.
- Keeps barriers from being built among disciplines.
- Makes it easier to match problems with talent.
- Allows engineering leadership to emerge naturally.

Of course, it's easier to operate a startup company this way than a large one, because in the beginning there are relatively few employees, and design is their primary responsibility. The business aspects, such as marketing, finances, and office administration aren't as important then as they will be when the company's first products come rolling off the line, ready to be marketed.

Clearly it gets more and more difficult to maintain a structureless management as the company gets bigger and bigger. Now we're small—120 people—and last year we earned just under \$2-million dollars. Before we become a \$50-million company, we'll undoubtedly have to install a certain amount of formal organization. But we intend to maintain a low-structure profile as long as we can, because, for one thing, it helps to make the engineer's work fun and interesting.

### Engineers enjoy being unencumbered

When a company grows, the relationships between engineering and the other departments become more exacting. To hold people accountable

**Joseph F. Cashen**, Director of Engineering, Prime Computer, Inc., Natick, Mass. 01760.

for such things as documentation, members of management start building a structured organization. They draw up organization charts that tell each man what his job is; the implication is that there are bounds around each job. Some engineers will give themselves bounds when they're given a job title.

In an unstructured atmosphere you can maximize the responsibility you give to people. When we started our computer company, we hired people to work on logic design, circuit design, system design and software problems. But no one did just one thing—we couldn't afford that luxury. Big companies can afford to have specialized groups that worry, for example, only about reliability.

In a small company like ours it's natural and easy, and almost unavoidable, in the beginning for everybody to do a little bit of everything in engineering. This is highly motivational. Our people like to work on a variety of jobs; they feel unencumbered, and they get a lot done.

Not everyone will be happy working in an unstructured company. Those who want to know exactly what they're supposed to do and who they're supposed to report to won't be happy. Those who lose interest in a problem once they've figured it out, who don't want to document what they did to help those who follow, won't fit into an unstructured atmosphere either.

So we looked for certain traits in the people we hired. For instance, we didn't hire a vertical specialist, because we found that he's either not interested in, or capable of, working on a job outside his own discipline. We looked for a mature, capable generalist, who we feel is, by talent and by personality, suited to jumping from one task to another. The best way to weed out the people who won't fit in is to interview them several times, lay your cards on the table and listen very carefully to how they think and how they approach problems.

You also have to be careful what discipline you hire. You may hire a specialist in a field that may not be as important a field tomorrow. Circuit design is one example. Developments in semiconductors and integrated circuits have some-



## Joseph F. Cashen and Prime Computer, Inc.

Before Joe Cashen helped to start Prime Computer in early 1972, he had spent five years with each of three employers. After earning a BSEE from Drexel Institute of Technology, and after completing course work for an MSEE at the University of Pennsylvania, he was hired as a development engineer by RCA. He quickly established himself as a superior engineer when he received the "David Sarnoff Outstanding Award" for his help in designing the RCA 110 computer.

By 1962, Joe moved on to the Digital Systems Div. of The Foxboro Company, first as a senior development engineer, and then as Manager of Hardware Development three years later. In 1967 he went to Honeywell and worked his way up to Chief Engineer of Data Acquisition and Control Systems. He is currently Director of Engineering at Prime where he's responsible for hardware design activities and interfacing with other organizations.

Within the first nine months of its operation, Prime shipped its initial computer—the Model 200. Before the next year was out two more computers, the Prime 200 and 300 were announced along with a full range of data communication and data acquisition products, and several new peripheral devices. By following a software-first design philosophy, Prime has been able to offer a completely compatible line of computers, plus a level of software flexibility that's reportedly unduplicated on any competitively priced systems.



what diluted the importance of circuit design as a technology. The people who are capable only in the world of circuit design have quite a problem, because the need for that kind of talent is not nearly as high as it was, say, five to 10 years ago. The ability to change and to shift is an important quality we look for in people.

### Making molehills out of mountains

Many engineering companies that have a structured management build barriers within their engineering department and between the engineering department and all other departments or disciplines in the company.

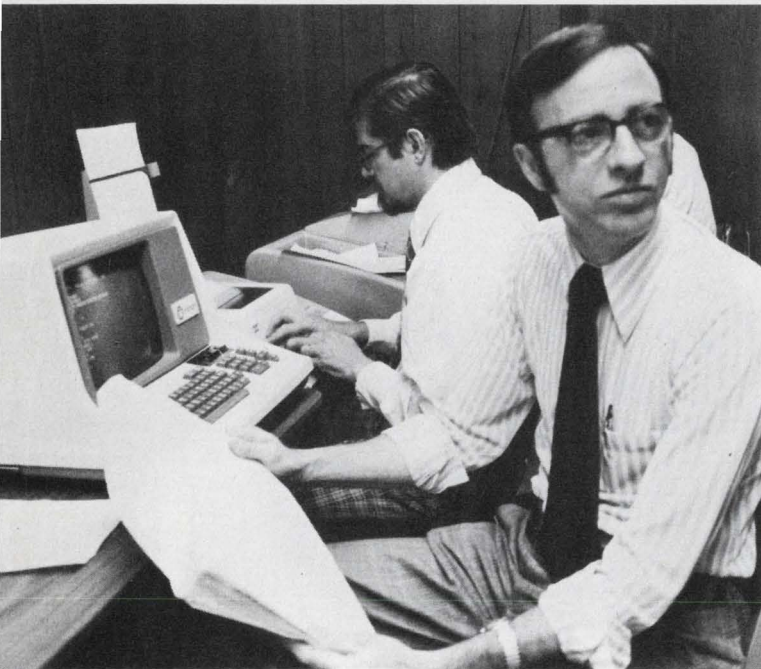

Cashen checks out a computer's interactive terminal.

In computers, people have typically classified themselves as either hardware or software designers. Few are able to work or talk both sides of the fence. This has led to a lot of problems, because in designing any product in computers, you have to make computer hardware/software tradeoffs. If your hardware people don't understand much about software, and vice versa, you can have trouble getting the right tradeoffs.

We think that if the hardware man learns more about software, he's going to be more valuable to the company, and he'll be more valuable as a professional. In an unstructured organization he can learn both sides of the fence. For every piece of hardware we design, there are certain pieces of software that we design with it. We create diagnostic software, and we write drivers for the appropriate operating systems. The man who designs that particular piece of hardware

has a goal to write the driver and the diagnostic software. If he needs some support, we'll give it to him. But if you're working in a structured company and you tell the software manager that you're going to let the hardware guy write a piece of software, he'd get annoyed.

When barriers are built between functional disciplines, people tend to develop procedures for interfunctional dealings. It seems that more important to department managers than cooperating to get the product finished is protecting their departmental interests. When engineering gives something to manufacturing, suddenly there are a score of things that must be done before manufacturing will accept it. That kind of red tape tends to mushroom among all the departments, and it slows product development.

### Structureless management aids in matchmaking

Another advantage that an unstructured company can give is the ability to match problems with the people most capable of solving them.

If you work in a structured organization, the man who's responsible for, say, central processor design is going to handle any problems you may have with central processors. But it's conceivable that someone else in the company might be much better suited to work on your particular problem.

Let's say that you want to do a detailed cost analysis of several processors, and you have some technical ideas that you want evaluated from cost and marketing viewpoints. There may be someone else in the company who isn't as technically competent as the processor manager, but because of his interest and knowledge of business, he's much better suited to handle your problems.

In an unstructured company you can make that kind of assignment—match the talents of the people to the particular jobs—and not make people feel slighted. If you alter the flow of responsibilities in a structured management, you imply that someone isn't capable of doing his job. You can lose a lot of flexibility when you're forced to do things strictly via organizational charts.

### Leaders aren't born—they emerge

When a company starts in business, certain people are assigned to certain jobs. What happens is that those with leadership ability eventually emerge. We'll put two or three guys together on the same problem and watch one of them take over. Often it's the strongest personality that emerges, instead of the one with more experience. What'll happen is they'll hit a snag, and the leader will assert himself and say, "I think we ought to do this."

That's a much better way to get leaders than putting titles on business cards, because when a man becomes a leader naturally, he's recognized by his co-workers. When he gets a reputation within the company for being able to handle a certain kind of problem, the people naturally go to him when they need help. If we had told this man that he was a manager, he might have automatically set up the bounds of his job, which would limit his effectiveness.

Our people don't want to feel that they're going to worry about only one kind of problem. They recognize that vertical specialization has a lot of shortcomings, and if they are only good in one particular area, they've limited their value. By letting leadership emerge, we control some of the problems of engineering obsolescence.

### Troubles along the way

I certainly don't mean to imply that there are no problems in operating a company with an unstructured management.

Communication, for example, can be a real problem. In an unstructured environment the word may not get to everybody. Once you're structured, the top manager will hold a staff meeting and tell everyone what's happening. Achieving the same result in the unstructured environment is sometimes a bit more difficult, mainly because of people's more flexible responsibilities. When a man is working on one class of problems today and another class tomorrow, making sure that he is always aware of what he needs to know can be difficult.

I think it's important for everyone to know a little bit more than they need to know to do their job; that gives them the feeling that somebody up there is concerned about them. It's very important to keep everyone aware of what the company is doing, trying to do, what its problems are and what the solutions are.

Another problem is that people feel a little less comfortable in an unstructured company than a structured one because there's a little less security. They miss not having a niche. Some people don't like not having a fixed boss to report to. If they want to change their vacation time, for example, whom do they ask? The answer for us has been for management to make itself available all the time. If anyone has a problem, he can walk into the office at any time and discuss it.

That's the answer to the challenge—to keep engineers happy and to maintain the atmosphere of a startup even after the company begins to grow. If the engineers and programmers believe that our company climate is pretty much the same at three years as it was at three months, that'll be quite an achievement. ■■

## You say you want a

low-profile snap-in-mounting push button switch or matching indicator that is interchangeable with most 4-lamp displays... available in a full range of cap colors... with a choice of bezels with or without barriers in black, gray, dark gray or white.

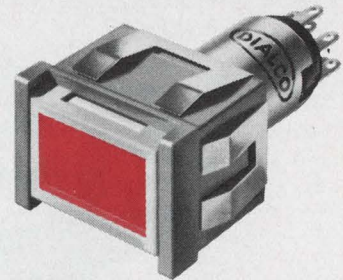

## and a

legend presentation that's positive (like this one) or negative (like the one below) or just plain (like the one above)... one that's white when "off" and red, green, yellow (amber), blue or light yellow when "on"... or colored both "on" and "off."

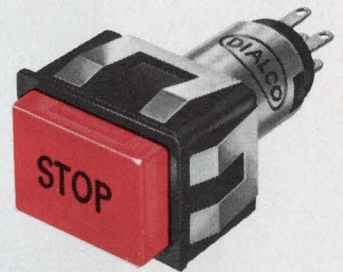

## and a

highly reliable switch proven in thousands of installations... available in momentary or alternate action... N.O., N.C. or two circuit (one N.O., one N.C.)... that accommodates a T-1 3/4 bulb with midjet flanged base, incandescent, in a range of voltages from 6-28V.

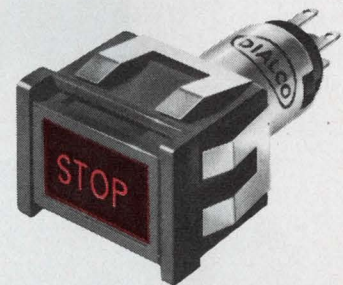

*etc.  
etc.  
etc.*

## Now, for the first time Dialight gives you custom panel designing with a standard line of push-button switches and matching indicators

Dialight offers a broader range of switch and indicator possibilities than you'll find anywhere in a standard single-lamp line. Sizes: 3/4" x 1", 5/8" and 3/4" square and round. Send today for our new full-color catalog.

# DIALIGHT

A North American Phillips Company  
Dialight 203 Harrison Place, Brooklyn, N. Y. 11237

# THE SECOND REVOLUTION



**IS HERE!**

## SCAN CONVERSION DISPLAYS THAT LOOK LIKE PHOTOS... WITH EXCLUSIVE LITHOCON II™ EXTRA-VISION™ IMAGE STORAGE SYSTEMS

Princeton revolutionized low-cost scan conversion with Lithocon® image storage tube technology. Now, our second revolution brings you Lithocon II™ image storage systems with **Extra-Vision™** advances.

**The proof is in the viewing:** that our new silicon image storage tube stands alone in its class. That as the heart of our improved PEP-400-R Video/Graphic Image Storage Terminal, it makes possible performance levels for your imaging system which obsolete all other scan conversion technologies.

Our PEP-400-R lets you get displays of scan conversions on your monitor that look like electronic photos. With the image fidelity, gray scale, stability, resolution, retention time and erase speed to answer your most demanding image processing applications. With the flexibility, performance and reliability you require for your system design.

**Features you can see** prove our exclusive advances. Image reading time of over two hours, combined with single frame erase. Resolution up to 2,300 TV lines per diagonal. Extended dynamic range (64 gray levels). Capability for slow-scan operation. Up to 36-times area magnification. Image integration. From 525-line to 1,225-line TV rasters. Solid state reliability, backed by a full year warranty.

**See for yourself.** We'll be pleased to arrange a demonstration. At your lab or ours. If your scanner or camera output's interface is compatible, it's as easy as just hooking up your X, Y, and Z-axis leads to the new PEP-400-R. The complete, self-contained scan converter. Beginning under \$3,800. Less in OEM quantities.

If you need ultra high resolution for your application, put the highest commercially available into your system. Our new PEP-402-R. Providing up to 3,500 TV lines per diagonal. With all the **Extra-Vision™** features exclusive in Lithocon II™ systems.

**Phone or write today.** For a demonstration. For more information. For literature. Or just to tell us about your imaging problems.



**PRINCETON ELECTRONIC PRODUCTS, INC.**  
P.O. Box 101, North Brunswick, New Jersey 08902  
Telephone: (201) 297-4448

# MOVE IT!



Your free subscription to *Electronic Design* comes up for renewal with the next issue. It's a new policy affecting every qualified subscriber. Inertia always seems to strike when it's time to renew. You know you're going to do it. You know it only takes 3 minutes of your time . . . so why put it off?

Help us both to save energy, paper, postage, time and money. This year send in your card as soon as you receive the Aug. 2 issue.

**WATCH FOR YOUR FREE RENEWAL APPLICATION  
IN THE NEXT ISSUE . . .**

***...THEN MAIL IT PROMPTLY!***

## Coupling circuit ensures drive current from op amp to emitter-follower booster

A nonconventional coupling circuit overcomes a common problem in obtaining sufficient drive current when boosting the output of an op amp. The easiest way to increase the current is to add a complementary emitter-follower. However, a chief drawback of the conventional diode-biasing scheme, circuit (a), is a lack of base drive at the maximum swings of large signals, just when the output current must be maximum. The circuit (b), with the use of a third diode in a different configuration, ensures adequate base drive. And the output of a 741 can be boosted to 300 mA.

In circuit (a), the base drive for  $Q_1$  and  $Q_2$  is supplied by resistors  $R_1$  and  $R_2$ , respectively. The op amp cannot source any appreciable current to the bases. At either extreme of the output signal swing, the amount of base drive, which is

$$(15 - V_{be} - V_o) / R_1,$$

is minimum, because  $V_o$  is maximum.

But in circuit (b), the op amp drives  $Q_2$  directly for negative outputs. On only small positive swings,  $R_1$  supplies base drive to  $Q_1$ . Above the offset voltage for  $D_3$ , the op-amp output is high enough to begin to source current through  $D_3$ . Diode  $D_3$ , a germanium diode chosen for its small forward drop, allows the op amp to source its maximum output of 5 or 10 mA for  $Q_1$ . Diodes  $D_1$  and  $D_2$  are silicon, so they can provide the

necessary offset to eliminate almost all the crossover distortion.

The price for improved performance is a second crossover point at the level at which  $D_3$  begins to supply  $Q_1$  base drive. At frequencies of less than 1 kHz (for a 741), this crossover distortion is unnoticeable, especially with small closed-loop gains. But at higher frequencies, the corrective response of the op amp begins to lag. Capacitor  $C_1$  (about 0.1  $\mu\text{F}$ ) helps diminish crossover distortion at higher frequencies. The 709 op amp might be a better choice when frequencies to 30 kHz are needed.

The small  $Q_1$ - $Q_2$  crossover distortion may be completely eliminated by insertion of a few hundred ohms in series with  $D_1$  and  $D_2$ . If made adjustable, this resistance can be increased from zero until the  $Q_1$ - $Q_2$  crossover distortion disappears from the waveform.

For stability, it is customary to place  $D_1$  in thermal contact with  $Q_1$  and  $D_2$  with  $Q_2$ .

This circuit can be handy if a high speed circuit is not required. The addition of  $C_2$  can slow the response without compensation problems. Other power drivers are not so easily "de-slewed."

*Neil Dvorak, Chief Electronics Engineer, Technical Equipment Corp., 917 Acoma St., Denver, Colo. 80204.* CIRCLE NO. 317

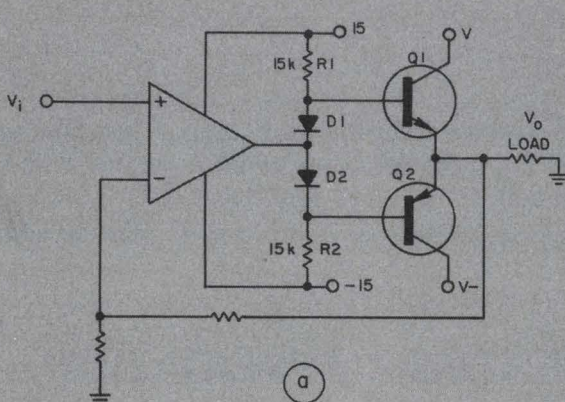

Conventional coupling circuit (a) fails to provide adequate drive current into the bases of  $Q_1$  and  $Q_2$ .

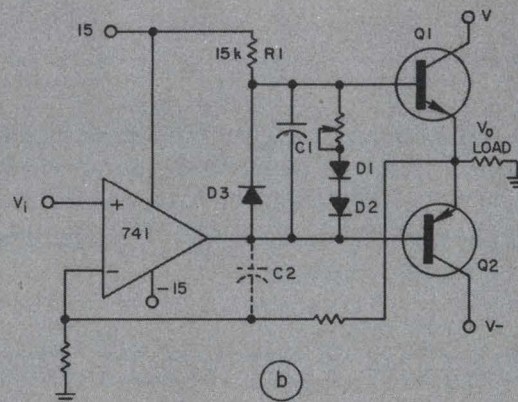

The circuit in (b), with one added diode, provides adequate current drive.

# OUR 5V POWER MINI'S STACK UP LIKE THIS

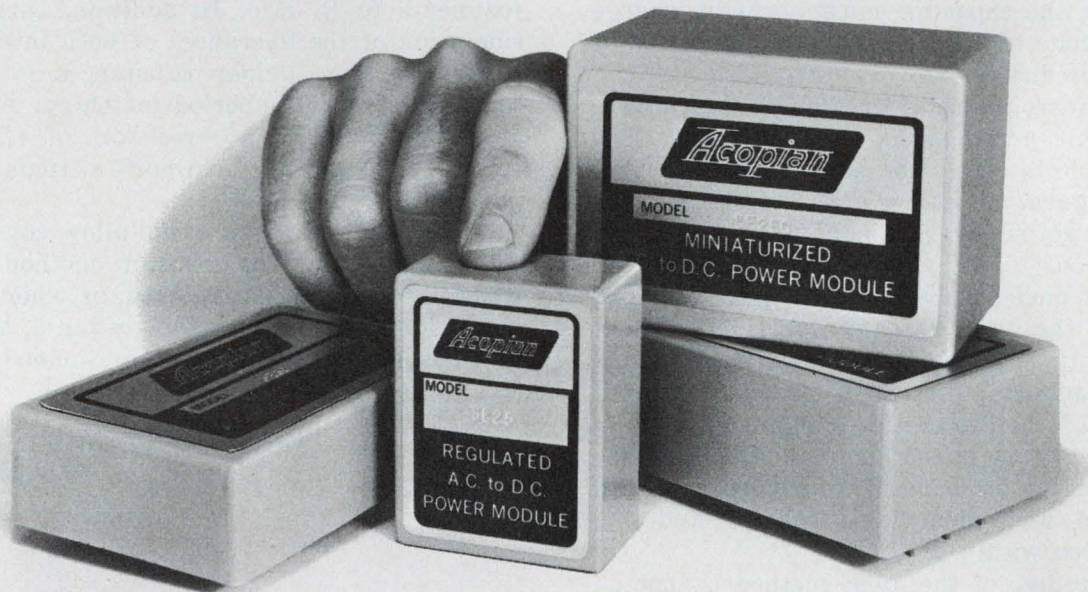

OUTPUT VOLTAGE	OUTPUT CURRENT AMPS.	REGULATION LOAD $\pm\%$	REGULATION LINE $\pm\%$	RIPPLE MV RMS	PRICE	MODEL	SIZE INCHES
5	.250	.05	.05	0.5	\$39.00	5E25	2.3 x 1.8 x 1.00
5	.500	.1	.05	1	49.00	5E50A	3.5 x 2.5 x 1.00
5	1.0	.2	.05	1	69.00	5E100	3.5 x 2.5 x 1.25
5	1.5	.3	.1	1	98.00	5E150	3.5 x 2.5 x 1.25
5	2.0	.15	.05	1	110.00	5E200	3.5 x 2.5 x 2.00
5	2.5	.15	.05	1	125.00	5E250	3.5 x 2.5 x 2.00

... and the model you choose will be shipped 3 days after Acopian receives your order. With a 105-125 VAC input, use it at full rated load to 71° C. Short circuits won't damage it. These mini-modules can be mounted on a printed circuit

board in a space of only a few square inches. Generous quantity discounts are available. Or, if you're working with other voltages, choose from hundreds of other models. Single outputs from 1 to 75 volts.

Duals for op-amps with output currents from 25 to 500 ma. Even triple outputs. Complete details on these plus a comprehensive line of other power supplies and systems are included in the Acopian 73-74 catalog. Request a copy.



Corp., Easton, Pa. 18042. Telephone: (215) 258-5441.

INFORMATION RETRIEVAL NUMBER 51

# Single part minimizes differences in monostable and astable periods of 555

A single inexpensive component—a diode or a resistor—can minimize the difference between monostable (one-shot) and astable (free-running oscillator) periods of a 555 timer. When the 555 timer is used as an oscillator, the timing capacitor normally charges from  $1/3 V_{cc}$  to  $2/3 V_{cc}$  to provide an output period of  $0.69 RC$ . However, when used as a one-shot, or when strobed via the reset input, the capacitor must normally charge from zero volts to  $2/3 V_{cc}$ , and a longer period of  $1.1 RC$  is produced.

In the figure, the solid lines show the conventional circuit arrangement for the timer. The switch *S* selects either the astable or the monostable configuration. Either a resistor  $R_3$  or diode *CR*, shown dotted, may be added to equalize the timing periods.

A 1N662 diode, placed between pins 3 and 5, pulls down the pin-5 reference voltage to about 0.9 V each time the output goes LOW. Thus the timing capacitor *C* must now drop to approximately 0.45 V before the level at pin 2 can trigger another output pulse. The capacitor therefore starts to charge from near ground level in both the astable and monostable modes, and the periods agree within 5%.

The advantage of the diode method is that no computations or high-accuracy components are required to provide close matching of pulse widths. Also single potentiometer control of pulse widths is still possible. However, the lower threshold, and therefore the pulse width, depends on the diode's offset and drift characteristics.

In a second method, resistor  $R_3$  forces the monostable period to approach that of the astable when it prevents the timing capacitor from discharging completely. Careful adjustment of the voltage divider formed by  $R_1$  and  $R_3$  permits the timing-capacitor voltage to drop only far enough to trigger a new pulse. The timing capacitor starts to charge from about  $2/3$  of the supply voltage in both the monostable and astable modes.

The advantage of the resistor method is that the periods of the two modes are governed by the adjustment of  $R_1$  and  $R_3$ . Thus the periods can

set very close to each other, and a bypass capacitor to ground can be placed on pin 5—as is done normally. Also the resistor method does not introduce the temperature drift of a diode, and the match of pulse widths tends to remain constant with supply-voltage variations.

One disadvantage is that the value of  $R_1$  cannot be varied to control pulse period without adjustments to  $R_3$  also. In addition, careful consideration of the tolerances of both internal and external voltage-divider resistances is required to attain close pulse-period matching. A cursory analysis shows that 5% resistors of 4.7-k $\Omega$  and 1.5-k $\Omega$  for  $R_1$  and  $R_3$  yield pulse periods matched to about 20%.

One-percent resistors would allow considerably closer matching. The resistor method is best when high stability is required, or when it is desirable to bypass or to modulate pin 5, and when it is not necessary to have a continuously adjustable pulse width.

Arthur R. Klinger, 3245 Stuff Dr., Orlando, Fla. 32809. CIRCLE NO. 318

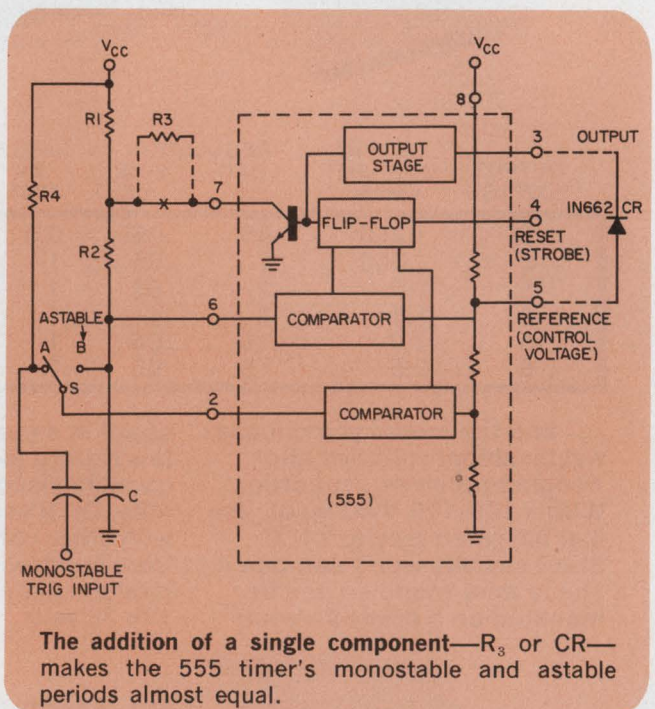

The addition of a single component— $R_3$  or *CR*—makes the 555 timer's monostable and astable periods almost equal.



# CONVERT 8 BITS IN 6 MICROSECONDS FOR \$25.....

*it's easy!*

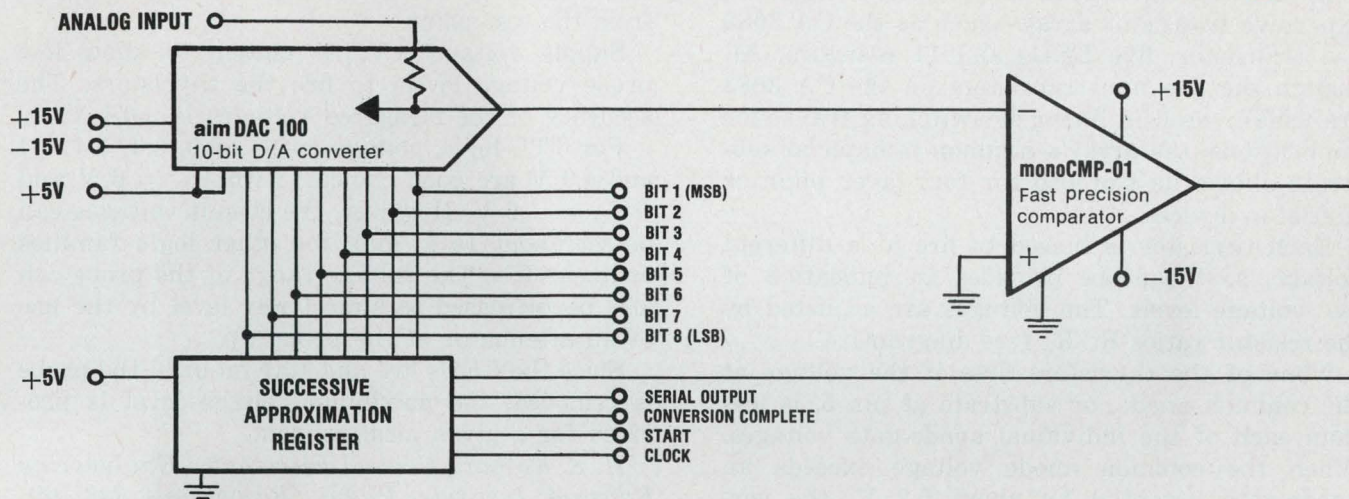

## THREE IC'S BUILD A FAST A/D CONVERTER - FOR UNDER \$25!

It's easy with high performance analog components from Precision Monolithics—start with PMI's aimDAC100 Low Cost D/A Converter—with its internal precision reference voltage, 10-bit resolution, choice of linearities and high speed current output, it's ideal for all D/A and A/D applications. Next, add the PMI monoCMP-01 Precision Comparator with its fast 90ns response, low Vos, drift and superior stability—complete your converter with a

successive approximation logic chip and that's it! Sound easy? You bet—and 10-bit versions can be built for under \$40! Circuit construction and performance are fully detailed in our new Application Note: pre-drilled demonstration circuit cards are available free by contacting your local PMI rep or stocking distributor—call him today and find out how easy A/D conversion can be!

SPECIFICATIONS		PRICES
aimDAC 100 DDT1*	0.30% Linearity Max-0/70°C	\$ 9.95 @ 100 pcs.
aimDAC 100 CCT1*	0.20% Linearity Max-0/70°C	\$12.00 @ 100 pcs.
aimDAC 100 BCT1*	0.10% Linearity Max-0/70°C	\$17.00 @ 100 pcs.
aimDAC 100 ACT1*	0.05% Linearity Max-0/70°C	\$26.00 @ 100 pcs.
*Specify T1 for 0 to 10 Volt usage; T2 for 0 to 5 Volt usage.		
monoCMP-01CJ	Vos 2.8 mV Max	\$3.25 @ 100 pcs.
monoCMP-01EJ	Vos 0.8 mV Max	\$7.50 @ 100 pcs.

### PRECISION MONOLITHICS REPRESENTATIVES

Alabama .....	(205) 539-4411	Maryland .....	(301) 944-8262	North Carolina .....	(919) 725-5384
Arizona .....	(602) 992-9884	Massachusetts .....	(617) 890-0011	Ohio, North .....	(216) 461-8333
California, North .....	(415) 948-6533	Michigan .....	(313) 557-1934	Ohio, South .....	(513) 293-3145
California, Los Angeles .....	(213) 340-1745	Minnesota .....	(612) 646-7217	Pennsylvania, East .....	(215) 644-3477
California, South .....	(714) 830-3939	Missouri, St. Louis .....	(314) 731-5799	Texas .....	(214) 363-8591
Colorado .....	(303) 771-4920	Missouri, Kansas City .....	(816) 761-6543	Virginia .....	(703) 548-7818
Connecticut .....	(203) 634-0179	New Jersey, North .....	(516) 567-5900	Washington .....	(206) 624-9020
Florida, Ft. Lauderdale .....	(305) 776-4800	New Jersey, South .....	(609) 966-4070	Wisconsin .....	(414) 933-2733
Florida, Orlando .....	(305) 425-5505	New Mexico .....	(505) 265-5655	Canada, Toronto .....	(516) 864-2666
Illinois, North .....	(312) 774-3535	New York, New York City .....	(516) 567-5900	Canada, Vancouver .....	(714) 979-4894
Indiana .....	(513) 252-9981	New York, Upstate .....	(716) 464-8636		

### AUTHORIZED DISTRIBUTORS

NEW YORK METROPOLITAN AREA Harvey Radio, Woodbury, N.Y.: (516) 921-8700 • NEW ENGLAND AREA Gerber Electronics, Dedham, Mass.: (617) 329-2400 • UPSTATE NEW YORK Harvey Federal Electronics, Binghamton, N.Y.: (607) 748-8211 • NORTHEAST Newark Electronics, Woburn, Mass.: (617) 935-8350 • BALTIMORE-WASHINGTON Whitney Distributors, Baltimore, Md.: (301) 944-8080 • PHILADELPHIA Hallmark Electronics, Huntingdon Valley, Pa.: (215) 355-7300 • MICHIGAN RS Electronics, Detroit, Mich.: (313) 491-1000 • SOUTHEAST Kirkman Electronics, Winston-Salem, N.C.: (919) 724-0541 • EAST CENTRAL Pioneer/Cleveland, Cleveland, Ohio: (216) 587-3600 • Pioneer/Dayton, Dayton, Ohio: (513) 236-9900 • CENTRAL Hallmark Electronics, Elk Grove Village, Ill.: (312) 437-8800 • Minneapolis, Minn.: (612) 925-2944 • St. Louis, Mo.: (314) 521-3800 • TEXAS-OKLAHOMA Sterling Electronics, Houston, Texas: (713) 623-6600 • Dallas, Texas: (214) 357-9131 • SOUTHWEST Sterling Electronics, Albuquerque, N.M.: (505) 345-6601 • Phoenix, Ariz.: (602) 258-4531 • WEST Westates Electronics Corp., Chatsworth, Calif.: (213) 341-4411 • Sterling Electronics, San Carlos, Calif.: (415) 592-2353 • Intermark Electronics, Sunnyvale, Calif.: (408) 738-1111 • Denver, Colo.: (303) 936-8284 • Salt Lake City, Utah: (801) 359-0531 • San Diego, Calif.: (714) 279-5200 • Santa Ana, Calif.: (714) 540-1322 • Almac-Stroum, Seattle, Wash.: (206) 763-2300 • Portland, Ore.: (503) 292-3534.



1500 SPACE PARK DRIVE, SANTA CLARA, CALIFORNIA 95050  
TEL. (408) 246-9225 • TWX 910-338-0528 • CABLE MONO

INFORMATION RETRIEVAL NUMBER 52

# Voltage probe uses five LEDs to indicate highest level reached

A versatile logic probe can be built with an inexpensive transistor array—such as the CA 3083—a transistor, five LEDs and 11 resistors. Although the five npn transistors on the CA 3083 are usually used in linear or switching transistor applications, the array's common p-material substrate allows its use also for four-layer pnpn or thyristor devices.

Each thyristor is biased to fire at a different voltage, so the probe provides an indication of five voltage levels. The voltages are adjusted by the resistor ratios  $R_a/R_b$  (see diagram).

None of the thyristors fires if the voltage at the common anode, or substrate at pin 5, is less than each of the individual anode-gate voltages. When the common anode voltage exceeds an anode-gate potential by about 0.7 V, the corresponding thyristor fires. The connected LED

lights and stays on until the probe tip is removed from the test point.

Supply voltage  $-V_{ee}$  is chosen to allow low probe voltage levels to fire the thyristors. The accuracy of the measured voltages is  $\pm 0.1$  V.

For TTL logic, voltage levels of 0, 0.4, 1.4, 2.4 and 4.9 V are good choices, with  $V_{cc} = 6$  V and  $-V_{ee} = -6$  V. However, the circuit voltages can be set about 15 V max for other logic families or linear ICs. The voltage range of the probe can also be increased to almost any level by the use of an attenuator at the probe tip.

Since the LEDs fire and stay on until the probe is removed, the maximum voltage level is provided for a given measurement.

*H. S. Kothari, Central Electronics Engineering Research Institute, Pilani (Rajasthan) 333 031, India.*

CIRCLE NO. 319

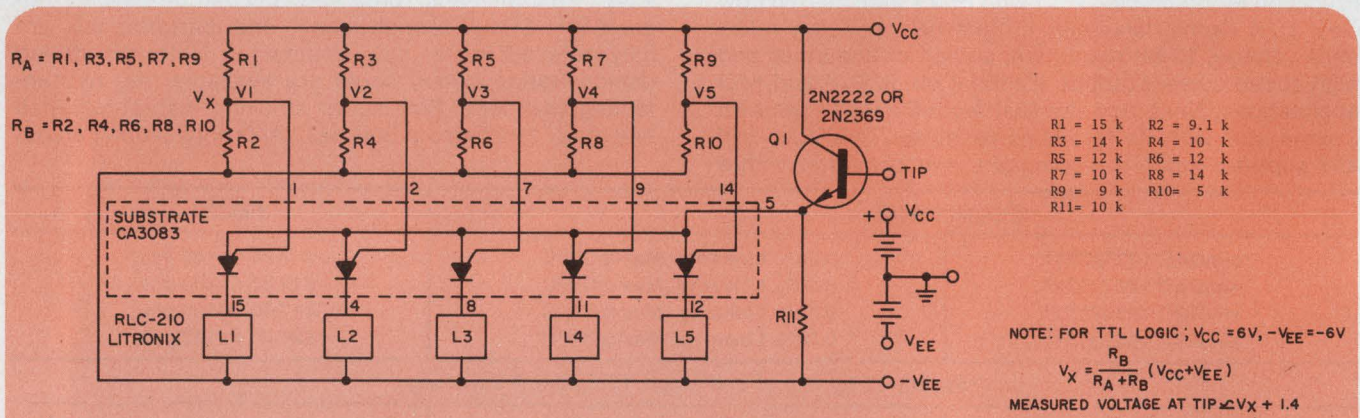

A LED lights when the voltage applied to the probe's tip passes a preset voltage level. All activated LEDs stay lighted, and the highest-valued

one indicates the maximum voltage. The LEDs extinguish when the probe is removed from the voltage source.

### IFD Winner of March 15, 1974

**Richard P. Rufer, Electronic Engineer,** University of California, Lawrence Livermore Laboratory, Livermore, Calif. 94550. His idea "Circuit Built with Quad Op Amp Measures Temperature Digitally" has been voted the Most Valuable of Issue Award.

**Vote for the Best Idea in this issue** by circling the number for your selection on the Information Retrieval Card at the back of this issue.

**SEND US YOUR IDEAS FOR DESIGN.** You may win a grand total of \$1050 (cash)! Here's how. Submit your IFD describing a new or important circuit or design technique, the clever use of a new component or test equipment, packaging tips, cost-saving ideas to our Ideas for Design editor. Ideas can only be considered for publication if they are submitted exclusively to ELECTRONIC DESIGN. You will receive \$20 for each published idea, \$30 more if it is voted best of issue by our readers. The best-of-issue winners become eligible for the Idea of the Year award of \$1000.

ELECTRONIC DESIGN cannot assume responsibility for circuits shown nor represent freedom from patent infringement.

# TECHNITROL Takes The Tough PT'S.

When it comes to pulse transformers (PT'S), Technitrol's experience leads the field. Technitrol was first with DIP transformer packaging and the H case. But, Technitrol is first where it really counts: getting the job—no matter how tough—done right. Here are two examples:

## 1/Tough Performance

Check these specs for a high-inductance transformer:  
**CMRR: 30 db @ 10 MHz**  
**Bandwidth: 5KC to 3 MHz**  
**Inductance: 20 mh min.**

Here's  
Technitrol's  
answer!



## 2/Tough Packaging

Here's what one customer wanted in a DIL-type case:  
**4 pulse transformers**  
**8 diodes**  
**8 resistors**

Technitrol put it  
all together with  
discrete, reliable  
components.

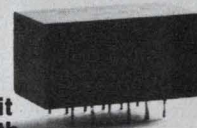

## Tough Competitor

That's Technitrol—whether your spec pushes the state-of-the-art or not. Next job, call Bill Chamberlin at (215) 426-9105. Or write for information.



*Technitrol, Inc.*

TECHNITROL, INC.

1952 E. Allegheny Avenue / Philadelphia, Pa. 19134.

Specialists in pulse transformers and completely transfer molded, welded DIP delay lines, under  $\frac{3}{16}$ " high—to 250 ns.

INFORMATION RETRIEVAL NUMBER 53

# MINI MAGIC

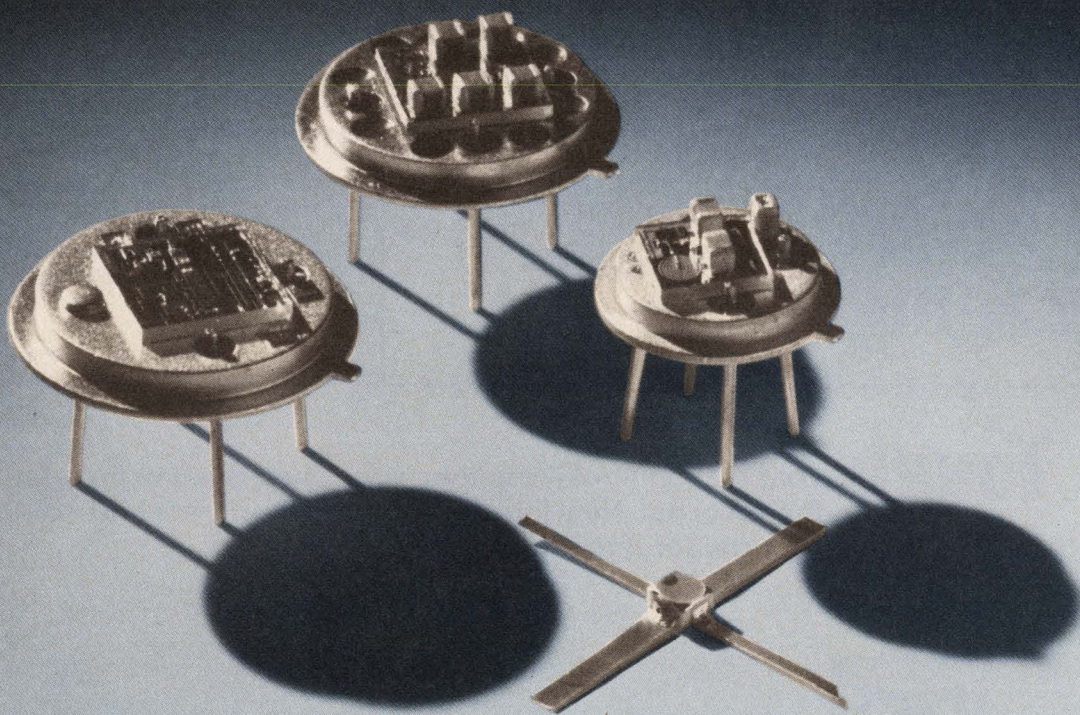



## Low-noise, Microwave Transistors

It's been said a manufacturer needs "magic" to make microwave transistors. It would appear, however, it takes even more than magic to make dependable deliveries.

**AVANTEK IS DELIVERING.** You'll find unbelievable inventories, along with some very impressive specifications. Take our AT-4641 for example. It offers a guaranteed noise figure of 3.5 dB maximum at 4 GHz—and it's available from stock! Just phone or return our coupon. We'll send complete data on the AT-4641 and other low-noise transistors in the 60 to 8000 MHz range. For a good measure, we'll also throw in our TRANSISTOR PRIMER, Parts I and II. **INFORMATION RETRIEVAL NUMBER 54**

**Mini Magic Marriage.** Combine the fantastic low-noise capability of Avantek transistors with thin film technology—and you've got a real mini magic marriage. Avantek miniature microwave amplifiers and oscillators offer the designer a new level of versatility, with NO compromises in performance.

### UTO

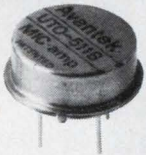

Looking for low-noise and high dynamic range from 5 to 2300 MHz? You'll find it in Avantek TO-8 packaged UTO amplifiers. All models are available in Hi Rel UTO "R" counterparts. Check our UTO "R" Series Brochure. It describes

the manufacturing processes and screening procedures for standard and "R" version UTO's. Data sheets also available for the asking. **INFORMATION RETRIEVAL NUMBER 55**

### VTO

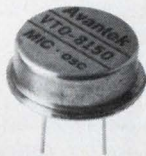

Avantek VTO's offer you the latest in microwave technology at remarkably low-cost: eight tunable, overlapping bands from 600 to 6600 MHz. They're the SMALLEST varactor-tuned units around, delivering power at +10 to +13

dBm. You'll find all the facts in our VTO Applications Brochure and Data Sheets. **INFORMATION RETRIEVAL NUMBER 56**

### GPD

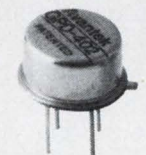

This "tame transistor" brings more than SIX OCTAVES of flat RF bandwidth to your circuit designs. You get the same UTO and VTO thin film construction—but in a tiny TO-12 can. A GPD-401 can give you 13 dB gain and 4.5 dB

noise figure at 5 to 400 MHz. The Avantek GPD, priced at \$30 or less in quantities of one to nine, clearly represents the best miniature amplifier buy today. Ask for Data Sheets and our 18-page booklet, **DESIGNING WITH GPD AMPLIFIERS.** **INFORMATION RETRIEVAL NUMBER 57**

# Avantek... years ahead today.

3175 BOWERS AVENUE  
SANTA CLARA, CALIFORNIA 95051  
(408) 249-0700  
TWX 910-339-9274

## DOMESTIC REPRESENTATIVES

**ALABAMA** (205) 534-9771  
Gentry Associates, Inc.  
2109 W. Clinton Ave., Room 422  
Huntsville, AL 35805

**ARIZONA** (602) 956-5300  
The Thorson Company  
2505 E. Thomas Road  
Phoenix, AZ 85016

**CALIFORNIA** (213) 476-2251  
Cain Technology  
522 S. Sepulveda Blvd.  
Suite 107  
Los Angeles, CA 90049  
(415) 948-6533  
Cain-White & Company  
175 S. San Antonio Road  
Los Altos, CA 94022

**COLORADO** (303) 355-3521  
The Thorson Company  
5040 E. 41st Avenue  
Denver, CO 80216

**D.C. and VIRGINIA**  
(202) 783-7319  
Applied Engineering Consultants  
Washington, DC

**FLORIDA** (305) 894-4401  
Gentry Associates, Inc.  
550 North Bumby Avenue  
Orlando, FL 32803

**ILLINOIS**  
(312) 298-3600 thru 3603  
Cozzens/Cudahy, Inc.  
1301 North Rand Road  
Des Plaines, IL 60016

**INDIANA** (317) 244-2456/1879  
Cozzens/Cudahy, Inc.  
21 Beachway Drive  
Indianapolis, IN 46224

**KANSAS** (913) 362-0919  
E.I.R. Company  
6405 Metcalf, Suite 205  
Shawnee Mission, KS 66202

**MARYLAND** (301) 465-1272  
Applied Engineering Consultants  
9051 Baltimore National Pike  
Building 3, Office A  
Ellicott City, MD 21043

**MASSACHUSETTS**  
(617) 272-4550  
Tritek, Inc.  
165A Bedford Street  
Burlington, MA 01830

**MICHIGAN** (313) 482-1229  
Micro Sales Corporation  
7522 Emily  
Detroit, MI 48234

**MINNESOTA**  
(612) 884-4336/4337  
Cozzens/Cudahy, Inc.  
10800 Lyndale Avenue South  
Minneapolis, MN 55420

**MISSOURI** (314) 837-0597  
E.I.R. Company  
47 Village Square Shopping Center  
Hazelwood, MO 63042

(314) 423-1234  
Cozzens/Cudahy, Inc.  
10534 Natural Bridges Rd.  
St. Louis, MO 63134

**NEW JERSEY (L.I. & N.Y.C.)**  
(201) 224-6911  
Technical Marketing Associates  
2460 Lemoine Avenue  
Fort Lee, NJ 07024

**NEW MEXICO** (505) 265-5655  
The Thorson Company  
5921 Lomas Blvd., N.E.  
Albuquerque, NM 87110

**NEW YORK** (315) 685-5731  
Robtron  
2-4 Fennell Street  
Suite 209  
Skaneateles, NY 13152

**NORTH CAROLINA**  
(919) 227-3639  
Gentry Associates, Inc.  
420 Almance Road  
Burlington, NC 27215

**OHIO** (513) 298-3033  
Micro Sales Corporation  
1250 West Dorothy Lane  
Dayton, OH 45409

(216) 243-7430  
Micro Sales Corporation  
2085 Riverside Drive  
Cleveland, OH 44107

**PENNSYLVANIA**  
(215) 927-7777  
Eastern Instrumentation of  
Philadelphia  
613 W. Cheltenham Avenue  
Philadelphia, PA 19126

**TEXAS** (214) 233-5744 thru 46  
The Thorson Company  
4400 Sigma Road  
Dallas, TX 75240

(713) 771-3504  
The Thorson Company  
6655 Hillcroft, Suite 224  
Houston, TX 77036

**WASHINGTON** (206) 632-0710  
The Thorson Company  
909 Northeast 43rd Street  
Suite 206  
Seattle, WA 98105

## LITERATURE COUPON

### SEND DATA SHEETS AND BROCHURES

- TRANSISTORS     UTO     VTO  
 GPD     HAVE REPRESENTATIVE CALL

NAME \_\_\_\_\_ TITLE \_\_\_\_\_  
COMPANY NAME \_\_\_\_\_  
ADDRESS \_\_\_\_\_  
MAIL STOP \_\_\_\_\_  
PHONE \_\_\_\_\_ EXT. \_\_\_\_\_

## Acoustic beam achieves millisecond delays

A surface-acoustic wave delay-line design with delays of the order of milliseconds has been developed at University College in London.

The delays are achieved when the acoustic beam is folded back and forth along the chords of a circular piezoelectric disc. At the disc periphery, the beam trajectory passes over the rounded edge, proceeds along a chord on the other side of the disc and emerges back over the edge onto another chord on the first face.

An infinite number of beam trajectories is possible. And when the beam is folded into a tightly woven pattern, full use is made of the available surface area.

Beam intersections do not lead to significant distortion unless they are particularly numerous, according to the researchers. In one design, a 22-mm-diameter disc of Y-cut quartz has two transducers on the upper face tuned to 41 MHz and isolated from each other by thin absorbing strips painted across the short direct

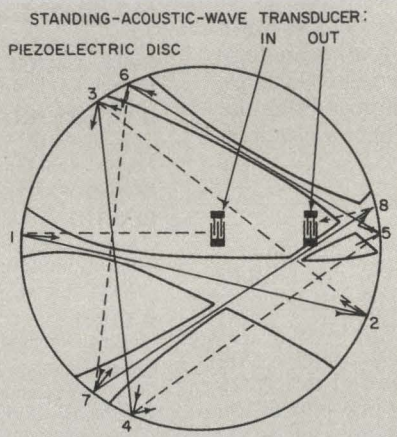

path. The acoustic beam takes a long path that involves several transits over the slightly rounded edges of the disc. The largest spurious response is 27 dB below the output at 96  $\mu$ s delay.

The experiment demonstrates that longer delay lines can be folded onto discs, with millisecond delays that call for a disc diameter of 50 mm. The illustration shows a delay line with eight beam trajectories.

itance resulting from the thin-film fabrication method.

The other critical parameter—microstrip inductance—calls for a thin-film disc diameter of 1 mm. This appears to be realizable, the researchers point out, because thin-film junctions have already been deposited on discs as small as 2 mm.

## Waveguide to carry 500,000 calls at once

A 45-km waveguide between Darmstadt and Heidelberg is being installed and tested by West German postal authorities. Millimeter waves in this waveguide will carry up to 500,000 telephone channels simultaneously.

After gaining practical experience with this line, telecommunications planners expect to extend it to Frankfurt.

## Bandpass filters use acoustic elements

Prototypes of a new generation of bandpass filters built with acoustic-wave technology are mass-producible and stable, according to Mullard Research Laboratories in England. The acoustic elements are also suitable for integration into hybrid circuitry.

The researchers say that although the filters are but 1/500th the volume of conventional counterparts, the tiny devices give a comparable performance.

A filter that Mullard proposes for TV receiver circuits consists of a piezoelectric substrate—0.5-mm thick  $\times$  0.5-cm wide and 1-cm long—overlaid with two interdigital electrode patterns, one at each end. An electrical input signal applied to one pattern generates an acoustic wave that travels to the other end, where it is converted at the second set of electrodes back into an electrical output. The bandpass characteristics are produced by the acoustic interactions with the electrode patterns.

Mullard is using a computer to design photomasks that will produce bandpass filters with center frequencies ranging between 10 MHz and 1 GHz, and with passbands between 100 kHz and 300 MHz.

## Microwave circulators replaced by TF versions

The familiar microwave circulator will be replaced by thin-film counterparts in the next few years, according to researchers at the Technical University of Gdansk in Poland.

The scientists forecast thin-film, lumped-element circulators that have broad bandwidth and allow easy adjustment of their operating frequencies because

they vary the level of the internal magnetic field of the thin films.

A bidirectional thin-film circulator—one that has two center frequencies—can be constructed by use of thin-film techniques, the researchers say. One of the two critical microwave-circulator parameters—common capacitance—would be in the same order of magnitude as the parasitic capac-

# 'SNO DRIFT



No temperature drift is just one of a pile of features of PSG Solid State Thermostats.

- NO TEMPERATURE DRIFT FROM SET POINT - SSTC series thermostats drift less than 0.05°C over a minimum life of 2 million cycles.
  - ACCURACY - ±0.25 to 3°F standard depending on model, other tolerances on request.
  - DIFFERENTIAL - 0.25 to 2°F standard depending on model, other ranges on request.
  - SHOCK & VIBRATION RESISTANT - Withstand 100 g's shock and 30 g's vibration at 2000 cps.
  - LOW COST - Solid state dependability at bimetal prices.
- WRITE OR CALL FOR THE SSTC SERIES DATA SHEET.



**PSG Industries, Inc.**  
 MANUFACTURER OF PRECISION THERMO AND ELECTRONIC CONTROLS  
 NINTH & RIDGE AVENUE • PERMASIE, PA. 18944  
 TELEPHONE (215) 257-3621  
 FORMERLY PHILA. SCIENTIFIC GLASS CO.

INFORMATION RETRIEVAL NUMBER 58

## VISHAY STAY-PUT TRIMMERS STAY PUT! DO YOURS?

- Tempco to 10ppm/°C
- Low Ranges - to 2Ω
- Low noise - 3Ω ENR typical
- 0.05% setability

VISHAY Accutrim™ Trimmers are available in a variety of 1¼" rectilinear and ¼" square styles

Write for Application Bulletins



**VISHAY RESISTIVE SYSTEMS GROUP**

OF VISHAY INTERTECHNOLOGY, INC.  
 63 LINCOLN HIGHWAY, MALVERN, PA. 19355 • PHONE: (215) 644-1300 • TWX: 510-668-8944

INFORMATION RETRIEVAL NUMBER 59

ELECTRONIC DESIGN 15, July 19, 1974

# Solder Clads for Electronics

TMI produces solder clads by pressure-bonding (cladding), re-flowing, and other proprietary methods. This enables us to offer a complete range of solder thicknesses and physical properties.

### Advantages:

1. Reduced labor cost.
2. Increased flexibility in design.
3. Elimination of multiple handling and inspection of stamped parts.
4. Improved and consistent quality of the end-product.
5. Permanent solderability, providing increased shelf life.

### Applications:

Among the major users of solder clads are the semiconductor and electronic industries. More recently, manufacturers of communication equipment, connectors for data processing equipment, jewelry, automotive, and computer parts have recognized the advantages offered by solder clads.

### Availability:

#### Thin Solder Stripes (for protective coating)

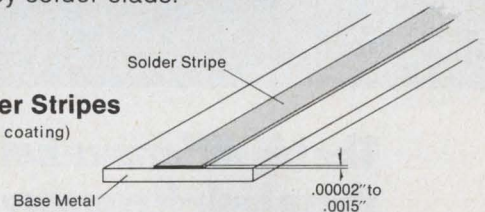

- To insure a solderable surface when subsequently soldering or brazing.
- To replace gold as a contact material.

Stripes can be on one or both sides. Complete overlay on one or both sides. All types of solder alloys.

#### Thick Solder Stripes (for replacing pre-forms or hand soldering)

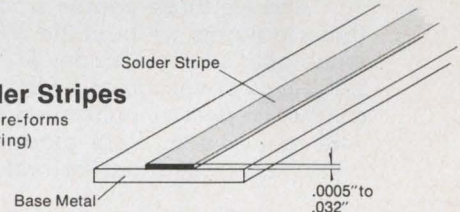

- Eliminates costly preform placement, applicable even to stainless and aluminum.

One or more stripes on one side only; however, complete overlays on one or both sides. All types of solder alloys. Base metals of any temper.

Write for our new "Design Aid for Solder Clads", showing all mill limits and tolerances, and a solder-alloy guide. Free on request.



**TECHNICAL MATERIALS, INC.**

25 Holden Street  
 Providence, Rhode Island 02908  
 Tel: (401) 272-4343

INFORMATION RETRIEVAL NUMBER 60

2001  
 2000  
 \$320

**The big difference between these high-frequency sweepers is \$320.**

The little differences are on the front panel (a start/stop mode of operation and a tape drive readout). Some people think they add up to \$320. For them, we built the 2001.

And for those people who don't require these features, we built the 2000. The 2000 is the only sweeper under \$1400 to offer frequency coverage of 1 MHz to 1.4 GHz, solid-state design, calibrated RF output from -80 to +10 dBm, P.I.N. diode leveling and a crystal-controlled marker system.

In addition, its frequency, bandwidth, and output level are programmable, making it ideal for production test and systems use as well as in the design laboratory. If you're still not sure which sweeper we built for you, send for more information. Just circle the reader service number or give us a call.

**WAVETEK®**

INDIANA INCORPORATED  
 P. O. Box 190, 66 North First Ave., Beech Grove, Indiana 46107  
 Tel. (317) 783-3221 TWX 810-341-3226

Model 2000  
 \$1375

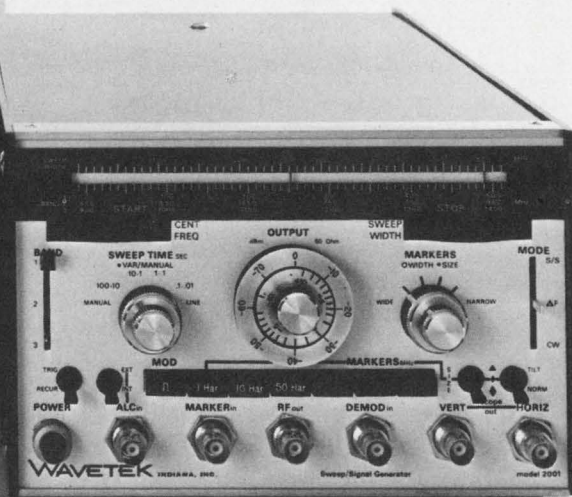

Model 2001  
 \$1695



## Bipolar op amp matches specs of chopper-stabilized units

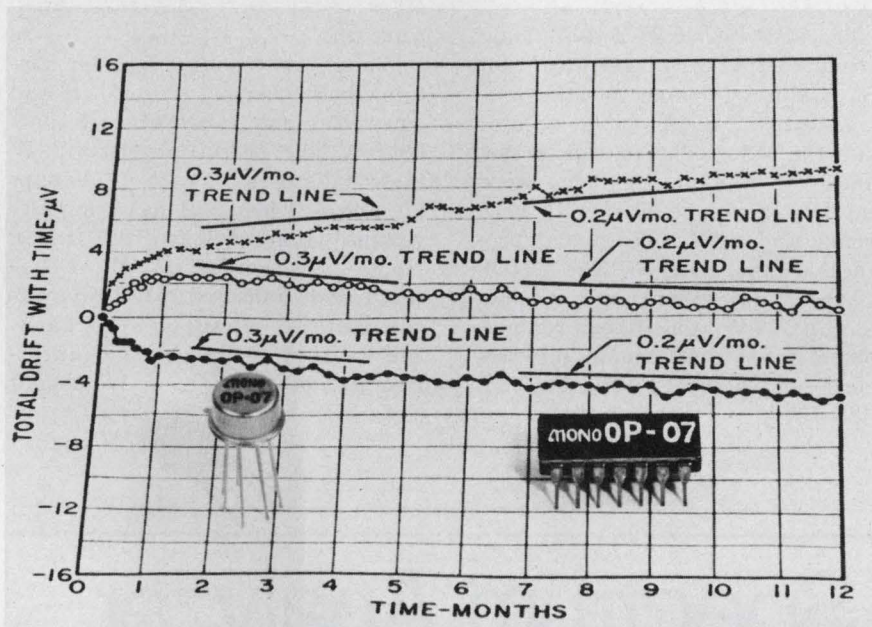

Precision Monolithics, 1500 Space Park Dr., Santa Clara, Calif. 95050. (408) 246-9225. P&A: See text.

If you need a low-drift amplifier, your first inclination may be to use a chopper stabilized unit. A better buy, however, may be the monoOP-07, a monolithic bipolar op amp made by Precision Monolithics. It has an offset drift vs temperature of only  $0.2 \mu\text{V}/^\circ\text{C}$ , and costs less than a third that of equivalent chopper-stabilized units.

The OP-07 has input offset voltages of  $10 \mu\text{V}$  or less, and long-term offset drift averages  $0.2 \mu\text{V}$  a month. The op amp doesn't require the large compensating or holding capacitors, resistors or potentiometers usually found in monolithic chopper-stabilized devices or modular units.

Microvolt offsets are of dubious value if noise obscures the input signal, but the OP-07 has the advantage of a low  $0.6\text{-}\mu\text{V}$  pk-pk maximum input noise—less than one-hundredth that of monolithic chop-

pers made by two other companies (Model 2905 from Harris Semiconductor, P.O. Box 883, Melbourne, Fla. 32901, and Model SN72088 from Texas Instruments, P.O. Box 5012, M/S 308, Dallas, Tex. 75222). Also, the OP-07 input bias current remains below  $2 \text{ nA}$  over the entire operating temperature range (MIL:  $-55$  to  $+125^\circ\text{C}$ ; Commercial  $0$  to  $70^\circ\text{C}$ ). Since its output is free from chopper spikes, the amplifier can be used in high-impedance circuits.

The amplifier's bipolar front end provides a full differential input that can handle common-mode voltages of  $\pm 14 \text{ V}$ . The amplifier also has a common-mode rejection ratio of  $126 \text{ dB}$  at low frequencies. At unity gain, the amplifier has a bandwidth of  $1.2 \text{ MHz}$ .

Open-loop gain of the OP-07 is typically  $500,000$  and is guaranteed at  $300,000$  minimum for the MIL version. Input impedance in the differential mode is a high  $80 \text{ M}\Omega$ , while the common-mode input  $Z$  is

$200 \text{ G}\Omega$ . The output impedance, a low  $60 \Omega$ , can drive many load variations. Although normally requiring  $\pm 15 \text{ V}$  supplies, the OP-07 can operate with supply voltages as low as  $\pm 3 \text{ V}$ —a feat chopper-types are hard-pressed to match.

The amplifier's microvolt offset voltages are achieved when each input device is trimmed during wafer testing. A string of trimming resistors is diffused in series with the input stage's collector resistor. Each trim resistor also has a reverse-biased zener placed in parallel across it.

In normal operation the zener doesn't conduct, since the voltage across it is less than its breakdown rating. Automatic equipment that measures the amplifier offset determines the needed resistance change. A large current pulse is then routed via probes through one or more selected zeners, causing permanent short circuits and reducing the over-all value of the resistor string.

The monoOP-07 can directly replace the 725, 108 and monoOP-05 amplifiers without circuit changes. It can also replace 741 op amps, if the 741's nulling potentiometer is removed.

Four versions of the OP-07 are available: AJ, J, EJ and CJ, with max  $V_{\text{OS}}$  of  $25, 75, 75$  and  $125 \mu\text{V}$ , respectively. The AJ and J models are specified over the MIL temp range, while the EJ and CJ are specified for the commercial. Prices in 100-piece lots are  $\$60, \$25, \$15$  and  $\$9.95$ , respectively.

The amplifiers are housed in TO-99 or DIP cases and are available from stock.

Precision Monolithics **CIRCLE NO. 252**  
Harris Semiconductor

Texas Instruments **CIRCLE NO. 254**

**CIRCLE NO. 253**

**CIRCLE NO. 254**

## FM audio system handles 2 W

ITT Semiconductors, 3301 Electronics Way, West Palm Beach, Fla. 33407. (305) 842-2411. \$2.20 (100-999).

A complete 2-W FM sound system in a single 14-pin DIP can be used to minimize the number of components needed in receiver applications. Called the ITT3701, the new circuit includes an i-f limiter, a quadrature type FM detector, a dc-operated volume control—which doesn't require the usual shielded cable—and an internally compensated 2-W audio amplifier. Full limiting occurs with less than 100  $\mu$ V input, and the circuit contains output short-circuit protection. The device can be operated at 4.5 and 10.7 MHz. Other intermediate frequencies are obtained with the connection of proper external components.

CIRCLE NO. 260

## 4-bit CMOS IC compares magnitudes

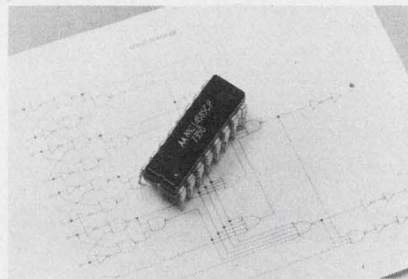

Motorola Semiconductor Products, Inc., Box 20924, Phoenix, Ariz. 85036. (602) 244-3466. \$3.90 up (100-999); stock.

The MC14585 CMOS 4-bit magnitude comparator takes two 4-bit words and determines whether one is less than, equal to or greater than the other. The IC can be cascaded to handle longer word lengths. It can be used with both binary and BCD codes and it provides a fanout of 50. The CMOS IC has a quiescent power dissipation of 25 nW, and it features pin-compatibility (but not direct electrical equivalence) with the TTL 7485 IC.

CIRCLE NO. 261

## Protected audio amp yields 7 W

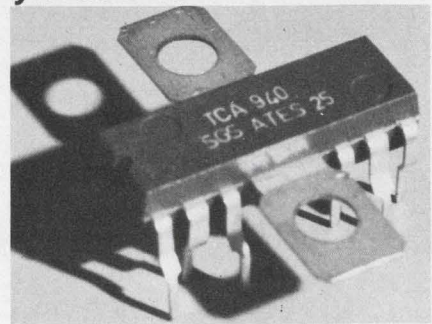

SGS-ATES Semiconductor Corp., 435 Newtonville Ave., Newtonville, Mass. 02160. (617) 969-1610. \$3.50 (100 up).

The TCA940 audio amplifier contains both thermal shut-down and power-limiting, short-circuit protection. The new IC outputs 7 W at 1% distortion (with 18 V supply and 4  $\Omega$  load). It has a supply-voltage range of 6 to 24 V and a ripple rejection of 45 dB. Other features include an open-loop voltage gain of 75 dB, a 3-dB bandwidth of 40 to 20-kHz and an efficiency of 65% at 5-W output power.

CIRCLE NO. 262

# Workhorse Spectrum Analyzer... 100Hz to 25MHz

The new Nelson Ross Model 236 is a multi-purpose, easy to use, workhorse Spectrum Analyzer with outstanding performance features and an exceptionally low price of \$3275.

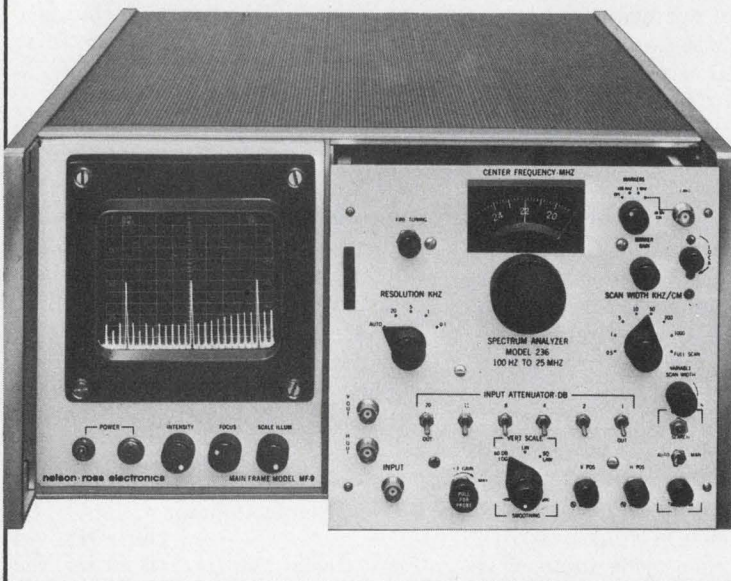

- Preset 0-25MHz quick-look scan and 0-10MHz adjustable scan widths
- 100Hz resolution, automatic and adjustable modes
- -105 dbm (1.25 $\mu$ V) sensitivity
- >60 db dynamic range for IM and Harmonic Distortion analysis
- Self-checking: Crystal frequency marker combs at 1MHz and 100KHz intervals. Absolute level reference

Numerous other versatile NR Spectrum Analyzers are available from sub-audio through microwave, 0.5Hz to 6.5GHz; complete free standing analyzers with interchangeable plug-ins, or just the plug-in analyzers for your TEK and HP scopes.

Call or write to the "Specialists"; complete specifications are yours for the asking; or, circle the reader service number.

**nelson • ross  
electronics**

A DIVISION OF POLARAD ELECTRONICS CORP.  
5 Delaware Drive, Lake Success, N.Y. 11040  
516-328-1100 • TWX: 510-223-0414

## Voltage amp aims for telephone use

*Plessey Semiconductors, 1674 McGaw Ave., Santa Ana, Calif 92705. (714) 540-9979. \$5.07 (100-999); stock.*

The SL 1020, a class A or AB voltage amplifier, contains a remote dc gain-control capability. The new bipolar IC is primarily intended for use as a channel amplifier in telephone equipment. The SL 1020 features temperature-insensitive dc-gain control, noninteractive adjustment of gain and a 1:1 600- $\Omega$  transformer output that can be optimized for low inductance.

CIRCLE NO. 263

## 256-bit S-TTL RAMs switch to epoxy

*Signetics, 811 E. Arques Ave., Sunnyvale, Calif. 94086. (408) 739-7700. P&A: See below.*

Two high-speed Schottky-TTL RAMs, formerly offered in silicone packages, are now being manufactured in epoxy packages at a unit price of \$14 (100), or one-half the cost of the earlier versions. The two RAMs are 256-bit bipolar circuits with access times of less than 30 ns. The Model 82S16 has three-state outputs, and the 82S17 has open-collector outputs. Read time is also 30 ns, and write time is 20 ns. Power dissipation is 1.5 mW per bit.

INQUIRE DIRECT

## Calculator IC consumes 10 mW

*Cal-Tex Semiconductor, Inc., 3090 Alfred St., Santa Clara, Calif. 95050. (408) 247-7660. \$15; stock (up to 1000).*

The CT5031 calculator circuit represents the company's first in an expected series of ion-implanted calculator ICs that require less than 10 mW for operation. The CT5031 features the basic four functions (with powers and reciprocals), floating point and six or eight digits. The circuit comes in a 28-lead DIP, and it requires only digit drivers, LEDs, and segment resistors to complete the electronic component list for a calculator.

CIRCLE NO. 264

# GET ON BOARD... with TANTALEX<sup>®</sup> Low-Cost Solid Tantalum Capacitors

## Sprague Gives You a Choice . . . . . for Flexibility in Your Printed Board Designs.

### DIPPED . . .

#### SPRAGUE TYPE 196D

Small size economical capacitors that utilize high-quality tantalum pellet construction. Conformal epoxy resin coating is highly resistant to moisture and mechanical damage. This capacitor has found wide usage in consumer and commercial electronic equipment. Operating temperature range,  $-55^{\circ}\text{C}$  to  $+85^{\circ}\text{C}$ . Available in all popular 10% decade values from  $0.1\mu\text{F}$  to  $330\mu\text{F}$ . Voltage range, 4 to 50 VDC. Standard lead spacing, 0.125" and 0.250". For complete data, write for Engineering Bulletin 3545B.



### MOLDED . . .

#### SPRAGUE TYPE 198D

Economically priced, molded-case Econoline<sup>™</sup> capacitors. Standard lead spacing, 0.100", 0.200", and 0.250". Tough, flame-retardant, crack resistant case has flattened section and polarity indicator for easy-to-read marking and error-free insertion. Fixed external dimensions allow increased productivity during assembly of PC boards. Designed for severe vibration and shock environment, where lead support alone is not adequate. Operating temperature range,  $-55^{\circ}\text{C}$  to  $+85^{\circ}\text{C}$ . Capacitance values from 0.1 to  $100\mu\text{F}$ . Voltage range, 4 to 50 VDC. For complete data, write for Engineering Bulletin 3546.

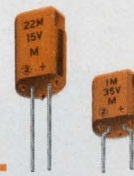

Call your nearest Sprague district office or sales representative, or write for the bulletins mentioned above to Sprague Electric Company, 347 Marshall Street, North Adams, Mass. 01247.

THE BROAD-LINE PRODUCER OF ELECTRONIC PARTS

**SPRAGUE**<sup>®</sup>

THE MARK OF RELIABILITY

INFORMATION RETRIEVAL NUMBER 63

**FROM  
BREADBOARD  
TO FINAL  
PACKAGING  
HARDWARE...**

**ALL AVAILABLE  
FROM ONE SOURCE**

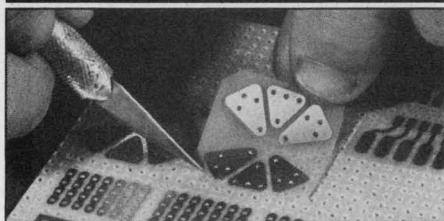

★ **ADHESIVE BACKED  
CIRCUIT SUB-ELEMENTS**  
(Over 200 Pre-Drilled component mounting  
patterns available "off-the-shelf.")

★ **EPOXY GLASS BOARD  
MATERIALS**

- 76 Standard "Off-the-Shelf" Boards.
- Including Unclad, Copper Clad, Cut & Peel Copper Clad, Pre-etched "X-Y" Pattern and Plated thru Hole Copper Clad.
- .100" Grid Hole Pattern or Undrilled.

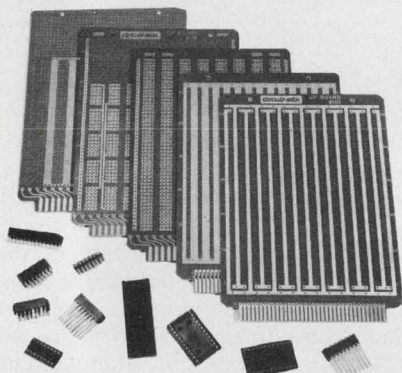

★ **GP CIRCUIT BOARDS and ACCESSORIES**

- Highest Quality — Choose from 74 "Off-the-Shelf" Boards.
- Sockets — Low & Standard Profile, P.C. and Wire Wrap. • Highest Quality Gold Contacts.
- Adapter plugs • Connectors
- Card Pull Handles.



SEND FOR OUR NEW CATALOGS #502 & #801

**circuIt-stik®**

P.O. BOX 3396 • Torrance, California 90510  
Phone (213) 530-5530

INTEGRATED CIRCUITS

## Static 1-k RAM accesses in 80 ns and has chip select



EMM SEMI, a division of Electronic Memories and Magnetics, 3883 N. 28th Ave., Phoenix, Ariz. 85017. (602) 263-0202. \$15 (100 to 999); September.

The first fully static 1024-word × 1-bit n-channel MOS random-access memory (RAM) to come in under 100 ns is the 1218 from EMM SEMI. The memory accesses in 80 ns. Its cycle time, 180 ns, is the same as that of its closest competitor. The chip includes a select port for easy memory-system design.

The competing unit—the 7001 from Advanced Memory Systems (1276 Hammerwood Ave., Sunnyvale, Calif.)—has a 60-ns access and a 180-ns cycle time. But the 7001 costs \$20 (100 to 999), \$5 more than the 1218. Additionally, the 7001 is not fully static; it requires external charge-pump circuitry. And conventional refresh is not used.

Both the 1218 and 7001 have automatic "power-down" when chip select is disabled. The popular 2102 RAM available from Intel (3065 Bowers Ave., Santa Clara, Calif. 95051) and several other companies does not have this power-down capability and it is slower. It does, however, have TTL-compatible inputs and outputs and sense amplifiers on the chip. Neither the 1218 nor the 7001 has sense amps on the chip.

On the 1218 two complementary data-out signals are provided, and they may be used to drive a differential sense amp. The minimum data-out valid time is 20 ns; the typical, 25 ns.

When you consider standby power, AMS's 7001 consumes less, 60  $\mu$ W/bit vs 130  $\mu$ W/bit for EMM SEMI's 1218. In the operating mode it's the reverse; the 1218 consumes 543 mW vs 655 mW for the 7001.

The units operate over 0 to 70 C and come in ceramic 22-pin DIPs. And both are fully decoded on the chip.

The 1218 requires supply voltages of +15, +5 and -4.4 V. These are TTL voltages, except for the +15 V necessary for chip select.

Input capacitance is 6 pF and output capacitance is 5 pF. Chip select input capacitance is 80 pF.

EMM SEMI also sells two other chips that are pin-compatible with the 1218: the 1216 and 1217. Both have TTL-compatible inputs and outputs with sense amps on the chip. The 1216 accesses in 260 ns and sells for \$11 (100 to 999), the 1217 in 145 ns for \$13 (100 to 999).

For EMM SEMI **CIRCLE NO. 255**

For Advanced

Memory Systems **CIRCLE NO. 256**

For Intel

**CIRCLE NO. 257**

POWER SOURCES

**Portable unit delivers sine waves to 120 VA**



Nova Electric Manufacturing Co., 263 Hillside Ave., Nutley, N.J. 07110. (201) 661-3434. From \$498; 45 days.

Porta-Power makes portable ac power available in ranges of 30, 60 and 120 VA. Weighing from 18 to 40 lb., and using nonspillable gelled electrolyte batteries, Porta-Power units can provide 60 Hz, 115 V ac power in excess of one hour. The accessory battery charger will recharge a fully rundown battery in 8 h. Output sine wave has a maximum distortion of 6% with voltage regulation of  $\pm 1\%$ . The units are short-circuit proof and current limited.

CIRCLE NO. 265

**Switching supplies claim zero response time**

Advanced Power, 1621 S. Sinclair St., Anaheim, Calif. 92806. (714) 997-0034. 50A: \$395; 100A: \$495; 30 to 60 days.

CDS Series of 5-V-dc switching regulator power supplies claims zero response time for a line step change of 10%, or a load step change of 25% at 75% of full load. Overshoot and undershoot performance is typically 1% for a line step change of 10%, with 2% maximum for a load step change of 25%. Regulation is 0.1% for a 10% line change, and  $\pm 0.1\%$  from 10% to full load.

CIRCLE NO. 266

**datum inc**



**save plenty on Rotating Memory Systems for your PDP-11 COMPUTERS**

DATUM, the leading independent manufacturer of peripheral equipment for minicomputers, can save you \$, with no compromise in system performance or service...

MEMORY TYPE	* DIGITAL EQUIPMENT CORPORATION	DATUM
262K Words Fixed Head Storage	RF 11-AA \$15,120	Model 3091 \$6,750
1.2M Words Cartridge Disk Drive	RK 11-DE \$11,000	Model 4091 \$8,250
20M Words Pack Disk Drive	RP 11-CE \$31,880	Model 4091 \$26,550

\*OEM Price List November, 1973

Delivery of DATUM manufactured equipment listed is available within 45 days of order date.

Similar savings apply to interfaces for other popular minicomputers. And DATUM has nationwide/worldwide service by company trained service engineers.

write or phone for further information

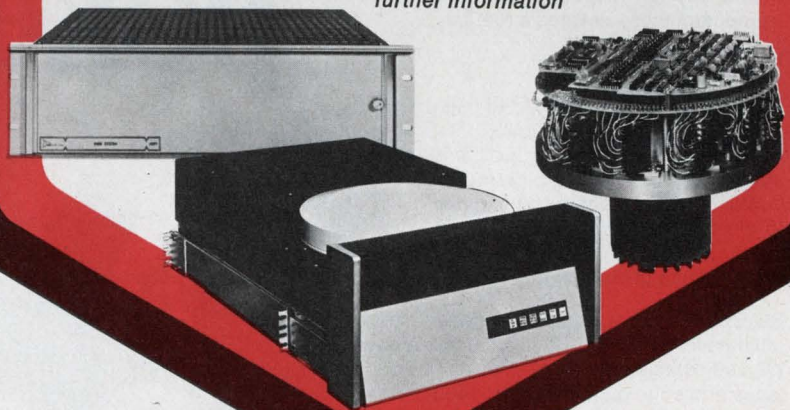

**Datum inc**

1363 S. State College Boulevard, Anaheim, California 92806 ■ 714/533-6333  
EUROPE ■ Datum House, Cranford Lane, Harlington, Middlesex, UK ■ 01-879-0456

INFORMATION RETRIEVAL NUMBER 65

# Incremental voltage divider.

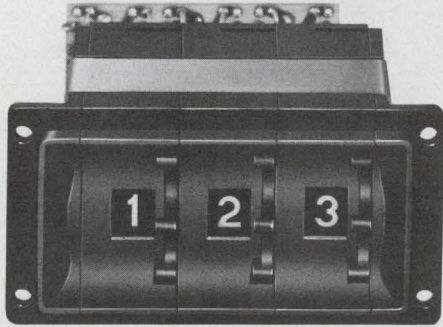

We call it Thumbpot™. And it'll do anything a 10-turn pot will do, but better. Obviously it's easy to read and easy to set. When you return to a setting it's **exactly** what you had before. Other advantages are a choice of sizes, incredible reliability, housings sealed against dust, low price, and such options as lighting, position stops, and shielding. It's available in stock from G.S. Marshall, Hall-Mark, and Schweber.

And us.

## E E C O

1441 East Chestnut Avenue/Santa Ana, California 92701/Phone 714/835-6000

INFORMATION RETRIEVAL NUMBER 66

Our paper tape punches and readers were built for comfort. Not for speed (max. — 50/60 cps). And, they're priced to barely budge your budget.

In fact, any self-respecting components savant would term these devices a real buy.

Why?

Because they're engineered to make your end-user happy. By practically eliminating I/O system down-time. By providing read stations sealed from dust, corrosion and contaminants. By not musing a hair on fuzziest tape. By functioning without continuous operator intervention . . . even under severe environmental extremes.

Besides being low-cost, they offer you the ultimate in flexibility. With bi-directional feed. With adjustable tape guides for standard tapes and edge punched cards (400 Series).

We offer a choice of 7 space-saver, basic, rack mounted or desktop punch and reader models.

If you want your customers to be happy with your total system installation, we suggest speed. Quick, contact any of our field representatives. Or, call OEM Products.

# slow poke

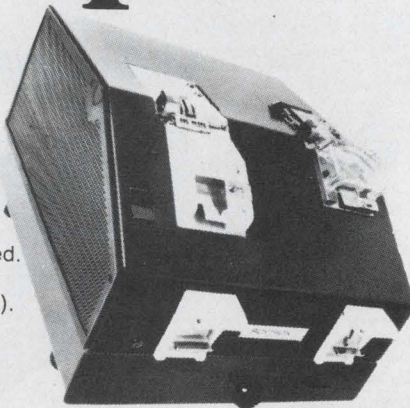

Model 582  
Combination Reader Punch Station



OEM PRODUCTS DIVISION

LITTON ABS

Automated Business Systems

34 Maple Avenue, Pine Brook, N.J. 07058/(201) 575-8100

INFORMATION RETRIEVAL NUMBER 67

## POWER SOURCES

### Dc/dc converter offers high isolation

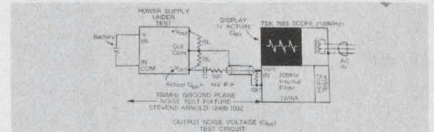

Stevens-Arnold, 7 Elkins St., South Boston, Mass. 02127. (617) 653-0355.

Super Iso-Pak Model B12/D15/60/Y dc/dc converter is designed primarily for applications requiring low leakage and high breakdown levels. Effective C is 5 pF, effective R is  $1 \times 10^{11} \Omega$  and breakdown voltage is 8000 V dc. Input voltage is 12 V dc  $\pm 2.0$  V. Power efficiency is 55%. Output rating is  $\pm 15$  V dc,  $\pm 60$  mA (60 mA available from both sides simultaneously;  $P_o = 1.8$  W). Line and load regulation are typically  $\pm 0.01\%$ . Output noise is 1 mW true rms, measured over a system noise bandwidth of 20 MHz. Reflected input-ripple current is kept to 2% of the input current. No derating or external heat sink is required over  $-25$  to  $+71$  C.

CIRCLE NO. 267

### Six triple-output units share one case size

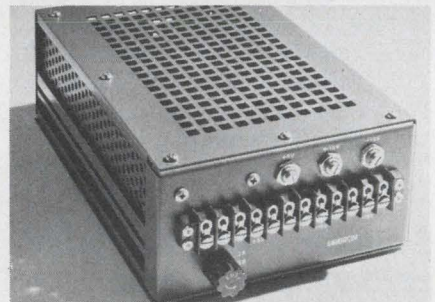

Faratron Corp., 280 Green St., South Hackensack, N.J. 07606. (201) 488-1440. \$152 to \$178; stock.

The triple-output MO series comes in six models, all in one case size. All units feature barrier-strip connections, with remote sensing leads available. Input is from 105 to 132 V ac, 47 to 420 Hz. Outputs are 5,  $\pm 15$  (or  $\pm 12$ ) V dc. Typical specs include line and load regulation of  $\pm 0.05\%$ , ripple of less than 1 mV rms, or 3.0 mV pk-pk, and stability of 0.05% or 20 mV. Tempco is 0.05%/°C + 1 mV.

CIRCLE NO. 268

## 30-W OEM series comes in four models

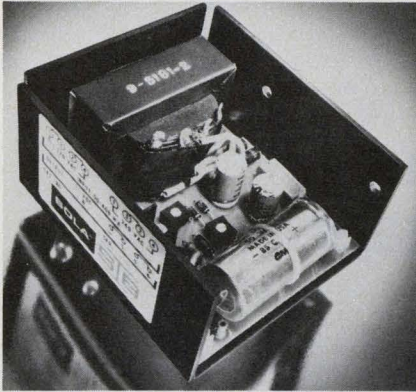

Sola Electric Co., 1717 Busse Rd., Elk Grove Village, Ill. 60007. (312) 439-2800. Approx. \$30; stock.

This line of 30-W, series-regulated dc supplies is for OEM use in minicomputers, point-of-sale terminals and other IC-logic circuitry. Four models are rated at 5 V/3 A, 12 V/1.8 A, 15 V/1.6 A and 24 V/1.2 A. Input voltage ranges from 108 to 132 V, or 216 to 264 V, with output regulation of  $\pm 1\%$ . Input frequency range is 50 to 400 Hz, with load derated to 75% for 400-Hz operation. Automatic short-circuit and overcurrent limiting is built in. Size is  $4 \times 4\text{-}3/4 \times 2\text{-}1/2$  in. and weight is 2-1/2 lb.

CIRCLE NO. 269

## Dc/dc converters offer high isolation

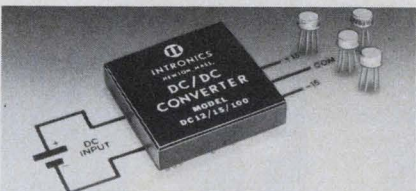

Intronics, 57 Chapel St., Newton, Mass. 02158. (617) 332-7350. 25 mA Series: \$45; 100 mA Series: \$69; 4 wks.

These dc/dc converters feature floating, tracking outputs with 0.02% regulation, a tempo of 0.02%/°C, output ripple and noise of 1 mV rms max and current limiting to 150% of full-load current. The internal oscillator frequency is 12 kHz. Two basic models provide either dual 25 mA or 100 mA outputs,  $\pm 12$  V or  $\pm 15$  V dc, with single unregulated voltage inputs from 5 to 28 V dc. Input/output isolation is  $10^9 \Omega/10$  pF.

CIRCLE NO. 270

# ENM COMPAC®

## time counts and we count time

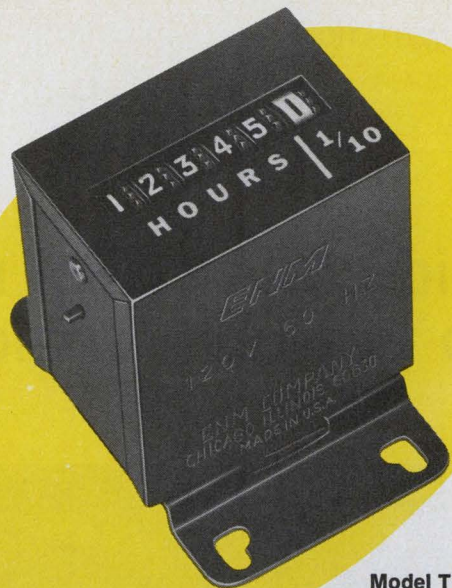

**Model T12**  
Elapsed Time Indicator  
6 Digit, Base Mount

ENM's Compac® Model T12 elapsed time indicator counts/records up to 100,000 hours with tenths of hours in relief.

So what? So think of a better way to schedule maintenance, time processes or establish rental fees. And what about the way you warrant your product? Hours of use are a lot more meaningful and protective than mere length of ownership. One user's month may be another owner's year. A calendar warranty can't fairly cover both.

Thanks to its space saving epicyclic step-down gearing, the American made compact Model T12 will fit on almost anything—and with its five mounting styles—anyway you'd like.



Back of Panel



Flange Mount



NEMA Bezel Panel Mount



Round Panel Mount

**Model T12** 6-digit time scale to 99,999.9 hours. Figures .140" high, hours white on black, tenths black on white. Universal base mount and other mountings illustrated above. Synchronous motor requires no lubrication. 115 V. AC. Case width 1.72". Priced from \$7.42 in 1000 lot quantities.

**Compac Digital Counter Buyers Guide**  
Write for it today, so you won't be wrong tomorrow.

# ENM COMPANY

5340 Northwest Highway, Chicago, Ill. 60630 • Telephone: (312) 775-8400

# Solid-state panel meter fills the gap between analogs and digitals



Simpson Electric, 5200 W. Kinzie St., Chicago, Ill. 60644. (312) 379-1121. Under \$100 (quan.).

In a push towards the ultimate panel meter, Simpson Electric has brought forth the ANA/LED, a solid-state indicator that claims some of the best attributes of both the APM and DPM.

Instead of a moving pointer, the ANA/LED displays signals with a linear array of discrete LEDs on a calibrated scale, 5-in. long. When an input is applied, all LEDs below the signal level light up in thermometer-like fashion.

A total of 53 LEDs are used: 50 to match the scale graduations, two to indicate reverse polarity and overrange, and one for zero—which remains on as long as the power does.

Is the ANA/LED the panel meter of panel meters? Not quite; nor was it intended to be. But the ANA/LED has a lot going for it. Among its virtues are these:

- has no moving parts.
- shows trends.
- responds fast: 15 ms, maximum, for dc.
- tolerates large overloads: 5-V spikes on a 50-mV signal have no affect.
- provides an amplified output signal of 0 to 5 V.

And the limitations? Unlike the APM—but like the DPM—the ANA/LED needs power: about 2.4 W worth from a dual 6-V supply. And like the DPM, signal isolation may be a problem if grounding precautions aren't taken or if bat-

teries aren't used to supply the power.

Since the ANA/LED responds to ac, as well as dc, signals, an active input filter is needed to prevent ripple from affecting the reading. The built-in filter attenuates a 120-Hz ripple by 10:1 but slows the meter down somewhat. However, the maximum delay for a zero-to-full-scale step is only 15 ms—and there's no overshoot.

The 7.87 × 1.97-in. dimensions of the ANA/LED hardly make it diminutive. But the surface-mount version projects just 3/4-in. in front of the panel, and even less behind.

Key specs of the Simpson ANA/

LED include an accuracy of ±2.0% of full scale, a linearity of ±0.1% of full scale and a tempco of ±0.03% of full scale per degree C. Operating temperature range is 0 to 60 C.

Maximum dc sensitivity of the solid-state unit is high compared with conventional APMs: Just 1 μA will light up all the LEDs—that is, give a full-scale reading. For ac, full-scale can go as low as 10 mV pk-pk.

Of course, the linear "bar-graph" concept isn't new. The old Time-Systems' line of DPMs (now Faratron) included one with an auxiliary linear analog scale, composed of lamps that lit or turned off in order.

And Burroughs recently unwrapped its Self-Scan bar graph—a 4-in.-long analog display with 200 digitally controlled neon elements, for a resolution of 0.5%.

For Simpson **CIRCLE NO. 250**

For Burroughs **CIRCLE NO. 251**

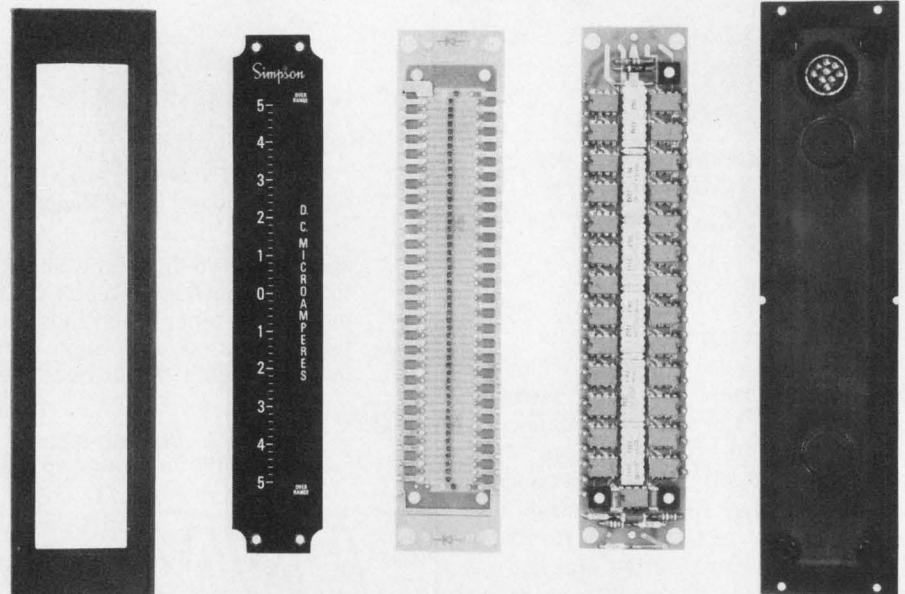

Five assemblies make up the ANA/LED: the cover, scale, LED board, electronics board (includes comparators and range network) and back plate.



Whether you buy  
one's, two's...



or multitudes—

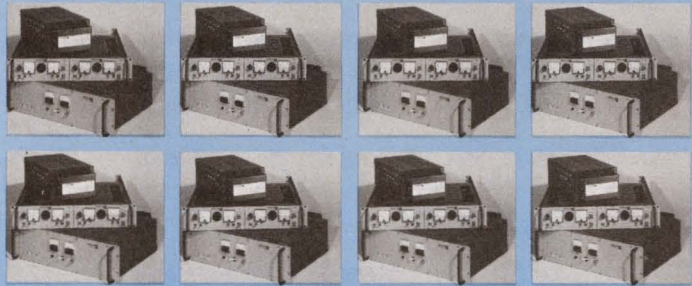

## North delivers power reliability!

MODEL	11000	12000	13000	14000	15000	16000	17000	18000
VDC	AMPERES							
5.0	3.9	5.3	11.3	13.0	20.0	32.5	49.0	82.0
12.0	2.8	4.2	8.0	10.5	15.0	23.0	36.0	58.0
15.0	2.4	3.7	7.5	9.5	14.0	20.5	27.0	47.0
18.0	2.1	3.3	6.0	8.0	13.0	18.0	26.0	40.0
24.0	1.5	2.8	4.2	7.0	11.0	15.0	21.0	33.0
28.0	1.4	2.4	4.0	6.3	9.0	14.0	20.0	29.0
36.0	1.2	2.2	3.1	5.6	8.0	11.0	14.0	23.0
48.0	95	1.8	2.6	4.2	6.0	8.0	10.0	18.0

MODEL	10000
VDC	AMPS
0-7.5	2.10
0-16	1.25
0-25	0.85
0-33	0.68

DUAL OUTPUT SUPPLIES	
MODEL	N03052
VDC	AMPS
±15-12	400MA
MODEL	N60052
VDC	AMPS
±15-12	1.0A

Listed here are the more popular models—many other voltages are available.

**NORTH**   
ELECTRIC COMPANY

North Electric Company / Galion, Ohio 44833 / A United Telecom Co.

Many O.E.M.'s agree that it just doesn't make sense to risk the reputation of a major piece of equipment over a minor component—especially, when the cost difference is so little.

If you're one of them, we'd like to quote your next power supply order. Whether you need one unit—or one hundred, North has the product selection and the production capacity to deliver more standard power reliability for your dollar.

To back it up, we offer the industry's finest technical specialists and over 40 years experience as the leader in custom power supplies.

Send for a catalog today, or call 419/468-8874.

SP-16

INFORMATION RETRIEVAL NUMBER 69

## Magnetic Reed BURGLAR ALARM

### Door and Window Switches for Concealed Installation

- No installation screws, nails or glue required
- No magnet loss in hollow doors
- Will operate through a big 1/2" gap
- Six types: SPST-NO, SPST-NC, SPDT. Each available with supervisory loop
- Guaranteed for 2 years or 10 million cycles
- Lowest price

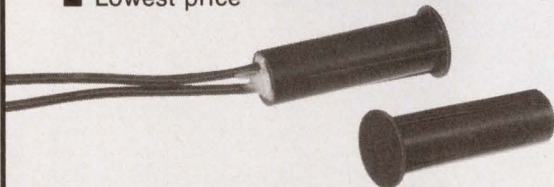

Also available for steel doors.

Ask for free sample of SPST-NO on your letterhead or call 308-235-4645.



**GEORGE RISK  
INDUSTRIES, INC.**

802 South Elm, Kimball, Nebraska 69145  
Phone: 308-235-4645 TWX: 910-620-9040

INFORMATION RETRIEVAL NUMBER 70

ELECTRONIC DESIGN 15, July 19, 1974

**ALCOKNB**

Don't just take our beautiful KNURLED KNOBS for granted! They're different because they are completely machined, including the KNURL and then anodized. This takes a little more time and effort, but we think it's worth it. You'll agree, too, when you see these knobs.



KN  
SERIES

Call us today at  
(617) 685-4371  
for samples  
and prices.

ALCO ELECTRONIC PRODUCTS, INC.  
1551 Osgood St., No. Andover, Mass. 01845

INFORMATION RETRIEVAL NUMBER 71

**ALCOKNB**

We call this our "GROOVY" knob series because of its unusual "MOD" appearance. Fully machined in aluminum and anodized. First time ever, we're offering mated pilots, pushbutton switches, etc. You've got to see this new line to believe your eyes.

Call (617) 685-4371 now for a sample and literature describing this exciting line.



KG Series

ALCO ELECTRONIC PRODUCTS, INC.  
1551 Osgood St., No. Andover, Mass. 01845

INFORMATION RETRIEVAL NUMBER 72

127

**WANT BIG PERFORMANCE  
IN A SMALL  
MEMORY?**

# **TRY THIS ON FOR SIZE**

If you need high speed, small capacity non-volatile storage — and cost is important — the MICROMEMORY 9000, is tailor-made for you. It is a complete memory system on a single 9" by 13.4" printed circuit card. No external circuitry other than power supply is required.

The MICROMEMORY 9000 cycles at 1.2 microseconds per bit, and accesses at 500 nanoseconds. Standard configurations are 8K by 1 bit and 4K by 1 bit. The system may be reconfigured (internally in the module) to binary multiples of the basic configuration. (e.g. the basic 8K x 1 module may be reconfigured to 4K x 2 or 2K x 4 or 1K x 8.)

The MICROMEMORY 9000 is an ideal solution for such applications as point of sale terminals, CRT displays, numerical controls, and any instrumentation application where data retention under power loss is essential.

Get full details on the MICROMEMORY 9000 from your local EMM office, or call Commercial Memory Products Marketing Department at (213) 644-9881.

**EMM** ELECTRONIC  
MEMORIES  
**COMMERCIAL MEMORY PRODUCTS**

A Division of Electronic Memories & Magnetics Corporation  
12621 Chadron Ave., Hawthorne, Calif. 90250

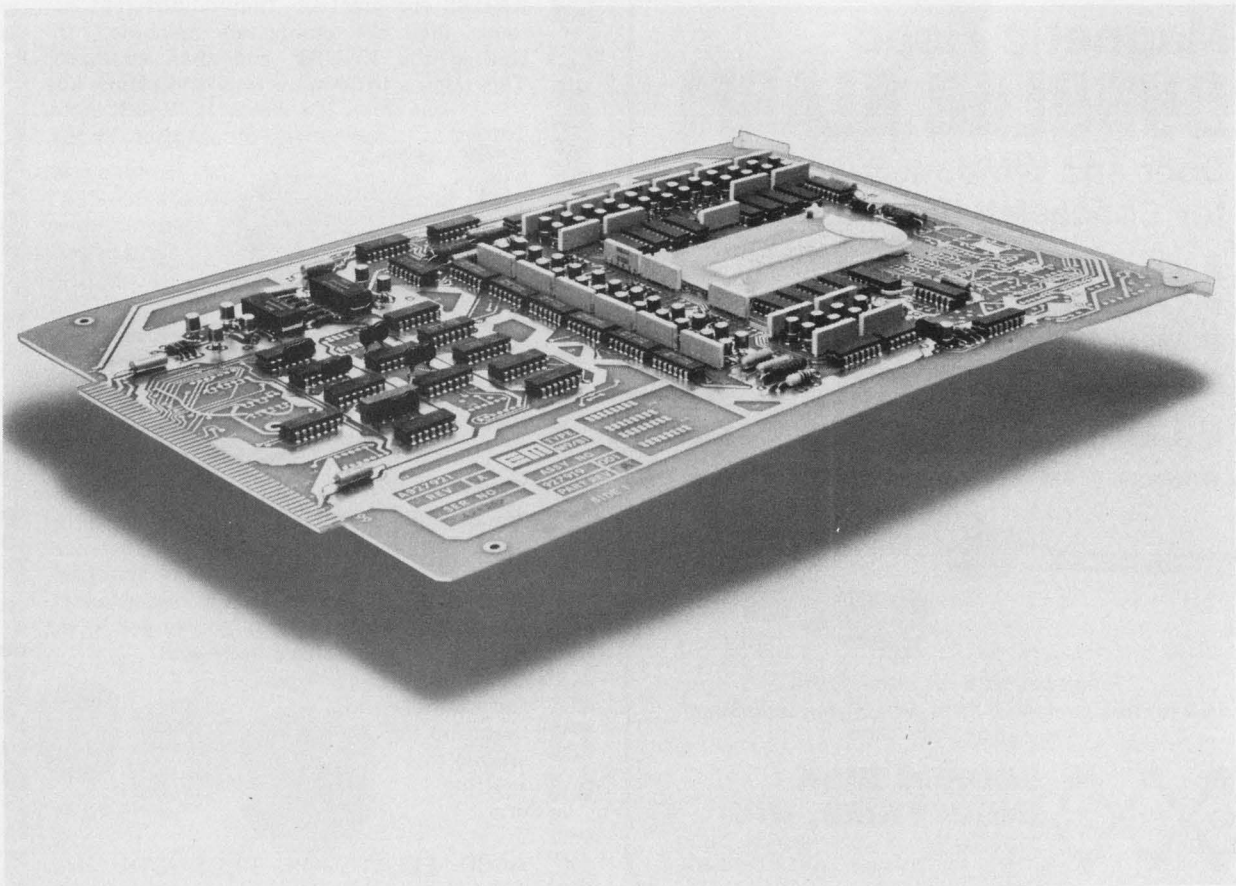

## INSTRUMENTATION

### Portable scopes come with built-in DMMs

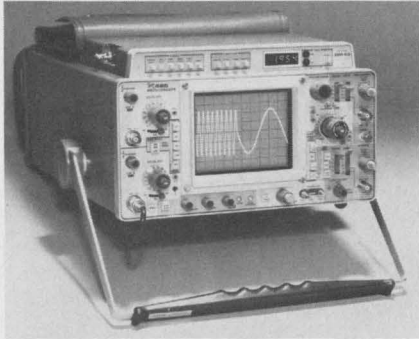

Tektronix, P.O. Box 500, Beaverton, Ore. 97005. (503) 644-0161. DM43, \$475; DM40, \$390 (add price of scope). August.

Models 465 and 475 portable scopes now come with optional, built-in digital multimeters. The 3-1/2-digit meter, called the DM43, offers five voltage ranges from 200 mV to 1200 V, 6 ohms ranges from 200  $\Omega$  to 20 M $\Omega$ , temperature probing capability from -55 to +150 C, and differential time-delay measurements between any two points on a CRT waveform display. A second version, the DM40, offers all of the above except temperature probing.

CIRCLE NO. 271

### Bench synthesizer covers vhf range



Syntest Corp., 169 Millham St., Marlboro, Mass. 01752. (617) 481-7827. \$2295.

Model SI-200 vhf synthesizer provides outputs from 1 Hz to 200 MHz with 6-1/2-digit resolution in eight ranges, and with the stability and accuracy of its internal 1-ppm crystal clock. Range and frequency are selectable with front-panel thumbwheel switches. Output level is also adjustable by front-panel controls.

CIRCLE NO. 272

### Light-beam oscillograph refrigerates paper

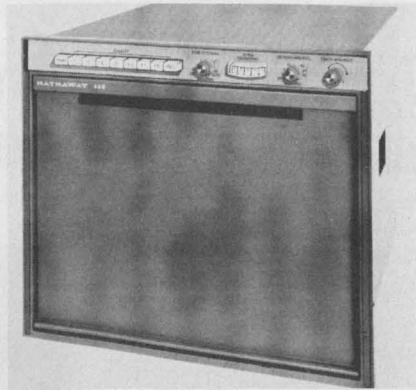

Hathaway Industries, 11611 51 St., Tulsa, Okla. 74145. (918) 663-0110. \$3350; 120 days.

Model 440, a new 12-in. direct-write oscillograph, is said to be the first light-beam unit with an optional solid-state refrigeration paper compartment. This compartment maintains the paper temperature below 100 F. With adaptors, paper width can be 8 or 10 in. The instrument has a 70-channel capacity, with chart speeds adjusted by seven pushbutton selectors. Speeds range from 0.1 to 80 ips.

CIRCLE NO. 273

### 510-MHz amplifier gives 3 W into any load



Electronic Navigation Industries, 3000 Winton Road S., Rochester, N.Y. 14623. (715) 473-6900. \$995.

Model 503L is a general-purpose, broadband amplifier capable of more than 3 W of linear power output when driven by any laboratory signal or sweep generator from 2 to 510 MHz. A linear Class A design, the 503L will boost the output of any signal source by a flat 40 dB  $\pm$ 1.5 dB and provide full forward output power into any load impedance from an open to a short. Although specified only over the 2-to-510 MHz frequency range, full power output is typically available from 1.6 to 540 MHz.

CIRCLE NO. 274

## There's an EMM office near you.

### WESTERN REGION

Regional Office

**SAN FRANCISCO**

(408) 247-9711

**LOS ANGELES AREA**

(213) 644-9881

**ORANGE COUNTY AREA**

(714) 639-5811

**MINNEAPOLIS AREA**

(612) 941-2404

**PHOENIX AREA**

(602) 968-2492

**DALLAS AREA**

(214) 231-7207

### EASTERN REGION

Regional Office

**BOSTON**

(617) 861-9650

**CHICAGO AREA**

(312) 297-7090

**WASHINGTON, D.C. AREA**

(703) 941-2100

**NEW YORK AREA**

(516) 423-5800

**CLEVELAND AREA**

(216) 842-8920

### International OFFICES

European Headquarters

**BELGIUM**

(03) 76.69.75

**UNITED KINGDOM**

(01) 751-1213

**WEST GERMANY**

(0811) 74.30.40

Far East Headquarters

**JAPAN**

(03) 404-8520

**EMM** ELECTRONIC MEMORIES & MAGNETICS CORPORATION.

12621 Chadron Avenue  
Hawthorne, Calif. 90250  
(213) 644-9881

# It pays to be narrow minded

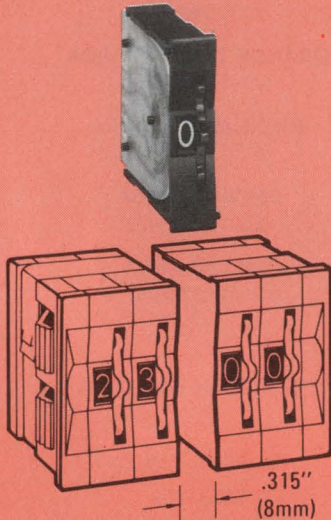

It pays in many ways to use our new Series 23000 narrow SNAP-IN SLIMSWITCHES. They cost less to buy, less to assemble, less to install. They conserve panel space too.

#### "LESS TO BUY"

Prices start at only \$2.50 per switch module... that's only 25¢ per switch function for a 10 position switch.

#### "LESS TO ASSEMBLE"

Using our unique assembly strap, you can stock parts and put switch assemblies together yourself without using tools. We will also build them for you at no extra cost.

#### "LESS TO INSTALL"

Snap-in mounting eliminates installation hardware and tools. The molded-on bezels cover irregular panel cut outs, chipped paint and panel abrasions.

#### "CONSERVES PANEL SPACE"

Width is only .315" (8mm) so you can put more switches into a given space with better readability.

So think "narrow"...think SLIMSWITCH...it really pays.

Send for more information today.

There is a Digitran distributor and sales engineering group near you.

**SNAP-IN SLIMSWITCH**  
SERIES 23000 • ANOTHER SWITCH FROM THE  
**DIGITRAN** COMPANY

Division of Becton, Dickinson and Company [B D]  
855 South Arroyo Parkway / Pasadena, Ca. 91105  
Telephone: (213) 449-3110 / TWX 910-588-3794

INFORMATION RETRIEVAL NUMBER 75

## COMPONENTS

# Uncased ceramic disc filters boost available capacitance

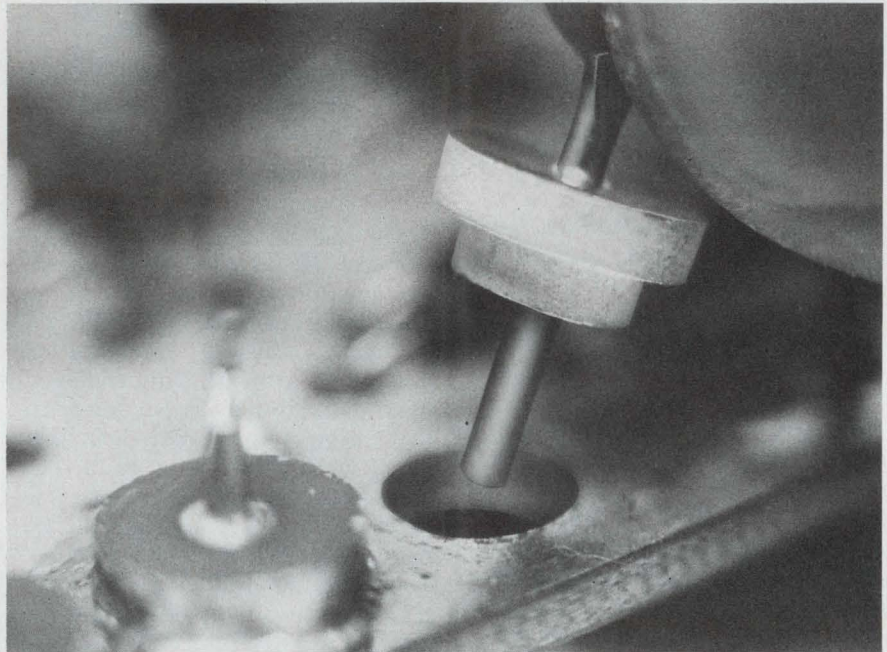

U.S. Capacitor Corp., Centralab Electronics Div., Globe-Union, Inc., 2151 N. Lincoln St., Burbank, Calif. 91504. (213) 843-4222. \$0.45 to \$0.85 (25,000-up) stock to 2 wk (prototype quantities).

Eliminate the case from a ceramic disc feedthrough capacitor and you increase the capacitance/unit volume by up to 10 times. That's what USCC/Centralab is offering in its "U" family of uncased, ceramic stack filters.

In addition, the company says, costs drop to about a third that for the cased version. Also elimination of the case and end seals, the epoxy, internal solder joints and flux is said to yield a more rugged and reliable product.

Voltage ranges in the U-series filters span 50 to 1000 V dc. Capacitance values cover 50 pF to 0.75  $\mu$ F. While current ratings up to 25 A are available.

Dielectric breakdown voltage is a minimum of 2 kV. The operating temperature range is -55 to +125 C. Insulation resistance is 100 M $\Omega$  minimum at the rated dc voltage. Maximum leak rate is 10<sup>-8</sup> cc/s.

The filter is a small monolithic ceramic disc made of barium titanate with a wire through the center and plated on the outside. The disc diameter ranges from 0.135 to 0.35 in.

When the filter is used as a feedthrough capacitor, dc power can pass while rf energy is shunted to the surface to which the filter is soldered. The filter functions to 10 GHz, with better than 70 dB of insertion loss. USCC/Centralab plans future models with "L" section filters incorporating a ferrite inductor for additional attenuation at rf frequencies.

The only other uncased ceramic disc filter on the market is made by Spectrum Control (152 E. Main St., Fairview, Pa.). Its units are single-layer, lower-capacitance filters with values ranging from 6.8 to 1000 pF. Prices start at 12.5¢ in 25,000 pc lots and they are available in standard, 0.25 in. diameters. Spectrum Control plans to introduce monolithic stack uncased filters by the end of this year.

USCC/Centralab CIRCLE NO. 258  
Spectrum Control CIRCLE NO. 259

# MEET THE LUCKY WINNERS

## OF Electronic Design's TOP TEN CONTEST



"We enjoyed every minute we were there," writes Paul R. Saunders, winner of last year's Top Ten Contest. "The islands, the people of those islands and the cruise are wonderful . . . the hardest part of the whole trip was returning to reality." Paul and his wife are shown, left, at the end of their trip at English Harbour, Antigua. Paul also won \$1,000 cash and round-trip air tickets for two to the Windjammer Cruise home port. At the time of the contest Paul was associated with Varisystems Corporation, Long Island, N.Y.

### 1974 CONTEST—READER WINNERS

**1st  
PRIZE**

#### C. R. GOWAN

Development Engineer  
Hewlett-Packard  
Cupertino Division (Cal.)

Mr. Gowan picked the ten best-read ads in *Electronic Design's* Jan. 4 Top Ten Contest issue, walked away with \$1,000 cash, air transportation and a Windjammer Cruise for two in the Caribbean.



**2nd PRIZE:** William H. Nott, Development Engineer, IC Development Section, Entertainment Products Division, GTEsylvania. Mr. Nott's prize is a portable color TV.



KRAMISH

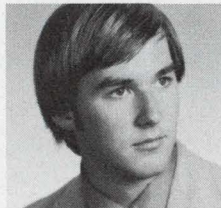

DISOSWAY

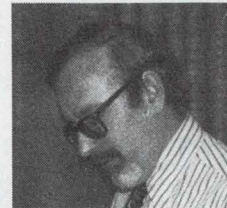

BIERMAN

**3rd, 4th and 5th PRIZES:** This year a tie means 4 Bulova electronic timepieces have been awarded. Here are the winners: ARNOLD KRAMISH, Science Advisor, American Embassy (OECD), Paris, France; MARK DISOSWAY III, Advanced Engineering Dept., Delco-Remy, Anderson, Indiana; MARVIN BIERMAN, Director of Quality Control, Vernitron Corp., Deer Park, N.Y.; and (not pictured) HARVEY KAYLIE, Engineer, Mini-Circuits Lab, Brooklyn, N.Y.

95 OTHER TOP TEN CONTEST WINNERS HAVE BEEN NOTIFIED BY MAIL.

**NEXT YEAR TRY YOUR LUCK — You may be a winner. Watch for future announcements.**

# ANALOG - TO - DIGITAL CONVERTER

## 13 BINARY BITS - .5 MICROSECOND

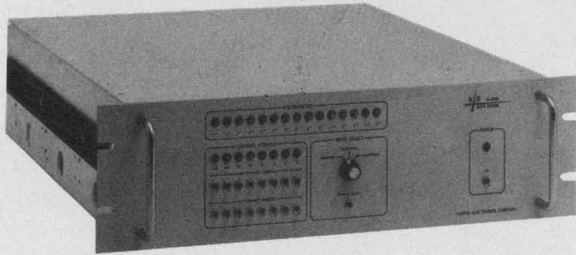

MODEL 2013 - 13 Binary Bits in 0.5 microsecond.

- 1.0 microsecond total throughput time with Sample and Hold Amplifier.
- Sample & Hold Aperture time is 1.0 nanosecond.

SERIES 2000 - From 8 Bits in 100 nanoseconds to 15 Bits in 1.0 microsecond.



**TUSTIN ELECTRONICS CO.**  
1656 South Minnie Street  
Santa Ana, Calif. 92707  
(714) 835-0677

INFORMATION RETRIEVAL NUMBER 77

## AT NCR/WICHITA YOU GET INVOLVED...

from conception through application of design... through manufacturing a reliable product profitably. In other words, you're an integral part of the whole.

That's because our management team is young and aggressive... educated and trained in the computer industry. We're working on many new projects, and the interaction you'll have with other products and divisions will give you a broader experience... and the opportunity to advance according to your ability.

### ENGINEERS:

- Minicomputer • Business Systems • Circuit Design
- Communications • Logic Design • Systems Formulation
- Systems Architecture • Design Automation • Analog Circuit Design

### SYSTEMS SOFTWARE PROGRAMMERS:

- Minicomputer Operating Systems • Communications
- File Management • Assemblers • Compilers

### MICROPROGRAMMERS:

- S-Languages • Emulators • Virtual Memory • Minicomputer Architecture

Don Wilde  
Professional Placement  
P. O. Box 1297CR  
Wichita, Kansas 67201  
(316) 687-5371



ACCOUNTING COMPUTER DIVISION

An Equal Opportunity Employer M/F

INFORMATION RETRIEVAL NUMBER 901

## COMPONENTS

### Pressure transducer made of stainless steel

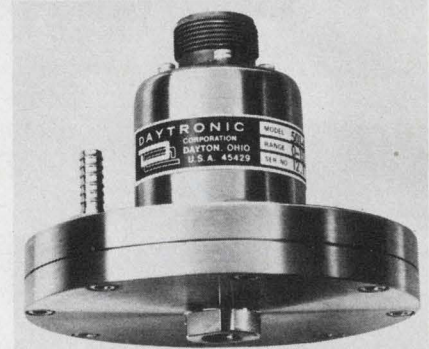

Daytronic Corp., 2875 Culver Ave., Dayton, Ohio 45429. (513) 298-7542. \$315 to \$345.

Measurement of low-level gauge or differential pressure is achieved by the new Series 501 pressure transducers. Based on the bonded-strain-gauge principle, these units are available in five ranges from 0-to-5 to 0-to-150 in. of water and provide 3-mV/V output with 0.2% accuracy in typical industrial use. Stainless-steel construction is used in all housings, diaphragms and pressure cavities. O-rings seal all electrical elements. The sensors are temperature compensated from -65 to 250 F and withstand shock acceleration of 200 G without damage.

CIRCLE NO. 275

### Nonpolar electrolytics operate to 160 WV



International Importers Inc., 2242 S. Western Ave., Chicago, Ill. 60608. (312) 329-9292. Typical: \$89.70 per thousand; NT(10,000 up); stock.

Rubycon aluminum electrolytic nonpolar capacitors are designed for use in crossover-network circuits or other low ac circuits. They are available with single-end leads (Type NW) or axial leads (Type NT). Operating temperatures for these units range from -10 to 70 C. Capacitance tolerance is  $\pm 20\%$ . Values for Type NW and NT capacitors range from 0.47 to 100  $\mu\text{F}$ , and they are available in seven different voltage ratings—from 10 to 160 WV.

CIRCLE NO. 276

## Special switch shorts all except one contact

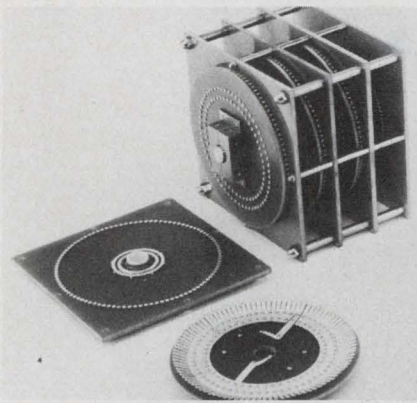

Langevin Precision Switches, 2030 Placentia Ave., Costa Mesa, Calif. 92627. (714) 642-8083.

In its paralleling form, all switch positions are shorted together except one. This selected position becomes isolated from the rest on the same deck. The paralleling switch can be used in multiple-circuit cable testing for both continuity and voltage breakdown. The switch can also be modified for notch or tab homing, binary coding and position selection for remote control. The switch is also available in a progressive-shortening form that connects a new contact to all preceding contacts, each time the switch is advanced. The progressively shorting decks can be used for paralleling capacitors in decade units and to vary capacitance values in multiple, fixed-frequency generators, receivers and transmitters.

CIRCLE NO. 277

## Keyboard switch provides form D contact

Cherry Electrical Products Corp., P.O. Box 718, Waukegan, Ill. 60085. (910) 235-1572. \$0.99 (2000 up).

A new keyboard switch has two sets of contacts, one SPST-NO and the other SPST-NC. When used exactly as supplied, the M62-0900 momentary-action keyboard switch is a form A plus a form B. When the switch button is depressed, it first causes the NO to close. When the button is pressed further, the NC opens. This is a make-before-break action. A Form D, or SPDT make-before-break, is obtained by the simple process of wiring the poles together.

CIRCLE NO. 278

## Power in the turns makes all the difference

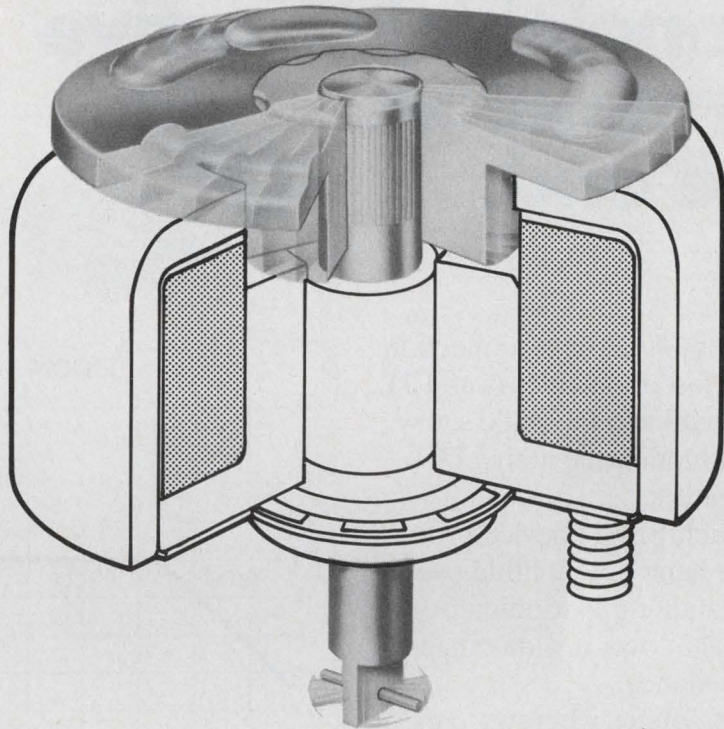

## in Ledex® Rotary Solenoids

You get all the power available when you apply a Ledex rotary solenoid to your turning application. The compact rugged design gives maximum power output with minimum weight and size.

You'll probably want high torque initially, or at the starting point of your turn. With Ledex it is available. Your design requirements can be matched to an existing broad range of solenoids, or specifically tailored for power where you want it.

Quality, to you, means longer life. Ledex solenoids provide dependable service, and a life of over 100,000,000 cycles is available for those who need it. When you are making professional decisions, specifying Ledex rotary solenoids, tubular solenoids, stepping switches, rotary switches and push button switches can make a dramatic difference.

Send now for our free catalog of specifications, types and sizes of rotary solenoids. It contains complete details on solenoid construction, torque and stroke, duty cycles and other specifications.

Toll free number for name of your nearest representative: 800-645-9200



**LEDEX INC.**  
123 Webster St.  
Dayton, Ohio 45401  
(513) 224-9891



# Announcing new low-cost monolithic ECL active terminators. The end.

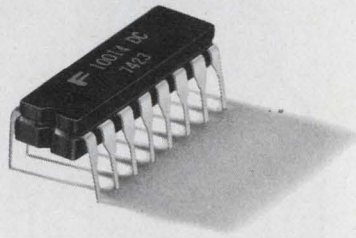

Now, ECL interconnection can be just about as easy as TTL.

Thanks to Fairchild's new F10014 monolithic active ECL terminators.

Each F10014 device provides a handy monolithic package containing 14 terminators—all useable over a wide range of impedance.

Of course, wherever carefully controlled impedances are maintained, matched passive resistor termination remains technically preferable.

But where they aren't, our inexpensive (7¢ per termination at the 100 quantity) F10014 active terminators can really come in handy.

## How Fairchild's remarkable new F10014 ECL active terminator works.

Looking at our F10014 characteristic curve you can see that the F10014 device exhibits a high impedance when the input signal is within normal ECL operating levels. But as soon as ringing or overshoot appear, the impedance drops.

And the voltages are clipped.

You can use the F10014 as the only termination. Or, in conjunction with passive termination as well.

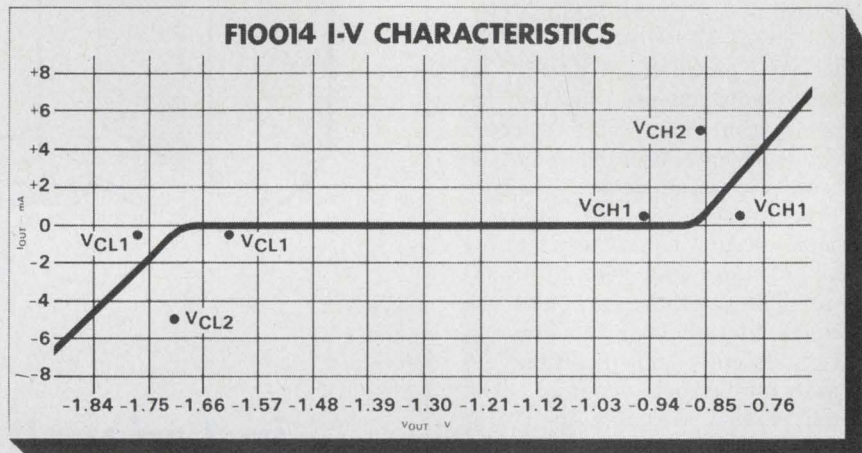

## Six key advantages.

Compared with diode clamps or conventional passive termination packages available, the new F10014 active terminator affords at least five or six worthwhile advantages.

1. The F10014 costs less per termination than other packages or diode clamps

(see cost comparison table).

2. It has self-contained reference voltages. No external components or -2V supply required.

3. The F10014 can reduce your total system cost. And it can help you save money in other ways. Like allowing you to use more wire-wrap interconnects.

4. It uses low power—about 7.0 mW per termination.

5. The F10014 reduces design time. It successfully terminates the varying impedances to be expected on wire-wrap boards used in prototyping or with design modifications.

6. The F10014 is compatible with all ECL families. It avoids heavy drain on ECL families not rated for driving resistive terminations.

## Comparative ECL Termination Costs.

Type	No. of Terminations	Price 100-999	Cost of Termination
Packaged Resistor Networks	10-12	0.74-2.25	.074-0.19
Clamping Diodes	1	1.00-2.00	1.00-2.00
F10014	14	.98	.07

INFORMATION RETRIEVAL NUMBER 79



## COMPONENTS

### Velocity transducer uses a PM core

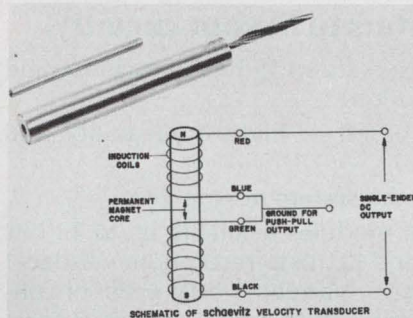

Schaevitz Engineering, U.S. Route 130 & Union Ave., Pennsauken, N.J. 08110. (609) 662-8000. \$78.50 to \$435.50; stock.

Schaevitz' new VT-Z Series of velocity transducers is electrical-ly and physically interchangeable with Hewlett Packard's LV Series. The units are of a permanent-magnet, self-generating type and require no excitation voltage or field calibration. The output voltage is linear to within 1.0% of full scale and directly proportional to the velocity of the movable core. The velocity transducers can be used for the measurement of acceleration by processing the velocity signal through a differentiator circuit.

CIRCLE NO. 279

### Chip and pellet caps suitable for microwaves



JFD Electronics Components Corp., 15th Ave. at 62nd St., Brooklyn, N.Y. 11219. (212) 331-1000.

Microwave, porcelain, ceramic, multilayer capacitors, called Micro-ceram have high Qs; high stability with temperature, voltage and frequency; have no aging or piezo-electric effects; are capable of withstanding severe environmental ambients; and they possess high-power and low-noise characteristics. The capacitors are suited for use in hybrid circuits. They are available in chip form 0.110 × 0.110 × 0.100-in. and pellet form 0.130 × 0.110 × 0.100 in., and in a variety of leaded configurations.

CIRCLE NO. 280

### Displays 32 characters from ASCII code



American Electronic Laboratories, P.O. Box 552, Lansdale, Pa. 19446. (215) 822-2929.

Alphanumeric LED display system, Model HMC 3093-32, is an ASCII compatible 32-character LED display with decimal points preceding each character. Complete display drive electronics and display data storage are included. The user need only provide parallel 6-bit ASCII data, data-load control, clock line and 5 and -12-V supply inputs. Three display modes are available. In the burst-display mode up to 32 characters are accepted in parallel code at speeds to 20,000 char/s and then displayed instantly following receipt of end-of-message signal. Internal refresh allows continuous display until new information is supplied. Start of a new message clears the old message in its entirety. The typewriter-display mode displays characters one by one as they are received, from left to right. Internal refresh is also provided. The walking-display mode displays characters one by one from right to left. As the 33rd character is entered the first entry is pushed out of the left end of the display.

CIRCLE NO. 281

### Thin-film trimmer pot in a TO-5 housing

Current Industries Inc., 3359 Ocean Ave., Oceanside, N.Y. 11572. (516) 678-3895.

A line of subminiature thin-film trimmer potentiometers in a TO-5 housing features a special glass-to-metal header whose polished surface serves as the substrate of a vacuum deposited film. The resistance of the film can be as high as 68 kΩ. A spring-loaded wiper arm ensures high stability and resolution. The power rating is 500 mW at 40 C.

CIRCLE NO. 282

### Where's the best place to use it?

Fairchild's intriguing new terminator is ideal for many applications. For example:

1. Economical PC board-to-board interconnect.
2. Fast, convenient intraboard design changes.
3. Breadboarding.
4. Extra "insurance." (At just pennies per termination, the F10014 makes excellent sense as a low-cost backup to conventional passive termination.)

### Where to get it.

The F10014 active terminator is now available in full production quantities.

The F10014 is just one of more than 40 Fairchild F10K ECL circuits available.

For complete design information, talk with your friendly Fairchild Distributor or Representative. Or write for your copy of our new ECL Designers Handbook today.

**MADE IN  
FAIRCHILD**

Semiconductor Components Group, Fairchild Camera & Instruments Corp., 464 Ellis St., Mountain View, CA 94040. Telephone (415) 962-5011. TWX: 910-379-6435.

INFORMATION RETRIEVAL NUMBER 80  
ELECTRONIC DESIGN 15, July 19, 1974

# Sophisticated systems need sophisticated converters

Perkin-Elmer will custom design Varidac<sup>®</sup> ac D/A converters to fit your circuitry.

- Custom converters up to 15 bits of accuracy and 18 bits of resolution.
- Transformer based — highest reliability and stability.
- Designed in the system perspective.
- Off-the-shelf modules available up to 13 bits of accuracy and 12 bits of resolution: Varidac-1 mini-converters, Varidac-2 dual channel converters for D/S systems, Varidac-4 computing resolvers, and complementary transformers.

Send for data sheets, and for a free laminated Binary/Angular Conversion Card. Perkin-Elmer Corporation, Electronic Products Dept., Main Avenue, Norwalk, CT 06856. (203) 762-4786.

**PERKIN-ELMER**



INFORMATION RETRIEVAL NUMBER 81

## MICROWAVES & LASERS

### Signal sources span 1 to 12 GHz

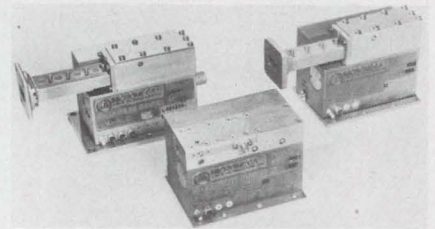

Micromega, 12575 Beatrice St., Los Angeles, Calif. 90066. (213) 391-7137.

A family of low-noise microwave signal sources, covering frequencies from 1 to 12.6 GHz, comes in both free-running and crystal-controlled models. Called the 28450 Series, the low-noise units feature a 22-cubic-inch package and stabilities of  $\pm .05\%$  (free-running oscillators) to  $\pm .0005\%$  (phase-locked sources with oven). Standard power levels are 10, 50 and 250 mW.

CIRCLE NO. 283

### Bandpass filters cover 1 to 16 GHz

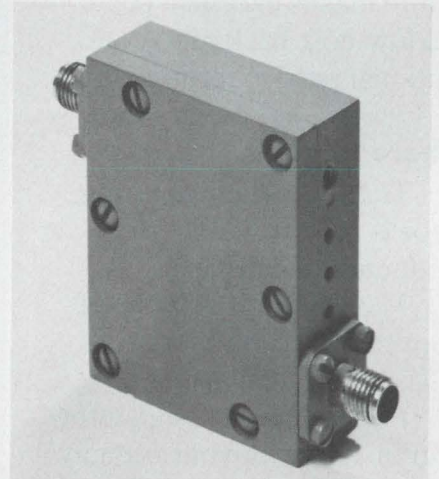

Microphase Corp., Box 1166, Greenwich, Conn. 06830. (203) 661-6200.

A line of octave-band, inter-digital bandpass filters, called the HI series, covers the 1-to-16-GHz frequency range. The largest model, the HI-312JJ for the 1-to-2-GHz band, has a passband insertion loss of 0.5 dB and a maximum VSWR of 1.4. The unit provides 60-dB minimum rejection at 0.75 and 2.30 GHz. It measures 0.5 x 2.23 x 2.46 in. and weighs 5 oz. Power rating for the series is 100 W average.

CIRCLE NO. 284

## new SWITCHING VOLTAGE REGULATORS

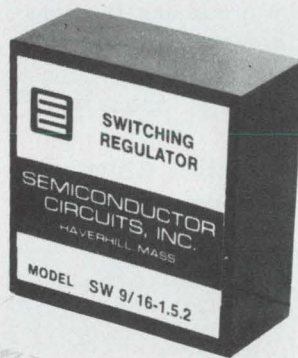

#### HIGH PERFORMANCE

High Efficiency ... to 90%  
MTBF > 100,000 hrs  
Low Case Temperature Rise ...  
< 10°C above ambient  
Load Regulation ... 0.1%

#### SMALL SIZE

2" x 2" x 7/8" Encapsulated Module

LOW COST From \$30<sup>95</sup> (1-9)

#### FOR USE IN

Point of Load Regulation  
High Efficiency Power Supply Designs  
Battery Powered Applications

1 or 2 Amp Models from 5 to 28 Vdc

Also Available: High Efficiency Power Supplies and Power Supply Kits

Our NEW 32 page catalog describes our full line of component module, PC card, open-frame, cased, and laboratory power supplies, DC/DC converters, DC/AC inverters, DC/DC isolators, switching regulators, and power kits.



SEMICONDUCTOR CIRCUITS, INC.

306 RIVER STREET ■ HAVERHILL, MASSACHUSETTS 01830  
(617) 373-9104

INFORMATION RETRIEVAL NUMBER 82

## 2-to-8-GHz oscillators output up to 10 W

Ailtech, 19535 W. Walnut Dr., City of Industry, Calif. 91748. (203) 965-4911.

Expanding its line of high-frequency power sources, the company now offers its 448 Series. The new units cover the 2-to-8-GHz frequency range, with output powers that reach 10 W. Units are fixed tuned to customer-selected frequencies.

CIRCLE NO. 285

## Combiner/divider line meets stringent tests



Waveline Inc., P.O. Box 718, West Caldwell, N.J. 07006 (201) 226-9100.

Designed for rugged satellite ground-terminal applications, the company's series of combiners/dividers consist of the following: the Model 91216, a 2:1 signal combiner; the 91197, a 4:1 combiner; and the 91150, a 16:1 combiner. The first two units operate from 5.9 to 6.5 GHz; the last operates from 3.7 to 4.2 GHz. All units feature a minimum isolation of 40 dB, while insertion loss varies from 3.5 to 13 dB.

CIRCLE NO. 286

## Isolators, circulators aim for land-mobile use

Western Microwave Lab., Inc., 1260 Birchwood Dr., Sunnyvale, Calif. 94086. (408) 734-1631. \$225 to \$240; stock.

Isolators (Model 2J-470-512) and circulators (Model 3J-470-512) are offered for the uhf land-mobile communications band of 470 to 512 MHz. The devices feature a minimum isolation of 21 dB, maximum insertion loss of 0.5 dB and maximum VSWR of 1.25. Input power rating is 350 W cw, and load rating for the isolator is 20 W cw.

CIRCLE NO. 287

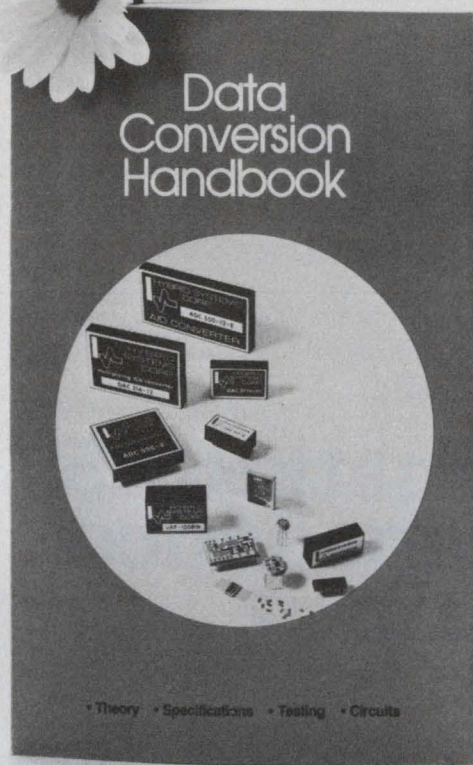

# The Book... From Hybrid Systems, Naturally.

This 176-page handbook is offered as a guide to design engineers and others who specify and/or buy electronics... and who are tired of groping their way through the muddle and mystique of data conversion.

It's readable... because it was written by practitioners rather than theoreticians, not to amaze but to inform. It defines the qualities, specifications and techniques that combine to give D/A and A/D converters their special character. It relates those considerations to specific areas of application.

Chapters include: DIGITAL-TO-ANALOG CONVERTERS  
• ANALOG-TO-DIGITAL CONVERTERS • SAMPLE/HOLDS  
• ANALOG MULTIPLEXERS • CODES.

Mail \$1.50 (for postage and handling) to:

87 Second Avenue, Burlington, Massachusetts 01803

**Hybrid Systems**  
CORPORATION

## Industrial klystron produces 50 kW cw

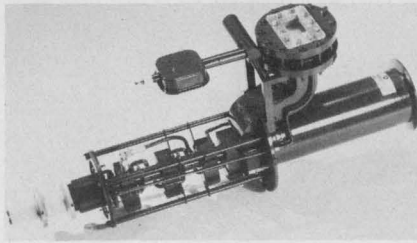

Thomson-CSF, Electron Tube Group, 8 rue Chasseloup-Laubat, 75737 Paris Cedex 15, France.

The Model TH 2054, 2450-MHz klystron generates up to 50 kW of cw power with an efficiency exceeding 60%. The klystron lists a gain of 49 dB, drive power of 700 mW and a beam rating of 25 kV and 3.2 A. A major use of the new klystron is expected to be in industrial materials-processing applications.

CIRCLE NO. 288

## Optical waveguide limits loss to 30 dB/km

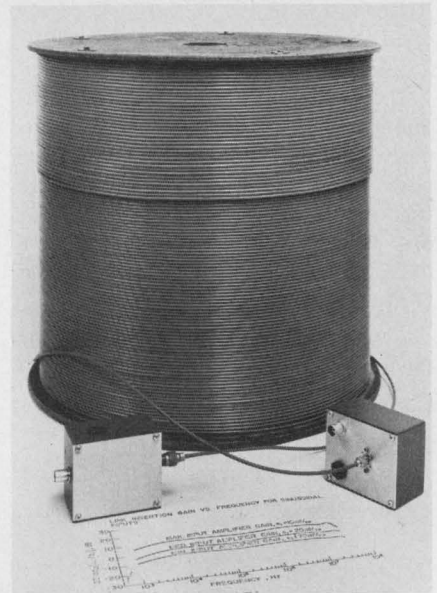

Corning Glass Works, Telecommunication Products Dept., Corning, N.Y. 14830. (607) 974-9000. P&A: See below.

Low-loss multimode optical waveguide bundles—Product #0790-B-19—and optical waveguide links—Product #0790-L-01—are available for prototype systems and related development work. The bundles have 30 dB/km maximum signal attenuation at a wavelength of 820 nm, and consist of 19 multimode step-index optical waveguides jacketed in polyvinylchloride.

The optical waveguide link consists of a 19-fiber bundle with an electrical-to-optical signal converter at one end and a reconversion unit at the other. Links are available in lengths up to a maximum of 500 meters.

Attenuation characteristics of the bundles are best at wavelengths between 800 and 900 nm, which correspond to available GaAlAs diodes, and at 1060 nm, which correspond to Nd:YAG lasers. With a typical numerical aperture of 0.14, the waveguide bundles accept incident light rays striking the waveguide fiber cores at angles of 8° or less.

Cost of bundle, also available in lengths up to 500 m, is \$57 per meter for orders under 5 km and \$28.50 per meter for orders of five or more kilometers; the minimum order is \$1000. The link costs \$1000 for the transmitter and receiver modules.

CIRCLE NO. 289

# Automatic 0.25% impedance measurement:



Our new Model 251 Digital Impedance Meter provides the most accurate measurements of inductance (L), resistance (R), capacitance (C), and conductance (G) available in any instrument up to five times the cost—plus it's fast and reliable.

Big, fat claims, right? But consider this: Accuracy of 0.25% + 1 digit, measurement speeds of a fraction of a second, high-intensity 3½-digit readout has overload blanking to prevent false readings, solid-state construction packed into a rugged 10-pound frame. And simple to operate.

You might consider this. Our reputation. We've led the building of precision impedance measur-

ing instruments for laboratory and quality control applications for 25 years.

Check us out, then call or write for the complete story. Ask about our discrete IC testers, too.

Electro Scientific Industries  
13900 N.W. Science Park Drive  
Portland, Oregon 97229  
Phone: (503) 646-4141

Openings: Product Manager, Application Engineers.

**\$990.**  
(U.S.A.)

**esi**  
ELECTRO SCIENTIFIC

### UV laser soars to 1 MW peak

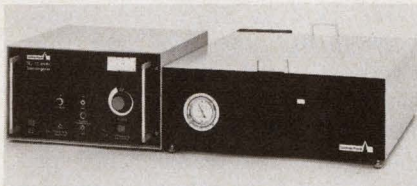

Lambda Physik GmbH & Co. KG, D-34 Goettingen, Am Schelhdorn 7, Germany.

The Model M100 UV pulsed gas laser offers a peak output of 1 MW at 337.1 nm. The nitrogen laser has a pulse halfwidth of 2.5 ns, beam dimensions of  $7 \times 15$  mm and repetition rates of 1 to 100 Hz. A dye-laser accessory, called the Model FL100, extends the laser's application range. With the accessory, a user can obtain a narrow linewidth nanosecond light source that can be tuned continuously from 235 to 800 nm.

CIRCLE NO. 290

### X-ray generator tests assembly lines

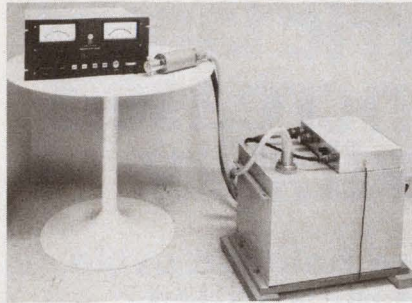

Analytical Development Associates Corp., 10300 Bubb Rd., Cupertino, Calif. 95014. (408) 255-6353.

The ADAC 100-kV constant-potential X-ray generator features solid-state electronics and computer-control interface for automatic operation. The generator produces both X-ray fluorescence and X-ray imagery to achieve nondestructive assembly-line testing of a variety of products. Other features include safety interlock and operating protection. The unit weighs less than 200 lbs.

CIRCLE NO. 291

### Components aid mm-wave designs

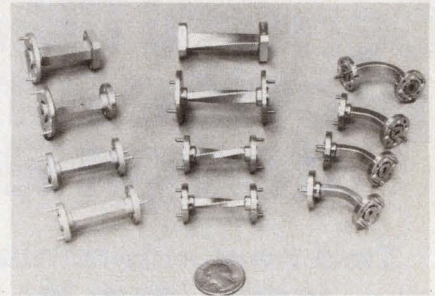

Electron Dynamics Div., 3100 W. Lomita Blvd., Torrance, Calif. 90501. (213) 534-2121. \$50 to \$175; 10 days.

Three series of waveguide components for the 26.5-to-110-GHz frequency range consists of E and H-plane bends, tapered transistions, and 45 and 90-degree twists. The E and H-plane bends are offered in 30, 45, 60, and 90-degree bend angles and in six standard waveguide sizes. Both the 45 and 90-degree twists are also available in six waveguide sizes.

CIRCLE NO. 292

GLENAIR

## SAV-CON CONNECTORS

Most electrical systems need connectors. But connectors can be a problem. Solution: Don't plug and unplug connectors, at least during the test and check out phase. Plug in a SAV-CON instead. SAV-CON interfaces between your test cable and unit connectors. Saves contact wear and tear on both. Do your connectors a favor. Plug in a SAV-CON.

GLENAIR Inc., 1211 Air Way, Glendale, California 91201. (213) 247-6000. TWX 910-497-2066. TELEX 67-3485.

Test cable connector

SAV-CON

Unit connector

One piece pin/socket contact design for maximum reliability.

# New and improved General Electric lamps provide for increased design flexibility.

## Two new sub-miniature halogen cycle lamps ideal for miniaturization.

These new T-2, 6.3V, 2.1 amps, 75 hour GE halogen cycle lamps are the smallest of their type (.265") and set industry standards for size and light output (16-20 candlepower). They are the perfect lamps for miniaturization of equipment such as reflectors, housings and optical systems, and they also save on overall cost of your equipment.

In addition, they are less than half the cost of the #1973 quartz lamp they replace. Two terminal configurations are available: #3026 (20 candlepower) has wire terminals; #3027 (16 candlepower) has a new two pin, ceramic base that plugs in to make installation and removal a snap.

These lamps have an iodine additive that creates a regenerative cycle that practically eliminates normal bulb blackening. They will produce approximately 95% light output at 75% of rated life.

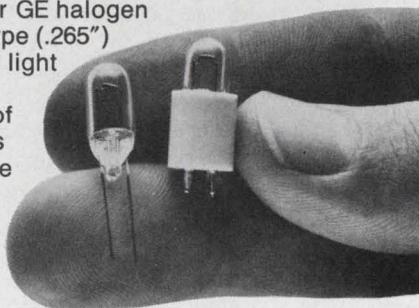

## An expanded line of Wedge Base Lamps for simple, low-cost circuitry.

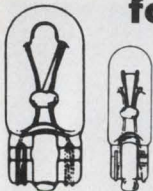

Now you can have greater design freedom than ever before with wedge base lamps. GE now offers six large lamps in its line of T-1 3/4 (.230" max.) all-glass, sub-miniature wedge base lamps. In addition to our three 14V lamps (#37, #73 and #74), we now also offer two 6.3V lamps (#84 and #86) and a 28V lamp (#85).

These lamps are ideal for applications where space is at a premium. Their wedge-based construction allows you to design for low-cost sockets and virtually ends corrosion problems because they won't freeze in the sockets. And the filament, which is always positioned in the same relation to the base, offers more uniform brightness.

## Green Glow Lamp has been improved over previous lamp.



Actual Size

Now our G2B Green Glow Lamp, the only domestic green lamp on the market today, gives a more uniform, purer green light than our previous model. It's bright enough for your circuit component applications. With appropriate current limiting resistors, it can be used for 120/240 volt green indicator service. Or used together with our high-brightness C2A red/orange/yellow glow lamps to emphasize multiple functions with color.

All GE glow lamps give the benefits of small size, rugged construction and low cost — 12¢ each for the G2B, 44¢ each for the C2A in 100,000 quantities.

## Send today for newest literature.

For the most up-to-date technical information on any or all of these lamps, write: General Electric, Miniature Lamp Products Department, #0747-L, Nela Park, Cleveland, Ohio 44112.

**GENERAL**  **ELECTRIC**

INFORMATION RETRIEVAL NUMBER 86

## MODULES & SUBASSEMBLIES

### Optical data transmitter and receiver fit TO-5

*Meret, 1815 24 St., Santa Monica, Calif. 90404. (213) 828-7496.*

Hybrid optoelectronic transmitters and receivers, Models MLT and MDA 425/325, work with off-the-shelf glass fiber cable. They provide data links capable of operation from dc to 70 Mbit/s at lengths greater than 20 meters. Both the transmitter and receiver sections consist of three-pin TO-5 header terminations. The transmitter (MLT300 series) combines a high speed, high efficiency IR-LED, designated as ML-35 and a TTL-compatible driver capable of producing high current pulses to 1 A with rise times less than 50 ns. The transmitter requires +5.5 V with a current drain at 50% duty cycle of 200 mA at maximum power output. Trigger signals are applied at the third pin. The MLT300 package is designed to allow direct detachable coupling to a ferrule terminated fiber cable from 1 to 3 mm in diameter with minimum loss of the radiated 850-to-900-nm signal. The receiver (MDA320) has power supply requirements of +5.5 to +15 V at a current drain of less than 6 mA. The single power supply provides bias for the p-i-n photodiode and the operating voltage for the transimpedance amplifier.

CIRCLE NO. 293

### Precision a/d converter delivers 12-bits fast

*Intech, 1220 Coleman Ave., Santa Clara, Calif. 95050. (408) 244-0500. \$5.50 (1 to 9); stock to 4 wk.*

The A-851 12-bit a/d converter has a total conversion time of less than 2.5  $\mu$ s. It uses successive-approximation and has a precision voltage reference which the company claims virtually eliminates errors due to power supply line and load variations. Gain and offset temperature coefficients are guaranteed to less than 20 ppm/°C. Linearity is specified to better than 1.2 LSB,  $\pm$ 120 ppm. The converter is housed in a 2 x 4 x 0.4 in. plug-in module.

CIRCLE NO. 294

# NOW!

## LINISTORS™

sensitive linear  
negative temperature  
coefficient thermistor  
assemblies

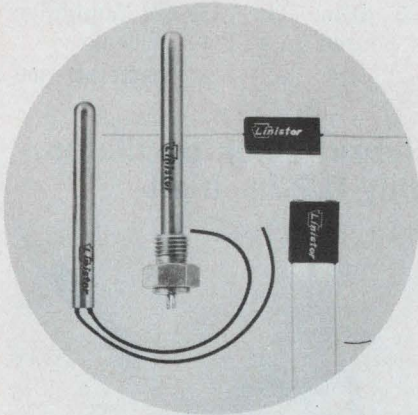

Linistor assemblies will provide you with an accurate straight line resistance/temperature plot from 0°C to 100°C.

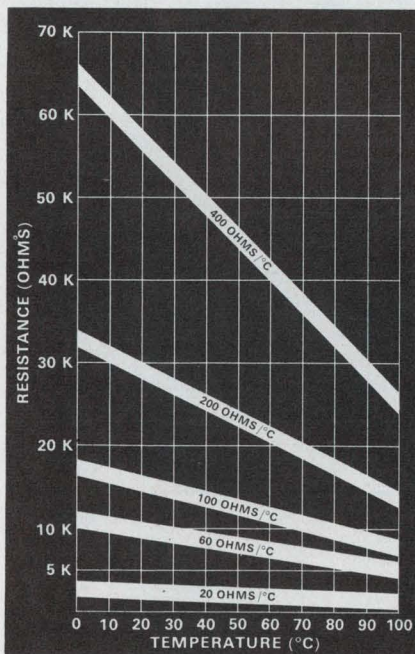

Linistors are ideal for temperature sensing and temperature compensating devices. They are now available in four standard enclosures to satisfy most design applications. Write for Data Bulletin L-601.

**Keystone**  
CARBON COMPANY

Thermistor Division  
St. Marys, Pa. 15857  
Phone 814/781-1591

INFORMATION RETRIEVAL NUMBER 87  
ELECTRONIC DESIGN 15, July 19, 1974

## Digital comparator can monitor data lines

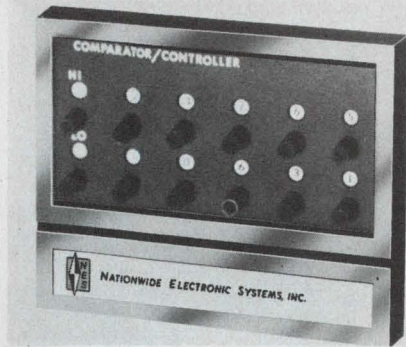

Nationwide Electronic Systems, 1536 Brandy Pkwy., Streamwood, Ill. 60103. (312) 289-8820. From \$122; 3 to 4 wk.

The Slimline digital comparator/controller automatically monitors BCD data from a digital instrument (voltmeter, counter, clock, thermometer, etc.). It provides a signal when the data exceed the limit preset on the comparator's switches. The small package (9/16 in. thick) is easy to mount on fixed panels or in portable equipment. Up to 100 comparator/controllers can be cascaded together for multiple preset operation. Both single and dual-limit models are available.

CIRCLE NO. 295

## Modular time delay units are accurate to 0.0016%

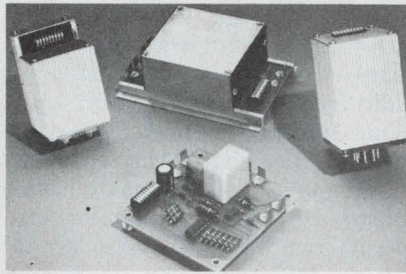

Essex International, 1601 Wall St., Fort Wayne, Ind. 46804. (219) 743-0311.

The 295 series of time delays is accurate to  $\pm 0.0016\%$ . They can be programmed from 1 to 511 s in 1-s intervals. The units use an integrated circuit to perform all the timing functions and a relay as an output device. The time delay modules handle input voltages from 12 to 240 V ac, 60 Hz. The output can have up to a 3pdt set of relay contacts with output-contact ratings of up to 10 A, 120 V ac, 1/3 hp. Three different packages are available—printed-circuit board, plug-in or panel mount.

CIRCLE NO. 296

## Terminate connection problems with Curtis terminal blocks

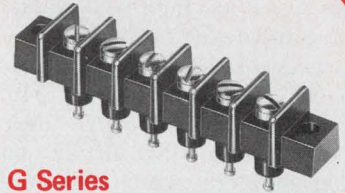

### G Series

Our popular 7/16" center barrier-type blocks are ideal for jobs demanding a variety of terminations at low cost. Tab, screw, clamp, PC pin, solder or taper pin terminals are available. Surface-connect and full feed-thru insulation models are also offered. Available in one thru 26 terminals. G Series feature precision-machined brass inserts, molded in place, for a full mechanical thread system. Rated 20 amps/300 volts.

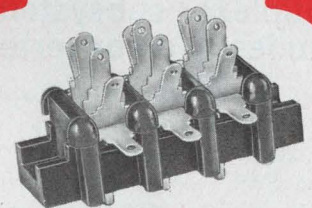

### E Series

Designed primarily for electronic control and low power circuit application, these 3/8" center inexpensive barrier-type blocks are available in one thru 22 terminals. Your choice of screw, clamp, two, four or six tab quick-connect, PC pin or solder terminals. Surface-connect and feed-thru models are offered. Rated up to 15 amps/300 volts.

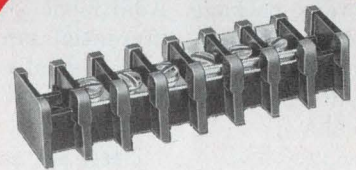

### SE Series

Several terminal variations coupled with miniature size make these 1/4" center blocks ideal for use in tight spaces where versatility must not be sacrificed. These barrier-type blocks are available in screw, clamp, two, four or six tab terminals. Surface-connect and full feed-thru insulation models are also offered. Available in one thru 26 terminals. Rated 5 amps/300 volts.

Send for free engineering catalog No. 1273.



**CURTIS**  
INDUSTRIES, INC.  
formerly Curtis Development & Mfg. Co.

3266 North 33rd Street, Milwaukee, Wisconsin 53216. Call (414) 445-1817 for the name of a representative or distributor near you. In Canada: A.C. Simmonds & Sons, Ltd., Willowdale, Ontario.

1680

INFORMATION RETRIEVAL NUMBER 88

### Dedicated analog divider has accuracy to 0.1%

Function Modules, 2441 Campus Dr., Irvine, Calif. 92664. (714) 833-8314. For 1 to 9 pcs: \$69 (J), \$89 (K), \$139 (L); stock to 2 wk.

The 540 Series of dedicated dividers uses an improved variable transconductance technique to achieve accuracies of  $\pm 0.5\%$  (Model 540J),  $\pm 0.25\%$  (Model 540K) and  $\pm 0.1\%$  (Model 540L) over a 100 to 1 divisor range. Unlike most analog dividers, which use multipliers connected in a feedback configuration, these generate a two-quadrant division function directly. The dividers are housed in  $1.5 \times 1.5 \times 0.4$  in. packages.

CIRCLE NO. 297

### Multiplexer subsystem includes a/d converter

Custer Research, P.O. Box 305, Fleetwood, Pa. 19522. (215) 376-2842. \$5630; 90 day.

The S5530 basic a/d multiplexer subsystem provides four single-ended analog channels. Each channel can handle a  $\pm 10$ -V signal. The internal converter delivers a 14-bit plus sign output, has a  $10 \mu\text{s}$  conversion time and 100 kHz throughput rate. The system is compatible with most Hewlett-Packard 2100 series operating systems. The S5530 also comes with a software package. Additional (up to 128) channels, differential sample-and-hold amplifiers and other special functions are optionally available.

CIRCLE NO. 298

### Two-way data sets hook up to ac power line

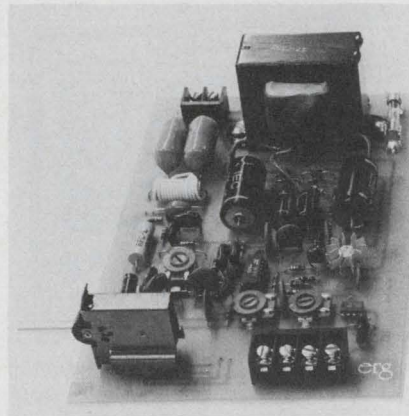

Electronics Research Group, 22 Mill St., Arlington, Mass. 02174. (617) 646-9760. \$109/pair; stock to 4 wk.

The ER-125 modular data transceivers wire directly to ac power lines. They transmit and receive digital (TTL) or analog data. An onboard switch determines the mode (transmission or reception) and LEDs monitor squelch presence. All transmission is FM on any of six carrier channels. Three inputs are available in the transmit mode: TTL, analog ( $\pm 1$  V max) and  $45 \Omega$  speaker. The receive mode allows three outputs: TTL, analog ( $\pm 5$  V range) and squelch. The analog output is buffered for a 200 mA load so that the same  $45 \Omega$  speaker can be used with the transmit/receive switch. Features of these modules include: audio frequency response to 7 kHz, signal limiting to prevent loss of phase locking and dc linearity better than 0.5% for the analog mode. Up to six carrier channels can operate two-way simultaneously in a large building.

CIRCLE NO. 299

### TO-8 housed rf amp delivers 14-dB gain

Optimax, P.O. Box 105, Advance Lane, Colmar, Pa. 18915. (215) 822-1311. \$85; stock.

A single stage, thick film, rf amplifier provides a gain of 14 dB at +15 V dc. It operates over a bandwidth of 10 to 500 MHz. The amplifier, designated AH-521, has a noise figure of 4.5 dB and its power output at 1-dB gain compression is +5 dBm. The AH-521 amplifier is housed in a TO-8 package.

CIRCLE NO. 300

### Hybrid clock oscillator only 0.2 in. high

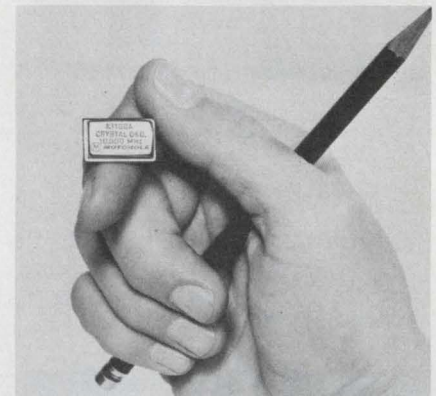

Motorola, Component Products, 2553 N. Edgington St., Franklin Park, Ill. 60131. (312) 451-1000.

Model K-1100A, hybrid clock oscillator, uses a crystal oscillator and thick-film hybrid processing. Factory adjusted frequencies from 250 kHz to 20 MHz are available. The oscillator has a frequency stability of  $\pm 0.01\%$  over 0-to-70-C temperature range. The oscillator package has a volume of only 0.083 in.<sup>3</sup> and is 0.2 in. high.

CIRCLE NO. 301

**AWA & LOG**

I WANT ANOTHER REMATCH. NEXT TIME I'LL USE AN A-860 TOO!

YOU'RE A POOR SPORT, LOG.

THAT'S RIGHT, LOG. THOSE NEW INTECH DACS ARE SUPERFAST.

ANALOGY  
ACE OUT THE COMPETITION WITH THE A-860 12-BIT DAC. YOUR SYSTEM WON'T NEED RIGGS FOR 100 NS CONVERSION SPEED AT 0.0125% LINEARITY. SETTLES TO THE BOTTOM LINE IN LESS TIME THAN HOWARD CAN SAY "WOMAN'S LIB."

**intech** INCORPORATED  
(408) 244-0500  
1220 COLEMAN, SANTA CLARA CA 95050



## Rf power module delivers 1.5 W at 20 dB gain

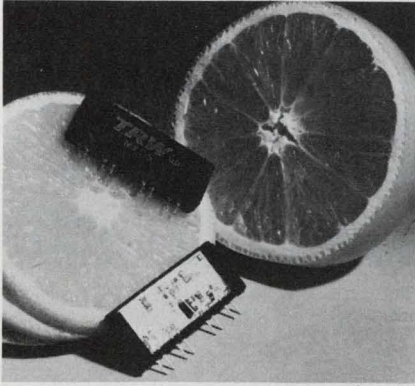

TRW, 14520 Aviation Blvd., Lawndale, Calif. 90260. \$41.75 (1 to 99); 6 to 8 wk.

The MX1.5 rf power modules are designed to operate from a 7.5 V battery supply. They provide 1.5 W at 20-dB gain with 50% efficiency. The units have full protection against overdrive and load VSWR. Harmonic outputs are more than 30 dB down. The modules are designed for operation in the 400-to-512-MHz range and have 50-Ω input and output impedances.

CIRCLE NO. 320

## CRT display generator makes 1, 2 or 3-D image

Optical Electronics, P.O. Box 11140, Tucson, Ariz. 85734. (602) 624-8358. From \$125 to \$3208; stock.

Model 6240 graphic display generator can produce static one, two and three-dimensional patterns and/or fixed graphic images. The 6240 uses one, two or three analog voltage inputs to address the various memory cells. Each cell consists of an external resistance element which is used to program the analog contents. The resistance may be a fixed resistor, potentiometer or FET. The user can change the memory contents as necessary although the intended application is for a nonchanging fixed background display. Some of the display generator's specs include  $\pm 10$  V analog video output voltage range, 1  $\mu$ s memory cell address time, 5  $\mu$ s minimum total memory scan time, -3 to +3 analog address voltage input,  $\pm 15$  V power supplies, minimum memory size of four cells and a maximum size of 262,144 cells.

CIRCLE NO. 321

*New*

## MICRO-VECTORBORD AND D.I.P. PLUGBORDS ARE HERE!

Save time — Save work — Save money

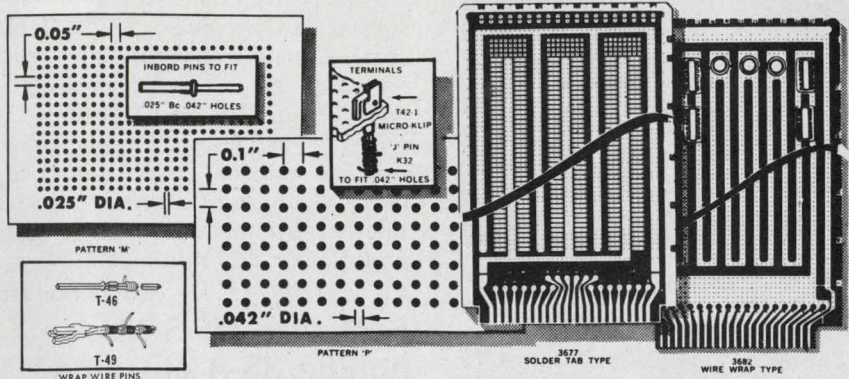

### WIDE SELECTION OF SIZES AND MATERIALS

**MICRO-VECTORBORD "P"** .042" holes match D.I.P. leads. Epoxy glass or paper, cop. cld. also 1/64" to 1/16" thk.

**MICRO-VECTORBORD "M"** .025" holes match Flat-Paks, 1/32" Epoxy glass, cop. cld. also or .007" Mylar.

**NEW SOLDER-PAD D.I.P. PLUGBORDS** — 3677 Series Epoxy glass, "P" pat., 1/16" thick with 44 etched plug contacts (2 side total) power, ground

busses, pads for up to 24 D.I.P.'s (14's). Also 21 units 16-leads D.I.P.'s, T-O's and discretes.

**NEW WRAP WIRE D.I.P. PLUGBORDS** — 3682 Series Similar to above but closely spaced bus lines for higher density. Up to 48-D.I.P. 14 lead wrap wire sockets mountable or T-O's and discretes.

**TERMINALS** — Micro-Klips, Mini-Wire-Wraps, Rd. Pins, Patch Cords, etc., available.

*Vector*

Visit our WESCON Booth 1014

**ELECTRONIC CO., INC.**

12460 Gladstone Ave., Sylmar, California 91342

Phone (213) 365-9661 • TWX (910) 496-1539



28-73-3

INFORMATION RETRIEVAL NUMBER 90

## Fight Brownouts with TOPAZ LINE REGULATORS

• No Distortion • Most Efficient

• Lowest Cost • Smallest Size



500 VA to 24 kVA

Priced from \$290.

### SPECIFICATIONS:

**Input:** 85 to 125V sine wave

**Output:** 117 V sine wave

**Operating Frequency:** 47 to 63 Hz

**Response:** Less than 1 cycle

**Efficiency:** 98%

**Audible Noise:** Typically 2 dB

**TOPAZ**  
ELECTRONICS

SOLUTIONS TO  
POWER PROBLEMS

3855 Ruffin Road, San Diego, CA 92123 Phone (714) 279-0831 TWX (910) 335-1526

INFORMATION RETRIEVAL NUMBER 91

### Schottky detector diodes operate up to 18 GHz



Aerotech Industries, 825 Stewart Dr., Sunnyvale, Calif. 94086. (408) 732-0880.

The A2S200 series units are zero bias, silicon Schottky detector diodes. They are designed for use as microwave detector diodes from 100 MHz to 18 GHz. This diode type performs well as compared with point contact, backward and standard biased type Schottky diodes and is optimized for tangential sensitivity and video resistance. Features include: No bias needed, typical  $T_{ss}$  of  $-59$  dBm and low I/f noise.

CIRCLE NO. 322

### Opto-isolators available in low cost packages

Monsanto, 3400 Hillview Ave., Palo Alto, Calif. 94304. (415) 493-3300. \$1.50 (1000-up); stock.

The MCT66 is a low-cost version of the company's MCT6 dual-channel phototransistor opto-isolator. Two 8-pin MCT66 packages fit into one standard 16-pin DIP socket. The two channels offer complete external isolation, and between channels of typically 2.5 kV. The current transfer ratio is 15% typical and 6% minimum.

CIRCLE NO. 323

### Fast turn-off SCRs handle 35-A currents

RCA, Box 3200, Somerville, N.J. 08876. (201) 722-3200. From \$4 (1000-up); stock.

Six 35 A, fast turn-off silicon controlled rectifiers (S7432 series) have 50, 100, 200, 300, 400 and 600-V repetitive peak reverse voltage ratings. Types 2N3654, 2N3655, 2N3656, 2N3657, 2N3658 and S7432M have a maximum turn-off time of 10  $\mu$ s.

CIRCLE NO. 324

### Stabistor diodes come in over 50 models

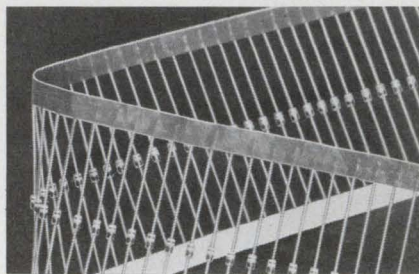

American Power Devices, 7 Andover St., Andover, Mass. 01810. (617) 475-4705. G129: From \$0.10 (25,000-up); 4 to 6 wk.

Fifty stabistor diode types are available in subminiature glass packages. These stabistors are diffused silicon diodes with controlled forward voltage characteristics. They have reference voltages from 0.56 to 3.7 V and are housed in DO-35 glass packages. Voltage tolerances are typically  $\pm 5\%$ . Stabistor families include 1N4156-7, 1N5179, 1N3896-98, 1N4829-30, 1N816, BZ102 series, BZX75C series, G129 series, ST22 series, STB series and APD200 series (replaces GE MPD series).

CIRCLE NO. 325

## An autoranging DMM for only \$299?

Yes. And it's a KEITHLEY—no less. The new Model 168 is a full-function DMM. It measures ac/dc volts, ac/dc amps and ohms too. Autoranging, optional battery operation, two-terminal input, push-button operation and lighted function indicators are only a few of its added features. Send for full details now.

1-year accuracy guarantee, too!

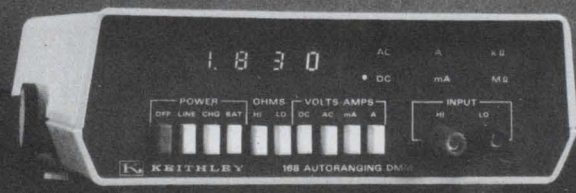

**KEITHLEY INSTRUMENTS**  
U.S.A.: 28775 AURORA ROAD, CLEVELAND, OHIO 44139  
EUROPE: 14, AVENUE VILLARDIN, 1009 PULLY, SUISSE

INFORMATION RETRIEVAL NUMBER 92

## Is the STATE-OF-THE-ART CREEPING UP on YOU?



The Center offers several informal programs for Engineers and Technicians who want to advance or keep abreast of the State-of-the-Art!

We have courses for you, or others in your organization; that will help bridge the gap from relays (or wherever you're at) to today's latest devices.

We have LOW COST "hands-on" learning programs which include: TTL, ECL and MOS, Digital I.C.'s, Transistors, Zeners, UJT's MOS/FET's & J/FET's... plus more.

## SEND FOR FREE CATALOG

or Call Gene Presta at 513/296-1020

Yes, I'm interested in learning about your programs!

Name \_\_\_\_\_

Street \_\_\_\_\_

City \_\_\_\_\_ State \_\_\_\_\_ Zip \_\_\_\_\_



Phone: 513/296-1020  
2876 CULVER AVENUE  
DAYTON, OHIO 45429

774ED

INFORMATION RETRIEVAL NUMBER 93

ELECTRONIC DESIGN 15, July 19, 1974

# Ten ways you get more from RCA's relay-protected VOM.

5. **Easy access** — Special compartment puts test leads and batteries at your fingertips.

4. **Extra durability** — High impact plastic case and glass epoxy circuit board.

3. **High accuracy** —  $\pm 2\%$  DCV,  $\pm 3\%$  ACV.

2. **High visibility** — Large 5½-inch mirrored meter.

1. **Full protection** — All functions, ranges, and meter are guarded by fast relay, renewable link fuse, and diodes.

For fast delivery and full information on the WV-532A, contact any one of the more than 1,000 RCA Distributors worldwide. Or, write: RCA Electronic Instrument Headquarters, Harrison, N.J. 07029.



6. **Overload indicator** — Lamp on meter face lights when relay is open.

7. **Battery condition indicator** — For overload protection circuit.

8. **Quick function identification** — Three-color-coded meter scale and panel.

9. **Three-to-one ranging** — Like VTVM.

10. **More economy** — Optional price: Only \$99.95.

Specialists demand the best tools of their trade.  
INFORMATION RETRIEVAL NUMBER 94

**RCA** Electronic Instruments

## TRANSDUCER KIT

### DP 15TL

Multiple Range  
Pressure Transducer Lab

AC OUTPUT ½% ACCURACY

Versatile rugged tool for laboratory applications—hydraulic research, pneumatic and control systems development

Accepts Corrosive Liquids and Gases, Both Sides.  
Interchangeable Diaphragms For the Ranges:  
 $\pm 1, \pm 5, \pm 20, \pm 75, \pm 250, \pm 1,000, \pm 3,000$  PSID  
Line Pressure to 3,000 PSI

Easy range changes  
in your laboratory...

operates with  
**CD 12**

TRANSDUCER INDICATOR

4 Digit Readout  
 $\pm 10$  VDC Output  
Selectable Frequency Response  
X10 Scale Expansion  
Short Circuit Proof.

Output: 0 to  $\pm 10$  VDC (10 ma into 1k ohm load).  
Output Impedance: 10 ohms nominal.

Compatible with all variable reluctance transducers



From Stock:  
CD 12 \$450.00



WRITE FOR CATALOG  
19414 Londelius Street  
Northridge, Calif. 91324  
Phone (213) 886-8488  
Telex 65-1303

## SWITCH TO CONTROL SWITCH

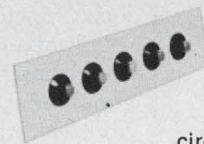

UNIFORM-PANEL  
APPEARANCE  
PUSHBUTTONS

They look alike even though they have different ratings, actions, and circuits!

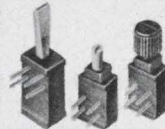

TWO-CIRCUIT MINIATURE  
PCB SWITCHES

Toggle or Push Button. No mounting hardware required! Ideal for sub-chassis check out.



TOGGLES

Hundreds of types in all configurations.

SEND FOR  
FREE  
TECHNICAL  
BULLETINS

PUSHBUTTONS  Circle #96 PCB SWITCHES  Circle #97 TOGGLES  Circle #98

**CONTROL SWITCH INC.**

A SUBSIDIARY OF CUTLER-HAMMER INC.  
1420 Delmar Drive • Folcroft, Pa. 19032 • (215) LU-6-7500

Representatives and Stocking Distributors Throughout the United States, Canada, and Europe



INFORMATION RETRIEVAL NUMBER 95

ELECTRONIC DESIGN 15, July 19, 1974

145

# GENERAL ELECTRIC'S 92F ADVANCED CAPABILITY COMPUTER-GRADE CAPACITOR...



Now! A highly reliable long life capacitor designed for applications requiring large amounts of ripple current at operating temperatures of 85 C and above. Ideal for power supplies, particularly the new switching mode types, energy storage and discharge, input filters for SCR power supplies . . . anywhere large amounts of ripple current are needed. Features include:

- 3,000 hour life rating at 85 C
- Ratings to maximum volt-microfarads per case size
- Capable of operating up to 125 C
- Standard screw-type terminal inserts

- Standard units available in 21 case sizes — over two hundred ratings

For more information on these, or any of General Electric's wide range of capacitors, call your nearest GE sales office today, or write Section 430-53, Schenectady, N. Y. 12345.

## MAKE SOMETHING OUT OF IT!

**GENERAL  ELECTRIC**

INFORMATION RETRIEVAL NUMBER 99

## new literature

The Industrial Buyer's Guide to Optical and Electronic Measuring Equipment



### Optical equipment

A 20-page illustrated buyers' guide features industrial microscopes such as measurescopes, polarizing microscopes, inspection and surface finish microscopes and dark field illuminators. Ehrenreich Photo-Optical Industries, Garden City, N.Y.

CIRCLE NO. 326

### Rf and i-f components

A 32-page catalog, "Rf and i-f Components, Circuits and Subsystems," includes sections on microwave mixers and modulators, mixer-preamplifiers, rf amplifiers, i-f amplifiers, rf sources, microwave cavities and subsystems. Varian, Beverly Div., Beverly, Mass.

CIRCLE NO. 327

### Cable-carrier system

A 32-page product bulletin covers the 82B cable-carrier system. The bulletin includes sections covering equipment identification, ordering information, installation procedures and maintenance. GTE Lenkurt, San Carlos, Calif.

CIRCLE NO. 328

### Torque fasteners

Prevailing-torque lock fasteners for general-purpose engineering assemblies are described in a six-page brochure. Elco Industries, Rockford, Ill.

CIRCLE NO. 329

### Power supplies

Descriptive material on standard off-the-shelf products, including military specification power modules, dc-to-ac inverters, OEM supplies, solid-state ac regulators, computer-application power units and related products, is contained in a four-page catalog. ERA Transpac, Moonachie, N.J.

CIRCLE NO. 330

### Hermetic connectors

Complete with dimensioned drawings, insert diagrams and lists of shell sizes and contact arrangements, a 14-page brochure describes a new family of ultra-high performance hermetic connectors. Gulton Industries, Buena Park, Calif.

CIRCLE NO. 331

### Copper

SSC-155, a new copper based metal, is detailed in a six-page bulletin. The bulletin presents data on strength, thermal and electrical conductivity, ductility and strength characteristics. Hussey Metals Div., Leetsdale, Pa.

CIRCLE NO. 332

### Pushbutton switches

The Series 90 switch light or indicator light units are described in a 16-page catalog. Master Specialties, Costa Mesa, Calif.

CIRCLE NO. 333

### Plastics guide

A desk-top leaflet, when opened, shows all of the major plastics families in terms of type, trade name, manufacturers, general characteristics and the standard shapes and sizes. Commercial Plastics & Supply, Cornwells Heights, Pa.

CIRCLE NO. 334

### Data-acquisition modules

A six-page brochure highlights DATAx, a line of data-acquisition system modules. Data Translation, Framingham, Mass.

CIRCLE NO. 335

# 1/32 of an ounce of prevention for your electronic circuits.

## MICROTEMP SAFETY THERMAL CUTOFFS\*

With a MICROTEMP installed on the winding of your motor or transformer, you'll get positive fail-safe protection without adding

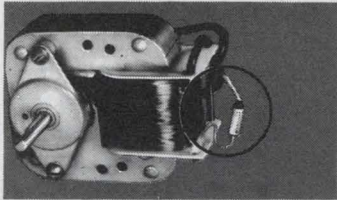

any appreciable weight or size. Facilitating transformer and motor compliance with many UL specifications, especially UL506, UL544, and UL547, MICROTEMP will sense excessive temperature and interrupt the power circuit

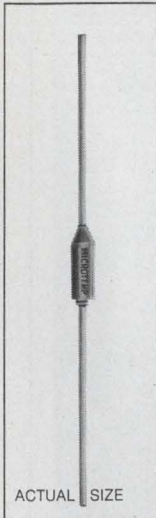

should a fault condition develop. An alternate means of protecting the transformer can be provided by a MICROTEMP which has a small heating element fitted to

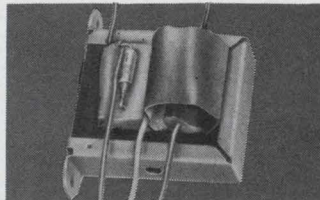

its case. This heating element is connected in series with the secondary coil winding and its load, transferring heat to the MICROTEMP with the flow of current. Should the current flowing through the element exceed normal operating levels, the resulting heat will cause the

MICROTEMP to open, thus also opening the primary or secondary coil winding to which it is connected. Reliable, inexpensive and accurate to  $\pm 3^\circ\text{F}$ , MICROTEMPS are available in ratings to fit your application. Add our little prevention to your product now!

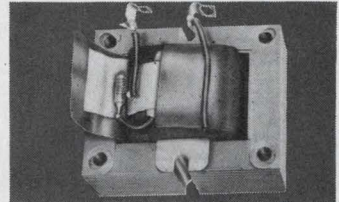

**MICRO DEVICES CORP.**  
1881 Southtown Blvd.  
Dayton, Ohio 45419  
(513) 294-0581

\* UL/CSA Recognized Component  
**MICRO DEVICES CORP.**

INFORMATION RETRIEVAL NUMBER 100

Millions already in use

**NEW KIT LETS YOU TRY IT**

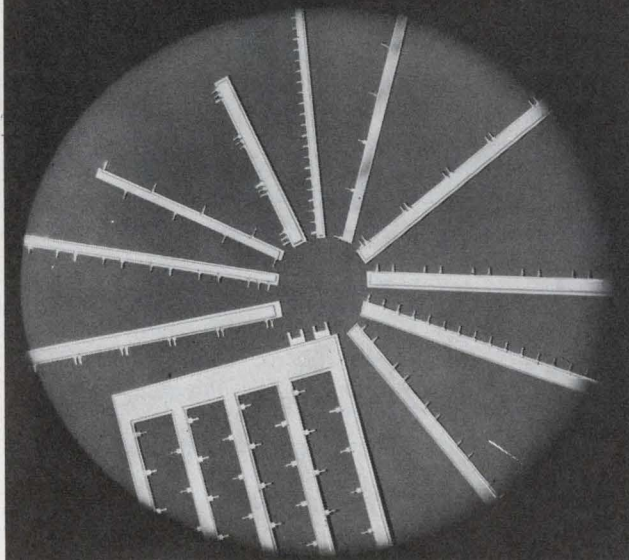

Evaluation kits @ \$25 in stock.  
Standard parts on 2 weeks delivery, or less!  
Custom parts 4 to 6 weeks delivery!

**MINI-BUS** The low-cost, noise attenuating, high packaging density, power distribution system for PC boards. Ask for data.



**Rogers Corporation / Chandler, Arizona 85224**  
West: (602) 963-4584 East: (203) 774-9605

INFORMATION RETRIEVAL NUMBER 101

ELECTRONIC DESIGN 15, July 19, 1974



\$395



\$445

Send today for your

**free**

brochure, price list and local stocking distributor list.



\$595

## **OmniScribe™** Strip Chart Recorders

Here are five versions of the **OmniScribe™** 10 inch strip chart recorder. They're just a sample of the more than a score of possible combinations of speeds, spans, accessories and other goodies designed into this beautiful little unit.



\$690

"YES! WE HAVE MOVED TO AUSTIN!"

**houston instrument**

**THE RECORDER COMPANY**

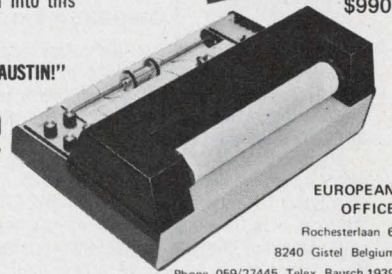

\$990

EUROPEAN OFFICE

Rochesterlaan 6  
8240 Gistel Belgium

Phone 059/27445 Telex Bausch 19399

ONE HOUSTON SQUARE (at 8500 Cameron Road) AUSTIN, TEXAS 78753  
(512) 837-2820 TWX 910-874-2022 cable HOINCO

INFORMATION RETRIEVAL NUMBER 102

147

**2-wire data modem**

An eight-page brochure describes the VA-3400—a modem which provides full duplex data transmission at 1200 bits per second on dial-up or two-wire leased lines. The Vadic Corp., Mountain View, Calif.

CIRCLE NO. 336

**Optical communications**

“Optical Communications: Their Present and Their Promise” is a brief, nontechnical overview of the technology of communicating on beams of light using glass optical waveguides. Corning Glass Works, Corning, N.Y.

CIRCLE NO. 337

**RFI/EMC products**

Instruments, components and accessories for the RFI/EMC engineer are described in a 38-page catalog. The catalog includes not only performance specs, but application notes with test setup diagrams and an EMI prediction graph for rectangular and trapezoidal pulse interference. Solar Electronics, Hollywood, Calif.

CIRCLE NO. 338

**CATV amplifiers**

CATV hybrid amplifiers and discrete transistors are described in an eight-page catalog. Photographs and dimensional drawings are presented. TRW Semiconductor, Lawndale, Calif.

CIRCLE NO. 339

**Gallium phosphide**

Photographs of single and polycrystalline gallium phosphide as well as the equipment used to produce it are shown in a six-page foldout. Image Analysing Computers, Monsey, N.Y.

CIRCLE NO. 340

**IC logic boards**

A 16-page catalog on standard and custom integrated circuit logic boards describes six standard series of 1/8-in. thick epoxy glass boards with wire-wrappable socket terminals. TRW/Cinch Connectors, Elk Grove Village, Ill.

CIRCLE NO. 341

**Three Cheers for  
FERRITES  
from the Permag Team**

- 1.** With Permag supplying application-rated Indiana General Corp. Ferramics, you'll always get exactly what you need.
- 2.** Complete fabricating facilities. Prototype quantities available. Plus engineering assistance, field testing.
- 3.** Prompt 24-hour delivery. Extensive stock of ferrite parts at all locations. New catalog available. Yea Team!

**FERRAMICS FROM PERMAG**  
Consult your Yellow Pages for address and telephone number of Permag near you.  
Cable Address: MAGNETS NEWYORK

YOUR NO. 1 SOURCE FOR ALL MAGNETIC MATERIALS

**PERMAG**

San Francisco    Los Angeles    Dallas    Boston    New York    Chicago    Toledo    Atlanta

ALL ACROSS THE COUNTRY

INFORMATION RETRIEVAL NUMBER 103

**NEW!**  
**CIRQTEL**

# CAN-CAN FILTERS

**2 MHz - 200 MHz**  
**Lowpass • Bandpass • Highpass**

Introducing our brand new line of rectangular “can” filters for PC board or chassis mounting. Most models are hermetically sealed and maintain super specs and performance—in the CIR-Q-TEL tradition.

Standardization is “our thing,” and these new “cans” complement our standard line of tubular filters from 500 Hz to 12.4 GHz. We also offer a standard line of magnetically shielded plug-in circulators/isolators for microstrip, stripline and other applications.

CALL COLLECT and talk to one of our applications/design engineers. We'll gladly discuss your needs and quote specs, prices and delivery dates by phone.

## CIRQTEL

10504 Wheatley Street  
Kensington, Maryland 20795  
(301) 946-1800

*Superior Products . . . by Design*

INFORMATION RETRIEVAL NUMBER 104

# bulletin board

A nationwide, direct dial "hot line" for information on liquid inert test media is now in operation, sponsored by 3M's Commercial Chemical division. Called ALERT (Assistance for Liquid Electronic Reliability Testing), the service functions as a clearinghouse for data on Fluorinert electronic liquids. The number is (612) 733-6282.

CIRCLE NO. 342

A phase-loss and phase-sequence sensor for use with auxiliary power generating systems, either portable or permanent—operating from 110 to 480 V—has been introduced by Logitek.

CIRCLE NO. 343

Engineering Index has introduced a computer-readable data base, COMPENDEX, through on-line access. COMPENDEX provides abstracts/bibliographic citations, covering worldwide developments in all fields of engineering.

CIRCLE NO. 344

Current capabilities of 300 mA per driver and output voltages of up to 40 V are provided by the series SG55450B/75450B and SG-55460/75460 high-speed dual-peripheral-driver ICs available from Silicon General.

CIRCLE NO. 345

Interactive time-sharing software is available at Remote Computing Corp. for generating plots on either the CalComp 910-1136 drum plotter at the company's data center or any Zeta terminal-connected plotter at a user's location.

CIRCLE NO. 346

HP-developed software now enables users to convert and run existing IBM 1130 Fortran programs directly on the multiterminal Hewlett-Packard 3000 series computers. Conversion of an 1130 Fortran program can be completed in a matter of minutes, according to HP. The software is also useful in converting IBM 1800 Fortran programs.

CIRCLE NO. 347

# TEKELEC, INC. TA



## Call Crystal

Toll Free at (800) 423-5163\*  
for your FREE 15-day trial.

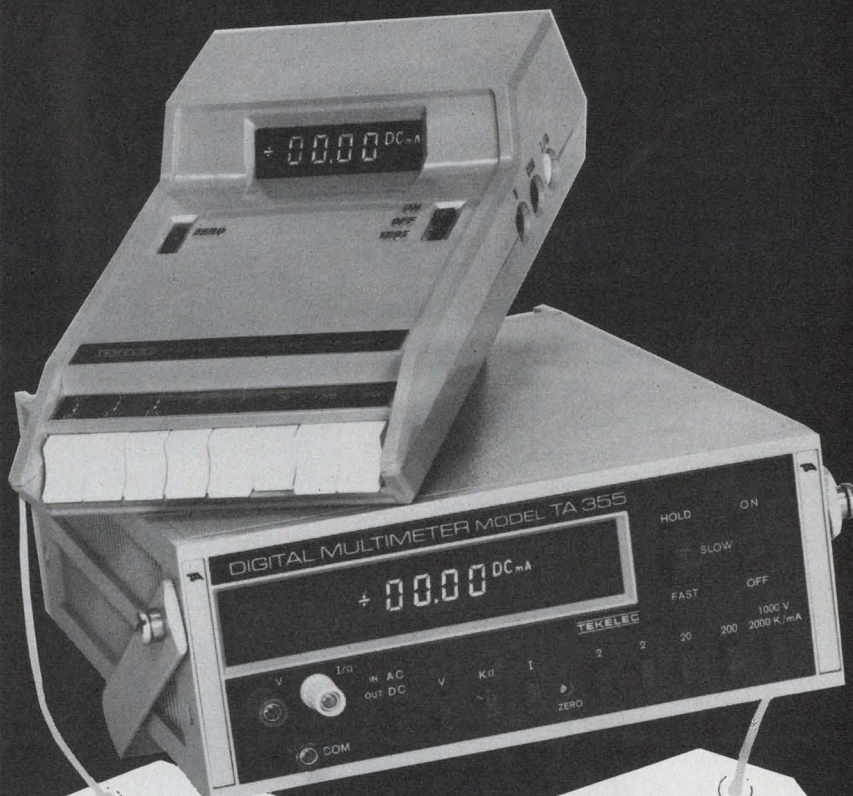

TA356  
DIGITAL MULTIMETER  
**\$289.00**  
Nicad Battery Pack  
and Charger Standard  
25 Ranges  
5 Functions  
3-1/2 Digits

Sensitivity:  
100  $\mu$ V AC & DC  
100 nA  
4" Extra Long Life Field Effect Liquid Crystal Display  
"Touch 'N Hold" Probe Optional  
Illuminated Function Indicators  
LSI Circuits  
Pushbutton Operation

TA355  
DIGITAL MULTIMETER  
**\$289.00**  
25 Ranges  
5 Functions

3 1/2 Digits  
Sensitivity:  
100  $\mu$ V AC & DC  
.1  $\Omega$   
100 nA  
"Touch 'N Hold" Probe Optional  
Dual Reading Rate  
Pushbutton Operation  
Illuminated Function Indicators  
4" Extra Long Life Field Effect Liquid Crystal Display

31829 W. LA TIENDA DR., WESTLAKE VILLAGE, CALIFORNIA 91361

\* In California, Call Collect: (213) 889-2834 TWX: 910-494-1910

# CUT



# Electronic Design's



# DOWN YOUR DETECTIVE WORK

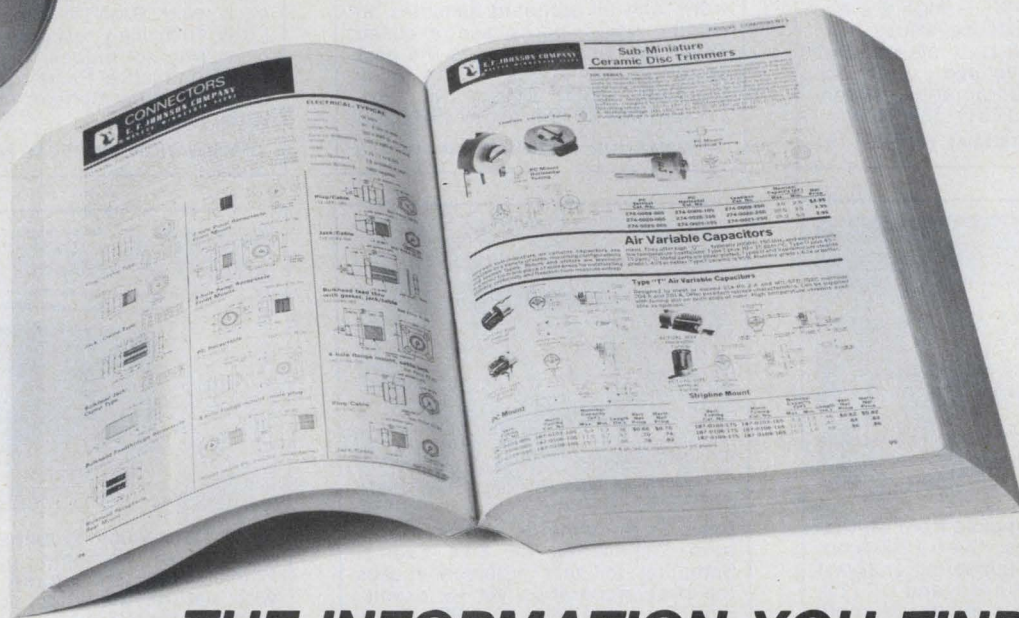

**THE INFORMATION YOU FIND HERE  
WILL SAVE YOU TIME AND MONEY**

When you see *Electronic Design's* GOLD BOOK you'll wonder how you ever got along without it. You don't have to be a super-sleuth to find out who makes what or where to find it.

For example, there are over 500 pages on Semiconductors; almost 300 pages on Power Supplies; 300 catalog pages on instruments; 150 pages on Switches—approx. 3,500 pages of directory data and technical material in all.

And the Directories — they're the most complete and comprehensive, the most thorough and useful reference sources ever compiled. Almost 7,500 manufacturers are listed with *complete* address, zip and phone. In most cases (where applicable) you also get 800 (toll-free) numbers, Telex, TWX, cable address, facsimile equipment with make and number, plus QPL and FSC designations, financial data and names of key officers.

5,700 distributors are listed — with both alphabetic and geographic access — in the *Distributors Directory*.

See how often *Electronic Design's* GOLD BOOK will answer your questions before you even pick up the phone. Keep the manufacturer's tech pages in front of you when you call — it can speed the discussion and help you communicate your needs quickly and easily.

# GOLD BOOK

COMING JULY, 1974

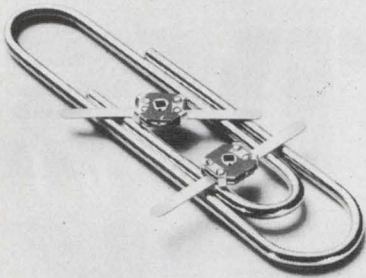

**Thin-Trim** variable capacitors provide a reliable means of adjusting capacitance without abrasive trimming or interchange of fixed capacitors. Series 9401 has high Q's and a range of capacitance values from 0.2-0.6 pf to 3.0-12.0 pf and 250 WVDC working voltage. Johanson Manufacturing Corporation, Boonton, New Jersey (201) 334-2676.

INFORMATION RETRIEVAL NUMBER 181



**Complete minicomputer** mag tape systems for the PDP-8, PDP-11, and NOVA feature IBM compatibility with low price. Three reel sizes to choose from, and all standard densities, including 1600 bpi phase encoded. These systems incorporate the best-designed transports built today. Digi-Data, 8580 Dorsey Run Rd., Jessup, MD 20794, (301) 498-0200.

INFORMATION RETRIEVAL NUMBER 182

## FREE 10 Ways To Use Conductive Paints



Our electrically conductive paints are solving "impossible" lab problems and reducing unit production costs. One customer saves a fortune each year PAINTING on four MILLION 1000 meg resistors. Think that over. Why not request "Ten Ways To Use Conductive Paints"? Micro Circuits Co., New Buffalo, Mich. 49117. (616) 469 2727.

INFORMATION RETRIEVAL NUMBER 183

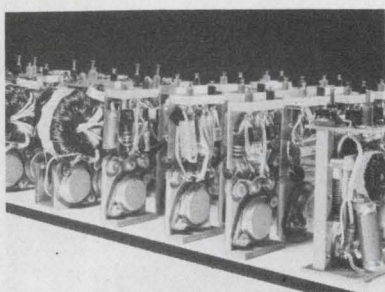

**Custom Power Supplies** from off-the-shelf sub-modules. Over 1200 configurations. No engineering charges! AC (115VAC, 50-500Hz) and DC (12, 28, 48 & 115VDC) inputs. Multiple isolated and regulated (to .1%) DC outputs. 1-500 Watts. Miniaturized. Efficiencies to 85%. Arnold Magnetics, Culver City, Ca. (213) 870-7014.

INFORMATION RETRIEVAL NUMBER 184



**Basic Engineering Sciences & Structural Engineering** for E-I-T Exams. Sampling for test problems makes the best preparation yet for exams. #5712-1, 424 pp., \$14.95. Circle the Info Retrieval No. to order 15-day exam copy. When billed, remit or return book with no obligation. HAYDEN BOOK CO., 50 Essex St., Rochelle Pk., N.J. 07662

INFORMATION RETRIEVAL NUMBER 185

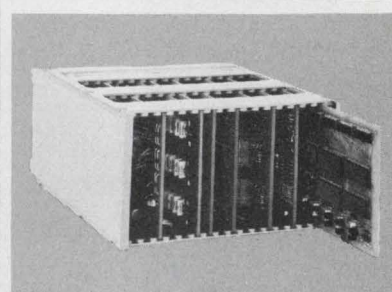

**Solid-State Voice Systems** for audio readout of numbers and words. Whole-words are stored in ROMs with natural sounding voice reproduction. Standard models offer 10 numeric words (0 - 9). Master Specialties, 1640 Monrovia, Costa Mesa, Calif. 92627. (714) 642-2427.

INFORMATION RETRIEVAL NUMBER 186

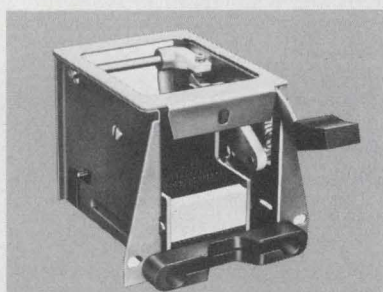

**AMP Capatron** offers a complete line of quality data entry products. From card reader/scanners to matrix badge readers. From tab and credit to magnetic and embossed card readers. All that makes it virtually certain we have what you need. AMP Incorporated, Capatron Division, Elizabethtown, Pa. 17022. (717) 367-1105.

INFORMATION RETRIEVAL NUMBER 187

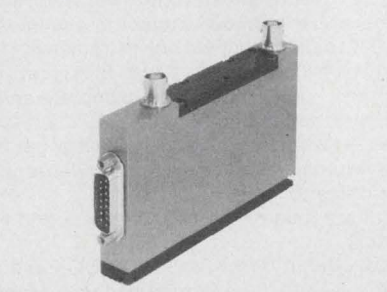

**Programmable Coaxial Attenuator**  
0 - 63.5 db Attenuation Range . . .  
.5 db Steps . . . DC thru 200 MHz  
. . . Seven Bit Binary Control . . .  
±2% Accuracy . . . Machined Aluminum Housing . . . MATRIX SYSTEMS CORPORATION . . . (213) 882-2008

INFORMATION RETRIEVAL NUMBER 188

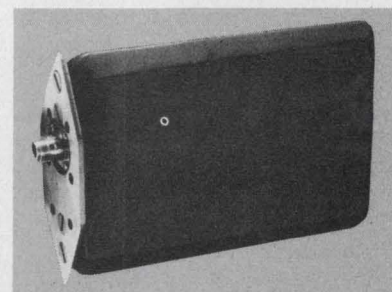

"VLF to HF ACTIVE AIRBORNE ANTENNA provides highly efficient reception for Omega, Loran C and Communication applications. Operating frequency is 10 KHz to 30 MHz with a 50 ohm constant output impedance." BAYSHORE SYSTEMS, Springfield, Va.

INFORMATION RETRIEVAL NUMBER 189

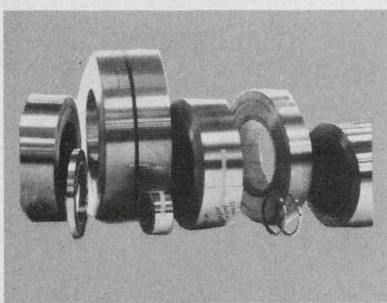

**SPECIALTY METALS HEADACHES? WE HAVE THE SOLUTIONS!** Come to Magnetics for fast action on high quality magnetic, electronic, expansion or custom alloys. Complete, integrated facilities include vacuum or air melting; powder metallurgy; hot or cold rolling; precision flattening, slitting, annealing etc. Magnetics, Butler Pa. 16001.

INFORMATION RETRIEVAL NUMBER 190

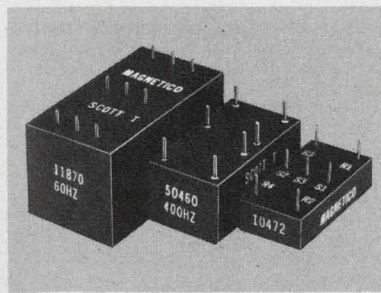

**Scott T Transformer.** 11870: 60HZ, 90v, L-L In. 1.1x2.1x1.1. 50460: 400HZ, 90v, L-L In. 7/8x1-5/8 x11/16. 50642: 400HZ, 11.8v, L-L In. 7/8x1-5/8x11/16. 10472: 400-HZ, 11.8v, L-L In. 3/4x1-1/2x3/8. All with 6v RMS sine & cosine output. MAGNETICO, INC., E. Northport, N.Y. 11731. 516-261-4502.

INFORMATION RETRIEVAL NUMBER 191



**A 10 MHz Frequency Synthesizer** with prices starting at only \$511.00. Options include low distortion sine wave output, range extension to 16 MHz, BCD external control and a high stability master oscillator for very accurate frequency control. SYNTEST CORP., 169 Millham Street, Marlboro, Mass. 01752 617-481-7827

INFORMATION RETRIEVAL NUMBER 192

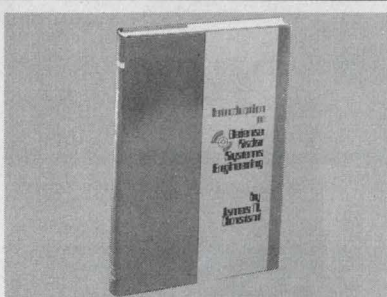

**INTRODUCTION TO DEFENSE RADAR SYSTEMS ENGINEERING.** Excellent introduction and practical reference to radar systems design and applications. #9194, 260 pp., \$20.00. Circle the Info Retrieval No. to order 15-day exam copy. When billed, remit or return book with no obligation. HAYDEN BOOK CO. 50 Essex St. Rochelle Park, N.J. 07662

INFORMATION RETRIEVAL NUMBER 193

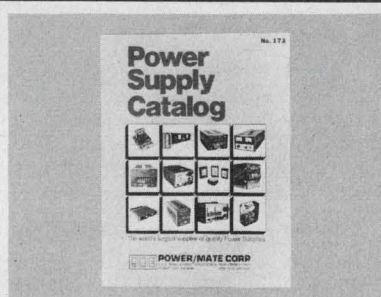

**Free catalog of 34,500 power supplies** from the worlds largest manufacturer of quality Power Supplies. New '74 catalog covers over 34,500 D.C. Power Supplies for every application. All units are UL approved, and meet most military and commercial specs for industrial and computer uses. Power Mate Corp. (201) 343-6294.

INFORMATION RETRIEVAL NUMBER 194

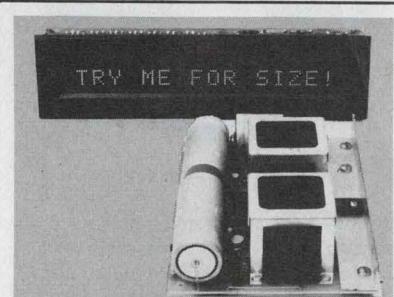

**POWER SUPPLY FOR SELF-SCAN USERS.** The 9760-PS . . . a compact, low cost, multiple-output power supply that is specially designed for use with Burroughs Self-Scan® display units. Will support 16 or 32 character displays plus additional T<sup>2</sup>L and MOS circuitry. TEXAS DIGITAL SYS. Bryan, Texas (713) 822-5446

INFORMATION RETRIEVAL NUMBER 195

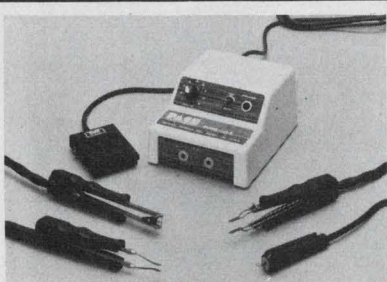

**Hot Shots: StripTweez, ResisTweez, ConductTweez, LapFlo—4** separate tools that plug into one power supply. For soldering, unsoldering, lap flow soldering, wire stripping, conformal coating removal, repairing broken circuit runs, unclenching leads, releasing sweat joints, etc. Pace, Inc., 9329 Fraser Street, Silver Spring, MD 20910. (301) 587-1696.

INFORMATION RETRIEVAL NUMBER 196



**MOS, Varactor and Other Junction Capacitance** measurements at applied voltage bias are made easy with the programmable source built in the 1 MHz Model 863 Capacitance Meter. 1, 10, 100 and 1000 picofarad ranges, 15 mV RMS test signal with 0.5% accuracy and digital readout. MSI Electronics Inc., 34-32 57th St., Woodside, NY 11377 (212) 672-6500

INFORMATION RETRIEVAL NUMBER 197

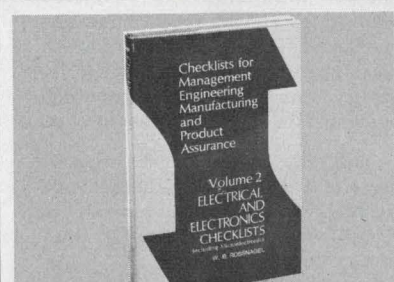

**ELECTRICAL/ELECTRONICS CHECKLISTS.** 22 detailed checklists to insure complete accuracy and efficiency for a broad array of designs. #9181, 190 pp., \$14.00. Circle the Info Retrieval No. to order 15-day exam copy. When billed, remit or return book with no obligation. HAYDEN BOOK CO. 50 Essex St., Rochelle Pk., N.J. 07660.

INFORMATION RETRIEVAL NUMBER 198

**We weigh  
the odds  
against  
your  
electronics.**



Whether it's a whole system or a single component . . . whether it's intended for commercial, military or industrial use . . . the odds are heavy against its long life. Associated can help "tilt the scales" in your favor by catching defects early to help protect your product against field and production failures.

Making sure that your product works and stays working has been Associated's business for sixteen years as one of the industries' leading test labs. Testing capabilities include qualification, reliability, burn-in, component screening, evaluation, failure analysis, environmental simulation and dynamics testing for shock, acceleration and vibration. Testing is performed to your specs, military specs or to industry standards. Where required, we can establish a program for you.

The product you develop is only as effective as the evaluation and reliability planning that go into it. Let Associated make sure the odds are in its favor:

**ASSOCIATED  
TESTING  
LABORATORIES  
INC.**

Northwest Industrial Park,  
Burlington, Mass. 01803, (617) 272-9050

9 Brighton Road, Clifton, N.J. 07012,  
(201) 473-6455

INFORMATION RETRIEVAL NUMBER 106

## Electronic Design

ELECTRONIC DESIGN's function is:

- To aid progress in the electronics manufacturing industry by promoting good design.
- To give the electronic design engineer concepts and ideas that make his job easier and more productive.
- To provide a central source of timely electronics information.
- To promote communication among members of the electronics engineering community.

**Want a subscription?** ELECTRONIC DESIGN is sent free to qualified engineers and engineering managers doing design work, supervising design or setting standards in the United States and Western Europe. For a free subscription, use the application form bound in the magazine. If none is included, write to us direct for an application form.

If you do not qualify, you may take out a paid subscription for \$30 a year in the U.S.A., \$40 a year elsewhere. Single copies are \$1.50 each.

**If you change your address,** send us an old mailing label and your new address; there is generally a postcard for this bound in the magazine. You will have to requalify to continue receiving ELECTRONIC DESIGN free.

**The accuracy policy of ELECTRONIC DESIGN is:**

- To make diligent efforts to ensure the accuracy of editorial matter.
- To publish prompt corrections whenever inaccuracies are brought to our attention. Corrections appear in "Across the Desk."
- To encourage our readers as responsible members of our business community to report to us misleading or fraudulent advertising.
- To refuse any advertisement deemed to be misleading or fraudulent.

Microfilm copies are available of complete volumes of ELECTRONIC DESIGN at \$19 per volume, beginning with Volume 1, 1961 through Volume 20. Reprints of individual articles may be obtained for \$2.00 each, prepaid (\$.50 for each additional copy of the same article) no matter how long the article. For further details and to place orders, contact the Customer Services Department, University Microfilms, 300 North Zeeb Road, Ann Arbor, Michigan 48106 telephone (313) 761-4700.

**Want to contact us?** If you have any comments or wish to submit a manuscript or article outline, address your correspondence to:

Editor  
ELECTRONIC DESIGN  
50 Essex Street  
Rochelle Park, N.J. 07662

## PIEZOELECTRIC TUNING FORK

**LOW PRICE  
HIGH RELIABILITY**

TYPE : TFQ 697.5Hz~1492.5Hz

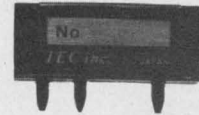

20<sup>L</sup> × 8.0<sup>H</sup> × 6.5<sup>W</sup> mm

TYPE : TFA 712.5Hz~1500Hz

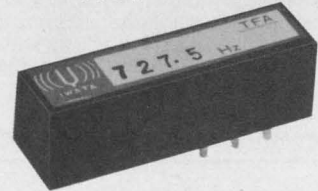

33<sup>L</sup> × 10<sup>H</sup> × 9<sup>W</sup> mm



IWATA ELECTRIC CO., LTD.

Mansei Bldg. Rm. 36 1-16, 1-Chome  
Soto-Kanda, Chiyoda-ku, Tokyo 101, Japan

INFORMATION RETRIEVAL NUMBER 107

## BROADBAND 50-75 ohms

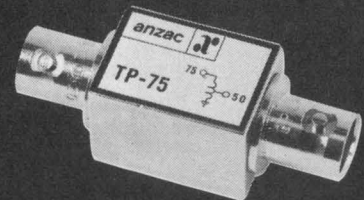

## TRANSFORMER

MODEL TP-75

- 2-200 MHz Frequency Range
- 0.25dB Insertion Loss
- 1.1:1 VSWR
- \$55/Stock Availability

**anzac**  
ELECTRONICS



39 Green Street, Waltham, Mass.

(617) 899-1900 ● TWX 710-324-6484

INFORMATION RETRIEVAL NUMBER 108

ELECTRONIC DESIGN 15, July 19, 1974

# Electronic Design

## Advertising Sales Staff

Tom W. Carr  
Vice President &  
Sales Manager

## Rochelle Park, N.J. 07662

Robert W. Gascoigne  
Daniel J. Rowland

(Recruitment, Quick Ads, Classified)

50 Essex Street  
(201) 843-0550  
TWX: 710-990-5071

## Philadelphia

Thomas P. Barth  
50 Essex Street  
Rochelle Park, N.J. 07662  
(201) 843-0550

## Boston 02178

Gene Pritchard  
P.O. Box 379  
Belmont, Mass. 02178  
(617) 489-2340

## Chicago 60611

Thomas P. Kavooras  
Berry Conner, Jr.  
200 East Ontario  
(312) 337-0588

## Cleveland

Thomas P. Kavooras  
(Chicago)  
(312) 337-0588  
(call collect)

## Los Angeles 90303

Stanley I. Ehrenclou  
Burt Underwood  
2930 Imperial Highway  
Inglewood, Calif.  
(213) 757-0183

## San Francisco 94022

Jerry D. Latta  
P.O. Box 1248  
Los Altos, Calif.  
(415) 965-2636

## London

For United Kingdom and Europe

John Ashcraft  
John Ashcraft & Co.  
12, Bear St.  
Leicester Square  
London WC2H 7AS England  
Phone: 01-930-0525  
W. J. M. Sanders  
John Ashcraft & Co.  
Herengracht 365  
Amsterdam C., Holland  
Phone: 020-24-09-08

## Tokyo

Haruki Hirayama  
Electronic Media Service  
5th Floor, Lila Bldg..  
4-9-8 Roppong  
Minato-ku  
Phone: 402-4556  
Cable: Electronicmedia, Tokyo

# EBR

## EPOXY BRIDGE RECTIFIERS

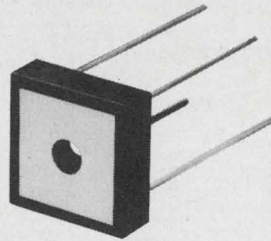
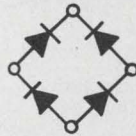

10 AMP

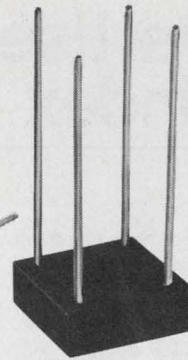

2 & 6 AMP

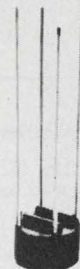

1 AMP

**Economical**  
**Reliable**  
**Easy to mount**

Controlled avalanche series with 250 V, 450 V, 650 V, and 850 V min. ( $V_{BR}$ ). Fast recovery series with 200 nsec. ( $t_{rr}$ ). 10 A EBR has bonded metal-to-ceramic substrate for electrical isolation with exposed copper mounting pad for low circuit-junction-to-heat-sink thermal impedance. Complete series includes: 1A, 2A, 6A, & 10A ( $I_o$ ), and 50 V, 100 V, 200 V, 400 V, 600 V & 800 V ( $V_{RRM}$ ).

10A, 200V **\$1.65** ea. (1000 qty.)

Design us in — We'll stay there **VARO**  
**VARO SEMICONDUCTOR, INC.**

P.O. BOX 676, 1000 N. SHILOH, GARLAND, TEX. 75040, 214/272-4551, TWX 910-860-5178

### Distributed by:

**ALLIED ELECTRONICS**, Chicago, Ill. 312/421-2400. **THE ALTAIR CO.**, Houston, Tex. 731/781-5300; Richardson, Tex. 214/231-5166. **BELL INDUSTRIES**, Sunnyvale, Cal. 408/734-8570; Skokie, Ill. 312/965-7500; Bellevue, Wash. 206/747-1515. **CRAMER ELECTRONICS**, Nationwide, Newton, Mass. 617/969-7700; **MILGRAY ELECTRONICS**, Nationwide, Freeport, N. Y. 516/546-6000; Hyattsville, Md. 301/864-1111; Cherry Hill, N. J. 609/424-1300. **WESTATES ELECTRONICS**, Chatsworth, Calif. 213/341-4411.

### In Canada:

**ELECTRO SONIC**, Toronto, Ont. 416/924-9301. **R.A.E. ELECTRONICS**, Vancouver, B. C. 604/687-2621.

INFORMATION RETRIEVAL NUMBER 109

# NEW! Build and test circuits as fast as you can think! No soldering or patch cords!

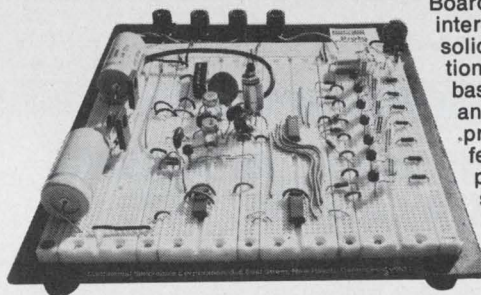

Four new Continental Specialties Proto Boards let you make all circuit and power interconnections with common #22 AWG solid hook-up wire, while power distribution buses make wiring a snap. Aluminum base plates offer solid work surfaces and perfect ground plane. Rubber feet prevent scratching. Each Proto Board features one or more 5-way binding posts to tie into system or power supply gnd. All are compatible with ICs (digital or linear), in TO5s, DIP packs and discrete components. Each is completely assembled, ready-to-use.

PAT. PENDING

Proto Board Model No.	14 Pin DIP Capacity	Size (L"xW")	Price (U.S. only)
101	10	5.8"x4.5"	\$29.95
102	12	7.0"x4.5"	\$39.95
103	24	9.0"x6.0"	\$59.95
104	32	9.5"x8.0"	\$79.95

Order today — or send for free selection guide, with applications, photos, specs and more.



**Continental Specialties Corp.**  
325 East St., Box 1942  
New Haven, CT 06509  
Telephone (203) 624-3103

CANADA: Available thru Len Finkler, Ltd., Downsview, Ontario

**FREE METRIC TO ENGLISH SLIDE RULE**  
Convert lengths, area, weight, volume instantly.  
Yours FREE with each Proto Board order!

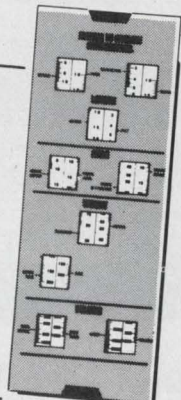

# advertiser's index

Advertiser	Page
AMP, Incorporated, Capatron Division	152
Abbott Transisor Laboratories, Inc.	6
Acopian Corp.	109
Alco Electronic Products, Inc.	127
Amerace Corporation, Control Products Division	39
Analog Devices, Inc.	72, 73
Analogic Corporation	51
Anzac Electronics	154
Arnold Magnetics Corp.	152
Asarco Intermetallics Corporation	159
Associated Testing Laboratories, Inc.	154
Augat, Inc.	100
Avantek, Inc.	114, 115
Bayshore Systems	152
Bendix Corporation, The Electrical Components Division	33
Bourns, Inc., Trimpot Products Division	20, 21
Burr-Brown Research Corporation	90
Burroughs Corporation	26
Center for Technical Development Inc.	144
Cir-Q-Tel	148
Circuit Stik, Inc.	122
Clare-Pendar	25
Continental Specialties Corporation	155
Control Switch, Inc.	145
Corning Glass Works, Electronic Products Division	10, 11
Curtis Development & Mfg. Co.	141
Cutler-Hammer, Specialty Products Division	45
Dale Electronics, Inc.	Cover II
Datum, Inc.	123
Dialight Corporation	47, 105

Advertiser	Page
Digi-Data Corporation	152
Digital Equipment Corporation, Components Group	16A-H
Digitran Company, The	130
EECO	124
EMN Company	125
ESI/Electro Scientific Industries, Inc.	138
Elec-Trol, Inc.	85
Electro Corporation	160
Electronic Arrays, Inc.	48A
Electronic Design	107, 131
Electronic Memories & Magnetics Corp.	128, 129
Erie Technological Products, Inc.	35
FMC Corporation, Special Products	24
Fairchild Semiconductor, A Division of Fairchild Camera and Instrument Corporation	134, 135
Ferroxcube Corporation	101
Fluke Mfg. Co., Inc., John	49
GTE Sylvania—Parts Division	41
General Electric Company	146
General Electric Company, Miniature Lamp Products Department	140
General Instrument Corporation	12, 13
Glenair, Inc.	139
Gold Book, The	150, 151
Harris Semiconductor	52, 53
Hayden Book Company, Inc.	152, 153
Heath/Schlumberger Scientific Instruments	84
Heinemann Electric Company	43
Hewlett-Packard	1, 54, 55
Houston Instruments, A Division of Bausch & Lomb	147
Hybrid Systems Corp.	137
ITT Semiconductor, A Division of International Telephone and Telegraph Corporation	94, 95
Intech, Incorporated	142
Iwata Electric Co., Ltd.	154
Johanson Manufacturing Corp.	152

Advertiser	Page
Keithley Instruments, Inc.	144
Keystone Carbon Company	141
Lambda Electronics Corp.	78, 79
Ledex, Inc.	133
Litronix, Inc.	4, 5
Litton OEM Products	124
3M Company	22
MSI Electronics, Inc.	153
Magneto, Inc.	153
Magnetics, Inc.	153
Master Appliance Corporation	160
Master Specialties	152
Matrix Systems	152
Micro Circuits Company	152
Micro Devices Corp.	147
Mini-Circuits Laboratory	159
Mostek Corporation	17
Motorola Semiconductor Products, Inc.	8, 9, 16
NCR Corporation	132
National Semiconductor Corporation	24 A1-A6
Nelson Ross Electronics	120
Nicolet Scientific Corp.	156
North Electric Company	127
Optron, Inc.	7
PSG Industries, Inc.	117
Pace Inc.	153
Permag	148
Perkin-Elmer Corporation	136
*Philips Electronic Components and Materials	11
*Philips Industries	10
Power/Mate Corp.	153
Precision Monolithics Incorporation	111
Princeton Electronic Products, Inc.	106
RCA Electronic Components	145
RCA Solid State Division	Cover IV
Reader Service Card	160AB
Risk Industries, Inc., Geo.	127
Rogers Corporation	147
Semiconductor Circuits, Inc.	136
Siemens Corporation	18, 19
Signetics Corporation	14, 15
Sprague Electric Company	121
Switchcraft, Inc.	158
Systron-Donner	56
Syntest Corp.	153

TRW/Cinch Connectors, an Electronic Components Division of TRW, Inc.	Cover III
TRW, Electronic Components	60, 61
TRW/IRC Resistors, an Electronic Component Division of TRW, Inc.	23
TRW/UTC Transformers, an Electronic Components Division of TRW, Inc.	48B
Technical Materials, Inc.	17
Technitrol, Inc.	113
Tekelec, Inc.	149
Tektronix, Inc.	59
Teledyne Semiconductor	29
Teledyne Relays, A Teledyne Company	2
Teletype Corporation	71
Texas Digital Systems, Inc.	153
Texas Instruments, Incorporated	62
Topaz Electronics	143, 160
Tustin Electronics Co.	132
USCC/Centralab Electronics Division, Globe-Union, Inc.	31
Validyne Engineering Corporation	145
Varadyne Industries, Inc.	37
Varo Semiconductor, Inc.	155
Vector Electronic Co., Inc.	143
Vishay Resistor Products, a division of Vishay Intertechnology, Inc.	117
Watkins-Johnson	91
Wavetek Indiana Incorporated	118

\*Advertisers in non-U.S. edition

## Design Data from Manufacturers

Advertisements of booklets, brochures, catalogs and data sheets. To order use Reader-Service Card (Advertisement)

### UBIQUITOUS<sup>®</sup>

- Spectrum Analyzers
- Correlators

### OMNIFEROUS<sup>™</sup>

- Dual Hi-Speed FFT Processor

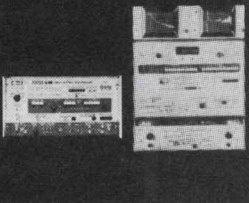

## REAL-TIME SIGNAL PROCESSORS CONDENSED CATALOG. FREE.

For instant diagnosis of noise & vibration in real time, new 8-pg. catalog describes well-known . . .

- UBIQUITOUS<sup>®</sup> 500-line combined Real-Time Spectrum Analyzer-Calculator that automatically computes digitally
- UBIQUITOUS<sup>®</sup> 256-point & 512-point real-time Correlators
- OMNIFEROUS<sup>™</sup> Dual Channel Hi-Speed instrument-type FFT Processor
- Memory & non-storage large-screen displays for real-time spectrum analyzers
- Range Translators
- Rotating Machinery Order Normalizers
- Digital Recorders & Post-Processors

CIRCLE NO. 171

**Nicolet Scientific Corp.** (formerly Federal Scientific Corp.)

245 Livingston St., Northvale, New Jersey 07647 (201) 767-7100. TWX: 710-991-9619

## recruitment and classified ads

**SAME DAY SHIPMENT**  
Minis & Peripherals  
**PDP SPECIALISTS**  
8, 8I, 8L & 11

**NEW 300 LPM**  
**PRINTERS**

**PDI CARD READERS**

**BRPE PUNCHES**

**\$750 Minis**

**TELETYPE 35 & 37**  
**DEC & HONEYWELL Modules**  
617/261-1100

Send for Free Report "Maintenance  
of Computers"

**AMERICAN USED COMPUTER CORP.**  
P.O. Box 68, Kenmore Sta.  
Boston, MA 02215  
Members Computer Dealers Association

### ENGINEERS

Specializing in placement of  
engrs & scientists. Openings in  
Calif. & nationwide. No fee to  
appl. Contact Jerry Halloran.  
(714) 299-8430

**RAFTERY & KING, INC. Agency**  
2384 San Diego Ave.  
San Diego, Calif., 92110

### FREE ALARM CATALOG

Full line of professional burglar and  
fire alarm systems and supplies. 96  
pages, 450 items. Off the shelf delivery,  
quantity prices.



**mountain west alarm**  
4215 n. 16th st., phoenix, az. 85016

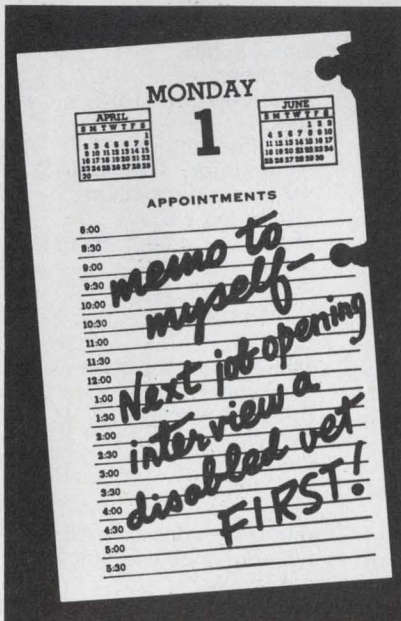

The President's Committee  
on Employment of the Handicapped  
Washington, D.C. 20210

## ELECTRONICS ELECTRONICS

Gilbarco Inc., long a leader in support products for the petroleum industry, is expanding its research and development activities in Electronics applications and Data Acquisition Systems. We have immediate requirements for the following positions.

### SENIOR ELECTRONICS ENGINEERS

BSEE with 3-5 years experience in digital, logic and circuit design, with project responsibilities. Must know TTL, MSI, discrete components and some MOS. Will have project responsibility from specifications and design through implementation.

### SENIOR MECHANICAL ENGINEER

BSME with 4-7 years experience in electronic packaging. Must know packaging of PC boards, chassis and sub-systems. Will be responsible for packaging of electronic systems and sub-systems and mechanical design related to such systems.

### MANUFACTURING ENGINEER

BSIE with 3-5 years experience in printed circuit board component and chassis layout and assembly, validation of schematics, and identification of potential manufacturing problems.

### QUALITY CONTROL ENGINEER/SUPERVISOR

BSEE with 3-5 years experience in circuitry designs utilizing TTL, MOS, and discrete components. Will aid in design of test equipment and carry full responsibility for supervision of Q.C. Technicians.

### BUYER

5-7 years experience in buying electronic components including printed circuit boards, transformers, resistors, and diodes. Experience should include knowledge of quality control aspects of procurement including test and acceptance levels, and ability to work closely with Engineering, Quality Control, and Inventory Control personnel.

These positions offer excellent growth opportunities, salary commensurate with experience, and a comprehensive benefit package. The location is at our corporate headquarters in Greensboro—a major population center in the desirable and attractive piedmont North Carolina area. Send resume including salary history and requirements to:

MANAGER, RECRUITING & EMPLOYMENT

**Gilbarco**

**7300 Friendly Rd, Greensboro, NC. 27420**

An Equal Opportunity Employer M/F

INFORMATION RETRIEVAL NUMBER 902

# A pushbutton switch for "peace of mind" applications--that's yankee ingenuity.

Switchcraft's ORCON pushbutton switches are designed and manufactured specifically for applications where economy is measured only by maximum reliability. Where "peace of mind" is mandatory.

ORCON Series OA lighted pushbutton switches provide you with 2PDT through 6PDT circuitry in a 3/4" diameter package. ORCON Series OB offers SPDT, DPDT switching in a 23/32" diameter housing. Both offer features that give you that extra peace of mind. Consider ORCON's exclusive snap-slide migration-free lifting and wiping action of the self-cleaning cobalt-gold contacts which eliminates arcing.

ORCON switches accept single lamp, redundant-lamp pushbuttons in a variety of colors and shapes—square, round, rectangular. And we have them all. You can specify momentary silent, momentary positive, alternate action or push lock/push release functions.

When you want to specify a little extra peace of mind, see what ORCON—and a little yankee ingenuity—can do for you. Contact your Switchcraft Representative, or Switchcraft Inc., 5555 N. Elston Avenue, Chicago, Illinois 60630. Or phone (312) 792-2700.

**SWITCHCRAFT**

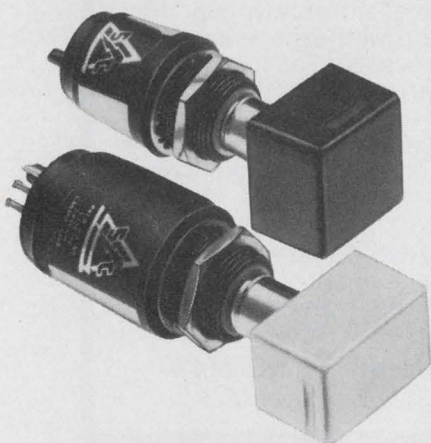

## product index

Information Retrieval Service. New Products, Evaluation Samples (ES), Design Aids (DA), Application Notes (AN), and New Literature (NL) in this issue are listed here with page and Information Retrieval numbers. Reader requests will be promptly processed by computer and mailed to the manufacturer within three days.

Category	Page	IRN	Category	Page	IRN
<b>Components</b>			<b>Discrete Semiconductors</b>		
capacitor	31	21	diodes, detector	144	322
capacitor, caseless	130	258	diodes, stabistor	144	325
capacitors	146	99	gallium phosphide	148	340
capacitors, ceramic	35	23	isolators, opto	144	323
capacitors, chip	37	24	LEDs	1	2
capacitors, chip	135	280	LEDs	47	29
capacitors, nonpolar	132	276	opto-electronic components	7	6
capacitors, tantalum	121	63	power semiconductor	24	17
clock panel displays	26	19	rectifiers	95	46
components	19	13	rectifiers, epoxy bridge	155	109
components	61	37	SCRs	144	324
display, 32 char.	135	281	transistors	115	54
elapsed time indicator	125	68			
ferrite cores	101	48	<b>Instrumentation</b>		
ferrites	148	103	amplifier	129	274
lamps	140	86	counters	56	35
potentiometer	21	14	counters	84	41
potentiometer, trim	135	282	DMM autoranging	144	92
pushbutton switches (NL)	146	333	impedance meter	138	84
pushbutton switches and indicators	105	49	laboratory testing	154	106
reeds, magnetic	127	70	multimeters	149	105
relay	2	3	oscillograph	129	273
relays, solid state	85	42	oscilloscope	59	36
resistors	11	246	panel meter	126	250
resistors, precision	23	16	recorders, strip-chart	147	102
sensors	160	114	scope/DMM	129	271
solenoids, rotary	133	78	spectrum analyzer	120	62
switch, keyboard	133	278	sweepers, high-frequency	118	61
switch, pushbutton	158	111	synthesizer	129	272
switch, rotary	133	277	VOM	145	94
switches	130	75			
switches	145	96	<b>Integrated Circuits</b>		
switches, rocker	45	28	amp, audio	120	262
switchlight	25	18	amplifier	121	263
terminators, monolithic ECL	134	79	amplifier, low drift	119	252
thermal cutoffs	147	100	CMOS	29	20
thermistors	141	87	calculator chips	121	264
thermostats, solid-state	117	58	comparator, 4-bit CMOS	120	261
transducer kit	145	95	FM audio subsystem	120	260
transducer, pressure	132	275	integrated circuits	24A-F	302
transducer, velocity	135	279	memory, random access	122	255
transformer, broadband	154	108	RAM, n-channel	48A	32
transformers	48B	31	static RAM, 256 x 4	13	9
transformers	160	116	transmitter	16	11
transformers, pulse	113	53			
trimmers	117	59	<b>Microwaves &amp; Lasers</b>		
tuning fork	154	107	combiner/divider	137	286
voltage divider	124	66	filters, bandpass	136	284
			generator	139	291
<b>Data Processing</b>			isolators	137	287
calculator, computer	55	34	klystron	138	288
data communications equipment	71	38	laser, UV	139	290
image storage systems	106	50	mm-wave components	139	292
memory	128	73	mixers, double-balanced	159	113
optical communications	148	337	oscillators	137	285
paper tape punches and readers	124	67	sources	136	283
rotating memory systems	123	65	waveguides, optical	138	289
terminals and peripherals	16A-H	12	YIG crystals	91	44
			<b>Modules &amp; Subassemblies</b>		
			amplifier, rf	142	300
			controller, digital	141	295



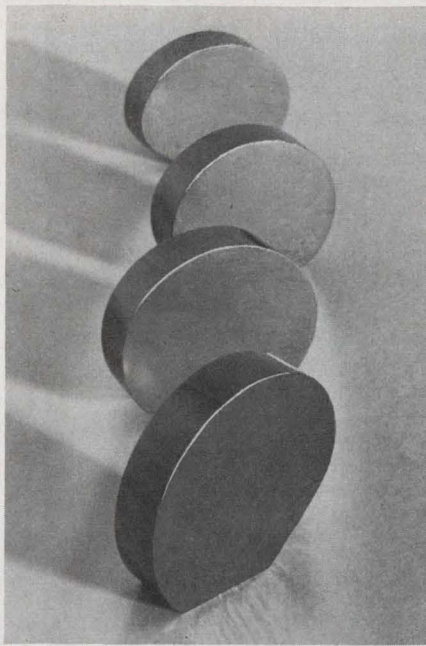

## Our compounds are your right answer for...

### DIODE DISPLAYS, INFRARED DEVICES, ELECTRONIC COMPONENTS

Asarco Intermetallics Corporation offers a wide range of III-V compounds used in the production of light emitting diodes (LED) and photoluminescent displays.

We provide gallium arsenide, gallium phosphide and indium phosphide in both polycrystalline and single crystal form. All polycrystalline materials are available as ingots. Gallium phosphide and indium phosphide are also available in granular form.

Gallium arsenide single crystals are boat grown with typical cross-sections of 19mm x 47mm for a (111) orientation and 33mm x 47mm for a (100) orientation.

You can order single crystals of our III-V compounds as ingots or slices, as cut or polished.

All materials are furnished in small quantities for evaluation or in large volume for production use. For more information contact us at 120 Broadway, New York, N.Y. 10005. Or call 212-732-9500.

# ASARCO INTERMETALLICS CORPORATION

INFORMATION RETRIEVAL NUMBER 112  
ELECTRONIC DESIGN 15, July 19, 1974

Category	Page	IRN
conversion, modules	51	33
converter, a/d	132	77
converter, a/d	140	294
converter, d/a	111	52
converter, 12-bit d/a	90	43
converters, d/a	136	81
DAC, 12-bit	142	89
data-acquisition modules (NL)	146	335
delays, time	141	296
dividers, analog	142	297
filters	148	104
generator, background	143	321
IC logic boards (NL)	148	341
links, optical data	140	293
module, rf power	143	320
oscillator, clock	142	301
subsystem, multiplexer	142	298
transceivers, data	142	299

#### Packaging & Materials

cable/connector, flat	22	15
circuit boards	143	90
circuit boards	155	110
circuit boards, g-p	122	64
compounds	159	112
connectors	139	85
connectors, PC board	39	25
connectors, PC edge	111	247
contact, gold dot	41	26
copper (NL)	146	332
filter connectors	33	22
gallium phosphide (NL)	148	340
heat gun	160	115
hermetic connectors (NL)	146	331
knobs	127	71
knobs	127	72
mini bus	147	101
plastics guide (NL)	146	334
socket panel	100	47
terminal blocks	141	88

#### Power Sources

dc/dc converter	124	267
dc/dc converter	125	270
overvoltage protector	43	27
portable ac power	123	265
power modules	6	5
power source	125	269
power supplies	79	40
power supplies	127	69
power supplies (NL)	146	330
regulators, line	143	91
switching supplies	123	266
triple-output supply	124	268
voltage regulator	136	82

#### new literature

CATV amplifier	148	339
cable-carrier system	146	328
copper	146	332
data-acquisition modules	146	335
gallium phosphide	148	340
hermetic connectors	146	331
IC logic boards	148	341
optical communications	148	337
optical equipment	146	326
plastic guide	146	334
power supplies	146	330
pushbutton switches	146	333
rf and i-f components	146	327
rfi/emc products	148	338
seminar	144	93
torque fasteners	146	329
2-wire data modems	148	336

# DOUBLE-BALANCED MIXERS

Great Value at

**\$7.95**  
500 piece quantities.

\$9.95 in quantities of 1 to 49 pieces

DC-500MHz  
6dB conversion loss  
40dB isolation  
EMI shielded case

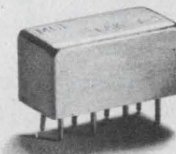

A breakthrough in technology and high production volume enables Mini-Circuits Laboratory to offer these new products at an unprecedented low price.

In today's tough competitive market can you afford not to use these remarkably low priced and high performance units?

Ruggedness and durability are built in the SRA-1. These new units are packaged within an EMI shielded metal enclosure and hermetically sealed header. They use well matched hot-carrier diodes and uniquely designed transmission line transformers.

We invite you to convince yourself. Place your order now and check our delivery, product performance and reliability.

## Mini-Circuits Laboratory

2913 Quentin Rd., Brooklyn, N.Y. 11229  
(212) 252-5252, Int'l Telex 620156  
A Division Scientific Components Corp.

\*FRANCE: S.C.I.E., \*31, rue George-Sand, Palaiseau 91, France \*GERMANY, AUSTRIA, SWITZERLAND: Industrial Electronics GMBH, \*Klüberstrasse 14, 6000 Frankfurt/Main, Germany \*UNITS IN STOCK

ENGLAND: Dale Electronics: Dale House, Wharf Road, Frimley Green, Camberley, Surrey. JAPAN: Denisho Kaisha, Ltd.: Eguchi Building, 8-1, 1-Chrome, Hamamatsucho, Minato-Ku, Tokyo.

\*UNIT IN STOCK.

INFORMATION RETRIEVAL NUMBER 113

159

# DI-MAG<sup>®</sup>

... SUPER SENSORS

## THE SENSIBLE CHOICE...

- **DIGITAL OUTPUT** — Constant amplitude pulses independent of surface speed or air gap.
- **COMPATIBILITY** — Direct interface with TTL, DTL or HTL logic.
- **NOISE IMMUNITY** — High signal-to-noise ratio not achievable in analog sensors.

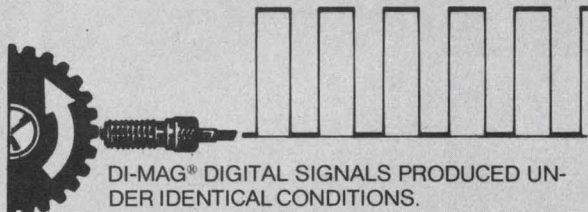
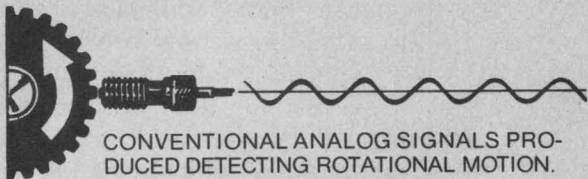

DI-MAGS<sup>®</sup> work particularly well in these computer peripheral functions and applications:

- FEED RATE CONTROL
- PRINT HAMMER SYNCHRONIZATION
- DISK POSITION INDICATION
- DISK AND TAPE DRIVE RPM MEASUREMENT
- INDEXING CONTROL
- CONTROL SIGNAL FOR CLOSED-LOOP SERVO SYSTEMS.

THAT'S WHY I'M CALLED THE SUPER SENSOR!

Send for your free copy of our Di-Mag<sup>®</sup> "AIR GAP/V/S SENSITIVITY" selector.



### ELECTRO CORPORATION

1845 57TH STREET, SARASOTA, FLORIDA 33580  
AREA CODE (813) 355-8411 • TELEX 5-2683

INFORMATION RETRIEVAL NUMBER 114

# MASTER-MITE<sup>™</sup>

## HEAT GUN FROM MASTER



Now bring a new dimension to heat shrinking as well as countless other industrial applications. Easier to handle ... only two pounds with nozzle ... perfectly balanced.

Three easily interchangeable color-coded nozzles to speed specific jobs. Silver (standard) ... used for most shrinkables (475°F.). Blue nozzle for Mylar<sup>®</sup> (500°F.) ... and Black for Teflon<sup>®</sup> (800°F.) both optional equipment. Nozzles can be changed in seconds.

Draws only 5.4 amps. High impact housing withstands hard knocks of shop use. For information on the MASTER-MITE Heat Gun or the full line of Master Heat tools, contact your distributor or write:

\*Reg. Trade Name of DuPont

Send for your free full line catalog page and price list.

**MASTER** appliance corporation  
**RACINE, WISCONSIN 53403**

In Canada, contact Martin Industrial Sales Ltd. 4445 Harvester Road, Burlington, Ontario, CJ-1

INFORMATION RETRIEVAL NUMBER 115

## Noise sensitivity problems go away

with Topaz Ultra-Isolation Transformers

Box-shielding techniques achieve maximum coupling between windings while offering a very low impedance for common-mode noise to ground.

Primary to secondary effective interwinding capacitances of:

- 0.005 picofarads
- 0.001 picofarads
- 0.0005 picofarads

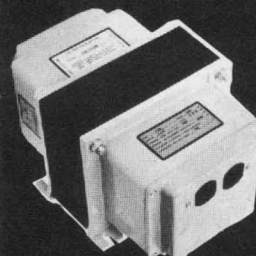

### SPECIFICATIONS:

**Common-Mode Noise Rejection:** to more than 145 dB.

**Transverse Noise Suppression:** greater than 125 dB at 1 kHz.

**Input/Output Voltages Available:** 115, 230, 240 and 480 VAC at 50 or 60 Hz.

### Models Available:

125 VA to 20 kVA 1 phase;  
3 kVA to 60 kVA 3 phase.

Priced from \$75.00

## TOPAZ ELECTRONICS

SOLUTIONS TO POWER PROBLEMS

3855 Ruffin Road, San Diego, CA 92123

Phone (714) 279-0831

INFORMATION RETRIEVAL NUMBER 116

ELECTRONIC DESIGN 15, July 19, 1974

# Cinch has the extras in .100" PC edge connectors

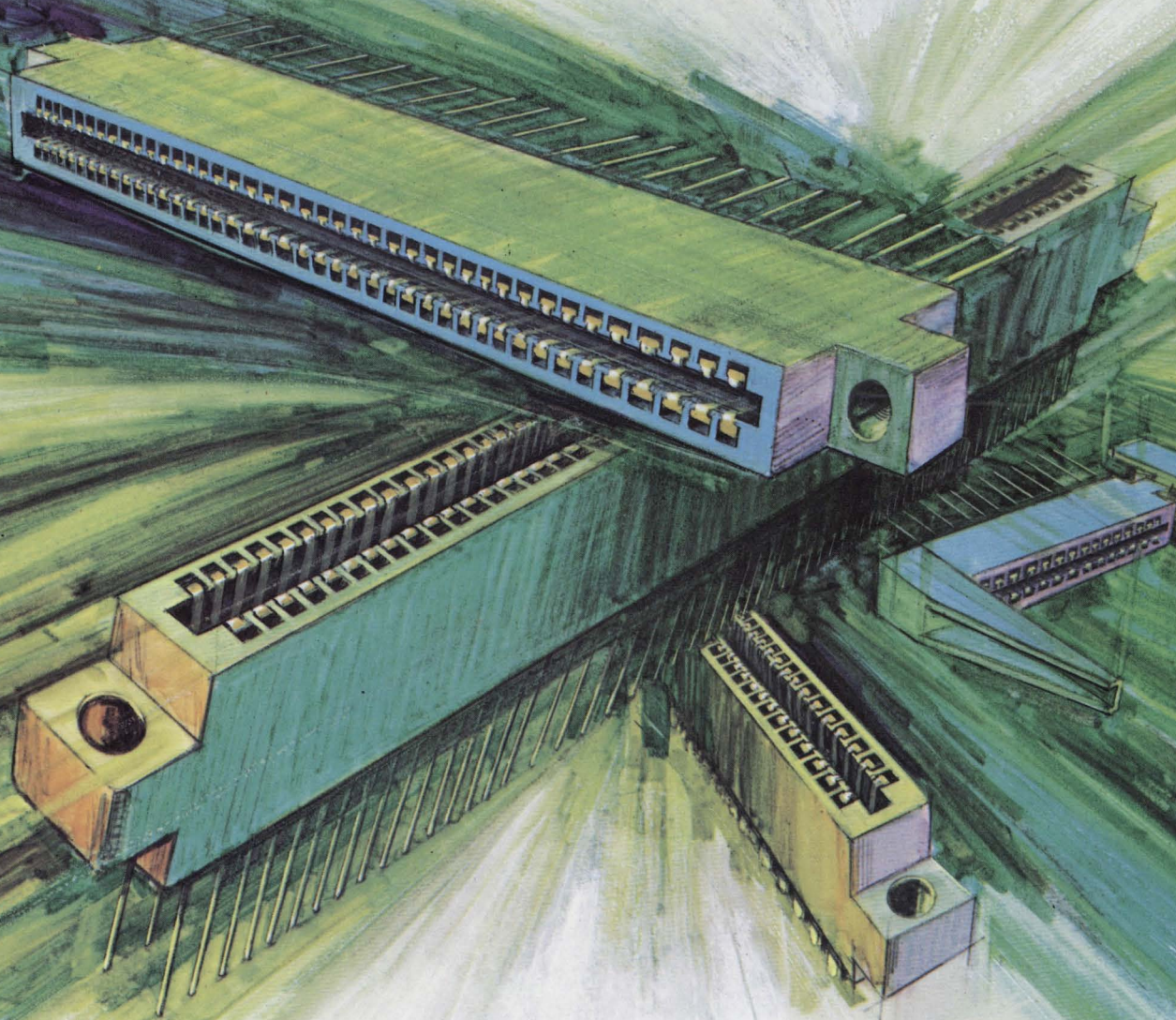

Extras that result in higher reliability, wider availability, and greater economy are integral to these TRW/Cinch edge connectors:

- Gold-plated contact reliability at a lower cost through Cinch selective plating (30 microinches on board contacting areas and 10 microinches on non-contacting areas).
- Cantilevered contact construction results in gap uniformity and controlled insertion and withdrawal forces, due to preloading of bifurcated contacts against insulator stop.
- Available in 16 sizes, from 10 to 50 double readout contact positions, with choice of wire wrap\*, dip solder

or solder tab terminations, and detachable card guides, for added versatility.

- Nation-wide stocking by TRW/Cinch distributors of six popular sizes (15, 22, 36, 40, 43, and 50 positions) for off-the-shelf availability.

For additional information, see detailed listings in EEM, contact your nearest TRW/Cinch sales office, or dial toll-free (800) 645-9201 for the name of your nearest TRW/Cinch distributor. Or write for Catalog C-24, describing the complete line of printed circuit edge connectors, to TRW/Cinch Connectors, an Electronic Components Division of TRW Inc., 1501 Morse Avenue, Elk Grove Village, Illinois 60007; phone (312) 439-8800.

\*T.M. Gardner-Denver

CM7401



**The digital pocket stockbroker.  
If you want to design one tomorrow,  
we're ready with your CMOS devices today.**

Portability is just one of the benefits CMOS can contribute to your design.

You know the others. CMOS has opened whole new worlds to the imagination, with its high noise immunity, low power consumption, and tolerance of varying supply voltages.

And you know who made it all possible. RCA. We created the technology, developed the manufacturing expertise, and introduced

the COS/MOS CD4000 series, accepted as the industry standard. A series that is growing monthly.

That's why the logical decision for CMOS is RCA. We're also a leading producer of linear IC's. As well as a commodity supplier of power transistors; developers of liquid crystal displays; technology innovators of RF power devices; and a major supplier of thyristors.

In addition to comprehensive technical product data, RCA gives

you professional and experienced field engineering and applications support. As well as a commitment to excellence in everything from research to manufacturing.

So whatever you're into, and whatever you need, check with us first. Chances are one or more of our products anticipate your needs. A good place to start is to check our handy product line guide. Write RCA Solid State, Section 57G19, Box 3200, Somerville, N.J. 08876.

**RCA** Solid State