

# Electronic Design 17

VOL. 19 NO.

FOR ENGINEERS AND ENGINEERING MANAGERS

AUG. 16, 1971

**Want a quick tour of Wescon?** Without leaving your desk you can take a trip through all the exhibit aisles and preview the latest in hardware, from op amps

to oscilloscopes. Then it's off to the technical sessions to hear the latest in technology whether it's on minis, memories or MOS. The journey begins on page W2.



**Electronic Design**  
FOR ENGINEERS AND ENGINEERING MANAGERS

Data communication: here's how—  
combine the right hardware with  
the right transmission service for  
your particular application. Easy?  
the relative economic merits

of various  
are then  
eva. sta.  
systems  
the repon

New from Dale...

# Metal film performance

# at a carbon comp price.



Don't settle for the loose tolerance and T.C. of commercial-grade carbon comps. Use new Dale DF metal film resistors to upgrade your circuits—without increasing your budget. Semi-precision DF's meet EIA Standard 196. They fill the performance gap between Mil-R-11 and Mil-R-22684 styles—giving you a great new source and the best resistor you can buy in the 3-cent range.

**How many million shall we ship you?**

Write today or phone 402-564-3131 for complete details.

---

#### DF RESISTOR SPECIFICATIONS

**Power Rating:** 1/4, 1/2, 1 watt

**Tolerance:**  $\pm 2\%$ ,  $\pm 5\%$ ,  $\pm 10\%$

**Temperature Coefficient:**  $\pm 100$ ,  $\pm 150$ ,  $\pm 200$  ppm/ $^{\circ}\text{C}$  depending on size and resistance range

**Resistance Range:** 10 ohms to 1 megohm

**Operating Temperature Range:**  $-65^{\circ}\text{C}$  to  $+150^{\circ}\text{C}$

**Coating:** Epoxy—specially-formulated for moisture protection and flame retardance

**DALE ELECTRONICS, INC.** 1300 28th Avenue, Columbus, Nebraska 68601

In Canada: Dale Electronics Canada, Ltd. A subsidiary of The Lionel Corporation

HEWLETT  PACKARD  
POWER SUPPLIES

*take a  
close look  
when you  
specify a  
power  
supply...*

There's a lot to consider when you specify a power supply, and HP gives you a lot. Take selection for example. HP offers well over 100 models ranging from 10uV to 4000V, from 1uA to 2000A . . . plus a selection of options that satisfy most applications. Performance is another major consideration. At HP, we don't practice "specsmanship". We present specifications conservatively and completely, so you get the performance you expect. And, every model is backed by a comprehensive operating and service manual detailing every aspect of the supply from operation to maintenance. But it doesn't end there . . . if you need assistance, we have an international network of 220 offices to serve you. And it's all based on a concept of quality and reliability — your assurance that you are getting the best value. Hewlett-Packard, New Jersey Division, 100 Locust Avenue, Berkeley Height, New Jersey 07922, Telephone (201) 464-1234.

**DC POWER SUPPLY SELECTION GUIDE**—this 36-page guide is factual and informative . . . clearly lists all the specs, features, options, prices, etc. on every HP power supply . . . makes it easy to find the right model for any application. Write for your copy.

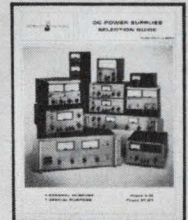

21103

INFORMATION RETRIEVAL NUMBER 2



6259B DC POWER SUPPLY  
HEWLETT - PACKARD 0-10V 0-50A

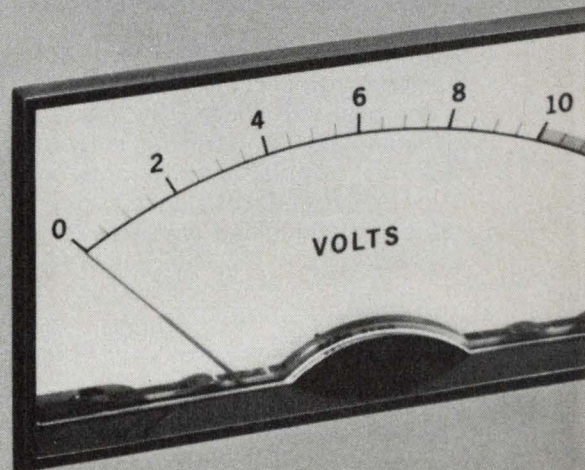

# Panel space shrinking?

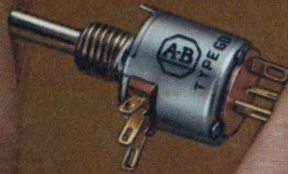

Actual Size

**TWO  
IN  
ONE**

**Solve your space  
problems with our  
dual section  
variable resistor;  
it's only 1/2 inch  
in diameter.**

Allen-Bradley Type GD. The most compact two-section variable resistor available today. The same diameter and only a fraction longer than our popular single-section Type G. Type GD resistance tracks are solid hot-molded elements for

long life. Noise level is low and resolution is virtually infinite. Low inductance. Usable at frequencies far beyond the range of wirewound variables. Ideal for use as bridged pad (T or L) attenuators. Entire unit immersion sealed. Available in re-

sistance values from 100 ohms to 5 megohms through your appointed A-B electronics distributor. Or write for publication 5213: Allen-Bradley, Electronics Division, Milwaukee, WI 53204. Export: Bloomfield, N.J. 00703. In Canada: Galt, Ontario.

NEW DIMENSION ELECTRONICS  
**ALLEN-BRADLEY**



# Electronic Design 17

VOL. 19 NO.

FOR ENGINEERS AND ENGINEERING MANAGERS

AUG. 16, 1971

---

## NEWS

- 19 **News Scope**
- 22 **A new era in computer design** is opening up with a growing family of program-it-yourself semiconductor memories.
- 24 **Pre-installation engineering** on the Navy's EA-6B electronic warfare aircraft could set a pattern for military cost-cutting programs.
- 26 **A new remote optical device** used in conjunction with a conventional laser interferometer can be used for both linear and angular measurements.
- 28 **More hope for cardiac patients**—the implantable bifocal demand pacemaker which provides two pulses to the heart instead of only one.
- 36 **Technology Abroad**
- 43 **Washington Report**

---

Wescon '71—A special section Pages W1 to W48

---

## TECHNOLOGY

- 58 **Ensure error-free MOS IC operation** in noisy environments. Here's a design guide for protection circuits, both on and off the chip.
- 62 **An AF synthesizer for less than \$200.** Build it with inexpensive components and only a small sacrifice of bandwidth and convenience.
- 68 **Prevent polarization fading** in microwave systems. How? By electronically modulating the polarization of either the transmitting or receiving antenna.
- 72 **Going through a career conversion?** Here's a three-point comparison that can help you change from a military job to a commercial one.
- 76 **Ideas for Design**
- 84 **Semiannual Index of Articles:** January through June, 1971

---

## PRODUCTS

- 91 **ICs & Semiconductors:** Compensated 15-MHz monolithic op amp handles 70 V/ $\mu$ s.
- 92 **ICs & Semiconductors:** Low-power IC comparator has 10-ns propagation delay.
- 102 **Modules & Subassemblies:** New a/d converters offer price breakthroughs.
- 98 Packaging and Materials
- 112 Instrumentation
- 114 Microwaves & Lasers
- 115 Components
- 118 Data Processing
- 136 Product Index

---

## Departments

- 47 **Editorial:** Secretaries and engineers need an idea exchange
- 7 Letters
- 13 Designer's Calendar
- 120 Evaluation Samples
- 122 Design Aids
- 124 Application Notes
- 126 New Literature
- 129 Bulletin Board
- 134 Advertisers' Index
- 136 Information Retrieval Card

**Cover:** Designed and photographed by Art Director, Bill Kelly

---

ELECTRONIC DESIGN is published biweekly by Hayden Publishing Company, Inc., 50 Essex St., Rochelle Park, N.J. 07662. James S. Mulholland, Jr., President. Printed at Brown Printing Co., Inc., Waseca, Minn. Controlled circulation postage paid at Waseca, Minn., and New York, N.Y. Copyright © 1971, Hayden Publishing Company, Inc. 82501 copies this issue.

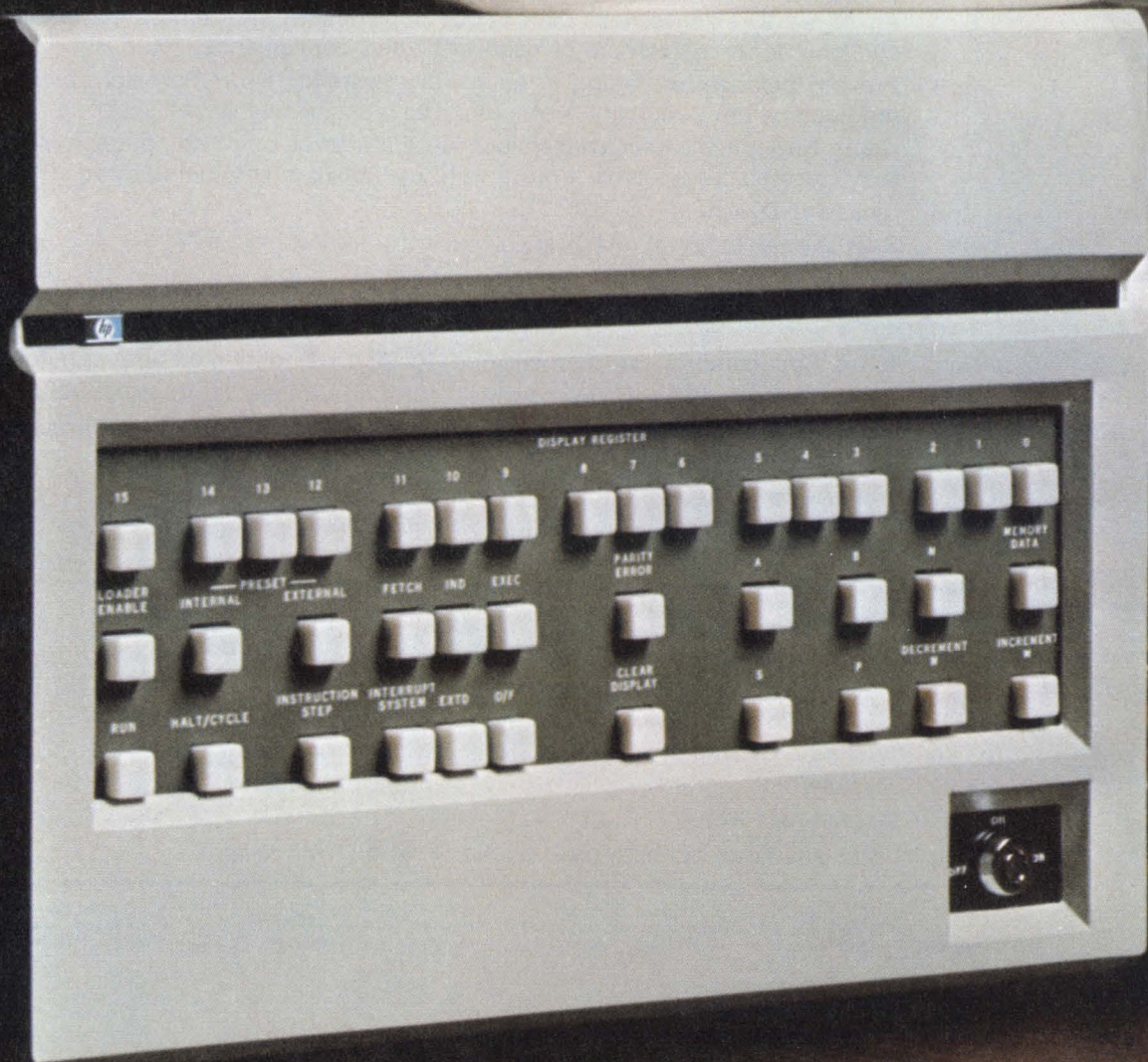

# Meet the thoroughly modern mini: our new HP 2100 computer.

It's much more than a pretty new face.

It's a big step forward in small computers.

The HP 2100 combines all three of our earlier minicomputers in one. And its sub-microsecond memory makes it almost twice as fast as any of them. It's also much smaller. And you can expand from 4K to 32K in the same convenient mainframe.

This mainframe, incidentally, houses a thoroughly modern design—including the latest in MSI/LSI technology. Plus control Read Only Memory (ROM). Standard features usually found only in bigger systems include parity checking and hardware multiplication and division. And they won't put a big crimp in your budget. In fact, the HP 2100 is the most attractively priced mini we've ever offered.

Peripheral vision. The way we see it, a mini-computer just isn't modern if it can't communicate simply and easily with the outside world. So we designed the 2100 to go to work with more than a dozen peripherals. As well as 47 instruments. All you do is plug them in. Apart from saving your time, this also saves you a great deal of money. Because you don't have to design special interfaces. After all, why

should a user have to do a computer designer's job?

All kinds of software. The 2100 uses FORTRAN, ALGOL, and BASIC. And we give you the widest choice of operating software packages available with any small computer. Time-share, real-time, and batch processing are the three main categories. And they're all compatible with our twenty-five hundred earlier systems.

Rugged testing. Our 2100 passes rigid environmental tests with flying colors. (Other small computers would simply fly apart at 3000 oscillations a minute, if they didn't freeze up at 32° F or melt at 131° F.) But our mini can really take it. It will hold its own in just about any situation — without missing a bit.

Add to these benefits our traditional worldwide support. Consider our reputation for quality. Evaluate our field engineering and analyst back-up. Check out our customer training programs. It all adds up to a thoroughly modern package.

That's why our new mini is much more than a pretty face. So how about getting better acquainted? Call your HP computer specialist. Or write Hewlett-Packard, Palo Alto, California 94304; Europe: 1217 Meyrin-Geneva, Switzerland.

Be the first one to see our thoroughly modern mini.  
Visit HP at Wescon Booth 1237, Brooks Hall, San Francisco.

HEWLETT  PACKARD

DIGITAL COMPUTERS

# How To Solve Your Power Supply Problem In 24 Hours



**400  $\phi$  to DC**  
Model W15D  
Size 2½" x 3½" x 3½"  
Output 15 VDC at 2.5 amps

**28 VDC to DC**  
Model C28D  
Size 2¾" x 3⅛" x 3⅝"  
Output 28 VDC at 1.8 amps

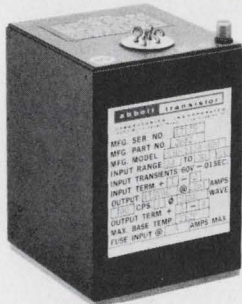

**DC to 400  $\phi$**   
Model S3D  
Size 2¾" x 3" x 4"  
Output 115 VAC at 30 VA



**60  $\phi$  to DC**  
Model R5S  
Size 6½" x 4" x 7½"  
Output 5 VDC at 5 amps

Abbott has four new lines of hi-performance power supply modules. **Most of the popular voltages are carried in stock for shipment within 24 hours from receipt of order.** All types of converters are available with any output voltage you need from 5 to 3,500 VDC—and DC to 400 Hz inverters, with either 1  $\phi$  or 3  $\phi$  outputs.

## 400 Hz to DC

Designed especially for 400 Hz input, these hi-performance converters feature close regulation ( $\pm 0.05\%$ ), low ripple (0.02%), automatic short circuit protection, complementary overvoltage protection and will meet the electromagnetic interference requirements of MIL-STD-461. **Popular sizes are in stock for immediate delivery.**

## DC to 400 Hz

These small lightweight inverters change 28 VDC to 115 Volts 400 Hertz at operating temperatures of 100°C at base plate. Six power ratings between 5 and 120

watts are available as well as frequencies of 400, 800, 1200 or 1600 Hertz and 115 or 27 volts output. **Popular sizes are in stock for immediate delivery.**

## 28 VDC to DC

These hi-performance converters change 28 VDC to any voltage between 5 and 100 VDC. They feature close regulation ( $\pm 0.05\%$ ), low peak to peak ripple of less than 50 millivolts and electromagnetic interference protection to meet the requirements of MIL-STD-461. **Popular voltages are in stock for immediate delivery.**

## 60 Hz to DC

Highly dependable, these convection cooled power supplies have output voltages from 5 to 100 VDC. They feature close regulation ( $\pm 0.05\%$ ), low ripple (0.02%), operation at 160°F ambient and minimum size and weight. **Popular voltages are in stock for immediate delivery.**

Please see pages 930 to 949 of your 1970-71 EEM (ELECTRONIC ENGINEERS MASTER Catalog) for complete information on Abbott modules.

Send for our new 68 page FREE catalog.

**abbott transistor**

**LABORATORIES, INCORPORATED**  
5200 W. Jefferson Blvd./Los Angeles 90016  
(213) 936-8185 Cable ABTLABS  
1224 Anderson Ave./Fort Lee, N.J. 07024  
(201) 224-6900

INFORMATION RETRIEVAL NUMBER 5

## Publisher

Peter Coley

## Editors

Editorial Offices  
50 Essex St.  
Rochelle Park, N.J. 07662  
(201) 843-0550  
TWX: 710-990-5071  
Cable: Haydenpubs Rochellepark

Editor: Frank Egan  
Managing Editor: Ralph Dobriner  
Managing Editor: Raymond D. Speer  
Microelectronics, Steven A. Erenburg  
Computers, Raymond D. Speer  
Microwaves, Michael J. Riezenman  
Circuits, Edward A. Torrero  
Special Projects, George Rostky  
Management, Richard L. Turmail  
Military-Aerospace, John F. Mason  
News, Michael P. London  
New Products, Roger Allan

## Field Offices

**Massachusetts**  
Jim McDermott  
P.O. Box 272  
Easthampton, Mass. 01027  
(413) 527-3632

**West Coast**  
David Kaye  
2930 Imperial Highway  
Inglewood, Calif. 90303  
(213) 757-0183

**Washington**  
Don Byrne  
1111 S. Army Navy Drive  
Arlington, Va. 22202  
(202) 296-8982

## Editorial Production

Dollie S. Viebig

## Art

Art Director, William Kelly  
Richard Luce  
Anthony J. Fischetto

## Production

Manager, Thomas V. Sedita  
Helen De Polo  
Kathleen McConkey  
Maxine Correal

## Circulation

Manager, Nancy L. Merritt

## Information Retrieval

Peggy Long



# letters

## IEEE cites value of trade exhibits

The April 29 *ELECTRONIC DESIGN* article concerning trade shows ("Trade Shows Are Great—Or Are They?") could spread some erroneous assumptions.

As example, and contrary to the content of the article:

1. Smaller companies are less prone to build "image" at shows than are some of the industry giants. Small companies almost invariably are there to show new or improved products.

2. The cost of "quality contact" at a show should be around \$15, which compares rather well with the generally accepted rating for a sales call of about \$55 per visit.

3. Comparison of a "live" show contact with a bingo-card response is a comparison of apples and oranges. You still have to follow bingo-card responses with personal demonstrations—at \$55, or probably more, apiece.

4. It is difficult to apply broadly a simple cost-vs-inquiry formula, because there are too many variables: Was the display an elaborate one-shot? How many nonworking executives were expensed in the budget? How well did you do in getting your prospects to the show? Does the show budget have to cover the entertainment expense?

Exhibiting has many related objectives. Some of which are hard to measure but all of which have unique benefits. As examples:

1. Introducing new or improved products—and new personnel—to a large number of interested people, quickly and inexpensively.

2. Demonstrating equipment "live" in a controlled environment.

3. Talking directly with qualified and influential individuals, many of whom just aren't reach-

able by sales call.

4. Obtaining an instant reaction to new products, features and prices. Use the visitors to critique the product.

5. Re-establishing top-level relationships between your management and that of other companies important to you.

6. Taking inventory of where the industry is trending.

As evidenced over and over in the pages of *ELECTRONIC DESIGN*, good shows and conferences generate product news, technical news and business news, because industry progress is clearly on view. They always will, for that reason.

Vis-a-vis the editorial in the same issue (What's a Show Without the Semiconductor Boys?) we agree that semiconductors ought to be part of the big expositions. It is true that everyone knows what a TO-5 can look like. Everybody knows what a Coke bottle looks like, too, but Coca Cola never stops promoting with ingenuity, imagination and enthusiasm.

*Bill Hilty*

Director, Convention and Publishing Services

IEEE  
345 E. 47th St.  
New York, N.Y. 10017

## Accuracy is our policy

In the Feb. 18, 1971 issue, p. 78, "Need a programmable word generator?" there were three errors. Column 1, paragraph 2, line 2, p. 78, "shift generator" should read "shift register." Column 2, paragraph 4, last sentence, p. 78, "clock is disabled" should read "clock is enabled." In Fig. 4 the NOR gate should be an exclusive OR gate.

Electronic Design welcomes the opinions of its readers on the issues raised in the magazine's editorial columns. Address letters to Managing Editor, *Electronic Design*, 50 Essex St., Rochelle Park, N. J. 07662. Try to keep letters under 200 words. Letters must be signed. Names will be withheld on request.

# SCANBE LOGIC PANELS

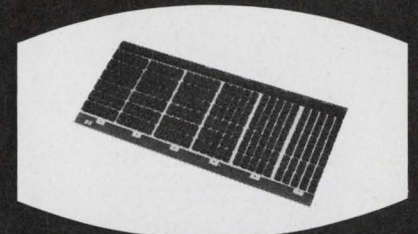

## MODULAR PANELS

- ◆ 30 to 180 positions in 30 socket zones
- ◆ 14 & 16 pin sockets with and without Vcc and GND pins
- ◆ Solderless Wrap Pins

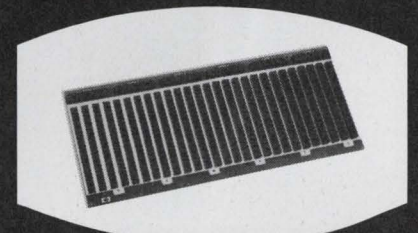

## UNIVERSAL MODEL

- ◆ Universal Panel accepts any DIP
- ◆ 18 row modules have 50 pins per row
- ◆ Vcc and GND pins provided

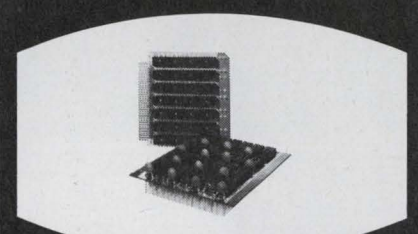

## CUSTOM TYPE

- ◆ Custom designed panels
- ◆ Available with any I/O system
- ◆ Unlimited configurations

All Panels use Scanbe's reliable ME-2 sockets. A complete Software/Wrapping service is available to provide the packaging engineer a complete system. **COMPLETE CATALOG** now available.



**MANUFACTURING CORP.**

3445 Fletcher Avenue  
El Monte, California 91731  
Phone: (213) 579-2300

# Build your next transceiver with TRW solid state technology –

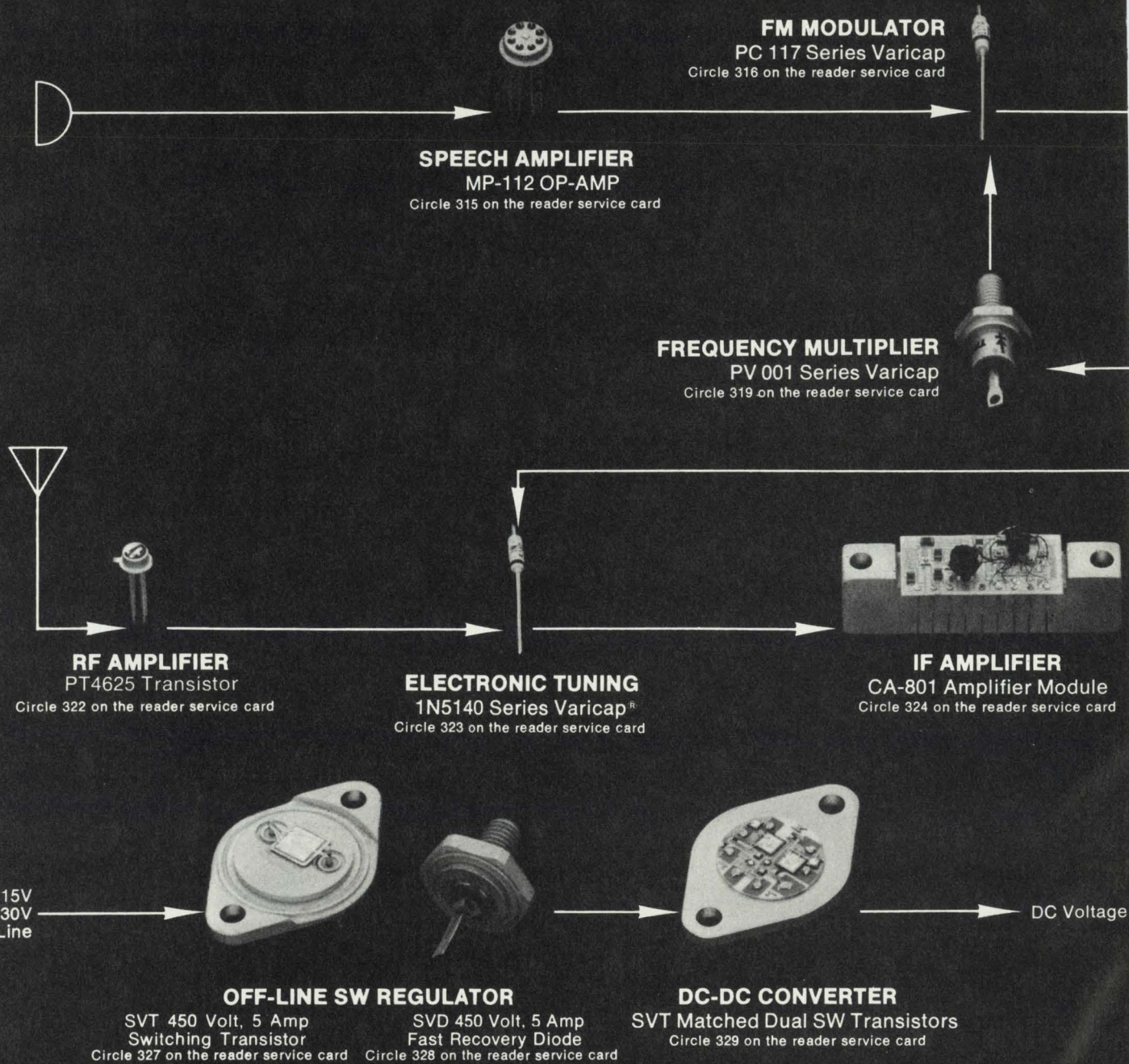

TOLL FREE

# Call 800-421-2061 for information and delivery!

(In California Call Collect (213) 679-4561, Ext. 455)

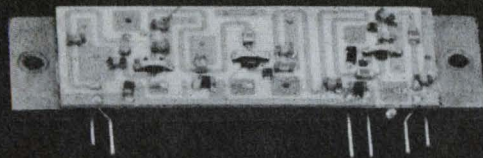

**BROADBAND POWER DRIVER**  
MV/MX Amplifier Module  
Circle 317 on the reader service card

12 Watts  
VHF/UHF

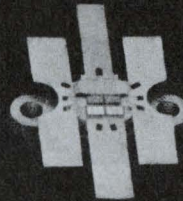

**BROADBAND POWER AMPLIFIER**  
J0 Transistor  
Circle 318 on the reader service card

100-400W  
VHF/UHF



**CRYSTAL OSCILLATOR**  
MCO-F Integrated Oscillator  
Circle 320 on the reader service card

**TRANSMIT RECEIVE SWITCH**  
PSV-1000 Series PIN Diode  
Circle 321 on the reader service card



**AUDIO AMPLIFIER**  
MP-112 OP-AMP  
Circle 325 on the reader service card



**AUDIO POWER AMPLIFIER**  
DPS 6000 Dual Darlington  
Circle 326 on the reader service card

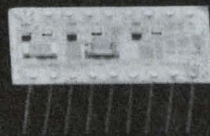

**TONE SIGNALLING**  
BP-300 Active Filter  
Circle 330 on the reader service card

For details and applications assistance please contact TRW Semiconductor Div., 14520 Aviation Boulevard, Lawndale, California 90260

**TRW**  
SEMICONDUCTORS

# High Energy Silicon for the 70's.

For Audio Amplification.

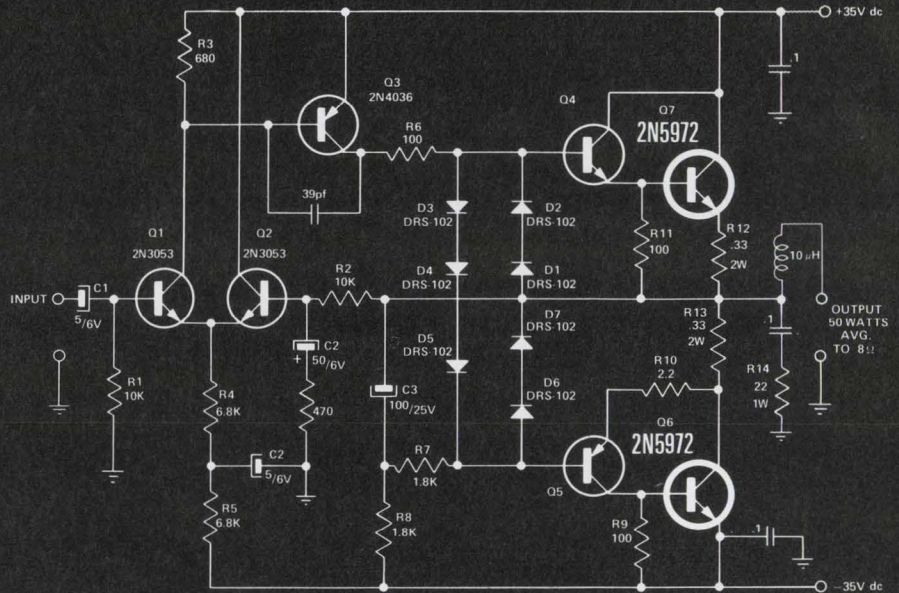

For Switching.

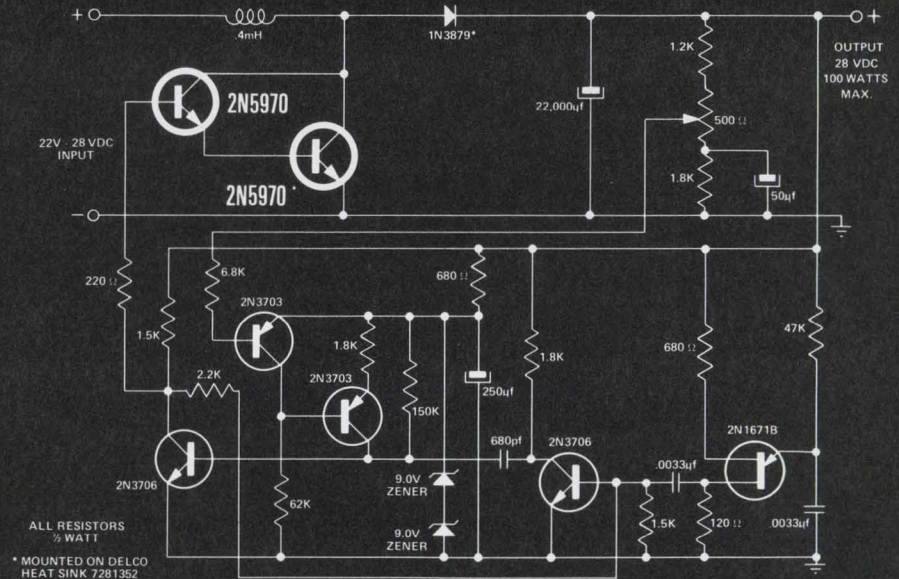

TYPE	I <sub>C</sub> Cont. Amps.	I <sub>C</sub> Pulsed Amps.	V <sub>CE0</sub> Volts	V <sub>CEX</sub> Volts	V <sub>CE0(sus)</sub> Volts	h <sub>FE</sub> (min.) @ I <sub>C</sub> =5A	h <sub>FE</sub> (min.) @ I <sub>C</sub> =15A	V <sub>CE(sat.)</sub> Volts @ I <sub>C</sub> =10A, I <sub>B</sub> =1A
2N5970	15	20	60	80	60	20	10	2.0
2N5971	15	20	60	80	60	50	20	1.5
2N5972	15	20	80	100	70	25	10	1.8
2N5973	15	20	100	120	80	25	10	1.8

Pulse Energy Test — @ V<sub>CE</sub>=40V, I<sub>C</sub>=4.5A ALL TYPES=1.8 Joules  
 t<sub>p</sub>=10 ms, duty cycle ≤ 4%

NPN Triple diffused silicon power transistors in TO-3 Solid Copper cases.

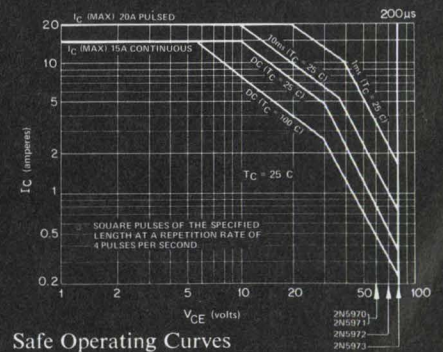

Safe Operating Curves

# Delco's New 2N5970 Series Transistors: 15 Ampere, Medium Voltage Fast, Versatile, Strong.

These high energy workhorses have built an excellent reputation for linear power amplification as well as for high efficiency switching.

The 2N5970 series offers switching capability up to 120V and 15 Amperes at rates of up to 50 kHz. They provide an optimum balance of energy handling capability and speed for maximum protection against failure from circuit fault conditions. When used for amplification the 2N5970s' linear transconductance over wide current ranges gives them superior performance.

As usual, Delco houses the high energy silicon elements in solid copper TO-3 cases for maximum thermal capacitance and low thermal resistance (1.17° C/W max.) to assure extra reliability in the toughest applications.

They're ideal for voltage regulators, power amplifiers and high efficiency switching circuits. The 28

volt shunt regulator shown is amply handled by the 2N5970 ( $V_{CEX}$  of 80 Volts). In the direct coupled audio amplifier, the 2N5972 displays its excellent frequency response, gain linearity and transconductance.

For fast shipment of small or large quantities of Delco's 2N5970 series, call your nearest Delco Electronics Distributor.

Application Notes 42 and 43 provide the data on the circuits.



## Delco Electronics

DIVISION OF GENERAL MOTORS CORPORATION, KOKOMO, INDIANA

### Available from these Delco distributors:

ALA., BIRMINGHAM • Forbes Distributing Co., Inc. (205)-251-4104  
ARIZ., PHOENIX • Cramer/Arizona (602)-263-1112 • Sterling Electronics (602)-258-4531  
CAL., LOS ANGELES • Kierulff Electronics, Inc. (213)-685-5511 • Radio Products Sales, Inc. (213)-748-1271  
CAL., PALO ALTO • Kierulff Electronics, Inc. (415)-968-6292  
CAL., SAN DIEGO • Milo of California, Inc. (714)-232-8951  
COLO., COLORADO SPRINGS • Walker Electronics (303)-636-1661  
COLO., DENVER • Cramer/Denver (303)-758-2100 • Denver Walker Electronics (305)-935-2406  
ILL., ROSEMONT (Chicago) • Kierulff/F-J-R (312)-678-8560  
ILL., SKOKIE (Chicago) • Merquip Electronics (312)-282-5400  
IND., INDIANAPOLIS • Graham Electronics Supply, Inc. (317)-634-8486  
MD., BALTIMORE • Radio Electric Service Co. (301)-823-0070  
MASS., NEWTON • The Greene-Shaw Co., Inc. (617)-969-8900  
MICH., ROMULUS • Harvey/Detroit (313)-729-5500  
MINN., MINNEAPOLIS • Stark Electronics Supply Co. (612)-332-1325  
MO., KANSAS CITY • Walters Radio Supply, Inc. (816)-531-7015

MO., NO. KANSAS CITY • LCOMP-Kansas City, Inc. (816)-221-2400  
MO., ST. LOUIS • LCOMP-St. Louis, Inc. (314)-647-5505  
N.J., CLIFTON • Eastern Radio Corporation (201)-471-6600  
N.M., ALBUQUERQUE • Cramer/New Mexico (505)-265-5767 • Sterling Electronics (505)-247-2486  
N.Y., BINGHAMTON • Harvey/Federal (607)-748-8211  
N.Y., NEW YORK • Harvey/New York (212)-582-2590  
N.Y., WOODBURY • Harvey/New York (516)-921-8700  
OHIO, CINCINNATI • United Radio, Inc. (513)-761-4030  
OHIO, CLEVELAND • Pattison Supply (216)-441-3000  
OHIO, DAYTON • Kierulff/F-J-R (513)-278-9411  
OKLA., OKLAHOMA CITY • Radio, Inc. (405)-235-1551  
OKLA., TULSA • Radio, Inc. (918)-587-9123  
PENN., PHILADELPHIA • Almo Electronics (215)-676-6000  
PENN., PITTSBURGH • RPC Electronics (412)-782-3770  
S.C., COLUMBIA • Dixie Radio Supply Co., Inc. (803)-253-5333  
TEXAS, DALLAS • Adleta Electronics Company (214)-741-3151

TEXAS, FORT WORTH • Adleta Electronics Co. (817)-336-7446  
TEXAS, HOUSTON • Harrison Equipment Co., Inc. (713)-224-9131  
UTAH, SALT LAKE CITY • Cramer/Utah (801)-487-3681  
VA., RICHMOND • Meridian Electronics, Inc., a Sterling Electronics Company (703)-353-6648  
WASH., SEATTLE • Kierulff Electronics, Inc. (206)-763-1550  
WASH., TACOMA • C & G Electronics Co. (206)-272-3181  
CANADA, ONT., SCARBOROUGH • Lake Engineering Co., Ltd. (416)-751-5980  
ALL OVERSEAS INQUIRIES:  
General Motors Overseas Operations  
Power and Industrial Products Dept.,  
767 Fifth Avenue, New York, N.Y.  
10022. Phone: (212)-486-3723.

Regional Headquarters, Union, New Jersey\*  
07083, Box 1018 Chestnut Station, (201)-687-3770 ■ El Segundo, Calif., 90245, 354 Coral Circle, (213)-772-5181  
■ Chicago, Illinois\* 60656, 5151 N. Harlem Avenue, (312)-775-5411 ■ Kokomo, Ind. 46901, 700 E. Firmin, (317)-459-2175 Home Office  
■\*Office includes field lab and resident engineer for application assistance.



# We pack more performance into less space

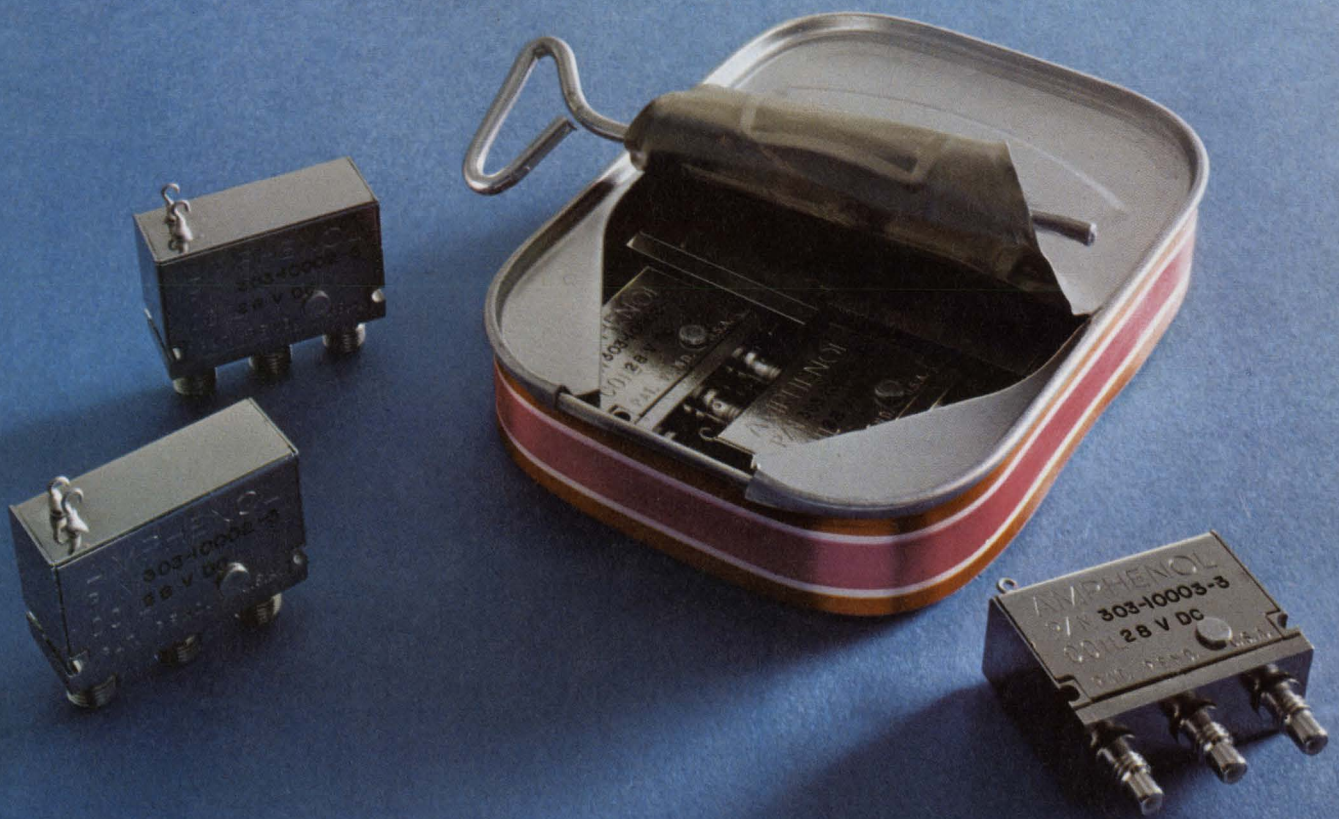

## and save you up to 50¢ on your dollar.

Amphenol's new 303 Series MINIform coaxial switch line is the answer to today's biggest component problem: Getting higher performance, using less space at the lowest possible cost.

High performance we have. From 0 to 1.0 GHz, the MINIform switches handle up to 150 watts CW, maintain maximum VSWR of only 1.1:1, 80 dB minimum crosstalk attenuation and 0.1 dB insertion loss. Maximum VSWR over the 1.1 through 3.0 GHz range is only 1.2:1 with power handling capabilities up to 70 watts CW.

True to their name, MINIform switches weigh only 1.2 ounces and occupy less than 1/2 cubic inch of precious space.

Three popular termination styles are available: SMA connectors, Amphenol SUB-Minax 27 Series connectors and pc contacts for solder or solderless wrap terminations.

To find out more about MINIform and how it can cut your switch costs in half, write to Amphenol RF Division, Bunker Ramo Corporation, 33 East Franklin Street, Danbury, Connecticut 06810.

**BUNKER  
RAMO** **AMPHENOL**

# designer's calendar

Aug. 25-27

International Geoscience Electronics Symposium (Washington, D. C.) Sponsor: IEEE. M. T. Miyasaki, Johns Hopkins Univ., 8621 Georgia Ave., Silver Spring, Md. 20910.

CIRCLE NO. 420

## SEPTEMBER 1971

S	M	T	W	T	F	S
			1	2	3	4
5	6	7	8	9	10	11
12	13	14	15	16	17	18
19	20	21	22	23	24	25
26	27	28	29	30		

Sept. 8-10

International Conference on Urban Transportation (Pittsburgh, Pa.) Sponsors: U. S. Dept. of Transportation et al. Arthur V. Harris, P.O. Box 2149, Pittsburgh, Pa. 15230.

CIRCLE NO. 421

Sept. 27-29

International Telemetry Conference (Washington, D.C.) Sponsor: International Foundation for Telemetry, Suite 6, 19730 Ventura Blvd., Woodland Hills, Calif. 91364

CIRCLE NO. 422

## OCTOBER 1971

S	M	T	W	T	F	S
					1	2
3	4	5	6	7	8	9
10	11	12	13	14	15	16
17	18	19	20	21	22	23
24	25	26	27	28	29	30
31						

Oct. 6-8

Electronic & Aerospace Systems Convention (Washington, D.C.) Sponsors: IEEE, G-AES, L. Goldmuntz, 29 Kalorama Circle, Washington, D.C. 20008

CIRCLE NO. 423

# POWERTEC'S WINNING OEM MULTIPLES

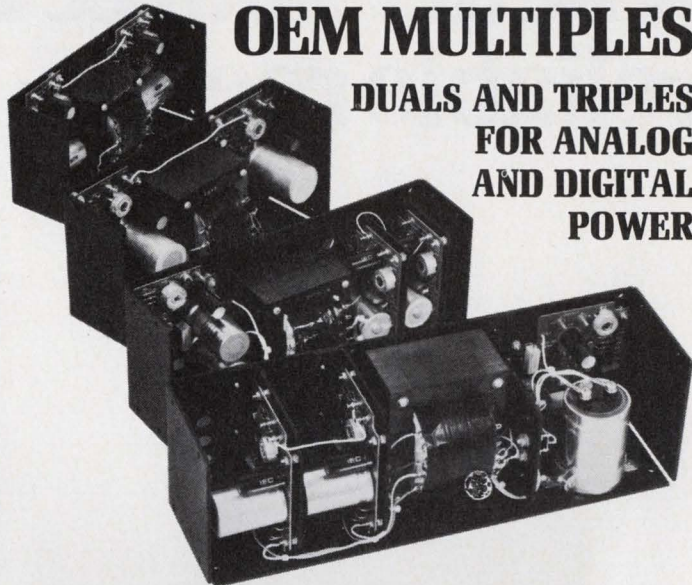

**DUALS AND TRIPLES  
FOR ANALOG  
AND DIGITAL  
POWER**

■ EXCEPTIONAL VERSATILITY ■ BEST POWER/COST RATIOS ■ PROVEN, RELIABLE DESIGN

Powertec, the fastest growing Powerhouse in the industry, introduces its new multiple output OEM line, with dual output models for analog circuits and the triple output models for digital and analog. Offering maximum versatility, the fully isolated outputs may be interconnected for any positive/negative requirement, including MOSFET and CCD.

This new design is an extension of our highly successful single output OEM series, has the same quality components and features the same low prices. Don't take second place — Win with the Power People from the Powerhouse — Powertec. Request free application data and catalog.

ALL MODELS DELIVERABLE FROM STOCK IN 24 HOURS.

Model Number	Output Power		Unit Price
	±12V or ±15V	5V	
2K15D-1.3	1.5A	1.3A	NA \$ 46.00
2L15D-2.8	3.0A	2.8A	NA \$ 81.00
2R-70T	1.5A	1.3A	6.0A \$ 86.00
2S-140T	3.0A	2.8A	12.0A \$149.00

• REGULATION: Line ±.25%, Load ±.25% • INPUT: 115 VAC ± 10V 47-63Hz • RIPPLE: 1mv RMS 5 & 15V  
• RESPONSE: 50µsec typical • TEMPERATURE: 0°C to 40°C derated to 71°C • O.L. PROTECTION: Current limit/foldback • Optional OVP available

# POWERTEC INC.

an Airtronics subsidiary

9168 De Soto Ave., Chatsworth, California 91311 (213) 882-0004 TWX 910-494-2092

INFORMATION RETRIEVAL NUMBER 10

# A better source for reliable reeds.

If you want the best source for reeds, go to the people who make them for their own equipment. Us. The "Vibrasponder" reeds that we use for thousands of remote control and signaling applications are now for sale.

Features include contactless design, narrow bandwidths, shock and vibration protection, and over 120 standard tones from 67Hz to 3225.8Hz. Specs available from Motorola Component Products Dept., 4545 W. Augusta Blvd., Chicago, Ill. 60651.



**MOTOROLA**





GRAPHIC ARTS PRESS



# Bodine helps graphic arts equipment

Tough little customers . . . Bodine motors, gearmotors and controls. Precision built to meet the quality you've built into your graphic arts equipment. Quiet. Reliable. Take long hard service in stride . . . with fewer field problems. Bodine fhp drives and controls are built for each other—a perfectly matched pair.

Whatever your graphic arts specialty is—movie cameras or projectors, film processors or dryers, platemakers or presses—you can do no better than to incorporate Bodine fhp drives and controls. Over 3500 standards to choose from. Custom fhp drives and controls also built to meet special requirements. Our engineers will be happy to help you select the right one for your application.

Write for bulletin. Bodine Electric Company, 2500 W. Bradley Place, Chicago, Illinois 60618.

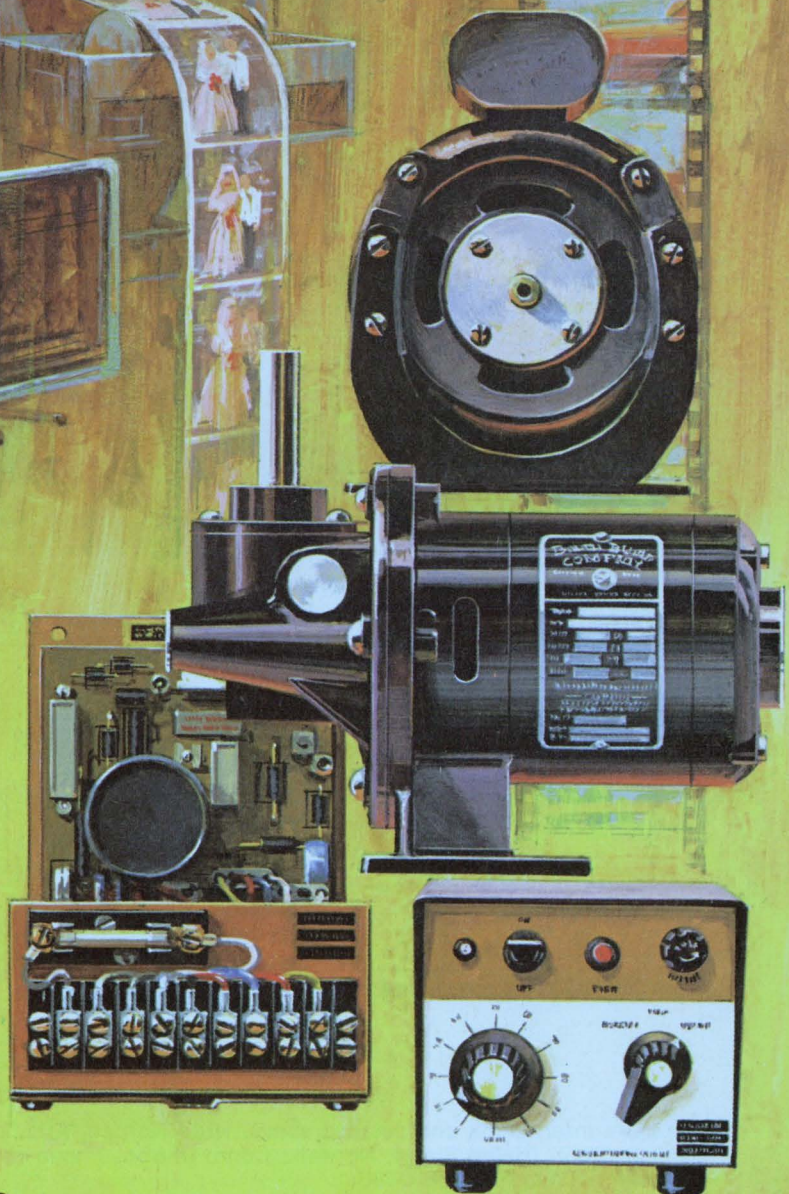

*"The Power Behind the Leading Products"*



**BODINE MOTORS/GEARMOTORS  
SPEED CONTROLS**



# Norden Encoders perform for you!

Look at these new 1971 additions to Norden's line. More are on the way.

	Total Count	Revolutions for Full Count	Diameter"	Model Number
<b>NEW! Optical Absolute</b>	10,000	50	2.25	OADC-23/4/BCDQ-200L
<b>NEW! Optical Absolute</b>	1,000	1	2.25	OADC-23/3/BCD-1000L
<b>NEW! Optical Incremental:</b> Series now available with shaft seal—permits drenched operation.				
<b>NEW! Contact Size 11</b>	8,192	32 or 64	1.06	ADC-11/13/BNRY-256L
<b>NEW! Contact Size 11</b> Altitude Reporting Encoder	1,280	16	1.06	ADC-11-ALT-1280
<b>NEW! Contact Size 11</b>	10,000	100	1.06	ADC-11/4/BCDX-100
<b>NEW! Contact Size 11</b>	3,600	36	1.06	ADC-11/4-36/BCDX-100
<b>NEW! Rugged Industrial Grade Optical Incremental Encoders</b>				
All available with quadrature and internal squaring circuit options	2,000 Pulses	1	3.500	OADC-35/2000/INC
	1,500 Pulses	1	3.500	OADC-35/1500/INC
	1,250 Pulses	1	3.500	OADC-35/1250/INC
	1,000 Pulses	1	3.500	OADC-35/1000/INC
	600 Pulses	1	3.500	OADC-35/600/INC
	500 Pulses	1	3.500	OADC-35/500/INC
	300 Pulses	1	3.500	OADC-35/300/INC
	200 Pulses	1	3.500	OADC-35/200/INC
	100 Pulses	1	3.500	OADC-35/100/INC
<b>Optical Incremental Encoders</b>				
All available with index marker, quadrature outputs and internal squaring circuit options. Other counts on special order	100 Pulses	1	2.250	OADC-23/100/INC
	250 Pulses	1	2.250	OADC-23/250/INC
	256 Pulses	1	2.250	OADC-23/256/INC
	336 Pulses	1	2.250	OADC-23/336/INC
	500 Pulses	1	2.250	OADC-23/500/INC
	512 Pulses	1	2.250	OADC-23/512/INC
	1,000 Pulses	1	2.250	OADC-23/1,000/INC
	1,024 Pulses	1	2.250	OADC-23/1,024/INC
<b>IC-Compatible Encoders. For direct interface with TTL &amp; DTL circuits</b>				
Binary	128	1	1.750	ADC-ST7-BNRY-E/L
	8,192	64	1.750	ADC-13-BNRY-E/L
	524,288	4,096	1.750	ADC-19-BNRY-E/L
Binary-Decimal Code	100	1	2.250	ADC-ST2-BCD/L
	1,000	10	2.250	ADC-3-BCD/L
	10,000	100	2.250	ADC-4-BCD/L
	100,000	1,000	2.250	ADC-5-BCD/L
	1,000,000	10,000	2.250	ADC-6-BCD/L
	360	1	2.250	ADC-3-36BCD-E-360L
	3,600	10	2.250	ADC-4-36BCD-E-360L
	36,000	100	2.250	ADC-5-36BCD-E-360L
	360	1	3.250	ADC-ST3-36-BCD/L
	3,600	36	2.250	ADC-4-36-BCD/L
	36,000	360	2.250	ADC-5-36-BCD/L
	360,000	3,600	2.250	ADC-6-36-BCD/L
<b>External Logic V-Scan Binary Encoders</b>				
	128 or 256	1	1.750	ADC-7/8-BNRY-XB
	8,192 or 16,384	64	1.750	ADC-13/14-BNRY-XB
	524,288 or 1,048,576	4,096	1.750	ADC-19/20-BNRY-XB
<b>Single Turn Gray Code Encoders</b>				
Available with various levels of RFI suppression	256	1	1.066	ADC/11/8/GRAY
	256	1	1.750	ADC-ST8-GRAY
	512	1	2.250	ADC-ST9-GRAY
	1,024	1	3.062	ADC-ST10-GRAY
<b>Multiturn Gray Code Encoders</b>				
Available with various levels of RFI suppression	1,024	4	1.062	ADC-11/10GRAY256
	1,024	16	1.062	ADC-11/10GRAY 64
<b>Low Cost Magnetic Noncontacting Encoders</b>				
Incremental	128	1	1.750	MADC-18/128/INC
Binary	128(V scan)	1	1.750	MADC-18/7/BV
Binary	8,192(V scan)	64	1.750	MADC-18/13/BV
Binary	524,288(V scan)	4,096	1.750	MADC-18/19/BV

For more information and detailed specs, write Norden, Att: Components Dept., Helen Street, Norwalk, Conn. 06856. Phone (203) 838-4471. TWX: 710-468-0788.

**Norden** DIVISION OF UNITED AIRCRAFT CORPORATION

# Centralab push button switches brighten your design...

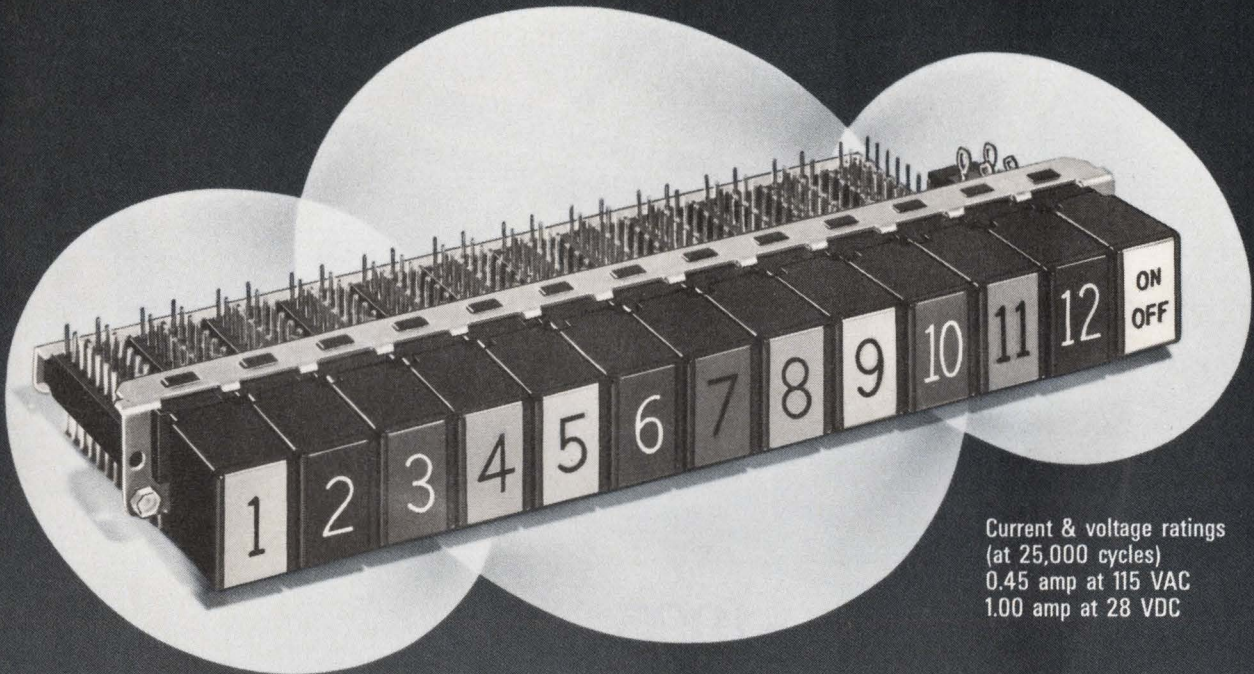

Current & voltage ratings  
(at 25,000 cycles)  
0.45 amp at 115 VAC  
1.00 amp at 28 VDC

## ...for as low as \$1<sup>25</sup> per module

When it comes to economy and performance the spotlight is on Centralab. Our push button switches\* (lighted or plain), which provide convenience and efficiency through modular design, are a bright example. In the first place, it's worth repeating that you can buy Centralab domestically manufactured lighted push button switches for as low as \$1.25 per module in production quantities. Plain modules are as low as 21 cents each. What's more, with our new RSD (Rapid Switch Delivery) program, we can deliver in four weeks, sooner in emergencies. On prototype orders, we'll deliver in two weeks.

Then there's the plain module itself, which contains only four parts to give longer, more reliable life. Two, four, six or eight pole, double-throw designs are available for printed circuit or panel mounting. As many as 29 modules can be ganged on a common mount-

ing bracket in the PB-10 Series, 15 modules in PB-15 and PB-20 Series. And standard functions include momentary, interlocking, push-push and push pull.

In lighted modules, interchangeable lenses and filters provide maximum color utility and aesthetic appeal. Front bulb replacement is another convenience feature.

For consumer and industrial applications, Centralab push button switches are lighting the way to new economy, performance and efficiency. For complete specifications, write Switch Sales Manager, Centralab Electronics Division, Globe-Union Inc.

\*Isostat Licensed

**CENTRALAB  
DELIVERS!**



**CENTRALAB**

Electronics Division  
GLOBE-UNION INC.

5757 NORTH GREEN BAY AVENUE  
MILWAUKEE, WISCONSIN 53201

M-7102

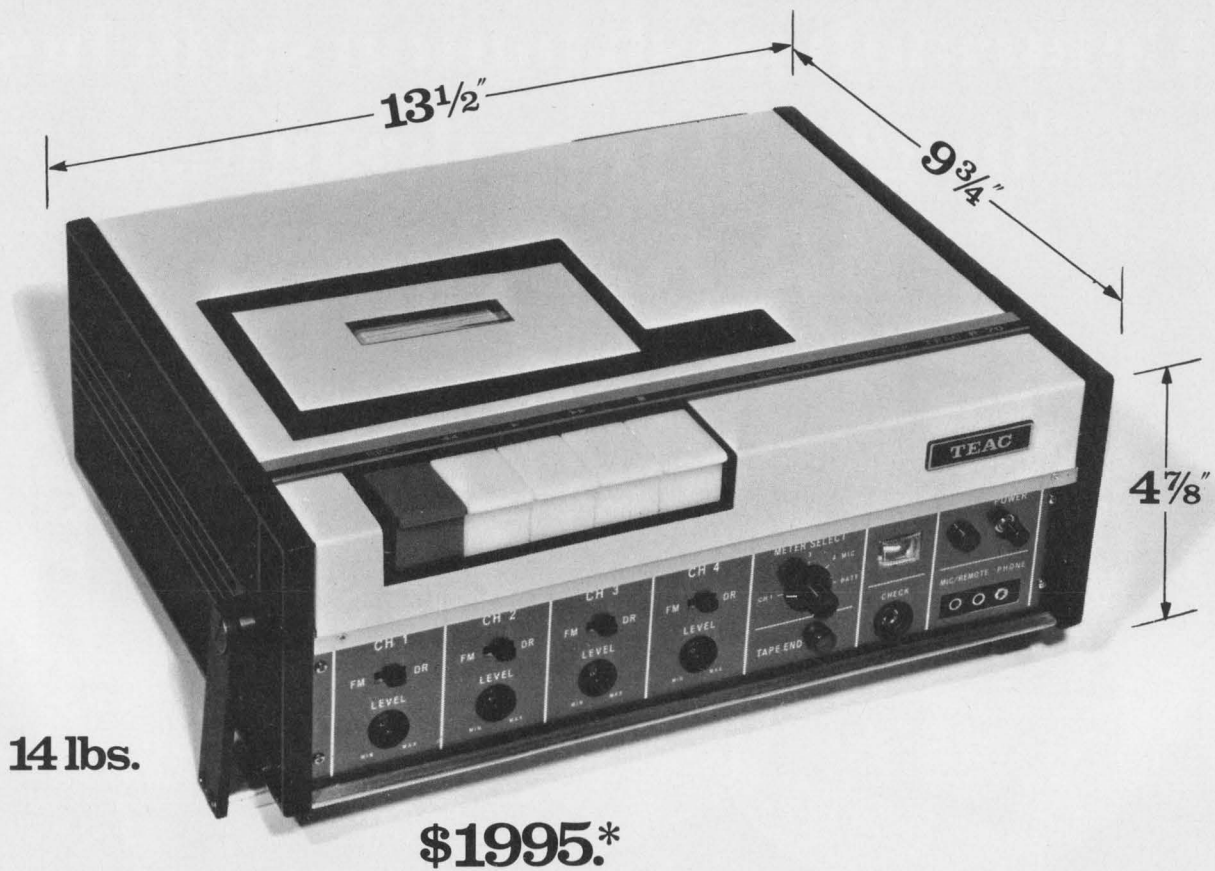

## This is a lot for your money?

If you judge superiority by size and worth by weight, the looks of our R-70 cassette data recorder may be deceiving.

But for what it's worth, it's not just another pretty face with a slim figure and expensive taste.

It's a handful of fine features that no other data recorder its size can measure up to.

We make it that way because the R-70 has the family name to uphold.

Its housing is a strong case against dust, vibration and manhandling. And it's made to do the job lying down or standing up.

Since both FM and direct record

electronics are built in, you can choose either with a mere flip of a switch on any of its four channels. And even add voiced comments.

Each channel can be individually monitored, too, via a meter or a built-in output to a scope or VTVM to insure proper input level.

And a built-in tape counter tells you the exact spot of any recorded data.

For those who tend to be forgetful, we've even included a warning light that tells you when you're at the end of your tape.

Frequency response in the FM mode is DC to 625 Hz while the direct mode is 100 to 8,000 Hz.

The unit uses commercially available instrumentation grade Philips-type cassettes.

Made to travel in fast company, the R-70 can operate on its own self-contained batteries, or draw upon outside AC or DC power sources.

For more of the fine points on this or other data recorders in our line, write or call Ken Williamson, Director of Marketing, Technical Products, TEAC Corporation of America, 7733 Telegraph Rd., Montebello, CA 90640. Telephone (213) 726-0303.

He'll tell you why it pays to

**go TEAC**

\*Price includes these accessories: TEAC CT-60 tape cassette; memo announcement microphone; monitoring earphone; input-output cords; fuses and lamps; AC power cord; DC power cord; check terminal cord; cleaning kit; vinyl cover; adjustment screwdriver; operating manual.

See us at WESCON - Booths 1222 & 1223

INFORMATION RETRIEVAL NUMBER 14

## Pentagon shifts its policy on weapons procurement

The Pentagon has issued changes in procurement practices for major weapons systems that have sounded the death knell for total-package procurement and scattered program management responsibility.

Since Melvin Laird moved into the head defense slot some two years ago, total packaging-procurement, whereby one contractor performs the R&D and production work on a major system, has been in disfavor. Both Laird and his deputy, David Packard, have stated on numerous occasions the Pentagon will operate on a fly-before-buy concept, but until now the concept has never been spelled out.

Under the new directive, the need for the system will be weighed as the program moves along, and the possibility of using existing hardware will be considered.

The effects of inflation will be continuously monitored. On all new major programs each armed service or Defense Dept. procuring agency will designate one individual, "such as an assistant secretary for R&D," to be responsible for "conceptual efforts on new major programs."

When the armed service or defense procuring agency is confident that the engineering is complete and that production is warranted, it will ask the Secretary of Defense for authority to proceed. The directive goes on to say that since it is not possible to determine precise production costs of a system before the system is developed, fixed-price contracts will be let whenever practical.

The directive is to be implemented by mid-October.

for example, it could be used to test an airplane wing on the field.

■ Three-dimensional imagery of manufactured parts and electronic components. The camera could be used to make permanent three-dimensional pictures of optical crystal growth, for example.

■ Industrial and biomedical microscopy. It could make in-depth studies of material surfaces or be used to make three-dimensional pictures of delicate surgical operations for use in teaching medical students.

■ General portraiture in fields as diverse as archeology, dentistry and surgery. The camera could make permanent three-dimensional records of archeological finds in their original state, or records of tooth positions for use in orthodontics.



Hand-held holography is possible with this lightweight holographic camera, developed by Dr. Donald H. Close at Hughes Research Laboratories.

## Snapshot holography developed by Hughes

Development of the first portable holographic camera has been announced by Hughes Research Laboratories, Malibu, Calif.

Dr. Donald H. Close, project head, says the camera weighs 17.4 pounds, including film, and measures just  $12 \times 13 \times 6/18$  inches. It uses a modified version of a laser and associated electronics originally developed by Hughes for a range-finding system for Army tanks.

The battery-operated camera incorporates a pulsed-ruby laser with an output energy of 20 millijoules at 0.694 micron. Pulse length is variable from 100 to 150 microseconds. Focal length is reported to be 23.6 mm, with a 4.5-mm field of view, 4-mm depth of field and

a resolution of 4.1 microns.

The camera records the interference pattern of two beams that are obtained by passing the laser output through a beam splitter. One beam shines directly on the film, the other is reflected to the film from the object being recorded.

When a camera pushbutton is pressed, an automatic sequence of four holograms is taken in 60 seconds.

The camera uses a 24-exposure roll film developed by Eastman Kodak. The film is 61.5 mm wide. Final holograms, 48 mm in diameter, are obtained by normal film processing methods, which take about 30 to 35 minutes per roll.

Dr. Close says that major applications of the camera could include these:

■ Nondestructive testing of aircraft components and structures—

## A new technology office proposed in Congress

A bill before committees in both the Senate and House of Representatives would establish a new Office of Technology Assessment.

The objective would be to provide Congress with the means to assess technological needs and priorities. The office would give Congress information on the immediate and long-range physical, economic, social and political impact of technology.

The bill also calls for establishing

an 11-member Technology Assessment Board, which would have four members from the public appointed by the President.

Sponsors of the bill are Senators B. Everett Jordan (D-N.C.), Winston L. Prouty (R-Vt.), Gordon L. Allott (R-Colo.), Edward M. Kennedy (D-Mass.) and John Pastore (D-R.I.).

Meanwhile Labor Secretary James D. Dodgson has appointed a 22-member group on professional, scientific and technical manpower to do the following:

- Provide a forum to deal with critical problems of professional, scientific and technical manpower.

- Serve as an agent for receiving and exchanging information between the sources of supply and demand for this manpower.

- Consider the implications of changes in federal, economic and expenditure policies and their effect on manpower.

- Advise the Labor Dept. on how to deal with those aspects of manpower that come within the department's purview.

- Recommend legislative and administrative actions to improve the Federal Government's programs for the development and use of manpower.

- Recommend actions that should be taken by the private sector, including the educational system, to promote the development and use of manpower.

- Encourage the formulation of a national science strategy.

Among the topics to be studied by the new committee will be the Labor Dept.'s program for unemployed engineers, scientists and technicians; the short-term outlook for the demand for engineers, and the expected supply and demand for college graduates through the 1970s.

Dr. Allan M. Cartter, chancellor of New York University, is chairman of the committee.

## Electronic coverage of '72 Olympics due

Next summer's Olympic Games in Munich, Germany, should be the most technologically sophisticated yet. The Germans plan to use the latest in communications and data-processing equipment to display the results at 72 information cen-

ters around Munich.

The results from all Olympic Games since 1896 are now being stored in computers in English, French and German, along with the rules relating to each event. Personality data on the 15,000 athletes and other participants in the games should be available instantly on request. The schedule of events will be updated several times a day.

Most of this work has been contracted to the Siemens Corp. Five Siemens Model 4004/45 and /46 data-processing units will handle the bulk of data for official scoring and communications to the press and public. Siemens intends to hire over 600 people to maintain the equipment for the games.

## Pacemakers being tested for interference potential

Laboratory studies of the sensitivity of heart pacemakers to electromagnetic interference are being conducted by the Society of Automotive Engineers for the U.S. Bureau of Radiological Health. The activity is a part of the society's little-recognized objectives to develop engineering standards, specifications and technical reports for the information of industry and government.

Pacemakers are becoming more efficient (see p. 28 this issue), but the interference problem encountered with them has not yet been overcome, though it has existed for some years. It is caused by a variety of equipment, including medical diathermy and electrocautery units, radio transmitters, radar scanners, microwave ovens, electric shavers and food mixers, television receivers and gasoline-engine ignition systems.

The Bureau of Health of the Dept. of Health, Education and Welfare has neither the experts nor the equipment for evaluating the electromagnetic susceptibility of pacemakers or for establishing standards for testing them. Learning of this, the Society of Automotive Engineers, under W. D. McKerchar, chairman of the group's Electromagnetic Committee, established a task force with two prime objectives:

- (1) To determine the vulnerability of pacemakers to radiation.

- (2) To develop simple, effective testing methods for the pacemaker industry.

Cornell Dublier/Electronics, in Venice, Calif., has volunteered its facilities for the studies. The sensitivity of pacemakers to electro-magnetic interference is being examined over a wide range of frequencies—"from zero to daylight," McKerchar says.

## Acoustic microscope aids medical research

Recent developments in acoustic microscopy could mean future break-throughs in bio-medical research, says Dr. Lawrence W. Kessler of the Zenith Radio Corp.'s Research Dept. in Chicago.

Dr. Kessler, along with Dr. A. Korpel and P.R. Palermo, reported on the development of a 100-MHz acoustic microscope in the July 9 issue of the British scientific journal "Nature."

According to Dr. Kessler, the acoustic microscope "sees" a biological specimen differently than either an optical microscope or an electron microscope does, and of its use, he says:

"What we will find, we're really not sure. The optical microscope 'sees' optical differences—differences in index or refraction and differences in percent transmission of light through objects. Sound, however, 'sees' mechanical properties. Structures may thus become visible which would not be visible by any other methods, and there is every reason to believe that these structures would be different."

A unique characteristic of Zenith's working instrument is the way it converts an acoustic image, through laser holography, so it can be displayed on a CRT. According to Dr. Kessler, an ultrasonic transducer sends a 100-MHz plane wave through a specimen (suspended in water) and strikes a plastic mirror. The mirror's surface then ripples in a pattern created by the spatial information carried by the wave. A focused laser beam, synchronized with the scan of a conventional TV monitor, periodically scans the surface of the mirror by means of two acousto-optic light deflector cells, and a magnified picture of the acoustic field at the mirror's surface appears on the screen.

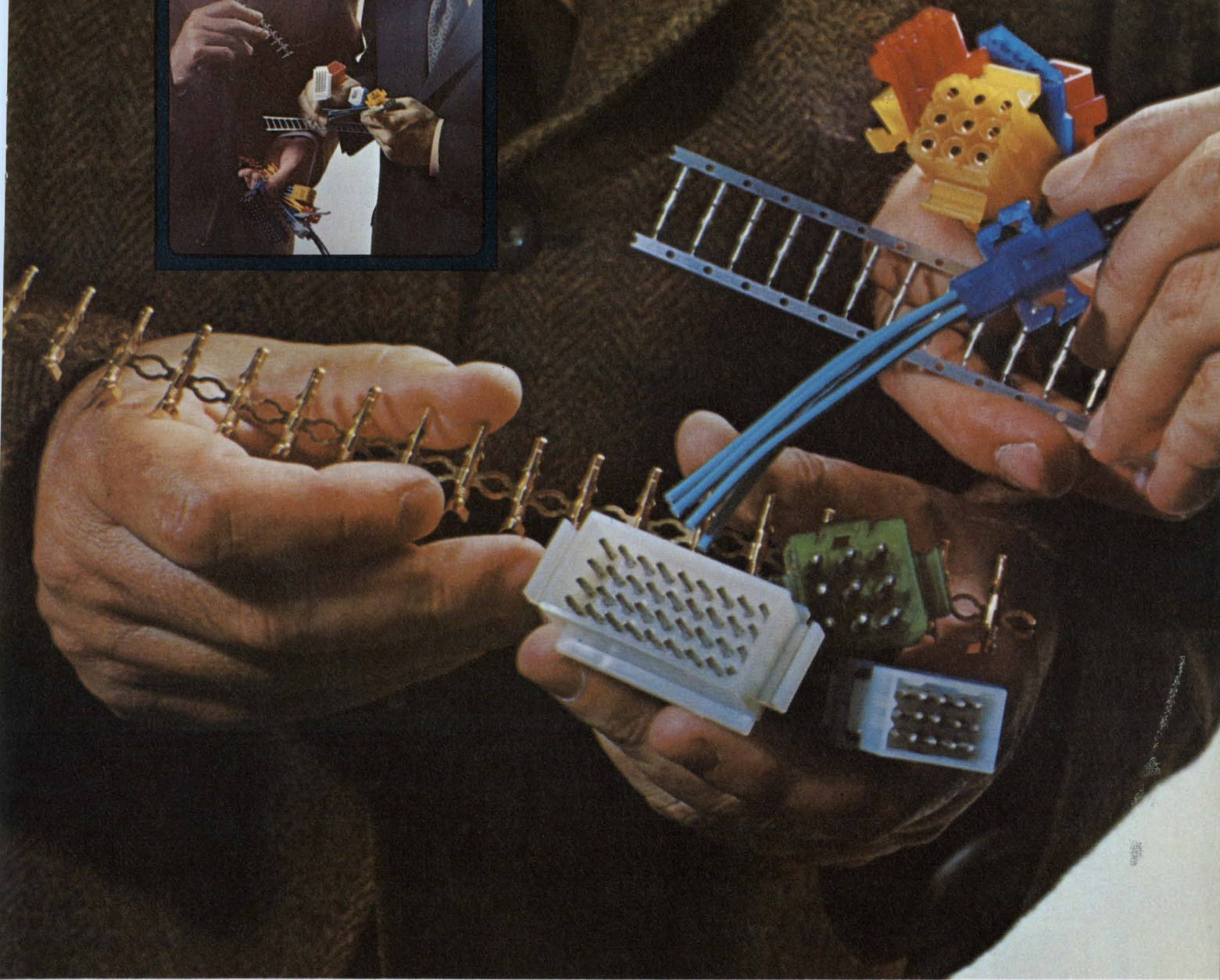

**MAKE YOUR CONNECTIONS: FAST.** With Molex standard and miniature connectors. They're easier to work with. Simplify wiring. Speed production. Save assembly steps. Make installation and servicing extra easy, too. This is why circuitry idea men everywhere are making connections with Molex. From one circuit to 104 or more. Production keyed and available in a variety of colors to meet design requirements. Molex has the

connector. Plus the design and engineering capability to solve the most complex wiring problems . . . fast. For a colorful free sample of the Molex connector write: Molex Incorporated, Downers Grove, Illinois 60515. Or you can make connections by calling (312) 969-4550.

*... creating components that  
simplify circuitry*



# A new era in digital design: program-it-yourself memories

Like instant coffee, there's a new generation of "instant" semiconductor memories that can be taken off the shelf, programmed by the user and be readied for use with only a few minutes of preparation. These electrically alterable programmable read-only memories, originally developed by Harris Semiconductor, Melbourne, Fla., and trademarked PROM, are creating a new era in digital design.

These pROMs are like conventional semiconductor ROMs that are programmed during fabrication by means of a mask with a customer-specified bit pattern. The electrically alterable pROMs can, however, be readily programmed with a new generation of test

equipment available, supplied by Spectrum Dynamics, Inc., Ft. Lauderdale, Fla., or Curtis Electro Devices, Mountain View, Calif.

Or the designer can use test equipment supplied by the device manufacturer to his distributors or directly to the user. For example, Intersil in Cupertino, Calif., which produces a 256-bit (32 x 8) memory, supplies their own programmer "in a suitcase."

In some cases, the device manufacturer provides the user with details for building his own programmer (see table). Motorola Semiconductor Products, Phoenix, Ariz., for example, does so for its 512-bit pROM.

Bud D. Broeker, section manager of memory applications notes that Motorola provides comprehensive data and schematics for building a simple programmer using but five

ICs, or for an automated design requiring 25 ICs.

## The many advantages of pROMs

Because the field-alterable pROMs can be so readily programmed, they provide the designer with substantial advantages over the mask-generated type. The pROMs can:

- Drastically reduce design and debugging time, saving weeks or even months, and from hundreds to thousands of dollars for new masks.
- Be purchased, often from distributors, on a single unit basis.
- Substantially reduce inventory problems because one basic type of memory can be stacked on shelves, and altered, as needed, for a variety of customer requirements.
- Eliminate secrecy problems for both supplier and user for sensitive government and business applications. The supplier doesn't have to be saddled with security regulations and customers can keep a tight, internal control over their own codes.

■ Be ordered in fairly high-volume quantities, eliminating entirely the cost of masks.

All of the available pROMs are TTL-compatible, and most are bipolar devices. But Intel Corp., Santa Clara, Calif., produces a new MOS structure called a floating avalanche-injection MOS pROM. Solid State Scientific, Montgomeryville, Pa., makes a pROM with CMOS bit-storage elements.

PROMs are manufactured as memories with logic "zeros" in every bit location, except for Intel's device, which has all "ones". The bit pattern is programmed onto the chips by four methods, all of which use voltage or current pulses. The methods are:

- Blowing a fusible nichrome

Jim McDermott  
East Coast Editor

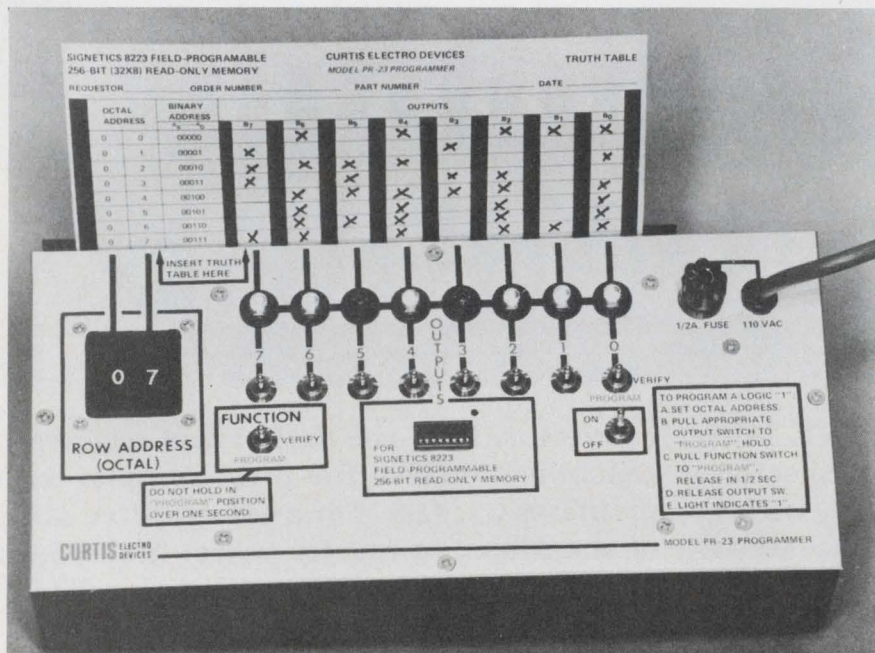

This portable field programmer is used to rapidly program fusible-link pROMs. The bits are inserted in the memory by using a truth table prepared by the computer designer. When a "one" is programmed, a light comes on.



## Table. Field programmable read-only memories (pROM)

Supplier of pROM	Type of pROM	pROM bit pattern	Electrical programming technique	Programming equipment
Harris	Bipolar	256(256x1) 256x(32x8) 512(64x8)	Fusible nichrome links	Spectrum Dynamics
Monolithic Memories		1024 (256x4) 2048 (512x4)		Supplies programmer
Motorola		512(64x8[+1])		Supplies data to build
Signetics		256(32x8)		Spectrum Dynamics Curtis Electro Devices
Fairchild	Bipolar	256(32x8)	Diode-junction shorting	Spectrum Dynamics
Intersil				Supplies programmer
Monolithic Memories				Supplies programmer
Intel	MOS	2048(256x8)	Applying trapped-gate charges	Supplies programmer or data to build
Solid State Scientific	CMOS	16x1	Fusing	Spectrum Dynamics

link, in a bipolar memory, with controlled currents.

- Shorting diode junctions, in a bipolar memory, with programmed micro-second breakdown pulses.

- Converting conducting links in the CMOS memory to an open state by electrochemical fusing.

- Applying a programmed charge pattern to "floating gates" in the floating avalanche-injection MOS structure.

### Bit patterns are permanent

Once the bit patterns have been programmed into the memories, they are permanent. The fusible links are destroyed, the diode junctions permanently shorted, and the MOS trapped-gate charges in the Intel device are estimated to remain at 70% of their value for more than 10 years at 125 C.

It is, however, possible to erase the charges in the Intel memory by shining ultraviolet light on the chip's open surface.

Michael Markkula, Intel's marketing manager says that the factory uses an ultraviolet prospector's lamp radiating at 2450 Å, with a power output of 120 μW/cm<sup>2</sup> at the lamp surface. To erase, the lamp is held 18 inches from the chip's surface for 10 minutes.

Markkula also points out that

once the chip is packaged, it is necessary to use X-ray radiation in the order of 5 x 10<sup>4</sup> rads, a value readily available from commercial X-ray generators.

To permit erasure of the memory in the field, Intel is developing a transparent quartz lid for the package, which should be available shortly. Once erased, the memory is again ready for re-programming.

Currently, the most widely available pROMs are the bipolar, TTL compatible memories ranging from 256 bits (32 x 8) to 1024 (256 x 4) (see table). Of these, two basic types are being produced—those with the fusible nichrome links, and those that are programmed by shorting diode junctions in the element pattern.

The fusible devices are the oldest types, being first introduced as diode matrices with fusible aluminum links by Harris Semiconductor, Melbourne, Fla. back in 1964.

The current bipolar memories, as well as the diode matrices that are still available, use nichrome as the fuse element.

These devices, supplied by Harris, Motorola, Signetics, and Monolithic Memories, have a solid link in each bit position, situated between the address selection line and the output buffer. Since they are fabricated with all bits in the zero state,

the fuse must be blown to obtain a "one". The propagation delay for this type is about 50 ns.

One of the problems with these devices is: how do you test them without blowing any of the fuses?

Motorola has come up with one answer in their MCM 5003/5004, a 512-bit (64 x 8) pROM. A ninth bit has been designed into each word to enable the manufacturer to pretest the memory.

The ninth bit, Bud D. Broeker, section manager of Motorola's Memory Applications, explains, is used during manufacture to determine if the address decoding logic is operating properly. Also, the extra bit assures that the links can blow without destroying any of the normal 64 x 8 bit array.

In addition, the ninth bit is located farthest away from the word line drivers, and consequently can be used for worst-case ac testing.

The second, and newer type of bipolar pROM, developed by Intersil, is a 256-bit memory manufactured using standard TTL techniques. It has no fusible links.

Supplied with logic "zeros" in all locations, the "ones" are produced by applying 2.5-μs, 200-mA pulses, limited to 36 V. These pulses provide a precisely controlled breakdown of a back-biased diode connected in a given bit location. ■■

# Pre-installation engineering cuts costs on military systems

In a time of growing inflation on top of budget cutbacks, builders of big weapon systems are looking for new ways to cut costs. One technique that Grumman Aerospace Corp. found successful in developing the Navy's EA-6B electronic warfare aircraft is now established procedure at this big Bethpage, N.Y. aerospace firm.

Three Air Force contractors are considering using Grumman's facilities for their programs. In fact, the technique may become standard in the development of most big military systems of the future.

By using a special, two-step, pre-installation engineering procedure for the EA-6B's avionics, "we saved two and a half years of flight test time and approximately \$40-million," says Roger S. Bush, Grumman's Business Development Manager for the EA-6B program.

First, the 8000 pounds of avionics, which consists of more than 50 black boxes or subsystems, are laid out in a row of equipment racks in the exact position they are intended to occupy in the aircraft.

All the equipment is set up in a shielded room with an IBM 360 computer alongside that is programmed to behave as if it were the IBM 4 Pi computer used in the EA-6B. The facility is called the Systems Integration Test Station (Sits). Except for the highly classified electronic warfare noise and deception jammers and transmitters, all the electronic equipment is operated here. The electrical interfaces between subsystems are examined and corrected and the electromagnetic interference (EMI) that shows up is eliminated.

"Using different sensors and

stimuli we actually got into the cockpit provided in the Sits and flew the whole system before the aircraft was even built," explains Bush, who before his present job, flight tested the EA-6B as an electronics warfare operator.

Things were so well integrated, Bush says, that when the wiring and black boxes were put into an airframe, the installation of the entire avionics system only took a few days, a job that usually requires about two months.

Another advantage in debugging before installing is that malfunctioning systems don't have to be torn out of an aircraft and reinstalled. This saves time and money.

"The EA-6B was operating after one flight," Bush says, "whereas it took the EA-6A approximately 40 flights before it was working."

The Sits facility was also used to check out the doppler navigation system. "We debugged the system, wrote the computer program for it, verified it and put it in the aircraft," Bush says. Instead of the 40 flights Grumman had scheduled, the work was finished after 19.

Grumman's avionics engineers are convinced, Bush says, that you can't take a bunch of black boxes and figure out how they're going to work together unless you actually try them in this kind of procedure first. Grumman continues to use

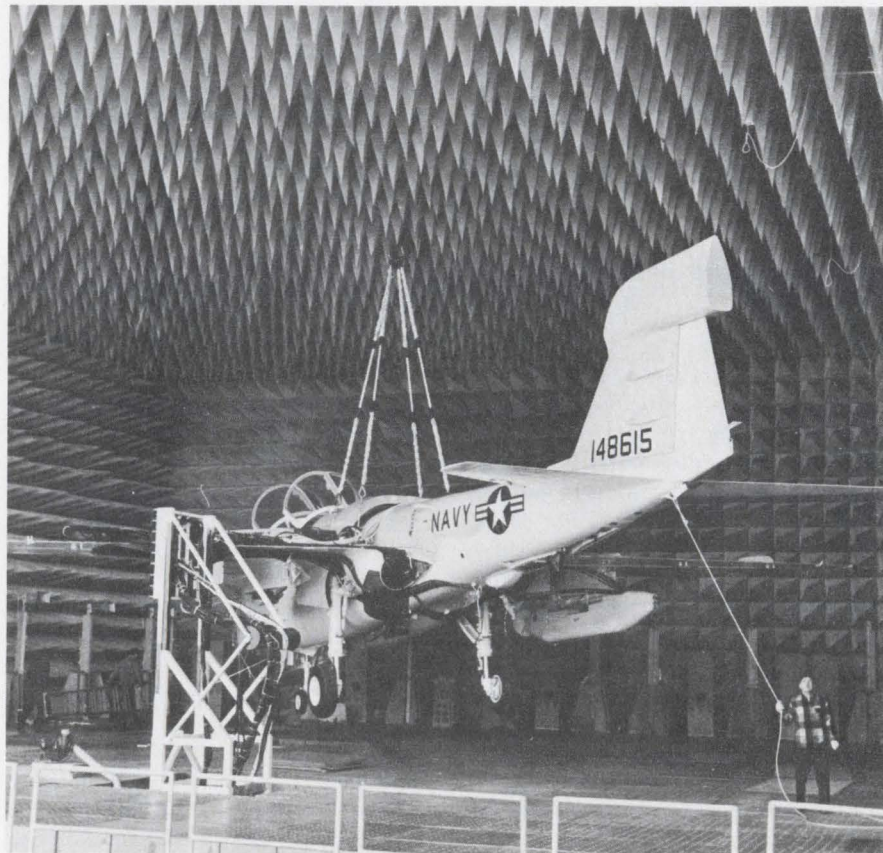

This giant anechoic chamber revealed 193 electromagnetic interference problems in the EA-6B electronic warfare aircraft before it was flown. Preflight engineering saved 2 1/2 years and \$40-million, Grumman says.

John F. Mason  
News Editor

the Sits in its growth program which involves adding more frequencies to the EA-6B's receivers and transmitters and doubling the 8000-word computer memory.

After Sits and all the equipment has been installed, the next step is to put the aircraft in an anechoic chamber built especially for the EA-6B program.

### Checking for EMI

The largest electromagnetically closed chamber in the non-communist world devoted to high power density testing, the enclosure is lined with 7300 absorber cones that create a radiant-energy absorbing test area 75 by 75 by 30 feet. Overall attenuation is 120 dB over the 65 MHz through 16 GHz region.

Suspended from the ceiling by a non-metallic sling, the aircraft is tested by transmitting and receiving antennas located within the chamber in a simulated real-world environment. Without breaching security or having to shut down because of bad weather, valid electromagnetic compatibility, radiation hazard and weapon system performance are evaluated.

## The all-electronic aircraft

The EA-6B is a carrier-based, twin jet, electronic warfare version of the A-6 attack aircraft. It is completely compatible with strike aircraft in speed, range and maneuverability. Its job is to move into a battle area to protect the attacking aircraft from enemy radar, both airborne and ground. With its wideband receivers it detects radar signals, analyzes them, checks them with a computer memory to determine whether or not they are a threat. It then instructs one or more of

10 jammers carried in five pods to jam the radars by noise. It can also instruct one of four jammers to transmit deceptive signals.

The computer has a memory bank of various important radar frequencies. It has the pulse repetition frequency, the pulse width and any unique features attributed to that radar. The panoramic display can present blips for all the radars being picked up, or, on request, only certain ones.

In the chamber, the noise jammers and deceptive devices were tested along with the entire avionics package. Because of the large number of switches on each of the 50 or more black boxes the entire system offered 20,000 electromagnetic combinations, 193 of which created EMI conflicts. All the problems have been solved.

Often the problem was discovered in the chamber before the flight crew noticed it in the air, says John Cunniff, manager of Elec-

tronic Warfare for Advanced Aircraft Systems at Grumman. "A chamber engineer might ask the flight crew to look at the fuel gage the next time they turned on the band-4 transmitter at a certain frequency to see of it jumped. Sure enough it would, and the problem would soon be solved. The chamber engineers found problems before the flight crews did," he says.

Two big problems arose with the AN/ARC-105, a high frequency radio. When it was keyed on a certain frequency the signal activated the autopilot causing the rudder to jump—a phenomenon that could have thrown the aircraft out of control. The hf radio also caused sporadic deflections to appear on the panoramic display. Both problems were solved by using filters.

The chamber revealed that often to avoid EMI even the bonding and shielding specifications had to be changed. Certain metals were found acting as capacitors or dielectrics. Besides using Sits and the chamber for further modifications of the EA-6B, Grumman used the facility for development of the Navy's F-14 fighter and the E-2C command and control aircraft. Grumman will use the facility in the future for any big weapon system it develops, Bush says.

The Air Force has talked with Grumman about using its facilities for Wild Weasel II, an airborne SAM suppression system; for integrating an electronic countermeasures pod that Westinghouse Electric in Baltimore is building for the F-4 aircraft; and for a surveillance system that UTL, Inc. of Garland, Tex., is proposing for the RF-4 reconnaissance aircraft. ■■

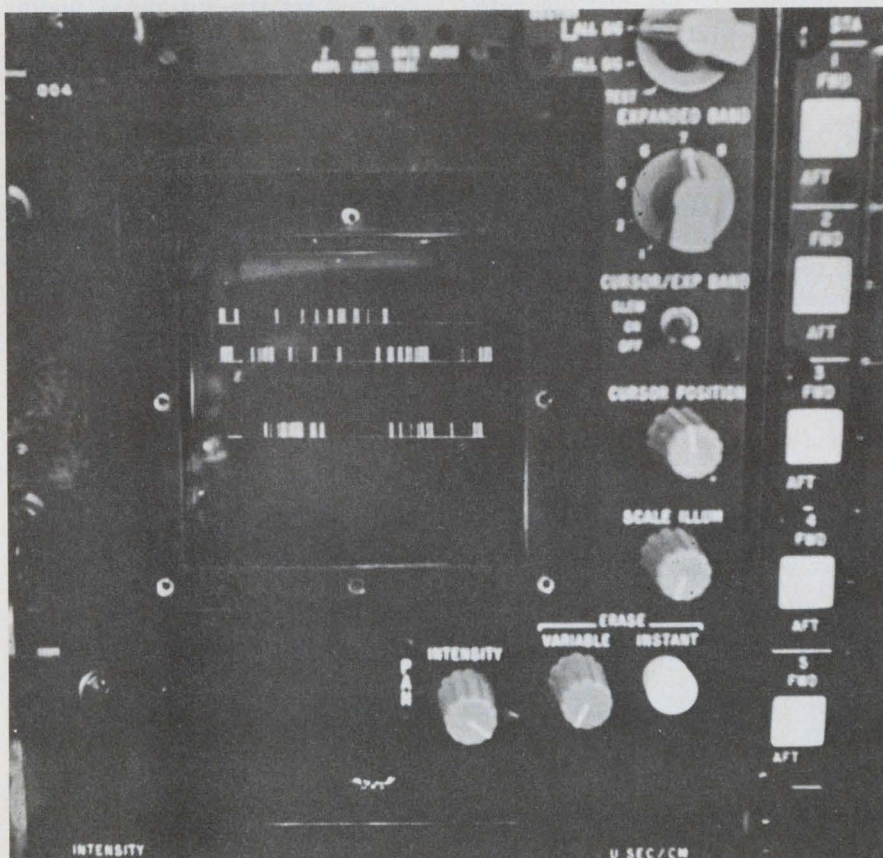

The panoramic display in the EA-6B shows a computer-derived status report on all transmitting radars within line of sight, both airborne and ground. Specific categories of radars can be selectively displayed on request.



# THE GREAT DAC DEAL

Tear out this ad and show it to some of the boys in your lab. It's an offer you can't pass up.

**OUR OFFER:** We'll send you your choice of any of our standard data conversion modules absolutely free — for a 30-day evaluation. Check your DAC's performance and compare competitive prices. In that way you'll learn some eye-opening facts about the new Philbrick and its ever-growing capabilities. Then, 30 days after you've plugged our D/A or A/D converter in your system we'll contact you. When we learn you like it, we'll apply the cost of your evaluation unit against your initial order — at the same discount price you earn through quantity purchases. If it doesn't perform to spec, return it. No questions asked . . . no hassle. One outstanding thing you'll discover when you plug in a Philbrick DAC is that it was "human engineered." Pins and bits are in sequential order. You get DIP pin compatibility. Features include  $< \pm 0.002\% / \% \Delta V_s$  power supply rejection ratio, unequalled temperature stability and buffered input to reduce sink current. Eight standard models with 8 to 14 bit resolution. Custom D/A and A/D's? You bet! We can produce hundreds of customer specified DAC's usually within four weeks on OEM quantity orders. And Philbrick DAC's are low-priced, too. From our general purpose DAC's to the highly sophisticated deglitched models like a 14-bit binary  $\pm 1/2$  LSB, deglitched output of  $< 10$  mV p-p and  $< 200$  nsec update rate. You get the best price/performance ratio. Philbrick power modules insure optimum performance and guarantee dependability. To help select your free trial evaluation module, send for our data packet containing all the details on Philbrick Data Conversion Modules. Contact your local field engineer or write Teledyne Philbrick, Allied Drive at Route 128, Dedham, Mass. 02026. TWX: (710) 348-6726. TELEX: 92-4438. Cable: TELEPHIL.

*PHILBRICK 4022 AND 4023  
GENERAL PURPOSE 10-BIT  
BINARY DAC'S. MAXIMUM  
LINEARITY  $\pm 1/2$  LSB. BOTH  
EXHIBIT LOW DRIFT (LESS THAN  
40 ppm/0°C). THE 4022 CURRENT  
OUTPUT IS 0 TO +2mA. THE 4023  
VOLTAGE OUTPUT IS ZERO TO -10V  
BOTH CAN BE USED UNIPOLAR  
OR BIPOLAR BY EXTERNAL  
CONNECTIONS. PRICES ARE  
\$27 AND \$29 IN SINGLE UNITS.*

*PHILBRICK 4103, 4104 AND 4105  
HIGH PERFORMANCE 12-10-8-BIT  
A/D CONVERTERS. IDEAL FOR  
HIGH SPEED CONVERSION OF  $< 30 \mu$  sec.  
LINEARITY OF  $\pm 1/2$  LSB. BOTH  
SERIAL AND PARALLEL OUTPUT  
AVAILABLE. ALL EXHIBIT LOW  
DRIFT (LESS THAN 20 ppm/0°C).  
LOW PROFILE PACKAGING.  
PRICE: \$ 275 FOR  
12-BITS IN  
SINGLES*

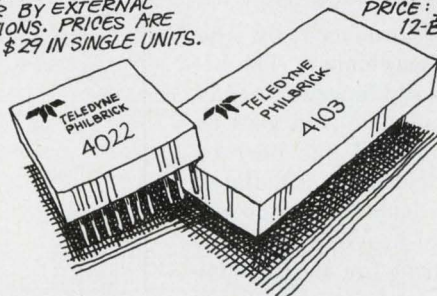

**FOR ROUND-THE-CLOCK  
TOLL-FREE READY DATA  
DIAL 800-225-7883**

**TELEDYNE PHILBRICK**  
DATA CONVERSION

INFORMATION RETRIEVAL NUMBER 16

# More hope for heart patients— the bifocal demand pacemaker

Over 50,000 Americans whose lives hang on each pulse from an electronic device can now cheer a new innovation. The device is the implantable electronic pacemaker and the innovation is American Optical Corp.'s Bifocal Demand Pacer which provides two, instead of the conventional one, pulses to maintain the heart's pumping action and increase its output.

Both the older fixed-rate and conventional demand pacemakers, as well as the new device, take over the transmission of electronic signals within the heart when the natural path is either partially or wholly broken. These signals are needed to trigger each heart beat, and maintain the steady rhythm required for continuous pumping action.

## Pacer pulses two chambers

The original fixed-rate pacemaker sends out a continuous string of pulses to stimulate the heart constantly. This was followed by the more advanced demand pacer which, as the name implies, adjusts its output to the demands of the heart. As long as the beat is regular and of sufficient strength the pacemaker does not provide stimulation. Both of the pacers send a single signal to one of the heart's chambers, either an atrium or a ventricle (see box), thus reinforcing the signal produced by the heart's natural pacemaker. The bifocal demand unit, however, sends a two-part signal. One part goes to the right atrium and one part to the right ventricle. This stimulates a more natural double beat and increases the total heart output.

The requirement for an artificial

pacemaker ordinarily comes about when the normal flow of electrons from the sinoatrial node—or the heart's natural pacemaker—to the atria, or from there to the ventricles is partially or totally blocked. This occurs when conducting cells die by being starved of blood, as is the case during a heart attack.

If the atrio-ventricular path is

broken, the atria continue to beat at the normal rate but the ventricular rate drops to only 30 to 40 beats per minute, a rate inherent to ventricular muscle. Existing artificial pacemakers correct this condition by stimulating the ventricles to beat at the higher, more natural rate.

Without an artificial pacemaker, the symptoms a person develops

## The Heart: How It Works

The normal human heart, which beats an average of 72 times a minute, adjusts to the body's needs by varying its rate as bodily activity demands. The pump consists of four chambers, two smaller upper chambers, or atria, which receive blood from the lungs and body and two larger lower chambers, or ventricles, which deliver blood to the lungs and body.

The heart's rhythm is controlled by a series of electrical impulses transmitted through nerve cells in the heart muscles by a process called depolarization. The signals emanate from

the sinoatrial node, also called the "pacemaker," which consists of a small mass of cells located in the right atrium which are too small to be seen without a microscope. The heart's pacemaker signal sequences events by causing the atria to contract and forcing blood into the ventricles. As the ventricles fill, the nerve impulse travels to the ventricles lower extremity and stimulates these muscle fibers into squeezing, and thus emptying, the ventricles. The heart relaxes, the atria refill, and the cycle begins anew. This cycle is repeated over 10,000 times a day.

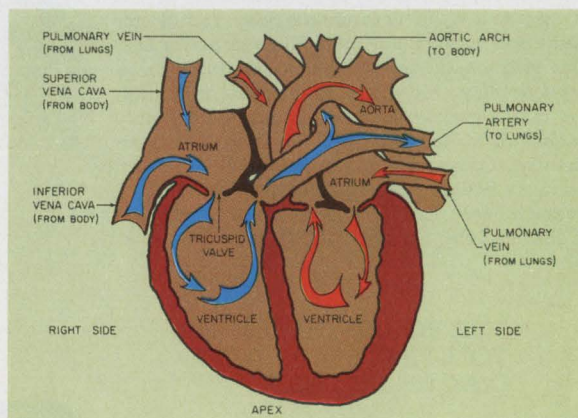

Michael P. London  
News Editor

# C-LINE PLASTIC SCRs



## A simple case of putting 12 years of thyristor know-how in a simple case.

### It's Elementary.

We offer plastic SCRs at competitive prices for those who don't require the optimum environmental protection of our hermetically sealed metal packages. In either case, there's the same Unitrode high quality inside. The kind you expect from a company that makes thyristors a major part of its effort . . . not just a sideline. Our expanding line of SCRs offers a wide range of choices for easy interchangeability in literally hundreds of applications, including lamp and relay driving, or as sensors in pulse generators, tuning circuits, motor controls and process controllers. We can build an even more convincing case for these IP100-IP104 series industrial SCRs when you request complete specs, pricing and samples. For fast action, call Sales Engineering collect at (617) 926-0404 Unitrode Corporation, 580 Pleasant St., Watertown, Mass. 02172

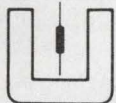

**UNITRODE** quality takes the worry out of paying less.

Unitrode Corporation, Inquiry Processing Dept. 8B  
37 Newbury St., Boston, Mass. 02116

Please send me two free samples of IP100 Series plastic SCRs in  
 30V,  60V,  100V,  150V,  200V models.

NAME \_\_\_\_\_ TITLE \_\_\_\_\_

COMPANY \_\_\_\_\_

ADDRESS \_\_\_\_\_

CITY \_\_\_\_\_ STATE \_\_\_\_\_ ZIP \_\_\_\_\_

# Scaled down size

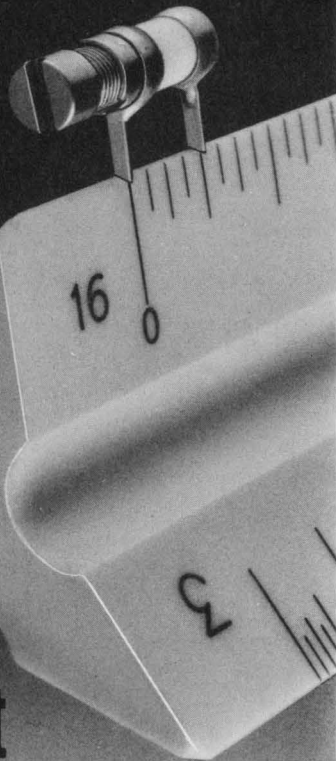



# Built up performance

50% more capacity in the same size is now available in these new Johanson *extended range* capacitors. Beautiful for microwave, VHF and UHF applications, they offer fine tuning, ultra high Q, low temperature coefficients and "sizes" for hybrid and microcircuit as well as standard applications.



For detailed specifications on Johanson air capacitors, send for our current catalog.

### Compare:

Model No.	Conventional	Johanson
(Actual Size)	Capacitance pf	Capacitance pf
 5452	.8 - 10	1 - 16
 5752	.4 - 6	.8 - 10
 5852	.35 - 3.5	.5 - 5.0

**Johanson Manufacturing Corporation**  
Rockaway Valley Road, Boonton, N. J. 07005  
(201) 334-2676

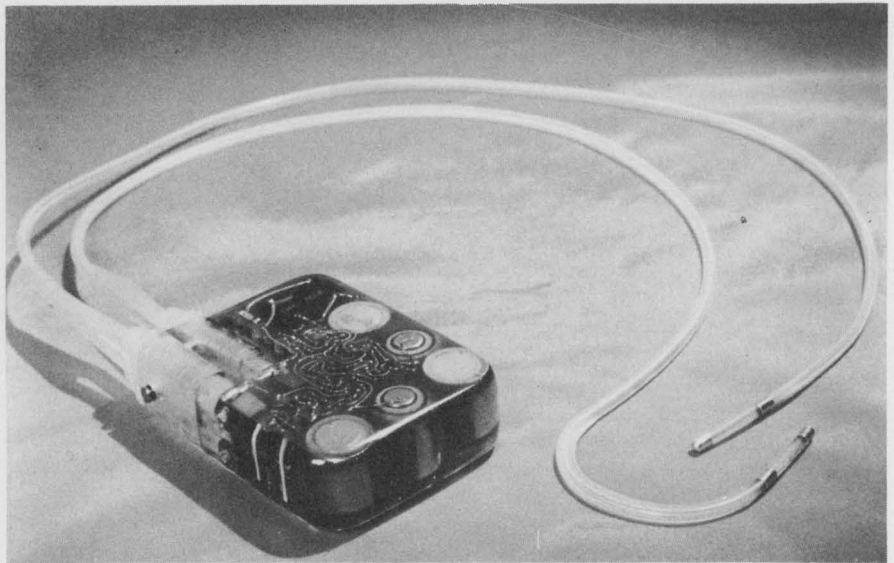

**New pacer shows the leads for both atrium and ventricle.** The unit sends two-phase pulses, simulates the heart's natural signal, and increases cardiac output by as much as 30%. It was developed by American Optical.

when his heart pumps at the lower rate will depend on individual metabolism. But the reduced flow of blood which results may cause anything from faintness and giddiness to cardiac arrest, brain damage and stroke.

According to Donald Small, applications engineer at American Optical in Framingham, Mass., the bifocal demand pacer performs the same role as the demand pacer does, that is stimulate the ventricle. But it adds a 6-volt signal to the atrium as well in those instances where the atrium beat has been affected too. This is accomplished by combining the amplifier and circuit functions of atrial and ventricular pacers into one unit, and by using two oscillators instead of one. Electrode leads then transmit a sequenced, 6-volt pulse, 1 millisecond in duration to both the atrium and the ventricle.

The earlier fixed-rate pacers are basically continuous oscillators driven by silver-mercury cells. The more sophisticated demand pacers, which are synchronous with heart depolarizations (the transfer of electrons within the ventricle), employ a sense amplifier and time-delay circuit in addition to the oscillator and battery.

According to Barough V. Berkovits, cardiovascular research manager at American Optical and associate in surgery at the Harvard Medical School in Boston, some patients exhibit borderline cardiac functions, and for them, the more

conventional ventricular pacing alone fails to restore adequate cardiac output.

### Heart pumps 30% more blood

Berkovits believes that atrio-ventricular synchronous pacing, the type provided by the bifocal demand pacer, "may, in some patients, increase cardiac output up to 30%. It automatically adapts its stimulations to patient needs. It may remain dormant, it may stimulate only the atria, or it may stimulate both the atria and ventricles.

Sensing for the bifocal pacer is accomplished in the ventricle. The lower electrode senses cellular depolarization and stimulates both the atrium and the ventricle when the heart skips its own beat. The pacer requires at least a 2-millivolt depolarization signal from the ventricle in order to accept it as a natural beat and be "inhibited" into not firing.

Describing the depolarization sensing process, Small explains that "the potential existing across a heart cell at rest (between beats) is minus 90 millivolts. Depolarization occurs when positively-ionized sodium outside each cell migrates inside, negatively-ionized potassium inside the cell migrates outside, and the cell contracts." Small says "the pacer senses the corresponding voltage increase which appears like a square wave with a rise time of about 20 Hz."



Because the pacemaker will eventually fail due to the two to three year life of its silver-mercury cells, most research is now directed toward extending battery life. It was first thought that demand pacemakers would last longer than the normal three years associated with fixed-rate pacers because these weren't firing all the time. The demand pacer's sensor, however, consumed about 25% of its power—an additional 10 microamps current drain. This reduced battery life to between two and three years; the bifocal demand pacer is only expected to operate 24 months.

### Body breaks down ICs

Although current work on low-power ICs could contribute to further reducing current drain, American Optical suggests that long term IC reliability leaves something to be desired. Small says that pacers must maintain continuous operation in the 99% humidity in the device when body fluids go through the epoxy encasement. "What remains once the fluid profuses through the epoxy is distilled water," according to Small, "and though it is non-conductive, it does have a tendency to break down some components." For this reason American Optical encases particular components in silicone rubber within the epoxy case.

Another approach to extending pacer life is using alternate power sources. American Optical is working on a solid-state lithium cell which they estimate will last about 5 years. Medtronic Inc. in Minneapolis is attempting to extend pacer life to 10 years by employing plutonium 238 heat-powered cells. Although the Atomic Energy Act of 1954 restricts the use of plutonium 238 in pacemakers in the U. S., Medtronic has implanted four such units in patients in Paris with the cooperation of the French Atomic Energy Commission. Medtronic encapsulated the power source in tantalum, with an inner core of platinum to provide gamma radiation shielding. Space is left between the two layers for helium to build up as the plutonium decays and the entire unit is sealed in titanium. ■■

# MORE digits PER DOLLAR



## THE NEW NATIONAL<sup>®</sup> NUMERIC DISPLAY PANEL

**Lowest cost per digit**—initial cost is lower than all other types of numeric displays. Installation costs are lower, too, because panels simply plug into mating connector. No alignment of digits necessary.

**More digits in smaller display area**—higher character density packs 16 digits into approximately  $7\frac{3}{4}$ " of display length. On .375" centers, numerals are 0.4" high. All numerals on the one-piece module are centered for distinct legibility.

**Packaging is exceptionally flexible**—panels are available in 8 through 16 digit displays. Multiple digit module can be custom designed to meet almost any customer needs.

SEND FOR DATA FROM:

**NATIONAL ELECTRONICS, INC.**  
a varian subsidiary

Geneva, Ill. 60134, phone 312-232-4300

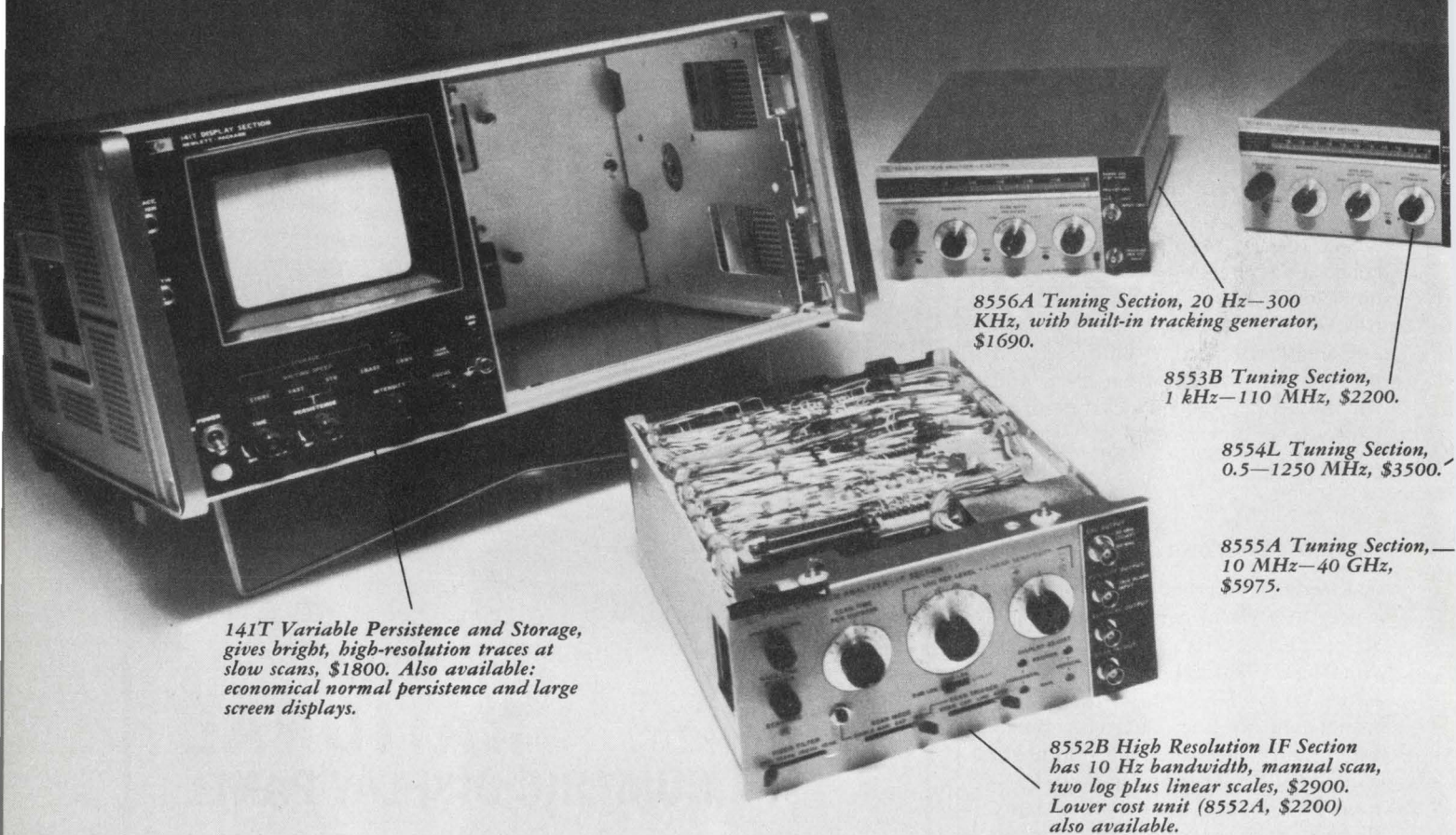

*141T Variable Persistence and Storage, gives bright, high-resolution traces at slow scans, \$1800. Also available: economical normal persistence and large screen displays.*

*8556A Tuning Section, 20 Hz—300 KHz, with built-in tracking generator, \$1690.*

*8553B Tuning Section, 1 kHz—110 MHz, \$2200.*

*8554L Tuning Section, 0.5—1250 MHz, \$3500.*

*8555A Tuning Section, 10 MHz—40 GHz, \$5975.*

*8552B High Resolution IF Section has 10 Hz bandwidth, manual scan, two log plus linear scales, \$2900. Lower cost unit (8552A, \$2200) also available.*

# HP's Family

## or how to add extra value

With HP's neatly-interrelated spectrum analyzers, you can take your choice of tuning sections, displays and companion instruments to tailor a system for your measurement needs—all the way from 20 Hz to 40 GHz. Then, as your requirements expand, re-configure your system simply by adding the related piece of equipment. That's the value of our family plan.

By themselves, any of the four spectrum

analyzers give you unparalleled signal analysis capability made possible by absolute amplitude calibration, low distortion, high resolution, and wide frequency scans—coupled with the ability to zoom down to a narrow scan.

And the family value really multiplies when you add the companion instruments. For example, the tracking generators combined with the analyzers make swept measurements over a 120 dB range

*Tracking generators for wide dynamic range, swept frequency response measurements.*

8443A 110 MHz  
Tracking Generator/Counter, \$3500  
(\$1975 w/o Counter).

8444 A/B 1300 MHz  
Tracking Generator, \$2950.

8445A, 18 GHz  
Automatic Preselector,  
for wide scans,  
free from unwanted  
responses, \$2000.

# Family Plan:

## to spectrum analysis.

thus forming precision swept frequency test systems.

And our automatic preselector for the microwave tuning unit does away with image, multiple and spurious responses.

All in all, HP's family of spectrum analyzers gives you the greatest depth and breadth of performance and the best value in signal analysis equipment available anywhere. For more information, call your local HP field engineer or write

to Hewlett-Packard, Palo Alto, California 94304;  
Europe: 1217 Meyrin-Geneva, Switzerland.

04110

HEWLETT  PACKARD

SIGNAL ANALYZERS

INFORMATION RETRIEVAL NUMBER 151

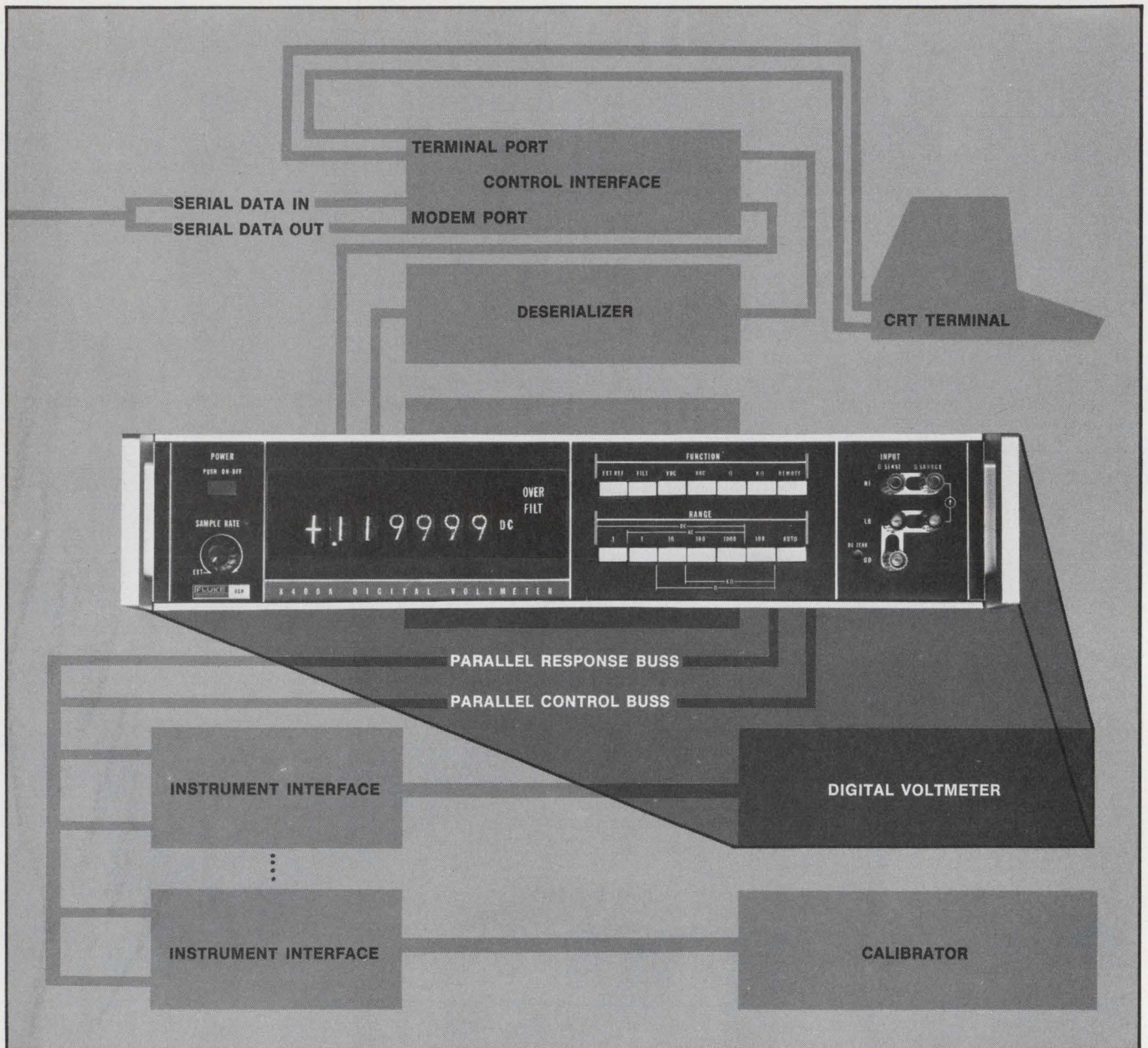

## The new systems DVM with the big accuracy spec (0.004% for 90 days, 0.01% per year).

Here's the systems DVM with all time 24 hour, 30 day, and year long accuracies. It's the new Fluke 8400A with certified specs, autoranging on all parameters, options galore, and superior systems compatibility.

**Five ranges** of dc from 0.1v full scale to 1,000v with **0.004% accuracy** for 90 days and 0.01% for one year guaranteed. We give you five full digits plus "1" for

20% overrange. Featuring modular construction, the new DVM is only 3½" high by 19" wide. Resolution is **1 microvolt**. The Fluke 8400A will make 33 readings per second with a 3 millisecond aperture sample and hold. A switched filter on all ranges provides better than 65db noise rejection.

Any or all of the following options can be added at any time.

**Seven ranges** of 4 terminal resistance from 10 ohms to 10,000K ohms. Four ranges of ac from 1 to 1,000 volts with 0.05% accuracy to 10 KHz, ac/ac ratio and 4-wire dc/dc ratio, isolated data output. And the **8400A will remember its remote control instructions** for convenient computer communication. Base price is \$2,450.



Fluke, Box 7428, Seattle, Washington 98133. Phone: (206) 774-2211. TWX: 910-449-2850  
 In Europe, address Fluke Nederland (N.V.) P.O. Box 5053, Tilburg, Holland.  
 Phone: (04250) 70130. Telex: 884-50237/In the U.K., address Fluke International Corp.,  
 Garnett Close, Watford, WD2 4TT. Phone: Watford 27769. Telex: 934583.

See us at Wescon Booth 1136-38

# THE ONLY ENVIRONMENTALLY SEALED SWITCH WITH A ONE-PIECE SEAL.

Check it out.  
Cutler-Hammer's new MIL-S-3950 switch line offers more designed-in reliability:

- A patented sealing process produces an exclusive-design seal of molded silicone rubber.
- Completely environmentally sealed. Tight enough to pass a mass spectrometer leak test.
- Improved dielectric capability because the one-piece seal is bonded to the lever, bushing, and the inside of the aluminum frame.
- Terminals that are molded into base without use of elastomers.
- No "O" rings to distort or age, and leak.
- A self-extinguishing Melamine base for increased arc resistance under contaminated conditions.
- Back-wired terminals with molded-in identification.
- A positive detent feel.
- A truly reliable momentary return action.
- Complete line including standard bat levers and lever-lock toggles in one, two, and four poles. Standard and special circuits.

- 25 MS configurations in stock for immediate delivery.
- Priced to meet many demanding commercial applications, too.

Cutler-Hammer's new MIL-S-3950 switches are a fitting companion line for our MIL-S-8834 positive-action switch line. For complete data and fast, helpful service, contact the Cutler-Hammer Sales Office or Stocking Distributor near you.

**CUTLER-HAMMER**  
SPECIALTY PRODUCTS DIVISION, Milwaukee, Wis. 53201



INFORMATION RETRIEVAL NUMBER 21

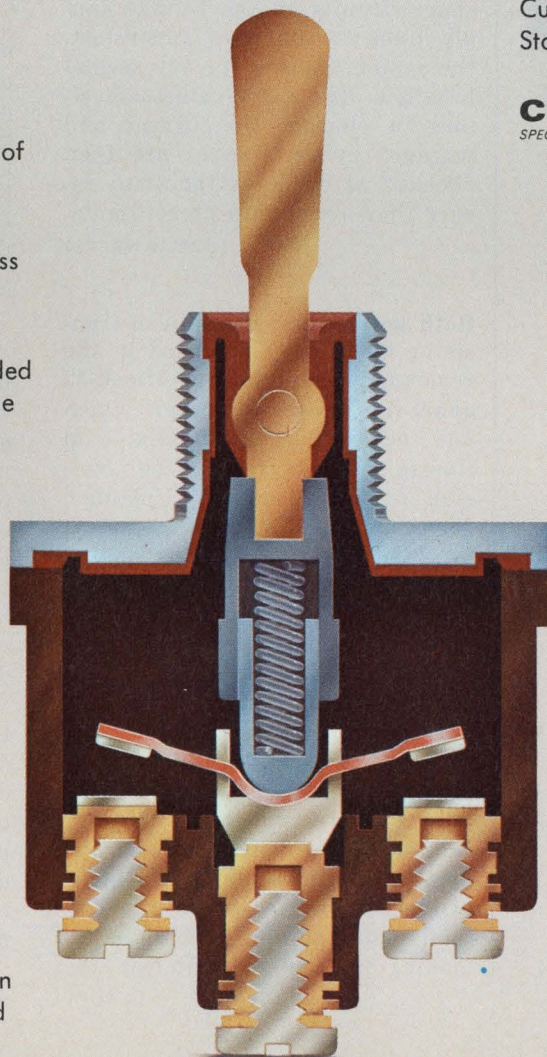

Switch  
to No.1

More than just switches;  
prompt availability,  
field help, innovation,  
quality assurance, too.

Here are 4  
out of 4000

## DIALCO SUBMINIATURE INDICATOR LIGHTS



SHOWN ACTUAL SIZE

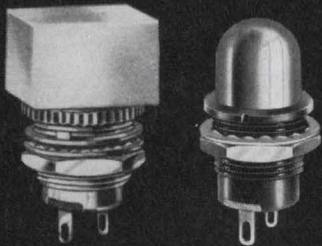

Designed to meet requirements of MIL-L-3661B and MIL-L-6723.

Sizes for mounting in  $1\frac{1}{32}$ ",  $\frac{1}{2}$ " or  $1\frac{1}{32}$ " clearance hole.

Incandescent for 1.35 to 28V and neon for 105-125V AC-DC or 110-125V AC.

Patented built-in current limiting resistor (U.S. Patent No. 2,421,321).

Wide selection of lens shapes and colors, hot-stamped or engraved legends.

Available off-the-shelf for prompt delivery.

**Send for free catalog**



**Dialight Corporation**

60 Stewart Ave., Brooklyn, N. Y. 11237.  
(212) 497-7600



A NORTH AMERICAN PHILIPS COMPANY  
INFORMATION RETRIEVAL NUMBER 22

## technology abroad

One of the largest cable-TV networks in the world—a network of 174 miles of main and 1575 miles of distribution feeders—will be installed in the Liege, Belgium, area. The network serves over 375,000 people in 56 communities in the Liege area on the edge of the Ardennes. Faced with the prospect of interference from surrounding national networks of Belgium, France, Holland, Luxembourg and Germany, the Liege Electrical Society created the new cable-TV system.

Up to 60 measurements in five seconds can be made on printed-circuit-board assemblies, electronic subassemblies and integrated circuits, using relatively inexpensive equipment recently introduced by Wayne Kerr, Chessington, Surrey, England. After first checking for short circuits on the voltage supply lines to the item under test, the system pauses for one second to allow any large-value capacitors to charge. Dc current and voltages or resistances are then checked at each test point to ensure they are within preset limits.

CIRCLE NO. 451

Both germanium and silicon transistor technology are used in the revamped version of the Minsk-32 general-purpose computer which has recently become available in Russia. An integrated-circuit version of the machine is planned for some time next year. But it is still considered lagging behind Western computer technology. The Minsk-32, which is about equivalent in power to the IBM 360/30, is available in a 32k word configuration. It can be supplied with both magnetic tape and disc units.

Low-cost light-emitting diodes and arrays of zinc selenide are being produced by Crystal Ltd., Scotland, using a new technique for making high-purity material. De-

veloped by John W. Allen of the University of St. Andrews, Scotland, the technique has produced LEDs with an efficiency comparable to that of gallium arsenide devices. The company also fabricates light-emitting, Schottky-diode junctions by evaporating a thin, translucent layer of gold on the substrate. The devices are TTL compatible. Typical driving voltage is 15 volts.

CIRCLE NO. 452

A plasma chemical process for making organic polymer thin-films for electronic applications has produced films 0.1 to 0.5  $\mu\text{m}$  thick. Japan's Susumiur Kogyo Co., the processor, claims the films have three to four times better heat resistance than those made by conventional methods. The company plans to use the new technique to make miniature, high-energy capacitors. In practice, monomer material is polymerized and vacuum-deposited on a plate following ionization at a temperature of several hundred degrees. Non-polymerized material is removed by chemical treatment, leaving the thin film.

CIRCLE NO. 453

By building a channel-plate electron multiplier into a high performance cathode-ray tube, research workers at the Philips "Laboratoires d'Electronique et de Physique Appliquee" in Brivannes, France, have substantially increased deflection sensitivity and high frequency response. Bandwidths of 2 GHz and 3.3 GHz, at deflection sensitivities of 20 mm/V and 5 mm/V, have been obtained with the new tube. In a conventional tube, brightness is dependent on gun current. Incorporating the channel-plate multiplier in the tube makes performance independent of gun current because of the high electron multiplier current gain.

CIRCLE NO. 454

# ANALOG SWITCH PITCH.

We'll get right to the point.

We're in the analog switch business. (In addition to our very own designs, we're also second sourcing all of the best switches in the industry. Including the entire DG 126 thru 164 series.)

More importantly, we're also in the op amp business.

*And* the sample-and-hold circuit business.

*And* the high speed voltage follower business.

*And* the comparator business.

*And* so on and so forth.

In short, if you have any kind of analog

switch application, we'll be glad to sell you the switches. And everything else you'll need in the same application. (Which means you'll only have to make one phone call, write one letter, TWX once or send a single cable.)

National Semiconductor Corporation,  
2900 Semiconductor Drive, Santa Clara,  
California 95051. Phone (408) 732-5000.  
TWX: (910) 339-9240. Cable NATSEMICON.

## National

what!



really!

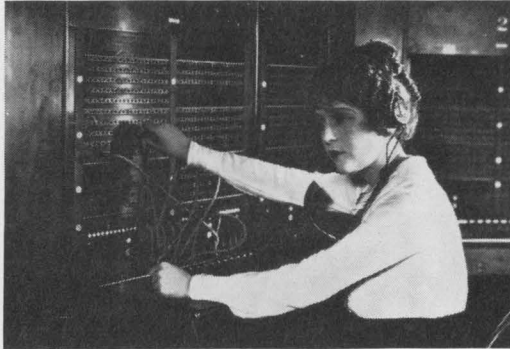

yes, mag  
tape  
terminals



TELETYPE?

It's true.

After helping a jillion feet of paper tape wind and unwind its way through communications systems everywhere, Teletype announces the addition of magnetic tape data terminals.

There are some basic advantages in both mediums. But as you are well aware, the medium that's right for a system depends a lot on the application criteria.

The new magnetic tape data terminals have many operational features that make life less complicated for the operator.

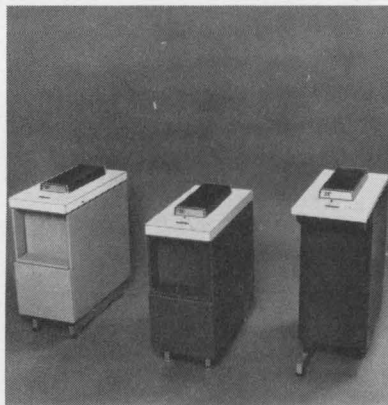

*New, modular line of Teletype® 4210 magnetic tape data terminals.*

For example, take a look at the tape cartridge, which was specifically designed for reliability required for data transmission.

Its vital statistics are: 3" x 3" x 1".

It contains 100 feet of 1/2" precision magnetic tape.

It will hold 150,000 characters of data, recorded at a density of 125 characters per inch. The equivalent of a 1000 foot roll of paper tape.

This means that your data is easier to store, easier to handle, easier to work with than ever before. And it's reusable.



# DATA COMMUNICATIONS

equipment for on-line, real-time processing

The units have a "fast access" switch which will move tape forward or reverse at a speed of 33 inches per second. A digit counter provides a reference point to help locate various areas of the tape.

Four ASCII control code characters can be recorded in the data format to aid character search operations. When the terminal's "search" button is pressed, tape moves at the rate of 400 characters per second

Also magnetic tape adds high speed on-line capability to low speed data terminals.

You can zip data along the line at up to 2400 words per minute. For example: Take a standard speed Teletype keyboard send-receive set, and a typical typist. Add a new magnetic tape unit to this combination and the on-line time savings can pay for the magnetic tape terminal in short order.

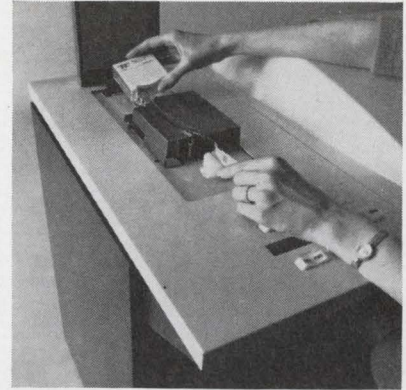

*Straight-through threading makes tape loading and unloading exceptionally easy.*

They can send or receive at high or low speed. Or can be used independently as stand-alone terminals on-line.

If you would like to know more about this new line of Teletype magnetic tape data terminals, please write Teletype Corporation, Dept. 89-15, 5555 Touhy Avenue, Skokie, Illinois 60076.



until the control code selected is detected. Then the terminal stops the tape automatically.

A "single step" switch is also provided which enables you to move the tape forward or backward one character at a time. In editing or correcting tape, you can send a single character using this feature.

You can take better advantage of voice grade line speed capabilities.

An operator can prepare data for magnetic tape transmission using the keyboard terminal in local mode. Then send it on-line via the magnetic tape terminal up to 2400 words per minute.

These new modular magnetic tape data terminals offered by Teletype are perfectly compatible with model 33, model 35, model 37 and model 38 keyboard send-receive equipment.



*Teletype 4210 magnetic tape data terminal with 37 keyboard send-receive set.*

***machines that make data move***

ELECTRONIC DESIGN 17, August 16, 1971

INFORMATION RETRIEVAL NUMBER 24



# Our name doesn't cost you any more.

We see no reason why you should pay extra for quality that should be in the product from the start.

Our adaptable V3 snap-action switch is a prime example. It offers more than 500 working variations in circuitry, electrical capacity, actuators and terminals. All without sacrificing quality or low cost.

In addition, the V3 has options like extended overtravel, extra long life, and low operating force. This, plus a wide temperature tolerance ( $-100^{\circ}\text{F}$  to specials of  $+600^{\circ}\text{F}$ ), make it ideal for use throughout industry.

And because the V3 is built to last, costly downtime is reduced.

Quality built, competitively priced — that's our V3 switch. For more information, contact your MICRO SWITCH Branch Office or Authorized Distributor (Yellow Pages under "Switches, Electric").

## **MICRO SWITCH**

FREEPORT, ILLINOIS 61032  
A DIVISION OF HONEYWELL

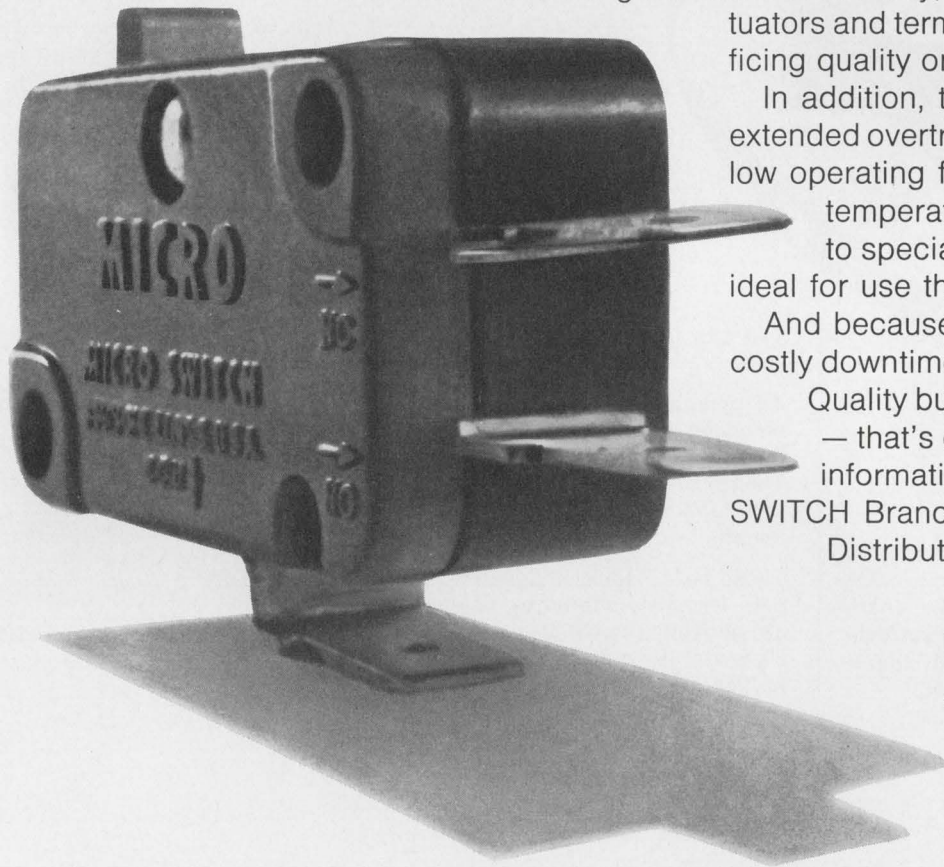

 <b>COMPUTER AUTOMATION, INC.</b> 895 West 16th Street, Newport Beach, California 92660, Phone (714) 642-9630, TWX 910-596-1377		
No.	Description	Cost per unit
16A	<b>ALPHA 16-BIT MINICOMPUTER</b>	\$3550.00
	4K WORDS OF MEMORY	N/C
	HARDWARE MULTIPLY/DIVIDE	N/C
	VECTORED PRIORITY INTERRUPTS	N/C
	TWO DIRECT MEMORY CHANNELS	N/C
	122 INSTRUCTION SET (500 WITH MICROCODES)	N/C
	BLOCK I/O	N/C
	KEYLOCK CONTROL CONSOLE	N/C
	AUTOMATIC I/O VIA STD DMC'S	N/C
	STANDARD SOFTWARE: CONVERSATIONAL	N/C
	ASSEMBLER, ONE OR 2-PASS ASSEMBLER,	
	RELOCATABLE LOADER, DEBUG, UTILITY,	
	DIAGNOSTICS, MATH & EDIT ROUTINES	
	<b>TOTAL</b>	<b>\$3550.00</b>

## \$3550 and down.

Our new ALPHA™ 16 is the first low-cost computer that's still a low-cost computer by the time you get it. That's because it gives you for free the kind of features that are extras with everybody else. For \$3550 we're talking about a fully-parallel, stored program, general purpose 16-bit computer — 1600 nanosecond full cycle and 4K 16-bit words of memory expandable to 32K. Plus all the standard features shown above. In addition, you get the most powerful instruction set in the industry — 122 basic instructions (including numerous multi-function instructions and unique immediates, Long Shifts, Jumps, and Memory-to-Register arithmetic). On top of this, a complete line of

peripherals and options, plus FORTRAN, BASIC, and Cross Assemblers are available. Finally, our list price of \$3550 usually goes even lower. Since that price is for a quantity of one. For larger quantities, OEM Discounts and Bonus Discounts reduce our starting price still further. (Incidentally, ALPHA 16 with 2K words is only \$3050 and down, and our 8-bit ALPHA 8 with 4K bytes goes for only \$2800 and down.) Send today for details on ALPHA. The best mini-computer at the lowest price in the industry.

**COMPUTER AUTOMATION, INC.**  
 895 West 16th Street • Newport Beach, California  
 92660 • Phone (714) 642-9630 • TWX 910-596-1377



# Take a turn for the better in rotary switches.

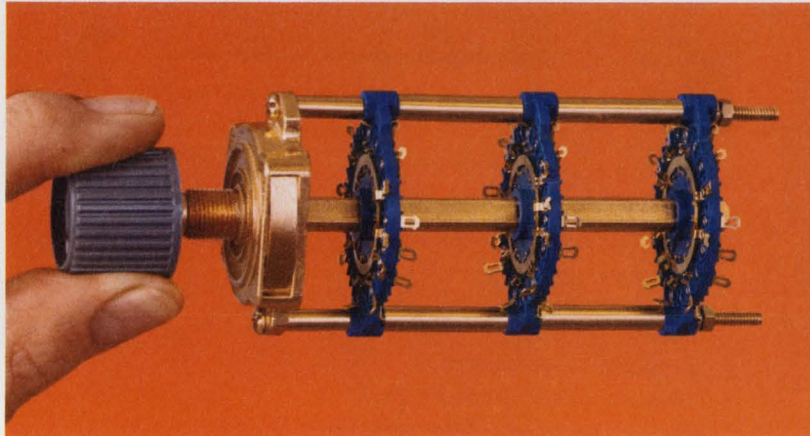

Oak continues to market the broadest line of rotary switches in sizes and configurations to fit your applications.

## For example:

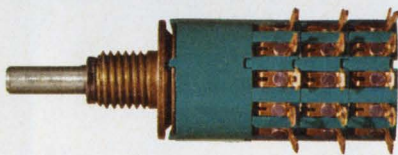

### Our 1/2-inch subminiature rotary switch.

Ultra-compact, yet provides superior insulating qualities and dimensional stability in demanding environments at lowest competitive price.

### A new 12-position Acorn rotary for printed circuits.



A size-saving design. Crisp, uniform detenting with Oak's patented Unidex™ indexing. Has glass epoxy wafer and tinned PC terminals ready for soldering.

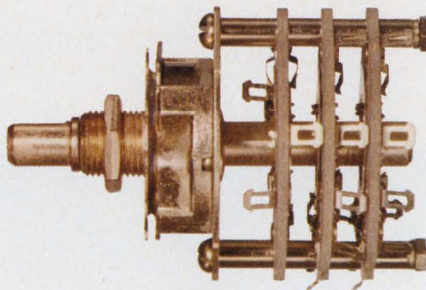

### Rotary switches with Unidex indexing, too.

Our F and JKN series. Versatile, economical. And Unidex detent means uniform torque, crisp feel.



### And our Multidex® rotary: the almost-universal switch.

Versatile enough to replace 7 old-style rotary designs. Thousands of variations available. With Unidex detent for sure switching time after time. Multidex cuts the cost of engineering design.

## There's more.

Miniaturized lever switch: Type 184. Improved dielectric properties plus more clips per stator.



Miniature rotary trim switch. For SPDT trim switching in tight PC-board locations. Long life. Low cost.



Stepping switches: Compact, lightweight. Subminiature to extra-heavy-duty types. Fast response.

## Now: order Moduline™ Switches from your distributor.

Choose from 2-million possible switch combinations. 72-hour delivery. Write for the Moduline Catalog.

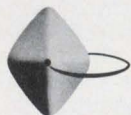

**OAK MANUFACTURING CO.**

CRYSTAL LAKE, ILLINOIS 60014 • A DIVISION OF OAK ELECTRO/NETICS CORP

Telephone: 815-459-5000

TWX: 910-634-3353

TELEX: 722-447

INFORMATION RETRIEVAL NUMBER 27

# washington report

DON BYRNE, WASHINGTON BUREAU

## **DOT lets contracts for personal rapid transit systems**

The Department of Transportation has let \$6-million for construction and demonstration of four Personal Rapid Transit systems (PRT) to be tested next spring at Dulles Airport. The Dashaveyor Co. of Los Angeles will build a 31-passenger, electrically propelled vehicle with a guideway switch, and Ford Motor Co. will build a smaller, similar model. Transportation Technology Inc. of Denver will build an air pad suspension vehicle powered by a linear induction motor and Varo Corp. of Garland, Tex., affiliated with the Rohr Co., will demonstrate an electrically powered monorail. All contracts run about \$1.5-million.

## **FB-111 avionics will probably go into B-1**

The Air Force is studying a set of recommendations on B-1 bomber avionics development submitted last month by its system project office. The recommendations, according to informed sources, call for primary reliance on existing avionics designed for the FB-111. Any new components are to be held to a minimum to keep costs down and to avoid schedule delays. Additional R&D work on the B-1 avionics will run about \$175-million, the Air Force said. North American was also the prime contractor for the FB-111 avionics.

## **Air Force computer buy delayed**

Negotiation difficulties have pushed back the Air Force order of computers for the World Wide Military Command and Control System until late this month or early next, a slip of about three months. In the running for a buy of 15 systems and an option for 20 more are Control Data, Honeywell Information Systems Division, IBM and Univac. The Pentagon had set a \$46.2-million limit on the purchase and the bidders are reportedly balking at the total because almost a year has passed since requests for proposals were sent out and inflation has continued over that period. The order is an attempt to reduce the number of different computers in use in the services.

## **Stop crying and get busy, Fairchild head says**

Edward G. Uhl, president of Fairchild Industries, Inc., says that the aerospace industry "should stop feeling sorry for ourselves and face life as it is." Uhl recommends that the industry go out on its own to develop new programs without government help. He told the Aero Club of Washington that a supersonic transport should be developed by a consortium of companies. Lasers for use as anti-ballistic missile weapons could be

developed the same way. Industry, Uhl says, should tell the public of the threat the U.S. faces—expanding military might of the Soviet Union. On the home front, Uhl criticized those in the industry who opposed government help for Lockheed. "The 'Kill-Lockheed campaign' in our industry hurts all of us," he said.

## **FCC transatlantic cable decision challenged**

American Telephone and Telegraph has asked the Federal Communications Commission to reconsider its policy on the new transatlantic submarine cable. AT&T said it would like to proceed now with an 840-circuit cable rather than wait for the development of a 3500-circuit cable as the FCC has directed. AT&T said that if satellite circuits had a major failure there would not be sufficient backup capacity in the next few years while waiting for development of the 3500-circuit cable. Meanwhile FCC chairman Dean Burch was telling Congress that he expects new CATV rules to go into effect sometime late in the year even though issued this summer. He said that despite predictions of doom, uhf stations should be helped by cable TV. He also said that CATV operators will probably be required to carry a non-broadcast channel for every broadcast channel carried and to provide capacity for two-way, non-voice communication.

**Capital Capsules:** The Washington Metropolitan Area Transit Authority has dropped Westinghouse Electric Corp. as a bidder on a computerized metro subway contract which may run between \$40-million and \$50-million. The Metro Authority said Westinghouse's proposals failed to meet metro specifications on computerization techniques. Westinghouse said its proposal was fully qualified and less costly than that proposed by the Authority. General Railway Signal Co. and Union Switch and Signal Construction Co. are in the running for the system that will automatically start and stop trains, maintain distance between cars and control speeds . . . The Navy has assigned a 40-man team of auditors and engineers to the Grumman Aerospace Corp. to pore over the F-14 program and other Grumman contracts including those for the A-6 all weather attack aircraft and the E-2 airborne early warning and control aircraft. Grumman says it cannot meet the original cost of \$8.3-billion for 710 F-14s because of inflation and the loss of other defense work . . . A government-industry test of microwave ovens has determined that an average of 10% of the ovens leak radiation, exceeding the voluntary industry limit of 10 milliwatts per square centimeter. On Oct. 6 the federal leakage limit will be one milliwatt prior to sale and five milliwatts afterwards . . . The Air Force says the much plagued Short Range Attack Missile (SRAM) has successfully passed its development test flight program. Costs of the missile, planned for use on the FB-111, B-52 and B-1, have just doubled and now stand at over a half million dollars each . . . North American Rockwell and the Navy are looking at the possibility of equipping the Condor air-to-surface electrically guided missile with an active radar seeker. The Navy plans to buy 670 of the 40-to-50-mile-range subsonic missiles although added capability may result in a larger production order . . . The House and Senate have approved a \$3.43-billion budget for NASA for fiscal year 1972, an increase of \$83.6-million over the Administration's request. The increase came in four programs—Skylab, the space shuttle, Nerva (nuclear engine), and aeronautical research and development. Reduced funds for personnel may mean a cut of 1600 employees.

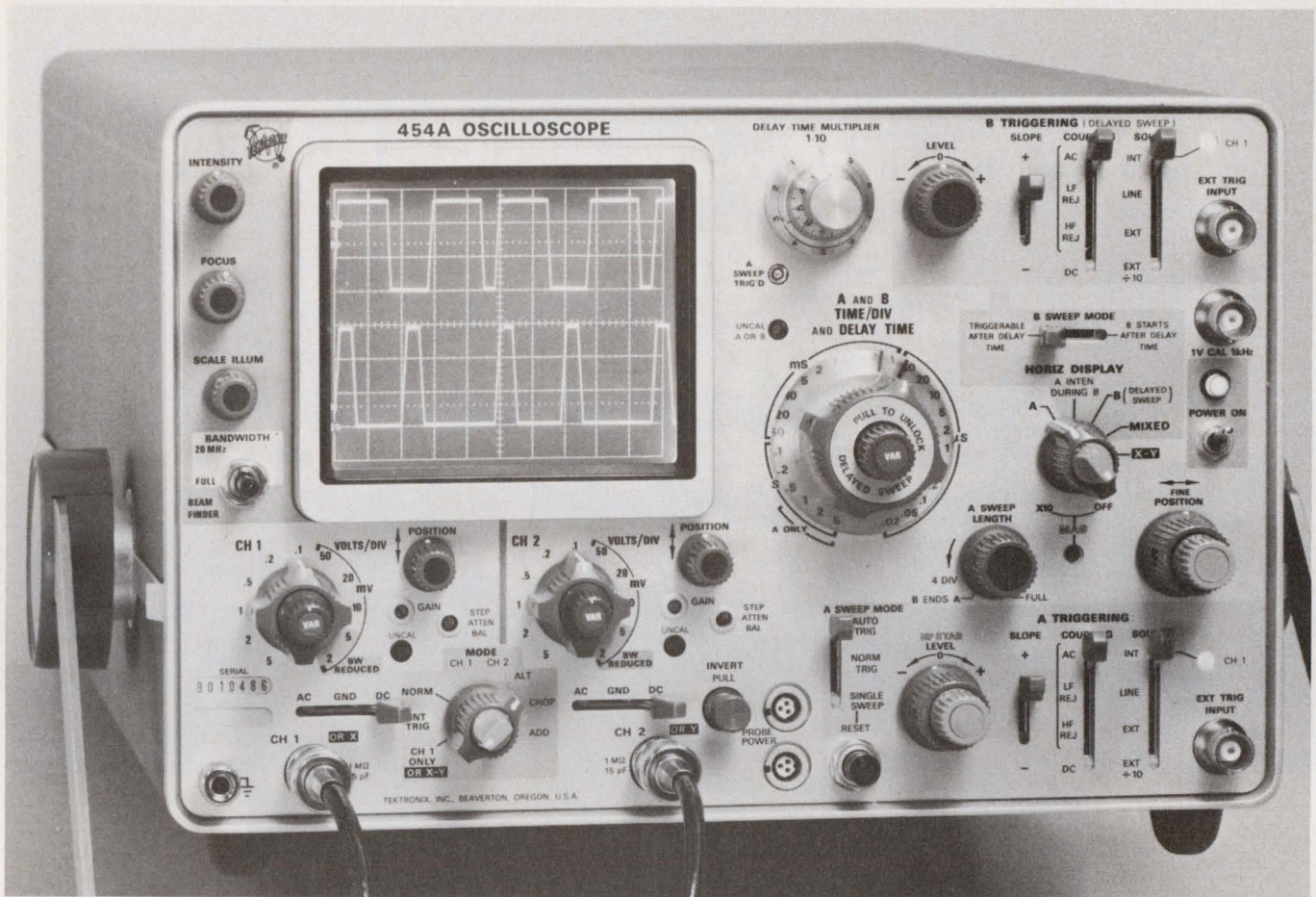

## THE NEW 454A 150-MHz OSCILLOSCOPE MAKES PORTABLE PERFORMANCE BETTER THAN EVER BEFORE

The New 454A has even more built-in performance and measurement ease than its field-proven predecessor. Here are just a few of many examples.

	BEFORE	NOW	TO YOU THIS MEANS
CRT Size	6 x 10 Div (0.8 cm/div)	8 x 10 Div (0.8 cm/div)	33% more display area—More vertical resolution
Max Sweep Rate	5 ns/div	2 ns/div	2 1/2 times more horizontal resolution
FET Inputs	No	Yes	More stability—More reliability
Max Def Fact @ 150 MHz	20 mV/div	10 mV/div	Measure lower amplitude signals at higher BW
Max Def Fact	5 mV/div	2 mV/div	2 1/2 times more gain
Calibrated Mixed Sweep	No	Yes	More display capability
Maintenance	Easy	Easier	More on-site measurement time
Color-Coded Panels	No	Yes	More operating ease
150-MHz Probe	Yes	Yes	It's easier to handle Still—maximum BW at the probe tip



Tektronix rental and lease programs are available in the U.S.

AND—just like the 454, high impedance inputs are standard on every 454A. It all adds up to a NEW model of a field-proven oscilloscope. An oscilloscope designed to measure with laboratory precision and to be carried with small-package ease.

Your field engineer will gladly arrange a demonstration. See for yourself *all* that's NEW about the 454A. U.S. Sales Price is \$3200 FOB Beaverton, Oregon.

**See This New Product At WESCON**  
INFORMATION RETRIEVAL NUMBER 28

# For built-in reliability, design with "Scotchflex" Flat Cable/Connector Systems.

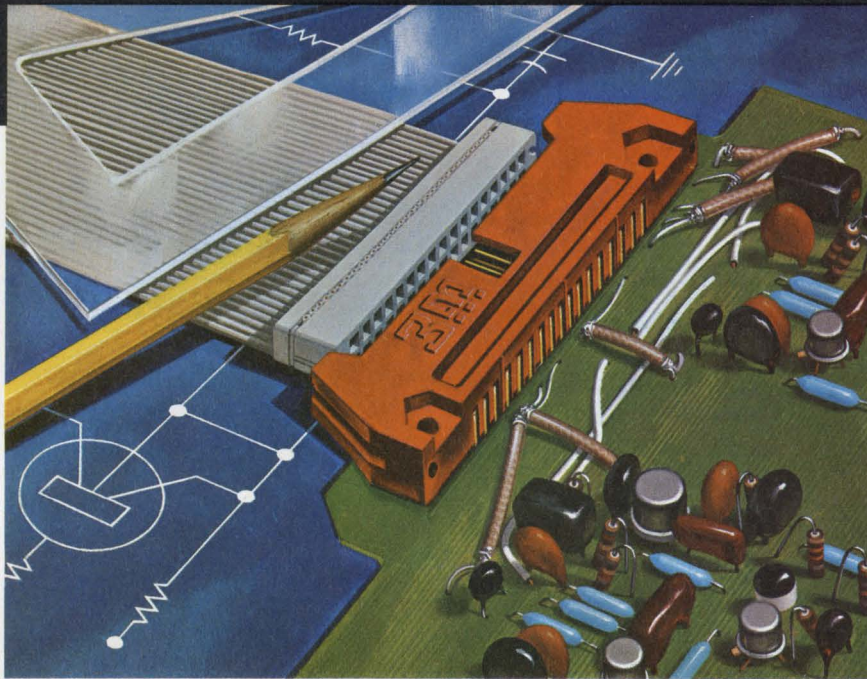

"SCOTCHFLEX" IS A REGISTERED TRADEMARK OF 3M CO.

"Scotchflex" Flat Cable and Connectors can offer you trouble-free packaging for your next generation equipment.

There's built-in reliability for your circuit inter-connects. Our flat, flexible PVC Cable has up to 50 precisely spaced conductors. The gold plated U-contacts are set into a plastic body to provide positive alignment. They strip through the insulation, capture the conductor, and provide a gas-tight pressure connection.

Assembly cost reductions are built-in, too. "Scotchflex" Connectors make up to 50 simultaneous connections without stripping or soldering. No special training or

costly assembly equipment is needed.

Off-the-shelf stock offers you flat cable in a choice of lengths and number of conductors from 14 to 50. Connector models interface with standard DIP sockets, wrap posts on .100 x .100 in. grid, or printed circuit boards. Headers are available to provide a de-pluggable inter-connection between cable jumpers and printed circuit boards (as shown). Custom assemblies are also available on request.

For full information on the "Scotchflex" systems approach to circuitry, write to Dept. EAH-1, 3M Center, St. Paul, Minn. 55101.

**3M**  
COMPANY



## editorial

# Secretaries & engineers need an idea exchange

Along with all the technical, marketing and other seminars at electronics shows, why not a seminar at which secretaries and engineering bosses could exchange frank views on how to work together more efficiently?

Sound wild? Maybe you read a recent article in *ELECTRONIC DESIGN* ("Memo From an Engineering Secretary," ED 13, June 24, 1971, pp. 76-77), in which three experienced secretaries had this to say about their bosses, among other things: They're lousy letter writers, equally poor in dictation, slow in handling reports, prone to fight the company paperwork system and do not—repeat, do not—use the full office abilities of their secretaries. Now that adds up to shoddy performance. And it can be costly. The best engineering ideas in the world can get lost in a tangle of company paperwork and it needn't happen if you and your secretary have worked out a scheme to keep the tangles out.

Now suppose IEEE or Wescon held seminars to help keep the paperwork flowing smoothly. A cross-section of companies in the U.S., and maybe even abroad, could send one or two of their top secretaries as representatives. Administrative engineers would also be present. There would be a lively exchange of ideas. Those attending could cull the best information and carry the message back to the home office.

Simple? Couldn't be easier. Practical? Very. But the hard part would be getting people to change their ways once they got the message. Old habits are hard to break. That could lead to another seminar on personality problems in engineering and how to cope with them effectively. Don't laugh; there are lots duller seminars at electronic shows, and with less practical information.

The point is this: As long as engineering remains basically a human activity, it makes good sense to consider the human problems in design as well as the technical. The two are so interdependent at times that they can hardly be separated.

A good place to begin is with office paperwork and your secretary. Buzz your secretary right now, before you forget. Tell her: "Miss Efficacious, take a letter . . . to the presidents of the IEEE and Wema . . . Dear Sir, It has been brought to my attention that a seminar for secretaries and engineers might be a good idea at the annual show sponsored by your organization. . ." Finish it in your own words.

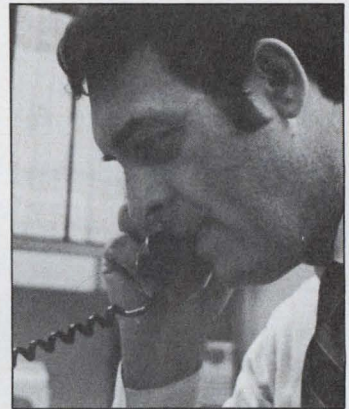

*Richard L. Turmail*

RICHARD L. TURMAIL

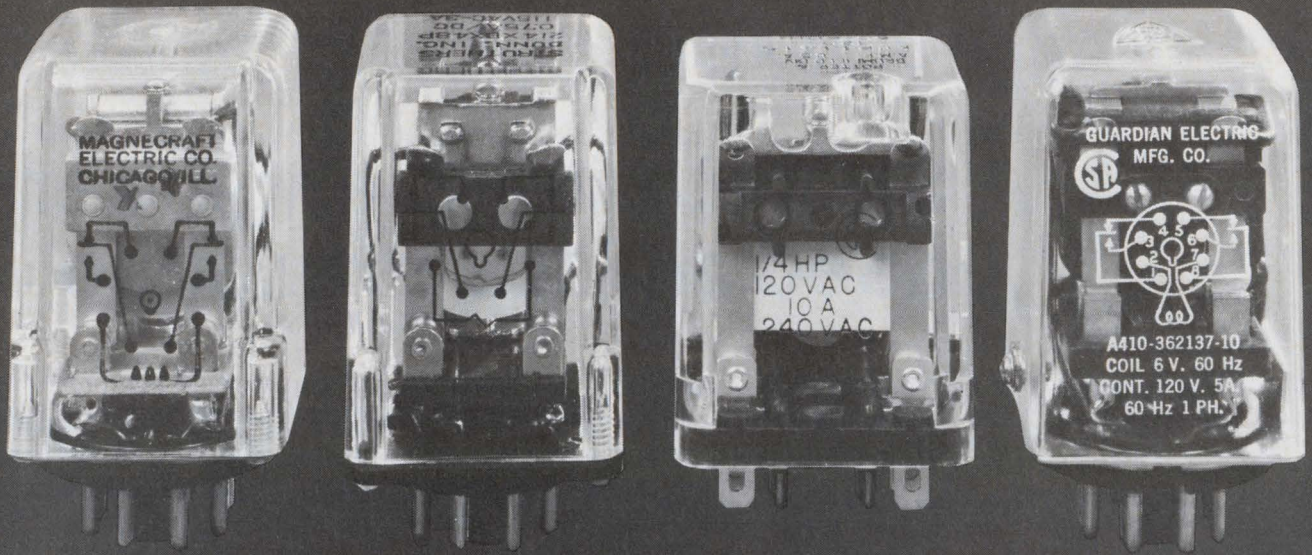

Switching 10 amps with a relay this size?

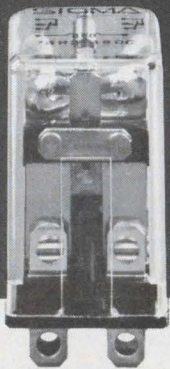

Do it in half the space with Sigma's new "76"

Shown actual size  
(1.0" x 0.8" x 1.6")

The new and unique Sigma Series 76 Relay is 50% smaller than any other 10-amp multipole relay available today: the 2PDT version (shown) is 1.0" x 0.8" x 1.6" high and takes only 0.8 sq. in. of chassis space. Yet nothing is sacrificed to gain this small size: reliability is high, operating life is long, price is lower.

The "76" will dependably switch loads such as small motors, solenoids and power contactors a minimum of 100,000 times, in photocopiers and vending machines . . . escalator, conveyor and machine tool controls . . . calculators, duplicators, alarm detectors, refrigerators and air conditioners. Longer

operating life under heavy loads results from significant design differences: a slotted base of Diallyl Phthalate to prevent build-up of vaporized contact material; an arc barrier between contact sets; an interlocked coil and frame to prevent lead wire breakage under vibration.

At present, the 2PDT Series 76 has both UL and CSA approval for component use. 4PDT versions of the Series 76 are also available. You can get immediate delivery from factory or distributor stocks—and lower cost matches the space you'll save. Call or write Sigma Instruments, Inc., 170 Pearl St., Braintree, Ma. 02185. Tel. (617) 843-5000.

**SIGMA**  
INSTRUMENTS INC

INFORMATION RETRIEVAL NUMBER 30

# The toughest lighted switches.

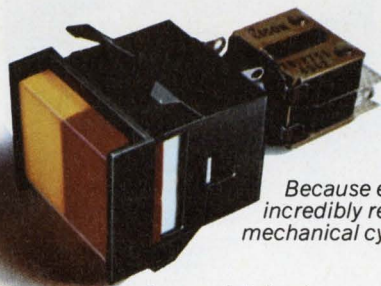
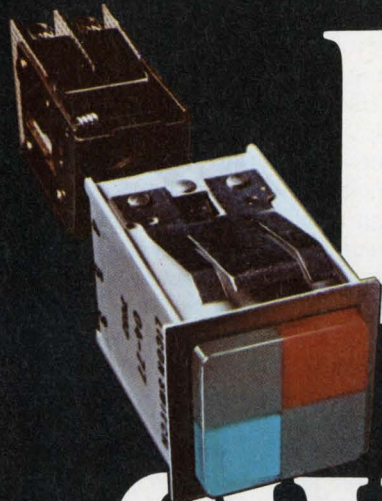

*Because every one is based on Licon's incredibly reliable (up to 20 million mechanical cycle) Butterfly switch.*

From the tiny inexpensive Type 01-700 to the four-lamp Type 04, every Licon® lighted switch incorporates one or more Licon Butterfly® switches. Thus the ultimate in double-break switches becomes the basis for one of the broadest lines of lighted switches available. Choose the indicating function required... one; two or four lamps... lens cap configuration... screen color and engraved legend. Name your switching

action... momentary, maintained, solenoid-held, indicator light only, or multi-circuit control. Select your mounting style... flange, barrier, bezel, bezel-barrier, horizontal or vertical, single-switch or multiple in matrix. Meet Mil Specs. In every choice, installation and servicing is fast and easy. Because ultra-reliable switching is our business. Test light the line yourself. Call your local Licon distributor or representative for a

lighted demo in your office. Or call or write for a Licon Switch Catalog. **Licon, Division Illinois Tool Works Inc., 6615 W. Irving Park Road, Chicago, Illinois 60634. Phone (312) 282-4040. TWX 910-221-0275.**



**itw LICON**

*The Innovating Electronic Group of ITW... LICON* ■ ELECTRO MATERIALS ■ PAKTRON

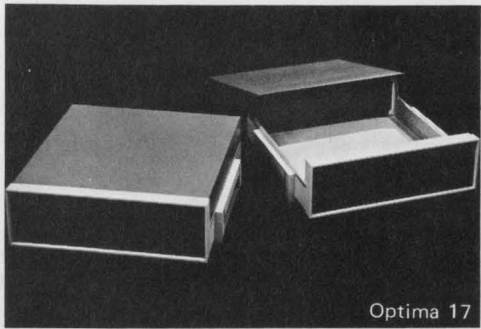

Optima 17

Instrument Cases

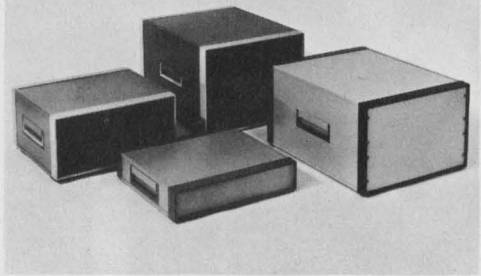

Vertical MC Rack

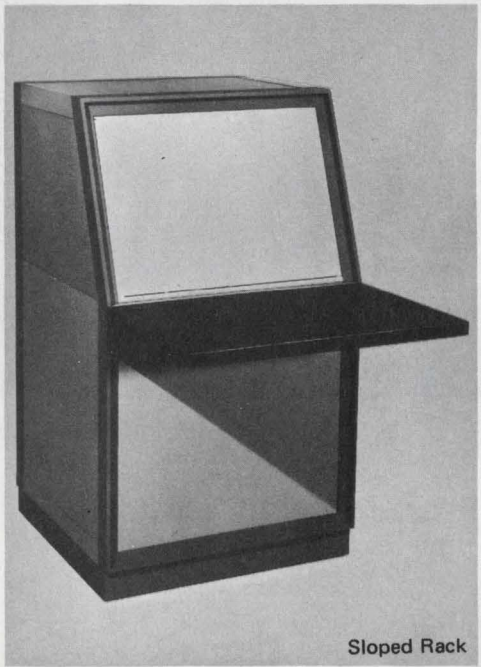

Sloped Rack

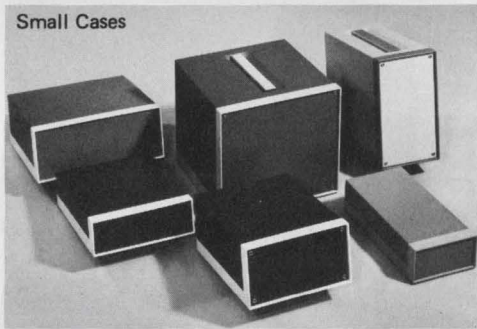

Small Cases

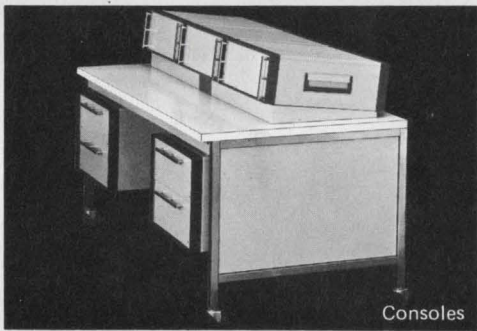

Consoles

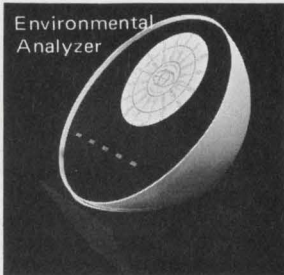

Environmental Analyzer



TV Broadcast Console



Digital Display Case

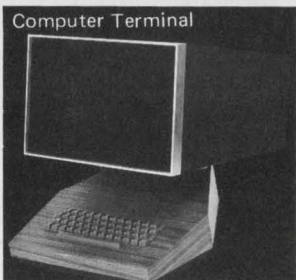

Computer Terminal

# OPTIMA STANDARD ENCLOSURES

We have over 14,000 standard enclosures at Optima. And we have a wider selection of finishes and color combinations than anybody in the industry. So, in effect, you can have an almost completely customized appearance at standard prices. There's a pretty good reason for all of this - Optima grew from the environment of the electronics industry. It was created specifically to design and manufacture enclosures for the instruments made by its parent company, Scientific-Atlanta. Our enclosures proved such unique, innovative solutions to our packaging problems that we offered them to the industry. Acceptance has been spectacular: we believe it's because there are no afterthoughts at Optima - because every feature of every enclosure meets a need and solves a problem. In fact, we've received awards for design excellence. These pictures show some of the reasons why . . .

- Optima 17 - an elegant total package consisting of chassis and case in one compact, lightweight unit.
- The classic Optima Instrument Cases - 72 basic sizes for both 19" and 24" panel mounted instruments.
- Small Cases, the rackable little boxes in 25 shapes and sizes that offer amazing flexibility.
- Three basic styles of racks. They are handsome, lightweight and look better, last longer, and do more than anyone else's - because we don't cut corners on quality.
- Optima Consoles, a unique concept of "executive-look" instrument housing combining flexibility, generous counter & storage space, fine workmanship, and a high degree of human engineering.

## CUSTOM DESIGN

If we haven't shown you enough, we also have a custom design service when one of our 14,000 standard enclosures won't do the trick. Our design staff can work out something that fits your requirements down to the last detail, no matter how large or small or intricate. OPTIMA - with the products and service to suit you. Give us a call.

## Optima enclosures

a division of Scientific-Atlanta, Inc.  
2166 Mountain Industrial Blvd.  
Tucker, Ga. 30084 Tel: 404-939-6340

# 0.47pf-15mfd in many "mini" styles

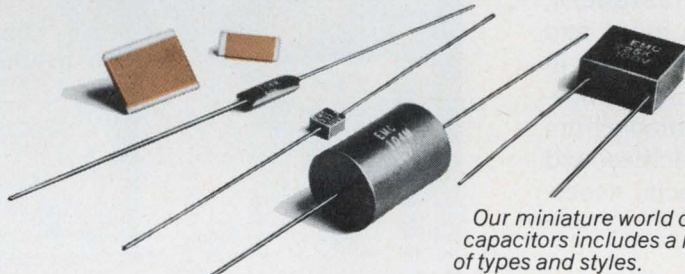

*Our miniature world of ceramic capacitors includes a huge range of types and styles.*

Whatever your multilayer ceramic capacitor need – precision tolerance for critical application or high volumetric efficiency for general purpose use – Electro Materials can deliver. At competitive prices. Select Electro Materials® layerized ceramic chips from a wide range of styles, voltages, temperature ranges, capacitance values and end terminations. The same holds true for

our axial or radial lead molded units ... and our new radial lead dipped models. Many styles available in rectangular or tubular shapes. We'll help you match the right ceramic capacitor to your specific project. And because of advanced technology and high volume production, we can pass along substantial savings to you. See for yourself. Contact your local Electro Materials representative

for full details. Or phone or write:  
**Electro Materials,  
Division Illinois  
Tool Works Inc.,  
11620 Sorrento  
Valley Road, San  
Diego, Calif. 92121.  
Phone (714) 459-  
4355. TWX 910-  
322-1130.**



## ELECTRO MATERIALS

*The Innovating Electronic Group of ITW... ELECTRO MATERIALS ■ PAKTRON ■ LICON*

# QUICK

One of these dependable,

# OPERATING

easy-to-install Simmons fasteners

# FASTENERS

may be exactly what you need

# FOR

to solve your fastening problem.

# ELECTRONICS

Standard Simmons panel fasteners, latches, pressure hinges, hole plugs and other devices have proved themselves in thousands of varied electronics applications. Most are immediately available from stock in various sizes and capacities, and all can be adapted to your special needs. Quickly. Economically.



Write for this 36-page catalog. Complete data on Simmons' quality quick-operating fasteners.

# SIMMONS

**FASTENER CORPORATION**

1782 North Broadway, Albany, New York 12201

**MINI-Q-LOCK** — quick-operating fastener for miniaturized electronics applications where space and weight limitations are important. ▼

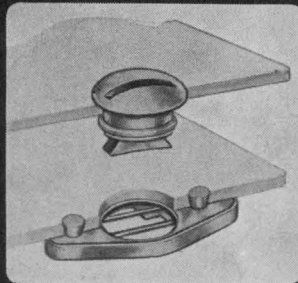
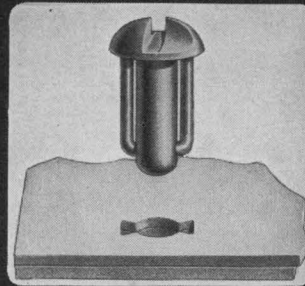

**QUICK-LOCK** — for removable panels and access doors; locks or opens with a 90° turn. Works with curved sheets or slightly misaligned holes. ▼

**SPRING-LOCK** — one-piece blind rivet for removable panels and control covers; self-adjusts to various panel thicknesses. Locks, unlocks with a ¼-turn.

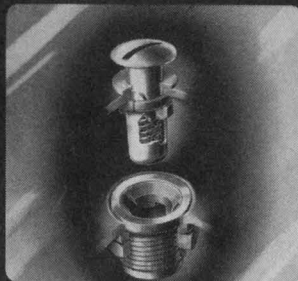
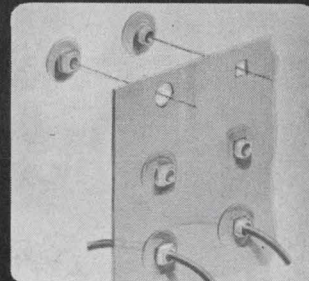

**HOLE PLUGS** (plastic) permit fast, secure, snap-in installation in round, square or unusual-shaped holes. Not affected by climate or temperature.

**LINK-LOCK** — ideal for latching where heavy locking pressure is required. High impact resistance. Available in medium and heavy duty. ▼

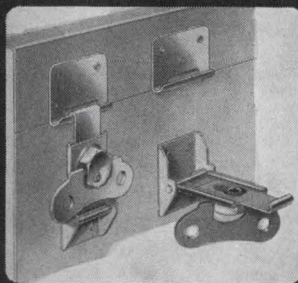
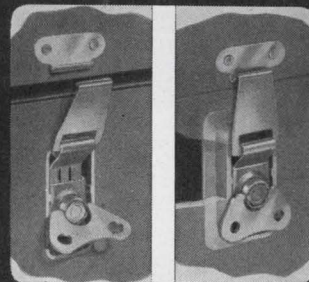

**RECESSED LINK-LOCK** — minimum protrusion, pressure-tight seal. Can be bonded with adhesive or riveted to any sheet, sandwich material or plywood.

**HINGE-LOCK** — rugged pressure hinge provides strong seal on hinge line of gasketed cases. (Matched hardware with Link-Lock fasteners.) ▼

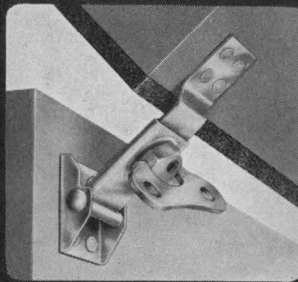
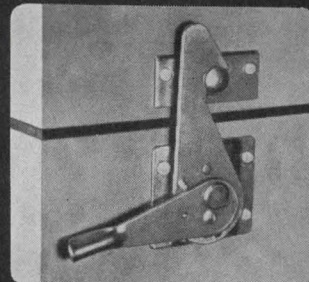

**HOOK-LOCK** — springless, positive-locking latch lies flat on mounting surface; high closing pressure and load-carrying capacity. Impact and shock-proof.

# 5 new capacitor ideas.



Last year, nobody  
could offer you any of these

From Paktron, the one U.S. company that keeps making news in film capacitor development and manufacturing automation advances. *Metalized Film Capacitors* for use in voltage multiplier circuits to replace and outperform more expensive ceramic disc capacitors. New *Paktron® Metalized Polypropylene Capacitors* for high voltage/high current application — up to 1200 volts. *Molded Polyester Capacitors*

designed for PC board use in the widest possible capacitance range and popular voltage ratings. *Micromatic® Type PP Polypropylene Capacitors* for specialized applications in the instrumentation and telecommunications industries. *Wrap and Fill Capacitors* that combine polycarbonate type performance with metalized type stability and miniaturization. For details on any of these — plus a long

line of standardized film capacitors— write to the domestic leader in film capacitors: **Paktron, Division Illinois Tool Works Inc., 1321 Leslie Ave., Alexandria, Va. 22301. Phone (703) 548-4400. TWX 710-832-9811.**



**i t w** PAKTRON

The Innovating Electronic Group of ITW... PAKTRON ■ LICON ■ ELECTRO MATERIALS

# 10 new ways to improve system performance

## MECL 10,000 means optimum performance

MECL 10,000 improves your system performance 10 ways — actually 16 when you consider devices previously introduced. This new “systems-oriented” logic family combines high speed (typically 2.0 ns propagation delay per gate), with low power (25 mW dissipation per gate), yielding the best speed/power combination available today.

But speed and power are only part of the story. Take a look at the design advantages of MECL 10,000.

Features such as collector and emitter dotting on chip allowing multiple functions with only single gate delays. Or open emitter outputs and Hi-Z inputs which permit you to select the optimum termination method for your system.

Interested in driving capacity? MECL 10,000 offers 50  $\Omega$  to 2 K  $\Omega$  driving capability. High Z inputs with parallel terminated lines allow “stubbing” off of a line at several points. Popular series terminating and series damping techniques

may be used with no loss in noise immunity.

Worried about cooling? Forget it! MECL 10,000 low power gates (25 mW/gate, 52 mW/gate with 50  $\Omega$  load) eliminate cooling and power distribution problems and ensure long term reliability. In fact the devices are so low power you can use them in any environment—from still air to specialized cooling.

These are only a few reasons for choosing MECL 10,000, — your evaluation will discover the rest.

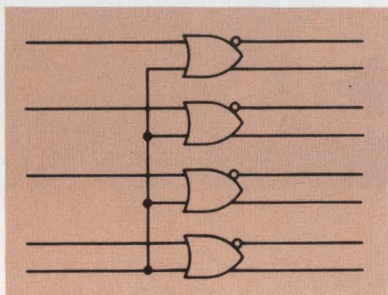

**MC10101 Strobed Quad OR/NOR Gate** — Very useful for distributing 4 bits of parallel information on or off card. With both OR/NOR outputs available, 4 twisted pair lines may be driven at data rates of 100 megabits/second. Use the single strobe input to gate the data on or off in 2 ns.

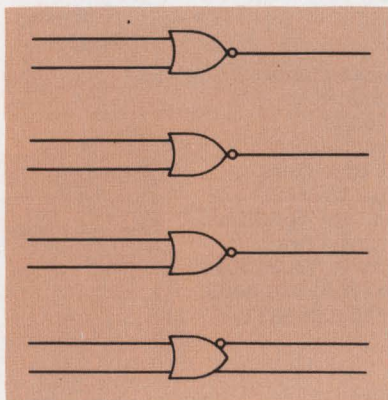

**MC10102 Quad 2-Input NOR Gate** — Offers four 2-input NOR gating functions with an additional OR output available. Input pulldown resistors on all devices eliminate need to tie unused inputs to an external supply.

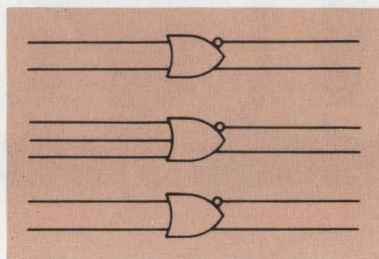

**MC10105 Triple 2-3-2 OR/NOR Gate** — A system oriented device aimed at reducing package count by providing three OR/NOR gates within one package. This versatile logic element provides manipulation of Boolean functions in typically 2 ns.

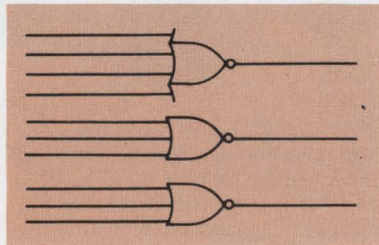

**MC10106 Triple 4-3-3 Input NOR Gate** — Basically a triple 3-input logic NOR function plus an additional input on one gate to provide added design versatility for maximum package use.

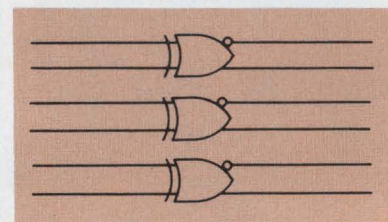

**MC10107 Triple 2-input Exclusive OR/Exclusive NOR Gate** — A three gate array providing the positive logic Exclusive OR and Exclusive NOR functions for high speed applications. Temperature compensated internal bias on 10,000 series devices insures that the threshold point remains in the center of the transition region over temperature.

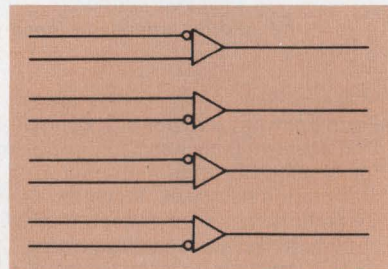

**MC10115 Quad Line Receiver** — Useful for receiving 4 bits of differential data transmitted over twisted pair or ribbon cable from the MC10101. Also recommended for MOS to MECL interfacing and is ideal as a sense amplifier equivalent for MOS 1103 type memory translation to MECL.

MECL 10,000, MECL 10,000 Logic and MECL 10,000 Series are trademarks of Motorola Inc.



# MECL 10,000 ...

(of course)

## MECL 10,000 — a comprehensive family

Originally designed as a computer-oriented logic family, MECL 10,000 also offers the optimum combination of parameters and flexibility required for high-speed digital communications, telemetry systems, and instrumentation. In addition to these 10 functions, here is a look at the line.

Previously announced and available:

MC10109 Dual 4-5 Input OR/NOR Gate  
 MC10110 Dual OR 3-Output Gate  
 MC10111 Dual NOR 3-Output Gate  
 MC10119 3-3-3-4 Input OR/AND Gate

MC10131 Dual D Flip-Flop  
 MC10181 4-Bit Arithmetic Unit

These functions will be added in 1971:

### Memory Elements

MC10133 Quad D Latch  
 MC10134 Dual D Latch W/2D Inputs & Select  
 MC10135 Dual J-K Master Slave Flip-Flop  
 MC10136 4 Bit Universal Counter  
 MC10139 256 Bit Fusible Link ROM  
 MC10140 64 Bit RAM  
 MC10141 4 Bit Universal Shift Register

### Line Receiver

MC10116 Triple OR/NOR

### Complex Functions

MC10160 12 Bit Parity Checker/Generator  
 MC10164 8 Line Multiplexer With Enable  
 MC10179 Look-Ahead Carry Block  
 MC10161 Three Bit Decoder w/two Enables  
 MC10162 Three Bit Decoder w/two Enables

Your local Motorola representative has complete MECL 10,000 data yours for the asking — or write to Motorola Semiconductor Products Inc., P.O. Box 20912, Phoenix, Arizona 85036. And for evaluation call your nearby Motorola distributor.

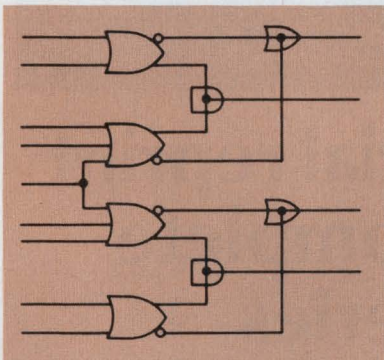

**MC10117 Dual 2-Wide OR-AND/OR-AND-INVERT Gate** — A powerful logic function featuring the first available OR-AND/OR-AND-INVERT emitter coupled logic gate. The internal collector AND/emitter OR dotted logic gate will perform the OR-AND/OR-AND-INVERT logic function in 2.4 ns. Useful for data multiplexing and data distribution.

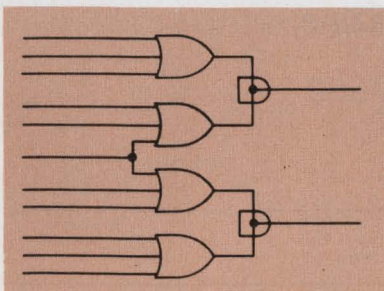

**MC10118 Dual 2-Wide 3-Input OR-AND Gate** — A highly functional basic building block to provide the OR-AND function. Recommended for digital multiplexing and data control applications.

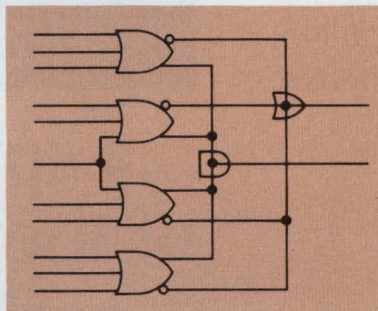

**MC10121 4-Wide OR-AND/OR-AND-INVERT Gate** — Another system oriented building block providing the simultaneous OR-AND/OR-AND-INVERT function, a natural for data distribution applications.

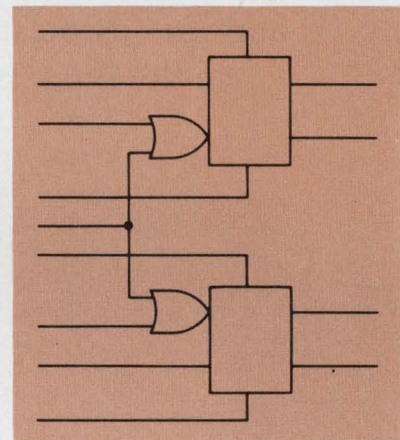

**MC10130 Dual Latch** — A clocked dual D type latch. Each latch may be clocked separately by holding the common clock in the low state, and using the clock enable inputs for the clocking function.

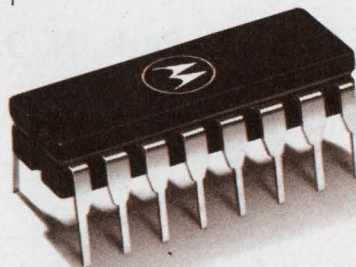

**MECL 10,000 eliminates the alternatives. The proof is in the comparison!**



**MOTOROLA MECL**  
 ... for faster computers & systems

INFORMATION RETRIEVAL NUMBER 36

# Get your extra copies now!

## The Minicomputer and the Engineer...

An in-depth, up-to-date and complete analysis of what the mini can do, how to specify it, the problems of programming, peripherals, interfacing and system applications, ELECTRONIC DESIGN's special technical series on the mini in the world of the engineer is *must* reading for every designer. In the minicomputer world of the 70's no engineer should be without it. Order extra copies now, for yourself and your associates, by filling in the order blank below.



...a special reprint  
of the complete  
6-part series  
for only \$3.75

---

**William H. Smith, Electronic Design Magazine,  
50 Essex Street, Rochelle Park, N. J. 07662**

Please send me \_\_\_\_\_ copies of  
THE MINICOMPUTER AND THE ENGINEER.

I enclose \$3.75 for each copy, including  
handling and postage.

- check  
 money order

Checks or money orders only, please.

Name \_\_\_\_\_

Firm \_\_\_\_\_

Street \_\_\_\_\_

City \_\_\_\_\_

State/Zip \_\_\_\_\_

# The big buy in big-screen lab scopes

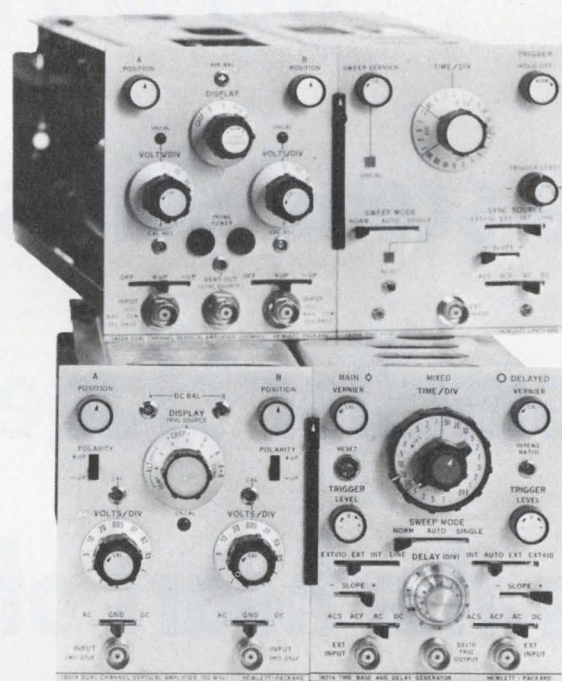
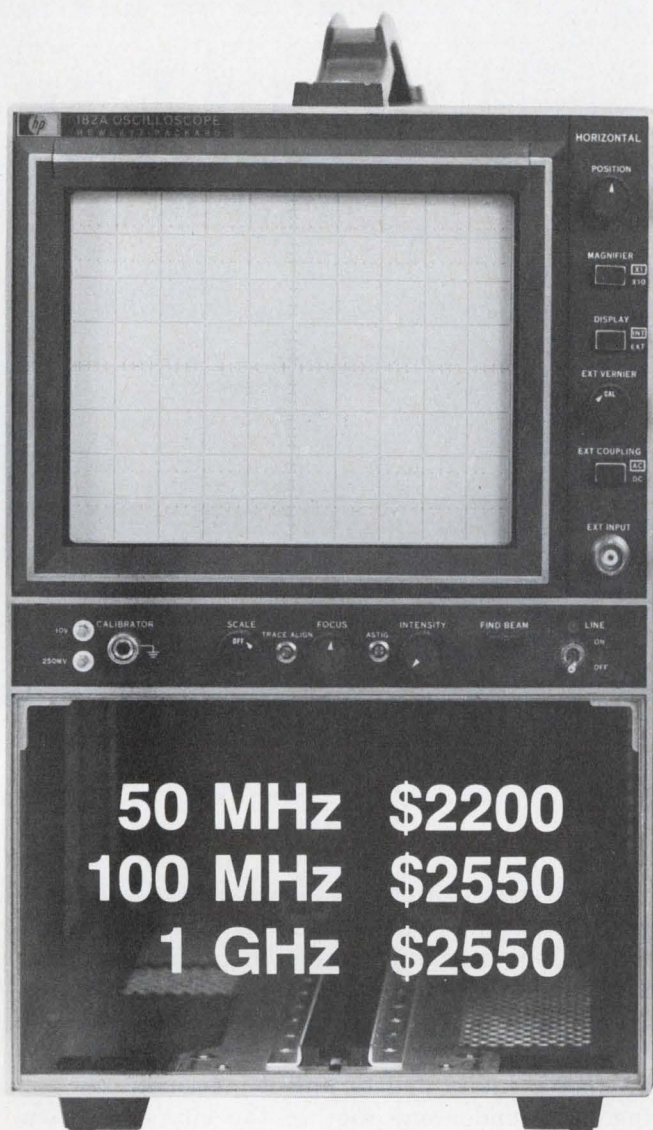

You don't have to give up performance capabilities to save money on a big-screen scope; HP's 182A gives you both.

For \$2200, you can get a mainframe, a 50-MHz dual-channel amplifier, and a delayed-sweep time base. This combination gives you the **biggest display area of any high-frequency scope** (8-div x 10-div, 1.3 cm/div), 5 mV/div sensitivity, and 10 ns/div sweep time.

And that's only the beginning. **The 182A system isn't limited to 50 MHz** in the plug-ins it can accept. Thanks to HP's pioneering advances in CRT technology, the 182A will take the entire family of 180 System plug-ins.

**For \$2550 you can get a 100 MHz system** (mainframe, dual-channel vertical amplifier, and non-delayed sweep; delayed sweep \$450 extra). Also available at \$2550 is HP's new 1 GHz sampling system (mainframe and plug-in) that's as easy to use as a real-time scope! And the 182A is the only large-screen lab scope that has these capabilities.

So, if you're in the market for a high-frequency scope—get the 182A in the 50-MHz configuration, and protect yourself against having to buy a whole new system for 100-MHz capabilities in the future. **It's like getting free "bandwidth insurance" with your mainframe!**

For further information on the 182A, contact your local HP field engineer, or write Hewlett-Packard, Palo Alto, California 94304. In Europe: 1217 Meyrin-Geneva, Switzerland.

Scopes are changing.  
Are you?



081/16

## Wescon 71

# The scene shifts to smaller stage in the heart of San Francisco



The Western Electronic Show and Convention is celebrating its 20th anniversary with a relatively modest but sparkling reception in the center of town. Instead of being held in the cavernous Cow Palace complex on the outskirts of San Francisco—as has been the case for over a decade—the product exhibits and technical meetings are taking place under one roof in the city's beautiful Civic Center (photo above).

Attendance is lower than in former years, and there are fewer exhibitors. But the technical program has been enlarged to 32 sessions, compared with last year's 27 in Los Angeles.

During the four-day program, Aug. 24-27, there are two special blocs of sessions—eight on computer-related subjects and six devoted to electronics manufacturing. Four sessions deal with engineering as a career and with technical management and marketing. Otherwise the program reflects a continued interest in civionics, combined with practical “here and now” technology.

For example, there are sessions on “Recognizing and Gearing Up for New Electronic Markets” (Session 4), and “Air-Pollution Control: Where We Are and Where We Are Going” (Session 32). On the more pragmatic side, there are sessions on “Automated Testing of MOS Integrated Circuits” (Session 3) and “Computer-Aided Design of High-



### Frequency Circuits" (Session 23).

Reflecting the current concern with engineering career and employment problems, there is a special panel session (Wednesday, Aug. 25) on future directions in engineering careers. The panel includes Dr. James Mulligan, IEEE president; Dr. R.C. Mercure Jr., president of WEMA; Paul Robbins of the National Society of Professional Engineers and Dr. Hubert Heffner, deputy director of the U.S. Office of Science and Technology.

Reflecting the economic downturn in the country, particularly on the West Coast, the number of engineers attending the show this year is estimated at 30,000, compared with nearly 45,000 in San Francisco in 1969. The number of companies displaying products has dropped sharply—from 610 two years ago to about 325 this year.

Nevertheless, in commenting on Wescon's move from the Cow Palace to downtown San Francisco, Robert M. Ward, chairman of the Wescon board of directors, sees a cheerful side to the picture:

"Visitors are going to find this Wescon easier to see, and the exhibitors are going to find it better to show in. This move has given us air-conditioned facilities, professional meeting rooms, better registration flow, easy access to hotels and eating places, good parking and better utility services."

<b>Design trends in major engineering areas as reflected in the technical papers . . .</b>	<b>W4</b>
Microelectronics . . . . .	W4
Minicomputers . . . . .	W6
Microwaves . . . . .	W7
Optoelectronics . . . . .	W9
Medical Electronics . . . . .	W10
Air Pollution Control . . . . .	W11
Marketing and Management . . . . .	W13

<b>Depressed aerospace giants turning to civionics for a lift . . . . .</b>	<b>W16</b>
---	------------

<b>Complete guide to technical papers listed by engineering subject . . . . .</b>	<b>W20</b>
---	------------

<b>Outstanding new products . . . . .</b>	<b>W30</b>
Data Processing . . . . .	W30
Instruments . . . . .	W34
Modules & Subassemblies . . . . .	W40
Packaging & Materials . . . . .	W42
Components . . . . .	W44
Microwaves & Lasers . . . . .	W46

# Come along on an express visit to the major technical sessions

This year's enlarged technical program (32 sessions, as compared to 27 last year) offers the designer a broad range of topics—from tomorrow's programmable calculators to the more traditional hybrid-circuit manufacturing techniques. Civionics papers are represented again, touching on such timely subjects as air pollution. There are quite a few computer-related papers. Eight of the 32 technical sessions deal with computer-related

subjects, such as "Peripherals for Minicomputers," "Exploration of Available Computer Programs in Electronic Circuit Design" and "Computer-Aided Design of High-Frequency Circuits." Other sessions that are drawing interest are Panel Session 7, "Engineer's Role in the Economic World," and Session 4, "Recognizing and Gearing Up for New Electronic Markets." Here's a sampling of the key papers:

## Microelectronics: Stress is on MOS, the hottest thing in IC technology

In microelectronics, the word this year is "MOS." It's the fastest-growing technology in integrated circuits, and it dominates three microelectronic sessions at Wescon—Nos. 3, 28 and 29. Three areas are covered by the papers:

1. **Automatic testing of MOS devices.** With MOS/LSI development, the chip is getting so complex that it's harder to test these circuits. Automatic testing methods are needed.

2. **Ion implantation of MOS devices.** The benefits here are higher speed, improved power characteristics and lower operating voltage.

3. **Micropower integrated circuits.** These are finding increased use in implantable medical devices and low-power instrumentation and communications equipment.

Session 3 covers "Automated Testing of MOS Integrated Circuits." Session 28 is considering "Ion-Implantation Technology for Microelectronics," and Session 29 is devoted to "Micropower Microelectronics."

"Proper testing of LSI chips is, at best, extremely difficult," says A. E. Pound of American Micro-systems, Inc., Santa Clara, Calif., who is giving a paper in Session 3 on "Designing MOS for Maximum Testability." Testing becomes even

more of a challenge as the complexity of LSI chips increases each year, Pound adds. For example, typical random-logic MOS chips now contain two to eight times the number of transistors included on chips designed just two years ago.

Development of a test plan for such circuits involves a balanced combination of activities that includes acquiring proper test facilities, properly specifying both the functional and parametric tests, and designing the circuits themselves so they are possible to test. This last factor is probably the most neglected and the main subject of Pound's paper.

### Growth for ion implantation seen

Ion implantation is gaining more and more recognition as a new process that is compatible with, but in many areas superior to, existing microcircuit fabrication methods. According to James A. Marley Jr. of Signetics Corp., Sunnyvale, Calif., who organized Session 28: "All present indications point to considerably greater utilization of this technology in future IC processing."

In his paper "Applications of Ion-Implanted Depletion Loads to MOS Large-Scale Integration,"



**Ion-implantation techniques** are gaining recognition as a process that is superior to existing microcircuit fabrication methods. Designers Richard Inman (left) and

Richard Petty of Mostek Corp., Carrollton, Tex., examine a mask for a new MOS integrated circuit that will be fabricated with ion implantation. (Session 28).

Gordon Hoffman of Mostek Corp., Carrollton, Tex., discusses how ion-implantation technology has fabricated MOS LSI circuits incorporating both enhancement and depletion-mode transistors on the same chip. The use of depletion-mode devices allows design techniques that result in superior speed-power performance. It also results in operation from a single, low-voltage power supply. Applications include random-access memories, display drivers and random-logic arrays.

Another Session 28 paper, "Ion-Implanted Complementary MOS Technology," by L.O. Bauer, P.J. Coppen and H.G. Dill of Hughes Aircraft Co., Newport Beach, Calif., describes recently developed techniques that complement and improve existing CMOS technology. The main implantation applications are formation of self-aligned gates, shifting threshold voltages and accurate control of impurity concentrations. Applications include circuits operating from supply voltages in the 1.2-to-25-V range, for use in electronic watches or as commercial shift-register products.

A paper on "Precision Ladder Networks Using Ion-Implanted Resistors," contributed by H.H. Stellracht, D. S. Perloff and J. T. Kerr of Signetics Corp., discusses some important properties of ion-implanted resistors, as compared with conventional diffused and thin-film resistors.

Resistors fabricated with thin-film technology offer a much wider choice of sheet resistivities and better manufacturing tolerance than diffused resistors. The matching and temperature coeffi-

cient of thin-film resistors are also more than an order of magnitude better than their diffused counterparts. However, thin-film resistors require several additional processing steps. These are, in general, quite critical and tend to decrease the integrated-circuit yields. The yield losses are usually caused by the high surface sensitivity and by stability problems associated with thin-film technology. These disadvantages make the process unattractive for the manufacture of low cost-high volume integrated circuits.

Ion implantation offers a third alternative for resistor fabrication that avoids some of the shortcomings of the other technologies. In particular, boron-implanted resistors with extremely low temperature sensitivity may be fabricated over a wide range of sheet resistivity. The absolute value tolerance of ion-implanted resistors is superior to that of both diffused and thin-film resistors, because of the precise doping control available through ion beam monitoring. The matching tolerance obtained with ion implantation is comparable to that obtained with thin-film technology.

In Session 29, the chairman, Alan G. Thiele of Motorola's Semiconductor Products Div., Phoenix, Ariz., observes:

"Initial impetus for the advancement of micro-power technology developed in response to needs for implantable medical instrumentation and portable communications equipment, where the desire for minimization of power consumption is particularly evident. More recently appreciated targets

for dramatic application of micropower microelectronics include all-electronic timepieces and remote, unattended sensing apparatus for environmental surveillance."

The availability of micropower devices gives design engineers the opportunity to worry less

about dissipating heat and more about avoiding its generation in many circuit and system applications. System reliability can be improved through incorporation of micropower subsystem redundancy, which would not otherwise be feasible, with constraints on power consumption. ■■

# Minicomputers: How to buy a good one and how to get the maximum out of it

Should you buy a minicomputer? What facts should you consider if you do buy one?

Questions like these are discussed in Session 1, "Choosing a Minicomputer: The User's Viewpoint."

How can you get the most out of a minicomputer once you've bought it?

Try Session 5, "Peripherals for Minicomputers."

Session 1, organized by Steven A. Erenburg, microelectronics editor of *ELECTRONIC DESIGN*, is keyed to two major premises:

1. Not all engineers have the familiarity, and therefore the confidence, to use a minicomputer as readily as they do a slide rule.

2. The largest and most expensive part of the minicomputer system consists not of the mini but of the peripherals and software.

The tendency for engineers who are unfamiliar with the minicomputer's potential is to commit themselves to larger and more expensive systems than necessary to perform control and analytical tasks, the participants in Session 1 suggest. There is general agreement that although a mini can handle complex jobs economically, there is no justification for using it where a cheap, hard-wired controller will do the job. The mini should be used only if it saves time or money, or can do something new and valuable.

On the other hand, a mini can often be used in place of a large, expensive CPU, the participants say. And, they note, if a dedicated minicomputer fails, only the one task to which it has been assigned is affected. This is in contrast with a large, time-shared computer failure, in which all terminals and the machines or processes to which they are connected are disabled. It may make good sense, for example, to apply several minis, instead of one large time-shared computer, to a plant control problem.

On the subject of how to buy, Frank C. Milstead, manager of marketing for Unitech, Inc., Austin, Tex., discusses the often overlooked factors of reliability, maintainability, user groups

and human factors. According to Milstead:

"The size of the CPU mainframe and the construction concept may create system packaging problems that can be costly to overcome."

Another item Milstead points to is the operator's console: "The switches and display, and their configuration, can affect operator's efficiency."

Are you interested in ultimate expansion of the mini's functions? Milstead advises:

- Determine if the mainframe should be a complete system or if extra modules will be necessary to provide memory and power.

- Evaluate the ability of the basic mainframe to accept internal interface controllers.

Expansion requirements are so basic to the mini system that their cost could be out of proportion to your initial budget and abort the entire project, Milstead cautions.

Of course, it isn't necessary to buy all the equipment at one time for the ultimate in expansion, he notes. But neither should the system be "frozen" because of short-sightedness.

When shopping for existing software, the market manager says, the buyer may find that a major cost of running the programs he can buy is that of additional hardware. Thus a manufacturer who can provide additional memory and interface controllers economically should prove appealing.

## Factors in choosing peripherals

As for peripherals, papers in Session 5 indicate that part of the user's problem is that there are more engineering disciplines involved in the design of a peripheral than in the mini itself. Factors such as materials, wear, lubrication, fatigue, vibration, servo-analysis, structural design and electronics all need to be understood by the evaluator.

Factors to consider when choosing a peripheral include these:

- The equipment should lock if the power fails and should be protected against operator error.



- The servo system should have sufficient margin to remain stable as the unit wears.

- A good way to evaluate reliability is to check the frequency of field service calls, since few companies can quote true MTBFs on machines in the field.

How can you get the most out of your mini? Grant Saviers, engineering manager of peripheral equipment at Digital Equipment Corp., Maynard, Mass., points out in a Session 5 paper on the "Application of Minicomputer Peripherals" that peripherals "allow the user to communicate with the machine, display information in tabular or graphic form and let the mini communicate with other systems."

One low-cost simple system for data processing and scientific computing might consist of a card reader and a low-speed printer tied to a mini, he says. A somewhat more sophisticated system might also include adapters to allow the mini to talk to another computer via communications lines.

The most basic input/output device used with minis are teleprinters, Saviers notes, and almost all minicomputer manufacturers offer an interface for the Teletype Corp.'s ASR-33.

Saviers says of the ASR-33: "This low-cost peripheral contains a paper-tape punch and reader, and can perform a number of functions when used as an I/O device. It can provide typewriter-

keyboard and paper-tape inputs to the computer and hard-copy printouts and paper tape outputs from the computer."

A device gaining favor among mini users is the line printer. According to Saviers, a "low-cost, 80-column line printer is a nice way to add volume alphanumeric output to the machine." The line printer also can produce multiple copies, he notes.

For interchanging data between computer systems, Saviers believes magnetic tape is still the most popular tool. It has been standardized by ANSI as to format, recording techniques and tape construction, to guarantee interchangeability between computer systems.

One of the most important things overlooked in specifying peripherals for a system, Saviers says, is that different systems have different data capacities and transfer rates. The question to ask when choosing a peripheral is: Is the peripheral versatile enough to adapt to different systems? The problem is obvious if an ASR-33 and a cartridge-disc drive are interfaced to a mini. To transfer the contents of the disc to paper tape, be prepared to spend about three days and nights punching out paper tape.

And while the transfer rate is what limits going from disc to paper tape, you should also evaluate in terms of capacity. "Dumping a disc pack onto a cassette, for example, may take several cases of cassettes," Saviers cautions. ■■

## Microwaves: A look at new trends in Impatts, Gunn diodes and transistors

New developments in Impatt (avalanche) diodes, Gunn diodes, transistors and microwave acoustic components are presented in papers in Session 26, "Microwave Solid-State Devices."

In his paper, "Impatt Diodes: Technology and Applications," A.M. Cowley of the Hewlett-Packard Co., Palo Alto, Calif., points out in Session 26:

"The most difficult technological problem in Impatt diode construction is efficient heat removal from the active portion of the device; Impatt diodes operate at high dc power densities—typically  $10^4$  to  $10^5$  W/cm<sup>2</sup>—and since only a small fraction of this power (6 to 12%) is converted to rf power, the remainder has to be removed as heat."

Solving the heat-removal problem, then, is the key to progress in Impatt-diode design. Cowley

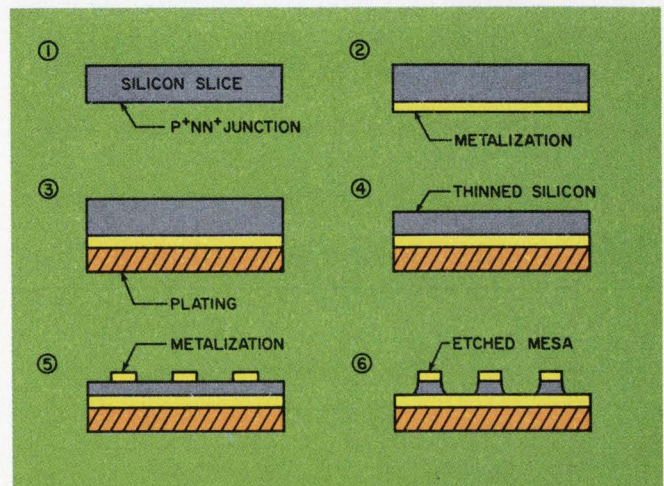

Plating the heat sink onto the silicon slice at the wafer stage not only cuts the cost of fabrication, it gives more reproducible results as well.

reviews several approaches to this problem, including the inverted mesa technique and the use of plated sinks.

In the involved mesa technique, the diode is made in the conventional manner and is then inverted and thermocompression-bonded to a copper heat sink. Solder cannot be used in this process because it would introduce excessive thermal resistance between the diode and the heat sink.

In the plated-heat-sink approach, the heat sink is electroplated onto the silicon at the water stage, before the individual diodes have been fabricated. This process has the advantage of forming the critical portion of the heat sink in batch fashion, which eliminates the cost of thermocompression-bonding each individual diode to the heat sink. It has a further advantage in being more reproducible than the thermocompression-bonding method, and in producing a mesa shape which is less susceptible to edge breakdown and reverse leakage (see figure).

#### Gunn devices are quieter

While an Impatt diode can produce more power at a given frequency than a Gunn diode can, it also produces more noise. Using the noise measure,  $M$ , as a figure of merit, Cowley compares Gunn and Impatt devices with two common types of klystrons. As the accompanying table indicates, silicon Impatt diodes are comparable to reflex klystrons in noise performance, while GaAs Impatts are considerably better. The Gunn devices have significantly lower noise than either Si or GaAs Impatt diodes.

Because of the importance of noise performance when Gunn diodes are used, much of a paper on "Review of Gunn-Effect Devices," by Dr. Berin Fank of Varian Associates, Palo Alto, Calif., is directed toward describing and reducing the noise that these devices produce. Among the suggested noise-reduction techniques are the use of high-Q cavities, injection locking and a combination of the two. In the last approach, the locking source

can be a low-noise Gunn diode mounted in a stabilizing cavity, and the locked oscillator can be a higher-power Gunn diode operating as a free-running oscillator.

#### Transistors are still around

Despite the great interest in and importance of the two-terminal, negative-resistance devices, transistors are still very much around—especially at the lower microwave frequencies. In a paper on "Transistors for the Era of Microwave Communication," Sanehiko Kakihana of Hewlett-Packard discusses the applications of four principal types of microwave transistors: power, low-noise, digital and CATV. For a straight-through type of rf repeater, Kakihana points out, the designer can find suitable transistors today only in the 2-GHz band.

"It is very likely," he predicts, "that enough gain and power will be available at 4 GHz late this year or early in 1972."

In the low-noise area, Kakihana points out, an L-band rf amplifier must have a noise figure of about 5 to 6 dB to be useful. This, in turn, requires a transistor noise figure of about 3 to 3.5 dB. In analyzing commercially available transistors, he finds:

"At least over the L and S bands, present state-of-the-art low-noise transistors will be useful in the front ends of straight-through rf repeaters."

In specifying transistors for high-speed digital applications, such as PCM systems, Kakihana explains that such small-signal figures of merit as  $f_{max}$  and  $f_T$  are not meaningful. These quantities are only defined for small sinusoidal signals at a fixed bias point, and these conditions are typically not satisfied by the ECL pairs used for such applications.

Despite this problem, qualitative correlation seems to exist between the switching speed and the  $f_T$  measured at low voltage and at low current, provided that the  $r_b C_c$  product of the collector is also kept small. At present it is not exactly clear to what degree each of these parameters affects the speed of a switching transistor.

The usual frequency band used for CATV extends from 40 to 300 MHz, and thus cannot accurately be claimed to fall into the microwave domain. However, it turns out that only microwave transistors can meet the extremely severe requirements of linearity, gain, phase angle and low noise over this frequency range. The devices must be specially tailored to optimize for these quantities, but the basic fabrication process is essentially identical to that required to produce high-quality microwave power transistors. ■■

#### Comparative noise performance

Device	"Small-signal" $M$ (dB)
Silicon Impatt	36
GaAs Impatt	30
Gunn device	25-35
Reflex klystron	40-45
Low-noise klystron	30-40

# Optoelectronics: Solid-state memories promise greater capacity and speeds

A new LED/photosensor memory, a holographic data-storage medium almost as sensitive as a photographic film and transparent ferroelectric plates on which images can be impressed and viewed or projected—these are some of the recent, rapid advances in optoelectronics that are being explored in Sessions 24 and 31.

The major thrust in the field right now is being made by memories.

One of the newest solid-state, optoelectronic read-only memories (ROMs) is one by Optical Memory Systems, Santa Ana, Calif., in which the bits are formed by an array of LEDs that energize an identical array of silicon p-i-n photosensors. In a Session 24 paper, "Optical Memories," Bruce Ballard, marketing director for Optical Memory Systems says that the new memory fills a gap in the ROM field between magnetic and semiconductor ROMs on the one hand and holographic systems on the other.

## The holographic memory

For large, fast memories of the future that can store billions of bits, the holographic is a leading contender. Laboratory demonstrations by RCA and others have proved the feasibility of the concept. But materials, particularly for the page composers and the high-density holographic storage medium, are still the prime problem. However, recent work in this field, including the use of both ferroelectric materials and liquid crystals, shows great promise.

Discussing advances in the field in the last year, Dr. George W. Taylor, director of research and development for Princeton Materials Science, Princeton, N.J., presents "The Application of Ferroelectric Materials in Optical Memories" in Session 31.

Taylor, who until recently was a member of the technical staff of RCA Laboratories, Princeton, engaged in material studies, describes a holographic storage medium in which RCA has stored images of photographic quality as well as holographic gratings of 1.26- $\mu\text{m}$  resolution. Most significant, the system sensitivity approaches that of photographic film. The data patterns were written with a cw laser that had a writing energy of only 10  $\mu\text{J}/\text{mm}^2$ .

The use of ferroelectric ceramics, such as lanthanum-modified lead zirconate/lead titanate is growing rapidly. J.R. Maldonado, a member of the technical staff of Bell Telephone Laboratories, Murray Hill, N.J., sees the application of this transparent material in a "strain-biased" mode as useful for page composers.



Tiny fiber optic strands are being investigated by researchers at Bell Telephone Laboratories as a possible transmission medium for laser beams (Session 31).

But he points out in his Session 31 paper, "Electro-optic Devices Using Strain-biased PLZT Ferroelectric Ceramics," that this may not be useful for a holographic storage medium, because the resolution is limited to possibly 100 lines/mm.

Bell Laboratories, which originated the strain-bias technique, bonds a thin plate of the PLZT ceramic (with a transparent photoconductive coating) to a plexiglas substrate. The plexiglas is bent mechanically to produce a tension axis in the plane of the plate. This produces a two-terminal, large-area device in which a particular point may be addressed optically.

Images formed in the PLZT plate, Maldonado explains, can be produced in arrays for a page composer. Or they may be pictorial images projected onto a large screen with a projection lamp and optical-projection system.

Development of the PLZT ferroelectric ceramic was carried out over the last three years at Sandia

Laboratories, Albuquerque, N.M. Within the last year significant improvements have been made in the optical properties and the transparency of the material, and three staff members of Sandia will report on them in Session 31.

Dr. Gene Haertling, ceramic engineer at Sandia, notes in a paper on "Electro-Optic Ferroceramic Materials" that while the birefringent electro-optical properties of PLZT have remained the same, the chemical homogeneity and transparency have been substantially improved.

In use of the material as an optical modulator, this has improved light transmission ratios to between 4 and 5 K to 1 in the ON and OFF states, Haertling says.

Better homogeneity has been obtained, he explains, by the use of a new chemical co-precipitation method of preparing the materials, while transparency has been upgraded by hot-pressing the ceramic in a pure oxygen environment. ■■

## Medical Electronics: Information nets that really work are still sorely needed

The main thing to emerge from this year's Wescon session on "The Future of Medical Information Systems" may be a consensus that past attempts in this area have failed. Because of that a crisis is developing in the health-care field, says Temple W. Neumann, manager of the Medical Systems Dept. in the Western Development Laboratories Div. of Philco-Ford Corp., Palo Alto, Calif.

Neumann, who is chairman of Session 10, says that "new resources will significantly lag the demands for service."

Most observers believe that early attempts at using a "total systems" approach have been at the root of past failures. In a paper entitled "The Medical Information Systems: Practice and Prospects," Dr. B.G. Lamson, director of hospitals and clinics at the University of California in Los Angeles, compares the total systems approach and the modular approach to medical information systems. He prefers the modular at this time.

The total systems approach was first tried, he says, in an attempt to automate all communications between patients and physicians and between physicians and management. This required the highest levels of sophistication for both computer hardware and software. Complete success

via this route is still way off, Dr. Lamson says.

A modular approach, on the other hand, offers a piecemeal build-up toward the same end, and it permits evaluation at every step of the way—a more conservative approach, but one more certain of success, according to Dr. Lamson. In describing some of the advantages of the modular approach, he enumerates the following:

- Each self-contained problem is smaller in scale; it is therefore possible to begin with smaller initial investments of both capital and staff.

- Fewer employees must be retrained to accommodate the new approach.

- Individual modules lend themselves to trial-and-error solutions, thus contributing to the evolution of a total solution.

- Hospital management can capitalize on internal strengths without having each department staffed at the high proficiency levels necessary for a hospital-wide system.

### Legal problems noted

There are nontechnical problems, too, that affect medical information systems. Dr. Ralph J. Gampell, a lawyer of San Jose, Calif., touches on some: the legal considerations of privacy, con-

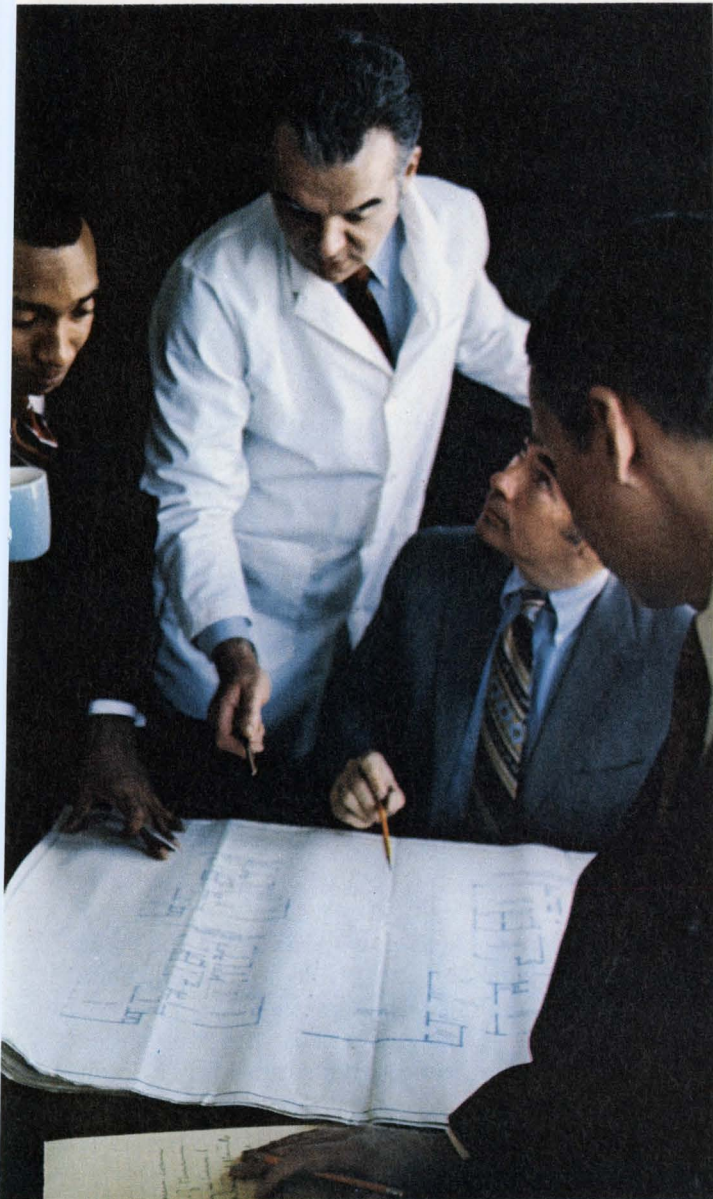

Doctors and engineers are working together to develop medical information systems that can rapidly and accurately measure, collect, organize, store and process a patient's medical profile for physician's evaluation. Shown here is a planning session at Sperry Rand's, Systems Management Div. in Great Neck, N.Y. (Session 10).

fidentiality and security of the patient record. He outlines them in a paper on "Boundary Condition—Key Legal, Ethical and Technical Medical Constraints on Medical Information Systems."

Will engineers and physicians work well together in the new world of medical electronics? Session 13, "Needs and Trends in Medical Electronics in the 70s," covers the requirements for cooperation between medicine and engineering.

In a paper entitled "Physiological Monitoring in Acute Hospital Environment: Some Obvious and Obscure Trends for the 70s," George I. Hickey Jr., a bio-medical consultant at Tarzana, Calif., says that "implicit in the avalanche of gadgetry into the acute hospital scene will be intrusion of the biomedical engineer and technician." He believes that "as this decade develops, they will become vital for the management of the sophisticated instrumentation and dedicated computers in the hospital." And he suggests that in addition to knowing about electronics and physiology, the new professionals will need chemistry, mechanics and systems engineering.

They may also need personalities that are not easily bruised, another speaker in Session 13 suggests. The speaker, Phillip A. DeLangis of the Artificial Kidney Center, Inc., Torrance, Calif., asserts that the engineer usually gets short-changed in his relationship with physicians.

In a paper entitled "Engineering Productivity in the Delivery of Health-Care Services," DeLangis refers to two ways in which the engineer traditionally becomes involved in health care:

1. He gets an idea and expands it into prototype instrumentation, then approaches a physician in the field to test its applicability.

2. A physician who has been working in a particular area calls on the engineer to provide the technical assistance to bring a program to fruition.

"In either case," DeLangis says, "it is the physician who will get full credit for the development and success of the program. Rarely does the engineer share in the glory." ■■

## Air Pollution Control: Measurement techniques track down contamination

Wescon is offering a liberal education to the working engineer in the growing, and potentially very large, world of air-pollution control.

Session 32 "concentrates particularly on regional air pollution problems—in this case, those in the western United States," says the panel's

organizer, Dr. Julia T. Apter of Presbyterian-St. Luke's Hospital in Chicago. The session chairman, Charles H. Wells, president of Systems Control, Inc., Palo Alto, promises an insight into "new methods for measuring air quality and new techniques for using data to develop useful



**New techniques for measuring and controlling air pollution** will be the subject of Wescon Session 32. This photo was taken by the session chairman, C. H. Wells of Systems Control, Inc., Palo Alto, Calif. The long wisp

of smoke at the center left comes from a cement plant. Wells calls it a "classic example of Gaussian plume dispersion from a single point source of pollutant." The photo was taken over Davenport, Calif.

models for both predicting and controlling air quality."

The lead-off paper, by Dr. Milton Feldstein, Bay Area Air Pollution Control District in San Francisco, gives a broad description of the chemical techniques being used now to measure and control air contaminants and how these techniques are falling short of needs. He then discusses instrumentation that is being sought to upgrade the operation in San Francisco.

#### **Accurate instruments needed**

Instrumentation needs are spelled out in detail in a paper by Dr. Rene Bertrand of Esso Research and Engineering, Linden, N. J., and Dr. A. Ellison of the Air Pollution Control Office, Environmental Protection Agency, Raleigh, N.C. This paper, based on a study sponsored by the Environmental Protection Agency, emphasizes the need for continuous, accurate measurements of trace contaminants in the air—which, in the case of certain contaminants, should be measured for concentrations as small as one part per billion.

The technique suggested for accomplishing this is measurement of the physical properties of the molecule itself, with the use of spectroscopy—mass spectrometry, spectrophotometry and correlation spectrometry. These techniques are proposed because they are not influenced by other contaminants or interfering compounds. The

techniques being used now are based on wet chemicals, which are susceptible to interference by other compounds in the sample.

The physical measurement of the molecules themselves is the trend, Bertrand and Ellison point out.

#### **Light-measurement techniques**

A third paper, by Dr. Anders Jepsen of Environmental Measurements, Inc., San Francisco, examines the theory and engineering practice of "correlation spectroscopy and its applications to remote sensing of ambient air quality."

Jepsen explains how to measure the wavelengths of light when the light is seen through a telescope. These measurements are then correlated with wavelengths of light that contains known contaminants.

Correlation equipment is used, as well as amplifiers and digital readouts. Jepsen doesn't use a computer, but discusses its application.

More hardware is discussed in a fourth paper, "Investigations of the Application of Microwave Spectroscopy to Air-Pollution Monitoring," by John Hearn and Howard Harrington of Hewlett-Packard, Palo Alto, Calif. This paper gives a brief explanation of the theory of detecting pollutants by use of microwave spectroscopy. The example Hearn uses is the examination of the sulfur dioxide molecule.

The final paper of the session, prepared by Session Chairman Wells and Ronald Lau, is entitled, "Stochastic Modeling and Control of Ambient Air Quality: A New Approach."

"The emphasis on the first four papers," Wells says, "is on how to measure air contaminants.

In our paper we discuss how to convert noisy biased data into real, usable information, and how to use that information to control air quality in the region you're dealing with."

In essence, he says, digital minicomputers are used to sample data once every three minutes. ■■

## Marketing & Management: The Trick is to turn the negative into positive

With the recession trying the patience, persistence and pocketbooks of engineers and employers alike, it's widely agreed that there's nothing the electronics industry needs more this year than a turnaround. Session 16, "Turnaround 71: Strategy for the 70s," describes ways that some companies have been able to improve their market positions this year.

According to the session's organizer, Frank J. Burge, director of marketing for Precision Monolithics, Inc., Santa Clara, Calif., the companies that are emerging winners are those that are turning outside negative influences into opportunities instead of excuses for poor performance.

Diversity has been the turnaround strategy of Dynamics Associates, Burlingame, Calif., says its president, Robert McGrath, a participant in Session 16. Once solely a rep firm, McGrath says Dynamics is now making it with a leasing company, a publishing company and a separate sales division. Comparing the turnaround year of 1971 to 1871, when Comstock Mines outside of San Francisco found a cheaper way to transport cheaper and harder-to-reach silver ore, McGrath says:

"Like the miners, our industry needs to search out the poorer grade of ore. The silver is still there but harder to recognize. We have to dig deeper and farther to find new applications for our products."

McGrath also notes that the people who made steady money in the Gold Rush of 1849 were not the gold miners but those who provided goods and services to the gold-seekers.

How to make it with technological innovation in a down market is described by Marvin Rudin of Precision Monolithics, Inc., Santa Clara, Calif. He tells how he launched his company with faith in the ability of his team of technologists to develop processes for producing increasingly more accurate, higher-quality, larger and lower-priced monolithic analog conversion functions. And he was sure that such ICs would find a ready market, because the only competition would be high-

priced modules. Philco-Ford, Westinghouse, Molecular and other financial giants had already dropped out of the field.

For insurance, Precision Monolithics is also offering a wide range of special testing, application assistance and even custom designs with the new ICs.

### Bankruptcy help available

One option for companies that find themselves in temporarily insurmountable financial trouble, according to Hal Tenney, president of Kinetic Technology, Inc., Santa Clara, Calif., is Chapter XI of the Federal Bankruptcy Act. In his paper, "What It Took to Come Out of Chapter XI," Tenney says that the laws in this country recognize that a company in deep financial waters can eventually bob to the surface and become profitable if it is granted short-term legal protection and the ability to negotiate with all its creditors as a group.

Tenney says that Chapter XI can be a temporary refuge from individual creditors who may be anxious to force the company into an involuntary form of bankruptcy and eventual liquidation. His company found that periodic court hearings are required under Chapter XI to convince the judge that progress is being made toward solution of the company's problems and that it is worthwhile to continue. Since a company's ability to obtain credit evaporates when it files for Chapter XI, the goal is to make maximum use of whatever company assets there might be.

In an allied session—"Employee Loyalty: A Two-Way Street," Session 11—two well known company presidents, Charles Sporck of National Semiconductor, Santa Clara, Calif., and James Riley of Intersil, Inc., Cupertino, Calif., are giving papers on stock options (Sporck) and employee rewards (Riley). Organized by Don Hoefler of *Electronic News*, this session also covers employer responsibility and benefits. ■■

**Reliability is 756 little dents  
and one big one.**





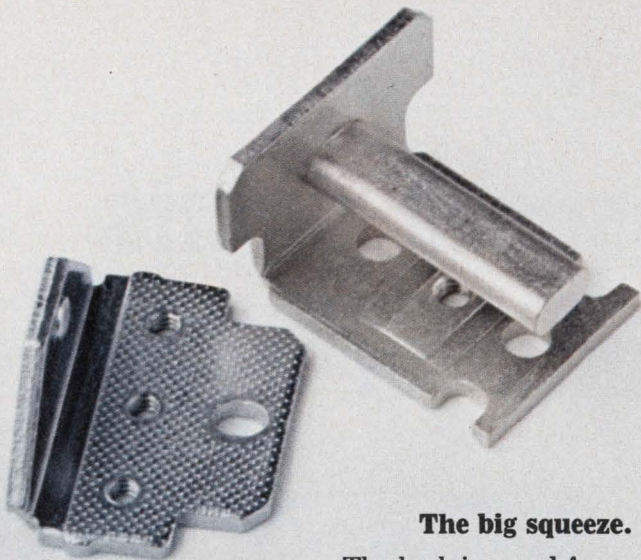

### The big squeeze.

The heelpiece and frame are the backbone of our Class H relay. The slightest squiggle or shimmy out of either and the whole relay is out of whack.

756 tiny dents on the heelpiece, plus one big one on the frame, make sure this'll never happen.

They're the result of planishing, a big squeeze. Planishing is an extra step we go through in forming the pieces to add strength and stability by relieving surface strain. It also makes the parts extra flat.

This takes the biggest press in the industry and the biggest squeeze. Both exclusively ours.

### A different kind of coil.

The heart of a relay is the coil. If ours looks different, it's because we build it around a glass-filled nylon bobbin. It costs us more, but you know how most plastic tends to chip and crack.

Also, moisture and humidity have no effect on glass-filled nylon. No effect means no malfunctions for you to worry about. No current leakage, either.

The coil is wound on the bobbin automatically. No chance of human error here.

### We didn't forget the solder.

We use a solderless splice. That's because solderless splice connections are sure-fire protection against the coil going open under temperature changes, stress, or electrolysis.

A solderless splice is more expensive to produce, so it's usually found only on the most reliable relays. AE is the only manufacturer to use this method on all of its relays.

Finally, we wrap the whole assembly with extra-tough, mylar-laminated material. A cover is not really necessary here; but why take chances?



### Springs and other things.

We don't take any chances with our contact assembly, either. Even things like the pileup insulators (those little black rectangles) get special attention. We precision mold them. Other manufacturers just punch them out.

It makes a lot of difference. They're stronger, for one thing; and because they're molded, there's no chance of the insulators absorbing even a droplet of harmful moisture. Finally, they'll withstand the high temperatures that knock out punched insulators.

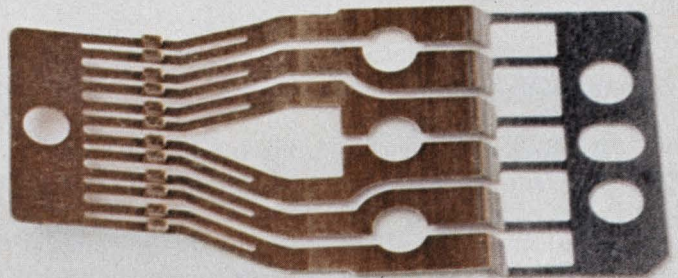

Then there are the contact springs.

Ours are phosphor-bronze. Others use nickel-silver. Our lab gave this stuff a thorough check, but found nickel-silver too prone to stress-corrosion. Atmospheric conditions which cause tarnish and ultimately stress corrosion have almost no effect on phosphor-bronze.



### Two are better than one.

Our next step was to make sure our contacts give a completed circuit every time. So we bifurcate both the make and break springs.

Each contact works independently to give you a completed circuit every time.

Edge-tinned contact springs save you the job of solder tinning them later. Also, edge-tinning enables you to safely use the same relay with sockets or mounted directly to a printed circuit board. A simple thing, but it takes a big chunk out of the inventory you have to stock.

### Etc. Etc. Etc.

There's a lot more to tell about what makes our Class H relay reliable. Now we're waiting to hear from you. GTE Automatic Electric, Industrial Sales Division, Northlake, Illinois 60164.

**GTE AUTOMATIC ELECTRIC**

# Depressed aerospace giants turning to civionics for a lift

The time was post-World War II—an era not unlike today, with aerospace companies attempting to convert to civilian markets. North American Aviation was one of those companies, and as Thomas M. Self, associate editor of *Business Week* in Los Angeles, recalls it:

“At North American Aviation, Inc., Chairman J. H. (Dutch) Kindelberger and his staff went through catalogs, believe it or not, marking goods they might build. Then the engineers came up with cost estimates and in every case they were at least 30% above the catalog price.

“So North American went into the private airplane business, designing and producing for awhile the Navion aircraft. The retail price was somewhere around \$17,000 a copy.

“A friend of Kindelberger asked him if he couldn't sell his old friend a Navion at cost. Kindelberger said he would be delighted—the certified true cost of each Navion was \$47,000.”

Self, who recounts the story in Session 4 at Wescon in a paper entitled “Case Histories of Aerospace Companies That Have Successfully Transitioned From Military to Nonmilitary Business,” mentions it to demonstrate that such business conversions are invariably fraught with pitfalls.

North American, of course, has progressed considerably since post-World War II days. Much of the impetus for change has come from the merger in 1967 of North American Aviation of El Segundo, Calif., with the Rockwell Standard Corp. of Pittsburgh. The new North American Rockwell Corp. is no longer solely an aerospace giant but also has divisions making knitting machines, printing presses, truck axles, yachts and a variety of other things.

With defense and aerospace business in a tailspin today, several other major aerospace companies have begun to seek new growth markets, and the new field of civionics strikes them as a natural.



**Touch-tone telephones may soon include MOS/LSI circuitry.** This aerospace technology is being applied by North American Rockwell to telephone communications. The circuit at the right will replace the electronics package alongside it. A typical MOS/LSI hybrid system (bottom of photo) could function as a modem that would scramble messages between telephones, or similar circuitry could convert ordinary dial-phone equipment into digital data transmission units.

Among the markets being pursued are anti-crime electronics, data communications, mass transportation, air traffic control and pollution control.

## Computer and semiconductor power

Harris A. Childs, assistant director of corporate development planning at Lockheed Aircraft Corp. in Burbank, Calif., tells of a common theme on diversification being played by aerospace companies: “Since the aerospace industry has so much in-house computer power and semiconductor production capability, these are two naturals for diversification.”

North American Rockwell, Boeing in Seattle,

---

David N. Kaye  
West Coast Editor

and Hughes Aircraft in Culver City, Calif., are orchestrating this theme into crescendos of great expectations.

North American Rockwell has set up the North American Rockwell Information Systems Co., specializing in the handling of data. It is working with the Police Departments in Tulsa, Okla., and Peoria, Ill., to develop crime information networks. It is also working on supervisory computer systems for banks and electric companies.

Boeing has set up Boeing Computer Services, offering smaller companies low-cost use of huge and powerful computers.

Hughes is using its computer facilities and software strength to solve special problems. One is the development of a central command and control communications and computer center for the Los Angeles Police.

McDonnell-Douglas offers the McDonnell-Douglas Automation Co., software specialists that have designed management information systems and industrial control systems. It is also operating a time-sharing network that makes its vast computer power available to others.

#### Microelectronics put to use

Aerospace microelectronics, too, is finding application in the civilian market. In July, 1970, North American Rockwell set up the Rockwell Microelectronics Co. It entered business with \$30-million in contracts from Sharp in Japan to build MOS/LSI calculator circuits. Since that time another \$30-million has been added to the contract, and the North American Rockwell Microelectronics Co. has expanded into new areas. For example, it is now making MOS/LSI circuits for electronic organs and appliance timers, as well as special circuits for digital filters and semiconductor memories. It is even getting into the liquid-crystal display business.

Boeing has set up the Electronic Products Group under Donald H. Atherly, general manager. Atherly points to integrated-circuit production facilities in Seattle that are turning out thick and thin-film hybrids and monolithic bipolar.

One of the biggest pushes at Boeing, Atherly says, will be a proprietary line of high-voltage monolithic integrated circuits. These will be bipolar logic functions designed to withstand 10 to 75 V. According to the general manager:

"These circuits are designed to operate in a noisy environment from existing power supplies. For example, they might operate off of 28 V in an aircraft, 24 V in commercial TV stations or 48 V in railroad control systems. They are also ideal for industrial control systems."

Hughes has been active in the semiconductor business for some time. Its main commercial prod-

uct for the near term is a multiplexer for the entertainment system on the new DC-10 tri-jet.

In addition Hughes in Newport Beach, Calif., was the first company to market an ion-implanted MOS/LSI circuit—a shift register. The company is now actively pursuing low-voltage CMOS ion-implanted technology, aimed at the electronic watch market.

Untapped semiconductor facilities still exist in the aerospace industry, and they may one day make their debuts in the commercial market. Notable among these is Lockheed's vast facilities in both its missile and space divisions.

In other areas of expansion, Lockheed, the Grumman Aerospace Corp. in Bethpage, N.Y., AIL of Melville, N.Y., and Cubic Corp. of San Diego are among the aerospace companies actively exploring the market for air traffic control systems for small terminals.

#### A low-cost scrambler

At Boeing Atherly tells of a full line of law-enforcement electronics products. The first product to be delivered is a low-cost communications scrambler. The unit, sold to the Los Angeles Police, can impart any of 8000 different codes to a voice message from a patrol car. A decoder at the base station interfaces with existing receivers. Future Boeing products will include digital communications equipment and a vehicle location system.

Boeing also plans an aggressive assault on the market for avionics in low-cost private aircraft, as well as electronics for small airports. The first line of products is to be low-cost landing aids for business aircraft.

Ground and water transportation is an area that Atherly feels may really expand dramatically in a few years. To this end, Boeing has an active program going in the development of electronic control systems for hydrofoils, and it is involved with Bendix in a joint surface mass-transportation venture. Under the guidance of Jet Propulsion Laboratory and the Dept. of Transportation in Washington, Boeing and Bendix are building a model "people mover" system, to be installed in Morgantown, W. Va.

Hughes Aircraft is pursuing developments in satellite communications, cable TV and a laser fabric cutter for the apparel industry. Grumman is involved in tracked-air-cushion vehicles, hydrofoils and a variety of other civionics endeavors.

Activities such as these are at present contributing only an infinitesimal sum to the total sales of the huge aerospace corporations. But the revenue is expected to grow in the coming years. Boeing is planning for a third of its corporate business to be in "nontraditional fields" by 1980. Others in the industry have similar plans. ■■

# MARCONI data line analyser

## measures:

- Peak-to-Average Rating (PAR)
- Frequency Response Characteristic
- System Noise Level

The New Marconi Data Line Analyser, Model TF 2809, is designed to test any voice band transmission line (telephone line, coax. cable system, microwave link) line-in to line-out for data transmission use. It is self contained and portable, using internal batteries. Testing is simple and easy, and usually accomplished inexpensively by the installation man.

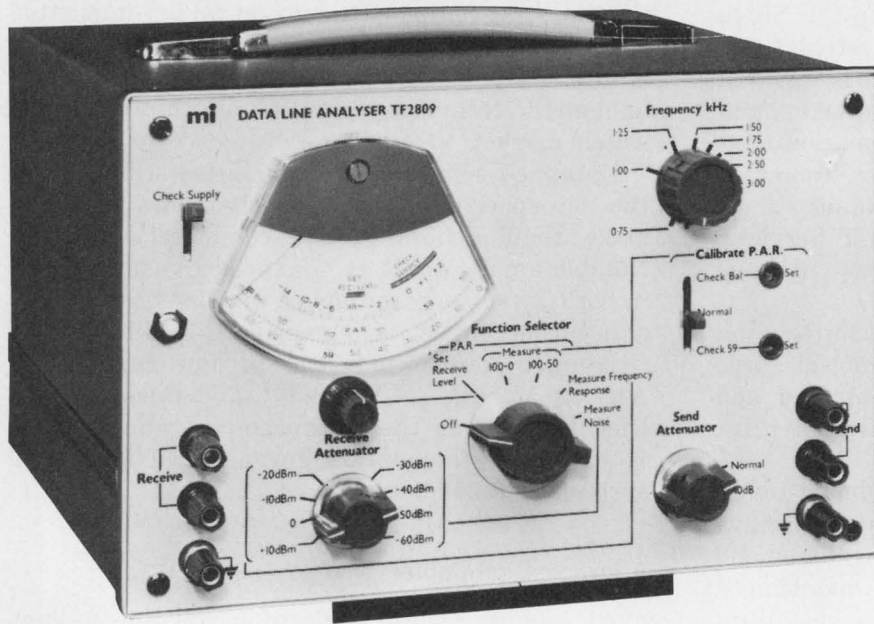

# now test Data Transmission Links

$$PAR = \left[ 2 \frac{\text{Peak-to-average ratio of the received signal}}{\text{Peak-to-average ratio of the transmitted signal}} - 1 \right] \times 100\%$$

Direct reading with phase intercept distortion correction

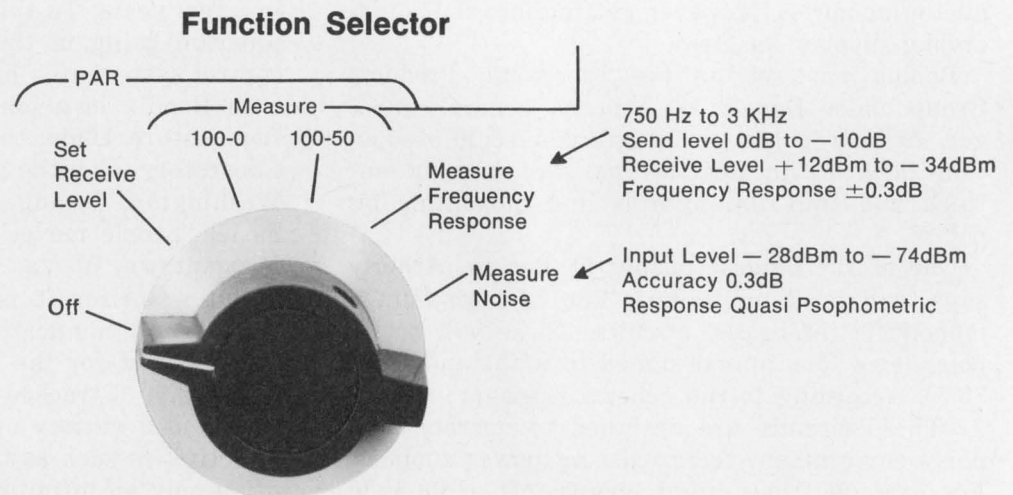

**mi** **MARCONI**  
**INSTRUMENTS**  
DIVISION OF ENGLISH ELECTRIC CORPORATION

111 CEDAR LANE □ ENGLEWOOD, NEW JERSEY 07631  
TELEPHONE: (201) 567-0607

See us at Wescon - Booths 1034 & 1035

722

# You get 25 ranges. We only get \$595.

Go ahead. Try to compare the new Weston 1242 with the other good multi-meters. They usually cost \$700 or more with options that add still more cost.

The 1242 is \$595 complete, including a 100-mV range for AC and DC, and a full 100% over-range ( $\pm 1.9999$  display).

The full-scale response speed of  $\frac{1}{2}$  second with input filtering is better than bench-meter performance. But the Weston 1242 measures just 3" x 7" x 7.9" and weighs less than 4 lbs.

What else do you get for \$595? Externally-replaceable fuses. Gold-on-gold contacts. Weston excellence in every detail. (Portable battery pack and leather case are optional.)

If you'd like the additional usefulness of a fully-isolated BCD output compatible with T<sup>2</sup>L logic, get the new Weston 1243. It's only \$100 more than the 1242. Order from Weston distributors, or direct from us. Weston Instruments, Inc., Newark, New Jersey 07114.

**WESTON®**

WESTON

1242

1 9 8 9 3

V- $\Omega$

COM

mA

ZERO

100 mV

100  $\mu$ A

1

10

100

1000

500 VAC

OFF

DC

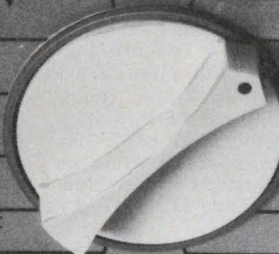

10 mA

100 K $\Omega$

1000

10M $\Omega$

AC

V- $\Omega$

mA

mA

V

=

=

$\approx$

$\approx$

(actual size)

WESTON

Schlumberger

# Here's the technical program, complete, at your fingertips

## Communications

- Laser Modulation Formats for Space Communications—Gary Lee and E. A. Paddon, McDonnell Douglas Astronautics, St. Louis, Mo. (6.1/Tues./p.m./B)
- Acquisition and Angle Tracking of Laser Communications Links—Art Kraemer, Sylvania Electro-Optics, Mountain View, Calif. (6.2/Tues./p.m./B)
- Critical Component Technology for Space Laser Communications—Robert R. Rice, McDonnell Douglas Astronautics, St. Louis, Mo. (6.3/Tues./p.m./B)
- Signal Processing Techniques for a 1000 MS/S Optical Communication Link—Carl Ryan, Motorola, Phoenix, Ariz. (6.4/Tues./p.m./B)
- A New 2-GHz Microwave System for Message and Video Transmission—James B. Murray, GTE Lenkurt, San Carlos, Calif. (12.1/Wed./p.m./D)
- Integrated Circuits and Other Solid-State Devices Improve Performance and Simplify Application of 2-GHz Microwave Systems—E. A. Gilmore and Mark W. Wilkens, Farinon Electric, San Carlos, Calif. (12.2/Wed./p.m./D)
- Design of an 1800-Channel Heterodyne Radio System—James J. Heinmann, GTE Lenkurt, San Carlos. (12.3/Wed./p.m./D)
- 18-GHz Short Hop PSK Radio System Experiment—John Kennedy, Richard P. Slade, Bell Telephone Labs, North Andover, Mass. (12.4/Wed./p.m./D)
- An OEM Views the Data-Communications Revolution—R. F. Dean, IBM Corp., Research Triangle Park, N.C. (15.1/Wed./p.m./C)
- The Challenge of Interactive Computer Networks Today—Max P. Beere, Tymshare Inc., Cupertino, Calif. (15.2/Wed./p.m./C)
- A Common-Carrier Network for Point-to-Point Switched Data Transmission—David E. Gourley, Data Transmission Co., Vienna, Va. (15.3/Wed./p.m./C)
- Data-Communications Networks: The Need for Standards—Kelly Griffith, Federal Communications Commission, Washington, D.C. (15.4/Wed./p.m./C)
- Modelling the Urban Propagation Medium—G. L. Turin, University of

- California, Berkeley, Calif. (27.1/Fri./a.m./C)
- The Accuracy of Vehicle Location by Trilateration in a Heavily Built Up Urban Area—H. Staras and S. N. Honickman, RCA Laboratories, Princeton, N.J. (27.2/Fri./a.m./C)
- Some Effects of Rayleigh Fading and Diversity on FM Co-Channel Interference—R. E. Langseth, Bell Telephone Labs, Holmdel, N.J. (27.3/Fri./a.m./C)
- Dynamic Channel Assignment in Multi-Channel Mobil Communications Systems—D. C. Cox and D. O. Reudinx, Bell Telephone Labs, Holmdel, N.J. (27.4/Fri./a.m./C)

## Computers and Computer-Aided Design

- Application Dependency—H. Nathan Yagoda, Computran Systems Corp., Hackensack, N.J. (1.1/Tues./a.m./A)
- Software—Gary Hornbuckle, Applicon Inc., Burlington, Mass. (1.2/Tues./a.m./A)
- Interface and Peripherals—Robert C. Larkin, U.S. Army Electronics Command, Fort Monmouth, N.J. (1.3/

- Tues./a.m./A)
- Purchasing the Mini—Frank C. Milstead, Unitech Inc., Austin, Tex. (1.4/Tues./a.m./A)
- Selection Strategies—Robin T. Ollivier, Sierra Data Systems, South Pasadena, Calif. (1.5/Tues./a.m./A)
- Application of Minicomputer Peripherals—Grant Saviers, Digital Equipment Corp., Maynard, Mass. (5.1/Tues./p.m./A)
- A Minicomputer Manufacturer's Look at Peripherals—Tenny Lode, Electronic Processors, Inc., Englewood, Colo. (5.2/Tues./p.m./A)
- The Minicomputer as a Peripheral—Richard Drew, Computer Automation Inc., Costa Mesa, Calif. (5.3/Tues.&p.m./A)
- Minisystems for the User—Arnold L. Mende, The Investors Advisory Group Inc., Waltham, Mass. (5.4/Tues./p.m./A)
- CIRC: DC, AC and Transient Simulation of Nonlinear Circuits—Richard McNair, Xerox Data Systems, El Segundo, Calif. (9.1/Wed./a.m./A)
- CIRCAL: On Line Interactive Simulation of Electronic Circuits—Ronald Rohrer, Sof Tech, Waltham, Mass. (9.2/Wed./a.m./A)
- COD: The Constrained Optimal Design System—William C. Cave, Optimal

### Code to abbreviations

a.m.—Morning sessions (10 a.m. to 12:30 p.m.)  
 p.m.—Afternoon sessions (2 p.m. to 4:30 p.m.)

All sessions (1 through 32) will be presented in Brooks Hall/Civic Auditorium, San Francisco. The four technical program meeting rooms are on the first floor of the Civic Auditorium

A—Meeting Room 1  
 B—Meeting Room 2  
 C—Meeting Room 3  
 D—Meeting Room 4

Numerals refer to sessions and to papers within a session—for example, 7.1 is paper 1 session 7.

### Papers by categories

- Communications
- Computers and Computer-Aided Design
- Environment and Pollution
- Industrial Electronics
- Management and Marketing
- Materials and Packaging
- Medical Electronics
- Microelectronics
- Microwaves
- Optoelectronics
- Testing and Instrumentation

## Expand your Measurement Horizon

### with Beckman's new Digital Printer

The Model 1454 Digital Printer accepts inputs from all logic forms — MOS, IC, and Transistor. It has an expandable capability of 1-to-21 BCD columns accomplished by the simple selection of optional plug-in modules... perfect for OEM applications. And the unique ability to accept inputs from as many as 3 different data sources, with up to 16 characters per column. Couple this with a printout in red and black on the same line, the ability to accept standard calculator or pressure sensitive paper, and you have the ideal printer for systems application. □ The instrument is so compact that two units can be mounted on a standard 19-inch rack. Weighing only 20

pounds, and with optional battery pack, you can easily take your 1454 into the field. Beckman has made this printer with few moving parts and generous use of integrated circuits. The results: a highly reliable and low-cost-to-maintain instrument. Power: 115 V/50 Hz to 400 Hz. □ Now, compare its low price, \$1,095\* with similar printers! You'll buy the Model 1454/1 Digital Printer. Or, as with all Beckman EID products, it's available through our new factory direct rental and lease program. Ask your local Beckman representative for details or call us direct (312) 671-3300.

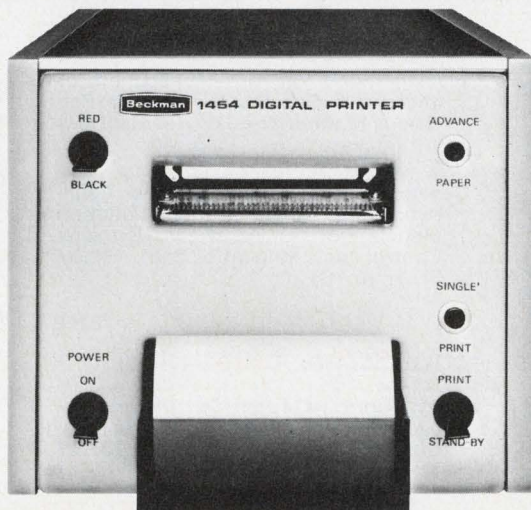

**Beckman**

**INSTRUMENTS, INC.**  
**ELECTRONIC INSTRUMENTS DIVISION**  
Schiller Park, Illinois 60176

Helping science and industry  
improve the quality of life.

- Systems Research, Manasquan, N.J. (9.3/Wed./a.m./A)
- The OPTINET Design System—Robert Hall, Dean Hall Associates, Los Altos, Calif. (9.4/Wed./a.m./A)
- Programming Languages for Component Testing—Milton Collins, Teradyne Inc., Boston, Mass. (14.1/Wed./p.m./B)
- The Dialect Concept in ATE Language Design—Michael Ellis, RPD Electronics, Syosset, N.Y. (14.2/Wed./p.m./B)
- ATLAS—Abbreviated Test Language for Avionics Equipment—T. A. Ellison, United Air Lines, San Francisco, Calif. (14.3/Wed./p.m./B)
- Instrumentation Languages for Production and Engineering—William Ray, Hewlett-Packard Microwave Div., Palo Alto, Calif. (14.4/Wed./p.m./B)
- An OEM Views the Data-Communications Revolution—R. F. Dean, IBM Corp., Research Triangle Park, N.C. (15.1/Wed./p.m./C)
- The Challenge of Interactive Computer Networks Today—Max P. Beere, Tymshare Inc., Cupertino, Calif. (15.2/Wed./p.m./C)
- A Common-Carrier Network for Point-to-Point Switched Data Transmission—David E. Gourley, Data Transmission Co., Vienna, Va. (15.3/Wed./p.m./C)
- Data-Communications Networks: The Need for Standards—Kelley Griffith, Federal Communications Commission, Washington, D.C. (15.4/Wed./p.m./C)
- Automatic Stimuli Generation—R. J. Johnson, Datapulse, Culver City, Calif. (17.1/Thurs./a.m./A)
- Computerized Waveform Measurements—Dave McCracken, Tektronix, Beaverton, Ore. (17.2/Thurs./a.m./A)
- Remotely Controlled Digital Measurement Instrumentation—Fred Kreiss, Systron Donner Concord Instrument Div., Concord, Calif. (17.3/Thurs./a.m./A)
- Automatic Test Equipment and Its Interface with a Computer or Controller—G. K. Mercola, Sagetec Corporation, Chatsworth, Calif. (17.4/Thurs./a.m./A)
- What Will Be the Design of Tomorrow's Programmable Calculator—Robert Watson, Hewlett-Packard Co., Loveland, Colo. (19.1/Thurs./a.m./C)
- What Will Tomorrow's Programmable Calculator Do?—Ned Chang, Wang Laboratories, Tewksbury, Mass. (19.2/Thurs./a.m./C)
- How Will Tomorrow's Programmable Calculator Fit Into Systems?—Francis Michel and Jay Minor, Tektronics Calculator Division, Sunnyvale, Calif. (19.3/Thurs./a.m./C)
- Who Will Use Tomorrow's Programmable Calculator?—Henry Pinault, Monroe International, Orange, N.J. (19.4/Thurs./a.m./C)
- How Not to Approach Computer-Aided Manufacturing—C. E. Coffee, Consultant, San Francisco, Calif. (22.1/Thurs./p.m./B)
- CAM Software: Inputs Required—and Outputs Produced—P. R. LaBahn, Standard Logic Inc., Santa Ana, Calif. (22.2/Thurs./p.m./B)
- Economic Advantages of Integrating Standard DIP Hardware with Flexible Software—Donald Miller, Scanbe Manufacturing Corp., El Monte, Calif. (22.3/Thurs./p.m./B)
- New Vistas for CAM—W. O. Fordiani, EECO, Santa Ana, Calif. (22.4/Thurs./p.m./B)
- The Computer-Aided Design of an L-Band Phase Shifter—Ted W. Houston, Texas Instruments, Dallas, Tex. (23.1/Thurs./p.m./C)
- A Medium Power VHF Amplifier with PNP-NPN Complementary Symmetry Transistors—Les Besser, Fairchild, Palo Alto, Calif. (23.2/Thurs./p.m./C)
- Hybrid Integrated Wide-Band Linear Power Amplifiers for S and C Band—A. Presser, H. Huang, R. Paglione, and H. Johnson, RCA Advanced Technology Lab., Princeton, N.J. (23.3/Thurs./p.m./C)
- Performance and Reliability of Transistors in Power MICs—Georg Luettgenau and R. E. Heijmanowski, TRW Semiconductor, Lawndale, Calif. (23.4/Thurs./p.m./C)
- Optical Memories—Bruce Ballard, Optical Memory Systems, Santa Monica, Calif. (24.4/Thurs./p.m./D)
- Incorporation of Computer-Controlled Laser Resistor Trimming in a Thick Film Facility with a Large and Varied Product Mix—Robert Marcum, Centralab Electronics, Milwaukee, Wis. (25.2/Fri./a.m./A)
- The Application of Ferroelectric Materials in Optical Memories—G. W. Taylor, RCA Laboratories, Princeton, N.J. (31.4/Fri./p.m./C)

## Environment and Pollution

- Needs in Air Pollution Instrumentation—Dr. Rene Bertrand, ESSO Research and Engineering Co., Linden, N.J. and Dr. Alfred H. Ellison, Environmental Control Agency, Research Triangle, N.C. (32.1/Fri./p.m./D)
- Measurement and Control of Regional Air Quality—Dr. Milton Feldstein, Bay Area Air Pollution Control District, San Francisco, Calif. (32.2/Fri./p.m./D)
- Correlation Spectroscopy and Its Applications to Remote Sensing of Ambient Air Quality—Dr. Anders Jepsen, Environmental Measurements Inc., San Francisco, Calif. (32.3/Fri./p.m./D)
- Investigations on the Application of Microwave Spectroscopy to Air Pollution Monitoring—J. Hearn, Hewlett-Packard Co., Palo Alto, Calif. (32.4/Fri./p.m./D)
- Development, Verification, and Application of Regional Air Pollution Models—Dr. C. H. Wells, Systems Control Inc., Palo Alto, Calif. (32.5/Fri./p.m./C)

## Industrial Electronics

- Electro-optic Ceramic Materials—Gene H. Haertling, Sandia Laboratories, Albuquerque, N.M. (31.1/Fri./p.m./C)

- Ceramic Electro-optic Properties and Devices—Philip D. Thacher and Cecil E. Land, Sandia Laboratories, Albuquerque, N.M. (31.2/Fri./p.m./C)
- Electro-optic Devices Using Strain-Biased PLZT Ferroelectric Ceramics—J. R. Maldonado, Bell Telephone Laboratories, Murray Hill, N.J. (31.3/Fri./p.m./C)
- The Application of Ferroelectric Materials in Optical Memories—G. W. Taylor, RCA Laboratories, Princeton, N.J. (31.4/Fri./p.m./C)
- Utilization of a Time-Shared Central Data System in a Manufacturing Test Environment—J. S. Chapman, C. E. Wichland, Honeywell FCO, Framingham, Mass. (18.1/Thurs./a.m./B)
- Automatic Interconnection of Chip to Circuit—Richard Faulke, Mech-El Industries Inc., Woburn, Mass. (18.2/Thurs./a.m./B)
- Automatic Packaging of ICs—Milton Stoll, Research Instrument Co., Westbury, N.Y. (18.3/Thurs./a.m./B)
- Additive Printed Circuit Technology—George Messner, Photocircuits, Glen Cove, N.Y. (18.4/Thurs./a.m./B)
- Commercial ATE Revisited—David S. Kline, Hewlett-Packard Automatic Measurement Division, Palo Alto, Calif. (21.1/Thurs./p.m./A)
- Automatic Test Equipment Design—P. W. La Clair and J. Katsikas, Librascope Division, Singer-General Precision, Glendale, Calif. (21.2/Thurs./p.m./A)
- AVMOTS—A New ATE Family—L. H. Bohl, Avco Systems Division, Wilmington, Mass. (21.3/Thurs./p.m./A)
- Automated Test of Jet Engine Accessories—O. T. Carver, RCA Burlington, Mass. (21.4/Thurs./p.m./A)
- How Not to Approach Computer Aided Manufacturing—C. E. Coffee, Consultant, San Francisco, Calif. (22.1/Thurs./p.m./B)
- CAM Software: Inputs Required—and Outputs Produced—P. R. LaBahn, Standard Logic Inc., Santa Ana, Calif. (22.2/Thurs./p.m./B)
- Economic Advantages of Integrating Standard DIP Hardware with Flexible Software—Donald Miller, Scanbe Manufacturing Corp., El Monte, Calif. (22.3/Thurs./p.m./B)
- New Vistas for CAM—W. O. Fordiani, EECO, Santa Ana, Calif. (22.4/Thurs./p.m./B)

## Management and Marketing

- Case Histories of Aerospace Companies Who Have Successfully Transitioned from Military to Non-Military Business—Thomas M. Self, Business Week Magazine, Los Angeles, Calif. (4.1/Thurs./a.m./D)
- Adjusting Internally to Best Serve New Markets—Dr. Charles Breitwieser, Cubic Corporation, San Diego, Calif. (4.2/Tues./a.m./D)
- Your Present Work Force: Retractable or Replaceable?—Paul E. Putney, Korn/Ferry International, Los Angeles, Calif. (4.3/Tues./a.m./D)



# Sperry explodes the LED myth

There has been a lot said in recent months about LED's representing the most significant advance in display technology and how they are destined to dominate the digital display market. We feel it's time to explode the myth and set the record straight. So, here's a direct, point-by-point, comparison of Sperry seven segment gas discharge planar displays† vs LED displays.

## COST

For the price of a single 1/4" LED digit you can buy three 1/2" or three 1/3" Sperry display digits\*. And, in the future, the Sperry displays should continue to be less expensive than LED displays. Gives you something to think about, doesn't it?



## SIZE Let the size speak for itself.



## READABILITY

Have you tried to read a 1/8" or even a 1/4" LED display at 20'? On the other hand, the Sperry 1/3" display is easy to read at that distance and the 1/2" model can be read at up to 40'. See the difference?



## COLOR

With LED's, you have the choice of red, red or red. Not so with Sperry. They come in an eye appealing orange — with amber and red available with filters. If you like red, why pay more for a LED?



## APPEARANCE

Which do you prefer — looking at individual red dots on LED devices or at continuous unbroken Sperry figures. The choice is yours.



## BRIGHTNESS

Sure you can read LED's indoors, but how about in bright light or direct sunlight? LED's fade fast while Sperry displays stay clearly legible with no appreciable loss in brightness. And, Sperry devices won't poop out when it gets hot!



Sperry advantages don't stop here either. The small Sperry package is only a shade larger than a LED and nearly as thin. Sperry power dissipation is also significantly lower. And, Sperry reliability is so good that they have proven fail-safe in stringent, high performance aircraft applications including the Boeing 747. There are no wire bonds to go bad, either. Don't just take our word for it. Arrange for a comparison demonstration and see for yourself what the difference will mean to your particular application.

For complete technical information on Sperry displays, use this publication's reader service card or phone or write:  
Sperry Information Displays Division  
P.O. Box 3579, Scottsdale, Arizona 85257  
Telephone (602) 947-8371

# SPERRY

INFORMATION DISPLAYS

## It's a whole new ball game in display devices!



† Patents pending

\*based on 1,000 digit quantity, and above. Sperry displays are available in 3 digit, 2 digit, and 1 1/2 (7 segment character and a 1 with + and -) digit models in both 1/3" and 1/2" sizes.

 SPERRY RAND

Financing the Entrepreneur in New Electronic Markets—Thomas J. Davis, Jr., Mayfield Fund, Menlo Park, Calif. (4.4/Tues./a.m./D)

## Engineer's Role in Economic World

(Panel Session)

Panelists: Dr. James H. Mulligan, President, IEEE.

Dr. R. C. Mercure, Jr., President, WEMA.

Dr. Hubert Heffner, Deputy Director, Office of Science and Technology, Executive Office of the President.

Paul Robbins, Executive Secretary, NSPE.

(Session 7/Tues./p.m./C)

Employment Contracts: Who Is Protected?—John Larson, Attorney-at-Law, Brobeck, Phleger & Harrison, San Francisco, Calif. (11.1/Wed./a.m./C)

Employer Responsibility in a Down Market—Warren J. Bowles, Fairchild Camera & Instrument Corp., Santa Clara, Calif. (11.2/Wed./a.m./C)

The Ups and Downs of Stock Options—Charles E. Sporck, National Semiconductor Corp., Santa Clara, Calif. (11.3/Wed./a.m./C)

Putting Together the Benefits Package—Jack R. Yelverton, Wilkinson, Sedwick & Yelverton, San Francisco, Calif. (11.4/Wed./a.m./C)

Rewarding the Superior Performer—James F. Riley, Intersil Inc., Cupertino, Calif. (11.5/Wed./a.m./C)

What It Took to Come Out of Chapter XI—H. D. Tenney, Kenetic Technology, Santa Clara, Calif. (16.1/Wed./p.m./D)

1871 Turnaround Year—Robert McGrath, Dynamic Associates, Burlingame, Calif. (16.2/Wed./p.m./D)

Making It With Technological Innovation in a Down Market—M. B. Rudin, Precision Monolithics, Santa Clara, Calif. (16.3/Wed./p.m./D)

Two Plus Two Equals Five—George Didinger, Intellex, Cupertino, Calif. (16.4/Wed./p.m./D)

## Materials and Packaging

Trends in Vacuum Deposition Technology—James C. Blair, Texas Instruments, Dallas, Tex. (2.1/Tues./a.m./B)

Trends in Vacuum Deposition Technology—R. W. Wilson, Motorola Semiconductor, Phoenix, Ariz. (2.2/Tues./a.m./B)

Trends in Vacuum Deposition Technology—Dr. Richard W. Hager, Alphasdyne Inc., Sunnyvale, Calif. (2.3/Tues./a.m./B)

Trends in Vacuum Deposition Technology—Dr. John Coburn, IBM Corp., San Jose, Calif. (2.4/Tues./a.m./C)

Automatic Interconnection of Chip to Circuit—Richard Faulke, Mech-El Industries Inc., Woburn, Mass. (18.2/Thurs./a.m./B)

Automatic Packaging of ICs—Milton Stoll, Research Instrument Co., Westbury, N.Y. (18.3/Thurs./a.m./B)

Beam-Lead Devices, Availability and Applicability—F. J. Francis and L. K. Keys, Magnavox Co., Fort Wayne, Ind. (20.1/Thurs./a.m./D)

Reliability of Beam-Lead Devices—Jorge Acosta, Raytheon, Bedford, Mass., and Harvey Siegel, Raytheon, Mountain View, Calif. (20.2/Thurs./a.m./D)

Beam-Lead Processing for Complementary MOS—L. W. Murray and Ben Richards, COSMOS Technology, RCA/Electronic Components, Somerville, N.J. (20.3/Thurs./a.m./D)

High Reliability Beam-Lead Devices—Richard L. Cunningham, Texas Instruments, Dallas, Tex. (20.4/Thurs./a.m./D)

Thin Film Advances—Ralph Ponce de Leon, Sloan Microelectronics, El Segundo, Calif. (25.1/Fri./a.m./A)

Incorporation of Computer-Controlled Laser Resistor Trimming in a Thick Film Facility with a Large and Varied Product Mix—Robert Marcum, Centralab Electronics, Milwaukee, Wis. (25.2/Fri./a.m./A)

Advances in Interconnection Techniques—Richard Fritz, Radiant Energy Systems, Newbury Park, Calif. (25.3/Fri./a.m./A)

Advances in Thick Film Materials—Dr. Sidney Stein, Electroscience Laboratories, Philadelphia, Pa. (25.4/Fri./a.m./A)

Electro-optic Ceramic Materials—Gene H. Haertling, Sandia Laboratories, Albuquerque, N.M. (31.1/Fri./p.m./C)

Ceramic Electro-optic Properties and Devices—Philip D. Thacher and Cecil E. Land, Sandia Laboratories, Albuquerque, N.M. (31.2/Fri./p.m./C)

Electro-optic Devices Using Strain-Biased PLZT Ferroelectric Ceramics—J. R. Maldonado, Bell Telephone Laboratories, Murray Hill, N.J. (31.3/Fri./p.m./C)

The Application of Ferroelectric Materials in Optical Memories—G. W. Taylor, RCA Laboratories, Princeton, N.J. (31.4/Fri./p.m./C)

## Medical Electronics

Health Care Delivery in the 70's—A Preview—(Introduction by T. W. Neumann, Philco-Ford, Palo Alto, Calif. (10.1/Wed./a.m./B)

The Medical Information System: Practice and Prospects—A Hospital Director's View—B. G. Lamson, M.D., UCLA, Los Angeles, Calif. (10.2/Wed./a.m./B)

Medical Information System: Basic Theology for a Realistic Approach—J. H. Grossman, M.D., Massachusetts General Hospital, Boston, Mass. (10.3/Wed./a.m./B)

Medical Data Input: A Critical Bottleneck—Warner V. Slack M.D. Beth

Israel Hospital, Boston, Mass. (10.4/Wed./a.m./B)

Boundary Conditions: Key Legal, Ethical, and Traditional Medical Constraints on Medical Information Systems—R. J. Gampell, M.D., J. D. Attorney, San Jose, Calif. (10.5/Wed./a.m./B)

Medical Electronics in the 1970s—Morton D. Schwartz, Biochemical Engineering, Cal-State, Long Beach, Calif. (13.1/Wed./p.m./A)

Automated Multitest Laboratories—Current Needs and Future Potential—M. F. Collen, M.D., Permanente Medical Group and Kaiser Foundation Research Institute, Oakland, Calif. (13.2/Wed./p.m./A)

Information Handling Needs for the Intensively Monitored Hospital Patient—G. I. Hickey Jr., Bio-Medical Eng., USC, Los Angeles, Calif. (13.3/Wed./p.m./A)

Exercise Pulmonary Response Testing and Pulmonary Function Testing Using a Time-Shared Computer—Paul H. Griffith and William L. Beaver, Varian Associates, Palo Alto, Calif. (13.4/Wed./p.m./A)

Engineering Productivity in the Delivery of Health Care Services—Philip A. DeLangis, Verite Scientific Inc., Torrance, Calif. (13.5/Wed./p.m./A)

Integrated Circuits for Medical Applications—J. D. Meindl, P. H. Hudson, and D. M. DiPietro, Stanford University, Palo Alto, Calif. (29.2/Fri./p.m./A)

Computer Braille Translation at the Atlanta Public Schools—Marion P. Boyles, Atlanta Public Schools, Atlanta, Ga., and Robert E. Lagrone, IBM/FSD, Gaithersburg, Md. (30.1/Fri./p.m./B)

An Automated Braille Translation System—R. L. Haynes, American Printing House for the Blind, Louisville, Ky. (30.2/Fri./p.m./B)

The Development of a Computer Grade 2 Braille Translation Algorithm—Dr. Lois C. Leffler, Argonne National Laboratory, Argonne, Ill. (30.3/Fri./p.m./B)

Enhancement of Grade 2 Braille Translation—E. L. Steele and R. E. Puckett, University of Kentucky, Lexington, Ky. (30.4/Fri./p.m./B)

## Microelectronics

Trends in Vacuum Deposition Technology—James C. Blair, Texas Instruments, Dallas, Tex. (2.1/Tues./a.m./B)

Trends in Vacuum Deposition Technology—R. W. Wilson, Motorola Semiconductor, Phoenix, Ariz. (2.2/Tues./a.m./B)

Trends in Vacuum Deposition Technology—Dr. Richard W. Hager, Alphasdyne Inc., Sunnyvale, Calif. (2.3/Tues./a.m./B)

Trends in Vacuum Deposition Technology—Dr. John Coburn, IBM Corp., San Jose, Calif. (2.4/Tues./a.m./B)

An Innovation Approach to the Testing of MOS on the Production Line—F. Mansfield Young, Teradyne, Boston, Mass. (3.1/Tues./a.m./C)

Designing MOS for Maximum Testability—A. E. Pound, American Micro-Systems, Santa Clara, Calif. (3.2/Tues./a.m./C)



# NEW! \$2,676

## 80 MHz FREQUENCY SYNTHESIZER

### Features

- 1 kHz to 80 MHz
- 1 Hz Resolution
- Remote Programming
- Minimum System Interface

### Model RF-828

The RF-828 offers the most desirable features of competitive models at half the price. Significant features include remote programmability; compatibility with RTL, TTL, or DTL logic levels; and maximum versatility at minimum system interfacing cost in automatic programming applications.

### Applications

- Programmed Test Equipment Systems
- Computer-Controlled Signal Source
- Automatic & Semiautomatic Test Stations
- Receiver & Transmitter Systems

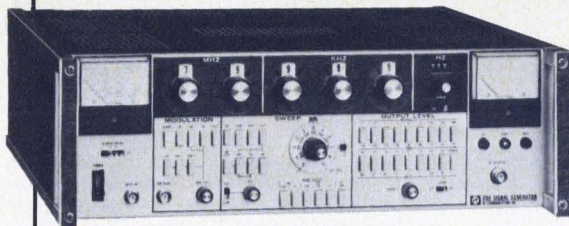

## RF-808 Signal Generator • Sweeper Frequency Synthesizer

In One Instrument Package

The RF-808 offers the benefits of three different instruments . . . all for \$3,576. Covering the frequency range of .05 MHz to 80 MHz in 1 kHz steps, the RF-808 combines generator and sweeper versatility with synthesizer accuracy and programmability.

Write today for your data package on the RF-808; RF-828; RF-815 Power Amplifier, tunable from 10 MHz to 500 MHz; and the RF-805 80 MHz wideband Power Amplifier.



### RF COMMUNICATIONS, INC.

Electronic Instrumentation Operation  
 1680 University Avenue, Rochester, New York 14610  
 Telephone: 716-244-5830 TWX: 510-253-7469  
 A Subsidiary of Harris-Intertype Corporation

Visit us at Wescon Booth No. 1046

# Exclusive

## Technical Session Order Form

Please send me the following WESCON technical session preprints at \$2.00 per session (average: four papers per session), plus \$1 mailing charge per complete order. I understand this order will be mailed to my address within two weeks after receipt. Offer good until November 1, 1971.

(Note: Papers bound by sessions; no individual papers available).

Session No.	Quantity	Session No.	Quantity
1		19	
2		20	
3		21	
4		22	
5		23	
6		24	
8		25	
9		26	
10		27	
12		28	
13		29	
14		30	
15		31	
16		32	
17			
18			

Total Sessions x \$2.00 = \$ \_\_\_\_\_

Plus \$1.00 Mailing Charge = \$ 1.00 \_\_\_\_\_

Total Cost = \$ \_\_\_\_\_

Make check payable to WESCON and mail with this form to:

**WESCON**  
3600 Wilshire Blvd.  
Los Angeles, Calif. 90005

DATE \_\_\_\_\_

NAME \_\_\_\_\_

FIRM \_\_\_\_\_

STREET ADDRESS \_\_\_\_\_

CITY, STATE, ZIP CODE \_\_\_\_\_

## WESCON '71

- MOS Test Instrumentation—William Routh, Fairchild System Technology Division, Sunnyvale, Calif. (3.3/Tues./a.m./C)
- Pitfalls in State Variable Filter Design—Yu Jen Wong and Brain K. Conant, Burr Brown Research Corp., Tucson, Ariz. (8.1/Tues./p.m./D)
- Design of Distributed Active-RC Filters—L. P. Huelsman, University of Arizona, Tucson, Ariz. (8.2/Tues./p.m./D)
- Coupled Resonator Crystal Filters—Desmond F. Sheahan and Charles E. Schmidt, GTE Lenkurt, San Carlos, Calif. (8.3/Tues./p.m./D)
- Surface Wave Signal Processing Filters—Joseph Burnsweig, Aerospace Group, Hughes Aircraft, Culver City, Calif. (8.4/Tues./p.m./D)
- Practical Digital Filter Structures Using MOS/LSI—Stanley A. White, NAR Microelectronics Co., Anaheim, Calif. (8.5/Tues./p.m./D)
- Integrated Circuits and Other Solid-State Devices Improve Performance and Simplify Application of 2-GHz Microwave Systems—E. A. Gilmore and Mark W. Wilkens, Farinon Electric, San Carlos, Calif. (12.2/Wed./a.m./D)
- Automatic Interconnection of Chip to Circuit—Richard Faulke, Mech-El Industries Inc., Woburn, Mass. (18.2/Thurs./a.m./B)
- Automatic Packaging of ICs—Milton Stoll, Research Instrument Co., Westbury, N.Y. (18.3/Thurs./a.m./B)
- Additive Printed Circuit Technology—George Messner, Photocircuits, Glen Cove, N.Y. (18.4/Thurs./a.m./B)
- Beam-Lead Devices, Availability and Applicability—F. J. Francis and L. K. Keys, Magnavox Co., Fort Wayne, Ind. (20.1/Thurs./a.m./D)
- Reliability of Beam-Lead Devices—Jorge Acosta, Raytheon, Bedford, Mass., and Harvey Siegel, Raytheon, Mt. View, Calif. (20.2/Thurs./a.m./D)
- Beam-Lead Processing for Complementary MOS—L. W. Murray and Ben Richards, COSMOS Technology, RCA/Electronic Components, Somerville, N.J. (20.3/Thurs./a.m./D)
- High Reliability Beam-Lead Devices—Richard L. Cunningham, Texas Instruments, Dallas, Tex. (20.4/Thurs./a.m./D)
- A Medium Power VHF Amplifier with PNP-NPN Complementary Symmetry Transistors—Les Besser, Fairchild, Palo Alto, Calif. (23.2/Thurs./p.m./C)
- Hybrid Integrated Wide-Band Linear Power Amplifiers for S and C Band—A. Presser, H. Huang, R. Paglione, and H. Johnson, RCA Advanced Technology Lab., Princeton, N.J. (23.3/Thurs./p.m./C)
- Performance and Reliability of Transistors in Power MICs—Georg Luettgenau and R. E. Heijmanowski, TRW Semiconductor, Lawndale, Calif.

(23.4/Thurs./p.m./C)

- Thin Film Advances—Ralph Ponce de Leon, Sloan Microelectronics, El Segundo, Calif. (25.1/Fri./a.m./A)
- Incorporation of Computer-Controlled Laser Resistor Trimming in a Thick Film Facility with a Large and Varied Product Mix—Robert Marcum, Centralab Electronics, Milwaukee, Wis. (25.2/Fri./a.m./A)
- Advances in Interconnection Techniques—Richard Fritz, Radiant Energy Systems, Newbury Park, Calif. (25.3/Fri./a.m./A)
- Advances in Thick Film Materials—Dr. Sidney Stein, Electroscience Laboratories, Philadelphia, Pa. (25.4/Fri./a.m./A)
- Ion-Implanted Complementary MOS Technology—L. O. Bauer, P. J. Coppen and H. G. Dill, Hughes Aircraft Co., Newport Beach, Calif. (28.1/Fri./a.m./D)
- Precision Ladder Networks Using Ion-Implanted Resistors—H. H. Stellrecht, Signetics, Sunnyvale, Calif., D. S. Perloff, J. T. Kerr, Corning R&D Lab. (28.2/Fri./a.m./D)
- Applications of Ion-Implanted Depletion Loads to MOS Large Scale Integration—Gordon Hoffman, Mostek Corp., Carrollton, Tex. (28.3/Fri./a.m./D)
- Particle Accelerators for Ion-Implantation—J. N. Cecil and N. A. Bostrom, Accelerator Inc., Austin, Tex. (28.4/Fri./a.m./D)
- Micropower Active Filters for VHF Applications—W. W. Gaertner, F. K. Weinert, Gaertner Research, Stamford, Conn., L. Kleinberg, NASA Goddard, Greenbelt, Md. (29.1/Fri./p.m./A)
- Integrated Circuits for Medical Applications—J. D. Meindl, P. H. Hudson, and D. M. DiPietro, Stanford University, Palo Alto, Calif. (29.2/Fri./p.m./A)
- Low-Power Digital Frequency Synthesis Application Demonstrates Unique CMOS Performance Characteristics—R. E. Funk, RCA Solid State Division, Somerville, N.J. (29.3/Fri./p.m./A)
- Silicon-Gate CMOS in Micropower Digital Systems—J. W. Foltz, Motorola Semiconductor Products, Phoenix, Ariz. (29.4/Fri./p.m./A)

## Microwaves

- A New 2-GHz Microwave System for Message and Video Transmission—James B. Murray, GTE Lenkurt, San Carlos, Calif. (12.1/Wed./a.m./D)
- Integrated Circuits and Other Solid-State Devices Improve Performance and Simplify Application of 2-GHz Microwave Systems—E. A. Gilmore and Mark W. Wilkens, Farinon Electric, San Carlos, Calif. (12.2/Wed./a.m./D)
- Design of an 18-Channel Heterodyne Radio System—James J. Heinemann, GTE Lenkurt, San Carlos, Calif. (12.3/Wed./a.m./D)
- 18-GHz Short Hop PSK Radio System Experiment—John Kenny, Richard P. Slade, Bell Telephone Labs, North Andover, Mass. (12.4/Wed./a.m./D)
- The Computer-Aided Design of an L-Band Phase Shifter—Ted W. Houston, Texas Instruments, Dallas, Tex. (23.1/Thurs./p.m./C)

# S-D puts the accuracy back into high speed DVMs



**FILTER FOR EMERGENCY ONLY**

## Make 30 accurate readings a second... even with noisy inputs

Most "high speed" digital voltmeters come to a screeching halt when they have to measure noisy signals. That's because most DVM's offer absolutely no noise rejection without using input filters—and even the best designed filter will limit a DVM to two or three readings a second.

Now Systron-Donner has done something to put the accuracy back into the high speed DVM. We designed our new fully-guarded 5-digit Model 7110 around Dual Slope Integration, the only reliable measuring technique that provides built-in noise rejection without the need for filters. As a result the 7110 will make 30 readings a second and give the right answer every time, even in the presence of unwanted noise and ripple. Yes, there's a filter, too, but you'll only need it for extremely noisy signals.

Built-in noise rejection is only one feature that makes the 7110 an outstanding lab or system meter. Five dc voltage and five dc ratio ranges are standard

with all-range autoranging from  $\pm 1$  microvolt to  $\pm 1100$  volts. Both ac voltage and 4-wire resistance measurements can be added and, for system use, a variety of fully isolated digital output and remote programming options are available.

We also added some little things, like a light that tells if you've selected an optional function that isn't installed. (There's also circuitry that withstands overloads up to 1000 volts even if you mis-program all controls and inputs.) And to protect your investment we designed the 7110 so that every option can be installed at any time by simply adding plug-in cards.

Model 7110 is priced from \$1,695 including 100 mV full scale and ratio ranges. Ask your local Scientific Devices office for technical data or contact: Concord Instruments Division, 888 Galindo St., Concord, CA 94520. Phone (415) 682-6161.

SYSTRON  DONNER

See us at Wescon Booth 1005-08 and 1050-53

**Another S-D instrument first!** Electronic counters/Digital voltmeters/Pulse generators/Data generators/Time code generators/Sweep generators/Spectrum analyzers/Digital panel meters/Digital clocks/Signal generators/Oscillators/Laboratory magnets/Precision power supplies/Analog & analog-hybrid computers/Data acquisition systems.

INFORMATION RETRIEVAL NUMBER 128

# Buying Power?

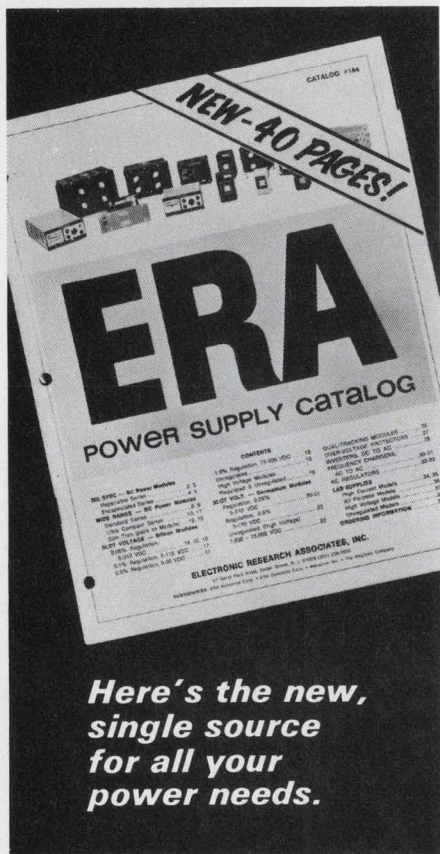

*Here's the new, single source for all your power needs.*

- Mil Spec DC Modules
- Wide Range DC Modules
- Slot Voltage DC Modules
- IC Logic Modules
- Full-Range Lab Supplies
- Inverters, Frequency Changers
- High-Voltage Supplies
- AC Regulators
- Full Technical Data
- Full Specifications
- Mechanical Data
- Model Types
- Prices & Availability

Ask for Your Free Catalog #157 Today!



## ERA TRANSPAC CORPORATION

67 Sand Park Road, Cedar Grove, N. J. 07009  
(201) 239-3000

A subsidiary of  
Electronic Research Associates, Inc.

INFORMATION RETRIEVAL NUMBER 129

W28

## WESCON '71

A Medium Power VHF Amplifier with PNP-NPN Complementary Symmetry Transistors—Les Besser, Fairchild, Palo Alto, Calif. (23.2/Thurs./p.m./C)

Hybrid Integrated Wide-Band Linear Power Amplifiers for S and C Band—A. Presser, H. Huang, R. Paglione, and H. Johnson, RCA Advanced Technology Lab, Princeton, N.J. (23.3/Thurs./p.m./C)

Performance and Reliability of Transistors in Power MICs—Georg Luettgenau and R. E. Heijmanowski, TRW Semiconductors, Lawndale, Calif. (23.4/Thurs./p.m./C)

IMPATT DIODES; Technology and Applications—A. M. Cowley, Hewlett-Packard Co., Palo Alto, Calif. (26.1/Fri./a.m./B)

Review of Gunn Effect Devices—F. Beringer Fank, Varian Associates, Palo Alto, Calif. (26.2/Fri./a.m./B)

Transistors for the Era of Microwave Communication—Sanehiko Kakihana, Hewlett-Packard Co., Palo Alto, Calif. (26.3/Fri./a.m./B)

Microwave Acoustic Devices for High Data Rate Processing—Donald B. Armstrong, Litton Electron Tube Division, San Carlos, Calif. (26.4/Fri./a.m./B)

Micropower Active Filters for VHF Applications—W. W. Gaertner, F. K. Weinert, Gaertner Research, Stamford, Conn.; L. Kleinberg, NASA Goddard, Greenbelt, Md. (29.1/Fri./p.m./A)

## Optoelectronics

Laser Modulation Formats for Space Communications—Gary Lee and E. A. Paddon, McDonnell Douglas Astronautics, St. Louis, Mo. (6.1/Tues./p.m./B)

Acquisition and Angle Tracking of Laser Communications Links—Art Kraemer, Sylvania Electro-Optics, Mountain View, Calif. (6.2/Tues./p.m./B)

Critical Component Technology for Space Laser Communications—Robert R. Rice, McDonnell Douglas Astronautics, St. Louis, Mo. (6.3/Tues./p.m./B)

Signal Processing Techniques for a 1000 MS/S Optical Communication Link. Carl Ryan, Motorola, Phoenix, Ariz. (6.4/Tues./p.m./B)

Optoelectronics Measurements—Al Seck, Centralab Semiconductor, El Monte, Calif. (24.1/Thurs./p.m./D)

Light Emitting Diode Reliability—Lin Wetterau and Walter Gill, Texas Instruments, Dallas, Tex. (24.2/Thurs./p.m./D)

Optical Character Recognition—A Status Report—Duane Baxter, IBM Systems Development Div., Rochester, Minn. (24.3/Thurs./p.m./D)

Optical Memories—Bruce Ballard, Optical Memory Systems, Santa Monica, Calif. (24.4/Thurs./p.m./D)

Electro-optic Ceramic Materials—Gene H. Haertling, Sandia Laboratories, Albuquerque, N.M. (31.1/Fri./p.m./C)

Ceramic Electro-optic Properties and Devices—Philip D. Thacher and Cecil E. Land, Sandia Laboratories, Albuquerque, N.M. (31.2/Fri./p.m./C)

Electro-optic Devices Using Strain-Biased PLZT Ferroelectric Ceramics—J. R. Maldonado, Bell Telephone Laboratories, Murray Hill, N.J. (31.3/Fri./p.m./C)

The Application of Ferroelectric Materials in Optical Memories—G. W. Taylor, RCA Laboratories, Princeton, N.J. (31.4/Fri./p.m./C)

## Testing and Instrumentation

An Innovative Approach to the Testing of MOS on the Production Line—F. Mansfield Young, Teradyne, Boston, Mass. (3.1/Tues./a.m./C)

Designing MOS for Maximum Testability—A. E. Pound, American Micro-Systems, Santa Clara, Calif. (3.2/Tues./a.m./C)

MOS Test Instrumentation—William Routh, Fairchild Systems Technology Division, Sunnyvale, Calif. (3.3/Tues./a.m./C)

Programming Languages for Component Testing—Milton Collins, Teradyne Inc., Boston, Mass. (14.1/Wed./p.m./B)

The Dialect Concept in ATE Language Design—Michael Ellis, PRD Electronics, Syosset, N.Y. (14.2/Wed./p.m./B)

ATLAS—Abbreviated Test Language for Avionics Equipment—T. A. Ellison, United Air Lines, San Francisco, Calif. (14.3/Wed./p.m./B)

Instrumentation Languages for Production and Engineering—William Ray, Hewlett-Packard Microwave Div., Palo Alto, Calif. (14.4/Wed./p.m./B)

Automatic Stimuli Generation—R. J. Johnson, Datapulse, Culver City, Calif. (17.1/Thurs./a.m./A)

Computerized Waveform Measurements—Dave McCracken, Tektronix, Beaverton, Ore. (17.2/Thurs./a.m./A)

Remotely Controlled Digital Measurement Instrumentation—Fred Kreiss, Systron' Donner Concord Instrument Div., Concord, Calif. (17.3/Thurs./a.m./A)

Automatic Test Equipment and Its Interface with a Computer or Controller—G. K. Mercola, Sagetec Corporation, Chatsworth, Calif. (17.4/Thurs./a.m./A)

Commercial ATE Revisited—David S. Kline, Hewlett-Packard Automatic Measurement Division, Palo Alto, Calif. (21.1/Thurs./p.m./A)

Automatic Test Equipment Design—P. W. La Clair and J. Katsikas, Librascope Division, Singer-General Precision, Glendale, Calif. (21.2/Thurs./p.m./A)

AVMOTS—A New ATE Family—L. H. Bohl, Avco Systems Division, Wilmington, Mass. (21.3/Thurs./p.m./A)

Automated Test of Jet Engine Accessories—O. T. Carver, RCA, Burlington, Mass. (21.4/Thurs./p.m./A)

# The SOLID STATE

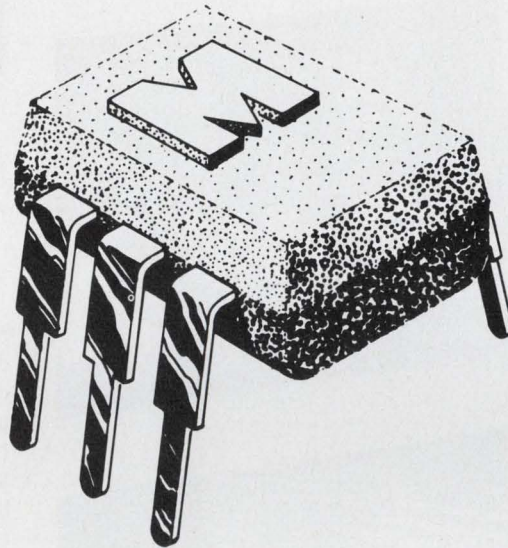

## Relays

Monsanto has them . . . . .  
a full line of opto-isolators that couple light emitting diodes to phototransistors, photodiodes, photo SCR's and now to a photo-darlington. All of these units offer the ruggedness and long life associated with solid state devices.

Plus, the new MCA2 photo-darlington relay has the advantage of high gain: an output of 125 mA at a 1 volt contact voltage for a 50 mA coil input current. Transfer ratios of 200% at an input of 10 mA and a VCE of 3 volts are typical.

The MCA2 can be used to replace reed and mercury wetted relays, pulse transformers and in other applications where fast operating time (10 $\mu$ s), high contact rating (125mA) and high isolation resistance between coil and contact (10<sup>11</sup> ohms) are important.

All this and more comes to you in a convenient plastic dual-in-line package weighing only 0.4 grams.

Monsanto makes them and Monsanto can deliver them.

SOLID STATE RELAYS with the following features:

Detectors: phototransistor  
photodiode  
photo SCR  
photodarlington

Isolation voltage to 25kV

Package styles: axial, 6 lead plastic DIP and hermetic TO-18.

Any of these products can be obtained from Monsanto distributors. Call the one nearest you today:

Elmar Electronics  
K-Tronics  
Kierulff Electronics (FJR & Schley)  
Liberty Electronics  
Schweber Electronics  
Semiconductor Specialists  
Western Radio

Also available through CESCO and Canadian Dynamics.

Or you can call or write Monsanto direct at 10131 Bubb Road, Cupertino, California 95014, (408) 257-2140.

## Monsanto

## WESCON '71 PRODUCTS

# Large-memory calculator uses plug-in function blocks



Hewlett-Packard, 1501 Page Mill Rd., Palo Alto, Calif. Phone: (415) 493-1501. P&A: \$2975 (basic unit); Oct., 1971.

A new desk-top calculator with six times the memory capacity of comparably priced units is the first to use plug-in function blocks to expand its operational capabilities.

The new series 9800 model 10 is small, light and rapid. Its plug-in blocks and optional accessories—such as X-Y plotters, card readers and typewriters—expand its memory, customize its keyboard, extend its input/output capability and provide problem solutions in words, numbers, drawings, or a combination of all three.

The basic model 10 has 51 registers and 500 program steps. It can perform all basic functions of addition, subtraction, multiplication, division and square root.

Hewlett-Packard-designed function blocks (read-only memories) plug into the top of the calculator to provide special capabilities. Each block, about the size of a deck of cards, has its own keyboard template that slips over 15 keys to define their functions.

One function block provides al-

phabet and punctuation printout so that a user can easily identify information and print accompanying program steps and instructions.

A special user-definable block allows a customer to designate functions that apply specifically to his profession. Single keys may be programmed to perform specific calculations<sup>3</sup> and the programs may be changed at any time. Additional function blocks provide mathematical and statistical programs.

Only one keystroke is required to square a number or get its reciprocal. Programming is simply a matter of setting the model 10 to the program mode, then pressing the keys in the desired sequence. No special language is needed.

Complex problems, such as the solution of as many as 17 simultaneous equations, are handled by recording data and program steps on small magnetic cards that slip into the machine.

The model 10's built-in thermal printer is capable of printing full alphanumeric information when the "Alpha" function block is plugged in. LEDs are used in the calculator's display panel.

Booth No. 1839 Circle No. 294

## Random-access unit simulates ROMs

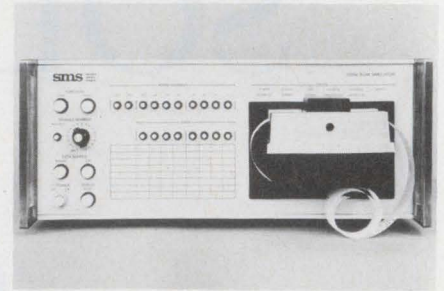

Signetics Memory Systems, 740 Kifer Rd., Sunnyvale, Calif. Phone: (408) 739-7101. P&A: \$4350; 8 wks.

The 1000A ROM simulator is a high-speed, random-access semiconductor storage system that is operated in a read-only mode to simulate ROM storage arrays. It can be configured to simulate up to 16 4096-bit ROMs or a total of 65,536 bits. The simulator interfaces with customer equipment via the 16 or 24 DIP connectors of its buffered simulation cable.

Booth No. 1712 Circle No. 263

## Graphic plotting system increases versatility

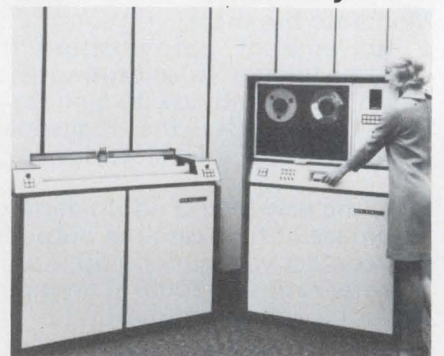

California Computer Products, Inc., 2411 W. La Palma Ave., Anaheim, Calif. Phone: (714) 821-2541.

The 900/1136 graphic-output system allows plotting in several colors and varying line widths, and can generate plots containing any alphanumeric character, line or curve. It consists of the model 900 controller with up to 32 kbytes of programmable memory and tape-cartridge loading, the model 937 tape transport and the model 1136 drum plotter.

Booth No. 1715 Circle No. 267



# UP-FRONT SIMPLICITY: LEVER-LITE III

Rugged modular construction gives you a reliable lighted lever switch that provides front-of-panel convenience on the assembly line or in the field.

Our new "Lever-Lite" III switches were designed to simplify installation and servicing of lighted lever switches on computers, telecommunications systems, industrial control equipment, intercoms, broadcast consoles and scientific or test instruments of all kinds.

SIMPLE to mount and terminate. "Lever-Lite" III switches are installed from the front. In a single hole. The lever assembly (lever-actuator, lamp and socket, and color filters) simply

slips into its housing. An escutcheon that "snaps-in" place secures the lever assembly and "trims" the mounted switch. Switching and lamp terminals are solder lug type but also accept standard quick connect-disconnect receptacles.

SIMPLE to relamp. Front-of-panel relamping or changing of color filters can be done easily by removing the escutcheon and lever assembly with your fingertips.

SIMPLE to find what you need. "Lever-Lite" III switches are available in 2- and 3-position types. With locking, non-locking and talk-listen functions. You can order multi-color (different colors in each position), mono-color (one color in all positions) or non-illuminated "Lever-Lite" III switches. And they can be specified with SPST to 8PDT switching.

SIMPLE to get. Contact your local Switchcraft distributor, sales representative, or write us direct. Switchcraft, Inc., 5529 N. Elston Avenue, Chicago, Illinois 60630.

OUR  25th ANNIVERSARY



**SWITCHCRAFT**  
INC.

See us in Booth 2226-2227 at WESCON

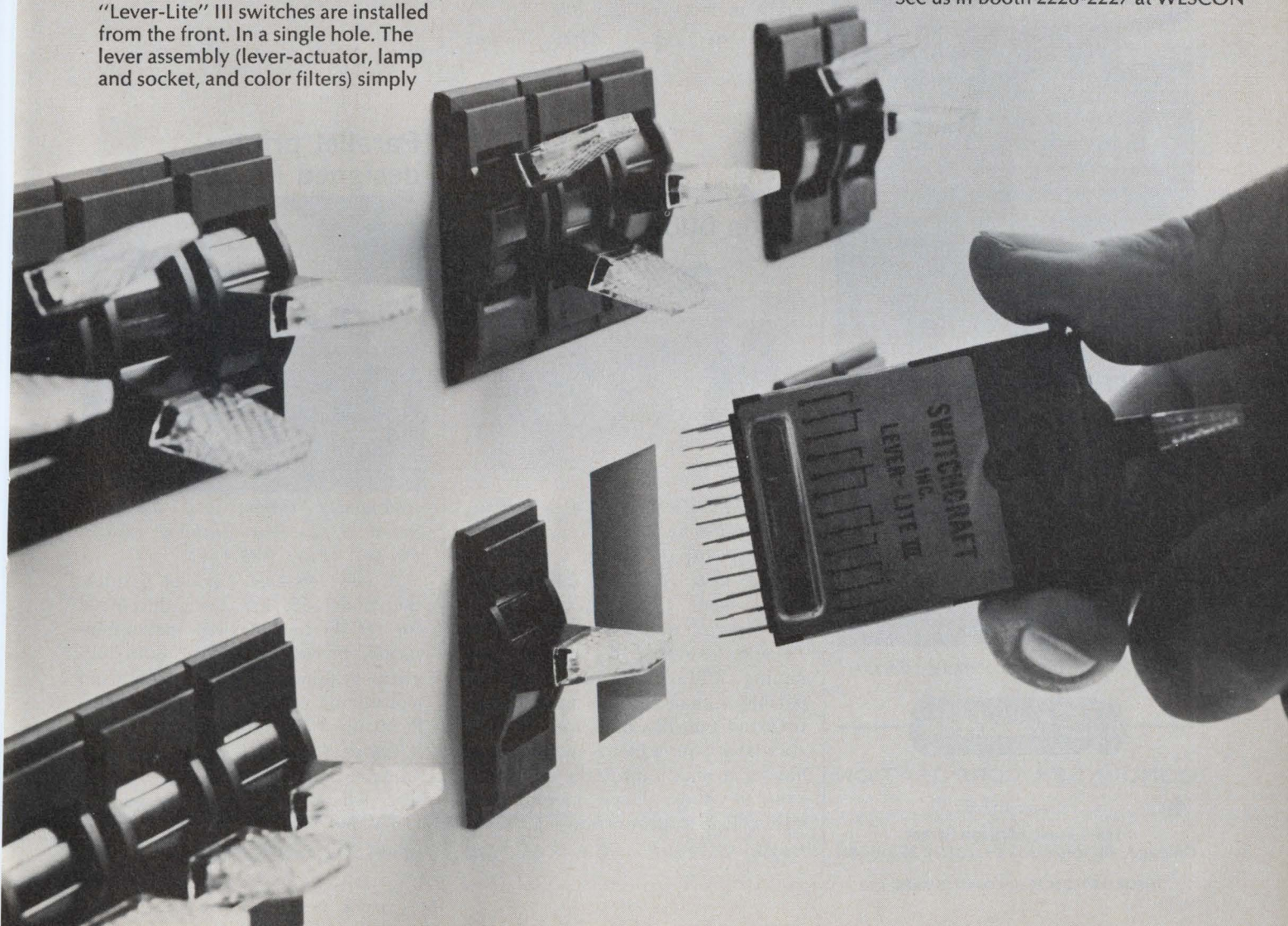

If you can't stand  
the heat ...

stay out  
of the  
kitchen!

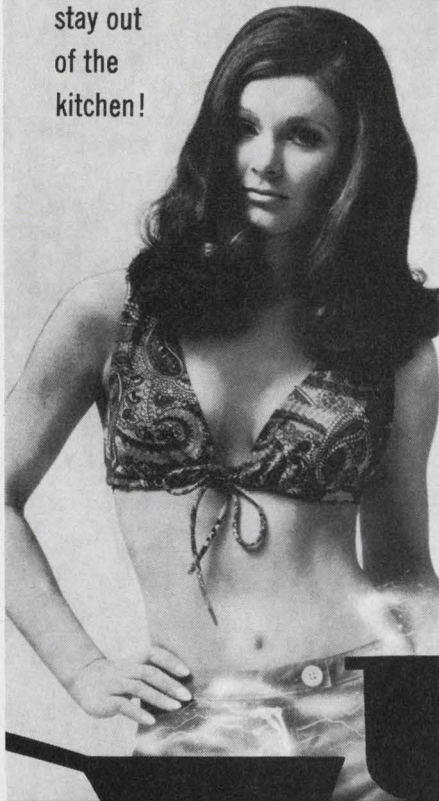

Here are components that stand the heat ... and the cold ( $-55^{\circ}\text{C}$  to  $+125^{\circ}\text{C}$ ) without voltage degrading. The dissipation curve is as flat as a pancake ... and the other specs are out of this world. Maybe your recipe calls for

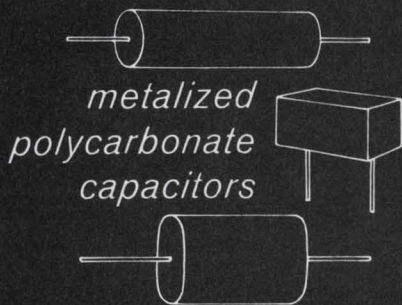

Try Standard's PC2-E (Rectangular Epoxy) and PC2-W (Wrap and Fill).

Send for Catalog and complete details.

**Standard**  
CONDENSER CORPORATION

Dept. ED-8  
1065 West Addison Street  
Chicago, Illinois 60613 • (312) 327-5440

INFORMATION RETRIEVAL NUMBER 132  
W32

DATA PROCESSING

Program calculators  
extend memory 2 ways



Wang Laboratories Inc., 836 North St., Tewksbury, Mass. Phone: (617) 851-7311.

The new 700C/720C electronic programmable calculators feature optional external memory devices. Both have extended memory capacity that is provided in two forms: external core modules and dual tape cassette units. The external core can be utilized to store from or recall program steps, data or alphabetic information to the main memory of the 700.

Booth No. 1815 Circle No. 265

Photo tape reader  
reads 500 character/s

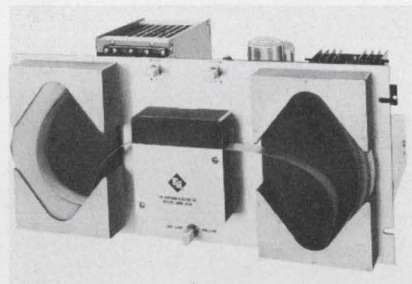

Superior Electric Co., Bristol, Conn. Phone: (203) 582-9561. P&A: \$980; 30 days.

The new Slo-Syn photoelectric tape reader type TRP500 has a reading rate of 0 to 500 characters/s and is suited for applications having TTL, DTL, or RTL-compatible signals. It has normal and inverted outputs and is used with standard 1-in.-wide, 8-channel tape having a maximum light transmission of 40%. Tape handling is either loop type or fanfold.

Booth No. 1101 Circle No. 266

Video hard copy unit  
makes TV-image copies

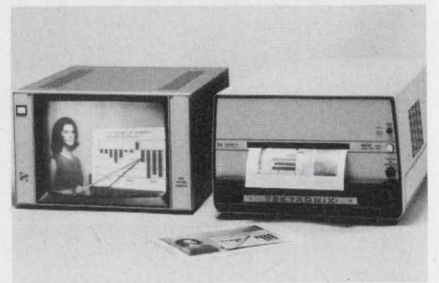

Tektronix, Inc., Box 500, Beaverton, Ore. Phone: (503) 644-0161. P&A: \$3750; 4th quarter, 1971.

A new video hard-copy unit is the model 4602 which provides a convenient means of making permanent facsimile copy from static TV signals. Composite TV video is applied to a loop-through input connection on the 4602 rear panel. This signal is copied by the 4602 providing an accurate gray-scale representation of the TV inputs.

Booth No. 1001 Circle No. 284

Parallel printer  
designed for OEMs

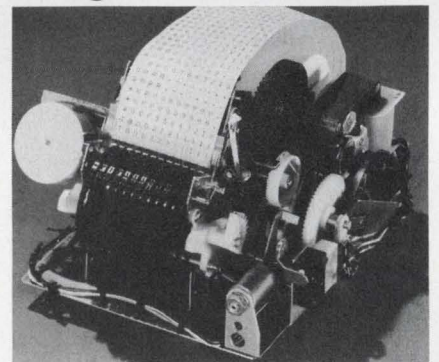

Addmaster Corp., 416 Junipero Serra Dr., San Gabriel, Calif. Phone: (213) 285-1121.

A new low-cost parallel printer, the model 55, has been developed for OEMs to use with instrumentation, inventory control, data logging, system readout, automation monitoring or point-of-sale devices. Printing 3 lines (36 characters)/s it has a 12-column capacity using numeric or limited-alpha characters. The printer operates with a 115-V/60-cycle ac drive motor.

Booth No. 1220 Circle No. 264

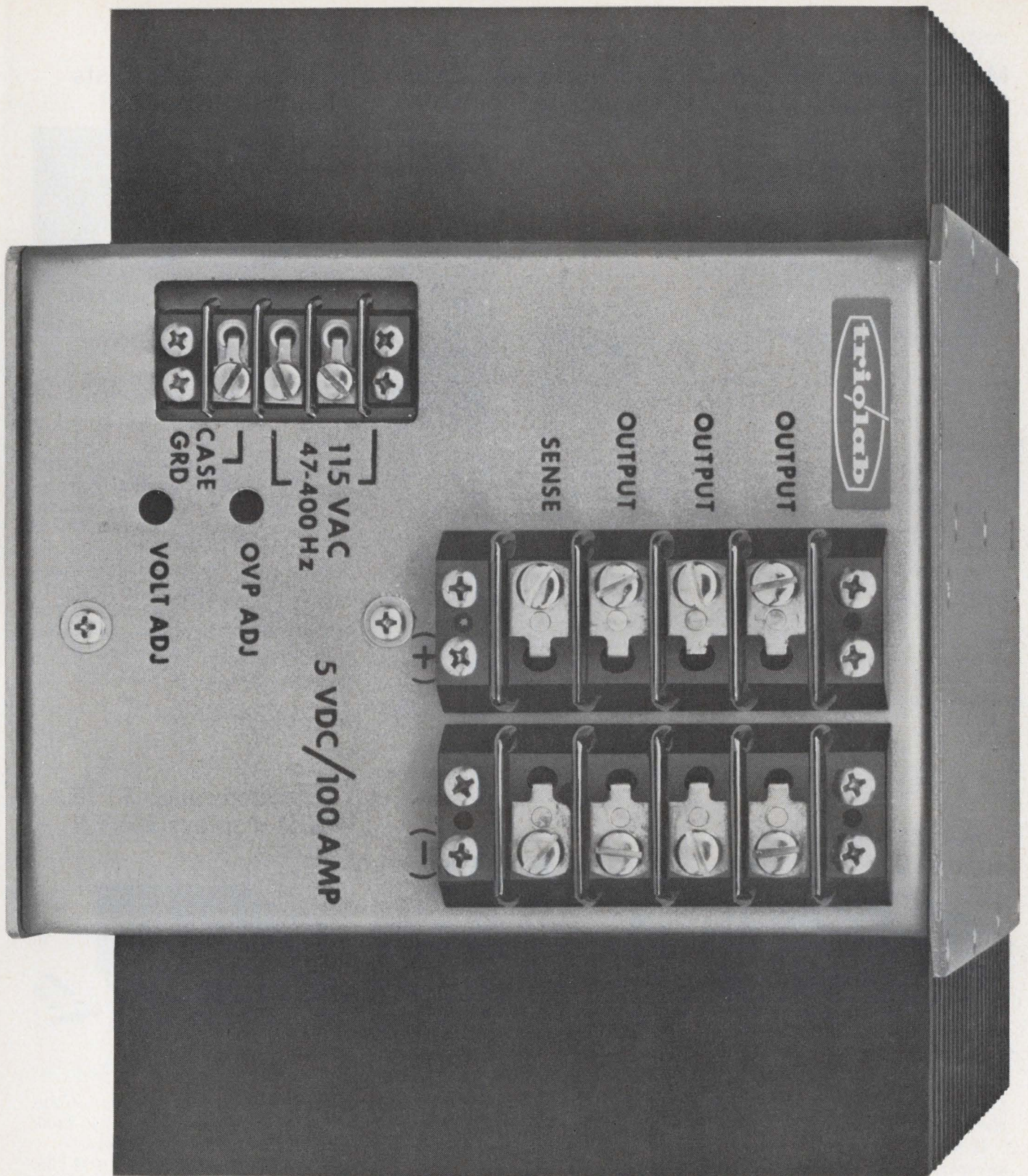

**Shown actual size. 5VDC/100A power supply. Off-the-shelf.**

The world's smallest 5VDC/100AMP supply gives you:

- Volume under 500 cubic inches!  
8½" x 6¾" x 8½"
- Lightweight. Less than 20 pounds.
- High Efficiency. 65% for all load conditions.
- Cool Operation. No forced air or external cooling for full rated output to 55°C.
- Low Cost. Priced lower than the large brute force supplies.

If our 500 watt supply overpowers your requirement,

let us talk with you about our complete line of off-the-shelf 100 watt supplies, which offer you the same advantages as above: small size, lightweight, high efficiency, cool operation, low cost.

They come in single, dual, and triple outputs with voltages from 5VDC to 30VDC. Commercial, Military, and European models available.

Contact: **Trio Laboratories, Inc.**  
80 Dupont Street, Plainview, L. I., N. Y. 11803  
Tel: (516) 681-0400 TWX: (510) 221-1861



## Memory exerciser tests RAMs and ROMs

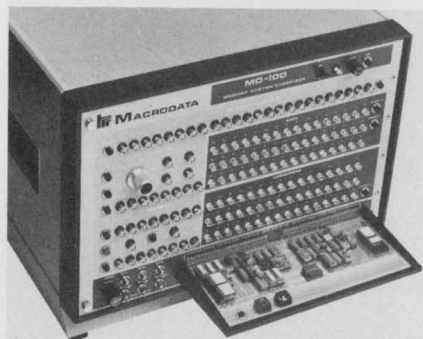

Macrodata Co., 20440 Corisco, Chatsworth, Calif. Phone: (213) 882-8880. Price: under \$17,000.

The MD-100 is a complete package for testing RAMs, ROMs, shift registers and memory systems. The power of the system comes from the fact that it uses neither fixed test sequences or burst testing from a buffer storage. The system consists of a special purpose multi-processor which is micro-programmed to provide worst-case test patterns of any length, on line, at the actual memory operating speeds up to 5 MHz.

Booth No. 1021 Circle No. 283

## Low-cost sweeper spans 10 to 1300 MHz



Hewlett-Packard Co., 1501 Page Mill Rd., Palo Alto, Calif. Phone: (415) 493-1501. Price: \$2750 (includes mainframe).

Hewlett-Packard's latest rf sweeper is the 86220A plug-in with the 8620B mainframe which covers the frequency range of 10 to 1300 MHz in one continuous sweep. It features significant improvements in stability, spectral purity, linearity, and power output. In addition, it provides cw operation, continuously calibrated start-stop, and incremental-frequency sweep.

Booth No. 1015 Circle No. 271

## Automated test system is computer controlled

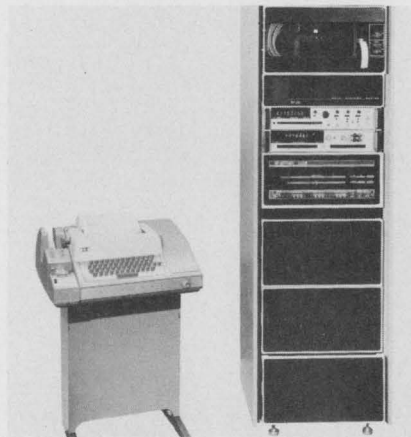

Systron-Donner Corp., 888 Galindo St., Concord, Calif. Phone: (415) 682-6161. Price: \$50,000.

The 3600 series Computer Automated Test System (CATS) offers performance and economy for complete dynamic testing and calibration of components, circuits boards, electronic assemblies and instruments. The basic CATS combines standard Systron-Donner programmable test instruments with a complete digital package of the PDP-11 computer and Systron-Donner's 3610 System Interface Unit.

Booth No. 1005 Circle No. 279

## Sweep/signal generator covers 2 to 18 GHz

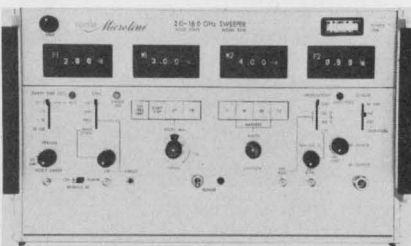

Narda Microwave Corp., Plainview, N.Y. Phone: (516) 433-9000.

The new broadband model 9530 sweep/signal generator covers the entire frequency band of 2 to 18 GHz. Its frequency control and readout consists of four digital frequency-programming wheels, eliminating the need for interpolation of a slide-rule type dial. Four operating modes are provided: start-stop, incremental-frequency, cw and external. Sweep times range from 0.01 to 100 s.

Booth No. 1252 Circle No. 291

## IR thermometer tests ICs without contact



Raytek, Inc., 1277 Terra Bella Ave., Mountain View, Calif. Phone: (415) 961-1650. P&A: \$1750; 3 wks.

The ThermoProbe model T1000 IR thermometer accurately measures IC operating temperatures without contact. Measurements of areas as small as 0.05 in. can be made with the instrument whose temperature range is 20 to 500°C. Accuracy is 1°C below 120°C. The T1000 is used to measure operating temperatures of TO-5 and DIP ICs.

Booth No. 1151 Circle No. 282

## Extended-range \$199 DPM displays 3999 V

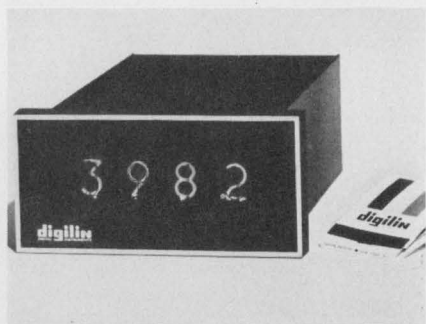

Digilin, Inc., 1007 Air Way, Glendale, Calif. Phone: (213) 240-1200. P&A: see text; 2 to 3 wks.

A new extended-range DPM fills the gap between 3-1/2 and 4-1/2-digit units providing a full-scale indication of 3999 V. At the same time, it retains the lower cost of 3-1/2-digit meters, by being priced at \$199. Type 2430 rezeros itself every measurement cycle automatically, has a maximum resolution of 500  $\mu$ V/digit and accuracy of  $\pm 0.05\%$  of indication  $\pm 1$  digit.

Booth No. 1121 Circle No. 280

# Belden the Special "Specials" specialist

Here's what to do when cable catalog specs just won't do the job: Dial Area Code 317 ■  
Then dial 966-6681 ■ You'll get action ■ From a man who devotes full time to solving  
engineered cable problems ■ A Belden specialist that "lives"  
with your design parameters from engineering through the  
actual production run ■ Cables for underwater-under-  
ground devices . . . extra-high voltage and pulse ap-  
plications . . . medical instrumentation . . . low-level  
signal interference problems . . . unusual environ-  
mental conditions . . . he's tackled them all ■

Phone now.

8-5-0

DIAL (317) 966-6681

**BELDEN** 

... new ideas for moving electrical energy

GET  
"INSTANT"  
ANSWERS  
AT

**WESCON**  
Booth 1607

Bring your cable problem  
to Belden's Custom Design  
Center at WESCON. And get  
on-the-spot answers from  
Belden's "Specials" team.

8-5-0W

## Digital level meter spans 30 Hz to 60 kHz



Siemens Corp., 186 Wood Ave. S, Iselin, N.J. Phone: (201) 494-1000.

The new digital level meter model D2010/D2014 provides the answer to the need for a level meter which could easily automate complex testing and checking over 30 Hz to 60 kHz. Because it is an easily quantized variable, time was chosen as the counting principle for the meter. The logarithmic relationship between voltage and time, as required for level indication, was achieved with the aid of the discharge function of an RC circuit.

Booth No. 1226 Circle No. 278

## Shearing microscope allows micro displays



Vickers Instruments, Inc., 15 Waite Court, Malden, Mass. Phone: (617) 324-6666.

A new image-shearing microscope offers a substantial technological advance in the field of micro-measurement. The compound binocular microscope is conventional with an image-shearing module positioned between the objective lens and the binocular viewing head. This module is a re-imaging system giving 1.0X magnification, so as not to change normal viewing conditions.

Booth No. 1220 Circle No. 276

## Multi-waveform source covers 0.1 Hz to 10 MHz

Wavetek, 9045 Balboa Ave., San Diego, Calif. Phone: (714) 279-2200.

Model 154 is a precision source covering 0.1 Hz to 10 MHz with sine, square and triangle waveforms and a dc voltage output. It has local and remote digital control of frequency, function, offset, and amplitude. Additionally, it may be controlled by an analog voltage in the following manner: the frequency and/or the amplitude may be programmed or modulated by an ac or dc signal.

Booth No. 1124 Circle No. 288

## Sweep generator adds detector/marker options

Wiltron Co., 930 E. Meadow Dr., Palo Alto, Calif. Phone: (415) 321-7428. P&A: \$1390; 6 wks.

A new solid-state sweep generator, model 610C, features detector and marker options with a combination cabinet-rack package only 7-in. high and under 12 lbs in weight. A range of 20 rf plug-ins is available for use with the 610C which offers a frequency range of 100 kHz to 18 GHz. Plug-ins for specific applications include CATV, hf, vhf, uhf, Tacan, radar, microwave and ECM models.

Booth No. 1323 Circle No. 274

## Sweep/signal generator tunes 350 to 650 MHz

Wavetek, Inc., Box 651, San Diego, Calif. Phone: (714) 279-2200. P&A: \$995; 30 days.

The new model 1003 sweep/signal generator tunes from 350 to 650 MHz with sweep widths adjustable from 200 kHz to 300 MHz. A calibrated output from +13 to -77 dBm is standard. The 1003 features sweep times from 100 to 0.01 s with line-lock, triggered and manual-mode sweeps. Crystal-controlled harmonic and single-frequency markers are available.

Booth No. 1124 Circle No. 275

## Die inspection system checks 3000 die/hour

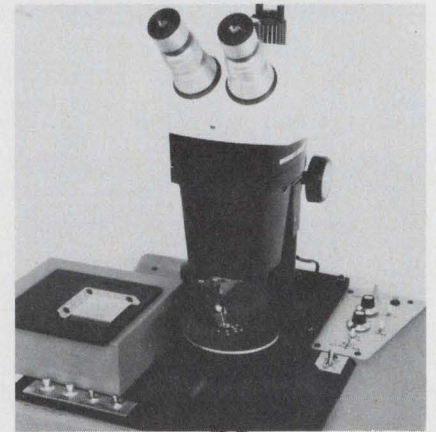

Mechanization Assoc., 140 S. Whisman Rd., Mountain View, Calif. Phone: (415) 967-4262.

The model 3100a die-inspection and automatic die-plating system works at a maximum rate of 3000 die/hour. Using the 3100a, an operator places loose die on a movable table under the microscope which is inspected and aligned to a cross-hair. If the die passes inspection, it is automatically transferred to the die plate in 1/2 a second.

Booth No. 1524 Circle No. 289

## Capacitance meter checks 0.01 to 2000 pF



Boonton Electronics Corp., Route 287 at Smith Rd., Parsippany, N.J. Phone: (201) 887-5110. P&A: \$1100; December, 1971.

The Model 72AD fully programmable, digital capacitance meter offers three-terminal and differential capacitance measurements from 0.01 to 2000 pF at 1 MHz and at a test level of 15 mV rms. Its four push-button selected ranges are 1, 10, 100 and 1000 pF full scale, each with 100% overrange capability. Resolution is 0.001 pF and accuracy is 0.25% of reading.

Booth No. 1045 Circle No. 273

# P&B Solid State Hybrid Relays.

We get them by mating semiconductors and relays. You get a whole new range of switching options.

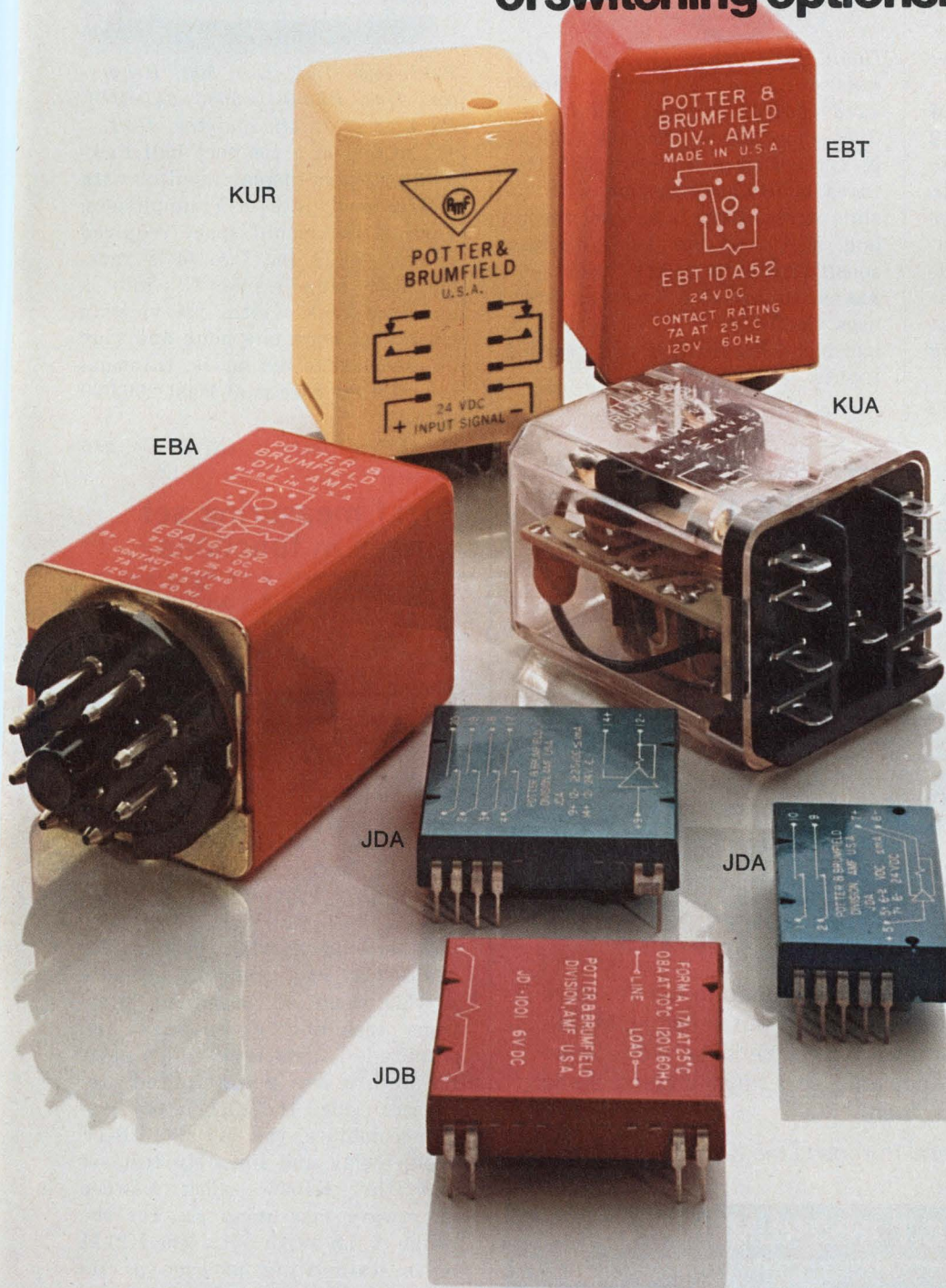

For example, you can interface semiconductor logic circuits with inductive loads like motors, solenoids, contactors. You can use inputs as low as 5 microwatts to switch 7 ampere loads. All with the isolation normal with relays. Wide choice of package sizes and terminations, too.

**EBT Solid State Hybrid Relay.** A solid state AC switch controlled by a reed relay. It switches 7 amperes rms, 60 Hz at 25°C ambient. Operate time: 2 milliseconds. Coil voltages range from 6 to 48V DC.

**EBA Sensitive Solid State Hybrid Relay.** Similar to the EBT but with sensitivity as high as 12 microwatts. Available for 12, 18 or 24V DC. Built-in polarity protection. Switching is bounce-free.

**KUA Amplifier-Driven Relay.** Standard sensitivity: 60 microwatts. DPDT contacts will switch 5 amperes at 28V DC or 120V 60 Hz, 80% PF. Features continuous duty operation, built-in polarity protection.

**KUR Alternate, Direct-Action, Impulse Relay.** Single coil, DPDT relay has permanent magnet in parallel with normal flux path plus solid state flip-flop circuit. Results? A relay with both permanent memory and alternate action features controlled from a single DC source. Contacts rated 5 or 10 amperes remain in last position without power.

**JDA Amplifier-Driven Reed Relay.** Low profile Dual Thin-Line reed relay has sensitivity as high as 5 microwatts (96 mw standard). Designed to operate in association with integrated circuits, in particular the output of DTL and TTL logics in current sourcing mode. High input/output isolation. Contact arrangements: 2 Form A and 4 Form A.

**JDB Solid State/Reed AC Switch** Ideal for interfacing solid state circuits intended to control 120V 60 Hz loads such as fractional HP motors, solenoids, contactors. Seated height: .275". 1 Form A contacts will switch 1.7 amperes at 25°C ambient.

P&B solid state hybrids are available from leading electronic parts distributors. For complete information, call your P&B representative or Potter & Brumfield Division of AMF Incorporated, Princeton, Indiana 47570. Telephone: (812) 385-5251.

**AMF**  
POTTER & BRUMFIELD

**P&B performance. Nothing else comes close.**

### True-rms, 20-MHz DVM measures from 300 $\mu$ V



Boonton Electronics Corp., Route 287 at Smith Rd., Parsippany, N.J. Phone: (201) 887-5110. P&A: \$1100; December, 1971.

The model 93AD true-rms DVM measures 300  $\mu$ V to 3000 V, in 12 programmable ranges of 1 mV to 300 V full scale, over 10 Hz to 20 MHz with an accuracy of  $\pm 1\%$  of reading. The 3-1/2-digit instrument has a small edge-meter mounted beside its display. The meter is calibrated in dBms and is also convenient as a peaking or nulling indicator.

Booth No. 1045 Circle No. 252

### Analog X-Y recorder slews at 40 in./s

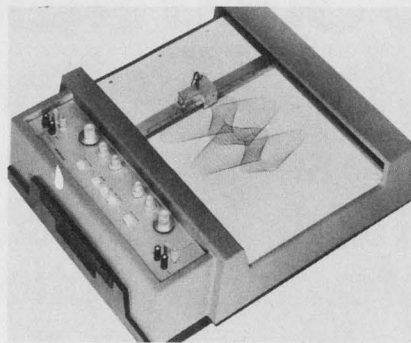

Gould Inc., Brush Div., 3631 Perkins Ave., Cleveland, Ohio. Phone: (216) 361-3315. Price: see text.

A new pressurized-ink analog X-Y recorder priced at \$1395 features a feedback system with no slide wires, 40-in./s slewing speeds and a 100- $\mu$ V to 1.0-V/division sensitivity range. The model 500 has a 10 by 15-in. writing area, uses electro-static-paper hold-down and balanced, floating and guarded inputs.

Booth No. 1207 Circle No. 272

### Compact storage display has 2-MHz bandwidth

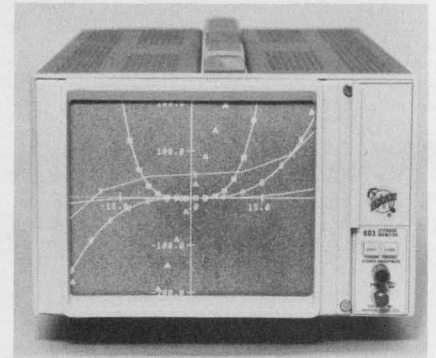

Tektronix, Inc., Box 500, Beaverton, Ore. Phone: (503) 644-0161. P&A: \$1100; 4th quarter, 1971.

The 603 is a compact half-rack-width storage display monitor with 2-MHz-bandwidth X-Y amplifiers. Vertical rackmount space required is only 5-1/4 in. Two 603s rack-mounted side-by-side fit into a standard rack width. Its viewing time is at least one hour and may be extended to ten hours. Information storage rate is at least 200,000 dots/s.

Booth No. 1001 Circle No. 285

## GENERAL PURPOSE TOGGLE SWITCHES with 1080 STANDARD OPTIONS...

**LEVER SHAPES**  
BAT HANDLE, FLAT HANDLE, OR BALL

**NOMINAL RATINGS**  
20 AMP, 125 VAC  
6 AMP, 125 VAC  
6 AMP, 125 VAC-DC

**TERMINALS**  
SPADE (PUSH-ON)  
SCREW LUG  
SOLDER LUG

**FINISHES**  
NICKEL, DULL OR BRIGHT  
CHROME, SATIN OR BRIGHT  
BLACK

**TYPES**  
SPST, SPDT  
DPST, DPDT  
3PST, 3PDT  
4PST, 4PDT

**CIRCUITRY**  
ST—6 CONFIGURATIONS  
DT—6 CONFIGURATIONS

... PICK THE ONE YOU WANT, AND IT WON'T COST YOU AN ARM AND A LEG, NOR RUIN DELIVERY

And if you want something special not included in the standard options, chances are good we can work it out sensibly. Maybe we've already done it for somebody else, because we've been building quality switches since 1952 and have tackled some pretty odd ball requests since then.

For more details on this General Purpose Line, Catalog TS-7. For sub-miniature toggles, MT-40.



**J-B-T INSTRUMENTS INC.**  
NEW HAVEN, CONNECTICUT 06508  
(203) 772-2220

Booth 1246 at Wescon

INFORMATION RETRIEVAL NUMBER 136

### Rf/i-f measuring set ranges in functions

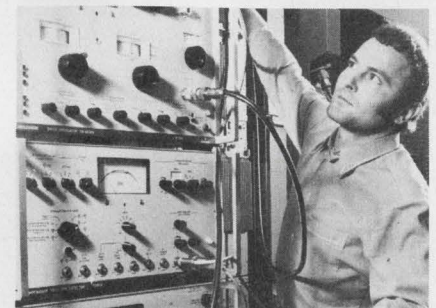

Siemens Corp., 186 Wood Ave. S., Iselin, N.J. Phone: (201) 494-1000.

A new measuring system for radio relay measurements provides a wide range of measuring functions including group-delay and amplitude distortion, nonlinearity, return loss and amplitude response. Called the K2111, the system combines the K1005 BB-IF group delay and linearity test set and the K1046 selective-sweep microwave measuring set for the range of 5.8 to 8.5 GHz. The K2111 is self-calibrating in each of its various measuring modes.

Booth No. 1226 Circle No. 277



# A couple of things you ought to know about Boeing's custom hybrid circuits.

1. High quality.
2. High quantity.

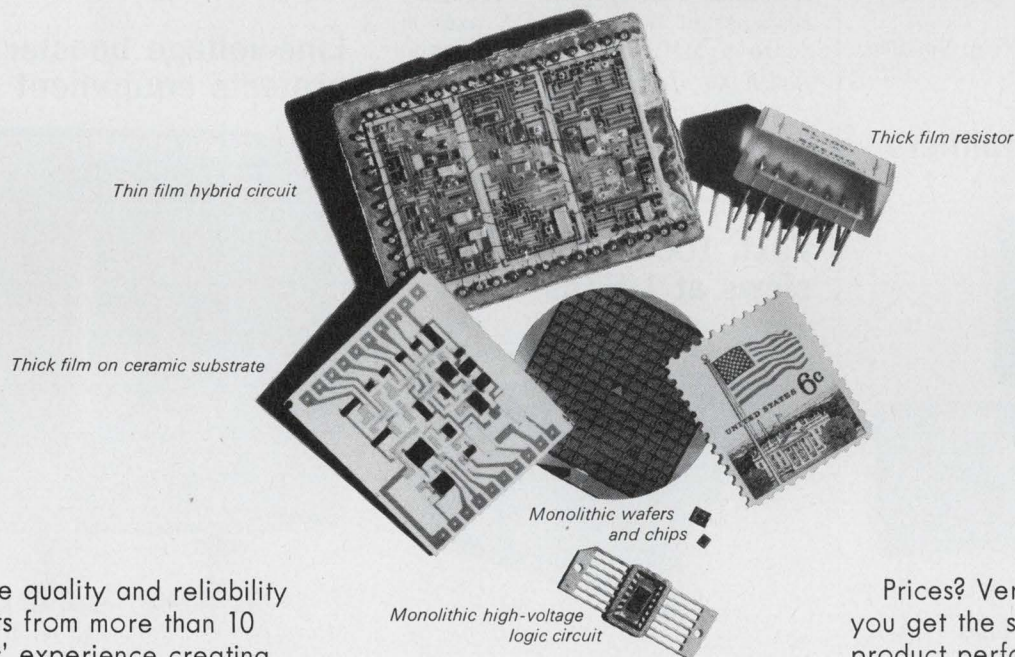

The quality and reliability results from more than 10 years' experience creating electronic parts and systems for demanding aerospace programs. Some \$600 million worth of electronic products thus far.

The quantity is possible because of our extensive facilities and manpower resources. Consider our delivery capability. We can make hybrid microcircuits to your specifications and production rate using the technologies shown above.

We're organized to respond quickly and efficiently. Our 700-man team has all the engineering, manufacturing, QC, contract and sales specialists needed to give you direct service. They're backed by a company that has the unique ability to custom design your microcircuitry and to select the technology that is right for your custom requirements.

Prices? Very competitive. Yet you get the same excellent product performance, quality control and schedule control for which Boeing is famous.

Contact us for more information. Call Herb Broadwell at 206-773-6116. Or write him at P.O. Box 3999, Seattle, Washington 98124.

We can do a lot for you.

**BOEING  
ELECTRONIC  
PRODUCTS**

INFORMATION RETRIEVAL NUMBER 137

### Very-fast, 10-bit d/a is a multiplier, too



Hybrid Systems Corp., 95 Terrace Hall Ave., Burlington, Mass. Phone: (617) 272-1522. Price: \$150.

The model 390-10 is a high-speed, 5-mA-output, 10-bit d/a (settles in 50 ns to 0.05%) that can also be used as a multiplying d/a for CRT display systems. This versatile d/a can accept a reference that can vary fully down to 0 V, including ramps and square waves. In addition, it has a built-in reference, so that it can be used as a conventional d/a.

Booth No. 1835 Circle No. 293

### Three buffer amplifiers program gains

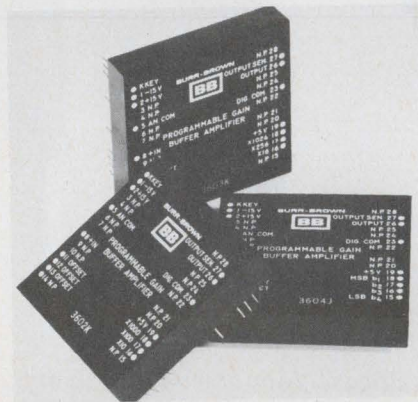

Burr-Brown Research Corp., International Airport Industrial Park, Tucson, Ariz. Phone: (602) 294-1431. P&A: see text; stock to 4 wks.

Three new digitally programmable, single-ended-input gain-scaling/buffer amplifiers are available. Models 3602K, 3603K and 3604K are priced at \$115 each. The first two have gain steps of 1, 10, 100 and 1000; and 1, 16, 256 and 1024, respectively. Model 3604 has gain steps of 1 through 16 programmed by four logic inputs.

Booth No. 2217 Circle No. 256

### 19-in. CRT display writes at 10 in./ $\mu$ s

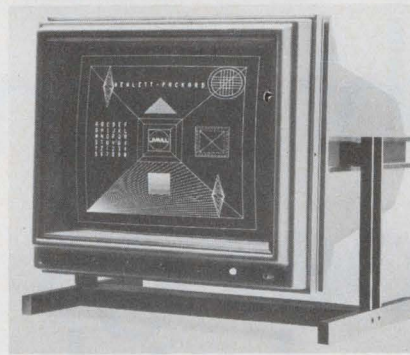

Hewlett-Packard Co., 1501 Page Mill Rd., Palo Alto, Calif. Phone: (415) 493-1501. P&A: \$3000; August, 1971.

A new 19-in. CRT display has an electrostatic deflection system that can reposition and settle its beam from one corner to the diagonally opposite corner in less than 1  $\mu$ s. The 10-in./ $\mu$ s model 1310A is intended for use in computer terminals and systems. Frequency response of both X and Y axes is dc to 5 MHz for 5-in. deflection. Booth No. 1015 Circle No. 255

### Fast, 100-MHz op amp slews at 1 V/ns

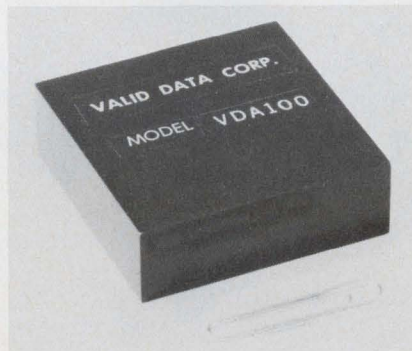

Valid Data Corp., Box 441, Calabasas, Calif. Phone: (213) 888-7170.

The model VDA-100 op amp with a  $\pm 10$ -V, 100-mA output features a 100-MHz bandwidth, settles in less than 60 ns and slews at 1 V/ns. It drifts less than 0.16 nA/ $^{\circ}$ C. It can be used as a building block for a/d converters having conversion rates of 10 MHz or more. Other applications include its use as a buffer and a line driver.

Booth No. 1227 Circle No. 286

### Low-cost, thin decoder has 30-V, 300-mA drive

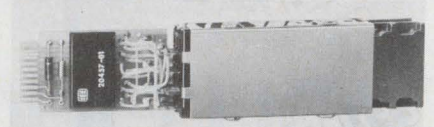

Industrial Electronic Engineers, Inc., 7720-40 Lemona Ave., Van Nuys, Calif. Phone: (213) 787-0311. P&A: See text; 6 wks.

Series 7610 driver/decoder is low in cost (\$21.45 in 1000 quantities), high in drive capability (up to 300 mA at 30 V) and has minimal depth behind a readout of 2-1/2 in. The series is delivered as a complete assembly, attached to the rear of a readout. It is DTL/TTL compatible and can be directly driven by IC circuitry operating on  $\pm 5$  V dc.

Booth No. 1039 Circle No. 258

### Line-voltage booster protects equipment



Microtran Co., Inc., 145 E. Mineola Ave., Valley Stream, N.Y. Phone: (516) LO1-6050. P&A: \$300 to \$750; stock.

A new booster automatically and economically protects computers, environmental test equipment, control panels and instruments from malfunction or damage due to low line voltage. The Auto-Boost automatically boosts line voltage 10% whenever the line voltage drops approximately 7% or more below its normal value. Switch-over time is under 15 ms.

Booth No. 2115 Circle No. 259

ATTENTION  
**COMPUTER,  
 COMMUNICATIONS  
 & ALLIED INDUSTRIES...**



"LC DIP"  
 World's Smallest  
 Dual-in-Line  
 14 Pin Tapped  
 Delay Line



**SPIRADEL®**  
 Most Compact  
 Highest Time  
 Delay to Rise  
 Time Ratio in  
 Distributed  
 Lines

**SEE THE WORLD'S  
 MOST ADVANCED  
 DELAY LINES  
 AT WESCON  
 BOOTH 2504**



**MINI-SPIRADEL**  
 The World's  
 Lowest Cost  
 Dual-in-Line  
 Delay Line

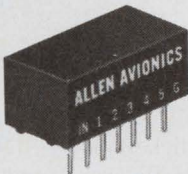

"DIP 5"  
 New Low Cost Dual-in-Line  
 Delay Line with  
 5 Tapped Delay Increments

**ALL ITEMS SHOWN ACTUAL SIZE**  
 (with exception of Standard Spiradel)

**WRITE FOR CATALOG  
 SEE OUR PAGES IN EEM**

**ALLEN AVIONICS, INC.**  
 MFR. OF FILTERS & DELAY LINES  
 224 E. 2nd St., MINEOLA, N. Y. 11501  
 PHONE: 516-248-8080

INFORMATION RETRIEVAL NUMBER 138

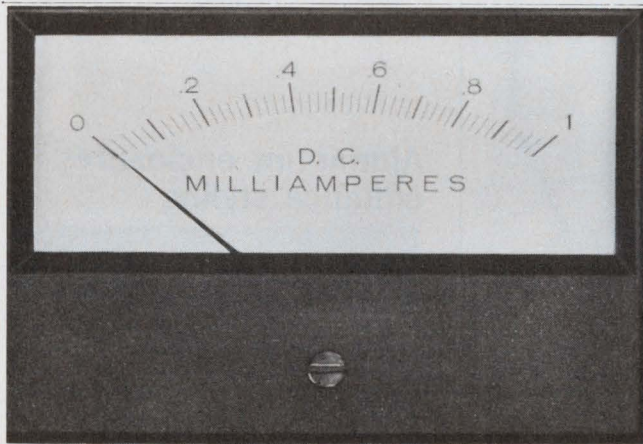

**The newest in panel meters**

from **Hoyt** MODEL NO. **2135**

- Modern blend of bakelite and glass
- Smooth satin finish
- Rugged case — no plastic
- Long wide scale
- Fast two stud mount
- Available with complete line of movements



Write or phone for complete quotation and specifications.  
**HOYT ELECTRICAL INSTRUMENT WORKS, INC.**  
 BURTON-ROGERS COMPANY Sales Division  
 556 TRAPELO ROAD · BELMONT, MASSACHUSETTS 02179 · (617) 489-1520

INFORMATION RETRIEVAL NUMBER 146

ELECTRONIC DESIGN 17, August 16, 1971

# This transceiver case had to be:

**Deep drawn, Shaped,  
 Pierced, Lanced,  
 Louvered, Debossed,  
 Spot welded,  
 Texture painted.**

Transceiver cases are used for the installation of transmitter-receiver units in police vehicles.

AMALCO designed and engineered it, made the necessary tools and dies and produced it from blank to the finished product all in our own plant. . . . and, we delivered it on schedule.

Besides the techniques required by the transceiver case we also do:

- Testing • Hydroforming • Spinning • Stamping
- Brake Fabrication • Heliarc, Spot and Stud Welding • Riveting • Heat Treating • Anodizing

. . . and we have our own prototype shop, too. If you have a fabrication problem, no matter how complex or how tight the specs, call Bill Lowry collect at (201) 233-3500.



**Manufacturers of Aluminum Products  
 for Industry Since 1910.**

**AMALCO**

**AMERICAN ALUMINUM COMPANY**

**230 SHEFFIELD ST., MOUNTAINSIDE, N. J. 07092**

INFORMATION RETRIEVAL NUMBER 139

**This  
Sweet  
MICROVOLT  
MULTIMETER** is  
**SENSITIVE to  $1\mu\text{V}$ ,  
STABLE within  $2\mu\text{V}/\text{day}$   
and easy on the budget at  
\$545**

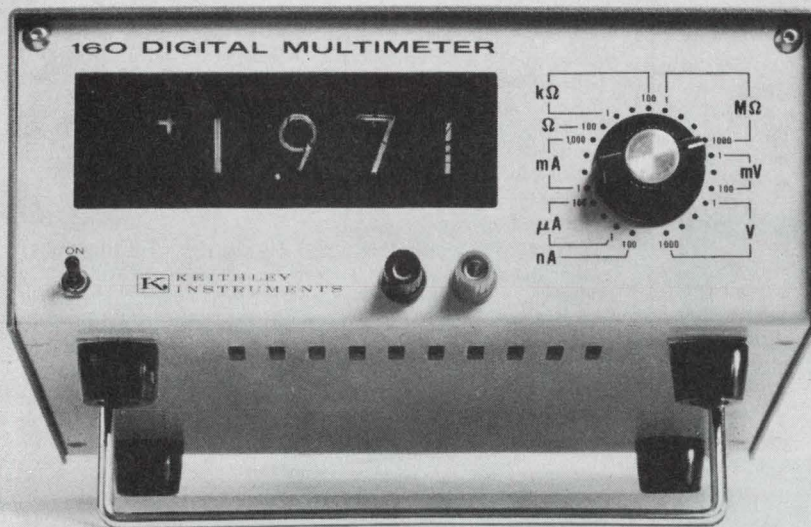

Users call it "the-how-sweet-it-is-meter".  
But it's really the Model 160 that . . .

- MEASURES WITH DIGITAL ACCURACY
  - Voltage** —  $1\mu\text{V}$  to 1000V
  - Current** — 0.1 nA to 2A
  - Resistance** —  $0.1\Omega$  to 2000 M $\Omega$
- 100% OVERRANGING
- ANALOG and OPTIONAL BCD OUTPUT
- MANY MORE SWEET PERFORMANCE FEATURES

**SEND FOR FULL DETAILS AND YOUR FREE "HOW SWEET IT IS" BUTTON**



**KEITHLEY  
INSTRUMENTS**

U. S. A.: 28775 Aurora Road, Cleveland, Ohio 44139  
Europe: 14, Ave. Villardin, 1009 Pully, Suisse

## PACKAGING & MATERIALS

### Lids for packages withstand 100 psi

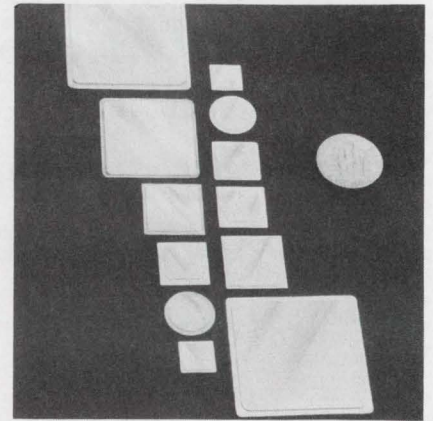

*Solid State Equipment Corp.,  
Philadelphia, Pa. Phone: (215)  
844-3501.*

Self-locating, UNiLIDS package lids withstand pressures of up to 100 psi without oil canning. Available in gold or nickel plate, UNiLIDS are supplied flat and remain flat, thus insuring extremely high yields of hermetically sealed parts. This important feature comes about because mechanical stresses are not induced into the lid by the manufacturing process.

*Booth No. 1423 Circle No. 269.*

### Aluminum enclosures enhance styling

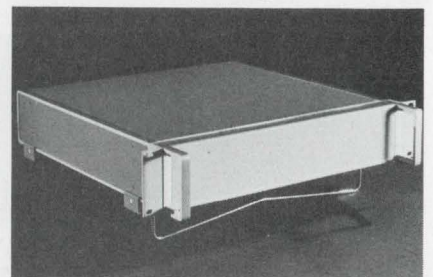

*Honeywell, Inc., Modu-Mount  
Group, 222 Bond St., Wabash, Ind.  
Phone: (219) 563-2161.*

New Styleline enclosures are designed for rack-mounting or free standing. An integral stand tilts the enclosures at an angle for easy viewing. Frame members are of cast aluminum to combine strength with light weight and frame sides extend forward to become carrying handles. For additional rigidity, the front, back, top, bottom and side panels are made of aluminum.

*Booth No. 1227 Circle No. 262*

## Transistor socket twist-locks in place

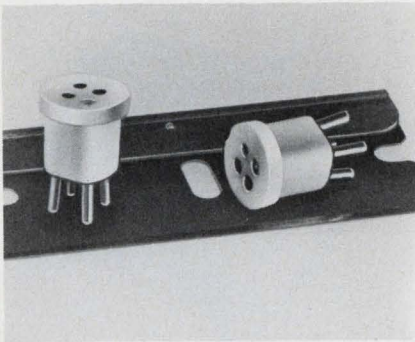

Sealectro Corp., 225 Hoyt St., Mamaroneck, N.Y. Phone: (914) 698-5600.

A new concept in socket mounting is displayed by a transistor and IC socket that is designed to accept standard TO-5 and TO-18 packages. Socket No. 027-1706 is designed for use in D-flat holes. The 1/4-turn socket is merely dropped through the mounting hole and is turned 90 degrees by a tool. Reversal of this procedure facilitates its removal.

Booth No. 1609 Circle No. 270

## Compact heat gun weighs only 18 oz.



Ungar, Div. of Eldon Industries, Inc. 233 E. Manville, Compton, Calif. Phone: (213) 774-5950. Availability: stock.

The 6955 Princess heat gun is a light-weight (18 oz.) unit with positive heat control. Its airstream width at the nozzle is 3/8 in. and it also includes a reducing baffle which reduces the air stream to 0.2 in. The heat gun delivers an air flow temperature at the nozzle of approximately 750 to 800°F in seconds.

Booth No. 1532 Circle No. 268

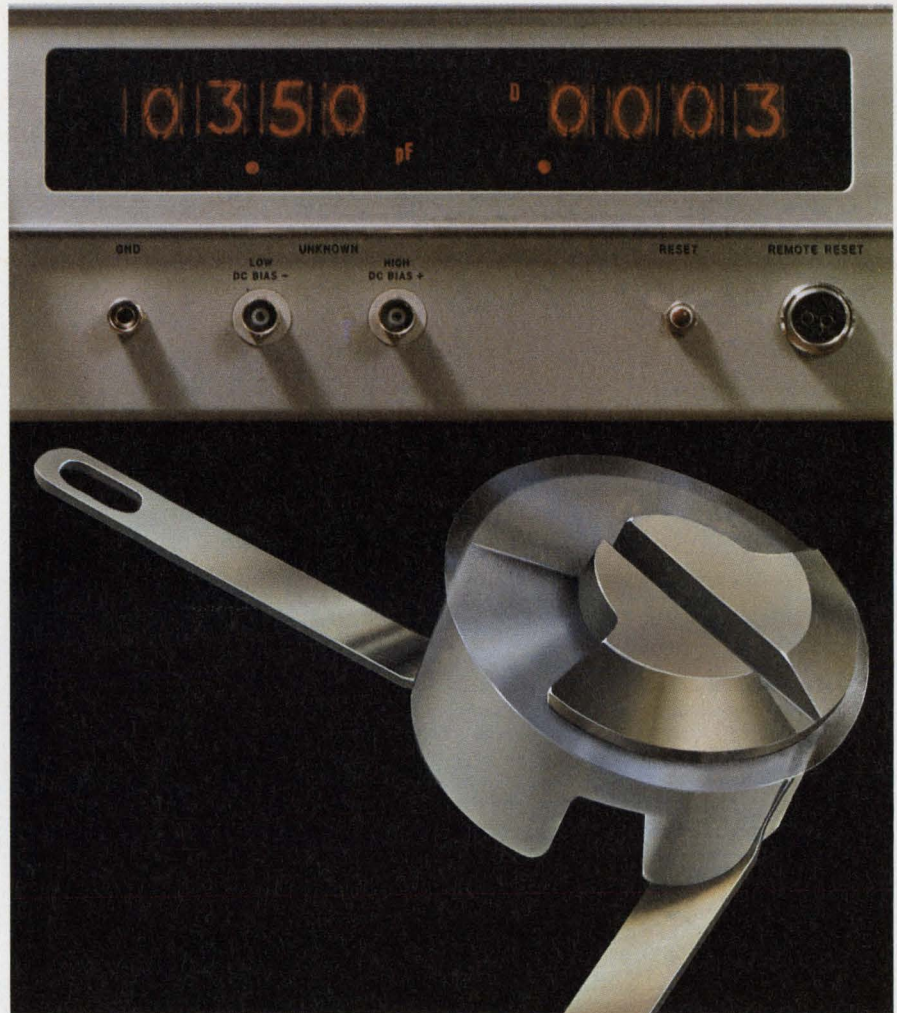

## Teflon\* gives you capacity to save a lot of money!

1.1 to 3.5 is a fairly narrow capacity range. But many applications fall within it.

And within that range, our new Teflon dielectric trimmer capacitors are every bit as reliable as capacitors costing a lot more money. So it makes sense to design with them in mind.

We make them for both stripline and PC mounting. And we make them miniature—just 0.250" diameter. With Q typically 2500 at 1MHz and temperature characteristics like these:

Max. % Capacitance Change from value at 25°C.

-55°C		+85°C		+125°C		
Max.	Min.	Max.	Min.	Max.	Min.	
+3.0	-0.5	+1.0	-3.0	0	-5.0	

Worth looking into? All it costs is a stamp.

\*Registered trademark of DuPont.

E. F. JOHNSON COMPANY / 3009 Tenth Ave. S.W. / Waseca, Minn. 56093  
Please send technical information and test samples of your new low-cost Teflon dielectric trimmer capacitors.

NAME \_\_\_\_\_

FIRM \_\_\_\_\_

TITLE \_\_\_\_\_

ADDRESS \_\_\_\_\_

CITY \_\_\_\_\_

STATE \_\_\_\_\_

ZIP \_\_\_\_\_



**E. F. JOHNSON COMPANY**

INFORMATION RETRIEVAL NUMBER 141

*regulates  
to 150 watts...*

New Ledex LMR-4  
thick film voltage regulator

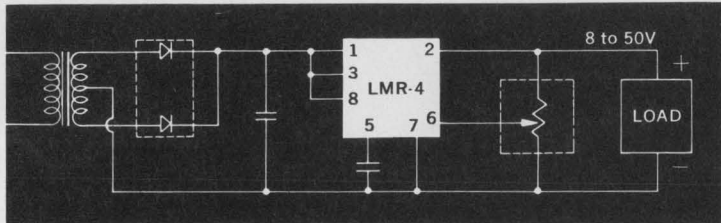

Typical application and connection diagram. Also available with built-in rectification and pre-set output voltage from 8 to 50 VDC.

**Typical Specifications ( $T_A = 25^\circ\text{C}$ )**

Parameter	Typical	Maximum
Input voltage	—	60V
Output voltage	8 to 50V	
Load current	1 amp	3 amp
Line regulation, basic mode	0.02%	0.2%
Load regulation, basic mode	0.2%	0.5%
Power dissipation	10 watts	25 watts

Here's a 1 ampere precision regulator with a 0.02% load regulation tolerance. You can go all the way up to 25 amperes with it by simply adding pass transistors... and still hold a respectable 2% variation.

The new LMR-4 comes with a built-in FET current source, so you get excellent ripple rejection (40 db minimum). And you can put your whole regulator circuit on one tiny board, because its design simplicity lets you get by with small and inexpensive capacitors.

Maybe you already know Ledex as the company with the positioning and switching technology people. We're also the people to see when it comes to blending microelectronic miniaturization and low logic levels with the higher current and voltage levels you need to drive electromechanical products.

For more information on Ledex standard and custom pulsers, drivers and regulators, ask for Catalog E-6000. Or, give us a call and let's talk about your application.

**LEDEX** *the total technology people*

**LEDEX INC.**  
123 Webster Street  
Dayton, Ohio 45401  
(513) 224-9891

**POSITIONING • SWITCHING • MICROELECTRONICS**

COMPONENTS

**Dc stepper doubles as ac synchronous motor**

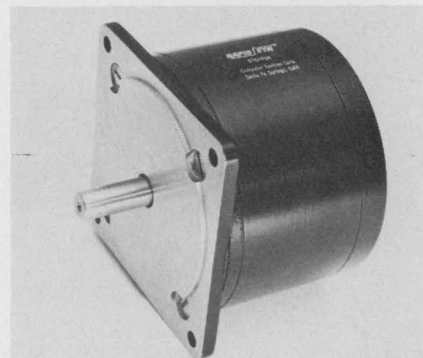

Computer Devices Corp., 11925  
Burke St., Santa Fe Springs,  
Calif. Phone: (213) 698-2595

The Rapid-Syn 34 high-temperature motor doubles as a 1.8-degree dc stepper and a 72-rpm ac synchronous motor. As a stepper, it is capable of 200 oz-in. of stall torque with 2 phases excited at 0.85 A/phase. As an ac synchronous motor, it can provide 100 oz-in. at 72 rpm for a 60-Hz input or 120 oz-in. at 60 rpm for a 50-Hz input, without internal or external gear reduction.  
Booth No. 1227 Circle No. 292

**Compact, tapped delay line comes in a DIP**

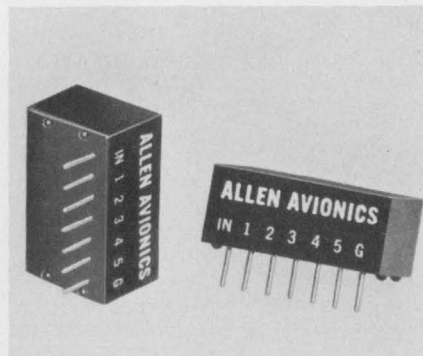

Allen Avionics, Inc., 224 E. 2nd  
St., Mineola, N.Y. Phone: (516)  
248-8080. Availability; stock.

DIP 5 is a low-cost lumped constant delay line that offers five tapped increments of delay. Measuring only 0.8 by 0.345 in., it is designed for DIP packaging. Standard units are available in 100, 500 and 1000-Ω impedances in a range of time delays from 10 to 1000 ns.

Booth No. 2504 Circle No. 287

## 35-ns bipolar ROMs pack 4096/2048 bits

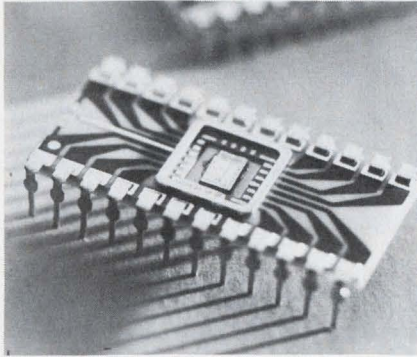

Signetics Memory Systems, 740 Kifer Rd., Sunnyvale, Calif. Phone: (408) 739-7101. Price: \$29.50, \$16.40 (100 quantities).

Two new high-density bipolar ROMs are the 8205, 4096-bit unit which is organized as 512 by 8 and the 8204 2048-bit unit, organized as 256 by 8. Both have 35-ns access times. A unique feature of the new ROMs is the integration of the output data register into the memory element which eliminates the need for eight external latches.

Booth No. 1712 Circle No. 254

## Mercury reed relay works in any position

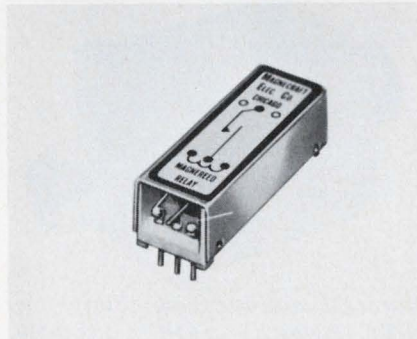

Magnecraft Electric Co., 5575 Lynch Ave., Chicago, Ill. Phone: (312) 282-5500. Availability: stock.

Switching with a mercury-wetted reed relay can now be done in any position with a new Class 137M unit. The relay is available in either a low-profile, PC-mounting package, or an in-line, axial-lead model. Outside dimensions are 1-1/8 by 1/2 by 13/32 in. (PC version) and 2-1/4 by 1/2 by 7/16 in. (axial-lead type).

Booth No. 2230 Circle No. 253

# Nytronics Inductors. Nytronics Capacitors. Off-The-Shelf Service.

## Just one big, happy sub-miniature family.

### If you buy Nytronics inductors, you should know about our little capacitors,

because we're getting to be pretty big in the capacitor field, with an extremely wide variety of film, paper, tantalum and ceramic units for commercial, industrial and military applications. Capacitance ranges are available from 5,000  $\mu$ f at 15 volts to 4.7 pf at 200 volts in sizes down to sub-miniature chips.

And the same precision construction and rigid quality that have made Nytronics inductors the industry standard go into our capacitors as well. Next time you call for Nytronics inductors, ask to see samples of Nytronics capacitors in the sizes and types you use. We're sure you'll be pleased.

### If you buy Nytronics capacitors, you should know about our little inductors,

because Nytronics is one of the nation's largest suppliers of miniature RF inductors. We offer MIL-Spec shielded, unshielded, chip and variable inductors in hundreds of off-the-shelf stock values with inductance ranges from .025  $\mu$ H to 12H and sizes ranging from the world's smallest shielded inductor to the most complex variable inductors. And Nytronics maintains rigid in-line quality assurance systems to meet or exceed the most demanding industrial and MIL-Spec requirements.

Whatever your capacitor or inductor requirements, it will be worth your while to check with Nytronics or our Local Distributor.



Orange Street, Darlington, S.C. 29532 • (803) 393-5421 • TWX 810-665-2182

**How  
you profit  
from our**

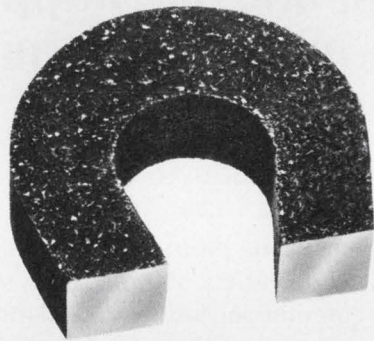

**APTITUDE**

Magnetics has been a special talent of ours for more than two decades. The devices and systems to magnetize, demagnetize, stabilize, measure—in the lab, in production, in the product—we have consistently engineered the most complete line available anywhere. And the top-value line.

RFL's gaussmeters cover every requirement—from the low cost and portability of the Model 505, to the unparalleled precision of the 3265. Then there's the 101 flux-gate type Magnetometer for measuring extremely low level flux densities... five different types of Magnet chargers for every requirement ranging from the economical, rugged 107A Magnet Charger to the Model 942 that takes on *any* shape or type of permanent magnet... the Magnetreater® for precisely controlled stabilization... and many more. Where needed, we can integrate standard RFL equipment to make a custom system, too.

**Write or phone for our 16 page catalog of  
Magnetics Instruments and Systems.  
Descriptions, specs, prices.**



**RFL Industries, Inc.**

Instrumentation Division • Boonton, New Jersey 07005

Tel: 201-334-3100/TWX: 710-987-8352/CABLE: RADAIRCO, N.J.

See us at Booth 1342

**MICROWAVES & LASERS**

**TO-46, IR, LED trio  
rate up to 6.7 mW**

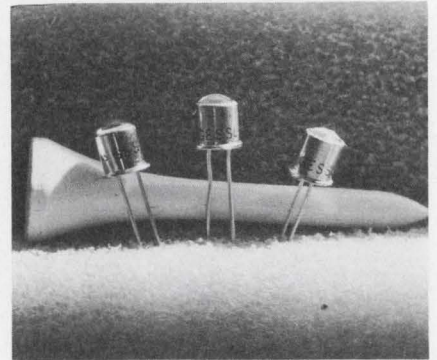

*General Electric Co., Miniature Lamp Dept., Cleveland, Ohio. Phone: (216) 266-2258. P&A: \$3.14, \$5.82, \$6.51; August, 1971.*

Three new TO-46 IR LEDs are the SSL-54, SSL-55B, and SSL-55C with typical ratings of 1.0, 4.8 and 6.0 mW, respectively. The narrow beam of the new GaAs lens-ended units contains about 50% of the total IR energy produced, nearly doubling the useful energy generated by other LEDs. The new lamps are ideally suited for use in mark-sense applications.

*Booth No. 2308      Circle No. 250*

**Small power monitors  
span 10 MHz to 12.4 GHz**

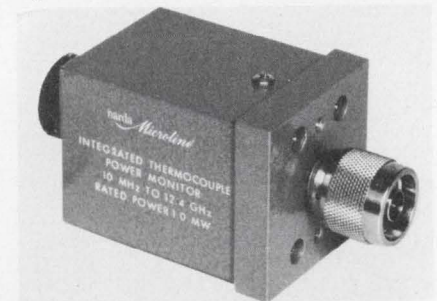

*Narda Microwave Corp., Plainview, N.Y. Phone: (516) 433-9000. Price: see text.*

New broadband 20 and 30-dB integrated thermocouple power monitors provide monitoring over 10 MHz to 12.4 GHz. These compact monitors are smaller in size and weigh less than previous models and utilize a thermocouple sensing element and op amp to provide a high level dc output. The 30-dB models 460 through 462 cost \$275 each. The 20-dB models 464 through 466 cost \$225 each.

*Booth No. 1252      Circle No. 251*



# CHUKYO ELECTRIC...MORE FOR LESS

Automatic Sorting Equipment and Assembling Machines

## High Speed Capacitor Sorters

CS-1, CS-2 for film and ceramics  
CS-2E for electrolytic capacitors  
CS-2ES for automatic aging and sorting  
of electrolytic capacitors

## Assembling Machines

Chukyo Electric manufactures equipment for several kinds of assembly work. Automobile parts, lamp bases, crossbar telephone switches, magnetic switch cores are just a few examples.

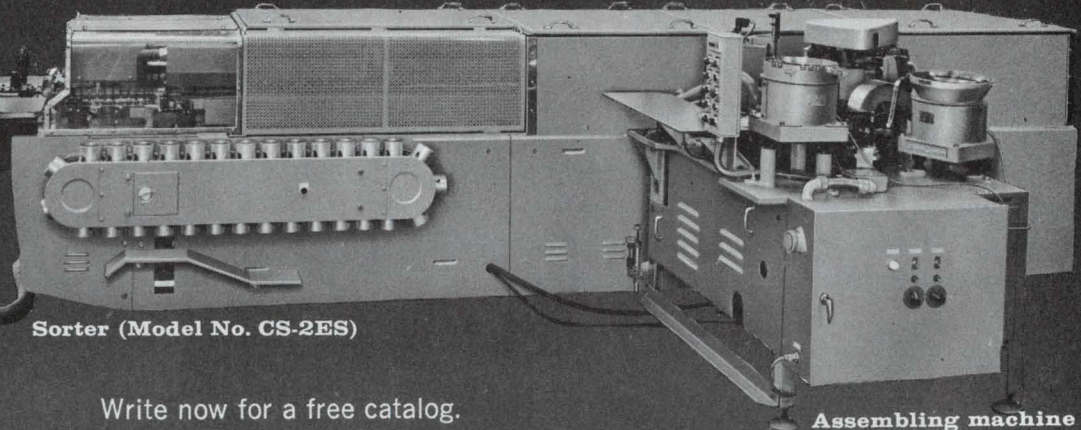
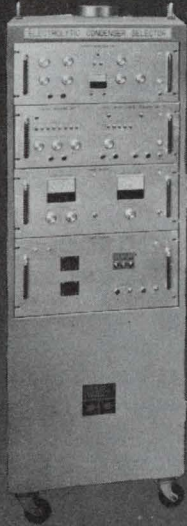

Sorter (Model No. CS-2ES)

Assembling machine

Write now for a free catalog.

### NEW YORK OFFICE

155 East, 55th Street, Suite 6G-H  
New York, N.Y. 10022  
Tel.: (212) 758-7762 Telex: 232930 NIP1

# CKD

### CHUKYO ELECTRIC CO.,LTD.

Overseas Depts.  
Tokyo: Meiho Building, 1-21-1,  
Nishi-shinjuku, Shinjuku,  
Tokyo 160,

Nagoya: 3-15, Shimohirocho,  
Nakamura-ku,  
Nagoya 450, Japan.

INFORMATION RETRIEVAL NUMBER 145

## Put precision into your direct mail program.

BY INDUSTRY

BY PRODUCT SPECIFIERS

BY SIC

BY TITLE

BY FUNCTION

BY DEPARTMENT ACTIVITY

BY STATE OR ZIP

KEY  
PROSPECTS

Electronic Design enables you to select your prospects by all sorts of parameters or combinations. Available are over 74,000 OEM engineers and engineering managers known to be currently working ...currently in a position to specify and recommend. Your direct mail program is no better than your mailing list. There are

no better lists available to reach OEM specifiers than those of Electronic Design. Call or write the Direct Mail Manager with your needs. A list will be tailor-made for you.

**Electronic Design,**  
50 Essex Street, Rochelle Park, N.J. 07662  
(201) 843-0550

# OPPORTUNITY

## FOR PROJECT DEVELOPMENT SOFTWARE DESIGN SYSTEM EVALUATION

**EXPANSION WITH STABILITY . . .** GTE Automatic Electric Laboratories is a leading innovator of electronic communication systems and the largest producer of switching equipment for the independent telephone industry. Telephone communications are growing at a fantastic rate. The number of GTE Automatic Electric plants have more than doubled in the past five years. Within the next ten years we must double our production of existing and new equipment just to meet current demands.

If you are experienced in any of several of the following positions consider joining a team of dedicated engineers who are in the process of developing systems as critical as those which sent a man to the moon and back.

**PROJECT DEVELOPMENT SPECIALISTS . . .** Responsible within a project group for system specification and definition of software organization for a small to intermediate computer controlled electronic system. BS/MSEE with 5 or more years experience in programming and real time systems and knowledgeable of hardware and software design. PCM design experience helpful.

. . . Responsible for assisting in formulating a computer controlled system structure, performing network analysis, system real-time capacity studies and evaluating hardware/software trade-offs. BS/MSEE or Computer Science with 7 or more years experience in the design and specification of stored program switching systems.

**APPLICATIONS SOFTWARE DESIGNERS . . .** Responsible for the development of call processing software for a computer controlled electronic switching system. BS/MSEE or Computer Science with 2 or more years software design (programming) experience in telecommunications or data systems.

. . . Responsible for the planning and specifications of real-time call processing programs for a computer controlled electronic switching system. BS/MSEE or Computer Science with 2 or more years software design (programming) experience in telecommunications or data systems.

**SYSTEM EVALUATION ENGINEERS . . .** Responsible for the evaluation, testing utility program generation of a computer controlled, electronic switching system prototype. Field testing and evaluation of first several field models. Minimal travel. BSEE or Computer Science with one or more years experience in program or hardware debugging or field engineering for telephone or computer manufacture.

**MAINTENANCE SOFTWARE DESIGNERS . . .** Responsible for specification and design of maintenance plan and maintenance software for computer controlled electronic switching systems. Will help lead the design and implementation of fault recovery and diagnostic programs in addition to interfacing with hardware designers and other programming groups. BS/MSEE or Computer Science with 3 or more years experience in software design of real time control systems and diagnostic program design.

. . . Responsible for design of fault recovery and diagnostic programs for computer controlled hardware of switching systems. BS/MSEE or Computer Science with several years experience in the design of electronic digital hardware using I.C.'s with experience in assembly level programming.

**FIELD SUPPORT ENGINEERS . . .** Responsible for field testing and evaluation of computer controlled electronic switching systems. BSEE with strong knowledge of telephony and several years experience in evaluation and testing of electronic switching systems. Assembly level language programming helpful.

Also, positions are available in Manufacturing for Systems Process Engineers (BSEE) and Test Equipment Designers (BSEE).

**SALARY OPEN!** Salary will be commensurate with experience and qualification. Applicants should submit a detailed resume outlining applicable experience, education, salary history and goals. Resumes will be held in strict confidence. Send to:

Robert Diana, Professional Employment

**GTE AUTOMATIC ELECTRIC LABORATORIES**  
INCORPORATED

A Part of General Telephone & Electronics

400 North Wolf Road

Northlake, Illinois 60164

An Equal Opportunity Employer

## MICROWAVES & LASERS

### Motorized attenuators span dc to 18 GHz

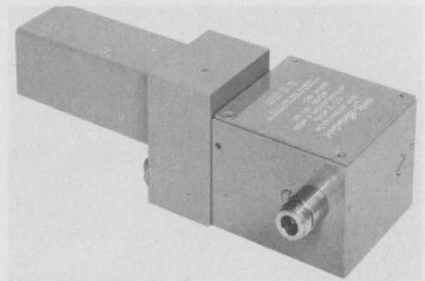

Narda Microwave Corp., Plainview, N.Y. Phone: (516) 433-9000.

New motorized step attenuators are available to cover dc to 18 GHz. A total of 12 units in a choice of single or dual configurations are standard for 0 to 99 dB, and 0 to 90 dB, with a variety of connectors. A unique feature is the attachable motor package. An engineer can originally order a manual style step attenuator, and attach a motor as his requirements change.

Booth No. 1252 Circle No. 260

### VSWR test system provides 60-dB checks

Wiltron Co., 930 E. Meadow Dr., Palo Alto, Calif. Phone: (415) 321-7428. P&A: from \$3240; 4 to 6 wks.

A new transmission and VSWR measuring system for the frequency range of 50 kHz to 12.4 GHz provides 60-dB gain or loss measurements with an accuracy of  $\pm 0.3$  dB +1%. It features resolution under 0.1 dB and return loss measurements from 0 to 40 dB, equivalent to a VSWR range of 1.02 to 20.

Booth No. 1323 Circle No. 261

### Darlington opto-isolator replaces reed relays

Monsanto Electronic Special Products, 10131 Bubb Rd., Cupertino, Calif. Phone: (408) 257-2140. P&A: from \$4.85 (1 to 9); stock.

A new photo-coupled pair is the MCA2 photo-Darlington opto-isolator. The opto-isolator consists of a GaAs planar IR LED optically coupled to a silicon planar photo-Darlington amplifier that functions as a solid-state replacement for reed relays.

Booth No. 2521 Circle No. 290



# I'll tell you something- we're really out to get the modules (even our own).

Our family of linear IC FET op amps is definitely not going to market as just another low priced substitute for something-or-other. Instead they're going as highest performance, in many cases unique, circuits. Some of them are so good they're replacing some of our discrete modules. Other IC's simply can't compete.

Look at the AD-506: Internally compensated; max  $I_b$  10pA; max  $V_{os}$  (internally laser-

trimmed) 1mV; guaranteed  $V_{os}$  drift 25uV/°C; min gain 50K; typical slew rate 5V/usec.

And the AD-516: Single capacitor externally compensated; slew rate to 20V/usec; settling time 3usec to 0.1%; 5MHz gain bandwidth; (with feed-forward compensation: slew rate to 50V/usec, gain bandwidth to 30MHz); max  $I_b$  20pA; max  $V_{os}$  (internally laser-trimmed) 1mV.

There are seven FET op amps in the basic family, all high performance, all functionally complete with little or no need for

outboard components, all manufactured and tested under our complete control using the most advanced techniques and equipment. Same is true of our other new IC's: multipliers, converters, instrumentation amplifiers, and dual transistors.

Get our 20-page facilities brochure and detailed catalog of products, free for the asking. Analog Devices, Inc., Norwood, Mass. 02062 (617) 329-4700.

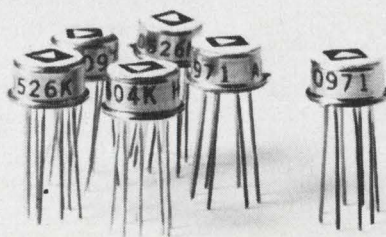

## Ensure error-free MOS IC operation in noisy environments. Here's a design guide for protection circuits, both on and off the chip.

MOS technology and computer-aided design have made custom LSI economically competitive for many applications—such as telephone switching, process control and industrial systems. But these new applications involve environments in which the electrical noise level can be very high. And the inputs of MOS gates are prone to pick up noise easily because of their inherent high impedance.

Protection circuits, both internal and external to the MOS chip, are needed in many systems to minimize the effect of noisy environments and guarantee error-free operation of the MOS components. Here is a guide based on the results of a study of typical four-phase MOS shift registers.

### Switching: the most common source

The most common sources of interference are circuits containing contacts in series with inductive loads. When the current through an inductive load is interrupted, transmission of complex electrostatic and electromagnetic waves takes place. The disturbance is of a transient nature and usually has the form of a damped, high-frequency oscillation. It is field-coupled to conductors of other electronic equipment. The number of errors per second,  $E$ , made by a logic circuit is a function of its distance,  $D$ , from the interfering source. As a general rule, for an environment with little metal work, the error rate is approximately

$$E = 20 (\exp) - 0.25D.$$

In an environment where electrostatic disturbances are generated in a random fashion and their level is unknown, vital MOS circuits, together with their associated components, should be provided with a grounded metal shield.

When MOS circuits are operated in close proximity to relays or other electromagnetic devices, use a magnetic shield in the form of a case made of ferrous material.

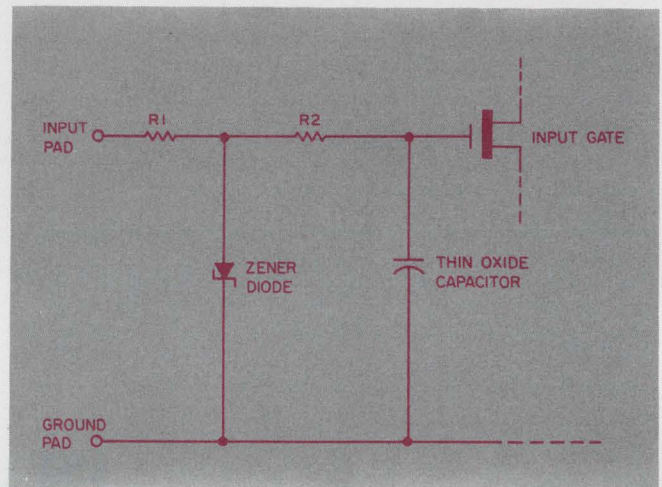

1. A resistor and zener diode within the chip protect the input gate oxide from being destroyed by static charges. An R-C integrator ( $R_2C$ ) following the diode clamp provides added protection.

Wires connected to MOS inputs are prone to pick up unwanted transients, because of the high input impedances of the MOS devices. When a device is driven from a low-impedance source, unwanted signals are in most cases sufficiently attenuated. However, when the driving stage is not directly adjacent to the MOS input in question, the inductive element of the connection reduces the beneficial effect of the low-impedance driving stage.

Inputs receiving signals at a very slow rate can be easily protected. A resistor and zener diode within the chip should be provided for every input to protect the delicate gate oxide from being destroyed by static charges (Fig. 1). If this circuit is followed by a suitable RC integrator, unwanted transients can be reduced further. The resistors are realized in the form of narrow diffusion runs. The capacitor is an aluminum-to-substrate capacitance with a thin oxide (gate oxide) as its dielectric.  $R_2$  and  $C$  act as an integrator and provide increased immunity to dynamic noise pulses.  $R_1$ ,  $R_2$  and  $C$  should be chosen so that wanted signals are passed without appreciable distortion.

This method of protection is particularly rec-

V. T. Hamvas, Project Engineer, PYE-TMC Ltd., New Products Div., London, England.

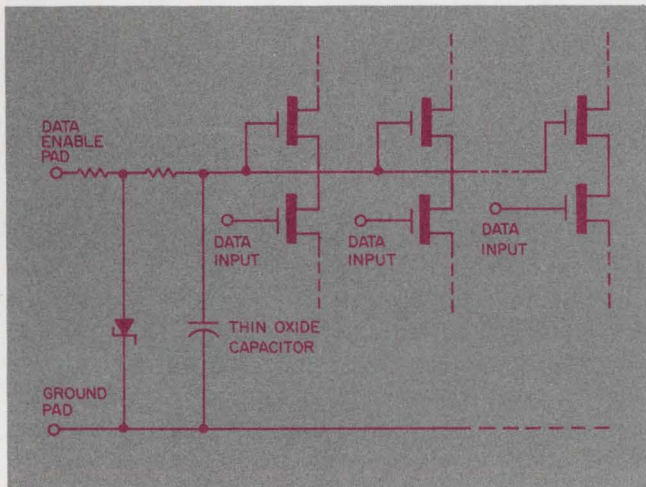

2. Gate the high-speed input lines to prevent transients from entering the logic system. The slower-responding data-enable line acts as an AND function to inhibit signals that may switch the input transistor.

ommended for control inputs, where erroneous data would have drastic consequences. An example of such a case is the "write" command input to an LSI memory. A single error signal in this case would result in destruction of, say, a 500-bit store, which for most applications would be a lot more serious than a simple bit error.

For high-speed inputs, the problem cannot be overcome so easily. The only recommendation that can be made is to feed the inputs from a low-impedance driver situated as close as possible to the driven input. In general, avoid fast data transfer to and from a MOS chip. At the design stage consider trading extra hardware, higher switching rates within chips, etc., to reduce data-transfer rates.

Whenever possible on custom circuits use a resistor, zener diode and RC input protection arrangement internal to the chip.

When fast flow of data into the MOS chip is required, it is not possible to integrate the input waveform. If such an input is used only from time to time (data entry inputs to a long-term memory for example) use a mutual inhibit input to a number of data inputs (Fig. 2). The inhibit input can be sufficiently protected by an inte-

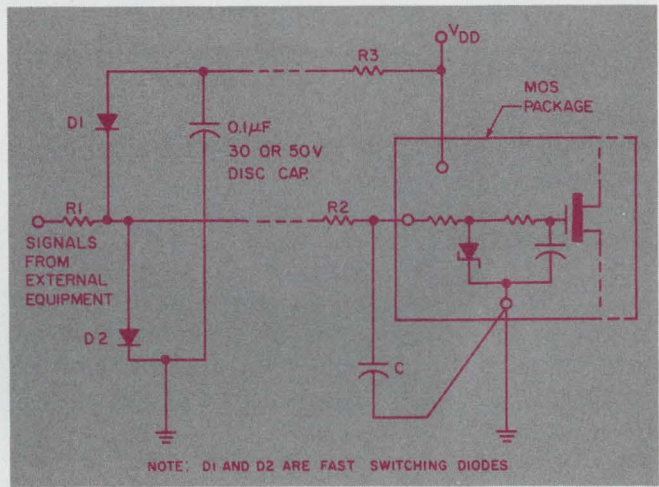

3. Suppress large transients at their source. Diodes  $D_1$  and  $D_2$  limit the signal amplitudes between  $V_{DD}$  and ground. With this arrangement, the long data transfer lines will transmit less interference.

grator. Once the gate is open—and only when it is open—it will permit signals from other inputs to enter the chip. The data inputs can still have a fast response.

### Beware of power-line noise

Unwanted energy can enter the susceptible circuit along conductive paths, such as power lines and signal cables, and even over poor ground lines. Transients, once they have entered the power or clock lines of the MOS system, are likely to be transferred to logic devices. When equipment or power sources are switched onto, or separated from, the distribution bus, transients exceeding 1000 V and lasting for up to about 1  $\mu$ s can be easily generated. It is clear that such surges have to be dealt with external to the MOS chip.

Power required for MOS circuitry can be derived from an already existing dc bus or from the ac line. If, for example, a 50-V dc bus already exists, power can be derived from suitably designed dc/dc converters or simply by dropping the voltage over a resistor and clamping it with a zener diode to a desired supply value.

# THINK DIGITAL

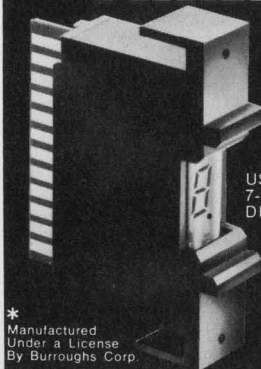

## NEON READOUT DRIVER MODULE

USES ELFIN\*  
7-SEGMENT  
DISPLAY TUBE

**13.62**  
IN 500 LOTS

Factory assembled Elfin readout modules with built-in decoder-drivers are ready to plug into your systems. Choice of decoder-drivers or with memory, counter. Model DM-17G-721

**ALCO**  
LAWRENCE, MASS.

\* Manufactured Under a License By Burroughs Corp.

INFORMATION RETRIEVAL NUMBER 181

## MAGNET REED MINIATURES

Super miniature proximity switch & magnet assembly includes an encased Alnico-5 magnet that actuates the reed switch within .39". Rating @ 50 VDC: 150ma break, 500-ma carry.

NORMALLY OPEN or



NORMALLY CLOSED

## ALCOSWITCH®

DIV. OF ALCO ELECTRONIC PRODUCTS, INC., LAWRENCE, MASS.

INFORMATION RETRIEVAL NUMBER 182

## ROCKER SWITCH

New brilliance in a miniature rocker featuring front panel lamp replacement. Entire switch simply snaps into .655" x .728" hole. Choice of 3 doublepole switching actions; 4 lens colors & 4 voltages. Replaceable lamp. Rated 6A @ 125 VAC.

ILLUMINATED

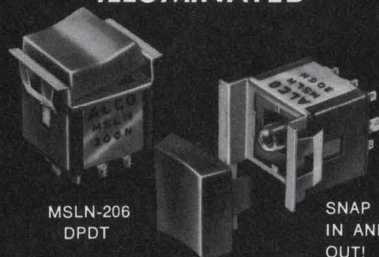

MSLN-206  
DPDT

SNAP  
IN AND  
OUT!

MINIATURE SIZE

## ALCOSWITCH®

DIV. OF ALCO ELECTRONIC PRODUCTS, INC., LAWRENCE, MASS.

INFORMATION RETRIEVAL NUMBER 183

## ALCO LITE OFFERS MORE

Miniature incandescent lamp assemblies have 5V 60 ma. rating, and 100,000-hr. life. Its sealed plastic assembly contains a T-1 #680 lamp. Mounting ring is included. Choice of 5 colors, pins or leads.

## PANEL INDICATORS

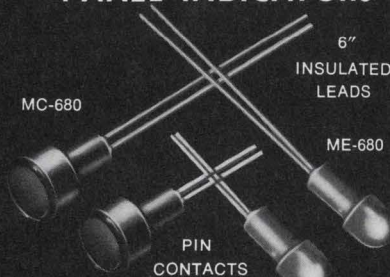

MC-680

6"  
INSULATED  
LEADS

ME-680

PIN  
CONTACTS

## ALCO

ELECTRONIC PRODUCTS, LAWRENCE, MASS.

INFORMATION RETRIEVAL NUMBER 184

The inherent quality of a resistor-zener method is its good immunity against transients. However, care must be taken that the resistor can stand at least a 2000-V surge across it. If no suitable single resistor is available, use a number of resistors connected in series. The zener diode must be able to handle the surge current. The resistor and zener method has the disadvantage of high power dissipation.

For larger MOS systems, consider using a dc/dc converter. The stabilizing mechanism of this converter must operate quickly to minimize the effect of transients present on the shared bus bars. The addition of a zener crowbar and decoupling to the output of the dc/dc converter may be necessary to take care of the remaining transients. Transients on MOS supplies must not exceed  $V_t - s$ , where  $V_t$  is the minimum threshold voltage and  $s$  is the arbitrarily assigned safety margin desired.

It must be remembered that any signal connection from external equipment that is fed from the common bus bar may have the same high level of interference as the bus itself.

Signals should first be clamped by diodes (Fig. 3) limiting their amplitudes between ground and  $V_{DD}$ , then suitably integrated to reduce transients further on. Signals from electromechanical equipment have limited speed—say,  $n$  pulses per second. An RC integrator with a time constant of  $1/20n$  to  $1/50n$  will block short transients without distorting data pulses.

The diode clamp may be situated at the signal source, but the integrator part of the protection circuit must be adjacent to the associated MOS circuit and have short connections to its ground pin and input pin.

Remember that voltage sensitivity of the ground terminal of a chip is equal to the sensitivity of a gate input. The significant difference is that the ground terminal will have a much lower impedance and therefore is less liable to pick up interference.

Nevertheless care must be taken when interconnecting ground terminals of a number of circuits. Circuits switching heavier currents may "pull" the ground terminal of others. The same thing may occur when a number of light-current circuits are switching simultaneously. It is hard to produce set rules, but it is best generally to avoid direct interconnection of ground pins of a power circuit with the ground pins of a sensitive logic circuit. If they are on the same board, use two or more pins on the printed-circuit edge connector to bring out the logic and power ground connections separately. The availability of a logic ground is essential to operate logic circuits reliably in a noisy ambient. If power is derived from the line, a separate line ground should also be provided. ■■

# Everything about this MOS/LSI packaging concept is economical, including our connector. And you can rely on that.

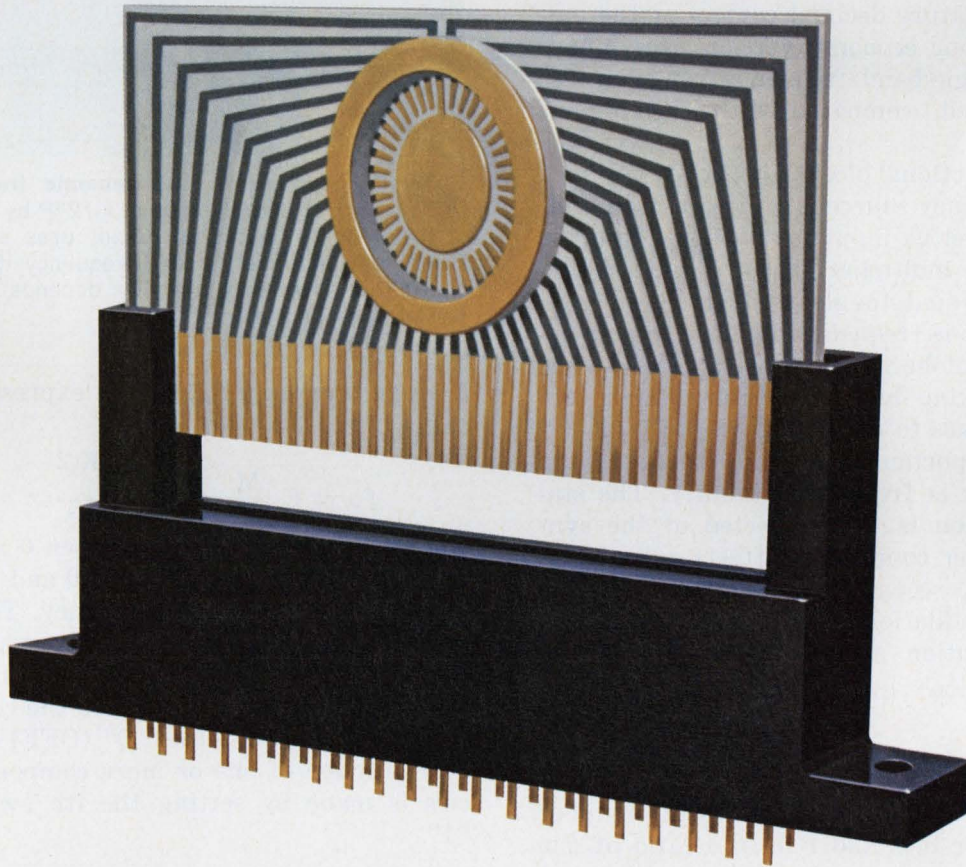

Our edgemount connector is specifically designed to help you take advantage of the economy and flexibility in leadless IC substrate packaging.

You get *all* the substrate advantages: low initial cost, greater packaging density, easy insertion/extraction, quick replaceability. And the low per line cost of our connector matches the package's economy. Now, that's cost savings all the way.

Can you depend on it? Yes. Because our connector is designed to give reliable, uniform contact with every pad across the substrate. In addition, posts are rigidly

molded in the block on .050" staggered centers, with no exposed bent metal.

For specs and information on this connector and new substrate packaging concepts, write:

**AMP Incorporated, Industrial Division,  
Harrisburg, Pa. 17105**

**AMP**  
INCORPORATED

Manufacturing and Direct Sales Facilities in: Australia, Canada, France, Great Britain, Holland, Italy, Japan, Mexico, Puerto Rico, Spain, Sweden, United States and West Germany.

INFORMATION RETRIEVAL NUMBER 40

# An AF synthesizer for less than \$200.

Build it with inexpensive components and only a small sacrifice of bandwidth and convenience.

A simple audio-frequency synthesizer, with frequency stability and accuracy determined by the quality of the crystal oscillator selected, can be put together for a total component cost of less than \$200. That's about one-tenth the price of some commercially available models.

The savings are achieved in part by sacrificing sophistication in switching: where the higher priced models feature decimal control of the output frequency, our economy version uses binary control. The single-band frequency range is also somewhat limited, compared with the higher-priced devices.

The major functional blocks are shown in Fig. 1. The basic frequency source is a crystal oscillator. It furnishes the clock input to an N-bit (12-bit in the system) rate multiplier, whose digits are controlled by individual toggle switches. The rate-multiplier output is frequency-divided from megahertz down to kilohertz and then applied to the input of a tracking bandpass filter, which converts square waves to sinusoids.

The most important factor in choosing the crystal oscillator is frequency stability. The stability specification is that expected of the synthesizer—no other component affects output frequency drift. A second factor is the required frequency of oscillation, which depends on the frequency resolution at the audio level  $f_x$ , as follows:

$$f_x = \frac{f_c}{2^N P}, \quad (1)$$

where  $f_c$  is the clock frequency, N is the number of rate-multiplier bits and P is the ratio of the frequency divider output-to-input frequencies.

Ordinarily it is best to choose the highest crystal-clock frequency consistent with oscillator accuracy-stability requirements and with rate multiplier capability. This permits an increase of the divider ratio, P, for improved filtering.

For a 12-bit rate multiplication, you can use two cascaded 6-bit SN-7497s (see Fig. 2). The rate-multiplier output is a pulse train with an

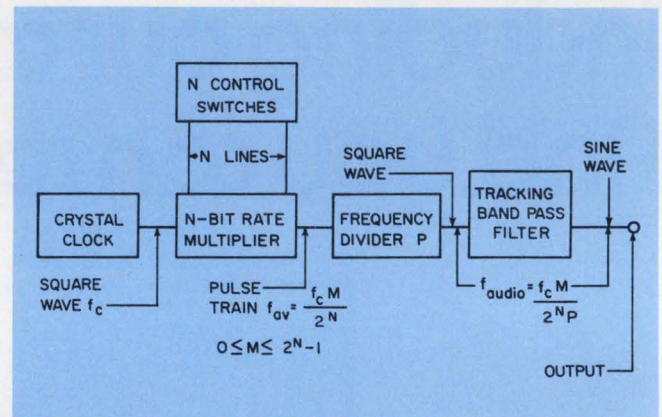

1. This AF synthesizer can generate frequencies from  $f_c(2^N-1)/2^N P$  to zero in steps of  $f_c/2^N P$  by manual control of the switches. A typical circuit uses a 2-MHz clock, 12-bit rate multipliers and a frequency divider ratio, P, of 1000:1. Frequency stability depends totally on the crystal-clock oscillator.

average frequency  $f_{av}$ , that is expressed as

$$f_{AV} = f_c \frac{M}{2^N} = f_c \frac{\sum_{i=0}^{11} K_i 2^i}{2^{12}}, \quad (2)$$

where M is any number between 0 and 4095 and  $f_{AV}$  may be anywhere between 0 and  $(2^N-1)/2^N = 4095/4096$  of the clock frequency. The resolution is  $f_c/2^N$ , and the averaging interval may be as long as the period corresponding to the frequency resolution. The  $K_i$  of Eq. 2 are the coefficients of the individual bits, either "0" (OFF) or "1" (ON). The selection of one or more component frequencies is made by setting the *i*th switch to logic "1".

## Frequency-divide to filter the pulse train

The pulse train is characterized by uneven spacing, except in cases where only one digit frequency is enabled. This irregularity can be mitigated to a great degree by frequency division, provided that the ratio of crystal-clock frequency to the highest desired audio output frequency is sufficiently large.

The frequency divider, a conventional type, is used to smooth out this irregularity. For this pur-

George M. Strauss, Senior Engineer, Kollsman Instrument Corp., Elmhurst, N.Y.



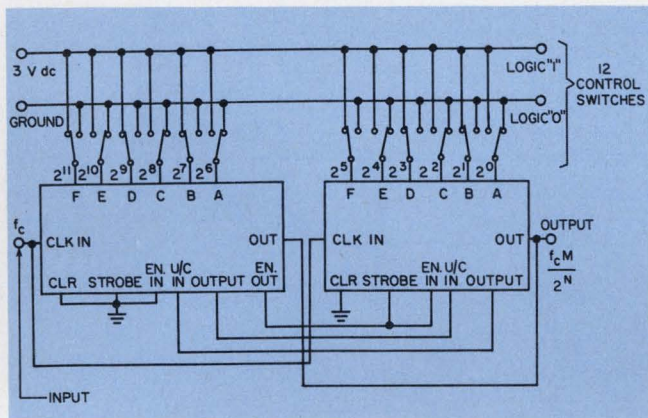

2. The 12-bit rate multiplier is formed by cascading two SN-7497 6-bit rate multipliers. Control of the output pulse-train average frequency,  $f_{AV}$ , involves an individual connection of the toggle switches to logic "1" (ON) or logic "0" (OFF). The output pulse train is generally characterized by uneven spacing.

pose, the divider ratio,  $P$ , should be comparable to the resolution of the rate-multiplier.

In the circuit shown, the clock frequency applied to the 12-bit rate-multiplier is 2 MHz. With a divider ratio,  $P$ , of 1000:1, residual jitter with any combination of bit frequencies appear to be less than half a microsecond.

The required inputs to the tracking bandpass filter are square waves, with a frequency  $f_{audio} = f_c M / 2^N P$  at a phase of  $0^\circ$  and  $90^\circ$ . To obtain these signals, which are formed within the frequency divider, the output at double audio-frequency,  $2f_{audio}$ , is obtained from an independent flip-flop—one not forming part of a feedback-divider path—so that this signal will be available as a 50% duty-cycle square-wave in both polarities  $Q$  and  $\bar{Q}$ . These lines are then applied to individual divider flip-flops, which provide the required quadrature phases.

The operation of the tracking bandpass filter takes advantage of the fact that signal phase shift through the filter at resonance is  $180^\circ$ , and that it changes sign in going through resonance (see Fig. 3). An electronic servo within the tracking bandpass filter uses phase deviations from  $180^\circ$  as the actuating error. Integrated error signals control the resonant frequency of a conven-

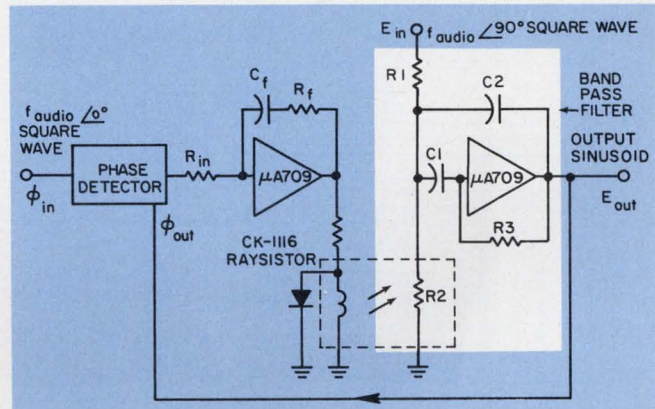

3. The tracking bandpass filter retunes automatically to the input frequency,  $f_{audio}$ . Consisting of a conventional bandpass filter and a filter-control circuit, the filter forces a change in  $f_{audio}$  to appear as a phase error at the phase detector. The error signal alters the filter resonance through the Raysistor.

tional bandpass filter by means of a photosensitive resistor element—the Raysistor CK-1116. Filter tuning to  $f_{audio}$  is automatic.

The Raysistor is a relatively slow element, but rapid dynamic performance is not among the requirements for this type of circuit. The slow response of the photosensitive resistor automatically filters phase-detector ripple without requiring any specific provisions for the purpose.

The phase detector is made up of two opposite-polarity FETs—one in series and one in shunt—with appropriate level-shifting circuits permitting both to be simultaneously controlled by the square-wave signal at  $f_{audio}$ . This type of phase detector produces zero output voltage when the signal input and the switching control voltage are at  $90^\circ$  phase, and it is for this reason that the square-wave at  $f_{audio}$  is provided at  $0^\circ$  and  $90^\circ$  phases.

Otherwise it would be necessary to incorporate an integrator after the filter amplifier, and the amplitude change of such a filter over an appreciable range of frequencies would be detrimental to phase-detector operation. The phase-detector input-output characteristic is nonlinear, but this does not affect matters to any great extent, except during slewing.

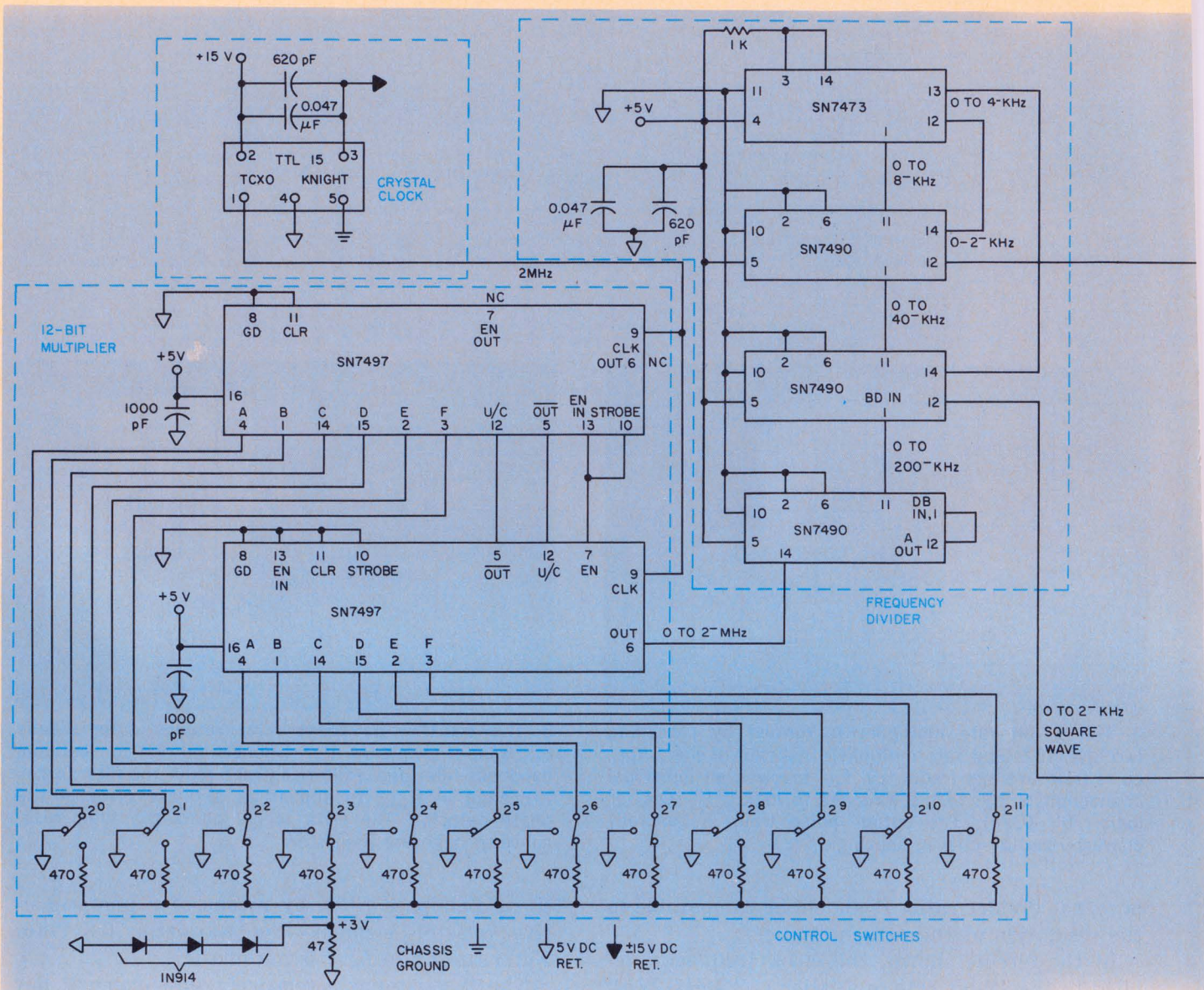

The loop gain varies considerably over the range of frequencies because the voltage sensitivity of the Raysistor element is much higher for low control voltage (high resistance) than at the other end of the range. The presence of the error integrator results in zero steady-state error, and the variability of loop gain appears to affect only the dynamic performance.

Over a small portion of the range, the loop gain may be assumed linear. The phase-detector transfer function is defined as  $K_d$  (volts/radian); the integrator transfer function as  $-G(1 + B/s) = -(R_f/R_{in})(1 + 1/R_f C_f s)$ ; the Raysistor transfer function as  $K_R/(1 + Ts)$  (ohms/volt); and the filter transfer function as  $K_o$  (radians/ohm); where the  $(1 + Ts)$  term in the denominator of the Raysistor transfer function represents its time lag,  $s$  is the Laplace variable and  $T$  is the time constant. Then, the linearized transfer function that is applicable over a small range where the loop gain is linear takes the form

$$\frac{\phi_{out}}{\phi_{in}} \cong \frac{1 + 2\zeta s/\omega_o}{s^2 + \frac{2\zeta s}{\omega_o} + 1} \quad (3)$$

The  $\phi_s$  are the phase inputs to the phase detector, and it is assumed that  $K_d G K_R K_o \gg 1$ . Here the undamped natural frequency of the loop is

$$\omega_o = \sqrt{\frac{K_d G K_R K_o B}{T}} \quad (4)$$

and the damping factor is

$$\zeta \cong \frac{1}{2} \sqrt{\frac{K_d G K_R K_o}{TB}} \quad (5)$$

The bandpass filter itself, which converts the square wave at its input to a sinusoid, is a conventional operational filter, with a transfer function similar to that of an LC tank circuit:

$$\frac{E_{out}}{E_{in}} = \frac{\frac{R_3}{R_1} \frac{C_1}{C_1 + C_2} \frac{s}{Q\omega_n}}{\frac{s^2}{\omega_n^2} + \frac{s}{Q\omega_n} + 1} \quad (6)$$

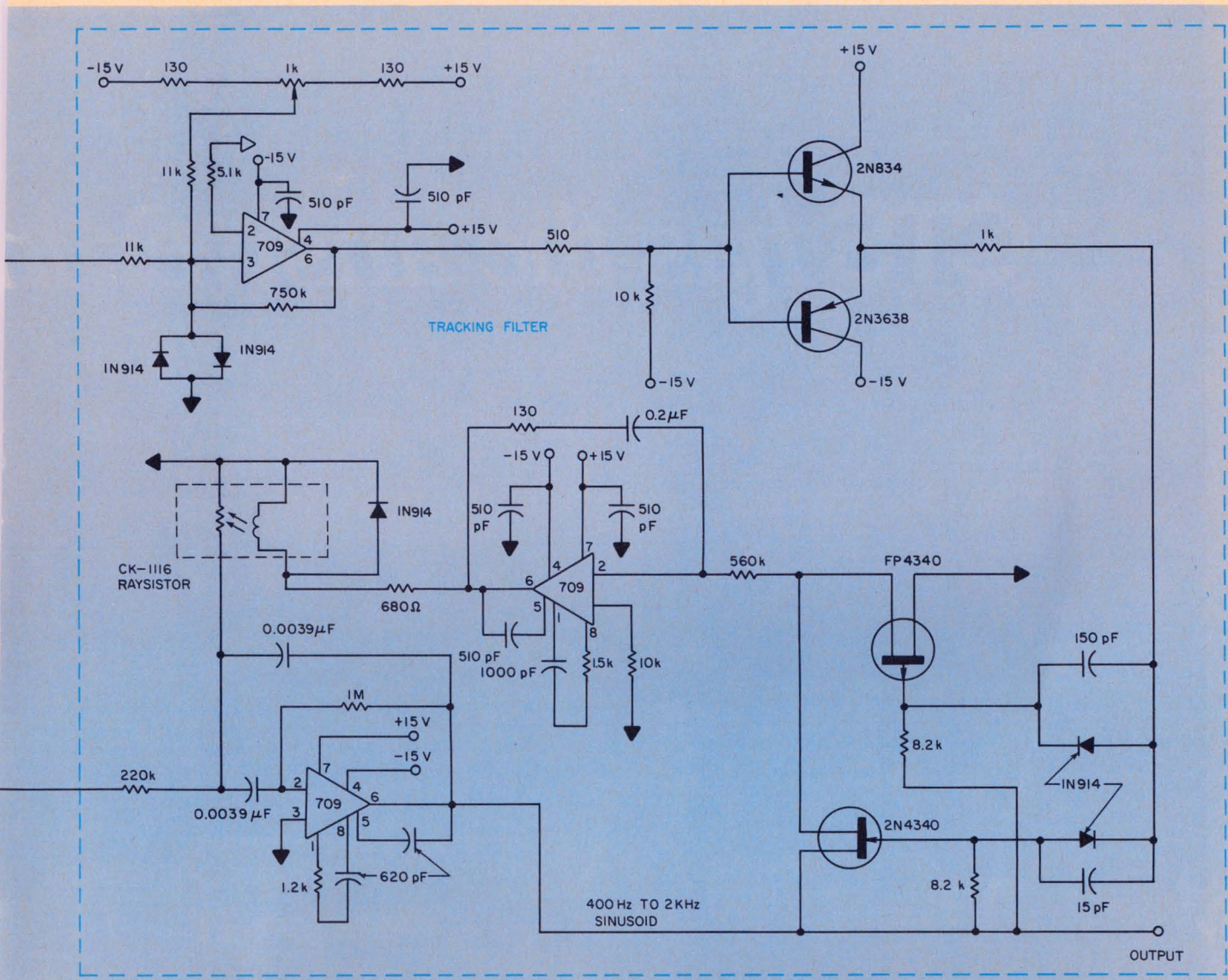

4. The complete AF synthesizer generates sine waves from 400 Hz to 2 kHz using a clock frequency of 2 MHz. Shown in detail is the frequency divider, which smooths out the uneven spacing of the pulse-train output of the 12-bit rate multiplier. Also shown is the phase detector, which is made up of two opposite-polarity FETs and provides the required error signal for the tracking filter.

see now what it takes to put the system together. A complete schematic of the audio-frequency synthesizer, designed to yield sinusoids in the range from 400 Hz to 2 kHz from a 2-MHz oscillator, is shown in Fig. 4.

Among the more expensive components are a crystal oscillator (approximately \$100); two SN-7497 rate multipliers (approximately \$15 apiece); three SN-7490 decade-dividers (approximately \$6 apiece); an SN-7473 dual flip-flop (approximately \$4) and three  $\mu$ A 709 amplifiers (approximately \$3 apiece) plus the usual assortment of diodes, resistors and capacitors. There is no special need for accuracy or stability of these components, since the phase-servo loop around the filter corrects for drift in tuning frequency. ■■

The resonant frequency is

$$\omega_n = \sqrt{\frac{R_1 + R_2}{R_1 R_2 R_3 C_1 C_2}} \quad (7)$$

and the frequency-selectivity factor is

$$Q = \frac{R_1 + R_2}{R_1 R_2 (C_1 + C_2) \omega_n} = \omega_n R_3 C_1 C_2 / (C_1 + C_2) \quad (8)$$

Thus the Q is seen to be proportional to the resonant frequency; the circuit exhibits a constant-bandwidth characteristic. It must, therefore, be so designed that selectivity is adequate at the lower end of the operating frequency range.

Automatic tuning of the filter to  $f_{\text{audio}}$  is achieved by using the photosensitive element of the Raysistor for  $R_2$ . This form of control leaves the circuit Q and the resonant-frequency gain

$$A(\omega_n) = -R_3 C_1 / R_1 (C_1 + C_2) \quad (9)$$

unaffected, and it has the additional advantage that one side of  $R_2$  is at ground.

Up to this point, only individual system blocks and their interfacing have been discussed. Let's

# CTS *has the answer in*

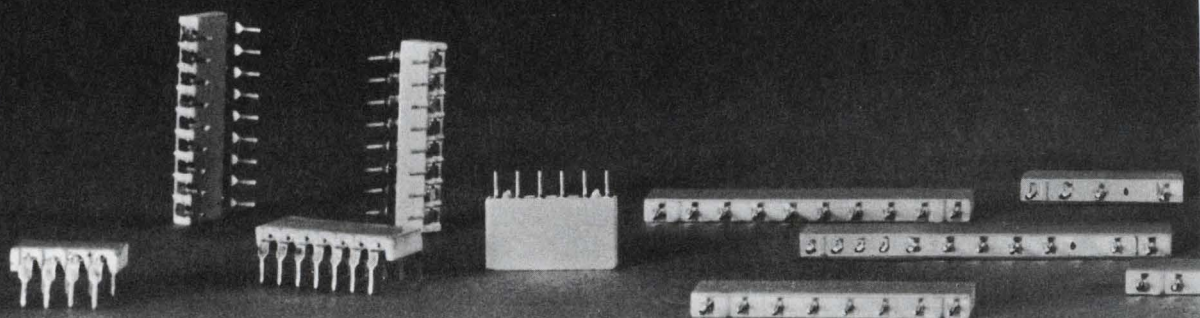

You name it—we have the exact cermet resistor network size and characteristics you need. Here's the choice you get right now: our *750 line* includes: .100" centers with 4, 6 & 8 pins; .125" centers with 2, 4, 6 & 8 pins; and .150" centers with 4 through 13 pins. And we're working on new designs right now!

All compact, extremely stable and highly reliable. Recently we packed even more circuitry into our *760 series*, giving you a choice of four popular space-saver packages: 8, 14, 16 and 18 flat lead styles. Packed with up to 17 resistors per module with flat leads standard (round leads on request).

# cermet resistor networks. So ask us!

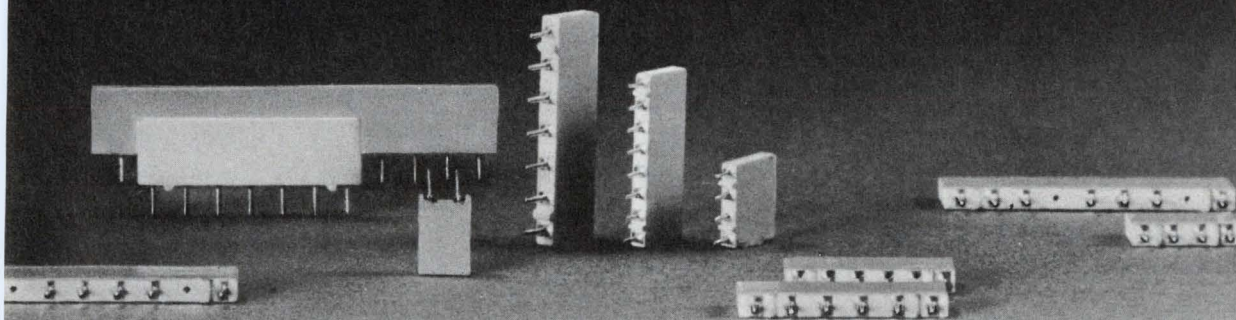

Our broad line provides an infinite number of circuit combinations, all with excellent TC, load and temperature characteristics supported by millions of hours of reliability testing. Ask your CTS sales engineer for data. Or write CTS of Berne, Inc., Berne, Indiana 46711. Phone (219) 589-3111.

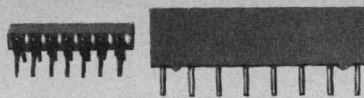

ACTUAL SIZE



**CTS CORPORATION** Elkhart, Indiana

A world leader in cermet and variable resistor technology.

# Prevent polarization fading in microwave systems. How? By electronically modulating the polarization of either the transmitting or receiving antenna.

In many microwave communications systems—particularly those in which the receiving or transmitting antennas, or both, are mounted on moving vehicles—polarization decoupling may cause fading of the received signal. It is often necessary to ensure that this fading does not seriously affect the information-transfer capability of the system.

Typically, this boils down to a requirement that the signal received by an antenna of arbitrary polarization never be more than 3 dB below the signal received when the incident electromagnetic waves have the same polarization as the receiving antenna.

The most common solution is to polarize the transmitted waves circularly (Fig. 1). This makes the system performance independent of rotational displacement of the receiver and/or the transmitter antennas about the line of sight between the two antennas.

This approach, however, runs the risk of being totally ineffective, since the receiving antenna can be orthogonally polarized with respect to the

electromagnetic waves delivered to it by the transmitting antenna.

To see how this can result, it is helpful to look at a Poincare sphere polarization map (Fig. 2). In this map—which has every possible polarization plotted—every pair of diametrically opposite points corresponds to a pair of electromagnetic-wave polarizations that are orthogonal to each other.<sup>1</sup>

Any receiving antenna whose polarization is orthogonal to the polarization of an electromagnetic wave incident upon it will not pick up any power from the incident wave. On the other hand, if the various possible polarizations of the incident wave are defined by a locus on the Poincare sphere which is everywhere one-quarter of the spherical circumference away from the polarization of the receiving antenna, the received power will be 3 dB below the maximum.

Since every point on the Poincare sphere has a corresponding opposite point, it seems impossible to ensure that the receiving antenna is never orthogonally polarized with respect to the waves that are incident upon it. The way to overcome this problem is to change constantly the polarization of either the transmitter or the receiver antenna.

**James M. Flaherty**, Advisory Engineer, Westinghouse Electric Corp., Aerospace and Electrical Systems Div., Friendship International Airport, Baltimore, Md. 21203

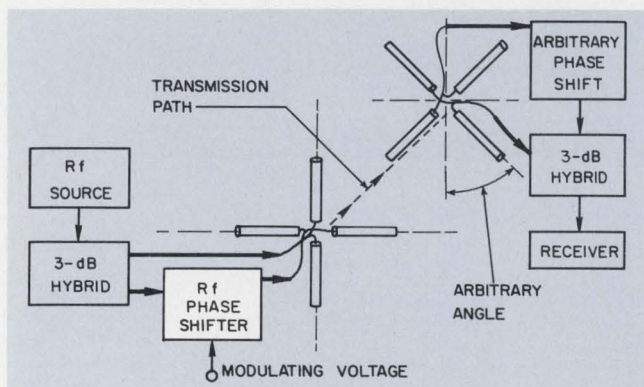

1. Polarization fading is usually attacked by circularly polarizing the transmitted wave. This can be accomplished by setting the rf phase shifter in the transmitter output to 90°. If the modulating voltage is a serrodyne waveform, the polarization will move around circle ABCD on the Poincare sphere of Fig. 2.

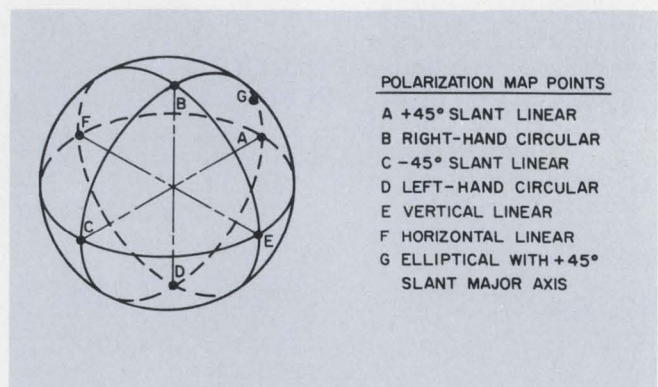

2. All possible polarizations are represented on the surface of this Poincare sphere. Points that are diametrically opposed represent polarizations that are orthogonal to each other. If these points correspond to the polarizations of a transmitter and a receiver, then the receiver will pick up none of the transmitter's power.

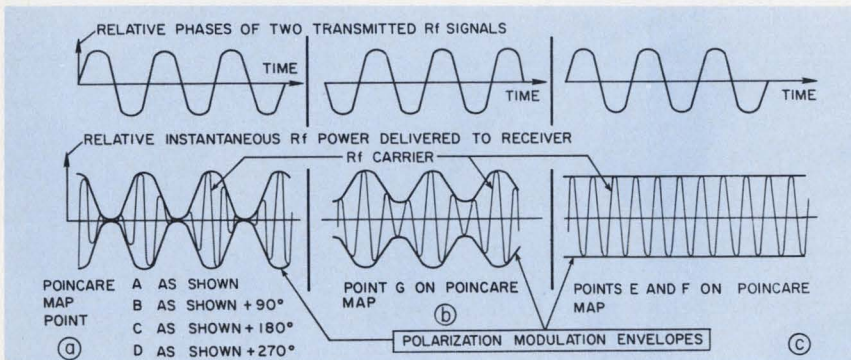

3. Polarization modulation at the transmitter becomes amplitude modulation at the receiver for most receiver polarizations (a,b). The AM is suppressed, however, for certain polarizations of the receiver antenna (c).

Referring back to Fig. 1, suppose that the modulating voltage applied to the rf phase shifter is a serrodyne signal—that is, a sawtooth wave whose linear ramp portion corresponds to exactly  $360^\circ$  of rf phase shift. Then the output of the phase shifter will have a frequency offset,  $\Delta f$ , equal to the serrodyne-signal frequency.

This creates a uniform, continuously increasing phase difference between the two rf signals being radiated. On the Poincare sphere polarization map, this leads to a constantly changing polarization around the locus ABCD at the rate of one cycle around the sphere for each period of the difference frequency,  $\Delta f$ .

This polarization modulation, in turn, leads to an amplitude modulation of the received signal (Fig. 3). If the receiver antenna polarization is defined by points A, B, C or D, then the received signal will have 100% modulation (Fig. 3a). Moving away from those points to, say, point G, cuts down on the amount of modulation (Fig. 3b). And, finally, if the receiver antenna polarization is defined by either points E or F, then the AM disappears completely (Fig. 3c).

To keep this modulation from disturbing the transmission of desired information, the difference frequency should be chosen high enough so

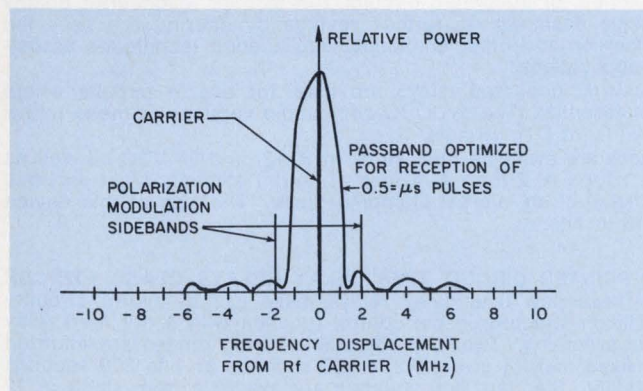

4. For optimum reception of  $0.5\text{-}\mu\text{s}$  pulses, the receiver has a 3-dB bandwidth of 2 MHz. Note that the polarization modulation sidebands, caused by a noisy sine or triangular wave, are symmetrically placed about the carrier. Like a serrodyne waveform, these noisy signals cause the polarization to move along path ABCD.

it is outside the information bandwidth of the system, but not so high that it results in unnecessary spectral spreading of the signal power. For example, if the system information is determined by detecting the presence or absence of  $0.5\text{-}\mu\text{s}$  pulses, we can assume that the receiver half-power bandwidth is 2 MHz. It thus appears that a serrodyne frequency shift of 2 to 4 MHz represents a reasonable compromise between these two conditions (Fig. 4).

For most applications, however, it may be better to use a noisy sine or triangular wave for the phase-modulation voltage. This would create symmetrically disposed sidebands with respect to the carrier frequency, by making the instantaneous polarization of the transmitter pass through points A, B, C and D in the Poincare sphere and then return back through points, D, C, B and A to a somewhat different end point (Fig. 4).

A study of the time-domain signals resulting from the modulation shown in Fig. 3, or the frequency-domain spectrum shown in Fig. 4, reveals that the desired objective of preventing orthogonal polarization fading has been achieved. When the received signal is averaged over any period of time greater than that of the difference frequency,  $\Delta f$ , and is equal to an integral number of the difference frequency periods, the received power is always equal to half the power the receiving antenna would pick up if it had the same polarization as the incident wave. ■■

#### Reference

1. Westman, H. P., editor, *Reference Data for Radio Engineers*, fourth edition, International Telephone and Telegraph Corp., New York, 1956, pp. 666-670.

#### Bibliography

Reed, H. A. and Russell, Carl M., *Ultra-High Frequency Propagation*, Boston Technical Publishers, Inc., Cambridge, Mass., 1966 Reprint, pp. 220-238 and 313-335.

Rumsey, V. H., Deschamps, G. A., Kales, M. L., and Bohnert, J. L., "Techniques for Handling Elliptically Polarized Waves with Special Reference to Antennas," *Proc. IRE*, Vol. 39, May, 1951, pp. 533-552.

Sichach, W. and Nail, J. J., "UHF Omnidirectional Antenna Systems for Large Aircraft," *IRE Trans. Ant & Prop*, January, 1954, pp. 6-15.

Silver, S., editor, *Microwave Antenna Theory and Design*, MIT Radiation Laboratory Series, Vol. 12, Boston Technical Publishers, Lexington, Mass., 1964 reprint, pp. 91-92.

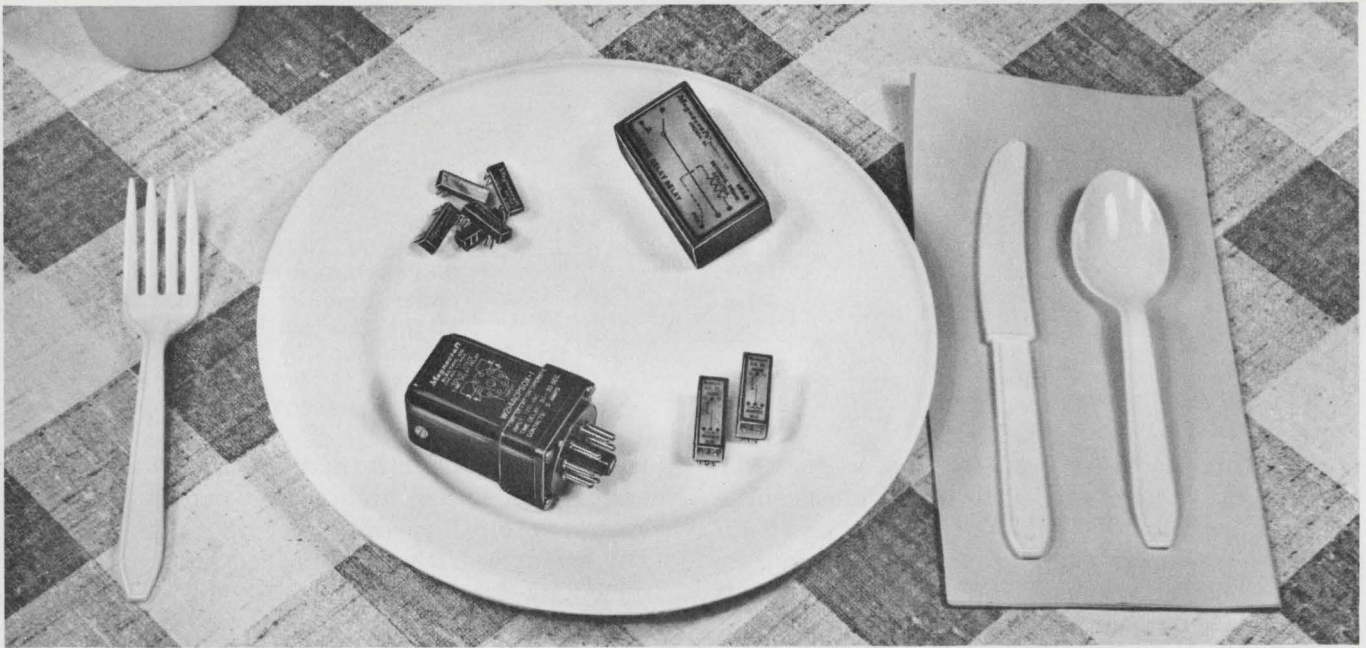

## designers will have a **PICNIC** with these new relays



INFORMATION RETRIEVAL NUMBER 230

**NON-POSITION SENSITIVE MINIATURE MERCURY WETTED REED RELAY CLASS 137MPC**—This amazing new relay represents a significant state-of-the-art advancement in relay technology. The low-profile miniature PC-mounting mercury wetted reed relay offers bounce-free operation in any position. Now circuit designers will have new freedom of design. Further, the relay is only 1.12 x .40 x .375 inches, requiring minimal area on printed circuit boards. This relay features stable contact resistance of 100 milliohms over its long life of over 20 million bounce-free operations with diode suppressed coil.

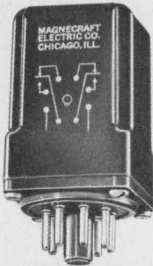

INFORMATION RETRIEVAL NUMBER 231

**SOLID STATE (HYBRID) TIME DELAY RELAY CLASS 214CP**—Magnecraft takes great pride in announcing this new time delay relay. Proven hinge-pin reliability designed into the output relay driven by a solid state circuit used in thousands of our timers, gives you the best low cost small size timing relay on the market. Operate delay timing ranges are offered between 3 hundred milliseconds and 4 minutes with  $\pm 5\%$  repeatability and input supply of 115VAC.

We are sure you will share our enthusiasm in this new product when you apply the small size and cost savings to your circuit designs. The body of the timer is only 1.4 x 1.4 x 2.1 inches, the size of our 88 general purpose relay case. The adjusting potentiometer gives full range timing control and the very popular octal socket pins extend just a bit beyond the body of the time delay relay to an overall height of 2.3 inches.

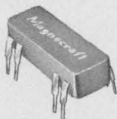

INFORMATION RETRIEVAL NUMBER 232

**DUAL-INLINE-PACKAGED REED RELAYS CLASS 107DIP, 108DIP, 117DIP AND 118-DIP**—Magnecraft is proud to announce its new DIP (dual-inline-package) line of 8-pin reed relays. These new relays are designed not only to be compatible with the standard packaging developed for integrated circuits, but to offer Magnecraft quality at a lost cost. This unique design gives further savings by offering the user the optimum in automated insertion and other economical installation techniques associated with printed circuit applications.

These fantastic new epoxy molded reed relays are ideal for use in circuits where high density packaging is essential. The 5VDC IC compatible versions of these relays will operate directly from TTL or DTL circuits.

Other standard coil voltages are available from stock in 6, 12, and 24 VDC as well as contact configurations in 1 form A, 2 form A, 1 form B, and 1 form C. Most versions are also offered with a choice of an internal clamping diode. The size of this device is a tiny .750 x .300 x .210 inches.



INFORMATION RETRIEVAL NUMBER 233

**SOLID STATE (HYBRID) PRINTED CIRCUIT TIME DELAY RELAYS CLASS 502PCSR AND CLASS 503PCSR**—These new time delay relays make use of hybrid circuitry combining a monolithic silicon structure in the control function with a dry reed relay performing isolated circuit switching. Two fully adjustable timing ranges are afforded by using a remote pot or fixed resistor giving 0.2 to 100 seconds or 1 to 300 seconds each with  $\pm 2\%$  repeatability. Standard coil voltages are available from stock in 12 and 24VDC as well as contact configurations in 1 form A rated at 1 amp and 1 form C at 0.5 amp. The size of this time delay relay is a mere 2.25" x 1.25" x .75".

See you at Wescon, Booth 2230

**Magnecraft**<sup>®</sup> ELECTRIC COMPANY

5575 NORTH LYNCH AVENUE • CHICAGO, ILLINOIS 60630 • 312 • 282-5500 • TWX-910-221-5221



You've had static card readers before. You know the problems. Now there's an optical static card reader that doesn't give you static. Panasonic's.

Our new static card reader is a simple micro-optical device for reading Hollerith type cards or badges. It has superb features that make it worth reading *about*. Like remarkably compact size. Extreme reliability. And tremendous simplicity of operation.

All these wonderful features are due to Panasonic's latest breakthrough. Unique, super-sensitive, diode-isolated light sensors.

We've arranged our new sensors in an X-Y matrix on a PC board. They're activated by tiny incandescent bulbs that shine through the holes in Hollerith cards. And they provide enough output voltage to drive your DTL or TTL directly.

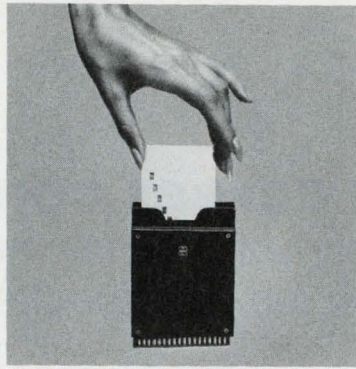

*Panasonic's optical static card reader*

All you have to do is plug our reader into your standard connectors. And you're ready to start scanning. Perfectly.

As if it weren't enough to make a reader that's infallible, we've made personnel infallible too. With an electro-optical and mechanical system that absolutely prevents improper card insertion.

The Panasonic optical static card reader is available in sizes to read any size Hollerith card. From small 10 x 10 to big 12 x 80. Send in the coupon below and find out more. We'll put your card reading problems in a whole new light.

Panasonic Industrial Division  
200 Park Avenue  
New York, New York 10017  
ATTN: Ken Terasaki  
(212) 973-8907

Please send me information about Panasonic's optical static card reader.

Please give me a call.

Name \_\_\_\_\_  
Title \_\_\_\_\_  
Company \_\_\_\_\_  
Address \_\_\_\_\_  
City \_\_\_\_\_ State \_\_\_\_\_ Zip \_\_\_\_\_  
Telephone \_\_\_\_\_

INFORMATION RETRIEVAL NUMBER 43

## We've finally found a reliable card reader.



See Panasonic's card reader, unique HPF products, relays, motor and VTR equipment at Wescon, booth No. 1811

**PANASONIC®**

just slightly ahead of our time

# Going through a career conversion?

Here's a three-point comparison that can help you change from a military job to a commercial one.

**Richard L. Turmail**, Management Editor

Most people resist change, and an engineer who has just changed jobs is no exception. One of the most difficult job switches to make is that from the military area to the commercial. How can an engineer make this change with the least difficulty?

David Jarrett Collins, president of Computer Identics Corp., Westwood, Mass., offers three points of comparison to help engineers see the problem more objectively. An MIT graduate, he once conducted studies for defense and commercial customers in the Applied Research Laboratory of Sylvania Data Systems. Before an engineer can successfully switch from military to commercial work, Collins says, he must convert:

1. From a specialist to a generalist.
2. From controlled to developed timetables.
3. From limited to unlimited product accounting.

## From a specialist to a generalist

The conversion from a specialist to a generalist is natural, because the engineer is tapping an engineering fundamental that perhaps he hasn't had a chance to use since school days—that of problem solving. The Defense Dept. tends to limit engineers. The military awards contracts to major companies on the basis of engineering skills. The bidder must have the individual skills necessary for each function within the total project. Each engineering specialist usually works on only a portion of the full contract.

By contrast, the commercial engineer is responsible for a broader design effort. If his experience does not span two or three specialties, he must at least have the foresight to prevent the design from drifting in concept as it moves from one hand to another. Specifications in commercial-industrial development are usually not as precise as they are in military-industrial.

What are some aids to help the specialist convert to a generalist in the commercial field? For one thing, he can bone up on product brochures and announcements on a broad scale. If he's an

optical specialist, for example, he should read not only about the optics field but about other fields too, including electronic design, packaging, mechanical engineering and related areas.

A second aid is to examine competitive products—products related to the kind that he'll be designing. He should examine each feature of the product and try to determine why the designer put each feature there. At first it may look like an unbalanced product, with too much emphasis in one area and not enough in another. But, it may be just what the customer is looking for.

This leads to a third aid—the need for the engineer to spend time with the customers. If he talks to enough, he'll develop a feeling for the features they want in the product he's going to be developing.

## From controlled to developed timetables

The former military engineer has learned to meet timetables, because in military design there is stress on the interrelationship of tasks as the parts of the final product or system flow together. But the timetables are imposed from above.

The commercial engineer is usually in control of his timetables. He must form his own. Since he's on a smaller engineering team than the military engineer, he is able to synchronize the work of his departments personally.

To convert from a schedule of controlled timetables to developed ones, the engineer needs training that he has not developed in military contracting work. He should have training in accounting, not necessarily the skills but the attitudes. He must know how these attitudes affect a balance sheet, a profit-and-loss statement, the design effort and certain manufacturing procedures that may involve new capital investment by the company.

He should also know how his company writes off its R&D. Is it treated as a current or a deferred expense? The answer will affect the market price of the final product.

The fledgling commercial engineer can't be

**“The commercial engineer should have the foresight to prevent the design from drifting in concept as it goes from one hand to another.”**

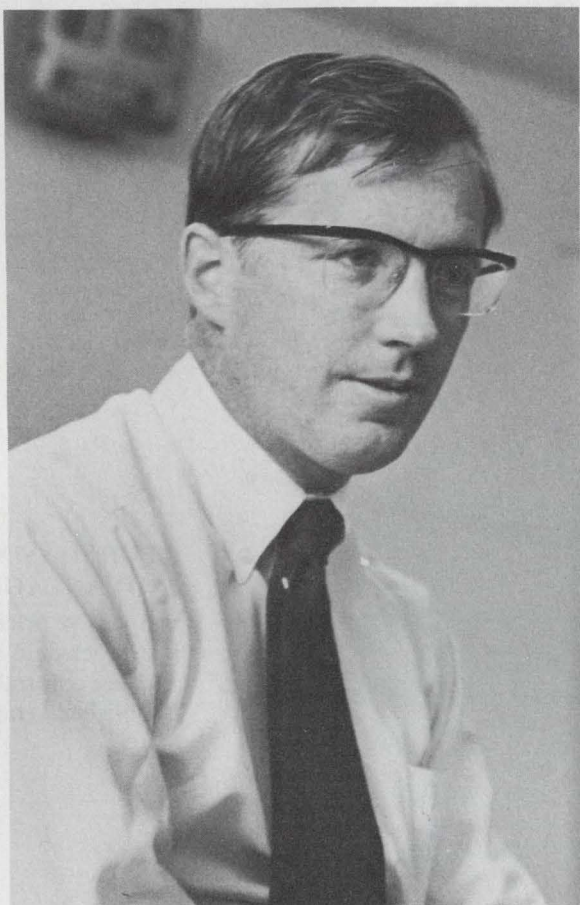

**“The commercial engineer has to understand up to 60 per cent of the marketers’ job so he can second guess them if they’re leading the company down a path that the product or the R&D effort won’t support”**

expected to assimilate this knowledge fully from management meetings or from his contemporaries. He acquires it also through intensive seminars or other classroom study.

Ordinarily the marketing role of companies engaged in military work is very limited. The tech representative usually has very little latitude to do more than keep close liaison with the customer to promote the best features of the product under development.

In the commercial world the marketing team has a prime role, and the commercial engineer must work effectively with the marketers. He has to understand up to 60% of their job, so he can second-guess them if they’re leading the company down a path that the product or the R&D effort won’t support. He’s got to know a great deal about selling, too: why, for instance, will a prospective customer ultimately buy his product instead of a competitor’s?

A good way to learn about the problems of the marketplace is to spend six or eight weeks in a training program that the company might have for freshly hired graduates bent on careers in marketing.

#### **From limited to unlimited accounting**

In a military project the engineer’s chief concerns are completing the job within the allocated time and budget. The industrial engineer is more concerned with product pricing, the cost of maintenance and the competition he faces.

As an aid in pricing the product, the engineer should instruct procurement to supply him with the volume cost profile of components since that’s what he’ll base his product reproduction cost on. Too often this request is not made clear.

No new products are truly comparable, the commercial engineer soon learns. Two manufacturers will bid for different places in the market. There is a spectrum of customers, with interests in different aspects of competing products. In this market the design engineer must look not only at the most economical design effort and ultimate reproduction cost; he must also know where he wants to position his product in the marketplace.

As soon as he knows where his product is headed, he examines the design effort. He can’t afford to focus on only one facet of design, the cost to complete it or to reproduce or service it. He must trade off these and other costs, so that the final product lands in the market spot he planned for it. ■■

# Now...phototransistors from Clairex!

right  
performance  
...right  
price

## DESIGN FEATURES

High current at low illumination  
Hermetically sealed  
Fast switching  
High breakdown voltages

## PURCHASING ADVANTAGES

Competitive pricing  
Fast, stock delivery  
Quality controlled  
Established vendor

Our 18 years of leadership in electro-optics can help you select the *right* phototransistor from our *growing* Clairex product line.

Let us help you balance the price/performance factors that are important to you!

For full data about our CLT 2000 series and CLT 2100 series call 914-664-6602 or write Clairex®, 560 South Third Avenue, Mount Vernon, N.Y. 10550.

## CLAIREX ELECTRONICS

A DIVISION OF CLAIREX CORPORATION

INFORMATION RETRIEVAL NUMBER 44

If you need panel instruments with **custom** dials, cases, accuracy, tracking, resistance, response time, or practically any combination of unusual specs...

Buy **Triplett's** designed-for-you Panel Instruments

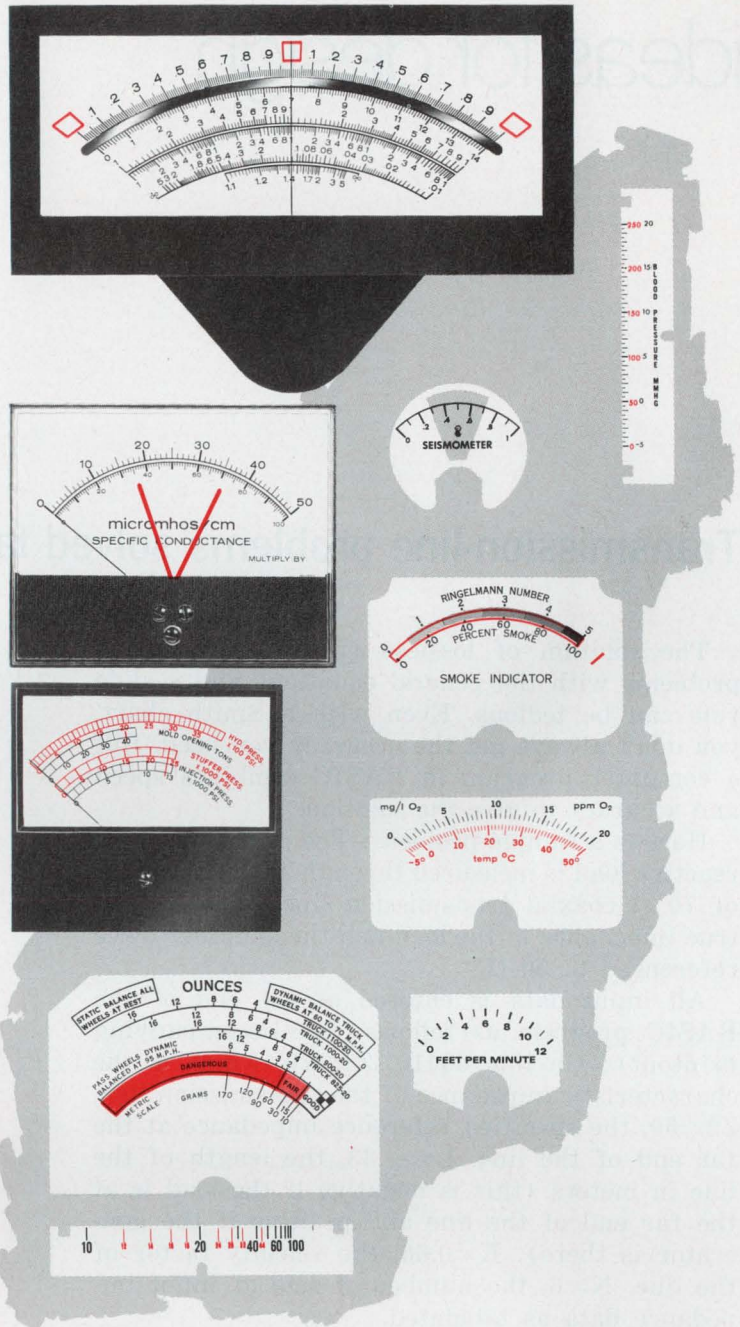

Although we stock some 1369 different styles, sizes and types of standard panel instruments, a very large proportion of our customers buy custom instruments.

Because they need:

**custom dials**

reading in such units as pH, roentgens, mm Hg, rpm, %, inches.

**custom cases**

square, round, rectangular, edge-wise (horizontal and vertical), wide, narrow, shallow.

**custom accuracy**

to within 1/2% with mirror scales and knife-edge pointers.

**custom tracking**

to match the specific needs of existing or new instrument designs.

**custom resistance**

for low circuit loading with tolerances as low as  $\pm 1\%$ .

**custom damping**

to meet stringent electrical and vibration requirements.

For instance, one of our customers had us design and manufacture a custom instrument to replace — in every detail of physical and electrical specifications — one which he was using on a delicate piece of medical instrumentation. Rejects from his previous source had risen to over 20%. He rejected only 3 of the first hundred we shipped — with almost negligible rejections from the many hundreds we've shipped since.

What custom panel instrument specifications do you need to make your

product more reliable, more accurate, more rugged and — in the long run — less expensive? For quick, dependable delivery of small quantities of Triplett's "designed-for-you" panel instruments, contact your Triplett Sales/Service/Modification Center. For prototypes or production quantities, contact your Triplett representative. He'll put you in touch with our Instrument Designers/Engineers who'll help you analyze the problem and suggest the optimum cost/result solution.

**TRIPLETT**  
BLUFFTON, OHIO 45817  
Manufacturers of the World's most complete line of V-O-M's

INFORMATION RETRIEVAL NUMBER 45

## Transmission-line problems solved fast with BASIC

The solution of lossless rf transmission-line problems with the general equations and a slide rule can be tedious. Even with a Smith chart, you don't always get the accuracy you need. But a computer program in BASIC combines speed and accuracy to give the solution.

Here is a sample problem: The impedance of a reactive load is measured through a 0.33-m length of 70  $\Omega$  coaxial transmission line. What is the true impedance at the load and the standing wave referenced to 50  $\Omega$ ?

All input data is entered at the end of the BASIC program as follows (see accompanying printout): On line 00410, Z1=70, which is the characteristic impedance of the transmission line. Z2=50, the specified reference impedance at the far end of the line. L=-.33, the length of the line in meters (this is negative if the load is at the far end of the line and positive if the generator is there). K=0.66, the velocity factor of the line. N=6, the number of sets of input impedance data as tabulated.

Input data is entered on lines 00420 and 00430 as follows (with F the frequency in megahertz, R1 the input resistance and X1 the input reactance):

F	R1	X1
100	100	-80
120	83	-32
140	60	12
160	48	43
180	65	67
200	113	86

The printout of the program is a tabulation of frequency, output impedance at the end of the line, the normalized output impedance and the standing-wave ratio. The latter two values are normalized to the specified reference impedance at the end of the transmission line.

Ronald J. Finger, 2727 Duke St., Alexandria, Va. 22314.

VOTE FOR 311

```

LIST
01/29/71. 16.11.15.
PROGRAM SMITHC

00100 REM PROGRAM SMITHC FOR TRANSMISSION LINE PROBLEMS
00110 READ Z1,Z2,L,K,N
00120 LET T1=1.2*L*1.74532925E-2/K
00130 LET A=1E3
00140 LET B=5E-4
00150 LET C=Z1/Z2
00160 PRINT"Freq,MHZ", "IMPEDANCE", " IMPEDANCE(N) SWR"
00170 PRINT
00180 FOR I=1 TO N
00190 READ F,R1,X1
00200 LET T=TAN(T1*F)
00210 LET R=R1/Z1
00220 LET X=X1/Z1
00230 LET D1=((1-(T*X))^2)+((R*T)^2)
00240 LET R0=(R*(1+T^2))*C/D1
00250 LET X0=((T*(1-X^2)-(X*T)-R^2)+X)*C/D1
00260 LET D2=R0^2+(2*R*X0)+X0^2+1
00270 LET R1=SQR(((R0^2+X0^2-1)^2)+(4*X0^2))/D2
00280 LET S=(1+R1)/(1-R1)
00290 PRINT F;TAB(10);INT(A*((R0*Z2)+B))/A;
00300 IF X0<0 THEN 00330
00310 PRINT TAB(19);"+";
00320 GOTO 00340
00330 PRINT TAB(19);"-";
00340 PRINT"J";ABS(INT(A*(X0*Z2)+B))/A);TAB(33);INT(A*(R0+B))/A;
00350 IF X0<0 THEN 00380
00360 PRINT TAB(42);"+";
00370 GOTO 00390
00380 PRINT TAB(42);"-";
00390 PRINT"J";ABS(INT(A*(X0+B))/A);TAB(54);INT(A*(S+B))/A
00400 NEXT I
00410 DATA 70,50,-.33,.66,6
00420 DATA 100,100,-80,120,83,-32,140,60,12
00430 DATA 160,48,43,180,65,67,200,113,86
00999 END

RUN COMPLETE.

01/29/71. 16.13.42.
PROGRAM SMITHC

FREQ,MHZ IMPEDANCE IMPEDANCE(N) SWR
100 56.482 +J 62.773 1.13 +J 1.255 3.086
120 64.467 +J 29.933 1.289 +J .599 1.782
140 74.785 -J 16.77 1.446 -J .335 1.624
160 66.528 -J 56.758 1.331 -J 1.135 2.677
180 56.945 -J 61.516 1.139 -J 1.23 3.014
200 49.725 -J 60.474 .994 -J 1.209 3.154

RUN COMPLETE.

```

Lossless transmission line problems are solved with this program in the BASIC language. The printout includes standing wave ratio and normalized impedance.

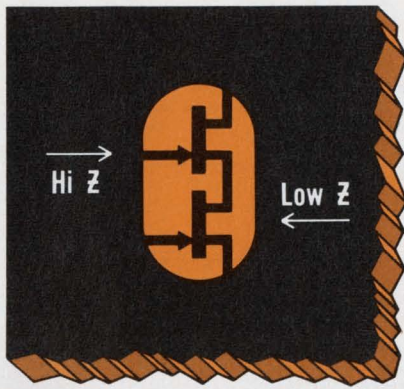

# LOW OFFSET Source Followers with DUAL FETS

Get near unity voltage gain impedance transformation, low offset voltage and low temperature drift with these Siliconix duals.

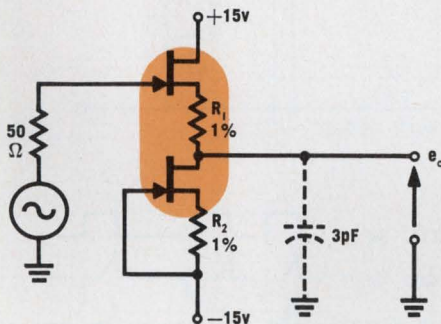

Here's a high-Z-to-low-Z example: The lower FET is the constant-current generator, the upper is the source follower. Offset voltage is given by  $V_{GS1} = I_{D1}R_1 = I_{D2}R_2 = V_{GS2}$ .

The devices typically perform this way:

DEVICE	Typical Offset (mV)	Typical Drift ( $\mu\text{V}/^\circ\text{C}$ )	$e_o$ max. (V p-p)	Voltage Gain ( $A_v$ )	BW (MHz)	Output Resistance ( $R_o, \Omega$ )	$R_1 = R_2$ ( $\Omega$ )
2N5519	15	80	27	.98	5.6	3,000	2,000
U235	25	100	28	.98	7.0	3,300	2,000
U257	100		27	.98	18.0	1,200	1,000

And these are typical gain-frequency plots:

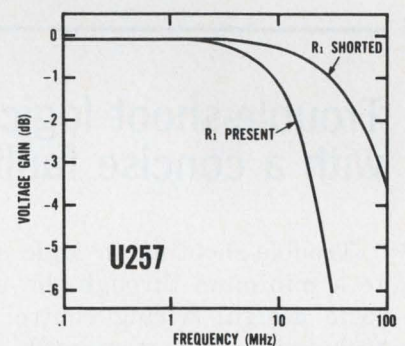
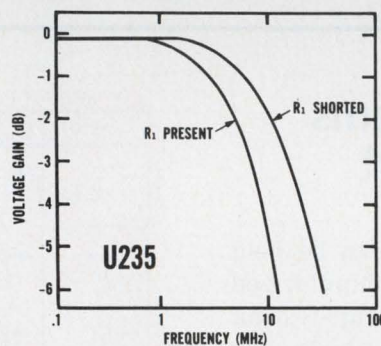
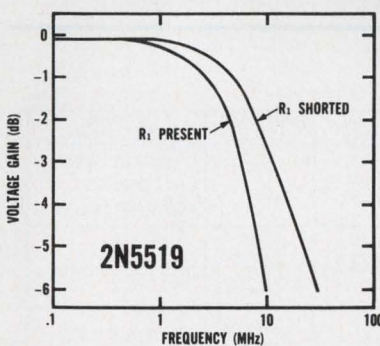

For complete data and supplementary information on Siliconix duals, write or call any of the numbers below.

New York: Sy Levine (516) 796-4680  
 New England: Al La Croix (617) 769-3780  
 Ft. Worth/Dallas: Charlie Williams (214) 231-8151  
 St. Louis: Jim Spicer (314) 291-3616  
 Minneapolis: Ed Koelfgen (612) 920-4483  
 Southern California: Dave Ferran (213) 420-1307  
 Northern California: Chuck Brush (408) 246-8000



**Siliconix incorporated**

2201 Laurelwood Road • Santa Clara • California 95054  
 Telephone (408) 246-8000 Extension 201 • TWX: 910-338-0227  
 In Europe: Siliconix Limited, Saunders Way, Sketty, Swansea, Great Britain

# Home tape recorder stores binary data

With just two simple circuits—one a voltage differentiator, the other a Schmitt trigger—you can use an ordinary tape recorder to record or play back binary data.

In the diagram the differentiator removes the low frequency and dc components of the binary data to be recorded and transforms the data to a series of positive and negative pulses. The values of R1, R2 and C1 were chosen to match the input impedance of the recorder and to minimize data-source loading. The time constant of the differentiator,  $(R1 + R2)C1$ , is about one-fourth of the bit time.

Zener diodes Z1 and Z2 force the amplitude of the recorded information to be essentially constant.

The Schmitt trigger, containing Q1 and Q2, differentiates between data pulses and any ringing in the waveform. Potentiometer VR1 is adjusted for the particular tape recorder to detect only the peaks and valleys in the playback waveform corresponding to bit edges. Transistor Q3 and associated components serve as a buffer between the Schmitt trigger and the output. The opposite polarity signal may be obtained at the output simply by connecting R8 to the collector of Q2 instead of Q1.

*L. E. Davies, Terminal Systems Dept., International Computers Ltd., Kidsgrove, Stoke-on-Trent, ST7 1TL, England.*

VOTE FOR 312

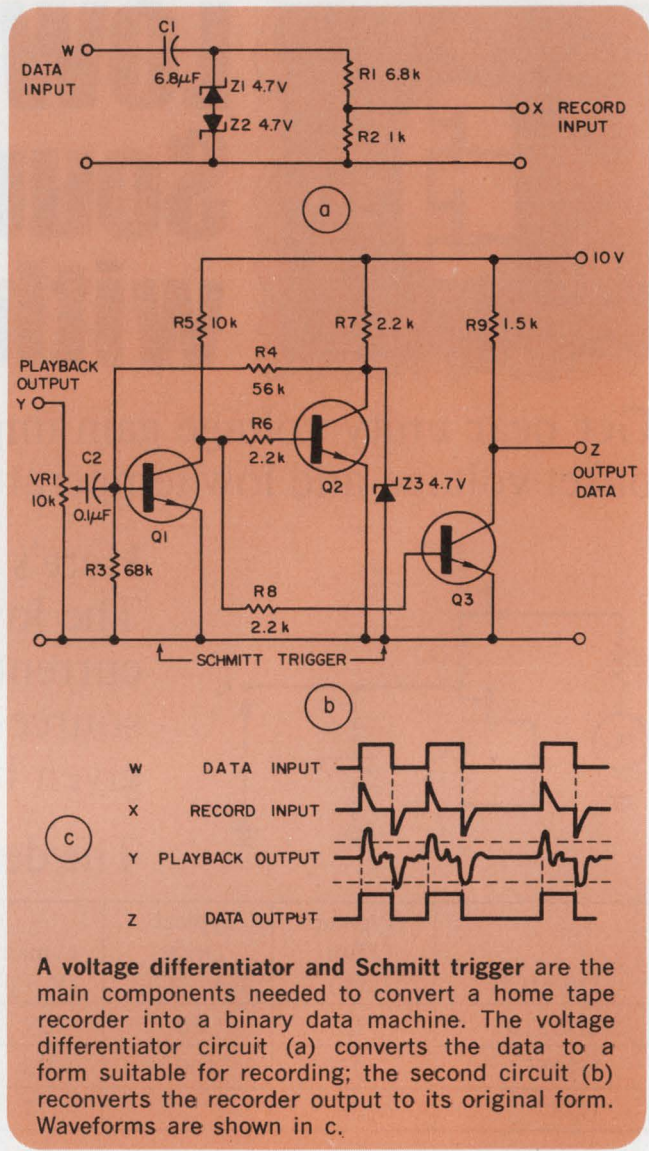

A voltage differentiator and Schmitt trigger are the main components needed to convert a home tape recorder into a binary data machine. The voltage differentiator circuit (a) converts the data to a form suitable for recording; the second circuit (b) reconverts the recorder output to its original form. Waveforms are shown in c.

# Trouble-shoot logic systems with a concise fault chart

Trouble-shooting in logic systems can be held to a minimum through the use of computerized logic design, wiring control and circuit-testing techniques. But even with these methods, the system can fail to perform as expected. When this happens, check the table shown here.

It will help in most of the remaining debugging. Assuming there are no component failures or logic design and conceptual errors, the trouble-shooting now centers on logic wiring errors and marginal component performance caused by stresses incurred during installation.

*Alphonso H. Marsh Jr., Senior Engineer, Raytheon Co., 111 Horse Pond Rd., Sudbury, Mass.*

VOTE FOR 313

INPUT	CIRCUIT DIAGRAM	ACTUAL OUTPUT	EXPECTED OUTPUT	ERROR CONDITION
				OUTPUT WIRE ORed TO ANOTHER CIRCUIT(S)
				NO DC POWER
				OUTPUT TIED TO ZERO
				OUTPUT TIED HIGH
DATA CLK				FLIP-FLOP PATTERN SENSITIVE
DATA CLK				OUTPUT WIRE ORed TO ANOTHER CIRCUIT(S)
1 0				INPUT FLOATING (NOT CONNECTED)



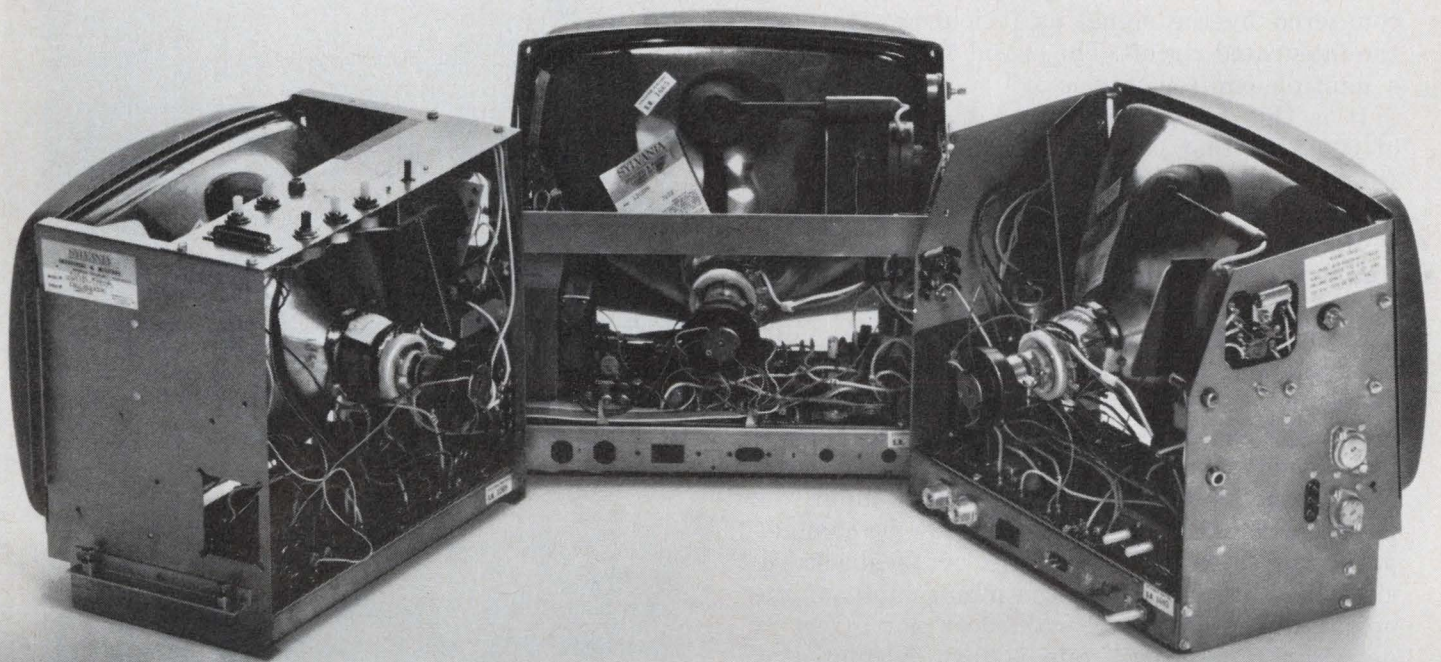

## We have only one standard 12" monitor. All three are shown above.

A 12" monitor is standard in everybody's line.  
Except in GTE Sylvania's.

The only thing standard about our 12" monitor is the size of the CRT.

We can't work magic with a 12" hunk of picture tube, but you'll be amazed at what we can do with the rest of the unit.

Would you like the controls on the top? Back? Front? Side?

Do you need more space in the upper right-hand corner? Or the lower left? Or maybe you need a little extra space on top.

That's no problem for us because our standard monitor is designed to be flexible.

If you can find the space for a 12" CRT, we'll find the space for the electronics.

Three versions of our standard monitor are shown above.

Yours could be number four.

Sylvania Electronic Components, Seneca Falls, New York 13148.

**GTE SYLVANIA**

## Op amp doubles as rf detector

An rf detector that amplifies the amplitude envelope of the carrier signal can be built with an op amp and a minimum of discrete components and power. The detector's advantages include elimination of a diode detector, determination of upper-frequency cutoff by resistors, low output impedance and a conveniently alterable input impedance.

The detector-amplifier takes advantage of the properties of the LM-107 amplifier, or equivalent op amp, (see Fig. 1). The LM-107 has an emitter follower as the first active device encountered by the signal as it journeys through the integrated circuit. The signal then encounters a multiple-emitter transistor.

It is this transistor, with a cutoff frequency of 500 kHz, that becomes the diode detector and filter required to separate the rf carrier from its amplitude characteristic.

Maximum efficiency in detection of the rf signal is obtained by feeding it into the plus input of the op amp, where losses can be easily kept low. Minimal losses can be achieved by various methods: tuning the input to the rf carrier frequency, minimizing lead lengths into the device, or providing a convenient impedance matching environment to the signal source.

With the signal supplied to the plus input, the resultant gain of that signal can now be changed very conveniently by the use of feedback resistances, R1 and R2, to the minus input of the op amp. The change in gain does not affect rf detection. The circuit gain is then calculated as  $1 + (R2/R1)$ .

The circuit uses a single supply voltage. Because of this, it requires the use of the voltage divider, R4 and R5, to raise the plus and minus op-amp inputs above ground and to put the device into the linear conduction region. If a dual power supply is used, these divider resistors can be omitted and the junction of R1 and R3 can be tied to the ground return.

Resistor R3 is used solely for balancing the input resistances to the op amp and for minimizing any drift effects caused by temperature at the output of the circuit. The L and C parameters are selected to give optimum performance at the rf frequency being detected. Capacitor C is selected for minimum reactance, and L is chosen to be self-resonant with the external and internal stray capacitances of the circuit.

The upper cutoff frequency of the detector can be selected without the use of an external capacitor. For the LM-107, the cutoff frequency is  $10^6 / (1 + R2/R1)$  Hz.

To correct for detection efficiency changes

with temperature, a thermistor may be used with, or to replace, R1.

The transfer characteristics of the rf detector-amplifier are similar to those of a diode (Fig. 2).

Vito Del Guercio, Senior Engineer, Bendix Aerospace Systems Div., 3300 Plymouth Rd., Ann Arbor, Mich. 48107.

VOTE FOR 314

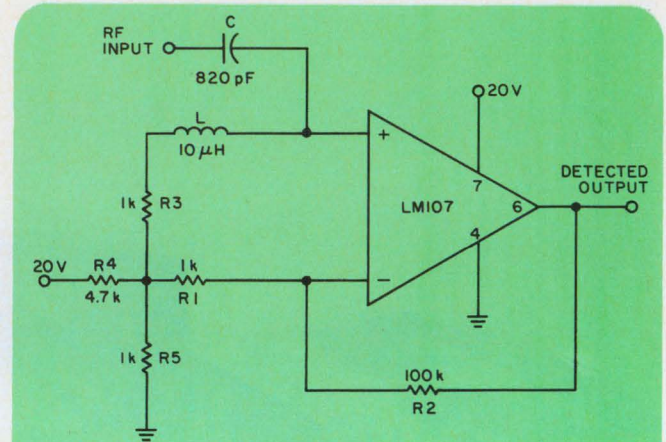

1. **Rf detector-amplifier uses an op amp for detection.** A multiple-emitter transistor within the LM-107, or equivalent, provides the necessary separation of the amplitude envelope from its rf carrier. The upper cutoff frequency is  $10^6 / (1 + R2/R1)$  Hz. No external capacitors are needed to select the rf cutoff.

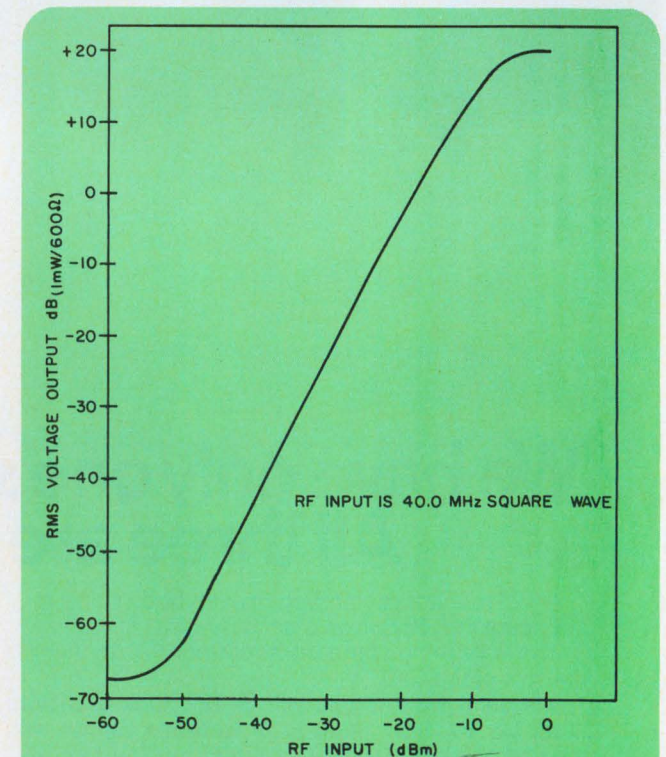

2. **Detector-amplifier transfer characteristics** resemble those of a diode detector. Linearity for small input-signal variations is held over most of a 40-dB range.

# What did you expect for \$29.00?

The best general purpose economy DAC in the industry, or something? Did you really think we could take the specs of a \$75 converter, tighten them a bit, and put them into a package costing less than half that?

Well, take a look. Here in a nutshell is the performance of the new DAC-10Z: Resolution 10 bits, speed  $5\mu\text{sec}$ , linearity  $\pm 1/2\text{LSB}$ , and temperature coefficient  $\pm 40\text{ ppm}/^\circ\text{C}$ , not to mention the good things that all Analog Devices converters are known to have — like DTL/TTL-compatible inputs and monotonicity. No compromise in quality at all. We just figured out how to make it less expensively — \$29 in 100's.

Thus encouraged, we looked into our line of 12-bit converters and developed a low cost, high performance version. The new DAC-12QZ doesn't really replace anything we now sell, but the price makes it a lot easier for you to think in 12's. Watch for it next month.

In the meantime, circle the inquiry number for detailed specs on the DAC-10Z. Better yet, for an immediate evaluation sample call (617) 329-4700 or write us on your letterhead. The DAC-10Z is in full production, and we have lots in stock. Analog Devices, Inc., Norwood, Mass. 02062



## IC amp with 200-V output uses few components

Large-signal audio amplifiers need not be complicated. Take this design, for example.

The circuit is basically that of a power-supply regulator. The primary difference is in the use of the reference voltage. Normally  $V_{in}$  would be a stable dc voltage and a reference for the regulated output voltage. But if the reference varies, so does the output. Here the reference is made the input signal.

The circuit uses a positive input clamped at ground. The circuit can just as easily handle negative inputs by grounding point A and applying the signal at point B. The input signal may be a waveform with a dc bias, as long as no part of the composite waveform drops below ground.

With a power supply voltage of 250 V dc, a linear output voltage swing of 230 V results. The basic regulator configuration provides isolation from variations in the supply voltage. This isolation is found, from the loop gain, to be 26 dB. Thus, a well-regulated, high-voltage power supply is not necessary.

The amplifier gain is determined solely by the ratio of  $R_5$  and  $R_6$  and is  $(R_5 + R_6)/R_6$ .

Capacitors  $C_1$  and  $C_2$  provide roll-off of the loop response to insure stability against oscillations. The fact that they do, also limits the bandwidth of the amplifier.

The input signal has the shape shown, with a rise time of  $0.15 \mu s$  to 10 V. The output follows the rise at a rate of 200 V per  $5 \mu s$  or 10 V per

$0.25 \mu s$ . With the input and output waveforms superimposed, there is no measurable phase shift.

Robert Oswald, Motorola Government Electronics Div., 8201 E. McDowell Rd., Scottsdale, Ariz. 85252

VOTE FOR 310

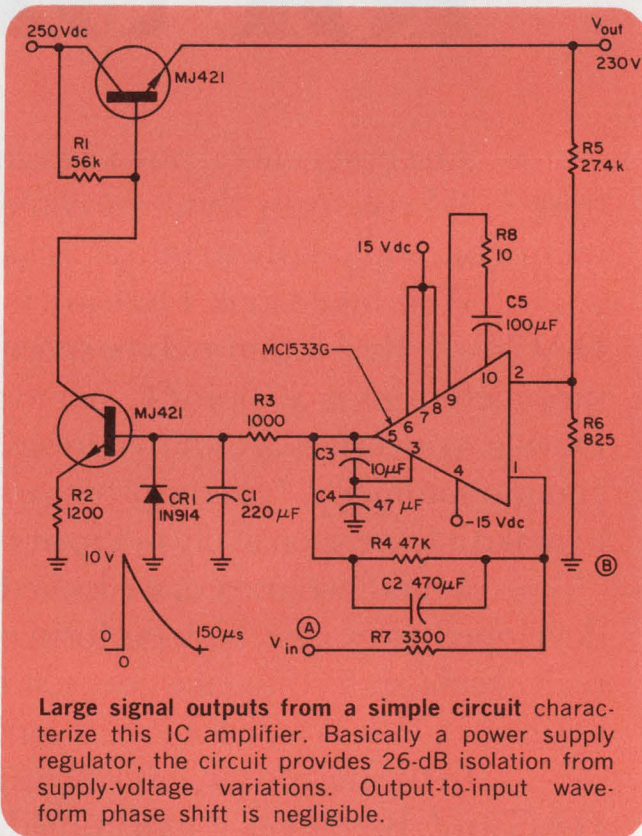

Large signal outputs from a simple circuit characterize this IC amplifier. Basically a power supply regulator, the circuit provides 26-dB isolation from supply-voltage variations. Output-to-input waveform phase shift is negligible.

### IFD Winner for April 29, 1971

P. C. Lipoma/C28, Lockheed Electronics, 16811 Camino, HASR/671-11, Houston, Tex. 77058. His idea "\$5 Wein-bridge oscillator is both stable and compact" has been voted the Most Valuable of Issue award.

Vote for the Best Idea in this Issue.

**VOTE!** Go through all Idea-for-Design entries, select the best, and circle the appropriate number on the Reader-Service-Card.

**SEND US YOUR IDEAS FOR DESIGN.** You may win a grand total of \$1050 (cash)! Here's how. Submit your IFD describing a new or important circuit or design technique, the clever use of a new component or test equipment, packaging tips, cost-saving ideas to our Ideas-for-Design editor. You will receive \$20 for each accepted idea, \$30 more if it is voted best-of-issue by our readers. The best-of-issue winners become eligible for the Idea Of the Year award of \$1000.

MOSTEK announces

# A breakthrough in counter/display circuits!

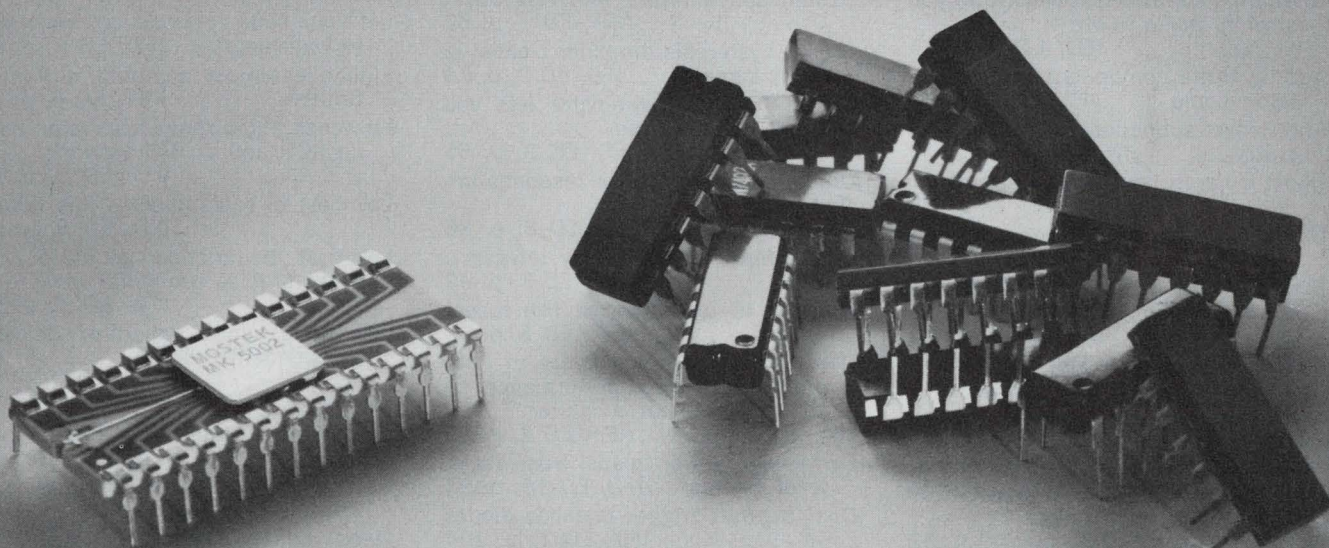
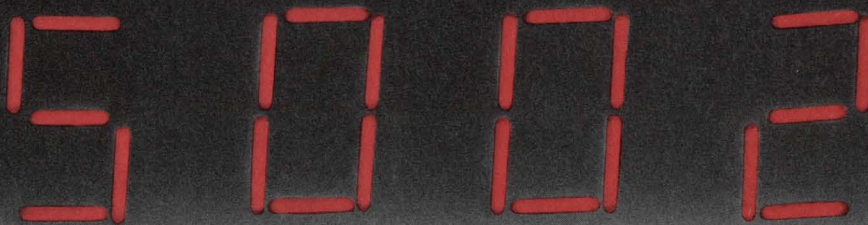

## Now...MOS replaces TTL

Four digits of counting/display logic in one package . . .  
same single +5V supply but 1/100th the power!

Our new MK 5002 P gives you all the logic you need for your counting/display systems: four decade-counters, four quad-latches, seven-segment decoder, multiplex logic, BCD outputs, leading-zero suppression. All of this in one package, with one +5V power supply and less than 20mW of power!

Our point is this. If you're now using TTL, better take a look at what MOSTEK's MOS technology can do for you. We've designed an entire instrument system on a single chip. We've replaced 12 ordinary TTL packages with a single 5002 and given you more performance

over a broader power range. (You can operate from +5V supply, or your 6V, 9V or 12V batteries, for instance.) And the cost of our 5002 is lower than TTL—even at today's prices.

Whether your application is in frequency counters, digital voltmeters, digital timers or event counters, for example, you need to consider the advantages of our new breakthrough circuit . . . made possible through MOSTEK's ion-implantation process. Call for detailed information to Gordon Hoffman or Dave West at (214) 242-1494. Or contact your nearest Sprague representative or distributor.

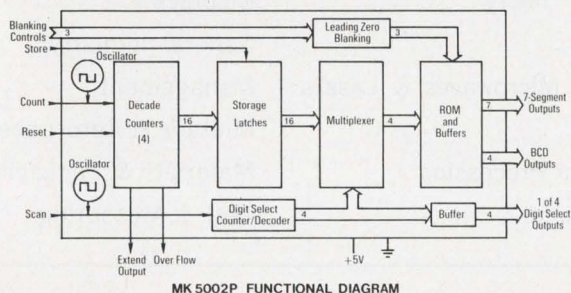

The  
Calculator-on-a-Chip  
Company

An affiliate of Sprague Electric Company  
1400 Upfield Drive  
Carrollton, Texas 75006

# Electronic Design Semiannual index of articles

## Circuits & Circuit Theory

- A voltage-controlled delay lets you stretch pulse width..... IFD, ED 8, p. 84
- Adding three components cuts regulator ripple..... IFD, ED 2, p. 76
- And, now, subnanosecond MOS circuitry..... NEWS, ED 6, p. 40
- Boost op-amp power in ac circuits..... ART, ED 1, p. 88
- Blank out insignificant zeros in your readouts..... IFD, ED 6, p. 90
- Build a pulse generator that covers from 1 ms to 1000 s..... IFD, ED 8, p. 84
- Check op-amp open-loop dc gain in one cycle of the test signal..... IFD, ED 7, p. 60
- Clean up switch closures with a fast UJT pulse..... IFD, ED 11, p. 92
- Constant-current diodes protect ICs and transistors..... IFD, ED 7, p. 62
- Controlled starting conditions overcome timing circuit errors..... IFD, ED 4, p. 90
- Current-source polarity is reversible at will..... IFD, ED 1, p. 104
- Custom compensate your op amp..... ART, ED 1, p. 92
- Cut delay times with look-ahead carry in high-speed ripple adders..... ART, ED 6, p. 74
- Cut the maintenance costs of motor control systems..... ART, ED 5, p. 40
- Delay a one-shot's output using only digital ICs..... IFD, ED 10, p. 90
- Design a 1200-bit/s FSK modulator for data transmission..... ART, ED 6, p. 80
- Design active filters with less effort..... ART, ED 1, p. 82
- Digital hysteresis amplifier cleans up noisy signals..... IFD, ED 2, p. 74
- Digital IC noise eliminator lets you count clean pulses..... IFD, ED 9, p. 65
- Digital IC tone detector responds immediately to inputs..... IFD, ED 8, p. 86
- Divide frequencies by any integer..... ART, ED 3, p. 42
- Do your IC op amps act like fuses?..... ART, ED 5, p. 53
- Don't minimize noise figure to optimize the noise performance of your operational amplifier..... ART, ED 2, p. 62
- Drive high-power loads from logic-level signals..... IFD, ED 10, p. 94
- Dual Schmitt trigger matches diodes..... IFD, ED 1, p. 104
- Get longer time delays with TTL ICs..... IFD, ED 2, p. 76
- Get programmable voltages from 50-mA emitter-follower..... IFD, ED 7, p. 64
- Graphical approach helps design doubly loaded bandstop filters..... IFD, ED 12, p. 80
- Halt noise spikes in IC logic gates..... IFD, ED 8, p. 88
- Here are more protective circuits for power supplies and their loads..... ART, ED 10, p. 64
- ICs simplify a two-phase bidirectional motor drive..... IFD, ED 1, p. 110
- Inexpensive isolator circuit solves interface problems..... IFD, ED 3, p. 50
- Let your slide rule convert frequency to wavelength..... IFD, ED 8, p. 88
- Linearize almost anything with multipliers..... ART, ED 8, p. 74
- Low-cost audio-range oscillator uses an SCR and an RC network..... IFD, ED 5, p. 58
- Low-cost circuit indicates line failure..... IFD, ED 6, p. 96
- Low-cost tri-function generator delivers precise triangular wave..... IFD, ED 4, p. 92
- Low-power clock generator delivers independent outputs..... IFD, ED 12, p. 84
- Measure pulse periods of 500 ns with hot-carrier-diode circuit..... IFD, ED 5, p. 60
- Need a programmable word generator?..... ART, ED 4, p. 78
- Need square waves in the MHz range?..... ART, ED 11, p. 68
- Negative-resistance circuit is adjustable and versatile..... IFD, ED 4, p. 90
- Phase-detector/modulator operates from dc to 30 kHz..... IFD, ED 12, p. 82
- Precisely control op-amp gain and output voltage limits..... IFD, ED 10, p. 92
- Precision ramp generator responds to clock in 25 ns..... IFD, ED 5, p. 58
- Prevent damage to loads and supplies with these protective circuits..... ART, ED 9, p. 42

## Departments key

ART	Technical Article
IFD	Idea for Design
NEWS	News
PF	Product Feature
SR	Special Report

## Subject Listing

Circuits & Circuit Theory	Displays
Civionics	General Industry
Communications, Microwaves & Lasers	Management
Components	Military & Aerospace
Computers & Data Processing	Materials & Packaging
Consumer Electronics	Test & Measuring

- Program the pulse width of a hybrid monostable... IFD, ED 11, p. 88
- Protect regulated series supply with only four components... IFD, ED 6, p. 96
- Pulse-shaping circuitry has zero recovery time... IFD, ED 13, p. 82
- PUT relaxation oscillator offers linear period control... IFD, ED 8, p. 82
- Regulated dc voltage source also supplies constant current... IFD, ED 6, p. 92
- 'Rubber-band' memory acts as adjustable scratchpad... ART, ED 13, p. 64
- Save money with analog multipliers... ART, ED 7, p. 44
- Semiconductor trip circuit protects delicate circuitry... IFD, ED 2, p. 80
- Set and reset flip-flops with separate pulses... IFD, ED 2, p. 74
- Set-reset flip-flop rejects input noise... IFD, ED 13, p. 80
- Simple delay technique doubles input frequency... IFD, ED 7, p. 64
- Simplify combination logic circuits with programmable read-only memories... ART, ED 13, p. 72
- Simplify high-speed counter design... ART, ED 4, p. 74
- Simulate matched transistors with an active load and a pot... IFD, ED 7, p. 62
- Single clock generator has guaranteed start-up... IFD, ED 13, p. 86
- Single differential amplifier shifts phase full 360 degrees... IFD, ED 6, p. 98
- Single-supply trigger circuit works for three types of logic... IFD, ED 13, p. 80
- Solve static saturation in your astable multi... IFD, ED 6, p. 94
- Speed up synchronous counters... ART, ED 2, p. 55
- Squelch noise pick-up by complementary emitter driver... IFD, ED 11, p. 88
- Stabilize a constant-current supply with an op amp... IFD, ED 3, p. 49
- Strobing multi-digit displays... ART, ED 9, p. 50
- Switch improves accuracy of op-amp comparator... IFD, ED 2, p. 78
- Switchable pulse multiplier delivers 10-to-1 pulse burst... IFD, ED 9, p. 66
- Symmetrical counter can handle any odd modulus... IFD, ED 1, p. 106
- Synchronize four digital signals using a crystal-controlled input... IFD, ED 4, p. 88
- Take a look inside the TTL IC... ART, ED 8, p. 68
- Temperature-compensated dc restorer offers variable clamping... IFD, ED 3, p. 50
- Test nonlinear system stability with the 'circle criterion'... ART, ED 7, p. 40
- To detect signals buried in noise, build a phase-locked receiver... ART, ED 12, p. 64
- Triple-function generator gives ramp, square, and pulse outputs... IFD, ED 4, p. 94
- TTL-compatible analog gate for only \$2 in parts... IFD, ED 1, p. 106
- TTL-compatible crystal oscillator operates from 5-V power supply... IFD, ED 10, p. 92
- Use a simple graphic technique to solve for parallel resistors... IFD, ED 6, p. 92
- Use latching inverters to control pulse width... IFD, ED 6, p. 94
- Use pulse coding to boost shift-register time resolution... IFD, ED 13, p. 84
- Use RGB for color TV. The red-green-blue circuit is cheaper... ART, ED 4, p. 66
- Use sample-and-hold method to simplify serial d/a converters... IFD, ED 5, p. 56
- Variable Schmitt trigger responds to 50-mV inputs... IFD, ED 11, p. 94
- Vary gain electronically with differential amplifiers... ART, ED 11, p. 78
- Vary one-shot's pulse width over 1600:1 controlled range... IFD, ED 12, p. 86
- Versatile ramp generator varies start and stop levels... IFD, ED 11, p. 90
- Versatile timing circuit is based on pulse coincidence... IFD, ED 11, p. 92
- Voltage-to-frequency converter provides linearity of 0.4%... IFD, ED 3, p. 49
- Watch those losses in low-power amplifiers... ART, ED 10, p. 58
- Wired-OR ECL NOR gates give an EXclusive-OR/NOR... IFD, ED 9, p. 64
- You need only one op amp to build a differential integrator... IFD, ED 8, p. 82
- \$5 Wein-bridge oscillator is both stable and compact... IFD, ED 9, p. 65
- 60-Hz relay senses frequency for fan control... IFD, ED 1, p. 110
- Civionics**
- Aerospace help sought in ground transportation... NEWS, ED 11, p. 19
- Another electric car suggested, but this one has a heat engine... NEWS, ED 11, p. 30
- Billions in U. S. shipbuilding open big field for electronic innovation... NEWS, ED 6, p. 30
- Civionics: An even better living through new electro-technology... SR, ED 6, p. S10
- Civionics: Mass Surface Transportation... SR, ED 1, p. 71
- Coast Guard gets an electronic ice 'bomb'... NEWS, ED 12, p. 30
- Computer cuts pollution in new steam buses... NEWS, ED 13, p. 20
- Computer probes secrets of human chromosomes... NEWS, ED 1, p. 21
- Coronary monitor learns heart-beat information... NEWS, ED 5, p. 21
- Designing for the pollution-free industrial era—a Civionics report on new hardware on tap to monitor pollution... SR, ED 10, p. 49
- 'Early warning system' for machinery available... NEWS, ED 5, p. 22
- Effect of heated water on environment studied... NEWS, ED 4, p. 22
- Electron-beam mining to be tested in field... NEWS, ED 3, p. 22
- 'Electronic sight' studied to help the blind see... NEWS, ED 10, p. 20
- Electronics helps advertisers keep track of their TV ads... NEWS, ED 11, p. 26
- Electronics to curb a runaway crime rate... SR, ED 4, p. 55
- Energy storage planned to save subway power... NEWS, ED 12, p. 19
- 'Explosive' growth seen for hospital systems... NEWS, ED 8, p. 22
- For pain and other suffering, new fast relief is electronic... NEWS, ED 8, p. 25
- Global weather net gets high-speed push... NEWS, ED 1, p. 22
- Introducing the electronic car: antiskid, antipolluting, pro-driver... NEWS, ED 2, p. 28
- Laser cuts men's suits—and cost too, by 25%... NEWS, ED 8, p. 22
- Laser to spot fog banks and alert Coast Guard... NEWS, ED 3, p. 22
- Laser winning converts as IC-trimming tool... NEWS, ED 12, p. 20
- Linear motor for mass transport improved by pulsed-dc technique... NEWS, ED 10, p. 30
- Low-cost NASA camera system shoots unattended under water... NEWS, ED 10, p. 28
- LSI replaces gears in process instrument... NEWS, ED 9, p. 19
- Mailgram service wins own computer center... NEWS, ED 1, p. 22
- Medical electronics stirring, and IC prognosis is excellent... NEWS, ED 6, p. 25
- Microwave ILS proposed for tomorrow's airports... NEWS, ED 2, p. 21
- Microwave radio system links local police to FBI... NEWS, ED 3, p. 21
- New electronics joins national war on crime... SR, ED 4, p. 56
- New heart pump uses advanced electronics... NEWS, ED 2, p. 22
- New job for the busy computer: Designing artificial heart valves... NEWS, ED 3, p. 27
- New welder fuses metal without mar- rying finish... NEWS, ED 4, p. 22
- No task too difficult for hand-held radar... NEWS, ED 5, p. 30
- Over-the-counter market gets an electronic 'board'... NEWS, ED 3, p. 21
- Pacemaker battery check is only a phone call away... NEWS, ED 5, p. 22
- People transponders proposed to

fight crime. NEWS, ED 4, p. 21  
 Point-of-sale terminal offered by Uni-Tote. NEWS, ED 12, p. 20  
 Post Office accelerates its automation program. NEWS, ED 7, p. 21  
 Radar weather data being sent by phone. NEWS, ED 2, p. 22  
 Skin effect proposed to heat oil pipelines. NEWS, ED 6, p. 22  
 System lets doctors see human heart in action. NEWS, ED 9, p. 19  
 The electronic car gets green light in Detroit. NEWS, ED 10, p. 22  
 U. S. urged to speed its air safety R&D. NEWS, ED 11, p. 19  
 We interrupt this magazine for a live preview of ERTS. NEWS, ED 11, p. 23  
 \$12 Army vibration transmitter may end up on industrial duty. NEWS, ED 8, p. 30

### Communications, Microwaves & Lasers

A designer's guide to data communications. SR, ED 9, p. C4  
 Beware the pitfalls in picking from a maze of terminal gear. SR, ED 9, p. C10  
 Communications: A look at future instead of the usual hardware. SR, ED 6, p. S7  
 Cut the costs of Doppler radars. ART, ED 13, p. 48  
 Eenie, meenie, minie, mo—Which carrier service? SR, ED 9, p. C6  
 Flying command posts to communicate by satellite. NEWS, ED 2, p. 21  
 For secret transmitting: A cable within a cable. NEWS, ED 13, p. 19  
 Good microstrip multipliers don't just happen. ART, ED 3, p. 36  
 Gunn-diode modulator covers 0 to 10 MHz. IFD, ED 1, p. 112  
 Here's a microwave choke that's easy to build. ART, ED 5, p. 50  
 Microstrip can reduce multiplier size. ART, ED 2, p. 46  
 Microwave transmission opened to competition. NEWS, ED 13, p. 19  
 Microwaves: Solid-state devices are ready, willing and able. SR, ED 6, p. S4  
 New gas laser from RCA generates many colors. NEWS, ED 4, p. 22  
 Radiophone net growing in the 450-MHz band. NEWS, ED 4, p. 22  
 Tuning in on IR—a laser first. NEWS, ED 5, p. 22  
 Two-way CATV arrives this spring. NEWS, ED 1, p. 21  
 Vlf system and geophones help rescue trapped miners. NEWS, ED 4, p. 30  
 4 at microwave symposium tell how to get high power from low. NEWS, ED 13, p. 30

### Components

Analog memory has logic alert. PF, ED 7, p. 84  
 Army developing 30¢ tuning capacitor. NEWS, ED 2, p. 30

Bipolar IC size cut 40% with Fairchild process. NEWS, ED 6, p. 22  
 CMOS 64-bit self-decoding RAM dissipates 0.3  $\mu$ W. PF, ED 11, p. 97  
 Costs are coming down for low-voltage CMOS. NEWS, ED 9, p. 20  
 Digital filters with LSI promise a new world of applications. NEWS, ED 2, p. 24  
 Don't be fooled by multiplier specs. ART, ED 6, p. 66  
 Electro-Optics: LEDs lead the way in a variety of new applications. SR, ED 6, p. S14  
 Fast complementary switch handles +10-V analog signals. PF, ED 2, p. 87  
 Fast MOS analog drivers switch on in just 90 ns. PF, ED 6, p. 101  
 Fast 16k by 36 memory drops cost to 1.8¢/bit. PF, ED 4, p. 122  
 FET op amp pair offers 1  $\mu$ V/ $^{\circ}$ C drift and 0.1 pA bias. PF, ED 6, p. S32  
 FET-input op amp slashes price to \$9.75. PF, ED 6, p. S30  
 Fiber electron optics: New uses for an old technology. NEWS, ED 1, p. 30  
 High-performance 1000-MHz balanced mixer costs \$29.95. PF, ED 12, p. 94  
 High-temperature IC op amps set performance standards. PF, ED 7, p. 82  
 Hybrid 1-A regulator needs no compensation. PF, ED 1, p. 122  
 Hybrid \$20 voltage regulator handles 85 W in 2.5-in.<sup>3</sup> case. PF, ED 6, p. S34  
 LED: The No 1 challenger to Nixies in digital readouts. NEWS, ED 3, p. 24  
 Line driver/receivers ease data interface. PF, ED 6, p. 102  
 MIC YIG is 2.1-in. long. PF, ED 3, p. 52  
 Microelectronics: Why they rave about semiconductor memories. SR, ED 6, p. S12  
 Monolithic power op amp provides 1-A output at 15 V. PF, ED 11, p. 98  
 MOS density offered in bipolar memory cell. NEWS, ED 13, p. 19  
 MOS/LSI digital filter kit, first on market. NEWS, ED 10, p. 20  
 MOS, 4-digit counter/display chip works from a +5-V line. PF, ED 13, p. 92  
 Multi-component DIPs increase flexibility. PF, ED 11, p. 110  
 New generation of emitter-coupled logic unfolds 2-ns speed and 25-mW dissipation. PF, ED 5, p. 61  
 Novel GaAs amplifier works at microwaves. NEWS, ED 7, p. 22  
 Optic scanner converts directly to digital outputs. NEWS, ED 7, p. 22  
 Phase-control device is a low-cost lamp dimmer. PF, ED 6, p. 104  
 Photodiode arrays available by the

yard. NEWS, ED 12, p. 30  
 Price break predicted for semi memories. NEWS, ED 2, p. 21  
 Put optoelectronic components to work in systems design. ART, ED 12, p. 46  
 Selecting preamps for lowest noise. ART, ED 3, p. 46  
 Sensitivity mark claimed for new PIN photodiode. NEWS, ED 7, p. 22  
 Silicon-on-sapphire 3300-bit \$64 ROMs access in 20 ns. PF, ED 12, p. 91  
 Smaller, cheaper power ICs emerge with hybrid designs. NEWS, ED 12, p. 26  
 'Smallest' TV camera weighs only 9 ounces. NEWS, ED 11, p. 19  
 Solid-state circuits parley turns to the medical field. NEWS, ED 4, p. 21  
 Solid-state clock solves battery-drain problem. NEWS, ED 12, p. 19  
 Solid-state loads provide versatility in power-supply testing. ART, ED 5, p. 46  
 Solid-state optoelectronic components put imagination in engineering. SR, ED 11, p. 44  
 Solid-state 1-A relay maximizes I/O isolation. PF, ED 3, p. 55  
 Specify custom cores the right way. ART, ED 7, p. 50  
 The one-chip calculator is here, and it's only the beginning. NEWS, ED 4, p. 34  
 Two new semi memories offering immunity to volatility problems. NEWS, ED 6, p. 28  
 Two op amps improve popular 108/741 types. PF, ED 4, p. 108  
 Unique bipolar semiconductor memory can tolerate a 5-ms total power loss. PF, ED 10, p. 99  
 Which photodetector will give best results? ART, ED 12, p. 50  
 With the price right, CMOS is headed for new applications. NEWS, ED 8, p. 32  
 8-bit a/d in only 2.8 in.<sup>3</sup>. PF, ED 7, p. 84  
 10-trillion-bit memory promised, but not many experts believe it. NEWS, ED 6, p. 40  
 500-MHz double balanced mixer cuts price to \$7.95. PF, ED 5, p. 66

### Computers & Data Processing

A designer's guide to data communications. SR, ED 9, p. C4  
 Beware the pitfalls in picking from a maze of terminal gear. SR, ED 9, p. C10  
 Calculators are in chips; Next: Mini-computers? NEWS, ED 4, p. 21  
 Computer program extends computation of factorials. IFD, ED 13, p. 86  
 Computers: If you think they're smart now, wait until you hear them gab. SR, ED 6, p. S6  
 Custom-designed mini can be bought for \$800. PF, ED 10, p. 112  
 Data distributor controls 240 chan-



nels . . . . . PF, ED 6, p. S54

Designers to mini makers: 'Please add improvements' . . . . . NEWS, ED 4, p. 36

Digital control center cuts software costs . . . . . NEWS, ED 3, p. 21

Eenie, meenie, minie, mo—Which carrier service? . . . SR, ED 9, p. C6

Honeywell announces new family of computers . . . . . NEWS, ED 5, p. 21

Improve your curve plotting with SuperBASIC software . . . . . IFD, ED 9, p. 62

NASA pushes research on trillion-bit computer . . . NEWS, ED 11, p. 20

New processor makes programming easy . . . . . NEWS, ED 4, p. 32

Program to design a bridged-T attenuator is BASIC . . . . . IFD, ED 1, p. 108

The minicomputer and the engineer —Part 1: Here's what the mini can do for you . . . . . SR, ED 8, p. 48

The minicomputer and the engineer —Part 2: Get the facts behind mini specs . . . . . ART, ED 9, p. C20

The minicomputer and the engineer —Part 3: Programming: the key to your mini's success . . . . . SR, ART, ED 10, p. 76

The minicomputer and the engineer —Part 4: Interfacing: A balancing act of hardware and software . . . . . ART, ED 11, p. 58

The minicomputer and the engineer —Part 5: Peripherals expand your mini's capabilities . . . . . SR, ED 12, p. 72

The minicomputer and the engineer —Part 6: A mini-based system takes careful planning . . . . . ART, ED 13, p. 56

**Consumer Electronics**

Broad security system devised for the home . . . . . NEWS, ED 6, p. 21

Designers of vhf-FM radios vie for new pleasure-boat market . . . . . NEWS, ED 5, p. 28

Digital design gets a star role in solving television problems . . . . . NEWS, ED 9, p. 25

For today's young Beethoven: A computer that composes . . . . . NEWS, ED 1, p. 36

Hardware for the 'cashless society' . . . . . NEWS, ED 3, p. 26

Holography, no longer a novelty, looks for consumer application . . . . . NEWS, ED 7, p. 24

Organ variations on an MOS theme . . . . . NEWS, ED 1, p. 38

Ultrasonics takes the needle out of sewing . . . . . NEWS, ED 2, p. 34

Use of LSI in consumer areas picks up, but problems remain . . . . . NEWS, ED 1, p. 32

**Displays**

GE promises 'exciting' displays with LED fabrication process . . . . . NEWS, ED 6, p. 36

LED alphanumeric display is a complete \$68 package . . . . .

**You say all you need  
is a delay relay  
that times pretty well  
and can carry  
the load it switches?  
And doesn't cost much?**

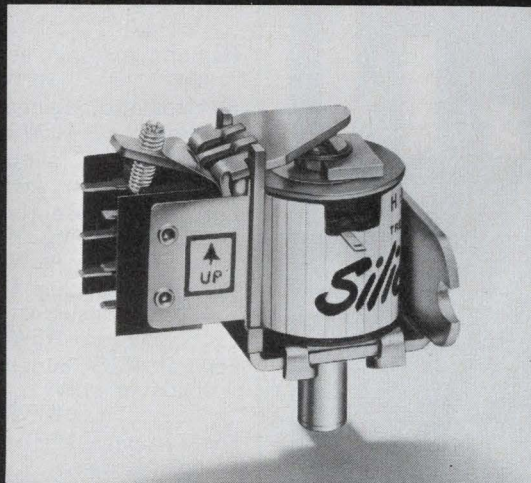

**Then this is it.**

For many applications, you don't need split-second timing accuracy in a delay relay. But you want something better than a thermal device.

Our Sillic-O-Netic® relays time out like our circuit breakers. A solenoid core moving at a controlled speed through a fluid dashpot.

Within their timing range (1/4 second to two minutes), we promise accuracy of ±50% of the selected delay. Doesn't seem like much, but it's plenty for most requirements. And you can depend on it.

Then the Sillic-O-Netic has a continuous-duty coil and heavy gold-plated silver contacts with up to 5-amp capacity—a combination that lets the delay relay act as its own load relay. You don't pay for extra components, or extra design time.

Finally, there's the reassuring Heinemann five-year warranty.

So if you want a reliable low-price delay relay, you ought to try one of our five models. They're described in Bulletin 5006. Heinemann Electric Company, 2616 Brunswick Pike, Trenton, N.J. 08602.



# General Electric's new 69F 2000 tantalum wet-slug capacitors

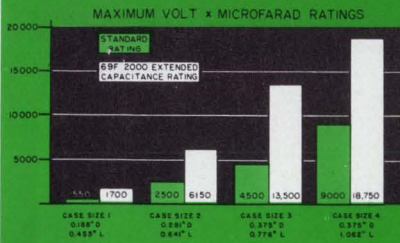

double...even triple the going capacitance ratings

The chart reflects it. Now you can design in one instead of two... in the same case size. Or, replace a standard MIL-type unit with a smaller case without losing capacitance or voltage.

Another plus is GE'S patented teflon/elastomer double O-ring seal that can withstand the environmental tests of MIL-C-39006.

Extended capacitance tubular tantalum wet-slug capacitors come in four sizes and are dual rated: 4 to 50 WVDC at 125 C; 6 to 75 WVDC at 85 C.

For more information, call your local GE Electronics Distributor, your GE Electronic Component Sales Office, or write Section 430-48, General Electric Company, 1 River Road, Schenectady, N. Y. 12305.

GENERAL ELECTRIC

..... PF, ED 4, p. 105  
LED DIP display for \$10 has decoder/driver and memory..... PF, ED 1, p. 115  
Need for new displays seen with cable TV... NEWS, ED 11, p. 20  
Plasma is getting better, and so is designer's choice of displays... NEWS, ED 13, p. 23

## General Industry

A billion-dollar decline in sales estimated for electronics in '70... NEWS, ED 1, p. 25  
A hot race for a change for IEEE presidency?.. NEWS, ED 12, p. 20  
A market in billions seen for medical electronics.. NEWS, ED 13, p. 20  
Color TV tube exports to 2 areas up 427%... NEWS, ED 2, p. 22  
Commerce Dept. predicts happy days through '80.. NEWS, ED 9, p. 19  
Demand for engineers reported at a low..... NEWS, ED 1, p. 22  
Electrostatic engineers set up a new society... NEWS, ED 13, p. 20  
Engineering is slipping as a career goal..... ART, ED 12, p. 54  
Europe component sales cloudy with a silver lining..... NEWS, ED 10, p. 19  
Europe outpacing U. S. in use of ICs in consumer products..... NEWS, ED 6, p. 38  
Federal R&D budget up, with new fields to study..... NEWS, ED 4, p. 21  
For European electronics, things are looking down..... NEWS, ED 12, p. 22  
Further cuts foreseen in aerospace jobs..... NEWS, ED 11, p. 20  
Honeywell joins trend to instrument rentals..... NEWS, ED 2, p. 22  
IEEE '71—Practical how and why for a changing industry..... SR, ED 6, p. S2  
Industry is cautioned U. S. won't bail it out.. NEWS, ED 12, p. 19  
Japan forms LSI council to gain competitive edge..... NEWS, ED 1, p. 21  
Job help for engineers pressed across U. S.. NEWS, ED 7, p. 21  
Matsushita challenges U. S. mini makers... NEWS, ED 12, p. 20  
Motorola aims to penetrate a growing CMOS market..... NEWS, ED 10, p. 19  
New group explores cure for unemployment... NEWS, ED 8, p. 21  
Petitioners demand change in IEEE priorities—now..... NEWS, ED 6, p. 21  
Power needs outrunning supply, expert warns... NEWS, ED 6, p. 22  
Soviet reports advance in nuclear electricity... NEWS, ED 8, p. 21  
Strong European technology preparing to challenge U. S..... NEWS, ED 13, p. 28  
Sweeping changes are urged to unify U. S. science policy..... NEWS, ED 7, p. 28

Trade shows are great—or are they?..... ART, ED 9, p. 58  
WEMA asks for a halt to trade-bill restrictions.. NEWS, ED 1, p. 21  
18% rise forecast in '71 for computer business..... NEWS, ED 6, p. 22

## Management

Be a welcomed speaker at technical sessions..... ART, ED 11, p. 84  
Firm name games are serious business..... ART, ED 2, p. 68  
Improve your project control with this 'hand-operated' reporting system..... ART, ED 10, p. 70  
Inventing a product is only half the job..... ART, ED 7, p. 56  
Memo from an engineering secretary..... ART, ED 13, p. 76  
U. S. management: better than you think..... ART, ED 5, p. 54  
Use a technical Rx for management ills..... ART, ED 1, p. 98  
What price unionization?..... ART, ED 4, p. 82  
What size company should you work for?..... ART, ED 8, p. 78  
Your product will get rave notices..... ART, ED 6, p. 86

## Materials & Packaging

A great tape developed; All it needs is a machine.. NEWS, ED 9, p. 20  
Aluminum gaining favor as electrical conductor... NEWS, ED 6, p. 21  
Chrome photomasks in mass production..... NEWS, ED 9, p. 20  
Computer control gives better silicon wafers... NEWS, ED 5, p. 31  
Conference promises 'firsts' in liquid crystals..... NEWS, ED 6, p. 21  
Data acquisition system fits in a 2.4-in.<sup>3</sup> module..... PF, ED 6, p. S36  
Enter, the ion-implantation age, where 'impossibles' are possible..... NEWS, ED 4, p. 25  
GaAs off-shelf wafers offered for first time... NEWS, ED 8, p. 22  
New LSI packaging opens the way for the micro-mini era..... NEWS, ED 5, p. 24  
New oxide boosts tape output and clarity..... NEWS, ED 8, p. 35  
New plastic package lowers rejects and costs... NEWS, ED 7, p. 31  
Those aren't movie reels—they're 35-mm rolls of ICs..... NEWS, ED 1, p. 40

## Military & Aerospace

A great TV show is lined up for that car trip on the moon..... NEWS, ED 9, p. 30  
AF to push studies in avionics program..... NEWS, ED 8, p. 22  
Civilian satellite use stressed in Europe..... NEWS, ED 10, p. 20  
Foes of the ABM unite..... NEWS, ED 5, p. 21  
General aviation assails FAA transponder rule—NEWS, ED 13, p. 20  
Navy's new subs to get improved

electronics...NEWS, ED 3, p. 21  
 New ABM net planned, a backup for Safeguard...NEWS, ED 5, p. 21  
 'Portable' recon system being used by RAF...NEWS, ED 5, p. 22  
 Satellites to provide first intrastate TV...NEWS, ED 2, p. 22  
 Soviet submarine expansion spurs rise in ASW market...NEWS, ED 2, p. 21  
 Space: Electronics for missions to Venus, Mars and orbit stations...SR, ED 6, p. S9  
 Space rescue programs are in planning stage...NEWS, ED 1, p. 22  
 Space-station program needs custom-made sensors...NEWS, ED 2, p. 32  
 The worst is over, Laird says of defense cutbacks...NEWS, ED 7, p. 21  
 Underwater holograms tested in Navy sub...NEWS, ED 3, p. 22  
 3 advanced satellites to study atmosphere...NEWS, ED 8, p. 21  
 1500-W power plant to be unfurled in space...NEWS, ED 3, p. 22

**Test & Measuring**

A new use for MOS transistors: To detect accumulated radiation...NEWS, ED 11, p. 32  
 Computer aids electron microscope...NEWS, ED 9, p. 31  
 Digital multimeter cost cut 50% by new design...NEWS, ED 13, p. 19  
 DPM uses LED display and custom parts for reliability...PF, ED 3, p. 51  
 DVOM pair offers 50-mΩ resolution and 0.1% accuracy...PF, ED 10, p. 104  
 Flexible scope system with 9 plug-ins allows economical measurements...PF, ED 2, p. 83  
 Portable 25-MHz scope offers split-screen storage...PF, ED 13, p. 89  
 Portable 500-MHz counter adds-on low-cost modules...PF, ED 10, p. 106  
 Premium 4-digit DMM starts as low as \$1395...PF, ED 4, p. 114  
 Remote-readout DPMs allow universal mounting...PF, ED 1, p. 120  
 Rf measuring unit offered by NBS...NEWS, ED 9, p. 31  
 Thrifty data-logging system handles 100 analog inputs...PF, ED 12, p. 96  
 Two-MHz a/d is a memory, transient recorder and d/a...PF, ED 11, p. 102  
 Unique portable instrument tests a/d and d/a converters...PF, ED 12, p. 98  
 10-MΩ panel meters include memory option...PF, ED 13, p. 90  
 50-kHz to 80-MHz generator locks-in output to ±10 Hz...PF, ED 8, p. 91  
 500-MHz counter has a \$1445 price...PF, ED 2, p. 84  
 500-MHz real-time scope can also handle 1 GHz...PF, ED 10, p. 106

# VACTEC

## "PLASTIC" PHOTOCELLS

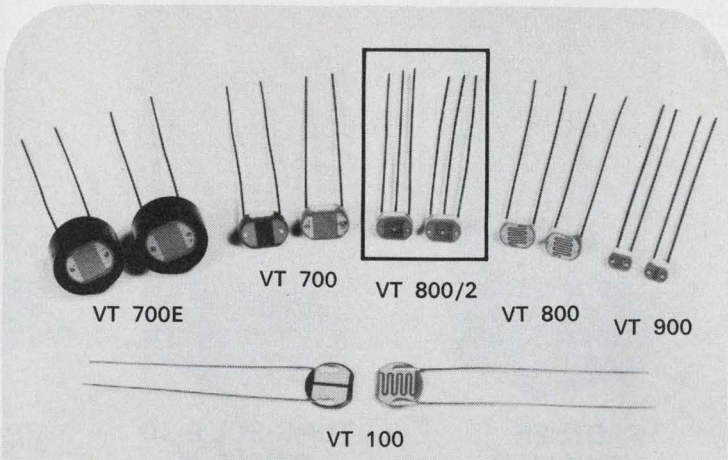

Actual size, priced as low as .25 each (±33% tolerance) in 10,000 quantities.

**EVEN LOWER FOR ±50% TOLERANCE**

**Low Cost Way to Meet Most Photocell Requirements**

Here is a complete line made with the same quality characteristics and precise tolerances by the originator of the first **stable** plastic coated cell. Six different thin-film materials of CdS and CdSe deposited on ceramic substrates. A VACTEC development with almost 10 years of production experience. When others said it couldn't be done — we were doing it! NOW improved passivation processes make them better than ever. Why experiment — buy where the experience is. The proof — they have been used in **millions** of cameras all over the world!

The newest addition is the VT 800/2 series, a dual element cell with bifilar type electrode for two-cell controls from a single light source. The expanded line also includes the epoxy encapsulated VT 700E series for protection against humidity and salt spray.

Costing less than 1/2 of hermetically sealed cells, they have excellent resistance to humidity, eliminating need for hermetic cells in **most** applications. VACTEC "plastic" photocells are conveniently controlled by ambient light or from closely coupled low voltage lamps. Industrial and commercial applications, like controlling relays in line voltage circuits; switching SCR's on or off; phase control and proportional circuits; audio controls; and feedback elements for motor speed controls in consumer appliances.

**Series Type**

VT 100  
 VT 700 and VT 700E  
 VT 800 and VT 800/2  
 VT 900

**Substitutes for hermetic type**

TO-8  
 TO-8  
 TO-5  
 TO-18

Write for Bulletin PCD-6 PCD-41, 57, 58, and 59



# VACTEC, INC.

2423 Northline Ind. Blvd. • Maryland Heights, Missouri 63043  
 (314) 872-8300

Specializing in standard Cds, Cdse, and Se cells. Custom engineering for every photocell need. Listed in EBG under "Semi-Conductors" and EEM Sec. 3700.

# ONLY TUNG-SOL PERFORMANCE IS LARGER

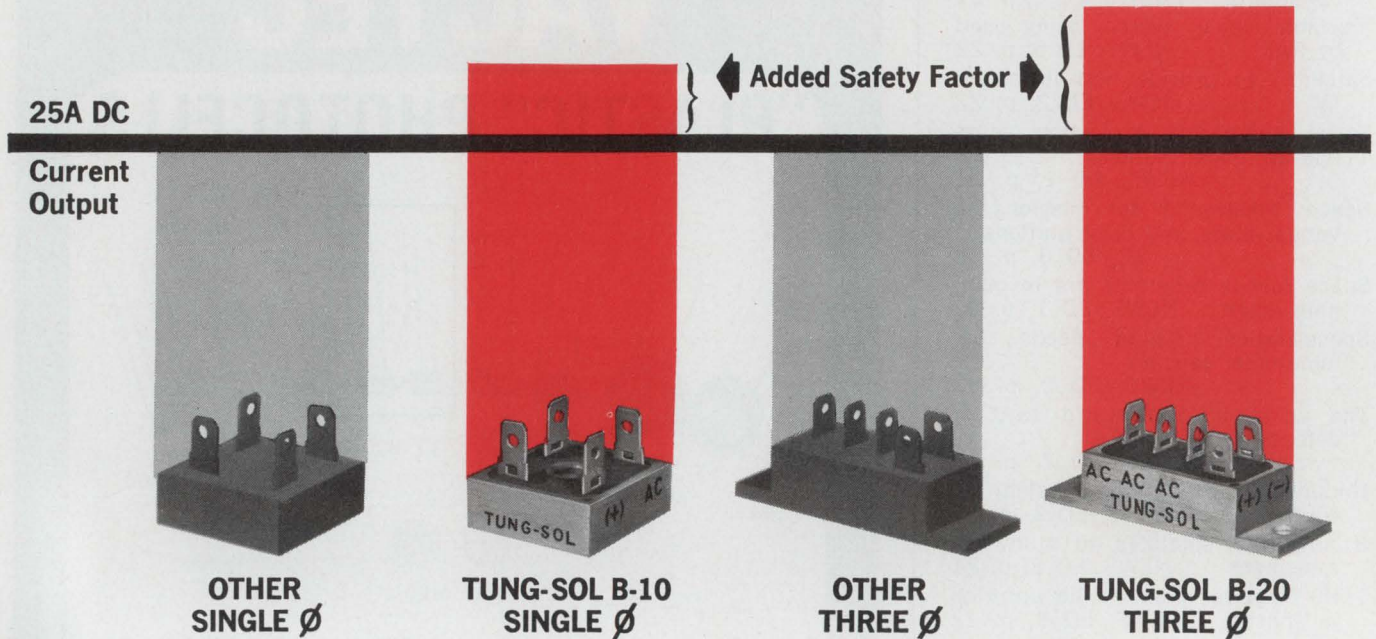

The physical dimensions of Tung-Sol single phase and three phase bridge rectifiers are identical to competitive devices. It is in the ratings for DC output and forward surge capacity that Tung-Sol bridges are substantially larger. This provides important added safety at normal operating levels. A minimum of internal connections gives Tung-Sol bridge rectifiers exceptional mechanical strength. *For all this performance reliability and convenience you pay no premium.*

**B-10 Series** • DC rating—30A @ 55°C. Forward surge rating—400A @ rated load. B-10 series replace similar bridges rated from 8 to 25A and from 50 to 1,000 PRV per leg.

**B-20 Series** • DC rating—35A @ 55°C. Forward surge rating—400A @ rated load. B-20 series replace similar bridges rated up to 25A and from 50 to 1,000 PRV per leg.

Terminals of both series are suitable for all types of connections.

**Tung-Sol Can Supply The Silicon Power Rectifiers You Need.** Tung-Sol makes a complete line of silicon power rectifiers in the DO-4, 5, 8, 9 and 21 configurations. Operational reliability is unmatched—a result of exclusive design features and quality control procedures that are the most exacting in the industry. Full field technical consultation is available from conveniently located sales offices.

*Write for complete technical information. Please indicate whether your interest is rectifier bridges, or power rectifiers.*

**Silicon Products Section TUNG-SOL DIVISION**  
WAGNER ELECTRIC CORPORATION

630 West Mt. Pleasant Ave., Livingston, N.J. 07039  
TWX: 710-994-4965  
Phone: (201) 992-1100; (212) 732-5426

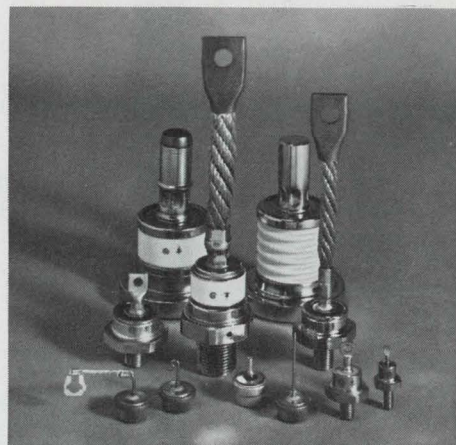
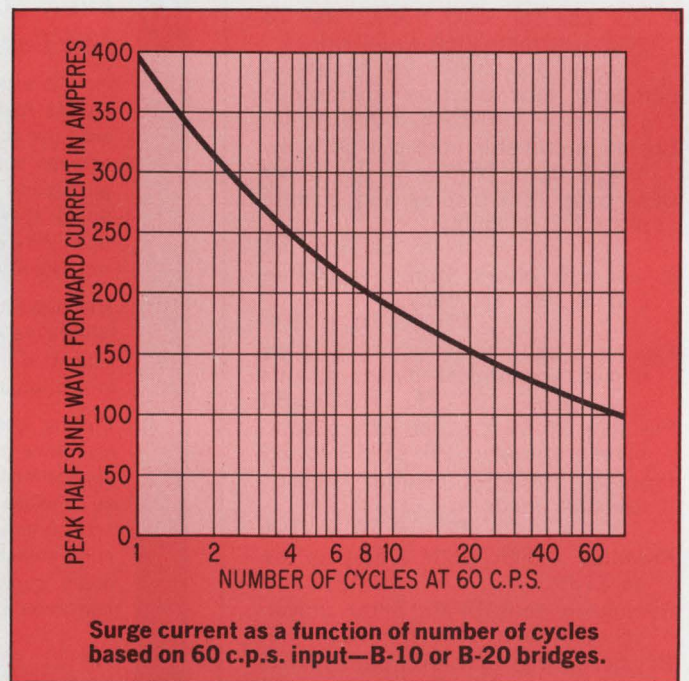

Trademark TUNG-SOL  
Reg. U.S. Pat. Off. and  
Marcas Registradas

# new products

## Low-cost, monolithic, compensated 15-MHz op amp slews at 70 V/ $\mu$ s

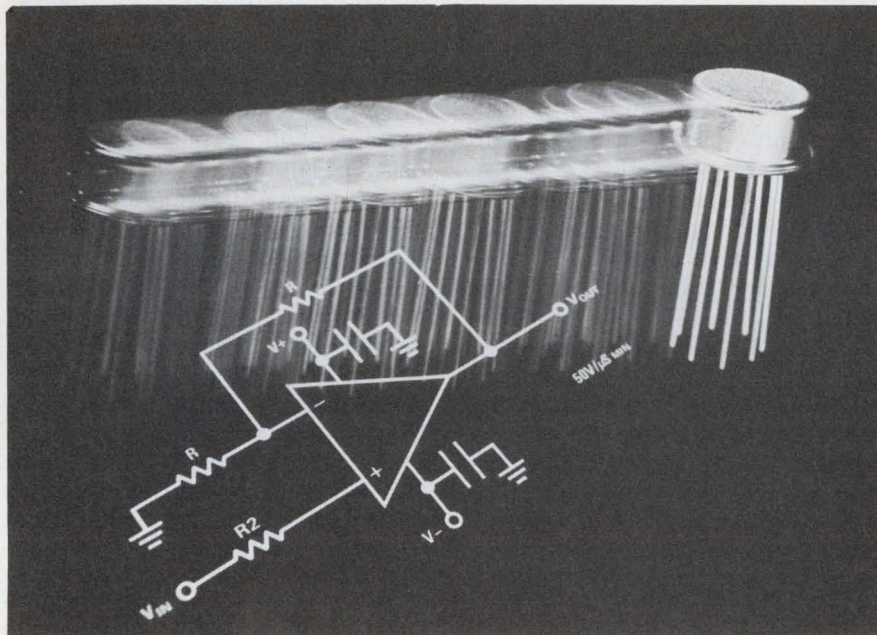

National Semiconductor Corp., 2900 Semiconductor Dr., Santa Clara, Calif. Phone: (408) 732-5000. P&A: \$29.95 (LM118), \$19.95 (LM218) and \$9.95 (LM318) for 100-piece quantities; stock.

The new LM118/218/318 is a versatile, precision monolithic op amp that offers a powerful combination of low cost, wide bandwidth and high slew rate, with no loss in flexibility over general-purpose devices.

The new op amp, which is unity-gain internally compensated, features a typical bandwidth of 15 MHz and a typical slew rate of 70 V/ $\mu$ s. Full-power bandwidth is rated at 1 MHz.

A wide range of voltages can be used to operate the LM118/218/318—anywhere from  $\pm 5$  to  $\pm 18$  V—with virtually no change in slew rate or bandwidth, making the LM118/218/318 independent of supply voltages.

One of the biggest limitations of today's internally compensated monolithic op amps is speed. With internal unity-gain frequency compensation, most general-purpose

monolithic op amps have bandwidths and slew rates on the order of 1 MHz and 0.6 V/ $\mu$ s, respectively. And they cannot be externally compensated for greater bandwidth and slew rate.

Op amps that are not internally compensated can be externally compensated, of course, but they usually have to operate in an inverting mode for unity gain applications. For non-inverting unity-gain applications, internally trimmed types have to be used.

The new LM118/218/318 offers both speed and flexibility in compensation. It can be externally compensated with feed-forward techniques to bring its slew rate up to 150 V/ $\mu$ s and to increase its bandwidth to 30 MHz. And it will operate in a non-inverting mode, even when externally compensated. Its common-mode voltage range is  $\pm 11.5$  V and its voltage gain is high—200,000. Output voltage swing is  $\pm 13$  V, and common-mode rejection ratio is 80 dB.

The op amp can drive a 100-pF load, as care was taken to minimize high-frequency stray capacitances at the op amp's inverting

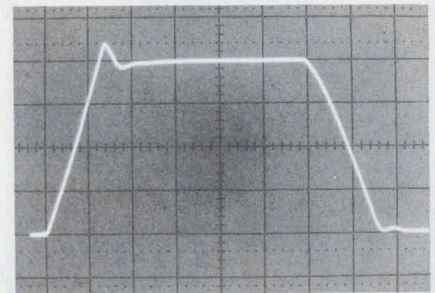

The LM118 monolithic op amp responds to a large-signal input pulse in 300 ns. Scale markings are 5 V/division (vertical) and 200 ns/division (horizontal).

input and at the output.

The new circuit features impressive input parameters. Its input offset voltage is only 2 mV, while input bias current is a mere 200 nA. Offset current is also quite low—only 20 nA.

The LM118/218/318 typically settles to 0.1% of its final output value in 500 ns, for a 10-V step. Settling time is defined here as the time necessary to slew a defined voltage difference and settle to within a defined error of its final output voltage.

Both input and output are protected against overload conditions. Shunt diodes placed in the input circuitry protect it from excessive voltage, while the output circuit is short-circuit protected. The op amp may be offset-balanced by using a small potentiometer, whose value is typically 200 k $\Omega$ .

The op amp is pin-for-pin compatible with popular type 101A and 741 op amps. No additional external components are needed.

The LM118 operates over the temperature range of  $-55$  to  $+125^{\circ}\text{C}$ . The LM218 is rated to operate over  $-25$  to  $+85^{\circ}\text{C}$ . The LM318 works over 0 to  $+70^{\circ}\text{C}$ . All three versions are available in eight-pin TO-5, flatpack or dual-in-line packages.

CIRCLE NO. 340

# HIGH POWER VOLTAGE REGULATORS

2 1/2" x 1 5/8" x 3/4"

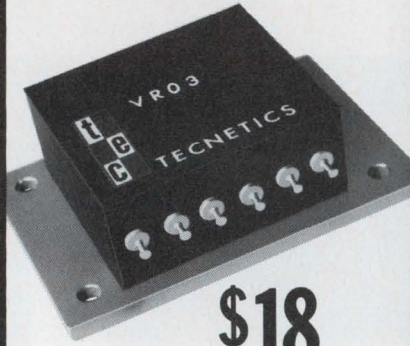

**\$18**  
EACH

Now, there's a second source for high power voltage regulators. Tecnetics offers the new VR03 Series. High powered, low cost, little packages. \$18 each in quantities of 100.

#### The VR03 Series offers:

- Short circuit and overload protection
- Increased current output when used as a driver for series regulating transistors
- Increased power handling capability with external regulation transistor
- Dual connection and negative regulator connection with transformer isolation
- Positive regulator
- Remote programming
- Up to 5 Amperes D.C. output
- Up to 28 Volts D.C. output
- Up to 70 Watts dissipation
- 0.2% Regulation, line or load
- 0.007%/°C temperature coefficient
- Remote sensing
- Electrically isolated case

Manufactured to your specifications

**tecnetics inc.**

P.O. Box 910, Boulder Industrial Park, Boulder, Colorado 80302  
(303) 442-3837 TWX 910-940-3246

INFORMATION RETRIEVAL NUMBER 54

## ICs & SEMICONDUCTORS

# Low-current comparators cut propagation to 10 ns

Signetics Corp., 811 E. Arques Ave., Sunnyvale, Calif. Phone: (408) 739-7700. P&A: see text, stock.

Two new IC comparators, the 527K and 529K, incorporate precision input stages and Schottky gates on the same chip to dramatically improve both accuracy and speed over presently available voltage comparators.

The 529K with its differential-pair input stage achieves a typical propagation delay from input to output of 10 ns. Its input impedance is 5 k $\Omega$  and bias current is typically 5  $\mu$ A.

The 527K uses a Darlington-input stage and has a slightly slower propagation delay of 15 ns, typical. However, it offers a factor-of-10 higher input impedance—50 k $\Omega$ —and seven times lower input bias current—0.7  $\mu$ A.

For a/d conversion systems, these new devices mean faster sampling rates and less degradation of input voltage due to input impedance values.

Since both devices have complementary Schottky-diode, TTL outputs, they can be used in high-speed system designs where gate delay is minimized.

Each comparator's amplifier section can be operated from balanced  $\pm 5$  to  $\pm 15$ -V supplies.

Both devices are offered in military (prefix SE) and commercial (prefix NE) temperature ranges. Both share a common pin configuration and are packaged in 10-pin, TO-100 metal-can cases.

Unit prices for 100-piece quantities are as follows: NE527K (\$8.50); SE527K (\$17); NE529K (\$6.50); SE529K (\$13).

CIRCLE NO. 341

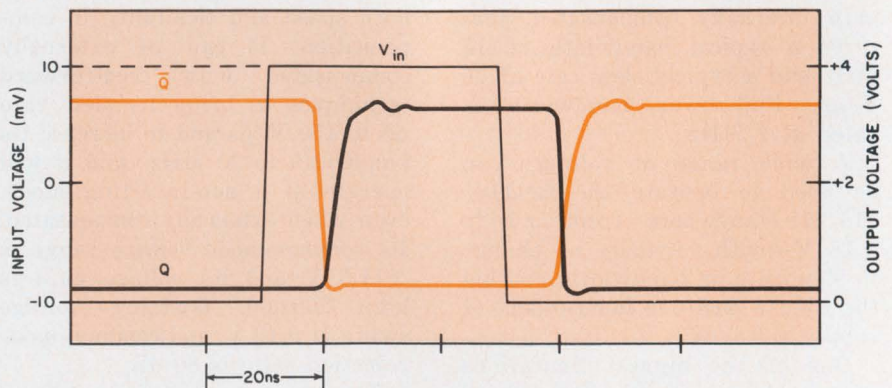
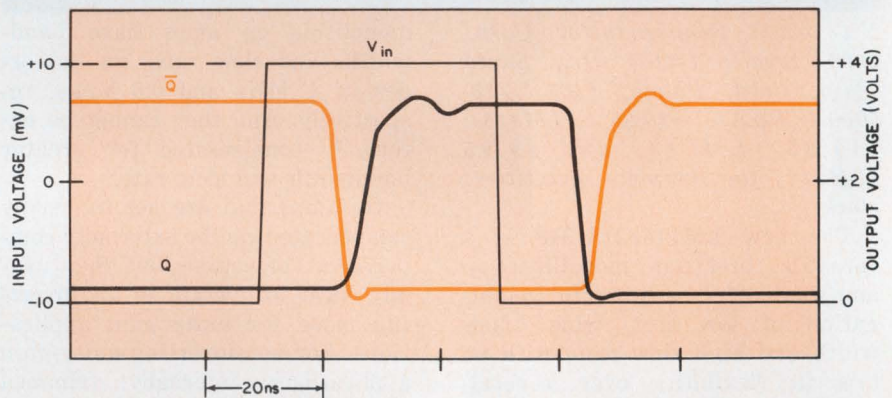

Two new IC comparators offer very fast propagation delay times. The 527K, a Darlington-input unit, has a typical delay time of 15 ns (top). The 529K, a differential-input device, is even faster at 10 ns (bottom).

# The first desk-top DZM\*

*Someday* you will turn to a CRT terminal on your desk for computer assistance on all your design efforts.

*Someday* a desk-top copier will give you instant access to texts and catalog information, via display or hard-copy reproduction.

*Someday* you will not only see and talk to a caller, but exchange documents with him from your desk.

*Today*, on your desk, you can have the first of these instant-information machines, one you will use regularly to characterize components for your designs, fast, accurately, easily. Why wait?

The new GR 1684 DZM measures resistance, inductance, and capacitance, at the push of a button to 1% accuracy on a 4-place digital readout. No more manual null balancing and interpolating analog results. Yesterday's methods are gone. The 1684 belongs on your design desk today.

And, for the day when your CAD's include computer-evaluated components, the 1684 has a data-output option for direct computer input of component characteristics.

Now consider the DZM's measurement ranges of 2,000,000,000:1, six-terminal connections for stray-free and in-situ accuracy, optional dissipation factor readout, small size, bright styling, and low \$1050 price.

The GR 1684 is the first of the new breed of economical, general-purpose impedance bridges. You should have one. Demonstrators are now available world-wide. Telephone your nearest GR office or write GR, 300 Baker Avenue, Concord, Mass. 01742. In Europe, write to Postfach124, CH 8034, Zurich, Switzerland.

Prices are net FOB, Concord, Mass.



## General Radio

NEW YORK (N.Y.) 212 964-2722 (N.J.) 201 791-8990 • BOSTON 617 646-0550  
CHICAGO 312 992-0800 • WASHINGTON, D.C. 301 881-5333 • LOS ANGELES 714 540-9830  
TORONTO 416 252-3395 • ZÜRICH (01) 55 24 20  
GRASON-STADLER 617 369-3787 • TIME/DATA 415 327-8322

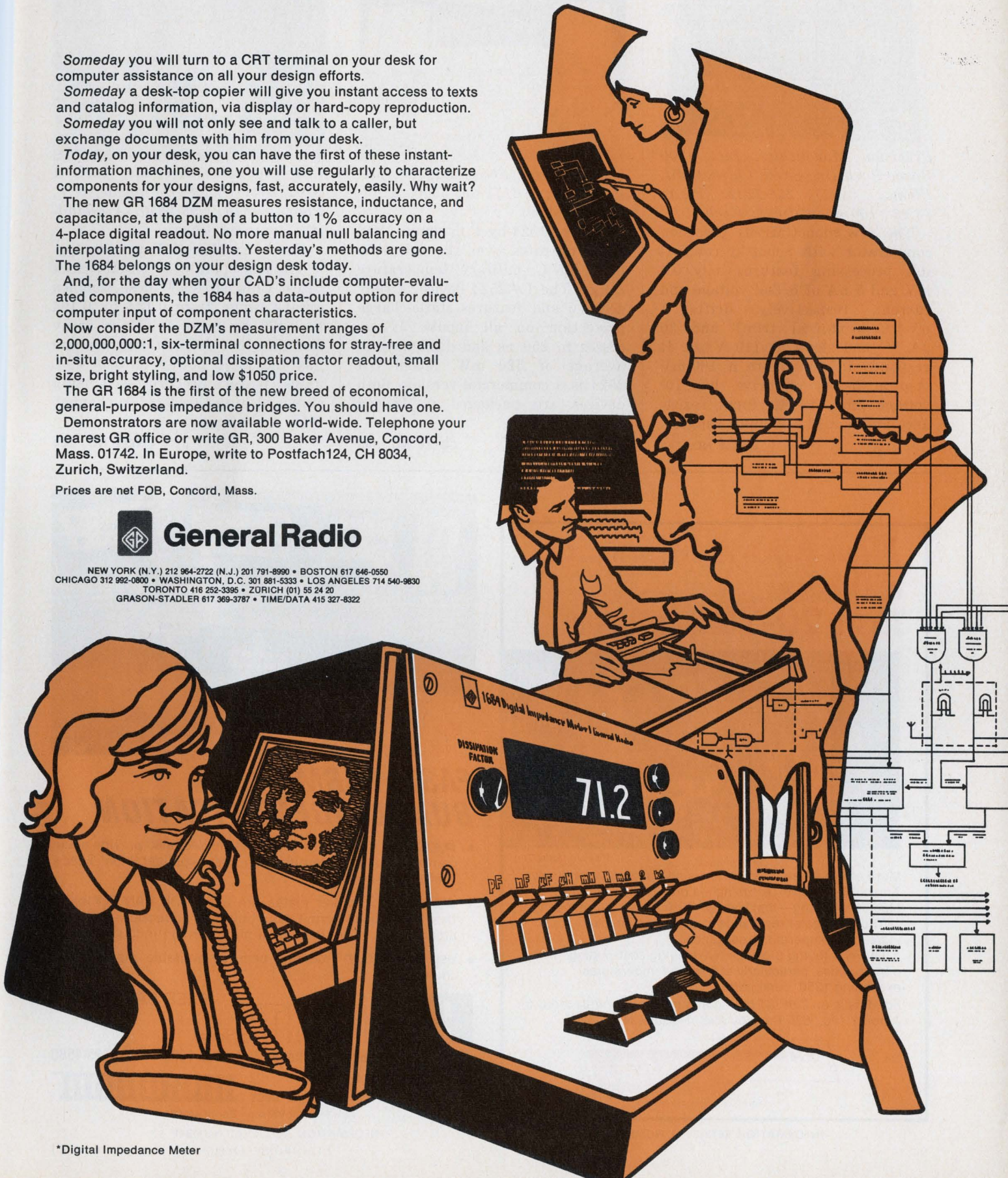

\*Digital Impedance Meter

### Fast IC comparator slews at 110 V/ $\mu$ s

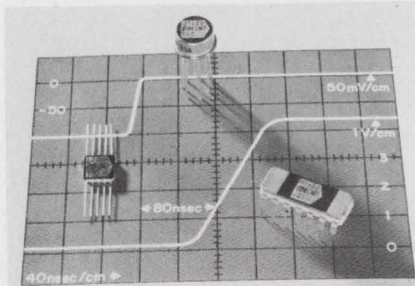

Precision Monolithics, Inc., 1500 Space Park Dr., Santa Clara, Calif. Phone: (408) 246-9222. P&A: \$3.25 (100 quantities); stock.

The new monoCMP-01 precision comparator with Schottky compatible processing features only 0.4 mV and 5 nA of offset voltage and current, respectively, drifts 1  $\mu$ V/ $^{\circ}$ C (external trim) and 30 pA/ $^{\circ}$ C and slews at 110 V/ $\mu$ s. It responds in 100 ns to a 100-mV step at 5-mV overdrive, has  $10^5$  voltage gain, 10-M $\Omega$  input resistance and a  $\pm$ 13.2-V input range.

CIRCLE NO. 342

### 1024-bit, MOS RAM works at $-55$ to $+125^{\circ}$ C

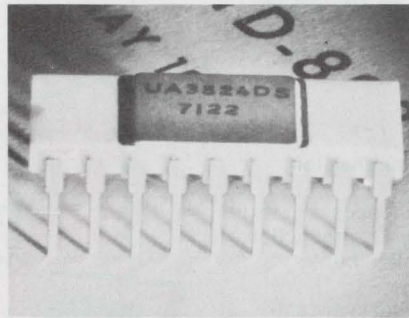

Unisem Corp., Street Rd., Treviso, Pa. Phone: (215) 355-5000. Availability: stock.

A new 1024-by-1 dynamic MOS RAM operates over the full  $-55$  to  $+125^{\circ}$ C military temperature range. The UA2524 device is fully decoded and features static-charge protection on all inputs. It accesses in 250 ns and dissipates an average of 320 mW. Model UA 3524 is a commercial version. Both devices are packaged in 18-lead ceramic DIPs.

CIRCLE NO. 343

### MOS/LSI arrays operate at 4 MHz

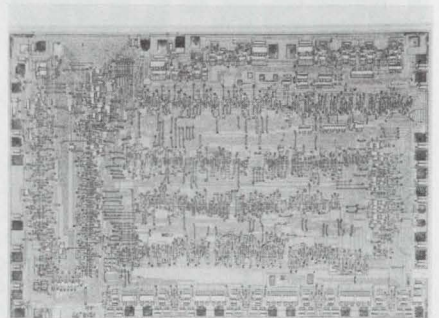

LSI Computer Systems, Inc., 1 Northwest Dr., Farmingdale, N.Y. Phone: (516) 293-3850. Availability: 10 to 12 wks.

Four new MOS/LSI random logic circuits operate at 4-MHz clock rates. Chip sizes of these complex arrays range from 0.134 by 0.194 to 0.173 by 0.198 in. Each array contains 1500 MOS transistors and has the logic power of 500 TTL gates. Wafers are processed using standard high-threshold, p-channel, MOS techniques.

CIRCLE NO. 344

## New quartz tubing for diffusion... lasts 20-30% longer.

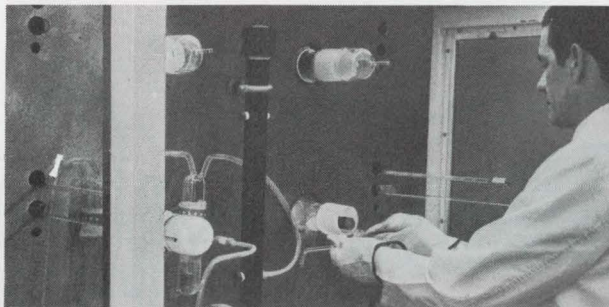

Courtesy Unitrode Corp.

More efficient furnace diffusion is now attainable with new Amersil T-07-OHF-ST tubing—a practically water free-stabilized-tubing—that lasts 20-30% longer than any other!

There's greater resistance to devitrification plus increased temperature resistance.

OHF-ST tubing provides outstanding cost-cutting opportunities, particularly at furnace temperatures exceeding 1250 $^{\circ}$  centigrade.

For details on OHF-ST tubing and technology, write today to: Amersil, Inc., 685 Ramsey Ave., Hillside, N.J. 07205.

**AMERSIL**  
INC.

**FUSED SILICA  
AND QUARTZ**

An Equal Opportunity Employer

208C

INFORMATION RETRIEVAL NUMBER 56

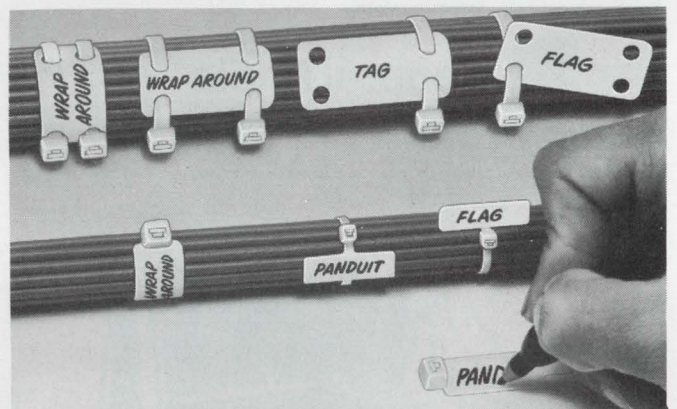

## FAST, PERMANENT BUNDLE IDENTIFICATION

- **PAN-TY**<sup>®</sup> marker ties secure harnesses; also provide clear, permanent bundle identification. Meet applicable Mil Specs. Tool or hand applied.
- **PANDUIT**<sup>®</sup> marker plates are used with PAN-TY<sup>®</sup> cable ties. Round holes permit mounting in any direction—as wrap-around, tag or flag. Individual plates or continuous rolls.
- Use **PANDUIT**<sup>®</sup> marking pens or available marking machines.

**PANDUIT** CORP.

Tinley Park, Ill. 60477 • Phone: 312-532-1800 • Telex 25-4560

FROM THE MANUFACTURERS OF  
**PANDUCT**<sup>®</sup> PLASTIC WIRING DUCT



Visit Panduit Wescon Booth #1601

INFORMATION RETRIEVAL NUMBER 57

ELECTRONIC DESIGN 17, August 16, 1971



# RCA ST-VIDICONS

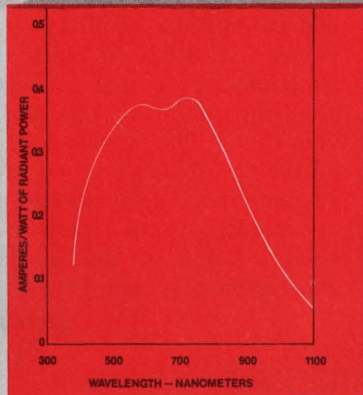

FIG. 1

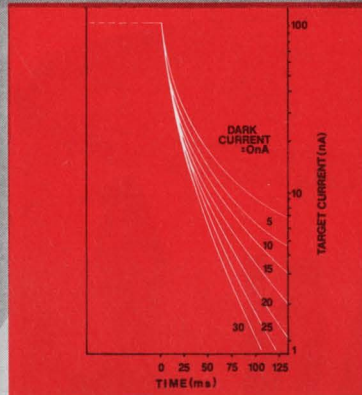

FIG. 2

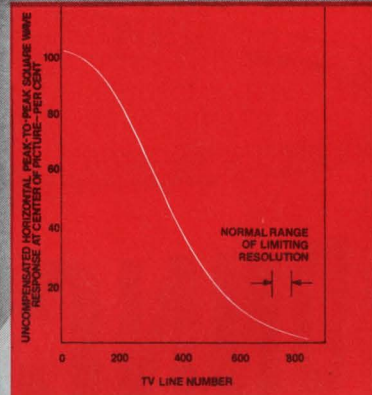

FIG. 3

## Confused about Silicon-Target Vidicon claims and names?

## Here are the facts!

Silicon-target vidicon camera tubes provide a sensitivity unmatched by other available camera tubes. They offer broad spectral response (see Fig. 1); they provide convenient operation in selected sensitivity modes by appropriate selection of optical filters; and they are virtually impervious to damage by intense light.

So much for *all* silicon-target vidicons.

You'll be interested in knowing about RCA's exclusive target structure for what it means to you in terms of improved performance. Here are some of the unique benefits of RCA ST-Vidicons.

First—lag vs. dark current—characteristics which must be considered together for a meaningful evaluation. Lag of a typical RCA ST-Vidicon approaches the 5% level at the 50 ms or 3rd field point of standard measurement in an optimized signal mode—with very low dark current.

Lag can be improved if the diodes are operated at high dark current (see Fig. 2). However, low dark current is very important—because it makes a major contribution to uniform picture background. RCA ST-Vidicons give you this low lag/low dark current combination as an inherent feature of the target structure. This fact also assures excellent low lag performance at elevated temperatures, since you start with low dark current.

As an additional benefit, RCA ST-Vidicon target geometry permits the scanning beam to discharge highlights more efficiently. Thus, you avoid annoying picture smear—the so-called "comet-tailing" on bright moving objects. And this is achieved without any sacrifice in its resolution, the highest in the industry (see Fig. 3).

RCA's answer to the confusion about silicon-target vidicon claims is clear-cut. Look for superior performance in RCA ST-Vidicons.

Check with your local RCA Representative or your local RCA Distributor. For technical data, write: RCA, Commercial Engineering, Section 57H16/ZC10, Harrison, N.J. 07029. International: RCA, 2-4 rue du Lièvre, 1227 Geneva, Switzerland, or RCA, Sunbury-on-Thames, U.K., or P.O. Box 112, Hong Kong.

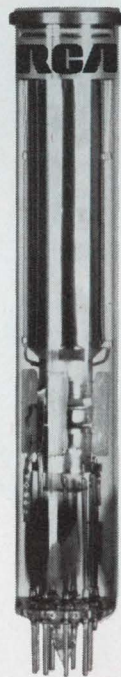

# RCA

our  
little

# Giant!

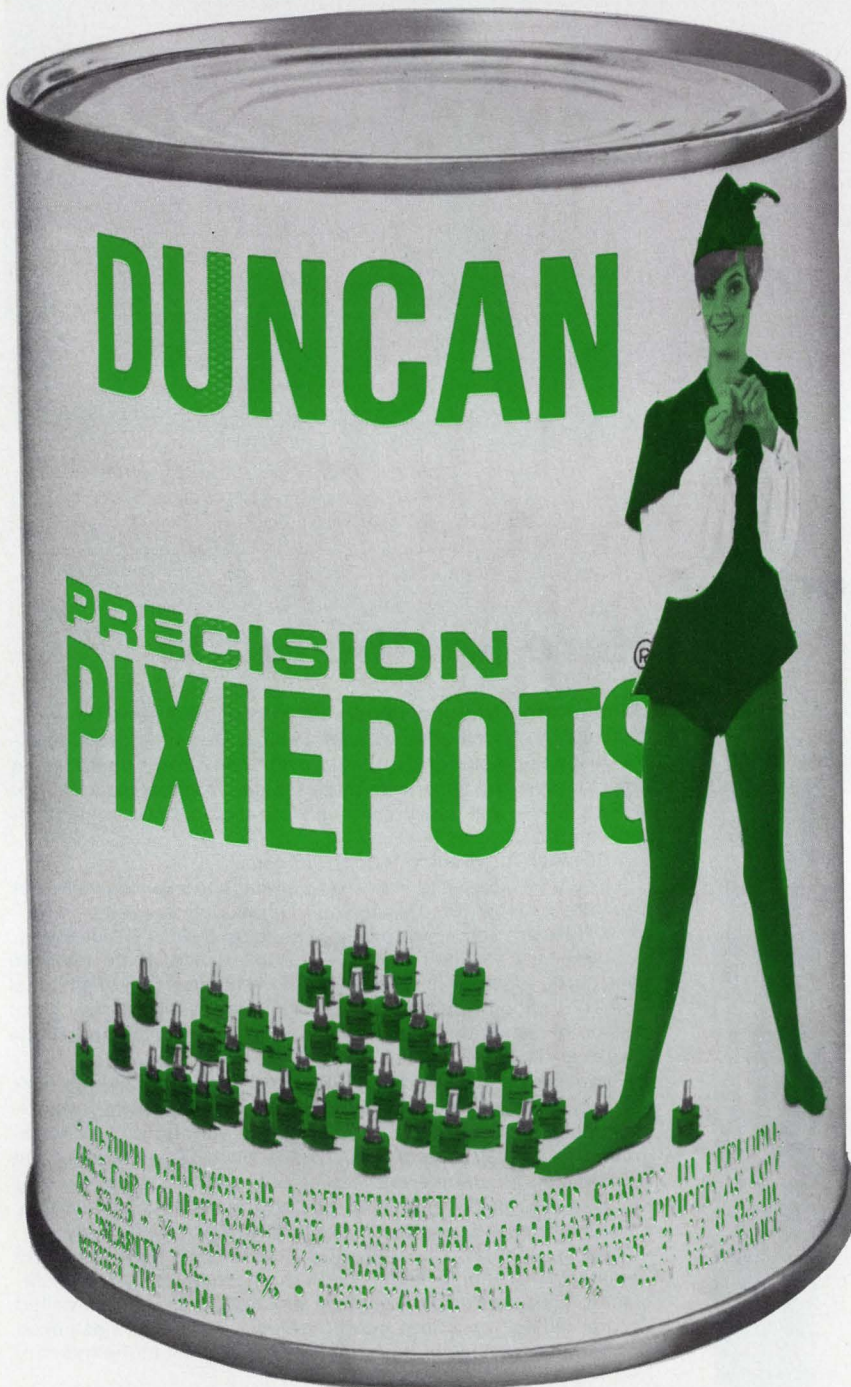

**DUNCAN ELECTRONICS**  
SUBSIDIARY

**SYSTRON**  **DONNER**

2865 FAIRVIEW ROAD □ COSTA MESA, CALIFORNIA 92626  
PHONE: (714) 545-8261 □ TWX 910-595-1128

INFORMATION RETRIEVAL NUMBER 58

ICs & SEMICONDUCTORS

## AM-receiver subsystem comes in a DIP IC

RCA Solid State Div., Route 202, Somerville, N.J., Phone: (201) 485-3900. P&A: \$1.40 (1000 quantities); stock.

An AM receiver subsystem and general-purpose amplifier array IC is the CA3088. It includes the functions of an AM converter, i-f amplifier, detector, and audio pre-amplifier. The CA3088 has low harmonic distortion, agc for the i-f amplifier, delayed agc for an rf amplifier, an internal zener voltage regulator, and an array of general-purpose amplifiers.

CIRCLE NO. 345

## MOS static registers are DTL/TTL compatible

Signetics, 811 E. Arques Ave., Sunnyvale, Calif. Phone: (408) 739-7700. Price: \$8.75 (2521/2522), \$10.50 (2518/2519).

Two new DTL/TTL-compatible, static, MOS shift register pairs are the dual 128/132-bit (models 2521/2522) with push-pull outputs, and the hexadecimal 32/40-bit (models 2518/2519). The former pair have 3-MHz clock operation, while the latter have 2-MHz clock rates. Both have recirculation paths on the chip and two-bit lengths.

CIRCLE NO. 346

## Clock driver handles 750 pF in 50 ns

Texas Instruments, Inc., 13500 N. Central Expressway, Dallas, Tex. Phone: (214) 238-2011. P&A: \$21.30 (100 quantities); 4 wks.

A new hybrid IC dual MOS clock driver features a switching speed of 50 ns or less into a 750-pF load. Designated the HIC138, it is designed for use as an interface between TTL and MOS logic levels where fast switching into capacitive loads is required. The hybrid circuit has a low 30-mW/driver standby power. Required supply voltages are +5 and -12 V.

CIRCLE NO. 347

# If you don't see the wet tantalum you want here, ask. For you we'll make an exception.

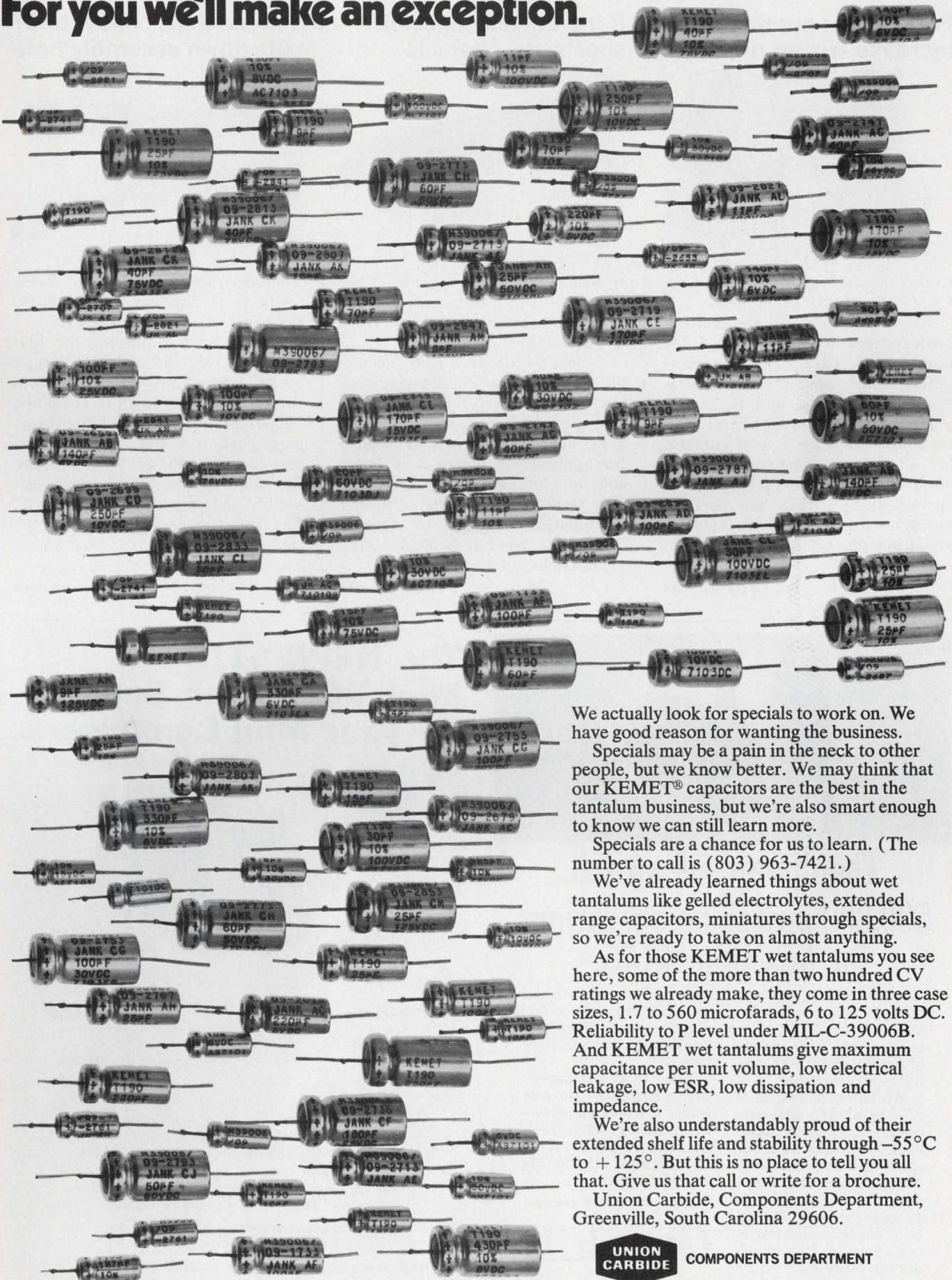

We actually look for specials to work on. We have good reason for wanting the business.

Specials may be a pain in the neck to other people, but we know better. We may think that our KEMET® capacitors are the best in the tantalum business, but we're also smart enough to know we can still learn more.

Specials are a chance for us to learn. (The number to call is (803) 963-7421.)

We've already learned things about wet tantalums like gelled electrolytes, extended range capacitors, miniatures through specials, so we're ready to take on almost anything.

As for those KEMET wet tantalums you see here, some of the more than two hundred CV ratings we already make, they come in three case sizes, 1.7 to 560 microfarads, 6 to 125 volts DC. Reliability to P level under MIL-C-39006B. And KEMET wet tantalums give maximum capacitance per unit volume, low electrical leakage, low ESR, low dissipation and impedance.

We're also understandably proud of their extended shelf life and stability through -55°C to +125°. But this is no place to tell you all that. Give us that call or write for a brochure.

Union Carbide, Components Department, Greenville, South Carolina 29606.



### Fork/blade connectors increase wiring density

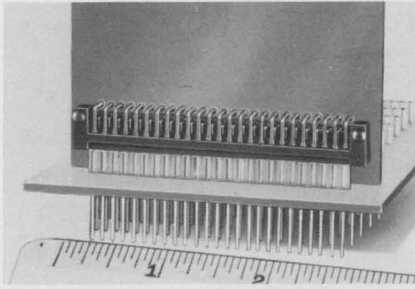

Berk-Tek, Inc., Box 60, Reading, Pa. Phone: (215) 376-8071.

New modular fork and mating blade connectors are designed for high-density back panels in computers and communications systems. Both blades and forks are gold-over-nickel plated. Their contacts are rated for 7 A of current, 0.006  $\Omega$  of resistance, and 500 M $\Omega$  of insulation. Mini-Plates can be custom made with a pre-specified number of terminations for installation on 0.1, 0.125 or 0.15-in. centers.

CIRCLE NO. 348

### Card edge connector shorts its contacts

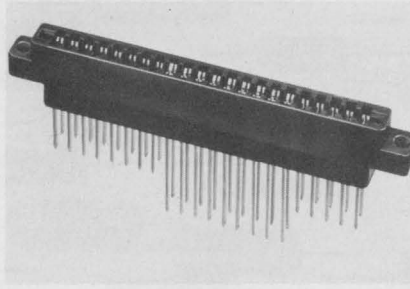

Methode Electronics, Inc., 7447 Wilson Ave., Chicago, Ill. Phone: (312) 867-9600. P&A: from \$1.95 to \$3.25; stock to 3 wks.

A new 44-pin card edge connector features selective shorting contacts. The connector is designed so that any or all contacts close when a PC board is removed. It is ideal for applications where it is desirable to eliminate an open circuit. The series 186 is available in any combination of open or shorted contacts to meet individual design applications.

CIRCLE NO. 349

### 3-piece SMA connector cuts down assembly time

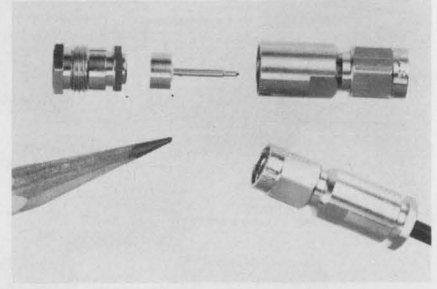

Amphenol RF Div., Bunker Ramo Corp., 33 E. Franklin St., Danbury, Conn. Phone: (203) 743-9272.

A new SMA connector for RG-174, 180, 188, 195 and 316/U coax cables comes pre-assembled into three component parts to cut down on assembly time. Use of the three-piece connector and a special low-cost tool kit (901-2500) to prepare the cable is expected to reduce assembly time by as much as 50%. The three pieces include a center contact, the connector body and a rear clamp unit.

CIRCLE NO. 350

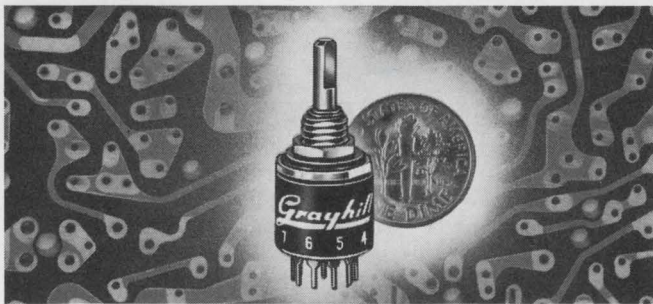

## The dime-sized switch. 500,000 switching operations for less than \$3.75.\*

Yes. It's the economy continuous rotation version of the Series 50. Just one example of a wide variety of readily available Grayhill rotary switches.

We have thousands of off-the-shelf miniature switches...single or multi-deck (recently we made some with 21 decks) with 15° to 90° angles of throw and a lot between, up to 12 poles per deck, 24 positions per pole, shorting or non-shorting, P.C. or solder lug terminals.

But if the life and load

ratings of our off-the-shelf switches are not acceptable for your application, we'll design and build one that is.

Like to know more? Write or phone for our latest general engineering catalog. Grayhill, Inc., 565 Hillgrove Ave., La Grange, Ill. 60525, (312) 354-1040.

\*Quantities of 100 or more.

**Grayhill**  
pioneers in miniaturization

INFORMATION RETRIEVAL NUMBER 60

## The NEWEST! Mini DC Power Supply for your Mini Computers.

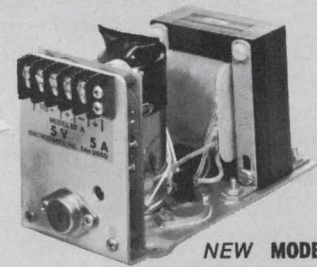

**\$69** ea.  
1 to 9 Units

NEW MODEL 50A

"IMMEDIATE DELIVERY" from "OFF THE SHELF EXPERTS"

#### SPECIFICATIONS:

- Eleven Models
- 3 to 30 volts
- 2 to 5 amps
- For IC's and computer logic circuitry
- Input 105-125V, 47-420 Hz
- Mini-sized: 3"W x 4"H x 6¾"L
- over voltage: optional
- Regulation: Line 0.005% or 2mV min. Load 0.05% or 10 mV min.
- Ripple: Less than 250  $\mu$ V
- Temp: -20° to +71° C
- Fixed current limiting
- Weight: 4½ lbs.

For full information TODAY Call (714) 279-1414  
Send for FREE DC Power Supply Catalog

**Electrostatics, Inc.**

7718 Clairemont Mesa Blvd., San Diego, California 92111

INFORMATION RETRIEVAL NUMBER 61

ELECTRONIC DESIGN 17, August 16, 1971

# OUR ANGLE: angle position indicators that do more and cost less

## SHOULDN'T YOU TAKE A NEW READING ON THIS COST-PERFORMANCE ANGLE?

For better ways to measure synchro and resolver data, North Atlantic offers the best of both worlds: budget prices for the popular API-8025; superior performance and increased capability of the new 8525. • Both are interchangeable without any mechanical or wiring modifications. North Atlantic's solid-state 8525 offers an accuracy of  $0.05^\circ$  (3 minutes). Following a  $180^\circ$  step input, it synchronizes a five-digit NIXIE readout in  $\frac{1}{2}$  second flat. And it tracks at up to  $1000^\circ$  per second. Where cost can be traded against performance, the proven electromechanical API-8025 . . . a recognized indus-

MODEL 8525



MODEL 8025

try workhorse . . . is available with its 6 minute accuracy,  $25^\circ$ /second slew speed, and many options. • Input of the 8525 is any 60 or 400Hz resolver/synchro data from control instrumentation. The patented servo design eliminates all inertia and improves dynamic performance many times over. Its digital outputs are especially suited to the computer-oriented requirements of today's automatic test systems. The 8525 . . . priced at \$1885 . . . and the API-8025 priced at \$995 actually cost less because they perform more functions per dollar. And with greater reliability. ®

For complete information on the cost-performance angle, please write or phone now.

ON DISPLAY at IEEE—Booths 3108-3110  
**NORTH ATLANTIC**  
*industries, inc.*

200 TERMINAL DRIVE, PLAINVIEW, NEW YORK 11803  
cable: noatlantic / twx: 510-221-1879 / phone: (516) 681-8600

INFORMATION RETRIEVAL NUMBER 62

# Service...Engineering...Experience

MAKE THE **BIG** DIFFERENCE  
BETWEEN A YOKE SPECIALIST  
AND A YOKE SUPPLIER

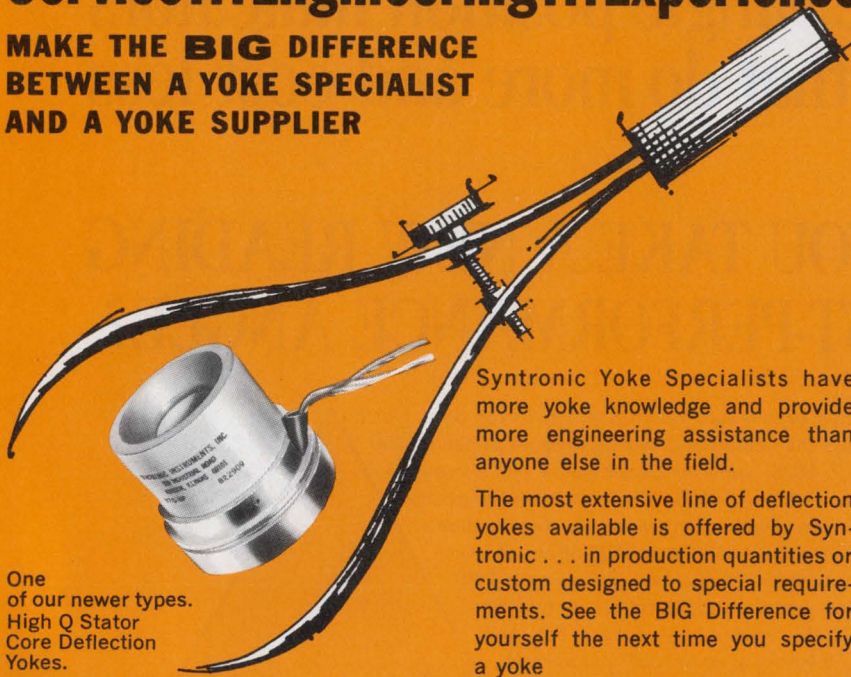

One of our newer types.  
High Q Stator  
Core Deflection  
Yokes.

Syntronic Yoke Specialists have more yoke knowledge and provide more engineering assistance than anyone else in the field.

The most extensive line of deflection yokes available is offered by Syntronic... in production quantities or custom designed to special requirements. See the BIG Difference for yourself the next time you specify a yoke

**syntronic** INSTRUMENTS, INC.  
100 Industrial Road, Addison, Illinois 60101 Phone 312, 543-6444

INFORMATION RETRIEVAL NUMBER 63

## Our new low-cost linearizing digital readout will divide and conquer your sensor's wildest curves.

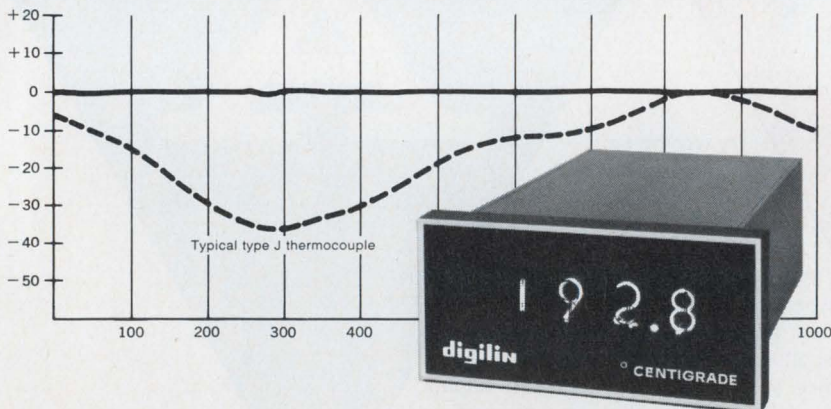

Digilin's linearizing readout breaks up your non-linear sensor information into ten straight-line segments that approximate the most capricious curve with all the accuracy you need for just about any transducer.

And our exclusive piecewise linear approximator works so well with our standard A/D conversion technique that you get the 3½-digit linearizing readout complete in one small panel meter package in

your choice of engineering units with BCD output for as low as \$195 in OEM quantities.

(Which means that now transducer manufacturers can expand their product line with an accurate digital readout and keep prices sharply competitive.)

Be first in your marketplace with Digilin linearizing digital readout. Call Stan Ericsson today. Digilin, Inc., 1007 Air Way, Glendale, Calif. 91201. (213) 240-1200.

**digilin**  
DIGITAL INSTRUMENTS

See us at Wescon Booth #1121

INFORMATION RETRIEVAL NUMBER 64

## Epoxy coat attenuates surface currents

*Emerson & Cuming, Inc., Canton, Mass. Phone: (617) 828-3300. Price: \$44/4-lb kit.*

Eccosorb coating 268E is a high-loss, magnetic, epoxy formulation which can be brushed on surfaces for the purpose of attenuating surface currents and reducing reflectivity from 50 MHz through the microwave band. It is useful in reducing energy in transmission lines, modifying antennas, and reducing the cross section of radar targets.

CIRCLE NO. 351

## Versatile PC boards double as heat sink

*International Electronic Research Corp., 135 W. Magnolia Blvd., Burbank, Calif. Phone: (213) 849-2481.*

A new concept in PC boards accomplishes heat dissipation and conduction functions plus all the normal board functions in one integral component. Called Metal Core Circuit Board (MCCB), it permits circuitry to be operated at power dissipation levels several times that possible with common epoxy boards while maintaining the same temperature rise above ambient.

CIRCLE NO. 352

## Chemicals kit removes most encapsulants

*Dynaloy, Inc., 7 Great Meadow Lane, Hanover, N.J. Phone: (201) 887-9270. Price: \$35.*

A decapsulation kit is available to dissolve most cured plastics used to package electronic assemblies. Materials removed by the kit's solvents include cast and transfer-molded epoxies, silicones, RTVs, varnishes, urethanes, elastomers, coatings and foams. Some are selective solvents and attack only one type of plastic while others dissolve several.

CIRCLE NO. 353

# At last. A high-reliability capacitor you actually can rely on.

Our brand new TLW. It's the first-ever capacitor with a special glass-to-metal seal for positive hermetic sealing to prevent electrolyte leakage. There's just no better way to seal a capacitor.

And no harder way. Ask the guys who're still trying.

We used a solid tantalum wire through a glass-to-metal hermetic seal—no double seals, no internal dissimilar metal-weld joints. Very simple. And very effective.

But we didn't stop with great construction. We built in great performance, too.

The TLW meets environmental and electrical characteristics of MIL-C-39006/9A style CLR 65.

If you require nothing but the best, this is it. Available now in three sizes. For tech data, call or write for Bulletin 4-607.



**MALLORY**

**MALLORY CAPACITOR COMPANY**

a division of P. R. MALLORY & CO. INC.

3029 E. Washington St., Indianapolis, Indiana 46206; Telephone: 317-636-5353

Electrical and electronic components • sequence timers • metallurgical products • batteries

# Low cost, a/d converters offer substantial savings

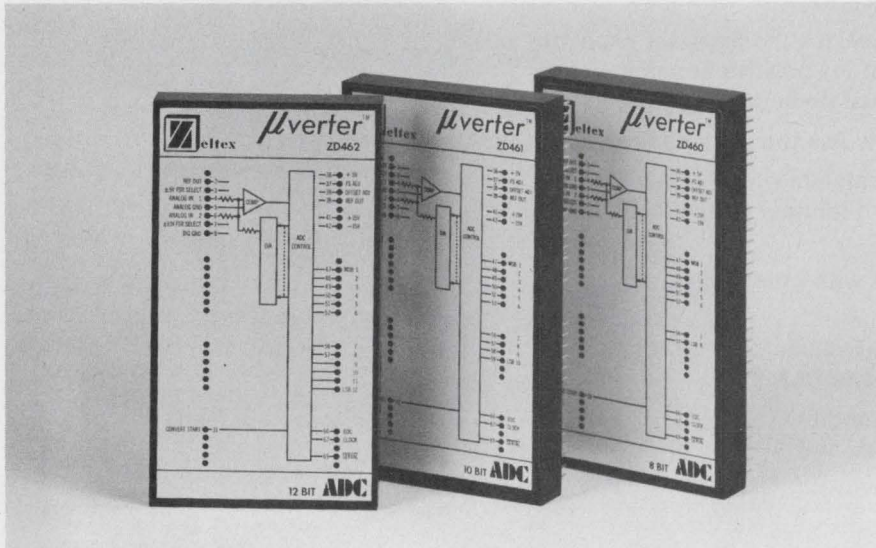

Zeltex, Inc., Sub. of Redcor Corp., 1000 Chalomar Rd., Concord, Calif. Phone: (415) 886-6660. P&A: see text; 30 days.

A new series of 8, 10 and 12-bit a/d converters are available with a range of performance characteristics and rock-bottom prices to match.

Designated as the M series, Models ZD460, ZD461 and ZD462 (8, 10 and 12-bit units) are priced at the lowest a/d prices yet—\$49, \$69 and \$99 respectively, for 1 to 99 quantities. The last price is well

below any competitive unit on the market.

They offer conversion times of 50  $\mu$ s for the ZD460 and 100  $\mu$ s for ZD461 and ZD462. The 8 and 10-bit converters have a temperature coefficient of 50 ppm/ $^{\circ}$ C. The 12-bit model ZD462 is rated at 20 ppm/ $^{\circ}$ C.

For faster conversions, models ZD470 (8 bits), ZD471 (10 bits) and ZD472 (12 bits) are available with 15, 30 and 40- $\mu$ s conversion times, respectively. They are also inexpensive, costing only \$79, \$99

and \$149, respectively. All three have TCs of 50 ppm/ $^{\circ}$ C.

Except for conversion times, temperature drift characteristics and prices, both sets of a/d converters are alike.

All the converters are TTL/DTL compatible and are rated to operate over a temperature range of 0 to +70 $^{\circ}$ C. They use high-speed, successive-approximation conversion techniques and include factory adjusted bit clocks and internal references.

All are DIP-grid compatible to fit most DIP PC boards. TTL logic power and ground pins are carefully laid out to fit standard 16-pin dual-in-line matrices. Pin layout is standardized between lower and higher resolution models, allowing one PC board layout to fit all units.

Three full-scale input-voltage ranges are possible— $\pm 10$ ,  $\pm 5$  and 0 to 10 V. An important feature is the fact that the  $\pm 10$  and  $\pm 5$ -V full-scale input-voltage ranges are easily obtainable by simply jumping two pins on the a/d converter. The 0 to 10-V range does not require any pin jumping.

An optional circuit is available for full-scale and offset-voltage adjustments. The circuit provides a full-scale adjustment range of  $\pm 10\%$  and an offset adjustment range of  $\pm 40$  mV.

CIRCLE NO. 354

# Very fast, stable op amp can handle 1800 V/ $\mu$ s



Optical Electronics, Inc., Box 11140, Tucson, Ariz. Phone: (604) 624-8358. P&A: \$150 (1 to 2), \$99 (100 to 999); stock.

Designed for high slew rate and dc stability, a new inverting-only op amp with  $\pm 2$   $\mu$ V/ $^{\circ}$ C maximum offset voltage drift is available with a minimum slew rate of 1800 V/ $\mu$ s.

This high-speed op amp, model 9808, is ideal for use in such applications as graphic display deflection amplifiers, linear rf power amplifiers for transmitters, and large-amplitude pulse amplifiers.

Its low input noise, 50 nV/ $\sqrt{\text{Hz}}$

maximum, makes it useful also for low-noise video and low-level decoupled preamplifiers.

Despite its high slew rate, the 9808 features a high gain-bandwidth product—50 MHz minimum. Its maximum settling time to 0.1% of full-scale value is 50 ns.

Input characteristics include  $\pm 1$  mV of maximum offset voltage,  $\pm 100$  nA maximum bias current and an input impedance of 500 k $\Omega$  and 6 pF.

The new op amp has high open-loop dc gain—a minimum of 120 dB. It provides an output of  $\pm 10$  V at  $\pm 100$  mA (100- $\Omega$  load).

Rated operating temperature of the 9808 is  $-55$  to  $+85^{\circ}$ C and its power dissipation is 900 mW. The unit will operate from any  $\pm 12$  to  $\pm 20$ -V supply.

CIRCLE NO. 355



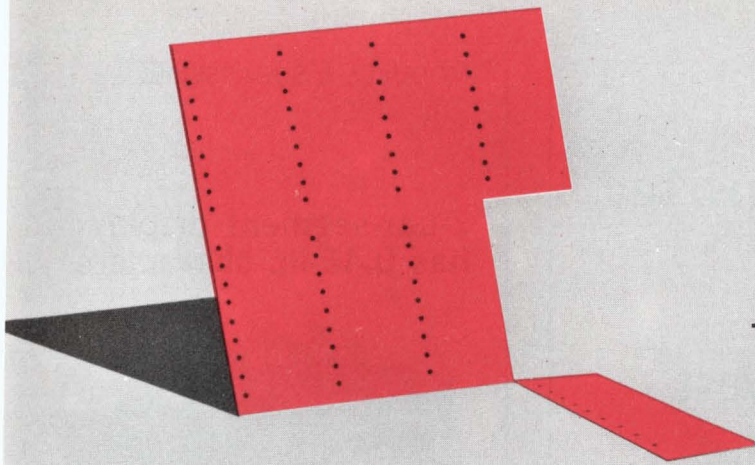

### TOOLED SNAP-STRATES

Snap-Strates made with this technology have been in existence for many years at American Lava with a history of excellent results.

A few of the advantages offered by this technique are:

- Economy.
- Accurate line placement in relation to slots or holes.
- Excellent breaking characteristics at any temperature used in normal processing.

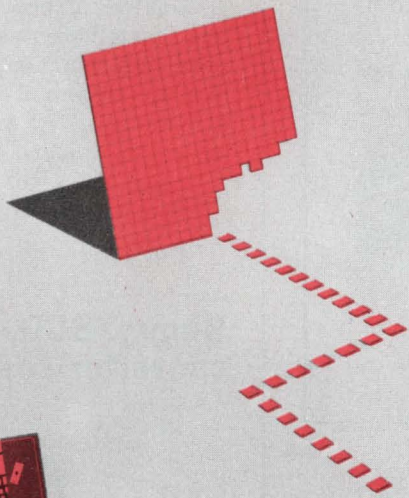
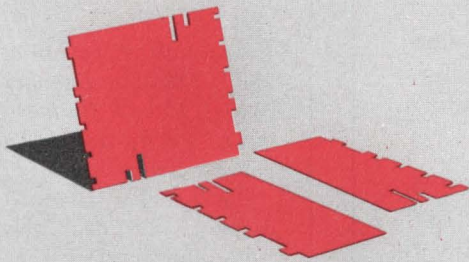

### LASER SNAP-STRATES

This new concept in precision Snap-Strates offers many advantages that were all but impossible previously.

Several of these are:

- More accurate line placement.
- No tool cost.
- Thin sections available with high snap yields.
- Working temperature range to 1000°C.
- Fast delivery.



New BULLETIN No. 712  
AlSiBase® Substrates and  
Snap-Strates sent on request.

# Al Si Base<sup>®</sup>

## CERAMIC SNAP-STRATES

CODE IDENT. NO. 70371

LAURENS, S. C. 29360, • PHONE 803/682-3215 • TELEX 570449  
CHATTANOOGA, TENN. 37405, • PHONE 615/265-3411 • TELEX 558432

For service, contact American Lava representatives in Offices of Minnesota Mining and Manufacturing Company in these cities (see your local telephone directory): Boston: Needham Heights, Mass. • Chagrin Falls, O. • Chicago: Elmhurst, Ill. • Dallas, Tex. • Indianapolis, Ind. • Laurens, S. C. • Los Angeles, Calif. • Metropolitan New York: West Caldwell, N. J. • Up-State New York and Canada: Phoenix, N. Y. • Orange, Conn. • Philadelphia, Penn. • St. Louis: Lee's Summit, Mo. • Salem, Va. • S. San Francisco, Calif. • Tempe, Ariz. • International: c/o American Lava Corporation, Chattanooga, Tenn. 37405, U.S.A., TELEX 558432

American Lava Corporation **3M**  
A SUBSIDIARY OF COMPANY

70th  
YEAR  
OF  
CERAMIC  
LEADERSHIP

**Stepping rates to 1000 steps/sec.  
Torque to 9oz-in.  
Step angles of 7½° and 15°  
And the prices are the lowest  
in the industry.**

All this plus 5-volt operation with simple, inexpensive electronic drive circuits. These are just some of the features of our new ID Line of permanent magnet logic stepper motors.

A new, patented motor design makes it possible. Allows us to combine high performance with economical, reliable permanent magnet motor design. Simplifies the electronic drive circuit, too.

As a result, an ID Stepper

Motor and solid state electronic drive usually costs a fraction of other methods of incremental control.

This combination of low cost, low power and high performance offers a wealth of new opportunities in instrumentation and control design. Five different models provide a choice of operating characteristics to fit your applications.

Write for information now!

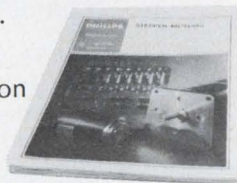

**THE A. W. HAYDON COMPANY**



232 North Elm Street, Waterbury, Conn. 06720 Tel. (203) 756-4481 TWX: 710-477-3141  
In Europe: Polymotor International · Brussels 1, Belgium

INFORMATION RETRIEVAL NUMBER 67

**MODULES & SUBASSEMBLIES**

**7-bar-segment display  
has 0.46-in. characters**

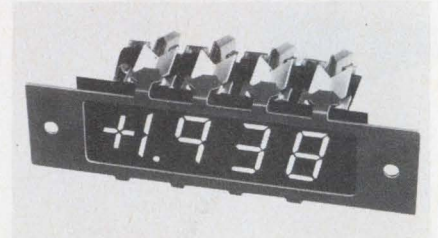

*Industrial Electronic Engineers, Inc., 7720-40 Leona Ave., Van Nuys, Calif. Phone: (213) 787-0311. P&A: \$11.31 per digit/decoder; 4 wks.*

The series 1040 7-bar-segment display provides bright 0.46-in.-high characters in a single-plane configuration. The simplified design and complete-package concept eliminates unnecessary assembly and installation time. The user need only plug in the series 1040 display. Optimum viewing is from a distance of 12 feet.

Booth No. 1039 Circle No. 257

**Binary/BCD, s/d  
converter costs \$350**



*Transmagnetics, Inc., 210 Adams Blvd., Farmingdale, N.Y. Phone: (516) 293-3100. Price: see text.*

A new, low-cost synchro-to-digital converter measuring only 3.5 by 2.5 by 1.5 in. accepts inputs from a 26-V or a 115-V synchro and provides a 12-bit binary or 4-decade BCD output at ±6 arc-minutes accuracy. The model 1623M has a maximum conversion rate of 400/s and will operate over the temperature range of 0 to +70°C.

**CIRCLE NO. 356**

# How low can you get?

Low Bias Current  
 $\pm 3\text{nA}$ , max.

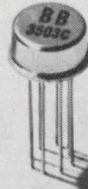
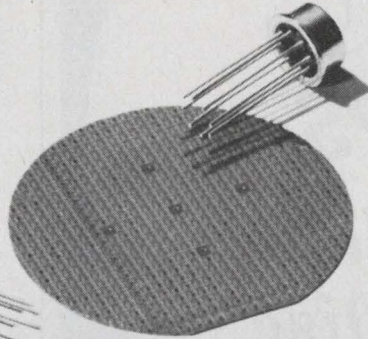
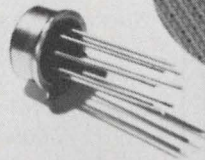

FET Input  
Low Bias Current  
 $1\text{pA}$ , max.

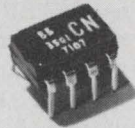

## Just try these two new IC Op amps from Burr-Brown

**MODEL 3501** This new Burr-Brown monolithic series represents the optimum combination of low input bias current, low voltage drift, low input noise and low price. The bias current is comparable to that of 108 type amplifiers, without the need for external frequency compensation. Other features are wide supply range, high common mode rejection, input and output protection, and high input impedance. The series is pin compatible with 741 and 108 type amplifiers.

**MODEL 3503 FET INPUT** These unique Burr-Brown amplifiers combine two separately fabricated monolithic chips on a ceramic substrate to achieve extremely low bias current in a small package (TO-99) and avoid the compromise necessary in all-monolithic 740 type amplifiers. They have the same pin configuration as 741 and 740 types but their performance is quite unique among IC amplifiers. Bias current is very low —  $1\text{pA}$ , max. The "bootstrapped" input stage, with its common mode input impedance of  $10^{13}\Omega$ , results in negligible bias current variation over the full common mode voltage range. These two characteristics make the 3503 an excellent choice for non-inverting operation as a buffer amplifier.

MODEL NO.	3501A	3501C	3503A	3503C
Open Loop Gain, min.	93 db	93 db	86 db	90 db
Slew Rate, min.	$0.1\text{V}/\mu\text{sec}$	$0.1\text{V}/\mu\text{sec}$	$2.5\text{V}/\mu\text{sec}$	$2.5\text{V}/\mu\text{sec}$
Input Offset Voltage vs temp, max.	$\pm 20\mu\text{V}/^\circ\text{C}$	$\pm 5\mu\text{V}/^\circ\text{C}$	$\pm 75\mu\text{V}/^\circ\text{C}$	$\pm 50\mu\text{V}/^\circ\text{C}$
Input Bias Current, max.	$\pm 15\text{nA}$	$\pm 3\text{nA}$	$-25\text{pA}$	$-1\text{pA}$
Input Impedance Common Mode	$10^{10}\Omega$	$10^{10}\Omega$	$10^{13}\Omega$	$10^{13}\Omega$
Power Supply Quiescent Current, max.	$\pm 1.5\text{mA}$	$\pm 1.5\text{mA}$	$\pm 6\text{mA}$	$\pm 6\text{mA}$
Price 100-249	\$9.90	\$16.70	\$9.90	\$19.00

Rated Output for all units is  $\pm 10\text{V}$ ,  $\pm 5\text{mA}$ .

**BOTH MILITARY AND COMMERCIAL TEMPERATURE RANGES ARE AVAILABLE  
ALL UNITS ARE 100% TESTED TO ALL MIN-MAX SPECIFICATIONS**

**For complete technical information on these two new IC op amp series, contact your Burr-Brown Engineering Representative or use this publication's reader service card.**

**NEW BURR-BROWN BOOK** "Operational Amplifiers — Design and Applications", over 500 pages, 300 illustrations. Written by Burr-Brown application-engineering staff, published by McGraw-Hill. U.S. price, 15.00 dollars. Order from Burr-Brown, today.



**BURR-BROWN**  
RESEARCH CORPORATION  
International Airport Industrial Park • Tucson, Arizona 85706  
TEL: 602-294-1431 • TWX: 910-952-1111 • CABLE: BBRCORP

# RMC DISCAPS

## the complete Ceramic Disc line

Over the years Radio Materials Company has maintained its leadership in the production of ceramic disc capacitors. A complete line offering outstanding quality has been the key to continuing growth.

### STANDARD

Type C, B, BA, JF, JL and JE

### SUBMINIATURE

Type SM, BT, TA and Magnacaps

### GREENCAPS

Type CG, JG, and BG

### SPECIAL

U.L. Listed Discaps, T.C. High Voltage, High K High Voltage and Dual Section By-Pass

### SOLDER-IN T.C. DISCAPS

For application in equipment where lead inductance effects must be reduced to an absolute minimum.

If your application requires special physical or electrical characteristics, contact RMC's Engineering Department.

### U.L. LISTED T.C. DISCAPS

Should be specified when the use is an integral part of an antenna coupling network where compliance with Underwriters' Laboratories specifications are required.



DISCAP  
CERAMIC  
CAPACITORS



**RADIO MATERIALS COMPANY**  
A DIVISION OF P. R. MALLORY & CO., INC.  
GENERAL OFFICE: 4242 W. Bryn Mawr Ave., Chicago 46, Ill.  
Two RMC Plants Devoted Exclusively to Ceramic Capacitors  
FACTORIES AT CHICAGO, ILL. AND ATTICA, IND.

## MODULES & SUBASSEMBLIES

### Seven-segment display has 1/2-in. characters

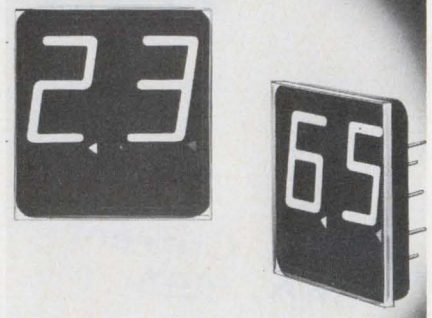

Sperry Information Displays Div., Box 3579, Scottsdale, Ariz. Phone: (602) 947-8371. P&A: from \$5.50/digit (single quantities) to \$2.30/digit (5000 quantities); stock to 15 days.

A new 1/2-in.-high seven segment, gas-discharge display known as the SP-750 can be easily read as far as 40 ft within a 150-degree viewing angle. The SP-750 series includes three, two, one and 1.2-digit models with the same height.

CIRCLE NO. 357

### 10-bit d/a converter settles in only 50 ns

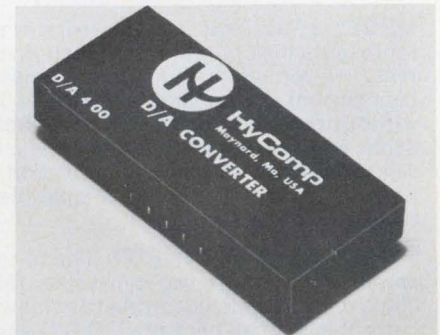

HyComp, Inc., 146 Main St., Maynard, Mass. Phone: (617) 897-4578. P&A: \$150 (100 quantities); 2 wks.

Model D/A 400 is a 10-bit, 10-MHz d/a converter that provides fast dynamic response — only 50 ns. The miniature encapsulated unit provides a linearity of  $\pm 1/2$  LSB and a full scale output of  $0.9990 \text{ V} \pm 1/2 \text{ LSB}$  (using an internal 1-k $\Omega$  resistor as a load). Only one  $\pm 15\text{-V}$  power supply is required for operation.

CIRCLE NO. 358

We haven't yet found a limit to the variety of printed circuitry we can make.

For example, everything from conventional single- and double-sided boards through exotic multi-layer circuitry (up to 23 layers).

Also, there's no limit to our design and production capabilities...from artwork to the complete, delivered circuit boards.

Nor is there any limit to ACD's ability to

react to your requirements, with our close technical liaison.

Explore the dimensions of ACD's capabilities. Then tell us *your* limits.

 **ADVANCED CIRCUITRY DIVISION**  
**LITTON SYSTEMS, INC.**

4811 West Kearney Street  
Springfield, Missouri 65803 (417) 862-0751

See if you can find  
our limits.



# WANG THE WORLD'S MOST TESTED CALCULATOR



When you buy a calculator, you want to get the best. That's us. We built our reputation and our company producing calculators for professional testers and examiners — scientists and engineers.

We've expanded our line to produce Wang calculators for any application you can think of, but we still maintained our exacting standards. Every calculator we make, and Wang is the widest line in the industry, has the best price/performance ratio in its class. And we still believe that the only good calculator is one that never becomes obsolete. That's why we designed every Wang product to be expanded in your office as your requirements increase. We have a world-wide sales and service organization to back up that promise.

By building the best calculators we've become the largest manufacturer in the United States. Give us any test you want; we've passed them all. Call Mr. Courtney, collect, at 617-851-7211.

**WANG** LABORATORIES, INC. Dept. ED-8  
836 NORTH STREET, TEWKSBURY, MASSACHUSETTS 01876,  
TEL. (617) 851-7311, TWX 710 343-6769, TELEX 94-7421

INFORMATION RETRIEVAL NUMBER 71

## MODULES & SUBASSEMBLIES

### Computer supply features triple output

*Arnold Magnetics Corp., 11520 W. Jefferson Blvd., Culver City, Calif. Phone: (213) 870-7014. P&A: \$195 (10 to 24 pieces); 2 to 4 wks.*

A new triple-output power supply is designed for computer peripherals. The supply is conduction cooled and mounts on the bottom mounting plate of a disc memory. Any combination of output voltages of 50 V dc may be specified, in each supply. Output is 40 W and input is 115/230 V ac at 60 Hz. Crowbar overvoltage is standard on all outputs.

CIRCLE NO. 359

### Analog-summing amp allows multiple gains

*Optical Electronics, Inc., Box 11140, Tucson, Ariz. Phone: (602) 624-8358. P&A: \$49; stock.*

Model 9000 five-input 0.1% analog-summing amplifier is a versatile building block not only as an analog summer but also as a precision gain amplifier, allowing gain increments to 5 for one module, up to 25 for 2 modules, and up to 125 for 3 modules. It has a  $\pm 10$ -V/ $^{\circ}$ C offset drift, a 300-kHz small-signal bandwidth and input and output of  $\pm 10$  V full scale.

CIRCLE NO. 360

### Fast-settling op amps cost down to \$17

*Burr-Brown Research Corp., International Airport Industrial Park, Tucson, Ariz. Phone: (602) 294-1431. P&A: \$17, \$22; stock.*

The new low-cost 3403 series op amps settle to 0.01% in 3 ms. Two versions are available: 3403A with 50- $\mu$ V/ $^{\circ}$ C drift and 3403B with 20- $\mu$ V/ $^{\circ}$ C drift. Both have differential FET inputs and will settle equally fast in inverting or non-inverting circuits. Both have gains of 100 dB, outputs of  $\pm 10$  V at 5 mA and slew at 12 V/ $\mu$ s.

CIRCLE NO. 361

Stackpole's phenomenal  
Ceramag® ferrite bead

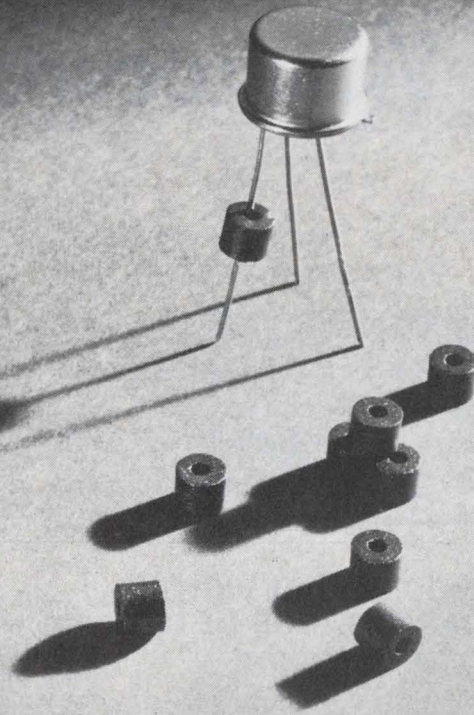

## The Silencers

### Ceramag® Beads Do Away with Noise

Stackpole ferrite beads offer a simple, yet effective means of suppressing spurious RF signals to prevent them from entering areas susceptible to such "noise." No other filtering method is as inexpensive as a ferrite bead.

How can you use a bead? Consider it as a frequency-sensitive impedance (Z) element. Beads are available in a variety of

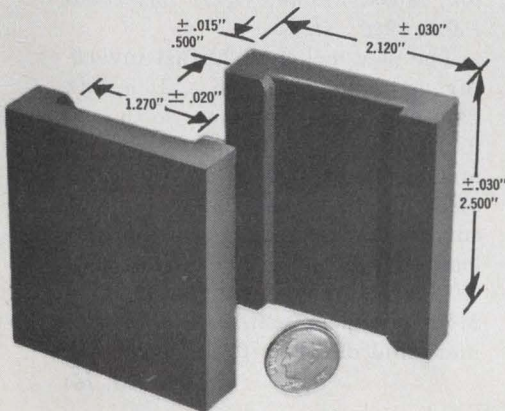

Stackpole Ceramag® materials. Depending upon the material selected, beads can provide increasing impedances. From 1 MHz to over 200 MHz. Keep in mind, the higher the permeability, the lower the frequency at which the bead becomes effective.

Should a ferrite bead be small? Not necessarily. The unique, giant bead shown below is used by IBM to eliminate the effect of transient noise.

The impedance of Stackpole ferrite beads can be changed by simply varying the length or the O.D.-I.D. ratio.

Installation of Stackpole beads is easy. And inexpensive. Simply slip one (or several) over the appropriate conductor(s) for the desired noise suppression or high frequency isolation.

Additional savings in production time and labor costs are possible by utilizing automatic insertion equipment to install ferrite beads *with leads* in printed circuit boards.

### CERAMAG® FERRITE BEAD CHARACTERISTICS

	24	7D	5N	11
Initial Permeability	2500	850	500	125
Volume Resistivity @ 25°C	1.0x10 <sup>2</sup>	1.4x10 <sup>5</sup>	1.0x10 <sup>3</sup>	2.0x10 <sup>7</sup>
Effective Suppression At: 1 MHz.	20 MHz.	50 MHz.	100 MHz.	
Curie Temperature	205	140	200	385

Beads are available in sleeve form in a range of sizes starting at .020 I.D., .038 O.D., and .050 long. For special compact filtering applications, beads can be supplied to tight mechanical tolerances.

Sample quantities of beads and beads with leads are available upon request. Send your requirements to: Stackpole Carbon Company, Electronic Components Division, St. Marys, Pa. 15857. Phone: 814-781-8521. TWX: 510-693-4511.



**STACKPOLE**  
ELECTRONIC COMPONENTS DIVISION

## MODEL 172A VARACTOR TESTER

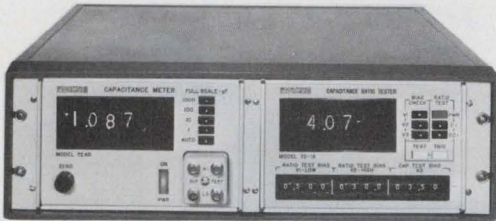

High-speed, simultaneous, semi-automatic measurements of varactor capacitance ratio at selected upper/lower bias limits, and of capacitance at a chosen bias, are now possible with the new 1 MHz digital 172A. BCD outputs, remote control, and auto-ranging are standard features. Ranges are 2 to 2000 pF fs, 0-20 ratio, and 0-200 V bias. Price: \$2700.

## MODEL 72AD DIGITAL CAPACITANCE METER



A wide-range, basic accuracy of 0.25% and a resolution of 0.001 pF distinguish this new programmable capacitance meter. Values from 0.01 to 2000 pF are quickly measured at a 1 MHz test level of 15 mV rms. BCD and analog outputs are standard; available as options are auto-ranging and logic-level programming. Price: \$1100. (An analog version is available at \$850)

CIRCLE NO. 362

## MODEL 93AD TRUE RMS DIGITAL VOLTMETER



Sensibly-priced true rms measurements from 300  $\mu$ V to 300 V, 10 Hz to 20 MHz, at a basic 1% accuracy, are features of this programmable meter. The nixie-type display, plus small edge-meter scaled in dBm, insures error-free readings. Selectable bandwidth and response time, BCD and analog outputs, are standard; dBm display and autoranging are optional. Price: \$1100.

CIRCLE NO. 363

## MODEL 92C LOW-COST SOLID- STATE RF MILLIVOLTMETER

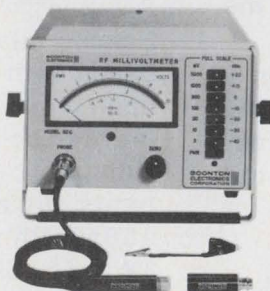

Economy with unstinted quality is achieved in the Model 92C by eliminating features not essential to all users. It offers 2%  $\pm$  1% rdg accuracy in 7 ranges from 1 mV to 3 V fs (up to 300 V with Divider), over a 10 Hz to 1.2 GHz frequency range (usable to 8 GHz). Solid-state chopper improves reliability and reduces maintenance costs. Price, with accessories, \$595.

**BOONTON  
ELECTRONICS**  
CORPORATION

ROUTE 287 AT SMITH ROAD  
PARSIPPANY, NEW JERSEY 07054  
TEL: (201) 887-5110  
TWX: 710-986-8241

## Instrumentation amps have high impedance

Zeltex Inc., 1000 Chalomar Rd., Concord, Calif. Phone: (415) 686-6660. P&A: see text; stock.

Two new instrumentation amplifiers are the ZA7 02M1 and ZA-703M1 which feature differential input impedances of  $5 \times 10^8$  and  $10^{11} \Omega$  and common-mode impedances of  $10^9$  and  $10^{11} \Omega$ , respectively. The former is a bipolar unit with a 30-nA maximum input current and costs \$19. The latter is a FET unit which has a maximum input current of 5 pA and costs \$29. Both have gain selection from 1 to 1000.

## Thumbwheel switch has 0.7-in. windows

Cherry Electrical Products Corp., 3600 Sunset Ave., Waukegan, Ill. Phone: (312) 689-7600.

A new 0.7-in.-wide-window thumbwheel function switch will accommodate a variety of character legends or readouts. Its maximum character height is 0.25 in. (10-position miniature) or 0.2 in. (10-position subminiature). Characters 0.15-in. high are possible in 16-position miniature models. Each switch model is 1.91-in. wide.

CIRCLE NO. 363

## 100-MHz bipolar op amp slews at 300 V/ $\mu$ s

Intronics, Inc., 57 Chapel St., Newton, Mass. Phone: (617) 332-7350. P&A: \$49; stock.

The new model A520 fast-inverting op amp features a 100-MHz gain-bandwidth product, settles to 0.01% in 1  $\mu$ s for a 20-V step and slews at 300 V/ $\mu$ s. This bipolar amplifier has 20 nA of input current and can deliver an output load current of  $\pm 20$  mA, at  $\pm 10$  V. Its full-power bandwidth is 5 MHz, open-loop voltage is  $10^6$  minimum and offset drift is 20  $\mu$ V/ $^\circ$ C.

CIRCLE NO. 364



# RAYTHEON SEMICONDUCTOR. OUR 64-BIT RAM WON'T QUIT. EVEN AT 125°C.

Some people claim their bipolar 64-bit RAM will work over the entire MIL temperature range. Others keep silent. We guarantee our RR5100 will operate within specs from  $-55^{\circ}\text{C}$  to  $125^{\circ}\text{C}$  ambient.

The RR5100 and its commercial version, the RR5102, are available in dual-in-lines, flat paks, and Raytheon Semiconductor's own beam lead configuration. Of course both of these 64-bit RAM's are compatible with our RAY III

TTL and other DTL/TTL.

And don't forget our other memory products. We've delivered thousands of our reliable RL80 series 16-bit scratch pad memories. And when it comes to custom devices we're second to none. Our custom 256-bit RAM doesn't know when to quit.

And we have plenty of new things in the mill. Denser bipolar chips with faster cycle times and a MOS-type power dissipation are on the way. Thanks to our

new revolutionary V-ATE bipolar process.

Don't get burned on your present projects. Get immediate delivery on our 16-bit and 64-bit memories from our local sales office or your nearest franchised Raytheon Semiconductor distributor. And call us direct for custom memories.

Raytheon Semiconductor, 350 Ellis Street, Mountain View, California, 94040. 415/968-9211.



RAYTHEON

**GUARANTEED.**

INFORMATION RETRIEVAL NUMBER 74

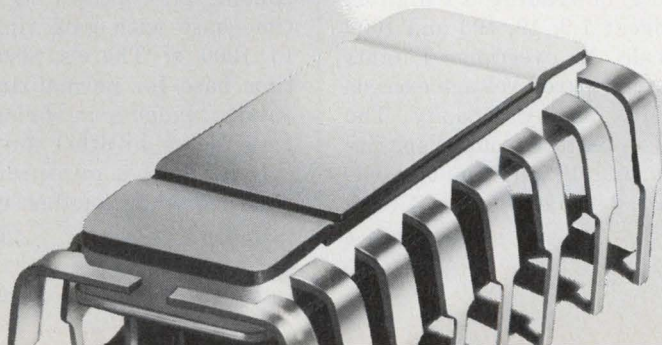
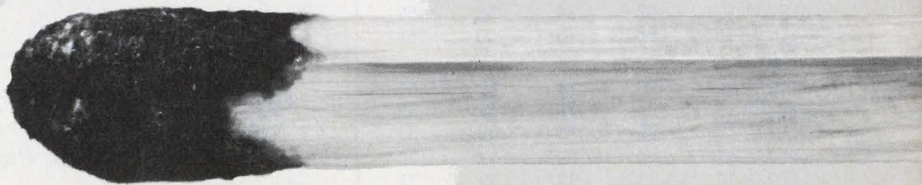

At Wescon attend the seminar on  
Advanced Semiconductor Products and Processes  
Daily 1:00 p.m. - 3:00 p.m. Wed. 7:00 - 9:00 p.m.  
Room 302-Ciuci Auditorium

# Check the cost

of these high quality



# POWER TRANSISTORS

for driver stages in  
AF amplifiers

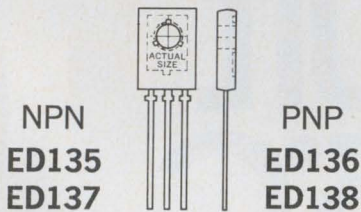

EEP offers you the highest quality at the lowest possible prices. Check the characteristics and costs of these complementary pairs and see for yourself.

Type	V <sub>ceo</sub>	I <sub>cm</sub>	P <sub>tot</sub>	Type
ED135	45	1.5A	6.5W	ED136
ED137	60	1.5A	6.5W	ED138

### HFE GROUPS

Group 6	Group 10	Group 16
ED135, 137	ED135, 137	ED135
ED136, 138	ED136, 138	ED136
HFE (40-100)	HFE (63-160)	HFE (100-250)

### PRICES

	1-24	25 up	100 up	500 up
<b>NPN</b>				
ED135-6	.70	.55	.44	.40
ED135-10	.73	.57	.46	.41
ED135-16	.76	.59	.48	.42
ED137-6	.90	.72	.56	.51
ED137-10	.93	.74	.58	.52
ED137-16	.96	.76	.60	.53
<b>PNP</b>				
ED136-6	.90	.74	.57	.52
ED136-10	.93	.76	.58	.53
ED136-16	.96	.78	.59	.54
ED138-6	1.20	.96	.77	.70
ED138-10	1.23	.98	.79	.71
ED138-16	1.26	1.00	.81	.72

Minimum order: \$15.00 per line item



10150 W. Jefferson Blvd.,  
Culver City, California 90230  
(213) 838-1912

INFORMATION RETRIEVAL NUMBER 75

## INSTRUMENTATION

### Bipolar 3-1/2-digit DPM costs only \$101

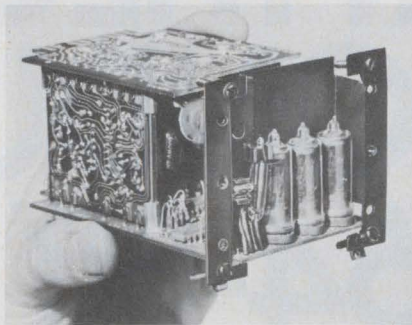

Datascan, Inc., 1111 Paulison Ave., Clifton, N.J. Phone: (201) 478-2800. P&A: see text; August, 1971.

A new 3-1/2-digit panel meter features ultra-low prices—\$95 for the unipolar model 610 and \$101 for the bipolar model 620, in 100-lot quantities. This single-slope-integration meter features full-scale readings from 100 mV to 100 V, 100% overrange, 0.1% ±1 digit full-scale accuracy and 150-ms response time. Hold and trigger inputs are standard and BCD outputs are optional.

CIRCLE NO. 365

### 3-1/2-digit DVM costs only \$120



Okaya Electric Industries Co., Ltd., Yasuda Bldg., 8-3-1 chome, Shibuya-Ku, Tokyo, Japan. P&A: see text; stock.

The low-cost model RD-101 portable DVM measures up to 1000 V dc at 0.3% of reading ±1 digit in four ranges: 1.9, 19, 190 and 1000 V full scale. An overrange 1 lights when the measured voltage exceeds the DVM's display capacity. The meter also features dual-slope integration and 10 MΩ input resistance (last 2 ranges).

CIRCLE NO. 366

### Portable meter makes optical measurements



United Detector Technology, 1732 21st St., Santa Monica, Calif. Phone: (213) 829-3357.

A complete optical measurements laboratory is the best description of the new 40A optometer. This battery-operated instrument measures radiometric power in μW, energy in μ-joules, photometric power in ft-candles and ft-lamberts and energy. Its dynamic range is from 0.1 μW/cm<sup>2</sup> to 10 mW/cm<sup>2</sup> in 7 ranges, in the radiometric mode; and 1 ft-candle to 10,000 ft-candles, in the photometric mode.

CIRCLE NO. 367

### Reversible counter is a transducer readout

Hewlett-Packard Co., 1501 Page Mill Rd., Palo Alto, Calif. Phone: (415) 493-1501. P&A: \$1995; stock.

A new 7-digit 10-MHz electronic counter is the model K20-5280A that counts forward and backward and excels as a transducer readout. Among its options is a crystal time base with gate times of 0.01 to 1000 s. There's also a preset time base for normalizing data, to obtain readouts in gallons/minute, feet, feet/s, or other units. A third option allows a measurement to be recorded while another is made.

CIRCLE NO. 368

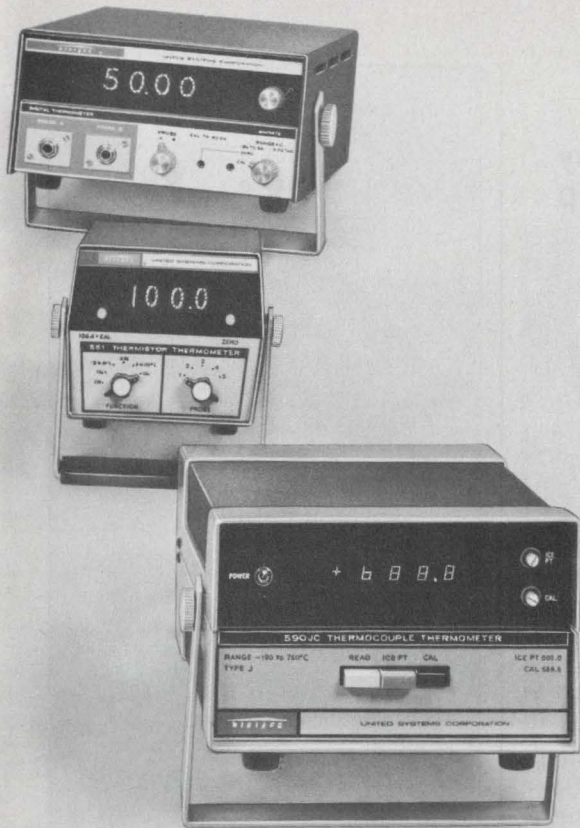

# DIGITEC DIGITAL THERMOMETERS

We delivered our first Digital Thermometer in 1963. We were the first to offer these unique, convenient instruments. Today we're still the leader with a broad line of accurate, wide range thermometers to meet the requirements of nearly any application.

DigiTec Thermometers are designed for use with thermistors, platinum resistance and thermocouples. Probes for the thermistor and platinum resistance units are available from stock. The Thermocouple Thermometers are for use with the five most common TC types in both °F and °C.

These instruments are value oriented with many outstanding features, some of which are: optional battery pack, LED displays, guarded input and isolated BCD output. Prices range from \$395 to \$825. Write or call for assistance in selecting the most suitable Thermometer for your application.

DIGITEC by UNITED SYSTEMS CORPORATION

918 Woodley Road • Dayton, Ohio 45403 • (513) 254-6251  
Representatives throughout the world  
For complete specifications, request new catalog

INFORMATION RETRIEVAL NUMBER 76

## How about a COOL DIP?

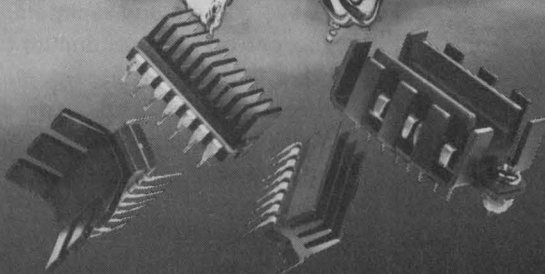

Thermalloy's new Dip Sinks mean greater stability and longer life for high performance IC's. This new series combines maximum thermal efficiency with minimum weight and physical size for optimum performance.

Models 6010, 6011 and 6012 are one-piece for 14 or 16 pin DIP's, require no additional board space and may be added after assembly. For minimum interface loss, the Dip Sink is bonded to the top surface with thermally conductive epoxy. Model 6007A two-piece design removes heat from top and bottom surfaces of 14 to 16 pin DIP's.

For more information, write for your FREE CATALOG.



**Thermalloy**  
8717 DIPLOMACY ROW • DALLAS, TEXAS 75247  
PHONE: 214/637-3333 • TWX: 910/861-4410

INFORMATION RETRIEVAL NUMBER 77

ELECTRONIC DESIGN 17, August 16, 1971

## ELECTRICAL/ELECTRONIC Template Set

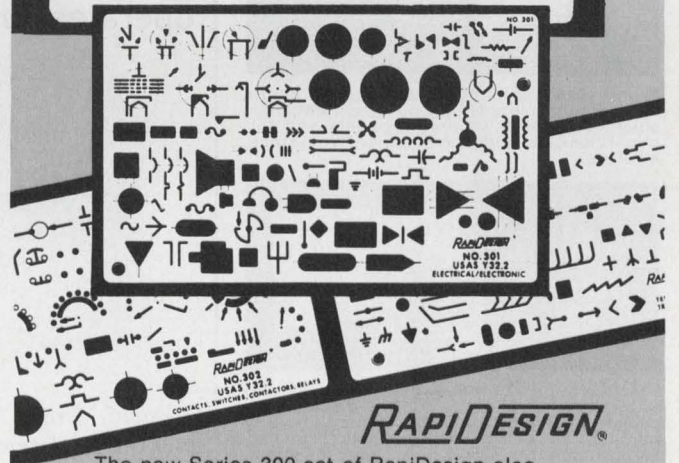

The new Series 300 set of RapiDesign electrical/electronic templates is the most comprehensive available. With this set, taken from USAS Y32.2, almost all electronic and electrical symbols can be easily drawn. Symbols are accurate and in correct relative size so that any size grid can be obtained through photographic reduction. Available as a set or individually. These precision manufactured templates are some of 200 templates described and pictured in the 1971 RapiDesign catalog. Send for your free copy today.

RAPIDESIGN, INC., P.O. BOX 6039, BURBANK, CALIF. 91505  
A SUBSIDIARY OF BEROL CORPORATION  
**BEROL**

INFORMATION RETRIEVAL NUMBER 78

## Your best choice in enclosures

- oil and dust tight
- EMI/RFI shielded
- rigid one-piece construction
- available from stock

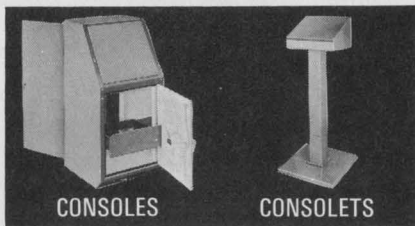

CONSOLES

CONSOLETS

**Consoles** in versatile stock design, 50" x 24" x 23", with gasketed front and rear doors. Options include rack angles, swing-out and stationary subpanels and writing desk. **Consolelets** are offered in eleven stock sizes for desktop mounting of remote controls. Floorstand optional.

All units are heavy gauge steel with all-welded seams, easily shielded.

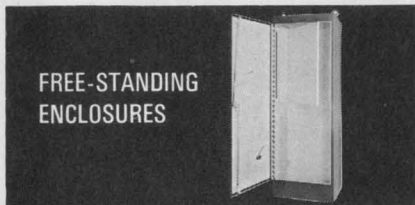

FREE-STANDING  
ENCLOSURES

NEMA 12 units in stock sizes up to 90" x 36" x 24". Rigid 12 gauge steel with all-welded seams, gasketed doors front and/or rear. Oil and dust tight. Options include several interior panel arrangements, rack angles and shielding.

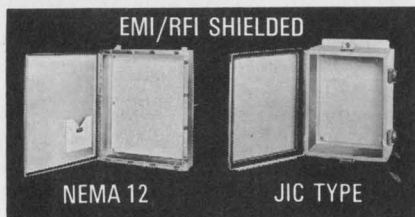

EMI/RFI SHIELDED

NEMA 12

JIC TYPE

Heavy gauge steel boxes with hinged doors, all cadmium plated. Oil and dust tight, fully shielded. Interior mounting panels and terminal block kits optional. Shipment from stock, all sizes.



NEMA 1  
ENCLOSURES

For mounting controls where oil, dust and water are not a problem. One-piece heavy gauge steel construction, finished in gray prime. Flush latches. Interior panels for mounting components. Wide size range in stock.

# Hoffman

HOFFMAN ENGINEERING COMPANY  
Division of Federal Cartridge Corporation  
Anoka, Minnesota, Dept ED-436

## ELECTRICAL ENCLOSURES

INFORMATION RETRIEVAL NUMBER 79

## MICROWAVES & LASERS

### 64-diode optical array self-scans on the chip

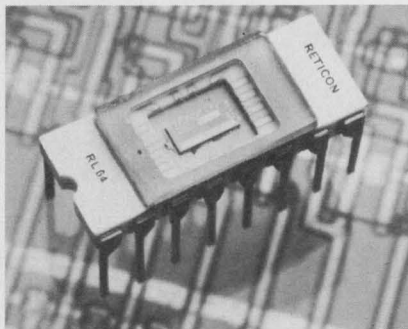

Reticon Corp., 365 Middlefield Rd.,  
Mountain View, Calif., Phone:  
(415) 964-6800. P&A: \$150; stock.

A new 64-element self-scanning optical array is the model RL64 designed for image sensing, optical-character recognition, facsimile and process-control applications. The device operates in the charge-storage mode permitting the use of very low illumination levels. Its photodiodes are spaced on 2-mil centers. Scan rates are up to 10 MHz.

CIRCLE NO. 369

### Single-ended mixer operates to 170 GHz

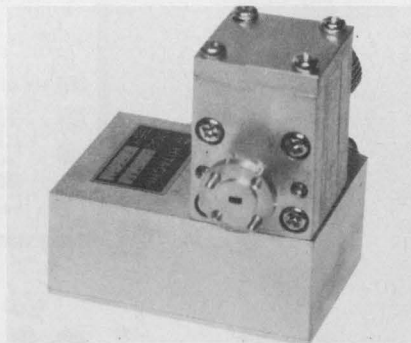

Hitachi, Ltd., Nippon Bldg., 6-2,  
2-chrome, Otemachi, Chiyoda-ku,  
Tokyo, Japan.

A new tunable single-ended mixer, model T3420, incorporates the model HED7312T mixer diode to operate up to 170 GHz. The diode, a low-noise GaAs, Schottky-barrier type with replaceable wave-guide-type configuration, offers 6.5 dB of local-oscillator conversion loss. Typical single-channel noise figure is 14 dB at 136 GHz.

CIRCLE NO. 370

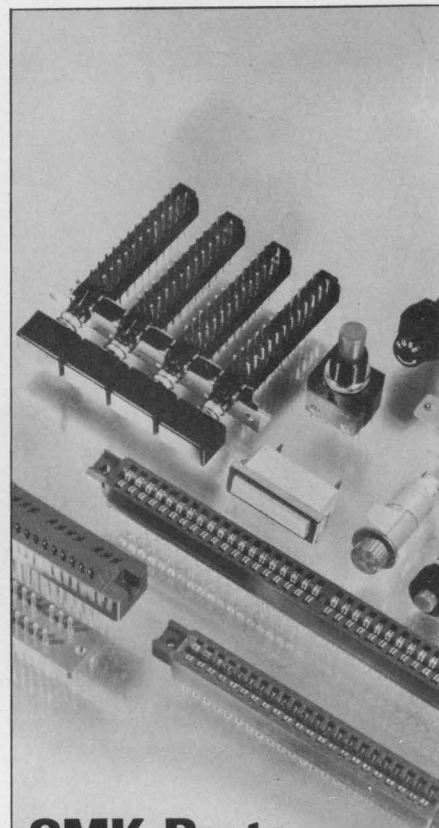

## SMK Parts pointing the way to top reliability

SMK parts perform to the maximum in a multitude of electronic devices and equipment. When it comes to reliability and engineering standards, SMK parts simply have no equal.

SMK practice calls for concentrating development and technological resources on each product in turn. To this is added stringent quality control, giving a high degree of product uniformity. But we have another word . . . perfection.

### SMK Products

Switches, connectors, fuse holders, lamp holders, terminals, plugs, jacks, sockets, and others.



For further information, please write to:  
**SHOWA MUSEN KOGYO CO., LTD.**  
No. 5-5, 6-Chome, Togoshi, Shinagawa-ku,  
Tokyo, 141, Japan.  
Cable: "SHOWAMUSEN TOK"  
Phone: 785-1111  
Telex: 246-6301 "SHOWAMUSEN TOK"

INFORMATION RETRIEVAL NUMBER 80  
ELECTRONIC DESIGN 17, August 16, 1971

## Crystal oscillator draws only 1 mA

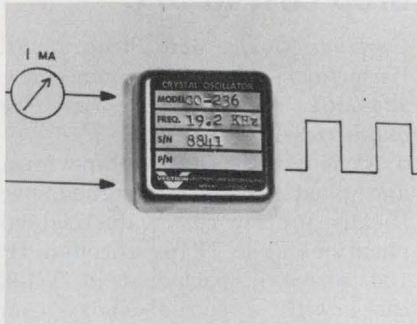

Vectron Laboratories, Inc., 121 Water St., Norwalk, Conn. Phone: (203) 853-4433. Price: \$105.

The CO-236 crystal-controlled clock oscillator draws only 1 mA in generating a high-stability, CMOS-compatible output, over 0.01 Hz through 2 MHz. This 1-1/2 by 1-1/2 by 1/2-in. module is designed for PC-board mounting and operates from 10 V providing stability of  $\pm 0.0025\%$  over 0 to  $+70^\circ\text{C}$ .

CIRCLE NO. 371

## 10-turn potentiometer costs down to \$5



Beckman Instruments, Inc., 2500 Harbor Blvd., Fullerton, Calif. Phone: (714) 871-4848. P&A: see text; stock.

The Model 7276 precision potentiometer is a 7/8-in.-dia, 10-turn wirewound unit costing only \$5 (1 to 9). This new potentiometer, measuring only 3/4 in. in length, features a standard resistance tolerance of  $\pm 5\%$  and independent tolerance of  $\pm 0.25\%$ . Units are typically within a tolerance of  $\pm 3\%$  and  $\pm 0.15\%$  linearity.

CIRCLE NO. 372

# REGULATED VOLTAGE

- Panel with voltage and ground planes separated into four groups. Each group tied to voltage regulator socket pattern. Heat sink included.
- Regulator on panel gives low impedance voltage source for better overall noise margins.
- 72 patterns, standard catalog item. Accepts 14 and 16 lead DIP's. Also available in Universal Style. (accepts all DIP's)
- Machined closed entry contacts assure positive retention of IC leads.

Mating connector available

Complete wire wrap service

IC PACKAGING PANELS

**AUGAT** INC.

Tel. 617-222-2202  
31 PERRY AVE., ATTLEBORO, MASS. 02703

Request Catalog 266

Wescon 1632-1633

INFORMATION RETRIEVAL NUMBER 81

# UNIVERSAL

GREATER FLEXIBILITY – ACCEPTS ALL I. C. PACKAGES

Wescon 1632-1633

Point to point wiring saves time, space and money

Available in multiples of 9 row sections up to 54 rows, as standard catalog item. Each 9 row section accepts 3 plugs for interfacing or input-output connections. Double sided board with power and ground planes connected to additional wire wrap terminations outside of contact row. Changes and replacements made at component level. Complete wire wrap service.

IC PACKAGING PANELS

Request Catalog 266

**AUGAT** INC.

TEL: 617-222-2202  
31 PERRY AVE., ATTLEBORO, MASS. 02703

INFORMATION RETRIEVAL NUMBER 82

# SOLDER DESOLDER SOLDER DESOLDER

## It's That Easy

... with PACE's Sodr-x-tractor®: the system that removes any soldered-in parts without damage. The Sodr-x-tractor applies three distinct modes of operation — pressure, vacuum, or hot air jet — through a tip with controlled heating capacities to 1000°F. Yes, you can

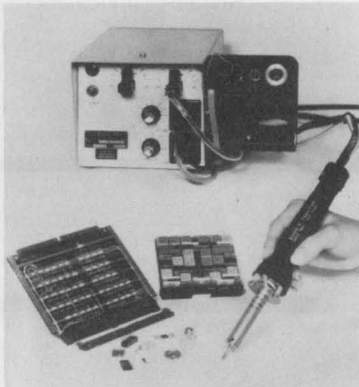

perform Sodr-x-traction and part replacement cleanly and efficiently with one integrated system. Solder, desolder, solder, desolder . . . but don't get carried away.

# PAGE

INCORPORATED

9329 Fraser Street  
Silver Spring, Md. 20910  
301/587-1696

# SOLDER DESOLDER SOLDER DESOLDER

INFORMATION RETRIEVAL NUMBER 83

## COMPONENTS

### Miniscule rf inductor is 0.14 in. end-to-end

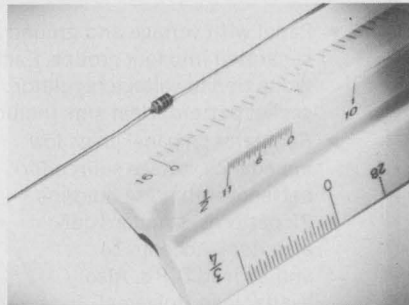

*Nytronics, Inc., Orange St., Darlington, S.C. Phone: (803) 393-5421. Availability: stock.*

The smallest unshielded rf inductor yet—measuring only 0.14 in. end-to-end, and having a dia of 0.075 in.—is the new Pee Dee Ductor. Designed for hybrid circuit applications, the new inductor meets the requirements of MIL-C-15305, Grade 2, Class 5. Its minimum Q values at rf frequencies range from 21 to 55. Inductance values range from 0.1 to 1000  $\mu$ H.

CIRCLE NO. 373

### Form A reed switches handle up to 30 kV dc

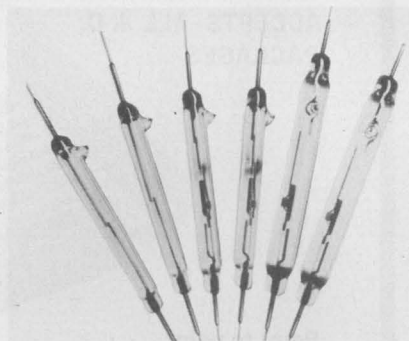

*Hamlin, Inc., Lake Mills, Wis. Phone: (414) 648-2361. P&A: \$13.60, \$17.00 (100 quantities); 3 wks.*

Two new high-voltage, Form A reed switches, the DRVT-25 and the DRVT-30, exhibit maximum breakdowns of 25,000 and 30,000 V, respectively. The ability of the DRVT series of switches to handle these high voltages is due to the use of tungsten contacts. At full-rated voltages, life span of the switches is a million operations.

CIRCLE NO. 374

### Plastic SCRs drop cost to 37¢

*Unitrode Corp., 580 Pleasant St., Watertown, Mass. Phone: (617) 926-0404. Price: from 37¢ (1000 quantities).*

A new series of high-performance plastic SCRs is designed specifically for low-cost industrial applications. The IP100 through IP-104 series is packaged in TO-92 cases with a special epoxy compound. It is available in voltage ratings up to 200 V with maximum ratings of 0.8 A rms, forward current, and 6 A of surge current for 8 ms. Gate sensitivity is 200  $\mu$ A.

CIRCLE NO. 375

### Metalized film capacitors handle large voltages

*Paktron, Div. of Illinois Tool, 1321 Leslie Ave., Alexandria, Va. Phone: (703) 548-4400. Price: 13.5¢ (1000-pF 9-kV unit).*

A new line of metalized-film capacitors is designed for use in voltage-multiplier circuits. Called type MC capacitors, the new line is designed for use in high-voltage, low-current and solid-state power-supply applications. The new capacitors are available in values from 0.0005 to 0.01  $\mu$ F.

CIRCLE NO. 376

### Digital display tubes improve performance

*RCA Electronic Components, 415 S. 5th St., Harrison, N.J. Phone: (201) 485-3900.*

New improvements to the popular DR2100 Numitron display tubes are types DTF137, 138, 139, 140, and 141, with 50% response and 70% power-consumption improvement. The 137 is a basic device with a numeral 8. The 138 adds on a left-side decimal and the 139 a right-side one. The 140 is a numeral 1 with a plus/minus sign and the 141 is a plus/minus sign. The new tubes dissipate only 170 mW.

CIRCLE NO. 377

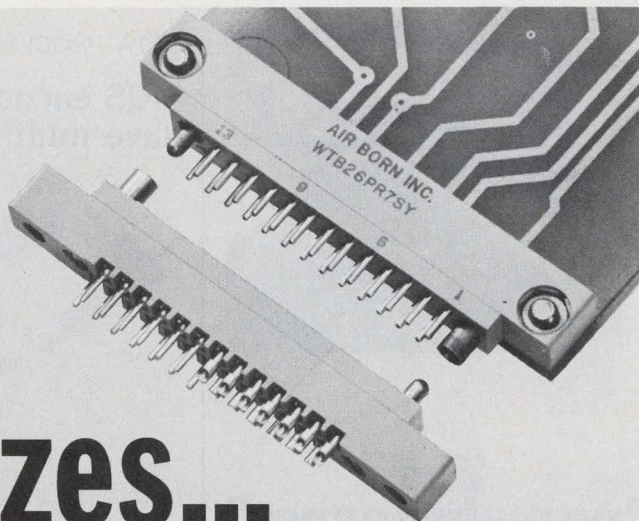
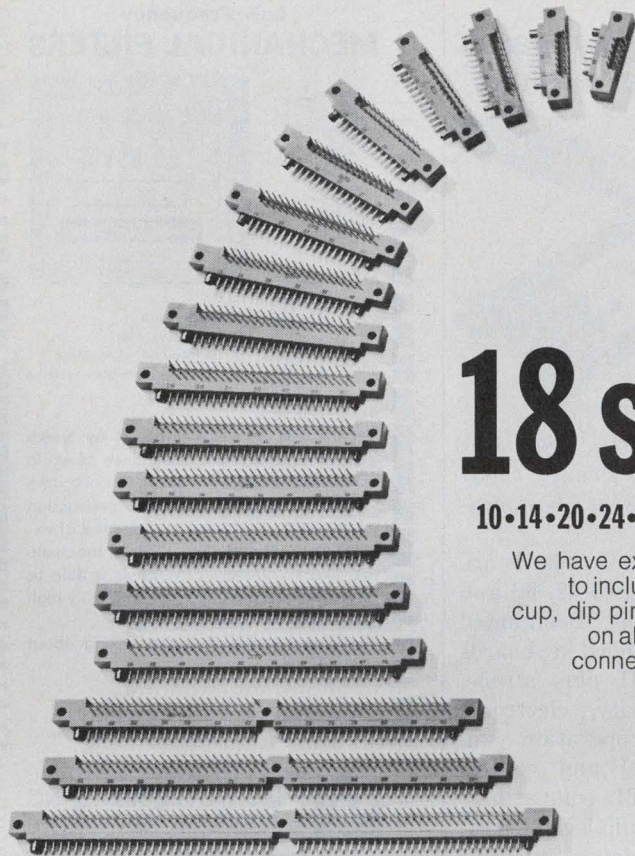

# 18 sizes...

10-14-20-24-26-30-36-40-44-50-54-56-60-66-70-90-100-120

We have expanded our series WTB right angle PC Connectors to include sizes up to 120 contacts and a choice of solder cup, dip pin, or Wire-Wrap\* terminals. Crimp terminals available on all sizes up to 90. This very versatile subminiature connector features. 100" spacing, 2 rows offset for .050".

For details, call 214-357-0274 or write  
2618 Manana Drive, Dallas, Texas 75220

\*Registered trademark of Gardner-Denver Company

## AirBorn, Inc.

INFORMATION RETRIEVAL NUMBER 84

**YES! I WOULD LIKE TO ORDER A QUICK AD** like the ads on pages 120, 121, 122 of this issue. Enclosed please find a glossy photo of my product, plus approximately 40 words which will set to no more than ten lines of 34 characters each. I understand Quick Ads cost only \$300 per insertion.

1x	7x	13x	19x	26x	39x	52x	104x
\$300	\$280	\$255	\$250	\$245	\$240	\$235	\$230

\_\_\_\_\_  
Company Name

\_\_\_\_\_  
Address

\_\_\_\_\_  
Authorized by                      Title                      Date

Mail to: ELECTRONIC DESIGN, 850 Third Ave., New York, NY 10022

## The gaussmeter comes to the production line.

If any of the products you make include permanent magnets, you could use a Bell gaussmeter. It's the best quality control check you can use. And in addition to testing, we can even help with production. We have a complete line of magnetizers, sorters, stabilizers, and demagnetizers. Write for our detailed brochure to: 4949 Freeway Drive East, Columbus, Ohio 43229.

**E.W. Bell Inc.**

A subsidiary of The Arnold Engineering Co.

INFORMATION RETRIEVAL NUMBER 86



## The "no maintenance" PUNCHED TAPE READER

- No edge guides
- No capstans, pinch rolls or brakes
- No lenses
- No lubrication
- No adjustments

You may have to replace this bulb after 25,000 hours.



New DECITEK Punched Tape Readers give greater accuracy, freedom from maintenance and longer tape life. With 20% to 30% fewer parts than units of comparable performance, they start, stop and hold tape accurately through a stepping motor/dual sprocket bi-directional drive. Tests at 300 cps for more than a quarter-million cycles showed insignificant sprocket hole wear.

DECITEK Readers interchangeably read 5, 6, 7 or 8-level paper, paper-polyester or metallized polyester tapes at 60 to 600 cps. Fiber optic elements illuminated by a single, easily replaced bulb eliminate cross-talk and partial or bit failure. Photo-transistor sensing delivers high signal-to-noise ratio outputs. Input-outputs are TTL or DTL compatible. For technical brochure, write DECITEK, 16 Sagamore Rd., Worcester, Mass. 01605. Call (617) 757-4577.

# DECITEK

A DIVISION OF JAMESBURY CORP.

INFORMATION RETRIEVAL NUMBER 87

## DATA PROCESSING

### MOS encoded keyboards have multi-key versions



George Risk Industries, Inc., Box 1035, Kimball, Neb. Phone: (308) 235-4645. Price: \$88 (47-key model).

New MOS encoded keyboards are available with standard 47, 56 and 73-key configurations. Designated as series 600, the new keyboards feature 9-bit ASCII plus strobe, odd and even parity, electronic lockout, quad-mode operation (un-shift, shift, control and control shift) and TTL/DTL compatibility. With the electronic lockout feature, the first key depressed locks out all others.

CIRCLE NO. 378

### Inexpensive calculator is high on performance



Singer Co., Friden Div., 2350 Washington Ave., San Leandro, Calif. Phone: (415) 357-6800. P&A: \$545; 45 days.

The model EC1117 compact calculator has 12-digit capacity, algebraic sign and decimal point. It features a memory and two operating registers and uses a floating-input, fixed-output decimal system. To end overflow problems, the new unit utilizes an underflow principle. When the calculator can handle no more numbers, it eliminates digits from the right.

CIRCLE NO. 379

## Low Frequency MECHANICAL FILTERS

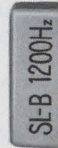
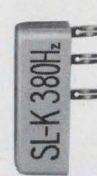

- Applications:
- Paging systems
- Remote control systems
- Remote supervisory systems

Mechanical filters distributed by Seiko Instruments Inc. are derivatives of world renowned SEIKO precision, the outcome of exacting processes and production technology. With almost a decade of experience in the manufacturer of mechanical filters, DAINI SEIKOSHA is able to offer miniature types exhibiting truly high performance. Reliability?

Not questionable if you're talking about one of our products.

Many types are available. On special order, we can satisfy a wide range of specifications.



Sole distributor in the United States:  
**SEIKO INSTRUMENTS, INC.**  
 14333, South Figueroa Street, Gardena, Calif. 90247 Phone: 213-770-0152  
 Telex: No. 673686

INFORMATION RETRIEVAL NUMBER 88

### Attention Advertisers:

Could you use copies of your ad exactly as it appeared in ELECTRONIC DESIGN? Then order your reprints directly from us; the minimum unit order is 500 copies.

Please specify if you would like the reprint line omitted on your copies and mail your written order to ELECTRONIC DESIGN, Production Dept., 50 Essex Street, Rochelle Park, New Jersey 07662.

500 1,000 Add'l M  
 8x10 or smaller

1 color, 1 side	\$74.70	82.95	18.15
2 color, 1 side	95.47	108.00	25.28
4 color, 1 side	311.03	342.00	44.33

#### Spreads

1 color	113.66	126.65	25.98
2 color	191.19	205.98	29.58
4 color	354.17	380.76	53.19

Prices FOB Waseca, Minn.



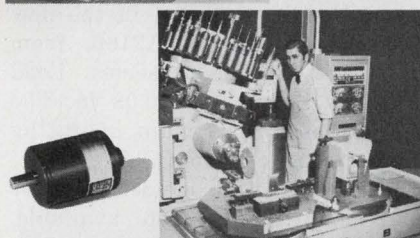
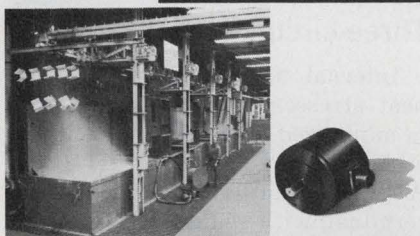
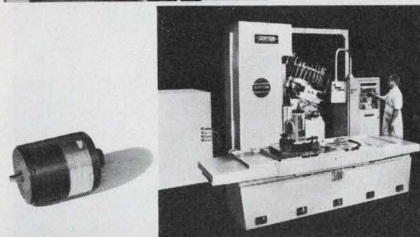
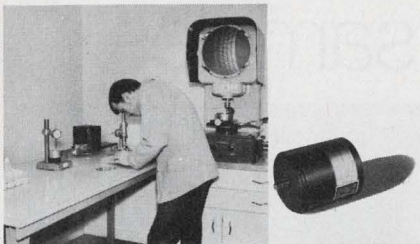

### WE'VE ALREADY SOLVED MANY OF YOUR ENCODER PROBLEMS.

For over ten years, Data Tech has been solving industry's problems in precision measurement, numerical control feedback, instrumentation, design and display. Our solutions are technically sound, economical and offer years of reliable repetitive system operation.

Wherever encoder technology makes good sense our technical skills and years of experience are available to you.

Typical **OPTECON**<sup>™</sup> Encoder Applications -

1. Measurement Laboratory Digitizing
2. N/C Machines and Readouts
3. Severe Industrial Environment Operations
4. Machining Center and Numerous Others



**New SUPERCON**<sup>™</sup> Offers  
High Performance:  
Frequency: 125 KHz Max.  
Accuracy: 3 arc min.  
Resolution: to 2500 cycles/turn  
Speed: up to 3000 RPM  
Drive Capability: up to 400 feet  
**WRITE FOR PUBLICATION**  
1-700 for complete information.

Write for **OPTECON**<sup>™</sup>  
Publication 1-601 and  
Application Notes.



<sup>™</sup> - Trade Names describing Data Technology, Inc.,  
series of Optical Encoders

**DATA TEChnology, inc.**  
65 Grove Street, Watertown, Massachusetts 02172 / 617 : 924-1773

INFORMATION RETRIEVAL NUMBER 89  
ELECTRONIC DESIGN 17, August 16, 1971

## Thermal-head terminal prints 300 words/min.



*National Cash Register Co., Day-  
ton, Ohio. Phone: (513) 449-2150.  
Price: \$2600.*

A new thermal-printing data terminal prints at speeds of 300 words/minute. Called the 260 data terminal, the device is about half the size of a conventional teletypewriter and requires no ribbon or ink. Instead, it converts electrical signals directly into characters or symbols by means of a small matrix-type printhead consisting of 35 tiny heat sources.

CIRCLE NO. 380

## Contactless keyboard lowers its profile

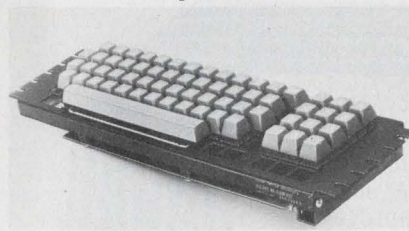

*Licon Div. of Illinois Tool Works,  
Inc., 6615 W. Irving Park, Chicago,  
Ill. Phone: (312) 282-4040.*

A new contactless keyboard features low-profile styling. The keyboard's buttons are designed to act as an umbrella above its thermo-plastic housing to keep out spilled liquid and solid materials—a common office keyboard-malfunction hazard. The magnetic-core keys include the encoding function.

CIRCLE NO. 381

# at prices from \$40 Hipotronics offers you immediate delivery on over 800 standard models of *regulated & unregulated* **hv dc power supplies**

... with output voltages  
from 1 to 1000 KV and  
current outputs from  
0.1 ma to 50 amperes



7.5 KV, 130 ma,  
air-insulated unit,  
with HV section included in control box.

**Standard regulation ranges:**  
Unregulated ..... 10-18%  
Regulated:  
Electromechanical  
(M Series) ..... 0.5%  
Electronic (R Series) ..... 0.01%

**HV components:** — transformers, capacitors, rectification assemblies, tanks, etc. — designed and manufactured under our roof.

**Custom design units:** for wide range of applications — electrostatics, accelerators, lasers, high power radars, high voltage testing, and more.

For more information call Keith Reed at  
(914) 279-8091, or send for our 24-page  
catalog, which lists complete specifica-  
tions: "High Voltage DC Power Supplies  
and Components."

High Potential Technology <sup>®</sup>



**HIPOTRONICS, INC.**  
Brewster, N. Y. 10509 / (914) 279-8091

INFORMATION RETRIEVAL NUMBER 90

# the grabber.

Our plunger action Mini-Test Clip is designed specifically for reaching into densely packaged miniaturized circuitry to make rapid, reliable tests.

- Gold plated copper contact hook makes positive connection, and won't damage lead wires.
- Specially designed tip slides down over square wire-wrap pins for solid contact.
- Integrally molded wire assures greater reliability and eliminates time-consuming assembly.
- Molded nylon probe provides complete insulation to point of connection.
- Four models offer widest selection of connecting plugs. Write for complete information and prices.

Visit us at Wescon Booth No. 1622

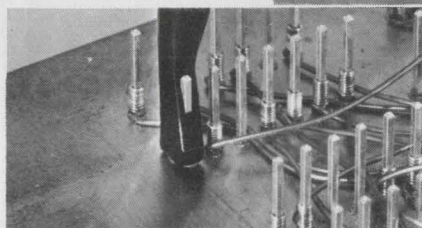
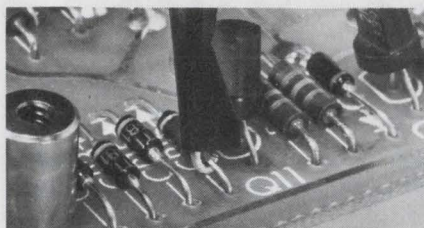
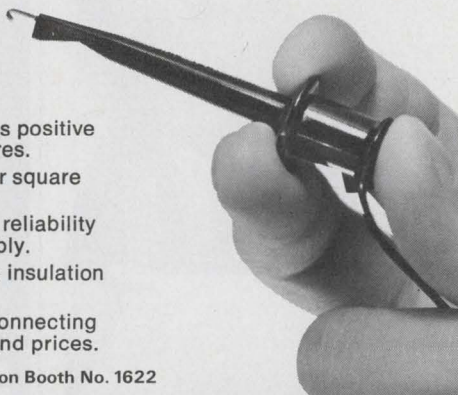

**POMONA ELECTRONICS**

1500 E. Ninth St., Pomona, Calif. 91766 • Telephone: (714) 623-3463

INFORMATION RETRIEVAL NUMBER 91

# Taking Over



Until now you've had to get by with something else. No more.

Changing to flat woven interconnect systems can be the simplest yet one of the most significant design improvements you've ever accomplished. Compact and uniquely flexible, cables and harnesses by Woven Electronics bring neatness and accuracy to every application. Fast, easy lead exposure and stripping are primary advantages.

Name your need. Woven Electronics will fit it, with basic interconnects or precise custom fabrication.

**WOVEN ELECTRONICS**

A Division of Southern Weaving Company  
P. O. Box 189 Mauldin, South Carolina 29662 (803) 288-4411

Represented nationally by Zippertubing

INFORMATION RETRIEVAL NUMBER 92

# evaluation samples

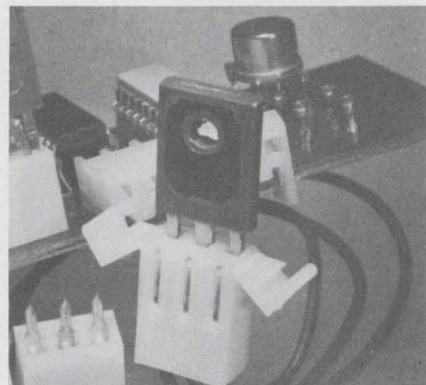

## Three-circuit socket

Internal fatigue damage from heat stresses in power transistors is minimized by a new three-circuit socket for PC connector systems. A double-cantilever, bellows-type terminal, with solder tail for board connection is employed in the new nylon socket, model A2169, from the 09-52 Conectcon series. Lead openings are 0.08 by 0.08 in. The socket has a maximum operating temperature of 105°C. A chassis-mount socket with molded ears for snap-mounting is also available. Detailed specifications and a free sample of the three-circuit socket are available. Molex, Inc.

CIRCLE NO. 382

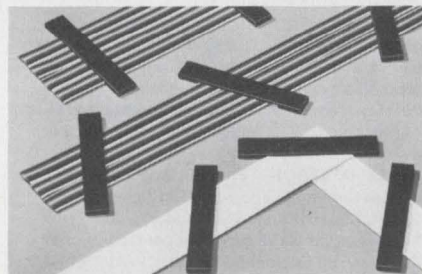

## Flat-conductor clamps

A new line of self-adhesive clamps are available to permanently position flat conductors such as flexible ribbon cables and harnesses. The user simply strings his cable along the desired course, peels off the clamp's Mylar backing and presses it over the flat cable for a neat and permanent installation. Since the new clamps have a flat top surface, they may be stack mounted. Free samples and literature are available. Richco Plastic Co.

CIRCLE NO. 383

# PROBLEM SOLVERS FOR YOU!

**GENERAL  
ILLUMINATION**

SUBMINIATURE LAMPS

MINIATURE  
INDICATOR LIGHTS

LIGHT EMITTING  
DIODES — LED'S

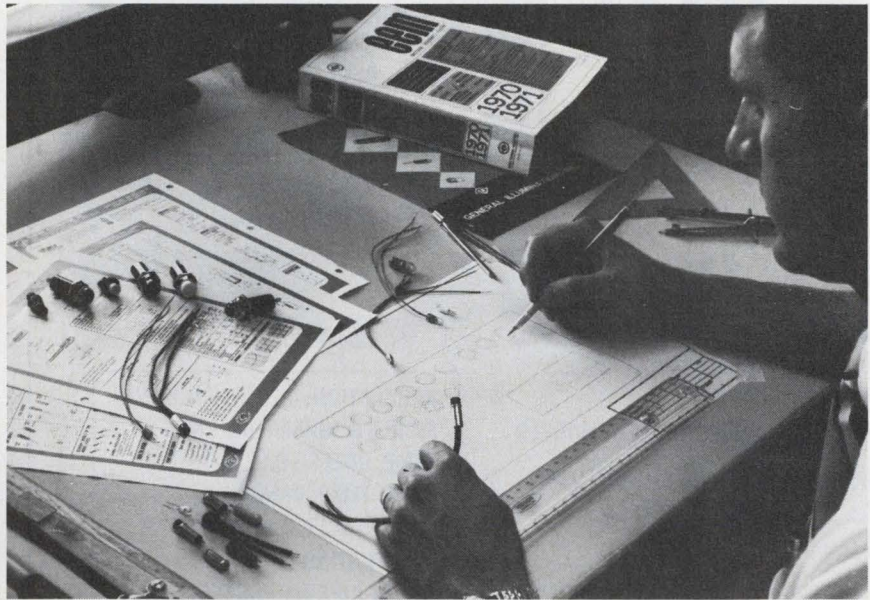

*Call* or write today for  
answers to your design problems  
ASK FOR BULLETIN RB-2



Available Through All Industrial Distributors  
**GENERAL ILLUMINATION, INC.**  
2233 University Avenue, St. Paul, Minn. 55114  
Phone (612) 646-2823

INFORMATION RETRIEVAL NUMBER 93

rubidium  
**Atomic**  
frequency  
standard...

... The Model 304D for both laboratory and field use: now available in two versions: 304D-1 (with guaranteed stability of  $1 \times 10^{-11}$ /month). 304D-2 (with guaranteed stability of  $2 \times 10^{-11}$ /month).

MTBF of more than 20,000 hours. Separate buffered outputs on front and rear panels, with built-in time scale selector and optional standby power and clock.

**Manufacturers of:** Rubidium and Crystal Frequency Standards and Clocks, VLF/LF Phase Tracking and Navigation Receivers, Frequency/Phase Comparators and Frequency Distribution Systems.

**Industrial Instruments**  
6500 Tracor Lane, Austin, Texas 78721, AC 512/926-2800



INFORMATION RETRIEVAL NUMBER 94

ELECTRONIC DESIGN 17, August 16, 1971

## MICROWAVE ABSORBER STOCK



PLATE

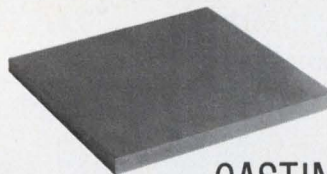

CASTING  
LIQUID



Catalog & Application Data

**MICROWAVE  
FILTER  
COMPANY, INC.**

135 WEST MANLIUS STREET  
EAST SYRACUSE, NEW YORK 13057  
(315) 437-4529

INFORMATION RETRIEVAL NUMBER 95

# BETTER TO BUY THAN BUILD\*

as low as **\$14**

DUAL REGULATED  
PLUG-IN  
POWER SUPPLIES  
FOR IC OP AMP  
APPLICATIONS



## LCD SERIES PROVIDES ELEVEN MODELS

**25mA:**  $\pm 6$ ,  $\pm 12$ ,  $\pm 15$ , &  $\pm 18$  VDC

**50mA:**  $\pm 6$ ,  $\pm 12$ ,  $\pm 15$ ,  $\pm 18$ , &  $\pm 24$  VDC

**100mA:**  $\pm 12$ , &  $\pm 15$  VDC

Designed to complement the devices they drive in price, performance and packaging . . . to offer a real \*BTBTB option

**REGULATION:** 0.20%, line & load  
 **RIPPLE & NOISE:** 1mV RMS  
**TEMP. COEFF.:** 0.02%/°C TYP.  
**OPER. TEMP. RANGE:**  
-25°C to +71°C

**NO DERATING**  
**SHORT CIRCUIT PROTECTED**  
**DIMENSIONS:** 2.5 x 3.5 x .875

**SEMICONDUCTOR CIRCUITS, INC.**  
306 RIVER STREET ■ HAVERHILL, MASSACHUSETTS 01830  
(617) 373-9104

INFORMATION RETRIEVAL NUMBER 96

# design aids

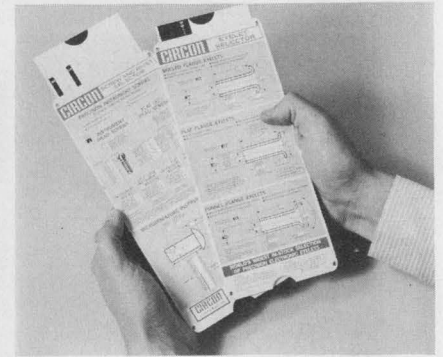

## Hardware slide-rule

A miniature-hardware slide-rule guide is available free. It contains complete specifications for over 1300 sizes of hard-to-find micro-miniature eyelets, rivets, washers and nuts used for printed-circuit board mounting. Material specifications and tolerances are shown for each product listed. Circon Corp.

Booth No. 1744 Circle No. 295

## Rotary-switch wall chart

A new wall chart shows a complete line of enclosed rotary switches. The two-color chart includes complete specifications on microminiature, miniature, standard rotary switches, and space-saver, pushbutton totally enclosed rotary switches. Also included are special electrical products—external ammeter shunts, bonding jumpers, bus bars and flexible bus assemblies. Janco Corp.

CIRCLE NO. 384

## Knobs wall chart

A free "Control Knob Selector" wall chart has been prepared for distribution to designers, engineers and purchasing personnel. Over 300 plastic and aluminum stock knobs are shown on the chart for consumer and industrial instrumentation applications. The 25-by-38-1/2-in. chart has eight separate catalogs keyed to it. These contain specifying information and design hints for custom applications. Electronic Hardware Corp.

CIRCLE NO. 385



RII Model 8011-75 Directional Coupler

**Unique new 20dB directional coupler covers the whole 1 KHz to 10 MHz range!**

Exceptional? Definitely! Our new, completely passive coupler combines a wide frequency range, a low insertion loss, high directivity, and other advantages to make it a real stand-out in performance and value.

### Specs in brief:

Frequency range	1 KHz to 10 MHz
Coupling	20.3 $\pm$ 0.3 dB
Insertion loss	< 0.25 dB
Directivity	> 30 dB
Impedance	75 ohms*
Size/weight	1.87" $\times$ 3.62" $\times$ 13/16"; 8 oz.
VSWR	< 1.1
Price	\$120

\*For 50 ohm operation, specify Model 8011-50.



Write or call today . . . to order, or for full specifications.

**REACTION INSTRUMENTS, INC.**

215 Mill St., N.E., Vienna, Va. 22180 (703) 281-4040

INFORMATION RETRIEVAL NUMBER 97

# Miniature High Voltage Resistors



**new Mini-Mox resistors offer 100 ppm TCR plus low noise characteristics**

Mini-MOX resistors have all the ingredients you need for new designs for ultra-critical applications. For instance, Mini-MOX resistors are a fraction the size of conventional types; they meet or exceed MIL-R-10509-F for environmental parameters . . . 100 ppm or less; T.C.R. stability better than  $\pm 2\%$  for 2,000 hours at full load; low-voltage coefficient less than 5 ppm/volt, measured between 100 volts and full-rated voltage; in addition typical quantech noise at 20 megohms is less than 0.5 microvolt/volt.

Available off-the-shelf, Mini-MOX resistors are ideally-suited for high-voltage applications where long-term stability and power-to-size ratios are critical.

Model	Resistance	Rating @70°C	*Max. Oper. Volts	Length Inches	Diameter Inches
MOX-400	1-2500 megs	.25W	1000V	.420	.130
MOX-750	1-5000 megs	.50W	2000V	.790	.130
MOX-1125	1-10,000 megs	1.00W	5000V	1.175	.130

Write for complete Technical Data Sheet on Mini-MOX Resistors: Victoreen Instrument Div. of VLN Corp., 10101 Woodland Ave., Cleveland, Ohio 44104. Telephone: 216/795-8200. DMA 558 Expertise in high voltage

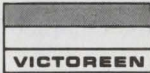

INFORMATION RETRIEVAL NUMBER 98

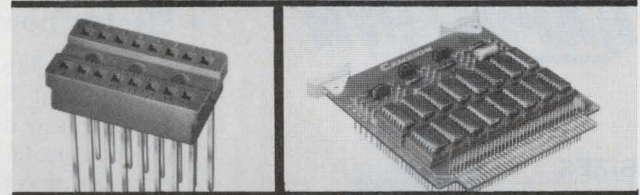
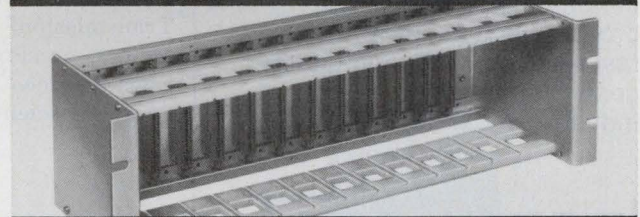
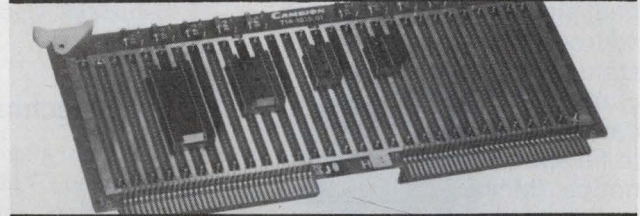
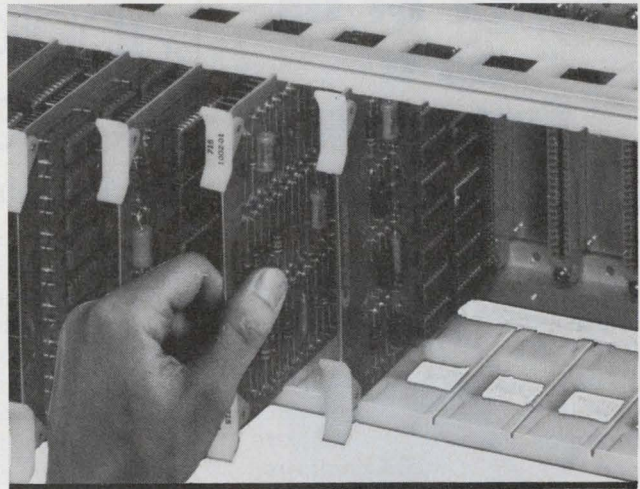

## if you design with ic's Cambion has the "works" for your work

If your digital system is a packaging puzzle, CAMBION can provide the solution.

We have the high density sockets, wire-wrappable Cambi-Cards®, PC logic cards, general purpose and discrete component cards for your functional requirements.

And to complete the picture: card files, power planes, card connectors and extenders, plus a complete numerically controlled Wire-Wrap\* service.

Result: Tightly integrated packaging systems. The "works" for your work.

For details, call us or write for the latest word on IC accessories and wire-wrapping. Cambridge Thermionic Corporation 445ED Concord Avenue, Cambridge, Mass. 02138. Phone: (617) 491-5400. In Los Angeles, 8703 La Tijera Boulevard 90045. Phone: (213) 776-0472.

\*Registered Trade Mark Gardner-Denver Co.

Standardize on

# CAMBION®

The Guaranteed Electronic Components

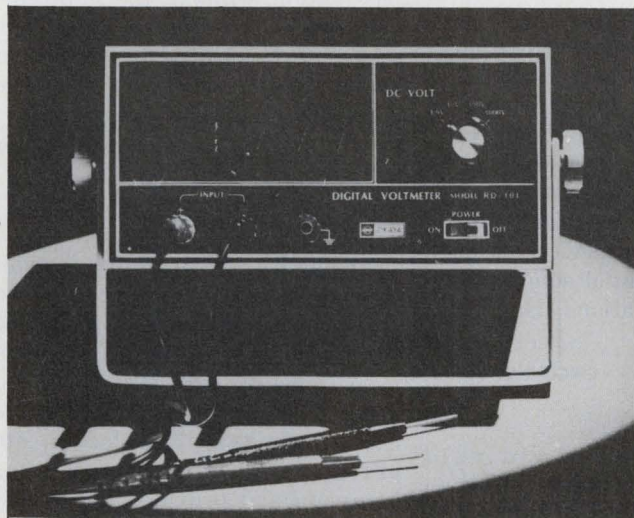

## Attractive Price and Design!

Small in size and weight but easy to read out, and increased precision by use of ICs and MSIs.

Digital Volt Meter . . . . .120\$

Digital Panel Meter . . . . .100\$

# OKAYA ELECTRIC INDUSTRIES CO., LTD.

Yasuda Bldg 3-8, 1-chome Shibuya Shibuya-ku TOKYO 150 JAPAN

INFORMATION RETRIEVAL NUMBER 99

ELECTRONIC DESIGN 17, August 16, 1971

INFORMATION RETRIEVAL NUMBER 100

# think of us as a STEPPER supermarket

We have the greatest flexibility in the industry. Standard RAPID-SYN steppers feature class H (180°C) insulation, and double shielded stainless steel bearings. RAPID-SYN steppers can be supplied with dampers, heat sinks, gearheads, pulse sources and a variety of solid state drivers. We supply every catalog item from stock and carry a complete stock of parts to fill special orders on short notice. (Most of our business is in non-catalog items.) Our broad selection, low prices, fast response and rigid quality control system are setting industry standards.



**RAPID SYN**  
STEPPERS

## SIZES

Frame sizes 8, 11, 15, 20, 23 & 34 in VR and PM are stock items. Other sizes available.

## ANGLES

Step angles of 1.8°, 5°, 7.5°, 15°, 45° and 90° are standard catalog items. Also available are 2°, 9° and 10° and a special driver that cuts all of the above angles in half (e.g., converts 1.8° to .9°, etc.)

## CHARACTERISTICS

More than 50 pages of catalog data showing torques up to 250 oz. in. and bi-directional speeds up to 2500 steps per second are just the beginning of our presentation. Depending upon the mode of excitation and appropriate drive circuits, we can lead you to the widest choice of stepper characteristics in the field.

Visit us at Wescon Booth #1227

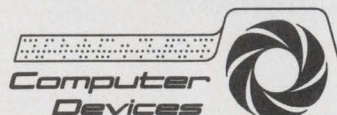

Computer Devices Corp. of California  
11925 Burke Street, Santa Fe Springs,  
Calif. 90670 • (213) 698-2595 - 723-6593

INFORMATION RETRIEVAL NUMBER 101

# application notes

## Shaft encoders

A 12-page bulletin provides the control systems engineer with tips on proper electrical connections to incremental shaft angle encoders. The application note deals with proper encoding loading, voltage drops in power lines, and recommended procedures for connecting cables to an encoder. Trump-Ross Industrial Controls, Inc.

CIRCLE NO. 386

## Video techniques

A four-page brochure entitled "Sampled Video, Techniques for Processing and Narrow Band Transmission" is available. It describes numerous unique applications of video technology in industrial and scientific fields. Colorado Video, Inc.

CIRCLE NO. 387

## Electric power control

A complete technical treatise discusses at length the revolution taking place in the control of electric power. This revolution is characterized by the current trend of industry to use solid-state controllers. Among subjects covered are general switching, markets for solid state switching devices, triac operation, and potential solid state controller applications. Hamlin, Inc.

CIRCLE NO. 388

## Resolver primer

"A Primer for Computing Resolvers" is the title of a monograph recently reprinted in response to popular demand. The 16-page, fully illustrated, primer describes in detail such definitive resolver properties as function error, transformation ratio, axis error, null, and electrical zero. Terminology used in manufacturer's data sheets and military specifications are analyzed in depth. Operation, theory, and the use of resolvers are fully explained. Theta Instrument Corp.

CIRCLE NO. 389

## Calculator terminology

A comprehensive, easy-to-read booklet about everyday electronics, designed to familiarize office management with new developments in calculators, has been prepared and is available free. The 20-page booklet, "Pocket Size Electronics," deals with the technical terms and other aspects of electronic calculators and is well illustrated with graphs and pictures. Facit-Odhner, Inc.

CIRCLE NO. 390

## Thyristor chips

A new applications bulletin covers the use and handling of thyristors (SCRs and triacs) in chip form. Intended to help the chip user in obtaining optimum results, the bulletin describes a newly developed and patented chip-construction technique that uses a proprietary, void-free glass for passivation, while at the same time eliminates problems previously caused by minute-edge fractures in the glass, which can cause device failure. Hutson Industries.

CIRCLE NO. 391

## Ac bridge balancing

An eight-page brochure is available describing the use of two-phase, lock-in amplifiers in balancing ac bridges, needed in precision measurements of complex impedances. The application note shows how to use two-phase lock-in amplifiers to greatly simplify measurements and provide diagrams of 13 types of impedance bridges, their balance equations and the advantages and disadvantages of each. Princeton Applied Research Corp.

CIRCLE NO. 392

## Injection-laser supplies

A 12-page application note tells how to build pulse power supplies for injection lasers. RCA Solid State Div.

CIRCLE NO. 393

# COMPLETE PACKAGING CAPABILITY

DELIVERY  
FROM  
STOCK

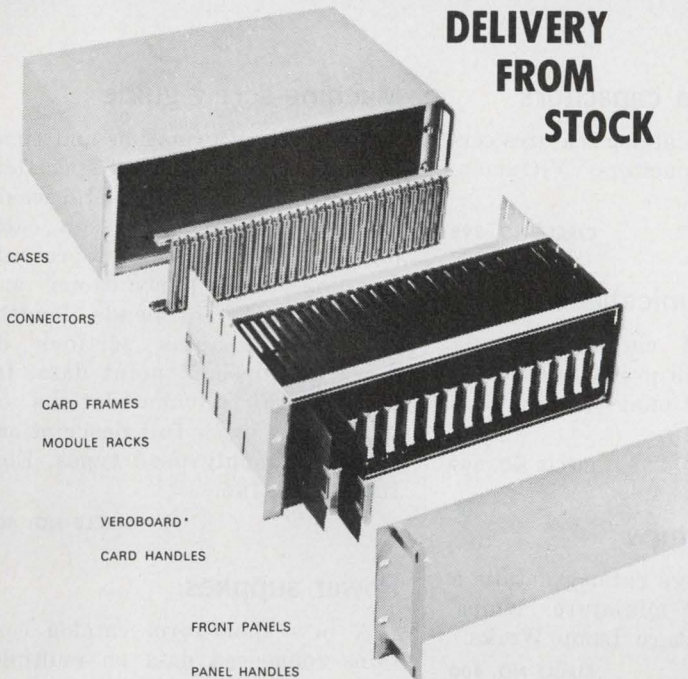

## MODULE RACK SYSTEM 1A

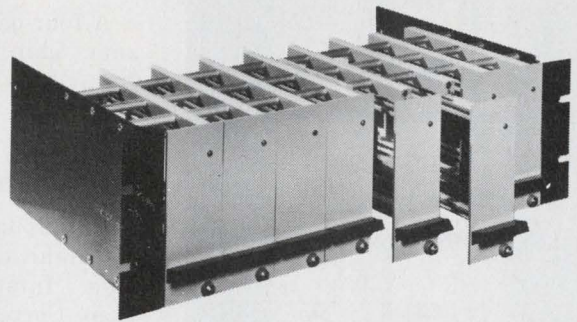

- Attractive finish & modern styling.
- Great versatility, over 1000 possible combinations.
- 5¼", 7", 8¾" High.
- 11" and 14" Deep.
- 1", 2", 4", 6", 8", 16" wide modules
- Suitable for standard 19" mounting.

**vero**

**VERO ELECTRONICS INC.** TWX510-227-8890  
171 BRIDGE ROAD, HAUPPAUGE, N. Y. 11787 TEL: 516-234-0400

INFORMATION RETRIEVAL NUMBER 102

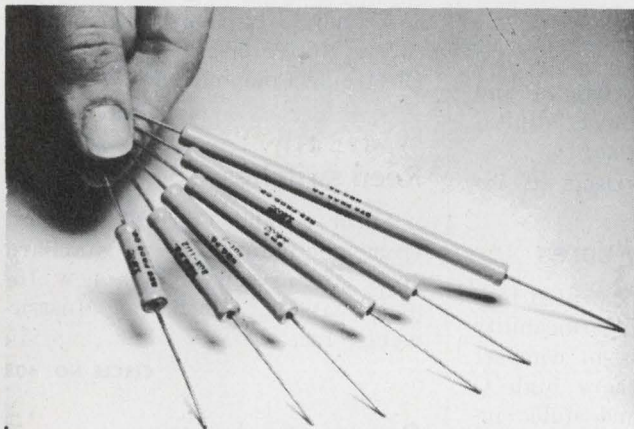

## Improved METAL OXIDE FILM RESISTORS

Tolerances: to 0.5%  
Power: 2.5W @ 10KV to 10.0W @ 40 KV  
Resistance: from 100 Ω to 20 G Ω  
Stability: ±0.2% / K-hrs.

**Resistance Products Co.**



914 SOUTH 13TH STREET  
HARRISBURG, PENNSYLVANIA 17104  
PHONE 717-236-5081

At 4 cents a terminal,  
it's easy  
pin money.

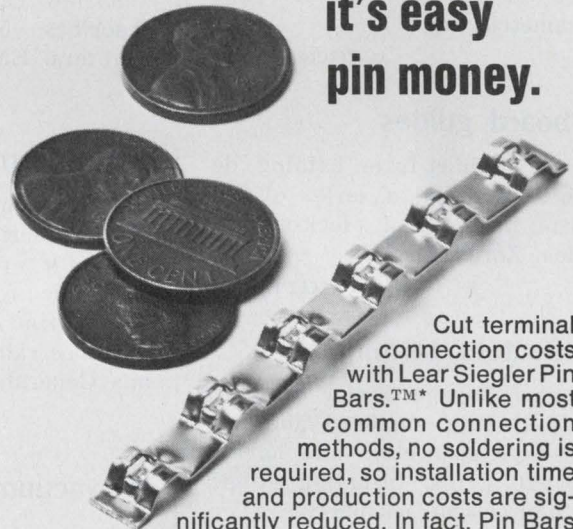

Cut terminal connection costs with Lear Siegler Pin Bars.<sup>TM</sup>\* Unlike most common connection methods, no soldering is required, so installation time and production costs are significantly reduced. In fact, Pin Bars offer more current-carrying ability, equalized resistance, enhanced terminal contact, and minimum electrical noise — for as low as 3 or 4 cents per terminal.

If you'd like to simplify your bussing operation while increasing your electrical integrity, pin us down for details and a free sample.



LEAR SIEGLER, INC.

ELECTRONIC INSTRUMENTATION DIVISION  
714 NORTH BROOKHURST STREET  
ANAHEIM, CALIFORNIA 92803  
PHONE (714) 774-1010

\*Patented

TWX 910-591-1157

# new literature

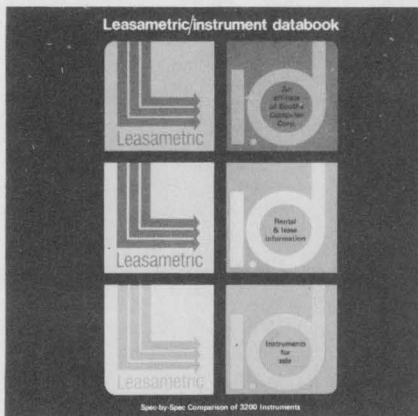

## Instruments catalog

The 1971-72 264-page Instrument Databook and Rental Catalog provides a comprehensive and useful cross-reference for over 3600 general-purpose electronic instruments. The catalog contains a comparison of pertinent instrument specifications and a cross-reference of manufacturers' model numbers. Certain manufacturers' data sheets are included to simplify alternate-source selections. A special section is devoted to rental rates and further provides a "blue-book" of prices of instruments for sale. Leasametric, Inc.

CIRCLE NO. 394

## PC-board guides

A new short-form catalog describes in detail a series of PC-board nests and locking-card guides. Zorak Co., Inc.

CIRCLE NO. 395

## Connectors/terminals

A new 20-page catalog describes a full line of standard and new Jones-type connectors and barrier terminal strips, including single-row and closed-back barriers. Vernitron Electrical Components, Beau Products Div.

CIRCLE NO. 396

## Converters

A new four-page brochure describes a complete line of low-cost d/a and a/d converters. Zeltext, Inc.

CIRCLE NO. 397

## Ceramic chip capacitors

A four-page catalog features ceramic chip capacitors. Vitramon, Inc.

CIRCLE NO. 398

## Data communications

An updated catalog of data communications products is available. International Communications Corp.

CIRCLE NO. 399

## Miniature lamps

A new 34-page catalog details a full line of miniature lamps. Chicago Miniature Lamp Works.

CIRCLE NO. 400

## Data modems

A new 12-page brochure outlines a new series of data modems and data sets. DataServ.

CIRCLE NO. 401

## Digital counters

A new catalog illustrates and describes 50 standard digital counters. ENM Company

CIRCLE NO. 402

## High-permeability cores

A new four-page illustrated brochure describes high-permeability cores for applications in compact electronic systems where high Q values, fine tuning and stable inductance values are required. Indiana General.

CIRCLE NO. 403

## HV vacuum components

A short-form catalog outlines a complete line of vacuum fixed and variable capacitors, with working voltages up to 40 kV and capacitances to 5000 pF. Also included are vacuum coaxial relays, high-power rf and ac/dc contactors and high-voltage measuring equipment, power systems and testers. ITT Jennings.

CIRCLE NO. 404

## Machine-screw guide

Complete information and timely suggestions to ease specification of machine screws and washers are contained in a new catalog. The 48-page booklet presents machine screw definitions and measurements for heads, lengths and threads, plus sections on drive designs and point data. Included are recommendations on head styles with full descriptions of 11 commonly used types. Elco Industries, Inc.

CIRCLE NO. 405

## Power supplies

A new short-form catalog contains condensed data on multiple-output power supplies for computer CRT terminals, card readers and digital cassettes. Astro Space Laboratories, Inc.

CIRCLE NO. 406

## He-Ne lasers

A new six-page laser guide covers He-Ne laser products. RCA Electronic Components.

CIRCLE NO. 407

## Reed switches

Form A and C reed switches, from microminiature to standard sizes, are presented in a new 16-page catalog. Hathaway Instruments, Inc.

CIRCLE NO. 408

## Conversion devices

A set of data sheets are available on devices to convert ac, dc and synchro signals into digital form. Dynalex, Inc.

CIRCLE NO. 409

## Discrete semiconductors

A new, 24-page discrete-semiconductors condensed catalog is available. It describes silicon rectifiers, diodes and bridge assemblies, MOS-FETs, high-voltage assemblies, germanium diodes and transistors. General Instrument Corp.

CIRCLE NO. 410



# DESIGN ENGINEERS—WE'VE GOT YOUR NUMBER

Whether It's Eye-easy Phosphorescent Display Tubes or Crt's and It'll Show You a Thing or Two in Quality, Performance, and Other Important Advantages That Constitute a Big Seeing-Is-Believing Difference

EXCITE  
YOUR  
CREATIVE  
APPETITE



Variety is the spice of life — and here it is on a silver platter. Legi variety comes big so you can design big, and it comes small so you can design small. The choice is yours. But the latitude in physical size isn't all you get with Legi. You also get important quality and performance advantages. Legi phosphorescent display tubes meet portable and circuit-board mounting requirements, have a readout as bright as day, and a dynamic life of 100,000 hrs; 'Multi-Legi' is our special package deal for display electronics system designers; Legi compact decoders and drivers are more designer specials in separate, composite, and Bipolar MOS types; and Legi picture perfect picture tubes let you design from 9" to 5-1/2" down to pocket-size 3" spec. There's a lot more you should know about Legi, if you don't know already. Write today for full particulars, and we'll show you how it pays to think Legi when you're thinking new systems. The spice of life is yours. Now.

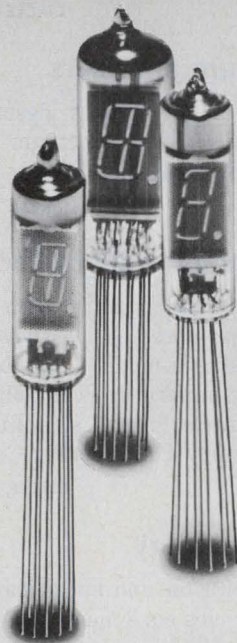

## SPECIFICATIONS (pulse operation)

TYPE	Filament Current mA	Filament Voltage V <sub>a.c.</sub>	Phosphor Segment Voltage V <sub>d.c.</sub>	Control Grid Voltage V <sub>p-p</sub>	Phosphor Segment Current mA <sub>p-p</sub>
DG12M	85	*1 0.8 ± 10%	50	*2 50	4
DG12H	85	*1 0.8 ± 10%	50	*2 50	3
DG19E	95	*1 1.7 ± 10%	55	*2 55	4
Unit					

TYPE	Control Grid Current mA	Phosphor Segment Cut-off Voltage V <sub>gco</sub> (MAX.)	Control Grid Cut-off Voltage V <sub>gco</sub> (MIN.)	Brightness Ft.-L
DG12M	19	0	-4	150
DG12H	18	0	-4	150
DG19E	22	0	-4	150
Unit	mAp-p	V	V	

\*1 Effective Value at 50 or 60 Hz A.C.  
\*2 Pulse condition—Duty Factor 1/16 pulse width 60 μsec.

*Legi* Sole U.S. Agent

## LEGI ELECTRONICS CORPORATION

3118A, West Jefferson Blvd. Los Angeles, California 90018, U.S.A.  
Tel: (213) 733-9105

**ISE** The Brighter Side of Electronics

## ISE ELECTRONICS CORPORATION

P.O. Box 46, Ise City, Mie Pref., Japan  
Phone: Mie (05963) 2-4944, (05963) 5-2121

# monolithics: the figures

Recently we've tried to dispel some of the misconceptions about monolithic crystal filters with some straight facts. Now, we'd like to augment these facts with some straight figures. Figures that should convince you that monolithics combine high performance/small size with low cost. Here goes.

1. Replacing conventional crystal filters with monolithics usually saves 10 to 20%, and sometimes as much as 50%!
2. PTI standard monolithic models save time and money. Over 20 models off-the-shelf at 10.7 MHz. Plus our new low-cost standards at 21.4 MHz. More on the board, too.
3. Designing from scratch around monolithics can save money by eliminating unnecessary parts and by optimum parameter choice.
4. No matter how you figure it, the performance of PTI monolithics makes money for you by adding value to your equipment.

It all adds up to this — higher performance at a price you can afford. Talk to us about your project. We've been making monolithics longer — and more of them — than anyone else. And we've got the figures to back it up.



**Piezo Technology Inc.**

2400 Diversified Way  
Orlando, Florida 32804  
305-425-1574

The standard in monolithic crystal filters

## NEW LITERATURE

### Instruments

A 12-page brochure describes performances and features of electronic counters, digital voltmeters and multimeters, data amplifiers and frequency synthesizers. Dana Laboratories, Inc.

CIRCLE NO. 411

### Digital/synchro sets

A two-page data sheet describes a series of digital-to-synchro conversion card sets for use in interface systems. North Atlantic Industries, Inc.

CIRCLE NO. 412

### Springs

New ways to stock, display and sell springs are described and illustrated in a catalog. Select-A-Spring Corp.

CIRCLE NO. 413

### Soldering irons/tips

Electric soldering irons, tips and related accessories and equipment are shown in a new 32-page catalog. Hexacon Electric Co.

CIRCLE NO. 414

### Switches

An informative, 28-page switch catalog provides a guide to the basic criteria for switch selection. Tech Laboratories, Inc.

CIRCLE NO. 415

### Spectrum analyzers

A 10-page booklet describes a complete line of spectrum analyzers. Hewlett-Packard Co.

CIRCLE NO. 416

### Temperature controller

A technical bulletin with outline drawings describes a new solid-state single-mode, proportional-control temperature controller with synchronous (zero) switching output. Victory Engineering Corp.

CIRCLE NO. 417

### Core memory

Description and specifications of a new series core memory are available in a brochure. Ampex Corp.

CIRCLE NO. 418

### Rf power amplifiers

A new four-page brochure describes broadband rf power amplifiers for MIL-STD-461A. Electronic Navigation Industries, Inc.

CIRCLE NO. 430

### Modular/graphic displays

A system of graphic displays used for monitoring control information and for illustrating flows, processes and locations is described in a catalog. Hathaway Instruments, Inc.

CIRCLE NO. 431

### Tantalum capacitors

Literature is available on solid tantalum, epoxy-sealed capacitors rated from 0.0047 to 330  $\mu$ F and 6 to 100 V. National Components Industries, Inc.

CIRCLE NO. 432

### Pen recorders

One and two-pen recorders that provide continuous and permanent records of process variables are depicted in a new four-page catalog. Thermo Electric.

CIRCLE NO. 433

### White-noise sources

A bulletin is available with data on white-noise generator modules and diodes. Codi Semiconductor.

CIRCLE NO. 434

### Pressure-sensitive labels

Pressure-sensitive property identification labels are described in a catalog. Seton Name Plate Corp.

CIRCLE NO. 435

### Thin-film resistors

A data sheet describes a line of thin-film resistor networks intended for use in voltage and current-switching d/a and a/d converters. Analog Devices, Inc.

CIRCLE NO. 436

### Planar triodes

A 16-page brochure describes the Eimac line of planar triodes. Varian, Eimac Div.

CIRCLE NO. 437



## Speed 'em up!

Our new Pull-Thru gun lets you pull (not push) contacts through a connector. At four times the speed. Works on many connectors. With three contact sizes. Fast? The no-holdup gun.

**HUGHES**

HUGHES AIRCRAFT COMPANY  
CONNECTING DEVICES

INFORMATION RETRIEVAL NUMBER 107

## Apollo New Products!! Counting Display Unit DN-1130 Series

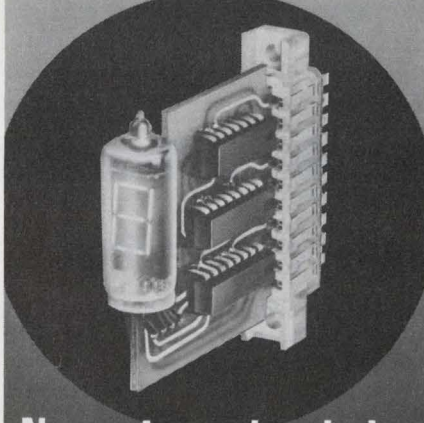

### Now, Just plug-in!

- Digital display of counted pulses
- Consists of NEW-TRON DA-1300 (7 segment incandescent digital readout tube), decoder/driver, decade counter and quad latch
- BCD counter output and reset input may be connected externally
- Only 5V power supply required
- Compact size: 0.5" (W) x 2" (H) x 2.05" (D)
- Multiple digit and other circuit design available on special order.

For further information, please contact:

**Apollo**  
CORPORATION

5-1, Togoshi 6-chome, Shinagawa-ku,  
Tokyo 141, Japan  
Phone: (03) 786-2001 - 3  
Cables: "APOLLOHAGITA" TOKYO

INFORMATION RETRIEVAL NUMBER 108

ELECTRONIC DESIGN 17, August 16, 1971

## bulletin board

of product news and development

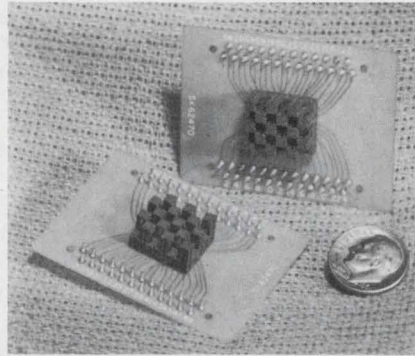

The Beau Products Div of Vernitron Corp., Laconia, N.H., announced a new concept in connectors for applications where high contact density and small size is needed. The company has developed a high-density connector that uses a cantilever-beam design and contacts that individually carry 2 A. The connector provides a closed-entry package that has contact protection. The connector's termination ends are of a barrel design that permits the soldering of wires up to AWG #30 and access to PC-board or flexible-circuit wiring using 0.03-in.-dia holes. Special configurations are now being worked on by Vernitron Corp. to offer densities in the area of 200 contacts per square inch.

CIRCLE NO. 438

Owens-Illinois, Inc., announced today it will begin commercial pilot-plant production of its "Digitivue" digital display/memory panel, a computer-driven, 1/2-in.-thick readout for the display of alphanumeric and graphic data.

CIRCLE NO. 439

Atlantic Technology Corp. has announced major price reductions in both rental and purchase rates of its ATC2000 data display terminal. For a 480-character system, rental rates have been reduced by up to 32%; up to 38% for a 960-character system and up to 50% for a 1920-character system. Purchases prices have also been reduced by 30 to 55%.

CIRCLE NO. 440

## Synchron® motors help money make money



In the vending business, a would-be customer with dollar bills and no coins might just as well be flat broke. Unless there's a bill changer around. Like this one made by Rowe International.

Feed it a dollar bill and, presto! Instant alchemy. That useless paper is turned into spendable change.

The acceptance of the bill provides a signal which is transformed into multiple pulses in a Hansen-actuated electromechanical pulse chopper. Impulses are then sent to a memory unit and the payoff is actuated. The major reason why Hansen motors are specified: "Dependability."

Contact your Hansen man and find out how Hansen dependability can help you.

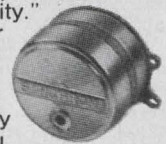

**HANSEN**  
Manufacturing Company, Inc.  
Princeton, Indiana 47570



**HANSEN REPRESENTATIVES: CAREY & ASSOCIATES,**  
Houston and Dallas, Texas; R. S. HOPKINS CO., Sherman Oaks, Calif.; MELCHIOR ASSOCIATES, INC., San Carlos, Calif.; THE FROMM CO., River Forest, Ill.; JOHN ORR ASSOCIATES, Grand Rapids, Mich.; H. C. JOHNSON AGENCY, INC., Rochester, N.Y.; WINSLOW ELECTRIC CO., Essex, Conn., Villanova, Pa., and Teaneck, N.J.  
**EXPORT DEPARTMENT: 2200 Shames Drive, Westbury, N.Y. 11590**

INFORMATION RETRIEVAL NUMBER 109

129

# Electronic Design

ELECTRONIC DESIGN's function is:

- To aid progress in the electronics manufacturing industry by promoting good design.
- To give the electronic design engineer concepts and ideas that make his job easier and more productive.
- To provide a central source of timely electronics information.
- To promote two-way communication between manufacturer and engineer.

**Want a subscription?** ELECTRONIC DESIGN is sent free to qualified engineers and engineering managers doing design work, supervising design or setting standards in the United States and Western Europe. For a free subscription, use the postfree application form inside the back cover. If none is included, write to us direct for an application form.

If you do not qualify, you may take out a paid subscription for \$25 a year in the U.S.A., \$35 a year elsewhere. Single copies are \$1.50 each.

**If you change your address,** send us an old mailing label and your new address; there is generally a prepaid postcard for this inside the back cover. You will have to requalify to continue receiving ELECTRONIC DESIGN free.

**The accuracy policy of ELECTRONIC DESIGN is:**

- To make reasonable efforts to ensure the accuracy of editorial matter.
- To publish prompt corrections whenever inaccuracies are brought to our attention. Corrections appear at the end of the Letters column.
- To refuse any advertisement deemed to be misleading or fraudulent.

Microfilm copies are available of complete volumes of ELECTRONIC DESIGN at \$19.00 per volume, beginning with Volume 9, 1961. Work is now in process to complete the microfilm edition of Volumes 1-8. Reprints of individual articles may be obtained for \$2.00 each, prepaid (\$.50 for each additional copy of the same article) no matter how long the article. For further details and to place orders, contact the Customer Services Department, University Microfilms, 300 North Zeeb Road, Ann Arbor, Michigan 48106; telephone (313) 761-4700.

**Want to contact us?** If you have any comments or wish to submit a manuscript or article outline, address your correspondence to:

Editor  
ELECTRONIC DESIGN,  
50 Essex Street,  
Rochelle Park, N.J. 07662

# Design Data from

## PC Drafting Aids Catalog

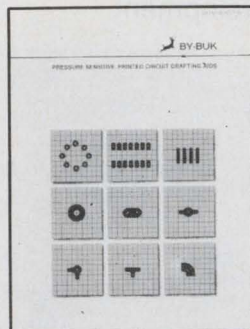

Thousands of time saving, cost saving artwork ideas are found in the By-Buk P-50 catalog of pressure sensitive printed circuit drafting aids. With the most practical artwork patterns for: TC cans, multi-pads, dual-inlines and flat packs featured. Donuts, connector strips, teardrops, ovals, tapes, tees, elbows, etc., by the hundreds are included in the most comprehensive list of sizes. Opaque black, transparent red and transparent blue materials for one and two-sided board designs. For a free copy and samples, write today.

**By-Buk Company**  
Subsidiary of Webtek Corp.  
4326 W. Pico Blvd.  
Los Angeles, California 90019  
(213) 937-3511

CIRCLE NO. 171

## Plastic Parts



CUSTOM production to your specs from patented, low-cost tooling. Any size, any quantity in Nylon, Delrin, other thermoplastics. Let us quote. We have 20 years experience.

STANDARD gears, racks, bearings, sprockets, pulleys, washers, insulators, many other components available quickly from stock tools. Over 2,500 items described in our 48-page catalogue. Write today for a free copy.

## Nylomatic

11 Nolan Ave., Morrisville, Pa. 19067  
A DIVISION OF WEHCO PLASTICS INC.

CIRCLE NO. 172

## 150°C Metallized Polysulfone Capacitors



Six pages of data on these new, high temperature capacitors present electrical ratings, performance curves and package dimensions.

More than 800 units in four voltage ratings and six case styles are listed, with complete part number ordering information.

Capacitance values range from .0010 to 20Mfd. Voltages available are 100, 200, 400, and 600 VDC. Case styles are round or oval wrap and fill, rectangular epoxy with axial or radial leads, plus round and rectangular hermetically sealed metal cases. The units are stable within 1% over the temperature range.

**Electrocube, Inc.**  
1710 South Del Mar Avenue  
San Gabriel, California 91776

CIRCLE NO. 173

# Manufacturers

Advertisements of booklets, brochures, catalogs and data sheets. To order use Reader-ServiceCard (Advertisement)

## Mini-Computer + Real-Time Analyzer for Automatic Testing



Complete Spectrum Processing System SP-6-1 automatically scales, equalizes, processes underwater acoustic data and noise/vibration signatures for production testing. Monitors on-line signals (nuclear reactor noise, heart sounds, machine tool vibration), recognizes aberrations, gives alarm. Setup conditions are entered via teletype unit as requested by computer. System prints out all spectral data or only frequency amplitude above preset levels. Data also pre-recordable on tape, played back often faster than real time. Analysis over frequency bands as wide as 40 kHz are possible. Many options.

### Federal Scientific Corporation

a subsidiary of Elgin National Industries, Inc.  
615 West 131st Street, New York, N. Y. 10027.

CIRCLE NO. 174

## Instant Circuit Boards<sup>TM</sup>



Engineers at CIRCUIT-STIK, INC., have developed a complete family of circuit sub-elements and circuit materials designed to work together producing "INSTANT PROTOTYPE CIRCUIT BOARDS." Individual circuit boards can be assembled and tested from engineering sketches the same day. CIRCUIT-STIK's sixteen page catalog describes circuit sub-elements and materials that are pre-drilled, pre-plated, fluxcoated, and have pressure sensitive adhesive substrates ready for mounting and soldering of electronic components. (U. S. Patent #3,538,389 and other patents pending)

SEND FOR YOUR FREE CATALOG AND SAMPLES

### Circuit-Stik, Inc.<sup>®</sup>

1518 West 132nd Street, Gardena, California 90249  
Telephone (213) 532-1450

CIRCLE NO. 175

## Centron Precision Drafting Aids Catalog

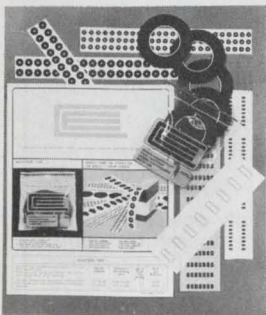

The latest catalog in pressure-sensitive precision component matched artwork symbols and drafting aids. Completely opaque pre-cut symbols are printed on pressure sensitive .0015" matte acetate film accurate to  $\pm .001$ ". Featured are choices in packaging to the user which affords greater convenience and cost savings. Donut pads are offered in both roll and strip form and precision tape is packaged in air-tight zipper bags to preserve freshness even after use. SEND FOR YOUR FREE CATALOG AND SAMPLES.

### Centron Engineering, Inc.

1518 W. 132nd Street  
Gardena, California 90249

CIRCLE NO. 176

# Electronic Design

## Advertising Sales Staff

Bryce Gray, Jr.  
Sales Manager

### Rochelle Park, N.J. 07662

Robert W. Gascoigne  
Samuel M. Deitch  
Daniel J. Rowland  
50 Essex Street  
TWX: 710-990-5071

### Philadelphia 19025

Mort Sullivan  
P.O. Box 126  
Dresher, Pa.  
(215) 884-6880

### Boston 02154

Joseph F. Palmer  
1268 Main Street  
Waltham, Mass.  
(617) 894-2700

### Chicago 60611

Thomas P. Kavooras  
Berry Conner, Jr.  
200 East Ontario  
(312) 337-0588

### Cleveland

Thomas P. Kavooras  
(Chicago)  
(312) 337-0588  
(call collect)

### Los Angeles 90303

Stanley I. Ehrenclou  
Burt Underwood  
2930 Imperial Highway  
Inglewood, Calif.  
(213) 757-0183

### San Francisco 94022

Jerry D. Latta  
95 Main Street  
Los Altos, Calif.  
(415) 941-3084

### London W. 1

For United Kingdom and Holland  
Brayton C. Nichols

For Eastern Europe  
Peter Kehr

### The American Magazine Group

27 Maddox Street  
London, W. 1, England  
Phone: 499-0180

Cable: Ammagnic, London

### Verviers, Belgium

For Continental Europe  
Andre Jamar  
1, Ru Mallar, 1  
(087) 253.83 Telex 41563

### Tokyo

Haruki Hirayama  
Electronic Media Service  
5th Floor, Lila Bldg.,  
4-9-8 Roppongi  
Minato-ku  
Phone: 402-4556  
Cable: Electronicmedia, Tokyo



**AMERICAN BUSINESS PRESS, INC.**

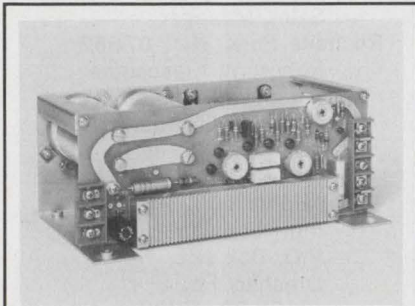

**T. D. I. offers expanded range and multiple outputs in its low cost XL line of power supplies.** All Models feature short circuit protection, remote sensing, adjustable outputs and 0.25% regulation. Outputs range from 1 to 30 Volts at current levels from 0.7A to 8A. Prices \$37.50 to \$115.00. Transistor Devices, Inc., Cedar Knolls, N. J.

INFORMATION RETRIEVAL NUMBER 201

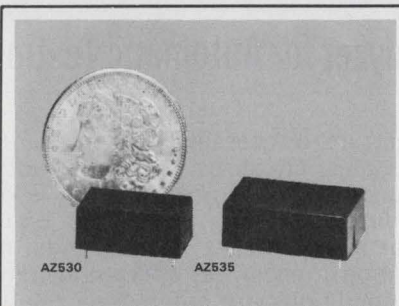

**Big power small size.** That's American Zettler's mini THINKPAK relays—the AZ530 Series with 2 and 5 amp SPDT contact configurations. These units were designed for requirements that cannot be met by reed relays, including its 0.6" center-to-center PC card mounting. Priced from \$1.44 each. American Zettler, Inc., Costa Mesa, Ca. (714) 540-4190.

INFORMATION RETRIEVAL NUMBER 204

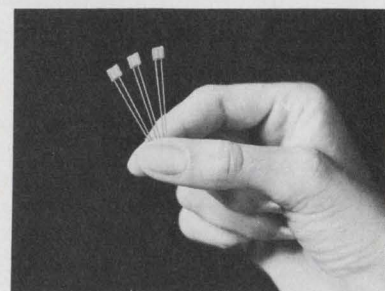

**Plastic encapsulated CdS photo-sensitive device.** Consists of two cells connected in series. Maximum cell temperature 60° C. D.c. and repetitive peak voltage is max. 50 V. Resistance at 50 lux, 2700° K colour temperature is 600Ω. Dimensions max. 6 x 6 x 2 mm. N. V. Phillips - Eindhoven, The Netherlands.

INFORMATION RETRIEVAL NUMBER 207

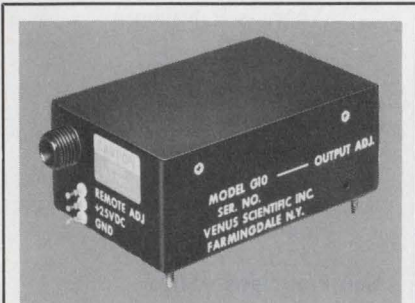

**"G" series miniature high voltage C.R.T. power supplies.** Three models, ideal for airborne applications, provide 500V to 5KV, 1KV, to 10KV, or 1.2KV to 12KV @ 500ua from a 15 cu. in.; 1 1/4 lb. package. Reg.: 0.1%, Ripple: 0.15% P-P @ F. L., Input 24 to 32VDC. Venus Scientific Inc., Farmingdale, N. Y. (516) 293-4100.

INFORMATION RETRIEVAL NUMBER 202



**Clean up signal pollution.** Our clean-up team of single and dual channel variable active filters offer highest accuracy, versatility and reliability. Literature available covering our complete line of signal "cleaner-uppers". Write Multimetrics Industries, Richmond Hill, N. Y. 11418. 212-441-3200.

INFORMATION RETRIEVAL NUMBER 205

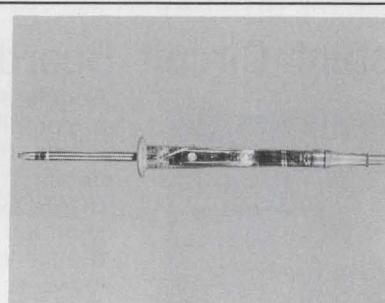

**The new loner soldering instrument** with electronic control built in handle automatically maintains thermal balance during each soldering cycle. The loner soldering instrument will idle at 9 watts or match any soldering thermal load up to 50 watts, with a precise temperature on demand. \$37.50. Edsyn Inc., Van Nuys, Calif. 91406. (213) 989-2324.

INFORMATION RETRIEVAL NUMBER 208

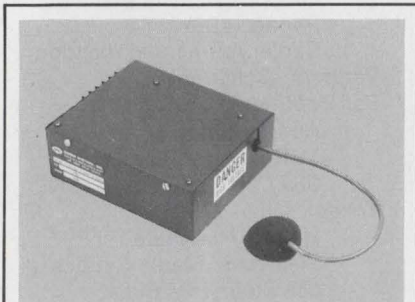

**CRT SUPPLY has THREE OUTPUTS and logic control.** +12,000 V, +500 V and -150 V. Ripple and Regulation are 0.1%. Input +24 volts. Short circuit protection — arc proof — R.F.I. shielded design. Prices: \$150-\$99 (1 to 100 quantity). Sierra Systems, Inc., Mtn. View, CA. (415) 969-3056.

INFORMATION RETRIEVAL NUMBER 203

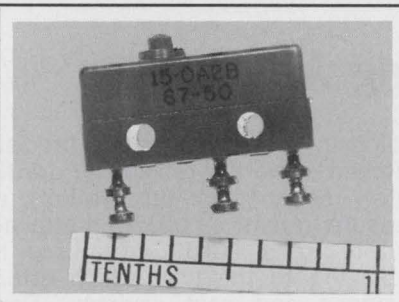

**Subminiature momentary snap action spdt switch 30¢ ea.** New computer grade mfg. by Hi-Tek for M.S.C. Contacts solid coin silver. 5 amps. @ 125/250 vac. Various terminals & actuator configurations available from stock. Quantity prices on request. Industrial Electronic Metals, Inc., P. O. Box 4280, Irvine, Calif. 92664. 714-546-9803.

INFORMATION RETRIEVAL NUMBER 206

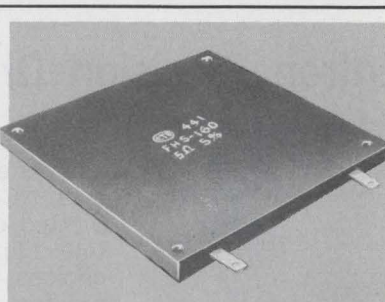

**New flat heat-sink power resistors** available with temperature coefficients of ±5 ppm and power ratings from 10 to 500 W. Noninductive low-tolerance (0.05, 0.5, 1, 5 and 10%) resistors are available within a resistance range of 0.003 to 1000Ω. Kelvin-Varley four-wire construction. Charles T. Gamble Industries, Riverside, N. J. 609/461-1900.

INFORMATION RETRIEVAL NUMBER 209

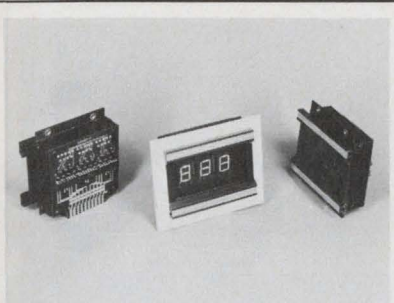

**Numerical decoder display 1.200"** behind panel, 140° viewing angles, single connector, seven segment fluorescent tubes, single mounting hole. Interfaces with four line B.C.D., compatible with I.C.'s. Three, four, and five decades standard off the shelf, specials available. 100 pcs. \$49.50 ea. Display General, Waltham, Mass. (617) 899-2704.

INFORMATION RETRIEVAL NUMBER 210

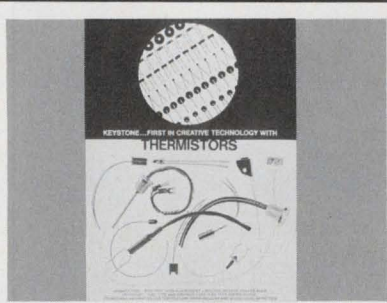

**Thermistors** — washer, rod, low-coefficient, cryogenic, glass bead, disc and molded-in-lead bead and rod types. Also 7 styles of probes and special assemblies for temperature measurement and liquid level detection . . . Keystone Carbon Company, St. Marys, Pa. 15857.

INFORMATION RETRIEVAL NUMBER 213

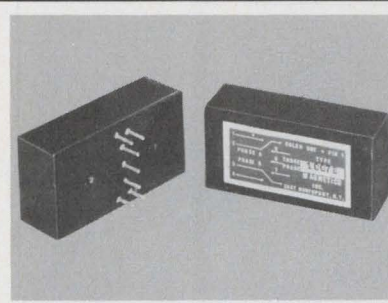

**Scott-T-Transformers** — 30 arc seconds accuracy, 90 volts or 11.8 line to line synchro inputs at 60 or 400 Hz sine & cosine outputs. Standard units resolver to synchro available. In quantity \$19.00 each. Magnetico Inc., East Northport, N. Y. (516) 261-4502.

INFORMATION RETRIEVAL NUMBER 216



**Meter and dial markings** give finished professional look to control panels and meter dial plates. Rotary switch marks, set for standard 15° and 30° detents are easily transferred at other angles. Design two-color meter scales in black and red arcs and graduations. The DATAK Corporation, 85 Highland Ave., Passaic, N.J. 07055.

INFORMATION RETRIEVAL NUMBER 211

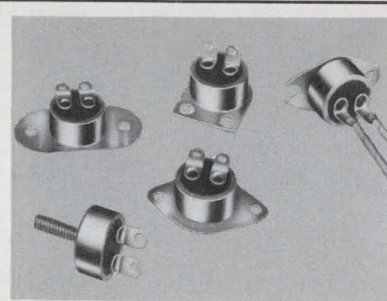

**Precision snap-action thermostats** from Elmwood, widely specified for quick, reliable response; proven industrial and military performance record. Environ. expos. -85° to 550° F; narrow or wide diff.; rated to 15 amps. Prototypes from stock. Wide choice of brackets, terminals. Elmwood Sensors, Inc. (401) 781-6500. TWX 710-381-6413.

INFORMATION RETRIEVAL NUMBER 214

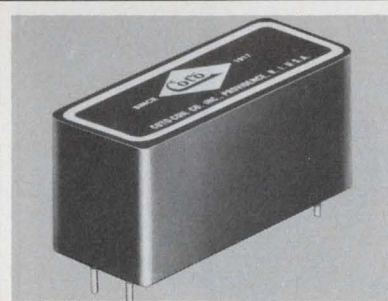

**Ultra-Low thermal emf relays** (with offsets less than 1 $\mu$ V) permit Hg wet, high-voltage reed relays to be used for very low-signal switching. Also available less than 500 nanovolts per switch (1 $\mu$ V differentially between switches). Many contact forms, pin configurations. Coto-Coil Co., Inc. (401) 941-3355.

INFORMATION RETRIEVAL NUMBER 217

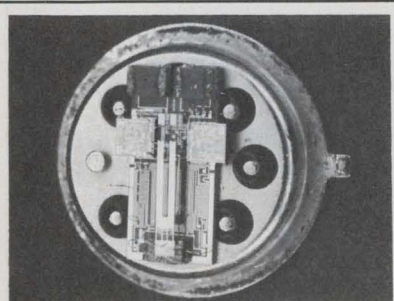

**Ultra-miniature crystal oscillator and filter products** are available from 10-100KHz in TO-5's or flatpacks, with as low as 10 micro amps consumption and Q's and 2-40K. Products include timers from seconds to months, telemetry systems, clocks, signal processing filters, etc. Statek Corp., 1200 Alvarez Ave., Orange, CA 92668. 714-639-7810.

INFORMATION RETRIEVAL NUMBER 212

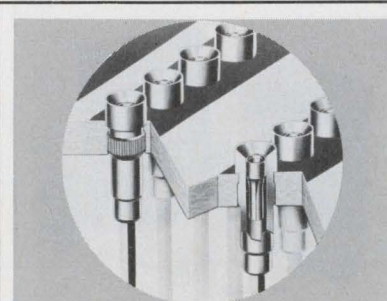

**"Funnel-Entry" Wire Wrap\* Terminals** with tapered-entry design vastly facilitates insertion of I.C. leads, manually or automatically. Nurl-Loc® prevents twisting. Low profile (.046" above P.C. Board). Available 2-3 levels of wrap; separately or mounted on EMC packaging panels. Electronic Molding, Woonsocket, R.I. 401-769-3800. \*® Gardner-Denver Co.

INFORMATION RETRIEVAL NUMBER 215

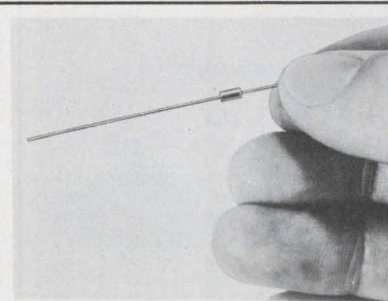

**Get higher power/size ratio** from new RS-1/8 precision wirewound resistor. Rated at .25 w. Dim: .155" L. x .065" D. Molded for -55 to +275°C operation. Res: 1-950 $\Omega$ . Tol: 1%, 3%, 5%. T.C.:  $\pm 20$ ,  $\pm 50$  PPM. Available fast from Dale Electronics, 1300 28th Ave., Columbus, Nebr. 68601. (402) 564-3131.

INFORMATION RETRIEVAL NUMBER 218

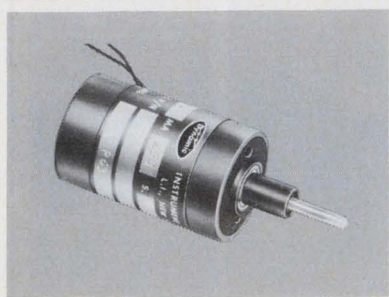

Dynamic has successfully coupled high performance with low cost engineering techniques to produce a clutch-drag/brake ideally suited to computer cassette tape-drive systems. It will assist in the elimination of many inherent problems presently plaguing designers. Catalog available from Dynamic Instrument Corp., Plainview, N. Y. 11803.

INFORMATION RETRIEVAL NUMBER 219

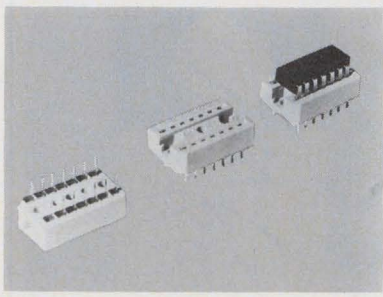

**VERO 14 CONTACT D.I.P. SOCKET** designed with a low 0.218 profile. Provide high density packaging. Large tapered entry channels aid I.C. insertion. Dual-leaf wiping contacts, for round or flat leads, low contact resistance and high reliability. Stand-offs provide an air gap between socket and board. Vero Electronics Inc., Hauppauge, N. Y. 516-234-0400.

INFORMATION RETRIEVAL NUMBER 222

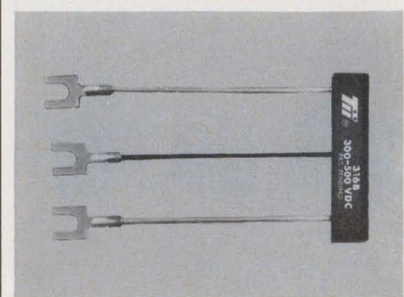

**Model 316 3-electrode gas arrester** offers maximum protection against longitudinal and metallic surges for sensitive equipment, data channels and solid state networks. Telecommunications Industries Inc., Copiague, N. Y. Phone 516-842-5000.

INFORMATION RETRIEVAL NUMBER 225

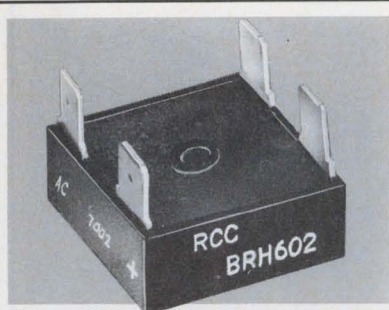

**BRH600 SERIES**, high rel. 6 amp. single phase, full wave bridges in voltage types of 50, 100, 200, 400, 600, 800 volts with max. single cycle surge current rating of 125 amps pk. Size 1 x 1 x .4". Features full glassivated diode elements. 1-99 quant. from \$2.95 to \$6.05 depending on voltage type. Rectifier Components, Freeport, N. Y. 516-868-0470.

INFORMATION RETRIEVAL NUMBER 220

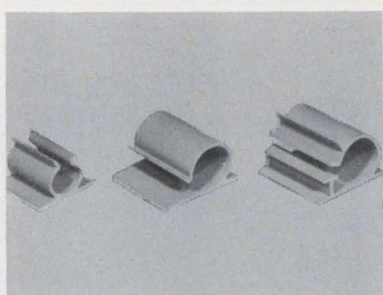

**Daburn "Stik Klips"**. Fast secure mounting to smooth surfaces — No screws, nails or staples — just peel backing and press on clean dry surface. Strong, insulated and pliable. Three styles (one locking). 4 I.D. sizes  $\frac{1}{4}$ ,  $\frac{3}{8}$ ,  $\frac{1}{2}$ ,  $\frac{3}{4}$ . New catalog just off the press, write Daburn Electronics & Cable Corp., Bronx, N. Y. 10458.

INFORMATION RETRIEVAL NUMBER 223

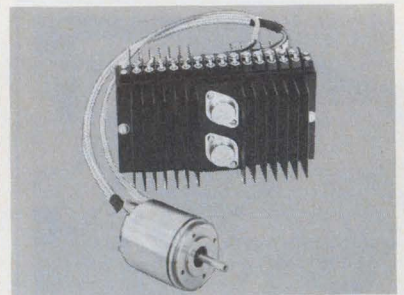

**100,000 rpm brushless dc motor** bidirectional variable speed control. High output capability with low motor loss. Custom built to specification. MacBar Mechanisms, Inc., Plainview, New York. Phone: 516-694-5360.

INFORMATION RETRIEVAL NUMBER 226

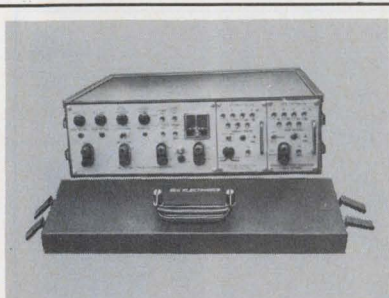

**SEG telephone channel simulation #1564**. Passive • Active • Equalizers • Simulators • Special devices • SEG offers the strongest most helpful application engineering assistance (FREE) in the Electronics Industry — supported by unsurpassed design and production facilities. SEG Electronics, Richmond Hill, N. Y. 11418. 212-441-3200.

INFORMATION RETRIEVAL NUMBER 221

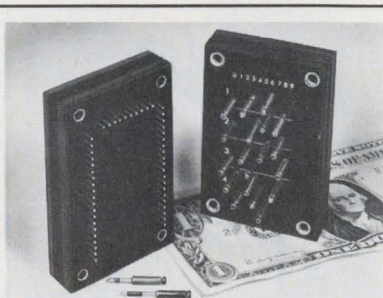

**New Co-Ord 3 deck Matrix Board Series #65000** features: .100" centers, up to 5000 crosspoints in one solid section, only .500" thick from front panel to rear cover, .063 dia. shorting or diode pins, .040 dia pin for P.C. mounting. Prices start at 25¢ per crosspoint. LVC Industries, Inc./Co-Ord Switch, 102-48 - 43rd Avenue, Corona, N. Y. 11368.

INFORMATION RETRIEVAL NUMBER 224

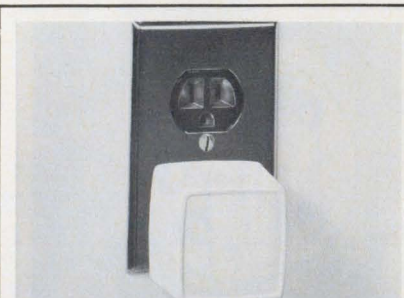

**Wall plug-in low voltage fast-rate charger**-Dynamic has a charging system capable of recharging sealed nickel cadmium fast-rate cells to full charge in less than one hour or proportionate partial charges. Needs only standard fast-rate cells, matching not necessary. Request C-4.5 bulletin from Dynamic Instrument Corp., Plainview, N. Y. 11803.

INFORMATION RETRIEVAL NUMBER 227







# GOODBYE SOLID STATE.



## Hello better switching alternatives.

Until today, solid state was the only approach to logic or power switching you considered. But there's another way.

### LOGIC

When you need a simple decision-making or interlocking circuit, why bother with a 5-volt supply, filter capacitor, ground plane pc board and logic packs? Clare general purpose relays can accomplish the same function at a fraction of your design time. You don't have to worry about line transients, overvoltages, lead capacitance, ambient temperature, etc.

*Less expensive, too.* Clare GP relays can provide logic circuitry at a fraction of the cost of solid state.

And you can switch indicating lamps, small motors and other output loads with the same relays used for the logic circuits. Try that with TTL!

Don't be oversold by solid state life

claims, you may be paying for operations you'll never use.

### POWER

In multipole switching, Clare GP relays offer advantages over solid state, too. They're less expensive . . . by a substantial margin. They're easier to work with. You don't have to worry about heat sinking,  $dv/dt$ ,  $di/dt$ , overvoltages or ambient temperature. And Clare GP relays provide you with as complete isolation from your control circuit to the power circuit as you're likely to find.

### A WORD ABOUT QUALITY

Our thirty years of relay experience helped develop a general purpose relay line with all the features we know you want—a simplified design so there are fewer parts to go wrong, a combustion-proof, virtually unbreakable Lexan\* cover, the highest UL motor control

recognition, and a wide choice of terminals and sockets.

### SUPPORT SERVICES

While we offer a better switching alternative to solid state for logic or power switching, our prices are competitive with the low-priced general purpose relays. We also provide the complete support services you expect from a large, well-established relay manufacturer.

For enough general purpose relay information to fill a coffee break, circle our reader service number or write C. P. Clare & Co., 3101 Pratt Ave., Chicago, Ill. 60645.

\*Registered Trademark of General Electric.



a GENERAL INSTRUMENT company

# Now 3 zero-voltage switches to trigger your thyristors

Here's new flexibility and economy for your zero-crossing Thyristor trigger application—3 RCA zero-voltage switches give you the exact combination of price and performance your application demands.

RCA Zero-Voltage Switches offer:

- Thyristor triggering at zero-voltage crossing for minimum RFI in 50, 60, and 400 Hz applications.
- Self-contained dc power supply

with provision for supply of dc bias current to external components.

- Built-in protection against sensor failure (in CA3058 and CA3059).
- External provision for zero-current switching with inductive loads. Provision for adding hysteresis or proportional control.
- Recommended for use with RCA's 2.5-40 amp., 100-600 volt series triacs, types 40693-40734. These RCA triacs

are rated for operation with the CA3058, CA3059 and CA3079.

For further information see your local RCA Representative or RCA Distributor. For technical data bulletin file Nos. 406 and 490 and Application Notes ICAN-6158 and ICAN-6268, write: RCA, Commercial Engineering, Harrison, N.J. 07029. International: RCA, Sunbury-on-Thames, U.K., or P.O. Box 112, Hong Kong, or Ste. Anne de Bellevue, 810 Quebec.

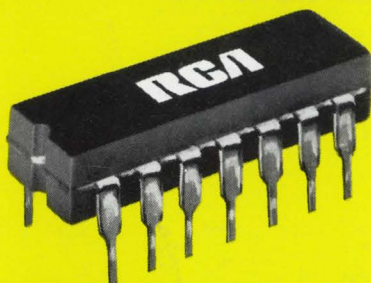

**FULL-FEATURE PERFORMANCE PLUS ECONOMY**  
CA3059 in 14-LEAD DIP  
Built-in protection,  
-40°C to +85°C operation  
\$1.95 (1000-UNIT LEVEL)

**NEW ECONOMY TYPE**  
CA3079 in 14-LEAD DIP  
-40°C to +85°C operation  
\$.99 (1000-UNIT LEVEL)

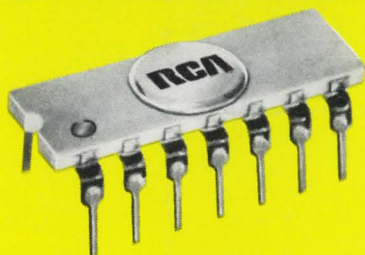

**NEW FOR FULL MILITARY TEMPERATURE RANGE**  
CA3058 in 14-LEAD DIC  
Premium performance,  
-55°C to +125°C operation  
\$3.50 (1000-UNIT LEVEL)

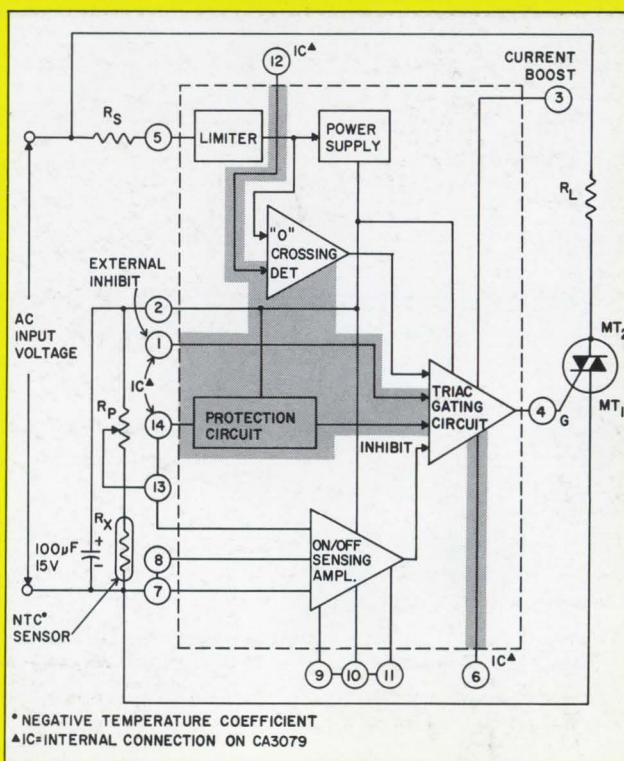

\* NEGATIVE TEMPERATURE COEFFICIENT  
▲ IC=INTERNAL CONNECTION ON CA3079

## Features

- 24V, 120V, 208/230V, 277V at 50, 60, or 400 Hz operation
- Differential Input
- Low Balance Input Current (max.)-µA
- Built-in Protection Circuit (Fail-Safe) for opened or shorted sensor (Term. 14)
- Sensor Range ( $R_X$ )-kΩ
- DC Mode (Term. 12)
- External trigger & inhibit (Terms. 6 & 1)
- DC Supply Volts (max.)

	CA3058	CA3059	CA3079
24V, 120V, 208/230V, 277V at 50, 60, or 400 Hz operation	✓	✓	✓
Differential Input	✓	✓	✓
Low Balance Input Current (max.)-µA	1	1	2
Built-in Protection Circuit (Fail-Safe) for opened or shorted sensor (Term. 14)	✓	✓	✓
Sensor Range ( $R_X$ )-kΩ	2 to 100	2 to 100	2 to 50
DC Mode (Term. 12)	✓	✓	✓
External trigger & inhibit (Terms. 6 & 1)	✓	✓	✓
DC Supply Volts (max.)	14	14	10

**RCA Solid State**