

Electronic Design

FOR ENGINEERS AND ENGINEERING MANAGERS

VOL. 19 NO.

7

APRIL 1, 1971

RECEIVED
MAR 30 1971
CALMA CO.

Consumer uses of holography are developing from scientific as well as engineering applications. Special holographic techniques produce new 3-D visual art and

make lifelike advertising displays and educational models. Also useful is a holographic method of testing children for handicaps in visual perception. See p. 24.

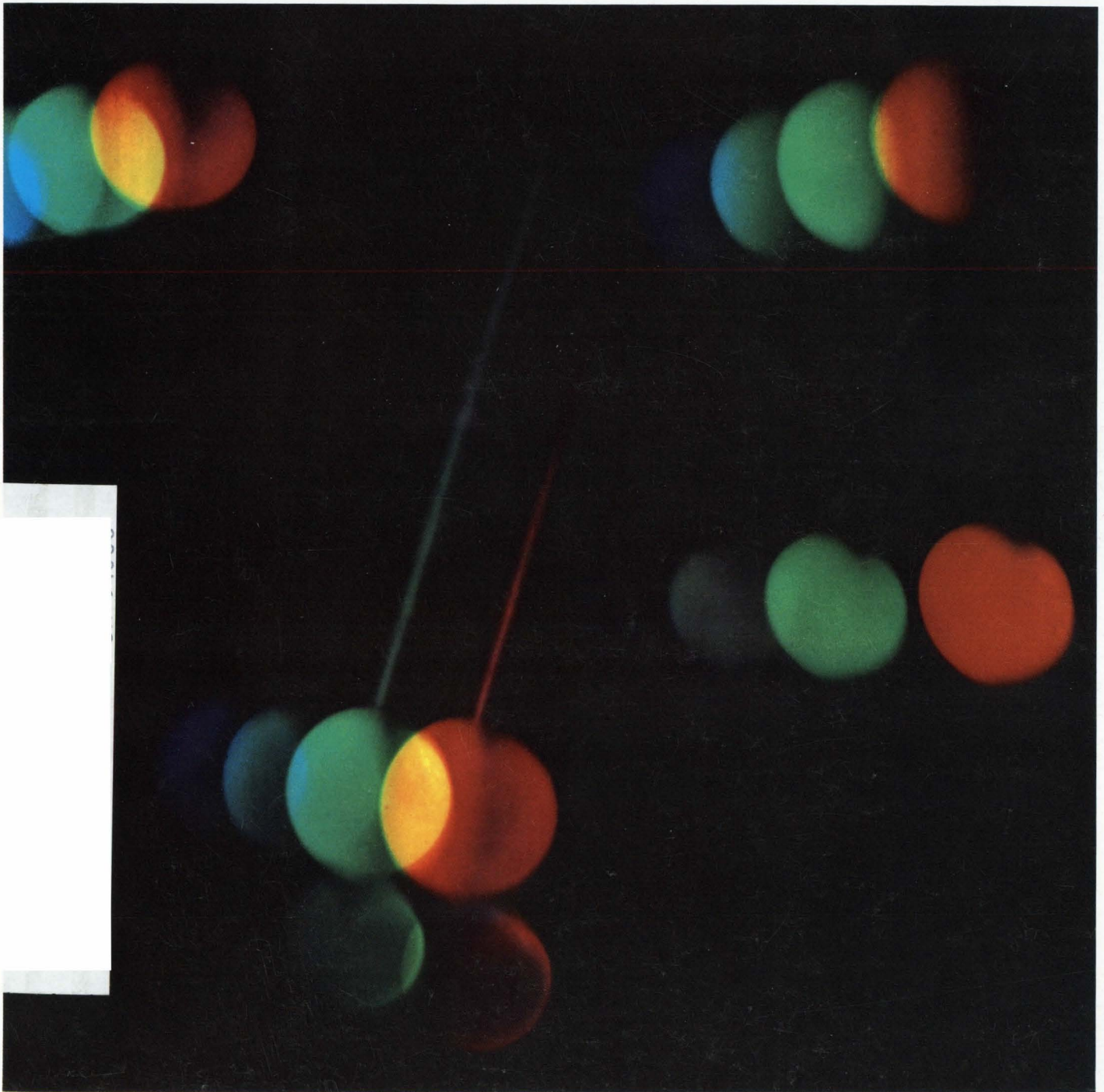



DALE
**COIL
COUNTRY**

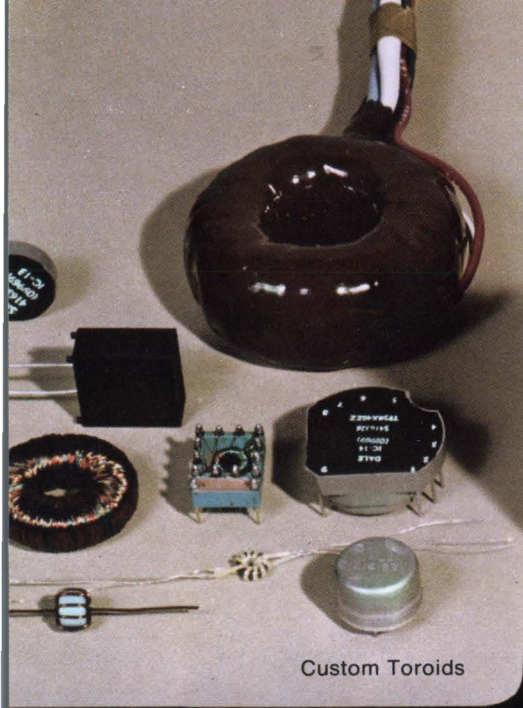

Custom Toroids

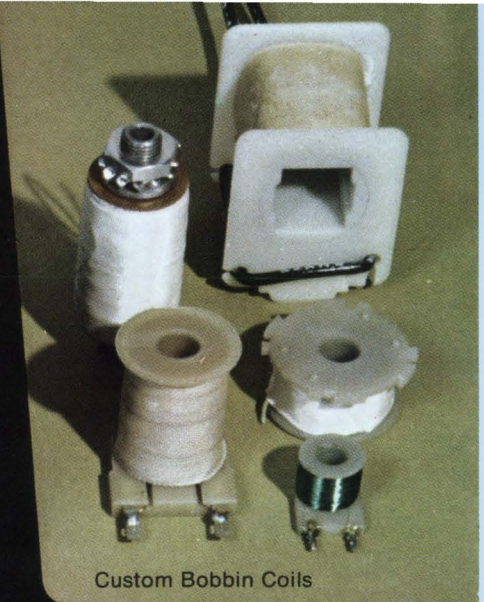

Custom Bobbin Coils

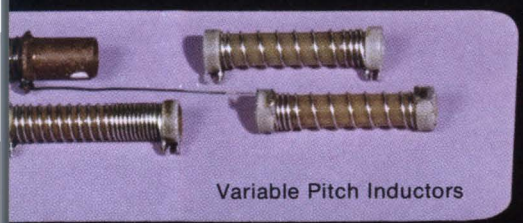

Variable Pitch Inductors

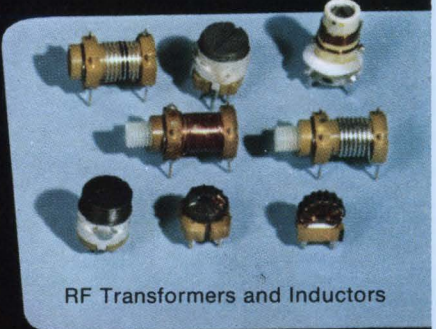

RF Transformers and Inductors



Series Resonant Traps

A good inductor source... just got better!



PC-Mount Toroids

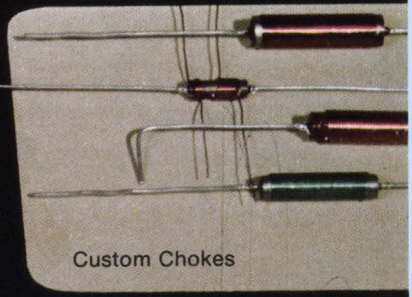

Custom Chokes



DIP Pulse Transformers

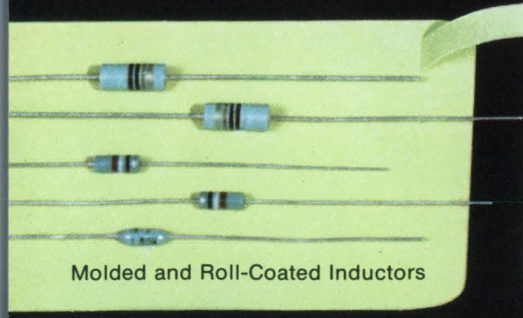

Molded and Roll-Coated Inductors

Dale is moving quickly to qualify as your preferred inductor source. In recent months we have:

DOUBLED our line of standard PC mount toroids (Mil-T-27C, Type TF5SX20ZZ). Standard inductances now available from .05 μ h to 20h, in a wide selection of Q vs frequency ranges.

ADDED Pulse Transformers in DIP configurations. Machine and hand insertable models (14,16 pins) are available containing up to four pulse transformers. Inductance range: 1 μ h to 2 mh; Tolerance \pm 20%; Leakage inductance: As low as .2% of total inductance; Interwinding capacitance: As low as 3 pf; ET product: Up to 10 volts- μ sec.

EXTENDED the values and frequencies available in molded inductors (Mil-G-15305D, Grade 1, Class A,B) and roll-coated chokes. Inductance: .10 μ h to 1000 μ h. Self-resonant frequency: 680 to 3.5 Mhz.

This increased ability to supply standard inductors (many direct from stock) balances well with our custom capabilities in bobbins, rf transformers, chokes and toroids. For a fast quote or immediate design help get in touch with Dale—*lots of people are!* Call today: 605-665-9301

INFORMATION RETRIEVAL NUMBER 181

R.M.S. VOLTS -- the scale says -- but what about the circuits behind that scale?

All of us have been making rms readings of ac voltages for years. We know we have, it says so right on the front of the meter.

If someone were to ask what we mean by rms voltage, we could quickly explain the concept of "root mean square." In the interest of accuracy we might add that the rms voltage indication on most meters is true only for a sinusoidal wave. Unfortunately, most measurements are not made on true sinusoidal waves. However, for many applications, average responding meters are adequate.

But it would seem logical, where accuracy is important, to use a meter that measures true rms voltage no matter what the wave shape—a true rms voltmeter.

Why isn't this done more often? Well, until recently, most true rms voltmeters were expensive, limited

in capability and rather slow responding.

Now Hewlett-Packard has adapted the thermocouple concept used in standard laboratories; added protective amplifiers to insure overload protection (800 V p-p); and reduced final-value step function response to less than 5 seconds.

When you combine these features with a low price of \$600, it adds up to the HP 3400A—the first practical true rms voltmeter for general use in the 10 Hz to 10 MHz range. And, a high crest factor (ratio of peak to rms) allows you to measure noise and other non-sinusoidal wave forms at a ratio of 10:1 full scale or 100:1 at 10% of full scale. You get accurate noise and pulse measurements — without having to make non-standard corrections.

The 3400 isn't just a fine true rms

voltmeter—although that's plenty in itself. It can also be used as an ac/dc converter and a current meter. Typical dc output accuracy is 0.75% of full scale from 50 Hz to 1 MHz. Use the HP 456A AC Current Probe (\$250) and you get quick dependable current measurements. The 456A probe has a 1 mA to 1 mV conversion allowing direct readings up to 1 amp rms.

So, if all your measurements aren't made on true sinusoidal wave shapes and if you like direct accurate rms voltage indication no matter what you're measuring, it's time to check into the HP 3400A true rms voltmeter. For more information, contact your local HP field engineer. Or, write to Hewlett-Packard, Palo Alto, California 94304. Europe: 1217 Meyrin-Geneva, Switzerland.

099/19B

INFORMATION RETRIEVAL NUMBER 2

HEWLETT  PACKARD

ANALOG VOLTMETERS

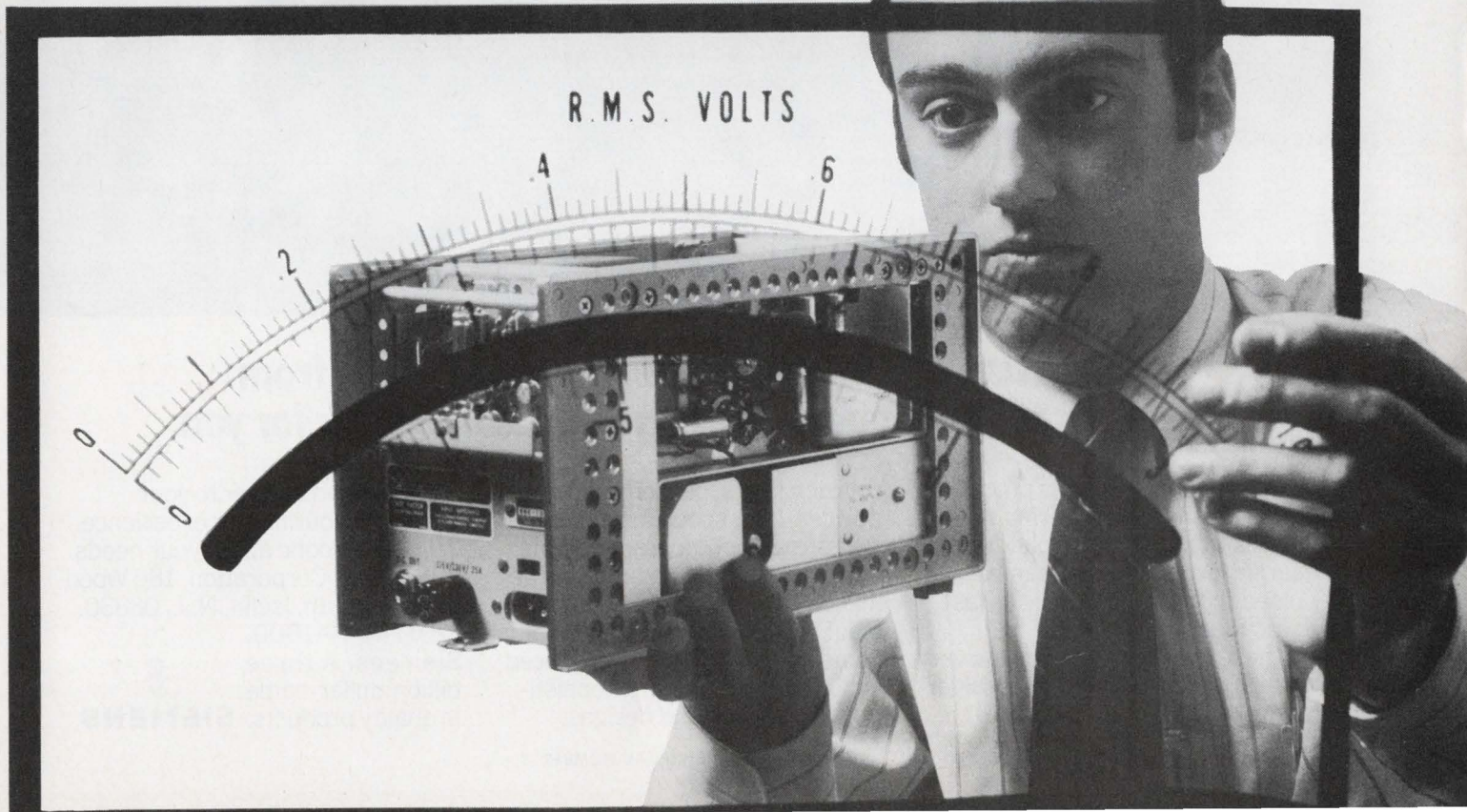

Siemens

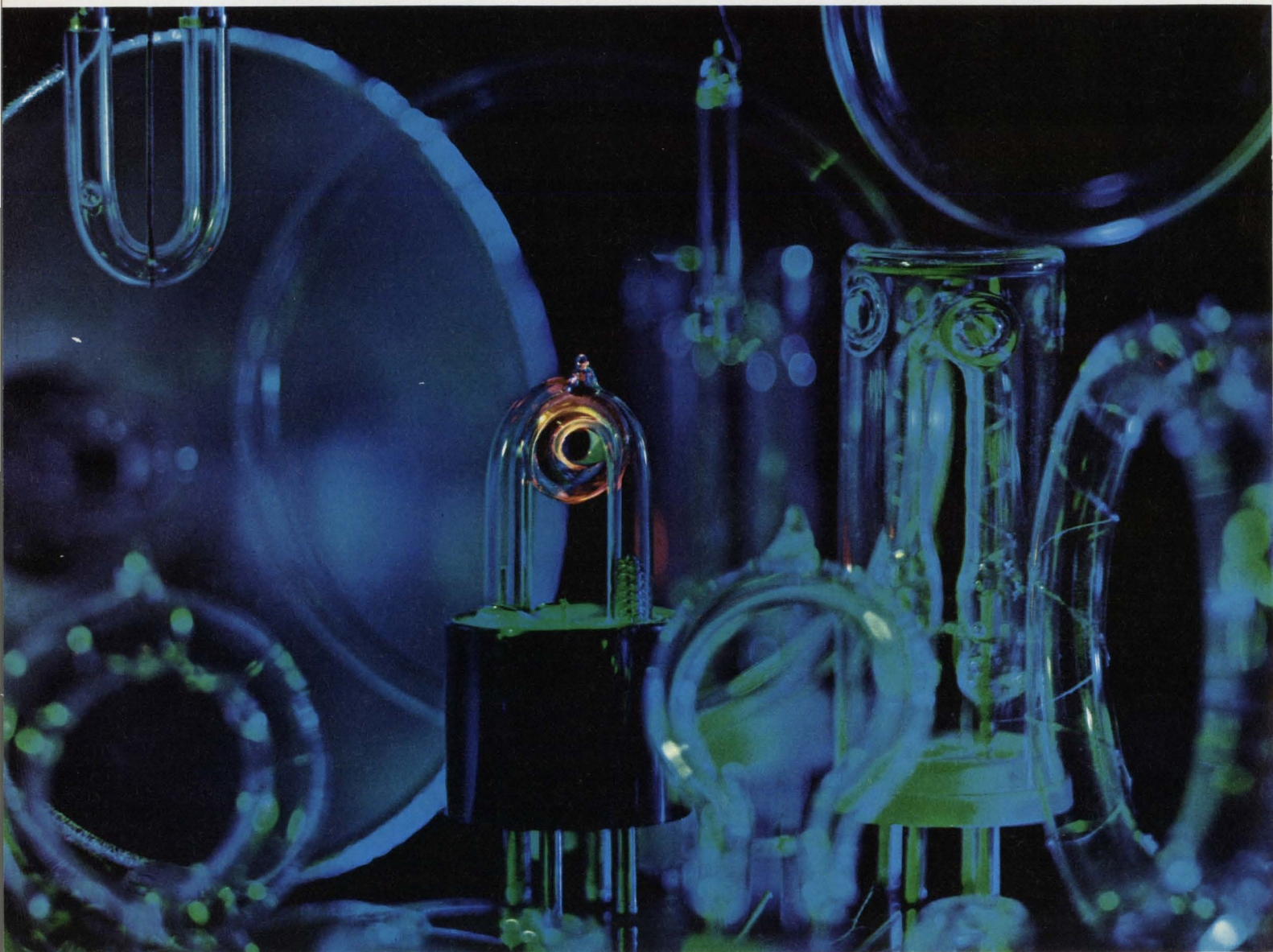

These flash tubes produce bursts of sunlight from small amounts of power. We can put them to work for you.

Our xenon flash tubes produce high intensity light covering wavelengths from the ultraviolet to the near infrared. And they can be pulsed thousands of times as fast as incandescent lamps.

These characteristics plus a very high efficiency make them ideal for laser stimulation, aircraft anti-

collision lights, beacons, timing devices, high-speed inspection systems and photographic lights.

We turn out these tubes by the millions in sizes and shapes to meet many different requirements. Some are low-cost units produced in high volume. Others, sophisticated, one-of-a-kind designs.

There's an answer to your problem in our files or experience. Tell Larry Boone about your needs.

Siemens Corporation, 186 Wood Avenue South, Iselin, N.J., 08830. (201) 494-1000. Siemens. A three billion dollar name in quality products. **SIEMENS**



NEWS

- 21 **News Scope**
- 24 **Holography, no longer a novelty, looks for new consumer applications, especially in advertising and education.**
- 28 **Sweeping changes are urged to unify U. S. science policy with debate centering on 1972 federal R&D budget.**
- 31 **New plastic package lowers rejects and costs.**
- 32 **Technology Abroad**
- 35 **Washington Report**

TECHNOLOGY

- 40 **Test nonlinear system stability with the 'circle criterion.'** It defines sufficient, but not necessary, conditions for feedback-system stability.
- 44 **Save money with analog multipliers.** The new low-cost IC units make multipliers more attractive than conventional circuitry for many applications.
- 50 **Specify custom cores the right way.** Use this simple form and a systematic approach to memory specification. It can reveal some unexpected trade-offs.
- 56 **Inventing a product is only half the job.** The next move is to sell it. You have three options, and how wisely you consider them will spell success or failure.
- 60 **Ideas for Design**
- 65 **'Top Ten' prize-winning advertisements**

PRODUCTS

- 82 **ICs & Semiconductors:** IC op amps have low drift, bias and offset to +125° C.
- 84 **Modules & Subassemblies:** An 8-bit a/d in only 2.8 in³.
- 84 **Modules & Subassemblies:** Analog memory signals occurrence of input peaks.
- 86 **Packaging & Materials**
- 88 **Instrumentation**
- 88 **Data Processing**
- 90 **Components**

Departments

- 39 **Editorial:** Control your work or it will control you.
- 7 **Letters**
- 13 **Designer's Calendar**
- 91 **Evaluation Samples**
- 91 **Design Aids**
- 91 **Application Notes**
- 92 **New Literature**
- 93 **Bulletin Board**
- 96 **Advertisers' Index**
- 96 **Information Retrieval Card**

Cover: Hologram courtesy of International Holographics, Inc., Lake Forest, Ill.

end your signal pollution problems

Beldfoil® ISO-Shielded™ Cable

It's the cable with virtually perfect shielding. It's a Belden exclusive. Beldfoil ISO-Shield is like a continuous metal tube enclosing each pair of conductors in a cable. It locks out crosstalk or interference . . . whether from outside sources or between shielded elements in the cable.

Beldfoil is a layer of aluminum foil bonded to a tough polyester film (for insulation and added strength.) To form an ISO-Shield, we apply it in any one of several unique ways to meet the requirements of different applications. (See Figures 1 and 2, for example). Each gives more physical shield coverage than braided wire or spiral wrapped (served) shields. And greater shield effectiveness . . . even after repeated flexing.

Beldfoil ISO-Shielded Cables are small, light-weight. They terminate easily. They're modest in price. Your Belden Distributor stocks a wide variety of standard Beldfoil shielded cables as listed in the "Belden Electronic Wire and Cable Catalog" (ask him for the latest edition). And, should you have specifications no standard product can meet, ask him to quote on a specially engineered design. Or, if you choose, contact: Belden Corporation, P. O. Box 5070-A, Chicago, Ill. 60680. Phone (312) 378-1000.

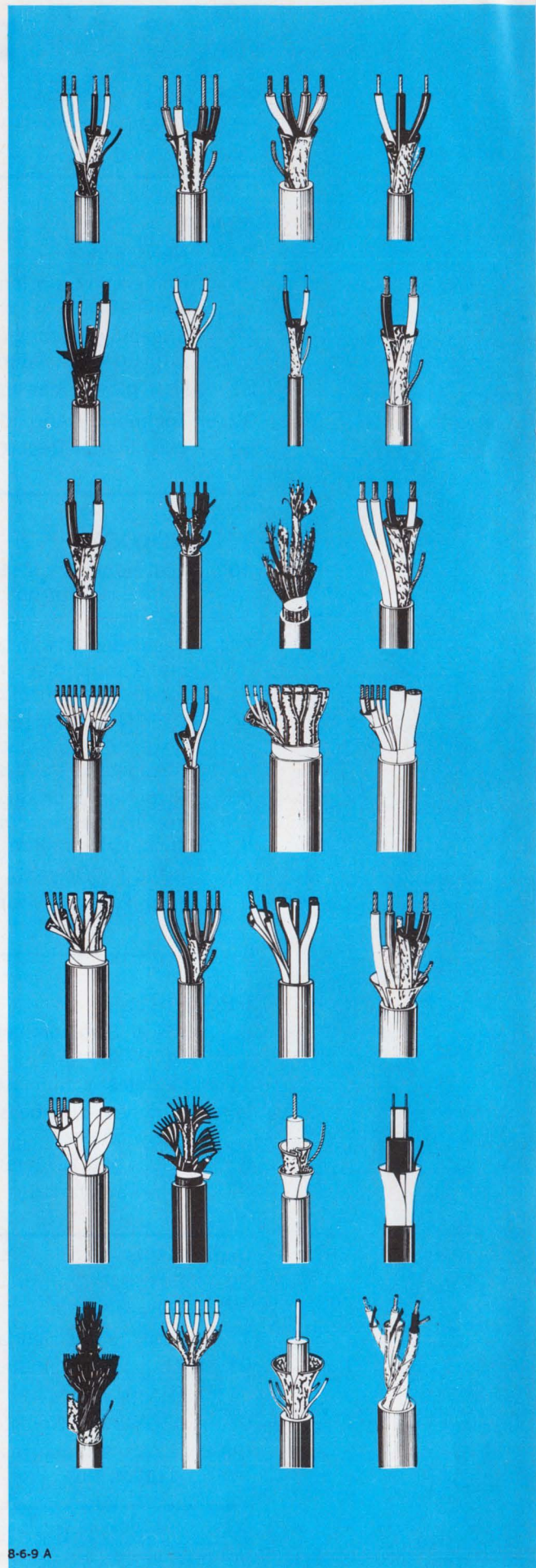

8-6-9 A



Metal (shield) foil, folded to assure metal-to-metal contact.

FIGURE 1

Polyester insulating layer folded to assure isolation between shields.

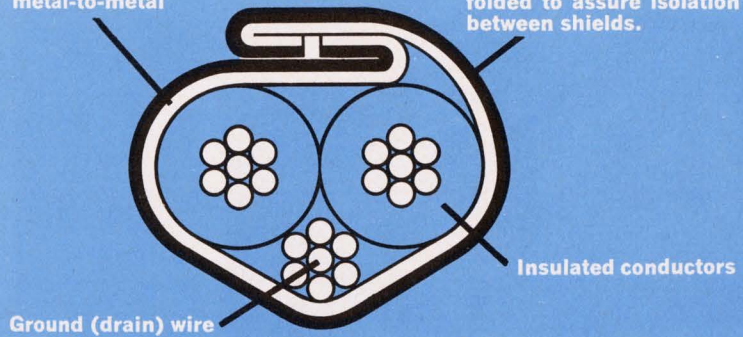

Beldfoil Multiple Pair Individually Shielded Cable

The Figure 1 cross-section shows Belden's exclusive Z-folded Beldfoil ISO-Shield. Note the metal-to-metal contact between the two edges of the aluminum foil. In essence, you have a continuous aluminum tube. And the polyester layer on the outside of the fold assures the isolation between shields so necessary for best performance in the field.

Technical Data

Nominal values for multiple pair individually shielded cables containing 3 to 27 pairs (including 8769 and 8773 through 8778 Series cables)
 Suggested working voltage: 300 volts rms max.
 Working voltage between adjacent shields: 50 volts rms max.
 Capacitance between conductors in a pair: 30 pf per ft. nom.
 Capacitance between one conductor and other conductor connected to shield: 55 pf per ft. nom.
 Capacitance between shields on adjacent pairs: 115 pf per ft. nom.
 Insulation resistance between shields on adjacent pairs:
 100 megohms per 1000 ft. nom.

Metal (shield) foil, folded to assure metal-to-metal contact.

FIGURE 2

Polyester insulation layer folded to provide bonus insulation between conductors and shield.

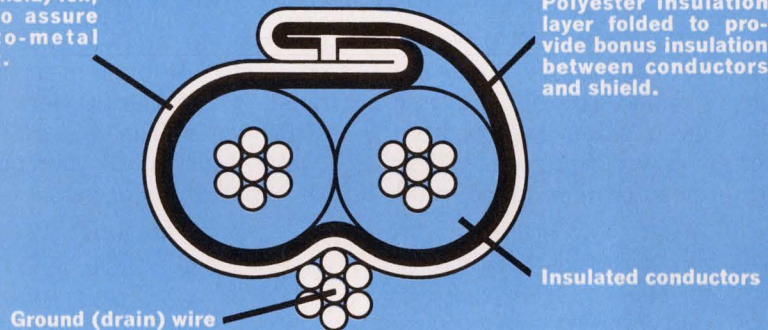

Beldfoil Shielded Single Pair Cable

The Figure 2 cross-section shows the exclusive Belden Z-fold with the polyester insulating layer inward. This makes use of the high dielectric strength of the polyester film as bonus insulation between the conductors and the shield. (The cable jacket provides the primary insulation of the shield from outside objects or adjacent cables.)

Technical Data

Nominal values for 8451 Shielded Pair Cable
 Suggested working voltage: 200 volts rms max.
 Capacitance between conductors: 34 pf per ft. nom.
 Capacitance between one conductor and other conductor connected to shield: 67 pf per ft. nom.



new ideas for moving electrical energy

IN STOCK

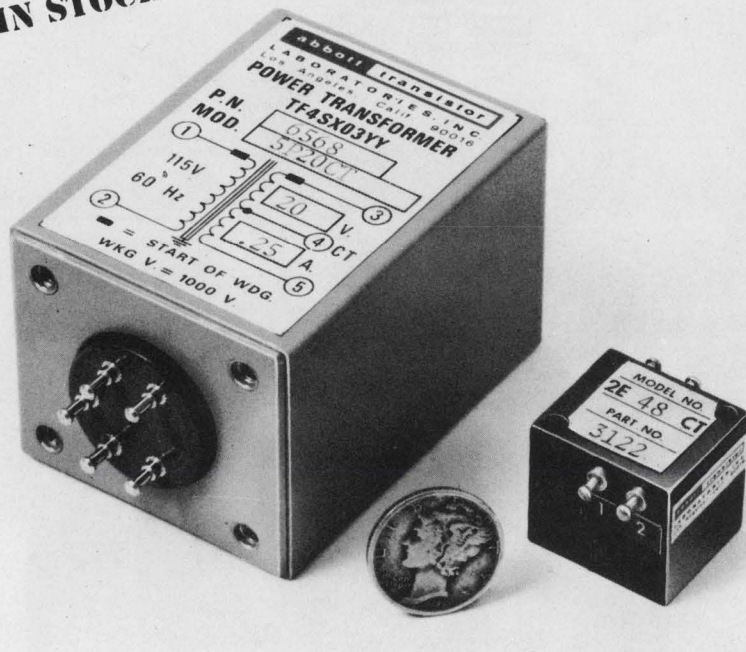

If You Need A Power Transformer Tomorrow - Call Abbott Today

Now Abbott Stocks 60 Hz and 400 Hz Transformers
With Output Voltages from 5 to 5000 Volts

Both the 60 Hz and the 400 Hertz transformers are built to meet the specifications of MIL-T-27C. Long life and reliability are inherent in these hermetically sealed, ruggedly built power transformers. The 60 Hertz line comes in eleven power ratings from 5 to 300 watts. The 400 Hz line comes in six power ratings from 2 to 175 watts. Most all of your power transformer needs can be found in this line of Abbott transformers.

	60 Hertz	400 Hertz
Input Primary	115 VAC, 60 Hz \pm 5 Hz, 1 phase	115 V, 400 Hz \pm 20 Hz, 1 phase
Insulation	1750 VAC or 150% of secondary voltage (whichever is higher)	2500 VDC or 150% of secondary voltage (whichever is higher)
Construction	TO MIL-T-27C, grade: 4, class: "S", life: "X" (10,000 hrs.), case: steel	To MIL-T-27C, grade: 5, class: "S", life: "X" (10,000 hrs.), case: smaller
Environment	To operate in 105°C maximum ambient temperature. Encapsulated to meet MIL-E-5272C and MIL-E-5400H for vibration, shock, acceleration, sand, dust, humidity, salt spray, fungus, sunshine, rain, explosion, and altitude (to a vacuum)	Encapsulated to meet MIL-E-5272C, including vibration to Proc. XII, temperature to 105°C, shock, sand, dust, humidity, salt spray, fungus, sunshine, rain, explosion, and altitude (to a vacuum)
Secondary	From 5 volts to 5000 volts at 32 milliamperes to 20 amperes	From 5 volts to 5000 volts at 14 milliamperes to 35 amperes

A complete description of all of these power transformers together with their prices is contained in Abbott's 10 page transformer brochure, available FREE on request.

Please see pages 2848 to 2851 of your 1970-71 EEM (ELECTRONIC ENGINEERS MASTER Catalog) for complete information on Abbott transformers.

abbott transistor

LABORATORIES, INCORPORATED
5200 W. Jefferson Blvd./Los Angeles 90016 1224 Anderson Ave./Fort Lee, N.J. 07024
(213) 936-8185 Cable ABTLABS (201) 224-6900

INFORMATION RETRIEVAL NUMBER 5

Publisher

Peter Coley

Editors

New York Office
850 Third Ave.
New York, N.Y. 10022
(212) 751-5530
TWX: 710-581-2874
Cable: Haydenpub

Editor: Frank Egan
Managing Editor: Ralph Dobriner
Managing Editor: Raymond D. Speer
Microelectronics, Steven A. Erenburg
Computers, Raymond D. Speer
Microwaves, Michael J. Riezenman
Circuits, Lucinda Mattera
Management, Richard L. Turmail
News, John N. Kessler
Military-Aerospace, John F. Mason
New Products, Roger Allan

Field Offices

Massachusetts
Jim McDermott
P.O. Box 272
Easthampton, Mass. 01027
(413) 527-3632

West Coast
David Kaye
2930 Imperial Highway
Inglewood, Calif. 90303
(213) 757-0183

Washington
Don Byrne
1425 N St. NW
Washington, D.C. 20005
(202) 667-6568

Editorial Production

Dollie S. Viebig

Art

Art Director, William Kelly
Rita Jendrzewski
Richard Luce

Production

Manager, Thomas V. Sedita
Helen De Polo
Kathleen McConkey
Leslie Stein

Circulation

Manager, Nancy L. Merritt

Information Retrieval

Peggy Long

letters

More light is shed on subject of lamps

Sir:

I read with interest the Idea for Design (ED 25, Dec. 6, 1970, p. 92) for a circuit to eliminate warm-up resistors in lamp-driver circuits.

I wish, however, to take exception to his statement, "... warming current reduces the life of a lamp." The greatest lamp failures are mechanical, stemming from the initial shock of providing current to a cold filament. In addition to this, a warm lamp can be run at much higher speeds, allowing faster indications of events.

James P. Malone

20 Woodlawn Ave.
Owego, N. Y.

Author's reply

First, let me state that I do not consider myself an expert in lamp technology. In answer to Mr. Malone, I can only refer him to technical information published by people who are experts in the field of lamp manufacture and related topics. I have chosen technical information from a copyrighted catalog of Lamps, Inc., because of its clarity and conciseness.

Question: Can warming current reduce the life of a lamp?

Answer (from catalog): "Design voltage should be supplied from the power source or through a transformer for optimum operation and life. When voltage is lowered through a resistor, lamp life can be reduced to as much as half the rated life."

Question: What are the mechanical effects of switching cold lamps ON and OFF?

Answer (from catalog): "Turning ON and OFF is not significantly harmful to miniature incandescent lamps. Life tests run at

one second ON and one second OFF at rated voltages reveal no significant difference for low-voltage/high-current lamps. Some deterioration has been noted for high-voltage/low-current lamps, but results are inconclusive . . . The tensile strength of tungsten is ten times greater when cold than when heated to operating temperature. Effects of this can be seen in the fact that miniature lamps vary greatly in their ability to operate under shock and vibration in their lit and unlit state."

I agree that a warm lamp can be run at much higher speeds, allowing faster indication of events. However, can the human eye perceive the delay of a few additional milliseconds in lamp turn-on?

Alphonso H. Marsh, Jr.

Senior Engineer
Raytheon Co.
Sudbury, Mass.

Accuracy is our policy

Our thanks to E. U. Thomas of Syosset, N.Y., for pointing out that the American Standards Association referred to in the article, "Use a Technical Rx for Management Ills" (ED 1, Jan. 7, 1971, page 102) no longer exists. It was superseded first by USASI, which in turn was superseded by the American National Standards Institute (ANSI), located in New York City.

In the article "Solid-state loads provide versatility" (ED 5, March 4, 1971) the value of the base-current limiting resistor was incorrectly given as $V_L = (V_{BE1} + V_{BE2} + V_{RE})$. The value should be $V_L - (V_{BE1} + V_{BE2} + V_{RE})$.

Electronic Design welcomes the opinions of its readers on the issues raised in the magazine's editorial columns. Address letters to Managing Editor, Electronic Design, 850 Third Ave., New York, N.Y. 10022. Try to keep letters under 200 words. Letters must be signed. Names will be withheld on request.

Want a free lunch?

Let ZEVA

demonstrate

to you their

fully auto-
matic p.c.

board soldering
machine.

If you don't
agree that it
surpasses in

performance
any other sol-
dering system
now available,

you get a free
lunch at the
nearby Florham
Park Inn.

{ if you do agree,
for sure you get }
a free lunch!

CALL OR WRITE FOR
MORE INFORMATION

ZEVA

ZEVA ELECTRIC CORPORATION
3 Great Meadow Lane,
Hanover, N. J. 07936
Phone (201) 887-1399

FAIRCHILD TTL FAMILY TREE GIVES YOU FREEDOM OF CHOICE.

OUR NEW 9341/74181 AND COSTS 50% LESS.



FAIRCHILD TTL FAMILY

The new high-speed, low-cost 9341/74181 ALU is another example of how the Fairchild TTL family offers the freedom-loving designer the broadest range of speed/power trade-offs including both proprietary and second-source devices.

ALU IS 25% FASTER

The price of liberty just went down. We're the first of the Big Guys to second source the 74181. But we second source our way: our 9341 is 25% faster than the original, costs but \$7.77*

And, for the first time, the low price of the 9341 permits you to design in a monolithic ALU for less cost than doing it with SSI packages.

First source, second source, we travel only one way: first class.

9341/74181 FEATURES:

- Generates all Boolean functions of two variables, including addition and subtraction.
- Full carry look-ahead for high-speed arithmetic operation.
- Pin-for-pin equivalent of 74181.
- Available now from any friendly Fairchild distributor.

*100-up, ceramic dip

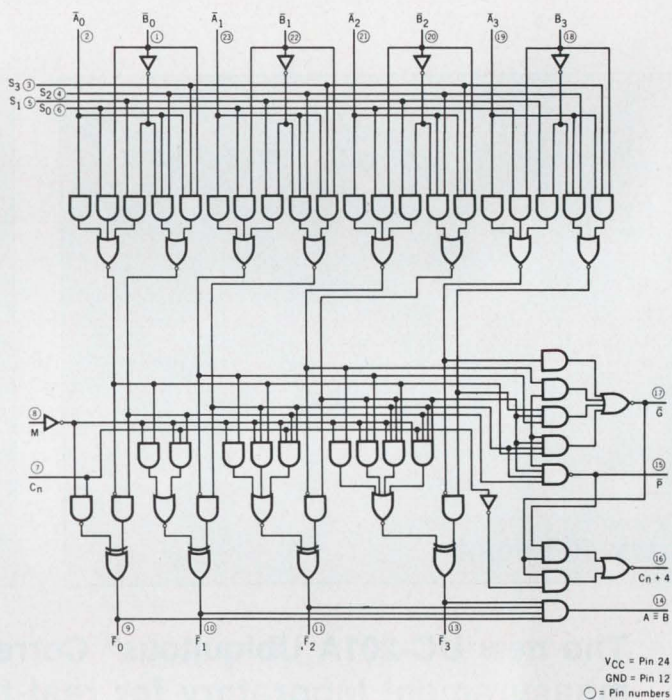
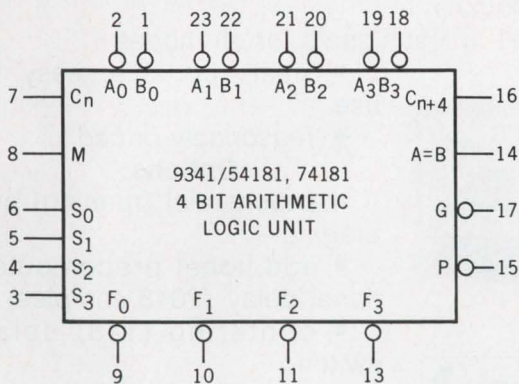

V_{CC} = Pin 24
GND = Pin 12
○ = Pin numbers

FAIRCHILD
SEMICONDUCTOR

FIGHT FZLERS

WITH THE NEW REAL-TIME

256^{POINT} CORRELATOR

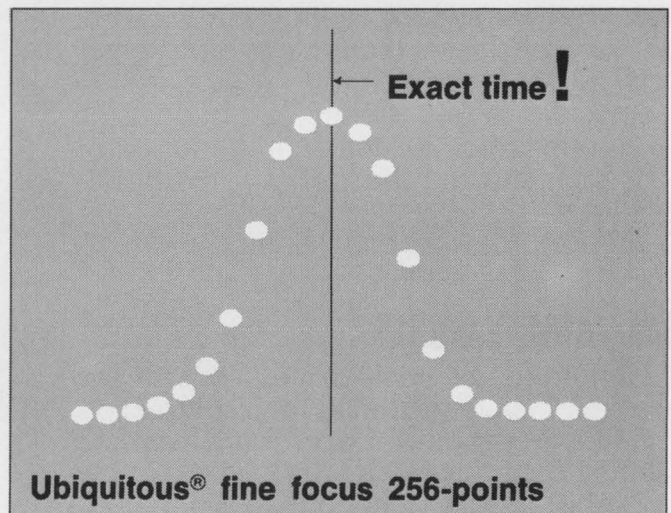
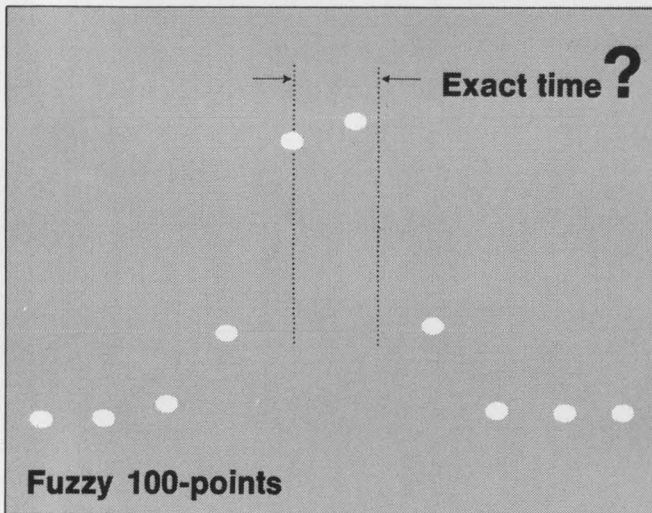

The new UC-201A Ubiquitous® Correlator is a complete time-domain measurement laboratory for real-time auto and cross-correlation

- signal enhancement • probability

For underwater acoustics, fluid dynamics, medical research, vibration analysis, noise source identification, aerodynamics, radio astronomy, geophysics, hydrodynamics.

Features:

- exact time measurements with digital dial
- computes the integral and differential of any stored function (converts probability density to cumulative distribution without rerunning data)
- precomputational delay built-in (256 samples)

- sampling increments from 1/2 usec to 2 sec
- complete external (computer) control plus digital outputs
- built-in test signals for all modes

- small, portable, easy to use

- reasonably priced

Options:

- exponential (running) averaging
- additional precomputational delay (2048 samples)
- centering (128) delay switch

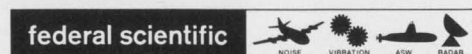

From FEDERAL SCIENTIFIC, originators of the Ubiquitous Spectrum Analyzer, the most widely used real-time unit of its type in the free world.

FEDERAL SCIENTIFIC CORPORATION, SUBSIDIARY OF ELGIN NATIONAL INDUSTRIES, INC.
615 W. 131st ST., N.Y., N.Y. 10027. TEL: (212) 286-4400

INFORMATION RETRIEVAL NUMBER 8

HOW LOW CAN WE GET?

We looked at the competition, then built a better potentiometer, the Model 3006, a low cost cermet unit for PC board use.

Here's how we did it:

GAVE IT MORE POWER

$\frac{3}{4}$ watt at 70°C

MADE IT SURER

superior setability: longer element, 15 turns and 16 independent wiper contacts to make sure

SEALED IT TIGHTER

to Mil-R-22097

BUILT IT LOWER

only $\frac{1}{4}$ " off the board

PRICED IT LOWER

only 81¢ in 25,000 piece quantity, much lower for more

Send for full data on the 3006, and we'll send along dramatic proof of how tough a little unit it really is.

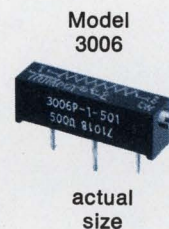

BOURNS, INC., TRIMPOT PRODUCTS DIVISION • 1200 COLUMBIA AVE., RIVERSIDE, CALIF. 92507

INFORMATION RETRIEVAL NUMBER 9

Think of it as a six pack...



one trimmer, five resistors, in one package. That's TRN.

Our new Trimming Resistive Network will cut resistor insertion and preparation cost by at least a 6:1 ratio. In addition it satisfies engineering requirements better than anything on the market. For instance, the TRN provides cermet TCR performance values of 50 or 100 ppm/°C. The one-paste, one-step deposition method that we use allows for uniform, predictable TCR drift within the range of ± 2 ppm/°C of each other for each resistor in the circuit. In addition, the unit features a ratio accuracy with respect to the variable re-

sistor available as low as $\pm 1\%$.

All componentry is housed in a single shell, which means that ambient temperature for each resistor in the circuit is the same for all others. Plus, you get versatility of applications, reliable long life and dimensions that are perfect for automatic insertion machines.

Like to know more? Write Bill Dunn. He's at Amphenol Controls Division, 120 S. Main Street, Janesville, Wisconsin 53545.



AMPHENOL
THE BUNKER-RAMO CORPORATION

designer's calendar

APRIL 1971						
S	M	T	W	T	F	S
				1	2	3
4	5	6	7	8	9	10
11	12	13	14	15	16	17
18	19	20	21	22	23	24
25	26	27	28	29	30	

April 28-30

SWIEEEO, Southwestern IEEE Conference & Exhibition (Houston, Tex.) Sponsor: IEEE. W. J. Groves, Texas Instruments, Inc., P. O. Box 66027, Houston, Tex. 77006. CIRCLE NO. 409

May 10-12

Electronic Components Conference (Washington, D. C.) Sponsors: IEEE, EIA. R. D. Allan, EIA, 2001 Eye St., Washington, D. C. 20006. CIRCLE NO. 410

MAY 1971						
S	M	T	W	T	F	S
						1
2	3	4	5	6	7	8
9	10	11	12	13	14	15
16	17	18	19	20	21	22
23	24	25	26	27	28	29
30	31					

May 16-20

International Microwave Symposium (Washington, D. C.) Sponsor: IEEE. R. V. Garver, Harry Diamond Labs., Conn. Ave. and Van Ness St., Washington, D. C. 20438. CIRCLE NO. 411

May 17-20

Spring Joint Computer Conference (Atlantic City, N. J.) Sponsors: IEEE, AFIPS. AFIPS Headquarters, 210 Summit Ave., Montvale, N. J. 07645. CIRCLE NO. 412

NEW VACTEC VACTROLS

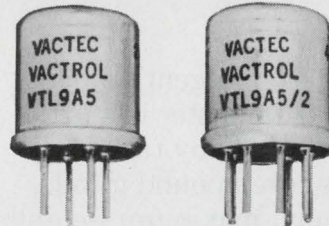

GENERAL PURPOSE PHOTON ISOLATORS

Both single and dual cell units are available in combinations with incandescent or neon lamps in a low cost aluminum case.

New Vactec Vactrols provide a wide range of control in the on-off mode or in proportional control circuits. Applications include photochoppers, DC isolators, noiseless switching, automatic gain controls, audio limiting and compression, SCR and Triac firing, audio effects, computer interfacing, and others.

MAXIMUM RATINGS

Maximum case dissipation (5)	400 mW — derate 10 mW/°C above 35°C — case
Maximum cell power	200 mW — derate 4 mW/°C above 25°C — case
Isolation voltage	500V
Thermal resistance — case to ambient	40°C/W
Ambient temperature	-40°C to + 75°C

SPECIFICATIONS @ 25°C

Part Number	LAMP		PHOTOCELL RESISTANCE — OHMS (3)		Cell Volts (max)
	Volts	mA	ON	OFF	
			Light Adapted (max)	(min)	
INCANDESCENT TYPES					
VTL9A1	1.5	50	400	10 ⁷	100
VTL9A2	6.0	40	60	10 ⁷	100
VTL9A3	10	14	250	10 ⁷	100
VTL9A4	10	22	300	10 ⁷	100
VTL9A5	10	22	1500	10 ⁷	200
VTL9A9	6.0	40	200	10 ⁷	300
VTL9A10	10	14	800	10 ⁷	300
VTL9A11	12	25	600	10 ⁷	300
NEON TYPES EXTERNAL RESISTOR REQUIRED					
VTL9B6	125 VDC*	1.5	300	10 ⁶	200
VTL9B7	125 VDC*	1.5	800	10 ⁷	300
VTL9B8	80 VDC*	.3	2000	10 ⁷	300

*Breakdown V.

For complete details and specifications, write for new Bulletin VTL 9 today!

Vactec manufactures a complete line of hermetic Vactrols with LED's or standard lamps. ALL Vactec production, including Vactrols, CdS & CdSe cells, and photovoltaic cells is confined entirely within the United States. Advanced mechanized techniques provide highest quality at prices competitive with other manufacturers anywhere in the world.

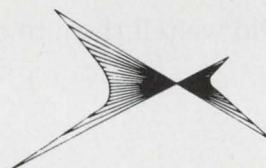

VACTEC, INC.

2423 Northline Ind. Blvd.
Maryland Heights, Mo. 63043
Phone (314) 872-8300

INFORMATION RETRIEVAL NUMBER 12

Electronic Memories unobtrusively mentions the development of its 7.3 million bits-per-module Megamemory 1000; very compact, but a little too large to be unobtrusive.

Speaking gently about this little monster is a little like talking baby talk to a five hundred pound gorilla. (Actually, maximum weight is only 350 lbs.). But its speed belies its bulk: full cycle time of 1.5 microseconds and access time of 850 nanoseconds. You get a wide range of storage capacities—from 32K by 160 to 524K by 14. It's definitely a compact monster. A patented drive/sense scheme eliminates several switches normally associated with 2 wire 2 1/2D design. This straight-forward, practical design approach enhances reliability and breaks through price barriers that have always restricted core memory use in large-scale storage applications. As an add-on memory, Megamemory 1000 has been designed for interface with virtually any

customer specification. If you need fast large storage either as an extension of your main frame memory or for peripheral memories, it would be difficult to conceive of a more compact, faster or more economical solution. But... you never know.

Here and Now: Megamemory 1000 is a little too large to lug to your place for a demo. But it's working at our place. We don't claim off-the-shelf deliveries, but we are geared up to produce. Fast.

EM Electronic Memories is a division of Electronic Memories & Magnetics Corporation, 12621 Chadron Avenue, Hawthorne, California 90250. Telephone (213) 644-9881.

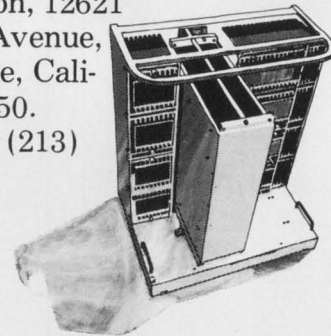

(“Did we tell them to call it Supercore or Epicore?”)

MEMO

Ed—
Your latest factory costs are excellent. Note, I've modified our ad to show new prices.

Gene

The same pricing advantage holds true for RCA's 2N5038 — at ~~\$8.25~~ ^{4.75} (Prices of 2N5039 and its companion type are based on 1000-unit purchases.) For the full story, call your local RCA Representative or your RCA Distributor. For technical data, write: RCA, Commercial Engineering, Section 57D-1/UT18, Harrison, New Jersey 07029. International: RCA 2-4 rue du Lièvre, 1227 Geneva, Switzerland, or P.O. Box 112, Hong Kong.

2N5039... switches off 15 A in less than 250 ns at ~~\$4.90~~

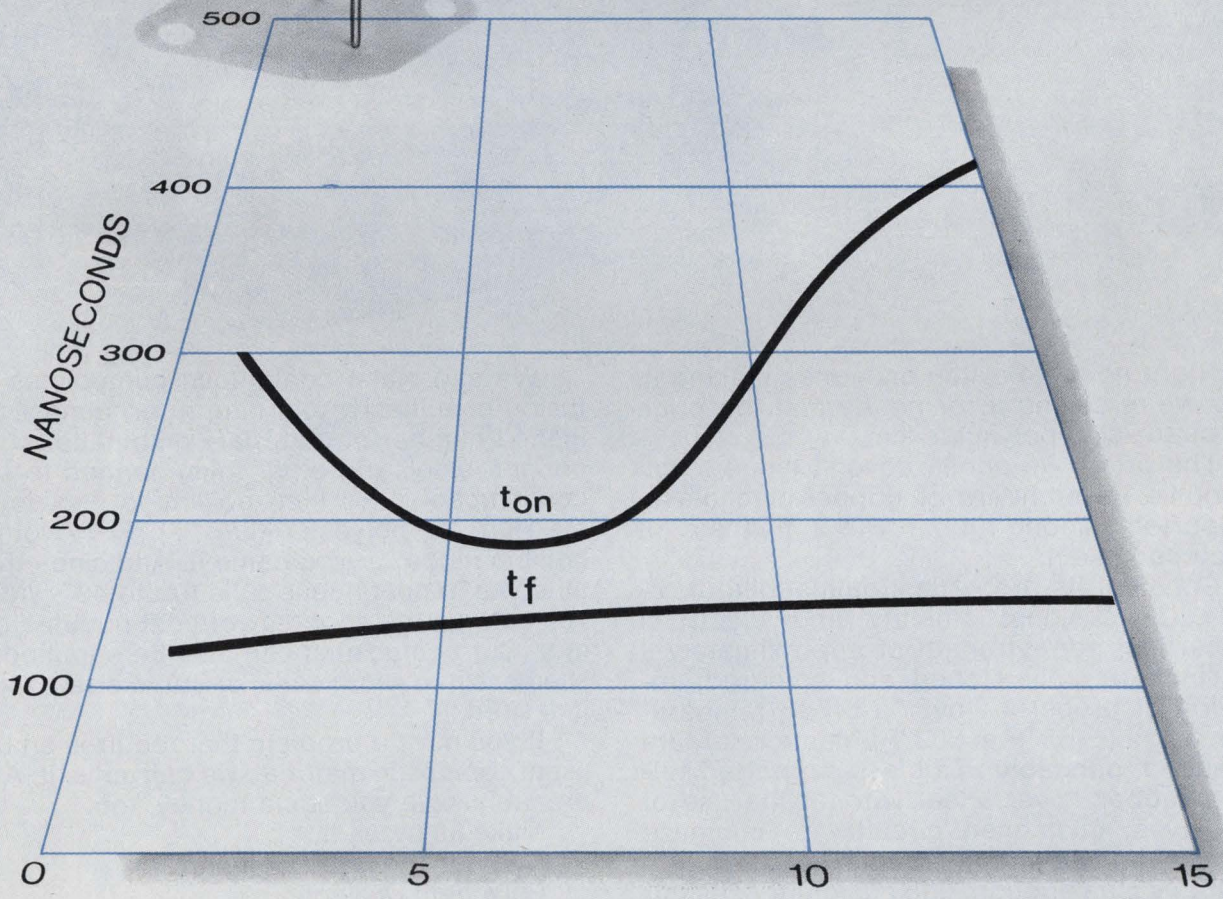

**We're doing
the unheard of in continuous
fusion bonded composites.**

**Ever hear of
copper-clad glass-supported
silicone rubber as a
flexible circuitry material?**

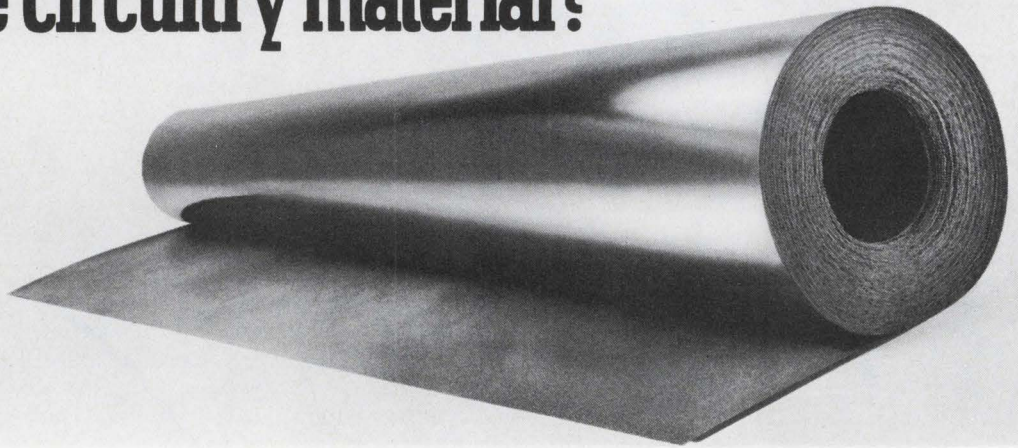

Right now, we're the only ones making it. And we're selling it for nearly half the price of copper-clad polyimide film.

The price, we admit, doesn't mean much if you've never heard of copper-clad glass-supported silicone rubber. But it means a lot if you can use it.

Consider its properties: outstanding flexibility, dimensional stability and electrical properties; peel strength of approximately 9 lbs./inch; readily etched and soldered; retention of properties over a broad temperature range (-65°F to 600°F); flame retardant if desired; bondable to a glass-supported silicone rubber cover sheet without the use of adhesives; cushioned circuitry to minimize fracture; and no circuit "swimming".

If this isn't enough, one customer uses our material to make flexible *multilayer* circuits.

A typical configuration is .003" silicone rubber/.004" glass fabric/.003" silicone rubber, clad either one or two sides with electrolytic or rolled copper. You choose.

We can make continuous composites by fusion or adhesive bonding in an almost unlimited number of material combinations . . . copper, steel, and other foils, bonded to silicone rubber, FEP film, polyimide film, ionomer film, or polyester film . . . FEP/Nomex combinations . . . you name it. And since they all come in continuous rolls (up to 40" wide), you can get the economy of continuous etching. (Our composites can also be supplied in sheets, slit to width coils, or cut to size panels if desired.)

If you have a problem that requires an unusual composite material, we can solve it. And probably save you some money, too.

Make us prove it.

Contact The Budd Company

Polychem Division

70 S. Chapel St., Newark, Delaware 19711

THE BUDD COMPANY
POLYCHEM DIVISION

#1



There are a lot of mini-computers around today. One of them is the runaway favorite.

The one with the heritage of over 10,000 mini-computers already delivered. That's more computers than all the other minimakers put together.

The one with the biggest, most experienced library of software. And the most active users society.

The one with the most peripherals. Over 70 standards. Plus specials.

The one with over 1400 sales/service engineers scattered over 65 locations around the world.

The one with UL approval.

The fastest selling mini-computer ever known.

PDP-8/E.

It's the one.

Digital Equipment Corporation, Main Street, Maynard, Mass. 01754 (617) 897-5111.

digital

More than 10,000 mini-computers delivered.

INFORMATION RETRIEVAL NUMBER 16

New Books in Contemporary Engineering

NEW OPPORTUNITIES

to Underpin Your Professional Skills



THE SUCCESSFUL ENGINEER-MANAGER

A Practical Guide to Management Skills for Engineers and Scientists

Edited by ROBERT C. HAAVIND, Editor, Computer Decisions; and RICHARD L. TURMAIL, Management Editor, Electronic Design

Valuable R & D, this guide is aimed toward the man who could be on surer ground in directing his career as well as toward the engineer or scientist who lacks background in the management art. It covers six crucial phases in managing: career, decisions, people, projects, finances, and communications. This practical success course is highlighted at every stage by the insights of top-flight managers in the electronics field.

176 pp., illus., #5879, clothbound, \$8.95

to meet specific design needs with the best resources . . .

Hayden Series in Materials for Electrical and Electronics Design
ALEX. E. JAVITZ, Editor-in-Chief

Combining background in fundamental principles with immediately workable data and techniques, these books are designed to meet the day-to-day needs of all who design components, devices, equipment, and systems. Each begins by examining the specific materials design function, then reviews the major types of materials used. Functional problems are covered, as well as conventional and advanced applications. Numerous graphs, charts, and tables illustrate discussion, and comprehensive bibliographies complete each volume.

MATERIALS FOR CONDUCTIVE AND RESISTIVE FUNCTIONS

G.W.A. DUMMER, Formerly, British Ministry of Technology.

336 pp., illus., #5636, clothbound, \$13.95

MATERIALS FOR STRUCTURAL AND MECHANICAL FUNCTIONS

GABOR KOVES, IBM General Systems Division.

368 pp., illus., #5637, clothbound, \$13.95

MATERIALS FOR MAGNETIC FUNCTIONS

FENNIMORE N. BRADLEY, Michigan Technological University.

360 pp., illus., #5635, clothbound, \$14.95

400 IDEAS FOR DESIGN, Volume 2

Selected from *Electronic Design*

Edited by FRANK EGAN, Editor, *Electronic Design*

Borrow, modify, or adapt any of the more than 400 ideas placed at your disposal in this stockpile of practical inspiration — the best contributions to *Electronic Design's* popular "Ideas for Design" column for the years 1965 through 1970. Arranged for quick reference, they encompass amplifiers, calculation shortcuts, design and laboratory aids, pulse, digital, and control circuits, and other areas. Each is ready to go. or to touch off creative thinking.

288 pp., illus., #5067, clothbound, \$11.95

DURABILITY AND RELIABILITY IN ENGINEERING DESIGN

GILBERT KIVENSON, Consulting Engineer

This path-breaking work cuts through the bewildering array of highly specialized technical literature to bring together and interweave valuable findings from all disciplines in a useful and thought-provoking source. It spells out materials properties, breakdown mechanisms and phenomena, and failure modes along with steps to counter them; provides a capsule course in reliability theory; relates design considerations to the user's needs; and points toward new applications.

200 pp., illus., #5851, clothbound, \$9.95

PRACTICAL DESIGN FOR ELECTROMAGNETIC COMPATIBILITY

Edited by ROCCO F. FICCHI

In this convenient, up-to-date working tool, a team of experts presents the basic information needed to analyze, predict, control, and reduce unwanted signals in electronic equipment and systems. It fully describes measurement techniques and equipment, covers the latest advances in filtering and shielding, and offers complete treatment of the special problems encountered in computers, semi-conductors, and solid-state devices.

272 pp., illus., #5685, clothbound, \$13.75

PRACTICAL INSTRUMENTATION TRANSDUCERS

FRANK J. OLIVER, Formerly Editor, *Electro-Technology*

Fully described, and illustrated with over 400 clearly drawn diagrams, charts, and tables, here are the basic operating principles and limits of accuracy of virtually every known physical-to-electrical transducer designed for industrial and aerospace applications. This definitive work reflects the latest trends, clears up areas of confusion, and offers immediate, reliable background for the job at hand.

340 pp., illus., #5833, clothbound, \$20.00

the most up-to-date guides to the PE examination . . .

Hayden Professional Engineering Examination Series

LAWRENCE J. HOLLANDER, P.E., Editor-in-Chief

Written by professional engineers, these conveniently organized guides present essential background, solve typical examination problems step by step, and highlight key points with numerous well drawn illustrations. Tables of contents for both topics and problems are ideal for open book exams. The first volume covers the comprehensive examination; both the others cover the technical as well as the economics and ethics portions of the professional exams.

BASIC ENGINEERING SCIENCES AND STRUCTURAL ENGINEERING FOR ENGINEER-IN-TRAINING EXAMINATIONS

H. JACK APFELBAUM, P.E., Lowell Technological Institute; and WALTER O. OTTESEN, P.E., Patent Counsel.

408 pp., illus., #5712, clothbound, \$13.95

ELECTRICAL ENGINEERING AND ECONOMICS AND ETHICS FOR PROFESSIONAL ENGINEERING EXAMINATIONS

JOHN S. LYONS, P.E., and STANLEY W. DUBLIN, New York University Medical Center.

320 pp., illus., #5715, clothbound, \$12.95

MECHANICAL ENGINEERING AND ECONOMICS AND ETHICS FOR PROFESSIONAL ENGINEERING EXAMINATIONS

EUGENE STAMPER, P.E., Newark College of Engineering; and STANLEY W. DUBLIN.

416 pp., illus., #5716, clothbound, \$14.95

PRACTICAL RELAY CIRCUITS

also by FRANK J. OLIVER

Another valuable engineering time-saver, this guide classifies relays by function. It brings together a variety of circuits for performing a given switching task, providing a broad view of those which can solve a specific problem quickly. Operating principles, reliability factors, standards, and specifications of the provisionally chosen circuits can then be checked from manufacturers' data or a source such as the *Engineers' Relay Handbook*, also published by Hayden.

384 pp., illus., #5802, clothbound, \$14.95

**Review
the books of
your choice
for 15 days!**

Please send the book(s) listed on a 15-day examination basis. At the end of that time, I will remit payment, plus postage, or return the book(s) without further obligation.

CAT. #	TITLE	PRICE	
_____	_____	_____	NAME
_____	_____	_____	FIRM
_____	_____	_____	INSTITUTION
_____	_____	_____	ADDRESS
_____	_____	_____	CITY/STATEZIP.....



HAYDEN BOOK COMPANY, INC., 116 W.14 St., N.Y., N.Y. 10011

71-57

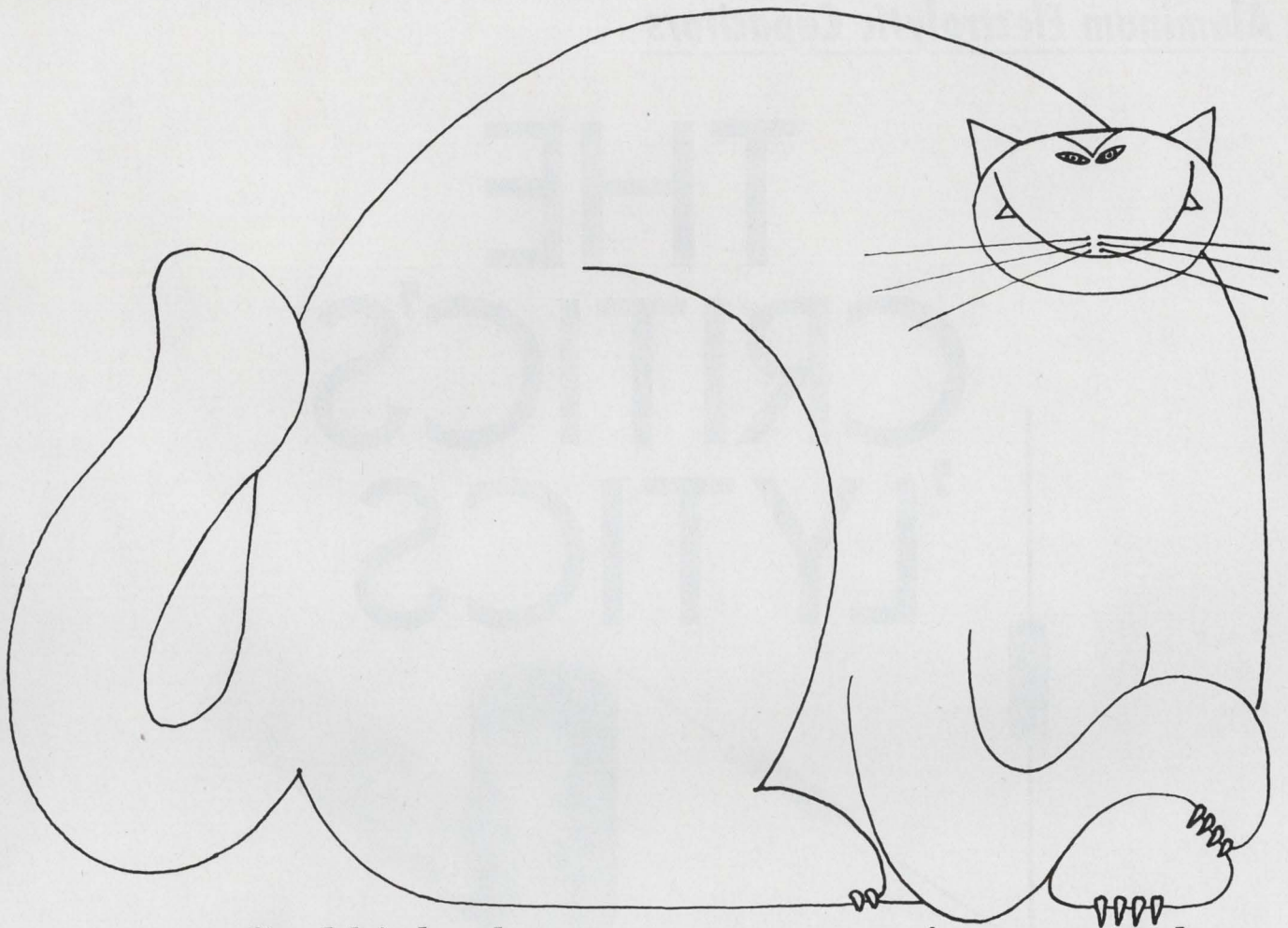

Could it be that your power transistor source has gotten too big to handle your special jobs?

And that's why he calls them "special?"

What you need is a source that needs you as much as you need him.

One that's big enough to give you the quantity and quality you need. But is also lean, quick and flexible enough to deliver it when you need it, instead of when he's good and ready.

Take us for example.

Within 48 hours of whenever you call one of our reps, we'll call you back with a price and delivery date (subject, of course, to final prints), no matter how "special" the parameters or requirements.

What's more, that delivery will come within days, not the weeks or months you may have grown to expect, and the products in it will have as high reliability as any you can get anywhere.

Which should come as no surprise, since the men at the top of our company are also among the top names in semiconductors, by virtue of having been at the bottom of the industry's founding and development.

They've melded together their technological experience in the semiconductor field, along with the purchase of ITT's RF power transistor line and other semi-

conductor lines.

Today, as a result, we're a major manufacturer and supplier (through some of the best, most knowledgeable reps in America) of "special" and "standard" high-reliability power transistors, priced from 60 cents to \$300 each, including:

A broad planar power line, capable of 100 amp collector currents and voltages to 325V.

A long and deep line of RF power transistors delivering the highest power available on the market; 100 watts at 175 MHz. This extensive line of high power devices is available in frequencies from 30 MHz to 1.2 GHz.

As well as our vast array of single diffused transistors, built to perform in all industrial, commercial and entertainment applications.

And our unique high-speed power switching transistors, performing at speeds of less than 75 nsec, total switching time at 25 amperes.

Kertron, Incorporated. 7516 Central Industrial Dr., Riviera Beach, Fla. 33404. Phone 305/848-9606, TWX 510-952-6679.

KERTRON

INFORMATION RETRIEVAL NUMBER 17

THE CRITIC'S 'LYTICS

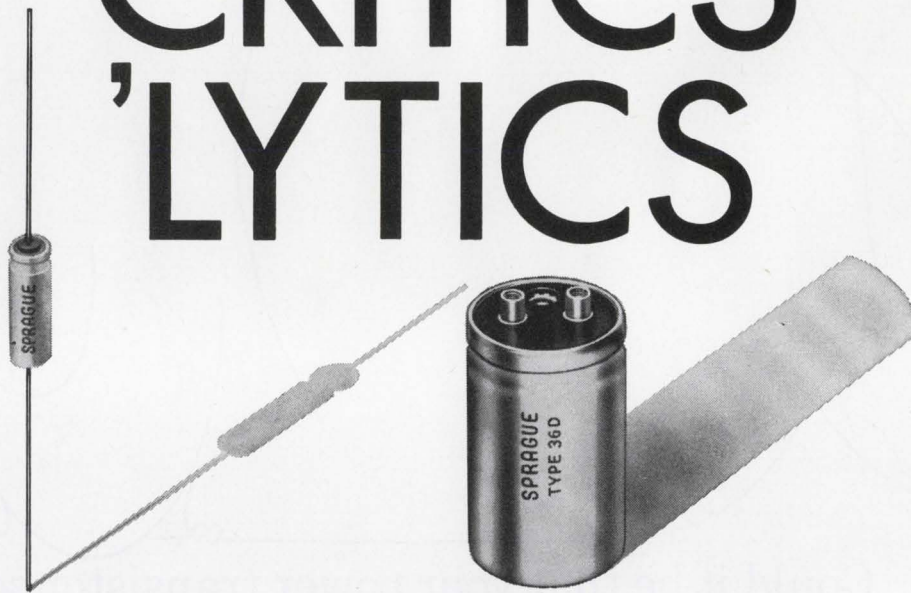

Be critical. Specify Sprague Powerlytic® Capacitors for maximum capacitance in minimum space.

Type 39D Tubular Case

Case sizes from 1/2" x 1 1/8" to 1" x 3 5/8". Operate at temperatures up to 85 C. Unique construction—anode and cathode terminals are welded—no riveted or pressure connections—prevents open circuits, even in microvolt signal range. Standard ratings include capacitance values to 18,000 μ F, voltages from 3 to 450 VDC.

Write for Engineering Bulletin 3415.

Type 36D Cylindrical Case

Improved materials and processes now permit extended capacitance ratings. New, large case size, 3" x 8 5/8", allows capacitance values up to 650,000 μ F. Ideal in applications such as computer power supplies, industrial controls, high gain amplifiers. Low equivalent series resistance, low leakage current, excellent shelf life.

Write for Engineering Bulletin 3431C.

*Technical Literature Service, Sprague Electric Co.
347 Marshall Street, North Adams, Mass. 01247*

Popular ratings are available for fast delivery from your Sprague Industrial Distributor.

THE BROAD-LINE PRODUCER OF ELECTRONIC PARTS



45M-0163

highlighting

THE ISSUE

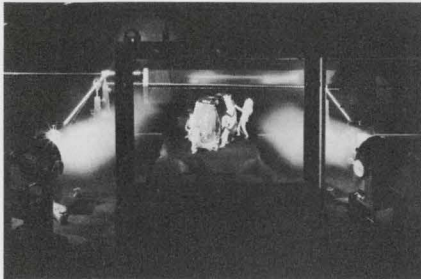

Five years ago a holographic picture of a Coke bottle and a glass drew long lines of curious engineers at electronic shows. Today holography may be ready to invade a number of consumer fields.

The rapid advance in the last few years has been made possible by:

- The development of pulsed and cw lasers with long coherence lengths, offering a larger depth of field for images.
- Improved emulsions that permit the use of a wider variety of lasers, bigger plates and faster production of holograms.
- A technique for making holograms, resulting in mass-produced holograms that can be viewed with ordinary white light.

All of these have pushed the science of holography to the point where scenes of breadth and depth can be created—to portray a number of persons sitting together around a table.

Page 24

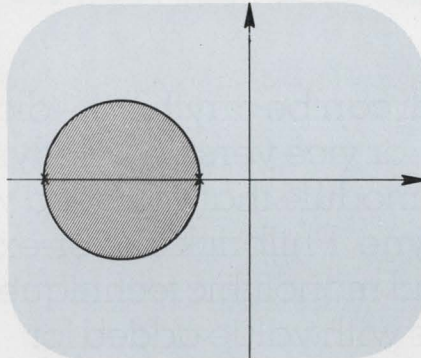

Stability analysis is always a headache in control system design. When the control system is nonlinear, the headache may assume epic proportions unless a convenient stability criterion can be applied.

The "circle criterion" is convenient. When applied to a nonlinear system, it provides sufficient, but not necessary, conditions for stability.

Page 40

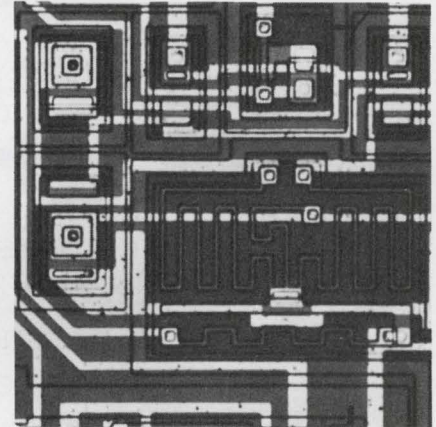

Two new monolithic operational amplifiers demonstrate exceptionally low drift, bias and offset levels for both low and high source-impedance applications at operating temperatures up to +125°C. Their performance is presently unsurpassed by any FET, IC or chopper-stabilized op amp over the range of -55 to +125°C.

This means that designers no longer have to choose premium-type op amps, each with different characteristics depending on how high or low the application's source impedance is.

Page 82

Modules operandi.

Your modulus operandi can be anything — digital, analog, digital-to-analog  or vice versa — Teledyne Philbrick has the specific module that you need within its five, broad product lines. Teledyne Philbrick's ever-expanding expertise in discrete, hybrid, and monolithic techniques results in a range of products with value added for the user, not the least of which are price and quality. Today

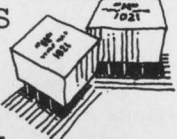
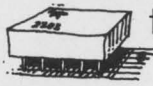
Teledyne Philbrick has the only complete **Linear** product line containing differential, compensated, FET, chopper stabilized and parametric operational amplifiers. **Nonlinear** modules  are designed with continuous-function or with synthesized function characteristics to perform virtually any mathematic or log function. **Data Conversion** modules for 8 to 12 bit A-to-D and D-to-A conversions in over 100 standard variations with pin layouts designed for your convenience — not ours. Teledyne Philbrick instrumentation also includes **Testers**, either manual or automatic, for operational amplifiers and manifolds for easy system simulation. **Power Modules** and regulators add dependability to our entire product line and make it operational. Our  Product Guide contains all the facts you need to know about the industry's most complete line. Contact your local field engineer or write Teledyne Philbrick, Allied Drive at Route 128, Dedham, Massachusetts 02026. Telephone: (617) 329-1600. TWX: (710) 348-6726

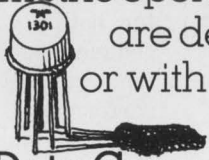
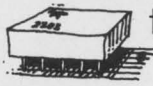
 **Linear** product line containing differential, compensated, FET, chopper stabilized and parametric operational amplifiers. **Nonlinear** modules are designed with continuous-function or with synthesized function characteristics to perform virtually any mathematic or log function. **Data Conversion** modules for 8 to 12 bit A-to-D and D-to-A conversions in over 100 standard variations with pin layouts designed for your convenience — not ours. Teledyne Philbrick instrumentation also includes **Testers**, either manual or automatic, for operational amplifiers and manifolds for easy system simulation. **Power Modules** and regulators add dependability to our entire product line and make it operational. Our  Product Guide contains all the facts you need to know about the industry's most complete line. Contact your local field engineer or write Teledyne Philbrick, Allied Drive at Route 128, Dedham, Massachusetts 02026. Telephone: (617) 329-1600. TWX: (710) 348-6726

Our  Product Guide contains all the facts you need to know about the industry's most complete line. Contact your local field engineer or write Teledyne Philbrick, Allied Drive at Route 128, Dedham, Massachusetts 02026. Telephone: (617) 329-1600. TWX: (710) 348-6726
Telex: 92-4438

 **TELEDYNE PHILBRICK**

The worst is over, Laird says of defense cutbacks

Defense Secretary Melvin Laird, in spelling out the Nixon Administration's "first five-year plan" for defense goals, told the House Armed Services Committee that defense employment should improve, because the sharpest cuts in programs "are now behind us."

Military R&D is becoming more important as the Administration tries to push the arms-limitation talks with the Soviet Union, he noted. He pointed out that in the Navy alone \$300-million in R&D funds had been ticketed for new ocean surveillance systems, improved communications at sea, surface-to-surface shipborne missiles, hydrofoil ships, better anti-aircraft protection and surface-to-air missiles.

R&D for the underseas long-range missile system (ULMS) will amount to \$110-million for the power plant, navigation guidance and launching system, the Secretary said.

For the Air Force, the B-1 bomber will get \$370-million for engineering development, with an overall review of the program scheduled for next year. Other programs that Laird emphasized included these:

Program	Funds (in millions)	
	1971	1972
Sram, short-range attack missile	\$266	\$359
Subsonic cruise armed decoy, Scad	0	10
Poseidon missile	1022	1278
Awacs, airborne warning and control system, and over-the-horizon radar	75	370
Safeguard deployment	1331	1278
Hard-site defense	25	65
AX close support aircraft	28	47
F-15 fighter	348	415
F-14 fighter	995	1034
EA-6B, electronic countermeasures aircraft, and E-2C, early-warning aircraft	300	554
P-3C antisubmarine warfare aircraft		

procurement	166	328
S-3A antisubmarine aircraft development	288	580
High-speed nuclear attack submarines	662	881
Destroyer escorts	481	599
Aegis, area defense missile	72	100

In line with the increased emphasis on R&D, Laird announced a proposal to expand the Defense Research and Engineering Office. A new group will be formed to evaluate new Communist weapon systems.

Laird predicted that future peacetime defense budgets would total no more than 7% of the Gross National Product. The 1972 budget is 6.8% of the GNP.

Post Office accelerates its automation program

The Post Office Dept. has leaped ahead of three on-going projects—all designed to develop machines that read envelope addresses and sort the envelopes to the correct bin.

Under a \$1.1-million contract, Recognition Equipment, Inc., is to develop and deliver by early next year a relatively unsophisticated optical character reader (OCR) that will not only read and sort letters; it will read the address and then print out a bar code for reading from then on by inexpensive bar-code readers throughout the rest of the system. This is ultimately the way the U. S. system will work, and the way it's operating now in an experimental letter-sorting facility in Cincinnati. The difference is that now, human operators have to read an address and then type on the bar code by hand. (See "The New Postal Service Plans a Rapid, 'Hands Off' Mail System," ED, Dec. 20, 1970, p. 22).

The automatic system will read

and print codes on 600 letter-sized envelopes a minute—provided, of course, as in the case of all OCRs, that the address is typed in block form. The Post Office is not trying at this time to develop OCRs that will read envelopes addressed by hand.

Recognition Equipment's system will read the bottom two lines of the address, check it for accuracy in a computer memory and then print out the bar code.

Except for the bar-code printer, three advanced OCRs already under development will be much more sophisticated. They will read up to four lines of an address block; will be able to find an address anywhere on an envelope; will be able to read through envelope windows; will not be thrown off by colored envelopes; will be able, through their computers, to cope with misspelled words; and will read twice as fast as present OCRs. Recognition Equipment and IBM are both developing advanced OCRs in competition. Prototypes are to be delivered to the Post Office in mid-1972.

Meanwhile Philco-Ford is building an OCR II that will not have the sophistication of the machines that IBM and Recognition Equipment are developing but is to be better than the 20 OCR I models now operating throughout the U. S. The OCR II will be delivered in June or July.

Although the Post Office has not told Philco-Ford to modify its OCR II to include a bar-code printer, "we could do it easily," a company spokesman says.

The Postal Service will eventually need approximately 140 OCR systems. Manual coding consoles will still be needed for handwritten envelopes.

Job help for engineers pressed across U. S.

On national and local fronts, drives are under way to help unemployed engineers find jobs.

In Washington, the IEEE called a special conference at which personnel specialists and job counselors met and formulated plans to attack the problem in four ways:

- By counseling and self-help, so that engineers can use the most ef-

fective ways to find professional employment.

- By projections of new occupations in such areas as pollution control, education and mass transportation.

- By compiling listings of training programs and guides that already exist.

- By giving attention to special problems, such as the admission of middle-aged people to degree programs at universities, medical assistance, and loans to meet the financial needs of engineers.

While this conference was focused primarily on providing engineers with guidance in determining future careers, the IEEE in cooperation with the American Institute of Aeronautics and Astronautics (AIAA) has been conducting job workshops in Los Angeles, Baltimore and New York.

In the Boston area, both working and unemployed scientists and engineers have formed a new organization, Association of Technical Professionals, at 239 Chestnut St., West Newton, Mass. The objectives of the new organization include:

- Obtaining relief for the unemployed by attempting to get increased state food allocations for those on welfare.

- Obtaining continued medical aid and life insurance.

- Helping to get job opportunity listings through Boston area centers of the American Institute of Aeronautics and Astronautics and the IEEE.

- Bringing government and non-government sources of money together with the proper people to aid in conversion to newer, non-military technologies.

- Initiating efforts to introduce and support legislation that helps engineers.

Meanwhile statistics prove what everyone in the industry has known for a long time: the demand for engineers is at an all-time low.

Using newspaper classified advertising as the basis for their index, Deutsch, Shea & Evans, a New York City advertising company, says that the demand as of the end of 1970 had dropped to 30. (1961 was used as a base of 100). Looking backwards, Deutsch, Shea & Evans noted that it was only 1966 when the engineer/scientist demand index reached 220.

So far as salaries of engineers are concerned, the picture follows general cost-of-living patterns. Current figures from the Engineering Manpower Commission in New York City show that after 10 years experience, an average engineer with a bachelor's degree earns \$14,650; with a master's degree, \$16,050, and with a Ph.D., \$17,700.

Optic scanner converts directly to digital outputs

Reportedly a "first," a solid-state electro-optical scanning device announced by Optonetics of Teterboro, N. J., converts optical inputs directly to digital outputs. Trademarked Solidscan, it is said to offer high-resolution image conversion at prices under \$100.

Formerly the analog outputs of optical scanning devices required the use of a/d converters, Optonetics points out. This not only meant costs of \$500 to \$600 but also limitations on resolutions due to the extra conversion step, the company notes.

The new scanning device uses digitally programmed cross-grid conductors sandwiched between a layer of photosensitive semiconductor and polycrystalline electroluminescent phosphor. The energized conductors cause the light from the phosphor layer to interact, point by point, with the surface of the photosensitive layer.

Sensitivity mark claimed for new PIN photodiode

A new, low-noise PIN silicon photodiode has achieved—for the first time—a sensitivity equal to that of photomultipliers, according to Philip Davis, vice president of United Detector Technology, Santa Monica, Calif., developers of the device.

The sensitivities, measured in the peak response region between 8500 and 9000 Å, give a noise-equivalent-power of 6×10^{-15} W for the company's UDT-020A, which has an active diameter of 20 mils, and of 1×10^{-14} W for the UDT-040A, which has an active diameter of 40 mils.

These high sensitivities, Davis reports, are due largely to the fact

that surface, edge and bulk leakage currents are reduced an order of magnitude over that of previously available devices. This achievement is possible, he says, through the use of improved diffusion processes and silicon materials. Also, these PIN photodiodes, which have the active element electrically isolated, do not have any guard ring around the element.

Using a 5-V supply, the new photodiodes can replace photomultipliers and their expensive and bulky power supplies in such applications as star trackers, earth resources scanners, laser ranging systems and particle detectors, Davis says. The advantages are listed as a substantial reduction in size and cost, as well as improvements in stability and spectral coverage.

Novel GaAs amplifier works at microwaves

A novel type of solid-state traveling-wave amplifier, useful for subnanosecond phase and amplitude switching in the 3-to-20-GHz region, provides gains as high as 28 dB at 9.2 GHz.

Developed by RCA Laboratories, Princeton, N. J., for the Avionics Laboratory at Wright-Patterson Air Force Base, Ohio, the experimental device has separate, coplanar tapered waveguide inputs and outputs.

The heart of the amplifier, according to its developer Dr. Raymond H. Dean, a member of the RCA technical staff, is a 1-micron strip of n-type gallium arsenide (GaAs) that is grown epitaxially on an insulating GaAs substrate. The strip is specially configured and biased to produce the transferred electron (Gunn) effect along its length.

The negative bias at the input end inhibits any return waves and makes the device unidirectional.

In the cw mode, at room temperature, the initial device has an output power of 0.2 mW max and a noise figure of about 25 dB. The instantaneous bandwidth is about 1/2 GHz.

Because the device is fabricated with the standard techniques used in monolithic ICs, it has the potential advantage of being mass produced and inexpensive.

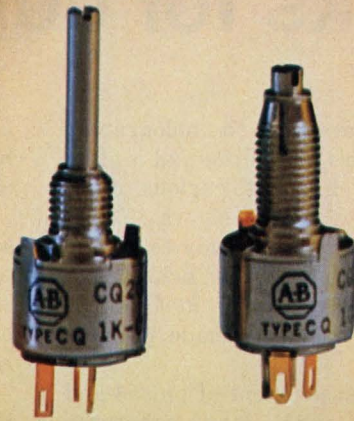

Compact new performer: 1/2 -inch, 1/2 -watt cermet pots

Allen-Bradley Type CQ handles your toughest applications. "Immersion-proof," can be encapsulated. Dissipates 1/2 watt at 125°C. Tough.

Our A-B cermet is formulated for long life. Rotational life 50,000 cycles with less than a

5% resistance change. Withstands "temperature cycling," as well as being vibration- and shock-resistant. A big performer in a small package.

Resistance range 100 ohms to 5 megohms. Temperature range -65°C to +175°C. Watertight bushings are standard in plain

or locking styles. Large variety of shaft and bushing options.

Allen-Bradley CQ. Available through your A-B electronics distributor, or write: Allen-Bradley, Electronics Division, Milwaukee, Wisconsin 53204. Export: Bloomfield, N. J. 00703. In Canada: Galt, Ontario.



NEW DIMENSION ELECTRONICS
ALLEN-BRADLEY



Holography, no longer a novelty, looks for consumer application

Five years ago a holographic picture of a Coke bottle and a glass drew long lines of curious engineers at electronic shows. Today holography may be ready to invade a number of consumer fields.

The rapid advance in the last few years has been made possible by:

- The development of pulsed and cw lasers with long coherence lengths, offering a larger depth of field for images.
- Improved emulsions that permit the use of a wider variety of lasers, bigger plates and faster production of holograms.
- A technique for making holo-

grams, resulting in mass-produced holograms that can be viewed with ordinary white light.

All of these have pushed the science of holography to the point where scenes of breadth and depth can be created—to portray a number of persons sitting together around a table.

Holography has grown to where it has found experimental application in advertising and sales displays; as a diagnostic aid for eye specialists, and as a new visual art form. Already the principle of three-dimensional movies has been demonstrated as feasible, and there is speculation that holography will turn up in closed-circuit television before long.

Long coherence length in a laser is the factor that determines the

depth to which the 3-D image remains in focus. Conductron Corp., St. Charles, Mo., has designed pulsed ruby lasers with coherence lengths of 10 to 20 feet, by using dye cells and apertures plus laser amplifiers, according to Craig Dwyer, one of the company's research scientists.

A 20-foot coherence length for a pulsed helium-neon laser camera has been obtained by KMS Industries, Ann Arbor, Mich., without any added optical elements. This is possible, according to Keeve M. Siegel, chairman of KMS, by so designing the laser structure that the mode with the longest coherence length is the dominant one.

The sensitivity of emulsions used for holographic films and plates is now up to 50 times faster than it was a few years ago, according to Daniel J. Nolan, technical services manager of Agfa-Gaevert, Teterboro, N. J. The spectral response of the emulsions has also been tailored to allow the use of more types of lasers, including helium-neon, ruby, argon and krypton.

Whereas early holographic workers were saddled with 4-by-5-inch films, Agfa now produces off-the-shelf plates up to 18 by 24 inches. Special-order plates up to 3 by 4 feet have been made and sold for holographic art.

Viewing in white light possible

By refining a technique called "real-image reflection" holography, Conductron has developed low-cost, mass-producible holograms that can be pasted into a book or magazine and viewed with white light from the sun or an ordinary penlight. This is in contrast with conventional holograms, which require viewing by laser.

The real-image hologram is ob-

Jim McDermott
East Coast Editor



Real objects can be placed inside their holographic images. This subject looks through a Conductron hologram and matches the blocks with their 3-D images. Such tests have proven useful to detect and measure perceptual handicaps.

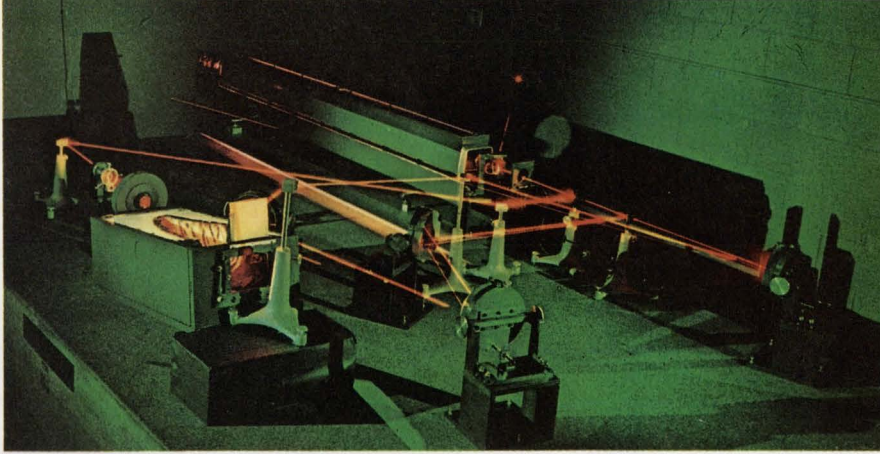

A studio setup at Conductron Laboratories for the production of a master hologram plate to produce reflection type holograms of a spastic colon for Hoffman-LaRoche, Inc., a pharmaceutical firm. Several thousand of the reflection holograms were mailed to doctors so they could show patients what a spastic colon looked like in 3-D.

tained by making a conventional hologram; then the holographic image is substituted for the objects in the original setup, and a hologram is made of this scene as shown in Fig. 1.

A principal advantage of the real-image hologram, Dwyer explains, is that the viewer can be made to see the object in one of three locations: behind the hologram plate (a virtual image), in space in front of the plate (a real image), or part in front and part in back of the plate (a projected image). This is accomplished when making the hologram by locating the real image at the location in which it is to be viewed with respect to the plate being exposed.

These so-called real-image holograms are of two types: transmission or reflection. The transmission

hologram is viewed by looking through it with the laser beam on the side opposite the observer, while the reflection hologram is seen with a white light shown on the same side as the viewer.

To make a real-image reflection hologram, the setup is arranged so that the light from the master image and the reference beam fall on opposite sides of the emulsion (Fig. 1). The physical effect is to create a complicated system of standing waves throughout the emulsion which, when developed, acts as a very-narrow-bandpass optical filter.

As a result, the hologram can be reconstructed with white light, because the filtering effect allows the viewer to see the image in a color closely corresponding to that of the recording laser light.

In the last few years holography has shown potential as an exciting tool in advertising and sales promotion. To help doctors show patients what a stomach ulcer looks like, Hoffman-LaRoche, Inc., Nutley, N. J., sent 36,000 Conductron transmission holograms to doctors, along with a penlight using a red filter.

But viewing this type of light was not too satisfactory, and when Conductron later refined the mass-production of reflection holograms that could be viewed in white light, Hoffman-LaRoche sent out 35,000 of these, showing a spastic colon undergoing spasms. The images proved to have better definition, and they were viewed with a regular penlight.

In other sales promotions, Conductron made a half million transmission holograms that were bound into each copy of the 1967 World Book Encyclopedia to supplement an article on holography. They were viewed with a penlight having a red acetate filter. In the same year, Photo Technical Research of Ann Arbor produced over 9000 transmission holograms and a filter and bound them into the magazine Laser Focus.

For measuring depth perception

A unique quality of holography is that real objects can be placed inside their holographic images; or holographic images can be mixed with real objects. This principle has been utilized by Conductron and the Instruction Systems Corp. of Ann Arbor to test the visual perception of children. The children look through a hologram at the virtual images of blocks of various sizes and positions. The object is to match the real block with the images.

The successful results of this

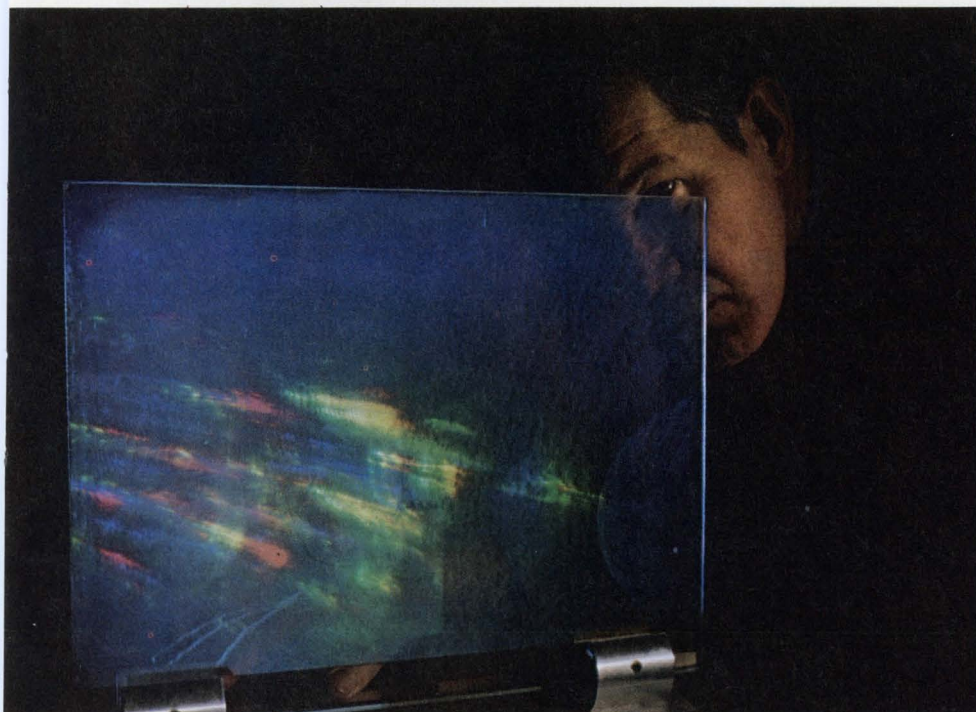

A composition of glass objects and spheres, this American Optical hologram, created by Harriet Casdin Silver and made by Larry Okonski, is viewed with a mercury arc. Diffraction of the white light creates the many colors.

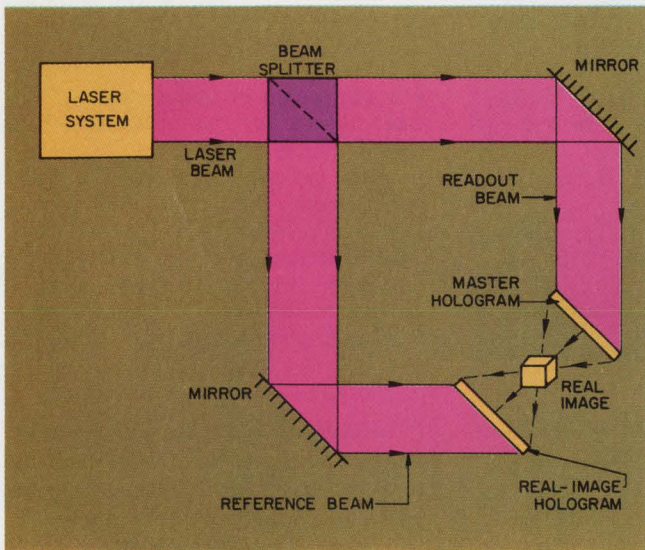

1. This setup is used for making real-image reflection holograms that can be pasted in magazines. The original object is replaced by its real image.

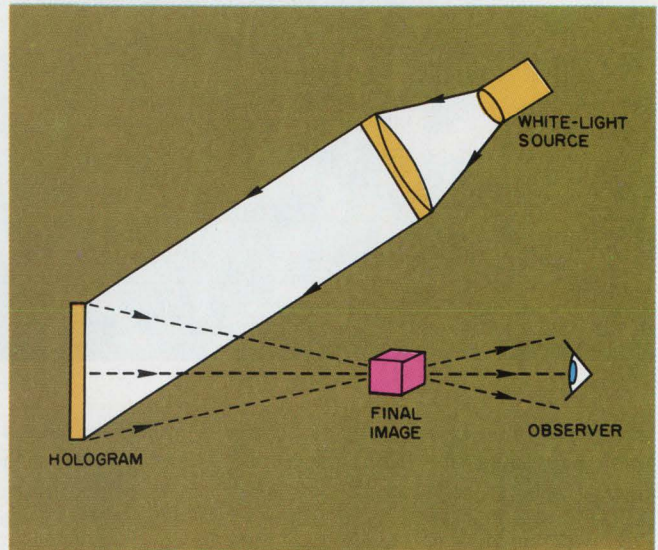

2. Real-image reflection holograms can be viewed using an ordinary penlight. The color of the image is close to that of the laser making the hologram.

study, according to Clark J. Char-netski, formerly group engineer with Conductron and now a private consultant, have indicated that holography can also be used in teaching addition, subtraction and solid geometry.

A big future for holography is in nonimaging applications, such as new types of visual art, according to Raoul F. van Ligten, chief of physical optics at American Optical's Framingham (Mass.) Research Facility. At the Museum of

Contemporary Art in Chicago last fall, an art hologram created by Harriet Casden Silver, a multimedia artist of Worcester, Mass., was shown. A number of glass forms and spheres were placed in front of a holographic plate, and laser object and reference beams were combined to form the Silver-conceived hologram (see photo, p. 25).

The hologram, made by Larry Okonski, research photographer at American Optical, is viewed by un-

filtered light from a mercury arc lamp. The white light, because of refractive effects, produces a rainbow of multicolored images. Miss Silver describes the reaction of viewers to her holographic art as excellent.

Movies still in research stage

The holographic movie, in which images are projected into a room and looked at from all sides, somewhat like a theater in the round, has been the subject of much development effort by companies. Conductron has produced an animated hologram projected at 15 frames a second. Dr. D. J. De Bitetto, staff scientist at Phillips Laboratories, Briarcliff Manor, N. Y., has an operational setup of a camera and projector using a continuous strip of film 8.5 inches across. It is a nonflickering system that can be run at any speed.

The Phillips hologram is recorded with the film moving vertically behind a small horizontal slit. With this method, Dr. De Bitetto says, vertical parallax is eliminated—which means you can't see around the image vertically—but this does not appear to be an objection, since the human eyes depend on horizontal parallax for their 3-D effect.

De Bitetto believes the Phillips method can be adapted eventually to closed-circuit and cable television, because with the slit technique, the bandwidth requirements of the holographic movie system are markedly reduced. ■■



Improved lasers have increased the depth of holograms up to several feet. This photo shows a Conductron setup for making an 18" x 24" advertising type display. The finished hologram is viewed by filtered arc light.

RF.

If You Alert Us To Your Designs, We'll Alert You With Ours.

- AIRCRAFT/MILITARY RADIO DESIGN KIT**
Application Notes
AN406 "UHF Broadband Amplifier Design"
AN481 "A Broadband 4 W Aircraft Transmitter"
AN503 "A 25 W Broadband Aircraft Transmitter"
AN507 "A 13 W Broadband AM Aircraft Transmitter"
Data Sheets
2N5635-7, 2N5641, 2N5862
- MARINE RADIO DESIGN KIT**
Application Notes
AN282 "Systemizing RF Power Amplifier Design"
AN495 "A 25 W, 175 MHz Transmitter for
12.5 V Operation"
Data Sheets
2N5889-91, 3, 10 and 25 W Power Amplifiers
- PORTABLE/LAND-MOBILE DESIGN KIT**
Application Notes
AN282 "Systemizing RF Power Amplifier Design"
AN495 "A 25 W, 175 MHz Transmitter for
12.5 V Operation"
Data Sheets
2N5589-91, 2N5644-46, 2N5846-49 3.5 to 40 W
Power Amplifiers

- CATV DESIGN KIT**
Data Sheet/Application Notes
2N5943/47 Designed and Completely Characterized
for Broadband
- LOW-NOISE AMPLIFIER DESIGN KIT**
Application Notes
AN215 "RF Small Signal Design Using
Admittance Parameters"
AN419 "UHF Amplifier Design Using Data Sheet
Design Curves"
AN421 "Semiconductor Noise Figure Considerations"
Data Sheets
2N4957/5031/5179/5829, 200 & 450 MHz
PNP/NPN Amplifiers
- GENERAL RF DESIGN KIT**
Application Notes
AN215 "RF Small Signal Design Using
Admittance Parameters"
AN267 "Matching Network Designs with
Computer Solutions"
AN282 "Systemizing RF Power Amplifier Design"
AN521 "Using Balanced Emitter Transistors in
RF Applications"
RF Transistor Selector Guide

RF is one of the most complex places to start designing from scratch. It can kill you before you start just by giving you so many device and circuit options, you finally make up your mind in desperation instead of calculation.

That's why we're offering the chance to pick your RF design area from these six categories and tell us what it is. We'll send you the application notes and data sheets so you can go right to work on your design without having to worry about incomplete or non-existent information about that design.

Some of the data sheets we're sending include state-of-the-art devices, too. The CATV parts are unique in complete characterization for broadband operation including distortion specs, noise figures and Y&S parameters. Plus a wealth of test technique information right on the data sheet.

The 2N5846-49 units represent 3.5, 8, 20 and 40 watt power units optimized for operation from 12.5 volt supplies — they offer rugged, stable operation in industrial communications equipment to 80 MHz.

And the 2N5862 is particularly suited for class AB, B or C designs to 175 MHz with 90 W peak output for 15 W input, built-in resistance

to load mismatch and stripline packaging for lower lead inductance.

Alert us through Box 20912, Phoenix 85036 with your letterhead request about your particular design. . . We'll alert you with a designers kit.

Contact your Motorola distributor with the coupon to realize 10% off the up-to-999 published price on any Motorola RF small signal or RF power device.

10% OFF RF

(Distributor) _____

I'm alert about Motorola RF!

I want up to 999 of these RF types off-the-shelf from you at 10% off their regular published price:

Name _____

Title _____

Company _____

Address _____

City _____

State _____ Zip _____



MOTOROLA RF

Not just more megahertz. More communication.

Sweeping changes are urged to unify U.S. science policy

Movement toward a complete overhaul of the nation's science and technology programs and policies appears to be gaining momentum.

In recent weeks, Sen. Joseph Montoya (D-N. M.) introduced sweeping legislation which would establish a cabinet-level department of science and technology, design a national science policy and put all government R&D testing under one roof. Senators George McGovern (D-S. D.) and Hubert Humphrey (D-Minn.) co-sponsored the legislation.

The new agency would have a budget of \$16 billion a year and have between 600 and 700 laboratories under its command.

The National Science Foundation, NASA and The Atomic Energy Commission would be incorporated into the new agency along with other departments of Government agencies involved in R&D testing work.

In addition, all weapons systems requested by the Department of

Defense would be measured by the agency against existing needs for R&D in such fields as housing, medicine and other scientific fields.

Montoya said that "If some central organization does not examine the priorities for scientific research, we may do irreparable damage to science in this country. In fact, that is just what is happening today. Budgets are being reduced and the cuts often come from projects that do not have the protection that a cabinet-level Dept. of Science and Technology would offer."

Next month, Dr. Edward E. David Jr., science advisor to the President, will present to the Chief Executive his own national blueprint for future R&D priorities. If the report gets presidential approval, it will go to Congress.

Many witnesses before recent hearings held by the House Subcommittee on Science Research and Development, pointed toward the need for an increased degree of coherence in Government R&D efforts.

Emilio Q. Daddario, former sub-

committee chairman and former Representative from Connecticut, noted that the hearings had been held, "not only because no Congressional committee has ever looked at the matter in its entirety, but because it was clear that the nation has no formalized science policy to guide it."

Expert testimony solicited

Testimony elicited from over 60 witnesses and observers, including Dr. Lee A. DuBridge, former director of the Office of Science and Technology; Dr. Harvey Brooks, dean of engineering and applied physics at Harvard University; Dr. James R. Killian Jr., chairman of the corporation, MIT, and Dr. Patrick E. Haggerty, chairman of the board of Texas Instruments, revealed the following occurring in the U. S. science-technology picture in recent times:

- Congressional moves to curb science support along two lines: (1) A general tendency to consider research a partly expendable item in over-all budget reductions, and (2) Specific efforts to move the mission-oriented agencies away from basic research, unless some sort of "relevancy" can be demonstrated.

- A public disenchantment with technology of uncertain dimensions induced by environmental, social and educational factors, among others.

- A movement away from science as a glamorized activity to which Government, scientists, and businessmen alike had responded favorably during the nuclear and space-engendered excitement of the past quarter century.

- Preoccupation of Government with seeking solutions, with off-the-shelf technology, to immediate crises—such as unemployment,

Ralph Dobriner
Managing Editor

What's in it for the industry?

What is the relationship between the debate on national science policy and the current state of the electronics industry?

If we had such a policy five or even 10 years ago, it might have been possible to:

- Alleviate or minimize the effect of today's aerospace-defense cutbacks.

- Zero in on "civionics" areas—mass surface transportation, anticrime electronics and air traffic control—and create markets for electronics hardware

years before the need became urgent.

- Prevent cutbacks in Government support of engineering research at colleges throughout the country. This might have diminished the threat to U. S. world leadership in such areas as computers, supersonic flight, electronmicroscopy and radio astronomy.

- Spur technological innovation in new areas of electronics research, semiconductor materials, metallurgy, cryogenics, lasers, etc.

When you're known for Rolls-Royces,

it's hard to get Volkswagen buyers to think of you.

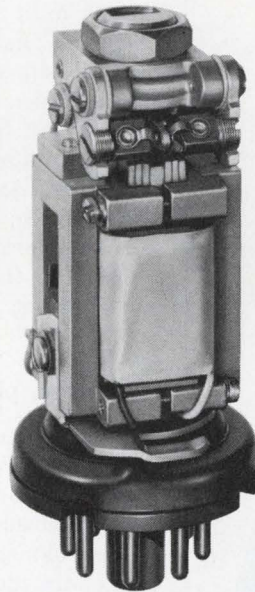

Series 72 Pulse and
Telegraph Polar Relay
... pulse repetition to
400/sec., life in hun-
dreds of millions of
operations

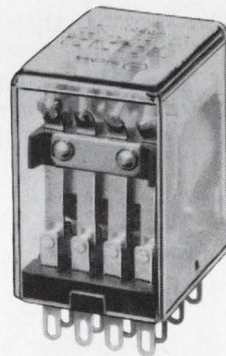

Series 67
General purpose
AC & DC, 4PDT, 5A

SIGMA has 2000 good, different general-purpose relays— many for 50¢/pole.

If you think of Sigma as a sensitive, close-differential relay house, you're partly correct. We're also a low-priced, general purpose relay house — as a substantial number of vending machine, alarm system, industrial control, copier and communications equipment manufacturers will attest.

For demanding applications such as computer peripherals, you can have one-cubic-inch 4PDT switching, on AC or DC coil signals, of low-level to 5-amp. loads at least 100,000 times with the Series 67. Fast wiring, mounting and interchangeability results from PC or solder terminals, or in sockets with PC or solder terminals.



Single-, two- or three-pole switching of loads up to 10 amps, for one million operations at 28 VDC or one-half million at 115VAC, is provided by the versatile and quickly-installed Series 68.

For up to 6PDT switching of low-level to 5 amp. loads by voltage adjustment, or 1-amp. loads on sensitive current adjustment, the Series 62 combines long life (up to 50 million operations with bifurcated contacts) with moderate cost.



For positive response to coil signals as low as 50 mw, at a cost of under 75¢/relay in quantity, the Series 65 is well-suited to TV channel selectors, slide projectors, vending machines and similar uses involving SPDT switching of 1-amp. loads.

Up to 3PDT switching of 5- or 10-amp. loads, on AC or DC voltages, is available in the compact and low-cost Series 50; wide application in automated equipment, switching small motors, solenoids and other relays.



We'll be glad to supply detailed technical data on any of the general-purpose relays mentioned, with complete price and delivery information on standards. Better yet, tell us your requirements (load, life, cost, driving signal, operating speed and environment) and let us recommend the relay best suited to the job. We can save you time, disappointment and perhaps some money as well. Sigma Instruments, Inc., 170 Pearl St., Braintree, Massachusetts 02185.

SIGMA INSTRUMENTS INC

INFORMATION RETRIEVAL NUMBER 22

Bliley IS Unique

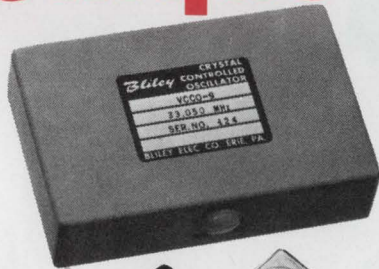

BLILEY offers you a unique combination of top crystal technology and state-of-the-art oscillator design capability

When you need precision crystals or crystal oscillators you can count on BLILEY expertise backed by 38 years of experience in frequency control.

CCO

Crystal Controlled Oscillators

TCCO

Temperature Compensated Crystal Oscillators

VCCO

Voltage Controlled Crystal Oscillators

Call or write us today with your specification requirements.



If you buy quality

BLILEY ELECTRIC COMPANY

2545 West Grandview Boulevard
Erie, Pennsylvania 16512

INFORMATION RETRIEVAL NUMBER 23

crime, environment, welfare, urban decay, military and foreign exigencies and the like.

The subcommittee found that the effects of these and other factors upon the scientific and academic communities had been far-reaching. And, to only a slightly less degree, they have affected a sizable portion of industry and most of the nonprofit research institutions.

Promising projects shelved

They noted that research teams had been decimated or disbanded. Promising projects have been slowed or shelved. Science and engineering enrollment at academic institutions are down. Medical schools, particularly the nonstate schools, are in serious financial straits. Graduate students have had to postpone their schooling and often abandon research fields. Planning of any kind for the future by the research community is difficult and in some instances impossible.

There is little question, the subcommittee report concluded, that the morale of the scientific community is at a low.

What then is being done to alleviate this situation and its consequences for the nation?

The subcommittee recommends:

- That a national science policy be stated and maintained as public law.
- That such policy be incorporated into the operations of every department or agency of the U. S. Government that utilizes science technology in its mission.
- That such a policy be flexible and subjected to continual review and re-evaluation in light of changing national goals and priorities.

The subcommittee also recommended that the Administration form a blue-ribbon task force to draft a basic national science policy for submission to Congress by the end of the year.

In their view, neither the executive nor legislative branches of Government can alone develop a credible, workable national science policy. As was the case with the recent national policy on the environment, a joint effort is needed.

Throughout the three months of testimony before the subcommittee one of the central issues con-

cerned itself with "the many real and potential blessings and curses that technology bears."

A new technology office?

Many witnesses expressed endorsement of a proposed new Office of Technology Assessment for the Congress.

As outlined by Clarence H. Linder, president of the National Academy of Sciences, "This institution would be charged with responsibility for marshaling appropriate cross-sections of expert knowledge and experience, including but going beyond science and engineering." Its major function, he observed, would be to "have responsibility for offering carefully winnowed and thoroughly evaluated inputs to the Legislative and Executive branches." Such an institution would also be responsible for furthering public understanding of technology assessments, according to Linder.

Among the other proposed changes in national science policy were these:

- A strengthening of the Office of Science and Technology. Now it is frequently used for tackling immediate crises, brushfire operations, which makes its function as a patron, planner and overseer of Federal science minimal.
- Submission by the Office of Science and Technology of an annual report to the President and Congress setting forth (1) A comprehensive review of the status of research and development in the U. S., and (2) A recommended program of scientific research and development for the coming year.

■ The setting up of a National Institutes of Research and Advanced Studies, which would improve coordination and efficient use of federally supported basic research funds.

■ Projection by the Office of Management and Budget of five-year scientific and technological trends—outlining national needs for scientific resources plus indications of probable levels of federal support for meeting the needs.

■ Wider use of the scientific method and technological research by regional, state and local organizations in seeking solutions to societal problems. ■■

New plastic package lowers rejects and costs

A low-cost, dual-in-line plastic package for sensitive miniature components eliminates rejects caused by the heat and pressure of conventional transfer molding.

There are no pressures on the components or chips because the package, called Dip-pak, is fabricated in parts: an open-header section, to which component connections are made, and top and bottom lids that snap into place.

According to William Ball 3d, vice president of Capsonic Group, Inc., Elgin, Ill., producer of the packages, the snap-in top and bottom lids are watertight and dust-proof. Also important, Ball says, is the fact that the component and its connections are accessible from both top and bottom. As a result, both sides of a hybrid circuit chip are open for testing before the unit is closed or sealed.

To encapsulate a component inside the Dip-pak, two thin-walled recesses are provided in the top lid, each covering a 0.015-inch hole. The holes are punched out and the encapsulating material—RTV or epoxy—is inserted through one hole until the package is filled.

The bottom lid can be designed with recesses or protrusions to hold components during assembly.

The cost of the package can be as low as 11 cents a unit in quantities of 100 K, Ball says, as contrasted with 60 to 90 cents for conventional packaging methods. ■■

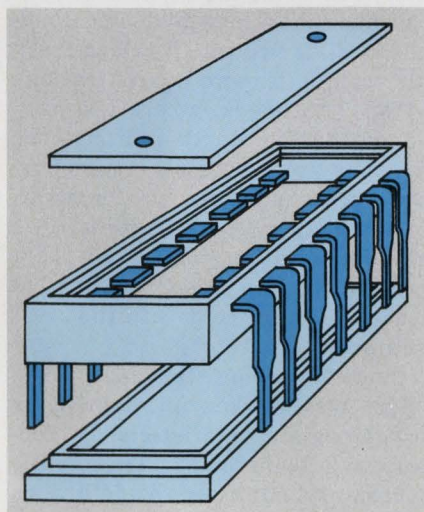

New Dip-pak plastic package, by Capsonic, has center header section and top and bottom snap-in lids.

You say all you need is a delay relay that times pretty well and can carry the load it switches? And doesn't cost much?

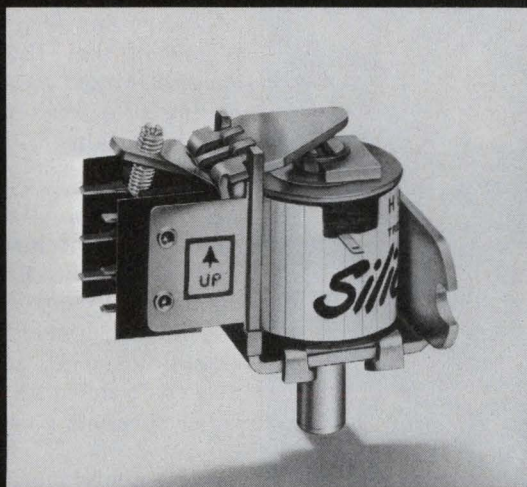

Then this is it.

For many applications, you don't need split-second timing accuracy in a delay relay. But you want something better than a thermal device.

Our Silic-O-Netic® relays time out like our circuit breakers. A solenoid core moving at a controlled speed through a fluid dashpot.

Within their timing range ($\frac{1}{4}$ second to two minutes), we promise accuracy of $\pm 50\%$ of the selected delay. Doesn't seem like much, but it's plenty for most requirements. And you can depend on it.

Then the Silic-O-Netic has a continuous-duty coil and heavy gold-plated silver contacts with up to 5-amp capacity—a combination that lets the delay relay act as its own load relay. You don't pay for extra components, or extra design time.

Finally, there's the reassuring Heinemann five-year warranty.

So if you want a reliable low-price delay relay, you ought to try one of our five models. They're described in Bulletin 5006. Heinemann Electric Company, 2616 Brunswick Pike, Trenton, N.J. 08602.

 **HEINEMANN**

INFORMATION RETRIEVAL NUMBER 24

5038

NEW MICRO-MINIATURE CERAMIC TRIMMER CAPACITOR



now
available for
45¢ in quantities
of 1,000



We are pleased to introduce the 9300 series. You will find the unit is truly micro-miniature (.315 high with a .276 diameter and .200 pin spacing). Its rotary assembly is designed with special ceramic materials which provide longer life and complete environmental stability. Capacitance values are available up to 70 pf. For immediate delivery, please phone (201) 334-2676.

STOCK MODELS

MODEL	CAPACITY RANGE pF	TEMP. COEF. @ ±10MHz	MIN. Q
9312	2.8 — 10	—350 PPM/°C	300
9313	3.2 — 18	—550 PPM/°C	300

Johanson

MANUFACTURING CORPORATION

400 ROCKAWAY VALLEY ROAD
BOONTON, NEW JERSEY 07005

ELECTRONIC ACCURACY THROUGH
MECHANICAL PRECISION

technology abroad

The potential of indium phosphide as a solid-state source of microwave frequencies was demonstrated for the first time in April 1970. But at that time the material was not available in large single-crystal form. Now, however, Metals Research of Melbourne, Cambridge, England, is producing the crystals using advanced crystal-pulling techniques first perfected in the UK. This involves encapsulating the seed prior to pulling in a glass boric-oxide skin which contains volatile phosphorous.

An MOS microcircuit for use in solid-state watches has been developed by the French semiconductor company Sescosem. The circuit divides an 8 kHz quartz crystal frequency down to the 2 Hz needed to drive an electric motor. In the present circuit, power consumption is 5 microwatts. But Sescosem engineers working at the Saint Egreve microcircuit center aim to get this down to 1 microwatt in the near future.

Radio frequency amplifiers with efficiencies as high as 90% have been obtained using a "switched mode" technique developed at Mullard's Central Application Laboratory, Mitcham, England. This amplification technique should find applications in portable transmitters where light weight and long battery life are important. Experimental circuits have been built to prove that the technique can handle frequencies up to 2 MHz.

High-speed frequency dividers operating up to 550 MHz have been developed at Plessey's Allen Clark Research Center, Caswell, Northampton, England. These dividers are the first circuits to employ Plessey's new high-speed emitter-coupled logic process. This is said to be comparable with Motorola's MECL III, as well as with the 10000 Series Motorola has recently introduced. Later, by adopting a

"bare-emitter" fabrication technique, Plessey hopes to boost the speed to the gigahertz region. Normally, signals in the 500 MHz range are handled by discrete tunnel diodes. When the new process is applied in operational amplifiers for low power medical applications, open loop gains of 1000 are obtained in circuits which consume about 1.5 microwatts of power.

A system study of a satellite communications system capable of transmitting TV programs to any western European country is to be carried out by STAR, a consortium of eleven European telecommunications manufacturers. Heading the group is Thomson-CSF, the French telecommunications company. An operational system is scheduled for 1978. ESRO, the European Space Research Organization, awarded the contract.

The world's first mobile laboratory for measuring odor as a form of air pollution is currently being operated in Sweden by the National Institute of Public Health and the Institute for Hygiene at the Karolinska Institute, Stockholm. The measuring equipment aboard the bus-laboratory features a mechanical device which relays fresh air with different concentrations of odor to hoods, where test personnel decide whether or not the air they are breathing is malodorous. It is hoped, in this manner, to establish an odor "threshold"—a concentration of smell that evokes similar responses in at least 50 per cent of the test subjects.

The technique for measuring odors was worked out jointly by psychologists, statisticians, doctors and technicians. The mobile laboratory, equipped for field work will take samples at sulphate mills and in traffic, as well as in other places.

New from Helipot... Standard Resistor Networks in dual in-line packages

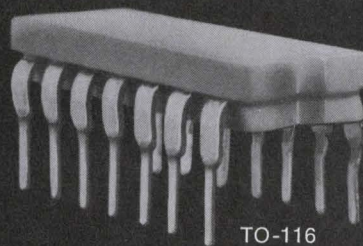

TO-116

DIGITAL PULL-UP NETWORKS

Model: 899-1-R2K and 899-1-R6K
For: unused gate pull-up, wired "OR" pull-up,
 parallel high speed pull-up
Standard Tolerance: $\pm 2.0\%$
Pricing: 1-99 \$1.45
 1,000-4,999 0.81

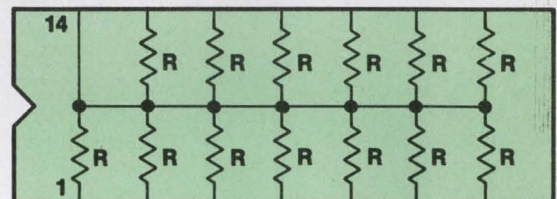

ANALOG SCALING NETWORKS

Model: 899-2-R10K
For: gain ranging, series attenuation,
 voltage division
Standard Tolerance: $\pm 0.1\%$ voltage ratio
Tracking: ± 15 ppm/ $^{\circ}\text{C}$
Pricing: 1-99 \$2.75
 1,000-4,999 1.55



DIGITAL LINE TERMINATOR ARRAYS

Model: 899-3-R110
For: twisted pair termination,
 coaxial line termination
Standard Tolerance: $\pm 2.0\%$
Pricing: 1-99 \$1.25
 1,000-4,999 0.72

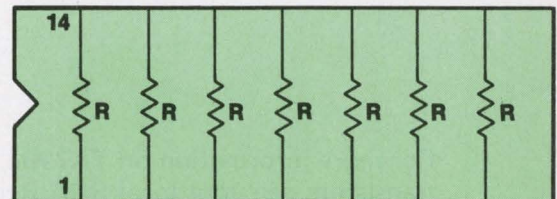

Beckman INSTRUMENTS, INC.

HELIPOT DIVISION
 FULLERTON, CALIFORNIA

HELPING SCIENCE AND INDUSTRY IMPROVE THE QUALITY OF LIFE

Call your local Helipot Sales Engineering Representative
 for additional information and application assistance.

TA 7994 - first commercially available, emitter-ballasted, microwave power transistor in a stripline package.

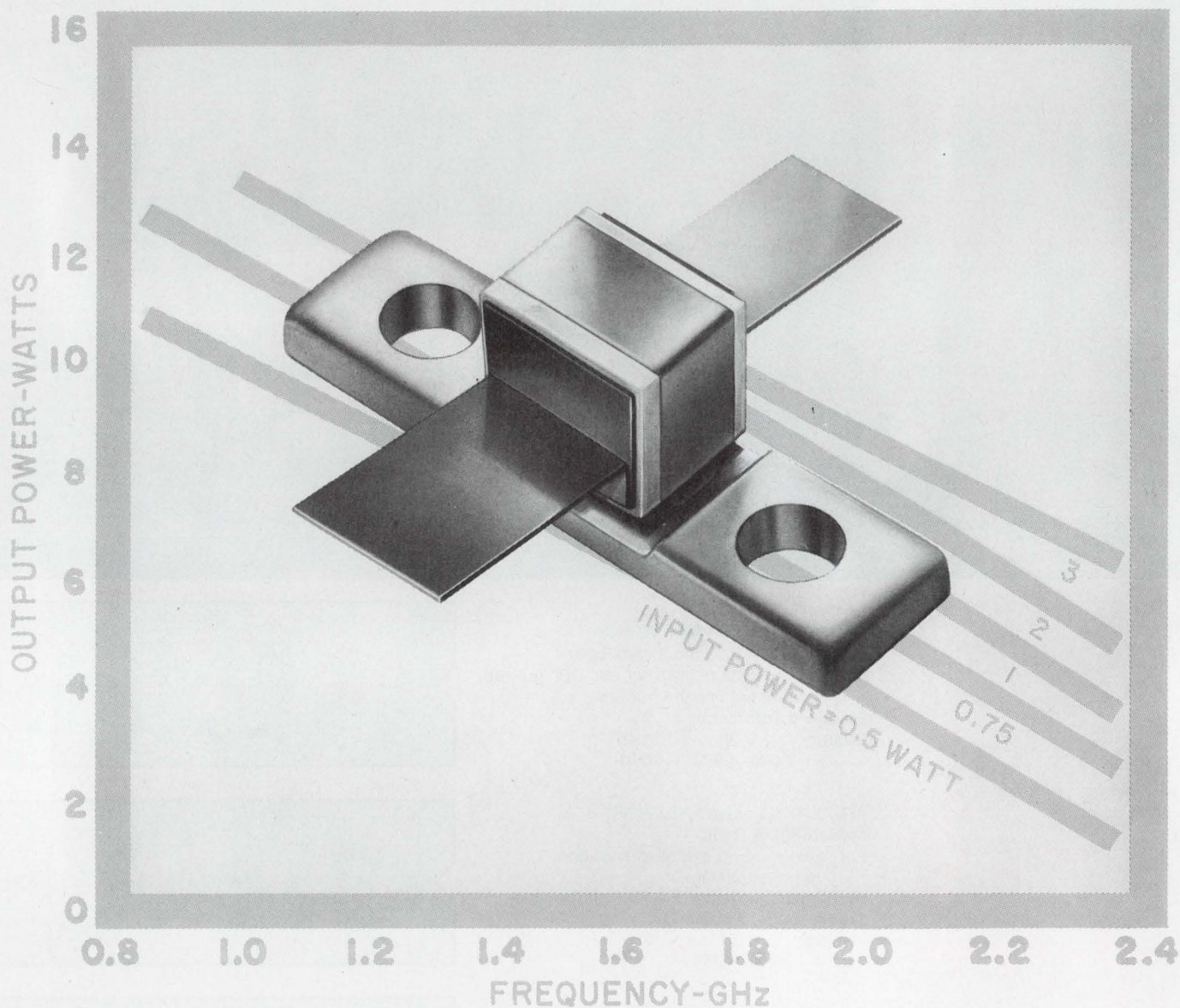

For more information on TA7994 and other RF power transistors, see your local RCA Representative or your RCA Distributor. For technical details, write: RCA, Commercial Engineering, Section 57D1/UF10, Harrison, N.J. 07029. International: RCA, 2-4 rue du Lièvre, 1227 Geneva, Switzerland, or P.O. Box 112, Hong Kong.

RCA
RF Devices

INFORMATION RETRIEVAL NUMBER 27

washington report

DON BYRNE, WASHINGTON BUREAU

Navy pushes LAMPS helicopter program

The Navy says it expects to issue requests for proposals on its light airborne multi-purpose system (called LAMPS) helicopters this June. Meanwhile the Naval Ship Systems Command has submitted plans to the Chief of Naval Operations for a new class of escort vessel to accommodate the new helicopters. The Navy estimates it will take another year to a year and a half to fix plans for the vessels. The helicopters are to be used primarily for antisubmarine warfare. The Navy plans to buy 369 of the craft eventually and has asked for \$68.5-million in this year's budget for the program.

Army and Air Force see sturdy Loran D market

The Army and Air Force are looking at proposals for Loran D navigational packages and see a possible market of more than 3000 sets. Loran D's ground transmitter network is air-transportable and can be set up for operation in less than 48 hours. (See "New Airborne Unit Planned for Tactical Loran," ED 15, July 19, 1970, p. 40.)

The Army wants the packages installed on 2500 helicopters, and the Air Force says it expects to install the units in 600 tactical aircraft. The Army would also like to equip many of its combat vehicles, such as tanks, armored troop carriers and even jeeps, with Loran D. It says it is also working on Loran D manpack gear for use by infantry patrols.

The Air Force now uses an airborne receiver-computer unit, the AN/ARC-92, made by ITT for Loran C/D navigation, but it is looking for a replacement that would be about one-fifth the present size for installation in fighter and transport planes.

NASA to try Apollo controls in aircraft

The National Aeronautics and Space Agency will install Apollo spacecraft electronic controls in an F-8C fighter in an effort to prove that tomorrow's aircraft can be flown electronically, or "by wire" as the spacecraft are. The electronic system would replace the complicated mechanical and hydraulic systems now used to control aircraft. NASA proposes a digital system using signals coming to a computer from sensors which read aircraft movement and the pilot's control column motion. The computer then transmits commands to the appropriate control surfaces of the aircraft. NASA expects to have the equipment installed this fall and in operation by next spring.

MCI-Lockheed joins domestic satellite sweepstakes

Just before the curtain rang down on filings for a domestic communications satellite system, the Lockheed Missiles and Space Co. and the Microwave Communications of America group presented a joint plan to the Federal Communications Commission. A new corporation formed by the two companies, called MCI-Lockheed Satellite Corp., proposed a system

that would utilize two satellites in synchronous orbit. The system would be capable of handling 48 television channels or 33,600 data circuits. The cost was set at \$168-million, with projected annual revenues of \$70-million.

Financing, according to the proposal, would be arranged through public stock offerings, private investment or a combination of both. MCI-Lockheed said it could have the system in operation by 1975.

In the last-minute scramble to file, Western Union, the first to put in its application months ago, revised its original proposal by adding another satellite. Similar expansions were filed by AT&T and Comsat, RCA, GT&E and Hughes Aircraft Co.

Standards for computer-telephone linkups?

A recent conference between Federal Communication Commission staffers, representatives of Telephone Companies and manufacturers of private branch exchanges (PBX) may lead to standardization and certification of connection devices between computers and the national telephone network. Under the FCC's Carterfone decision, and later definitions of that decision, a protective device must be attached to all customer-owned terminal equipment to keep it from feeding faulty electronic signals into the telephone network. The problem for computer manufacturers in designing gear to be hooked up with the telephone system—say for a time-sharing operation—is that standards for the protective devices have not been worked out. Although the telephone company provides such a device, many manufacturers prefer their own.

At the meeting a working group was set up to end what has been an impasse. Bernard Strassburg, chief of the FCC Common Carrier Bureau, who ran the meeting of about 100 representatives, said that similar meetings might be held in the future for other types of equipment.

Capital Capsules: NASA estimates that the re-opening of the Mississippi Test Facility near New Orleans in early 1973 will mean about 500 jobs for engineers and test personnel, split evenly between contractors and Government employees. Tests on the forthcoming space-shuttle engine are to run for about five years. At its peak seven years ago, the facility employed 4500 people. . . . For some time, Aeronautical Radio, Inc., a communications subsidiary of the airlines, has been saying that it may go to its own microwave communications system if common-carrier rates go up. However, at a recent rate hearing before the FCC, the AT&T made public the findings of a study it had ordered on Arinc's proposed private system. **The findings charged that the system was badly engineered, full of errors, probably would not work and would cost far beyond the \$391-million price tag set by Arinc.** The report was compiled for AT&T by Marvin L. Norton of Northrop Page Communications Engineers, Inc. . . . **McDonnell Douglas and North American Rockwell have received \$3.4-million contract extensions** for their work on the design, development and fabrication of an information management program that is to be used for testing subsystems in the manned earth-orbital space station. The contracts run through the balance of this year . . . **The Treasury Dept. is expected to issue a "dumping" finding against Japanese TV manufacturers,** opening the door for higher duties on the Japanese imports. The Federal Trade Commission has already ruled that Japanese TV makers are offering their sets in this country at prices lower than they charge in Japan. The Treasury Dept. agrees with this ruling. Customs would get the job of assessing higher duties. This may take months, officials say.

Simpson® has the world's largest selection of

PANEL METERS and METER RELAYS

OVER 1500 RANGES, SIZES AND TYPES IN STOCK AT ELECTRONIC DISTRIBUTORS NATIONWIDE



WIDE-VUE
1 1/2", 2 1/2", 3 1/2", 4 1/2", 8"



DESIGNER SERIES
3 1/2", 4 1/2"

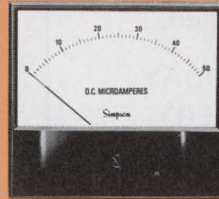

NEW CENTURY SERIES
1 1/2", 2 1/2", 3 1/2", 4 1/2"



BOLD-VUE
2 1/2", 3 1/2"



RECTANGULAR
2 1/2", 3 1/2"
round style available

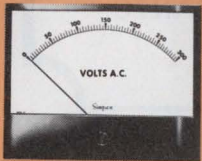

RUGGED SEAL
3 1/2", 4 1/2", 4" x 6"

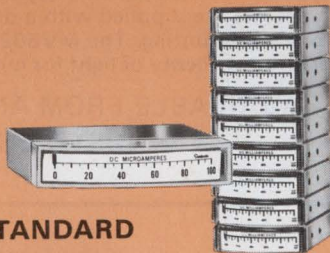

STANDARD EDGEWISE
1 1/2", 2 1/2"

STACKABLE EDGEWISE
1 1/2", 2 1/2"



NEW 3 1/2" STACKABLE EDGEWISE METER

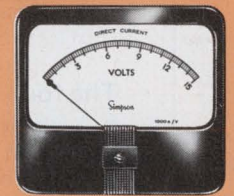

RECTANGULAR
4 1/2"



DIGITAL
Model 2800



PYROMETERS
4 1/2"



METER RELAYS
3 1/2", 4 1/2", 4" x 6"



NEW 3 1/2" EDGEWISE CONTROLLER
Many features.
Request Bulletin C1206

- THE ABOVE PANEL METERS ARE AVAILABLE IN AC/DC VOLTMETERS, AMMETERS, MILLIAMMETERS, MICROAMMETERS . . . DC MILLIVOLTMETERS AND GALVANOMETERS . . . RF AMMETERS AND MILLIAMMETERS.
- METER RELAYS AVAILABLE IN DC MICROAMPERES, MILLIAMPERES AND MILLIVOLTS . . . AC AMPERES

- MATCHING WATTMETERS, RADIO FREQUENCY, SEGMENTAL, VU AND DB, RECTIFIER AND ELAPSED TIME METERS ALSO AVAILABLE.

- SIMPSON CAN MAKE CUSTOM PANEL METERS AND METER RELAYS TO YOUR SPECIFICATIONS. ANY PRACTICAL RANGE CAN BE SUPPLIED. SEND US YOUR REQUIREMENTS.

GET "OFF-THE-SHELF" DELIVERY FROM YOUR LOCAL ELECTRONIC DISTRIBUTOR. WRITE FOR NEW CATALOG 3000A.



SIMPSON ELECTRIC COMPANY

5200 W. Kinzie St., Chicago, Ill. 60644 • (312) 379-1121 • Cable: SIMELCO

IN CANADA: Bach-Simpson Ltd., London, Ontario

IN INDIA: Ruttonsha-Simpson Private Ltd., International House,
Bombay-Agra Road, Vikhroli, Bombay



MANUFACTURERS OF THE WORLD FAMOUS SIMPSON 260®



1/10th of an inch and shining.

That's our mighty MV50. The available LED from Monsanto.

750 ft-L at only 20 mA and 1.6 V.

Great, for a little light that will last 10^6 hours. Bright, small and available NOW, off-the-shelf, in almost any quantity you need.

CALL YOUR DISTRIBUTOR TODAY FOR 'OFF-THE-SHELF' DELIVERY

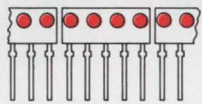

.10" Center to Center
Actual Size

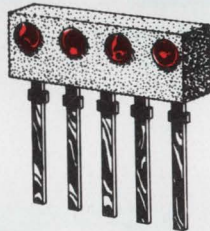

The four-in-one MV5040

Four times the indicating ability for your diagnostic or panel light needs. The MV5040 is actually 4 LED's in one easy-to-handle, easy-to-mount package.

It is ideal for array mounting with .10 inches center-to-center when stacked end-to-end.

Brightness is a high 1,000 ft-L (typ.) and it features the same long life, small size and ruggedness you have grown to expect from Monsanto GaAsLite products.

IN STOCK NOW AT YOUR MONSANTO DISTRIBUTOR

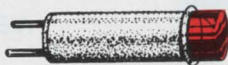

Plug an LED in your socket.

The Monsanto MV9000 series cartridge lamps will fit your indicator needs - from 4 to 30 volts. These long lasting LED's are mounted in a standard black aluminum case and are offered with red, green or amber clear plastic lenses.

The NEVER-REPLACE-REPLACEMENT features a projected life of 10^6 hours and requires only 10 to 50 milliamps to operate.

READY FOR YOUR SOCKET AT ANY MONSANTO DISTRIBUTOR

GaAsLITE Update

FEATURING THE AVAILABLE LEDs

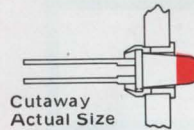

Cutaway
Actual Size



Panel indication is a SNAP - with the MV5020 Series

This series of four panel lights will fit right in to your 1/16 or 1/8 inch panel. They are available in four lens types and are supplied with a dual purpose snap-in clip for easy mounting. The MV5020 offers 750 ft-L (typ.) brightness. Plenty of light for most ambient conditions.

AVAILABLE FROM ANY MONSANTO DISTRIBUTOR

MONSANTO DISTRIBUTORS

the on the shelf source for GaAsLITE products from Monsanto. Call today to order or discuss product applications.

- Elmar Electronics (415) 961-3611
- Kierulff Electronics (415) 968-6292
- K-T/WESCO (213) 685-9525
- Liberty Electronics (213) 776-6252
- Schweber Electronics (516) 334-7474
- Semiconductor Specialists (312) 279-1000
- Western Radio (714) 239-0361

Monsanto

For additional technical information write
Monsanto Electronic Special Products
10131 Bubb Road, Cupertino, California 95014
(408) 257-2140

editorial

Control your work or it will control you

Two apparently unrelated types of news stories keep coming up in the popular and business press:

The first is the news item stating that Ralph Rustic, a famed environmentalist, claims that engineers are responsible for just about everything that's wrong with this world—from air pollution to traffic jams.

The second is the story of 4×10^8 California aerospace engineers who have just been laid off because of a cancelled contract.

In point of fact, these stories are not unrelated at all. They both reflect the fact that engineers exercise practically no control over their work or over their professional lives. Instead, they seem to be content to leave both the responsibility for, and the control of, their work in the hands of the men who pay them.

For example, if an electric power company decides that it's cheaper to build a power plant that pollutes the atmosphere than one that does not, then its engineers will build a stinkpot. And if the same company feels that it won't be needing any new plants for a while, then its engineers will be laid off.

The lesson, I think, is obvious: Keeping your nose clean and doing what you're told is no way to guarantee the security of your job. And while we don't want to suggest that taking responsibility for the consequences of your work will safeguard your job, we do feel that failure to take such responsibility will ensure that it will never be secure.

MICHAEL J. RIEZENMAN

Mike Riezenman

Test nonlinear system stability with the 'circle criterion.'

It defines sufficient, but not necessary, conditions for feedback-system stability.

Stability analysis is always a headache in control system design. When the control system is nonlinear, the headache may assume epic proportions unless a convenient stability criterion can be applied.

The "circle criterion" is convenient. It applies to feedback systems that can be represented by the block diagram of Fig. 1a, where the nonlinearity can be bounded as shown in Fig. 1b. It should be noted that the circle criterion provides sufficient, but not necessary, conditions for stability.

It's easy to apply the circle criterion. Simply follow these five steps:

1. Draw the Nyquist diagram of $G(j\omega)$ in the $G(j\omega)$ plane. (The x-axis is $\text{Re}[G(j\omega)]$ and the y-axis is $\text{Im}[G(j\omega)]$.)
2. Determine the bounds, α and β , on the nonlinearity, as defined in Fig. 1b.
3. Plot the $-1/\alpha$ and $-1/\beta$ points in the $G(j\omega)$ plane (Fig. 1c).
4. Construct a circle of radius $(1/2)|(1/\alpha) - (1/\beta)|$ centered halfway between the two points (Fig. 1c).
5. Examine the Nyquist diagram of $G(j\omega)$. If the Nyquist plot does not intersect or encircle the region defined by the circle of Step 4, then the feedback system is stable.

These results should prove useful

Two commonly encountered nonlinearities are shown in Fig. 2 along with their associated prohibited regions. The first is that of a real-world linear amplifier—it has a linear gain, K , over a limited range, but will saturate if overdriven. For this case $\alpha = 0$, and the prohibited region is a semi-infinite plane covering the area to the left of the line $\text{Re}[G(j\omega)] = -1/K$.

The second nonlinearity is a comparator or switch. This nonlinear characteristic is typical of

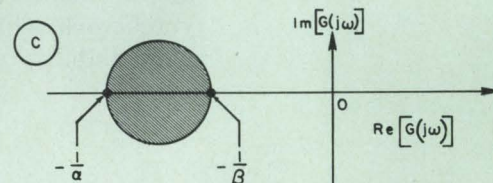
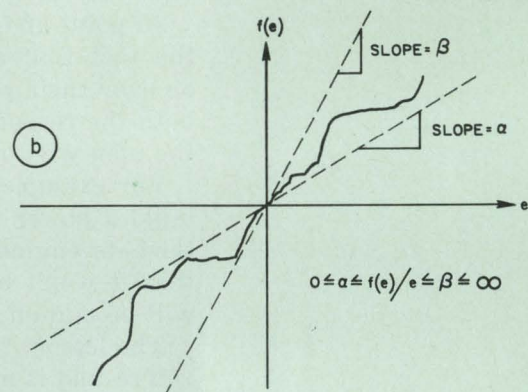
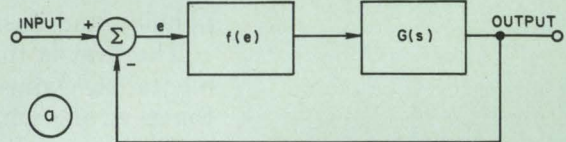

1. The circle criterion applies to systems like this (a) where $f(e)$ is a memoryless nonlinear transfer function (b) and $G(s)$ is the Laplace transform of the linear portion of the system. The prohibited region (c) is the circle centered between the points $\text{Re}[G(j\omega)] = -1/\alpha$ and $\text{Re}[G(j\omega)] = -1/\beta$.

"bang-bang" servos, such as the thermostats used to control refrigerators and household furnaces. (Often this type of servo has considerable hysteresis; this means that it violates the requirement that it be memoryless, and so the circle criterion cannot always be used.) The switch characteristic is bounded only by the values $\alpha = 0$ and $\beta = \infty$; hence the prohibited region is the entire left-half plane.

To see how the circle criterion is applied, consider the circuit of Fig. 3a. The Nyquist plot of $G(j\omega)$ is shown in Fig. 3b along with the prohibited region. Since the plot does not intersect

Gaylord W. Carlock, Aerosystems Engineer, Radar and Navigation Section, Mail Zone 2448, General Dynamics, P. O. Box 748, Fort Worth, Tex. 76101.

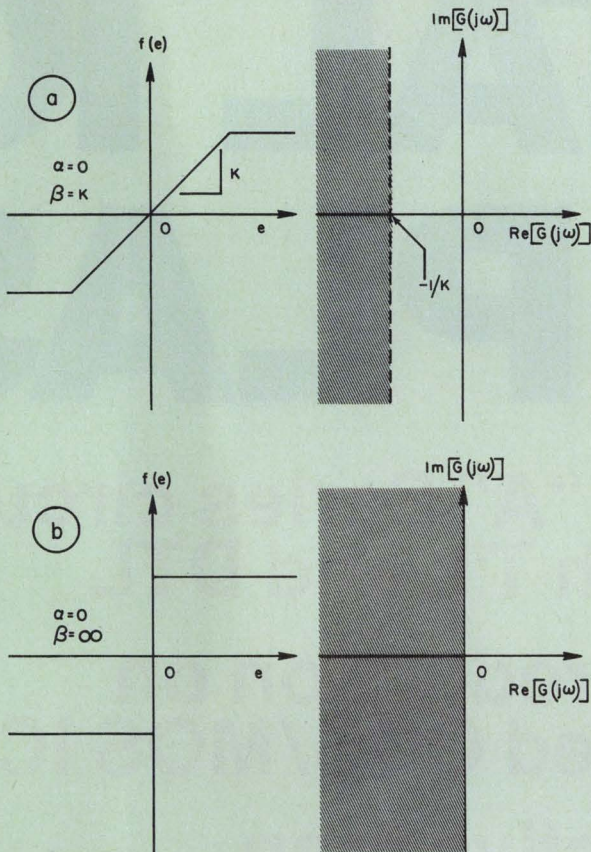

2. Since the real world is not linear, it is helpful to be able to deal with its more common nonlinearities. The saturating amplifier (a) and the switch (b) have semi-infinite planes for prohibited regions.

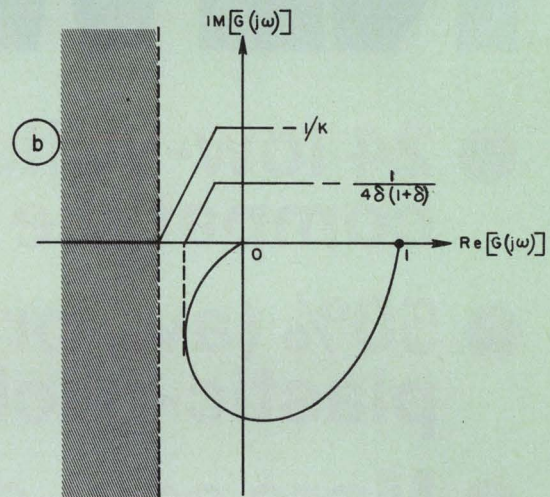
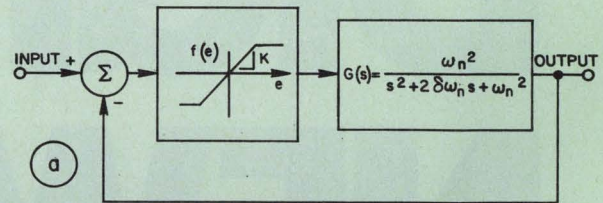

3. This amplifier circuit (a) will remain stable so long as $K < 4\delta(1 + \delta)$, as shown in the $G(j\omega)$ -plane diagram (b). The unsaturated amplifier, without feedback, has a gain of K at dc.

the prohibited region as long as $(-1/K) < -1/4\delta(1 + \delta)$, the system is stable for all $K < 4\delta(1 + \delta)$ by the circle criterion. ■■

Bibliography

Sandberg, I. W., "A Frequency-Domain Condition for the Stability of Feedback Systems Containing a Single Time-Varying Nonlinear Element," *Bell System Technical Journal*, July, 1964.

Zames, G., "On the Input-Output Stability of Time-Varying Nonlinear Feedback Systems—Part II: Conditions Involving Circles in the Frequency Plane and Sector Nonlinearities," *IEEE Transactions on Automatic Control*, Volume AC-11, No. 3, July, 1966.

Test your retention

Here are questions based on the main points of this article. Their purpose is to help you make sure you have not overlooked any important ideas. You'll find the answers in the article.

1. What is the circle criterion?
2. How are the points $-1/\alpha$ and $-1/\beta$ determined?
3. What are the limitations on the types of nonlinearities to which the circle criterion applies?

FROM RCA

NEW 3-15V DIGITAL IC NEW PLAS

- 24 low-voltage "A" Series circuits compatible with T²L and DTL
- 50% (av.) price reduction on plastic-packaged COS/MOS ICs
- More cost-effective than saturated logic

See your local RCA Representative or RCA Distributor for COS/MOS IC price and delivery information and a copy of RCA's new "Low-Voltage COS/MOS Product Guide" (COS-278), which presents basic data on RCA's complete COS/MOS line. Copy of this product guide may also be obtained by writing to RCA, Commercial Engineering, Section 57D-1/CDC58, Harrison, N.J. 07029. International: RCA, 2-4 rue du Lièvre, 1227 Geneva, Switzerland, or P.O. Box 112, Hong Kong.

COS/MOS

SHOCKING TIC PRICES

RCA, Commercial Engineering
Section 57D-1/CDC58, Harrison,
N.J. 07029.

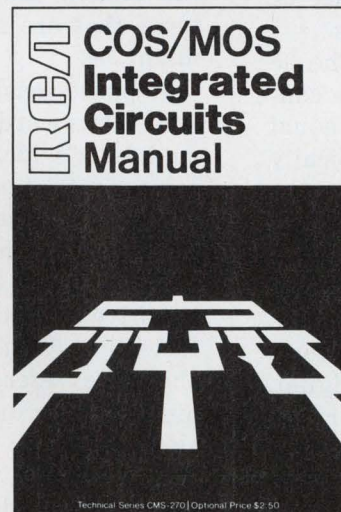

COS/MOS Manual CMS-270
may also be purchased at
your RCA Distributor's.

Send me RCA's new COS/MOS IC
manual CMS-270 that provides de-
vice fundamentals including charac-
teristics, processing essentials, and
layout procedures. This complete
guide to existing RCA COS/MOS
products contains an informative
"how to use and design" section plus
extensive applications data.

Name _____

Title _____

Company _____

Street _____

City _____

State _____ Zip _____

Enclosed please find my check or
money order for \$2.50*

*Optional price.

RCA
Solid State

INFORMATION RETRIEVAL NUMBER 69

Save money with analog multipliers.

The new low-cost IC units make multipliers more attractive than conventional circuitry for many applications.

Second of three articles

Until recently, analog multipliers were so expensive that they were used only where no other devices would do. The new IC units, however, with price tags in the \$20 to \$30 range, make it possible for the engineer to use them in a wide variety of applications.

Here are some areas, beyond that of computation, in which they can be applied:

- Rectification.
- Phase-sensitive demodulation.
- Automatic level control.
- Rms power measurement.
- Building phase-locked loops.

In some cases the multiplier approach costs less than the conventional methods. In others, it simply works better. Often, it has both of these advantages.

Reducing rectifier ripple

It is probably not obvious to engineers who are accustomed to thinking of an analog multiplier as a computation element that the device makes an efficient, precision, full-wave rectifier. Nonetheless, the circuit of Fig. 1 develops a dc output from ac inputs, and matches the performance of many circuits based on op amps and diodes.

Because of the comparator's high gain, the ac signal applied to the multiplier's X input is converted to a square wave whose amplitude is equal to the comparator's full-scale swing—typically ± 10 V. The multiplier's Y input receives the unmodified sinusoidal input. Since the multiplier's output is proportional to the product of the two analog inputs ($V_o = V_x V_y / 10$), we can see that, for a positive input, the output becomes $-10 \times V_y / 10 = -V_{in}$. This is because the comparator reverses the polarity of the input signal, applying -10 V to the X input whenever the input signal is positive. When V_{in} reverses polarity, the comparator applies $+10$ V to the

multiplier's X input, so the output remains negative. The circuit thus operates as a conventional full-wave rectifier, whose average dc output is $(2/\pi) \times V_{in(\text{peak})}$ and whose ac ripple frequency is twice the signal frequency.

An alternative rectifier circuit can be formed by omitting the comparator, and applying V_{in} to both X and Y terminals. In this case, the circuit functions as a squarer, and develops a dc output $\cos^2 A = (\cos 2A + 1)/2$. The double-frequency ac ripple then forms a much larger proportion of the total output (actually swinging between zero and twice the average dc value) than it does if the comparator is used.

Since the use of a comparator lowers the ac output component, it reduces the amount of filter capacitance required, permitting a much faster response to amplitude changes.

Cut harmonics in phase demodulators

Several circuits are available for precision full-wave rectification, so the arrangement of Fig. 1 is mainly an interesting illustration of the multiplier's capabilities. However, when it comes to phase-sensitive demodulation or null detection, the analog multiplier provides distinct advantages that are not as widely appreciated as they might be.

A phase-sensitive demodulator is similar to a straightforward rectifier, except that the demodulator's dc output is proportional to the component of signal that is in-phase with the reference source. For example, if a sinusoidal input signal is phase-displaced by an angle θ from its (coherent) reference source, then the phase-sensitive demodulator's output is reduced by a factor $\cos \theta$. Incidentally, it is possible to phase-shift the reference by 90° so that the circuit measures the quadrature component of the input signal.

Analytically, the rectifier of Fig. 1 is not unlike the ring demodulator of Fig. 2a except that the ring demodulator's two inputs, although coherent, are out of phase. For zero phase shift, the ring demodulator's dc output component is, in effect, proportional to the product of the input

Richard Burwen, Director of Advanced Development, Analog Devices, Inc., Rte. 1 Industrial Park, P. O. Box 280, Norwood, Mass. 02062.

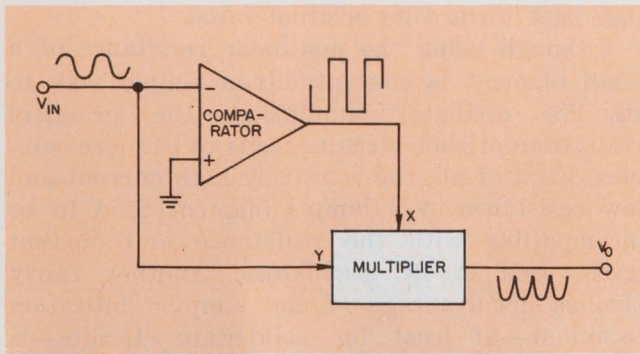

1. This multiplier circuit compares favorably in performance with precision rectifier circuits based on diodes and op amps. It works well whether the comparator is included or not. Adding the comparator reduces the output ripple.

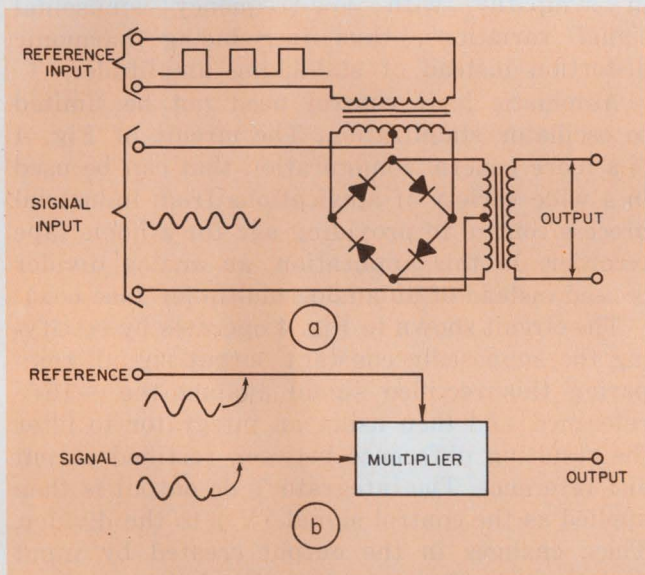

2. Not only is the ring demodulator (a) more expensive than the multiplier circuit (b) but it suffers from the frequency limitations of its transformer. In addition, it takes up much more room.

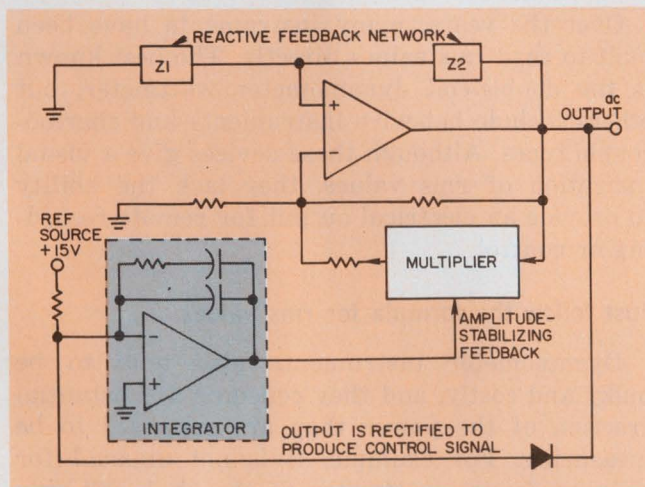

3. There's no troublesome lamp in this Wein bridge oscillator; instead, the automatic level-control function is performed by a multiplier. Increasing the output amplitude causes the multiplier to increase the amount of negative feedback to the oscillator.

signal and a reference square wave of unity amplitude, yielding a signal, after filtering, of KV_{in} . Phase shift between signal and reference introduces the factor $\cos \theta$, reducing the output to $KV_{in} \cos \theta$.

Unfortunately, this demodulation process leaves much to be desired in its handling of any odd harmonics contained in the input signal. In effect, the demodulation process multiplies the harmonic-laden input signal

$V_1 \sin \omega t + V_2 \sin 2\omega t + V_3 \sin 3\omega t + \dots$
by the square-wave reference, which may also be represented as an odd-harmonic power series
($E_1 \sin \omega t - E_3 \sin 3\omega t + E_5 \sin 5\omega t - \dots$).

Investigating this result more closely, we can see that the product of the signal's fundamental and the fundamental of the reference square wave produces a desired dc output component plus double-frequency ripple:

$V_1 E_1 \sin \omega t \sin \omega t = V_1 E_1 (1 - \cos 2\omega t)/2$,
where the dc component is $V_1 E_1/2$. It is also easy to appreciate that the product of the signal fundamental and any of the higher reference signal harmonics contributes no dc component to the output, but instead produces sum and difference components that are removed from the output by filtering.

However, interactions between the higher harmonics of the reference square wave and the odd harmonics of the input signal do, unfortunately, develop dc output components. Consider the multiplication of the third harmonic of the input signal by the third harmonic of the square-wave reference. This contributes a dc component to the output of value $V_3 E_3/2$. The same is true for the interaction between other harmonics of the input signal and corresponding harmonics of the square-wave reference.

This harmonic content can be a serious deficiency in servo positioning equipment whose accuracy depends upon the phase-sensitive detector's accuracy. The effect also degrades the performance of phase-sensitive null detectors, since harmonics can obscure accurate null readings.

A better phase-sensitive demodulator is based on an analog multiplier (Fig. 2b) rather than a ring of diodes. The most important difference between the two demodulators is that the multiplier unit is driven by a sinusoidal rather than a square-wave reference. In fact, the reference is often carefully filtered to eliminate harmonics. It is apparent that, because the reference is a pure sinusoid, there are no higher reference harmonics that can mix with the input signal's odd harmonics and create an output error.

Thus, for the best demodulator or null-detector accuracy, a true analog multiplier offers considerable advantage over the diode ring circuit. In addition, of course, the multiplier is simpler, it solves the low-frequency limitations of trans-

former coupling, and now, with multipliers available at low cost, the whole circuit will be considerably more economical than its more cumbersome alternative.

Automatic level control made simple

An analog multiplier is a natural for automatic level control because one of its inputs can always be thought of as a gain-control signal for the other. One practical application of this idea is in the stabilization of the amplitude of the output signal from a Wein bridge oscillator (Fig. 3). The multiplier is used to control the amount of negative feedback applied to the amplifier's inverting input terminal.

The more the output signal increases from its desired amplitude, the more the multiplier must

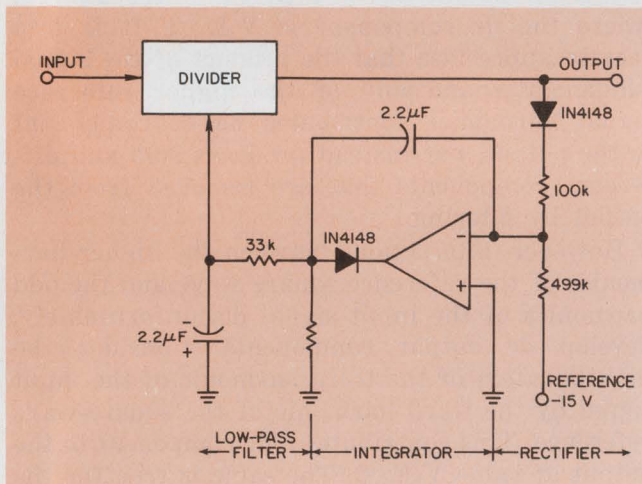

4. This ALC circuit uses an analog divider instead of a multiplier to control the output level. The input can vary from 0.7 V to 7.0 V rms and from 30 Hz to 50 kHz, and the output will remain within 1% of 7.0 V.

apply negative feedback to the amplifier's input terminal to bring the signal amplitude back to its correct level. Thus, the rectified difference between output and reference is applied by the integrator in order to pass more signal through the multiplier as the oscillator output rises. Conversely, reduced oscillator output cuts back the multiplier control signal, thereby lowering the negative feedback, and returning the circuit's output toward its correct level.

Traditionally, RC oscillators have been stabilized by introducing low-current lamps into the negative feedback path. In such circuits, the lamp current rises with the oscillator output amplitude, thereby heating the filament and developing an increased voltage across the lamp terminals. The increased voltage is introduced into the circuit in such a way as to increase the amount of negative feedback and return the output ampli-

tude back toward its original value.

Although using the nonlinear resistance of a lamp filament is conceptually a simple way to stabilize oscillator amplitude, the practical realization of such circuits tends to be more complex. First of all, the relatively high current and low resistance of a lamp's filament tend to be incompatible with the resistance and current levels used in RC oscillators. Another fairly obvious disadvantage of the lamp stabilization technique—at least for solid-state circuits—is lamp fragility and heat dissipation. Less obvious—unless one has recently tried to build a lamp-stabilized oscillator—is the difficulty of finding suitable lamps. Last, and perhaps most serious, is the fact that the low thermal inertia of low-current lamps enables the lamp to heat and cool in sympathy with low-frequency sinusoidal signal variations, thus introducing harmonic distortion instead of stabilizing amplitude.

Automatic level control need not be limited to oscillator stabilization. The circuit of Fig. 4 is a more general configuration that can be used in a wide variety of applications from industrial process control to providing agc for a home tape recorder. In this application, an analog divider is used instead of an analog multiplier (see box).

The circuit shown in Fig. 4 operates by rectifying the supposedly constant output signal, comparing this rectified signal against the -15-V reference, and then using an integrator to filter the resulting difference between rectified output and reference. The integrator's dc output is then applied as the control signal (V_x) to the divider. Thus, changes in the output created by input variations develop a control signal that compensates for the input changes. This simple circuit holds the ac output at 7 V within $\pm 1\%$ using a single integrator and half-wave rectifier diode.

Over the years, many instruments have been built to read rms values directly. The best known is the double-coil dynamometer wattmeter, but others include hot-wire instruments and thermocouple types. Although these devices give a visual indication of rms values, they lack the ability to provide an electrical output for remote recording or control.

Just follow the formula for rms values

Dynamometer instruments also tend to be bulky and costly, and they consume a substantial fraction of the power they are supposed to be measuring. For example, it is not unusual for a dynamometer wattmeter to absorb 1 volt-amp from the power source being monitored.

The circuit of Fig. 5 develops rms values by simply performing the mathematical operations called for by the definition of rms. It squares the

Using other multipliers

All of the circuits described in this article are built with the Analog Devices model AD530J multiplier. This unit has a built-in output amplifier—it can be used as a divider or square rooter simply by strapping the appropriate terminals together and using the right input terminals.

Multipliers that do not contain their own output amplifiers can be made to act as dividers or square rooters by adding an op amp and hooking them up as shown in the diagram.

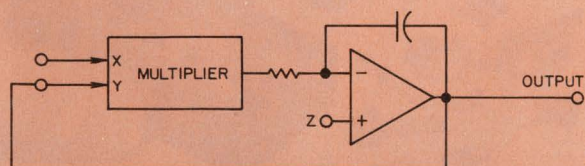

DIVIDER: $V_{OUT} \cong Z/X$

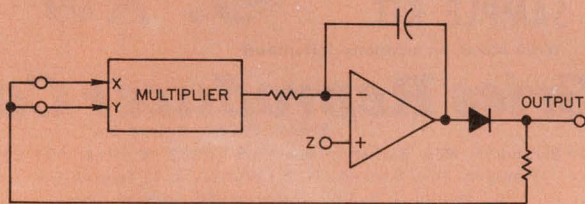

SQUARE ROOTER: $V_{OUT} \cong \sqrt{Z}$

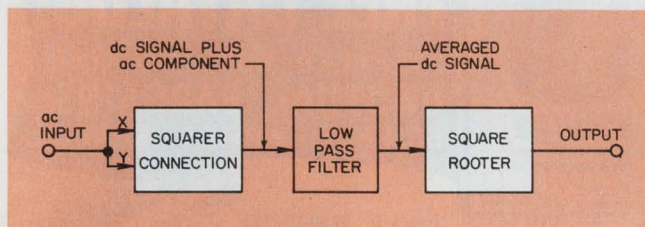

5. Two multipliers and a filter make a low-cost rms measuring circuit. The square rooter is an AD530J multiplier hooked up in its square-rooter connection.

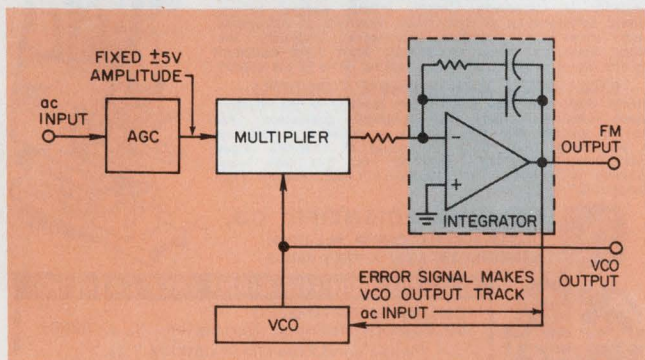

6. The multiplier is the phase detector in this phase-locked loop. The integrator filters out the ac component of the multiplier's output, leaving a dc signal proportional to the frequency modulation on the ac input.

input, forms its mean by low-pass filtering it, and then extracts the square root of the mean-square (see box). The circuit not only develops ± 7 V (for a 20-V p-p input) at 5 mA for driving a visual rms indicator (voltage, current or power), it has the additional advantage of developing sufficient electrical output for subsequent processing or recording. For example, the configuration could be used with a portable alternator to adjust the excitation for optimum power factor, or provide feedback proportional to rms (rather than average) values in other control applications.

Phase-locked loops can also benefit

Many tricks can be performed with phase-locked loops, among them the extraction of information from a frequency-modulated carrier signal, the reproduction of a distorted, jittery, or weakly received signal and, with additional divider circuitry, the synthesis of thousands of discrete frequency values that are digitally related to some highly stable frequency source.

In building phase-locked loops, an analog multiplier can be used as a phase detector (Fig. 6). The phase-locked loop (PLL) controls the phase and frequency of the voltage-controlled oscillator (VCO), causing the VCO to operate in synchronism with the incoming signal. If the input signal varies in frequency, then the multiplier's output error signal brings the VCO back into the correct phase relationship with the input. The multiplier's filtered output also provides a signal proportional to the frequency-deviation of the carrier, thus acting as an FM demodulator.

At synchronism, the VCO operates 90° out of phase with the input signal. Carrier signal $V_1 \sin \omega t$ and VCO signal $V_2 \sin (\omega t + \theta)$ are applied to the multiplier, resulting in output components $V_1 V_2 \cos \theta$ and $V_1 V_2 \cos 2\omega t$. The dc component— $V_1 V_2 \cos \theta$ —is zero for $\theta = 90^\circ$, but any deviation from synchronism alters the relative phase shift between input and VCO signals, producing a non-zero multiplier output that brings the VCO phase back into alignment with the input. The integrator's purpose is to remove the double-frequency component present in the multiplier's output and to feed only the dc control signal to the VCO.

Phase-locked loops are widely used to demodulate ac carrier signals. A rather different application is generating clean and highly stable reference frequencies from, for example, NBS time and frequency broadcasts. If the received signal is subject to fading, introducing a sort of flywheel into the system can eliminate jitter and compensate for phase shifts caused by multiple signal reflections. In this instance, the local voltage-controlled oscillator can produce a more stable and pure signal than the NBS broadcast. ■■

Broadband Low Distortion RF Power Amp

- 10 watts output
- Flat response from .05 to 80 MHz



Model RF-805 is a solid-state amplifier with -30 db harmonic and intermodulation distortion. Gain is 47 db minimum, constant within 1 db for full output with less than 0.1 volt at 50 ohm input.

Tunable 10-500 MHz RF Power Amp

- Up to 8 watts into 50 ohms
- Small and lightweight
- 35 db minimum gain

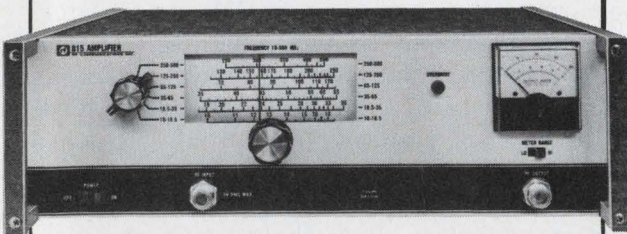

Model RF-815 is tunable in six band-switched ranges from 10 to 500 MHz. All solid state except for the one tube output stage, the unit's simple mechanical design makes maintenance easy. Output metering and overload protection are provided.

Applications

Radio Communications • Laser Modulation • Accelerator Driver • NMR • RF Power Calibration • Ultrasonics • Transmitter Driver



RF COMMUNICATIONS, INC.

Electronic Instrumentation Operation
1680 University Avenue
Rochester, New York 14610
Telephone: 716-244-5830 TWX: 510-253-7469
A Subsidiary of Harris-Intertype Corporation

INFORMATION RETRIEVAL NUMBER 30

See us at the Design Show • Booth #1639

SAMPLES PROVE IT!

See what "higher value"

**GRC TINY
ZINCALLOY
DIE CASTINGS**
can do for you



Get this
SAMPLE KIT

Write today on company letterhead

Gries Reproducer Co.

Division of Coats & Clark Inc.

40 Second St., New Rochelle, New York 10802 • (914) 633-8600
Plants in: New Rochelle, N. Y.; Warren, R. I.; Toccoa, Ga.
In Canada: Gries Div., Dyncast Ltd. Lachine, Que.

INFORMATION RETRIEVAL NUMBER 31

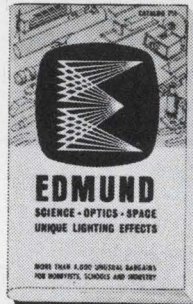

FREE CATALOG!

148 PAGES • MORE THAN 400
UNUSUAL BARGAINS
SCIENCE • OPTICS • SPACE

1000's OF HARD-TO-FIND
BUYS FOR INDUSTRY.

Speed your work! Improve quality! Cut development and production costs! Completely new edition loaded with on-the-job helps, quality control aids, unique items available nowhere else. 148 easy-to-read pages packed with new products, charts, diagrams, illustrations. A treasure house of optical and scientific equipment available direct from stock for industry, research labs, design engineers, experimenters, hobbyists.

AMERICA'S GREATEST ONE-SOURCE MARKET PLACE

Hard-to-get surplus bargains. Ingenious scientific tools. Thousands of components: lenses, prisms, wedges, mirrors, mounts, accessories of all descriptions. Hundreds of instruments: lasers, comparators, magnifiers, microscopes, projectors, telescopes, binoculars, photo attachments, black light equipment and the largest selection of unique lighting items in the country.

ORDER DIRECT WITH ABSOLUTE CONFIDENCE

Edmund ships more than 5,000 orders monthly to the country's largest industrials. Every item completely guaranteed. You must be satisfied with any purchase or return it in 10 days for your money back. Shop the catalog of America's largest Science-Optics-Space Mart. Send for your free copy today. Absolutely no obligation. No salesman will call. Request FREE catalog "DA".

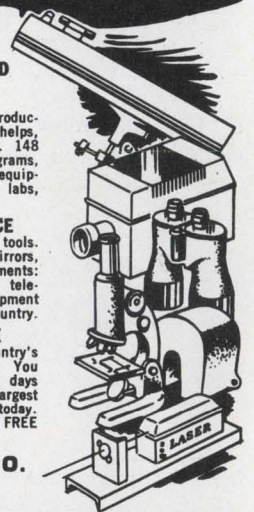

EDMUND SCIENTIFIC CO.
300 EDSCORP BLDG.
BARRINGTON, NEW JERSEY 08007

MAIL COUPON FOR GIANT FREE CATALOG!

EDMUND SCIENTIFIC CO.
300 Edscorp Building, Barrington, N. J. 08007
Please send Free Giant Catalog "DA"

NAME _____
COMPANY _____
ADDRESS _____
CITY _____ STATE _____ ZIP _____



INFORMATION RETRIEVAL NUMBER 32

ELECTRONIC DESIGN 7, April 1, 1971

Choose from 47 styles of film capacitors...

There's one to meet your exacting requirements

HERMETICALLY-SEALED METAL CASE TUBULAR CAPACITORS



BARE METAL CASE

Style LJ8, metalized polysulfone film
 Style LP8, metalized polycarbonate film
 Style LM8, metalized PETP-polyester film
 Style LS8, metalized polystyrene film
 Style AP8, polycarbonate film
 Style AM8, PETP-polyester film
 Style AS8, polystyrene film
 Style AF8, PTFE-fluorocarbon film

METAL CASE WITH INSULATING SLEEVE

Style LP9, metalized polycarbonate film
 Style LM9, metalized PETP-polyester film
 Style LS9, metalized polystyrene film
 Style AP9, polycarbonate film
 Style AM9, PETP-polyester film
 Style AS9, polystyrene film
 Style AF9, PTFE-fluorocarbon film

WRAP-AND-FILL ROUND TUBULAR CAPACITORS



Style LJ66, metalized polysulfone film
 Style LP66, metalized polycarbonate film
 Style LP88, met. polycarb. film (Fuz-ion Sealed*)
 Style LM66, metalized PETP-polyester film
 Style LS66, metalized polystyrene film
 Style AP66, polycarbonate film
 Style AM66, PETP-polyester film
 Style AS66, polystyrene film

*Trademark

EPOXY-CASE RECTANGULAR CAPACITORS



AXIAL-LEAD

Style LP7A, metalized polycarbonate film
 Style LM7A, metalized PETP-polyester film
 Style LS7A, metalized polystyrene film
 Style AP7A, polycarbonate film
 Style AM7A, PETP-polyester film
 Style AS7A, polystyrene film

RADIAL-LEAD

Style LP7S, metalized polycarbonate film
 Style LM7S, metalized PETP-polyester film
 Style LS7S, metalized polystyrene film
 Style AP7S, polycarbonate film
 Style AM7S, PETP-polyester film
 Style AS7S, polystyrene film



WRAP-AND-FILL OVAL TUBULAR CAPACITORS



Style LP77, metalized polycarbonate film
 Style LM77, metalized PETP-polyester film
 Style LS77, metalized polystyrene film
 Style AP77, polycarbonate film
 Style AM77, PETP-polyester film
 Style AS77, polystyrene film

HERMETICALLY-SEALED METAL CASE RECTANGULAR CAPACITORS



Style CML, high voltage paper/PETP-polyester film, inserted tab construction.

HERMETICALLY-SEALED CERAMIC CASE TUBULAR CAPACITORS



Style SML, high voltage paper/PETP-polyester film, inserted tab construction.
 Style SMLE, high voltage paper/PETP-polyester film, extended foil construction.

HERMETICALLY-SEALED GLASS CASE TUBULAR CAPACITORS



Style GML, high voltage paper/PETP-polyester film, 85 C
 Style GTL, high voltage paper/PETP-polyester film, 125 C

EPOXY CASE RECTANGULAR CAPACITORS



Style EFX, high voltage paper/PETP-polyester film.

For engineering bulletins on the capacitor styles in which you are interested, write to Dearborn Electronics, Inc., Box 530, Orlando, Fla. 32802.

Dearborn Electronics, Inc.
 (a subsidiary of the Sprague Electric Company)

FOREMOST IN FILM CAPACITORS

INFORMATION RETRIEVAL NUMBER 33

Specify custom cores the right way.

Use this simple form and a systematic approach to memory specification. It can reveal some unexpected trade-offs.

In large quantities, custom-designed core memory systems are superior on a cost-performance basis to standard designs. In the first place, since the custom design includes only those features you want, you won't be paying for something you didn't need. And, second, the job of specifying a custom memory need not be difficult—if you use a systematic approach and a simple form, like the one shown.

This form is not a substitute for a complete specification, but it covers the essential points. It is designed as a guide to raise questions about interface and system costs that should be resolved before a development program gets under way. Each item in the form, and the trade-offs involved, are described for core memory systems, but the same system can be applied to other types of memories—with different trade-offs.

Brief discussions of the form items follow.

Memory capacity

Since the lowest cost memory stack is packaged on a single card, the most frequently sold capacity can determine the basic module size. The specification form asks for the most commonly used storage capacity. Smaller capacities than the basic module are then achieved by a reduction in memory stack size, and larger capacities by mixing modules containing various stack sizes. This will result in added economies in inventory and stocking of spare parts. In most cases, the control electronics are identical, no matter how big the stack.

Memory capacity is usually described in terms of a binary multiple of 1024 words, each of which contains a specified number of bits. A basic-system memory module may be used as a plug-in unit to expand the total system capacity.

Minicomputer manufacturers frequently select a rather small capacity—typically, 4096 words—as the basic module size for marketing standardization. This is because it is convenient to use 4k

blocks of words to assemble the commonly used 8k, 12k and 16k capacities. But it has been generally overlooked that a high percentage of minicomputers sold contain a minimum of 8k of storage—and a single 8k block is considerably less expensive than two 4k modules.

Operating modes and speed

These sections describe the memory's intended use and cycle time. List only those modes that optimize the surrounding system—don't overspecify.

The implications of speed, relating to memory design, are often misunderstood. An engineer who is seeking superior safety margins by specifying 1.0 μ s when he intends to operate at 1.5 to 2.0 μ s may be defeating his purpose, because he has demanded tighter timing tolerances than are necessary. These tolerances grow tighter as design speed rises, and a point is ultimately reached where circuit components must be matched and selected to set pulse widths within the proper limits. Then trouble shooting and component replacement become more difficult, and parts costs rise.

Specify the largest timing tolerances possible, since this permits the use of standard components and reduces manufacturing and maintenance costs.

Speed also affects power demand. In a small 2.0- μ s design, inhibit drivers might need a 5-V drive. The same system, designed for 1.0 μ s, even though it is used at 2.0 μ s, requires 12 V, a power increase of 140% if the current remains the same. This means more heat dissipation and lower reliability.

Access time is also important. Buffering of memory outputs minimizes some production problems, but it increases access time because of propagation delays through the buffering devices.

Additional output signals

A custom-designed memory offers many options in specifying memory output signals without significantly influencing costs. Whether

CORE MEMORY SPECIFICATION FORM

MEMORY CAPACITY:

Number of words/module _____
Expandable to _____ words
Number of bits/word _____
Most frequently used storage capacity _____ words
Maximum total storage capacity _____ words

OPERATING MODES:

Full cycle (clear/write, read/restore) _____
Split cycle (read/modify/write) _____
Other _____

ADDRESSING:

Single sided _____ Double sided _____
With address register _____
Without address register _____

OPERATING SPEED:

Maximum full cycle: _____
Maximum split cycle: _____
Access time: _____
Average duty cycle: _____

SPECIAL FEATURES:

Data protection with power failure _____
Other _____

ADDITIONAL OUTPUT SIGNALS:

Memory busy _____ logic level _____
Cycle complete _____ logic level _____
Data available _____ logic level _____
Memory available _____ logic level _____

POWER AVAILABLE:

_____ Watts maximum, operating at _____ °C _____ (rate)
_____ Watts maximum, standby
_____ Volts (dc) at _____ amperes ± _____ % tolerance

CORE MEMORY SPECIFICATION FORM (Continued)

INTERFACE SIGNALS:

Logic "1" _____ V Logic "0" _____ V
Current _____ mA Current _____ mA
Pulse rise time _____ ns Pulse rise time _____ ns
Pulse fall time _____ ns Pulse fall time _____ ns

Type of interface circuit: _____
TTL, DTL, ECL, npn collector, npn emitter, pnp collector, other

Number of lines for: Start _____ Mode _____ Data in _____
Address _____ Reset _____ Data out _____
Other _____

Are mode and address lines settled at time of start pulse? _____

How long do the input lines remain settled after leading edge of clock pulse? _____

PHYSICAL CHARACTERISTICS:

Maximum circuit board dimensions: _____ inches x _____ inches x _____ inches

Usable board area: _____ inches x _____ inches x _____ inches

Are circuit boards mounted horizontally _____ or vertically _____

Center-to-center spacing of mounted boards _____ inches

Connector Manufacturer _____ Model No. _____

How many connectors _____ Connector side of card _____ inches. Number of pins _____

TEMPERATURE RANGE:

Operating _____ °C to + _____ °C

Storage _____ °C to + _____ °C

Type of cooling available: Fans _____
Natural convection _____
Cold plate _____
Radiation _____

QUANTITY & SCHEDULE:

Quantity per year _____ 1st yr. _____ 2nd year _____ 3rd year

Production start date _____ year _____

Desired prototype delivery date _____

memory system timing is self-contained or external, these signals—memory busy, cycle complete, data available, memory available—are usually obtainable at slight additional cost. Specify both the signals desired and their logic or voltage level.

Power available

Tailoring the power supply to the memory frequently offers an avenue for substantial savings. Power supplies are expensive, and the bigger they are the more they cost. If voltage levels are higher than needed, power is wasted in the memory system. Well designed core memories usually do not need better than $\pm 5\%$ regulation. Temperature tracking of the power supplies is not required, but line filtering should be provided to eliminate sharp transients.

Interface signals

The choice of interface signals between memory and logic influences design and production costs only slightly, but it can be the most likely area of misunderstanding between the memory development group and the system user. For that reason these requirements must be clearly delineated. Adding an interface timing diagram to show the relationship of logic pulses and memory cycle helps.

Physical characteristics

Physical size and shape strongly affect both hardware expense and development program charges. Size is determined by the dimensions of continuously wired planar core arrays and the corresponding interconnect system for plugging the arrays into a mother board. The manner in which these components are assembled dictates the package shape of the system.

The physical layout of core memory systems also influences electrical performance. Since a rate of change of current is involved, items such as inductance and capacitance become critical. The ideal solution is a single card memory with little or no hand wiring. In this way the wiring is fixed, consistent wire paths are established and production units are sure to be like the prototypes. The mounting arrangement and spacing of modules for both system wiring and cooling of the memory module must also be given attention. Similarly, placement and selection of the connector interface affects the electronics layout.

In most commercial applications where cost is the predominant design criteria, minimum cost

consistent with good commercial practice, high reliability and producibility should be the basis for the specification.

The memory system accounts for an important percentage of hardware cost in most computer-based systems. And core stacks are the most expensive elements in the memory. Controlling their cost is most imperative.

Temperature range

Generally, it is the electronic components that determine the operating temperature range for commercial systems, not the core array. A typical temperature limit for a lithium core is $+150^{\circ}\text{C}$. A typical operating temperature range is 0° to $+50^{\circ}\text{C}$ for data processing. These limits can be extended to -10° to $+70^{\circ}\text{C}$ for industrial control applications with little cost penalty.

Costly trade-offs arise when a memory is required to operate above 100°C . As one example, specially insulated core wire is needed. This wire requires chemical stripping, a time-consuming, hard-to-control process. However, few applications call for continuous memory operation above 100°C . Temperatures at the low end of the range pose no major problem until they fall below -55°C —an unlikely commercial temperature specification.

If artificial cooling is used, the type of air flow supplied is important. If forced air is used, specify the direction of flow with respect to the boards. Where a choice exists, specify vertical mounting of circuit boards, rather than horizontal mounting, for better air circulation and cooling. For memory speeds slower than $2.0\ \mu\text{s}$, natural convective cooling is normally adequate. Speeds faster than $1.5\ \mu\text{s}$ require forced air cooling—another example of hidden costs resulting from higher speeds.

Quantity and schedule

Manufacturing quantity and schedule dates affect many aspects of a development program. It is desirable to obtain prototype core stacks from the same vendor who will be supplying the production items. This vendor should be selected on the basis of competitive bidding for initial volume and delivery requirements, and should be qualified on the prototype. Competitive bidding for volume production quantities will affect cost and delivery of the prototypes and thus influence the development schedule. Early dependable information in this area can lead to a significant reduction in program costs and shorten the lead time to manufacturing. ■■

MEPCO'S NEW THICK FILM RESISTORS—

SUPERIOR PERFORMANCE

(50 Meg or better)

IN THIS SMALL SIZE

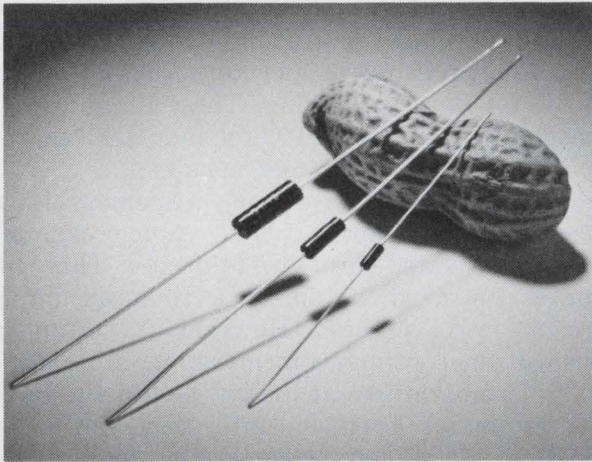

FOR PEANUTS !

Mepco's new GE Series is the very latest in thick film resistors. Combining high impedance with miniature size and low price, they are ideal in power supplies as bleeder resistors, in indicating instruments as meter multipliers, and with operational amplifiers as impedance matching devices.

Mil configurations 1/20 W to 1/4 W
TCs 150 ppm & 200 ppm/°C
Tolerance 1% and 2% (standard)
Also available as leadless devices

Features include:

- cap & lead construction for full 360° contact.
- uniform film deposition for tolerances as precise as 0.5%.

Send today for complete data. Write Dept. GE 1.

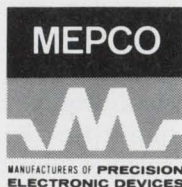

MEPCO, INC.

Columbia Road, Morristown, N. J. 07960

A NORTH AMERICAN PHILIPS COMPANY

INFORMATION RETRIEVAL NUMBER 34

POWERTEC

THE POWER HOUSE

OEM SERIES ADJUSTABLE POWER SUPPLIES

\$24⁹⁵

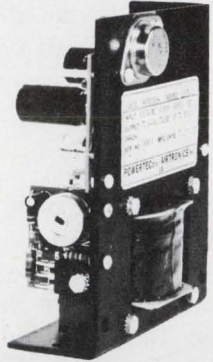

TO 12 AMPS

4 TO 26 VDC 3 TO 12 AMPS
RIPPLE: 1 MVRMS
SHORT CIRCUIT PROTECTED
FOLD BACK CURRENT LIMITING
OPTIONAL OVER VOLTAGE PROTECTION
REGULATION: LINE ±0.25% LOAD ±0.25%

MODEL	PRICE		DIMENSIONS
	1-9	100	
2B5 - 3 AMPS	\$24.95	\$19.50	4.8 W X 4 L X 1.8 D
2C5 - 6 AMPS	\$44.00	\$36.00	4.8 W X 5.7 L X 2.8 D
2C5 - 12 AMPS	\$75.00	\$60.00	4.8 W X 9 L X 3 D

OEM CONTRACTS AVAILABLE

POWERTEC AIRTRONICS INC.

A DIVISION OF
9168 DESOTO AVENUE
CHATSWORTH, CALIFORNIA 91311
(213) 882-0004 TWX 910-494-2092

INFORMATION RETRIEVAL NUMBER 35

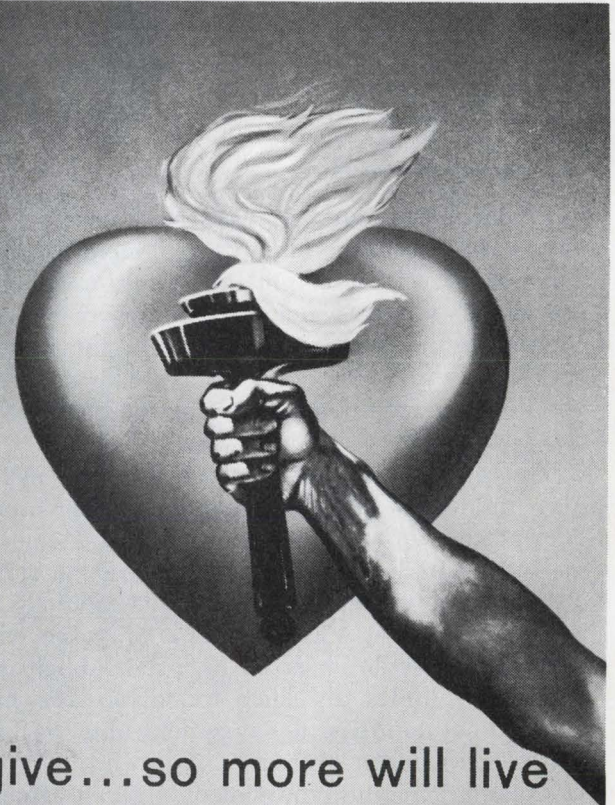

give...so more will live

HEART FUND

*If your problem
is in-circuit
testing of
transistorized
and integrated
circuits . . .
Solve it with
Triplett's 601*

Model 601

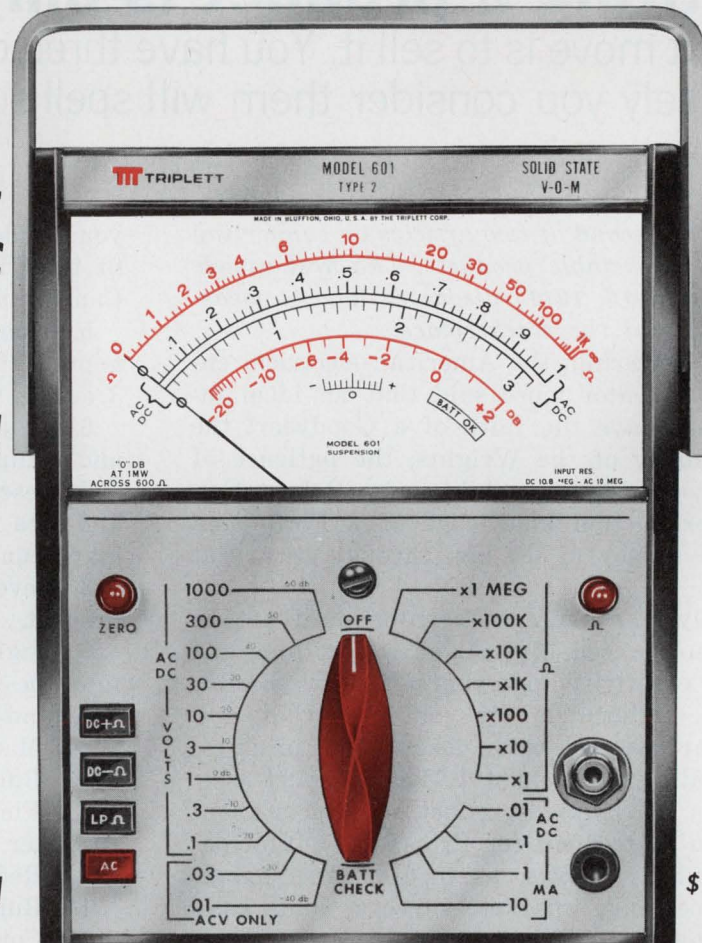

1. Low power ohms — 7 ranges with 75 mV power source.
2. High sensitivity — 10 mV AC full scale at 10 megohm input impedance; 100 mV DC at 11 megohm input resistance.
3. Simplified scale — only 4 arcs for all 53 ranges.

It has 7 low-power resistance ranges that apply only 75 mV to the device under test . . . does not activate or damage solid-state component . . . full-scale DC measurements down to 100 mV and 10 μ A and AC as low as 10 mV and 10 μ A, it's obvious the Model 601 was designed for in-circuit testing.

Add such features as 10 megohm input impedance on AC

and 11 megohm input resistance on DC, voltage readings to 2% DC and 3% AC (current: 3% DC and 4% AC), separate range-selection and function-selection switches, and a simplified dial on which all 53 ranges are read on only 4 scales, and it's equally obvious that here's a V-O-M that has what you need to do the job better, faster and more easily.

See the capable Model 601 —

INFORMATION RETRIEVAL NUMBER 36

priced at \$166 — at your local Triplett distributor. For more information, or for a free demonstration, call him or your Triplett sales representative right away. Triplett Corporation, Bluffton, Ohio 45817.

TRIPLETT

The World's most complete line of V-O-M's...
choose the one that's just right for you

Inventing a product is only half the job.

The next move is to sell it. You have three options, and how wisely you consider them will spell success or failure.

This is the second of two articles on converting ideas into marketable products. The first article (ED 6, March 15, 1971) discussed how to measure the pulse of the marketplace.

Charles Kettering, the American electrical engineer and inventor, once said that an ideal inventor must have the faith of a Goodyear, the creative ability of the Wrights, the patience of an Edison, the business ability of a Robert Fulton, the production knowledge of a Ford—and bundles of money to see him through recurrent failures.

Obviously, the average inventor need not be so gifted to succeed. But if you expect to profit from your creativity, give yourself every possible advantage. Determine, for example, what new products are needed. Also, learn some practical aids, including a checklist to help convert your idea into a marketable product, and facts about patents, an Agreement for Proprietary Information (popularly known as a disclosure agreement), licensing, market surveys and sales presentation.

Following is a description of these steps and how they can apply to your own product ideas on their march to the marketplace.

16 long steps to success

Many checklists have been devised to convert ideas into marketable items, but experience has taught me that these 16 chronological steps are the most important:

1. Product concept. Good products are usually the result of satisfying a need.
2. Preliminary screening. Eliminate impractical and otherwise unacceptable ideas by researching what has already been done in the product area.
3. Patent search. Someone may have thought of your idea first.
4. Preliminary technical/economic survey. If

J. Peter McGregor, TRW Systems Group, Redondo Beach, Calif. This article is based on book entitled: **How to Convert Ideas into Marketable Products**, by Peter McGregor, to be published in the fall by Impact Publishing Co., Costa Mesa, Calif.

you decide to sell or license your product, does it fit into the prospective investor's product line? Can he produce it at a suitable profit?

5. Final screening. Acceptance or rejection of a product is determined by the finding of steps 3 and 4.

6. Project scheduling. Assign funds, priorities and manpower.

7. Research. Establish basic new principles and data related to the project; parts of the idea may require new investigation.

8. Development. Construct a model of the product.

9. Engineering. Incorporate sound principles into the model, so it can be easily assembled, used and serviced.

10. Management review.

11. Building a prototype model.

12. Field-testing the prototype. Give it to a customer and let him use it.

13. Redesign. (If it comes back broken.)

14. Building the production model.

15. Conducting a realistic cost analysis.

16. Management review. Approval of production and release for sale.

When to patent—when to disclose

Now that you have the complete picture of how your idea can become a product, you'll want to know when to patent and when to sell, license or make the product yourself.

Most books on invention development suggest that you file a patent application after you've developed the *product-invention*. Most patent lawyers will advise:

- Don't file for a patent application right away. It's expensive and not always necessary. In the U. S. you can place an invention on sale, put it in public use, or describe it in a publication for up to a year before you have to file.

- Conduct a patent search to determine if your creation is new and patentable. If the results of your search are positive, you can decide on one of three actions: (1) To sell the invention to a manufacturer; (2) To license it to a manufacturer, or (3) To make it, advertise it, and sell it

yourself.

If you plan to sell or license your invention, the absence of patent protection is not a hopeless obstacle, provided your patent attorney draws up a disclosure agreement between you and the prospective manufacturer. This agreement protects the inventor's product idea from disclosure to unauthorized persons.

The purpose of this pact is to help the interested company evaluate the invention. Every possible guarantee that the product is new, however, must be established by the inventor before a firm will make such a commitment. Most large corporations receive many unsolicited and unpatented ideas every year and cannot be expected to undertake a patent search for each.

Of course, the disclosure agreement is not as safe as the issuance of a patent. But patent application costs can run as high as \$1000. Then, too, the element of risk in disclosure is not nearly as high as is generally believed, especially when reputable manufacturers are approached. Competition for new products is so keen today that manufacturers are loath to risk their reputations for fair dealing.

Selling your creation is the safest and easiest of the three choices, but if the product is a real winner, you lose profits to be made. The time to sell is when you have doubts about the marketability of your product. When you do, sell it as quickly and for as much cash as you can. If you decide to manufacture and market the product yourself, beware of these obvious pitfalls: You will need the business ability and the capital for such a project.

Should you decide to license the manufacture and marketing of your product, realize that either you or the licensee is taking a risk. In making a royalty agreement, there's always the possibility that both you and the manufacturer could be mistaken about the amount of the potential profits.

If you cannot decide on the disposition of your invention, seek the advice of a professional marketing consultant.

What the investor wants to hear

But let us suppose that you decide to license or sell the rights to your new product. Most professionals will tell you to conduct a market survey.

In the electronics industry, a simple, effective market technique is to phone or interview 50 to 100 people (engineers, marketing personnel and other potential customers) who are widely distributed in all areas of the field, and poll them on your product.

The success of most market surveys depends both on asking the questions the investor would

ask and telling him what he wants to hear. In general, the manufacturer wants you to poll prospective customers in both large and small companies, and he also wants to know the name and title of each person polled.

Here's a list of four questions the potential manufacturer will ask the inventor, including the answers the manufacturer wants to hear:

1. How much can you charge for the product, and how much does it cost to make? *The product should have a fivefold markup; if it costs \$10 to make, it should sell for \$50.*

2. How many of those polled thought the product would be useful? *For the promise of a successful sale, manufacturers estimate that 75% or more of those polled must find the product useful.*

3. What are the different applications of the product? *The more uses the better.*

4. How diversified is the product in its use for different disciplines? *The more diversified the product, the more area a salesman can cover on one call.*

If the results of your market survey are positive, the manufacturer will then want to know:

■ How long will it take to double his money? If it will take 10 years, he can make the same amount by leaving his cash in the bank, at a minimum of risk. He expects to double or triple his investment in about three years.

■ What are the risks? Your survey should ex-



plain the risks. Remember that some products take more capital to develop than others.

If you plan to make and sell the product yourself, the investor will want to know:

- Are you going to set up a corporation? Are you going to sell more shares? If you're going public in the future, the manufacturer's shares will be worth more.

- Is this the only product you have? The manufacturer wants you to create a line of products if possible, to capitalize on his original investment in you. He will accept good ideas.

Most general managers in electronics companies are between the ages of 40 and 55. They've worked hard and long to get where they are, and they don't want to jeopardize their position. They've been burnt often on products that have failed to make a suitable profit. The manager's boss has told him that he must increase his sales by 15% every year.

One manager has told me that he looks for a product that appeals to him personally, one that he thinks the public would buy.

Notes on finding a buyer

If you've decided to sell or license your new product, the following basic rules will make it easier for you to find a buyer.

Rule 1. Take a second look at your product and ask yourself three questions:

a) Which area or areas of the industry does my product best fit into. List them in order of importance.

b) Which firms do business in these areas? Again, list by order of importance. You can find this information from several sources: Standard Industrial Classification (SIC), a U. S. Government publication found in large libraries. Once you have the SIC code number, refer to Dunn & Bradstreet books (again in the library) for a complete description, financial and otherwise, on every firm you may be interested in.

Rule 2. If possible, pick the companies in your immediate area. Most inventors haven't the money for several plane trips to the firm's parent company, only to be told they are not interested in your product.

Rule 3. Never make your presentation until you have first made contact with one of the more aggressive salesmen in that company. Briefly explain your product and ask for his opinion of it. Also ask:

a) Does the product fit in with his company's line of products or what they're doing or intend to do?

b) Can he arrange a presentation with higher management if it does?

c) Can he suggest another firm if your product isn't suitable for his company?

d) What features should be stressed at the presentation. In other words, what does his company want to hear from you to be turned on?

The salesman will be very cooperative if he likes your product, because every new product that he can bring into his company means more prestige and money for him.

If you have been able to "sell" the salesman your product, your next move is the product presentation.

Separating entrepreneurs from inventors

The presentation is one of the most important steps in the innovative process—it separates the entrepreneur from the inventor.

Don't look and act like an inventor. Instead look and act like a successful entrepreneur. An enthusiastic, confident entrepreneur can do more to set an attitude at a presentation than all the marvelous features of his invention put together. You must be prepared to give the best sales pitch of your life, and if you think you can't, get someone who can.

Distribute copies of your presentation *before* you start. The presentation should include the following:

1. State the problem.
2. State the solution.
3. State how you solved it.
4. State the applications.
5. Discuss who would buy it.
6. Show your market survey results.
7. Discuss the sales advantages.
8. Discuss the technical features.
9. Discuss product development to date.
10. Discuss the marketing plan.

During your talk use professionally printed flip-charts or slides. Discuss only the important points of your product; don't go into detail. If the people listening to your presentation get turned on, they'll ask you for all the details later.

Be sure you have all the facts about your product at your fingertips. There must be no hesitation and no apologies; they could be fatal to your success. Your invention must be perfect. The men who are going to pay for your invention very likely are neither mechanically nor scientifically inclined. If your device doesn't work, they will not be interested. They will make no allowances.

The prospective buyer of your product will want to know several things about it. Questions he will ask that you must be prepared to answer include:

1. Is there a demand for your invention?
2. How big is the demand, and how long will it last?
3. How much competition will it have?
4. Is it practicable?

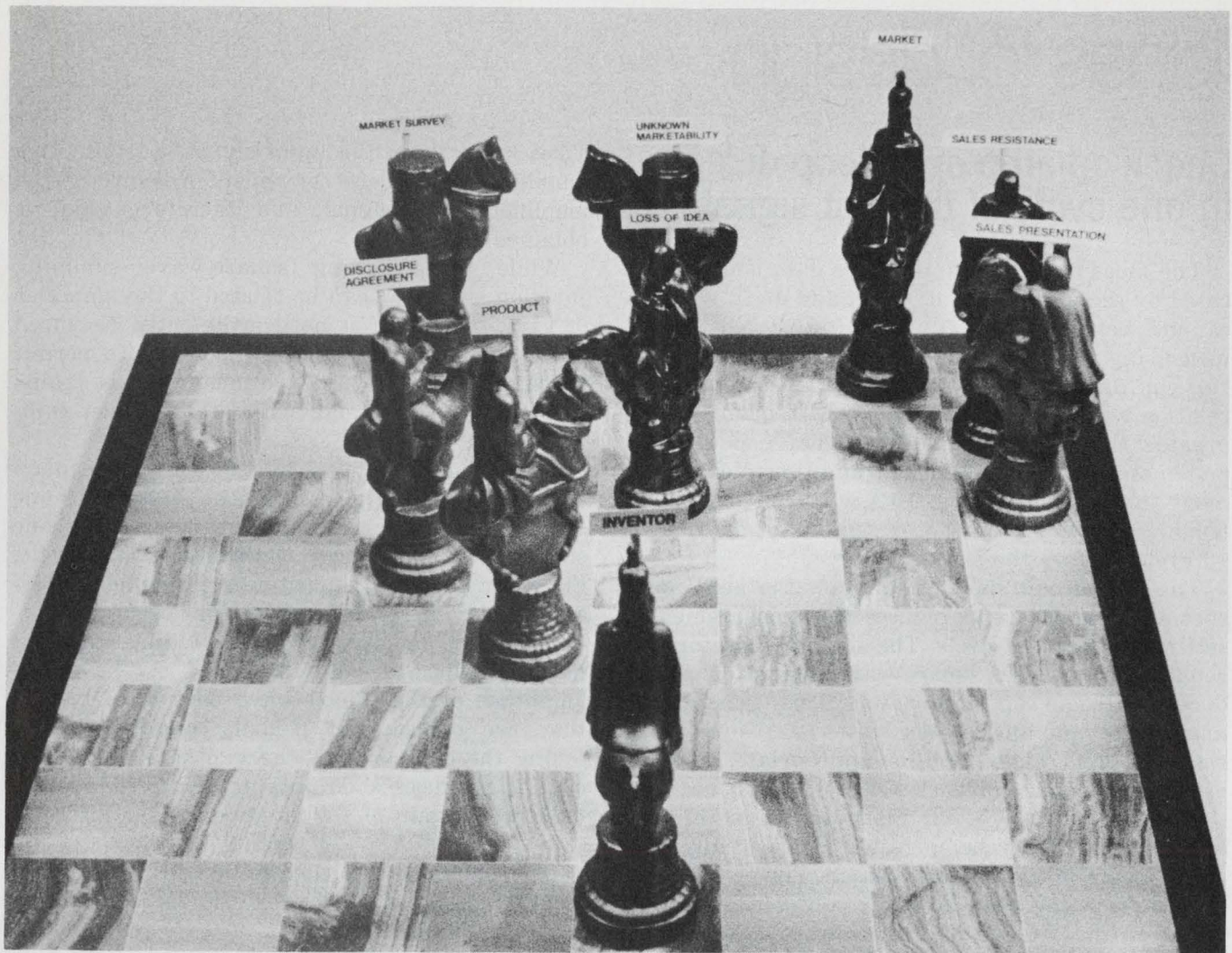

Checkmate! By neutralizing such product perils as unknown marketability, loss of idea, and sales resistance with market survey, disclosure agreement and sales

presentation, the inventor has given his product a clear shot at the market in the competitive game of commercial chess that's played in the electronics industry.

5. Is it better than comparable products already on the market?
6. Will it cost less to make than similar devices?
7. Can it be sold more cheaply than others?
8. Is it patentable?

The buyer's point of view

Several managers of electronic companies have responded to my question: "What advice can you give an inventor who wants to sell or license his invention to a company?" It is interesting to note that those who responded said basically the same thing:

1. *Have an appreciation for what goes into the cost of manufacturing and selling an item.* Many inventors determine their costs by what it would cost if they made the product in their garage. They never take into account overhead.
2. *Don't come up with a solution to a problem when the world is not looking for one.*
3. *Don't overvalue your invention.* Remember

the buyer is taking all the risks. He is entitled to the lion's share of the benefits.

4. *Don't make exaggerated claims* that can be proved false later. Once this happens, the buyer wonders if some of your other statements should be questioned.

5. *Know your product.* This includes not only the technical aspects but also the cost, market potential, etc.

6. *Make a good product presentation.* You can have the greatest mousetrap, but if you can't convince the world, you'll never sell it.

7. *Show that you have faith in your product* by a willingness to share some of the buyer's risks—for example, make your profit contingent on the success of the product.

If you have succeeded in convincing the manufacturer that there's an opening for your invention, the hardest part of your task should be over. All you have to do then is to demonstrate to him that your device is the one above all others that can meet the demand. ■■

ideas for design

Check op-amp open-loop dc gain in one cycle of the test signal

The measurement of op-amp dc gain is complicated by the presence of dc offset and drift, which cannot be distinguished from dc signals. By measuring gain with an ac signal, you can avoid this confusion. However, because an accurate correlation with dc gain requires a test frequency not greater than 1 Hz, standard signal generators and meters can't be used. In addition measurement times can approach 10 s with conventional techniques, which sometimes require as many as 10 cycles before the signal settles.

The test circuit shown eliminates the need for special equipment and reduces the measurement settling time to one cycle. The signal generator is replaced by a 1-Hz square-wave generator produced with an op amp (A_1). This generator drives the amplifier under test (A_3) over its rated output range for the appropriate values of summing and feedback resistors.

Because the two 50-k Ω resistors are of equal value, the amplifier being tested is essentially in a unity-gain inverter configuration. The test setup differs from the basic inverter configuration because of the voltage divider connected between the summing junction and the inverting amplifier input.

The divider forces the feedback voltage to develop a summing junction signal, e_j , that is 100

times larger than the input signal, e_i . With this amplification, a more convenient measure of the amplifier input signal, and therefore gain, is obtained.

While the resulting square-wave summing junction signal, e_j , can be related to the amplifier dc gain, this signal is not conveniently measured and it includes a dc offset component. To permit measurement with a dc voltmeter, e_j is transformed to a dc voltage without the offset component.

The offset is removed by the coupling capacitors and FET switches. On one half-cycle, one coupling capacitor is grounded, referencing one side of the signal to zero. On the other half-cycle, the other coupling capacitor is grounded, referencing the other side of the signal to zero.

From this opposite phase switching, the signals developed at the inputs of A_2 have the amplitude of the square-wave portion of e_j , but they are opposite in polarity and phase. By taking the difference of the two signals (e_1 and e_2), A_2 produces a dc output, $(E_o)_2$, that is related to the gain of the amplifier under test, A_o :

$$A_o = 10^4 / [(E_o)_2]$$

Only one cycle is needed to make this measurement, since the switches provide rapid charging of the coupling capacitors.

Jerry Graeme, Manager, Monolithic Engineering, Burr-Brown Research Corp., International Airport Industrial Park, Tucson, Ariz. 85706.

VOTE FOR 311

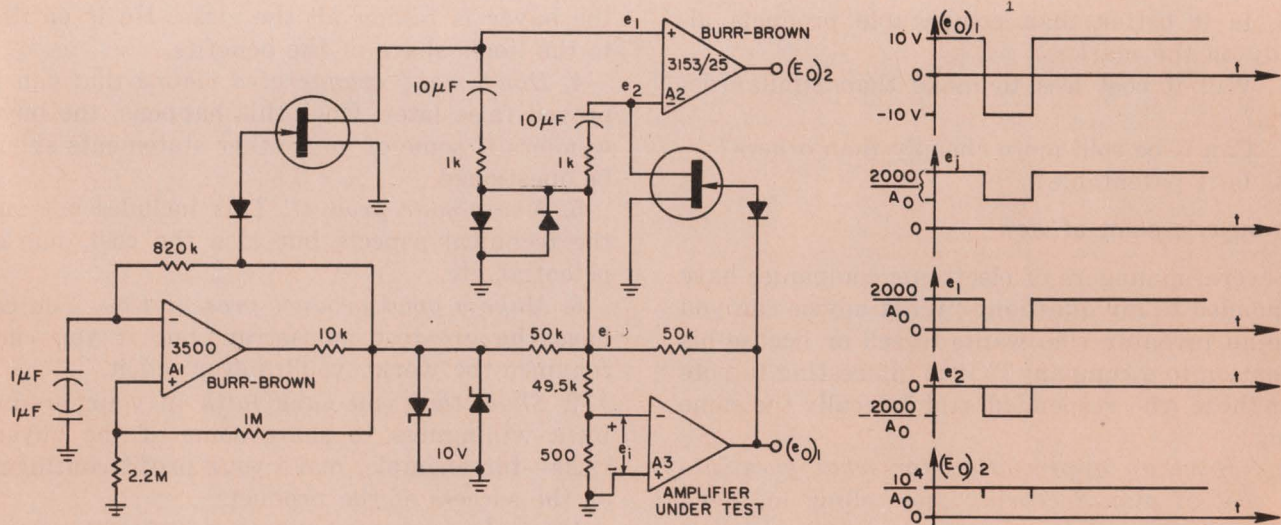

Measure the open-loop dc gain of your op amp with an ordinary dc voltmeter. This circuit boosts the amplitude of its square-wave test signal and

then eliminates the dc offset component with FET switches and coupling capacitors. Its dc output, $(E_o)_2$, is directly related to amplifier gain, A_o .

Want to see them do it again?

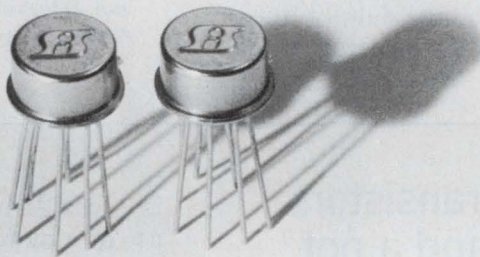

Analog switch/drivers so fast, you'd think they would cost a fortune.

They might have six months ago. If you could get them at all. But now you can choose from a complete line of both JFET and MOS analog switch/drivers that switch three times faster than previous designs (≈ 200 ns). And they'll run as low as \$3 to \$4 per switch function (100 quantity).

The secret of the Siliconix high speed switch: Schottky diodes. Their advantage: To prevent saturation of the output-drive transistors. Result: Extremely fast switching.

What's more, the R_{on} is independent of signal

frequency. And there's no load on the signal source in the OFF condition. These Siliconix devices are especially suited for high speed RF-IF or video

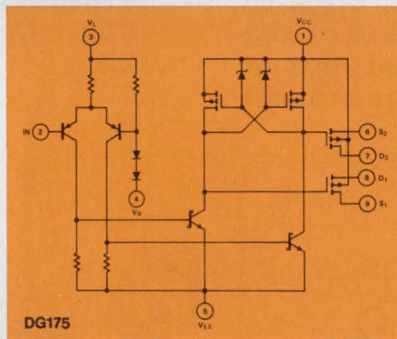

switching applications because of 70 dB OFF isolation at 1 MHz.

All devices are off-the-shelf, specified to MIL-883, Class B, Notice 2; or industrial grade over -20 to $+85^\circ\text{C}$ range.

See how the new Siliconix switching circuits can improve your system and better your application while saving you money. For more information on the JFET and MOS analog switch/drivers, call your Siliconix representative and ask for specs and prices on the JFET DG150 and 160 series, or the MOS DG171, 175 and 176. You'll be glad you did.



Siliconix incorporated

2201 Laurelwood Road • Santa Clara • Calif. 95054
Phone (408) 246-8000 Ext. 201 • TWX: 910-338-0227

New York: Sy Levine (516) 796-4680 **New England:** Al La Croix (617) 769-3780 **St. Louis:** Jim Spicer (314) 291-3616 **Minneapolis:** Ed Koelfgen (612) 920-4483 **Southern California:** Dave Ferran (213) 420-1307 **Northern California:** Chuck Brush (408) 246-8000 **In Europe:** Siliconix Limited, Saunders Way, Sketty, Swansea, Great Britain. Siliconix GmbH, 7024 Bernhausen, Postfach 1340, W. Germany. Siliconix 9, Ave d'Arromanches, 94-Saint-Maur, France.

INFORMATION RETRIEVAL NUMBER 38

Constant-current diodes protect ICs and transistors

Using a FET constant-current diode as a short-circuit limiter is a simple and effective way to protect circuit elements from catastrophic failure. The diode can protect either low-level transistors or integrated circuits.

The transistor in the diagram operates at a nominal collector current of 0.5 mA, and the 2-mA current limiter is inserted in series with the load resistor. During normal operation the current through the diode is below its pinched-off constant-current point, thereby introducing a very small voltage drop of about 0.3 V. In the event of a collector-to-emitter short, the diode limits the maximum current to 2 mA, protecting the circuit from the effects of a complete short.

Similarly an integrated circuit can be protected from a short through its voltage supply lines, without affecting other elements connected to the

supply bus. The usefulness of this technique is limited only by the ingenuity of the circuit designer.

L. H. Garner, TRW Inc., One Space Park, Redondo Beach, Calif. 90278.

VOTE FOR 312

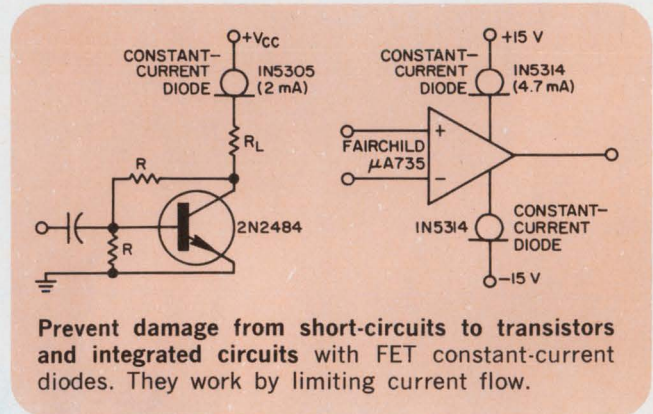

Simulate matched transistors with an active load and a pot

A good way to achieve very high voltage gain in a differential-amplifier stage is by using an active device as a collector load. A simple and economical approach is to use a discrete pnp transistor (such as a plastic economy type) and a V_{be} -matching diode with some emitter degeneration to swamp their voltage differences (Fig. 1a).

Another technique is shown in Fig. 1b, but has the drawback of compromising temperature performance. Q_3 and R_1 create a temperature-dependent voltage imbalance proportional to the V_{be} of Q_3 . This performance does not effectively utilize the balanced temperature characteristics of high-quality matched monolithic pairs that are available for use as Q_1 and Q_2 . A third approach

is "ideal," but expensive, since it involves the use of a matched pnp pair (Fig. 1c) for the load.

Ideally, the collector currents of Q_1 and Q_2 should be matched over their temperature range since any imbalance will reflect a change in the Q_1 - Q_2 input offset voltage. With the adjustable balance (Fig. 1a) between Q_1 - Q_2 current provided by $R_{balance}$, the initial offset voltage of the differential pair can be cancelled by a compensating change in their current ratio.

Once set, the balance is maintained by the tracking of D_1 and Q_3 . Since epoxy transistor prices are quite low, D_1 can be a diode-connected transistor of the same type as Q_3 , making the entire circuit very economical.

Walter G. Jung, Box 59 B, Forest Hill, Md. 21050.

VOTE FOR 313

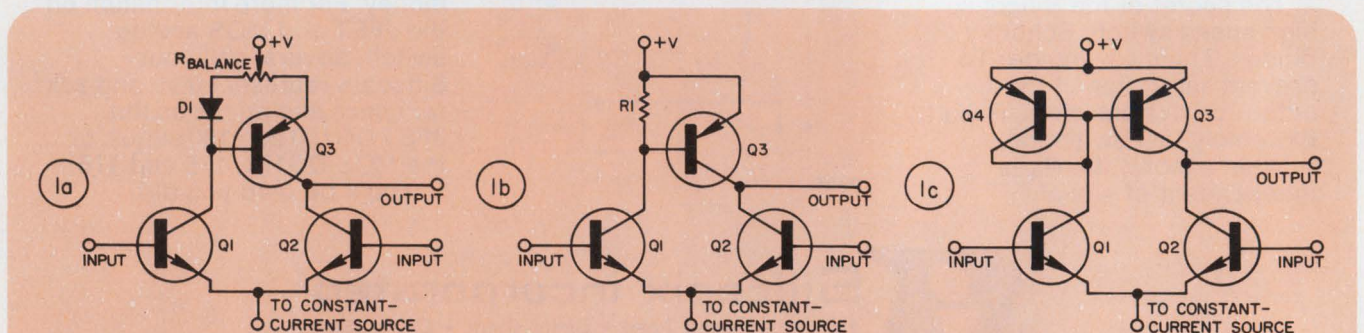

Matched-transistor performance for a differential amplifier is achieved inexpensively (1a) with an active load and a potentiometer. Method 1b with an active load and a fixed resistor is economical but

temperature-dependent. Method 1c shows a matched pair of pnp transistors for the active load. This configuration gives excellent temperature performance, but at high cost.



The only 160-MHz synthesizer with a full-range sweep!

If you're testing amplifiers, filters, or delay lines, GR's new 1065 Sweeping Frequency Synthesizer has the built-in full-range sweep capability, remote programmability, and low residual fm that you need. The 1065 gives you 24 calibrated sweep widths from 5 Hz to 160 MHz with sweep times from 20 ms to 50 s, plus a step-attenuated output from +13 to -67 dBm. The fixed-frequency characteristics include 1-Hz resolution and stability better than one part in 10^9 /day. Harmonic spurs are more than 30 dB below signal level and non-harmonics are more than 60 dB down. The 1065 does the whole job for just \$8950.*

and two just for fixed-frequency work

For those applications that require the stability and accuracy of a synthesizer, but don't need the sweep capability, there's the new 1168 Frequency Synthesizer. The 1168 gives you the same fixed-frequency characteristics as the 1065, with a continuously adjustable output from +13 to -7 dBm and a substantial cost savings — the 1168 with its precision internal oscillator is only \$6400. If you already have a stable 5- or 10-MHz source, you can save even more by ordering the \$5900 slave version of the 1168 to operate from your external source.

Should you need the synthesizer, but require only 100-Hz resolution, then the 1165 Frequency Synthesizer will fill the bill with still more savings because of its \$5900 price tag. The 1165 is also available in a slave version for \$5400.

If these three synthesizers don't provide just the performance you need, then let GR tailor a fixed-frequency or sweeping synthesizer to your specs. Complete information on the standard synthesizers or on special models is available from the nearest GR office or from 300 Baker Ave., Concord, Mass. 01742. In Europe write to Postfach 124, CH 8034, Zurich, Switzerland.

*Prices are net FOB, Concord, Mass.



General Radio

BOSTON 617 646-0550 / CHICAGO 312 992-0800 / LOS ANGELES 714 540-9830
NEW YORK (N.Y.) 212 964-2722 (N.J.) 201 943-3140 / WASHINGTON, D.C. 301 881-5333
TORONTO 416 252-3395 / ZURICH (051) 47 70 20

INFORMATION RETRIEVAL NUMBER 39

Get programmable voltages from 50-mA emitter-follower

Many test applications require a circuit that is capable of programmable output voltage levels and low-output-impedance characteristics. This two-transistor emitter-follower can be easily adjusted for output levels between ground and V_{CC} , and it has a load capacity of 50 mA.

When the input to the circuit is low, Q_2 is OFF, and the output of Q_1 will be at its high level set by R_2 and R_3 . The base bias and drive current for Q_1 is determined by R_1 , R_2 and R_3 .

When the input to the circuit is high, Q_2 saturates shorting R_3 and causing the output of Q_1 to fall to its lower level, which is set by R_1 and R_2 . The base drive current and input voltage levels required to switch Q_2 are fixed by R_4 and R_5 .

Resistors R_1 and R_5 should be selected to saturate Q_2 fully in one state and to turn Q_2 OFF fully in the other state. R_6 is chosen to set the output impedance at a desired level. The values for R_2 , R_3 and R_6 yield an output voltage range of 4.5 to 7 V dc.

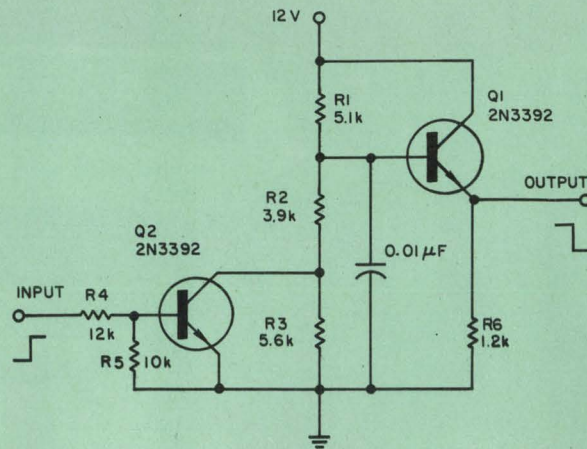

Variable output voltages, low output impedance and a 50-mA load capability are the features of this emitter-follower test circuit.

Arthur G. Kriss, Quality Control Engineer, Quindar Electronics, Inc., 60 Fadem Rd., Springfield, N. J. 07081.

VOTE FOR 314

Simple delay technique doubles input frequency

A fixed frequency doubler that basically consists of two retriggerable one-shots offers symmetry and input impedance characteristics superior to standard differentiator circuits. The resistor and capacitor values shown yield a 1-MHz doubler.

The two cascaded retriggerable one-shots delay the leading and trailing edges of the input waveform by equal time periods to obtain a 90-degree phase shift. This phase-shifted waveform is then applied to an EXclusive-OR gate, G_3 , along with the original input waveform. The output of G_3 will be twice the frequency of the input signal.

Ronald O. Brennan, Principal Engineer, Lockheed Electronics Co., Manned Spacecraft Center, 16811 El Camino Real, Houston, Tex. 77058.

VOTE FOR 315

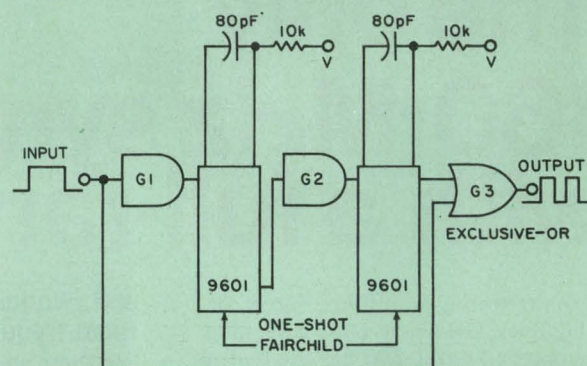

This EXclusive-OR gate accepts a 90-degree phase-shifted waveform, plus the original waveform, to double input signal frequency. Two retriggerable one-shots delay the input waveform.

IFD Winner for December 6, 1970

Wesley A. Vincent, Electronic Engineer, Motorola Inc., Government Electronics Div., 8201 E. McDowell Rd., Scottsdale, Ariz. 85252. His idea "Insure Proper Starting Polarity of Astable Multivibrators" has been voted the Most Valuable of Issue award.

Vote for the Best Idea in this Issue.

VOTE! Go through all Idea-for-Design entries, select the best, and circle the appropriate number on the Reader-Service-Card.

SEND US YOUR IDEAS FOR DESIGN. You may win a grand total of \$1050 (cash)! Here's how. Submit your IFD describing a new or important circuit or design technique, the clever use of a new component or test equipment, packaging tips, cost-saving ideas to our Ideas-for-Design editor. You will receive \$20 for each accepted idea, \$30 more if it is voted best-of-issue by our readers. The best-of-issue winners become eligible for the Idea Of the Year award of \$1000.

Electronic Design presents the 'top-ten' winners

The following pages display the 10 outstanding advertisements that appeared in our Jan. 7 issue, which featured the "Top-Ten" contest. The contest attracted thousands of readers who attempted to match their ratings of the 10 most memorable advertisements with the "recall-read" scores from ELECTRONIC DESIGN's regular Reader-Recall survey.

The winning advertisements combine attractive colors, tasteful design and well-written copy. The result: impact. The winners, in order of highest Reader-Recall score, are as follows:

1. Monsanto Electronic Special Products
2. General Instrument Corp.
3. Burroughs Corp., Electronic Components Division
4. Micro Switch, A Div. of Honeywell
5. Motorola Semiconductor Products, Inc.
6. Fairchild Semiconductor, A Div. of Fairchild Camera and Instrument Corp.
7. Systems Engineering Laboratories
8. Motorola Semiconductor Products, Inc.
9. Hewlett-Packard Co.
10. Instrument Specialties Co., Inc.

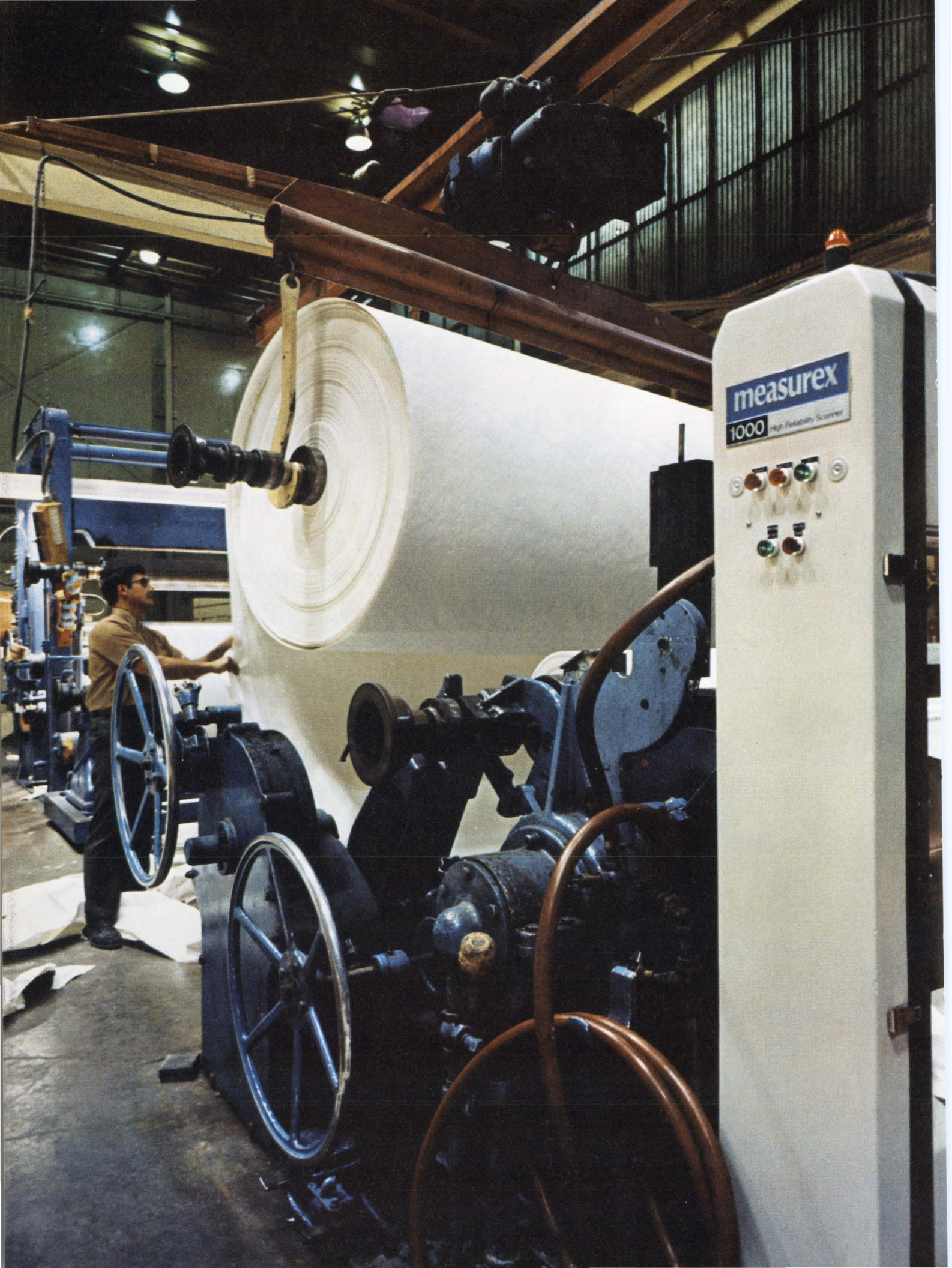

measurex
1000 High Reliability Scanner

A minicomputer here?

Sure!

And ours is helping boost profits up to \$20,000 a month.

Paper mills can be pretty rough on electronic equipment. So any computer system put there had better be able to take it — especially if it's guaranteed to increase profits. And Measurex of Santa Clara, California does just that. They guarantee profit increases from \$4,000 to \$20,000 a month.

That's one big reason why they chose our 2116 Computer as the heart of their paper mill process control system. They knew it would keep on working in spite of heat, humidity, vibration and corrosive fumes — acting as an on-the-spot control center in Measurex's unique system for regulating the moisture and fiber content of paper speeding along at hundreds of feet per second.

It's a job that affects profitability in a big way. Misjudging fiber or water content, even slightly, can be costly. But improved reliability and accuracy can pay off to the tune of half a million dollars a year in added profit. With so much at stake, it's not surprising that Measurex chose our computer.

There are other things to like about our small computers: good specs, comprehensive software and simple interfacing with all system components. Constant updating without obsoleting your present system. (Measurex will soon switch to our new 2116C just by plugging it into the old interfaces.) Plus our complete line of input/output devices, available off-the-shelf.

Another benefit: our minicomputers don't put the squeeze on an OEM like Measurex — or any other purchaser. For instance, you can now buy our new powerful 2116C, with up to 32K of core memory — all in the mainframe — for just \$50,000. If you don't need that kind of power, our 4K version of the 2114C costs just \$8500. And we've doubled the memory of this computer, too. So you can now get a 16K version for \$22,000.

Get the full story on computers you can depend on. Call your nearest HP sales office or write to Hewlett-Packard, Palo Alto, California 94304; Europe: 1217 Meyrin-Geneva, Switzerland.

HEWLETT  PACKARD

DIGITAL COMPUTERS

**WHAT THIS COUNTRY
NEEDS IS A GOOD**

**5¢
RECTIFIER***

OVER 16 MILLION
of these Rectifiers
SHIPPED since this
ad appeared
on September 14, 1970



HERE IT IS...GENERAL INSTRUMENT'S 1N4004

1N4004

PIV = 400V

$I_o = 1.0A @ 75^\circ C$

$I_R = 5.0 \mu A @ 25^\circ C$

$V_F = 1.1V @ 1.0A @ 25^\circ C$

***Conditions of Sale**

Minimum Order Quantity : 25,000 units scheduled within 60 days
Minimum Delivery : Minimum Shipment 10,000 pcs.
Packing : Bulk Packing, 2000 unit/box
Marking : Cathode Band, 1N4004, GI, Date Code
AQL : 1%
Specifications : per EIA

For full information write General Instrument Corporation, Dept. R, 600 West John St., Hicksville, N.Y. 11802, or call in New York: 516-733-3333; in Chicago: 312-774-7800; in Los Angeles: 213-641-7411. In Canada, call or write to General Instrument Canada, Ltd., 61 Industry St., Toronto 337, Ontario, Canada, Tel: 416-763-4133. (In Europe, write to General Instrument Europe S.P.A., Piazza Amendola 9, 20149 Milano, Italy; in the U.K., to General Instrument U.K. Ltd., Stonefield Way, Victoria Road, South Ruislip, Middlesex, England.)



GENERAL INSTRUMENT CORPORATION • 600 WEST JOHN STREET, HICKSVILLE, L. I., NEW YORK

INFORMATION RETRIEVAL NUMBER 37

...AND A GOOD

25¢ SILICON BRIDGE RECTIFIER*

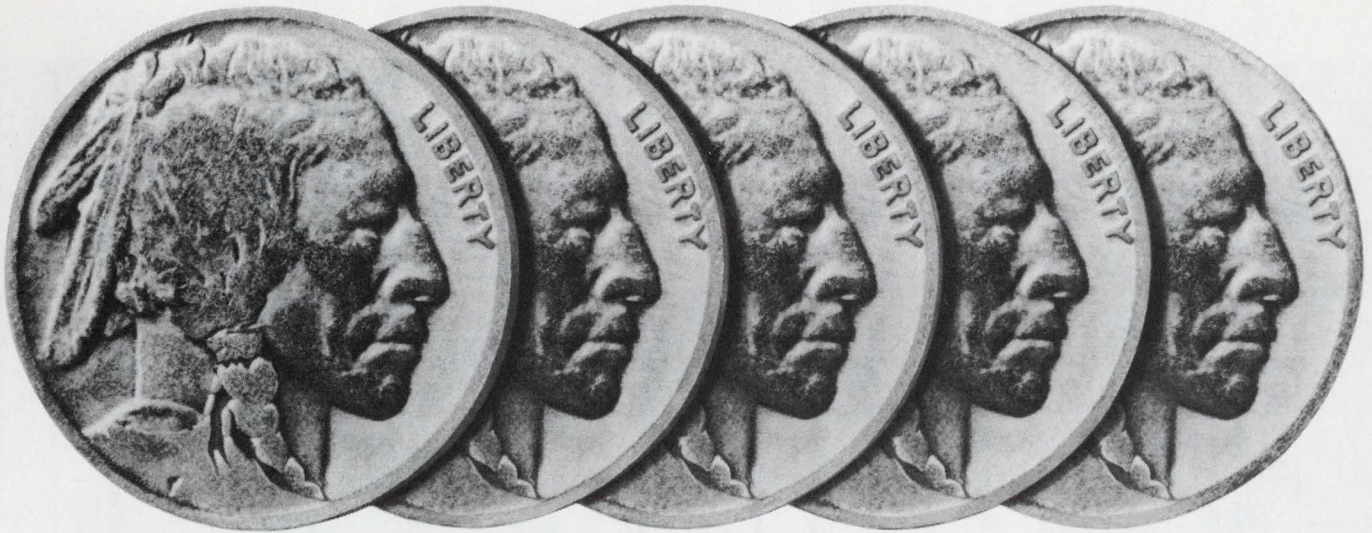

HERE IT IS...GENERAL INSTRUMENT'S WO4



WO4

PIV = 400V

$I_o = 1.5A @ 50^\circ C$

$I_R^\dagger = 10\mu A @ 25^\circ C$

$V_F = 1.0V^\ddagger @ 1.0A @ 25^\circ C$

† Total Bridge ‡ Per Element

***Conditions of Sale**

Minimum Order Quantity : 10,000 units scheduled within 60 days

Minimum Shipments : 2,500 units

Packing : Bulk

Marking : WO4, AC and +, GI

AQL : 1%

Specifications : As above

For full information write General Instrument Corporation, Dept. B, 600 West John St., Hicksville, N.Y. 11802, or call in New York: 516-733-3333; in Chicago: 312-774-7800; in Los Angeles: 213-641-7411. In Canada, call or write to General Instrument Canada, Ltd., 61 Industry St., Toronto 337, Ontario, Canada, Tel: 416-763-4133. (In Europe, write to General Instrument Europe S.P.A., Piazza Amendola 9, 20149 Milano, Italy; in the U.K., to General Instrument U.K. Ltd., Stonefield Way, Victoria Road, South Ruislip, Middlesex, England.)



GENERAL INSTRUMENT CORPORATION • 600 WEST JOHN STREET, HICKSVILLE, L. I., NEW YORK

INFORMATION RETRIEVAL NUMBER 41

Our TTL family gives you freedom where it counts.



The Fairchild TTL family offers the freedom-loving designer the broadest range of speed/power trade-offs and an extraordinary variety of logic and memory and interface support functions.

**FAIRCHILD
TTL FAMILY**

*Available January, 1971.

Now you can design with Low Power TTL/MSI at even less cost than with Standard!

93L21 Dual 1 of 4 Decoder		93L22 Quad 2 Input Multiplexer				
93L11 1 of 16 Decoder		93L12 8 Input Multiplexer	93L28 Dual 8 Bit Shift Register	93L14 4 Bit Latch	93L40 4 Bit Arithmetic Logic Unit	93L16 Binary Counter
93L01 1 of 10 Decoder	93L18 8 Input Priority Encoder	93L09 Dual 4 Input Multiplexer	93L00 4 Bit Shift Register	93L08 Dual 4 Bit Latch	93L24 5 Bit Comparator	93L10 Decade Counter
DECODERS/ DEMULTIPLEXERS	ENCODERS	MULTI- PLEXERS	REGISTERS	LATCHES	OPERATORS	COUNTERS

Our Low Power TTL now sells for the same price as Standard TTL and costs even less to use.

If you don't need the speed of Standard, why pay the freight? In our TTL Family you'll find 15 low cost Low Power MSI devices to choose from. All compatible. All off the shelf.

It's the largest, most complete, most versatile selection in the business. Designed to give the cost-conscious designer freedom now. And freedom where it really counts:

- No board redesign (pin-for-pin equivalent to and compatible with Standard TTL/MSI devices).
- Smaller power supply.
- Less noise (fewer decoupling elements required).
- Less heat.
- High fanout (fewer buffers needed).
- Largest Low Power MSI/TTL family around.

Typical performance:

Gate Tpd = 20ns Gate Pd = 2mW
Binary Toggle Rate = 10MHz
MSI Clock Rate = 10MHz

You might re-examine your current design. If speed is not a critical factor, then look at our 93L Low Power series. If you care about costs, they have a lot to give. Our new catalog tells the whole story. Send for it.

FAIRCHILD
SEMICONDUCTOR

256 TO 1 YOUR BEST B BURROUGHS

LEADING TODAY'S DISPLAY REVOLUTION

NIXIE® INDICATOR TUBES

Burroughs NIXIE Tubes are available in a complete line of sizes, shapes and costs to satisfy all of your requirements for numeric displays requiring 1 to 8 digits of displayed readouts. Get proven reliability, with non-deteriorating light output and error-proof accuracy. Plan for superior design flexibility with a complete letter/number/symbol selection including decimals and commas.

BURROUGHS NIXIE TUBE MODULES

Off-the-shelf, low-cost readout system flexibility for 3- to 15-digit numeric applications. Decoder drivers and counters are available in any number of configurations for all applications requiring 1 to 15 digits. Ready-to-use assemblies with or without bezel come complete with NIXIE Tubes. Plug-in modules used singly or in combination meet exact application requirements.

PANAPLEX™ NUMERIC PANEL DISPLAYS

Lowest cost-per-digit, in-plane numeric readout for 8 to 16 digit applications provides a 150° viewing angle. Nine-segment format allows centered numeral "1". Less than 2 connections per digit. One-piece common-segment construction with no internal welds assures digit alignment and guarantees high shock vibration resistance. Unitized packaging cuts display length by 25%. Available in 8, 10, 12 or 16-digit displays, these units are designed for time-shared applications and require a minimum of drive electronics.

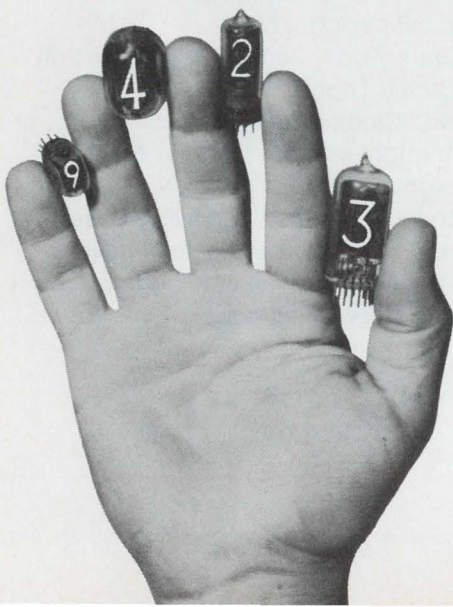

ET IS

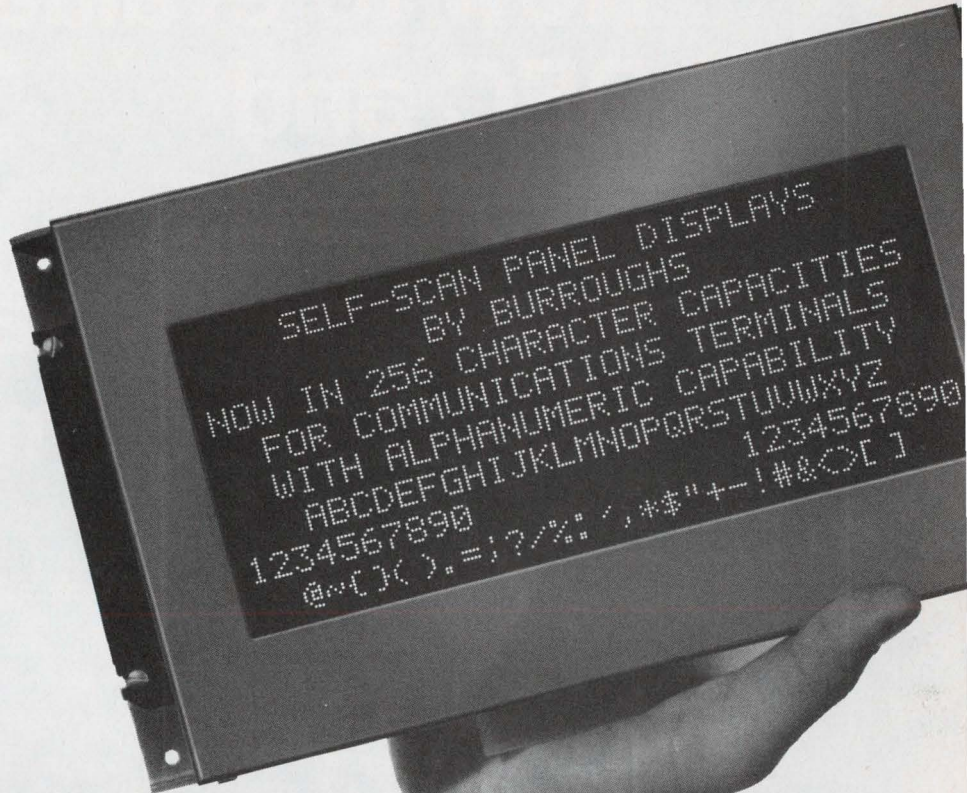

32-, 18-, 16-CHARACTER SELF-SCAN™ PANEL DISPLAYS

This family of SELF-SCAN panel displays is available in a variety of sizes and complexities for any application requiring 16 to 32 characters of alphanumeric information displayed on one line. The dots in the 32-character panels are on 0.030" centers, and dots in 16- and 18-character displays are on either 0.030" or 0.060" centers. These units have a complete electronics package mounted on the display bezel and require only power and ASCII code for a 64-character format. Units can be supplied less the electronic board for graphic or special applications.

256-, 128-, 64-CHARACTER SELF-SCAN PANEL DISPLAYS

Alphanumeric displays equivalent to over 12,000 light-emitting diodes arranged in a matrix format. These lightweight, in-plane displays with dots on 0.040" centers are available in a variety of capacities including 256 characters (8 rows of 32 characters); 128 characters (4 rows of 32 characters); and 64 characters (2 rows of 32 characters). SELF-SCAN panel display subsystems are available as "panels only" for graphic or special applications or in any degree of system complexity, up to a full display system with a complete line of options.



For further information, write or call:
Burroughs Corporation, Electronic
Components Division, Box 1226,
Plainfield, N.J. 07061 (201) 757-3400

Burroughs



How to evaluate DEC and SYSTEMS and other small real-time computers.

Go to a company that makes a complete line for the OEM and end-user markets. Which leaves only DEC and SYSTEMS.

Forget everything you've heard. Take a hardnosed look for yourself. Compare dollars against performance—right down both lines.

If you need large memory, compare SYSTEMS 72 with the PDP-8 and PDP-11. You'll find the SYSTEMS 72 has a little more speed and a lot more memory (max. 65,000 words of programmable memory—almost twice as much as the other two). On many applications, this will cut cost as much as 40%.

If you need more speed, you'll find the SYSTEMS 82 is 4-5 times faster than the PDP-8 or 11. And because it's designed for real-time systems use, you can hang on a wide variety of analog front ends and peripheral equipment.

If you need even faster speeds and heavier software, check out SYSTEMS 810B—the fastest field-proven 16-bit machine in the business. It comes with a whole library of software including FORTRAN IV and a foreground-background-middleground programming system called Real-Time Executive.

SYSTEMS also makes some very large, very fast real-time computers. But that's another story.

As far as small real-time computers go, don't take our word for it. Send the coupons.

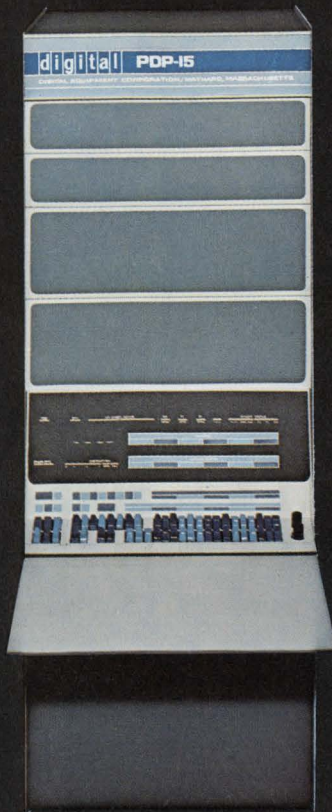

PDP-15

Word length—18-bit
Cycle time—800 nanosec.
Maximum core memory—131

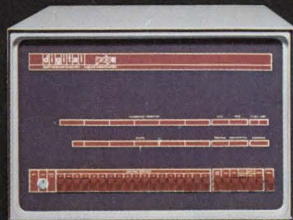

PDP-11

Word length—16-bit
Cycle time—1200 nanosec.
Maximum core memory—32

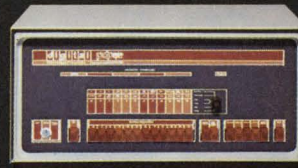

PDP-8 Series

Word length—12-bit
Cycle time—1200-1600 nanosec.
Maximum core memory—32

10

Digital Equipment Corp.

146 Main Street
Maynard, Mass. 01754

I'd like to compare the DEC and SYSTEMS lines of small real-time computers. Please send me more information.

Name _____

Title _____ Tel. _____

Company _____

Address _____

City _____ State _____ Zip _____

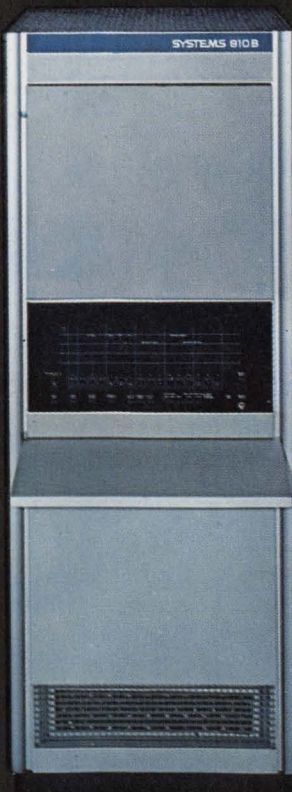

SYSTEMS 810B

Word length—16-bit
Cycle time—750 nanosec.
Maximum core memory—32

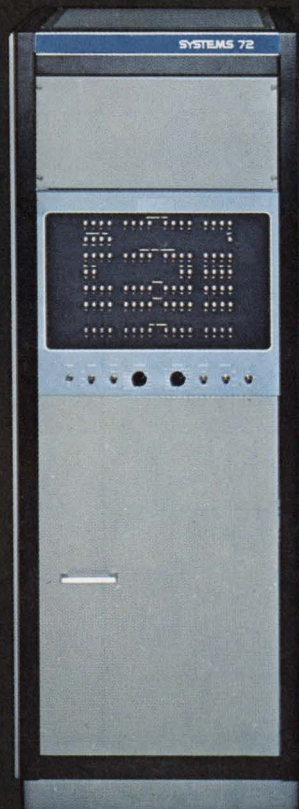

SYSTEMS 72

Word length—16-bit
Cycle time—880 nanosec.
Maximum core memory—65



SYSTEMS 82

Word length—16-bit
Cycle time—900 nanosec.
Maximum core memory—16

10

SYSTEMS Engineering Laboratories

6901 West Sunrise Blvd.
Ft. Lauderdale, Fla. 33313

I'd like to compare the SYSTEMS and DEC lines of small real-time computers. Please send me more information.

Name _____

Title _____ Tel. _____

Company _____

Address _____

City _____ State _____ Zip _____

WHEN EVERY NANOSECOND COUNTS . . .

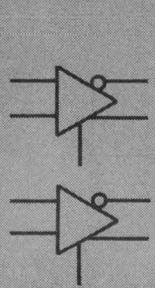

MC1650
Dual A/D Comparator

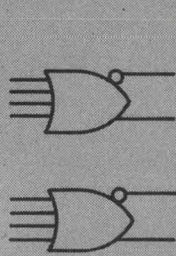

MC1660 (High Z)
MC1661 (Low Z)
Dual 4-Input
OR/NOR Gate

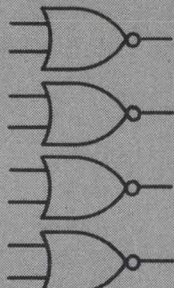

MC1662 (High Z)
MC1663 (Low Z)
Quad 2-Input
NOR Gate

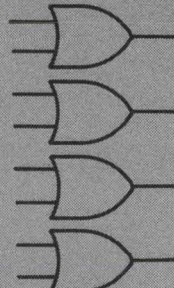

MC1664 (High Z)
MC1665 (Low Z)
Quad 2-Input
OR Gate

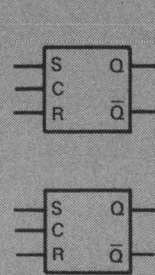

MC1666 (High Z)
MC1667 (Low Z)
Dual Clocked
R-S Flip-Flop

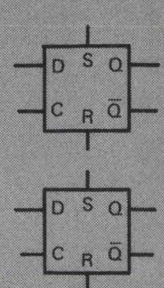

MC1668 (High Z)
MC1669 (Low Z)
Dual Clocked Latch

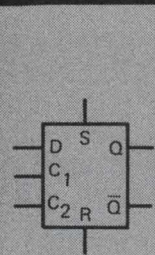

MC1670 (High Z)
MC1671 (Low Z)
Master Slave
Type D Flip-Flop

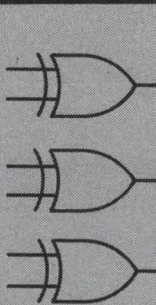

MC1672 (High Z)
MC1673 (Low Z)
Triple 2-Input
Exclusive OR Gate

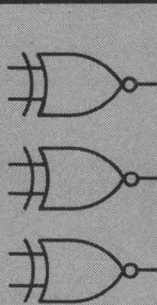

MC1674 (High Z)
MC1675 (Low Z)
Triple 2-Input
Exclusive NOR Gate

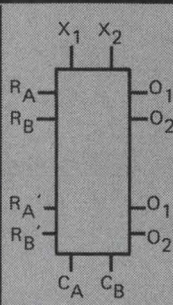

MC1680 (High Z)
MC1681 (Low Z)
Random Access Memory
(RAM) Cell

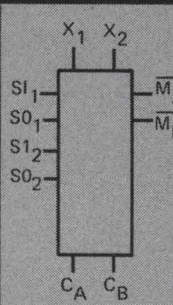

MC1682 (High Z)
MC1683 (Low Z)
Content Addressable
Memory (CAM) Cell

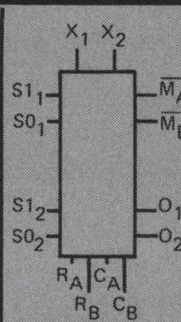

MC1684 (High Z)
MC1685 (Low Z)
Content Addressable
Random Access (CARAM)
Memory Cell

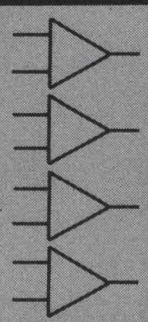

MC1692
Quad Line Receiver

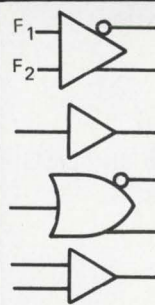

***MC1644**
Digital Mixer
MECL/TTL

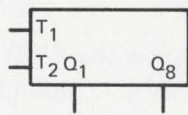

***MC1646**
Prescaler —
Binary Counter/
TTL Translator

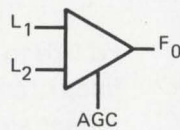

***MC1648**
Emitter Coupled
Oscillator

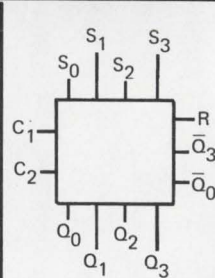

***MC1678** (High Z)
MC1679 (Low Z)
Bi-Quinary Counter

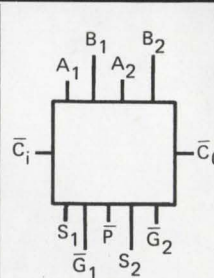

***MC1686** (High Z)
MC1687 (Low Z)
Dual Arithmetic
Unit

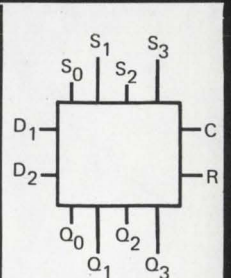

***MC1694** (High Z)
MC1695 (Low Z)
4-Bit Shift
Register

*AVAILABLE EARLY 1971

. . . MECL III HAS THE ANSWERS

As a chain is as strong as its weakest link so are system capacities limited by logic speed. MECL III nanosecond logic is providing the answers to today's increasing data handling demands. Answers in the form of high-speed memories operating at 2.5 ns access times, A/D conversion at 3.5 ns rates, a shift register capable of 300 MHz shift rates, gates with 0.9 ns propagation delay, and a master slave type D flip-flop toggling at 350 MHz.

But speed is only part of the MECL story. Designers have discovered that MECL's Complementary Outputs and the Wired OR Capability have increased circuit flexibility and reduced overall system package count. And if you have high fan-out requirements, MECL III is equal to the task.

MECL offers a definite advantage above 30 MHz by showing a minimal increase in power dissipation even with high capacitive loading or the driving of terminated lines. As the complementary MECL gate is switched from one state to another, power supply current remains constant within 5%. The result — fewer power supply decoupling problems and reduced system fabrication costs.

And take note of MECL's extremely low system crosstalk and noise generation . . . single supply operation . . . voltage and temperature compensated logic swing . . . and driving capability for 50 ohm lines . . . need we say more?

MECL III is now available in stud-mounted flat packs and 16-pin ceramic dual in-line packages to meet your circuit requirements. And in case you haven't noticed, MECL III offers a comprehensive family plus more on the way, all at new lower prices.

Get the whole MECL story. Just write to Motorola Semiconductor Products Inc., P.O. Box 20912, Phoenix, Arizona 85036 and ask for the "MECL High-Speed Systems Design Library." It's full of FAST ANSWERS!

MECL - Trademark of Motorola Inc.



MOTOROLA MECL
the only way to go . . . FASTER

Solve trickiest RFI problems with this new twist!

Super
A **stickn fingers**[®]

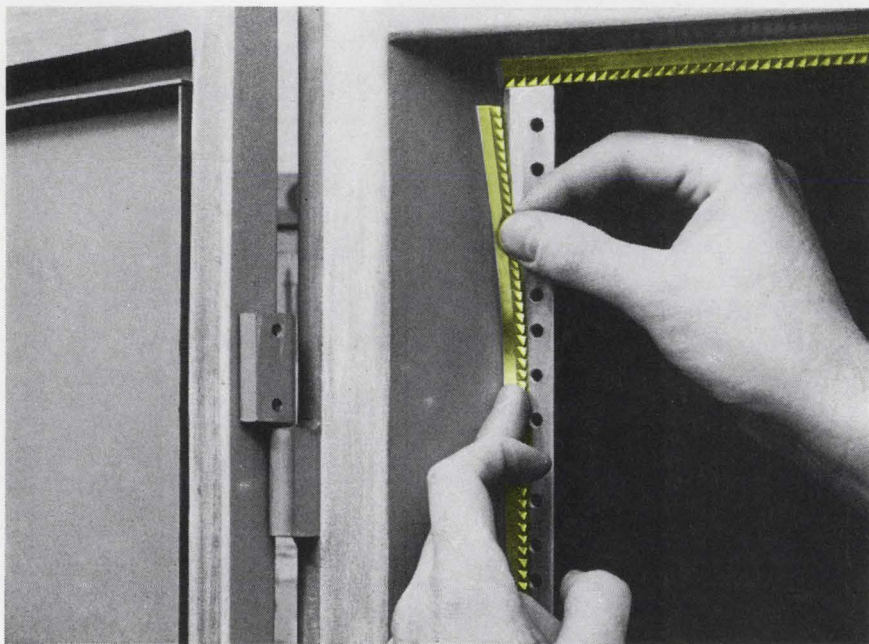

Latest addition to the Sticky Fingers line!

We've made STICKY FINGERS beryllium copper contact strips narrower; given them a new twist; and a new super adhesive—to make even your trickiest RFI/EMI problems practically disappear.

Take our series 97-555. It measures a scant 3/8" wide, yet offers shielding effectiveness with a dynamic range of 1/16"! It's the ideal all-purpose contact strip for just about any type panel or equipment shielding, where space is at a premium.

For equally effective shielding of equipment in panel-divider bar cabinets, specify series 97-560. Only 1/2" wide, its unique design permits any unit to be easily removed without chance of damage to the strip itself.

And a new, stickier, stronger, self-adhesive makes application quick and simple...no holes to drill...no mechanical fasteners to use.

Just cut strip to size...peel off the protective backing...mount firmly in place. Holds instantly; bonds permanently.

New twist-series SUPER STICKY FINGERS are available in a variety of surface finishes. Even if you've already seen samples of STICKY FINGERS, write today for complete technical information and free samples of the new SUPER STICKY FINGERS. Address: Dept. ED-61.



97-555



97-560



INSTRUMENT SPECIALTIES CO., INC.
Little Falls, New Jersey
Phone 201-256-3500

Our economy model.

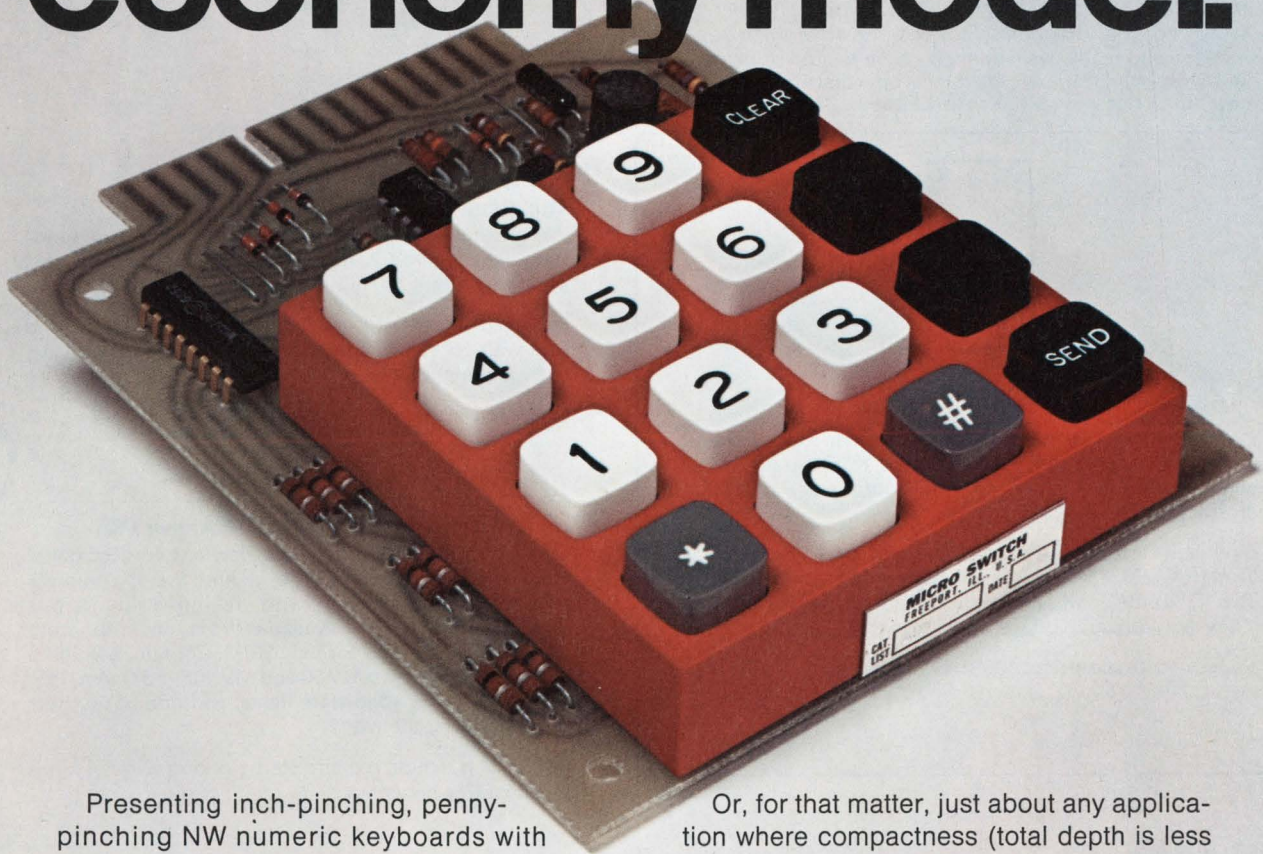

Presenting inch-pinching, penny-pinching NW numeric keyboards with DTL encoding.

They can squeeze in back of most any panel. Because a low-profile design doesn't take up valuable, behind-panel space.

And they offer a slow make, slow break contact action at a low per-station cost.

Key formats are available in "adding machine," Touch-Tone* or in custom colors and legends within existing housings. Which makes our new models ideal for desk top calculators, point of sale stations and credit verification equipment.

Or, for that matter, just about any application where compactness (total depth is less than one inch), life (tested to one million electrical operations) and low cost are important.

NW keyboards are available in either 12 (3x4) or 16 (4x4) stations. Each with BCD or Excess 3 codes. But if you don't require our encoding, non-encoded keyboards are also offered.

Your MICRO SWITCH Branch Office can arrange for off-the-shelf availability for evaluation and prototype use. Call them or write for our special NW keyboard literature.

*Trademark of AT&T.

MICRO SWITCH
FREEPORT, ILLINOIS 61032
A DIVISION OF HONEYWELL

HONEYWELL INTERNATIONAL: Sales and service offices in all principal cities of the world.

INFORMATION RETRIEVAL NUMBER 47

99¢

Hooray! Price reductions for both red and amber GaAsLITEs.

Effective immediately, prices (suggested resale in 1,000 quantities) on our red light-emitting diodes MV 50, MV 10B and our amber GaAsLITE MV 1, have been cut to 99¢. Smaller quantity prices have gone down, too. Get the details from your distributor.

If you've been considering GaAsLITEs in sockets where you need good brightness, low power drive, high reliability, and ready availability, it's time to stop thinking and send a P.O. Wow! ~~Contact~~ Contact your distributor for new low prices on Monsanto LEDs.



MAN 1001 New: Polarity and overflow display

Customers who have bought and used our MAN 1 displays asked us to build a ± 1 device to integrate into digital readout displays, cockpit instruments, and industrial controls.

Voila! the MAN 1001. Same size and package as the MAN 1 GaAsLITE display. Same high brightness (typ. 350 ft-L @ 20 mA) and IC-compatible power requirements (3.4V typ. forward voltage per segment @ $I_F = 20$ mA).

Suggested resale price, 100's: \$11.50 each.

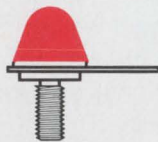

Meet Big Red, the MV 4 The GaAsLITE becomes an illuminator

Photography fans will be delighted to hear that we've developed the MV 4 series of light-emitting diodes. They put out 5,000 ft-L @ $I_F = 1.0$ A in the 6700 Å region, well above the sensitivity range of most photographic emulsions. Mounted in a TO-5 stud-type header, the MV 4 can take up to 1A continuous current in an efficient heat sink.

MV 4's will also serve well as high intensity locators and warning indicators when pulsed. They will handle peak currents of 25A at 1 μ sec, 300 pps limits.

Price: (resale, 100's) \$9.25.
Delivery: off the shelf.

GaAsLITE Update



MV 2: The green GaAsLITE is GO...

We are now in full production with our green solid-state light, the MV 2. Its active gallium phosphide puts out a very bright 300 ft-L in the 5600Å range @ 650 mA.

Packaged in a TO-18 header, the MV 2 completes the stop-wait-go color choices that display designers have been looking for.

Suggested resale price, 1,000's: \$3.75.

... and it's in our new GaAsLITE Answer Kit.

Creative display designers want new answers for panel indicator light problems. They'll find them, complete with applications ideas and design help, in our GaAsLITE Answer Kit, available from any Monsanto distributor worldwide for only \$9.95. Contains a volume of GaAsLITE Tips, two MV 50 and MV 10B red GaAsLITES, two MV 1 amber solid-state lights, and one of our new green answers, the MV 2.

Get out a purchase req and start working with all kinds of GaAsLITEs now.

Monsanto

For additional technical information write
Monsanto Electronic Special Products
10131 Bubb Road, Cupertino, California 95014
(408) 257-2140

Now You Need All This To Build A Power Supply:

1.
Darlington Power Transistor
\$1.57

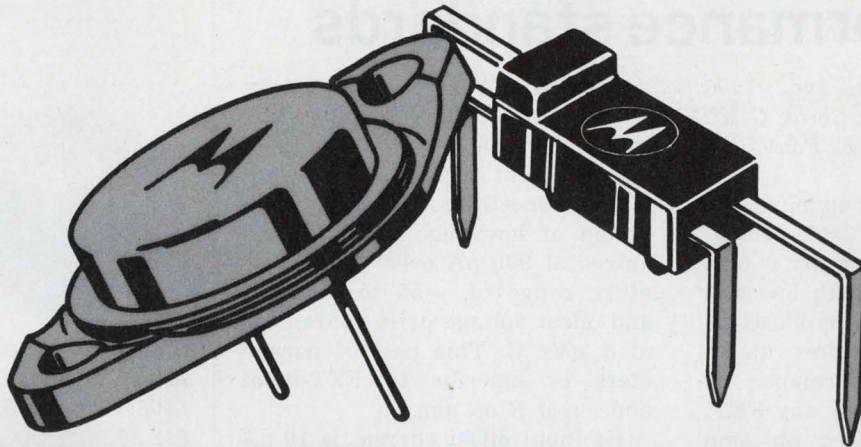

2.
Functional Circuit
90¢

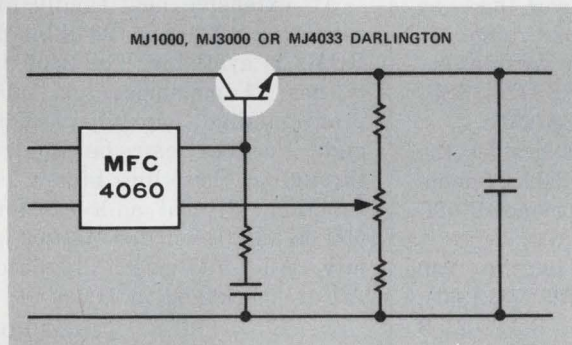

Economical "Darlington + Functional" circuit performs as 3, 5, or 10 A, 5 V regulator. An MJ1000 ($I_{out} = 3$ A) affords load regulation of 0.02% @ 0°C, 0.2% @ 25°C and 0.04% @ 75°C. An MJ3000 ($I_{out} = 5$ A) furnishes 0.04% load regulation for each temperature. An MJ4030 ($I_{out} = 10$ A) yields load regulation of 0.04% @ 0°C and 25°C and 0.06% @ 75°C. MFC4060 is the same as MFC6030 except for current limiting 30 V outputs possible for both circuits.

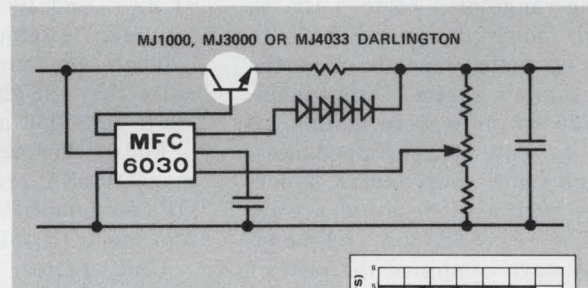

A short-circuit protected supply with 3, 5, and 10 A outputs obtained with MJ1000, MJ3000 or MJ4030 Darlington and an MFC6030 regulator. For each output, load regulation is 0.08% when used as 5 V regulator. Short-circuit characteristics indicate limiting performance with each Darlington. MFC6030 Functional Circuit has 38 V maximum input voltage, 200 mW maximum load current and 3 V minimum voltage differential.

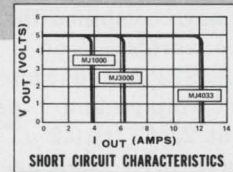

Just 2 Active Components!

... that's all it takes now to build reliable, regulated power supplies for your commercial / light industrial / computer peripheral equipment.

One Darlington and one "functional" eliminates a dozen or more resistors, diodes and discrete devices . . . PLUS their associated wiring . . . PLUS the cost involved in their assembly!

Power Darlington's furnish state-of-the-art performance and design simplicity in most any relay and solenoid drivers, audio amplifiers, servo amplifiers and series pass regulators by forever obsolescing conventional, "one-for-one" driver and output transistors and associated base-emitter resistors. Complementary in polarity, the metal and plastic series

offers many "firsts" — 2,500 typical h_{FE} , up-to-100 V sustaining voltage, 5 A @ 30 V safe operating area and 100-up prices low as \$1.35.

MFC4060/6030 functional circuits afford industrial-quality performance through precision voltage regulation. Load regulation is 0.2% and line regulation is 0.03%/V maximum at 30 V. $T_C = \pm 3.0$ mV/°C and output voltage is adjustable from 4.8 to 35 V. The MFC-6030 can be externally programmed to current-limit from 100 to 200 mA. 90¢ buys you an MFC4060 in 100-up quantities!

Both are new, both offer unique advantages individually, both are available now from your Motorola distributor for team evaluation on your prototype power

supply workbench. Your inquiry will bring you a complete package of product data and how-to-do-it power supply circuits. Write for it today . . . it's all you'll need. Box 20912, Phoenix, Arizona 85036.

POWER DARLINGTONS

PNP/NPN Series	I_C Range (cont) A	V_{CE} (sus) V	h_{FE} @ I_C (min)	P_D W	SOA	Price Range 100-up
MJ900 to MJ4033	4-16	60-100	750-1000 @ 1.5, 3, 4, 5 & 10 A	75-150	3 A @ 25 V to 5 A @ 30 V	\$1.35-5.35

FUNCTIONAL VOLTAGE REGULATORS

Type	Outstanding Characteristics	Price 100-up
MFC4060	Ultra-low cost, precision, series pass regulator in 4-lead plastic	\$.90
MFC6030	Short-circuit protected, 6-lead version programmed to current limit from 100 to 200 mA	\$1.78



MOTOROLA POWER
—where the priceless ingredient is care!

INFORMATION RETRIEVAL NUMBER 49

new products

High-temperature IC op amps set performance standards

Precision Monolithics, Inc., 1500 Space Park Dr., Santa Clara, Calif. Phone: (408) 246-9222. P&A: see text.

Two new monolithic op amps, the SSS725A and monoOP-08A, demonstrate exceptionally low drift, bias and offset levels for both low and high source-impedance applications at operating temperatures up to +125°C. Their performance is presently unsurpassed by any FET, IC or chopper-stabilized op amp over the range of -55 to +125°C.

Until now, designers had to choose op amps depending on the application's source impedance. Type 725 op amps were mainly intended for low source impedances. For high source impedances, super- β types such as 108 op amps were used. The new SSS725A and monoOP-08A have combined the best of those two worlds.

The SSS725A guarantees 100 μ V offset voltage and 1 nA offset current at 25°C. Its 0.2 μ V/°C offset voltage drift challenges chopper-stabilized op amps, and it doesn't have their disadvantage of spiking and low bandwidth.

Input bias current ranges from 60 to 120 nA over the temperature range of -55 to +125°C. Input offset current drift is 20 pA/°C.

The monoOP-08A offers a combination of low bias current, guaranteed at 990 pA over the temperature range of -55 to +125°C, and offset voltage drift guaranteed at 4 μ V/°C. This pair of parameters is superior to FET-input and super- β op amps.

Its input offset current is 10 pA at 25°C and 100 pA over the -55 to +125°C temperature range.

There are four other versions besides the SSS725A: SSS725, SSS725B, SSS725C and SSS725E.

Four other versions besides the monoOP-08A are available: monoOP-08, monoOP-08B, monoOP-08C and monoOP-08D.

Unit prices for 100 to 249 quantities are: SSS725 (\$21.60), SSS725A (\$50.75), SSS725B (\$13.95), SSS725C (\$16.30) and SSS725E (\$16.30), monoOP-08 (\$29.45), monoOP-08A (\$65.90), monoOP-08B (\$19.75), monoOP-08C (\$9.90). All units are available from stock.

CIRCLE NO. 250

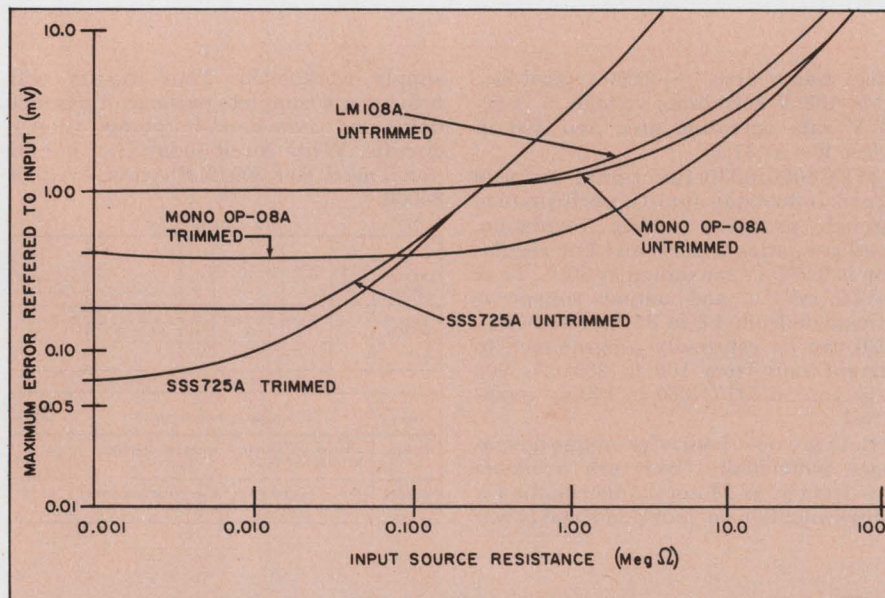

Two monolithic op amps provide low total input error over -55 to +125°C. The total error includes all voltage and current drifts and offsets and current bias over a wide range of input source resistances.

MOS ROM family has 1024/2048 bits

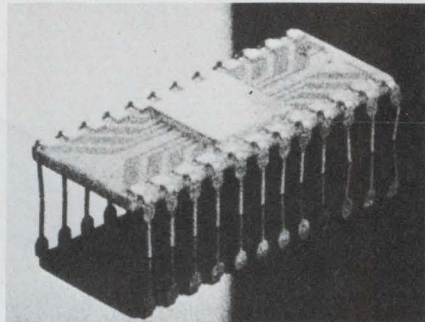

Signetics Corp., 811 E. Arques Ave., Sunnyvale, Calif. Phone: (408) 737-7700. Price: \$13.80 or \$18.80.

An extensive new family of inexpensive 1024 and 2048-bit MOS ROMs is available. The 2400 family has 11 memories and on-chip programming capability. Up to eight devices can be controlled through a three-line binary coded function. Typical address time is 550 ns and power dissipation is 150 mW. All units are fully decoded. All are packaged in DIPs.

CIRCLE NO. 251

Five linear IC op amps have 1 MHz unity gain

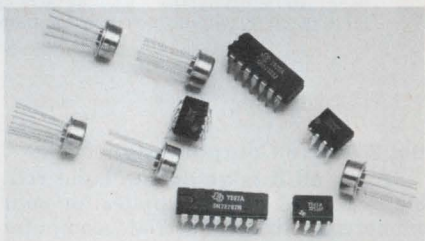

Texas Instruments Inc., 13500 N. Central Expressway, Dallas, Tex. Phone: (714) 238-2011. P&A: 94¢ to \$9; stock.

Five new linear IC op amps feature unity gain-bandwidth products of 1 MHz and 0.5-V/ μ s slew rates. They are the SN52/72747, SN52/72758 and SN52/72558 with 20-V/mV gain, each. Also included are the SN52107/72307 and SN52101A/7230A with gains of 25 and 50 V/mV. Input offset currents range from 20 to 200 nA. SN52 and SN72 versions operate over -55 to +125 and 0 to +70°C, respectively.

CIRCLE NO. 252

1% accurate multiplier is fully self-contained

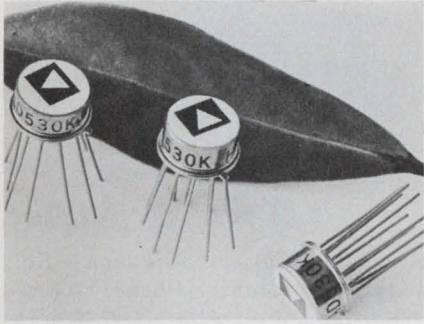

Analog Devices, Inc., 221 Fifth St., Cambridge, Mass. Phone: (617) 492-6000. P&A: \$20 or \$30; 2 wks.

Truly a complete IC analog multiplier on a single chip, the new model AD530K operates as a multiplier, squarer, divider, or square-rooter, without requiring an operational amplifier in an external feedback loop. As a result, the circuit's over-all accuracy is guaranteed to 1%. Another version, the AD530J, offers identical performance with an accuracy of 2%.

CIRCLE NO. 253

Wideband impatt diodes cost only 5¢/mW

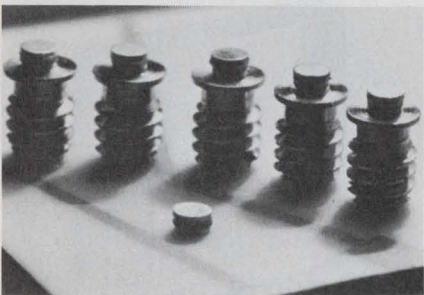

Hughes Aircraft Co., 3100 W. Lomita Blvd., Torrance, Calif. Phone: (213) 534-2121. P&A: See text; stock.

A new type of impatt diode, featuring a new packaging technique, costs as low as 5¢ per milliwatt in 1000-lot quantities. Included in the new packaging concept is a new pill configuration which allows direct banding into microstrip circuits. This configuration is called the Minidisc package. The diodes cover X, Ku and KA bands and are available on a threaded stud.

CIRCLE NO. 254

Quad current switches

The ICL8018 series quad current switches feature 12-bit accuracy, 100-ns switching speed and a wide power supply range. Intersil, Cupertino, Calif. (408) 257-5450. P&A: \$9.60 to \$36; stock.

CIRCLE NO. 255

Tempco zener diode

The low dynamic-impedance LM113 tempco zener has breakdown-voltage change of 6 mV for a current change of 0.5 to 20 mA. Drift is 0.01%/°C. National Semiconductor, Santa Clara, Calif. (409) 732-5000. P&A: \$7.50; stock.

CIRCLE NO. 256

5-μW binary counter

The CD4004D COS/MOS binary counter dissipates only 5 μW. It's a seven-stage ripple-carry type in 14-lead DIP. RCA Solid State, Somerville, N. J. (201) 722-3200.

CIRCLE NO. 257

Scratch-pad memories

Two 16-bit scratch-pad bipolar memories with direct-address and non-destructive readout are available. Type US7481A has single-write amplifier inputs while type US7484A has dual inputs. Sprague Electric, N. Adams, Mass. (413) 664-4481.

CIRCLE NO. 258

Quad Exclusive OR

A static CMOS Quad Exclusive OR uses enhancement-mode n and p-channel MOS transistors interconnected in complementary-symmetry. The SCL-5201 operates from 6 to 20 V. Solid State Scientific, Montgomeryville, Pa. (215) 855-8400.

CIRCLE NO. 259

Static/dynamic registers

Two new shift registers are the dynamic M125 and static M127. The former has 512-bit complexity in two sections, the latter 100 bits. Both shift to 1 MHz. Societa Generale Semiconduttori, Milan, Italy.

CIRCLE NO. 260

4096-bit bipolar ROM

A new 4096-bit bipolar ROM is available. The 8223 is organized 1024 by 4, accesses in 55 ns and dissipates 125 μW/bit. Signetics Memory Systems, Sunnyvale, Calif. (408) 729-7101. Price: \$67.

CIRCLE NO. 261

Diode matrices

Two new series of programmable diode matrices are fabricated by epitaxial techniques. They are high-speed TIDM1 and medium-speed TIDM2. Texas Instruments, Dallas, Tex. (214) 238-2011. P&A: \$4 to \$7; 3 wks.

CIRCLE NO. 262

2048-bit bipolar ROM

The MM6205 2048-bit bipolar ROM is available. It dissipates 0.2 μW/bit and accesses in 30 ns. Monolithic Memories, Sunnyvale, Calif. (408) 739-3535. P&A: 3¢/bit; 3 to 4 wks.

CIRCLE NO. 263

Communications ICs

Three new ICs are designed for communications systems. They are the SN56/76502 log amp, the SN56/76514 double balanced mixer and the SN52/72733 differential video amp. Texas Instruments, Dallas, Tex. (214) 238-2011. P&A: \$1.80 to \$7; 2 wks.

CIRCLE NO. 264

Second-source op amps

Four new improved second-source IC op amps are available. These are 5741, 5748, 5558 and 5556. Available in TO-5, 14-pin and 8-pin DIP cases. Signetics, Sunnyvale, Calif. (408) 739-7700. Availability: stock.

CIRCLE NO. 265

8-bit shift registers

Two 8-bit shift registers are available. Type US74164A is serial-in parallel-out up to 14 MHz. Type US74165A is parallel-in serial-out up to 20 MHz. Sprague Electric, N. Adams, Mass. (413) 664-4481.

CIRCLE NO. 266

8-bit a/d in only 2.8 in.³

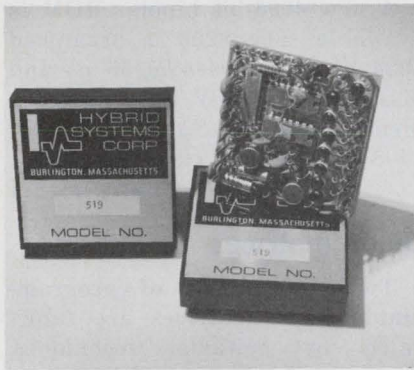

Hybrid Systems Corp., 95 Terrace Hall Ave., Burlington, Mass. Phone: (617) 272-1522. P&A: \$99; stock to 2 wks.

The smallest 8-bit encapsulated a/d converter yet is the model 519. It measures only 2.3 by 2.3 by 0.525 in. and includes a reference, ladder, switches and amplifiers.

The new module requires three power supply voltages of ± 15 V at 25 mA and +5 V at 90 mA. Its

input voltage range, normally 0 to +10 V, can be changed by external adjustment to -5 to +5 V. Conversion time is 200 μ s and over-all linearity is 1 LSB.

The 519 operates from 0 to +70°C. Drift vs temperature is specified at 75 ppm/°C.

The 519 a/d operates through an internal d/a converter and a counter. The counter's value is increased at a basic clock rate causing the d/a output voltage to increase proportionally.

The output of the d/a is then compared with the analog input to the 519. The counter is stopped when the two voltages are equal. Its digital value is then proportional to the input analog signal.

A strobe signal initiates conversion. Its leading edge resets the counter to zero and its trailing edge initiates counting. A busy bit indicates that conversion is over.

CIRCLE NO. 267

0.01% multiplexer has only 1 μ V noise

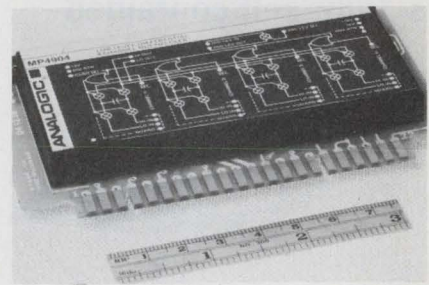

Analogic Corp., Audubon Ra., Wakefield, Mass. Phone: (617) 246-0300. P&A: \$200; 4 to 6 wks.

A new 4-channel floating differential-input low-level multiplexer features 0.01% transfer accuracy and less than 1 μ V of noise at throughput rates over 25 kHz. The AN4904M has an input range of ± 5 to ± 500 mV full-scale, channel-to-channel offset of less than ± 3 μ V and common-mode rejection of 120 dB. It consists of a Modupac MP4904 mounted on a plug-in PC card.

CIRCLE NO. 269

Analog memory has logic alert



Optical Electronics, Inc., P. O. Box 11140, Tucson, Ariz. Phone: (602) 624-8358. P&A: \$167 (1 to 2), \$150 (3 to 9), \$136 (10 to 29); stock.

The 5891 analog memory module accepts up to 10 V analog and produces two outputs: one analog (up to 10 V) representing the peak amplitude of the input analog signal and the other a digital alert signal (3 to 5 V) that indicates when that input peak occurs.

This function is useful for capturing transient voltages, measuring peak noise and signal amplitudes, such as a transducer's output, and measuring the amount of stress before failure of a device under test.

Other applications include the detection of the largest, first or last pulse in a system and infinite memory and digital readout when the module is used with a digital panel meter.

The module may be commanded to reset its memory, bringing the analog and digital outputs to zero. A gate command disconnects the 5891 from the input signal to ignore any further input peaks.

A total acquisition time of 350 ns is available. Maximum reset time is 50 μ s. Total device power dissipation is only 600 mW, and useful dynamic range is more than 40 dB.

Compatibility with DTL and TTL logic levels and complete over-voltage and short-circuit protection are additional characteristics of the 5891. Operation is from ± 15 -V supplies. The 5891 is encapsulated and measures 3-1/4 by 1-1/2 by 5/8 in.

CIRCLE NO. 268

8-bit hybrid d/a costs just \$19

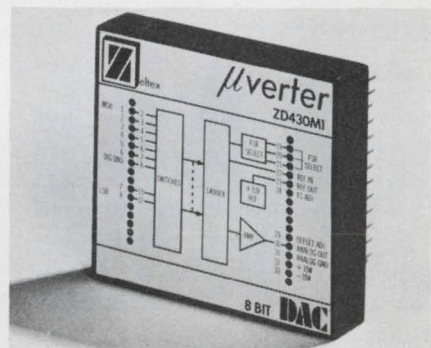

Zeltex, Inc., 1000 Chalomer Rd., Concord, Calif. Phone: (415) 686-6660. P&A: \$19; stock.

A new hybrid thick-film d/a converter features 8-bit resolution, 20- μ s settling time, linearity of $\pm 1/2$ LSB and a price of only \$19. Each ZD430M1 has a digital interface buffer, current switches, ladder, reference and output amplifier. Each is TTL/DTL compatible and offers binary or BCD input coding. Operating temperature is 0 to +70°C and TC is 20 ppm/°C.

CIRCLE NO. 270

10-kHz reference d/a

A new 13-bit d/a accepts references from dc to 10 kHz over ± 10 V. Accuracies to $\pm 0.00625\%$. UDAC series accepts arbitrary reference waveforms. DDS, Hicksville, N. Y. (516) 433-5330. P&A: \$200 to \$500; stock to 3 wks.

CIRCLE NO. 271

Converter accepts 10 mV

The 250 voltage-to-frequency converter accepts 10 mV to 3 V full scale in six input ranges. Vidar, Mountain View, Calif. (415) 961-1000.

CIRCLE NO. 272

5 to 15-V converter

The PWRPAC MP3015 provides ± 15 V to 200 mA from +5 V digital supplies. Line and load regulation are 0.1% and noise is 1 mV rms. Analogic, Wakefield, Mass. (617) 246-0300. P&A: \$89; 2 to 4 wks.

CIRCLE NO. 273

Thrifty displays

SP-730 7-segment gas-discharge displays cost \$2.30/digit (5000). Characters are 0.33-in high at 100 to 500 foot-lamberts. Sperry Rand, Scottsdale, Ariz. (602) 947-8371. Availability: stock to 30 days.

CIRCLE NO. 274

Variable-mode op amp

The 9716 is a variable mode op amp with 3 open-loop gains. High speed at 66 dB gain, low current at 90 dB gain and high gain of 86 dB. Optical Electronics, Tucson, Ariz. (602) 624-8358.

CIRCLE NO. 275

0.33-in.-high display

A new solid-state numeric indicator provides seven-segment plus decimal-point display with 0.33-in. character height. Type SLA-1 uses red GaP. OPCOA, Edison, N. J. (201) 287-0355.

CIRCLE NO. 276

Measure True RMS

$$E_{RMS} = \sqrt{\frac{1}{T} \int_0^T [E_1(t)]^2 dt}$$

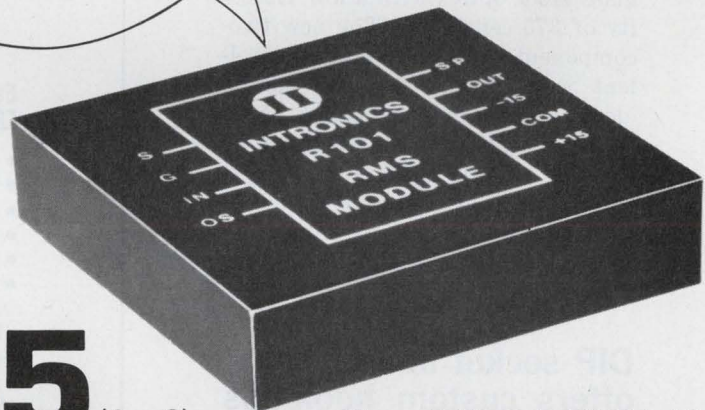

\$85 (1 - 9)

Size: 1.75" X 1.75" X 0.4"

INTRONICS' MODEL R101 CONVERTER

Intronics' new R101 converter measures true RMS of complex wave forms with 0.1% accuracy packaged in a 1.25 cubic inch module. The new converter accepts most wave forms, allowing measurement of random noise, pulse trains, distorted sine waves and SCR outputs. With externally adjustable time constant, the R101 provides maximum flexibility and the ideal solution to system design problems.

FEATURES:

- 0.1% accuracy
- 1 MHz @ 7 VRMS (sine wave)
- Variable time constant
- Only two adjustments required (gain and offset)
- Measures RMS value of most wave forms

 **intronics**

57 CHAPEL STREET, NEWTON, MASS. 02158 • (617) 332-7350 (TWX 710-335-6835)

INFORMATION RETRIEVAL NUMBER 50

Low-viscosity epoxy bonds fiber optics

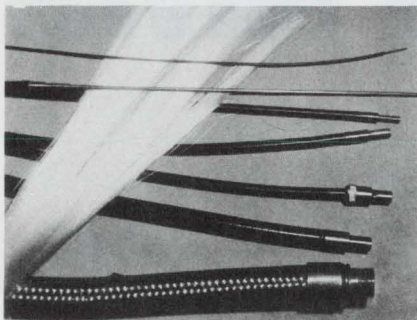

Epoxy Technology, Inc., 95 Grove St., Watertown, Mass. Phone: (617) 926-0136. P&A: \$10/1-lb kit; stock.

Epo-Tek 330 is a new epoxy particularly designed for bonding glass fiber optics with a low viscosity of 375 centipoise. The new two-component epoxy exhibits excellent wetting and capillary action along the fibers and can be cured in 10 minutes at 120°C or in 30 minutes at 100°C. A unique feature is its color change when it is heat cured.

CIRCLE NO. 277

DIP socket board offers custom hook-ups

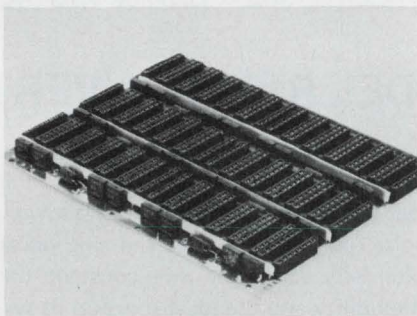

Electronic Engineering Co. of Calif., Electronic Products Div., 1441 E. Chestnut Ave., Santa Ana, Calif. Phone: (714) 547-5651.

Able to accept 36 16-pin DIP sockets, the model H-2920 socket board allows power and ground connections to be distributed to any of the pins on an individual socket. The board maintains the low-impedance power that is normally required for TTL and MSI circuits. Power connection flexibility is obtained through unique wire-loop power connections.

CIRCLE NO. 278

new

BIPOLAR KEYBOARD ENCODER

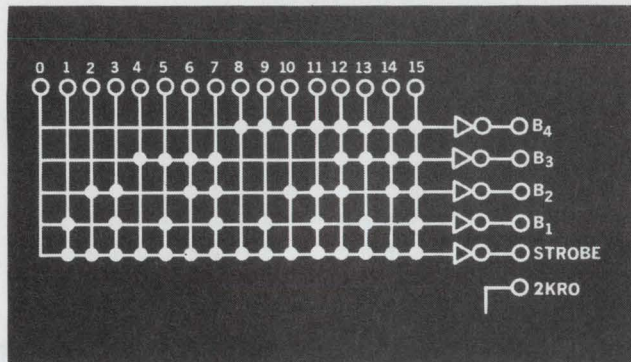

OFF-THE-SHELF DELIVERY

Easy configuration to any binary code, including ASC11 and EBCDIC, without time-consuming keyboard modification.

- 16 x 5 Matrix — Adaptable in Parallel Operation for 256 keys
- Self-contained strobe compatible with DTL and TTL levels
- Detects two or more keys depressed at the same time
- Propagation Delay — 115ns
- Power Supply — 5V, 52mA
- Temperature Range — 0°C to +75°C

The **HD-0165** is available in a 24-lead dual in-line package at: \$4.60*ea.

*100 to 999 unit price.

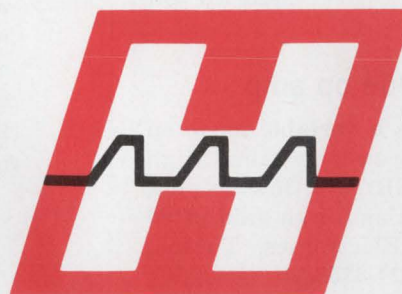

HARRIS

SEMICONDUCTOR

A DIVISION OF HARRIS-INTERTYPE CORPORATION

P. O. Box 883, Melbourne, Florida 32901 (305) 727-5430
 DISTRIBUTORS: HARVEY/R & D ELECTRONICS—Lexington, Mass. (617) 861-9200/R. V. WEATHERFORD CO.—Albuquerque (505) 265-6112, Anaheim (714) 547-0891, Dallas (214) 231-6051, Denver (303) Enterprise 165, Glendale (213) 849-3451, Palo Alto (415) 321-5373, Phoenix (602) 272-7144, Pomona (714) 623-1261, San Diego (714) 278-7400, Seattle (206) 762-4200/SEMICONDUCTOR SPECIALISTS INC.—Chicago (312) 279-1000, Detroit (313) 255-0300, Minneapolis (612) 884-8132, Kansas City (816) 452-3900, St. Louis (314) 428-6100, Dallas (214) 358-5211, Indianapolis (317) 243-8271, Pittsburgh (412) 781-8120, Dayton (513) 278-9455.

IC'S

IN STOCK RELIABLE LOW COST

The Harris family is designed to solve your problems

When you need to — convert to binary or decimal codes, convert voltage to current pulses, interface with modems, transmit and receive over a party line, encode a keyboard or restore current pulses to voltage pulses — Call Harris.

DIGITAL I.C.'s

Keyboard Encoder

Adapt to any Binary code
HD-0165

Line Driver/Receiver

Meets EIA RS-232-C
Interface specification
HD-1488, HD-1489

Party Line Transmitter/Receiver

Compatible with DTL
and TTL Logic
HA-245, HA-246

Diode Matrix

Easily customized to
specific pattern
7 configurations

When you need to — amplify, buffer, compare, multiplex, convert D to A or anything else in analog signal processing — Call Harris.

LINEAR I.C.'s

Op Amp

General Purpose/
Low Power
HA-2700
Wide Band
HA-2620, HA-2625
High Slew Rate
HA-2500, HA-2510, HA-2520
Low Noise
HA-2909
High Impedance
HA-2600

8-Bit D/A Converter

Monolithic/Guaranteed Accuracy
HI-1080

10-Bit Ladder Network

Low Cost, High Accuracy
HI-0910, HI-1010

16-Channel Multiplexer

J-FET/Bipolar
HS-1000

When you need to — convert a code, microprogram a computer, store information and recover it quickly — Call Harris.

MEMORY I.C.'s

64 x 8 PRØM™

Field Programmable
HROM-0512

256 x 1 PRØM™

Field Programmable
Very high speed
HROM-1256

16-Bit RAM

High speed
HRAM-0016

64-Bit RAM

High speed, fully decoded
HRAM-0064

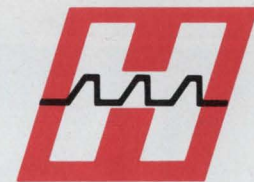

HARRIS SEMICONDUCTOR

A DIVISION OF HARRIS-INTERTYPE CORPORATION

P. O. Box 883, Melbourne, Florida 32901

Please send me more information on the
Harris Off-the-shelf I.C.'s checked below.

- Memories
 Linear Circuits
 Digital Circuits

NAME _____ TITLE _____

ADDRESS _____

CITY _____ STATE _____ ZIP _____

PHONE _____

DISTRIBUTORS: HARVEY/R & D ELECTRONICS—Lexington, Mass. (617) 861-9200/R. V. WEATHERFORD CO.—Albuquerque (505) 265-6112, Anaheim (714) 547-0891, Dallas (214) 231-6051, Denver (303) Enterprise 165, Glendale (213) 849-3451, Palo Alto (415) 321-5373, Phoenix (602) 272-7144, Pomona (714) 623-1261, San Diego (714) 278-7400, Seattle (206) 762-4200/SEMICONDUCTOR SPECIALISTS INC. — Chicago (312) 279-1000, Detroit (313) 255-0300, Minneapolis (612) 884-8132, Kansas City (816) 452-3900, St. Louis (314) 428-6100, Dallas (214) 358-5211, Indianapolis (317) 243-8271, Pittsburgh (412) 781-8120, Dayton (513) 278-9455.

SALES OFFICES: P. O. Box 883, Melbourne, Florida 32901 (305) 727-5430/Lexington, Massachusetts (617) 237-5430/Frederick, Maryland (301) 662-5400/Palos Heights, Illinois (312) 448-9110/Albuquerque, New Mexico (505) 268-3549/Palo Alto, California (415) 321-2280/Dallas, Texas (214) 231-9031/Long Beach, California (213) 426-7687/Norwalk, Connecticut (203) 853-3646/EXPORT SALES, DAGE CORPORATION, STAMFORD, CONNECTICUT.

RADIATION MICROELECTRONICS HAS CHANGED ITS NAME TO HARRIS SEMICONDUCTOR

INFORMATION RETRIEVAL NUMBER 51

Six-digit counter spans 5 Hz to 32 MHz

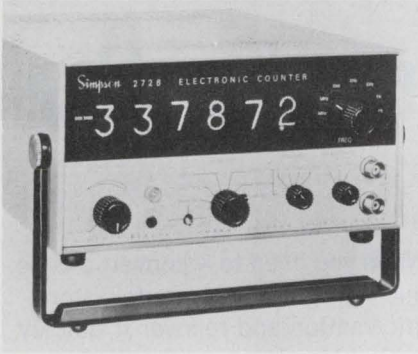

Simpson Electric Co., 5200 W. Kinzie St., Chicago, Ill. Phone: (312) 379-1121. P&A: \$575; stock.

A new six-digit electronic counter, model 2726, displays frequencies from 5 Hz to 32 MHz in six switch-selectable time bases. Period measurements (single and multiple) and frequency ratios (referenced to 1, 10, 100 or 1000 Hz of the base frequency) can be made. Additional capabilities include time-interval measurement and pulse totalizing.

CIRCLE NO. 280

8-channel multiplexer enhances displays

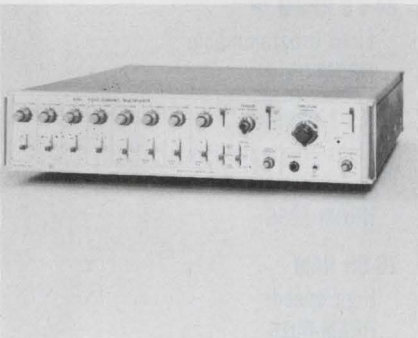

Tektronix, Inc., Box 500, Beaverton, Ore. Phone: (503) 644-0161. P&A: \$1500; 2nd quarter, 1971.

The 4701 is an eight-channel multiplexer that can be used with most XYZ storage or non-storage CRT displays. It has a calibrated time base and is compatible with Tektronix types 601 and 611 storage display units, the non-storage 602 display unit and the 4501 scan converter. Up to eight Y-T, four X-Y or a combination of Y-T and X-Y displays are possible.

CIRCLE NO. 281

4-1/2-digit DPMs use LED displays



Electronic Research Co., Box 913, Shawnee Mission, Kan. Phone: (913) 631-6700. Price: \$400.

A new series of 4-1/2-digit panel voltmeters incorporate LED numeral displays. Series 4000 instruments are self-contained in an all-metal case measuring 4-1/4 by 2-1/2 by 7 in. Basic range is 1999.9 mV full scale with other ranges available up to 1 kV. Measurement accuracy is 0.01% full-scale. Auto-polarity and isolated BCD outputs are standard.

CIRCLE NO. 282

Low-cost synthesizer is programmable

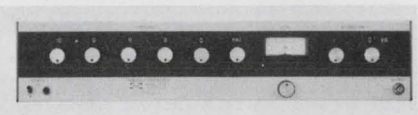

Pacific Measurements Inc., 940 Industrial Ave., Palo Alto, Calif. Phone: (415) 328-0300. P&A: \$1990; 2 to 4 wks.

With a price tag of \$1990, a programmable frequency synthesizer, model 1028, features five-digit resolution, seven ranges and a clean signal that is flat to ± 0.1 dB over the range of 1.0000 Hz to 12.9999 MHz. Programming can be manual by controls, or remote with BCD and octal codes.

CIRCLE NO. 283

Graphics terminal shows curved contours



Conographic Corp., 380 Green St., Cambridge, Mass. Phone: (617) 491-5820. P&A: \$9000; 30 days.

The Congraph/10 is a graphic display terminal producing curvilinear drawings, graphics, alphanumeric and symbols via a technique that uses conic sections to produce any curved contour regardless of its mathematical function. It compresses data by 10 to 100 times. Its generator can transform parameters, allowing translation rotation, and deformation of an image.

CIRCLE NO. 284

12-lb LSI calculator does complex algebra



Eugene Dietzgen Co., 2425 N. Sheffield Ave., Chicago, Ill. Phone: (312) 549-3300. Price: \$1795.

A compact 12-lb electronic calculator that uses LSI circuitry does logarithms, trigonometric functions, algorithms, square roots and factorials and raises any number to any power in milliseconds. It displays 10 significant digits with sign and decimal point and a two-digit exponent with a sign. Six storage resistors are included. Power dissipation is 20 W.

CIRCLE NO. 285

TV-display terminal

The TeleComputer converts (by clip leads to the antenna) any TV into an I/O terminal. Telephone coupler built-in. Digi-Log Systems, Conshohocken, Pa. (215) 824-1440. Price: \$650.

CIRCLE NO. 286

16-bit minicomputer

The D-216 is an MSI 16-bit minicomputer. RAM and ROM options available in increments of 256, 1024, or 4096 words. Digital Controls, Fairfield, N. J. (201) 227-4861. Price: \$2600.

CIRCLE NO. 287

8-1/2-in.-reel handler

A new low-cost tape drive handles 8-1/2-in. reels. Mod 8 provides data densities of 200, 556, 800 and 1600 cpi at 12-1/2 in./s. Wang Computer Products, Los Angeles, Calif. (213) 478-7727.

CIRCLE NO. 288

13 to 132-char. printer

The model HP-030 serial printer has an adjustable 13 to 132-character print line. It has full 63 characters. Singer-Friden Div., San Leandro, Calif. (415) 357-6800. P&A: \$725; 2nd quarter, 1971.

CIRCLE NO. 289

Reliable ROM system

A new planar braid ROM system is designed to extremely high reliability. System PBS has capacity to 196,608 bits. Memory Technology, Boston, Mass. (617) 443-9911. Price: 1.5¢ to 2¢/bit.

CIRCLE NO. 290

Five mega-bit memories

Complete semiconductor memory systems up to five million bits are available. Each has separate memory planes or is complete. Monolithic Memories, Sunnyvale, Calif. (408) 739-3535. Price: 5¢/bit.

CIRCLE NO. 291

Volume Resistance of Thermosetting Compounds at 160° F, 100% RH

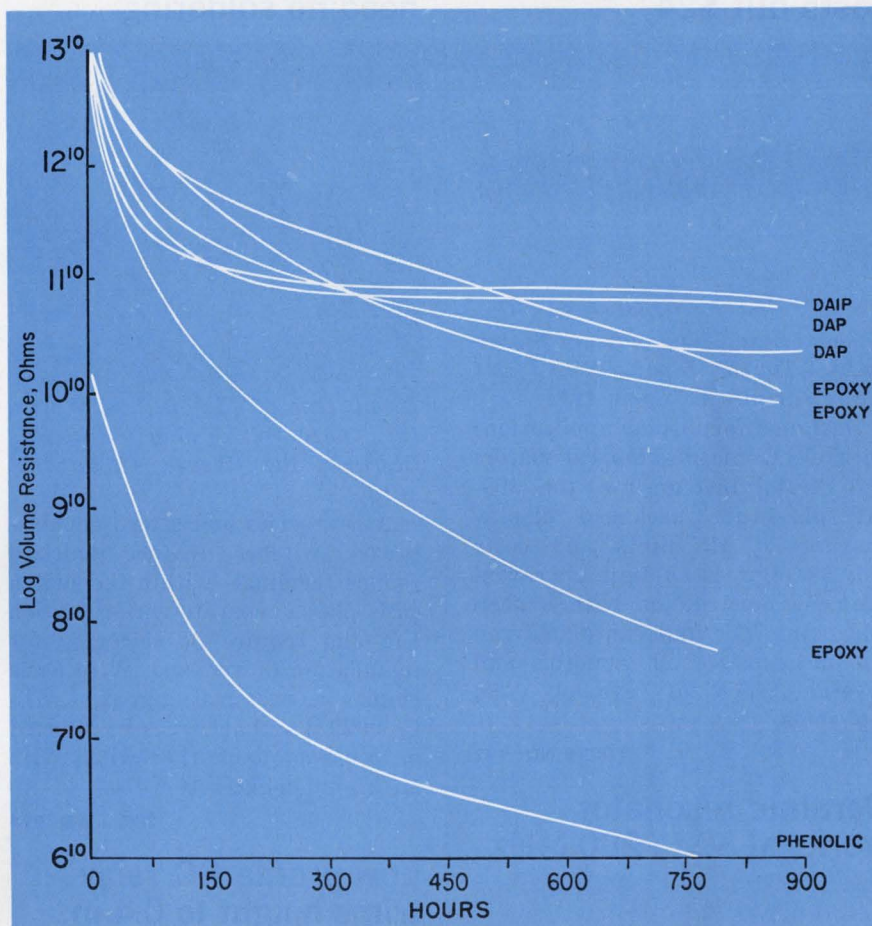

Which resin do you pick?

That's right! DAP. That's our DAPON® and DAPON M diallyl phthalate resins, filled with glass fiber, on top after 900 hours at 160 degrees F (70 degrees C) and 100 percent relative humidity. The property being measured is volume resistivity which is what an insulating plastic is all about.

The story is more involved than that, of course. Let us send you reprints of "Chemical and Thermal Resistance of Thermosetting Molding Materials" and "The Effects of Temperature and Humidity on Electrical Properties of Thermosetting Plastics" and get the complete story.



ORGANIC CHEMICALS DIVISION
FMC CORPORATION

633 Third Avenue, New York, N. Y. 10017

INFORMATION RETRIEVAL NUMBER 52

12-digit tube display costs but \$24



Okaya Electric Industries Co., Yasuda Bldg. 8-3-1 chome, Shibuya-ku, Tokyo, Japan. P&A: \$2/digit; samples in April, 1971.

Designed for display applications with electronic desktop calculators and digital instruments, the MG-112 glass-tube packaged display consists of 12 digits and costs only \$2/digit. Each digit has seven-segment construction with a decimal point. The unit can display on one flat surface all numerals and several types of symbols and alphabets.

CIRCLE NO. 292

Ceramic resonator works at 30 to 200 MHz

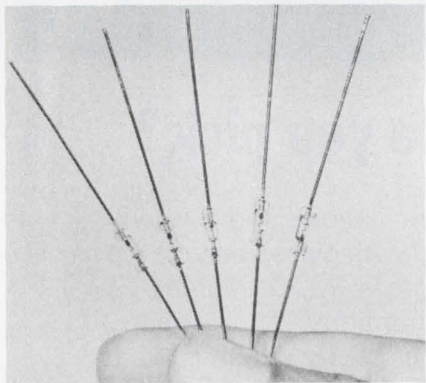

Matsushita Electric Corp. of America, 200 Park Ave., New York, N. Y. Phone: (212) 973-5700.

The Panasonic Piezonator is a piezoelectric ceramic resonator that works at frequencies between 30 and 200 MHz. It utilizes a unique asymmetric structure which eliminates spurious responses and is suited for use in solid-state filters. Because it works in the vhf region, applications for TV video circuits are possible, permitting tuned circuits to be made compact.

CIRCLE NO. 293

Butterfly switches need no soldering

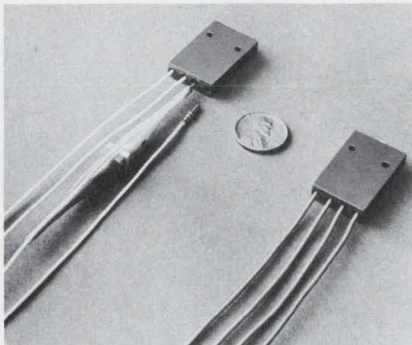

Licon, Div. of Illinois Tool Works, Inc., 6615 W. Irving Park Rd., Chicago, Ill. Phone: (312) 282-4040.

A new series of Butterfly double-break switches feature unitized female terminals within the switch case, plus a separate wire-retention clip and require no soldering for installation or removal. Wire leads employ a #20 male pin per MIL-C-39029/1A that is easily inserted or removed from the switch with an insertion-extraction tool.

CIRCLE NO. 294

Low-profile PC relay trims height to 0.4 in.

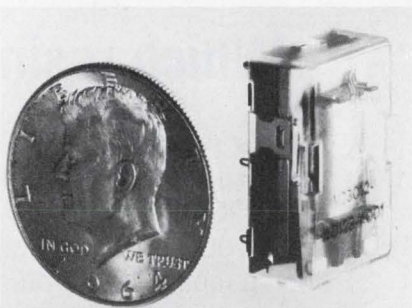

Siemens Corp., 186 Wood Ave. S., Iselin, N. J. Phone: (201) 494-1000. P&A: approx. \$2; stock.

A new low-profile PC-board relay, model V23012, weighs only 0.5 oz and measures 0.401 by 1.16 by 0.778 in. Its contact arrangements are dpdt, coil pull-in power is 250 mW, maximum switching rate is 50/s and contact rating is 1 A resistive at 24 V dc and 0.3 A resistive at 115 V ac/dc. Terminals are layed out on standard grill spacings of 0.1 in.

CIRCLE NO. 295

GaAs LED uses 150 mW

The IRL-40 GaAs LED in a TO-46 metal can dissipates only 150 mW. Forward voltage is 1.2 V. Clear dome lens is used. Litronix, Cupertino, Calif. (408) 257-7910. P&A: \$1.95; stock.

CIRCLE NO. 296

LED comes in a cartridge

The Datalamp LED is a solid-state lamp in a cartridge. Available in voltages from 3.6 to 28 V dc at 20 mA. Dialight, Brooklyn, N. Y. (212) 497-7600.

CIRCLE NO. 297

High-resolution encoder

The 300DT digital shaft encoder can sense 5 minutes of an arc. It's a ratiometer and an a/d built into a 0.025%-linear pot. New England Instruments, Natick, Mass. (617) 873-9711. Price: \$500.

CIRCLE NO. 298

DIP resistor networks

Standard new resistor networks come in DIPs. Series 899 units include digital pull-up, analog scaling and digital line terminator networks. Beckman Instruments, Fullerton, Calif. (714) 871-4848. P&A: from \$1.25; stock.

CIRCLE NO. 299

TO-8 60-Hz filters

New 60-Hz rejection filters come in TO-8 or black-box cases. Rejection rating is 65 dB. Other frequencies are available. Dale Electronics, Columbus, Neb. (402) 564-3131.

CIRCLE NO. 300

High-isolation xformer

Model IT-3063 transformer isolates $10^{12} \Omega$ and 9 pF from secondary to primary-core combination. Rating is 2.5 VA. Secondary at 48 V center-tap. Stevens-Arnold, S. Boston, Mass. (617) 268-1170. P&A: \$6.25; 4 wks.

CIRCLE NO. 301

evaluation samples

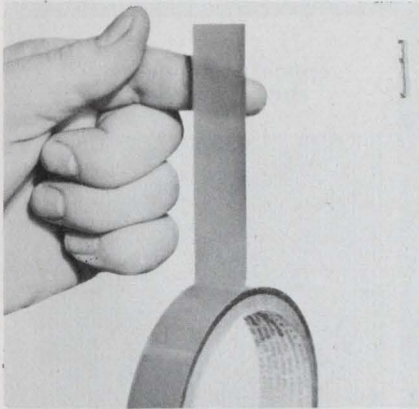

Sticky Teflon tape

Reinforced sticky Teflon tape is available with a variety of reinforcing backings to meet specific applications. Strong tape backing keeps it from curling up. The tape has excellent adhesion and is reusable. It retains its adhesive properties during its shelf life. Low elongation and coefficient of friction are other characteristics. It is available in colors in 1, 2, 3, 4 and 5-mil TFE thicknesses. Complete data and a free sample are available. Dielectrix Corp.

CIRCLE NO. 340

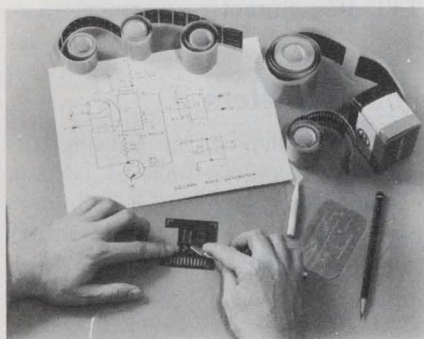

Drafting aids

Called B Neg, new component drafting aids in negative form are available in TO, DIP, flatpack, connector-contact and many other configurations. The negative patterns are made in 1:1 scales and are produced on 1.5-mil acetate film rolls. The rolls can be laid down and lifted repeatedly because they are backed with a special pressure-sensitive adhesive. Free samples and literature are available. Bishop Graphics, Inc.

CIRCLE NO. 341

design aids

Rotary switch guide

Two comprehensive rotary switch reference guide wall charts are available. Containing photographs, line drawings, electrical characteristics and mechanical specifications on many switch lines, the first chart is fully cross-referenced by position, contacts, throws and dimensions. The result is a time-saving graphic selection guide for specifying the right rotary switch for any given circuit application. The second chart is a two-color guide measuring 17 by 21 in. and also includes rotary configurations, contacts and switch sections—all shown in actual size. Oak Manufacturing Co.

CIRCLE NO. 342

Data processing ruler

The Card Count Ruler is a key-punch production measuring device that gives maximum accuracy, standardization and speed of card counting by each operator. It can also be used in programming and control operation where cards need to be counted. The ruler is injection molded of clear durable plastic with a compression slide designed to give even pressure. The ruler printing is silk-screened in blue ink. Unit cost is \$2.25. Card Count Co., Inc.

CIRCLE NO. 343

Fastener selector

A free selector chart for self-clinching fasteners offers design engineers quick, concise data on part numbers, panel hole sizes, fastener dimensions, available thread sizes, and minimum distances in which fasteners can be located to panel edges. The selector tables cover 36 different styles of self-clinching fasteners and two types of weld nuts. The fasteners include self-locking nuts as well as standard types of self-clinching nuts, studs and standoffs. Penn Engineering & Manufacturing Corp.

CIRCLE NO. 344

application notes

Ferrite applications

Opportunities and trade-offs involved in ferrite component selection are discussed in a new brochure called "Ferrite Components for Digital Circuits." The 12-page publication serves an idea source on how advancements on ferrite component development can be applied to design of computer-related products and to their digital circuit equipment. Indiana General.

CIRCLE NO. 345

Broadband power amps

General design considerations for 16 and 25-W broadband power amplifiers are discussed in a 12-page application note. Several illustrations and circuit diagrams are given including a Smith chart. The discussion is centered around three rf power transistors designed for the 225 to 400-MHz range. RCA.

CIRCLE NO. 346

Signal analysis

A detailed discussion of correlation and probability analysis and signal enhancement is contained in a 20-page technical bulletin. The bulletin explains random variables, distributions and densities involved in probability analysis and concepts and properties of correlation functions and signal enhancement. Signal Analysis Industries Corp.

CIRCLE NO. 347

Hydrogen thyratrons

Hydrogen thyratrons, what they are, how they work and where they are used are the subject of a 40-page handbook. After its general introduction dealing with principles of operation, the booklet goes on to define the terms used to describe hydrogen thyratron operating circuits. Copies of this new booklet are available free of charge, to qualified engineers. English Electric Valve Co. Ltd.

CIRCLE NO. 348

new literature

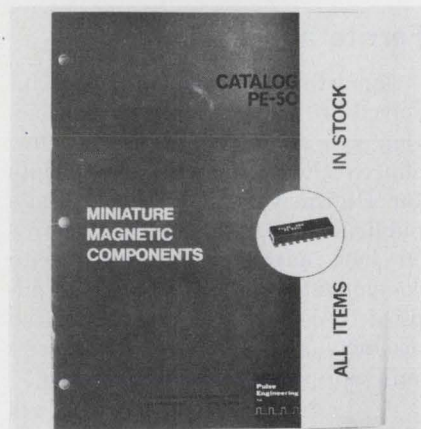

Magnetic components

A new catalog contains information on pulse transformers, SCR and triac driver transformers, inverter transformers and delay lines. Nomographs, application data, schematics and outline drawings are included. Pulse Engineering, Inc.

CIRCLE NO. 349

Synchronous motors

Stepping and slow-speed synchronous motors are described in an eight-page catalog. Sigma Instruments, Inc.

CIRCLE NO. 350

Power supplies

Over 3000 modular power supply models are listed with prices and applications in a new catalog. Abbott Transistor Laboratories, Inc.

CIRCLE NO. 351

Miniature relays

Microminiature relays which provide 100,000 to 10 million operations are described in a bulletin. The relays have spdt or dpdt contacts and are hermetically sealed. Electromechanical Products Div., Hi-G, Inc.

CIRCLE NO. 352

Components

A 24-page catalog of transducers, accelerometers, amplifiers, readout equipment, connectors and headers is available. Statham Instruments.

CIRCLE NO. 353

Display terminals

A set of six technical bulletins describe a series of interactive display terminals. Included are overall descriptions of the systems and their configurations. Computek Inc.

CIRCLE NO. 354

Shaft encoders

Shaft encoders and their uses are described in a series of technical bulletins. They cover pin-contact, optical and GaAs optical encoders and define and detail their operations. Encoder Div. of Litton Industries.

CIRCLE NO. 355

Transducers

An illustrated brochure includes technical specifications, application data and prices on a line of gravity-sensing, electrolytic transducers. Hamlin, Inc.

CIRCLE NO. 356

Semiconductors

A short-form catalog describes lines of silicon epoxy semiconductor devices such as rf/i-f amplifiers, saturated switches, uhf/vhf oscillators and consumer and industrial amplifiers. Carter Semiconductor Inc.

CIRCLE NO. 357

Data concentrators

A four-page brochure describes remote data concentrators. Typical configurations showing rack positions and space allocation are included in the brochure. General Electric Co.

CIRCLE NO. 358

Function modules

"Function Module Instrumentation" is a new 24-page four-color brochure that describes more than 40 standard analog function modules for the design of industrial control, monitoring and computational systems. Bell & Howell.

CIRCLE NO. 359

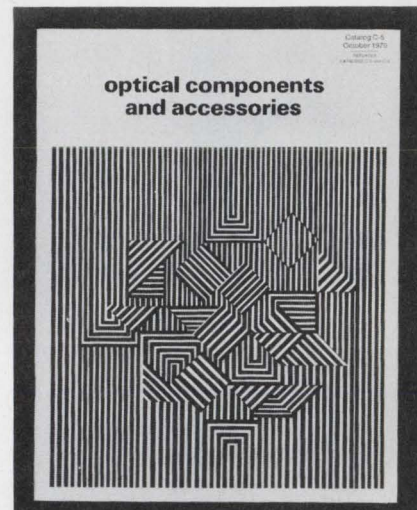

Optical components

Optical interference, exciter, barrier and neutral-density optical filters are fully detailed and illustrated in a new 36-page catalog of optical components. Baird-Atomic, Inc.

CIRCLE NO. 360

5400/7400 ICs

A comprehensive 128-page paperback handbook describes a complete family of 5400/7400 TTL ICs. Signetics Corp.

CIRCLE NO. 361

Potentiometers

A new short-form catalog describes expanded lines of cermet, carbon, and wirewound trimmers and potentiometers and rotary selector switches. CTS Corp.

CIRCLE NO. 362

Storage tubes

A short-form catalog contains information on direct-view and scan-converter storage tubes. Hughes Aircraft Company.

CIRCLE NO. 363

Dc torquers

A new completely revised catalog describes dc torquers and ac gimbal components. It gives complete details about eighteen limited and continuous-rotation dc torquers. Singer-General Precision Inc.

CIRCLE NO. 364

Magnetic Components

A new edition of the "Selection Guide for Magnetic Components" is now available. It has information designed to aid the circuit designer in the specification of proper transformer or magnetic amplifiers. Polyphase Instrument Co.

CIRCLE NO. 365

Power supplies

A 12-page two-color catalog provides illustrations, descriptions, characteristics and prices for 681 regulated silicon power supplies. Circuit Power Inc.

CIRCLE NO. 366

Tools

An illustrated 68-page catalog describes over 1000 precision hand tools designed for use in areas such as data processing, ICs, instrumentation, aerospace, medical and consumer applications. Swiss American Precision Imports.

CIRCLE NO. 367

5 to 15-V converter

Installation and operating instructions are given in an application brochure on a ± 5 to ± 15 -V dc converter. The brochure discusses the converter's use and includes block diagrams and illustrations. Analogic.

CIRCLE NO. 368

Silver mica capacitors

A new four-page catalog describes a complete line of dipped silvered mica capacitors. The capacitors meet or exceed the requirements of EIA specifications RS-153. JFD Electronics Corp.

CIRCLE NO. 369

Instruments

A 78-page instrument catalog covers complete lines of variable filters, oscillators, function generators, amplifiers and ac sources. Krohn-Hite Corp.

CIRCLE NO. 370

Wire-wrap plates

A 40-page comprehensive catalog covers lines of wire-wrap plates and connecting devices. Masterite Industries.

CIRCLE NO. 371

Data system

A 12-page summary describing a shared-processor data-preparation system is available. Consolidated Computer International.

CIRCLE NO. 372

Mercury switches

A four-page brochure discusses several types of mercury switches such as horizontal and vertical tilt-actuated, timing and spin-insensitive types. Kahl Scientific Instrument Corp.

CIRCLE NO. 373

Modem

A complete modem on a PC card that provides transmission rates up to 1800 bits/s is described in an eight-page brochure. Sanders Associates, Inc.

CIRCLE NO. 374

A/d/a converters

A comprehensive four-page short-form catalog contains detailed electrical and mechanical information on a line of a/d and d/a converters. Varadyne Systems.

CIRCLE NO. 375

Photoconductive cells

A new catalog shows a complete line of photoconductive cells. They include photosensitive CdS, CdSe and modified types. Vactec Inc.

CIRCLE NO. 376

High-power op amps

Class B op amps designed for driving dc servo motors, power inverters and hydraulic valve controls are described in a brochure. Torque Systems.

CIRCLE NO. 377

bulletin board

of product news and developments

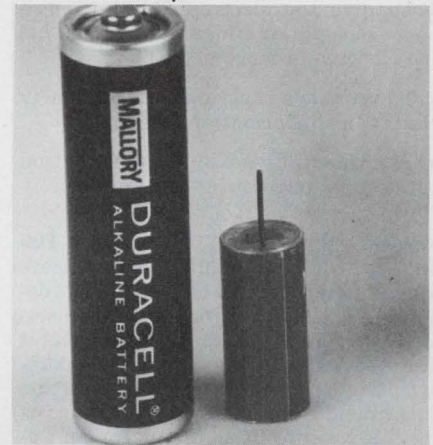

Mallory Battery Co., has developed a solid-state battery with a projected shelf life greater than 10 years at 70°F. The new battery has an ion-conductive and electronically insulative lithium solid which serves as a separator between anode and cathode. Its cells are pressed together and stacked in a suitable container that is sealed with a hermetic cap.

CIRCLE NO. 378

Twelve new elements have been added to the Signetics family of 54/74 TTL ICs. These include decoders, decoder/drivers, adders, shift registers, up-down counters, multivibrators and decoder/multiplexers.

CIRCLE NO. 379

Prices have been slashed by Motorola on three popular LEDs. Types MLED 50, 600 and 630 have been reduced in unit prices from 95¢, 99¢ and 99¢, to 49¢, 59¢ and 69¢, respectively, for 1000-lot quantities.

CIRCLE NO. 380

TABS is a new software system designed to cope with problems of managing a computer installation in a multi-programming environment. It's a product of the Datchron Corp.

CIRCLE NO. 381

A new user-oriented interactive computer program for nonlinear circuit analysis is IMPACT. Environmental Computing, Inc., is its vendor.

CIRCLE NO. 382

ELECTRONIC DESIGN's function is:

- To aid progress in the electronics manufacturing industry by promoting good design.
- To give the electronic design engineer concepts and ideas that make his job easier and more productive.
- To provide a central source of timely electronics information.
- To promote two-way communication between manufacturer and engineer.

Want a subscription? ELECTRONIC DESIGN is sent free to qualified engineers and engineering managers doing design work, supervising design or setting standards in the United States and Western Europe. For a free subscription, use the postfree application form inside the back cover. If none is included, write to us direct for an application form.

If you do not qualify, you may take out a paid subscription for \$25 a year in the U.S.A., \$35 a year elsewhere. Single copies are \$1.50 each.

If you change your address, send us an old mailing label and your new address; there is generally a prepaid postcard for this inside the back cover. You will have to requalify to continue receiving ELECTRONIC DESIGN free.

The accuracy policy of ELECTRONIC DESIGN is:

- To make reasonable efforts to ensure the accuracy of editorial matter.
- To publish prompt corrections whenever inaccuracies are brought to our attention. Corrections appear at the end of the Letters column.
- To refuse any advertisement deemed to be misleading or fraudulent.

Microfilm copies are available of complete volumes of ELECTRONIC DESIGN at \$19.00 per volume, beginning with Volume 9, 1961. Work is now in process to complete the microfilm edition of Volumes 1-8. Reprints of individual articles may be obtained for \$2.00 each, prepaid (\$.50 for each additional copy of the same article) no matter how long the article. For further details and to place orders, contact the Customer Services Department, University Microfilms, 300 North Zeeb Road, Ann Arbor, Michigan 48106; telephone (313) 761-4700.

Want to contact us? If you have any comments or wish to submit a manuscript or article outline, address your correspondence to:

Editor
ELECTRONIC DESIGN,
850 Third Avenue,
New York, N.Y. 10022.

ICX Series: New DC Power Supplies for IC's

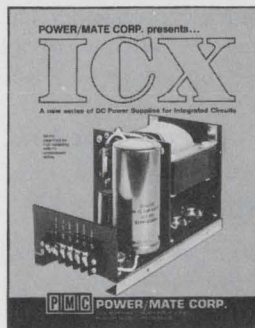

Power/Mate Corp. has introduced its new series of 32 models of "ICX" DC power supplies for integrated circuits now described in a new four page catalog. The new "ICX" Series contain all the essentials for high reliability with no unnecessary extras. The "ICX" models collectively cover from 3.6 to 18 VDC with currents to 20 amperes and feature adjustable voltages, high performance, extremely low cost and are backed by Power/Mate's full Five Year. Warranty. The catalog covers complete specs, model numbers, sizes and prices. Write, call or TWX for your free copy.

Power/Mate Corp.
514 South River Street
Hackensack, New Jersey 07601
(201) 343-6294 TWX: (710) 990-5023

CIRCLE NO. 171

How To Write Technical Articles



A guide for the engineer-author, "How to Write Articles for Electronic Design" shows how easy it is to write for publication—once the engineer knows what to write and how to write it. The Author's Guide includes a complete run-down of the types of articles published by Electronic Design—plus detailed instructions on how to prepare technical articles and short special features. A MUST for every "would-be-writer" in the electronics industry. Send for your complimentary copy by circling the number to the right.

Electronic Design
850 Third Avenue
New York, N.Y. 10022

CIRCLE NO. 172

PC Drafting Aids Catalog

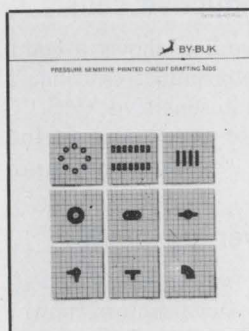

Thousands of time saving, cost saving artwork ideas are found in the By-Buk P-50 catalog of pressure sensitive printed circuit drafting aids. With the most practical artwork patterns for: TO cans, multi-pads, dual-inlines and flat packs featured. Donuts, connector strips, teardrops, ovals, tapes, tees, elbows, etc., by the hundreds are included in the most comprehensive list of sizes. Opaque black, transparent red and transparent blue materials for one and two-sided board designs. For a free copy and samples, write today.

Webtek Corporation
(formerly By-Buk Company)
4326 W. Pico Blvd.
Los Angeles, California 90019
(213) 937-3511

CIRCLE NO. 173

Manufacturers

Advertisements of booklets, brochures, catalogs and data sheets. To order use Reader-ServiceCard (Advertisement)

Pre-etched, Pressure-sensitive Copper Component Patterns for Instant PC Boards



Circuit Zaps® are 1 ounce copper circuit component patterns, pads, and conductor paths, precision-etched on 5 mil (.005") glass epoxy base material, backed by a special pressure-sensitive adhesive. Circuit Zaps® completely eliminate the artwork, photography, photoprinting, touch up, etching, stripping, and other time-consuming steps in PC board development.

Write today for the FREE TECHNICAL BULLETIN 1003 with FREE SAMPLE.

Bishop Graphics, Inc. 7300 Radford Avenue (ED) CIRCLE NO. 174
North Hollywood, California 91605 (213) 982-2000 Telex: 674672

New Signature Analysis Systems Track Machinery Automatically

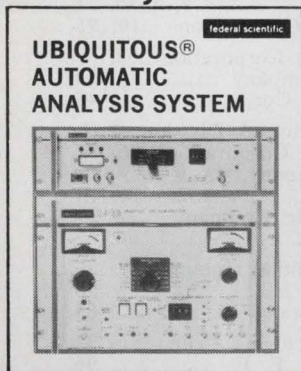

Based on the Ubiquitous® Real-Time Spectrum Analyzer, (200, 400, 500 or 1000 spectral lines), new Automatic System tracks rotating machinery over speed variations as wide as 30:1 without change in setting. Obtains frequency signatures of jet engines in terms of engine orders from idle to full throttle, and for other varying speed devices. Options: automatic anti-aliasing filtering; interface with MINI-computers for automatic data scaling, interpretation, and pattern recognition.

Federal Scientific Corporation
a subsidiary of Elgin National Industries, Inc.
615 West 131st Street, New York, N. Y. 10027

CIRCLE NO. 175

ENGINEERS' RELAY HANDBOOK

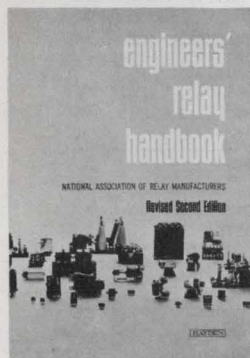

Reflecting the latest advances in the technology, the Revised Second Edition of this authoritative guide answers the needs of all who use, buy, specify, or trouble-shoot relays. Sponsored and prepared by the **National Association of Relay Manufacturers**, the handbook presents complete, illustrated coverage of relays, inspection testing, life testing, military specifications, and standardized definitions. 368 pages, 7 3/8 x 10 1/8, illustrated, \$13.95. Circle the reader-service number below for 15-day examination copies.

Hayden Book Company, Inc.
116 West 14th Street
New York, N. Y. 10011

CIRCLE NO. 176

Electronic Design

Advertising Sales Staff

Keith Aldrich
Sales Manager

New York 10022

Robert W. Gascoigne
Samuel M. Deitch
Daniel J. Rowland
850 Third Avenue
(212) Plaza 1-5530
TWX: 867-7866

Philadelphia 19025

Mort Sullivan
P.O. Box 126
Dresher, Pa.
(215) 884-6880

Boston 02154

Joseph F. Palmer
1268 Main Street
Waltham, Mass.
(617) 894-2700

Chicago 60611

Thomas P. Kavooras
Berry Conner, Jr.
200 East Ontario
(312) 337-0588

Cleveland

Thomas P. Kavooras
(Chicago)
(312) 337-0588
(call collect)

Los Angeles 90303

Stanley I. Ehrenclou
2930 Imperial Highway
Inglewood, Calif.
(213) 757-0183

San Francisco 94022

Jerry D. Latta
95 Main Street
Los Altos, Calif.
(415) 941-3084

London W. 1

For United Kingdom and Holland
Brayton C. Nichols

For Eastern Europe
Peter Kehr
44 Conduit Street
Tel: REGent 4714

Verviers, Belgium

For Continental Europe
Andre Jamar
1, Ru Mallar, 1
087) 253.83 Telex 41563

Tokyo

Haruki Hirayama
Electronic Media Service
5th Floor, Lila Bldg.,
4-9-8 Roppongi
Minato-ku
Phone: 402-4556
Cable: Electronicmedia, Tokyo



Taking Over



Until now you've had to get by with something else. No more.

Changing to flat woven interconnect systems can be the simplest yet one of the most significant design improvements you've ever accomplished. Compact and uniquely flexible, cables and harnesses by Woven Electronics bring neatness and accuracy to every application. Fast, easy lead exposure and stripping are primary advantages.

Name your need. Woven Electronics will fit it, with basic interconnects or precise custom fabrication.

WOVEN ELECTRONICS

A Division of Southern Weaving Company
P. O. Box 189 Mauldin, South Carolina 29662 (803) 288-4411

Represented nationally by Zippertubing

INFORMATION RETRIEVAL NUMBER 53

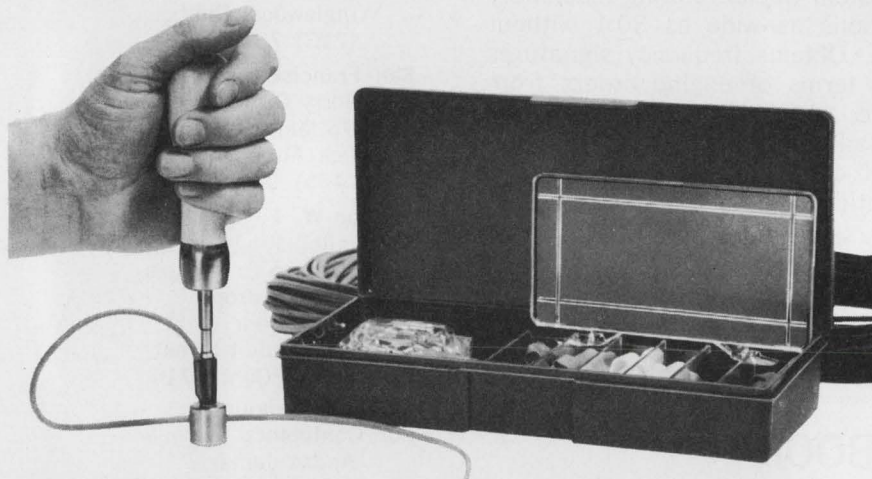

**Make and repair your own patchcord stacking plugs in seconds.
Any color, any length for 40% less cost.**

These new kits contain everything you need to custom assemble and/or replace damaged molded stacking patchcord plugs: 60 metal banana or .080 standard tip metal plugs, 60 housings, 10 in each of the six standard colors. An assembly tool and fixture for fast, easy assembly. Use with standard 0.144" wire (not included in kit). To assemble, simply feed stripped end of wire through cross-hole metal contact. Insert contact and wire into housing. Place in fixture and snap contact into place.

Convenience and flexibility, plus savings of at least 40% over molded stacking patchcord plugs.

E. F. Johnson Company, Waseca, Minnesota 56093

Please send me complete information on your new stacking patchcord kits.



Name _____ Firm _____
Address _____
City _____ State _____ Zip _____

E. F. JOHNSON COMPANY

INFORMATION RETRIEVAL NUMBER 54

advertiser's index

Advertiser	Page
Abbott Transistor Laboratories Incorporated	6
Allen-Bradley Co.	23
Amphenol, The Bunker-Ramo Corporation	12
Beckman Instruments, Inc., Helipot Division	33
Belden Corporation	4, 5
Bishop Graphics, Inc.	95
Bliley Electric Company	30
Bourns, Inc.	11
Budd Company, The	16
Burroughs Corporation	72, 73
Centron Engineering, Inc.	95
Circuit Stik, Inc.	94
Dale Electronics, Inc.	Cover II
Dearborn Electronics, Inc.	49
Digital Equipment Corporation	16A
Edmund Scientific Company	48
Electronic Memories, A Division of Electronic Memories & Magnetics	14
FMC Corporation	89
Fairchild Semiconductor, A Division Fairchild Camera and Instrument Corporation	8, 9, 70, 71
Federal Scientific Corporation	10, 95
General Instrument Corporation	68, 69
General Radio Company	63
Gries Reproducer Corp.	48
Harris Semiconductor, A Division of Harris Intertype Corporation	86, 87
Hayden Book Company, Inc.	2, 16B, 64B
Heinemann Electric Company	31
Hewlett-Packard	1, 66, 67
Instrument Specialities Company, Inc.	78
Intronics, Incorporated	85
Johanson Manufacturing Corp.	32
Johnson Company, E. F.	96
Kertron, Incorporated	17
Mepco, Inc.	54
MicroSwitch, A Division of Honeywell	79
Monsanto Company	38, 80
Motorola Semiconductor Products, Inc.	27, 76, 77, 81
Philips Electronic Components and Materials Division	64A, Cover III
Power-Mate Corp.	94
Power-Tec Division, Airtronics, Inc.	54
RCA Electronic Components and Devices	15, 34, 42, 43, Cover IV
RF Communications, Inc.	48
Siemens Corporation	2
Sigma Instruments, Inc.	29
Siliconix Incorporated	61
Simpson Electric Company	37
Sprague Electric Company	18
Systems Engineering Laboratories Inc.	74, 75
Teledyne Philbrick	20
Triplett Corporation	55
Vactec, Inc.	13
Webtek Corporation	94
Woven Electronics	96
Zeva Electric Corporation	7

Should you switch to solid aluminium capacitors?

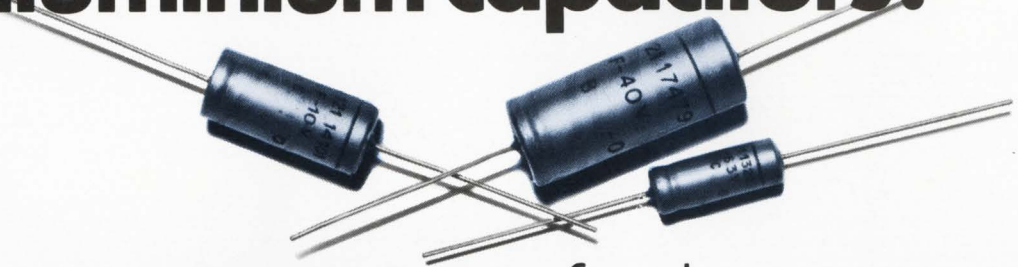

It's easy to find out.
Just test them...
with our compliments!

If you're designing a micro-miniaturised circuit where every square centimeter is critical, perhaps you'd better stick to your tantalums.

But if **reliability, long life and low price** are the important things, it's time to take a good long look at the new Philips "121-Series" Solid Aluminium Capacitors.

They are 100 times more reliable than tantalum capacitors, and their price is substantially lower!

There are other advantages too. Higher ripple current ratings. Freedom from discharge current limitations (no series resistors needed). Ability to withstand up to 15% reverse voltage. Reforming is eliminated even after long storage periods.

Range

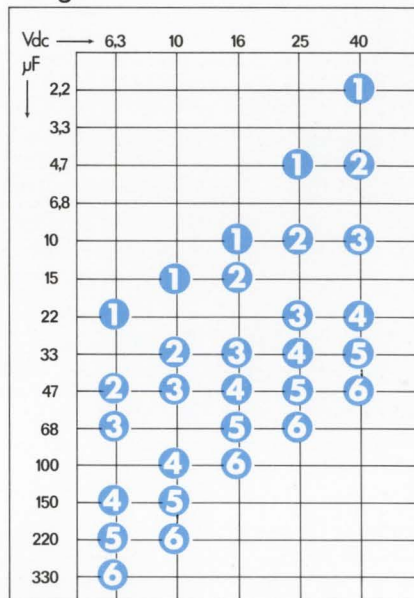

Case sizes:

- 1 Ø 6.6 x 17.5 mm
- 2 Ø 6.6 x 24 mm
- 3 Ø 8.3 x 24 mm
- 4 Ø 10.4 x 24 mm
- 5 Ø 10.4 x 32 mm
- 6 Ø 12.9 x 32 mm

Brief specifications

- Capacitance range 2.2 µF to 330 µF (± 20%)
- Voltage range 40 V to 6.3 V
- Operating temperature range -80 °C to +125 °C
- Metal case/insulating plastic sleeve

We are now delivering the "121-Series" in quantity...
off the shelf!

But before you order, put them to your own test. Send for Q.C. and Reliability Test Data, plus test samples. If you **should** switch... you'll soon know it!

N.V. Philips'
Gloeilampenfabrieken
Electrical Components and
Materials Division
Eindhoven -
the Netherlands



electronic components
and materials

PHILIPS

RCA Announces the Industry's First Power Transistor Thermal-Cycling Ratings.

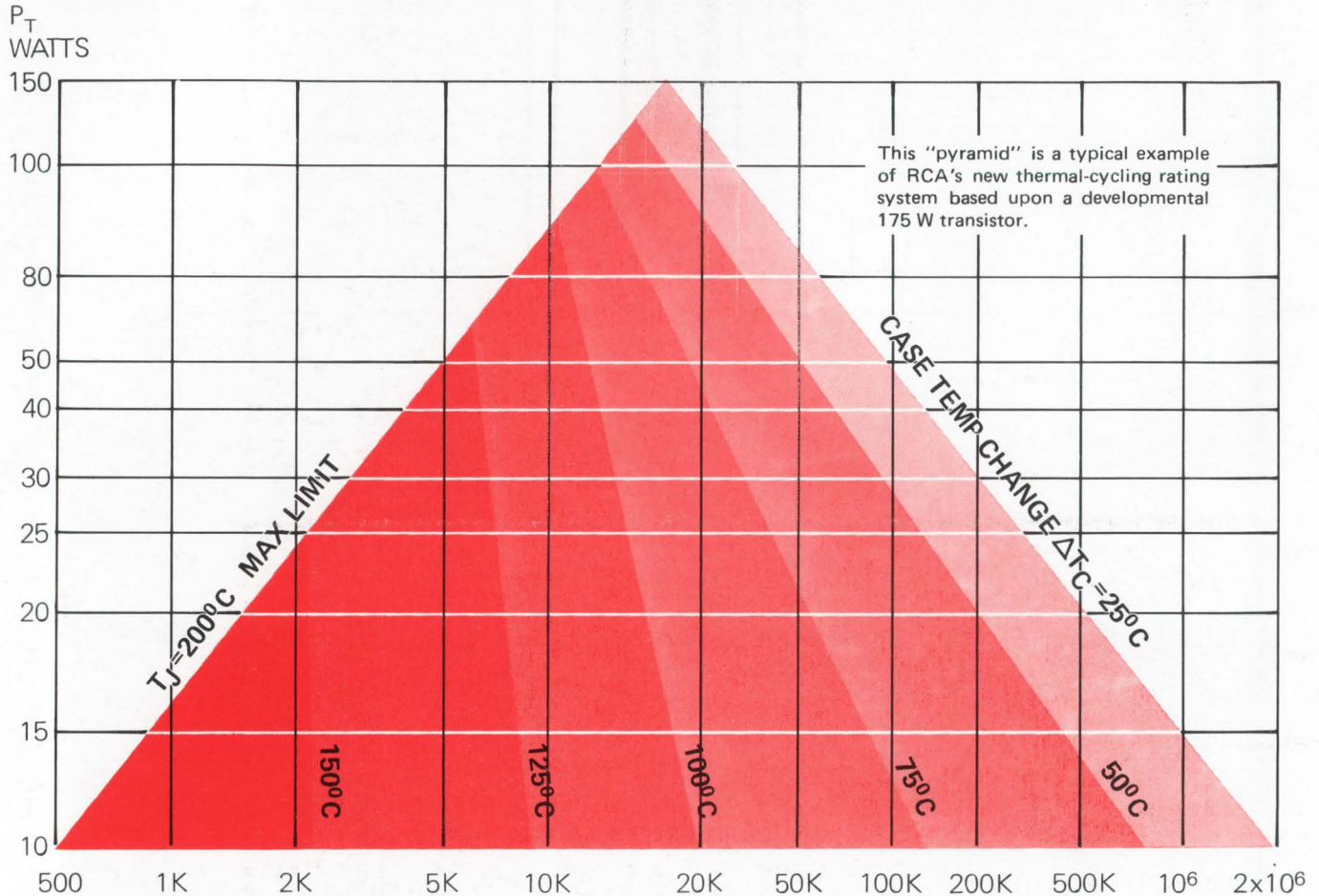

The Rating "Pyramid" – built with the help of RCA's Controlled Solder Process.

RCA, the industry leader in over-all silicon resources, introduces a totally new concept in thermal-cycling ratings to help you establish and extend equipment life.

Using these new thermal-cycling ratings, you can tell at a glance the life expectancy of any given RCA power transistor in terms of number of cycles, power dissipation, and case temperature change. A rating chart is being developed for each family of RCA power transistors, and will be included in data sheets as they are completed. RCA's Controlled Solder Process (CSP) has made possible these ratings – the only such ratings in the industry.

Controlled Solder Process is an RCA development. With it, RCA can control the effects of thermal stress between the pellet and mounting base, and thereby extend the number of times a transistor can be cycled thermally. CSP increases the device thermal-cycling capability from five to 20 times. The RCA "pyramid" is the only rating chart yet devised to help you avoid thermal-fatigue failure in the field.

This announcement of thermal-cycling ratings on power transistors is made in the same spirit as RCA's pioneering disclosure in 1964 on Second Breakdown capability. The philosophy, simply, is to continue to provide power transistor users with the best possible tools to achieve the optimum interface between the capabilities of RCA devices and the needs of their applications.

For more information on RCA's new thermal-cycling ratings, consult your local RCA Representative or your RCA Distributor or write:
RCA, Commercial Engineering, Section 57D-1/UT 16, Harrison, N.J. 07029.
International: RCA, 2-4 rue du Lièvre, 1227 Geneva, Switzerland, or P.O. Box 112, Hong Kong.

RCA