

Electronic Design 21

FOR ENGINEERS AND ENGINEERING MANAGERS

VOL. 18 NO.

OCT. 11, 1970

Eying Europe's traffic flow by land, sea and air are growing numbers of electronic sensor systems. Automated highways, precision radars for aircraft

and ships, and computer-operated trains are among the innovations. Monitoring and control are being done via IR, closed-circuit TV and doppler devices. See p. 26.





Dale breaks metal film value barriers

**Exclusive new
LMF/HMF Resistors
go as low as 1 Ohm...
and as high as 50 Megohms!**

Now you can use low-priced Dale Metal Film Resistors in more applications than ever. New LMF and HMF Series let you extend the use of high stability metal film parts to your lowest and highest resistance requirements. This Dale breakthrough gives you design and performance uniformity you've never had before. T.C.'s are no longer a problem — packaging is easier, too. The price: Competitive with the non-precision carbon film parts you previously had to use in low and high value situations. Check the specifications at right, then ask Dale for details on the industry's broadest and most useful line of metal film resistors.

Phone 402-564-3131 today

or write:

DALE ELECTRONICS, INC.

1300 28th Avenue
Columbus, Nebraska 68601

In Canada: Dale Electronics Canada, Ltd.
A subsidiary of The Lionel Corporation



SPECIFICATIONS

RESISTANCE		T.C.	
LMF 1-9.9 ohms	HMF 100K-50M	150 PPM	
5-30 ohms	100K-50M	100 PPM	
10-30 ohms	100K-30M	50 PPM	
15-30 ohms	100K-5M	25 PPM	

Tolerance: 1% standard. Special tolerances and T.C.'s available.

Applicable Mil Specifications: MIL-R-10509
(Char. C, D, E), MIL-R-22684 (RL-07, RL-20).

Power Rating:

LMF — 1/10, 1/8, 1/4, 1/2 watt.

HMF — 1/20, 1/10, 1/8, 1/4, 1/2, 3/4, 1 watt.

Per Char. C & E 125° C rating, MIL-R-10509.

FLAME RETARDANT COATINGS

are standard on all Dale 1/10 thru 1/2 watt conformally-coated metal film resistors.

These resistors have excellent color stability when subjected to short time overloads and prolonged high temperature operation. They have withstood 100 times rated power for as long as 10 minutes without exhibiting flame.



If price and performance are important— here's a 7 MHz value

This is a lab-quality, all-solid-state scope—at a price you'd ordinarily expect to pay for older vacuum-tube models.

Value—DC to 7 MHz bandwidth. This frequency range covers audio, video and most control circuit applications.

Value—5 mV to 20 V per division deflection factor. Here is sufficient capability to pick up most electronic or electro-mechanical system outputs without distortion or need for additional amplifiers.

Value—Rock solid triggering with capabilities ordinarily found only in more expensive lab type oscilloscopes . . . triggered or recurrent sweep, single-sweep, and automatic triggering.

Value—Low drift, long-term stability. Field effect transistors virtually eliminate drift from temperature changes, shock or vibration. Long-term stability means less frequent calibration.

Value—Easy to use. Logical arrangements of controls, beam finder, auto-triggering make operation easy. Interlocking controls on sweep time and magnifier prevent readout errors.

Value—Easy-to-see display. Internal graticule, 8 x 10 cm CRT for measurement accuracy. Bright, small spot-size trace increases visibility and resolution.

Value—Available in single channel cabinet or rack versions (1215A or 1215B), or in dual-channel cabinet or rack versions (1217A or 1217B). Electrical characteristics are identical. Rack version is only 5¼" high. Panel on the cabinet version is about the size of this page.

Value—Price, 1215A/B, \$950; 1217A/B, \$1175. Add up the features, then divide by price and you'll find this is the greatest performance/dollar value ever offered.

These 7 MHz oscilloscopes are new members of HP's growing family of low- and mid-frequency oscilloscopes. In addition to these new mid-range scopes you have 500 kHz scopes in 14 models with your choice of: Single or dual trace, 100 μ V/cm or 5 mV/cm deflection factors, conventional display or variable persistence and storage, all in cabinet or rack versions.

If you're looking for accurate mid-frequency measurements, ease of use, reliability—all at a low cost—here's a real 7 MHz value!

Call your local HP field engineer. Or, write to Hewlett-Packard, Palo Alto, California 94304. Europe: 1217 Meyrin-Geneva, Switzerland.

HEWLETT  PACKARD
OSCILLOSCOPE SYSTEMS

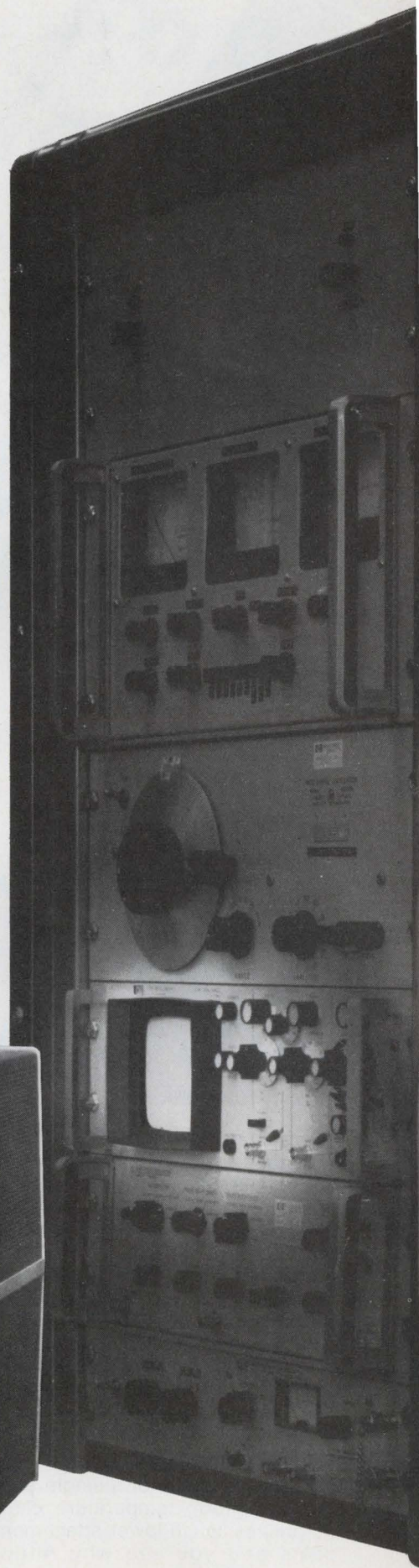
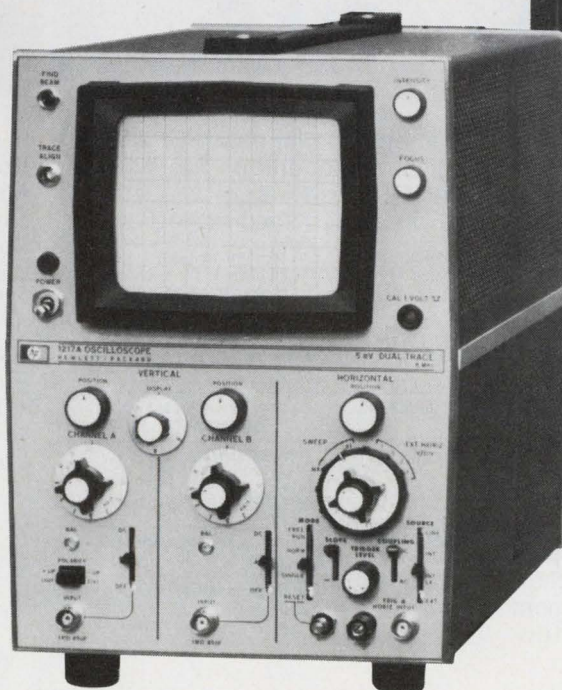

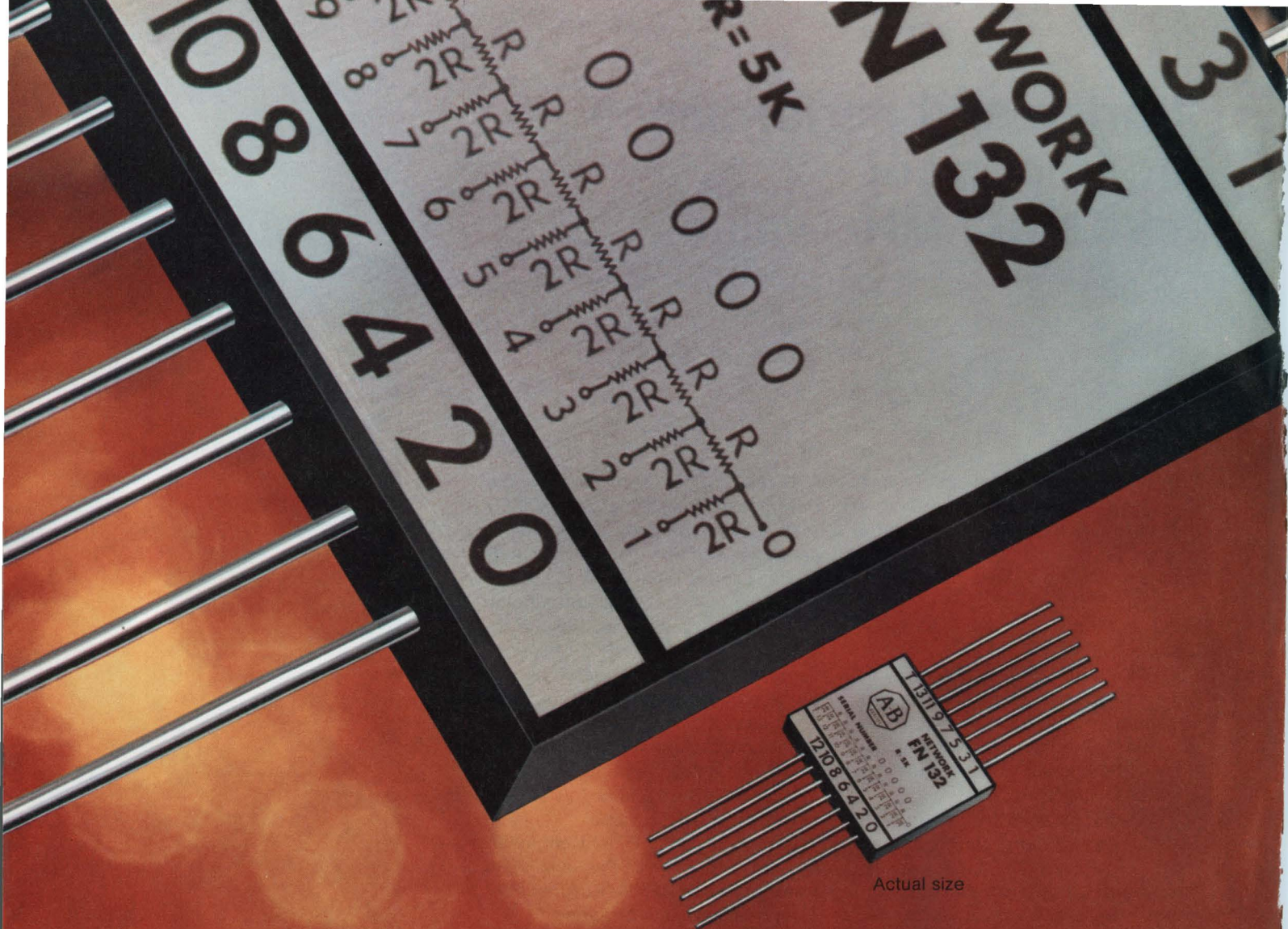

Now true precision in Allen-Bradley thin film networks.

Resistance networks for A/D and D/A conversion, digital volt meters and numerical control systems demand extreme precision. Allen-Bradley can deliver. Precision that starts with a patented chromium-cobalt resistive material vacuum deposited on a substrate made to Allen-Bradley specifications. Precision based on exclusive computer drawn grids. Precision backed by extensive design and testing facilities. Precision on a continuing basis assured by Allen-Bradley's 14 solid years of experience.

Add the reliability of a single substrate, uniform temperature characteristics, much lower attachment costs and you see why Allen-

Bradley thin film networks are the logical replacement for discrete precision resistors.

SELECTED SPECIFICATIONS

RESISTANCE RANGE	1K ohms to 2 megs, standard 25 ohms to 50 megs, special (Single substrate range— 10,000 to 1)
TCR LEVELS -55°C to +125°C	± 25 ppm/°C ± 10 ppm/°C ± 5 ppm/°C
TCR TRACKING	± 5 ppm/°C standard to ± 1 ppm/°C special
TOLERANCES	Absolute to ± .01% @ +25°C Matching to ± .005% @ +25°C
RESOLUTION	Line width and spacing to .0001 inch
ENDURANCE	Exceeds MIL-R-10509F Characteristic E Procedure: MIL-STD-202D

Investigate the superiority of Allen-Bradley thin film networks. Write: Marketing Department, Electronics Division, Allen-Bradley Co., 1201 South Second Street, Milwaukee, Wisconsin 53204. Export office: 1293 Broad St., Bloomfield, N. J. 07003, U.S.A. In Canada: Allen-Bradley Canada Ltd., 135 Dundas Street, Galt, Ontario. Several standard networks are available through your appointed A-B industrial electronic distributors.

**NEW
DIMENSION
ELECTRONICS**

NEWS

- 23 **News Scope**
- 26 **Europe travels electronically.** An on-the-scene glimpse at how the Old World controls and speeds land, sea and air transportation
- 32 **0.1¢-per-bit storage seen with new memory.** General Dynamics' magneto-acoustic method said to overcome limitations of planar models
- 34 **Precision scale uses electronic feedback**
- 46 **'Magic wand' terminal to speed store sales**
- 50 **Technology Abroad**
- 53 **Washington Report**

TECHNOLOGY

- 70 **Try 'back-door' circuit analysis.** Simply use an auxiliary feedback loop to set the input and let a computer do the calculations.
- 76 **Make very wide-range log amps easily** by sequentially summing several basic log stages. Custom-tailored performance is no problem.
- 82 **Explore IC performance with a curve tracer.** It will display characteristics not found in manufacturers' specifications.
- 86 **Simplify function generator design.** You can reproduce any periodic function by using sampling and ROM storage.
- 92 **How to succeed in spite of the slump.** The experiences of two small firms may guide engineer and manager alike through the slowdown.
- 96 **Ideas for Design**
- 107 **Product Source Directory:** Low-Power Microwave Tube Oscillators

PRODUCTS

- 123 **Instrumentation:** Pulse generator system delivers 1-GHz outputs.
- 131 **Data Processing:** Programming unit patterns read-only memories.
- 137 **Microwaves & Lasers:** GaAsP LEDs span 630-690-mm wavelengths.
- | | |
|-----------------------------|------------------------------|
| 126 ICs & Semiconductors | 143 Packaging & Materials |
| 134 Components | 145 Tools & Engineering Aids |
| 140 Modules & Subassemblies | 162 Product Index |

Departments

- 69 **Editorial:** Are trade restrictions really the answer?
- | | |
|------------------------|------------------------|
| 13 Designer's Calendar | 148 Annual Reports |
| 43 Letters | 150 Application Notes |
| 60 Sidelights | 152 New Literature |
| 146 Evaluation Samples | 157 Bulletin Board |
| 147 Design Aids | 160 Advertisers' Index |

Information Retrieval Service Card inside back cover

Cover: Collage, depicting European travel, designed by Clifford M. Gardiner, art director.





**Now there's
a better way.**

**Our new DOS brings
batch processing costs
down to
\$765 a month.**

If you've been hanging on to old-fashioned ways because you thought a computer was too expensive, think again. Our new Disc Operating System brings the cost of computation and general purpose processing right down to where your budget lives.

With our new DOS, you'll easily create, check out and run your own programs. Use it for scientific calculations, business-accounting functions, information retrieval, inventory control, school administration — in fact, problem-solving of all kinds.

Anyone who can poke a typewriter key or pencil-mark a card can use our DOS. Because the assembly (or compilation), loading and execution of your programs are under the control of a teleprinter keyboard or batch input device.

On the other hand, if you're already batch processing with another system, give this a thought. Our DOS can probably do everything you're doing now — for about half the cost.

Because both the software and the hardware are fully modular, our DOS accommodates the needs of many different applications. Lets you vary the number of input/output devices. Add more core memory. Use a card reader as well as teleprinter. Add a line printer, paper tape punch, photo reader and magnetic tape. Other advantages include software protection and program segmentation. Plus automatic program retention so your programs can be easily reused.

Our basic DOS includes an 8K computer with direct memory access, 2.4 million-character disc, one teleprinter and one high-speed paper tape reader. Price is just \$35,600. Or \$765 per month on a five-year lease. And it's upward expandable for your future needs.

Get the full story by calling your local HP computer specialist. Or write Hewlett-Packard, Palo Alto, California 94304; Europe: 1217 Meyrin-Geneva, Switzerland.

HEWLETT  PACKARD

DIGITAL COMPUTERS

INFORMATION RETRIEVAL NUMBER 4

Motorola's new age of FET pricing is here...



For a new generation of FET designs.

Now — in one bold stroke — you can add new performance and practicality to those new and existing designs you may have hesitated to take off the shelf because of FET prices ...more than 125 top Motorola MOSFET and JFET prices have been cut as much as 69%!

FET's have long been desirable as choppers and in RF-VHF designs but cost factors minimize their usefulness. No longer. Full maturity of manufacturing and testing technologies has led to very high yields and total production which no longer justifies previous price levels. The additional reliability of Motorola's

exclusive silicon-nitride passivated MOSFET's has generated such market acceptance that even many of these types are included in the action.

Our calculator shows just a few representative, reduced 100-up prices . . . for details on how you can join the new age of FET pricing, write Motorola Semiconductor Products, Inc., Box 20912, Phoenix 85036 or contact your nearest Motorola distributor.

We'll send along a price list and a FET Selector/Cross-Reference Guide that will show you the best in FET's at the newest in economy!

 **MOTOROLA FET**
—where the priceless ingredient is care!

Penny Wise

(An ordinary single break switch)

1. Common
2. Two contact surfaces per circuit
3. One gap
4. Current-carrying stressed blade
5. Mechanical life cycle: 4 to 5 million
6. Single circuit control
7. Contact bounce: moderate to excessive
8. Mechanical parameters: fixed
9. Military approval: some
10. Cost: initially it's moderate or perhaps even low, but...



Foolish Only in Its Absence

(Licon® Butterfly® Double Break Switch)

1. Unique (Patented.)
2. Four contact surfaces per circuit
3. Two gaps
4. Non-current carrying coil spring
5. 15 to 20 million
6. Double circuit control
7. Limited
8. Flexible
9. All but one
10. Moderate (for *actual* cost savings read 1-9 and the headline again).



We make our Butterfly Double Break switches in sizes that range from sub-miniature (type 18 rated at 7 amps) up to heavy-duty industrial versions (the type 14, 20 amp unit)—each with a wide variety of actuators and terminal variations.

The complete double break story—including sizes and ratings available—fills a book. A book that's yours free for the asking. Just circle No. 783 on the response card in the back of this magazine or write on your company letterhead to:

LICON

Division Illinois Tool Works Inc.,
6615 West Irving Park
Road, Chicago,
Illinois 60634.



In Philly,
the less expensive
(el cheapo) switch is
known as penny wise and
pound dumb.

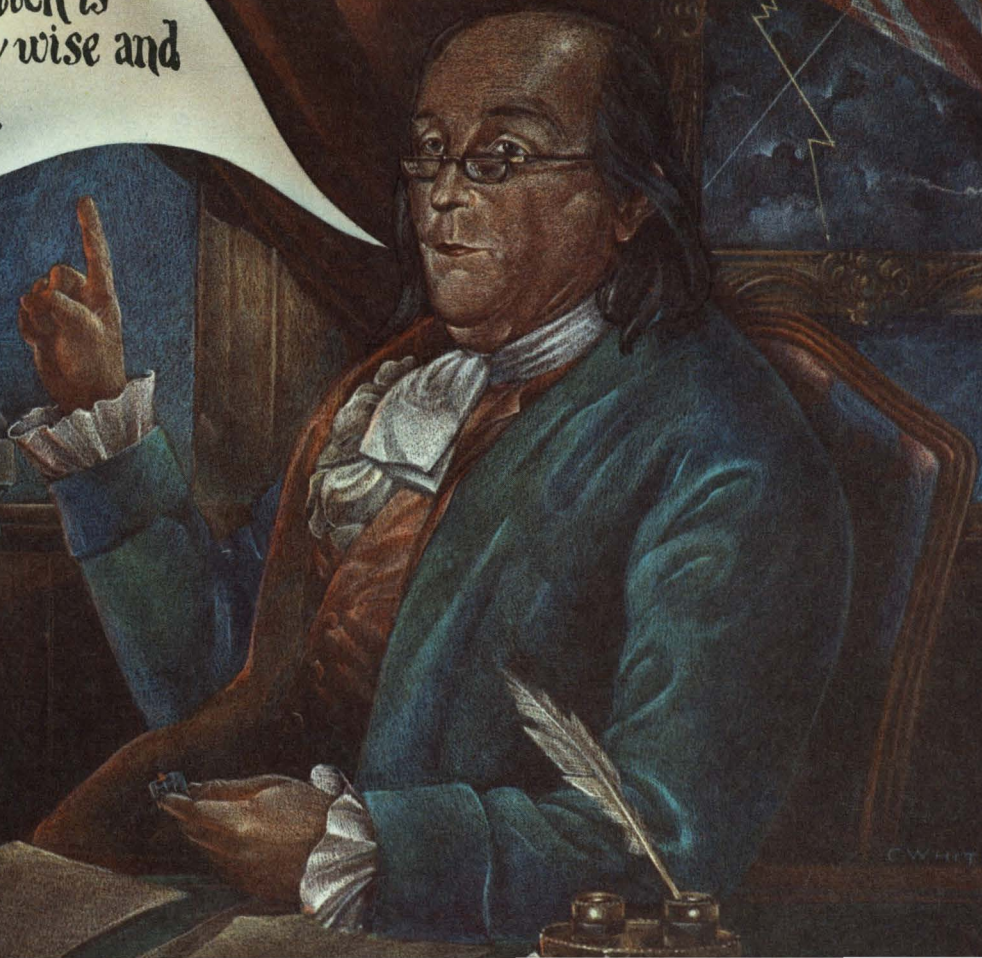

Good old Stackpole and the new electronic technologies.

Who?

Stackpole. Producers of electrical/electronic componentry for over sixty years. First to the automotive industry. Then to the radio, home entertainment, appliance, railroad, chemical and, most recently, the aerospace industries. Five million quality components daily.

Electronics is fast becoming an important part of every industry. Automated production. Medical electronics. Computers. Education and communications. The needs are diverse. The qualifications demanding. Stackpole has the needed components. Rotary switches. Controls. Precise ferro-magnetic materials. Resistors and contacts. But more importantly, it has the capability to develop still more. Ours is a value approach. Quality products, reasonably priced, delivered on time and backed by service and experience.

If you are part of the emerging industrial electronics technology, then you need reputable, reliable sources. Experienced and capable people. Discover Stackpole. Our components are just about everywhere. Unseen usually, but working. A lot of companies have built their reputations on it.

Stackpole Carbon Company, St. Marys, Pa. 15857.

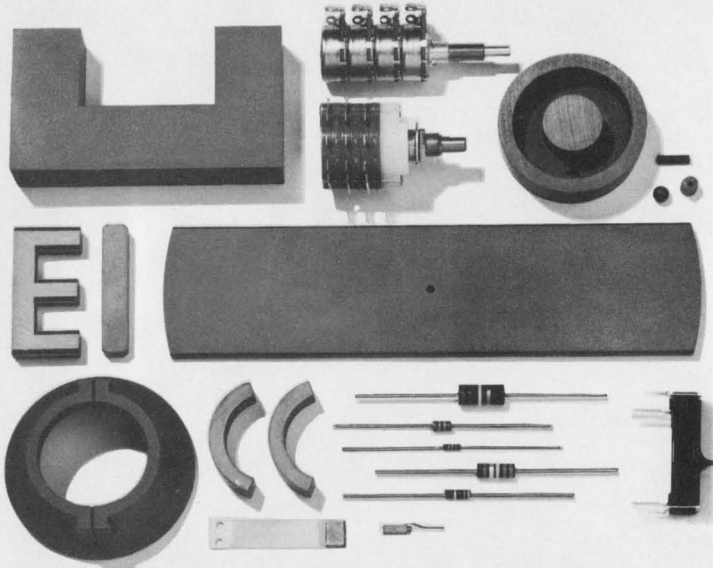

STACKPOLE

INFORMATION RETRIEVAL NUMBER 7

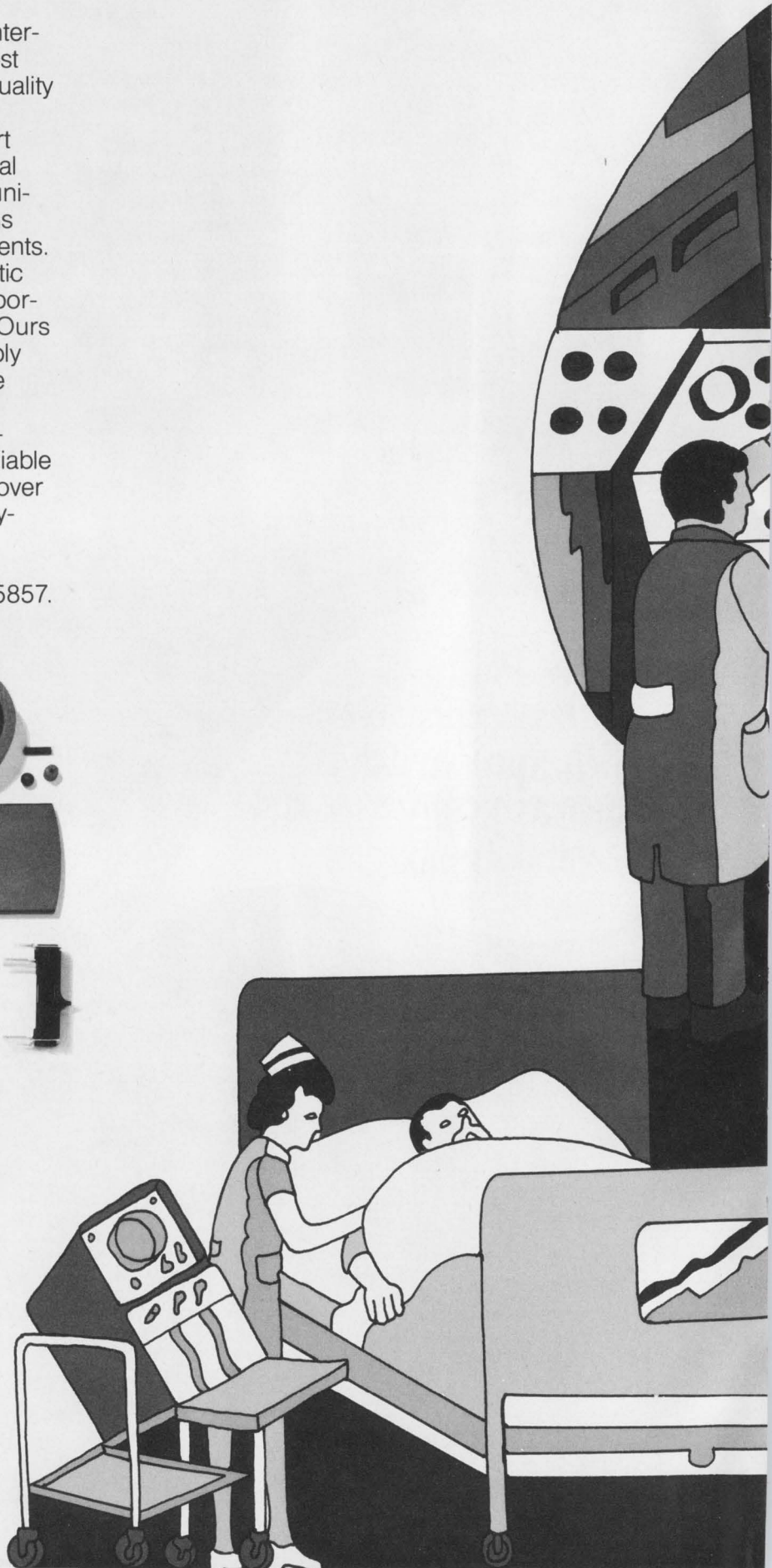

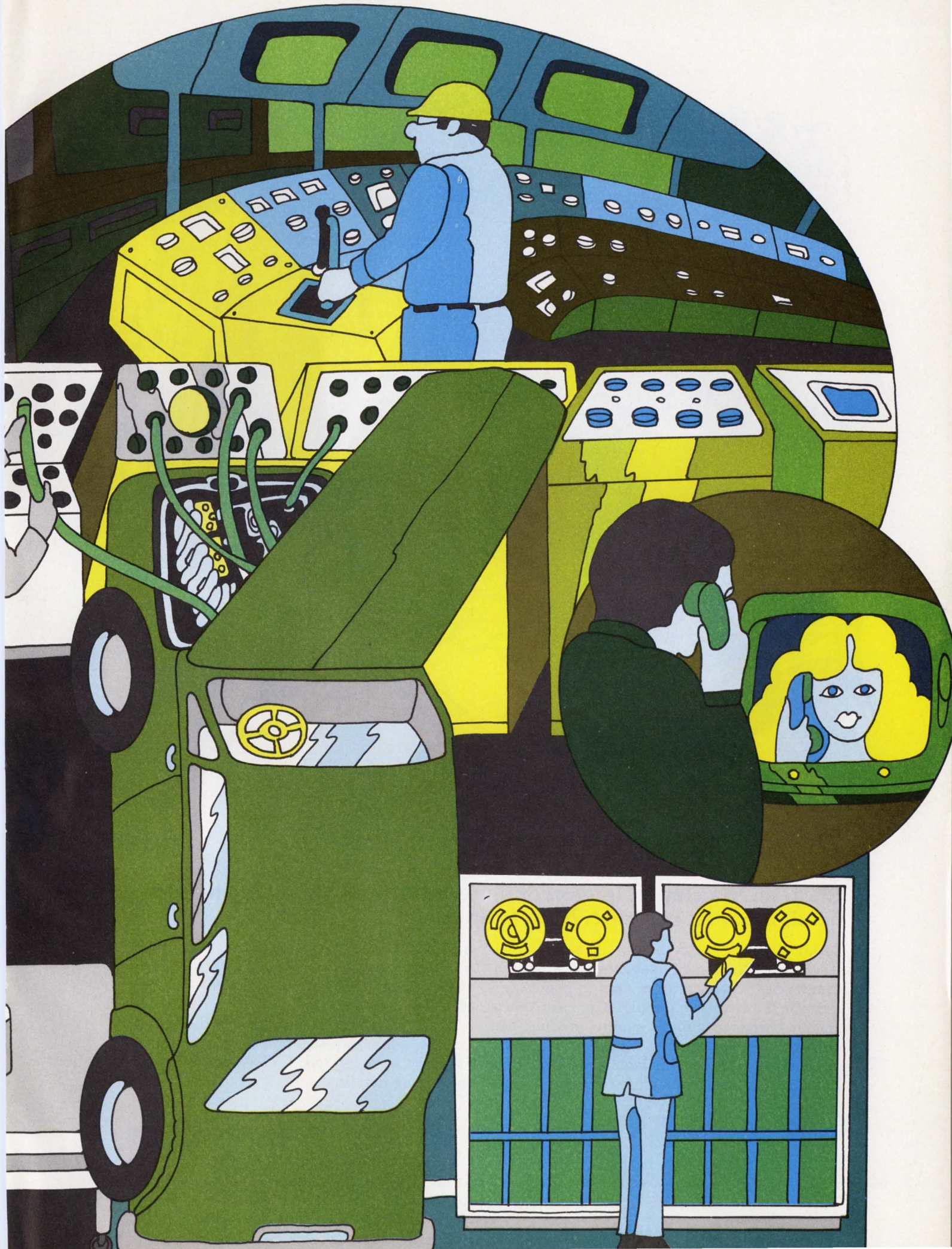

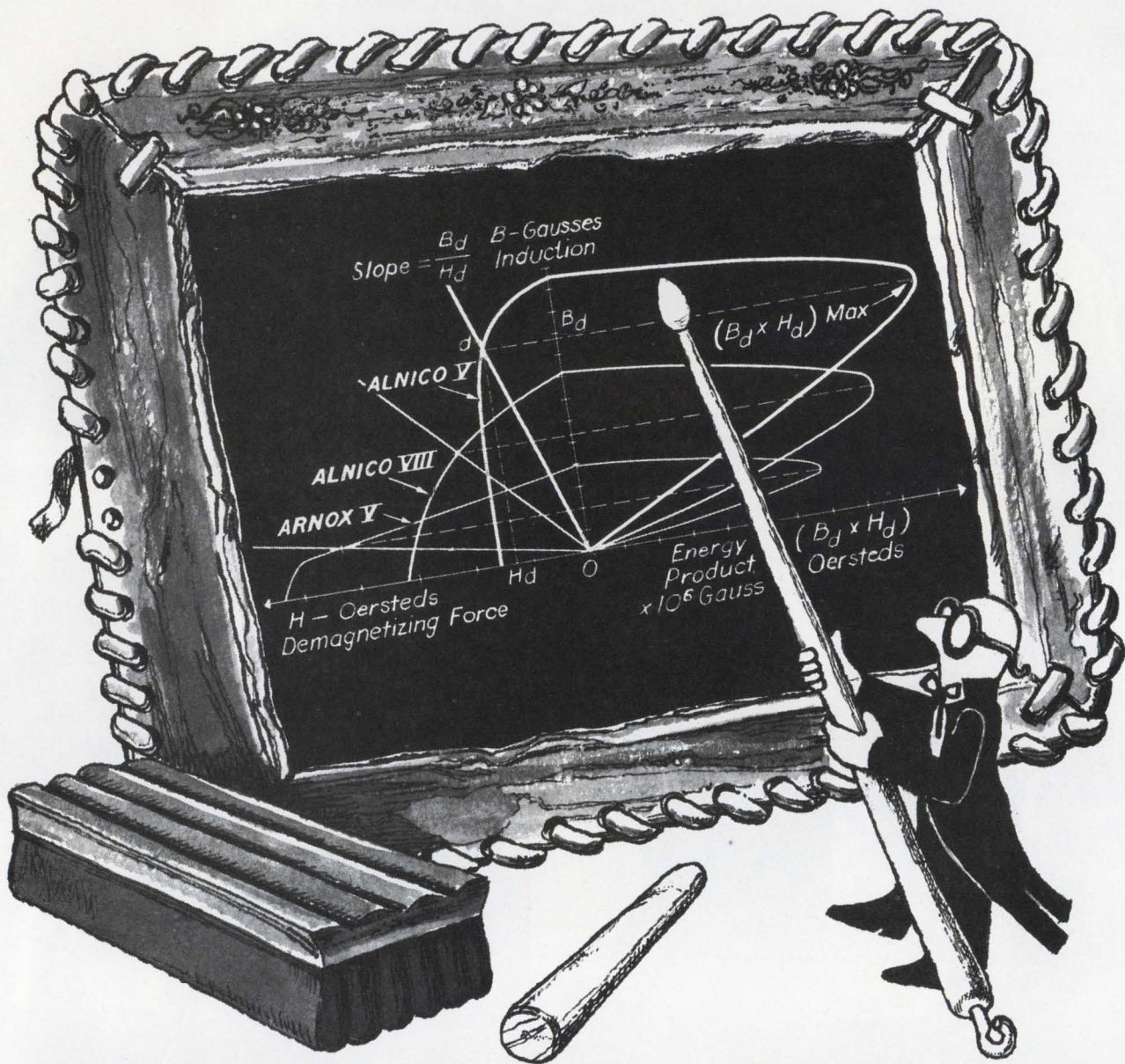

Energy product.

Choose: Maximum in cast or sintered Alnico. Or as much as you need in Arnox ceramic. Both from Arnold.

Seeking a top-quality source of supply and service for permanent magnets for anything from mikes to meters to motors to magnetos? Arnold's the answer. Examples: Our cast Alnico magnets with maximum energy product per unit volume. Our sintered Alnico—same maximum energy product in homogeneous, close-tolerance magnets available in intricate shapes.

And our Arnox® hard ferrite magnets, made from non-strategic materials, with a variety of energy products, in non-oriented or highly oriented configurations.

Trust the Arnold reputation for the newest and the best in permanent magnets. At measurable cost savings, too. Call or write for the convincing details.



did you know?

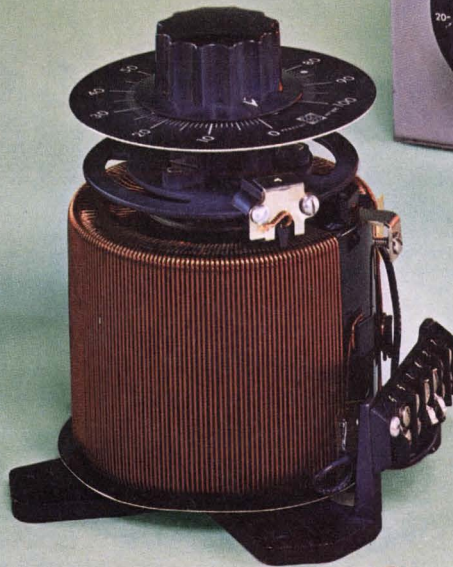

General Electric **volt-pac**[®] variable transformers help you vary voltage dependably...year after year,* after year, after year, after year, after year, after year, after year, after year...

Send in this coupon for free bulletin giving complete details on Volt-Pac transformer features, ratings and application data; or see your GE sales representative today.

* Laboratory tested for over one million failure-free operations.

GENERAL  ELECTRIC

.....
• Section 413-34
• General Electric Company
• Schenectady, New York 12305
• Please send me free bulletin GEA-8110 on Volt-Pac Variable Transformers.
• NAME _____
• COMPANY _____
• TITLE _____
• ADDRESS _____
• CITY _____ STATE _____ ZIP _____

New IC's from Burr-Brown



a new monolithic op amp

with low bias current (15 nA), low drift ($5 \mu\text{V}/^\circ\text{C}$), low noise ($0.8 \mu\text{V}$, p-p), and wide supply range (± 3 to ± 20 Vdc).



two new hybrid multipliers

with $\pm 0.5\%$ linearity. No external components required. Miniature hermetically sealed package. Temperature range -55 to $+125^\circ\text{C}$.

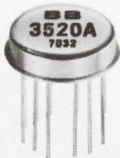

a new hybrid FET op amp

with ultra-low bias current (5 pA), low drift ($5 \mu\text{V}/^\circ\text{C}$), and fast slew rate ($6\text{V}/\mu\text{sec}$). Hermetically sealed TO-8 package.

...and you didn't think we made IC's!

These four new units join a rapidly growing family of Burr-Brown IC products. All have the high quality you've come to expect from Burr-Brown, quality that's assured in every processing step. In addition to the above, we have a POWER BOOSTER (± 10 V @ ± 100 mA) for use with any IC op amp, another series of HYBRID FET OP AMPS, and a series of low bias BIPOLAR OP AMPS . . . all in dual-in-line packages. We are also supplying HYBRID COMPARATORS and ACTIVE FILTERS.



Better get your Burr-Brown IC-PAK. For your copy of the Burr-Brown IC-PAK, containing complete information on all of our IC products, simply use this publication's reader service card or phone us.

BURR-BROWN
RESEARCH CORPORATION

International Airport Industrial Park • Tucson, Arizona 85706
TELEPHONE: 602-294-1431 • TWX: 910-952-1111 • CABLE: BBRCORP



Designer's Calendar

NOVEMBER 1970						
S	M	T	W	T	F	S
1	2	3	4	5	6	7
8	9	10	11	12	13	14
15	16	17	18	19	20	21
22	23	24	25	26	27	28
29	30					

Nov. 15-19
Engineering in Medicine & Biology Conference (Washington D. C.). Sponsors: AEMB, IEEE. William Maloney, Conference Coordinator, 1970 ACEMB, 6 Beacon St., Suite 620, Boston, Mass. 02108.

CIRCLE NO. 400

Nov. 16-18
Hybrid Microelectronics Symposium (Beverly Hills, Calif.). Sponsor: ISHM. Anthony Valachovic, IBM, East Fishkill, N. Y. 12533.

CIRCLE NO. 401

Nov. 17-19
Fall Joint Computer Conference (Houston, Texas). Sponsors: AFIPS, IEEE. L. E. Axsom, IBM Scientific Center, 6900 Fannin, Houston, Texas 77025.

CIRCLE NO. 402



Nov. 17-20
Magnetism & Magnetic Materials Conference (Miami Beach, Fla.) Sponsors: AIP, IEEE. F. B. Hagedorn, Bell Telephone Labs., Murray Hill, N. J. 07971.

CIRCLE NO. 403

Dec. 2-3
Conference on Display Devices (New York City). Sponsor: IEEE. Sam Stone, General Tel. & Elec., 208-20 Willets Pt. Blvd., Bayside, N. Y. 11360.

CIRCLE NO. 404

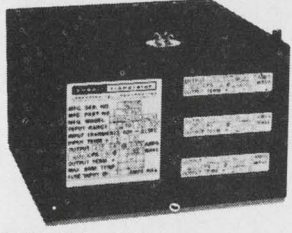
How To Solve Your Power Supply Problem—

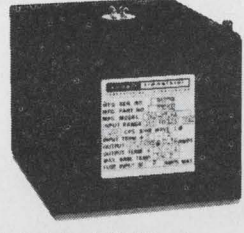
 <p>28 VDC to 400 A 3ϕ Model Q10D-115A-400Y Size 6" x 6" x 4" — Wt. 8.3 lbs. Output 100 volt amps</p>	 <p>400 A to DC (Reg) Model T3D-48.6A Size 2$\frac{3}{4}$" x 3" x 3$\frac{1}{4}$" — Wt. 2.3 lbs. Output 48 VDC at 618 ma</p>
 <p>60 A to DC (Reg) Model V6D-27.6A Size 4$\frac{1}{2}$" x 6" x 4" — Wt. 10.3 lbs Output 28 VDC at 2.1 amps</p>	 <p>28 VDC to DC (Reg) Model AK1D-1970A Size 1$\frac{1}{2}$" x 2$\frac{3}{4}$" x 3" — Wt. 1 lb. Output 2000 VDC at 5 ma</p>

NEW! Mil-Spec Quality Power Supply Modules for All Types of Power Conversion

Abbott has a new line of power supply modules. They are built to meet military environment-MIL-E-5272C. All types are available with any output voltage you need from 5 volts to 10,000 volts DC — and DC to 400 A inverters with either 1 ϕ or 3 ϕ outputs.

DC to 400 A, 3 ϕ — This new inverter changes 28 VDC battery voltage to three phase power with outputs of 33, 66, and 100 volt amps, 400 cycles or 800 cycles, as well as output voltages of 115 VAC or 27 VAC. All three phases are identically regulated at 1%. Also, 1 ϕ output units are available with powers of 30, 60, 120 and 180 volt amps, 400 cycles or 800 cycles, at 115 VAC or 27 VAC. All of these solid state inverters are completely described on Pages 13, 26 and 27 of our new catalog.

60 A to DC — These modules are the smallest, lightest weight 60 A to DC power supplies we have seen. They are well regulated for line and load changes. Hermetically sealed for military environment they will operate to 160°F heat sink temperatures. They are available in any output voltage you need — 5 volts to 10,000 volts,

with power outputs of 5, 10, 20, 30, 60, 120, and 240 watt sizes as standard catalog listings. You will find them completely described with prices on Pages 2, 3, and 4 of our new catalog.

400 A to DC (Reg) — Designed especially for 400 A input power, this line of converters is available with any output voltage you want — 5 volts to 10,000 volts DC. Power outputs of 5, 10, 20, 30, 60, 120, and 240 watt sizes are standard. Well-regulated and hermetically sealed, these units are described on Pages 5, 6, and 7 of our new catalog.

DC to DC (Reg) — Some of these DC to DC converters are as small as a package of cigarettes and weigh less than a pound. Output voltages from 5 volts to 10,000 volts are all listed as standard models in our new catalog. Power outputs come in standard sizes from 5 to 240 watts. These converter modules feature close regulation, short circuit protection and hermetic sealing for rugged applications found in military environment. They are listed in order of increasing output voltage on Pages 8, 9, and 10 of our new catalog.

If you need a power supply module in a hurry please check pages 1727 to 1740 in your EEM (1968-69 ELECTRONICS ENGINEERS MASTER Directory). Most of the above units are listed there. Or, for a complete list of our power supply line please send for your FREE 36-page catalog.

abbott transistor

LABORATORIES, INCORPORATED
 5200 W. Jefferson Blvd. • Los Angeles 90016
 Area Code 213 • WEbster 6-8185

TO: Abbott Transistor Labs, Inc., Dept. 41
 5200 W. Jefferson Blvd.
 Los Angeles, California 90016

Sir:
 Please send me your latest catalog on power supply modules:

NAME _____ DEPT. _____
 COMPANY _____
 ADDRESS _____
 CITY & STATE _____

**Reliability is a single-sided frame,
a ball and a cricket room.**

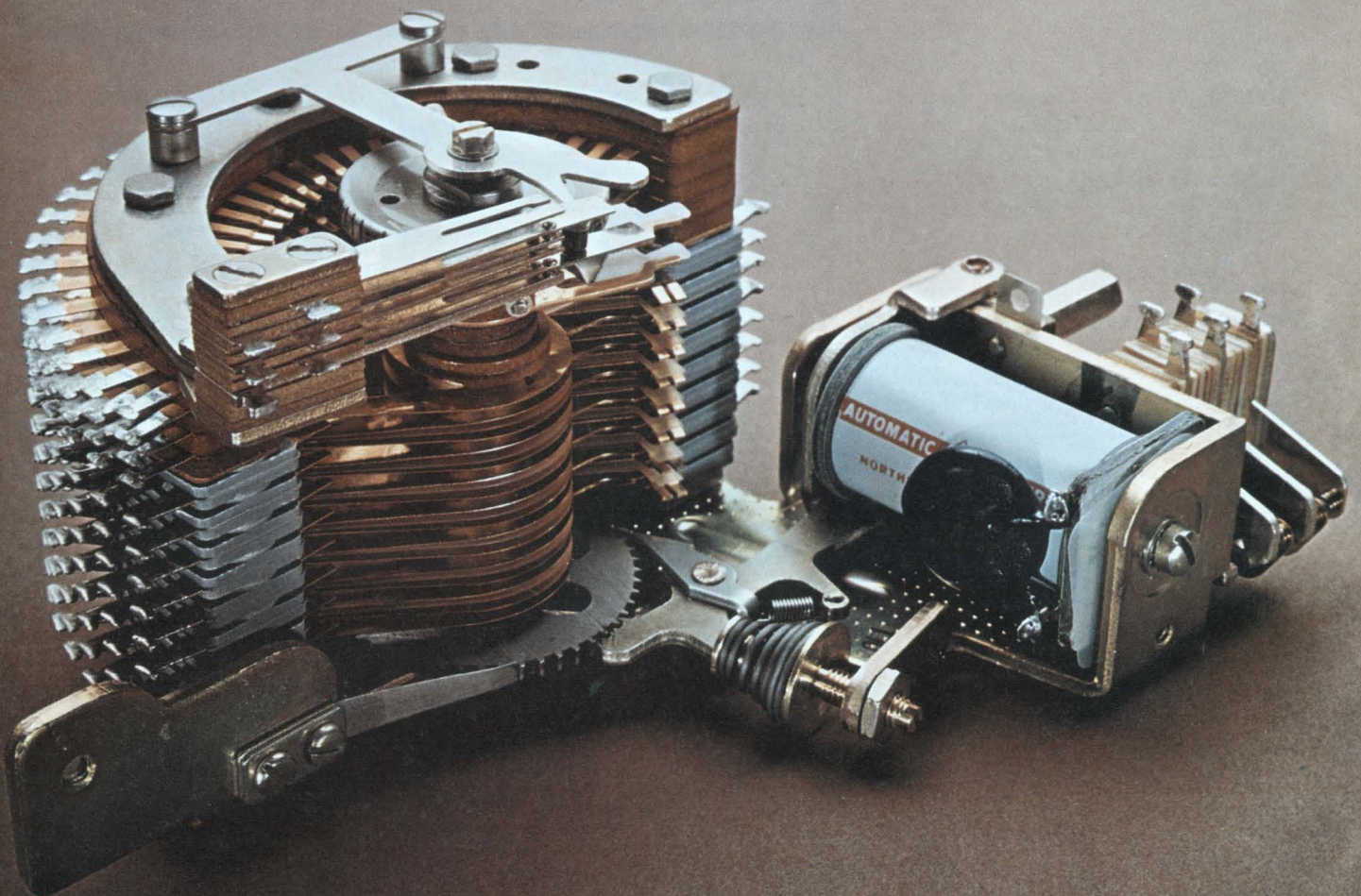

Our Type 45 rotary stepping switch is made to be forgotten. We build them to work hard, fast and long without constant fiddling or adjusting. They've got to be able to work in heat or cold, take bumps and grinds and still click-click along with close-spaced consecutive operations.

We start out really flat

To keep everything on the level we start our assembly with an open-type, one-piece frame. Thick and really flat. Some manufacturers use two thinner frames. But we found that starting with a single thick frame eliminates problems of matching the switch parts. Everything stays in line. And a single-sided frame takes a lot less room—the switch is only as wide as need be.

A lube job that lasts a lifetime The entire wiper assembly rotates on a large-diameter stainless steel shaft around a full-length hub bearing. We lubricate this bearing and seal it during assembly. So throw away the oil can.

Then we supply a pinch that's just right Each pair of wipers is tension-adjusted during assembly. As they click around the bank levels on a flat plane, we want each pair to pinch the contact just the right amount. Too hard a pinch and the contacts will wear out quickly. Too soft a pinch will cause a poor connection. We teach our wipers to pinch just right.

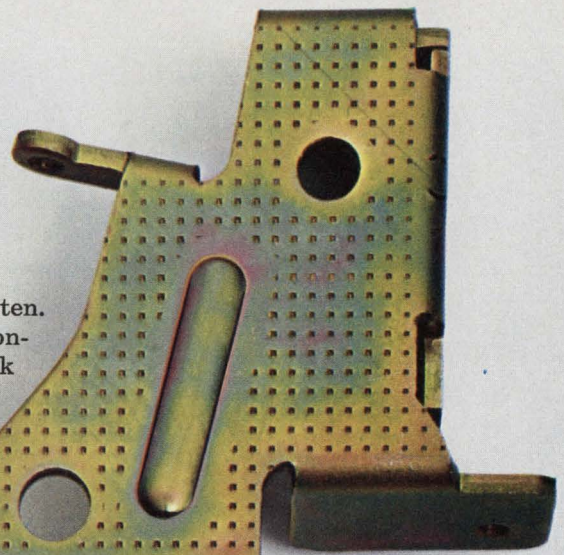
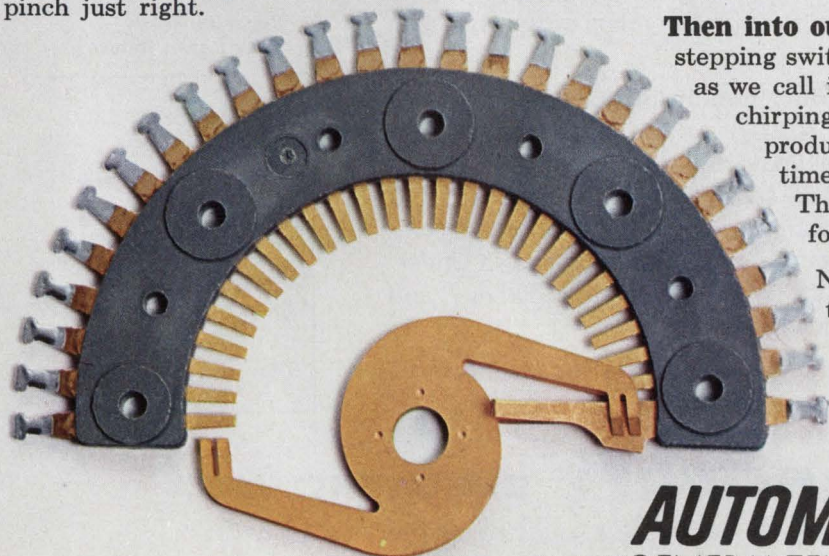

Then comes our big wheel

The entire wiper assembly is turned by the ratchet wheel. It's big and it's strong and it has 52 flat case-hardened teeth. Why flat teeth? So when they mesh with the teeth on the ratchet wheel they mesh tight. No banging, wiggling, or scraping. And as the teeth wear, they just mesh deeper in the grooves.

Ball bearing anchor for good measure

The armature assembly has to be securely fastened to keep it from wiggling up and down, or everything goes out of whack. So we choose a big stainless steel pin and secure it with wide bearings to the armature yoke. To make sure this pin never slips out of the yoke, we drill a hole in both ends. Then we force a steel ball bearing into these holes. This expands the walls of the pin into and against the walls of the armature and the whole assembly is anchored for life. We're the only ones that do it this way. So we're the only ones that offer a lifetime fit.

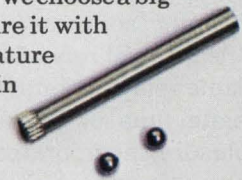

Then into our cricket room

Every single AE stepping switch goes to the run-in test room. Or, as we call it, the cricket room, because of the chirping noise all the switches we're testing produce. Here, every switch is tested 50 times a second for 45,000 operations. Then, and only then, are they ready for delivery to our customers.

Now that we've explained all the little things we do to make our Type 45 reliable, put it through your own tests. Industrial Sales Division, Automatic Electric Company, Northlake, Ill. 60164.

AUTOMATIC ELECTRIC
GENERAL TELEPHONE & ELECTRONICS

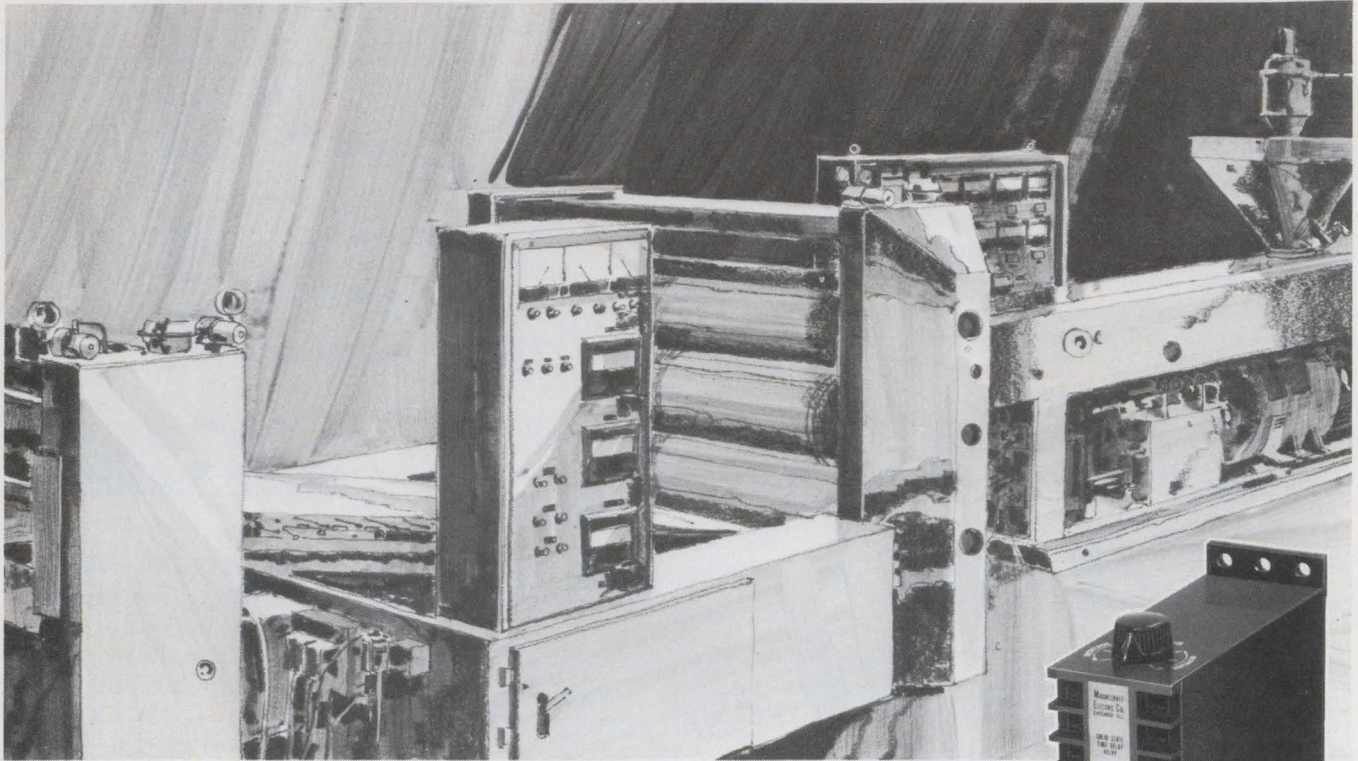

MAGNECRAFT THE CONTROLLER

*Heavy duty time delay and power relays
for rugged industrial applications*

The Solid State (hybrid) Class 211M time delay relay is designed for heavy duty service requiring accurate time delay control with $\pm 5\%$ repeatability. This time delay relay makes use of hybrid technology combining solid state circuitry for the timing function with an electromechanical relay for DPDT 10 ampere output switching. This highly reliable relay operates on AC or DC, has an adjustable delay for either operate time or release time. The surface mounted molded plastic enclosure incorporates screw terminals. In stock for immediate delivery, this new relay costs less than \$29.00 in single quantities.

The Electromechanical Class 112M time delay relay comes in a package similar to the 211M. However, it utilizes a highly reliable precision air dashpot for the timing function, and an electromechanical relay for the 10 amp DPDT output switch. The designer will quickly recognize the inherent quality and simplicity in the design. Also in stock for immediate delivery, this time delay relay costs less than \$29.00 in single quantities.

The Class 99 is ideal for heavy duty industrial power relay applications. Occupies less than $2\frac{1}{2}'' \times 2\frac{1}{2}'' \times 2\frac{1}{8}''$ of space. Yet, it's capable of switching 115 volts at up to 50 amps. Available with a "Magnetic-Blowout" for greater arc suppression and increased DC switching. Class 99 power relays can be supplied with contact combinations from SPST to DPDT at ratings up to 50 amps and in Underwriters Laboratories Listings. In stock for immediate delivery and priced as low as \$5.66 in single quantities.

For your source of 512 different stock relays, write for Magnecraft's Catalog No. 271.

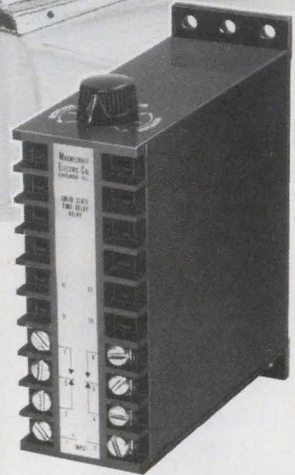

Class 211M
Class 112M
Time Delay
Relay

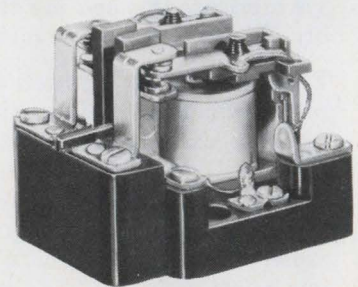

Class 99 Heavy
Duty Power Relay



Magnecraft[®] ELECTRIC CO.

5575 NORTH LYNCH AVENUE • CHICAGO, ILLINOIS 60630 • 312 282-5500 • TWX-910-221-5221

INFORMATION RETRIEVAL NUMBER 13

INFORMATION RETRIEVAL NUMBER 248 ▶

Now, Pixiepot® precision 10-turn wirewound pots priced as low as \$3.25



Now, you can order *new, improved Pixiepot® 10-turn wirewound potentiometers directly from this data sheet at the lowest pot prices anywhere!*

For as little as \$3.25 (see price schedule), you get the world's smallest precision mini-pots for commercial and industrial applications, with all these special high performance features available: • High torque 2 to 8 oz. — in., • Custom bushing length, shaft configurations and lengths, • Any resistance within the range, • Linearity tol. $\pm 1\%$, • Resistance tol. $\pm 2\%$. Standard features include: • Newly developed superior high impact plastic housing, $\frac{3}{4}$ " length and $\frac{7}{8}$ " diameter size. • Gold-plated terminals, welded terminations and slotted stainless steel shaft with bushing mounting. *Call your nearest Pixiepot distributor listed on the opposite side of this page for fast off-the-shelf delivery of standard models.*

PRICE LIST FOR PIXIEPOT POTENTIOMETERS

DESCRIPTION	1-9	10-24	25-49	50-99	100-249	250-499	500-999	1000-2499	2500-4999	5000-9999	10,000 UP
Model 3253, Std. Res.	4.95	4.90	4.80	4.70	4.50	4.30	4.10	3.90	3.65	3.47	3.25

SPECIAL FEATURES (ADDITIONAL CHARGES)

	1-9	10-24	25-49	50-99	100-249	250-499	500-999	1000-2499	2500-4999	5000-9999	10,000 UP
$\pm 2\%$ Res. Tol.	5.00	3.00	2.00	1.50	1.00	.75	.60	.50	.45	.40	.35
Hi-Torque (HT)	.95	.85	.75	.65	.60	.55	.50	.45	.40	.35	.30
Ind. Lin. $\pm 0.1\%$	5.00	3.00	2.50	2.25	2.00	1.75	1.60	1.50	1.50	1.50	1.25
Shaft Lock	.50	.45	.40	.35	.30	.25	.25	.25	.20	.20	.20
Spec. Res. (1) Min. quan. 10 pcs.	3.50	1.60	1.05	.65	.30	.20	N/C	N/C	N/C	N/C	N/C

(1) Any value between 100 Ω and 100K other than standard values shown in table. For resistance values outside this range, contact factory.



SPECIFICATIONS

ELECTRICAL	
Actual electrical travel ($+10^\circ - 0^\circ$)	3600°
Normal resistance range	100 Ω to 100K
Extended resistance range	25 Ω to 150K
Resistance tolerance, standard	$\pm 5\%$
special	$\pm 2\%$
Power rating at 20°C derating to 0 at 85°C	.2
End resistance	within linearity tolerance or 0.1 Ω whichever is greater
Linearity, independent, tolerance, standard	$\pm 0.25\%$
special	$\pm 0.1\%$
Equivalent noise resistance, max. (ohms) meas. per VRCI stds.	100
Insulation resistance at 500 VDC, min. (megohms)	1,000
Dielectric withstanding voltage (volts RMS)	1,000
MECHANICAL	
Total mechanical travel ($+15^\circ - 0^\circ$)	3600°
Mechanical life, shaft revolutions, normal conditions	500,000

Cups, max. number	1
Moment of inertia, approx. (gm-Cm ²)	0.3
Weight (oz)	0.5
Stop strength, static (oz-in)	.50
Torque: Standard starting, Max. (oz-in)	1.0
Special (designated H.T.) (oz-in)	5 ± 3

ENVIRONMENTAL	
Temperature range, standard	-25° to +85°C
Humidity and dust protection	enclosed construction
Vibration	10G to 2,000 cycles
Shock	50G

TYPICAL SPECIAL FEATURES AVAILABLE
Shaft lock • Any resistance within the range • High Torque • Resistance Tol. $\pm 2\%$ • Linearity Tol. $\pm 0.1\%$.

CUSTOM FEATURES AVAILABLE
• Bushing length • Shaft configurations and length

Pixiepots are also available in a combination package with Model 61 miniature turns-counting dials at one super-budget price! Example: 5,000 ... \$6.95

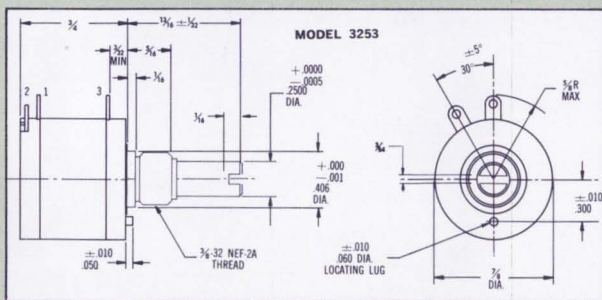

NOTE: Lock washer and hex nut supplied with each unit. Design details subject to change without notice. Certified Drawings available on request. Tolerances unless otherwise specified: Fractional: $\pm \frac{1}{4}$ " Decimal: $\pm .005$ " Angular: $\pm 1^\circ$

Talk to Duncan engineers direct for immediate answers to your special requirements. You can use this toll-free telephone number from anywhere in the nation: 800-854-3252. (California residents, call collect (714) 545-8261)

DUNCAN ELECTRONICS
SUBSIDIARY

SYSTRON + DONNER

2865 FAIRVIEW ROAD COSTA MESA, CALIFORNIA 92626

TYPICAL COIL CHARACTERISTICS FOR STANDARD RESISTANCES

Standard Resistance (Ohms)	Theoretical Resolution Nominal (%)	Max. Appl. Voltage (Volts DC)
100	.051	14
200	.042	20
500	.036	32
1K	.025	45
2K	.023	63
5K	.021	100
10K	.016	140
20K	.015	200
50K	.011	316
100K	.008	447

All resistances shown are manufactured with resistance wire with temperature coefficient of .002%/°C (20 ppm) nominal.

HOW TO SPECIFY

When ordering a PIXIEPOT, indicate the model number, resistance, linearity tolerance and any additional special features. The letters "R" and "L" precede the resistance and linearity respectively.

Example: 3253 R1K L.25 HT
Model Number _____
* Resistance (Standard Tolerance) _____
Linearity Tolerance (\pm) _____
Code letter SL Shaft Lock / HT High Torque _____

* If the resistance tolerance is $\pm 2\%$ show the tolerance in parenthesis () after the resistance. E.g. R1K(2) designates a 1K resistance with a tolerance of $\pm 2\%$. For resistance values less than 1,000 ohms (1K), show the actual value omitting the letter "K". E.g. 3253R100L.25 is a 100 ohms resistance.

Duncan Model 3253



Call your nearest distributor for fast delivery of in-stock Pixiepots

DISTRIBUTORS

Akron Elect. Supply Co.
Akron, Ohio 44306
(216) 762-8818

John A. Becker Elect. Co.
Dayton, Ohio 45402
(513) 224-1071

Bodelle Co., Inc.
Chicago, Ill. 60627
(312) 468-1017

Bodelle Co., Inc.
Detroit, Mich. 48235
(313) 273-6920

Bodelle Co., Inc.
Fort Wayne, Ind. 46815
(219) 485-3929

Mace Electronics
Erie, Pa. 16505
(814) 838-3544

Radar Electric Co.
Seattle, Wash. 98119
(206) 282-2511

Richey Elect., Inc.
North Hollywood, Ca. 91601
(213) 877-2651
(213) 761-6133

*San Diego, Ca. 92103
(714) 291-4955

*Las Vegas, Nev. 89102
(702) 870-5996

*Agents of Richey Elect.

Solid State Electronics
Dallas, Texas 75220
(214) 352-2601

Southwest Elect., Inc.
Houston, Texas 77036
(713) 782-3060

Sterling Electronics
Watertown, Mass. 02172
(617) 926-9720

Perth Amboy, N.J. 08861
(201) 442-8000

South Norwalk, Conn. 06854
(203) 853-3153

Terminal-Hudson Elect., Inc.
Mountain View, Ca. 94040
(415) 969-9240

M. Leff Radio Parts Co.
Braddock, Pa. 15104
(412) 271-2800

SALES REPRESENTATIVES

FLORIDA & P.R.

Orbe, Inc.
St. Petersburg, Fla. 33733
(813) 894-0687

Orlando, Fla. 32804
(305) 425-9004

METRO. NEW YORK & NO. NEW JERSEY

Sencor, Inc.
Albertson, L.I., N.Y. 11507
(516) 747-1273

Montclair, N.J. 07042
(201) 783-5990

MIDWEST STATES

Carlson Elect. Sales Co.
Chicago, Ill. 60648
(312) 774-0277

St. Louis, Mo. 63141
(314) 991-0262

Exon Electronics
Minneapolis, Minn. 55421
Tel: (612) 788-4111

MICHIGAN

Elko Sales Corp.
Grosse Pointe Woods,
Mich. 48236
(313) 884-7893

Grand Rapids, Mich. 49506
(616) 949-1451

SOUTHERN STATES

Grady Duckett Sales Co.
Atlanta, Ga. 30329
(404) 451-3529

Greensboro, N.C. 27420
(919) 273-4617

Huntsville, Ala. 35804
(205) 881-1213

**WASH., OREGON,
IDAHO & MONTANA**
Reeve Mktg. Assoc.
Seattle, Wash. 98133
(206) 542-5889

ARIZONA & UTAH
Southwest e/m Eng., Inc.
Phoenix, Az. 85020
(602) 944-1521

OHIO, KY. & W. PENNA.

Rockford Cont. Ohio
Dayton, Ohio 45414
(513) 278-7362(3)

Euclid, Ohio 44132
(216) 731-5250

Columbus, Ohio 43209
(614) 231-5890

TEXAS, OKLA. ARKANSAS & LA.

Kemp Engring. Co., Inc.
Dallas, Texas 75220
(214) 357-6663

Houston, Texas 77023
(713) 928-5426

COL., WYOMING & NEW MEXICO

Waugaman Assoc., Inc.
Wheatridge, Colo. 80033
(303) 423-1020

MID-ATLANTIC STATES

Marktron, Inc.
Rockville, Md. 20850
(301) 762-6210

Towson, Md. 21204
(301) 825-8222

S. NEW JERSEY & E. PENNA.

Sencor, Inc.
Philadelphia, Pa. 19152
(215) 342-0223

NEW ENGLAND STATES

Gerber Sales Co., Inc.
Waltham, Mass. 02154
(617) 891-8040

New Haven, Conn. 06515
(203) 777-6279

East Longmeadow,
Mass. 01028
(413) 525-3059

NO. CALIF. (RENO)
Jack Pyle Company
San Mateo, Ca. 94402
(415) 349-1266

SO. CALIF.

Factory Sales Office
Costa Mesa, Ca. 92626
(714) 545-8261

UPSTATE NEW YORK

Reed Electronics, Inc.
Rochester, N.Y. 14618
(716) 473-2767

Vestal, N.Y. 13850
(607) 748-7391

East Syracuse, N.Y. 13057
(315) 463-8955

INTERNATIONAL REPRESENTATIVES

AUSTRALIA

Rutherford Imports Pty. Ltd.
E. Doncaster, 3109
848-3033

BELGIUM & LUXEMBOURG

N. V. Nijkerk S.A.
Brussels 2, Belgium
28.20.70 (2 1.)

CANADA

Aero Sales Eng. Co.
Rexdale, Ontario
(416) 743-9130

Ottawa, Ontario
(613) 828-8560

ENGLAND

Steatite Insulations Ltd.
Birmingham
EDG 6961/2

FRANCE

Radio TV Francaise
92 Neuilly-Sur-Seine, (Paris)
722-70-40

GERMANY (WEST)

Elektronik Bauelemente GMBH
46 Dortmund 1
(231) 528065

HOLLAND

Nijkerk's
Handelsonderneming N.V.
Amsterdam
(020) 428933

ISRAEL

STG Int. Ltd.
Tel-Aviv
53459

ITALY

Ingg. S. & Agostino Belotti
Milano
54 20 51

JAPAN

Shoshin Shoji Kaisha Ltd.
Tokyo
(270) 5921-6

NEW ZEALAND

P. H. Rothschild & Co. Ltd.
Lower Hutt
63-581

NORWAY

J. M. Feiring A/S
Oslo 4
21 82 12

PORTUGAL

Sociedade Comercial
Romar Lda.
Lisbon
672161

SPAIN

REMA Leo Haag S.A.
Madrid 3
253.40.03

SWEDEN

ALLHABO
10028 Stockholm 49
224600

SWITZERLAND

E. Fenner
4450 Sissach
(061) 853385

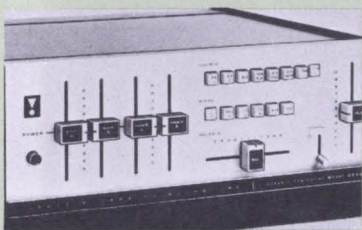

Send today for free catalog with complete specs.

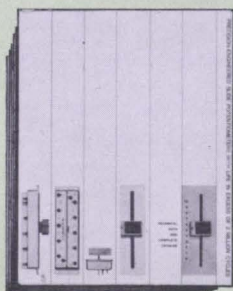

Slide actuated pots

The Duncan KP 200 series precision slide actuated potentiometer provides users with a 2 3/4" linear travel featuring essentially infinite resolution at low cost. The KP 200 series also provides: • Single or dual resistive elements • Linear or audio tapers • Standard tap positions • All metal housing and complete electrostatic shielding. Primarily used in the broadcast and recording industries, special applications in SCR lighting controls and commercial sound systems also have been numerous.

NEW! DUNCAN FADERS

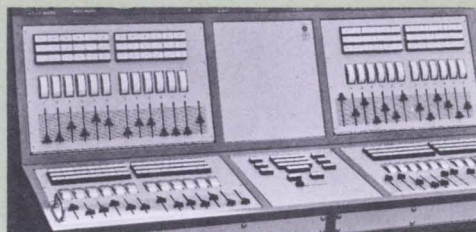

Contact factory direct for information on Duncan faders — call toll-free from anywhere in the nation: 800-854-3252. (California residents, call (714) 545-8261 collect.)

DUNCAN ELECTRONICS

SUBSIDIARY

SYSTRON  **DONNER**

2865 FAIRVIEW ROAD □ COSTA MESA, CALIFORNIA 92626
PHONE: (714) 545-8261 □ TWX 910-595-1128

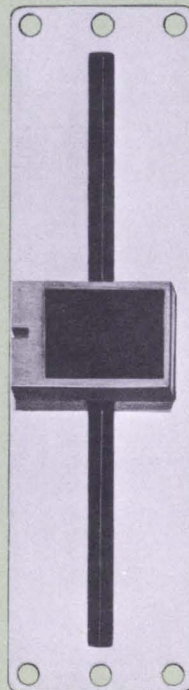

**Open up
closed-circuit
markets...**

**...with this new
one-inch-diameter
Plumbicon***

*Registered trade-mark of
N.V. Philips' Gloeilampenfabrieken
Eindhoven, the Netherlands

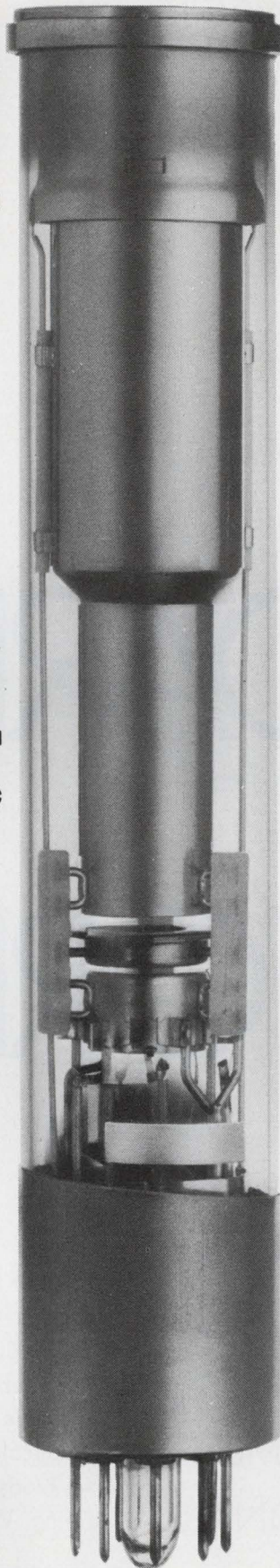

What a boost the entire CCTV industry would enjoy if existing cameras could operate well at significantly lower light levels and higher response speeds. That's exactly what this new Philips **Plumbicon** camera tube has to offer. Its one-inch-diameter makes it **retrofitable into existing cameras now using vidicons**. Developed originally to meet the exacting needs of live broadcast television, the **Plumbicon** won the industry's "Emmy" in 1967, as the year's most significant technological advance. Since then it has dominated its field - today it's in 9 out of 10 colour cameras in use throughout the world. When used in CCTV applications - in medicine, industry, education or commerce - this superb tube makes practical many applications hitherto only theoretical. The very high sensitivity, low dark current and fast response mean greatly improved picture quality - even when the subject is poorly illuminated or moving rapidly. All of which means the **Plumbicon** can make existing CCTV equipment work better, can make **CCTV colour** a practical proposition... can open up vast new markets, not only for cameras, but for related equipment as well! Let's help you open up new opportunities!

**Philips Electronic Components
and Materials Division,
Eindhoven, the Netherlands.**

Manufactured, distributed and sold
in the U.S. by
Amperex Electronic Corporation,
Electro-Optical Devices Division,
Slatersville R.I.

PHILIPS

INFORMATION RETRIEVAL NUMBER 14



BOARDABLE & AFFORDABLE

• RIGHT ON THE MONEY
FOR PRINTED WIRING BOARDS
IN INDUSTRIAL, COMMERCIAL,
AND ENTERTAINMENT
ELECTRONICS

Sprague Type 196D Dipped Solid-Electrolyte Tantalex® Capacitors cool the performance/budget argument. Newly broadened line—now available in all popular 10% decade values between 0.1 μ F and 330 μ F. Voltage range: 4 to 50 vdc. Hard insulating resin coating is highly resistant to moisture and mechanical damage. Straight or crimped, long or short leads. Operate to 125C with only 1/3 voltage derating. Write for Engineering Bulletin 3545A.

Technical Literature Service
Sprague Electric Company
347 Marshall Street
North Adams, Mass. 01247



THE BROAD-LINE PRODUCER OF ELECTRONIC PARTS

45M-0139

INFORMATION RETRIEVAL NUMBER 17

Highlighting

THE ISSUE

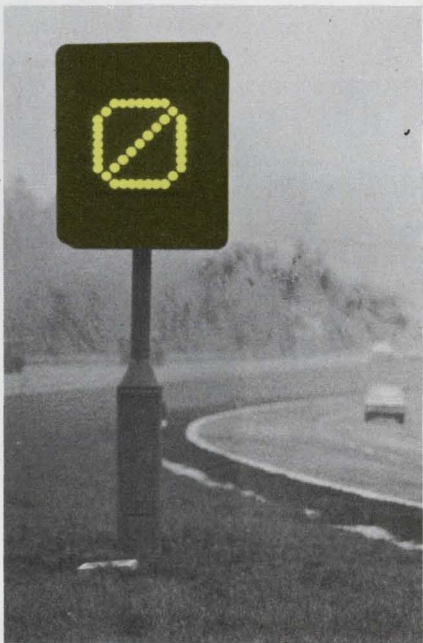

Europe is making a big push to speed its land, sea and air transportation by the use of electronics—from the remotely controlled highway signal shown above to computers, display and communication equipment.

Even underground—in subway systems—electronics is playing a growing role in controlling European traffic. News Editor Jack Kessler gives an on-the-scene glimpse of Old World transportation working in new ways.

Page 26

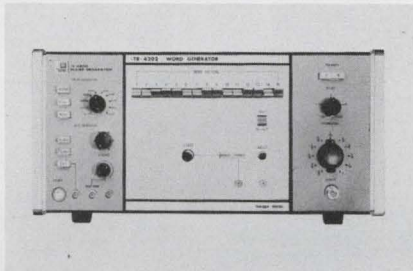

A new pulse generator system comprised of a \$9800 mainframe and three plug-ins not only supplies high-speed ± 2 -V pulses with rise and fall times under 250 ps but clocks out at an amazing rate of 1000 MHz.

With its three complementary plug-ins, the new generator system can produce three types of output modes: programmable word patterns, pseudo noise sequences and continuous-pulse trains.

Either an external clock signal or the system's internal clock signal can be arbitrarily selected. The external signal is continuously variable over the frequency range of 100 to 1000 MHz.

Page 123

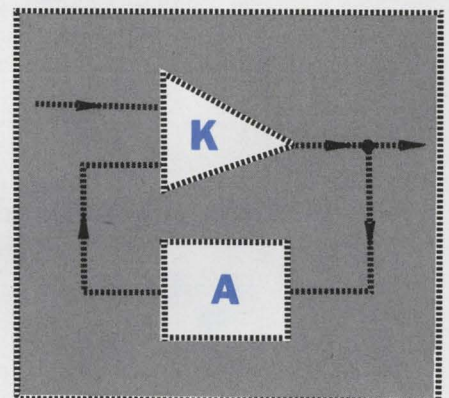

In many cases, circuit analysis can be simplified by approaching it in an unorthodox way. Choosing the output and then computing the input that caused it is an unfamiliar way to determine gain or attenuation, but it is a very useful technique when saturation or limiting of the output is possible.

This back-door approach is especially helpful when a computer-aided analysis program, such as CIRC or ECAP, is to be used. The computer performs the detailed computations, which may be more involved than in conventional analysis, but the results are more significant because the operating region of the output is determined in advance.

Page 70

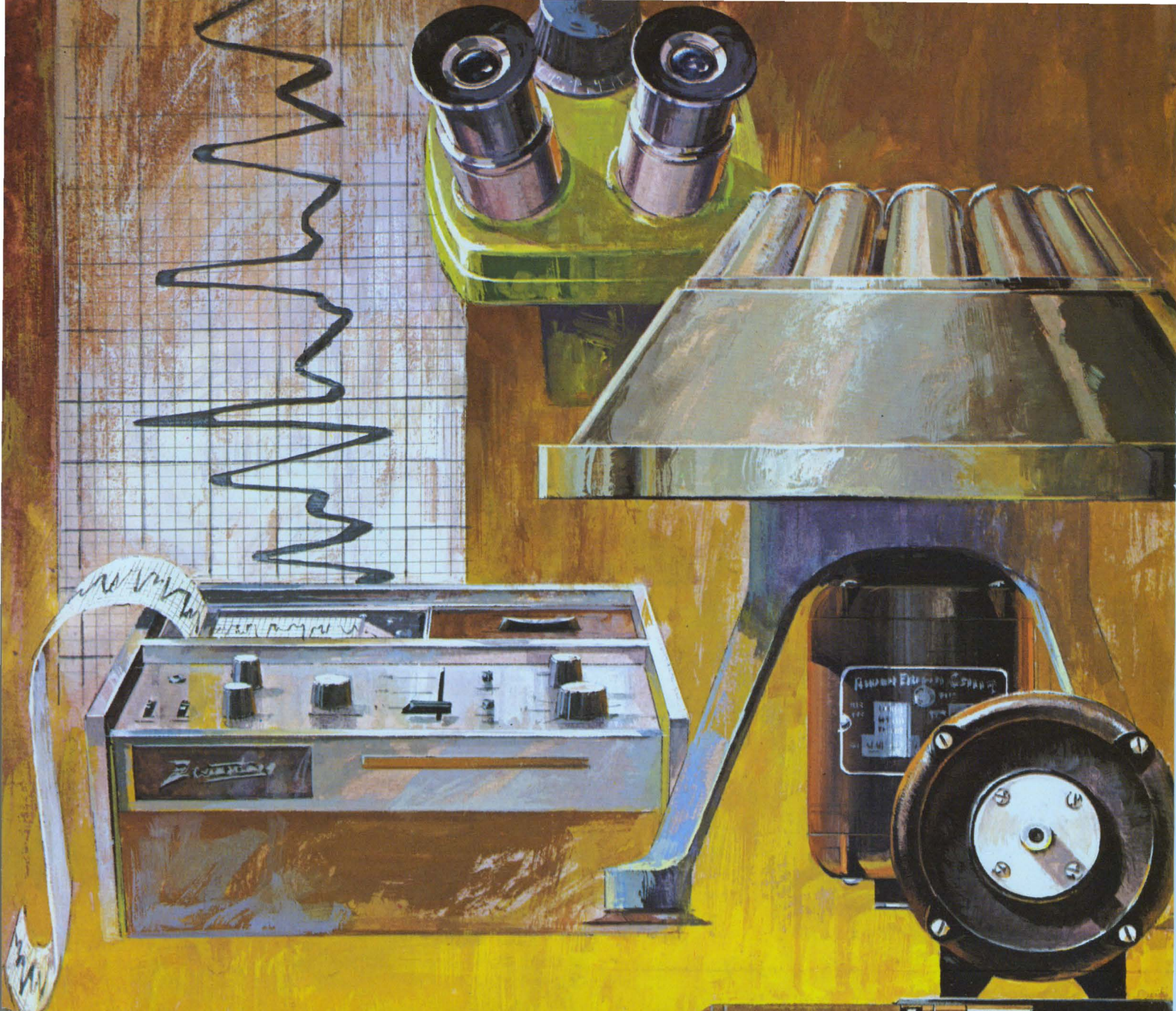

Bodine helps keep medical equipment strong hearted...

Bodine fractional horsepower drives. Small. Quiet. A complete line designed to keep medical equipment and apparatus powered precisely, reliably, for a long, long time. Motors built with all the integrity you've designed into your product—that deliver as specified with fewer callbacks and service problems. If this is the kind of power you're looking for, you'll find no better source.

Over 3,500 standard specifications to choose from. Bodine also builds custom and special fhp motors to design requirements. Our engineers will be happy to help you pinpoint the right one for your specific application need. Mechanical organ, heart recorder, test unit, pumps—whatever your product, specify Bodine fhp drives. The power behind the leading products for some 63 years. Write for bulletin. Bodine Electric Company, 2500 W. Bradley Place, Chicago, Illinois 60618.

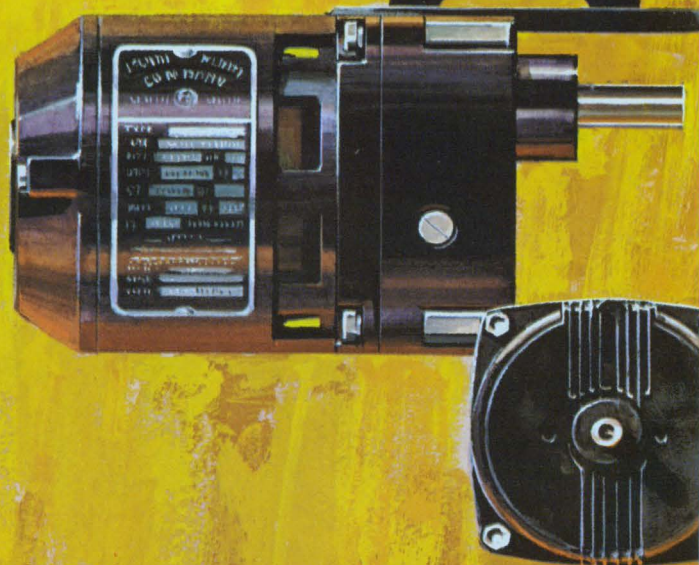

Bodine Motors Wear Out—It Just Takes Longer

BODINE MOTORS/CONTROLS

Ask about Bodine SCR motor speed controls

Laser makers are offering mass-production capability

NEW YORK CITY—After years of R&D and largely disappointing sales, the laser industry is moving to stabilize its beachhead in the electronics market by mass-producing products at low cost.

Two companies have announced the availability of mass-produced lasers at prices ranging from \$30 upward.

The announcements were made by RCA and Metrologic Instruments, Inc., at the Electro-Optical Systems Design Conference, held here Sept. 22-24. No recession was apparent at the show. The number of booths were up from 173 at last year's conference to 245—an increase of more than 34%. Lasers of all kinds—continuous wave, pulsed, tunable, solid-state and gas—dominated the exhibition.

The new, high-production line by RCA Electronic Components, Lancaster, Pa., included cw helium-neon lasers with 1-mW output at 6330 Å.

"A typical single-unit price for the 1-mW system is \$275," John H. Crowe, manager of laser marketing at RCA, told ELECTRONIC DESIGN. "But in high volume, the price can go as low as 30%."

Crowe said the new line had potential application in general research, surveying and alignment work, holography and metrology.

A 10-foot stack of operating, low-cost lasers was shown by Metrologic Instruments of Bellmawr, N. J. These were the company's Model 310 cw helium-neon lasers, radiating 0.5 mW at 6328Å. The price, including housing and power supply, was quoted by C. Harry Knowles, president, at \$48 each in quantities of 1000.

He also pointed out that Metrologic had devised a cheap way to modulate the output by varying tube current. Response to date has been about 0.5 MHz.

Knowles sees a large market for his company's low-cost lasers in communications and data processing, as well as for use in the teaching of optics.

Rapid recent advances in infrared photodevice technology were also demonstrated, at the conference. Mullard, Ltd., of Southampton, England, and the Honeywell Radiation Center, Lexington, Mass., announced the availability of room-temperature (300K°) cadmium mercury telluride cells, suitable for the 3-to-7 micron IR range.

And a room-temperature pyroelectric detector for CO₂ lasers and millimeter wavelengths was demonstrated by Laser Precision Corp., Yorkville, N. Y.

Luna 16 feat impresses Jet Propulsion Lab

The success of the Soviet Union's unmanned Luna 16 spacecraft in bringing back rock from the lunar surface brought mixed reactions from the Jet Propulsion Laboratory in Pasadena, Calif.—the moving force behind the United States' unmanned space program.

While conceding that the Russian feat was significant, Dr. William P. Pickering, director of the laboratory, noted that this country's Surveyor vehicle lifted off the moon and moved about 20 feet before setting down again, demonstrating the ability to fire from the earth rocket engines that are on the moon.

However, "one technical capability that the Russians demonstrated was getting the moon sample into the re-entry vehicle and hermetically sealing it," Dr. Pickering commented, adding:

"We need a balance between manned and unmanned missions. Manned missions provide the basic

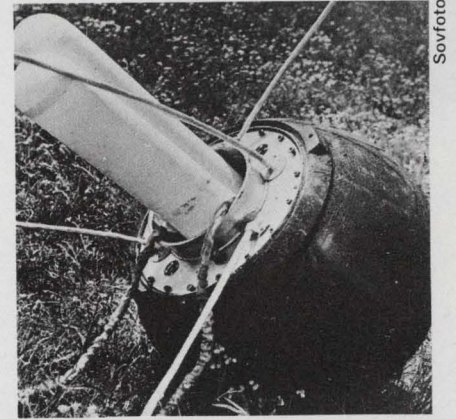

Moon rocks from Luna 16 mission were hermetically sealed in a spacecraft like this. Visible are twin capsules, in which the rocks were stored, three antennas and parachute lines. Test vehicle is shown above.

knowledge that allows us to send unmanned vehicles for more specific purposes."

IBM surprises industry with its new memory

The announcement last month by IBM of the first use of an all-monolithic (silicon bipolar) main memory came as a surprise to experts in the field. The new computer—the Model 145—may be an omen of what to expect in the future.

Dr. Henry S. McDonald, assistant director of the Communications Principles Research Laboratory at Bell Telephone Laboratories, Murray Hill, N. J., says he had expected semiconductor main memories in one or two years.

"The next benchmark," says McDonald, "will be for the semiconductor memory to move up (to the IBM System 370 Model 165 and 155 series) as well as down the line—if there's going to be a Model 135 or 125."

The Model 145 has a main memory capacity of over half a million bytes—twice that of IBM's System 360, Model 40. The new memory has an access time of 540 ns; its basic machine cycle (the time it takes to perform 1 micro-instruction) ranges from 202.5 to 315 ns.

In shifting from machines with combined ferrite core memories and very fast semiconductor cache buffers, IBM is the first to prove

the economics and technology of semiconductor circuits: they not only increase performance but also cut memory space needs in half.

McDonald points out that, at about 128 bytes, the cost of complete semiconductor memory becomes competitive with cores plus semiconductor buffer memory systems. McDonald says, "It looks like IBM is able to produce a 500-ns transistor memory for about only twice the cost per bit that it can produce a 2- μ s core.

Another innovation of the Model 145 is the ease of adding more memory by means of a pre-written disc cartridge. For example, it can hold all instructions needed to perform arithmetic to 34 decimal digits. The contents of the disc are loaded into the machine, and the standard 32,000 characters of control storage can be expanded to 64,000 by using a portion of main memory.

Monthly rental for the 145 will range from \$14,950 (112,000 characters of main memory) to \$37,330 (512,000 characters). Shipments will be scheduled by late next summer.

Cancer fighter shoots subnuclear particles

A new cancer weapon being developed at the Stanford University School of Medicine may prove several times more effective than radiation-therapy techniques now in use, according to Dr. Malcolm A. Bagley, head of the Division of Radiation Therapy.

A new large-scale superconducting linear accelerator that is near completion at Stanford will be used to shoot high-speed subnuclear particles called pi mesons through the body into a tumor, where they explode, destroying surrounding tissue.

The pi meson produces little tissue damage on the way in, but wherever it stops, it releases a great deal of destructive energy. To make sure that pi mesons will

stop in a tumor, rather than elsewhere, said Dr. Bagley, their kinetic energy will be controlled as they enter the body, possibly by means of a shield that would slow them down.

The energy required to accelerate the pi mesons has been available only from extremely large accelerators that cost \$55 million or more. However, Dr. Bagley said that the new Stanford superconducting accelerator suggests the possibility of smaller machines that would cost one-tenth as much and thus could be built for hospitals and medical centers.

Swift growth seen for interface ICs

A rapidly climbing world market for interface integrated circuits—to roughly \$80 million by 1972—is forecast by Jerry Robertson, manager of linear IC marketing in Texas Instruments' Components Group in Dallas.

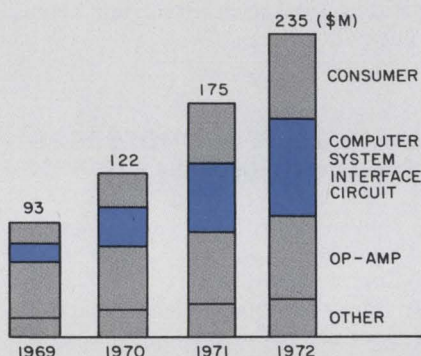

Texas Instruments view of worldwide linear IC market (in \$ millions).

Robertson, who estimates that the U. S. Government alone spends \$100 million per year on circuits that form the interface between vacuum-tube, bipolar, and MOS equipment, sees a sweeping move by the industry toward standardization of interface ICs. The immediate field of use of the devices is computers and peripheral gear.

Even when plated wire or semiconductor memory begins to replace ferrite cores memories—in about two years, according to Robertson—interface problems, which involve changes in impedance, current or voltage levels, will remain.

It is these problems that generate the increasing demand for the interface ICs.

GE plans big expansion of data-processing net

Although General Electric's data-processing service—described as the world's largest—is not yet in the black, GE has greatly expanded the scope and performance of its initial \$100-million investment.

In 1971, the company's data net will include three interconnected "supercenters," making data-processing services available to 150 cities in the U. S., Canada and—via Comsat satellite—to London. Expansion of the U. S.-based network to additional international cities is being evaluated, the company said.

Two new services will be offered. One will be a 24-hour-a-day, 365-days-a-year super-reliable service. The other, called, "interprocessing," will let customers exchange high-speed data between in-house computers and the GE network.

GE's supercenter in Cleveland is now operational, and by early 1971 the company will open supercenters in Los Angeles and Teaneck, N. J.

Boeing plans to sell electronic systems

Boeing Aircraft is going into the electronics business. The Seattle, Wash., company will not only manufacture electronics for its own aircraft but plans to market microelectronics and minicomputers as well.

An analysis of the make-or buy strategies of the aerospace industry convinced Boeing that the company must build electronics systems if it is to remain in the aerospace business.

Boeing has decided to develop guidance and control systems so they built a sizable, and very well equipped, microelectronics R&D facility. Now they're planning to turn to actual production of ICs for inside use and for the commercial market. In January, 1971, Boeing will offer a gyrator circuit and a line of noise-tolerant logic.

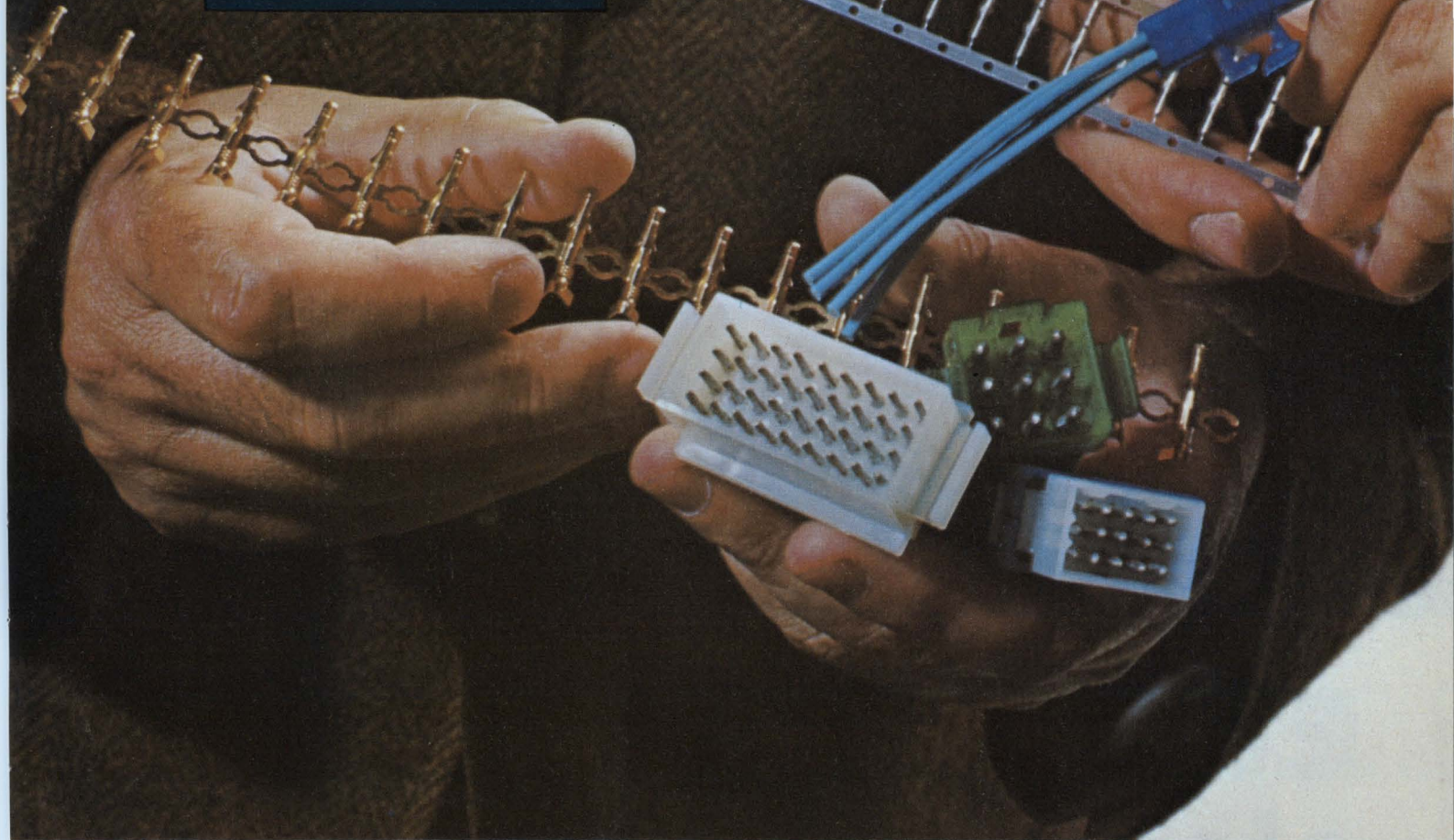

MAKE YOUR CONNECTIONS: FAST. With Molex standard and miniature connectors. They're easier to work with. Simplify wiring. Speed production. Save assembly steps. Make installation and servicing extra easy, too. This is why circuitry idea men everywhere are making connections with Molex. From one circuit to 104 or more. Production keyed and available in a variety of colors to meet design requirements. Molex has the

connector. Plus the design and engineering capability to solve the most complex wiring problems . . . fast. For a colorful free sample of the Molex connector write: Molex Incorporated, Downers Grove, Illinois 60515. Or you can make connections by calling (312) 969-4550.

*... creating components that
simplify circuitry*



OUTSIDE of London, on the M4 Motorway to Heathrow Airport, is the Heston Police Control Center—a facility for highway signaling and surveillance that exemplifies Europe's vitality in using electronics to control transportation. The electronics in the center include a computer, display and communication equipment.

The officer in charge moves a small joystick on his console and the picture on one of two TV monitors in front of him changes. He "zooms in" on a white sports car that has collided with a truck. The accident doesn't appear to be serious, but he presses a button

and speaks into a microphone:

"Tango two six. Tango two six. This is Motorway Police at Heston. Will you give your position?"

The patrol car reply comes from a speaker on the console. "This is Tango Two Six. I'm in Shepher-ton. Winton Road."

"There's been a traffic accident near you on M4. Can you help?"

Accidents happen, of course, even on highways that are monitored and controlled by electronics, but traffic police officers in Europe say there are significantly fewer collisions on the controlled highways, despite the fact that traffic flow is increased. And

when accidents do occur, help can be dispatched rapidly.

Underground—in subway transportation—in the air and at sea, electronics is also playing a growing role in controlling traffic.

Robert J. Gompert, director of the industrial division of Automatic Electric S. A. of Antwerp, Belgium, says that Europe's subway systems are already ahead of those in the United States.

"The Victoria Line in London," he told *ELECTRONIC DESIGN*, is completely automated. There is no need for a motorman—he is there for safety only. In Paris there is one line which is also completely



Europe travels electronically

By John N. Kessler, News Editor

An on-the-scene glimpse at how the Old World is controlling and speeding land, sea and air transportation—and moving ahead of the U.S. in some areas

automated. The Germans are also very advanced."

In Munich, a continuous inductive train control system developed by Siemens is being installed as the backbone of a highly automated subway line. A similar system is in operation in Hamburg. Control is based on the use of continuous conductor loops coupled by a coil to short sections of track. As the train wheel speeds over these coupling points, the train's position can be determined and control signals can be generated.

At airports the demand for radars to control ground traffic is reported rising steadily. And as

computer. If anything is out of order, the computer writes a statement on a teleprinter, giving the location of the hardware.

Control of the system is in the hands of the traffic police operator, who types directions on the teleprinter. The computer checks the messages and routes them to the proper stations on the highway. The computer also produces time and space sequence signals for the police operator to use in slowing traffic to a safe speed.

The control room at Heston includes a map panel of the motorway under control. Signals in use are indicated by color lamps. Along

containers, with heaters and even window wipers. In good weather, the cameras provide a view of 17 miles of traffic controlled road.

Vehicle-detection loops, embedded at about half-mile intervals in the roadway, provide the computer with constant rate-of-flow information—from crawling to normal speed. This is highly useful at night to inform oncoming traffic of a blockage and to notify drivers to slow down, change lanes or leave the highway.

Forty-four emergency telephones along the road are connected to the control center. When the receiver Gregory describes the unit as



Britain's traffic control systems use remotely controlled signs, computers and closed circuit TV. Control for 900 miles of road is planned for '71-'72.

for marine developments, new radars by Decca are designed to track accurately from 15 yards to 48 nautical miles.

The traffic-control system on 17 miles of the M4 highway was designed, developed and installed by GEC-Elliott Automation Ltd., Borehamwood, Herts. The central part of the system is a GEC-Elliott Automation 903 computer with a basic store of 8000 18-bit words that can be expanded to 65,000 words. The other elements—signs, TV cameras, telephones and vehicle detection loops—are checked automatically every five minutes by the

the highway there are 20 traffic signs in each direction. Each of these is made up a matrix of 139 bulbs, arranged in a 13-by-11 format and enclosed in a weather-proof container. The signs are controlled from the Heston station and can be changed to indicate:

- Stop.
- Advised maximum speed.
- Lane clear.
- Lane closed.
- Change lanes.
- Leave motorway at next exit.

Four TV cameras are mounted on overpasses above the highway. These are also in weatherproof

for one is picked up, a light appears on the controller's console, indicating the telephone box number. While answering a call from one of these telephones, a police officer can also use a TV camera to check the situation visually.

An experimental radar detector is undergoing tests at present. It is similar in function to conventional vehicle-detection loops in that it indicates the number of vehicles passing a point and their speed. But, according to Albert Gregory, sales manager for GEC-Elliott, "the radar can be buried in the road and requires no maintenance."



Ground radar like this is being installed at Orly Airport. Planes can be seen taking off on east-west runways. The radar operates at Ku band.

basically an experimental wave-guide—"a cast-iron box fed by a Gunn diode." Signals, he says, are analyzed to get a doppler-effect reading. In this way, vehicle speed and traffic density on sections of the highway can be determined.

More road systems due

Next year and the year after, GEC-Elliott will begin installing a National Motorway Communications System of computer and traffic control centers for use throughout 900 miles of England and Wales. Computer-controlled traffic systems are also being installed in Munich, Frankfurt, Madrid, Barcelona, Lisbon and other cities in Europe.

Last spring the city of Berlin commissioned Siemens of Munich to try out a new electronic signalling system for traffic control on a five-lane arterial street. When the system is complete, 30 signals, mounted on overpasses, will be set up along a three-mile stretch. The signals will make additional lanes available in one direction by limiting the number of lanes in the

opposite direction. Traffic lights will be controlled by detectors embedded in the road. A central computer, fed with information from all the intersections, will be programmed to change the lights to achieve a desired traffic flow—for instance, to ease the flow into the city in the mornings and out of it in the evenings.

England is connected to the ancient Welsh city of Cardiff by the Severn Bridge, which spans the second greatest tidal fall in the world—32 feet between high and low tide. The Severn Bridge uses a computer toll-collection system, designed to prevent fraud by collectors and the public. The system uses a GEC-Elliott Arch 100 central processor with 4096 18-bit words. It calculates bridge traffic, tolls and the date and time of toll collections, and it also collects temperature information from four sensors on the bridge, so it can automatically alert drivers if freezing conditions exist on the road.

As a driver approaches the bridge, green arrows indicate which of the 10 lanes are open. Gates bar nonoperating lanes. There are

17 vehicle categories, ranging from motorcycles to six-axle trucks.

"The computer scans 24 inputs and interrogates 48 others as it processes each vehicle," reports J. G. Reeks, toll manager at the bridge. If there is a discrepancy between the fee paid and the number of axles counted, the computer sounds an alarm.

Inertial navigation for SST

The Anglo-French SST Concorde, despite headaches in development and production, is another example of Europe's determination to advance the application of existing technology to achieve better transportation facilities.

Because compasses are subject to magnetic fluctuations at supersonic speeds and cannot be relied on to indicate direction accurately, the Concorde's designers asked Ferranti in Edinburgh, Scotland, to develop an inertial navigation system.

Richard J. Thornborough, a former Royal Air Force pilot who now manages a marketing group at the British Aircraft Corp. in Filton, describes the essential advantage of inertial guidance in one sentence: "We used to fly rhumb line tracks at subsonic speeds using magnetic compasses, but now, with Concorde's inertial system, we have a small airborne computer that calculates the differences in heading and makes it possible to fly Great Circle routes."

British stress radar development

Britain, which once ruled the seas, still holds a leading position in the production and development of marine radars. Latest figures from Britain's Central Office of Information indicate that about three-fourths of all radar-equipped merchant ships in the world use British equipment.

At Decca's Research facilities in Chessington, Surrey, Eric R. Ibbetson, head of the Marine Radar Laboratory, describes recent approaches to the design of Decca's marine radar for large ships. These radars, operating on the 10-cm wavelength, have a minimum range of about 15 yards and a maximum of 48 nautical miles.

The main effort, according to Ibbetson, has been to use solid-

state elements throughout.

In building new radars, Decca engineers are giving special attention to the following:

- **Transmitter**—Keeping the driving power down to 3 kW instead of the 10 kW required for previous radars.

- **Modulator**—Designing an all-solid-state unit (with the exception of the mechanical relays used for pulse-length selection) and using an SCR for modulating the magnetron at 50 ns—all without an increase in costs.

- **Display**—Obtaining a pulse-repetition frequency high enough to get a bright display even when the radar is used with pulses as narrow as 50-ns.

- **Oscillator**—Replacing the klystron with a solid-state local oscillator and thus increasing the life of the unit and greatly reducing power requirements.

- **Crystal mixer**—Preventing the high-voltage spikes that get past the TR switch from damaging the crystal.

The result is anti-collision marine radar marketed by Decca since last year that indicates both the true and relative motion of as many as five ships (see photo). The radar operator assigns markers (short cursors) to nearby echo blips on the display. Each marker points toward the operator's ship, and once set, a marker remains at the same range and bearing, moving across the display with the user's ship.

A risk of collision exists if incoming ships travel down the markers on a constant compass bearing. If the echo blip moves off the line, there is no danger of collision, and the relative motion of the blip can be followed to insure that it stays on a safe course.

The radar has eight closely spaced range scales from 0.5 to 48 nautical miles, with true motion available between 0.75 and 24 nautical miles. The range speed is from 2 to 36 knots and a high-speed conversion kit can extend this to 72 knots. The motion markers can operate at 3, 6 and 12 miles.

Ground radar for airports

Increasing air traffic at Europe's international airports and the corresponding rise in ground

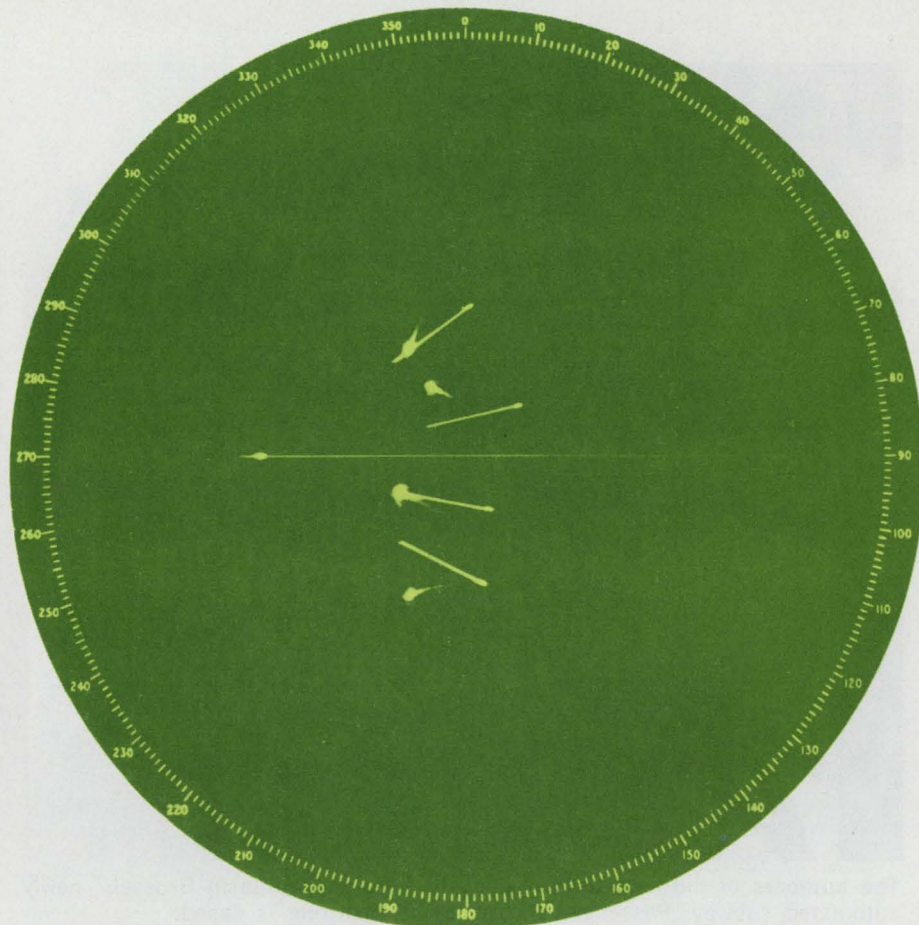

Anti-collision marine radar shows relative motion of as many as five ships. Each echo is assigned a marker pointed at operator's ship.

activity have created a market for radars to monitor runways and taxiways. Compagnie Radio Maritime of Paris and Decca Radar, Ltd., of London have just begun installing a Ku-band ground radar at Orly Airport, outside Paris.

The system, called Airfield Surface Movement Indication, is designed to provide a high-brightness, high-definition picture of all aircraft and vehicles from 0.5 to 2.5 nautical miles from the antenna. The high rotation rate of the antenna provides a flicker-free picture without afterglow, according to Decca.

Two displays are being installed at Orly. Dual transceivers will provide stand-by facilities and permit maintenance on one unit while the other is in operation; remote control of the transmitters and antenna will be possible from the control room.

The market for ground radars, according to Decca, will grow particularly in the next few years as aircraft are equipped for landings in Category II and Category III conditions—when the visibility is 100 to 200 feet and zero to 50 feet,

respectively. This will make it essential to know how to get planes to their docking facilities and the shortest way off the runway.

Automation speeds subway travel

In the new subway system being established in Brussels, it's possible for two men to handle the entire operation from a central control station, according to Gompert, the industrial division director of Automatic Electric S.A. At the central control is a lighted diagram of the system. The chief controller can follow the progress of all cars by observing the lights on the diagram.

A small, special-purpose computer, designed by Automatic Electric, continuously tracks each car. The braking of the cars, the dispatching system and all 34 power stations in the system are all automatically controlled.

Gompert says there as many as 5000 supervisory points, 1200 remote controls, 10,000 signal lights and 1000 miles of wire in the system. These are used to operate automatically:

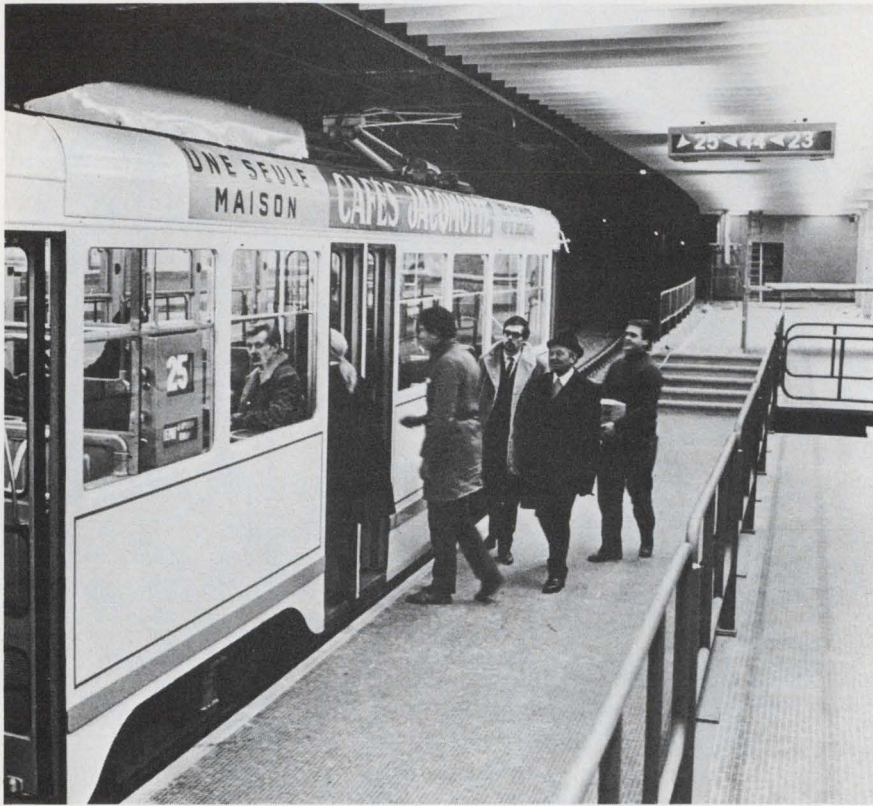

The numbers of the next three trains are shown in lights in Brussels' newly automated subway. Passenger congestion in boarding is eased.

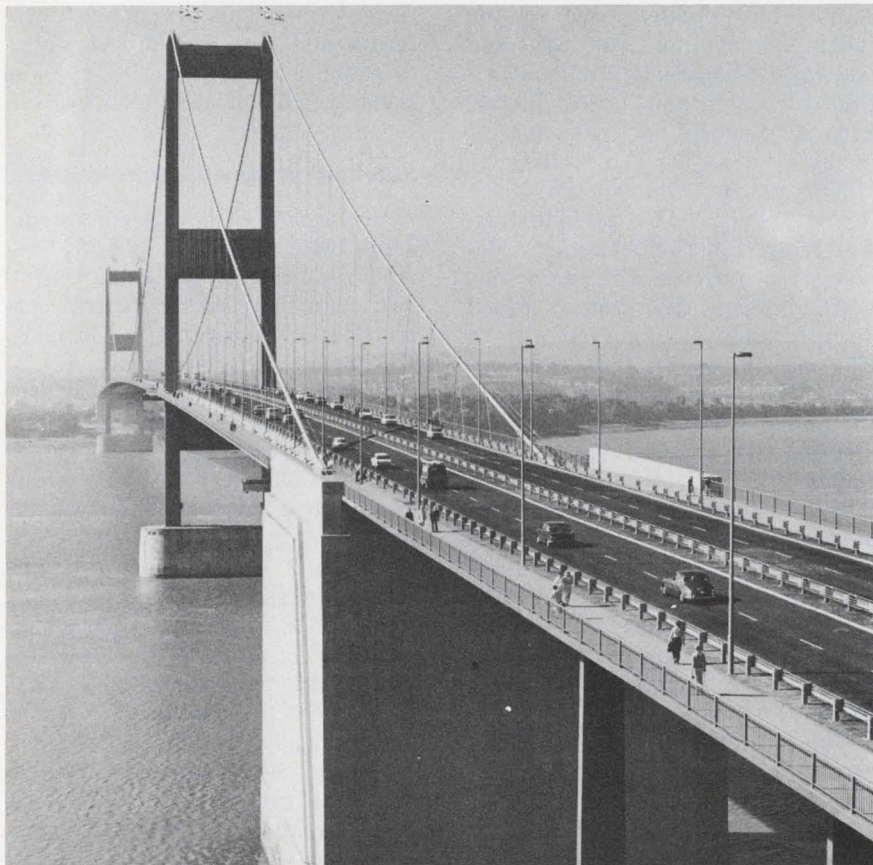

The Severn Bridge, connecting England and Wales, uses a computer-based toll collection system that also issues ice and fog warnings.

- Lighting in the station at 25 or 100%.
- Escalators that carry passengers from street level down into the station—and defrosting systems for the escalators.
- Emergency lighting in tunnels.
- Emergency traffic signaling in tunnels.
- A closed-circuit TV system for surveillance of each subway station—where the cameras can be remotely turned to observe the tracks, train or the platform.
- Power lines feeding the subway cars.
- Telemetry—to monitor continuously current voltage and power at points in the system.
- A data logger, which records possibly unsafe conditions on a paper tape.
- Route identification equipment for each car—so that passengers at the station can be alerted to impending arrivals several minutes before each train pulls in.
- Monitoring equipment for all signals—to make sure all are operating satisfactorily.

Automation like this achieves some very practical results—like preventing bunching up by passengers at station platforms. The idea is simple: Electronic sensors between stations read the route number of each subway train as it passes in the tunnel and flash the information ahead to an electronically controlled sign in each station. The sign gives the route numbers of the next three trains that are due to arrive. Passengers can wait on an upper-level platform until shortly before their train pulls in, then step down to a lower level leisurely and board the train.

The identification equipment is called KarTrack, and was developed in the U. S. by General Telephone and Electronics, Sylvania Div. It uses an electro-optic scanner installed at the side of the track. The scanner transduces optically coded data into electrical analog signals, which pass through a decoder that converts them to digital outputs.

Such simple electronic solutions to alleviate crowding and the anxiety of passengers at a subway platform have yet to be adopted by the world's largest subway system in New York City. ■■

That #!☆?!*! MIL-M-38510!

There, there, Signetics understands.

We not only understand MIL-M-38510, we can supply IC's to it. Right this minute.

Fact is, we've been using just about the same hard-nosed testing procedures it calls for, for better than five years.

Signetics S. U. R. E. program (Systematic Uniformity and Reliability Evaluation) includes practically all the Military Standard 883 tests plus a few more of our own.

So: send for our new Confidence Report on 38510/883 and for our new S.U.R.E./883 brochure.

And specify Signetics digital and linear circuits for your high reliability requirements.

You'll swear by them.

Signetics

Signetics Corporation / 811 E. Arques Ave., Sunnyvale, California 94086 / A subsidiary of Corning Glass Works

INFORMATION RETRIEVAL NUMBER 20

0.1¢-per-bit storage seen with new memory

General Dynamics' magneto-acoustic method said to overcome limitations of previous planar models

Jim McDermott
East Coast Editor

Researchers have been striving for some time to perfect the magneto-acoustic memory—a kind of delay-line memory in which an ultrasonic pulse propagating down a metal line writes bits onto the line or reads them from it—because this approach holds promise of giving the same performance that

cores give at 10 times less cost.

But material uniformity, high pulse attenuation and high power requirements have stymied development of the magneto-acoustic memory.

A new version developed by General Dynamics Electronics of Rochester, N. Y., is said to overcome the limitations. Invented by J. W. Gratian, one of the company's principal engineers, it stores

data in the form of magnetic states in thin, magnetostrictive film plated on wires ranging from 2 to 10 mils in diameter, depending on the configuration.

This wire memory has the potential, according to Gratian, of ultimately providing storage at a cost of 0.1 cent per bit. It also can provide faster access to data (typically 30 to 60 ns) than that provided by drums and discs (10 to 30 msec), or tape (seconds), the inventor says.

Other advantages of what he calls the ferro-acoustic-line memory include these: It provides nonvolatile storage of data as well as nondestructive readout. It is a serial type of memory that permits use of low-cost circuits for reading, writing and parity check.

The power required to write data into a single wire line in the General Dynamics version, says Gratian, is only about 100 mW for writing rates of several megabits per second. And the ultimate upper writing limit is on the order of hundreds of MHz.

Both the wire and the thin film stress-sensitive magnetic coating have been specially developed for the new memory, according to Gratian.

Present plans of General Dynamics call for in-house development of 32-kilobit modules as the building blocks for megabit systems. Each module is to be constructed of four submodules, the latter comprised of a transducer and 32 data lines plus clock and parity lines. Each of the 32 data lines will store 256 bits, thus providing a total of 8,000 bits.

The basic submodule consists of a piezoelectric transducer driving the storage media—a bundle of fine wire lines (see photo). The particular line in which data is to be written or read out is selected by transistor switches. During write-in, the transducer converts the data bits to a series of ultrasonic pulses that propagate down the line (see figure). ■■

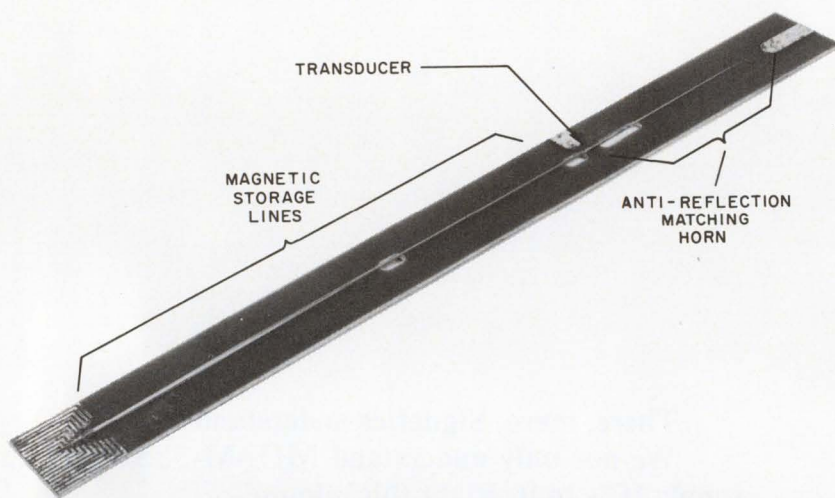

General Dynamics' magneto-acoustic memory has 16 data lines that are driven by a piezoelectric transducer. The horn eliminates reflections.

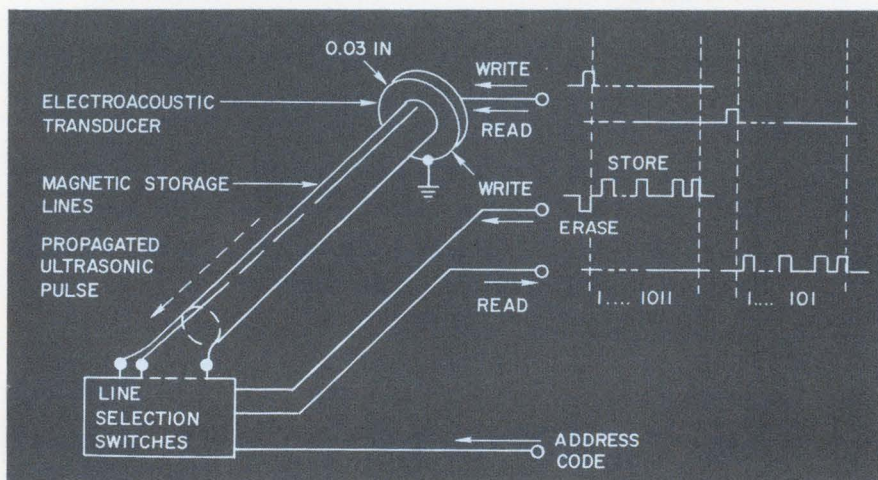

Ultrasonic pulses impress information on the data lines or read it off from the bit locations in the stress-sensitive magnetic coating.

CELANESE NYLON. THE HEAD START MATERIAL.

Give your products a head start on top product design, performance and economics. With Celanese Nylon.

General Electric does. In GE hair dryers, for example, the resilience of Celanese Nylon gives coil bobbins the kind of snap-fit that holds parts together snugly. So assembly is simple, less expensive.

But of course there are lots of other reasons for choosing Celanese Nylon. Like the fact that it has U/L rating on electrical properties of 105°C. Or its great mechanical strength and toughness. Or its high dielectric properties,



so you can design more compact units with thinner walls. Or the fact that Celanese Nylon is made in a totally continuous process. So it's whiter in the pellet. Whiter in your product. Whiter through successive regrinds. And more consistent from lot to lot.

Maybe that's why retainer rings in GE hair dryers are also molded in Celanese Nylon. And why GE uses Celanese Nylon for gears and bushings and bobbins in their broad line of oscillating fans and heaters.

Give your products a good head start by writing for a copy of our brochure on electrical applications of Celanese Nylon. And a U/L Yellow Card. Celanese Plastics Company, Dept. N-502, 550 Broad St., Newark, N. J. 07102.



Celanese Plastics Company is a division of Celanese Corporation. Canadian Affiliate: Chemcell Resources, Ltd. Export: Amcel Co., Inc., and Pan Amcel Co., Inc., 522 Fifth Avenue, New York 10036.



Precision scale uses electronic feedback

A precision electronic balance said to measure any weight from 10 micrograms to 200 grams in 7 seconds—with an accuracy of one part in 20,000—combines an electronic feedback network with standard analog techniques borrowed from the mechanical balance. It is made by Ainsworth & Sons, Inc., Englewood, Colo., and is used by the Bureau of Mines in Pittsburgh to weigh pollutants in the atmosphere of coal mines. According to James Smith, the company's vice president of engineering, a digital voltmeter displays the weight of the unknown object visually or in BCD form for interface with a computer, printer or tape recorder for permanent record.

Capacitive sensor is used

The Ainsworth electronic balance, like its mechanical counterpart, consists of a beam with center bearing and frame, but only one stirrup and pan for the unknown weight. In place of the second pan and known weights, it contains an electronic feedback system that consists of a capacitive differential sensor (shown here in simplified form), an amplifier and a force coil and magnet. When an

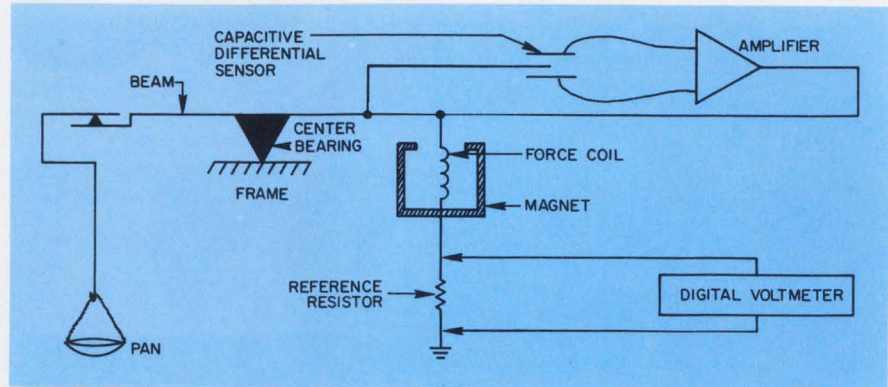

The Ainsworth electronic balance combines an electronic feedback network with standard analog techniques borrowed from the mechanical balance.

unknown weight is placed in the pan, the beam starts to move, changing the capacitance of the differential sensor and producing a current that is proportional to the change in capacitance. This current is amplified and sent to the force coil, restoring the beam to its position of equilibrium. The force current, which is proportional to the unknown weights, is measured by the digital voltmeter as a voltage across the reference resistor.

The instrument can be calibrated to read out a wide range of weights, either as weights or as

numbers (for example, numbers of pins of a given weight), simply by changing the reference resistor. In this instrument the accuracy is limited by the precision of the digital voltmeter.

The instrument is accurate to one part in 20,000, according to Smith. If higher accuracy is required, he says, a second pan with known weights can be used, as in the mechanical balance, and the electronic feedback loop then measures the difference between the known and unknown weights. With this setup, an object can be measured to one part in 20 million. ■■

A 'magnetic' vehicle for transit studied

A new rapid transit vehicle that can travel a foot above ground at over 300 miles an hour will be evaluated on a test track now being built by Stanford Research Institute, Menlo Park, Calif. Held on course by powerful magnetic forces, the vehicle is designed to be propelled by a linear induction motor. SRI researchers are confident that such a vehicle could whisk passengers between downtown New York and Washington, D. C., in about an hour—less than half the time it takes to make the

trip today by jetliner and taxi to and from the airports.

Key to the system are superconductor electromagnets on the vehicle that induce currents in an aluminum guideway causing a repelling force that lifts and guides the vehicle so that it can be pushed along at high speed without friction from the track. Superconducting electromagnets, when cooled to below about -450°F , can produce enormously powerful magnetic fields with a small amount of electrical energy. When in the

superconducting state, these magnets maintain their magnetic fields without constant additions of electrical energy. A small initial supply of electricity keeps circulating within the magnet as long as the temperature is kept below the critical level. Such low temperatures are attained by submerging the magnet in liquid helium.

The suspended vehicle could be propelled by jet engines, rocket motors, propellers or linear-induction motors according to Stanford Research Institute scientists. ■■

Letters

Engineers—get out, this reader advises

Sir:

Have you ever watched a good game of chess, a contest with a careful and crushing plan well executed to the last step—and then a blunder? Frustration abounds—the same frustration I felt after reading your editorial (ED 16, Aug. 2, 1970, p. 51), dealing with the economic plight that faces engineering and engineers. You accurately assessed the economy and considered the possible shift in national goals toward peace and away from war. I commended you for advising engineers to “reappraise their careers.” The editorial was almost finished. I prepared myself for the closing brilliancy—and I read, “New skills may be necessary, or revised attitudes, or possibly even drastic measures, such as relocation.”

A gloom of frustration, sprinkled with irony and amusement, settled over me. “New skills,” meaning medical electronics, and “relocation,” meaning some quixotic search for Shangri-la? Well, that is too much for this former engineer. Do you really believe that 25,000 engineers descending upon the medical field—with proper training, of course—could be absorbed? Probably 50 additional engineers would create a surplus. As for relocation—where? Engineers face a depression that is nationwide, ubiquitous and persistent. My suggestion is simply this: get out. Engineers have an average IQ placing them in the top 4.5% of the population. They can learn anything they set their minds to, so why not choose something in demand like law or business, instead of glutting a minuscule segment of the economy such as medical electronics?

I do hope the editors of ELECTRONIC DESIGN will pause, some day, as they flit among the moguls of industry, and scan the want ads of *The New York Times* or talk to some real live engineers out back behind the machine shop—and then

(continued on page 44)

it's fast. it's close. it's wide.



Now circuit design using custom capacitors goes from breadboard to production in less time than ever before. WESCO ships evaluation quantities of film-wrapped capacitors in the precise value you need *within 48 hrs.*

When you design WESCO capacitors into your circuit you can count on performance. Advanced production and testing techniques assure every capacitor we ship goes “into the circuit”

—meets every specification.

WESCO manufactures a custom line of capacitors (let your computer select the exact value—any value between .001 μf to 10.0 μf).

All are made to tolerances of $\pm 2\%$ (or lower). Choose from film dielectric custom capacitors in Mylar, metalized Mylar, Polystyrene, Polycarbonate and metalized Polycarbonate. We make custom capacitors at “off-the-shelf” prices. Write for WESCO’s new capacitor catalog today. WESCO Electrical Company, Inc., 27 Olive Street, Greenfield, Massachusetts 01301.

Tel.: (413) 774-4358. **WESCO**

it's wesco.

Look what just blew in.

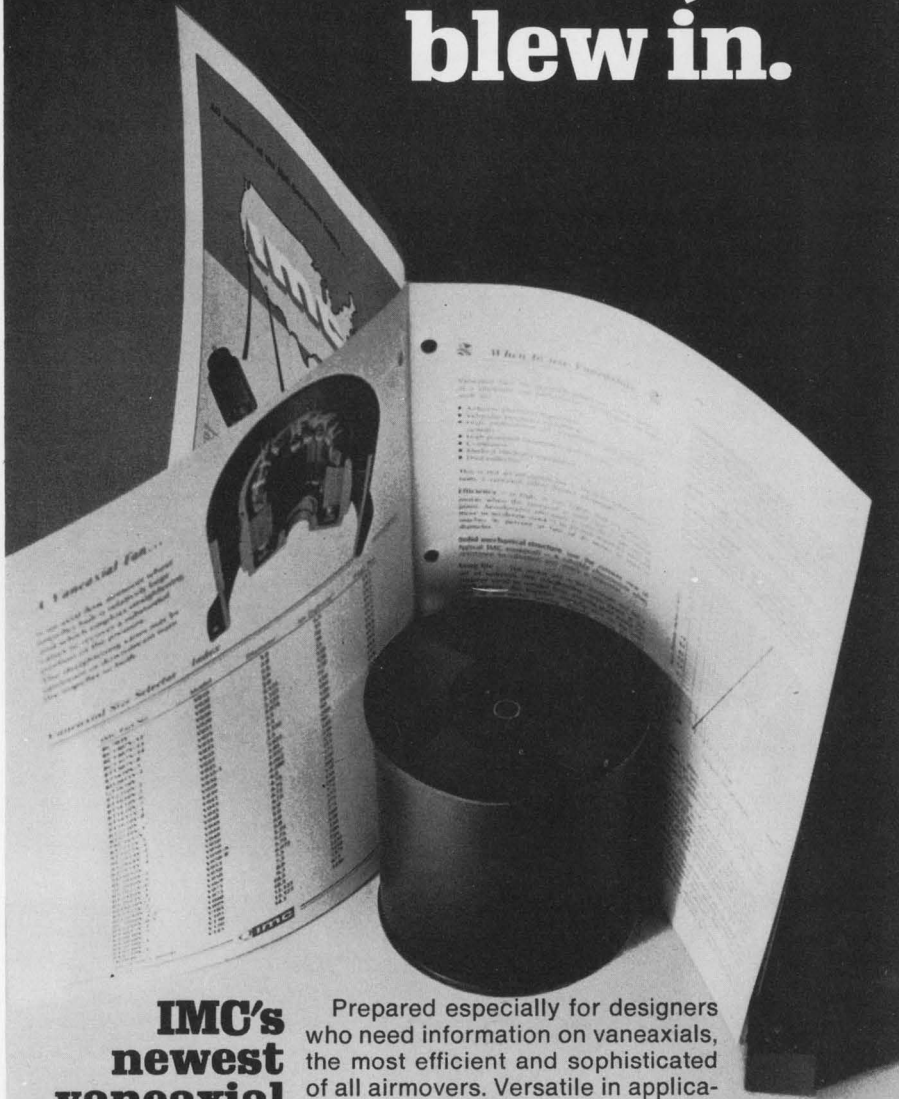

IMC's newest vaneaxial catalog

Prepared especially for designers who need information on vaneaxials, the most efficient and sophisticated of all airmovers. Versatile in application—for cooling electronic enclosures, ECM, klystrons, high-power tubes, and also for inflating shelters, dispensing chaff, refrigeration equipment, dust precipitators, and many others.

The 32-page catalog presents 40 different vaneaxial airmovers ranging in size from one to 15 inches in diameter, from 6.5 to 3450 cfm in output. Ample technical notes precede the detailed presentation of performance parameters, dimensions, and other specifications.

IMC IMC Magnetics Corp., Eastern Division, 570 Main St., Westbury, N.Y. 11591, (516) 334-7070, TWX 510-222-4469.

LETTERS

(continued from page 43)

transfer what they see and hear into an editorial or article that really says something.

Jay Freeman

Digital Consultants
Flushing, N. Y. 11365

Editor's reply: We still feel the electronics industry suffers each time a competent, trained engineer leaves to enter another field.

Involvement rated above high pay

I am greatly disappointed to see the opinions expressed in your editorial for the Aug. 16, 1970, issue (ED 17, p. 69).

I feel that the prevalence of an attitude that "Uncle Sugar" should bear the cost of most technical advancement is more likely the cause of the lags you describe. Sure, money will buy technology, but more money does not buy proportionately more technology.

What this country probably lacks more is the interest, enthusiasm, and concern with problems that seem to need technical advancements for solution. How many engineers were attracted to the field by visions of higher-than-average income? And who was responsible for the large demands for engineers which in turn caused the attractively high salaries? That's right—DOD.

I would really like to see a program to encourage people to enter the scientific—or engineering, or whatever—field because they are interested, excited and *concerned to the point of involvement* with the field and the problems that need solving.

Finally, how much government support do you suppose R&D programs receive in Germany, France and Japan? I have always maintained that we in the U. S. could take a lesson from the Japanese on their industriousness.

William H. Nott

Design Engineer
Aircraft Equipment Div.
General Electric Co.
Binghamton, N. Y.

Editor's reply: The U. S. is currently spending about 1.6% of its gross national product on R&D.

This compares with:

1.4% for West Germany

1.5% for Japan

1.6% for France

2.3% for Great Britain

We're spending more dollars because our GNP is way ahead, but in Germany and Japan R&D is rising at a compound rate of 10% per year, while in the United States it's declining.

'Organic gardeners' fight pollution

In your editorial for the July 5 issue (ED 14, p. 51) you talked about solving some of the environmental-pollution problems with breadboard methods. Many of the ecology problems have already been solved on a small scale by an ever-growing group of dedicated people who have, since the early 1940s, seen the problem of our pollution-oriented society. These people are called "organic gardeners." They recycle plant and animal wastes into useful products, and they do not pollute the air, water or soil since they do not use pesticides. Their yields have always exceeded those of their neighbors who do not practice these conservation methods.

The breadboards for waste disposal are working, but what we need is a systems approach to the total problem.

Eugene D. Bednar

6139 Imogene
Houston, Texas

Accuracy is our policy

The Centrim line of trimmer potentiometers from the Centralab Div. of Globe-Union Inc. consists of cermet units, not carbon units as stated in the Sept. 1 Product Source Directory (ED 18, p. 94).

In the Idea for Design, "Don't Neglect Cable Error in High Loss Measurements" (ED 16, August 2, 1970, pp. 66-68), an error was made in the calculation of R_4 (max). In about the middle of the text on p. 68, it is given as 3.0 m Ω ; it should have been 0.30 m Ω .



Would you believe they'll do the job for a fraction of SMA prices?

Until now you've had to buy SMA connectors built to MIL specification. And pay the price. There just wasn't any other kind.

Johnson has changed that. With this new series of JCM miniature RF coaxial connectors. Up to 3 GHz you get the same electrical performance as with the expensive SMA types. Only we don't over-build them. That way we don't have to charge as much for them.

We make 7 types—for panel and PC mounting and for flexible cable assemblies. All are interchangeable and intermateable with the standard, expensive SMA connectors. So you can use them without making any changes . . . and without compromising required performance. And JCM connectors accept virtually any size cable, so you don't have to stock a big variety. It's worth looking into, isn't it? All it costs is a stamp.

E. F. JOHNSON COMPANY / Waseca, Minnesota 56093

Please send technical information and test samples of your new low-cost series 142-0200-001 JCM connectors. Specify model #: _____.

NAME _____

FIRM _____

TITLE _____

ADDRESS _____

CITY _____

STATE _____

ZIP _____



E. F. JOHNSON COMPANY

INFORMATION RETRIEVAL NUMBER 24

'Magic wand' terminal to speed store sales

NCR device, part of customer-transaction system, bars errors in tallying prices and checking credit

John F. Mason
News Editor

The race by a number of electronic companies to offer systems to speed up customer service in retail stores grew hotter last month with the announcement by National Cash Register of Dayton, Ohio, that it was ready to take orders for mid-1971 delivery for its 280 point-of-sale system. The system has already had a two-month run with "gratifying results," company officials say, in a Montgomery Ward store in Lima, Ohio.

Other companies readying electronic cash-register bookkeeping systems include the Friden Div. of the Singer Co., San Leandro, Calif.; Pitney Bowes-Alpex, Inc., Danbury, Conn.; and American Regitel Corp., San Carlos, Calif. Further down the pike are projects to provide systems to automatically check out and tally up totals for items in supermarket food stores.

The department-store market, NCR says, consists of 300 major chain-store corporations that now use approximately 300,000 cash registers. For a relatively small store, NCR states, a \$25,000 point-

of-sale system will do the job. A big store might need up to \$1-million worth of equipment. The cost depends on the number of terminals, the size of the computer and the use of optional equipment.

MOS-LSI aids development of 280

The 280 development was possible, NCR says, because of the availability of MOS-LSI technology. In the past, an electronic terminal was linked to a central system on which it was completely dependent. If the computer broke down, or was occupied by other users, the terminal had to wait. Now, with MOS-LSI circuitry enough memory storage capacity can be put into the terminal to make it function as a small, reliable, inexpensive computer itself.

One of the system's main attractions, NCR says, is its "magic wand"—resembling a pen light—that the clerk uses to read and transmit information on price tags, credit cards and identification badges. Since the clerk has no input to the transaction, human error is ruled out.

The wand also verifies credit, calculates the entire sale, and computes any applicable taxes or discounts. All of these operations are performed automatically, and transaction details are stored on magnetic tape for computer processing.

From the wand, the information goes to the NCR 280 data terminal, which has a 256-character magnetic core memory. The terminal has a small keyboard and a check-off list that guides the salesman through the complete transaction, step by step. Data, such as that required by the store for inventory control, customer billing, sales audit, and such key management reports as departmental and sales-clerk productivity, is captured on conventional magnetic tape in a data collector. As many as 48

terminals can be attached to the data collector.

Data taped in the collector can be forwarded periodically, either physically or by direct "on-line" wire transmission, to a central receiver or computer for processing. The system operates with NCR's Series 100 or 200 computers, or with similar computers made by any manufacturer. If the customer buys an NCR computer, software is provided.

The wand's design is based on fiber optics technology. A light from the tube illuminates color-coded bars on tags and other items. Colored light is then reflected back through a flexible cord of fiber optic bundles through filters that translate the code and send the data to the register.

A one-tone beep from the wand tells the clerk that the tag was properly read, another tone says to try again. The data is read correctly whether the wand is moved quickly or slowly across the tag. It can be read correctly in either direction because the color code, utilizing white, green and black bars, is reversible and orientation is not critical. Information from the tags is displayed to both the operator and the customer. ■■

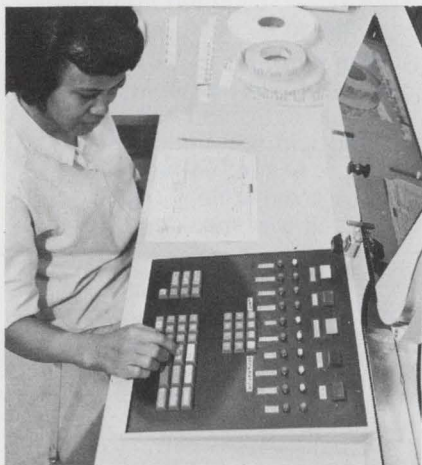

NCR 747 tag printer for new point-of-sale information system automatically produces string-type, pin-on and adhesive price labels.



Hand-held "light wand" on fiber optic cable reads color-bar codes on articles bought in retail stores, automating and recording the sale.

Programming: Choose either 128 or 256 step models for linear or conditional branching operations.

Dynamic range of 10^{-99} to 10^{+99}
Decimals printed in either preset or scientific notation.

Automatic special functions:
 a^x , \log_{10}/\log_e SIN/COS,
 $\text{SIN}^{-1}/\text{COS}^{-1}$, $x!$, $\frac{1}{x}$,
radians to degrees,
single key Σx , Σx^2 , N,
rectangular to polar conversion.
Automatic entry
of values for e and π .

Ten independent, directly addressable storage registers.

Special punch card system allows programming without tying up the calculator.

Accessory card reader for automatic entry of program data, special functions and decision-making capability not shown on keyboard.



Model 1665 shown.
All MOS/LSI circuitry.
Available with or
without programming.

**The latest
MOS/LSI technical
calculators. As close
to you as your telephone
in over 350 cities. For
the location nearest
you call collect
800 243-6000***

*In Connecticut: 800 942-0655

**Monroe. The
Calculator
Company**



Fight noise pollution

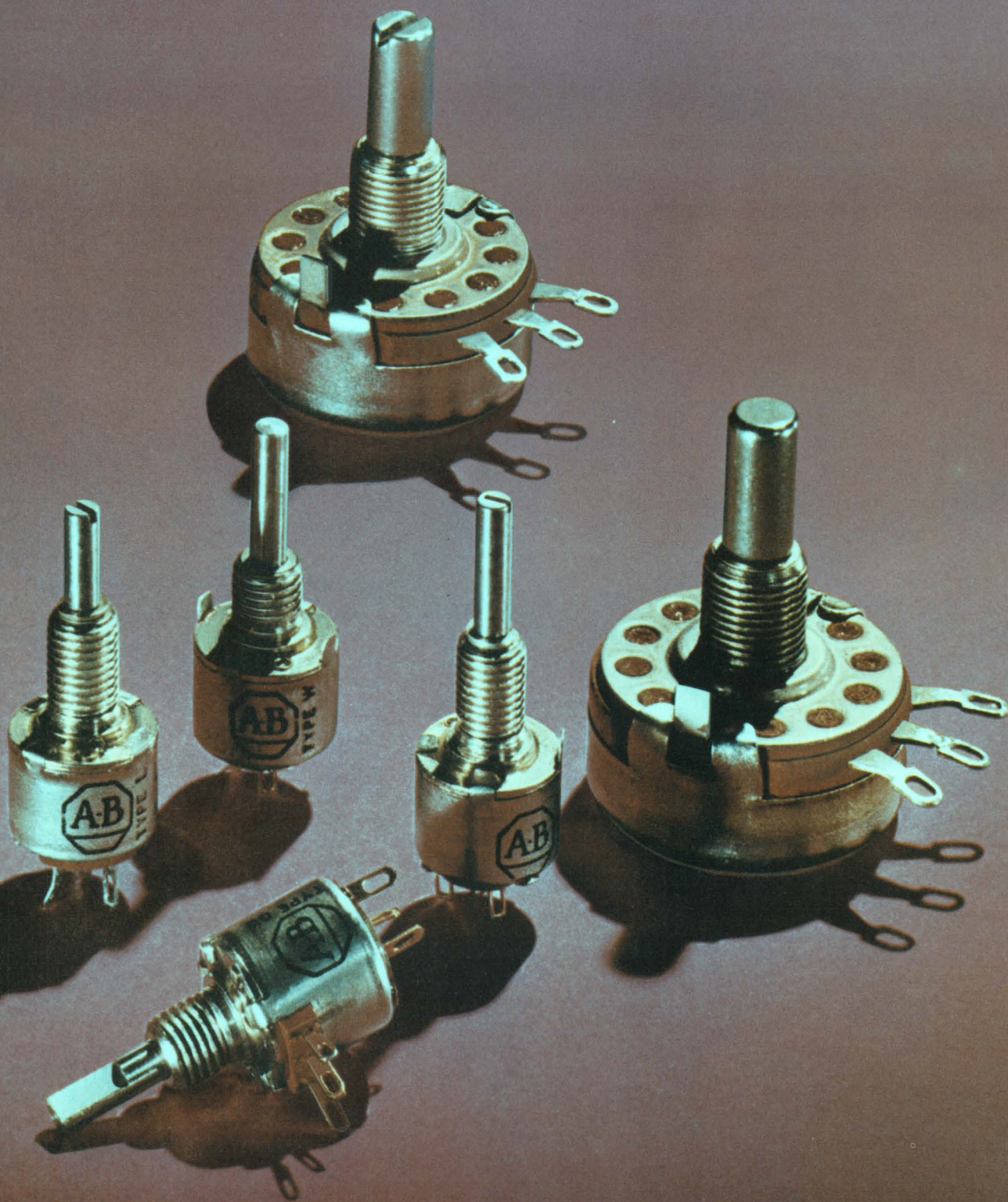

with this quiet family.

Hot Molding with Allen-Bradley's exclusive technique, gives these composition variable resistors an unusually low noise level. And importantly, this low noise level actually decreases in use. Under tremendous heat and pressure the resistance track is molded into place. A solid element with a large cross-section is produced.

This important Allen-Bradley difference means better short-time overload capacity and a long operating life. Control is smooth, resolution almost infinite. These variable resistors are ideal for high frequency circuits. Why should you trust the performance of

your designs or your reputation to anything less than Allen-Bradley quality? Use the most thoroughly "field tested" (over 20 years) variable resistors available today. Quantity stocks of popular types J, G, W and GD available for immediate delivery from your appointed A-B industrial electronics distributor.

For information write: Marketing Department, Electronics Division, Allen-Bradley Co., 1201 South Second Street, Milwaukee, Wisconsin 53204. Export office: 1293 Broad Street, Bloomfield, N. J. 07003, U.S.A. In Canada: Allen-Bradley, Canada Ltd., 135 Dundas Street, Galt, Ontario.

SPECIFICATIONS

	TYPE J— STYLE RV4	TYPE K	TYPE G— STYLE RV6	TYPE L	TYPE W	TYPE GD
CASE DIMENSIONS	5/8" deep x 1-5/32" dia. (single section)	5/8" deep x 1-5/32" dia. (single section)	15/32" deep x 1/2" dia.	15/32" deep x 1/2" dia.	15/32" deep x 1/2" dia.	35/64" deep x 1/2" dia.
POWER at + 70°C	2.25 W	3 W	0.5 W	0.8 W	0.5 W	0.5 W
TEMPERATURE RANGE	-55°C to +120°C	-55°C to +150°C	-55°C to +120°C	-55°C to +150°C	-55°C to +120°C	-55°C to +120°C
RESISTANCE RANGE (Tolerances: ±10 and 20%)	50 ohms to 5.0 megs	50 ohms to 5.0 megs	100 ohms to 5.0 megs	100 ohms to 5.0 megs	100 ohms to 5.0 megs	100 ohms to 5.0 megs

TAPERS Linear (U), Modified Linear (S), Clockwise Modified Log (A), Counter-Clockwise Modified Log (B), Clockwise Exact Log (DB). (Special tapers available from factory)

FEATURES (Many electrical and mechanical options available from factory)	TYPE J	TYPE K	TYPE G	TYPE L	TYPE W	TYPE GD
	Single, dual, and triple versions available. Long rotational life. Ideal for attenuator applications. Snap switches can be attached to single and dual.	Single, dual, and triple versions available. Long rotational life.	Miniature size. Immersion-proof. SPST switch can be attached.	Miniature size. Immersion-proof.	Commercial version of type G. Immersion-proof.	DUAL section version of type G. Ideal for attenuator applications. Immersion-proof.

ALLEN-BRADLEY

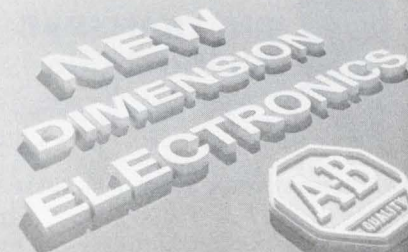
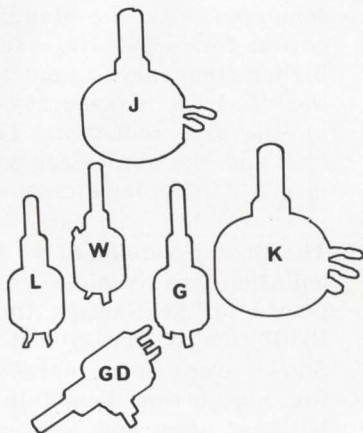

INFORMATION RETRIEVAL NUMBER 26

ANNOUNCING:

Cool power

Model CP-5-5
Price: \$145.00



for IC logic

These new power modules from ERA provide *cool performance, total protection* for specialized use in IC, computer, telemetry, strain gauge and transistor applications.

The Transpac CP series is equipped with unique heat sinking for cool (71°C, free air) operation at high currents, protects itself and your equipment through built-in short circuit protection with instant recovery, adjustable current limiting and overvoltage protection.

A special burn-in test program at the factory assures reliability while compact silicon design saves space.

Send for catalog. Write today — before you design.

STANDARD MODELS

Output Voltage VDC	Current @			Model	Price
	50°C	60°C	71°C		
3.6	3.2	2.8	2.5	CP-3P6-2P5	\$125.00
5	3.2	2.8	2.5	CP-5-2P5	\$125.00
3.6	6.5	5.7	5.0	CP-3P6-5	\$145.00
5	6.5	5.7	5.0	CP-5-5	\$145.00
3.6	13.0	11.4	10.0	CP-3P6-10	\$185.00
5	13.0	11.4	10.0	CP-5-10	\$185.00
3.6	22.0	19.5	17.0	CP-3P6-17	\$230.00
5	22.0	19.5	17.0	CP-5-17	\$230.00
3.6	32.0	28.5	25.0	CP-3P6-25	\$310.00
5	32.0	28.5	25.0	CP-5-25	\$310.00



ERA TRANSPAC CORPORATION

A Subsidiary of
Electronic Research Associates, Inc.
67 Sand Park Road, Cedar Grove, N.J. 07009
(201) 239-3000

INFORMATION RETRIEVAL NUMBER 27

Technology Abroad

The British and Russians have agreed to cooperate in a five-year program to standardize their electrical equipment and compare optical, mechanical and radiation standards. The cooperative venture will employ gas lasers in efforts to improve the precision of linear measurements. Increased exchange of scientific information is a prime objective.

Exports of electronics products from South Korea totaled \$27,682,000 for the first seven months of 1970, according to the Korean Ministry of Commerce and Industry. A total of \$19,234,000 of the exports were by foreign companies operating in Korea. Of the remaining exports, \$6,663,000 was by local firms and \$1,785,000 was due to joint local and foreign enterprises.

A particle counter has been adapted at the Danderyds Hospital outside Stockholm for use with a computer to permit rapid measurement of airborne pollution. The system measures round-the-clock variations in the distribution of particulate matter in wards, operating rooms and laboratories. The counter, which can measure particles between 0.3 and 10 microns in size, was linked to a computer by the Royal Institute of Technology in Stockholm. It is hoped that this technique will eventually give an exact correlation between airborne particles thought to be carriers of disease and the incidence of disease.

A 24-channel community antenna television system is under construction in the luxurious Lomas de Chapultepec section of Mexico City. Built by a subsidiary of Communications Properties, Inc., of the United States, the CATV network will initially serve some 9000 homes, with later expansion planned to reach 7000 more. Two of the 24 channels will be reserved by the Mexican Government for educational television. At present there are five com-

mercial TV stations and one educational in Mexico City serving an estimated 1.5 million homes.

Two new European facilities to formulate precious-metal compositions for thick-film microcircuits have been announced by the duPont Electrochemicals Dept., Wilmington, Del. One will be at Hemel Hempstead, England, in present duPont laboratories there that serve customers in the European Free Trade Association. The other will be established in West Germany by duPont Fotowerke ADoX G.m.b.H. for customers in the Common Market.

A \$5.2-million Control Data 6700 Computer system has been ordered by Tel Aviv University in Israel to support research, faculty and administration programs, and also as an aid in student training. Scheduled for installation next month, the computer will be the largest in Israel.

A miniaturized tuning-fork watch movement, less than half the volume of standard Accutron movements in men's watches, has been developed at Bienne, Switzerland. The Mini-Accutron, designed by the Bulova Watch Co.'s Swiss research and development laboratories for women's watches, uses the same battery as the larger size but reduces the tuning-fork length from 1 inch to 5/8-inch. The new fork vibrates at 480 Hz, compared with the standard Accutron fork's 360 Hz. Use of the higher frequency is said to offset the decrease in accuracy caused by the size reduction. The new fork and electronics are packaged in a 3/4-inch-diameter movement.

The French version of an electric, pollution-free vehicle was displayed at the German Industries Exhibition in Berlin last month. Shown were small cars suitable for use inside hospitals or at building sites and airports. The cars have a useful range of about 30 miles.



When you're adding a new "twist" to tornado tracking...

Symbolic representation of global weather as plotted by Burroughs ILLIAC IV computer.

bring ERIE in early.

Cyclone off Ceylon. 17-inch snow at Salem. Tropical storm in Trinidad. World-wide weather reports? No, forecasts! Made four days in advance... with the same accuracy as present one-day predictions. That's just one of the superscale jobs possible with the incredible new ILLIAC IV computer designed by the University of Illinois and built by Burroughs Corporation. Unlike conventional computers that process serially, ILLIAC IV utilizes parallel processing... crunching numbers on many matrix problems or differential equations simultaneously, and at super speeds. From the start, ERIE engineers have worked closely with Burroughs to develop the highly-sophisticated resistor/capacitor and resistor modules at the heart of ILLIAC IV. Proof, once again, that it pays to bring ERIE in early.

ERIE TECHNOLOGICAL PRODUCTS, INC.
644 West 12th Street, Erie, Pennsylvania 16512
(814) 453-5611

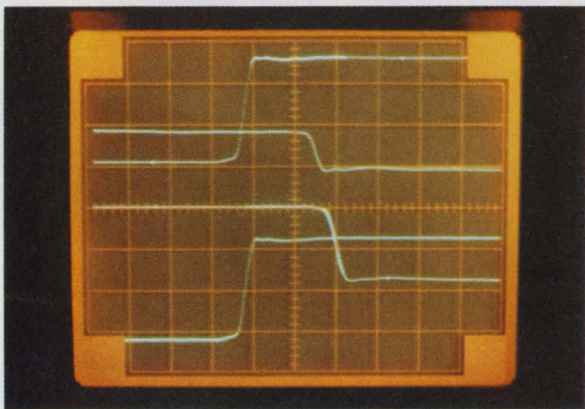
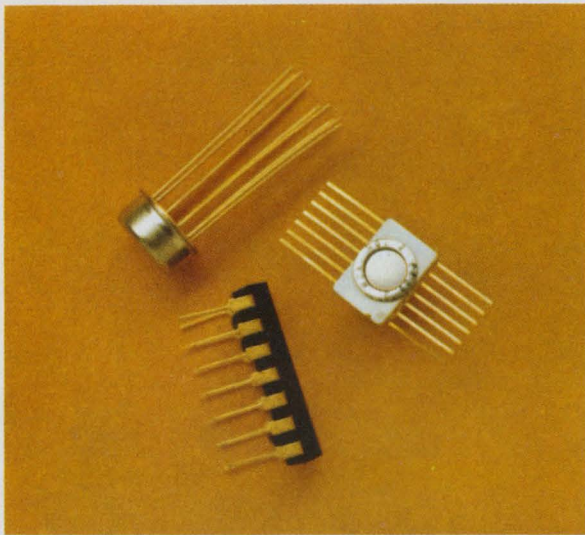

E-H the simple solution

If you want to simplify your testing operations to the point where a relatively untrained technician can make sophisticated tests with complete confidence and accuracy, E-H Research Laboratories, Inc., and its subsidiary, Automated Measurements Corporation, offer the simple solution.

First, take a look at the **AMC Model 1100 Digital Readout Oscilloscope**. It's the only four-channel, four-trace digital readout oscilloscope on the market. It was developed for the most versatile laboratory and benchtop applications, using remote sampling units to give you greater freedom in your testing operations. It has the capability for simultaneous viewing of four waveforms. And the digital display can show time accuracy to 1% f.s. and voltage accuracy to 1% f.s.

The ideal companion for the AMC Model 1100 is the **E-H 135 Pulse Generator**. It's fondly called the Universal Pulser because of its great versatility and capability of handling just about any pulser requirement you might have today and for some time to come. The E-H 135 is the only 50 MHz pulser available that has unattenuated baseline offset to $\pm 5V$ into 50 ohms. It also features rise and fall times of from 3 ns to greater than 8 ms.

The two instruments mentioned above are just a sample of a complete line of E-H and AMC equipment available. So no matter how complex your testing problems are, get to the simple solution fast. Contact your E-H representative today.



E-H RESEARCH LABORATORIES, INC.

515 Eleventh Street • Box 1289, Oakland, California 94604 • Phone: (415) 834-3030 • TWX 910-366-7258
 In Europe: E-H Research Laboratories (Ned) N.V., Box 1018, Eindhoven, The Netherlands, Telex 51116
 In Japan: Iwatsu Electric Company, Ltd., 7-41, 1-Chome Kugayama Suginami-Ku, Tokyo 167, Japan

INFORMATION RETRIEVAL NUMBER 29

ELECTRONIC DESIGN 21, October 11, 1970

Washington Report

DON BYRNE, WASHINGTON BUREAU

AF to help Lockheed but strengthen C-5A control

The Air Force and Lockheed are negotiating a reworking of the C-5A contract that could cut Lockheed's projected loss on the aircraft considerably but would also mean much tighter control by the Air Force, including supervision of plant activities, personnel and engineering changes. Air Force sources say the negotiations now going on could cut Lockheed's estimated loss of between \$500-million and \$600-million by almost half. Congress has approved a \$200-million "contingency fund" for Lockheed included in the DOD appropriations bill for this year, but the Air Force would have to get Congressional approval to spend the money. Critics have accused the Air Force of trying to bail out Lockheed, but the Air Force maintains it is saving the C-5A program not the company.

House and Senate to get separate computer system

The House of Representatives has decided that when and if it goes to computers it will do so alone. After several months of committee bickering and almost a month of floor debate, the House rejected a proposal that would have provided a joint House-Senate computer system for such badly needed services as legislative history and background of bills, past legislation and reference on pending bills. Both houses of Congress are now expected to pursue their own systems, and experts guess the spending may run as high as \$20 million in the House alone.

DOD plans to cut about 35,000 more jobs

DOD officials are quietly letting government union leaders know that they can expect a cut of about 35,000 jobs within the next year or so. Cuts will come, say DOD officials, because of Congressional belt tightening: the DOD budget is expected to drop about 6% next year. Defense has already taken a job cut of 100,000 in the past year—about 10 per cent of the civilian work force. Although 100,000 jobs went by the board, only about 40,000 people were actually fired as the balance filled other jobs or took early retirement.

Comsat opposes setting a cable / satellite formula

The Communications Satellite Corp. has urged the Federal Communications Commission not to set any definite mix on future construction of submarine cables and communication satellites for overseas telecommunications services. COMSAT said that such an inflexible policy could hamper technological advancement and thereby diminish the public good.

The operating subsidiaries of the International Telephone & Telegraph Co. supported the views of American Telephone & Telegraph Co., which

avored a 50-50 cable/satellite mix. The other two American international carriers—RCA Global Communications and Western Union International—urged more flexibility in cable/satellite mix. They agreed with AT&T, however, on the priorities for new cable projects in the next decade, especially citing the urgent need for another transpacific cable. In that regard both RCA and Western Union asked that the cable's construction be delayed until 1973-4 as AT&T had urged. Meanwhile, in other submarine cable developments AT&T filed an application for a construction permit for an \$8,400,000 cable system between the U. S. and the Bahamas. The system would have initial capacity for 360 circuits and eventually for 1380 circuits. It would be owned jointly by AT&T and the Bahamas Telecommunications Corp. WYI also asked the FCC for permission to participate in the construction and operation of a sixth transatlantic cable (TAT-6) proposed recently by AT&T. WUI said its requirements would be for 100 voice-grade circuits.

Unger nomination to FCC hits mysterious snag

The nomination of Sherman E. Unger to the Federal Communications Commission has seemingly hit some sort of a snag. His 1968 income tax return is being audited. The White House and Unger said the audit was routine procedure, but there have been reports that the information the Internal Revenue Service was seeking might take a while to produce. One source quoted Unger as saying that, because of the delay and the length of the vacancy on the FCC, the White House might want to withdraw his name.

Capital Capsules: The House Committee on Science and Astronautics has prepared a report on the "Practical Returns from Space Investment." The report, No. 91-1446, lists benefits in communications, weather forecasting, business management, medicine, education, aeronautics, and the home growing out of the space program. You can get a copy by writing to your Congressman. . . . **DOD is expected to release requests for proposals to the industry in the next few weeks for a new heavy-lift helicopter.** The helicopter is seen as a successor to the United Aircraft CH54 flying crane and will be used by the Army and Navy. . . . **Defense is also setting up a computerized deserter information point** in Washington for all the Armed services. . . . The Security and Exchange Commission will reopen hearings on **just what information defense contractors must disclose to stockholders.** The case grew out of the Lockheed C-5A contract when it was charged that some Lockheed officials sold off stock in the company on learning of the overrun problems of the aircraft. SEC started the investigation in July but recessed amid a dispute over what could be admitted as evidence in the hearing. Initial SEC investigation cleared company officials of any wrongdoing but said that the company may have failed to disclose adequately certain facts about the aircraft. . . . The General Services Administration is making final reviews on **bids for a \$25 million computer purchase for the Internal Revenue Service.** The purchase includes 10 computers and about 3,000 remote cathode-ray tube terminals.

Auto Scale-Factor Readout

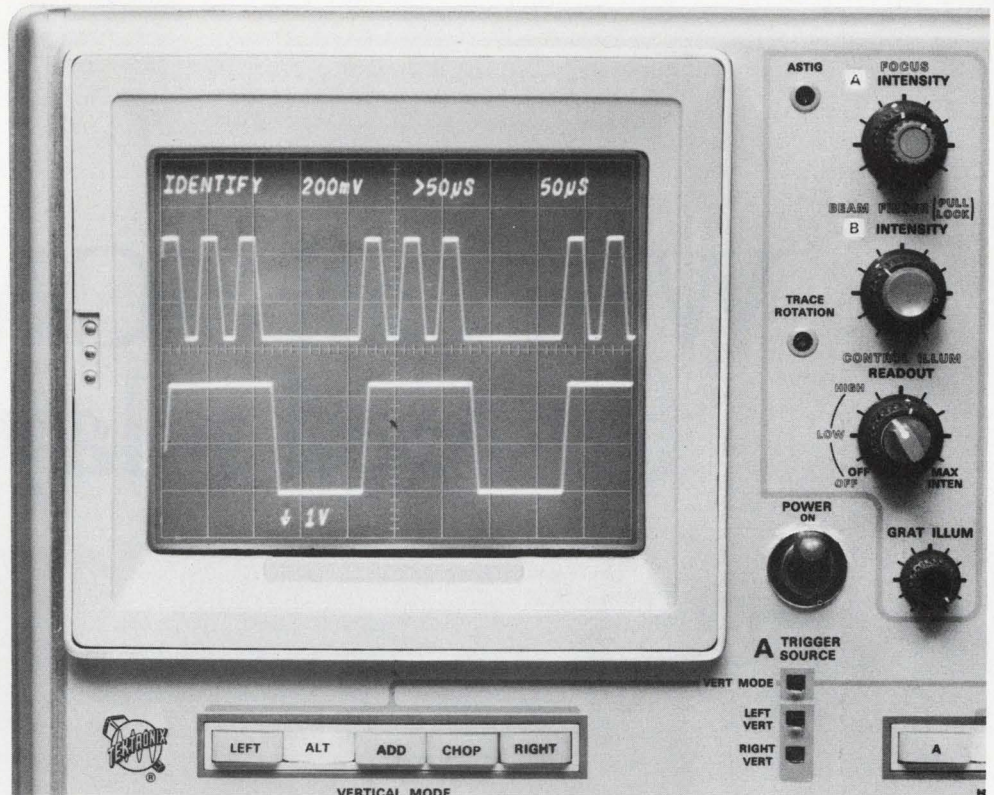

means faster measurements with fewer errors

The New Tektronix 7000-Series Oscilloscope System has AUTO SCALE-FACTOR READOUT—just one of many new convenience features available only from Tektronix. Auto Scale-Factor Readout labels the oscilloscope graph with time and frequency; volts, amps, ohms and C (temperature); invert and uncalibrated symbols, and identifies the trace and its data. When magnified sweeps and the P6052 or P6053 10X probes are used, the readout is automatically corrected. Press either a probe-tip or front-panel switch, the trace shifts vertically and its deflection factor is replaced by the word IDENTIFY to associate waveforms with scale factors. Scale factors of *inverted* and *uncalibrated* displays are prefixed by invert (\downarrow) and uncalibrate ($>$) symbols. Now, you can forget the inconvenience of hand labeling photographs. With AUTO SCALE-FACTOR READOUT you look in only one place for accurate data. On the CRT where it's displayed automatically . . . with the waveforms!

New Convenience, a Wider Performance Spectrum, and Four-Plug-In Flexibility are just a few of the factors which make the New Tektronix 7000-Series Oscilloscopes a valuable addition to your measurement capabilities.

Prices of instruments shown: 7704 150-MHz Four-Plug-In Oscilloscope \$2500, 7A12 Dual-Trace Amplifier Plug-In \$700, 7A16 Single-Trace Amplifier Plug-In \$600, 7B71 Delaying Time Base Plug-In \$685, 7B70 Time Base Plug-In \$600. Four other 7000-Series Oscilloscopes are also available.

U.S. Sales Prices FOB Beaverton, Oregon

Available in U.S. through the Tektronix lease plan
For information, call your local Tektronix Field Engineer or write:
Tektronix, Inc., P. O. Box 500, Beaverton, Oregon 97005.

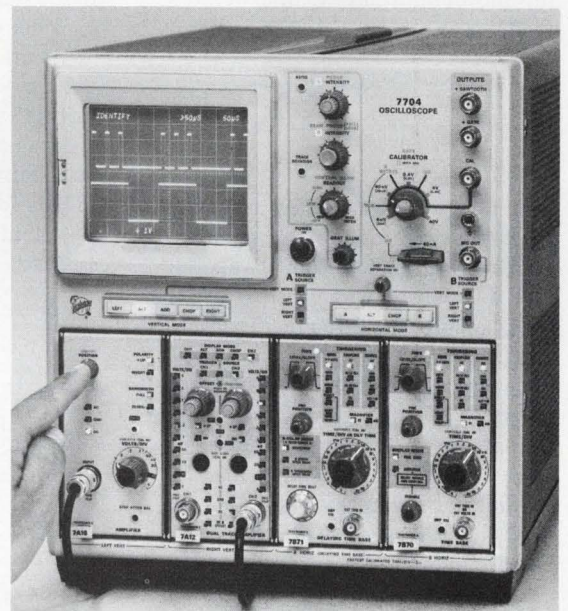

The Readout System responds to various functional instructions and is presently capable of generating up to 49 symbols. All of the symbols are not used by today's plug-ins.



TEKTRONIX®

committed to
technical excellence

INFORMATION RETRIEVAL NUMBER 30

Why call SIGMA for reed relays?

The acquisition of General Reed now gives us some unusual capabilities in the realm of reed relays. By manufacturing our own reed switches, we totally control the characteristics of this most important essential of any reed relay.

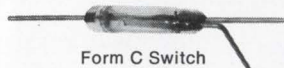

Form C Switch
Actual size

In fact, we have total control over the entire relay manufacturing process, starting with the selection of vacuum-melt nickel/iron wire used to form the reeds, all the way through 37 subsequent steps. This includes our ability to change performance characteristics by varying contact plating materials as well as pickup and dropout levels. Such complete control gives you considerably more assurance that the final product will meet your special requirements.

In seven years of making many million reed switches, we've learned from experience how to achieve desired performance. This can be particularly useful when you need a non-standard

type. For example, consider our spec. no. 63024: Form C; $250 \pm 50 \mu\text{sec}$ operate and release times; thermal drift less than $6 \mu\text{V}$ max.; electrostatic shielding for microamp signal levels. In the realm of specials like this, we consider ourselves experts.

Where a standard reed relay will do the job, we offer five series: up to 4 Form C and 6 Form A... 42 QPL types qualified to MIL-R-5757/29... ultra-miniature and dual in-line types (DIP) for IC compatibility. Sigma Distributors across the country are stocked.

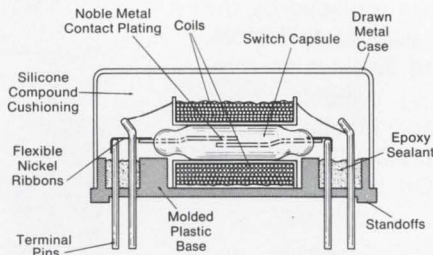

For application help, quotations on specials and technical bulletins, contact General Reed Division, 19 Walnut Avenue, Clark, N.J. 07066. Tel. (201) 382-7373.

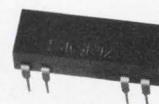

Series 191
Dual in-line (DIP)
for IC compatibility

Series 200
12 models,
3 case sizes

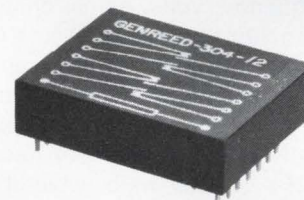
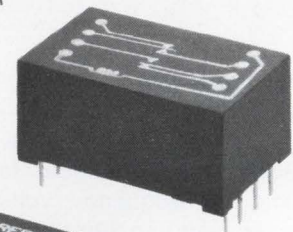

Series 300
10 models,
3 case sizes

Series 400
Qualify to
MIL-R-5757/29

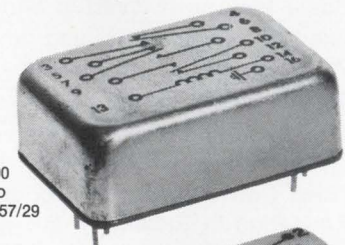

Series 500
Miniature:
1 Form A Case Size
.280" x .330" x .750"

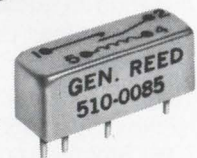

SIGMA
GENERAL REED DIVISION

INFORMATION RETRIEVAL NUMBER 31

IT'S NEW! IT'S NOW!

series two thousand

**THE LOOK OF THE
21ST CENTURY
IS HERE TODAY**

**Your product can
achieve an
individualistic look
when housed in a
standard cabinet.**

**The following points make
SERIES TWO THOUSAND
cabinetry your
best buy today.**

1. All cabinets shipped ready for immediate use thus eliminating time and cost for assembly.
2. Designer's colors — royal blue . . . charcoal grey . . . precious gold . . . give the look of tomorrow to today's products.
3. Immediate delivery from stock at your local authorized Bud distributor. *
4. Priced below that "special fabrication" you have had to consider in the past.

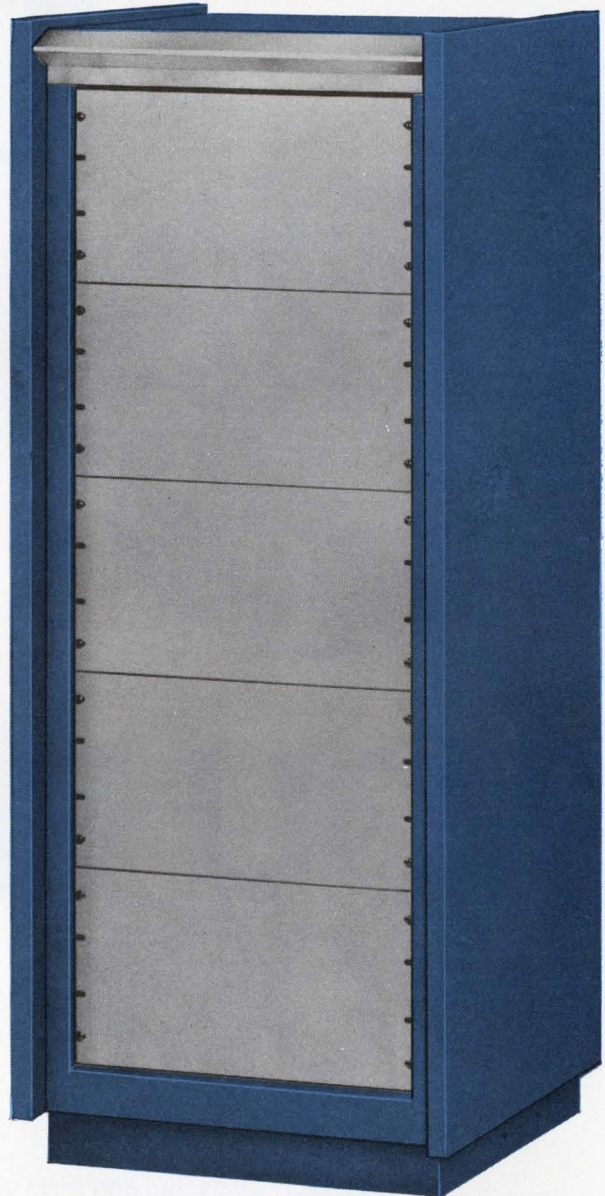

*Write for literature and the name of the nearest authorized
SERIES TWO THOUSAND Distributor.*

**If his stock has been temporarily depleted we will ship to him
within one week of receipt of his order. NOW YOU CAN
ELIMINATE COSTLY WAITING!!!*

BUD

BUD RADIO, INC.
Willoughby, Ohio 44094

INFORMATION RETRIEVAL NUMBER 32

**AS FAR AS
WE KNOW...**

THIS IS



**THE
ONLY
WORLD**

**YOU HAVE TO
WORK WITH.**

Poverty, prejudice, pollution, population . . . With all its problems, this is our world, too.

At NCR we design and build advanced computers and computer systems that have many uses. They help hospitals and doctors. They help children learn. They're an important weapon in fighting pollution. They help population planners. They help business and industry.

We think you can find a world of satisfaction working with NCR.

Write:

**T. F. Wade, Executive and Professional Placement
The National Cash Register Company, Dept. E-10
Dayton, Ohio 45409**

We are an Equal Opportunity Employer M/F



Kurz-Kasch Digital Logic Instruments*



... complete logic systems analysis through the Logic-Probe concept

Rugged, all solid-state, Kurz-Kasch LOGIC PROBE testers are designed for fast, accurate testing of logic levels in all types of integrated circuit systems. A simple readout system indicates "true", "zero", or "pulse" readings precisely through color-coded visual electronic readouts in the probe tip. Absence of Logic levels is indicated by all readouts remaining OFF.

Applications—Logic levels can be accurately tested in virtually any (DTL, TTL, RTL) IC system including desk calculators, business machines, N/C devices, computers or telephone systems. Power is derived from the unit under test allowing use in the field or in the lab.

Specifications :

Readout Light Red=Logic "1"
Readout Light White=Logic "0"
No Readout Light="infinity"

High input impedance prevents loading of circuit under test.
Size $\frac{9}{16}$ " dia., 6" long, $26\frac{3}{4}$ " leads with pin terminals

A pulse detection feature is available on most models of LOGIC PROBE testers. A third readout is provided to display high speed pulse trains or a single cycle pulse of less than 50 nanoseconds on the standard Model LP-520. Overload protection to +50, -20 volts DC is also available.

Standard Probes—LOGIC PROBE testers are presently available in four standard models. MODEL LP-500 for use in testing 4.75-5.0 V DC logic systems. MODEL LP-510 for testing 4.75-5.0 V DC systems... includes overload protection to +50, -20 V DC. MODEL LP-520... for 4.75-5.0 V DC logic systems... includes overload protection and

pulse detection features. MODEL LP-530 for testing of 12-15 V DC logic systems... includes overload protection to +50, -20 V DC.

Kurz-Kasch shrinks square wave generator to LOGIC PROBE size—Model LG-580 is a new shirt pocket size, all solid-state logic (square wave) generator for trouble-shooting, testing, or inspection of digital circuitry. Use it to... set flip-flops... run counters... perform clock functions. A unique one-shot mode plus 100 Hz, 1 K Hz, 100 K Hz, and 1 M Hz signals are injected through the probe tip. The Model LG-580 is power lead reversal protected and is priced at \$79.95.

Special Probes—As a routine service, Kurz-Kasch will custom design Logic Probes to your specifications. Custom designs can include: both positive and negative logic levels from 5 to 30 volts... special pulse detection characteristics... floating or grounded cases... custom power supply requirements... power lead reversal protection... and your choice of logic crossover parameters.

Kurz-Kasch LOGIC PROBE testers provide all the information you need to quickly and accurately evaluate all logic systems... and they are the most economical logic testing instruments available. Standard Models range in price from \$39.95 to \$69.95. Write today for complete details on all standard and special Logic Probe testers.



Kurz-Kasch, Inc.

Electronics Division,
1421 S. Broadway, Dayton, Ohio 45401.

*Patent #3,525,939 applies, others pending.

INFORMATION RETRIEVAL NUMBER 33

A big market in our own backyard?

In nearly three weeks of traveling in Europe, last spring, News Editor Jack Kessler says he encountered virtually no delays that were not of his own making. Generally, it seemed to him that European transportation was better equipped, better maintained and better planned than comparable transportation in the U. S.

While electronics is not primarily responsible for these conditions, it is finding an increasingly important role in modern transportation systems.

Computer-controlled traffic systems have been installed in Munich, Madrid, Barcelona, Lisbon and Glasgow. By 1972 Britain will have 900 miles of traffic-controlled roads. European cities are automating their subway systems. The French-British SST Concorde is being built with inertial navigation systems. Maritime traffic is being automated with new harbor control radar. There are electronic toll collectors.

Mike East, of GEC-Elliott Automation, told Jack, "Every city with a population of 400,000 or more is a potential customer of our traffic-control systems."

The message Jack got was this: the U. S. has many cities of 400,000 or more; we have the components for electronic transportation systems.

"If electronics can do something to make transportation better, maybe we've got a big market in our own backyard," says Jack.



THIS IS A RELAY

A MERCURY-WETTED RELAY THAT OPERATES IN ANY POSITION

Don't be fooled by the dual-in-line package. It's a Logcell® mercury-film relay that is completely compatible with DTL/TTL power driver IC's. It operates in any mounting position without contact bounce. And you can mount it into DIP-drilled printed circuit boards or DIP sockets without special handling. Other features include:

- Long life—tested to billions of cycles
- 2.5 millisecond speed
- Thermal noise less than 1 microvolt
- AC noise below instrumentation levels
- 10^{-6} to 1 ampere load switching range
- Open circuit resistance in excess of 10,000 megohms
- 0.05 ohms maximum contact resistance
- Available in bi-stable or mono-stable configurations

Logcell DIP relays open new vistas of switching system operation and packaging. For more information, write Fifth Dimension Inc., Box 483, Princeton, New Jersey 08540 or call (609) 924-5990.



FIFTH DIMENSION INC.



A control panel for electronic toll collection is examined by News Editor Jack Kessler, left, and Toll Manager J. G. Reeks at the Severn Bridge between Bristol, England, and Cardiff, Wales.

OUR ANGLE: angle position indicators that do more and cost less

SHOULDN'T YOU TAKE A NEW READING ON THIS COST-PERFORMANCE ANGLE?

For better ways to measure synchro and resolver data, North Atlantic offers the best of both worlds: budget prices for the popular API-8025; superior performance and increased capability of the new 8525. • Both are interchangeable without any mechanical or wiring modifications. North Atlantic's solid-state 8525 offers an accuracy of 0.05° (3 minutes). Following a 180° step input, it synchronizes a five-digit NIXIE readout in $\frac{1}{2}$ second flat. And it tracks at up to 1000° per second. Where cost can be traded against performance, the proven electromechanical API-8025 . . . a recognized indus-

MODEL 8525

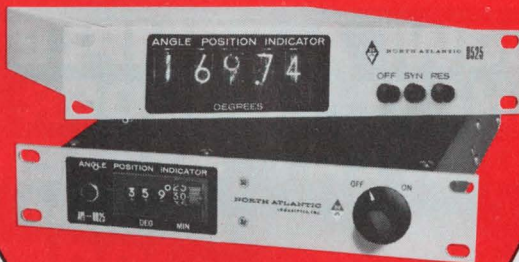

MODEL 8025

try workhorse . . . is available with its 6 minute accuracy, 25° /second slew speed, and many options. • Input of the 8525 is any 60 or 400Hz resolver/synchro data from control instrumentation. The patented servo design eliminates all inertia and improves dynamic performance many times over. Its digital outputs are especially suited to the computer-oriented requirements of today's automatic test systems. The 8525 . . . priced at \$2475 . . . and the API-8025 priced at \$995 actually cost less because they perform more functions per dollar. And with greater reliability. ®

For complete information on the cost-performance angle, please write or phone now.

NORTH ATLANTIC
industries, inc.

200 TERMINAL DRIVE, PLAINVIEW, NEW YORK 11803
cable: noatlantic / twx: 510-221-1879 / phone: (516) 681-8600

INFORMATION RETRIEVAL NUMBER 35

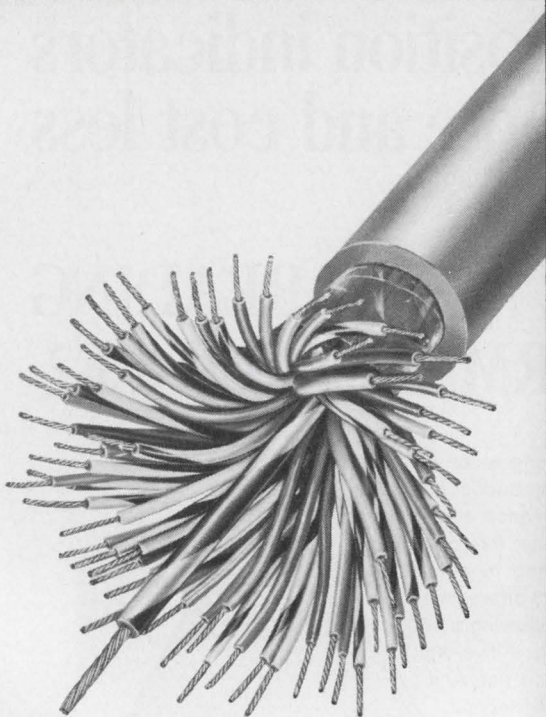

**What do you
need in
Multi-Conductor
Cable?**

Victor
will make it.

Get exactly what you need in multi-conductor cable. We'll design and produce multi-conductor cable to meet just about any individual requirement.

We have the plant, the equipment, the personnel and the know-how to solve your particular problem.

Victor
Electric Wire & Cable Corp.
WEST WARWICK, RHODE ISLAND

INFORMATION RETRIEVAL NUMBER 36

Leakproof Liquid Cooled Plates



Wakefield Type LCP aluminum cold plates can be used to cool most types of power transistors, rectifiers and high power resistors. Thermal resistance, plate to inlet water, is 27°C/W with devices mounted on 3" centers and water flow of 1.0 GPM. These Liquid Cooled Plates may be considered an integral portion of the high current bus work and may be run at higher current densities than open uncooled busing. The use of drawn copper tubing assures a leakproof system which will stand high pressures. 6" and 12" lengths are stocked by Distributors; other lengths up to 6' are available on factory order with or without hole patterns drilled to your specifications. With aluminum or copper tubing. Send for Bulletin LCP.

WAKEFIELD
ENGINEERING INC., Wakefield, Mass. 01880 • 617-245-5900

INFORMATION RETRIEVAL NUMBER 37

NOW! A COMPLETE SHAFT ENCODER & DISPLAY SYSTEM

ONLY
\$995⁰⁰



The LEM Instrument Corporation Model EDS-170 is a complete high-reliability position measuring system consisting of a unique absolute shaft encoder, a compact display and an interconnecting cable. NO ADDITIONAL EQUIPMENT IS REQUIRED.

The display accepts the BCD (8421) output of the encoder, translates and displays the position information in parallel decimal form on gas discharge tubes. All necessary power supplies and circuitry are built in. Auxiliary BCD outputs are available as are many other options and models.

All LEM encoders feature low torque and inertia, low noise, FAR FEWER BRUSHES, non-ambiguous output, and long trouble-free life. Request new data sheet.

Total Range: 00.00 to 99.99 revolutions
Resolution: 0.01 revolution
Encoder Starting Torque: 0.12 oz-in maximum
Power Required: 115 V, 60 Hz, 10 watts max.

LEM

INSTRUMENT CORPORATION
Subsidiary of TWIN DISC, INCORPORATED
20 Sarah Drive, Farmingdale, New York 11735
Phone (516) 293-7240

INFORMATION RETRIEVAL NUMBER 38

ELECTRONIC DESIGN 21, October 11, 1970

You asked for it.

The New Electronic Printing Calculator from Toshiba

Remember when we asked you what your new electronic printing calculator should be like? Remember what you told us?

Give us an electronic calculator that prints on standard paper tape, vertically, like it should. Give us a way to show off credit balances and negative entries. In red? In red. Naturally, the machine should multiply and divide as well as add and subtract. It should have a memory. Make it compact so it doesn't take up space. Make it solid so it won't jiggle around when in use. And please... make it quiet.

Okay. To which we added a unique

© Toshiba America Inc. 1970

short-cut called "Automatic Accumulation". And finally, a price that floors the competition! That was a pretty big order. But we filled it.

Thanks to your own ideas, you now have the most exciting, highest performing, competitively-priced electronic printing calculator on the market.

The new 1415P.

Now comes the most profitable part of all. Selling it.

Toshiba America, 477 Madison Ave.
New York, N.Y. 10022,
212-758-6161.



TOSHIBA

In Touch with Tomorrow

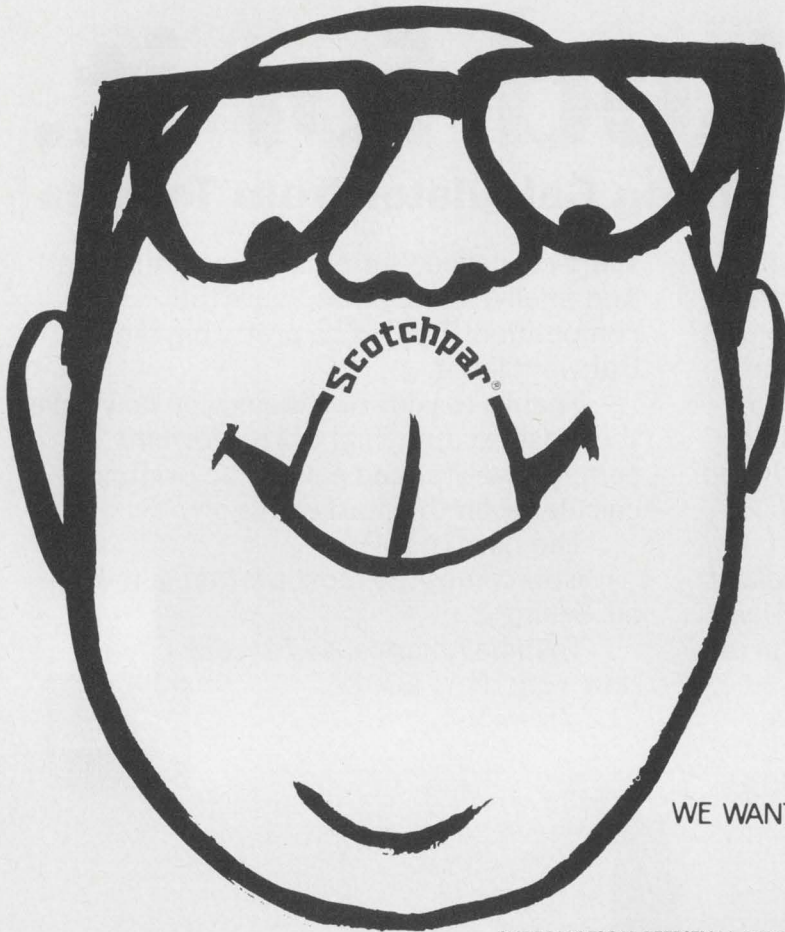

WE WANT OUR NAME ON THE TIP OF YOUR TONGUE!

Scotchpar 3M
BRAND POLYESTER FILM COMPANY

INFORMATION RETRIEVAL NUMBER 40

POWERTEC

THE POWER HOUSE

OEM SERIES
ADJUSTABLE POWER SUPPLIES

\$24⁹⁵

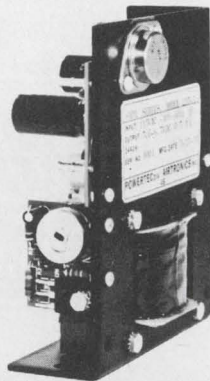

TO 12 AMPS

4 TO 26 VDC 3 TO 12 AMPS
RIPPLE: 1 MVRMS
SHORT CIRCUIT PROTECTED
FOLD BACK CURRENT LIMITING
OPTIONAL OVER VOLTAGE PROTECTION
REGULATION: LINE $\pm 0.25\%$ LOAD $\pm 0.25\%$

MODEL	PRICE		DIMENSIONS
	1-9	100	
2B5 - 3 AMPS	\$24.95	\$19.50	4.8 W X 4 L X 1.8 D
2C5 - 6 AMPS	\$44.00	\$36.00	4.8 W X 5.7 L X 2.8 D
2C5 - 12 AMPS	\$75.00	\$60.00	4.8 W X 9 L X 3 D

OEM CONTRACTS AVAILABLE

POWERTEC A DIVISION OF
AIRTRONICS INC.
9168 DESOTO AVENUE
CHATSWORTH, CALIFORNIA 91311
(213) 882-0004 TWX 910-494-2092

INFORMATION RETRIEVAL NUMBER 42

DEPENDABLE DURANT COUNT/CONTROL

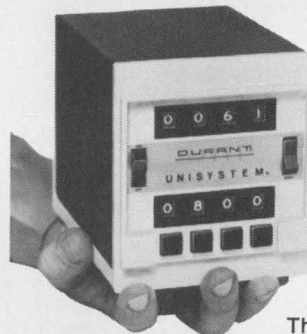

Lowest cost per million counts
of any comparable unit.
Speeds to 300 cps.*

In performance and design, Durant's Unisystem fills the need for fast, accurate count and control. There are two basic Unisystem series, available in optional splash- and dustproof versions.

The 49600 Series starts its count at zero and adds to a variable predetermined number. When it reaches this number, two form "C" predetermining contacts are actuated.

The 49800 Series starts its count at a variable predetermined number and subtracts. It actuates two form "C" predetermining contacts when the count reaches a fixed prewarn value, and two more when the count reaches zero.

All Unisystems give you a design that eliminates missed counts and retains preset and count values, even if power fails. Your choice of automatic or manual recycling. For full information, write for Unisystem Catalog, 622 N. Cass St., Milwaukee, Wis. 53201.

*With accessory divide-by circuit.



DURANT
DIGITAL INSTRUMENTS

A CUTLER-HAMMER COMPANY
In Europe: Durant (Europa) N.V. Barneveld, Netherlands

INFORMATION RETRIEVAL NUMBER 41

ELECTRONIC DESIGN 21, October 11, 1970

A Reminder...

A PRECISE MICRO-AMP REGULATED CONSTANT CURRENT SOURCE

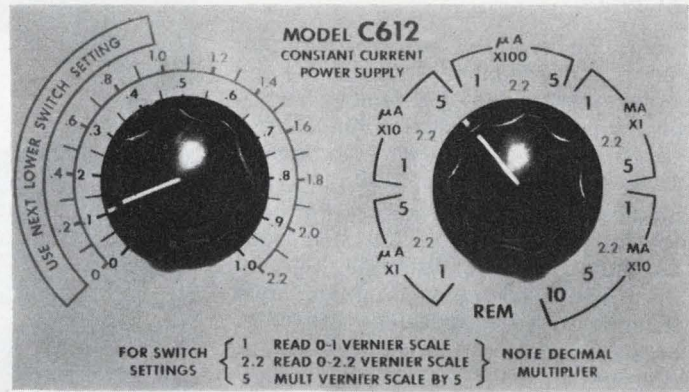

9 Discrete Micro-amp Settings Plus Vernier Control

MICRO-AMP CONSTANT CURRENT SOURCE • 16-POSITION RANGE SELECTOR SWITCH • VERNIER CONTROL • REMOTE PROGRAMMING • VOLTAGE LIMITING

LABORATORY/SYSTEMS APPLICATIONS:

Resistivity Measurements
PIV Testing
Diode Testing

Relay Testing
IC and Transistor Testing
Capacitor Forming

MODEL #	OUTPUT		CURRENT	REGULATION		RIPPLE 0.4% OF SETTING +		SIZE	PRICE
	COMPLIANCE			LINE	LOAD	NEG.	POS.		
	FULL I	DERATED I							
C 612 AM	0-100	100-260	1ua-100ma	0.15%	0.1%	0.5ua	0.1ua	3 1/2 x 19 x 9 1/4	\$320.00
C 630 CM	0-200	200-280	10ua-1A	0.15%	0.1%	4ua	4ua	8 3/4 x 19 x 15	962.00
C 633 CM	0-300	300-420	2.2ua-300ma	0.15%	0.1%	0.5ua	0.1ua	5 1/4 x 19 x 15	500.00
C 636 CM	0-600	600-730	2.2ua-220ma	0.15%	0.1%	1ua	0.2ua	8 3/4 x 19 x 15	700.00

CALL TOLL FREE 800-631-4298

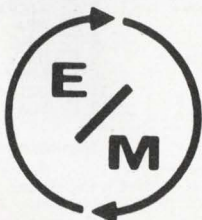

ELECTRONIC MEASUREMENTS INC.

405 Essex Road, Neptune, New Jersey 07753



**You'll find it easier
than ever before
to attend FJCC...**

PRE -

**"Convenience" Key to Houston FJCC
"Systems and Society" Conference
Nov. 17 to 19.**

This year the world's largest computer conference and exhibition will also be the most convenient. Houston's famous Astrohall will house an extensive technical program plus computer hardware, software, and services valued at over \$200-million.

Air conditioned busses will add to the convenience by shuttling you between your hotel or motel and the Astrohall. Special tours of NASA's computer complex have been planned with transportation provided.

The conference committee has done everything possible to make your FJCC attendance pleasant and convenient — but there's one thing they can't do for you — PRE-REGISTER. These Advance Registration and Housing forms will allow you to avoid on-site registration. A confirmation card will be mailed to you as soon as your completed forms are received. (Hotel rooms will be assigned on a first-come basis.)

'70 FJCC Broadens Program Appeal

A unique feature of the FJCC technical program will be a *Special Survey Session* which explores new developments and industry trends and provides a broad, general view of where the industry stands and where it's headed. This *Special Survey Session* will allow specialists to keep abreast of developments in other fields and will give generalists a full industry overview.

In addition numerous technical sessions will cover the latest developments in hardware, software, systems and applications of major importance to the computer field and users of EDP systems.



Site of all FJCC exhibits and educational sessions is Houston's Astrohall, the world's largest single convention facility.

NASA TOUR HIGHLIGHTS FJCC ATTRACTIONS

The role of the computer in the successful Apollo moon flights and the dramatic rescue of Apollo 13 is a source of pride to the industry. Tours of NASA's Manned Space Flight Center have been scheduled which will take you into areas not usually open to the public, especially the Simulator Lab where space flights are "rehearsed" prior to launch. Such critical simulations made possible the safe return of Apollo 13.

Government Control and the Computer Industry — A panel will discuss existing and pending legislation which affects the computer industry. Congressman Jack B. Brooks, Dr. Herbert R. J. Grosch of the National Bureau of Standards, and representatives of computing equipment firms and user groups will participate.

Interfacing Computers and Education — A special session will explore the implications of bringing the computer into the educational process, with special emphasis on the reaction of students to computer aided instruction, training system users and integrating programming skills with competence in subject matter.

Ross Perot to Keynote Conference — An internationally recognized computer leader, Ross Perot, will keynote the conference, addressing the theme . . . "Systems and Society".

Art, Vice and Games — An intriguing session will take a fresh look at the possibilities and limitations of computers by reporting on their unorthodox use in art, games and vice.

**Avoid that
last minute crush...
fill in these forms
and mail TODAY**

**FJCC Registration
AFIPS Headquarters
210 Summit Ave.
Montvale, N. J. 07645**

REGISTRATION — 1970 FJCC				OCCUPATION		FEES	
FJCC Registration — AFIPS Headquarters 210 Summit Ave., Montvale, N.J. 07645				(Check One Only)			
NAME _____				1 <input type="checkbox"/> Management/ Administration		MEMBER OF:	
Last First Initial				2 <input type="checkbox"/> Engineering		MEMBER OF:	
COMPANY _____				3 <input type="checkbox"/> R & D		20.00	
ADDRESS _____				4 <input type="checkbox"/> Consultant		(Check all applic- able)	
CITY-STATE _____				5 <input type="checkbox"/> Teaching		1 <input type="checkbox"/> ACM	
ZIP _____				6 <input type="checkbox"/> Sales/Application Eng.		2 <input type="checkbox"/> IEEE	
WIFE WILL ALSO ATTEND <input type="checkbox"/> YES <input type="checkbox"/> NO				7 <input type="checkbox"/> Systems & Procedures		3 <input type="checkbox"/> SCI	
				8 <input type="checkbox"/> Programming Application		4 <input type="checkbox"/> ACL	
				9 <input type="checkbox"/> Full Time Student		5 <input type="checkbox"/> AIAA	
						6 <input type="checkbox"/> AICPA	
						7 <input type="checkbox"/> ASA	
						8 <input type="checkbox"/> ASIS	
						9 <input type="checkbox"/> ISA	
						10 <input type="checkbox"/> SIAM	
						11 <input type="checkbox"/> SID	
						12 <input type="checkbox"/> SLA	
						<input type="checkbox"/> Non-Member: \$40.00	
						<input type="checkbox"/> Full-Time Student: \$5.00	
						<input type="checkbox"/> Texas Bar-B-Q \$7.50	
						<input type="checkbox"/> Luncheon \$8.00	
						TOTAL:	

REGISTER

NOW!

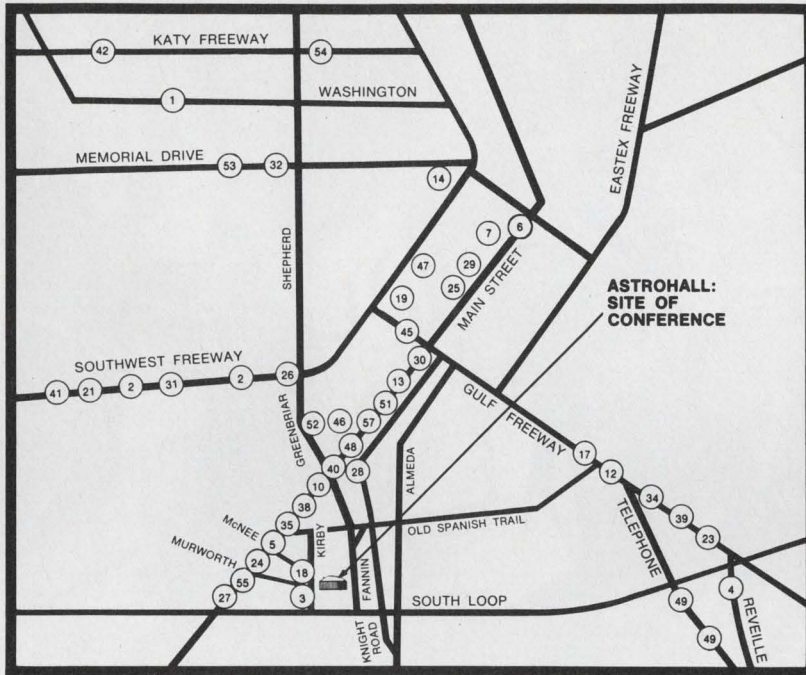

Numbers not shown on above map are in Houston area and will also be served by conference busses.

HOTELS/HOUSTON	SINGLE	DOUBLE	TWIN	SUITE
31. QUALITY COURTS MOTEL	12-50	16-50	15-50	1-Jr. 1-2 rm. 20-50
32. RAMADA INN — ALLEN PARKWAY	10-11	13	19	2-2 rm. 30
33. RAMADA INN — EAST	13	15-50	15-50	10 Jr., 1-2 rm.
34. RAMADA INN — GULF FREEWAY	14-50	16-50	19-50	2-Pool, 19-50-up
35. RAMADA INN — MAIN	14	18	22	
36. RAMADA INN — S.W.	12-50-15	17-20	17-50-20	2-Jr., 6-2 rm. 2-3 rm., 30-up
37. RICE HOTEL	10-50-20	16-50-22-50	17-50-28	39-2 rm., 42-up
38. ROADRUNNER INN	9-50	9-50		
39. RODEWAY INN — GULF FREEWAY	10	12	15	
40. RODEWAY INN — MAIN	9-50	12	15	
41. RODEWAY INN — S.W.	11-13		15	2-Fam. rm. 25 2-2 rm., 16
42. RODEWAY INN — KATY			16	25-up
43. ROYAL COACH INN	18	25-26	25	28-Par., 40 9-Tur. suites, 40 5-Bi-level, 55
44. SAM HOUSTON HOTEL	7-8	9-10	12-14	
45. SAVOY FIELD INN	16-19	20-23	22-23	6-1 rm., 20-28 6-2 rm., 35-up
46. SHAMROCK HILTON HOTEL	14-30	20-36	20-36	2 rm., 45-up 3 rm., 80-up
47. SHERATON LINCOLN HOTEL	16-22	23-27	21-27	10-2 rm., 40-80
48. SHERATON OAKS MOTEL	12	14	18	30-up
49. SKYLANE INN		12-16	14-18	5-2 rm., 22-50-25
50. TEXAS STATE HOTEL	10	14	15	
51. TIDELANDS MOTOR INN	16-18-50	18-50	22-50-24-50	
52. TOWERS HOTEL	12-18	16-20	16-24	
53. TOWN HOUSE MOTOR HOTEL	8-50-16	11-18	12-22	5-2 rm., 24-30
54. TRAVELodge MOTOR HOTEL	10-50	14	15-50	
55. TWENTY NINE PALMS MOTOR INN				
56. VAGABOND MOTOR HOTEL	9-10	12	14	
57. WARWICK HOTEL	18-30	28-30	28-30	2-2 rm. 64-240 3-3 rm., 90-275
58. WHITE HOUSE MOTOR HOTEL	16-20	20-22	25-30	
59. WILLIAM PENN HOTEL	8-50	9-50	11	
60. HOLIDAY INN — NASA	12-25-14-25	16-25-20-25	18-25-20-25	2-Jr., 2-2 rm. 1-3 rm., 32-50-up
61. NASSAU BAY HOTEL	15	20	24-28	
62. RAMADA INN — NASA	12	14	16-50	Jr., \$20 2 rm., \$35 3 rm., \$50
63. SHERATON KING'S INN	20	20	20	3-3 rm., 60-up

HOTELS/HOUSTON	SINGLE	DOUBLE	TWIN	SUITE
17. HOLIDAY INN — MIDTOWN	11-50-16	16-18	18	
18. HOLIDAY INN — S.W. 610	13-15	16	17	
19. HOTEL SONESTA	16-24	20-24	23	10-2 rm. 65-110
20. HOUSTON AIRPORT INN	12	15	15	
21. HOUSTONAIRE MOTOR INN	14	17	18-26	32
22. HOWARD JOHNSON MOTOR LODGE — KATY	14	17	20	
23. HOWARD JOHNSON MOTOR LODGE — GULF	13-16	16-20		
24. KING MOTOR LODGE	14	20	20	
25. LAMAR HOTEL	13-50-24	17-50-24	20-25	11-Jr. 25-45 6-2 rm. 30-60 4-3 rm. 60-90 5-Exec. 48-50 5-2 rm. 20
26. LA QUINTA MOTOR INN			16	
27. LAS VEGAS MOTOR HOTEL	12-13	15-16	17-50-23-50	1-2 rm. 65 1-3 rm. 85
28. MARRIOTT MOTOR HOTEL	16-21	21-26	21-26	35-up
29. MCKINNEY HOTEL	10-13-50	12-14-50	16-50	
30. MITCHELL INN	11	14	18	

HOTELS/GALVESTON	SINGLE	DOUBLE	TWIN	SUITE
1. FLAGSHIP HOTEL	18-75	21-75	21-75	
2. GALVEZ HOTEL	17-50	21-50	21-50	
3. GAIDOS MOTEL	20-00	24	26	
4. HOLIDAY INN	13-18	17-22	17-22	
5. JACK TAR MOTEL	16	18	20	
6. COMMODORE HOTEL				22
7. DRIFTWOOD HOTEL	11	14	16	
8. SEAWALL HOTEL	14	16	16-18	22
9. TREASURE ISLE HOTEL	12	16-20	16-20	

MAIL HOTEL RESERVATIONS TODAY to:

**FJCC Housing Bureau
Housing Visitors &
Convention Bureau
1006 Main
Houston, Texas 77002
USA**

HOTEL RESERVATIONS — 1970 FJCC
FJCC Housing Bureau — Housing Visitors and
Convention Bureau
1006 Main; Houston, Texas 77002

Accommodations Desired:	Rate Desired:	Hotel Choice
___ Room(s) 1 person (single)	\$ _____	1. _____
___ Room(s) 2 persons (double)	\$ _____	2. _____
___ Room(s) 2 persons (twin)	\$ _____	3. _____
___ Room(s) ___ persons (double-double)	\$ _____	4. _____
___ Suite(s) parlor and 1 bedroom	\$ _____	
___ Suite(s) parlor and 2 bedrooms	\$ _____	

ROOMS WILL BE OCCUPIED BY: CITY & ARRIVAL DEPARTURE
NAME (Please Print) STATE HOUR — DATE HOUR — DATE

Please designate those who will share same rooms. List additional names on separate sheet. Be sure to show arrivals and departure. Please cover the full period of your intended stay, as it may be difficult to extend the time actually reserved.

I want to stay in Galveston.

**INDIVIDUAL REQUESTING RESERVATIONS:
PLEASE PRINT OR TYPE**

Applicant _____

Firm Name _____

Street Address _____

City _____ State _____ Zip _____

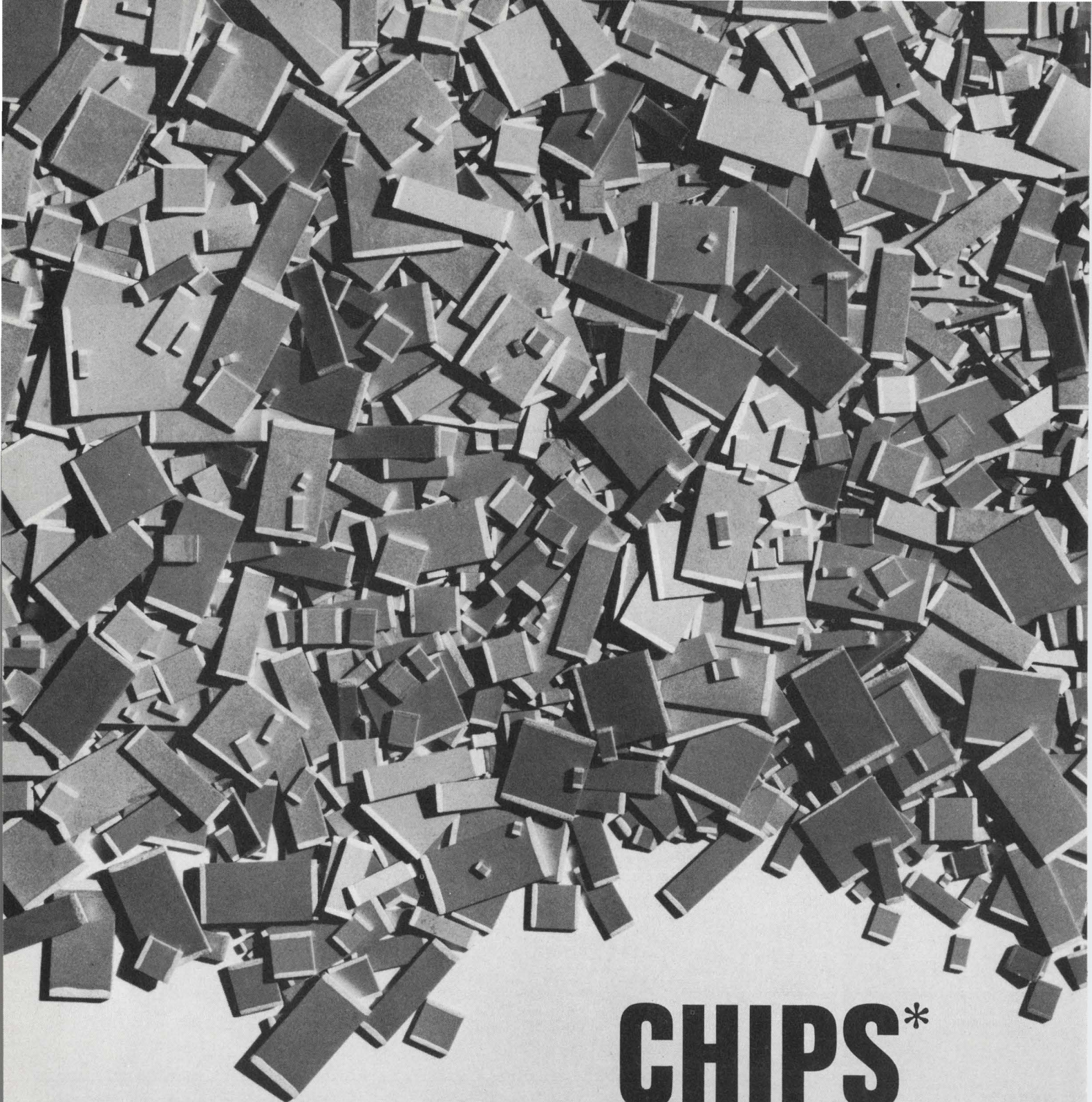

CHIPS*

***USCC CERAMOLITHIC® CHIP CAPACITORS FOR ANY HYBRID CIRCUIT DESIGN PROBLEM**

SPECIFICATIONS: Capacitance range: 10pF to 3.3Mfd. Voltage ratings: 50, 100 and 200 WVdc. Dielectrics: W and NPO. Sizes: start with .050" X .050" X .040". End terminations: noble metal and special combinations. Meets all applicable requirements of MIL-C-11015 and MIL-C-39014.



U.S. Capacitor Corporation, 2151 No. Lincoln St., Burbank, Calif. 91504, Phone (213) 843-4222 • TWX: 910-498-2222

CERAMIC CHIP CAPACITORS, MINIATURE CERAMIC CAPACITORS, EMI/RFI FILTERS

Publisher

Hugh R. Roome

Editors

New York Office
850 Third Ave.
New York, N.Y., 10022
(212) 751-5530

Editor: Frank Egan
Managing Editor: Ralph Dobriner
Managing Editor: Raymond D. Speer
Microelectronics, Steven A. Erenburg
Computers, Milton J. Lowenstein
Microwaves, Michael J. Riezenman
Management, Richard L. Turmail
News, John N. Kessler
Military-Aerospace, John F. Mason
New Products, Roger Allan
New Products, Lucinda Mattera
Copy, Marion Allen

Field Offices

Massachusetts
Jim McDermott
P.O. Box 272
Easthampton, Mass. 01027
(413) 527-3632

San Francisco
Elizabeth de Atley
Suite 6, 95 Main St.
Los Gatos, Calif. 94022
(415) 941-3087

Los Angeles
David Kaye
2930 Imperial Highway
Inglewood, Calif. 90303
(213) 757-0183

Washington
Don Byrne
1425 N St. NW
Washington, D.C. 20005
(202) 667-6568

Editorial Production

Dollie S. Viebig
Richard D. Grissom

Art

Art Director, Clifford M. Gardner
Assistant, William Kelly
Rita Jendrzewski
JoJo Miskimmon

Production

Manager, Thomas V. Sedita
Helen De Polo
Kathleen McConkey
Leslie Stein

Circulation

Manager, Nancy L. Merritt

Information Retrieval

Peggy Long

EDITORIAL



Are trade restrictions really the answer?

Trade relations between the United States and Japan became somewhat heated after the breakdown in textile talks late this summer. The Japanese refused to impose voluntary quotas on their textile exports, contending that the U. S. industry has not been materially harmed. The U. S. textile industry, on the other hand, claims the loss of 65,000 American jobs, and is pushing hard for the imposing of quotas on imports from Japan.

Similar situations exist or are arising in other industries, including electronics, thanks to Japan's unique combination of technology, skilled labor, marketing aggressiveness and Government cooperation. But is the answer outright protectionism as some insist?

Quota restrictions and tariff hikes are two-way streets. And when a country uses them it must recognize that retaliation is a possibility. So, in spite of the over 600% increase in the importation of consumer electronic items from Japan in the past decade, and in spite of the many "dumping" charges against Japanese electronic items, considered thought is called for rather than precipitous action.

It has been estimated that in an all-out trade war the U. S. would lose three jobs based on exports for every one it regained by protectionism. This is surely not very sane economics for the nation as a whole, regardless of the good it may do for a few selected industries.

The message is clear. Electronics is becoming more and more a world market. And as this happens, the well-being and future of those involved in the industry will increasingly be subject to national and even international considerations. This will be difficult for many to accept, particularly when the individual's best interest does not coincide with the nation's. But if we are to remain true to our long-standing principles of liberalized trade, that's the way it must be.

FRANK EGAN

Try 'back-door' circuit analysis.

Simply use an auxiliary feedback loop to set the input and let a computer do the calculations.

In many cases, circuit analysis can be simplified by approaching it in an unorthodox way. Choosing the output and then computing the input that caused it is an unfamiliar way to determine gain or attenuation, but it is a very useful technique when saturation or limiting of the output is possible.

This back-door approach is especially helpful when a computer-aided analysis program, such as CIRC¹ or ECAP², is to be used. The computer performs the detailed computations, which may be more involved than in conventional analysis, but the results are more significant because the operating region of the output is determined in advance.³

Let's examine the analytic technique. To force the input to a circuit to be the value required by the desired output, an auxiliary operation amplifier must be inserted. Note that this op amp (Fig. 1), is present only as a computational aid and does not appear in the final circuit design. A loop is set up, with the amplifier to be analyzed in the feedback circuit around the auxiliary op amp. The output of amplifier A is thus the input to the op amp, and the output of the op amp is the input to A.

Define the terms

The input and output of the circuit to be analyzed are V_{IN} and V_{OUT} , respectively. The circuit's gain (or attenuation) is A. The auxiliary differential op amp has a gain of $-K$, and its input and output signals are V'_{IN} and V'_{OUT} . A spurious offset voltage, V_{OFF} , may appear at the output of circuit A.

In Fig. 1, $V_{IN} = V'_{OUT}$. The closed loop gain is $A' = K/(1+KA)$, and if the open loop gain $|KA| \gg 1$ and $V_{OFF} = 0$, then $A' \approx 1/A$. V'_{IN} determines V_{OUT} through the relationship:

$$V_{OUT} = V'_{IN}KA/(1+KA) \approx V'_{IN}$$

The difference between V'_{IN} and V_{OUT} is the error, $V_e = V'_{IN}/(1+KA)$.

V_e can be made as small as desired by proper selection of a value for K. Note that KA must be inherently negative, for stability. If A is positive, $-K$ must be chosen as shown; if A is negative, $+K$ must be used.

The minimum value of K depends upon the magnitude of permissible error, the desired value of V_{OUT} and the magnitude of the gain A of the amplifier—that is,

$$K = (V_{OUT} - V_e)/AV_e \quad (1)$$

If the desired output voltage for a particular circuit is 1 V, with an acceptable error of 1 mV, and the nominal circuit gain is unity, then the minimum acceptable value of K is $(1-0.001)/0.001 = 999$. A good margin is provided if the K used is two to 10 times the minimum.

A more general type of analysis is possible if $V_{OFF} \neq 0$. Given the offset voltage shown re-

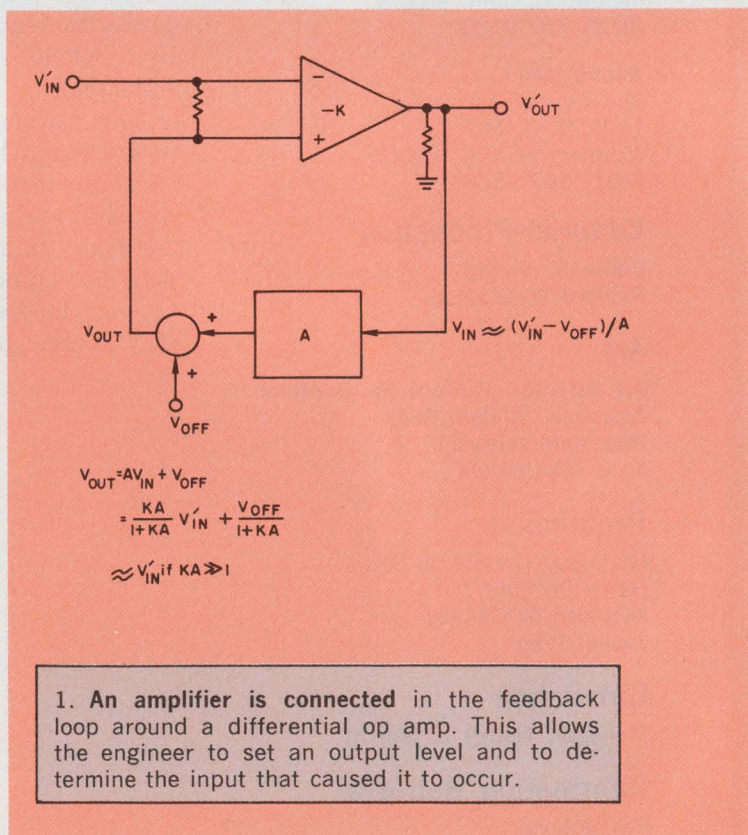

Donald B. Herbert, Member of Technical Staff, Xerox Data Systems, Inc., El Segundo, Calif. 90245

ferred to the output, what must the input V_{IN} be to set the V_{OUT} to a desired V'_{IN} ? The output voltage is again equal to the desired value when the open loop gain (KA) is much greater than unity. The input signal V_{IN} to the original circuit is then proper to cancel the offset and force the desired output. Closed-loop gain is inversely proportional to A as long as $|KA| \gg 1$. Selection of a value for K is again dependent upon the acceptable error between V_{OUT} and V'_{IN} . The minimum value is given by:

$$K = (V'_{IN} - V_{OFF} - V_e) / AV_e \quad (2)$$

Assign model parameters carefully

The op amp with a gain of K can be modeled for computer-aided analysis if the controlled current source in Fig. 2 is used. This op amp model must be assigned an input resistance, R_{IN} , an output resistance, R_{OUT} , and a voltage gain of $g_m R_{OUT}$. The sign of the voltage gain is determined by the sign of g_m and the direction in which the assumed currents in the resistance elements are defined; negative gain is shown. Transconductance, g_m , is used because many general-purpose programs, such as ECAP, have no provision for direct voltage transfer. Typical values for R_{IN} , $g_m R_{OUT}$ and R_{OUT} are 1000M ohms, 1×10^6 and 1 ohm respectively.⁵

However, no larger value of $K = g_m R_{OUT}$ than is necessary should be used. Since $V'_{OUT} =$

$K(V_{OUT} - V'_{IN})$, the larger the value of K , the smaller the difference $V_{OUT} - V'_{IN}$ for the desired V'_{OUT} . The computation of this difference may exceed the digit accuracy of a particular program when K is too large.

Small variations in V_{OUT} can result in relatively large variations in V'_{OUT} , so that a program using nonlinear diode and transistor models may require an excessive number of iterations to converge to a solution. Too large an op-amp gain tends to complicate convergence, because a small error in the calculation of a circuit variable can be amplified and returned as a very large change in the equation solutions. In severe cases convergence may be impossible.⁶

Since a model is a mathematical abstraction, a nonlinear feedback equivalent circuit often will not be unique—that is, many solutions are mathematically possible. In general only one of the solutions is physically realizable. Therefore it is desirable to impose constraints that prevent nonrealizable solutions from occurring. One possible constraint is the diode limiter circuit in Fig. 2. The battery voltages limit the output to realizable levels for a specific circuit.

Voltage divider typifies method

A simple voltage divider (Fig. 3) demonstrates how a feedback loop works. Here, it is desired to set the output voltage to 1 V and determine the

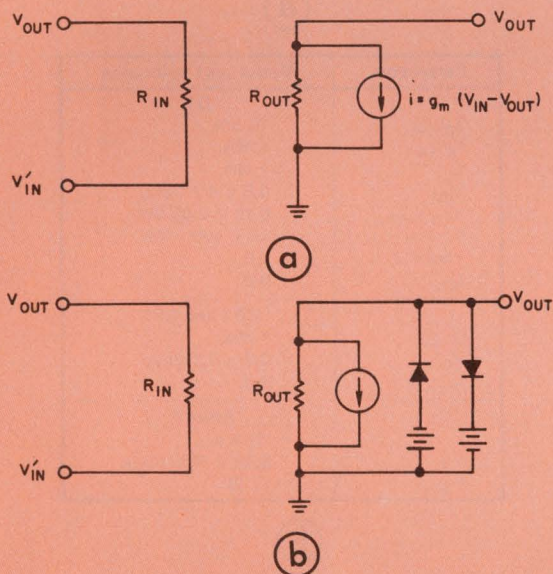

2. The equivalent circuit of an op amp "a" does not provide for output limiting. The diodes in "b" prevent the occurrence of physically unrealizable solutions.

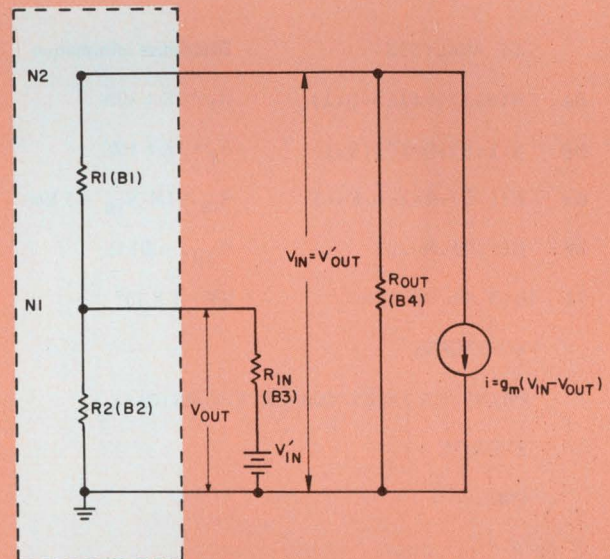

3. A voltage divider (R1-R2) is connected in the feedback loop around an op amp model (right). N1 and N2 are nodes, and B1, B2, B3 and B4 are branches for ECAP analysis.

range of required input voltages as a function of the tolerances of R_1 and R_2 . The problem, though trivial, provides a good example of how a circuit is drawn with the aid of a dependent current source.

A model in a feedback configuration is shown in Fig. 3. Here, the battery, in series with R_{IN} , sets the desired output voltage. The transconductance across R_{OUT} develops a current out of node N2 proportional to V_{OUT} . The voltage V_{IN} is related to the difference between the desired and the actual output voltage by the $g_m R_{OUT}$ product. When R_{OUT} is negligibly small, compared with the operational amplifier load, its voltage is

$$V'_{OUT} = V_{IN} \approx g_m R_{OUT} (V'_{IN} - V_{OUT}).$$

The output signal is:

$$V_{OUT} = \frac{g_m R_{OUT} R_2 / (R_2 + R_1)}{1 + g_m R_{OUT} R_2 / (R_2 + R_1)} V'_{IN}.$$

These equations simplify to

$$V_{IN} \approx V_{OUT} (R_2 + R_1) / R_2$$

and $V_{OUT} \approx V'_{IN}$ when $g_m R_{OUT} R_2 / (R_2 + R_1) \gg 1$. for $R_1 = R_2 = 1 \text{ K ohms}$, $R_{OUT} = .01 \text{ ohm}$, $V'_{IN} = 1 \text{ V}$ and $V_e = .001 \text{ V}$, the minimum transconductance value is:

$$g_m = (1 - 0.001) / (0.5 \times 0.001 \times 0.01) = 1.998 \times 10^6 \text{ mho (K = 1998)}.$$

Typical ECAP input data coding for the voltage divider with feedback is shown in Fig. 4.³ The op amp model is defined by B3, B4 and the transconductance T1, and its coding is a guide

for any similar ECAP problem.

The threshold circuit shown in Fig. 5 provides a more representative example of the computer analysis procedure. The objective is to ascertain the range of supply voltages, V_{IN} , required to set the output threshold V_{OUT} at a dc level of 2 V. The input circuit is analyzed for the worst-case with the aid of CIRC.

An op amp model is connected to sense the threshold level and compare it with a dc refer-

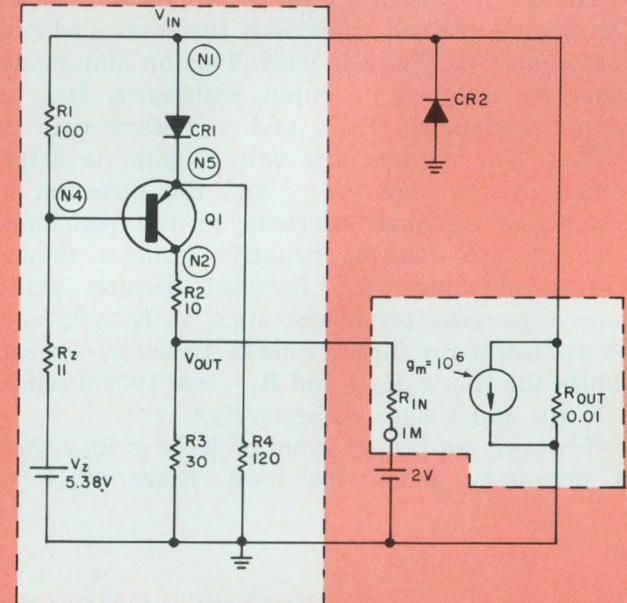

(a)

Parameter	Value and tolerance
Q1	
$I_{C \text{ SAT}}$	10 MA
$I_{B \text{ SAT}}$	1 MA
I_E	1 MA
V_{BE}	0.8 ± 0.2 Volts
$V_{CE(SAT)}$	0.25 ± 0.05 Volts
β	50, + 100 -25
Inverse β	1.0
I_{CO}	0.0
CR1 and CR2	
I_{Fwd}	1 MA
V_D	0.8 ± 0.2 Volts
I_{Rev}	0.0
Zener 1	
I	20 MA
V_Z	$5.38 \pm 10\%$ Volts
R_Z	11 Ω

(b)

DC ANALYSIS

Descriptive information

B1	N(2,1),R=1E3(0.1)	$R_1 = 1K \pm 10\%$
B2	N(1,0),R=1E3(0.1)	$R_2 = 1K \pm 10\%$
B3	N(1,0),R=1E6,E=-1	$R_{IN} = 1M, V'_{IN} = 1 \text{ Volt}$
B4	N(2,0),R=.01	$R_{OUT} = .01 \Omega$
T1	B(3,4),GM=1E6	$GM = 1 \times 10^6$

WORSTCASE

PRINT, VOLTAGES, CURRENTS, WORSTCASE

EXECUTE

END

4. ECAP coding of the circuit in Fig. 3 allows the computer to do all the calculations. The righthand column describes the ECAP entries and is not a part of the program.

5. A threshold circuit is at the left of "a" and the op amp model that closes the loop is at the right. Data for the semiconductor devices in the circuit is given in "b".

ence of 2 V. The difference or error signal is amplified and inverted by the gain of the op amp model and applied to the supply input as V_{IN} . A diode, CR2, acts as a one-sided limiter to avoid a nonrealizable negative solution during computer solution convergence.

In addition a sufficiently large gain of 10 k is used to minimize the effect of circuit-gain variations.

The passive parameter value data are given

CIRC INPUT CODING	Descriptive information
5	Number of Nodes
1	One Supply
N	No Special Equations
6,1,1,2,1	Res, Vrs, Cur, Diodes, Transistor
2	Supply 1 (V_{in}) = 2 Volts
25	Semiconductor Junction Temperature
N1,N4	R1 Node Connections
100,S5,S5	R1 Value and % Tolerance
N2,N3	R2 Node Connections
10,R	R2 Value, Reuse R1 Tolerances
N3,G0	R3 Node Connections
30,R	R3 Value, Reuse R1 Tolerances
N5,G0	R4 Node Connections
120,R	R4 Value
N1,G0	R5 (R_{out}) Node Connections
.01	R5 Value
N3,S1	R6 (R_{in}) Node Connections
1E6	R6 Value
N4,G0	Vrs (Zener Model) Connections
5.38,D10,U10	Zener Voltage and % Tolerances
11	Zener Slope Resistance
N1,G0,R6,V	GM Connections, Control Element, Control
1E6	GM Value
N1,N5	Diode 1 Node Connections
1E-3	Diode 1 Forward Current, I_D
.8,.6,.1,0	Diode 1 Junction Voltage, Min, Max
0	Diode 1 Reverse Current
G0,N1,C1	Diode 2 Connections, Copy Diode 1
N4,N2,N5,C0,P	Q1 Connections, Copy 0, PNP
10E-3	I_{CSAT}
1E-3	I_{BSAT}
1E-3	I_E Active
.8,.6,.1,0	$V_{BE} @ I_E$ Active
0.25,.0.2,.0.3	$V_{CE SAT} @ I_{CSAT}$ and I_{BSAT}
50,.25,.150	Beta Normal
1	Beta Inverse
0	I_{CO}

6. CIRC coding of the threshold circuit is listed in the lefthand column. The righthand column describes the entries and is not part of the program input data.

in Fig. 5a. The CIRC program has built in non-linear models for diodes and transistors based on the ideal diode equation and the Ebers-Moll transistor equations.¹ The input data for these models can often be obtained directly from manufacturer's data sheets. Figure 6 gives the CIRC coding of the circuit of Fig. 5.

The nodes 1 and 3 were worst-case analyzed with the following results:

	Minimum	Nominal	Maximum
NODE 1	6.424	7.428	8.444
NODE 3	1.99916	1.99926	1.99936

These solutions not only indicate the worst-case range of input voltages but also show the adequacy of the loop gain for setting the threshold—that is, the largest error between 2 V and node 3 potential is 0.84 MV.

While these examples have been entirely related to voltage considerations, the feedback technique is easily extended to handle voltage-to-current, current-to-voltage, and current-to-current input-output signals by proper modeling of the forward-loop amplifier. Other analysis programs besides ECAP or CIRC can be used with suitable modifications to the method. ■■

References

1. McNair, R. D., "Computer Talks to the Circuit Designer," *Electronic Design*, Oct. 11, 1967, pp. 58-63.
2. IBM 1620 *Electronic Circuit Analysis Program User's Manual*, (ECAP), IBM Corp. White Plains, N. Y., February, 1965.
3. Berding, H. R., and Collins, T. E., "Reverse Monte Carlo for Computer-Aided Circuit Analysis," *EEE*, June, 1967, pp. 69-72.
4. Pottle, C., *A Textbook Computerized State-Space Network Analysis Algorithm*, Cornell University Report, September, 1968.
5. Herbert, D. B., "Simulate ICs with Analog Black Boxes," *Electronic Design*, Nov. 22, 1967, pp. 75-79.
6. Calahan, D. A., *Computer Aided Network Design*, McGraw-Hill Book Co., New York City, 1968, pp. 16-21.

Test your retention

Here are questions based on the main points of this article. Their purpose is to help you make sure you have not overlooked any important ideas. You'll find the answers in the article.

1. Why must limiters sometimes be used at the output of the operational amplifier?
2. What establishes the minimum operational amplifier gain required? The maximum?
3. Why are the equations written in terms of transconductance (g_m)?
4. What transistor model is used by CIRC?

MSI/TTL CIRCUITS:

DECODERS

SN54/7442	BCD-to-Decimal Decoder*
SN54/7443	Excess-3-to-Decimal Decoder*
SN54/7444	Excess-3-Gray-to-Decimal Decoder*
SN54/7445	BCD-to-Decimal Decoder/Driver*
SN54/7446	BCD-to-7-Segment Decoder/Driver*(30V)
SN54/7447	BCD-to-7-Segment Decoder/Driver*(15V)
SN54/7448	BCD-to-7-Segment Decoder*
SN54/7449	BCD-to-7-Segment Decoder*
■ SN54/74141	BCD-to-Decimal Decoder/Driver*
■ SN54/74145	BCD-to-Decimal Decoder/Driver*
SN54/74154	4-to-16-Line Decoder/Demultiplexer*
■ SN54/74155	Dual 2-to-4-Line Decoder/Demultiplexer
■ SN54/74156	Dual 2-to-4-Line Decoder/Demultiplexer (0-C)

MEMORIES/LATCHES

SN54/7475	Quad Bistable Latch*
SN54/7477	Quad Bistable Latch*
SN54/7481	16-Bit RAM*
SN54/7484	16-Bit RAM, Gated Write Inputs*
■ SN54/7488	256-Bit ROM, Custom Programmed*
SN7489	64-Bit RAM*
SN54/74100	Dual Quad Bistable Latch
■ SN54/74170	4-by-4 Register File (Buffer Memory)

ARITHMETIC ELEMENTS

SN54/7480	Gated Full Adder*
SN54/7482	2-Bit Binary Full Adder*
SN54/7483	4-Bit Binary Full Adder*
■ SN54/7485	4-Bit Magnitude Comparator
■ SN54/7485	4-Bit Magnitude Comparator*
SN54/7486	Quad 2-Input Exclusive-OR*
SN54/7486	Quad 2-Input Exclusive-OR*
SN54/7487	4-Bit True/Complement*
■ SN54/74181	4-Bit Arithmetic Logic Unit, Function Generator*
■ SN54/74182	Look-Ahead for Arithmetic Logic Unit*
■ SN54/74183	Dual Carry-Save Full Adder

■ New circuit introduced 1970 *Multi-source product

SHIFT REGISTERS

SN54/7491A	8-Bit*
SN54/7491	8-Bit
SN54/7494	4-Bit (Parallel-In, Serial-Out)*
SN54/7495	4-Bit Universal*
SN54/7495	4-Bit Universal*
SN54/7496	5-Bit (Dual Parallel-In/Out)*
SN54/7498	4-Bit Data Selector/Storage Register
SN54/7499	4-Bit Universal
■ SN54/74164	8-Bit Serial-In, Parallel-Out*
■ SN54/74165	8-Bit Parallel-In, Serial-Out*
■ SN54/74166	Synchronous Parallel-Load 8-Bit
■ SN54/74198	Universal 8-Bit Parallel-In/Out, Left/Right
■ SN54/74199	8-Bit Parallel-In/Out, J-K Inputs

DATA SELECTORS/MULTIPLEXERS

SN54/74150	16-Bit Data Selector*
SN54/74151	8-Bit Data Selector*
SN54/74152	8-Bit Data Selector
SN54/74153	Dual 4-to-1-Line Data Sel./Multiplexer*

COUNTERS

SN54/7490	Decade*
SN54/7490	Decade
SN54/7492	Divide-by-12*
SN54/7493	4-Bit Binary*
SN54/7493	4-Bit Binary*
■ SN54/74160	Synchronous 4-Bit Decade*
■ SN54/74161	Synchronous 4-Bit Binary*
■ SN54/74162	Fully Synchronous 4-Bit Decade
■ SN54/74163	Fully Synchronous 4-Bit Binary
■ SN54/74190	Synchronous 4-Bit Up/Down Decade, 1-Line Mode Control*
■ SN54/74191	Synchronous 4-Bit Up/Down Binary, 1-Line Mode Control*
■ SN54/74192	Synchronous 4-Bit Up/Down Decade*
■ SN54/74193	Synchronous 4-Bit Up/Down Binary*
■ SN54/74196	Asynchronous Presettable Decade*
■ SN54/74197	Asynchronous Presettable Binary*

PARITY GENERATOR

SN54/74180	8-Bit Parity Generator/Checker
------------	--------------------------------

SCHOTTKY-CLAMPED TTL CIRCUITS:

These represent the latest development in TTL integrated circuits. A totally new technology, TI's Schottky-clamped TTL circuits combine the high speed of unsaturated logic and the low power of TTL saturated logic: 3 ns at 20 mW. Here's a brand-new list of recently announced devices. For more information on this fastest TTL family, circle 191 on the Reader Service Card.

■ SN74S00	Quad 2-Input Positive NAND Gate
■ SN74S01	Quad 2-Input NAND Gate, Open-Collector Outputs
■ SN74S04	Hex Inverter
■ SN74S10	Triple 3-Input NAND Gate
■ SN74S11	Triple 3-Input AND Gate
■ SN74S20	Dual 4-Input Positive NAND Gate
■ SN74S22	Dual 4-Input NAND Gate, Open-Collector Outputs
■ SN74S112	Dual J-K Negative-Edge Triggered Flip-Flop, Separate Preset, Clear and Clock
■ SN74S113	Dual J-K Flip-Flop, Separate Clock
■ SN74S114	Dual J-K Flip-Flop, Common Clock

SSI/TTL CIRCUITS:

STANDARD SSI CIRCUITS

SN54/7400	Quad 2-Input NAND Gate*
SN54/7401	Quad 2-Input NAND Gate, Open-Collector Output*
SN54/7402	Quad 2-Input NOR Gate*
SN54/7403	Quad 2-Input NAND Gate, Open-Collector Output*
SN54/7404	Hex Inverter*
SN54/7405	Hex Inverter, Open-Collector Output*
■ SN54/7406	Hex Inverter Buffer/Driver, Open-Collector High-Voltage Output
■ SN54/7407	Hex Buffer/Driver, Open-Collector High-Voltage Output
■ SN54/7408	Quad 2-Input Positive AND Gate*
■ SN54/7409	Quad 2-Input Positive AND Gate*
SN54/7410	Triple 3-Input NAND Gate*
■ SN54/7412	Triple 3-Input NAND Gate, Open-Collector Output
■ SN54/7413	Dual 4-Input NAND Schmitt Trigger*
■ SN54/7416	Hex Inverter Buffer/Driver, Open-Collector High-Voltage Output
■ SN54/7417	Hex Buffer/Driver, Open-Collector High-Voltage Output
■ SN54/7420	Dual 4-Input NAND Gate*
■ SN54/7423	Expandable Dual 4-Input Positive NOR Gate with Enable
■ SN54/7425	Dual 4-Input Positive NOR Gate with Enable*
■ SN54/7426	Quad 2-Input High-Voltage Interface NAND Gate*
■ SN54/7427	Triple 3-Input NOR Gate*
SN54/7430	8-Input NAND Gate*
■ SN54/7432	Quad 2-Input OR Gate*
■ SN54/7437	Quad 2-Input NAND Buffer*
■ SN54/7438	Quad 2-Input NAND Buffer with Open-Collector Output
SN54/7440	Dual 4-Input NAND Buffer*
SN54/7450	Expandable Dual 2-Wide 2-Input AND-OR-INVERT Gate*
SN54/7451	Dual 2-Wide 2-Input AND-OR-INVERT Gate*
SN54/7453	Expandable 4-Wide 2-Input AND-OR-INVERT Gate*
SN54/7454	4-Wide 2-Input AND-OR-INVERT Gate*

SN54/7460	Dual 4-Input Expander*
SN54/7470	J-K Flip-Flop*
SN54/7472	J-K Master-Slave Flip-Flop*
SN54/7473	Dual J-K Master-Slave Flip-Flop*
SN54/7474	Dual D-Type Edge-Triggered Flip-Flop*
SN54/7476	Dual J-K Master-Slave Flip-Flop, Preset and Clear*
SN54/74104	Gated J-K Master-Slave Flip-Flop*
SN54/74105	Gated J-K Master-Slave Flip-Flop*
SN54/74107	Dual J-K Master-Slave Flip-Flop, Preset and Clear*
■ SN54/74110	Gated J-K Master-Slave Flip-Flop, Data Lockout
■ SN54/74111	Dual J-K Master-Slave Flip-Flop, Data Lockout
SN54/74121	Monostable Multivibrator*
■ SN54/74122	Retriggerable Resetttable Monostable Multivibrator*
■ SN54/74123	Dual Retriggerable Resetttable One-Shot*

HIGH-SPEED SSI CIRCUITS

SN54/74H00	Quad 2-Input NAND Gate*
SN54/74H01	Quad 2-Input NAND Gate, Open-Collector Output*
SN54/74H04	Hex Inverter*
SN54/74H05	Hex Inverter, Open-Collector Output*
SN54/74H10	Triple 3-Input NAND Gate*
SN54/74H11	Triple 3-Input AND Gate*
SN54/74H20	Dual 4-Input NAND Gate*
SN54/74H21	Dual 4-Input AND Gate*
SN54/74H22	Dual 4-Input NAND Gate, Open-Collector Output*
SN54/74H30	8-Input NAND Gate*
SN54/74H40	Dual 4-Input NAND Buffer*
SN54/74H50	Expandable Dual 2-Wide 2-Input AND-OR-INVERT Gate*
SN54/74H51	Dual 2-Wide 2-Input AND-OR-INVERT Gate*
SN54/74H52	Expandable 4-Wide 2-2-2-3-Input AND-OR Gate*
SN54/74H53	Expandable 4-Wide 2-2-2-3-Input AND-OR-INVERT Gate*
SN54/74H54	4-Wide 2-2-2-3-Input AND-OR-INVERT Gate*

SN54/74H55	Expandable 2-Wide 4-Input AND-OR-INVERT Gate*
SN54/74H60	Dual 4-Input Expander*
SN54/74H61	Triple 3-Input Expander*
SN54/74H62	4-Wide 3-2-2-3-Input AND-OR Expander*
SN54/74H71	J-K Flip-Flop with AND-OR Input*
SN54/74H72	J-K Master-Slave Flip-Flop*
SN54/74H73	Dual J-K Flip-Flop, Separate Clock*
SN54/74H74	Dual D-Type Edge-Triggered Flip-Flop*
SN54/74H76	Dual J-K Flip-Flop, Preset and Clear Inputs*
SN54/74H78	Dual J-K Flip-Flop, Preset and Clear Inputs*
SN54/74H101	J-K Flip-Flop, AND-OR Inputs
SN54/74H102	J-K Flip-Flop, AND Inputs
SN54/74H103	Dual J-K Flip-Flop, Separate Clock Inputs
SN54/74H106	Dual J-K Flip-Flop, Preset and Clear Inputs
SN54/74H108	Dual J-K Flip-Flop, Preset and Clear Inputs

LOW-POWER SSI CIRCUITS

SN54/74L00	Quad 2-Input NAND Gate*
■ SN54/74L01	Quad 2-Input NAND Gate, Open-Collector Output
■ SN54/74L02	Quad 2-Input NOR Gate
■ SN54/74L03	Quad 2-Input NAND Gate, Open-Collector Output
SN54/74L04	Hex Inverter*
SN54/74L10	Triple 3-Input NAND Gate*
SN54/74L20	Dual 4-Input NAND Gate*
SN54/74L30	Single 8-Input NAND Gate*
SN54/74L51	Dual 2-Wide 2-Input/2-Wide 3-Input AND-OR-INVERT Gate*
SN54/74L54	2-2-3-3-Input AND-OR-INVERT Gate*
SN54/74L55	2-Wide 4-Input AND-OR-INVERT Gate*
SN54/74L71	R-S Master-Slave Flip-Flop*
SN54/74L72	J-K Master-Slave Flip-Flop*
SN54/74L73	Dual J-K Master-Slave Flip-Flop*
SN54/74L74	Dual D-Type Edge-Triggered Flip-Flop*
SN54/74L78	Dual J-K Master-Slave Flip-Flop, Common Clear and Clock*

■ New circuit introduced 1970 *Multi-source product

Looking for low-cost solutions to high-performance design problems?

**You'll find a lot of new ones in TI's 54/74 line
—still your broadest choice
of state-of-the-art TTL integrated circuits.**

If you're going to design the best equipment for your customers, you need the best tools available. Design after design has proven TTL the top logic tool from a standpoint of circuit efficiency and cost effectiveness.

Not for your state-of-the-art system? Look again. A lot has happened in the last few months. Enough to justify a careful review of your latest logic diagrams and product plans.

Take another look at the TTL leader—TI's 54/74 family.

MSI choice and complexity. Begin with the opposite page. Here, to help you reduce package count, simplify designs and improve performance, is an unmatched array of catalog MSI functions. The line has just about doubled in the past nine months and there are still more to come of ever-increasing complexity.

SSI back-up in depth. But in using TTL/MSI, you need the substantial back-up of versatile SSI circuits.

Check the opposite page again.

Four speed/power choices. Within TI's big TTL family, you have a selection of four speed/power ranges to help optimize your designs. There are 1 mW per gate low power circuits, standard- and high-speed circuits *plus* the revolutionary new Schottky-clamped TTL functions which attain speeds of 3 ns at 20 mW.

Complete compatibility. Even with this wide choice, you avoid compatibility problems. All members of TI's Series 54/74 family are designed to work together—saving you both design and component costs.

And TTL logic is also most economical on the basis of cost-per-function...in whatever package types you need: ceramic and plastic DIP or flat pack.

Ready availability. Not only has TI significantly increased its TTL production capacity, but we maintain large factory inventories (averaging more than 150,000 MSI

parts alone) in all three packages and in both temperature ranges. More than 100 authorized distributor locations stock full inventories of TI's TTL circuits...representing an additional stock, in the field, of more than 300,000 MSI parts.

And if your system requires multiple sources, you'll find more of TI's 54/74 line is backed up by other reputable semiconductor suppliers. It makes good business sense. (Asterisks on opposite page indicate multiple-source devices.)



The time is now to consider TTL for today and tomorrow. The decision-making facts are in our new MSI brochure, CB-125.

For your copy, circle 189 on the Reader Service Card or write Texas Instruments Incorporated, P.O. Box 5012, M.S. 308, Dallas, Texas 75222. Your authorized TI Distributor has copies, too.



TEXAS INSTRUMENTS
INCORPORATED

Make very wide-range log amps easily

by sequentially summing several basic log stages.
Custom-tailored characteristics are no problem, either.

Logarithmic video amplifiers are becoming more widely used in radar direction finders, crystal video receivers and many other applications in which a large dynamic range is needed. And this growing popularity has created a demand for a simple, straightforward technique for the design of good wide-range amplifiers.

The sequential current-summing approach¹ does an excellent job of filling this need. It allows custom design of the amplifier's logarithmic characteristic to compensate for imperfections in other components. In addition, any desired accuracy and range can be obtained by simply using a sufficient number of stages.

Before getting into the design procedure, let's take a quick look at the operation of a basic single-polarity log stage and then briefly review the sequential current-summing approach.

Transistor junctions are log elements

The basic single-polarity log stage of Fig. 1 provides logarithmic gain to within ± 0.75 dB over a 20-dB range. The collector current of the stage is given by

$$I_C = I_S [\exp (mV_{BE})] \quad (1)$$

where I_S is the diode saturation current; $m = q/\eta KT$ (q is the electronic charge, η is a diode constant approximately equal to unity, K is Boltzmann's constant and T is the absolute temperature); and V_{BE} is the transistor base-emitter voltage.

Both the base-emitter voltage and the collector current of the transistor are made up of two components—a quiescent (bias) component and a component caused by the input voltage e_{in} . If a subscript, Q , is used to denote quiescent values, we can write:

$$I_{CQ} = I_S [\exp (mV_{BEQ})] \quad (2)$$

and

$$I_C = I_{CQ} [\exp (me_{in})] \quad (3)$$

For negative input voltages, the output voltage is given by

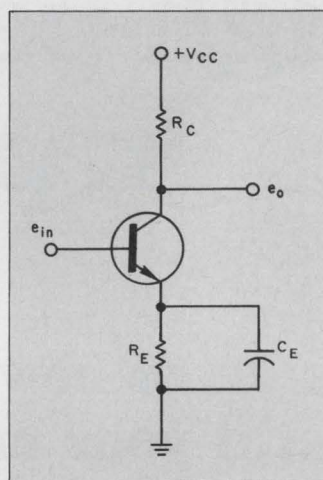

1. The basic log stage provides an excellent approximation to a logarithm over about a 20-dB range.

$$e_o = I_{CQ} R_C \left[\frac{\exp (me_{in}) - 1}{\exp (me_{in})} \right], \quad (4)$$

which provides an excellent approximation to a logarithmic function over about a 20-dB range. For $I_{CQ} R_C = 0.1$ V, and $T = 27^\circ\text{C}$, the center of the logarithmic region is about 32 dB below 1 V (-32 dBV).

To build a logarithmic amplifier with a dynamic range greater than 20 dB, it is merely necessary to combine several basic log stages. Separate linear amplifiers (or attenuators) are used to phase in the log stages over their appropriate ranges as the input voltage increases. The individual output currents are summed in a common load to produce the extended-range response (Fig. 2).

The exact number of log stages needed to cover a given dynamic range depends upon the required accuracy. If each stage covers 20 dB, the accuracy is ± 0.75 dB. For a 17-dB range, the accuracy improves to ± 0.5 dB, and a 15-dB range yields an accuracy of ± 0.3 dB.

The design procedure is simple

Once the amplifier's accuracy and the upper and lower limits of the input signal are specified, the design of the log amp is straightforward. Here is a recommended procedure:

Step 1: Choose the dynamic range to be cover-

Richard S. Hughes, Senior Electronic Engineer, Code 40203, U. S. Naval Weapons Center, China Lake, Calif. 93555.

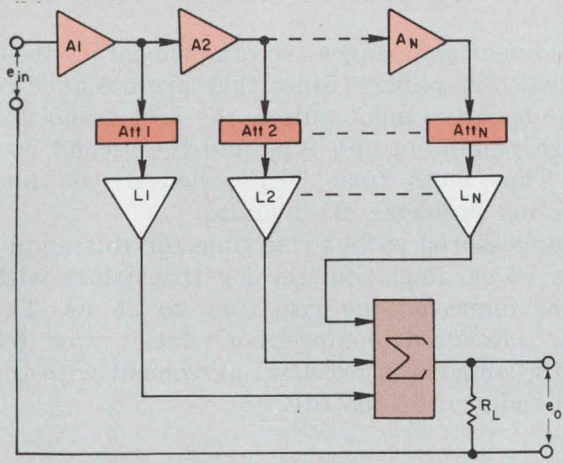

2. Wide-range operation is obtained by cascading several log stages. The linear amplifiers, A_1 through A_N , and the attenuators phase in the log-amp stages in sequence. The output currents pass through R_L to produce e_o .

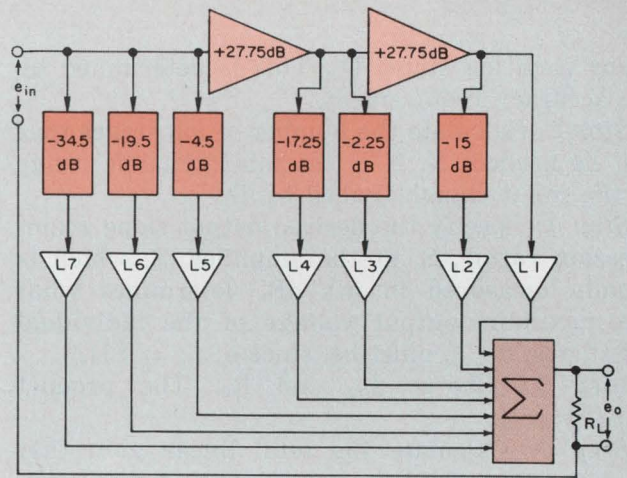

3. Considerable savings can be realized by eliminating several of the linear amplifiers. Here, two amplifiers and six attenuators are combined to provide seven output levels spaced exactly 15 dB apart.

4. This log amp covers 105 dB with seven 15-dB log stages. The transistors in the log stages are all 2N929s. Note that the collectors of all of the log transistors are connected to sum their output currents.

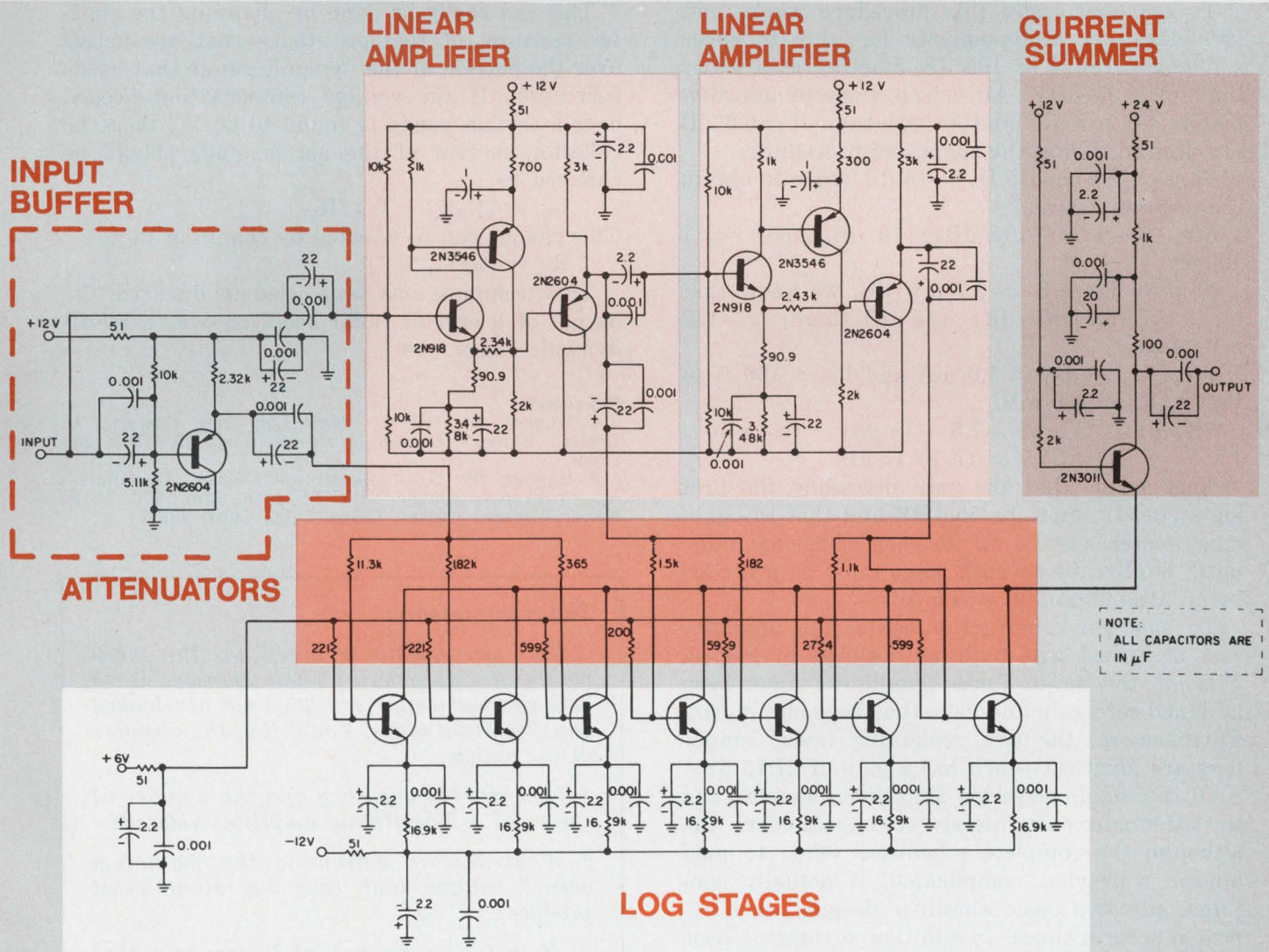

ed by each log stage, D_s . This is determined by the accuracy requirement.

Step 2: Calculate the number of log stages that will be needed, N . N is the total dynamic range of the input signal divided by D_s .

Step 3: Specify the desired output slope (compression ratio), S , of the amplifier. S , which is usually measured in mV/dB, determines what the maximum output voltage of the individual log stages, $e_{o \max}$, must be, since $e_{o \max} = SD_s$.

Step 4: Choose I_{CQ} and R_C . The product $I_{CQ}R_C = e_{o \max}$.

Step 5: Calculate the total linear gain that must precede each log stage. Note that this is the sum of the gains (in dB) of all the linear amplifiers and/or attenuators preceding the log stage in question. The gain preceding the n th stage is given by:

$$G_n = -32 - D_s/2 - (n-1) D_s - e_{in \min}$$

Note that $e_{in \min}$ is the minimum expected input signal in dBV.

It's easier done than said

To see how easily this procedure works out, let's design a single-polarity log amp to cover a dynamic range of 105 dB, starting at a lower limit of -95 dBV. An output slope of approximately 6.7 mV/dB and an accuracy of ± 0.3 dB are desired. Using the suggested procedure:

Step 1: We choose $D_s = 15$ dB/stage to obtain the desired accuracy.

Step 2: $N = (105 \text{ dB}) / (15 \text{ dB/stage}) = 7$ stages.

Step 3: Since $S = 6.7$ mV/dB, we know that $e_{o \max} = (6.7 \text{ mV/dB}) (15 \text{ dB/stage}) = 100$ mV/stage.

Step 4: Let $I_{CQ} = 1.0$ mA and $R_C = 100 \Omega$ so that $I_{CQ}R_C = 100$ mV.

Step 5: $G_L = -32 - 7.5 - (-95) - (n-1) 15$
 $= 55.5 - (n-1) 15$ dB.

This means that the gain preceding the first log stage, L_1 , must be 55.5 dB and that the gain must decrease by 15 dB for each additional stage until, finally, the seventh stage must be preceded by an attenuation of -34.5 dB.

To save on construction costs, the amplifier just described was built as outlined in Fig. 3. Five of the seven linear amplifiers have been assigned zero gain and have thus been eliminated. Furthermore, the two remaining linear amplifiers are identical—each has a gain of 27.75 dB.

Of course all seven log amps are identical, and the attenuators are merely voltage dividers. So, although the complete schematic (Fig. 4) may appear somewhat complicated, it actually contains only two basic amplifier designs, each repeated several times. In addition, a common-base summing amplifier (Q_1) has been used to minimize the Miller feedback capacitance.

The linear gain stages are complementary feedback video amplifiers. Since they are designed to handle negative input pulses, the first transistor of each pair is an npn type and the second is a pnp. Thus, both turn OFF when driven and saturation problems are avoided.

The measured output rise time for this amplifier is 70 ns. Replacing the log transistors with 2N918s improved the rise time to 25 ns. The actual measured compression ratio was 6.5 mV/dB, which is in excellent agreement with the design value of 6.7 mV/dB.

Custom-tailoring the amplifier

In some applications it may be desirable for the response of the log amp to differ from a perfect logarithmic function to compensate for an imperfection in another component. For example, if the output of a crystal detector forms the input to the log amp, it may be desirable to have the amplifier compensate for the crystal's deviation from a square-law response at high signal levels.

This can easily be done by changing the emitter resistors of the log stages that are active over the portion of the dynamic range that needs correction. If the voltage compensation needed over a certain range is found to be V_c , then the collector current of the active stage should be changed to

$$I_{CQ}' = (I_{CQ}R_C + V_c) / R_C$$

This change can be effected by changing R_E to

$$R_E' = R_E (I_{CQ} / I_{CQ}')$$

This technique has been used to linearize the output of a crystal radar receiver over a 60-dB dynamic range.² ■■

References:

1. Hughes, Richard S., "New Log Amp Cascades to Desired Range," *Electronic Design*, Oct. 25, 1969, pp. 86-89.
2. Hughes, R. S., "Logarithmic Video Amplifiers," *Naval Weapons Center NWC-TP 4869*, Jan. 1970, U. S. Naval Weapons Center, China Lake, Calif. 93555

Test your retention

Here are questions based on the main points of this article. Their purpose is to help you make sure you have not overlooked any important ideas. You'll find the answers in the article.

1. How are the accuracy and the number of stages of a logarithmic amplifier related?
2. What factors determine the maximum output voltage that each log stage must produce?
3. How is the amount of linear gain that must precede each log stage calculated?

HANDY

Handy by virtue of its operating convenience and its small size, Triplett's Model 310 V-O-M is no miniature when it comes to rugged capability on the job.

With outstanding readability from 0.05 to 1200 V DC in 5 ranges at 20,000 ohms per volt . . . 0.05 to 1200 V AC in 5 ranges at 5,000 ohms per volt . . . 5 ohms to 20 megohms in 4 ranges . . . 10 μ A to 600 mA DC . . . 0.1 to 300 A AC with the optional Model 10 clamp-on adapter . . . the Model 310 can handle practically every electrical measurement you'll need to make. Accuracy on the DC ranges is 3%—4% on AC.

For all its conveniences and features, this great Triplett instrument . . . the World's most popular miniature V-O-M . . . is only \$44 suggested USA user net. If you'd rather have a high voltage range of 600 V (AC and DC) and an AC sensitivity of 15,000 ohms per volt, ask for the Triplett Model 310-C at \$56 suggested USA user net. See them both at your local Triplett distributor or, for more information, call him or your Triplett sales representative. Triplett Corporation, Bluffton, Ohio 45817.

TRIPLETT

The World's most complete line of V-O-M's . . .
choose the one that's just right for you

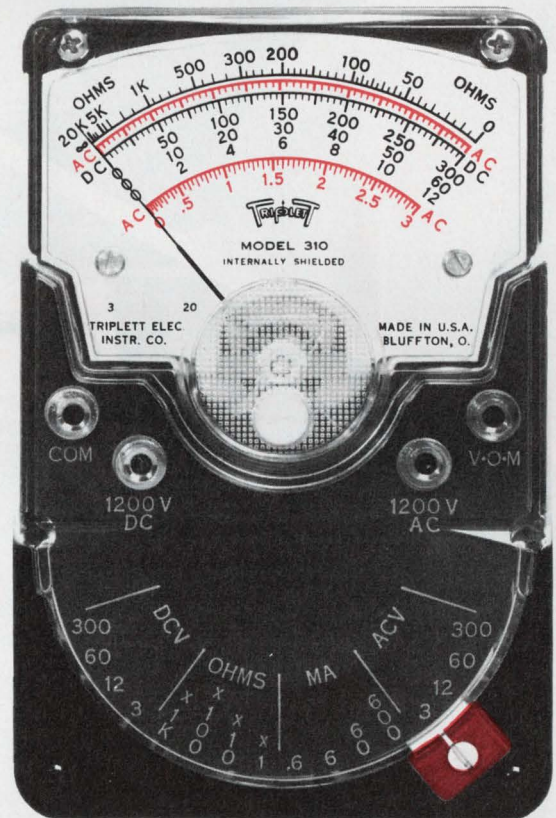

1. Hand size V-O-M with provision for attaching AC clamp-on ammeter.
2. 20,000 Ohms per volt DC sensitivity 5,000 AC.
3. One selector switch minimizes chance of incorrect settings and burnouts.

Shown actual size

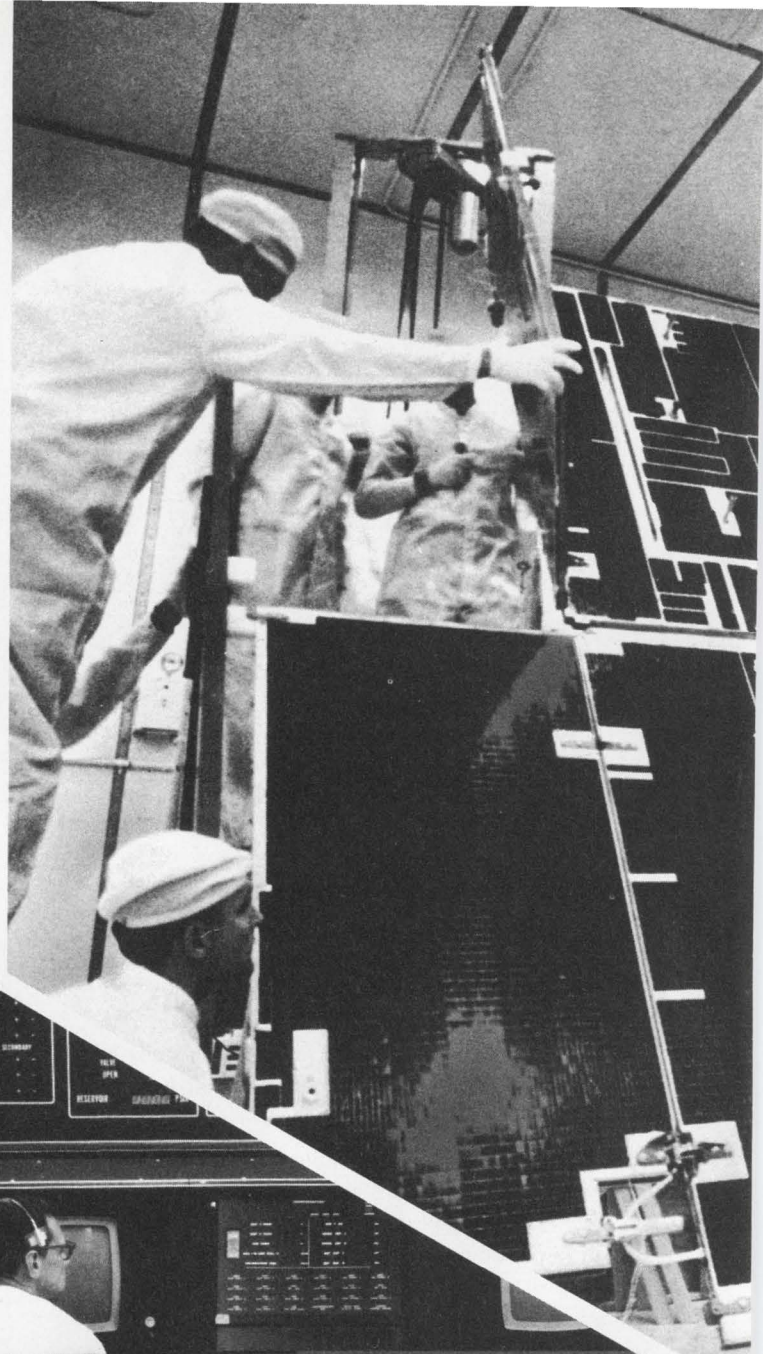
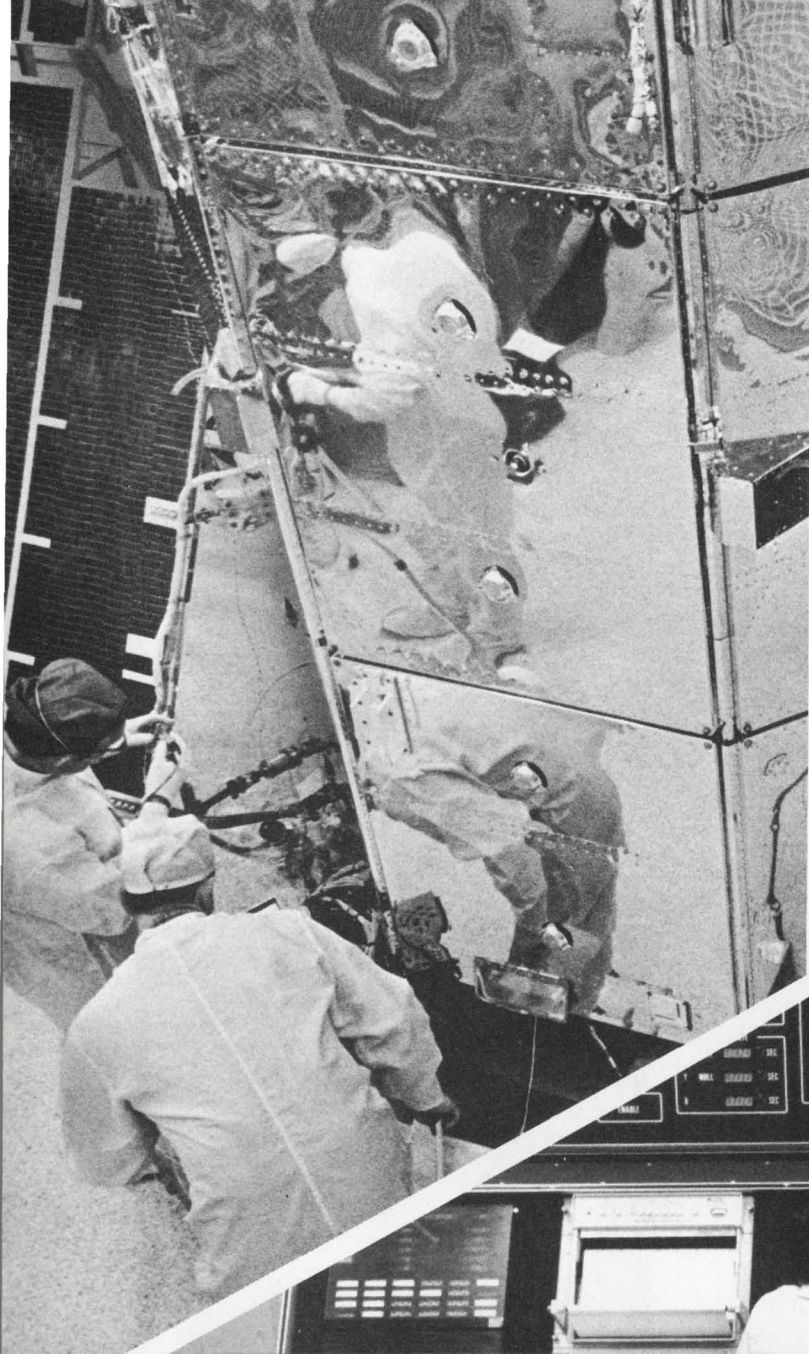

When the Goddard Space Flight Center wrote their specs for a hardcopy printer, they wound up with a choice of one.

They didn't mean to. It just turned out that way.

Because of all the printers around, the Gould 4800 was the only printer which could give the Goddard people all they asked for.

Speed Goddard asked for 1000 lines per minute. The 4800 will whip out 4800.

Silence Goddard planned to put their printer right in their on-line control room. And weren't about to put up with a noisy impact printer. With the Gould 4800, they don't have to. It's electrostatic. And very quiet.

Printout Width Goddard wanted a full 80 columns wide. The Gould 4800 provides it.

On convenient 8½" wide paper.

The Goddard people also were impressed by several other important factors:

alphanumerics and graphics — the Gould 4800 delivers words and pictures,

simultaneously, direct from computer output; *permanent paper* — special,

high-contrast, won't curl, get yellow or brittle . . . you can write on

it with anything; *reliability* — smooth, quiet, impact-free operation means less wear and tear on parts, less maintenance, little downtime; *versatility* — Gould 4800 generates wide variety of fonts, from smallest matrix on up, in many weights, sizes and faces. It can be integrated into a console set-up (see Goddard installation photo on opposite page) or used independently as shown below.

One more thing: The Gould 4800 is priced at or below printers that can't come close to the performance. So the Goddard people not only got quite a lot more than they bargained for. They also got quite a bargain.

Talk to your computer people about the Gould 4800. Then talk to us about a demonstration.

We're ready whenever you are.

Gould Inc., Graphics Division, 3631 Perkins Avenue, Cleveland, Ohio 44114.

 **GOULD**

Gould 4800. The next generation of high-speed printers.

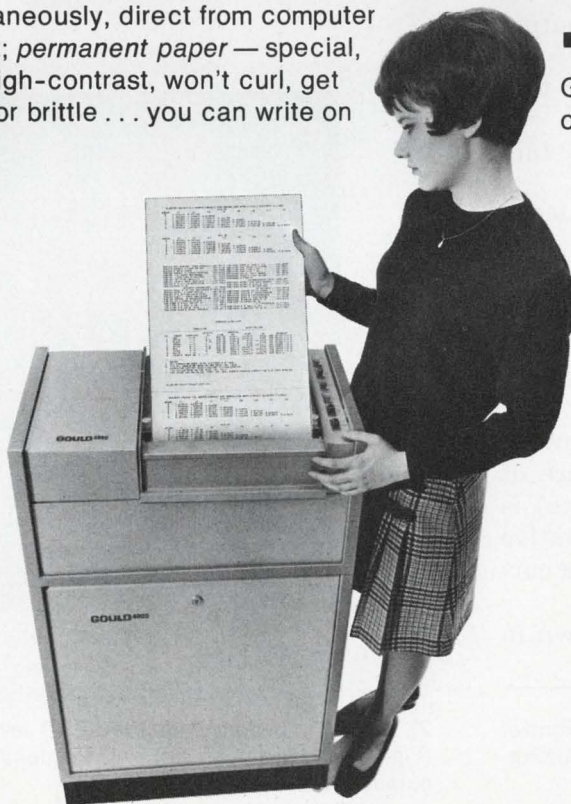

Explore IC performance with a curve tracer.

It will display characteristics that are not found in manufacturers' specifications.

Although the curve tracer^{1,2} is well known as a useful test instrument for displaying the characteristics of diodes, transistors and discrete semiconductors, few engineers realize that it can also be used to display the important characteristics of integrated circuits. With this useful technique, the circuit or system designer can obtain a graphical display of the characteristics required to use ICs in a system.

Determine fan-out capability

The output impedance of a logic circuit (in its ONE or ZERO state) is important because it determines the circuit's fan-out capability (the number of gates that can be driven). The output impedance of most logic circuits is extremely nonlinear, but data sheets usually specify only the impedance at one point.

The curve tracer can be used to display the IC's total characteristics, including all of its nonlinearities. The current into and out of the circuit is displayed as a function of the output voltage.

The basic components of the curve tracer that are used are:

- The collector sweep voltage—a 60-Hz full-wave rectified sweep-voltage source.
- The horizontal and vertical amplifiers, which display the currents or voltages at various points in the circuit.

In this test setup the normal circuit supply voltage V_{cc} is applied from an external power supply, and the collector sweep voltage is used to drive the output.

When the polarity switch of the collector sweep voltage is selected as positive, the impedance of the gate for positive currents (into the device) is displayed on the curve tracer's CRT. A negative polarity displays the impedance for negative currents (out of the device).

A typical TTL NAND gate circuit is shown in

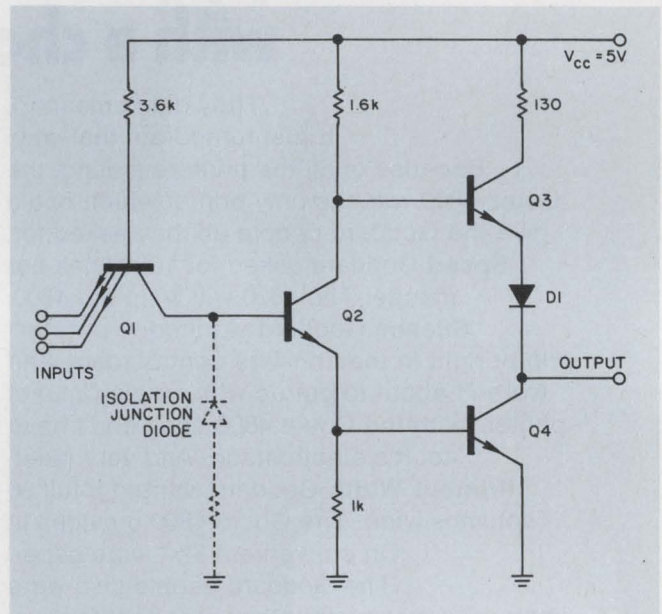

1. A typical TTL NAND gate was chosen to demonstrate the use of the circuit tester for ICs. The technique can easily be extended to other circuit families.

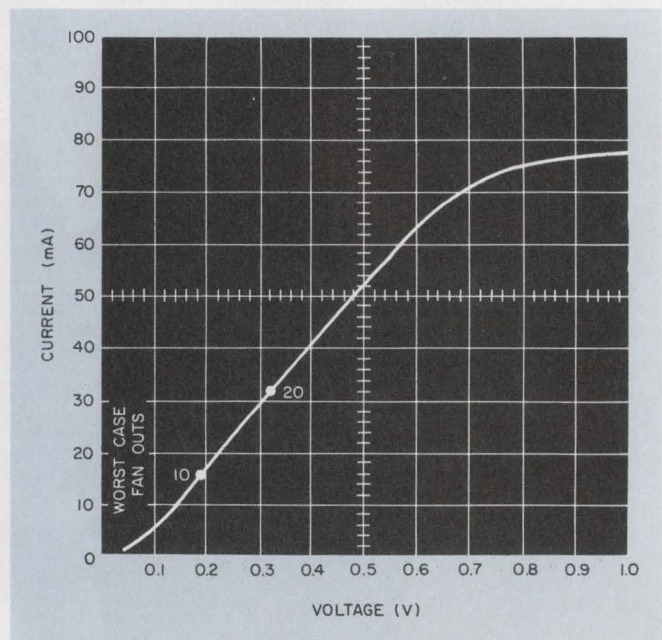

2. Output impedance for the ZERO level of the TTL gate (Fig. 1) has a linear slope corresponding to R_{sat} of the output transistor (Q4).

John A. DeFalco, Senior Engineer, Computer Control Div., Honeywell, Inc., Old Connecticut Path, Framingham, Mass. 01701.

Fig. 1. The TTL family was chosen as an example, but the circuit technique is easily extended to any other circuit family. When all of the inputs are in the ONE state, the output is in the ZERO state. The ZERO-level output impedance is shown in Fig. 2 where the linear slope corresponds to the collector resistance, R_{sat} , of the output transistor.

The value of the output ZERO level for any value of positive load current (into the device) can be determined from this curve. For example, the output ZERO voltage is seen to be 0.47 V with a load current of 50 mA. Note that for currents above 70 mA, the ZERO-level impedance becomes nonlinear. This nonlinearity occurs because the base current being supplied to the output transistor can no longer keep it saturated.

For use in designing with this logic circuit, Fig. 2 can also be marked in units of fan-out. In this way the circuit designer has a graphical display of the increase in the ZERO-level voltage he must give up to use this circuit for various

fan-outs. The designer, therefore, has a graph at his disposal that is marked in terms of either current or fan-outs and output voltage, and the relationship between the various parameters is easily seen.

Digital circuits have a completely different output characteristic in the ONE level. A typical ONE-level output impedance curve for a TTL gate is shown in Fig. 3. This curve is obtained in the same manner as the ZERO-level impedance, but in this case one input is grounded. The output voltage is seen to be about 3.5 V, or the supply voltage, 5 V, minus the V_{be} drop of Q3 and the diode drop of D1 (Fig. 1). The output voltage decreases as the current out of the device is increased. This output characteristic is especially useful in determining the ONE-level output voltage when supplying a particular current to a load.

In Fig. 3, if the gate were required to supply 12 mA to a load device, it could do so while maintaining an output voltage of 2.4 V. Lines

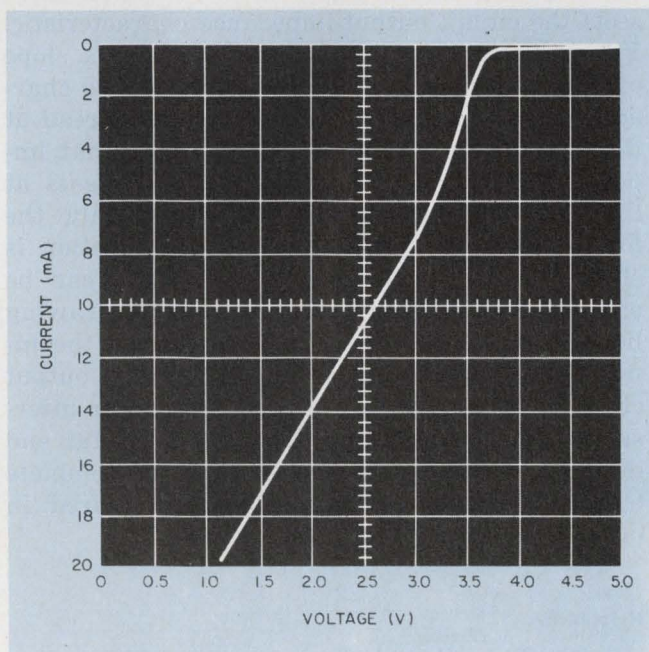

3. The ONE-level output impedance curve shows the voltage drop caused by V_{be} of Q3 and the diode drop of D1 of the TTL gate (Fig. 1).

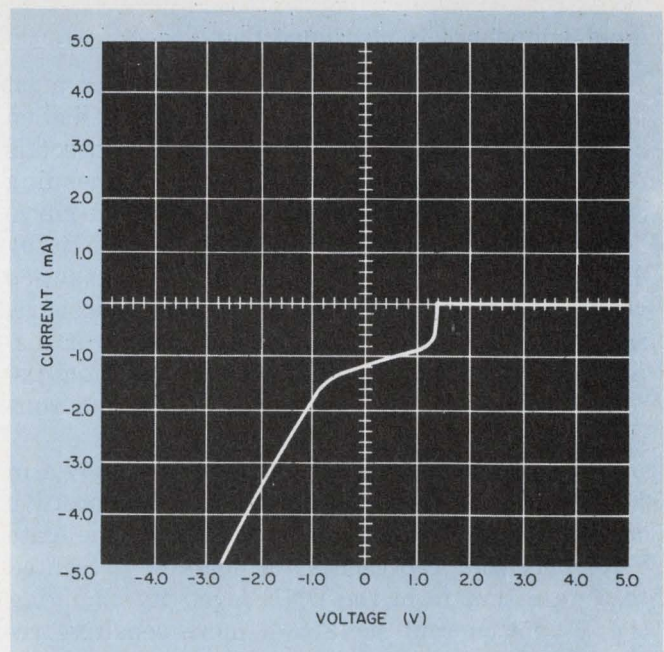

4. The input impedance curve of the TTL circuit indicates that the driving circuit must be able to sink 1.2 mA if its ZERO state has a 0-V output.

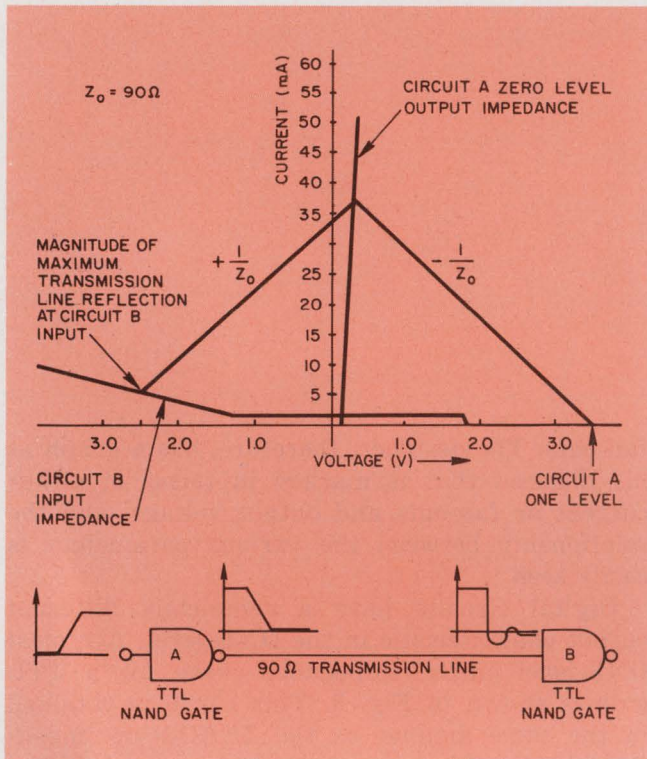

5. Transmission-line reflections can be predicted by plotting input, output, and transmission-line impedances. The ZERO-level output impedance is used for the plot.

with slopes corresponding to various load impedances can be drawn on the output characteristic, and the current and voltage present when driving a particular load impedance can be easily read from this characteristic. Again, using Fig. 3, the output voltage is seen to be 3.1 V when driving at 500-ohm load, which requires 6.2 mA.

Input impedance is also important

In using any logic circuit, the designer must be aware of the loading effect one circuit has on another. For TTL circuits this loading effect is nonlinear because the loading varies depending on the input voltage to the load circuit. The curve tracer can display this complex characteristic by driving the circuit input with the collector sweep voltage. If the sweep polarity switch is positive, the input impedance for positive currents is displayed. The negative sweep polarity position displays the input characteristic for negative voltages.

A typical TTL input characteristic is shown in Fig. 4. The area in quadrant one, for positive currents and voltages, corresponds to the gate being ON and represents the loading presented to a gate that is in the ONE level. By changing the Y-axis current scale to a more sensitive region, this current can be read quite accurately and is normally less than 50 μ A. Note that this current must be supplied from the previous cir-

cuit. Below 1.5 V the load current becomes negative and the previous circuit becomes a sink for this current. If the driving circuit had an ideal ZERO-state level of 0 V, it would have to sink (from Fig. 4) a current of 1.2 mA.

For negative input voltages, the characteristic shows a break at 0.8 V and then a linear slope for further increases in negative voltages. This break occurs because the collector-substrate isolation junction of Q_1 begins to conduct. The slope of the input impedance characteristic in this region is important because it determines the kind of reflections that can be developed when one TTL circuit drives another through a long unterminated transmission line.

Predict transmission-line reflections

The curve-tracer plots of output and input impedance are used in conjunction with a graphical technique to predict the transmission-line reflections that, unless controlled, can often cause a system to malfunction. The technique requires plotting of the input, output, and transmission-line impedance on a current-voltage diagram (Fig. 5).

The first step is to plot the circuit's ZERO-level output impedance (from Fig. 2) and the input impedance (from Fig. 4). The current direction for input impedance has changed sign because, relative to the gate that is driving the transmission line, this current is now positive.

The next step is to read the ONE-level voltage at zero current from Fig. 3 and enter it on the graph. From this point a line with a slope equal to the negative reciprocal of the transmission-line impedance ($-1/Z_0$) is drawn until it intersects the circuit output-impedance characteristic. From this intersection draw a line with a slope of $+1/Z_0$ until it hits the input-impedance characteristic curve. The voltage and current read at the intersection of the $+1/Z_0$ and the input impedance curve are the voltages and currents at the first transmission-line reflection. Only the first (and usually most important) reflection is shown in Fig. 5. Subsequent reflections can be obtained by continuing the procedure of drawing lines with $-1/Z_0$ and $+1/Z_0$ slope from the input characteristic reflection point to the output characteristic reflection point. Every other intersection corresponds to a reflection at the far end of the transmission line. Note that the complete output impedance characteristic is required in order to plot the later reflections. ■■

References:

1. *Instruction Manual, Type 575 Curve Tracer*, Tektronix Inc., Beaverton, Ore.
2. *Instructional Manual, Type 6200B Curve Tracer*, Fairchild Instrumentation, Mountain View, Calif.

C-LINE ZENERS 19¢

surge protection
doesn't
cost you more...

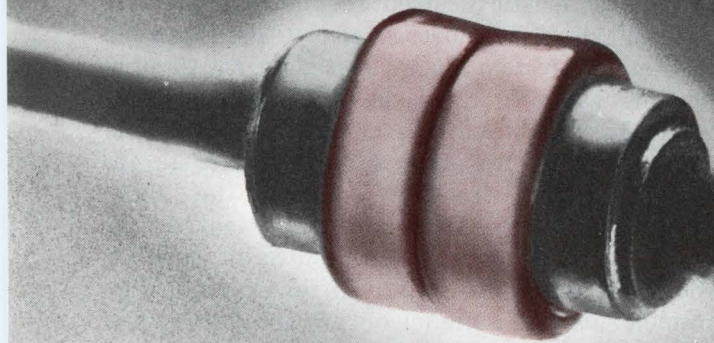

and it's nice to know it's there.

For the same prices as plastic devices, you can get up to 5 times greater surge protection. In fact, you can use C-line 1 and 5 watt zeners instead of conventional 10 and 50 watt chassis mounted types. And for far less money. Unitrode's unique fused-in-glass construction assures you of monolithic, void-free zener diodes with permanently stable electrical characteristics. And they'll withstand voltage surges high enough to make them hot enough to glow. They're in stock now, ready for immediate delivery. (1 watt ratings as low as 19¢ in 100k lots.) Can you afford not to use them? For fast action, call Sales Engineering collect at (617) 926-0404
Unitrode Corporation,
580 Pleasant St., Watertown, Mass. 02172



UNITRODE quality takes the worry out of paying less.

Unitrode Corporation

Inquiry Processing Dept. 10 B, 63 Atlantic Ave., Boston, Mass. 02110

Please send C-line zener samples in 1 watt, 5 watt rating with complete specifications.

NAME _____ TITLE _____

COMPANY _____

ADDRESS _____

CITY _____ STATE _____ ZIP _____

Simplify function generator design

You can reproduce any periodic function by using sampling and ROM storage.

Designing digital sinusoidal function generators for data-processing systems can be a trying experience. Many approaches place severe hardware constraints on the system or result in accuracies that degrade with time (see box). But there's a better way to do it.

With the hardware now available, an accurate, economical digital-function generator can be designed simply. The method relies on the repetitive nature of the function and uses ROMs for storage rather than for generating the function each time it is required. A very important point to remember is that these techniques are suitable for generating any cyclic function, not just sinusoids.

Consider the design of a sinusoidal generator with a 70-dB signal-to-noise ratio (S/N) at the sampling instants.

Simplified approach to the problem

A sampled function can be described as a collection of digital words that represent the magnitude of the function at the sample points. A sinusoid has a cyclic property that makes it a very interesting candidate for sampled systems. The cyclic property means that sampled values will repeat each cycle; and if the sample points are chosen wisely, they will repeat each half-cycle with a sign change. Furthermore, a repeat of the sample values will occur each quarter-cycle if the look-up order is mirror-imaged about 90° and 270° .

The important property is that these sample values do repeat and thus can be stored in a memory for recall rather than being generated each time they are required by a feedback structure.

Memory size is governed by the number of sample points desired to describe the function (number of data words) and the accuracy to which each point must be defined (number of bits per data word). Unlike recursive structures

that produce time-degraded outputs, the memory locks in the accuracy of any point and reproduces that accuracy every time it is called up. This reduces the number of bits required for a given accuracy to that set by the least significant bit value (LSBV) of the data word.

Programmable or variable frequency is another characteristic desired for more utility. If a sine function is represented by 2048 sample points and a system clock is used to set sample time intervals, T , then the frequency of the reproduced sine wave will be $1/(2048 T)$. This assumes looking up each sample point stored. Different output frequencies with the same sample time, T , can be produced by looking up every M^{th} sample point. This results in stepping through the function samples in fewer but larger increments, giving a higher output frequency. The frequency thus becomes $M/(2048 T)$.

With the cyclic waveforms stored in memory, it remains to develop a means of addressing the memory in the right sequence to reproduce a sine wave of the right frequency.

Generate the angle address

Since all the values of $\sin \omega_0 T$ occur between 0 and $\pi/2$ only one quadrant of values need be stored in memory. Every other value of $\sin \omega_0 t$ between $\pi/2$ and 2π is equal to that of some angle in the first quadrant. Using the read-only memory storage for these values simplifies referring the angles to a first-quadrant equivalent.

Input addresses to ROMs can be defined any way the user chooses for a particular desired output. This freedom of choice of address vs output when specifying a read-only memory allows the use of convenient address values. The output values are already specified as being $|\sin \omega_0 T|$. For $\sin(0)$ the address is chosen to be $0_1 0_2 \dots 0_n$. This address increases with the increasing angle, but $\sin \omega_0 T$ comes back to its original value of $\omega_0 T = 2\pi$. If the angle address is stored in an n -bit accumulator register, the state $00 \dots 0_n$ can represent a completely empty or completely full register since the two are equivalent. The angle π can be represented by a half-full register, $100 \dots 0_n$. Thus $\pi + \pi$ would

D. F. Elliot and A. D. Sypherd, Members of the Technical Staff, Autonetics Div., North American Rockwell, Dept. 521, Mail Code HB10, P.O. Box 4173, 3370 Miraloma Ave., Anaheim, Calif. 92803.

Don't do it this way

Some seemingly simple and straightforward approaches to the design of digital sinusoidal function generators should be avoided because round-off errors that increase with time are likely to result.

Suppose, for instance, we must implement a function generator whose output is $\sin(n\omega_0 T)$, where n is the number of the sampling interval, ω_0 is the oscillator frequency and T the sampling period. One design that might be considered is shown in Fig. A.

The problem with this system is that round-off occurs at each sampling interval in the multiplication of the signal s_n by $2 \cos(\omega_0 T)$. This round-off can be considered as a scaled reference, $r_n \sin(\omega_0 T)$, fed back to the input at the n th sampling interval. Since round-off is usually random, these feedbacks represent random reference signals of small amplitude. Nevertheless, they do not satisfy the requirement of having a zero reference signal for the time greater than zero.

Over a long period of time, the random reference signals caused by round-off, even though small, begin to affect the total output. The output is noisy and grows more so with time.

Suppose the round-off errors, which produce the reference inputs at each sampling interval, are independent random variables with a mean value of zero and a mean square value of $(\text{LSBV})^2/12$, where LSBV is the least significant bit value. Then at the n th sampling interval, the mean square noise (MSN) output for the mechanization is given as follows:^a

$$\text{MSN} = \frac{(\text{LSBV})^2}{12} \frac{n}{\sin(\omega_0 T)} \quad (\text{A})$$

Note the MSN output is proportional to the number, n , of the sampling interval.

A second digital mechanization (Fig. B) results from the matrix equation

$$z \begin{bmatrix} y \\ x \end{bmatrix} = \begin{bmatrix} \cos(\omega_0 T) & \sin(\omega_0 T) \\ -\sin(\omega_0 T) & \cos(\omega_0 T) \end{bmatrix} \begin{bmatrix} y \\ x \end{bmatrix} + \begin{bmatrix} e_1 \\ e_2 \end{bmatrix} \quad (\text{B})$$

In Eq. B, e_1 and e_2 are noises generated by the combined effect of round-off or truncation of the two digital multiplications required to determine both x and y . At the n th sampling interval we have, for the mechanization of Fig. B.

$$\text{MSN} = \frac{(\text{LSBV})^2}{12} n. \quad (\text{C})$$

While the noise in the output of the second

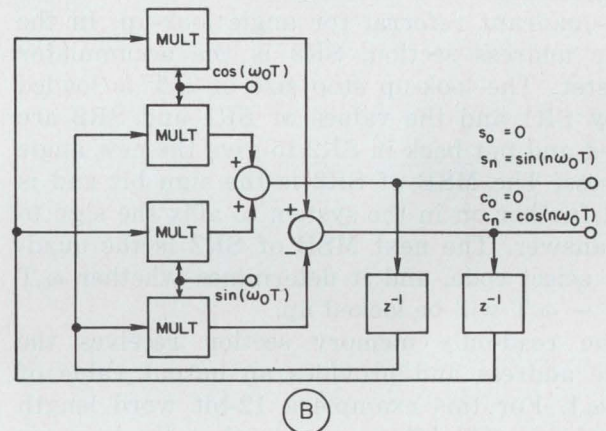
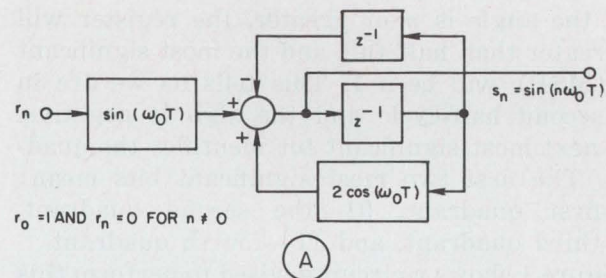

mechanization is decreased by a factor of $1/\sin(\omega_0 T)$ with respect to the first mechanization, the MSN still increases with time.

A previous article^b describes a highly accurate method of generating $\sin A$ using read-only memories (ROMs) given an angle A in the first quadrant. Letting $A = N + H$ where N is the number of whole degrees and H the fractional degree in hundredths, the identity $\sin(N+H) = \sin(N)\cos(H) + \cos(N)\sin(H)$ (D)

was used to generate $\sin A$. Generation of each of the four components on the right-hand side of Eq. D required only 2648 bits of ROM to give an error of less than 2^{-15} . However, for the sinusoidal function generator application, additional hardware is required, before applying the trigonometric identity, to reduce $n\omega_0 T$ to an equivalent first quadrant angle and to determine sign $[\sin(n\omega_0 T)]$. Extensive additional hardware is required to perform the multiplications and additions indicated by Eq. D and to affix the sign. Memory size increased an order of magnitude, and hardware requirements more than doubled for complete mechanization of the identity equation.

References

- a. Rader, C., and Gold, B., "Digital Filter Design Techniques," *Proc. IEEE*, Vol. 55, No. 2, February, 1957, pp. 149-171.
- b. Hamel, A., "Slash ROM sizes with Equivalent Functions," *Electronic Design*, Vol. 17, No. 4, 1969, pp. 66-74.

cause an overflow in the register, but the remaining address would be $00 \dots 0_n$ representing 0 or 2π . This overflow technique also presents a pattern to the address that can be decoded for picking sign and quadrant of the angle.

If the angle is π or greater, the register will be greater than half full, and the most significant bit (MSB) will be a 1. This tells us we are in the second half-cycle and the sign is negative. The next most significant bit identifies the quadrant. The first two most significant bits mean: 00—first quadrant, 01—the second quadrant, 10—third quadrant, and 11—fourth quadrant.

Figure 1 shows a circuit devised to perform this first-quadrant referral for angle look-up. In the angle address section, SR2 is the accumulator register. The look-up step size or $\omega_0 T$ is loaded in by SR1 and the values of SR1 and SR2 are added and put back in SR2 to give the new angle address. The MSB of SR2 is the sign bit and is used further on in the system to affix the sign to the answer. The next MSB of SR2 is the quadrant select code, and it determines whether $\omega_0 T$ or $\pi - \omega_0 T$ will be looked up.

The read-only memory section receives the angle address and provides an output value of $\sin \omega_0 t$. For this example a 12-bit word length was chosen (11 bits + sign); thus the memory must store one quadrant ($1/4 \times 2048$ samples) of 11-bit data words or $11 \times 512 = 5632$ bits. This would require six 1024-bit ROMs.

Memory output is an 11-bit parallel word with the sign bit coming from the address register. Format is signed magnitude. If other formats are desired such as serial, two's complement, or one's

complement, a little additional logic will easily convert the data.

Determine the generator S/N ratio

We wish to determine the S/N for the digital sinusoidal function generator using a ROM that has $2^9 = 512$ entries of 11 bits each. Since the entries are for angles equally spaced between 0 and $\pi/2$ radians, there are $(\pi/2) \times 2^9$ radians between entries.

Suppose our requirements are satisfied by a family of sine waves of such frequencies that there is always an exact entry in the ROM for the angle, A. This assumption restricts the smallest increment of angle A to be $\pi/2 \times 2^9$ radians and guarantees that we can always look up $|\sin A|$ in the ROM. The value of $|\sin A|$ and the MSB of angle A determine $\sin A$ as previously discussed. Under these assumptions, the only sources of error in the generation of $\sin(n\omega_0 T)$ are: (1) round-off of the entry stored in memory, and (2) variations in the period, T.

Consider first round-off errors. One bit of each 12-bit word must be allotted for sign, leaving 11 bits for accuracy. While $|\sin A|$ varies from 0 to 1, the bits representing it vary from 0 to $2^{11} + 2^{10} + \dots + 2^0 = 2^{12} - 1 = 4095$. Assuming that the last bit is rounded, it is accurate to $1/2 \times 2^0 = 2^{-1}$. Suppose this round-off error is uniformly distributed between $-1/2$ and $1/2$. The average value of a random variable uniformly distributed between $-a$ and a is zero, and the mean square value¹ is $1/3 a^2$. Thus, the mean square noise power, N, due to roundoff is given by

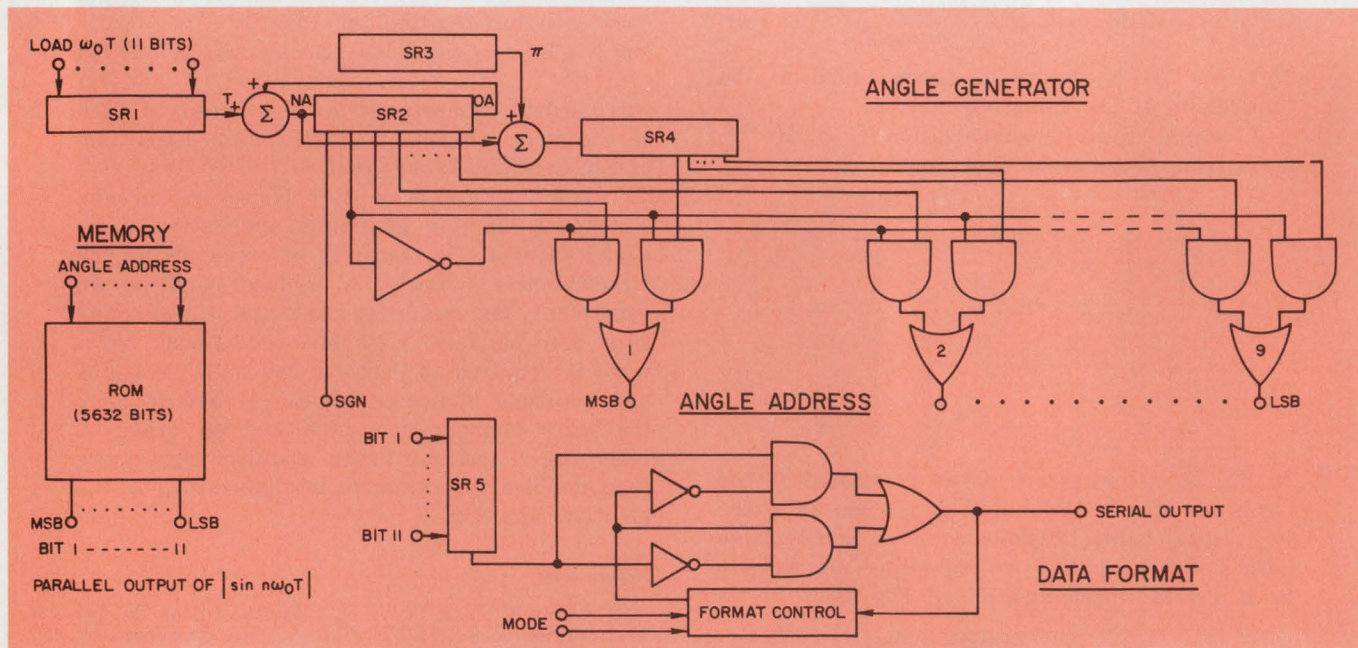

1. Round-off errors do not increase with time in this simplified sine-wave generator. The angle generator section reduces the angle generated to a first quadrant

equivalent. Thus the memory section need contain only one quadrant of values for look-up. The data-formatting section is optional for serial outputs.

$$N = \frac{1}{3} \left[\frac{1}{2} \right]^2 \quad (1)$$

The signal power, S, in a sampled sine wave is given by

$$\begin{aligned} S &= \sum_{n=1}^M B^2 \sin^2(n\omega_0 T) \cong B^2 \overline{\sin^2 \omega_0 t} \\ &= \frac{B^2}{2} \cong 2^{23} \end{aligned} \quad (2)$$

where $B = 4095$ is the maximum amplitude and M is the number of samples obtained from the oscillator. Therefore, at the sampling instants the signal-to-noise power ratio at the digital oscillator output is

$$\frac{S}{N} = \frac{2^{23}}{\frac{1}{3} \left[\frac{1}{2} \right]^2} = 3 (2^{25}) \cong 80 \text{ dB.} \quad (3)$$

Consider now the noise introduced by randomness in the sampling period, T . This randomness would be introduced, for example, by clock frequency drift. Suppose the time intervals by which pulses are perturbed about their mean position is subject to a Gaussian probability distribution with a mean value of zero and a standard deviation of σ . Suppose the power spectral density of a single pulse occurring at time $t = 0$ is $G(\omega)$, where ω is angular frequency in rad/sec. Then the signal-to-noise power ratio, due to variations in pulse spacing, is given approximately² by

$$\frac{S}{N} = \frac{\int_{-\infty}^{\infty} \exp(-\sigma^2 \omega^2) |G(\omega)|^2 d\omega}{\int_{-\infty}^{\infty} \{1 - \exp(-\sigma^2 \omega^2)\} |G(\omega)|^2 d\omega} \quad (4)$$

In the present case $G(\omega)$ is given by

$$G(\omega) = \frac{1}{2} [\delta(\omega - \omega_0) + \delta(\omega + \omega_0)] \quad (5)$$

where δ is the Dirac delta function. Substituting Eq. 5 into Eq. 4 and evaluating gives

$$\frac{S}{N} = \frac{\exp(-\sigma^2 \omega_0^2)}{1 - \exp(-\sigma^2 \omega_0^2)} \quad (6)$$

For $\sigma^2 \omega_0^2 \ll 1$, we can make the approximation $\exp(-\sigma^2 \omega_0^2) = 1 - \sigma^2 \omega_0^2$ which gives us

$$\frac{S}{N} \cong \frac{1 - \sigma^2 \omega_0^2}{\sigma^2 \omega_0^2} \cong \frac{1}{\sigma^2 \omega_0^2} \quad (7)$$

Suppose the oscillator period, T_0 , is nominally given by $T_0 = 10T$. Then

$$\frac{S}{N} = \frac{1}{\sigma^2 \left[\frac{2\pi}{10T} \right]^2} = \left[\frac{T}{\sigma} \right]^2 \left[\frac{100}{2\pi} \right]^2 \quad (8)$$

Suppose finally that $T = 1000(\sigma)$. Then

$$\frac{S}{N} = \frac{10^{10}}{4^2} \cong 84 \text{ dB.} \quad (9)$$

Assuming that the noise powers due to round-

off and randomness in the sampling period are additive, the S/N is better than 78 db. It is readily seen that Eq. 3 can be generalized to give

$$\frac{S}{N} = 3(2)^{2b+1} \quad (10)$$

where b is the number of bits mechanized including sign.

Change the frequency increment

The minimum angular increment, $\Delta\omega_0 T$, by which $\omega_0 T$ can be changed is $(\pi/2) \times 2^{-9}$. Consider a low-frequency communication system employing a sampling interval, $T = 128 \mu\text{s}$, and an angular increment, $\Delta\omega_0 T = \pi \times 2^{-10}$. Then from $\Delta\omega_0 T = 2\pi\Delta f T$ we have

$$\Delta f = \frac{2^{-11}}{128 \times 10^{-6}} \cong 2^{-18} (2^{10})^2 = 2^2 = 4 \text{ Hz.} \quad (11)$$

Note that Δf is determined by the minimum angular increment, $\Delta\omega_0 T$, and by the sampling period, T . The value of Δf can be made smaller by making $\Delta\omega_0 T$ smaller, which requires more bits in the angle generator. We could then increase the ROM capacity to guarantee a look-up for every possible angle or simply look up the closest angle and accept an equivalent degradation in S/N. The maximum value of T is constrained by the well-known sampling theorem, which requires that the highest frequency be sampled at least twice per cycle. It is apparent, then, that a trade-off must be performed between minimizing hardware expense and minimizing the frequency increment to optimize design of a sine generator that must be finely tuned.

The engineer furthermore has the option of increasing the number of bits in the words containing the angle, A , and the angle, $\pi - A$. Thus he may obtain as fine a resolution, Δf , as he desires. As the bit length of A is increased, the ROM capacity may be increased and/or the angle rounded before looking up $|\sin A|$ in the ROM. When both the angle A and the stored values of $|\sin A|$ are rounded, the S/N may be computed, using appropriate expressions.

Extension of the design presented to other cyclic functions should be obvious. Any periodic function can be reproduced using the sampling technique and ROM storage. Custom-programmed ROMs³ provide new possibilities for low-cost, programmable, multifunction generators. ■■

References

1. Papoulis, A., *Probability, Random Variables, and Stochastic Processes*, McGraw-Hill Book Co., New York, 1965.
2. MacFarlane, G. G., "On the Energy-Spectrum of an Almost Periodic Succession of Pulses," *Proc. IRE*, Vol. 37, No. 10, 1949, pp. 1139-1143.
3. Sypherd, A. D., and Salman, N. D., "Automatic Laser Encoding of Semiconductor Read-Only Memories," *Proc. National Electronics Conference*, Vol. 24, 1968, pp. 206-209.



...try a Teletype® 37
...and look
into mag tape!

We don't have a crystal ball. And rarely resort to mystic means in recommending what terminal should be used for a particular data communications application.

Some of the things, we at Teletype look at, that make the job a little easier are these:

Distribution	Volume
Urgency of message	Language
Frequency of use	Accuracy

The diagram below demonstrates how you can fit a number of Teletype terminals

into a system based on function and usage requirements. Magnetic tape makes the speed and language of various terminals compatible. In this hypothetical case we use one computer program, one major line control procedure, one computer port, one type of data set per link. And deliver greater data through-put per on-line dollar. Using terminals that offer the best capabilities within each station's communication situation.

Using Teletype magnetic tape data terminals, combined with various Teletype keyboard send-receive sets, you obtain

some unique system flexibility. And the on-line time saving aspects of operation are really dramatic. Magnetic tape data terminals can keep data flowing on-line at up to 2400 wpm.

In the example shown, the manufacturer has linked sales, engineering, accounting and inventory control departments to a central office computer. As well as manufacturing plants, warehouse and regional offices. He's covered all critical data points with a common medium speed link, using a variety of terminals. Magnetic tape data terminals make it possible.

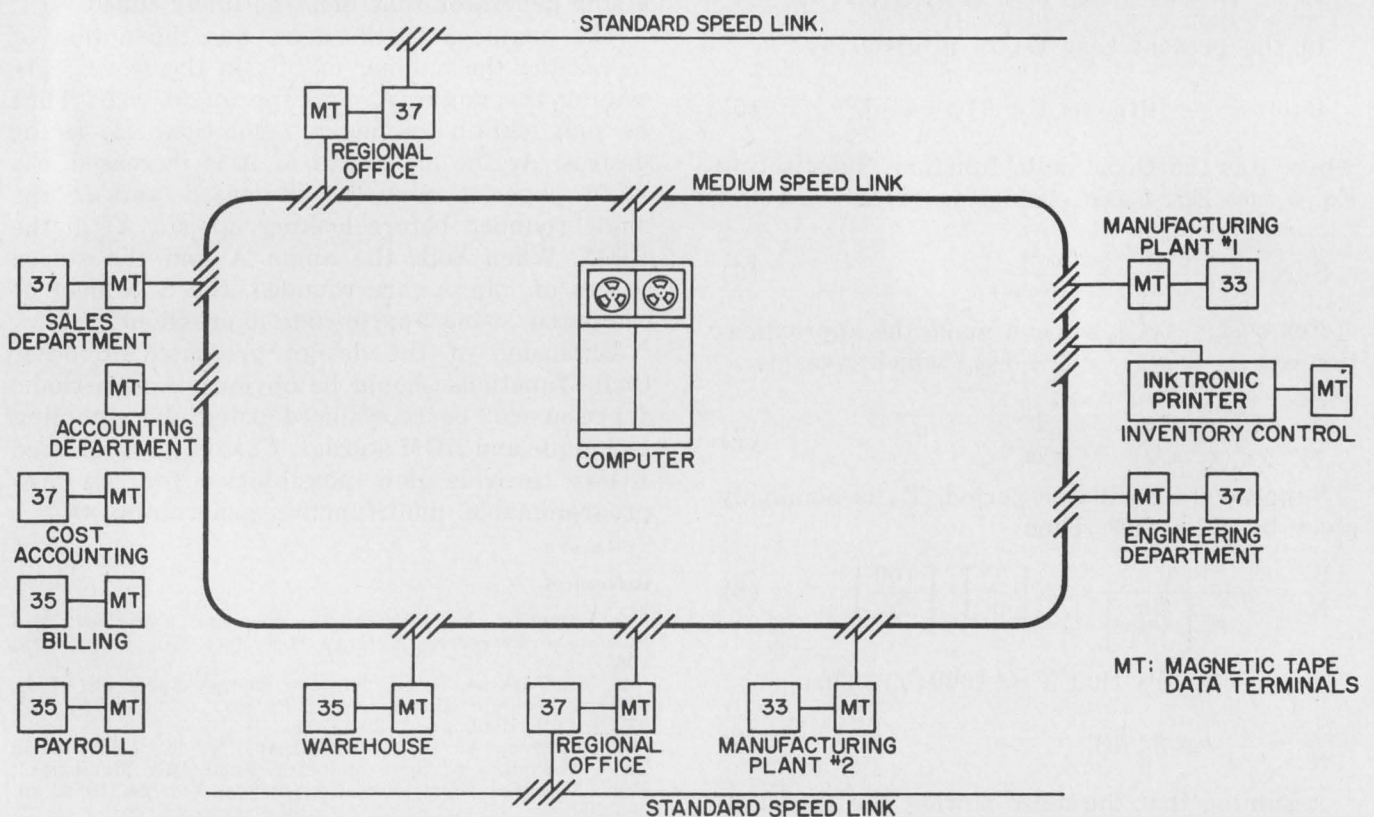

DATA COMMUNICATIONS

equipment for on-line, real-time processing

Routine aspects of the system are maintained in standard speed links. Branch offices are tied into the regional office terminals on standard speed networks. Regional offices batch routine branch office data on one magnetic tape. Transmit the data to the central office processor at one time. Saving a number of additional computer port requirements.

Since data generated at manufacturing plants is urgently needed, but volume is low, low-cost model 33 terminals are used here. The warehouse data volume is higher, but not complex, so a heavy-duty model 35 is working here.

Volume requirements are heaviest in the accounting department. Cost accounting, payroll, billing and invoice payment functions generate data all day long. Here magnetic tape is prepared off-line at various terminals. And an on-line stand-alone magnetic tape terminal is used to transmit data to and receive data from the central processor.

Sales and engineering departments are equipped with Teletype 37 terminals. But for different reasons.

This terminal offers engineering people some unique format flexibility. Half-line and full-line forward and reverse line feed can be used to communicate complex equations and engineering formulae to the processor. It is possible to add special graphic engineering symbols to the normal compliment of letters, numbers and punctuation marks found in the typebox (up to 32).

The sales department uses the model 37 for order processing. It has on-line vertical and horizontal tab set control, and form feed platen (optional) which makes data transmission and reception on multiple copy business forms easy and economical.

At the inventory control point, this manufacturer has an urgent need to obtain printed page copy of large volumes of inventory items. Magnetic tape is used to feed data to the processor and a Teletype Inktronic® KSR set receives data and prints page copy on-line up to 1200 words per minute.

As you can see, Teletype's modular terminal design allows you to use vari-

ous units as building blocks to meet the most demanding system needs. Teletype also has the station and error control accessories necessary for more efficient and economical data communications operations. Since cost is a very important part of the mix, Teletype offers greater terminal capabilities on a price/performance basis than any other manufacturer.

If you're involved in designing a teleprocessing, time-sharing, remote batch or computer switched system; looking into a multi-point private line, point-to-point private line or switched data communications network; talk to Teletype about terminals. For ideas, equipment and understanding, you'll find no better source. Anywhere.

Teletype data communications equipment is available in send-receive capabilities of up to 2400 words per minute. If you would like specific information about any of the equipment described here, write: Teletype Corporation, Dept. 89-16, 5555 Touhy Ave., Skokie, Ill. 60076.



model 33 series: An extremely low-cost 100 wpm terminal line. Uses ASCII. The most widely used terminal in time-sharing systems today.



model 35 series: A rugged, heavy-duty line of 100 wpm terminals. Uses ASCII.



model 37 series: One of the most versatile heavy-duty terminal lines going. Generates all 128 characters of ASCII. Operates at 150 wpm. Prints in upper and lower case.



Inktronic® data terminals: A unique electronic, solid state terminal. Prints up to 1200 wpm. Forms characters through electrostatic deflection (no typebox). ASCII compatible.



magnetic tape data terminals: Use compact reusable tape cartridges. Operate on-line at up to 2400 wpm, and connect "locally" to lower speed Teletype terminals using ASCII.

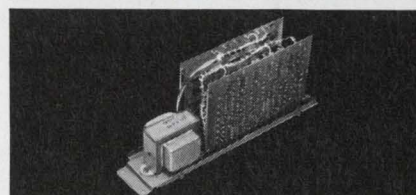

Stuntronic™ accessories: Electronic solid state terminal logic devices offering many control options. Such as, automatic station control, error detection and correction capabilities.

Teletype is a trademark registered in the U.S. Pat. Office

machines that make data move



INFORMATION RETRIEVAL NUMBER 49

How to succeed in spite of the slump.

The experiences of two small surviving companies may help engineer and manager alike direct their firm through the slowdown.

Richard L. Turmail, Management Editor

The statement made by a professional football lineman that, if he didn't react properly to events around him, he would be at their mercy, can easily apply to the small electronics company in the event of a business slump.

When business is sluggish, large firms automatically cut back on employees and/or salaries as a precaution against going into the red. But the more financially vulnerable small companies have a much shorter lead time to bankruptcy and must fight for their very survival.

Two small Massachusetts-based companies encountered two separate but related problems during the current slump: one discovered that 75% of its business was being booked and delivered within a month, giving it little time or capital to maneuver; the other found that its customers didn't have enough money to buy its products—at a time when it was attempting to establish a product line. Although neither company has found the final answer for its dilemma, they have managed to survive. How they did it should be of service to the manager and engineer who have a stake in a small company.

All chiefs and no Indians

Trump-Ross Industrial Controls, Inc., a small producer of rotary pulse generators in North Billerica, Mass., was reaching for its second \$1-million annual sales income plateau when the general economy began to lag.

The company's British-born president, Dennis Trump, told *ELECTRONIC DESIGN* that in May, 1970, he had noticed that 24% of his business was being booked and delivered within the same month, compared to the norm of about 14% turn-around in January.

"By June," Trump said, "our one-month turn-around business had reached 75%."

The company was forced to lay off 17 employees out of 52, including three engineers. It is operating with a skeleton staff, rather than go out of business. According to Trump, the firm had not extended itself. It had been nursed along at a reasonable pace, expanding only when nec-

essary, and only when profitable.

"It doesn't take Indians to organize a company," Trump said. It took only two chiefs, Trump and his partner, Edward Ross, along with a secretary, to start the company on little more than the knowledge that there was a need for low-cost encoders.

"Ed and I each contributed \$10,000 (total capitalization is now at \$100,000), and Ed handled the marketing of a plastic typing coder I designed that could be sold at a low price," Trump said. When they had earned enough to afford a sales manager, they hired one, and when profits warranted it, they hired an engineering manager. Trump said that by that time they had a small staff of employees, one of whom they promoted to production manager and sent to industrial management school.

"When we reached \$1 million in sales," Trump said, "all departments were covered."

How to parlay a company

How Trump-Ross has been able to ride out the economic storm, and, according to its president, "service the encoder industry better than most," is due to two main factors: the company's ability to communicate and to organize people.

The company maintains close communication among all its managers on a weekly basis so that each one knows what the other is doing for a customer of mutual interest.

"One golden rule," Trump said, "is that we don't discuss the engineering aspect of any product at these meetings. That's important because our customers' needs are very different. We have to relate to each one on a personal basis concerning the pricing and application of his product." Trump added that lately they've had to discuss the user's credit as well. Of its thirty or so customers, the company discusses an average of six at each meeting.

Another way the company has attempted to improve communication is by its "record of telephone inquiry" form. This is divided into three sections: "Inquirer," "Applications Under Consideration" and "Action." A similar sheet has been run off for "Personal Contacts."

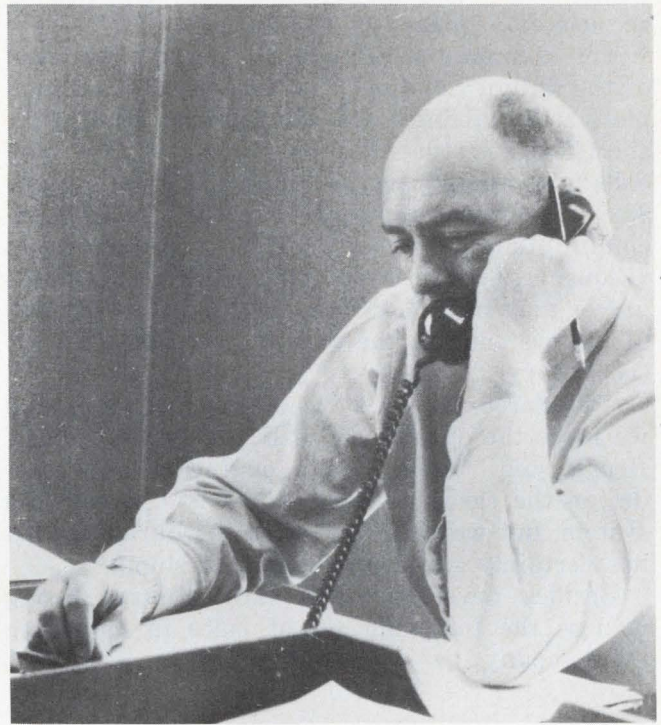

President Trump of Trump-Ross in N. Billerica, and **President Bragg** of I/O Systems in Natick.

As for the company's ability to organize people, Trump's staffers claim he comes by it naturally. As one of them observed: "He has a feeling for hiring people who are compatible and who aren't afraid to make decisions."

Trump himself says that if he doesn't hire people who can make some decisions on their own, he would find himself swamped by detail work and would fail to develop as a manager.

As every good manager knows, if employees are to be organized properly, they must first be motivated properly.

"We're slightly paternalistic here," Trump said, "because of the extra incentives we offer our employees."

These incentives include:

- Pay for non-absentees: It goes to the employee who hasn't missed a day's work in a year.
- No time clocks: Production people are put on the same status as office personnel. The company claims the honor system has improved employee morale.
- Bonuses: Extra time off or extra pay is given to employees for solving problems.

"What's most important," one of Trump's managers said, "is that the president must set the example for everyone to maintain a quality operation that's profitable. And he does."

An exhausting job, particularly in light of the

fact that new business isn't exactly knocking down the door these days.

Producer gambles on library cards

I/O Systems of Natick, Mass., is a tiny electronics company (\$25,000 sales in 1969) engaged in the development of input-output systems and subsystems for use in digital computers and other digital data-processing systems.

Until the business slump, the company's president and founder, John Bragg, was developing two product lines, which were being marketed to business and industrial users. One of these lines adds graphic capabilities to time-sharing terminals; the other is a line of data-preparation and transmission units.

"The products are pretty much a luxury purchase," Bragg said. "They make an operation easier, but they are not absolutely vital, and our customers don't have the money to buy them, now."

To survive the cutback, Bragg is directing his company to develop input-output systems and subsystems that will make its customers' equipment more versatile. According to Bragg, there's little competition in the applications area because most of the large companies have laid off their systems and logic engineers.

Bragg maintains a staff of 15, including one

engineer, one technician, and two production people. All systems work is turned around within a month.

"We work on two or three jobs at one time," Bragg said, "and the operation is simplified by the use of a library of functions."

The company uses cards to accomplish most of the design functions that are required to complete a digital interface. Its engineer studies the specifications that the customer requires and calls upon the library to put together the system. The library is comprised of 25 to 30 cards, including data receivers; buffers; programmers (sequences); and output (transmitters). The engineer may have to design one card at either end of the system, but the rest of it he can fill from the library.

"We force the input to suit our library, and we force the output to fulfill the specifications," Bragg said. "Most design engineers would redesign the cards each time they had to create a system, but we gain time with the library and it has certainly saved us during the slump."

Besides developing the card library, Bragg utilizes the following set of rules in managing his company:

1. Clearly define the chain of authority (not command).

2. Institute an open-door policy, but feed back down the chain so that authority cannot be bypassed.

3. Give your managers full authority relevant to responsibility.

4. Review decisions closely but do not overrule them except when absolutely necessary. In that case inform the responsible person that he is to make the change himself to preserve the chain of authority.

5. Give reasons for your decisions whenever it is appropriate, to provide character and policy guidance to others down the chain and develop company operating philosophy.

6. Provide challenge at all levels by delegating responsibilities according to each person's potential capacity; then monitor closely.

7. Develop and cross-train managers to permit promotions rather than in-job raises.

8. Do not promote company loyalty but encourage its development by offering a future of personal progress.

9. Prepare your replacement to take over smoothly when you advance. ■■

Consultant notes five major classic management blunders

There are almost as many management errors as there are employees, systems and good intentions. Some of the mistakes that plague management however, are more serious than others, especially during times of business slowdown. We asked David W. Brown, president of Technical Marketing Associates, Inc., a management consultant firm in Concord, Mass., what the most common technical management mistakes are and how they can be avoided. According to Brown, there are five basic "classic blunders" that company management is heir to. His observations follow:

1. *Reluctance to plan.* Some executives find it difficult to analyze their own companies objectively. The best course, in time of trouble, would be for the president of the company to call in a cool, hard-nosed outsider who will give him an objective viewpoint.

2. *Failure to generalize.* When management talks to a customer about a new product, it's a mistake to speak of the product in specific terms. Because the market is always changing, the company will have to apply a new set of standards to the product for each change that comes along. It's better to establish common general criteria for a product, rather than specific data that will soon become obsolete.

3. *Duped by fashionable methods.* Company acquisitions, dependence on aerospace business

and installation of a stock option plan are a few of the management methods that have, in the past, become so fashionable that many companies have adopted them regardless of suitability. Perhaps it would be more profitable for your firm to build its own plant, develop its own business, and find other ways to motivate its employees.

4. *Failure to anticipate the market.* Some businesses, like furniture, rarely have to anticipate and/or forecast the market they're in. The electronics industry changes daily, and the best way to figure the competition is to hire a marketing expert to do it for you every day.

5. *Failure to recognize product obsolescence.* When your big users start telling you what they want you to build, they don't want to pay you for creativity anymore. You can either become a low-overhead manufacturer, or you can replace your product with an up-to-date model.

The over-all blunder of many company managements is the failure to set priorities that will insure the company's success. Most R&D failures, for example, failed at the point of conception because the company didn't know whether to sell the product or use it for window dressing. Too often a company gambles on the success of one product. Others fail because they don't have the engineering capability to meet their future needs. Management often doesn't give its engineers guidelines that will take the company where it wants to get.

The new PDP-8/e: Its own mother wouldn't know it.



The PDP-8/e is a radical departure in computer design. There's no back panel wiring — everything plugs into the OMNIBUS,[™] even the CPU. In any order. It's completely flexible; you buy only what you need. And if you need more later, just buy it and plug it in. And the PDP-8/e is easier to interface and easier to maintain than old-style computers.

We've made a few other changes. Easier programming. 1.2 μ sec memory cycle time. 15 added instructions. 256 words of read-only memory. 256 words of read/write memory.

Yet there's no generation gap between the PDP-8/e and the rest of the PDP-8 family computers in 7500 world-wide installations. They all use the same peripherals (over 60 of them). They're all program and interface compatible, they all have extensive applications and documentation. PDP-8/e was born with a silver software package in its mouth.

The basic 4K machine sells for less than \$5000. With teletype, less than \$6500. Quantity discounts available.

digital
COMPUTERS • MODULES

Digital Equipment Corporation
Maynard, Mass. 01754 (617) 897-5111

Ideas For Design

Use a self-adjusting method for forward-biasing diodes

Forward biasing provides diodes with the necessary potential to function as linear rectifiers. This clearing potential varies with temperature and from diode to diode even within a fixed family type. The self-adjusting circuit presented has little temperature dependence and will work properly with a wide variety of silicon and germanium diodes.

A bridge-type circuit is used with a second diode, D_2 , to provide a current reference and a negative peak clamp (see diagram). The bridge circuit divides the dc bias into a current sufficient for full conduction of diode D_2 and a current slightly less than is necessary for full conduction of diode D_1 . A major difference between this circuit and conventional forward-bias methods is the relative independence of the value chosen for the bias source.

The only critical components are input capacitor C_1 , which should be kept as small as possible, and R_1 , which should be less than 10% of the load impedance.

A 2N3684 FET in a follower configuration was selected for output coupling because of its high input impedance and low noise, low drift and large voltage swing. Bias voltage is supplied by the drain resistor with the intention of providing a drift-correcting feedback loop. The dynamic range was found to exceed 86 dBV, when a scope

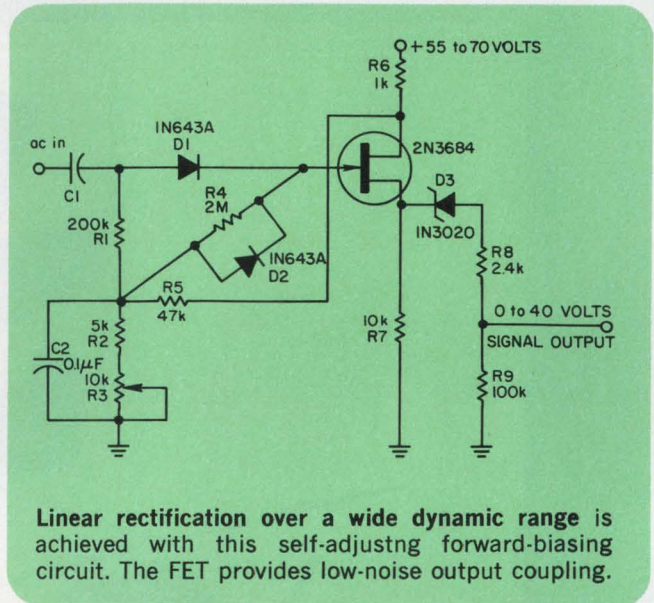

probe was connected at the source. The frequency response is good up to 2 MHz without peaking or neutralization.

Output low-pass can be provided by the use of a small gate-to-drain capacitor. For an input of 600 kHz, 470 μ F was used, but it is not indicated in the figure. This method of low-pass is recommended since it does not interact with the zener diode at the output.

Donald Savage, Naval Air Development Center, P.O. Box 397, Forrest Grove, Pa. 18922.

VOTE FOR 313

Improve amplifier efficiency with positive feedback

Power-transfer efficiency is limited to 50% if the conventional approach is followed to match source and load impedances in power-amplifier applications. But if both positive and negative feedback are used, the efficiency can be raised to 85%.

Normally, negative feedback is used to give the amplifier a very low output impedance. Then a series line impedance is added to obtain the desired match. With the approach described the load is presented with a matched source ($\pm 5\%$), even though the series matching resistance is only one-sixth of the value that would normally be used.

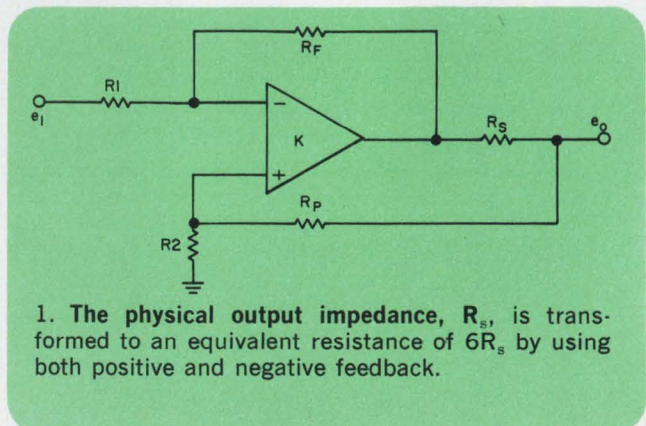

1. The physical output impedance, R_s , is transformed to an equivalent resistance of $6R_s$ by using both positive and negative feedback.

Helipot Trims Price & Profile



89PR100K

The new Helipot Series 89 industrial cermet trimmers feature:

Low Cost:

\$1.35 each in 1-9 quantities;
less than \$1.00
in quantities over 1,000.

Low Profile:

Maximum height of .250 inches
allows for closer p-c board stacking.

Series 89 trimmers with two different pin spacings
are available "off-the-shelf"
from 17 locations across the country.

Beckman®

INSTRUMENTS, INC.
HELIPOT DIVISION
FULLERTON, CALIFORNIA

INTERNATIONAL SUBSIDIARIES: AMSTERDAM; CAPE TOWN; GENEVA; GLENROTHES,
SCOTLAND; LONDON; MEXICO CITY; MUNICH; PARIS; STOCKHOLM; TOKYO; VIENNA.

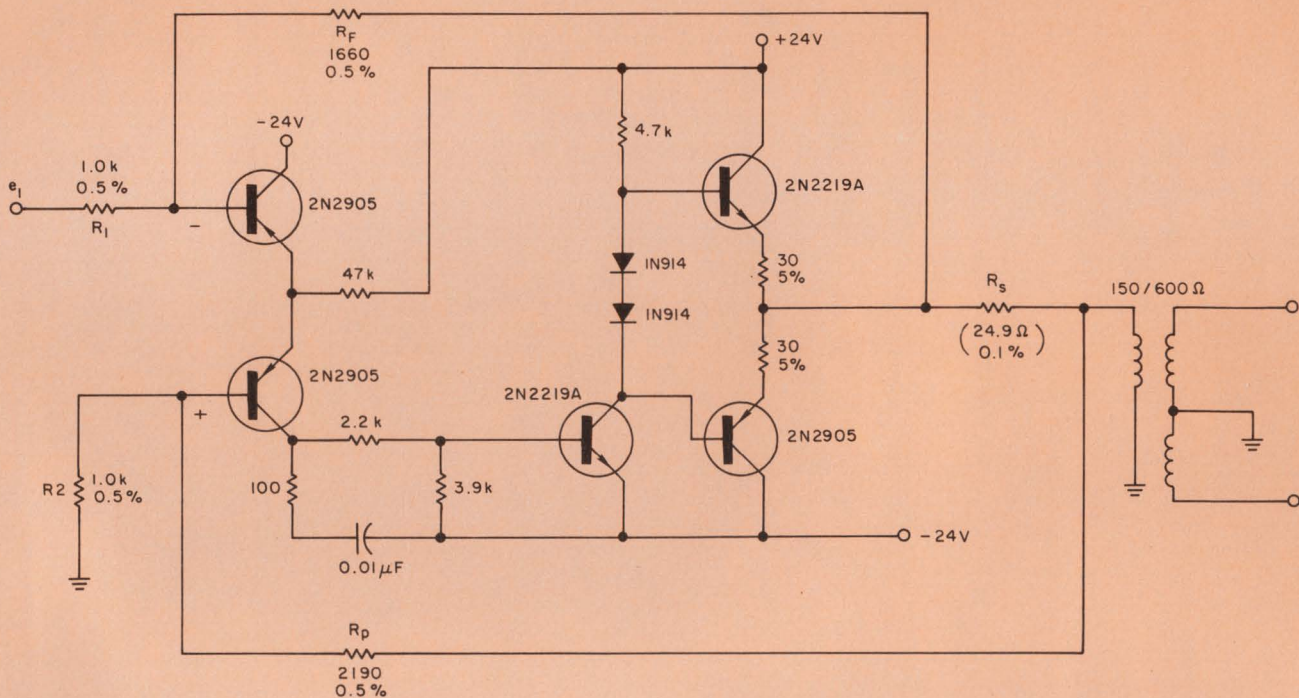

2. Adding positive feedback enables this circuit to deliver 0.5 W with a power efficiency of 85%,

much better than the 50% efficiency obtained with conventional techniques.

The circuit of Fig. 1 uses both positive and negative feedback to transform a physical R_s to an equivalent output resistance of $6R_s$. In this case, the ac power lost in the matching resistance R_s is only 17% of the power that is delivered to the load.

In terms of the design parameters

$$G = \frac{K}{1 + (\sigma - \beta)K} = \frac{1}{\sigma - \beta} \text{ if } (\sigma - \beta)K \gg 1,$$

$$R_o = \frac{(1 + \sigma K)R_s + R_1}{1 + K(\sigma - \beta)}$$

$$= \frac{R_s}{1 - \frac{\beta}{\sigma}} \text{ if } (\sigma - \beta)K \gg 1 \text{ and } R_1 \ll \sigma KR_s$$

where

- K = closed-loop gain
- G = open-loop no-load gain
- σ = negative-feedback factor = R_1/R_f

- R_1 = open-loop output resistance of amplifier
- R_s = matching resistance
- R_o = closed-loop output impedance
- β = positive-feedback factor

$$= \frac{R_1 + R_f}{(R_2 + R_p)R_f}$$

Once the closed-loop gain and output impedance are specified, it is easy to determine the requirements of the other components. Figure 2 is the circuit that will provide a voltage gain of 10 (20 dB) with an output impedance of 150 ohms.

The $\pm 5\%$ impedance match is obtained with resistances having the tolerances shown. These values are obtained by trimming. The closed-loop gain is flat within ± 0.5 dB from dc to 200 kHz.

Roland J. Turner and Richard W. Spencer, General Atronics Corp. 1200 E. Mermaid Lane, Philadelphia, Pa. 19118.

VOTE FOR 314

Use this pnpn latch to make a stable frequency divider

By using a pnpn latch as an equivalent programmable unijunction transistor, any engineer can easily make a stable frequency divider.

The trigger point of the latch (Q_3 and Q_4) is determined by the voltage division ratio of R_6 and R_7 plus V_{be} of Q_3 . In general, the pnpn trigger point is

$$E_{TR} = V_{beQ3} + (E_{bb}R_7)/(R_6 + R_7).$$

In this case the trigger point is 5.6 V.

The output time constant (frequency) is set

New TRW 40 W. UHF Lineup

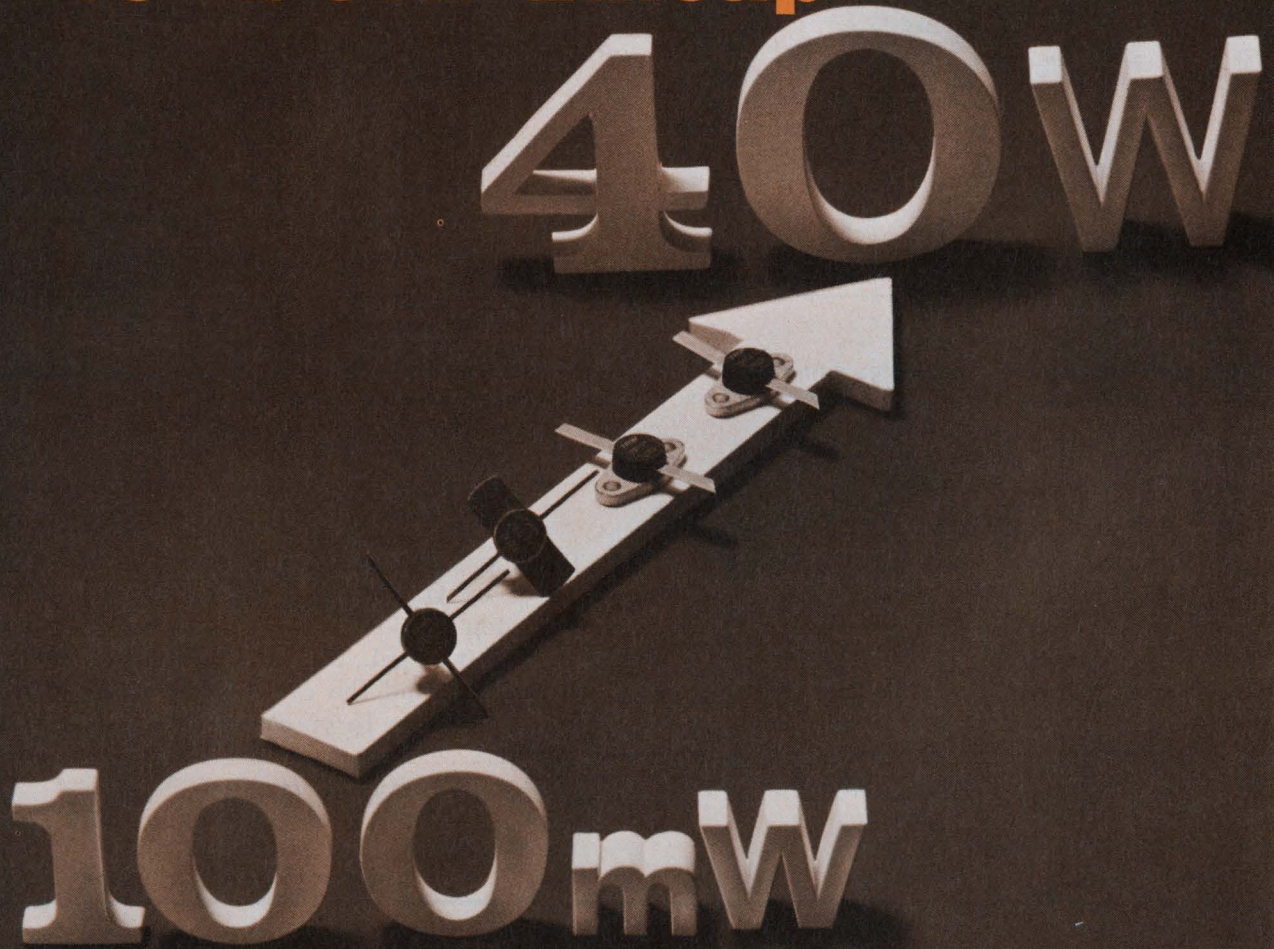

...optimized for bandwidth, ruggedness, and power gain

8-70

A new TRW series of four ruggedized UHF transistors makes 40 watts of output power available across the full 225-400 MHz band. The lineup can be varied to meet precise input and output requirements.

Ruggedized for performance under severe mismatch condi-

tions, these 24-28 volt "building blocks" provide high uniformity, reduce or eliminate variable circuit elements...and cost less. And the 1.5 W. 2N5773, 8 W. 2N5774, 20W. 2N5775, and 40W. 2N5776 are all available for immediate delivery from any TRW distributor.

For applications assistance, contact TRW Semiconductor Division, 14520 Aviation Blvd., Lawndale, Calif. Phone: (213) 679-4561. TWX: 910-325-6206.

TRW®

INFORMATION RETRIEVAL NUMBER 52

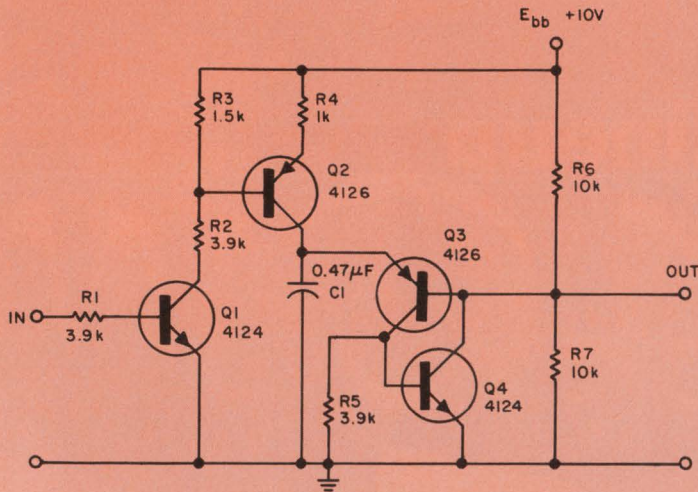

Capacitor C_1 is charged by stair-step current pulses until the pnpn triggers. The output frequency is

determined by the source Q_2 . A 15:1 frequency division can be obtained by this circuit.

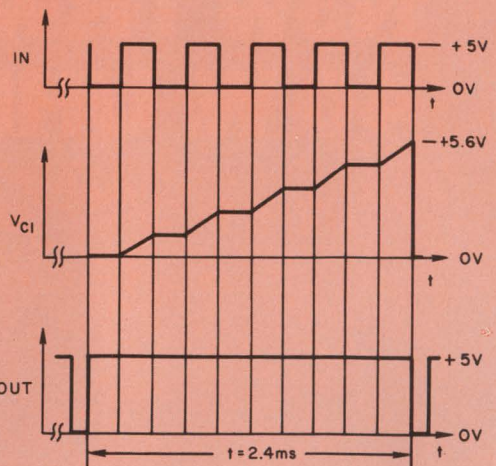

by the current output of constant current source Q_2 , capacitor C_1 and the pnpn's trigger point. It is given by

$$T = (C_1 E_{TR}) / (I_{Q2} D),$$

where D = duty cycle of input pulses. For square waves, $D = 0.5$.

Q_1 is an interface switch that supplies constant-voltage pulses to Q_2 at the input pulse rate.

These voltage pulses are converted to current pulses by Q_2 . The current pulses charge C_1 in stair-step fashion. When the trigger point of the pnpn is reached, the latch conducts and C_1 is discharged, and the cycle starts again. Division ratios of 10 or 15 or easily obtained with good stability.

Charles A. Herbst, Dumont, N. J.

VOTE FOR 315

Determine the series inductance of noninductive resistors

Precision wire-wound resistors often are required when circuit stability is a critical factor. In addition to resistance, the wire-wound units can possess series inductance and shunt capacitance.

If an attempt is made to measure the inductive effect on an impedance bridge, extremely high errors can result. This is primarily due to the small ratio of inductance to resistance. If a square-wave comparison test is used, the resolution is still poor enough to result in large errors.

Because of the difficulties of these two methods, a test was developed using inductive coupling with a reference coil. This method increased the accuracy of measurement by effectively eliminating the series resistance and, in addition, eliminating the effect of the shunt winding capacitance.

The inductive coupling method, as used to

check a 20- μ H inductance limit for a noninductive 1.925-K resistor, follows:

1. Make a 20- μ H air core reference coil by winding 60 turns of #28 insulated copper wire on a 1-M Ω 1/4-W composition resistor of approximately 1/8-inch diameter. Measure the exact value of the coil on an inductance bridge.

2. Make a 5-turn, close-wound, self-supported drive coil of #18 copper wire with an inside diameter of approximately 1/2 inch (large enough to fit over the resistor under test). Connect this coil to a low-voltage filament transformer secondary. Connect the primary through an autotransformer to a 115-V 400-Hz sine-wave supply.

3. Set the autotransformer to give a current of 5 A through the drive coil.

4. Place the 20- μ H reference coil inside the drive coil and connect it to a high-impedance ac

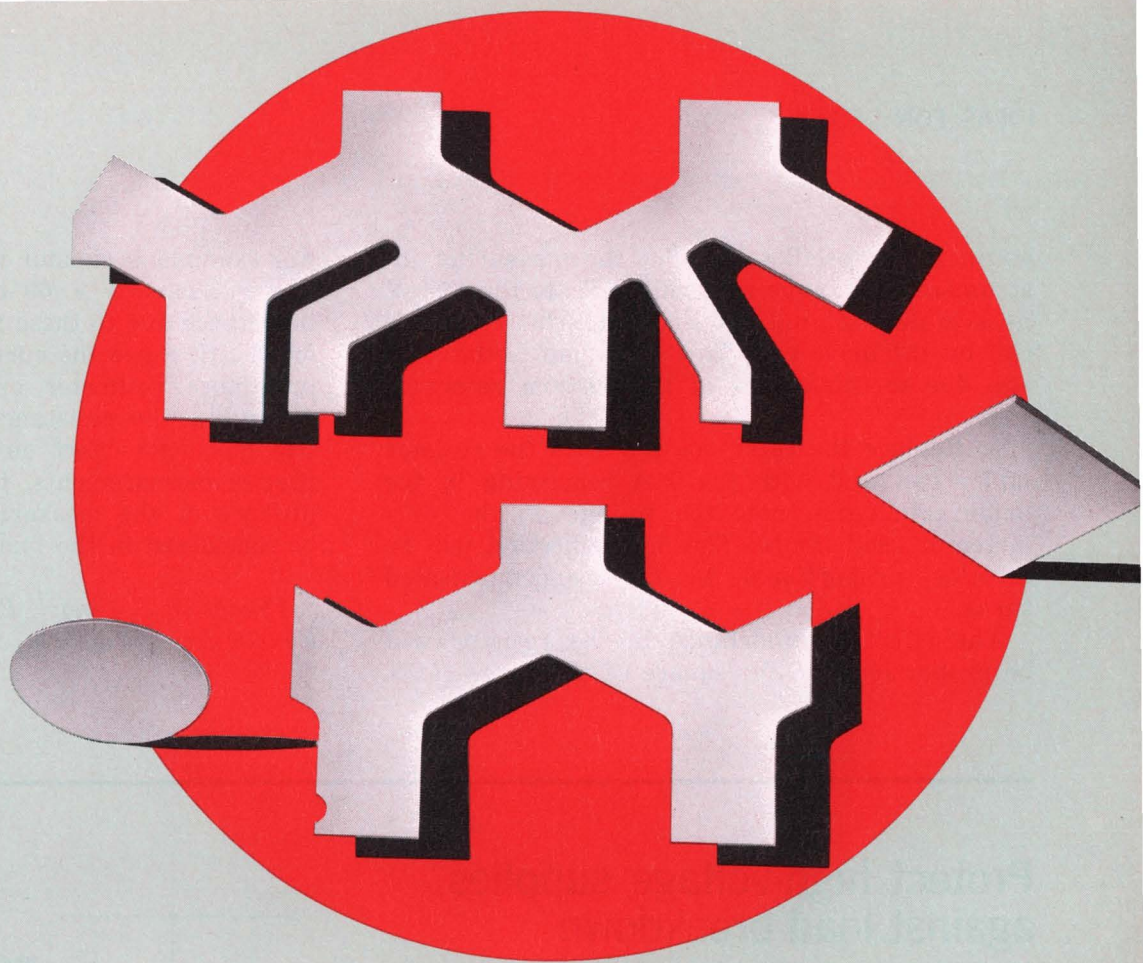

Al Si Base[®]

POLISHED SUBSTRATES

Better Surface, Better Control on Dielectric Constant

AlSiBase[®] substrates with ground, polished surfaces are available in sizes to 5" x 5" with surface quality which sets new standards. Smaller sizes such as 1" x 1" are available with ground surfaces of less than one microinch, intermediate sizes as low as 2 microinches or better, and larger substrates 10 microinches or better.

The substrates are ground for thickness and flatness control with a remarkably uniform surface. The basic ceramic is a specially processed AlSiMag[®] 772 which is a 99.5% alumina ceramic

composition with superior strength and electrical characteristics. When required, the dielectric constant variation may be maintained at a level of $\pm 1\%$ or less. Many of these substrates are being used in microwave technology.

This is the first time that volume deliveries of ceramics of this quality have been commercially available. Our technical staff with specialized experience will be glad to make suggestions if you will outline your requirements. Prototypes in many shapes can be supplied to your specification without tooling.

CODE IDENT. NO. 70371

PHONE 803/682-3215 • LAURENS, SOUTH CAROLINA 29360, U.S.A.
PHONE 615/265-3411 • CHATTANOOGA, TENNESSEE 37405, U.S.A.

American Lava Corporation **3M**
A SUBSIDIARY OF **COMPANY**

For service, contact American Lava representatives in Offices of Minnesota Mining and Manufacturing Company in these cities (see your local telephone directory): Boston: Needham Heights, Mass. • Chagrin Falls, O. • Chicago: Elmhurst, Ill. • Dallas, Tex. • Indianapolis, Ind. • Laurens, S. C. • Los Angeles, Calif. • Metropolitan New York: West Caldwell, N. J. • Up-State New York and Canada: Phoenix, N. Y. • Orange, Conn. • Philadelphia, Penn. • St. Louis: Lee's Summit, Mo. • Salem, Va. • S. San Francisco, Calif. • Tempe, Ariz. • International: c/o American Lava Corporation, Chattanooga, Tenn. 37405, U.S.A., TELEX 558432

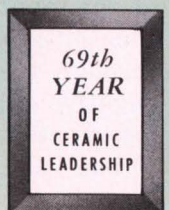

voltmeter or oscilloscope. Set the measuring instrument to a range that will indicate the 16-mV peak-to-peak signal induced into the reference coil by the drive coil. This deflection is the voltage due to inductance of the 60-turn reference coil.

5. Replace the reference coil with the resistor under test and with the 5 A remaining in the drive coil, again note the voltage on the voltmeter or oscilloscope. The new deflection will be directly proportional to the noncompensated turns.

The effective inductance in the resistor will be proportional to the square of the turns ratio.

For example, a resistor with a 32-mV pk-pk voltage will have 2×60 turns or 120 turns. The inductance due to these turns will be $4 \times 20 \mu\text{H}$ or $80 \mu\text{H}$. Since the current drawn by the high-impedance voltmeter or oscilloscope is almost negligible, the resistance of the resistor under test has little effect on the reading. For more precise measurements, the drop due to the impedance of the measuring instrument can also be considered in the final calculation.

Frederick J. Lingel, BLH Electronics, Inc., 42 Fourth Ave., Waltham, Mass. 02154.

VOTE FOR 316

Protect high-voltage supplies against load breakdown

A silicon-controlled rectifier (SCR) circuit that senses very small changes in high-voltage power-supply output currents can be used for circuit protection. Current changes of $2 \mu\text{A}$ can turn off the input voltage to the high-voltage power supply.

Sensitivity of the circuit depends on the value of R_8 (see diagram). When +28 V is applied to the input, capacitor C_1 charges through R_1 , applying a positive voltage to the base of Q_1 . Q_1 is turned on, the collector voltage is low and the SCR cannot fire.

During the time that Q_1 is held on by the RC time constant of R_1C_1 , the high-voltage supply will reach its maximum output. The current from the high-voltage supply, through R_7 and R_8 , will develop a positive voltage across R_8 that will hold Q_1 on. With R_8 set at 30 k Ω , an additional current of $2.5 \mu\text{A}$ will cause a drop across R_6 , which in turn will cause a proportional drop across R_8 . The voltage across R_8 will then be insufficient to hold Q_1 on, thus causing the collector voltage to rise. More of the current through Q_2 then flows through R_3 and R_4 , producing a voltage across R_4 sufficient to turn on the SCR, CR_3 .

With the SCR turned on, Q_2 is off as its base is held near ground. To reset the circuit, the +28 V on the input must be interrupted for a short time. Current-limiting diode, CR_1 , limits the current through the SCR to 3 mA. Diode CR_2 clips the negative spike caused by C_1 when the +28 V is interrupted.

The table shows the values of R_8 needed to shut

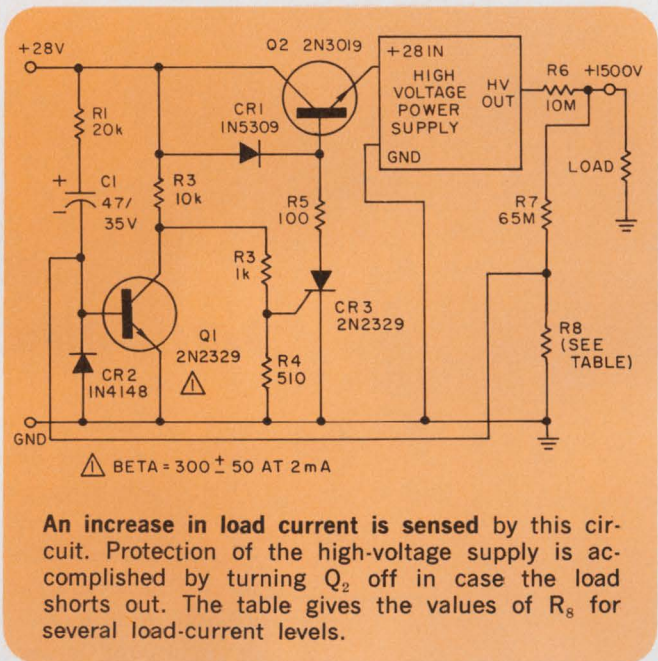

off the high-voltage power supply for various increases in output current.

LOAD CURRENT	R8
2.5 μA	30 k
20 μA	32 k
40 μA	40 k
60 μA	52 k
80 μA	62 k
100 μA	109 k

C. M. Cornell, Electronics Engineering Dept., University of California, Lawrence Radiation Lab., P.O. Box 808, Livermore, Calif. 94550.

VOTE FOR 317

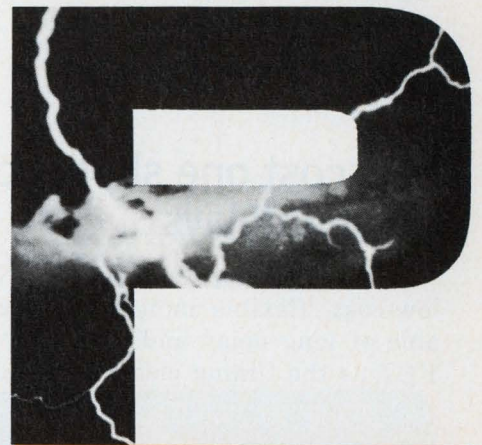
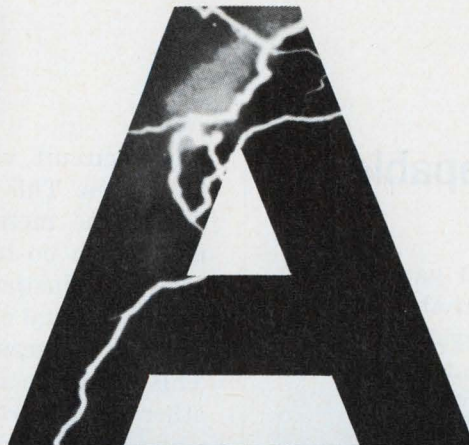
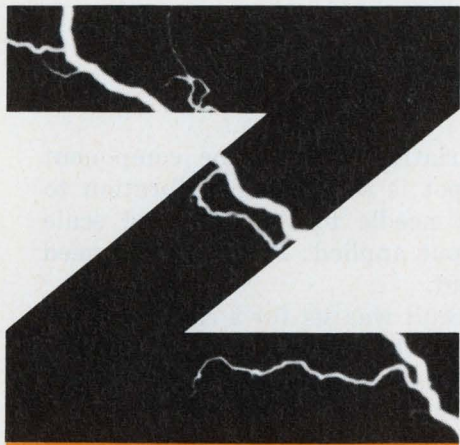

this



**protects
equipment
against
voltage
surges**

Electronic equipment is constantly running the risk of being "zapped" . . . by lightning, short circuits, switching of inductive components, etc. These ceramic gas filled arresters, from Signalite, offer maximum protection against voltage surges. They are low priced (under \$1.00) . . . reduce maintenance and down time . . . withstand shock and vibration. Some of the more vital statistics are listed, but for complete details, contact Signalite.

**Guaranteed 50
discharges . . .
200 typical**

**Fast response . . .
40 kv/nsec. wavefront**

**High temperature
capability with true
follow-on capability**

**Rugged ceramic
construction . . .
no glass**

Low cost...under \$1



**AVAILABLE UPON
REQUEST**

Detailed Data Sheet . . .
on Signalite Subminiature
Low Voltage Ceramic Gas
Filled Surge Arresters.



**The Broadest Line of Spark Gaps In
The World . . .** are described in the
Signalite "300" Spark Gap brochure . . .
including definition of terms,
characteristics of gap operation and
application information.

Signalite



**DIVISION OF
GENERAL INSTRUMENT**

1933 HECK AVE., NEPTUNE, N.J. 07753
(201) 775-2490

Low-cost one shot is capable of long delays

Two transistors and one NAND gate make a low-cost, flexible monostable multivibrator capable of long delay and high duty cycle. With the FET as the timing element (see diagram), R can

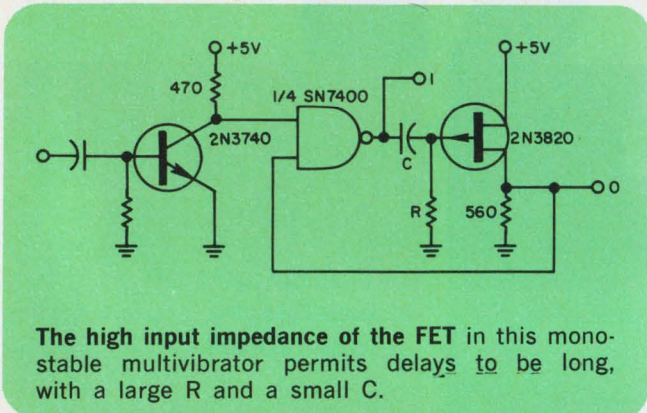

The high input impedance of the FET in this monostable multivibrator permits delays to be long, with a large R and a small C.

be quite large (over 10 MΩ), and long delays are possible with low values of C. Delay time is approximately 0.6 RC, but this varies with the saturation resistance of the FET.

A positive step or pulse triggers the delay, with the input time constants set for reliable triggering. The circuit is capable of approximately 98% duty cycle, at rates up to 100 kHz. The input transistor can be omitted if a narrow (less than 60% of the delay) negative pulse is available for triggering.

Ralph Tenny, P.O. Box 545, Richardson, Tex. 75080.

VOTE FOR 318

Two FETs make a sensitive suppressed-zero voltmeter

High input impedance and zero suppression are achieved in a differential dc voltmeter by connecting two FETs back to back. The low end of the meter range is adjusted by variable resistor R₁ in the return supply lead, which creates a bias to set the lower mark on the scale. The high end of the desired scale is set by the 50 kΩ pot, R₂ connected in series with the meter.

A push-to-read switch is included in the circuit because, with no input, or with voltages above or below the desired range, the meter needle will peg either up or down scale.

A meter-zero pot is included to correct for

minor circuit variations due to the component tolerances. This pot is set during calibration to adjust the meter needle to the left-hand scale mark with no input applied; it should not need further adjustment.

The original circuit was set for a range of 1:35 to 1.6 V to measure the voltage of mercury cells. This circuit can also be used for a meter for other voltage ranges. The unit is calibrated by using a DVM to set the high and low points.

J. Agnew, Vicon Instrument Co., Colorado Springs, Colo. 80901.

VOTE FOR 319

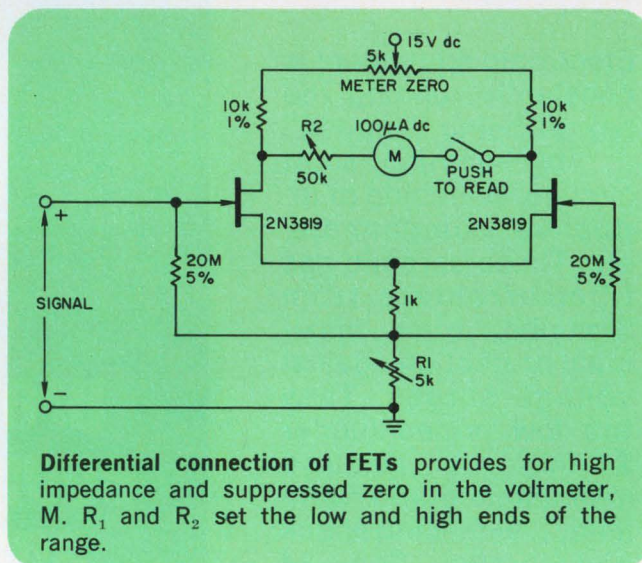

Differential connection of FETs provides for high impedance and suppressed zero in the voltmeter. M, R₁ and R₂ set the low and high ends of the range.

VOTE! Go through all Idea-for-Design entries, select the best, and circle the appropriate number on the Reader-Service-Card.

SEND US YOUR IDEAS FOR DESIGN. You may win a grand total of \$1050 (cash)! Here's how. Submit your IFD describing a new or important circuit or design technique, the clever use of a new component or test equipment, packaging tips, cost-saving ideas to our Ideas-for-Design editor. You will receive \$20 for each accepted idea, \$30 more if it is voted best-of-issue by our readers. The best-of-issue winners become eligible for the Idea Of the Year award of \$1000.

IFD Winner for June 7, 1970

Anthony C. Caggiano, Design Engineer, RR # 1, Box 35 L, Ridge, New York. His idea "Schmitt Trigger Program Uses Standard Resistor Values" has been voted the Most Valuable of Issue Award.

Vote for the Best Idea in this Issue



DUAL FETS for DIFF AMPS from Siliconix

Does your diff amp design call for low noise, low distortion, high input Z and wide dynamic range? (1.) Try this long tailed pair arrangement, (2.) use a Siliconix dual and (3.) get the performance below:

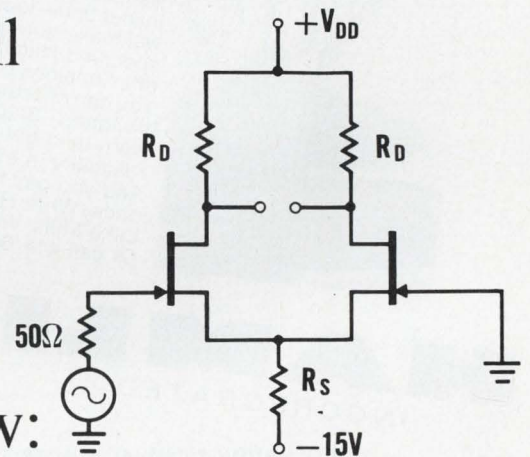

DEVICE TYPE	+V _{DD} (V)	R _D (KΩ)	R _S (KΩ)	VOLTAGE GAIN (dB)	BANDWIDTH 3 dB (MHz)	DIFF V _O (V _{p-p})	
						1% THD	2% THD
2N5519	30	60	39	26	0.25	10	13
U235	30	39	20	30	0.6	10	16
U257	20	5.6	3.6	25	6.0	4.5	5.5

Other applications include Phase splitters Push-pull drivers Unbalanced-to-balanced transformation Etc. For complete data and applications assistance, write or call any of the offices below.

New York: Sy Levine (516) 796-4680
New England: Al La Croix (617) 769-3780
Ft. Worth/Dallas: Charlie Williams (214) 231-8151
St. Louis: Jim Spicer (314) 291-3616
Minneapolis: Ed Koelfgen (612) 920-4483
Southern California: Dave Ferran (213) 420-1307
Northern California: Chuck Brush (408) 246-8000



Siliconix incorporated

2201 Laurelwood Road • Santa Clara • California 95054
 Telephone (408) 246-8000 Extension 201 • TWX: 910-338-0227
 In Europe: Siliconix Limited, Saunders Way, Sketty, Swansea, Great Britain

INFORMATION RETRIEVAL NUMBER 55

YOU PAY FOR HAMLIN RELIABILITY.

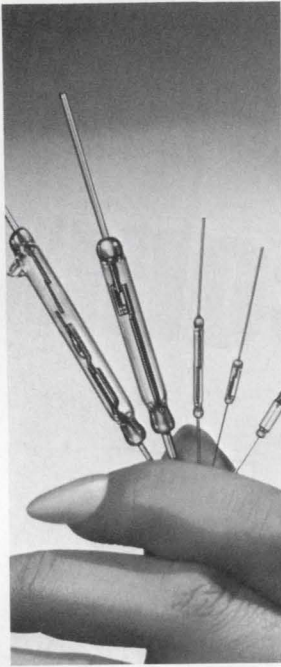

JUST ONCE.

Hamlin reed switches cost a few pennies more. But it pays off. A reed switch failure can cost hundreds of times the price of the switch. Hamlin reduces the chance of failure to almost zero with rhodium contacts, assembly in white rooms, the industry's most effective hermetic seal, 100% electrical inspection—features that will make you glad you specified Hamlin even after millions of closures. You can choose from 2,000 switches—3/10 to 660 watt—and get Hamlin reliability in every one. And you pay for it only once. Write Hamlin, Inc., Lake Mills, Wis. 53551. Or call 414/648-2361.

HAMLIN
INCORPORATED

INFORMATION RETRIEVAL NUMBER 161

7804

REED SWITCH SPEEDS WITH NO CONTACT BOUNCE.



Hamlin's miniature, mercury-wetted switches offer all the advantages of high-speed, reed switches with the low contact resistance and high-power capacities of mercury switches. Precise, "on-off" actuation makes mercury-wetted switches ideal for applications where contact bounce cannot be tolerated. Available in form A (100 VDC) and form C (28 VDC). Useable length as low as .835". Write for catalog. Hamlin, Inc., Lake Mills, Wis. 53551. Or call 414/648-2361.

¾ actual size.

HAMLIN
INCORPORATED

INFORMATION RETRIEVAL NUMBER 162

20 MILLIWATTS CONTROLS UP TO 25 AMPS WITH THE SOLID-STATE

CONTROL-PAK™

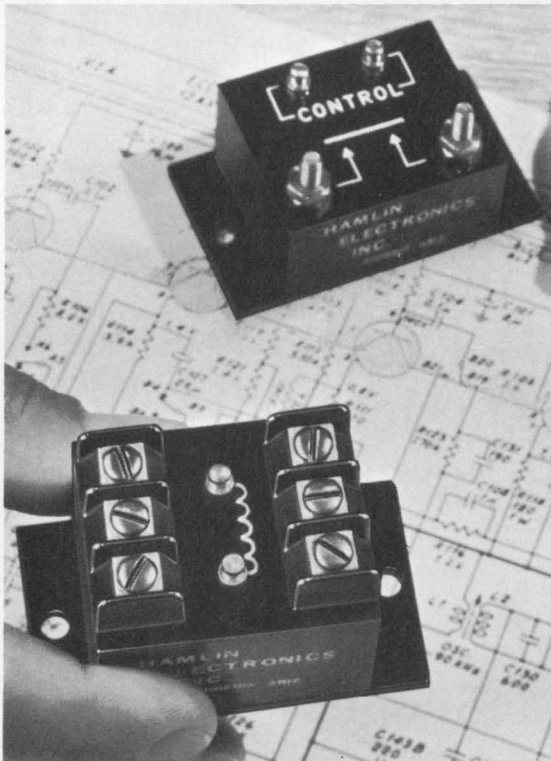

Control-Pak operates on I.C. logic without amplification. Handles as much as 25 amps with arcless, bounceless switching. And it's fast—operates in a millisecond, releases within ½ cycle. No noise—electrical or acoustical. Zero switchline for minimum RFI and EMI. Control-Pak controls inductive, capacitive, high-inrush and resistive loads. And it's completely encapsulated. Fumes, dirt and moisture that can ruin ordinary relays can't hurt Control-Pak. It's tough, too—resists shock and vibration—has no moving parts to wear or require replacement. So Control-Pak units keep right on functioning for millions of operations without maintenance. For more information, write Hamlin Electronics, Inc., 3066 West Clarendon, Phoenix, Arizona 85017. Or call, 602/277-4834.

HAMLIN
ELECTRONICS, INC.

INFORMATION RETRIEVAL NUMBER 163

ELECTRONIC DESIGN 21, October

7803

Product Source Directory

Low-Power Microwave Tube Oscillators

The low-power microwave tube oscillators in this Product Source Directory are divided into four groups—klystrons, planar triodes, magnetrons and backward-wave oscillators. The tubes are arranged in ascending order by upper frequency limit and then alphabetized by manufacturer. All tubes listed in this directory are

continuous-wave devices with a maximum output power of approximately one watt.

Manufacturers are identified by the abbreviations shown in the Master Cross Index below. The following abbreviations are used in the tables: ina—information not available; n/a—not applicable; req—price on request; typ—typical.

Abbrev.	Company	Information Retrieval No.
Beam Tube	Beam Tube Corp. 11 Beach St. Milford Mass. 01757 (617) 473-0660	450
EEV/CEI	English Electric Valve Co., Ltd. Calvert Electronics Inc. 220 E. 23rd St. New York, N.Y. 10010 (212) 679-1340	451
GE	General Electric Co. Electric Components Div. Tube Dept. Microwave Tube Operation 1 River Rd. Schnectady, N.Y. 12305 (518) FR 4-2211	452
Gencom	Gencom Div. Vanan/EMI 80 Express St. Plainview, N.Y. 11803 (516) 433-5900	453
ITT	ITT Electron Tube Box 100 Easton, Pa. 18042 (215) 252-7331	454
Klystronics	Klystronics, Inc. Mid-Monmouth Industrial Park Box 534 Eatontown, N.J. 07724 (201) 542-6800	455
MCL	Microwave Cavity Laboratories, Inc. 10 N. Beach Ave. La Grange, Ill. 60525 (312) 354-4350	456
Metcom	Metcom, Inc. 76 Lafayette St. Salem, Mass. 01970 (617) 744-8400	457
MET/IEC	Mullard Electron Tubes International Electronics Corp. 316 S. Service Rd. Huntington Station, N.Y. 11746 (516) 694-7700	458
Mictron	Mictron Inc. Div. of KMS Industries, Inc. Sarasota, Fla. 33578 (813) 955-4259	459

Abbrev.	Company	Information Retrieval No.
Nippon	Nippon Electric New York Inc. 200 Park Ave. New York, N.Y. 10017 (212) 661-3420	460
OKI	OKI Electronics of America, Inc. 500/506 S.E. 24th St. Ft. Lauderdale, Fla. 33316 (305) 523-7202	461
Raytheon	Raytheon Co. Microwave & Power Tube Div. Microwave Tube Operation 190 Willow St. Waltham, Mass. 02154 (617) 899-8400	462
RCA	RCA Commercial Engr. 415 S. 5th St. Harrison, N.J. 07029 (201) MU 5-3900	463
Siemens	Siemens Corp. 186 Wood Ave. S. Iselin, N.J. 08830 (201) 494-1000	464
Sperry	Sperry Rand Corp. Electron Tube Div. Gainesville, Fla. 32601 (904) 372-0411	465
Thomson	Thomson-CSF Electron Tubes, Inc. 50 Rockefeller Plaza New York, N.Y. 10020 (212) 245-3900	466
Tripp	Tripp Research Corp. 841 Warrington Ave. Redwood City, Calif. 94063 (415) 365-2828	467
Varian	Varian Assoc. Electron Tube & Device Group 611 Hansen Way Palo Alto, Calif. 94303 (415) 326-4000	468
WJ	Watkins-Johnson Co. Stewart Div. 3333 Hillview Ave. Palo Alto, Calif. 94304 (415) 326-8830	469

Mfr	Model	Operating Frequency Range (GHz)	Electronic Tuning Range (MHz)	Output Power Min-Max (mW)	FM Modulation Sensitivity (MHz/V)	Notes	Price (\$)	Mfr	Model	Operating Frequency Range (GHz)	Electronic Tuning Range (MHz)	Output Power Min-Max (mW)	FM Modulation Sensitivity (MHz/V)	Notes	Price (\$)
Raytheon	RK5981	1.245-1.460	n/a	70 typ	ina	absw	req	Nippon	8V69	7.350-7.850	45	80 min	1.6	ab	123
Thomson	KRA1080	1.7-2.0	ina	170 min	ina	ac	req	Nippon	8V69(LD)	7.350-7.850	45	80 min	1.6	abe	123
Thomson	KRA1081	1.7-2.7	6.5 min	35 min	ina	ac	req	Nippon	8V217	7.550-7.850	40	20 min	1.5	ab	179
Raytheon	726C	2.7-2.96	n/a	140 typ	ina	absw	req	Varian	VA-225B, 225C	7.0-8.0	20 min	20 min	0.1 min	a	req
Klystronics	ZV1011A	0.500-3.0	ina	50 min	ina	ac	req	Sperry	SRX-4951	8.0	n/a	8 min	ina	abdkz	req
Thomson	6BM6	0.55-3.0	ina	50 min	ina	ac	req	Sperry	SRX-4952	8.0	n/a	40 min	ina	abdkz	req
Thomson	5837	0.55-3.0	ina	50 min	ina	ac	req	Gencom	R9701	5.0-8.2	6	25 typ	ina	ac	req
Klystronics	ZV1010	0.700-3.0	ina	28 min	ina	ac	req	Nippon	8V77	7.650-8.200	45	30 min	1.1	ab	123
EEV/CEI	K3067	2.95-3.225	20	40 typ	ina	ac	req	Varian	VA-244E	7.7-8.4	30	700 min	0.15	a	req
Sperry	2K-41	2.76-3.41	10 min	50 min	ina	ab	req	Klystronics	TK753	7.75-8.4	35	60 min	ina	a	req
EEV/CEI	K3033	2.65-3.7	30	100 typ	ina		111	Raytheon	QKK753	7.75-8.4	25	150 typ	0.5		req
Nippon	2K54C	3.650-3.900	ina	400 min	ina	ab	req	Varian	VA-264	7.1-8.5	15	80 min	0.3	a	req
Raytheon	2K29	3.4-3.96	n/a	110 typ	ina	absw	req	Varian	VA-225	7.5-8.5	25	700 min	0.2	a	req
Thomson	2K28	1.8-4.0	20 min	80 min	ina	ac	req		(series)						
Sperry	2K-42	3.3-4.2	10 min	250 min	ina	ab	req	Varian	VA-244F	7.75-8.5	30	700 min	0.15	a	req
Nippon	2K54A	4.050-4.300	ina	400 min	ina	ab	req	Sperry	SRX-4953	8.5	n/a	8 min	ina	abdkz	req
Nippon	2K54DA	4.250-4.350	35	30 min	1.2	ab	req	Sperry	SRX-4954	8.5	n/a	40 min	ina	abdkz	req
Nippon	4V27	3.600-4.350	10	80 min	ina	c	140	Varian	VA-272A	8.5-8.7	30	500 min	0.5 min	a	req
Raytheon	2K56	3.84-4.46	n/a	100 typ	ina	absw	req	EEV/CEI	K359	8.1-8.75	55	90 typ	2.0	def	req
Gencom	CV2116	1.8-4.5	42	23 typ	ina	ac	req	Sperry	SRX-4955	8.78	65 min	500 min	ina	abkh	req
								Varian	VC-722D	8.78	65	500 min	0.5	ak	req
Raytheon	2K22	4.24-4.95	n/a	115 typ	ina	absw	req	EEV/CEI	K3079	8.05-8.8	35	90 typ	ina	def	req
Raytheon	QKK1313	4.3-5.0	25	30 min	0.5	ac	req	Sperry	SRX-4591	8.8	50 min	750 min	ina	abkh	req
Gencom	CV6071	1.0-5.4	45	35 typ	ina	ac	req	Sperry	SRX-4592	8.8	65 min	500 min	ina	abkh	req
Gencom	R9559	1.0-5.4	45	35 typ	ina	ac	req	Sperry	SRX-4597	8.8	50 min	450 min	ina	abkh	req
Varian	VA-221H	5.36-5.56	25	20 min	0.6	a	req	Varian	BL-829	8.8	45	450 min	0.66 min	a	req
Sperry	2K-43	4.05-5.85	15 min	250 min	ina	ab	req	Varian	BLK-029	8.8	23	700 min	0.66	a	req
Klystronics	TK69/6584	4.1-5.9	35	70 min	ina	ac	req	Varian	VC-721A	8.8	40	500 min	0.5	a	req
Raytheon	QKK412	5.1-5.9	n/a	90 typ	ina	absw	req	Varian	VC-722A	8.8	65	500 min	0.5	ak	req
Raytheon	RK6115A	5.1-5.9	n/a	100 typ	ina	absw	req	Varian	VC-722E	8.8	65	500 min	0.5	a	req
Klystronics	TK80/6584	5.4-5.9	35	85 min	ina	ac	req	Sperry	SRX-4596	8.82	65 min	500 min	ina	abkh	req
Klystronics	TK108/6584	5.4-5.9	35	150 min	ina	ac	req	Varian	VC-722C	8.82	65	500 min	0.5	ak	req
Varian	VA-118A	5.4-5.9	28	100 min	ina	a	req	EEV/CEI	K391A	8.8-8.885	40	90 typ	1.0	ef	200
Varian	VA-119A	5.4-5.9	30	35 min	ina	a	req	MET/IEC	YK1042	8.1-8.9	40	60 typ	ina	a	req
Klystronics	ZV-1009/7049	1.5-6.0	ina	50 min	ina	a	req	EEV/CEI	K342	8.5-9.0	35	70 typ	0.75	f	req
Nippon	6V211	5.985-6.285	45	25 min	1.5	ab	179	Sperry	SRX-4594	9.1	50 min	400 min	ina	abkh	req
Nippon	6V23	6.225-6.325	50	300 min	1.0	ab	224	Varian	BL-815A	9.147	20	20 min	3	a	req
Nippon	6V200	6.225-6.325	50	100 min	0.8	ab	230	Metcom	MXK-61	9.75-9.15	±10	500 min	ina	an	325
Raytheon	QKK549	5.925-6.425	25	150 typ	0.5	ac	req	Sperry	SRX-4772	9.25	n/a	10 min	ina	abdkz	req
Varian	VRJ-7203A	5.925-6.425	30	100 min	0.9	a	req	EEV/CEI	K3020A	8.74-9.26	40	45 typ	ina	req	
Thomson	6BL6	1.6-6.5	ina	25 min	ina	ac	req	Sperry	SRX-4771	9.28	n/a	10 min	ina	abdkz	req
Nippon	6V26AMR	6.100-6.500	55	100 min	1.6	ab	157	Varian	VA-272B, C, D	8.7-9.3	30	500 min	0.5 min	a	req
Nippon	6V26AR	6.100-6.500	35	100 min	1.2	ab	95	EEV/CEI	K391	9.16-9.34	30	40 typ	ina	e	185
Varian	VA-113	5.925-6.575	15	50 min	ina	a	req	EEV/CEI	K3007	9.295-9.395	32	40 typ	0.7	e	200
Nippon	6V212	6.285-6.585	40	25 min	1.5	ab	157	MET/IEC	YK1041	8.6-9.4	40	60 typ	ina	u	req
Varian	X-26E/6460	5.3-6.6	28	700 min	ina	a	req	Thomson	TV2223	9.21-9.48	17 min	60 min	1 min	ab	req
Varian	VA-244A	5.8-6.6	30	700 min	0.15	a	req	EEV/CEI	K311	8.5-9.5	30	45 typ	ina	req	
Sperry	2K-44	4.89-6.69	15 min	250 min	ina	ab	req	MET/IEC	YK1040	9.1-9.5	35	55 typ	ina	u	req
Nippon	7V213	6.505-6.705	40	25 min	1.5	ab	157	MET/IEC	K59-40	9.3-9.5	30	40 typ	ina	t	req
Raytheon	QKK531	6.575-6.875	25	150 typ	0.5	ab	157	EEV/CEI	K300	9.32-9.5	30	30 typ	ina	g	157
Nippon	7V214	6.705-7.005	40	25 min	1.5	ab	157	EEV/CEI	K302	9.32-9.5	30	30 typ	ina	g	157
Nippon	2K26	6.250-7.060	50	80 min	1.6	ab	req	Sperry	SRX-4955	9.5	n/a	8 min	ina	abdkz	req
Nippon	2K26(LD)	6.250-7.060	50	80 min	1.6	abe	req	MET/IEC	K59-20	8.702-9.548	40	25 typ	ina	s	req
Raytheon	QKK532	6.875-7.125	25	150 typ	0.5	a	req	Nippon	VA-203H	9.250-9.550	50	12 min	ina	ab	381
Varian	VA-114	6.575-7.175	15	50 min	ina	a	req	Thomson	TV203H	9.25-9.55	70 min	40 min	1 min	ab	req
Nippon	7V215	6.955-7.255	40	25 min	1.5	ab	157	EEV/CEI	K3003	9.35-9.55	40	55 typ	2.25	e	98
Varian	VA-244B	6.5-7.3	18 min	25 min	0.250 min	a	req	EEV/CEI	K3020	9.35-9.55	40	45 typ	2.25	e	110
Raytheon	RK5976	6.2-7.425	n/a	125 typ	ina	absw	req	EEV/CEI	K3077	9.35-9.55	45	50 typ	ina	f	req
Raytheon	RK5976	6.2-7.425	25	150 typ	0.5	ac	req	Nippon	9V54	8.200-9.600	40	250 min	ina	ab	392
Nippon	5976	6.250-7.425	55	80 min	1.6	ab	req	EEV/CEI	K3078/6975	8.5-9.6	37	35 typ	1.1	f	req
Nippon	5976(LD)	6.250-7.425	55	80 min	1.6	abe	req	Klystronics	2K25	8.5-9.6	35	20 min	ina	req	
MET/IEC	KS7-85	6.5-7.5	38	100 typ	ina	s	req	Klystronics	TK62/6116	8.5-9.6	45	20 min	ina	req	
Sperry	SRX-4950	7.5	n/a	8 min	ina	abdkz	req	Klystronics	TK76/6940	8.5-9.6	45	20 min	ina	req	
Nippon	LD-588	7.050-7.550	50	80 min	1.6	ab	62	Klystronics	TK106/8460	8.5-9.6	35	20 min	ina	req	
Nippon	7V216	7.255-7.555	40	25 min	1.5	ab	157	Klystronics	TK115/6116	8.5-9.6	45	20 min	ina	req	
Beam Tube	6236	3.8-7.6	ina	125 min	ina	ac	req	Klystronics	TK126/7787	8.5-9.6	35	20 min	ina	req	
Raytheon	QKK623	7.125-7.65	25	150 typ	0.5	ac	req	MET/IEC	K59-30	8.5-9.6	57.5	43 typ	ina	t	req
Varian	VA-115	7.175-7.725	15	50 min	ina	a	req								
Raytheon	QKK752	7.125-7.75	25	150 typ	0.5	ac	req								
Gencom	R9687	6.8-7.8	16	70 typ	ina	ac	req								
Varian	VA-244C	7.1-7.8	18 min	20 min	0.150 min	a	req								

Make Waves...

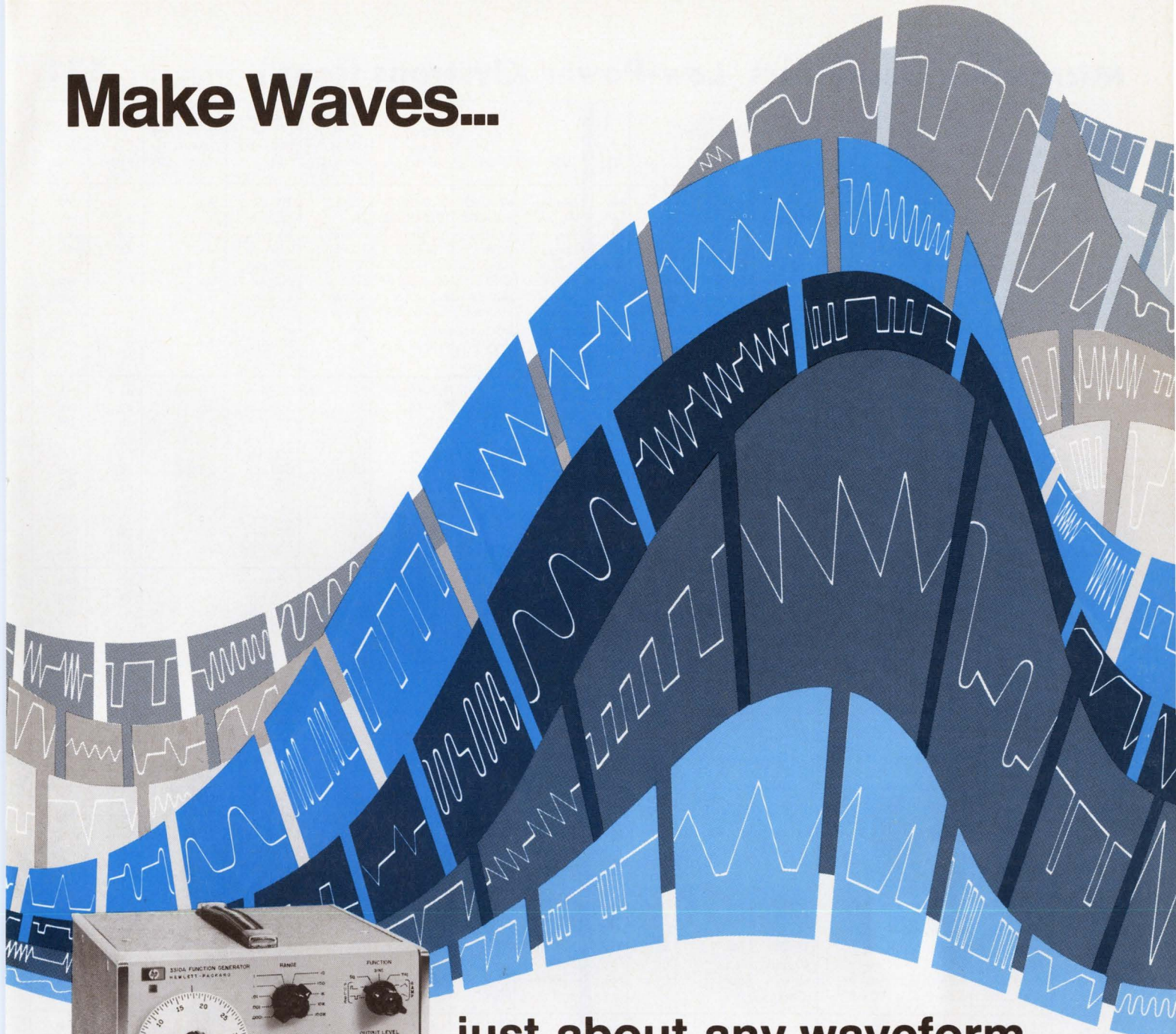

just about any waveform you can imagine

HP's 3310A is the function generator that gives you seven different waveforms—in three different modes—in one inexpensive package.

In its basic form, the 3310A gives you a continuous output of square waves, sine waves, and triangle waves — plus positive and negative ramps and pulses—for only \$595.

By adding HP's new Option H10 (only \$140), you can generate each of these seven waveforms in two other modes—single-cycle and multiple cycle "bursts." These "bursts" can be triggered either manually or

by an external oscillator; starting-point phase can be varied by $\pm 90^\circ$.

With or without Option H10, the 3310 gives you a choice of ten frequency ranges—from 0.0005 Hz to 5 MHz—and an output voltage range from 15 mV pk-pk to 15 V pk-pk into 50 Ω load. Dc offset of ± 5 V into 50 Ω load is also standard.

With Option H10, the 3310A can be used in frequency-response and transient-response testing, as a waveform converter, for generating phase-coherent waveforms, and as a frequency multiplier or divider,

among other things. Applications include testing television and communications systems, radar systems, and analog or digital circuits.

For further information on the 3310A and Option H10, contact your local HP field engineer, or write to Hewlett-Packard, Palo Alto, California 94304. In Europe: 1217 Meyrin-Geneva, Switzerland.

090/41

HEWLETT  PACKARD
SIGNAL SOURCES

Microwave Oscillators, Low-Power Klystrons (cont.)

131

Mfr	Model	Operating Frequency Range (GHz)	Electronic Tuning Range (MHz)	Output Power Min-Max (mW)	FM Modulation Sensitivity (MHz/V)	Notes	Price (\$)	Mfr	Model	Operating Frequency Range (GHz)	Electronic Tuning Range (MHz)	Output Power Min-Max (mW)	FM Modulation Sensitivity (MHz/V)	Notes	Price (\$)
MET/IEC Metcom	K59-40B 6975/ MXK-21	8.5-9.6 8.5-9.6	40 ±10	35 typ 20-30	ina ina	t ac	req 145	Metcom Varian Thomson	MXK-22 BLK-008 TV210C	10.0-10.25 10.0-10.25 10.03-10.28	±15 20 20 min	100 min 150 min 20 min	ina 1 1 min	a a ab	145 req req
Nippon Sperry Sperry Thomson Thomson Thomson Thomson Varian	VA-203B SRX-4244 SRX-4245 6975 TV217C TV217CH TV2217H VA-201B	8.500-9.600 8.5-9.6 8.5-9.6 8.5-9.6 8.5-9.6 8.5-9.6 8.5-9.6 8.5-9.6	45 50 min 50 min 30 min 40 min 40 min 40 min 20	20 min 150 min 150 min 20 min 20 min 30 min 20 min 40 min	1.5 ina ina 1 min 1.5 min 1.5 min 1.5 min 0.5	ab ab(1) ab(1) ab ab ab ab a	403 req req req req req req req	Sperry Varian EEV/CEI Sperry Varian Varian Varian	2K39 VA-272J K3073 SRX-92 BLK-001 BLK-011 V-290/ 6314	7.5-10.3 10.1-10.3 10.1-10.4 8.5-10.5 8.5-10.5 8.5-10.5 8.5-10.5	15 min 30 40 30 min 30 30 30	250 min 500 min 60 typ 20 min 25 min 20 min 50 min	ina 0.5 min ina ina 1 1 2.0	a a f ab a a a	req req req req req req req
Varian	VA-203B/ 6975	8.5-9.6	30	20 min	1.0	a	req	Varian	BLK-005	9.0-10.5	30	500 min	2	a	req
Varian	VA-203J	8.5-9.6	30	20 min	1.0	a	req	Varian	VC-708	9.0-10.5	50	500 min	ina	a	req
Varian	VA-217C	8.5-9.6	40	20 min	1.5	a	req	Nippon	11V18	10.518- 10.532	25	55 min	0.7	ab	168
Varian	VA-217H	8.5-9.6	25	500 min	0.2	a	req	EEV/CEI	K3069	10.525	ina	100 typ	ina	f	125
Varian	VA-265	8.5-9.6	40	600 min	ina	a	req	Thomson	TV2218	10.525	40 min	500 min	0.5 min	ab	req
EEV/CEI	K351	8.5-9.655	35 min	30 min	1.3 min	de	700	Varian	VA-218, 218B	10.525	ina	55 min	ina	ak	req
MET/IEC	K59-20A	8.5-9.66	40	35 typ	ina	s	req								
Nippon	2K25	8.500-9.660	50	20 min	ina	ab	req	EEV/CEI	K3074	10.50-10.55	20	25 typ	ina		req
Raytheon	2K25	8.5-9.66	n/a	40 typ	ina	absw	req	Varian	VA-523	9.5-10.6	ina	200 min	(3)		req
Thomson	6116(a)	8.5-9.66	45 min	20 min	ina	ab	req	Varian	VA-524	9.5-10.6	ina	200 min	ina	d (3)	req
EEV/CEI	K335	9.555-9.685	30	25 typ	ina	g	req	MET/IEC	YK1044	10.1-10.6	40	60 typ	ina	u	req
Varian	VA-272E,F	9.3-9.7	30	500 min	0.5 min	a	req	Varian	VA-288A	10.6	ina	150 min	ina	ak	req
Sperry	SOX-2397	9.7	n/a	500 min	ina	dkz (3)	req	Varian	VC-703A	10.6	30	150 min	ina	a	req
Varian	V-55D	9.79	40	450 min	0.5	a	req	Sperry	SRX-4550	10.575- 10.625	50 min	150 min	ina	abh	req
Varian	BLK-019	8.5-9.8	ina	90 min	1	a	req								
Varian	X-13C	7.0-10.0	25	50 min	ina	a	req	Nippon	10V54	9.400- 10.700	50	100 min	0.9	ab	392
Thomson	TV152C	8.0-10.0	ina	15 min	ina	ab	req								
Metcom	6310/ MXK-14	8.5-10.0	±15	15-40	ina	a	95	Varian	VA-287H	10.25-10.7	20	100 min	ina	a	req
Metcom	6312/ MXK-15	8.5-10.0	±15	15-40	ina	a	95	Varian	VA-272K, L	10.3-10.7	30	500 min	0.5 min	a	req
Metcom	6314/ MXK-16	8.5-10.0	±15	15-40	ina	a	95	EEV/CEI	K3076	10.5-10.7	30	60 typ	ina	f	req
								EEV/CEI	K361B	10.675-10.7	35	50 typ	1.5		req
								EEV/CEI	K357	10.66-10.72	30	12 typ	ina		130
Metcom	6315/ MXK-17	8.5-10.0	±15	30-50	ina	a	95	EEV/CEI	K3066	10.66-10.72	45	15 typ	ina	h	req
Metcom	6316/ MXK-18	8.5-10.0	±15	15-35	ina	a	95	EEV/CEI	K361	10.7-10.725	35	50 typ	1.5	a	130
Metcom	6781/ MXK-11	8.5-10.0	±15	15-40	ina	a	135	Thomson	TV210B	9.6-10.8	20 min	30 min	1 min	ab	req
Metcom	MXK-12	8.5-10.0	±15	15-40	ina	a	95	Varian	VA-210B	9.6-10.8	20	30 min	1.0	a	req
Metcom	MXK-19	8.5-10.0	±15	15-35	ina	am	225	Nippon	LD-788	10.400- 10.800	60	450 min	1.2	ab	req
Metcom	MXK-32	8.5-10.0	±15	75-320	ina	a	245	Thomson	TV2215	10.84-10.86	35 min	120 min	0.4 min	ab	req
Metcom	MXK-38	8.5-10.0	±15	15-200	ina	ap	195	Raytheon	QKK1022	9.5-10.9	ina	125 typ	ina	f	req
Raytheon	RK6310	8.5-10.0	ina	40 typ	ina	f	req	Varian	VA-287T	10.5-10.9	ina	500 min	ina	a	req
Raytheon	RK6312	8.5-10.0	ina	40 typ	ina	f	req	Varian	VA-272M	10.7-10.9	30	500 min	0.5 min	a	req
Thomson	6781	8.5-10	20 min	15 min	ina	ab	req	Beam Tube Klystro- nics	ZK48 ZV1011/ 8052	4-11 4.0-11.0	ina 6	20 min 20 min	ina ina	ac a	req req
Varian	BL-803/ 6781	8.5-10.0	20	40 min	3	a	req	Nippon	5721	4.000- 11.000	30	20 min	ina	c	req
Varian	BL-807	8.5-10.0	40	50 min	2	a	req	Metcom	MXK-26B	7.1-11.0	±15	100 min	ina	a	275
Varian	BL-825	8.5-10.0	40	500 min	2	a	req	Varian	X-13B	7.5-11.0	ina	100 min	ina	a	req
Varian	BL-847	8.5-10.0	30	50 min	3	a	req	Metcom	MXK-20	8.5-11.0	±15	15-40	ina	a	300
Varian	V-58,58C	8.5-10.0	40	500 min	ina	a	req	Varian	VC-102	9.5-11.0	50	500 min	ina	a	req
Varian	V-157	8.5-10.0	40	50 min	ina	a	req	Sperry	SRX-4957	11.0	n/a	8 min	ina	abdkz	req
Varian	V-260/ 6310	8.5-10.0	30	25 min	3	a	req	Varian	BLK-010	11.0	30	50 min	3	a	req
Varian	V-270/ 6312	8.5-10.0	30	25 min	3	a	req	Beam Tube	6390	6.7-11.05	ina	60 min	ina	ac	req
Varian	VA-153/ 6315	8.5-10.0	43	10 min	1.5	a	req	Thomson	TV242	8.5-11.1	40 min	500 min	0.5 min	ab	req
EEV/CEI	K324	9.0-10.0	30	45 typ	ina		255	Varian	VA-242 (A-N)	8.5-11.1	40	500 min	0.5	a	req
								Sperry	SRX-4840	10.9-11.1	30 min	20 min	ina	ab	req
								Varian	VA-272N	10.9-11.1	30	500 min	0.5 min	a	req
EEV/CEI	K337	9.0-10.0	24	45 typ	0.75	f	300	Varian	VA-266A	9.5-11.2	40	230 min	ina	a	req
Thomson	TV232	9.2-10	27 min	155 min	0.5 min	ab	req	Metcom	MXK-24	9.8-11.2	±15	70 min	ina	a	145
Varian	VA-232	9.2-10.0	27	155 min	1.25	a	req	Varian	BLK-004	9.8-11.2	20	500 min	1	a	req
Sperry	SRX-4956	10.0	n/a	16 min	ina	abdkz	req	Nippon	11V651	10.700- 11.200	55	450 min	1.2	ab	426
Thomson	TV262	8.45-10.05	ina	65 min	ina	ab	req								
Varian	V-262	8.45-10.05	ina	65 min	ina	a	req	Thomson	TV2246A	11.2	50 min	400 min	0.50 min	ab	req
MET/IEC	YK1043	9.3-10.1	40	60 typ	ina	u	req	Thomson	TV2246X	11.4	50 min	400 min	0.50 min	ab	req
Varian	VA-272G,H	9.7-10.1	30	500 min	0.5 min	a	req	Varian	V-55,55B	8.2-11.5	40	200 min	ina	a	req
Sperry	SRX-5300	9.9-10.1	55 min	500 min	ina	ab	req	Varian	BL-849	10.5-11.5	32	70 min	3	a	req
Metcom	MXK-60	9.75-10.15	±10	500 min	ina	an	325	Thomson	TV2246B	11.6	50 min	400 min	0.50 min	ab	req

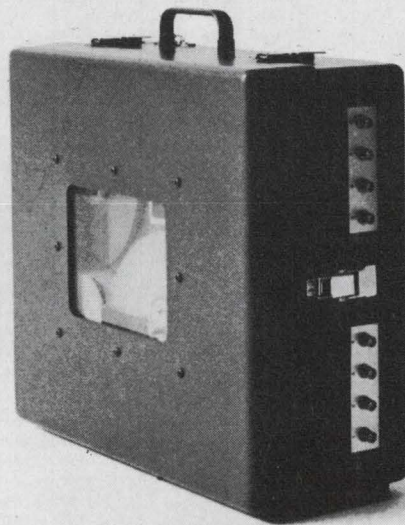
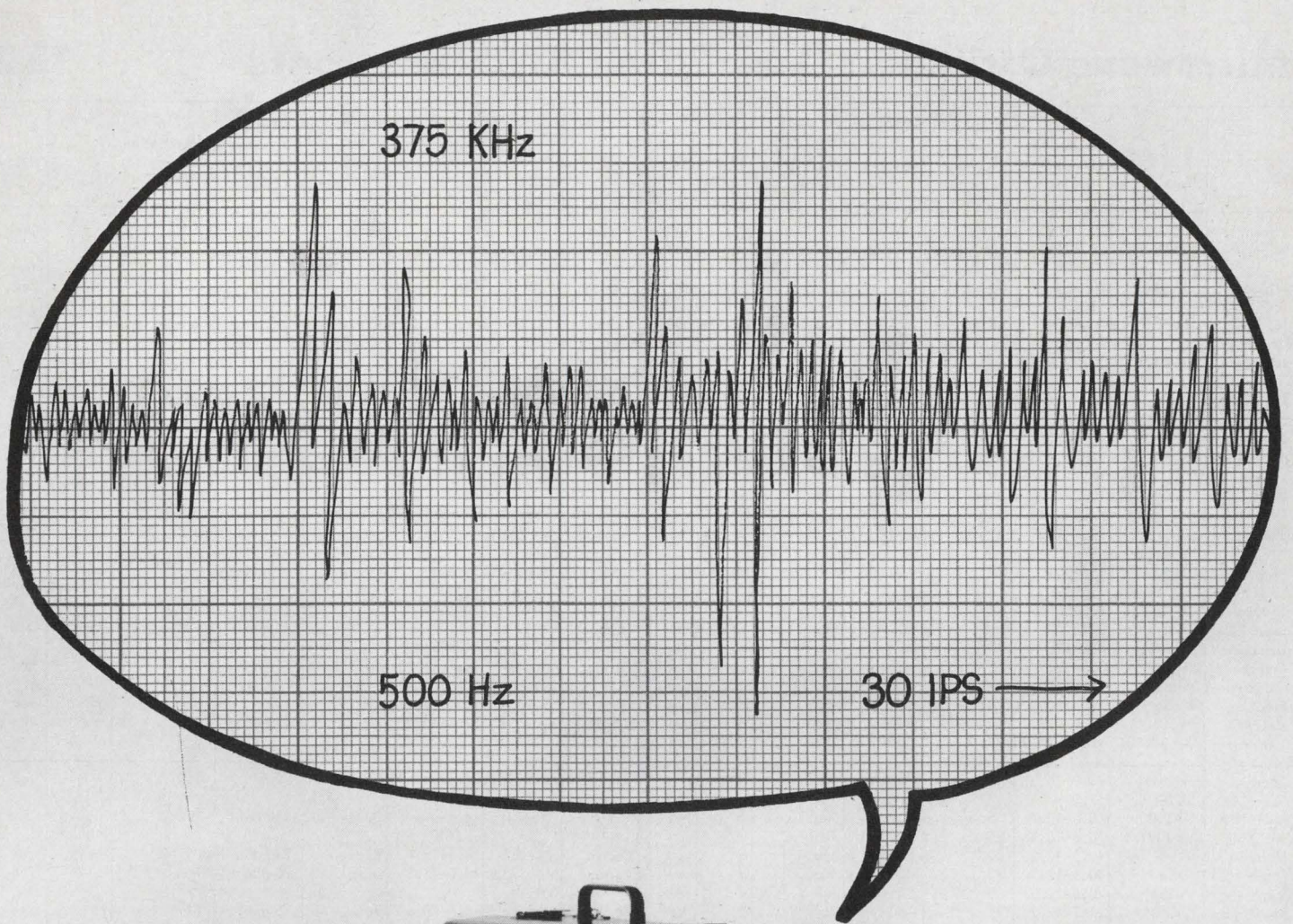

No other 28-lb. data recorder can make that statement.

Now available, our new 417 WB speaks wideband to the tune of 374.5K Hz at 30 ips. Of course it's not the only recorder that meets IRIG specs for wideband Group II. But it's the only one that weighs less than 50 lbs. (The 417 WB's 28 lbs. also includes its carrying case and self-contained battery, by the way.) And it's the only one small enough to fit under an airplane seat.

So, when you have to hit the trail for data, let the new 417 WB take a load off your back. And off your mind. It needs less maintenance and fewer adjustments than any other portable recorder. It ignores bumps, jolts, vibrations and odd

mounting angles. It normally draws only 25 watts of power. It records on seven channels. And it matches large rack machines for accuracy.

But that's just a taste. For the full 417 WB story and spec sheet, write Mr. Fred Romer, Dept. 412-10, Lockheed Electronics Company, Plainfield, New Jersey 07061. Or call him at (201) 757-1600. He, too, speaks wideband.

Lockheed Electronics
A Division of Lockheed Aircraft Corporation

We've upped the line to 7 pin spacings without upping the price.

CTS cermet industrial trimmers
still **50¢** each.*

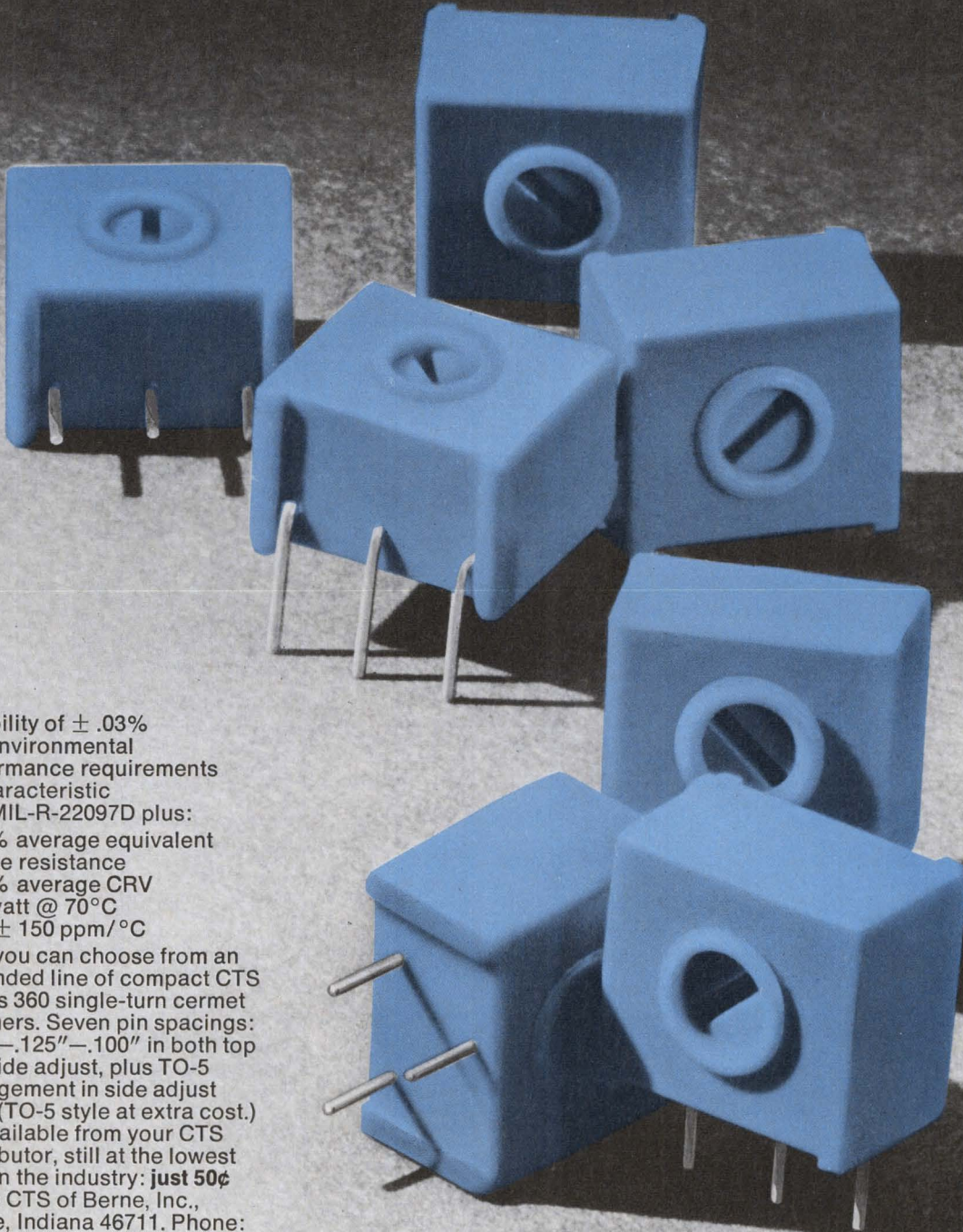

Stability of $\pm .03\%$
and environmental
performance requirements
of characteristic
C of MIL-R-22097D plus:

- 1.5% average equivalent
noise resistance
- 0.5% average CRV
- $\frac{1}{2}$ watt @ 70°C
- TC ± 150 ppm/°C

Now you can choose from an
expanded line of compact CTS
Series 360 single-turn cermet
trimmers. Seven pin spacings:
.150"—.125"—.100" in both top
and side adjust, plus TO-5
arrangement in side adjust
only. (TO-5 style at extra cost.)
All available from your CTS
Distributor, still at the lowest
cost in the industry: **just 50¢
each**: CTS of Berne, Inc.,
Berne, Indiana 46711. Phone:
(219) 589-3111.

*in 50,000 quantity for $\pm 20\%$
tolerance. Add 4¢ for 10% tolerance.
Comparably low prices for smaller
quantities.

CTS CORPORATION

Elkhart, Indiana



Your CTS Answer Man
stands ready to fit our
expanded trimmer line
into your application.

Mfr	Model	Operating Frequency Range (GHz)	Electronic Tuning Range (MHz)	Output Power Min-Max (mW)	FM Modulation Sensitivity (MHz/V)	Notes	Price (\$)	Mfr	Model	Operating Frequency Range (GHz)	Electronic Tuning Range (MHz)	Output Power Min-Max (mW)	FM Modulation Sensitivity (MHz/V)	Notes	Price (\$)
Sperry	SRU-4194	15.0-17.5	50 min	80 min	ina	ab	req	EEV/CEI	K038	33.5-36.0	60	250 typ	ina		req
Sperry	SRU-419	15.5-17.5	30 min	150 min	ina	ab	req	EEV/CEI	K039	33.5-36.0	60	30 typ	ina		req
Sperry	SRU-4191	15.5-17.5	40 min	150 min	ina	ab	req	Sperry	SRU-4401	35.9-36.1	75 min	50 min	ina	ab (2)	req
Sperry	SRU-2163	16.5-17.5	100 min	500 min	ina	ab	req	Beam Tube	35BT/A	32-37	ina	200-600	ina		1144
Sperry	SRU-4438	16.5-17.5	50 min	30 min	ina	ab (2)	req	OKI	35V10	32-37	100	75 typ	1.7	ab	695
Sperry	SRU-4196	17.1-17.5	40 min	300 min	ina	ab	req	OKI	35V11	32-37	90	220 typ	2.0	ab	1075
Gencom	R9676	12.4-18.0	60	300 typ	ina	ab	req	OKI	35V12	32-37	90	650 typ	1.9	ab	1310
Varian	VA-308 (series)	14.0-18.0	50	800 min	0.4	a	req	Gencom	R9674	26.5-37.5	70	200 typ	ina	ab	req
Varian	VA-309 (series)	14.0-18.0	40	250 min	1.0	a	req	Gencom	R9546	32.3-37.5	77	60 typ	ina	ab	req
Gencom	R9626	15.0-18.0	60	100 typ	ina	ab	req	OKI	33-38	33-38	90	650 typ	1.9	ab	1325
								Sperry	SRV-4406	38.4-38.6	50 min	20 min	ina	ab (2)	req
Varian	VA-311 (series)	15.0-18.0	50	20 min	1.5	a	req	Varian	VA-322 (series)	26.5-40.0	90	300 min	ina	a	req
OKI	17V10	15.5-18.5	45	100 typ	0.5	ab	485	Gencom	R9521	35.0-40.0	85	60 typ	ina	ab	req
Sperry	SRK-4650	18.45-18.55	80 min	500 min	ina	ab	req	Beam Tube	40BT/A	37-42	ina	200-700	ina	ab	1144
Sperry	SRK-4660	18.3-18.7	80 min	500 min	ina	ab	req	OKI	40V10	37-42	90	90 typ	2.3	ab	885
Varian	V-40B, 40C	15.0-21.0	ina	20 min	ina	a	req	OKI	40V12	37-42	100	500 typ	2.5	ab	1350
Sperry	SOK-2922	21.6	10 min	500 min	ina	k (3)	req	Varian	VA-302 (series)	40.0-45.0	50	100 min	ina	a	req
Varian	V-253 (series)	15.0-22.0	40	150 min	2.0	a	req	OKI	45V10	42-48	100	85 typ	3.0	ab	925
OKI	20V10	18-22	45	150 typ	0.6	ab	515	OKI	45V12	42-48	100	250 typ	3.0	ab	1385
Sperry	SRK-4642	21.9-22.1	70 min	30 min	ina	ab (2)	req	Beam Tube	45BT/A	42-49	ina	150-600	ina	ab	1199
Gencom	R9622	18.0-22.5	60	100 typ	ina	ab	req	Beam Tube	47BT/A	43-51	ina	200-800	ina	ab	1199
								OKI	47V10	43-51	150	80 typ	4.5	ab	975
Sperry	SOK-2921	23.8	10 min	500 min	ina	k (3)	req	OKI	47V11	43-51	120	160 typ	3.5	ab	1190
OKI	22V10	20-24	35	165 typ	0.5	ab	525	OKI	47V12	43-51	120	220 typ	3.5	ab	1425
Gencom	R9621	22.0-24.0	60	100 typ	ina	ab	req	Beam Tube	50BT/A	46-54	ina	200-800	ina	ab	1144
Sperry	SRK-4640	23.95-24.05	100 min	100 min	ina	ab (2)	req								
Varian	VA-98 (series)	23.6-24.4	50	100 min	ina	a	req	OKI	50V10	46-54	140	60 typ	4.5	ab	1030
Klystrons	TK50	23.5-24.5	70	15 min	ina		req	OKI	50V11	46-54	145	160 typ	4.5	ab	1350
Sperry	SRK-4780	23.5-24.5	60 min	400 min	ina	ab	req	OKI	55V10	52-58	140	65 typ	5.2	ab	1085
Sperry	SRK-4641	24.55-24.65	60 min	225 min	ina	ab (2)	req	OKI	55V11	52-58	190	150 typ	5.0	ab	1390
Sperry	SRK-4781	24.0-25.0	60 min	400 min	ina	ab	req	Beam Tube	55BT/A	51-59	ina	150-400	ina	ab	1320
Sperry	SRK-4762	25.7	n/a	75 min	ina	abkz	req	OKI	60V10	57-63	140	65 typ	5.0	ab	1595
Sperry	SRV-5270	30.4-30.6	75 min	100 min	ina	ab (2)	req	OKI	60V12	57-63	150	200 typ	5.2	ab	1860
OKI	24V10A	22-26	50	250 typ	0.8	ab	525	Beam Tube	60BT/A	55-65	ina	80-200	ina	ab	1760
OKI	24V11	22-26	50	600 typ	0.5	ab	950	Tube							
Gencom	R9602	22.5-26.0	60	100 typ	ina	ab	req	Beam Tube	65BT/A	60-70	ina	60-130	ina	ab	2310
Gencom	R9675	18.0-26.5	60	250 typ	ina	ab	req								
Varian	EM-1138 (series)	18.0-26.5	50	200 min	ina	a	req	MET/IEC	YK1010	67-73	100	100 typ	ina	u	req
Varian	EM-1188 (series)	18.0-26.5	70	500 min	ina	a	req	Beam Tube	70BT/A	65-75	ina	60-130	ina	ab	2387
Varian	VA-282 (series)	18.0-26.5	40	450 min	ina	a	req	OKI	70V10	65-75	140	65 typ	4.0	ab	1995
Gencom	R9729	26.0-29.0	68	70 typ	ina	ab	req	OKI	70V11A	65-75	165	180 typ	5.5	ab	2450
OKI	28V12	26-30	75	600 typ	0.6	ab	1175	Varian	VRE-2101A	43-80	100	500 min	ina	a	req
Beam Tube	30BT/A	27-32	ina	200-600	ina	ab	1144	Varian	VRE-2102A	43-80	100	350 min	ina	a	req
OKI	30V10	27-32	70	75 typ	0.7	ab	585	Varian	VRE-2103A	43-80	100	150 min	ina	a	req
OKI	30V11	27-32	75	225 typ	0.65	ab	995	Varian	VRE-2103B	43-80	100	150 min	ina	a	req
OKI	30V12	27-32	70	600 typ	0.65	ab	1240	Varian	VRE-2104A	43-80	100	50 min	ina	a	req
Sperry	SRV-4400	31.9-32.1	50 min	75 min	ina	ab(2)	req	Varian	VRE-2105A	43-80	100	10 min	ina	a	req
Gencom	R9518	27.8-32.2	68	80 typ	ina	ab	req								
Sperry	SRV-4405	32.9-33.1	50 min	20 min	ina	ab (2)	req								
Gencom	R9651	31.2-33.7	70	60 typ	ina	ab	req								
Varian	VA-97B	32.6-34.0	60	10 min	1.0	a	req								
Varian	V-283 (series)	26.5-35.0	50	300 min	ina	a	req								
Varian	VA-312 (series)	26.5-35.0	50	100 min	ina	a	req	Beam Tube	75BT/A	70-80	ina	40-120	ina	ab	2420
Sperry	SRU-5250	34.0-35.0	90 min	10 min	ina	ab (2)	req	OKI	80V10A	75-85	140	40 typ	4.0	ab	2350
Sperry	SRU-5130	35.0	n/a	10 min	ina	abkz(2)	req	OKI	80V11	75-85	180	150 typ	5.0	ab	2900
Gencom	R5146	34.2-35.5	70	90 typ	ina	ab	req	OKI	90V10	85-95	180	30 typ	6.0	ab	2495
Varian	VA-97	34.0-35.6	60	10 min	1.0	a	req	OKI	90V11	85-95	280	90 typ	20.0	ab	2900
EEV/CEI	K035	34.1-35.6	60	30 typ	ina	ab	req	Varian	VRB-2114A	90-100	100	50 min	ina	a	req
EEV/CEI	K065	34.1-35.6	60	30 typ	ina	ab	req	OKI	100V10A	95-105	250	25 typ	8.0	ab	2675
MET/IEC	K535-50	31-36	60	100 typ	ina	u	req	OKI	100V11	95-105	300	80 typ	20.0	ab	4450
OKI	33V10	31-36	100	75 typ	1.6	ab	650	Varian	VRB-2111A	80-110	150	400 min	ina	a	req
OKI	34V12	31-36	95	600 typ	1.8	ab	1285								

The white "Mini⚡Bus"
on this board
cuts cost and noise
like you wouldn't believe!

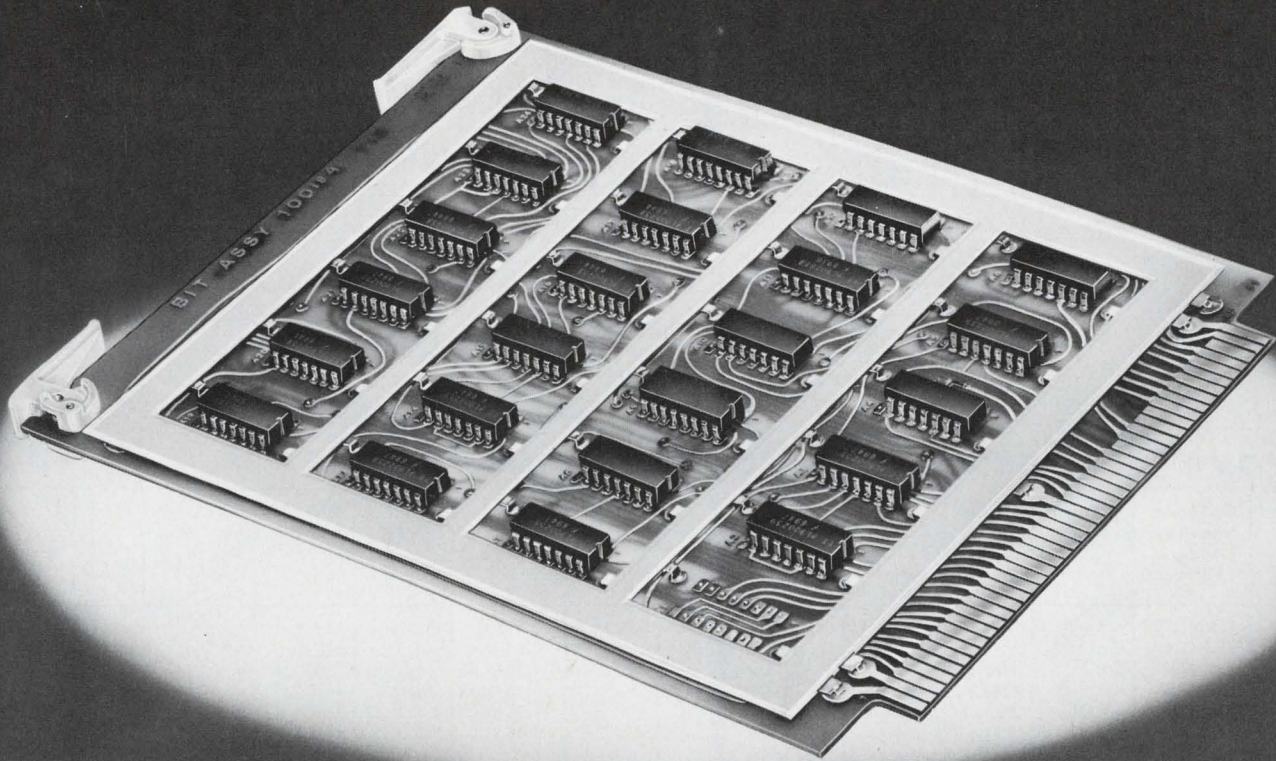

Here's why.

The Mektron® Mini/Bus is a small, voltage-distributing busbar. With V_{cc} and ground return in the bus, not the board, high-density packaging is accomplished without multilayer board construction. *There's cost-cutting!*

And that little bus has so much more capacitance than you could ever get in the board itself, ICs can't be clobbered by surges in line voltage. Also, the capacitance bonus keeps your logic circuitry from being faked out by system transients. Noise-cutting like that means better, more reliable equipment.

Want more details? Design help? Mini/Bus prices?
Ask the people who pioneered laminar bus. Us.

Rogers Corporation / Rogers, Connecticut 06263

Rogers' Mektron products are available from: Mektron Division, Rogers, Connecticut;
Circuit Systems Division, Chandler, Arizona; Mektron N.V., Ghent, Belgium



Microwave Oscillators, Low-Power Klystrons (cont.)

134

Mfr	Model	Operating Frequency Range (GHz)	Electronic Tuning Range (MHz)	Output Power Min-Max (mW)	FM Modulation Sensitivity (MHz/V)	Notes	Price (\$)	Mfr	Model	Operating Frequency Range (GHz)	Electronic Tuning Range (MHz)	Output Power Min-Max (mW)	FM Modulation Sensitivity (MHz/V)	Notes	Price (\$)
Varian	VRB-2112A	80-110	150	200 min	ina	a	req	Varian	VRT-2121A	110-141	150	100	ina	a	req
Varian	VRB-2113A	80-110	150	75 min	ina	a	req	Varian	VRT-2125A	110-142	150	10 min	ina	a	req
Varian	VRB-2113B	80-110	150	75 min	ina	a	req	Varian	VRT-2122A	140-170	150	50 min	ina	a	req
Varian	VRB-2115A	80-110	150	10 min	ina	a	req	Varian	VRT-2122B	140-170	150	50 min	ina	a	req
OKI	120V10	107-122	350	10 typ	20.0	ab	3850	Varian	VRT-2124A	140-170	150	25 min	ina	a	req
MET/IEC	DX237	110-124	200	40 typ	ina	u	req	Varian	VRT-2124B	140-170	150	25 min	ina	a	req
Varian	VRT-2123A	110-140	150	25 min	ina	a	req	Varian	VRT-2124B	140-170	150	25 min	ina	a	req
Varian	VRT-2123B	110-140	150	25 min	ina	a	req	Varian	VRT-2131A	170-220	150	10 min	ina	a	req

Microwave Oscillators, Low-Power Planar Triodes

135

Mfr	Model	Operating Frequency Range (GHz)	Electronic Tuning Range (MHz)	Output Power Min-Max (mW)	FM Modulation Sensitivity (MHz/V)	Notes	Price (\$)	Mfr	Model	Operating Frequency Range (GHz)	Electronic Tuning Range (MHz)	Output Power Min-Max (mW)	FM Modulation Sensitivity (MHz/V)	Notes	Price (\$)
RCA	6562/5794A	1.68-1.692	n/a	600 typ	n/a	v	req	RCA	A15314	0.9-3.4	n/a	250 typ	n/a	v	req
RCA	7533	1.68-1.692	n/a	575 typ	n/a	v	req	RCA	A15235	3.05-3.4	n/a	100 typ	n/a	v	req
RCA	A15227	1.85-2.2	n/a	600 typ	n/a	v	req	MCL	7200	4.15-4.55	n/a	5-30	n/a	w	300
RCA	A15229	2.15-2.5	n/a	400 typ	n/a	v	req	MCL	9015	4.15-4.55	n/a	2-30	n/a	w	250
RCA	A15231	2.45-2.8	n/a	300 typ	n/a	v	req	MCL	7014	5.25-6.05	n/a	5-30	n/a	w	300
RCA	A15233	2.75-3.1	n/a	120 typ	n/a	v	req	MCL	5024	8-10	100	100-200	1	(5)	1000

Microwave Oscillators, Low-Power Magnetrons

136

Mfr	Model	Operating Frequency Range (GHz)	Electronic Tuning Range (MHz)	Output Power Min-Max (mW)	FM Modulation Sensitivity (MHz/V)	Notes	Price (\$)	Mfr	Model	Operating Frequency Range (GHz)	Electronic Tuning Range (MHz)	Output Power Min-Max (mW)	FM Modulation Sensitivity (MHz/V)	Notes	Price (\$)
Varian	EM-1089	0.190-0.300	110	15 min	0.19	i	req	Micron	1L1-2S	1.0-2.0	1000	1000 max	0.87	dj (7)	900
Micron	.5P.2-.4S	0.2-0.4	200	500 max	0.23	dj (7)	900	Varian	EM-1320	1.0-2.0	1000	100 min	1.3	i	req
Varian	EM-1300	0.250-0.500	250	100 min	0.3	i	req	Varian	EM-1166	1.45-2.35	900	50 min	ina	dj	req
Varian	EM-747	0.400-0.120	800	50 min	0.7	i	req	Varian	EM-1165	1.59-2.47	880	50 min	1.3	i	req
Varian	EM-1151	0.500-0.750	250	50 min	0.47	dj	req	Varian	EM-1323	1.0-2.5	1500	300 min	1.3	i	req
Micron	1P.5-1S	0.5-1.0	500	1000 max	0.436	dj (7)	900	GE	ZM-6086	1.420-2.607	1187	36-114	1.66	ij	req
Varian	EM-1310	0.500-1.0	500	100 min	0.6	i	req	Varian	EM-1321	1.5-3.0	1500	500 min	1.2	i	req
Varian	EM-1313	0.450-1.15	700	300 min	0.7	i	req	Varian	EM-1332	2.0-3.0	1000	100 min	1.3	i	req
Varian	EM-1092	0.8-1.4	600	500 min	0.9	i	req	Micron	1S2-4S	2.0-4.0	2000	1000 max	1.74	dj (7)	1300
GE	ZM-6085	0.885-1.485	600	36-114	1.00	ij	req	Varian	EM-1336	2.5-4.0	1500	500 min	2.2	i	req
Micron	.5P.5-1S5	0.5-1.5	1000	500 max	0.61	dj (7)	1100	GE	ZM-6087	2.507-4.310	1803	36-114	2.88	ij	req
GE	ZM-6051	1.000-2.000	1000	100-398	1.50	ij	req	Micron	1C4-6S	4.0-6.0	2000	1000 max	2.5	dj (7)	1300

Tips on cooling off hot semiconductors

As power levels go up and up and package size shrinks, circuit designers are keeping semiconductors cool with IERC Heat Sinks/Dissipators. Reducing junction temperature gives many benefits: faster rise and fall times, faster switching speed and beta, fewer circuit loading effects and longer transistor life and circuit reliability.

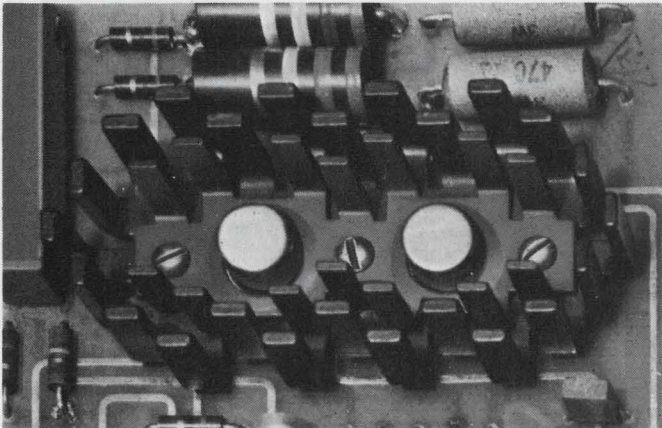

Thermal mating of matched transistors, such as these TO5's shown on a dual LP, maintains matched operating characteristics. The LP's unique multiple staggered-finger design (both single and dual models) maximizes radiation and convection cooling, results in a high efficiency-to-weight and -volume ratio.

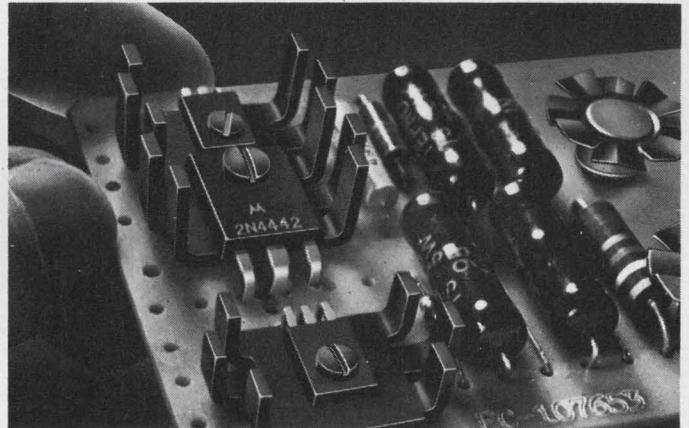

Power levels of plastic power devices such as X58's, MS9's, and M386's can be increased up to 80% in natural convection and 500% in forced air when used with PA and PB Dissipators. PA's need only .65 sq. in. to mount; PB's 1.17 sq. in. Staggered finger design gives these light-weight dissipators their high efficiency.

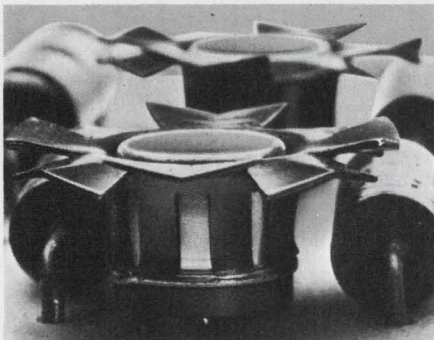

TO5's and TO18's in high density packages can be cooled off with efficient push-on Fan Tops that cost only pennies. T-shaped, need no board room, let other components snugle close. Spring fingers accommodate wide case diameter variations. Models for RO97's, RO97A and D-style plastic devices also.

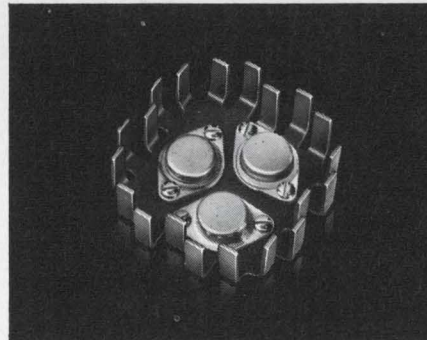

High power TO3's, TO66's, TO6's, TO15's, etc. can be operated with much more power when used with HP's. These compact, light-weight staggered finger devices accommodate from one to four TO3's. Provide the same heat dissipation as an extrusion that's three times heavier and one-third larger.

Heat problems? IERC engineers welcome the opportunity to help solve your heat dissipation problems. As the world's largest manufacturer of heat sinks/dissipators for lead and case mounted semiconductors, they can come up with a practical, low cost solution.

Free four-page Short Form Catalog. Send for your copy today.



Heat Sinks/Dissipators

IERC



Mfr	Model	Operating Frequency Range (GHz)	Electronic Tuning Range (MHz)	Output Power Min-Max (mW)	FM Modulation Sensitivity (MHz/V)	Notes	Price (\$)	Mfr	Model	Operating Frequency Range (GHz)	Electronic Tuning Range (MHz)	Output Power Min-Max (mW)	FM Modulation Sensitivity (MHz/V)	Notes	Price (\$)
WJ	SE223	0.5-1.0	500	30 min	ina		req	Varian	VA-441F	3.7-8.3	4600	20 min	1.0	x	req
ITT	F-2508	1.0-2.0	1000	100 typ	1.11		1360	WJ	SE211B	3.7-8.3	4600	15 min	ina		req
Varian	VA-183M	1.0-2.0	1000	100 min	0.2	x	req	WJ	OD5.2-8.3	5.2-8.3	3100	10 min	ina	y	req
WJ	OD1-2	1.0-2.0	1000	50 min	ina	y	req								
WJ	SE214A	1.0-2.0	1000	100 min	ina		req	Siemens	RW05	5.8-8.5	2700	100 typ	ina		req
WJ	SE219	1.4-2.5	1100	100 min	ina		req	ITT	F-2518	6.6-8.7	2100	50 typ	3.72		1815
WJ	OD1.5-2.5	1.5-2.5	1000	50 min	ina	y	req	Varian	VA-450N	8.5-9.6	1100	50 min	3.0	x	req
Varian	VA-186M	1.0-2.6	1600	50 min	0.2	x	req	Varian	VA-451N	8.5-9.6	1100	30 min	11.0	x	req
WJ	OD1-2.6	1.0-2.6	1600	50 min	ina	y	req	Varian	VA-460N	8.5-9.6	1100	60 min	3.0	x	req
WJ	SE214	1.0-2.6	1600	30 min	ina		req	Varian	VA-461N	8.5-9.6	1100	30 min	11.0	x	req
								Varian	VA-462N	8.5-9.6	1100	40 min	8.0	x	req
ITT	F-2507	1.8-2.8	1000	100 typ	2.22		1360	WJ	WJ2044	4.5-10.0	5500	10 min	ina	x	req
WJ	WJ2002	1.4-2.9	1500	50 min	ina		req	Sperry	SBX2981	9.0-10.0	1000	50 min	ina	(4)	req
ITT	F-2513	1.3-4.0	2700	25 typ	1.17		1750	Varian	VA-443M	5.2-10.4	5200	30 min	1.0	x	req
ITT	F-2509	2.0-4.0	2000	100 typ	1.33		1360	WJ	WJ2048	5.5-11.0	5500	40 min	ina	x	req
Tripp	TR520	2.0-4.0	2000	100 min	0.85/2.5		req	WJ	F-2547	7.0-11.0	4000	10 typ	4.32		req
Varian	VA-184M	2.0-4.0	2000	50 min	0.5	x	req	WJ	OD7-11	7.0-11.0	4000	15 min	ina	y	req
Varian	VA-184T	2.0-4.0	2000	100 min	0.5	x	req	WJ	WJ2001-10	7.0-11.0	4000	25 min	ina		req
Varian	VA-435M	2.0-4.0	2000	50 min	0.5	x	req	WJ	WJ2042	7.0-11.0	4000	30 min	ina	x	req
WJ	OD2-4	2.0-4.0	2000	30 min	ina	y	req	WJ	WJ818-1	7.4-11.0	4400	30 min	ina		req
WJ	SE213	2.0-4.0	2000	40 min	ina		req	WJ	OD6-12	6.5-11.5	5000	10 min	ina	y	req
WJ	SE215A	2.0-4.0	2000	75 min	ina		req	EEV/CEI	N1010 (series)	7.0-11.5	4500	40-130	1.0		req
WJ	SE310	2.0-4.0	2000	50 min	ina		req								
WJ	WJ2018	2.0-4.0	2000	70 min	ina	x	req	WJ	WJ2033-2	6.0-12.0	6000	10 min	ina	x	req
WJ	WJ2024	2.0-4.0	2000	50 min	ina		req	ITT	F-2554	8.0-12.0	4000	10 typ	2.39		req
WJ	WJ2051	2.0-4.0	2000	30 min	ina	x	req	Sperry	SBX-2980	8.0-12.0	4000	15 min	ina	(4)	req
Tripp	TR521	1.7-4.2	2500	30 min	0.75/2.7		req	ITT	F-2520	7.0-12.4	5400	20 typ	2.69		req
Varian	VA-184F	1.7-4.2	2500	40 min	0.5	x	req	Tripp	TR541	7.0-12.4	5400	40 min	2/7		req
WJ	SE215	1.7-4.2	2500	30 min	ina		req	Varian	VA-173M	7.0-12.4	5400	40 min	1.0	x	req
WJ	WJ2014-10	3.6-4.3	1300	375 min	ina		req	Varian	VA-450M	7.0-12.4	5400	20 min	1.0	x	req
WJ	WJ2014	2.0-4.5	2500	50 min	ina		req	WJ	SE209	7.0-12.4	5400	10 min	ina		req
								WJ	WJ2001	7.0-12.4	5400	25 min	ina		req
WJ	WJ2040	2.0-4.5	2500	50 min	ina	x	req	ITT	F-2511	8.0-12.4	4400	25 typ	2.38		1360
EEV/CEI	N1034 (series)	2.4-4.5	2100	90-400	1.0		req	Tripp	TR540	8.0-12.4	4400	50 min	2.7/7.2		req
ITT	F-2556	2.6-5.2	2600	10 typ	3.51		req	Varian	VA-161F	8.0-12.4	4400	20 min	3.0	x	req
Varian	VA-187M	2.6-5.2	2600	70 min	0.5	x	req	Varian	VA-161M	8.0-12.4	4400	20 min	3.0	x	req
Varian	VA-436M	2.6-5.2	2600	50 min	0.5	x	req	Varian	VA-173T	8.0-12.4	4400	80 min	1.0	x	req
WJ	SE310-3	2.6-5.2	2600	20 min	ina		req	Varian	VA-173TA	8.0-12.4	4400	100 min	1.0	x	req
WJ	WJ2013	2.6-5.2	2600	50 min	ina		req	Varian	VA-175M	8.0-12.4	4400	80 min	1.0	x	req
WJ	WJ2038	2.6-5.2	2600	25 min	ina		req	Varian	VA-175T	8.0-12.4	4400	100 min	1.0	x	req
ITT	F-2517	3.7-5.5	1800	50 typ	2.73		1275	Varian	VA-450C	8.0-12.4	4400	40 min	1.0	x	req
WJ	WJ2046-1	2.6-5.6	3000	50 min	ina		req	Varian	VA-451M	8.0-12.4	4400	15 min	3.0	x	req
WJ	OD3.7-5.9	3.7-5.9	2200	30 min	ina	y	req	Varian	VA-460M	8.0-12.4	4400	50 min	1.0	x	req
Varian	VA-160N	5.4-5.9	500	400 min	1.0	x	req	WJ	SE209A9	8.0-12.4	4400	20 min	ina		req
Varian	VA-440N	5.4-5.9	500	100 min	3.0	x	req	WJ	WJ313	8.0-12.4	4400	50 min	ina		req
WJ	OD5.4-5.9	5.4-5.9	500	50 min	ina	y	req	WJ	WJ2001-1	8.0-12.4	4400	50 min	ina		req
WJ	WJ2032-2	3.0-6.0	3000	20 min	ina	x	req	WJ	WJ2006	8.0-12.4	4400	50 min	ina	x	req
WJ	WJ2046	3.0-6.0	3000	50 min	ina		req	WJ	WJ2008-2	8.0-12.4	4400	80 min	ina		req
WJ	SE221	3.5-6.75	3250	40 min	ina		req	WJ	WJ2026	8.0-12.4	4400	20 min	ina		req
WJ	WJ2049	3.5-6.75	3250	40 min	ina	x	req	WJ	WJ2027	8.0-12.4	4400	50 min	ina		req
Varian	VA-160E	3.6-7.2	3600	20 min	0.5	x	req	Varian	VA-461M	8.2-12.4	4200	20 min	3.0	x	req
WJ	SE304C-2	3.92-7.5	3580	40 min	ina		req	WJ	OD7-13	8.2-12.4	4200	10 min	ina	y	req
ITT	F-2555	4.0-8.0	4000	10 typ	2.29		req	WJ	WJ303	8.2-12.4	4200	20 min	ina		req
Tripp	TR530	4.0-8.0	4000	50 min	2/5.9		req	WJ	WJ2004	9.5-13.0	3500	10 min	ina	x	req
Varian	VA-160M	4.0-8.0	4000	50 min	0.5	x	req	Varian	VA-177M	10.0-15.0	5000	50 min	1.0	x	req
Varian	VA-185M	4.0-8.0	4000	100 min	1.0	x	req	Varian	VA-472M	10.0-15.0	5000	20 min	1.0	x	req
Varian	VA-440M	4.0-8.0	4000	20 min	0.5	x	req	WJ	OD10-15	10.0-15.5	5500	10 min	ina	y	req
Varian	VA-441M	4.0-8.0	4000	50 min	1.0	x	req	WJ	SE220	10.0-15.5	5500	10 min	ina		req
WJ	OD4-8	4.0-8.0	4000	10 min	ina	y	req	WJ	WJ2059	10.0-15.5	5500	25 min	ina	x	req
WJ	SE211A	4.0-8.0	4000	30 min	ina		req	Sperry	SBU-4531	14.0-16.0	2000	20 min	ina	(4)	req
WJ	WJ304	4.0-8.0	4000	20 min	ina		req	Varian	VA-470N	14.0-17.0	3000	50 min	4.0	x	req
WJ	WJ2015	4.0-8.0	4000	60 min	ina		req	WJ	WJ308A	14.0-17.0	3000	10 min	ina		req
WJ	WJ2019	4.0-8.0	4000	30 min	ina	x	req	WJ	WJ2029	14.0-17.0	3000	10 min	ina	(4)	req
WJ	WJ2025	4.0-8.0	4000	20 min	ina		req	Sperry	SBU-4530	15.4-17.0	1600	20 min	ina		req
WJ	WJ2030	4.0-8.0	4000	50 min	ina		req	Tripp	TR560	12.4-18.0	5600	30 min	2.3/8.5		req
WJ	WJ2034	4.0-8.0	4000	60 min	ina	x	req	Varian	VA-162M	12.4-18.0	5600	50 min	4.0	x	req
WJ	WJ2045	4.0-8.0	4000	50 min	ina	x	req	Varian	VA-470M	12.4-18.0	5600	20 min	40	x	req
WJ	WJ2047	4.0-8.0	4000	50 min	ina		req	WJ	OD12-18	12.4-18.0	5600	10 min	ina	y	req
WJ	WJ2050	4.0-8.0	4000	30 min	ina	x	req	WJ	SE216	12.4-18.0	5600	10 min	ina		req
ITT	F-2510	4.0-8.2	4200	25 typ	2.15		1360	WJ	WJ307A	12.4-18.0	5600	20 min	ina		req
Tripp	TR531	3.7-8.3	4600	20 min	1.6/6.4		req	WJ	1N1J2003	12.4-18.0	5600	40 min	ina		req
Varian	VA-185F	3.7-8.3	4600	50 min	1.0	x	req	WJ	WJ2007	12.4-18.0	5600	40 min	ina		req

Clare's new PRME DIP relay: Europe was its proving ground.



True electrical and physical compatibility with DIP-packaged IC logic families plus the Clare Picoreed capsule.

France. Italy. Germany. Belgium. The Netherlands. This microminiature sealed-contact relay has been built by Clare International, and has proved itself over most of Europe in data process and process control applications. The users? Some of the biggest names over there. Now Clare's new PRME DIP Relay is ready for you.

Check its credentials. Electrically and

physically compatible with DIP-packaged IC logic families. Drive the 5-volt model directly from most DTL/TTL standard gates without power NANDS or external driver/buffers. Total DIP package compatibility also. That means IC DIP dimensions, epoxy molding, automatic machine insertability.

And here's a big plus: The PRME is built around Clare's own Picoreed capsule, basis for the inherent reliability of Clared relays.

Some other points. Available for 5, 6, 12 and 24-V dc operation. Operates within 500 μ seconds, releases within 100 μ seconds. Sensitivity: 35 mW with ICs—45 to 130 mW with other circuit types. Switch 500 mA, 100 V, 10 VA max; carry 2.0 A max. Internal

diode-coil suppression and electrostatic shield options.

Care to know more about the new Clare relay that is already a sensation on the Continent? Circle the Reader Service Number now.

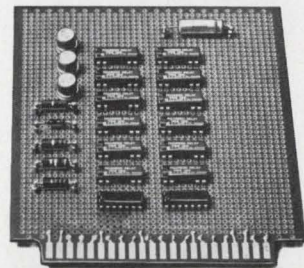

C. P. Clare & Co.
Chicago 60645 and worldwide.
A General Instrument company.

Mfr	Model	Operating Frequency Range (GHz)	Electronic Tuning Range (MHz)	Output Power Min-Max (mW)	FM Modulation Sensitivity (MHz/V)	Notes	Price (\$)	Mfr	Model	Operating Frequency Range (GHz)	Electronic Tuning Range (MHz)	Output Power Min-Max (mW)	FM Modulation Sensitivity (MHz/V)	Notes	Price (\$)
WJ	WJ2028	12.4-18.0	5600	20 min	ina		req	WJ	WJ2058	26.5-40.0	13,500	10 min	ina	x	req
WJ	WJ2043	12.4-18.0	5600	30 min	ina	x	req	Sperry	SBV-4370	34-40	6000	20 min	ina	(4)	req
WJ	WJ2056	12.4-18.0	5600	40 min	ina	x	req	Siemens	RW040	26.5-42	25,500	60 typ	ina		req
Varian	VA-162F	10.0-20.0	10,000	5 min	3.0	x	req	OKI	BA47F	43-52	9000	150 typ	ina	r	3705
Varian	VA-178M	15.0-22.0	7000	25 min	4.0	x	req	OKI	BA47H	45-52	7000	600 typ	ina	q	6185
Varian	VA-482M	15.0-22.0	7000	10 min	4.0	x	req	OKI	BA50H	48-55	7000	600 typ	ina	q	6185
WJ	OD15-22	15-22	7000	5 min	ina	y	req	OKI	BA54H	51-55	4000	700 typ	ina	q	6555
WJ	WJ2054	15-22	7000	5 min	ina		req	OKI	BA55B	50-59	9000	120 typ	ina	r	4445
WJ	WJ2064	15-22	7000	5 min	ina	x	req	Siemens	RW060	40-61	21,000	2 typ	ina		req
Varian	VA-163M	18.0-26.5	8500	25 min	5.0	x	req	OKI	BA60H	54-62	8000	600 typ	ina	q	6555
Varian	VA-480M	18.0-26.5	8500	10 min	5.0	x	req	Sperry	SBM-4212	50-63	13,000	5 min	ina	(4)	req
WJ	SE218	18.0-26.5	8500	20 min	ina		req	OKI	BA60C	54-65	11,000	120 typ	ina	r	4995
WJ	WJ311	18.0-26.5	8500	5 min	ina		req	Siemens	RW075	50-75	25,000	5 typ	ina		req
WJ	WJ2057	18.0-26.5	8500	20 min	ina	x	req	Sperry	SBE-4023	70-86	16,000	2-5	ina	(4)	req
WJ	OD18-27	18.0-27.0	9000	5 min	ina	y	req	Siemens	RW080	60-90	30,000	1 typ	ina		req
Varian	VA-490N	34.0-36.0	2000	20 min	8.0	x	req	Sperry	SBF-4221	86-98	12,000	3-7	ina	(4)	req
Varian	VA-164M	26.5-40.0	13,500	10 min	5.0	x	req	Thomson	C010-1	290-300	10,000	200-1000	20		21,000
Varian	VA-490M	26.5-40.0	13,500	5 min	5.0	x	req	Thomson	C010	290-310	20,000	10-80	40		20,000
WJ	SE222	26.5-40.0	13,500	10 min	ina		req	Thomson	C009	320-350	30,000	10-80	20		19,500
WJ	SE312	26.5-40.0	13,500	5 min	ina		req	Thomson	C006EA	480-520	40,000	3-30	35		19,500
								Thomson	C005EA	570-630	60,000	3-30	30		19,500

- | | |
|--------------------------------------|--|
| a. Reflex-type klystron | t. Integral waveguide tuning |
| b. Integral cavity | u. Waveguide output |
| c. External cavity | v. Pencil Tube |
| d. Low noise | w. Mechanically tuned |
| e. Low drift | x. Fully shielded |
| f. Rugged | y. Solenoid focused |
| g. Micrometer tuning | z. Stabilized cavity |
| h. Long life | (1) Constant reflector voltage with tuning |
| i. Extremely high FM modulation rate | (2) Fixed reflector voltage |
| j. Voltage-tuned magnetron | (3) Two-cavity klystron |
| k. Fixed tuned | (4) Permanent-magnet focused |
| m. Insulated tuner | (5) Includes varactor multiplier |
| n. Dielectric tuning | (6) Control electrode |
| p. Differential screw tuner | (7) Pulsable |
| q. Water cooled | (8) Gap tuner |
| r. Air cooled | (9) Trimmable |
| s. Probe output | |

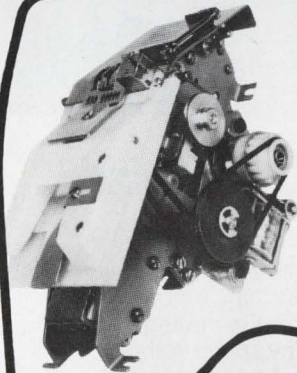
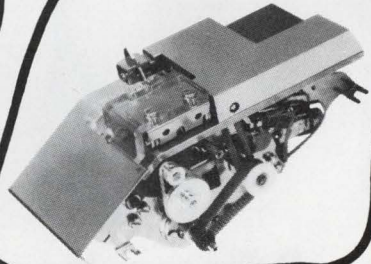
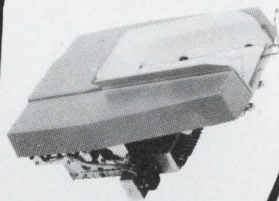
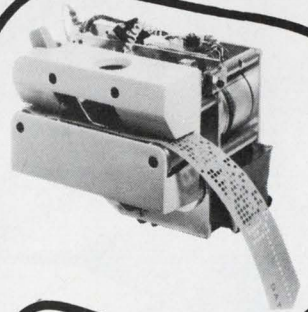
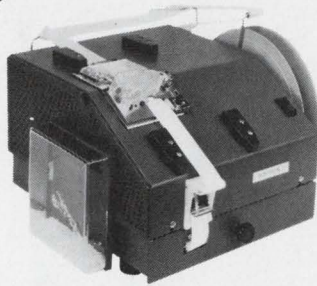
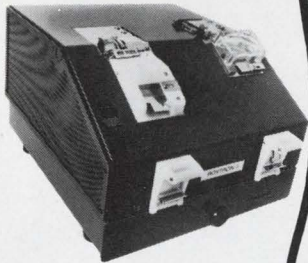

if it reads punched paper tape, punched cards, edge punched cards, pin sensing, cards, badges, optical, reflective, key sort, mark sensing, brush and magnetic stripe cards, we have it!

in more models . . . to fulfill more OEM applications . . . to sell faster and more profitably . . . and stay "on-board" longer with less maintenance than any other readers in the industry.

If you think that's something, you should see our punch line.

FJCC - BOOTH 1401

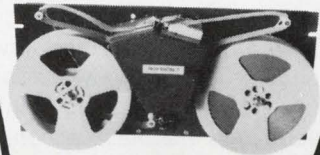
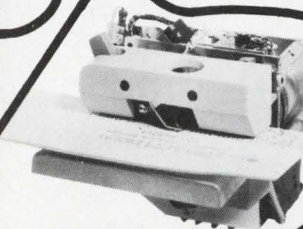
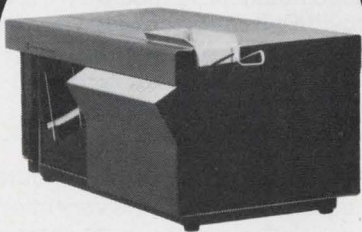
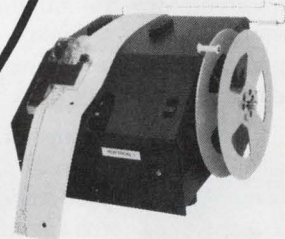

For more information
call Frank Misiewicz
OEM Products
(201) 935-2200

LITTON ABS
automated business systems



600 WASHINGTON AVENUE, CARLSTADT, NEW JERSEY 07072

INFORMATION RETRIEVAL NUMBER 63

Malco presents Dip-Mates, another great moment in mating



Man discovers something better.

Some guys are never satisfied with their mates. They're always looking for something new. Something a little more... uh... reliable. And preferably, something with a little less resistance.

Well look no further.

The newest Malco-Mate was specifically designed for the guy who wants something better. It's DIP-MATE.

The most advanced, most reliable dual-in-line circuitry interconnection system available.

The not-so-secret secret of Dip-Mates is the newly designed fork type contact plus the low resistance ground and power connections. Now you can plug in thin DIP leads and maintain a consistently reliable connection. In Dip-Mates, the base plate functions as the ground while a thin, insulated aluminum power plate is attached under the module board.

The new Dip-Mate design keeps thermal problems to a

minimum by air cooling both the top and bottom of the plugged-in package. And on the wrapost side, a low profile interconnection design allows for a maximum area available for wire wrapping.

But let's get to the best part. Dip-Mates are the most versatile dual-in-line (MSI and LSI, too) connectors because they can be used as both a flat I.C.

board or in a cubic configuration using a mother plate with daughter plates inserted at right angles. In fact, you can even stock spare modules.

Not only does this configuration

save gobs of space, but it lets you add as many modules as you need. Reliably.

To make it even more tempting,

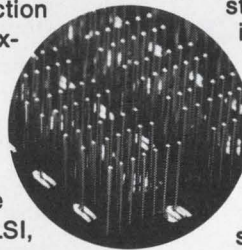

Dip-Mates used in the cubic configuration can have built-in heat sinks installed, so you can stuff the entire mating system into a tiny space without worry. And Dip-Mates accept everything from the standard 14-pin I.C. up to an infinite number of contacts. Almost.

Naturally, you can order Dip-Mates to meet your unique design specifications. In fact, we'll even provide wire-wrap for you. Or, you can order any of our off-the-shelf Dip-Mates in standard configurations. And even not so standard configurations.

If you're looking for a new mate that can offer you some very interesting variations, discover Dip-Mates. They're something better.

We solve your mating problems.



MALCO
MALCO MFG COMPANY INC
5150 WEST ROOSEVELT ROAD
CHICAGO, ILLINOIS 60650
(312) 287-6700

Send for your free copy of
Dip-Mates Exposed.
A Guide To Reliable Mating.

New Products

High-speed ± 2 -V generator clocks out at a 1-GHz rate

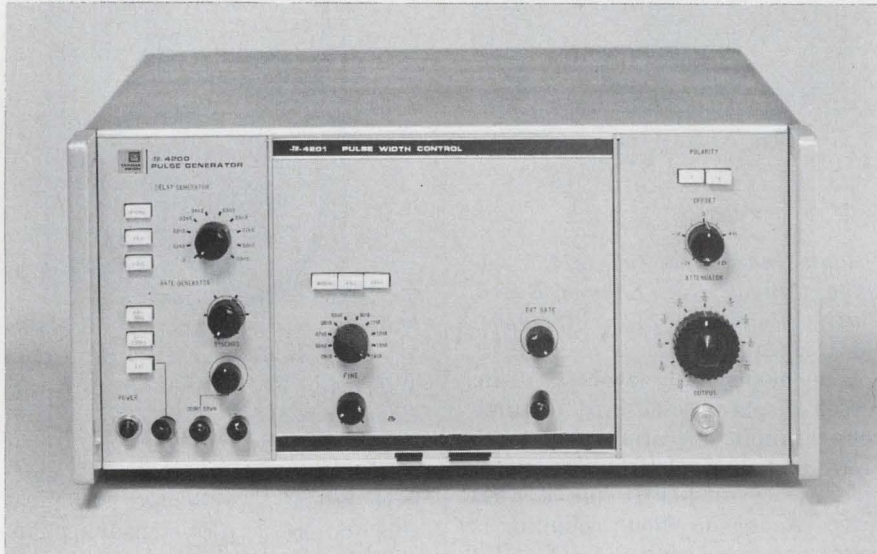

Takeda Riken Industry Co., Inc., Nichimen Co., Inc., 60 Broad St., New York, N. Y. Phone: (212) DI4-3456. P&A: \$32,000; 120 days.

Supplying high-speed ± 2 -V pulses with rise and fall times under 250 ps, the TR-4200 series pulse generator system comprised of a \$9800 mainframe and its three plug-ins bursts forth with an amazing clock rate of 1000 MHz.

With its three complementary plug-ins, the new generator system can produce three types of output modes: programmable word patterns, pseudo random noise sequences and continuous pulse trains.

Either an external clock signal or the system's internal clock signal can be arbitrarily selected. The external signal is continuously variable over the frequency range of 100 to 1000 MHz. An age circuit is available at the external clock-signal input to ensure a broad dynamic input range.

Another important feature of the new pulse generator system is that the offset position of the output base line is fixed, regardless of the output pulse amplitude, which is adjustable to ± 2 V.

When varied in its output-amplitude range of ± 2 V, the base line

contains less than 10% of distortion which includes overshoot and sag characteristics.

The generator can be delayed in output by internal incremental adjustments of 100 ps over the range of 100 ps to 2.5 ns. This can be extended up to 20 ns by externally attaching a coaxial cable.

Two synchronization output signals are available. One is a 50-MHz count-down signal and the other is a 0.5-V pk-pk signal.

The TR-4201 is the continuous-pulse plug-in whose frequency range is 100 to 1000 MHz. It provides output pulse width over the range of 400 ps to 2.5 ns and is capable of generating pulse bursts. Its output is of a return-to-zero mode. Cost is \$3900.

The TR-4202 is the word generator plug-in with a frequency range of 100 to 1000 MHz. It can supply 15-bit words or 9-bit words which are switchable. Cost is \$8500.

The TR-4203 is the pseudo random noise plug-in with a frequency range of 100 to 1000 MHz. Its maximum period-length sequence pulse train is selectable from $2^9 - 1$ to $2^{15} - 1$ bits. Output is of a non-return-to-zero mode and cost is \$9800.

CIRCLE NO. 250

Three-digit multimeters have \$179 price tag



Numeric Laboratories, 329 S. Greenwood Ave., Palatine, Ill. Phone: (312) 359-5985. P&A: \$179, \$195; stock.

Series 300 three-digit multimeters with 1% accuracies include the \$179 model 350 which measures dc voltage and current and resistance and the \$195 model 351 which measures dc and ac voltage and current, and resistance. Both models feature 10% overrange, include an automatically-positioned decimal point and sample at a rate of 60/s.

CIRCLE NO. 251

110-MHz 6-digit marker is a 15-MHz counter

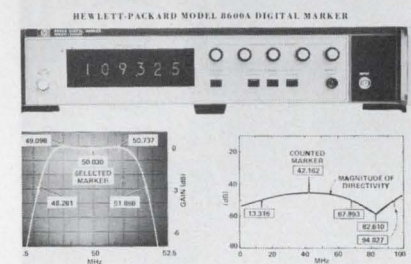

Sweeping band pass filter markers identify frequencies of band center, band edges, and -3 dB points.

Bandpass directivity measurement. Frequencies being counted is automatically identified by up-pointing marker.

Hewlett-Packard, 1501 Page Mill Rd., Palo Alto, Calif. Phone: (415) 326-7000. P&A: \$1100; 45 days.

Five variable markers, that can be set anywhere in the range of 0.1 to 110 MHz with a 6-digit counter read-out, now come in one package along with a 15-MHz counter, all for \$1100. Model 8600A digital marker functions with the 8610A 110-MHz sweep generator and with any swept display to produce five frequency markers.

CIRCLE NO. 252

Benchtop X-Y recorder plots X-t functions

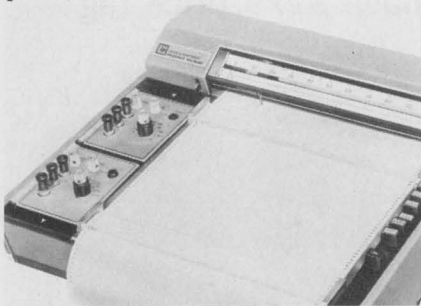

Leeds & Northrup Co., Sunnyside Pike, North Wales, Pa. Price: \$1570.

The Speedomax XL 683 benchtop X-Y recorder converts instantly into an X-t recording device with optional selection of 1, 2, 3, or 10 chart speeds. Chart travel is horizontal as the X function drives the recorder pen across the chart while the Y function drives the low-inertia chart beneath the pen. Chart span is 250 mm on each axis. A pushbutton chart-advance system automatically positions the Y-axis for the next plot.

CIRCLE NO. 253

Optical-power system is a mere \$1100



Hewlett-Packard, 1501 Page Mill Rd., Palo Alto, Calif. Phone: (415) 326-7000. P&A: \$1100; 60 days.

Accurately measuring both total power and power density of optical radiation in the μv visible and IR regions with a single probe, the model 8330A/8334A optical-power meter system costs only \$1100. Radiant flux resolution is 5 nW to 10 mW, irradiance resolution is 50 nW/cm² to 100 mW/cm², and radiance resolution is 5 nW/cm²/steradian to 10 mW/cm²/steradian.

CIRCLE NO. 254

Display oscilloscope lowers cost to \$425

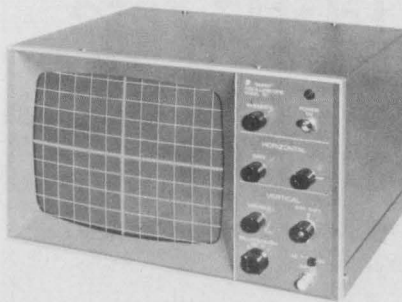

Telonic Industries, Inc., 21282 Laguna Canyon Rd., Laguna Beach, Calif. Phone: (714) 494-9401. P&A: \$425; stock.

The model 121 low-cost 11-in. screen display oscilloscope features vertical-input operation of dc to 15 MHz and horizontal-input operation of dc to 1 kHz for a \$425 price. Ac or dc input coupling is used and sensitivity is 1 mV/division and 100 mV/division for vertical and horizontal inputs, respectively.

CIRCLE NO. 255

Wideband analyzer is -100-dBm sensitive



Syston-Donner Corp., Microwave Div., 14844 Oxnard St., Van Nuys, Calif. Phone: (213) 786-1760. P&A: \$5950; 90 days.

The new model 761 calibrated spectrum analyzer operates in the 10-MHz to 40-GHz range with -100-dBm sensitivity. It is also capable of operating up to six hours from a Ni-Cd battery pack. Calibrated scan widths are featured from 100 kHz to 500 MHz with 5 i-f bandwidths ranging from 1 kHz to 1 MHz.

CIRCLE NO. 256

Wheatstone bridge checks 0.08 Ω to 60 k

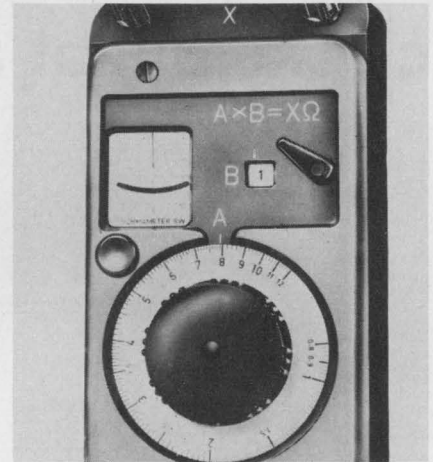

Norma Instruments of Vienna, Freed Transformer Co., Inc., 1718 Wierfield St., Brooklyn, N. Y. Phone: (212) 386-1300. P&A: \$98.50; stock.

The 1802-30201 Norma slide-wire Wheatstone bridge is a portable dc resistance-measuring instrument operating between 0.08 Ω and 60 k Ω with a six-position multiplier switch. The bridge has an 8-1/4-in. scale and is accurate to $\pm 0.5\%$ except at the extreme ends of the scale where it is accurate to $\pm 2\%$.

CIRCLE NO. 257

Calibrated analyzer displays X-Y functions

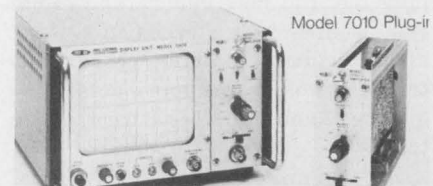

Kruse Electronics, 790 Hemmer Lane, Mountain View, Calif. Phone: (415) 967-2299. P&A: \$690; 60 days.

The model 7000 calibrated X-Y CRT display with three linear and logarithmic plug-in vertical amplifiers allows the convenient analysis of a wide range of rf and microwave frequencies. Horizontal amplification is 1 V/cm, response is dc to 300 kHz and input impedance is 10 k Ω . Vertical amplification is controlled by plug-ins that provide calibrated displays.

CIRCLE NO. 258

The industry's chameleon.



The adaptable V3 snap-action switch. So versatile it offers more than 500 working variations in circuitry, electrical capacity, actuators and terminals. In addition, the V3 offers options like extended overtravel, extra long life, and low operating force. This, plus a wide temperature tolerance (-100° F to specials of +600° F), make it the "standard" throughout industry. It also reduces costly downtime. Even better, it's inexpensive and readily available. For more information on the adaptability of the V3 contact your MICRO SWITCH Branch Office or Authorized Distributor. Or write for Catalog 50.

MICRO SWITCH

FREEPORT, ILLINOIS 61032
A DIVISION OF HONEYWELL

HONEYWELL INTERNATIONAL: Sales and service offices in all principal cities of the world.

INFORMATION RETRIEVAL NUMBER 65

NEW

from BULOVA...

DC Servo Amps

2.5w to 2,500w

Here's a line of servo amps packaged for flexibility and priced for system saving. It's another example of Bulova's unique capability in producing quality servo products at a price lower than you can make or buy.

Available from 2.5 w to 2.5 Kw —
 Styled in flat pack, modular or
 rack mount — to meet industrial
 or mil-spec — able to operate from
 AC or DC — to include power supply
 when required.

FEATURES:

- Adjustable Gain
- Current Limiting
- Voltage or Current Feedback
- Wide Bandwidth
- Low Cost

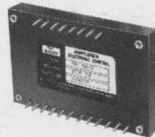

DCA Series

DESIGNED TO DRIVE:

- DC Torque Motors
- Low Inertia Motors
- DC Servo Motors
- Servo Valves
- Deflection Coils



DCAR Series

Don't miss out on this Bulova Servo Special. For new applications or old . . . for help in planning new servo systems . . . for the lowest price on DC Servo Amps . . . Look to Bulova!

Call (212) 335-6000, or write —



Electronic Division of Bulova Watch Company, Inc.
 61-20 Woodside Avenue
 Woodside, N. Y. 11377 (212) 335-6000

Bulova also offers a complete line of AC servo products, including servo amplifiers, modulators and demodulators, plus a line of power supplies.

INFORMATION RETRIEVAL NUMBER 66

ICs & SEMICONDUCTORS

Pnp 120-V transistors
 switch on in 300 ns

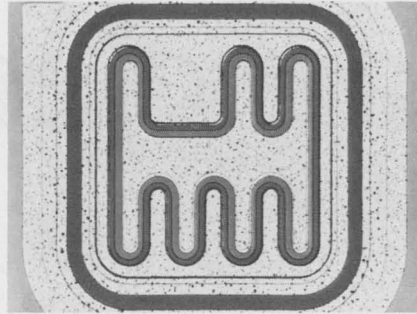

Fairchild Semiconductor, 313 Fairchild Dr., Mountain View, Calif.
 Phone: (415) 962-3563. P&A: \$9.75, \$12.75; stock.

Operating from high voltages, four pnp small-signal transistors switch on in 300 ns and turn off in 1 μ s. The 2N3494 and SN3495 are TO-5 units, while the 2N3496 and 2N3497 are TO-18 units. The 2N3495 and 2N3497 provide a minimum collector-to-emitter voltage of 120 V. The 2N3494 and 2N3496 have a minimum collector-to-emitter voltage of 80 V.

CIRCLE NO. 259

64-bit random memory
 accesses in 35 ns

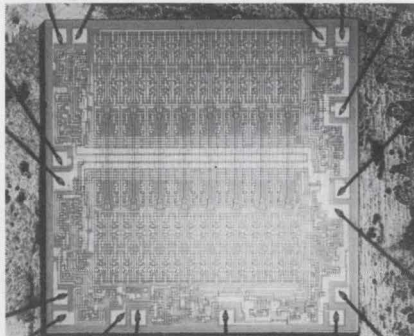

Radiation Inc., Microelectronics Div., Melbourne, Fla. Phone (305) 727-5412. P&A: \$25.60; stock.

Organized as a 16-word by 4-bit array with full decoding, a new 64-bit bipolar random-access memory accesses in 35 ns. It operates over a temperature range of -55 to $+125^{\circ}\text{C}$ and dissipates 6 mW/bit. It is compatible with DTL and TTL and features an open-collector output for wired-OR expansion in the word dimension. Write pulse width is 25 ns and packaging is in a 16-pin dual in-line case.

CIRCLE NO. 260

Pulling down the cost of lighting up an instrument

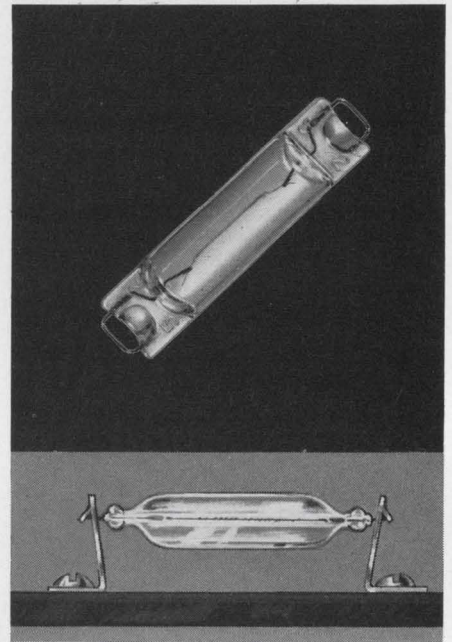

For a high-reliability light source, the Tung-Sol baseless cartridge lamp is about as simple as you can get. Elimination of cemented-on bases removes two potential failure sources while lowering cost. There are no anchors to generate noise and no soldered connections. Design permits use of an inexpensive clip-type mounting bracket which achieves low silhouette. Can be supplied in 6 v. and 12 v. types. Complete information and application assistance available. Write for catalog A-21. Tung-Sol Division, Wagner Electric Corporation, 630 W. Mt. Pleasant Avenue, Livingston, N.J. 07039; TWX: 710-994-4865, Phone: (201) 992-1100; (212) 732-5426.

TUNG-SOL® BASELESS CARTRIDGE LAMP

TUNG-SOL—WHERE BIG THINGS ARE DONE WITH SMALL LAMPS

® Trademark TUNG-SOL Reg. U.S. Pat. Off. and Marcas Registradas

INFORMATION RETRIEVAL NUMBER 67

MOS decade counters strobe and reset

Plessey Co. Ltd., Microelectronics Div., Cheney Manor, Swindon, Wiltshire, England.

Two new integrated p-channel MOS decade counter circuits, the MP123B and MP124B, provide output strobe and counter resets and have four master slave flip-flops connected as decade counters. The MP123B generates a BCD down-count and the MP124B includes decoding gates to give decimal outputs. A negative logic convention is used. Both devices come in TO-5 or dual-in-line cases.

CIRCLE NO. 261

MOS adaptive logic gate checks optical patterns

Integrated Photomatrix Ltd., Teknis Inc., 93 South St., Plainville, Mass. Phone: (617) 695-3591.

When interconnected, the MC901 MOS adaptive logic gate can be taught to recognize different optical patterns or to alternatively serve as a sequence generator. The new gate, which is TTL compatible, enables all the logic functions of four binary inputs to be realized with respect to one output of 65,520 bits by recognizing the required output for each of the 16 binary input patterns. Several of the new devices may be used together to provide several input adaptive gates.

CIRCLE NO. 262

16-bit memory chip includes logic too

Fairchild Semiconductor, 313 Fairchild Dr., Mountain View, Calif. Phone: (415) 962-3563. P&A: \$75; stock.

The MuL4102 is a bipolar 16-bit random-access associative memory that combines logic circuits and memory cells on the same silicon chip. Featuring a 35-ns match time, it is organized into four 4-bit words, each with its own address line. It is designed to signal a match whenever data at its inputs corresponds to data stored.

CIRCLE NO. 263

the Giant Killer...



New Heath EU-70A...

\$565.00*

**ASSEMBLED &
TESTED**

- Solid-state
- Dual trace
- Triggered
- DC-15 MHz
- X-Y
- 15" deep
- 8x10 cm flat face CRT
- Send for the free EU-70A spec sheet...
and watch the giants fall

EU-70A PARTIAL SPECIFICATIONS: Frequency Response: DC-15 MHz, down 3 dB. Rise Time: 24 nsec. Time Base: Triggered with 18 calibrated rates, 0.2 usec/div to 100 msec/div in 1, 2, 5 sequence. Sweep Magnifier: X5, accuracy $\pm 5\%$. Triggering: Internal - Channel 1; Channel 2; Channels 1 / 2. External. Line. Adjustable. + or - slope. AC or DC coupled. Triggering Requirements: Internal - triggers from Channel 1, Channel 2 or Channels 1 / 2 X-Y mode capability. 8x10 cm grid, edge lighted. Dimensions: 10 1/2" W x 12 1/2" H x 15" D.

NEW FREE 1971 CATALOG!



The latest edition, with many new, exciting kit-building projects... over 300 kits for stereo/hi-fi, color TV, electronic organs, guitar amplifiers, ham radio, marine, educational, CB, home & hobby. Mail coupon or write Heath Company, Benton Harbor, Michigan 49022.

HEATH COMPANY, Dept. 520-26
Benton Harbor, Michigan 49022



Rush my new HeathKit Catalog

Enclosed is \$ _____, plus shipping.

Please send model(s) _____

Name _____

Address _____

City _____ State _____ Zip _____

Prices & specifications subject to change without notice.

*Mail Order Prices; F.O.B. Factory

EK-290

Resettable TTL multi is dual retriggerable

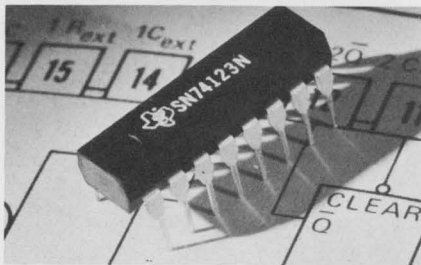

Texas Instruments Inc., 13500 N. Central Expressway, Dallas, Tex. Phone: (214) 238-2011. P&A: \$4.72 to \$16.12; stock.

Featuring dc triggering from high and low-level active inputs, the SN54/74123 TTL multivibrator exhibits dual-retriggerable resettable operation. It has an overriding direct clear input and a fan-out of 10 for both positive and negative output pulses. Power dissipation is 100 mW and propagation delay is 21 ns.

CIRCLE NO. 264

Differential op amp settles in 1/2 μs

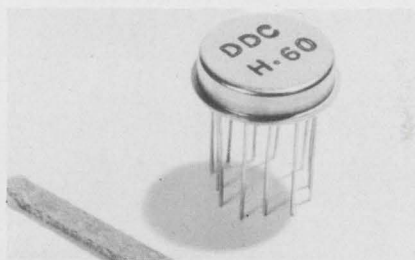

DDC, Div. of Solid State Scientific Corp., 100 Tec St., Hicksville, N. Y. Phone: (516) 433-5330. P&A: \$125; stock.

Featuring an offset voltage of 2 mV, which can be externally trimmed to zero by use of a 50-kΩ potentiometer, the H60 differential FET-input operational amplifier settles to 0.01% in 1/2 μs. Other specifications include a 200-V/μs slew rate, a 25-MHz unity-gain bandwidth and 100-dB open-loop dc-voltage gain.

CIRCLE NO. 265

Silicon rectifiers accept 10 kV PIV

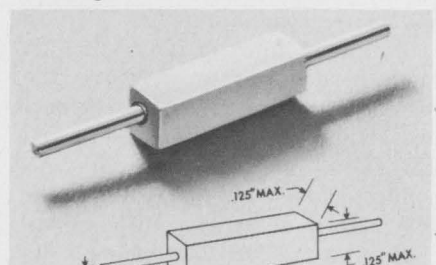

Electronic Devices, Inc., 21 Gray Oaks Ave., Yonkers, N. Y. Phone: (914) 965-4400.

The new DR series of low-cost fast-recovery high-voltage silicon rectifiers range in voltage ratings from 3000 to 10,000 V PIV at a current rating of 25 mA. Each rectifier measures only 0.437-in. long by 0.125-in. square and has 0.2-in.-long leads. Avalanche characteristics include a maximum reverse-recovery time of 300 ns and a peak surge current of 1 A.

CIRCLE NO. 266

KEYBOARD **MINIATURES**

Unusual momentary magnetic repulsion Alco push button switches have ceramic magnets that eliminate springs. Glass reeds, 1/2" dia. metal case, 100 mA @ 50 VDC. SPST, N.O. or N.C. .110" flat or .058" round terminals.



ALCOSWITCH® MAGNETIC ACTION
DIV. OF ALCO ELECTRONIC PRODUCTS, INC., LAWRENCE, MASS.

INFORMATION RETRIEVAL NUMBER 69

TOGGLE SWITCH **MINIATURES**

Higher ratings, longer life 250,000 operations. Metal construction, high impact insulation allows use under wide range of environmental conditions. U/L approved. SPDT, DPDT. 1/4" or 13/32" bushings.

10A @ 125 VAC



MCT Series

ALCOSWITCH® CYLINDRICAL CASE
DIV. OF ALCO ELECTRONIC PRODUCTS, INC., LAWRENCE, MASS.

INFORMATION RETRIEVAL NUMBER 70

who cares what a control knob looks like?

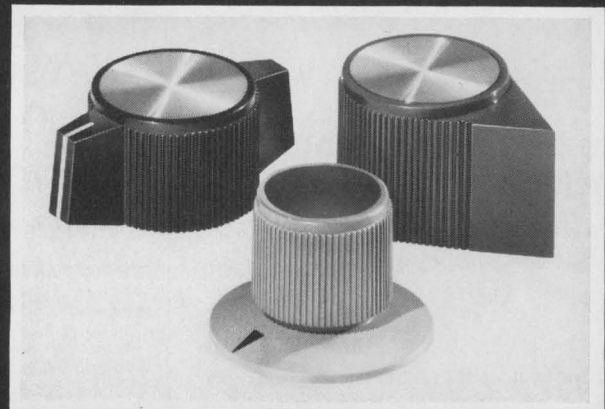

we do.

Roqan

BROTHERS, INC.

Outline your requirements for quotation and free knob sample. Also write for free, full-color catalog.

8019 N. MONTICELLO AVE., SKOKIE, ILLINOIS 60076, PHONE: (312) 675-1234

INFORMATION RETRIEVAL NUMBER 71

ELECTRONIC DESIGN 21, October 11, 1970

Npn power transistors rate 400 V at 3 A



Sensitron Semiconductor, 221 W. Industry Court, Deer Park, N. Y. Phone: (516) 586-7600.

A new series of silicon npn high-voltage power transistors, STS-1131 to STS-1134, offer collector-to-emitter voltages as high as 400 V and collector currents up to 3 A. Collector-emitter voltage ratings range from 225 V for the STS-1131 to 400 V for the STS-1134. Current gain at 3-A ratings is a minimum of 18 and a maximum of 60.

CIRCLE NO. 267

Fast MOS register shifts at 3-MHz rate

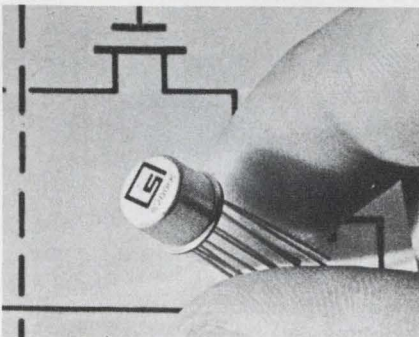

Signetics Corp., 811 E. Arques Ave., Sunnyvale, Calif. Phone: (408) 739-7700. P&A: \$4; stock.

A new MOS dual 100-bit static shift register, the N2010K, operates at shift rates ranging from dc to 3 MHz. It has a typical propagation delay of 200 ns and a maximum of 250 ns. Two external 28-V clock phases as well as a -14 V-dc and a -28 V-dc supply are required for operation. A third phase is generated on the MOS chip.

CIRCLE NO. 268

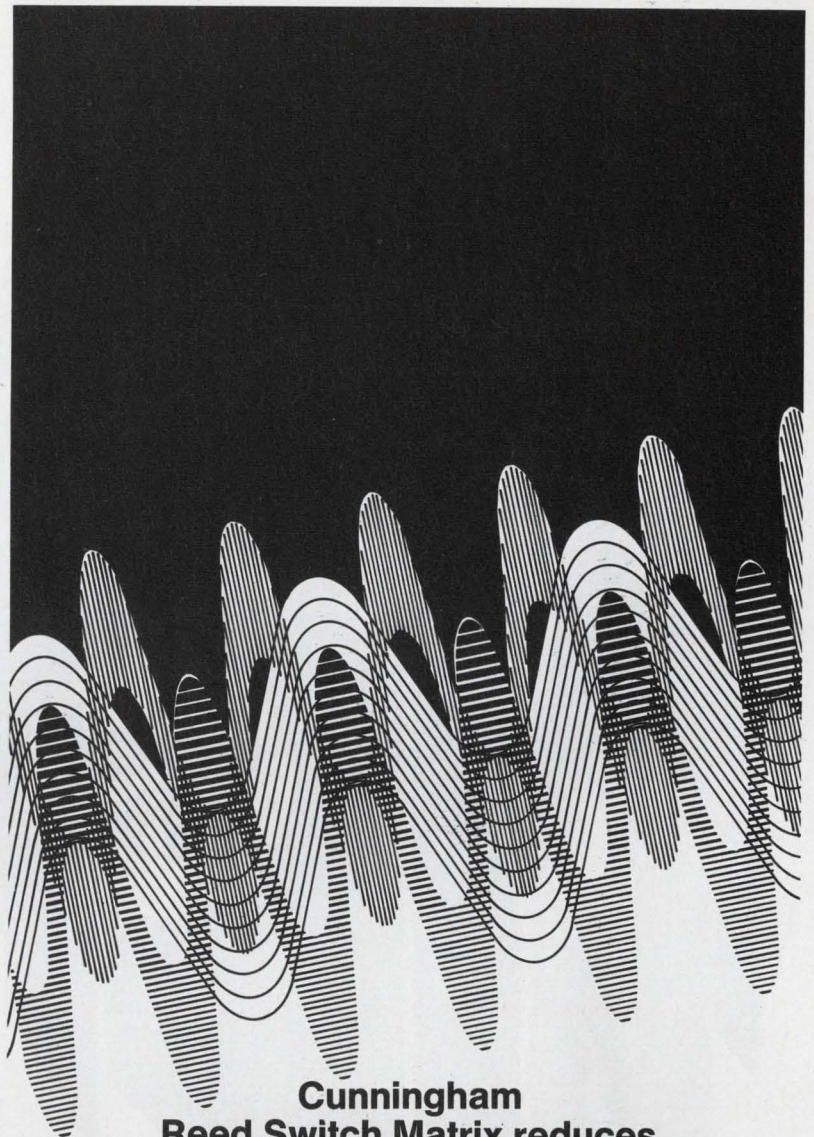

Cunningham Reed Switch Matrix reduces high-frequency crosstalk to a new low.



Isolation does it. Through an unusual "sandwich" design, matrix-mounted reed switches are sealed, shielded and separated from their controls, achieving maximum open circuit isolation and negligible crosstalk.

The matrix is ideal for interconnecting video channels, broadband data switching, test systems for nano-second digital pulses, telemetry equipment for multiple data channels, antenna switching, and medical data monitoring. Proven reliability up to 100 million operations. The whole story about

the Cunningham Reed Switch Matrix's excellent signal characteristics, 100% random access, computer compatibility, single package design and dual coaxial connectors for multiple expansion is told in Data Sheet No. 500. Write or phone Cunningham Corporation, 10 Carriage St., Honeoye Falls, New York 14472. Phone (716) 624-2000.

Cunningham Corporation

SUBSIDIARY OF GLEASON WORKS

INFORMATION RETRIEVAL NUMBER 72

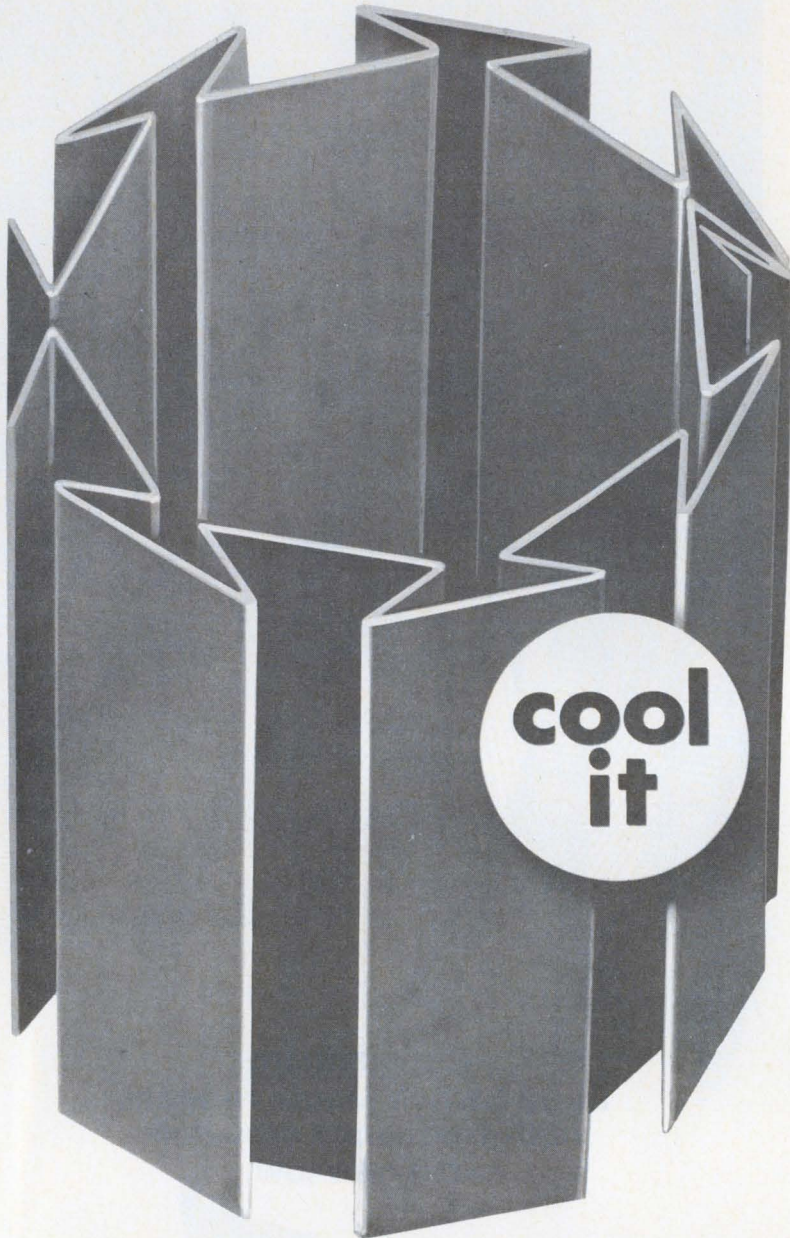

Atlee's delta-wave configuration keeps components 80°C cooler than other inserts.

Atlee has a complete line of full-contact heat dissipating inserts for cooling many types of electronic components. Made of beryllium copper to provide unexcelled heat conduction. Provide cooling when used inside cans or castings or are interlocked to form a circle and slid over the component.

Exclusive delta-wave design proves more effective

than that of any conventional insert because more than 80% of the surface contacts the flat area of the delta. Particularly effective when forced air systems are used. Available with or without finish, cut to any length, or in rolled uncut form. Write today for complete information and samples. Atlee Corporation, 2 Lowell Avenue, Winchester, Massachusetts 01890.



INFORMATION RETRIEVAL NUMBER 73

MOS 64-bit register dissipates but 1μ A

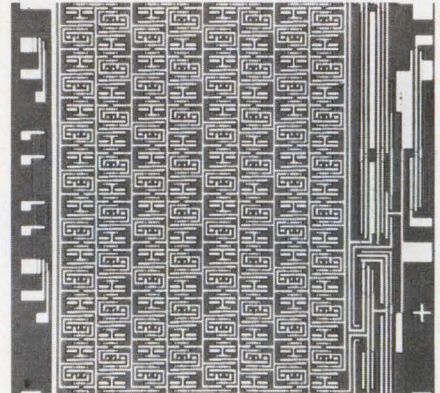

Ragen Semiconductor, 53 S. Jefferson St., Whippany, N. J. Phone: (201) 887-4141. Availability: stock.

Operating from dc to 25 MHz, a new MOS 64-bit shift register array with serial input and output exhibits ultra-low power dissipation of less than 1 μA of current drain over the range of 5 to 16 V, in the static mode. Other features of the MS612 are a single-clock input with a capacitance only 5 pF, use of a single power supply and operation from -55 to +125°C.

CIRCLE NO. 269

Four-bit MSI register eases data input

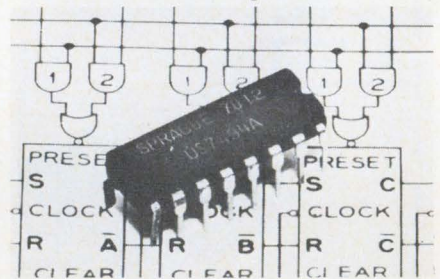

Sprague Electric Co., Semiconductor Div., 551 Marshall St., North Adams, Mass. Phone: (413) 664-4411.

The new US7494A four-bit MSI parallel-input serial-output register features 2-input OR-gate presets for individual bits, a 2-input OR-gate preset for all bits in parallel, serial input and all-bit clear. Input data may be entered in parallel or serially and transfer of information into the output occurs during the clock's positive transition. The new IC comes in a 16-pin dual-in-line package.

CIRCLE NO. 270

Portable field programmer patterns read-only memories

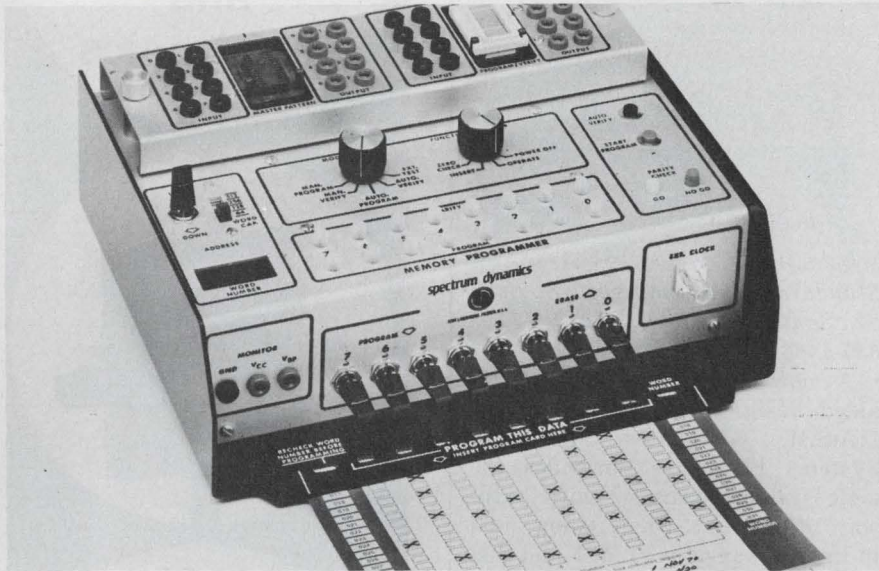

Spectrum Dynamics, Inc., Box 23699, Fort Lauderdale, Fla. Phone: (305) 566-4467. P&A: \$945; 6 wks.

Able to establish patterns on read-only memories, the model 402 portable IC-memory programmer provides an accurate and economical means of electronically programming off-the-shelf read-only memories, in the field.

Programs are first worked out for each word on supplied truth-table cards. The cards are then aligned with programming switches on the model 402 programmer and a master IC memory is then manually programmed.

Additional devices can then be automatically programmed and verified at a rate of 400 ms word. Initial programming and verification for the first master memory takes 30 minutes.

If we assume 50% programming of logic states ONE, a typical 64-word eight-bit memory can be completed in just 30 seconds. The advantage is that once a user programs a master memory, any off-the-shelf memory can be accurately programmed in the field in only seconds.

The 402 programmer has an address capacity of 512 words maximum, selectable as 64, 128, 256,

and 512 words. Output capacity is 8 bits.

Interchangeable socket assemblies are available on the 402 programmer for 24-pin dual-in-line, 24-pin flatpack and 16-pin dual-in-line packages. Eight spring-return switches allow the operator to correct bit information before programming.

Display is on a seven-segment three-digit word counter that displays 20 words per second or single words with manual up-down control via a three-position lever switch.

Access points are available for all inputs and outputs such as voltage supply and ground points for manual testing on monitoring.

A rear-panel 50-pin connector provides coupling for automatic programming methods using card or tape readers, or for dynamic device testing.

Built-in features of the model 402 include a 5-V dc collector supply source, an insert switch for disabling all pins on both master and unprogrammed memories, a function selector that allows parity checks in both automatic and manual modes and a word-capacity switch that prevents the over and under-programming of memories.

a little about pots.



When space is limited, buy the Weston 1/4-inch trimmers. The 566-569 Series is a new 1/4-inch round, single-turn, CERMET, commercial, trimming potentiometer rated at 0.50 watts at 70°C.

The main features are:

- small size**
1/4-inch round
- wide resistance range**
10Ω to 1 meg
- low-cost**

only \$1.11 in 500 quantities, with substantial reductions in larger quantities

temperature coefficient
±100 ppm/°C, maximum
delivery from stock

You have two configurations to choose from. The Models 566-567 are 1/4-inch round top adjust, with PC pins base mounted. The Models 568-569 are side adjust with PC pins edge-mounted. To provide a model for your design, several pin arrangements are available.



For samples, or complete details, call 717-876-1500 or write Weston Components Division, Archbald, Pa. 18403, a Schlumberger company.

WESTON®

INFORMATION RETRIEVAL NUMBER 74

CIRCLE NO. 271

Our D servomotor is mad with power.

That's our SU-680D-29 permanent-magnet D-C servomotor. We call it our D motor for short. It's small, rugged and powerful. It delivers 12.7 watts of continuous power output at 8600 rpm and is a natural for any servomechanism that requires a prime mover. It has a high repeatability-to-time ratio which makes it immensely stable, a 0-10,000 rpm speed range and a high acceleration Torque/Inertia. Torque peaks at 15 oz-in., 2 oz-in. continuous at 8600 rpm. It measures only 1 1/8 inches in diameter and weighs just 8 1/4 ounces.

SERVO-TEK PRODUCTS COMPANY
1086 Goffle Road, Hawthorne, New Jersey 07506.

SERVO-TEK
PRODUCTS COMPANY

For full details write for our interesting technical sheets and get mad with power yourself.

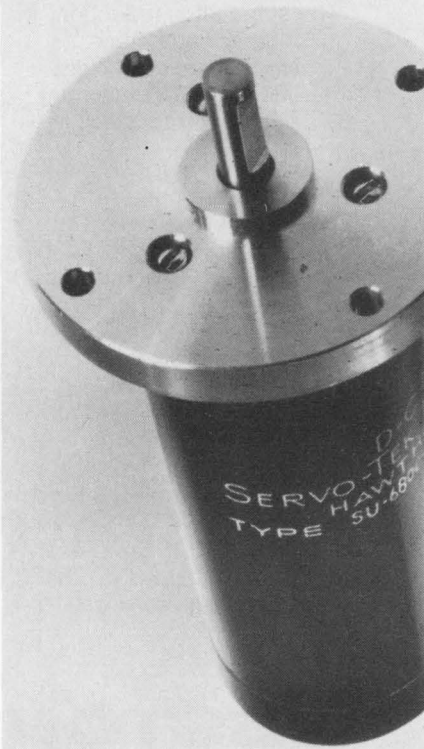

INFORMATION RETRIEVAL NUMBER 75

DATA PROCESSING

Computer-system cards make logic design easy

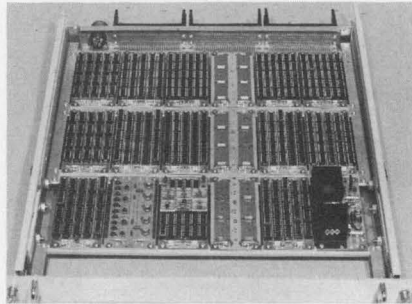

Standard Logic Inc., 1630 S. Lyon St., Santa Ana, Calif. Phone: (714) 835-5466. Availability: stock.

A new approach in computer-aided design hardware known as C.A.S.H. (Computer Automated Systems Hardware) provides the logic systems designer with hardware flexibility when using dual in-line packaged ICs, MSI and discrete components. With C.A.S.H.'s modular DIP card assemblies, the designer can mix and match the exact number of 14, 16 and 24-pin DIPs which his system requires.

CIRCLE NO. 272

Solid-state keyboard has bounce-free output

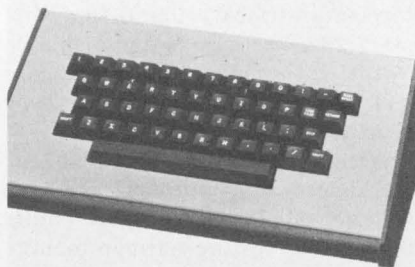

TEC, Inc., 6700 S. Washington Ave., Eden Prairie, Minn. Phone: (612) 941-1100.

A new 47-key contactless solid state opto-electronic keyboard features a bounce-free output and data strobes. It combines optical code generation and solid-state logic to detect and amplify the data bits and is DTL/TTL compatible. Sixty-five ASCII-character codes are generated. Options include two-key roll over, repeat, shift-lock and bit parity features.

CIRCLE NO. 273



E F C
fiberoptics
and
electronics

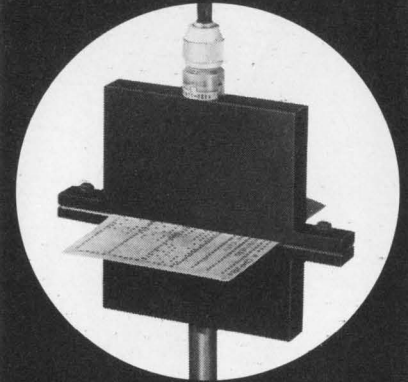

**Read stations
for 80 column and
new IBM system 3 cards**

From machines to medicine EFC combines electronics and fiberoptics to solve component and system design problems. Call us.

Data Sheets on Request:

- 101 Flexible light guides
- 102 Optical fibers
- 103 Omni reader, 12 channel
- 104 Flexible image bundle
- 105 Miniature bulb
- 106 Omni sensor
- 107 Light distributor
- 108 Optical tachometer



**ELECTRO FIBEROPTICS
CORPORATION**

998 Hartwell Street,
West Boylston, Mass. 01583
Phone 617 835-6082

INFORMATION RETRIEVAL NUMBER 76
ELECTRONIC DESIGN 21, October 11, 1970

Calculator with program works statistical data



Cintra, Inc., sub. of Physics International Co., 1089 Morse Ave., Sunnyvale, Calif. Phone: (408) 734-3630. P&A: \$3780; 60 days.

A new programmable calculator, the statistician 911, performs statistical calculations and solves many mathematical problems. It can obtain factorials for any unknown integer value from zero to 69 without any programming. Independent accumulation of any unknown value in the display can also be accomplished.

CIRCLE NO. 274

BCD-to-decimal decoder interfaces instruments



Addo-X Inc., 437 Madison Ave., New York, N. Y. Phone: (212) 758-9171.

Designated the 47-1321-00, a new decoder converts BCD numbers to decimal digits to make possible the direct feed of information from measuring instruments to digital printers. It allows an operator to take any system using old converters, and by means of direct plug-in components, to get printed output and accumulation. Its capacity is 8 BCD positions and 12 decimal positions.

CIRCLE NO. 275

a little more about pots.



When you need a wide range of resistance with high resolution in a $\frac{3}{8}$ -inch Squaretrim® buy Weston's CERMET 546-548 Series. These 25-turn trimming potentiometers are rated at 0.50 watt at 85°C with a temperature coefficient of ± 100 ppm/°C maximum, from -55°C to $+150^\circ\text{C}$. Prices are as low as \$3.81 each in quantities of 500 units, with substantial reductions in larger quantities. Delivery is from stock.



The 520-523 Series is a NEW, $\frac{1}{2}$ -inch commercial, rectangular trimming potentiometer. Models 520 and 521 are wirewound units and Models 522 and 523 are CERMET. All models are rated at 0.3 watts at 85°C. Write for samples.

The 561-562 Series are $\frac{1}{4}$ -inch square, multiturn, wirewound trimmers designed to meet MIL-R-27208 Style RT26. The main features are: small size; excellent resolution; a temperature coefficient of ± 50 ppm/°C maximum; low cost, only \$4.40 each in quantities of 500, lower prices in larger quantities. Delivery is from stock. MIL qualification is in process.



For samples or complete details please call 717-876-1500 or write Weston Components Division, Archbald, Pa. 18403, a Schlumberger company.

WESTON®

10% OFF Call Now



Digital Panel Meters 3½ and 4½ digits

All of the high quality DPM's listed below are specially priced with a 10% discount in quantities of 1-9. If you call or write within 7 days as a result of this ad (you must mention this publication), you will receive a 10% discount card good for one month.

If you require specials for OEM applications such as ratiometers, comparators, or customs (mechanical/electrical) we would like to quote it and give you the best price.

**Take off 10% from these
Published 1-9 Prices**

3½ digit Model 510 Unipolar	\$195. Now \$175.50
3½ digit Model 520 Autopolarity	\$225. Now \$202.50
4½ digit Model 720 Autopolarity	\$370. Now \$333.00

I need complete specifications and information. Send literature!
 Send me a 10% discount card. No obligation. It's good for 30 days.

Model: 510 Quantity _____
 520 _____
 720 _____

Name _____
 Title _____
 Company _____
 Address _____
 City _____
 State _____ Zip _____

Datascan Inc.

1111 Paulison Avenue, Clifton, New Jersey 07013
 (201) 478-2800

COMPONENTS

Miniature trimmers span 1.7 to 50 pF

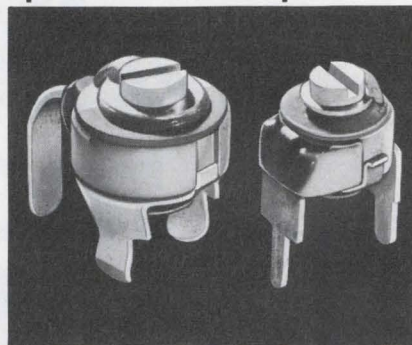

Johanson Mfg. Corp., 400 Rockaway Valley Rd., Boonton, N. J. Phone: (201) 334-2676. P&A: 18¢ to \$1.90; stock.

The 9300 series of low-cost micro-miniature rotary ceramic trimmer capacitors span a capacitance range of 1.7 to 50 pF. Outstanding features include their linear tuning as well as their high resistance to shock and vibration. A wide range of temperature coefficients and dielectric strengths of 250 V are available.

CIRCLE NO. 276

Tiny pulse transformer is housed in a DIP

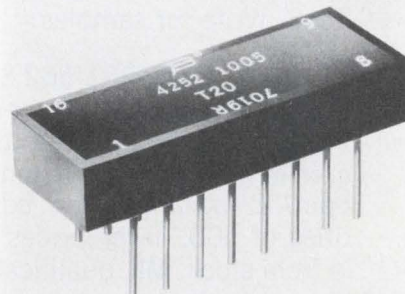

Bourns Pacific Magnetics Corp., 28151 Highway 74, Romoland, Calif. Phone: (714) 657-5195.

The model 4252-1005 is a miniature pulse transformer that is encased in a 1 by 0.385 by 0.2-in. 16-pin dual-in-line case and meets the requirements of MIL-T-21038 Grade 7 specifications. Its features include an insulation resistance of $10^4 \Omega$, an operating temperature range of 0 to 70°C and pulse inductance of 150 μH . Leakage inductance is 1 μH .

CIRCLE NO. 277

Adhesive thermistor measures up to 500°F

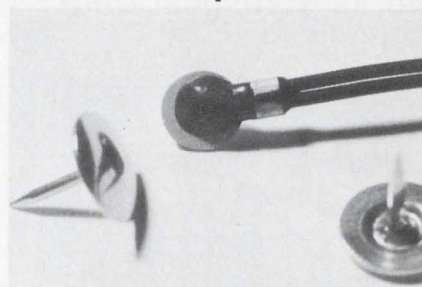

Fenwal Electronics Inc., 63 Fountain St., Framingham, Mass. Phone: (617) 875-1351.

Type H49 surface sensor is a fast-response thermistor assembly which is adhesive mounted for control or measurement of surface temperatures up to 400°F, and up to 500°F on special order. Its typical applications include industrial measurement and control of temperature in electronic equipment processes, and virtually any industrial application where surface temperature is a critical process control factor.

CIRCLE NO. 278

Silver-ribbon fuses protect semiconductors



Carbone-Ferraz, Inc., Box 324, Rockaway, N. J. Phone: (201) 627-6200.

Protistor cartridge fuses are fusible elements made of 99.99%-pure silver ribbon. When properly applied, they will carry rated circuit currents indefinitely without aging or deteriorating. Standard fuses are available in 26 models rated at 250 V (70 to 1000 A) and 26 models rated at 600 V (70 to 550 A). All are designed to operate at a temperature of 250°C or less.

CIRCLE NO. 279

lots more about pots.

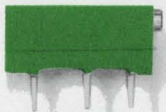

When you need a trimming potentiometer to meet *any* configuration, you can depend on WESTON to supply the right unit. Volume production of 3/4-inch rectangular pots, the 530-533 Series enables Weston to supply these models at the lowest prices in the industry. We'll supply them in wirewound with a temperature coefficient of ± 70 ppm/ $^{\circ}\text{C}$ maximum, or CERMET with a T.C. of ± 100 ppm/ $^{\circ}\text{C}$, maximum. Prices are as low as \$1.09 each in quantities of 500 units, with substantial reductions in larger quantities. Delivery is from stock.



Then, too, it's hard to beat our 1/2-inch 701 Series Squaretrim[®] potentiometer available with either commercial or military specs. Prices are as low as \$1.85 each in quantities of 500 units.

When you want a small, single-turn, wirewound Squaretrim[®] potentiometer, order the 501-505 Series. Prices are as low as \$1.95 each in quantities of 500 units.

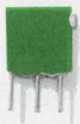

Buy them all from WESTON.

For samples or complete details on any or all of these units, call 717-876-1500, or write Weston Components Division, Archbald, Pa. 18403, a Schlumberger company.

WESTON[®]

INFORMATION RETRIEVAL NUMBER 79

Pulse transformers come as dual-in-lines

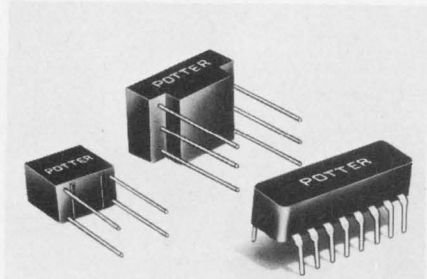

The Potter Co., 500 W. Florence Ave., Inglewood, Calif. P&A: 50¢ to \$1; 4 wks.

Ranging in inductance from 10 μ H to 100 mH, a new line of low-cost pulse transformers is available in both conventional and dual-in-line package configurations. Units have turns ratios from 1:1 to 10:1 with up to four windings each. Special types are available for use in computer systems which feature high permeability and temperature stability.

CIRCLE NO. 280

Trimmer potentiometers slim cases to 1/4 in.

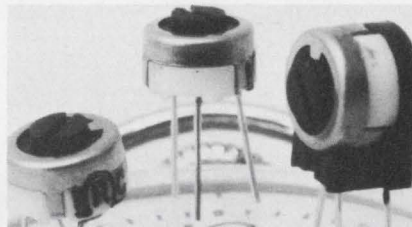

TRW Inc., Electronics Group, 1100 Glendon Ave., Los Angeles, Calif. Phone: (213) 477-6061. P&A: \$1.31; stock.

The 170 Pillpot series of trimming potentiometers features infinite-resolution metal glaze (cermet) elements in a 1/4-in.-round case. The series has a resistance range of 10 Ω to 1 M Ω and a standard temperature coefficient of ± 100 ppm/ $^{\circ}$ C over a temperature range of -55 to $+150^{\circ}$ C. Standard resistance tolerance is $\pm 20\%$ and power rating is 1/2 W at 85° C.

CIRCLE NO. 281

Low-cost capacitors retail from 15¢

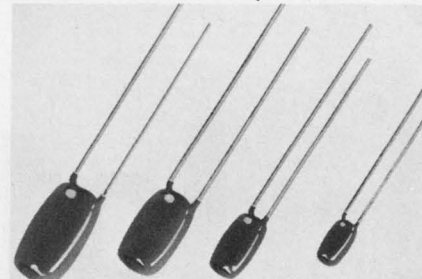

Dickson Electronics Corp., Box 1390, Scottsdale, Ariz. Phone: (602) 947-2231. Price: 15¢ to \$3.45.

Series GS dipped solid-tantalum capacitors feature rugged plug-in lead construction at costs as low as 15¢. They operate at full-rated voltages from -55 to $+85^{\circ}$ C. Capacitances range from 0.47 μ F at 50 V through 330 μ F at 6 V. Four cylindrical cases are available, ranging from 0.175 to 0.4 in. in diameter by 0.35 to 0.75 in. high.

CIRCLE NO. 282

ARITECH VOLTAGE CONTROLLED FILTERS

VCFs

can help you

**solve problems
in radar, telemetry, voice coding,
signal conditioning, data acquisition,
plus many other areas.**

VCFs allow you to electronically shift cut-off frequency without affecting the shape of the response. They are compact, stable, and extremely reliable.

Our standard VCFs — now in stock — are 4-pole Butterworth, 24 dB/octave, either high-pass, low-pass, or band-pass.

Cut-off Frequency Range	0.1 Hz to 20 kHz
Tuning Ratio	50:1
Tuning Voltage	0 to 5 VDC
Module Size	0.75" x 2.15" x 2.15"

Quantity prices for some versions — under \$80.

See us also for custom active filters.

ARITECH
CORP

130 Lincoln St., Brighton, Mass. 02135
Telephone: (617) 254-2990

INFORMATION RETRIEVAL NUMBER 80

FOR EXCELLENCE IN ROTARY SWITCHES SPECIFY GRAYHILL

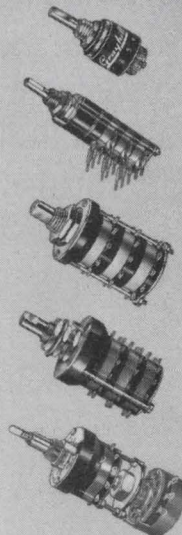

- 15°, 30°, 36°, 45°, 60° or 90° Angle Of Throw
- 2 To 24 Positions Per Pole
- Ratings Up To 15 Amps.
- 1 To 6 Poles Per Deck
- 1 To 12 Decks
- Diameters 1/2" To 2 1/4"
- Shorting Or Non-shorting Contacts
- Explosion Proof
- Military Or Commercial Styles
- Single Or Concentric Shafts
- Solder Lug Or Printed Circuit Terminals
- Switch And Potentiometer Combinations
- Key Lock Option
- Homing Rotor (Bridging And Shorting) Option
- Spring Return Option
- Power or Signal Switching
- Isolated Position (Pull-To-Turn) Option
- Adjustable Stop Option



For your Grayhill
Engineering Catalog
offering complete technical
data — contact

565 Hillgrove Avenue
LaGrange, Illinois 60525
Area Code 312, Phone 354-1040

Grayhill
INC

... the Difference Between Excellent and Adequate

INFORMATION RETRIEVAL NUMBER 81

GaAsP LED sources cover 630 to 690 nm

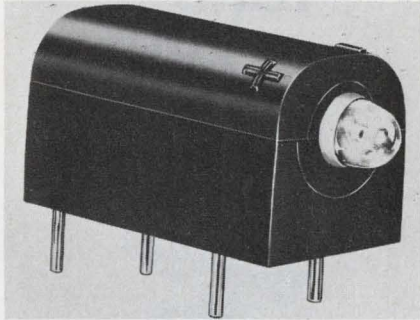

Solar Systems Inc., Box 128, 8124 N. Central Park Ave., Skokie, Ill. Phone: (312) 676-2040. Price: \$4, \$2.

A new gallium-arsenide-phosphide light source features a maximum spectral emission region between 630 and 690 nm. Two configurations are offered: one for PC boards that is solderable by conventional methods; and a panel-board type with Tinnerman attachments. Forward current is 50 mA. Luminance is 1250 foot-lamberts.

CIRCLE NO. 283

Beam-lead p-i-n diodes lower capacitances

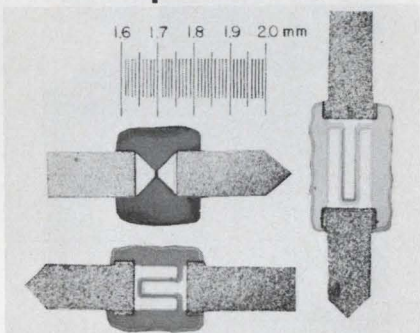

Texas Instruments Inc., 13500 N. Central Expressway, Dallas, Texas. Phone: (214) 238-2011. P&A: \$10; stock.

Three new 30 by 10-mil beam-lead p-i-n diodes, MD90, MD100 and MD101, provide low reverse-bias capacitances ranging from 0.02 to 0.12 pF. They are silicon-dioxide passivated and exhibit maximum series resistances of 8, 5 and 4 Ω , respectively. Each diode can be used in stripline circuits and each has a maximum breakdown voltage of 40 V.

CIRCLE NO. 284

Fast custom design hybrid microelectronics

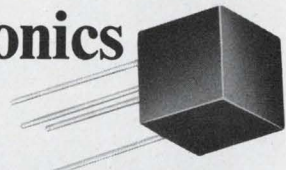

... like a 7 amp pulser driver

LMD-70 PULSER DRIVER

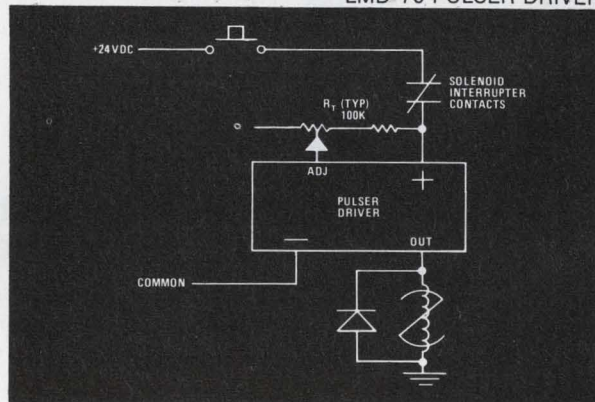

Typical Application and Connection Diagram

Typical Specifications

Operating voltage range	12 to 35 VDC
Maximum surge current (20 msec. max.)	7 amp
Time interval (max.)	200 msec.
Timing accuracy	$\pm 20\%$
Maximum case temperature	175° C

Our people designed this hybrid pulser and SCR driver circuit to control long interval stepping rates for stepping switches or solenoid/interrupter switch combinations.

The time interval is controlled by external resistance.

It is useful for driving light loads, or heavy loads at low speed or intermittent duty.

We're equipped to give you fast design and prototype service on any custom hybrid microelectronics package. Our engineers will come to you, if that's what you need.

You'll find our delivery dependable and our production standards among the highest in the industry.

The circuit described above is now stocked. Ask for catalog sheet. Or, for the whole story on our capability, write for brochure, "Custom Hybrid Microcircuits."

Specialists in hybrid microelectronic circuits



LEDEX MICROELECTRONICS, LEDEX INC.
123 Webster Street, Dayton, Ohio 45401 phone (513) 222-6992

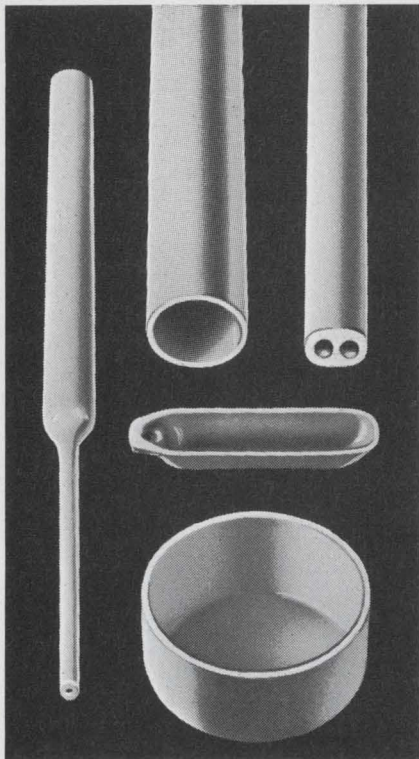

REFRACTORY PRODUCTS...

In addition to its famous lines of Vitrosil® and Spectrosil® fused quartz products, Thermal American is now supplying a line of crystalline oxide refractory ware and cement for use by industry and laboratories. These products are designed for high resistance to heat, low reaction with metals and chemicals, low porosity, high thermal conductivity, and good mechanical strength.

Included in the complete 16 page catalog with a separate price list is a selector chart providing instant technical, mechanical and application data for refractory products of Aluminous Porcelain, Recrystallized Alumina, Zirconia and Magnesia. Write for your copy.



FREE CATALOG

73

VITREOUS FUSED QUARTZ CO.
VITROSIL
 RT. 202 & CHANGE BRIDGE RD.
 MONTVILLE, NEW JERSEY
 ZIP CODE 07045

INFORMATION RETRIEVAL NUMBER 83

MICROWAVES & LASERS

Photomultiplier tube responds beyond 900 nm

EMI Electronics Ltd., Hayes, Middlesex, England.

Type 9659B photomultiplier tube with an extended S-20 photocathode provides infra-red response extending to beyond 900 nm with a quantum efficiency of 2.5% at 800 nm. The new tube has a borosilicate window and is also available with a fused silica window as type 9659QB for ultra-violet response to 165 nm. Both versions have the same low dark-current and high-gain characteristics.

CIRCLE NO. 285

Fast photomultiplier has 100-mA density

Instrument Technology Ltd., Nuclear Product Co., Inc., 6660 Variel Ave., Canoga Park, Calif. Phone: (213) 887-1010.

Tracing of single-pulse lasers on real-time oscilloscopes is made possible by a new high-speed gated photomultiplier with a current density at the anode of 100 mA. Its dynode arrangement enables transit time spread to be reduced to give a rise time of only 0.7 ns. Under pulsed conditions, photocurrent may be 100 μ A, which improves the signal-to-noise ratio.

CIRCLE NO. 286

Search-and-lock unit centers on 60-MHz

Varian, Solid State Div., 611 Hansen Way, Palo Alto, Calif. Phone: (415) 326-4000.

The ITF-4 solid-state search-and-lock automatic frequency-control unit for systems employing varactor-controlled devices features a center frequency of 60 MHz. Other characteristics include a pk-pk discriminator bandwidth of ± 8 MHz, a required input signal level at ± 1 dB of 0 dBm, minimum input pulse width of 0.1 μ s and sensitivity of 3 V/MHz. The unit operates from -40 to $+70^\circ$ C.

CIRCLE NO. 287

SHIELDED BOXES

Take your pick.

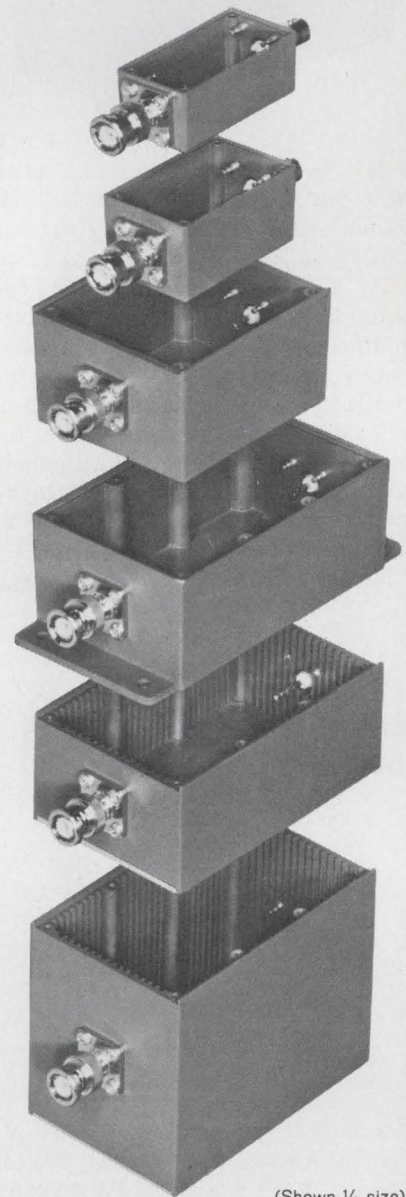

(Shown 1/3 size)

The newly expanded line of Pomona Shielded "Black Boxes" now comes in six different sizes; in cast or extruded aluminum; some slotted to accept circuit boards; in a broad choice of connector combinations or no connectors. There's bound to be one to meet your requirement. Write for complete information in our General Catalog.

POMONA ELECTRONICS

1500 E. Ninth Street • Pomona, California 91766

INFORMATION RETRIEVAL NUMBER 84
 ELECTRONIC DESIGN 21, October 11, 1970

Energy-beam emitters project up to 20 in.

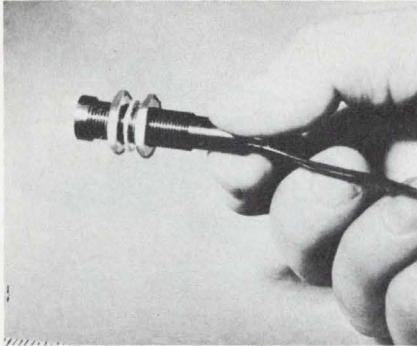

Chicago Miniature Lamp Works, 4433 N. Ravenswood Ave., Chicago, Ill. Phone: (312) 784-1020.

Series CM20 beam emitters project narrow cones of infrared and luminous energies over distances of 7 to 20 in. The minimum energy across the target for the CM-20-8-01 at 7 in. is 20 foot-candles and for the CM20-9-01 at 14 in. it is 15 foot-candles. The emitters consume only 850 mW of power. Operating voltage is 2.5 V nominal with a current drain of 0.34 A.

CIRCLE NO. 288

One-GHz transistors deliver up to 20 W

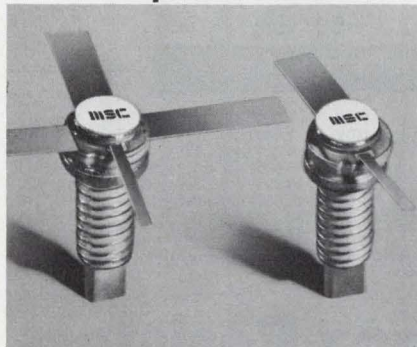

Microwave Semiconductor Corp., 100 School House Rd., Somerset, N. J. Phone: (201) 469-3311. P&A: \$150, \$75, \$50; stock.

A new line of 1-GHz transistors feature both ruggedness and high performance. The MSC1020 delivers 20 W at 1 GHz and has 8.2-dB gain. The MSC1010 handles 10 W at 1 GHz and has 8.2-dB gain. The MSC1005 supplies 5 W at 1 GHz with 10-dB gain. All feature low input Q and are packaged in common-base grounded-stud cases.

CIRCLE NO. 289

The mouse that soared.

This tiny curved connector (No, it's not warped!) is the very critical little mouse that helps make the mighty Hawk missile soar.

A diallyl phthalate* compound from U.S. Polymeric's Parr Division made the molding of this arc-shaped part possible for National Connector Division, Fabri-Tek. The resin's negligible lifetime shrinkage and dimensional stability, along with the high heat resistance and retention of insulating properties, assured correct alignments and reliable performance. For more information, let us send you "The Effects of Temperature and Humidity on Electrical Properties of Thermosetting Plastics."

*FMC supplies basic diallyl phthalate and diallyl isophthalate resins under the tradename DAPON. Write for complete information and a list of companies supplying molding compounds and prepreps based on these resins.



ORGANIC CHEMICALS DIVISION
633 Third Avenue
New York, N.Y. 10017

FMC Chemicals

Square-cap fuse holders snap into panels

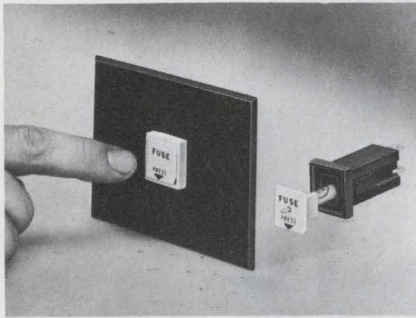

Littlefuse, Inc., 800 E. Northwest Highway, Des Plaines, Ill. Phone: (312) 787-7700.

Two new series of low-profile square-cap fuseholders snap into chassis panels without mounting hardware. The holders project only 3/16 in. above the panel and snap into a 5/8-in.-square mounting hole in chassis thicknesses from 1/32 to 1/8 in. Two series are available: the 348000 for standard and pin-type 3AG fuses and the 378000 for 8AG fuses.

CIRCLE NO. 290

Dc power amplifier gives out 25 W

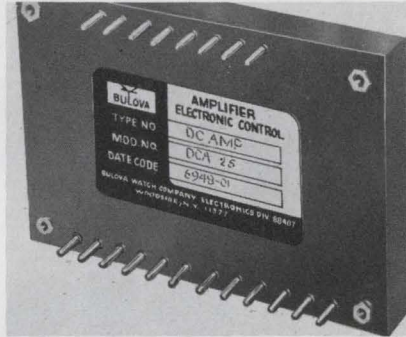

Bulova Watch Co., Inc., Electronics Div., 61-20 Woodside Ave., Woodside, N. Y. Phone: (212) 335-6000.

Designed to mount on PC boards and to drive dc torque and servo motors, model DCA25 power amplifier supplies output power of 25 W. All electrical connections are made at its pin-type terminals and it meets the requirements of MIL-E-5400 and MIL-STD-704. Other features include current limiting, a wide bandwidth, a differential input and variable gain.

CIRCLE NO. 291

Fiber-optic readout has a 1-in. face

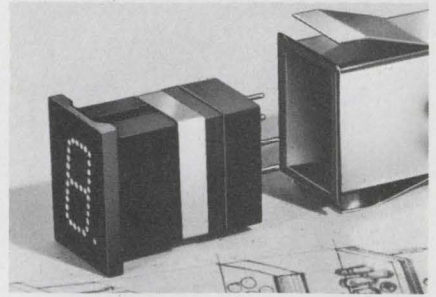

Master Specialties Co., 1640 Monrovia, Costa Mesa, Calif. Phone: (714) 642-2427. Availability: 2 to 3 wks.

A new large-character fiber-optic readout series features a one-inch face size, individually replaceable lamps and plug-in crimp-type terminals. Series 904 readout, allows relamping from the front panel and utilizes 40-mil-dia fiber-optic characters to transmit light to a 1-in.-high by 3/4-in.-wide readout face in a 0.64-in.-high by 0.32-in.-wide pattern.

CIRCLE NO. 292

MAGNET REED MINIATURES

Super miniature proximity switch & magnet assembly includes an encased Alnico-5 magnet that actuates the reed switch within .39". Rating @ 50 VDC: 150ma break, 500-ma carry.

NORMALLY OPEN or NORMALLY CLOSED

ALCOSWITCH®
DIV. OF ALCO ELECTRONIC PRODUCTS, INC., LAWRENCE, MASS.

INFORMATION RETRIEVAL NUMBER 86

REMOTE CONTROL MINIATURES

ISOLATION RELAY

For safe, shock-free remote control circuit applications. Compact, plastic case houses step-down transformer & relay. 115 VAC input, 5A capability. Available with U/L approval. FR-105.

ALCOSWITCH®
DIV. OF ALCO ELECTRONIC PRODUCTS, INC., LAWRENCE, MASS.

U/L AVAILABLE

INFORMATION RETRIEVAL NUMBER 87

Ultra critical uses?

Model	Resistance Range	Power Rating @ 70°C	*Max. Oper. Volts	Length Inches	Diameter Inches
MOX-400	1 - 2500 megs	.25W	1,000V	.420 ± .050	.130 ± .010
MOX-750	1 - 5000 megs	.50W	2,000V	.790 ± .050	.130 ± .010
MOX-1125	1 - 10000 megs	1.00W	5,000V	1.175 ± .060	.130 ± .010
MOX-1	10K - 500 megs	2.50W	7,500V	1.062 ± .060	.284 ± .010
MOX-2	20K - 1000 megs	5.00W	15,000V	2.062 ± .060	.284 ± .010
MOX-3	30K - 1500 megs	7.50W	22,500V	3.062 ± .060	.284 ± .010
MOX-4	40K - 2000 megs	10.00W	30,000V	4.062 ± .060	.284 ± .010
MOX-5	50K - 2500 megs	12.50W	37,500V	5.062 ± .060	.284 ± .010

*Applicable above critical resistance. Maximum operating temperature, 220°C. Encapsulation: Si Conformal.

Mastermox Resistors are still the best answer.

10K ohms to 10,000 Megohms Resistance

Mastermox resistors bring new accuracy to ultra-precision applications. Advanced metal oxide glaze construction. More watts per cubic inch means twice the performance in equivalent space. Stable? To new limits! Use Mastermox resistors to obtain new performance highs.

Send for Mastermox brochure.

DMA 536

VICTOREEN INSTRUMENT DIVISION
10101 WOODLAND AVENUE • CLEVELAND, OHIO 44104
EUROPE: ARNDAL HOUSE, THE PRECINCT, EGHAM, SURREY, ENGLAND • TEL: EGHAM 4887

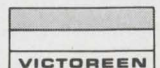

INFORMATION RETRIEVAL NUMBER 88

PC power supplies are field repairable

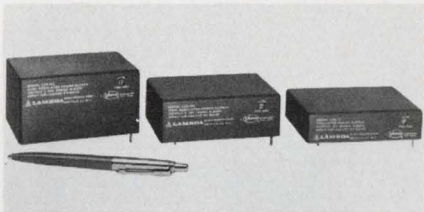

Lambda Electronics Corp., Route 119, Melville, N. Y. Phone: (516) 694-4200. Price: \$35 to \$65.

Lambda-Paks are a new line of unencapsulated PC-board-mountable ac-to-dc regulated power supplies that are fully repairable in the field. Features include continuously adjustable voltages, multi-voltage ratings, foldback current limiting and an input-voltage range from 105 to 132 V ac. Ten models range in output voltage from 3 to 30 V dc at 900 mA.

CIRCLE NO. 293

Hybrid regulators slash prices to \$5

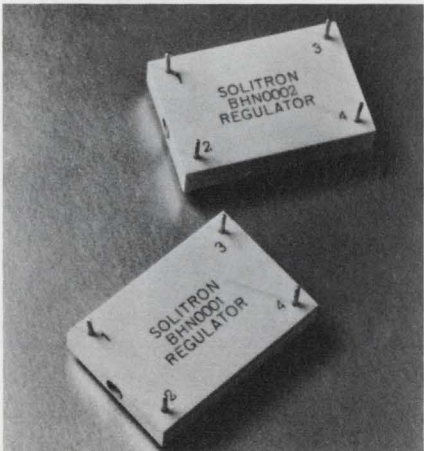

Solitron Devices, Inc. 256 Oak Tree Rd., Tappan, N. Y. Phone: (914) 359-5050. P&A: \$5; 2 wks.

Two new series of hybrid voltage regulators, BHN0001 (5 to 8-V range) and BHN0002 (8 to 30-V range), feature low costs of \$5 each in 100-piece lots. Other features include output current to 1 A, user-adjustable voltage outputs, the use of silicon semiconductors and small plastic housings measuring only 1 by 1-1/2 by 0.31-in.

CIRCLE NO. 294



...measure 1 μ v to 1000V and enjoy multimeter convenience



Here's the sweetest little performer around in a low-priced, 3 $\frac{1}{2}$ -digit dc multimeter. A new entry fielded by Keithley, leader in low voltage measurements, the Model 160 sweetens its fantastic $\pm 1 \mu\text{V}$ sensitivity with $\pm 0.1\%$ accuracy, true input impedance of 10 megohms, $\pm 1 \mu\text{V/day}$ stability and high ac rejection.

As an ammeter, it stands alone handling $\pm 0.1 \text{ nA}$ to ± 2 amperes full scale, with $\pm 0.2\%$ accuracy. Similarly, as an ohmmeter, this versatile performer spans a resistance range from 0.1 ohm to 2000 megohms full scale measured using 2-terminal leads.

Wide capability in measuring voltage, current and resistance make the Model 160 useful on every R & D and production test bench. Conven-

ience features are numerous. A display rate of two readings per second with 100% overranging. When overloaded, the display blanks the last 3 digits for no-error interpretation. Two front panel input terminals handle all functions. Choice of grounded or floating operation. And lots of other sweet features. Including a low price of \$545.

See how sweet it is. Call your Keithley Sales Engineer or contact us direct for details. Get a free "how sweet it is" button, too. (Great for the kids.) Keithley Instruments, Inc., 28775 Aurora Road, Cleveland, Ohio 44139. Or telephone 216/248-0400. In Europe: 14, Ave. Villardin, 1009 Pully, Suisse. Prices slightly higher outside the U.S.A.



KEITHLEY



Iridium Platinum

Iridium Platinum is probably the best known alloy in the Platinum metal family. By varying the Iridium content from 5% to 40%, a very wide range of physical and electrical properties is obtained.

Diameters available range from rod sizes down to 0.0005" and, in some alloys, to 0.0002". With alloys high in Iridium, fantastic tensile strength can be obtained particularly in the smaller diameters. All of the alloys have excellent corrosion resistance and are not affected by any single acid.

Resistivity, temperature coefficient and tensile strength graphs are available. Write for complete data.

Sigmund Cohn Corp.

121 S. Columbus Ave.
Mount Vernon, N.Y. 10553
(914) 664-5300

INFORMATION RETRIEVAL NUMBER 90

MODULES & SUBASSEMBLIES

Dc power amplifier provides 250-W output



Melcor Electronics Corp., 1750 New Highway, Farmingdale, N. Y. Phone: (516) 694-5570.

Up to 250 W of dc output power is available from the model 2044 amplifier that requires only a single 28-V supply. It has a built-in inverter supply for operation of internal preamplifiers. Output current limiting is factory set at 12.5 A and can also be adjusted externally if required. Full-power bandwidth is 1 kHz and packaging is in a 3 by 5-1/2 by 6-in. case.

CIRCLE NO. 295

Crystal oscillator stabilizer to 2×10^{-7}

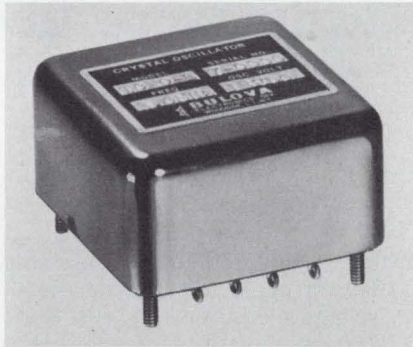

Bulova Watch Co., Inc., Electronics Div., 61-20 Woodside Ave., Woodside, N. Y. Phone: (212) 335-6000.

Containing a voltage regulator and optimized compensation networks, the TCSO-2 temperature-compensated crystal oscillator features a frequency stability of $\pm 2 \times 10^{-7}$ over the temperature range of -40 to $+75^\circ\text{C}$. The new oscillator operates over the frequency range of 3 to 5 MHz and ages at a rate of $\pm 1 \times 10^{-8}$ /week. It is packaged in a four-cubic-in. case and weighs only 5 oz.

CIRCLE NO. 296

High-voltage modules handle 25 kV

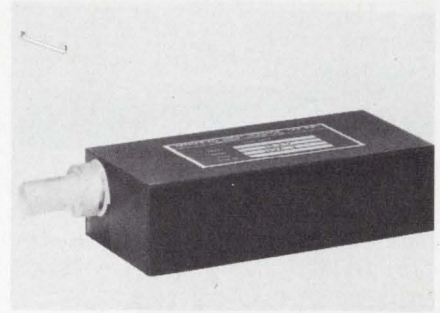

Advanced High-Voltage Co., Inc., 8635 Yolanda Ave., Northridge, Calif. Phone: (213) 886-3334. P&A: from \$65; 4 to 6 wks.

Series HVA modules are compact high-voltage sections with outputs up to 25 kV. Inputs are 20 to 40 V at 15 to 40 kHz. All units are encapsulated and are corona-free. They feature output sampling for closed-loop regulation and can be used without regulating circuitry because of their inherent low internal impedances.

CIRCLE NO. 297

Sample-hold modules increase storage times

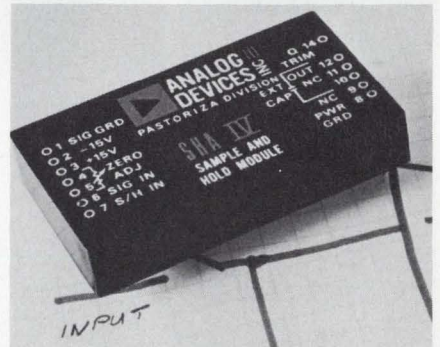

Analog Devices, Inc., 221 Fifth St., Cambridge, Mass. Phone: (617) 492-6000. P&A: \$95, \$120; stock.

Two new sample and hold modules, models SHAIII and SHAIIV, feature a hold-to-sample ratio of 10,000:1, 10 mV/s droop, and 0.01% hold accuracy for 100-ms hold periods. The former has a maximum transient amplitude of ± 7 V and requires 100 μs to settle within 1 mV of the final output value. The latter has a ± 200 -mV maximum transient and settles to within ± 1 mV in only 10 μs .

CIRCLE NO. 298

**Instrument cases
use Formica**

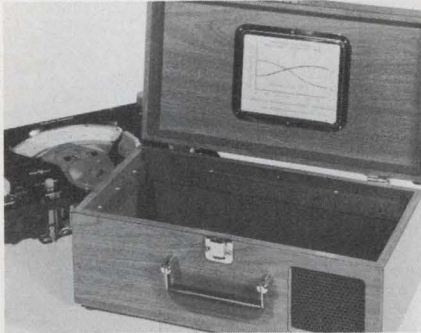

W. A. Miller Co., Inc., Mingo Loop, Oquossoc, Maine. Phone: (207) 864-3344. Price: from \$45.

Utilizing a laminating procedure of Formica/wood/Formica with waterproof epoxy glue, WAMCO custom-built instrument cases are available in a multitude of Formica colors and patterns. They are resistant to moisture and abrasion, easily cleaned and are unaffected by most solvents and alcohol. All critical dimensions are held to a 1/64 in. tolerance.

CIRCLE NO. 299

**High-density backplane
houses 101 DIPs**

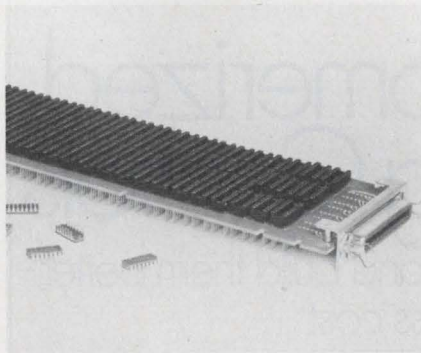

Data Technology Corp., 1050 E. Meadow Circle, Palo Alto, Calif. Phone: (415) 321-0551. P&A: \$178; stock.

A new high-density IC backplane accommodates 101 dual-in-line packages (92 14-pin and 9 16-pin). The model 4401, complete with wire-wrap sockets and a 50-pin I/O connector, is fabricated from 3/16-in. copepr-clad G-10 epoxy. It features a ground plane area on one side and a voltage plane on the other. It measures 14.65 by 3.95 in.

CIRCLE NO. 335

FINALLY ...

**a better source
for those
mobile,
avionics,
and marine
RF Power
building blocks**

Now you have a better source for these critical RF Power devices . . . all electrically and mechanically identical to your present source, based on competitive evaluation . . . and available off-the-shelf. These ballasted emitter devices offer optimum performance reliability and operational versatility in mobile, avionics and marine communications systems:

- 2N5589 3.0 W @ 175 MHz, 12.5V
- 2N5590 10.0 W @ 175 MHz, 12.5V
- 2N5591 25.0 W @ 175 MHz, 12.5V
- 2N5641 7.0 W @ 175 MHz, 28V
- 2N5642 20.0 W @ 175 MHz, 28V
- 2N5643 40.0 W @ 175 MHz, 28V

In addition to its standard line of RF power devices, SSS offers a complete customer assistance service on RF Power chains technically evaluated to meet *your* specific requirements — over and above those of standard published data.

GET THIS NEW SOURCE APPROVED NOW!

It will make meeting your program requirements as easy as A B C.



SOLID STATE SCIENTIFIC INC.

MONTGOMERYVILLE, PENNA. 18936 ■ 215-855-8400

TWX-510-681-7267

Aluminum heat sinks increase dissipation

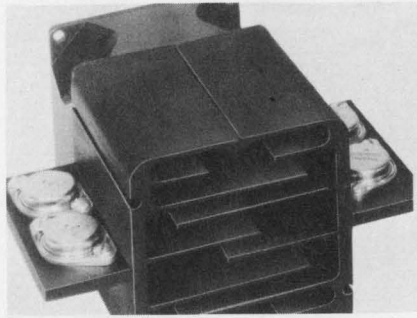

Precision Dipbraze Tor, Republic Corp., 14715 Arminta St., Van Nuys, Calif. Phone: (213) 786-6524.

When cooled by natural air convection, the model 1722B 6-in.-long heat sink will handle two 50-W devices at a temperature of 73°C. When fan-cooled at 40 ft³/minute, the model 1722A will handle the same two 50-W devices with a temperature rise of 12°C. The new heat modules are mounted on racks or panels by means of bolts. Standard finish is aluminum.

CIRCLE NO. 336

Coaxial connectors shrink in size

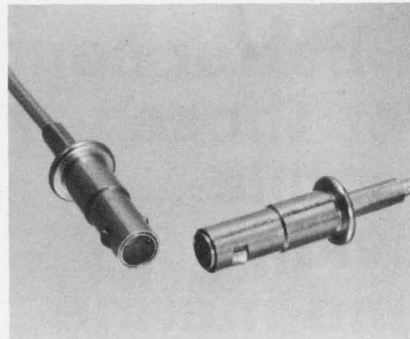

Microdot Inc., Connector Div., 220 Pasadena Ave., S. Pasadena, Calif. Phone: (213) 682-3351.

Four of the new Ridgelok series 50-Ω coaxial connectors occupy the same area required for two 50-Ω BNC-type connectors. The new three-piece connectors utilize the Twist/Con contact system which assures perfect contact alignment with extremely low engaging forces. When in the locked position, they are uncoupled by pulling back on their outer housings.

CIRCLE NO. 337

Tunnel structures enhance memories

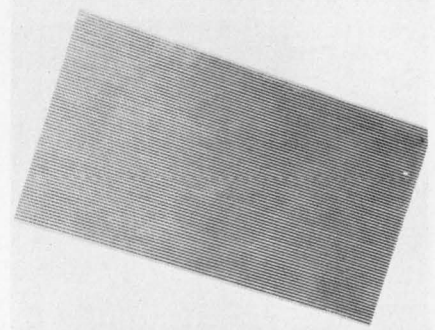

Ansley Div. of Thomas & Betts Corp., Old Easton Rd., Doylestown, Pa. Phone: (215) 345-1800. P&A: \$26; 2 wks.

Standard tunnel structures are available for plated-wire memories. They are fabricated of Kapton and FEP Teflon with tunnels on a 0.015-in. or 0.025-in. pitch for 5-mil plated wire. Maximum standard tunnel-structure widths are 250 tunnels on a 0.025-in. pitch or 425 tunnels on a 0.015-in. pitch. Lengths are 11, 16, 21, and 26 in.

CIRCLE NO. 338

WHEN IT COMES TO TIME CODE INDEXING THINK DATAMETRICS

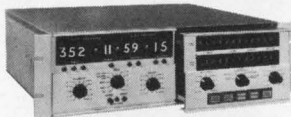

Model SP-400 Time Code Generator/Reader

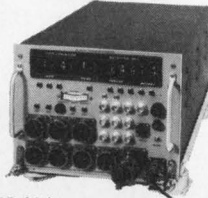

SP-375 Airborne Synchronized Generator

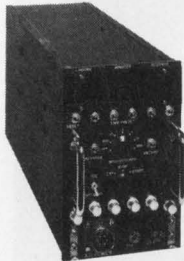

SP-300 Airborne Time Code Generator



Model SP-105 Miniature Generator

Datametrics offers the most complete line of off-the-shelf Time Code Equipments for Airborne, Spaceborne, Underwater, and ground applications.

Our Application Engineering group is at your prompt service to review your timing problems and to offer our optimum solution.

DATAMETRICS DIVISION

CGS SCIENTIFIC CORPORATION

127 Coolidge Hill Road, Watertown, Mass. 02172 (617) 924-8505

INFORMATION RETRIEVAL NUMBER 92

Customized Timing Controls

We design and build them better - faster - at less cost.

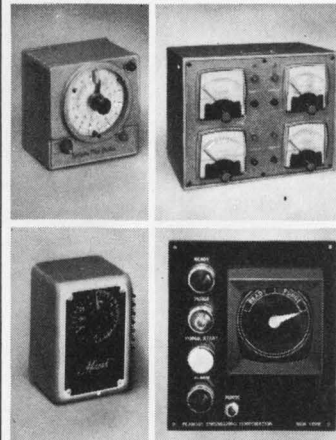

If your product requires a custom timing control it will pay you to let us build it for you. That's because it's a specialty of the house . . . since 1949.

Whether your projected controls are simple or complex, we have the hardware, we have the experience. So why not tell us what you need by writing or phoning us (201-887-2200). Ask for Systems Development Department.

SINGER
INDUSTRIAL TIMER CORP.

Industrial Timer Corp., U.S. Highway 287, Parsippany, N.J. 07054 201/887-2200

INFORMATION RETRIEVAL NUMBER 93

ELECTRONIC DESIGN 21, October 11, 1970

Cordless power handle works hand tools

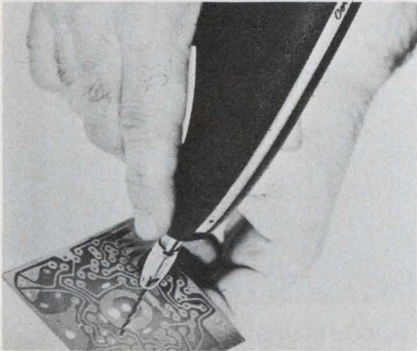

Jensen Tools and Alloys, 4117 N. 44th St., Phoenix, Ariz. Phone: (602) 959-2210. Price: under \$45.

There is no need to get twisted up with or trip over messy power cords when you use the new Pierce Cordless Power Handle for powering small work tools. It weighs only 8-1/2 oz and is controlled by a built-in switch. Power takeoff is provided at each of its ends for clockwise and counterclockwise rotation. No-load handle speed is 4000 to 5000 rpm and maximum power is 5 in.-oz.

CIRCLE NO. 339

Portable rework center facilitates IC repairs



Pace Inc., 9337 Fraser St., Silver Spring, Md. Phone: (301) 587-1696. P&A: \$785; 10 days.

A new portable rework center facilitates the rework, repair and modification of electronic assemblies and modules including micro-electronic circuits. Called the PRC-150, it permits the restoration of assemblies and modules without degradation. A power source provides pneumatic, mechanical and electrical modes of operation which can be combined in sequences.

CIRCLE NO. 340

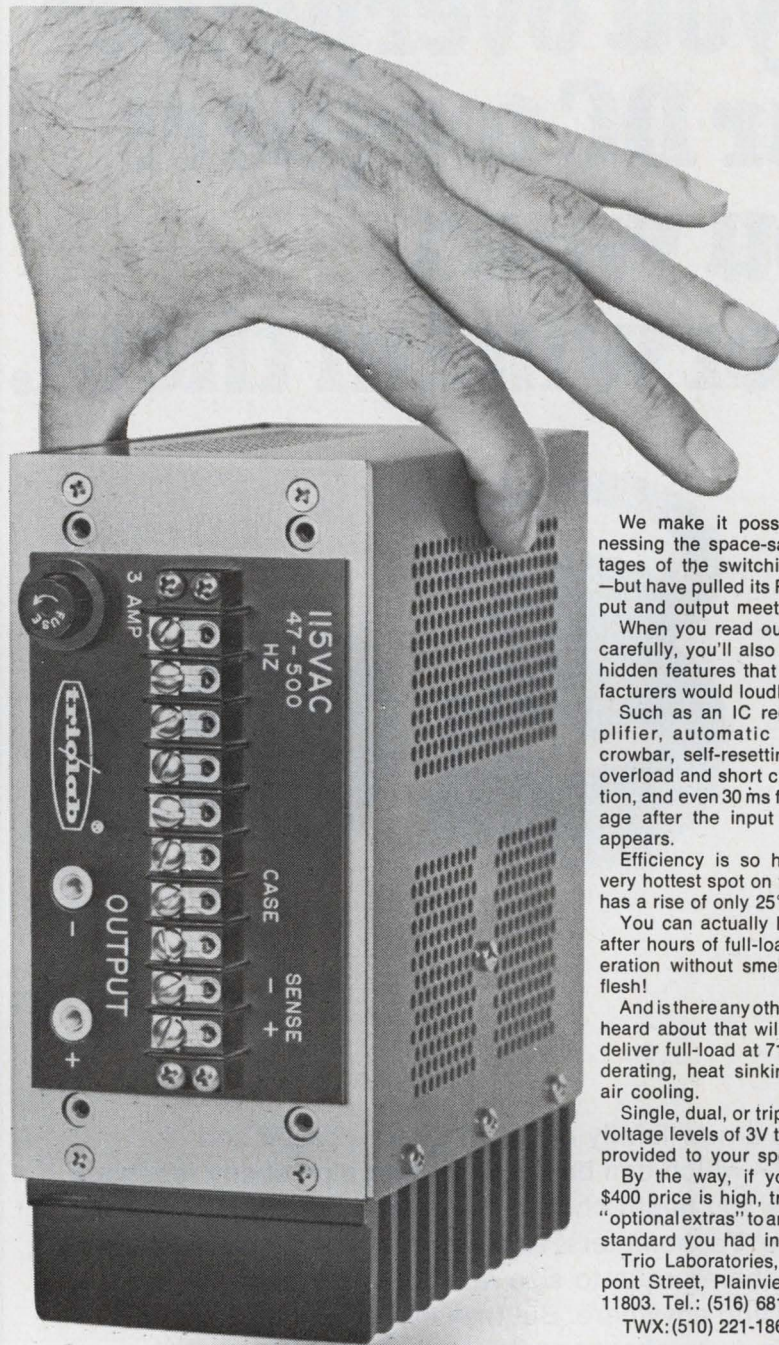

We make it possible by harnessing the space-saving advantages of the switching regulator—but have pulled its RFI fangs (input and output meet MIL-I-6181).

When you read our data sheet carefully, you'll also find it full of hidden features that other manufacturers would loudly acclaim.

Such as an IC regulating amplifier, automatic overvoltage crowbar, self-resetting automatic overload and short circuit protection, and even 30 ms full-load storage after the input voltage disappears.

Efficiency is so high that the very hottest spot on the heat sink has a rise of only 25°C.

You can actually hold our unit after hours of full-load bench operation without smelling burning flesh!

And is there any other unit you've heard about that will continue to deliver full-load at 71°C.—without derating, heat sinking or forced air cooling.

Single, dual, or triple outputs at voltage levels of 3V to 30V can be provided to your specific needs.

By the way, if you think our \$400 price is high, try adding the "optional extras" to anybody else's standard you had in mind.

Trio Laboratories, Inc., 80 Dupont Street, Plainview, L. I., N.Y. 11803. Tel.: (516) 681-0400.

TWX: (510) 221-1861.



Now you can squeeze your 5V/20A power supply down to fit your microcircuitry.

Design Aids

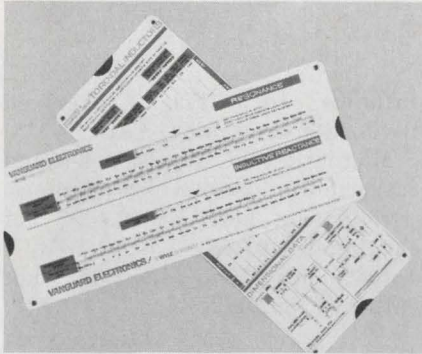

Inductance slide rule

A unique slide rule enables circuit designers to determine inductive reactance and resonance values instantly. Simply set the values of known parameters in the appropriate windows of the slide rule and then line up inductance and capacitance values on the sliding scale. Resonance or inductive reactance values are read directly on the slide rule's face. The new slide rule costs only \$2. Vanguard Electronics.

CIRCLE NO. 343

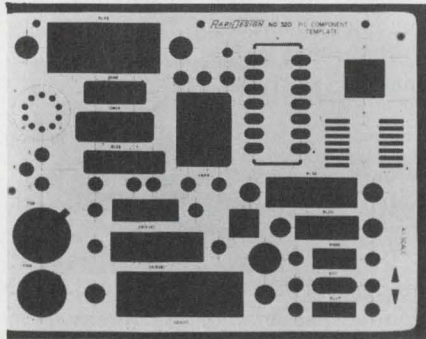

PC drafting templates

Four new drafting templates for components contain the most commonly used symbols in printed-circuit design. These include the model 320 with a 4:1 ratio and 0.06-in. thickness, costing \$8; and the model 320A with a 4:1 ratio and 0.03-in. thickness, costing \$6.50. Also included are model 321 with a 2:1 ratio and 0.06-in. thickness, costing \$6.50; and the model 321A with a 2:1 ratio and 0.03-in. thickness, costing \$5. Rapidesign, Inc.

CIRCLE NO. 344

Need State-Of- The-Art A/D's?



Computer Labs has delivered hundreds of analog-to-digital converters with 7-bit and 8-bit words at 10 MHz rates; or 4 bits at 25 MHz; or 9 bits at 5 MHz (and aperture time of 0.2 ns)! You can get yours with a matching D/A in 3-5 weeks.

**COMPUTER
LABS**
for tomorrow's technology today

1109 South Chapman St. / Greensboro, North Carolina 27403 / (919) 292-6427 / TWX 510 922-7954
INFORMATION RETRIEVAL NUMBER 96

Annual Reports

Solitron DEVICES, INC.

Gulton Industries, Inc. infonics

ESB **EMS** **AMPEX**
ELECTRONIC MICRO SYSTEMS

PE **imc** **VARO**

Diebold Computer Leasing, Inc.

Ampex Corp., 401 Broadway, Redwood City, Calif.

Communications, leisure and entertainment products, computers, educational technology.

1969: net sales, \$296,319,000; net earnings, \$13,702,000.

1970: net sales, \$313,582,000; net earnings, \$12,237,000.

CIRCLE NO. 345

Diebold Computer Leasings, Inc., Park/80 Plaza East, Saddle Brook, N. J.

Leasing of computer systems and equipment.

1968: revenues, \$12,813,000; net income, \$1,098,000.

1969: revenues, \$30,947,000; net income, \$1,441,000.

CIRCLE NO. 346

Electronic Micro Systems, Inc., 1672 Kaiser Ave., Santa Ana, Calif.

Data acquisition, opto-electronics and semiconductor switches.

1968: sales, \$74,048; net income, \$4,051.

1969: sales, \$150,711; net income, \$20,858.

CIRCLE NO. 347

ESB Inc., 2 Penn Center Plaza, Philadelphia, Pa.

Batteries and power systems for consumer, industrial and scientific applications.

1969: sales, \$248,358,000; net income, \$7,834,000.

1970: sales, \$288,751,000; net income, \$11,091,000.

CIRCLE NO. 348

Gulton Industries, Inc., 212 Durham Ave., Metuchen, N. J.

Computer and data systems, power sources, instruments, capacitors, music systems.

1969: net sales, \$92,201,813; pre-tax earnings, \$5,144,536.

1970: net sales, \$104,288,585; pre-tax earnings, \$5,405,804.

CIRCLE NO. 349

IMC Magnetics, Corp., 570 Main St., Westbury, N. Y.

Turret lathes, stepper and drive motors, solenoid valves, blower, centrifugal and propeller fans.

1969: sales, \$9,082,768; net income, \$462,503.

1970: sales, \$9,246,131; net income, \$423,180.

CIRCLE NO. 350

Infonics, Inc., 1723 Cloverfield Blvd., Santa Monica, Calif.

Magnetic-tape cassettes and cassette duplicators and adapters. 1968: net sales, \$322,479; net earnings, \$40,098.

1969: net sales, \$1,082,363; net earnings, \$92,472.

CIRCLE NO. 351

Potter-Englewood Corp., 5801 S. Halsted St., Chicago, Ill.

Capacitors, filters, delay lines, electrical supplies.

1969: net sales, \$41,689,657; net income, \$530,287.

1970: net sales, \$49,109,847; net income, \$808,920.

CIRCLE NO. 352

Siliconix Inc., 2201 Laurelwood Rd., Santa Clara, Calif.

Microwave semiconductors, silicon wafer processing, mercury and silver-cadmium batteries.

1968: net sales, \$7,048,524; net income, \$846,263.

1969: net sales, \$9,216,154; net income, \$737,130.

CIRCLE NO. 353

Solitron Devices, Inc., 256 Oak Tree Rd., Tappan, N. Y.

Rf and power transistors, diodes, MOS read-only and random-access memories, linear ICs.

1968: sales, \$24,261,108; earnings, \$5,962,227.

1969: sales, \$30,054,228; earnings, \$6,973,052.

CIRCLE NO. 354

Varo, Inc., Garland Bank Building, Garland, Tex.

Vending machines, high-voltage rectifiers, pattern generators.

1969: operating revenues, \$54,864,811; earnings, \$2,183,727.

1970: operating revenues, \$46,263,496; earnings (loss) (\$2,046,830).

CIRCLE NO. 355

up-to-date "clocking" solves your advanced LOAD TIMING/CONTROL PROBLEMS

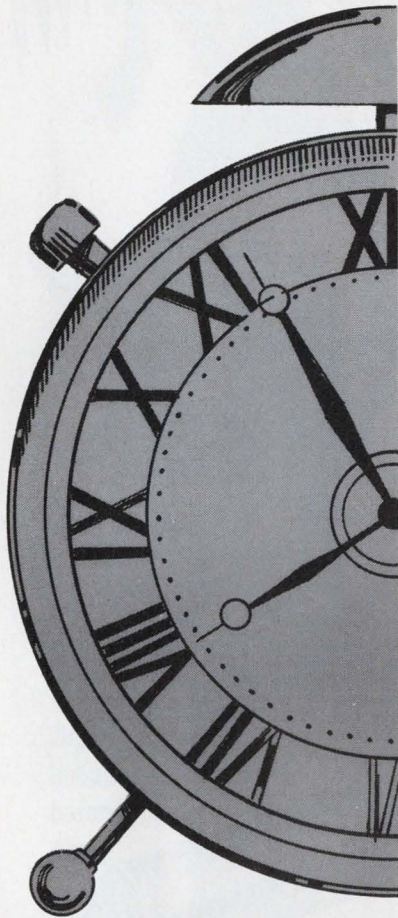

Precision timing and control of high current (mercury displacement) load switching requires advanced, reliable components and circuitry. Where nanoseconds, seconds, minutes, or even hours must be controlled, precision solid-state circuitry must be employed to insure maximum dependability. ADLAKE now offers two new timing devices, plus a unique solid-state bistable relay designed for precise and reliable control. These versatile products will find applications in circuits ranging from the most simple electro-mechanical apparatus to highly sophisticated computers.

PULSE LATCH

The **Pulse Latch** is a solid-state bistable relay of advance design which controls loads in excess of 3 amps (8-200 Volts). Positive input pulses as narrow as 100 usec. to the same terminal will alternately latch the two outputs. Switching rates as high as 2 kHz are attainable, depending on output loading.



The **Pulse Latch** is unaffected by shock or vibration and is internally suppressed against voltage transients. Many standard models are available. **Pulse Latches** to accommodate your particular load, voltage, and switching parameters can be built on special order.

HYBRID TIMER

For the first time, an economical timer to handle 35 amp loads for the full timing period (no derating necessary). No need for a costly additional driven relay for high currents. Inputs up to 220 VAC and/or 200 VDC are time delayed from 50 msec. to over 2 minutes. $\pm 5\%$ accuracy under all load conditions in an operating temperature range from -30 to 200°F . Fixed or adjustable timing periods in excess of 15 minutes available special. Wide variety of combinations of "On", "Off", "Delay", "Instant Close or Open", with N.C. or N.O. switching.

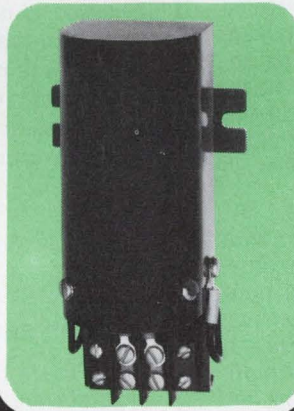

DC-DC TRANSFER TIMER

Provides positively controlled, delayed dc output from dc input — timing interval is 10 msec. to 10 minutes. Timing period can be fixed (external resistor) or adjustable (external potentiometer).

Output timing accuracy is within $\pm 2.5\%$ at recycle times as low

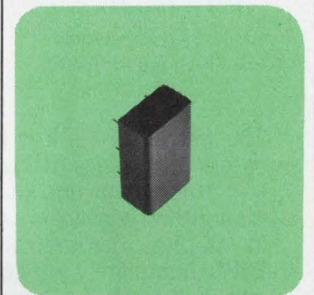

as 20 msec. Operating temperature range is -30 to 170°F .

Selection of screw-type, PC, or quick connect-disconnect terminations minimize your production line problems. N.O. delay operate mode standard; N.O. quick operate-delayed release on special order. Solid-state AC or input/output isolation available special.

Specify ultra-reliable solid-state ADLAKE Timers and Control components for critical timing and heavy current load switching applications.

Won't you let us help you?

Our engineering applications specialists have modern answers to your most frustrating power timing and switching problems.



THE ADAMS & WESTLAKE COMPANY

A SUBSIDIARY OF



ALLIED PRODUCTS CORPORATION

(219) 264-1141 • TWX 219-522 3102 • TELEX 25 8458 • CABLE ADLAKE

1025 North Michigan Street, Elkhart, Indiana 46514

INFORMATION RETRIEVAL NUMBER 97

Here's The First
Of Our New

μ verters

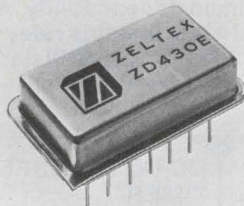

8-BIT D/A CONVERTER

- 14-Pin Hermetic Dip
- Completely Self-contained
- 1/2 LSB Linearity
- $\pm 10V$ Buffered Output
- DTL, TTL Compatible
- $\pm 0.1\%$ Output Stability

\$49

The Model ZD430E is only one of our new series of " μ verters" — a complete line of hybrid/monolithic conversion products in 14-pin, hermetically-sealed DIP's. Completely self-contained, our hybrid D/A Converter includes internal reference, thick-film ladder network, current switches, and compensated, short-circuit-proof output amplifier.

Other ZELTEX " μ verters" include: A/D Converters with choice of successive approximation or staircase conversion; Four channel Analog Multiplexer featuring MOSFET switches and drivers; and a Track/Hold Amplifier with internal hold capacitor and input buffer.

See us for your signal conditioning requirements too! We have a complete line of operational, instrumentation and programmable hybrid/monolithic amplifiers.

"See our complete catalog
in the 1970-71 eem"

Zeltex INC.

A SUBSIDIARY OF REDCOR CORP.
1000 Chalmers Road - Concord, California 94520

INFORMATION RETRIEVAL NUMBER 98

Application Notes

True-rms measurements

A detailed discussion on the advantages of true-rms measurements is given in an eight-page application note. It tells why true-rms measurement techniques accurately measure signals that contain very high distortion, such as square waves, pulse trains and signals that contain noise. Graphs show the effects of distortion on measurements by average-resonating instruments. Several examples are given of signals that can only be measured accurately with true-rms converters. Hewlett-Packard.

CIRCLE NO. 356

Kilo-watt amplifiers

A four-page article includes an interesting discussion on Class S or switching-mode kilo-watt solid-state amplifiers. It illustrates typical circuits and discusses the behavior of solid-state amplifiers with reactive loads. The problems of current and voltage spikes are discussed along with current-limiting, load-matching and power-control factors. Typical waveforms are shown for voltages and currents across resistive and inductive loads. Instruments, Inc.

CIRCLE NO. 357

Ceramic sealing

The basic processes occurring in ceramic-to-metal sealing are tutorially presented in a technical article. Explained in detail are the various concepts of sealing processes, seal geometries and typical electro-optical applications such as xenon and alkali-metal sapphire arc lamps and optical windows. Two types of processes are given attention: the moly-manganese and the active metal processes. The article includes illustrations, microphotographs of seals, and performance curves. ILC Laboratories, Inc.

CIRCLE NO. 358



unwanted

noise or signals
effectively reduced
or eliminated
with



Rtron

Cylindrical Style Interference Filters

that reduce or eliminate unwanted noise or signals. Small size, light weight, maximum attenuation. Voltage current or insertion loss characteristics required, determine physical size. Maximum isolation of terminals and high frequency performance are assured by threaded neck design for bulkhead mounting. Feed-thru capacitor circuitry conservatively rated for both military and commercial applications.

Send us your specifications.
Ask for catalog and complete details.
Dept. E-10

Rtron corporation
P.O. Box 743 Skokie, Illinois 60076
Phone 312 • 327-4020

INFORMATION RETRIEVAL NUMBER 99
ELECTRONIC DESIGN 21, October 11, 1970

Active filters

Technical insights required in choosing between Butterworth, Bessel and Tchebyscheff filter designs are provided in a new six-page foldout application note on active filters. It discusses the fundamental principles of the three filter networks mentioned and presents the pros and cons of high-pass, and low-pass types. It also includes bandpass as well as band-reject versions. One page contains a collection of valuable idealized-response curves for Butterworth, Bessel and Tchebyscheff filter networks. The curves show attenuation, phase-shift and step-response characteristics for low-pass and high-pass types. They also include bandpass and band-reject responses. Analog Devices, Inc.

CIRCLE NO. 359

Filter analysis

A nine-page application abstract describes a computer program that enables time-sharing users stationed at desk-side remote terminals to select a filter transfer function such as Bessel, elliptic, Butterworth-Thomson and ultraspherical from a comprehensive list. Geometries such as low-pass, bandpass, high-pass and band-reject models can also be selected in a similar manner. Remote Computing Corp.

CIRCLE NO. 360

Timing circuits

Typical circuits and performance data on high-capacitance energy-storage devices is given in a new application note. One circuit shown is a simple free-running multivibrator that is capable of cycle times up to several million seconds, by simply using presently available energy-storage devices. Also shown are many variations in this circuit's design to provide time delays, pulse generation and electronic timing. Gould Ionics, Inc.

CIRCLE NO. 361

WE'VE GOT A BETTER WAY TO MAKE PRINTED CIRCUITS!

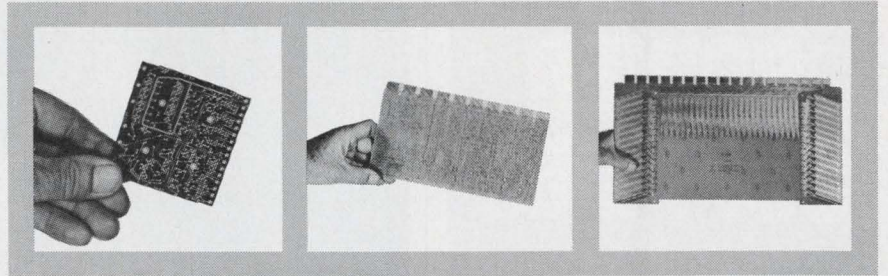
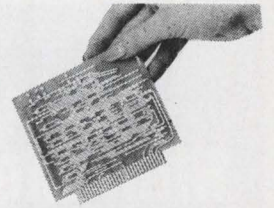

To avoid the necessity of a multi-layer circuit board for a process computer, we produced this high-density dual-inline double-sided board with a 6 mil line width and 8 mil line spacing. Ask us . . . we've got a better way to make printed circuits!

This 3-layer circuit board was designed to be as economical as most double-sided circuit boards...for the Control Data 7600 Computer. Ask us...we've got a better way to make printed circuits!

Not all multi-layer circuit boards are small. Although some of our circuits measure a fraction of an inch, double-sided circuit board produced for a memory system measures 18" x 22". Ask us . . . we've got a better way to make printed circuits!

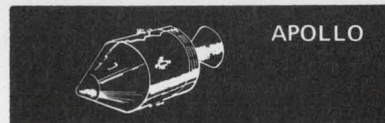

APOLLO

Our circuit boards were on Apollo, LEM, and seis. experiment. Sequential laminating, extra-fine line width and spacing, plated slots and edges.

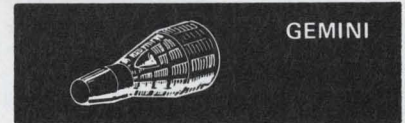

GEMINI

Again, top reliability was required and delivery on-time was made to the customer.

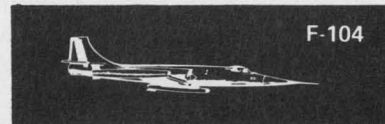

F-104

Developed new technique to produce circuit boards with more reliable plated-thru holes.

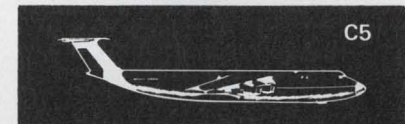

C5

We introduced circuit boards that had the highest density circuitry ever used before on a production basis.

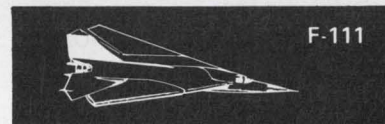

F-111

New industry technique was used to produce multilayer circuit boards with an internal heat sink.

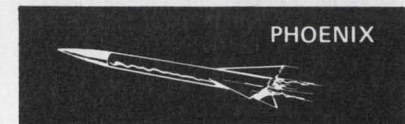

PHOENIX

Required new techniques for manufacturing heat sinks and insulation by chemical milling.



707

Reliable circuit boards in high volume at low cost were produced for this project.



POSEIDON

Developed new technology for sequential laminating multi-layer circuit boards with aluminum backbone.



This design and production experience can work for you . . . CALL US NOW.

CONTROL DATA
CORPORATION

CONTROL DATA CORPORATION
CIRCUITS DIVISION
7800 COMPUTER AVENUE
MINNEAPOLIS, MINN. 55435
PHONE: (612) 927-5681

NEW Mini-Module Regulated dc POWER SUPPLIES

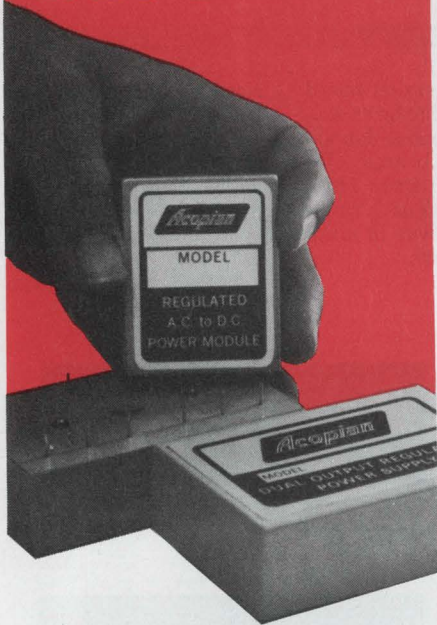

Now you can save space and improve reliability by mounting an Acopian mini-module power supply directly into a printed circuit board. Sizes start at 2.32" x 1.82" x 1". Both single and dual outputs are available. And the duals can be used to power op amps or for unbalanced loads. Other features include:

- Choice of 58 different single output modules ranging from 1 to 28 volts, 40 ma to 500 ma
- 406 combinations of dual output modules with electrically independent, like or different outputs in each section
- 0.02 to 0.1% load and line regulation, depending on model
- 0.5 mv RMS ripple
- Prices as low as \$39 for singles, \$58 for duals

Do you have the latest Acopian catalog? It lists over 82,000 AC to DC power modules for industrial or MIL-spec applications. For your copy, write Acopian Corp., Easton, Pa. 18042, or call (215) 258-5441. And remember, every Acopian power module is shipped with this tag...



INFORMATION RETRIEVAL NUMBER 102

New Literature

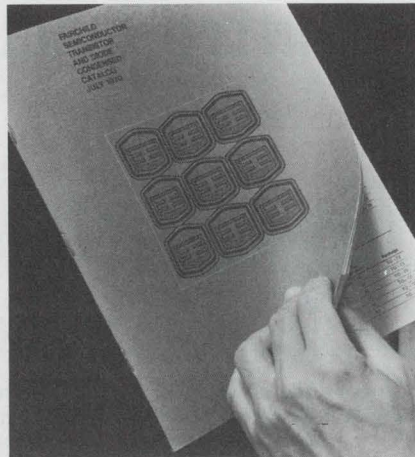

Semiconductors

An 80-page transistor and diode catalog listing a complete line of discrete off-the-shelf products is now available. These include diodes, dual transistors, communication devices and specialty diode products. Fairchild Semiconductor.

CIRCLE NO. 362

Gages and sensors

Developed to serve as a basic guide to the theory and application of semiconductor gages and sensors, this 16-page manual provides details on gage factors, resistivity, linearity, hysteresis, strain range and basic gage construction. Kulite Semiconductor Products, Inc.

CIRCLE NO. 363

Trimmer pots

A newly published compact and comprehensive six-page catalog illustrates and lists in a single table the latest additions to a line of off-the-shelf trimming potentiometers. Weston Components Div., Weston Instruments, Inc.

CIRCLE NO. 364

Toroidal coils

A 16-page catalog describing MIL-type toroidal coils, molded rf chokes and environmental test facilities is now available. J. W. Miller Co.

CIRCLE NO. 365

Records timetable

How long must you keep important records? Answers are given in an eight-page folder which lists the proper government authorities and the specified time the law demands for the retention of over 165 office records. Listed too, are the kinds of material records may appear on, such as paper, film or plastic and even light metals. Electric Wastebasket Corp.

CIRCLE NO. 366

Plastic packaging

In four pages, a new catalog provides detailed technical information on plastic packaging systems designed expressly for encapsulation of semiconductor devices. Furane Inc.

CIRCLE NO. 367

Photomultiplier tubes

Specification details of over 140 photomultiplier tubes are contained in a 64-page publication. The introduction describes the operation of photomultiplier tubes, the parameters involved and factors influencing the selection of tubes. EMI Electronics.

CIRCLE NO. 368

IC analysis

Actual sections from detailed analyses reports of packaged integrated circuits have been combined into an informative article on the details of what's really on the inside of integrated circuits. Integrated Circuit Engineering Corp.

CIRCLE NO. 369

A/d and d/a converters

A short-form 16-page catalog summarizes a line of a/d and d/a conversion, signal-conditioning and display products. Analogic.

CIRCLE NO. 370

MSI ICs

A new comprehensive 100-page handbook is divided into three sections describing MSI complex-array ICs. The section on general design characteristics provides information necessary to allow reliable system design while the section on electrical characteristics gives specific test limit and test condition information for use in device evaluation for 21 MSI ICs. A third section on parameter measurement information provides complete dc and ac measurement methods and procedures. Sprague Electric Co.

CIRCLE NO. 371

Business courses

A six-page pamphlet outlines a unique home-study course that trains you to manage a company with simulated on-the-job experience. The pamphlet includes information about how the course prepares you to move ahead in your job by teaching fundamental financial management methods. Management Games Institute.

CIRCLE NO. 372

TV distribution line

An informative 32-page booklet, "Systems and Products for TV Distribution," includes numerous specifications tables and application notes, systems antennas and accessories, head-end equipment, distribution equipment and components and installation aids. Jerrold Electronics Corp.

CIRCLE NO. 373

Rf transmission line

A comprehensive, 44-page guide to the selection of flexible and semi-flexible rf coaxial cable discusses all the parameters which must be taken into account in the construction of a cable for a particular application. Time Wire and Cable Co.

CIRCLE NO. 374

Now choose either

PLASTIC

or

GLASS

FIBER OPTICS

from

WELCH ALLYN

For minimum cost (as in disposable products) or for maximum bundle flexibility, check the advantages of fiber optics assemblies or systems made with Welch Allyn's newly developed *plastic* fibers.

For high precision work, where infra-red light transmission is important, or where fiber optics are exposed to high heat, our *glass* fibers are normally still preferable.

COORDINATED FIBER OPTICS/LAMP SYSTEMS

Glass or plastic, your fiber optics system will have maximum optical performance with custom-built, precision Welch Allyn miniature lamps.

Ask us about your glass or plastic fiber optics assemblies or lamp/fiber optics systems.



Welch Allyn, Inc., Skaneateles Falls, N. Y. 13153 Tel (315) 685-5788

INFORMATION RETRIEVAL NUMBER 103

Everything's clearer with the flat one!

Letters! Digits! Symbols! Equations! All varieties of data are displayed as undistorted images on Zenith Flat-Face Metal CRTs. Ideal for light pen operations, alphanumeric and analog presentations — they're even available with a rear port for optical chart projection. When you need CRTs, face up to the flat one. Write for details.

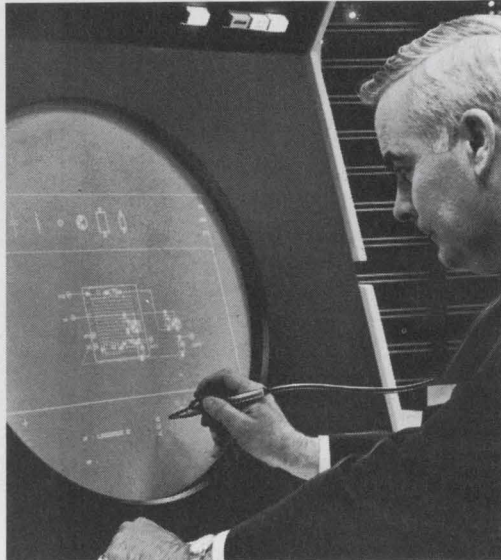

ZENITH RADIO CORPORATION
THE RAULAND DIVISION
5616 W. JARVIS AVE. • CHICAGO, ILL. 60648 • 312-647-8000

INFORMATION RETRIEVAL NUMBER 104

the **NEW** mighty-mini

Schrack's **NEW MINIATURE STEPPING SWITCH**, Type RTM, is the smallest stepping switch available on the market today. Only $\frac{1}{4}$ the size of comparable steppers, it combines high performance with economy of space and cost.

The RTM is equipped with 2 x 10 or 2 x 12 gold-plated contacts and mates with our socket which meets standard printed circuit spacings. Unique hold-down spring enables mounting in any position.

Write for free catalog today. Schrack also manufactures all types of relays, stepping switches and accessories. Catalogs upon request.

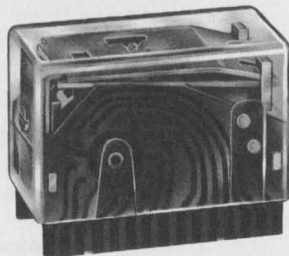

1 41/64" L x 13/16" W x 15/16" H

Selected territories available for representation.

SCHRACK ELECTRICAL SALES CORP.
1140 Broadway, New York, New York 10001
tel: (212) 683-0790

INFORMATION RETRIEVAL NUMBER 105

NEW LITERATURE

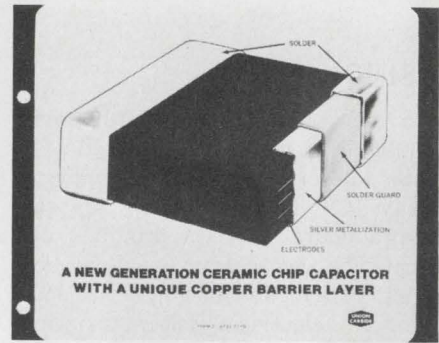

Chip capacitors

A catalog describes a new generation ceramic chip capacitor designed for hybrid circuit use. The capacitor contains a unique copper barrier layer in the end termination that prevents silver scavenging or leaching during solder reflow assembly operations. Union Carbide Corp.

CIRCLE NO. 375

Soldering handbook

A 64-page catalog presents over 300 off-the-shelf terminals and features a comprehensive 18-page soldering standards handbook. The handbook offers a fully illustrated and detailed text on terminal soldering quality assurance and workmanship standards. United Products Co.

CIRCLE NO. 376

Sensitive tapes

A four-page brochure lists complete electrical and mechanical properties of 42 pressure-sensitive tapes. Also included with the literature is a postpaid reply card offering samples for evaluation. The Connecticut Hard Rubber Co., a Hitco Co.

CIRCLE NO. 377

Emi shielding

A 28-page short-form catalog covering shielding materials, gaskets and components is now being offered. The catalog is fully illustrated and contains all necessary ordering information, full specifications and extensive part number tabulations. Metex Corp.

CIRCLE NO. 378

Synchron[®] motors help money make money



In the vending business, a would-be customer with dollar bills and no coins might just as well be flat broke. Unless there's a bill changer around. Like this one made by Rowe International.

Feed it a dollar bill and, presto! Instant alchemy. That useless paper is turned into spendable change.

The acceptance of the bill provides a signal which is transformed into multiple pulses in a Hansen-actuated electromechanical pulse chopper. Impulses are then sent to a memory unit and the payoff is actuated. The major reason why Hansen motors are specified:

"Dependability."

Contact your Hansen man and find out how Hansen dependability can help you.



HANSEN
Manufacturing Company, Inc.
Princeton, Indiana 47570



HANSEN REPRESENTATIVES: CAREY & ASSOCIATES, Houston and Dallas, Texas; **R. S. HOPKINS CO.,** Sherman Oaks, Calif.; **MELCHIOR ASSOCIATES, INC.,** San Carlos, Calif.; **THE FROMM CO.,** River Forest, Ill.; **JOHN ORR ASSOCIATES,** Grand Rapids, Mich.; **H. C. JOHNSON AGENCY, INC.,** Rochester, N.Y.; **WINSLOW ELECTRIC CO.,** Essex, Conn., Villanova, Pa., and Teaneck, N.J.
EXPORT DEPARTMENT: 2200 Shames Drive, Westbury, N.Y. 11590

INFORMATION RETRIEVAL NUMBER 106

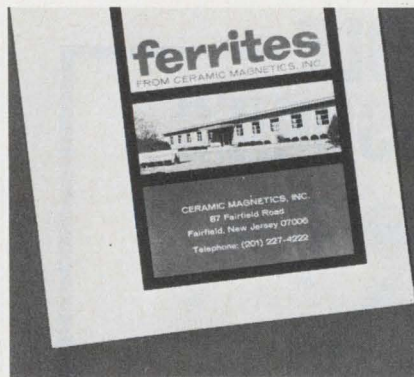

Ferrites

Ferrite applications, including inductors, transducers, filters, shielding devices, transformers and magnetostrictive devices are described in a 16-page brochure. Ceramic Magnetics, Inc.

CIRCLE NO. 379

Optical measurements

A 16-page illustrated catalog of radiant-energy measurement instrumentation describes a full line of optical test equipment and accessories for the detection and digital display of absolute radiometric, photometric and thermal measurements of both cw and pulsed phenomena. Cintra, Inc.

CIRCLE NO. 380

Power converters

An eight-page condensed catalog describes the features, specifications, modifications, and mounting dimensions for miniature and sub-miniature power conversion equipment. Arnold Magnetics Corp.

CIRCLE NO. 381

Components

Seventy-six pages of a new catalog are devoted to thorough listings of industrial, military and commercial capacitors, resistors and transistors. Sprague Products Co.

CIRCLE NO. 382

Connectors

A 23-page catalog describes a new microminiature printed circuit connector and a series that offers emi shielding. ITT Cannon Electric.

CIRCLE NO. 383

Versatile reed relays

Economical Series G Relays Offer These Features:

- Wide switching capability—Low level to 450 VA. Voltages up to 5000 V DC.
- Low coil power to 50 mw—
- High IR—to 10¹⁴ ohms.
- Electromagnetic and/or Electrostatic Shielding.
- Dry Reed or Hg wet switches.
- Vertical mounting available for limited board space—Series VR mounts in .4" square.

Three sizes available:

Series MG-Miniature
Series SG-Standard
Series CG-Compact

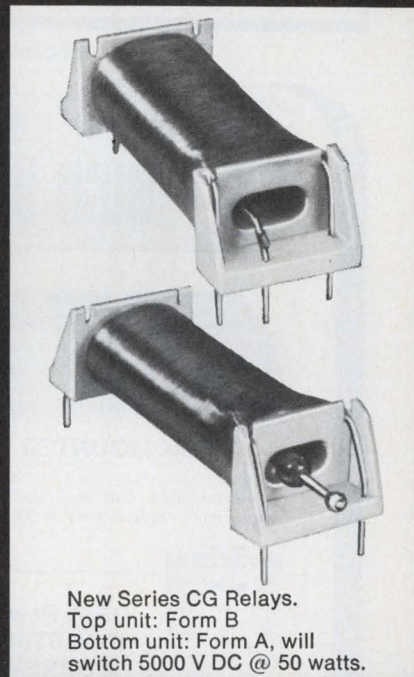

New Series CG Relays.
Top unit: Form B
Bottom unit: Form A, will switch 5000 V DC @ 50 watts.

You're also sure of outstanding reliability with Series G relays, thanks to their rugged construction features:

- Welded switch leads.
- Unitized nylon bobbins.
- Coil leads terminated under wrap to eliminate open coils.

DOUGLAS RANDALL, INC.

6 Pawcatuck Ave.,
Pawcatuck, Conn. 02891
(203) 599-1750
A Division of
Walter Kidde & Co., Inc.



INFORMATION RETRIEVAL NUMBER 107 ►

FLAT CABLE PLUG ACCESSORIES

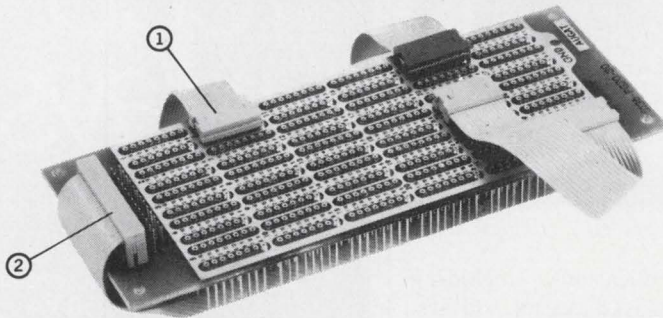

Greater flexibility in Prototyping and Packaging. Plugs come un-assembled, unique contact design eliminates cutting, stripping, soldering or crimping. Permits installation of plugs at ends of cable or any desired bussing location with a fast and simple press operation. Assembly tool available.

1. 14 & 16 Pin Plug – Used for interfacing, input-output connections and testing. May also be used for cable termination into P.C. board. Pins are on .100" centers and .300" between rows.

2. 26 Pin Plug – Designed for input-output connections on standard Augat panels. May also be used for interfacing and testing. Pins are on .100" centers and .100" between rows. Header Assembly also available, mates with plug.

Request I.C. folder

AUGAT INC.

TEL: 617/222-2202
31 PERRY AVE., ATTLEBORO, MASS. 02703

INFORMATION RETRIEVAL NUMBER 108



SPELLMAN HIGH VOLTAGE EQUIPMENT

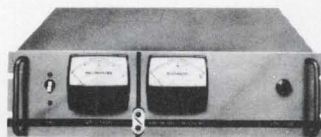

RACK MOUNTED

General purpose and laboratory power supplies. Both regulated and unregulated models. 1 KV to 500 KV.

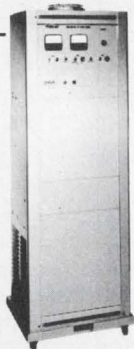

High Power CONSTANT CURRENT and SERIES REGULATED

For heavy duty industrial applications and laser sources.



ELECTROSTATIC FLOCKING SYSTEMS

Automated electrostatic flocking equipment for continuous webs, flat panels, walls and 3 dimensional objects.

MINIATURE ENCAPSULATED MODULES

For OEM display supplies and photomultiplier applications. 400V to 30,000V



Write or call for detailed technical literature

SPELLMAN
HIGH VOLTAGE
ELECTRONICS CORP.



Our third decade of leadership in high voltage technology.
1930 Adee Avenue
Bronx, New York 10469
212/671-0300

INFORMATION RETRIEVAL NUMBER 109

NEW LITERATURE

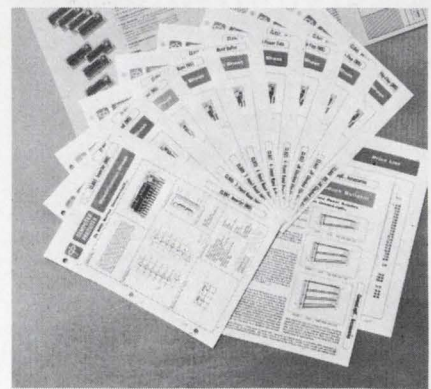

Circuit modules

A comprehensive folder contains electrical and mechanical descriptions on 17 new circuit modules, packaging accessories, and companion power supplies. Computer Products, Inc.

CIRCLE NO. 384

Ac instruments

A collection of ac measuring instruments for laboratory and industry are discussed in a new bulletin. Included are large portable voltmeters, specialty current transformers, ac potentiometers and many other instruments. James G. Biddle Co.

CIRCLE NO. 385

16-bit computer

Featured in a new 20-page brochure is a 16-bit computer system. The multi-register architecture, instruction format and addressing structure of the system is described. Data Computer Systems, Inc.

CIRCLE NO. 386

TWTs

A nine-page booklet describing the latest advances in traveling-wave tubes for space communications has been made available. Described is the present state of TWTs and developing trends, including discussions of measured life performance, electrical characteristics, and developments. Hughes Electron Dynamics Div.

CIRCLE NO. 387

Bulletin board

of product news
and developments



Tektronix, Inc., has entered the N/C (numerical control) field with the unveiling of its 1701 and 1702 machine-control units. The 1701 is a two-axis unit and the 1702 is a three-axis one. Both interface with type 611 and 601 storage monitors for quick tool path checkout. They provide and accept necessary signals for controlling a typical machine tool.

A new product from **Dest Data Corp.**, of Sunnyvale, Calif., improves the legibility of television images. Called the VRE100, the new product increases clarity of detail in a horizontal band across the monitor in a monochrome CCTV system. The enhanced area may be between 10 and 20% of the picture's vertical height and can be moved by operator control. A vertical magnification ratio of 2:1 is also possible within the enhanced area, permitting operators to read or identify information which is marginal or often illegible in normal operation. Price is under \$1200.

CIRCLE NO. 388

Price reductions of 50% have been announced on Advanced Micro Devices' 723 IC voltage regulator and 741 IC frequency-compensated operational amplifier in die forms. The new price for 100-piece lots or more in mixed quantities is \$1.50.

CIRCLE NO. 389

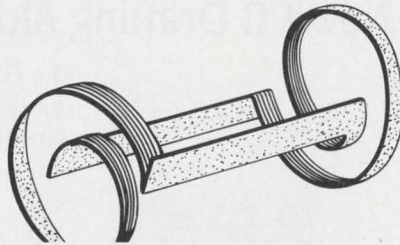

Rolamite, Inc., of San Francisco, Calif. has developed a new process for making electric coils. The new process involves the parallel winding of inductors, thereby offering the first viable means for producing low-cost electrical coils by using thin laminates to replace copper wiring. A flat laminate belt holds the conductor pattern in a rectangular configuration which is topologically twisted and rolled to form the coil from the two-dimensional laminate used without deforming the materials.

A new software program has been announced by **Tri-Data Corp.**, of Mountain View, Calif. for users of PDP-8 computers. Designated as the P-100A software package, it provides users with magnetic-tape versions of the programs normally supplied by the PDP-8 manufacturer, the Digital Equipment Corp. It consists of RIM and binary loaders, a CartriFile diagnostic program, an ASCII paper-tape-to-CartriFile utility program, an assembler, an editor, an I/O subroutine and a program library generator, all on magnetic tape. The program's price is \$250.

CIRCLE NO. 390

A new miniature three-wire reversible-step servo motor whose rotor automatically returns to zero-degree position when power is interrupted has been developed by **Haydon Switch & Instrument, Inc.**, of Waterbury, Conn. Series 31700 motor accomplishes this feature by having only one angular position of equilibrium when no power is in its winding.

CIRCLE NO. 391

Another
unique quality
of Electro Cube
is to pack
more into a
small package
reliably



electro cube
capacitors

Our new 50 Volt metallized polycarbonate capacitors, with .00008 gauge film, make conventional units look like elephants. If space is a problem, ask. We'll help. **Electro Cube, Inc.**, 1710 South Del Mar Avenue, San Gabriel, California 91776. (213) 283-0511.

Electronic Design

ELECTRONIC DESIGN'S function is:

- To aid progress in the electronics manufacturing industry by promoting good design.
- To give the electronic design engineer concepts and ideas that make his job easier and more productive.
- To provide a central source of timely electronics information.
- To promote two-way communication between manufacturer and engineer.

Want a subscription? ELECTRONIC DESIGN is sent free to qualified engineers and engineering managers doing design work, supervising design or setting standards in the United States and Western Europe. For a free subscription, use the postfree application form inside the back cover. If none is included, write to us direct for an application form.

If you do not qualify, you may take out a paid subscription for \$25 a year in the U.S.A., \$35 a year elsewhere. Single copies are \$1.50 each.

If you change your address, send us an old mailing label and your new address; there is generally a prepaid postcard for this inside the back cover. You will have to requalify to continue receiving ELECTRONIC DESIGN free.

The accuracy policy of ELECTRONIC DESIGN is:

- To make reasonable efforts to ensure the accuracy of editorial matter.
- To publish prompt corrections whenever inaccuracies are brought to our attention. Corrections appear at the end of the Letters column.
- To refuse any advertisement deemed to be misleading or fraudulent.

Microfilm copies are available of complete volumes of ELECTRONIC DESIGN at \$19.00 per volume, beginning with Volume 9, 1961. Work is now in process to complete the microfilm edition of Volumes 1-8. Reprints of individual articles may be obtained for \$2.00 each, prepaid (\$.50 for each additional copy of the same article) no matter how long the article. For further details and to place orders, contact the Customer Services Department, University Microfilms, 300 North Zeeb Road, Ann Arbor, Michigan 48106; telephone (313) 761-4700.

Want to contact us? If you have any comments or wish to submit a manuscript or article outline, address your correspondence to:

Editor
ELECTRONIC DESIGN,
850 Third Avenue,
New York, N.Y. 10022.

Design Data from

New PC Drafting Aids Catalog

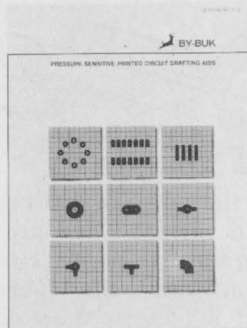

By-Buk Company
4326 W. Pico Blvd.
Los Angeles, California 90019
(213) 937-3511

CIRCLE NO. 171

The By-Buk 1970-71 catalog of pressure sensitive printed circuit drafting aids is now available. With thousands of ideas to promote accuracy and efficiency in printed circuit master artwork layouts. Featured are new artwork patterns for: TO cans, multi-pads, dual in-lines and flat packs. Also the most comprehensive listings of conductor line tapes, pads, donuts, connector strips, elbows, corners, etc. Available in opaque black, transparent red and transparent blue materials. Send for your free catalog and samples.

Plastic Parts



CUSTOM production to your specs from patented, low-cost tooling. Any size, any quantity in Nylon, Delrin, other thermoplastics. Let us quote. We have 20 years experience.

STANDARD gears, racks, bearings, sprockets, pulleys, washers, insulators, many other components available quickly from stock tools. Over 2,500 items described in our 48-page catalogue. Write today for a free copy.

CIRCLE NO. 172

Nylomatic

28 Nolan Ave., Morrisville, Pa. 19067

How To "Design-Your-Own" Precision Power Supply In Minutes.



Trio Laboratories, Inc.
80 Dupont Street
Plainview, N.Y. 11803

CIRCLE NO. 173

Superreg® miniature, pre-packaged, precision power regulators (series and shunt types) make possible design/fabrication of custom power supplies with virtually no engineering time or effort. Data Sheets S201A, S202A, S204 show how just a front end of raw DC or a transformer with rectifying diodes and filter capacitor — and a heat sink mounting area — are all that are needed. Single or multiple outputs easily accommodated. 104 models provide wide range of voltage levels, maximum layout flexibility, low output Z(0.01% regulation), temperature compensation 0.01%/°C, 125°C operation, output adjustability ±10%, short circuit protection.

Manufacturers

Advertisements of booklets, brochures, catalogs and data sheets. To order use Reader-ServiceCard (Advertisement)

PEM Captive Nuts for Circuit Boards



PEM® broaching-type KF fasteners solve special captive fastening problems involving panels and components of relatively brittle materials such as glass laminates, epoxy and other circuit board materials. A PEM KF fastener tightly grips a non-ductile material as its interference-fitting shank is squeezed into a pre-drilled hole. Pushout resistance and torque characteristics are excellent. Installation forces are low. PEM KF fasteners are available in thread sizes .086-56 through .250-20 for use in non-ductile materials too thin for threading.

CIRCLE NO. 174

PENN ENGINEERING & MANUFACTURING CORP.
Doylestown, Pa. 18901

Bus Bars For Noise Reduction

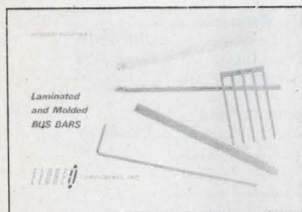

A 16 page Technical Bulletin is now available, describing a new concept in power or signal distribution. Basic mechanical and electrical design principles, along with descriptive pictures and diagrams, are included in this bulletin. These compact buses can replace bulky cable harnesses and repetitive wiring for computer or modular application. This method of construction satisfies the demanding requirements of low inductance and resistance of high speed, solid state systems, while controlling electrical noises.

Send For Free Sample CIRCLE NO. 175

Eldre Components, Inc.
1239 University Avenue
Rochester, New York 14607

BISHOP CIRCUIT ZAPS



PRE-ETCHED, PRESSURE-SENSITIVE COPPER COMPONENT PATTERNS FOR INSTANT PC BOARDS. Circuit Zaps® are 1 ounce copper circuit components patterns, pads, and conductor paths, precision-etched on 5 mil (.005") glass epoxy base material, backed by a special pressure-sensitive adhesive. Circuit Zaps® completely eliminate the artwork, photography, photoprinting, touch up, etching, stripping, and other time-consuming steps in PC board development. Circuit Zaps® provide maximum flexibility.

Now you can save time and money in making designs, proving theories, checking circuits and densities — for all prototype PC work.

Write today for the **FREE TECHNICAL BULLETIN 1003** with **FREE SAMPLE.**

CIRCLE NO. 176

Bishop Graphics, Inc.
7300 Radford Avenue
North Hollywood, California 91605
(213) 982-2000 Telex: 674672

Electronic Design

Advertising Sales Staff

Keith Aldrich
Sales Manager

New York 10022

Robert W. Gascoigne
Samuel M. Deitch
Daniel J. Rowland
850 Third Avenue
(212) Plaza 1-5530
TWX: 867-7866

Philadelphia 19025

Mort Sullivan
P.O. Box 126
Dresher, Pa.
(215) 884-6880

Boston 02154

Joseph F. Palmer
1268 Main Street
Waltham, Mass.
(617) 894-2700

Chicago 60611

Thomas P. Kavooras
Berry Conner, Jr.
200 East Ontario
(312) 337-0588

Cleveland

Thomas P. Kavooras
(Chicago)
(312) 337-0588
(call collect)

Los Angeles 90303

Stanley I. Ehrenclou
Jerry D. Latta
2930 Imperial Highway
Inglewood, Calif.
(213) 757-0183

San Francisco 94022

Arthur R. Shields, Jr.
95 Main Street
Los Altos, Calif.
(415) 941-3084

London W. 1

For United Kingdom and Holland
Brayton C. Nichols
44 Conduit Street
Tel: REGent 4714

Verviers, Belgium

For Continental Europe
Andre Jamar
1, Rue Mallar, 1
087) 253.83 Telex 41563

Tokyo

Haruki Hirayama
Electronic Media Service
5th Floor, Lila Bldg.,
4-9-8 Roppongi
Minato-ku
Phone: 402-4556
Cable: Electronicmedia, Tokyo



SPACERS STANDOFFS

SHIPPED
SAME
DAY
FROM
STOCK

STANDARDIZED & CUSTOM
We cross Ref. most MFRS.

MIL
SPEC
PLATING &
MATERIALS

CONCORD

ELECTRONICS CORPORATION
37 GREAT JONES ST. • NEW YORK, N.Y. 10012
(212) 777-6571 TWX 710-581-4930

INFORMATION RETRIEVAL NUMBER 111

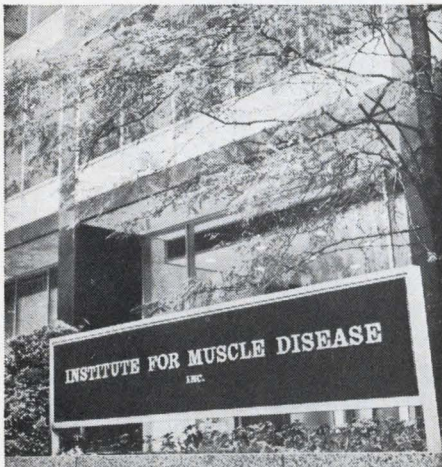

What chemical events take place within living muscle tissue? How does muscle work? Why does it waste away in diseases like muscular dystrophy? At the Institute for Muscle Disease, answers to these questions are being sought on a broad scientific front—ranging from the study of single muscle fibers to an exploration of the body's complex metabolic pathways. The Institute, a tower of hope to millions suffering from disorders of the neuromuscular system, is sponsored by

**MUSCULAR DYSTROPHY
ASSOCIATIONS OF AMERICA, INC.**

1790 Broadway, New York, N.Y. 10019

Advertisers' Index

Advertiser	Page	Advertiser	Page
Abbott Transistor Laboratories Incorporated	13	LEM Instrument Corp.	62
Acopian Corporation	152	Ledex Microelectronics, Ledex, Inc.	137
Adams & Westlake Company, The	149	Licon, Division Illinois Tool Works, Inc.	7
Alco Electronic Products, Inc.	128, 140	Lockheed Electronics, A Division of Lockheed Aircraft Corporation	111
Allco	130B	3M Company Scotchpar	64
Allen-Bradley Co.	2, 48, 49	Magnecraft Electric Company	16
American Lava Corporation	101	Malco Manufacturing Company, Inc.	122
Aritech Corp.	136	MicroSwitch, A Division of Honeywell	125
Arnold Engineering Company, The	10	Molex, Incorporated	25
Atlee Corporation	130	Monsanto Company	Cover III
Augat, Inc.	156	Monroe, The Calculator Company	47
Automated Business Systems, Division of Litton Industries	121	Motorola Semiconductor Products, Inc.	6
Automatic Electric Company	14, 15	National Cash Register Company, The	58
Beckman Instruments, Inc., Helipot Division	97	North Atlantic Industries, Inc.	61
Bishop Graphics, Inc.	159	Nylomatic Corporation	158
Bodine Electric Company	22	Penn Engineering and Manufacturing Corp.	159
Bud Radio Company, Inc.	57	Philips Electronic and Materials Division	19, 130A
Bulova Servo Products Electronic Division of Bulova Watch Company	126	Pomona Electronics Co., Inc.	138
Burr-Brown Research Corporation	12	Power-Tec Division, Airtronics, Inc.	64
By-Buk Company	158	RCA Electronic Components and Devices	Cover IV
CTS Corporation	113	Rtron Corporation	150
Celanese Plastics Company	33	Rogan Brothers, Inc.	128
Clare & Co., C. P.	119	Rogers Corporation	115
Cohn Corp., Sigmund	142	Rohde & Schwarz	130C
Computer Labs	147	Schrack Electrical Sales Corp.	154
Concord Electronics Corporation	160	Sercel	130D
Control Data Corporation	151	Servo Tek Products Company	132
Cunningham Corporation	129	Sigma Instruments, Sigma Instruments, Inc.	56
Dale Electronics, Inc.	Cover II	Signalite Division of General Instruments	103
Datametrics Division, CGS Scientific Corporation	144	Signetics Corporation	31
Datascan, Inc.	134	Siliconix Incorporated	105
Digital Equipment Corporation	95	Singer-General Precision, Inc. Kearfott Division	146
Douglas Randall, Inc.	155	Solid State Scientific, Inc.	143
Duncan Electronics, Inc.	17, 18	Spellman High Voltage Co. Inc.	156
Durant Digital Instruments, A Cutler-Hammer Company	64	Sprague Products Company	20
E-H Research Laboratories, Inc.	52	Stackpole Carbon Company	8, 9
ERA Transpac Corporation	50	Sylvania Electric Products, Inc., Electronic Components Group	35 thru 42
Eldre Components, Inc.	159	TRW Semiconductor Division of TRW, Inc.	99
Electro Cube, Inc.	157	Tektronix, Inc.	55
Electro Fiberoptics Corp.	132	Teletype Corporation	90, 91
Electronic Design	66, 67	Texas Instruments Incorporated, Components Group	74, 75
Electronic Measurements, Inc.	65	Thermal American Fused Quartz Co.	138
Erie Technological Products, Inc.	51	Toshiba America	63
FMC Corporation	139	Trio Laboratories, Inc.	145, 158
Fifth Dimension, Inc.	60	Triplet Corporation	79
General Electric Company	11	Tung Sol Division, Wagner Electric Corporation	126
General Electric Company, Lamp Metals & Components Dept.	161	U. S. Capacitor Corporation	68
Gould, Inc., Graphics Division	80, 81	Unitrode Corporation	85
Grayhill, Inc.	136	Victor Electric Wire & Cable Corp.	62
Hamlin, Inc.	106	Victoreen Instrument Division	140
Hansen Manufacturing Co., Inc.	155	Wakefield Engineering, Inc.	62
Heath Company	127	Welch-Allyn, Inc.	153
Hewlett-Packard	1, 4, 5, 109	Wesco Electrical Company, Inc.	43
IERC Division, International Electronic Research Corporation	117	Weston Instruments, Inc. Components Division	131, 133, 135
IMC Magnetics Corporation	44	Wheelock Signals, Inc.	161
Industrial Timer Corporation	144	Zeltex, Inc.	150
Johnson Company, E. F.	45	Zenith Radio Corporation	154
Keithley Instruments, Inc.	141		
Kurz-Kasch, Inc.	59		

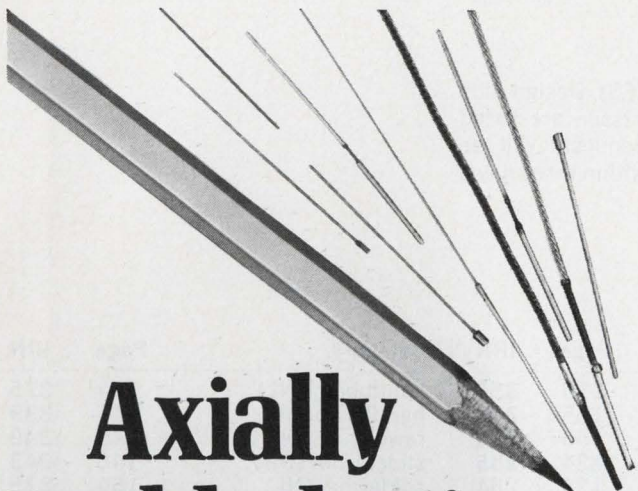

Axially Welded Wires?

...take our lead. General Electric has the facilities and advanced techniques to provide butt weld combinations of copper, nickel, Dumet, tungsten, molybdenum, nickel-iron-cobalt alloys, nickel clad copper, copper clad iron, and others. Available in wire diameters from .008 to .100 in. with many length and material combinations. Take advantage of GE's experience in producing billions of lamp, electronic tube and semiconductor lead wires every year. Minimum order of 100,000. Product data sheets on request. General Electric Company, Lamp Metals & Components Department, 21800 Tungsten Road, Cleveland, Ohio 44117. Tel: (216) 266-3472.

GENERAL  ELECTRIC

INFORMATION RETRIEVAL NUMBER 112

"IT'S GOOD BUSINESS
TO HIRE THE HANDICAPPED."

ISN'T THAT A GREAT IDEA, SNOOPY?



THE PRESIDENT'S COMMITTEE ON EMPLOYMENT
OF THE HANDICAPPED, WASHINGTON, D. C.

*we're
BIG...*

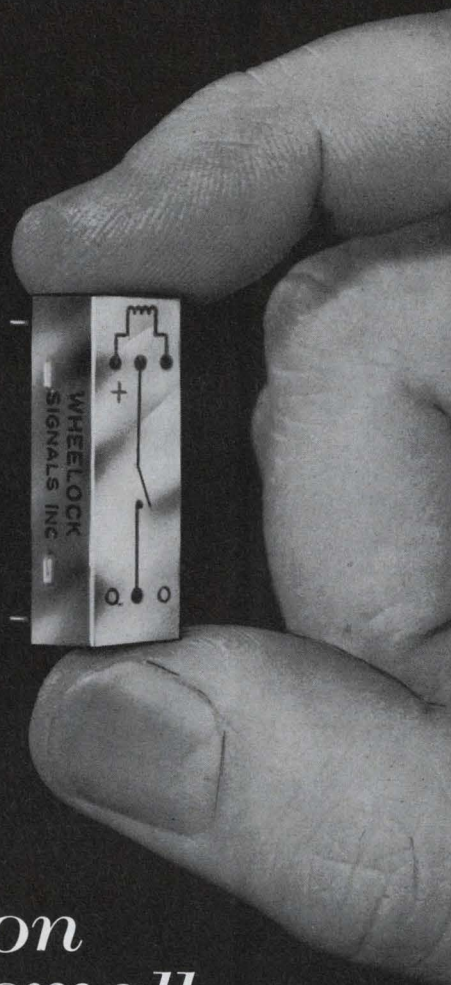

*on
small*
**REED
RELAYS**

Wheelock probably has the reed relay
you're looking for. Write for catalog
describing the Wheelock Big Family
of Small Relays

Wheelock

SIGNALS, INC.

273 Branchport Ave.
Long Branch, N. J. — 201-222-6880

INFORMATION RETRIEVAL NUMBER 114



**The counter
of the future—
here today.**

If headlines like that underwhelm you, think of the most rigorous counting requirement you are likely to encounter in the next few years. Then set these features of our new Model 120A Counter beside it:

Frequency range to 512 MHz • Time base autoranging for optimum resolution (manual selection too, of course) • Monsanto solid-state numerics, the display that makes all others obsolete • Over 60% MSI construction for maximum dependability and function density • Extensive use of plug-in ICs for ease of servicing, minimum downtime • All functions digitally programmable for maximum system compatibility • BCD output, TTL compatible • Full complement of universal counter/timer functions, including "Burst Mode"

In terms of original investment, performance and long-range "Cost of Usership," the Model 120A has no equal. Because it's the counter of the future. Prices? They begin at just \$1775. Write Monsanto Electronic Instruments, West Caldwell, New Jersey 07006.

Monsanto

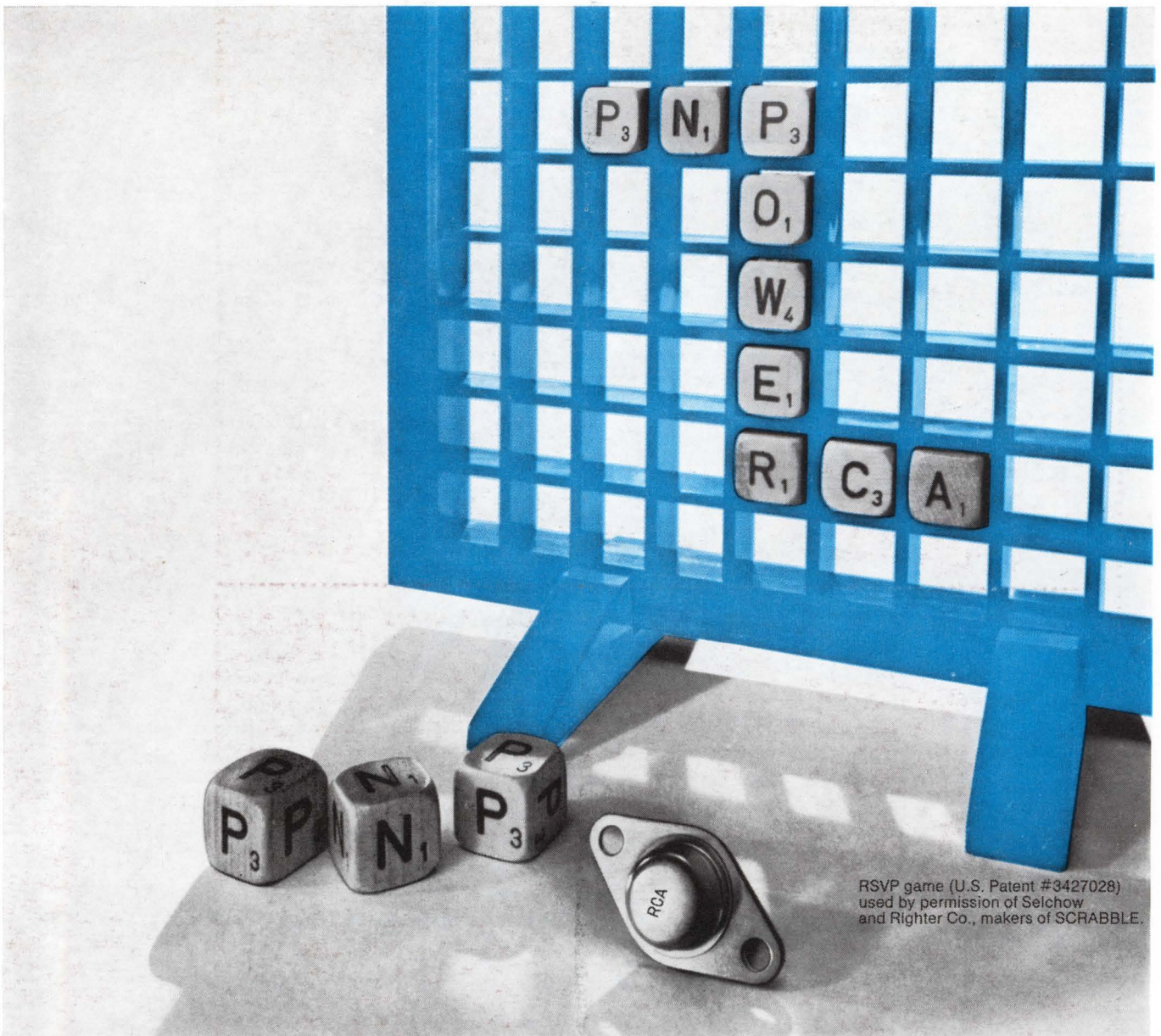

RSVP game (U.S. Patent #3427028) used by permission of Selchow and Righter Co., makers of SCRABBLE.

You Win With RCA P-N-P Power... New 2N5954 Family (2N3054 Complement)

This new RCA p-n-p transistor has the qualifications that can make winners of you and your designs. The 2N5954 is a silicon power unit in a hermetically-sealed TO-66 package. Complementing the 2N3054 (already widely known in sockets in military, industrial, and commercial equipment), the 2N5954 features controlled second-breakdown ratings. To be sure, each transistor is individually tested to meet specified parameters before it is shipped.

The new 2N5954 family with its multiple epitaxial structure and emitter ballasting techniques add up to a traditionally rugged RCA power device...giving you the design capability to achieve high performance levels in your equipment. One of three new RCA p-n-p types now offered for switching and amplifier applications, 2N5954 (or its family types, 2N5955 or 2N5956), together with its n-p-n complement, provide bi-directional control and phase inversion advantages.

P-n-p/n-p-n complements are particularly advantageous if you're trying to cascade four or five stages. In a power supply design, for example, the use of complementary types can eliminate voltage build-up that would be encountered if cascaded n-p-n, or cascaded p-n-p types were employed.

Check the chart on these new types. For more information, consult your local RCA Representative or your RCA Distributor. For technical data, write: RCA Electronic Components, Commercial Engineering, Section 57J-11/UT8, Harrison, N. J. 07029. In Europe: RCA International Marketing S.A., 2-4 rue du Lièvre, 1227 Geneva, Switzerland.

Type No.	V _{CB0} (V)	V _{CEX} (sus) (V)	V _{CER} (sus) (V)	V _{CEO} (sus) (V)	I _C (A)	P _T (W) @ T _C = 25°C
2N5954	85	85	80	75	-6	40
2N5955	70	70	65	60	-6	40
2N5956	50	50	45	40	-6	40

RCA