

# Electronic Design 22

VOL. 14, NO

THE MAGAZINE OF ESSENTIAL NEWS, PRODUCTS AND TECHNOLOGY

SEPTEMBER 27, 1966

**Electro-optics illuminates** the scene from studies of materials to data transmission. The five-corner reflector shown makes it possible to track a space craft continuously.

It is only one of many applications from this new field. New light modulators and deflectors make laser trackers and communications both efficient and competitive. (page 50)

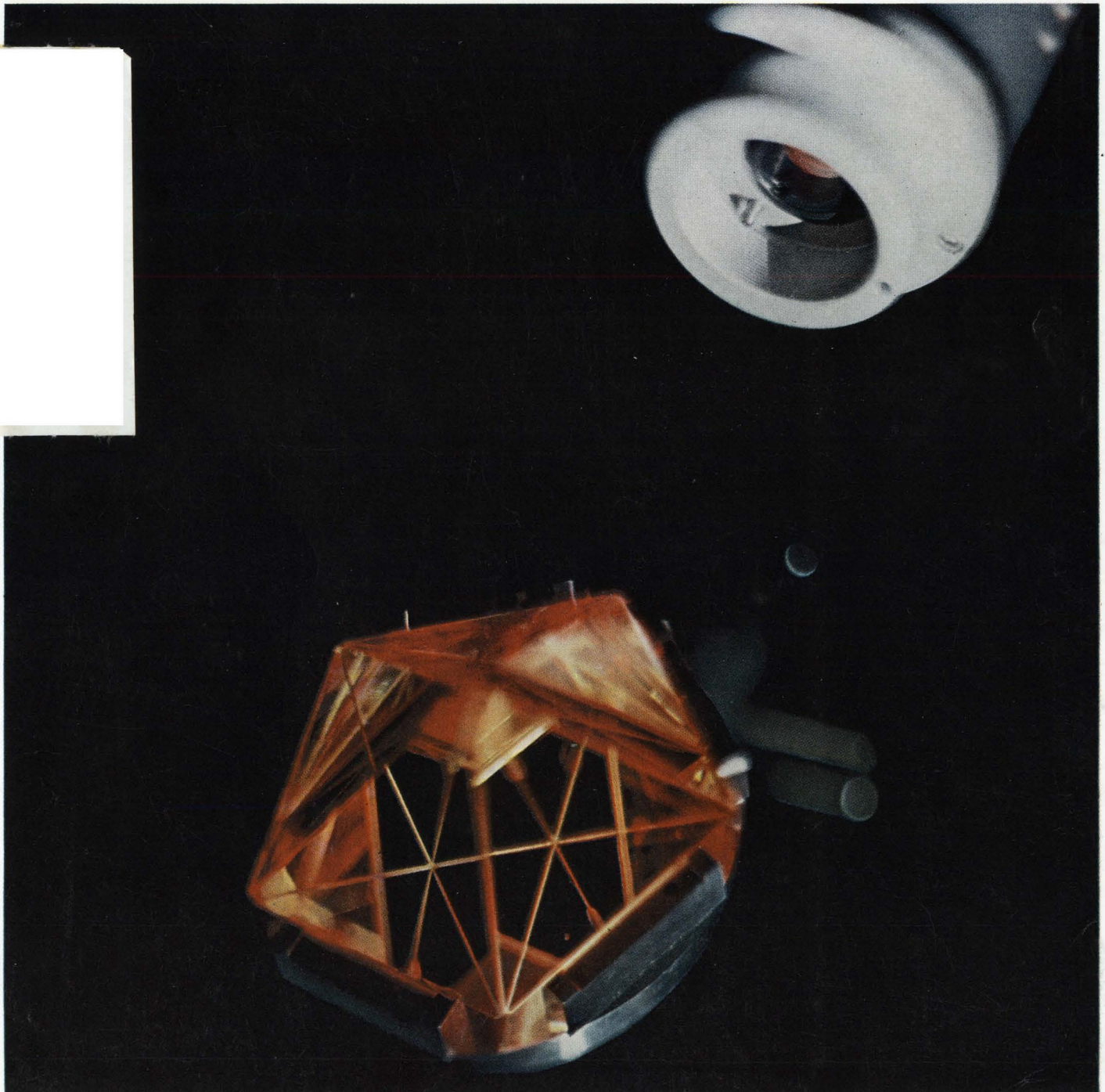



Press a button . . . Read a trace . . .

# SPEED YOUR CIRCUIT DESIGNING

*hp 155A/1550A Features Push-Button Programmability – No DC Drift, and Calibrated  $\pm 25$  cm Offset for Precise Measurements*

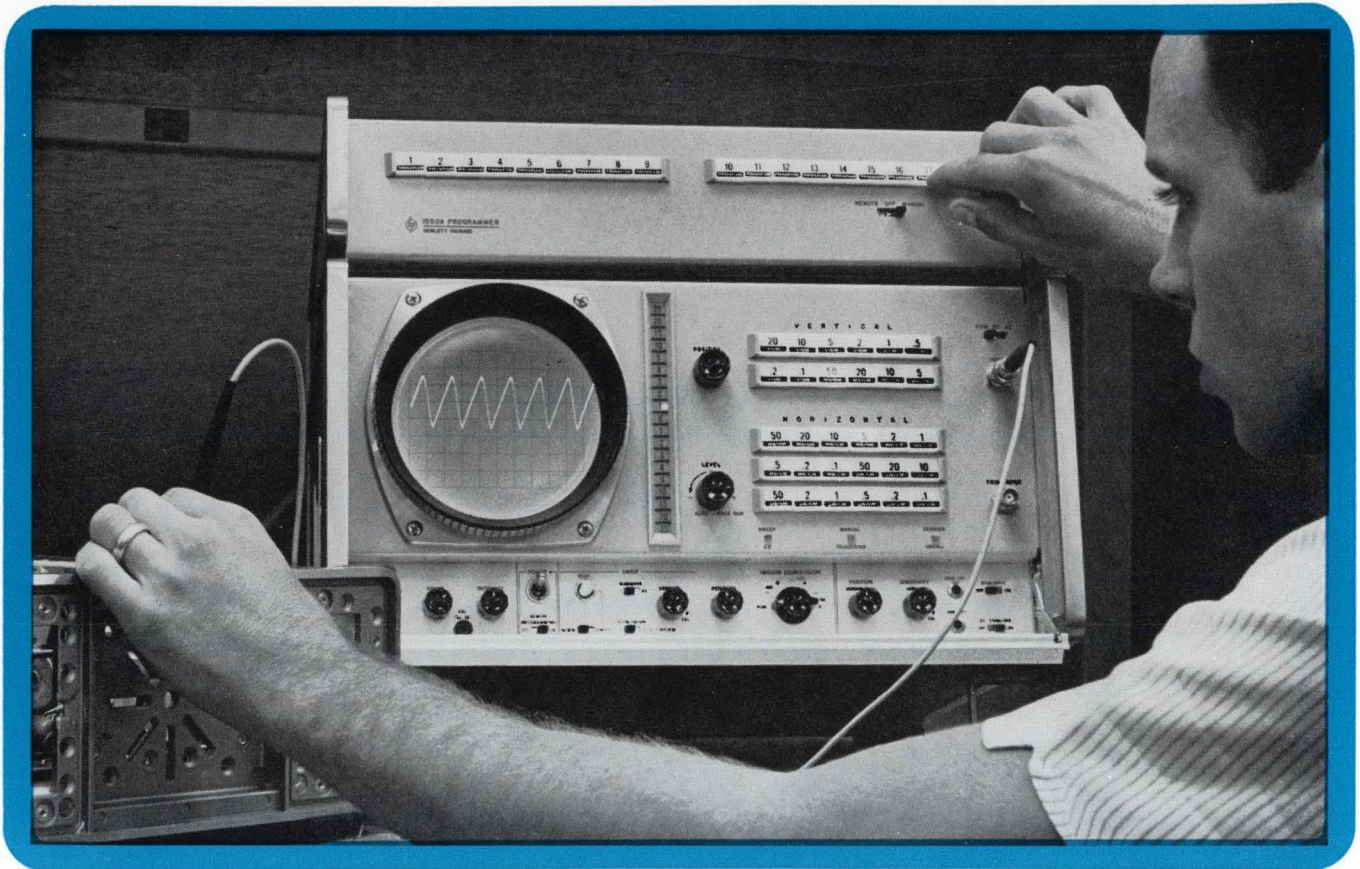

Cut the time required to optimize your circuit designs by pre-setting repetitive tests with the new high-sensitivity, high-frequency (5 mv/cm, 25 MHz) hp Model 155A/1550A Push-Button, Programmable Oscilloscope. Pressing one pushbutton automatically programs all major scope functions—leaves you free to concentrate on your circuit design—without adjusting scope controls! If the need arises, you can override the program mode at any time to “look around.”

Each program set into the scope digitally controls any, or all, of the six major oscilloscope functions—including sensitivity, input coupling, vertical positioning, sweep time, trigger source, and trigger slope. To make your circuit design check, simply choose the test point, press the program button, then read the trace!

For the first time in any scope, you have the advantage of calibrated DC positioning. New hp DC stabilizer circuitry prevents DC drift and shift encountered in conventional DC coupled amplifiers. This driftless operation coupled with wide dynamic range makes the calibrated DC positioning possible. Trace can be offset to  $\pm 25$  cm—and expanded for increased waveform resolution and accuracy.

With the new DC stabilizer circuitry, your trace stays in place—indefinitely! Use the scope to check for drift in your circuitry. No base-line shift caused by the scope with changes in sensitivity setting. Reference levels are maintained. Trace can be recalled to the same position at any time.

Typical DC measurement accuracy is  $\pm 2\%$ . You measure with voltmeter accuracy. You can also simultaneously observe ripple and transients with the DC level.

Test programs can be changed quickly. Only a few minutes are required to set up or change a complete program in the 15" x 10" diode pin board.

For non-routine tests, the 155A/1550A scope operates as a regular high-sensitivity, high-frequency oscilloscope—with the added advantage of push-button convenience and calibrated DC positioning.

To see firsthand how this versatile scope can speed your circuit designing, call your nearest hp sales office for a demonstration and full specifications. Or, write to Hewlett-Packard, Palo Alto, California, 94304. Telephone (415) 326-7000; Europe: 54 Route des Acacias, Geneva. Price: hp Model 155A Oscilloscope, \$2450.00; hp Model 1550A Programmer, \$600.00; Option 01, 155A Oscilloscope with push-button sensitivity and sweep and no drift vertical amplifier but without programming capability, \$2150.00.

**HEWLETT**  **PACKARD**  
An extra measure of quality





# A NEW 100-MHz Pulse Generator... **for only \$995** in U.S.A.

- 1 to 100 MHz generated internally; dc to 100 MHz, externally.
- 2-ns rise and fall times.
- Calibrated output, 0 to 4 volts into 50  $\Omega$  in 1/2-volt steps.
- Duty ratios up to 96%.
- Output-pulse duration variable from 4 to 99 ns in 1-ns steps.
- Trigger-level and slope controls for use with external triggering.



**Type 1394-A High-Rate Pulse Generator**

The development and testing of today's high-frequency digital circuitry call for a pulse generator whose output pulses have:

1. High repetition rate.
2. Fast rise and fall times.
3. Sufficient voltage to switch circuits.

GR's new pulse generator meets these requirements, and it has many other useful features for testing high-speed computers, radar systems, digital-communication systems, and other sophisticated equipment. It has, for instance, calibrated controls for pulse duration, delay, amplitude, and repetition frequency, and pulses of either polarity are available at the output. The fast-rise-time capability of the 1394-A makes it also well suited for the study of component characteristics, such as semiconductor switching speed and pulse-transformer rise time. Add to these features a price that is substantially less than that of comparable instruments and you have a pulse generator that has an unusually high performance/price index.

An accessory unit, the Type 1394-P1 Pulse-Offset Control, is available for applications requiring a dc-coupled output. This unit fixes the base line of the output pulses to any reference voltage from -2 to +2 volts and is continuously adjustable. Price: \$255 in USA.

**Other  
Pulse Instruments**

**Type 1217-C Unit Pulse Generator**  
... high performance at minimum cost, prf up to 1.2 MHz. Price: \$275 in USA.

**Type 1398-A Pulse Generator**  
... rise and fall times less than 5 ns, 60-V output pulses, prf up to 1.2 MHz. Price: \$595 in USA.

**Type 1395-A Modular Pulse Generator**  
... produces practically any pulse shape or train you may want, five different modules available, main frame accommodates up to 7 modules. Price: Main Frame, \$575; Modules, \$160 to \$400 in USA.

**Type 1397-A Pulse Amplifier**  
... linear amplifier with 1.2-ampere output for use with Types 1217-C and 1398-A or any other pulse generator with negative output pulses. Price: \$495 in USA.

*Write for complete information*

ON READER-SERVICE CARD CIRCLE 2

BOSTON • NEW YORK • CHICAGO • PHILADELPHIA • WASHINGTON, D.C.  
SYRACUSE • DALLAS • SAN FRANCISCO • LOS ANGELES • ORLANDO  
CLEVELAND • TORONTO • MONTREAL  
BOURNE END, ENGLAND      ZURICH, SWITZERLAND

**GENERAL RADIO**  
WEST CONCORD, MASSACHUSETTS



NEW Model 111

# NANO **2** SECOND

VARIABLE RISE PULSE GENERATOR with  
PRECISION DC BASELINE OFFSET... 4 Hz to 40 MHz  
rep. rates... single or double pulse...  $\pm 5v$  output... narrow  
pulses to 5 nanosec. ■ Fully controllable fast pulses for  
exact waveform simulation... worst case testing ■ Precision  
dc baseline offset control for off-ground logic simulation  
... noise susceptibility analysis ■ Ultra high rep. rates for  
high speed circuit development ■ Auxiliary dc output for  
test biasing ■ Double pulses to 25 MHz (simulates 50 MHz)  
for flip-flop resolution checks...



Model 111  
Pulse Generator

Write for Technical Data.

Datapulse is the leading producer of solid state pulse instrumentation.  
48 technical sales offices and 7 field service centers in 18 countries.

Datapulse welcomes technical employment inquiries.

**DATAPULSE**<sup>®</sup>

DATAPULSE/Division of Datapulse Incorporated/509 Hindry Ave., Inglewood, California 90306/(213) 671-4334, 678-4275/TWX: 910-328-6109/Cable DATAPULSE  
DATAPULSE • NESCO INSTRUMENTS • DE MORNAY-BONARDI • KRS INSTRUMENTS

ON READER-SERVICE CARD CIRCLE 3



---

## NEWS

- 13 News Scope
- 17 **Sonar looks askance at sea bottom**  
Advanced electronics help side-looking sonar to bridge gap between echo sounders and TV.
- 22 **Laser radars take a giant step**  
With one major problem solved, optical phased arrays may soon be in use.
- 24 Flexible printed circuits stick like tape.
- 27 Microwave tower has 'new look.'
- 31 Washington Report
- 33 IC yield and adaptive antennas investigated by Stanford.
- 34 New alloy is superconductive.
- 38 Letters
- 47 **Editorial:** The Merchant Marine is in need of help.
- 

## TECHNOLOGY

- 50 **Staff Report: Electro-optics**
- 51 **Better laser modulation sought with electro-optical method.**
- 56 **Solid state competes with lasers as light source.**
- 62 **Are lasers practical for communication systems?**
- 70 **Try diodes for remote gain control**—if properly biased, their nonlinearities cancel out to yield a linear, temperature-stable gain.
- 74 **DTL logic gates bring versatility** to tuning-circuit design. A standard IC and a capacitor yield a variety of monostable and astable multivibrators.
- 81 **Design Directions:** The germanium FET: needful or needless?
- 86 **Digital computers are no mystery** if you think of them in terms of the functions that they perform instead of their hardware.
- 94 **Halve the number of filters** used in the chains of harmonic generators by arranging the varactor diodes so that the odd or even harmonics are generated.
- 98 **Convert units of laser radiation** from photon energy to frequency, or from wave number to wavelength, with the aid of a simple chart.
- 100 **Learn the basics of contracts.** Here's a primer of existing contractual agreements and their relative effectiveness.
- 108 Ideas for Design
- 

## PRODUCTS

- |     |   |                               |
|-----|---|-------------------------------|
| 126 | <b>Semiconductors:</b> Pnp has 500-V $BV_{CEO}$ , | completes complementary pair. |
| 130 | Test equipment                                    | 154 Power Equipment           |
| 136 | Microelectronics                                  | 156 Microwaves                |
| 142 | Components  | 158 Materials                 |
| 152 | Systems   | 166 Production Equipment      |
- 

## Departments

- |     |                   |     |                     |
|-----|-------------------|-----|---------------------|
| 116 | Book Reviews      | 174 | New Literature      |
| 170 | Design Aids       | 182 | Advertisers' Index  |
| 172 | Application Notes | 184 | Designer's Datebook |
-



# Meet any programable or fixed voltage need

Up to 150 volts • Up to 95 amps

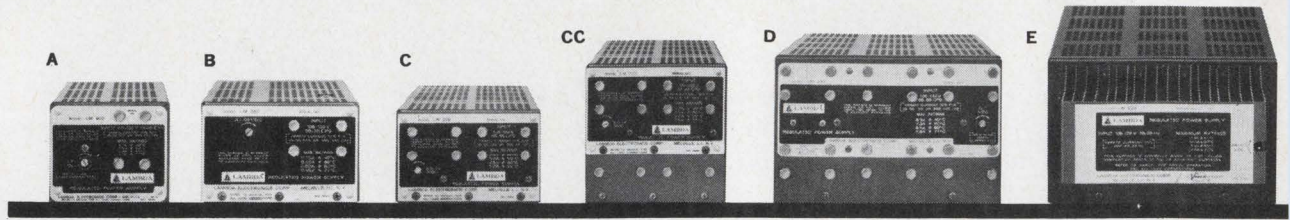

## FEATURES and DATA

Full line of accessories and options to meet your system needs. Meet Mil. Environment Specs. RFI—MIL-I-16910: Vibration: MIL-T-4807A: Shock: MIL-E-4970A • Proc. 1 & 2: Humidity: MIL-STD-810 • Meth. 507: Temp. Shock: MIL-E-5272C • (ASG) Proc. 1: Altitude: MIL-E-4970A • (ASG) Proc. 1: Marking: MIL-STD-130: Quality: MIL-Q-9858: Fungus Proofing (optional) all models available with MIL-V-173 varnish for all nutrient components.

Convection cooled—no heat sinking or forced air required  
Wide input voltage and frequency range—105-132 VAC, (200-250 VAC, optional at no extra charge) 45-440 cps  
Regulation (line) 0.05% plus 4MV (load) 0.03% plus 3MV:  
Ripple and Noise—1 MV rms, 3MV p to p  
Overvoltage protection available for all models up to 70 VDC

High Performance Option—All models available with these specifications for \$25.00 extra: Line regulation—.01% + 1MV; Load regulation—.02% + 2MV; Ripple and Noise—½MV rms; 1½MV p to p: Temp. Coef.—.01%°C

## ACCESSORIES and OPTIONS



### System Rack Adapters

LRA-5 • 3½" height by 27½" depth. Price \$35.00

LRA-4 • 3½" height by 14" depth. (For use with chassis slides) Price \$55.00

LRA-5 and LRA-4 mount the following combinations of LM models: up to 4 A package sizes • 3 B or 3 C package sizes • 2 A and 1 B or 1 C package sizes

LRA-3 • 5¼" height by 27½" depth. Price \$35.00

LRA-6 • 5¼" height by 14" depth. (For use with chassis slides) Price \$60.00

LRA-3 and LRA-6 mount the following combinations of LM models: up to 4 A, B or C package sizes • 3 CC package sizes • 2 D or 2 E package sizes • 2 A, B or C and 1 CC or 1 D or 1 E package sizes • 1 CC and 1 D or 1 E package sizes • 1 D and 1 E package sizes

**Metered Panels** • 3½" Metered panel MP-3 is used with rack adapters LRA-4, LRA-5 and packages A, B and C. Price \$40.00

5¼" Metered panel MP-5 is used with rack adapters LRA-6, LRA-3 and packages A, B, C, CC, D and E. Price \$40.00

To order these accessory metered panels, specify panel number which MUST BE FOLLOWED BY THE MODEL NUMBER of the power supply with which it will be used.

F and G LM Packages are full rack power supplies available metered or non-metered. For metered models, add suffix M to the Model No. and \$30 to the non-metered price.

**Other Options** • Also available are Overvoltage Protectors, Fungus Proofing, and High Performance Options at moderate surcharges.

## WIDE VOLTAGE RANGE

### PROGRAMABLE LM SERIES MODELS

PACKAGE A 3½" x 13½" x 16½"	ADJ. VOLT. RANGE VDC	*MAX. AMPS AT AMBIENT OF:				Price**
		40° C	50° C	60° C	71° C	
LM 251	0-7	0.35	0.31	0.29	0.27	\$ 69
LM 201	0-7	0.85	0.75	0.70	0.55	79
LM 202	0-7	1.7	1.5	1.4	1.1	89
LM 252	0-7	2.0	1.8	1.4	1.1	99
LM 257	0-14	0.27	0.24	0.23	0.22	69
LM 203	0-14	0.45	0.40	0.38	0.28	79
LM 204	0-14	0.90	0.80	0.75	0.55	89
LM 258	0-14	1.2	1.1	1.0	0.80	99
LM 259	0-24	0.18	0.16	0.15	0.14	69
LM 260	0-24	0.35	0.30	0.25	0.20	79
LM 261	0-24	0.70	0.65	0.60	0.45	89
LM 262	0-24	0.80	0.75	0.70	0.60	99
LM 263	0-32	0.14	0.12	0.11	0.10	69
LM 205	0-32	0.25	0.23	0.20	0.15	79
LM 206	0-32	0.50	0.45	0.40	0.30	89
LM 264	0-32	0.66	0.60	0.50	0.32	99
LM 265	0-60	0.08	0.07	0.07	0.06	79
LM 207	0-60	0.13	0.12	0.11	0.08	89
LM 208	0-60	0.25	0.23	0.21	0.16	99
LM 266	0-60	0.35	0.31	0.28	0.25	109
LM 267	0-120	0.10	0.09	0.08	0.07	109
LM 268	0-120	0.13	0.12	0.10	0.09	119

PACKAGE B 3½" x 14½" x 16½"	ADJ. VOLT. RANGE VDC	*MAX. AMPS AT AMBIENT OF:				Price**
		40° C	50° C	60° C	71° C	
LMB-0-7	0-7	2.8	2.6	2.3	1.5	\$109
LMB-0-14	0-14	1.6	1.5	1.3	1.2	109
LMB-0-32	0-32	0.80	0.70	0.60	0.5	109
LMB-0-60	0-60	0.45	0.40	0.35	0.3	109
LM-217	8.5-14	2.1	1.9	1.7	1.3	119
LM-218	13-23	1.5	1.3	1.2	1.0	119
LM-219	22-32	1.2	1.1	1.0	0.80	119
LM-220	30-60	0.70	0.65	0.60	0.45	129

PACKAGE C 3½" x 14½" x 19½"	ADJ. VOLT. RANGE VDC	*MAX. AMPS AT AMBIENT OF:				Price**
		40° C	50° C	60° C	71° C	
LM-225	0-7	4.0	3.6	3.0	2.4	\$139
LMC-0-14	0-14	2.2	2.0	1.8	1.5	139
LMC-0-32	0-32	1.1	1.0	0.90	0.80	139
LMC-0-60	0-60	0.60	0.55	0.50	0.45	139
LM-226	8.5-14	3.3	3.0	2.5	2.0	139
LM-227	13-23	2.3	2.1	1.7	1.4	139
LM-228	22-32	2.0	1.8	1.5	1.2	139
LM-229	30-60	1.1	1.0	0.80	0.60	149

PACKAGE D 4½" x 17½" x 19½"	ADJ. VOLT. RANGE VDC	*MAX. AMPS AT AMBIENT OF:				Price**
		40° C	50° C	60° C	71° C	
LM-234	0-7	8.3	7.3	6.5	5.5	\$199
LMD-0-14	0-14	4.9	4.2	3.4	2.7	199
LMD-0-32	0-32	2.5	2.1	1.7	1.3	180
LMD-0-60	0-60	1.3	1.1	0.95	0.75	239
LM-235	8.5-14	7.7	6.8	6.0	4.8	199
LM-236	13-23	5.8	5.1	4.5	3.6	209
LM-237	22-32	5.0	4.4	3.9	3.1	219
LM-238	30-60	2.6	2.3	2.0	1.6	239

PACKAGE E 4½" x 17½" x 11½"	ADJ. VOLT. RANGE VDC	*MAX. AMPS AT AMBIENT OF:				Price**
		40° C	50° C	60° C	71° C	
LME-0-7	0-7	12.0	10.5	8.5	6.8	\$249
LME-0-14	0-14	7.4	6.4	5.2	4.1	249
LME-0-32	0-32	3.7	3.2	2.6	2.1	249
LME-0-60	0-60	2.1	1.7	1.4	1.1	249

PACKAGE F 3½" x 18" x 16½"	ADJ. VOLT. RANGE VDC	*MAX. AMPS AT AMBIENT OF:				Price**
		40° C	50° C	60° C	71° C	
LMF-0-7	0-7	25.0	21.0	17.0	14.0	\$425

PACKAGE G 5½" x 19" x 16½"	ADJ. VOLT. RANGE VDC	*MAX. AMPS AT AMBIENT OF:				Price**
		40° C	50° C	60° C	71° C	
LMG-0-7	0-7	35.0	29.0	24.0	20.0	\$575



# with Lambda Modular Power Supply Systems

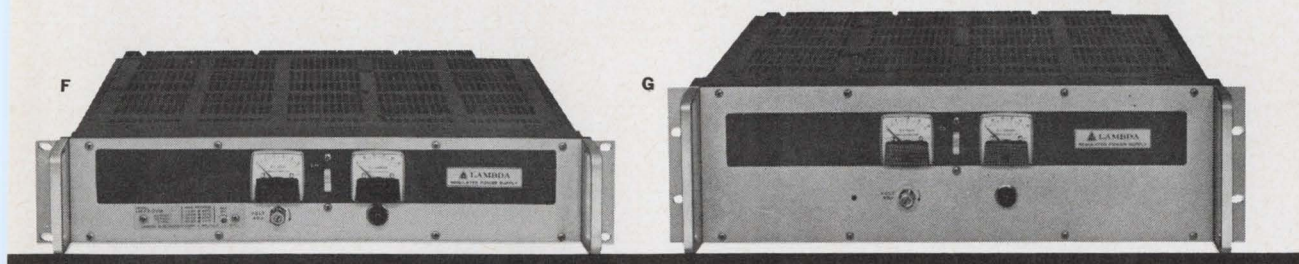

## FIXED VOLTAGE RANGE LM SERIES MODELS

PACKAGE B 3 1/2" x 4 1/2" x 6 1/2"	ADJ. VOLT. RANGE VDC	*MAX. AMPS AT AMBIENT OF:				Price**
		40 C	50 C	60 C	71 C	
LM B3	3 ±5%	3.8	3.3	2.6	1.6	\$119
LM B3P3	3.3 ±5%	3.8	3.3	2.6	1.6	119
LM B3P6	3.6 ±5%	3.8	3.3	2.6	1.6	119
LM B4	4 ±5%	3.8	3.3	2.6	1.6	119
LM B4P5	4.5 ±5%	3.7	3.2	2.5	1.5	119
LM B5	5 ±5%	3.7	3.2	2.5	1.5	119
LM B6	6 ±5%	3.2	2.9	2.4	1.4	119
LM B8	8 ±5%	3.2	2.9	2.4	1.4	119
LM B10	10 ±5%	2.7	2.5	2.2	1.4	119
LM B12	12 ±5%	2.5	2.3	2.1	1.3	119
LM B15	15 ±5%	2.2	2.0	1.8	1.3	119
LM B18	18 ±5%	2.0	1.8	1.7	1.3	119
LM B20	20 ±5%	1.8	1.6	1.5	1.2	119
LM B24	24 ±5%	1.4	1.3	1.2	1.1	119
LM B28	28 ±5%	1.3	1.2	1.1	1.0	119
LM B36	36 ±5%	1.1	1.0	0.90	0.85	129
LM B48	48 ±5%	0.9	0.85	0.80	0.75	129
LM B60	60 ±5%	0.7	0.65	0.60	0.54	129
LM B100	100 ±5%	0.37	0.34	0.30	0.28	139
LM B120	120 ±5%	0.30	0.28	0.25	0.23	139
LM B150	150 ±5%	0.25	0.23	0.20	0.19	149

PACKAGE C 3 1/2" x 4 1/2" x 9 1/2"	ADJ. VOLT. RANGE VDC	*MAX. AMPS AT AMBIENT OF:				Price**
		40 C	50 C	60 C	71 C	
LM C3	3 ±5%	5.3	4.6	3.7	2.5	\$139
LM C4	4 ±5%	5.2	4.5	3.6	2.5	139
LM C4P5	4.5 ±5%	5.1	4.4	3.5	2.4	139
LM C5	5 ±5%	5.1	4.3	3.4	2.4	139
LM C6	6 ±5%	4.8	4.1	3.3	2.4	139
LM C12	12 ±5%	4.0	3.5	2.9	1.9	139
LM C15	15 ±5%	3.5	3.2	2.8	1.9	139
LM C20	20 ±5%	3.1	2.9	2.6	1.8	139
LM C24	24 ±5%	2.5	2.4	2.2	1.5	139
LM C28	28 ±5%	2.3	2.1	2.0	1.4	139
LM C48	48 ±5%	1.6	1.4	1.3	1.0	149
LM C150	150 ±5%	0.39	0.36	0.33	0.30	169

PACKAGE E 4 1/2" x 7 1/2" x 11 1/2"	ADJ. VOLT. RANGE VDC	*MAX. AMPS AT AMBIENT OF:				Price**
		40 C	50 C	60 C	71 C	
LM E3	3 ±5%	22.0	20.0	16.5	10.0	\$269
LM E4	4 ±5%	21.0	19.0	16.5	10.0	269
LM E4P5	4.5 ±5%	20.0	18.0	16.4	10.0	269
LM E5	5 ±5%	20.0	18.0	16.4	10.0	269
LM E6	6 ±5%	19.0	17.3	15.6	10.0	269
LM E12	12 ±5%	15.0	13.6	12.3	9.5	269
LM E15	15 ±5%	14.0	12.7	11.5	8.6	269
LM E20	20 ±5%	12.0	10.9	9.8	8.5	269
LM E24	24 ±5%	11.0	10.0	9.0	7.6	269
LM E28	28 ±5%	10.0	9.0	8.0	7.1	269
LM E48	48 ±5%	6.0	5.4	4.9	4.3	299
LM E150	150 ±5%	1.4	1.3	1.2	1.0	299

NEW PACKAGE CC 4 1/2" x 4 1/2" x 9 1/2"	ADJ. VOLT. RANGE VDC	*MAX. AMPS AT AMBIENT OF:				Price**
		40 C	50 C	60 C	71 C	
LM CC3	3 ±5%	11.0	9.4	8.2	5.5	\$179
LM CC4	4 ±5%	11.0	9.4	8.2	5.5	179
LM CC4P5	4.5 ±5%	10.5	9.0	8.0	5.5	179
LM CC5	5 ±5%	10.5	9.0	8.0	5.5	179
LM CC6	6 ±5%	9.0	8.4	7.7	5.5	179
LM CC12	12 ±5%	7.3	6.8	5.9	4.7	169
LM CC15	15 ±5%	6.0	5.6	5.1	4.3	169
LM CC20	20 ±5%	5.0	4.6	4.2	3.6	169
LM CC24	24 ±5%	4.0	3.7	3.4	3.0	169
LM CC28	28 ±5%	3.5	3.4	3.1	2.8	169
LM CC48	48 ±5%	2.5	2.4	2.2	1.9	189
LM CC150	150 ±5%	0.7	0.67	0.62	0.55	199

PACKAGE F 3 1/2" x 9" x 16 1/2"	ADJ. VOLT. RANGE VDC	*MAX. AMPS AT AMBIENT OF:				Price**
		40 C	50 C	60 C	71 C	
LM FA3	3 ±5%	31.5	28.5	24.0	18.0	\$375
LM FA4	4 ±5%	31.5	28.5	24.0	18.0	375
LM FA4P5	4.5 ±5%	31.5	28.5	24.0	18.0	375
LM FA5	5 ±5%	31.5	27.7	23.7	18.0	375
LM FA6	6 ±5%	30.5	26.0	22.0	18.0	375
LM FA12	12 ±5%	22.0	19.0	16.2	13.2	375
LM FA15	15 ±5%	19.4	18.3	15.2	12.6	375
LM FA20	20 ±5%	16.0	14.7	12.6	10.5	350
LM FA24	24 ±5%	14.0	13.0	11.4	9.0	350
LM FA28	28 ±5%	13.5	12.0	10.4	8.5	350
LM FA48	48 ±5%	8.1	7.5	6.5	5.4	375
LM FA150	150 ±5%	2.4	2.1	1.8	1.4	410

PACKAGE D 4 1/2" x 7 1/2" x 9 1/2"	ADJ. VOLT. RANGE VDC	*MAX. AMPS AT AMBIENT OF:				Price**
		40 C	50 C	60 C	71 C	
LM D3	3 ±5%	13.1	11.3	9.2	6.2	\$199
LM D4	4 ±5%	13.1	11.3	9.2	6.2	199
LM D4P5	4.5 ±5%	13.1	11.3	9.2	6.2	199
LM D5	5 ±5%	12.6	10.8	9.2	6.1	199
LM D6	6 ±5%	12.4	10.6	8.9	6.0	199
LM D12	12 ±5%	10.0	9.2	8.3	5.7	199
LM D15	15 ±5%	9.0	8.4	7.9	5.3	209
LM D20	20 ±5%	7.4	6.9	6.5	4.9	209
LM D24	24 ±5%	6.7	6.3	5.8	4.8	219
LM D28	28 ±5%	6.0	5.6	5.2	4.7	219
LM D48	48 ±5%	4.1	3.9	3.6	3.1	239
LM D150	150 ±5%	1.1	1.0	0.90	0.80	254

PACKAGE G 5 1/2" x 9" x 16 1/2"	ADJ. VOLT. RANGE VDC	*MAX. AMPS AT AMBIENT OF:				Price**
		40 C	50 C	60 C	71 C	
LM G3	3 ±5%	95.0	80.0	62.0	45.0	\$575
LM G4	4 ±5%	85.0	80.0	62.0	45.0	575
LM G4P5	4.5 ±5%	85.0	80.0	62.0	45.0	575
LM G5	5 ±5%	80.0	75.0	62.0	45.0	575
LM G6	6 ±5%	80.0	75.0	62.0	45.0	525
LM G12	12 ±5%	56.0	46.0	37.0	29.0	525
LM G15	15 ±5%	45.0	42.0	36.0	28.0	525
LM G20	20 ±5%	35.0	32.0	28.0	21.0	525
LM G24	24 ±5%	32.0	26.0	21.0	16.0	480
LM G28	28 ±5%	28.0	25.0	21.0	16.0	480
LM G48	48 ±5%	17.0	14.0	12.0	9.0	575
LM G150	150 ±5%	5.5	5.2	4.5	3.7	675

### NOTE:

Space does not permit listing all LM Series fixed-voltage power supplies. In every package size there are models for each voltage range listed under the B package. Call or write for data and prices.

\* Current rating is from zero to I max. at ambient. Current rating applies over entire output voltage range.

Current rating applies for input voltage 105-132 VAC 55-65 cps.

For operation at 45-55 cps derate current rating 10%.

For operation at 360-440 cps consult factory for ratings and specifications.

\*\* Prices F.O.B. Factory, Melville, N. Y. All specifications and prices subject to change without notice.

SEND FOR NEW CATALOG ON FIXED VOLTAGE  
AND WIDE RANGE MODULAR POWER SUPPLIES

**LAMBDA** ELECTRONICS CORP. A **Veeco** SUBS. DIARY  
515 BROAD HOLLOW ROAD · MELVILLE, L. I., NEW YORK · 516 MYRTLE 4-4200

ON READER-SERVICE CARD CIRCLE 4



# IRG

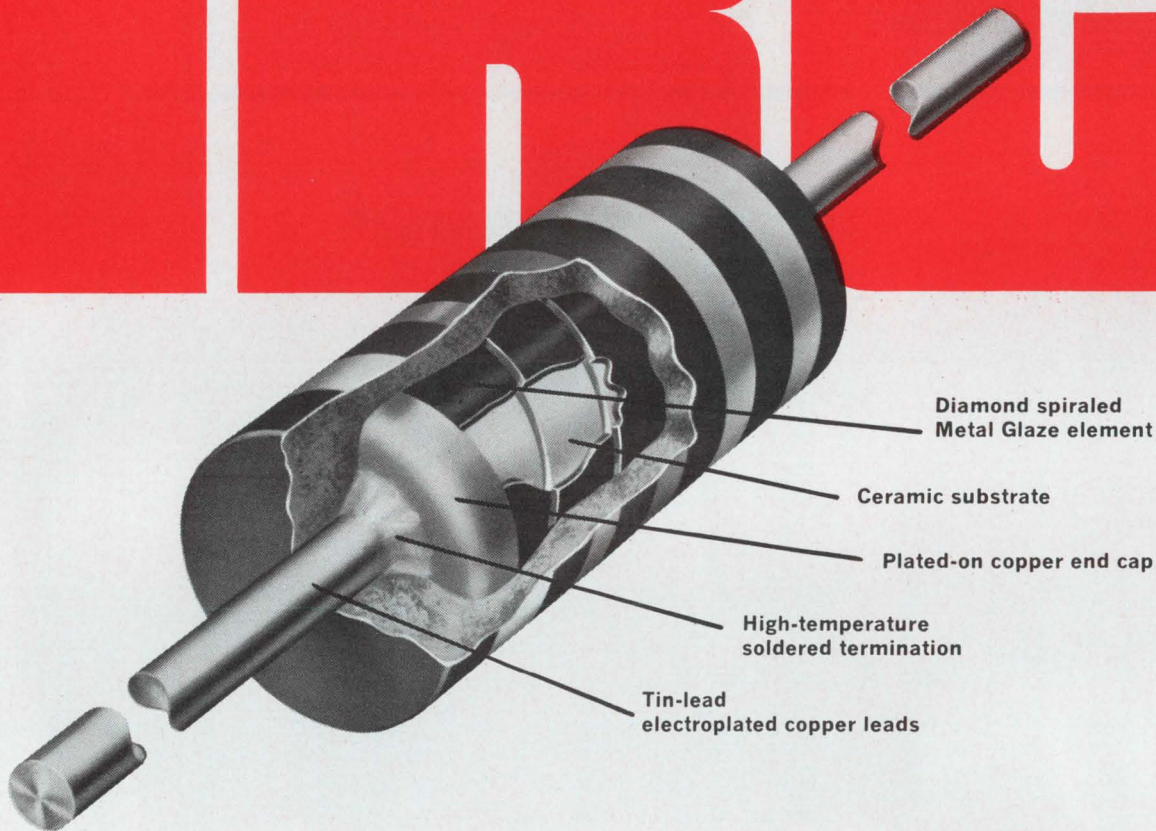

## New low-cost Metal Glaze<sup>®</sup> resistors for MIL-R-22684

4 times better load-life stability



IRC's new molded Metal Glaze resistors provide stability, reliability and precision unmatched anywhere for the price.

Tested for over 15 million unit hours, they meet or exceed all MIL-R-22684 requirements. Load life stability, for instance, is four times better than MIL allowance. Typical  $\Delta R$  is 0.5% after 1000 hours, full load at 70°C. Even at higher temperatures,  $\Delta R$  is still typically under MIL limits.

The Metal Glaze resistance element is extremely rugged. It is 100 times thicker than conventional films and is impervious to environmental extremes. The tough, uniform molded body resists solvents and the mechanical abuse of automatic machines.

New IRC molded Metal Glaze resistors are immediately available in four forms of packaging to cut your production costs. For complete data, prices and samples, write to: IRC, Inc., 401 N. Broad St., Philadelphia, Pa. 19108.

### CAPSULE SPECIFICATIONS

		
MIL-R-22684B:	RL07	RL20
WATTAGE:	¼ W @ 70°C	½ W @ 70°C
RESISTANCE:	51 $\Omega$ thru 150K $\Omega$	10 $\Omega$ to 470K $\Omega$
TOLERANCES:	±2%, ±5%	±2%, ±5%
TEMPERATURE COEFFICIENT:	±200ppm/°C max.	±200ppm/°C max.
VOLTAGE:	250V max.	350V max.
SIZE:	.250" x .090" dia.	.375" x .138" dia.
IRC TYPE:	RG07	RG20



Speed Inquiry to Advertiser via Collect Night Letter  
ON READER-SERVICE CARD CIRCLE 5



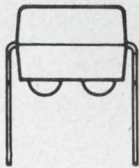
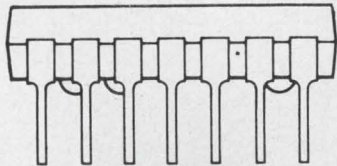
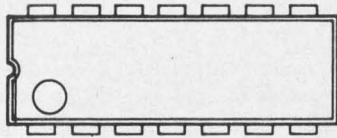

# Now- Motorola 830-Series MDTL Integrated Circuits in PLASTIC!

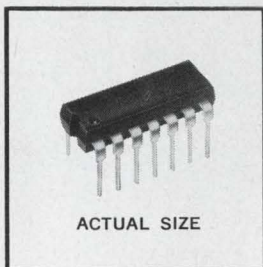

ACTUAL SIZE

Here's the popular 830-series DTL integrated circuit complement in plastic packages at prices from 30 to 60% lower than what you have been paying for metal!

Offering the same wide range of circuit functions as previous metal and flat-packaged types, Motorola's new MC830P series, for operation from 0 to +75°C, provides an unusual opportunity for reducing production costs.

For example, the Motorola-designed Unibloc\* plastic package, with dual in-line pin arrangement, offers great advantage for use in production assembly with automatic insertion equipment.

("Unibloc" is Motorola's trade name for its solid, single-piece pressure-molded package that offers unusual physical strength for internal leads and connections, plus improved heat transfer characteristics.)

Here are the new MDTL\* circuit prices:

Circuit Function	Price† (1-999)
MC830P Dual 4-Input Gate	\$1.55
MC831P Clocked Flip-Flop	3.00
MC832P Dual Buffer	1.65
MC833P Dual Expander	1.35
MC844P Dual Power Gate	1.65
MC845P Clocked Flip-Flop	3.00
MC846P Quad 2-Input Gate	1.65
MC848P Clocked Flip-Flop	3.00
MC862P Triple 3-Input Gate	1.65

†See your Motorola representative for even more substantial savings in larger quantities.

For complete details write to: Motorola Semiconductor Products Inc., Dept. TIC, Box 955, Phoenix, Arizona 85001.

\*Trademark of Motorola Inc.



## MOTOROLA Semiconductors

*- where the priceless ingredient is care!*

Speed Inquiry to Advertiser via Collect Night Letter  
ON READER-SERVICE CARD CIRCLE 6



From 2A to 35A, from 100V to 600V...

# Whatever your control application, RCA has the *right* TRIAC or SCR at the *right* price

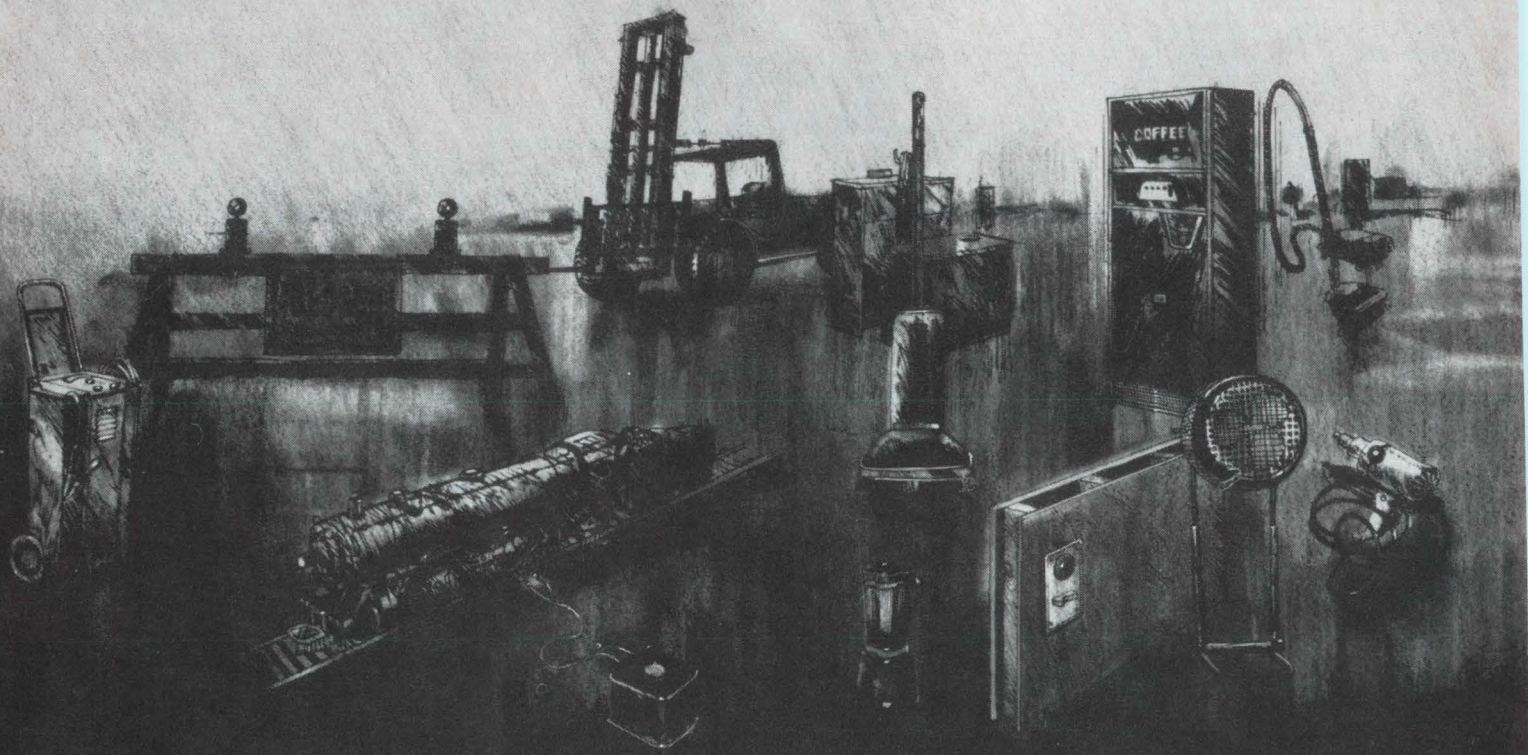

## LOW VOLTAGE SUPPLY $V_{BOO} = 100\text{ V}$

- Flasher or Distress Lights
- Model Train Speed Controls
- Small DC Motors (Electric Windows)
- Fork-Lift Trucks
- Battery Chargers and Plating Supplies

RCA Type	$I_{rms}$
<b>Triacs</b>	
TA2892	2.5A
<b>SCRs</b>	
TA2888	2A
TA2652*	5A
2N3668	12.5A
2N3870	35A
2N3896	35A

## 120-VOLT SUPPLY $V_{BOO} = 200\text{ V}$

- Universal Motor Speed Control (Hand Tools, Floor Polishers, Food Blenders)
- Light Dimmers
- Vending Machines
- Gas Appliances
- Fan Controls

RCA Type	$I_{rms}$
<b>Triacs</b>	
TA2893	2.5A
TA2676	6A
TA2728	6A
TA2918	6A
<b>SCRs</b>	
2N3528	2A
TA2889	2A
2N3228	5A
TA2653*	5A
40378	7A
2N3669	12.5A
2N3871	35A
2N3897	35A

RCA ELECTRONIC COMPONENTS AND DEVICES, HARRISON, N. J.



The Most Trusted Name in Electronics

ELECTRONIC DESIGN 22, September 27, 1966



From continuous speed control of mass-volume appliances . . . to precise control of vital military radar, RCA offers a broad selection of reliable, low-cost Triacs and SCRs . . . plus the technical "know-how" to design them into your equipment. Call your local RCA Representative for prices and delivery.

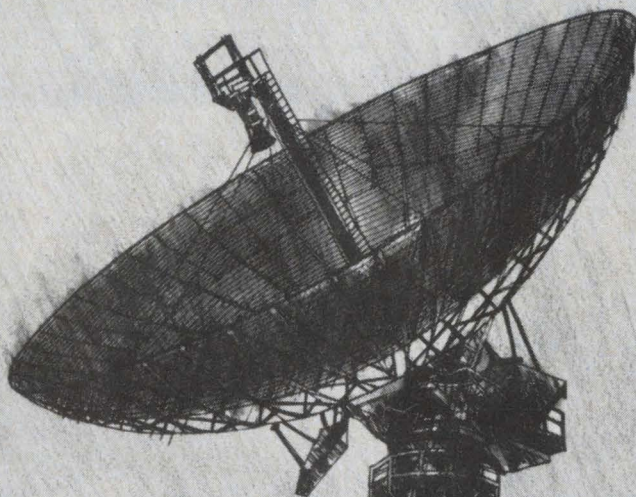

### 240-VOLT SUPPLY $V_{BOO} = 400\text{ V}$

- Space Heaters
- Air Conditioners and Ventilation Equipment
- Welder Control Equipment
- Street Lights
- Ovens and Ranges

RCA Type	$I_{rms}$
<b>Triacs</b>	
TA2685	6A
TA2729	6A
TA2919	6A
<b>SCRs</b>	
2N3529	2A
2N3525	5A
TA2654*	5A
40379	7A
2N3670	12.5A
2N3872	35A
2N3898	35A

### HIGH VOLTAGE SUPPLY $V_{BOO} = 600\text{ V}$

- Ignition Systems
- Pulse Modulators (Radar)
- Fluorescent Lighting
- Machines and Controls (Motor-Driven Cranes)
- DC Power Supplies

RCA Type	$I_{rms}$
<b>SCRs</b>	
2N4102	2A
2N4101	5A
TA2655*	5A
2N4103	12.5A
2N3873	35A
2N3899	35A
40216	900A (pulsed)
*Fast-switching SCR, $t_{off} = 4\ \mu\text{s}$ typ.	

**ALSO AVAILABLE THROUGH YOUR RCA DISTRIBUTOR**  
ON READER-SERVICE CARD CIRCLE 7



# RESISTORS FOR PERSPICACIOUS DESIGN ENGINEERS

## FILMISTOR® PRECISION METAL-FILM RESISTORS

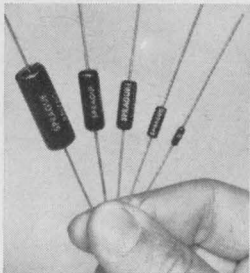

Extended-range Filmistor Resistors now give you dramatic space savings in all wattage ratings — 1/20, 1/10, 1/8, 1/4, 1/2, and 1 watt — with absolutely *no sacrifice in stability!*

Filmistors offer extended resistance values in size reductions previously unobtainable. For example, you can get a 4.5MΩ resistor in the standard 1/4 watt size, which had conventionally been limited to 1 MΩ. Filmistor Metal-Film Resistors are now the ideal selection for "tight-spot" applications in high-impedance circuits, field-effect transistor circuits, etc.

Other key features are ±1% resistance tolerance, low and controlled temperature coefficients, low inherent noise level, negligible coefficient of resistance, and rugged molded case.

Filmistors *surpass* the performance requirements of MIL-R-10509E.

Write for Engineering  
Bulletin 7025C

## ACRASIL® PRECISION/POWER WIREWOUND RESISTORS

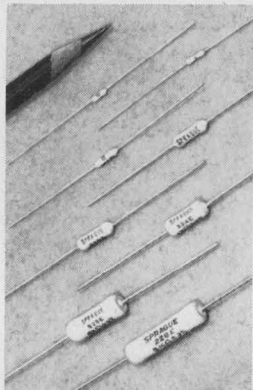

These silicone-encapsulated resistors combine the best features of both precision and power wirewound types, giving them unusual stability and reliability.

Acrasil Resistors are available with tolerances as close as .05%, in power ratings from 1 to 10 watts. Resistance values range from 0.5 ohm to 66,000 ohms.

Their tough silicone coating, with closely matched expansion coefficient, protects against shock, vibration, moisture, and fungus.

Acrasil Resistors meet or exceed the requirements of MIL-R-26C.

Write for Engineering  
Bulletin 7450

## BLUE JACKET® VITREOUS ENAMEL PRECISION/POWER WIREWOUND RESISTORS

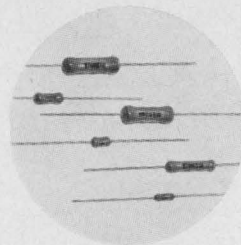

Axial-lead resistors available in ratings from 1 to 11 watts, with resistance tolerances to ±1%. Non-inductive windings available to ±2% tolerance.

All welded end-cap construction securely anchors leads to resistor body. Vitreous coating and ceramic base have closely matched expansion coefficients.

Write for Engineering  
Bulletins 7410D, 7411A



Tab-terminal Blue Jacket Resistors can be had in a wide selection of ratings from 5 to 218 watts, with several terminal styles to meet specific needs.

Tab-terminal as well as axial-lead Blue Jacket resistors can be furnished to meet the requirements of MIL-R-26C.

Write for Engineering  
Bulletins 7400B, 7401

## KOOLOHM® CERAMIC-SHELL POWER WIREWOUND RESISTORS

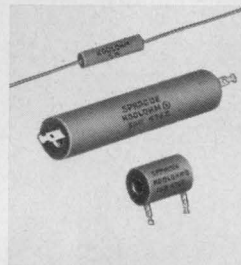

Koolohm Resistors are furnished in axial-lead, axial-tab, and radial-tab styles, in a broad range of ratings from 2 to 120 watts. Both standard and non-inductive windings are available.

Exclusive ceramic-insulated resistance wire permits "short-proof" multilayer windings on a special ceramic center core for higher resistance values. The tough non-porous ceramic shell provides complete moisture protection and electrical insulation. Koolohms can be mounted in direct contact with chassis or "live" components.

Axial-lead Koolohm Resistors to MIL-R-26C are available in MIL styles RW55 and RW56.

Write for Bulletins  
7300, 7305, 7310

## STACKOHM® POWER WIREWOUND RESISTORS



Sprague Stackohm Resistors are especially designed for equipment which requires power wirewound resistors of minimum height. Their flat silhouette permits stacking of resistor banks in close quarters.

Aluminum thru-bars with integral spacers act as mounting means and also conduct heat from within the resistance element. Resistance windings are welded to end terminations for maximum reliability. An outstanding vitreous coating protects the assembly against mechanical damage and moisture. Ceramic core, end terminations, and vitreous enamel are closely matched for coefficient of expansion.

Stackohm Resistors are available in both 10-watt and 20-watt ratings, and can be furnished with resistance tolerances as close as ±1%. Resistance values range from 1 ohm to 6000 ohms.

Both 10- and 20-watt types meet the stringent requirements of MIL-R-26C.

Write for Engineering  
Bulletin 7430

Send your request to Technical Literature Service, Sprague Electric Co., 347 Marshall St., North Adams, Mass. 01247, indicating the engineering bulletins in which you are interested.

ON READER-SERVICE  
CIRCLE 882

ON READER-SERVICE  
CIRCLE 883

ON READER-SERVICE  
CIRCLE 884

ON READER-SERVICE  
CIRCLE 885

ON READER-SERVICE  
CIRCLE 886

## SPRAGUE COMPONENTS

RESISTORS  
CAPACITORS  
TRANSISTORS  
THIN-FILM MICROCIRCUITS  
INTEGRATED MICROCIRCUITS

PULSE TRANSFORMERS  
INTERFERENCE FILTERS  
PULSE-FORMING NETWORKS  
TOROIDAL INDUCTORS  
ELECTRIC WAVE FILTERS

CERAMIC-BASE PRINTED NETWORKS  
PACKAGED COMPONENT ASSEMBLIES  
BOBBIN and TAPE WOUND MAGNETIC CORES  
SILICON RECTIFIER GATE CONTROLS  
FUNCTIONAL DIGITAL CIRCUITS

**SPRAGUE®**  
THE MARK OF RELIABILITY

\*Sprague' and '®' are registered trademarks of the Sprague Electric Co.



# News

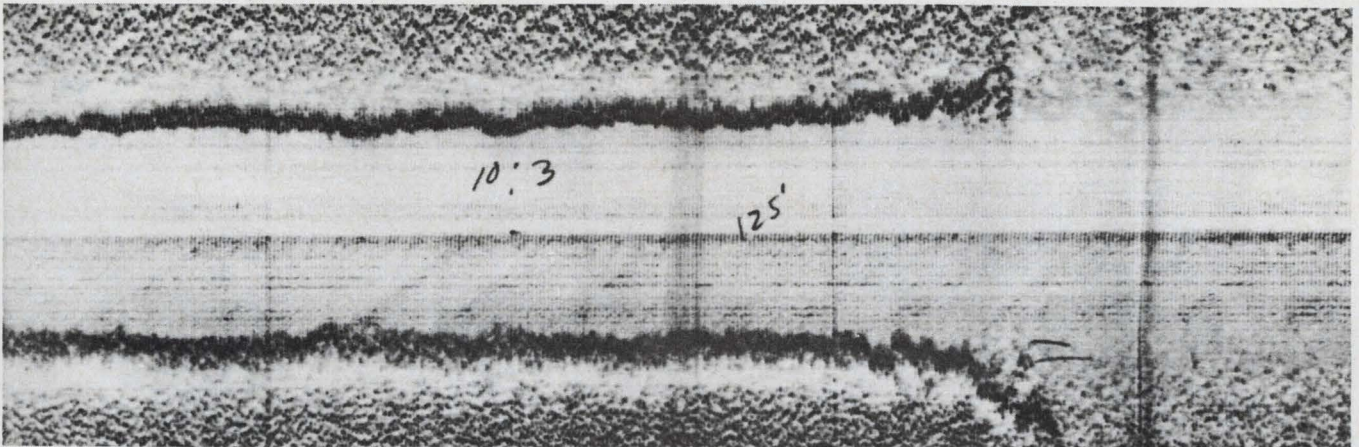

**Side-looking sonar** is proving to be a valuable oceanographic tool for providing detailed,

real-time information about the ocean bottom and undersea objects. Page 17.



**New look in microwave towers** is erected with the aid of a helicopter. Page 27.

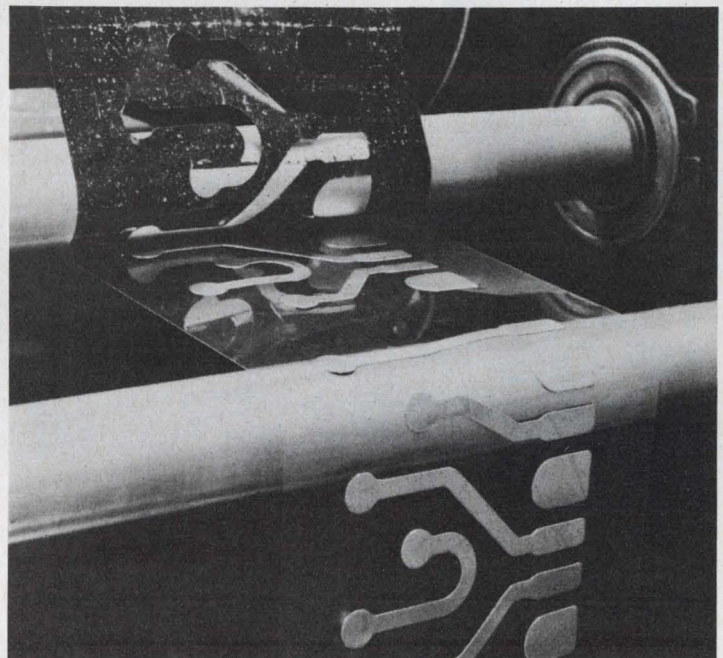

**Flexible printed circuits** with pressure-sensitive backing stick in place. Page 24.

## Also in this section:

**Laser radar** is electronically scanned. Page 22.

**Rotating anode** used in Lunar Orbiter scan tube. Page 28.

**News Scope**, Page 13 . . . **Washington Report**, Page 31 . . . **Editorial**, Page 47.



# Tina proves that anyone can measure microwave frequencies with a Systron-Donner counter

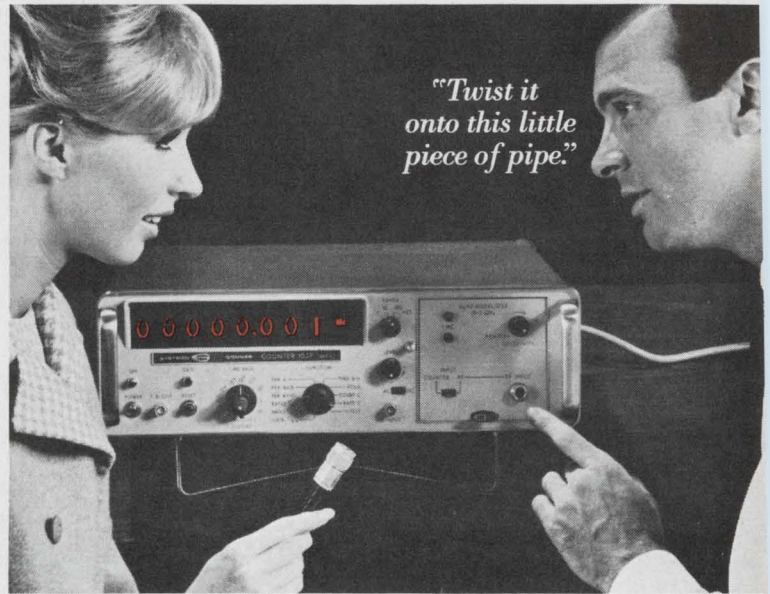

Tina is a fashion model. We lured her to our lab to show you that technically unskilled people can now measure microwave frequencies with our Counter/ACTO® system.

True, we set the trigger level and the gate time for her. But that's what you do with any simple frequency counter. The rest went just as you see. And Tina produced the correct answer accurate to eight significant figures.

Microwave measurements of this

speed and simplicity are possible only with ACTOs,® our Automatic Computing Transfer Oscillator plug-ins. Three plug-ins cover the full range from 0.3 to 12.4 GHz. They fit into any Systron-Donner 50 MHz or 100 MHz counter and produce measurements of counter accuracy because the input is phase locked.

Though we didn't design ACTOs for other brands of counters, we find that a slightly modified ACTO will work beau-

tifully with an HP5245L frequency counter. So if you already have an HP counter, you don't have to buy another counter to get ACTO performance.

*Send for complete technical data on Counter/ACTO systems.*

Expansion has created many professional opportunities in engineering and marketing at Systron-Donner. Interested engineers may phone Ronald Abdo, Personnel Manager, collect at (415) 682-6161.

Systron-Donner Corporation, 888 Galindo Street, Concord, California

**SYSTRON**  **DONNER**

Speed Inquiry to Advertiser via Collect Night Letter  
ON READER-SERVICE CARD CIRCLE 9



# News Scope

## Computer-aided design: analysis or synthesis?

Proponents of two widely divergent schools of thought on computer-aided circuit design locked horns during the University of Santa Clara's institute on modern solid-state circuit design last week. The key question raised at the California institute was: "Is the computer to be used merely for iterative analysis, or is it a real tool that can lead directly to design synthesis programs?"

While there was no clear-cut answer to this question, it became very evident that the engineer who must design with a thought to profit and loss is looking for ways to use the computer as a straight design tool. Backing this approach, Dr. Richard Dorf, chairman of the University of Santa Clara's Electrical Engineering Dept., told the institute: "Let us, wherever and whenever possible, aim at direct synthesis. Working around the analysis phase will mean a lot in terms of saved time and costs."

Chief obstacles to the implementation of computer-aided design technology continue to be lack of available up-to-date programs and management hesitancy to invest in development of in-house programs.

One step toward alleviating this

situation was announced during the institute by the National Aeronautics and Space Administration, a front-runner in computer-aided circuit design and a cosponsor of the institute. According to Dr. William Happ, chief of the Design Criteria Branch of NASA's Electronic Research Center, all future NASA contracts involving computer-aided design may contain a clause stipulating that all computer programs evolving under the contract must be made available to industry.

The institute was attended by some 80 representatives of government, universities and industry. Spokesmen from the computer and semiconductor industries were conspicuously absent from the formal program of the institute.

*(A special report on computer-aided design will appear in the October 11 issue of Electronic Design.)*

### RCA chief criticizes over-emphasis on satellites

The president of RCA Communications Inc. has warned that neglect of cable and radio in favor of satellite communications does "a major disservice to all who use international communications." Howard R. Hawkins told the House Military Operations Subcommittee that such imbalance could badly hurt "a necessary national resource."

What was needed, he said, was a "multimedia system" incorporating satellite, cable and hf radio facilities in a complete international communication network. And to this end, similar rates should be charged for comparable service through whichever medium. The economic benefits of satellite technology would then be shared among all communications users and be reflected in all services.

"In the glamor that frequently surrounds satellites and space tech-

nology," he added, "we are apt to overlook the remarkable and continued improvement in both performance and economy achieved in cable and radio communications as a result of continuing research, development and investment in new facilities. Coaxial cables, for instance, promise to rival satellites for some time to come in both capacity and economy in providing voice and record communications."

Hawkins also urged Congress to take steps to ensure that the Communications Satellite Corp. acts as a carrier for the nation's carriers, as he claimed was intended, rather than as their competitor. He accused Comsat of trying to "usurp the historical common carriers' function of providing leased channels directly to users."

### Western Union to study emergency hospital beds

Western Union is conducting a 16-week study of the feasibility of a computer-communications system that would keep track of beds available for emergency cases in the 42 hospitals in Brooklyn, N. Y.

The study will determine the most effective means for the hospitals to exchange data on the availability of beds by hospital departments, i.e., beds for emergency adult medical and surgical cases, pediatric medical and surgical cases, and obstetrics.

The survey will be carried out in ten representative hospitals under a contract awarded by the Hospital Review and Planning Council of Southern New York, Inc., a non-profit agency. When completed, Western Union will recommend a suitable systems design.

### Is there an electric Ford in your future?

The president of the Ford Motor Company, Arjay Miller, has announced that the firm is working on an advanced concept of a battery-powered electric automobile.

Miller said the Ford car "would offer tremendous improvement in range, performance and cost" over any previous electric auto. Although electric cars are noiseless and fumeless, their limited range and performance have kept them from competing with gasoline powered vehicles (see "Electric car makers



Computer-aided design in dispute.



# News Scope

CONTINUED

prepare to rally," ED 13, May 24, 1966, p. 17).

The reason for Ford's interest in developing such a vehicle was contained in an immediately preceding statement: "Under current conditions, management cannot effectively discharge its long-run responsibilities to its shareholders unless it also behaves responsibly toward employees, customers, government, education and the public at large." Miller said that the company hoped their efforts would lead to a practical, exhaust-free vehicle for local transportation needs.

General Motors has been experimenting for some time with an electric Corvair. The car is powered by silver zinc batteries made by Yardney Electric Corp., New York.

Westinghouse Electric Co., Pittsburgh, has announced plans to market an electric car for town use. Its car will have two dc motors powering its two rear wheels.

## More standards urged by new organization

The American Standards Association has been reorganized to expand and accelerate its program for producing voluntary national standards. The new organization will be known as the United States of America Standards Institute.

Standards approved by the new institute will be designated USA Standards.

The major objectives of the USASI will be to increase the participation of all interested industrial, academic and government agencies, increase representative leadership in an international standards program and place new emphasis on consumer products.

Two new operating arms are included in the institute: the Consumer Council and the Company Member Council. Consumer and company representatives can recommend projects for development into appropriate standards. They have the right to request reviews or approval of any standard.

ASA formerly had only one council with exclusive responsibility for

all standardization, and its membership was restricted to national trade, technical and professional groups.

Approval of USA Standards will continue to be based on the consensus of all parties concerned. The hundreds of national trade associations, and technical, professional and scientific societies that develop standards will be encouraged to extend this consensus principle to their own operations. The institute, under the terms of its constitution, will not be permitted to develop standards on its own. It will promote the development of needed standards by appropriate, competent and accepted organizations.

## Psychology pays off in packaging technique

By implementing the philosophy that "seeing is believing," Cutler-Hammer, Ltd., of Canada has cut down significantly on damage and abuse to its delicate electronic control equipment during shipment. On the assumption that shipping and handling personnel would be more careful if they could see the nature of the boxes they handle, instead of just reading "Fragile" labels, the company started using wooden frames and polyethylene sheeting to



Transparent wraps prevent damage.

pack their equipment. The results have been more than gratifying.

An extra benefit of the packing technique is that the polyethylene sheeting also protects the intricate equipment from moisture and provides an environmental seal against harmful, dust-laden atmospheres in newly constructed plants.

## Computer to store public opinion polls

The first step in what may lead to a global information network for social scientists is to be taken this fall at William College, Williamstown, Mass. The world's largest file of public opinion data, covering nearly 400 million answers to questions asked in polls since 1936, will be programmed into a computer for high-speed classification and recall.

Under the direction of the Roper Public Opinion Research Center at the college, the computer will keep ready for recall the results of more than 7000 studies conducted in the United States and abroad by Roper, Gallup and 101 other U.S. and foreign polling organizations.

The computer, an RCA 301, was donated to the Center by RCA. Next year it will be linked by telephone line to the University of California, the Massachusetts Institute of Technology and the University of Michigan in an experiment sponsored by the National Science Foundation. According to Prof. Philip K. Hastings, director of the Roper center, this will allow social scientists at the participating institutions to determine quickly public attitudes on a variety of subjects since 1936. These attitudes will also be broken out easily in terms of the respondents' age, sex, race, education, income and geographic location.

## Better airport landing facilities sought

The Air Transportation Association (ATA) is calling for a major speed-up in the establishment of improved ground facilities for approach and landing of commercial aircraft. ATA is concerned about the facility limitations at most airports and the lack of progress in installing better instrument-landing systems. Only four airports now have runways that meet the high-quality Category-II specifications.



**THIS  
LONG-A-WAITED  
REFERENCE  
IS  
JUST OUT**

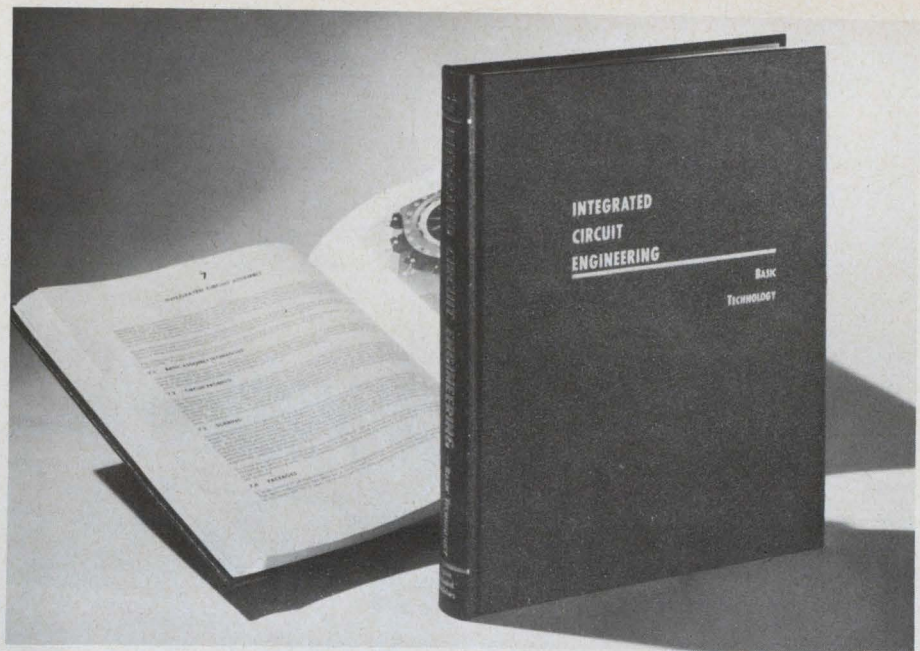

## INTEGRATED CIRCUIT ENGINEERING — BASIC TECHNOLOGY

By Glen R. Madland, Dr. Robert L. Pritchard, Howard K. Dicken, Frank H. Bower, Robert D. Richardson and David B. Kret.

*The authors are recognized experts with over 100 years of cumulative experience in semiconductor science and technology.*

R & D scientists and process engineers, reliability and application engineers, will find it a handy day-to-day reference. The manufacturers and users of integrated circuits can refer to up-to-date costs and yields data which will influence their "make or buy" decisions. The suppliers can study the details of equipment, materials and tolerances required in the fabrication of integrated circuits; and the investors and marketing people can gauge the present and projected economic impact of the advent of integrated circuits. The book will be as useful and interesting to an E. E. graduate student as it will be to a multi-million dollar corporation president.

Thousands of man hours were spent on the preparation of this authoritative book. Its previous loose-leaf edition was sold at an incredible price of \$250.00 per copy.

### FREE BOOKS

On prepaid orders for *Integrated Circuit Engineering—Basic Technology*, receive an equal number of FREE BOOKS from the following list. Also, save handling and postage charge.

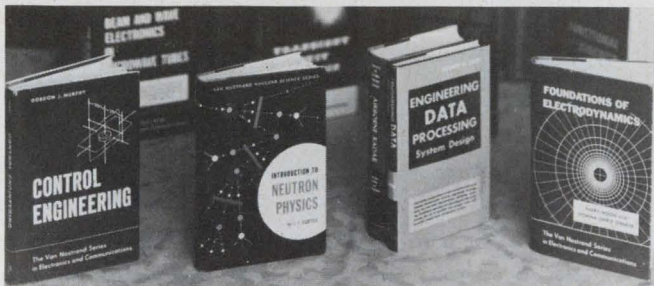

- 1 **METALLURGY OF SEMICONDUCTORS**  
By Yu. M. Shashkov. Authorized Translation from the Russian by J.E.S. Bradley, B. Sc., Ph.D. (1961) 183 Pp. Illus., Orig. Price: \$9.50
- 2 **CONTROL ENGINEERING**  
By Gordon J. Murphy, Ph.D., Professor of Electrical Engineering and Industrial Engineering, Northwestern University (1959)  
385 Pp. Illus., Orig. Price: \$7.50
- 3 **INTRODUCTION TO NEUTRON PHYSICS**  
By L. F. Curtiss, Consultant to Director of Standards (1959)  
380 Pp. Illus., Orig. Price: \$10.75
- 4 **ENGINEERING DATA PROCESSING SYSTEM**  
By Arthur D. Even, Ph.D., Management Consultant (1960)  
282 Pp. Illus., Orig. Price: \$8.50
- 5 **FOUNDATIONS OF ELECTRODYNAMICS**  
By Parry Moon, Professor of Electrical Engineering, M.I.T., and Domina E. Spencer, Assoc. Prof. of Mathematics, Univ. of Connecticut (1960)  
314 Pp. Illus., Orig. Price: \$9.75

**Boston Technical Publishers, Inc.**  
CENTRAL SQ., CAMBRIDGE, MASS. 02139 • Phone 617-491-0443

20 detailed sections cover the full integrated circuit spectrum from materials to failure analysis.

**Contents:** The Economic Impact of Integrated Circuits; The Basic Materials and Processes of Microcircuits; Photolithography; Silicon Wafer Processing; Process Control; Thin Film Processes; Integrated Circuit Assembly; Testing Completed Integrated Circuits; Basic Integrated Design Considerations; The Mathematics of Integrated Circuit Design; Digital Integrated Circuits; Linear Integrated Circuits; Implementing Integrated Circuit Systems; Tolerances; Photomask Design and Layout; Specifications for Integrated Circuits; General Reliability Consideration; Reliability Specifications; Failure Analysis; Future Capabilities.

**"Most comprehensive and up-to-date reference. . . . With its immense coverage, it is virtually an encyclopedia of IC's."**

**405 Pp. 438 Illus. 8 1/2" x 11"  
DeLuxe Hardcover Binding \$22.50**

#### ORDER FORM

BOSTON TECHNICAL PUBLISHERS, INC.  
Central Square, Box 111ED  
Cambridge, Massachusetts 02139, U.S.A.

Please send \_\_\_\_\_ copies of *Integrated Circuit Engineering—Basic Technology*.

Bill me  Bill Company, P.O. enclosed

Name \_\_\_\_\_ Date \_\_\_\_\_

Employer \_\_\_\_\_ Title \_\_\_\_\_

Address \_\_\_\_\_

City \_\_\_\_\_ State \_\_\_\_\_ Zip \_\_\_\_\_

Check Enclosed \$\_\_\_\_\_. I am entitled to the following FREE BOOKS with no charge for postage/handling.

1 2 3 4 5

Send a FREE catalog of Boston Tech. Publications.

**30-DAYS UNCONDITIONAL RETURN PRIVILEGE**

ON READER-SERVICE CARD CIRCLE 10



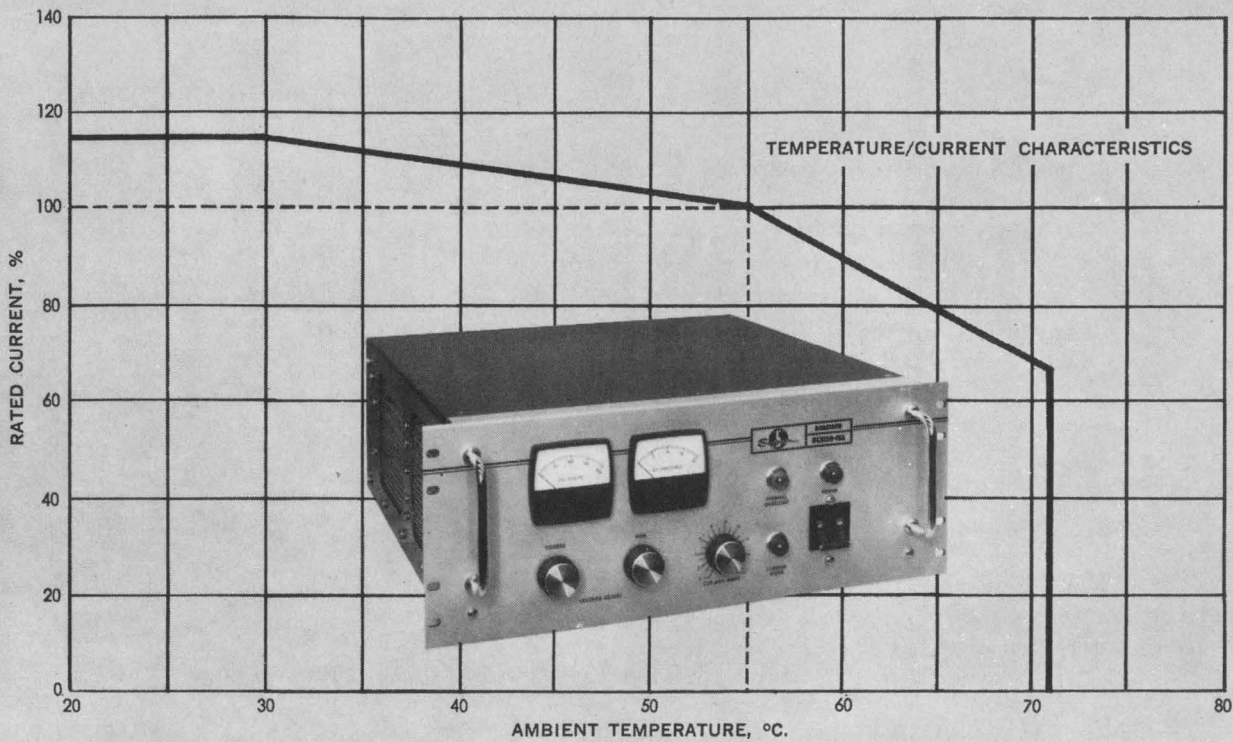

Sorensen DCR Series now with temperature capability to 71°C.

# Sorensen Wide Range Power Supplies to 20 kW.

Sorensen's wide range DCR Series has been up-dated and improved. What's new about the DCR's? They are now 100% silicon; ambient temperature capability is now to 71°C. • Four 3-phase models have been added extending power capability to 20 kW; 24 models are now available with ranges up to 300 volts. • Multiple mode programming—voltage/current/resistance. • Voltage regulation, line and load combined, is  $\pm 0.075\%$  for most models • Constant current range 0 to rated current. • DCR's meet MIL-I-26600 and MIL-I-6181

specifications and conform to proposed NEMA standards. • Front panel indicator for voltage/current crossover. These features of the improved DCR (model numbers will have an "A" suffix) are offered at no increase in price. For DCR details, or for data on other standard/custom power supplies, AC line regulators or frequency changers, call your local Sorensen rep, or write: Raytheon Co., Sorensen Operation, Richards Avenue, Norwalk, Connecticut 06856. Tel: 203-838-6571.

MODEL SELECTION CHART

Voltage	Amps.	Model	Price	Amps.	Model	Price	Amps.	Model	Price	Amps.	Model	Price
0-20	125	DCR 20-125A	\$1055	250	DCR 20-250A	\$1495	—	—	—	—	—	—
0-40	10	DCR 40-10A	325	20	DCR 40-20A	525	35	DCR 40-35A	\$ 710	60	DCR 40-60A	\$925
0-40	125	DCR 40-125A	1350	125	DCR 40-125A	1995	500	DCR 40-500A	2950	—	—	—
0-60	13	DCR 60-13A	525	25	DCR 60-25A	710	40	DCR 60-40A	900	—	—	—
0-80	5	DCR 80-5A	325	10	DCR 80-10A	525	18	DCR 80-18A	710	30	DCR 80-30A	875
0-150	2.5	DCR 150-2.5A	325	5	DCR 150-5A	525	10	DCR 150-10A	710	15	DCR 150-15A	825
0-300	1.25	DCR 300-1.25A	325	2.5	DCR 300-2.5A	525	5	DCR 300-5A	710	8	DCR 300-8A	825



ON READER-SERVICE CARD CIRCLE 11



# Sonar looks askance at sea bottom

## Advanced electronics help side-looking sonar bridge gap between echo sounders and TV.

Neil Sclater  
East Coast Editor

Side-looking sonar (SLS) promises to become as valuable for mapping the ocean floor as the aerial camera is for land mapping. Large areas of underwater terrain may now be seen in real time by means of this improved acoustic technique.

Bridging the gap between long-range, low-resolution sonar and short-range, high-resolution optical techniques, SLS yields more detailed information about the ocean bottom than either conventional echo sounders or television.

### SLS makes the scene

SLS was first used by the British in the 1950s to make a geological survey of the English Channel. The recordings from this survey gave, for the first time, remarkable details of the channel floor.

Westinghouse SLS equipment was employed in the search for the

nuclear submarine "Thresher" and for studying the offshore effects of the intense Alaska earthquake of 1964.

An EG&G built SLS has been installed in the deep-submergence vehicle "Trieste II." High-definition sonar will be installed in other exploration and rescue submersibles in the future.

While SLS was used recently in the search off Spain for the lost U.S. hydrogen bomb, it did not actually pinpoint the location. However, its use narrowed the search area to the probable drop zone.

Although side-looking sonar can at present be adapted for many different oceanographic tasks and has already proven itself in important assignments, it is still in its early stages of development.

In an effort to overcome what some observers have termed a 40-year lag between aerial surveying and underwater mapping, industri-

al laboratories are pushing development in many areas.

The incorporation of IC circuitry has improved portability and versatility. New displays are being evolved to replace recorders. Transducer fabrication and energy focusing techniques are being improved and at least one organization is working on 3D sonar presentations.

SLS, close relative of the echo sounder and conventional wide-beam military sonar, quickly produces detailed maps that are both accurate and continuous. All objects on the ocean, lake or river bottom are portrayed to scale in relief showing shape and orientation.

Besides its usefulness for underwater searches, SLS can be employed to make bottom surveys for scientific, geological and geophysical purposes, for mineral and petroleum prospecting, for locating offshore construction or cable-laying, and bottom navigation.

### Fan-shaped pings make it work

The useful properties of SLS are based on the formation of a fan-shaped acoustic beam directed downward in a plane perpendicular to the vessel on which it is mounted.

The fan beam is directed below the water's surface at a shallow angle forward from the perpendicular. Pulses of acoustic energy of very narrow width fan out and down onto a narrow strip of the bottom. As in other sonar, the bottom and objects lying on it reflect the acoustic energy and return some of it as an echo.

However, unlike broad-beam sonar, echoes are returned from a discrete region that in some systems may be on the order of a foot wide. It is this narrow, selective propagation that accounts for the sonar's high definition.

With proper choice of frequency, power, ping duration and forward projector speed, continuous maps may be traced. The display may be either on a cathode ray tube or on a graphic recorder similar to those conventionally used to indicate depth-measurement profiles.

(continued on p. 18)

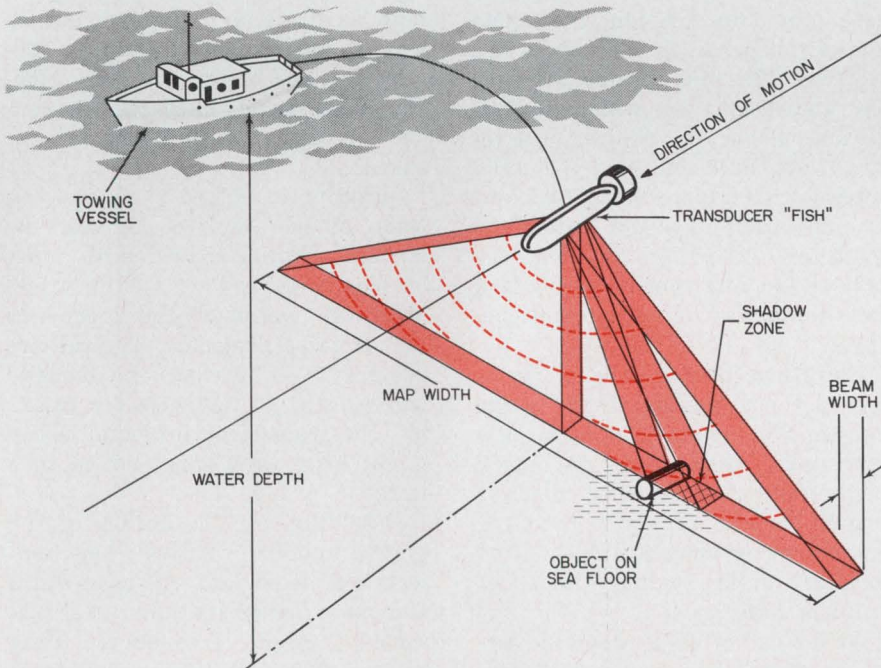

**Geometry of side-looking sonar** is as follows: Sound striking the bottom is reflected to indicate underwater topography in narrow strips. Acoustic beams from the towed transducer are shaped as narrow fans. Elevations produce shadows whose length depends upon the height and size of the object. Images are traced continuously to give a relief map. Range is about 10 times altitude.



(sonar, continued)

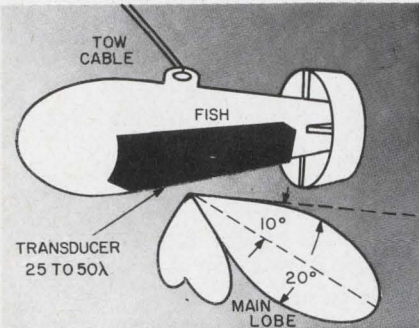

Transducer case contains both projector and hydrophone linear arrays. Arrays are long with respect to wavelength in order to shape the fan beams less than 2 degrees wide and up to 20 degrees high.

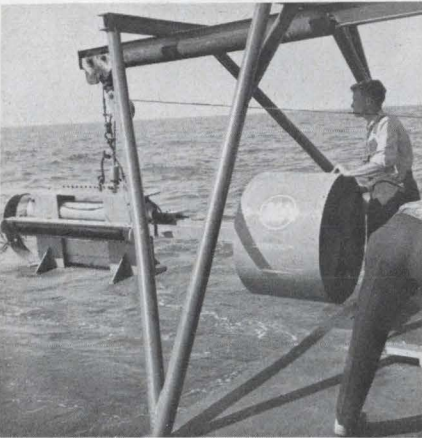

Completely portable SLS system can transform a small craft into a research vessel. All electronics are board-mounted in the rack at the left side of the recorder case. EG&G engineer holds a 260-kHz fish.

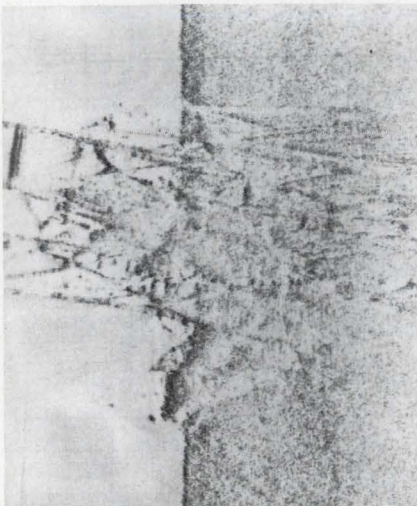

SLS reveals an offshore oil platform destroyed by a storm and lying at a depth of about 200 ft. Westinghouse fish moved from bottom to top of picture. Dark area represents depth.

The positions and shapes on the record are accurate scale representations of true shape and position because they are based on the round-trip travel time of acoustic energy. Ranges and bearings of objects traced out may be determined directly on the strip chart. The intensity of the graphic markings are dependent on the reflectivity of the surfaces insonified. An accurate estimate of the projecting height of bottom objects may be obtained by observation of the lapses, or "shadows," on the record.

The sending and receiving transducers for SLS can be located either on a ship's hull or on a torpedo-shaped "fish" that is towed behind the survey vessel. Mounting on a towed fish has many advantages over hull mounting: ease of maintenance, opportunity to interchange fish during a survey to optimize resolution and range characteristics, and background noise reduction.

In addition, the fish can be set to operate at various altitudes above the sea floor in order to give the best results.

### Stylus records topography

The recorders used with SLS have a stylus that traverses a slowly moving, sensitized paper strip. Starting at one edge coincident with ping transmission, the stylus marks the paper as the echoes are received. The first returns are usually indications of water surface distance above the projector, a result of acoustic side lobes. Then the bottom return appears, giving a scalar indication of depth below the projector. Following this come the various gradations of light and dark lines indicative of bottom topography.

Elevations produce shadow zones behind them relative to the sound source. The length of the shadow depends on the height of the object. Depressions also produce shadows beyond the rim closest to the SLS. Smooth topography is indicated by smooth, uninterrupted lines of uniform tone.

At the end of each sweep the stylus is returned in typewriter fashion to begin again. As the fish advances, the display scan, scaled to the rate of advance, builds up a picture line by line.

Some systems use dual-channel

recorders to register simultaneously both port and starboard sweeps. Others use a single transmitter-receiver channel, time-shared between both transducers and displays.

### Leveling the returns

Echoes from near objects are stronger than those from distant objects. Therefore, circuitry is used to compensate for this signal-strength decay with distance. Time-variable gain (tv<sub>g</sub>) is usually used and can be set for optimum search conditions. This circuitry permits the target to be represented at the display as a voltage whose amplitude is independent of gain.

Amplification stages and additional automatic gain control (agc) are included in the receiver to regulate the gain and avoid excessive saturation due to unpredictable variations in the signal level.

### Decisions, decisions . . .

A wide choice of operating characteristics is open to the SLS user to suit the objectives of his survey: frequency, power, ping length, forward speed of the tow vessel, and in some systems the sonic projector's angle of tilt.

Present models of SLS are constructed for operation in the approximate range of 50 to 250 kHz. The same generalization applies here as in radar: low frequencies give longer range and higher frequencies are better for resolution. For most search purposes frequencies greater than 150 kHz are selected.

In order to obtain a narrow fan beam of one to two degrees, the horizontal transducer length must be long with respect to the wavelength in water of the frequency that is to be projected. Typical values are 25 to 50 times the acoustic wavelength. At 150 kHz for example, the transducer projector array might be a yard long and an inch wide.

Resolution, or the ability of the system to define relatively small objects, is dependent on beamwidth and pulse length, assuming a reasonably high frequency. Ping lengths of 0.10 to 0.20 ms are typical.

The speed of the tow ship is set so that the ping-to-ping interval is approximately equal to fan beamwidth. A speed of 3 to 5 knots en-



# Open whole new silicon transistor application areas for under 40¢.



**Only the rugged Bendix B-5000 silicon power transistor is that promising, that inexpensive, that powerful. 25 watts at 2.5 amps, 10 volts and 100°C.**

If you still think the Bendix B-5000 is just another low-cost plastic silicon power transistor, you're in for a pleasant surprise. *It's a real breakthrough*—in itself, and in what it can do for your design capability.

The B-5000's small size and small price, coupled with its high power and high reliability, mean you can now afford to put silicon power to work in many industrial and consumer applications. Lighting equipment, TV sets, audio amplifiers and industrial controls—to name a few.

What's more, the B-5000 can expand your production capability. You can tailor its mounting techniques to fit your needs exactly. For example, the B-5000 is readily adaptable to the newer assembly solder techniques

without degradation. And it lends itself equally well to other production line techniques. Mounting assistance? Call on us.

Reliability? The B-5000 already has 500,000 hours of successful life-testing behind it without a single failure! And it exceeds environmental and mechanical requirements of MIL-STD-750A.

Only new manufacturing and packaging techniques make the B-5000 possible. The result is a simple, low-cost, rugged transistor, with no power compromise when mounted upon the normal heat sink. Leads and collector strips are highly conductive, offering excellent solderability, strength and ability to withstand flex and pull. Plastic encapsulation provides outstanding insulation resist-

#### Electrical specifications

Characteristic	Limits			Test Conditions				
	Min.	Max.	Unit	V <sub>CB</sub> V	V <sub>CE</sub> V	I <sub>C</sub> A	I <sub>B</sub> mA	T <sub>J</sub> °C
V <sub>CEO</sub>	35	—	V	14	25	0.2		150
I <sub>CEO</sub>	—	10	mA					
I <sub>CBO</sub>	—	1.5	mA					
V <sub>BE</sub>	—	1.2	V					
h <sub>FE</sub>	30	250	—					
h <sub>FE</sub>	20	—	—					
V <sub>CE(s)</sub>	—	1.2	V					

#### Absolute maximum ratings

V<sub>CEO</sub> = 35 volts, I<sub>C</sub> = 3 amps, I<sub>B</sub> = 1 amp, T<sub>stg</sub> = -65 to 175°C, T<sub>J</sub> = -65 to 150°C.

ance, hermeticity, adhesion ability and high temperature characteristics. All for under 40¢ in volume.

Why not contact us for all the details on the B-5000? You won't be disappointed.

Baltimore (Towson), Md.—(301) 828-6877; Chicago—(312) 637-6929; Dallas—(214) 357-1972; Detroit—(313) Jordan 6-1420; Holmdel, N. J.—(201) 946-9400; Los Angeles—(213) 776-4100; Miami Springs, Fla.—(305) 887-5521; Minneapolis—(612) 926-4633; Redwood City, Calif.—James S. Heaton Co., (415) 369-4671; Seattle—Ray Johnston Co., Inc., (206) LA 4-5170; Syracuse, N. Y.—(315) 474-7531; Waltham, Mass.—(617) 899-0770; Export—(212) 973-2121, Cable: "Bendixint," 605 Third Avenue, New York; Ottawa, Ont.—Computing Devices of Canada, P.O. Box 508—(613) TALbot 8-2711.

**Bendix Semiconductor Division**  
HOLMDEL, NEW JERSEY



ON READER-SERVICE CARD CIRCLE 12



## New from Sprague!

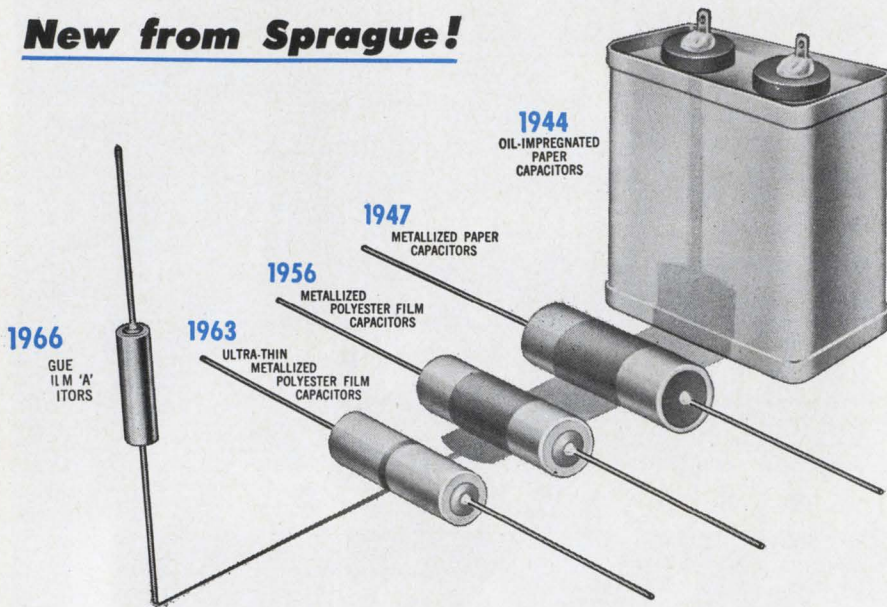

## METFILM\* 'A' CAPACITORS... dramatically smaller in size, yet more reliable than military-grade capacitors of the past!

Just a few years ago, the only 10  $\mu$ F capacitor considered dependable enough for military applications was Type CP70 (to JAN-C-25), and was a block-busting 3 $\frac{3}{4}$ " wide x 1 $\frac{3}{4}$ " thick x 4" high. Today, you can get a military-quality 10  $\mu$ F tubular capacitor measuring only  $\frac{1}{2}$ " in diameter x 2 $\frac{1}{4}$ " long. And it's more reliable than any capacitor of the past!

Sprague Type 680P Metfilm 'A' Metallized Capacitors meet all environmental requirements of MIL-C-18312, yet they occupy only one third the volume of conventional metallized film capacitors of equivalent capacitance and voltage rating. Employing a new thin organic film dielectric system, Type 680P capacitors use a dual film totalling only 0.00008" thick, as compared to conventional polyester-film capacitors with a single film measuring 0.00015".

Another distinct advantage of the Metfilm 'A' dielectric system is minimum degradation of electrical properties during life.

Hermetically sealed in corrosion-resistant metal cases, capacitor sections are effectively of non-inductive construction, resulting in capacitors with performance characteristics superior to those of comparably-sized capacitors.

Type 680P Metfilm 'A' Capacitors are available with capacitance values to 10  $\mu$ F in both 50 and 100 volt ratings.



For complete technical data, write for Engineering Bulletin 2650 to Technical Literature Service, Sprague Electric Company, 347 Marshall Street, North Adams, Massachusetts 01247.

\*Trademark

### SPRAGUE COMPONENTS

CAPACITORS  
TRANSISTORS  
RESISTORS

THIN-FILM MICROCIRCUITS  
INTEGRATED CIRCUITS  
INTERFERENCE FILTERS

48C-6111

PACKAGED COMPONENT ASSEMBLIES  
FUNCTIONAL DIGITAL CIRCUITS  
MAGNETIC COMPONENTS  
PULSE TRANSFORMERS  
CERAMIC-BASE PRINTED NETWORKS  
PULSE-FORMING NETWORKS



'Sprague' and '®' are registered trademarks of the Sprague Electric Co.

ON READER-SERVICE CARD CIRCLE 13

## NEWS

(sonar, continued)

sures that the map strips will be adjacent, neither overlapping nor leaving spaces.

Ideally, it is desirable to pass 3 or 4 strips across a target or feature of interest. Since the beam diverges with distance, resolution depends on lateral range. Effective range is about 10 times the altitude of the fish above the bottom.

### SLS for sale or rent

Manufacturers in England and the U.S. are making side-looking sonars that operate in a similar manner but differ in details. These companies will sell the equipment outright or contract for its services.

Kelvin Hughes of London markets a version known as a towed surveying ASDIC. (The term ASDIC, the British equivalent of sonar, is named after the World-War-II Anti-Submarine Detection and Identification Committee). The equipment includes a six-foot-long fish, and a desk-mounted dry-paper recorder. The fish contains a 27-ele-

### Transducers—metal shapes or ceramic blocks?

SLS projector transducers are based on either magnetostriction or piezoelectric effect. The actual selection is based on engineering and economic considerations. Receiving transducers or hydrophones are usually piezoelectric devices.

A magnetostrictive transducer is made up of a large number of coils, usually connected in a series-parallel arrangement. One end of each element is connected to a diaphragm in contact with the water.

Although magnetostrictive devices are only about 30% efficient, they have high power-handling capabilities and are used when long range is desired.

Modern piezoelectric transducers are made of ceramics such as lead zirconate titanate (PSI) and barium titanate. The ceramics, typically shaped as blocks, are metalized and joined into arrays for both transmit and receive functions.

Piezoelectric ceramics, usually encapsulated in rubbery plastics, exhibit efficiencies up to 65%.



ment magnetostrictive transducer operating at a frequency of 48 kHz. The beam width of the main lobe to the half-power points is  $7.5^\circ$  in the vertical plane and  $1.6^\circ$  in the horizontal plane. Typical records produced by the K-H ASDIC depict an area up to 800 yards wide.

The transducer housing can be preset to any desired angle of tilt below horizontal and directed to either side of the fish.

The latest SLS available from Westinghouse's Underseas Division in Baltimore is a refinement of their "Thresher" search units. Called Ocean Bottom Scanning Sonar (OBSS), the system includes a fish with four identical transducers, each 45 in. long. The fish is designed to be towed approximately 220 feet off the bottom and has a total lateral search range of 2460 feet.

A horizontal acoustic beam width of  $0.31^\circ$  produces a resolution of six feet at 1230-foot range, decreasing to 2.5 feet at close range. The transducers are capable of simultaneous port and starboard search.

The transducer housings are oil-filled and pressure-equalized. Each of the two transducer housings (port and starboard) contains a receiving and transmitting transducer. Each transducer consists of a line array of 16 barium titanate piezoceramic elements.

The underwater electronics package contains two transmitters and two preamplifiers. Power of about 10 watts comes from two 12-volt automotive batteries in series. The solid-state electronics are in a cylindrical housing designed to withstand 10,000-psi ambient pressures.

The complete receiver units for the port and starboard systems operate at 215 kHz and 225 kHz, respectively. Each unit contains a 6-kHz bandwidth filter amplifier, a time-varied voltage source, and automatic gain control circuitry. A signal return is amplified and transmitted up the tow cable to the switch gate assembly, where it is passed to the 6-kHz bandwidth filter amplifier. The signal is further amplified to a level determined by the tvg and agc amplifiers, and its final output is fed to a dual-channel recorder-amplifier.

EG&G International of Boston has built a side-scan sonar that is so portable it can be operated from

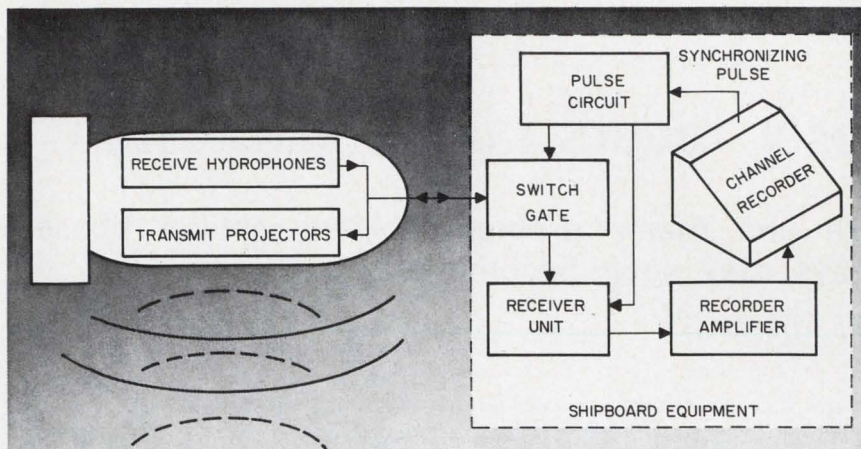

Westinghouse version of SLS fish is prepared for launch. Main frame of the unit is 6-in. steel I-beam. Trans-

ducer cases (black stripe) are along the beam sides, the electronic package is above, the batteries below.

small craft. It is organized to permit interchange of transducer fish to suit any specific survey. The system can be operated with either a 50-kHz, 125-kHz or 260-kHz transducer fish. The beam patterns in the horizontal plane are less than 2 degrees wide at the half-power points and about 20 degrees in the vertical plane.

The use of state-of-the-art solid-state electronics permitted EG&G engineers to incorporate sound source and receiver circuitry along with a single-channel recorder in a suitcase weighing less than 50 lbs. The power supply can be simply several auto batteries in series to provide the required 23 to 30 volts dc.

All electronic circuitry is arranged on standard circuit boards. These can be interchanged to furnish a variety of pulse lengths and reception characteristics.

The electronics make extensive use of low-noise FETs—both enhancement-mode and normal planar MOS varieties. FETs are used as variable-resistance devices in the time-gain circuitry.

Transducer drivers use capacitor discharges. Charged capacitors are discharged into a tuned transformer which pulses the transducer elements in phase. The high-intensity pulse created draws only small average power.

Various types of SCRs and switching transistors are used in this circuitry. Ramp functions for time-variable gain and some of the other variable functions are obtained by use of high-frequency op-

erational amplifiers. The amplifiers are also used as precision rectifiers and summing averagers.

The signal conditioner-recorder can also be used with a bottom-profiling transducer that projects sonic energy directly at the ocean bottom and is used to obtain profiles of the bottom sediment on the rock layers.

Other applications for the basic recorder-amplifier include its use for tracking transponder beacons to obtain accurate bearings.

In considering the prospects for the future of SLS, Melvin Hiller, Westinghouse's manager for SLS instrumentation at Baltimore, emphasized its effectiveness compared with TV or visual observation. With a practical viewing range of about 50 feet television does not give effective coverage. Hiller said that SLS and other high-definition systems fill a definite need in oceanography. He added that Westinghouse is currently working on a system that rivals TV underwater pictures in quality for use on a deep-submergence rescue submarine.

Martin Klein, EG&G's sonar program manager, stressed the importance of state-of-the-art electronics in high-definition sonar and said that EG&G was working on even more advanced systems than SLS. Their new sonar features omnidirectional arrays using solid-state phase-switching. He said that a lot of engineering effort was being brought to bear on improved sonic-projector focusing and methods to increase transducer efficiency. ■ ■



# Laser radars take a giant step

**With one major problem solved, optical phased arrays may soon become practical.**

**Roger Kenneth Field**  
News Editor

What has no moving parts, no antenna, and can pinpoint a target to within a few inches in several miles?

A phased-array laser radar!

Attractive idea? Apparently a number of large companies think so. For over two years Hughes, Westinghouse, General Electric, Autonetics, Philco, Electro-Optical and Sperry have all actively pursued the elusive laser array. But beam steering at optical frequencies requires precise control of the phase at each radiator, and even long laser wavelengths are only around one or two microns. Imagine trying to control precisely the phase of a number of radiators operating at about three million gigahertz.

## Phase control can work

"We have proved that it can be done," says Irving Itzkan, head of the laser section of the Electro-

Optics Group, Sperry Gyroscope, Great Neck, N. Y. Itzkan uses a reference beam from a cw gas laser to keep the effective differences of the path lengths in two legs precisely an integral number of cycles. The continuous beam travels the same paths as the pulsed beam and is sensed by a photodetector (see block diagram).

A servo analyzes the photodetector's output and regulates the voltage across a piezoelectric crystal that moves a mirror. As this mirror moves in and out, the length of one leg is decreased and increased. Itzkan uses a crystal with a response time of four ms—an adequate speed for neutralizing the effects of temperature changes and mechanical movements of the system. When the neodymium laser pulses, the gas laser extinguishes momentarily. This prevents the reference beam from interfering with the power beam.

The experimental setup uses a neodymium-doped calcium tungstate oscillator because that ma-

terial gives extremely clean pulses. The two amplifiers are made of neodymium glass, which affords good gain (gain is proportional to length and neodymium glass crystals can be easily grown to long length).

## Finding the minor line

The breakthrough that makes possible cw control reference of the neodymium tungstate pulsed laser was the development of a stable cw gas laser operating close to the 1.0582- $\mu$  wavelength of the pulsed beam.

Itzkan was able to isolate a minor line of the helium neon laser by designing special layered mirrors that transmit rather than reflect the main spectral lines. The mirrors, then, only reflect the minor 1.0621- $\mu$  line and the gases only lase at the frequency that corresponds to that wavelength.

The next step in the development of a working laser radar should be the separation of the now coincident beams. Itzkan feels that this should be easily accomplished. Then the number of legs would be increased, and the multi-

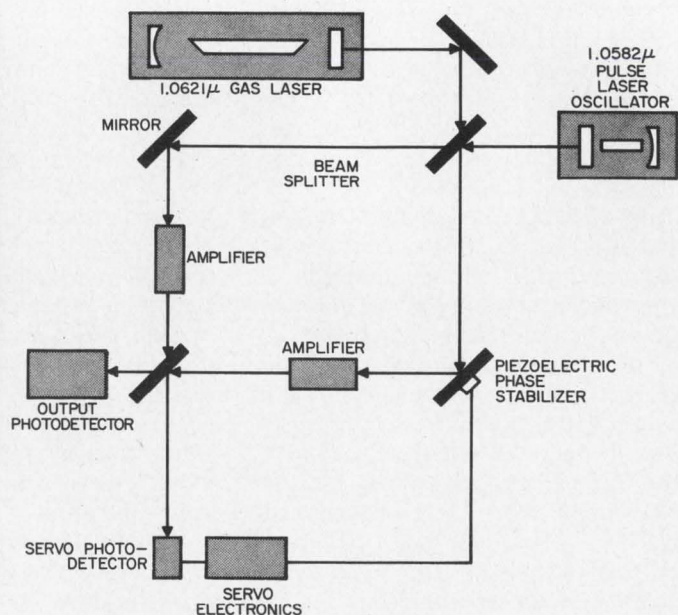

Dual laser system for phase control is shown in this block diagram (right). The key was the development of a gas laser operating right near the frequency of the 1.0582 pulse laser. Irving Itzkan checks output on scope (left).



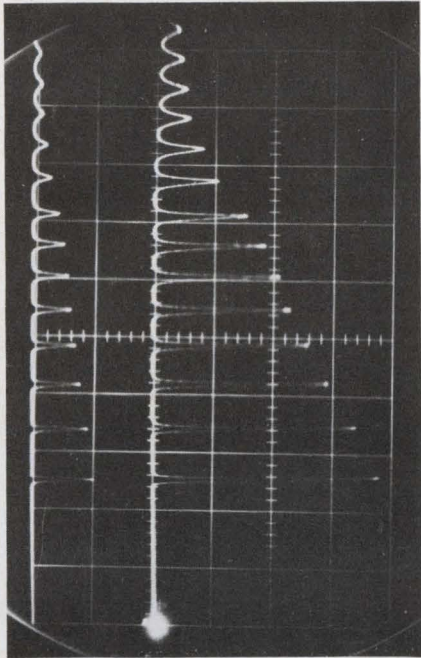

When beams are in phase combined intensity (right) is four times that of each input (left). Pulse of the neodymium tungstate oscillator is clean.

ple source wavefront could be steered by a set of piezoelectric crystals. This would allow the beam to scan at acoustical speeds. Though this would scan far faster than a swinging antenna, Itzkan feels that the ultimate use of electro-optical phase shifters should permit scanning rates in the RF range. But, he points out, acoustical rates of scan are fine for many purposes.

#### Visible or digital images

The near-infrared signal would actually be invisible to the human eye. An image converter, such as an ordinary, "snooperscope," could make the reflections visible but Itzkan thinks that detectors (quite possibly silicon photodiodes which are presently available) would sense the returning portions of the scanning beam and continuously stream the resulting electronic signals directly into a computer. Unlike most present radars there would be no visible image. But its accuracy reduces the role of the human eye.

There is no formidable obstacle in the way of the remaining development of a phased laser array. It should ultimately offer the aerospace industry a lightweight, antennaless and highly accurate alternative to present lower-frequency radars. ■ ■

basic measuring tools from

**HEWLETT  
PACKARD**



## hp 465A, 467A Amplifiers

### 465A Solid-State General-Purpose Amplifier:

High power gain ( $5 \times 10^3$ ); voltage gain selectable (10 or 100)  
 Bandwidth 5 Hz to 1 MHz ( $< 2$  db down)  
 Gain accuracy  $\pm 0.1$  db (1%) at 1 kHz  
 10 megohm input impedance, true 50-ohm output impedance  
 Low noise  $< 25$   $\mu$ v rms referred to input (1 meg across input)  
 Output 10 v rms open circuit, 5 v into 50 ohms  
 3-terminal device isolated from chassis, float up to 500 v dc above chassis ground

### 467A Power Amplifier:

Gain X1, X2, X5, X10 plus variable control  
 Accuracy  $\pm 0.3\%$ , dc-10 kHz with load of 40 ohms or greater  
 Distortion  $< 0.01\%$  at 1 kHz  
 Frequency response  $\pm 1\%$ , dc-100 kHz;  $\pm 10\%$  dc-1 MHz  
 Output:  $\pm 20$  v peak at 0.5 amp peak (10 w)  
 Also use as  $-20$  to  $+20$  v variable, regulated dc power supply

Here are two high-performance amplifiers for a multitude of applications. Use the 465A as a general-purpose lab instrument, an oscilloscope preamp, an in-system amplifier component, power amplifier for solid-state oscillators, impedance converter. Ideal for cascading, compact, light weight. hp 465A, \$190. Use the 467A to drive magnetic cores, ultrasonic transducers, recording galvanometers, servo motors, or to amplify

oscillator inputs, as a dc power supply. Protected from short circuits or input overloads to 200 v p-p. hp 467A, \$575.

Call your Hewlett-Packard field engineer for complete specifications, or write Hewlett-Packard, Palo Alto, Calif. 94304, Tel. (415) 326-7000; Europe: 54 Route des Acacias, Geneva.

Data subject to change without notice. Prices f.o.b. factory.

**HEWLETT**  **PACKARD**  
 An extra measure of quality

1742

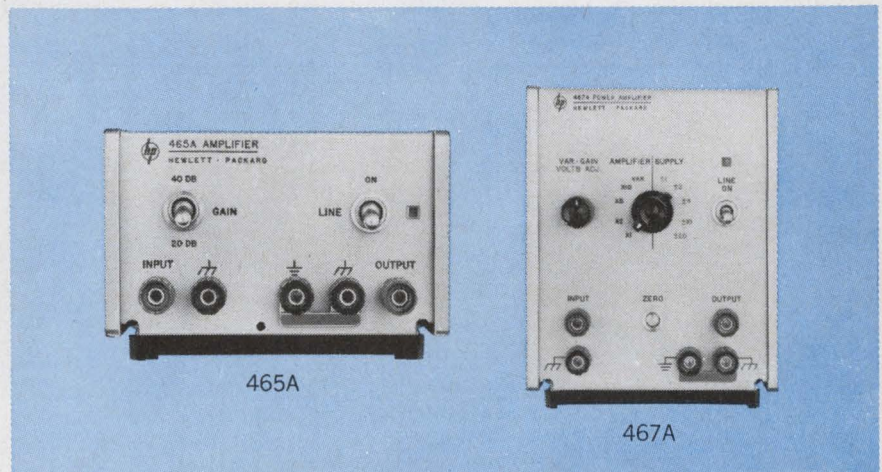

ON READER-SERVICE CARD CIRCLE 14



## Press-on circuitry wires auto dashboards

**High-speed die-cutting process assures low-cost, uniform laminated circuits for consumer products.**

Ever reach under the dashboard of your car to find that short in the cigar lighter? If you have, you've come up with a handful of spaghetti. Not so now, if you own a late model Chevrolet Impala or Buick Invicta or Special. All dashboard wiring in these autos consists of die-cut flexible circuitry with a pressure-sensitive adhesive backing.

The circuitry, produced by the Morgan Adhesives Co., is expected to gain still more of the wiring

market for the automobile and small-appliance industries and the acid-etched, printed-circuitry market for radios and electronic equipment. The process is said to remove certain limitations imposed by the acid-etch method. For example, the high-speed die-cutting method eliminates 35 separate steps required by the acid-etch method. Repeatable quality in register, deposition and definition is assured with the die-cutting method; frequent variations are en-

countered in etching circuits. In addition, waste rewind stations on the die-cutting press reclaim all stripped copper and insulation.

The circuitry is formed by laminating or heat-sealing conductive material (copper, nickel, aluminum, silver) with an insulating plastic film. The equipment is a high-speed Webtron die-cutting press, which includes stripping and rewind stations for rolls of circuits or stripping and cut-off stations for sheets. Dies can be changed instantly, and physical limitations on the circuitry are imposed only by the diemaker (cutting edges can be brought to within only 1/32-in. of each other). Lamination or heat-sealing machinery completes the processing equipment. The equipment is capable of running at 300 feet/minute (about 72,000 circuits/hour).

Here's the entire procedure:

- The insulation film is die-cut.
- The conductor foil is cut only to the backing paper, except for locating holes which are cut all the way through.
- The surplus foil is peeled off the backing paper, leaving the metal circuit in place.
- The die-cut insulation film is parted from its backing paper and laminated in register over the metal circuit (which is still in position on its backing paper).

This procedure is for a single-plane circuit; crossovers are made simply by applying additional layers of foil and film. Processing steps are the same. Although the process is designed for flexible circuitry, the insulation/copper combination may be separated from the backing and bonded to a non-conductive surface to be used as a rigid circuit, if desired.

The flexible circuit market has grown from a \$15 million operation in 1956 to a projected \$120 million in 1971. Next year's General Motors' line should find the Morgan circuitry not only under the dashboard, but extending from the firewall to the trunk as wiring for the tail lights. ■ ■

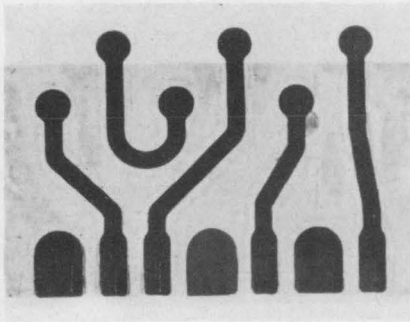
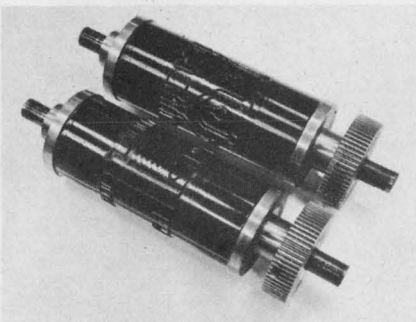

Typical dies (upper left) are for insulation material and copper foil, respectively. The die-cut circuit with Mylar release backing is shown feeding onto rewind reel. By application of insulating material, circuit is finished (upper right).



# MONOLITHIC COUNTING LOGIC

Off-the-shelf delivery: Fairchild counting MICROLOGIC® integrated circuits give you complete counting and display capabilities with a minimum of components. For example, you can get full decade count, decode, and display driver functions with just two C<sub>μ</sub>L devices (C<sub>μ</sub>L9958, C<sub>μ</sub>L9960). You can get the only monolithic decoder/display driver on the market (C<sub>μ</sub>L9960). You can get the only monolithic mod 16 binary counter with 25MHz typical characteristics (C<sub>μ</sub>L9989). Best of all, you can get them off-the-shelf in any quantity. Count on it. For details contact us or the nearest Fairchild Distributor.

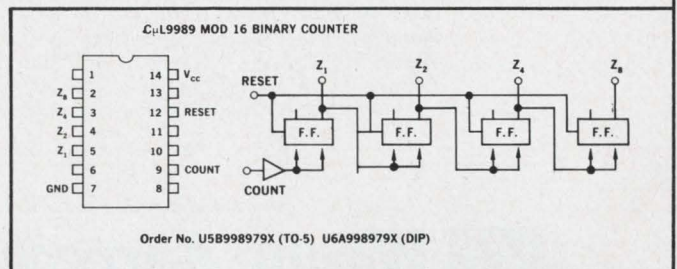
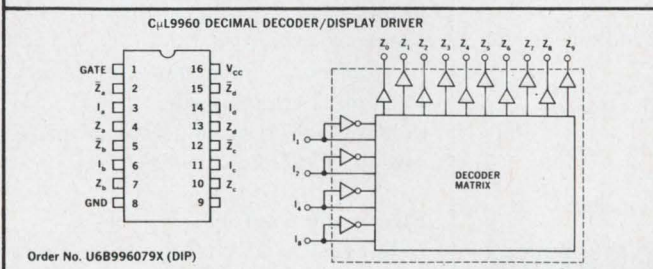
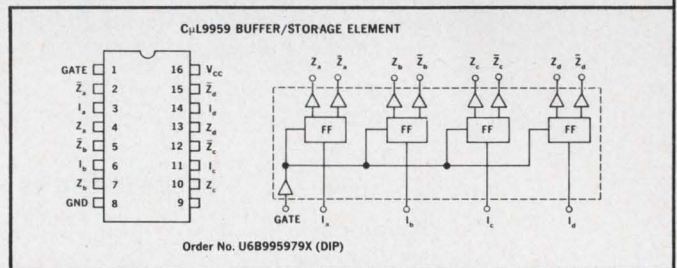
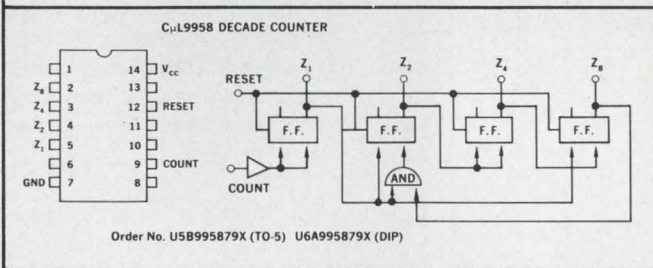



# World's Most Accurate 100 kHz—1 MHz C/R Bridge

# 0.1%

ACCURACY

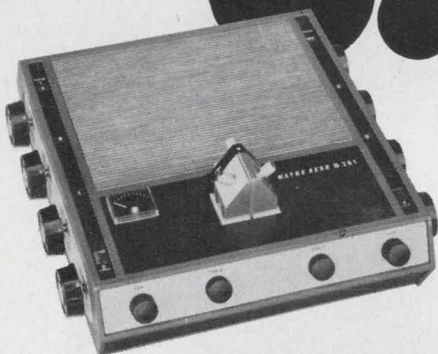

## New Wayne Kerr B201 Bridge

Designed for highly precise, simultaneous in-circuit measurement of capacitance and conductance over an extremely wide range—from 0.001 pF—10,000 pF and from 0.01  $\mu$ Mho—100 mMho—the B201 Bridge is invaluable for checking capacitors and components of printed circuits and/or encapsulated assemblies.

A four-figure digital readout provides excellent discrimination enabling the B201 to be used for the observance of minute changes in component values or alterations in the constants of lines, filters, aerials, equalizing circuits and a variety of passive 2- or 3-terminal networks. A built-in level control simplifies evaluation of semi-conductors and other non-linear devices.

An all solid state design, the B201 is portable and completely self-contained with battery and rectifier unit housed internally.

### SPECIFICATIONS

**Measurement Ranges:** 0.001 pF—10,000 pF; 0.01  $\mu$ Mho—100 mMho in six ranges.

**Frequency Range:** 100 kHz—1 MHz (plug-in Source and detector units for 100 kHz—1 MHz).

**Accuracy:**  $\pm 0.1\% \pm 1$  minor division (4th significant figure).

**Discrimination:**  $\pm 1$  minor division or better.

**Price:** \$1900 (B201X, including sources and detectors, low admittance adaptor and transfer standards). FOB Montclair, N. J.

For literature and detailed specifications, write:



## Wayne Kerr CORPORATION

18-B Frink St., Montclair, N.J. 07042 • Phone (201) 746-2438  
INNOVATIONS IN INSTRUMENTATION

ON READER-SERVICE CARD CIRCLE 16

## NEWS

### Law enforcement papers sought

Scientists, engineers and law-enforcement officials throughout the nation have been invited to submit papers for presentation at the First National Symposium on Law-Enforcement Science and Technology scheduled for March 7-9, 1967.

This open call for papers is necessary, say symposium officials, because a national symposium of this kind has never been held before. Consequently there exists no assembled mailing list designed to reach the broad community of scientists, engineers and law-enforcement officials who are potential contributors to such a meeting.

The symposium is being sponsored by the U.S. Dept. of Justice Office of Law-Enforcement Assistance and the IIT Research Institute of Chicago. It will be held on the campus of the Illinois Institute of Technology.

Prospective authors should submit 75-word abstracts and 700-word summaries of their papers to S. A. Yefsky, Chairman, First National Symposium on Law-Enforcement Science and Technology, IIT Research Institute, 10 West 35 St., Chicago, Ill. 60616. Deadline for submission is October 15.

In issuing his call for papers, chairman Yefsky stated that scientists and engineers from all disciplines are invited to submit papers on any aspects of science and technology associated with, or relating to, the problem areas of criminal justice. Examples of these areas are:

#### Communications

- Control center access and real-time display of patrol vehicles
- Radio system vulnerability
- Secure communications
- Interurban transmission systems
- Facsimile transmission
- Control center radio access from remote locations

#### Electronic warfare

- Debugging and countersurveillance
- Vehicle tracking
- Remote visual surveillance
- Voice identification. ■ ■



# Microwave tower shows 'new look'

Residents of Barlow, Ohio, may be kept busy for some time explaining to visitors that "that thing" they see is not a modern version of Jack's beanstalk. The "thing" is actually a tubular microwave tower rising 315 feet.

It is the tallest tower of its type in the country and, according to the General Telephone Company of Ohio, which erected it, the tower represents the newest design for microwave structures. Compared with the conventional steel ladder tower, the tubular configuration is easier to maintain, and it has a more attractive appearance—an important factor in a residential area.

The new tower, situated 12 miles west of Marietta, is part of a five-hop microwave system for telephone communications in three

counties of southeastern Ohio.

The tower consists of 12 sections of tubular steel, each 20 to 30 feet long and weighing between 1000 and 2000 pounds. The sections are tapered, so that the tower has a maximum diameter of 24 inches at the bottom and a minimum of 18 inches at the top.

A helicopter was used during installation to hoist each section into place. To do the job, it was necessary to give the helicopter pilot a reference point in the sky for locating the top of the tower as he hovered over it. The installers solved the problem by strapping a 50-foot guideline mast to each succeeding top section of the tower and pointing it skyward at about a 25-degree angle. This enabled the pilot to get his bearing. ■ ■

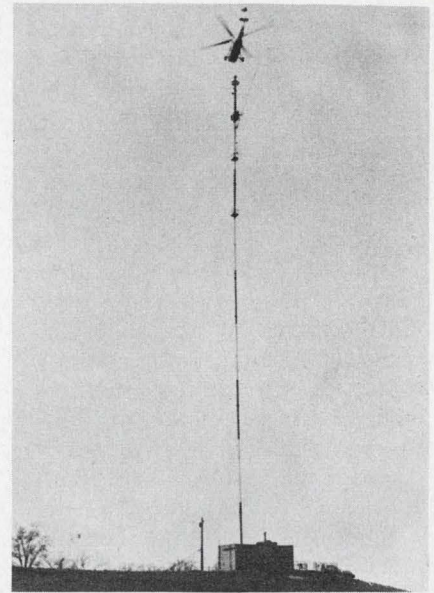

Tallest tubular microwave tower rises 315 ft into the air.

# Computer-typewriter makes secretary's life easier

With the help of a central computer, a typist can now replace a phrase, word or paragraph, change type face on material already typed and store typed text in her typewriter.

Her IBM 2741 communication terminal looks and can be used just like an ordinary electric typewriter. But a special "attention" key alerts the central computer to receive instructions. The typist can then direct it to retrieve a certain document, delete one of its lines and substitute new copy. Should it later receive a request from any terminal for that document, it responds by printing out the updated version.

The system is called DATATEXT by IBM. With it, up to 40 typists can simultaneously communicate with the computer. Each terminal is linked to the computer by conventional telephone lines.

Besides storing and retrieving text and tables, the computer can print out a specific number of characters per line, put automatic headings on all pages, number each page of print-out, and even justify both left and right sides of the text.

Here's an example of an interchange between a typist and her typewriter (translation is in paren-

theses):

Girl: c (Clear working storage)

Computer: CLEARED

Girl: a (Computer operates in automatic mode. It decides where to print each word.)

Computer: AUTOMATIC MODE

Girl: g279 (Get document 279 from storage.)

Computer: 4 UNITS "A" MODE, STATUS REPORT

(This tells girl the length and title of document and the mode in which it will be printed.)

Girl: pn65 (Print at 65 characters/line.)

Computer: SIGNAL WHEN READY

Girl: Firmly depresses "attention" button and smiles crisply. The Machine begins to type. ■ ■



DATATEXT system allows a secretary to make changes to a document (left) and then receive a print-out of the corrected version (right).



## Flying spot sends moon photos

A cathode-ray tube whose fluorescent screen is a rotating drum was used on Orbiter I to send pictures back to Earth on its recent jaunt around the Moon.

The novel tube was the source of a scanning light beam used to convert a photographic image into a video signal for transmission to Earth. Scanning rate and light level were maintained by an electron gun focused on the unusual phosphor-coated cylinder within the vacuum envelope (See ED 21, Sept. 13, 1966, pp. 24-26).

Engineers at CBS Laboratories in Stamford, Conn., developed the Line Scan Tube and its associated electronics in cooperation with the Eastman Kodak Co.

Photographs of the Moon's surface were processed as negatives, dried, and stored on the spacecraft. On command, the electronic read-out system formed the intense light source which scanned the negative rapidly. The light

beam, on passing through the negative, was modulated by variations in density before impinging on a photomultiplier tube. Output video signals were then encoded for transmission to the ground station.

According to CBS laboratory engineers, a conventional cathode-ray tube could not have been used to perform the illumination function because it is limited in its ability to dissipate heat. The phosphor face of the tube would have been destroyed by the intense electron beam sweeping in a limited area because the phosphor would not have had time to cool.

The phosphor on the rotating metal drum within the Line Scan Tube does not return to the scanning area until the drum has rotated completely, so the coated surface has enough time to cool.

As a result of this innovation, the tube's light output is at least ten times greater than that of a conventional tube with no resolu-

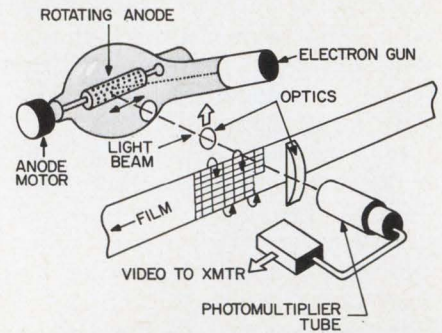

**Line scan tube** with phosphor-coated rotating drum gives light to scan Orbiter moon photos. Electron beam sweeps drum horizontally and optics focus intense resulting light beam vertically.

tion loss. Another factor contributing to the tube's effectiveness is its construction, which permits the light spot to emit from the same side of the phosphor as that on which the electron beam impacts. This eliminates the transmission loss through the tube that occurs in most CRTs. ■ ■

## Versatile tester leapfrogs technology

A great deal of effort by semiconductor manufacturers these days is devoted to fitting more and more circuitry into less and less space. Complex arrays, large-scale integration and "computer on a chip" are some of the terms that have sprung up as a result.

Although significant advances have been made in this area of complex circuitry, to date most of the resulting devices are either developmental or produced in limited numbers. Large-scale production, as is now used for more conventional semiconductor devices, is still in the future.

At least one manufacturer of production test instrumentation, though, is not waiting for that time to come. The 8000 Array Test System, recently introduced by Fairchild Instrumentation, has been designed, says the company, to production-test today's mass-produced circuits as well as those now under development.

The system performs functional

logic tests on complex digital circuits, which may be in the form of printed-circuit cards, potted modules, ICs, thin-film circuits, complex arrays, large-scale integration and system subassemblies. The basic unit can test 48-pin devices. However, it can be expanded in 12-pin increments to accommodate up to 144 pins.

Programming of the Series 8000 can be either by computer or magnetic disk. With a magnetic disk, the unit reportedly can operate at a speed of 1,000 tests per second for devices with up to 72 active pins, and 500 tests per second for devices with up to 144 active pins.

In operation, the system applies a series of digital inputs to the device under test and compares the responding outputs with the expected outputs set into the program. Various operating modes and system components make it possible to use the unit for data-logging and diagnostic testing, as well as for functional testing. ■ ■

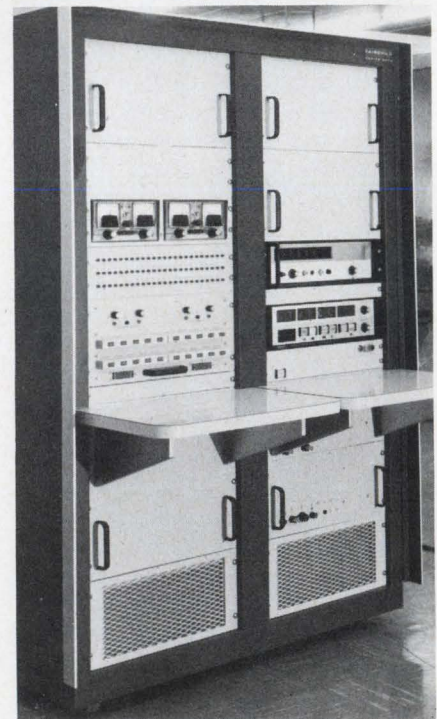

**Series 8000 Test System** developed by Fairchild Instrumentation, performs functional logic tests on complex digital circuits.



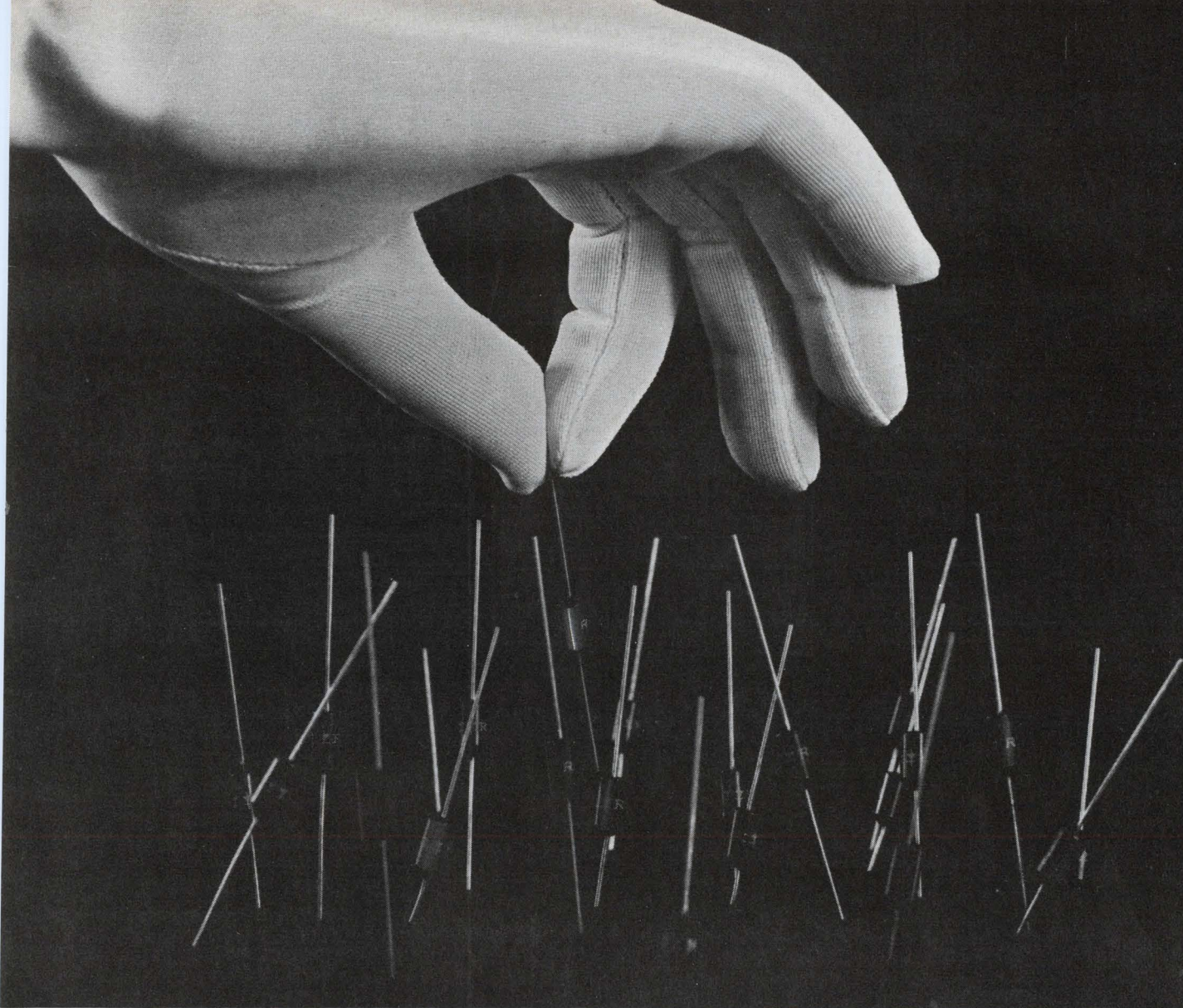

## Pick a peck of plastic zeners at the volume price

NEW 1 watt molded design...3.3 to 15 volts

There's a harvest of value in this bumper crop of the new International Rectifier 1ZM molded plastic zener line. In addition to low cost, IR's new one-watt plastic design offers best selection in the most widely used voltage ranges, from 3.3 to 15 volts, with 5%, 10% and 20% tolerances available in quantity in every rating.

Performance of the 1ZM zener features sharp knees, low thermal impedance and excellent dielectric characteristics. Environmental features include superior shock, vibration and thermal shock capabilities. Moisture resistance to the stringent MIL-STD 202C, Method 106A further demonstrates the structural integrity available in the 1ZM plastic design. In all, this new zener line offers full economy plus the assurance of a lifetime guarantee—exclusive with all IR zeners.

Fast delivery of your particular requirement has been

assured by full "stocking" by the 50 Authorized Industrial Distributors IR maintains across the nation, and by extensive inventories ready at the El Segundo plant.

**INSPECT THE SPECS ON PLASTIC ZENERS.** Whatever your need: process control, instrumentation, switching, measurement, modulation, energy conversion, transmission or generation—you'll discover time and dollar savings by getting all the details. Write for IR's new 1ZM zener bulletin C-102, and full line Catalog C-66, it's free and loaded with complete data. For immediate help, contact your nearest IR Sales Office or Authorized Industrial Distributor.

**IR. INTERNATIONAL RECTIFIER**  
(213) OR 8-6281 • TELEX 6-74666 • EL SEGUNDO, CALIF.



**ONLY 3C OFFERS...**

# **A CHOICE OF 1 $\mu$ SEC I/C CORE MEMORIES WITH 4K TO 32K WORDS IN 5 $\frac{1}{4}$ " UNITS**

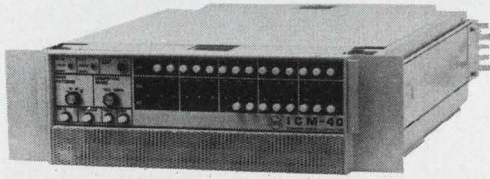

Standard ICM-40 mounts horizontally, provides  $\frac{1}{2}$  million bits of economical high speed storage in a single compact 5 $\frac{1}{4}$ " high unit which pulls out, swings, and tilts for easy access.

1  $\mu$ sec cycle time, 500 nsec access time — capacities from 4K x 4 bits to 32K x 84 bits. Extensive features of ICM-40† Core Memories include proven I/C reliability, adjustment-free operation, and compact packaging with unique ready access to all components.

ICM-40's are designed and built for critical computer level speeds and reliability at minimal user cost. All logic, addressing, decoding, control, line driving, and sensing functions utilize 3C  $\mu$ -PAC integrated circuit logic modules. All modules are interchangeable. ICM-40's interface comfortably with both discrete component and integrated circuit systems.

## **SPECIFICATIONS**

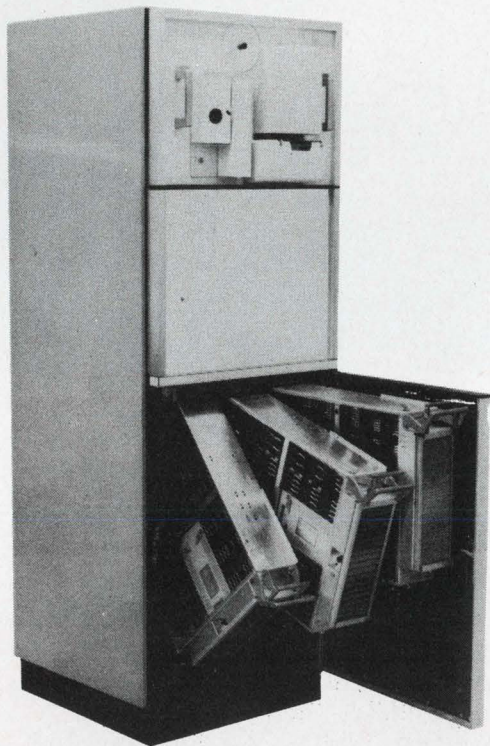

Shown: About 1 $\frac{1}{2}$  million bits (98K words) of core memory. Standard 5 $\frac{1}{4}$ " ICM-40 mounts vertically in standard 19" x 24" cabinet. Memory module swings out, tilts for easy access to module side or wired side of hardware.

<b>Capacity*</b> (in a single 5 $\frac{1}{4}$ " high unit)	4096 words x 4 – 28 bits 8192 words x 4 – 28 bits 16,384 words x 4 – 28 bits 32,768 words x 4 – 14 bits
<b>Speed</b>	1.0 $\mu$ sec for Clear/Write and Read/Regenerate 1.25 $\mu$ secs for Read/Modify/Write <0.5 $\mu$ sec
<b>Access</b>	
<b>Input logic levels</b> (other input logic levels on request)	ZERO: 0.0 volts to +1.0 volt ONE: +3.0 volts to +6.5 volts
<b>Output logic levels</b> (other output logic levels on request)	ZERO: 0.0 volts to +0.4 volt ONE: +4.0 volts to +6.5 volts
<b>Power</b>	115 or 230 volts, 50 or 60 cps
<b>Weight</b>	<55 pounds
<b>Environment</b>	Operating temperature: 0° to 50°C Non-operating temperature: –25° to +80°C Humidity: 95% without condensation Shock and vibration: normal shipping conditions

†Patent Applied For

\*NOTE: System word capacity and bit length can be increased by combining several ICM-40's in a single cabinet.

Ask for complete details. Write Honeywell, Computer Control Division, Framingham, Massachusetts 01701.

# **Honeywell**



**COMPUTER CONTROL DIVISION**

Speed Inquiry to Advertiser via Collect Night Letter  
ON READER-SERVICE CARD CIRCLE 18

ELECTRONIC DESIGN 22, September 27, 1966



Sen. Magnuson pushes electric cars.



# Washington Report

S. DAVID PURSGLOVE,  
WASHINGTON EDITOR

## Electric car bill boosts battery R&D

The Electric Vehicle Development Act introduced by Sen. Warren G. Magnuson (D-Wash.) goes far beyond just the construction of a prototype electric car that had been expected. Its potential influence, in fact, begins well before design work on such a car even starts.

The Act would coordinate all present Federal research on batteries and fuel cells, bring most of it under the direction of the Dept. of Commerce, and set up new programs. It re-echoes the recommendations of a number of Congressional committees and the White House science adviser's office that the Government must fund a major research and development program on powerful, durable, lightweight batteries and fuel cells. The Senator, when introducing the bill, urged that much of such a program should be conducted through industry contractors.

The bill has three major emphases: development of batteries and fuel cells that are both light and lasting; development of vehicles specifically designed to be propelled by such storage units; construction and demonstration of prototypes. It is expected to pass the Senate easily: It has been referred to the Commerce Committee, of which Magnuson is chairman, and other interested committees have already called on the Administration to undertake such a R&D program. The House is similarly inclined.

Magnuson indicated that he sees nothing inherently wrong with existing electric cars. (There are 40,000 battery-powered delivery vehicles in the U.K., and the British National Electricity Council foresees more than a million within ten years. There are 100,000 battery-powered material-handling trucks in U.S. plants.) Magnuson said that British vehicles operate at 35-40 mph over a range of 20-40 miles on a single charge, and that a battery-powered commuter train

that can accelerate to 60 mph in 60 seconds with 150 persons aboard has been developed in Germany. Such vehicles could theoretically fill U.S. needs. Magnuson cited a survey that showed that a car's average speed over major arteries into a large city during morning rush hour was 13 mph, the average speed within the city dropped to 8.5 mph, and that 28% of the cars involved traveled less than 50 miles a day.

The Senator conceded, however, that most Americans want larger and faster cars than that, and therefore there is a need to develop improved batteries and fuel cells. His bill specifically requires the Commerce Dept. to make available to interested manufacturers all data obtained from the R&D program. He points out that the lack of a market has kept manufacturers' electric-car research at a low key, and he wants to see them encouraged.

The main inspiration for the bill, as stated by Magnuson, the White House and various Congressional committees, is the aim to reduce air pollution caused by automobiles. Observers predict, however, that increased interest in electric cars will hasten the development of electronic controls both on highways and in automobiles. It would be easier, for instance, to install in an electric car an integrated warning, drive and control system. Wider use of such cars, they add, would justify the establishment of the highway electrical-power networks that would be needed for electronic highway control and safety systems.

## Automated hospital opened

The Veterans' Administration has opened in Atlanta one of the most modern hospitals in the country and considers it a pace-setter for future electronic facilities. It is literally automated from top to bottom, from automatic tray conveyers and washer-sterilizers to closed-circuit television to permit isolation patients to see visitors and chapel services.



# Washington Report

CONTINUED

There is also a pocket paging system and an intercom system that allows two-way contact on a room-microphone basis between points all over the building.

Gordon A. Friesen International, Inc., the VA's consultant on automation and communications, is collaborating with Ampex Corp. on a visual patient-nurse communications setup. A spokesman for the consultants also commented: "So far there is no existing total automatic data-processing system designed especially for hospitals, but we are working on the development of one now with Stanford University."

## SBA starts new "small business" policy

The Small Business Administration's steps to classify the American Motors Co. as a "small business" reflect a new and possibly far-reaching policy. AMC ranks sixty-third in U.S. corporation sales, comparable to Sperry Rand Corp., Litton Industries and Singer Corp., none of which is a "small business."

From now on the smallness of a business will be determined not merely by its gross sales or staff but also on the ground of its being the smallest of a group of giants. The "small business" classification affects a company in several minor bookkeeping ways and in one major one: It makes it eligible for special government contract "set asides."

An SBA spokesman says the concept is "nothing new," for the Government sometimes awards aircraft and arms contracts to companies that are not the lowest bidder "because we need to keep them in business." None of the large electronic companies is likely to be classed "small," however, because the industry is already overrun by really little "small business," the spokesman noted.

## Classification survey played down

The Pentagon's Advanced Research Projects Agency (ARPA) has denied that a new study of the results of classifying information may be used to show information officers how better to "manage" news. While owning that the study *could* be used to this end, an ARPA spokesman stressed that it would not be used to withhold any more information

from industry than hitherto. He added, however, that it was unlikely to free any more information for industry, either.

Timothy C. Brook, associate professor of psychology at Ohio State University, who was named to head the study, has deplored the manner in which he thinks the Pentagon has played down the probable importance of the study in an apparent attempt to allay the fears of the press.

---

**Rumors in Washington corridors** have it that the Nike-X Project Office may sign a new contract with the Nuclear Division of Kaman Aircraft Corp., Colorado Springs, Colo. The contract would be for a major, new, definitive study on nuclear weapon damage and the effects of fallout.

**The Bureau of Public Roads** has seemingly downgraded the standing of such developmental highway hazard warning systems as Ford-Philco's Road Radio Alert (See ELECTRONIC DESIGN, Aug. 30, 1965, p. 6) and General Motors' DAIR (see ELECTRONIC DESIGN, Aug. 16, 1966, p. 31). The bureau had been under informal pressure to pick which one is the better. Now it appears that the bureau is only routinely interested in all *warning* systems and is becoming increasingly enthusiastic about *surveillance* systems. It is believed particularly impressed by a monitoring system presently operating on Detroit's Lodge Freeway.

**The Housing and Urban Development Dept.** has awarded a \$50,000 grant to the Southeastern Wisconsin Regional Planning Commission to pioneer the use of computers for planning a major urban development. The commission is to design and test a computerized land-use model to minimize development costs in the design of land-use patterns and community development.

**Interior Dept.** is checking various data-processing systems in order to select one to handle the huge volume of figures that the oil industry is required to supply to its mineral resources section. It would be the Interior Dept.'s first major move into ADP for operations of a statistical nature. The use of computers will not only speed the flow of information back to the industry, but also reduce the amount of data demanded of the oilmen.





*explorer I*  
*explorer IV*  
*tiros*  
*telstar*  
*syncom*

*ranger VII*  
*ranger VIII*  
*ranger IX*  
*saturn I*  
*surveyor*

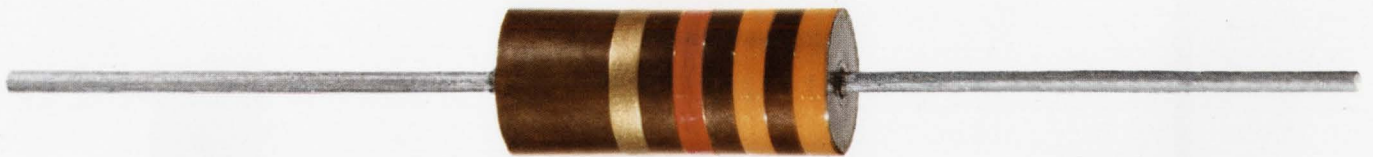

## the most honored resistor in the Space Program

■ Allen-Bradley hot molded resistors were chosen to participate in these many history-making space projects for only one vital reason—a history of proven performance that dates back for more than a quarter of a century! A record more conclusive than any testing program could possibly provide!

The superiority of Allen-Bradley resistors is found in the exclusive hot molding process. Through the use of completely automatic machines—developed and used *only* by Allen-Bradley—there is obtained such uniformity of characteristics from resistor to resistor, year after year, that the resistors' long term performance can be accurately predicted. Furthermore, no Allen-Bradley hot molded resistor has ever been found to have failed catastrophically.

The widespread use of the Allen-Bradley hot molded resistors in these space programs should convince you that to include this plus value in the equipment which you produce gives it the mark of "extra quality." Let us tell

you more about the complete line of Allen-Bradley electronic components. Please write for Publication 6024. Allen-Bradley Co., 222 W. Greenfield Ave., Milwaukee, Wis. 53204. In Canada: Allen-Bradley Canada Limited. Export Office: 630 Third Ave., N. Y., N. Y. U.S.A. 10017.



**HOT MOLDED FIXED RESISTORS** are available in all standard EIA and MIL-R-11 resistance values and tolerances, plus values above and below standard limits. **Shown actual size.**

TYPE BB 1/8 WATT

MIL TYPE RC 05

TYPE CB 1/4 WATT

MIL TYPE RC 07

TYPE EB 1/2 WATT

MIL TYPE RC 20

TYPE GB 1 WATT

MIL TYPE RC 32

TYPE HB 2 WATTS

MIL TYPE RC 42

# ALLEN-BRADLEY

QUALITY ELECTRONIC COMPONENTS





ALLEN-BRADLEY Type J  
Hot Molded Variable Resistor  
rated 2.25 watts @ 70°C  
shown 2 times  
actual size.

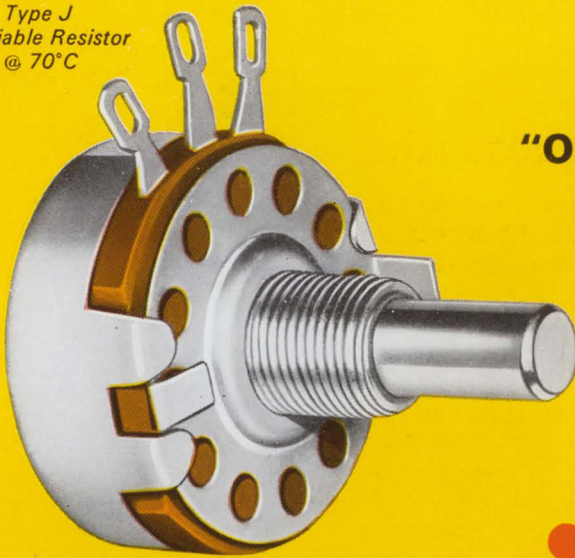

**"Only Allen-Bradley Type J pots  
give us the smooth control  
to maintain the high calibration  
accuracy of our instruments"**

Krohn-Hite Corporation

● This quickly locates the positions of the Type J potentiometers in the illustration below.

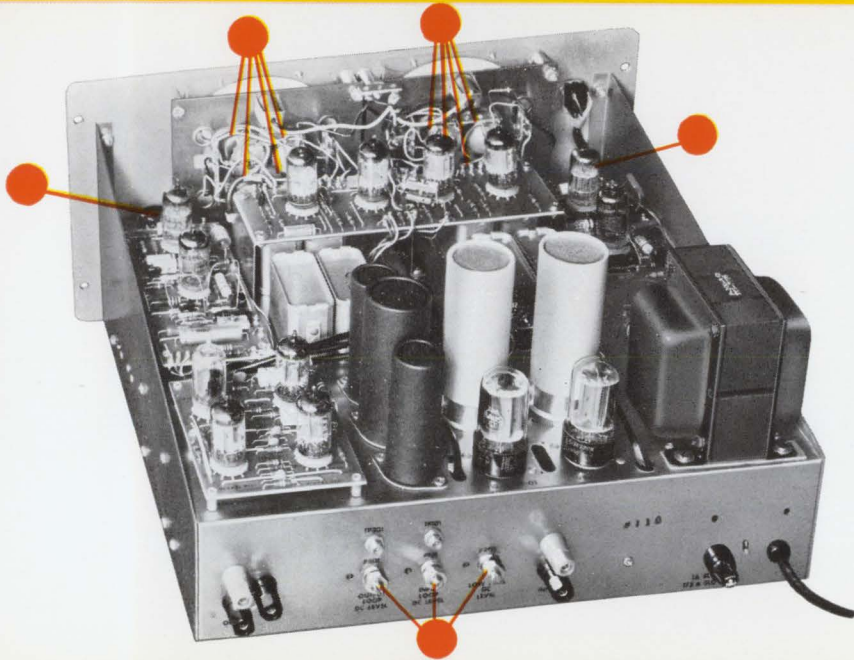

**THIS KROHN-HITE VARIABLE FILTER** provides low-pass, high-pass, band-pass, and band-reject operation with high and low cutoff frequencies independently adjustable from 0.02 cps to 20 kc.

**IN THE MODEL 335**, continuous tuning of the high and low cutoff frequencies is accomplished by simultaneously varying four potentiometers with a single knob. Only A-B Type J controls have been found to provide the smooth control and precise tracking without discontinuities to achieve the required calibration accuracy.

■ Krohn-Hite engineers have found that only Allen-Bradley Type J potentiometers provide the smooth control, low noise, long term stability, and low temperature coefficient they require for their precision instruments such as the variable electronic filter.

The Type J control has the resistor, terminals, faceplate mounting bushing, and insulating material hot molded into a solid integral unit. The solid resistance track assures smooth, quiet control that is free from the undesirable discrete steps of wire-wound units. On accelerated tests, Type J exceeds 100,000 complete operations with less than 10% resistance change.

Insure the performance of your equipment by insisting on Allen-Bradley Type J hot molded potentiometers. Besides, when you use Allen-Bradley fixed and variable hot molded composition resistors you provide your apparatus with the label of "quality." For more complete specifications, please write for Publication 6024: Allen-Bradley Co., 222 West Greenfield Ave., Milwaukee, Wis. 53204. In Canada: Allen-Bradley Canada Ltd. Export Office: 630 Third Ave., New York, N.Y., U.S.A. 10017.

**ADDITIONAL ALLEN-BRADLEY HOT MOLDED VARIABLE RESISTORS**

**TYPE G CONTROLS** are only 1/2" in diameter. Quiet, stepless operation. Rated 1/2 watt at 70°C. Values to 5 megohms. Type L are similar in construction but rated 1/2 watt at 100°C.



**TYPE F CONTROLS** are for mounting directly on printed wiring boards by means of their terminals. Rated 1/4 watt at 70°C. Values to 5 megohms. Type O are similar but rated 0.4 watt at 70°C.

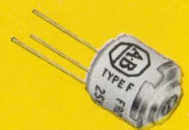

**TYPE R ADJUSTABLE FIXED RESISTORS** are built to withstand environmental extremes. Only 1 1/4" in length. Have stepless adjustment. Watertight and can be encapsulated. Rated 1/4 watt at 70°C. Values to 2.5 megohms. Type N for less severe environments are rated 1/2 watt at 50°C.

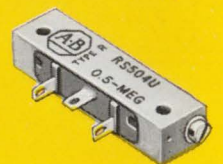

**ALLEN-BRADLEY**  
QUALITY ELECTRONIC COMPONENTS



## IC yield and adaptive antenna investigated

Will the inclusion of spare parts in large-scale integrated-circuit structures result in improved yield?

This was one of many questions discussed during Stanford University's annual Electronic Research Review last month. Attending the event were some 400 invited representatives of government and industry eager to learn more about the university's research and development activities.

Drawing on preliminary results of a research program sponsored by the USAF, Stanford scientists E. Tamaru and J. B. Angell reported that "through judicious use of spare components, it appears possible to decrease the cost of good integrated circuits via an improvement in initial yield." With a digital adder as an example, they pointed out that even in some irregular-logic structures there are certain patterns which appear repeatedly. If it were possible to test each of these repeated structures prior to final interconnection, a discretionary final metalization that avoids any defective region could be arranged.

Their example was assumed to have a full adder containing the same three-gate substructure in four different locations. By the ad-

dition of one spare substructure and the use of four different masks, it would be possible to connect the spare in place of any of the other subsections. Testing the substructures, including the spare, by means of peripheral test pads would take place as an intermediate fabrication process prior to final, second-layer metalization. The yield for such an adder with its built-in spare is estimated at 22 per cent, even though it includes only the same bipolar technology and defect density that provides 10 per cent in a nonredundant form.

To date, the program has been carried on without considering cost factors. Stanford predictions, however, are that the spare-parts approach would apply only to large arrays where yield is a function of the area.

One of the most interesting reports of the four-day meeting covered the application of an adaptive system theory to the problem of automatic beam-forming for antenna arrays. While the research project is being carried out in the field of sonar array processing for the U.S. Navy, the method is applicable to arrays at any frequency, according to Stanford research-

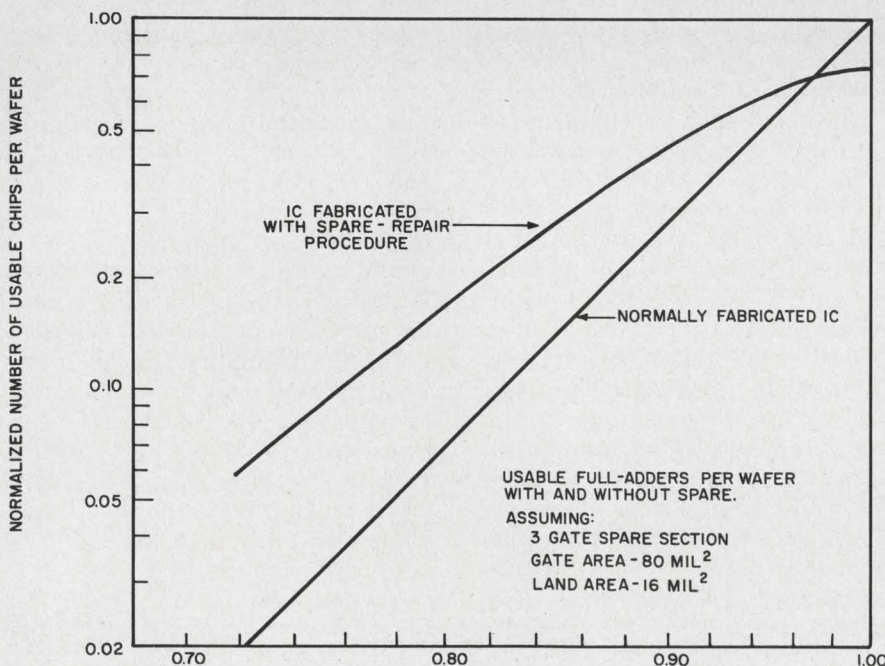

Spare-parts integrated-circuit approach offers possibility of improving yield in large arrays.

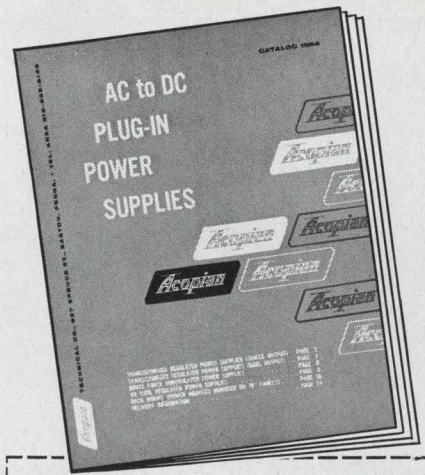

Please send me the latest Acopian catalog that lists

# 62,000 DIFFERENT POWER SUPPLIES

available for shipment in 3 days.

Name

Title

Company

Address

City

State

ZIP

ACOPIAN CORP.  
 EASTON, PENNSYLVANIA  
 TEL: (215) 258-5441





**BRUSHLESS  
SYNCHROS  
DON'T HAVE  
THESE  
TROUBLE-MAKERS**

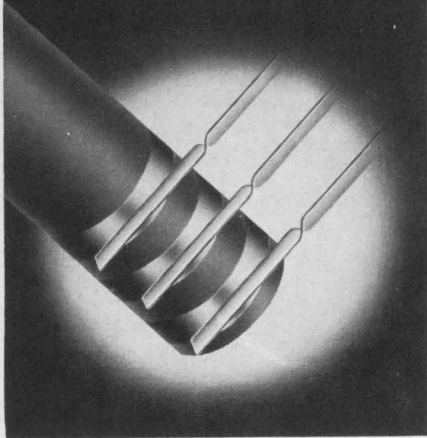

**OR THESE TROUBLES:**

Brush wear • Arcing • RFI emission  
• Contact bounce • Bearing contamination from brush-wear particles • Brush friction error

We left out all these synchro problems by leaving out the brushes. Rotary transformers couple signals into rotors without contact. Result is far longer synchro life — which can exceed 10,000 hours — with performance equal to the best of brush types.

Patented Harowe brushless synchros are available for all common functions, in sizes 5, 8, 10, and 11 as standard; larger sizes as special. All types meet applicable requirements of MIL specs. Request complete data from —



Servo, Stepper &  
Synchronous Motors  
Motor Generators • Synchros  
Resolvers • Pancakes • Gearheads

**HAROWE SERVO CONTROLS, INC.**

20 Westtown Road  
West Chester, Pa. 19380  
(215) 692-2700

ON READER-SERVICE CARD CIRCLE 20

**NEWS**

er Lloyd Griffiths. The method involves a simple iterative technique which allows an array to produce maximum sensitivity in some prescribed direction while simultaneously nulling out strong directional noises whose statistics and directions are not only unknown but also changing with time. In addition, it minimizes the effect of any independent innate noise or amplifier noise which may be present at each antenna element.

In his report on the project, Griffiths limited his discussion to planar arrays composed of isotropic radiators in free space. At each element, variable gain and phase control are effected by use of two multiplying weights. A phase-shifting network provides a 90-degree phase shift at the center frequency of the array. The weights are allowed to assume values between plus and minus infinity, thus providing any gain or phase shift between input and output.

The adaptive procedure for ad-

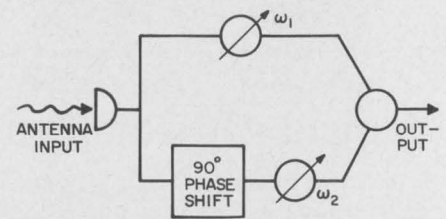

**Signal processor** for adaptive array uses two weights which automatically adjust to obtain maximum sensitivity in some specified direction.

justing the two-weight-per-array-element signal processor is referred to as the "two-mode adapt" method. During the first or signal-adapt mode, a strong simulated signal is electrically inserted at each antenna element. In the second or noise-adapt mode, no external signal is injected into the array.

Digital simulations demonstrating the performance of the adaptive array have been carried out for some time on an IBM 1620 computer at Stanford. Investigators at the university feel, however, that more research into the adaptive system theory must be done, before the Navy can look for its first "on-board" operational system. ■ ■

**New alloy is superconductive**

A partially disordered alloy of chromium and osmium has been identified as a new low-temperature superconductor. Discovered during a Government-sponsored program of research into alloys of the platinum-metal group, the new alloy is believed to offer possibilities for new types of electronic devices.

The scientists hope to produce alloys which become superconductive at higher temperatures than are now possible. Present alloys used in high field magnets, for example, require cryogenic cooling to approximately 4°K and use expensive liquid helium. Alloys which become superconductive at higher temperatures (above 20°K) would use less expensive liquid hydrogen.

A disordered metal alloy is one whose atoms do not arrange themselves with precision in the metal's crystal structure. Alloys in the platinum-metal group, which includes the new superconductor, have crystal-lattice structures shaped like cubes. The atoms tend to arrange themselves uniformly at the corners and faces of the cube. This affinity

is termed long-range order, a property related to the alloy's strength, hardness and electrical conductivity.

Government scientists found that alloys with low long-range orders tended to have superconducting properties.

Studies were conducted jointly at the National Bureau of Standard's Institute for Materials Research and the U.S. Navy's Marine Engineering Laboratory. The discoverers, Drs. R. M. Waterstrat of NBS and E. S. van Reuth of the naval laboratory, studied 18 alloy combinations in the platinum-metal group using X-ray diffraction methods. They found that the chromium-osmium alloy had the lowest long-range order—0.66 out of a possible 1.00. Other alloys, containing such metals as vanadium, titanium, iridium and rhodium were also found to be superconductors.

Further research by Dr. R. D. Blaugher at Westinghouse's Defense Space Center showed that the chromium-osmium alloy becomes superconducting at 4.03°K. ■ ■



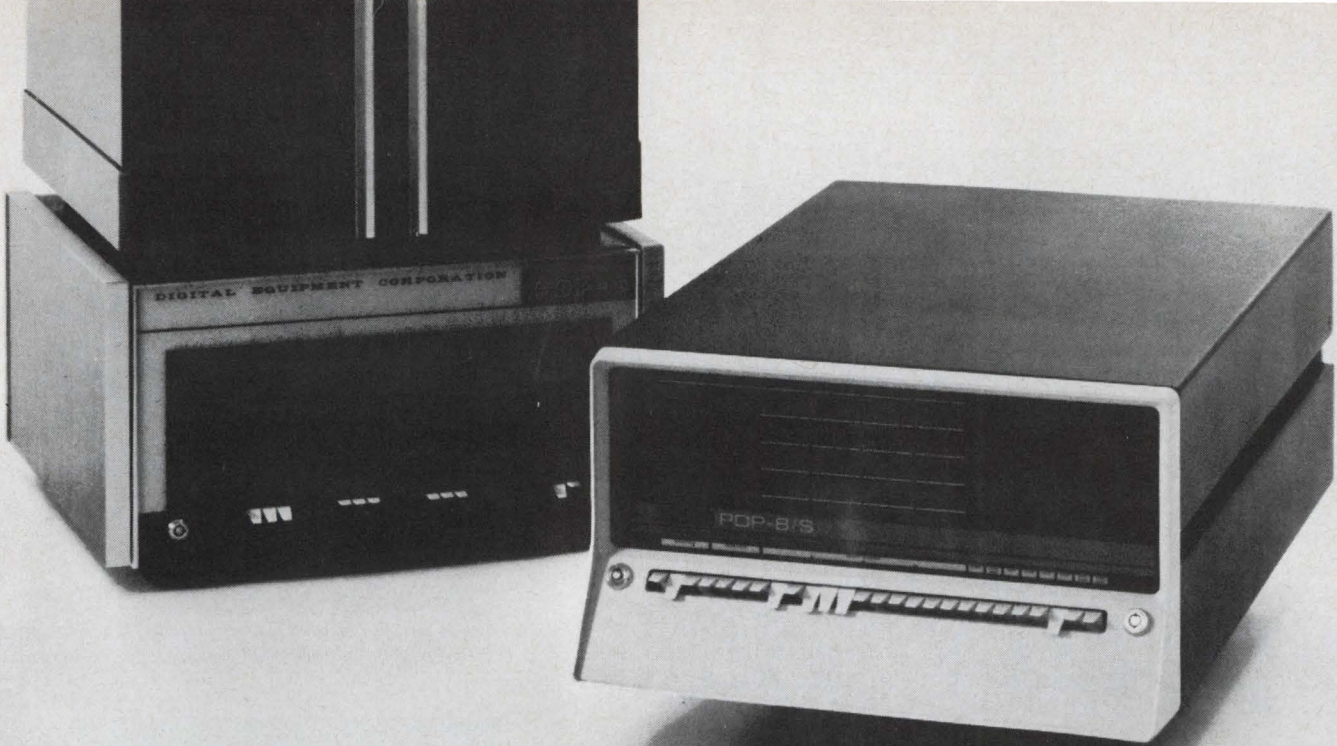

## And Now, the \$10,000 Computer

**PDP-8/S: A new high speed general purpose digital computer. Modular construction for repackaging. Field proven reliability. 4,096 word core memory. Microsecond speeds. Complete software including FORTRAN. Flexible input/output bus. Deliverable 90 days ARO. Teletype included.**

The single unit price for the PDP-8/S is \$10,000, and there are liberal OEM discounts for multiple units.

Designed to be used in instruments or systems, the PDP-8/S can be rack mounted or repackaged.

The new PDP-8/S is a close relation of DIGITAL's PDP-8, the most successful on-line, real time computer in the history of the scientific community. At a base price of \$18,000, more than 500 PDP-8 systems have been sold. Its success results from a design concept that makes it the most flexible, versatile, adaptable digital computer ever made.

The PDP-8/S uses the same programs, the same instructions, the same operations, and the same basic design as the parent PDP-8. It has the same size memory, is equally expandable, and indeed, uses the same line of modules and components.

But the PDP-8/S is a bit slower. It takes 32 microseconds to add. For process control and analysis, you probably won't even notice.

But you'll notice the price.

**digital**  
COMPUTERS • MODULES



# One dozen good reasons for you to specify AE

Buy from AE, and you never have to settle for a relay that's only "marginally" right.

You can choose *exactly*, from a line that's broad enough to give you what you're after — in weights, types, dimensions, configurations, mountings.

And you always get the benefit of AE's experience. Decades of experience in product design, manufacturing techniques, and methods of quality control.

Want some helpful, detailed design information? Ask for Catalog 4071: Selection Guide to AE Relays and Switches. Just drop a line to the Director, Relay Control Equipment Sales, Automatic Electric, Northlake, Illinois 60164.

***AUTOMATIC ELECTRIC***  
SUBSIDIARY OF  
GENERAL TELEPHONE & ELECTRONICS **GTE**

Maximum life  
and reliability

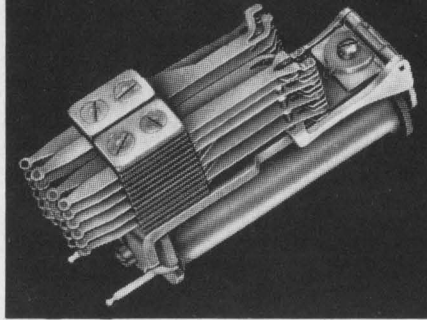

**CLASS B RELAY.** Finest quality telephone-type. Provides hundreds of millions of operations under all mounting and service conditions — with unfailing contact reliability. Combines sensitivity, contact stability, and circuit adaptability. Bifurcated twin-contacts. Long or short armatures for wide range of practical timing. Also for quiet AC operation.

Minimum size  
and weight

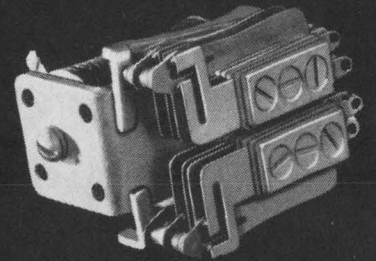

**CLASS S RELAY.** Miniaturized telephone-type for aircraft and similar applications. Small mass, low self-inductance. Provides high contact pressures and absolute contact reliability under extreme vibration, shock and humidity.

Minimal size,  
large contact  
capacity

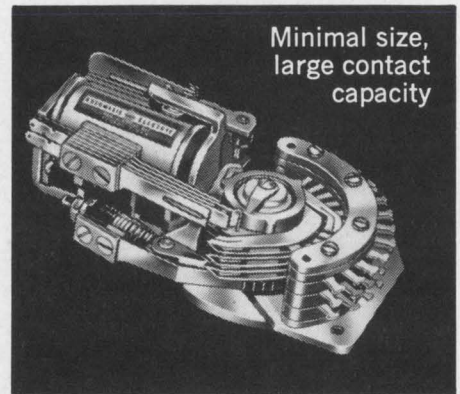

**TYPES 40, 44, 80 and 88 ROTARY STEPPING SWITCHES.** Small switches with large, flexible capacities. Fit almost any DC application. Provide swift, sure, impulse-controlled response . . . plus self-interrupted operation that's smooth and trouble-free. Up to twelve 10- or 11-point levels. Prewired, hermetically sealed units available.



High performance,  
small size

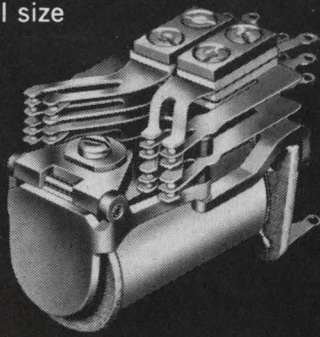

**CLASS E RELAY.** A lightweight space-saver with most of the features of the Class B. Life exceeds 200 million operations. Industry's widest terminal options: taper pin, integral socket, conventional solder, taper-tab, solderless wrap and printed circuit terminals.

Economical  
telephone-type

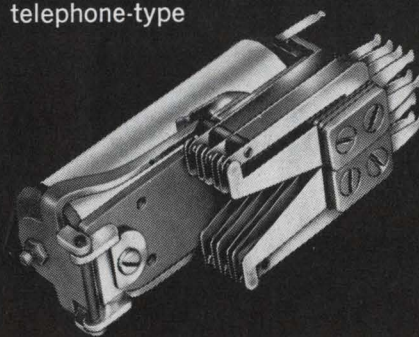

**CLASS A RELAY.** Sturdy and dependable. Can be mounted in any position. The original "workhorse" telephone relay — recommended when the extremely high performance of the Class B is not mandatory.

Premium quality  
space-saver

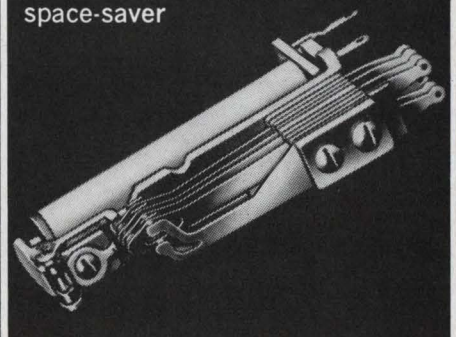

**CLASS C RELAY.** Incorporates many of the features of the Class B relay—but is only half as wide. Use where quality is a must, but space is at a premium. Quick- and slow-acting types, for operation at up to 150 volts DC. Two to twelve contact springs.

Economy and  
small size

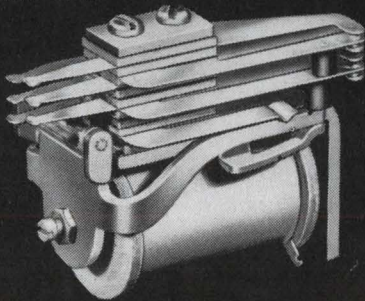

**CLASS Z RELAY.** Small and lightweight, but designed for service where flexibility is most important. Provides adequate coil volume to permit slugging for long operate and release timing. Four types for DC, one for AC, and two with snap-action contacts.

Multiple circuit  
transfers

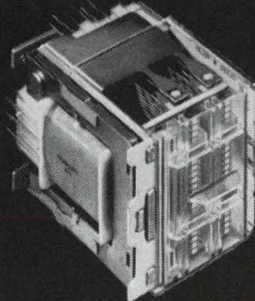

**CLASS W RELAY.** 17, 34 or 51 form C contact-spring combinations. Features low loss insulation, high insulation resistance. Extremely low inter-spring capacitance. Life in excess of one billion operations. Gold contacts available for low-level switching.

Customized  
programming

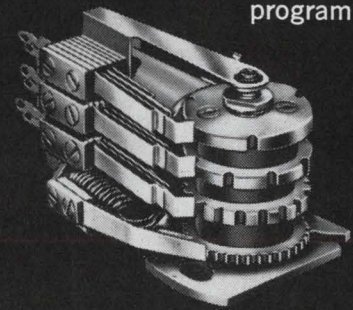

**SERIES OCS RELAY.** Compact and low in cost. For "packaged" programming: will follow or initiate a prescribed series of events at 30 steps per second impulse-controlled — or 65 per second self-interrupted. Much better than an interlock relay — when you're designing for shock, vibration or easy field maintenance.

Maximum capacity—  
unusual versatility

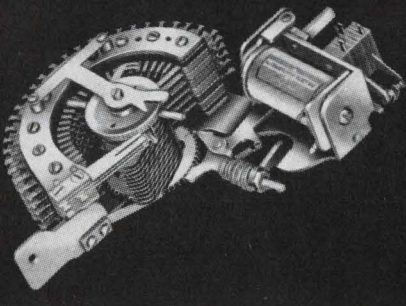

**TYPE 45 ROTARY STEPPING SWITCH.** Larger capacity: up to twelve 25-point levels, eight 50-point levels. For any DC voltage up to 110, or 115 volts AC with rectifier. Can be impulse-controlled or self-interrupted. Available with normally open or normally closed circuits (Type 45NC). Also available as prewired, hermetically sealed units.

High-speed  
control



**CLASS V MERCURY-WETTED RELAY.** For computers, data processing and control equipment. Up to 200 operations per second. No contact erosion, no bounce. Over 1 billion operations without change, maintenance or adjustment. Can be operated within 30° of vertical. Polarized and nonpolarized versions. 1 pole to 4 pole double throw contact forms.

Dry reed switches  
for printed  
wiring boards

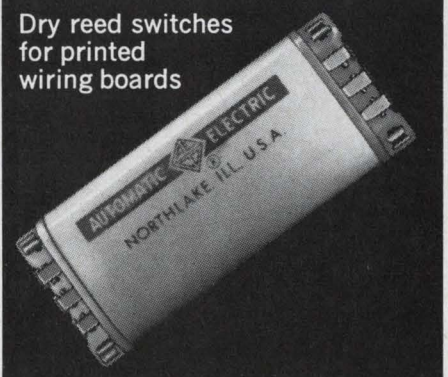

**PRINTED CIRCUIT CORREEDS.\*** Strong, moisture-resistant, compact. Unstressed contact leads provide firm, positive connections. Glass-filled plastic bobbins prevent moisture absorption. Low profiles and magnetic shielding permit high density within standard PC terminal spacing (multiples of 0.200 inches). Available with 1, 2, 3 and 5 capsules and magnetic latching. Contact forms A, B, & C.

\*U.S. Patent applied for



# Letters

## Or did we bark up the wrong tree?

Sir:

In answer to Mr. Klimko's criticism that "phony setups and other Madison Avenue hocus pocus" has no place in your magazine [ED 17, July 19, 1966, p. 38], I disagree with him violently! We engineers don't laugh at ourselves enough. When we can't laugh any longer, we might as well be dead. After all, other reputable magazines find room for humor.

F. Goodenough

Section Head  
Project Mohole  
Brown & Root, Inc.  
Houston

Sir:

Are you sure that you spelled that "frivolity" cat's name right? You guys will really be in big trouble if you didn't, or if he ever reads Roger Field's editorial ["The quest is on for the perfect micronym," ED 17, p. 43] or Digital Equipment Corp.'s advertisement on p. 95 of the same issue! In the meantime, the other 99.9% of your steady readers like a little "frivolity." Heaven protect us from the humorless ones.

H. P. Bradley

Applications Engr.  
Lockheed Electronics Co.  
Los Angeles

## The case against siemens is summed up

Sir:

I wrote my note on the siemens vs the mho [ED 10, Apr. 26, 1966, pp. 35 & 38] in the hope of provoking correspondence that would draw attention to the threatened change. Well, I certainly have gotten my correspondence and such a torrent cannot have failed to attract a good deal of attention.

Now let me see whether I can clear the air a bit. First, let me apologize to the American Mr. Siemen [ED 16, July 5, 1966, p. 33], who seems to have taken my protest personally. I am sorry that he was caught in the cross fire. The proponents of the siemens had better

hope that no one named Mho shows up. Secondly, let me observe that the relative merits of the English and International systems are not at issue here (as was suggested in one letter [ED 15, June 21, 1966, p. 54]); the mho is a metric unit just as is the proposed siemens.

One or two people have taxed me with failure to look up Siemens' career before sounding off. Now, these people have missed a fundamental point: If a man's accomplishments are not famous enough to be common knowledge among most technical people, then he is not fit to have a unit of measurement named after him. The whole point is, you do *not* have to look up Ohm to know what *he* did.

As for the astonished Mr. Boman [ED 19, Aug. 16, 1966, pp. 54 & 56], I am equally astonished that he had never heard of Henry. I have always known that Henry discovered the phenomenon of self-induction, and I read somewhere that he made the mistake of not publishing soon enough. Since I have never had to look him up to see what he did, I cannot provide Mr. Boman with a reference.

Mr. Boman and some others have regaled me with lists of Siemens' accomplishments. To judge by these accounts, Siemens was certainly a remarkably brilliant and inventive man, rather like our Edison. (I would consider the edison just as bad a choice as the siemens.) As these accounts themselves show, Siemens was an inventor, not a scientist; and none of his work, as outlined by my informants, has any particular bearing on electrical conductance *per se*. If there was a reason why Siemens' name was an especially appropriate choice, none of these correspondents has remembered it. On the other hand, Ohm's association with resistance is common knowledge, as is Coulomb's with charge, Newton's with force, and so on through the majority of units in use today.

Finally, if we are asked to substitute the siemens for the mho, I think the burden of justification lies on those who want the change. I think the rest of us may ask: "Why should the siemens be thought better than the mho?" Answers to this question might be that the mho is inconvenient to abbreviate (but not impossible), that it is said to be a



NEW!

3 PHASE/6 SCR  
MAGNETIC AMPLIFIER  
CONTROL for

Fast Rising  
'Hard Firing'  
Output  
Pulses!

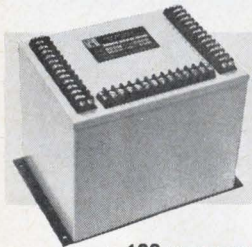

The R613 Series is a family of 3-phase, full wave devices for controlling 6-SCR's in AC and/or DC circuits.

- 100 nanosecond initial pulse rise time
- Delivers 2 amps short circuit current
- Allows mixing of "+" and "-" control signals in 5 control windings
- Sensitivity approximately One Ampere Turn

• Write for Bulletin R613 for full details



**FIRING  
CIRCUITS,  
INC.**

DIV. of MARATHON  
ELECTRIC MFG. CORP.

Muller Avenue • Norwalk, Conn. 06852  
(203) 846/1633

ON READER-SERVICE CARD CIRCLE 23



Each Fluke all-solid-state voltage calibrator gives you more for your instrumentation dollar! Things like 0.0005% line and load regulation in every model. Compact and lightweight construction for portability. Heatfree, fanfree operation for long life and best stability. High speed remote programming in two models. Calibration accuracy to 0.003%. Price range \$1,295 to \$2,490.

Model	Voltage	Current	Stability	Readout	Calibration Accuracy	Panel Height and Weight	Price
313A	0 to 50 vdc 0 to 5 vdc	0 to 2 amps	±0.002%	6 digit inline	±0.01%	5¼"–50 lbs.	\$1,295
315A*	0 to 50 vdc	0 to 1 amp	±0.005%		±0.025%	5¼"–50 lbs.	\$1,895
332A	0 to 1111 vdc	0 to 50 ma	±0.0015%	7 digit inline	±0.003%	7" –60 lbs.	\$2,490
382A	0 to 50 vdc 0 to 5 vdc	0 to 2 amps	±0.002%	6 digit inline	±0.01%	5¼"–50 lbs.	\$1,595
383B*	0 to 50 vdc	0 to 2 amps	±0.005%		±0.025%	5¼"–50 lbs.	\$1,950

\*Remotely Programmed



FLUKE • Box 7428, Seattle, Washington 98133 • Phone: (206) 776-1171 • TWX: (910) 449-2850

Model 332A  
Voltage Calibrator

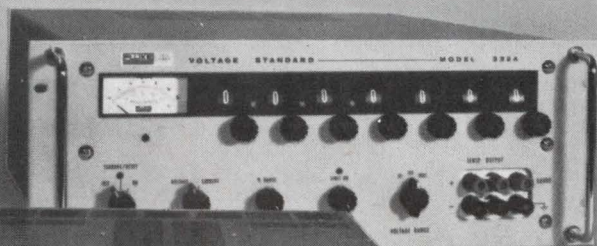

Model 383B  
Remotely  
Programmed  
Voltage/Current  
Calibrator



Model 315A High-Speed  
Remotely Programmed Voltage Calibrator



Model 382A Voltage/Current Calibrator



Model 313A  
Voltage Calibrator

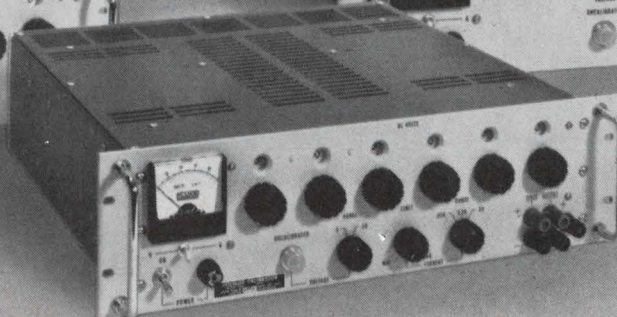



**A NEW  
QUALITY STANDARD  
IN GOLD  
PLATING OF  
SUBMINIATURE  
CONTACTS, ETC.**

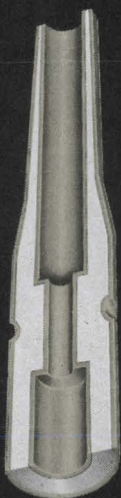

Bisected sub-miniature contact point, shown approximately ten times size, illustrates gold coverage with Burton's new plating processes.

\*  Burton's new plating processes makes it possible to gold plate sub-miniature hollow parts to specification MIL G45204, with complete coverage inside and out, without bleed holes. Full electrical properties are assured. Specialized equipment enables 48 hour turn around after receiving parts! May we tell you more about it?

\* ACTUAL SIZE



*Burton Silverplating Company*

6341 ARIZONA CIRCLE, LOS ANGELES, CALIF. 90045 • (213) 776-4090 • 391-6743

LETTERS

little more recent than the siemens, and that it is silly to spell a person's name backwards. I question whether these reasons are weighty enough to set our technical community to revising its terminology. In particular, I question whether mere antiquity is a valid criterion. Lord Kelvin himself must have been aware of the Paris Congress of 1881; yet he thought it worthwhile to propose the mho, and it has been used extensively ever since, probably because the mho is self-explanatory while the siemens is not.

There remains the question whether we should name a unit of conductance after the inventor of a new kind of insulation. There also remains the matter of giving all that free advertising to Siemens A.G. But I rest my case. I feel we have wasted enough space in ED's pages on this. If through continued American apathy we end up with the siemens, we shall have deserved no better. Perhaps somebody should start a campaign to change the unit of potential from the volt to the general electric. They might let us use their famous script trademark for the symbol.

Thomas W. Parsons  
Cardion Electronics, Inc.  
Woodbury, L. I., N. Y.

**The Chinese have  
a name for it**

Sir:

The proposal aired in your letters column to rename the unit of conductance the "siemens" does dishonor to an important figure in the field of electronics whose contributions are already much neglected.

Mho Wang Fu (1193-1127 B.C.), the distinguished Chinese philosopher, began his first crude experiments with electricity in 1161 B.C. His experimental apparatus consisted of zinc and copper electrodes connected by a copper strap and immersed in an electrolyte of sea water. As the copper connector disintegrated in a burst of heat and light, Mho discovered the phenomenon of conductance, the unit of



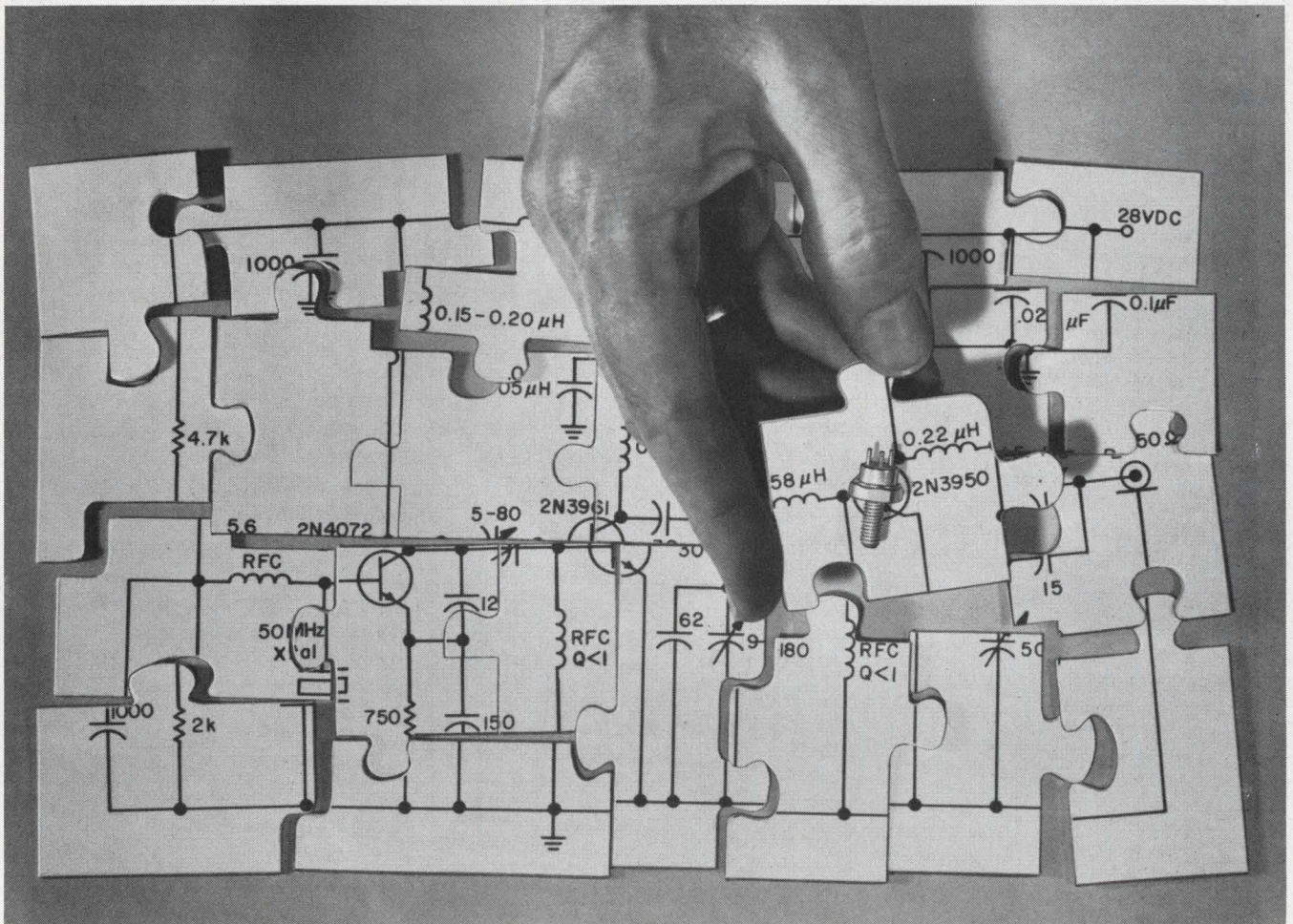

## The First RF Power Transistor that **GUARANTEES** 50 Watts(min) at 50 MHz and, is reasonably priced!

If you're designing a class C circuit where high-power output and high gain are mandatory, the new Motorola 2N3950 RF transistor is your best answer. For industrial or military use (airborne or mobile), for AM-FM, or single sideband applications — any application where *Guaranteed* power output at a realistic cost is required — the 50 watt at 50 MHz power output performance (with 8 dB minimum gain) of this newest Motorola transistor is the solution to your problem.

In addition, you get sustained, high VHF power with lower package losses — using Motorola's highly efficient TO-60, grounded-emitter package.

For complete data about the 3-stage transmitter design illustrated above ask for Motorola Applica-

Try the new Motorola MM1500

**MICROWAVE POWER TRANSISTOR**

**FEATURING**

¼-watt Power Output @ 1500 MHz  
... for microwave links, transmitters,  
and telemetry!

tion Note 246. Or, for applications information and detailed specifications about Motorola's 2N3950 or MM1500 — or any other RF Power transistor in the broad Motorola line — write to Technical Information Center, Motorola Semiconductor Products Inc., P.O. Box 955, Phoenix, Arizona 85001.



**MOTOROLA Semiconductors**  
*— where the priceless ingredient is care!*

Speed Inquiry to Advertiser via Collect Night Letter  
ON READER-SERVICE CARD CIRCLE 26





*we've been around...*

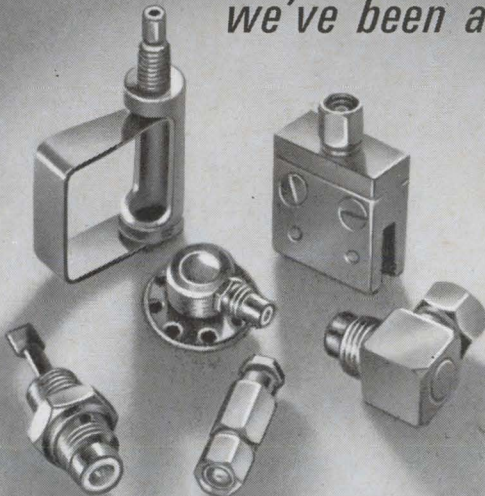

## SUBMINIATURE R.F. CONNECTORS

We've been performance proven around the world on every major space effort. Our specifications, VSWR, electrical and mechanical reliability, and cable retention ability, are not just words on a sheet of paper, they have been proven the hard way... in space, in aircraft, in every application where precision performance is a must. Plus... we're over 300 strong to meet virtually every conceivable subminiature R. F. connector specification. Screw-on, snap-on, and slide-on mating engagements; cable crimp and cable clamp cable retentions, gold plating, Teflon<sup>®</sup> insulation, and captivated contacts are all included in our family. Write for our complete biography, it's yours for the asking.



R. F. COMPONENTS DIVISION

**SEAELECTRO**  
CORPORATION

HOYT STREET • MAMARONECK • NEW YORK  
PHONE: 914 698-5600 TWX: 710-566-1110

Seaelectro Ltd., Portsmouth, Hants, England

\*Registered Trademark E. I. DuPont De Nemours & Co.

ON READER-SERVICE CARD CIRCLE 27

## LETTERS

which was named in his honor. Unfortunately Mho's later experiments were unsuccessful because he never progressed to the point of removing the shorting bar from across his primitive battery. In 1127 B.C., Mho was attempting to extract electricity from the atmosphere by flying a large dragon kite from a wire lead in a thunderstorm. A large bolt of lightning struck the kite and he was electrocuted instantly.

Years later, as the study of electricity again developed, the unit of conductance was named after Mho and the letters of his name were reversed to designate the unit of resistance, the ohm. Unfortunately Mho's contributions to the study of electricity were totally eclipsed by the rise of European Nationalism in the middle 1800s. Unwilling to give credit to a foreigner and an Oriental for significant scientific developments, nationalists created the mythical figure of George Simon Ohm, to whom they attributed Mho's more important discoveries.

Today, Mho's reputation is in almost complete oblivion. Even the most complete encyclopedias fail to mention his name or achievements. The only monument remaining to this great man is the use of his name for the unit of conductance and even this seems to be on the verge of being denied to him.

Roger T. Stevens  
Annandale, Va.

## Accuracy is our policy

In "Single-digit read-outs" in the Components listing of the Products Section of ED 17, July 19, 1966, p. 120, the incandescent lamps are rated at 0.07 A, not at 0.7 A as printed.

Hewlett-Packard's 1-GHz sampling plug-ins described on p. U104 of ED 19, Aug. 16, 1966, were not assigned a Reader-Service number. For information on models 1410A and 1425A, circle No. 121 on the Reader-Service Card appearing in this issue.



# CERASEAL®!

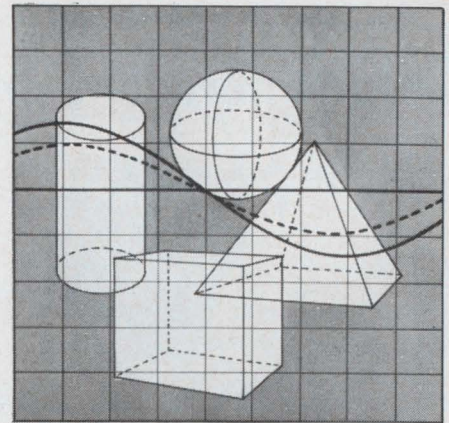

## a new solid state-of-the-art ceramic capacitor!

<p><b>MIL BX CHARACTERISTICS</b></p>	<p><b>DOCUMENTED RELIABILITY</b></p>	<p><b>MONOLITHIC CONSTRUCTION</b></p> <p><b>COMPLETE HERMETICITY</b></p>	<p><b>RADIATION RESISTANT</b></p>	<p><b>CKR06 &amp; CKR12 SIZES</b></p>
--------------------------------------	--------------------------------------	--	-----------------------------------	---------------------------------------



NOW FROM Hi-Q... the originators and pioneers of second generation ceramic capacitors comes the first in a series of a complete new *third generation* ceramic capacitor CERASEAL! Here is a truly solid-state capacitor featuring monolithic construction, complete hermeticity... yet *without* any exterior encapsulation. This completely new capacitor construction offers you all the guaranteed and documented reliability of our now famous second generation CERALAM capacitor.

CERASEAL offers you unexcelled characteristics including extremely high radiation resistance, MIL BX characteristics ( $\pm 15\%$  without voltage,  $+15\%$   $-25\%$  with voltage), and operating temperature range from  $-55^{\circ}\text{C}$  to  $+125^{\circ}\text{C}$ .

Selected commercial and military Hi-Q products are available off-the-shelf from Authorized Aerovox Distributors.

ON READER-SERVICE CARD CIRCLE 28



**AEROVOX CORPORATION**  
OLEAN, N. Y.



# NEW DEUTSCH SYSTEM OBSOLETES

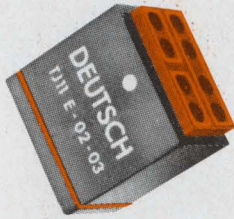

## THE TERMINAL JUNCTION

A new system for point to point wire connection and integration

This newest, most flexible system releases today's engineer from the limitations usually associated with interconnection. One wire or thousands of wires may be connected by this simple, reliable method that:

- Replaces terminal strips and binding posts
- Does away with contact damage
- Eliminates splices and solder
- Uses standard crimp tools
- Uses **one** fail-safe, expendable assembly tool
- Uses **one** fool-proof assembly procedure
- Is self-locking
- Is modular
- Saves weight and space
- Connects and disconnects instantly
- Protects connections without potting
- Meets or exceeds MIL-C-26482 where applicable, and exceeds most user specifications

The Terminal Junction system is the ultimate in simplicity.

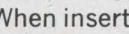
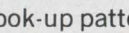
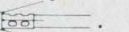
- The wire termination is ruggedized so that it can't bend, break, bind or gall .
- Crimping the terminal to any wire is done with standard tools, and provides strong, reliable termination . When inserted in the modular block, the terminations are interconnected instantly in a variety of hook-up patterns .
- The low-resistance connections are secured by self-locking retainers that defy vibration, shock and high pulling loads .

System build-up, breadboarding and all processes where one must patch, bus, splice or feedthru can be vastly simplified with this flexible, "people oriented" system. Its simplicity, combined with total reliability, makes possible immediate conversion without special training of assembly personnel... and, with the move to Terminal Junctions come the benefits of efficiency and upgraded connections.

The following columns describe how you can save time, space and circuits. Read on... let your own ingenuity dictate how you can benefit by using this revolutionary system.

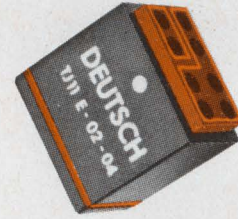

## TIME SAVER

The Terminal Junction system eliminates wasted time and motion in all phases of equipment design, breadboard, prototype, assembly, checkout and maintenance.

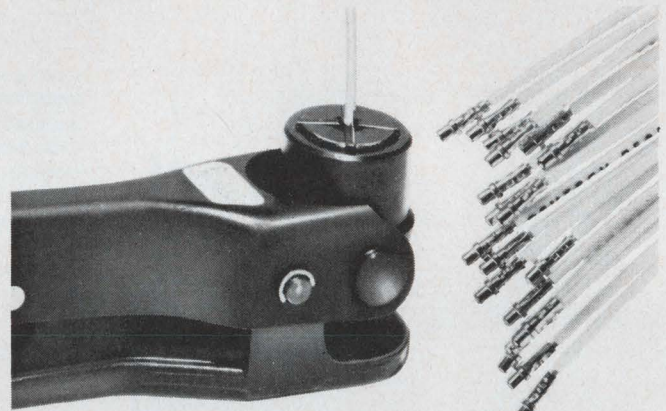

Quick, reliable crimp termination of wires with standard tools.

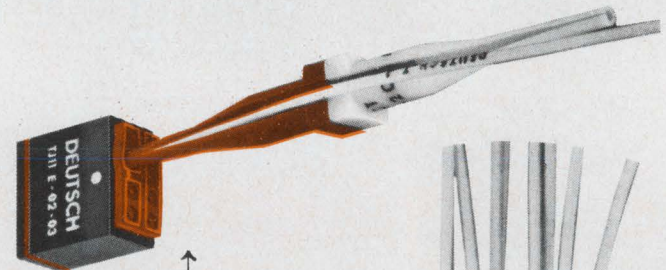

Instant connection (or disconnection) requires one, fail-safe, expendable tool which is small enough to be stored with wire harnesses.

One Terminal Junction module, with eight wires that have been connected in a fraction of the time required by other methods. 

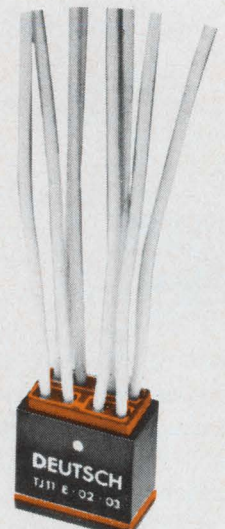

\*Terminal Junction modules shown are model TJ11E-02\*\* which connect wire sizes AWG 20 through AWG 24.



# EXISTING CONNECTION METHODS

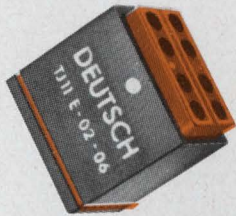

## SPACE SAVER

Terminal Junctions occupy a fraction of the space formerly needed for an equal connection capacity. And, there is no limit to the number of modules and multi-module assemblies that may be used to form high density interconnection panels and systems.

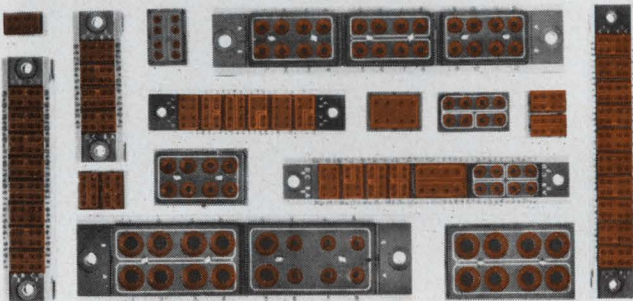

Typical module and multi-module assemblies for space-saving connection and integration. Standard units shown will handle wire sizes AWG 24 through AWG 4. White lines on each module outline points of common connection.

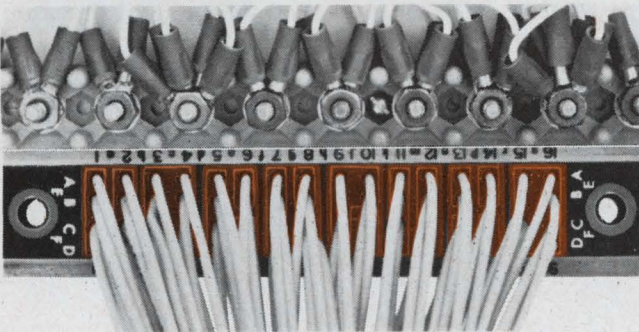

Sixty four size AWG 20 wires perfectly connected and fully protected in a fraction of the space previously needed. Compare the amount of space saved in this case... the terminal strip handles only 28 wires, and affords them no protection.



Use Feedthru Terminal Junctions for all through-connection applications; use them as high density, lightweight, fully environmental connectors; or, use multi-module assemblies for patchboard and through-panel applications.



The **JIFFY JUNCTION**® is a fully environmental single conductor connector. Use it as a replacement for splices or any one-wire connection problem.

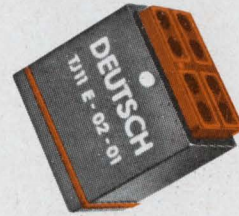

## CIRCUIT SAVER

Circuit and equipment failures due to the breakdown of exposed or poorly protected junctions and splices are eliminated by Terminal Junctions. All connections in each module are protected from mechanical damage by solid dielectric material; shorting caused by moisture and contaminants is prevented by resilient silicone rubber sealing glands at each wire entry point; the positive locking retention system resists shock, vibration and high pulling loads to assure perfect continuity in each circuit. Dielectric separation between circuits exceeds military specifications, and because the tool used for connection and disconnection is of dielectric material the shorting possibility normally associated with checkout and maintenance is reduced to a minimum.

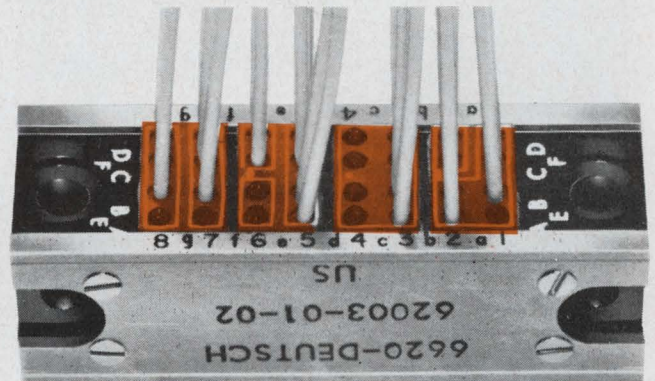

Actual size modules are shown in a multi-module assembly; typical busing layouts are included (white lines outline common connection points). Those entry points not occupied by wires are sealed by plugs to assure complete environmental immunity.

The Terminal Junction is the newest member of the performance proven Rear Release Family of Deutsch connectors and interconnection devices. Using **one** type of crimp tooling, **one** assembly procedure, and **one** fail-safe insertion/removal tool, any interconnection system may be upgraded to modern levels of efficiency and reliability. For more information about Terminal Junctions contact your local Deutschman, or write today; ask for Data File TJ-3.

# DEUTSCH

ELECTRONIC COMPONENTS DIVISION • Municipal Airport • Banning, California

ON READER-SERVICE CARD CIRCLE 29



**TRW**  
gives you...

**THE MOST  
EFFICIENT  
5 AMP  
SWITCHING  
TRANSISTORS  
IN SPACE**

**SPEED: 80MHz**

**GAIN:  $50h_{FE}$  @ 1A**

**SATURATION: 1V @ 5A**

Every characteristic the designer needs for top performance airborne inverters and switching regulators are combined in the new TRW 2N4305—2N4312 power transistors...high frequency...high gain...low collector saturation voltage.

Another plus factor in this outstanding new series is operating voltage characteristics as high as 120V.

Available in TO-5 packages. Available in Low Profile Isolated Stud packages. Available NOW from authorized distributors everywhere!

For detailed technical information write TRW Semiconductors Inc., 14520 Aviation Blvd., Lawndale, Calif. 90260. Phone: 679-4561. TWX: 910-325-6206. Cable TRWSEMICONs / Telex: 67-7148.

**TRW SEMICONDUCTORS**

ON READER-SERVICE CARD CIRCLE 30



**Co-Publishers**

James S. Mulholland, Jr.  
Robert E. Ahrensdorf

**Editorial Director**

Edward E. Grazda

**Editor**

Howard Bierman

**Managing Editor**

Robert C. Haavind

**Technical Editors**

Joseph J. Casazza  
Rene Colen  
Maria Dekany  
Mark B. Leeds

**News Editors**

Frank Egan  
Roger K. Field

**East Coast Editor**

Neil Sclater

**West Coast Editors**

Ralph Dobriner  
Peer Fossen

**Copy Editor**

Peter Beales

**New Products Editors**

David Surgan  
Genevieve Adey

**Washington Editor**

S. David Pursglove

**Editorial Production**

Dollie S. Viebig  
Mary Lou Goldstein

**Art Director**

Clifford M. Gardiner

**Art Assistant**

William Kelly

**Technical Illustrators**

Lewis D. Hill  
Cheh Nam Low  
Douglas Luna  
Robert Ranta

**Production Manager**

Thomas V. Sedita

**Asst. Production Manager**

Helen De Polo

**Production Assistants**

Carl Merkin  
Bernard Wolinsky

**Circulation Manager**

Nancy L. Merritt

**Reader Service**

Diane Pellechi

## EDITORIAL



## The Merchant Marine is in need of help

If the recommendations of a Presidential task force appointed to study the nation's shipping industry are accepted, the U.S. Merchant Marine will, in 1985, only be large enough to carry about 8% of this nation's waterborne foreign trade. Contrast this with 40% in 1950 and the plight of our merchant fleet is obvious.

Decline in U.S. shipping and the accompanying decay of the nation's shipbuilding capacity can only worsen the balance of payments problem as well as gravely hinder the nation's abilities to meet its worldwide commitments, the most recent and obvious of which is Vietnam.

The one reason most often put forth for the sorry state of our merchant marine is the high operating costs of U.S. ships and shipbuilding. The bulk of these high operating expenses are blamed on the high wages of U.S. seamen and craftsmen, coupled with the extremely high safety standards required by Federal law. Similar problems have been faced, and met, in other segments of U.S. industry.

We believe that the electronic industry has a role to play in improving the picture. Automation may spell the difference between a healthy, competitive, emergency-ready merchant fleet and virtually no fleet at all. True, some seagoing automation is in existence: engine room controls, some cargo-handling machinery, container ships, etc. But no real, concerted effort has been made to broaden the automation of ships, shipbuilding facilities and shore-based cargo-handling facilities.

The Federal Government, in our opinion, would be well advised to implement a forced-draft program of modernization to encompass the nation's entire shipping industry. If this program were undertaken with the objective of building, maintaining and encouraging a merchant fleet designed to improve our trading position vastly vis-à-vis the great maritime powers, then the co-operation of both unions and management would be all but automatic. With the promise of increased profits and jobs, what else could it be?

The electronic industry has not only an opportunity here but also a responsibility. Our technological capacity and abilities are second to none and should be marshaled to focus on a problem which has plagued the United States during major crises throughout the Twentieth Century. The electronic engineer may hold the key to the survival of our ability to compete effectively in the world market place. Time is not on our side. Technology is. Let's use it.

JOSEPH J. CASAZZA



# OPERATIONAL AMPLIFIERS

these 8 op amps meet 65% of industry's needs  
we have 20 more models for the other 35%

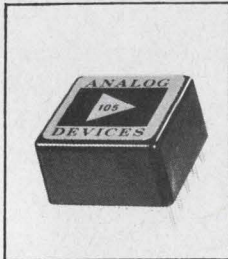

## GENERAL PURPOSE \$19

20  $\mu\text{V}/^\circ\text{C}$ , 1.5  $\text{na}/^\circ\text{C}$  drift

Model 105 specs include  $\pm 10\text{ V}$ , 2.2 ma short-proof output, 30,000 min gain, 1.5  $\mu\text{V}/^\circ\text{C}$  current drift (each input), 20  $\mu\text{V}/^\circ\text{C}$  voltage drift, 150 na max offset, 150 K and 50 megohm input impedance. PRICE \$19



## CHOPPER STAB'D \$157

1  $\mu\text{V}/^\circ\text{C}$ , 2  $\text{pa}/^\circ\text{C}$  drift

Model 210 has built-in chopper drive and fast overload recovery circuit. Unit features 100  $\text{V}/\mu\text{sec}$  slewing rate, full output to 500 KHz,  $\pm 10\text{ V}$ , 20 ma output, 5  $\mu\text{V}$  P-P voltage noise. PRICE \$157



## FAST RESPONSE

10 MHz noninverting

Model 102 settles to 0.1% in 1  $\mu\text{sec}$ . Includes 20  $\mu\text{V}/^\circ\text{C}$  and 0.4  $\text{na}/^\circ\text{C}$  max drift,  $2 \times 10^6$  gain, 30  $\text{V}/\mu\text{sec}$  slewing rate, full power to 500 KHz,  $\pm 11\text{ V}$ , 20 ma output. PRICE \$95 (\$120 for 5  $\mu\text{V}/^\circ\text{C}$ )



## VARACTOR BRIDGE

$10^{-12}$  amp offset,  $10^{12} \Omega$

Model 301 harnesses parametric principles to achieve ultra-low offset, drift, and noise, has  $\pm 300\text{ V}$  common-mode rating. Specs include 1  $\text{pa}$  offset and 0.06  $\text{pa}/^\circ\text{C}$  drift at 25 $^\circ\text{C}$ , 0.01  $\text{pa}$  & 1  $\mu\text{V}$  P-P noise. PRICE \$198



## ULTRA-LOW DRIFT

0.2  $\mu\text{V}/^\circ\text{C}$ , 0.5  $\text{pa}/^\circ\text{C}$

Model 203 chopper-stabilized op amp has built-in chopper drive and fast recovery circuit,  $10^6$  gain,  $\pm 11\text{ V}$ , 20 ma output, 10 MHz gain-bandwidth, 20  $\mu\text{V}$  initial offset, 1  $\mu\text{V}$  long-term drift. PRICE \$215



## FET INPUT

$10^{-10}$  amp offset

Model 140 is a low-cost op amp for high-impedance circuits. Input impedance is  $10^{11}$  ohm (diff),  $10^{12}$  ohm (C.M.). Other features are 1.5 MHz gain-bandwidth, 50,000 gain,  $\pm 10\text{ V}$ , 2 ma output. PRICE \$85.

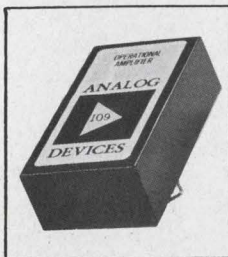

## HIGH CURRENT \$55

$\pm 10\text{ V}$ , 20 ma output

Model 109 is a low-cost, high-current unit with performance embracing 150,000 gain, 20  $\mu\text{V}/^\circ\text{C}$  voltage drift, 1.5  $\text{na}/^\circ\text{C}$  current drift (each input), 1.5 MHz gain-bandwidth, and  $\pm 10\text{ V}$ , 20 ma output. PRICE \$55



## LOW CURRENT DRIFT

0.3  $\text{na}/^\circ\text{C}$  drift

Model 108 is for high-impedance, low-frequency use. Includes 30,000 gain, 20  $\mu\text{V}/^\circ\text{C}$  voltage drift, 0.3  $\text{na}/^\circ\text{C}$  current drift (each input),  $\pm 10\text{ V}$ , 2.5 ma output, 4 megohms and 500 megohms input impedance. PRICE \$35

If you'd like to try any one of Analog Devices' 28 different models in your circuit, we'll be glad to ship it to you on loan. Just drop us a line.

We also offer four free application manuals, covering theory, circuits, selection criteria, and current-& voltage drift. We'll send these too.



**ANALOG DEVICES, INC.**  
221 FIFTH STREET  
CAMBRIDGE, MASS. 02142  
PHONE: 617/491-1650





Improve  
Color TV life,  
reduce costs

Multifunction G-E compactrons do the job of 2 or more ordinary tubes . . . require less wiring and simplify your circuitry. Now G.E. offers 5 new types. G.E.'s new 6AG9 is the industry's first ultra-high transconductance video output pentode to incorporate other functional elements (in this case, a triode). The 6EF4 is an improved 40-watt, high voltage regulator that protects against destructive arcing.

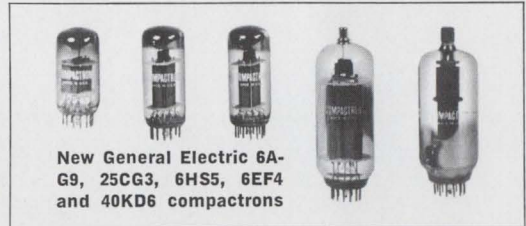

New General Electric 6A-G9, 25CG3, 6HS5, 6EF4 and 40KD6 compactrons

The 6HS5 is a new type of high voltage regulator of the pulse-shunting variety. The 40KD6 and the 25CG3 are series-string versions of the 6KD6 and 6CG3 respectively, designed for 270-volt large-picture sets. Circle **Number 90** for more details.

How tiny can  
a transistor get?

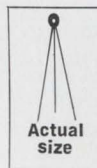

0.07 x 0.07 x 0.085 inches is all G.E.'s new microtab transistors measure. Yet each delivers precisely the same performance as its larger, conventional-sized counterpart. They're perfect for hearing aids, miniature operational amplifiers and very small instruments . . . or for your hybrid circuits, and linear and analog circuits. Equivalents to 2N930, 2N2484 and 2N918 transistors are already available for less than \$1.00 in quantities. Circle **Number 91** on the magazine inquiry card.

Designing small motors?  
Better check this  
new magnetic material.



Improved Cast Alnico 8

General Electric's new Improved Cast Alnico 8, the best material for small motor applications, is now available. Although this new material can be substituted directly for some existing designs at comparable costs, it is more economical and efficient to redesign the motor to utilize the improved properties available. Improved properties provide greater flux density, high coercive force, extreme temperature stability, and greater useful recoil energy. Circle **Number 92** for complete information.

What's new  
for peripheral  
computer equipment?

**Instant response**—inertial time constants low as 1 millisecond—is what you get with the new G-E Hyper-Servo\* motor. And it accelerates faster than any other motor ever developed by General Electric. Hyper-Servo motors greatly increase the overall capacity of peripheral data processing equipment. They're available in 3.4-, 4.6-, and 4.8-inch diameters. Performances include torque-to-inertia ratios in excess of 350,000 rad/sec<sup>2</sup> and continuous torque ratings from 32 oz-in at 2700 rpm to 326 oz-in at 2800 rpm. A wide variety of models can provide the high performance drive motor for nearly every computer peripheral application. Circle magazine inquiry card **Number 93**.



New high-response  
d-c motor

\*Trademark of the General Electric Company.

Switch to the  
lowest cost SCR



G-E C106 SCR's cost from 35 to 50¢ in volume. That's about half the price of other "low cost" SCR's. Yet you buy them at no sacrifice to performance or quality. New, planar C106's are reliable . . . give exceptional electrical uniformity and long term stability. They feature up to 200-v blocking capability, microamp triggering, and a configuration that's excellent for printed circuits, plug-in sockets, screw mounting, and point-to-point wiring. Circle **Number 94** on the magazine inquiry card.

Actual size G-E C106 SCR

**MORE**





Tried this  
45-minute timer circuit?

Check this circuit against others like it. See for yourself how it eliminates the need for many other components. The 2N2646 transistor applies a sampling pulse to base 2 of the 2N1671C and reduces required trigger current by 1,000:1 or more. Circle **Number 95** if you'd like a comprehensive paper on this and many other circuits like it.

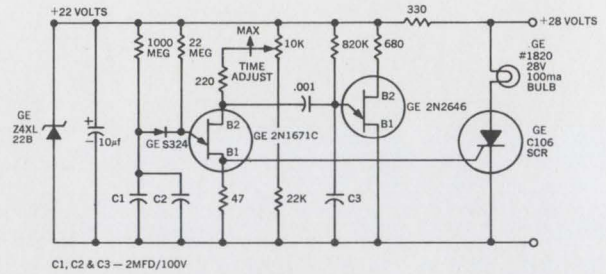

Featuring the low-cost 2N2646 transistor and C106 SCR

Look!  
A 5-amp relay  
in a  
2-amp package

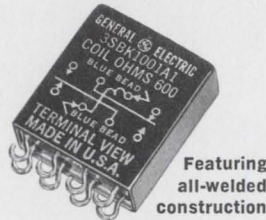

Weight: just 0.7 ounce maximum. Now, the proven magnetic motor design of G.E.'s 3SAF microminiature relay is combined with new, heavy-duty contacts and terminal leads. Result: 5-amp switching capability in a microminiature grid-space package. We call it the 3SBK. Electron-beam welding eliminates the need for solder flux, adding greater strength and delivering more trouble-free performance. Circle magazine inquiry card **Number 96**.

Up to 50 kv  
in this small ignitron

Use the ZG-7248 ignitron for high-energy-rate switching or crowbar service. You'll find that when adequate anode-to-cathode temperature differential is maintained, it is a reliable 50 kv device that will conduct up to 25,000 amps and a total charge of over 20 coulombs. Or you can take advantage of the auxiliary electrode that's provided for circuit control at very low currents. Maintain a current of just 10 amps between the auxiliary electrode and the cathode, and the tube will maintain its conducting state even for main anode currents of a few amps. Circle magazine inquiry card **Number 97**.



The ZG-7248

Introducing...  
new sub-miniature  
wet-slug capacitor

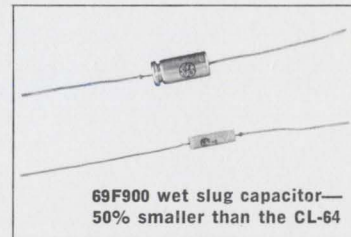

Why struggle with larger-sized capacitors in your miniaturized circuits? Use G.E.'s new 69F900 sub-miniature tantalum wet-slug capacitor. Delivers performance and application characteristics virtually identical to those of standard military CL-64 units. Voltage ranges from 6 to 60 volts. Capacitance from 3.3 to 450 microfarads. And the 69F900 is especially suited for data processing, communication, and other industrial applications. Circle **Number 98** on the magazine inquiry card.

Tiny tubes for new  
telemetry frequencies

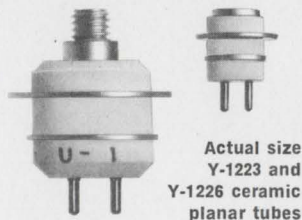

Use the tubes specifically designed for the new 2200-2300 MC telemetry frequencies—G.E.'s Y-1266 and Y-1223 ceramic planar tubes. The Y-1266 packs excellent gain and efficiency, and 2-watt power capability into a tiny, 2-ounce package. The Y-1223's new high dissipation anode gives 10-watt power output at 2300 MC to provide higher power... improved RF characteristics, too. Couple the two tubes together for a small, reliable, low cost, two-tube circuit for space probes. Circle **Number 99** for more details.

**WE MAY NOT OFFER EVERYTHING YOU WANT FROM ONE COMPONENTS SUPPLIER. BUT WE DO COME A LITTLE CLOSER THAN ANYONE ELSE.**

**GENERAL ELECTRIC**



# Technology

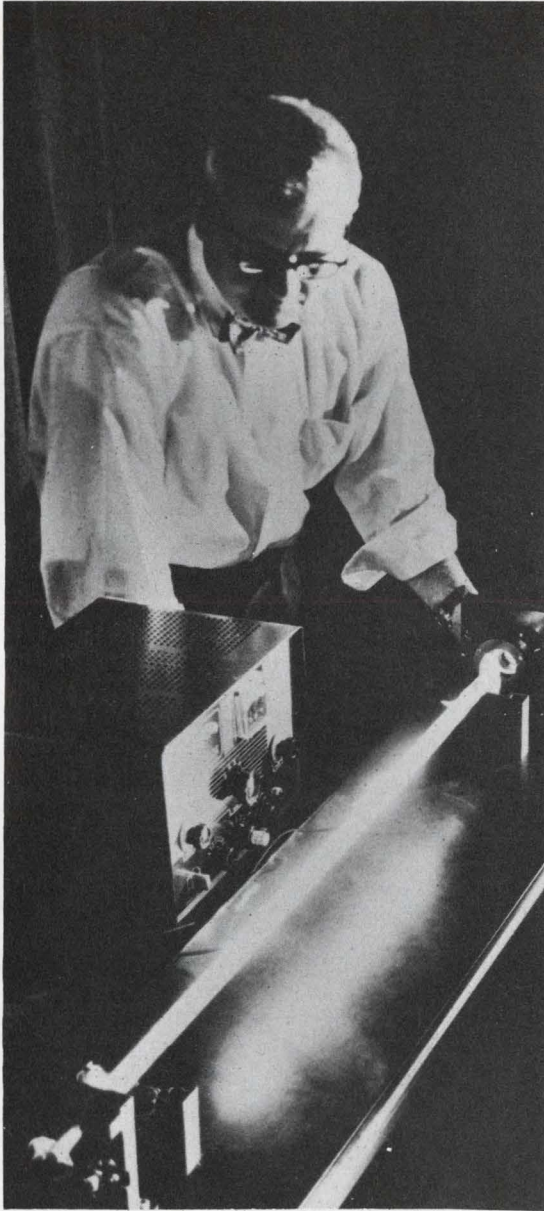

**Electro-optical equipment** like this laser is opening up new design fields. Page 50

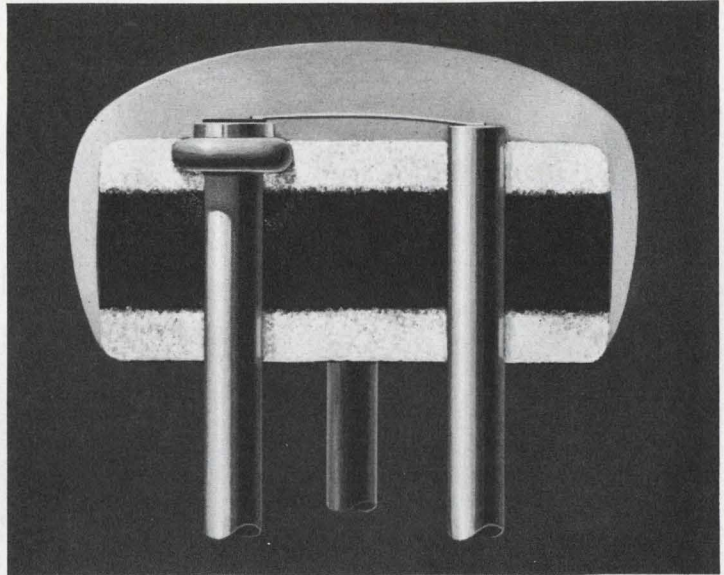

**Germanium FETs**, their applicability and use, stir controversy among engineering experts. Page 81

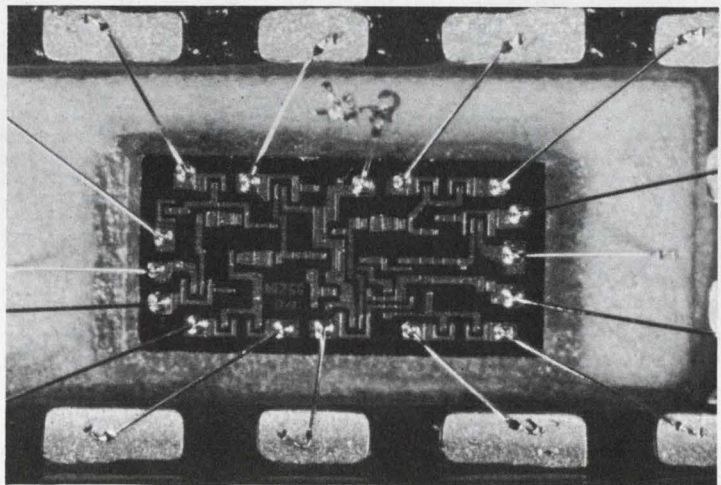

**DTL logic gates** and a capacitor can be used in a whole range of different multivibrators. Page 74

## Also in this section:

**For remote gain control**, properly biased diodes yield linear, stable gain. Page 70

**Digital computers** are simple if thought of in terms of their functions. Page 86

**Learn the fundamentals** of contracts. Page 100



# ELECTRO-OPTICS

Design engineers can no longer afford to neglect electro-optics, an expanding field of growing importance, where electronics is already harnessing laser energy.

By **Maria Dekany**, Technical Editor





## Better laser modulation sought

with electro-optical method. Present research could pave the way for everyday application of beam.

There are several ways to modulate and deflect a laser beam, but none has yet proved completely satisfactory. Two problems have prevented full exploitation of the laser in communications, data transmission, computers, television and other areas: the beam must be modulated at a reasonably high rate, and the cost must be economical.

These requirements—in one form or the other—expose the major drawbacks in mechanical and electrical modulators, the two broad methods in use today. Of the two methods, electrical modulation—specifically electro-optical—offers electronic designers the best hope for the future. Research is under way to improve electro-optical modulator performance to the point where it will be feasible to use lasers in everyday applications.

A look at the modulators available today shows that mechanical modulators are merely mirrors that vibrate at the information rate and change the path length of the beam. This in turn changes the beam's phase with respect to an unaffected beam. The drawback is speed: The mirrors cannot respond to a driving rate much above 5 MHz.

There are two kinds of electrical modulators: electro-acoustical and electro-optical. In the first, acoustical waves are set up in certain materials. They interfere with the incident laser beam and deflect it. The deflection also yields a small amount of frequency shift. But because the frequency shift is small, applications are limited to a very few areas, mostly in laboratory testing and experimental work.

Electro-optical modulators, on the other hand, offer wide dynamic ranges and can follow rapid variations in applied voltage. In this method the crystals change their refractive index with the electric field. The incident beam is split in two and each travels at a different velocity within the crystal. This results in a phase difference between the two parts at the output. Electro-optical modulators are most suitable for applications in the electronics industry. They do have limitations, though:

- They are temperature-sensitive. It is difficult to operate them with a cw laser.

- They require a large driving voltage, and this means expensive, high-voltage, vacuum-tube circuitry.

- They demand perfect crystal structures for peak performance, and this is very hard to achieve; any nonuniformity deteriorates high-frequency performance.

Still, they are the best available today for electronics engineers. And an examination of the

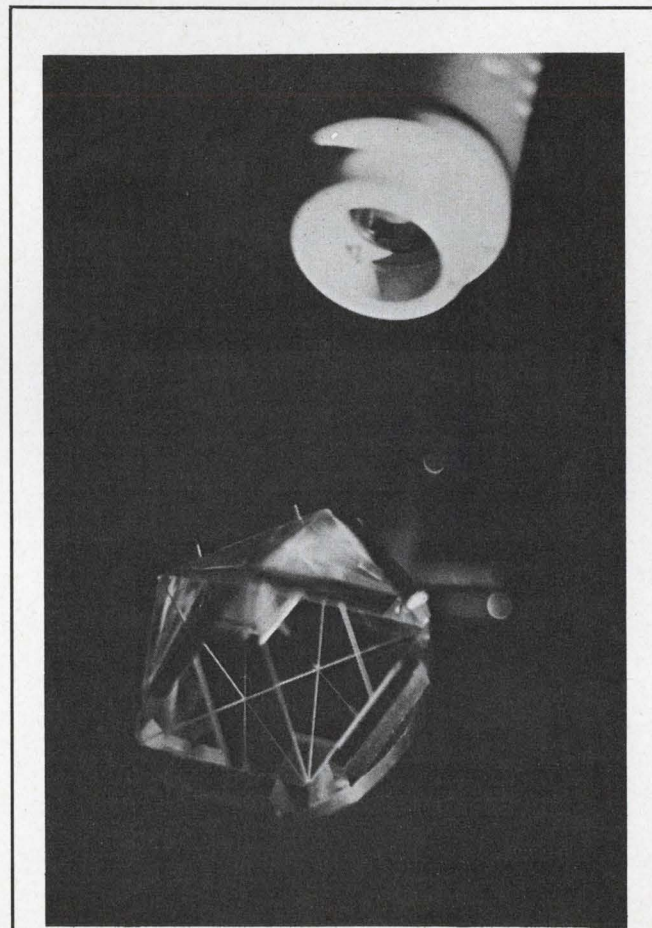

**Five-corner cube reflector**, designed for laser trackers, returns the light beams at the path of incidence. Its sphere-like behavior enables engineers to track missiles, airplanes or spacecraft without fear of losing the target. (Perkin-Elmer, Inc.)



theory and method involved shows why they hold promise for the future.

### Basic principle: phase retardation

The electro-optical effect is expressed as a function of the applied field as follows:

$$\Delta(1/n^2) = rE + gE^2, \quad (1)$$

where  $r$  is the electro-optical coefficient,  $g$  the coefficient of the quadratic effect, and  $n$  the refractive index.

Such a crystal may be called a retardation type of modulator, for its operation is based on two factors: the introduction of interference between two portions of the incident radiation, and the ability to vary the phase retardation between these two portions.

The path length is changed through the birefringent characteristics of crystals. Birefringence is a phenomenon of double bending of light by the crystal that, for example, can create double images of an object when viewed through the crystal. The difference between the greatest and

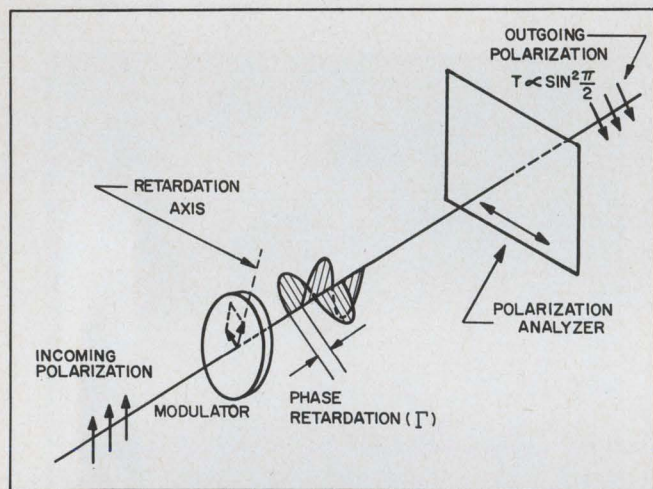

1. Modulation with electro-optical devices is based on phase retardation, accomplished by the variable birefringent property of the crystal.

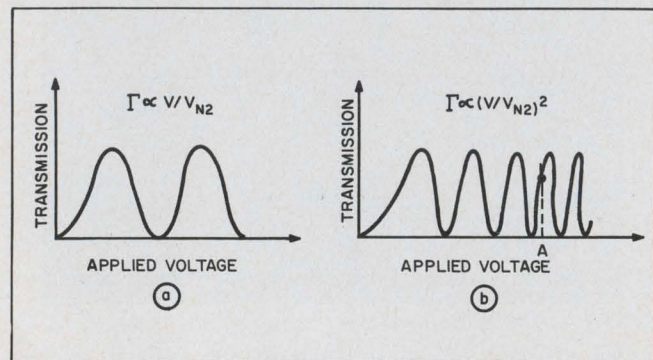

2. Comparison of the Kerr and the Pockels effects shows quadratic nature of former and linear response of latter. The modulating voltage for Kerr crystal may be reduced if the crystal is biased to point A.

the least refractive index for the light is the measure of the material's birefringence. A plot of the index's variation across the crystal's cross section is its index ellipsoid.

The retardation axis, induced by the applied electric field, is at a  $45^\circ$  angle to the polarization of the incoming beam. The beam is therefore divided into equal components, as shown in Fig. 1. The components emerge with a phase retardation and are recombined in the output polarization analyzer.

The introduction of phase retardation with voltage may be the product of either the *Pockel effect* (the first term in Eq. 1) or the *Kerr effect* (the second term in Eq. 1). Their transmission characteristics are shown in Fig. 2.

The Pockel effect is observed in materials that do not have a center of symmetry, like piezoelectric crystals. The electro-optical coefficient,  $r$ , becomes a matrix for unisotropic crystals—crystals which do not possess the same properties in all directions. The retardation in Pockel crystals is proportional to the applied field and its axis is perpendicular to the field.

For the Kerr effect, the retardation depends on the square of the applied voltage and its axis is along the electric field. The quadratic effect may be made linear if the electric field is large enough, since:

$$E^2 = E_{dc}^2 + E_{RF}^2 + 2E_{dc}E_{RF}, \quad (2)$$

and the last two terms are small enough to be neglected. However, the RF field heats up the crystal and thus causes a number of problems.

### Crystal is a capacitive load

All electro-optical modulators may be considered to be essentially capacitive loads to the driving source. The desirable characteristics, in general, may be defined as low driving power, high optical transmission and large dynamic range.

The capacitive-load assumption allows the required driving power to be estimated in terms of the center frequency  $f_0$ , the quality factor  $Q$  and the voltage required to attain a specific modulation level,  $V_{rms}$ . From the simple equivalent circuit in Fig. 3, the driving power is:

$$P = 2\pi f_0 C V_{rms}^2 / Q. \quad (3)$$

The bandwidth between half-power points is  $\Delta f_0 = f_0 / Q$ , so that  $P = 2\pi \Delta f_0 C V_{rms}^2$ . The necessary power is therefore proportional to the bandwidth. The factor  $2\pi C V_{rms}^2$  (typically mentioned as watts per megahertz) characterizes a given device. For minimum driving power, it is clear that the reduction of the driving voltage and the simultaneous minimization of the capacitance is of prime importance.

To find out the percentage of modulation, the



transfer characteristics of these devices must be examined. A simplified presentation, shown in Fig. 4, is sufficient to provide a basic understanding. It also furnishes several important specifications. For positive quarter-wave voltage,  $+V_{\lambda/4}$ , the output optical power is maximum— $P_{out}(+V_{\lambda/4})$ . For negative quarter-wave voltage, it is minimum— $P_{out}(-V_{\lambda/4})$ . The slope of the transfer characteristic  $V_s$ , with zero applied voltage, helps specify the needed peak-to-peak voltage for small modulation indexes:

$$V_{p-p} = mV_s, \quad (4)$$

where  $m$  is the modulation index.

The dynamic range of operation is defined by the extinction ratio:  $P_{out}(+V_{\lambda/4})/P_{out}(-V_{\lambda/4})$ . The curve of Fig. 4 is approximated mathematically with the following expression:

$$P_{out} \propto P_{in} \sin^2(\pi/4 + \pi V/4 V_{\lambda/4}). \quad (5)$$

If an alternating voltage is applied, then  $V = V_o \sin \omega t$ , and a Fourier analysis of the above expression results in:

$$P_{out} \propto P_{in} [0.5 + J_1(\pi V_o/V_{\lambda/4}) \sin \omega t + J_3(\pi V_o/V_{\lambda/4}) \sin 3\omega t + \text{odd terms}], \quad (6)$$

where  $J_1, J_3$  are the odd-order Bessel functions. The percentage of modulation of the fundamental component is thus given as:

$$m = 2J_1(\pi V_o/2 V_{\lambda/4}). \quad (7)$$

A 100% modulation is achieved when  $V = 0.76 V_{\lambda/4}$ . At this voltage the modulation of the third harmonic is less than 7%.

The phase change  $\theta$ , is given as:

$$\theta = 2\pi L\Delta n/\lambda, \quad (8)$$

where  $\Delta n$  is the change in the refractive index,  $L$  is the length and  $\lambda$  is the wavelength. For a realistic modulator, at least 1 radian phase change is needed.

The electro-optical effect is roughly proportional to the induced polarization. Above a certain temperature, called the Curie temperature, the crystal's properties change drastically and this

effect becomes very small. Therefore only those crystals should be considered whose Curie temperature is above room temperature.

### KTN is too expensive

The most promising material that uses the Kerr effect is potassium tantalate niobate (KTN). Crystals of this material have a Curie point above room temperature; they are small; and they require only small operating voltages, ranging from 20 to 60 V peak with a 300-V dc bias. For example, a 3-mm cube crystal can modulate at 10 MHz, the bandwidth of real-time TV. Its size is limited only by the cross section of the light beam.

The ac modulating voltage can be reduced by biasing the material with a dc voltage to a point like  $A$  in Fig. 2. The amount of bias is usually limited only by the breakdown point of the crystal. Besides reducing the drive voltage, the bias also increases the linear electro-optical effect by moving the operating region to the steeper slope of the response curve.

Inadequate material technology is the major limiting factor. At present it is not feasible to prepare KTN crystals with acceptable purities in large enough sizes, because the cost is prohibitive compared with other electro-optical modulators'. Moreover, a higher degree of temperature control is needed to operate them as they approach the Curie temperature; the induced RF field heats the crystal. Therefore, most researchers feel that the next step is up to the materials scientist. He must come up with something better.

Dr. Charles J. Peters, manager, Electro-Optical Dept., at Sylvania, disagrees with this view. He compared the difficulties of electro-optical materials to those confronting semiconductor people: "Many people would like to see better materials for transistors, but we are still making transistors from the same material that was used for the first one." There will not be revolutionary breakthroughs, but evolutionary improvements, he asserted.

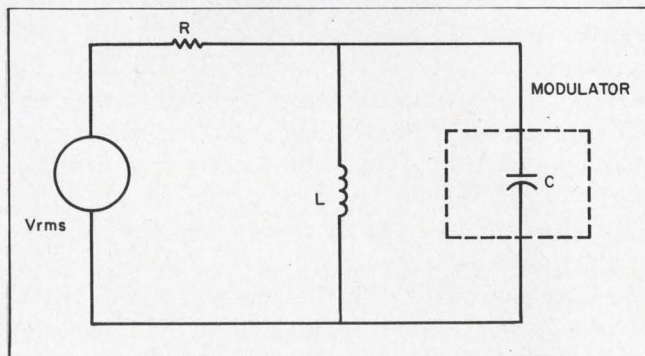

3. Modulators present a capacitive load to the driving source. The equivalent circuit helps to determine the required driving power for the given frequency and quality factor.

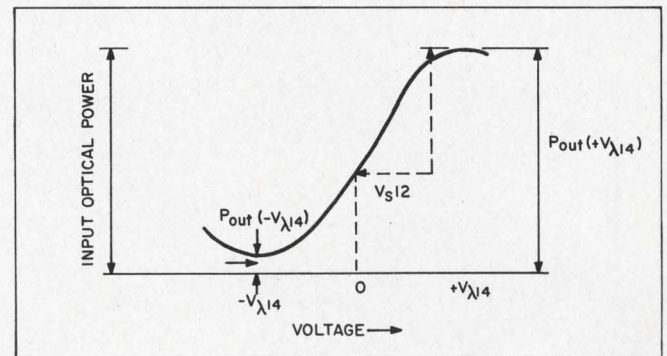

4. Transfer characteristic of commercially available modulators defines specifications, including the dynamic range and the maximum output power. An efficient, yet inexpensive, modulator with a fast response is needed.



Other promising materials are lithium niobate and gallium arsenide. In both cases the purity of the lattice structure is the biggest problem.

The Kerr effect is also utilized in Q-switching of pulsed laser systems where a liquid, typically nitrobenzene, is used. However, its application to cw modulation of lasers is difficult because of its large power-vs-bandwidth quotient.

### KDP needs large drive voltage

All these problems with Kerr modulators have led to widespread interest in modulators employing the Pockel, or linear, effect. These modulators usually use potassium dihydrogen phosphate (KDP). The crystal's index ellipsoid changes when an electric field is applied to it. To illustrate the change, assume that the field is applied along the  $zz'$  axis in Fig. 5. Without this field, the inter-

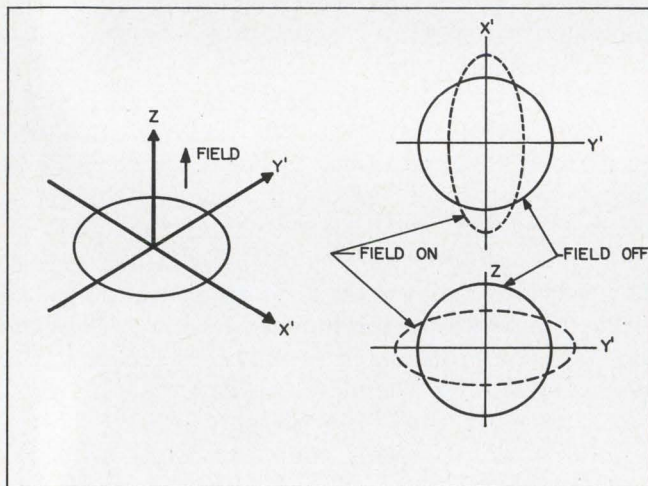

5. The index ellipsoid of Pockels-effect devices changes with the application of an electric field. The induced slow ( $x'$ ) and fast ( $y'$ ) retardation axes are at an angle of  $90^\circ$  to the optic axis of the crystal. Only crystals without a center of symmetry will show this behavior.

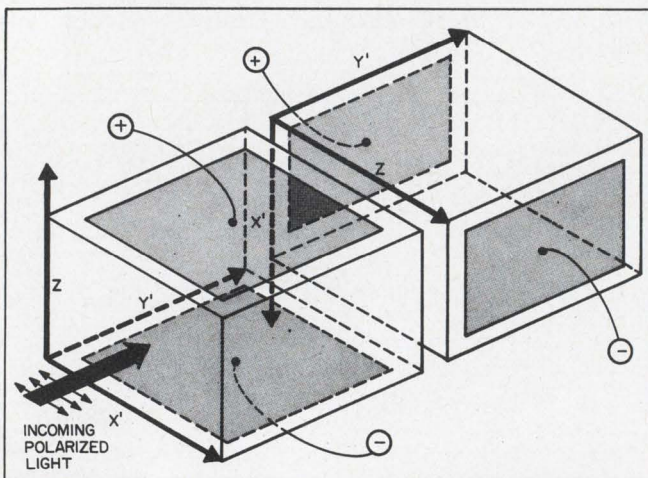

6. Transverse modulator may use two or more crystals, rotated by  $90^\circ$  with respect to each other to eliminate the temperature-dependence of their birefringence.

section of the ellipsoid with the  $xy$  plane is a circle. With the field, the circle becomes an ellipse, with axes at  $45^\circ$  to the crystalline  $x$  and  $y$  axes. The length of the ellipsoid along the  $z$  axis remains constant. Therefore, a retardation axis is induced at an angle of  $90^\circ$  to the optic axis of the crystal and at  $45^\circ$  to the  $x$  and  $y$  crystalline axes. The induced slow and fast axes are labeled as  $x'$  and  $y'$ .

The devices based on this effect may be grouped into two types: *longitudinal* and *transverse*.

In the longitudinal modulator, light propagates along the longitudinal  $z$  axis. The retardation is a function of the applied voltage only, since it is proportional to the product of the field strength and the length of the crystal. Therefore, for a single-crystal device, the capacitance depends only on the length.

In the transverse modulator, light travels along one of the induced axes. The temperature dependence of the birefringence may be eliminated by turning two crystals back to back, as shown in Fig. 6. The half-wave voltage is less than that needed for the longitudinal modulator, but half of the electro-optical effect is discarded since the light propagates along one of the induced axes of birefringence.

To see how much voltage is needed for a typical single-crystal modulator to obtain 1 radian phase shift, only a few simple equations are needed. The  $r$  of a KDP is about  $10^{-10}$  m/volt:

$$\begin{aligned} \partial(L/n^2) &= rE = -2\partial n/n^3, \\ \partial n &= n^3 rE/2, \\ \theta &= (2\pi L/\lambda)\partial n = \pi L/\lambda n^3 rE. \end{aligned}$$

The advantages of a high electro-optical coefficient and refractive index are clear. For example,  $\text{LiNbO}_3$  has  $r=3r_{\text{KDP}}$  and  $n > n_{\text{KDP}}$  ( $n=2.2$ ). Therefore it needs about nine times less field than KDP.

The necessary field may be decreased by an increase in  $L$ , since the phase shift is directly proportional to the electric field  $E$  and the length. Consideration of the dissipated power— $P_{\text{diss}} = ALE^2$ —also postulates an increase in length. The power dissipated per phase shift is proportional to  $A/L$ ; therefore to decrease dissipation, the length should be increased. However, if the sample is longer than  $\lambda/2$  of the modulating RF field, the RF field in the sample changes sign, and so cancels the modulation. The so-called traveling-wave modulator solves this problem by having the modulating wave travel at the same speed as the light. The speed of the light is  $v=c/n$  and the velocity of the modulating wave is  $v=c/\sqrt{\epsilon}$ . Therefore if  $n$  can be made equal to  $\sqrt{\epsilon}$ , the two waves will travel at equal velocities and the length of the modulator may be made arbitrarily long. The difficulty with this seemingly simple approach is that  $n$  in most cases is not equal to  $\sqrt{\epsilon}$ . The exception is GaAs, where both  $n$  and  $\sqrt{\epsilon}$  are about equal to 3.2. How-



ever, there is no cement with the same  $n$  that will glue the crystals together. All optical cements have an  $n$  of about 1.7; therefore only crystals with an  $n$  of 1.7 could be used in order to avoid losses due to mismatches at the glue-to-crystal interfaces. Nevertheless, the velocities may be matched with a dielectrically loaded waveguide structure, where the dielectric constants of the air gaps and of the crystal yield the proper  $\epsilon$ .

### Mechanical resonance adds to optical effect

The piezoelectric nature of crystals like KDP actually enhances the electro-optical effect at low frequencies. The mechanical resonance of the crystal manifests itself as linear increase of the electro-optical effect without any increase in the drive voltage. This may be observed up to about 100 kHz, depending on the size of the crystal. Above this frequency the enhancement becomes smaller and finally disappears around 300 kHz. Of course, as the size of crystal is reduced, its resonant frequency increases.

### What are the research goals?

There are several devices, either in the research laboratories or in production that combine the most advantageous properties of both the longitudinal and transverse groups.

At Sylvania's Electronic Systems Div., Waltham, Mass., a KDP type of electro-optical modulator was developed recently that has a bandwidth to 3 GHz and needs about 5 watts to achieve 30% modulation. The 2-mm-cross-section crystal has about a 3-dB loss. The device can operate with a cw laser having several watts' output, according to Dr. Peters. Its limitations under pulsed operation have not been measured, he says. The modulator is well suited to short-range data transmission systems. The goals of Dr. Peters' group include the reduction of the drive power and light losses, more rugged construction and larger crystal apertures.

Commercially available video modulators of Sylvania with bandwidths up to 5 MHz will be used in an optical PCM system, being built by Dr. Peters' group.

It is very simple to incorporate the modulators into an existing PCM system, he says. The PCM pulse train is applied to the modulator, with properly adjusted voltage levels, and it, in turn, modulates the laser. At the receiver, a photomultiplier picks up the modulated light beam and transfers it into the pulse train. The only serious problem is to avoid mechanical resonances resulting from the piezoelectric nature of the crystal.

In the video modulator, crystals from the KDP family are stacked up in order to reduce the driving power by providing a longer path. The identi-



Sylvania's optical system uses an interference filter to modulate dual channel laser beam.

cal crystals are turned back to back to eliminate temperature sensitivity. The laser beam is amplitude-modulated instead of phase-modulated, because it is easier to receive. The variation in the light intensity can be seen even on a wall and can be recorded on a photosensitive plate. Phase modulation requires superheterodyne receivers—that is, tunable laser local oscillators, and this makes the system more complicated.

The next generation of modulators may be typified by a project underway at Sylvania to develop a 100-MHz modulator that operates at 100% amplitude modulation with about 10 watts of power. Attempts will be made to eliminate expensive high-voltage vacuum tube circuits and use instead low-power transistorized drivers. ■ ■

### Bibliography:

- Bass, M., Franken, P. A., Hill, A. E., Peters, C. W. and Weinreich, G. "Optical Mixing," *Phys. Rev. Letters*, VIII (Jan. 1, 1962), 18.
- Bloembergen, N. and Shen, Y. R. "Multimode Effects in Stimulated Raman Emission," *Phys. Rev. Letters*, XIII (Dec. 4, 1964), 720.
- DeAngelis, X. and Niblack, W. "Electro-optic Interference Filter Light Modulator," *Proc. IEEE*, LI (Sept., 1963), 1258.
- Giordmaine, J. A. "Mixing of Light Beams in Crystals," *Phys. Rev. Letters*, VIII (Jan. 1, 1962), 19-20.
- Gordon, E. I. and Rigden, J. D. "The Fabry-Perot Electro-optic Modulator," *BSTJ*, XLII (Jan., 1963), 155.
- Kaminow, I. P. "Balanced Optical Discriminator," *Appl. Opt.*, III (April, 1964), 507.
- and Liu, Julia. "Propagation Characteristics of Partially Loaded Two-Conductor Transmission Line for Broadband Light Modulators," *Proc. IEEE*, LI (Jan., 1963), 132-136.
- Peters, C. J. "Gigacycle Bandwidth Coherent Light Traveling-Wave Phase Modulator," *Proc. IEEE*, pp. 147-153.
- Renton, C. A. "Amplitude Modulation of Light by Reverse-Biased pn Junctions," *Proc. IEEE*, LII (Jan., 1964), 93-94.
- Stone, S. M. "A Microwave Electro-optic Modulator Which Overcomes Transit Time Limitations," *Proc. IEEE*, (Apr., 1964), pp. 409-410.



# Are lasers practical for communication systems?

Researchers look for space applications to precede any earthbound system, but both approaches are studied.

It may be 10 years before earthbound laser communication systems become practical. Deep-space laser communications, radars, trackers and other systems, on the other hand, should fare better; for they offer clear-cut advantages or do things that were previously not possible.

This conclusion is based on a survey by ELECTRONIC DESIGN among companies involved in this type of research.

The first question to be answered is not the feasibility of such systems but their practicality, says Dr. Rudolph Kompfner, a pioneer in development of the traveling-wave tube and now associate executive director, Research Communication Services Div., Bell Laboratories, Holmdel, N. J. He says that for long-range, earthbound communication systems, lasers may not be needed in any case during the next decade. Intermediate systems planned at Bell Laboratories will suffice to handle the information flow, he states. These plans include a coaxial system, whose capacity is to be 30,000 voice channels, and a millimeter system with a bandwidth of 70 GHz (from 30 to 100 GHz).

The calculated losses of the millimeter system are about 15 dB per mile, which means that repeaters are needed at every 15 miles. This is still cheaper and simpler than a laser. Lasers would be considered, he adds, only if these other systems became inadequate.

Furthermore, Dr. Kompfner points out, a laser communication system above ground is limited to short distances—the expected path length is about 2.6 km. Its main advantage, however, is that it can handle wide-deviation systems, like FM and digital data transmission.

For long-range terrestrial communication systems, pipes would have to be laid, he says; and without some auxiliary systems, the pipes would have to be laid in a straight line, which is an obvious impossibility.

## Gas lenses steer beam in pipes

Lenses installed in the pipes, however, can make the light beam follow curves in the pipes. This would allow the pipes to be laid following the

contour of the ground. The best lenses are those that use gases having refractive indices near unity. Low refractive indices yield low reflection losses.

Gas lenses are created by filling the pipe with gas and controlling the temperature gradient of the gas. A cylindrically symmetrical temperature gradient<sup>1</sup> will make the gas behave as a lens. If the pipe curves, the gas acts as a prism and deflects the beam in the direction of the pipe's curvature. A cool gas may be blown along a hot tube for a convergent lens, or the temperature gradient between a hot helix and a cold cylindrical enclosure may be controlled for a helical convection lens.<sup>2</sup> An experimental setup is shown in Fig. 1.

According to Dr. Kompfner, it takes about 1 watt per meter to heat the gas, which would constitute only a small fraction of the total cost of running such a system. The loss caused by gas lenses is too minute to be measured. Dr. Kompfner says: "It is possible to transmit information from New York to Chicago without repeaters" by such a system.

Research efforts on gas lenses are concentrated on two targets:

- A reduction of the focal length, for better and quicker bending of the beam.
- An increase in the diameter. The small diameter of the lens detracts from its effectiveness, if the beam is spread out or deviates from the center.

To overcome the latter difficulty, theoretical studies are under way at Bell Laboratories to devise a bridge-like circuit that senses the direction of the traveling light beam. If it is off center, a corrective signal is fed back to the last lens to readjust the beam's direction.

## Better lasers are needed

If laser communication systems are eventually to become practical, many improvements are needed in the laser itself. Lasers are noisy, unstable, susceptible to microphonics and have a tendency to jump modes. Also, the output of a laser can contain many modes, transverse and axial, that



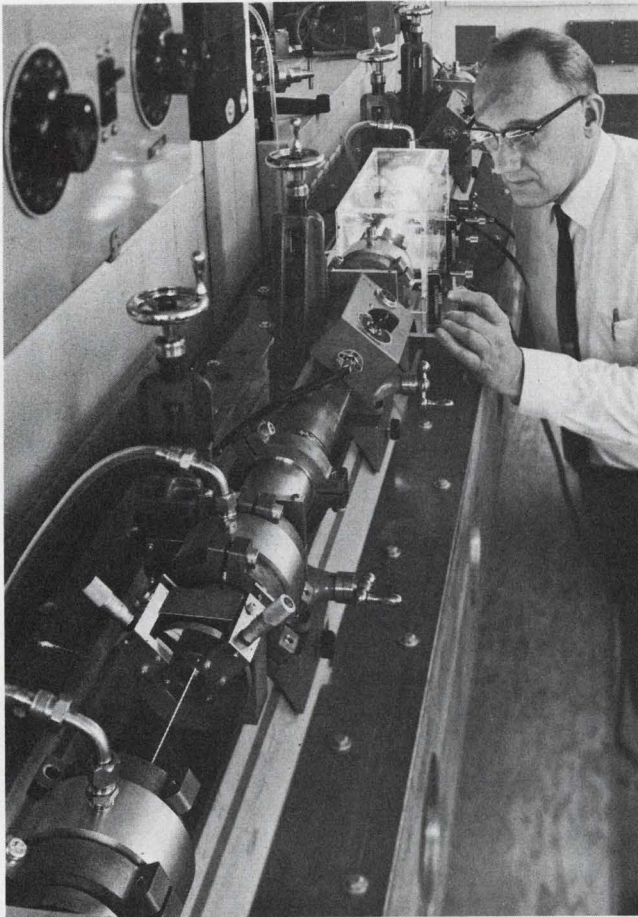

1. Gas lenses are under intense investigation at Bell Labs., Murray Hill, N.J., since they can efficiently bend laser beams traveling in pipes.

reduce the energy at any specific frequency.

The transverse modes in the cavity can be selected with a simple device, such as an iris placed in the cavity. The troublesome modes are the longitudinal or axial ones, which depend on the length of the cavity. The output of the laser may contain 15 to 20 longitudinal modes. It is possible to select one with the aid of a mode selector placed outside the cavity, but the method is very inefficient, since only the power contained in the selected mode is utilized.

### Single-mode laser through FM modulation

A new technique, developed at Sylvania Electronic Systems, Mountain View, Calif., produces essentially single-frequency light from the entire output of a high-power multimode laser, without the loss of power that is inherent in conventional approaches involving the suppression of modes.<sup>3</sup> An intracavity phase perturbation is used to force the laser modes to assume the phases and amplitudes of the sidebands of a frequency-modulated (FM) signal. The phase perturbation is introduced by a KDP electro-optical modulator in the cavity (Fig. 2). The output of the FM laser is passed through an external phase modulator, driven 180° out of phase and with the same peak

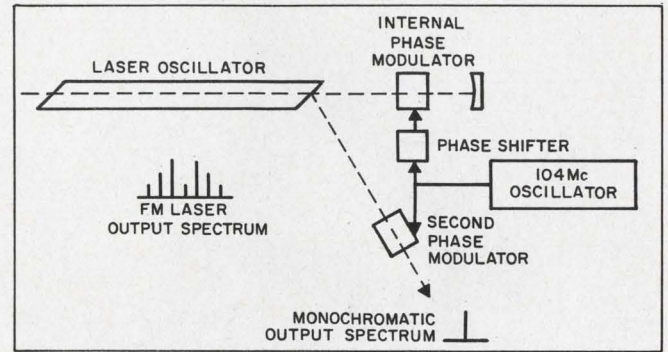

2. Single-frequency light is obtained from the output of an FM laser. The FM output is created by a KDP modulator inside the cavity. The modulator outside the cavity removes the FM and leaves only a single frequency.

optical phase deviation as the output of the FM laser. Whereas the output from the FM laser is made up of a large number of optical frequencies, the light leaving the external modulator is, in principle, a monochromatic signal.

The light output of such a laser closely approximates an FM signal and can be described as:

$$E = E_o \cos (\omega_c t + \Gamma \sin \omega_m t), \quad (1)$$

where  $E_o$  is the peak amplitude of the optical field,  $\omega_c$  is the center frequency of the optical output spectrum,  $\omega_m$  is the modulation frequency, and  $\Gamma$  is the peak phase deviation of the FM oscillation. If this FM signal is passed through a second-phase modulator, driven at the same frequency as the internal modulator, the resulting optical signal will be:

$$E' = E_o \cos [\omega_c t + \Gamma \sin \omega_m t + \Gamma' \sin (\omega_m t + \theta)], \quad (2)$$

where  $\Gamma'$  is the maximum phase deviation and  $\theta$  is the phase of the second modulator. If  $\Gamma'$  is made equal to  $\Gamma$  and  $\theta$  equals  $(2n+1)\pi$  radians, where  $n$  is an integer, then  $E'$  becomes simply  $E_o \cos \omega_c t$  and the signal is monochromatic. If the relative phase  $\theta$  is not properly set, then the signal may have FM deviations up to twice that of the FM laser.

In the experiment at Sylvania, the frequency difference between adjacent FM modes or "sidebands" was 104 MHz, and the output power was 100  $\mu$ W.

The external modulator is an 8-cm KDP. The applied electric field is along the crystal optic axis and at right angles to the path of the light. The crystal's orientation is such that the light is polarized parallel to one of the induced electro-optic axes; thus pure phase modulation is produced. Mirrors reflect the light through the modulator three times. The phase shift of the modulation during transit in this device is about 1 radian.

The internal phase modulator converts the free-running laser from an ensemble of independent modes with random phases into an ensemble of coherent FM sidebands. This coherence is essential, if the light output is to be demodulated by the



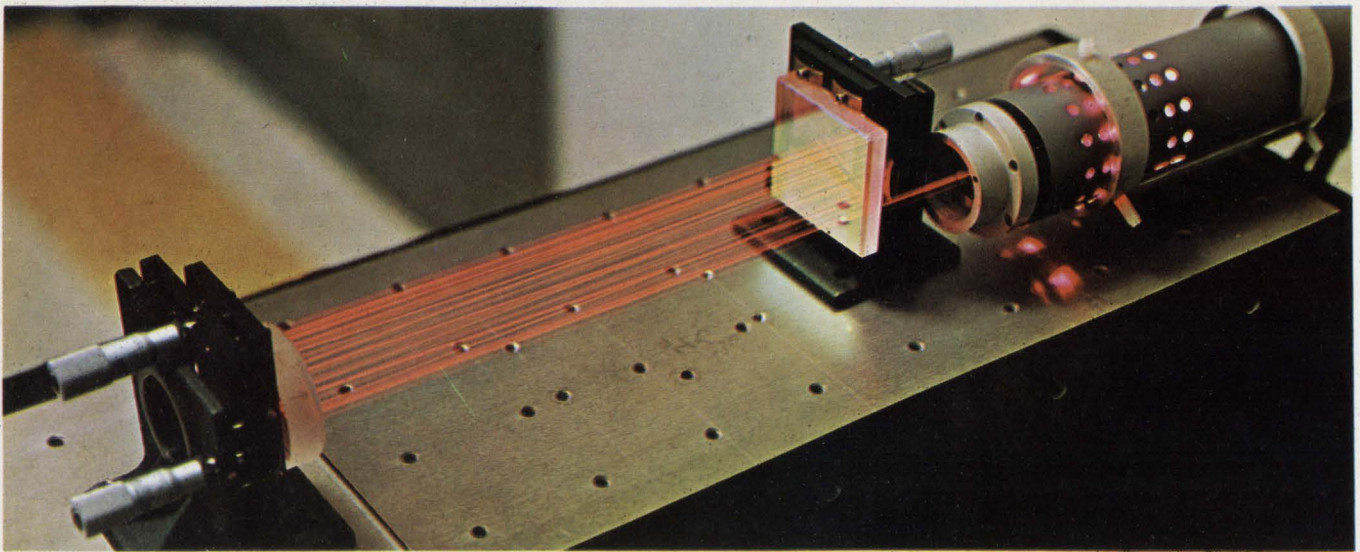

**Curtain of light.** generated with mirrors from a laser beam at Perkin-Elmer, Inc., detects dust and other contami-

nants that may be present during the construction of microcircuits, missiles and other sensitive systems.

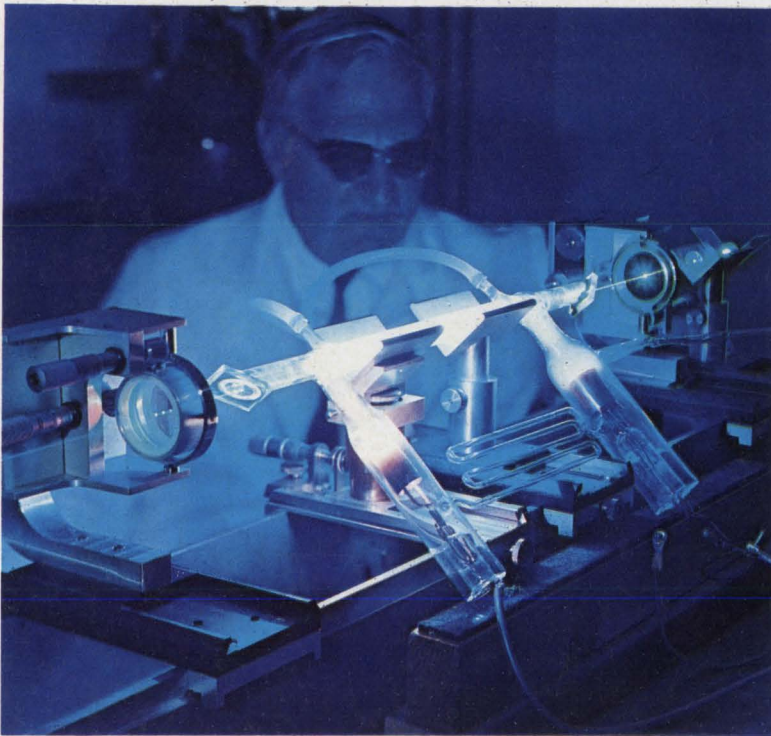

**An early model** of an ionized argon laser is adjusted by scientists of Electro-Optical Systems, Inc. This unit produced about 4.5 watts during continuous-wave operation. With a ceramic laser tube, advance devices produce about 3 watts continuous wave. These are being built under a classified military contract.

**Green laser beam** is generated by frequency doubling, from 1.06 to 0.53  $\mu$ , with repetition rates up to 10 Hz at Electro-Optical Systems, Inc. Dr. Fred Johnson (in the background) says that it is particularly suitable for oceanographic applications, and may be used, with slight modification, for coded military systems.

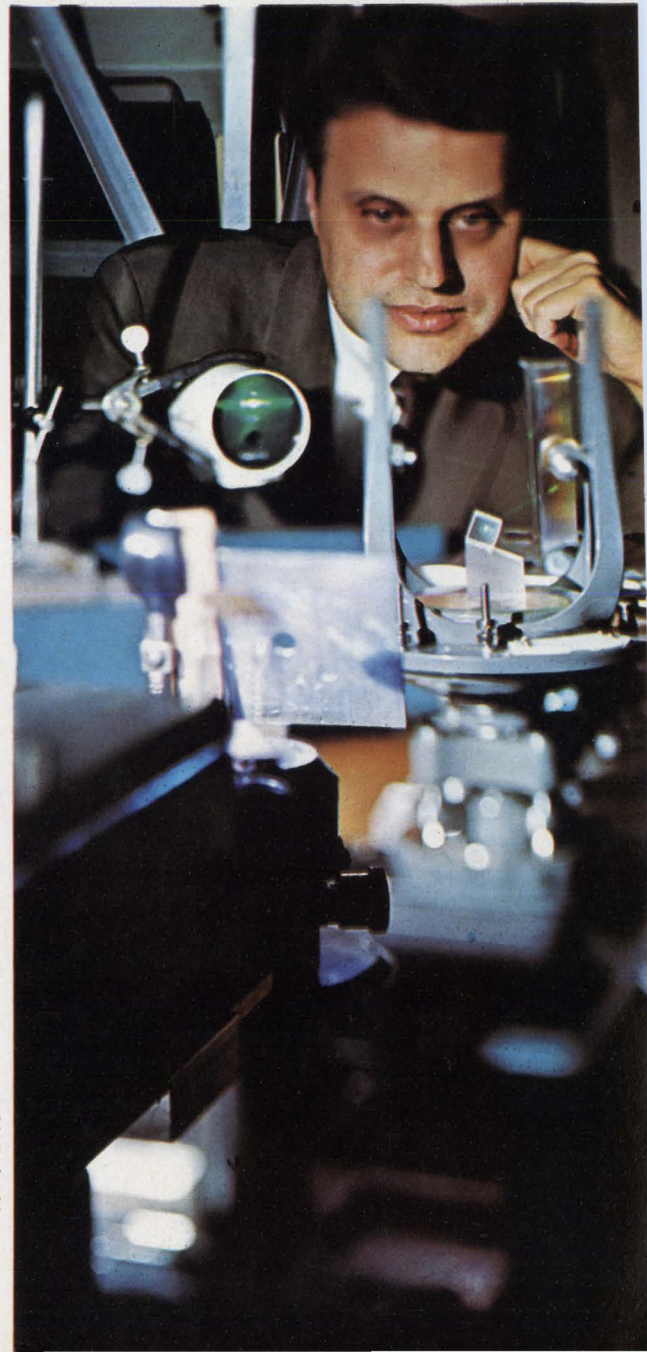



external phase modulator. The external modulator is pulsed, to avoid heating the KDP crystal.

The system may be simplified by replacing the external modulator with a Fabry-Perot etalon (two mirrors that select a single frequency).

A variety of methods are at hand to permit operation on a cw basis:

- More electro-optic material in the modulator.
- Refinement of the multiple-pass technique.
- Use of a superior electro-optic material.

The single-frequency "super-mode" technique is by no means limited to gas lasers and may, in fact, find particular use in high-gain, solid-state lasers having great numbers of axial modes.

### Injection lasers to operate at room temperature

Both for deep-space communication systems and for short-range earth-bound ones, the injection laser is preferred, since it can be modulated by the drive current. Gallium arsenide is the most thoroughly investigated material, and GaAs diodes are at the threshold of practical applications in digital data transmission.

A modified approach to the preparation technique of the pn junction, under investigation at IBM, Watson Research Center, Yorktown Heights, N. Y., appears to make possible the major research goal of operating these diodes at room temperature either in cw or pulsed mode. So far the rise of the junction temperature and the consequent need for cryogenic cooling have limited the generation of light and canceled the advantage of the small size of GaAs diodes prepared by conventional double-step diffusion techniques. The junction temperatures can go up to 100-150°C when the diode is operated at room temperature, and they reach room temperature when the diode is cooled by liquid nitrogen.

Solution regrowth, or epitaxial diodes with an n-type regrowth on a p substrate, says Dr. H. Rupprecht, head of the Semiconductor Laser Dept. at IBM, use only a small area of GaAs as a light-emitter; the rest acts as a heat sink. Thus, the diode can generate more power without the

need for elaborate heat sinks. An experimental setup is shown in Fig. 3 and the diode in Fig. 4. A silicon-oxide mask covers the nonemitting areas, leaving just a small area exposed.

The solution regrowth technique affords further benefits besides better use of the bulk material. It lowers the threshold current density and eliminates turn-on delays that may be as high as 35 ns in diffused diodes.

At present, epitaxial GaAs lasers are operating much closer to room temperatures than other lasers—they are at -40°C. Barring technological breakthroughs, the maximum expected capability of these diodes is around 0.1 watt of cw power at room temperature, with a 0.3 A/cm<sup>2</sup> threshold current and an efficiency of 20%, according to Dr. Rupprecht.

In the pulsed mode, the diode is capable of output powers up to 10 to 20 watts with 50-ns pulses. Duty cycles up to 50 kHz are possible. Of course, Dr. Rupprecht adds, it is very difficult to measure power that is in the form of light. The absolute power measurements are accurate only to about 10% to 15%. The most widely accepted technique uses a calibrated lamp and an integrat-

### Electrons in motion emit and detect light

Electroluminescent diodes emit light when excited by a current. The phenomenon is explained by the energy-band structure of the material. Electrons, excited by the current, are raised to higher energy levels. As they return to their unexcited levels, photons are emitted at wavelengths proportional to the energy differences between the unexcited and the excited energies.

Photodetectors may be said to operate on the opposite principle. Photons, striking the semiconductor surface, transfer their energy to the electrons. This transfer either excites the free electrons or creates electron-hole pairs. In either case, the end result is a potential difference at the output terminals of the photodetector. Avalanche action may be started if the transferred energy is sufficient to force the electron up to a higher energy level, so that it creates new electron-hole pairs that will continue the process.

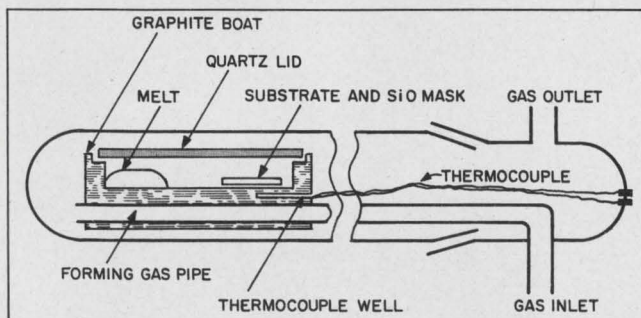

3. Experimental setup for solution regrowth of epitaxial GaAs diode lasers. The gallium arsenide melt is brought into contact with the substrate which is covered with a silicon oxide mask except in the designated emitting area.



4 Lasing diode indicates size of emitting area. The rest of the gallium arsenide acts as heat sink, which will permit higher power output and eventually, it is hoped, operation at room temperature.



ing sphere with a small opening. The device to be measured is placed inside the sphere and the light through the small opening is compared with a calibrated source. But the light intensity is not uniform inside the sphere and the calibration is not very exact.

To further increase the power output, the lasing surfaces can be arranged in an array, Dr. Rupprecht points out. But simple enlargement of the emitting surface is not a good approach, he explains. Its width is not linearly proportional to the output light: Internally reflected transverse modes consume power if the emitting surface is too wide. The ideal width appears to be  $10\mu$  for GaAs; the width-to-length ratio should be around 10 for spontaneous light emission.

One disadvantage of the solution regrowth process is the increased series resistance at room temperature (0.1 ohms), as opposed to about 0.04 ohms in diffused types. This is due to the lighter doping, which is limited by the process itself. This slightly increases the generated heat, but the other advantages outweigh this undesirable effect, according to Dr. Rupprecht.

Electronic engineers can contribute to the development of practical laser systems by designing better power supplies which can supply short, well-shaped pulses with pulse-lengths of 20 to 50 ns and currents up to 100 A. Dr. Rupprecht says that most power supplies either cannot provide enough current or the pulse shapes are not good enough.

### Optical radars fare better

The development of laser trackers and radars has reached a point where practical systems are being built. Laser radars have definite advantages over microwave ones: lack of ground clutter, a highly directional beam and, consequently, better target definition, according to Dr. Leonard W.

Holmboe, head of engineering at Sperry Gyro-scope, Great Neck, N. Y. To those who feel that atmospheric conditions impose serious limitations, he says that even though clouds scatter the laser, enough power would overcome the problem. But millimeter systems, he continues, are limited by material technology. "It is very difficult to machine the hardware with the required accuracy when the component itself is only a few millimeters in size," he points out.

Typical of the capabilities of laser radars is that of one developed at Sperry with commercially available components. An infrared angle tracker, operating with a beacon mounted on the friendly target, aims the laser beam so that it strikes an array of corner reflectors and is reflected back to a photomultiplier. The laser beam is used as a carrier for a precise digital FM cw ranging system, which is amplitude-modulated on to the beam by an electro-optical light modulator, as shown in Fig. 5. After signal processing by the receiver and a computer, the information on the range and range rate are presented in a digital form. Azimuth and elevation data are derived from precision shaft encoders.

Distributed targets such as clouds and the sky yield a dc signal level which can be suppressed.

The range of the system is about 10 km; it is limited by the available transmitter power, the necessary beam spread and atmospheric conditions for practical optical ranging. The power density of the laser (HeNe gas, at  $632 \text{ \AA}$ , 50 mW) is sufficient to give a receiver a S/N of better than 10 in daylight.

The angle measurement accuracy of the Sperry model is 0.25 mrad, which is imposed by the dynamic lag in tracking high-speed targets—those that travel at 200 mph, accelerate in the 3-G range and move at altitudes as low as 1 km. When low-speed targets are tracked, the signal integration

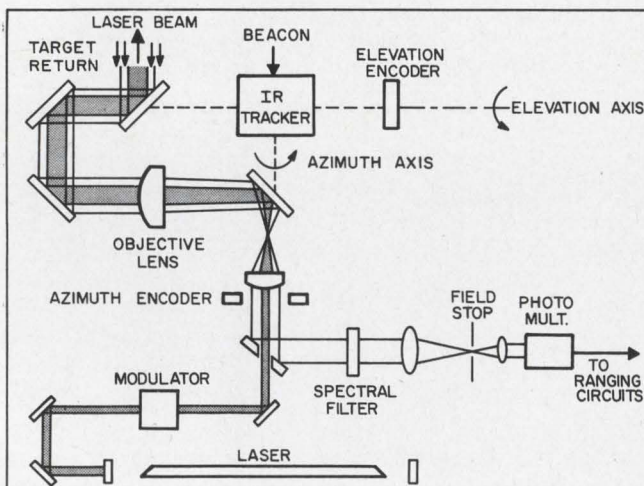

5. Optical path of signal in laser radar is steered by an infrared tracker. The range of the system is about 10 km with commercially available components.

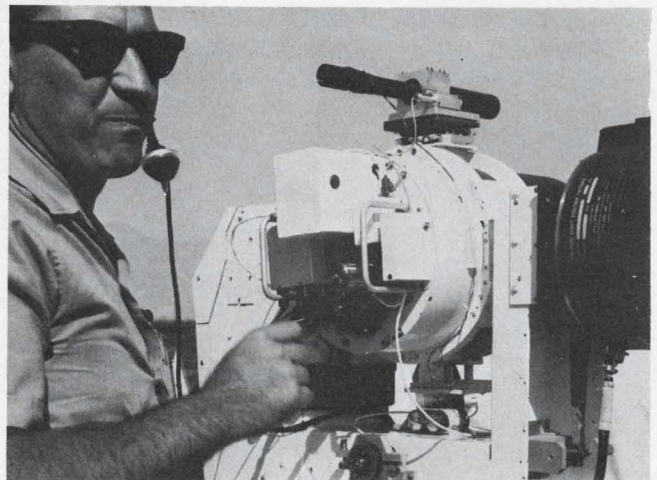

6. Feasibility of optical radars has been demonstrated with the Sperry system. The range and range rate data are presented in digital form.



time may be increased and accuracy consequently improved. This trade-off is common in infrared trackers and also in microwave radars. Static tracking errors less than 10 seconds of arc.

The positional error is low, less than 0.25 m at a range of 1 km, for example. The system's ranging accuracy is mainly determined by the required rate of range read-out. For the proto-type model, shown in Fig. 6, accuracy was limited to  $\pm 1$  meter. Range resolution of 1 part in  $10^6$  can be attained in free space; in the atmosphere, measurements are limited by variations in the index of refraction.

The velocity measurement is accurate to 20 meters per second. It can be improved by use of a separate Doppler channel that uses the same laser carrier.

The choice of operating wavelength for the angle tracker depends on the availability of a good beacon source, on the photo detector and on expected atmospheric conditions. These considerations lead to a wavelength of 0.8-1.5 $\mu$  for the Sperry tracker.

#### Raman scattering offers new uses for lasers

Turning to more research-oriented applications, we find that the laser beam may become the most precise tool for studying molecular structures, checking impurities in semiconductors and detecting coupling between the impurities and the lattice of semiconductors.<sup>4,5,6</sup> It may also be used to measure dielectric constants, observe spin and acoustical waves and phase transitions directly. So says Dr. Sergio P. S. Porto, supervisor of Quantum Electronic Research, at Bell Laboratories.

A laser beam may also be instrumental in the generation of coherent radiation at frequencies where lasers cannot provide an output, according to Dr. Fred M. Johnson, manager, Radiation Interaction Research section, Electro-Optical Systems, Inc., Pasadena, Calif.

The laser beam is capable of all these through a phenomenon called Raman scattering.

The intense laser beam interacts with the molecules of any material in its path. The scattering of the beam by the material, (Raman scattering) is the result of multiplication of the laser's and of the molecular frequencies, and depends on the shape of the molecules.

But before the Raman scattering may be used to study materials, many questions must be answered, Dr. Porto says. The scattering depends on the incident radiation in ways that are not fully understood. The major factors appear to be:

- The angle of incident radiation.
- The polarization of incident radiation. The scattering material may radiate as a dipole or as a superposition of many dipoles, depending on the polarization.

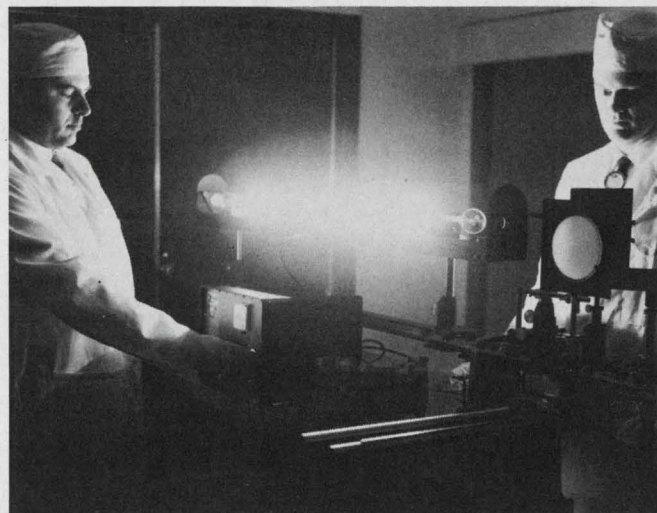

Laser communications for space are under investigation at General Dynamics' Fort Worth division. The facility does research on rocket surveillance, reconnaissance and target tracking with visible, infrared and ultra violet lasers.

- The frequency of incident radiation.

The last factor is linked to the matter of conservation of momentum during the scattering process. It seems that if the material is uniaxial, then the velocity of the photons changes with the angle of incidence. Therefore, Dr. Porto concludes, the frequency depends on the momentum, and it is this dependence that may be utilized in the construction of a tunable laser. ■ ■

#### References:

1. W. H. Steier, "Measurements on a Thermal Gradient Gas Lens," *Digest of 1965 GMIT Symposium* (Clearwater, Fla.), pp. 7-10.
2. D. Marcuse and S. E. Miller, "Analysis of Tubular Gas Lenses," *Bell System Tech. J.*, XXXIV, Part II (1964), 1759-1782.
3. G. A. Massey, M. Kenneth Oshman and Russell Targ, "Generation of Single-Frequency Light Using the FM Laser," *Appl. Phys. Letters*, VI, No. 1 (Jan. 1, 1965), 10-11.
4. S. P. S. Porto, B. Tell and T. C. Damen, "Near-Forward Raman Scattering in Zinc Oxide," *Phys. Rev. Letters*, XVI, No. 11 (March, 1966).
5. B. Tell, T. C. Damen and S. P. S. Porto, "Raman Effect in Cadmium Sulfide," *The Physical Review*, CXLIV, No. 2 (April, 1966), 771-774.
6. J. M. Worlock and S. P. S. Porto, "Raman Scattering by F Centers," *Phys. Rev. Letters*, XV, No. 17 (Oct., 1965).

#### Bibliography:

- Anderson, L. K. "Measurement of the Microwave Modulation Frequency Response of Junction Photodiodes," *Proc. IEEE (Correspondence)*, LI (May, 1963), 846-847.
- Harris, S. E., et al. "FM Oscillation of the He-Ne Laser," *Appl. Phys. Letters*, V (Nov. 15, 1964), 202-204.
- . "FM Laser Oscillation—Theory," *ibid.*, pp. 205-206.
- . "Proposed Frequency Stabilization of the FM Laser," *ibid.*, VII (Oct. 1, 1965), 184-186.
- Targ, R., Caddes, D. E. and McMurty, B. J. "The Traveling-Wave Phototube. Part II: Experimental Analysis," *IEEE Trans. on Electron Devices*, Vol. ED-11 (Apr., 1964), 164-170.
- Yariv, A. "Internal Modulation in Multimode Laser Oscillators," *J. Appl. Phys.*, XXXVI (Feb., 1965), 388-391.



# Solid state competes with lasers

as a light source. With improved photodetectors, flat-screen TV is among possible applications.

The manufacturers of solid-state electroluminescent devices are not inclined to surrender their market to the laser makers. New applications are opening up—in tracking and short-distance data transmission—where the electroluminescent devices are competing successfully with lasers. New and improved photodetectors are helping to increase the versatility of these light sources that can emit both coherent and incoherent light.

The advantages of solid-state light sources are many. They are small, inexpensive, easy to make in quantity, very rugged and reliable.

Reliable operation is opening a new market for the light-emitting diode in computers, where it is replacing tungsten filament bulbs as pilot lights or card scanners, for example. In aircraft and many military applications, its ruggedness and resistance to vibration make it preferable to the filament bulb. Its small size becomes important in the construction of light-emitting matrices, the display of letters and numbers, and the eventual fabrication of flat-screen TVs.

Gallium arsenide is the most widely used material. It affords the most efficient direct transition from electric current to infrared light at 9000 Å. The limitations of GaAs light-emitting diodes are based on three major sources:

- Area size.
- Atmospheric conditions.
- Stability of output.

The area size limits the output power. Theoretically it is possible to increase the area. Then, however, the device may not be considered a point source. In practice, the largest area being made is about 25 mils square. In the dc mode (when the diode operates continuously), GaAs diodes may handle modulating currents up to about 100 mA, yielding powers up to about 125 mW. In the pulsed mode, with a low duty cycle (from 1 to 2%), the current may go to a peak of 10 A without causing overheating.

In general, atmospheric conditions limit the

distance between emitter and receiver. This is often the case in optical communication systems, but the limited output power of GaAs makes this an even more significant problem. Absorption and distortion due to air turbulence are principle causes of all optical transmission losses.

The stability of the output light decreases with time. Usually it drops to 50% of its original intensity within 1000 hours. The cause of this deterioration has not been found yet; theory only partly explains it. The lack of a satisfactory explanation is attributable to incomplete understanding of the material itself. The most widely accepted explanation is that faults occurring in the diode act as recombination centers and do not radiate. For example, cracks which may result from faulty manufacturing or during the mounting, soldering and welding of contacts, can reduce the light output considerably.

## Trade bandwidth for intensity

The modulation of light from GaAs diodes is accomplished by modulating the forward drive current. The response time of the diode depends on the minority carriers' lifetime, which is usually around 10 to 25 ns. The light generated in the diode also depends on the lifetime:

$$Q = I_f \tau, \quad (1)$$

where  $I_f$  is the forward drive current and  $\tau$  is the lifetime of the minority carriers. The generated light is increased by lengthening this lifetime, as the drive current is limited by temperature considerations. This, however, will result in slower response times. At Hewlett-Packard, Palo Alto, Calif., the diode's generating ability was augmented by a factor of three by increasing the life time to 50-70 ns. The diffusion profile was altered to achieve a higher  $\tau$  by a change in the semiconductor processing, according to Robert Johnson, manager, Opto-Electronic Division. A resultant



decrease in the bandwidth starts to limit the operation to about 15 to 20 MHz.

The trade-off between the amount of generated light and the bandwidth is significant only if the diode is operated in the pulsed mode. For most dc operation, the light intensity is the prime factor and not the frequency response. For example, in computers, where the light is used to scan cards, a more intense light beam allows the use of lower-grade detectors at the receiver side, reducing over-all cost considerably. A weak light beam either requires very good detectors or the addition of transistor amplifiers following the photodiodes.

### Detectors to fill gap in spectrum

Research into detectors has several aims:

- To develop detectors at wavelengths where powerful lasers are operating but no detectors are presently available. Such wavelengths are  $10.2\mu$  (for the  $\text{CO}_2$  gas laser) and  $3.39\mu$  and  $1.06\mu$  (for other infrared lasers).

- To improve the gain-bandwidth product of all detectors; i.e., to improve the photoconductive gain or conversion gain, which in turn increases the bandwidth of response. By improving the detectivity through better conversion gains, the bandwidth is increased too.

- To develop high-speed detectors, with modulation frequencies up to and beyond 1 GHz.

The impetus for these efforts has been the increased interest in active infrared radar systems and optical heterodyning and in passive detecting systems that are useful for mapping and tracking

reflecting objects.

### Silicon and germanium detectors under development

Conventional photomultipliers are vacuum-type devices; they provide gain through secondary emission.

Simple pn-junction-type detecting diodes, silicon or germanium, operate on the one-electron-per-photon basis, and therefore provide no current gain. In silicon diodes, the incident photon creates an electron-hole pair that divides at the junction and so generates a voltage at the output. In germanium types the photon changes the conductivity of the diode, through the free electrons in the material, and this yields a voltage difference. An example of present capabilities is a silicon junction photodiode, under development at Sperry Research Center, Sudbury, Mass., that is to operate above  $1\mu$  ( $10^4\text{ \AA}$ ) with a better than 50% quantum efficiency and a frequency response of 5 GHz.

Even though the process of detection does not provide amplification, it is possible to avoid the use of external amplifiers. It has been shown at Sperry that the junction diode may be used as the active device in a parametric amplifier. The detecting junction may be considered a variable capacitor to be handled like the variable capacitance of varactor diodes. This technique yields gains of 20 to 25 dB. The trade-off is in limited bandwidth. Normally the bandwidth of these devices is limited only by the external circuitry. In the parametric amplifier mode, the bandwidth

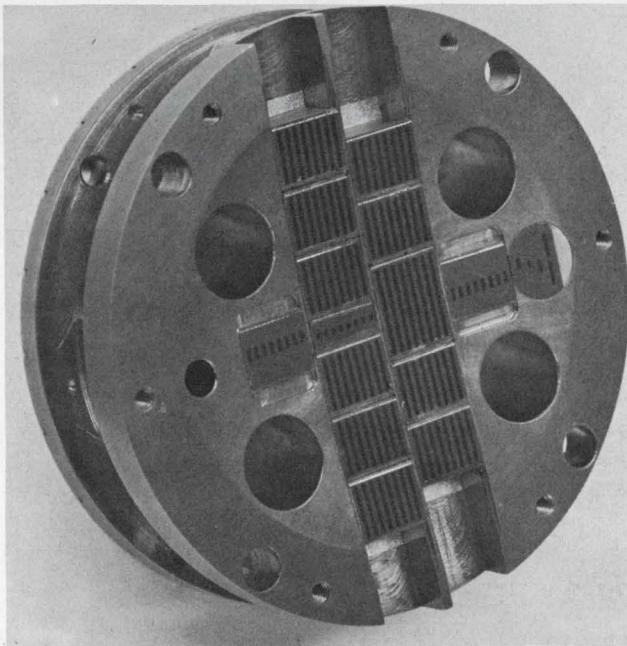

(a)

1. **Mercury-doped germanium array** consists of 20 crystals, placed below silicon lenses and reticles (a). The system includes miniature transistorized preamplifiers in

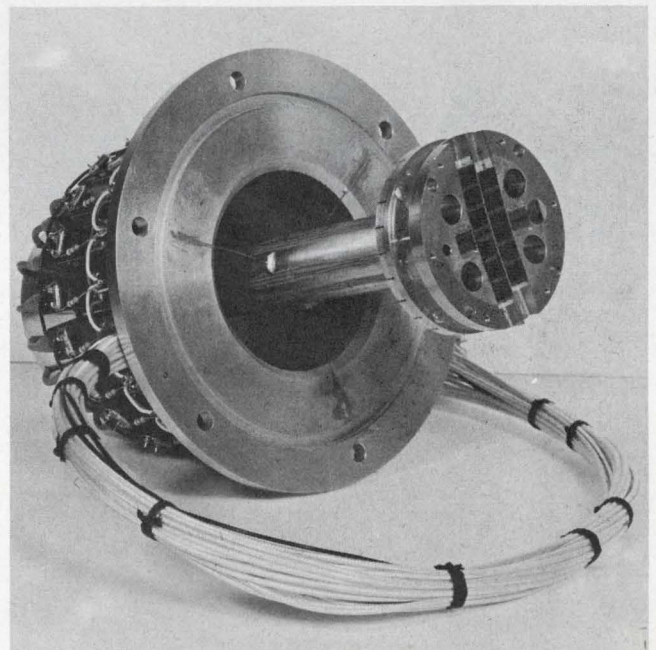

(b)

a hydrogen cryostat that maintains the operating temperature below  $40^\circ\text{K}$  (b). The system was built by the Santa Barbara Research Center, Goleta, Calif.



becomes only a few per cent, owing to the limited region of amplification.

### Avalanche types show great promise

There is a third type of photodetector that is just beginning to appear on the market: avalanche pin diodes that perform photomultiplication.

The theoretical understanding of the avalanche process is complete. However, manufacturing has not reached the mass-production stage because of the difficulties of achieving a uniform junction. To control the noise generated by the avalanche process, the diffusion must be very precise. So far the technique has not been perfected. Diligent research is going on in this area, however, and designers can expect to see these devices on the market in quantity in the near future.

The response time of the avalanche devices is extremely short—about 3 ns, in theory. In practice, however, the external circuitry loads down the detector. This decreases the avalanche diode's detectivity and slows down its response time.

Several materials are under investigation for use as avalanche diodes. They include germanium, silicon, indium arsenide and indium antimonide.

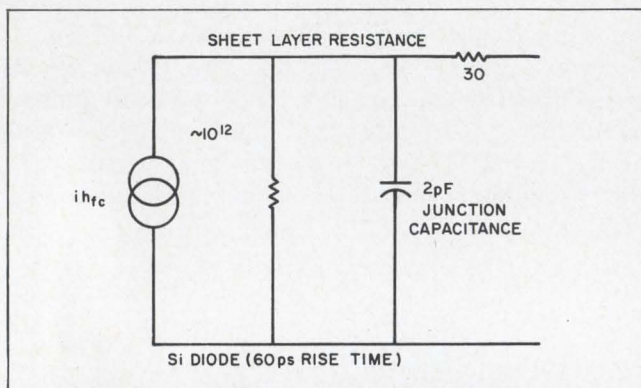

2. Equivalent circuit of silicon photodiode points out the fact that it is essentially a current generator. The numerical values typify Si diodes built by HP Associates, a division of Hewlett-Packard Co., Palo Alto, Calif.

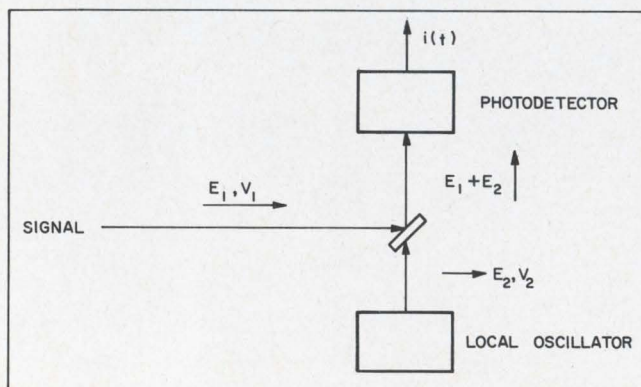

3. Optical heterodyning setup adds the incoming and the local-oscillator signals in front of the photo-detector. The output current from the detector includes the product of the two signals, provided that both signals are coherent.

Germanium appears to be the only candidate for laser communication systems and radars, because it can receive at the frequencies of lasers suitable for these applications. However, so much less is known about germanium than about silicon that development of practical, immediately applicable germanium devices lags behind those made of silicon.

Mercury doping enables the germanium diode to receive in the 8-to-14- $\mu$  optical window, which means that it could be incorporated into a system based on the CO<sub>2</sub> gas laser; copper doping extends the diode's range to 30  $\mu$ . The state of the art in doped germanium devices is best illustrated with the array of Fig. 1, built at the Santa Barbara Research Center, Calif., a subsidiary of Hughes Aircraft Co. The 20-element array is placed on a curved focal plane for better detection. The crystals are placed below silicon lenses and reticles. The elements operate in the 2-to-14- $\mu$  range at temperatures below 40°K. Without doping, the diode operates at 1.6  $\mu$ , which is the wavelength of many infrared solid-state lasers.

Developmental work is directed toward wider bandwidths and faster detection. Germanium has an inherently fast recombination time of about 1 ns. It is also a high-impedance device, with impedances ranging from 100 k $\Omega$  to several megohms. In an actual detector package, the diode is followed by a low-impedance, broadband, low-noise amplifier, which loads the detector and hence slows its response time and degrades the signal amplitude. Investigations are under way to overcome these limitations.

### Heterodyning needs tunable lasers

The heterodyning technique, under study at Hughes Research Center, Malibu, Calif., and elsewhere, is essentially similar to that at microwave frequencies. Two optical signals, slightly shifted with respect to each other, are combined before the detector. The detecting surface, which acts as a current source (see Fig. 2), mixes the two frequencies; the output consists of the two sidebands, both of which are in the IF region. The heterodyning process, properly speaking, is the pumping up of the noise and signal levels by a laser local oscillator to the point where the signal becomes background-limited rather than limited by the noise inherent in the avalanche process.

A simplified diagram of an optical heterodyning setup is shown in Fig. 3. The output current includes the product of the two input signals:

$$i(t) \propto (E_1 + E_2)^2 \propto E_2^2 + 2E_1 E_2 \cos 2\pi(v_1 - v_2)t, \quad (2)$$

where input signal  $E_1$  has a velocity  $v_1$  and the local oscillator signal  $E_2$  has a velocity  $v_2$ . It is assumed that  $E_2 \gg E_1$ .



This approach holds promise of applicability in practical systems, according to Dr. Gerald Picus, senior scientist at Hughes, provided that the auxiliary components can be built. The major difficulty, at least at  $10\ \mu$ , is the construction of a stable, tunable local oscillator. The  $\text{CO}_2$  laser is very narrow-band, and it is difficult for an external device to shift its emission lines. In any case, Dr. Picus adds, its bandwidth is about 75 MHz, and communication people have been talking about wider bands of several hundred megacycles and above. The heterodyning technique does not impose any special requirements on the detector—all photodetectors can be used as mixers, he says.

To increase the information rate of mercury-doped germanium avalanche diodes, Texas Instruments, Inc., Dallas, is examining methods to reduce the recombination times. Another program at Texas Instruments aims at widening the optical spectrum of detection by packaging several detectors in one housing and placing optical filters over some of them.

#### Si diodes need stable source

Silicon avalanche diodes, operating just below  $1\ \mu$ , are offering solid-state reliability in applications previously dominated by photomultipliers. They can detect information in six to seven TV channels, have wider spectral response than photomultipliers and may operate as heterodyne detectors.

Texas Instruments is introducing a silicon avalanche diode, with an  $\text{np}\pi\text{p}$  structure. It has a gain-bandwidth product of 100 GHz and a noise equivalent power of  $10^{-12}$  at 1 GHz.

The use of these avalanche diodes requires some care. The operating curves of the silicon diode have a sharp knee in the reverse region, where the avalanche process starts. To avoid the generation of excess noise, the driving voltage source must be stable. The gain must be carefully selected; if it is too high, for instance, the avalanche noise may overwhelm the signal completely. Also, the detector should be followed by a low-noise amplifier. According to Texas Instruments engineers, the optimum gain is usually at the point where the avalanche noise is about equal to the input noise of the amplifier.

Indium arsenide is being studied at the Santa Barbara Research Center. An avalanche process, observed at cryogenic temperatures and at video modulating speeds, yielded 10 charge-carriers per photon. The device operates at  $3.2\ \mu$  and is said to be able to operate at high modulating speeds as well. Another project at Santa Barbara involves indium antimonide, at room temperature, for detection at  $7\ \mu$ . Laboratory tests, currently under way, indicate that its response time should be less than 30 ns (Fig. 4).

Light-sensitive transistors (phototransistors) may also be used as detectors. The base lead is removed and the incident light beam acts in its

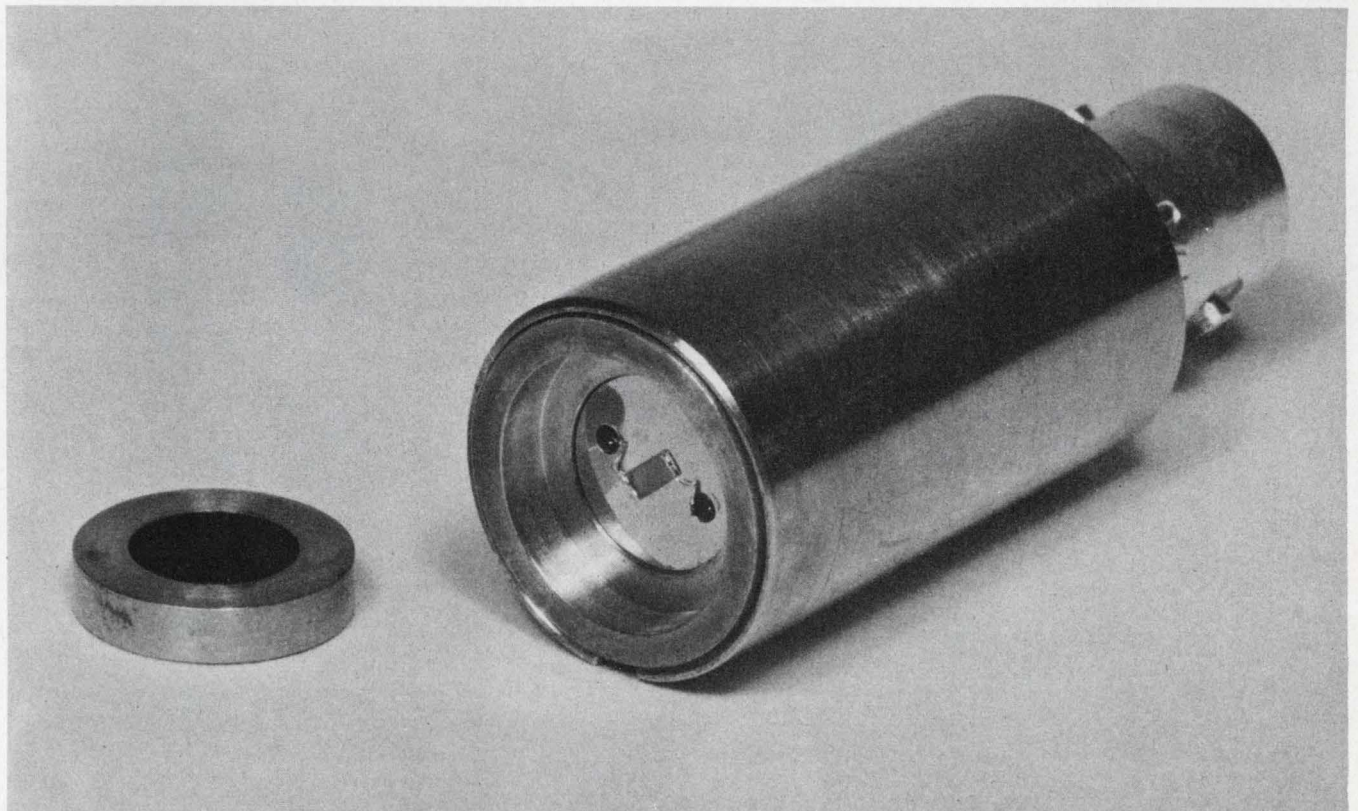

4. Indium antimonide photoconductive detector operates at room temperature. Its wavelength is  $7\ \mu$  and its

response time should be less than 30 ns, according to Santa Barbara Research Center experiments.



place to activate the transistor. The two-lead transistor is slow and sensitive to temperature changes. And it is difficult to obtain repeatable performance with it. However, it is inexpensive and provides gains up to 30 dB. The wavelength of operation depends on the intrinsic material; it may be made of silicon, for example, yielding a range up to 1  $\mu$ .

### Flat-screen TV is no fantasy

Miniaturization and integrated-circuit technology are making their mark in the emitter and detector fields. Linear and two-dimensional arrays are available from several companies.

Texas Instruments is adapting monolithic

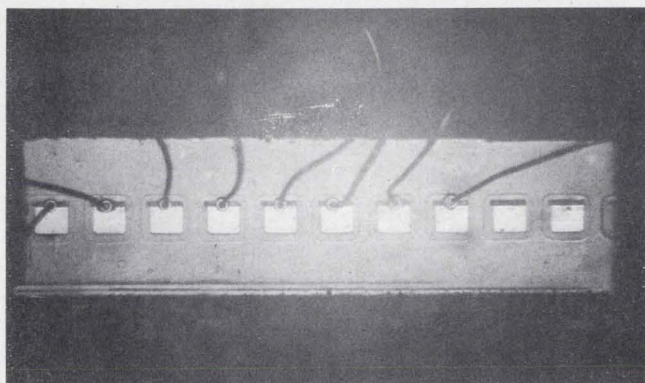

5. Gallium arsenide light-emitting array of Texas Instruments, Inc., is built with planar process. Each infrared element is 9 mils square and individually modulated. The turn-on time is less than 50 ns.

planar technology to light-emitting arrays. The p-type emitting surfaces are diffused on to an n-type GaAs substrate. One such array is shown in Fig. 5. Each element is 9 mils square on a 13-mil center and is individually modulated. Its turn-on time is less than 50 ns. The largest line array to date consists of one hundred 9-mil dots on one substrate. The difficulty of making homogeneous GaAs substrates and of controlling the doping, however, prevents the construction of much larger arrays, according to Dale T. Wingo, a senior member of Texas Instruments' technical staff. Comparing GaAs with Si, he mentioned that GaAs substrates are usually 0.5 inch square while Si ones may be as large as 1.25 inches square. The applications for such arrays include read-out of computers, card-scanning and map-making. The advantage of the arrays is the same as that of conventional ICs: The small size reduces lens requirements and is compatible with optical systems.

In the visible region, gallium phosphide arrays are being built for alphanumeric displays and high-speed print-outs (Fig. 6). Their green light is easily read by the human eye. The color of the emitter light depends on the energy bands of the material; gallium phosphide, doped with oxygen, will emit the whole spectrum from red to green. The only color not obtainable from emitters is blue.

The matter of color is essential if one considers the tremendous commercial future of a flat color-

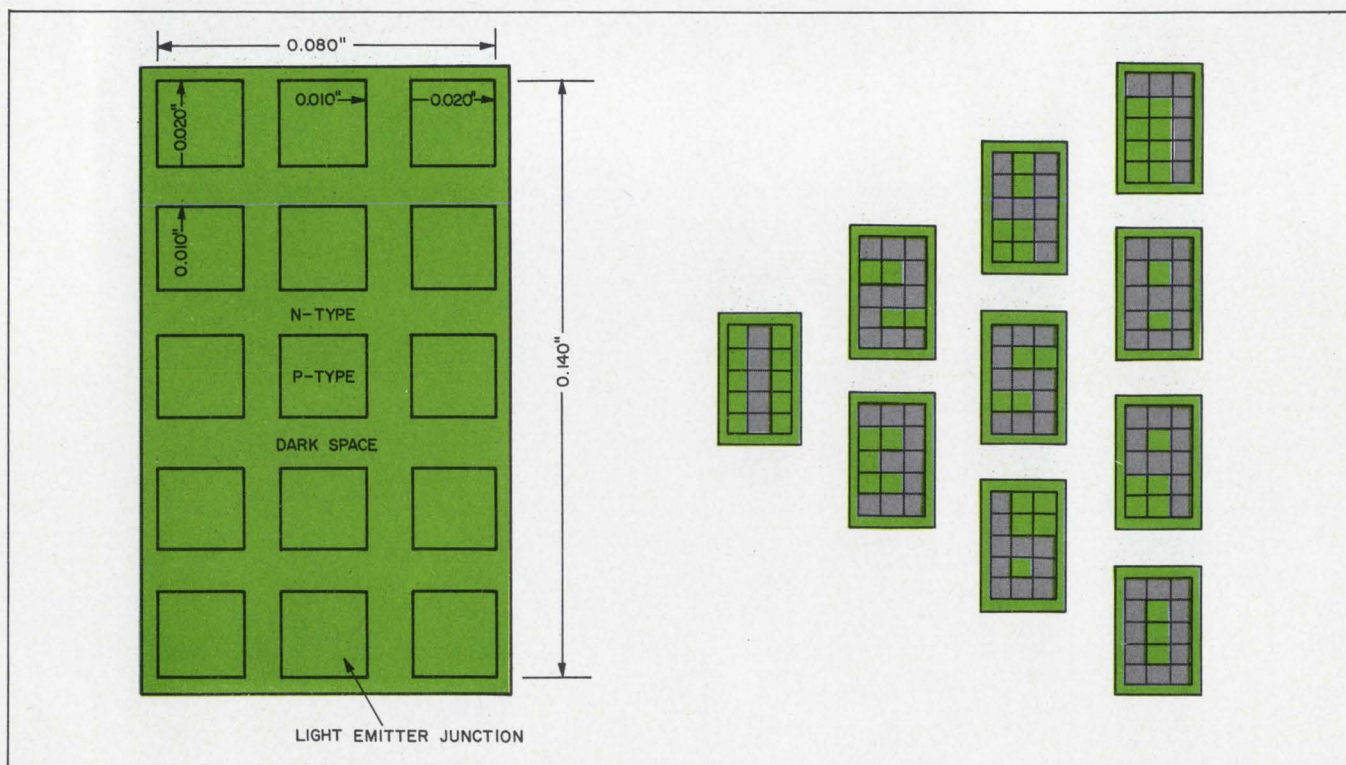

6. Gallium phosphide monolithic array emits green light and is preferred for alphanumeric displays and high-

speed print-outs, according to Texas Instruments. The green light is easily visible to the human eye.



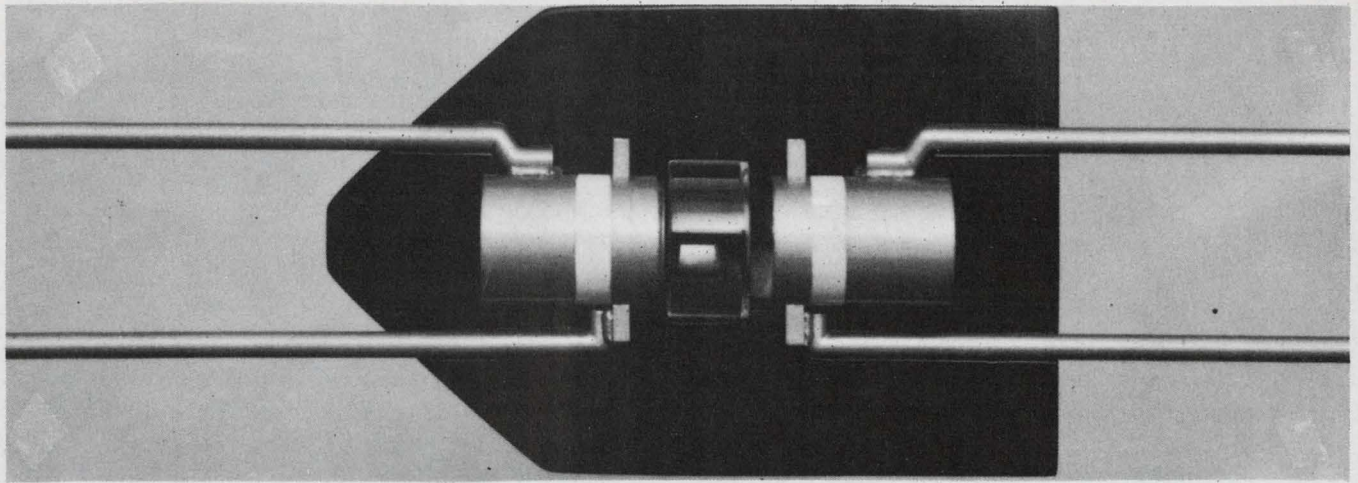

7. **Optical coupler** uses a GaAs light emitter, a light-transmitting medium and a Si photodetector. It may

replace isolating transformers and switches or break ground loops.

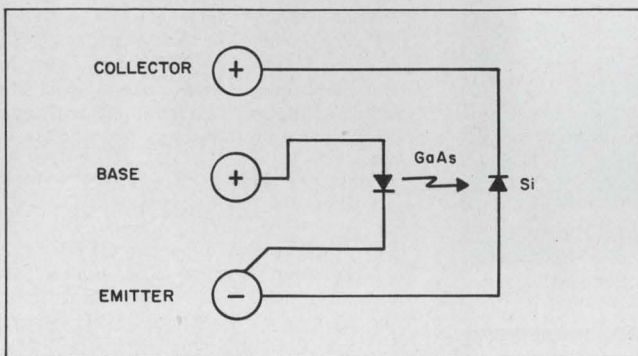

8. **The optical coupler** may be looked upon as a grounded-base transistor with a low  $\beta$ , whose emitter is the photodetector.

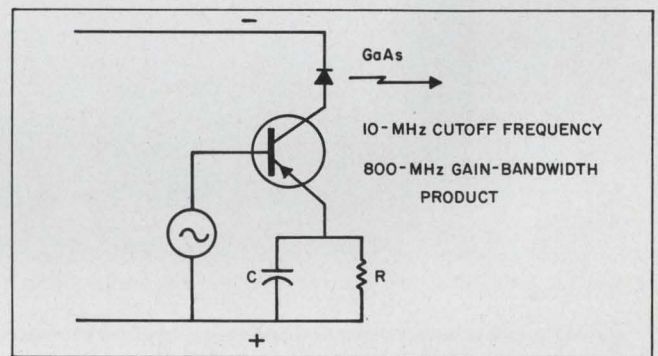

9. **Drive circuit** of the electroluminescent diode uses a transistor and an RC network. The numerical values represent HP Associates' optical couplers.

TV picture tube devoid of an electron gun assembly. Flat-screen TV is feasible with efficient, light-emitting arrays that utilize integrated-circuit technology.

Of course, great technological difficulties remain to be solved before it can be fully developed. Materials for visible sources are very expensive. A wafer of GaAs costs \$20-\$25; a wafer of visible light-emitter might cost \$150-\$250. Moreover, materials technology has not advanced to the point of reliable production. In view of the tremendous commercial possibilities, however, more and more money and effort are being pumped into the development of these materials, especially gallium arsenide phosphide. Robert Johnson of Hewlett-Packard, summed up the situation: "The technology in the visible region is at the point now where gallium arsenide was five years ago."

### Optical coupler resembles transistor

The versatility of photodetectors and light-emitters is demonstrated by a device called an optical coupler or isolator, depending on the manufacturer. It is a small package (see Fig. 7) in

which the emitting surface is separated from the detector by a light guide that may be an air gap, or a piece of fiber or glass. It may replace isolating transformers, break ground loops or perform as a switch. For the electronic engineer, the device may be looked upon as a grounded-base transistor with a low  $\beta$ , as shown in Fig. 8. The photodetector takes the place of the emitter in the equivalent transistor.

A typical drive circuit for a light-emitting GaAs diode is shown in Fig. 9. The equivalent circuit of the diode and the forward bias is just a 1-volt battery in series with a 1-ohm resistor.

The efficiency of the package is mainly determined by the losses of the GaAs diode and of the transmitting medium. ■ ■

### Bibliography:

- Bode, D. E., and Graham, H. A. "Comparison of Ge:Cu with Ge:Hg," *Proc. IRIS*, VIII, No. 3 (Aug., 1963), 105.
- and Nielsen, R. L. "The Effect of Background Radiation on Ge:Cu and Ge:Hg," *ibid.*, IX, No. 3 (Sept., 1964), 107.
- Bratt, P. *et al. Infrared Physics*, Vol. I. 1961.
- Bube, R. H. *Photoconductivity of Solids*. New York: J. Wiley & Sons, 1960.
- Rytkin, S. M. *Photoelectric Effects in Semiconductors*. New York: Consultants Bureau, 1964.



# New TTL complex-function for lower-cost,

Your equipment designs can now take advantage of the latest integrated-circuit technology with TI's new TTL complex functions. These units include more than ten circuit functions interconnected on a single silicon bar.

These new complex circuits make possible reductions of 50 percent or more in parts alone, with one package now doing jobs formerly requiring five to nine standard TTL integrated-circuit packages. Additional savings are realized through simplified board layout and reduced handling and assembly.

The new complex functions are the initial units of a family now being designed which complements and expands TI's standard Series 54 TTL logic line. The full benefits of Series 54 performance are retained, along with improvements in speed and power drain. Most of the new complex functions are available both in military (Series 54) and industrial (Series 74) versions.

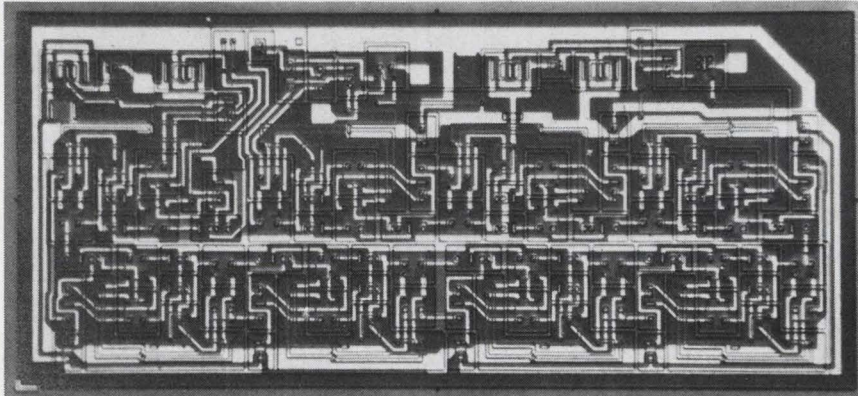

Figure 1. 8-bit shift register uses 144 component elements to perform 11 circuit functions.

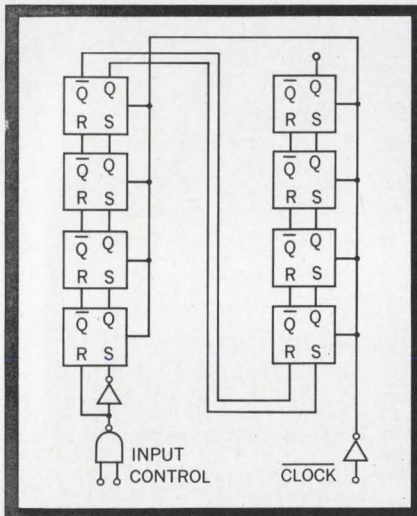

Figure 2. Shift frequency of 8-bit shift register is 15MHz, an order of magnitude faster than comparable MOS circuits.

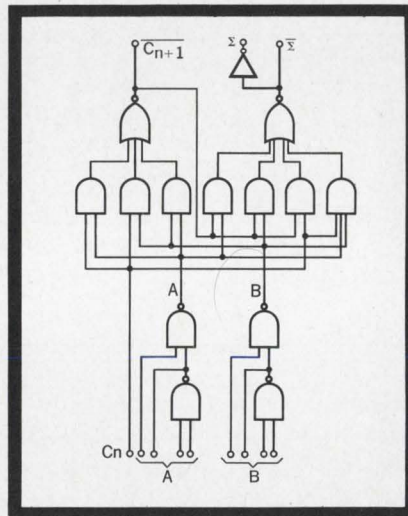

Figure 3. Gated Full Adder eliminates need for extensive "look-ahead" and "carry-cascading" circuitry, greatly improving performance.

## SN5491/SN7491 8-bit Shift Register

This high-speed 8-bit serial shift register replaces nine standard TTL units. Power dissipation at 190 mW is one-third that of the equivalent nine packages. Shift frequency is 15 MHz, two orders of magnitude faster than comparable MOS circuits. The 60 by 130-mil silicon bar uses 144 component elements to perform 11 circuit functions, including eight flip-flops, input gating, and a clock buffer.

The serial-in/serial-out shift register requires only one signal input, since an inverter is included internally. The SN5491 can also be used for delay-line applications.

## SN5480/SN7480 Gated Full Adder

The SN5480 is a single-bit, high-speed, binary full adder with gated complementary inputs, complementary sum outputs, and inverted carry output. The adder is designed for medium-to-high-speed, multiple-bit, parallel-add/serial-carry applications, and is compatible with both TTL and DTL circuits. The need for extensive "look-ahead" and "carry-cascading" circuitry has been eliminated. Performance is substantially better than can be attained with five standard TTL integrated circuits connected to perform comparable full-adder functions. Speed (70-nsec add time, 8-nsec carry time) is about 35 percent faster, and power dissipation (105 mW) is 20 percent lower. Price of the SN5480 is less than half that of the equivalent five multi-function packages, with additional savings in circuit boards, assembly, and inventory.

## SN7490 BCD Decade Counter

The SN7490 is a decade counter with binary-coded decimal output. It can be used as a divide-by-five circuit, a divide-by-two circuit, or a divide-by-ten circuit with symmetrical square-wave output. This flexibility is achieved by external connection of the leads. The counter



# integrated circuits from TI better-performing systems

can be reset to zero or a BCD count of nine. Count frequency is 12 MHz, and power dissipation is 150 mW. In addition to counters, applications include frequency synthesizers and digital test and readout equipment. Versions of this unit which will divide by 12 and 16 will be available soon.

## New Multi-function Circuits Also Available

In addition to the new circuits with "third generation" complexity, TI also has expanded the family of standard Series 54 TTL multi-function circuits to 13. These multi-function units incorporate up to four circuit functions, with all inputs and outputs brought outside the package.

**SN5453 - Quadruple 2-input AND/OR/INVERT Gate.** This unit performs the OR function internally. It is expandable to 24 inputs using the SN5460 expander. Propagation delay is 30 nsec, power dissipation is 40 mW, and fan-out is 10.

**SN5472 Master/Slave Flip-flop.** This circuit features two 3-input AND gates at the J and K inputs. It has reset capability independent of the clock state. Propagation delay is 30 nsec, power dissipation is 40 mW, and fan-out is 10.

**SN5473 Dual Master/Slave Flip-flop.** This is a dual version of the SN5472. When supplied in the 16-pin plug-in package, separate inputs are provided for preset, clear, and clock lines for each flip-flop. Power dissipation is 40 mW per flip-flop.

**SN5474 Dual Latch.** The unit consists of two single-input master/slave flip-flops with set and reset. The gated latches are clock-controlled. Propagation delay is 30 nsec, power dissipation is 40 mW per latch, and fan-out is 10.

## New Molded Package Gives You Broad Selection

Most of the 130 standard TI integrated circuit types are now available in a variety of packages. The newest addition is a molded package with 14 plug-in pins on 100-mil centers, with the rows spaced 300 mils apart. The new package is designed for economical high-speed assembly and testing, with an index notch for automatic insertion. The solid, molded construction provides maximum protection against shock and vibration. Reliability of the transfer-molding technique and the encapsulating material has been proved by TI's production of millions of SILECT™ transistors over the past two years.

## Design Trends Toward TTL

TI's new complex-function and multi-function units emphasize the current design trend toward TTL for high-speed saturated logic. For an optimum combination of high performance and low cost, specify TI Series 54 TTL integrated circuits.

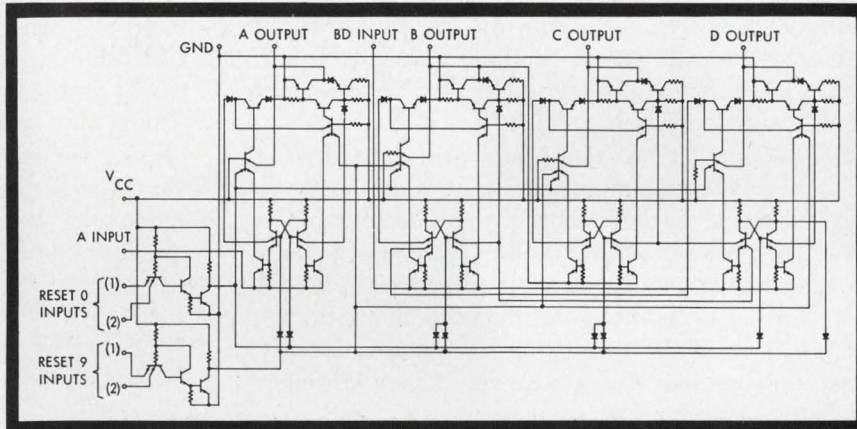

Figure 4. BCD decade counter can also be applied as divide-by-five, -two or -ten circuit.

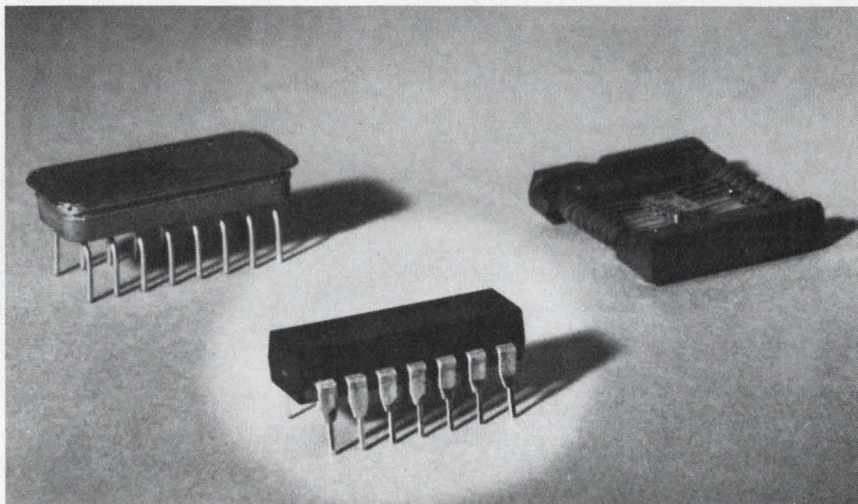

Figure 5. New package with solid molded construction is TI's newest addition to a full line of packages for every integrated-circuit application.



**TEXAS INSTRUMENTS**  
INCORPORATED  
13500 N. CENTRAL EXPRESSWAY  
P. O. BOX 5012 • DALLAS 22, TEXAS

SEMICONDUCTOR PLANTS IN BEDFORD, ENGLAND • NICE, FRANCE • DALLAS, TEXAS

ON READER-SERVICE CARD CIRCLE 32

21802



# Try diodes for remote gain control—

if properly biased, their nonlinearities cancel out to yield a linear, temperature-stable gain function.

When dealing with remote gain-control applications, remember that pairing diodes will make it possible to eliminate their nonlinearities. This will yield a linear, variable-gain element that is not temperature-dependent.

This property gives diodes a distinct advantage over other active components that may be used. Unlike variable- $\mu$  tubes, light-controlled photocells, FETs, thermistors and bipolar transistors, they have stability without the usual circuit complexity. Their linearity, component for component, is better than that achieved with most of other devices. Moreover, the diode design can easily be adapted to integrated-circuit technology.

## Requisites for a diode

The requirements for a diode to operate satisfactorily in this application are:

- High conductance.
- Low capacity.
- Low series inductance.
- High speed.
- Low leakage currents.

A combination of these parameters is found in a silicon, planar, epitaxial, high-speed diode—for example, the FD6001. Other diodes could possibly be used but results would vary, depending on how closely they met the five requirements. Note that the diode approach to these gain-control circuits is not exclusive; bipolar transistors form part of the system design, but the bias circuit, which is the key portion, relies on the diodes.

There are many places where remote gain control of electrical signals is required. Among these are audio gain control of a rack-mounted amplifier from a remote-control panel, regulation of video gain in a TV camera from a remote-control desk in an equipment room; and control of a video-fade amplifier in a TV studio.

Both the diode and transistor circuits make use of the variation in diode impedance with current bias.<sup>1</sup> Many of the circuit configurations provide

some form of compensation for the nonlinear diode characteristics. The ideas presented here show a method in which the diode characteristics are actually used to advantage.

The bias network is shown in Fig. 1. Circuit operation relies on high-conductance diodes that have very low series impedances compared with the incremental junction impedance. For such a diode, the current voltage relationship is given by:

$$I = I_o (\epsilon^{qV/kT} - 1), \quad (1)$$

where  $I_o$  is the reverse leakage current,  $V$  the forward voltage,  $k$  Boltzmann's constant,  $T$  the absolute temperature and  $q$  the charge of an electron. For silicon diodes,  $I_o$  is very small, and Eq. 1 may be modified so that:

$$I = I_o \epsilon^{qV/kT}. \quad (2)$$

## Dividing the current sources

The following calculations show that the signal current will divide in the same ratio as the dc currents in the diodes and will be independent of the amplitude of the signal swing. This holds true if the diodes are operated in their logarithmic region.

For any diode:



Using high-speed diodes, Author Bray constructs his remote gain-control circuit design. System gain is linear and temperature-stable, shows little distortion and is not subject to nonlinear characteristics of the diode.

Derek Bray, Applications Engineer, Fairchild Semiconductor, Mountain View, Calif.



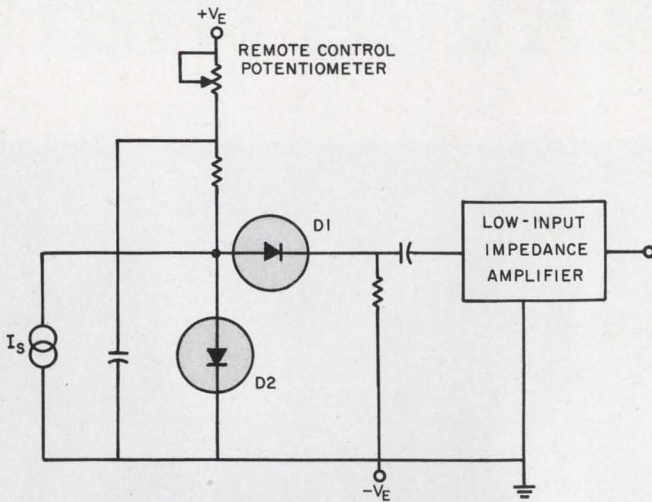

1. Diode gain-control circuit provides a linear, variable gain that is not temperature-dependent. Output current is varied in proportion to dc control current and is independent of diode nonlinearities.

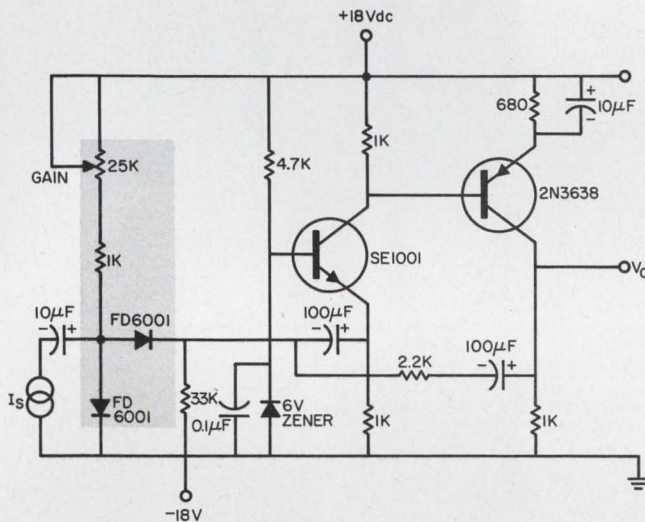

2. Remote video gain-control circuit incorporates diode bias circuit of Fig. 1 and two video amplifiers. Harmonic distortion at 1 kHz is less than 1%. The gain range is 25 dB.

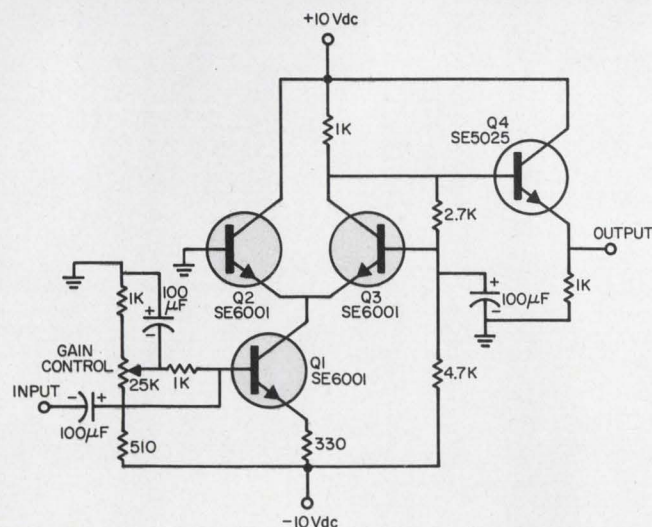

3. Transistor version of gain-controlled amplifier features current source (Q1) and two logarithmic amplifiers (Q2, Q3). The gain range is 18 dB from 10 Hz to 12 MHz. Harmonic distortion at 1 kHz is less than 2%.

$$\frac{dI}{dV} = I_0 \frac{q}{kT} e^{qV/kT} = \frac{q}{kT} I. \quad (3a)$$

For diode  $D1$  (see Fig. 1):

$$\frac{dI_1}{dV_1} = I_1 \frac{q}{kT} = [I_{1dc} + I_{S1}] \frac{q}{kT}; \quad (3b)$$

and for diode  $D2$ :

$$\frac{dI_2}{dV_2} = I_2 \frac{q}{kT} = [I_{2dc} + I_{S2}] \frac{q}{kT}. \quad (3c)$$

Note that the same signal voltage appears across each diode. Therefore  $dV_2 = dV_1$ ,  $I_{S1} = dI_1$ , and  $I_{S2} = dI_2$ . Using this information, we can write:

$$\frac{I_{S1}}{I_{S2}} = \frac{I_{1dc} + I_{S1}}{I_{2dc} + I_{S2}}. \quad (4)$$

Rearranging gives:

$$\frac{I_{S1}}{I_{S2}} + 1 = \frac{I_{1dc}}{I_{2dc}} + 1. \quad (5)$$

This may be expressed as:

$$\frac{I_{S1} + I_{S2}}{I_{S2}} = \frac{I_{1dc} + I_{2dc}}{I_{2dc}}. \quad (6)$$

Finally, we simplify terms to produce:

$$I_{S2} = I_S \frac{I_{2dc}}{I_{dc}}. \quad (7)$$

In the circuit of Fig. 1,  $I_{2dc}$  is fixed and  $I_{dc}$  is variable; therefore, the output current  $I_{S2}$  can be varied in proportion to the dc control current,  $I_{dc}$ , and is independent of the diode nonlinear characteristics. Another advantage is that the circuit is not temperature-dependent (as can be seen from Eq. 7).

### Distortion low in video application

Figure 2 shows a circuit that has been used in an image orthicon television camera to provide remote gain control of the video output signal. A differential gain control of 1% at 3.58 MHz and a video bandwidth of 20 MHz, over the full 20-dB range, has been obtained with this circuit. This system shows a frequency response which is 3 dB down at 100 Hz and 10 MHz. Its gain range is 25 dB, and the distortion (at 1 kHz) is less than 1% of the 0.5-volt peak-to-peak output.

This basic circuit can be modified to use transistors instead of diodes, as shown in Fig. 3, where  $Q1$  acts as the signal current source. The input impedance of the two common-base stages,  $Q2$  and  $Q3$ , acts as the logarithmic elements. Dc current in  $Q3$  is stabilized by negative dc feedback, and gain control is achieved by variation of the dc current in  $Q1$  and  $Q2$ . This circuit exhibits a frequency response which is 3 dB down at 10 Hz and 12 MHz. Its gain range is 18 dB, and the 1-kHz distortion is less than 2% of the 0.5-volt peak-to-peak output. ■ ■

### Reference:

1. Beneteau and Riva, *A Balanced Video Diode Attenuator* (Fairchild Application Note APP 57).



# Monsanto solves many

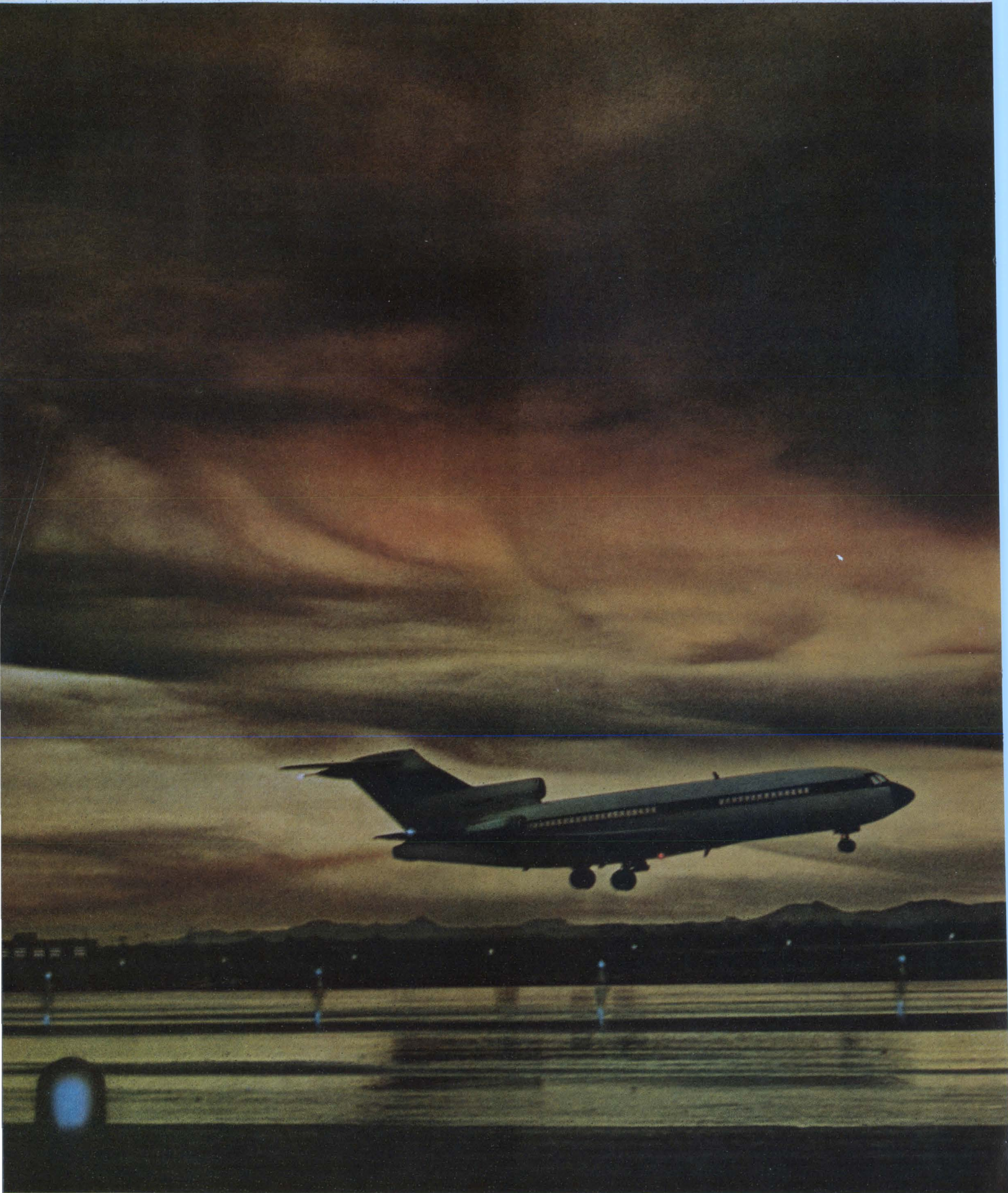



# problems for you



**That's why airplanes fly better and why electronic instruments are more versatile than ever.**



The Men from Monsanto developed a hydraulic fluid that's never burned in flight. It is the reliable lifeblood of a modern jet's hydraulic system. So good, it's specified by all of the world's major airlines.

Last year this scientific, technically oriented company introduced 43 basic new products. And Monsanto scientists secured a new patent every day of the year! That's an example of the capabilities that have helped Monsanto grow six-fold in the past 15 years. Through a broad mix of over 1000 products, Monsanto serves 50 industries.

Monsanto's innovative efforts now stand behind a growing family of quality electronic instruments. These test and measurement instruments feature advanced microcircuitry. They are ready to help solve *your* problems today. Monsanto, Electronics Technical Center, 620 Passaic Avenue, West Caldwell, New Jersey 07006.

ON READER-SERVICE CARD CIRCLE 33



**ELECTRONIC  
INSTRUMENTS**



# DTL logic NAND gates bring versatility to timing-circuit design. A standard IC and a capacitor yield a variety of monostable and astable multivibrators.

Low cost and design flexibility in timing and clocking circuits for digital systems are easy to achieve. Simply use a standard DTL logic gate and a single external capacitor to construct a variety of monostable and astable multivibrators.

Output pulse widths range from 100 nanoseconds to 4 seconds, with just three or four packages of the same IC device type. Operation over a temperature range of  $-55$  to  $+125^{\circ}\text{C}$ , in the face of  $\pm 30\%$  variations in power supply voltage, is guaranteed.

The design approach is also flexible. By varying the number of IC packages used and the interconnections between each, the engineer can build different versions of the basic multivibrator circuit. Each has some specific function or characteristic optimized for the application at hand; for example, better thermal stability, less stringent capacitance needs, or extra "command" signals (e.g., a "stop").

## Closing in on '1' and '0' definitions

The following design criteria are assumed and applied to all the circuits:

- The ONE-state and ZERO-state voltage levels of the input trigger waveform must conform to those shown in the table.
- The output pulse is triggered when the input waveform switches from the ONE to the ZERO state.

- The width of the input trigger pulse must be less than the output pulse width (i.e.,  $t_{TW} < t_{OW}$ ). The pertinent waveforms applicable to all of the multivibrator stages constructed, along with the definitions of voltage and time parameters, appear in Fig. 1. Note that:

$$t_{TW} < t_{OW}, \quad (1)$$

$$t_{TB} > 1.4 t_{OW}. \quad (2)$$

Because no internal capacitance coupling is used, and since only a logic gate threshold voltage need be exceeded, the transition time  $t_o$  [often

called fall time (10 to 90% points)] is not critical. Thus, any slope on the input signal, from nanoseconds to seconds, will cause the monostables to trigger. Delay time, however, will be affected by the input slopes—the sharper the slope, the smaller the ensuing delay.

Figure 2a presents the logic diagram of a monostable composed of three gates. One standard WM 206 or 226 triple-gate package, plus an external timing capacitor, is all that is necessary to do the job. Figure 2b shows typical waveforms which can be expected at pertinent circuit points.

As for circuit performance, the variation in pulse width over the full military temperature range for a wide selection of capacitor values is seen to be small (Fig. 3a). Variations in pulse width caused by a change of up to  $\pm 30\%$  from the nominal power supply voltage (see curves in Fig. 3b) are like-wise minimal. Finally, note the extremely wide range of pulse widths obtainable with this monostable (Fig. 3c).

Table. Defining logic state amplitudes

		$-55^{\circ}\text{C}$	$+25^{\circ}\text{C}$	$+125^{\circ}\text{C}$
ONE—STATE amplitude	$V_{T,0}$ Max	1.4 V	1.0 V	0.6 V
ZERO—STATE amplitude	$V_{T,1}$ Min	2.3 V	2.0 V	1.7 V

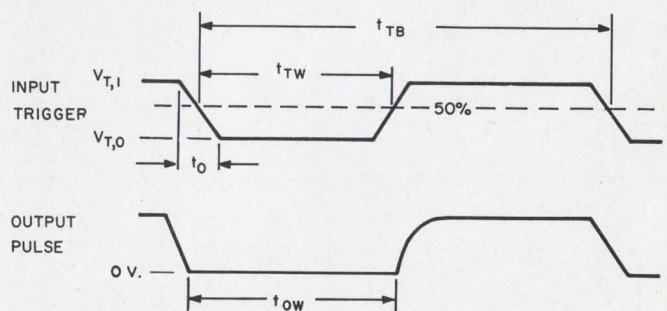

1. Multigate monostable multivibrator waveforms must adhere to values specified in the table above.

G. M. Ammon, Digital Applications Engineer, Westinghouse Electric Co., Molecular Electronics Div., Elkridge, Md.



In addition, Fig. 3c compares the output pulse width versus timing capacitance values of this triple-gate monostable with those of a quadruple-gate version.

### Extra gate improves stability

The addition of only one more NAND gate to the triple-gate monostable of Fig. 2 makes it

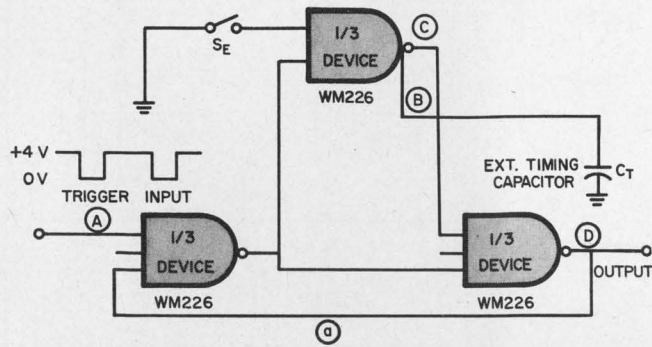

2. Standard DTL gates (type WM226) are used to construct a triple-gate monostable multivibrator (a).  $S_E$  is an optional external "inhibit" switch. Typical waveforms appear in (b). Here,  $V_{CC} = 6.0$  V, and  $C_T = 500$  pF; no collector resistor is used in the output stage. The horizontal scale in all three traces is  $0.2 \mu\text{s}/\text{cm}$ ; vertical scale is  $0.5$  V/cm for all traces but B of the upper diagram (where it is  $2.0$  V/cm).

possible to obtain better thermal stability; also, less capacitance per output pulse width is required. The additional gate requires only two inputs. Only one quarter of a WM 246 or 266 satisfies this requirement, thus leaving three additional gates available for other logic functions.

For this type of monostable, it is also necessary for one gate to have a collector resistor. This resistor is needed to provide a path for the charg-

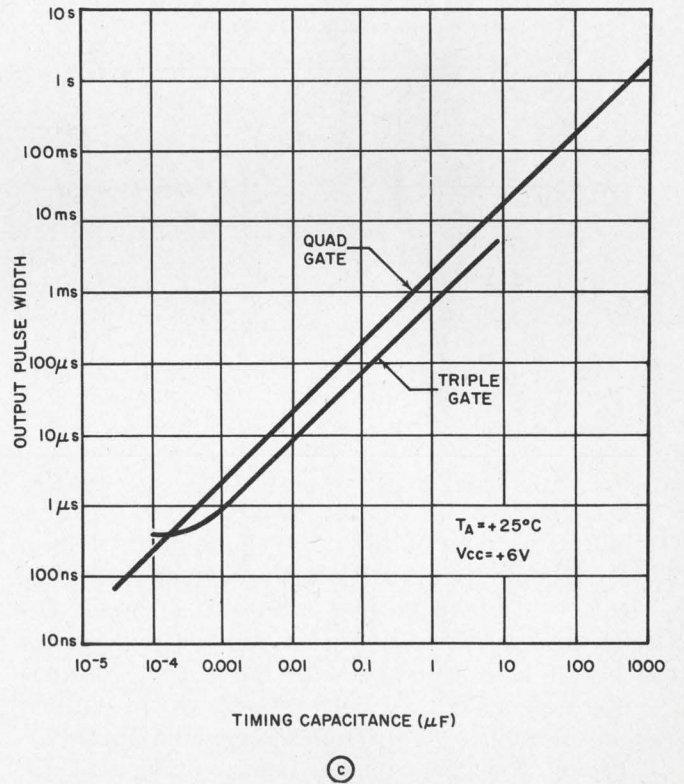
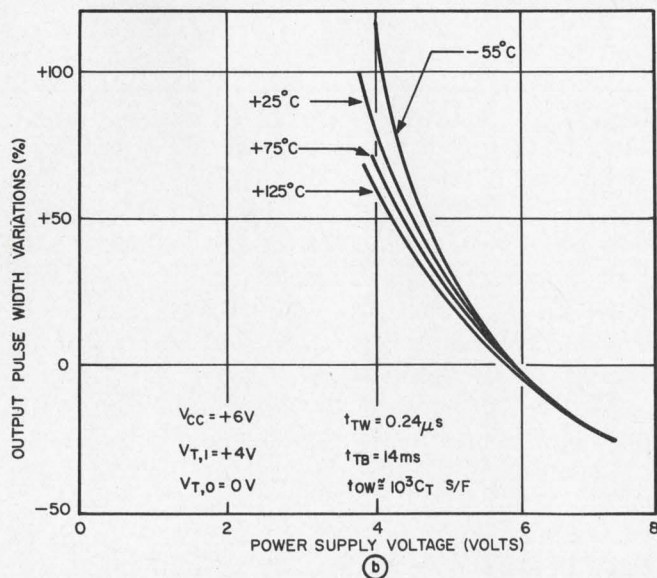
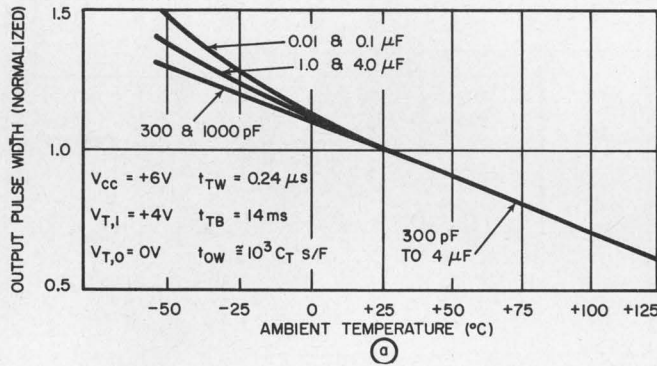
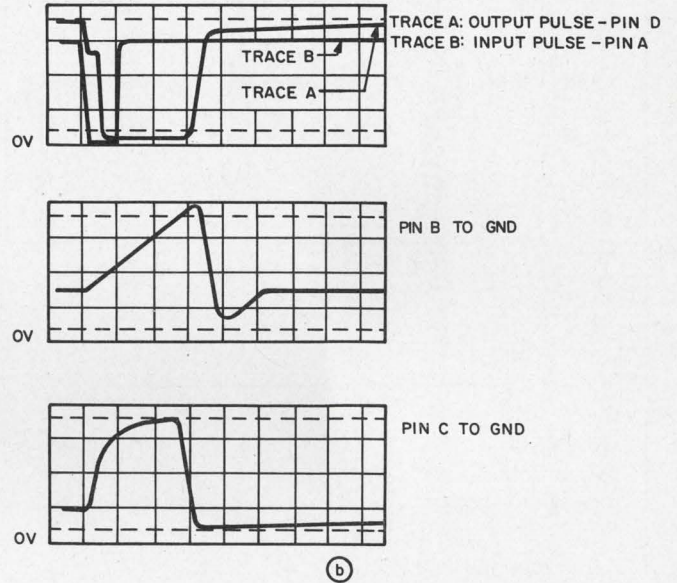

3. Performance of triple-gate monostable circuit is exemplar, as confirmed by plots of: pulse width vs temperature with different capacitor values (a), pulse width vs power supply voltage over the full temperature range (b) and pulse width vs timing capacitance (c). Part (c) also compares 3-gate version with the quad, 4-gate, circuit.



## Standard DTL NAND gates

Here are the equivalent circuits of the triple (WM206 and WM226) and quadruple (WM246 and WM266) integrated circuit gates cited in the article. Each (at 25°C) has a minimum fan-out of 11 and a zero-state noise margin of 550 mV (min.). The

average switching time is 58 ns for the 226 and 266 devices; it's 45 ns for the 206 and 246 types. Power consumption is 15 mW (max) per gate for the 226 and 246; with the 206 and 246 the corresponding figures are 9.5 mW(max) of power per gate.

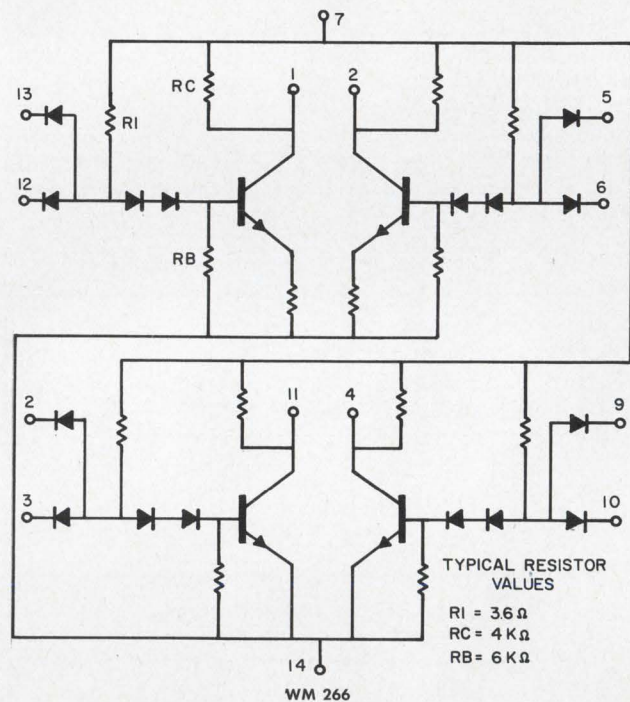
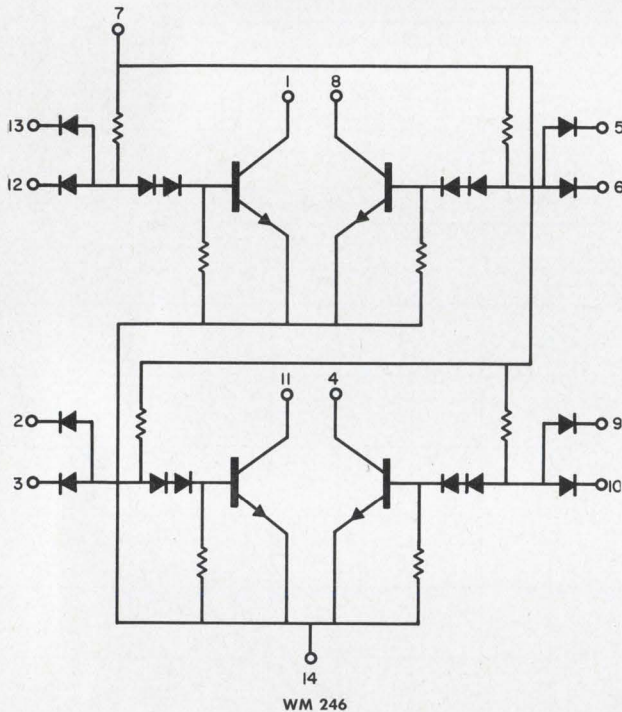
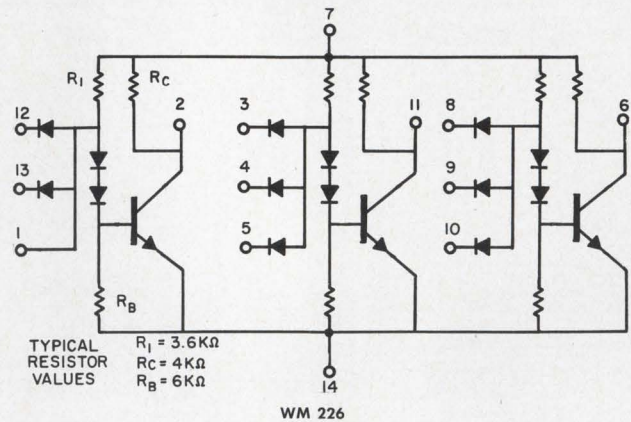
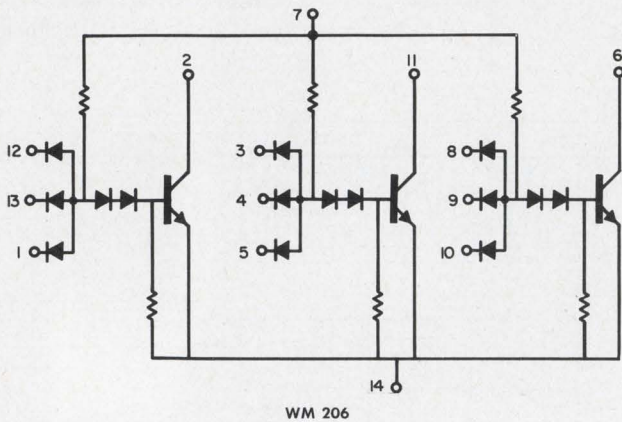

ing current of the timing capacitor. As with the triple-gate monostable, the quad-gate version must include a gate with an input node available. The choice of an output gate with or without a collector resistor depends on the output voltage swing or load requirement. Figure 4 shows three configurations of 200-Series gates which, with an external capacitor, provide monostable operation.

Figure 5 is a graphical representation of the dynamic operation of the quad monostable. In comparison with the triple-gate monostable, approximately only one-third the capacitance is required in the external timing capacitor for a given pulse width. Variation in pulse width over

the temperature range is typically 50% less for a "quad mono" than for the "triple mono". The "quad-gate mono" output width similarly varies only about 50% as much as the "triple-gate mono" over a power supply range of  $\pm 30\%$  (+6 V is nominal). In the circuit,  $V_{CC} = 6\text{V}$ ,  $V_{T,1} = 4\text{V}$ ,  $V_{T,0} = 0\text{V}$ ,  $t_{TW} = 0.24\text{ }\mu\text{s}$ ,  $t_{TB} = 14.0\text{ ms}$  and  $t_{ow} \approx 4 \times 10^3 C_T$  (seconds per farad).

Figure 6 provides a waveform analysis at the pertinent points in the "quad mono" circuit.

Referring to the trace describing the waveform at Pin C to ground (Fig. 6c), it can be seen that the voltage at the node goes negative by a value equal to the supply voltage less three diode drops.



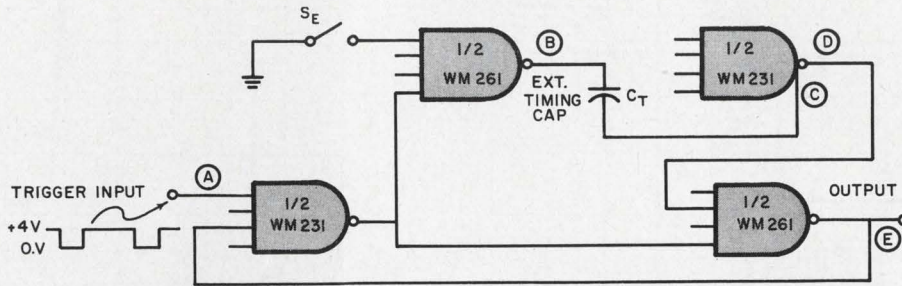

(a)

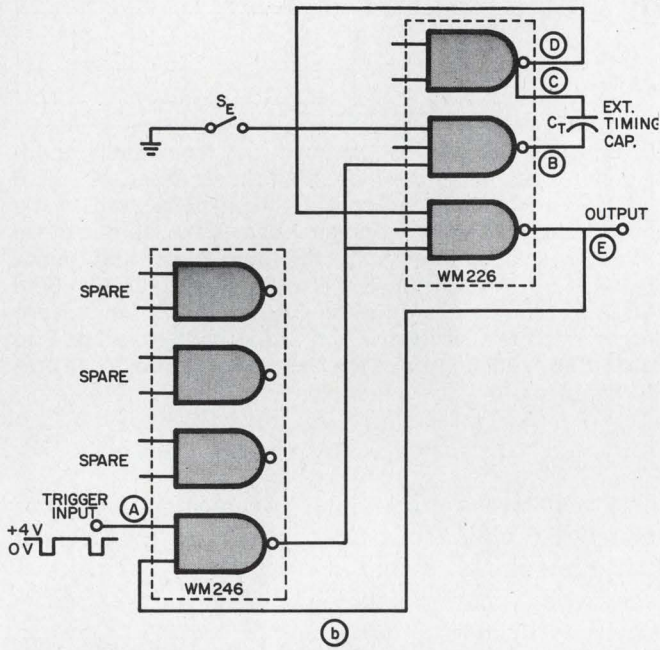

(b)

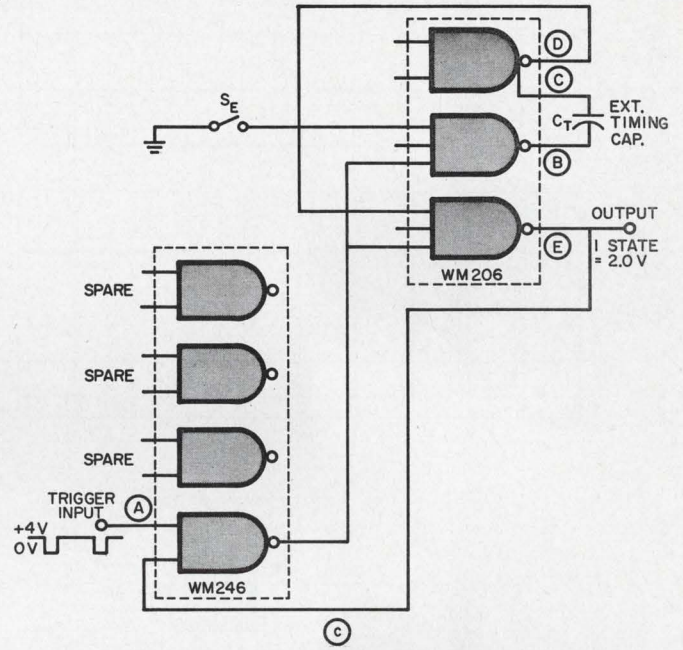

(c)

4. **Quad-gate monostable** uses two standard 200-series DTL gates (a WM231 and a WM261).  $S_E$  is an optional, external "inhibit" switch. In (b), a WM226 and a WM246 are combined for added monostable flexibility. Note that three spare gates are available for logic functions in the

input side (WM246 package). Still another monostable version can be built with 200-Series elements (c). Here a WM206 is used in place of the WM226 of (b). With each of these quad gates, thermal stability is superior to that of the triple gate and timing capacitor ( $C_T$ ) is reduced.

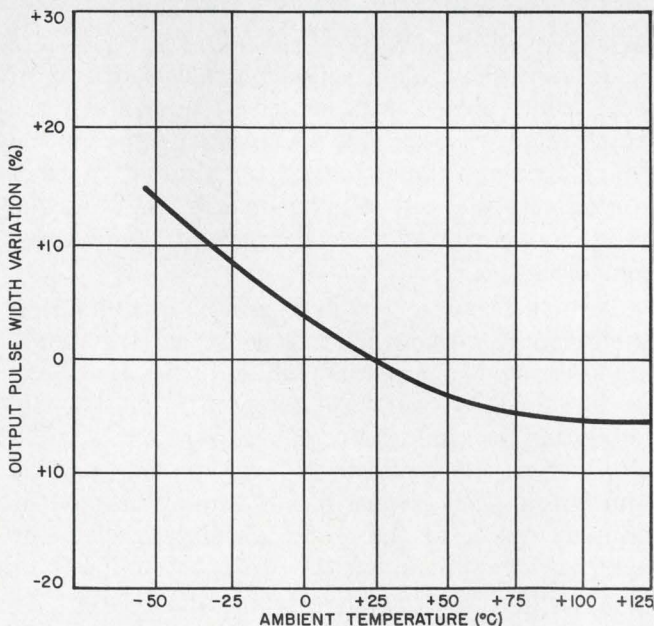

(a)

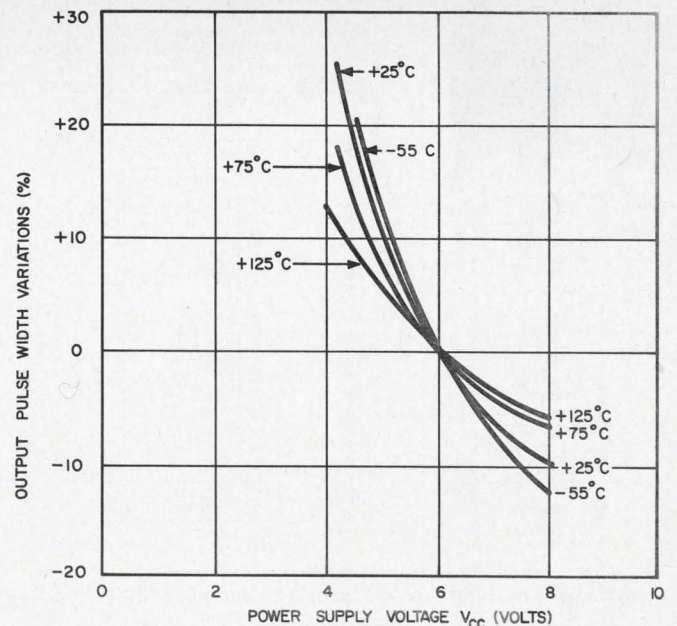

(b)

5. **Output pulse width variations** as functions of changes in temperature (a) and supply voltage (b) are less for the

quad-gate (see Fig. 4) circuit than for the triple-gate (see Fig. 2) version.



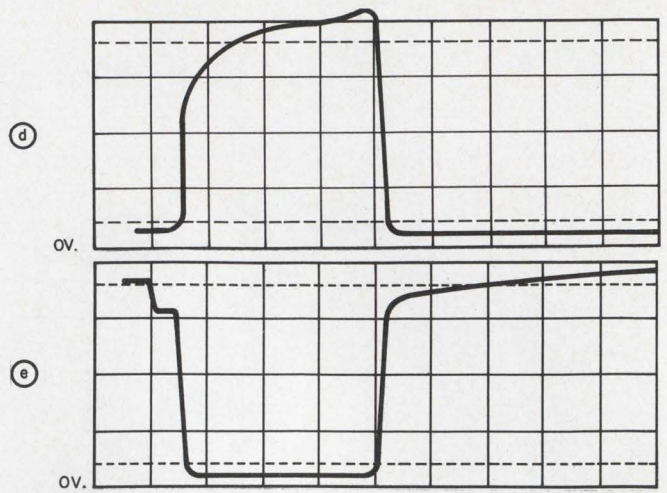
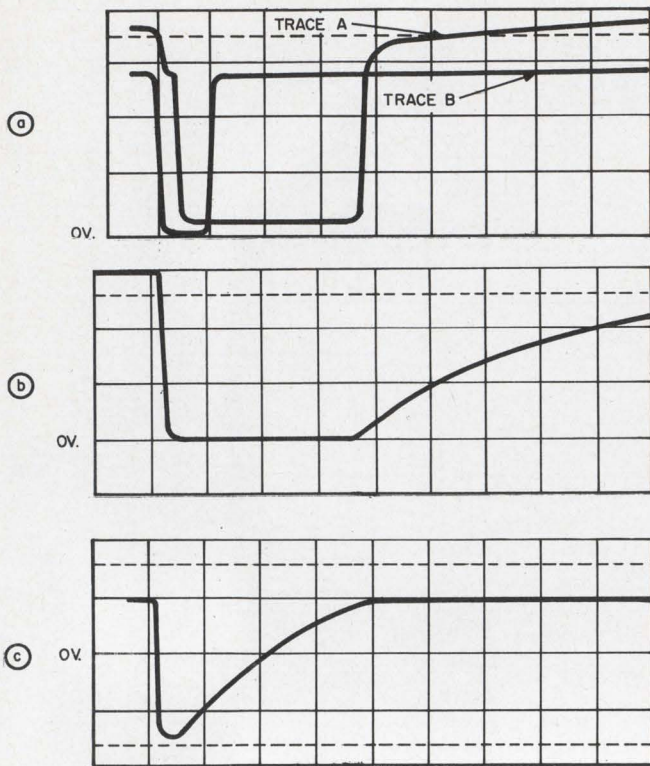

6. Typical waveforms for the quad-gate monostable multivibrator (see Fig. 4) are illustrated. In all cases,  $V_{CC} = 6$  V,  $C_T = 500$  pF and no collector resistor is used in the output stage. In (a), the upper trace is the output pulse at Pin E (scale is 0.5 V/cm); the lower trace is the input pulse at Pin A (scale = 2 V/cm). Trace (b) is Pin B to GND (2V/cm scale), (c) is Pin C to GND (2 V/cm scale), (d) is Pin D to GND (0.5 V/cm scale) and (e) is Pin E to GND (0.5 V/dm scale). The horizontal scale in (a)-(e) is 0.5  $\mu$ s/cm.

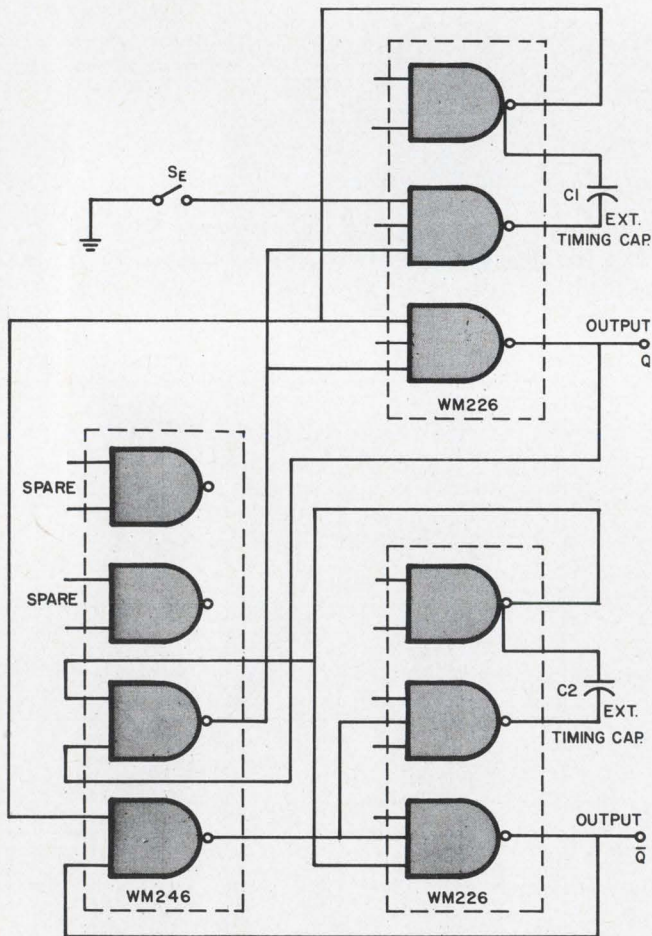

7. Astable multivibrator is formed by two quad-gate monostables. Here  $C_1 = C_2$  and  $V_{CC} = +6$  V. Note that only three IC packages are required, and that spare gates are available for other logic functions. Moreover, two of the ICs are of the same type.

The negative voltage level reached is approximately 3.5 volts. It is for this sort of application that a maximum rating at the node of  $-7$  volts is shown on all data sheets which describe 200-Series gates with nodes.

#### Astable formed by 2 quad gates

The quad gate and the triple gate may also be used to construct an astable multivibrator. Figure 7 provides a logic diagram for two quad-gate monostables cross-coupled to create a free-running astable multivibrator circuit. Typically,  $C_1 = C_2$ .

Figure 8 shows data reflecting the sensitivity of pulse width output changes with temperature and power supply variations. A performance option chart—expected pulse output for a given value of timing capacitance—is given in Fig. 8c. Note the relative linearity and broad range of this subsystem design.

It should be observed in Figs. 4b, 4c and 7 that the standard circuits used to construct the monostables provide spare gates which the designer can exploit for any other logic purpose in addition to obtaining the timing circuits. For example, with either type of monostable and/or the astable multivibrator, it is possible to employ one of the unused inputs to the gate associated with the external timing capacitor for "stopping" or preventing input pulses from triggering the monostables. This points up further the versatility of the standard DTL logic gate approach to timing-circuit design. ■ ■



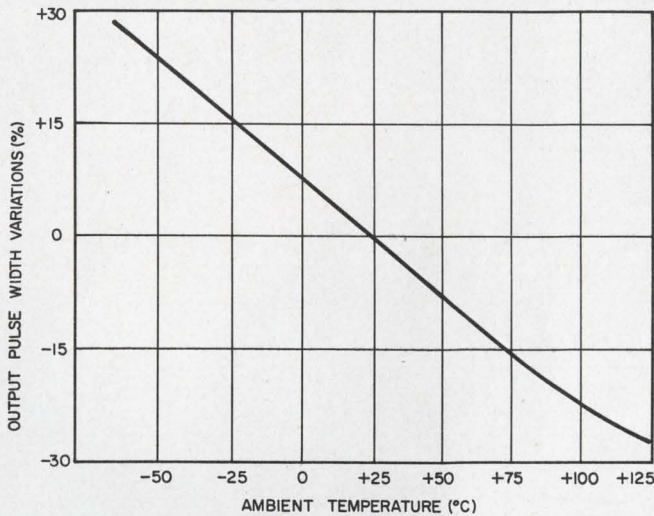

(a)

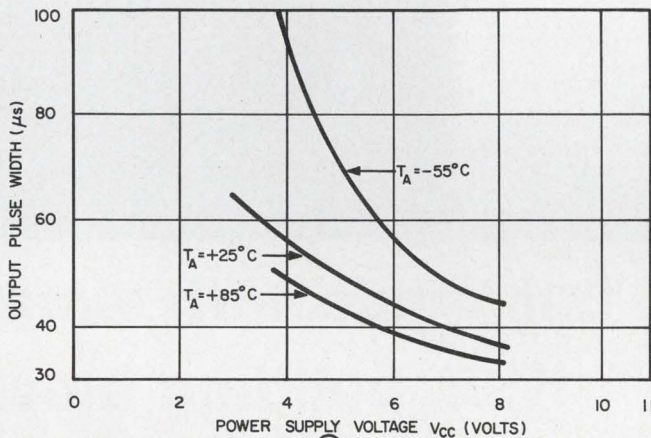

(b)

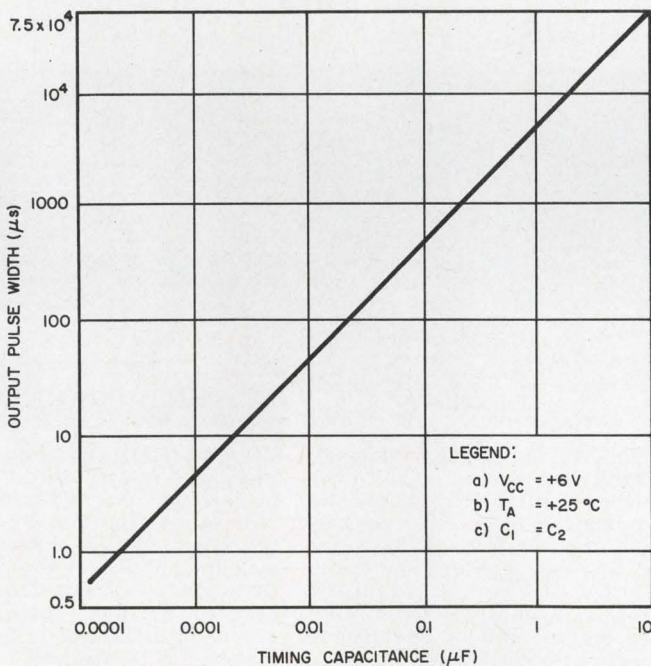

(c)

8. Output pulse width as a function of temperature (a) and power supply voltage (b) for the astable multivibrator. In (a),  $V_{CC} = +6$  V,  $C_1 = C_2$ , and  $t_{OW} \approx 4.5 \times 10C_1$  (seconds per farad); in (b),  $C_1 = C_2 = 0.01 \mu F$  (see Fig. 7). Output pulse width as a function of timing capacitance (at  $25^\circ C$ ) appears in (c). Note the linearity of the relationship.

# The micro-miniature tuned-circuit package.

## JFD TO-5 Enclosed MTLC Tuners

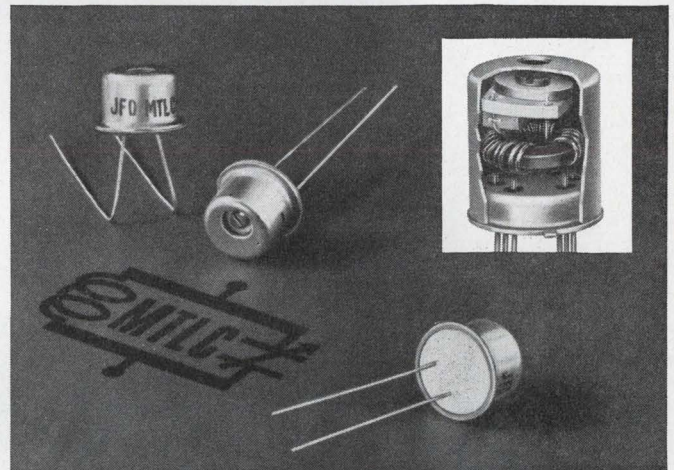

Capacitors shown enlarged 20%

JFD MTLC tuners enable circuit designers to shrink various LC circuits into TO-5 configurations completely compatible with today's miniaturized or hybrid circuitry. The tuning element is a subminiature variable ceramic capacitor measuring: .208 x .280 x .120 inch thick. These variable ceramic capacitors offer high capacitance plus a choice of wide  $\Delta C$ s in extra small, ultra stable units.

JFD builds these miniature circuits with high quality ferrite and iron inductor toroidal cores, providing maximum Q for any given frequency. Where necessary, special JFD Uniceram fixed capacitors are used with Modutrim units to yield lower center frequencies or to satisfy special circuit requirements.

Ten standard tunable LC networks are available for a wide range of applications. Variations of these standard units, or special designs, will satisfy most other requirements. Write for bulletin MTLC 65-2.

**JFD** "TODAY'S COMPONENTS BUILT FOR TOMORROW'S CHALLENGES"  
 JFD ELECTRONICS CO. / COMPONENTS DIVISION 15th Avenue at 62nd Street  
 Brooklyn, N. Y. 11219 / Phone 212-331-1000 • Sales Offices—Arcadia, Calif.  
 Chi., Ill. / Balt., Md. / Saxonville, Mass. / Bklyn., N. Y. / New Hartford, N. Y.  
 Cinn., Ohio / Phila., Pa. / Pitts., Pa. / Paris, France / Azor, Israel

Speed Inquiry to Advertiser via Collect Night Letter  
 ON READER-SERVICE CARD CIRCLE 34



# The new concept in keyboards and control panels

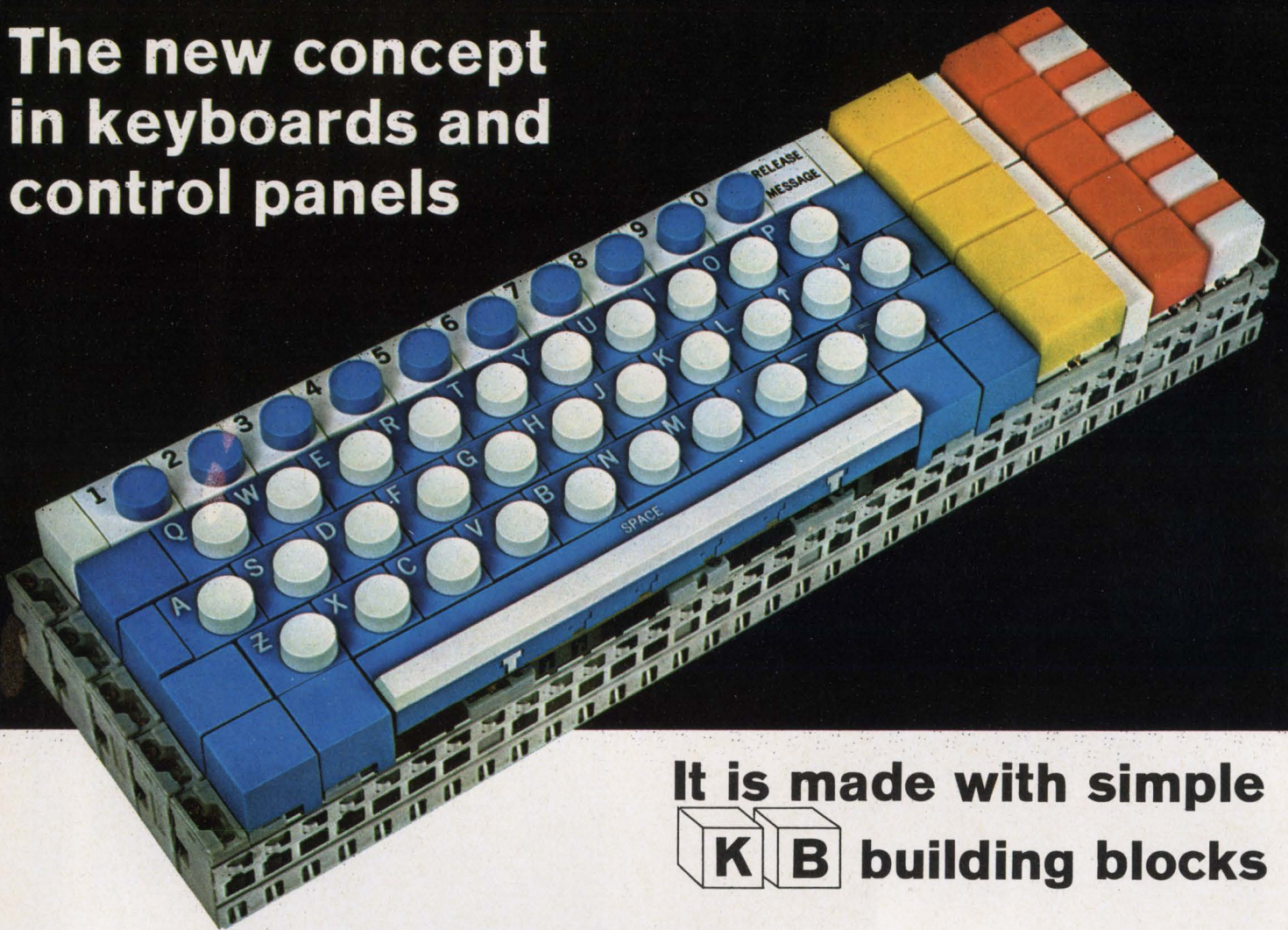

It is made with simple  
**KB** building blocks

**KB offers these exclusive advantages:**

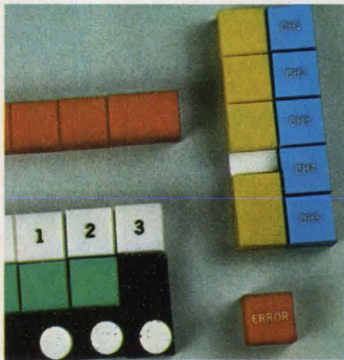

**KB allows new freedom of arrangement.** Modular construction makes it easy to customize your panels—economical, too.

Switches and indicators available in a wide variety of colors, shapes, sizes. Arrange in vertical columns, horizontal rows, compact rectangles, or individually—all, in a single cutout.

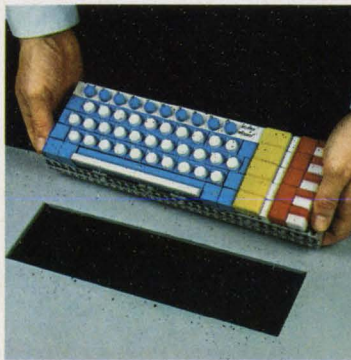

**KB allows bench assembly.** Assemble a complete keyboard matrix at the bench where the job is easier, faster. Even the wiring is done before the matrix is set into the console.

And only one panel cutout is required because KB forms its own self-supporting matrix—no additional support required.



**KB provides plug-in modularity.** With KB plug-in switches, simply loosen two screws, lift out the unit and plug-in a replacement—all from the front of the panel.

Store a reserve unit right in the board—or "borrow" one that is not as urgently needed elsewhere on the panel. Downtime is practically eliminated.

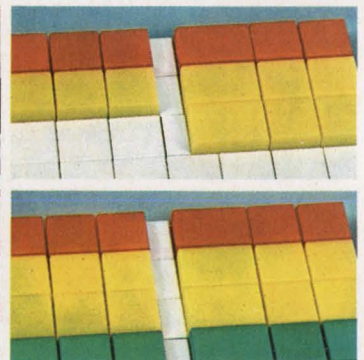

**KB simplifies expansion.** KB modular construction makes planned or unplanned expansion easy, economical. In many cases, you simply remove spacers and plug-in additional switch or indicator modules to up-date your panel. No additional cut-outs, no wiring, no soldering, no behind-the-panel work required.

**What is KB?** The KB system provides all the components necessary for a complete, self-supporting matrix, including: Power Switches and Indicators with lighted display, Encoding Switches with up to eight output bits, Mechanical Interlock Modules for a variety of sequential functions, and a unique Modular Framework System.

Find out what KB can save you in engineering time, tooling costs, assembly costs, panel space and weight—and how KB can put more sales appeal into your panels.

For a KB demonstration, call a MICRO SWITCH Branch Office (see Yellow Pages ). Or, write for literature.

## MICRO SWITCH

FREEMONT, ILLINOIS 61032

A DIVISION OF HONEYWELL



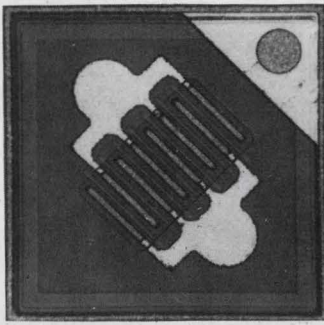

# Design Directions

... AN EDITOR'S COMMENTARY

## The Germanium FET: Needful or Needless?

Mark B. Leeds  
Technical Editor

When the germanium field-effect transistor was introduced earlier this year\* to American design engineers, a typical reaction was: "Who needs germanium when silicon FETs are doing such a good job?" But don't be surprised to see the Ge FET elbowing its way into the market, particularly for vhf applications.

Its advocates maintain that germanium, because of its higher mobility, offers superior performance to silicon (Si) in FET circuits operating at 0.1 GHz and above. They also credit the Ge FET with superior cryogenic attributes. The device may find use in applications from below  $-25^{\circ}\text{C}$  to  $77^{\circ}\text{K}$  (in a transducer preamplifier, for example) when auxiliary heating means are not feasible.

These conclusions are supported by a sampling by ELECTRONIC DESIGN of leading FET manufacturers. Most respondents indicated that germanium's strong points would win it a small place in the market. Some FET manufacturers declined to speculate at present, however. And at least one expert said flatly that there is no need for the Ge FET.

### Ge and Si FETs compared

A comparison of germanium and silicon FET properties (see Table) shows that Ge has:

- Better mobility across the board, resulting in a higher figure of merit for RF circuitry.
- A low-temperature attribute that features better gain and stability in the vicinity of  $-25^{\circ}\text{C}$  and colder.
- Operating capabilities to  $85^{\circ}\text{C}$  and slightly higher, enough to warrant design consideration for some "common ambient" use ( $0^{\circ}\text{C}$  to  $85^{\circ}\text{C}$ ).

\*At the March, 1966, IEEE Show in New York by Texas Instruments, Inc. Atlantic Instruments and Electronics, of Newton, Mass., U.S. representative for SESCO, a Paris semiconductor manufacturer, also displayed Ge FETs but these were general-purpose switching types and a 10-A power FET, not high-frequency units.

But Ge FETs also have these disadvantages:

- Higher leakage than silicon types.
- Greater thermally induced variations in parameters, in all but the frigid range.
- Operating constraints that call for special precautions in the biasing circuitry.

An examination of the advantages and shortcomings shows that they can balance out in actual designs. FETs are traditionally viewed as voltage-amplifying devices that feature extremely high input impedances. But in the RF region it is more appropriate to consider FETs as power amplifiers that possess moderate input-impedance levels.

In RF-amplifying applications the gate leakage current of any FET is normally of little concern. This is because low-value resistors are employed in tuned-amplifier circuits as dc gate returns. The resistors (with typical impedances of 50 or 100 ohms) govern circuit behavior because the FET's  $Z_{in}$  is much higher.

### Mobility higher in germanium

The high-frequency figure of merit is the ratio of transconductance to input capacitance. Because the mobility of Ge is higher, the transconductance is correspondingly larger. Theoretically the figure of merit for Ge p-channel units should be 1.4 times that of silicon n-channel types. With n-channel devices—and their innate greater electron mobility than hole mobility—the figure of merit for Ge is 2.7 times that of Si. If p-channel silicon is compared, the mobility advantage of germanium (n and p) is even greater.

Also related to the mobility question is the matter of resistance levels, although this issue is somewhat obscure. Some FET experts maintain that parasitic gate resistances are lower in germanium units than in silicon types. This has not been conclusively proved, however, and most semiconductor makers, including Texas Instruments, say that a consistent advantage does not exist here.

This gate resistance, if it were lower, would



# Design Directions

CONTINUED

mean a higher input impedance for common-source configurations (a favorable property) and higher output resistance for common-gate and common-source modes (a liability).

Theoretically the germanium unit should have a lower parasitic gate resistance.<sup>†</sup> If this property could be realized in mass-produced units, it would give the Ge FET an extended high-frequency cutoff.

## Ge FET operable at 85°C

Disagreement also exists about the operating-temperature capability of germanium devices. In practice, most engineers turn to silicon semiconductors for temperatures in excess of 70°C. Although the Ge FET has a lower maximum operating junction temperature than its Si counterpart, it is nonetheless rated for use at 85°C.

In fact, the TIXM12 device, "can be used at even higher temperatures for applications starting in the 0.5-1.0-MHz range," says Jack Abernathy, senior product design engineer at Texas Instruments. However, the operating temperature capabilities of silicon FETs (such as the 2N3823, a high-frequency type) remain both higher and more stable.

The smaller upper operating-temperature limit of germanium poses a design problem, especially in military equipment. Joel M. Cohen, chief engineer at Crystalonics, Div. of Teledyne Inc., Cambridge, Mass., points out that "even at room temperature, the maximum power dissipation of a germanium FET is only half that of a silicon unit." He adds that as one approaches and exceeds the 85°C level, so common in military designs, silicon FETs further outperform germanium types. But Cohen emphasizes that this "power-handling limitation posed by the temperature property is not a serious drawback in small-signal applications [of a few milliwatts or less]."

Also related to temperature are the leakage properties of the Ge FET. At any given temperature, the leakage current of a germanium gate-junction is several orders of magnitude higher than that of corresponding silicon FETs. This shortcoming precludes the use of Ge FETs as ultrahigh input impedance devices for all but frigid environments. If there

is one general FET property that design engineers appreciate (in other than RF situations), it's the high  $Z_{in}$  characteristic.

## Design precautions with Ge FET

The leakage drawback may be somewhat offset if design precautions are taken. The Ge FET has better leakage properties than silicon units at -25°C and below. For example, the TIXM301 (metal-can version of the TIXM12), rated to -65°C, may be operated at liquid-nitrogen temperature (77°K), provided the device is gradually brought down to this extreme.

At other temperatures, particularly those involved in most applications (0-100°C), safety measures must be taken to offset the high leakage. When self-bias is used in Ge FET amplifiers, the resistance between gate and source should be kept below approximately 47 kΩ. This will ensure operating-point stability from -55°C to +100°C. The upper limit here knocks out the contention that germanium devices may not be successfully operated at temperatures much above 65-75°C.

According to Abernathy, "This resistance-limit precaution is unnecessary in tuned RF and transformer-coupled audio circuits." He adds: "as with other semiconductors, bootstrapping may be employed to provide extra stability."

## Biasing design is critical

Abernathy cautions, however, that Ge FETs should never be operated in a zero-bias condition. He maintains that the junction requires a minimum of 0.5-volt reverse bias, because of the low forward-voltage drop of the gate diode. But even with these safety measures, many FET experts view the temperature dependence of the leakage current with concern.

James S. Sherwin, manager of FET applications at Siliconix, Inc., Sunnyvale, Calif., emphasizes: "Bias in a Ge FET is very temperature-dependent, in a nonlinear fashion. This is particularly severe where large-value gate resistors are used."

Dr. Jean A. Hoerni, manager of research and development at Union Carbide's Linde Div., Mountain View, Calif., believes that the germanium FET has no future in electronic designing. He says that its two prime faults—high junction leakage caused by low-energy band gap, and a limited operating temperature range—are reasons enough to rule it out.

Cohen considers high leakage "disastrous at frequencies lower than RF." He adds: "Since high input impedance is a must at these frequencies, the germanium FET must be

<sup>†</sup>See "Field-Effect Transistors," Sevin, L. J., McGraw-Hill, N. Y., N. Y., 1965, p. 44.



considered unsuitable for these applications.”

Philip A. Weygandt, a marketing manager at Amelco Semiconductor Div. of Teledyne, Inc., Mountain View, Calif., suggests: “Silicon FETs are just innately more stable than germanium FETs, and most designers do not want to contend with the greater temperature dependencies of the germanium device.”

#### Foreseeable processing problems

Moreover, the major advantage of Ge FETs—higher mobility—is also subject to question, according to some of the FET experts. Sherwin believes that “the mobility advantage of germanium over silicon is largely offset by processing-control difficulties.” He says: “I doubt if the theoretical advantages can be fully realized, particularly since the germanium FET technology is well behind that of silicon.”

Cohen says: “For the same geometry and same material resistivity, a germanium FET will have approximately twice the transconductance and only three-fourths the junction capacitance of a silicon unit. All things being equal, the high-frequency merit figure will be two and one-half times higher with Ge.”

However, he continues: “There are factors other than the processing difficulties and the broader silicon experience that detract from the Ge FET’s mobility advantage. Since geometry has an effect on transconductance range,” Cohen says, “the ratio of package capacitance to junction capacitance and the power dissipation limits at high transconductance points must also be considered. In low- $g_m$  units the high-frequency figure of merit may be

#### Comparison of Ge and Si FET properties

Consideration	Ge	Si
1. Mobility	higher	high
2. Cut-off frequency	1 GHz	0.5 GHz
3. Lowest operating temperature	-200°C	-50°C
4. Normal operating range	-65°C-85°C	-40°C-100°C
5. Leakage current	two orders of magnitude higher than silicon	low
6. High frequency figure of merit ( $y_{fs}:C_{iss}$ )	Approx. twice as high as silicon	Typically 500
7. Extra biasing design precautions	Two	None
8. Input impedance	High	Ultra-high
9. Highest realizable transconductance (units now on market)	10,000 $\mu$ mhos	100,000 $\mu$ mhos

reduced by the package capacitance.

“It is not now feasible to manufacture large batches of germanium junction FETs with pinch-off voltages held to a maximum much below three volts. This means a transconductance-to-drain-current ratio of approximately unity. Since the drain current creates the dissipation problem, the optimum transconductance range for germanium units would be limited to 10,000  $\mu$ mhos [corresponding to 10 mA of drain current].”

Dr. Hoerni feels that “one cannot attain the theoretical advantages of germanium over silicon in production-line quantities for frequencies below one gigahertz.”

#### TI sole U.S. Ge FET source

The market for all field-effect devices is healthy and growing. But aside from Texas Instruments, no U.S. semiconductor manufacturer has reported an intention to produce germanium FETs. Among those standing pat with silicon are Siliconix, which makes more FET types than any other company; Crystalonics, a leader in power FETs; Amelco; Union Carbide, and Fairchild. Each already has a vested interest in FETs for high-frequency applications.

In Europe, where germanium FETs have dominated the market thus far, there is evidence of a shift to silicon units. SESCO, a Paris semiconductor manufacturer, for example, makes number of germanium power and general-purpose FETs. Its American representative, John Newman, marketing manager of Atlantic Instruments and Electronics, says: “We intend to convert some of our present germanium FET products over to silicon types. Although we don’t plan to replace all germanium devices, and haven’t abandoned that technology altogether, I expect silicon soon to dominate our FET product line. We feel that it has better over-all performance advantages than germanium, particularly in the temperature-behavior aspect.” The germanium line probably will be restricted to just a few types, Newman says.

Meanwhile, Texas Instruments has designed and tested Ge FET circuits successfully. Among these have been RF amplifiers and mixers, 50-to-500-MHz oscillators, and low-noise pre-amplifiers for a cryogenic transducer.

As the world’s largest semiconductor manufacturer, Texas Instruments isn’t neglecting its heavy investment in silicon FET’s—not by a long shot. But it appears convinced that the Ge FET is here to stay—even if the role is relatively small. ■ ■



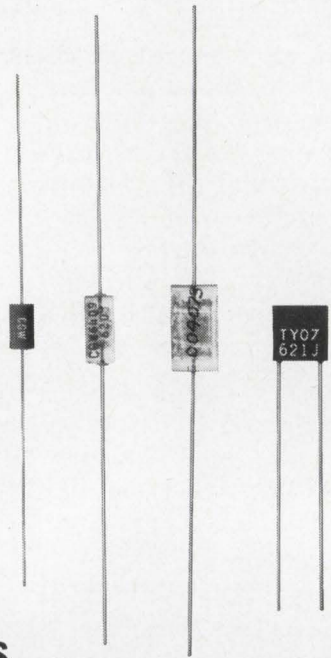

from .5 to 100,000 pf, nothing's as stable as glass



Boil, freeze, bury, drown or irradiate glass, and you won't measure any dielectric change.

Freeze a capacitive element inside that glass, and it's as immune as any capacitor can get to environment, temperature, time, voltage, moisture, frequency, vibration, shock.

That's why nothing comes closer to being the perfect circuit symbol than a CORNING® glass capacitor. And only Corning makes the glass capacitors to meet all these critical circuit needs:

**High capacitance in small space.** The CORNING® GLASS-K capacitor crams from 1,000 to 100,000 pf in a quarter-inch case size.

**Dense circuitry, without doubts.** The CORNING® TYO capacitor, from 1 to 2700 pf, has radial leads, precision case for snug up-right mounting.

**Documented stability and reliability.** Every CORNING® CYFR capacitor, from .5 to 10,000 pf, meets our punishing J-950 specification, and is backed by a heritage that includes use in Surveyor, Minuteman, Gemini, among others.

**Low cost, high reliability.** The CORNING® CYFM capacitor, from .5 to 10,000 pf, gives you CYFR-type environment-proof performance at substantial savings.

Why risk an entire system on capacitors that cannot give you the assurance of

Corning dielectric stability? Send for the new CORNING® GLASS CAPACITOR GUIDE to Corning Glass Works, 3909 Electronics Dr., Raleigh, N.C.



**CORNING**  
ELECTRONICS

ON READER-SERVICE CARD CIRCLE 36



# Digital computers are no mystery if you think of them in terms of the functions that they perform instead of their hardware.

## Part 1 of a series

Digital computers, for all their seeming complexity, are really rather simple functionally. Regardless of the amount of hardware involved, the computer operates by repeatedly performing the Boolean operations, AND and OR, or simple compounds of these.

By thinking of a computer in terms of these simple functions, the design engineer can develop a solid understanding of digital computers—a vital step in the design process.

To help this understanding along, let's take a look at what we might call the "anatomy" of a computer; that is, what the really basic operations are and how they are performed.

Computers process data and control data flow. To do these jobs, a computer is composed of the following:

- *Data paths*—In these we find arithmetic, data-transfer and temporary-storage functions. The three types of functions are generally made up of two-input ANDs, ORed together with no variables in common. Since there are no common variables, the input function is in its simplest form. Furthermore, the ANDs usually are mutually exclusive. That is, only one control line is ON at a time and therefore only one gate can operate at a time. This arrangement will appear throughout the functions to be described.

- *Controls*—These set up the sequencing and routing of data by using the same functions as data paths plus decision-tree structures. They are essentially the "traffic cops" of a computer. Of course, there are some areas where this distinction between processing and control is not quite so sharp. For example, some control functions may depend on actual data rather than being based on an independent clock oscillator. However, for simplification, the data-path-versus-control concept is valid.

### Data paths do the arithmetic

Data paths, which are primarily arithmetic in nature, consist of registers, shifters, adders, bus checking logic and leading zero detectors. Taking these one at a time:

- *Registers* hold data for later use or

processing. Figure 1, a typical example of a register pair, shows a simple standard set of functions.

- *Shifters* are used for normalization, (i.e., putting a 1 in the leading bit position), fraction alignment and, of course, shifting. There are many shifter designs but all are usually some variation of the basic logic shown in Fig. 2.

- *Adders*, which also perform subtraction, are more involved than either the register or shifter. As shown in Fig. 3, two basic functions are used: the exclusive OR and the "majority" function. In practice, more complex arrangements are used, especially in high-speed adders (see "Microelectronics opens the gate," ED 16, July 5, 1966, pp. 52-57). Also, in some cases, both the sum and the carry are derived from common gates. Still, the two basic functions shown in Fig. 3 are all that it is necessary to know about adders.

Subtraction usually requires complementing of an operand (i.e., changing all 1's to 0's and all 0's to 1's) and sometimes of the result as well. When the control line is 1, the true (i.e., noncomplemented) data are passed. When the control line is 0, the complemented data are generated. This is done with the exclusive-OR as shown in Fig. 4. Usually several inputs to an adder or a shifter are bused together, as shown.

- *Checking*, which usually means parity checking, is another data path function. This function, shown in Fig. 5, serves both for parity generation and parity checking.

- *Leading zero detection* for normalization (Fig. 6) is straightforward. The simplicity of most of the functions found in the data paths of computers can be seen from Figs. 1 through 6. Even the most complex data paths do not vary too much functionally from the configurations shown. For example, high-speed multipliers use carry-save adders (see "Microelectronics opens the gate," ED 16, July 5, 1966, pp. 52-57) composed of the functions shown in Fig. 4.

Why this simplicity? First, remember that we are looking at a highly simplified view. Second, the functions themselves (i.e., ANDs and ORs) are simple; the actual hardware involved, however, can be quite complex depending on the type of circuitry used to implement the functions.

Even with these qualifications data paths are still simple in terms of function. Two-way ANDs predominate and they are used both to gate



# Circuits used to process data

Here are the circuits used by a digital computer to perform arithmetic, transfer data, and temporarily store information.

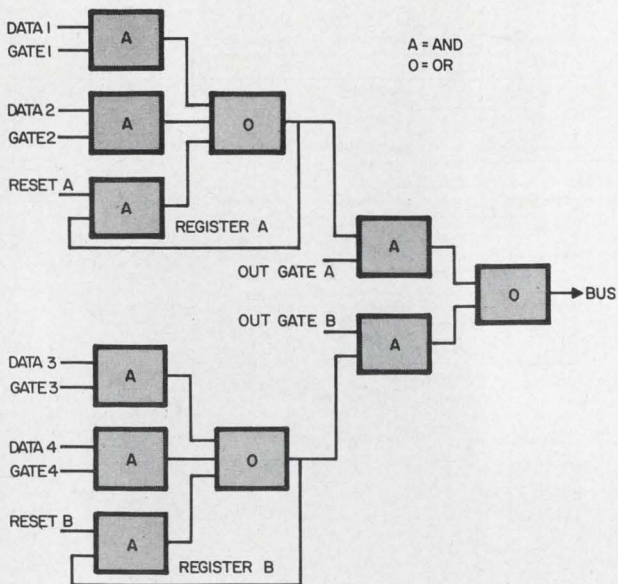

1. Data path register pair, out-gated and ORed

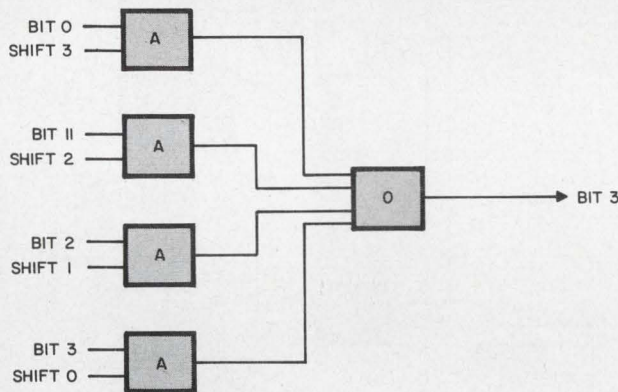

2. One bit of a four-way shifter

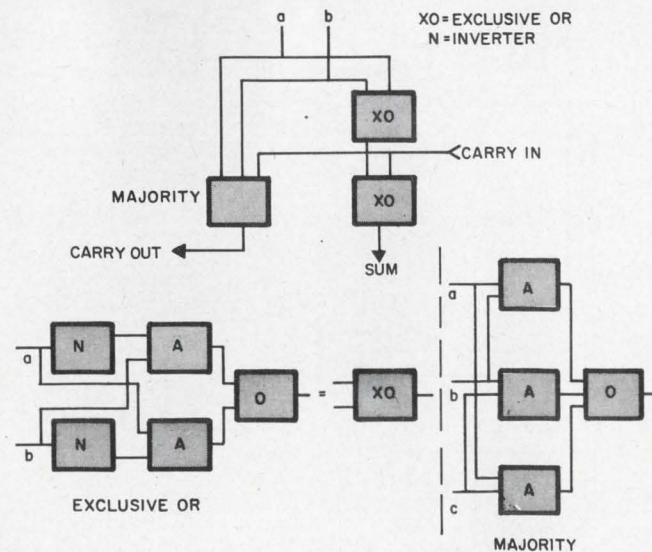

3. Adder functions

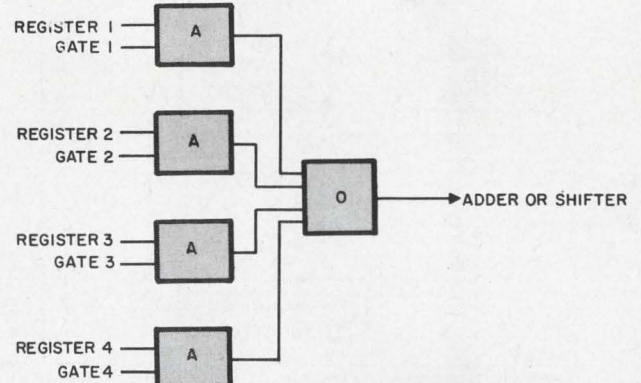

4. In-gates to an adder or shifter

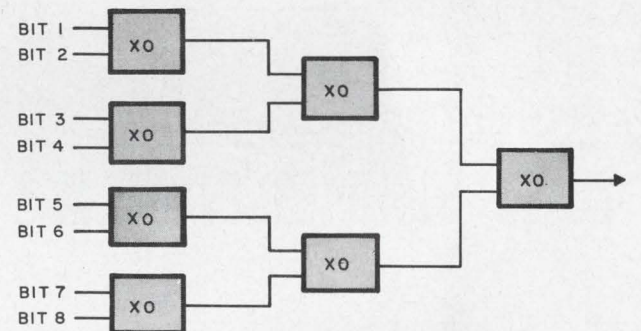

5. Eight-bit parity tree for checking

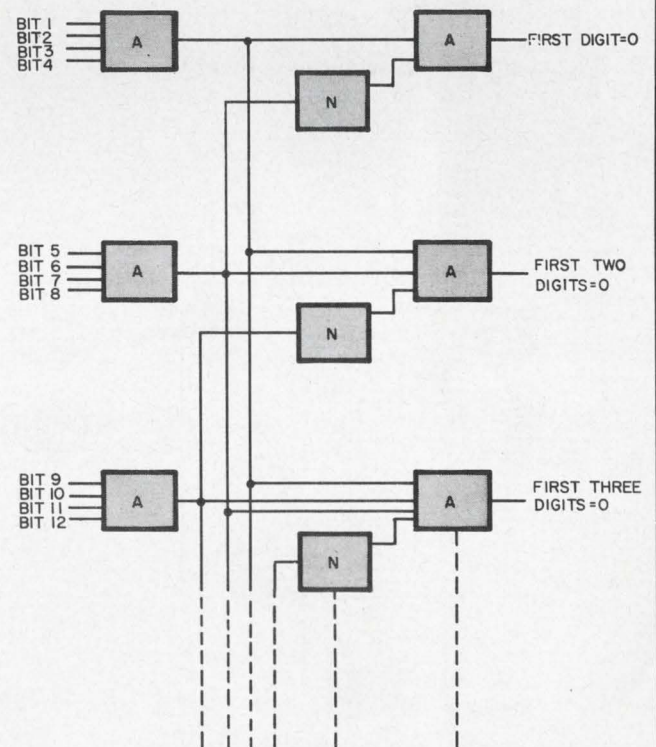

6. Leading zero detector for hexadecimal numbers



# Circuits used to route and sequence data

Complex though they may appear, control circuits are basically made up from the simple functions used to process data.

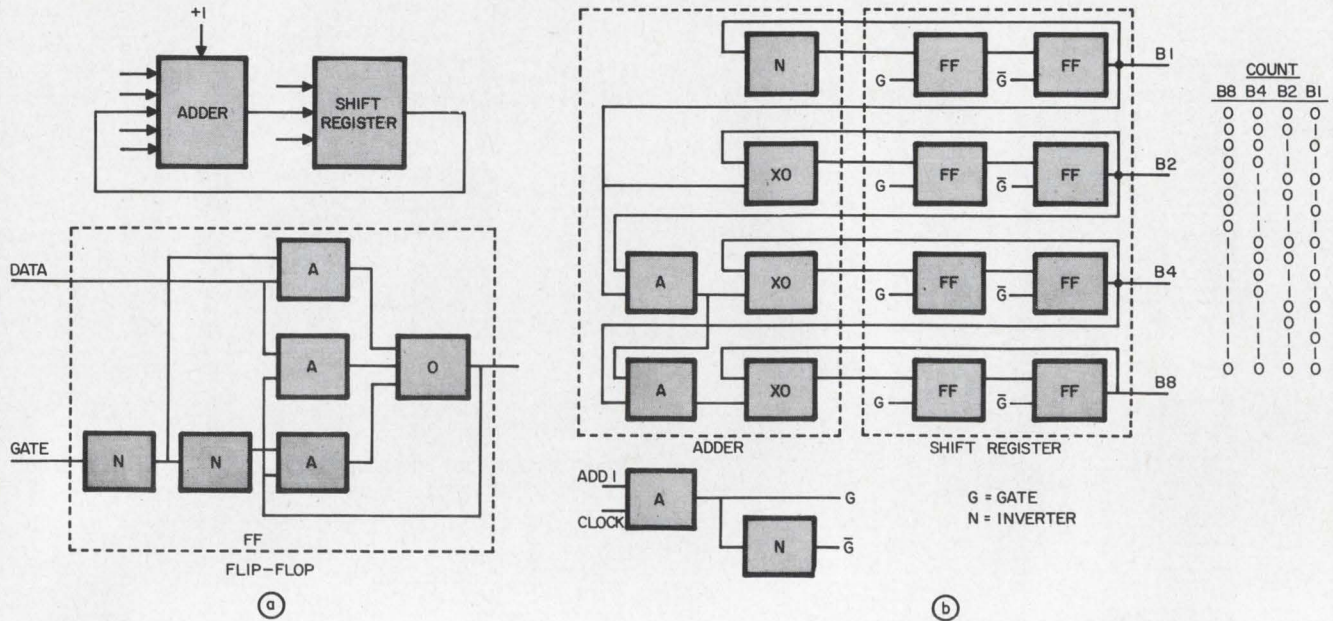

## 7. Four-bit binary counter

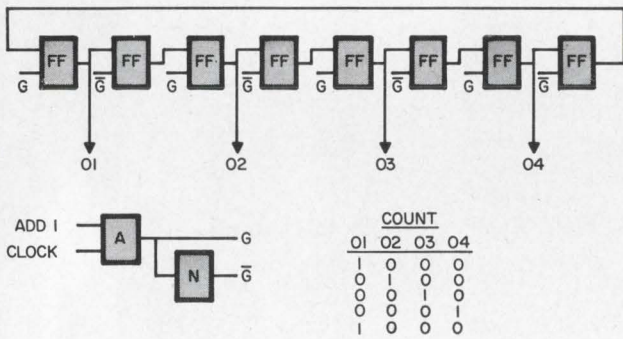

## 8. Ring counter counting one-out-of-four code

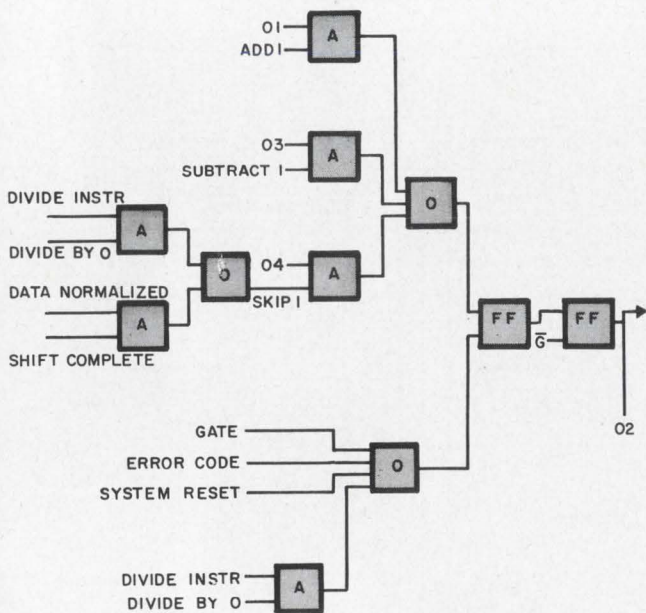

## 9. Web-of-decision build-up for one bit (O2) of counter in Fig. 8

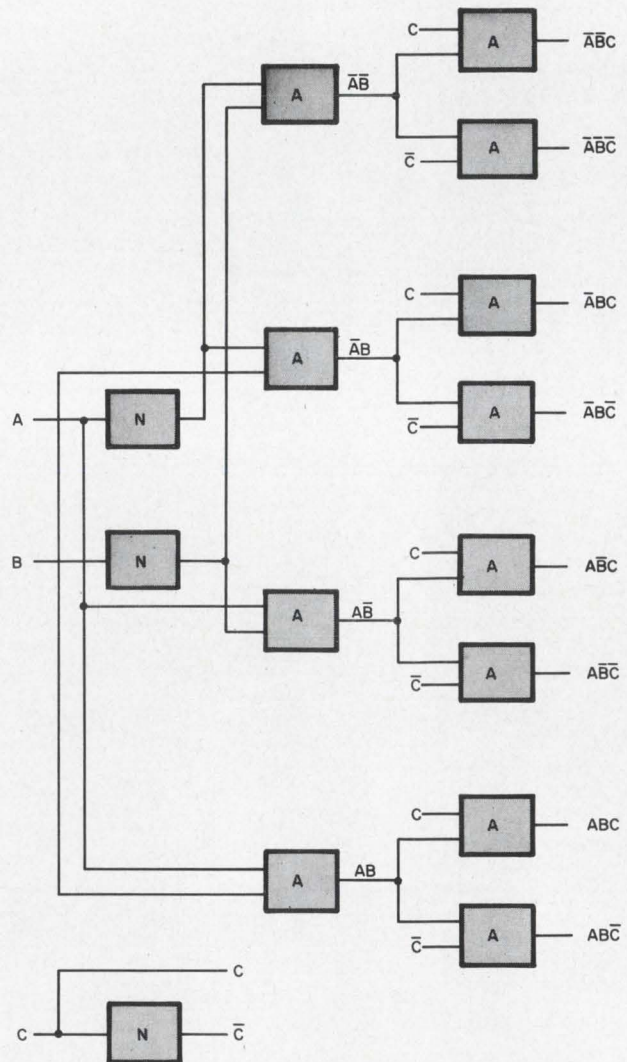

## 10. Three-bit decoder



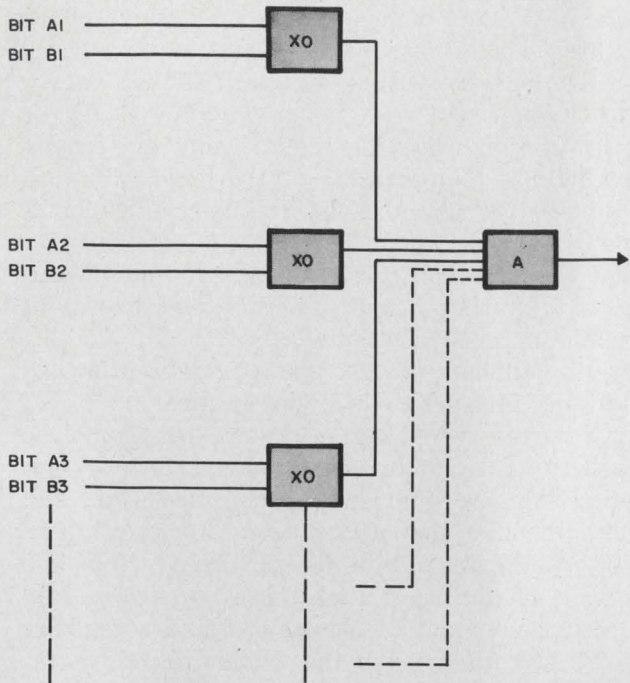

**11. Compare logic**

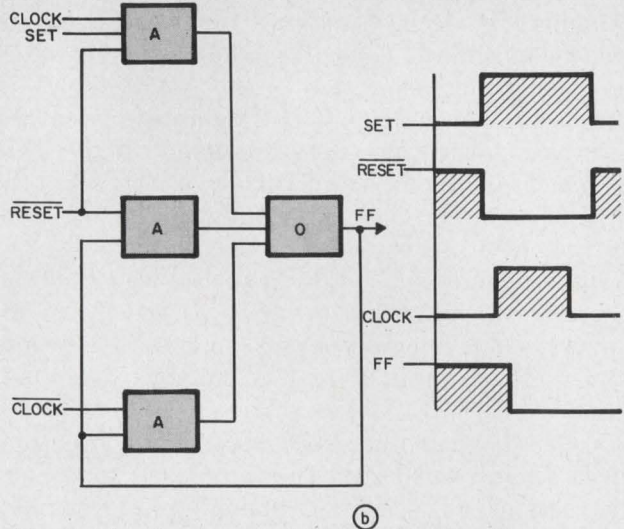
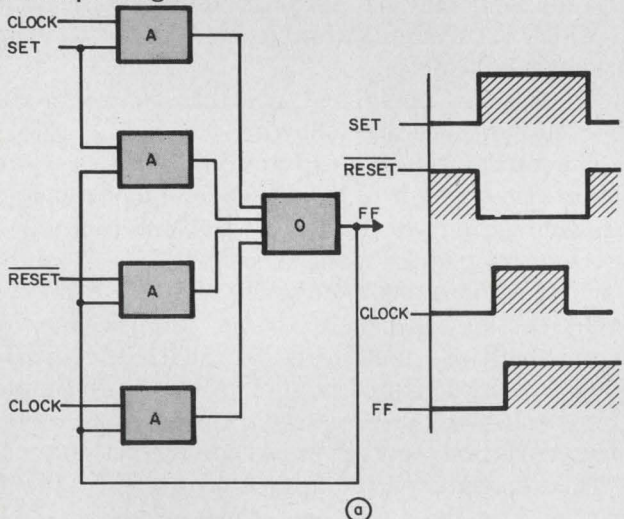

**12. Set-dominant control trigger (a)** (FF will set when set & reset occur during same clock pulse)  
**Reset-dominant control trigger (b)** (FF will reset when set & reset occur during same clock pulse)

data and to move them through a complex of intersecting paths. ORs serve to combine data into one bus. Both ANDs and ORs also store data while they are waiting to be used—as in Fig. 1.

Once the data are routed, they must be operated on (i.e., added, subtracted, divided, multiplied, compared, etc.). Most of these operations involve some form of addition.

The shifter does a little bit of both routing and operating. But what it does can be looked upon as simply routing data or as performing an arithmetic operation (e.g., shifting left one bit position is equivalent to multiplying by two).

In actual design situations things are more complicated. For example, for several ANDs feeding into a single OR, there may be an additional set of control lines or a single clock line going to each AND. The functions found in registers may also vary. There can be complements of the outputs, or there can be different logic designs, or there can be different circuit designs, or any combination of these. Design philosophy can also affect the actual functions. Some philosophies require in-gating (i.e., a register bit position may have multiple inputs) to registers; some require out-gating (i.e., multiple outputs); other designs may require both types of gating.

The fundamental simplicity of the Boolean functions that have been described, however, does not change.

**Counter is the heart of controls**

Controls, for all their bulk, also contain simple functions. Computers, especially in the high-performance range, are among the most complicated machines designed by man. But it is this very complexity that forces a functional simplicity, especially in controls.

Controls generally perform two essential functions: they sequence data through the data paths, and they sequence instructions and operands through the memory. They do these as the result of complex decision functions based on many control conditions. These include interrupts, instructions, exceptions, data dependencies, feedback from peripheral areas, error signals and, in the larger systems, a vast system of interlocks. These factors lead to a web-like decision-making complex superimposed on the basic sequencing problems.

For controls, the major part of the design effort is spent simply specifying the problem that the controls must cope with. Only a small part of the total effort can be allotted to actual circuit implementation. And, since the mere specification of the problem is so difficult, the design and organization of the control section must be straightforward and essentially simple. Since the over-all job of the control is so highly complex, it is built out of the



individually simple functions described below.

▪ *Counters* handle the primary job of a control section sequencing. Counters normally count in one of two basic modes; either in binary (or modified binary such as binary-coded decimal) or in one-out-of- $n$  code. There are variations, but for simplicity only these two modes need be considered. Here is how a typical counter operates.

A four-bit binary counter made up of flip-flops is shown in Fig. 7. The middle gate (Fig. 7a), is used simply for timing purposes. As shown, the flip-flops perform a shift-register function in a feedback loop into a simple add-one adder.

Logic details of the counter are shown in Fig. 7b. Here an add-1 and a clock signal generate a gating signal that initiates the operation of the shift register. The first bit feeds back on itself through an inverter to form a gated logical oscillator. The flip-flop associated with each bit from  $B_2$  on is "set" when the output of the exclusive OR of the bit in question and the preceding bit is 1.

The shift register portion of the counter in Fig. 7 is a standard sequential function found in both data paths and in controls. All logic feeding back on itself in de-coupled logic requires two flip-flops for reliable operation. If designed together, they make one bit of a shift register. These are also used widely in serial machines in the data paths.

On the other hand, a ring-counter counts in a one-out-of- $n$  code. As shown in Fig. 8, a ring is composed of a series of flip-flops, where only one flip-flop is ON at a time. Each time the clock, or the add-1 pulse, comes along, the information bit moves one flip-flop pair further down the line.

While many more flip-flops would be required in a ring counter as opposed to an equivalent binary counter, the ring counter has the advantage of functional simplicity.

The build-up of these basic functions into a relatively simple but realistic configuration is shown in Fig. 9. This shows one of the bit positions of the counter of Fig. 8 and demonstrates how involved circuitry can become when one bit of data is dependent of any of several unrelated conditions. For example, in Fig. 9 there is the capacity for adding 1 to the count (top gate) or subtracting from the count (second gate). In the next gate, a count state can be skipped under the control of the complex of conditions indicated. With the logic at the bottom, the flip-flop can be reset as a function of error codes or system-reset. It could also be reset as a function of a complex of control conditions.

In general, control-function gates are more likely than data-path gates to have common variables appear at their inputs. This permits manipulation and minimization, but is seldom taken advantage of.

It is, for instance, quite often very difficult to determine just how one control signal is related to

other control signals—or even if any relation exists at all. And determining which combination of control conditions never occurs is more difficult, even for the sophisticated designer. If such "never occur" conditions were taken advantage of, the control section would be considerably more complex, because minimization of the logic functions would tend to obscure the original logic conditions.

The fact that control functions are not so complex and that they remain inherently an overlay of simple functions is because:

1. It's difficult to tell what combination of conditions interact or will not occur.

2. Even if the designer knew, he would be afraid to take advantage of them. Later engineering changes could change the interactions and nonoccurrences and necessitate alteration of a considerable part of the design. Even worse, the designer could forget that these conditions and nonoccurrences had been exploited and some rare event might then make the system fail.

3. The decision level at which a signal comes into the logic may be more a function of the time at which it becomes available than its position in the logic scheme.

To see how a typical control design might proceed consider the following.

The initial conditions required to initiate an action are: no error code, no divide underflow, and the timing ring set at stage two. A single flip-flop or a control trigger could be set with these conditions. It is more likely, however, that the designer would set up a separate control trigger for the error condition, another trigger with the divide underflow, and a third trigger in the timing ring. The outputs of the three separate triggers would then be ANDed together to initiate the action.

This separate-trigger approach is usually taken since each of the initial conditions will be used by a number of decision-making functions throughout the machine. Thus, it makes sense to latch each condition separately (that is, to hold an output state even after the stimulus which caused it has gone) rather than to blend them. This approach is taken also because a trigger that signals an error has a meaning in itself. It is convenient—and often of prime importance—to assign triggers and coding in such a way that the meaning of each trigger can be retrieved by designers, servicemen and by the many other people who must understand and/or maintain the machine.

▪ *Decoders*, another standard control function, serve several purposes. They are used to decode instructions, as encoders to change binary counter outputs into one-out-of- $n$  codes, and as control decoders at the output of read-only storage.

The decoding function usually takes the form of a tree network and ANDs, starting with a few bits



and cascading out to form all the canonic terms (i.e., all possible combinations) of the input variables.

A three-bit decoder with two levels of ANDs is shown in Fig. 10. Note that it is the functional nature of the decoder that we are trying to describe rather than a graceful implementation. Decoder outputs can be mixed with gating and control signals. Desired combinations of these outputs may be implemented through partial tree structures. Also several decoder outputs may be ORed together to make a somewhat less than full decode.

Decoders are sometimes inserted into data paths to translate between one code and another. Here they are either encoders or decoders. At least one of the codes is often redundant and thus permits a simplified tree design.

▪ *Control triggers*, used to hold the control status as well as input information that may come in asynchronously from the outside, in general tend to differ from data triggers. For control triggers, as shown in the flip-flop of Fig. 9, both set and reset functions of logical control conditions. This is different, for example, from the data trigger of Fig. 1, where the reset line is a single control-clocked line. Control-status triggers are generally overlaid with more decision logic than are data-path registers.

It is frequently desirable to set up control triggers as in Fig. 12. For the functions shown, if both set and reset triggers occur simultaneously, one signal will dominate.

Two other simple functions perform important tasks in any fair-sized machine. The first is a high fan-in AND gate. This ANDs down many conditions and interlocks to determine a prime sequence. For example, a "fat" (i.e., high fan-in) AND can also be used to detect a register that contains all zeros.

The dual of the high fan-in AND is the many-way OR. The many-way OR can be used to collect the various conditions that initiate an action to open a gate. It can be used to bus together large numbers of data signals on to a single line. And it can be used to collect all error signals in the machine to set a single error trigger.

Often control functions require compare circuits to determine whether parts of two data words or instruction words match exactly. This may be done with an adder or with the logic of Fig. 11. Figure 11 essentially consists of the exclusive-OR of Fig. 4 and the many-way OR mentioned above. If the complement of the exclusive-OR were used, a high fan-in AND would be used instead of the many-way OR.

The second article in this series will deal with the steps a designer should follow in selecting logic-circuit modules for use in a digital computer. ■ ■

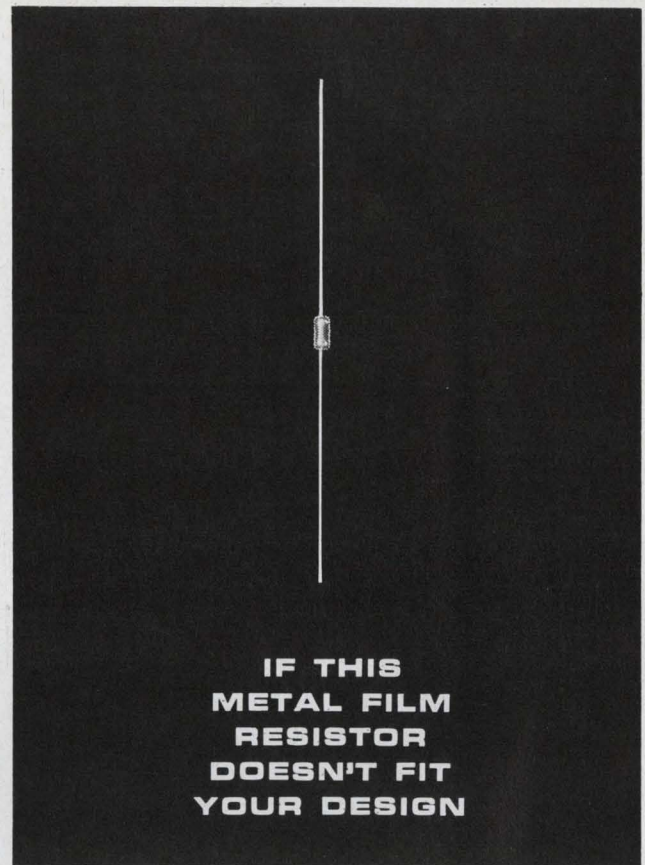

**Try These . . . high megohm resistors**

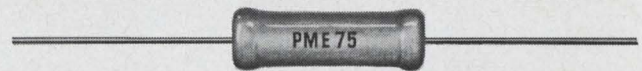

**Or These . . . resistor networks**

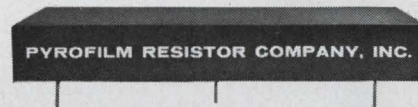

**Or These . . . high reliability  
carbon film resistors**



Pyrofilm's resistors are changing a lot of design ideas. Perhaps your design needs the small size and high performance ( $\frac{1}{8}$  watt rating) of the PME 50 Pyromet metal film resistor . . . or the extremely high resistance (25 megohms) of the Pyromet PME 75 high meg metal film resistor . . . or the compact-size resistor networks matched within .01% . . . or the stability and reliability of the long accepted PyroSeal carbon film resistors.

There's a Pyrofilm resistor for your most precise circuit designs. Send for free data file which provides complete specifications on the entire Pyrofilm line.

**PYROFILM RESISTOR  
COMPANY, INC.**

3 SADDLE ROAD • CEDAR KNOLLS, NEW JERSEY • 201-539-7110

ON READER-SERVICE CARD CIRCLE 37



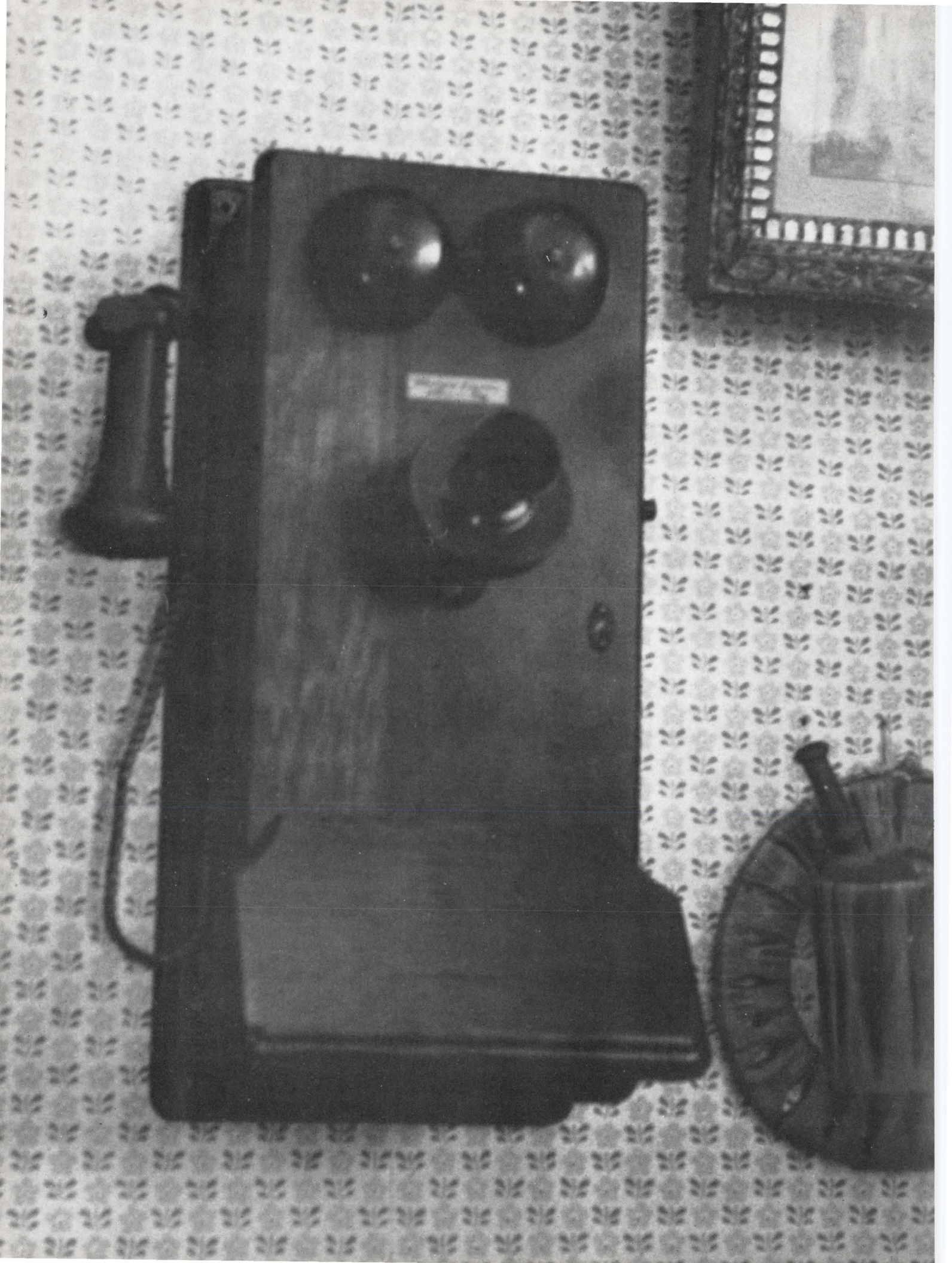



DOW CORNING

## Before you abandon that new design . . .

### check with us

In 1903 this battery operated telephone was an *innovation* . . . a turn of the crank and you could call one of the few subscribers in the area.

Suppose those who designed this unit had access to *today's* technical skills. Would it have looked like this?

Hardly!

Suppose *tomorrow's* electronic materials know-how were available to *you* right now. Would it affect your next product design? Fact is, a lot of it *is* available now . . . at Dow Corning.

Dow Corning, the acknowledged leader in silicone research and development for over twenty years, has a history of producing materials to meet unheard of performance requirements . . . and materials is our *only* business.

Our Electronic Products Laboratory offers prompt technical assistance in solving your specific problem. Write Dept. 3509, Electronic Materials Department, Dow Corning Corporation, Midland, Michigan 48640. Or phone (517) 636-8940 for more information and the name of the Dow Corning representative in your area.

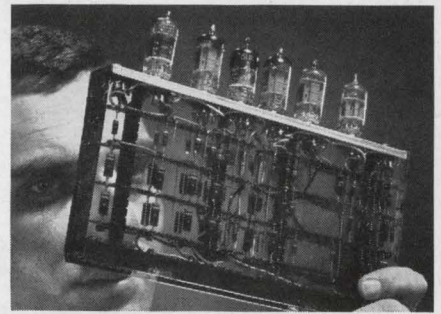

#### For transparent encapsulation

of electronic components and systems, specify Sylgard® 182 resin, usable from -65 to 200 C. Designed for potting, embedding, encapsulating, this solventless silicone is applied as a low viscosity fluid . . . cures to a flexible, resilient embedment that permits visual inspection. Cut away for repairs—replace with new resin. Also—Sylgard® 183 resin, *opaque* for security purposes. *Circle No. 851*

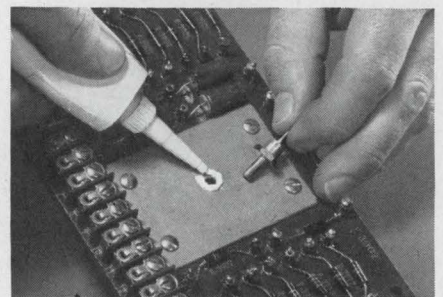

#### Uprate device power capacity

by specifying Dow Corning® 340 silicone heat sink compound to dissipate heat fast. Does not dry out, harden, gum or melt, even after long exposure to temperatures up to 200 C. This grease-like material fills tiny air spaces, maintains total contact between components and heat sink or chassis . . . assures *faster*, uniform heat transfer. *Circle No. 852*

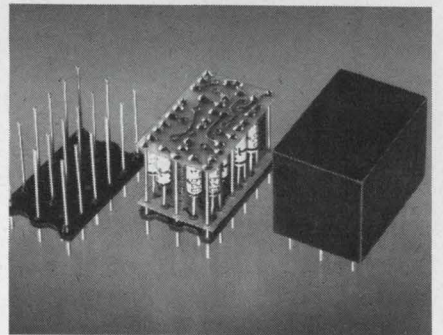

#### For "zero defect" device packages,

Dow Corning® brand silicone molding compounds are chemically inert . . . do not affect device performance. Designed for transfer molding, compounds produce void-free, dimensionally-stable, self-extinguishing, moisture resistant packages . . . assure reliability from -65 to 250 C . . . low dielectric losses at high frequencies and temperatures. *Circle No. 853*

*We're a materials producer exclusively. Let us tailor a material to your need.*

Speed Inquiry to Advertiser via Collect Night Letter



# Suppress harmonics at the source:

arrange the varactor diodes in harmonic generator chains so that only the odd or even harmonics are generated.

Simplify the filtering problem of harmonic-multiplier chains by designing the multiplier to generate either odd or even harmonics only. Besides halving the number of unwanted harmonics, the design permits higher-order multiplications at every stage.

In harmonic-generator chains, an input signal's frequency is multiplied through several stages to provide an output signal at some desired multiple of the input frequency, as shown in Fig. 1. The output, however, may also contain some undesired frequency components caused by generation and multiplication of unwanted harmonics in the chain. Filters are used between stages to suppress these spurious signals; for efficient filtering, the harmonics are kept relatively far apart by low-order multiplication (2 or 3) in the first stages.

The generation of only odd or only even harmonics is a result of waveform symmetry produced by circuit symmetry. The output contains only even harmonics of the input frequency, if the current waveform is the same during the second half cycle of driving voltage as during the first half cycle, as in Fig. 2a. If the current waveform changes sign (but not shape) during the second half cycle, as in Fig. 2b, then the output contains only odd harmonics of the input frequency. If the period of the input signal is represented by  $T = \omega_{in}/2\pi$ , the output signal,  $I(t)$ , contains only even harmonics of  $\omega_{in}$  when the following condition exists:

$$I(t) = I(t + T/2). \quad (1)$$

Conversely,  $I(t)$  contains only odd harmonics of  $\omega_{in}$  when the following condition exists:

$$I(t) = -I(t + T/2). \quad (2)$$

A symmetrical arrangement of nonlinear circuit elements is required to produce the waveform symmetry described by Eqs. 1 and 2.

The back-to-back arrangement of varactor diodes in Fig. 3 yields a current that has the symmetry of Eq. 2. It contains only odd harmonics

of the driving frequency. Therefore, the output signal developed across the load resistor  $R_{LOAD}$  contains the frequencies  $\omega$ ,  $3\omega$ ,  $5\omega$ , and so on. One of these frequencies can be selected if  $R_{LOAD}$  is replaced by a resonant tuned circuit that provides high impedance at the desired harmonic and shunts out the other harmonics. The unwanted frequencies can be further filtered in the output lines.

Only even harmonics are produced by the circuit in Fig. 4. In this circuit the diode symmetry is such that the current through the load has the waveform symmetry of Eq. 1. The desired multiple of the input can be taken off across a resonant tuned circuit used in place of the load resistor, and filtering can be performed in the output as discussed previously.

Numerous variations of these circuits can be devised using varactors, nonlinear inductances, snap-diodes, or other devices to produce waveforms for odd- or even-harmonic selection and suppression. ■ ■

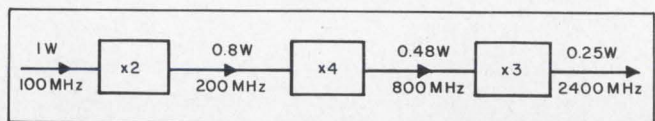

1. Typical harmonic generator chain multiplies all unwanted harmonics along with the desired signal.

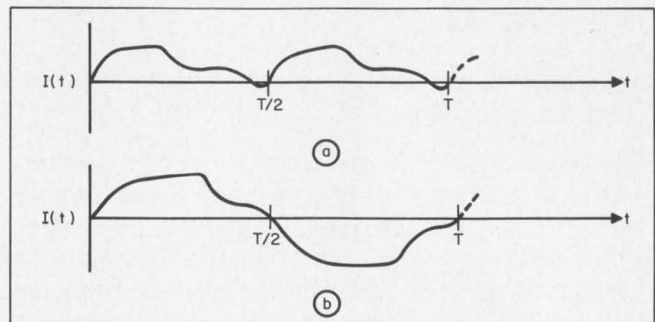

2. Output signal contains only even harmonics of the input (a) if the current waveform does not change during the two half-cycles of the drive voltage. Only odd harmonics are present if the current changes sign but not shape (b) during the second half cycle.



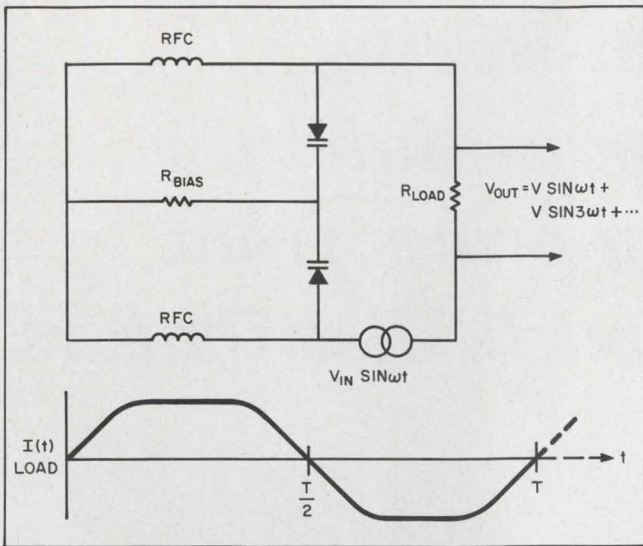

3. Back-to-back arrangement of varactor diodes results in an output that contains only odd harmonics of the input frequency.

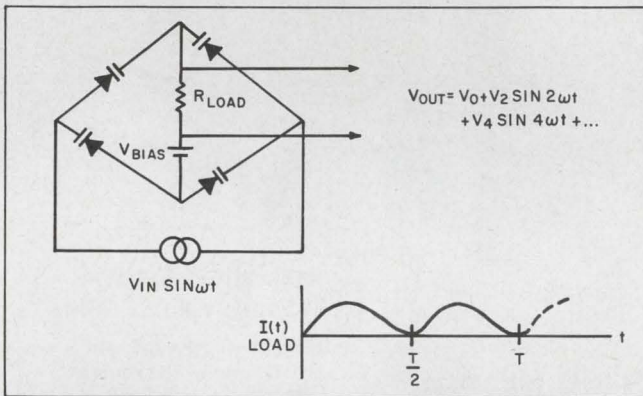

4. Ring-line symmetry of diodes produces only the even harmonics of the input frequency.



5. The assembling of the multiplier can easily be done at the desk, as the author demonstrates.

# What do we know about switches and military relays?

# We wrote the "books"!

Free: Three new catalogs from Cutler-Hammer—the company with the most versatile line of switches and relays in the industry! Order the ones you want!

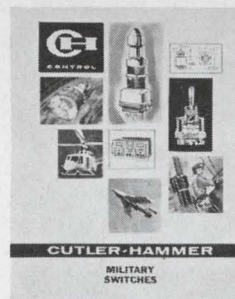

### Military Switches

Here is complete descriptive data on the Cutler-Hammer switch line, designed especially for military applications—everything from push-buttons to "Positive Action" switches (nearly everything that flies uses Cutler-Hammer "Positive Action" switches!)

Reader Service No. 100



### Commercial Specialty Switches

New 36-page catalog is filled with detailed information on hundreds of switches for every application . . . appliances . . . power and hand tools . . . photo equipment . . . business machines . . . you name it! Truly a buyer's guide for quality switches.

Reader Service No. 101

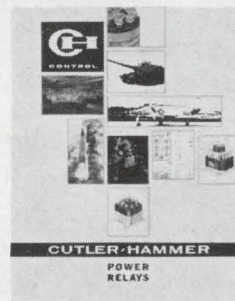

### Power Relays

Here is *the* book on performance-tested relays designed for electrical control on aircraft, space vehicles, ordnance, and ground-support equipment. Contains illustrative photos, engineering data, drawings and ratings on our full line of military power relays. A must!

Reader Service No. 102



# CUTLER-HAMMER

Milwaukee, Wisconsin 53201



# NEW! *Four problem-solving P&B relays . . . all immediately available at factory prices from leading electronic parts distributors*

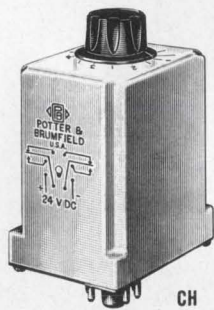

CH

## Solid State Time Delay Relays for as little as \$17.50

Here is a practical cost saving answer to many timing applications in the range of 1.0 to 180 seconds. You can save up to 60% on relay cost. They're available for AC or DC, knob adjustable, and accuracy is +10% over a -10°C to +55°C temperature range and include an internal 10 amp DPDT relay.

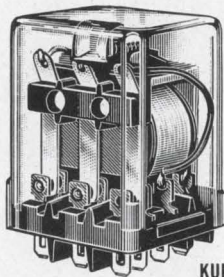

KUP

## Versatile KUP relay can be a cost-saving answer to your plug-in relay problem

Save up to \$2.00 each over similar relays with octal-type plugs. Get greater reliability, too. Relay has quick connect/solder terminals. Nylon socket (sold separately) rated for 10 amperes. One to three poles. Cover is heat and shock resistant lexan. For DC or AC operation.

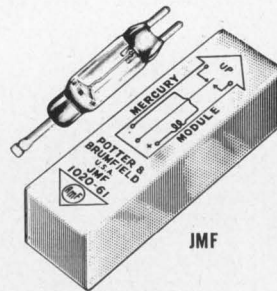

JM-F

## The answer to billions of trouble free operations and speeds up to 1 millisecond

Mercury-wetted contact relay modules give you fast response, reliability, high sensitivity and extremely long life. Designed for printed-circuit mounting. Has SPDT, break-before-make (Form C) contact arrangement for single-side-stable or bi-stable operation.

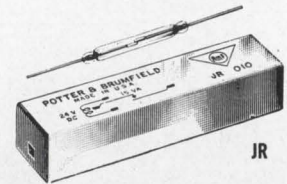

JR

## Reed Relays may replace expensive solid state devices

In many applications JR reed relays may be used in place of more expensive solid state devices over which they have one basic advantage . . . they are not subject to inadvertent switching by line transients.

For applications where fast operate time, low power and long life are required. Their high sensitivity and compact size recommend them for data processing, computer equipment, logic circuitry, for voltage or current sensing and various other types of control circuits.

*and there are 60 other basic types to choose from . . .*

*They're all in this new Stock Catalog 100. Free from your electronic parts distributor. Ask for your personal copy today.*



## POTTER & BRUMFIELD

Division of American Machine & Foundry Company, Princeton, Indiana  
Export: AMF International, 261 Madison Avenue, New York, New York

Speed Inquiry to Advertiser via Collect Night Letter  
ON READER-SERVICE CARD CIRCLE 38



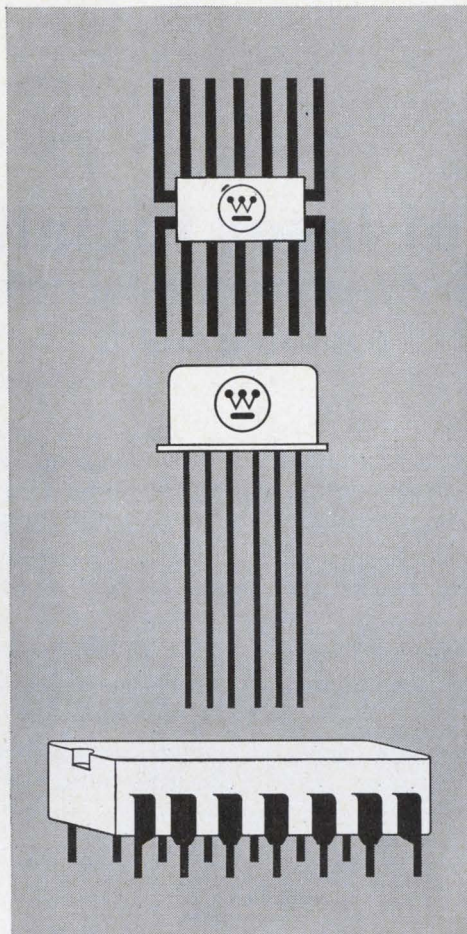

# Workhorse DTL

Four reasons why Westinghouse WC 200 IC's are a clear first choice for trouble-free computer and control systems.

The Westinghouse DTL line has been designed into so many successful computer and control equipments that it has won the supreme endorsement: It is being second-sourced by four major integrated circuit producers.

Reasons? First — reliability. WC 200 series designs have been proved by 5 million hours of life testing since their introduction in 1962 and have been continually improved since then. Major users report a 20 to 1 improvement in system reliability over previous discrete-component circuits. Just try to find any other digital line backed by such massive proof of reliability!

Second reason — speed. WC 200's six volt design with or without built in collector resistors increases speed and flexibility, keeps power dissipation down. And the use of the single-stage JK flip-flops rather than a master-slave arrangement makes WC 200 inherently fast.

Third reason — the greatest versatility in commercial DTL. Circuits are available in all 3 industry accepted packages. The line includes 15 gate circuits with 1 to 6 gates per package in a variety of input arrangements, 2 RS flip-flops, 2 JK flip-flops, 1 pulse binary counter, plus diode expanders and a large variety of interface circuits.

Fourth reason — immediate local availability at competitive prices. Behind the Westinghouse WC 200 line are both the most advanced IC plant in the industry and the longest production experience in integrated DTL. Result: high yields, and the greater production, increased reliability, and lower costs that you would expect to go with them.

These should be all the reasons you need to investigate WC 200 series DTL now. For immediate delivery, call your Westinghouse electronic distributor. For technical data, write Westinghouse Molecular Electronics Division, P.O. Box 7377, Elkridge, Maryland 21227.

You can be sure if it's Westinghouse

J-09134



ON READER-SERVICE CARD CIRCLE 39



# Convert units of laser radiation from photon energy to frequency, or from wave number to wavelength with the aid of a simple chart.

If laser radiation is reported in terms of photon energy or wave number, what's the frequency or wavelength? These factors are all related through simple equations but it is much easier to look at the nomograph below and read off the needed parameter.

Any one of these terms may be related to the others by a horizontal line across the accompany-

**Donald J. Blattner**, Member Technical Staff, RCA Laboratories, Princeton, N. J.

ing nomograph. For example, light at a wavelength of 0.5 microns can also be specified as having: (1) a wavelength of 5,000 Å, (2) a frequency of  $6 \times 10^{14}$  Hertz, or 600 terahertz, (3) a wave number of  $20,000 \text{ cm}^{-1}$ , or (4) a photon energy of 2.48 electron volts.

A glance across this chart also shows that electrons when falling through 4 volts will radiate at 3100 Å and that light at 200 terahertz will produce conduction in semiconductors with band-gaps up to 0.83 volts. ■ ■

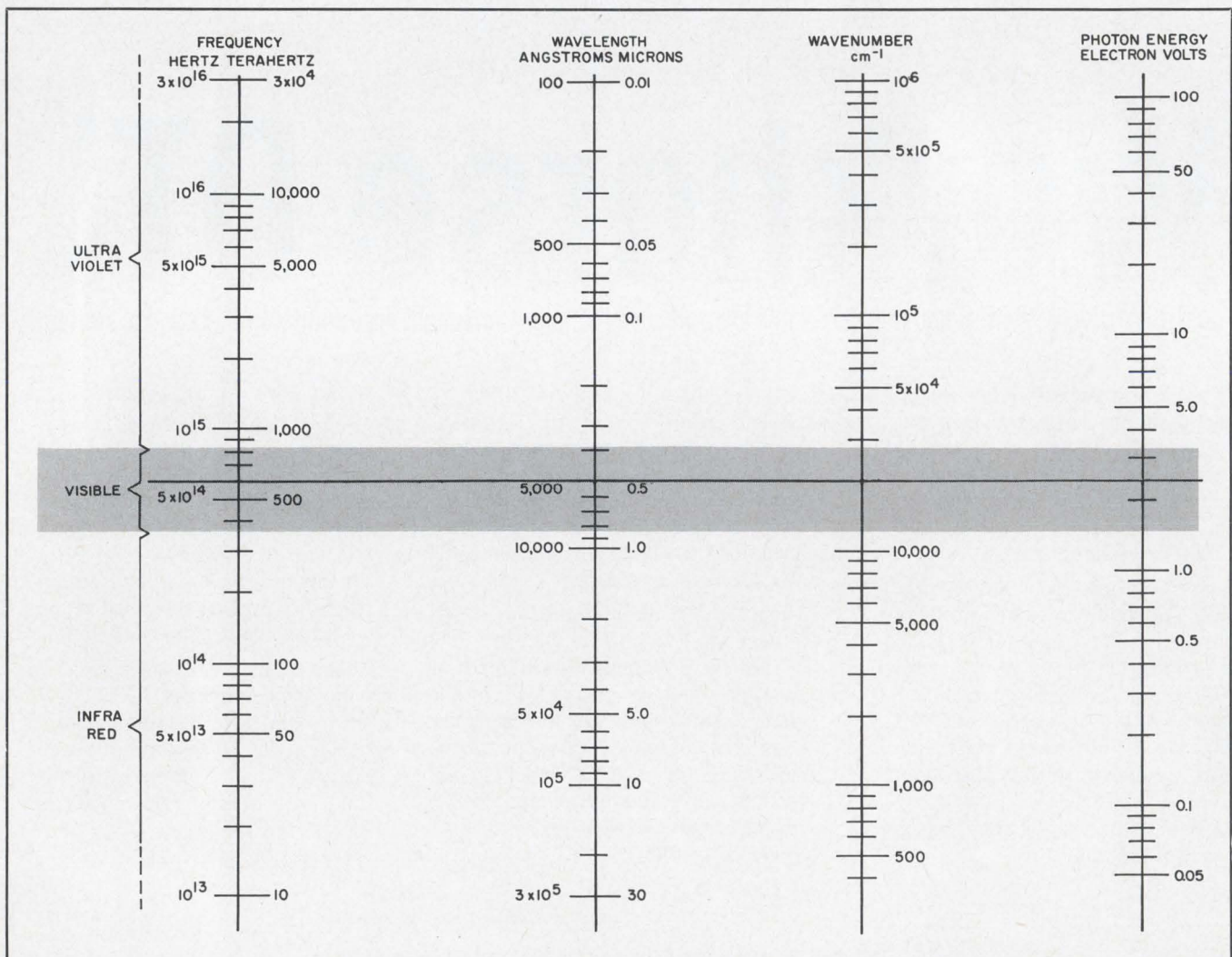



# Get a record you can *clearly* read— even at 5 KC

... from the one system  
supplied complete with your  
choice of amplifier

Now you can have all the Sanborn advantages of a DC—5KC optical oscillograph supplied as a *complete, integrated package ready to record*—plus clearer, higher resolution recordings made possible by improvements in optical system design and chart papers. Put one to 8 traces on the 8" ultraviolet-sensitive chart of a standard 4508B system— with p-p amplitudes up to 4" at DC—5kHz, to 8" at DC—3kHz. Or record up to 25 channels of high frequency information with a 4524B system. Save valuable time by recording all frequencies up to 5 kc with a *single* set of galvanometers driven by amplifiers incorporating frequency boost and compensating circuits, thus eliminating an "inventory" of different galvanometers and the time required to install and align a new set for each recording requirement. Make signal connections quickly and conveniently to front-panel or rear input connectors, and have complete operational control with amplifier front panel basic controls for each signal. Change system sensitivity from 2.5 mv/inch to 625 mv/inch by easily changing 8-channel amplifier modules (choice of three). Load paper in daylight . . . select any of 9 chart speeds by pushbutton or control them remotely . . . see fully developed traces a few seconds after recording . . . use system in mobile console, rack mount or portable cases.

Ask your local Sanborn Division/Hewlett-Packard sales office for technical data and expert application assistance. Offices in 47 U.S. and Canadian cities, and major areas overseas. Hewlett-Packard Company, Sanborn Division, Waltham, Massachusetts 02154.

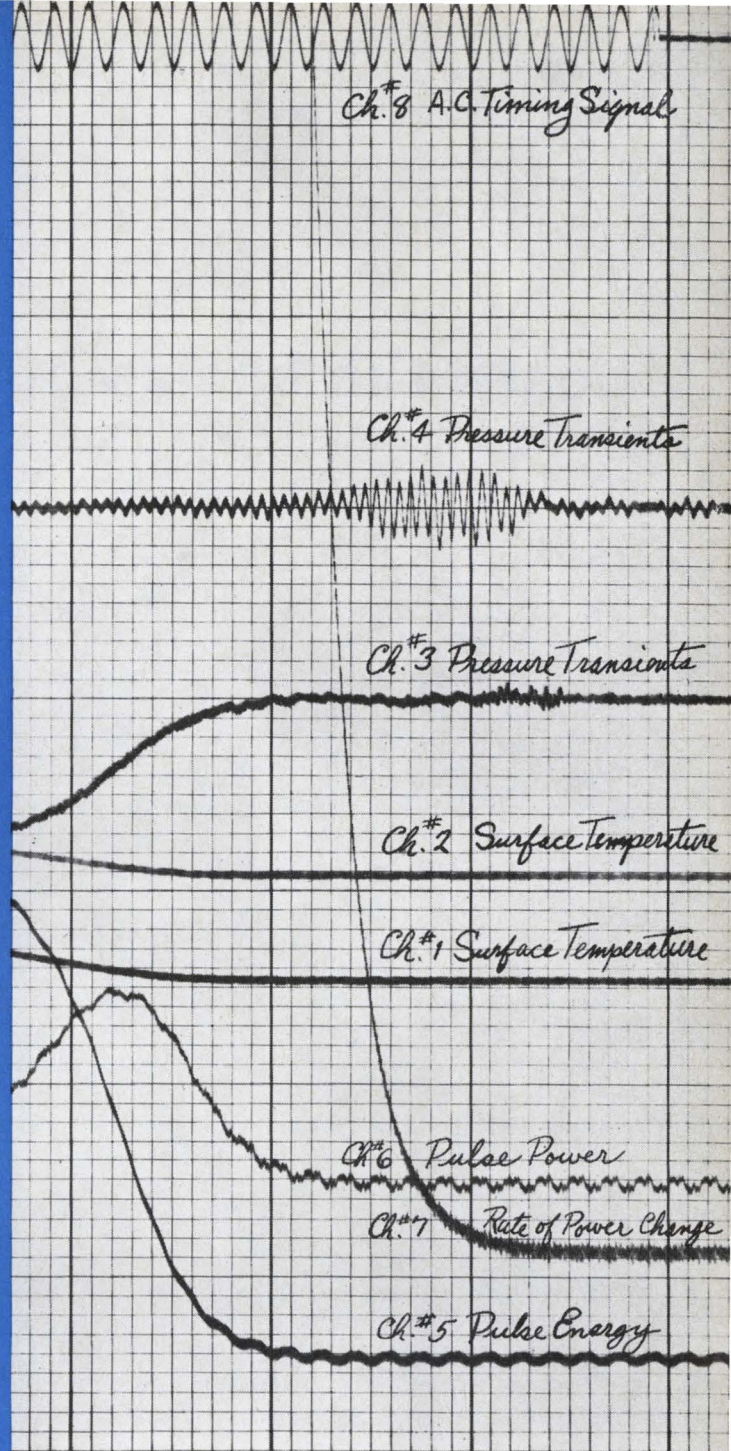

## Specifications — 4500 Series Optical Oscillographs

<b>Sensitivity</b>	625 mv/1", 50 mv/1", or 2.5 mv/1", depending on amplifier chosen.
<b>Frequency Response</b>	DC to 5 KC (—3db) at 4" p-p
<b>Common Mode Performance</b>	Rejec. ratio at least 140 db at DC, max. c.m. voltage $\pm 500$ v (with Medium Gain Amplifier)
<b>Linearity</b>	1½% of full scale (8 inches)
<b>Gain Stability</b>	Better than 1%, 0° to 50°C, 103 to 127 (line) volts
<b>Noise</b>	0.02" p-p, max.
<b>Chart Speeds</b>	Nine, 0.25 to 100"/sec.
<b>Prices</b>	Complete 8-channel system in cabinet, with galvanometer driver amplifiers, \$7400; with medium gain amplifiers, \$8980 (F.O.B. Waltham, Mass.)

**HEWLETT  
PACKARD**  **SANBORN  
DIVISION**



# Learn the basics of contracts. Here's a primer of existing contractual agreements and their relative effectiveness.

In 1962, the Whirlpool Corporation supplied Sears Roebuck with more than \$300 million worth of appliances, including all of Sears' washers and dryers. In itself this may not be too startling, but when you consider that Sears is Whirlpool's largest customer and that Whirlpool, conversely, is Sears' largest individual supplier, the fact that the relationship has endured for years without benefit of a written contract is unusual, if not unique.

At one time or another, all of us in the contracting business wish the same informality characterized Government buying. We'd avoid a lot of red tape and possibly progress a little more rapidly than we seem to now. But human as we are, abuses would be bound to creep in. We are in actuality compelled to resort to some sort of written agreement—cost-plus-fixed-fee, firm-fixed-price, or incentive contracts.

A simple graph has been developed (Fig. 1) which can be used to study these contractual relationships in a given procurement situation. We call it a "cost-profit chart" and have found that it can describe a whole variety of contracts.

On this graph, the horizontal axis represents profit-loss. Price is not shown directly, but happens to be the algebraic sum of the measurement on the two axes that describe a point. Though our later discussion will relate incentives on performance and delivery to this chart, we will first discuss the cost-incentive aspects, because these determine the type of contract and will often be the only incentive aspects in it. Performance and delivery incentives are never included unless cost incentives are also built in.

## CPFF contracts encourage inefficiency

Figure 1 shows a cost plus fixed-fee (CPFF) cost-profit relationship. The fee (profit) is a fixed

dollar amount which does not vary as costs increase. This CPFF line represents a contract where the estimated cost was 100 and the fixed fee 6. Under this agreement, the Government will pay all of the reasonable allowable and allocable costs incurred in fulfilling the contract. This is called a 100-0 sharing situation, since the Government pays 100% of the cost. Whether the final actual cost is 80, 100, or 120, the contractor's fee is the same. Obviously, there is little motivation in this contract to minimize costs: profit is guaranteed. In some procurement situations, this contract form is necessary because minimizing cost is not a prime consideration.

Both DOD and industry officials agree that CPFF contracts not only fail to provide incentives for economy, but actually deaden management efficiency by removing the need for either the Department or the contractor to estimate costs accurately and to plan and control programs tightly.

In the 10 years between 1951 and 1961, DOD dollars spent under CPFF contracts rose from 13% of total expenditure to three times that figure. Accordingly, in 1962, the Department of Defense assigned to each military department a specific goal for reducing CPFF contracts during

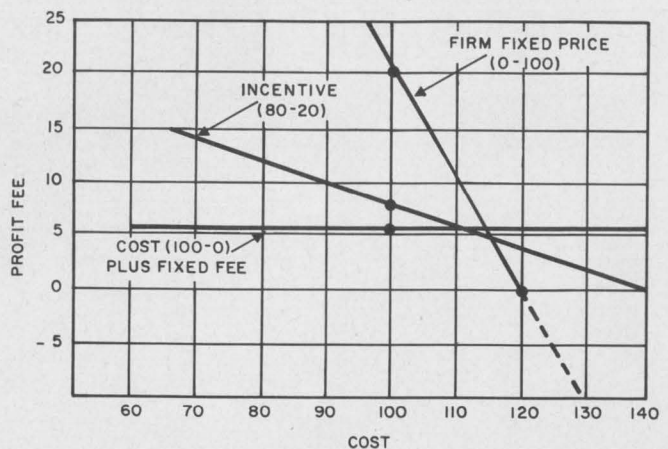

1. "Cost-profit chart" presents a clear relationship between the three basic contract agreements in existence.

John A. Bianchini, Vice-president, Jovin Industries Corp., Farmingdale, L. I., N. Y.



fiscal years 1963, 1964, and 1965. The goal for 1963 was to reduce such contracts to 25.8% of total contract awards (compared with 38% in the first nine months of 1961). By the end of 1966, the CPFF contracts are to be down to around 12% of total contracts.

The Armed Services Procurement Regulation (ASPR) now tends to restrict CPFF contracts to research or study programs, where the level of effort is unknown, and to development work for which an incentive contract is impractical.

#### Firm-fixed-price contracts involve high risk

ASPR has also taken a new look at firm-fixed-price (FFP) contracts. In the past, the government contracting officer justified the use of the FFP contract by extensive competition or historical cost data; now he must try to identify the risks involved and negotiate a price that reflects a reasonable division of these risks between the

contractor and the Government. Even though costs may vary widely from the estimate, a contract providing for "high profit potential and concomitant contractor risk" may still be used. Government negotiators have been directed to use the type of contract best calculated to "stimulate outstanding performance." For this purpose, the firm-fixed-price contract is still preferred when costs are predictable with a fair degree of accuracy.

The FFP cost-profit line in Figure 1 represents a contract where the estimated cost is 100 and the profit at this cost is 20. The line portrays a relationship where every dollar of cost reduces profit by one dollar. We call this 0-100 share; the contractor pays 100% of the cost, whatever it might be. The fixed price to the Government is 120 and does not change. When actual costs exceed 120, the contractor loses money. This loss is represented by the dashed line. Such a contract places maxi-

### Summary of the major contract types

Type of contract	Definition	Where appropriate
CPFF—Cost plus fixed fee	Government pays all costs plus a fixed fee.	Where cost and management efficiency are not prime objective; e.g., to meet a vital system need.
FFP—Firm fixed price	Price remains the same regardless of costs.	Maximizes cost incentives, hence is preferred by Government. Can only be applied if: <ul style="list-style-type: none"> <li>• Cost estimates are quite accurate (otherwise windfall profits or big losses are possible).</li> <li>• Performance can be strictly defined.</li> </ul>
CPIF—Cost plus incentive fee	Profits linked to costs, but floor and ceiling profit levels set.	Where tolerances are needed in cost estimates. Has the disadvantages that: <ul style="list-style-type: none"> <li>• Government doesn't know in advance how much it will have to pay.</li> <li>• Contains no incentive for cost-cutting once profit floor is reached.</li> </ul>
CPA—Cost plus award	Minimum profit set; additional award decided by impartial board on basis of costs and performance.	Where cost and performance estimates are virtually impossible to make in advance. Vagueness to both parties is disadvantage.
FPIF—Fixed price incentive fee	Profits linked to costs; profit ceiling set but no floor. Fixed maximum price means contractor can lose money if costs run high (Fig.3).	Similar to CPIF, except that contractor has much greater incentive to cut costs lest they climb above target level.
FPIS—Fixed price incentive with successive targets	Same as FPIF except that profit floor set. Under specific conditions, whole contract may be revised as work proceeds; e.g., if some system component doesn't work and needs further development.	Where system design involves some unknown factors. Must be used with care since contractor could purposely keep early costs high to gain higher profits through renegotiation.
Performance incentive	Similar to previous types but with additional incentives tied to these factors: <ul style="list-style-type: none"> <li>• Performance.</li> <li>• Schedules.</li> <li>• Weighted combinations of these plus costs.</li> </ul>	Where factors beyond costs are vital. Requires careful definition of goals and methods of testing performance.



imum emphasis on reducing costs. The Government considers it a most desirable contract form when it can be used.

Basically, the factors that restrict use of the FFP contract are:

- Inability to establish a realistic cost objective within acceptable tolerances. If the cost estimate is not sufficiently close to what the actual cost will be, the potential for windfall profit or loss is greater than either the Government or the contractor can accept.
- Inability to define the work in the detail needed to permit enforcement of the contract. This is related to the first problem. If the Government cannot define exactly what it wants, as opposed to defining something to do, then the Government cannot estimate the cost fairly or be sure it is getting what is paid for.

### Incentive contracts are tailored to a problem

When conditions preclude the use of FFP contracting, the Government must try to balance the uncertainties in a procurement by using a form of incentive contract. Any number of cost incentive arrangements could be made, with their characteristic curves falling between the FFP line

Table 1. Performance Incentives

	Reward or penalty (\$)	Limit (\$)
<b>Delivery</b>		
On schedule	0	—
Early	+10,000/day	+300,000
Late	-10,000/day	-300,000
<b>Performance</b>		
Aircraft flies at 100,000 ft	0	—
Above	+40,000/1000 ft	+400,000
Below	-20,000/1000 ft	-400,000*

\*If aircraft does not reach 80,000 ft, the system is unacceptable

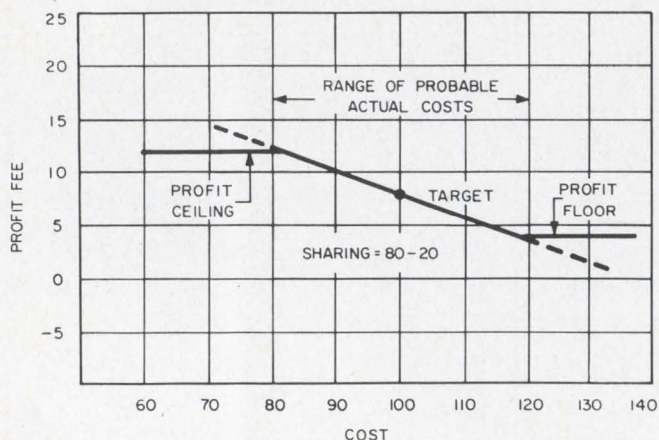

2. Simple incentive curve converts to a CPIF contract by adding a profit ceiling and profit floor. Note that these limits exist outside the range of probable costs.

and the CPFF line in Figure 1. The one shown describes an arrangement where the estimated cost is 100 and the profit at that cost is 8. But actual costs may vary from this target. Some formula is used for sharing the increased or decreased costs between the Government and contractor. In this case, the cost-sharing formula is 80-20, which means that the Government pays 80% of any added cost, the contractor 20 per cent. Similarly, cost-savings are shared according to the formula. For example, if the actual cost is 90, the profit is 10. This is arrived at by adding the bonus for cost reduction to the target profit as follows:

$$\begin{array}{r} \text{Profit at estimated cost (target)} \quad 8 \\ 20\% \text{ of the cost reduction (10)} \quad +2 \\ \hline \text{Earned Profit} \quad 10 \end{array}$$

Likewise, if the actual cost were 110, the profit would be 6, a reduction of 2 from target. Another way to say this is that for every dollar of added cost the contractor spends, his potential profit is reduced twenty cents.

The sharing arrangement could be anything from 99-0 to 0-99, although these extremes are theoretical. Usually, real sharing arrangements will fall between 50-50 and 95-5 or some combination of these shares within different cost ranges. The sharing arrangement determines the slope of the curve drawn through the target point.

There are three basic forms of incentive contracts—cost-plus-incentive-fee (CPIF), fixed-price-plus-incentive-fee (FPIF) and fixed-price-plus-incentive-fee with successive targets (FPIS).

### Let's examine the CPIF contract first

Figure 2 shows a CPIF contract that may be described as follows:

$$\begin{array}{ll} \text{Target Cost} & = 100 & \text{Profit Ceiling} & = 12 \\ \text{Target Profit} & = 8 & \text{Profit Floor} & = 4 \\ \text{Sharing} & = 80-20. & & \end{array}$$

We have introduced a new term on this

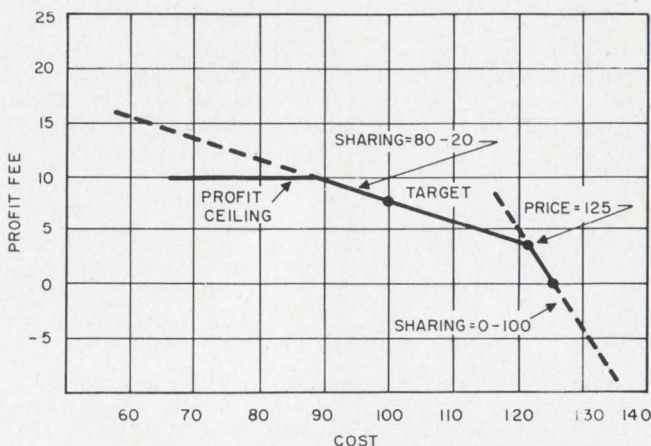

3. In the fixed-price-plus-incentive-fee contract, the incentive curve becomes a firm-fixed-price curve when a specified total price is reached; in this case, 125.



chart—"range of probable actual costs." Remember that incentive contracts are used, as opposed to the most desirable form, the FFP contract, because it is difficult to establish a cost estimate within the tolerances that are acceptable to the contracting parties. In the situation portrayed in Figure 2, it is agreed that 100 is a reasonable estimate for the cost of the effort, though the actual cost may be as great as 120 or as little as 80. If the contractor produces at a cost of 80, he has performed in an outstanding manner.

The profit ceiling and floor prevent a windfall profit or loss when the final actual cost is less than 80 or more than 120. Though the basic assumption is that the final actual cost will fall somewhere in the range of probable costs and that the contractor will have produced a product of desired quality at minimum cost, the share line is constructed to cover the whole range of actual costs.

Without changing the incentive arrangement portrayed on the chart, we could keep the same profit ceiling and floor, the same share (80-20), the same range of probable actual cost, and state the target cost as either 90 with a target fee of 10, or 110 with a target fee of 6. As a matter of fact, when we leave the negotiating table, the incentive arrangement is the pricing provision of the contract. The price of the contract to the Government will be the actual allowable and allocable cost of performance, plus a profit determined by the curve at that cost level. The Government, therefore, won't know precisely what the contract price is until after the work is done.

The cost-plus-award contract is merely a variation of CPIF. Instead of setting up yardsticks ahead of time which, by mechanical application, will determine the profit to be paid, this contract suspends the decision regarding profit until the work has been completed; the judgment required in setting targets is deferred from before the fact until after it.

Under the cost-plus-award concept, the Govern-

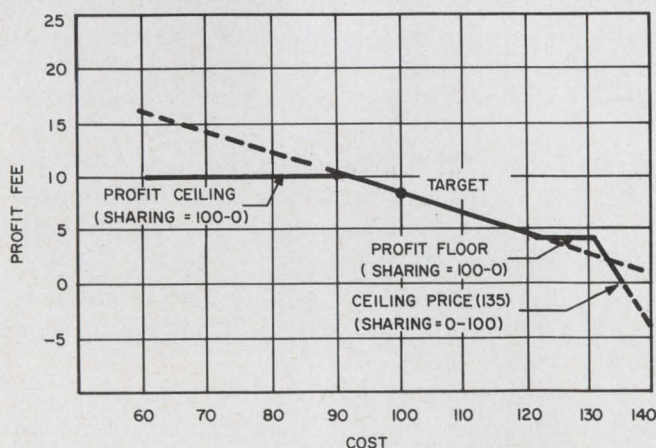

4. Profit ceiling, profit floor and ceiling price are added to the simplified incentive curve to form the more involved fixed-price-incentive contract with successive targets.

ment does not predetermine the target cost of the sharing formula. A floor is set under the profit. After paying all allowable and allocable costs incurred in fulfillment of the contract, the Government agrees to pay a minimum fee of 2 as profit.

Where does the incentive come in? After establishing the minimal profit, the contract states that, upon completion of the project, an impartial board will review the manner in which the contractor has performed. Based on its evaluation of efficiency, quality of workmanship, timeliness of fulfillment, and any other pertinent considerations, the board is authorized to award an additional fee, ranging perhaps up to 6 or 8.

Half of this fee may depend upon costs alone—upon how efficient the contractor was in keeping them down. The other half of the award may be based on the quality of the product and/or its delivery schedule. If it is delivered ahead of time, the contractor may be awarded an extra 2. If its quality is better than expected, he may be given from 1 to 8 units of profit for superior quality control.

The award fee emphasizes only one aspect of the procurement, such as cost alone, but at the expense of all other aspects, which may be of equal importance. It is useful when the problem of predetermining target costs, target fees, and cost-sharing formulas is too great to permit application of the usual CPIF provisions.

#### Fixed price incentives involve greatest complexity

Now a brief look at two other incentive forms. Figure 3 shows the profit-cost relationship for a fixed-price-incentive-fee (FPIF) contract with firm targets. This is a contract that has:

Target Profit	= 8	Share	= 80-20
Target Cost	= 100	Ceiling Price	= 125% of Target Cost

The Government has established a fixed price ceiling of 125 on this contract and so draws a fixed-price share line. This line starts at the profit = 0, cost = 125 point. Note that when the actual cost reaches approximately 121, the 80-20 line through the target point intersects this line, so that the contract really becomes a fixed-price contract. Beyond that point, the contractor is paying 100% of increased costs. The ceiling price and the sharing formula see to that. Above 125, the contractor pays out of his pocket, actually losing money.

The other type of incentive contract is known as a fixed-price-incentive contract with successive targets (FPIS). This contract is also subject to change as time goes on. It differs from the FPIF contract by setting an initial floor and ceiling for profit, an initial target cost, and an initial target



profit, all of which are subject to revision.

Though the Government begins with an initial formula, it may be renegotiated at a specific point in time or in the event of some specific event. There are occasions where the revision may be done more than once.

Figure 4 shows an initial formula for a procurement where the estimated cost is 100, the target profit is 8, the off-target cost sharing 80-20. To this, we add a minimum profit of 4, a maximum profit of 10, and a price ceiling of 135. All the limiting features of the CPIF and the FPIF contracts are combined in this initial formula. If the costs overrun the estimate by 31%, the contractor is working on a fixed-price relationship. This fixed-price ceiling cannot be increased when the Government reviews the formula. It may be decreased.

At revision time, the Government negotiates a new target cost for the contract. The initial formula applied to the new target cost determines the new target profit. For example, if the new target cost were 90, the profit would be 10. If the new target cost were 120, the profit would be 4.

With a new target profit and target cost thus established, the Government can now make an FPIF contract, using any sharing arrangement desired and a price ceiling of 135 or less; or the Government can convert to a FFP contract, in which the price would be the new target profit plus the new target cost. Generally speaking, the new cost-profit arrangement negotiated during revision will always be one of these two contract forms.

The FPIS contract has to be used with considerable discretion. Like the renegotiable type, which it closely resembles, the FPIS contract is subject to some exploitation. The contractor may keep costs high, up to the point of negotiating the reset, in order to ensure a higher firm target cost. Initial targets, therefore, should be conservatively set by the Government.

#### **Performance incentives are also valuable**

Before 1962, incentive contracts applied the incentives to dollars of cost alone. Presently, they also apply to performance reliability and to scheduling as well, and are used in both the development cycle and the production cycle. For example, in July, 1963, the Government committed \$460 million on incentive contracts; 25% of these obligations were on contracts that contained performance as well as cost incentives.

This is in line with the basic principle of incentive contracting, which holds that a contractor should be motivated, in calculable monetary terms, to:

- Turn out a product that meets significantly advanced performance goals.

- Improve on the schedule of progress, up to and including final delivery.

- Reduce the cost of work by substantial amounts.

- Accomplish the project under a weighted combination of some or all of these objectives.

Though no specific rules exist for setting performance incentives, there are three general rules that should be recognized. For our discussion, these are termed identification, definition, and balance.

Identification determines what specific qualities in the performance of the product, or of the contractor, the Government may wish to emphasize. It may be the time of delivery, to insure compatibility with other items entering the defense system. Or it may be the altitude, or the payload, or the mean time before failure, or any of a thousand other things. Generally, an attempt is made to specify the factor, or factors, that would contribute most to making the total system a success. This decision is not made by the Government people alone. The technical people have a large say in it. Once the factor is identified, however, the Government has to include it in the contract.

After the factor is identified, it must be defined in measureable terms. How else will the Government know whether the contractor has been successful? This means that the technical staffs (Government and contractor) must together establish a definite guideline for the testing of performance. Usually a test document is developed and incorporated in the contract. It will define specifically what is being measured and how. Too often this step is neglected; the results are some awful tussles.

One thing further remains to be done: the balancing of the performance-incentive arrangements with the cost-incentive arrangement. The Government has to assign properly weighted values to each of the identified parameters. If the cost is most important, it should bear the greatest weight; likewise, delivery and system-performance weighting should show their relative standing. Obviously, there are trade-offs to be made. The Government does not want to write a contract that says, "Spend as much as you like for performance and we'll give you a big bonus for it." Likewise, the Government does not want to pay a big bonus for cost reduction at a sacrifice of quality. Significantly, performance and schedule incentives may no longer be used in DOD contracts unless appropriate cost-control incentives operate at the same time.

Performance incentives can be shown in the cost-profit chart. Usually they are stated as an adjustment to the fee that is otherwise payable. Let's assume a very simple example. The contract is for an aircraft that has an estimated cost of



Table 2. Profit Possibilities\*

	Max	Target	Min
On cost	\$11,300,000	\$7,300,000	\$3,300,000
On performance	800,000	400,000	0
On delivery	600,000	300,000	0
Total profit	\$12,700,000	\$8,000,000	\$3,300,000

\*Taken from the three points plotted in Fig. 5.

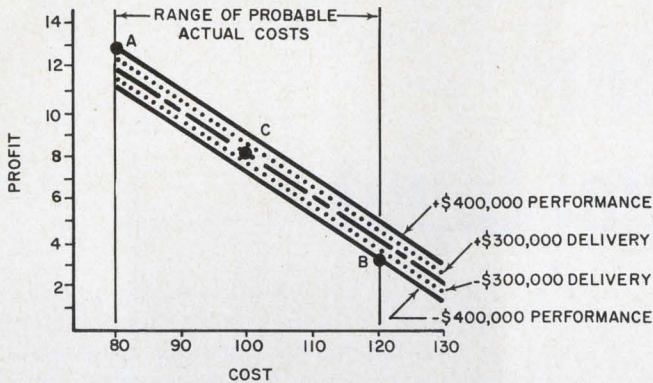

5. Performance and delivery incentives can also be added to the cost-profit chart. In this particular case, the major profit motive is still dependent on cost reduction.

\$100 million, a profit (at that cost) of \$8 million, and a share formula of 80-20. Performance incentives are on delivery and flying altitude and are characterized in the accompanying table. The cost-profit chart, shown in Figure 5, can then be drawn.

Looking at this relationship another way, we select three points on the chart for comparison: the maximum profit at the lowest point in the range of probable actual cost (A), the minimum profit for the highest point on the range (B), and the target (C). We now add up combinations of these extremes (see Table 2) to illustrate the balance of incentives.

If the aircraft is delivered late (zero profit), flies at only 80,000 ft (zero profit) but is manufactured at a cost of 20% under target, the contractor realizes a profit of \$11,300,000 and (see Table 2) this is still better than meeting target on all three elements. Obviously, the weighting of incentives in this case says that delivery is not too important; that the government can get along with an 80,000-ft performance; but that, above all, costs have to be watched.

This is a simple illustration, but one can see the importance of balancing incentives so that they properly motivate the contractor to achieve what the Government wants. Once the effort is launched, the contractor is continually confronted with trade-off decisions that affect his profit. ("Should the Government spend the extra \$372,000 to carry out an effort that has 87% probability of adding 1000 ft to performance?") By adding in ten, twenty, or more performance parameters, each of which interrelates with the others, the situation becomes even more complicated. ■ ■

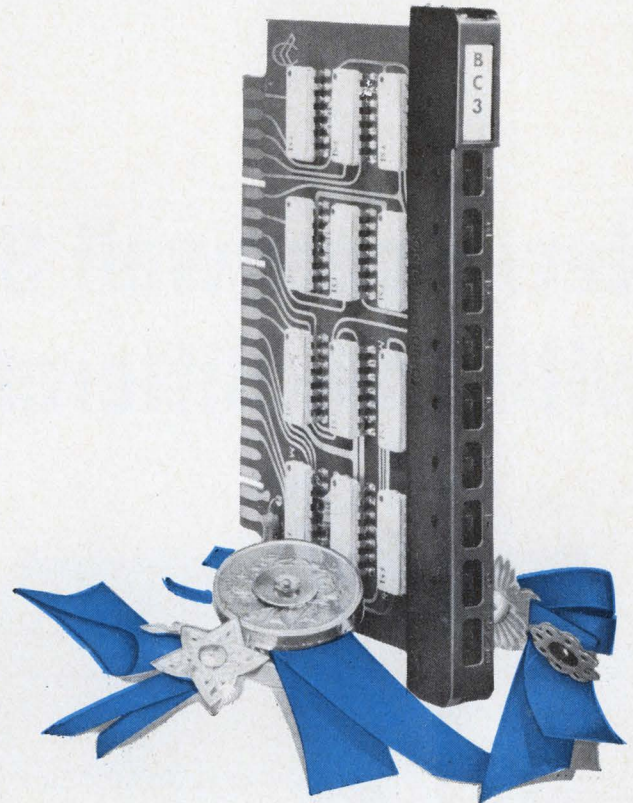

## BLUE RIBBONS.

That's what these "Series C" cards really deserve because they are the most advanced 5MC logic cards available! Why? Because they're the only cards produced combining the high reliability and small size/weight features of TTL monolithic circuits with proven logical and packaging techniques . . . because they feature high noise rejection over a wider temperature range plus the ability to drive high capacity loads . . . because they feature in line IC modules for low cost assembly and easy replacement . . . because test points on the front of the card simplify checkout and maintenance . . . because they have nickel rhodium fingers . . . because they're available with complete accessories to simplify application and use. We could go on. And we haven't forgotten other important considerations. They're competitively-priced even if they do more, and they're immediately available. But why don't you be the judge? Use these 5MC logic cards once and see for yourself!

Write or phone for descriptive literature.

### ELECTRICAL SPECIFICATIONS

FREQUENCY: DC to 5MC, plus 10MC counting  
SIGNAL LEVELS: 0V and +3V  
FANOUT: 6 to 24  
NOISE REJECTION: 1V (Min.)  
SUPPLY VOLTAGES: +5V  
TEMPERATURE: 0°C to +70°C

 **CONTROL LOGIC, INC.**  
subsidiary of Schaevitz Engineering

3 STRATHMORE RD., NATICK, MASSACHUSETTS 01762  
TEL: 617 655-1170 or 617 235-1865

CONTROL LOGIC ALSO PRODUCES DISCRETE COMPONENT MODULES, SPECIAL PURPOSE SYSTEMS, AND RELATED ACCESSORIES

ON READER-SERVICE CARD CIRCLE 41



Here's the first AC-powered, high sensitivity Null Detector that won't upset circuit balance!

# New Honeywell 3990 with True Differential Input

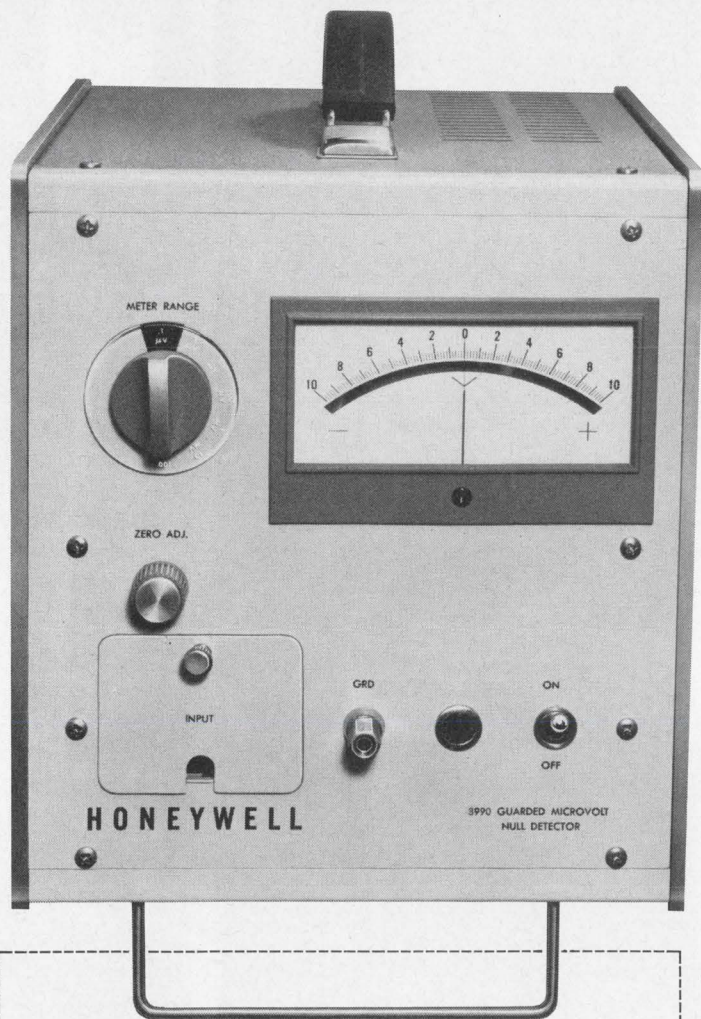

The new Honeywell 3990 Null Detector's true differential, symmetrical input permits AC operation while providing isolation and common mode rejection comparable to similar battery powered units. When reversing polarity, absolutely no Zero Offset is experienced. A wide performance range is assured by sensitivity of better than 20 nanovolts, with seven full scale ranges from  $\pm 0.1$  microvolts to  $\pm 100.0$  millivolts. And, the new 3990's high input impedance allows its use with source impedances or unbalance as high as 6000 ohms without degradation of performance.

The Honeywell 3990 eliminates these common measurement problems:

- False balance when reversing polarity
- Inaccuracies due to ground loops
- Large decrease in sensitivity due to high source impedances
- High noise levels due to high source impedances
- Stray noise pickup
- Poor common mode rejection on AC operation

These features make the 3990 the most versatile Null Detector you've ever used:

- Failsafe operation with excessive input overload
- AC operation — no battery replacement
- Chopper stabilized operational amplifier assures excellent stability
- High CMR; greater than 160 db @ 60 Hz
- Expanded scale meter for greater resolution
- Grounded recorder output, completely isolated from input.
- Available as bench or rack-mounted model

All these outstanding features, yet the new 3990 is as easy to use as a galvanometer and you don't have to worry about vibration! For complete information, contact your Honeywell Representative, or mail the coupon for fully illustrated literature.

**LABORATORY STANDARDS**  
**Honeywell**

Carl Boyer  
Mail Station 414  
Honeywell Test Instruments Division  
Denver, Colorado 80217

Please send Model 3990 Null Detector literature to:

Name \_\_\_\_\_

Company \_\_\_\_\_

Address \_\_\_\_\_

City \_\_\_\_\_ State \_\_\_\_\_ Zip \_\_\_\_\_

ON READER-SERVICE CARD CIRCLE 42



# *microwave-miser*

No circuit laminate conserves critical microwave energy quite like low-loss REXOLENE S, irradiated polyolefin.

Dielectric constant: 2.32 from 10M to 10 GHz

Dissipation factor: .00004 @ 1 MHz; .00006 @ 10 MHz; .00018 @ 10 GHz

Looking for ways to boost Q? Lower insertion losses? Get actual characteristics closer to design?

Write for the details on REXOLENE S.

One of Brand-Rex microwave circuit laminates covering the broad spectrum of frequency and environment.

AMERICAN ENKA CORPORATION

BRAND-REX DIVISION

WILLIMANTIC, CONNECTICUT 06226  
PHONE 203 423-7771

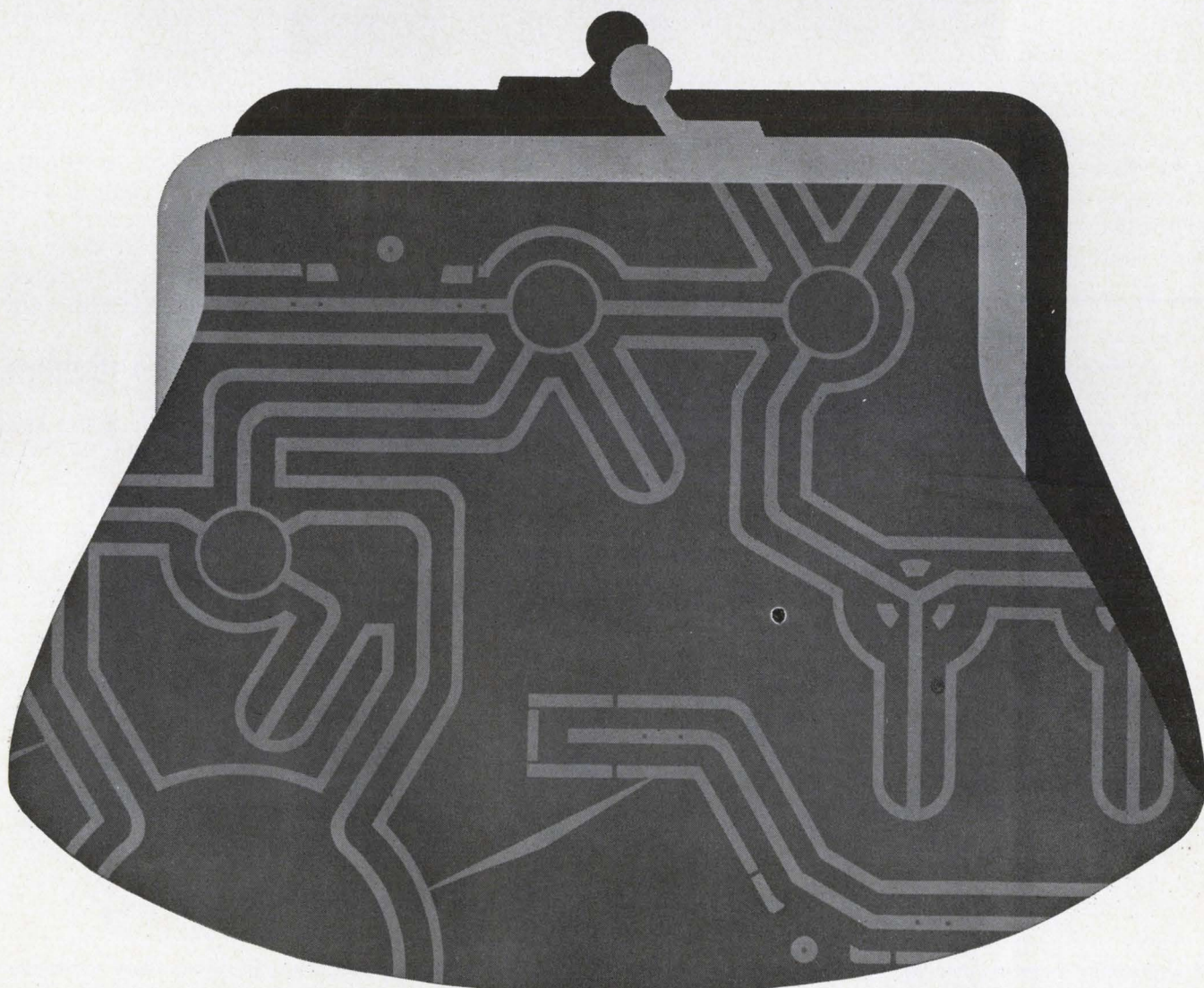
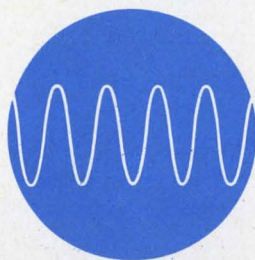

Speed Inquiry to Advertiser via Collect Night Letter  
ON READER-SERVICE CARD CIRCLE 43



# Clamp and complementary pair form amplitude monitor

It is often desirable to monitor the amplitude of a signal wave or pulse train regardless of its frequency or duty cycle. By use of a clamped charging circuit and a complementary emitter-follower pair, a dc voltage equal to the peak amplitude is obtained for this purpose.

This circuit, which is accurate to 30 mV, is also inexpensive to build. It works for duty cycles as low as 0.1% and, except for one of its components, requires element tolerances of only 20%. The 51-Ω input termination is the only precision unit required (see schematic).

Transistor parameters also are unimportant, provided Q3 has a reasonable gain and the breakdown voltage of the Q2 base-emitter diode is higher than the voltage to be monitored.

Storage capacitor C1 is charged by Q2; Q2 in turn is clamped to the input by Q1. R1 makes this stage operate in a low-current saturated mode, so

that most of its emitter current is supplied by the base.

Hence, on positive pulses or half-waves the Q1-Q2 bases will rise to  $V + V_{BE}$  and C1 will be charged to V by Q2. When the input voltage is decreased, Q2 will be turned OFF, leaving C1 in a charged state loaded only by the high-impedance sensing circuit.

The test circuit proves to be insensitive to variation of component values or supply voltages. It is also inherently temperature-compensated. Sources of error are voltage divider R3-Q1-R2, which leaves a residual input voltage at zero and the load-dependent turn-on voltage of Q2, which gives a mismatch at low levels.

The latter problem may be overcome by substituting FET current-limiters for R4 and R5, if increased tracking accuracy is desired.

The present circuit, however, is linear down to 0.2 V, giving a dynamic range of 30 dB. The range may be extended upwards by connecting the Q1 emitter to a tap on R1.

*Ambjorn Berg, Design Engineer, SAAB Aktiebolag, Linkoping, Sweden.*

VOTE FOR 110

**VOTE!** Circle the Reader-Service-Card number corresponding to what you think is the best Idea-for-Design in this issue.

**SEND US YOUR IDEAS FOR DESIGN.** Submit your IFD describing a new or important circuit or design technique, the clever use of a new component, or a cost-saving design tip to our Ideas-for-Design editor. If your idea is published, you will receive \$20 and become eligible for an additional \$30 (awarded for the best-of-issue Idea) and the grand prize of \$1000 for the Idea of the Year.

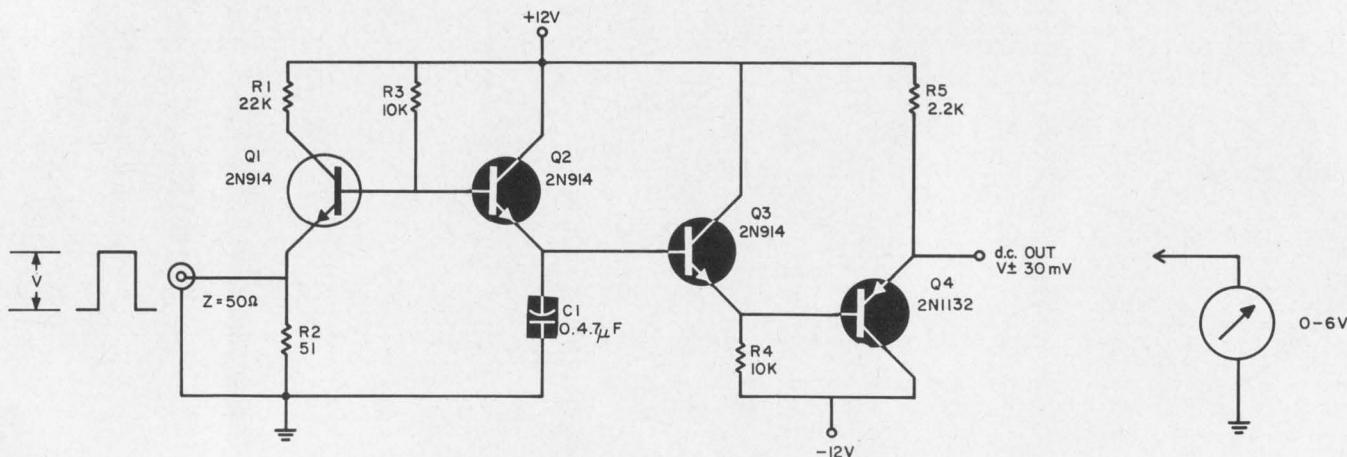

Accurate amplitude monitoring is inexpensively and simply achieved with noncritical (loose-tolerance) compo-

nents forming a clamped charging circuit, and a complementary emitter-follower stage.



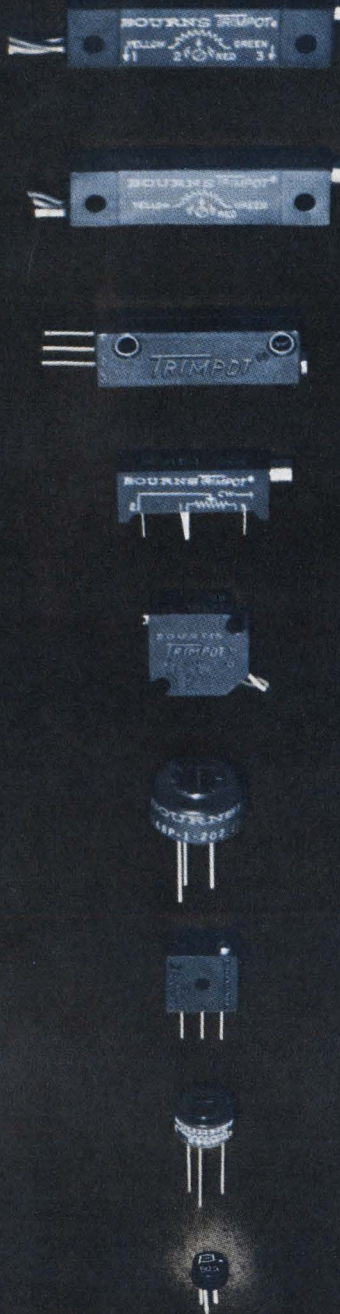

## WHO ELSE WOULD DEVELOP THE WORLD'S SMALLEST POTENTIOMETER?

It should come as no surprise that Bourns has introduced the world's smallest adjustment potentiometer. We started the trend in 1952 with the original compact TRIMPOT® Potentiometer. Now, the commercial, single-turn Model 3317 is Bourns' newest answer to industry's need for even smaller components. It measures  $\frac{3}{16}$ " in diameter, is less than  $\frac{1}{8}$ " high, has only six parts for greater reliability, and costs under \$2.00 in quantity. Offered with top or side adjustment, the wirewound 3317 has flat gold-plated grade A nickel leads for improved solderability and weldability.

While it is a true commercial potentiometer . . . not a downgraded military type . . . the Model 3317 receives the same closely controlled in-process and final inspections as all Bourns products. Periodic environmental requalification is provided by Bourns exclusive Reliability Assurance Testing Program. In size, price and performance, the model 3317 Adjustment Potentiometer is unmatched. Write today for complete technical data.

### Standard Specifications

Model  
3317P



Model  
3317W



Resistance range	20 ohms to 5K ohms
Resistance tolerance	±10 percent
Temperature range	-65 to +105°C
Power rating	0.2 watt at 25°C
Shock	20G
Vibration	10G
Size — 3317P	.188" dia. x .105" high
Weight — "	.08 grams



BOURNS, INC., TRIMPOT DIVISION • 1200 COLUMBIA AVE., RIVERSIDE, CALIF.  
PHONE (714) 684-1700 • TWX: 714-682 9582 • CABLE: BOURNSINC.



## Current-controlled VCO circuit offers linear frequency transfer

Use of a current source in a voltage-controlled oscillator will develop a linear relationship between the oscillator frequency and the level of the monitored signal. In essence, action similar to that of a stable multivibrator is generated.

Voltage-controlled oscillators are often applied in the detection and amplification of direct current and voltage variations. If the frequency of the device is allowed to vary in accordance with the signal level of interest, the inherent difficulties of dc amplifiers (such as thermal fluctuations) can be avoided.

Ordinarily, when astable multivibrators are employed for this purpose, the frequency of the unit is controlled by the base supply-voltage. Changes in this voltage, however, result in nonlinear variations; in fact, the frequency of oscillation varies as the square of this voltage change. Incorporation of a voltage-controlled current source in the base circuit of the multivibrator yields a linear relationship between the monitored signal and the oscillator frequency.

This modification is illustrated in the figure where Q1 and Q2 form the active components of the multivibrator, and Q3 is the voltage-controlled current source. The collector current of Q3, which determines the discharge rate of the base capacitors, is controlled by the applied signal  $V_s$ . The operation of the circuit is as follows:

Assume that when time  $t = 0$ , Q1 just turns ON

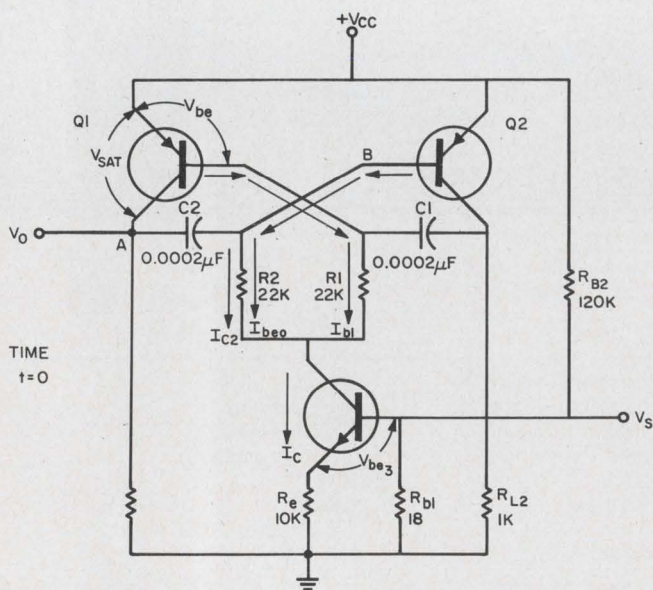

Constant current source (Q3), controlled by voltage  $V_s$ , permits multivibrator (Q1 — Q2) to relate its frequency linearly to the level of the monitored signal input.

and Q2 turns OFF. Prior to this time (when the situation is reversed), the voltage at A is zero (Q1 is nonconducting), and the voltage at B equals  $V_{cc} - V_{be}$ . The initial charge on capacitor C2 is then:

$$C2(V_A - V_B) = C2(V_{be} - V_{cc}). \quad (1)$$

When  $t = 0$ , the voltages because of the initial charge on C2 become:

$$V_A = V_{cc} - V_{sat}, \quad (2a)$$

$$V_B = 2V_{cc} - V_{sat} - V_{be}. \quad (2b)$$

Transistor Q2 is thereby held nonconducting by a reverse voltage given by:

$$V_B - V_{cc} = V_{cc} - V_{sat} - V_{be}. \quad (3)$$

The charge on C2 whenever time  $t$  is greater than zero is:

$$q = -C2(V_{cc} - V_{be})e^{-t/R2C2}. \quad (4)$$

The discharge current due to the charge is then:

$$I_{c2} = [(V_{cc} - V_{be})/R2]e^{-t/R2C2}. \quad (5)$$

The voltage at B may now be written as:

$$V_B = [(V_{cc} - V_{be})(R1 + R2)/R2] [e^{-t/R2C2}] + I_{beo}(R1 + R2) + V_{cc} - V_{be} - I_c R1. \quad (6)$$

When time  $t = \tau$  (Q2 off-time),  $V_B = V_{cc} - V_{be}$ , which yields a Q2 off-time of:

$$\tau = R2 C2 \ln [(V_{cc} - V_{be})(R1 + R2)/R2] \{1/[R1 I_c - I_{beo}(R1 + R2)]\}. \quad (7)$$

In Eq. 7,  $I_c$  is given by:

$$(1/R_e) [V_{cc} R_{B1}/(R_{B1} + R_{B2})] [-V_{be3} \pm V_s]. \quad (8)$$

The problem that originally led to the design of this circuit involved slow-varying, direct-current measurements from thermocouples. The circuit has also been successfully employed in a frequency-modulated transmitter.

Anthony C. Caggiano and J. Thomas Conaway, Electronic Instrumentation Design Engineers, Grumman Aircraft Engineering Corp., Calverton, N. Y.

VOTE FOR 111

## Circuit tests flex-life of shielded cables

Here is a relatively simple circuit for testing the life of flexing cables used in oscillating antennas. The circuit may also be used for testing the flex-life of shielded wires or bundles containing both shielded and unshielded wires, including coaxial cables.

The circuit (see schematic) automatically shuts off when a fault occurs and indicates the nature of the fault. A counter, either electrical or mechani-



# ULTRA-PERFORMANCE

TELONIC'S NEW MODEL 1001 SOLID-STATE SWEEP/SIGNAL GENERATOR DELIVERS UNMATCHED FLEXIBILITY AND PERFORMANCE FOR FREQUENCY AND CW TESTING FROM 100 kHz TO 20 MHz

## ULTRA-WIDE SWEEP RATIO

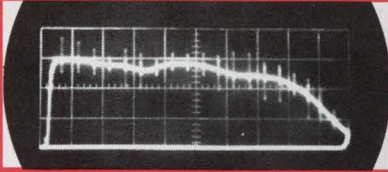

A. Frequency response of broad-band video amplifier, 500 kHz to 20 MHz.

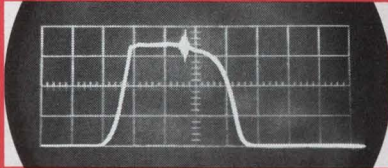

B. Crystal filter response, 3 db bandwidth is 2.8 kHz wide at 10.7 MHz center frequency.

## ULTRA-STABLE

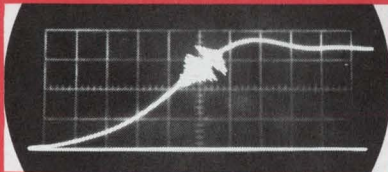

C. Same crystal filter as in (B) above, with 1/10 the sweep width (100 Hz/Div.).

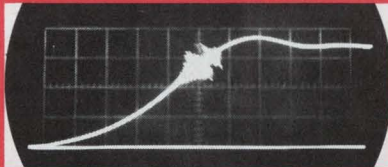

D. Five minutes later, no significant drift; birdy marker is 100 Hz wide.

## ULTRA-NARROW MARKERS

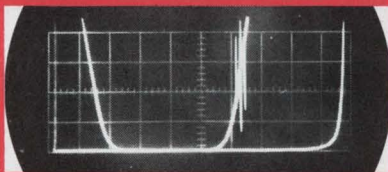

E. Location of birdy marker is difficult to determine on vertical.

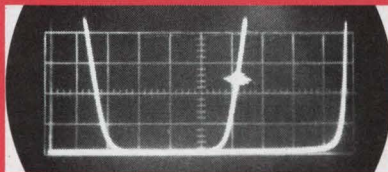

F. Tilted marker permits precise frequency determination.

### PLUS

- VARIABLE SWEEP RATE FROM .01 TO 60 Hz
- MANUAL OR EXTERNAL SWEEPING FOR XY PLOT
- 1 VRMS OUTPUT WITH 103 db ATTENUATION

The 1001 sweeps frequency in three ranges from below 200 Hz up to the full range of 20 MHz—that's a ratio of 100,000 to 1 overall—plus CW and modulated CW! This one instrument serves for narrow and broadband applications in RF, IF, and video frequencies.

New solid-state power supplies for the 1001 provide exceptional frequency stability of 100 Hz for short term operation (1 min.), and 5 kHz over long term (1 hour). Calibrating and adjusting are minimized, test results more dependable.

Harmonic (1 MHz) and variable (100 kHz-20 MHz) frequency markers may be deviated from 10 kHz to as narrow as 100 Hz for precise frequency determination. Unique time-sharing circuit allows any combination of markers to be displayed simultaneously without interference. Marker tilt control provides precise readings even on steepest part of skirt.

THE

# 1001

SWEEP/SIGNAL GENERATOR

100 kHz - 20 MHz



### SPECIFICATIONS

CENTER FREQUENCY	100 kHz - 20 MHz
SWEPT RANGE	100 kHz - 20 MHz
SWEPT WIDTH	
Narrow Range	200 Hz - 200 kHz
Intermediate Range	1 kHz - 2 MHz
Wide Range	10 kHz - 20 MHz
SWEPT RATE	
Variable	0.01 - 60 Hz
Line-Lock	50/60 Hz
OUTPUT	1 VRMS into 50 ohms
STABILITY	
Short Term (1 min.)	100 Hz
Long Term (1 hour)	5 kHz
HARMONIC MARKER	1 MHz
VARIABLE MARKER, RANGE	100 kHz - 20 MHz
VARIABLE MARKER, WIDTH:	
Narrow	100 Hz
Intermediate	1 kHz
Wide	10 kHz

APPLICATION DATA FILE DESCRIBING USE OF TELONIC SWEEP GENERATORS IN RESEARCH, PRODUCTION AND Q.C. APPLICATIONS AVAILABLE ON REQUEST.

**Telonic** INDUSTRIES INC.  
60 NORTH FIRST AVENUE  
BEECH GROVE, INDIANA 46107  
TEL: (317) 787-3231 TWX: 810-341-3202

Representatives in all major cities in the U.S. and foreign countries. Factory offices located at Maidenhead, England and Frankfurt, Germany



"Would you believe I can turn you on for \$39.50?"



"No!"



"Would you believe I can control you with less than 100 microwatts?"



"No."



"Would you believe my pulse rises in 100 nanoseconds?"



"No, sir."



"Say, I don't believe you know me—Crydom's new SCR FIRING CIRCUIT MODULE."



"Yes, I mean no... make me acquainted."



### SCR FIRING CIRCUIT MODULE

*Check These Features*

- ✓ 0.5 milliamperes for control of linear region.
- ✓ Linear control of sine wave power.
- ✓ 0.5 ampere, 100 nanoseconds rise time firing pulse minimizes di/dt failures.
- ✓ 0.7 volt negative bias prevents false firing.
- ✓ 50 microwatts control power sensitivity.
- ✓ 115 or 230 volt, 47-63 Hz operation.
- ✓ Responds to d.c. polarity for closed loop applications.

Write for complete information.



**CRYDOM** laboratories, inc.

3115 West Warner Ave., Santa Ana, California  
Area Code 714 • 540-1390

ON READER-SERVICE CARD CIRCLE 46

### IDEAS FOR DESIGN

cal, can be used to record the number of flex cycles up to the time of failure. If the failure is intermittent, the equipment will not start again until the "start" button is pushed. The equipment, therefore, does not require constant attention.

As a safety factor, a low-voltage source is used (12 to 28 volts, ac or dc) in the cables. A separate higher-voltage source may be used to drive the flex assembly motor and is isolated from the cables being tested.

The circuit is shown using a 28-volt-dc low-voltage source and the component values are those actually used in the tester. However, a 12- or 14-volt source could be used instead, if the component values are altered to secure proper voltage distribution.

SW1 is a momentary NO switch which, when closed, will connect relay coil K1 in series with K2, thus closing the "hold" circuit through TB2 and the 115-volt supply to the drive motor.

SW2 is a momentary NC switch which, when opened, will open the circuit to relay coil K1.

K1 is a 12-volt-dc relay operating at about half

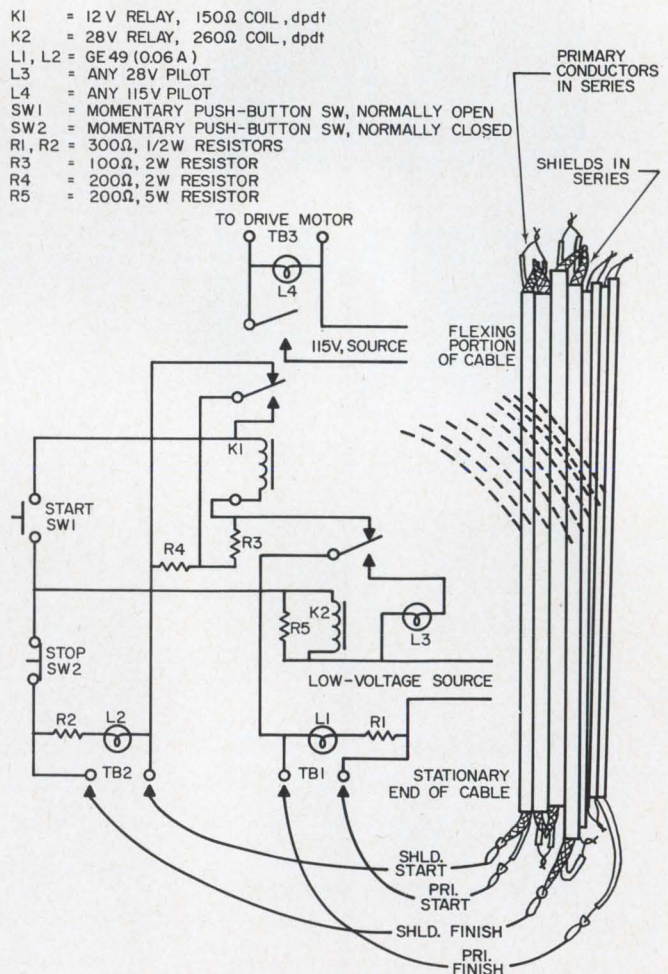

**Simple circuit measures flex-life** of shielded cables. Fault detection results in immediate shut-off with an indication of the nature of the fault. Low voltages applied to cables ensure operator safety.

ON READER-SERVICE CARD CIRCLE 105 >



the low-voltage source of 28 volts, so that it will "pull in" when connected in series with  $K2$ . The coils of  $K1$  and  $K2$  should be of about the same resistance. If the coil resistance of  $K2$  is considerably higher than that of  $K1$ , a parallel resistor should be connected across the  $K2$  coil to equalize approximately the resistances of  $K1$  and  $K2$ . Relay  $K2$  is a 28-volt type, which remains open until coil  $K1$  is shorted. In the circuit shown, this will occur when the shield "shorts" to the primary conductor, thus breaking the circuit through  $K1$  and subsequently opening the 115-volt motor-drive circuit.

If the shield is not shorted to the primary conductor,  $K2$  remains open. The primary conductors "short"  $TB1$  and the shields "short"  $TB2$ ; this holds  $K1$  closed after the start button is pushed. When either the primary conductor or the shield is broken, the short is removed and the pilot light with the series resistor is placed in series with the coil of  $K1$ , which will reduce the voltage enough to release  $K1$ 's armature and open the circuit to the drive motor.

Pilot lights  $L1$  and  $L2$  must be very-low-current types so that there is sufficient series resistance to enable relay  $K1$  to open when a short is removed from  $TB1$  or  $TB2$ .

*R. Steinmetz Smith, Design Engineer, Aerospace Div. of Westinghouse Electric Corp., Baltimore, Md.*

VOTE FOR 112

## Diode feedback protection for complementary amplifiers

Output short-circuit protection of a complementary-pair amplifier is simply achieved by the addition of a diode as a feedback element. As a result, the normally used current-limiting series-resistor is eliminated and the output of the amplifier can swing all the way up to the supply voltage.

In the standard npn-pnp amplifier (see schematic a) the current-limiting resistor  $R_{LIM}$  protects transistor  $Q2$ , should the output go to ground. Unfortunately,  $R_{LIM}$  also limits the output to the load, since  $V_{OUT}$  decreases as the load current increases.

By the addition of  $CR1$  and  $R_D$  (see b), the limiting resistor can be removed from the circuit. Now, when an input voltage is applied, current initially flows into  $Q1$ , turning  $Q1$  ON. This draws current out of the base of  $Q2$  and turns  $Q2$  ON, thus providing current to the load,  $R_L$ .

Should the output be grounded, the input is immediately clamped to approximately 0.7 volts (forward voltage drop of  $CR1$ ). The voltage divider consisting of  $R_{IN}$  and  $R_D$  is set so that, when  $V_{IN} \leq 0.7$  volts,  $V_B$  of  $Q1$  will be less than 0.3

## FOR MORE EFFICIENT TRANSFORMER DESIGN...

### THINK THIN

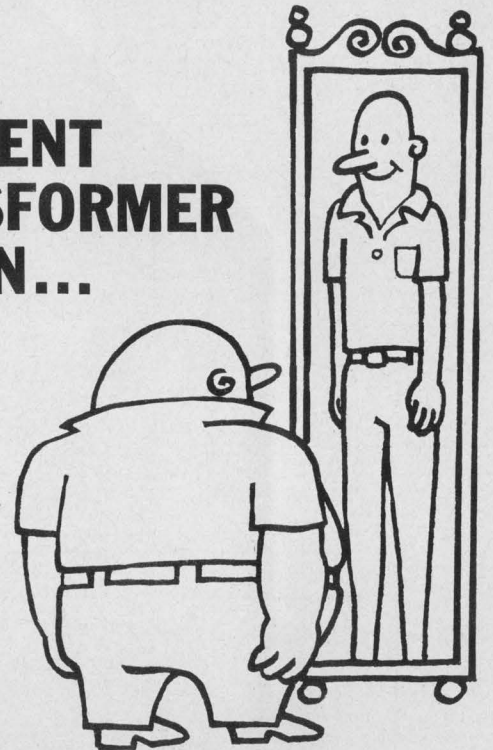

#### T&S THIN LAMINATIONS, THAT IS!

T&S Thin Laminations reduce core weight as much as 50% or more, while maintaining the same performance. Thinlams permit more compact transformer design . . . easier installation and mounting. Their flatness and extremely thin insulation result in a very high stacking factor . . . less weight and less copper. Made from 4 to 6 mil Orthosil® . . . a grain-oriented squared hysteresis loop iron-silicon alloy . . . Thinlams are available in most of Thomas and Skinner's complete line of transformer lamination shapes and sizes. They are especially desirable for use in high-frequency transformer and inductor applications where a high ratio of Br/Bm is called for.

In addition to standard EI Lamination shapes, the following T&S laminations are available in 4 and 6 mil Orthosil:

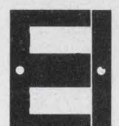

**WIDE WINDOW LAMINATIONS**—Expanded windows with increased winding areas further improve copper/iron loss ratios . . . utilize fully the improved core loss characteristics of existing core materials.

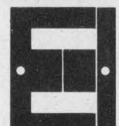

**CENTRA-GAP LAMINATIONS**—Precision die-cut air gap reduces hum and vibration . . . cuts stray fields to practically zero. Offers more stable operating inductance. Ideal means of achieving a high incremental inductance where stability and low mechanical hum levels are required.

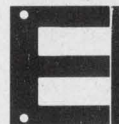

**THREE PHASE LAMINATIONS**—Assures high performance at 400-cycle and higher frequencies. T & S has the most experience in manufacturing and design of 3φ laminations . . . insuring the most consistent high magnetic quality and widest variety of sizes, gauges and grades.

Mr. Magnetician, symbol of over 60 years T & S experience in the field of magnetics.



For complete information, write:



**Thomas & Skinner, Inc.**

Box 120 1120 EAST 23rd STREET  
INDIANAPOLIS, INDIANA 46207 • PHONE 317-WA 3-2501

ON READER-SERVICE CARD CIRCLE 47



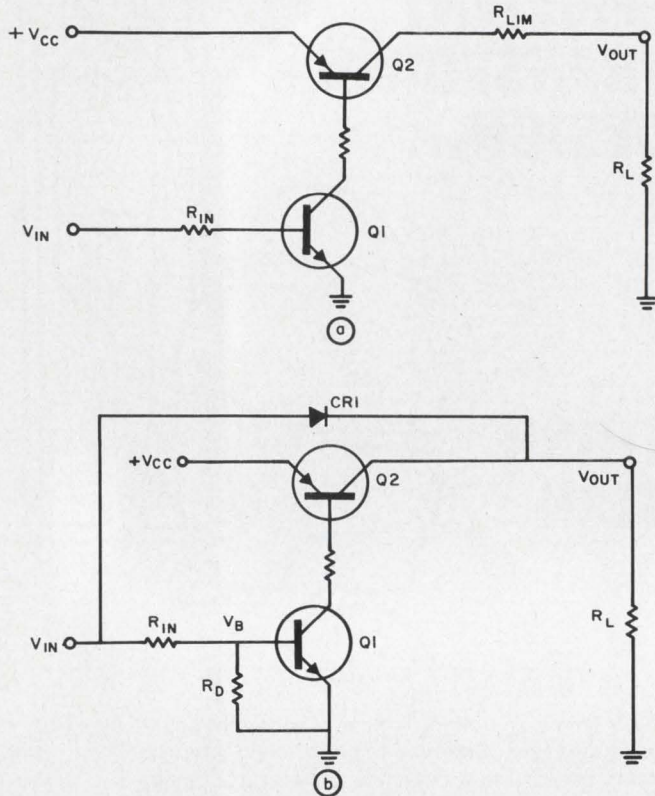

**Current-limiting** series resistor,  $R_{LIM}$ , is eliminated from the output line (a) by using diode feedback element (b). As output goes to ground,  $V_{IN}$  limits at 0.7 V and  $V_B$  becomes 0.3 V, turning Q1, and subsequently Q2, OFF.

volts. This is stated as:

$$0.7 R_D / (R_{IN} + R_D) \leq 0.3 \text{ V,}$$

or

$$R_D \leq 0.75 R_{IN}.$$

When  $V_B$  is less than 0.3 volts, transistor Q1 turns OFF. This turns transistor Q2 OFF and prevents excessive current from flowing through Q2. During normal operation, CR1 is back-biased and does not affect the rest of the circuit.

Paul C. Cornett, Design Engineer, Northern Ordnance Div., FMC Corp., Minneapolis, Minn.

VOTE FOR 113

## Shunt circuit smooths power-supply output

Many stabilized power supplies use series regulation and as much negative feedback as a circuit will withstand without oscillation. But there are occasions when a shunt circuit combined with positive feedback may be more appropriate.

For example, it was found that a conventionally regulated power supply provided regulation adequate for the requirements of a particular load circuit, but provided insufficient smoothing of

the ripple at twice the supply frequency. The peak-to-peak ripple across the regulator diode was 50 mV and an improvement by some 40 dB was called for.

The modified system (see schematic) provided sufficient smoothing to solve this problem. The nominally 28-volt line has  $\pm 2$  volts of ripple, feeding  $\pm 2$  mA of current through R1 to the regulator diode. The purpose of the transistor in shunt with the diode is to pass an identical current but eliminate the ripple at the output terminals of the power supply. If the transistor were ideal and the effect of the base-bias resistors ignored, the desired performance would be obtained by setting variable resistance  $R_V$  equal to R1.

In practice, however,  $R_V$  is rather smaller than R1, principally because of the finite base current and base-emitter diode of the transistor. Adjustment of  $R_V$  reduces the output ripple voltage to a small fraction of a millivolt. This residual ripple is

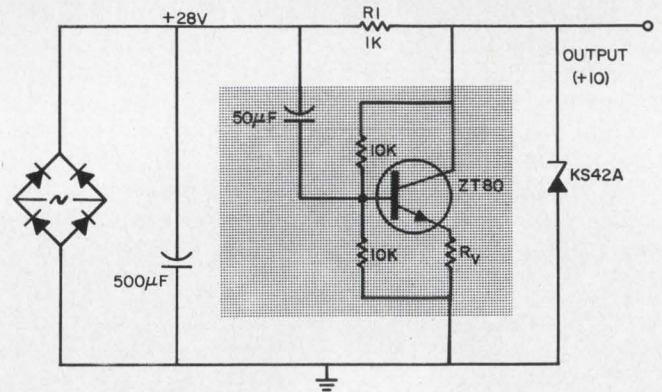

**Shunt circuit** serves to smooth output fluctuations in this power supply.

caused by distortion in the transistor, which arises mainly from the nonlinear characteristic of the input junction. Operation of the transistor as an emitter-follower with large forward bias ensured that the distortion, and therefore the residual ripple, are also small.

H. Sutcliffe, Reader in Electrical Engineering, Royal College of Advanced Technology, Salford, Lancashire, England.

VOTE FOR 114

### IFD Winner for June 7, 1966

R. Couturier, Senior Project Engineer, STELMA, Inc., Stamford, Conn.

His idea, "Diodes ensure start of astable multi-vibrator," has been voted the \$50 Most Valuable of Issue Award.

Cast Your Vote for the Best Idea in this Issue.

### IFD Winner for June 21, 1966

Edward G. Olson, Design Engineer, Naval Air Development Center, Johnsville-Warminster, Pa.

His idea, "Remote-control time delay needs no turn-off signal," has been voted the \$50 Most Valuable of Issue Award.

Cast Your Vote for the Best Idea in this Issue.



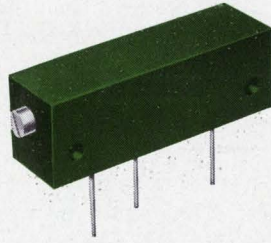

## what's in it for you?

Just this...15 times the winding length and 10 times the resolution in the Clarostat Series 76JA Trimming Potentiometer... and it looks and mounts like any ordinary trimmer pot. That's the kind of superb engineering you've come to expect from Clarostat. Naturally, it's designed for your needs; production time is reduced by eliminating critical mechanical settings, and you enjoy more mechanical freedom than with bulky multi-turn pots. Completely interchangeable with other trimmers. But most important...resolution is ten times better than you can get from ordinary trimming potentiometers.

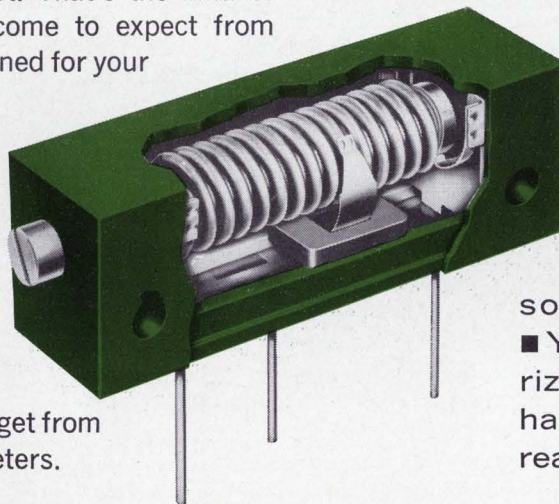

**SPECIFICATIONS:** Mechanical Travel: 12 turns approximate; ■ Effective travel: 11 turns ( $\pm 1/4$ ); ■ Resistance Range: 100 ohms to 20,000 ohms; ■ Resistance Tolerance:  $\pm 5\%$ ; ■ Power Rating: .75 watts @ 85°C. derated linearly to zero power @ 150°C. ■ Available with printed circuit or solder lug terminations. ■ Your local Clarostat Authorized Industrial Distributor has the Series 76 in stock ready for immediate delivery.

# CLAROSTAT

CLAROSTAT MFG. CO., INC. DOVER, NEW HAMPSHIRE  
ON READER-SERVICE CARD CIRCLE 48



# Book Reviews

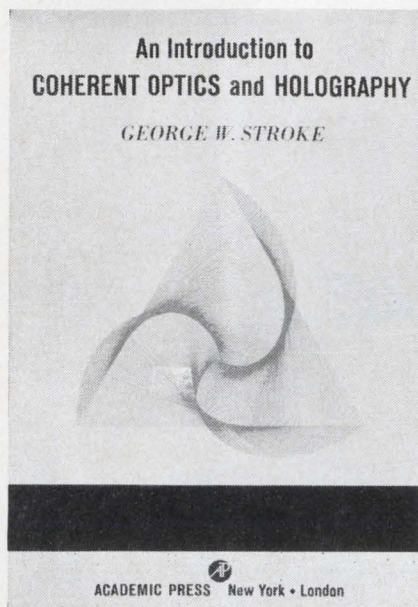

## Learn about holography with a knowledge of math

Holography, the lensless re-creation of visual images, is becoming important in optics as well as electrical engineering. Recently holographers have developed methods to measure extremely small distances very precisely with holographic images, called holograms. In addition, the holograms can resolve images better than lens systems can, as they are not subject to distortions introduced by the critical angles and different refractive indices of glass.

There is a need for detailed books on this important topic, and George Stroke has written one.

Stroke feels that the historical development of holography has been based on theoretical reasoning: "Perhaps the single most important element in the rapid development of electro-optical sciences is the great simplicity that results from the deliberate use of a sophisticated but powerful mathematical formulation." And it is this clean, elegant tool that enables Stroke to give his reader a comprehensive introduction to coherent optics.

He starts by dipping into grating equations that solve diffraction problems, but before he finishes he has described topics that range from the general role of coherent

optics in communication theory to the definition of three types of coherent light.

In a chapter on the theoretical foundations of wavefront imaging, Stroke presents clear descriptions of the recording and reconstruction processes. They alone are worth the price of the book to anyone who does not have a good grasp of the mechanism by which holograms modulate an impinging wavefront.

In the back of the book, Stroke reprints the three original papers on holography by Dennis Gabor. These papers, and part of one chapter of the text, discuss holographic microscopy, a highly interesting subject. The book is also sprinkled with small historical sections that provide a sketch of the development of holography.

This is an excellent book for anyone who has a good mathematical background and a budding interest in this field.

*An Introduction to Coherent Optics and Holography*, George W. Stroke (Academic Press, Inc., New York) 270 pp., \$10.00.

—Roger Kenneth Field

## Laser receivers

This book gives an integrated presentation of the fundamentals of laser receivers that range from theoretical foundations and available components to system concepts. The terminology and emphasis of the book has been directed to the electronic engineer who is not necessarily familiar with quantum mechanics or quantum electronics.

*Laser Receivers, Devices, Techniques, Systems*, Monte Ross (John Wiley & Sons, Inc., New York) 405 pp \$14.95.

## Computer programming

Designed for people with no prior computer experience, this book can convert the no-user to a competent practitioner. Containing 110 graded exercises, the presentation requires of the reader only a minimal background in algebra, and some logical

ability. The author concentrates on developing the reader's ability to use the computer and makes no claim for showing him how it works or what its effects may be. The FORTRAN statements and programming techniques he covers are explained, demonstrated, and drilled thoroughly.

*Introductory Computer Programming*, Frederick Stuart, (John Wiley & Sons, Inc., New York) 155 pp \$5.95

## Antenna analysis

This book treats more than one hundred antennas, and leans toward the needs of design engineers. The entire analytical literature of antenna theory is reviewed—not from the point of view of the theorist, but rather to give the engineer a greater appreciation of the assumptions inherent in design equations and the derivation of antenna properties. Mathematical models are developed, without unnecessary elaboration. A wide selection of references is provided for those who want to investigate specific topics more deeply.

*Antenna Analysis*, Edward A. Wolff (John Wiley & Sons, Inc., New York) 514 pp \$25.00.

## Relay switching

Based on the teaching experience of the authors, this book deals with the theoretical basis of switching techniques. Chapters on the calculations of relays, elementary circuits, switching algebra and codes are followed by studies of practical switching techniques; the design of circuits for counting, decoding, checking, locking, connecting, recording, translations, identifications and analysis. This book contains examples, while problems (with answers) allow the reader to test his understanding of the subject.

*The Handbook of Relay Switching Technique*, J. Appels, B. Geels (Springer-Verlag, New York) 321 pp.



# CAREER INQUIRY - confidential

Respond to the career opportunities advertised in this issue. Fill out and send us this handy resume. **Electronic Design** will do the rest - neatly typed copies of this form will be mailed to the companies of your choice, indicated by the circled Career Inquiry Numbers at the bottom of this page.

22

Name \_\_\_\_\_ Home Phone \_\_\_\_\_

Home Address (Street) \_\_\_\_\_ City \_\_\_\_\_ State \_\_\_\_\_ ZIP Code \_\_\_\_\_

Age \_\_\_\_\_ U.S. Citizen  Yes  No Security Clearance \_\_\_\_\_

Prime Experience	Secondary Experience

Desired Salary \_\_\_\_\_ Availability Date \_\_\_\_\_

**Employment History - present and previous employers**

Company	City, State	Dates	Title	Specialty
		to		
		to		
		to		

**Education - indicate major if degree is not self-explanatory**

Degree	College	City, State	Dates
			to
			to

**Additional Training - non-degree, industry, military, etc.**

\_\_\_\_\_

\_\_\_\_\_

\_\_\_\_\_

**Professional Societies**

**Published Articles**

- Career Inquiry Numbers:
- 900 901 902 903 904 905 906 907 908 909
- 910 911 912 913 914 915 916 917 918 919

**ELECTRONIC DESIGN**  
 850 Third Avenue  
 New York, New York 10022



# Would you believe... NOT ALL MARRIAGES ARE MADE IN HEAVEN!



The squiggly engineers vs. the angular engineers. RF vs. digital. How could Motorola possibly achieve a harmonious marriage between these two hostile technologies? It wasn't easy, but we did it. With the know-how gained from our S-band Rendezvous System, we used the best features of tone ranging, plus the advantages of digital (pseudo random noise) ranging — and came up with a real love-match: *Motorola's Hybrid Ranging System*.

We're still a bit shorthanded to make this a prolific marriage. Sorry about that. So if you can do systems analysis, circuit design (you can play the squiggles or work the angles) — or have picked up some specialty of your own — write Phil Nienstedt, Manager of Recruitment, Department 629.

Other Specific Opportunities are:

Space Communications  
Radar Systems  
Tracking & Telemetry  
Fuzing  
Digital Data Transmission  
Guidance & Navigation  
ECM & Elint

Checkout Systems  
Coherent Transponders  
Radar Transponders  
Integrated Electronics  
Antennas & Propagation  
Reliability & Components  
Advanced RF & Microwave Techniques

**MOTOROLA**



**in PHOENIX**

**Government Electronics Division • Aerospace Center**

P.O. Box 1417, Scottsdale, Arizona

MOTOROLA ALSO OFFERS OPPORTUNITIES AT CHICAGO, ILLINOIS — AN EQUAL OPPORTUNITY EMPLOYER

## BOOKS

### Reference tables

Created for the mechanical engineer, this handbook is composed of tables for sizes, threads, accessories and other data. Topics covered in sixty-one sections include: drills and reamers, threads for pipes and screws; bolts, nuts and washers, keys and keyways, cutter and saws, gauges, conversion tables, mathematical formulas, and many drawings.

*Mechanical Engineer's Reference Tables*, Z. Elzanowski, (Chemical Publishing Co. Inc., New York) 82 pp \$10

### Computer application

The integration of engineering mathematics and information processing in computers is viewed as a quasi-intelligent robot, capable of serving in almost any desired capacity.

The anatomy and physiology of the robot and plans for more complex constructions are examined in a variety of life science settings.

Included in this book is a glossary of technical terms which apply specifically to this field.

*Computers and the Life Sciences*, Theodor Sterling, Seymour Pollack, (Columbia University Press, New York) 342 pp. \$12.50.

### Readout meters

Written for use as a text for student technicians, this handbook explains a wide variety of digital, differential, and analog meters in basic terms and provides detailed technician-level circuit descriptions for the most widely used types. Also, laboratory meters are covered in logical progression following sequence, from pickup devices, through the processing circuits, to the display functions. Proceeding each group is a discussion outlining typical operating limits for each meter.

Many illustrations are included to improve understanding of the subject.

*Direct Readout Meters*, John D. Lenk (Howard W. Sams & Co., Inc. Indianapolis, Ind.) 154 pp \$3.25



# DISCOVER THE WIDENING WORLD OF WESTON

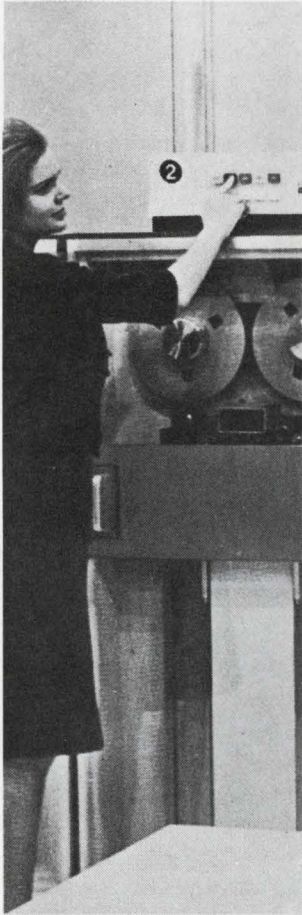

**WE HELP  
IBM  
MAKE BETTER  
COMPUTERS**



**WE HELP THE  
NAVY WITH  
UNDERWATER  
COMMUNICATIONS**

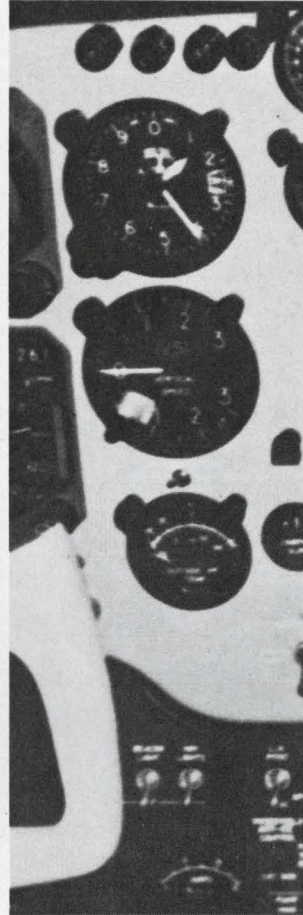

**WE HELP  
BEECHCRAFT  
MAKE BETTER  
PLANES**

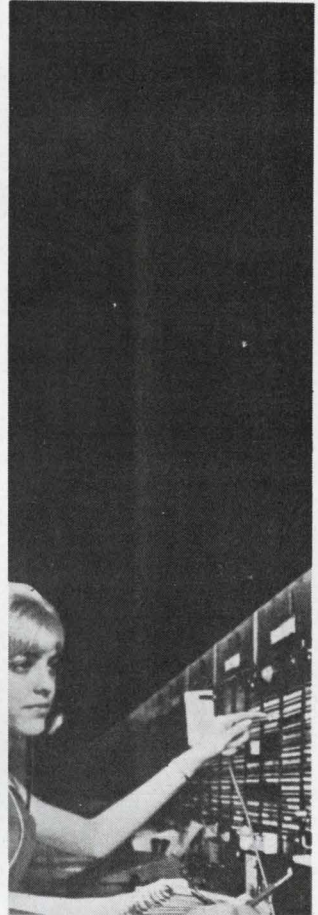

**WE HELP YOU  
MAKE PHONE  
CALLS  
FASTER**

On land, under the ocean, or miles above its surface, Weston precision-measuring products are playing their part to preserve our way of life and to improve it.

Our six integrated divisions are currently keeping pace with the diversified needs of industry and government through thousands of different products, programs and projects.

For example, Weston fully-transistorized Acoustic Communicators enable frogmen and their supporting landing craft, destroyers and submarines to communicate with crystal-clear clarity underwater. Weston engine function indicators keep Beechcraft executive planes flying safely. Weston potentiometers keep IBM in the forefront of the computer

technology. And Weston's "705" relay which is an integral part of Bell's overseas systems speeds your trans-oceanic calls.

This is just an infinitesimal segment of the Weston spectrum. We're the nation's prime source for precision-measuring products under every conceivable condition. It has been thus since 1888 (when we developed the first practical yardstick for measuring electrical current). It's truer today than ever.

Engineers, scientists and professional personnel looking for new challenges are invited to discover the widening world of Weston. And widen their personal worlds, too.

Write in confidence to Corporate Personnel Manager

## WESTON

INSTRUMENTS, INC.

614 Frelingheusen Avenue, Department E.D.-2, Newark, New Jersey

### PLANTS AND DIVISIONS

Weston-Newark  
Newark, N. J.

Weston-Archbald  
Archbald, Penna.

Weston-Poughkeepsie  
Poughkeepsie, N. Y.

Weston-Transicoil  
Worcester, Penna.

Weston-Rotek  
Watertown, Mass.

Weston-Boonshaft & Fuchs  
Hatboro, Penna.

**Weston • Prime Source for Precision . . . Since 1888**

An Equal Opportunity Employer

ON CAREER-INQUIRY FORM CIRCLE 901



AMERICAN MACHINE & FOUNDRY CO. • AVCO •  
 BEECH AIRCRAFT • BELL & HOWELL • BOEING •  
 BURROUGHS • CHRYSLER CORPORATION •  
 CONTROL DATA CORPORATION • CORNING  
 ELECTRONICS • DOUGLAS AIRCRAFT COMPANY •  
 DOW CHEMICAL • FMC • GENERAL ELECTRIC CO. •  
 THE GOODYEAR TIRE & RUBBER COMPANY •  
 ITT FEDERAL LABORATORIES • LITTON INDUSTRIES •  
 LOCKHEED AIRCRAFT • MCDONNELL •  
 MARTIN COMPANY • NORTH AMERICAN AVIATION,  
 INC. • NORTHROP • RADIO CORPORATION OF  
 AMERICA • RAYTHEON • SIKORSKY AIRCRAFT •  
 SOLAR DIVISION OF INTERNATIONAL HARVESTER  
 CO. • TEXAS INSTRUMENTS • T R W •  
 UNION CARBIDE • WESTINGHOUSE  
 ELECTRIC CORPORATION

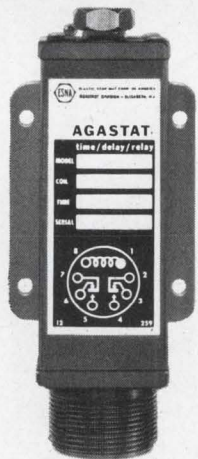

why is the miniature  
**AGASTAT**<sup>®</sup>

time/delay/relay

the only MIL-SPEC pneumatic?

Some of our best customers know it's the only one that offers . . .

- **RUGGEDNESS** . . . exceeds MIL E-5272 specs for vibration, shock, acceleration.
- **HERMETIC SEALING** . . . recirculates its own inert gas supply—free of dust and moisture.
- **COMPACTNESS** . . . no other pneumatic t/d/r packs so much into a 1.52" x 1.52" x 4.4" can.
- **WIDE TIMING RANGES** . . . nine models, from .03 seconds to 3 minutes.

- **EASY ADJUSTMENT** . . . exclusive dial head for true linear adjustment—no needle-valve "cut and try."
- **PLUS** . . . freedom from transient effects . . . voltage-and-temperature resistance . . . maximum weight 16 oz. . . instant recycling . . . high repeat accuracy . . . broad terminal selection; solder lug, octal plug, "AN" connector or to your order . . . wide range of AC or DC operating voltages . . . unsealed models for industrial applications, too. Write today for complete specifications. M9

**AGASTAT** TIMING INSTRUMENTS  
 ELASTIC STOP NUT CORPORATION OF AMERICA  
 AGASTAT DIVISION • ELIZABETH, NEW JERSEY

IN CANADA: ESNA LIMITED, 271 PROGRESS AVENUE, SCARBOROUGH, ONTARIO

Speed Inquiry to Advertiser via Collect Night Letter

ON READER-SERVICE CARD CIRCLE 49

BOOKS

**Modern radar**

The different aspects of the field of modern radar are discussed. This text begins with a general introduction and then proceeds to basic signal and noise analysis and description, statistical target detection and parameter estimation methods, techniques for coping with resolution and ambiguity problems, radio frequency considerations, and specific procedures for analysis and design of search and tracking systems. Current references at the end of each chapter emphasize utility rather than exhaustive coverage.

*Modern Radar*, Raymond S. Berkowitz, (John Wiley & Sons, Inc., New York) 660 pp \$19.50.

**Transistor guide**

An illustrated guide to the characteristics and use of various types of transistors describes the junction transistor, epitaxial planar, field effect, metal-oxide silicon and thin-film types. Associated semi-conducted devices such as junction rectifier, silicon-controlled rectifier, zener diode, tunnel diode, varactor diode and phototransistor are also discussed.

*Transistors: Principles and Applications*. R. G. Hibberd (Hart Publishing Company, Inc.: New York). 304 pp. \$5.95 (cloth edition) and \$2.45 (paperback).

**Physical phenomena and electronics**

An illustrated text examines the physical phenomena underlying the practical applications of electronics. It discusses the structure of matter and the various, basic forms of energy.

Charging and discharging, excitation and radiation, ionization and emission—the main electronic phenomena—are discussed and inter-related. The physical operations and applications of electron tubes and solid state devices are also covered. Special fold-out charts and the periodic table are included.

*The Physical Basis of Electronics*. J.G.R. van Dijk (Hayden Book Company, Inc.: New York). 362 pp., \$11.95.



**Now available in  
16 different configurations  
— all with 0.01% accuracy —**

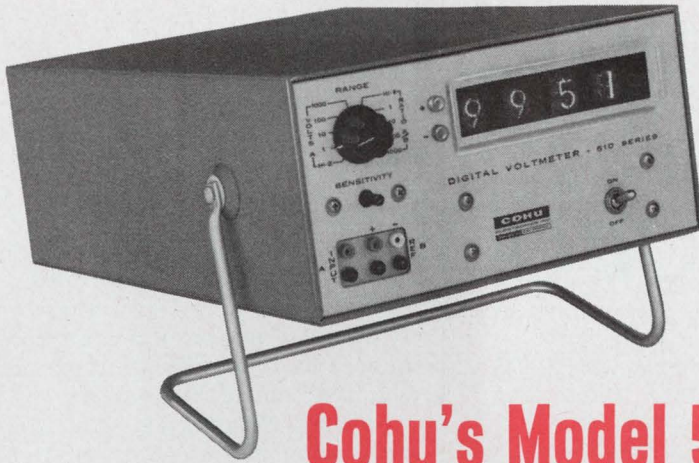

## **Cohu's Model 510 Series Digital Voltmeter-Ratiometer!**

This highly reliable and stable instrument is now being delivered in models to meet virtually every application—laboratory, bench and assembly line. The basic cabinet model weighs only 12 lbs. and sells for \$995, while the basic rackmount model is \$1050. Both prices are FOB San Diego. Additional export charge.

The 510 series is available either with manual ranging only or optionally with both manual and automatic ranging of the four voltage ranges. Electrical output options are biquinary, 1248 BCD, or 1224 logic level outputs, enabling this DVM to drive most types of digital recording devices. An optional accessory probe is also available.

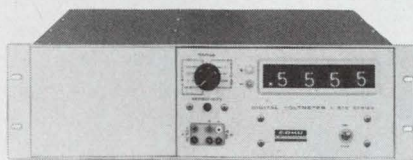

### **These features are common to all models in the 510 Series:**

- 0.01%  $\pm$  1 digit accuracy
- automatic polarity indication
- 4-place reading on all ranges
- 4 manual ranges, 2 functions  
(1V to 1000V, 1:1 to 1000:1 ratios)
- single control, range and function
- front panel sensitivity control
- high input resistance
- solid-state reference and circuitry
- bidirectional tracking logic

For full details, contact Cohu engineering representatives in major cities throughout the world.



Box 623  
San Diego, California 92112  
Phone 714-277-6700

ON READER-SERVICE CARD CIRCLE 50



# SEARCHING FOR LOW-COST, MILITARY QUALITY, $\frac{1}{2}$ INCH, 10-TURN POTS?



ACTUAL SIZE

COMPARE THESE SPECS AGAINST COMPETITIVE EQUIVALENTS (IF YOU CAN FIND ANY!)

Resistance Range: 100 ohms to 100K ohms  
Resolution: 0.101 to 0.015% • Linearity: 0.30%  
Power Rating: 2 watts @ 40°C.  
Operating Temperature: -55°C. to +125°C.

## spectrol

Prices start at less than \$9.00 in 100 quantities, and yet these quality pots meet or exceed many military environmental specifications. For full information, send for a data sheet.

Spectrol Electronics Corporation, 17070 E. Gale Ave., City of Industry, Calif. 91745

# ...YOU'VE JUST FOUND THEM!

A standard  $\frac{3}{32}$ -inch shaft  $\frac{1}{4}$ -32 thread bushing mount,  
a popular  $\frac{1}{4}$ -inch shaft  $\frac{3}{8}$ -32 thread bushing mount,  
and a unique low-cost servo mount — all with  
rear terminals!



ON READER-SERVICE CARD CIRCLE 51

## BOOKS

### Programming and theory

An introduction to the mathematical theory of processes, this text provides various problems, making this book useful for both classroom and individual study. Chapter 1 is devoted to the general concept of multistage processes both deterministic and stochastic, with time taken to be both continuous and discrete. In chapter 2 multistage decision processes are discussed. Chapter 3 goes into the examination of computational aspects of dynamic programming, with Chapter 4 discussing communication and control processes for which analytical results can be obtained. Ending with a study of adaptive control processes.

*Dynamic Programming and Modern Control Theory*, Richard Bellman, University of Southern California, Los Angeles, Calif. Robert Kalaba, Rand Corporation, Santa Monica, Calif. (Academic Press, New York) 112 pp clothbound \$5.50 paperbound \$2.95

### Reliable reliability

Reliability Handbook provides coverage of all aspects of reliability from design stage to field use and maintenance, with detailed information on mathematical and statistical techniques used in designing conducting and evaluating test programs.

The reader does not have to be highly trained in mathematics and statistics to make use of the ideas, concepts and principles presented. The handbook combines management and technical aspects of reliability programming and covers management and cost aspects of reliability and system effectiveness.

Some of the topics covered are: selecting reliability test plans, accession and organization of reliability data, and testing programs.

Complete with tables, charts and illustrations as well as a complete index, the handbook provides reference material for all phases of reliability.

*Reliability Handbook*, W. Grant Ireson, (McGraw Hill Book Co., New York) 699 pages \$22.50.



# New Mercury Relay Applications From Adlake

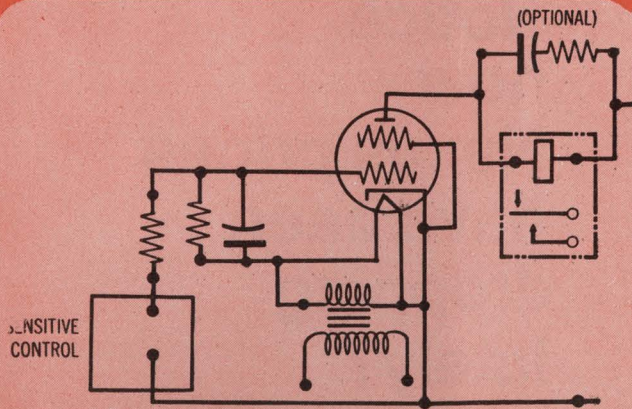

**MERCURY  
DISPLACEMENT  
RELAYS**

## *Small Currents Control "Heavy Duty" Load Relay*

In applications having extremely sensitive controls, this circuit illustrates how very small currents are capable of controlling an Adlake "Heavy Duty" load relay. Resistive loads of 35, 50 or 75 amperes at 120 volts, 60 cycles, are easily met up to 44 operations per minute. 100 ampere loads at the rate of 6 operations per minute.

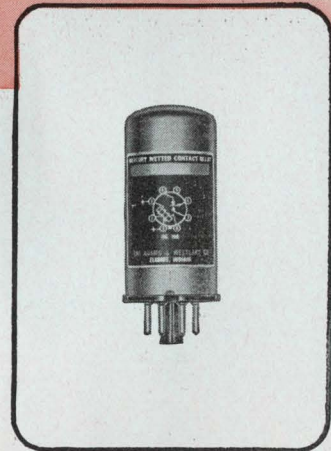
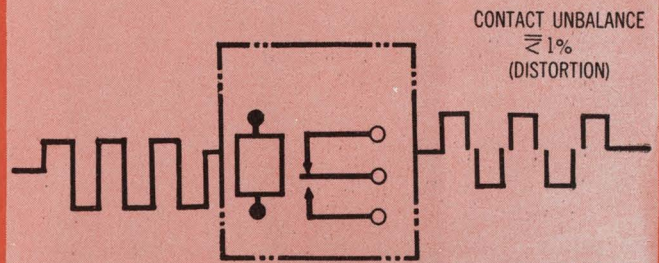

**MERCURY  
WETTED  
CONTACT  
RELAYS**

## *Ideal for Data Transmission or Tele-Typing*

Adlake Polar Relays—Form C—are ideal for data transmission or tele-typewriting where a series of equal length impulses represent an alpha-numeric character or function. Baud rates up to 120 are available with Contact Unbalance—Distortion—of 1% or less including transition. Transition time is normally 200 microseconds or less.

Backed by sound research and disciplined engineering, Adlake applies the industry's broadest line of mercury displacement and mercury wetted relays to the creative solution of design circuit problems. However unique or special your application, Adlake can assist you in developing it. For prompt, personal and knowledgeable attention to your relay needs, contact the one source that is the complete source in the mercury relay field. Contact Adlake today for catalog and further information.



**THE ADAMS & WESTLAKE COMPANY**

Dept. 1096 • Elkhart, Indiana 46514 • Phone (A.C. 219) CO 4-1141

WINDOWS & CURTAIN WALLS • DOORS & ENTRANCES • TRANSPORTATION EQUIPMENT • MERCURY RELAYS • CONTRACT MANUFACTURING

ON READER-SERVICE CARD CIRCLE 52



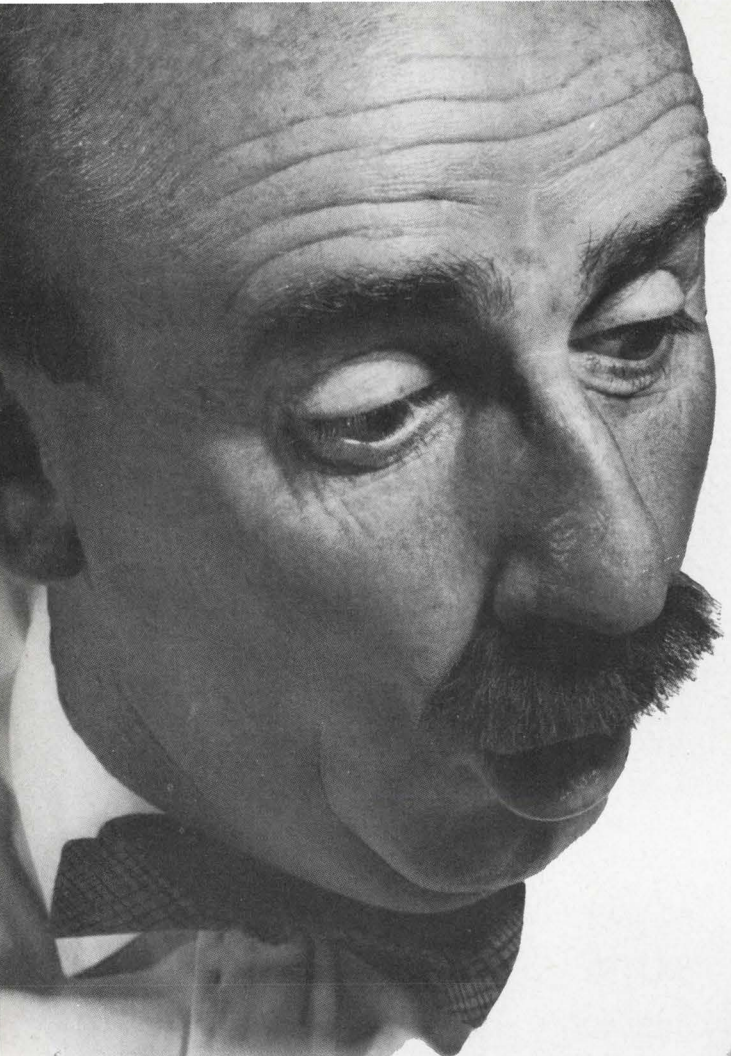

# Notice how Nexus prices have been dropping lately?



Take the Type SA-3a (improved version of the SA-3) high-performance operational amplifier. Its unit price has just plummeted from a low \$45 to an unheard of \$35.

You won't find a better buy anywhere in the industry (unless it's the Nexus SQ-10a which lists for an unprecedented \$17).

The SA-3a affords the user the following very significant typical performance:

Differential input impedance — 1.0 megohm; 1 nanoamp of offset current (referred to either input);  $3 \mu\text{V}/^\circ\text{C}$  offset voltage, and an open-loop gain of 80,000 at D.C.

Since it may be used with megohm input and feedback resistors it is particularly useful in sensitive instrument applications. As a follower or non-inverting amplifier its input impedance approaches the common

mode impedance (several hundred megohms at low frequencies), reducing the loading error on signal sources with high equivalent source impedance.

As with other recent reductions in Nexus off-the-shelf prices, the new SA-3a price reflects savings realized through increased production quantities and increased production efficiencies. As more and more companies buy Nexus quality, more and more benefit from the industry's lowest prices.

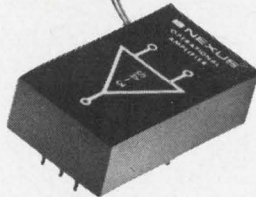

#### CHARACTERISTICS

	(typical @ 25°C unless noted)
Supply Voltage (3-wire D. C.)	±15 v
Supply Current Quiescent	±8 ma
Voltage Offset Stability @ Const. Temp. (long term)	±50 $\mu\text{V}$
Offset Voltage Temp. Coeff. —25°C to +85°C	±3 $\mu\text{V}/^\circ\text{C}$
Offset Voltage/Supply Voltage Stability Coeff.	200 $\mu\text{V}/\text{v}$
Input Offset Current	±1 na
Offset Current Temp. Coeff. (Either Input)—25°C to +85°C	0.06 na/ $^\circ\text{C}$
Open-Loop Gain @ D. C. $R_{L} = 10\text{K}$	80,000
Frequency Limit For Full Output (Unity Gain Inverter)	5 Kc
Differential Input Impedance @ D. C.	1.0 Megohm
Common Mode Input Impedance @ D. C.	500 Megohms

\*In quantities of 1-9

VISIT US AT ISA BOOTH NO. 1440; NEC BOOTH NO. 865; AESCON BOOTH NO. 124

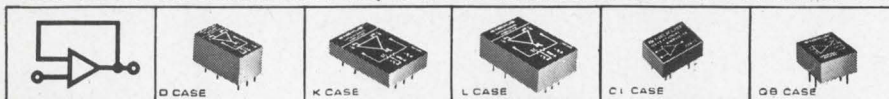

**NEXUS**  
RESEARCH LABORATORY, INC.  
480 NEPONSET STREET, CANTON, MASS. 02021  
TEL: (617) 828-9000 TWX (617) 828-1022

Prices F.O.B. Canton, Massachusetts — Prices apply to North America only.



# Products

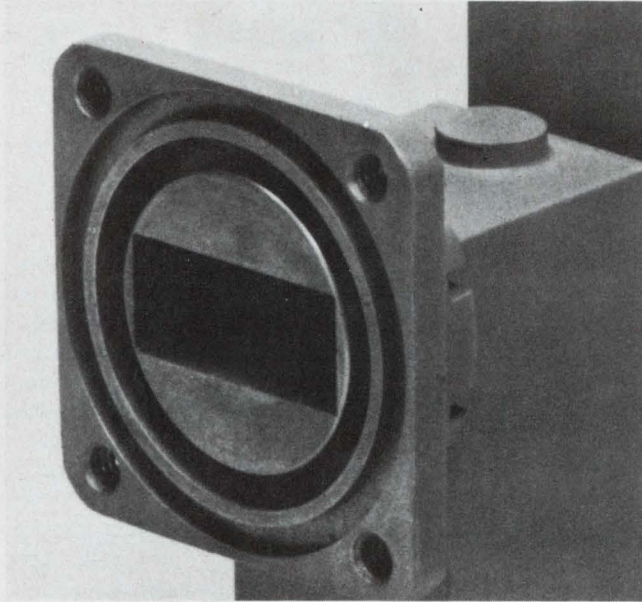

**Solid-state noise source** replaces argon lamps, covers 2 to 12 GHz. Page 156

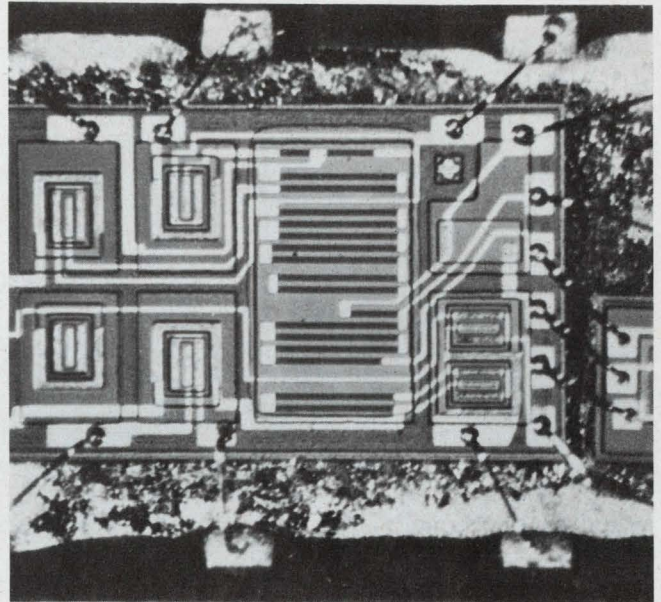

**Parasitic-free op-amps** operate without lead and lag compensation networks. Page 136

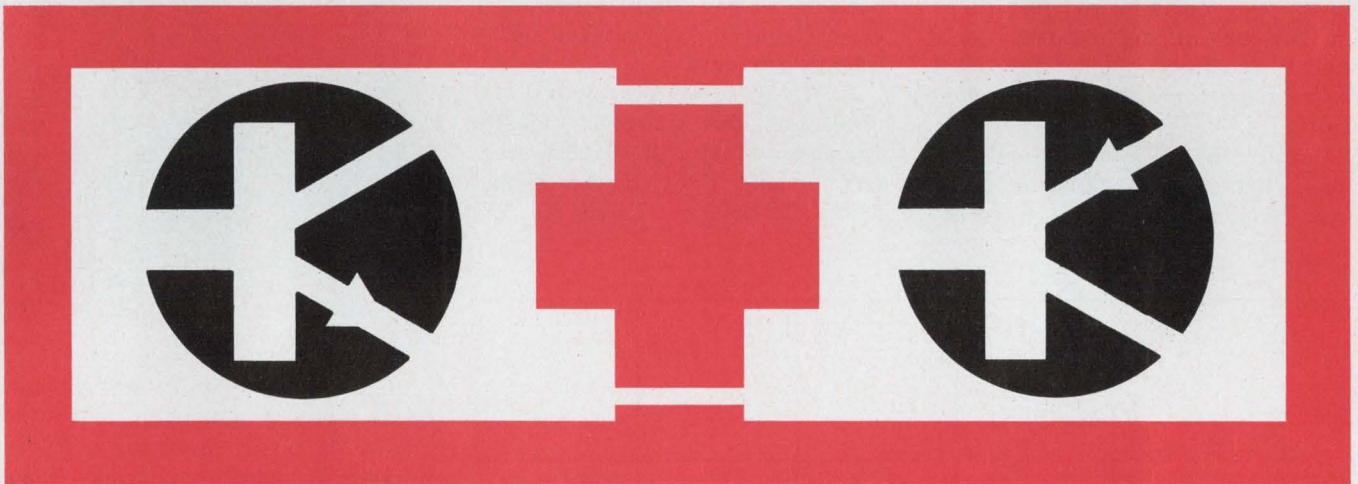

**Silicon pnp transistor** completes complementary pair. The unit offers a 500-V breakdown

and 50-MHz gain-bandwidth and replaces series-stacked low-voltage devices. Page 126

## Also in this section:

**IC variable attenuators** (up to 60 dB) are designed for agc control circuits. Page 138

**Micromin rotary switches** use ball-like rotor as conductor and detent. Page 142

**Laser safety goggles** protect against solar simulator and argon laser sources. Page 168



## Pnp has 500-V breakdown, completes complementary pair

As a complement to their 50-MHz, 800-V breakdown npn, Industro Transistor Corp. is now offering the pnp type P4504. These devices, offering the combination of a 500-V max breakdown and a 50-MHz gain-bandwidth product, should replace series-stacked low-voltage transistors in many applications. In addition, complementary symmetry will bring design ease and improved stability and power dissipation.

The transistors are silicon mesa units with very heavy base region doping. Although current ratings are fairly low (500 mA is maximum surge current) leakage currents are also low—in the  $\mu\text{A}$  range—and gain-bandwidth product is 50 MHz.

The high-voltage/high  $f_t$  units are intended as drivers for electrostatically deflected CRTs, as output stages for high-voltage op-amps, and in solid-state relays and controls. As replacements for SCRs in low-current applications, their switching time is quicker and there is no need for special gating circuits.

Despite the extreme voltage ratings, current gain specs are good. Open-loop gain ( $h_{FE}$ ) at a collec-

tor-to-emitter voltage ( $V_{CE}$ ) of 15 V is approximately 30 at a collector current of 1 mA, 50 at 10 mA, 60 at 30 mA and 40 at 50 mA.  $V_{CE(SAT)}$  is 2.3 V at a collector current of 10 mA and base current of 1 mA, and 6.7 V at 30 mA and 3 mA. Voltage snap-back is negligible after the avalanche breakdown point.

The units are supplied in three packages: a glass-based TO-5 which dissipates 2 W, a metal-based TO-5 dissipating 4 W and a heat-sinked TO-5 (MD-14) which dissipates 15 W.

A less expensive unit is also available with breakdown voltages specified at 300 V.

The high voltage/high gain-bandwidth devices are apparently unique. RCA has some 500-V units but they are specified for switching. Delco Radio produces a 500-V device also, but this is a power unit with a much lower frequency response and higher leakage currents.

P&A: \$6 (1000 lots) 300 V, \$11 (1000 lots) 500 V; stock. Industro Transistor Corp., 35-10 36th Ave., Long Island City, N. Y. Phone: (212) 392-8000. *Circle No. 222*

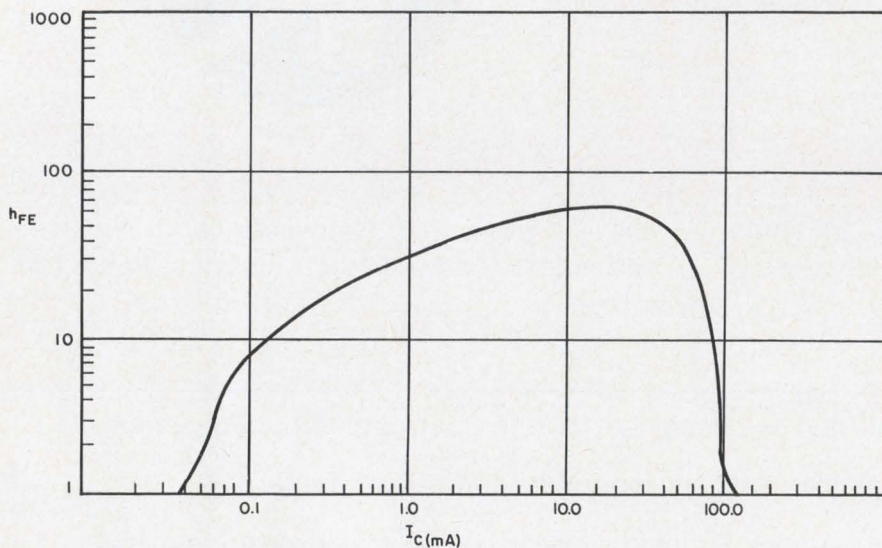

$h_{FE}$  of 500-V device reaches 60 at a 10-mA collector current.

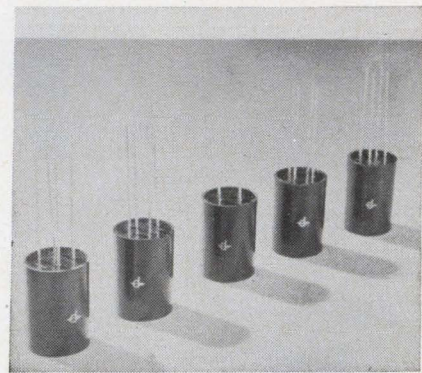

### Reference amplifiers

With a nominal reference voltage of  $7\text{ V} \pm 5\%$ , this line of reference amplifiers has temperature coefficients of 10, 25, 50 and 100 ppm over a  $-25$  to  $100^\circ\text{C}$  range. With this time and temperature stability, the designer can build power supplies with close control of output voltages. Each amplifier consists of an npn silicon transistor and a silicon voltage regulator having temperature coefficient equal in magnitude and opposite in polarity.

Dickson Electronics Corp., 310 S. Wells Fargo Ave., Scottsdale, Ariz. Phone: (602) 949-0146.

*Circle No. 223*

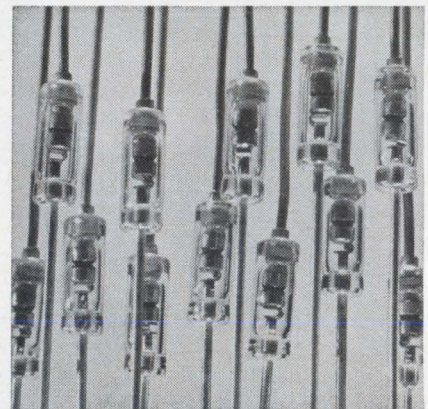

### Glass rectifiers

These silicon double-diffused all-glass rectifiers deliver up to 1 A at  $100^\circ\text{C}$  at reverse working voltages of 1000 V max. The units have very low operating reverse leakage currents at elevated temperatures and controlled avalanche characteristics so they can withstand instantaneous reverse transient power surges above their normal ratings. The glass package provides a hermetic seal with leak rates of  $1 \times 10^{-10} \text{ cm}^3/\text{s}$  max.

Price: \$0.48 (1 to 99) Sylvania Electric Products Inc., 730 3 Ave., New York. Phone: (212) 551-1000.

*Circle No. 224*



# RCA LOW-COST OP AMPS GO HIGH VOLTAGE

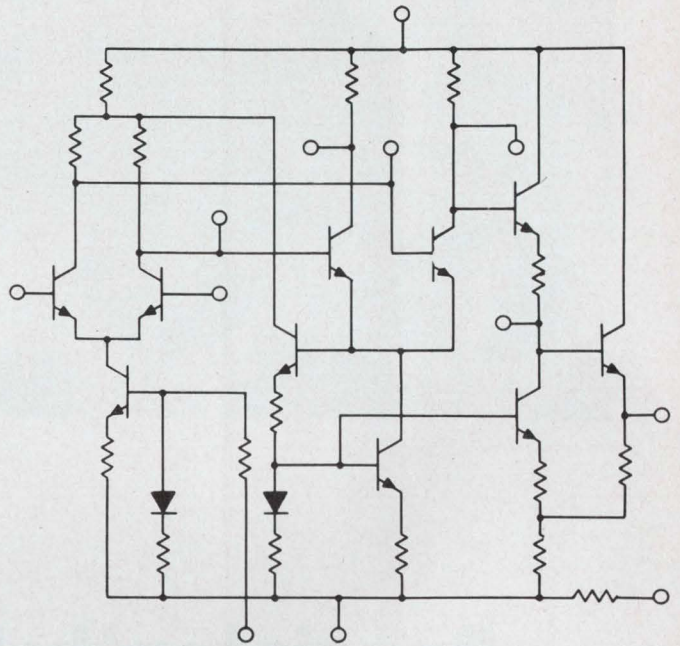

- 70dB typ open-loop voltage gain
- 320 kHz typ bandwidth at -3dB point
- 103dB typ common-mode rejection ratio
- 92 ohms typ output impedance
- 14 volts typ output voltage swing
- $\pm 3V$  to  $\pm 12V$  supply
- $-55^{\circ}C$  to  $+125^{\circ}C$  operation

The industry's biggest performance/dollar values  
in monolithic linear integrated circuits

New CA3015 12-lead TO-5 style...\$7.50 (1000+)

New CA3016 14-lead Flat Pack ... \$8.50 (1000+)

FOR MORE INFORMATION, check your RCA Distributor for his prices on CA3015 and CA3016, or contact your nearest RCA representative. For Technical Bulletin and Application Note, write Commercial Engineering, Section ICG9-4 RCA Electronic Components and Devices, Harrison, N.J. 07029.

Look into RCA's growing linear line

CA3000	CA3001	CA3002	CA3004 CA3005 CA3006	CA3007	CA3008 CA3010	CA3011 CA3012	CA3013 CA3014
DC Ampl	Video Ampl	IF Ampl	RF Ampls	AF Ampl	Opr Ampls	Wide- Band Ampls	Wideband Ampl Discrim- inators

AVAILABLE THROUGH YOUR RCA DISTRIBUTOR



THE MOST TRUSTED NAME IN ELECTRONICS



# MOL Resistors

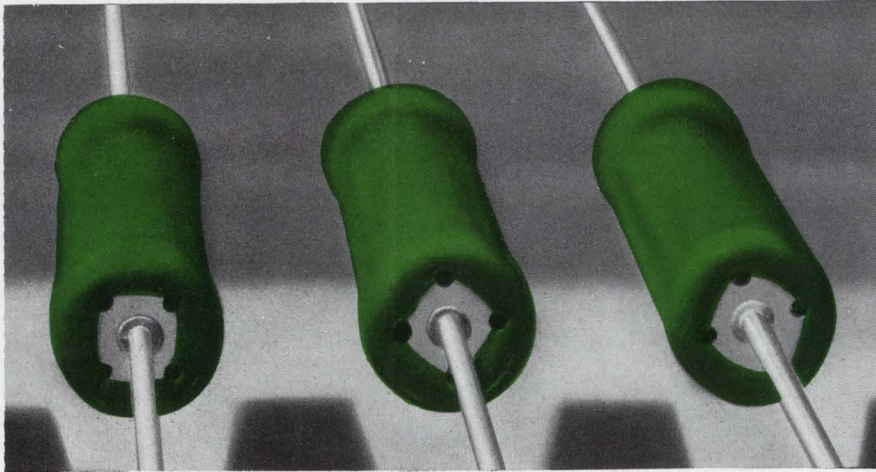

## Consistently high QUALITY

... is one of many reasons why every major TV manufacturer uses Mallory MOL film resistors. Out of millions made in the past two years, customer rejections have been practically nil. Reason: automated production backed by tight quality control. There are other reasons, too: temperature coefficient only 250 PPM/°C; proved flame resistance; less than 5% resistance change after 10,000-hour load-life tests; high stability in humidity. *And* prompt shipment of orders. Write for data and quotation. Mallory Controls Company, a division of P. R. Mallory & Co. Inc., Frankfort, Indiana 46041.

**50<sup>th</sup>**  
ANNIVERSARY

**MALLORY**

ON READER-SERVICE CARD CIRCLE 55

## SEMICONDUCTORS

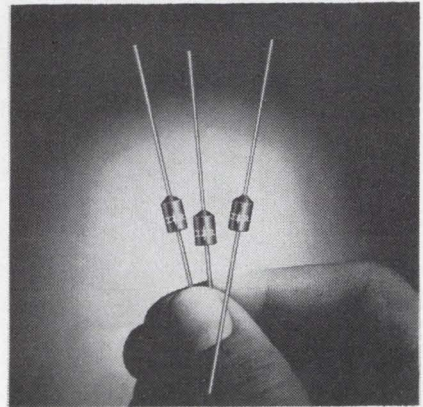

### Zener voltage regulators

An insulated pack with high moisture-, thermal shock- and vibration-resistant capabilities is given in this line of zener voltage regulators. Ratings are from 3.3 to 15 V and 60 to 300 mA max. These molded 1-W diodes are designed as regulators and protection devices for control, regulating and monitoring functions. Applications include process control, instrumentation and switching measurement.

P&A: \$0.60 to \$1.10 (100 to 999); stock. International Rectifier, 233 Kansas St., El Segundo, Calif. Phone: (213) 678-6281.

Circle No. 225

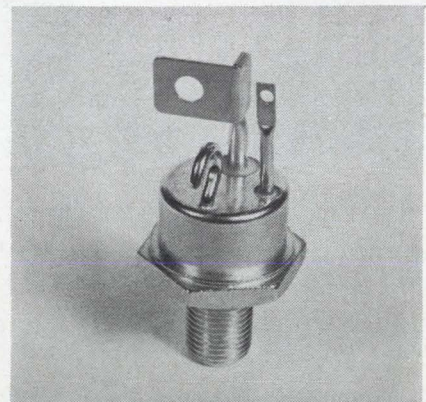

### Npn power transistors

With a current of 60 A these 300-V transistors can dissipate 350 W at 25°C. This series has a 40-A  $h_{FE}$  of 10 to 40. Saturation voltage at 40 A is 2 V or less, both  $V_{CE}$  and  $V_{BE}$ . Each device has an  $h_{FE}$  of 5 min at a collector current of 60 A. Both  $V_{CB}$  and  $V_{CE}$  (sus) range from 200 V for the SDT 8951 to 300 V for the SDT 8955. Total switching times is 3 ms and  $f_t$  is 20 MHz.

Availability: stock. Solitron Devices, Inc., 1177 Blue Heron Blvd., Riviera Beach, Fla. Phone: (305) 848-4311.

Circle No. 226



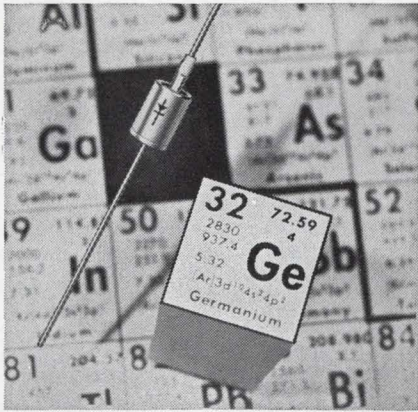

### 1-A germanium rectifier

Forward voltage drop of 0.45 V and rectification efficiency of 75% at 100 kHz are exhibited by this germanium rectifier. These units have applications in low-power circuits where voltage losses must be minimized. At an ambient temperature of 75° and  $I_0$  (max forward dc current at 180° conduction angle) of 0.1 A the rectifiers will block 80% of their 100-, 200- or 300-V PIV ratings. Up to 55°C,  $I_0$  to 1 A, 100% reverse blocking capability is sustained.

Price: \$0.55 to \$1.80. Motorola Semiconductor Products Inc., E. McDowell, Phoenix, Ariz. Phone: (602) 273-4560. *Circle No. 227*

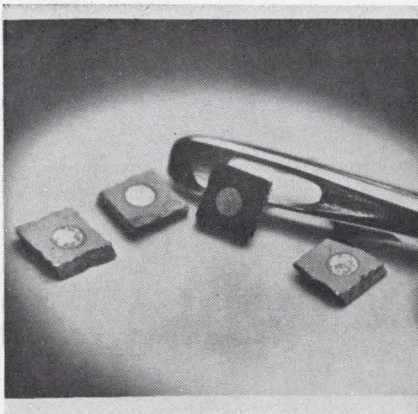

### Chip zener diodes

Available with a 6.8- to 33-V range, these chip zener diodes can be used with other chip-form components in micromin and hybrid circuitry. The three series include the DFA series for operation at low current levels and the CFB and CFC series for higher operation and test current levels. Special selections for voltage and other electrical parameters are available.

Dickson Electronics Corp., 310 South Wells Fargo Ave., Scottsdale, Ariz. Phone: (602) 947-5751.

*Circle No. 228*

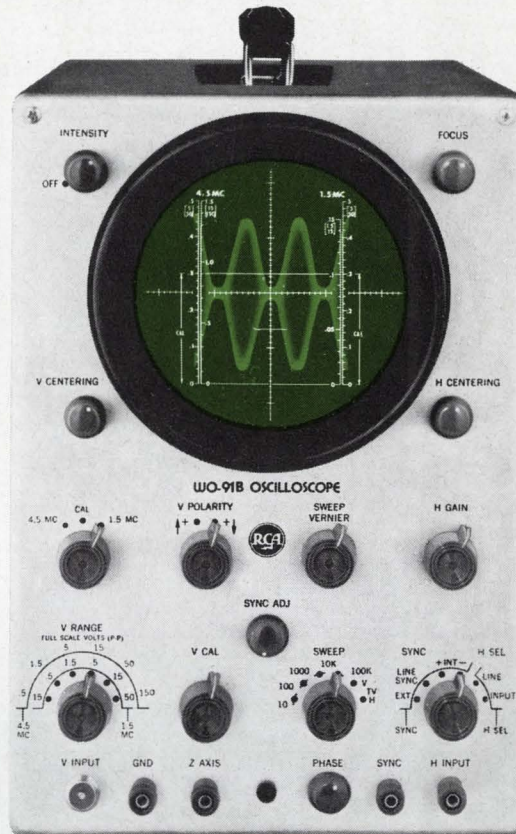

THE  
'SCOPE  
WITH THE  
HIGH  
**IQ\***

RCA WO-91B...  
\* INEXPENSIVE QUALITY

## Why pay for Oscilloscope capabilities you don't really need?

There are many situations—production line work, product quality checks, basic laboratory measurements—that require a large number of scopes or employ standard measurements... and where simplicity of operation is essential.

### That's where you need the RCA WO-91B!

Of course the so-called "industrial/laboratory" type scopes will make certain measurements that ours won't. They may feature triggered sweep, horizontal deflection in microseconds, and other costly refinements. Whenever you need these extras... capability for those extremely precise measurements... spend the money and buy an expensive scope.

Actually, for many very precise research, experimental and lab measurements, we don't even recommend ours (we use theirs).

### But if your requirements call for scopes with characteristics such as the following, the RCA WO-91B is probably your best buy:

- Built-in voltage calibration—large 5-inch screen with VTVM-type voltage scales for fast, simultaneous peak-to-peak measurements and waveshape display
- Flat response ( $\pm 1$  dB) from 10 cps to 4.5 Mc
- 0.018 rms volt per inch maximum sensitivity for use at low signal levels
- Continuously adjustable (to 100 kc) sweep oscillator with excellent linearity
- Z-axis input for direct modulation of CRT permitting use of timing and calibration markers on trace
- Provision for connecting signals directly to the vertical deflection plates of the CRT.

The Optional User Price of the RCA WO-91B is \$249.50. It is available locally from your Authorized RCA Test Equipment Distributor. Ask to see it or write for complete specifications to RCA Commercial Engineering, Section I-18W-4, Harrison, N.J.

RCA ELECTRONIC COMPONENTS AND DEVICES



The Most Trusted Name in Electronics



# AMPERITE

## GLASS ENCLOSED Thermostatic DELAY RELAYS

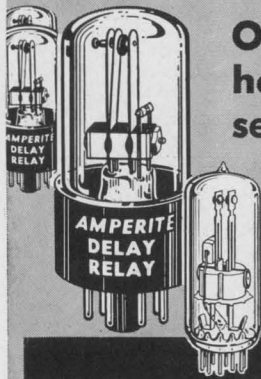

Offer true hermetic sealing—

— assure maximum stability and life!

### Delays: 2 to 180 seconds

Actuated by a heater, they operate on A.C., D.C., or Pulsating Current... Being hermetically sealed, they are not affected by altitude, moisture, or climate changes... SPST only — normally open or normally closed... Compensated for ambient temperature changes from  $-55^{\circ}$  to  $+80^{\circ}$ C... Heaters consume approximately 2 W. and may be operated continuously. The units are rugged, explosion-proof, long-lived, and inexpensive!  
TYPES: Standard Radio Octal and 9-Pin Miniature... List Price, \$4.00  
PROBLEM? Send for Bulletin No. TR-81.

# AMPERITE

## BALLAST REGULATORS

Hermetically sealed, they are not affected by changes in altitude, ambient temperature ( $-50^{\circ}$  to  $+70^{\circ}$  C.), or humidity... Rugged, light, compact, most inexpensive.

List Price, \$3.00

Write for 4-page Technical Bulletin No. AB-51

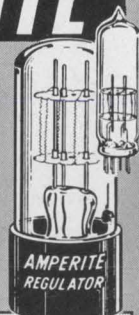
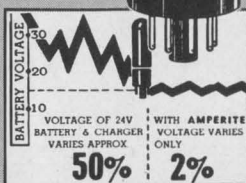

# AMPERITE

600 PALISADE AVE., UNION CITY, N.J.  
Telephone: 201 Union 4-9503  
In Canada: Atlas Radio Corp., Ltd.,  
50 Wingold Ave., Toronto 10

## TEST EQUIPMENT

### Volt-ohm milliammeter

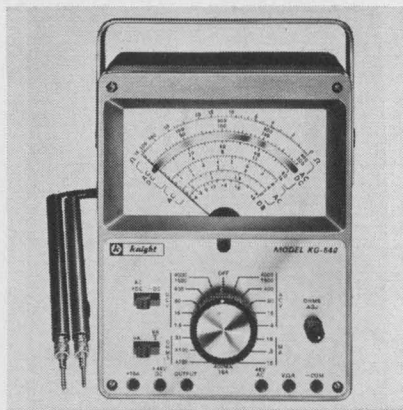

This taut-band VOM has a sensitivity of  $20,000 \Omega/V$ . 57 ranges starting at 0.8 Vdc are covered by a positive-action range/function switch and range-doubler switch which doubles the effective number of ranges. Accuracy is within 3% of full-scale reading on dc to 1600 V and within 5% of full-scale reading on ac to 1600 V.

Price: \$39.95 to \$59.95. Allied Radio Corp., 100 N. Western Ave., Chicago. Phone: (312) 421-6800.

Circle No. 229

### Gyro tester

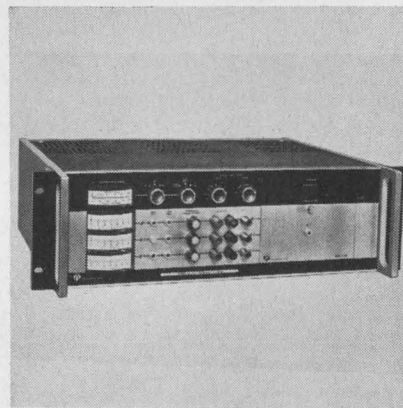

Two- or three-phase gyros are tested by this polyphase ac power source. The unit delivers pure stable ac power from 40 to 10,000 Hz. Frequency stability is within 10 ppm and amplitude variations are 0.01% max. Regulation is within 0.01% for 10% line variation and internal resistance is adjustable through zero.

P&A: \$2100 to \$3100; 45 days. Optimization Inc., 7243 Atoll Ave., North Hollywood, Calif. Phone: (213) 877-0221.

Circle No. 230

### Ac to dc converter

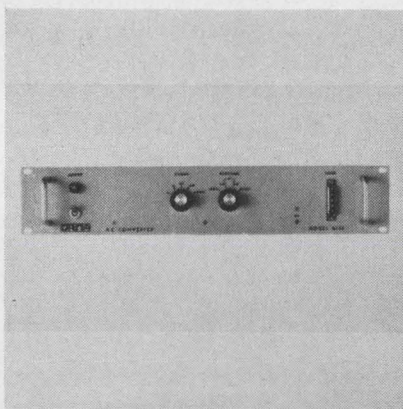

Ac and dc signals are measured by this unit which converts ac signals as low as 1 Hz. At 50 Hz the settling time is 0.2 s. Conversion accuracy is  $\pm 0.1\%$  of reading from 2 Hz to 10 kHz and better than  $\pm 1\%$  of reading from 1 Hz to 100 kHz. Model 615A circuitry averages the input and scales this by a factor of 1.11 to 1 to produce a dc voltage equivalent to the rms value of the input signal.

Dana Laboratories Inc., Irvine, Calif. Phone: (714) 833-1234.

Circle No. 231

### Decade voltage divider

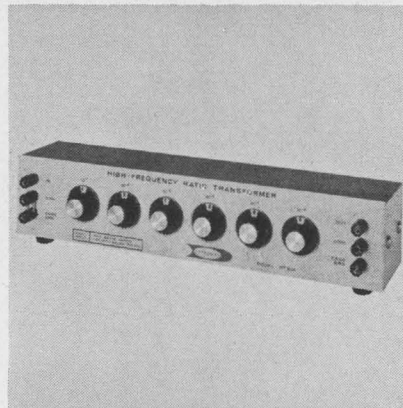

Capable of making tests and measurements within the ultrasonic and lower radio-frequency regions, this ratio transformer (inductive voltage divider) can divide an input voltage into over 106 steps. Six decade dials display the ratio of the output voltage to the applied input voltage. Model RT-501 operates from 4 to 500 kHz.

P&A: \$350; stock. Dytronics Co., Inc., 5566 N. High St., Columbus, Ohio. Phone: (614) 885-3303.

Circle No. 232



# Ballantine DC/AC Voltmeter/Ohmmeter

Model 345

Price: \$375

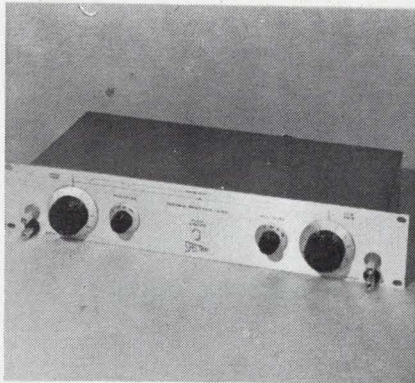

## Band pass filter

This solid-state active band pass filter may be tuned to pass any band from 20 Hz to 200 kHz. Both high and low stop bands alternate at 24 dB/octave. Nominal pass band gain is unity. The filter behaves as a cascade of a low pass filter and a high pass filter, each approximating a 4-pole Butterworth voltage transfer function. Panel dials and decade range switches independently and continuously vary high and low cutoff frequencies defining the pass band.

Spectrum Instruments, Inc., Box 474, Tuckahoe, N. Y. Phone: (914) 779-8111. *Circle No. 233*

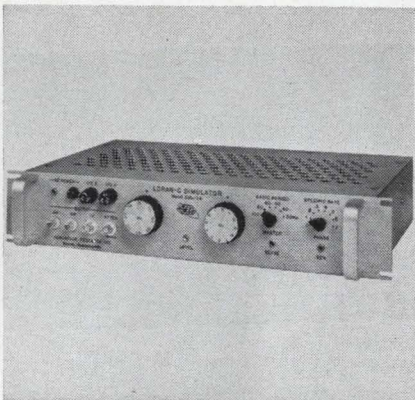

## Loran-C signal generator

Loran-C navigation and timing equipment is tested and calibrated by this Loran-C simulator. The signal output of the device is a standard burst of 8 Loran-C RF pulses recurring at a selected Loran-C repetition rate. A 3-pole envelope filter forms these pulses in order to duplicate the standard Loran-C waveform. The pulse bursts are phase coded in either the "master" or "slave" mode, as selected by a toggle switch.

Price: \$2850. Aerospace Research Inc., 130 Lincoln St., Boston, Mass. Phone: (617) 254-7200.

*Circle No. 224*

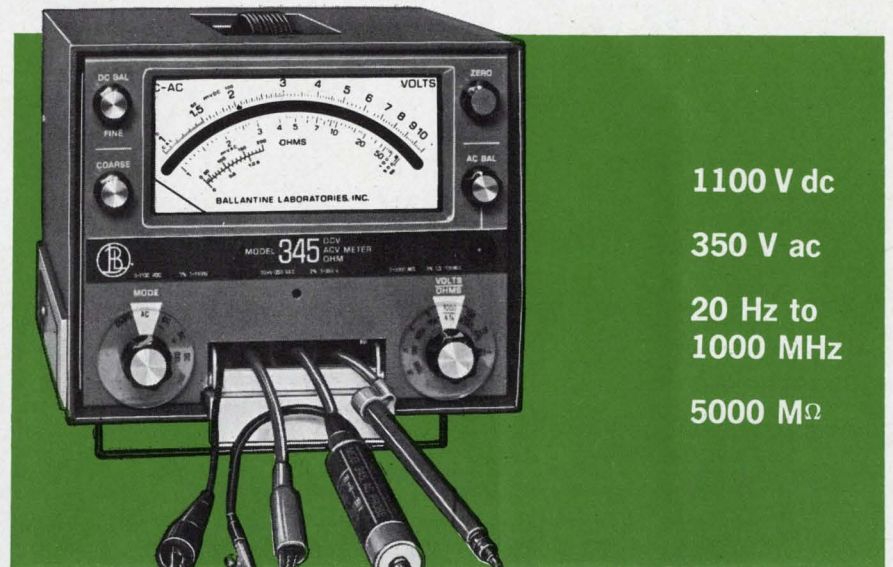

1100 V dc  
350 V ac  
20 Hz to 1000 MHz  
5000 M $\Omega$

## Features Accuracy not available in any other Volt/Ohmmeter for both ac and dc volts...and ohms

A single five-inch logarithmic scale of Ballantine's Model 345 is used for *all* ac and dc voltage measurements except very low voltages, where red scales are used to reach zero. This single scale can be read with no confusion compared to the *four* scales commonly used on volt/ohmmeters on which there are two scales for ac and two more for dc.

Ballantine's *single* scale results in faster measurements, with the possibility of fewer reading errors. Its logarithmic scale spreads out the readings over the full five inches with the same resolution and accuracy in *% of reading* at the very bottom of the scale as at the top. The same features apply to the ohms scale.

Use of a Sola<sup>®</sup> regulating power transformer provides exceptionally high stability as a function of power line voltage changes that are commonly experienced in many locations. This feature speeds up accurate measurements.

### PARTIAL SPECIFICATIONS

**Voltage Range:** 0 to 1000 V dc; 0 to 350 V ac  
**Accuracy:** 1% of indication, 1 V to 1100 V dc; 2% of indication, 1 V to 350 V ac, 50 Hz to 100 MHz; 3% of indication, 1  $\Omega$  to 100 M $\Omega$   
**Resistance Range:** 0 to 5000 M $\Omega$   
**Power Supply:** 115/230 V, 50 or 60 Hz as specified  
**Optional Accessories:** Include T Adapter, N/BNC Adapter, and 10,000 volt dc probe

Write for brochure giving many more details

Member Scientific Apparatus Makers Association

— Since 1932 —



**BALLANTINE LABORATORIES INC.**  
Boonton, New Jersey

CHECK WITH BALLANTINE FIRST FOR DC AND AC ELECTRONIC VOLTMETERS/AMMETERS/OHMMETERS, REGARDLESS OF YOUR REQUIREMENTS. WE HAVE A LARGE LINE, WITH ADDITIONS EACH YEAR. ALSO AC/DC LINEAR CONVERTERS, AC/DC CALIBRATORS, WIDE BAND AMPLIFIERS, DIRECT-READING CAPACITANCE METERS, AND A LINE OF LABORATORY VOLTAGE STANDARDS FOR 0 TO 1,000 MHz.

Speed Inquiry to Advertiser via Collect Night Letter

ON READER-SERVICE CARD CIRCLE 58



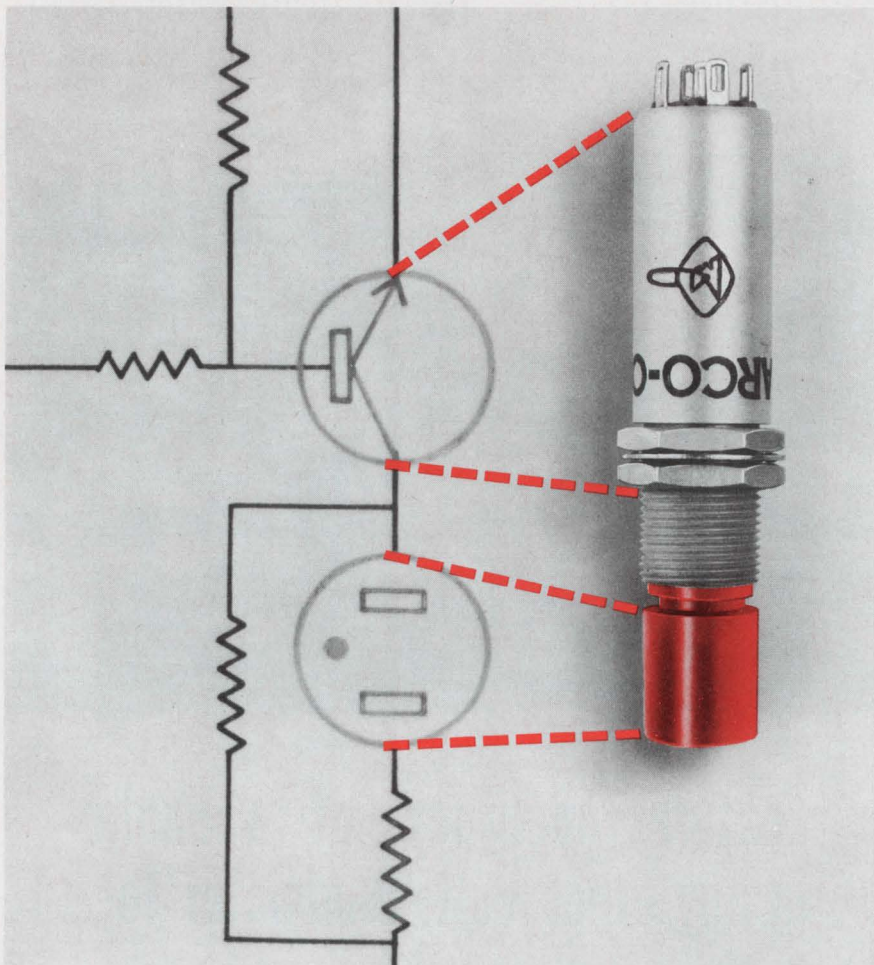

## ONE COMPACT UNIT FILLS TWO GAPS IN THIS CIRCUIT

Marco-Oak subminiature transistorized indicator lights do a big job for their size. They combine a neon or incandescent lamp with means for transistor switching where voltage changes are small. High voltage series is designed for connection to power at 90 volts or more, low voltage series for circuits of 6 or more volts.

They are adaptable to a full range of transistorization from high-quality micrologic to commercial units, mounting from back of panel.

Many options are available in dimensions, terminals, circuits, caps (shape, finish, color) . . . more features relating to components and circuitry than could possibly be described here. Write today for full details in the new T66 descriptive bulletin.



**MARCO-OAK INDUSTRIES**

A DIVISION OF **OAK ELECTRO/NETICS CORP.**

207 SOUTH HELENA STREET, ANAHEIM, CALIFORNIA 92805

PHONE: 714-535-6037 • TWX: 714-776-6111

ON READER-SERVICE CARD CIRCLE 59

## TEST EQUIPMENT



### 1.5-W FM transmitter

This crystal-stabilized FM transmitter has an RF output of 1.5 W min in the 216- to 260-MHz telemetry band under a worst case combination of  $-20$  to  $85^{\circ}\text{C}$ , 15-G vibration, 100-G shock and 60-G acceleration. Frequency stability is  $\pm 0.01\%$  of center frequency and frequency deviation is  $\pm 150$  kHz; 1 V rms producing peak deviation. Distortion is 3% max and incidental FM is 5 kHz max.

American Bosch Arma Corp., Tele-Dynamics Div., 5000 Parkside Ave., Philadelphia. Phone: (215) 878-3000.

Circle No. 235

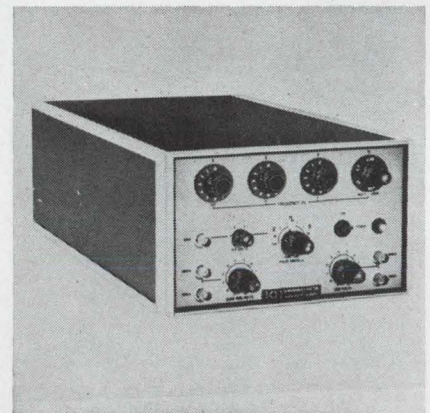

### Oscillator

Series 4000 oscillators have harmonic distortion typically 0.01% max from 0.1 Hz to 20 kHz and under 0.1% at 0.001 Hz. Cycle-to-cycle amplitude deviations are within 0.01% and average amplitude drift is within  $\pm 0.01\%/h$ . Frequency response is  $\pm 0.05$  dB between 10 Hz and 100 kHz and slightly over 0.01 dB at 0.01 Hz.

P&A: \$850 to \$1200; January. Krohn-Hite Corp., 580 Massachusetts Ave., Cambridge, Mass. Phone: (617) 491-3211.

Circle No. 236



# TEA ?

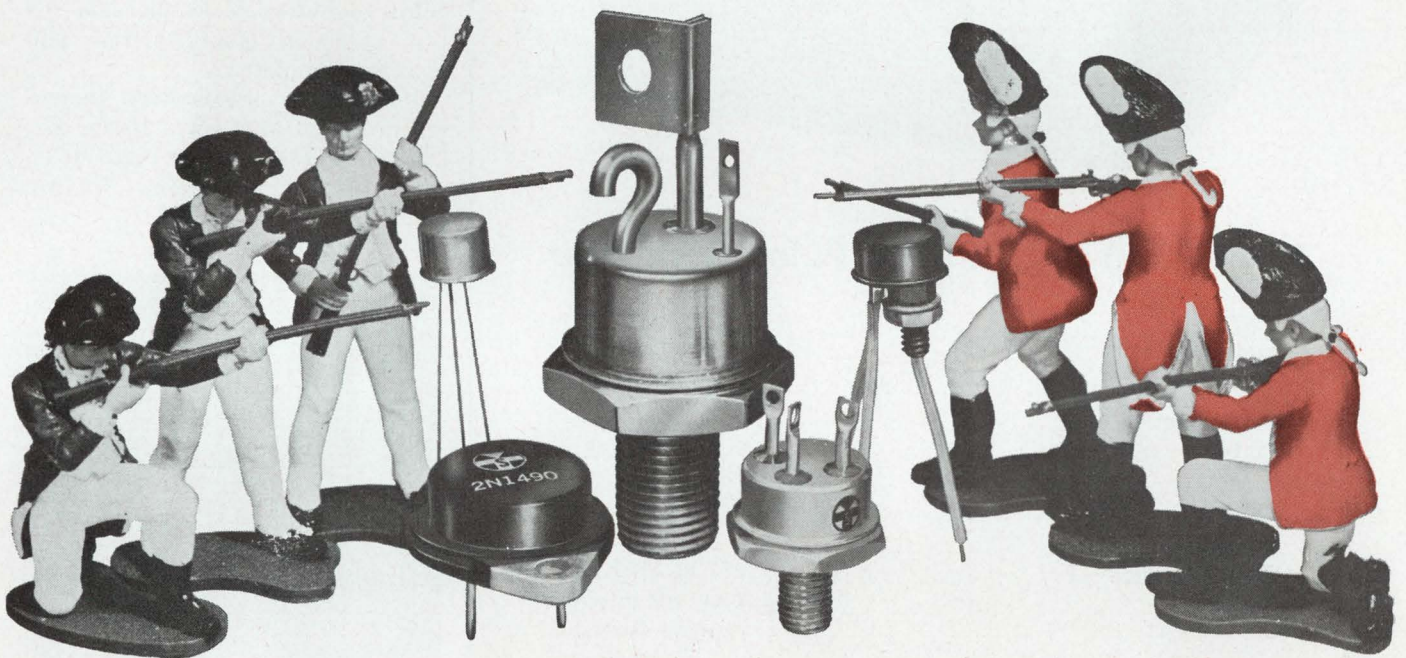

**independence and dependability** ... You've both when you do manufacturing battle with Silicon Transistor Corporation on your side. Silicon Transistor Corporation: the invincible source for silicon power devices. Up to 500 watts in a single, military quality silicon transistor. As little as 3 watts... each with the highest versatility in packaging. Planars, PNP's, NPN's. □ Join forces with Silicon Transistor Corporation and victory is assured. (We may even have a tea party.) Call . . . . .

**SILICON  
TRANSISTOR  
CORPORATION**



EAST GATE BLVD., GARDEN CITY, NEW YORK 11532  
516 Pioneer 2-4100. TWX 510-222-8258

REGIONAL OFFICES:

CHICAGO, ILL. 60625, 5555 NORTH LINCOLN AVE.,  
312-271-0366-7, TWX 910-221-1304

LOS ALTOS, CALIF. 94022, 1 FIRST ST., 415-941-2843



# to 20KW peak



## Model 350 High Power Pulse Generator

- PRF: ..... 3 to 100,000 cps
- Pulse Width: ..... 0.1 to 200  $\mu$ sec
- Rise Time: ..... 50 nanoseconds
- Fall Time: ..... 70 nanoseconds
- Output: ..... to 2,000 volts neg.  
10 Amps @ 200  $\Omega$
- Droop: ..... <0.05% per  $\mu$ sec
- Ripple: ..... Negligible
- Duty Factor: ..... 1% at 20 KW,  
greater for lower  
output levels.
- Price: ..... \$3,990.00

## Fast Rise Time: Complete Flexibility

VELONEX brings you a high power pulse generator capable of operating up to 20 KW output yet as easy to operate as an ordinary low-power lab pulse generator. In addition to **continuous** variability of all pulse parameters, VELONEX has added the dimension of **Impedance Matching**. Plug-ins match 0.5  $\Omega$  with **170 ampere** capability or 20,000  $\Omega$  with **19 KV**. You can match almost **any load** between. But even if you only need 300 W of peak power there is nothing like it on the market. The wide range of stocked plug-ins assure you the 350 will not be obsolete to do tomorrow's job as well as today's.



a division of Pulse Engineering, Inc.

560 Robert Avenue, Santa Clara, California. Area Code (408) 244-7370;

ON READER-SERVICE CARD CIRCLE 60

## TEST EQUIPMENT

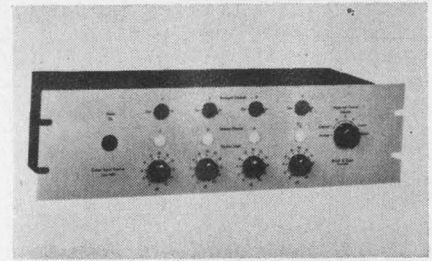

## Four-channel averager

The lowest, highest or average of the rms value of two to four vibration exciter control signals can be automatically selected by this unit. The dc output of a vibration meter serves as the input signal for each channel of interest. Each channel can be attenuated from 0 to 20 dB before selection to compensate for test specimen non-linearities and specification limits.

P&A: \$915; stock. B&K Instruments Inc., 5111 W. 164th St., Cleveland. Phone: (216) 267-4800.

Circle No. 237

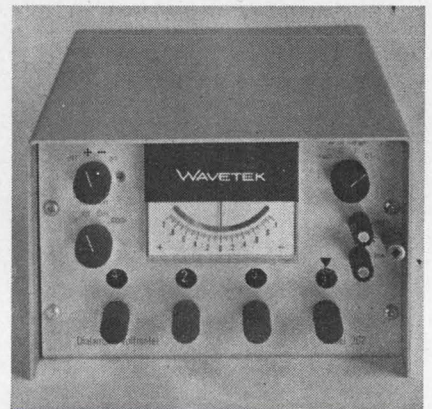

## Voltmeters

These voltmeters incorporate a device which mechanically couples decade switches so that "carries" are transferred to the next higher decade. This process also works in reverse or each switch can be set individually. The unit has a non-saturating null amplifier with quick overload recovery so the operator can dial the balancing voltage without changing null sensitivity. Model 201 measures dc voltages from 0 to 1000 V in four ranges. Model 202 measures both ac and dc ranging from 1 mV to 1 kV.

P&A: \$595 (model 201), \$795 (model 202); 30 days. Wavetek, Box 651, San Diego, Calif. Phone: (714) 279-2200.

Circle No. 238



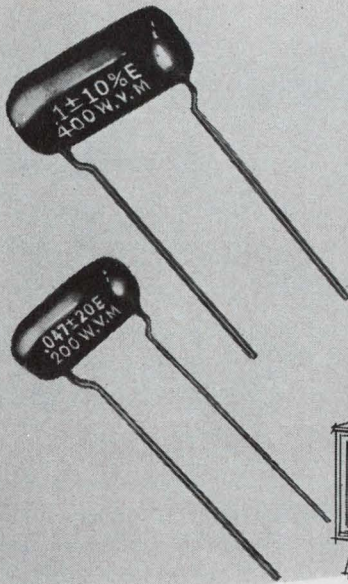

# Proof Positive of High Reliability of EL-MENCO \*MYLAR-PAPER DIPPED Capacitors

OVER 330,000,000 OF THESE HIGH QUALITY UNITS USED IN TV SETS SINCE 1959!

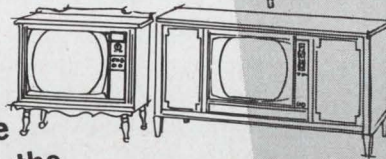
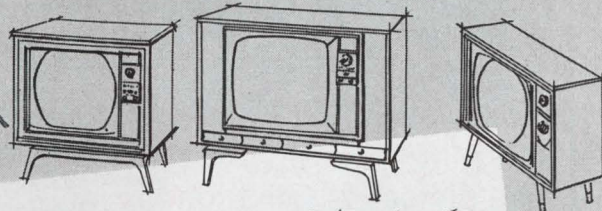

Imagine!  
Over 330 million EL-MENCO Mylar\* Paper Dipped Capacitors have been used in black and white and in color TV sets since 1959! These capacitors of the highest quality and reliability help bring programs to millions of people who have invested in TV sets . . . and 330 million is just a drop in the bucket! For the demand for EL-MENCO capacitors still far exceeds the supply!

The number of EL-MENCO capacitors in TV sets is truly amazing. This figure of 330,000,000 represents more than the total population of the following countries:

- United States and Possessions
- United Kingdom and Canada
- Argentina      Belgium
- Denmark      Ecuador      Chile

299,813,929 people (1960 Census)

Even with this tremendous mass production the quality of EL-MENCO capacitors has not suffered. Here's a fine tribute of the high reliability of EL-MENCO capacitors from a leading TV manufacturer:

**"... I am certain that you are aware of the enthusiasm our Engineering and Quality people have displayed for this unit, for to us it represents the virtual elimination of capacitor field problems in the future ..."**



Write dept. AE for descriptive bulletin #MPD

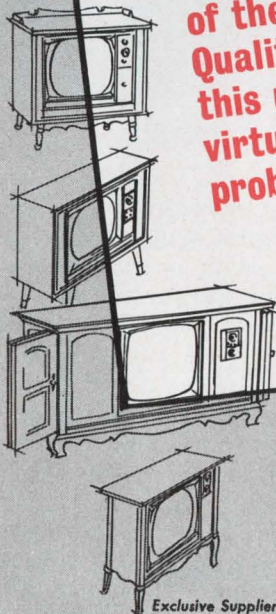

**EL-Menco**  
Capacitors

**THE ELECTRO MOTIVE MFG. CO., INC.**  
WILLIMANTIC, CONNECTICUT

DIPPED MICA  
MOLDED MICA  
SILVERED MICA FILMS  
MICA TRIMMERS & PADDERS  
MYLAR\* PAPER DIPPED  
PAPER DIPPED  
MYLAR\* DIPPED  
TUBULAR PAPER

\*Registered Trade Mark of DuPont Co.

Exclusive Supplier to Jobbers and Distributors in the U. S. and Canada

ARCO ELECTRONICS, INC., COMMUNITY DRIVE,  
GREAT NECK, L. I. NEW YORK

West Coast Manufacturers Contact:

COLLINS & HYDE CO., 1020 CORPORATION WAY, PALO ALTO, CALIFORNIA  
5380 WHITTIER BOULEVARD, LOS ANGELES, CALIFORNIA

ON READER-SERVICE CARD CIRCLE 61



# "RELAIS"

In my Father's high school Physics textbook this device was described as a "Relais." It could lift a lot of weight — even you and me together — *reliably*.

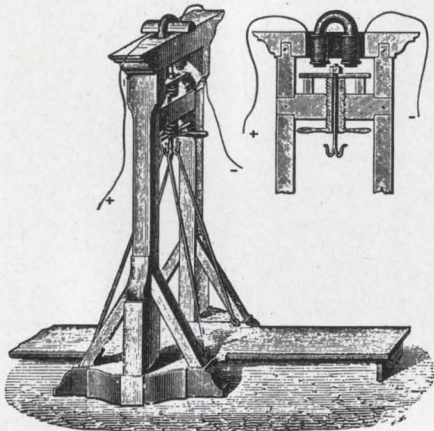

The relays we make today can energize this contraption and fit in the palm of your hand. Here are some examples:

## RELAY-CONTACTOR G11 Series

25 Amperes, single or three phase loads, either 3PST normally open or 2PST, double make, double break, .45 lbs., 1.490" x 1.490" x 1.812".

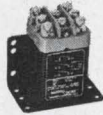

**MINIATURE POWER RELAY G12 Series**  
10 Amperes 2PDT, .07 lbs., .525" x .935" x 1.025".



**MINIATURE POWER RELAY G14 Series**  
6PDT double make, double break, 10 Amperes and 3PDT 20 Amperes, double make, double break, both .03 lbs. 1.070" x 1.250" x 1.800".



Write us about your problems (I mean relay problems); you will not be disappointed.

*Gabriel M. Giannini*

**GIANNINI** | **VOLTEX**

12140 E. RIVERA RD., WHITTIER, CALIF. 90606  
PHONE: 213-723-3371, TELETYPE: 213-685-6261

An Independent Company/An Equal Opportunity Employer

ON READER-SERVICE CARD CIRCLE 62

136

## MICROELECTRONICS

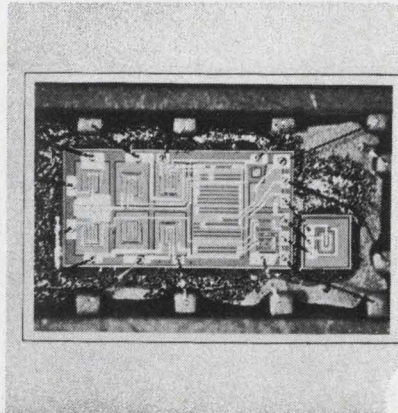

### Parasitic-free op-amps use dielectric isolation

Unconditionally stable integrated op-amps using dielectric isolation operate without the need of lead and lag compensation networks. Dielectric isolation techniques provide parasitic-free amplifiers and makes savings possible in design cost and packaging space. Tighter tolerance and improved temperature coefficients are also made possible through the use of thin-film resistors over the oxide. These provide large common-mode range and rejection, large power supply rejection, low offset voltage, low input current, low output impedance, high input impedance and high gain.

The series of amplifiers includes the RA-238 (general purpose), the RA-239 (broadband) and the RA-240 (high gain). The RA-238 is optimized for general use as a medium gain, low offset voltage, low input current, high input impedance amplifier with a unity gain bandwidth of 7 MHz. The RA-239 broadband amplifier operates on a bandwidth of 15 MHz, with lower output impedance and greater negative output current. Both the RA-238 and the RA-239 have a phase margin in excess of 45° of unity gain. The RA-240 high gain amplifier is designed for use where higher gain and input impedance are required. Voltage gain is 50,000. This unit exhibits a phase margin in excess of 30° of unity gain. Standard temperature range is -55 to 125°C.

Radiation Inc., P. O. Box 220, Melbourne, Fla. Phone: (305) 727-3711.

Circle No. 239

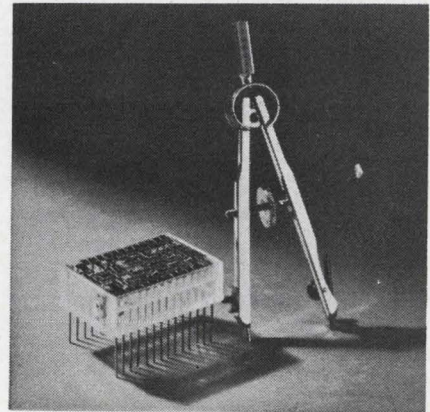

### IC data distributor

This hybrid integrated circuit data distributor offers total plug-in capability. With an over-all accuracy of  $\pm 0.1\%$  the unit occupies 0.645-in.<sup>3</sup>. Decommutation rate of the data distributor is 10 Hz to 10 kHz to within 0.1% accuracy. Also available is a mother board which can accept from 1 to 16 of the plug-ins. The board is 8- x 12-in. and requires one standard card space.

Redcor Corp., 7800 Deering Ave., P. O. Box 1031, Canoga Park, Calif. Phone: (213) 348-5892.

Circle No. 240

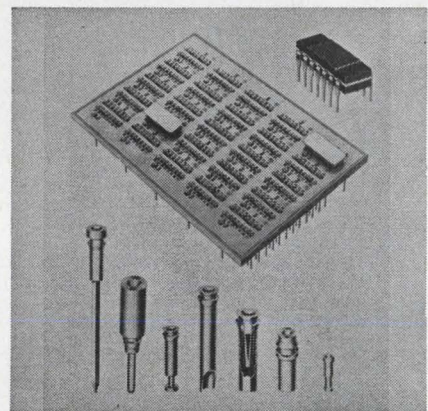

### Packaging panels

Custom-designed multi-pattern, high density packaging panels are offered. A typical application is the socket/panel with wire-wrap terminations for packaging dual-in-line ICs. The double-sided board provides power and ground planes. A selection of socket terminals for various lead diameters and a variety of terminations is available. Construction is brass sleeves with closed-entry, beryllium copper, gold-plated contacts.

P&A: about \$1 to \$3 per pattern; 6 to 8 wks. Augat Inc., 33 Perry Ave., Attleboro, Mass. Phone: (617) 222-2202. Circle No. 241



Report from

**BELL  
LABORATORIES**

# High-performance amplifiers for coaxial transmission



Field-trial installation of the new transistor amplifiers in manhole near Dayton, Ohio. Amplifiers and associated circuits comprise repeaters; they are mounted in drawer-type boxes, then placed in gas-tight cylindrical housings. With the new system, a pair of coaxials will carry up to 3600 telephone conversations on an 0.5-MHz to 20-MHz band. A fully utilized coaxial cable could handle up to 32,400 conversations. On a coast-to-coast connection over the new system, about 2000 repeaters would be needed for each direction of transmission, with a total one-way amplification of as much as 75,000 dB.

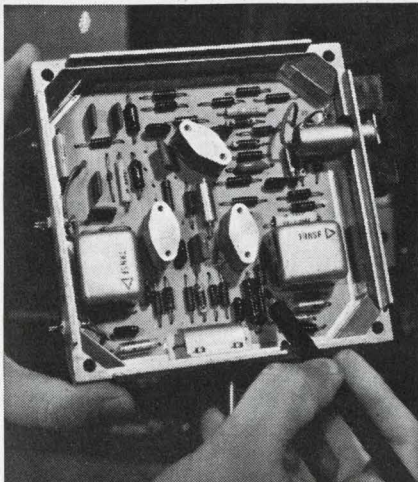

Low-distortion, wideband transistorized amplifier developed at Bell Laboratories for a new coaxial cable system.

Every "hi-fi" enthusiast knows that faithful reproduction of music requires an amplifier with constant gain and low distortion over a wide band of frequencies. Amplifiers for such purposes are available today with 100 watts of power, gain deviation of less than 1.0 dB from 20 to over 20,000 hertz, and less than 0.4% distortion. This high level of performance has been obtained by utilizing to the fullest the best of today's electronics technology.

At Bell Telephone Laboratories, the development of modern coaxial cable systems for transmitting thousands of telephone conversations also requires amplifiers which push electronics technology to its limits. The low-frequency limit for these amplifiers need not be as low as that for hi-fi amplifiers, but the high-frequency limit must be much higher—20 megahertz. The power output can be less—on the order of 1/10 watt—but the gain deviation must be less than 0.25 dB, and the distortion must be limited to 0.0004%. These requirements arise from the large number of simultaneous voice signals which these amplifiers must transmit and the large number of amplifiers that must be connected in tandem for a coast-to-coast system.

In the past, such amplifier performance was impossible. Today it is possible because of circuit-design techniques which include close control of feedback and the use of digital computer techniques to optimize circuit parameters. And of considerable importance to the design, new transistors were developed at Bell Laboratories with properties that are constant over wide dynamic and frequency ranges.



**Bell Telephone Laboratories**  
Research and Development Unit of the Bell System



# Why IEE rear-projection readouts make good reading

Not the kind of good reading you'd curl up with on a rainy night. But a more important kind if you're designing equipment that requires message display. Reason is that IEE readouts are the most readable readouts around. If you've seen them, you know this to be fact. If you haven't as yet, here is why our readouts make such good reading:

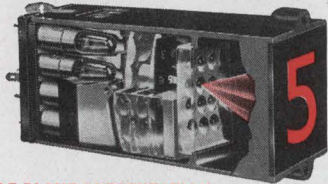

## SINGLE-PLANE PRESENTATION

No visual hash of tandem-stacked filaments. IEE readouts are miniature rear-projectors that display the required messages, one at a time, on a non-glare viewing screen. Only the message that's "on" is visible.



## EASY-TO-READ CHARACTERS

Since IEE readouts can display anything that can be put on film, you're not limited to thin wire filament, dotted, or segmented digits. Order your IEE readouts with familiar, highly legible characters that meet human factors and Mil Spec requirements. This section from our sample type sheet gives you an idea of the styles available that offer optimal stroke/width/height ratio for good legibility.

## BALANCED BRIGHTNESS/CONTRAST RATIO

The chart below is a reasonable facsimile of character brightness and how



it affects readability. The background is constant, but the brightness increases from left to right. You can draw your own conclusions, armed with the fact that IEE readouts give you up to 90 foot lamberts of brightness. Brightness, however, isn't the sole factor in judging readability. Background contrast is equally important—a fact we've simulated below, reading from left to right.



Obviously, brightness without contrast or vice versa, doesn't do much for readability. A balanced ratio of both gives you the crisp legibility of IEE readouts.



## WIDE-ANGLE READABILITY

IEE's unique combination of single-plane projection, flat viewing screen, balanced ratio of brightness/contrast, and big, bold characters makes for wide-angle clarity and long viewing distances.

## OTHER WAYS IEE READOUTS MAKE GOOD SENSE

As if the superior readability of our readouts weren't enough, here are a few reasons why IEE readouts make good sense in other areas:



## INFINITE DISPLAY VERSATILITY

Because our readouts use lamps, lenses, film, and a screen, they can display literally anything that can be put on film. That means you have up to 12 message positions with each readout to display any combination of letters, words, numbers, symbols, and even colors!

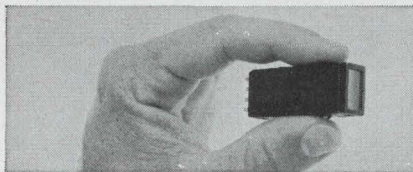

## FIVE SIZES TO PICK FROM

IEE readouts now come in five sizes providing maximum character heights of  $\frac{3}{8}$ ",  $\frac{5}{8}$ ", 1", 2", and 3 $\frac{3}{8}$ ". The smallest is the new Series 340 readout that's only  $\frac{3}{4}$ " H x  $\frac{1}{2}$ " W, yet can be read from 30 feet away. The largest, the Series 80, is clearly legible from 100 feet away.

## EASY TO OPERATE

IEE readouts are available with voltage requirements from 6 to 28 volts, depending on lamps specified. Commercial or MS lamps may be used, with up to 30,000 hours of operation per lamp. Lamps may be rapidly replaced without tools of any kind.

Our readouts operate from straight decimal input or will accept conventional binary codes when used with IEE low-current driver/decoders.

For more proof why IEE rear-projection readouts make good reading, send us your inquiry. You'll see for yourself why they've been making the best seller list, year after year!

**IEE INDUSTRIAL ELECTRONIC ENGINEERS, INC.**

7720 Lemona Avenue, Van Nuys, California  
Phone: (213) 787-0311 • TWX (910) 495-1707  
Representatives in Principal Cities © 1966 IEE

## MICROELECTRONICS

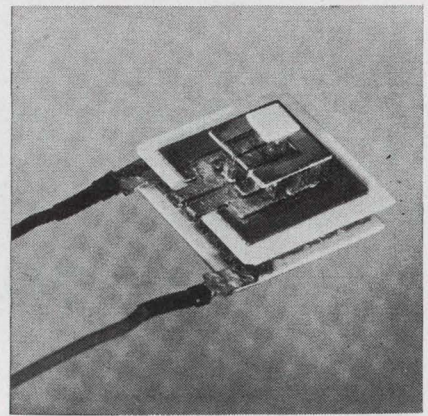

## Thermoelectric module

Capable of cooling small thermal loads to  $-80^{\circ}\text{C}$  from an ambient temperature of  $40^{\circ}\text{C}$  this thermoelectric module can withstand mechanical shock and vibration up to 40 Gs. Rated at 5 A max at 5 V, the unit is most efficient at 4 A and 4 V. The cooler can be supplied separately or in an evacuated and sealed header with control thermistor and infrared detector mounted on the cooler.

EG&G Inc., 160 Brookline Ave., Boston, Mass. Phone: (617) 267-9700. Circle No. 242

## IC variable attenuators

Variable electronic attenuators consisting entirely of monolithic ICs are designed for AGC control circuits. The controllable loss circuits operate on a principle which permits control of the gain of an amplifier without changing its operating parameters. This diminishes the chance of distortion or phase shift in amplifiers. Type ULX-0101 and 0102 AGC blocks can attenuate signals up to 60 dB at frequencies as high as 65 MHz. The circuits are insensitive to power supply variations. When used in AGC applications, there is virtually no distortion for a constant output of 1 mV rms over a 60-dB attenuation of the input signal. Maximum input voltage is 1 V. The ULX-0101 requires 2 mW of control power and has a rated circuit dissipation of 110 mW, while the 0102 has a circuit dissipation of 65 mW and requires 36 mW control power. The units are offered in both hermetically sealed TO-5 cans and flat-packs.

Sprague Electric Co., 347 Marshall St., North Adams, Mass.

Circle No. 243



# CTC

**CONTROLLED TEMPERATURE CHARACTERISTIC**

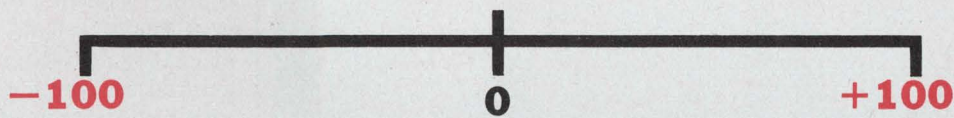

## IRC metal film resistors with any specified TC between -100 and +100ppm

Now, IRC announces Controlled Temperature Characteristic—a new line of precision metal film resistors available with any specified TC between -100 and +100ppm,  $\pm 5$ ppm.

New CTC resistors offer fast rise times, negligible inductance and capacitance, and superior reliability . . . especially at higher resistance values. They replace wirewound resistors with significant space and cost savings.

Previously available only as a costly "lab" item or "special," IRC offers delivery at a price that makes them practical for temperature compensating in analog computers and delicate sensing instruments. Write for data and prices. IRC, Inc., 401 N. Broad St., Philadelphia, Pa. 19108.

### CAPSULE SPECIFICATIONS

	
<b>SIZE</b>	RN65
<b>TC</b>	Any TC between -100 and +100ppm, $\pm 5$ ppm
<b>TEMP. SPAN</b>	Any 50°C increment between -55°C and 165°C
<b>POWER</b>	¼-W@125°C, ½-W@70°C
<b>RESISTANCE</b>	50Ω to 360KΩ
<b>STD. TOLERANCES</b>	0.1, 0.05, 0.025%

### INDUSTRY'S LARGEST SELECTION OF METAL FILM RESISTORS

 <p><b>ASSURED RELIABILITY METAL FILM</b></p> <p>An industry first. 0.1, 0.01 or 0.001% levels. 1/20 to 2 watts. 20 ohms to 1 meg. <math>\pm 25</math>, 50 and 100ppm. 0.25, 0.5 and 1% tolerances.</p>	 <p><b>HIGH STABILITY METAL FILM</b></p> <p>Molded and coated types, including microminiature, 1/10 to 2 watts. 30 ohms to 10 meg. 8 TC's from <math>\pm 25</math>ppm. Tolerances from 0.05%.</p>	 <p><b>ECONOMICAL METAL FILM</b></p> <p>Molded and coated types for MIL-R-10509. TC guaranteed to within 100ppm. 1/10 to 2 watts, 10 ohms to 10 meg. 0.5 and 1% tolerances.</p>	 <p><b>DEPOSITED CARBON FILM</b></p> <p>Molded types from ¼ to 2 watts, coated types from ½ to 2 watts. 10 ohms to 1 meg. 0.5, 1 and 2% tolerances. MIL-R-10509.</p>
--	--	--	---



Speed Inquiry to Advertiser via Collect Night Letter  
ON READER-SERVICE CARD CIRCLE 64



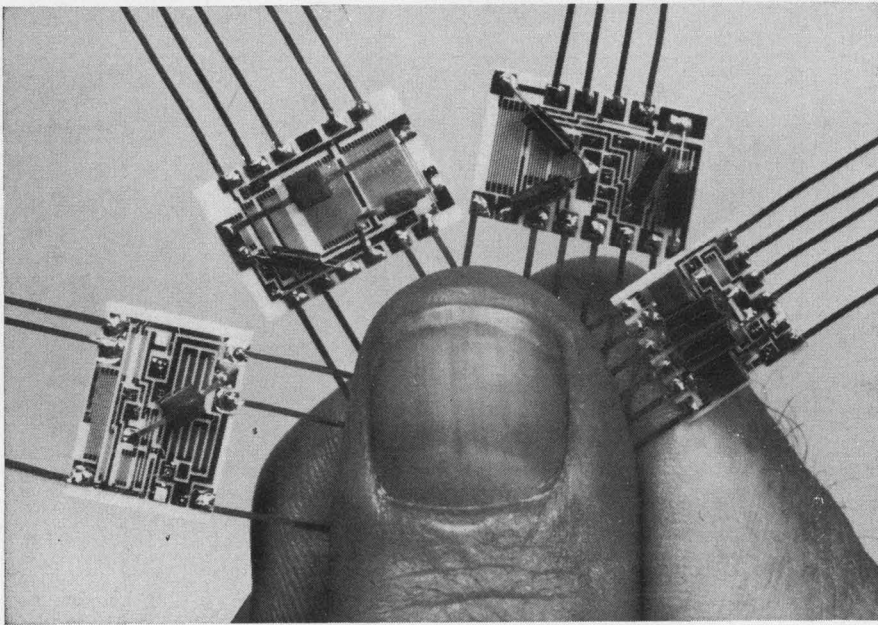

High reliability circuits produced for the Lunar Excursion Module

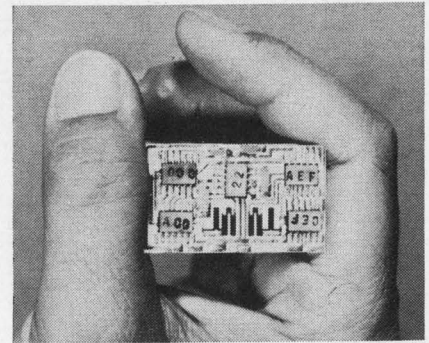

### 455-kHz hybrid amplifier

Consisting of two tuned IF stages and an agc circuit, this IF amplifier has a high Q of 55. The center frequency of 455 kHz has a stability of  $\pm 0.5\%$  and Q stability of  $\pm 10\%$ . Offering good agc characteristics over a 60-dB range, the unit has an input of  $10\text{ k}\Omega$  and output of  $50\ \Omega$ . Over-all gain is 55 dB with an output level swing of 1 V rms max.

Sprague Electric Co., 347 Marshall St., North Adams, Mass.  
Phone: (413) 664-4411.

Circle No. 244

## BUNKER-RAMO CUSTOM HYBRID MICROCIRCUITS

### DESIGN AND PACKAGING FREEDOM

Mix integrated circuits, precision resistors, tunnel diodes—whatever you need to get the function you want in the package you want.

### SPEED

Digital logic circuits to 250 megacycles; other circuits to microwave frequencies.

### POWER

Up to 40 watts per square inch of resistor area without heat sink.

### LOW COST, QUICK DELIVERY

Simplified processes mean lower tooling and start-up costs even for short runs or prototypes; faster delivery, too.

### PRECISION RESISTORS

Production-run thin-film resistor tolerances to  $\pm 0.01\%$  initial adjustment, with  $\pm 0.05\%$  tracking accuracy at full load for 10,000 hours;  $\pm 5\text{ppm}/^\circ\text{C}$  temperature coefficient control.

### APPLICATION ENGINEERING

To explore solutions to your circuit problems, call or write our application engineers.



### THE BUNKER-RAMO CORPORATION DEFENSE SYSTEMS DIVISION

8433 FALLBROOK AVENUE • CANOGA PARK, CALIFORNIA 91304 • (213) 346-6000, EXT. 546

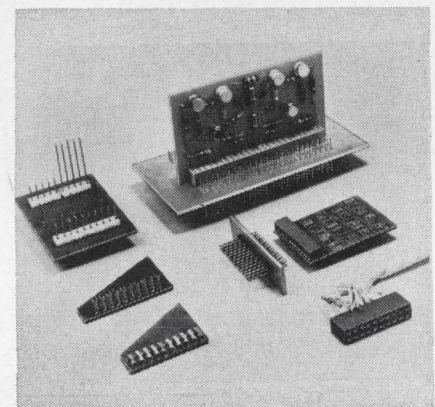

### Interconnection system

For perpendicular or parallel mating or parallel stacking of PC laminates, this interconnect system consists of a family of one-piece rectangular receptacles and corresponding male posts. The receptacles contain two long opposing cantilever beams. Standard or short receptacle contacts can be staked to PC laminates at up to 1800/hr. Male posts may be staked directly to the PC laminates or used with nylon insulators in metal chassis or panels.

Amp Inc., Harrisburg, Pa.  
Phone: (717) 564-0101.

Circle No. 245

ON READER-SERVICE CARD CIRCLE 65



## SITUATION WANTED

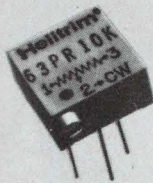

Young trimming potentiometer seeks small ( $\frac{3}{8}$ " opening in electronics firm. Accurate, dependable worker. Good background. Will accept low pay for chance to prove ability and help company grow.

# Hire Helipot's $\frac{3}{8}$ " cermet trimmer for the jobs too tough for wirewounds

Got a big job for a small, square trimmer? Sign up the new Helitrim® Model 63P trimming potentiometer. Smallest of its class in size and price, the tough little 63P offers essentially infinite resolution, with ruggedness and reliability twice as high as you'd expect.

No wonder. Beneath its sealed  $\frac{3}{8}$ " x  $\frac{3}{8}$ " x  $\frac{1}{16}$ " molded plastic housing, the 63P has a heart of cermet. No other resistance element can match its combination of high power rating, essentially infinite resolution, freedom from sudden failure, resistance stability, and wide 10 ohm to 2 megohm resistance range. Wirewounds or carbon won't even come close.

References? This new trimmer just graduated from Helipot. It's been thoroughly checked out and tested again and again.

It meets or exceeds requirements of MIL-R-22097B. We'll vouch for it... and so will you, once you've tried it. Send now for full details, or ask a Helipot sales rep to introduce you.

---

### RESUME

#### GENERAL

Ambient temp. .... -65 to +150°C  
Power rating, watts... 0.5 at 85°C, derating to 0 at 150°C  
Adjustment turns, nominal..... 20

#### ELECTRICAL

Standard res. range, ohms..... 10 to 2 meg.  
Resistance tolerance .....  $\pm 20\%$   
Resolution ..... essentially infinite

#### MECHANICAL

Stop..... clutch action, both ends  
Starting torque, max..... 5.0 oz.-in.  
Weight, approx. .... 1 gm.

---

**Beckman®**

INSTRUMENTS, INC.

HELIPOT DIVISION

FULLERTON, CALIFORNIA • 92634

INTERNATIONAL SUBSIDIARIES: GENEVA; MUNICH; GLENROTHES, SCOTLAND; TOKYO; PARIS; CAPETOWN; LONDON; MEXICO CITY

Speed Inquiry to Advertiser via Collect Night Letter  
ON READER-SERVICE CARD CIRCLE 66



## OVER 200 BASIC JACKS

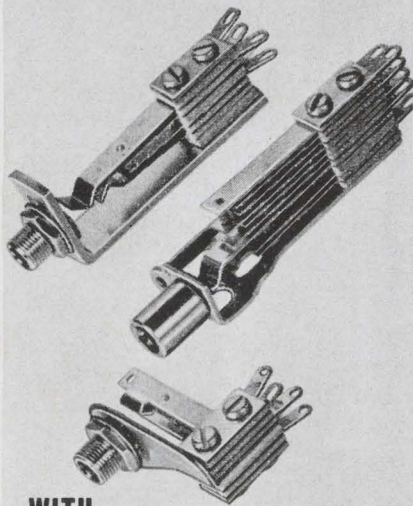

WITH  
**ONE BASIC QUALITY**

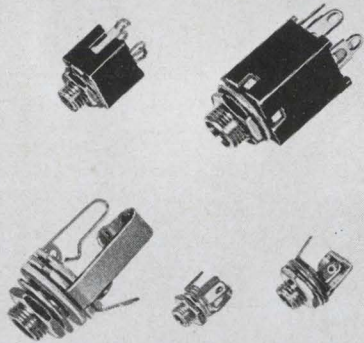

## EXCELLENCE

### SWITCHCRAFT PHONE "JAX"

Keep this one time-saving fact in mind: SWITCHCRAFT MAKES OVER 200 DIFFERENT PHONE JACKS, ALL OF INCOMPARABLY UNIFORM AND HIGH QUALITY, AT NO HIGHER COST THAN THE SECOND BEST JACKS. Period! New enclosed molded jacks . . . Tini-D and Hi-D Jax . . . phone jacks, Tini-Jax, Micro-Jax, Littel-Jax, Twin-Jax, Extension Jax, short and long frame Telephone-type Jax, Shielded Jax, Mil-types, 2-conductor or 3-conductor, stereo, bushing, P.C. board, rivet or jack panel mounting, thick panel jacks  $\frac{1}{4}$ " or  $\frac{3}{8}$ " bushing lengths, .2085", .250 or .210" bushing diameters, insulated or non-insulated jack sleeves . . . and more switching circuits available than any other commercial jacks on the market! Each is 100% quality inspected and hand adjusted prior to shipment. You name it—chances are it's "from stock," and listed in the incomparable line of Switchcraft Jacks.

SEND FOR CATALOGS J-101 and J-103 or see your Switchcraft Authorized Industrial Distributor for immediate delivery at factory prices.

**SWITCHCRAFT**<sup>®</sup>  
INC.

5529 North Elston Avenue  
Chicago, Illinois 60630

## COMPONENTS

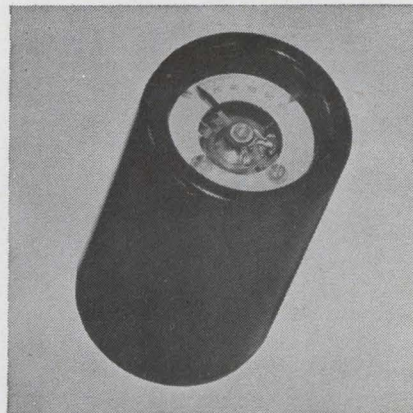

### Galvanometer relays

Microsensitive galvo relays have direct switching with 5-W capacity up to 125 Vac or dc. Switches are electrically isolated from the coil assemblies. Switch life is  $10^6$  operations with resistive load. The pull-in drop-out resolution is within 1.5% of coil deflection. The switch can direct control of high-powered SCRs or multi-contact external relays.

Sensitak Instrument Corp., 531 Front St., Manchester, N. H. Phone: (603) 627-1432.

Circle No. 246

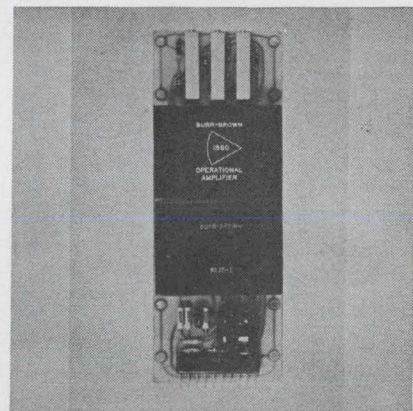

### FET op-amp has fast slewing rate

A slewing rate of  $100 \text{ V}/\mu\text{s}$  and a  $\pm 10\text{-V}$  output at  $\pm 30 \text{ mA}$  is featured in this FET op-amp. The unit has a 30-MHz bandwidth at unity gain for fast sample and hold operation. The op-amp may be used in a circuit which samples instantaneous voltage and holds this value for the period of time needed to read out and record the value or control the function of a succeeding circuit. Input impedance of model

1560 is  $10 \text{ G}\Omega$  and current offset is  $\pm 0.1 \text{ nA}$ . Input noise from dc to 10 kHz is  $10 \mu\text{V rms}$ .

P&A: \$175 (1 to 9); stock to 3 wks. Burr-Brown Research Corp., 6730 S. Tucson Blvd., Tucson, Ariz. Phone: (602) 294-1431.

Circle No. 247

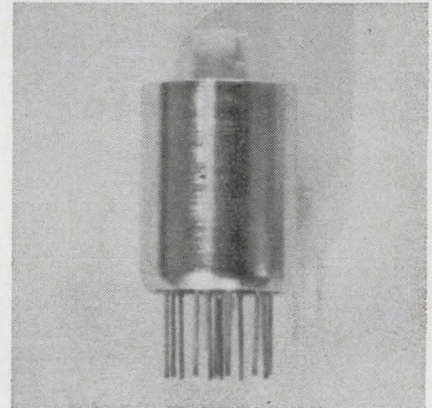

### Micromin rotary switches

The trend toward microminiaturization continues, even into the field of switches. These miniature rotary switches, designed for use with ICs, are no larger than any other discrete component on a PC board. Basically a single pole switch, the two 6-position versions have 0.187- and 0.093-in. diameters. The 10-position version has a 0.3-in. diameter.

A ball-like rotor on an activating shaft makes contact between desired pins. All pins extend through the stator and act as leads that can be dip soldered to a board. Available in evaluation quantities, the 0.093-in. version can be directly welded to IC chips. The ball acts as both conductor and detent mechanism. The unit is actuated by turning the rotor shaft via screw-driver actuation, a permanently installed knob or shaft extension. Contacts are spring-tempered copper alloy and/or precious metals, depending on application, and can be shorting or nonshorting.

The switches are rated at 0.5 A at 28 Vdc and 0.75 A at 120 Vac noninductive. Breakdown voltage is 500 Vac between contacts or between contacts and ground. Insulation resistance is  $25 \text{ G}\Omega$  between terminals to ground, particularly important in dry circuit applications.

P&A: about \$6; stock. Oak Mfg. Co., Crystal Lake, Ill. Phone: (815) 459-5000.

Circle No. 248



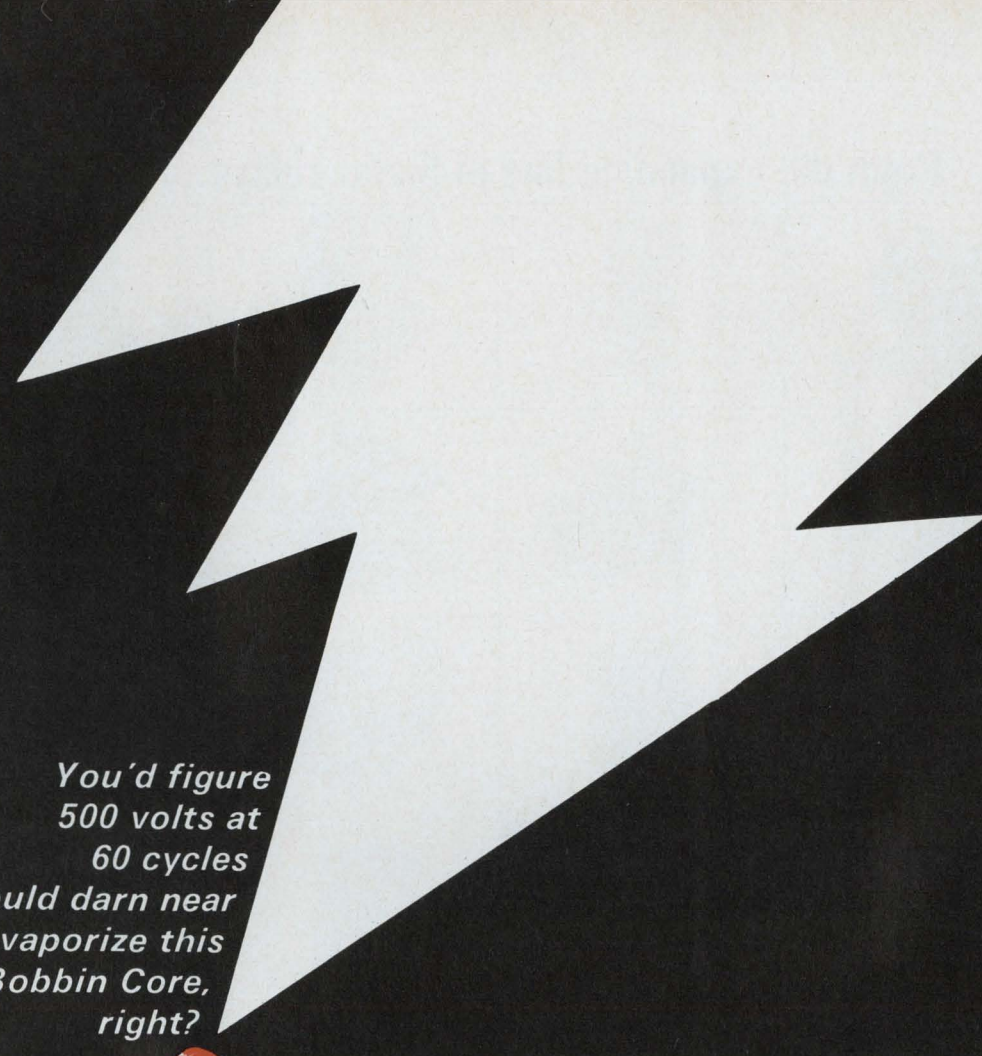

*You'd figure  
500 volts at  
60 cycles  
would darn near  
vaporize this  
M.A. Bobbin Core,  
right?*



**Wrong! Its got GVB\*.** Even at more than 1500 volts, tests show no breakdown on M.A. bobbin cores with GVB. In addition to guaranteeing the core's ability to withstand at least 500 volts between bare winding and bobbin, GVB finish also seals the bobbin to withstand a ten-inch mercury vacuum.

It seals against potting material, provides a resilient, non-slip base for winding, and its epoxy skin protects the core against wire cuts. Abraded wire problems are eliminated and no prior taping is required.

GVB has proven itself on thousands of cores . . . and now Magnetics has applied it to the bobbin core, the

miniature workhorse of computers, high frequency counters, timers, oscillators, inverters and magnetic amplifiers.

Made from ultra-thin permalloy 80 and Orthonol® (0.001" to 0.000125"), Magnetics' bobbin cores are available in tape widths from 0.023" to 0.250" or wider on request. Core diameters range down to less than 0.100" with flux capacities down to several maxwells.

For more information on GVB Bobbin Cores, write Magnetics Inc., Dept. ED-42, Butler, Pa. 16001.



\*Guaranteed voltage breakdown



From the expanding line of Sigma relays . . .

ON READER-SERVICE CARD CIRCLE 69

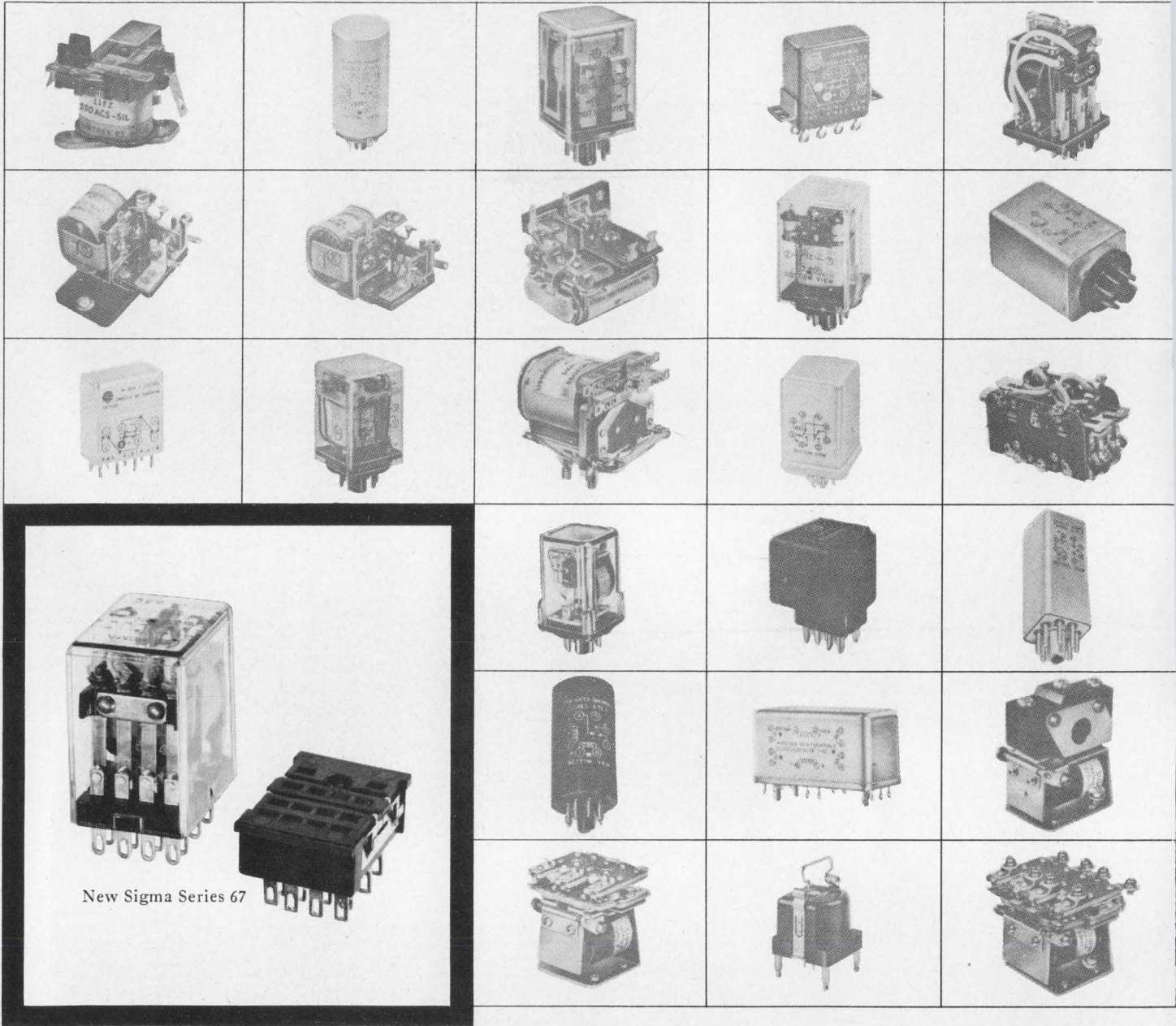

New Sigma Series 67

# Miniature 4PDT relay switches Try the new Series 67—or any

We'd like to give you a new Sigma Series 67—or any of our other standard relays. Test and compare it against the brand you may now be using. It's the best way we know to prove what we say about Sigma relay performance.

Test the new Series 67, for example. This rugged AC-DC relay, only slightly larger than a cubic inch, brings new reliability and versatility to precision switching. Each of its four poles can switch a low-level to 3-ampere load 100,000 times minimum.

The relay's in-line contact arrangement extends mechanical life to 100 million operations DC, and 50 million operations AC.

Completely versatile, the Series 67 is available for either direct solder-terminal installation or fast, easy, socket mounting with choice of solder or printed-circuit-terminal connections. The socket can be installed in seconds, with no need for screws or fasteners. It simply snaps into the face of the panel and four spring clips lock it.



ON READER-SERVICE CARD CIRCLE 69

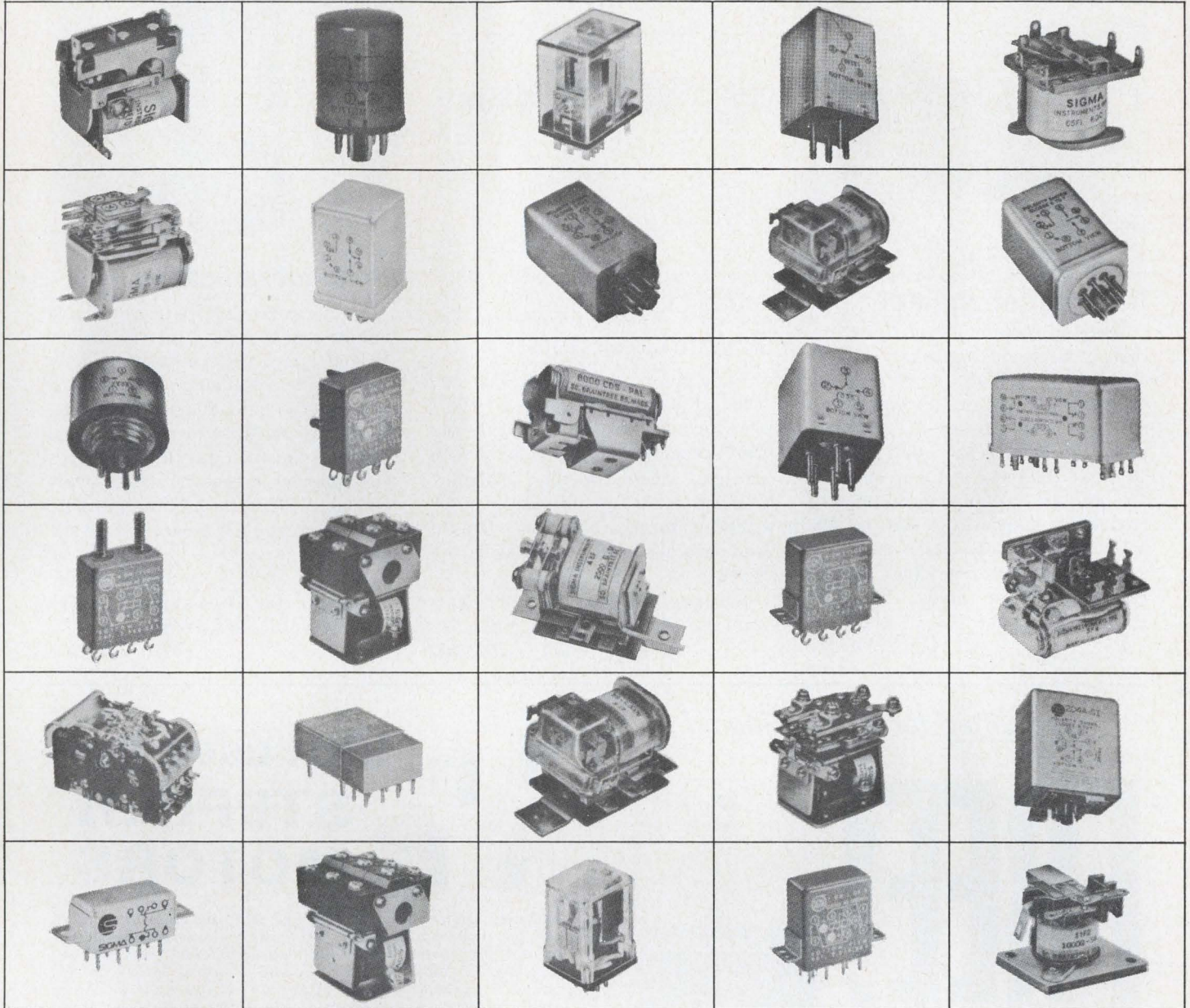

# 3 amps 100,000 times minimum. Sigma relay—absolutely free.

Put Sigma relay performance to the test yourself, free of charge. Just send for the new Preferred Standard and Stock Relay Catalog of the expanding line of Sigma relays. Then select the

relay you want to test and compare, and your Sigma representative will see that you get it. Offer limited to original equipment manufacturers having applications for relays.

SIGMA DIVISION  SIGMA INSTRUMENTS INC  
*Assured Reliability With Advanced Design / Braintree, Mass. 02185*

Need Sigma relays fast? Call your Sigma distributor for off-the-shelf delivery of our most popular types.

ON READER-SERVICE CARD CIRCLE 70



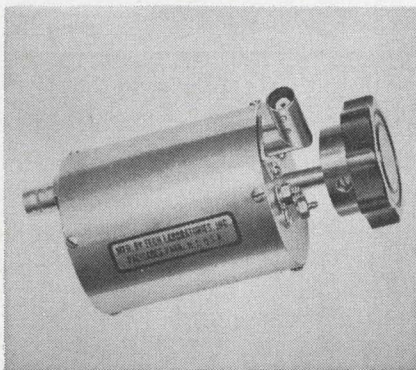

### RF drum attenuator

Used in low impedance circuits, this resistive attenuator has a standard impedance of 50  $\mu$ . Units are available in 5 or 10 steps with a max loss of 60 dB per unit. Accuracy at 100 MHz is 20  $\pm$ 0.01 dB and 50  $\pm$ 0.5 dB. Vswr is 1.2 at 60 MHz. The circuit is unbalanced pi and frequency response is flat to 400 MHz under 50-dB loss.

Tech Laboratories, Inc., 50 E. Edsall & Bergen Blvds., Palisades Park, N. J. Phone: (201) 944-2221.

Circle No. 249

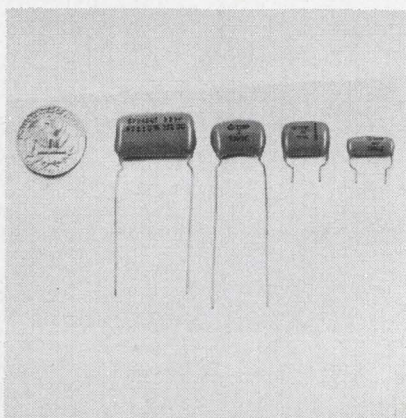

### 75-Vdc capacitors

Capacitors rated at 75 Vdc and 0.001  $\mu$ F at 100-, 200-, 400- or 600-V are included in this line. Series 225P capacitors are available with straight leads, inside "hairpin" crimped leads or outside "hockey stick" crimped leads. The straight leads are also available in short pin types.

Sprague Electric Co., 347 Marshall St., North Adams, Mass.

Circle No. 250

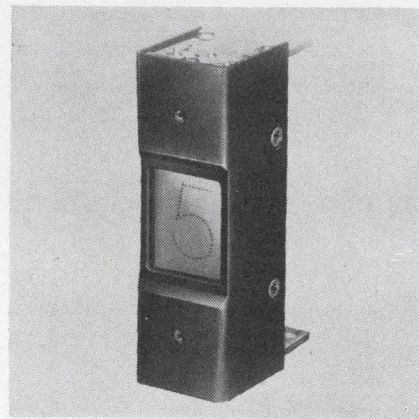

### Readout indicators

Numeric readout indicators have illuminated 3/4-in. digits on an engraved lucite plate edge-lighted by an incandescent lamp. Providing a life of 30,000 to 50,000 hours, the lamps are soldered in place. Optical distance between the light sources and display screens is short. Overall size is 2-1/2-in. high and 3/4-in. wide. Six- or 14-V models are available.

Price: \$9.95. Alco Electronic Products Inc., Lawrence, Mass. Phone: (617) 686-3888.

Circle No. 251

## Combined for Convenience!

# FREE!



## CAMBION® Catalog 700 and CAMBION Catalog 700 Supplement

Now — for your convenience, the industry's most complete file of technical data for quick, easy specifying. If you're currently without *both* CAMBION Catalog 700 and CAMBION Catalog 700 Supplement, now you can have them bound together under one convenient cover.

Filled with technical and performance data, specifications, outline drawings and dimensions, the new CAMBION publication offers a complete selection of battery holders, panel and chassis hardware, digital modules, solder terminals, swagers, terminal boards, insulated terminals, coil forms, shielded coil forms, coils, RF chokes, capacitors, connectors — plugs and jacks, component clips, handles, kollet knobs, thermoelectric modules and magnetic bearings.

For your free copy write Cambridge Thermionic Corporation, 407 Concord Ave., Cambridge, Mass. 02138. Tel: (617) 876-2800; or 8703 La Tijera Blvd., Los Angeles, Cal. 90045. Tel: (213) SP6-0472.



Standardize on CAMBION... the guaranteed electronic components  
Speed Inquiry to Advertiser via Collect Night Letter

ON READER-SERVICE CARD CIRCLE 73

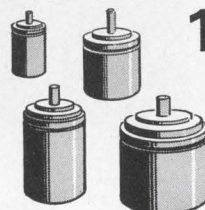

## 1001 uses for STEPPER MOTORS

Because their output is in discrete increments, Cedar stepper motors have many advantages over conventional motors for precise positioning applications. They are bi-directional and have high torque output. They can be run at high stepping rates or as slow as you wish. Because shaft rotation is incremental, damping is not required.

Some of the applications for which stepper motors have been used are: replace motor-tachometers in servo systems, control missile ailerons, shutter control on high-speed cameras, open loop positioner in checkout systems, high-speed counter in such applications as rapid firing weapons, replace ultra low-speed dc motors, incremental tape handlers, and digital-to-analog and analog-to-digital conversion equipment.

The uses for stepper motors are as unlimited as your imagination. New applications are constantly being discovered. What new use will you next make of stepper motors? Let us know about your ideas; we'll be happy to work with you.

Cedar Stepper Motors are available in sizes 5, 8, 11 and 15 in both permanent magnet and variable reluctance types, and with a wide variety of stepping angles. All meet the full requirements of MIL-E-5272. For free booklets on stepper motor application ideas, write or call:

<b>CEDAR</b> ENGINEERING DIVISION	<b>CONTROL DATA</b> CORPORATION
--------------------------------------	------------------------------------

5806 West 36th Street, Minneapolis 16, Minnesota. Phone 929-1681

ON READER-SERVICE CARD CIRCLE 74

ELECTRONIC DESIGN 22, September 27, 1966



# high-speed

**Tektronix Oscilloscope with general-purpose convenience**

## Type 585A / 82 unit features

■ **Dual-Trace Operation** with 4 operating modes and independent controls for each channel—for individual attenuation, positioning, inversion, and ac or dc coupling as desired.

■ **Bandwidth DC-TO-85 MHz** (3-db down) at 100 mV/cm (12-db down at 150 MHz), and typically DC-TO-80 MHz (3-db down) at 10 mV/cm.

■ **Calibrated Sensitivity in 9 steps** from 100 mV/cm to 50 V/cm, and in *10X Amplifier Mode*, from 10 mV/cm to 5 V/cm, variable between steps.

■ **Internal and External Triggering** to 150 MHz.

■ **Sweep Range from 10 nsec/cm to 2 sec/cm.**

■ **Single-Sweep Photography** at 10 nsec/cm.

■ **Calibrated Sweep Delay** from 2 microseconds to 10 seconds.

■ **Bright, High-Resolution Display** with small spot size.

■ **Conventional Passive Probes** for convenience.

## plus

■ **Compatibility with Letter and 1-Series Plug-Ins** to permit differential, multi-trace, sampling, spectrum analysis, other laboratory applications—when used with Type 81 adapter.

Type 585A Oscilloscope . . . . . \$1725  
 Type RM585A Oscilloscope . . . . . \$1825  
 Type 581A Oscilloscope . . . . . \$1425

No sweep-delay capabilities, but other features similar to Type 585A.

Type 82 Dual-Trace Unit . . . . . \$ 650  
 Type 86 Single-Trace Unit . . . . . \$ 350  
 Type 81 Plug-In Adapter . . . . . \$ 135

Allows insertion of 17 Tektronix letter-series plug-ins. Passband (up to 30 MHz) and Sensitivity depend upon plug-in used.

U.S. Sales Prices, f.o.b. Beaverton, Oregon

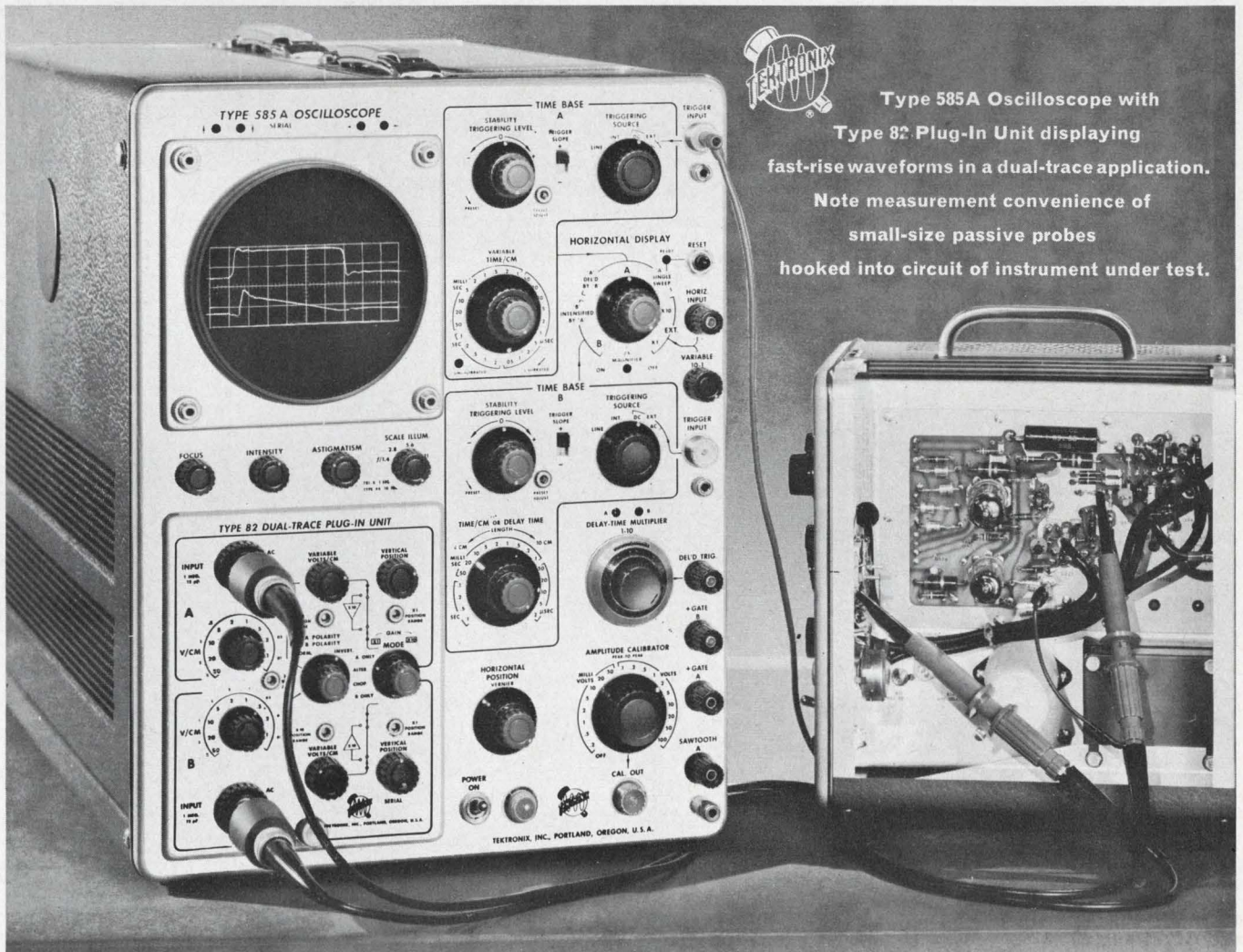

**Type 585A Oscilloscope with Type 82 Plug-In Unit displaying fast-rise waveforms in a dual-trace application.**  
 Note measurement convenience of small-size passive probes hooked into circuit of instrument under test.

**Tektronix, Inc.**



For complete information, contact your nearby Tektronix field engineer or write:  
 Tektronix, Inc., P.O. Box 500, Beaverton, Oregon 97005

ON READER-SERVICE CARD CIRCLE 75



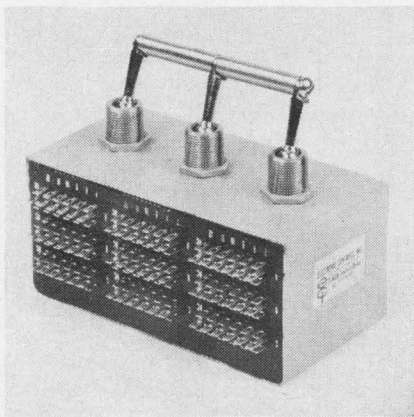

### 108pdt toggle switch

Environmentally sealed 12pdt to 108pdt toggle switches are enclosed in dry nitrogen and helium. They switch dry circuits to 5 A. Compatible with communication, instrumentation, or computer circuits, the switches are used for interfacing, bypassing, programing, logic inversion and reference voltage selection.

P&A: \$237.50; 6 wks. Electronic Controls Inc., Danbury Rd., Wilton, Conn. Phone: (203) 762-83511.

Circle No. 252

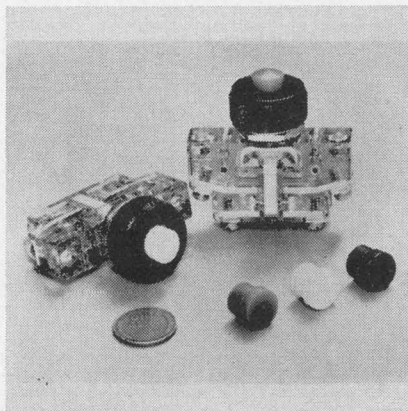

### Pushbutton switch

Any of five color inserts may be inserted in this pushbutton switch to change coding on the line. The clear housing makes the contacts and actuating mechanism always visible for inspection. Contacts are available in either hard silver or silver cadmium oxide. The spdt switch is guaranteed for 10<sup>7</sup> operations.

P&A: under \$2 (over 7500); Sept. Milton Ross Controls, Southampton, Pa. Phone: (215) 355-0200.

Circle No. 253

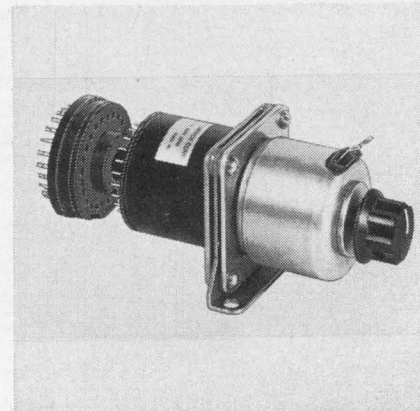

### Multi-pole rotary switch

Providing multi-pole switching of single- or double-pole circuits, these rotary reed switches with motor drive permit remote control of complex switching functions. The switches can also be wired for selective operation of several different circuits. Rotation is reversible by manual drive and uni-directional by motor drive.

Electro Switch Corp., 167 King Ave., E. Weymouth, Mass. Phone: (617) 335-5200.

Circle No. 254

GLOBE

5/8" DIA. ULTRA MINIATURE MOTOR

VT motor

VT gearmotor

Globe's Type VT permanent magnet d.c. motor is the smallest **standardized** power motor we know about. Fourteen standard armature windings are available for 3 to 50 v.d.c., with no-load speeds from 5,000 to 22,000 rpm. You can apply this miniaturized unit for continuous duty ratings up to 1-1/2 watts, and for starting torques up to 1.0 oz. in. Unit is 5/8" in diameter by 1-5/8" long; weight is 1.5 ounces.

Type VT precision planetary gearmotors are available with 19 gear ratios from 14.58:1 to 36,873:1. Request Bulletin VT. **Globe Industries, Inc., 2275 Stanley Avenue, Dayton, Ohio 45404, Tel: 513 222-3741.**

give...so more will live

HEART FUND

ON READER-SERVICE CARD CIRCLE 76

148

ELECTRONIC DESIGN 22, September 27, 1966



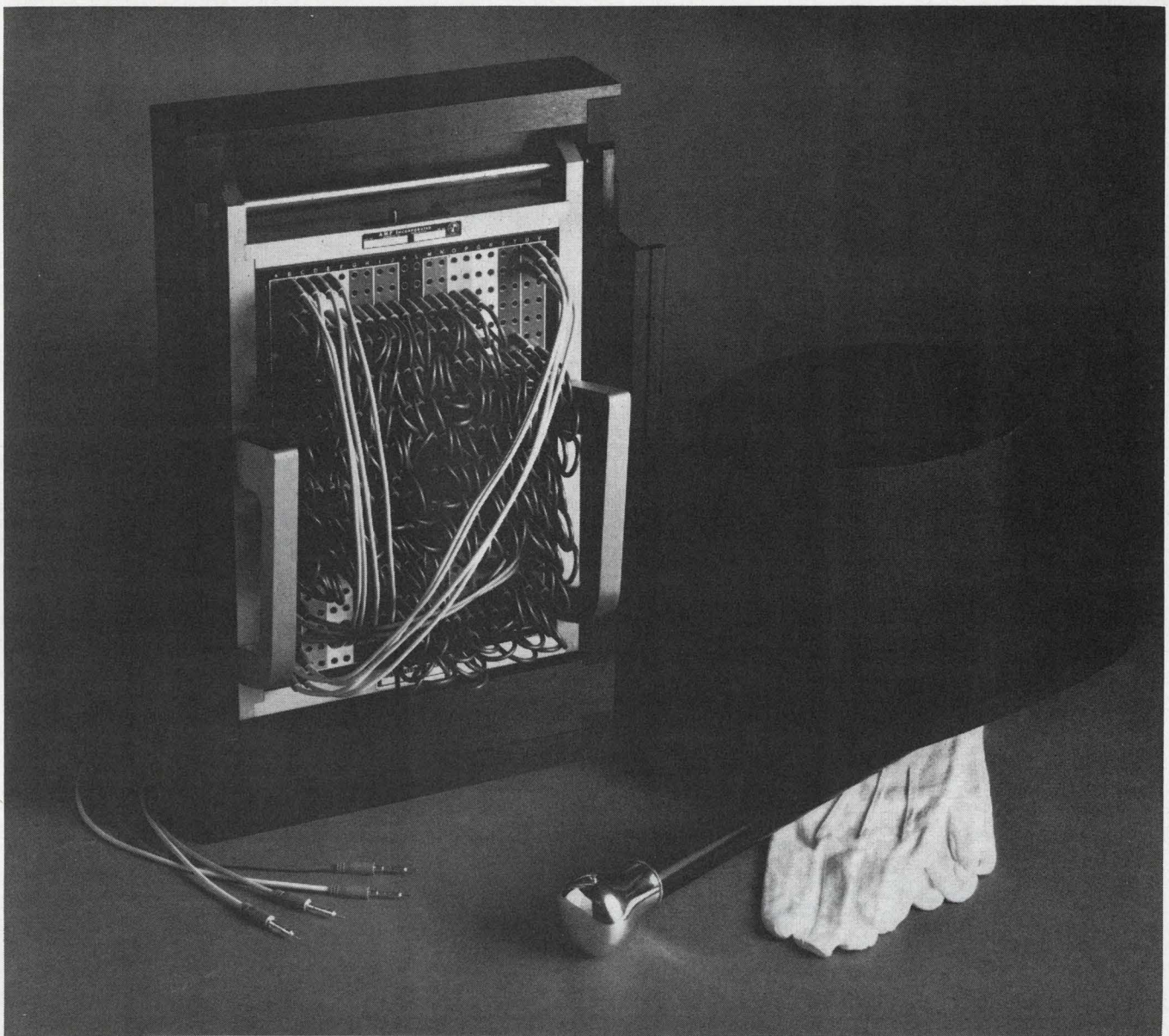

## Soft-spoken coaxial programming for your low-level circuits

The very low crosstalk and VSWR values of this Coaxial Programming System are easy on low-level circuits. It's perfect for programming HF communications, telemetry equipment, analog computers and similar low-voltage switching applications. And it lets you change up to 2024 coaxial circuits in seconds!

Pre-program a panel with the coaxial patchcords and slip it into the frame for convenient, quick-change programming. The exclusive camming action of AMP's Coaxial Patchcord System provides a unique wiping action that pre-cleans each coaxial contact. Excellent shielding between inner and outer conductor and between adjacent cells reduces losses and interference to the minimum. When necessary, patchcords may be removed and inserted after the patchboard is in place, permitting program changes without any interruption to other circuits.

Worried about installation? That's easy too—permanent wiring of the rear board is accomplished with one crimp on each coaxial contact for rapid, reliable connection to the equipment. The patchboards and rear panels are made of diallyl phthalate (or proven equivalent) and are retained by rigid aluminum frames; the operating mechanism is of stainless steel; result—rugged, compact design. Some other features of this out-of-the-ordinary Coaxial Programming System:

- Redundant contacts on both center and outer conductor
- Standard sizes—506, 1012, 2024, 3036—plus hybrid systems
- Unique contact cleaning action
- Adjacent circuit crosstalk —60db at 100 Mc
- Individual coaxial contacts
- Exclusive AMP gold over nickel plating
- Maximum VSWR of 1.2 at 100 Mc

If you need a reliable coaxial programming system for your critical low-level equipment, go no further—this is the only one available. But investigate first. Write today for all the facts about AMP's full line of programming systems.

\*Trademark of AMP INCORPORATED

**AMP**  
INCORPORATED  
Harrisburg, Pennsylvania

A-MP\* products and engineering assistance are available through subsidiary companies in: Australia • Canada • England • France • Holland • Italy • Japan • Mexico • Spain • West Germany

Speed Inquiry to Advertiser via Collect Night Letter  
ON READER-SERVICE CARD CIRCLE 77



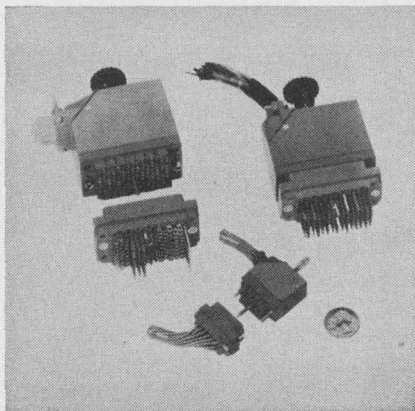

### Cable connectors

These rack-and-panel or cable connectors are available with 20, 90 or 120 contacts spaced at 0.15 in. in a honey comb grid pattern. Insulators are one-piece molded diallyl phthalate. Polarizing pins, sockets, single-post actuating screw, locking nut, cable and clamp may be assembled to a receptacle or plug.

P&A: \$2.26 to \$5.10; stock. Elco Corp., Maryland Rd., Willow Grove, Pa. Phone: (215) 659-7300.

Circle No. 255

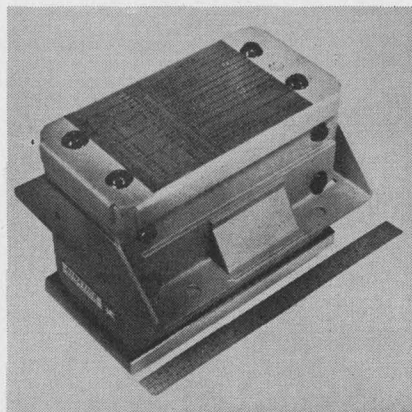

### 75-ms transfer switch

Three 5-A break-before-make double-throw poles are provided by this motor-driven switch. Transfer time is 75 ms max with all contacts transferring within 10 ms max of each other. The actuating motor operates at 28 Vdc with 200-W max consumption. No holding current is required. Operation is reliable in environments of 100 G shock.

Kinetics Corp., 410 Cedros Ave., Solano Beach, Calif. Phone: (714) 755-1181.

Circle No. 256

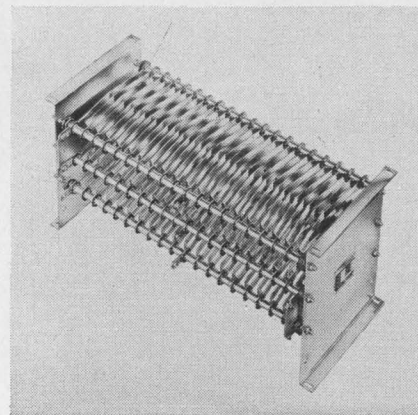

### Grid resistors

Resistors with preformed grids that move in one direction eliminate warping and shorting failures. They are available up to 1 Ω in ratings from 50 W to 20 kW. The units have mica insulation and are welded to eliminate hot-spots and resistance fluctuations. Series or parallel connections yield additional values. Any number of taps can be used.

Milwaukee Resistor Co., 700 W. Virginia St., Milwaukee. Phone: (414) 271-9900.

Circle No. 257

**LOOK WHAT'S HATCHED AT  
LITTELFUSE**

**The world's smallest fuse—Picofuse.  
1/8 thru 5 amps...1/6 gram...125 v.**

**LITTELFUSE**  
DES PLAINES, ILLINOIS

ON READER-SERVICE CARD CIRCLE 78

**trimmer news**

1 ONE ADJUSTMENT SCREW

2 TWO RESISTANCE ELEMENTS

5 FIVE PERCENT ELECTRICAL PHASING ON MATCHED RESISTANCE ELEMENTS

**miniature dual trimmer**

Here's the precision way to make simultaneous adjustments, balance or null two circuits and be sure of tandem settings and phasing. One adjustment screw (25:1 ratio) sets both wirewound resistance elements. Set it once and forget it! In the Series 190, resistance is stable under vibration or thermal shock. Units meet applicable MIL-SPEC paragraphs.

**SPECIFICATIONS**

Resistance range (per section)	10 to 50K ohms
Power rating (per section):	1 watt at 50°C
Operating temperature:	-65° to 175°C
Standard tolerance:	±5%
Size:	.405" x .775" x .185"

Technical data sheets are available from:

**TECHNO**  
TECHNO-COMPONENTS CORP.

7803 Lemona Avenue ■ Van Nuys, California 91405 ■ (213) 781-1642 ■ TWX: 910-495-2015

ON READER-SERVICE CARD CIRCLE 79



# MIL-T SPECS call for 22% to 32% wax coating on LACING TAPE.

• But what really is the right amount  
for trouble-free, tight-knot lacing?

• GUDEBROD KNOWS. They make yard after  
yard after yard exactly right!

• GUDEBROD TAPE cuts harness costs!

• Send for a sample.



Give the sample any comparative test  
you want. Let your harness crew try it.  
Send it to your lab. It's exactly what  
you'll get when you order Gudebrod  
tape—everytime.

You are often required to lace with tape that meets MIL-T Specs—  
with a specified range of wax content. But that's no assurance that  
you are using a tape that ties tight, holds tight, that probably won't  
be rejected—unless, of course, you have Gudebrod Gudelace. Like  
all Gudebrod Lacing Tapes it's manufactured under strict quality  
control including the wax coating. Every yard of Gudelace is im-  
pregnated exactly the same, exactly right. You can count on that—and on  
speedier, easier, better harnessing. That's where you save real  
money. Want to know more? Get in touch with Gudebrod.

#### GUDEBROD CABLE-LACER

The first hand tool engineered for wire harnessing.  
Handle holds bobbins, feeds tape as needed,  
grips tape for knotting. Speeds, eases  
harnessing. Pays for  
itself in time saving.



Area Code 215, WA 2-1122



## GUDEBROD BROS. SILK CO., INC.

FOUNDED IN 1870

*Electronics Division*

12 SOUTH 12th STREET, PHILADELPHIA, PENNSYLVANIA 19107

ON READER-SERVICE CARD CIRCLE 80





Tenney-Mite Strat—  
Stratosphere Simulator

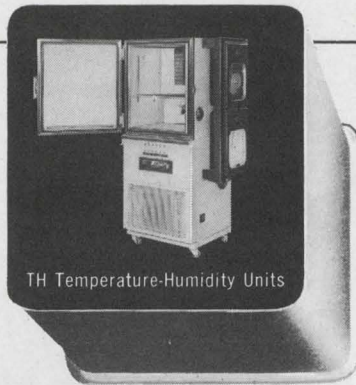

TH Temperature-Humidity Units

# Tenney

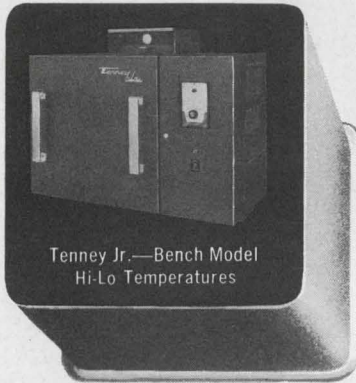

Tenney Jr.—Bench Model  
Hi-Lo Temperatures

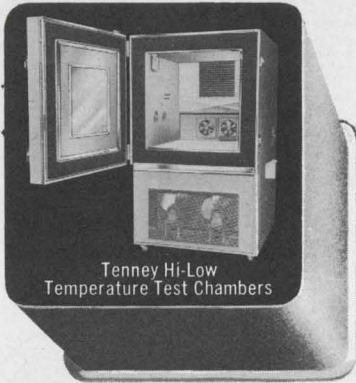

Tenney Hi-Low  
Temperature Test Chambers

## push-button environments



Space Jr.—  
Deep Space Simulator



A B C Space Simulator

## ...any size, any shape!

Need an environmental test chamber as large as a house, as small as a typewriter—or any size in between? Tenney can meet your needs exactly! If we don't stock it, we can usually build one in short time. And we'll accurately simulate anything in nature or outer space—altitude, temperature, humidity, explosion, sand and dust, fog—singly or in any combination.

For further information, write or call today.

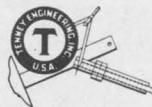

# Tenney

ENGINEERING, INC.

1090 Springfield Road • Union, New Jersey 07083  
Western div.: 15700 S. Garfield Ave. • Paramount, Calif. 90723  
Oldest and Largest Manufacturer of Environmental Test Equipment

335

## SYSTEMS

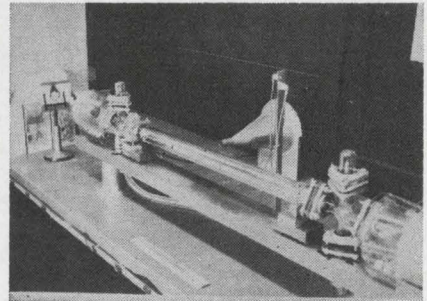

### CO<sub>2</sub> laser

Operating at 10.6 microns, this molecular gas laser tube is a continuous coherent output device. Input is 200 W and output is 10 W. Turn on delay time is 20 ms max, direct modulation frequency is 1 kHz and efficiency is 5 to 15%. Applications include optical ranging and communications, telemetry, cutting and welding.

Price: \$4000. Seed Electronics Corp., 258 East St., Lexington, Mass. Phone: (617) 862-8090.

Circle No. 258

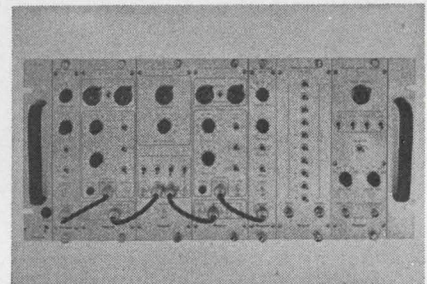

### Coincidence system

With a resolving time of one ns min, this system makes multiple coincidence measurements without degradation of time accuracy. For anti-coincidence determinations, a blanking gate opens symmetrically in time about the coincidence pulse. Gate widths are 10 ns. Pulse timing may be made from either the leading edge or the zero crossover point. Time pick-off sensitivity control monitors triggering sensitivity to suit the characteristic pulse shape of the detector. The system consists of two double delay line linear amps, two low-jitter pulse height analyzers and a fast ramp coincidence module.

Hamner Electronics Co. Inc., Box 531, Princeton, N. J. Phone: (609) 737-3400.

Circle No. 259

ON READER-SERVICE CARD CIRCLE 81





For those who think big—about availability, that is. Babcock's 1/6-size Model BR10 with unique universal contacts gives you "nonstop" load performance dry circuit to 1 amp. in the same unit. Now, you can order *one* relay to meet all your high-density circuit-board requirements—at no cost premium. And you'll find that this subminiature unit has everything... MIL-R-5757 conformance, unitized construction, solder-sealed or welded versions, standard circuit-board grid pattern, and a wide choice of terminal and mounting styles. Get more information about

the BR10, and the complete Babcock line of relays, all with universal contacts. Write Babcock Relays, Division of Babcock Electronics Corp., 3501 Harbor Blvd., Costa Mesa, Calif.; (714) 540-1234.



**SPECIFICATIONS**

<b>SIZE:</b> .405" h. x .500" l. x .230" w.	<b>PULL-IN POWER:</b> Low as 80 mw.
<b>WEIGHT:</b> Approx. 0.15 oz.	<b>LIFE:</b> To 150,000 operations
<b>CONTACT ARRANGEMENT:</b> DPDT	<b>TEMP. RANGE:</b> -65° C + 125° C

**Babcock**  
**model BR10**  
**1/6-size relays**



**dry circuit**  
**to 1 amp**  
**universal**  
**contacts**

ON READER-SERVICE CARD CIRCLE 82



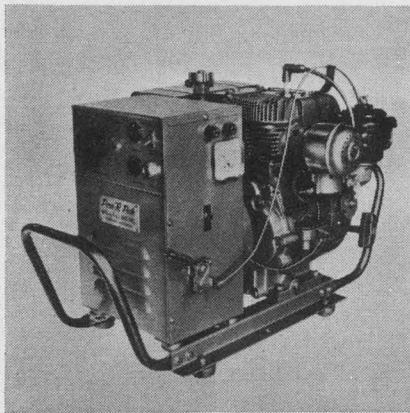

### Ac/dc power supply

Both ac and dc current is produced simultaneously by this self-contained power unit rated at 115 Vac, 3.3 kW and 6 to 30 Vdc. The supply is powered by a 7-1/4-hp four-cycle engine with either recoil or optional electric starting. An ac alternator rectifies dc current for more sustained power flow. Rate of charge is regulated by adjusting the speed of the motor.

T & J Mfg., Inc., Oshkosh, Wis. Phone: (414) 231-8217.

Circle No. 260

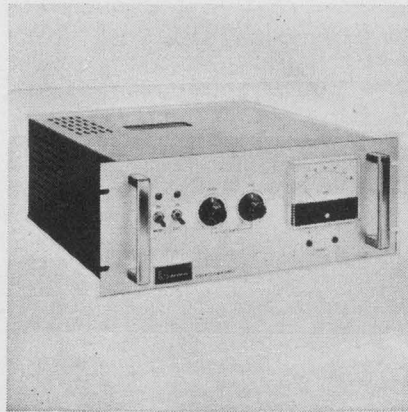

### 400-μA power supply

Providing 400 μA at up to 60 kV, these power supplies measure 7 x 17 x 19 in. Output voltage is adjustable between 6 and 60 kV. Model 905 has positive polarity and model 906 has negative polarity. The solid-state comparator amplifier is a PC board coupled by edge connectors and the remaining larger components are supported by an alloy frame.

Price: \$686. Brandenburg Ltd., 139, Sanderstead Road, South Croydon, Surrey, England.

Circle No. 261



### Miniature power modules

Measuring 1-5/8 x 3-1/2 x 3-5/8 in. typically, this series of regulated power modules operates from an 115-Vac input at 60 Hz. Each unit delivers 70 W of regulated dc with line regulation of 1% max and 3% load regulation. A typical model has a dc output of 28 V at 2.3 A and weighs about 35 oz. Ripple is 1% max and operating range is -10 to 85°C.

P&A: \$150; 4 to 5 wks. Arnold Magnetics Corp., 6050 W. Jefferson Blvd., Los Angeles. Phone: (213) 870-7014.

Circle No. 262

## 1 NANOSECOND LIGHT-PULSE GENERATOR

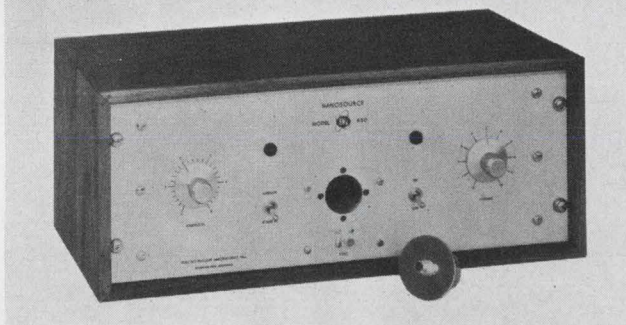

### ENL MODEL 450 NANOSOURCE LIGHT PULSE GENERATOR

- One-nanosecond rise time
- Selectable light-pulse width
- For use in determining rise time of PM tubes and solid-state (p-n or PiN) detectors
- For measurement of minority carrier lifetime in semiconductors
- Spectrum typical of high pressure Hg arc, rich in UV, visible, and IR

For further information, write or call:



**ELECTRO-NUCLEAR LABORATORIES, INC.**

115 Independence Drive, Menlo Park, Calif. 94025; (415) 322-8451

ON READER-SERVICE CARD CIRCLE 83

to your exact specifications...

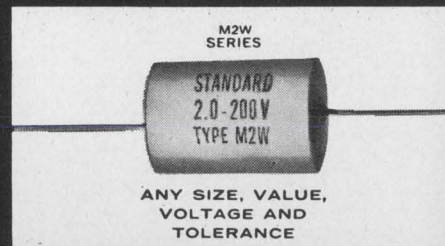

ANY SIZE, VALUE, VOLTAGE AND TOLERANCE

at stock prices

### METALIZED MYLAR CAPACITORS

Unique, self-healing units that remain in circuit during voltage surges with little or no loss of electrical properties. Use the M2W's where size and weight are limiting factors and long life and dependability are required. The units utilize metalized Mylar\* Dielectric with film wrap and custom formulated epoxy resin end fill. Available in round and flat styles.

\*Du Pont Trademark for Polyester Film

Samples available on your letterhead request

**Standard CONDENSER CORPORATION**

DEPT ED-9, 3749 N. CLARK STREET, CHICAGO, ILLINOIS 60613

Speed Inquiry to Advertiser via Collect Night Letter

ON READER-SERVICE CARD CIRCLE 84

ELECTRONIC DESIGN 22, September 27, 1966



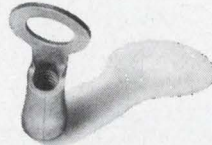

This is a naked YAES terminal.



We've stripped it to show why Burndy YAES Insulug® terminals are unique.

Once the insulation is off, it's easy to see that this terminal is a one-piece unit. That's a Burndy exclusive. Look closely and you'll see that the seam on the terminal body has been brazed. Another unique Burndy feature. And all YAES terminals are *fully* plated. You won't find any exposed copper edges. In fact, there are no unplated edges where the terminal is separated from the carrier. Look inside the terminal body, too. The surface has been serrated to insure intimate contact.

Additionally, each terminal is marked with the range of wire acceptable. As a double check, the tough, nylon insulation is color-coded to indicate wire size.

Installation is quick and easy with either MS 25037 or MR 8 83 ratchet-controlled hand tools.

Automatic installation tools are available, too. Burndy's Bandolug® equipment, the SME and the SME 10, handles wire ranging from 22 to 10. And they handle them quickly, simply and inexpensively. More so than any other tools.

Burndy YAES terminals meet both the Class I and II requirements of MIL-T-7928 when installed with appropriate tools.

There really is more than meets the eye when it comes to Insulug terminals and tools. Write for Bulletin YAES-66 and see for yourself.

 **BURNDY**  
NORWALK, CONNECTICUT

INTERNATIONAL SALES HEADQUARTERS AND MANUFACTURING FACILITIES:

CANADA: Scarboro, Ontario / ENGLAND: St. Helens, Lancs. / BELGIUM: Mechelen / MEXICO: Naucalpan de Juarez / BRAZIL: Sao Paulo / JAPAN: Tokyo / Sales Offices in Other Major Cities

ON READER-SERVICE CARD CIRCLE 85





# 1μV RESOLUTION MICRO/MILLIVOLT STANDARD\*

COMPARE  
performance  
..... price

EDC's dc Millivolt Standard — with 1 microvolt resolution — is an all-solid-state 5-decade precision source with . . .

- Absolute Accuracy . . . . . ±0.01%  
(NBS traceability)
- Outputs (2) . . . . .  $\left\{ \begin{array}{l} 111.110\text{mv} \\ (\mu\text{v steps}) \\ 11.1110\text{v} \\ (100 \mu\text{v steps}) \end{array} \right.$
- Stability . . . . . ±0.001%  
(Short term — 8 hrs)
- Output current . . . . . 10 ma
- Delivery . . . . . from stock
- Price . . . . . \$745

Model MV-100-N a direct reading standard has: automatic recovery . . . short circuit and overload proof . . . warm-up time of 30 sec. Designed as a portable standard for production and laboratory applications, it may be used in: thermocouple simulation; simulation of thermal emf; and in calibration of strip chart recorders, oven controllers, furnace controllers, millivolt meters, strain gauge indicators . . . Weighs only 8 pounds. Traceable certification supplied.

\*Other models to 1000 vdc.

Literature available on request.

**ELECTRONIC  
DEVELOPMENT  
CORPORATION**



423 WEST BROADWAY • BOSTON, MASS. 02127  
Tel: 617 268-9696

ON READER-SERVICE CARD CIRCLE 86

## MICROWAVES

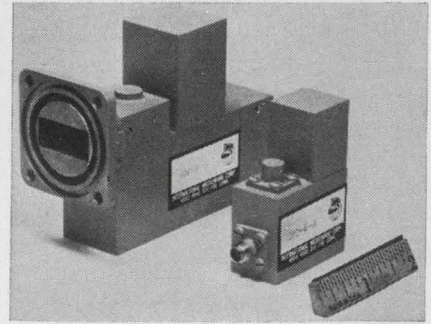

### Solid-state noise source covers 2 to 12 GHz

All solid-state microwave noise sources are designed as substitutes for argon noise lamps. The devices have been developed for application where over-all accuracy is not as important as the low power drain and small size of the solid-state source. The noise sources are available in a series covering 2 to 12 GHz with 20% bandwidths. The series has three models: 15 ±0.5 dB, 15 ±0.75 dB and 15 ±1 dB excess noise levels. Output vswr is less than 1.2 with no significant change between the fired and unfired conditions.

The pure, incoherent white noise is generated by a shot noise source and is therefore temperature stable. The sources are capable of operating for 250 hours from a single flashlight type mercury cell. They are designed for continuous use in monitoring low noise receiver performance of high-power, long-range radars and tropo-scatter communications systems with no significant effect on system performance.

Availability: 60 to 75 days. International Microwave Corp., Cos Cob, Conn. Phone: (203) 661-6277.

Circle No. 263

### Log-limiting IF amplifier

A logarithmic video output and a limited IF output is simultaneously provided by this amplifier with a 50-dB dynamic range. The limited IF output is 3 dBm ±1/2 dB for a range of inputs from -60 to -10 dBm. Video output is proportional within ±1 dB to the log of the input. The unit is available at 30-MHz center frequency.

P&A: \$750; 6 wks. Varian Assoc., LEL Div., Akron St., Copague, N. Y. Phone: (516) 264-2200.

Circle No. 264



# Now...frequency difference between any two oscillators determined instantly...



## at a price you can afford: \$2,850.00

TFA-266

The new TRACOR Model 527A Frequency Difference Meter allows adjustment of two oscillators to the same frequency, adjustment to a specific offset, determination of offset—all instantly—plus both short-term and long-term stability analysis. No additional equipment is

needed. Reading is direct and immediate in parts per  $10^7$  up to  $10^{11}$ . A front panel oscilloscope allows reading to parts per  $10^{12}$ . Inputs may be 100 kc, 1 mc, 2.5 mc, or 5 mc but the reference and signal frequencies need not be the same.

For further information:

TRACOR, Inc., 6500 Tracor Lane, Austin, Texas 78721, Phone 512-926-2800



***Instruments / Components / Systems***

REPRESENTATIVES IN PRINCIPAL CITIES

We are looking for EE's, ME's and Physicists for design consultation or systems development in ASW and undersea problems—experience in penetrations aids—design studies, tests, analysis and reports on electronic and mechanical systems. Your reply strictly confidential.

ON READER-SERVICE CARD CIRCLE 87



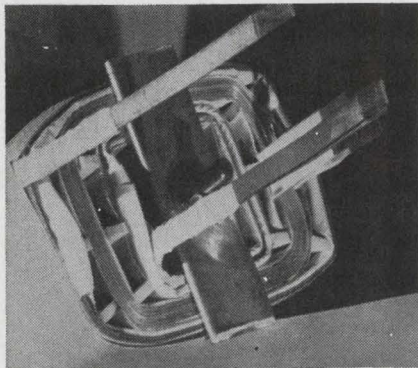

### Glass cloth insulators

For layer and barrier insulation in Class H dry transformers at 500 V or greater, these two materials combine glass cloth backing and silicone resin binder with a "Mica Mat" layer. High resistance to corona and thermal degradation and heat of 220°C is characteristic. These materials are wetted by impregnating resins to provide good thermal conductivity and cooler transformer operation. The G-E

77888 has a median thickness of 10 mils and G-E 7885 has a median thickness of 7 mils.

General Electric Co., 1 Campbell Rd., Schenectady, N. Y. Phone: (518) 374-2211.

Circle No. 265

### Conductive paint

Requiring no formulating, this conductive polymer alloy is a solderable silver-filled paint which is cured by air drying. Optimum adhesion and conductivity is achieved by forced air drying. This paint adheres readily to conventional solder, metals, plastic, glass, rubber and ceramic. Applications include coatings for tantalum anodes, electrostatic shielding and component grounding.

Price: \$10. Henry Mann Co., Box 104, Cornwells Heights, Penn. Phone: (215) 639-4048.

Circle No. 266

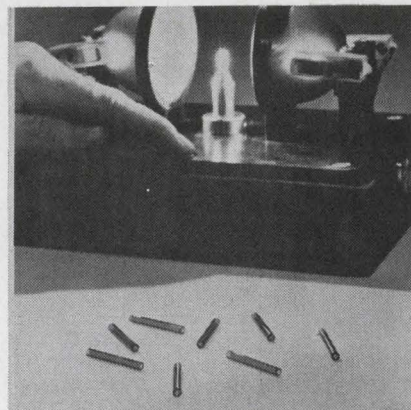

### Sealing glass

When this heat-absorbent sealing glass is exposed to infrared energy, sealing time is substantially reduced. The glass has very high absorption energy in the infrared region from 1 to 4 microns. Heat absorption is localized in the seal area so heat-sensitive devices are not damaged during encapsulation. The glass is available as cut tubing and multiform preforms.

Corning Glass Works, Corning, N. Y. Phone: (607) 962-4444.

Circle No. 267

# Telrex



The Choice of the Discriminating Communication Engineer . . . the Man who Never Settles for Anything Less than THE-VERY-BEST!

## telrex "BEAMED-POWER" ANTENNAS and ANTENNA SYSTEMS

Provide optimum performance and reliability per element, per dollar. Antennas from 500 Kc to 1500 Mc. Free PL88 condensed data and pricing catalog, describes military and commercial antennas, systems, accessories, Towers, Masts, Rotators, "Baluns" and transmission line data.

ANTENNAS SINCE 1921

Communication and TV Antennas

# telrex

## LABORATORIES

Asbury Park 41, New Jersey, U.S.A.  
ON READER-SERVICE CARD CIRCLE 88

# Audio Amplifier? AC Power Supply?

the Compact NA Series gives you both!

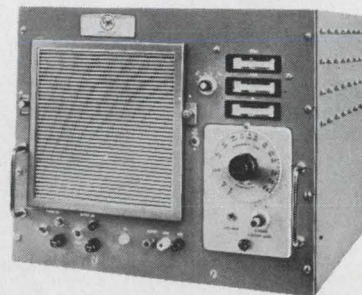

The NA Series of AC Power Supplies are exceptionally flexible sources of audio power. Each power supply consists of a Regulated Audio Power Amplifier with interchangeable fixed or variable Plug-In Oscillators for a wide range of precision AC power

applications. The Amplifier has a full power range of 45-6,000 cycles. With the incorporation of a CML Plug-In Oscillator precise fixed or adjustable output frequencies are available anywhere within this range. For complete information, write today.

CML, Inc. 

A subsidiary of Tenney Engineering, Inc.  
350 Leland Avenue • Plainfield, New Jersey  
(201) 754-5502 • TWX: 201-756-2064



# New 2N3494: 80 V<sub>CE</sub> f<sub>T</sub>=200 MHz minimum

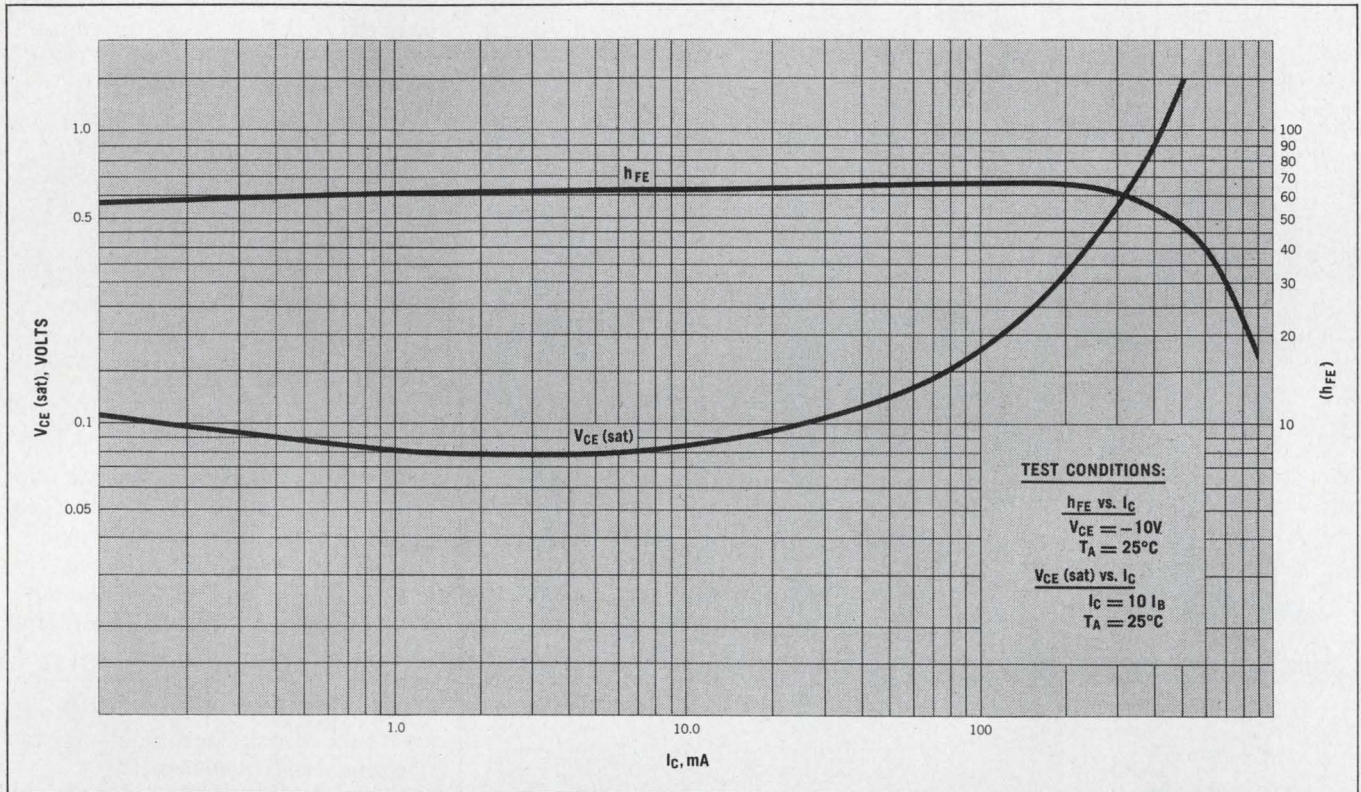

**Now! Design your high voltage PNP circuits** around this reliable planar product. Rated at 80 volts V<sub>CE</sub> and f<sub>T</sub>=200 MHz minimum, this device is outstanding for high voltage switching and linear amplifier applications at current levels up to 1/2 ampere.

**More new additions to Raytheon's line of PNPs.** Now, you can get 2N4080s with f<sub>T</sub>=1 Kmc minimum for VHF-UHF amplifiers, oscillators, and high-speed non-saturating switches. And Raytheon high-cur-

rent core drivers—2N3244s and 2N3467s—for fast switching at current levels up to 1 ampere.

**Proven reliability of every type.** Raytheon manufactures all PNPs under its exclusive Mark XII reliability program which provides *complete lot traceability* to the silicon ingot. And all Raytheon PNPs are of PLANEX\* silicon planar design, utilizing *Channelstopper*<sup>TM</sup> construction to eliminate channeling problems. \*Raytheon's designation for planar epitaxial.

2N3494 TYPICAL DATA			
Absolute Maximum Ratings			
		Units	
V <sub>CBO</sub>	-80	volts	
V <sub>CEO</sub>	-80	volts	
Conditions			
		Min.	Max. Units
h <sub>FE</sub> (DC current gain)	I <sub>C</sub> =50mA, V <sub>CE</sub> =-10V	40	
V <sub>CE</sub> (sat)	I <sub>C</sub> =10 mA, I <sub>B</sub> =1mA		-0.3 volts
h <sub>fe</sub> (High frequency current gain)	V <sub>CE</sub> =-10V, I <sub>C</sub> =20 mA, f=100 mc	2.0	

Send reader service card for all PNP data sheets. Or write for information: Raytheon Company, Components Division, 141 Spring Street, Lexington, Mass. 02173.





# ANY ENCLOSURE... ...ANY WEIGHT

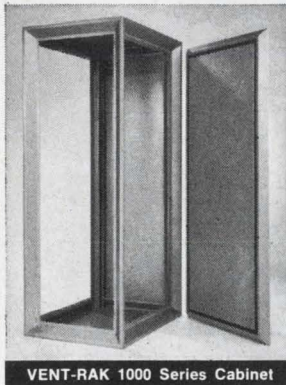
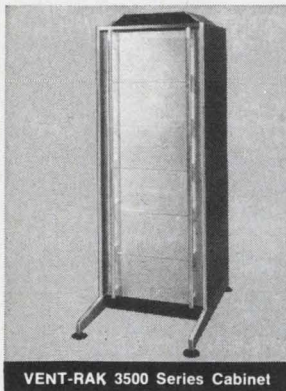

**FROM  
CUSTOM  
OR  
STANDARD:**

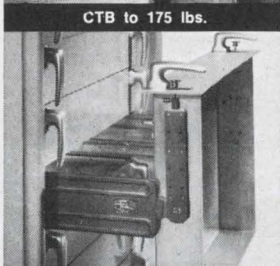
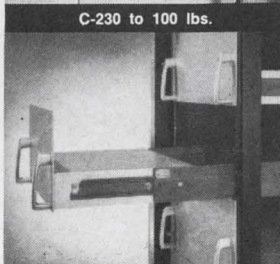
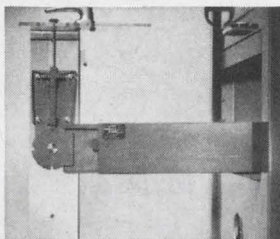
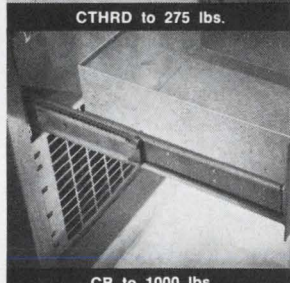
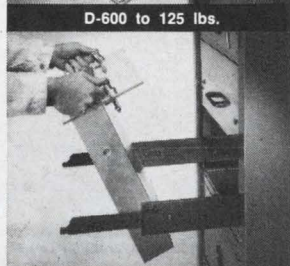
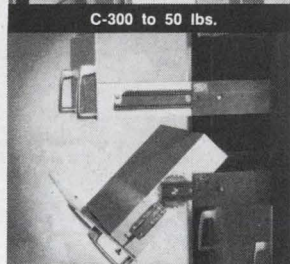
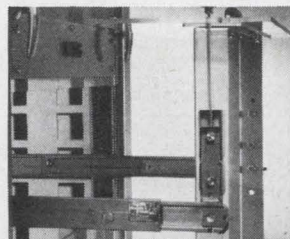

From Chassis-Trak you get the broadest range of slide weight capacities and the ideal enclosure for your application. Flexibility . . . plus uncompromising Chassis-Trak quality . . . have made Chassis-Trak a part of the package on every major missile project.

Just make sure the slides you order have the Chassis-Trak of Indianapolis, Seal of Quality . . . your protection against inferior imitations . . . ask about Vent-Rak cabinets.

*A Package for Every Major Missile Project from*

**525 South Webster Avenue, Indianapolis, Indiana**

ON READER-SERVICE CARD CIRCLE 182

With Chassis-Trak, you get:

- Ultra-thin slides for standard racks and cabinets
- Choice of tilt, non-tilt, tilt-lock versions in most models
- Poxylube 75 dry-film lubricant
- Choice of solid or roller bearings
- Delivery from stock in standard models



## MATERIALS

### Silicone encapsulant

This family of room-temperature vulcanizing silicone rubber encapsulants includes three bases and three catalysts to form nine different rubber materials. The catalysts are used at a 10:1 base-to-catalyst ratio. Curing times can be varied from 15 minutes to 8 hours. All cure effectively in thick sections and remain rubbery from  $-65$  to  $250^{\circ}\text{C}$ . Dielectric constant at  $25^{\circ}\text{C}$  and 100 Hz is 3 for the 3110 encapsulant, 3.2 for the 3112 and 3.8 for the 3120.

Dow Corning, 500 S. Saginaw, Midland, Michigan. Phone: (517) 636-8507.

Circle No. 268

### Ruby laser crystal

Produced by the Czochralski growth process, these ruby laser rods are available in diameters to  $3/4$  in. and lengths to 12 in. The higher of the two qualities available has parameter specs of passive beam divergence of 80% of the output energy within  $0.2$  mrad/in. (length), fringe count of 2 fringes/in. (length) max. and angle scatter of  $0.1\%$ /cm max. The rods are of  $60^{\circ}$  crystallographic orientation and contain  $0.05\%$   $\text{Cr}_2\text{O}_3$ .

Union Carbide Corp., 270 Park Ave., New York. Phone: (212) 551-4613.

Circle No. 269

### Plastic insulators

Composed of glasses reinforced with special fillers, these plastic insulators can be moulded by compression or transfer molding. The material does not shrink during molding and is unaffected by polymerization, temperature degradation or moisture absorption. Metal inserts can be integrally molded-in with expansion coefficients matched between hardware and specific formulations of the insulator. Dielectric constant ranges from 6.6 to 10.2.

Haveg Industries Inc., 336 Weir St., Taunton, Mass. Phone: (617) 824-4011.

Circle No. 270



Say you started out to design a hi-rel regulator that would replace bulky DO-7 and 13 cans.

But still deliver at commercial prices.

First you'd tap management for quite a few kilobucks and a room full of the best brains.

Then, after both were spent, you'd find you'd developed a thermally-grown, oxide-passivated, silicon wafer. With brazed leads. Snug fitting slugs. And exclusive hermetic seal.

And you'd pass the word along that it'd take more heat and current than the old metal cans.

Now what?

You'd expand the line and wind up with twenty-eight each HW 1 watt or HM 400 mw micro-glass, micro-miniature regulators that you could deliver in a week.

Which is what we did right here.



**Hoffman** | SEMICONDUCTOR

A Division of Hoffman Electronics Corporation, Hoffman Electronic Park, El Monte, California 91734

ON READER-SERVICE CARD CIRCLE 183



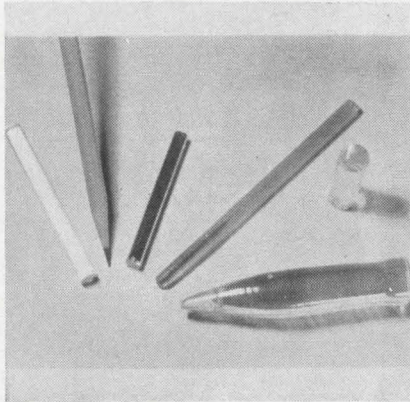

### YAG crystals

Available with up to 1.5 atom per cent doping of neodymium, these yttrium-aluminum garnets (YAG) are guaranteed to lase. The crystals measure 3 x 30 mm, 3 x 50 mm or 3 x 75 mm and come as raw blanks, with ground ends, polished ends or as finished components with dielectric coatings on both ends.

P&A: about \$815; 3 to 4 wks. Aremco Products, Inc., Box 145, Briarcliff Manor, N. Y. Phone: (914) 762-1685.

Circle No. 271

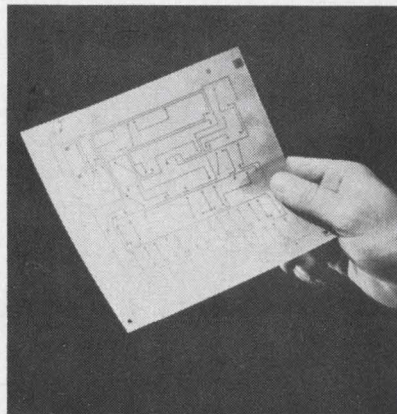

### Epoxy glass laminate

Clean circuits are fabricated with this copper-clad epoxy glass laminate. The laminate is used with three epoxy-resin impregnated glass-cloth bonding sheets. Because there is no copper oxide on the foil, base laminate staining is eliminated. The material is available with 1- or 2-oz copper clad on one or both sides in base (etched) or laminate thicknesses from 0.002 through 0.015 in.

General Electric Co., Coshocton, Ohio. Phone: (614) 622-5310.

Circle No. 272

### Resin-cored solder

This mildly activated resin-base cored solder is used where a water-white resin flux is too weak for production soldering. Active ingredients are nonionic and nonconductive even in the presence of moisture. Like resin, this solder becomes active only at high temperatures. It is used where post-soldering cleaning is not feasible and the residue must be highly insulating.

Alpha Metals, Inc., 56 Water St., Jersey City, N. J. Phone: (201) 434-6778.

Circle No. 273

### Iron/nickel alloy

Age-hardenable 43% nickel alloy gives 20,000-bit torsional magnetostrictive delay lines less than 0.5 ppm/°C delay stability over a range of 0 to 50°C. This alloy exhibits a constant modulus with a zero thermoelastic coefficient over a range of -50 to 150°F. After aging, the hysteresis or back error is 0.04% max.

Hamilton Watch Co., Lancaster, Penn. Phone: (717) 394-7161.

Circle No. 274

## NEW BLUE M FULL-RANGE CONSTANT TEMPERATURE/HUMIDITY CABINET



MEETS ANY CURRENT MIL HUMIDITY SPEC!  
-20°C. to +93°C. Range

Convenient and compact top loading cabinet; 18" W. x 16" H. x 16" D. I.D. Features patented Dual Wet and Dry Bulb POWER-O-MATIC 60® Saturable Reactor Control Systems, programming, separate recorder. Only 29" W. x 63" H. x

30" D. overall. 1/2" thick removable Plexi-Glass panel top permits many fixturing capabilities . . . unit accessories greatly extend operational flexibility. Unmatched for reliability and dependability. 120 V./1 Ph./60 Cy. A.C. Competitively priced.

SEND FOR FULL INFORMATION



**BLUE M Engineering Company**

A DIVISION OF BLUE M ELECTRIC COMPANY

Corporate Headquarters: BLUE ISLAND, ILLINOIS 60406

## A New Waterproof Series

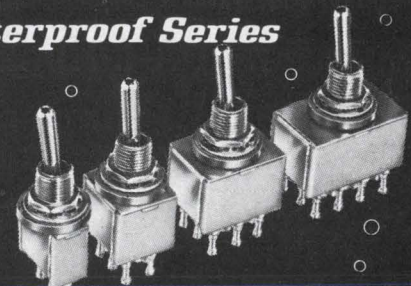

## MINIATURE

TOGGLE SWITCHES

with the most wanted features



New case design with double high voltage barriers, and extremely low-loss, high impact, high temperature materials.

Wide silver contacts bonded on silver-plated copper turret terminals. Neoprene "O" rings and sealed terminals provide a waterproof advantage. Conservatively rated 6 amps @ 125 VAC. Available in One, Two, Three and Four Pole configurations all in compact unitized bodies.

SPECIFY THE NEW "E" SERIES BY

FREE PRODUCT PLANNING CATALOG

# ALCOSWITCH

DIV. OF ALCO ELECTRONIC PRODUCTS INC., LAWRENCE, MASS.



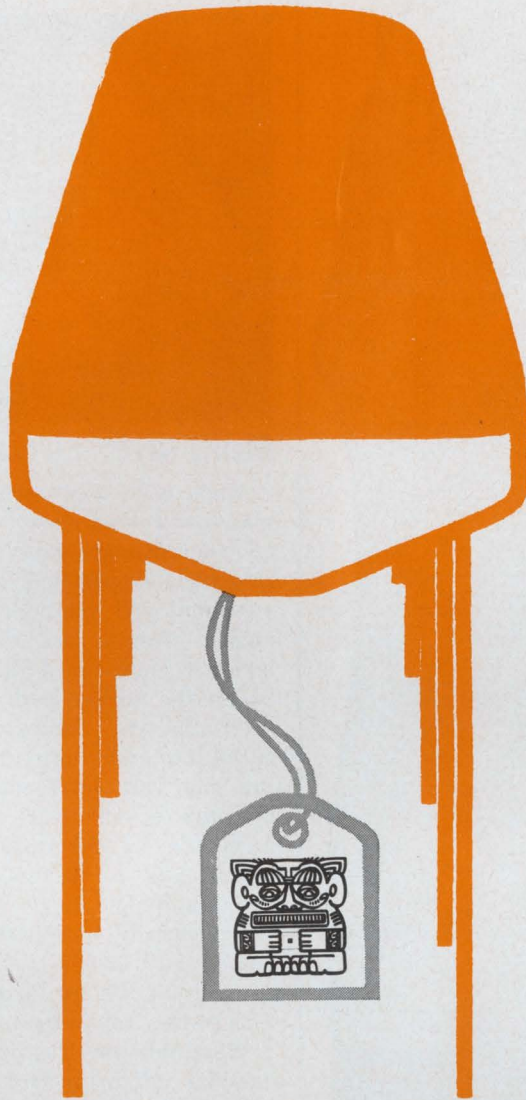

# The dual inline packaging on our new E-line 930 Series DTL is almost as surprising as the price tag.

## Just check over these prices:

- JK Flip Flop . . . . . (100 to 999) \$2.80
- Dual 4-input Nand Gate . . . . . \$1.65
- Dual 4-input Buffer . . . . . \$1.95
- Dual 4-input Expander . . . . . \$1.40
- Dual 4-input Line Driver . . . . . \$1.95
- Triple 3-input Nand Gate . . . . . \$1.65
- Quad 2-input Nand Gate . . . . . \$1.65
- Hex 1-input Nand Gate . . . . . \$1.65

They're the lowest on the market today, because our E-line Series DTL is packaged in our low-cost Taiwan production facility.

The other surprising feature about our dual inline packages is the specially-designed ceramic base—an excellent heat dissipator. It enables us to guarantee the same levels of fan-out and noise immunity

over 0° to 75°C that are available in hermetically-sealed packages. Special packaging features include standard 100 mil center-to-center spacing between round kovar leads, and standard 300 mil spacing between lead ranks. Our E-line packages are easy to handle, automatically insertable, and designed for stand-off. They are also immune to chemical solvents used in cleaning the p. c. board.

And one last surprise, they're available now. IMMEDIATE DELIVERY.

Call for the name of your nearest distributor. **Philco Microelectronics Division Sales Offices:** 2920 San Ysidro Way, Santa Clara, California (408-245-2966) / 999 North Sepulveda, El Segundo, California (213-772-6226) / 594 Marrett Road, Lexington, Mass. (617-862-6000) / Benson Manor, Suite 114B, Washington Lane, Jenkintown, Pa. (215-885-0430) / 314 South Missouri Ave., Suite 212, Clearwater, Florida (813-446-0124) / 815 Connecticut Avenue, N. W., Washington, D. C. (202-965-0903).

**Microelectronics Division**

SANTA CLARA, CALIF. • LANSDALE, PA. • SPRING CITY, PA.

**PHILCO**

A SUBSIDIARY OF *Ford Motor Company*

Speed Inquiry to Advertiser via Collect Night Letter  
ON READER-SERVICE CARD CIRCLE 186



it must be nice  
to have money  
to burn...

*if you're using mil spec.  
when industrial units  
will meet your needs...*

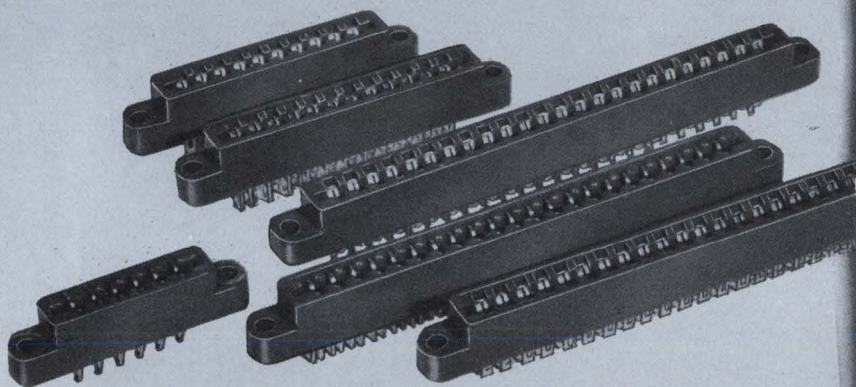

Methode Electronics can supply you with Reli-Acon printed circuit connectors from the largest to the smallest sizes with a variety of contact designs.

If you require the super-precision of military specifications . . . you get it from Methode with our usual prompt delivery.

If an industrial grade will fill your particular requirements, Methode can save you money.

*We invite your inquiry.*



Avnet stocks Methode's two full lines of military and industrial connectors across the country.



Connector Division  
**Methode Electronics, Inc.**  
7447 W. Wilson Ave.  
Chicago, Illinois 60656 • 312-867-9600

ON READER-SERVICE CARD CIRCLE 187

## MATERIALS



### Multi-layer circuits

Made with copper-clad sheets of glass-reinforced epoxy, these multi-layer circuits are first etched on the thin rigid copper-clad sheets by conventional PC methods. Next, the etched circuits are stacked, with layers of semi-cured glass-epoxy between the copper-clad sheets. This shelf-adhesive sandwich is then fused into a laminate unit by applying moderate heat and a molding pressure of about 50 psi. Finally, terminals in the different circuit layers are connected by plating through drilled holes. The copper-clad comes in base laminate thicknesses from 0.0025 to 0.062 in. Resin content is uniform to  $\pm 3\%$ . Sheet sizes range up to 43 x 36 in.

Westinghouse Electric Corp., Industrial Micarta Div., Box 868, Pittsburgh. Phone: (412) 391-2800.

Circle No. 275

### Liquid encapsulants

These two liquid potting compounds are rated to operate in the Class H range. The C58 encapsulant is an anhydride-cured system characterized by thermal conductivity of  $13 \times 10^{-4}$  cgs. Coefficient of thermal expansion is  $23 \times 10^{-6}$  in.<sup>2</sup>/°C. The C59 encapsulant protects semiconductors which are compatible with amine-cured encapsulants. This material has thermal conductivity of  $11 \times 10^{-4}$  cgs and very good moisture and temperature resistance. Coefficient of thermal expansion is  $18 \times 10^{-6}$  in.<sup>2</sup>/°C.

Hysol Corp., 1100 Seneca Ave., Olean, N. Y. Phone: (714) 372-6300.

Circle No. 276



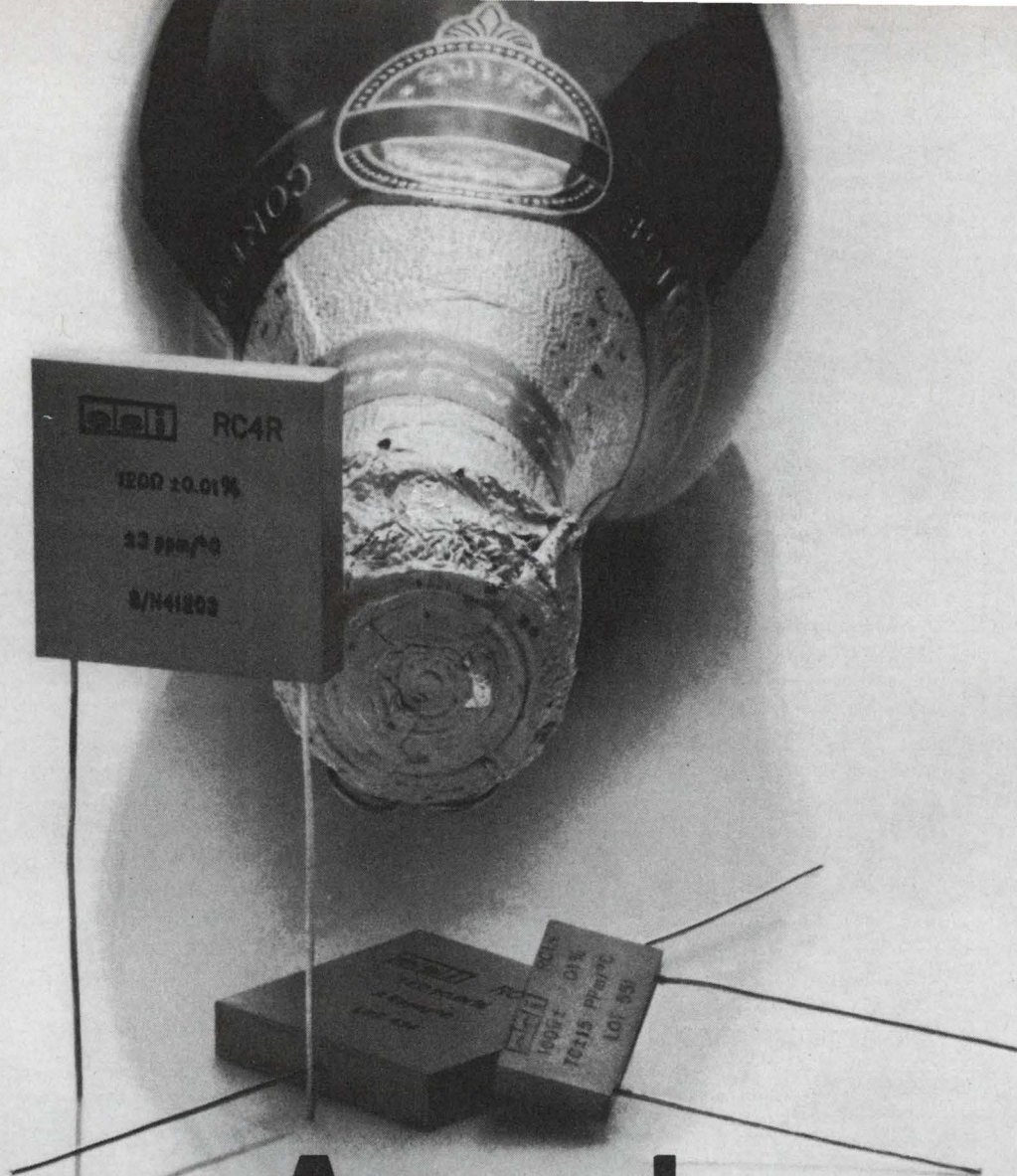

# Aged

Our precision resistors are aged to improve reliability, and we guard the process like a vintage champagne maker. Ageing is one of many extra steps that make our precision components the most reliable you can specify. The four families of ESI components are described briefly below. A detailed catalog can be yours by return mail.

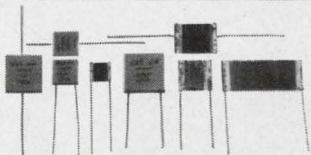

## 1. Precision Wire-Wound Card Resistors

Whenever small changes in the resistive element can affect the performance of the final assembly, you should consider the wire-wound ESI card resistor. Initial accuracy to  $\pm 0.0015\%$ . Yearly stability to  $\pm 10$  ppm.

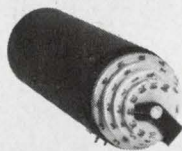

## 2. Dekastat® Decade Resistors

Designed for use with dc and at audio frequencies, these multi-decade resistors make use of a patented ESI circuit giving high accuracy and resolution. Accuracy is  $\pm 0.02\%$ . All units carry a two-year guarantee.

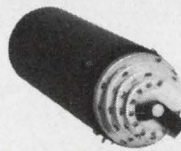

## 3. Dekapot® Resistive Voltage Dividers

Like all ESI decade units, these rapid-setting potentiometers are available with flange for panel mounting. They have terminal linearity up to  $0.002\%$ . Kelvin-Varley circuit provides constant input impedance.



## 4. Dekatran Transformer Voltage Dividers

The patented coaxial dial on these and other ESI decade units is easy to read and adjust. Accuracy of  $0.001\%$  and long-term stability are achieved through gapless toroidal cores of very high permeability.

Electro Scientific Industries, Inc., 13900 NW Science Park Drive, Portland, Oregon 97229.

**esi**®

ON READER-SERVICE CARD CIRCLE 188



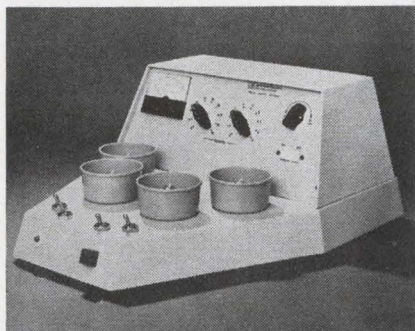

### Photoresist spinner

This four-spindle photoresist spinner uniformly coats semiconductor substrates of up to 1-1/2-in. diameter and provides independent vacuum switching to allow discriminate use of chucks. Operation is continuously variable from 0 to 5,000 rpm or 0 to 15,000 rpm with a 1- to 99-s time cycling. Snap-on vacuum chucks run in polypropylene cups which retain excess material.

P&A: \$975; stock. Macronetics Inc., 220 California Ave., Palo Alto, Calif. Phone: (415) 321-6750.

Circle No. 277



### Solder reflow machine

For joining flat-packs to PC boards, this machine consists of an ac supply, a programmer and controller for the head actuation, a dual reflow solder head which handles 14 leads at once, a PC board holding and locating fixture and a swing-away component loading device. The operator manually positions a flat-pack in the loading device, places it under the head, and actuates the machine for pick-up, po-

sitioning, and soldering. The entire cycle takes 10 to 11 s. The machine will accommodate PC boards up to 24 x 24 in.

P&A: \$5935; 6 to 8 wks. Wells Electronics Inc., 1701 S. Main St., South Bend, Ind. Phone: (219) 288-4651.

Circle No. 278

### Vacuum encapsulator

For encapsulation of components under high vacuum conditions, this potting unit is a semi-automatic 12-ton encapsulation and continuous proportioning, mixing and dispensing machine. Resins can be placed in the chamber by twisting the locking ring which unlocks the lid. Air power handles the remaining opening and closing operations. The unit has positive turntable drive.

Hull Corp., 6591-K Dairsville Rd., Hatboro, Pa. Phone: (215) 675-5000.

Circle No. 279

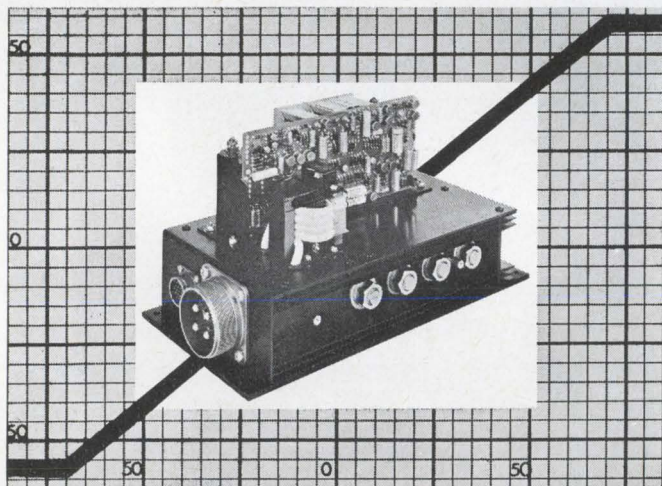

## Bi-directional, Full wave MOTOR CONTROL

The new Model A480, 17 KW power output servo amplifier is designed to drive 1 to 8 HP DC motors in applications where superior performance is required. The output of the amplifier features smooth, full wave, bi-directional control with linear operation through null. Adjustable current limiting and three signal inputs with 100 K input impedance are standard features. The amplifier is 12 x 6 x 6 and weighs only 14 lbs.

Servo Amplifiers / Static Inverters / Power Supplies

**WESTAMP**

1542 15TH ST., SANTA MONICA, CALIF. 90404, 213+393-0401

ON READER-SERVICE CARD CIRCLE 189

## SUBMINIATURE TOGGLE SWITCHES

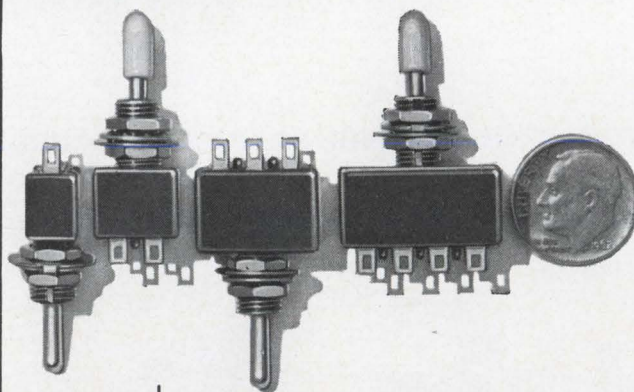

- SPDT
- DPDT
- 3PDT
- 4PDT

Designed to meet the highest standards of reliability, C&K's quality subminiature toggle switches combine maximum performance with small size! They feature rugged construction, simple mounting, excellent appearance, and long, trouble-free operation!

A competitively-priced, made-in-America product. Write for literature today!

**C&K**  
COMPONENTS, INC.

quality electro-mechanical products  
103 Morse Street, Watertown, Massachusetts 02172  
Telephone: 617 926-0800

C&K also manufactures a quality line of magnetic code converters, timers and logic elements.

ON READER-SERVICE CARD CIRCLE 190

ELECTRONIC DESIGN 22, September 27, 1966



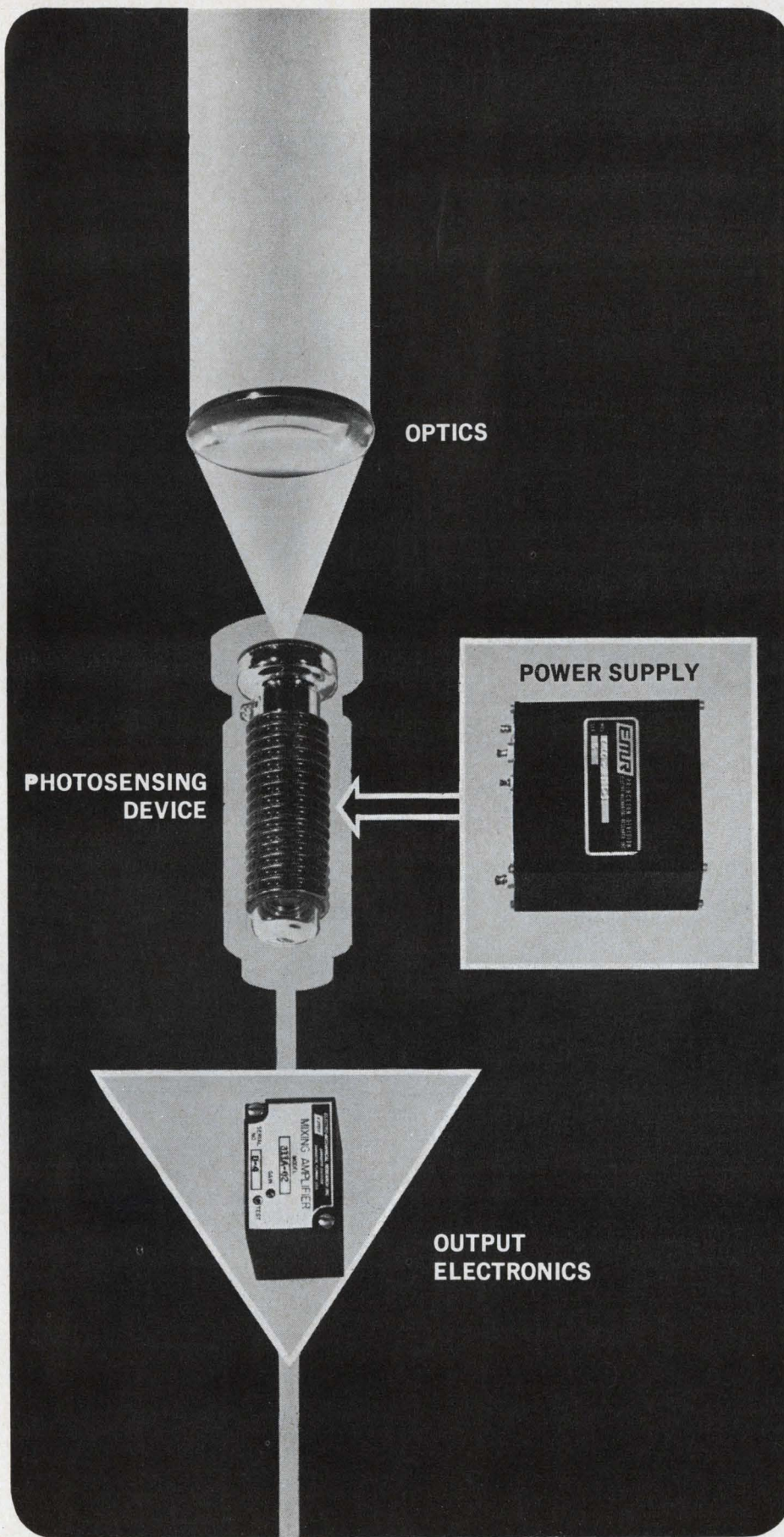

## From EMR: creative answers to photodetection problems

Research, development and manufacture of photosensing devices and systems at EMR includes:

- Multiplier Phototubes
- Electron Multipliers
- Photodiodes
- Image Converters
- Image Dissectors
- Power Supplies
- Amplifiers
- Scintillators
- Position Sensors
- Optics

For engineering answers to your photodetection problems, contact:

**Photoelectric Division**  
**Electro-Mechanical Research, Inc.**  
 P. O. Box 44  
 Princeton, New Jersey 08540

**PHOTOELECTRIC DIVISION**



Speed Inquiry to Advertiser via Collect Night Letter  
 ON READER-SERVICE CARD CIRCLE 191



**MIDGET**  
IN SIZE  
**GIANT**  
IN POWER



**TYPE LK**  
rectangular high voltage  
**CAPACITORS**

"The little one" with the tremendous power!  
4 times the life of MIL-C-25A in case sizes  
reduced up to 80%! And you also get:  
superior resistance, better power factor,  
withstands greater overloads, may be operated  
to 125°C and voltage ratings from  
600 to 500,000 volts.

Write today for Bulletin LK

Also ask for FREE pocket size  
"Comparator" and "Conversion" chart

**Plastic Capacitors, INC.**

2620 N. Clybourn • Chicago 14, Illinois  
DI 8-3735

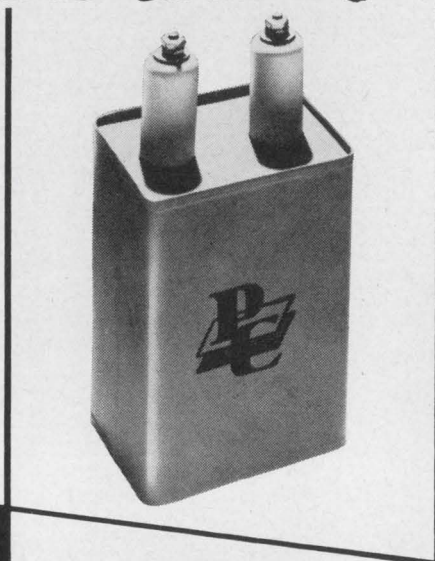

**Engineering at  
Production Prices**

ON READER-SERVICE CARD CIRCLE 192

PRODUCTION EQUIPMENT

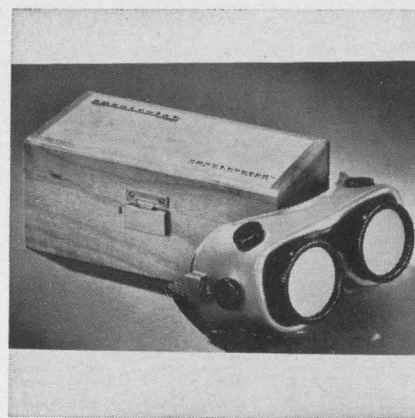

**Laser safety goggles**

These broadband-laser safety goggles protect against radiation while permitting clear viewing in normal light. The goggles contain lenses that combine two types of filter glass separated by a multilayer reflective coating. They reject ultraviolet radiation from solar simulator sources, argon laser radiation from 0.20 to 0.54 microns and reflected radiation from 0.61 to 1.25 microns.

Textron Electronics Inc., 12500  
Gladstone Ave., Sylmar, Calif.  
Phone: (213) 365-4623.

Circle No. 280

**New  
CDS Type 6C  
PHOTOCHOPPER CELLS**

- High Efficiency
- Low Temperature Coefficient
- Resistance Tolerance  $\pm 50\%$
- Internal Electrostatic Shielding
- Dumet Leads

Write for new  
4-page Bulletin  
110/170 866



**CLAIREX**

"The LIGHT Touch in Automation and Control"  
1239 Broadway, New York, N. Y. 10001  
212 MU 4-0940

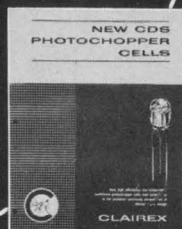

ON READER-SERVICE CARD CIRCLE 193

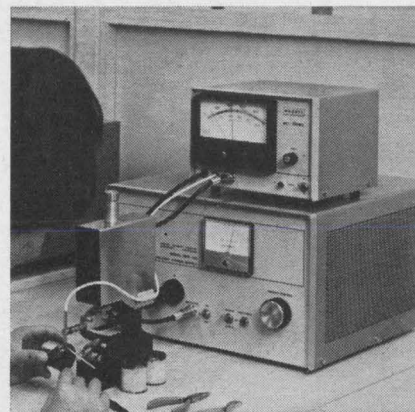

**Welding system**

Insulated wires are welded by this system. After a heated electrode melts through insulating materials, a welding current is triggered automatically. Electrode temperature is adjustable from ambient to 1,000°F. System components include a heat-protected weld head and a temperature and weld sequence-control circuit.

P&A: about \$1,195; two wks.  
Hughes Aircraft, 2020 Oceanside  
Blvd., Oceanside, Calif. Phone:  
(714) 722-2101. Circle No. 281



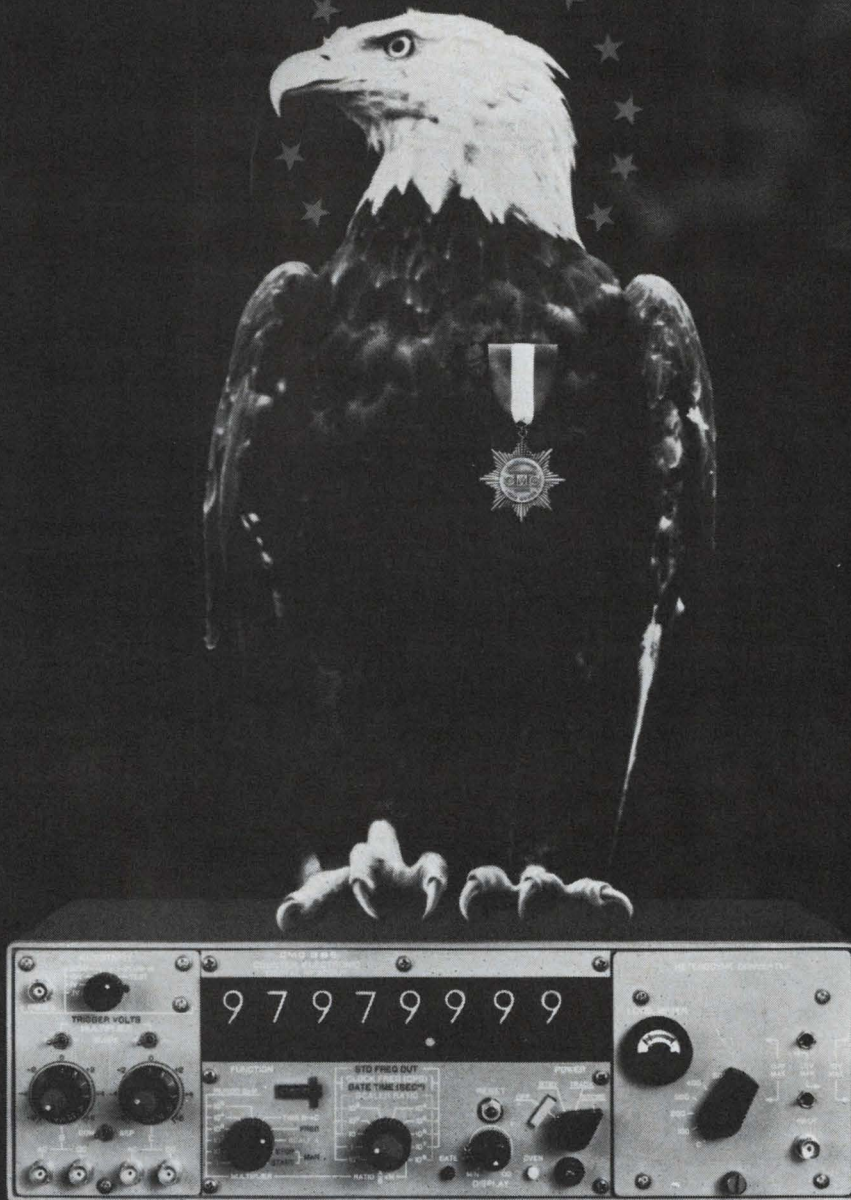

## This is where the eagle sits

Look who stepped out of the Great Seal to wear a CMC Crusading Engineers' medal. Think he looks proud? You should see us! **He's on the first and only solid-state counter fully militarized to meet Mil Specs.**

If you want the safety of a counter providing full Mil Specs reliability at a price surprisingly close to a commercial counter, then check these specs: 0 to 100 Mc frequency range; oscillator stability of 1 part in  $10^9$ ; meets or exceeds MIL-E-16400, including appropriate temperature, humidity, vibration, shock, and RFI

specs; built-in time interval measurement. Three militarized plug-ins available: 500 Mc heterodyne converter, 3 Gc heterodyne, and a 15 Gc transfer oscillator.

It may take some time, but you can probably expect copies of this counter from our creative competition at high-powered H-P and big, bad B. But they'll be copying the instrument



originated and designed by CMC. State-of-the-art development of a fully militarized solid-state counter isn't the first or last technological coup for CMC. Add to it the first all solid-state counter, first all-silicon solid-state counter, first 10-line-per-second low-cost printer, first dual plug-in counter, and numerous others. Write today for a complete spec sheet on our new Model 880 so you can compare when and if the others arrive on the market. And remember, we won't give you the bird, we'll give you a medal.

12973 Bradley • San Fernando, California • Phone (213) 367-2161 • TWX 213-764-5993

COMPUTER MEASUREMENTS COMPANY IS A LEADING DESIGNER AND MANUFACTURER OF ELECTRONIC INSTRUMENTATION TO COUNT, MEASURE, AND CONTROL.  
Speed Inquiry to Advertiser via Collect Night Letter  
ON READER-SERVICE CARD CIRCLE 194







# this is a commercial:

about commercial memory stacks. Like the one on the right, for instance.

It's one of 30 we designed and built this year for new computers. This one, as well as the 29 others, was developed by our responsive, technically talented engineering group. They're concerned solely with the design of economical, fast commercial stacks.

For most of the stacks, we used or adapted standard cores from stock. In the case of the well-arrayed model at the right, we quickly made a brand new one. That's why we have our own core-development plant, staffed by research ceramists, chemists and pilot line people. All specialists in ferrite cores.

Since 1961 we've been producing high reliability cores, stacks and memory systems for commercial, military and aerospace use, in one's and two's and production lots. For small computers, big computers, everyday computers and wayout computers.

If you're designing something new, all you have to do is tell us what you have in mind. We'll send you some cores to test and evaluate. Or, you might want an array to check out your electronics. If you're well into your design we'll build you a prototype stack. How's that for a commercial?

If you'd like a further word from our sponsor write or phone.

## **EM** electronic memories

Memory systems, stacks, and cores for commercial, military and space applications

Dept. 2E, 12621 Chadron Avenue, Hawthorne,  
California 90250, (213) 772-5201

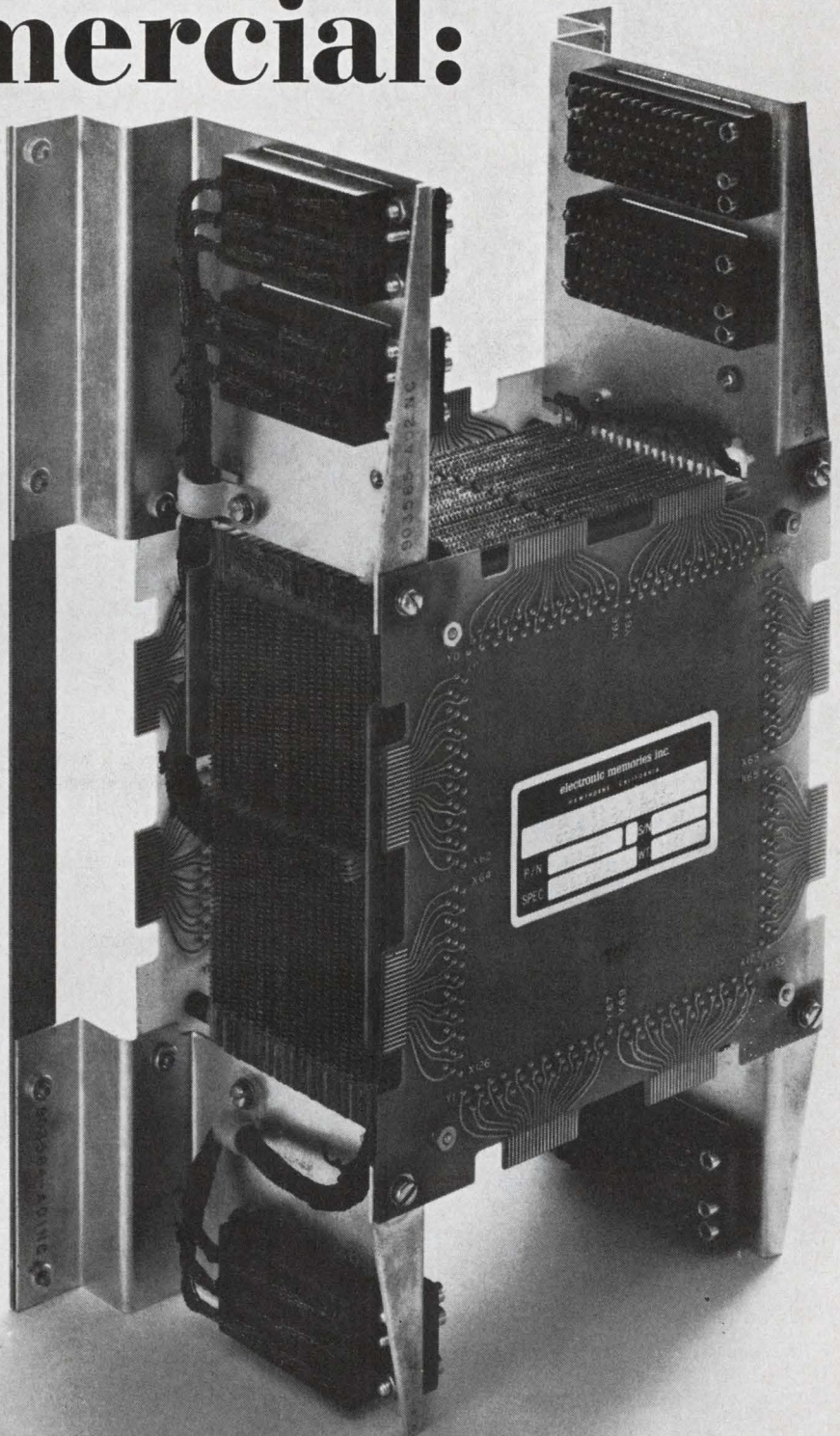



# NEW

## Cold-Weld Crystals

withstand 20g vibration  
at 10-2,000 Hz

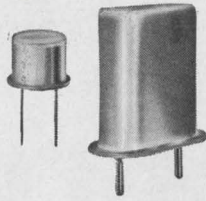

Actual Size

### TYPICAL SPECIFICATIONS

Frequency Range ... 300 to 700 KHz    Shock ..... 100g  
Holder ..... HC-6 type    Vibration .... 20g at 10-2,000 Hz

After 5,000-hour life test at 65°C,  
 $\frac{\Delta F}{F}$  less than  $2 \times 10^{-8}$  per day.

Reeves-Hoffman's high reliability cold-welded crystals meet all requirements for space programs such as Apollo and Ranger. Cold welding solves problems of damping and corrosion, permits minaturization, provides typical specifications as shown above. We invite your inquiry for complete information.



ON READER-SERVICE CARD CIRCLE 197

# FREE!

To the  
first hundred persons  
who answer this ad

## A copy of Sanders new FLEXPRINT® Circuit Design Handbook

Learn how you can cut your wiring installation costs in half and get out of the Spaghetti bind, too!

Sanders new FLEXPRINT Circuit Design Handbook gives you the complete low-down on how to beat the high installed cost of wiring. It's loaded with facts on design advantages, typical applications, mechanical and electrical considerations, layout and design of FLEXPRINT Circuits plus tips on low cost configurations.

**SANDERS ASSOCIATES, INC.**  
**Flexprint Products Division**  
CREATING NEW DIRECTIONS IN ELECTRONICS



We usually sell this book for \$2.00. But, if your name is among the first 100 inquiries we receive, we'll gladly send you a copy of the handbook free of charge. Act now, while you think of it. This informative Sanders Technical Handbook can be yours just for the asking. Write today to: Sanders Associates, Inc., FLEXPRINT Products Division, Dept. CE-2, Nashua, New Hampshire.

\*T.M., Sanders Associates, Inc.

ON READER-SERVICE CARD CIRCLE 198

# Application Notes

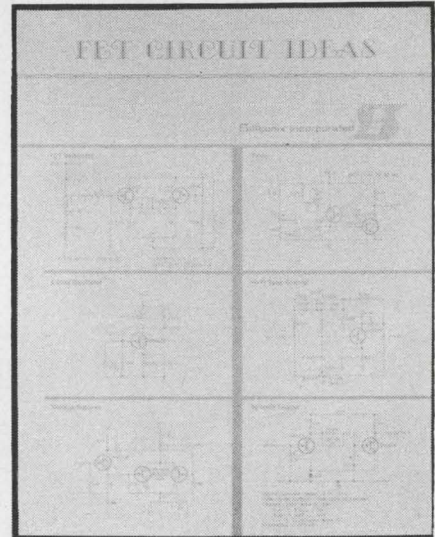

## FET circuit ideas

Fifteen FET-based circuits are detailed in this 4-page application note. All component values and types are fully specified. Circuits include timers, oscillators, amplifiers, Schmitt triggers, voltage squarers, agc circuits and flip-flops. Siliconix, Inc.

Circle No. 285

## Silicon solar cells

A 6-page application note details some basic circuits utilizing the silicon solar cell. Photoconductive, photovoltaic, energy conversion and parameter applications are discussed. Circuits include control circuits for FETs and SCRs, bias circuits, diode and relay circuits, power supplies, light level detectors and frequency doublers. Schematics and waveforms are included. Solar Systems Inc.

Circle No. 286

## Electrometer op-amp

Described in this 4-page note are applications of the electrometer op-amp as a linear or logarithmic current amplifier, current integrator or charge amplifier and impedance matching amplifier. Complete specifications, mounting details and power requirements are included. Keithley Instruments Inc.

Circle No. 287



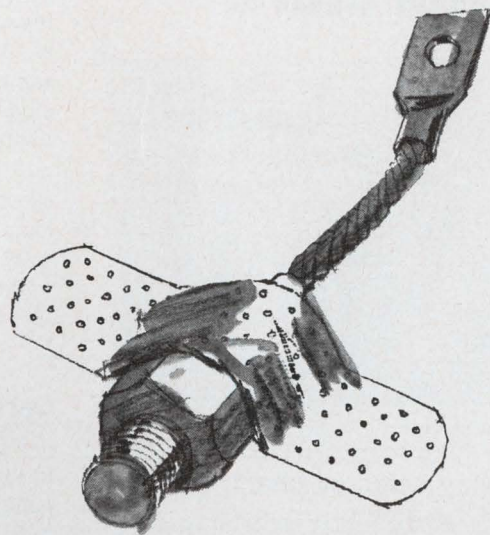

# **never needs first aid!**

**enduring toughness without special care!**

No first aid needed! Syntron Avalanche Silicon Rectifiers are tough! Designed with built-in mechanical strength where it's needed. They provide protection against voltage transients. The Avalanche Silicon Controlled Rectifier gives you the same protection plus all diffused construction which assures exceptional uniformity and stability of characteristics. You get the dependability and efficiency you need to help you meet the highest standards of reliability and top performance.

Write for Detailed Information

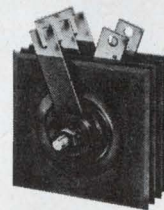

**SYNTRON**

**SYNTRON COMPANY**

283 LEXINGTON AVENUE • HOMER CITY, PA.

66R9

ON READER-SERVICE CARD CIRCLE 199



# HATHAWAY

# NO. 1 DRIREED

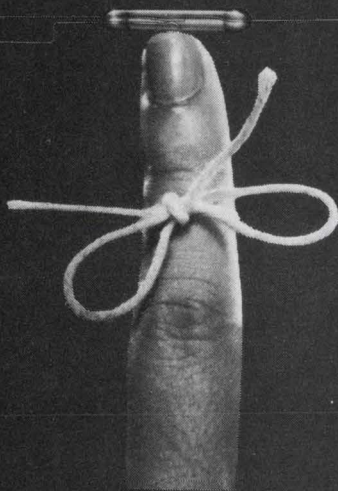

# and don't forget it

...not a scaled down single purpose telephone version  
...but a highly refined electronic switch available in 4 specific application types  
...from DC to 300 MHz and from micro amps to 500 m.a. For detail information call collect or write

**HATHAWAY INSTRUMENTS, INC.**  
5250 EAST EVANS AVENUE  
DENVER, COLORADO 80222  
(303) 756-8301 • TWX 292-2935

## New Literature

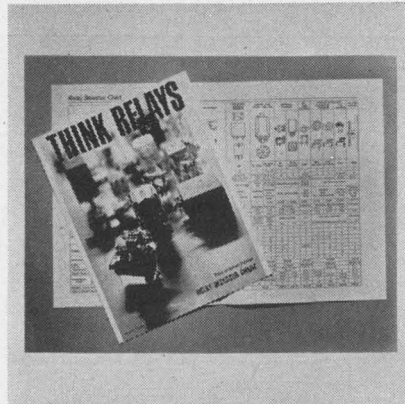

### Relay selector chart

A 4-page relay selector chart is designed to quickly give necessary technical information on miniature general purpose, general purpose, program, bistable, time delay and telephone relays. Timers and dc contactors are also covered. Cornell-Dubilier.

Circle No. 288

### Thermosetting laminates

A line of thermosetting laminates is described and pictured in this brochure. The line includes phenolic, polyester, silicone, melamine and epoxy resin systems, in combination with cotton, Dacron, asbestos, glass or paper base materials. Recommended applications, as well as mechanical, physical and electrical properties are listed in tabular form for the different grades of products, which come in sheets, tubing, rods, angles, channels, zees and other molded shapes. Westinghouse Electric Corp., Industrial Micarta Div.

Circle No. 289

### Transistor catalog

For use by product engineers as well as purchasing agents, this 12-page catalog boasts a complete pricing schedule. Every 2N epitaxial mesa and planar, Philco-type germanium, silicon alloy, silicon alloy diffused, silicon epitaxial, and germanium and silicon consumer-entertainment type transistor in the catalog is listed in numerical order with prices given in quantities of 1-99, 100-999 and 1000-up. Lansdale Transistor and Electronics, Inc.

Circle No. 290

### Trimmer catalog

Microminiature and miniature trimmer resistors are described in this 12-page catalog. Detailed drawings show dimensions of single and 2-, 3-, or 4-trimmer devices on the same substrate. Specifications include voltage ratings, temperature coefficient, aging and other information as well as usual resistance specifications. The catalog includes examples of complete resistive networks that can be obtained fired on the same ceramic baseplate. Centralab, Globe-Union Inc.

Circle No. 291

### Ceramic capacitors

This 12-page, loose-leaf catalog describes complete lines of high-capacitance, microminiature rectangular and tubular ceramic capacitors. Electrical, environmental and physical characteristics, including tolerances for each style are given. Applicable MIL-SPECs are also called out. Typical characteristic curves are given for: capacitance change vs temperature, IR  $M\Omega-\mu F$  vs temperature, dissipation factor vs frequency, dissipation factor vs temperature and capacitance change vs frequency. U.S. Capacitor Corp.

Circle No. 292

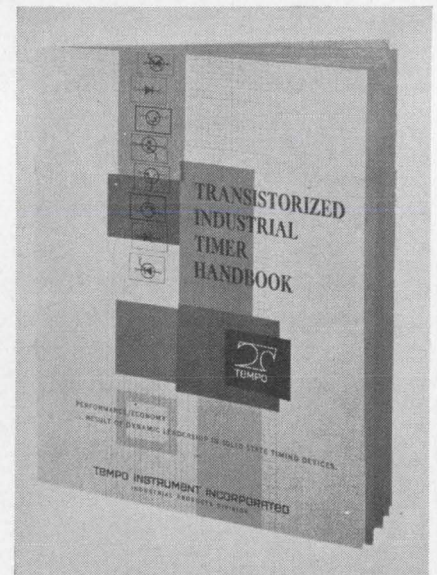

### Transistorized timer

Operation, capabilities and applications of the transistorized timer are detailed in this 20-page handbook. Solid-state timer fundamentals are given as well as specifications and a glossary of terms. Tempo Instrument Inc.

Circle No. 293



# CLIFTON

## steps in to the Stepper Motor field

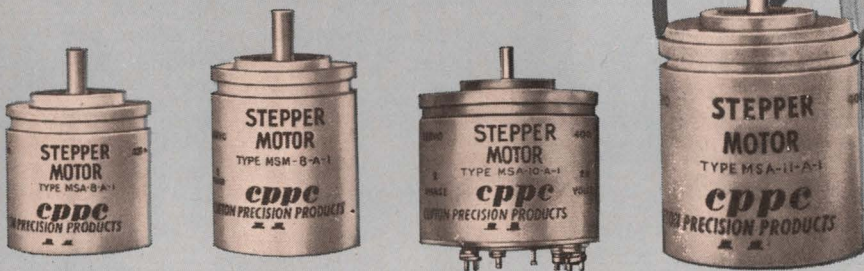

### CLIFTON STEPPER MOTORS

SIZE	8	10	11	11	8	8	8	11	8	15
LENGTH (M.F.)	0.770	0.770	1.215	1.215	1.062	1.112	0.770	1.215	1.062	1.535
WEIGHT (OZ.)	1.0	1.6	3.2	3.2	1.5	1.5	1.0	3.2	1.5	6.4
INERTIA (GM-CM <sup>2</sup> )	0.19	0.19	0.77	0.37	0.18	0.45	0.19	0.77	0.10	2.4
INDEX ANGLE	90° ±3°	90° ±3°	90° ±3°	15° ±1°	90° ±3°	90° ±3°	45° ±2°	45° ±2°	15° ±1°	90° ±3°
TYPE	PM 2∅	PM 2∅	PM 2∅	VR 3∅	PM 2∅	PM 2∅	PM 2∅	PM 2∅	VR 3∅	PM 2∅
RATED D.C. VOLT.	28V	28V	28V	28V	28V	28V	28V	28V	28V	28V
RESISTANCE (OHMS/PHASE)	300	300	300	150	300	300	135	130	150	150
NO LOAD RESPONSE RATE PULSE/SEC	320	350	185	600	360	280	500	440	950	150
NO LOAD SLEW RATE PULSE/SEC	930	700	190	1600	375	650	2700	1200	1800	150
HOLDING TORQUE OZ-IN ONE PHASE	0.35	0.50	1.4	0.60	0.80	0.58	0.60	1.5	0.54	3.2
DETENT, OZ-IN ZERO INPUT	0.05	0.05	0.24	—	0.17	0.10	0.05	0.12	—	0.8
TYPE NUMBER	MSA-8-1	MSA-10-A-1	MSA-11-A-1	RSA-11-A-1	MSM-8-A-1	MSL-8-A-1	MSA-8-A-3	MSA-11-A-2	RSA-8-A-1	MSA-15-A-1

EXCITATION MODE: TWO PHASES PARALLELED ALTERNATELY. TYPICAL CHARACTERISTICS

After careful testing and having already had units in end-use equipment in the field, we are now ready to announce a full line of size 8, 10 & 11 stepper motors and the controllers that go with them.

Steppers are gaining popularity rapidly in digital systems because of their quick response, high resolution, and many other distinct advantages over the con-

ventional servo motor.

We'd like to step in to your stepper motor picture with Clifton Precision quality, reliability and application knowledge.

Clifton Precision Products, Division of Litton Industries, Clifton Heights, Pa., Colorado Springs, Colo. Area 215 622-1000; TWX 510 669-8217.

*cppe*

**CLIFTON** PRECISION PRODUCTS  
DIVISION OF LITTON INDUSTRIES





# FREE

## with every **EMC-10 RFI/EMC METER**

- AN AUDIO WAVE ANALYZER—  
20 Hz-50 KHz—with optional built-in  
electronic frequency scanning
- A FREQUENCY SELECTIVE  
VOLTMETER—  
with 40 DB meter display
- A VLF RECEIVER—  
with .003 microvolts sensitivity
- A SIGNAL GENERATOR  
for checking network or filter trans-  
missibility ratios
- A LOW-NOISE AUDIO  
AMPLIFIER—  
response to 20, 50 and 500 KHz

**ALL THESE — AND MORE —  
ARE IN THE EMC-10!**

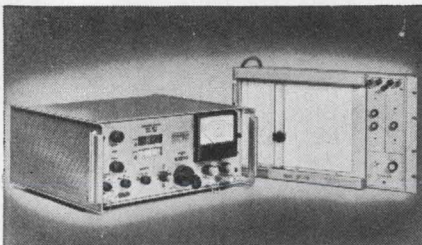

Model EMC-10E with optional EXY-125 Plotter.

A modern shielded solid-state unit, operating from its self-contained rechargeable battery, or external AC or DC. Minimum internal noise and maximum sensitivity... approximately 3 nanovolts in its 5-Hz bandwidth position. Can be remotely tuned, manually or by electronic sweep, over the complete 20 Hz to 50 KHz spectrum. Satisfies the most stringent RFI/EMC specifications. Deliveries from stock.

## FAIRCHILD

**ELECTRO-METRICS  
CORPORATION**  
A SUBSIDIARY OF FAIRCHILD CAMERA AND INSTRUMENT CORPORATION

68 CHURCH ST., AMSTERDAM, NEW YORK 12011  
ON READER-SERVICE CARD CIRCLE 203

### NEW LITERATURE

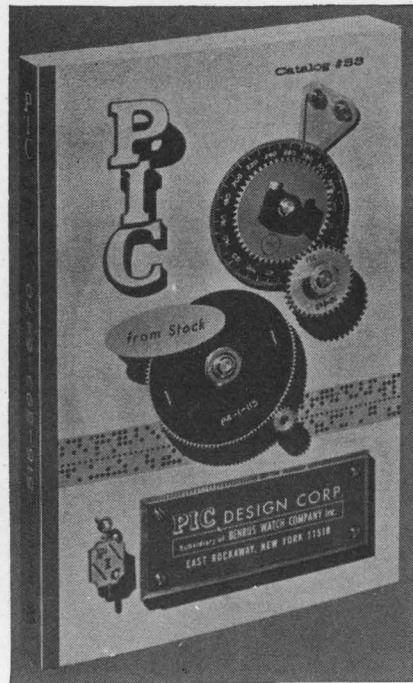

#### Component catalog

More than 25,000 stock precision instrument parts and components are listed in this 528-page handbook. It contains drawings, specs and prices plus technical information, charts and tables. In addition, the company's positive drive belts and geared pulleys are described. PIC Design Corp.

Circle No. 294

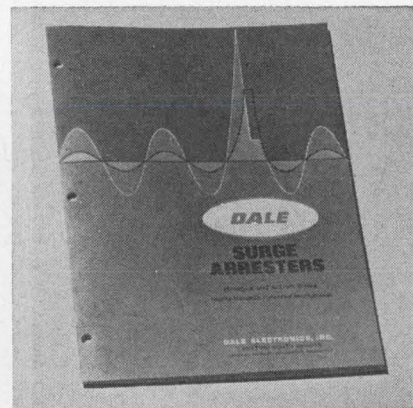

#### Surge arresters

Complete mechanical and electrical specifications for magnetic surge arresters are featured in this brochure. Both dust-sealed and hermetically sealed models are described and complete drawings of various case configurations and mounting accessories are included. Dale Electronics.

Circle No. 295

#### Relay booklet

Information on hermetically sealed relays, contractors, and control switches that meet or exceed MIL specs is given in this 16-page bulletin. Included are descriptions, drawings, specs and photographs of these components. A number of the dc relays shown in the catalog can be manufactured for ac operation up to 400 Hz. Guardian Electric Manufacturing Co.

Circle No. 296

#### Vacuum capacitors

This 44-page vacuum capacitor catalog describes physical and electronic characteristics in detail. The book also contains several pages of application notes for design purposes. ITT Jennings Radio Mfg. Corp.

Circle No. 297

#### Electroplating guide

This guide lists all electroplating and physical data for gold, rhodium, palladium, platinum, silver and nickel. Included are plating costs, amount of metal used and plating times, as well as the physical and chemical properties of the electrodeposits. Technic, Inc.

Circle No. 298

#### Connectors and adapters

Features and installation of connectors and adapters for use with shielded and coaxial cable are described in this illustrated 20-page brochure. A selector chart for shielded and coaxial cable is also presented. The chart offers a list of cable designations, both inner and outer connectors, as well as installing tools for the various products. Catalog numbers are listed. Thomas & Betts Co.

Circle No. 299

#### Wire and cable terminology

A 63-page glossary of wire and cable terminology lists alphabetical common terms, expressions and units used in the electrical wire and cable industry. The pocket-sized reference is intended for engineers, designers, technicians and purchasing personnel. Standard Wire and Cable Co.

Circle No. 300



# Thump...Thump...Thump...Thump...Thump...Thump...

The incredible Pacemaker keeps hesitant hearts beating steadily with tiny electrical impulses. Plus an assist from the reliability of KEMET solid tantalum capacitors.

In this life-or-death situation, the obvious need is for reliability. Our High-Reliability capacitors meet the stringent performance requirements of the Pacemaker specifications. That's because these capacitors have accurately predictable failure rates, established through special accelerated test



techniques (which we'll be glad to describe in detail for you, if you wish).

KEMET Graded Reliability capacitors range from 0.0047 to 330 microfarads, 6 to 100 VDC, for use from -55 to +125° C. Available failure ratings are as low as 0.001% per thousand operating hours. Standard tolerances are 5 and 10% with lower tolerances on request.

When capacitors must not fail: KEMET Graded Reliability solid tantalums. Mail the coupon for details.

Clip, fill in name and title, attach to letterhead.

Union Carbide Corporation  
Electronics Division, Dept. ED-94  
270 Park Avenue, New York 10017

Please send details on High-Reliability  
KEMET Solid Tantalum Capacitors

Name \_\_\_\_\_

Title \_\_\_\_\_



REGIONAL SALES OFFICES. East Coast: J. G. Egan, 1341 Hamburg Turnpike, Wayne, New Jersey 07472. Phone: 201-696-2710. Mid-Atlantic: R. H. Robecki, 1341 Hamburg Turnpike, Wayne, New Jersey 07472. Phone: 201-696-2710. Mid-West and South: K. S. Collart, P.O. Box 6087, Cleveland, Ohio 44101. Phone: 216-221-0600. West Coast: D. A. Purcell, 701 East Whittier Blvd., Whittier, California 90605. Phone: 213-698-8077.  
KEMET is a registered trade mark of Union Carbide Corporation.

ON READER-SERVICE CARD CIRCLE 204



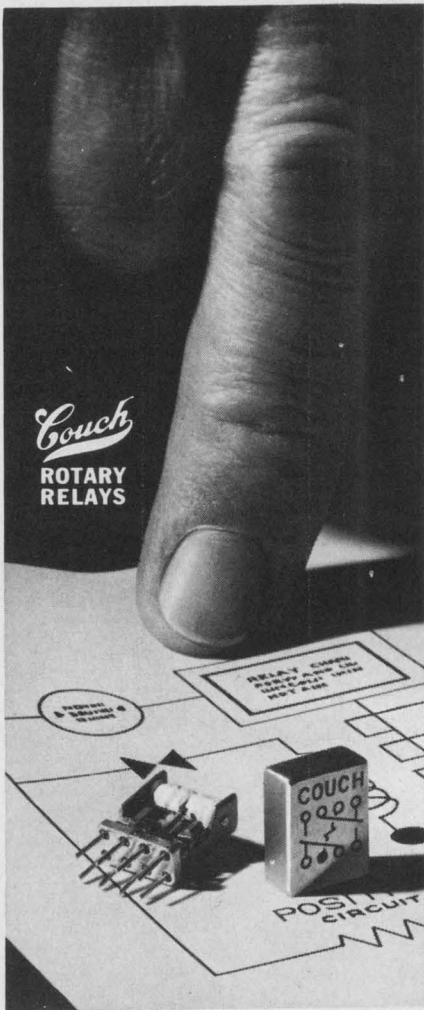

## Cramped for space?

### Use Couch 1/7-size Relays

Space/weight problem? The new Couch 2X 1/7-size crystal can relay gives you tremendous savings in space and weight. 0.1" grid — plus many outstanding specs — *all in micro-miniature*. Thoroughly field-proven in electronics and space applications.

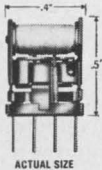

	2X (DPDT)	1X (SPDT)
Size	0.2" x 0.4" x 0.5"	same
Contacts	0.5 amp @ 30 VDC	same
Coil Operating Power	100 mw 150 mw	70 mw 100 mw
Coil Resistance	60 to 4000 ohms	125 to 4000 ohms
Temperature	-65°C to 125°C	same
Vibration	20 G	same
Shock	75 G	same

Broad choice of terminals, coil resistances, mounting styles. Write for detailed data sheets.

RUGGED ROTARY RELAYS  Dynamically and Statically Balanced

## COUCH ORDNANCE INC.

3 Arlington St., North Quincy, Mass. 02171, Area Code 617.  
CYPRESS 8-4147 • A subsidiary of S. H. COUCH COMPANY, INC.

ON READER-SERVICE CARD CIRCLE 205

## NEW LITERATURE

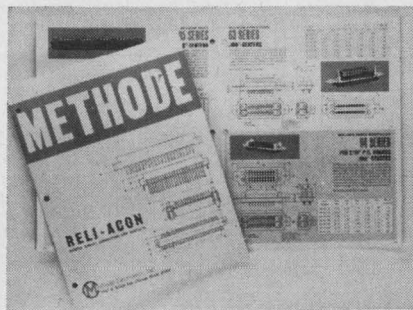

### PC connectors

A 20-page, full-color catalog contains photographs, ratings, and engineering drawings describing connectors and fork contacts for industrial and military specifications. Sizes and materials are explained and application data is provided. Methode Electronics, Inc.

Circle No. 301

### Plating on plastics

All aspects of plating on plastics are covered in this 8-page brochure. The bulletin gives detailed operating data on each step of both an electroless copper and nickel process. Advantages and limitations of each process are discussed. Enthone Inc.

Circle No. 302

### Plastic coated cable

This 4-page brochure presents findings of an investigation of various thermoplastic jackets on steel cable. Designed to provide users of plastic coated cable with a guideline to the selection and use of plastic jackets for specific applications, the data presented is based on more than 800 million test cycles. The brochure charts cable fatigue life for both plastic coated and bare cable. In addition, plastic life expectancy under varying temperature conditions is given for seven different types of plastic jackets. Long term chemical resistance for both plastic coated and bare cable is charted for some 25 environmental conditions. Basic dimensions such as standard cable constructions, breaking strengths and diameters over the jacket are shown. A basic information table provides data on cut-through resistance, abrasion resistance and relative plastic costs. Bergen Wire Rope Co.

Circle No. 303

## High selectivity and stability

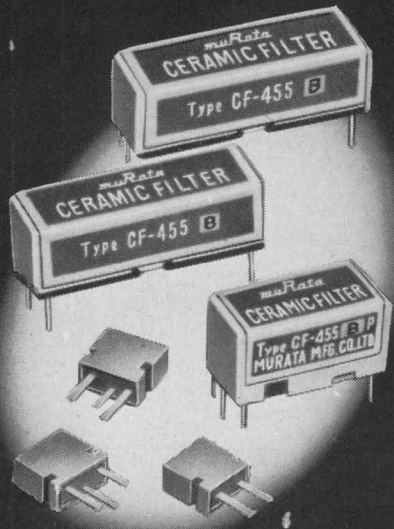

*muRata*

## CERAMIC FILTER

Murata ceramic filters include the series type, the by-pass type and ladder type.

These filters are compact, require no alignment or tuning, remain perfectly flat regardless of temperature changes and stay in A-1 operating condition for years. And they're designed to provide effective operation beyond the scope and capacity of IFT.

Write today for detailed information to:

## MURATA MFG. CO., LTD.

Nagaoka, Kyoto, Japan  
Cable Address: MURATA KYOTO

MURATA CORP. OF AMERICA  
440 Park Avenue South, New York  
N.Y. 10016

ON READER-SERVICE CARD CIRCLE 206



### Laminated plastic catalog

A 14-page illustrated catalog incorporates technical data and specifications on various types and grades of laminated material. Featured are a series of charts and tables listing major properties and data on NEMA and MIL-SPEC designations, standard sizes, tolerances and mechanical and physical properties. The catalog gives detailed information on copper-clads for printed circuitry and multilayer epoxy glass laminates. Thiokol Chemical Corp.

Circle No. 304

### Adhesive bonding aluminum

Thirty-two adhesive bonding applications including radar reflectors and coil connectors are presented in this 96-page book. Basic technology pertaining to the adhesive bonding of aluminum with the accent on structural applications is given. Tables of adhesive properties and studies of typical applications are included. Reynolds Metals Co.

Circle No. 305

### High-alumina ceramics

This technical report on high-alumina ceramics and their applications in the electrical, electronic, electromechanical and wear fields is offered. Comparative properties of the manufacturer's ceramics are summarized in a table listing a range of values for four material classifications. Details about tolerances, threads, glaze, configuration and other design information are discussed as an aid to the understanding and specifying of ceramic components. Critical uses and characteristics are described and illustrated. The 8-page report is titled "How You Can Use Diamonite High Alumina Ceramics In Your Products." Diamonite Products Mfg. Co.

Circle No. 306

### Magnetic shielding material

An 8- x 10-inch sample of "Hiper-nom" shielding material is included in this 4-page booklet. The thin-gauge foil is designed as shielding material around transformers, reactors, CRT cables, miniature tubes and other devices. Westinghouse, Materials Mfg. Div.

Circle No. 307

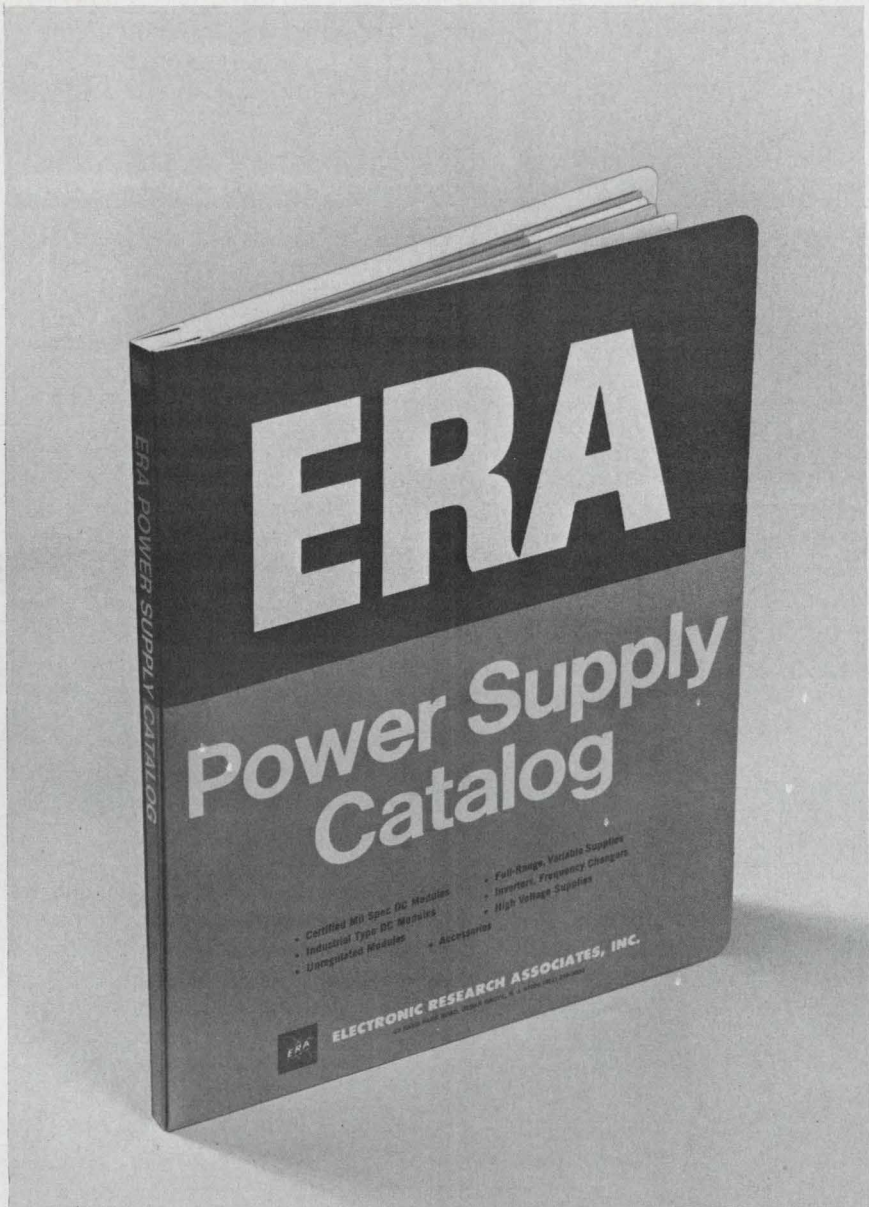

# Buying Power?

Here's the new, single source for all your power needs.

- Certified Mil Spec Transpac® DC Modules
- New Low-Cost Silicon Transpac DC Modules
- Full-Range Variable Supplies
- Inverters, Frequency Changers
- High-Voltage Supplies

**AC to DC • DC to AC • AC to AC • DC to DC**



Send for Your Free Copy TODAY!

**ELECTRONIC RESEARCH ASSOCIATES, INC.**

Dept. ED-9, 67 Sand Park Road, Cedar Grove, N. J. 07009 • (201) 239-3000

SUBSIDIARIES: ERA Electric Co. • ERA Acoustics Corp. • ERA Dynamics Corp. • ERA Pacific, Inc.

ON READER-SERVICE CARD CIRCLE 207



# Design Data from Manufacturers

Advertisements of booklets, brochures, catalogs and data sheets. To order use Reader-Service Card.

(Advertisement)

## Automatic Dual In-Line Package Insertions



Now a commercial reality—high speed, high reliability mechanized insertion of single type and programmed sequences of dual in-line modules. Universal can supply DIP insertion systems for full-scale printed circuit board assembly at rates up to 3000/hr. New technical bulletin describes both pantograph and N/C machines with single, 2, 4, 8 or 16 separate magazines. Also complete specifications and PC board design guidelines. Important educational reference for design and assembly engineers.

**Universal Instruments Corporation**  
East Frederick Street  
Binghamton, New York

**171**

## How To Write Technical Articles



A guide for the engineer-author, "How to Write Articles for Electronic Design" shows how easy it is to write for publication—once the engineer knows what to write and how to write it. The Author's Guide includes a complete run-down of the types of articles published by Electronic Design—plus detailed instructions on how to prepare technical articles and short special features. A MUST for every "would-be-writer" in the electronics industry. Send for your complimentary copy by circling the number to the right.

**Electronic Design**  
850 Third Avenue  
New York, N.Y. 10022

**172**

## Books For The Electronics Engineer

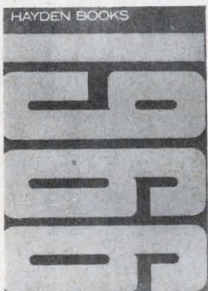

The 1966 Hayden Book Company, Inc., catalog contains such new titles as "Microelectronic Design," "100 Ideas for Design '66," "The Electron in Electronics," "Synthesis of RC Networks with Arbitrary Zeros," "Transistor and Diode Network Calculations," and "Matrix Algebra for Electronic Engineers." As well as the expanded list for design engineers, the catalog includes Hayden and John F. Rider Publisher training texts at all levels. Send for your free catalog today.

**Hayden Book Company, Inc.**  
116 West 14th Street  
New York, N. Y. 10011

**173**

## NEW LITERATURE

### Teflon tapes and film

A 4-page fact sheet describes the several manufacturing methods employed in the fabrication of the Teflon tape, sheet and film. Photomicrographs and diagrams develop a clear picture of the subtle differences between the three different methods available, and how these processes effect the mechanical and electrical parameters of the final products. The brochure offers an insight into which type of Teflon tape, sheet or film is suitable for a particular application. Dilectrix Corp.

Circle No. 308

### Materials brochure

Ultra-high purity metals, single crystals, fabricated pure metals and alloys are described in this brochure. Information on precision doping, custom alloying and X-ray services is included. The 6-page bulletin features a metal selector chart which gives a complete listing of materials, their available forms, typical mass spectrographic analysis and complete interstitial analysis. Materials Research Corp.

Circle No. 309

### Subscription Policy

ELECTRONIC DESIGN is circulated free of charge to qualified design engineers in the U.S., Western European Continent and Britain. To establish your qualifications, send ELECTRONIC DESIGN the following information on your company's letterhead: Your name, engineering title, description of your design duties and a list of your company's major products. The letter must be signed by you personally.

Subscription rates for nonqualified subscribers—\$25 a year in the U.S., \$35 in all other countries. Single copy, \$1.50.

### Change of Address

A subscriber's change of address requires a restatement of his qualifications. To expedite the change, and to avoid missing any issues, send along a label from a back copy.

### Microfilm Copies

Microfilm copies of all 1961, 1962, 1963, 1964 and 1965 issues of ELECTRONIC DESIGN are available through University Microfilms, Inc., 313 N. First Street, Ann Arbor, Mich.



# HAYDEN BOOKS FOR DESIGN

## Advertising Representatives

**New York 10022**  
Robert W. Gascoigne  
Thomas P. Barth  
Samuel M. Deitch  
Richard W. Nielson  
850 Third Avenue  
(212) PLaza 1-5530  
TWX: 867-7866

**Philadelphia 19066**  
Fred L. Mowlds, Jr.  
P. O. Box 206  
Merion Station, Pa.  
(215) MO 4-1073

**Marblehead 01945**  
Richard Parker  
7 Redstone Lane  
(617) 742-0252

**Chicago 60611**  
Thomas P. Kavooras  
Berry Conner, Jr.  
720 N. Michigan  
(312) 337-0588

**Cleveland 44107**  
Robert W. Patrick  
8410 Treetower Drive  
Chagrin Falls, Ohio  
(216) 247-7670

**Los Angeles 90303**  
Stanley I. Ehrenclou  
Terrence D. Buckley  
W. James Bischof  
2930 W. Imperial Highway  
Inglewood, Calif.  
(213) 757-0183

**San Francisco**  
Ashley P. Hartman  
175 South San Antonio Rd.  
Ste. 243  
Los Altos, Calif. 94022  
(415) 941-3084

**Southwestern 75206**  
Tommy L. Wilson  
6200 North Central Express-  
way  
Dallas, Tex.  
(214) EMerson 1-2311

**London W. 1**  
Brayton C. Nichols  
44 Conduit Street

**Tokyo**  
Yoshihiro Takemura  
International Planning  
Service, Inc.  
Room 231 Tokyu-Mita Bldg.  
1, Shiba-Mita Koun-cho  
Minato-ku, Tokyo

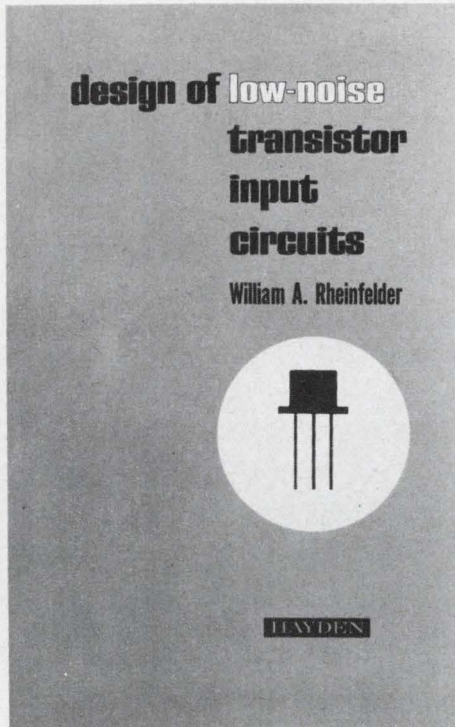

## Design of Low-Noise Transistor Input Circuits

WILLIAM A. RHEINFELDER

A unique and comprehensive exposition for the practical circuit designer. A multitude of graphs and curves directly applicable to modern design problems provide clear and easily understandable insights into low noise fundamentals. Special features of this book which make it a valuable reference and supplementary text include a generalized approach to the noise theory and specific treatment of three distinct design variables involving equal spectral density for both sign and noise, uneven noise distribution, and nonuniform signal distribution.

CHAPTERS: The Noise Figure Concept. The Measurement of Noise Figure. Noise of Spectral Discontinuity. Tube and Transistor Noise. Design of Practical Circuits Above Approximately 100 Mc. The Design of Front Ends of Receivers to Approximately 100 Mc. Low Noise Audio Design. Typical Low-Noise Circuits. Appendices.

**128 pages Illustrated Clothbound, \$5.50 Paperbound, \$3.95**

Dept. ED-84, HAYDEN BOOK COMPANY, INC. 116 W. 14 St., N.Y., N.Y. 10011

Please send me "Design of Low-Noise Transistor Circuits" for a 10-day Free Examination period. At the end of ten days I will remit payment plus postage or return the book. I would like the version checked below.

#5014, Clothbound, \$5.50

#5013, Paperbound, \$3.95

Name \_\_\_\_\_ Title \_\_\_\_\_

Company \_\_\_\_\_

Address \_\_\_\_\_

City \_\_\_\_\_ State \_\_\_\_\_ Zip \_\_\_\_\_

Check if payment enclosed. Publisher pays postage, with same return guarantee. (Foreign orders, except Canada, must include payment in \$ U.S.)



**AMERICAN BUSINESS PRESS, INC.**



**PORTABLE TYPE  
32MHz FREQUEN-  
CY COUNTER  
-TR- 3666 GIVES  
INSTANT AND  
HIGH MEASURING  
ACCURACY**

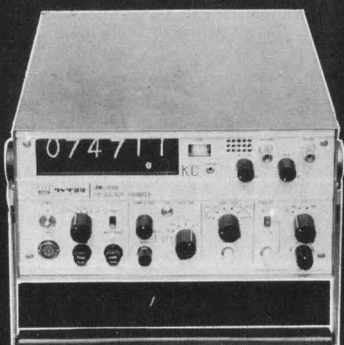

■ Greater portability ■ Compact—12.0" wide × 6.0" high × 14.6" deep  
■ Lightweight—24.5 lbs ■ Durable  
■ Power—DC 12/24V and AC 115 V ■ Withstands use under rugged conditions ■ Low power consumption—34 W ■ Built-in power line noise filter ■ Built-in WWV receiver—5/10MHz ■ High input sensitivity—50mV rms/min ■ High degree of measuring accuracy available instantly. No waiting for crystal oscillator oven temperature to build up.

**Specifications:**

□ Range: 10Hz to 32MHz □ Input Sensitivity: 50mV rms minimum, 140mV rms maximum □ Accuracy: ± 1 count ± time base accuracy  
□ Registrations: 6 digits in-line digital display tubes with display storage □ Time Base Accuracy:  $1 \times 10^{-7}$  or less adjustable after calibrated by WWV □ WWV Receiver: Sensitivity: 3 $\mu$ V, 5MHz and 10 MHz optional changeover  
□ Power Requirements: DC 24V ± 4V, approx. 24W; DC 12V ± 2V, approx. 36W; AC 100V ± 20V, approx. 34W □ Operating Temperature Range: -10°C ~ +50°C  
□ Weight: Net 24.5 lbs □ Dimensions: 12" wide, 6" high, 14.6" deep

See for yourself by visiting Booth No. 158, WESCON/66, Hollywood Park, Los Angeles

For further details, write to:

**Takeda Riken Industry Co., Ltd.**

285, Asahi-cho, Nerima-ku, Tokyo, Japan  
Cables: TRITRONICS TOKYO Phones: 930-4111

# Advertisers' Index

## \*PARTICIPANTS IN NIGHT LETTER PROGRAM

Advertiser	Page	Advertiser	Page
*AMP, Incorporated	149	Hewlett-Packard, Sanborn Division	99
Acoplan Corp.	33	Hoffman Semiconductor Division, A Division of Hoffman Electronics Corporation	161
Adams & Westlake Company, The	123	*Honeywell, Computer Control Division	30
Aerovox Corporation	43	Honeywell Test Instruments Division	106
*Agostat Timing Instruments, Elastic Stop Nut Corporation of America	120	*IRC, Inc.	6, 139
Alco Electronic Products, Inc.	162	Industrial Electronic Engineers, Inc.	138
Allen-Bradley Co.	32 A-B	*International Rectifier Corp.	29
Allied Radio Corp.	128 A-B	*JFD Electronics Co./Components Division	79
American Enka Company, Brand-Rex Division	107	Lambda Electronics Corp.	4, 5
Amperite	130	Littlefuse	150
Analog Devices, Inc.	48	*Magnetics, Inc.	143
Automatic Electric, A Subsidiary of General Telephone & Electronics	36, 37	Mallory Controls Company	128
Babcock Relays, A Division of Babcock Electronics Corporation	153	Marco-Oak Industries/Division of Oak Electro/Metric Corp.	132
*Ballantine Laboratories, Inc.	131	Method Electronics, Inc.	164
*Beckman Instruments, Inc., Helipot Division	141	*MicroSwitch, A Division of Honeywell Monsanto Chemical Company, Electronics Department	72, 73
Bell Telephone Laboratories	137	*Motorola Semiconductor Products, Inc.	7, 41
Bendix Corporation, The, Semiconductor Division	19	Murata Mfg. Co. Ltd.	178
Blue M Electric Company	162	Nexus Research Laboratory, Inc.	124
Boston Technical Publishers, Inc.	15	Nytronics, Inc.	184
*Bourns, Inc.	109	Oak Manufacturing Co.	112 A-B
Bunker-Ramo Corporation, The	140	*Philco, Microelectronics Division	163
Burdny Corporation	155	Plastic Capacitors, Inc.	168
Burton Silverplating Company	40	*Potter & Brumfield Division of American Machine & Foundry Company	96
C&K Components, Inc.	166	Pyrofilm Resistor Co., Inc.	91
CML, Inc.	158	RCA Electronic Components and Devices	8, 9, 127, 129 Cover IV
*Cambridge Thermionic Corporation	146	Raytheon Company, Industrial Components Division	159
Cedar Engineering Division, Data Control Corporation	146	Reeves Hoffman Division of DCA	172
Chassis-Trak Inc.	160	Robinson Technical Products Inc.	170
Clairex Corporation	168	Sanders Associates, Inc.	172
ClaroStat Mfg. Co., Inc.	115	Sealectro Corporation	42
Clifton Precision Products, Division of Litton Industries	175	Sigma Instruments, Inc.	144, 144 A-B, 145
Cohu Electronics, Inc.	121	Silicon Transistor Corporation	133
*Computer Measurements Company	169	Sorensen Operation, Raytheon Company	16
Control Logic, Inc.	105	*Spectrol Electronics Corporation	122
*Corning Glass Works	84, 85	Sprague Electric Company	10, 20
Couch Ordnance, Inc.	178	*Standard Condenser Corporation	154
Crydom Laboratories, Inc.	112	Switchcraft, Inc.	142
Cutler-Hammer, Inc.	95	Syntron Company	173
*Dale Electronics, Inc.	Cover III	*Systron-Donner Corporation	12
Datapulse, Division of Datapulse, Incorporated	2	TWR Semiconductors	46
Deutsch Electronic Components Division	44, 45	Takeda Riken Industry Co. Ltd.	182
*Digital Equipment Corporation	35	Techno-Components Corp.	150
*Dow Corning Corporation	92, 93	Tektronix, Inc., Oscilloscopes	147
*Electro-Mechanical Research, Inc.	167	Telonic Industries, Inc.	111
Electro-Motive Mfg. Co.	135	Telrex Laboratories	158
Electro Nuclear Laboratories	154	Tenney Engineering, Inc.	152
Electro Scientific Industries, Inc.	165	Texas Instruments Incorporated, Semiconductors-Components Division	68, 69
Electronic Development Corporation	156	Thomas & Skinner, Inc.	113
Electronic Design	183	Tracor, Inc.	157
*Electronic Memories, Inc.	171	Union Carbide Corporation, Electronics Division	177
Electronic Research Associates, Inc.	179	Universal Instruments Corp.	180
Fairchild Electro-Metrics Corporation	176	Velonex, A Division of Pulse Engineering Inc.	134
Fairchild Semiconductor, A Division of Fairchild Camera and Instrument Corporation	25	Wayne-Kerr Corporation	26
Firing Circuits, Inc.	38	Westamp, Inc.	166
*Fluke Mfg. Co., Inc., John	39	Westinghouse Molecular Electronics Division	97
General Electric Company, Electronic Components, Sales Operation	48 A-B	Career Advertising: Motorola Military Electronics Division	118
General Radio Company	1	Weston Instruments, Inc.	119
Giannini Voltex	136		
Globe Industries, Inc.	148		
Gudebrod Bros. Silk Co., Inc.	151		
Harowe Servo Controls, Inc.	34		
Hathaway Instruments, Inc.	174		
Hayden Book Company, Inc.	181		
Hewlett-Packard	Cover II, 23		



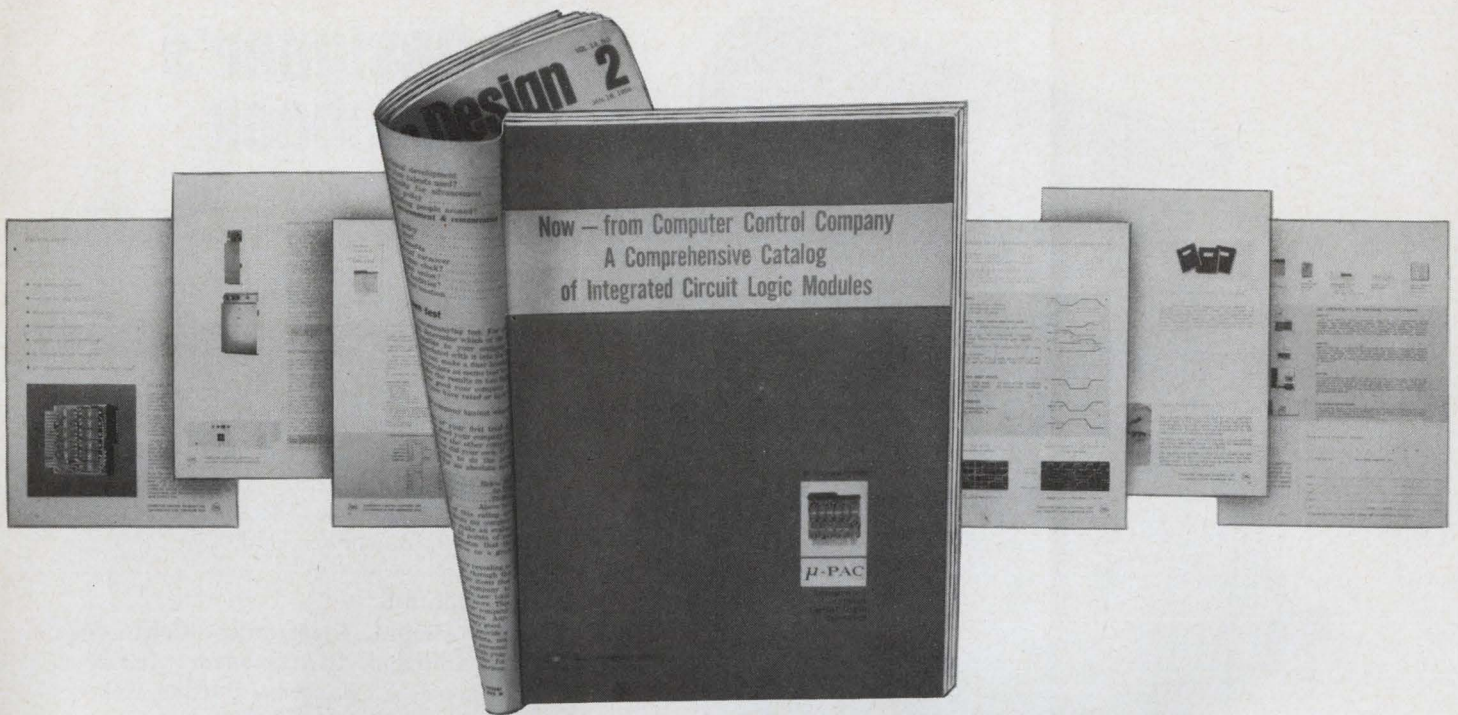

# "orders zoomed 250%"



William F. Taylor  
 Director of Advertising  
 Honeywell, Computer Control Division

Computer Control Division of Honeywell  
 builds amazing sales with unique  
 catalog insert program



**William F. Taylor, Director of Advertising, Honeywell, Computer Control Division, reports that Electronic Design has helped achieve record sales goals for his company. Mr. Taylor writes:**

"Our 44-page catalog insert in the January 18 issue of *Electronic Design* is judged a complete success . . . every objective was met.

"Although we could have communicated our digital logic module product story to customers and potentials in an "ad" of less magnitude, we would not have achieved a particularly strong *impression per reader*. Since the easy-to-detach catalog insert contained complete specifications on 128 logic modules, potential customers were able to make detailed product comparisons. Result-

ing inquiries, therefore, were of a qualified nature and dealt primarily with delivery time and in some cases quantity pricing — product suitability was already a fait accompli and the cost per sale was automatically reduced.

"Because of the recognized correlation between advertising and sales, (I consider communication, not sales, to be the primary function of industrial advertising), it is interesting to note that our order entries zoomed 250% since the insert appeared."

**No wonder the Computer Control Division of Honeywell gets these remarkable results . . . Electronic Design is the best read publication in this industry. If you have a case history of interest to our management readers, please let us know. We'll pass it along in this series.**

## Electronic Design

SERVES BY COMMUNICATING



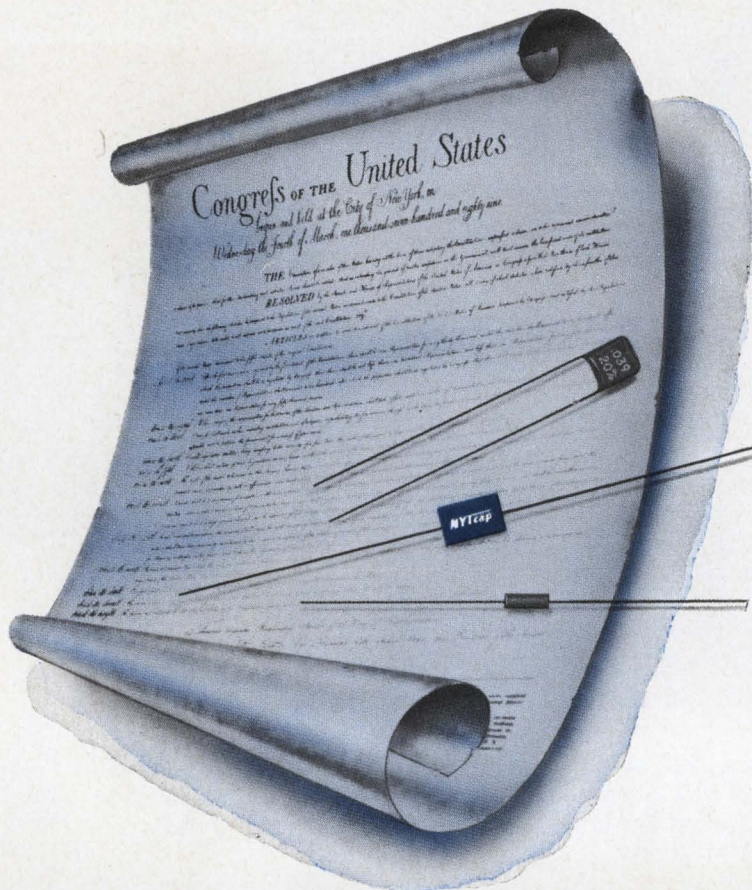

## and now...the Fifth Freedom: FREEDOM FROM CAPACITOR PROBLEMS!

A continuous development program has refined the performance of these critical components to an unprecedented level of excellence. With our complete production tooling we can offer a standard line of subminiature ceramic capacitors with extremely large capacitance-to-size ratio and exceptional stability.

Designed to meet the highest custom standards of the missile, communications, computer, and navigational industries, they are available in volume quantities for immediate, off-the-shelf, delivery. In three complete lines:

**DECI-CAP** — a subminiature ceramic capacitor with an epoxy molded envelope 0.100" diameter by 0.250" long, axial leads with capacitance range 4.7 pf to 27,000 pf, tolerance  $\pm 10\%$ . Unit designed to meet MIL-C-11015.

**HY-CAP** — offers extremely high capacitance range .01 mfd to 2.5 mfd in  $\pm 20\%$  tolerance. Voltage 100 WVDC, no derating to 125°C. Unit designed to meet MIL-C-11015.

**NYT-CAP** — an ultra high stability ceramic capacitor packaged in a miniature molded epoxy case 0.350" x 0.250" x 0.1". Capacitance range 100 pf to 1000 pf. Tolerance  $\pm 10\%$ . Voltage rating 200 volts D.C.

Our inventory of other standardized, high quality components includes inductors, delay lines and resistors. Custom component capability is also available. Write today for complete engineering data.



# NYTRONICS

...for Precision Electronic Components

550 Springfield Ave., Berkeley Heights, N.J. 07922 ■ (201) 464-9300 ■ TWX: 710-984-7977

ON READER-SERVICE CARD CIRCLE 200

## Designer's Datebook

OCTOBER						
S	M	T	W	T	F	S
						1
2	3	4	5	6	7	8
9	10	11	12	13	14	15
16	17	18	19	20	21	22
23	24	25	26	27	28	29
30	31					

NOVEMBER						
S	M	T	W	T	F	S
						1
2	3	4	5	6	7	8
9	10	11	12	13	14	15
16	17	18	19	20	21	22
23	24	25	26	27	28	29
30						

### Oct. 3-5

**Aerospace & Electrical Systems Convention** (Wash., D.C.) Sponsor: IEEE, G-AES; Harold Schutz, Westinghouse Electric, P. O. Box 746, Baltimore, Md.

### Oct. 3-5

**National Electronics Conference** (Chicago, Ill.) Sponsor: IEEE et al; J. C. Hancock, Purdue University, Lafayette, Ind.

### Oct. 18-20

**Seventh National Symposium of the Society for Information Display** (Boston, Mass.) Sponsor: S.I.D.; Glenn Whitham, Society for Information Display, P. O. Box 413, Wayland, Mass.

### Oct. 18-20

**2nd Annual International Telemetering Conference** (Los Angeles, Calif.) Sponsor: International Foundation for Telemetering; J. E. Hinde, Sandia Corp., P. O. Box 5800, Albuquerque, N. M.

### Oct. 24-26

**16th Annual IEEE Machine Tools Conference** (Milwaukee, Wisc.) Sponsor: IEEE, G-IGA; Grant L. Wittberger, Allen-Bradley Co., 1201 S. Second St., Milwaukee, Wisc.

### Oct. 24-27

**21st Annual ISA Instrument-Automation Conference & Exhibit** (New York) Sponsor: Instrument Society of America; Daniel R. Stearn, Instrument Society of America, 530 William Penn Pl., Pittsburgh, Pa.

### Nov. 2-4

**1966 Northeast Electronics Research and Engineering Meeting (NEREM)** (Boston, Mass.) Sponsor: IEEE, New England sections; T. A. Longo, IEEE Boston Office, 31 Channing St., Newton, Mass.



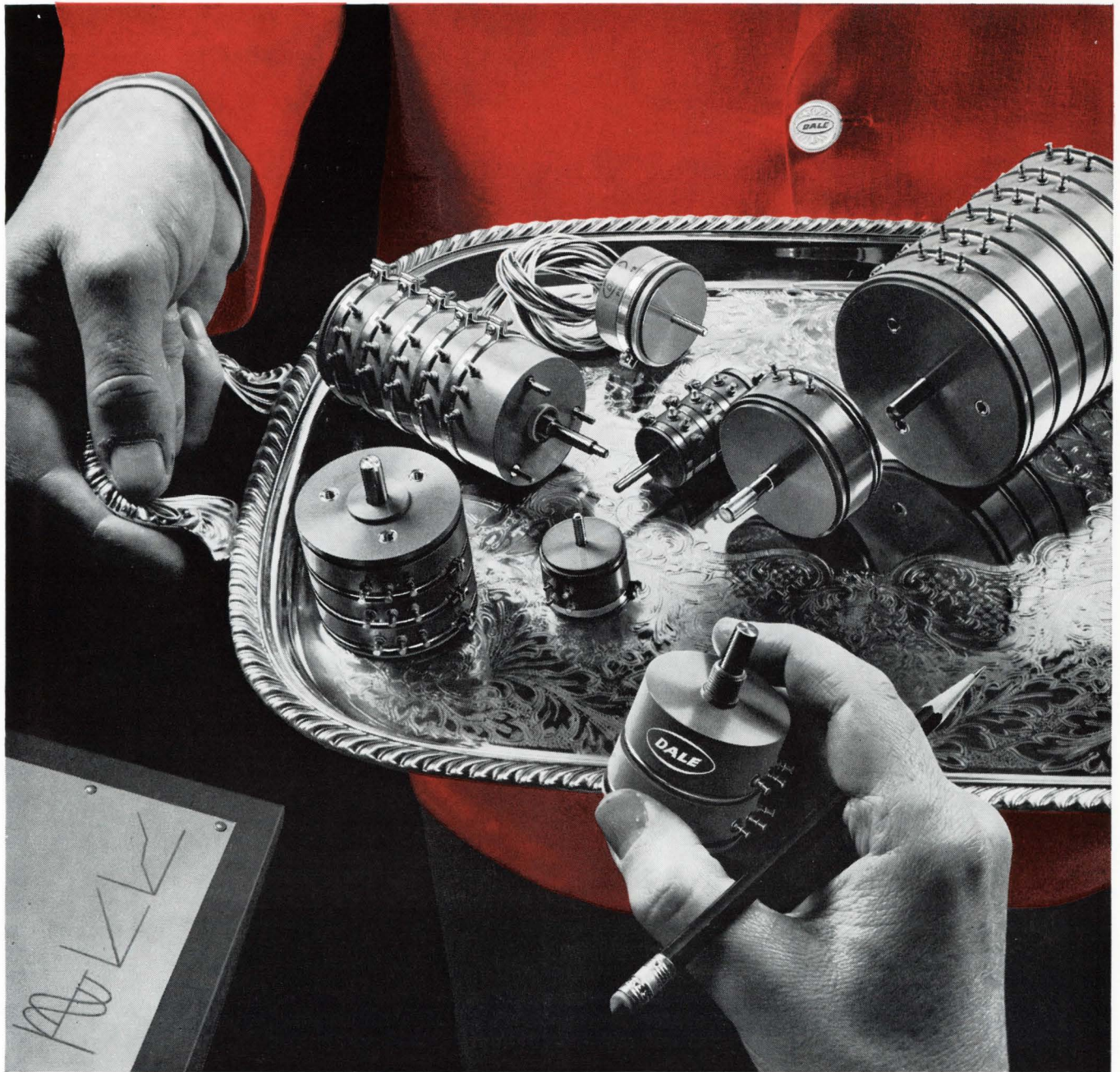

## Let Dale serve your next precision pot requirement

Standard or special—Dale's Potentiometer Division can focus quickly on your servomechanism and instrumentation requirements. These basics, found in every Dale wirewound precision pot, are your assurance of reliability: ■ Precision machined aluminum housing lined with molded diallyl phthalate provides an exceptional combination of structural, environmental and dielectrical characteristics plus accuracy-affecting concentricities attainable by no other method. ■ Pre-

cision resistance wire and precious metal wiper materials are procured to the strictest standards in the industry. ■ Separate quality control department exercises joint control of fabrication and inspection documents, insuring that all design parameters are met. Tell us what you need to do and we'll show you how we can do it simply, reliably and competitively. Write or phone (564-3131, A.C. 402) today.

**Write for Catalog B**

### **DALE ELECTRONICS, INC.**

1328 28th Avenue, Columbus, Nebraska  
In Canada: Dale Electronics, Canada, Ltd.

Speed Inquiry to Advertiser via Collect Night Letter  
ON READER-SERVICE CARD CIRCLE 210





When it comes  
to color-TV  
receiving tubes



RCA  
Engineers  
never let  
well-enough  
alone!

TAKE DAMPER TUBES FOR EXAMPLE:

First...

THEY DESIGNED THE 6AU4GT. THEN THEY DEVELOPED THE 6DW4 WITH IMPROVED CHARACTERISTICS. THIS TUBE IS NOW PERFORMING IN MILLIONS OF COLOR-TV SETS.

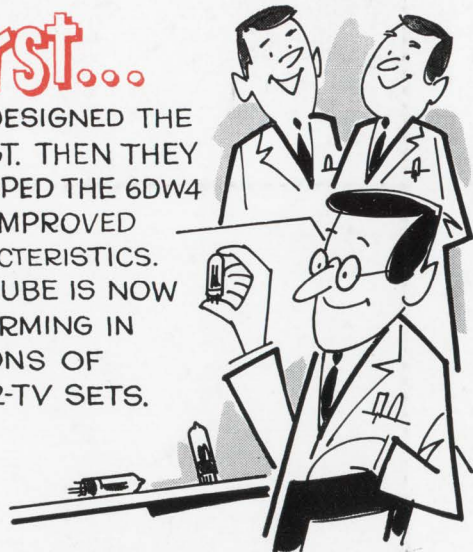

But...

THERE ARE STIMULATING CHALLENGES FOR THE ENGINEER TO STILL FURTHER IMPROVE DAMPER TUBES. FOREMOST IS TO REDUCE TUBE-VOLTAGE DROP.

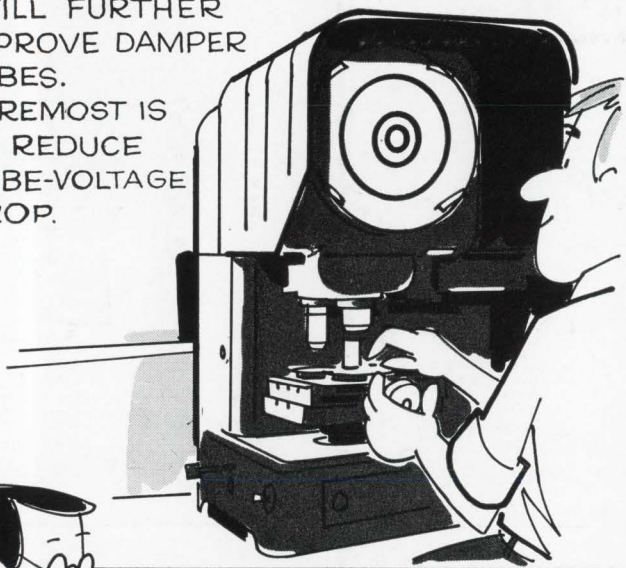

Now...

THEY HAVE A NEW CATHODE WITH A PRESSURE-WELDED COATING - THE BEST EVER FOR DAMPER TUBES. IT PERMITS TIGHTER SPACING WITH NO DANGER OF DAMAGE TO THE COATING RESULTING FROM ARC-OVER, SPUTTERING OR HOT SPOTS. RESULT: RCA'S NEW 6CL3 WITH LOWER TUBE-VOLTAGE DROP LESSENS THE LOAD ON THE HORIZONTAL-DEFLECTION OUTPUT TUBE.



✓CHECK THESE RCA-6CL3 FEATURES:

HEATER ... 6.3V @ 1.2 A  
MAX. PEAK INVERSE PLATE VOLTAGE ... 5500 V  
MAX. PEAK PLATE CURRENT... 1300mA  
MAX. AVERAGE PLATE CURRENT.. 250mA  
MAX. PEAK NEGATIVE HEATER-CATHODE VOLTAGE... 5500 V  
TUBE VOLTAGE DROP ... 16V @ 350 mA (INSTANTANEOUS)  
MAX. PLATE DISSIPATION 8.5 W

THE SAME PERFORMANCE PROFILE IS AVAILABLE IN BOTH 12CL3 (12.6V, 0.6A HEATER) AND 17CL3 (16.8V, 0.45A HEATER) TYPES.

RCA Engineers are quite excited about the pressure-welded coating of the new cathode. They see it as giving them new opportunities for still further improvements in damper tubes and other types as well. But RCA Engineers are always pursuing new ideas, working on new designs to bring color-TV circuit designers tubes that will provide even better performance at the lowest possible cost.

For news of the latest color-TV receiving tube developments, call your nearest RCA District Office. For specific data on the 6CL3, write to RCA Electronic Components and Devices, Commercial Engineering I18DE-4Harrison, N. J. 07029.

**RCA DISTRICT OFFICES**—OEM SALES: EAST, 2075 Millburn Ave., Maplewood, N. J. 07040, (201) 485-3900 • MID-ATLANTIC, 605 Marlton Pike, Haddonfield, N. J. 08034, (609) 428-4802 • MID-CENTRAL, 2511 East 46th St., Bldg. Q2, Atkinson Square, Indianapolis, Ind. 46205, (317) 546-4001 • CENTRAL, 446 East Howard Ave., Des Plaines, Ill. 60018, (312) 827-0033 • WEST, 6363 Sunset Blvd., Hollywood, Cal. 90028, (213) 461-9171 • INTERNATIONAL OPERATIONS, RCA International Division: Central and Terminal Aves., Clark, N. J. 07066, (201) 382-1000 • 118 Rue du Rhone, Geneva, Switzerland, 35 75 00.



The Most Trusted Name in Electronics